

PRODUCT LINE OVERVIEW
2020-2021

Celebrating

ANNIVERSARY
1980-2020



NEW REPLACEMENT PARTS FOR HEAVY EQUIPMENT



ANNIVERSARY
1980-2020

QUALITY WITH VALUE...
GUARANTEED™



TABLE OF CONTENTS

AIR INLET & EXHAUST SYSTEM

Air Intake/ Exhaust Clamps	10
Manifolds	10
Single Manifolds	10
Group Manifolds	11
Mufflers	12
Inlet & Exhaust Pipes	14

TURBOCHARGERS

Turbochargers for Caterpillar®	15
Turbochargers for Komatsu®	20
Heat Shields	21

BEARINGS

Composite Bearings	22
Sleeve Bearings	22
Spherical Bearings	23
Tapered Roller Bearings	23
Cone Bearings	24
Cup Bearings	24
Other Tapered Bearings also Available	24
Needle Bearings	25

BELTS & HOSES

Belts	25
Serpentine Belts	26
Belt Tensioner	29
Engine Hoses	29
Pulleys	30
Engine & Air Brake Hose Assemblies	30
Rubber Hoses	35
Heater Hoses	35
Radiator Hoses	35
Clamps	36
Hi-Torque Clamp	36
T-Bolt Clamp	36
V-Band Turbo	36
V-Band Clamp	36

BRAKING SYSTEM

Actuators	37
Actuator Kits	37
Parts for Braking System	37
Brake Pedals	37
Brake Pedal Assemblies	38
Pedals and Valves	38
Brake Lining	38
Brake Lining Disc Kits	38
Shoe Lining & Bands	38
Friction Discs	39
Clutch Discs	39
Brake Discs	39
Master Clutch Discs	39

Steering Clutch Discs	40
Pilots	40
Steering and Braking System	40
Power Shift Transmission Discs	40
Friction Discs & Plates for Komatsu®	41
Friction Discs For Komatsu®	41
Plates For Komatsu®	41
Air Compressors	41
Air Compressors Repair Kits	41
Air Compressor Piston & Rings	42
Air Compressor Blocks & Crankshafts	42
Air Compressor Governor	43
Air Compressor Miscellaneous Parts	43

CABIN & ACCESSORIES

Cabin Glass	44
Backhoe Loader	45
Excavators	45
Excavator / Material Handler	46
Track Type Tractor / Dozer	46
Motor Grader	46
Wheel Loader	46
Wheel Loader /	47
Inte grated Toolcarrier / Compactor	47
Wheel Loader / Integrated Toolcarrier	47
Vibratory Compactors	47
Wiper Motors	48
Digital Hour Meters	48
Gauges	49
Mechanical Pressure Gauges	49
Electrical Temperature Gauges	49
Pressure Transducer	49
Electrical Pressure Gauges	49
Mechanical Pressure Gauges	49
Ammeters	50
Gas Springs	50
Steps	51
Steps Support	51
Ignition Switches	51
Mirrors	51
Mirrors for Komatsu ®	52
Fuel Caps	52
Repair Kit	52
Seats	52
Enhancing the Operator's Comfort	53
Summary Table of Key Features	58

COOLING SYSTEM

Oil Coolers	59
Engine Oil Coolers	59
Hydraulic Oil Coolers	60
Radiator Oil Coolers	60
Torque Converter Oil Coolers	60
Transmission Oil Coolers	60
Radiators	60
Folded Core Radiators	61
Reversible & Standard Fans	62
Standard Fans	62
Reversible Fans	62
Guards	63
Fan Drives	63
Coolant Temperature Regulators	63
Water Pump Impellers	63
Sea Water Pumps & Components	64
Water Pumps & Components	64

ELECTRICAL PARTS

Alternators	67
Air Conditioning Compressors	68
Receiver / Dryer	68
Alarms & Horns	68
Alarms	68
Horns	68
Armatures	69
Circuit Breakers	69
Batteries	69
Brushes	69
Brushes for Electrical Motor Starters	69
Brushes for Alternators	70
Brush Kits for Starter Motors	70
Electrical Terminals	70
Terminal Connector Kits	70
Glow Plugs	71
Spark Plugs	71
Governor Control Motors	71
Lighting	72
LED Lamp Groups	72
Sealed Lamps	72
Driving and Traffic Lights	72
Lamps Assembly Kits	72
Lamp Groups	72
Signal, Stop Lamps and Lenses	73
Standard Lights	74
Lamp Bulbs	74
Warning Lights	74
Amber LED	74
Spherical LED Head	75
Thin Aux. LED with Rectangular Bezel	75
Other Warning Lights	75
Linear Actuators	76
Speed Sensors	76
Pressure Sensors	77
Magnetic Switches	77
Kickout and Bucket Positioners	77
Solenoids	77
Starting Motor Solenoids	77
Semi Solid Solenoids	77
Fuel Shutoff Solenoids	77
Starter Motors	78
Vane Air Starter Motors	78
Switches	80
Ignition Switch	80
Toggle Switch	80
Liquid Level Switch	80
Capillary Switch	80
Flow Switch	80
Rotary Switch	80
Sensing Switch	81
Pressure Sensing	81
Temperature Sensing	81
Starter Selenoid Switch	81
Push Button Switch	81
Limit Switch	81
Horn Switch	81
Specialty Switches	81

DIESEL ENGINE COMPONENTS

Engine Blocks	82
Custom Engines	84
Inframe Overhaul Kits	84
Inframe Overhaul Kits for Backhoe Applications	85
Premium Inframe Overhaul Kits	85
Crankshafts	86
Crankshafts for Komatsu®	88
Engine Bearings	88
Camshafts	89
Lifters	90
Liners	90
Wet Engine Liner	91
Dry Engine Liner	91
Liner Kits	91
Pistons	92
Crowns and Skirts	92
Piston Kits	95
Piston Pins	96
Piston Ring Sets	97
Connecting Rods	98
Connecting Rod Kits	99
Engine Oil Pumps	99
Engine Oil Pumps For Komatsu®	102
Cylinder Heads	102
C Series Head Bolts	103
Pre-Combustion Chambers	104
Engine Valves	104
High Performance Valves	105
Valve Guides	105
Valve Seat Inserts	106
Valve Springs	113
Engine Valve Rotocoils	113
Engine Mounts	114
Engine Ferrules & Seals	114

FILTERS

Air Filters	115
Air Filter Indicators	116
Oil & Fuel Filters	116
Strainers	117
Strainers for Caterpillar® machines	117
Strainers for Komatsu® machines	118
Cab Air Filters	118

FUEL INJECTION

Fuel Injection System	119
Injectors	119
Nozzles	119
Plungers & Barrels	120
Service Groups	120
Fuel Line Assembly	120
Remanufactured Fuel Injectors	121
Diesel Fuel Lift Pumps	122
Diaphragm-type or Mechanical	123
Vane Pump or Electrical	123
Fuel Additive	123
Actuators for Governors	123

GROUND ENGAGING TOOLS

Bit Cutters	124
-------------	-----

End Bits	84
Bulldozers & Compactors End Bits	84
General Duty End Bits	84
Extended Wear Life End Bits	84
Finish Dozing End Bits	85
End Bits Overlay End Bits	85
Moldboard End Bits	85
Bulldozer Blades	86
Grader Blades	88
Carbon Steel Grader Blades	88
Motor Grader Inserts	89
Excavator Sidecutters	90
Tips & Adapters	90
Pin and Retainers for GET's	91
Cleaner Bars & Stands	91
Shank Protectors	91
Adapter Shanks	92
Bucket Sidebar Protectors	92
Bolt on Corner Adapter	95
2-Bolt on Corner Adapter	96
Bolt on Center Adapter - 3 Holes	97
Bolt on Center Adapter - 2 Holes	98
Side Pin Teeth	99
Tips for Komatsu®	99
Blades & end bits for Komatsu®	102
Cutting Edges	102
Side Edges	103
End Bits	104
Ripper Shanks	104
Style Ripper Teeth	105
Ripper Teeth	105
Tamping Feet	106
Clean Bar	113
Flush Mounted Adapters	113
Weld on Bottom Strap	114
Bolt on Monoblock Teeth	114
Shanks and Pins for Motor Graders	115
V-Series Self-Sharpening Teeth	115
Weld On Double Strap Adapters	116
Heavy Duty Adapters	116
Track Shoes	117
Loader Segments	117
Scraper Cutting Edges	118

HARDWARE PARTS

Adapters	119
Bolts	119
Bonnets	119
Fuel Injection	119
Oil Cooler	120
Oil Cooler Transmission	120
Connectors	120
Bushings	121
Cotter Pins	122
Dowels	123
Grease Fittings	123
High-head Bolts	123
Lifting Eyebolts	123
Lock Nuts	124
Nuts	124
Heavy Nylon Locknuts	124

Motion Transfer Devices	125
Rod Ends	125
End Yoke	125
Ball Joint	125
Pins	125
Screws	126
Self-Locking Nylon Patched	126
Rivets	126
Studs	128
Snap Rings	128
Woodruff Keys	128
Woodruff Keys - Bar	128
Washers	129

HYDRAULIC SYSTEM

Hydraulic Pumps	129
Gear Pumps	129
Piston Pumps	129
Vane Pumps	129
Hydraulic Motors	129
Fan Motors	130
Drive Motors	130
Dump Pumps	130
Cartridges	130
Hydraulic Piston Rotating Groups	130
Hydraulic Cylinders	131
for Backhoses and Excavator	131
Hydraulic Steering Control Units	131
Hydraulic Oil Filters	131
Flanges	132
Split Flange Half Code 61	133
Split Flange Half Code 62	133
Thick Flange Half	133
Excavator Couplings	133
Hydraulic Hoses	133
100R1 Single Wire Braid	133
100R2 Double Wire Braid	133
100R2 Hose Assembly	133
100R4 Textile with Helical	134
100R4 Hose Assembly	134
100R5 One	134
Wire Braid with Textile Cover	134
100R5 Hose Assembly	134
100R12 4 Wire Braid	135
100R12 Hose Assembly	135
100R13 4 Wire Spiral	136
100R13 Hose Assembly	136
100R15 6 Layer Spiral	137
100R15 Hose Assembly	137
Wiper Rod Seals	137
U-Cup Seals	137

POWER TRAIN

Bevel Gears & Gear Sets	138
Gears	138
Gear Sets	138
Carriers	139
Carriers for Komatsu®	139
Drums	140
Clutch System Application	140
Final Drive System Application	140
Brake System Application	140

Motion Transfer Devices	141
Rod Ends	141
End Yoke	141
Ball Joint	141
Pins	141
Screws	141
Self-Locking Nylon Patched	142
Rivets	142
Studs	142
Snap Rings	143
Woodruff Keys	143
Woodruff Keys - Bar	143
Washers	143

SEALS & GASKETS

Manufacturing	165
Gasket Materials	166
ABC Gasket Program	168
What is the program about?	168
Why buy CTP's ABC Gasket Kits?	168
Applications we cover:	171
C-7	171
C-9	174
C-9.3	175
C-10	176
C-11	180
C12	181
C-13	183
C-15	186
C-18, C27	187
3114, 3116	188
3126	192
3176, 3204, 3208	208
3304	209
3306	211
3406	213
3408	215
3412	216
3456, 3508, 3512, 3516	217
3520G, D353	218
Gasket Kits for C-Series Engines	218

Special Gasket Kits for Engines:

C-7	218
C-9	219
C-10, C-11, C-12	220
C-13	221
C-15, C-16	222
C-18, C-27, 3046, 3054, 3054E	223
3056, 3116	223
3126, 3126B, 3176, 3176C	224
3204, 3208, 3408, 3412, 3412E	225
G3412, 3512	225
3516, 3524, 3508, 3512, 3516	226

Head Gaskets

Crankshaft Seals	226
O-Ring Kits	227
D-Ring Kit	227
Oil Seals	227
Metal Face Seals	227
Seal Kits for Case™ Machines	228
Seal Kits for Skid Loaders	228
Excavators 336	228

UNDERCARRIAGE/FRAME & BODY

Frame Assemblies	229
Sliding Frame Assemblies	229
Swing Frame Assemblies	229

Spider Universal Joint	161
Transmission Seal Rings	162
Torque Converter Stators	162
Torque Converter Impellers	163
Final Drive for Excavator	163
Final Drive & Swing Components	163
Excavator Gears	164

165

Top Rollers	165
Mini Excavator Rollers	166
Idlers	166
Sprockets & Segments	168
Sprockets	168
Sprocket Segments	168
Sprockets For Mini Excavator	171
Spring Recoil	171
Bronze Wear Strips	174
Non-Metallic Strips	175
Track Adjusters	176
Link Assemblies	180
Undercarriage System	181
Rims & Wheels	183
Backhoe Wheels	186
Backhoe Loader Pads	187
Tie Rods & Sockets	188
Pins	192
Control Group - Bucket	208
Boom Group	209
Mounting Group	211
Linkage - Bucket	213
Bar Group	215
Frame Group	216
Axle Group - Front	217
Hitch Group	218
Guard Group	218
Bucket Group	218
Cylinder & MTG Group	219
Blade Group	219
Other Pins also Available	220
Arm Group	221
Pivot Pins	222
Rubber Tracks	223
Mini-Excavators	223
Compact Track Loaders	224

CABLES

Braking System Cables	225
Cables for Electrical & Starting Systems	226
Cables for Lock System	226
Cables for Fuel System	226
Frame and Body Cables	227
Undercarriage Track Adjuster Cables	227
Powertrain Cables	227

TOOLS & SUPPLIES

Crimping Tool	227
Grease Gun Kit	228
Grease Pump	228
Strap Wrench	228
Tetragauge	229
Other Tools & Supplies	229

COLLECTIBLE REPLICAS

	249
--	-----

Bogies	229
Bogie Major	229
Bogie Minor	230
Equalizer Bars	230
Rollers	230
Single Flange	230
Double Flange	231
Top Rollers	231
Mini Excavator Rollers	231
Idlers	231
Sprockets & Segments	232
Sprockets	232
Sprocket Segments	232
Sprockets For Mini Excavator	232
Spring Recoil	232
Bronze Wear Strips	233
Non-Metallic Strips	233
Track Adjusters	234
Link Assemblies	235
Undercarriage System	236
Rims & Wheels	237
Backhoe Wheels	237
Backhoe Loader Pads	237
Tie Rods & Sockets	238
Pins	238
Control Group - Bucket	238
Boom Group	239
Mounting Group	239
Linkage - Bucket	239
Bar Group	239
Frame Group	239
Axle Group - Front	239
Hitch Group	239
Guard Group	239
Bucket Group	239
Cylinder & MTG Group	239
Blade Group	239
Other Pins also Available	240
Arm Group	240
Pivot Pins	240
Rubber Tracks	240
Mini-Excavators	240
Compact Track Loaders	241

245

Braking System Cables	245
Cables for Electrical & Starting Systems	245
Cables for Lock System	246
Cables for Fuel System	246
Frame and Body Cables	246
Undercarriage Track Adjuster Cables	246
Powertrain Cables	246

TOOLS & SUPPLIES

Crimping Tool	247
Grease Gun Kit	247
Grease Pump	247
Strap Wrench	247
Tetragauge	247
Other Tools & Supplies	248

COLLECTIBLE REPLICAS

	249
--	-----

Caterpillar®	249
CAT® 390FL HYDRAULIC EXCAVATOR	249
CAT® 18M3 MOTOR GRADER	249
CAT® D11T TRACK-TYPE TRACTOR	249
CTP DOZER TRACK-TYPE TRACTOR	249
CAT® D11T TRACK-TYPE TRACTOR	250
CAT® D10T TRACK-TYPE TRACTOR	250
CAT® D8T TRACK-TYPE TRACTOR	250
CAT® D7ET TRACK-TYPE TRACTOR	250
CAT® 4M MOTOR GRADER	250
CAT® 793F MINING TRUCK	250
CAT® 432F2 SIDE SHIFT BACKHOE LOADER	250
CAT® 336D L HYD.EXCAVATOR	250
CAT® 613G WHEEL TRACTOR SCRAPER	250
CAT® 587T PIPELAYER	250
CAT® 5110B HYD. EXCAVATOR	251
CAT® 330D L HYD. EXCAVATOR	251
CAT® 323D L HYD. EXCAVATOR HAMMER	251
CAT® 320D L HYD. EXCAVATOR	251
CAT® 365C FRONT SHOVEL	251
CAT® 994F WHEEL LOADER	251
CAT® 950H WHEEL LOADER	251
CAT® 725 ARTICULATED DUMP TRUCK	251
CAT® P5000 LIFT TRUCK	251
CAT® 3516 ENGINE GENERATOR	251
CAT® 272C SKID STEER LOADER	251
CAT® G3516 GAS ENGINE	251
CAT® 980G WHEEL LOADER	251
CAT® 777D OFF-HIGHWAY TRUCK	251
CAT® CT660 DUMP TRUCK	251
CAT® 140H MOTOR GRADER	251
CAT® 299C MOTOR GRADER	251
Komatsu®	252
D65EX-17 SIGMADOZER WITH RIPPER	252
GD655-5 MOTOR GRADER WITH RIPPER	252
PC138USLC-11 EXCAVATOR	252
D155AX-8 SIGMADOZER WITH RIPPER	252
HM400-5 ARTICULATED DUMP TRUCK	252
PC360LC-11 EXCAVATOR	252
PC210LC-11 EXCAVATOR	252
WA500-7 WHEEL LOADER	252
PROMOTIONAL MERCHANDISE	253
Apparel	253
Gloves	254
Caps	254
Bags	255
Office Supplies	255
Rain Gear	257
Stickers	257
Signs	257
Gadgets	257
Miscellaneous Items	257

MESSAGE FROM OUR FOUNDERS



Dear Valued Customers,

We are incredibly proud and humbled by the fact that we have reached our 40th year in service, we know that this milestone in our business' history could not have been achieved without the trust and confidence that you all instill in us.

This year marks not only our **40th anniversary** but also the grand opening of our new headquarters located in Doral, FL, just around the corner from our current offices. This new structure will bring a merge to all of our warehouses, allowing us to operate out of one single unit, thus making our overall operations more effective. Our new headquarters will house all of our parts under one roof in a **450,000 Sq. Ft.** state of the art facility.

Though new changes are upon us for 2020, one thing remains the same, and that is our company motto, *"Quality with value guaranteed."* As a team, we will continue to go above and beyond to exceed our customers' expectations, and we know that without your continued support and loyalty, none of this would be possible.

*Thank you for your support,
Gilberto and Teresa Uribe*

NEW VICE-PRESIDENT



As far back as she can remember, Melissa Uribe-Gil has in one way or another, been involved in or worked at Costex Tractor Parts. She can remember being a kid and helping out around the warehouse where her father Gilberto Uribe would give her tasks like; counting and packaging parts. Since graduating from High School, Melissa has officially held a position at Costex, beginning her career in the Special Orders Department. Melissa worked and excelled in her position as the head of special orders purchasing, all while being enrolled in and attending Florida International University, where she

was working towards her Bachelors Degree in Business Administration. Melissa holds a BA in Business Administration, as well as a Masters Degree in International Business both from Florida International University. In 2004 upon her graduation from FIU, Melissa launched the Costex's Marketing Department. She had the idea that building a brand and marketing parts for heavy equipment did not have to be something "bland" and "stale", so she took her approach and built a successful and productive marketing department around it. For the past 15 years, Melissa has led the marketing department at Costex and has taken the department to new heights with her exceptional team leading skills and her constant "push" and encouragement for fresh and innovative ideas. The Costex marketing department is responsible for building the CTP brand that is synonymous with replacement parts in the industry on a worldwide level. We are confident that with the help and guidance of Gilberto and Teresa Uribe, Melissa will lead Costex into the next generation.

NEW PRODUCTS TO LOOK FOR...



Lighting

Our Lighting has been updated to show all our new lighting offering.

PAGE 72



Switches

Switches are now classified by type to make it easier to find what you are looking for

PAGE 80



Pulleys & Belt Tensioners

Over 100 NEW Pulleys are now available, plus 11 NEW Belt Tensioners have been added including Komatsu® applications.

PAGE 26



Pistons

Our Piston section has been updated with 23 NEW numbers for a total of 117 pistons.

PAGE 92



Air Compressors

12 NEW Air Compressors have been added to our catalog along with repair kits, governors and repair components

PAGE 41



Valve Seat Inserts

Over 60 NEW Valve Seat Inserts have been added to our catalog

PAGE 106



Remanufactured Injectors

New Quality Remanufactured Fuel Injectors for most applications.

PAGE 121



Crankshafts

37 Crankshafts available including 3 NEW Komatsu® Crankshafts

PAGE 86

1980

COSTA EXPORT IS INCORPORATED. SPECIALIZING IN SOURCING AND SELLING REPLACEMENT PARTS FOR HEAVY EQUIPMENT.

CTP SE INCORPORA COMO COSTA EXPORT ESPECIALIZADA EN LA VENTA DE PARTES DE REEMPLAZO PARA MAQUINARIA PESADA.



1982

COSTA EXPORT CHANGES ITS NAME TO COSTEX TRACTOR PARTS, A DIVISION OF COSTEX CORPORATION.

COSTA EXPORT CAMBIA SU NOMBRE A COSTEX TRACTOR PARTS, UNA DIVISIÓN DE COSTEX CORPORATION.



1987

COSTEX TRACTOR PARTS MOVES TO A 25,000 SQ.FT. FACILITY.

CTP SE TRASLADA A UN ESTABLECIMIENTO CON MÁS DE 25.000 FT2.



1990

COSTEX TRACTOR PARTS PARTICIPATED IN ITS FIRST TRADE SHOW IN MACON.

COSTEX TRACTOR PARTS PARTICIPA EN SU PRIMERA FERIA EN MIACON.



1996

COSTEX PROVES CONTINUOUS GROWTH BY OCCUPYING A LARGER FACILITY IN FRONT OF ONE OF SOUTH FLORIDA'S BUSIEST HIGHWAYS, WITH OVER 50,000 SQ. FT. OF WAREHOUSE SPACE.

COSTEX MUESTRA SU CRECIMIENTO CONTINUO ADQUIRIENDO UNA BODEGA MÁS AMPLIA FRENTE A UNA DE LAS AUTOPISTAS MÁS GRANDES. AHORA CON 50.000 FT2 DE ALMACENAMIENTO.



1998

CTP BRAND IS TRADEMARKED THROUGHOUT THE WORLD.

LA MARCA CTP ES REGISTRADA ALREDEDOR DEL MUNDO.



1999

CTP SHIFTED TOWARDS MANUFACTURING, AND INTRODUCED THE CTP GASKETS. AT THE SAME TIME, CTP'S FACILITIES ARE EXPANDED TO OVER 160,000 SQ.FT.

CTP CREA SU PROPIA LÍNEA DE EMPAQUETADURAS. EN EL MISMO AÑO EXTIENDE SUS ALMACENES A 160.000 FT2.



2005

CTP CELEBRATES ITS 25TH ANNIVERSARY.

CTP CELEBRA SU ANIVERSARIO NÚMERO 25.



2006

CTP IS RECOGNIZED AS A "CERTIFIED PARTNER" BY INTERFACE SOLUTIONS INC., FOR ITS COMMITMENT TO PROVIDE 100% ASBESTOS-FREE AND 100% SOLVENT-FREE GASKET MATERIALS.

CTP ES RECONOCIDO COMO "SOCIO CERTIFICADO" DE INTERFACE SOLUTIONS, INC. POR SU COMPROMISO DE PROVEER MATERIAL DE EMPAQUETADURAS 100% LIBRES DE ASBESTOS Y SOLVENTES.



2007

A NEW DISTRIBUTION CENTER IS OPENED IN DALLAS, TX TO SERVE THE CENTRAL AND WEST COAST REGIONS OF THE U.S. TOTALING OVER 220,000 SQ.FT. OF WAREHOUSE SPACE.

SE ABRE UN NUEVO CENTRO DE DISTRIBUCIÓN EN DALLAS, TX CON EL PROPÓSITO DE ABASTECER RÁPIDAMENTE LAS REGIONES PACÍFICAS Y CENTRALES DE LOS ESTADOS UNIDOS. AHORA CON 220.000 FT2 DE ALMACENAMIENTO.



2008

CTP IS NAMED "BUSINESS OF THE YEAR" BY SOUTH FLORIDA BUSINESS JOURNAL AND REGIONS BANK.

CTP ES NOMBRADA EMPRESA DEL AÑO POR SOUTH FLORIDA BUSINESS JOURNAL Y REGIONS BANK.VV



2011

CTP BECOMES AN ISO 9001-2008 CERTIFIED COMPANY.

CTP ES CERTIFICADA POR ISO 9001-2008.

CTP LAUNCHES CTP.TV. CTP INAUGURA CTP.TV.

CTP ACQUIRES MORE WAREHOUSE SPACE, FOR A TOTAL OF OVER 400,000 FT2 (37,000 M2).

CTP ADQUIERE MÁS ESPACIO DE ALMACENAMIENTO, AHORA CON UN TOTAL DE 37000 M2 (400,000 FT2).



2012

CTP JOINED FORCES WITH DANIEL'S DIE-CUTTING, TO FORM CTP BOXES AND PACKAGING. THUS PROVIDING A ONE-STOP SHOP TO OUR CUSTOMERS FOR THEIR PACKAGING SOLUTIONS.

CTP ADQUIERE DANIEL'S DIE CUTTING FORMANDO ASÍ CTP BOXES AND PACKAGING, PARA PROPORCIONAR A NUESTROS CLIENTES SOLUCIONES DE EMBALAJE.



2015

CTP CELEBRATES 35 YEARS OF EXCELLENCE.

CTP CELEBRA 35 AÑOS DE EXCELENCIA.



2017

CTP LAUNCHES A NEW WEBSITE WITH EASY ACCESS FROM ALL MOBILE DEVICES AND COMPATIBLE WITH ALL BROWSERS. ORDERING AND FINDING PARTS ALSO BECAME CONVENIENTLY EASIER AND USER FRIENDLY ON OUR CTP ONLINE STORE, 24 HOURS A DAY, 7 DAYS A WEEK!

CTP LANZA SU NUEVO SITIO WEB CON FÁCIL ACCESO DESDE TODOS LOS DISPOSITIVOS MÓVILES Y COMPATIBLE CON TODOS LOS NAVEGADORES. ¡ENCONTRAR Y ORDENAR PIEZAS TAMBIÉN SE VOLVIÓ MUCHO MÁS FÁCIL EN NUESTRA TIENDA EN LÍNEA CTP, LAS 24 HORAS DEL DÍA Y LOS 7 DÍAS DE LA SEMANA!



2019

CTP HOSTED THE GROUNDBREAKING CEREMONY FOR WHAT WILL BE IT'S NEW HEADQUARTERS. THE CEREMONY MARKED THE BEGINNING OF THE CONSTRUCTION FOR THE FUTURE HOME OF COSTEX TRACTOR PARTS.

SE REALIZÓ LA CEREMONIA DE INAUGURACIÓN DE LO QUE SERÁ SU NUEVA SEDE. EL EVENTO MARCÓ EL COMIENZO DE LA CONSTRUCCIÓN DE LA FUTURA CASA DE COSTEX TRACTOR PARTS.



AIR INLET & EXHAUST SYSTEM



AIR INTAKE/ EXHAUST CLAMPS



Part Number	Description	Diameter	
		(in)	(mm)
6B3771	CLAMP	2.5	63.5
6B3771	CLAMP	3.14	79.8
6B3771	CLAMP	3.22	81.8
6B3771	CLAMP	3.28	83.3
6B3771	CLAMP	3.67	93.3
6B3771	CLAMP	3.78	96
6B3771	CLAMP	4.17	106
6B3771	CLAMP	4.31	109.5
6B3771	CLAMP	4.67	118.6
6B3771	CLAMP	5.17	131.4
6B3771	CLAMP	5.18	131.6
6B3771	CLAMP	5.25	133.4
6B3771	CLAMP	5.59	142
6B3771	CLAMP	6	152.4
6B3771	CLAMP	6.32	160.5
6B3771	CLAMP	6.77	171.9
6B3771	CLAMP	6.86	174.2
6B3771	CLAMP	7.04	178.8
6B3771	CLAMP	7.15	181.6

MANIFOLDS

Single Manifolds



Model/ Engine Application	Manifold	Gaskets
3054	1301425	0358218 (2)
3126	1515911	1136200 (3)
3126	7E9314	1136250 (1)
3204	9Y5168	9L8027 (1)

Model/ Engine Application	Manifold	Gaskets
3304	2P6571	9Y1979 (2)
3306	7G5618	-
342	5P9243	-
3508	6V5951	-
3512	6V3738	3831576 (1)
120G, 12G, 130G	3P0890	-
120G, 12G, 130G, 140G	8J5917	-
120G, 936E, 950B	1P1216	9Y1979 (2)
12E, 12F, 120, 561, 561B	1M6128	1M0090 (6)
12F, 561C, 3306, D5, D6C	9S2355	9Y1979 (3)
135H, 3126B	1482516	-
205B, 211B, 918B, 924F, 3114, 3114T, CB-434	7E4238	1136200 (2)
235B, 572R, 973, D7G	6T6051	6Y8864 (1)
24H, 631E, 631G	1127750	1299452 (8)
24H, 631E, 631G	1127751	1299452 (8)
320, 320B, 320L, 320N	1786552	5I7681 (2)
320, 322, 3066	5I7547	1352367 (2)
320D, 320DL, 3066	1786552	1786553 (2)
3306, D6C	9S2354	9Y1979 (3)
3412, 3408B	7N5219	-
416C, 428C	1386903	-
428C, 416C, 3054	6I0567	0358218 (2)
515, 527, 963, 3304	6N5392	9Y1979 (2)
589, 361E, 637E, 357E, D9R, 3408, 3408C	7E3205	-
613B	8L6273	9L8027 (2)
613B	8L6274	9L8027 (2)
627E/F/G, 637E/G, D7H	7W4473	9Y1979 (3)
631D, 633D, 639D, 3408	8N0784	-
631D, 988B, D8L	4N6971	-
63G, 773, 992, D348	3P0037	3S4534 (6)
777B	1138172	3208974 (2)
785C, 785D, 789C	3042740	1074396 (1)
815, 140G, D6C, D6H, 3306	1P1216	9Y1979 (3)
815, 140G, D6C, D6H, 3306	7N3486	9Y1979 (3)
910	6P6035	-
950, 955K, 955L	9S2578	9Y1979 (2)
950, 955K, 955L	1051738	1136200 (3)
950, 955K, 955L	7G8279	-
950F, 960F, 953	1051738	1136200 (3)

Model/ Engine Application	Manifold	Gaskets
951B, 3304	9S2356	9Y1979 (2)
966, 950	1P2568	8M1280 (1)
977, 977K	7M4204	1M0090 (6)
988B, 631	4N1675	7N8175 (8)
988B, 631	7N5218	-
C13, C11	2504409	2832238 (6)
C9, C9.3	1613398	1613411 (6)
D379, D379B	6V3735	7L6005 (1)
D398, D398A, D398B	4L6193	4L8097 (4)
D399	6V9252	-
D4C24A, D4C40A	7M4358	1M0090 (4)
D6C, D6D, D7F	3P6812	-
D6C, D6D, D7F	1447878	-
D7, D7E, 571A, 572E	1S3926	-
D7G	3P0364	8M8621 (1)
D7G	3P4863	3P5625 (1)
D8K, D8H	3P5929	9S8848 (2)
D8N	1087742	-
D9H, D94H, D353	5N8879	7M7666 (6)

Group Manifolds



Model/ Engine Application	Manifold			Gaskets
	Front	Center	Rear	
3126	-	6I1099	6I0915 (L) 1154144 (R)	1136200 (3) 2721956 (6)
3126B	1273467	-	-	2721956 (6)
3126, C7	-	1836854	1836856	2721956 (6)
3126, 3126B, C7	-	1836854	1836854	2721956 (6)
3306	-	7W8584	-	9Y1979 (3)
3306	7W8583	7W8584	7W8585	9Y1979 (3)
3306	8S7716	8S7717	8S7718	8S6410 (1)

Part numbers are used for reference purposes only.

Costex Tractor Parts Copyright © 2020. All rights reserved.

Manifolds (cont.)

Model/ Engine Application	Manifold			Gaskets
	Front	Center	Rear	
3306	9L5519	9L5520	9L5521	8S6410 (1)
3306, 3406B	8N5383	8N5385	8N5386	9Y1979 (3)
3412	1078106 (2)	1078107 (2)	1078108 (L) 1078109 (R)	1299452 (12)
3412	1078106	1078107 (2) 1078112 (2)	1078106	1299412 (12)
3412	1078106 (2)	8N0989 (8)	1078108 (L) 1078109 (R)	1299452 (12)
12H, 140M, 160M, 2391, 2491	2037775	1924697	2037778	1613411 (6)
16G, 245, 3406	1028608	1028502	1028608	1299452 (6)
235B, 572R, 973, D7G	8N5386	7C8281	8N5384	9Y1979 (3)
24M, 3406B, 3406C	-	1501916	1333359	-
3406B, 3406C, 623F	1028608	1045283	1028608	1299452 (6)
3406C, 3406E, C15	-	3367595	1333359	-
3406E	-	1469445	1333359	1384611 (6)
3406E	-	1501914	1333359	1384611 (6)
3406E, 3456, D350E	1028608	1028503	1028608	1299452 (6)
3412C	1078106 (4)	-	7W8791 (R)	1299452 (12)
583, D8, D8H, D8K, D342	5N8657	-	3S2252	8H5324 (6)
594, D9G, D353	5N9055	7M8265	5N9055	7M7666 (6)
594H, D9H, D353	5N9055	6N7295	5N9055	7M7666 (6)
631C, 633C, 637	7M7140	9S2586	9M1887	2M6203 (6)
657, 666, D343	7M7140	9M1848	9M1887	2M6203 (6)
768B, 769, 824, 825B, 826B, 834, 988	7M7140	2S2938	2S2939	2M6203 (6)
C12	4P8280	1152989	4P8279	1095313 (6)
C12	4P8280	1612726	4P8279	1095313 (6)
C12	4P8280	1612726	4P8280	1095313 (6)
C13	-	2472834	2319030	2832238 (6)

Model/ Engine Application	Manifold			Gaskets
	Front	Center	Rear	
C15	-	2313462	1333359	-
C15/18, 657G, D8T, D9T	-	2211426	1333359	-
C9, C9.3, C7.1	2037775	1924697	2037778	1613411 (6)
D6R/F, 140H, 12H, 160H	8S7716	1344200	8S7718	9Y1979 (3)
D8L, C-15, 3406B, 621F, C18	1028608	1017354	1028608	1299452 (6)
D9R	-	1128247 (L) 1128248 (R)	1633103	1299452 (12)
D7H, 3306	3Y9984	-	3Y9985	9Y1979 (3)



MUFFLERS

Application	Part No.
215	6N3964
235	2W3428
307	1172362
330	1099463
350	7Y1978
518	9S9328
943	1W9832
953	1W9519
963	1004594
120, 130G, 140G	1123249
120G	6N1878
120G, 120, 130G	4N8297
120H, 135H	7C3693
12F, 922, 930, 944, 951B/C, D4D, D6C	3K3124
140H, 160H	2126961

Application	Part No.
16H, 16G	4P6649
215, 225B (WHEEL)	1W2572
215B	7N0061
215B, 215C, 215D, 219, 219D	4P4010
235C, 235BD, D6C	4W3632
245B	7C6398
245D	4P1463
311, 312	517914
311, 312, 312B	517935
312, 315, 317, 317N, 3114 GENERATOR SET	9Y1403
320D	3244156
320, 320B, 320B L	2724674
320, 320EX	7Y2040
320, 322, 325, 325B	7Y1508
320B, 320B L	2724673
325, 320B	1189906
325B	1099323
330, 330B	616425
3306/B, 3406C/B, C27, C32 GENERATOR SET	8N4975
345B, 345B L, 345B LC	1398723
416, 416B, 416C, 426B, 428B	1278592
416, 416B, 416C, 426B, 428B, 436B, 438B	1278594
416, 426, 428, 428II	7W5194
416C, 416D, 424D, 426C, 428C	1125089
416C/D, 426C, 428C/D, 438C/D, 442D	1125090
416E, 416D, 420E, 420D, 422E, 432E, 434E	2355363
561M, D5M, D5M LGP, D5M XL	1737129
572G, 571G, D7G	4N5191
621, 980	8S6558
621B, 623B	6N4184
621E, 623E, 627E, 621F	1W4187
621F, 637E, 627E	7W7439
627, 637	9S7786
627, 966C	8S0905
627B, 992	6N4183
631C, 631D, 639D	7N4839
631E, 631E II, 637E, 637E II	2W8437
825C (Soil), 980C, 980F	7N1393
830M, 988	8S6443
834B, 988B	7W8445
928F, 938F	9Y4668
938G, IT38G	1376995
939, D4C III, D5C III	1077473
950, 966C, 977K	7S8443

Part numbers are used for reference purposes only.

Application	Part No.
950B, 950E	8N5388
950F	1P9139
950F II	6I3662
950F, 950F II	7E2944
953C	2220458
955, D5B	2P2744
955K, 955L	7N8117
955K, 955L, 951B	8S2809
963, 963B	1374097
966C, 140	2P5609
966D, 814B, 815B	7C5851
966E, 966D	4W5053
966F	4P6548
966F II	1018740
966G	1608583
970F, 966F, 814F, 815F, 816F	6I2408
980B, D9H	4N5184
980F, 980C	7N9674
980G	1345423
988F	4P2496
992C, 992D	7W7182
AP-1000, CS-533, CS-563, CS-573	7C7344
D10N	7W5867
D250B, 980B, D350E, D400E	7N3235
D3C, D3C III	1260734
D4E	2P6255
D4H	1121665
D5, 12E, 120, 926	7S8301
D5, D4, 951, 941	8S4996
D5H	2W3597
D6D	1W1766
D6H	4Y4951
D6M	2666252
D6M, D6M XL, D6M LGP	2521152
D6M, D6M XL, D6M LGP	2666251
D7F, D7	6N0731
D7H, D7H II, D7R, 572R	1W9229
D8H, D8	4N4577
D8K	6N5969
D8L, D9N, D9R	4W8485
D8N	2003200
D8R, D8T, 583T, 587T, 583T, 587T	2958281
D9H, 594H	7N9647
E200B, EL200B	1R7158

Costex Tractor Parts Copyright © 2020. All rights reserved.

INLET & EXHAUST PIPES



Part No.	Specification	Application	Clamp Part No.
0964204	Straight Pipe	Exhaust	417554
1M5270	Straight Pipe	N/A	N/A
1P8460	45° Square Cut Outlet	Exhaust	9S8071
1P8463	45° Outlet	Exhaust	9S8071
1P9554	Straight Pipe	Exhaust	5S0580
1W0214	45° Outlet	Exhaust	9S8068
1W0528	Straight Pipe	N/A	3H8604
1099322	Straight Pipe	Exhaust	7C0752
1099464	Straight Pipe	Exhaust	7E3870
1226070	45° Outlet	N/A	9S8068
2P1438	Straight Pipe	Exhaust	8H2758
2P2784	Straight Pipe	Exhaust	8S6783
2P4611	45° Square Cut Outlet	Exhaust	7S8735
2P5226	Straight Pipe	Exhaust	6F8814
2P5608	Straight Pipe	Exhaust	8S6783
2392270	Radial Square Cut Outlet	Exhaust	N/A
2552900	45° Square Cut Outlet	Exhaust	7E6455
2666346	N/A	Exhaust	417554
3R5327	Radial Square Cut Outlet	Exhaust	8S1460
4N5958	Radial Square Cut Outlet	Exhaust	7N5686
4N6639	Straight Pipe	Exhaust	3H8604
4N6668	Straight Pipe	Exhaust	8S1460
4P0494	N/A	Exhaust	1W2431
4P4455	N/A	Exhaust	9Y8315
4P6589	45° Outlet	Exhaust	2P7806 & 4P3806
4S6941	Straight Pipe	Exhaust	5D5017

Part No.	Specification	Application	Clamp Part No.
4W5729	45° Outlet	Exhaust	2P7806 & 8S6783
5I8004	Straight Pipe	Intake	5I7639
5I8040	Straight Pipe	Intake	5I7639
5M0880	Straight Pipe	Intake	4F4974
5M5856	45° Square Cut Outlet	Exhaust	7H4266
6C0027	Straight Pipe	Exhaust	1081770
6I2409	Radial Square Cut Outlet	Exhaust	4P3806
6N5354	45° Square Cut Outlet	Exhaust	8S1460
6N7665	Straight Pipe	Exhaust	N/A
6N7922	Straight Pipe	Exhaust	5S0580
6N8645	Straight Pipe	Exhaust	8S1460
6N8749	Straight Pipe	Exhaust	5S0580
6U6271	Radial Square Cut Outlet	Exhaust	7E6455
7C6450	45° Outlet	Exhaust	9Y8315
7C7004	N/A	Exhaust	1W5455
7E3509	45° Square Cut Outlet	Exhaust	7E1397
7E3560	45° Outlet	Exhaust	2P7806 & 4P3806
7E9506	45° Square Cut Outlet	Exhaust	7E3870
7E9871	45° Square Cut Outlet	Exhaust	1374499
7N1760	N/A	Exhaust	8S5444
7S7117	N/A	Intake	5S0580
7S7128	45° Square Cut Outlet	Exhaust	5S0580
7S7681	45° Square Cut Outlet	Exhaust	5S0580
7S8736	45° Square Cut Outlet	Exhaust	6F8815
7Y1315	45° Square Cut Outlet	Exhaust	6F8815
7Y1513	45° Outlet	Exhaust	7C0752
8H2718	Straight Pipe	Exhaust	8H2758
8H4477	Straight Pipe	Exhaust	6F8814
8N4445	45° Square Cut Outlet	Exhaust	8M0280
8S0985	Straight Pipe	Intake	5S0580
8S4652	N/A	Intake	N/A
8S5120	Straight Pipe	Exhaust	7S8735
8S8981	Straight Pipe	Exhaust	6F8815
9S1768	Straight Pipe	Exhaust	6F8815
9S6120	Straight Pipe	Exhaust	8S1460
9S7534	45° Square Cut Outlet	Exhaust	5S0580

TURBOCHARGERS

TURBOCHARGERS



CTP Turbochargers are engineered with the best materials and fine craftsmanship to ensure they conform to our standards of excellence. Our turbochargers are machined and assembled with high dimensional accuracy, resulting in better performance and higher durability.



Engine	Part No.	Cartridge	Equipment
1673C, 1674, 3306	9N1280	4N9534	D7G
1673C, 3306	8S8039	7N7248	627, 627B, 637, D6C
1693, 3406	9L5918	4N5647	657B, 776, 992, D348
3024, 3024C, C2.2	2389349		226B, 226B3, 232B, 242B, 247B, 247B3, 257B
3044C	2354964		236B, 246C, 252B, 256C, 262C, 267B, 268B, 272C, 277C, 287C, 297C
3044C	2461271		906, 906H, 907H, 908, 908H
3044C, C3.4	3149972		236B, 236B3, 242B3, 246C, 252B, 252B3, 256C, 257B3, 259B3, 262C, 262C2, 277C, 277C2, 279C, 279C2, 287C, 287C2, 289C, 289C2
3046	1076338	5I7589	939, 939C, D3G, D4G, D5C III, D5G
3046	1177867	5I7589	315, 315B, 315C, 317B LN, 318B
3054	1188384	6I4203	AP-800C, BG-225B, CB-534B, CB-534C, CB-535B, CP-433C, CS-431C, PS-200B, PS-300B, TH103, TH62, TH63, TH82, TH83
3054	1213226		315, 317
3054	1232926	1359275	914G, IT14G
3054	2197618	1662787	315B L, 554, BG-225C, M312, M315

Part numbers are used for reference purposes only.

Costex Tractor Parts Copyright © 2020. All rights reserved.

Turbochargers (cont.)

Engine	Part No.	Cartridge	Equipment
3054	2199772	1662851	426C, 430D, 436C, 438C, 438D, 442D
3054	2199773	1662787	416C, 416D, 420D, 428C, 428D, 432D
3054	7C3446	7C4930	416, 416B, 416C, 426, 426B, 426C, 428, 428B, 428C, 436, 436B, 436C, 438, 438B, 438C
3054, 3054B	2199766	1662192	AP-800C, BG-225B, CB-534C, CB-535B, CP-433C, CS-431C, CS-433C, PF-290B, PS-200B, PS-300B, PS-360B, TH103, TH62, TH63, TH82, TH83
3054, 3056	1142577	1359275	312
3054C	2373786		414E, 416D, 416E, 416F, 420D, 420E, 420F, 422E, 422F, 424D, 428D, 428E, 428F, 430D, 430E, 430F, 432D, 432E, 432F, 434E, 434F, 442D, 442E, 444E, 444F
3054C, 3054E	2258529		CB-534D, CB-564D, TH460B
3054C, 3054E	2339534		AP-650B, AP-800D, CP-533E, CS-533E, PS-360C
3054C, 3054E, C4.4	2342988		CD-54, CP-433E, CS-433E, PF-300C, PS-150C, TH220B, TH330B, TH340B, TH350B, TH355B, TH460B, TH560B, TH580B
3054T	2205621	1662192	312C
3056E	2168685		AP-655C, M316C, M318C, M318C MH, M322C
3056E	2359694	709947-8	924G, 924GZ, 930G, IT28G
3056	1662881		924G, 924GZ
3064	1967988	5I7940	311C, 312C, 312C L, 314C
3064	5I7903	1859211	311, 312
3064	5I8122	5I7940	311, 311B, 312, 312B
3066	2228219	5I7589	320C
3066	2331159	5I7589	318C, 319C, 320C, 320D LRR, 321C
3066	2797860	5I7589	320C, 320C FM, 320C L, 320D, 323D L, 323D LN
3066	5I7952	5I7589	318C, 320, 320 L, 320B, 320B L, 320N
3066	5I8018	5I7589	320B, 320B FM LL, 320B U, 320C, 320C FM, 320D LRR, 321B, 321C
3066	4N9618	4N9536	235, 966C, 977K, D5, D6C
3114	1143601	6I0190	924F, IT24F
3114	6I0193	6I0190	918F, IT18F
3114	7E5187		211B
3114	9Y3124	7C6714	CB-434, E120B

Engine	Part No.	Cartridge	Equipment
3114	9Y4031	7C6714	446, 446B
3116	1005864	1005991	928F, 950F, IT28F
3116	1005865	1005992	950F, 950F II
3116	1028410	1006915	960F
3116	1030651	6I0175	
3116	1030655	6I0175	
3116	1032084	6I0175	
3116	1032085	6I0179	
3116	1045857	1006916	561M, 938F, 953C, AP-1000, CB-634C, CS-563C, CS-583C, D5M, D6M
3116	1055059	1006919	950F II, 960F
3116	1124896	7E4821	
3116	1144658	6I2290	
3116	1151179	1055064	120H NA, 135H NA, 320B, M318, M320
3116	1151181	1006916	928G, 938F, IT28G, IT38F
3116	1155853	1006915	120H, 120H NA, 135H, 135H NA, 322B, 322B L, 325B, 325B L
3116	1155854	1006915	322 FM L, 322 LN
3116	1249332	1246277	120H ES, 322B L, 322B LN, 325B L, M325B
3116	1251123	1055064	953C, AP-900B, CS-563D, CS-573D, CS-583D
3116	1251124	1055064	928G, 938F, IT28G, IT38F
3116	1251126	1251134	950F, 950F II, 960F
3116	1251128	1055064	120H NA, 135H, 135H NA, 320B
3116	1352650	1356806	120H, 120H ES, 120H NA
3116	1574386	1584645	
3116	4P2768	6I2278	325 L, 325 LN
3116	4P4681	6I2278	213B, 214B, 325 L
3116	4P4682	6I2278	613C II, AP-1000, AP-1050, CP-563, CS-531, CS-531C, CS-531D, CS-533, CS-533C, CS-533D, CS-563C, CS-573, CS-573C, CS-583, CS-583C, D250D
3116	4P5523	6I2278	320 L
3116	4P7709	6I2259	320 L, 322, 322 FM L, 322 LN
3116	5I5016	5I7887	E200B
3116	6I2260	6I2269	325, 325 L
3126	1981845	2063097	525B, 535B, 938G, 950G, 962G, IT38G, IT62G
3126, 3126B, 3126E	1918028	1918031	
3126, 3126B, 3126E	1956020	1956001	

Engine	Part No.	Cartridge	Equipment
3126, 3126B, 3126E, C7	1918019	1918031	
3126B, C7	2500841	2619287	120K, 140G, 525C, 535C, 545C, 815B, 938G II, 950G II, 950H, 962G II, 962H, IT38G II, IT62G II, IT62H
3126B	1871603	1960268	120H, 135H, 561N, 953C, 963C, D5N, D6N
3126B, 3126E	1955995	1956001	938G
3126B, 3126E	1974998	1918032	AP-1055D, BG-2455D, BG-260D
3126B, 3126E, C7	1956000	1956005	
3126B, C7	1770440	1956025	322C, 322C FM, 324D, 324D FM, 324D FM LL, 324D L, 324D LN, 325C, 325C FM, 325D, 325D FM, 325D FM LL, 325D L, 325D MH, 326D L, 328D LCR, 329D L, C7, M325C MH, M325D L MH, M325D MH
3176	1741644	1679671	140H, 143H, 14H, 160H, 163H
3176	1962775	1962482	345B, 345B L
3176, 3176B	1011684	1021719	R1700 II
3176, 3176C	1855732	1679671	814F, 815F, 816F, 966G II
3176, 3176C	1962776	1962482	345B, 345B II, 345B II MH, 345B L, TK1051, W345B II
3196	1906216	1962481	365B, 365B II, 365B L
3204	6N8477	8N4780	916, 926, 953, IT18B, IT28B
3208	6N0580	4N7601	
3208	7W2874	7W2878	225D, 231D, 3208, 613C, FB221
3208	7W2875	7W2878	PR-1000
3304	2W1953	4N6860	229D, 3304, 950B, 950B/950E, CB-534
3304	4N6859	4N6860	518, 930, 950, D4D, D4E
3304	6N7924	6N7926	955K, 955L
3304	7N4651	4N6860	120G, 130G, 215, 215B, 215C, 215D, 219D, 225, 225D, 229, 3304, 3304B, 518, 518C, 936, 936F, 950B, 950B/950E, 963, CS-643, D4E, D4H, D4H XL, D4HTSK III, D5H, D5H XL, D5HTSK II, E240, FB518, G936
3304	7S5739	7N7250	
3304	8S4590	7N7250	950
3304	8S9239	4N9530	955K, 955L
3306	1W1227	9N0111	814B, 815B, 816B, 966D
3306	1W1228	9N0111	973
3306	1W5575	1W8695	235

Engine	Part No.	Cartridge	Equipment
3306	1W9383	9N0111	966D, 972G
3306	1067407	2191909	140H, 143H, 14H NA, 160H, 160H ES, 160H NA, 163H NA, 330, 330B, 330B L, W330B
3306	1137924	2146914	814F, 815F, 816F, 966F II, 970F, 972G, 973C
3306	1451697	1107692	R1300, R1300G
3306	1760389	2191909	330, 330 FM L, 330 L, 330B, 330B L, W330B
3306	2199711	2146914	545, 627B, 627E, 627F, 627G, 966G
3306	4N4746	7N7249	
3306	4N8969	6N1524	140B, 140G, 14G, 235, 3306, 528, 814, 815, 816, 966C, 966R, 977K, 977L, D5, D5B, D6C, D6D
3306	4N9544	4N9534	1673C, 1674, 235, 3306, D7F, D7G
3306	4N9555	8S4580	D6C
3306	6I3739	7E9167	350
3306	6N7519	9N0111	621R, 980B
3306	7C7576	7C7597	
3306	7C7577	7C7599	235C, 235D, 637E
3306	7C7578	7C7596	143H, 14G, 3306, 3306B, 627E, 627F, D7H
3306	7C7579	7C7596	966F, 966F II, 972G, D250B, E300, E300B
3306	7C7580	7C7598	330, 330 FM L, 330 L, 3306, 3306B, 615C, 621E, 637E, 65, D300B
3306	7C7581	7C7598	65C, 70C
3306	7C7587	7C7601	
3306	7C8632	7C9309	12H ES, 140G, 140H, 140H ES, 140H NA, 143H, 14H NA, 160H, 160H ES, 160H NA, 163H NA, 3306, 528B, 530B, D6H, D6H II, D6H XL, D6H XR, D7H
3306	7E0726	7C9309	D6E SR, D7H
3306	7N2515	9N0111	571G, 572G, D398, D398B, D7G
3306	7N7748	7N7750	140G, 143H, 14G, 160H, 3306, 3306B, 966C, 966R, D5B, D6D, D6D SR, D6E, D6F SR, D6G, D6G2 XL, D6H
3306	8N1441	4N9534	966D
3306	8N7320	8N7183	235
3306	8N9247	7N7750	140G, 143H, 160G, 160H, 528, D6D, D6E SR, D6G SR
3306, 3306B	2W1744	1W6865	D25C, D25D, D300B, D30C, D350C, D35C, D6D
3306, 3306B	1W3429	1W1604	627B
3306, 3306B	1111653	4P9594	
3306, 3306B	2W7277	1W1604	D250B

Turbochargers (cont.)

Engine	Part No.	Cartridge	Equipment
3306, 3306B	2199710	2146914	350, 611, 615C, 637D, 637E, 637G, 972G
3306, 3306B	7C7582	7C7598	D25D, D300D
3306, 3306B, G3512	2W3556	2W3558	
3306, 3306C	1106979	1107692	
3306, 3306C	4P9584	4P9594	
3306C	1106980	1107692	
3306C	1199258	1107692	D250E, D250E II
3406	1W2583	8N9685	245
3406	1072060	1092196	16H NA, 583R, 824G, 825G, 826G, 980G, D8R, D8R II
3406	1072061	1092197	D8R
3406	4N7157	9L6239	245, 621B, 824C, 825C, 826C
3406	4P7499	4P7500	375, 375 L, 5080
3406	7C7690	7C7503	D8N
3406	7C9895	7C9896	245B, 3406B, 621E, 621F, 623E, 627E, 627F
3406	7E7987	7E7962	980C, 980F, 980F II
3406	7N9478	8N0817	245, 621, 621B, 623B, 627B, 824C, 825C, 826C, 980C, 983B
3406	9L6308	9L6239	16G, 3406, 3406B, 980C, 983B
3406	9N2703	9N3676	824C, 825C, 826C, 980C, 992C
3406, 3406B	4N6700	4N9538	
3406, 3406B	9N5264	9N5263	9N5264
3406, 3406B, 3406C	1W3728	1W3729	
3406, 3406B, 3406C	6N0577	4N7601	
3406, 3406B, 3406C	1W1052	1W1053	
3406, 3406C	7C7691	7C7503	16G, 16H NA, 578, 980C, D8N
3406, 3406C, 3406E	1795922	2024081	578, 583R, 824G, 825G, 826C, 826G, 980C, 980G, D8N, D8R, D8R II
3406, 3412	1789572	1679270	5110B, D8R, D8R II
3406, C15	2388683	2407359	583T, 587T, D8R, D8T
3406B	1107897	1107898	
3406B	7C7685	7C7693	
3406B	9Y1907	1198517	
3406B	7C6609	1198516	
3406B	7C7687	7C7693	
3406B	7W7125	8N2361	
3406B	7W9472	4W5192	
3406B	7W9568	7W5972	
3406B, 3406C	1312427	1312428	
3406B, 3406C	4P2060	4P2524	

Engine	Part No.	Cartridge	Equipment
3406B, 3406C	7C6615	7C6610	D40D, RR-250, SM-350, SS-250
3406B, 3406C	7C6702	6N6130	
3406B, 3406C	7C7692	7C7631	D8N
3406B, 3406C, 3412E	1305469	1411468	HT400, PM-465, RM-350B, SM-350
3406B, 3406E	4P2064	4P2063	R2900
3406C	1196210	1196211	623F, D350E, D400E, RM-250C, RR-250B
3406C	1247622	1196211	
3406E	2080037	2078197	735, 740
3406E	1418936		
3406E, 3456	1323649	1964155	
3408	1W1654	1W1653	
3408	1W1809	4N7601	988B
3408	1W3439	1W1653	
3408	4P8730	4P8731	D8L, D9N, D9R
3408	4W9104	8N6553	589, 657E, D8L, D9N
3408	7N2495	6N7960	988B
3408	8N1447	1294864	D8L
3408	9N6753	1N3999	
3408, 3408B	1N3988	1N3999	
3408, 3408B, 3408C, 3412, 3508, 3512, G3512, G3516	1W5285	6N7960	
3408, 3408B, 3408E	1W5580	1W1653	631D, 69D, 769C, 769D, 771D, 834B, 836, AD40, AD45, AE40, AE40 II, PM-565, PR-450, PR-450C
3408, 3412	9N0888	4N7601	988B
3408B	1W3897	4N7601	631D, 633D, 637D, 639D, 768C, 769C, 771C, 834B, PM-565
3412	1W1810	1W1814	772B, 773B
3412	2W5697	7N9399	D10N, D9L
3412	7C0353	7C0354	992C, 992D
3412	7C6706		
3412	8N8312	6N3276	
3412	4W7500	9N3676	PR-1000, PR-750B
3412	6N6606	6N6607	
3412, 3412C	4P2783	4P2785	
3412, 3412C	4W1237	4W1225	
3412, 3412C	6N2020	6N3902	
3412, 3412C	6N7812	6N3902	
3412, 3412C	7C2485	1W1053	
3412, 3412C, 3412E	1034051	1034052	772B, 773B, 775B

Engine	Part No.	Cartridge	Equipment
3412, 3412C, 3412E, 3512, 3516	4W1232	4W1225	
3412, 3412C, 3412E, PM3412	1418938		PR-1000
3412, 3412C, 3412E, PM3412	1444568	9N3676	PR-1000
3412, 3412C, 3512	1020290	1020292	PM3412, PM3512, SCT673, SPS342, SPT342
3412, 3412C, 3516	4W1148	4W1225	
3412, 3412C, PM3412	4P2784	4P2785	
3412, D399	7N3205	6N3276	
3412E	1343592	1343668	
3412E	1644610	1679269	651E, 657E, D10N, D10R, D9L
3456	1922827	2024081	834G, 836G, 988G
3456	1965946	2024081	735, 773B, 773D, 773E, 775B, 824C, 824G, 824G II, 825G II, 826G II, 844, 980G, 980G II, 990 II
3456	2112254	2112255	651B, 834G, 836G, 988G
3508, 3508B, 3512, 3516, 3516B	1182987	1182988	
3508, 3512	7W8008	6N7960	
3508, 3512, 3516	1W6551	6N7960	
3508, 3512, 3516, PM3516	1182989	1182988	
3508, 3516	9Y8266	9Y8267	776C, 777B, 789, D11N
3508B, 3512B, 3516B, PM3508, PM3516	1180400	2890372	
3508B, 3512C, 3516B, PM3508, PM3516, PP3516	2454339	2464718	
3508B, 3516	3016871	3016868	776D, 777B, 777C, 777D, 789, 789B, 789C, 789D, 854G, 992G, 994F, 994H
3508B, 3516B, PM3508, PM3516, PP3516	2071351	2032155	
3512, 3512B, 3516, G3412, G3516	1020294	1020292	
3512, 3516	1020299	1004095	
3512, 3516	1020300	1004095	

Engine	Part No.	Cartridge	Equipment
3512, 3516, PM3512	1020297	1004095	
3512B	2585636	2890375	
3512B, PM3512	2598424	2891453	
3516	1153306	9Y8267	5130, 5230, 776C, 789, 789B, D11N, D11R
3516	2045462	2071333	5230B, 785C, 789C
C4.4	3159721		416E, 422E, 428E, 428F, 432E, 432F, 434E, 442E, AP-300D
C4.4	3160468		420E, D3K XL, D4K XL, D5K LGP
C4.4	3160477		CB-54, CB-54B, CB-64, CS-54B, M313D, M315D, M315D 2, M317D 2
C4.4	3160514		SPF343C
C4.4	3269153		420F, 428E, 428F, 430F, 432E, 432F, 434E, 434F, 442E, 444E, 444F
C6.4	2056741	517589	320C, 320C FM, 320C L, 320D, 323D L, 323D LN
C6.4	2870049	517589	320D, 320D FM, 320D FM RR, 320D GC, 320D L, 320D LN, 320D LRR, 320D RR, 321D LCR, 323D L, 323D LN, 323D SA
C6.6	3159810		938H, IT38H
C6.6	3160413		938H, IT38H
C7	2375271	1956005	
C7	2507696	2619367	120K, 120K 2, 324D, 324D FM, 324D FM LL, 324D L, 324D LN, 325D, 325D FM, 325D FM LL, 325D L, 325D MH, 326D L, 328D LCR, 329D, 329D L, 329D LN, C7, C9.3, M325D L MH, M325D MH
C7	2692920	2692929	
C9	1885156	1965463	973C, D6R II
C9	1915094	1966097	330C, 330C FM, 330C L, 330C MH, 627G, MTC735, TK711, TK721, TK722, TK732, TK741, TK751, TK752
C9	2485246	2355507	330C, 330C FM, 330C L, 330C MH
C9	2507700	2355507	2290, 2390, 2391, 2491, 2590, 330D, 330D FM, 330D L, 330D LN, 330D MH, 336D, 336D L, 336D LN, 336D2, 336D2 L, 340D L, 340D2 L, 511, 521, 521B, 522, 522B, 532, 541, 541 2, 551, 552, 552 2, C9, CX31-C9I
C9	2525165	2622870	D6R, D6R III, D6R STD, D6T, D7R XR

Turbochargers (cont.)

Engine	Part No.	Cartridge	Equipment
C9	3584923	3584926	TH31-E61
C9	3584924	3586181	586C, TH31-E61
C-9	2167815	1966097	330C, 330C L, 637D, 637G
C-10	1941116	1906222	725, CPT372, R1600G, R1700G
C-10	2046489	2046520	
C-10, C-12	1906212	1906222	
C11	2472957	2574323	966H
C-12	1906205	1906222	
C-12	1906210	1906222	
C13	2395581		
C13	2472964	2747104	CX31-C13I, TH35-C13I
C13	2472965	2747104	CX31-C13I, TH35-C13I
C13	2472969	2626139	345C, 345C L, 345C MH, 345D, W345C MH
C13	2485352	2574323	16M
C13	2520205	2626139	345C, 345C L, 345C MH, W345C MH
C13	2847707		
C13	2915480	2796060	345C L, 345C MH, 345D, 345D L, 345D L VG, 349D, 349D L
C15	2303542	2626757	735, 740
C15	2321811		
C15	2385102	2407359	365C, 365C L, 365C L MH, 657E, 657G, 770
C15	2399988	1947919	CX31-C15I, TH35-C15I
C15	2400003	2555477	651B, CX31-C15I, TH35-C15I
C15	2514820		
C15	2627096	2678584	980H
C15	2627099	2407359	824H, 825H, 826H
C-15	1915431	2024081	
C-15	1965951	1964157	
C-15	2616857	2266636	
C-16	1947921	1947919	651B
C18	2191911	2191909	12G, 12H, 12H ES, 12H NA, 140G, 140H, 140H ES, 140H NA, 143H, 14G, 160H NA, 235B, 3306, 3306B, 572R, D6G2 LGP, D6G2 XL, D6H, D6H XL, D6R, D7G, D7G2, D7H, D7R
C18	2385105	2626756	D9T
C18	3619711	3021410	834H, 836H, 988H
C18	3620838	3021410	385C, 385C FS, 385C L, 385C L MH, 390D, 390D L
C27	2341524	2680183	D10R, D10T
C32	3027439	3021409	777F, 854K, 992K

Engine	Part No.	Cartridge	Equipment
D339	4S9706	7N7250	571A, 572E, D7E
D342	1P1163	7N7251	D8H
D342	4N4441	7N7251	D8H
D342	4N5645	4N5649	D8H
D342	6N3253	6N3252	D8K
D342	6N7203	6N7202	583K, D8K
D342	8N5510	8N5511	583K, D8K
D353	8N6554	8N6553	594H, D9H
D353C	2P4664	4N5647	D9G, D9H
D353C, D398, D398B	6N8458	4N4040	
D379, D379A	6N8221	9N0111	
D379, D379B	6N8218	9N0111	
D398, D398A, D398B	6N8464	4N4040	
D399	3S4258	3S4007	
D399	6N8460	4N4041	
D399	8N3323	8S6009	

Turbochargers for Komatsu®

Machine Model	Part No.
D155A, D150A-1, D155A-2, D155C-1D, EG300-1, D155W-1	6502-13-2003
D155A, D155A-2A, D155AX-3, D155AX-5, D155A-5, D155C-1, D355C-3	6505-52-5410
D275A, D275A-5, D275AX-5, D275A-5D	6505-65-5140
D355A, D355A-5, D355A-3	6502-12-9005
D65E, D65E-12, D60P-12, D65PX-12, D65EX-12H, D85ESS-2A, D85ESS-2	6151-81-8500
D66S, D66S-1, 540-1, 540B-1, EC210Z-1	6138-81-8101
D85E, D65E-12, D60P-12-E, D65PX-12-E, D85ESS-2, D85ESS-2A, D65EX-12	6151-82-8500
EM436A	6205-81-8130
EM440	6135-81-8300
EM640A, EM640A-A	6137-82-8500
HD325, PC1800-6-M1, HD405-6, HD325-6, HD325-6W	6505-65-5030
HD465-7E	6502-51-5010
HD465-7R	6502-52-5010
HD785-7	6505-67-5040
HD785-7	6505-67-5030
IH530	6138-81-8102
LW250L-1X, LW250L-1NH, LW250L-1NX, LW250L-1H	6152-81-8700
PC-88MR-6	6205-81-8270

Machine Model	Part No.
PC100, PC100-5, PC100-5Z, PC120-5S, PC130-5, PC100-5S, PC120-5Z	6205-81-8110
PC120, PC100N-6, PC120-6Z, PC128UU-1, PC120-6S, PC130-6, PC100L-6, PW130-6K	6205-81-8150
PC120, PC120-2, PC100-1, PC120-1, EC105Z-1, EG65S-2, PC100L-1, PW100-1	6135-82-8200
PC130-7	6208-81-8100
PC130, PC130-7, PC130-7K, PC128US-2, PC138US-2	6208-81-8100
PC200-3, PC220-2, GD505A-2, EG125-2, WA300-1, GD611A-1, PF5-1, EG125-1, GD505A-3, EC170Z-1, GD500R-2A, LW200L-1, BP500-3, JV100WP-1, WA320-1, EG125S-1	6137-82-8200
PC200-8	6754-81-8090
PC200, PC200-5, PC200LC-5, PC200-5X, PC200LC-5X, BR200S-1, BR200J-1, BR200R-1, PC200-5C, PC200LC-5C, PC200-5T	6207-81-8210
PC200, PC200-6S, PC200CA-6, PC200LC-6, PC228UU-1, PC228USLC-1, PC210-6	6735-81-8300
PC200, PC200-6S, PC200LC-6S, PC200-6Z, PC200-6H, PL210-6, PC210LC-6G	6207-81-8331
PC200, PC200-6S, PC220-6	6735-81-8201
PC200, PC200-7, PC200LC-7, PC228US-3YB, BZ210-1, PC210LC, BP500-7	6738-81-8092
PC200, PC220-5, PL220LC-5, BR310JG-1, BR300J-1	6207-81-8220
PC220, JV100WA-2, GD405A-3, GD505A-3A, WA250-3-SN, WA200-3, PLC210-6D, PC228US-1, PC230-6, D41P-6K, CD60R-1A	6735-81-8031
PC220, PC220-6, PC220-6Z, PC250LC-6, PC230-6, PC220LC-6, PC250HD-6Z, BR350JG-1, BR250RG-1	6735-81-8400
PC220, PC220-7, PC270-7, PC230-7, PC220LC-7, PC230LC-7, BR300S-2-M1, BR380JG-1	6738-81-8192
PC300, PC300-3, PC300LC-3	6152-81-8110
PC300, PC300-5, PC310-5, PC310LC-5, PC300LC-5, PC300HD-5K, PC300LC-5K	6222-81-8210
PC300, PC300-6, PC300LC-6, PC350-6, PC350LC-6, PC300-6Z, PC380LC-6K, PC340NLC-8	6222-83-8171
PC350, PC300-7, PC300-7-AA, PL300LC-7, PC350-7-AA, PC350LC-7, PC350-7, CD110R-2, PC340NLC-7K, PC380LC-7K	6743-81-8040
PC400-7	6156-81-8170
PC400, PC400-3, PL400LC-3, PC410LC-5, PC410-5, PC400-5, CS210-1, PC400HD-5K	6152-81-8210
PC400, PC400-5	6152-83-8110
PC400, PC400-6, PC450LC-6K-KE, HD255-5, WF450T-3, PC400ST-6LC, WA450-3A-TN, WA450L-3, PL400LC-6Z	6152-82-8210
PC400LC, PC400LC-8, PC450-8, PC400-8, PC450LC-8, BR580JG-1, PC450-7E0, PC450LC-7E0, PC450LCHD-8	6506-21-5020
PC600LC, D155AX-5, PC600-7-M1, PC650-7-M1, PC650LC-7-M1, CS360-2, CS360SD-2, WA500-3, GD825-2E0, WA500-3LK	6505-65-5020
PD300-8	6745-81-8040
WA150, WA150-1, WA180-1, GD511A-1, PL150LC-3, PC150-3, GD510R-1, GD405A-2S, CL60-2	6207-81-8130

Machine Model	Part No.
WA200, WA200-3, GD505A-3A, JV100WA-2, GD405A-3S, WA250-3, WA180-3, JV100A-2T, WA150-3-SN, GD521A-1E	6735-81-8200
WA320, WA320-3CS, WA320-3, WA300L-3	6736-81-8190
WA350, WA350-1, WA380-1, WA400-1, WA420-1, EC210Z	6138-82-8201
WA350, WA350-3, PC300-5, PC220LC-6, PC250-6	6222-81-8170
WA420, WA420-3, WA400-3A-S	6222-81-8311
WA450, WA450-1, WA450-3, WA450-3A, WA470-1, EG220BS-2, WF450T-1A, GD705A-4, EG220B-2, D75S-5, D85A-21B, GD725A-1	6152-81-8310
WA450, WA450-6, WA470-6, WA480-6, D85PX-15E0, D85EX-15E0	6506-21-5010
WA600, WA600-1, WA600-1H, WD600-1, PC000-1, D375A-2	6505-52-5510

† Please allow 30 to 45 days to get your order
Komatsu® is the registered trademark of Komatsu Ltd.



Part No.	Description	Machine/ Engine model
1035419	SHIELD A	120H, 135H, 140H, 143H, 160H
1W7546	SHIELD-HEAT	160G
1140915	SHIELD AS	631E, 631G, 633, 637G
1140917	SHIELD AS	631E, 631G, 633, 637G, D9R
1265057	SHIELD AS	631E, 631G, 633, D9R
8N1620	SHIELD AS	631E, 657E, D8L
8N1622	SHIELD AS	631E, 657E, D8L
1N3300	SHIELD AS	631E, 657E, D9R, D10
8N1594	SHIELD AS	631E, 657E, D9R, D10
8N1616	SHIELD	631E, 657E, D9R, D10
8N1619	SHIELD	631E, 657E, D9R, D10
1265056	SHIELD AS	631E/G, 633E, 637G, 651E, 657E, D10R, D9R
8N2258	SHIELD	637G, 657E, D9R
8N2368	SHIELD AS	637G, 657E, D9R
1309117	SHIELD AS	651E, 657E, D10R
1W6183	SHIELD AS-MANI-FOLD	651E, 657E, D9L, D10
1W6184	SHIELD	651E, 657E, D9L, D11
1W6185	SHIELD AS	651E, 657E, D9L, D12
1W6186	SHIELD	651E, 657E, D9L, D13
8G7194	SHIELD AS	943, 953
1W0460	SHIELD AS - RH	990, 992C, 992D
1W0464	SHIELD AS - LH	990, 992C, 992D
1W0466	SHIELD AS - LH	990, 992C, 992D
1W0458	SHIELD AS - RH	990, 992C, 992D
4N9587	SHIELD	D4E, D5E
4P3306	SHIELD-HEAT	D6R, 160G, 966F
1W6299	SHIELD AS - LH	D9L
1268525	SHIELD AS - LH	D9R

Part numbers are used for reference purposes only.

Costex Tractor Parts Copyright © 2020. All rights reserved.

BEARINGS



COMPOSITE BEARINGS



CTP Filament Wound Plastic Self-Lubricating Composite Bearings meet the need for high load, self-lubricating bearings that provide low wear rates in a wide variety of applications. Our composite bearings combine the excellent lubricating properties of filled PTFE with the high strength and stability of an oriented glass fiber wound structure.

Typical Applications:

- ✓ Steering linkages
- ✓ Hydraulic cylinder pivots
- ✓ King pin bearings
- ✓ Boom lifts, scissor lifts
- ✓ Cranes, hoists, lift gates
- ✓ Backhoes, trenchers
- ✓ Skid steers loaders, front-end loaders

Part No.	Application
1545404	416C, 416D, 420D, 424D
1832358	416C/D, 424D, 426C, 420D, 428C, 430D, 436C
2G3686	120G
3G2579	140G, 140M, 160H
3G2581	140G
6Y3548	D7H
7D8889	120M, 12G, 12M, 130G
8D4137	14G
8D4138	14G, 14H, 14M
8D4496	14G, 14H, 14M
8D6629	130G
8D7086	12H, 12M, 140M, 160H
8D7282	12G, 130G, 140G
8D7284	120G, 12G, 130G, 140G
8D7685	320D
8D7996	120G, 120H
8D8168	120H
8D9296	120, 120G
9D0047	120G
9D0057	120G
9D1511	120G
9D1512	120G

SLEEVE BEARINGS



Part No.	Application
1297768	320, 320B, 320C, 320S, 322B LN, 322C
1372817	325, 325C, 325L, 325LN, 330C
1372818	330C, 330 C L, 330 C LN
1372819	320, 320B, 320C, 320S, 325C, 330B, 345B
1372820	320B, 320C, 320S, 322B, 322L, 325, 325B, 325L, 5080
1372821	330BL
1372822	330, 330L, CAT-3
1372919	315C, 320B, 320BL, 320BLN, 320BN, 320BS, 320C, 320CL, 320D, 320S, 330C, 330CL
1413420	345B, 345BII, 345BL, 365B, 365B
1433841	318 C, 319D, 320C, 321C, 322BL, 322BLN, 322C, TK1051
1483091	345B, 345BL, 345B-II, 345B-L, W345B-II
1633749	315C, 315CL, 320D, 322CL, 325, 325C, 345B, 385B
1928318	322C, 325C, 325CL, 330CL, 330CLN
2285614	315C, 315DL, 320D, 320DL, 323DL, 323DLN, 323DS, 324DFM, 325D, 325DL, 328DL, 328DL, 329D, 329DL, 330D, 330DMH
2285615	315DL, 320D, 320DL, 323DL, 323DS, 324C, 324DFM, 325D, 325DL, 328DL, 329D, 329DL, 330D, 385C
2285617	324D, 324DL, 325BL, 325C, 325D, 325DL, 330D, 330DL, 330DLN, M325B, M325D
2285619	330D, 330DL, 330DLN, 336DL, 336DLN, 345D, 345C, 345CL
2285621	320C, 330, 330D, 330D-L, 330D-LN, 330D-MH, 345D, 345C, 345DL, 365C, 365B, 365BII, 365C, 365C-L
2285621	330D, 330D L
2285622	322C, 345C, 345D, 345C, 345C-L, 345DL, 365C, 385B, 385C, 385C-L
2291092	311C, 311DLRR, 312C, 313C, 314C, 314DCR, 314DL, 320C, 320DL, 324DL, 325D, 329DL
2291096	315DL, 319D, 320D, 320C, 320C-L, 321C, 325C, 325CL, 365B
2343749	385B
2402912	320C, 320D, 320DL, 322C, 323D, 323DL, 325C, 325D, 325DL, 330DL, M325D-LM
2402913	312D, 320B, 320BL, 320BLN, 320BS, 320C, 320D

Part numbers are used for reference purposes only.

Part No.	Application
2402914	318C, 319C, 320B, 320BL, 320BS, 320C, 322D, 325C, 325BL, 325C, 345B, 345B-II, 345BL, 962GII
2402915	320B, 320C, 320B-L, 320B-N, 320C, 325C, 325C-L, 345BII
2402916	320C, 322CL, 325C, 325CL, 325D, 325DL, 330C, 345C, 345CL, 365CL
2402937	322B, 322C, 322BL
2417231	324D, 329D, 330D, 336D-C9
2417280	324D, 325D, 330D, 336D
2417382	319D L, 319D LN, 323D L, 323D LN, 323D S, 324D L, 325D, 325D L, 330D, 330D L, 330D LN, 336D L, 345 C L
2444360	315DL, 320D, 320DL, 320DLRR, 323D, 323DL, 323DS, 324D, 3244DFMM, 324DL, 325D, 325DL, 330DL, 345CL, M325DLM
2487835	311DLRR, 312D, 312DL, 314DCR, 314DL, 3244, 325D, 329D
2627043	416E, 420E, 422E, 428E, 430E, 432E, 434E, 442E, 444E
2627044	416C, 416E, 426C, 436C, 637E

SPHERICAL BEARINGS



Part No.	Part No.	Part No.
058639	3W8357	6Y4457
0665815	3W8570	7J3216
1078126	4D0298	7J3297
1173006	4D2619	7T9147
1174013	4D4431	8G0890
1342733	4T1684	8G4189
1401185	4V2057	8G4259
1587749	5J1446	8G4371
1599311	5J9451	8J4585
1600305	5P7802	8J6861
1649309	6J1144	8J7978
1976439	6J5383	8J8906
1976440	6S3976	8T0333
2159572	6V0444	9J3206
1U2729	6V3249	9J6070
1U3988	6V3340	9J7964
2D8652	6V5002	9M1328
3G3521	6V5003	9M3914
3G5337	6V8105	

Costex Tractor Parts Copyright © 2020. All rights reserved.

TAPERED ROLLER BEARINGS



Cone Bearings

Part No.	Part No.	Part No.	Part No.
0037501	1B4034	2H0930	4B5180
0049040	1B4040	2K5065	4B5181
050471	1B4043	2K5066	4B7255
0054834	1B4046	2K5103	4B7270
081902	1B6572	2K9295	4B7941
300061	1B6577	2M8714	4B8395
0301957	1B6579	2N2139	4B9373
1069823	1H4203	2N2189	4D3848
1091779	1H4493	2N3254	4D4324
1100012	1H5337	2P1371	4D7997
1119033	1J4757	2P1372	4D8649
1162024	1K7737	2P1374	4F0559
1194133	1K7990	2P1824	4H4615
1238905	1K7992	2P4649	4L7250
1249536	1L7518	2P8101	4M1552
1260588	1L7519	2P8353	4W1204
1265859	1M7912	2P8987	5D4301
1326597	1M8735	2P8988	5D6297
1417518	1P2567	2P9091	5D7453
1556648	1P2662	2R0524	5D9662
1564593	1P2694	2S0479	5F0585
1730593	1P2696	2S6400	5F1248
1788608	1P3935	3B7389	5F2466
2125030	1P4694	3D0294	5K3932
2642769	1P4696	3D1101	5L1544
1B3897	1P5419	3D3715	5L2030
1B3908	1P7835	3D9125	5L9656
1B3924	1P7895	3F3049	5P0505
1B3930	1P9593	3F5789	5P0885
1B3933	1T0163	3F5950	5P1948
1B3939	1T0434	3F7182	5P2504
1B3941	2A4577	3F7183	5P2522
1B3950	2D7691	3H1011	5P2523
1B3953	2D8493	3L9410	5P3088
1B3980	2D9191	3N4968	5P4297
1B3990	2D9453	3N4969	5P4355
1B3991	2D9455	3P1210	5P6457
1B3993	2D9457	3P6371	5P6663
1B4008	2F8509	3P8681	5P7605

Part No.	Part No.	Part No.	Part No.
5P8139	6L9764	6V2652	7J8210
5P8296	6M1882	6V2702	7K8877
5P9290	6S2829	6V3606	7L3290
5P9533	6S6032	6V7527	7M5334
6B3183	6V0247	6V8499	7S1874
6B4852	6V0347	6Y0208	7T5426
6D1137	6V0661	6Y0942	7T6652
6F8110	6V0663	6Y1031	7T6653
6I8849	6V0832	6Y1574	7T6654
6K5617	6V0957	6Y2539	7T8272
6K8074	6V1636	7D8636	7T8858
6K8275	6V1882	7H2621	7T9122
6L9749	6V2449	7H4573	7T9526

Cup Bearings

Part No.	Part No.	Part No.	Part No.
0020754	1J2860	2K5069	4D4325
0021212	1K7991	2N2138	4D8648
0050469	1L7319	2N2188	4F2041
093691	1M6573	2N3253	4K5843
300060	1M7911	2P1370	4L7249
0310426	1M8736	2P1373	4M6104
0688099	1P2566	2P1823	4W1203
1100013	1P2636	2P4651	5D6298
1200295	1P2695	2P8100	5D7449
1238906	1P2697	2P8986	5F0589
1417519	1P3934	2P8989	5F2465
1556647	1P4693	2R0525	5K3931
1730594	1P4695	2S0480	5L1545
1744504	1P5420	2S6401	5L2031
1753770	1P6872	3B2263	5P1949
2038609	1P7834	3B4124	5P2503
1B3909	1P7896	3B5790	5P2524
1B3918	1P9594	3D0295	5P2525
1B3922	1T0299	3D1100	5P2526
1B3925	1T0433	3D3716	5P3087
1B3928	2A4576	3D9126	5P4298
1B3931	2B3380	3D9133	5P4354
1B3934	2B9175	3F3840	5P5319
1B3937	2D6511	3F5920	5P5354
1B3955	2D6513	3K0649	5P7606
1B3978	2D8496	3L9409	5P8138
1B3994	2D9190	3N6408	5P8876
1B4009	2D9454	3P6372	5P9532
1B4012	2F8508	3P8680	5P9534
1B4038	2H0929	4B3034	6B2695
1B6573	2J2152	4B8393	6B3223
1B6578	2J6232	4B8394	6B3224
1H5338	2J7137	4B9374	6B4370

Part No.	Part No.	Part No.	Part No.
6B4851	6S2828	6Y2547	7T5427
6D1138	6S3051	6Y2737	7T8273
6D1734	6S6031	7B4956	7T8859
6D7690	6V0662	7D8348	7T9527
6F2956	6V2200	7D8637	8H0901
6I8860	6V3579	7J8209	
6K5528	6V3605	7J8894	
6K8328	6V4636	7K5448	
6L9773	6V5131	7K7883	
6M1638	6Y1032	7L3283	
6M1883	6Y2540	7L4434	

Other tapered bearings also available

Part No.	Part No.	Part No.	Part No.
1087930	2B2631	4D2156	5P9769
1367808	2B3116	4D7995	6B3824
1437356	2B9049	5D6296	6B5158
1650002	2D6512	5H3030	6H3566
1741527	2F7779	5J9348	6K8329
1926341	2H3721	5K3929	6S2826
1987823	2H3724	5M6592	6S2827
2074263	2J6233	5P1370	6V1194
2074267	2J7227	5P3236	6V2323
2105932	2J9120	5P5826	6V3578
3530314	2K5097	5P5863	6V7423
1B3900	2P8120	5P6420	6V8121
1B3915	2P8482	5P7843	7D8437
1B3920	3D9058	5P7844	7F1117
1F0883	3D9059	5P9531	7H4566
1L7203	3F4210	5P9651	7K8876
1T0589	3K6396	5P9652	7L6551

NEEDLE BEARINGS



Part No.	Application
1F4503	992, D397, D38
1F4622	G348, G349
1J3710	D4H, D6G, D5E
1P3958	992K, 740, 980C, 980K
1P6070	D4H
1S9110	633, 834
1T0655	621

Part numbers are used for reference purposes only.

Part No.	Application
1994582	322L, 322LN
2H2213	D343
2H3822	657G, 633E, 637G
2K5830	594
2L0611	920, D8K, D5B, D7G
2M5685	657
2P3187	12G, 14G
2S0669	D7F
3K6711	769B, 773, 120, 768B
4B2090	D8
4B3671	D8, D8H, D5, D6C
4J2667	120H, 140H, 160H
4J3044	D6H, D7R, D8R, D9R, 631E
4M3915	D8H, D9, D9G, 966B, 966
5D2989	D6R, 980C, 980K
5F0255	120B, 140B, 621B
5F2830	980C, 980K, 826H
5M0578	966C, 814, 815, 650B
5M2051	D9G, 775B, 637G
5M2054	633, 621H, 627H, 12G, 980K
5M2055	14H, 14G, 613C, 613G
5M5018	12G, 14H, 621H, 637G
5M6126	D6, D7, 977
5M6228	D5H, D9R, D5M
5M7925	966C, 814, 815, 650B
5P0403	980C, 980K, 980G
5P1901	D6G, D7G
5P3930	D8N, 3406
5P6254	D9N, 3412
5P6441	777, D348, D8L
5P6721	D9R, D9T, D10N
5P7661	740, 740B, 770G
6D3886	D9R, 994F, D10N
6K4487	966C, 815, 966C
6K8088	12G, D6G, 530B
7B5670	D398B, D399
7K2135	12G, 160H, 14H
7S4534	637, 966K, 962H
8B4132	D4H, D5H, D5M
8S0542	916, 920
9H5205	966C, 966R
9S4775	D3C, D5C, D5D
9S6465	994D, D9R, D6G

Costex Tractor Parts Copyright © 2020. All rights reserved.

BELTS & HOSES



BELTS

Size		Length		Set Part No.	Single Part No.
(in)	(mm)	(in)	(mm)		
1/2	12.7	43.5	1105	9N1330 (3)	9N1329
1/2	12.7	44.0	1118		1N3743
1/2	12.7	49.0	1245		4P0454
1/2	12.7	49.5	1257	4N8580 (2)	1P4334
1/2	12.7	50.0	1270	9L6128 (2)	3P0130
1/2	12.7	50.5	1283		2P6212
1/2	12.7	51.5	1308		4N6130
1/2	12.7	52.5	1334		2P4191
1/2	12.7	55.5	1410		2S2743
1/2	12.7	56.5	1435		4N7610
1/2	12.7	57.5	1460	7N8518 (2)	
1/2	12.7	63.0	1600		9L4479
1/2	12.7	65.5	1664	9L6130 (2)	2P8720
1/2	12.7	78.0	1981		8M0760
1/2	12.7	82.0	2083		9Y1954
1/2	12.7	84.0	2134		7E3898
11/16	17.5	65.5	1664		7C9001
11/16	17.5	65.5	1664		9N1320
11/16	17.5	90.0	2286	1W8043 (2)	1W8044
15/16	23.9	64.5	1638	6N3637 (2)	6N3636
15/16	23.9	79.5	2019	5R7276 (2)	
15/16	23.9	79.5	2019	7M0305 (3)	
1/2	12.7	33.5	851		0618384
1/2	12.7	34.5	876		7E0744
1/2	12.7	35.0	889		0303289
1/2	12.7	37.5	952	5L3980 (2)	5L3979



Size		Length		Set Part No.	Single Part No.
(in)	(mm)	(in)	(mm)		
1/2	12.7	39.0	991		1N4635
1/2	12.7	43.5	1105	1N4223 (2)	
1/2	12.7	44.5	1130		5L3834
1/2	12.7	45.0	1143	3N4658 (2)	4L6060
1/2	12.7	46.0	1168	6L7954 (2)	9M1091
1/2	12.7	47.5	1206		6L3408
1/2	12.7	48.0	1219	9L0619 (2)	9L2248
1/2	12.7	48.5	1232		6N3113
1/2	12.7	49.0	1245	5N6350 (2)	3K3408
1/2	12.7	50.0	1270	8L8984 (2)	5M8137
1/2	12.7	51.5	1308	3N1491 (2)	5M8135
1/2	12.7	51.5	1308	9S6760 (3)	5M8135
1/2	12.7	52.0	1321	9L0895 (2)	9L0894
1/2	12.7	52.5	1334		3S8448
1/2	12.7	53.5	1359	4N8771 (2)	3S6272
1/2	12.7	53.5	1359	8L4526 (3)	3S6272
1/2	12.7	54.0	1372		0617140
1/2	12.7	55.0	1397		9L1553
1/2	12.7	55.5	1410		2S2743
1/2	12.7	57.0	1448	9L3047 (3)	9L1128
1/2	12.7	57.5	1460	4W6025 (2)	
1/2	12.7	58.0	1473	9L1226 (2)	7L5001
1/2	12.7	58.5	1486		2S5218
1/2	12.7	59.0	1499		6L5115
1/2	12.7	60.0	1524	9L1106 (2)	2S9506
1/2	12.7	61.0	1549		5N4692
1/2	12.7	62.0	1575	8M8341 (2)	8M8336
1/2	12.7	63.0	1600		9L4479
1/2	12.7	64.0	1626	8M8340 (2)	8M8335
1/2	12.7	64.5	1638		2P7333
1/2	12.7	65.0	1651		4S6209
1/2	12.7	65.5	1664	1S4700 (2)	1S4699
1/2	12.7	66.5	1689	4W8729 (2)	5S5249
1/2	12.7	67.0	1702		9L1130
1/2	12.7	68.0	1727	1S1187 (2)	3S9652
1/2	12.7	68.5	1740		4W8654
1/2	12.7	69.0	1753	4W8662 (2)	5S5052
1/2	12.7			9L2526 (3)	5S5052
1/2	12.7	70.0	1778	2S2481 (2)	

Part numbers are used for reference purposes only.

Size		Length		Set Part No.	Single Part No.
(in)	(mm)	(in)	(mm)		
1/2	12.7	70.5	1791	2P5618 (2)	
1/2	12.7	72.0	1829	9L2520 (3)	
1/2	12.7	72.5	1842		1S4761
1/2	12.7	74.0	1880		9L1629
1/2	12.7	75.0	1905		5M0923
1/2	12.7	75.5	1918		1N4555
1/2	12.7	79.0	2007	7E6192 (2)	
11/16	17.5	45.5	1156		8P3064
11/16	17.5	49.0	1245	9L6654 (2)	9L6653
11/16	17.5	51.0	1295		5B8473
11/16	17.5	51.5	1308		6N0341
11/16	17.5	53.5	1359	7N3949 (2)	
11/16	17.5	54.0	1372	8L5137 (3)	
11/16	17.5	55.5	1410	7L7020 (3)	
11/16	17.5	56.0	1422	4N8217 (2)	4N8216
11/16	17.5	57.0	1448		9L6639
11/16	17.5	58.5	1486	4N6373 (2)	4N8220
11/16	17.5	59.0	1499	9L6642 (2)	9L6641
11/16	17.5	61.0	1549		9L6643
11/16	17.5	61.5	1562	4N2532 (2)	4N2531
11/16	17.5	62.5	1588		9L6645
11/16	17.5	63.5	1613		6N6657
11/16	17.5	64.5	1639	9L6724 (2)	4N8218
11/16	17.5	66.5	1689	9L6648 (2)	9L6647
11/16	17.5	66.5	1689	6N6652 (3)	9L6647
11/16	17.5	68.5	1740	9L6650 (2)	9L6649
11/16	17.5	68.5	1740	6N9158 (3)	9L6649
11/16	17.5	70.0	1778		6N6654
11/16	17.5	71.0	1803		4N8221
11/16	17.5	71.5	1816		9L6651
11/16	17.5	72.0	1829		6N0073
11/16	17.5	73.0	1854		4N8277
11/16	17.5	74.5	1892		6N6650
11/16	17.5	75.5	1918		4N8219
11/16	17.5	77.0	1956		4P8088
11/16	17.5	78.0	1981	6N7053 (3)	6N7054
11/16	17.5	80.0	2032	7C2500 (3)	7W6129
11/16	17.5	81.0	2057	6N5337 (3)	6N5338
11/16	17.5	83.0	2108		7W8132

Costex Tractor Parts Copyright © 2020. All rights reserved.

Belts (cont.)

Size		Length		Set Part No.	Single Part No.
(in)	(mm)	(in)	(mm)		
11/16	17.5	84.0	2134	1W3711 (2)	4N8197
11/16	17.5	84.0	2134	4N8198 (3)	4N8197
11/16	17.5	85.0	2159		7N8538
11/16	17.5	86.0	2184		1N3464
11/16	17.5	87.0	2210	7N4829 (2)	7N4828
11/16	17.5	88.0	2235		7N2143
11/16	17.5	89.0	2261		8N6693
11/16	17.5	90.0	2286	1W8043 (2)	1W8044
11/16	17.5	94.0	2388		8N6717
11/16	17.5	95.0	2413		5L7425
11/16	17.5	96.0	2438	8N6705 (6)	8N6709
11/16	17.5	97.0	2464		8N6719
11/16	17.5	99.0	2515		2W5092
3/4	19.1	47.5	1206		5M5345
3/4	19.1	54.0	1372		3S8402
3/4	19.1	59.5	1511		7M3921
3/4	19.1	61.5	1562		3P0025
3/4	19.1	62.0	1575		4M6292
3/4	19.1	62.5	1588	2P6142 (2)	
3/4	19.1	64.0	1626	7M6100 (2)	
3/4	19.1	64.5	1638	4S7754 (2)	
3/4	19.1	65.0	1651		5M2733
3/4	19.1	66.0	1676		7S9859
3/4	19.1	66.5	1689	8M1714 (2)	8M1715
3/4	19.1	67.0	1702	1S1126 (2)	
3/4	19.1	68.0	1727	5S9078 (2)	5S9505
3/4	19.1	69.0	1753		5S9506
3/4	19.1	70.0	1778	7S9810 (2)	
3/4	19.1	70.5	1791	5M5343 (2)	5M6096
3/4	19.1	71.0	1803		4M9386
3/4	19.1	72.5	1842	9M6933 (2)	9M6934
3/4	19.1	73.0	1854	2P6140 (2)	2P6139
3/4	19.1	74.0	1880	2P2357 (2)	2P2356
3/4	19.1	76.0	1930		7S8349
3/4	19.1	81.0	2057	2S8268 (2)	2S9911
3/4	19.1	82.0	2083		7M7373
3/4	19.1	83.0	2108	2W8952 (2)	2S5279
15/16	23.9	55.5	1410	7M4711 (2)	9F1899

Size		Length		Set Part No.	Single Part No.
(in)	(mm)	(in)	(mm)		
15/16	23.9	56.0	1422		1L5514
15/16	23.9	57.0	1448	4N6529 (2)	5L9902
15/16	23.9	58.5	1486		8F5164
15/16	23.9	59.0	1499		8M9708
15/16	23.9	59.5	1511		4M8218
15/16	23.9	61.0	1549	2P2369 (2)	3S2347
15/16	23.9	62.5	1588	2P2696 (2)	
15/16	23.9	63.0	1600		4F6390
15/16	23.9	64.0	1626	2P1388 (2)	
15/16	23.9	66.0	1676	7M7476 (3)	7M7477
15/16	23.9	66.5	1689		3L7540
15/16	23.9	67.0	1702		2H1383
15/16	23.9	67.5	1714		2M8183
15/16	23.9	96.0	1753		9M7220
15/16	23.9	69.5	1765	3P0071 (2)	5H4207
15/16	23.9	70.0	1778		4M5429
15/16	23.9	71.0	1803	5L5656 (3)	4M5413
15/16	23.9	71.5	1816	7M4719 (2)	7B0344
15/16	23.9	72.5	1842		5H1678
15/16	23.9	72.5	1842		5H1678
15/16	23.9	74.0	1880	7M0185 (2)	
15/16	23.9	76.0	1930		7H9806
15/16	23.9	76.5	1943	7M4703 (2)	2M7863
15/16	23.9	77.0	1956	7M4718 (2)	1H6929
15/16	23.9	77.5	1968		3L7539
15/16	23.9	78.5	1994	7M4721 (2)	8B3546
15/16	23.9	80.0	2032		9M7800
15/16	23.9	81.0	2057	8M8681 (2)	
15/16	23.9	81.0	2057	3S7520 (3)	
15/16	23.9	83.0	2108		4S7796
15/16	23.9	85.0	2159	7M4710 (2)	5H7371
15/16	23.9	86.0	2184	7C3559 (2)	7C3560
15/16	23.9	87.0	2210	2W8951 (2)	1M7303
15/16	23.9	87.0	2210	7M4701 (3)	
15/16	23.9	89.0	2261	2W8952 (2)	2S5279
15/16	23.9	90.0	2286	6N7575 (4)	5B9790
15/16	23.9	92.0	2337		4W7507

Size		Length		Set Part No.	Single Part No.
(in)	(mm)	(in)	(mm)		
15/16	23.9	102.0	2591		7W1664
15/16	23.9	107.0	2718		4W5092
15/16	23.9	113.0	2869		9Y8466
1 1/16	26.9	52.5	1334		5H4239
1 1/4	31.8	60.5	1537		7B2774

SERPENTINE BELTS



Part No.	RIBS	Lenght (MM)
1359505	7	1790
1003725	8	1054
1417116	8	1093
2363842	8	1230
2414981	8	1345
2414982	8	1395
2679281	8	1430
1908143	8	1450
2260443	8	1480
1906560	8	1515
1644599	8	1523
2202945	8	1585
2432143	8	1610
2129353	8	1790
1983611	8	1816
1851911	8	1824
2884641	8	1840
2193303	8	1860
2466296	8	1900
2486195	8	2010
2601527	8	2005
2201856	8	2041
3341623	8	2050
1855872	8	2095
2631830	8	2110
2302190	8	2127
2307198	8	2130
2412896	8	2160
2933908	8	2165
1834494	8	2180
2213775	8	2223

Part No.	RIBS	Lenght (MM)
1904155	8	2246
2269380	8	2274
1788481	8	2275
2082833	8	2285
2113576	8	2315
1892218	8	2376
2023198	8	2410
1915215	8	2445
2193304	8	2481
2431324	8	2485
2242638	8	2520
2534531	8	2521
2198689	8	2555
2431276	8	2555
2173031	8	2594
2395944	8	2658
2023197	8	2808
2606106	8	2820
1749690	8	2860
1143552	10	1455
2941781	12	1850
2228372	12	1860
2977825	12	1870
2128585	12	1880

BELT TENSIONER



Part No.	Engine Model	Part No.	Engine Model
1333543	3176	2002279	C15
1333544	C10, C12	2117895	C11, C13
1333545	C10, C12	2178938	C15, C18, 3406, 3456
1352142	C7, C9, 3126B	2201209	C7, C9, 3426E
1352151	3126B, C7	2222880	C7, C9, 3126E
1382514	3126, 3126B, C7	3368955	C15, C16
1421987	C10, C12	7E0339	3116
1900634	3116, C10, C12	7E3999	3126E, 3126B, 3116
1900642	C12, C10		
1900643	C9		
1900649	3196, 3176C		



ENGINE HOSES

Material	Resistance	Temperature Range (in Celcius)
EPDM (Ethylene Propylene)	Used with fireproof hydraulic fluids, hot and cold water and alkalis. Unsatisfactory with oils, gasoline, halogenated solvents and acids.	-50 to 150C
Blue Silicone	Heavy duty pressure connections in hostile engine environments. Resists hardening, cracking, cold leaks, steam and many chemicals.	-54 to 177 C
Red Silicone	Typically used between the turbocharger and the engine.	-54 to 260 C

Engine Hoses Available

Part No.	Engine Model	Application
1N4102	3304, 3306	FUMES DISPOSAL
1P1195	3304, 3306	LINES GP-AIR
1327370	C7, C18, 3126B	LINES GP-WATER
1786557	3066	LINES GP-AIR
2A6941	3306, 3116	LINES GP WATER
2109479	C9, C15, C18, 3408C	LINES GP-WATER, RADIATOR GP
2806794	C9, 3406E	HOUSING & REGULATOR GP, KIT ENGINE OVERHAUL
3N6033	G3304/B, G3306, 3304/B, 3306/B, 3316	RADIATOR GP, CONNECTION GP-WATER
3R1317	C11, C12, 3126B, 3304, 3306/B, 3176/C, 3408E	LINES GP-WATER, RADIATOR GP
4N2230	3204	COOLER GP-ENGINE OIL
4N6855	D342, 3304, 3306	LINES GP-AIR, RADIATOR GP
4N7431	3176C, 3306/B, 3406, 3408/E, 3412/E, 3516	LINES GP-WATER, DUST EJECTOR GP, RADIATOR GP
517699	3066	LINES GP-WATER
518053	3066	LINES GP-AIR
5S5063	C27, 3304, 3408C, 3412	HEATER GP, DUST EJECTOR, AIR CLEANER GP
6N6236	3204, 3304, 3306	LINES GP-AIR, AIR LINES
6N7030	3408B/C/E, 3412C/E	LINES GP-WATER, HEAT EXCHANGER GP
7C3615	3114, 3116, 3126	AFTERCOOLER GP- WATER
7C4343	G3508, 3508B, 3512/B, 3516/B	LINES GP-WATER
7C6214	3116, 3126	LINES GP-AIR

Part No.	Engine Model	Application
7E3508	3116	LINES GP-WATER
7E8630	C9, C13, C15, C18, C27, C32, 3176/B/C, 3196	LINES GP-AFTERCOOLER AIR, LINES GP-COOLING
7W9077	3208	LINES GP-WATER
7Y1941	3064, 3066	RADIATOR GP, RADIATOR OIL COOLER GP
7Y1942	3066	RADIATOR GP
8N5254	C32, G3408, 3508/B/C, 3512/B/C, 3516/B/C	AIR CLEANER GP, CONNECTION GP-AIR, LINES GP-AIR
8X4176	3306, 3306B	LINES GP-WATER
9S1102	C9, 3176/C, 3304, 3306/B, 3406C	DUST EJECTOR GP, AIR CLEANER GP



PULLEYS

Part No.	Description	Applications
1154204	PULLEY AS-IDLER	120H, 120H ES, 120H NA, 135H, 135H NA, 30/30, 3114, 3116, 3126, 3126B, 3126E, 320B, 322B L, 322B LN, 322C, 322C FM, 325B L, 35, 446, 446B, 446D, 45, 525B, 533, 535B, 539, 543, 55, 550, 561M, 570, 574
1731498	PULLEY AS-IDLER	120H, 12H, 135H, 140H, 143H, 14H, 160H, 163H, 16H, 3126, 3126B, 3126E, 3176C, 3196, 3406E, 345B, 345B II, 345B II MH, 345B L, 365B, 365B II, 365B L, 385B, 5090B, 584, 725, 730, 938G II, 938H, 950G II
1979642	PULLEY AS-IDLER	14M, 16M, 3126, 3126B, 3126E, 330D, 330D FM, 330D L, 330D LN, 330D MH, 336D, 336D L, 336D LN, 336D2, 336D2 L, 3406E, 340D L, 340D2 L, 345C, 345C L, 345C MH, 345D, 345D L, 345D L VG, 349D, 349D L, 525C
9S6129	PULLEY	120, 120G, 12F, 12G, 130G, 140, 140G, 14E, 14G, 160G, 215, 215B, 225, 235, 330, 330 FM L, 330 L, 330B, 330B L, 515, 518, 518C, 525, 528B, 530B, 627B, 814, 815, 816, 920, 930, 941, 950, 951B, 955K, 955
3054908	PULLEY GP-IDLER	320C, 320C FM, 320C L, 320D, 320D FM, 320D FM RR, 320D GC, 320D L, 320D LN, 320D LRR, 320D RR, 321C, 321D LCR, 323D L, 323D LN, 323D SA

Part No.	Description	Applications
1979641	PULLEY AS-IDLER	3126B, 3126E, 3406E, 3512C, 793F, 793F-XQ, 795F AC, 797, 797B, 797F, 938H, 966G II, 972G II, C-12, C-15, C-16, C13, C15, C7, C9, CX31-C131, CX31-C9I, IT38H, TH31-E61, TH35-C131
7N2949	PULLEY	215, 215B, 225, 235, 330, 330B L, 627B, 920, 930R, 941, 950, 951B, 955K, 955L, 977L, D4D, D4E, D4E SR, D4H XL, D5H, D5H XL, D5HTSK II, D6C, D6D, D6E SR, D6G SR, D7G, E300
6N2789	PULLEY	120B, 140B, 330, 3304B, 330B L, 518C, 528B, 530B, 627E, 627F, 627G, 637E, 637G, 920, 930, 930R, 950, 951B, 955L, 966C, D5H, D6C, D6D, D6E
1337023	PULLEY AS-IDLER	120M 2, 3176C, 3196, 3406E, 345B, 345B II, 345B II MH, 345B L, 365B, 365B II, 365B L, 365C, 365C L, 365C L MH, 374D L, 385B, 385C, 385C FS, 385C L, 385C L MH, 390D, 390D L, 5090B, 621B, 621G, 623G
7N1152	PULLEY-FAN	120B, 140B, 215B, 215C, 235C, 330, 330 FM L, 330 L, 3304B, 330B, 330B L, 518, 518C, 545, 637D, 920, 930, 930R, 941, 951B, 955K, 955L, 966C, D4D, D4E, D4E SR, D5H, D5H XL, D5HTSK II, D6D, D6E, D6E
3277193	PULLEY GP-IDLER	311D LRR, 312C L, 312D, 312D L, 313D, 314D CR, 314D LCR, 315D L, 318D L, 319D L, 319D LN, 320C, 320D, 320D FM, 320D FM RR, 320D GC, 320D L, 320D LRR, 320D RR, 321D LCR, 323D L, 323D LN, 323D SA
2P6128	PULLEY	120B, 140G, 330, 330 L, 330B L, 515, 517, 525, 527, 528B, 530B, 627B, 627E, 627F, 627G, 637D, 637E, 637G, 639D, 815, 920, 930, 941, 950, 951B, 955K, 955L, 966C, 980B, D4D, D4E, D4H, D4H XL, D4HTSK III
2W8494	PULLEY-ALTERNATOR	3126B, 3176B, 3176C, 3196, 572R, 621E, 627E, 65, 65C, 65E, 70C, 75, 75C, 75D, 75E, 814B, 814F, 815B, 815F, 816F, 85C, 85D, 85E, 95E, 966D, 966F, 966F II, 970F, 972G, 973, 973C, C-10, C-12, C-9, C11
4N8225	PULLEY-ALTERNATOR	245, 245B, 245D, 3116, 3406, 3406B, 3406C, 3406E, 3408, 3408B, 3408C, 3408E, 3412, 3412C, 3412E, 375, 375 L, 5080, 583R, 587R, 589, 621, 621B, 621E, 621F, 621G, 623E, 623F, 623G, 627E, 627F, 627G
7N9137	PULLEY-FAN	215B, 225, 229, 235, 330, 330 FM L, 330B L, 515, 518, 525, D4E, D6D
5S7609	PULLEY	12F, 14E, 561C, 920, 941, 950, 955K, D4D, D5, D5B, D5E, D6C, D7G

Part No.	Description	Applications
1445611	PULLEY AS-IDLER	120H, 12H, 135H, 140H, 143H, 14H, 160H, 163H, 16H, 3116, 3126, 3126B, 3126E, 3512C, 3516B, 525C, 535C, 545C, 613G, 725, 730, 789D, 793D, 797B, 815B, 844, 854G, 938G II, 938H, 950G II, 950H, 962G II
2078118	PULLEY AS-IDLER	966H, 972H, 980C, 980K, 980M, 982M, AP555E, BG500E, C11, C13, C7, C9, CX31-C131, D8N, TH31-E61, TH35-C111, TH35-C131, TH35-C13T
6N3641	PULLEY-TIGHTENER	631D, 631E, 631G, 633E II, 637D, 637E, 637G, 639D, 651E, 657E, 69D, 769C, 769D, 771C, 771D, 773B, 773D, 773E, 773F, 773G, 773G LRC, 773G OEM, 775B, 775D, 775E, 775F, 775G, 775G LRC, 775G OEM, 834B
1154237	PULLEY-IDLER	120H, 120H ES, 120H NA, 135H, 135H NA, 3114, 3116, 3126, 3126B, 3126E, 320B, 322B L, 322B LN, 322C, 322C FM, 325B L, 35, 446, 446B, 446D, 45, 525B, 535B, 539, 550, 561M, 570, 574, 580, 613C II, 814F
6N0714	PULLEY	571G, 572G, D7G, D7G2
1230791	PULLEY	2864C, 3126, 3126B, 3126E, 3176C, 3196, 3406E, 345C, 345C L, 345C MH, 345D, 345D L, 345D L VG, 349D, 349D L, 349E, 349E L, 349E L HVG, 349E L VG, 349F L, 365C, 365C L, 365C L MH, 374D L, 385B, 385C
1230790	PULLEY	140H, 143H, 14H, 160H, 163H, 16H, 3126E, 3176C, 3196, 345D L, 374F L, 390F L, 621H, 621K, 623H, 623K, 623K LRC, 627H, 627K, 627K LRC, 725, 725C, 730, 730C, 770, 770G, 770G OEM, 772, 772G
4N2697	PULLEY	245, 245B, 245D, 375, 375 L, 5080, 578, 583R, 587R, 621, 621B, 621E, 621F, 621G, 623E, 623F, 623G, 627E, 627F, 627G, 651B, 657B, 824C, 826C, 980C, 980F, 983B, D8N, D8R, D8R II, R2900, R2900G, R3000H
8X1805	PULLEY	120H, 120H ES, 120H NA, 120K, 120K 2, 12H, 12H ES, 12H NA, 12K, 135H, 135H NA, 140H, 140H ES, 140H NA, 140K, 140K 2, 143H, 160H, 160H ES, 160H NA, 160K, 163H
7W3780	PULLEY	120H, 120H ES, 120H NA, 135H, 135H NA, 214B, 30/30, 3116, 3126, 3126B, 3126E, 320 L, 320B, 322B, 322B L, 322B LN, 322C, 322C FM, 325, 325B, 325B L, 35, 446B, 446D, 45, 525B, 535B, 539, 55, 550, 561M
1030880	PULLEY GP-IDLER	3516B, 776C, 776D, 777, 777B, 777D, 784B, 784C, 785, 785B, 785C, 785D, 789, 789B, 789C, 793B, 793C, 994, 994D
1144294	PULLEY-TIGHTENER	D8L, D9R

Pulleys (cont.)

Part No.	Description	Applications
6I0502	PULLEY	3054, 3054B, 3054C, 3054E, 307, 312, 312B L, 312C, 315, 315B L, 315C, 317, 414E, 416B, 416C, 416D, 416E, 420D, 420E, 422E, 424D, 426B, 426C, 428B, 428C, 428D, 428E, 430D, 430E, 432D, 432E, 434E, 436C
7W5698	PULLEY-CRANKSHAFT	627E, 65C, 815B, 966D, 972G, D6H, D6H XL, D6R, D7H
1W4369	PULLEY-ALTERNATOR	320B, 322C FM, 325B L, 611, 615, 615C, 814B, 815B, 950B, 950B/950E, 963, 966D, 973, 973C, CS-643, G936
1230858	PULLEY-ALTERNATOR	1090, 1190, 1190T, 120M, 120M 2, 1290T, 12M, 1390, 3116, 3126, 3126B, 3126E, 336E, 336E H, 336E HVG, 336E L, 336E LH, 336E LN, 336F L, 561N, 568 FM LL, 570B, 573, 580B, 584, 613G, 627G, 637D, 637E
7E4839	PULLEY	3508, 3508B, 3508C, 3512, 3512B, 3512C, 3516, 3516B, 3516C, 5130, 5130B, 5230B, 776C, 776D, 777, 777B, 777C, 777D, 784B, 784C, 785, 785B, 785C, 785D, 789, 789B, 789C, 789D, 793B, 793C, 793D, 797, 797B
7C3938	PULLEY-ALTERNATOR	3114, 3116, 3126, 3126B, 613C II, 950F, 953B, 953C, 963B, 963C, D8L, D9N, D9R
1470782	PULLEY AS-IDLER	3516B, 776C, 776D, 777D, 784B, 784C, 785B, 785C, 789B, 793B, 793C, 994, 994D
1303880	PULLEY-FAN DRIVE	3054, 3054B, 3054C, 3054E, 3056, 3056E, 312B L, 312C, 315B L, 315C, 414E, 416C, 416D, 416E, 420D, 422E, 424D, 426C, 428C, 428D, 428E, 430D, 432D, 436C, 438C, 438D, 442D, 550B, 560B, AP-300, AP-650B
1247792	PULLEY AS-IDLER	120K, 120K 2, 12K, 140G, 140K, 140K 2, 140M, 14M, 160K, 160M, 3116, 3126, 3126B, 3126E, 777C, 777D, 814F, 815F, 824C, 953C, 963C, 966G II, 972G II, 980G, 980G II, 980H, AP-1055D, AP-755, BG-2455D
4N4534	PULLEY-CRANKSHAFT	245, 375, 375 L, 5080, 578, 583R, 587R, 621B, 621E, 621F, 621G, 623E, 623F, 623G, 627E, 627F, 627G, 651B, 826C, 980C, 980F, 983B, D8N, D8R, D8R II, D9N
1079579	PULLEY	120K, 120K 2, 12H, 12H ES, 12H NA, 12K, 140H, 140H ES, 140H NA, 140K, 140K 2, 143H, 160H, 160H ES, 160H NA, 160K, 163H NA
1421988	PULLEY AS-IDLER	C-10, C-12, C7, C9, TH31-E61
2128584	PULLEY	320C, 320C FM, 320C L, 320D, 320D FM, 320D FM RR, 320D GC, 320D L, 320D LN, 320D LRR, 320D RR, 321C, 321D LCR, 323D L, 323D LN, 323D SA

Part No.	Description	Applications
2396626	PULLEY-IDLER	311D LRR, 312C, 312C L, 312D, 312D L, 313D, 314D CR, 314D LCR, 315C, 315D L, 318C, 318D L, 319C, 319D, 319D L, 319D LN, 320C, 320C FM, 320C L, 320D, 320D FM, 320D FM RR, 320D GC, 320D L, 320D LN, 320D
1303879	PULLEY-FAN DRIVE	3054, 3054B, 3054C, 3054E, 3056, 3056E, 307, 312, 315, 317, 416C, 416D, 420D, 420E, 424D, 426C, 428C, 428D, 430D, 430E, 432D, 432E, 434E, 436C, 438C, 438D, 442D, 442E, 444E, 554, 914G, AP-650B, AP-800
3P0165	PULLEY-FAN DRIVE	120G, 12G, 130G, 140G, 14G, 160G
7N0619	PULLEY-FAN	120G, 12G, 130G, 140G, 160G, 621E, 627E, 65, D6H, D6H XL, D6H XR, D7G, D7G2
2941784	PULLEY	311D LRR, 312D, 312D L, 314D CR, 314D LCR, 315D L, 318D L, 319D, 319D L, 319D LN, 320C, 320C FM, 320C L, 320D, 320D FM, 320D FM RR, 320D GC, 320D L, 320D LN, 320D LRR, 320D RR, 321C, 321D LCR, 323D L
9N6611	PULLEY	65, 65C, 814B, 814F, 815B, 815F, 816F, 966D, 966F, 966F II, 970F, 972G, D6H, D6R, D7H, D7R
2666337	PULLEY	320C, 320D, 320D FM, 320D FM RR, 320D GC, 320D L, 320D LN, 320D LRR, 320D RR, 321C, 321D LCR, 323D L, 323D LN, 323D SA
7W3773	PULLEY-CRANKSHAFT	120H, 120H ES, 120H NA, 135H, 135H NA, 214B, 30/30, 3114, 3116, 3126, 3126B, 3126E, 320 L, 320B, 322B L, 322B LN, 322C, 322C FM, 325, 325B, 325B L, 35, 446B, 446D, 45, 525B, 533, 535B, 539, 543, 55
7E3641	PULLEY-FAN DRIVE	D8N, D8R, D8R II
4P7051	PULLEY-ALTERNATOR	35, 45, 55, 561M, 938G, 950F, 950F II, 950G, 960F, 962G, D5M, D6M, DEUCE, IT38G, IT62G
2P1129	PULLEY	583K, D8K
2P2407	PULLEY-FAN DRIVE	572G, D6C, D7G, D7G2
1845484	PULLEY	3056E, 924G, 924GZ, 930G, IT28G
5S8168	PULLEY	14E, D6C
6N1186	PULLEY	24H, 5110B, 992, 992C, 992D, D10N, D10R, D9L

Part No.	Description	Applications
2128613	PULLEY	320C, 320C L, 320D, 320D FM, 320D FM RR, 320D GC, 320D L, 320D LN, 320D LRR, 320D RR, 321C, 321D LCR, 323D L, 323D LN, 323D SA
5I7984	PULLEY	311B, 311C, 311D LRR, 312, 312C, 312C L, 312D, 312D L, 313D, 314C, 314D CR, 314D LCR, 315, 315B, 315C, 315D L, 317B LN, 318B, 318C, 318D L, 319C, 319D, 319D L, 319D LN, 320 L, 320B, 320B L, 320C, 320C
1979581	PULLEY	12H, 140M, 140M 2, 160M, 160M 2, 2290, 2390, 2391, 2491, 2590, 3126, 3126B, 3126E, 330C, 330C FM, 330C L, 330C MH, 330D, 330D FM, 330D L, 330D LN, 330D MH, 336D, 336D L, 336D LN, 336D2, 336D2 L, 340D
2153291	PULLEY	973C, D6R II, D6R III
7W5692	PULLEY-CRANKSHAFT	3304, 3304B, 3306, 3306B, 3306C, CB-534, D250E, D250E II, D300E, D300E II, G3304, G3304B, G3306, G3306B
6N7378	PULLEY-CRANKSHAFT	3406, 3406B, 3406C, 3406E, 3456, C-15, C-16, C-18, C15, C15 I6, C18, C18 I6, CX31-C15I, CX35-P800, D350E, D350E II, D35HP, D400, D400E, D400E II, G3406, HT400, PM-565, PM-565B, PM3456, RM-250C, RM-350
1173437	PULLEY	120H, 120K, 12K, 135H, 140K, 140K 2, 160K, 3116, 3126, 3126B, 3126E, 322C, 322C FM, 324D, 324D FM, 324D FM LL, 324D L, 324D LN, 325C, 325C FM, 325D, 325D FM, 325D FM LL, 325D L, 325D MH, 328D LCR, 329
8L8867	PULLEY	3116, 3126, 3304, 3304B, 3306, 3306B, 330B L, 637D, CB-534, D250B, D250E, D250E II, D25C, D25D, D300B, D300D, D300E, D300E II, D30C, D350C, D35C, G3304B, G3306B
2P1126	PULLEY	D8K
7W5699	PULLEY	814B, 814F, 815B, 815F, 816F, 966F, 966F II, 970F, 972G, 973, D6H
2W8493	PULLEY-FAN DRIVE	572R, 814B, 815B, 966F, 966F II, 970F, 972G, D6R, D7H, D7R
3S7517	PULLEY	D8H
4N5390	PULLEY	D8K
4W8595	PULLEY-CRANKSHAFT	375, 375 L, 5080, 651B, 824C, 826C, D8N, D8R, D8R II, R2900, R2900G, R3000H

Part No.	Description	Applications
6N0762	PULLEY	583K, D8K
7N1275	PULLEY-FAN DRIVE	578, 583R, 587R, 589, 631E, 633E II, 637D, 637E, 651E, 657E, 69D, 768C, 769C, 769D, 771C, 771D, 773B, 773D, 773E, 775B, 775D, 775E, 988B, D8L, D8N, D9L, D9N
4W2180	PULLEY-CRANKSHAFT	3204, 943, 953, D4HTSK II
5S8038	PULLEY	518, 941, 955K, 955L, D4D
7W1532	PULLEY	215C, 518C, D5H, D5H XL, D5HTSK II
6N5300	PULLEY-CRANKSHAFT	657E, 69D, 768C, 769C, 769D, 771C, 771D, 834B, 988B
5I7959	PULLEY AS	320, 320 L
7C7890	PULLEY	3114, 3116, 3126, 533, 543, 918F, 924F, 950G, AP-1000, AP-1000B, AP-1050, AP-1055B, BG-2455C, BG-245C, CB-434, CB-634C, CB-634D, CP-563, CS-531C, CS-533C, CS-563C, CS-573C, CS-583C, D250D, IT12B, IT24
4N4679	PULLEY-FAN DRIVE	3304, 3304B, 3306, 3306B, D250B, G3304, G3304B, G3306, G3306B
5I7619	PULLEY	320 L, 320N
1352335	PULLEY	311C, 320B
2S6739	PULLEY	140G, 16, 627, 637D, D6C, D7G
4N7982	PULLEY	D5, D5B, D5E, D6C
1077750	PULLEY	214B, 3114, 3116, 3126, 3126B, 550, 570, 574, 580, 613C II, 950F, 950F II, 953B, 953C, 960F, 962G, 963B, AP-1000, AP-1050, BG-2455C, BG-245C, CB-434, CB-634C, CB-634D, CP-563, CS-531C, CS-533C, CS-563.
8X1809	PULLEY	12H, 12H NA, 140H, 140H ES, 140H NA, 160H, 160H ES, 160H NA
1134457	PULLEY-ALTERNATOR	416B, 416C, 416D, 420D, 424D, 426B, 426C, 428B, 428C, 428D, 430D, 432D, 436C, 438C, 438D, 442D, 908, 914G, CB-434D, CB-534D, CB-564D, CB-634D, CD-54, IT14G
2S8892	PULLEY	D8H

Pulleys (cont.)

Part No.	Description	Applications
4W0839	PULLEY-CRANKSHAFT	589, D8L
7W5685	PULLEY-CRANKSHAFT	611, 615C, 815B, 936F, 963, 973, 973C, G936
7C6628	PULLEY-ALTERNATOR	578, 966F II, 966G, 970F, 972G, D8N
7W6173	PULLEY-CRANKSHAFT	D10N, D9L
1094848	PULLEY-CRANKSHAFT	235B, 572R, D6R, D7R
6N0597	PULLEY-FAN DRIVE	14H NA, 3406, 3406B, 3406C, 3406E, 3408, 3408C, 3408E, 3412, 3412C, 3412E, 3456, C-15, C-16, C-18, C13, C15, C18, C27, C32, C9.3, CX31-C131, CX31-C151, CX31-C181, CX35-C181, CX35-P800, D379B, G3406
9S5447	PULLEY	814, 966C, D7F
4N8090	PULLEY	D9G, D9H
4N9325	PULLEY-ALTERNATOR DRIVE	14H NA, 16G, 16H NA
8N0597	PULLEY	D9H
2Y8924	PULLEY-ALTERNATOR	3304B, 3306, 930, 930R, 966C, D4E SR, D6E SR
7E3596	PULLEY-FAN DRIVE	950F, 950F II, 960F
4N4356	PULLEY	D6C, D7G
854772	PULLEY	311, 311B, 312B, 315, 315B, 317B LN, 318B, 320 L, 320B, 320N, E110B, E120B
1303881	PULLEY-FAN	3054, 3054C, 3054E, 3056, 3056E, 416C, 416D, 420D, 424D, 426C, 428C, 428D, 430D, 432D, 436C, 438C, 438D, 442D, 559, 914G, 930G, C4.4, C6.6, C7.1, CP-433E, CP-533E, CS-423E, CS-433E, CS-533E, IT14G
3S7519	PULLEY	D8H
8L4529	PULLEY-ALTERNATOR	3304, 3304B, 3306, 3306B, G3304, G3304B, G3306, G3306B
5S9080	PULLEY-ALTERNATOR	518C, 627, 627B, 627E, 627F, 627G, 637D, 637E, 637G, 639D, 966C, 977K, D6D, E300B

Part No.	Description	Applications
7C3729	PULLEY-ALTERNATOR	205B, 214B, 3114, 3116, 3126, 3306, 3306B, 910E, 918F, 924F, 928F, 938F, 938G, AP-1000B, AP-1055B, AP-900B, BG-2455C, BG-245C, CB-434, CB-634, CB-634C, CP-563, CS-531, CS-531C, CS-533, CS-533C
8N9327	PULLEY	814B, 815B, 950B, 950B/950E, 966D
1030887	PULLEY-IDLER	3516B, 776C, 776D, 777, 777B, 777D, 784C, 785, 785B, 785C, 785D, 789, 789B, 789C, 793C, 938G, 950G, 962G, 994, 994D, IT38G
1838234	PULLEY	320C
7W5684	PULLEY-CRANKSHAFT	814B, 815B, 950B, 973
5I7598	PULLEY	311, 311B, 312B, 312C L, 314C
2S8961	PULLEY	D9G, D9H
5M7580	PULLEY	225, 3208, 613B, 613C, FB221, PR-1000, PS-500
9N3899	PULLEY-PUMP DRIVE	225, 3208, 613B, 613C, FB221, PR-1000, PS-500
1S4701	PULLEY	16, 769, 834, 977H, 980, D8H
1P1404	PULLEY	966C, 980B
1S0183	PULLEY	12E, 977H
2Y4213	PULLEY	3306, 930, 966C, 966R, D6D
3P0163	PULLEY	D8H
1M7709	PULLEY	12E
9S3065	PULLEY	D8H
9Y1917	PULLEY-FAN DRIVE	824C, 826C, 980C, 980F, 980F II
2Y4206	PULLEY	120B, 140B

Part No.	Description	Applications
2463198	PULLEY-ALTERNATOR	216, 216B, 226B, 232B, 242B, 247B, 257B, 3013C, 3024, 3024C, 3054C, 3054E, C1.5, C2.2, C3.3, CB-214E, CB-334E
7N8297	PULLEY	621R
6743-61-3441	PULLEY, IDLER KOMATSU	PC300, PC300HD, PC300LL, PC350, PC350HD, PC350LL, PC360, PC390, PC390LL, SAA6D107E, SAA6D114E, WA380, WA430
6732-61-3750	PULLEY KOMATSU	175C, 4D102E, 6D102E, D32E, D38E, D39E, D51EX/PX, PC200, PC200LL, PC200Z, PC210, PC220, PC220LL, PC250, PC270, PC290, PW160, PW180, PW200, PW220, S4D102E, S6D102E, SA6D102E, SAA4D102E, SAA4D107E

ENGINE AND AIR BRAKE HOSE ASSEMBLIES



Part No.	Part No.
1777862	6N3246
1Y0683	6N4447
2G2477	7D6096
3D6395	7J0664
3D6931	8D7495
3D8942	8D7495
3G5402	8W2664
3G5404	9C2633
3G6659	9D2549
4D2847	9G0682
4N4937	9K8141
4V4770	9L5158
6I9457	9L5452
6J7929	9W1709
6N1047	9Y1116

RUBBER HOSES



Heater Hoses

Part No.	Desc.	Hose I. D.		Hose O. D.		Max Work Pressure	
		(in)	(mm)	(in)	(mm)	(psi)	(kPa)
5P0767	HOSE	0.625	15.9	0.94	23.9	62	437
5P0765	HOSE	0.750	19.0	1.06	26.9	50	350

Radiator Hoses

Part No.	Desc.	Hose I. D.		Hose O. D.		Max Work Pressure	
		(in)	(mm)	(in)	(mm)	(psi)	(kPa)
5P0763	HOSE	1.500	38.1	2.05	52.3	112	784
5P0764	HOSE	3.500	88.9	4.05	96.8	50	350
5P1251	HOSE	1.000	25.4	1.55	39.6	140	980
5P1252	HOSE	1.125	28.6	1.68	42.8	135	945
5P1253	HOSE	1.250	31.8	1.81	46.0	125	875
5P1254	HOSE	1.310	33.3	1.87	47.5	125	875
5P1255	HOSE	1.375	34.9	1.93	49.1	120	840
5P1256	HOSE	1.625	41.3	2.18	55.5	100	700
5P1257	HOSE	1.750	44.5	2.31	58.7	100	700
5P1258	HOSE	1.875	47.6	2.43	61.8	90	630
5P1259	HOSE	2.000	50.8	2.55	65.0	88	616
5P1260	HOSE	2.250	57.2	2.81	71.4	88	616
5P1261	HOSE	2.375	60.3	2.93	74.5	80	560
5P1262	HOSE	2.500	63.5	3.05	77.7	75	525
5P1263	HOSE	2.750	69.9	3.31	84.1	60	420
5P1264	HOSE	2.875	73.0	3.43	87.2	60	420
5P1265	HOSE	3.000	76.2	3.55	90.4	60	420
5P1266	HOSE	3.250	82.6	3.81	96.8	50	350
5P1267	HOSE	3.750	95.3	4.31	109.5	40	280
5P1268	HOSE	4.000	101.6	4.55	115.8	38	266
5P1269	HOSE	4.500	114.3	5.05	128.5	30	210
5P1270	HOSE	5.000	127.0	5.55	141.2	25	175

CLAMPS



All CTP Clamps are made of stainless steel. They are designed for performance and manufactured with the highest quality standards to deliver durability and reliability.

Hi-Torque Clamp

For applications where double and triple clamping is needed.

Part No.	Description
1102445	CLAMP HOSE HI-TORQUE
1274471	CLAMP
1803007	CLAMP-HOSE
1P4278	CLAMP-HOSE
1W4724	CLAMP-HOSE
2J1737	CLAMP-HOSE
2N8109	CLAMP
2S3440	CLAMP-HOSE
3E7419	CLAMP
4J8536	CLAMP-HOSE
4W3034	CLAMP
5D1026	CLAMP
5P0597	CLAMP-HOSE
5P0598	CLAMP-HOSE
5P0599	CLAMP HOSE
5P0600	CLAMP HOSE
5P1717	CLAMP
5P2230	CLAMP HOSE
5P3860	CLAMP HOSE
5P4868	CLAMP
5P4869	CLAMP
5P4961	CLAMP
7C0752	CLAMP
8T6726	CLAMP
8T9402	CLAMP-HOSE
9M0164	CLAMP-HOSE
9M2904	CLAMP
9M6738	CLAMP-HOSE
9M7958	CLAMP
9M7959	CLAMP HOSE

T-Bolt Clamp

High strength clamping for applications that require thermal expansion.

Part No.	Description
2086054	CLAMP T-BOLT
2086055	CLAMP T-BOLT
2087448	CLAMP T-BOLT
2094573	CLAMP T-BOLT

Part No.	Description
2094578	CLAMP T-BOLT
2094579	CLAMP T-BOLT
2094580	CLAMP T-BOLT
2094588	CLAMP T-BOLT
2126933	CLAMP T-BOLT
2147457	CLAMP T-BOLT
2162211	CLAMP T-BOLT
2162212	CLAMP T-BOLT
2166945	CLAMP T-BOLT
2176885	CLAMP T-BOLT
2190313	CLAMP T-BOLT
2303671	CLAMP T-BOLT
2395609	CLAMP T-BOLT

V-Band Turbo

Fast secure coupling for flanged joints. High strength and positive sealing integrity. Used in turbocharge applications. Stainless steel 410.

Part No.	Description
1371602	CLAMP AS.-
1270929	V-CLAMP
1W2431	CLAMP
1W3088	CLAMP
1W5455	CLAMP
Part No.	Description
1W6694	CLAMP
2N8109	CLAMP
3S5129	CLAMP AS
4W3034	CLAMP
5L7631	CLAMP
6L3005	CLAMP
6U6481	CLAMP-HOSE
7C0752	CLAMP
7M9917	CLAMP
7W7778	CLAMP A
8N0878	CLAMP
8N0879	CLAMP
9N1941	CLAMP
9N2038	CLAMP A-TURBO
5S4558	V CLAMP

V-Band Clamp

Spring loaded t-bolts with spring designed for constant tension.

Part No.	Description
8T6703	CLAMP
9N2039	CLAMP A-COMP
9X2201	CLAMP-HOSE
9X2488	CLAMP
2N8109	CLAMP

BRAKING SYSTEM



Part numbers are used for reference purposes only.

ACTUATORS



Part No	Description	Machine Model
1029004	ACTUATOR	16G, 16H
1298090	ACTUATOR A	926H, 950H/K, 962H/K, IT62H
1548041	ACTUATOR A	814F, 815F, 816F, 950F, 960F, 966F
1548042	ACTUATOR A	824G, 825G, 826G
3V7028	ACTUATOR GP	980B
5T0925	ACTUATOR GP	130G, 140G, 14H, 120G, 14G, 12G
6W4280	ACTUATOR	980W, 980F
8R2488	ACTUATOR-GP	966R, 966C
8W8357	ACTUATOR G	627E, 627G, 623G, 623E
8W8358	ACTUATOR G	627E, 623F, 627G, 621E, 621G
9V8693	ACTUATOR G	528G, 936, 936E
9V8736	ACTUATOR G	950F, 966F, 814B

Actuator Kits

Part No.	Description	Machine Model
4E5986	ACTUATOR KIT	816B
1870424	ACTUATOR KIT	966F

Parts for Braking System

Part No.	Description
1233426	CYLINDER A
3D2219	CYLINDER A-BRAKE
3D9334	REBUILD KIT MASTER CYLINDER
4K5968	CYLINDER A-BRAKE GR
5T6520	CYLINDER A
5T6533	CYLINDER KIT WHEEL
5T6605	CYLINDER KIT
5T6617	CYLINDER A
5T6618	CYLINDER ASSY
9C0166	CYLINDER G-AIR
9K1591	CYLINDER (MASTER)

Costex Tractor Parts Copyright © 2020. All rights reserved.

BRAKE PEDALS



Brake Pedal Assemblies

Part No.	Description
2R0617	VALVE A-W/PEDAL
4E5669	VALVE A-W/PEDAL
4V4154	VALVE A-W/PEDAL
6K1265	VALVE A-W/PEDAL

Pedals and Valves

Part No.	Description
1196744	VALVE GP
2R0696	TREADLE A
4D2287	VALVE A.
7D8075	VALVE A
9V2434	TREADLE A



BRAKE LINING

Part No.	Application
8W9176	112F, 12E
8R0807	518, 528, 530B
6Y2356	561D
6Y2383	583K
6Y2384	594
9C0567	725, 730, 771C
9C0566	730, 613C, 936E
1149297	771C
1149299	771C
1512628	906, 908
9C8021	926, 930T

Part No.	Application
2V9135	930
1322084	933
1322085	933
8Y4387	955L
8Y4388	955L
6Y2370	977, 983, D6
6Y7164	D3, 931
8Y4138	D4
8Y4139	D4
6Y2357	D5B
6Y1935	D6
8E5820	D6
6Y1937	D6, D7
6Y2364	D7G
6Y1948	D8



Brake Lining Kits

Part No.	Application
6D0554	120
8X1900	120B
9C8681	235D
1271665	446B
2839976	530B, IT24F, 924F
1346064	621F, 627F
8Y6289	931
8R7764	950
8R1932	950, 966C
3Y0076	955
9C9837	950E/F, 966G
3Y0076	955L
8R1284	966D
9C9843	966DE, 980C
8R7776	980
8R0302	988
5S1513	983, D7F
8Y6307	D4

Part No.	Application
8Y6311	D4D
4V2249	D4E
4V2249	D4E LPG
5H2307	D6, D7, D8, 983
8E9115	D8H
8E9116	D9



Shoe Lining and Bands

Part No.	Application
6D0552	112E/F
6D0552	120, 140
8X0534	120B, 12E
8X0535	120B, 12E
9C5971	528B, 530B, 930T
9C8682	613C, 918F, 928G
9C9842	814F, 966F, 970F
8R1930	966
8R1930	966, 966C
8S4501	988
8R1286	D350C, D300D
8E6415	D6C, D4D
8E7641	D6G2

FRICTION DISCS



I/S T= Inside Teeth
O/S T= Outside Teeth

Clutch Discs

Part No.	Specifications	Application
1085751	52 I/S T	12H/M, 120M, 140H/K/M, 160K/M
6Y7961	30 I/S T	14E

Part numbers are used for reference purposes only.

Part No.	Specifications	Application
6Y7962	18 I/S T	14E
6Y7964	45 I/S T	14E
8E1204	40 O/S T	16G, 3406/16H
6Y7922	52 I/S T	910E
6Y7920	75 O/S T	D10N
6Y7919	24 I/S T	D3C
6T4944	75 O/S T	D6D 3X
6Y7977	120 O/S T	N/A

Brake Discs

Part No.	Specifications	Application
6Y7915	54 I/S T	120G, 150H
6Y7916	64 I/S T	12G, 160H
6Y7917	88 I/S T	16H, 14G
6Y7909	18 I/S T	215B/C/D
6Y7956	24 I/S T	227, 235
8E2183	80 I/S T	621H/K, 623H/K, 770G, 772G, 777D/F
9W7019	60 I/S T	824C, 980C
9W7020	68 I/S T	825C, 826C, D400E, D350E
1058750	80 I/S T	826G, 836, 980G/H
2010737	30 I/S T	836G/H/K, 980K, 982M
6Y2082	18 I/S T	938F/G, 938G II, IT38G
1708714	56 O/S T	953C/D, 963C/D, 973C/D
9W7017	120 I/S T	977 TRUCK
9W7018	62 I/S T	988F
6Y7970	18 I/S T	IT12F, IT12B, IT14B, IT14F, 910E/F
6Y5913	18 I/S T	IT28F, 928F
1173321	18 I/S T	IT28G, 928G
2172895	36 I/S T	TH220B, TH330B, TH340B, 424B

Master Clutch Discs

Part No.	Specifications	Application
6D2348	64 I/S T	14
6Y7925	48 I/S T	14
4S9073	94 I/S T	12, 14, D7E, D7H
1590927	52 I/S T	12H/K/M, 120H/M, 140H/K/M, 160H/K/M
7S3992	62 I/S T	825B, 824B, D343
1V8279	62 I/S T	825B, 824B, D343
6Y1300	45 I/S T	924F/G/Gz/H, 924Hz, 928G/H, 930G
4S9072	64 I/S T	D7E, D7H, D4 82J, D6 44A
3T1407	48 I/S T	D7H, D6H
6Y7968	45 I/S T	IT18F, 924H, 924Hz, 446B
2312236	52 I/S T	IT38F, 938F/G/H

Costex Tractor Parts Copyright © 2020. All rights reserved.

Steering Clutch Discs

Part No.	Specifications	Application
8E4075	71 I/S T	3204, D3B, D3B LGP
1015144	104 I/S T	527, 587R, D6R Series II, D7R Series II
6Y7914	95 O/S T	941 B-C
5V0593	95 O/S T	95, 922B, 941B, 951B
9P9382	120 O/S T	983, D5B
3F5504	95 O/S T	D4C, D4D, 40A, 82J
6Y7160	120 O/S T	D5, D6B
1015141	58 I/S T	D5M, D5N, D6R Series II, D7R
5M1199	120 O/S T	D6C, D7E, D7F
4Y0709	120 O/S T	D6D, D6G, D6G2, D7G, D7G2, 571G
7H2118	128 O/S T	D8K
3B7974	128 O/S T	D9
8S2174	142 O/S T	D9G
5H8530	119 O/S T	N/A

Part No.	Specifications	Application
6Y5914	54 I/S T	12G, 140G
6Y2027	101 I/S T	12G, 140G, 160G, 3306
3S7981	81 I/S T	14, D4D
6Y7954	50 I/S T	140H, 160H, 163H
1267924	18 I/S T	24F, 924F
1221880	26 O/S T	416C, 426C, 436C
1P4110	96 I/S T	621H/K, 623H/K, 627G/H/K, 773B/E
4S8724	65 I/S T	627, 631C, 633
2P9314	5 O/S T	627B, 988B
9P4251	96 I/S T	633, 633C, 637
5S7830	138 I/S T	657, 657B
6Y9807	75 I/S T	735/B, 740/B, 770,771C/D
6Y7932	52 I/S T	75E, 85C
9P4252	74 I/S T	768B, 769B, D343
8S9112	80 I/S T	769B, D343
9W4662	65 I/S T	773B, 627, 633
3369318	114 I/S T	776B/D, 777C/D/F/G, 992G
6Y7219	124 I/S T	776D, 777D/F/G, 793C/D
6I8030	18 I/S T	814F, 970F
1S3736	124 I/S T	824, 988
6I9255	65 I/S T	824C, 825C, 3406
2346707	65 I/S T	826G, 834K, 836K, 980F/G/H/K, 982M
3P5955	6 O/S T	85J, 86J, 955K, D5
8P8683	81 I/S T	915C, D4D
3T9960	35 I/S T	931B, 3204, D3B, D4B
2S1456	66 I/S T	944, 950, 966
6Y2084	18 I/S T	950F
7T3456	63 I/S T	950G/H, 962G/H, 966C/H/K/R
2200189	18 I/S T	966G
3284375	48 I/S T	980G, D8R
8E0985	101 I/S T	D10, D348, 992
1697055	80 I/S T	D11R, 776D, 777D/F/G,844
8P5646	138 I/S T	D346, D7F, 666B
6Y7935	54 I/S T	D3C
1028671	85 I/S T	D400E, 776D
6Y7965	54 I/S T	D4C, D4C LGP, D4H, D4H LGP
6Y5916	96 I/S T	D6E
6Y7946	88 I/S T	D6H
6Y9373	88 I/S T	D6H, D7H
9P7390	75 I/S T	D6R
3284374	75 I/S T	D6R, D8R, 615C, 815F, 980C/H/K
8M8550	108 I/S T	D7F
7T2336	96 I/S T	D7G, 572G
8M5070	142 I/S T	D8, D9G

Part No.	Specifications	Application
8P4736	88 I/S T	D9H, 594H, D353
8P4316	5 O/S T	D9L, 589
8P8360	88 I/S T	D9L, D10N, 3412
6Y5352	61 I/S T	G936, 936E



FRICION DISCS & PLATES FOR KOMATSU

Friction Discs For Komatsu®

Part No.	Application
424-15-12711	85PX-15,WA380-6, D155AX-6,
195-15-32710	D155AX-6,
17A-22-11170	D155AX-6, D155AX-7
104-22-33321	D21
120-22-31233	D31E, D37A, D40
195-22-13441	D375A-5
195-15-42721	D375A-6
131-21-43220	D40,D50
14X-15-22710	D65PX-15
125-21-23121	D75S
154-22-11230	D85A,D155A-2
23S-15-12740	GD355A, GD623A,GD625
417-33-11290	WA100-3
418-17-39710	WA200-6, WA320-6,
419-33-11243	WA320-1, WA300
418-33-21340	WA320-6
235-25-11360	WA350, WA400

Part numbers are used for reference purposes only.

Part No.	Application
714-07-29710	WA380-6
714-07-29720	WA380-6
714-12-19711	WA380-6
714-08-19710	WA480-6
425-33-11510	WA500-7,WA500-6

Plates For Komatsu®

Numéro de piece	Application
175-15-42721	D155A-1
175-15-42920	D155A-1
175-22-21160	D155A-1
17A-22-12120	D155AX-7, D155A-5
10E-22-21320	D21
195-22-13370	D375A-6
130-22-11320	D53A, D50,D57
14X-15-22780	D65EX-16, D65EX-17
426-15-12720	D85E-21
363-15-22750	WA30-3, WA50-1
418-17-38221	WA320-6 , WA250-6
714-16-19730	WA320-6,WA380-6,WA250-6
232-25-51430	WA400-3, WA350-1
714-08-19730	WA480-6
566-33-41230	WA500-6



AIR COMPRESSORS

Part No.	Description	Application
1N2992	AIR COMPRESSOR AS-SEMBLY	3406B, 3406C, 623F
1P0028	AIR COMPRESSOR AS-SEMBLY	518, 920, 950

Costex Tractor Parts Copyright © 2020. All rights reserved.

PILOTS



Steering and Braking System

Part No.	Description	System Application	Model / Engine Application
5M1990	PILOT	STEERING CLUTCH	D7F, 983
9M0702	PILOT	STEERING CLUTCH	D6C LGP, 977K, 3306

Power Shift Transmission Discs

Part No.	Specifications	Application
6Y7929	45 I/S T	416
6Y7957	45 I/S T	416
9P4253	62 I/S T	627
6Y5348	87 I/S T	816
6Y7934	36 I/S T	916
6I8911	52 I/S T	120H
6I8912	53 I/S T	120H
8M5136	56 I/S T	12F, 641, 651
6Y7981	32 O/S T	12G, 120G, 140H

Air Compressors (cont.)

Part No.	Description	Application
1W6473	COMPRESSOR GP	120G, 12G, 130G, 140G, 14G, 518, 528, 920, 930, 930R, 936, 950B, 950B/950E, FB518
1W6753	COMPRESSOR GR-W/GOV	950B, 950B/950E
1043823	COMPRESSOR GP	950F, 950F II
1105764	COMPRESSOR AIR/13.2CFM@1200RPM	12H, 12H ES, 12H NA, 140G, 140H, 140H ES, 140H NA, 143H, 14H NA, 160H, 160H ES, 160H NA, 163H NA, 1673C, 3304, 3306, 3306B, 3306C, 611, 615C, 966F, 966F II, G3306
1117994	COMPRESSOR	120G, 12G, 12H, 12H ES, 12H NA, 130G, 140G, 140H, 140H ES, 140H NA, 143H, 160G, 160H, 160H ES, 160H NA, 163H NA, 518C, 528B, 530B, 936F
1316679	COMPRESSOR AIR TF-550	140H, 143H, 14H, 160H, 163H, 16H, 3176C, 3196, 3406E, 621B, 621G, 623G, 627F, 627G, 631D, 631E, 631G, 633E II, 637D, 637E, 637G, 657B, 657E, 657G, 824C, C-10, C-12, C-15, C-16, C-18
1440744	COMPRESSOR AIR/13.2CFM@1250RPM	14H NA, 3306, 3306C, 611, 615C
1494915	AIR COMPRESSOR TF-550	120K, 120K 2, 12K, 140K, 140K 2, 160K, 3116, 3126, 3126B, 3126E, 815B, C-9, C7, C9, CX31-C9I, SPP101, TH31-E61
1647557	COMPR GP-B	3116, 3126, 3126B, 3126E
1647564	COMPRSR GP TF-750	3176C, 3196, 3406E, 3456, C-10, C-12, C-15, C-16, CPT372, PM-200, PM-201, SBF214, SUF557
1647566	COMPRESSOR	3406E, 3456, 651B, C-15, C-16, C-18, PM-200, PM-201
2240003	vCOMPRESSOR GR	120H, 12H, 12M, 135H, 140G, 140M, 160M, 3126B, 3126E, C7
3850937	COMPRESSOR GR	C15, C18, CX31-C15I, CX35-P800
4N3927	COMPRESSOR AS	627, 814, 815, 816, 966C
4N6954	COMPRESSOR GP	16G, 3406, 621B, 627B, 824C, 825C, 826C, 980C
4P5433	COMPRESSOR AS	3114, 3116, 613C II, 950F, 950F II
4W6425	COMPRESSOR GP	16G, 16H NA, 3406B, 3406C, 621E, 623E, 627E, 814B, 824C, 825C, 826C, 980C, 980F, 980F II
7E6807	COMPRESSOR G	3306, 12G, 14G
7E7739	COMPRESSOR G	3408, 3406A
7E7740	COMPRESSOR AIR-REMAN	3406C
8N2051	COMPRESSOR GP	3204, 916, 926, 926A, G916, G926, IT18, IT18B, IT28, IT28B
20Y-979-6121	COMPRESSOR 10S15C 1B 5/8 IN GR	BP500, PC1250, PC1250SE, PC1250SP, PC130, PC160, PC180, PC200, PC2000, PC200LL, PC200SC, PC210, PC220, PC300, PC360, PC400

Air Compressor Repair Kits

Part No.	Description	Application
1S9874	KIT REP. COMPRESSOR	120G, 130G, 528, 613, 613B, 920, 930, 950, 950B, 966C
1070260	REPAIR KIT	120G, 12G, 12H, 12H ES, 12H NA, 130G, 140G, 140H, 140H ES, 140H NA, 143H, 160G, 160H, 160H ES, 160H NA, 163H NA, 3114, 3116, 518C, 528B, 530B, 613C II, 936F, 950B/950E, 950F, 950F II
4W9492	REPAIR KIT	3204, 916, 926, IT28
7E9918	REPAIR KIT	120G, 12G, 130G, 140G, 160G, 3116, 528, 936, 936F, 950F
7N2834	KIT-COMPRESSOR MAJOR REPAIR	120G, 518, 528, 920, 930, 950, 950B, G936
7N7435	KIT-MAJOR REPAIR	14G, 14H NA, 16G, 16H NA, 3176, 3176B, 3176C, 3196, 3304, 3306, 3306B, 3306C, 3406B, 3406C, 3406E, 3508, 3508B, 3512, 3512B, 3516, 3516B, 611, 615C, 621, 621E, 621F, 621R, 623E, 623F, 627E, 627F, 814B
8A2305	KIT-GOVERNOR MAJOR REPAIR	120G, 518, 528, 920, 930, 950, 950B, D6C, G936
8N3666	REPAIR KIT-COMPRESSOR	1673C, 16G, 3176, 3176B, 3208, 3304, 3306, 3306B, 3306C, 3406, 3406B, 3406C, 3408, 3408C, 3408E, 3412, 3412E, 3512, 3512B, 3512C, 3516C, 5130, 5230, 613C, 627B, 627E, 631D, 631E, 631G, 633D, 633E II
9M0402	REPAIR KIT	120G, 120H, 120H ES, 120H NA, 120K, 120K 2, 120M, 12G, 12H, 12H ES, 12H NA, 12K, 12M, 130G, 135H, 135H NA, 140G, 140H, 140H ES, 140H NA, 140K, 140K 2, 140M, 143H, 14G, 14H, 14H NA, 14M, 160G, 160H

Air Compressor Piston & Rings

Part No.	Description	Application
1W2804	PISTON ASSEMBLY	120G, 130G, 528, 613B, 950, 950B
1059218	PISTON GR/WITH RINGS	120G, 214, 518, 528, 920, 930, 950, 950B, D6C, G936
1440503	PISTON & RING	14G, 14H NA, 16G, 16H NA, 3126, 3126B, 3176, 3176B, 3176C, 3196, 3304, 3306, 3306B, 3306C, 3406B, 3406C, 3406E, 3508, 3508B, 3512, 3512B, 3516, 3516B, 611, 615C, 621E, 621F, 623E, 623F, 627E, 627F
4P3966	PISTON & ROD ASSY	120H, 120H ES, 120H NA, 120K, 120K 2, 12H, 12H ES, 12H NA, 12K, 135H, 135H NA, 140G, 140H, 140H ES, 140H NA, 140K, 140K 2, 143H, 14G, 14H, 14H NA, 160H, 160H ES, 160H NA, 160K, 163H, 163H NA, 1673C
6I2125	PISTON KIT	3114, 3116, 613C II, 950F, 950F II
7C0563	PISTON & ROD ASSY	3204, 916, 926, IT28
7E8924	PISTON & ROD AS	3116, 3126, 3126B, 3126E, 3176, 3176B, 3176C, 3196, 3304, 3306, 3306B, 3306C, 3406B, 3406C, 3406E, 3456, 3516B, 651B, 776C, 776D, 777, 777B, 777C, 777D, 784C, 785, 785B, 785C, 785D, 789, 789B, 789C

Part No.	Description	Application
7N4837	PISTON AS-COMPRESSOR	1673C, 16G, 3114, 3116, 3126, 3176, 3208, 3304, 3306, 3306B, 3306C, 3406, 3406B, 3406C, 3408, 3408C, 3408E, 3412, 3412C, 3412E, 3512, 3512B, 3512C, 3516C, 5130, 5230, 613C, 627B, 627E, 631D, 631E,
1S9875	RING KIT (8 RING)	120G, 130G, 528, 613, 613B, 920, 930, 950, 950B, 966C
1059236	KIT-PISTON RING	120G, 214, 518, 528, 920, 930, 950, 950B, D6C, G936
1101337	KIT-PISTON RING	3408, 631D, 631E, 631G, 633E II, 637E, 637G, 651E, 657E, 69D, 769C, 769D, 771C, 771D, 773B, 773D, 773E, 775B, 775D, 775E
4W9491	KIT-PISTON RING	3204, 916, 926, IT28
7C0570	KIT-PISTON RING	120G, 12G, 12H, 12H ES, 12H NA, 130G, 140G, 140H, 140H ES, 140H NA, 143H, 160G, 160H, 160H ES, 160H NA, 163H NA, 3114, 3116, 518C, 528, 528B, 530B, 613C II, 936, 936F, 950B/950E, 950F, 950F II
7C4943	KIT-PISTON RING	1673C, 3176, 3176B, 3176C, 3196, 3306, 3306C, 3406B, 3406C, 3406E, 3408, 3408C, 3408E, 3412, 3456, 623F, C-10, C-12, C-15, C-16
7E8925	KIT-STANDARD RING	120H, 120H ES, 120H NA, 12H, 12H ES, 12H NA, 135H, 135H NA, 140G, 140H, 140H ES, 140H NA, 143H, 14G, 14H, 14H NA, 160H, 160H ES, 160H NA, 163H, 163H NA, 1673C, 16H, 3114, 3116, 3126, 3126B, 3126E
8A2250	RING KIT (5 RING)	120G, 214, 518, 528, 920, 930, 950, 950B, D6C, G936
1440502	KIT-PISTON RING	14G, 14H NA, 16G, 16H NA, 3126, 3126B, 3176, 3176B, 3176C, 3196, 3304, 3306, 3306B, 3306C, 3406B, 3406C, 3406E, 3508, 3508B, 3512, 3512B, 3516, 3516B, 611, 615C, 621E, 621F, 623E, 623F, 627E, 627F
1647572	KIT-PISTON RING	14G, 14H NA, 16G, 16H NA, 3126, 3126B, 3176, 3176B, 3176C, 3196, 3304, 3306, 3306B, 3306C, 3406B, 3406C, 3406E, 3508, 3508B, 3512, 3512B, 3516, 3516B, 611, 615C, 621E, 621F, 623E, 623F, 627E, 627F
3S0916	KIT-PISTON RING	1140, 1673, 1673B, 1676, 1693, 3208, 3306, 3406, 3512, 621, 631C, 641B, 768B, 769, 772, 773, 777, 980, 980B, D348, D6C, D9G

Air Compressor Blocks & Crankshafts

Part No.	Description	Application
2P7850	CRANKSHAFT	120G, 528, 920, 930, 950, 950B, D6C, G936
2P8670	CRANKSHAFT	120G, 130G, 528, 950, 950B, 966C
4P2974	CRANKSHAFT	14G, 14H NA, 3176, 3176B, 3304, 3306, 3306B, 3306C, 611, 615C, 621E, 814B, 815B, 966D, 966F, 966F II, 972G
7C0562	CRANKSHAFT	120G, 12G, 12H, 12H ES, 12H NA, 130G, 140G, 140H, 140H ES, 140H NA, 143H, 160G, 160H, 160H ES, 160H NA, 163H NA, 518C, 528, 528B, 530B, 936, 936F, 950B, 950E
1W6471	CRANKCASE	120G, 528, 920, 930, 950, 950B, G936

Part No.	Description	Application
7N7445	CYLINDER BLOCK	14G, 14H NA, 16G, 16H NA, 3176, 3176B, 3176C, 3196, 3304, 3306, 3306B, 3306C, 3406B, 3406C, 3406E, 3508, 3508B, 3512, 3512B, 3516, 3516B, 611, 615C, 621, 621E, 621F, 621R, 623E, 623F, 627E, 627F, 814B
8S4582	BLOCK ASSEMBLY	120G, 130G, 528, 950, 950B, 966C

Air Compressor Head Assemblies

Part No.	Description	Application
1082522	CYLINDER HEAD AS	120G, 12G, 12H, 12H ES, 12H NA, 130G, 140G, 140H, 140H ES, 140H NA, 143H, 160G, 160H, 160H ES, 160H NA, 163H NA, 3114, 3116, 518C, 528B, 530B, 613C II, 936F, 950B/950E, 950F, 950F II
4W9485	CYLINDER HEAD AS	3204, 916, 926, IT28
7N2833	HEAD ASSEMBLY	120G, 518, 528, 920, 930, 950, 950B, G936
7N7447	HEAD AS-COMPRESSOR	14G, 14H NA, 16G, 16H NA, 3176, 3176B, 3176C, 3196, 3304, 3306, 3306B, 3306C, 3406B, 3406C, 3406E, 3508, 3508B, 3512, 3512B, 3516, 3516B, 611, 615C, 621, 621E, 621F, 621R, 623E, 623F, 627E, 627F, 814B
8S4581	HEAD ASSEMBLY	120G, 130G, 528, 920, 930, 950, 950B, 966C

Air Compressor Governor

Part No.	Description	Application
1P7125	GOVERNOR AS-AIR COMPRESSOR	16G, 3204, 3412E, 613, 621E, 621F, 623E, 623F, 627E, 627F, 814B, 815B, 824C, 826C, 916, 926, 966D, 972G, 980C, C27, IT28, TH48-E70
1W8939	GOVERNOR AS-SEM.	518, 528, 528B, 530B, 930, 930R, 936, 936F
4N9679	GOVERNOR AS-AIR COMPRESSOR	3116, 3126, 3126B, 3126E, 3208, 3508, 3512, 3516, 5130, 5130B, 613B, 613C, 613C II, 621B, 621G, 623G, 627B, 627E, 627F, 627G, 631D, 631E, 631G, 633E II, 637D, 637E, 637G, 815, 815B, 966C, 966F, 966F
4N9680	GOVERNOR GP-AIR COMPRESSOR	16G, 3114, 3116, 3126, 3126B, 3126E, 3176C, 3196, 3306C, 3406B, 3406C, 3408, 3408C, 3412, 3412C, 3412E, 3512, 3512B, 3512C, 3516B, 3516C, 5130, 5130B, 518C, 5230, 5230B, 621B, 621E, 621F, 621G, 623E
4N9681	GOVERNOR AS-AIR COMPRESSOR	3508, 3508B, 3512, 3512B, 3512C, 3516, 3516B, 613, 613B, 950
6I1240	GOVERNOR AS-AIR COMPRESSOR	120G, 120H, 120H ES, 120H NA, 12G, 12H, 12H ES, 12H NA, 130G, 135H, 135H NA, 140G, 140H, 140H ES, 140H NA, 143H, 14G, 14H NA, 160G, 160H, 160H ES, 160H NA, 163H NA, 16G, 16H NA, 3306B, 550, 550B, 560B

Air Compressor Governor (cont.)

Part No.	Description	Application
7N7765	GOVERNOR AS-SEM.	528, 920, 950, G936
7N9195	GOVERNOR AS-AIR COMPRESSOR	120G, 12G, 130G, 140G, 14G, 160G, 3412C, 611, 615C, 966C, C15

Air Compressor Miscellaneous Parts

Part No.	Description	Application
1P5480	COVER ASSEM.	120G, 518, 528, 920, 930, 950, 950B, D6C, G936
7C0564	COVER AS-END	120G, 12G, 12H, 12H ES, 12H NA, 130G, 140G, 140H, 140H ES, 140H NA, 143H, 160G, 160H, 160H ES, 160H NA, 163H NA, 518C, 528, 528B, 530B, 936, 936F, 950B/950E
7N7441	COVER-AIR COMPRESSOR	14G, 14H NA, 16G, 16H NA, 3176C, 3196, 3304, 3306, 3306B, 3306C, 3406B, 3406C, 3406E, 611, 615C, 621E, 621F, 621R, 623E, 623F, 627E, 627F, 814B, 815B, 826C, 966C, 966D, 966F, 966F II, 972G, 980C, 980F
4N4027	KIT REP.	TUBE KIT
1505146	UNLOADER KIT (Governor Lines)	120G, 528, 920, 930, 950, 950B, D6C, G936
611220	KIT-UNLOADER	1673C, 3114, 3116, 3126, 3176, 3176B, 3176C, 3196, 3208, 3304, 3306, 3306C, 3406B, 3406C, 3406E, 3408, 3408C, 3408E, 3412, 3412C, 3412E, 3456, 613C, 623F, 627E, 631D, 631E, 631G, 633E II, 637E, 637G
7C0571	KIT-UNLOADER	120G, 12G, 130G, 140G, 160G, 3114, 3116, 518C, 528, 528B, 530B, 613C II, 936, 936F, 950F, 950F II
2G6285	VALVE KIT	120G, 120H, 120H ES, 120H NA, 120K, 120K 2, 12G, 12H, 12H ES, 12H NA, 12K, 130G, 135H, 135H NA, 140G, 140H, 140H ES, 140H NA, 140K, 140K 2, 143H, 14G, 14H, 14H NA, 160G, 160H, 160H ES, 160H NA, 160K
9M0386	VALVE COVER (CAP)	1140, 1673, 1673B, 1673C, 1676, 1693, 3176, 3208, 3306, 3306C, 3406, 3408, 3408C, 3408E, 3412, 3508, 3512, 3516, 621, 631C, 651, 768B, 769, 772, 773, 777, 784C, 785C, 789C, 793C, 980, 980B, D348, D6C
1S9867	BEARING-SLEEVE	120G, 130G, 1673C, 1676, 1693, 3176, 3306, 3306C, 3406, 3406B, 3406C, 3408, 3408C, 3408E, 3412, 528, 613, 613B, 623F, 920, 930, 950, 950B, 966C, 980B, D9G
1S9873	ROD ASSEM.	120G, 130G, 528, 613, 613B, 920, 930, 950, 950B, 966C
1W2803	PLUG	120G, 130G, 1673C, 3114, 3116, 3126, 3176, 3176B, 3176C, 3196, 3304, 3306, 3306B, 3306C, 3406B, 3406C, 3406E, 3408, 3456, 3508, 3512, 3512B, 3512C, 3516, 3516C, 5130, 5230, 528, 613B, 623F, 627E, 631D

Part No.	Description	Application
2032389	KIT-CARTRIDGE DESICCANT	120H, 120K, 120K 2, 12H, 12K, 135H, 140H, 140K, 140K 2, 143H, 14H, 160H, 160K, 163H, 16H, 3516C, C175-16
4N3982	BEARING SET (2PCS/SET)	120G, 130G, 528, 950, 950B, 966C
4N3983	BEARING .010	120G, 130G, 528, 950B, 966C
4N3984	BEARING .020	120G, 130G, 528, 950B, 966C
4N3994	BEARING	1673C, 3176, 3176B, 3176C, 3196, 3208, 3306, 3306C, 3406, 3406B, 3406C, 3406E, 3408, 3408C, 3408E, 3412, 3456, 623F, 980B, C-10, C-12, C-15, C-16, D6C
4W9480	ROD A	3204, 916, 926, IT28
7C0566	BEARING	120G, 12G, 12H, 12H ES, 12H NA, 130G, 140G, 140H, 140H ES, 140H NA, 143H, 160G, 160H, 160H ES, 160H NA, 163H NA, 518C, 528, 528B, 530B, 936, 936F, 950B/950E
7N7444	ROD AS-AIR COMPRESSOR	14G, 16G, 3176, 3176B, 3304, 3306, 3306B, 3406B, 3406E, 3512, 615C, 621, 621E, 621R, 815B, 966C, 966D, 966F, 966F II, 980C, 980F, C-10, C-12, D25C, D300B, D30C, D350C, D35C
7T2799	KIT-BEARING	120G, 120H, 120H ES, 120H NA, 12G, 12H, 12H ES, 12H NA, 130G, 135H, 135H NA, 140G, 140H, 140H ES, 140H NA, 143H, 14G, 14H NA, 160G, 160H, 160H ES, 160H NA, 163H NA, 16G, 16H NA, 235, 245, 3114, 3116
8A2248	ROD ASSEM.	120G, 214, 518, 528, 920, 930, 950, 950B, D6C, G936
8A2251	LINER	120G, 214, 518, 528, 920, 930, 950, 950B, D6C, G936
8S4645	LOCK	1140, 1673B, 1673C, 1676, 3176, 3208, 3306, 3306C, 3406, 3406B, 3406C, 3408, 3408C, 3408E, 3412, 623F, 772, 773, 777, 980B, D6C
8S7599	SEAT	120G, 130G, 528, 920, 930, 950, 950B, 966C
9M0381	SEAT	1140, 120G, 130G, 1673, 1673B, 1673C, 1676, 1693, 16G, 3176, 3208, 3304, 3306, 3306B, 3306C, 3406, 3406B, 3406C, 3408, 3508, 3512, 3512B, 3512C, 3516, 3516C, 5130, 5230, 528, 613, 613B, 627B, 627E
9M0385	PLATE	1140, 120G, 120H, 120H ES, 120H NA, 130G, 135H, 135H NA, 1673, 1673B, 1673C, 1693, 3114, 3116, 3208, 3304, 3306, 3406, 3408, 528, 613, 613B, 613C II, 621, 621B, 631C, 637D, 651, 768B, 769, 772, 773
9M0397	ADAPTER	120G, 12G, 12H, 12H ES, 12H NA, 130G, 140G, 140H, 140H ES, 140H NA, 143H, 14G, 14H NA, 160G, 160H, 160H ES, 160H NA, 163H NA, 1673, 1673B, 1673C, 1693, 16G, 16H NA, 3114, 3116, 3126B, 3176, 3204, 3208



CABIN & ACCESSORIES

CABIN GLASS



Backhoe Loader

Part No.	Application	Type
8Y7264	416C, 420D, 428C, 438C, 442D	LOWER PANEL, LH
1228999	416C, 426C, 428C, 436C	DOOR, LH
8Y7252	416C, 426C, 428C, 436C, 438C	FRONT
8Y7253	416C, 426C, 428C, 436C, 438C	FRONT LOWER, RH
8Y7254	416C, 426C, 428C, 436C, 438C	FRONT LOWER, LH
8Y7290	416C, 428C, 438C	DOOR, RH
8Y7263	416C/D, 420D, 426C, 428C/D, 430D, 432D, 436C, 438C/D, 442D, 446D	DOOR LOWER, RH
1641065	416D, 420D, 420D, 428D, 442D	REAR DOOR, LH
1641064	416D, 420D, 424D, 428D, 430D, 432D, 438D, 442D, 446D	REAR, RH
1641066	416D, 420D, 424D, 428D, 430D, 432D, 438D, 442D, 446D	DOOR UPPER, RH
1641068	416D, 420D, 424D, 428D, 430D, 432D, 438D, 442D, 446D	REAR CORNER, RH
1641069	416D, 420D, 424D, 428D, 430D, 432D, 438D, 442D, 446D	REAR CORNER, LH
1641071	416D, 420D, 424D, 428D, 430D, 432D, 438D, 442D, 446D	FRONT LOWER, RH
1641072	416D, 420D, 424D, 428D, 442D	FRONT, LH
1641070	416D, 420D, 428D, 430D	FRONT
1641067	416D, 420D, 428D, 442D, 424D	DOOR UPPER, LH
2059607	416E, 420E, 422E, 428E, 430E, 432E, 434E, 442E, 444E	FRONT

Backhoe Loader (cont.)

Part No.	Application	Type
2059587	416E, 422E, 428E, 430E, 432E, 432F, 434E	DOOR UPPER, LH
2059588	416E, 422E, 428E, 430E, 432E, 432F, 434E	DOOR LOWER, LH
2059598	416E, 422E, 428E, 430E, 432E, 432F, 434E	DOOR, RH
2059605	416E, 422E, 428E, 430E, 432E, 432F, 434E	FRONT LOWER, LH
2059606	416E, 422E, 428E, 430E, 432E, 432F, 434E	FRONT LOWER, RH
2059612	416E, 422E, 428E, 432E, 442E, 444E	REAR, RH
2059608	416E, 422E, 428F, 428E, 432F, 434E	REAR, RH
2059609	416E, 422E, 428F, 428E, 432F, 434E	REAR, LH
2059622	416E/F, 420E/F, 430E/F, 432F, 450F	LOWER, LH
2059638	422E, 428E, 432E, 434E, 442E, 444E	REAR LOWER
8Y7264	416C, 420D, 428C, 438C, 442D	LOWER PANEL, LH
8Y7290	428C, 438C, 416C	DOOR, RH

Excavators

Part No.	Application	Type
1566474	307, 312, 320C/D, 325D, 330C, 330D, 340D	DOOR, LH/RH
1566475	307, 312, 320C/D, 325D, 330C, 330D, 340D	DOOR, LH/RH
1566472	311D, 320C, 323D, 330D, 345D	WINDOW, RH
1419371	312B/B L, 315B L, 317B L, 318B L, 320B, 322B L, 325B, 330B L, 345B, 365B, 385B / B L	SLIDING FRONT LOWER
2868866	312C, 315, 319C/D, 323D L, 345D, 385C L	WINDOW DOOR KIT, LH/RH
2346489	312D, 315D, 319D, 320D, 324D, 336D	WINDOW, RH
1516789	315C, 318C, 320C, 325C, 330C	WINDOW, RH
1516790	315D, 320D, 323D, 336D, 370D, 385D, 390D	DOOR REAR, LH
3346483	319D, 329D, 329E, 336D, 336E, 374F	FRONT UPPER
6C9004	320/L/N/S, 322L/LN/N, 325/L/LN, 330/L/LN, 350/L, 375/L	FRONT UPPER
1325097	320B, 320B L/N/S/LN, 322B L/LN, 325B, 330B, 345B, 365B	REAR, LH
1325098	320B, 320B L/N/S/LN, 322B L/LN, 325B, 330B, 345B, 365B	REAR
1566473	320C, 325D, 330D L	FRONT LOWER

Part No.	Application	Type
2358911	320D, 325D, 330D, 345C/D, 365D, 374D	WINDOW, RH
1674142	323D, 325D, 330D, 385C, 390D	REAR
2868867	323D, 330D, 385C, 390D	FRONT DOOR SLIDING, LH
1566471	950H, 962H, 966H, 980H, 972H	DOOR, LH

Excavator / Material Handler

Part No.	Application	Type
1677038	307C, 311C, 312D, 315C, 318C, 320C, 324D, 325, 330CL	DOOR, LOWER LEFT
1674065	312C, 315C, 318C, 319C, 320C, 325, 330DL	FRONT UPPER
1674065	319C, 323D, 324D, 345C, 365C, M315C, M322C	UPPER FRONT
1674064	319D, 320C, 322C, 325, 330DL, 345C, 385C	FRONT GLASS
1674064	319D, 320C/C L/C LN, 322C/C LN, 323D LN/D S, 324D/D L/LN, 325C/C L /C LN, 325D/D L, 329D L/D LN, 330C/C L /C LN, 330D L/D N, 336D/D L /D LN, 345C/C L, 345D L, 365C/C L, 374D/D L, 385C/C L, 390D, M325C, M322C, M318C, M316C, M315C, M313C	FRONT
2250329	320, 322C, 324DL, 325C, 329DL, 330D, 345DL	REAR
3346533	320, 329, 336, 339, 345DL	DOOR, LOWER LEFT

Track Type Tractor / Dozer

Part No.	Application	Type
7G2454	D6R, D6T, D7R, D10N, D11R	FRONT TINTED
2141802	D8T, D9T, D10T	DOOR, LH/RH

Motor Grader

Part No.	Application	Type
1029381	120H, 12H NA, 135H, 14H, 140H, 140H NA, 16H, 160H, 163H, 143H	REAR
6G2583	12G, 120G, 130G, 14G, 140G, 16G,	FRONT PANEL
1505105	12G/H, 120G/H, 130G, 135H, 14G/H, 140G/H, 143H, 16G, 16H, 160H, 163G	LOWER FRONT
8X5456	12H, 120H, 135H, 14H, 140H, 140H NA, 143H, 160H, 163H,	FRONT

Motor Grader (cont.)

Part No.	Application	Type
1029372	12H, 120H, 135H, 14H, 140H, 143H, 16H, 160H, 163H	REAR
8X4448	12H, 120H, 14H, 140H, 143H, 160H, 12K	DOOR, LH/RH
1493409	12H, 120H/K, 14H, 140H/K, 135H, 160H/K, 163H	LOWER FRONT
2956374	14M, 120M, 140M, 160M	DOOR, RH
2956652	14M, 120M, 140M, 160M	DOOR, LH
8X5456	12H, 120H, 135H, 14H, 140H, 140H NA, 143H, 160H, 163H,	FRONT

Wheel Loader

Part No.	Application	Type
1049733	814F, 815F, 816F, 924F, 938F, 950F, 960F, 970F	FRONT QUARTER, LH
1074602	826H, 950H, 962H, 966H, 980G, 988G	REAR, LH
1074600	834G, 950G, 926G, 962G, 966G, 980G	REAR, RH
1875124	914G, 928G, 938G, IT28	DOOR, LH
1076144	928G, 924G, 930, 938G, IT38G, IT28G, IT14G, 914G	FRONT, LH
1074605	950G, 962G, 966G, 972G, 980G	FRONT, LH
1074604	950G, 962G, 966G, 972G, 980G	FRONT CORNER, RH
1485249	950G, 962G, 980G, IT62G, 966G, 972G	DOOR, RH
1857533	950G/H, 962G/H, 966G/H, 972G/H, 980G/H, IT62G/H	DOOR, RH
1732142	950H, 962G, 966H, 966G, 972G, 972H, 980G, 980H	FRONT
1732143	950H, 962G, 966H, 966G, 972G, 972H, 980G, 980H	FRONT CORNER, RH
1732144	950H, 962G, 966H, 966G, 972G, 972H, 980G, 980H	FRONT CORNER, LH
1857524	950H, 962G/H, 966G/H, 972G/H, 980G/H, 986H	DOOR, LH
1857525	950H, 962H, 966H, 972H, 980H	DOOR STATIONARY, LH
1871469	950H, 962H, 966H, 972H, 980H	DOOR, LH

Wheel Loader / Integrated Toolcarrier / Compactor

Part No.	Application	Type
1110178	910G, 914G, 928G/H, 928HZ, 930G/H, 938G/H, CS-683E, CP-663, CS-663E, CS-583E, CP-583E, CS-573E, CP-573E, CS-573D, CS-531D, CS-563E, CP-563E, CP-563D, CS-563D, CP-533D, CS-533D, CS-433E, CP-433E, CS-423E, IT14G, IT28G, IT38G,	REAR, RH
1076145	924G, 928G, 938G, IT28G, CS573D/E, CS583D/E, CS563W, CP563D, CS433E, CP433E, IT38G II	FRONT, CENTER
1076147	928G, IT28G, IT38G, CS573D/E, CS583D/E, 938G, CS563W, CP563D, CS433E, CP433E	REAR
1076146	CS531D, IT14G, 914G, 924G/H, 938G/H, IT38G	REAR, LH

Wheel Loader / Integrated Toolcarrier

Part No.	Application	Type
1049732	814F, 815F, 816F, 918F, 924F, 928F, 938F, 950F, 960F, 966F, 970F, IT18F, IT24F, IT28F, IT38F	FRONT
1074603	824G, 825G, 826G, 950G, 962G, 966G, 972G, 980G, IT62G,	FRONT
1074601	824G/H, 825G/H, 826G/H, 834G/H, 836G/H, 950G/H, 962G/H, 966G/H, 972G/H, 980G/H, 988G/H, IT62G/H	REAR
1110177	924G, 928G, 930G/H, 938G, IT38G	FRONT, RH



Vibratory Compactors

Part No.	Application	Type
1469006	CS-683E, CP-663E, CS-663E, CS-583D/E, CP-583E, CS-573D/E, CP-573E, CS-563D/E, CP-563D/E, CP-533D/E, CS-533D/E, CS-531D, CS-433E, CP-433E, CS-423E, CS76, CS44, CP44, CS54, CP54, CS56, CP56, CS64, CP64, CS74, CP74, CP76	FRONT, LH
1469007	CP433E, CP563D, CP573E, CP583D, CS423E, CS531D, CS533D, CS563D, CS573D	FRONT PANEL, RH

WIPER MOTORS



Part No.	Description				
120H, 140H, 16H	2031107	6V8258	6V5853	FRONT, UPPER	450
160H	1010744	6V8259	6V5853 1234355	FRONT UPPER FRONT LOWER	450 335
216/B, 226/B, 228, 232B	3305012	2632135	1010745	FRONT, LH, RH	600
226B, 232B	3305012	2632135	6W3924	FRONT, LH, RH	558
430E	1862589	1545410	1010745	FRONT	600
621H	3305017	1125869	5C8811	REAR	500
914G, 924H, 938H	1555783	2147636	6V7419	FRONT	700
924F	1477971		1010745	FRONT	600
938G	1477969	1171856	6V7419	FRONT	700
950G	3305050	2147634	6V7419	REAR	700
972H	1898622	1545410	6V7419	FRONT	400
992K	1555784	1852155	6V5851	REAR	400
D11R	1477976		6V5849	DOOR, LH, RH	350
D11T	2225376	2225378	1285040	DOOR, LH	330
D5R XL	3044505		1258175	DOOR, RH	450
D6R	3305013	1510255	6V5849	DOOR, LH	350
D6R, D8R	3305014	1510254 / 2225374	6V5849	DOOR, RH	350
D6T	3221494	1753761	6V5851	FRONT	400
D7R, D9R	1477976	1458741	6V5851	FRONT	400
D8T	1350611	2225374	1285040	DOOR, RH	330
R1700G	1350611	6V8658	6V5851	FRONT	400

DIGITAL HOUR METERS



Part No.	Description
2005717	METER
2005725	METER
2681964	METER KIT

Part No.	Description
3620288	METER KIT
3620289	METER KIT
9W1490	METER KIT
9W1491	METER KIT
9W1492	METER KIT
9W1493	METER KIT
9W1494	METER KIT
9W1495	METER KIT

GAUGES

Mechanical Temperature Gauges



Part No.	Type	Range	Capillary Length (inches)
1706542	Oil	0 - 150 °C	N/A
1997952	Water	50 - 150°C	82"
1997953	Water	50 - 150 °C	100"
1997954	Water	50 - 150°C	132"
1997955	Water	50 - 150°C	132"
2005220	Water	0 - 130 °C	36"
2005222	Water	50 - 130°C	68"
2005227	Water	50 - 130°C	225"
2005231	Water	50 - 130°C	35"
2005233	Water	50 - 130°C	75"
2005234	Oil	50 - 120 °C	108"
2005235	Water	50 - 120°C	155"
2005236	Water	50 - 120°C	202"
2005247	Water	50 - 120°C	29.25"
2243343	Water	40 - 130°C	79"
2243344	Water	40 - 120 °C	108"
4N7562	Water	40 - 120 °C	203"
4W2683	Water	130 - 250 °F	130"
7N1990	Water	40 - 120 °C	232"
8S4914	Water	N/A	133"

Electrical Temperature Gauges



Part No.	Operating Voltage	Type	Range Type	DIA (mm)
4W0483	24V DC	WATER	0-140 °C	52mm
4W0485	24V DC	ENGINE OIL	40-160 °C	52mm
4W1129	24V DC	ENGINE OIL	40-120 °C	52mm
6N0674	24V DC	ENGINE OIL	40-120 °C	52mm
7W4927	24V DC	ENGINE OIL	79 Sweep Angle	52mm
7W2060	24V DC	WATER	40-160 °C	52mm
7W2061	12V DC	WATER	0-120 °C	52mm

Part numbers are used for reference purposes only.



Pressure Transducer

Part No.	Range	Working Voltage	Thread Size
9X1124	0-80 PSI	12 or 24 V	1/8" -27 NTP



Electrical Pressure Gauges

Part No.	Operating Voltage	Type	Range Type	DIA (mm)
6N0673	24V	OIL PRESSURE	0-100PSI	52mm
7W2937	24V	OIL PRESSURE	0-80 PSI	52mm

Mechanical Pressure Gauges



Part No.	Range	Engine Model	DIA (mm)
1W0703	0-30 PSI	FUEL PRESSURE	52 mm
1W0705	0-50 PSI	OIL PRESSURE	52 mm
1W0707	0-28 PSI	FUEL PRESSURE	52 mm
1W0708	0-150 PSI	AIR PRESSURE	52 mm
1W5353	0-15 PSI	OIL PRESSURE	52 mm
1W7554	0-30 PSI	FUEL PRESSURE	52 mm
1W7572	0-70 PSI	AIR PRESSURE	52 mm
2W3681	0-70 PSI	OIL PRESSURE	52 mm
2W3684	0-300 PSI	AIR PRESSURE	52 mm
2660889	0-50 PSI	FUEL PRESSURE	52 mm
3H3344	0-28 PSI	FUEL PRESSURE	52 mm
4W0506	0-100 PSI	AIR PRESSURE	66 mm
4W0509	0-400 PSI	AIR PRESSURE	66 mm
4W0510	0-50 PSI	AIR PRESSURE	66 mm

Costex Tractor Parts Copyright © 2020. All rights reserved.

Ammeters



Part No.	Range	DIA (mm)
1F7307	-30,0, +30A	52 mm
8M7892	-60,0, +60A	52 mm

GAS SPRINGS



Part No.	Use	Machine
1137329	ENCLOSURE GP-STORAGE	M312, M316C, M318, M320
1148861	HOOD GP ENGINE	416D, 442D, 428D, 420D, 436C
1151624	GUARD GP-OVERHEAD/ GUARD GP-FRONT WINDOW	320, 320L, 320N, 322, 325, 325C, 325B, 325L, 325LN, 330L, 345B II, 350, 375, 375A, 375L
1166325	ENCLOSURE GP-ENG/ GUARD GP-FAN/DOOR GP/ SUPPORT GP	M315, M315C, M316C, M318, M318C, M318D, M322C, M322D,
1166326	ENCLOSURE GP- STORAGE/ WALKWAY GP/ ENCLOSURE GP-ENG	M315, M315C, M316C, M318, M318C, M318D, M322C, M322D,
1219748	WINDOW GP - CAB	428C, 416C, 436C, 426C
1225762	CABIN GP	M318, M315, M312, M320
1429287	ARMREST GP	216, 216B, 216B3, 226B, 226B3, 228, 232B, 236, 236B, 236B3, 242B, 242B3, 247, 247B, 247B3, 248, 252B, 252B3, 257B, 257B3, 259B3, 267, 267B, 268B, 287
1439434	HOOD & GUARD GP	924G, 924GZ, 988F II
1439435	HOOD & GUARD GP	988F
1458867	COLUMN GP-ADJ/GAS SPRING AS/COLUMN AS-STEER	385B, 824G, 825G, 826G, 950G, 962G, 962G II, 966G, 972G, 972H, 980G, 988H,

Part No.	Use	Machine
1532682	SPRING GP-CAB / KIT - CAB DOOR / HANDLE GPASSIST	216, 216B, 226, 226B, 228, 232,232B, 236, 242, 242B, 246, 246C, 247, 248, 252, 256C, 257, 262, 267,267B,268B, 272D, 277, 277B, 277C, 277C2, 279C, 279C2, 287, 289C, 297C, 299C, 299D,
1572193	WINDOW GP- CAB	301.5 302.5 303.5 304.5
1532682	DOOR GP-CAB	216, 226, 228, 232, 236, 242, 246, 247, 248, 252, 257, 262, 267, 277,287
1594269	DOOR GP-CAB	420E, 450E, 416E, 428E, 428F
1606154	HOOD & GUARD GP	914G, IT14G, IT14G2, R1300GII, R1600G, R1600H, R1700 II R1700G
1641328	WINDOW GP - CAB	414E, 416D, 416E, 416F, 420D, 420E, 420F, 422E, 424D, 428D, 428E,430D, 430E, 430F, 432D, 432E, 434E, 438D, 442D, 442E, 444E, 446D,450E, 450F
1674179	WINDOW GP - CAB	312C, 312D, 315C, 315D L, 318C, 319C, 319D, 320C, 322C, 323DL, 323D LN, 324D, 324D L, 324D LN, 325C, 325D, 325D L, 329D L,330C, 330C L, 330D, 330D L, 330D LN, 330D MH, 336D L, 336D LN, 345C, 345C L
2035470	CANOPY GP	AP-600D, AP-655D, CP-433E, CP-44, CP-533E, CS-423E, CS-433E,CS-44, CS-533E, CS-54
2102516	DOOR GP-HOOD	IT28G, 928G
2102518	DOOR GP-HOOD	IT28G, 928G
2102519	DOOR GP-SIDE	928G, IT28G,
2287696	HOOD & GUARD GP	928 USAF10K ATFL, 924H & 924Hz, 924G & 924Gz, 930G
2303214	DOOR GP-CAB	216, 216B, 216B3, 226B, 226B3, 228, 232B, 236, 236B, 236B3, 242B,242B3, 247, 247B, 247B3, 248, 252B, 252B3, 257B, 257B3, 259B3,267, 267B, 268B, 287
2535343	ENCLOSURE GP-ENG	CP-573E, CP-663E, CS-563E, CS- 583E, CS-663E, CS-683E
3199510	STEERING COLUMN GP	IT28G, 938, 938H, 914G, 924H
3199512	STEERING COLUMN GP	416D, 420D, 424D, 428D, 430D, 432D, 438D, 442D, 446D, CB- 434D,CB-534D, CB-564D, CW-34

Part No.	Use	Machine
3381508	COLUMN AS-STEERING	414E, 416E, 416F, 420E, 420F, 422E, 422F, 428E, 428F, 430E, 430F,432E, 432F, 434E, 434F, 442E, 444E, 444F, 450E, 450F
8T7041	1 CABIN GP	R2900G, R1600G, R1700G, R3000H, 446B, 924F

STEPS



Part No.	Application
1987380	120K, 16H, 140K, 160K, 12H
1987379	12H, 135H, 120H, 160H, 140H
4V9809	16H, 12K, 140K, 120K, 12H
2234472	773F, 777F, 795F-AC, 775F
4V9810	785B, 789C, 785C, 793B, 793C
7T5140	D10, D8R, D9R, D11N
2341530	980H, 972H, 962H, 966H

Steps Support

Part No.	Step
8X1032	1987380, 1987379, 223447, 4V-9809, 4V-9810

IGNITION SWITCHES



Part No.	Description
1107887	SWITCH A
1428858	SWITCH AS-START

Part No.	Description
1632659	SWITCH AS-START
3E0156	SWITCH GP-START
7Y3918	SWITCH GP-HEAT START
9G7641	SWITCH G

*All switches include the key. The key is also sold separately.
Ask about part No. 5P8500



MIRRORS

Application	Part No.	Description
12H/K, 130G, 140G/H/K	5P6871	MIRROR
12H/M, 24M, 140M, 160M	2001173	MIRROR AS - EXTERIOR (LH)
12M, 16M, 120M, 140M	5P6874	MIRROR
12M, 16M, 120M, 140M	5P6877	MIRROR - LH/RH
24M, 374F, 993K, 972G	5P6879	MIRROR
24M, 816F/K, 825G, 836K	8Y4512	MIRROR - INTERIOR
307D, 315B, 318B, 311D/F	1225311	MIRROR
325D, 330B, 345B, 385C	4I8135	MIRROR
555D, 785C/D, 789D	2662292	MIRROR AS
555D, 793D, 797F, 924K	2755588	MIRROR
621F, 623F, 963D, 627F	5P6875	MIRROR - 2-POINT MOUNT
771D, 773B, 777D, 785C	6V6962	MIRROR A
771D, 775E/F, 777D/F/G,	1442227	MIRROR - EXTERIOR (RH)
772, 775F, 777F, 994K	3000560	MIRROR AS - HEATED
773B, 769C, 776B, 777B	5P6880	MIRROR
773E, 776D, 777D	2212465	MIRROR AS
773F, 775F, 777F	3227277	MIRROR AS ADHESIVE BACKED
773F, 777F, 789D	2790467	MIRROR AS - EXTERIOR (LH)
775D, 777D, D8R, D9R	8T2287	MIRROR
775F/G, 777D/F/G	7X7468	MIRROR - CONVEX

Part numbers are used for reference purposes only.

Costex Tractor Parts Copyright © 2020. All rights reserved.

Mirrors (cont.)

Application	Part No.	Description
775G, 777G, 793C/D	2219264	MIRROR AS - EXTERIOR (LH)
777G, 797F, 793B	3117059	MIRROR AS
797/B/F, 793D, 789D, 773G	1534010	MIRROR AS
797B, 793F, 794	3117058	MIRROR AS
814F, 816F, 924F, 960F	5P6876	MIRROR - LH / RH
D8T, D9R, D10R	6V9156	MIRROR

Mirrors for Komatsu®

Part No.	Application
20Y-54-28911	Excavators
20Y-54-74280	Excavators



FUEL CAPS

Fuel cap Part No. 3497059 is a direct replacement for Part No. 7X7700. It features a new filter to ensure better absorbance. It is built with an O-ring seal inside to provide better sealing and prevent fuel from leaking out of the fuel tank.

Part No.	Application
3380912	962H, 950H, 938H
3497059*	D7E, D9R, 326F, 12M, 320D, 950K

*Repair Kit # 3507735 is available. Includes Fiber seal, screws and washers.



Repair Kit

Part No.	Description
3507735	Filter Kit for Fuel Cap # 3497059

SEATS



CTP Seats now include more features to enhance the operator's comfort!

(seats only for heavy equipment)



CTP906A

- Adjustable armrest, flip up
- Weight Adjustment.
- Fore and Aft Adjustment Handle
- Document Pouch
- Backrest Angle regulator

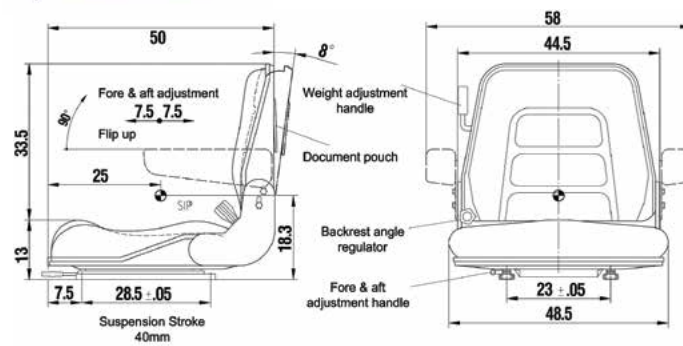

CTP906B

- Fore and Aft Adjustment Handle

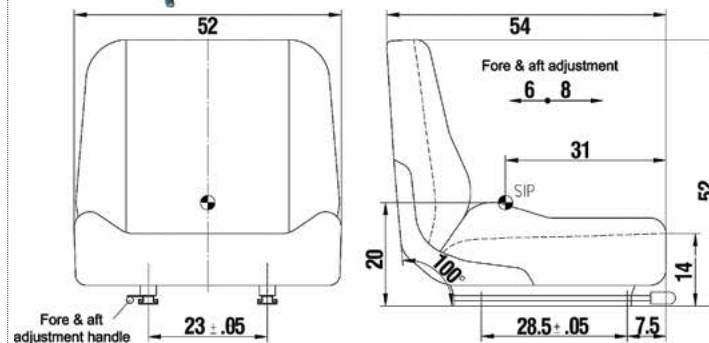

Enhancing the Operator's Comfort



CTP906C

- Backrest Angle Regulator
- Weight Adjustment
- Height Adjustment
- Suspension included
- Backrest angle regulator up to 28°
- Fold Forward Seat
- Durable Vinyl
- Option for headrest (see CTP906D)

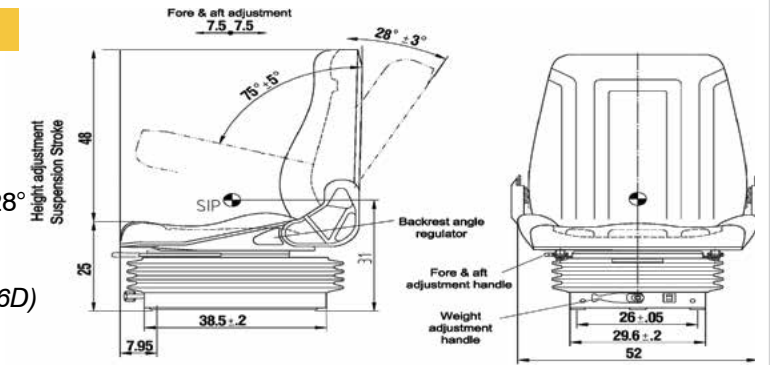

CTP906C

- Backrest Angle Regulator
- Weight Adjustment
- Height Adjustment
- Suspension included
- Backrest angle regulator up to 28°
- Fold Forward Seat
- Durable Vinyl
- Option for headrest (see CTP906D)

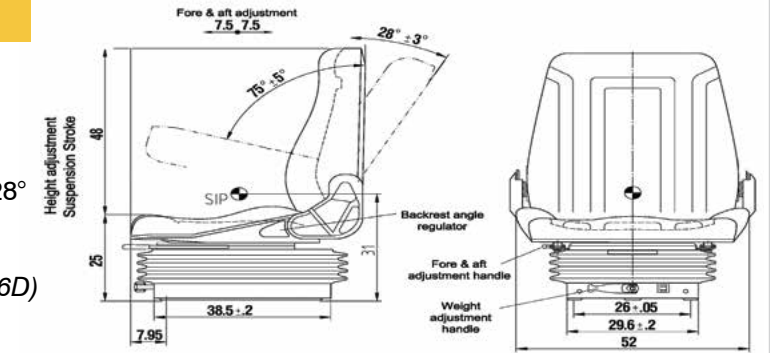

CTP906D

- Weight Adjustment
- Height Adjustment
- Suspension Stroke
- Backrest angle regulator up to 28°
- Fold Forward Seat
- Fore and Aft Adjustment handle
- Adjustable armrest
- Headrest

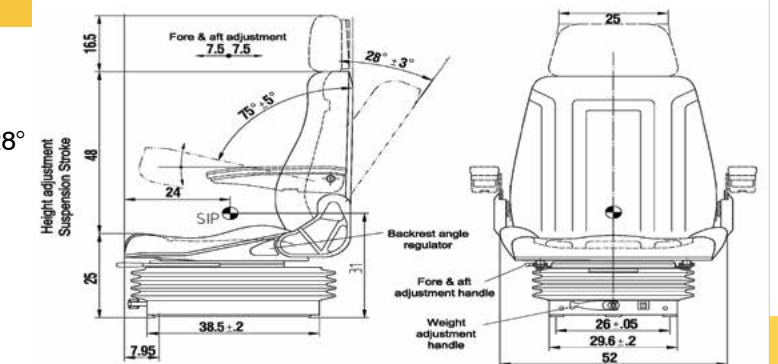

†All Measurements in CM

†All Measurements in CM

Part numbers are used for reference purposes only.

Part numbers are used for reference purposes only.

Seats(cont.)



CTP907C

- Fire resistant upholstery materials
- Standard Mounting
- Full foam support
- Mid-High back support
- Optional arm rest available, Part Number CTP907BA

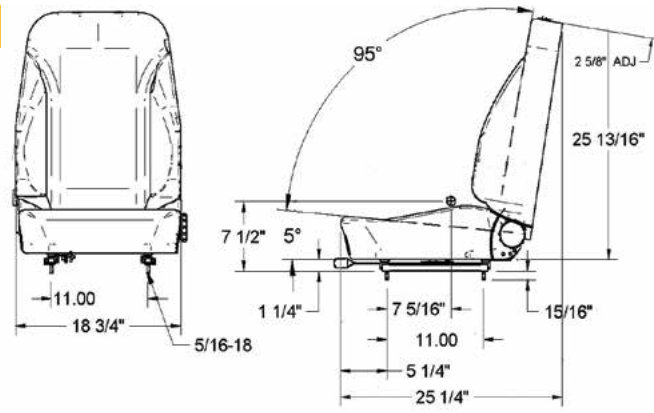

CTP907H

- Heavy duty/low profile mechanical suspension
- Adjustable Joystick armrests
- Bellow suspension cover
- Mid-Highback
- 3-inch height adjustment

Two weeks for delivery.

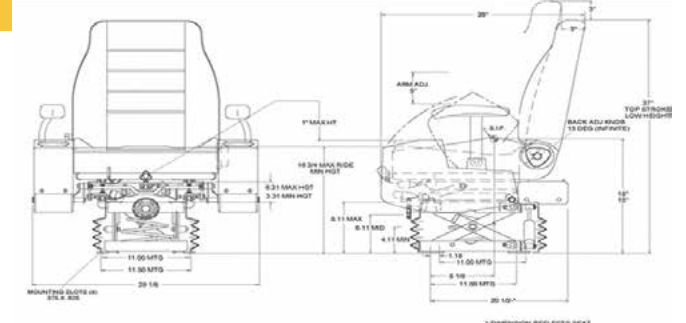

CTP907D

- Vinyl Upholstery
- Height Adjustment
- Mechanical Suspension
- Weight Adjustment
- Optional arm rest available, Part Number CTP907BA

**Arms sold separately*

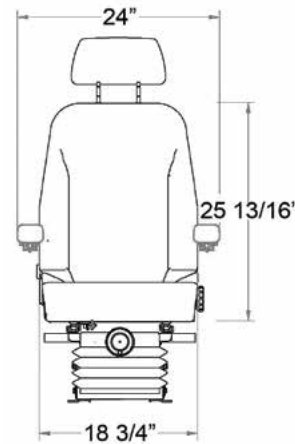

CTP907J

- Deep full foam cushion
- Wrap around back for side support
- Heavy duty vinyl covering
- Contoured, ventilated back
- 7-inch fore/aft slide adjustment

Two weeks for delivery.

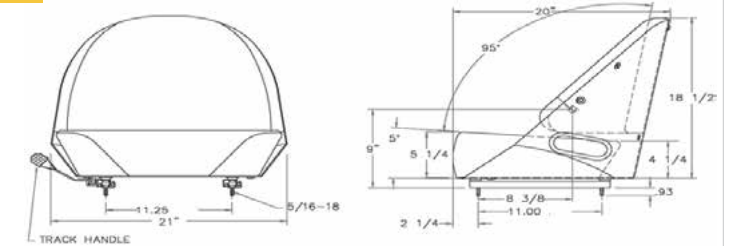

CTP907E

- Patented "knee-action" mechanical suspension
- Built-in, contoured lumbar and thigh support
- High or low-profile backrest
- Easy and fast one-hand control height adjustment with four positive lock positions
- Operator weight adjustments
- Contour comfort cushions
- Backrest angle regulator up to 15°
- Fore/Aft Adjustment handle

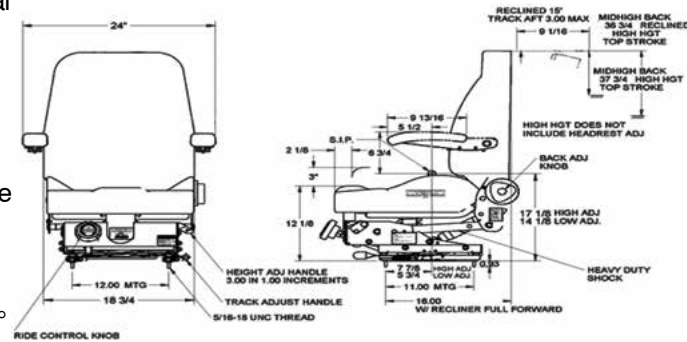

CTP907L

- Fire resistant upholstery materials
- Standard Mounting
- Full foam support
- Armrest

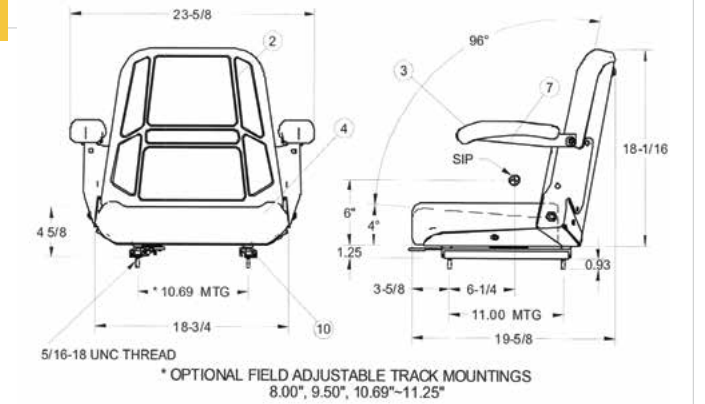

CTP907G

- Built-in, contoured lumbar and thigh support
- Mid-Highback backrest
- 2-way lumbar
- Mechanical Suspension
- Headrest
- Self-Skinned arms
- Fore/Aft Adjustment handle

Two weeks for delivery.

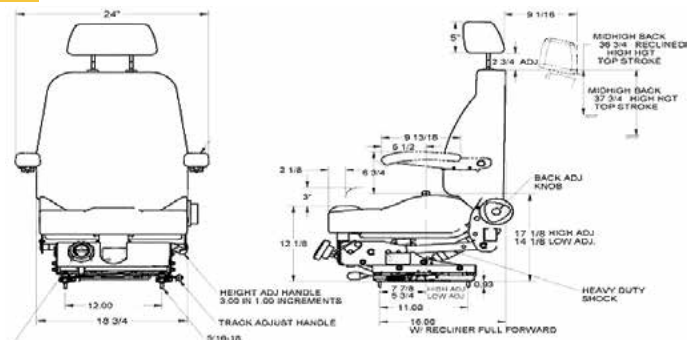

CTP907N

- Low Back
- No Recline
- 32 OZ Black Vinyl
- EVC Cushion Comfort System
- 5" Single Locking Tracks
- Low Profile Mechanical Suspension with 1.5" Suspension Stroke and Skirt
- Mounting 11.25" x 11.00"

Two weeks for delivery.

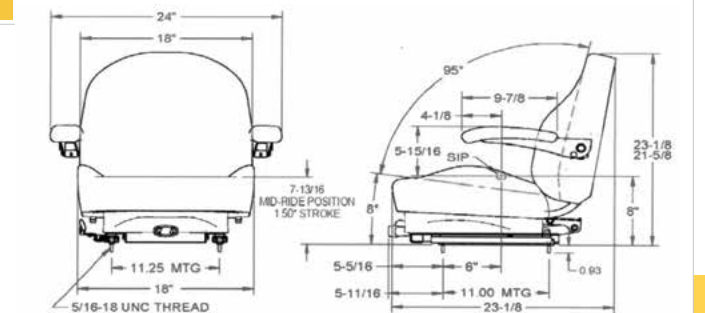

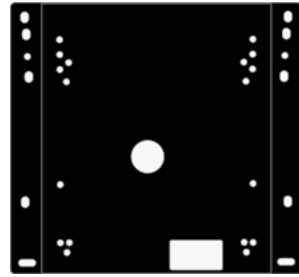

CTP907K

- Adapter Plate
- Several Mountings Available

Two weeks for delivery.

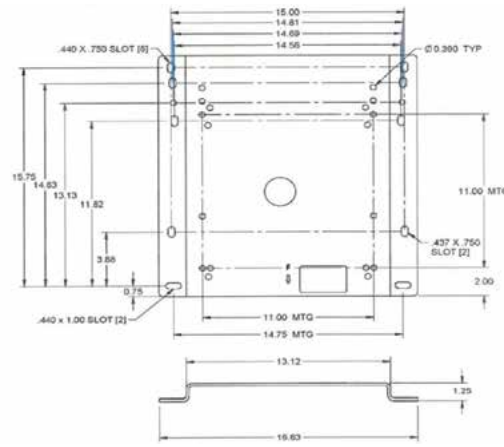

CTP907AS

- Heavy Duty Air Suspension



CTP907MS

- Mechanical Suspension

SEATBELT2 ^Δ

- Fully retractable seatbelt
- Two point

^Δ This item is sold for orders outside of the US only. Only for Export.



OIL COOLERS



Engine Oil Coolers

Application	Part No.	Description
D9L, 3412B	7C0145	CORE AS
D9, D9G, D9H	6N9654	CORE AS
D8L	7C3039	CORE AS
D8L	7W2164	CORE AS
D8H, D6K	7N0113	CORE AS
D7F, D8K	7N0110	CORE AS
D7E, D8H, D8K	6N9653	CORE AS
D6D, 3304	7N0165	OIL COOLER
D6C	7N6677	CORE AS
D399	4W5551	CORE AS
D398A, G398	4W5549	CORE AS
D379, G379	4W5550	CORE AS
D353, D353G, G353	7N0125	CORE AS
D343, 988	6N9213	CORE AS
D342, D8	5H1093	CORE AS
C13	2775774	CORE AS
988G	1330125	CORE AS
977K, 977L	7N6668	CORE AS
955K	7N0098	CORE AS
854K, 992C, 3412C	4W0419	CORE AS
785C, 3512B	4W4980	CORE AS
773G, 775D, 777D, 785C	2005975	CORE AS
773D, 785D, 789D	7W1713	OIL COOLER
631E, 740B	2237962	CORE AS
630, 631, 633, 657	6N9670	CORE AS
5230, 793C, 994D/F	1008008	CORE AS
5130, 777C, 3508B	1245142	CORE AS
345D, 349D, 966H, C11, C13	2368745	CORE AS
345B, C10	1154517	CORE AS
3208, 613C	1328597	CORE AS
231D, 3208	1328590	CORE AS
140M, 390D, 627G, 966M, C9	7W1762	CORE AS



SUMMARY TABLE OF KEY FEATURES

	CTP906A	CTP906B	CTP906C	CTP906D	CTP906E	CTP906F	CTP906G	CTP906H	CTP906I	CTP906K	CTP907A	CTP907B	CTP907C	CTP907D	CTP907E	CTP907F	CTP907G	CTP907H	CTP907J	CTP907L	CTP907N	
Backrest Angle Regulator	✓		✓	✓				✓	✓	✓												
Weight Adjustment handle	✓		✓	✓		✓		✓	✓	✓				✓	✓	✓	✓	✓				
Height Adjustment			✓	✓				✓	✓	✓				✓	✓	✓	✓	✓				✓
Mechanical Suspension included			✓	✓				✓	✓	✓				✓	✓	✓	✓	✓				
Fold Forward Seat				✓	✓		✓	✓	✓													✓
Handrail					✓		✓															
Headrest				✓				✓	✓	✓							✓					
Slides for Fore and Aft Adjustment						✓		✓		✓	✓	✓			✓		✓		✓			✓
Adjustable Armrest	✓			✓				✓	✓	✓					✓	✓	✓	✓		✓	✓	✓
Document Pouch	✓						✓															
Fore and Aft Adjustment Handle	✓	✓	✓	✓		✓	✓		✓	✓					✓	✓	✓	✓	✓			

Part numbers are used for reference purposes only.

Costex Tractor Parts Copyright © 2020. All rights reserved.

Engine Oil Coolers (cont.)

Application	Part No.	Description
3516	4W5405	CORE AS
3208	7W1762	CORE AS
3126	2674743	CORE AS
988	6N9220	CORE AS
910	2W7590	CORE AS

Hydraulic Oil Coolers

Application	Part No.	Description
D7H, 12G	1W0289	CORE A OIL COOLER
D5/B, D6C, D7G	2W9978	CORE A OIL
980B	4N5915	CORE A OIL
966C	1W0219	CORE A OIL
928F, 938F	9Y1962	CORE A OIL
416C, 436C	1134941	CORE AS
345B	2813581	CORE A OIL
330B	2316877	CORE A OIL
320D, 321D	3128338	CORE AS
320C, 320C L	1838101	CORE A OIL
320C	2653563	CORE A OIL
320B, 322B	1189954	CORE A OIL
235C/D	1047366	CORE A OIL COOLER
120H, 135H, D7R	1437397	CORE A OIL
320	7Y1961	CORE A

Radiator Oil Coolers

Application	Part No.	Description
994F/H/K	2235121	CORE AS
966, 966C	5S4587	CORE AS
950B/E	4W1533	CORE AS
815B, 966D, 3306	2W7933	CORE AS
330, 330L	7Y1363	CORE AS
320, 320L	7Y1960	CORE AS
5130	6I4186	CORE AS

Torque Converter Oil Coolers

Application	Part No.	Description
N/A	1S0172	CORE AS
D9H	6N9514	OIL COOLER
D7E, 663, 657	6N9211	CORE AS
D6D	8N4363	CORE AS
980B	1W0223	CORE AS
977K, 977L	1W0225	CORE AS
972K, C9, D6T, D6R	1873523	CORE AS
955K	1W0220	CORE AS
836B, 173B, 183	6N9752	CORE AS
777D	1414109	CORE AS

Transmission Oil Coolers

Application	Part No.	Description
D9R	1011741	CORE AS
815N, 950	1275537	CORE AS
966G, 972G	1551216	CORE AS
3408B	1W0156	CORE AS
D8, 3406B	4P7731	CORE AS
776D, 785B, 785D	4W5056	CORE AS
D10T, C27	4W5412	CORE AS
3406	4W7382	CORE AS
D8T, C11, C15	4W9822	CORE AS
D5, D6C/D, D7F, 966C	6N9215	CORE AS
3412, D10N	7C6461	CORE AS
D400E	7C8858	CORE AS
D330, 3304	7N0104	CORE AS
D4, D4E, D5, D5B	7N0128	CORE AS
3306, D6	7N3521	CORE AS
D8K, D8L	7W0205	OIL COOLER
621E, 623F, 637E	7W6459	CORE AS
527, D5H	1023514	CORE AS
936F	1052077	CORE AS
834B, 836, 988B	1058651	CORE AS
824G, 826G, 980H	1355577	CORE AS
834G, 836G, C15, C16, C31	1459283	CORE AS
572R, C13, D7R	1668598	CORE AS
140M, 160M, 163M	1757453	CORE AS
615C, D7G, D11R	4W5363	OIL COOLER
735, 740, C15, C16	7E2660	CORE AS



RADIATORS

Machine/ Engine Model	Part No.
924F, IT24F, IT18F	1104347
330, 330L	1132923
420, 416D, 428C, 436C	1403634
320B, 320L	1415722
322B, 322BLN, 325B	1415975
320B, 320BL	1843896
140H, 120H, 160H, 12H	1857980
320C, 318C, 319C	1932767
414E, 416E, 420E, 422E	2105948
345C, 345D, 349D	2302966

Machine/ Engine Model	Part No.
320C, 320CL, 320CS	2364430
325CL, 325CLN, 322CL	2364454
330D, 336D, 340D2L	2459359
950H, 962H	2565310
14G	2625755
320CL, 320C	2653563
420E, 422E, 434E, 416E	3019672
320D, 321D, 323D	3128338
320D, 325D, 324D, 329D	3263870
950G2, 962G2	3347677
950H, 962H	3498238
320D, 323D	3609273
320D, 323D	3786178
320D, 323D	4331670
966D, 966E	1N3219
977L, 977K	1P1683
966C	1P4404
D4D	1S0364
950B	1W1895
955K, 955L	2P1332
D6, D6C, D6D	2P3775
D4E, D4D	2P4648
D6, D6C	4N6298
3412, 3406C, 3408C	4N8559
3408C, 3412C	4N8995
416B, 428B	4P3377
428B, 436B, 416B	4P3379
988B	4W4987
D4D	5S4592
D5	5S8450
D5, 561C	6N0541
D5B	6N0542
D7G	6N1218
416C, 428C, 438C, 436C	7E4639
528, 530B	7N3111
D8L	7N3112
D6D, D6E, D6G, D250E	7N3542
D5B, D5E	7N4987
D4D, D4E	7N6223
950	7S2244
320, 320L	7Y1961
120G, 140G, 12G, 160G	8N0073
D8K	8N2602
D4E	8N3545
930R	8N7857
930, 930R, 120B	8N7859

Machine/ Engine Model	Part No.
980B	9S5149
3508B, 3512B, 3516, 3516B	9Y5983



Folded Core Radiators

Machine Model	Part No.
1516, 797B	2W6632
24H, D10R, D9R	1194774
5130/B	6I4186
527, 938F, 950G, 962G, D5D, D6M	1082387
583R, D8R, D7R	1139539
587R, D7R, D8R, D10R, 972G, 966G, 621G, 627G	1093622
631E, 657E, D9N, D11N, 769D, 771D	9Y3317
631G, 637G	1192166
75D, 65D, 65C/E, 627F, 637G, 950B, 950E, 793C	2W5539
776B/D, 777B/C/D, 797B	7W2173
785C/D, 789B/C, 784C	2W0181
789D, 795F, 980C	9Y3318
815F, 936F, 966F, 970F, D4H	4P0897
916, D4D, D4H, 936F	4P0890
928F, IT28F, IT38F, IT18F	4P0891
950F, 960F	4P0893
966D, D6H, D8N, D7G, 621G, D7H, 793C, 623G, 633	2W5540
970F, 980F	4P6508
980G, 578, 980F, D8N	7E9595
980H	2235060
988F	4P5711
992G/K, 854G/K, 994D/H	2235120
D10N/R/T, D9T	2139906
D10N/T, D9R, D9T	2562090
D10R, 631G	1708541
D10T	2139907
D10T, D9R	1634057
D11N	7W9541
D11R, D11T	2138188
D11R/T	2191073
D5H	4W4146
D6D	2W5537
D6H, D6H XL, D6R, D7R	4P0854
D6R, D7R	1750505
D6R/T	2235111
D7H, D6H	4P0894
D7R	2278918
D8L, D9N, D9R	6I2433
D8R	1634062

Folded Core Radiators (cont.)

Machine Model	Part No.
D8R, D9R	1634061
D8R/T	2200538
D9R	1634059
D9R	1634058
D9R, 980G, 814F, 815F	612432
IT28/B, IT18/B, D4H, 926/F, 936	2W5536
N/A	2W5538

REVERSIBLE & STANDARD FANS



Standard Fans

Part No.	Description
1080725	D6M
1188458	D7R, D8R
1197864	938G, IT38G, 950G, 120H, 135H, IT62G, 962G
1200300	M318, M320
1265975	416C, 416D
1423391	416C
1730419	D8R
1786578	320C/C L/C LN, 318C L/C LN, 319C LN, 320C U/C LU
1947049	12H, 120H, 14H, 140H, 140H NA, 135H, 160H, 163H
2040910	320C, 320CL, 320CLN, 330C, 330CL, 330CLN
2302892	320E
2459343	320D, 320D L, 321D LCR
2459344	320D/D2, 320D L, 320D LN, 323D, 323D L, 321D
2501911	583T, 587T, D8R, D8T
1N8173	3304/B, 3306, 3512, G3408, G333C, D333C
1P7936	235B, 235C, 235D, 627B
1S0572	D8H, D8
1W7940	D6H, D6HLGP, D6H-XL, D6H-LS, D6H-XR
2P2521	CS-573/C, CS-533/C, CS-531, CS-583/C, CP-533, CP-563C
2P8907	12G, 120G, 14G, 130G, 160G
2S4638	633C, 637, 988, D8H
2W5082	D8L
3N2444	255
4I7592	320, 320L, 320N
4N2572	330
4N3092	C9, 350, 350L
4N3339	3406, 3408B/C/E, 3412/C/E, 3508, C15, C18, C27, C32, 3516, D379/B

Part No.	Description
4N8344	955, G936, 936E, D5B
4N8434	16H, 16G, 621B
4N8871	D4D, D4H, D4H-XL, D4H-LPG, 517, IT18B, IT28B, 916, 926E/F, D4E, G926
4W0255	973, 966D, D6R, D7H
4W8409	D8K
5I7894	317, 318BL & BLN
5I8000	320, 320L, 320N, 315C, 315CL
5M5880	D5, 950, 951, 955
5M5881	12E
5S1421	966C, D7E
5S9897	D4D, 561, 574
6I1363	910, 931
6I1364	IT12, 931C, 935B/C, D3C, D3C-LGP, 931B, 910, D3, D4B, D4C, D4C-LGP, G910, D3B
6N2687	C15, C16, C18, R1600/G/H, R1700, R2900, 980C/F, TH35-C151, 826C, 983B
6N5339	534B, 836, 988B
7C5591	3304
7E3557	R1700G, 815F, D7R, 966F, 572R, 814F, 970F, R2900, 966
7N0476	963, 950B
7N2131	D8L
7N8253	924F, 924F, D5H, IT24F
7S0542	920, 930, 350, D4, D5
7S0543	D5
7S0544	D6C, 613C, D5B, 955L
7S0545	627, 875, 966
7S0546	966, 966C, 966R, 977L,
8N0036	235B, 235C, 235D, 627B
8N6584	D6D
9M1904	950
9N6010	322C, 325
9S9696	D7, D7F, D7G, 572G
9Y7840	950F



Reversible Fans

Part No.	Machine Model
1251362	D6R, D6T, D7H & D7HLGP, D8N
1359960	D9R
1479670	N/A
1479672	D8K, 583K, 983B/D

Guards

Part No.	Machine Model
1P7763	D6C, D6D, D6F
1P7764	D6C, D6D, D6G

Fan Drives

Part No.	Machine Model
2813588	320D, 321C, 321D, 323D
4629952	N/A
3096159	D6N LGP
3592658	320E, 323F L, 323E L, 323E LN, 326D2 L, 326D2, 329D2, 330D2 L
2813589	M325D L, M325D, 324D, 324D LN, 325D, 325D L, 325D LN, 328D L, 329D, 329D LN, 329D L
3240123	320D, 320D L, 320D, 320D LN, 321D L, 323D L, 323D, 323D LN, 320D, 320D F

COOLANT/TEMPERATURE REGULATORS



Application	Part No.
3056	4W8063
3066	5I8010
3116	1I93075
3204	3062103
3208	1028392
3054, 3054C	2202748
3054C, C6.6	2542267
3056E	2169737
3114, 3116	1265869
3116, 3208	9N5121
3116, 3208	9N6341
3304, 3306	1118010
3306, G3612, C12, C15	2477133
3512C, 3516C	2193240
3516, 3512	2485513
3606, 3608, 3612	6I4955
44H, D4D	9S3808
966C	2S4044
C2.2, 3024	2495541
C9, 3126, 3208	2845421
D342	4W4011
D353	6N4540

Part numbers are used for reference purposes only.

Application	Part No.
G3306	1167577
G3616	6I4953

WATER PUMP IMPELLERS



Machine/ Engine Model	Part No.	Water Pump
3304, 3306	1725190	1727772
3406, 3456, C12, C15, C16, C18	1299907	1745986, 3520203, 3520211, 3520212
3408E	1371930	1371338
C27	1371970	1371339
3114, 3116	1523952	7C4508
3304, 3306, 3306B	1725189	1727760, 1727762
3304, 3306	1726712	1727775, 1727775
C9	1771056	2027674
3066, C6.4, C4.2	1786634	1838232, 1786633
212, D2	1M7567	1M8042
D315	1M7571	4M3973, 1L0655
933, 955	1M7573	9H8382
3304, 3306	1P9952	1727775, 1727776
3056, 3508B, 3512C	2128183	2914311, 2914312, 2914313
3516	2128184	2128177
3508	2128187	2128176
C13, C11	2239143	3520205
C7	2266039	2274300
3204, 3208	2W3535	2W1223, 2W1225
D333	4M2346	2S5597
N/A	5F9872	N/A
3064, 3066	5I7694	1252989, 1252991, 5I7777
D353	6N6423	6N6424
3306, 3304	6N8411	1727766
3408B	7C1067	1341486, 1371338
3412	7C1068	1371339
D399	7L0103	6L8983
D399	7L0104	2N0955
D379, D398	7L0104	4L8800
342, D342	7M5692	6N6015

Costex Tractor Parts Copyright © 2020. All rights reserved.

Water Pump Impellers (cont.)

Machine/ Engine Model	Part No.	Water Pump
3306, 3304	7N5910	1727767, fw3060, 1w6602
D320A, D4D,951B,955H/K	8H9329	1S5910, 4S7441, 3S7553
3406	8J5479	4T2767

Machine/ Engine Model	Part No.	Water Pump
D353	8M6561	6N6424
14E,D6C,D7F,941,966C	9S8041	5S6684
3406B, 3406C	9Y3778	1354926



SEA WATER PUMPS & COMPONENTS

Engine Model	Part No.	Impeller	Shaft	Seal Lip	Seal Group	Bearing	Water Seal	Wear Plate	Cam
3116	4P7168	7E0321	6I2072	1149088	N/A	8H4320	2003052	7E0328	7E0319
3406/B/C	3N4851	3N4859	3N4858	3N4863	N/A	1B3867	3N5632	3N4862	3N4860
3408B/C,3412/B/C/D	7C3613	3N8449	7C3493	5N2902	5N6055	4M6107	N/A	5N4504	N/A
C12	2533459	5N9360	5N9359	1635713	7L2130	N/A	5J2974	4L8473	2592553
D343,D353E	3N1888	3N4859	3N5692	3N4863	3N5632	1B3867	3N4866	3N4862	3N4860

WATER PUMPS & COMPONENTS



Engine Model	Water Pump Part No.	Repair Kit	Impeller	Shaft	Seal Lip	Seal Group	Bearings	Water Seal
3046	1175033	N/A	N/A	N/A	N/A	N/A	N/A	N/A
3046, 3044C	1072473	N/A	N/A	N/A	N/A	N/A	N/A	N/A
3054	6I0441	1514840	N/A	N/A	N/A	6I0444	N/A	1514838
3054	3541672	2470144	N/A	N/A	N/A	N/A	N/A	N/A

Engine Model	Water Pump Part No.	Repair Kit	Impeller	Shaft	Seal Lip	Seal Group	Bearings	Water Seal
3054	1514825	N/A	N/A	N/A	N/A	N/A	N/A	1514838
3054	2396142	6V6899	N/A	N/A	N/A	N/A	N/A	N/A
3054, 3056	2396142	2340636	N/A	N/A	N/A	N/A	N/A	N/A
3054C	2307355	2470144	N/A	N/A	N/A	2257738,2257739	N/A	N/A
3056	1487192	N/A	N/A	N/A	N/A	N/A	N/A	1514838
3056E	2346110	2340636	N/A	N/A	N/A	N/A	N/A	N/A
3066	1252991	N/A	5I7694	5I7961	N/A	N/A	5L6326	1252990
3066	1838232	N/A	1786634	1838233	N/A	N/A	0968381	1786636
3066, 3064	1252989	N/A	5I7694	5I7695	N/A	N/A	5L6326/ 2H3814	1252990
3114, 3116	4P8520	N/A	1523952	2777089	N/A	2W0712	N/A	3505417
3116	4P3683	N/A	1523952	2777089	N/A	1475088	N/A	3505417
3116	7E7398	N/A	1523952	2777089	N/A	N/A	N/A	3505417
3116	1593142	N/A	1523952	2777089	N/A	N/A	N/A	1475088
3116	1265918	N/A	1523952	2777089	N/A	N/A	N/A	2W0172
3116, 3126	3522150	N/A	1523952	2777089	N/A	N/A	N/A	3505417
3116, 3126	1593140	N/A	1523952	2777089	N/A	N/A	N/A	1475088
3116, 3126, 3114	7C6438	N/A	1523952	2777089	N/A	N/A	N/A	3505417
3116, 3126E	4W7589	N/A	1523952	2777089	N/A	N/A	N/A	1475088
3126	3522152	N/A	1523952	2777089	N/A	N/A	N/A	3505417
3126, 3116	3522151	N/A	1523952	2777089	N/A	N/A	N/A	3505417
3126, C7, C9, 3126B/E, 3116	1208402	2641260	1523952	2777089	N/A	N/A	N/A	3505417
3126/B/E, C7	1408068	N/A	1523952	4W0250	N/A	N/A	N/A	1475088
3126/E/B, C7	1593141	N/A	1523952	2777089	N/A	N/A	N/A	1475088
3126B, C7	3522138	N/A	1523952	1291170	N/A	N/A	N/A	3505417
3126B, C7	3522139	N/A	1523952	1291170	N/A	N/A	N/A	3505417
3176, 3176B	1025844	1074912	6I2847	1030730	8C3100	N/A	N/A	2W0712
3204	2W1223	6V6896	2W3535	1W5646	6V5014, 6V6917	N/A	1W5646	2W0712
3208	2W1225	6V6894	2W3535	9N3078	N/A	N/A	5P7807	2W0712
3304, 3306	1727772	1700560	1725190	2W7255	8C5210	N/A	6H3957	4W3864
3304, 3306	1727778	1700556	1726712	1725188	8H9520	N/A	6H3957	1313815
3304, 3306	1727775	1700556	1726712	1P9929	6V3988	N/A	6H3957	1313815
3304, 3306, 3306B	1727766	1700567	1725189	1725185	N/A	1691750	6H3957	1544482
3304, 3306, 3306B, 3304	1727771	1700567	1725189	1725185	N/A	1691750	6H3957	1544482
3304, 3306B	1727767	1700570	1725189	1725185	1544482	N/A	6H3957,8H9789	1691750
3306	1752382	1700564	1725189	1725185	1544482	N/A	6H3957,8H9789	1691750
3306	1727763	1700567	1725189	1725185	1544482	1691750	6H3957	N/A
3306	1727776	1700558	1726712	1725188	8H9520	N/A	6H3957	1313815
3306	1752382	1700564	1725189	1725185	N/A	1691750	6H3957	1544482
3306, 3304, G3306B, 3304B	1727760	1700560/1700564/1700570	1725189	1725185	1544482	1691750	6H3957	N/A

Water Pumps & Components(cont.)

Engine Model	Water Pump Part No.	Repair Kit	Impeller	Shaft	Seal Lip	Seal Group	Bearings	Water Seal
3306, 3304, G3306B, 3306B	1727767	1700564, 1700570	1725189	1725185	N/A	1691750	8H9789	1544482
3306, 3306B	1727762	1700556	1725189	1725185	N/A	1691750	6H3957 (2)	1544482
3306, 3306B	1727765	1700564, 1700570	1725189	1725185	N/A	1691750	N/A	1544482
3406, 3406B, 3406C	3520203	3777037	1299907	1354928	1531256	N/A	1087930	3492654
3406, 3406E, 3456	3520212	3777037	1299907	1354928	1531256	N/A	1087930	3492654
342, D342	6N6015	N/A	7M5692	6N5987	N/A	6N4743	2L5271, 8H9789	6N5475
3508, 3508B, 3512, G3512	2128176	2225153	2128187	2128180	3D2824	4160603	N/A	8C5236
3516	2128177	2225152	2128184	2128180	N/A	4160603	N/A	8C5236
4.236 Perkins	7E9195	7E9197	N/A	N/A	N/A	N/A	N/A	N/A
C2.2, C1.5, 3014, 3024/C	3110053	N/A	N/A	N/A	N/A	N/A	N/A	N/A
C4.4, 3054C	3541672	2470144	N/A	N/A	N/A	N/A	N/A	N/A
C4.4, C6.6, C7.1, 3054C	3544754	N/A	N/A	N/A	N/A	N/A	N/A	N/A
C6.4, C4.2, 3066	1786633	N/A	1786634	1786635	N/A	N/A	5L6326	1786636
C7, 3126, 3126E	1268227	N/A	1523952	2777089	N/A	N/A	N/A	3505417
C7, C7.2, C9	3522109	N/A	2266039	3971832	N/A	N/A	N/A	3505417
C7, C9, 3126E	3522080	N/A	2266039	3971832	N/A	N/A	N/A	3505417
C9	3522125	N/A	1771056	3971832	N/A	N/A	N/A	3505417
C9	3502537	N/A	1771056	1771050	3505417	N/A	N/A	3505417
C9	3502536	N/A	N/A	N/A	N/A	N/A	N/A	3505417
C9	3522076	N/A	N/A	N/A	N/A	N/A	N/A	3505417
C9, C7, C7.2, 3126B	3522081	N/A	2266039	3971832	N/A	N/A	N/A	3505417
C10, C12, 3176C, 3196	3522077	N/A	1766995	3971832	8C3100	N/A	1B3867(2)	3505417
C11, C13	3520205	N/A	2239143	2916905	8C3100	N/A	1B3867	3492654
C11, C13	3520206	N/A	2239143	2916905	8C3100	N/A	1B3867	3492654
C12, C15, C16, C18	1745986	3777037	1299907	1354928	1531256	1280317	1386744	3492654
C15, C16, C18	3520211	6V6938	1299907	1354928	1531256	N/A	1087930	3492654
C15, C16, C18, 3406, 3408C	3520211	3777037	1299907	1354928	1531256	N/A	1087930	3492654
C15, C18	3362213	2672839	2463129	2463130	1531256	N/A	1087930	3362212
C32	4N5837	3777037	1371970	1354928	1531256	N/A	1087930	3492654
C32, 3412, G3412	3520200	3777037	1371970	1354928	1531256	N/A	1087930	3492654
D353, D9H, 594H	6N6424	N/A	6N6423	6N6422	7M4236	1664376	2H8726 (1)	4160603
D379, D398	4L8800	1W7080	7L0104	5N4378	2N2560	1664376	4L3756/5L2660	4160603
D7F, 930, 950, D5, 951B, 561C	5S6684	1W7082	9S8041	5S6116	N/A	N/A	N/A	1N9177
G3306, G3306B, G3304	1727764	1700557	1725189	1725185	1544482	N/A	6H3957(1), 1B3867(1)	1691750
G3408, 3408, 3408E	4N1951	3777037	1371930	1354928	1531256	1280317	1087930	34926542
G3408, 3408C, 3408	3520209	3777037	1371930	1354928	1531256	N/A	1087930	3492654
G3516, 3508/B, 3512, 3516	2914313	2944935	2128183	2128179	9X4594	N/A	N/A	2624378
G3516, 3516B, 3512/C, 3508	2914311	2944935	2128183	2128179	9X4594	N/A	N/A	2624378

ALL PART NUMBERS ARE SOLD SEPARATELY UNLESS OTHERWISE STATED.

ELECTRICAL PARTS



ALTERNATORS

Part No.	Voltage	Engine Model	Machine
6N9294	24V 35A	C7, 3406C, 627F, 3508B	140k, 627F, 12H, Industrial
1125041	24V 50A	3406/C, 3408/E, 3412	16G/H, 627F, 637E, 120H
1005047	24V 50A	3406/C, 3408/E, 3306	16H, 627F, 631E, 769C, 12H
1693345	24V 60A	3406C, C15, C7, C13, 3412E	16H, 771D, 627F, C280-16
2721889	24V 150A	C13, C6.6, C32, C9.3, C7.1	16M, 930K, D11T, 797F
1449954	12V 55A	3034, 3044c	216, 226, 228, 236
3943496	12V 85A	C1.5	216B, 226B, 232B
2035492	12V 110A	3044C, C3.4, 3046, 3034	277C, 259B3, 246C, 939C
2128622	24V 50A	3064, 3066	311C U, 320C/L
517615	N/A	3066	320, 320 L
2128561	24V 54A	C6.4, 3066	323D, 320D
3E7577	24V 75A	3512C, 3408E, 3456, 3306	385B, D8R, 627F, 12H, 797B
3832556	12V 100A	C6.6, C4.4, 3054C	416E, 414E, 422E, Industrial
3832557	12V 120A	420D, 432D, 434F, 416F	416F, 420D, 432D, 434F
1052813	12V 90A	3054/B/C	426C, 428C, 436C, 424D, 416D
1171379	12V 130A	C7, C9, C12, C16, 3126B	460, 85C, 470 R, 480 R, 75C
3062174	24V 150A	C13, C7, C15, 3512B, C27	587T, 583T, D6R, D8T, D7R
1855294	24V 65A	3406E, C7, C13, C9, C15	740, D8R, 336D2, 340D2
2008281	24V 75A	3406E, 3408/E, C15, 3456	740, D9N, 623G, 621G
2002232	24V 75A	C15, 3406E, C18, 3408E	740B, 657G, 631E, 623G, 633E
3445081	24V 115A	C15, C18	772G
2267683	24V 95A	C32, C18, C27, C7.1, C15	777F, D11T, 772G, 390F
1978820	24V 95A	3516, C7, C15, 3516B	789C, 793C, D8T, 140K
3167251	24V 105A	3516, 3406C, C7, C18	793C, 789C, 16H, 793B
2579466	24V 95A	C15, C18	826H, 836H
7N6118	12V 40A	3204	931, D3/LPG, 910
7N4784	12V 40A	3204	935C, 931C, D3C, 931B
8N2268	12V 75A	3204	935C, D3C, 931C, 910, D4C
2357132	24V 65A	C6.6	938H
1052811	12V 55A	3046	939/C, D4C/LGP, D5C, 933
2357133	24V 80A	C13, C9.3, C11, C7.1, C15	972H, 366F, 14M, 329E, 352F
3397766	12V 85A	C4.4	CB54, CB64
3469826	24V 55A	C2.2, 3056E, 3024C	CS-563E, Industrial
6T1195	12V 61A	4.236	CS323, CP-323
3469827	24V 75A	C4.4	CS54B, CP54B, 420E, CS44
2Y8310	28V 21A	3304, 3306/B, 3408B	D4E, D5E, 966C, 930T
1077977	24V 70A	3116, 3306, 3196, 3176	D6M/LGP, DR7, 365B, 572R



Part numbers are used for reference purposes only.

Costex Tractor Parts Copyright © 2020. All rights reserved.

Alternators (cont.)

Part No.	Voltage	Engine Model	Machine
3662756	24V 115A	D6R, D7R, 980H, 950H	D6R, D7R, 980H, 950H
2047449	24V 100A	3408C, 3456, C9, 3176C	D9R, 836G, D6R, D8R, D7R
0969299	24V 30A	N/A	E200B
6T1395	24V 35A	C15, 3406C, 3408C, G3306B	Gas, Industrial, Petroleum
3E7892	12V 85A	3408C, C27, 3412E, C32	HT400, CX31-C9I
2253143	12V 85A	C2.2, C4.4, 3024C	Industrial
3397767	12V 65A	C6.6, C4.4, C3.3, 3054C	Industrial
3491369	12V 85A	3024C, C.2	Industrial
4N3986	24V 60A	3406, 3512, 3508, 3126	Industrial, Gas, Petroleum
1259597	12V 145A	C7, C13, C9, 3196, 3176	Industrial, Petroleum, 95E
5N5692	24V 45A	3512C, 3406E, C15, C18	Industrial, Truck, Petroleum
9W3043	24V 52A	3054, 3116, 3126, 3208	M318, 938G, IT28G, 322C/LN
3991485	24V 75A	M322D/420E/914G	M322, 420E, 914G
1092362	24V 55A	3056/E, 3054/T	M322C, M315, 312, 317/N
2667226	24V 75A	3516B, C18, C7, C32, C9	Marine, Industrial
6T1396	12V 51A	C15, 3406E, G3304, 3306	Marine, Industrial, Gas
2667227	24V 60A	C15, 3508, 3406C/E, C7	Marine, Industrial, Truck
2667224	12V 110A	C7, C15, C9, 3406C, 3126B	Marine, Petroleum, Industrial
1492061	12V 65A	4.236	N/A
7G7889	12V 60A	C7, C9, C13, C18, 3406C	Petroleum, Industrial
515178	24V 50A	EL200B	S6KT
3331184	12V 65A	C3.3, C4.4C, 3054, 3056	TH-35-C13I, TH35-C15I
2076036	12V 105A	3054, C32, C13	TH350B, TH220B
1008223	12V 55A	3054, 3056	TH62, TH103, TH63, Industrial
1214134	12V 115A	3176B, 3406C, C15, 3456	Truck, Industrial, Petroleum

AIR CONDITIONING COMPRESSORS



Part No.	Engine Model	Part No.	Engine Model
1540490	3046	1984564	3508
3E1908	3054	1149484	3116, 3126
1717495	3066	1630872	3176C
2457781	3066	2777245	C11
1065122	3116	1835106	C15
7N4296	3208	3050325	C7
2180324	3412	1789570	C9
7N4297	3412	3050324	C9
8T8816	3412		

RECEIVER / DRYER



Part No.	Application	Description
416F2, 420F2, 426F2, 427F2, 428F2, 430F2, 432F2, 434F2, 444F2	4155056	DRYER AS - (RE-CEIVER)
225, 235, 245, 621B, 623B, 627B, 637D, 663D, D7G, D8K	6P1309	DRYER - (RE-CEIVER)
550B, 560B, 574B, 580B, D350E, D400E	1065532	DRYER - (RE-CEIVER)
12G, 14G, 16G, 120G, 130G, 140G, 988F, 994/D/F	1065533	DRYER - (RE-CEIVER)
416B, 426B, 428B, 631E, 633E, 637E, 814B, 816B, 824C	1065534	DRYER - (RE-CEIVER)

ALARMS & HORNS



Alarms

Part No.	Description	Voltage
1545428	BACK UP ALARM	12-36 Volts
2139100	BACK UP ALARM	12-36 Volts
3701485	BACK UP ALARM	12-36 Volts
3T1815	BACK UP ALARM	12-24 Volts
3E6328	ALARM	24V
9G9813	ALARM	24V
9G9813	ALARM	24 Volts

Horns



Part No.	Description	Voltage
1631201	FORWARD WARNING HORN (LOW TONE)	24 Volts
1747875	FORWARD WARNING HORN (HIGH TONE)	24 Volts
7Y3919	HORN AS (LOW TONE)	24 Volts

Part No.	Description	Voltage
7Y3920	HORN AS (HIGH TONE)	24 Volts
9D4049	AIR HORN	N/A
5D6998	AIR HORN	N/A



ARMATURES

Part No.	Application	Voltage
0949885	3066, S6K	-
3E7855	322B, 325C, 926G, 928G, 950G, 960F	24 VOLT
3T0867	12G, 120G, 215/B, 518, 936/E, 3204	24 VOLT
3T5425	769, 823, 834, 983, 988, D353, 1693	24 VOLT
4M1868	12E, 16G, 623B, 824C, 826C, 1673	24 VOLT
5L8877	12G, 920, 930, 941/B, 950/B, 951B/C	24 VOLT
7M8651	627, 637, 641B, 650B, 651B, 657B, 66B	24 VOLT
7T3275	3176B, 3176C, C-10, C-12	12 VOLT
7T3276	621E, 623E, D8N, G916, G926, 3204	24 VOLT
7X1951	322C, 325C, 543, 3116, 3126/B, M325B	24 VOLT
8S1546	235, 528, 627B/E, 814/B, 815/B, 816B	24 VOLT
9X1280	910E, 918F, 924F, 3114, CB-434, E1108	24 VOLT

CIRCUIT BREAKERS



AMP	Part No.
10 AMP	6T3642
15 AMP	3T2662
15 AMP	4K5124
15 AMP	6N8589
20 AMP	6T3644
40 AMP	5M2555
50 AMP	1712206
60 AMP	1712208
60 AMP	2V2380
60 AMP	6T3645
80 AMP	1712210
80 AMP	9S4693
90 AMP	1712211
105 AMP	1712212
105 AMP	3E7294
150 AMP	1712215

BATTERIES



Part No.	GRP	CCA's	RC	Volts
CTPDYB	8D	1400	430	12
CTPDYC	4D	1050	290	12
CTPDYD	31	1000	185	12
CTPDYE	31	730	190	12
CTPDYF	31	730	185	12
CTPDYG	31P/30H	1000	185	12
CTPDYH	31P/30H	950	175	12
CTPDYI	31P/30H	950	165	12
CTPDYJ	31P/30H	760	170	12
CTPDYK	24	650	120	12
CTPDYL	74	800	115	12
CTPDYM	58	580	85	12
CTPDYN	2	780	200	6
CTPDMO	31	700	182	12
CTPDYAP	65	880	150	12

BRUSHES



Brushes for Electrical Motor Starters

Part No.	Description	Engine Model/ Application	Electrical Motor Starter
5L8732	BRUSH A	3145, 3150, 3160, 1673, D333	3T2657
4M1845	BRUSH A	3204, 3304, 3306, 3406, 3412, D320, D330/C, D333C, D336, D348	6V5227/ 6V5539 2071556
3T5047	BRUSH A	3304, 3306, 3406	6V3948
5L9056	BRUSH	3304, 3306, D320	6V5227/ 6V5539 2071556
3T4703	BRUSH A	3306, 3406, D348	6V5539, 2071556
7N1282	BRUSH PLATE	3402, 3304, 3204, 3306	6V5227
7M0330	PLATE A	3408, 3408B, 3412, 3306, 3308	6V0501, 2371962, 6V0588
7M0329	BRUSH A	641B, 650B, 660B, 651B, D346, 3412B, 3408, 3406, D379B, D399, 3412, 3306	6V0890
3T9524	BRUSH A	D398B, 3306, 3408, 3512, 3508	6V0513

Brushes (cont.)

Part No.	Description	Engine Model/ Application	Electrical Motor Starter
7F3508	BRUSH A	D364, D397, D375, D343, D342, D398, D379, D353, D348, D346	6V0890

Brushes for Alternators

Part No.	Desc.	Engine Model/ Application	Alternator
3E5459	BRUSH A	3306, 3116, 3126, 3196	1077977, 1214134
1P1130	BRUSH KIT	D342, D353, 3406	6N9294
1275953	BRUSH	323D, 323DL, 3066	2724754

Brush Kits for Starter Motors



Part No.	Engine Model/Application	Electrical Motor Starter
3E0128	D4D, 225B, D6E, 3306, 637E, D6G, 627E, 3204, 3208	6V4641/ 6V5227 2371962
3T0844	916, 3204, D4H, 953, 943, 926E	6V4641/ 6V5227 2371962
4N7554	3204, 4.236, D398B, D379B	4N0241, 9X0354
4N8618	613, 613B, 3208, 227	6V5227
4N9401	225, D5B, 980C, 621E, 3406, 3306, 3208	6V5539 2071556
8C3655	G926, 325C, 3204, 3306, 3126	6V4641/ 6V5227 2371962
9X4825	3126, 3116	1068558 2071517

ELECTRICAL TERMINALS



Terminals

Part No.	Part No.	Part No.
1S7252	2L8075	6T1124
1254785	2L8076	7F4906
1636790	2L8077	7N1269
2L8058	2L8078	7N1271
2L8065	2L8079	8T8566
2L8066	3N1915	
2L8067	4S1988	
2L8069	5P4571	
2L8071	6K0613	

Terminals Kits

Part No.
1409944†
3N3763
7N7807
7N7808
7T2804
9G7559
9S2012
9S2013

† The CTP Electrical terminal kit part # 1409944 includes: The most popular electrical terminals, the splice wires and the crimping tool. All in only one box.

TERMINAL CONNECTOR KITS

The CTP Terminal Connector Kits come conveniently packed in a special protective suitcase.

Deutsch™ DT Series



Deutsch™ DT are an environmentally-sealed connectors designed specifically for cable to cable applications. These connectors provide an excellent connection for signal level circuits in harsh environmental conditions, where even a small degradation in connection may be critical.

Features	HD20
Part No.	1753700
Number of pieces	386
Durability	No electrical or mechanical defects after 100 cycles of engagement or disengagement.
Moisture & Corrosion Resistance	Thermoplastic (-550 C to + 1250 C rated) housings and silicone seals allow the connector to withstand conditions of extreme temperature and moisture.
Fluid Resistance	Properly wired and mated connection will withstand immersion under three feet of water without loss of electronic qualities or leakage.
Vibration	No unlocking or unmating and exhibits no mechanical or physical damage after vibration level testing
Typical applications	The chassis, in the cab, under the hood, on the engine and the transmission.

Deutsch™ HD20 Series



The Deutsch™ HD (Heavy Duty) Connector series was developed with the heavy-duty equipment and off highway industry in mind. HD Series connectors are a **thermoplastic cylindrical coupling** that offers arrangements from 3 to 9 cavities for heavy-duty applications. These connectors are easy to install, environmentally sealed and compact in size. The simplicity of the HD Series Connectors help reduce assembly difficulty, maintenance time, and are built to meet industry standards to provide sustainability in demanding environments.

Features	HD20
Part No.	1908900
Number of pieces	236
Durability	No electrical or mechanical defects after 100 cycles of engagement or disengagement.
Moisture & Corrosion Resistance	Water does not penetrate seals when submerged in 3 feet of water. No evidence of corrosion after exposure to 48 hours of salt spray testing.
Fluid Resistance	Connector show no damage when exposed to most fluids used in industrial applications.
Vibration	Maintains continuity and exhibits no mechanical or physical damage during or while subject to vibration.
Typical applications	High current high current connections such as solenoids, relays and switches.

† To ensure proper electrical performance, contact terminals must be crimped using crimping tool **Part No. 1U5804**, which needs to be ordered separately. See page 154 for more information.

DEUTSCH™ is a trademark used by TE Connectivity family of companies.



Part No.	Description	AMPS
1138490	Mini-Fuse	10 AMPS
1138491	Mini-Fuse	15 AMPS
1138492	Mini-Fuse	20 AMPS
3D4529	Fuse	14 AMPS
7L6750	Fuse	70 AMPS
8M0456	Fuse	20 AMPS
9W1441	Fuse	15 AMPS
9W1442	Fuse	10 AMPS
9W1446	Fuse	20 AMPS

GLOW PLUGS



Part No.	Voltage	Engine
1073659	11	3044C, 3046
2268770	24	3054C/E, C6.6
2326662	12	3054C/E, C4.4, C6.6
2929881	24	C6.6
3H2033	24	977, 955, D315
3T8705	12	3304, 3306, 3406, 3408B
3T8706	24	3412B, 3408B/C, 3306
3T9561	12	D336
3T9562	24	D10, 776, 777, 583
3T9563	32	D398B

SPARK PLUGS



The new design has been improved to provide better reliability:

- ✓ Design optimized to only one piece to prevent possible failures.
- ✓ Teflon boot was eliminated.
- ✓ Sealing glue and screw joint were removed.
- ✓ The pre-chamber comes with only one welding.
- ✓ It comes with a black oxidized shield to improve antirust performance.

Part No.	Engine Model
1286238	G3408, 3408C, 3412
1593219	G3600
1948518	3500 GAS
2434291	G3500, G3600
2953099	C7.1, C9, C9.3, C13, C18

Part numbers are used for reference purposes only.

Part No.	Engine Model
2N0553	G398, G3306
2N2839	3412 GAS
3016663	G3508, G3512, G3516, G3616
3465123	G3520, G3508, G3516
4797702	G3508, G3512, G3516, G3606, G3616

GOVERNOR CONTROL MOTORS



Part No.	Machine Model
1604648	301.5, 301.6, 301.8
415496	311, 312
2475206	311C
1263021	312
2475229	312B, 312B L
2475227	312B, 312B L
1060080	315, 315L
1263020	315, 317, 317N
2475228	317B L, 317B LN, 318B L, 318B LN
2475228	318B
2475211	318C, 318C L, 318C LN, 319C LN
7Y3913	320, 320L
1060092	320, 320L, 320N
7Y3914	320, 320L, 320N
1263019	320, 320L, 320N, 320S
2475232	320B/L/S, 322B/ LN, 325B
2475214	320C
2475213	320C, 320C L, 320C LN, 323D, 323D L, 323D LN
2475212	320C, 320C L, 320D, 320D L
2475231	320C, E312B, E320B
3863439	320D2, 320D2 L
1028031	322, 322L, 322LN, 322N
1263018	322L, 322LN, 322N
1060100	325, 325L, 325LN
7Y5461	325, 325L, 325LN
1060097	330, 330L, 330LN
7Y5571	330, 330L, 330LN
2475235	330B L, 330B LN
1263007	350, 350L
7Y3991	350, 350L
7Y5468	375, 375 L

Costex Tractor Parts Copyright © 2020. All rights reserved.



LIGHTING

LED Lamp Group



Part No.	Voltage
3838634	24V
3861717	24V
3861718	24V 35W
3861722	9/32V
3861723	9/32V
4170977	9/32V
4410314	24V
4410315	24V

Sealed Lamps



Part No.	Description
1M5898	SEALED UNIT 24V
1M5899	SEALED UNIT 24V
1M5928	SEALED UNIT 24V
2M4168	SEALED UNIT 12V
2M4169	SEALED UNIT 12V
2P7469	SEALED UNIT
5S5149	SEALED UNIT 24V
6N7987	SEALED UNIT 24V
8T8753	SEALED UNIT 24V
9W1280	SEALED UNIT 24V
9W1281	SEALED UNIT 24V

Driving & Traffic Lights



Features:

- ✓ Combination drive light E-approved, SAE and ASAE
- ✓ High/Low Beam, Pilot light, turn signal and repeater
- ✓ Available in left hand and right hand traffic

Part No.	Description
1950189	LAMP GP-HD & SIGNAL RH
1950190	LAMP GP-HD & SIGNAL LH
1950191	LAMP GP-HD & SIGNAL RH
1950192	LAMP GP-HD & SIGNAL LH
3020409	LAMP GP-HD & SIGNAL RH
3443455	LAMP GP-HD & SIGNAL RH
3443456	LAMP GP-HD & SIGNAL LH
3E7584	LAMP GP-HD & SIGNAL RH

Lamp Assembly Kits



Kit Part No.	Body Part No.
1M1882	2P2541
4K8033	2P2540
6N7989	6N7988

Lamp Groups



Part No.	Voltage
1071301	12V 55W
1076689	24V 70W
1428637	12V 55W
1717213	24V 35W

Part No.	Voltage
1760311	12V 55W
1993137	24V 70W
2108423	21/24V 35W
2196488	24V 70W
2255075	24V 70W
2905749	24V 70W
2908118	24V
1058069	12V 55W
1068964	24V 65W
1074402	24V 21W
1097041	24V
1267487	24V 70W
1336335	24V 70W
1336336	24V 70W
1428637	12V
1532073	24V 70W
1532521	24V 70W
1532523	24V
1547986	12V
1570305	24V 70W
1613509	24V 70W
1623294	24V 70W
1673441	24V 70W
1712065	24V 70W
1717214	24V 65W
1729973	24V
1760312	12V 55W
1760780	24V
2108423	12/24V 35W
2129347	12V 55W
2142968	12V 55W
2142969	12V 55W
2196485	24V 55W
2196486	24V 70W
2196487	24V 70W
2275978	24V 70W
2344324	24V 70W
2344325	24V 70W
2347727	12V 55W
2423514	24V 70W
2423517	24V 70W
2423519	24V 70W
2470294	70W

Part No.	Voltage
2548155	24V 55W
2905760	12V 55W
2908117	24V
3329402	24V 35W
3479427	24V 35W
3593427	24V 35W
3593428	24V 35W
3886295	24V 35W
4N9303	24V
518250	24V 65W
9X1439	24V 70W
9X6853	12V 55W
9X7169	24V
9X7170	24V
9X7779	12V 55W
9X8179	12V 55W
9X8180	12V 55W
9X6853	12V 55W
9X7169	24V
9X7170	24V
9X7779	12V 55W
9X8179	12V 55W
9X8180	12V 55W

Signal, Stop Lamps and Lenses



Part No.	Description
1054849	LAMP GP-SIGNAL
1054850	LAMP GR-SIGNAL
1072282	LAMP G - SIGNAL 24V 21W
1074401	LAMP A-STOP LIGHT 24V
1074402	LAMP G - SIGNAL 24V 21W
2026611	LENS AS
3345409	LAMP GR-SIGNAL
3345410	LAMP GR-SIGNAL

Signal, Stop Lamps and Lenses (cont.)

Part No.	Description
3348049	LAMP GR-SIGNAL
3E6466	LAMP GR-SIGNAL
3E7586	LAMP GR-SIGNAL
3E7587	LAMP GR-SIGNAL
3E9382	LAMP GR-SIGNAL
3T3967	LAMP GR-SIGNAL
5C8964	LAMP A-RH 24V
5C9029	LAMP A-LH 24V
6N7982	LAMP A-STOP LIGHT 24V
7G9318	LAMP GP-SIGNAL
7M7147	LAMP A-STOP LIGHT 24V
8C6207	LAMP A-STOP LIGHT 24V
8C6207	LAMP A-STOP LIGHT 24V
8T9683	LAMP GR-SIGNAL
9X1407	LAMP GR-SIGNAL
9X3064	LENS A
9X3066	LENS A
9X3068	LENS A
9X4174	LENS A
9X7797	LENS A
9X7798	LENS A

Standard Lights



Part No.	Voltage	Wattage	Light	Len. Size
CTPXE12V3X3	12V	35 watts	Xenon	3x3
CTPXE24V3X3	24V	35 watts	Xenon	3x3
CTPH12V5X5	12V	55 watts	Halogen	5x5
CTPH24V5X5	24V	65 watts	Halogen	5x5
CTPH12V3X3	12V	55 watts	Halogen	3x3
CTPH24V3X3	24V	65 watts	Halogen	3x3



Lamp Bulbs

Part No.	Part No.
1003245	7N9943
2D1959	7N9967
3519918	7X2058
3E8825	8D1429
3H2691	8L9801
3N5719	8T9749
5D0019	9W0607
5M8034	9X3465
7H2976	9X4492
7N1996	9X4493
7N5876	

WARNING LIGHTS

Amber LED



Features:

- ✓ Snap-on bezel
- ✓ 25 customer selectable flash patterns, including steady-on
- ✓ Versatile LED warning lights that are built with fully encapsulated circuitry
- ✓ Can be mounted just about anywhere, interior or exterior
- ✓ Optional mounting brackets are also available (need to place a special order)

Part No.	Description	Voltage	Amp. Draw
CDLX3-A	3 Amber Flush Mount	10-16V DC	0.29 amps
CDLX4C-AW	4 Amber/White Flush Mount	10-30V DC	0.7 amps @ 12V DC 0.3 amps @ 24V DC
CDLX6-AA*	6 Amber	10-30V DC	0.9 amps @ 12V DC 0.5 amps @ 24V DC

* Designed for bracket mounting only. Incorporates a Heavy Duty heat Sink

Spherical LED Head



Part No.	Description	Features
CDLS306-AW	Amber/White Black Bezel	<ul style="list-style-type: none"> » Kit includes a snap-on polycarbonate bezel that will hide the screw heads for a clean install. » 25 customer selectable flash patterns, including steady on » Maximum light output in a minimum package
CDLS306C-AW	Amber/White Chrome Bezel	<ul style="list-style-type: none"> » No need to install a separate flasher unit; it's built into this miniature housing » Lens has diffusing optics for wider coverage » Circuitry is fully encapsulated within the housing for vibration and water resistance
CDLS306-AA	Amber/Amber Black Bezel	<ul style="list-style-type: none"> » Interior/exterior mount » 10-30V DC voltage » 1.2 amps max = Amp Draw

Note: CDLS306-AW/CDLS306C-AW/CDLS306-AA are all the same. The difference is the color of the lights & the bezel.
A = Amber W = White C = Chrome bezel



Thin Aux. LED with Rectangular Bezel



Part No.	Description	Features
CDLXT-121-AA	Amber/ Amber Black Bezel	<ul style="list-style-type: none"> » Standard warning LED light » 21 customer selectable flash patterns, including steady-on
CDLXT-121C-AA	Amber/Amber Chrome Bezel	<ul style="list-style-type: none"> » Only 1/2" thick » Can be mounted just about anywhere, interior or exterior » Amber/Amber and Amber/White split colors
CDLXT-121-AW	Amber/White Black Bezel	<ul style="list-style-type: none"> » Built with fully encapsulated circuitry » Optional brackets are available (special order required)
CDLXT-121C-AW	Amber/White Chrome Bezel	<ul style="list-style-type: none"> » Voltage = 10-16V DC » Amp Draw = 0.3 amps @ 12V DC

Note: CDLXT-121-AA/CDLXT-121C-AA/CDLXT-121-AW/CDLXT-121C-AW are all the same. The difference is the color of the lights & the bezel.
A=Amber W=White C=Chrome bezel

Other Warning Lights:

Description	Part No.	Features
 LED PAR36 WHITE HAZARD TURN	CLDHT362-T-C	<ul style="list-style-type: none"> • Clear lens • Swivel mount • Quick installation in any situation • 32 customer selectable flash patterns, including steady-on • Turn signal input • Trapezoidal • Voltage = 10-30V DC • Amp Draw = 1.1 amps max
 AMBER HALOGEN TEARDROP LIGHT	C1166HMA-24	<ul style="list-style-type: none"> • Aerodynamic light is ideal for unmarked cars or volunteers • Voltage = 24V DC • Cigarette plug with light on/off switch • Magnet mount
 AMBER PANCAKE LIGHT WITH MAGNET MOUNT	C1169HMA-24	<ul style="list-style-type: none"> • Low profile design, allows it to fit under sloping windshields with minimum obstruction and visibility • Wide angle reflector for longer flash duration and brighter pulse • Voltage = 24V DC • Cigarette plug with light on/off switch • Magnet mount

Other Warning Lights (cont.)

Description	Part No.	Features
 <p>AMBER CONTOUR M-TECH PLUS MINIBAR</p>	C9100LEDV-A	<ul style="list-style-type: none"> Extremely low profile, made to "contour fit" to the roof of your vehicle Super bright LED technology Provides a superior warning light image Injection molded polycarbonate base is combined with two rubber coated vacuum magnets to "custom mount to your vehicle" 12" cigarette plug with lighted on/off and pattern select switch 20 customer selectable flash patterns 10-16V DC voltage 2.3 amps max = Amps draw
 <p>LAMP GROUP</p>	1081029	<ul style="list-style-type: none"> Revolving light Magnet mount Voltage = 24V DC Amp Draw = 4.0 amps (50 watt) Rugged die-cast aluminum base Enclosed bottom Patented shock mounted rotators with two sealed roller bearings provide quiet, smooth, and maintenance free operation Lock-and stay bulbs are field replaceable Durable polycarbonate plastic outer domes keep our lights corrosion, weather, and impact resistant
 <p>LAMP GROUP</p>	2843757	<ul style="list-style-type: none"> LED Amber lens Durable, lightweight polycarbonate, universal flange base: three-hole permanent mount 28 customer selectable flash patterns including steady-on Fully encapsulated circuitry for weather and shock resistance Interchangeable lens Voltage = 10-30V DC Amp Draw = 0.4 amps @ 12V DC, 0.8 amps max

LINEAR ACTUATORS



CTP Linear actuators feature:

- ✓ Die-cast aluminum power heads available in several gear ratios able to handle loads up to 4000 lbs.
- ✓ Motor voltages include 12, 24, 36 Volt DC or 110 and 220 volt AC.
- ✓ Acme and ball screws are available.
- ✓ Dynamic load capacity of 3000 lbs.
- ✓ Static load capacity 5000 lbs.
- ✓ Temperature Range: 90°C, 194°F Maximum to -35°C, -30°F Minimum.

Part No.	Application
3058958	950H, 962H, 966H, 972H,
3082073	980C

Other linear actuator parts also available:

Part No.	Description
2624918	POWERHEAD AS. - ACTUATOR
1171559	MOUNT AS. - ACTUATOR
1224233	WIPER - ACTUATOR

Part No.	Description
1682166	GASKET - MOTOR ACTUATOR
2036473	GASKET - ACTUATOR
2056029	MOTOR AS. - ACTUATOR
2126854	ROD END - ACTUATOR
3058966	POWERHEAD AS. - ACTUATOR
3058969	POST AS. - ACTUATOR
3082071	ROD END - ACTUATOR

SPEED SENSORS



Part No.	Diameter & Thread Size	Total Length (in)	Threaded Length (in)	Engine Model/ Application
517579	M16-1.5	2.2	1.5	320, 3066
1252966	M16-1.5	2.2	1.5	E320C
3244131	5/8"-18	3.125	3.125	320D
3181181	5/8"-18	3.25	3.25	C13, C15, C18, 3176

PRESSURE SENSORS



Engine Model	Part No.	Engine Model	Part No.
3056	2746720	C7, C9	1611703
3056E	2163448	C7, C9	2482169
3456	1619930	C7, C9, C13, C15	2746717
3126, 3406E, C-10, C-12	1619927	C7.1, C13, C15	3203061
3126B	1946723	C9	1611705
3126E, 3126B, C7 C9	2392396	C9, 3126B	2244536
3126E, C7	1834760	C9, C13	2842728
3412C/E	1619926	C9, C18	1638512
3508B	1946724	C-9, C-12, C7, C9	1611704
988K	3447390	C11, C13, C15	2746719
C4.2, C6.4	2380118	C13	2393478
C4.4, C6.6	2785225	C13, C15, C18	2746718
C4.4, C6.6	2785273	C15, C18, C27	3203063
C6.4	4343436	C27	1946722
C7, C-9, C9, C13, C15	2968060	D5K	2146863
C7, C11, C13, C27, C32	2769067	G3508	2168684
C7, C13, C15	3203062	G3516, G3406, 3412B	1638516
C7, C3126E, 3126B	2392395		

MAGNETIC SWITCHES



Kickout and Bucket Positioners

Part No.	Machine Model
3E0461	769D, 771D, 773D/E, 775D/E, 784B, 785B, 789B, 793B/C, 963BLGP, 992C, 994
9X4393	994, 992C
3E5493	950F, 950FII, 966F, 960F, 970F, 980F/G
9X9509	950F, 950FII, 960F, 966F, 966FII, 970F, 980F
3E7843	420D, 428D/E, 430EIT, 432D/E, 434E, 442D/E, 444E, 910F, 914G, 924F/H/HZ, 930G/H, 938F/G, 988F, 990H, 992D, IT12F, IT14G, IT18F, IT28G
3E7844	910F/G, 914G/G2, 924G/GZ, 928G/GZ, 930G/H, 938F/G/H, 938GII, 950G, 962G/GII, 966G/GII, 972GII, 980GII, 988F, 990H, 992D, IT14F, IT14G2, IT24F, IT28G, IT38F/G, IT62G, 950GII, 972G, 980H, IT12F, IT38H, IT18F, D6R
1765459	910G, 938G/H, 938GII, 994F, 950GII, 962G, 962GII, 966G, 966GII, 972G, 972GII, 980GII, 980H, 986H, IT38G/H, IT62G/H, D6RXL, D6R
1458670	938G, 938GII, 950G, 962G, 966G, 972G, 980G, IT38G, IT62G

SOLENOIDS



Starting Motor Solenoids

Part No.	Engine	Starting Motor
3T5045	3406, 3304, 3306	3T2879, 3T2654, 3T3154, 3T2661, 3T2655
3T5068	3208, G3516	7T9255, 3T2657, 3T8635
3T8635	3304, 3306, G3412	9G4338, 6T0640, 3T4582

Semi Solid Solenoids

CTP Semi-Solid Solenoids extend the life of your starting motors by:

- ✓ Providing better contact weld breaking force
- ✓ Reducing stuck contact failures by low system voltage

Solenoids	Engine	Starting Motor
9X0301	3116, 3126	2071517
3E7859	3116, 3126, C7	1504247, 1068559
9X0332	3208, 3304, 3306	3T6305, 3T2371
3764353	3304, 3306B, C7, C9, C13, C15	2071545, 2071551, 2071556, 2071560
2508279	3508, 3516, G3508, C16	2371962, 2071556
2508279	3508B, 3512, 3516B, 3412C	2071562, 1068554
2068784	C7, 3116, 3126/B	2049742, 2071516, 2071517, 2071519
1938570	C7, C9, 3406C, 3412E	2071551, 2071556
9X0332	C9, C12, C15, C16	3383454
3383453	C13, C15	3383454

Fuel Shutoff Solenoids



Part No.	Description	Engine model
1727209	SOLENOID A	3034
517518	SOLENOID	3066
6N9988	SOLENOID G 12V	3208

Fuel Shutoff Solenoids (cont.)

Part No.	Description	Engine model
6N7035	SOLENOID GR	3304
6N3748	SOLENOID GR	3306
1255771	SOLENOID A	12V 3116, 3126
1255772	SOLENOID A	24V 3116, 3126
7W6249	SOLENOID	3054, C4.4
1766219	SOLENOID	3054C, C4.4
5I8008	SOLENOID	3064, 3066
1554651	SOLENOID A	3116, 3126
1554652	SOLENOID A	3116, 3126
1554653	SOLENOID	3304, 3306
1023506	SOLENOID A	3304, 3306, 3412B
1106464	SOLENOID	3406B
1255774	SOLENOID A	3406B
1255773	SOLENOID G	3406C
1197017	SOLENOID	3406C
9X1413	SOLENOID A	3408B, 3412
4N3890	SOLENOID-SHUT OFF	3408C, C18
6N9987	SOLENOID GR 24V	613C, 3208
1106465	SOLENOID	972G, 3306

STARTER MOTORS



Engine Model	Part No.	Engine Model	Part No.
3024	1633361	3114, 3114T	3E5381
3034	1449955	3114, 3126	3E5382
3046	1053133	3116, 3126B	2071510
3046	1347023	3116, 3126B/E	2071519
3054	1430538	3306, 3306B/C	2071545
3054	1430541	3406, 3406C, 3412E	4N1062
3066	1352361	3406E	1249780
3204	3E1865	3408, 3412	6V0513
3208	2071527	3408, 3412, 3508B	1238686
3306	2071525	C4.2, C6.4, 3064, 3066	2724774
3306	7T4957	C7	3395406
3054, 3054B, 3056, 3056E	1092361	C7, 3116, 3126	2071517
3054, 3054C	1008224	C7, 3126	2071551
3054C	3127539	C7, 3126B/E	2071514
3054C, 3056	2253150	C7, 3126E	2071513
3056E	2342637	C9	2071556

Engine Model	Part No.
C9, 3306, 3304	2071560
C9, C11, C13	2071524
C9, C12, C13, 3176, 3196	2071521
C11, C13, 3196, 3176C	1654619
C15, C16, C18, 3406C	2071532

Engine Model	Part No.
C18, 3176C, 3408E, 3456	2371962
D342, 583, 583K	3T8950
D343	6V0588
D4.236, T4.236, 4.236	7X1361
S3L2	1992334

VANE AIR STARTER MOTORS



Features:

- ✓ Sealed for use in air or gas applications.
- ✓ Offset design for simple mounting
- ✓ Powerful motors
- ✓ Multiple offset gear ratios: B = 2.18:1; C = 2.53:1; C = 2.69:1; D = 3.44:1, D = 3.94:1; E = 3.46:1
- ✓ Backcap ports for injection lubricating

Ingersoll Rand® - 150BM Series	
150BMGE21RH6	
150BMPE88R53	
150BMPE88R54	

Ingersoll Rand® - SS800 Series	
SS815FGB03L32	
SS815FGB03R31	
SS825FGC03L26	
SS825FGC03R25	

Ingersoll Rand® - ST900 Series	
ST999BP03R31	
ST999CP03R25S	

Ingersoll Rand® - SS350 Series	
SS350GE03R29	
SS350GE03R31	

Other parts also available:

Part No.	Description
20BM-20C	BOLT - SOCKET END
SS800-K150	BULKHEAD
9BM-6-2S	BUSHING - DRIVE HOUSING
SS350-367A	CLUTCH SPRING CUP - SLEEVE
SS800-367	CUP - SPRING
SS800-K3	CYLINDER

Part No.	Description
150BM-3	CYLINDER - INGERSOLL RAND
150BM-A735	DEFLECTOR - 1.25"
20BM-98	DOWEL
150BME-9	DRIVE GEAR
ST400-13-31	DRIVE PINION
SS825R-13-25	DRIVE PINION - INGERSOLL RAND
10BM-8	DRIVE SHAFT
150LF-284	GASKET - GEAR CASE
150LF-283	GASKET - MOTOR HOUSING
SS815B-9	GEAR A
SS825C-9	GEAR AS. DRIVE
10BM-40	HOUSING - MOTOR
SS800-140	HOUSING - MOTOR
SS350-K3	HOUSING A
SS825-K300	HOUSING KIT - DRIVE
SS800R-K587	JAW AS - CLUTCH
10BM-610	KEY
SS800-TK2	KIT - AIR STARTER
34U-58-10	LOCKWASHER
HDL2	LUBRICATOR GP
NL-24-8	LUBRICATOR GP-AIR MOTOR
SS800-A202	MOTOR HOUSING COVER AS
SS800-65	NUT-ROTOR CLAMP
9BM-642	OILER, BUSHING
150BME-17	PINION
SS350E-17	PINION
SS815L-13-32	PINION - DRIVE
SS815R-13-31	PINION - DRIVE
101BMPD-17	PINION - ROTOR
150BMP-703	PISTON ASSY
SS800-K703	PISTON KIT
150LF-11A	PLATE - FRONT END
SS800G-11	PLATE - FRONT END
150LF-12A	PLATE - REAR END
SS800R-12	PLATE - REAR END

Part No.	Description
599-11	PLATE CYL
SRV150	RELAY VALVE - 1.5"
20BM-200	RETAINER
20BM-67B	RETAINER - PINION
101BMP-705-1	RING - SHAFT
SS800-109	RING RETAINER
SS825-53	ROTOR
10BMP-53	ROTOR - ALUMINUM /AIR STARTER
SS350-53A	ROTOR FOR AIR STARTER
SS800-53	ROTOR FOR AIR STARTER
SS825C-17	ROTOR PINION-15 TOOTH
SS350-TK2	SEAL & VANE KIT
HDL2-TK1	SEAL KIT - TUNE-UP KIT
SS800-191	SEAT SPRING
150BMP-8-2	SHAFT - DRIVE
SM450LA-8	SHAFT - DRIVE
SS800R-8	SHAFT - DRIVE
SS800-A674-90	SILENCER
150BM-A674	SILENCER - 1.25"
SS800-A674	SILENCER - AIR STARTER
SS800-335	SLEEVE SPRING
20BM-65	SPACER
10BMP-602	SPACER, SHAFT RING
SS800-700	SPRING
SS800-583	SPRING - CLUTCH
SS800L-419	SPRING - PINION
SS800R-419	SPRING - PINION
101BMP-700-1	SPRING - PISTON RING
10BM-42-5	VANE KIT
10BM-15	WASHER
20BM-7	WASHER
SS800-224	WASHER
SS800-177	WASHER - DRIVE GEAR CUP
SS800-725	WASHER - DRIVE PINION

SWITCHES



IGNITION SWITCH



Part No.
9W1077
1107887
1428858
1543197
1632659
1684609
2552751
4678535
3E0156
08086-10000
1107887C
7Y3918
9G7641
5P8500

TOGGLE SWITCH



Part No.
1392116
1586634
1655970
2848381
3012980
3T4405
7N8001
7N8005
7N8008
8D2676
2757764
3T6655
1114799

LIQUID LEVEL SWITCH



Part No.
1728660
2N9768
7N5389

CAPILLARY SWITCH



Part No.
1199631
3E5464
3E5465

FLOW SWITCH



Part No.
1346054
1718708
1718709
1718710
1718711
3E2030

ROTARY SWITCH



Part No.
1060107
1083320
3K1650
3N5979
6P3236
7S6402

SENSING SWITCHES

PRESSURE SENSING



Part No.
1070611
1070612
1070616
1199985
1300270
1496371
1620782
1727071
1744058
1753244
2081093
2276744
2374894
2526677
2537910
2552282
2666210
3095768
3095769
3095795

Part No.

3135104
3495382
3495383
3567685
3917125
2L3402
2M9346
3E2026
3E6455
3E6455
3E7692
3L6306
4D4785
6T4949
6T6652
6T7663
7N5946
7T0988
7V5647
9G8009
9G8010
9G8011
9X4276
6T4949C
6T1546C
1145333

SENSING SWITCHES



TEMPERATURE SENSING

Part No.
1305453
1737527
2033219
2033221
2033222
2033223
2351790

Part No.
2358747
3E6451
3E7298
3E9350
3T5825
8C3569

STARTER SOLENOID SWITCH



Part No.
0302266
0993955
1183534
1352362
1654026
2418368
2941857
3980940
3E0075
3E0154
3T3421
7N5933
8N0410
9M0990
9X8124
1251302
08088-30000
9G5517
2Y2398
1632659
1655970
1718710

Part No.
1718711
1753244
2L3402
2M9346
2N7124
2N9768
2Y2397
2Y2398

PUSH BUTTON SWITCH



Part No.
3T3453
1327419
1327450
2381596
3D9718
6I5088
8Y7237
9R9868
9X4959

LIMIT SWITCH



Part No.
1056117
1056118
1296466
1327077
3T3132
9N1750
9P9520
9X0023



HORN

Part No.
1586632
3T2357
8P0230

SPECIALTY SWITCHES

Part No.
8V7195
7N1062



Part No.
3109354
3109355
2739190



Part No.
7N0718
7N4160



DIESEL ENGINE COMPONENTS

CTP® Engine Parts are designed and manufactured to work hard as an integrated system. We continually improve our techniques to ensure our customers receive quality products with the best technology available in the market.

We are changing the way the industry looks at replacement parts.

Las piezas de motor CTP® están diseñadas y fabricadas para trabajar fuertemente como partes de un sistema integrado. Estamos mejorando nuestras técnicas continuamente para asegurarnos que estamos ofreciendo productos de calidad con la mejor tecnología disponible en el mercado.

Estamos cambiando la forma en que la industria ve las piezas de reemplazo.

CTP Engine components are engineered and designed to meet or exceed our customers' expectations. By finding new resources and innovative production techniques and materials, we are having an impact on the replacement industry worldwide.

Los componentes de motor CTP están fabricados para ser mejores que otras piezas del mercado de reemplazo. Nuestro propósito es exceder las expectativas de nuestros clientes. Nuestro esfuerzo continuo por encontrar nuevos recursos y técnicas innovadoras de producción y materiales, hace que causemos impacto en el mercado de las piezas de reemplazo a nivel mundial.

Liners Camisas



Designed for use in high mileage in-frame rebuilds, CTP Wet Liners are manufactured to meet and surpass stringent design specifications.

A wet liner has no supporting bore structure and it is held in place by the flange, the flange has to withstand and endure continuous bending and flexing forces. To overcome these stresses all CTP liners receive a Deep Pressure Roll burnishing on the radius directly below the flange. This process strengthens the flange area by more than 50% and reduces metal fatigue, preventing liner fractures. The liners are induction hardened to decrease premature surface wear. All CTP liners receive a special coating to minimize cavitation damage and resist corrosion.

Diseñadas para reparaciones en vehículos de alto millaje, las camisas CTP están fabricadas para cumplir y sobrepasar las especificaciones de diseño más estrictas. Las camisas húmedas no tienen una estructura de soporte y se mantienen en su lugar por la brida, la cual tiene que soportar fuerzas de flexión. Para asegurarnos que las camisas CTP aguantan estas tensiones, estas son sometidas a un proceso de pulido profundo en el radio directamente debajo de la brida. Este proceso fortalece el área de la brida en más de un 50% y reduce la fatiga del metal, evitando así las fracturas de la camisa. Las camisas pasan por un tratamiento de inducción para disminuir el desgaste prematuro de la superficie. Todas las camisas CTP tienen un recubrimiento especial para reducir al mínimo el daño por cavitación y resistir la corrosión.

Engine Bearings Cojinetes



CTP Engine Bearings are constructed of multiple layers, comprised of different metal alloys. The most common is the Tri-metal bearing; composed of a steel backing, followed by a copper plated layer with a lead-tin alloy surface. The Bi-metal bearing has a steel backing with an aluminum bearing alloy. These bearing composites are engineered for durability, conformability and embeddability, while providing high strength and high wear resistance. The aluminum alloy bearings are designed to increase thermal transfer to draw damaging heat away from critical surfaces.

Los cojinetes están fabricados con múltiples capas compuestas de diferentes aleaciones metálicas. El más común es el cojinete Tri-metal; compuesto de un soporte de acero, seguido de una capa de cobre con una superficie de aleación de plomo. El cojinete Bi-metal tiene una capa de acero con una aleación de aluminio. Estos materiales compuestos están diseñados para proporcionar una larga durabilidad y alta resistencia al desgaste. Los cojinetes de aleación de aluminio están diseñados para aumentar la transferencia térmica para mantener el calor dañino lejos de superficies críticas.

Crankshaft Cigüeñales



CTP Crankshafts are made out of forged steel, for strength and durability. The forging process allows for the continuity of material grain flow which assists in the transmission of stresses for maximum strength and reliability. All crankshafts are balanced to perfection, both statically and dynamically to provide a smooth and vibration free operation.

Los cigüeñales CTP están hechos de acero forjado para proporcionar alta calidad y resistencia. El proceso de la forja permite la continuidad del grano del material, asistiendo la transmisión de las tensiones para ofrecer máxima resistencia y confiabilidad. Todos los cigüeñales se balancean a la perfección, tanto estática como dinámicamente para proporcionar una operación suave y libre de vibración.

Piston Pistón



CTP Aluminum Pistons are manufactured out of hypereutectic aluminum with a special heat treatment that modifies and improves the grain structure for added strength and durability. The aluminum hypereutectic alloy provides good wear resistance due to its extreme hardness. The unique characteristics of this alloy provides the piston with exceptional high strength and stiffness that reduces scuffing, while retaining dimension consistencies during thermal expansions therefore improving power, fuel economy and service life.

Los pistones CTP están fabricados de aluminio hipereutéctico con un tratamiento térmico especial que modifica y mejora la estructura para brindar mayor resistencia y durabilidad. La aleación de aluminio hipereutéctico ofrece buena resistencia al desgaste debido a su extrema dureza. Las características únicas que esta aleación proporciona al pistón con alta resistencia y rigidez reduce el desgaste abrasivo y conserva las dimensiones consistentes durante las expansiones térmicas, por tanto, mejora la potencia, la economía de combustible y su vida útil.

Part numbers are used for reference purposes only.

Rods Bielas



CTP New Replacement Connecting Rods are machined from high-tensile forged steel for high durability. With increased strength and a lightweight design, these connecting rods improve strength more than any other replacement offerings. CTP Connecting Rods are an economically priced alternative to the time and expense involved in salvaging and reworking used connecting rods.

Las bielas de reemplazo CTP están diseñadas con acero forjado para ofrecer una gran resistencia. Con el aumento de la fuerza y su diseño ligero, estas bielas brindan más resistencia que cualquier otra ofrecida en el mercado de accesorios. Las bielas CTP son una alternativa al original con mejores precios para sus reparaciones.

Piston Rings Anillos de Pistón



CTP Steel compression rings come with several types of coatings; Moly, Chrome and Ceramic PVD Coatings. These coatings offer higher tensile strength and greater hardness, while offering improved stress resistance and durability. Our secondary compression rings are manufactured out of non heat treated grey cast iron for better conformability that improves oil control. Our low tension oil rings reduce friction and cylinder wear for longer service life.

Anillos de pistón CTP están hechos de varios tipos de recubrimientos: molibdeno, cromo y PVD de cerámica. Estos recubrimientos ofrecen una mayor resistencia a la fricción, una mejor dureza, mejor durabilidad y resistencia al estrés. Los anillos secundarios se fabrican de hierro de fundido para una mejor adaptabilidad mejorando el control de aceite. Nuestros anillos de aceite de baja tensión reducen la fricción y el desgaste del cilindro para ofrecer una vida útil más larga.

Valves Válvulas



CTP valves are manufactured under strict guidelines and design parameters to ensure a reliable product. The proper type of material and design is crucial to the valve operating performance and reliability. Our valves are manufactured from specific alloys depending on the application. Some of these specialty alloys include Stellite™ and Inconel™ two superalloys that are used for their outstanding hardness and toughness and also for their oxidation and corrosion resistant properties, that are well suited for service in extreme high temperature environments subjected to pressure like today's diesel engines.

Las válvulas CTP están fabricadas bajo parámetros de diseño estrictos para garantizar un producto confiable. El uso del material y diseño adecuado es crucial para el rendimiento operativo de la válvula. Nuestras válvulas se fabrican de aleaciones específicas dependiendo de la aplicación. Algunas de estas aleaciones especiales incluyen Stellite™ e Inconel™ dos super aleaciones que se utilizan para lograr su dureza y resistencia a la oxidación y la corrosión, bien adaptados para el servicio en ambientes de temperaturas extremas y sometidos a la presión de los motores diesel de hoy.

Costex Tractor Parts Copyright © 2020. All rights reserved.

ENGINE BLOCKS

Two of the most popular engines in the heavy equipment industry are the 3304 and 3306. For the past thirty years, hundreds of thousands of these engines have been produced and are still in service. CTP offers these two workhorse engines at a great value.

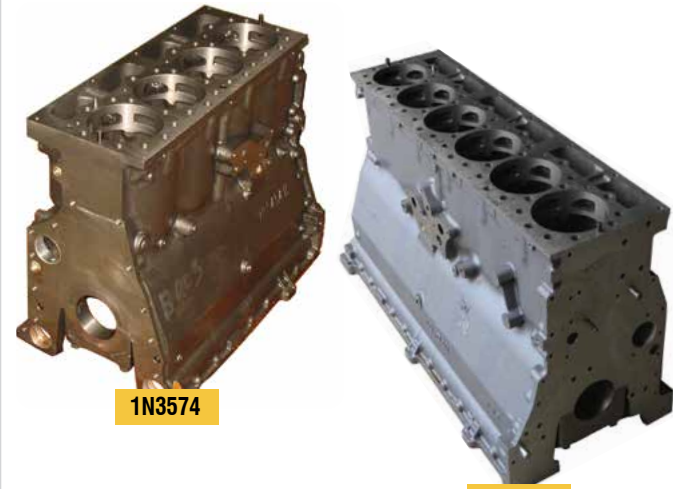

Part No.	Engine	Serial No.
1N3574	3304	02B, 04B, 05B, 9Z, 1NS, 1PS, 10E, 13E, 2WL, 37Y, 78P, 83Z, 9HK, H4G, A4E
7N6552	3304	12Z, 07Z, 4XB, 10E, 09Z, 1NS, 1PS, 1BZ, N4F, 02B, 04B, 05B, 13E, 37Y, 78P, 83Z, 9HK, H4G, A4E
1N3576	3306	02B, 04B, 05B, 09Z, 1NS, 1PS, 10E, 13E, 2WL, 37Y, 78P, 83Z, 9HK, H4G, A4E

CUSTOM ENGINES

Two of the most popular and versatile engines in heavy equipment are engines 3304 and 3306. For the past 30 years, hundreds of thousands of these engines have been produced and are still in service. CTP offers these two workhorse engines at a great value.



A new CTP engine offers several advantages over a re-manufactured or used engine. One of the key benefits is time, often we can assemble a custom made engine in just a few short days, this means getting your equipment back into service quicker. Another key factor is that the engine contains all new components that will last a very long time.

	Description
PC	PRE-COMBUSTION (Pre-Combustion type cylinder head)
DI	DIRECT INJECTION (Direct injection type cylinder head)
SB	SHORT BLOCK (Complete engine assembly, no cylinder head no oil pump)
MB	MEDIUM BLOCK (complete engine assembly, w/cylinder head no oil pump)
LB	LONG BLOCK (Complete engine assembly, w/cylinder head & oil pump)

How the CTP engine numbering system works:

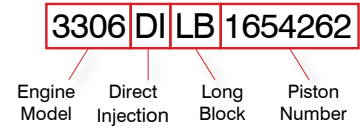

Long block engines come completely assembled with NEW:

- ✓ Block
- ✓ Block Plate
- ✓ Wet Liners
- ✓ Cam Bearings
- ✓ Crankshaft
- ✓ Connecting rods
- ✓ Piston & Rings
- ✓ Gaskets
- ✓ Camshaft & Lifters
- ✓ Cylinder Head Assy
- ✓ Oil Pump
- ✓ Seals

†Some engines could take up to 3 weeks to complete, based on parts availability.

Engines currently in stock:

Part No.	Description	Piston
3304DIMB	3304 Direct injection Medium Block	1654262
3306DISB	3306 Short Block Engine	8N3182
3306DIMB	3306 Medium Block Engine	1654262
3306DILB	3306 Long Block Engine	1654262

INFRAME OVERHAUL KITS



CTP Inframe Overhaul Kits offer quality parts engineered to work together for maximum performance.

- » Superior durability to give extended life between overhaul repairs.
- » Reduced break in oil consumption for greater economy.
- » Incredible savings to keep your engine running profitably.
- » Inframe Kits may be built to oversize and undersizespecifications.

Includes:

	INFRAME OVERHAUL KITS	PREMIUM OVERHAUL KITS
Connecting rod		✓
Liners	✓	✓
Pistons	✓	✓
Piston Rings	✓	✓
Piston Pins	✓	✓
Retainers	✓	✓
Rod Bearings	✓	✓
Main Bearings	✓	✓
Thrust Plates	✓	✓
Valve Grinding	✓	✓
Central Gasket Kit	✓	✓
Seals Kits	✓	✓
Lower Gasket Kit	✓	✓

Engine Model	Part No.	Piston No.
3066	CTP2977750-IK6	2977750
3066	CTP2977752-IK	2977752
3066	CTP2977752-IK010 (†)	2977752
3066	CTP2977753-IK6	2977753
3116	CTP1051710-IK	1051710
3116	CTP1077545-IK	1077545
3116	CTP1077563-IK	1077563
3116	CTP1077563-IK0S (†)	1077563
3116	CTP6I1144-IK	6I1144
3116	CTP7C5668-IK	7C5668
3126	CTP1504621-IK	1504621
3126	CTP2382729-IK	2382729
3176	CTP4P5852-IK	4P5852
3208	CTP2W4831-IK	2W4831
3208	CTP2W8410-IK	2W8410
3208	CTP2W8410-IK010 (†)	2W8410
3208	CTP2W8412-IK	2W8412
3208	CTP7E4729-IK	7E4729
3208	CTP9L7737-3IK	9L7737
3304	CTP1646560-IK4	1646560
3304	CTP1290358-IK4	1290358
3304	CTP8N3182-IK4	8N3182
3304	CTP8N3182-IK40S (†)	8N3182
3304DI	CTP1654262-IK4	1654262
3304DI	CTP1654262-IK40S (†)	1654262
3306	CTP1290358-IK6	1290358
3306	CTP1646560-IK	1646560
3306	CTP8N3182-IK6	8N3182
3306	CTP8N3182-IK60S (†)	8N3182
3306	CTP8N3182-IK6020 (†)	8N3182
3306	CTP9N5250-IK6	9N5250
3306DI	CTP1654262-IK6	1654262
3306DI	CTP1654262-IK60S (†)	1654262
3406	CTP7E0292-IK	7E0292
3406	CTP7E8700-IK	7E8700
3406	CTP9Y3116-IK	9Y3116
3406	CTP9Y4004-IK	9Y4004
3406	CTP9Y7212-IK	9Y7212
3406	CTP1010016-IK	1010016
3406B	CTP1601131-IK	1601131
3406B	CTP7E8656-IK	7E8656
3406C	CTP1010016-IK6	1010016
3406C	CTP9Y9889-IK	9Y9889
3406E	CTP1352837-IK	1352837
3406E	CTP1495566IF6A	1495566
3406E	CTP7C2888-IK	7C2888
3408	CTP9Y7212-IK8	9Y7212

Engine Model	Part No.	Piston No.
3412	CTP9Y7212-IK12	9Y7212
C12	CTP1442948-IK	1442948
C15	CTP2250115-IK	2250115
C15	CTP1807352-IK	1807352
D342	CTP7N1366-IK	7N1366

Inframe Overhaul Kits for Backhoe Applications

Kit Part Number	Engine Model	Piston No.	Liner No.
CTP1072553-IK4	3054	1072553	6I0164
CTP1072553-IK6	3056	1072553	6I0164
CTP1350264-IK4	3054	1350264	6I0164
CTP1350264-IK6	3056	1350264	6I0164
CTP1521390-IK4	3054	1521390	6I0164
CTP1521390-IK6	3056	1521390	6I0164
CTP1072553-IK4A	3054	1072553	1111815
CTP1072553-IK6A	3056	1072553	1111815
CTP1350264-IK4A	3054	1350264	1111815
CTP1350264-IK6A	3056	1350264	1111815
CTP1521390-IK4A	3054	1521390	1111815
CTP1521390-IK6A	3056	1521390	1111815
CTP2168323-IK6A	3056	2168323	1111815



Premium Inframe Overhaul Kits

Kit Part Number	Engine Model	Piston No.	Conrod No.
CTP1290358-IKCK6	3306	1290358	8N1721
CTP1646560-IKCK6	3306DI	1646560	8N1721
CTP1654262-IKCK4	3304DI	1654262	8N1721
CTP1654262-IKCK6	3306DI	1654262	8N1721
CTP8N3182-IKCK4	3304	8N3182	8N1984
CTP8N3182-IKCK6	3306	8N3182	8N1984
CTP9N5250-IKCK6	3306PC	9N5250	8N1721
CTP9Y4004-IKCK6	3406	9Y4004	8N1726
CTP9Y4004-IKCK6C	3406	9Y4004	7E5996
CTP9Y7212-IKCK6	3406	9Y7212	8N1726
CTP9Y7212-IKCK8	3408	9Y7212	8N1728
CTP9Y7212-IKCK12	3412	9Y7212	8N1728
CTP9Y9889-IKCK6	3406B	9Y9889	8N1726

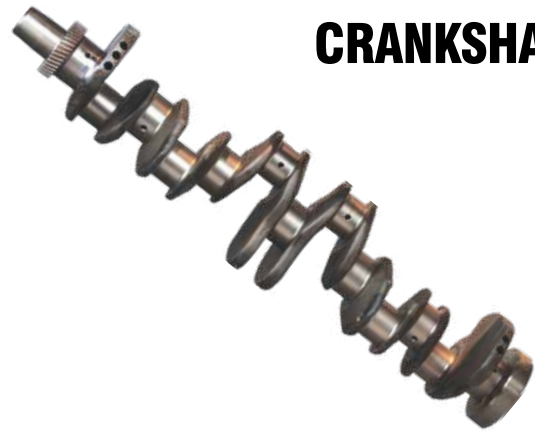

CRANKSHAFTS

Part No.	Engine	Equipment	Front Seal	Rear Seal
1352419	3064	311B, 311C, 312B, 312C, 312C L, 314C	517656	517660
1253005	3066	318C, 319C, 320, 320B, 320B L, 320C, 320C FM, 320C L, 320D, 320D LRR, 320N, 321B, 321C, 323D L, 323D LN	2457339	2223910
2715658	3116, 3126, 3126B, 3126E	120H, 120H ES, 120H NA, 120K, 120K 2, 12K, 12M, 135H, 135H NA, 140G, 140K, 140K 2, 140M, 160K, 214B, 30/30, 320B, 322B L, 322B LN, 322C, 322C FM, 324D, 324D FM, 324D FM LL	2457339	2223910
1W9771	3204	215, 916, 926, 931B, 943, 953, D4HTSK II	9L7735	7W3202
9N6221	3208	225, 613B, 613C, FB221, PR-1000, PS-500	7C6660	7W3200
4N7692	3304	120G, 130G, 215, 215B, 215C, 225, 225D, 229D, 518, 920, 930, 936, 941, 950, 950B, 950B/950E, 951B, 955K, 955L, 963, CB-534, D4D, D4E, D5H, E240, FB518, G936	9Y9895	4W0452
4N7693	3306, G3306	120B, 12G, 140G, 14G, 160G, 1673C, 235, 235B, 235C, 528, 561C, 561D, 571G, 572G, 615, 615C, 627B, 637D, 639D, 814, 814B, 815, 815B, 816, 816B, 966C, 966D, 973, 977K, 977L, 980B, D250B	9Y9895	7C4297
6N8079	3306, 3306B	12G, 12H ES, 12H NA, 140G, 140H, 140H ES, 140H NA, 143H, 14G, 14H NA, 160G, 160H, 160H ES, 160H NA, 163H NA, 1673C, 235, 235B, 235C, 235D, 3126, 330, 330 FM L, 330 L, 350, 528, 528B, 530B	9Y9895	7C4297

Part No.	Engine	Equipment	Front Seal	Rear Seal
6I1453	3406, 3406B, 3406C, 3406E	16G, 16H NA, 245B, 375, 375 L, 5080, 578, 583R, 587R, 621E, 621F, 621G, 623E, 623F, 623G, 627B, 627E, 627F, 627G, 657B, 814B, 824C, 824G, 825G, 826C, 826G, 980C, 980F, 980G	1425867	1425868
7C4859	3406, 3406B	16G, 578, 621E, 623E, 627E, 814B, 826C, 980C, G3406, SS-250	1425867	1425868
1W5009	3408, 3408B, 3408C, 3408E	589, 631D, 631E, 631G, 633D, 633E II, 637D, 637E, 637G, 639D, 657E, 69D, 768C, 769C, 769D, 771C, 771D, 834B, 836, 988B, 988F, 988F II, AD40, AD45, AE40, AE40 II, CG137-08	1425867	1425868
1W6209	3408	657E, 988B	1425867	1425868
2W4088	3412, 3412C, 3412E, G3412, G3412C	24H, 651E, 657E, 773B, 773D, 775B, 775D, 844, 990, 990 II, 992C, 992D, D10N, D10R, D9L, PR-1000, PR-750B, SCT673, SPS342, SPT342	1425867	1425868
1397018	3054, 3054B	312, 312C, 315, 317, 416C, 416D, 420D, 424D, 428D, 430D, 432D, 438D, 442D, 554, 914G, CB-534B, CB-535B, CP-433C, CS-431C, IT14G, PS-300B	2880422	4W5360
2218057	3054, 3054B	TH103, TH350B, TH355B, TH460B, TH62, TH63, TH82, TH83	2880422	4W5360
2327400	3054C	414E, 416D, 416E, 420D, 420E, 422E, 424D, 428D, 428E, 430D, 430E, 432D, 432E, 434E, 442D, 442E, 444E, 914G, AP-300, AP-300D, AP-650B, AP-800D, C4.4, CB-434D, CB-534D, CB-564D, CD-54, CP-433E	2880422	4W5360
3133996	C11	14M, 725, 730, 966H, R1600H, R1700G, RM-300, TH35-C11	1694166	7C1728
1694189	C-12	85D, 972G II	1694166	7C1728
1694187	3176C, C12	345B, 480, 75D, 966G II, D7R II, R1600, R1600G	1694166	7C1728
3133997	C13	16M, 345C, 345C L, 345C MH, 345D, 345D L, 345D L VG, 349D, 349D L, 621H, 621K, 623H, 623K LRC, 627H, 627K LRC, 730, 730C, 972H, 980C, 980K, 980K HLG, C13, C13 XQ350, CX31-C13I, D8N, TH35-C13I	1694166	7C1728

Part No.	Engine	Equipment	Front Seal	Rear Seal
1601799	3406E, C-15, C-16, C15,	824C, 824G, 824G II, 825G II, 826G II, AD30, MTC835, R2900G	3197401	3190785
1894918	C-18, C18	24M, 385C, 385C FS, 385C L, 385C L MH, 390D, 390D L, 631E, 631G, 633E II, 637E, 637G, 657E, 657G, 772, 834H, 836H, 988H, AD45B, AD55, D9T, PM-200, PM-201	3197401	1425868
2611544	C9, C-9	12H, 140M, 140M 2, 160M, 160M 2, 2290, 2390, 2391, 2491, 2590, 330C, 330C FM, 330C L, 330C MH, 330D, 330D FM, 330D L, 330D LN, 330D MH, 336D, 336D L, 336D LN, 336D2, 336D2 L, 340D L, 340D2 L, 511, 521	2457339	1608136
8M4505	D330A	955H, 955K, D4D	9Y9895	4W0452
3442603	3306, 3306B, 3306C	12H, 12H ES, 12H NA, 140G, 140H, 140H ES, 140H NA, 143H, 14H NA, 160H, 160H ES, 160H NA, 163H NA, 235B, 330, 330B L, 350, 545, 572R, 611, 615C, 627B, 627F, 627G, 637E, 637G, 814F	9Y9895	4W0452
6N2823	342, D342	D8K	9N2539	2W2191
3370872	3304, 3304B, G3304, G3304B	120G, 130G, 515, 517, 518C, 525, 527, D4H, D4H XL, D4HTSK III, D5HTSK II	3628853 (CW) / 9Y9895 (CCW)	4W0452
3348389	3306, 3306B	12G, 12H ES, 12H NA, 140G, 140H, 140H ES, 140H NA, 143H, 14G, 14H NA, 160G, 160H ES, 160H NA, 163H NA, 1673C, 330, 350, 528B, 530B, 615C, 627E, 627F, 637E, 815B, 966F, 966F II, 970F, 972G	3628853 (CW) / 9Y9895 (CCW)	4W0452
1W6213	3412, G3412	D9L	1425867	1425868
1070992	3046	933, 939, 939C, D3C III, D3G, D4C III, D4G, D5C III, D5G	2398429	1032835
1172830	3046	315, 315B, 315C, 317B LN, 318B, 933C, 939C	2398429	1175015
1253005	3066	318C, 319C, 320, 320B, 320B L, 320C, 320C FM, 320C L, 320D, 320D LRR, 320N, 321B, 321C, 323D L, 323D LN	517656	517660
1352419	3064	311B, 311C, 312B, 312C, 312C L, 314C	517656	517660
1601799	3406E, C-15, C-16, C15	824C, 824G, 824G II, 825G II, 826G II, AD30, MTC835, R2900G	3197401	1425868
1694187	3176C, C-10	345B, 480, 75D, 966G II, D7R II, R1600, R1600G	2264757	2264755

Part No.	Engine	Equipment	Front Seal	Rear Seal
1694189	C-12	85D, 972G II	2264757	2264755
1894918	C-18, C18	24M, 385C, 385C FS, 385C L, 385C L MH, 390D, 390D L, 631E, 631G, 633E II, 637E, 637G, 657E, 657G, 772, 834H, 836H, 988H, AD45B, AD55, D9T, PM-200, PM-201	3197401	1425868
2327400	3054C	414E, 416D, 416E, 420D, 420E, 422E, 424D, 428D, 428E, 430D, 430E, 432D, 432E, 434E, 442D, 442E, 444E, 914G, AP-300, AP-300D, AP-650B, AP-800D, C4.4, CB-434D, CB-534D, CB-564D, CD-54, CP-433E	2880422	4W5360
2611544	C-9	12H, 140M, 140M 2, 160M, 160M 2, 2290, 2390, 2391, 2491, 2590, 330C, 330C FM, 330C L, 330C MH, 330D, 330D FM, 330D L, 330D LN, 330D MH, 336D, 336D L, 336D LN, 336D2, 336D2 L, 340D L, 340D2 L, 511	2457339	2854073
2715658	3116, 3126, 3126B, 3126E	120H, 120H ES, 120H NA, 120K, 120K 2, 12K, 12M, 135H, 135H NA, 140G, 140K, 140K 2, 140M, 160K, 214B, 30/30, 320B, 322B L, 322B LN, 322C, 322C FM, 324D, 324D FM, 324D FM LL	2457339	1154120
3133996	C11	14M, 725, 730, 966H, C11, R1600H, R1700G, RM-300, TH35-C11I	2264755	2264757
3133997	C13	16M, 345C, 345C L, 345C MH, 345D, 345D L, 345D L VG, 349D, 349D L, 621H, 621K, 623H, 623K LRC, 627H, 627K LRC, 730, 730C, 972H, 980C, 980K, 980K HLG, C13, C13 XQ350, CX31-C13I, D8N, TH35-C13I, TH35-C1	2264755	2264757
3216442	3304, G3304	120G, 130G	3628853	4W0452
3348389	3306, 3306B	12G, 12H ES, 12H NA, 140G, 140H, 140H ES, 140H NA, 143H, 14G, 14H NA, 160G, 160H ES, 160H NA, 163H NA, 1673C, 330, 350, 528B, 530B, 615C, 627E, 627F, 637E, 815B, 966F, 966F II, 970F, 972G	3628853 (CW) / 9Y9895 (CCW)	7C4297
3370201	C15	374F L, 735B, 740B, TH35-C15T	3197401/1425868	1425867

Crankshafts (cont.)

Part No.	Engine	Equipment	Front Seal	Rear Seal
3370872	3304, 3304B, G3304, G3304B	120G, 130G, 3304, 515, 517, 518C, 525, 527, D4H, D4H XL, D4HTSK III, D5HTSK II,	3628853 (CW) / 9Y9895 (CCW)	4W0452 (CCW)
3442603	3306, 3306B, 3306C	12H, 12H ES, 12H NA, 140G, 140H, 140H ES, 140H NA, 143H, 14H NA, 160H, 160H ES, 160H NA, 163H NA, 235B, 330, 330B L, 350, 545, 572R, 611, 615C, 627B, 627F, 627G, 637E, 637G, 814F	3628853 (CW) / 9Y9895 (CCW)	4W0452 (CCW)
3642828	3054, 3054B	312B L, 312C, 416B, 416C, 416D, 420D, 426C, 428B, 428C, 430D, 436C, 438C, 908, 914G, CB-434B, CB-434C, CB-535B, CB-544, CB-545, CP-433C, CS-323C, CS-431C, IT14G, M312, M315, PS-150B	2880422	4W5360
3645145	C7.1	120M 2, 2384C, 2484C, 2570C, 2670C, 312E, 312E L, 314E CR, 314E LCR, 316E L, 318E L, 320D2, 320D2 GC, 320D2 L, 320E, 320E L, 320E LN, 320E LRR, 320E RR, 323D2 L, 323E L, 324E, 324E L, 324E LN, 329E	3718059 / 3718062	2920886
3849906	3412, 3412C, 3412E	24H, 5110B, 651E, 657E, 773B, 773D, 773E, 775D, 775E, 844, 990, 990 II, 992C, C30, D10N, D10R, D9L, G3412, PM3412, PR-1000, SPS342, SPT342	1425867	1425868
9M2337	1673, 1673B, D333A	561B, D333A	1S4604	9H1129
6127-31-1012	S6D155, SA6D155		**6127-21-3510	6128-21-4230
6211-31-1010	S6D140, S6D140E, SA6D140, SA6D140A, SA6D140E, SAA6D140E, SDA6D140E	6D140, DCA, WA500	6150-21-3230	6151-21-4161
6240-31-1101	SAA6D170E		**6162-23-3510	6162-23-4251

Crankshafts for Komatsu®

Part No.	Engine Model	Part No.	Engine Model
6127-31-1012	S6D155	6211-31-1010	S6D140
6162-33-1202	S6D170		
6240-31-1101	SAA6D170		

Komatsu® is the registered trademark of Komatsu Ltd.

ENGINE BEARINGS



*Special Oversizes in Stock. Please use part number as described (-followed by size)

Part No. Main Bearing	Size (inches)	Engine Model	Part No. Con. Rod Bearing
5I7588	Standard	3066	5I7637
5I7784	0.010	3066	5I7794
5I7785	0.020	3066	5I7795
5I7786	0.030	3066	5I7796
1011530	Standard	3114, 3116, 3126	2246638
1450163	0.010	3114, 3116, 3126	7C6976
1450165	0.020	3114, 3116, 3126	7C6977
7C6973	0.030	3114, 3116, 3126	N/A
1077708	Standard	3114, 3116	2246638
1450162	0.010	3114, 3116, 3126	7C6976
1450164	0.020	3114, 3116, 3126	7C6977
7C6963	0.030	3114, 3116, 3126	N/A
1077708	Standard	3126	2246638
4W8092	Standard	3145, 3150, 3160, 3208	9N5923
8N9022	0.010	3145, 3150, 3160, 3208	9N5924
8N9023	0.020	3145, 3150, 3160, 3208	9N5925
8N9023-030*	0.030	3145, 3150, 3160, 3208	N/A
8N9023-040*	0.040	3145, 3150, 3160, 3208	N/A
8N9020	0.050	3145, 3150, 3160, 3208	9N5926
4W8093	Standard	3204	8N6308
8N8976	0.010	3204	1N3821
8N8972	0.020	3204	1N3822
8N8972-030*	0.030	3204	1N3822-030*
8N8972-040*	0.040	3204	8N6308-040*
8N8974	0.050	3204	1W3906
4W8092	Standard	3204	8N6308
8N9022	0.010	3204	1N3821
8N9023	0.020	3204	1N3822
8N9023-030*	0.030	3204	1N3822-030*
8N9023-040*	0.040	3204	8N6308-040*
8N9020	0.050	3204	1W3906
8N8973	Standard	3204	8N6308
8N8971	0.020	3204	1N3822
8N8975	0.050	3204	1W3906
1W0312	Standard	3204	8N6308
1W1661	0.010	3204	1N3821
1W1662	0.020	3204	1N3822
1W1663	0.050	3204	1W3906
4W8093	Standard	3208 Late	7E7894
8N8976	0.010	3208 Late	9N5920
8N8972	0.020	3208 Late	9N5921

Part No. Main Bearing	Size (inches)	Engine Model	Part No. Con. Rod Bearing
8N8972-030*	0.030	3208 LATE	9N5921-030*
8N8972-040*	0.040	3208 LATE	9N5921-040*
8N8974	0.050	3208 LATE	9N5922
4W8092	Standard	3208 LATE	7E7894
8N9022	0.010	3208 LATE	9N5920
8N9023	0.020	3208 LATE	9N5921
8N9023-030*	0.030	3208 LATE	9N5921-030*
8N9023-040*	0.040	3208 LATE	9N5921-040*
8N9020	0.050	3208 LATE	9N5922
4W8091	Standard	3208, 3160	9N5923
8N9065	0.010	3208, 3160	9N5924
8N9064	0.020	3208, 3160	9N5925
4W8091-030*	0.030	3208, 3160	N/A
4W8091-040*	0.040	3208, 3160	N/A
2323233	Standard	3306	3285572
8N8225	0.010	3306	8N8221
8N8226	0.020	3306	8N8222
8N8227	0.030	3306	8N8223
8N8227-040*	0.040	3306	8N8223-040*
8N8227-050*	0.050	3306	8N8223-050*
8N8227-060*	0.060	3306	8N8223-060*
8N8228	Standard	3306	3285572
8N8229	0.010	3306	8N8221
3178766	Standard	3406/B, 3408/B, 3412/B	3285574
4W5492-010*	0.010	3406/B, 3408/B, 3412/B	9Y9497-010*
4W5492-020*	0.020	3406/B, 3408/B, 3412/B	9Y9497-020*
4W5698	0.025	3406/B, 3408/B, 3412/B	4W5702
4W5698-040*	0.040	3406/B, 3408/B, 3412/B	4W5702-040*
4W5699	0.050	3406/B, 3408/B, 3412/B	4W5703
4W5700	Standard	3408, 3408B, 3412	3285574
4W5701	0.025	3408, 3408B, 3412	4W5702
3215746	Standard	3406C, 3406E	3285573
4W5492-010*	0.010	3406C, 3406E	9Y7735-010*
4W5698	0.025	3406C, 3406E	7E0558
4W5698-040*	0.040	3406C, 3406E	N/A
4W5699	0.050	3406C, 3406E	7E0559
1496031	Standard	3508/B, 3512/B	1077330
1496032	0.025	3508/B, 3512/B	1077331
1496033	0.050	3508/B, 3512/B	1077332
1N4316	Standard	D353, G353D	1N4336
1N4322	0.050	D353, G353D	1N4338
7W2138	Standard	TRACTORS 619C	7W2136
8N5346	0.025	TRACTORS 619C	8N5339
8N5347	0.050	TRACTORS 619C	8N5338
1N4316	Standard	D353, G353D	1N4336
1N4319	0.025	D353, G353D	1N4337
1N4322	0.050	D353, G353D	1N4338

Part No. Main Bearing	Size (inches)	Engine Model	Part No. Con. Rod Bearing
8N7764	Standard	D379, G379	8N7769
8N7765	0.025	D379, G379	8N7770
8N7766	0.050	D379, G379	8N7771
8N7923	Standard	Tractors D7E	8N7933
8N7923-010*	0.010	Tractors D7E	8N7933-010*
8N7923-020*	0.020	Tractors D7E	8N7933-020*
8N7924	0.025	Tractors D7E	8N7934
8N7923-030*	0.020	Tractors D7E	8N7933-030*
8N7925	0.050	Tractors D7E	8N7935

Conversion Factors:

Inches	Milimeters
0.005	0.13
0.010	0.25
0.020	0.50
0.025	0.64
0.030	0.75
0.040	1.00
0.050	1.27

CAMSHAFTS



Part No.	Description	Engine Model	Camshaft Bearing
1323930	CAMSHAFT	3054	0365802 (1)
1006298	CAMSHAFT W/ GEAR	3116	2W7211 (1), 2W7213 (6)
1345276	CAMSHAFT A	3116	2W7211 (1), 2W7213 (6)
6I2342	CAMSHAFT W/ GEAR	3116	2W7211 (1), 2W7213 (6)
7W5426	CAMSHAFT W/O GEAR	3116	2W7211 (1), 2W7213 (6)
2W1221	CAMSHAFT	3204	1W5920 (1), 9N5246 (2)
9Y1723	CAMSHAFT W/O GEAR	3304	8N4110 (1), 7M4046 (2)
4P2942	CAMSHAFT W/O GEAR	3306	8N4110 (1), 7M4046 (4)
8N9245	CAMSHAFT W/O GEAR	3406	4N6658 (1), 4N0685 (6)
1007408	CAMSHAFT W/O GEAR	3406B	4N6658 (1), 4N0685 (6)

Camshafts (cont.)

Part No.	Description	Engine Model	Camshaft Bearing
2W7980	CAMSHAFT W/O GEAR	3408	4N6658 (2), 4N0685 (3)
3699486	CAMSHAFT	3408	4N6658 (2), 4N0685 (3)
4N0963	CAMSHAFT GP	3408	4N6658 (2), 4N0685 (3)
2W5289	CAMSHAFT W/O GEAR	3412	4N6658 (2), 4N0685 (5)

Numbers in parenthesis () indicate the quantity of camshaft bearings needed per camshaft installation

LIFTERS



Part No.	Engine Model	Mechanic Attached to:
1140, 1145, 1150, 1160, 3145, 3150, 3160, 3208	9N5786	Cylinder Head & Valve
3116	7C6078	Fuel Pump & Valve
3304, 3306	8N1317	Fuel Injection
3306	4P9832	Fuel Injection
3306, 3406/C, 3408/C/E, 3412/E, G3406	4223883	Valve Gp
3406, 3408B, 3412	4W0736	Fuel Injection
3406, 3408B, 3412C	7E6011	Fuel Injection
3408B, 3412B	8N6981	Fuel Injection
3508, 3512, 3516, G3508, G3512/E, G3516	3467515	Valve Gp
C9, C9.3	4535998	Valve Gp
C10, C11, C12, C13, 3176/C, 3196	2027475	Valve Gp
C10, C11, C12, C13, 3176/C, 3196	2511005	Valve Gp
D379, D398, D399, G398	1021561	Cylinder Head & Valve
D6C, D7F, D330A, D330C, D333A/B,C, 3304, 3306	7S3161	Cylinder Head & Valve
D7E, D8, D8H, D342	5S1220	Cylinder Head & Valve
D9, D9D, D9E, D9G, D353	2H3069	Cylinder Head & Valve

LINERS



WET LINERS

When rebuilding a diesel engine that utilizes wet liners, machining is not required. Although installation is fairly simple "slip fit" installation, liner protrusion is critical and careful measuring of this protrusion is required. CTP wet liners are manufactured for faster break-in and durability.

CTP Wet liners feature:

- Roll burnished under-the-flange radius provides superior strength and prevents fractures.
- Induction heat-treated high-grade steel or gray iron construction offers greater strength and durability.
- Precision manufacturing ensures perfectly round bores and correct cross hatch pattern for quick break-in and proper ring seating.

DRY LINERS / REPAIR SLEEVES

There are several types of dry liners and repair sleeves;

Flanged dry liner, this is a slip type fit, where machining of the block is not required, the flange holds the liner in place, the inside bore is finished and honed.

Interference fit dry liners; these liners must be pressed in place after removing the old liner from the block, some come prefinished and honed.

Repair sleeves, where the block must be bored to accept this type of sleeve, these are interference fit and require pressing, repair sleeves do not come with finished or honed ID. *

CTP Dry liners feature:

- High-grade steel or gray iron construction for durability and strength.
- Precise and uniform outside dimension for ease of installation.
- Pre-finished bore liners have accurate cross hatch pattern finish for quick break-in and proper ring seating. *

Wet Engine Liner

Part No.	Application
6I3550	3176, 3176B
1979330	3196, C11, C12, C13
3715941	3304, 3306
1979322	3406, 3408, 3412
3221126	3408, C18, C32
1238206	3508, 3512, 3516
2117826	3508, 3512, 3516
1482125	C10, C12, 3176
4695314 NEW	C10, C12, 3176

Part No.	Application
4202631	C16
4695312	C9
4695313 NEW	C9.3
4F6486	D315
8S2240	D330, D333
8N5676	D339, D342, D364
1260739	D343
8N9174	D353, D379, D398
7C9522	1676

Dry Engine Liner

Part No.	Application	I.D.	O.D.	Length	Flange O.D.
1W8311	4.236	98.50mm	103.21mm	227.55mm	106.40mm
7C3182	4.236	98.47mm	104.20mm	226.44mm	107.33mm
1111815	3054, 3056	100.00mm	104.23mm	227.50mm	107.44mm
6I0164	3054, 3056	100.00mm	104.23mm	226.44mm	107.44mm
1227311	3046	93.25mm	98.05mm	185.50mm	
5I7523	3066	101.00mm	105.070mm	195.50mm	
9N6275	3208	113.40mm	119.18mm	196.85mm	
105RS NEW	3054C, 3054E, C4.4 C6.6 (Semi-Finished)	103.90mm	109.70mm	261.00mm	
7C6208	3114, 3116	104.00mm	109.86mm	196.80mm	
1077604	3126, C7	109.16mm	114.83mm	196.85mm	

LINER KITS



Use the PISTON No. to identify the Liner Kit
(Kit No. = Piston No. + LK)

*1609874 Seal Kit

Engine	Part No.	Engine	Part No.
3064, 3066	2977752LK	3114, 3116 TRUCK	6I1144LK
3114, 3116	1077553LK	3114, 3116 IND.	1077563LK
3114, 3116	6I4248LK	3116	4P2990LK
3114, 3116 IND.	1051710LK	3116, 3116 IND.	1154124LK
3114, 3116 IND.	7C5668LK	3406	7N3633LK
3114, 3116 IND.	7E3428LK	3046	1078366LK
3114, 3116 TRUCK	1014495LK	3406	9Y4004LK

Engine	Part No.	Engine	Part No.
3046	1282952LK	3204, 3208	9L7737-3LK
3046	2254284LK	3204, 3208	2W4831LK
3064, 3066	2977752LK	3304, 3306	1073565LK
3114, 3116	1077553LK	3304, 3306	1290358LK
3114, 3116	6I4248LK	3304, 3306	1548087LK
3114, 3116 IND.	1051710LK	3304, 3306	1646560LK
3114, 3116 IND.	7C5668LK	3304, 3306	1654262LK
3114, 3116 IND.	7E3428LK	3304, 3306	1684531LK
3114, 3116 IND.	1077563LK	3304, 3306	8N3180LK
3114, 3116 TRUCK	1014495LK	3304, 3306	8N3182LK
3114, 3116 TRUCK	6I1144LK	3304, 3306	8N3184LK
3116, 3116 IND.	1154124LK	3304, 3306	9N5403LK
3126B, 3126E	2382729LK	3406, 3406C	1684540LK
3176, C10	1337098LK	3406, 3408, 3412	6N4126LK
3176C	4P5852LK	3406, 3408, 3412	7N3511LK
3204, 3208	7E4729LK	3406B	9Y3116LK

Part numbers are used for reference purposes only.

Costex Tractor Parts Copyright © 2020. All rights reserved.

Liner Kits (cont.)

Engine	Part No.	Engine	Part No.
3406B, 3406C	7E8700LK	C12, 3196	1979328LK
3406B, 3406C	9Y9889LK	C15	1807352LK
3406B, 3406C TRUCK	7E0292LK	C15	3564787LK
3406C	1175063LK	C15	3569946LK
3406C	1168154LK	C15	3889354LK
3406C TRUCK	1010016LK	C15, 3406E	2212305LK
3406C TRUCK	1601131LK	C15, 3406E	2250115LK
3406C TRUCK	7E0539LK	C18	3294510LK
3406E	1352837LK	D315/G, D318/G	8H2000LK
3406E	1495566LK	D330/A, D333/A	2M5558LK
3412C	9Y7212LK	D334	5S2886LK
3508, 3512, 3516	7C2431LK	D342	7N1366LK
3508, 3512, 3516	9Y4124LK	D343	9N2874LK
C7	2382720LK	D346, D348	8N0931LK
C9	1979297LK	D353	7N4515LK
C9	3851657LK	D353	7N5036LK
C12, 3196	1442948LK		



PISTONS

Crowns and Skirts

Part No.	Description	Engine	Equipment
1W6588	PISTON G ROD	3304, 3304B, 3306	120G, 12G, 12H, 12H ES, 12H NA, 130G, 140G, 140H, 140H ES, 140H NA, 143H, 14G, 160G, 160H, 160H ES, 160H NA, 163H NA, 3304, 3304B, 3306, 517, 561D, 930, 930R, 936, 936F, 966C, 966R, CB-534, D4E, D4E
1010016	PISTON A	3406B	TRUCK
1014495	PISTON BODY	3116	TRUCK
1051710	PISTON	3114, 3116	TRUCK
1070984	PISTON (STD)	3046	315, 315B, 939, 939C, D5C III
1073565	BODY AS- PISTON	3306, 3306C	R1300, R1300G

Part No.	Description	Engine	Equipment
1077563	BODY AS-PISTON	3116	120H, 120H ES, 120H NA, 135H, 135H NA, 446B, 446D, 924F, 928G, 938F, 953C, 963B, AP-1000, AP-1050, CB-634C, CB-634D, CP-563, CS-531C, CS-531D, CS-533C, CS-533D, CS-563C, CS-573C, CS-583, CS-583C
1078255	PISTON AS-(OS 0.25MM)	3046	315, 315B, 933, 933C, 939, 939C, D3C III, D4C III, D5C III
1078256	PISTON AS-(OS 0.50MM)	3046	315, 315B, 933, 933C, 939, 939C, D3C III, D4C III, D5C III
1078366	PISTON STD	3046	933, 933C, D3C III, D4C III
1127021	PISTON ASM	3054, 3056	416B, AP-800C, BG-225B, PS-200B, PS-300B, TH103, TH62, TH63, TH82, TH83
1154124	PISTON AS	3114, 3116	320 L, CB-634, CB-634C
1166107	PISTON	4.236, 3054	
1168154	PISTON AS	3406C	16H NA, 3406C, 583R, 587R, 621F, 623E, 623F, 627B, 627F, 814B, 824G, 825G, 826G, 980G, D350E, D400, D400E, D8R, RM-250C, RR-250B
1175063	BODY AS	3406C	TRUCK
1243528	PISTON AS	3054, 3056	914G, IT14G, M312, M315
1282952	PISTON	3046	933, 933C, D3C III, D3G, D4C III, D4G, D5G
1283295	PISTON (STD)	3046	315, 315B, 939C, D5C III, D5G
1290358	PISTON A	3304	936F
1306763	PISTON AS-	3054	416C, 428C
1350264	PISTON AS	3054, 3056	307, 416B, 416C, 428B, 428C, CB-434B, CB-434C, CB-544, CB-545, CP-433C, CS-323C, CS-431C, PS-150B, TH62, TH63, TH82
1548087	BODY AS-PISTON	3306C	TRUCK
1568263	BODY AS-PISTON	3306	330, 330B, 330B L, W330B
1601131	BODY AS-PISTON	3406B, 3406C	375, 375 L, 5080, 621F, 623E, 627F, 980C, 980F, D8N, HT400, SM-350
1606600	PISTON	3046	317B LN, 318B

Part No.	Description	Engine	Equipment
1646560	PISTON BODY	3304, 3304B, 3306	120G, 12G, 12H, 12H ES, 12H NA, 140G, 140H, 140H ES, 140H NA, 143H, 14G, 160H, 160H ES, 160H NA, 163H NA, 517, D4E SR, D5E, D5H, D5H XL, D6D, D6E, D6G2 LGP, D6G2 XL, D6H, D6H XL
1654262	BODY AS-PISTON	3304, 3304B, 3306, 3306B	525, 527, 611, 615C, 637E, 637G, 815B, 963, 966F, 966F II, 970F, 972G, D250E, D250E II, D300E, D300E II, D6D, D6G SR, D7G
1684531	BODY AS-PISTON	3304, 3304B, 3306, 3306B	14H NA, 235B, 330, 330 FM L, 330 L, 330B L, 350, 515, 525, 527, 545, 572R, 627B, 627E, 627F, 627G, 814F, 815F, 816B, 816F, 966F, 966F II, 966G, 972G, 973, 973C, D6H XL, D7G
1723280	BODY AS-PISTON	3408E, 3412E	24H, 631E, 633E II, 637E, 651E, 657E, 769C, 769D, 771D, 773D, 775D, 834B, 836, 844, 988F II, 990 II, AD40, AE40, D10R, D9R, PM-565, PM-565B
1746102	BODY AS-PISTON	3408E, 3412, 3412C	PM-565B
1850104	PISTON AS-STD	3054B	416D, 424D, CS-423E, TH210, TH215
1850106	PISTON AS-(OS 0.50MM)	3054B	416D, 424D, CS-423E, TH210, TH215
1850107	PISTON AS-(OS 1.0MM)	3054B	416D, 424D, CS-423E, TH210, TH215
1922208	BODY AS-ST	3408E, 3412E	24H, 5110B, 631D, 631E, 633E II, 637E, 651E, 657E, 69D, 769C, 769D, 771D, 773B, 773D, 773E, 775D, 775E, 834B, 836, 844, 988B, 988F II, 990, 990 II, 992C, AD45, AE40 II, D10N, D10R, D8L, D9N, D9R
1922209	BODY AS-ST	3412E	631D, 631G, 637G, 769C, 769D, 771D, 773B, 773D, 773E, 775B, 844, 988F II, 990 II, D10N, D10R, D8L, D9N, D9R
1923896	BODY AS-PISTON	G3508, G3516B, G3520B	
1973765	BODY AS-PISTON	G3508, G3512, G3516, G3516B	PMG3516

Part No.	Description	Engine	Equipment
1979374	CROWN AS	C-12	
2M5558	BODY-PISTON	G3306B	
2W4831	PISTON BODY-STD	3204, 3208	215, 613C, 916, 943, 953, D4HTSK II, FB221, PS-500
2W8410	PISTON BODY-(OS .020")	3204, 3208	215, 613C, 916, 943, 953, D4HTSK II, FB221, PS-500
2W8412	BODY A- STD	3208	225
2123677	PISTON AS-	3034	216, 236, 247, 267
2254284	PISTON	3046	315C, D3G, D4G, D5G
2344814	PISTON-STD	3044C	236B, 246C, 252B, 256C, 262C, 267B, 268B, 272C, 277C, 287C, 297C, 906, 906H, 907H, 908, 908H
2382698	BODY AS-PISTON	C7	120K, 120K 2, 12K, 324D, 324D FM, 324D FM LL, 324D L, 324D LN, 325D, 325D L, 326D L, 328D LCR, 329D, 329D L, AP-755, M325D L MH, M325D MH
2382729	BODY AS.-P	3126B, 3126E	120H, 135H, 322C, 322C FM, 325C, 561N, 938G II, 953C, 963C, D5N, D6N, IT38G II, M325C
2622061	BODY AS-PISTON	G3516C, G3520C	PMG3516
2706968	PISTON AS-	3024, 3024C, C1.5, C2.2	226B, 226B3, 232B, 242B, 247B, 247B3, 257B
2706968-1	PISTON BODY	3024, 3024C, C1.5, C2.2	
2822224	PISTON AS-	C6.6	963D, AP1000E, AP1055E
2881394	PISTON AS-(OS 0.50MM)	3054C, 3054E	312D2, 312D2 GC, 312D2 L, 313D2, 313D2 LGP, 318D2 L, 414E, 416D, 416E, 416F, 420D, 420E, 420F, 422E, 422F, 424D, 428D, 428E, 428F, 430D, 430F, 432D, 432E, 432F, 434E, 434F, 442D, 442E
2881395	PISTON AS-(OS 1.0MM)	3054C, 3054E	312D2, 312D2 GC, 312D2 L, 313D2, 313D2 LGP, 318D2 L, 414E, 416D, 416E, 416F, 420D, 420E, 420F, 422E, 422F, 424D, 428D, 428E, 428F, 430D, 430F, 432D, 432E, 432F, 434E, 434F, 442D, 442E

Pistons (cont.)

Part No.	Description	Engine	Equipment
2889942	PISTON AS-(OS 0.50MM)	3054C, 3054E	414E, 416D, 416E, 422E, 422F, 424D, AP-300, C3.3, C4.4, CB-434D, CS-323C, CS-423E, TH210, TH215
2973080	PISTON AS-	3024, 3024C, C2.2	216, 216B, 216B3, 232B, 242B, 304.5, AP-255E, BB-621C, CB-334E, CB-34, CB34B, CB34B XW, CC34B
2977750	PISTON STD	3064, 3066	311C, 312C, 312C L, 314C, 318C, 320C, 320C FM, 320C L, 320D, 320D LRR, 321C, 323D L, 323D LN
2977751	PISTON STD	3064, 3066	318C, 319C, 320C, 320C FM, 320C L, 320D, 320D LRR, 321C, 323D L, 323D LN
2977752	PISTON STD	3064, 3066	320B
2977753	PISTON	3064, 3066	311C, 312C L, 320C, 320C FM
2977754	PISTON AS-(OS 0.25MM)	3064, 3066	311C, 312C, 312C L, 314C, 318C, 320C, 320C FM, 320C L, 320D, 320D LRR, 321C, 323D L, 323D LN
2977755	PISTON AS-(OS 0.50MM)	3064, 3066	311C, 312C, 312C L, 314C, 318C, 320C, 320C FM, 320C L, 320D, 320D LRR, 321C, 323D L, 323D LN
2995204	PISTON AS	3508, 3508B, 3512, 3512B, 3512C, 3516, 3516B, 3516C	5130B, 5230B, 776D, 777, 777B, 777C, 777D, 784C, 785, 785B, 785C, 789, 789B, 789C, 789D, 793C, 793D, 854G, 992G, 994D, D11N, D11R, PM3508, PM3512
3S1824	PISTON BODY	D379B	
3109269	PISTON AS-	C4.4	420E, 430E, 914G, C4.4, CB-54B, CP-44, CS-44, CS-54, CS-54B, CW-34, D3K XL, D4K XL, D5K LGR, IT14G, IT14G2, SPF343C
3153395	PISTON AS-	C4.4	416E, 420F, 422E, 428E, 428F, 430F, 432E, 432F, 434E, 434F, 442E, 444E, 444F, AP-300D
3196715	BODY AS-PISTON	C18	GENERATOR SET
3196716	BODY AS-PISTON	C32	777D, 777F, 854K, 992K, 993K, D11R, D11T, TH48-E70
3196717	BODY AS	C27, C32	TH48-E70
3220329	BODY STL AS-PISTON	C13	972H, TH35-C131, TH35-C13T

Part No.	Description	Engine	Equipment
3244235	PISTON STD	C6.4	320D, 320D FM, 320D FM RR, 320D GC, 320D L, 320D LN, 320D LRR, 320D RR, 321D LCR, 323D L, 323D LN, 323D SA
3244238	PISTON STD	C4.2	311D LRR, 312D, 312D L, 313D, 314D CR, 314D LCR, 315D L, 318D L, 319D, 319D L, 319D LN
3294511	BODY AS.-P	C18	24M, 385C, 385C FS, 385C L, 385C L MH, 390D, 390D L, 631E, 631G, 633E II, 637E, 637G, 834H, 836H, 988H, D9T
3564787	BODY-STL P	C15	TRUCK
3569946	BODY-STL P	C15	TRUCK
3780509	PISTON	3406B, 3406C	16G, 3406B, 3406C, 578, 621F, 623E, 627F, 980C, 980F, 980G, D8N
3889354	BODY AS-PISTON	C15	374F L, 583T, 587T, 621B, 621G, 623G, 627F, 627G, 631D, 651B, 657E, 657G, 735, 735B, 740, 740B, 770, 770G, 824C, 824H, 825H, 826H, 980G, 980H, AD30, CX31-C15I, D8R, D8T, PL83, PL87, R2900G, R3000
4P2990	BODY AS 16:1	3116	TRUCK
4W5819	PISTON A	4.236, 3054	206
5I7792	PISTON AS-(OS 0.25MM)	3066	311, 311B, 312B, 320 L, 320B
5I7793	PISTON AS-(OS 0.50MM)	3066	311, 311B, 312B, 320 L, 320B
6I1144	PISTON BODY	3116	TRUCK
6I3650	PISTON AS	3066	330 L, 992
6N4126	PISTON BODY	3412	621B
6N4221	PISTON A	C6.6	
7C1146	BODY A-PISTON	3204	931B
7C2431	BODY AS-PISTON	3508, 3512, 3516	
7C5668	BODY A-PISTON	3116	214B, E200B, IT12B
7E0292	PISTON AS	3406B	TRUCK
7E0305	BODY A PISTON	3406B	GEN SET
7E0539	BODY AS PISTON	3406B	TRUCK
7E1298	PISTON	3114, 3116	446B, AP-1000, AP-1050, CB-434, CP-563, E240C
7E3428	PISTON	3114, 3116	320 L, 918F, IT28F, RT100

Part No.	Description	Engine	Equipment
7E3888	BODY A PISTON	G3406, G3408, G3412	7DB
7E4729	PISTON BODY	3208	953, D5C
7E8656	BODY A	3406B	TRUCK
7E8700	BODY A	3406B	TRUCK
7N1366	PISTON BODY	D342	D8 D8H D8K
7N3509	PISTON BODY	3406	
7N3511	PISTON BODY	3406 3406 3412	
7N3633	PISTON BODY	3406, 3408, 3412	INDUSTRIAL ENGINE 3406, 3408 MARINE ENGINE 3412
7N4515	PISTON BODY	D379B	
7N5036	PISTON BODY	D353	D9H
7W3846	PISTON BODY, STD. 17.5:1	3208	CS-551, PS-500
8H2000	PISTON BODY	D315G, D318G	
8N0931	PISTON BODY	D346, D348, D349	
8N3182	BODY A PISTON	3304, 3306 PC	
8N3184	PISTON A	3304, 3306 PC	930
9L7737	PISTON-STD	1160, 3208	
9N2874	PISTON BODY	D343	
9N5250	PISTON BODY	3304, 3306 PC	D7F
9N5403	PISTON BODY KIT=9N5403LK	1673C, 3304, 3306	621R
9N6431	PISTON G-STD	3208	613B
9Y3116	BODY A PISTON	3406B	
9Y4004	PISTON	3406B, 3406C	16G, 16H NA, 578, 621E, 621F, 623E, 627E, 627F, 826C, 980C, 980F, D8N, RR-250, SS-250
9Y4124	PISTON AS	3508, 3512, 3516	
9Y7212	PISTON	3406B, 3408, 3408C, 3412, 3412C	589, 631E, 637E, 651E, 657E, 769C, 771C, 773B, 775B, 834B, 988B, 988F, 990, 992C, 992D, D10N, D9R, PM-565, PM3412, PR-1000, PR-450C
9Y9889	PISTON BODY	3406B	TRUCK



PISTON KITS

Includes the crown, skirt, pin, retainer and the ring group.
Kit No. = Crown No. + PK

Engine Model	Part No.
3046	1078366PK
3046	1282952PK
3054, 3056	1350264PK
3054, 3056	1521390PK
3066	2977751PK
3066	2977752PK
3066	2977753PK
3066	2977750PK
3114, 3116	6I4248PK
3114, 3116	1051720PK
3114, 3116	1154124PK
3114, 3116	1051710PK
3114, 3116	1077563PK
3116	1077545PK
3116	1077553PK
3116	6I1210PK
3126	1443444PK
3126	1504621PK
3126	1646556PK
3126	1723282PK
3126	2382729PK
3126	1335044PK
3126, 3126B	1334983PK
3176/B/C, C10	4P5852PK
3204, 3208	2W8410PK
3208	2W8412PK
3306B	1654262PK
3400	1495566PK
3400	1684540PK
3400	7C2888PK
3406	9Y4004PK
3406	1352837PK
3406, 3408, 3412	9Y7212PK
3406B, 3406C	1601131PK

Part numbers are used for reference purposes only.

Costex Tractor Parts Copyright © 2020. All rights reserved.

Piston Kits (cont.)

Engine Model	Part No.
3412E	1723280PK
C7	2382698PK
C7	2382720PK
C9	1979297PK
C9	1979345PK
C9	2382701PK
C9	3851657PK
C10, 3176	1337098PK
C12	1979328PK
C12	1979374PK
C12	1442948PK
C15	1807352PK
C15	2250115PK
C15	3564787PK
C15	3569946PK
C15	2212305PK
C18	3294510PK

PISTON PINS



Pin Part No.	Retainer Part No.	Piston Part No.	Engine
0947134	517667 (2)	517537	3066-3064 EX
1029796	7E1177 (2)	1175063	3406
1388506	8N7296 (2)	7C2431, 9Y4124	3508 / 3512 / 3516
1388507	8N7296 (2)	Crown=1338383, Skirt=1252782	3500 / 3508B / 3516B
1540873	1540874 (2)	2973080	3024
1663648	7X2908 (2)	1889141, 1979302, 1979385	C9

Pin Part No.	Retainer Part No.	Piston Part No.	Engine
1687224	7C0111 (2)	1777500, 2123659	3126 TRUCK
1687226	7C0111 (2)	1077614, 1443445, 1393530	3126
1687246	7E1177 (2)	1010016 Crown=1684540, Skirt=1300241 Crown=1807352, Skirt=1326663	3406C TRUCK* 3406C C15
1730148	7E5665 (2)	1928809	3508
1979251	N/A	Crown=1442848, Skirt=2382712	C12
1979335	6I2720	1323203	3176
1979371	1979372(2)	2382720	C7
2344815	N/A	1070984, 1078255, 1078256, 1283295, 1282952	3046
2638955	2531238 (2)	2780247, 3145005	3508B/3512B 3516B
4M5489	4F7021 (2)	8H2000	D315/D318/D318G/ D315G
7C0115	7C0111 (2)	1014495 4P2990 1051710 / 1077563 1154124 / 7C5668 7E3428	3114/3116 TRUCK 3114/3116 IND. 3116
7C3901	7C0111 (2)	2382716 (Crown=1077545, Skirt=1051720)	3116, 3204
7N9803	8N7294 (2)	2W4831 2W8410 2W8411 2W8412 2W8414 6N4221 7E4729 9L7737-3 9L7737 9L9317 9L9318	3204/3208 STD 3204/3208 .020 3204/3208 .040 3204/3208 STD 3204/3208 .020 3204 3204/3208 3204/3208 3 RING-STD 3204/3208 STD 1140/1145 1150
7N9804	9H4015 (2)	8N3184 2M5558 8N3180 / 8N3182	3304/3306 D330/D333 3304/3306
7N9805	1S9543 (2) 9H4015 (2) 2531238 (2)	1073565 /1290358 1548087 1646560 1654262 /1684531 9N5403 5S2886 9N5250 2M5558 /1338383 1440720	3304/3306 D334 D330C/333C/3300 D330A/D333A
7N9806	3F8513 (2) 7E5665 (2)	9N2874 6N4080 / 7N3511	D343/1693 3406/3408/3412
7N9807	7E5665 (2)	6N4126, 7N3509, 7N3633	3406/3408/3412
7N9808	3F8513 (2)	8N0931	D343/D346 D348/D349
7N9809	7M4926 (2)	7N1366	D339/D342/364/D375/ D386/D397
7N9810	7M4926 (2)	7N4515, 7N5036	D353/D379/D398
8N1608	7E5665 (2)	1601131 / 7E0539 7E8700 9Y3116 9Y4004 9Y7212 / 9Y9889	3406C TRUCK 3406B/3406C TRUCK 3406/3408/3412 3406B/3406C 3406/3408/3412

PISTON RING SETS



CTP Piston Rings are technically optimized with:

- » Advanced surface finish utilizing chrome plating, gas nitriding, spray coating and ceramic coating
- » Superior base material such as gray cast iron, ductile cast iron and stainless steel
- » High precision machining

The benefits:

1. Excellent sealing performance will dramatically reduce blow-by gas and oil consumption.
2. High anti-wear and breakage performance will assure you a longer part-life span.

Ring Set No.	Application	Top	Inter	Oil	Piston
1N3601	D353	1N3592	6N6640	1W5061	1N3600
1N3967	3508, 3512, 3516	8N1233	8N7810	7W2221	8N7963
1W5105	D379, D398, D399, G398, G399	9S7507	3S4059	1W5061	7N4515
1W8922	3406B, 3408, 3408B, 3412	1343761	2P2817	7N7078	1W9372
1979297RS	C9	1613425	1687209	1979299	1979297
2W1709	3304, 3304B, 3306, 3306B	2W1707	2W1708	7E6047	8N3102
2W6091	3304, 3306	9S3029	5S6750	7E6047	1290359
2W8265	3204, 3208	9L6233	N/A	2W8045	2W4831
2W8646	3204, 3208 (RING SET- 0.020" OS)	9N0581	N/A	2W8416	9L7827-3, 2W8414- 3
2W8647	3204, 3208	9N0578	N/A	2W8417	2W4831
2114321	3304, 3304B, 3306, 3306B	2W1707	2W1708	6I0497	1654262
3S4023	D320A	1S7082	9M4602	9M4603	2M5126
3S4029	1673, D330A, D336	3S4027	3S4026	7M2126	3S4028
3S4031	D342, D342C	4N3875	2S8884	3H0881	3S4040
3S4058	G342C	4N3875	2S8884	5M5697	3S4041, 3S4042
4P6914	3116	1077787	4P1807	4P1806	1051710
7C8937	3406B	1343761	7C8939	7N7078	7C3496
7E2899	G3508, G3512, G3516	7E7581	8N1234	7W2221	1973765

Ring Set No.	Application	Top	Inter	Oil	Piston
7E4729-RS	3208	1303987	1303997	7E7297	9Y4187, 7E4729
7E5213	3114, 3116	1077787	7E5786	7C5232	1077563
7E5214	3114, 3116	1077787	7E5786	7C5232	1166107
8N0822	3406, 3408, 3412	8N0502	2P2817	7N7078	7N3633, 9N2874
8N5760	D342 D375	8N5654	6N5026	3H0881	7N1366
9H1212	D315	3S4027	3S4026	9S4867	8H2001
9S3068	3304, 3306	9S3029	5S6750	9S7788	9N5250, 8N3182
1P0734	D346, D348	9S2263	7C8939	1P0708	9S2266
1P0735	D346, D348	1P0431	7C8939	1P0708	9S2266
1P1127	D343	1P0431	7C8939	1P8474	1P0435
1337082	3176, 3176B, 3176C, C10	1095318	1095319	4P1659	4P5852

Ring Set No.	Application	Type	Piston	Notes
1032857	3046	SET	1078366	RING SET-PISTON (STD)
1032859	3046	SET	1078256	RING SET-0.50-MM OS
1127020	3054, 3056	SET	1072553	RING SET-PISTON (STD)
1258726	3054	SET	1243528	RING SET-PISTON (STD)
1382073	3054, 3054B, 3056	SET	1382047, 1521390	RING SET-PISTON (STD)
1461780	3054, 3056	SET	1350264	RING SET-PISTON (STD)
1531029	3034	SET	2123677	RING SET-PISTON (STD)
1786543	C4.2	SET	2128484	RING SET-PISTON (STD)
1786544	C4.2	SET	2128485	RING SET-0.25-MM OS

Piston Ring Sets (cont.)

Ring Set No.	Application	Type	Piston	Notes
1786545	C4.2	SET	2128486	RING SET-0.50-MM OS
1850109	3054	SET	1850104	RING SET-PISTON (STD)
1850110	3054	SET	1850106	RING SET-0.50-MM OS
1850111	3054	SET	1850107	RING SET-1.00-MM OS
2W8265-3	3208	SET	9L7737-3, 2W8412-3	THREE RING SET
2171456	3024, C1.1, C1.5, C2.2	SET	2973080	RING SET-PISTON (STD)
2171573	3056E	SET	2168323	RING SET-PISTON (STD)
2255436	3054C, 3054E	SET	2255437	RING SET-PISTON (STD)
2268204	3044C	SET	2254284, 2398506	RING SET-PISTON (STD)
2337231	3054C, 3054E	SET	2538755, 2337232	RING SET-PISTON (STD)
2706970	3024, 3024C, C1.5, C2.2	SET	2706968	RING SET-PISTON (STD)
2767476	C4.4, C6.6	SET	2767475, 3109269, 2822224	RING SET-PISTON (STD)
3341997	3054C, 3054E	SET	2889943	RING KIT-1.0MM
3342318	3054C, 3054E	SET	2881395	RING KIT-1.0MM
3342319	3054C, 3054E	SET	2881394	RING KIT-0.50 MM
3802065	C4.4, C6.6	SET	3802062, 3913732	RING KIT-0.50 MM
3964482	C4.4	SET	3109269	RING KIT-0.50 MM
517538	3064, 3066	SET	517537	RING SET-PISTON (STD)
517790	3064, 3066	SET	517792	RING SET-0.25-MM OS
517791	3064, 3066	SET	517793	RING KIT-0.50 MM

Ring Set No.	Application	Type	Piston	Notes
610225	3054	SET	610226	RING SET-PISTON (STD)
7W2513	3054, 4.236	SET	7C3185	RING SET-PISTON (STD)
7W7732	3054, 4.236	SET	4W5819	RING SET-PISTON (STD)
1032858	3046	SET	1078366	RING SET-0.25-MM OS

* Other part no. not included in the list are available. Please contact your sales representative if you have any questions. Part Numbers are used for reference purposes only.

CONNECTING RODS



Part No.	Description	Engine Model
0676879	Connecting Rod AS	416, 4.236, 3054
1039680	Connecting Rod AS	3046, C3.4
1139016	Connecting Rod AS	C12 3196
1540867	Connecting Rod AS	3024, C2.2
1556629	Connecting Rod AS	C10, 3176
1566980	Connecting Rod AS	C10, 3176, 3176C
1608199	Connecting Rod AS	C9
2133193	Connecting Rod AS	3116, C7
2239150	Connecting Rod AS	C13
2243245	Connecting Rod AS	C15, C18
2255441	Connecting Rod AS	3054, C4.4
2255453	Connecting Rodv AS	3054, C4.4
2255454	Connecting Rod AS	3054, C4.4
2323232	Connecting Rod AS	C27, C32
2562235	Connecting Rod AS	4.236
3590724	Connecting Rod AS	C4.4, C6.6
1P0009	Connecting Rod AS	D398B
3S8285	Connecting Rod AS	D343
4P8577	Connecting Rod AS	3114, 3116
517668	Connecting Rod AS	3066, 320

Part No.	Description	Engine Model
7E4728	Connecting Rod AS (Tapered)	3208
7E5996	Connecting Rod AS (Tapered)	3406B
7N3229	Connecting Rod AS (Narrow Taper)	3408, 3412
8N1721	Connecting Rod AS (Straight 1.70" Pin)	3304, 3306
8N1726	Connecting Rod AS (Wide Taper)	3406
8N1728	Connecting Rod AS	3408, 3412
8N1984	Connecting Rod AS	3306
8N3753	Connecting Rod AS	3204
9N0407	Connecting Rod AS (Straight)	3208
9Y6054	Connecting Rod AS (Tapered)	3406, C15, C16
9Y6054	Connecting Rod A - Tapered	3406

CONNECTING ROD KITS



A Connecting Rod Kit, also known as a Cylinder Pack, come completely assembled and ready to install in your machine. Complete with piston, piston rings, connecting rod, liner and even the liner seal kit to reduce the time you will take to repair your engine. Receive a 10% discount with the purchase of a set of 6, 8 or 12.

Application	Part No.	Uses Piston	Connecting Rod
3304, 3306	1290358CK	1290358	8N1721
	8N3180CK	8N3180	8N1984
	9N5250CK	9N5250	8N1721
	1684531CK	1684531	8N1721
	1654262CK	1654262	8N1721
	8N3182CK	8N3182	8N1984
	1646560CK	1646560	8N1721
3306C	1073565CK	1073565	8N1721
G3304, G3306	4P2654CK	4P2654	8N1984
	4P2655CK	4P2655	8N1984
3406	7N3633CK	7N3633	8N1726
	9Y4004CK	9Y4004	8N1726
	1010016CK	1010016	9Y6054
	1684540CK	1684540	9Y6054

Part numbers are used for reference purposes only.

Application	Part No.	Uses Piston	Connecting Rod
3406B	1601131CK	1601131	7E5996
3406B, 3406C	9Y9889CK	9Y9889	8N1726
3406C	1168154CK	1168154	7E5996
3408, 3412	9Y7212CKA	9Y7212A	8N1728
	9Y7212CK	9Y7212	8N1726

* Other part no. not included in the list are available. Please contact your sales representative if you have any questions. Part Numbers are used for reference purposes only.

ENGINE OIL PUMPS



Part No.	Description	Engine	Equipment
0676925	ENGINE OIL PUMP	4.236	206, RT50
1003717	ENGINE OIL PUMP	3056	924G, 924GZ, CS-663E, CS-683E
1068958	ENGINE OIL PUMP	3306, 3306B, 3306C	12H, 12H ES, 12H NA, 140G, 140H, 140H ES, 140H NA, 143H, 14H NA, 160H, 160H ES, 160H NA, 163H NA, 235B, 330, 330B L, 350, 545, 572R, 611, 615C, 627B, 627F, 627G, 637D, 637E, 637G
			24H, 631D, 631E, 631G, 633E II, 637E, 637G, 651E, 657E, 69D, 769C, 769D, 771D, 773B, 773D, 773E, 773F, 773G, 773G LRC, 773G OEM, 775B, 775D, 775E, 775F, 775G, 775G LRC, 775G
1161980	ENGINE OIL PUMP	3408E, 3412C, 3412E	446B, 446D, 910E, 918F, 924F, IT12B, IT14F, IT18F, IT24F, RT100
1192925	ENGINE OIL PUMP	3114	589, D8L, D9N, D9R
1614110	ENGINE OIL PUMP	3408, 3408C	

Costex Tractor Parts Copyright © 2020. All rights reserved.

Engine Oil Pumps (cont.)

Part No.	Description	Engine	Equipment
1614111	ENGINE OIL PUMP	3406, 3406B, 3406C	16G, 16H NA, 621F, 623E, 623F, 627B, 627F, 814B, 824G, 825G, 826G, 980C, 980F, 980G, 980G II, HT400, PM-465, RM-250C, RM-350B, RR-250B, SM-350
1614112	ENGINE OIL PUMP	3406, 3406C, 3406E	375, 375 L, 5080, 578, 583R, D8N, D8R, D8R II
1614113	PUMP GP-OIL ENGINE	3406B, 3406C, 3406E, 3408, 3408B, 3408C, 3456	24M, 583T, 587T, 621B, 621G, 623G, 627F, 627G, 631D, 631E, 631G, 633E II, 637D, 637E, 637G, 651B, 657B, 657E, 657G, 735, 735B, 740, 740B, 770, 770G, 770G
1730141	ENGINE OIL PUMP	3034	216, 236, 247, 248, 267, 287, 906
1898777	ENGINE OIL PUMP	3116, 3126, 3126B, 3126E	120H, 120H ES, 120H NA, 120K, 120K 2, 12K, 12M, 135H, 135H NA, 140G, 140K, 140K 2, 140M, 160K, 30/30, 320B, 322B L, 322B LN, 322C, 322C FM, 324D, 324D FM, 324D FM LL, 324D L
1958098	PUMP GROUP	C9, C-9	12H, 140M, 140M 2, 160M, 160M 2, 2290, 2390, 2391, 2491, 2590, 330C, 330C FM, 330C L, 330C MH, 330D, 330D FM, 330D L, 330D LN, 330D MH, 336D, 336D L, 336D LN, 336D2, 336D2 L, 340D L, 340D2 L, 511, 521
1981508	ENGINE OIL PUMP	3406B, 3406C, 3406E, 3408, C-15, C-16, C-15, C-18,	365C, 365C L, 365C L MH, 374D L, 374F L, 375, 375 L, 385B, 385C, 385C FS, 385C L, 385C L MH, 390D, 390D L, 390F L, 5080, 5090B, 583R, 587R, D8N, D8R

Part No.	Description	Engine	Equipment
2P1784	ENGINE OIL PUMP	3304, 3304B, 3306, 3306B, G3304, G3306	120G, 12G, 12H, 12H ES, 12H NA, 130G, 140G, 140H, 140H ES, 140H NA, 143H, 14G, 14H NA, 160G, 160H, 160H ES, 160H NA, 163H NA, 215, 215B, 215C, 215D, 219D, 225, 225D, 229, 229D, 235, 235B, 235C, 235D
2P7830	ENGINE OIL PUMP	3304, 3306	120B, 140B, 950, D6C
2S9535	ENGINE OIL PUMP		D7E
2004497	ENGINE OIL PUMP	3116, 3126, 3126B, 3126E	120H, 120H ES, 120H NA, 120K, 120K 2, 12K, 12M, 135H, 135H NA, 140G, 140K, 140K 2, 140M, 160K, 30/30, 320B, 322B L, 322B LN, 322C, 322C FM, 324D, 324D FM, 324D FM LL, 324D L
2168625	ENGINE OIL PUMP	3056E	550B, 560B, 564, 574B, 924G, 924GZ, 930G, AP-655C, BB-760, CP-573E, CP-663E, CS-563E, CS-583E, CS-663E, CS-683E, IT28G, M316C, M318C, M318C MH, M322C
2231608	ENGINE OIL PUMP	C11, C13, C13	621H, 621K, 623H, 623K LRC, 627H, 627K LRC, 980K, 980K HLG, XQ350, CX31-C13I
2258329	ENGINE OIL PUMP	3054C, 3054E	312D2, 312D2 GC, 312D2 L, 313D2, 313D2 LGP, 315C, 318D2 L, 414E, 416D, 416E, 416F, 420D, 420E, 420F, 422E, 422F, 424D, 428D, 428E, 428F, 430D, 430E, 430F, 432D, 432E, 432F, 434E, 434F

Part No.	Description	Engine	Equipment
2335220	ENGINE OIL PUMP	3176, 3176B, 3176C, 3196	140H, 143H, 14H, 14M, 160H, 163H, 16H, 16M, 345B, 345B II, 345B II MH, 345B L, 345C, 345C L, 345C MH, 345D, 345D L, 345D L VG, 349D, 349D L, 365B, 365B II, 365B L, 572R II
3154678	ENGINE OIL PUMP	3046	
3318905	ENGINE OIL PUMP	C9, C-9	12H, 140M, 140M 2, 160M, 160M 2, 2290, 2390, 330C, 330C L, 330D, 330D FM, 330D L, 330D MH, 336D, 336D L, 336D LN, 336D2 L, 340D L, 340D2 L, 511, 521, 521B, 522, 522B, 532, 541, 541 2, 552, 552
3738014	ENGINE OIL PUMP	C6.6, C7.1	120M, 12M, 2470C, 320D GC, 320D L, 320D2, 320D2 GC, 320D2 L, 323D L, 323D2 L, 525D, 535D, 545D, 553C, 559, 613G, 924H, 924HZ, 924K, 928H, 928HZ, 930K, 938H, 938K, 950 GC, 953D, 963D, AP-600D, AP-655D
4N8735	ENGINE OIL PUMP	3406, 3406B, 3406C, 3406E, 3408, C-15, C-16,	583R, D8R
4P5638	ENGINE OIL PUMP	3508B, 3512, 3512B, 3512C, 3516, 3516B, G3508, G3512, G3512E, G3516, G3516B, G3516C, G3516E,	777D, 784B, 784C, 785, 785B, 785C, 785D, 789, 789B, 793, 793B, 797, 797B, 994, PM3512, PMG3516, SPF343

Part No.	Description	Engine	Equipment
6I0253	ENGINE OIL PUMP	3054, 3054B	307, 416B, 416C, 416D, 424D, 428B, 428C, CB-434B, CB-434C, CB-544, CB-545, CP-433C, CS-323C, CS-431C, PS-150B, TH210, TH215, TH62, TH63, TH82
6I0911	ENGINE OIL PUMP	3054	312, 315, 317, 416B, 426B, 428B, 436B, 438B, 914G, AP-800C, BG-225B, CB-534B, CB-534C, CB-535B, CP-433C, CS-431C, IT14G, PS-300B
6I0912	ENGINE OIL PUMP	3054, 3054B	312, 312B L, 312C, 315, 315B L, 317, 416B, 416C, 416D, 420D, 426C, 428B, 428C, 428D, 430D, 432D, 436C, 438C, 438D, 442D, 554, 908, 914G, AP-800C, BG-225B, BG-225C, CB-434C, CB-534B
6I1343	ENGINE OIL PUMP	1673C, 3306, 3306B, 3306C, G3304, G3304B, G3306, G3306B	966F, 972G
6I1346	ENGINE OIL PUMP	3304, 3304B, 3306, 3306B, G3304	120G, 12G, 12H, 12H ES, 12H NA, 130G, 140G, 140H, 140H ES, 140H NA, 143H, 14G, 14H NA, 160G, 160H, 160H ES, 160H NA, 163H NA, 215D, 219D, 225D, 229D, 235B, 235C, 235D, 330, 330 FM L, 330 L,
6N1030	ENGINE OIL PUMP	3126, 3412, 3412C, 3412D, G3412, G3412C	772B, 773B, 992C, CG137-12, PM3412, PR-1000, PR-750B, SCT673, SPS342, SPT342
6N2450	ENGINE OIL PUMP	D353	594H, D9H
6N2460	ENGINE OIL PUMP	D353C, G353D	INDUSTRIAL, MARINE

Part numbers are used for reference purposes only.

Costex Tractor Parts Copyright © 2020. All rights reserved.

Engine Oil Pumps (cont.)

Part No.	Description	Engine	Equipment
6N2642	ENGINE OIL PUMP	3304, 3304B, 3306, 3306B, G3304, G3306	120G, 12G, 12H, 12H ES, 12H NA, 130G, 140G, 140H, 140H ES, 140H NA, 143H, 14G, 14H NA, 160G, 160H, 160H ES, 160H NA, 163H NA, 215B, 215C, 215D, 219D, 225, 225D, 229, 229D, 235, 235B, 235C, 235D, 330, 330 FM L, 330 L, 350, E240, E300
6N2790	ENGINE OIL PUMP		955K
6N2792	ENGINE OIL PUMP		D5, D6, D6B, D6C, 922, 944, 951B, 955H, 955K, 966, 977H, 977
6N2809	ENGINE OIL PUMP		12E, 12F, 14E
6N2815	ENGINE OIL PUMP		12E, 12F, 14E
6N2820	ENGINE OIL PUMP	G3306	D7F
6N2821	ENGINE OIL PUMP		D4D, D5, D6C, 920, 922B, 930, 941, 941B, 944, 951B
7C1531	ENGINE OIL PUMP	3408, 3412	651E, 657E, 769C, 771C, 772B, 773B, 775B, 988F, 990, 992C, 992D
7C1772	ENGINE OIL PUMP	3412, 3412E, C27, C32	D10N, D10R, D10T, D11R, D11T, D9L
7E2971	ENGINE OIL PUMP	3114	446, 446B, 446D, 910E, 918F, 924F, IT12B, IT14B, IT14F, IT18F, IT24F, RT100
7N4170	PUMP GP	342, D342	583K, D8K
7W0053	ENGINE OIL PUMP	3508, 3508B, 3508C, 3512, G3508, G3508B, G3512	5130, 5130B, 776C, 776D, 777, 777B, 777C, 777D, 854G, 992G, D11N, D11R, PM3508

Part No.	Description	Engine	Equipment
9N0541	ENGINE OIL PUMP	3208	225, 613B
9S1195	ENGINE OIL PUMP	D343, G343	120, 140, 631C, 633C, 637, 657B, 666, 768B, 769, 824B, 825B, 826B, 834, 983, 988,

Engine Oil Pump For Komatsu®

Part No.	Description	Engine	Equipment
6221-51-1100	ENGINE OIL PUMP	KOMATSU®	EGS160, EGS190, PC300, S6D108, SA6D108, WA380

CYLINDER HEADS



CTP Manufactured Diesel Cylinder Heads for your equipment

CTP cylinder heads are CNC machined to exact specifications using premium materials and state-of-the-art manufacturing to ensure the quality of every casting. CTP Cylinder Heads are available as budget-friendly bare Cylinder Heads for repairs, where re-usable parts are swapped over from the original cylinder head. We offer a complete inventory of new replacement valvetrain parts to complete the job.

Engine Model	Bare Cylinder Head	Assembled Cylinder Head
3066	1838171 (REAR)	Custom Build Only
3066	1838174 (FRONT)	Custom Build Only
3116	1407373	1605130
3116	1154158	7E4204
3116	1605130	4P8264
3116	1753218	N/A
3126	2275952	2275955
3304	7S7070	7S7070C
3304	8N1188	8N1188C
3304	1N4304	1N4304C
3306	8N6796	8N6796C
3306	8N1187	8N1187C
3306	1P4303	1P4303C

Engine Model	Bare Cylinder Head	Assembled Cylinder Head
3408	7W2225	7W2224
3408	7N0858	7N0858C
3408	1430041	N/A
3412	7W2243	7W2242
3412	1433615	1081887
3412	1430047	N/A
3500	2425328	3172440
3500	2425327	3356218
3500	2425328	2014257
3500	2425327	4W9560
3500	2425328	3172440
3176C, 3196	1799462	1482149
3204, 3208	6I2378	7C3807
3406B	1105097	4W5311
3406B, 3406C	1105096	7W2202
3406C	1105096	7W2203
3412A	7N0848	2W5746
4.236, 3054	N/A	2W6947
C9	3323619	3453752 / 2528439 / 3442149
C9	3117226	2733034
C10, C12, 3176C	1799461	1482144
C12	1482133	1482134
C15, C18	2811640	2635055
C15, C16, C18	2237263	2239250
C15, C16, C18	2454324	1835296
D330	2S9004	2S9004C
D333	5S1884	7L4498
D339	4N7000	N/A
D342	8N6004	8N6004C
D342	8N6000	8N6000C
D343	4N6765	4N6765C
D353	7N3630	7N3630C
D353	7N6340	7N6340C
D353	5N8335	N/A

Special Fully Assembled Cylinder Head Kits

Engine Model	Cylinder Head	Cylinder Head Kit
3304	1N4304C	7N8874*
3306	8N6796C	7N8876*
3500	3356218	4W0095*

* (Kit Includes Head Gasket)

Part numbers are used for reference purposes only.



CTP also offers complete Cylinder Heads fully built, ready to install. The heads are assembled using blueprinting methods; where all the parts and components are checked for fitment prior to assembly. All of our cylinder heads are checked for dimensional accuracy, straightness and surface finish. The valve seats are micro finished and the assembled cylinder heads are vacuum leak tested to assure a positive valve to seat seal.

Cylinder Head Groups (Following items available upon request)

Special Fully Assembled Cylinder Head Kits		
Engine Model	Bare Cylinder Head	Assembled Cyl. Head
3304	1N4304C	7N8874*
3306	8N6796C	7N8876*
3500	3356218	4W0095*

* Kit Includes Head Gasket

C SERIES HEAD BOLTS



Engine	Part No.	Description	Specifications	Req.
C7	2768134	BOLT		14
C9	2632915	BOLT-12 POINT	M16-2.00 X 180MM 12 POINT	26
	9X8268	WASHER	17.5 X 30 X 3.5 MM THK	26
C10	1750454	HEAD BOLT	M16X2X160-MM	26
	2S5658	WASHER HARD	17 X 29 X 3MM THK	26
C11, C13	2421811	BOLT HEX	M16 - 2.00 X 220MM 12.9 HX PL	26
	2104460	HEX CAP SCREW	M10 - 1.50 X 130MM 10.9 PLAIN ST	8
C12	2S5658	WASHER HARD	17 X 29 X 3MM THK	26
	1750454	HEAD BOLT	17 X 29 X 3MM THK	26
C15, C16, C18	1241855	BOLT-12 POINT HEAD	3/4 - 16 X 7.638 - IN.	16
	5H1504	WASHER HARD	20 X 33.5 X 5 MM THK	26
	1241854	BOLT-12 POINT HEAD	3/4 - 16 X 8.5 - IN.	10
C27, C32	1241855	BOLT-12 POINT HEAD	3/4 - 16 X 7.638 - IN.	32
	5H1504	WASHER HARD	20 X 33.5 X 5 MM THK	52
C30	1241854	BOLT-12 POINT HEAD	3/4 - 16 X 8.5 - IN.	20
	2K2813	BOLT	3/4 - 16 X 10 - IN.	40
	5H1504	WASHER HARD	20 X 33.5 X 5 MM THK	40

Costex Tractor Parts Copyright © 2020. All rights reserved.

PRE-COMBUSTION CHAMBERS



Engine Model	Part No.	Glow Plug
3204	4N8809	3T8705
3406, 3408, 3412	4N3714	3T8705/3T8706
D311, D315, D318	2S1273	3H2033
D315, D318, 3208	1S1967	3H2033
D315, D330	5S1833	3H2033/3T8705
D318G	1S1970	3H2033
D320	2M8590	3T9562
D330, D333	5S1822	3T8705
D330C, D333C, 3304, 3306	5S6795	3T8705/3T9561
D333C	8S1522	3T8705
D339, D342C	2P0483	3T9562
D342, D342C	2P0484	3T9562
D343, 1693	8S1523	3T9562
D346, D348, D349	8N9489	3T9562
D346, D348, D349	9S6743	3T9562
D353	7S5787	3T9562/3T9563
D353	8S3617	3T9563
D375, D386, D397	5F8265	-
D9H, D353	6N6969	7L2123

ENGINE VALVES



Engine	Intake Valve	Exhaust Valve
3013	1566985	1566986
3024C, 3034	1888640	1529857
C2.2	3081860	3441624
C9	2527803	2418383
C12, 3176B/C, 3196	1570672	1570671
C15, C27, C32, 3508B	2365605	1537024
D346	1N4885	7E7830

Engine	Intake Valve	Exhaust Valve
C1.1, C1.5, C2.2	4359544	3081861
3306, 3304	5S6452	5S6449
3208	7C0362	1196772
G3304B, G3306	7W7490	7W7491
G342, G343, G353	8M2553	8M2552
G3406, G3408, G3412	1227353	1018314
3406, 3408, 3412	1152368	1152367
3208	9L7682	1196772
3406E, 3408, 3408E	1220322	1220321
C10, C12, 3176	1929213	1337029
C10, C12, 3176	7E9578	1337029
3116, 3126	1614280	1360819
3114, 3116	7W8064	1360819
3054, 3056	1382052	1382050
3054, 3056	1456855	1382050
3054, 3056	1456855	1456857
3126B/E, C7	1457390	1478211
3126B/E, C7	2527801	1478211
C7, 3126E	2527801	1478211
3304, 3306	1007860	1487455
3406E	1528380	1527585
3406E	1537023	1537024
3116, 3126	1632431	1632432
3412C, 3412E, C32	1642543	1642542
3054C	1763134	1763137
C9	1632442	1883122
3508B, 3512C/E	2102542	1944897
3500 Series	2102542	2102529
G3408C	2120932	2120933
C11, C13	2243028	2243030
C11, C13	2527802	2243030
3054C	2255495	2255499
3044C, 3046, C3.4	2335469	2335470
C9	2418382	2418383
C6.4	2941684	2941685
3500 Series	2102542	3074641
1676, D334, D336	2S8143	1S2903
621, 980	7S2514	1S2903
D342	1W1818	1W1819
D320	9H4811	2M7727

Engine	Intake Valve	Exhaust Valve
G3406, G3408, G3412	4W5374	2W2443
G3306	2W2621	2W2877
D379, D398, D399	1W8606	2W3211
C6.6	3096678	3399637
D315, D318	6H3026	4F0212
3066MHI 320C	2128477	5I7739
3066	5I7738	5I7739
3500	7E4609	1219839
D343, D346	1P0407	7E7830
3054	2W6988	7W2522
3054, 3056	1004626	7W4602
3054, 3056	6I0282	7W4602
3054, 3056	6I1196	7W4602
D342	8H1993	8H1994
3304, 3306	2W2621	8N0875
D398B, D399	7M7817	8N3723
3208	9L7682	9L7683
1673, D330A/B, D333A/B	7M7358	9M4163
3204, 910, 953	9N0180	9N0185

HIGH PERFORMANCE VALVES



Today's trends are shifting towards higher performance, fuel economy, natural resource conservation, and the introduction of special blended fuels. All these pose a special demand on diesel engines, especially on the exhaust valves. One of the key requirements of exhaust valve materials is oxidation resistance. Nimomic® 80A alloy, a nickel-base, high temperature alloy, containing a high percentage of chromium, is characterized by excellent high oxidation resistance and super resistance to fatigue under very high temperature conditions.

CTP's new High Performance Nimomic® 80A super alloy Intake & Exhaust Valves offer rugged reliability, extended life and durability. This technology allows us to provide the highest level of performance and reliability for your engine.

Engine	Intake Valve	Exhaust Valve
3013	1566985	1566986
3024C, 3034	1888640	1529857

Engine	Intake Valve	Exhaust Valve
C2.2	3081860	3441624
C9	2527803	2418383
C12, 3176B/C, 3196	1570672	1570671
C15, C27, C32, 3508B	2365605	1537024

* Other part no. not included in the list are available. Please contact your sales representative if you have any questions. Part Numbers are used for reference purposes only. Nimomic® is a registered trademark of Special Metals Corporation.

VALVE GUIDES



Engine Model/Application	Part No.	Description
342	1W1816	GUIDE VALVE
1674	5S2921	GUIDE VALVE
3046	1039247	GUIDE VALVE
3054	1605436	GUIDE-INTAKE
3054	1605438	GUIDE-EXHAUST
3208	6I2864	GUIDE-INTAKE
3208	6I2865	GUIDE-EXHAUST
3306	1621589	GUIDE VALVE
3306	3N0515	GUIDE VALVE
3412	2137536	GUIDE-INTAKE
3412	2137537	GUIDE-EXHAUST
3516	1845494	GUIDE VALVE
3516	1845495	GUIDE VALVE
3056, 3054	1639256	GUIDE-EXHAUST
3056, 3054	1850882	GUIDE-INTAKE
3114, 3116	9Y8848	GUIDE VALVE
3126B/E	1409670	GUIDE VALVE
3126E	1478220	GUIDE VALVE
312C & 312C L/3064	1838172	GUIDE VALVE
312C & 312C L/3064	1838173	GUIDE VALVE
3176, C10	1008150	GUIDE VALVE

Valve Guides (cont.)

Engine Model/Application	Part No.	Description
3306, G3306	9Y7895	GUIDE VALVE
3306C	1487425	GUIDE VALVE
3406, 3408, 3412	1737188	GUIDE VALVE
3406C	1227374	GUIDE VALVE
3406E, C15	1227375	GUIDE VALVE
3508, 3512, 3516	1339306	GUIDE-INTAKE
3508, 3512, 3516	1976995	GUIDE-EXHAUST
C13	2682953	GUIDE VALVE
C9	2595829	GUIDE VALVE
C9	2604856	GUIDE VALVE
D318, D4, D315	4F6949	GUIDE VALVE
D330/D333	4N3668	GUIDE VALVE
D343, D346, D348	6N2236	GUIDE VALVE
D379, D398, D399	2N9298	GUIDE INTAKE
D379, D398, D399	2N9299	GUIDE-EXHAUST
D379, D398, D399	7C3720	GUIDE VALVE IN 0.005" OS
D7, D8, D8H	7N2051	GUIDE VALVE
D8, D342	2S0893	GUIDE VALVE
D8H	6N8847	GUIDE-EXHAUST
D9, D9G, D9H	4N3664	GUIDE-INTAKE
G3300	4W9176	GUIDE VALVE
G3306	7E1551	GUIDE VALVE
G3400	1511330	GUIDE-VALVE
G3406	1516235	GUIDE-EXHAUST
G3408	7W1636	GUIDE VALVE
G3508, G3512, G3516	9Y1846	GUIDE-EXHAUST
G3508, G3512, G3516	9Y1847	GUIDE VALVE
G3516	1916766	GUIDE-INTAKE
G3516	2550897	GUIDE-EXHAUST
G3516B	2061541	GUIDE-EXHAUST
N/A	2592186	GUIDE VALVE
N/A	4H0621	GUIDE VALVE
N/A	7C0363	GUIDE VALVE



VALVE SEAT INSERTS

Part No.	Description	Engine	Equipment
1P6837	VALVE SEAT INSERT (INLET)	3306, G3304, G3306	12G, 528, 930, 950, 955K, D4D
1S2894	VALVE SEAT INSERT (INLET)	1674, 1676	621, 980, D334, D336
1S2895	VALVE SEAT INSERT (EXHAUST)	1674, 1676	621, 980, D334, D336
1S5738	VALVE SEAT INSERT (EXHAUST)	D353C, D379B, G353D, G379, G398, G399	
1W2713	VALVE SEAT INSERT (EXHAUST)	3114, 3116, 3126	120H, 120H ES, 120H NA, 135H, 135H NA, 205B, 214B, 224B, 30/30, 320 L, 320B, 322 FM L, 322B L, 322B LN, 322C, 322C FM, 325, 325 L, 325B, 325B L, 35, 446B, 446D, 45, 525B, 533, 535B
1W5283	VALVE SEAT INSERT (EXHAUST)	3406, 3406B, 3406C, 3406E, 3408, 3408B, 3408C, 3408E, 3412, 3412C, 3412D, 3412E, 3516B,	16G, 16H NA, 245, 24H, 375, 375 L, 5080, 5110B, 578, 583R, 587R, 589, 621, 621B, 621E, 621F, 623E, 623F, 627B
1W5321	VALVE SEAT INSERT (EXHAUST)	3304, 3306	120B, 140B, 1673C, 235, 930, 955L, D6D, D7F, D7G

Part No.	Description	Engine	Equipment
1039252	VALVE SEAT INSERT (INLET)	3044C	236B, 236B3, 242B3, 246C, 252B, 252B3, 256C, 257B3, 259B3, 262C, 262C2, 267B, 268B, 272C, 277C, 277C2, 279C, 279C2, 287C, 287C2, 289C, 289C2, 297C, 299C, 315, 315B, 315C, 317B LN, 318B, 906
1039253	VALVE SEAT INSERT (EXHAUST)	3044C	236B, 236B3, 242B3, 246C, 252B, 252B3, 256C, 257B3, 259B3, 262C, 262C2, 267B, 268B, 272C, 277C, 277C2, 279C, 279C2, 287C, 287C2, 289C, 289C2, 297C, 299C, 315, 315B, 315C, 317B LN, 318B, 906
1070265	VALVE SEAT INSERT (EXHAUST)	3304, 3304B, 3306, 3306B, 3306C	120G, 12G, 12H, 12H ES, 12H NA, 130G, 140G, 140H, 140H ES, 140H NA, 143H, 14G, 14H NA, 160G, 160H, 160H ES, 160H NA, 163H NA, 235B, 330, 330 L, 330B L, 350, 515, 517
1070268	VALVE SEAT INSERT (INLET)	3304, 3304B, 3306, 3306B, 3306C,	120G, 12G, 12H, 12H ES, 12H NA, 130G, 140G, 140H, 140H ES, 140H NA, 143H, 14G, 14H NA, 160G, 160H NA, 163H NA, 1673C, 235B, 330, 330 L, 3304, 3304B, 3306, 3306B, 3306C, 330B L, 350, 515
1085912	VALVE SEAT INSERT (INLET)	3406E	R2900
1093428	VALVE SEAT INSERT (EXHAUST)	3054, 3056	307, 416B, 416C, 426C, 428B, 428C, 436C, 438C, CB-434B, CB-434C, CB-544, CB-545, CP-433C, CS-323C, CS-431C, PS-150B, PS-200B, PS-300B, TH103, TH62, TH63, TH82, TH83
1225963	VALVE SEAT INSERT (INLET)	G3512, G3516, G3516B, PMG3516	

Part No.	Description	Engine	Equipment
1227352	VALVE SEAT INSERT (INLET)	931C, G3406, G3408, G3408B, G3408C, G3412, G3412C	
1233287	VALVE SEAT INSERT (EXHAUST)	3054, 3056	914G, IT14G, M312, M315
1241223H2	VALVE SEAT INSERT (INLET)		S6D114E, SA6D114E, SAA6D114E, WA320, WA380, WA420
1301501	VALVE SEAT INSERT (INLET)	3054, 3056	307, 416B, 416C, 426C, 428B, 428C, 436C, 438C, 914G, CB-434B, CB-434C, CB-544, CB-545, CP-433C, CS-323C, CS-431C, IT14G, M312, M315, PS-150B, PS-200B, PS-300B, TH62, TH63, TH82, TH83
1302607	VALVE SEAT INSERT (INLET)	3508, 3508B, 3508C, 3512, 3512B, 3512C, 3516, 3516B, 3516C	5130, 5130B, 5230, 5230B, 776C, 776D, 777, 777B, 777C, 777D, 784B, 784C, 785, 785B, 785C, 785D, 789, 789B, 789C, 789D, 793B, 793C, 793D, 797
1302608	VALVE SEAT INSERT (EXHAUST)	3508, 3508B, 3508C, 3512, 3512B, 3512C, 3516, 3516B, 3516C	5130, 5130B, 5230, 5230B, 776C, 776D, 777, 777B, 777C, 777D, 784B, 784C, 785, 785B, 785C, 785D, 789, 789B, 789C, 789D, 793B, 793C, 793D, 797
1314340	VALVE SEAT INSERT (EXHAUST)	3508, 3508B, 3512, 3512B, 3516, 3516B, 5130B, 5230B	776D, 777, 777D, 785C, 789C, 793C, 854G, 992G, 994D, D11R
1336997	VALVE SEAT INSERT (EXHAUST)	3176B, 3176C, 3196, C-10, C-12	345B L, 75C, 75D, 85C, 85D, 95E

Valve Seat Inserts (cont.)

Part No.	Description	Engine	Equipment
1337030	VALVE SEAT INSERT (EXHAUST)	3176, 3176B	75C, 85C
1382006	VALVE SEAT INSERT (INLET)	3176B, 3176C, 3196,	140H, 143H, 14H, 160H, 163H, 16H, 345B, 345B II, 345B II MH, 345B L, 365B, 365B II, 365B L, 480, 572R II, 65E, 725, 730, 75C, 75D, 75E, 814F, 815F, 816F, 85C, 85D, 85E, 95E, 966G
1456853	VALVE SEAT INSERT (INLET)	3054, 3056	312B L, 315B L, 416C, 416D, 420D, 426C, 428C, 428D, 430D, 432D, 436C, 438C, 438D, 442D, 908, 924G, 924GZ, CB-434C, CS-323C, CS-663E, CS-683E, PS-150B
1456854	VALVE SEAT INSERT (EXHAUST)	3054, 3056	312B L, 315B L, 416C, 416D, 420D, 426C, 428C, 428D, 430D, 432D, 436C, 438C, 438D, 442D, 908, 924G, 924GZ, CB-434C, CS-323C, CS-663E, CS-683E, PS-150B
1478218	VALVE SEAT INSERT (EXHAUST)	3126, 3126B, 3126E	120H, 120K, 12K, 12M, 135H, 140K, 140M, 160K, 322C, 322C FM, 324D, 324D L, 324D LN, 325C, 325C FM, 325D, 325D L, 328D LCR, 561N, 570B, 580B, 938G II, 950G II, 950H, 953C, 962G II
1527582	VALVE SEAT INSERT (EXHAUST)	3406E, 3456	365C, 365C L, 385B, 385C, 385C FS, 385C L, 385C L MH, 5090B, 583T, 587T, 621G, 623G, 627F, 627G, 631G, 637G, 651B, 657B, 657E, 657G, 735, 740, 770, 772, 824C, 824G II, 824H, 825G II, 825H
1559504	VALVE SEAT INSERT (INLET)	3126, 3126B, 3126E	120H, 135H, 322C, 322C FM, 325C, 325C FM, 561N, 570B, 580B, 938G II, 950G II, 953C, 962G II, 963C, C7, D5N, D6N, IT38G II, IT62G II, M325C MH

Part No.	Description	Engine	Equipment
1639063	VALVE SEAT INSERT (INLET)	3116, 3126	120H, 120H ES, 120H NA, 135H, 135H NA, 30/30, 320B, 322B L, 322B LN, 322C, 322C FM, 325B L, 35, 45, 525B, 533, 535B, 539, 543, 55, 550, 561M, 570, 574, 580, 613C II, 928G, 938F, 938G, 950F
1753617	VALVE SEAT INSERT (INLET)	3406E, 3456	365C, 365C L, 385B, 385C, 385C FS, 385C L, 385C L MH, 5090B, 583T, 587T, 621G, 623G, 627F, 627G, 631G, 637G, 651B, 657B, 657E, 657G, 735, 740, 770, 772, 824C, 824G II, 824H, 825G II, 825H
1767688	VALVE SEAT INSERT (INLET)	C-9, C9	12H, 330C, 330C FM, 330C L, 330C MH, 627G, 637D, 637G, 973C, D6R II, MTC735, TK711, TK721, TK722, TK732, TK741, TK751, TK752
1767690	VALVE SEAT INSERT (EXHAUST)	C-9, C9	12H, 330C, 330C FM, 330C L, 330C MH, 627G, 637D, 637G, 973C, D6R II, MTC735, TK711, TK721, TK722, TK732, TK741, TK751, TK752
1799453	VALVE SEAT INSERT (EXHAUST)	3176C, 3196, C-10	140H, 143H, 14H, 160H, 163H, 16H, 345B, 345B II, 345B II MH, 345B L, 365B, 365B II, 365B L, 480, 572R II, 65E, 725, 730, 75C, 75E, 814F, 815F, 816F, 85C, 85E, 95E, 966G II, 972G II,
1799454	VALVE SEAT INSERT (INLET)	3176C, C-10, C-12	CPT372, R1600, R1600G, R1700G, SBF214, SUF557
1838809	VALVE SEAT INSERT (INLET)	3508, 3508B, 3508C, 3512, 3512B, 3512C, 3516, 3516B, 3516C	776C, 776D, 777D, 784C, 785, 785B, 785D, 789C, 793D, D11N, PM3516, SPF343C, TH48-E80, TH55-E70, XQC1200, XQC1600
1916760	VALVE SEAT INSERT (EXHAUST)	G3508, G3508B, G3512, G3512B, G3516, G3516B, G3520B	PMG3516

Part No.	Description	Engine	Equipment
1986529	VALVE SEAT INSERT (EXHAUST)	G3406, G3408, G3408B, G3408C, G3412	
2N8943	VALVE SEAT INSERT (INLET)	1140, 1160, 3160, 3204, 3208,	215, 613B, 613C, 926, 943, 953, D4HTSK II, PR-1000, PS-500
2120936	VALVE SEAT INSERT (EXHAUST)	G3406, G3408, G3408B, G3408C, G3412	CG137-08, CG137-12
2128474	VALVE SEAT INSERT (INLET)	3064, 3066	311C, 312C, 312C L, 314C, 318C, 319C, 320C, 320C FM, 320C L, 320D, 320D LRR, 321C, 323D L, 323D LN
2128917	VALVE SEAT INSERT (EXHAUST)		140M, 140M 2, 160M, 160M 2, 2290, 2390, 2391, 2491, 2590, 330D, 330D FM, 330D L, 330D LN, 330D MH, 336D, 336D L, 336D LN, 336D2, 336D2 L, 340D L, 340D2 L, 511, 521, 521B, 522, 522B, 532, 541, 541 2
2143286	VALVE SEAT INSERT (INLET)	G3406, G3408, G3408B, G3408C, G3412, G3412C	CG137-08, CG137-12
2168332	VALVE SEAT INSERT (INLET)	3056E	550B, 560B, 564, 574B, 924G, 924GZ, 930G, AP-655C, BB-760, CP-573E, CP-663E, CS-563E, CS-583E, CS-663E, CS-683E, IT28G, M316C, M318C, M318C MH, M322C
2168333	VALVE SEAT INSERT (EXHAUST)	3056E	550B, 560B, 564, 574B, 924G, 924GZ, 930G, AP-655C, BB-760, CP-573E, CP-663E, CS-563E, CS-583E, CS-663E, CS-683E, IT28G, M316C, M318C, M318C MH, M322C

Part No.	Description	Engine	Equipment
2175213	VALVE SEAT INSERT (INLET)	3126, 3126B, 3126E	120H, 120K, 12K, 12M, 135H, 140K, 140M, 160K, 322C, 322C FM, 324D, 324D L, 324D LN, 325C, 325C FM, 325D, 325D L, 328D LCR, 561N, 938G II, 950G II, 950H, 953C, 962G II, 962H, 963C
2241270	VALVE SEAT INSERT (EXHAUST)		14M, 16M, 345C, 345C L, 345C MH, 345D, 345D L, 345D L VG, 349D, 349D L, 349E, 349E L, 349E L HVG, 349E L VG, 349F L, 621H, 621K, 623H, 623K, 623K LRC, 627H, 627K, 627K LRC, 725, 730, 730C, 966H, 972H
2242410	VALVE SEAT INSERT (INLET)	C11, C13	725, 730, CX31-C13I, TH35-C13I
2243983	VALVE SEAT INSERT (INLET)	3406E, 3456	24M, 365C, 365C L, 365C L MH, 385B, 385C, 385C FS, 385C L, 385C L MH, 5090B, 583T, 587T, 621G, 623G, 627F, 627G, 631D, 631G, 637G, 651B, 657B, 657E, 657G, 735, 740, 770, 772, 773F, 773G
2265561	VALVE SEAT INSERT (EXHAUST)	3406E, 3456	24M, 365C, 365C L, 365C L MH, 385B, 385C, 385C FS, 385C L, 385C L MH, 5090B, 583T, 587T, 621G, 623G, 627F, 627G, 631D, 631G, 637G, 651B, 657B, 657E, 657G, 735, 740, 770, 772, 773F, 773G
2321285	VALVE SEAT INSERT (EXHAUST)	3126, 3126B, 3126E	120H, 120K, 120K 2, 12K, 135H, 140G, 140K, 140K 2, 140M, 160K, 322C, 324D, 324D FM, 324D FM LL, 324D L, 324D LN, 325C, 325D, 325D FM, 325D FM LL, 325D L, 325D MH, 326D L, 328D LCR
2418388	VALVE SEAT INSERT (INLET)		140M, 140M 2, 160M, 160M 2, 2290, 2390, 2391, 2491, 2590, 330D, 330D FM, 330D L, 330D LN, 330D MH, 336D, 336D L, 336D LN, 336D2, 336D2 L, 340D L, 340D2 L, 511, 521, 521B, 522, 522B, 532, 541, 541 2

Valve Seat Inserts (cont.)

Part No.	Description	Engine	Equipment
2562084	VALVE SEAT INSERT (INLET)	3011C, 3013C, 3024, 3024C,	216B, 216B3, 226B, 226B3, 232B, 242B, 247B, 247B3, 257B, AP-255E, BB-621C, C1.1, C1.5, C2.2, CB-14, CB-214E, CB-22, CB-334E, CB-34, CB22B, CB24B, CB32B, CB34B, CB34B XW
2562085	VALVE SEAT INSERT (INLET)	3011C, 3013C, 3014, 3024, 3024C,	216B, 216B3, 226B, 226B3, 232B, 242B, 247B, 247B3, 257B, AP-255E, BB-621C, C1.1, C1.5, C1.6, C2.2, CB-14, CB-214E, CB-22, CB-334E, CB-34, CB22B, CB24B, CB32B, CB34B
2579166	VALVE SEAT INSERT (INLET)	G3508, G3512, G3516, G3520B	
2604855	VALVE SEAT INSERT (INLET)		14M, 16M, 345C, 345C L, 345C MH, 345D, 345D L, 345D L VG, 349D, 349D L, 349E, 349E L, 349E L HVG, 349E L VG, 349F L, 621H, 621K, 623H, 623K, 623K LRC, 627H, 627K, 627K LRC, 725, 730, 730C, 966H, 972H
2646157	VALVE SEAT INSERT (INLET)	3126, 3126B, 3126E,	120H, 120K, 120K 2, 12K, 135H, 140G, 140K, 140K 2, 140M, 160K, 322C, 324D, 324D FM, 324D FM LL, 324D L, 324D LN, 325C, 325D, 325D FM, 325D FM LL, 325D L, 325D MH, 326D L, 328D LCR
2668718	VALVE SEAT INSERT (INLET)	G3508, G3508B, G3512, G3512B, G3516, G3516B, G3520B, PMG3516	
2803979	VALVE SEAT INSERT (INLET)		24M, 3406E, 365C, 365C L, 365C L MH, 374D L, 374F L, 385C, 385C FS, 385C L, 385C L MH, 390D, 390D L, 390F L, 583T, 587T, 621B, 621G, 623G, 627F, 627G, 631D, 631E, 631G, 633E II, 637D, 637E, 637G, 651B

Part No.	Description	Engine	Equipment
2899745	VALVE SEAT INSERT (EXHAUST)	3508, 3508B, 3508C, 3512, 3512B, 3512C, 3516, 3516B, 3516C	776C, 776D, 777D, 784C, 785, 785B, 785D, 789C, 793D, D11N, PM3516, SPF343C, TH48-E80, TH55-E70, XQC1200, XQC1600
3054883	VALVE SEAT INSERT (EXHAUST)		311D LRR, 312D, 312D L, 313D, 314D CR, 314D LCR, 315D L, 318D L, 319D, 319D L, 319D
3054884	VALVE SEAT INSERT (INLET)		311D LRR, 312D, 312D L, 313D, 314D CR, 314D LCR, 315D L, 318D L, 319D, 319D L, 319D LN
3229663	VALVE SEAT INSERT (EXHAUST)	3054C, 3054E	312D2, 312D2 GC, 312D2 L, 313D2, 313D2 LGP, 315C, 318D2 L, 414E, 416D, 416E, 416F, 420D, 420E, 420F, 422E, 422F, 424D, 428D, 428E, 428F, 430D, 430E, 430F, 432D, 432E, 432F, 434E, 434F
3296655	VALVE SEAT INSERT (INLET)	3054C, 3054E	312D2, 312D2 GC, 312D2 L, 313D2, 313D2 LGP, 315C, 318D2 L, 414E, 416D, 416E, 416F, 420D, 420E, 420F, 422E, 422F, 424D, 428D, 428E, 428F, 430D, 430E, 430F, 432D, 432E, 432F, 434E, 434F
3770399	VALVE SEAT INSERT (INLET)		120M, 12M, 2470C, 320D GC, 320D L, 323D L, 323D2 L, 420E, 430E, 450E, 535D, 545D, 553C, 559, 613G, 914G, 924H, 924HZ, 924K, 928H, 928HZ, 930K, 938H, 938K, 950 GC, 953D, 963D, AP-600D, AP-655D, AP1000E

Part No.	Description	Engine	Equipment
3770400	VALVE SEAT INSERT (EXHAUST)		120M, 12M, 2470C, 320D GC, 320D L, 323D L, 323D2 L, 420E, 430E, 450E, 535D, 545D, 553C, 559, 613G, 914G, 924H, 924HZ, 924K, 928H, 928HZ, 930K, 938H, 938K, 950 GC, 953D, 963D, AP-600D, AP-655D, AP1000E
4N5893	VALVE SEAT INSERT (INLET)	3176, 3176B, 3176C, 3196, 3406, 3406B, 3406C, 3408, 3408B, 3408C, 3408E, 3412, 3412C, 3412D, 3412E,	16G, 16H NA, 245, 24H, 345B L, 3516B, 375, 375 L, 5080, 5110B, 578, 583R, 587R, 589, 621, 621B, 621E
4S8896	VALVE SEAT INSERT EXHAUST (.005" OVERSIZE)	D342, D342C, G342C	D8H, D8K,
4S8897	VALVE SEAT INSERT EXHAUST (.010" OVERSIZE)	D342, D342C, G342C	D8H, D8K,
4S8898	VALVE SEAT INSERT INLET (.005" OVERSIZE)	1693, 3406, 3408, 3412, D343, D346, D348, D349, G343	245, 631C, 637D, 641B, 650B, 651E, 657, 657B, 657E, 666, 768B, 769, 772, 777, 824B, 825B, 826B, 834, 980C, 983, 988, 988B, 992, 992C, D10,
4S8899	VALVE SEAT INSERT INLET (.010" OVERSIZE)	1693, 3406, 3408, 3412, D343, D346, D348, D349, G343	245, 631C, 637D, 641B, 650B, 651E, 657, 657B, 657E, 666, 768B, 769, 772, 777, 824B, 825B, 826B, 834, 980C, 983, 988, 988B, 992, 992C, D10,

Part No.	Description	Engine	Equipment
4S8902	VALVE SEAT INSERT EXHAUST (.005" OVERSIZE)	1693, 3406, 3408, 3412, D343, D346, D348, D349	245, 631C, 637D, 641B, 650B, 651E, 657, 657B, 657E, 666, 768B, 769, 772, 777, 824B, 825B, 826B, 834, 980C, 983, 988, 988B, 992, 992C, D10,
4S8903	VALVE SEAT INSERT EXHAUST (.010" OVERSIZE)	1693, 3406, 3408, 3412, D343, D346, D348, D349	245, 631C, 637D, 641B, 650B, 651E, 657, 657B, 657E, 666, 768B, 769, 772, 777, 824B, 825B, 826B, 834, 980C, 983, 988, 988B, 992, 992C, D10,
4S8905	VALVE SEAT INSERT EXHAUST (.010" OVERSIZE)		676, 621, 980
4S8906	VALVE SEAT INSERT EXHAUST (.005" OVERSIZE)	D353C, D379, D379A, D379B, D398, D398A, D398B, D399, G353D, G379, G398, G399	D9G, D9H,
4S8907	VALVE SEAT INSERT EXHAUST (.010" OVERSIZE)	D353C, D379, D379A, D379B, D398, D398A, D398B, D399, G353D, G379, G398, G399	
4S8909	VALVE SEAT INSERT INLET (.010" OVERSIZE)	D353C, D379, D379A, D379B, D398, D398A, D398B, D399, G353D, G379, G398, G399	

Valve Seat Inserts (cont.)

Part No.	Description	Engine	Equipment
4S8912	VALVE SEAT INSERT INLET (.005" OVERSIZE)	D342, D342C, G342C	D8H, D8K
4W4325	VALVE SEAT INSERT (EXHAUST)	G3406, G3408, G3408B, G3412	
5I8011	VALVE SEAT INSERT (INLET)		311B, 311C, 312, 312B, 312C L, 320 L, 320B, 320B L, 320C, 320C FM
5I8012	VALVE SEAT INSERT (EXHAUST)		311B, 311C, 312, 312B, 312C, 312C L, 314C, 318C, 319C, 320 L, 320B, 320B L, 320C, 320C FM, 320C L, 320D, 320D LRR, 321C, 323D L, 323D LN
5S1757	VALVE SEAT INSERT (INLET)	D353C, D379, D379A, D379B, D398, D398A, D398B, D399, D9G, D9H, G353D, G379, G398, G399	594
5S7218	VALVE SEAT INSERT (INLET)	1673C, 3304, 3306, G3304, G3306	130G, 561C, 627, 814, 941, 950, 955K, 955L, 966C, 977K, 980B, D4D, D5, D6C, D7F, D7G,
6I1197	VALVE SEAT INSERT (INLET)	3054, 3056	312, 315, 317, 416C, AP-800C, BG-225B, CB-534B, CB-534C, CB-535B, CP-433C, CS-431C, TH62
6I1713	VALVE SEAT INSERT (GAS)	G3508, G3512, G3516, G3516B, G3520B, PMG3516	
6I4019	VALVE SEAT INSERT (INLET)	G3406, G3408, G3408B, G3412	
7C5335	VALVE SEAT INSERT INLET (.005" OVERSIZE)		

Part No.	Description	Engine	Equipment
7C7604	VALVE SEAT INSERT INLET (.020" OVERSIZE)	3406B, 3406C, 3406E, 3408, 3408B, 3408C, 3408E, 3412, 3412C, 3412D, 3412E, 3516B,	16G, 16H NA, 24H, 375, 375 L, 5080, 5110B, 578, 583R, 587R, 589, 621E, 621F, 623E, 623F, 627E, 627F, 631D, 631E, 631G
7C7605	VALVE SEAT INSERT INLET (.030" OVERSIZE)	3406B, 3406C, 3406E, 3408, 3408B, 3408C, 3408E, 3412, 3412C, 3412D, 3412E, 3516B	16G, 16H NA, 24H, 375, 375 L, 5080, 5110B, 578, 583R, 587R, 589, 621E, 621F, 623E, 623F, 627E, 627F, 631D, 631E, 631G
7N1649	VALVE SEAT INSERT (EXHAUST)	G3304, G3304B, G3306, G3306B	
7W0028	VALVE SEAT INSERT (GAS)	G3508, G3512, G3516	
7W1581	VALVE SEAT INSERT (EXHAUST)		206, 212, 214, 416, C280-6, C280-8, CS-431B, PS-110
7W8065	VALVE SEAT INSERT (INLET)	3114, 3116,	205B, 214B, 224B, 320 L, 325, 446B, 446D, 613C II, 918F, 924F, 928F, 938F, 950F, 950F II, 953B, 960F, 963B, AP-1000, AP-1000B, AP-1050, AP-1055B, BG-2455C, BG-245C, CB-434, CB-634C, CP-563
8M4014	VALVE SEAT INSERT (EXHAUST)	D353C, D379, D379A, D379B, D398, D398A, D398B, D399	594, D9G, D9H
8M9810	VALVE SEAT INSERT (EXHAUST)	D342, D342C, G342C	D8H, D8K
9M3205	VALVE SEAT INSERT (INLET)	1693, D343, D346, D348, D349, G343	631C, 641B, 650B, 651, 657, 657B, 666, 768B, 769, 772, 777, 824B, 825B, 826B, 834, 983, 988, 992, D10,

Part No.	Description	Engine	Equipment
9M6495	VALVE SEAT INSERT (EXHAUST)	1673, 1673B	12E, 561B, 951B, 955H, 955K, 977H, 977K, D330A, D330B, D333A, D333B, D4D
9M8745	VALVE SEAT INSERT (INLET)	D342, D342C, G342C	D8H, D8K
9N0181	VALVE SEAT INSERT (INLET)		943
9N2837	VALVE SEAT INSERT (EXHAUST)	3204, 3208,	215, 225, 613B, 613C, 926, 931B, 943, 953, D4HTSK II, PR-1000, PS-500
6216-11-1330	VALVE SEAT INSERT (INLET)	SA12V140, SA6D140, SA6D140E, SAA12V140Z, SAA12V140Z, SAA6D140E	330M, DCA, EGS1000, EGS1050, EGS1200, EGS500, EGS570, EGS630, HD785, HM350,

Oversized Valve Inserts

Engine Model	Intake Insert	Exhaust Insert	Size (in)
3300	N/A	7C5335	0.005
3406	7C7604	N/A	0.02
651, 657	4S8898	N/A	0.005
651, 657	4S8899	N/A	0.01
D334/D336	4S8915	4S8905	0.01
D399	4S8909	4S8907	0.01
D8H, D8K	4S8912	4S8896	0.005
D8H, D8K	4S8913	4S8897	0.01
D9E/G, D353C/D	4S8908	4S8906	0.005



VALVE SPRINGS

Inner Spring	Outer Spring	Engine Model
6I0284	6I0283	3054
9N5495	9N5496	3208
4W2472	4W2471	3406
1406188	1376718	3126B, C7

Inner Spring	Outer Spring	Engine Model
2244441	3322152	3176B, 3196, C12, C13
7N1903	7N1904	3508, 3512, 3516
1011177	1011180	3512B, 3516B
1944902	2816157	3512B, 3516B
1W1749	1W1748	3608, 3612, 3616
5F3111	5F3112	977, 955, D315
2113122	2479908	C15, C18, 3406E
1906115	1906117	C9 INDUSTRIAL
9M5349	9M5350	D7, D7E, D8, D8H
4F5409	4F5408	D8D, D7C, D9D, D9G

ENGINE VALVE ROTOCOILS



Engine No.	Part No.	Lock Keeper
3304, 3306	1W5300	2A4429
3304, 3306, G3408	6N7175	2A4429
3306C	1031800	2A4429
3406B, 3406C	9Y3329	2A4429
3406B, 3408	6N7154	2A4429
3406C	4W2474	2A4429
3406E, C15	4P4962	2A4429
3408E	1376500	2A4429
3500, 3508C	3165978	2A4429
3508C	3165979	1977055
3512B	1976999	2A4429
3516B	1977062	2A4429
3516B	1977063	1977055
988, G343	4N6761	2A4429
C10, 3176B	6I2663	2A4429
C15, C18	1862001	2A4429
D4, D5, G3306	8N7782	2A4429
D436	2S2813	2A4429
D5, D6, 955	3S0461	2A4429
D7, D8, D9	7N7639	3B1142
3512B	1976999	2A4429

ENGINE MOUNTS



Engine Model	Part No.
C2.2, 3014, 3013	0643274
C4.4, 3054, 3054C	9W9910
C9	1786473
C9	1786474

Engine Model	Part No.
C9	1877331
C9, 3126B	9W9940
C9, C9.3, C13	1398736
C9, C9.3, C13	1398737

Engine Model	Part No.	Engine Model	Part No.
3024	0966661	3406	6T6080
3024	0966662	3408	6N1572
3046	1189933	3408	6N6013
3046	1189934	3408	6Y2065
3046	4N8204	3408	7C3567
3054	3E4903	3412	6Y2090
3054	3E4924	3412	7N1210
3054	6Y9915	3044C, C3.4	9R0390
3054	9W9931	3044C, C3.4	1182990
3064	0938267	3046, 3064	1189935
3064	0938268	3046, 3064	1189936
3064	0994708	3046, 3064	1932744
3064	0994709	3054, 3054T	1102562
3114	9W9920	3054, 3054T	1102563
3116	2047786	3054C, 3056E	9W9915
3116	2085967	3066, 3116	1099349
3116	4I7433	3066, 3116	1099368
3116	4I7434	3066, 3116, C7	1099350
3116	9W9930	3066, 3116, C7	1099369
3304	7N1164	3204, 3406B	4N4161
3304	7N5206	3306, 3208	6N3256
3306	1099445	3306, 3406	3434836
3306	1099446	3306, 3406	7Y1035
3306	4E1063	3508, 3512, 3516	7C4349
3306	6N2008	3524B	1644413
3306	6N2009	4.236 DI	4W2020
3306	6N2549	4.236 DI	7W8327
3306	8N1214	C11, C13, C15	6Y9960
3306	9M1853	C11, C15, C32	6Y9980

ENGINE FERRULES & SEALS



Engine / Model Application	Ferrule Part No.	Seal Part No.
General Usage	6B6224	6L7813
General Usage	7B2420	6L7814
D326, D337, D343, G3434, 1693	3H5912	3H5887
D342	7N8851	8S4275
D/G342, D/G346, D/G348, D/G349	-	8S4275
D343, G3434, 1693, 3304, 3306	9S5746	9S5747
D4D, D6C, 951B, 951C, 3408	7S4433	-
416	0328047	-
1676	2S0735	6L7813
3054	1293493	-
3204	7N4637	7N4636
3304, 3306	-	7N8018/9Y1798
3406, 3408, 3412	-	3E6772
3508, 3512, 3516	-	4200652/4200653

FILTERS



AIR FILTERS



Primary Air Filter	Secondary Air Filter	Primary Air Filter	Secondary Air Filter
1006845	1006848	2567902	2567903
1059741	N/A	1006846	1006849
1063969	1063973	1029388	1029387
1080671	1080672	1282686*	6I2502
1106326	1106331	1777375	N/A
1131578	1131579	2515885	9Y7663
1232367	1232368	2S5648	N/A
1236855	1236856	3I2013	N/A
1304678	1304679	3N2896	2S1286
1318822	1318821	3S9606	3S4745
1327165	6I2504	4199172	2777838
1327167	6I2510	4I7575	6I6582
1327168	1063973	4L9852	4L9851
1348726	1402334	4L9853	N/A
1355788	1355787	4N0015	N/A
1421339	1421340	4N0326	4N0313
1421403	1421404	4P0710	4P0711
1467472	1467473	4S5348	N/A
1517737	1890202	4S8337	4S8340
1527217	1527219	4S8833	4S8834
1651689	6I2508	4W5228	1N4864
1805474	1805475	4W5716	6N6067
2065234	2065235	5L1203	N/A
2124478	2124477	5S4282	3S4745/3S9606
2229020	2229021	6I0273	6I0274
2277448	2277449	6I1450	6I1451
2310167	2310168	6I2499	6I2500
2335182	2335184	6I2501	6I2502
2453818	2453819	6I2503	6I2504
2456375	2456376	6I2505	6I2506
2465009	2465010	6I2507	6I2508
2515886	1W3636	6I2509	6I2510
2525001	2525002	6I6434	

Air Filters (cont.)

Primary Air Filter	Secondary Air Filter	Primary Air Filter	Secondary Air Filter
6I6582	N/A	6I6582	N/A
6N6064	N/A	6N6064	N/A
6N6071	6N6072	6N6071	6N6072
7C1571	N/A	7C1571	N/A
7C1572	N/A	7C1572	N/A
7N1225	4N0015	7N1225	4N0015
7W3920	2S1284/7C1062	7W3920	2S1284/7C1062
7W5216	1P8482/7N1308	7W5216	1P8482/7N1308
7W5313	1P8482/6N6444	7W5313	1P8482/6N6444
4S5348	N/A	7W5316	1P7360/ 1P8482/ 2S1287/8N6883
4S8337	4S8340		
4S8833	4S8834	7W5317	2S1286/9S9972
4W5228	1N4864		
4W5716	6N6067	7W5389	2S1285/ 4N0313/ 8N4901
5L1203	N/A	7W5495	1P7360
5S4282	3S4745/3S9606	7W9853	7W9567
6I0273	6I0274	7Y0404	5I5208
6I1450	6I1451	7Y0404	5I5208
6I2499	6I2500	7Y1196	7Y1197
6I2501	6I2502	7Y1323	7Y1322/5I5208
6I2503	6I2504	8N5006	N/A
6I2505	6I2506	8N5504	4W6691
6I2507	6I2508	8N6309	8N2556
6I2509	6I2510	8T7462	8T7463
6I6434			

OIL & FUEL FILTERS



Engine Model	Engine Oil Filter	Fuel Filter Primary	Fuel Filter Secondary	Component
12E	8B5935		1R0750	Motor Grader
120H	1R0658		1174089 1R0753	Motor Grader
140B	8B5935			Motor Grader
320	5I7950		9M2341	Excavators
320L	1R0658 7W2326		5I7951 1383098 1634465	Excavators
416/B, 426/B, 428/B	7W2327		1383098 0676987	Backhoe Loaders
426B	7W2327	1383098	1311812 1383098 676987	Backhoe Loaders
433C, 436B, 438B	7W2326		1383098/1311812 1634465	Backhoe Loaders
931B, 931C, 935B	1R0713		1R0710	Track-Type Tractor
966F	1R0658	9M2341	1R0711 1R0750	Wheel Loader
953	1R0714		1R0710 1R0750	Track-Type Tractor
3054	7W2326			General
3056	7W2327 (2)			Generator Sets
3114			1R0750	General
3116	1R0658		1R0750 1R0751	General
3116	1R0658		1R0750	Truck
3116	1R0658	8N9803	1R0750	Industrial
3126	1R0658		1R0751	General
3176	1R0716 1W8845		1R0749	General

Engine Model	Engine Oil Filter	Fuel Filter Primary	Fuel Filter Secondary	Component
3208	1R0734		1R0750	General
3208	1R0713 1R0734		1R0750	Generator Sets
3306	1R0658	8N9803	1R0750	General
3306	1R0658	9M2341	1R0750	Generator Sets
3406	1R0716	9M2341	1R0750 1R0749	Generator Sets
3508	1R0716 (3) 1R0726 (3)	1R0756 (5)	1R0756 (7) 1R0755 (5)	General
3512	1R0716 (3) 1R0726 (3)	1R0756 (1-5)	1R0756 (5-7) 1R0755 (1-2)	General
3516	1R0716 (3-4) 1R0726 (3)	1R0755 (2) 1R0756 (5)	1R0755 1R0756 (5-7)	General
3145, 3150, 3160	1R0734		1R0710	General
3176B	1R0716 1W8845		1R0749	General
3208T	1R0714	8N9803	1R0750	General
3304, D5H	1R0658		1R0750	General
3304B, 3306C, D330C, D333C	1R0658		1R0750	General
3306B	1R0658	8N9803	1R0750	General
3406, 3408, 3412	1R0716 (1-2)		1R0749	General
3406B	1R0716		1R0749	General
3406B, 3406C	1R0716	9M2341	1R0750 1R0749	Generator Sets
3406C, 3408E, 3408C			1R0749	General
3408E, 3412E	1R0716			General
3412, 3412C	1R0716 (2)	9M2341	1R0749 (2)	Generator Sets
3508B	1R0726 (3)	1R0756 (5)	1R0749 1R0755	General
3612, 3616			1R0756	General
C10, C12	1R0716 1W8845		1R0749	General
D10	1R0716 (2)		1R0711 (2) 1R0749 (2)	Track-Type Tractor

Engine Model	Engine Oil Filter	Fuel Filter Primary	Fuel Filter Secondary	Component
D20D	1R0658			Articulated Trucks
D250D/E, D250C/D, D300D/E, D30C	1R0658		1R0750	Articulated Trucks
D30D	1R0658	1R0750	9M2341	Articulated Trucks
D326, D353D	1R0659			General
D350C, D350D, D35C, D6E	1R0658		1R0750	Articulated Trucks
D35HP, D40D, D44B	1R0716		1R0749	Articulated Trucks
D379B	1R0721			General
D4C, D5C, D10C, D353E	1R0721		4H8792	General
D9G	1R0721		9M2341	Track-Type Tractor
D9H	1R0729		4B5949	Track-Type Tractor
E70B	1R0713 1R0734		5I7951	Track-Type Tractor
G3306	7W2327			Excavators
G342C	1R0658			General
G353D	1R0726			General

AIR FILTER INDICATORS



Knowing when to change the air filters of your machine is a critical part of your machines service. Stop changing the air filters of your machine too late or too soon by using Air filter indicators.

Air filters indicators:

- ✓ Help you reduce filter cost by reducing filter changes when working under low dust working conditions.
- ✓ Indicate the remaining lifetime of your filter.
- ✓ Help improve engine performance.

Part No.	Description
0965028	INDICATOR
1W0613	INDICATOR
7S0687	INDICATOR
7W7417	INDICATOR
8N2694	INDICATOR

STRAINERS



Strainers for Caterpillar® machines:

Part No.	Engine Model/Application	Use
1J9575	12G, 120G, 14G, 140G, 16G, 160G	Hydraulic Tank Gp
5I4510	312, 320, 320L	Fuel Tank Gp
2P8679	3208, 3412, 3412C	Governor Gp
7T2651	416, 426, 428	Transmission Gp
5D7927	416C, 426B, 430D, D250E, 621, 627, 769, 773, 420D	Hydraulic Tank Gp
9P7121	420D, 621B, 814F, 816F, 933, 953C	Fuel Tank Gp
6J2025	518, 955K/L, 930	Tank & Filter Gp
3D6678	666, 666B, 824	Tank & Valve Gp

Strainers (cont.)

Part No.	Engine Model/Application	Use
4D1998	772, 641/B, 651/B, 657	Fuel Tank Gp
8H3498	824B, 825B, 826B, 920, 966C	Fuel Tank Gp
9J3047	920, 930, 943, D6D, D5B	Tank & Valve Gp
3G7250	D9L, D8L, 183B, 193, D7G, D7H	Filter Tank Gp

Strainers for Komatsu® machines:

Part No.	Engine Model/Application	Use
07056-18416	WA800-3E0, WA900-3E0, WA420-3, CD30R-1, D85A-21	Fuel tank
07056-18425	PC300-8, PC350-8, PC130-8, PC300LC-8, PC270-8, PC300LC-8M0	Fuel tank
14X-60-11120	D39EX-22, D31EX-22, D37EX-21, D37EX-22, D37PX-23, D65EX-12	Hydraulic Tank
175-04-00210	D150A-1, D155A-2A, D155A-1, D155A-2	Fuel Piping
20Y-60-21311	GD755-5R, BR200S-1, CD110R-2, PC200-6, PC100L-6	Hydraulic Tank
20Y-60-31140	PC300-8, PC350-8, PC2000-8, PC200LC-8, PC220-8	Hydraulic Tank
20Y-60-31171	PC160LC-8, D275A-5R, PC270-8, PC220LC-8, PC200-8	Hydraulic Oil tank
207-60-61250	PC300-8, PC350-8, PC400LC-8, PC450-8, HD405-7R, HD465-7R	Hydraulic tank, steering and hoist piping
22B-60-11160	D85PX-15E0, WA470-6, PC350-8, PC350LC-8, D155AX-6, WA430-6	Hydraulic Tank
419-15-14510	WA320-3, WA380-3, WA150-3, WA120-3, WA180-3, WA250-3L	Transmission pump and piping
419-15-14650	WA320-3, WA380-3, WA150-3, WA120-3, WA180-3, WA250-3L	Transmission pump and piping
56D-15-19311	WA430-6, WA480-6, WA470-6, GD555-5, WA380-6, HM300-2	Torque converter and Transmission

CAB AIR FILTERS



Part No.	Model
1127448	1090, 1190, 1290T, 1390, 320C/D, 322C, 324D, 325C/D, 330C/D, 824G/GII, 824H, 825G/H, 826G/H, 950G, 962G, 966G, 972G, 980G, 988G
1491912	120M, 140M, 160M, 773F/G, 775F/G, 777F/G, 854G, 963C, 973C
2112660	120M, 140M, 414E, 416F, 420E, 430F, 432E, 434F, 442E, 444E
7G6599	12G, 130G, 140G, 14G, 16G, 613C, 627E, 631E, 637E, 651E, 657E, 784B, 785/B, 789/B, 793/B, 916, 926, 936F

Part No.	Model
2318132	216B, 226B, 232B, 242B, 248B, 267B, 268B, 277B, 287B, 904H
1858154	312C, 320C, 322C, 330C, 543, 770, 870, 1190, HA871, M313C, M315C, M318C, M322C, TK371, TK711, TK721, TK741, TK751, TK752
2112661	414E, 416E/F, 420E/F, 422E, 428F, 430E/F, 432F, 442E, 444E/F, 450E/F
1707272	416D, 420D, 424D, 430D
7G8116	5130, 5230/B, 621E, 623E, 627E, 631E, 633E, 637E, 651E, 657E, 785/B, 789/B, 793/B, D5N, D6N, D8L, D9L
6T0988	517, 527, D5M, D6G/M, D6R/RII/T, D7R/RII, D8R
2098217	587T, 770G, 772G, 953D/K, 973D/K, D10T, D11T, D3K/K-XL, D4K/K-XL, D6K, D7E, D8T, PL61, PL87
2686704	613G, 621G/H, 623H, 627G, 657G, 725, 735, 740B
2593222	730, 735, 740, 621G, 623G, 625C, 627G, 657G, 730C, 735C, 745C, 770G, 772G
2667765	730, 740, 621G, 623G, 627G, 657G, 770G, 772G, 953D/K, 973K, D3K XL/LGP, D6K LGP/XL
1070266	769D, 771D, 773D/E/F, 775D/E/F, 776D, 777D/F, 784C, 785 C, 793C/D, 797B, 824G, 836G, 950G, 966G, 980G, D9N/R, D10R, D11R
7X6041	814F, 815F, 816F, 918F, 924F, 928F, 933C, 938F, 939C, 950H, 962H, 966G/H, 970F, 972H, 980H, D3CIII, D4CIII, D5CIII, IT18F
2V0036	815H, 824C, 825C, 826C, 950E/F, 955L, 966F, 977L, 980C/F, D4E, D5B, D6D, R2900G, R3000H
8P5343	834B, 836, 988B/F, 988G, 992C/D, 994D, D10
9X8216	844, 854K, 990H, 992G/H, 994F
7T1889	910F, 926E/F, 936F, IT12F, IT18B, IT28B
1807487	910G, 924G/GZ, 924H, 928G, 930G, 938G/GII/H, IT28G, IT38G,
1130305	914G, 924G/GZ, 928G, 938G, IT28G, IT38G
3197944	D11T
1832813	D3G, D4G, D4G-XL, D5G, D5G-XL
3E7904	D4H, D5H/N/5M-XL/M-LGP, D6M/N
7T1890	D8L, D9L/N/R, D10N, D11/R
2380479	D8T, D9T, D10T, D11T
9X3352	IT18F, IT24F, IT28F, IT38F, 814F, 815F, 816F, 918F, 924F, 938F, 950F, 966F, 970F
2457823	M314D, M316F, M318D, M322D, M325D, MH3037, 307D, 311D/F, 312D, 319D, 323D2, 330D, 336D, 340D, 345D, 349D, 365C, 385C
3050329	M315D, M318D, M322D, M325D, 307D, 320D/D L, 323D, 336D L, 365C L, 385C/C L

*Other part no. not included in the list are available. Please contact your sales representative if you have any questions. Part Numbers are used for reference purposes only

FUEL INJECTION



FUEL INJECTION SYSTEM



Diesel fuel injection systems components are critical to the performance and emissions of diesel engines. **The most crucial component of the fuel system is the fuel injectors/nozzles.** Injectors and nozzles need to meet the performance, emissions, reliability, and durability requirements of the engine. The CTP injector nozzle hole size and shape are manufactured to strict parameters using the latest EDM process and are fully tested with laser optic electronic devices to make sure they are built to the exact specifications. Each CTP Injector/nozzle is engineered for exact precision and durability for long service life.

Key Features:

- ✓ Case hardened needle seat for maximum durability
- ✓ Ultra precise needle-to-body gap for proper hydraulic performance
- ✓ Hydraulic grinding for exact fuel delivery and atomization



Injectors

Part No.	Engine Model	Part No.	Engine Model
2666830	3054	3861752	3512
2169786	3056	1278218	3116, 3126
1278207	3116	4P9075	3508, 3512, 3516
1278213	3116	2361674	C4.4
1278216	3116	4P2995	C7
1278222	3116	2915911	C18
1278225	3116		
1747526	3412		
3282582	3512		



Nozzles

Part No.	Engine Model	Part No.	Engine Model
9N2366	1100, 3100	8N7005	3304, 3306
1053433	3054	1007559	3306
1305187	3054	1049453	3306
1487111	3054	1291351	3306
8N3175	3204	1677489	3306
9L6969	3204, 3208	1705181	3306
1W5829	3208	8N7003	3306
4W1819	3208	1705187	3306, 3306B
4W7016	3208	1007556	3406
7W3710	3208	7W7031	3406
9N3299	3208	1007562	3406, 3406C
1705183	3304	7W7030	3406, 3408
7N0449	3304, 3306	4W7017	3406, 3408, 3412

Part numbers are used for reference purposes only.

Costex Tractor Parts Copyright © 2020. All rights reserved.

Nozzles (cont.)

Part No.	Engine Model	Part No.	Engine Model
7N9843	3406, 3408, 3412	4W7019	3408, 3412
9N3246	3406, 3408, 3412	4W7020	3408, 3412
4W7018	3406B	1301804	3412
7W7040	3406B, 3406C	7W7032	3412
7W7043	3406B, 3406C	4W8483	3508
4W7022	3406B, 3412	7C0344	3508, 3512
1007558	3406C	7C2238	3508, 3512, 3516
4W7015	3408	7C0340	3508, 3516, 3512
4W7021	3408	9N6173	D334, 1674
7W7026	3408	8N3177	D336, 1674
7W7037	3408	8N1831	D342T, D8K, D9H
9L6884	3408	8N3176	D343, D346



Plungers & Barrels

Part No.	Description	Engine Model
1082104	PLUNGER	3406
1086631	PLUNGER & BARREL	3406
1P6400	PLUNGER & BARREL	D342, D343
1W6541	PLUNGER & BARREL ASSY	3306B
3S8336	PLUNGER & BARREL ASSY	D336
4N4997	PLUNGER & BARREL	3408B
4P9830	PLUNGER & BARREL	3306
4S5758	PLUNGER A	3204
5I5129	PLUNGER A	3066
6N7527	BARREL/PLUNGER ASSY	D333C, 3306
7N1183	PLUNGER A	3408, 3412
7N1220	PLUNGER A	3406
7S6681	PLUNGER & BARREL ASSY	D334
7W0182	PLUNGER A	3408, 3408
7W5929	PLUNGER & BARREL	3306
8N3539	PLUNGER & BARREL A.	3204
8S3656	PLUNGER & BARREL ASSY	D343, D346
9H5796	PLUNGER & BARREL ASSY	D320A
9H5797	PLUNGER	D330A, D333
9M9788	PLUNGER	3408, 3412



Service Groups

Part No.	Description	Engine Model
3S6638	SERVICE GROUP	D333C/3306
5H7936	SERVICE GROUP	D353
6H3364	SERVICE GROUP	D311/D320
7M7431	SERVICE GROUP	D379/D398
8M1584	SERVICE GROUP	D333C/3306
8N8796	SERVICE GROUP	3304

FUEL LINE ASSEMBLY



Eng. Model	Line 1	Line 2	Line 3	Line 4	Line 5	Line 6
3204	4N0471	4N0472	4N0473	4N0474		
3066	5I7707	5I7708	5I7709	5I7710	5I7711	5I7712
3054	1720051	1668797	1013890	1013891		
3204	1W7121	1W7122	1W7123	1W7124		
3204	7N6151	7N6152	7N6153	7N6154		
3304	4N3281	4N3282	4N3283	4N3284		
3304	4P9961	4P9962	4P9963	4P9964		
3304	8L5661	7N3872	8L5663	8L5664		
3304	7N2871	7N2872	8N9733	7N2874		
3304	1W8641	8N4222	8N4223	8N4224		
3306	2Y5721	2Y5722	2Y5723	2Y5724	2Y5725	2Y5726
3306	7N2871	7N3872	8N9733	7N2874	7N2876	
3306	4N3281	4N3282	4N3283	4N8814	6N1965	6N1966
3306	4N9941	4N9942	4N9943	4N9944	4N9945	4N9946
3306	4P9381	4P9382	4P9383	4P9384	4P9385	4P9386
3306	4P9381	4P9382	1044253	1044254		
3306	7C7991	7C7992	7C7993	7C7994	7C7995	N/A
3306	8L5691	8L5692	8L5693	8L5694	8L5695	8L5696
3306	8N1141	8N1142	8N1143	8N1144	8N1145	8N1146
3306	8N4371	8N4372	8N4373	8N4374	8N4375	8N4376
3306	6I0341	6I0342	6I0343	N/A	6I0345	6I0346
3306C	1003831	1003832	1003833	1003834	1003835	1003836
3406	4N9971	4N9972	4N9973	4N9974	4N9975	4N9976
3406	9Y1081	9Y1082	9Y1083	9Y1084	9Y1085	9Y1086
3406	1917941	1917942	1917943	1917944	1917945	1917946
D315, D330	4M1451	8M2042	4M1453	4M1454		
D330	5S7211	8S4002	5S7213	5S7214		
D330C	5S7211	5S7212	5S7213	5S7214		
D333, 1673	7M4331	7M4332	2M6613	2M6614	2M6615	2M6616
D333C	5S7171	5S7172	5S7173	9S1230	5S7175	5S7176
D333C	1N5401	1N5402	1N5403	1N5404	1N5405	1N5406
D333C, 3306	8L5691	8L5692	8L5693	8L5694	2P8890	8L5696
D339	4H9691	4H9692	4H9693	4H9694		
D342	4H9611	4H9612	4H9613	4H9614	4H9615	4H9616
D342	2P2651	2P2652	2P2653	2P2654	2P2655	2P2656
D342	7N791	7N792	2P2653	2P2654	2P2655	2P2656
D343	1S2081	1S2082	1S2083	1S2084	1S2085	1S2086
D343	8S9301	8S9302	8S9303	8S9304	8S9305	8S9306
D353	8N3451	8N3452	8N3453	8N3454	8N3455	8N3456

Eng. Model	Line 1	Line 2	Line 3	Line 4	Line 5	Line 6	Line 7	Line 8	Line 9	Line 10	Line 11	Line 12
3208	9Y0231	9Y0232	9Y0233	9Y0234	9Y0235	9Y0236	9Y0237	9Y0238				
3208	9Y0141	9Y0142	9Y0143	9Y0144	9Y0145	9Y0146	9Y0147	9Y0148				
3408	6I0031	6I0032	6I0033	6I0034	6I0035	6I0036	6I0037	6I0038				
3408	6I1021	6I1022	6I1023	6I1024	6I1025	6I1026	6I1027	6I1028				
3408	6I1031	6I1032	6I1033	6I1034	6I1035	6I1036	6I1037	6I1038				
3412	6N4731	6N4732	6N4733	6N4734	6N4735	6N4736	6N8637	6N4738	6N8979	6N4740	6N8641	6N8642
3412	4P7801	4P7802	4P7803	4P7804	4P7805	4P7806	4P7807	4P7808	4P7809	4P7810	4P7811	4P7812
3412	8N4201	8N4202	8N4203	8N4204	8N4205	8N4206	8N4207	8N4208	8N4209	8N4210	N/A	8N4212
3412C	6I1031	6I1032	6I1033	6I1034	1245945	6I1036	1245947	6I0038				
D346, 772, 650B	2S4505	2S4506	2S4507	2S4508	2S4509	2S4510	2S4511	2P9574				
D379, D398	1W9201	1W9202	1W9203	1W9204	1W9205	1W9206	1W9207	1W9208	1W9209	1W9210	1W9211	1W9212
D399 (1 THRU 8)	1W9191	1W9192	1W9193	1W9194	1W9195	1W9196	1W9197	1W9198				
D399 (1 THRU 16)	1W9198	1W9197	1W9196	1W9195	1W9194	1W9193	1W9192	1W9191				

REMANUFACTURED FUEL INJECTORS



Peak performance for any diesel engine relies mostly on the fuel injectors delivering the proper amount of fuel at the proper time. CTP remanufactured injectors will bring your engine back to optimal performance while providing excellent fuel economy.

Quality Features:

- ✓ All components are quality inspected.
- ✓ New seals installed.
- ✓ New tips installed.
- ✓ All units are fully tested on state of the art testing equipment.
- ✓ Each unit is individually shrink-wrapped to avoid contaminants.
- ✓ Each injector unit is shipped in a protective foam filled package.

Eng. Model	Part No.	Reman Part No.
3126E	1780199	10R0782
3126E	1786342	10R1257
3126E	2225965	0R9348
3126E	2225966	10R0781
3126E	2225967	0R9349
3126E	2225968	10R1306
3126E	2225972	0R9350
3176	2123462	10R0967

Eng. Model	Part No.	Reman Part No.
3406E	1705238	0R9594
3406E	2113022	10R0956
3406E	2113023	10R0957
3406E	2113024	10R0958
3406E	2490709	10R1273
3406E	2530616	10R3265
3406E, 3456	2113027	10R0959
3508, 3508B, 3512, 3512B, 3516B	3920214	20R1275
3508B, 3512B/C, 3516B/C	3920200	20R1264
3512, 3512C, 3516C	3920222	20R1282
3512B, 3516B	3920202	20R1266
3512B, 3516B	3920217	20R1278
C4.2	3264756	10R7951
C4.2, C6.4	3264740	10R7676
C4.4	2360957	10R9002
C4.4	3200680	10R7672
C4.4, C6.6	3200677	10R7671
C6.4	3264700	10R7675
C7	3879428	20R8059
C7, C9	3879436	10R2828
C9	3879431	20R8069
C9	3879432	20R8065

Part numbers are used for reference purposes only.

Costex Tractor Parts Copyright © 2020. All rights reserved.

Remanufactured Fuel Injectors (cont.)

Eng. Model	Part No.	Reman Part No.
C10, C12	3507555	20R0056
C11	2490712	10R3147
C12	2295918	10R1814
C12	2123460	10R0960
C12	2123463	10R0963
C12	2123466	10R0968
C12	2123467	10R1259
C12	2123468	10R1258
C13	2394908	10R1274
C15, C18	2530618	10R2772
C15, C18, C32, C27	3740750	20R1914
C16, 3406, 3406C	2113025	10R0955
C18	1660149	0R4530
C18	2915911	10R7230
C18, 3406E	2113026	10R9787/ 10R0724
C18, C27, C32	2768307	10R7231
C18, C32	2959085	10R8988
3920200	3508B, 3512, 3512B, 3512C, 3516B, 3516C	20R1264
2490712 (C)	14M, 725, 730, 966H, C11	20R1266
3920202 (D)	3512B, 3516B	20R1270
3920206	3508, 3508B, 3512, 3512B, 3512C, 3516B, 3516C, 854G, 992G	20R0849
3920211	3508, 3512, 3516	20R1278
3920217	3508B, 3512B, 3516B, PM3508, PM3512, PM3516, PP3516	20R1282
3920222	3508C, 3512, 3512B, 3512C, 3516B, 3516C	20R8069
3879431	C9	20R8065
3879432	330D, 330D L, 336D L, 336D LN, 586C, 973D, C9	20R8068
3879436	C9	0R9595
1537923	3176B, 75C, 85C	20R0055
3175278	140H, 143H, 14H, 160H, 163H, 572R II, 814F, 815F, 816F, 966G II, D7R II	10R1258
2123468	C-12, C12, SBF214, SUF557	10R3147
3264740 (E)	315D L, 318D L, 319D, 319D L, 319D LN	10R7676

* Other part no. not included in the list are available. Please contact your sales representative if you have any questions. Part Numbers are used for reference purposes only.

DIESEL FUEL LIFT PUMPS



A diesel fuel lift pump is a priming pump that transfers fuel from the tank to the fuel injection system. They are called lift pumps, because in most equipment the tank is located below the engine, the fuel has to be lifted up from the tank to the engine.

There are three common types of fuel priming pumps:

- ✓ The plunger type or manual, operated by the user prior to start-up.
- ✓ The diaphragm-type pump or mechanical, operated by the engine's camshaft.
- ✓ The vane pump or electrical, powered by the equipment's 12V system.

Plunger/Manual Lift Pumps

Part No.	Engine Model
4N6836	3204
2396656	3064, 3066
2552969	3064, 3066
8N3365	3116, 3304, 3306C
9H2256	3304, 3306
8N5251	3306C
1623906	3512, 3516,
1375541	C7, C9, C15, 3306C
1832823	C7, C9, C15, C18, 3116, 3508B, 3512B/C, 3516B
1052508	C9, C10, 3114, 3116, 3208, 3304, 3306, 3406
1832824	C9, C13, C15, C18, 3116
1623904	D353
10R1273	3406E
10R3265	3406E
10R0959	3406E, 3456
20R1275	3508, 3508B, 3512, 3512B, 3516B

Diaphragm-type or Mechanical

Part No.	Engine Model
7C2798	4.236
1530488	3034
2010877	3054
6I0570	3054
1329447	3056
1438498	3056
2552453	3056
1W0568	3204
1W1695	3306
1W1700	3406
4W5481	3406
1282050	3116, 3126
4W5477	3408, 3412
4W5479	3408, D8L
4N1101	3412, 3408C
3137770	3516C, 3508C
4N4873	950, 966C
9M4953	966B
2954070	C1.5, C2.2
4N4878	D330C, D333C
5M6488	D343
3S1467	D346, D348
3N2078	D346, D349, D398B
8M2667	D4D
4N4864	D4D, D5, D6C, D7F
4P9827	D6H, 3306C
1P0005	D8H
4N4880	D8H
1P3409	D8H, D7E
2S7264	D9G
9M4955	D9G
6N1813	D9G, D353
3137770	3516C, 3508C
4N4873	950, 966C

Vane Pump or Electrical

Part No.	Engine Model
1908970	C9, C11, C13, C15, C18, C32, 3126B
4677011	3054

* Other part no. not included in the list are available. Please contact your sales representative if you have any questions. Part Numbers are used for reference purposes only.

Part numbers are used for reference purposes only.



FUEL ADDITIVE

Part No.	Size
3081504	16oz Treats. (500 Gallons)

Water is welcome almost everywhere except in your diesel fuel. Water in diesel fuel severely damages injectors, corrodes tanks and fosters the growth of bacteria. Our highly concentrated Diesel Power™ is also an all in one package which contains lubricity. Increase your engine's performance by giving Diesel Power™ a place in your engine today.

Advantages of CTP Diesel Power™:

- ✓ Totally disperses water for complete combustion. *Dispersa totalmente el agua para una combustión completa.*
- ✓ Contains lubricity additives. *Contiene aditivos de lubricación.*
- ✓ Contains cetane improvers. *Previene la acumulación de ceras y sustancias gelatinosas.*
- ✓ Eliminates the formation of algae and harmful acids. *Elimina la formación de algas ácidos dañinos.*
- ✓ Decarbonizes combustion chamber. *Decarboniza la cámara de combustión.*
- ✓ Cleans injection systems. *Limpia el sistema de inyección.*
- ✓ Reduces exhaust smoke. *Reduce el escape de humo.*
- ✓ Improves fuel economy. *Mejora el ahorro de combustible.*
- ✓ Contains no alcohol. *No contiene alcohol.*
- ✓ Prevents icing. *Previene la formación de hielo.*
- ✓ Stabilizes fuel. *Lubrica las paredes cilíndricas para prevenir la corrosión de metales que están en contacto con combustible diesel.*

ACTUATORS FOR GOVERNORS



Part No.	Description	Engine Model
1086281*	ACTUATOR A	3512
1187590*	ACTUATOR A	G3508, G3512, G3516
1380777*	ACTUATOR A	3406C
7W6652*	ACTUATOR A	3406B
7W6653*	ACTUATOR A	3408B, 3408C, 3412C, 3412E

*Available upon request. Please allow 2 to 3 weeks lead time.

Costex Tractor Parts Copyright © 2020. All rights reserved.

GROUND ENGAGING TOOLS



BIT CUTTERS



CTP Bit Cutters are created using a 4140 steel body and a tungsten carbide tip for high wear and impact resistance. Whether milling asphalt or concrete roads, our bit cutters offer outstanding fracture resistant toughness to keep your project running smoothly.

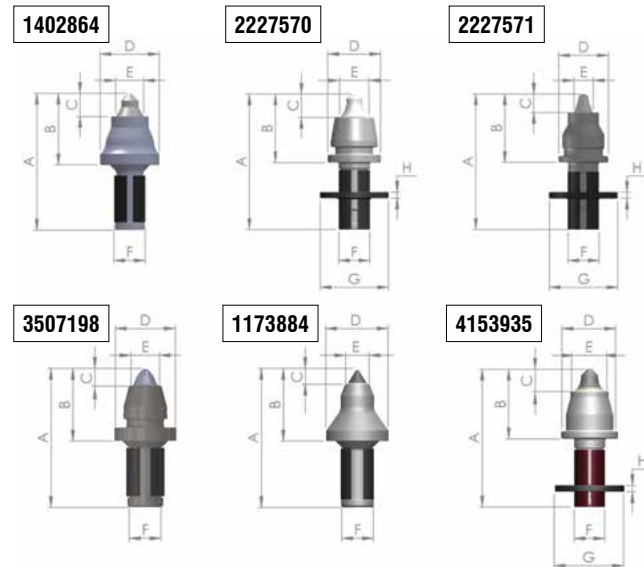

Part No.	Holder Part No.	Machine Model
1402864	1519941	PM-201, PM-465, PM-565, RM-250C, RM-350, RR-250, SS-250B
2227570	2414559	PM310, PM312, PM313, PM620, PM622, PM820, PM822, PM825, RM-500
2227571	4861915	PM-201, PM310, PM-565, PM620, PM622, PM820, PM822, RM-500, T15, T6B, T9
3507198	1519941	PM-200, PM-201, PM310, PM620, PM622, RM-350B, RM-500
1173884	1174076	RM-250C, RM-300, RM-350B, RM-500, SS-250B
4153935	1519941	PM-200, PM-201, PM310, PM-565, PM620, PM622, RM-300, RM-500

Reference Chart

Part No.	Dimensions (mm)							
	A	B	C	D	E	F	G	H
1402864	87	46	15	38	17	20	--	--
2227570	88	45	16	34	17	20	44	4
2227571	88	45	13	32	13	20	44	4
3507198	86	45	10	38	20	24	--	--
1173884	83	43	9	38	15	20	--	--
4153935	88	44	14	36	24	20	44	4

END BITS



Bulldozers & Compactors End Bits General Duty End Bits

Model Engine Application	Blade Model	Thickness		General Duty End Bits		Bolts	Nuts	Washers
		(in)	(mm)	(Left Hand)	(Right Hand)			
D4, D4 LGP, D5, D5 LGP	Straight	0.88	22	3G8322	3G8321	3F5108(6)	4K0367(6)	5P8247(6)
D6	Angle	1.18	30	6Y4410	6Y4411	5J4773(6)	2J3506(6)	5P8248(6)
D6, 815F	Angle	0.88	22	3G8296 3G8298	3G8295 3G8297	3F5108(6) 4F7827(6)	4K0367(6) 2J3506(6)	5P8248(6)
D6, 815S	Straight	0.88	22	3G8320	3G8319	5J4773(6)	2J3506(6)	
D7	Universal	0.88	22	3G8294	3G8293	6F0196(7)	2J3505(7)	5P8249(7)
D7	Universal	1.38	35	9W6198	9W6199	6F0196(7)	2J3505(7)	5P8249(7)
D7, D8, 814/6, 824/6, 835	Angle	1.12	28	3G8316	3G8315	6F0196(7) 5J2409(7)	2J3505(7) 2J3507(7)	5P8249(7)
D8	Semi-U	1.58	40	3G8278 3G8280	3G8277 3G8279	4J9058(7)	2J3507(7)	5P8250(7)
D8	Universal	1.58	40	3G8286 3G8288	3G8285 3G8287	5J2409(7)	2J3505(7)	5P8249(7)
D8	Semi-U	1.12	28	3G8300 3G8302	3G8299 3G8301	4J9258(7)	2J3507(7)	5P8250(7)
D8	Angle	1.18	30	3G8318	3G8317	4J9208(7)	2J3507(7)	5P8250(7)
D8	Angle	1.58	40	8E4194	8E4193	4J9058(7)	2J3507(7)	5P8250(7)
D8	Semi-U/ Angle	1.97	50	9W8652 9W8654	9W8651 9W8653	4J9258(7)	2J3507(7)	5P8250(7)
D8, D9	Semi-U	1.58	40	3G8284	3G8283	4J9208(7) 8J2928(7)	2J3507(7)	5P8250(7)
D8, D9	Semi-U/ Universal	1.38	35	3G8292	3G8291	4J9208(7) 8J2928(7)	2J3507(7)	5P8250(7)
D8, D9	Universal	1.97	50	8E4196	8E4197	4J9058(7) 8J2928(7)	2J3507(7)	5P8250(7)
D9	Semi-U	2.16	55	8E4198	8E4199	6V8360(7)	3K9770(7)	4K0684(7)
D9, 824	Semi-U	1.58	40	1U1546 3G8282	1U1545 3G8281	6V8360(7) 8J2928(7)	3K9770(7) 2J3507(7)	4K0684(7) 5P8250(7)
D10	Universal	1.75	45	8E4198	8E4199	5P8823(7)	3K9770(7)	4K0684(7)
825		1.12	28	3G8288	3G8287	4F4042(7)	2J3507(7)	

Extended Wear Life End Bits

Model Engine Application	Blade Model	Thickness		General Duty End Bits		Bolts	Nuts	Washers
		(in)	(mm)	(Left Hand)	(Right Hand)			
D4, D4 LGP, D5, D5 LGP	Power Angle	0.88	22	4T5408	4T5407	3F5108(3)	4K0367(3)	5P8247(3)
D6	Angle	1.18	30	9W1876	9W1875	5J4773(6)	2J3506(6)	5P8248(6)
D6	Straight/ Angle	1.18	30	4T4454	4T4455	5J4773(6)	2J3506(6)	5P8248(6)
D8	Universal	1.58	40	7T4090	7T4091	5J2409(7)	2J3505(7)	5P8249(7)
D8	Semi-U	1.12	28	7T4089	7T4088	4J9258(7)	2J3507(7)	5P8250(7)
D8	Angle	1.18	30	7T4090	7T4091	4J9208(7)	2J3507(7)	5P8250(7)
D8	Angle	1.58	40	8E4538	8E4537	4J9208(7)	2J3507(7)	5P8250(7)
D8, D9	Semi-U/ Universal	1.38	35	8E4540	8E4539	4J9208(7) 8J2928(7)	2J3507(7)	5P8250(7)
D8, D9	Universal	1.97	50	8E4540	8E4539	4J9058(7) 8J2928(7)	2J3507(7)	5P8250(7)
D9, 824	Semi-U	1.58	40	8E4542	8E4541	6V8360(7) 8J2928(7)	3K9770(7) 2J3507(7)	4K0684(7) 5P8250(7)
D10	Universal	1.75	45	8E4542	8E4541	5P8823(7)	3K9770(7)	4K0684(7)
D10, D11	Semi-U	2.36	60	8E4546	8E4545	5P8361(9)	3K9770(9)	4K0684(9)

Finish Dozing End Bits

Model Engine Application	Blade Model	Thickness		General Duty End Bits		Bolts	Nuts	Washers
		(in)	(mm)	(Left Hand)	(Right Hand)			
D3	Power Angle	0.62	16	4T6229	4T6229	3F5108(3)	4K0367(3)	5P8247(3)
D4		0.75	19	4T3044	4T3043	3F5108(6)	4K0367(6)	5P8247(6)
D4, D4 LGP, D5 LGP	Power Angle	0.88	22	4T6229	4T6229	3F5108(3)	4K0367(3)	5P8247(3)
D4, D4 LGP, D5, D5 LGP	Straight	0.88	22	4T3052	4T3051	3F5108 6	4K0367(6)	5P8247(6)
D5		0.75	19	3G4285	3G4285	5J4773(4)	2J3506(4)	5P8248(4)
D5	Power Angle			8E7078	8E7079	5J4773(4)	2J3506(4)	5P8248(4)
D5		0.88	22	8E9378	8E9379	5J4773(4)	2J3506(4)	5P8248(4)
D5	Angle	0.75	19	4T3050	4T3049	3F5108(6)	4K0367(4)	
D6	Angle	1.18	30	9W8875	9W8874	5J4773(6)	2J3506(6)	5P8248(6)
D6	Straight/ Angle	1.18	30	4T4436	4T4435	5J4773(6)	2J3506(6)	5P8248(6)
D6, 815F	Angle	0.88	22	4T3042	4T3041	3F5108(6) 4F7827(6)	4K0367(6) 2J3506(6)	5P8248(6)

Finish Dozing End Bits (Cont.)

Model Engine Application	Blade Model	Thickness		General Duty End Bits		Bolts	Nuts	Washers
		(in)	(mm)	(Left Hand)	(Right Hand)			
D6, 815S	Straight	0.88	22	4T3046	4T3045	5J4773(6)	2J3506(6)	
D7	Universal	1.38	35	4T6506	4T6505	6F0196(7)	2J3505(7)	5P8249(7)
D7, D8, 814/6, 824/6, 835	Angle	1.12	28	4T6506 4T6242	4T6505 4T6241	6F0196(7) 5J2409(7)	2J3505(7) 2J3507(7)	5P8249(7)
D8	Angle	1.58	40	6Y4278	6Y4277	4J9058(7)	2J3507(7)	5P8250(7)
D8, D9	Universal	1.97	50	6Y4278	6Y4277	4J9058(7) 8J2928(7)	2J3507(7)	5P8250(7)

Motor Grader End Bits Overlay End Bits

Model / Engine Application	Thickness		Overlay End Bit Part No.	Bolts	Nuts
	(in)	(mm)			
12, 12G, 120, 120G, 130, 130G, 140, 140G	6	152	6D1904	4F3658(5)	4K0367(5)
12, 12G, 120, 120G, 130, 130G, 140, 140G	8	203	6D1948	4F3658(5)	4K0367(5)
12G, 12H, 120G, 120H, 130G, 135H, 140G, 140H, 143H	6	152	9W1767	4F3658(5)	4K0367(5)
12G, 12H, 120G, 120H, 130G, 135H, 140G, 140H, 143H	8	203	9W1768	4F3658(5)	4K0367(5)
14G, 16G	8	203	7D9999	1J6762(5)	2J3506(5)
14G, 14H, 16G, 140H, 143H, 160H, 163H	8	203	6Y2805	1J6762(5)	2J3506(5)

Moldboard End Bits

Model / Engine Application	Moldboard Part No.	Bolts	Nuts
12, 12G, 112, 120, 130, 140	7D2052	3F5108(5)	4K0367(5)
14, 14B, 14C	7D2083 7D2084	3F5108(5)	4K0367(5)
16G, 16H	8E5530	1J6762(5)	2J3506(5)
14G, 14H, 140H, 160H, 163H	8E5529	5J4773(5)	2J3506(5)
12G, 12H, 120G, 120H, 130G, 130H, 140G, 140H, 143H	8E5531	3F5108(5)	4K0367(5)
14G	9J4405 9J4406	4F7827(4)	2J3506(4)

BULLDOZER BLADES



Model	Part No.	Desc.	Bolts Per Edge	Nuts Per Edge	Washers Per Edge
816, 834, 825	4T6532	CENTER	6F0196 (6)	2J3505 (6)	
826G, 834, 835	4T6515 (2)	CENTER	6F0196 (12)	2J3505 (12)	
834H, 834K	9W4397	CENTER	4J9058 (14)	2J3505 (14)	5P8247 (14)
D3 LGP	4T6232 (2)	CENTER	3F5108 (8)	4K0367 (8)	5P8247 (8)
D3, D4	4T6230 (2)	CENTER	3F5108 (6)	4K0367 (6)	5P8247 (6)
D3C	4T6231 (2)	CENTER	3F5108 (7)	4K0367 (7)	5P8247 (6)
D4	1402187 (2)	CENTER	3F5108 (6)	4K0367 (6)	5P8247 (6)
D4	4T2972	L / R	3F5108 (4)	4K0367 (4)	5P8247 (4)
D4	4T3026	L / R	3F5108 (4)	4K0367 (4)	5P8247 (4)
D4	4T3027	CENTER	3F5108 (3)	4K0367 (3)	5P8247 (3)
D4	6Y5841 (2)	CENTER	3F5108 (6)	4K0367 (6)	5P8247 (6)
D4	8E9377 (2)	CENTER	5J4773 (7)	2J3506 (7)	5P8248 (7)
D4 LGP	4T2982	CENTER	4F3654 (7)	4K0367 (7)	5P8247 (7)
D4 LGP, D5	6Y5842 (2)	CENTER	3F5108 (8)	4K0367 (8)	5P8247 (8)
D4, D5	4T3028	L / R	3F5108 (4)	4K0367 (4)	5P8247 (4)
D4, D5	4T2983	CENTER	3F5108 (3)	4K0367 (3)	5P8247 (3)
D4, D6	4T3021	CENTER	3F5108 (18)	4K0367 (18)	5P8247 (18)
D4A	8A8580	CENTER	4F3654 (7)	4K0367 (7)	5P8247 (6)
D4A	4T2981	CENTER	4F3654 (23)	4K0367 (23)	
D4A, D5	4T2973 (2)	END	4F3654 (6)	4K0367 (6)	5P8247 (6)
D4A, D5	4T2974	CENTER	4F3654 (5)	4K0367 (5)	5P8247 (5)
D4A, D6	4T2977	CENTER	4F3654 (18)	4K0367 (18)	5P8247 (18)
D4H, D4LGP	4T8940 (2)	CENTER	5J4773 (8)	2J3506 (8)	5P8248 (8)
D4H, D5	3G9306 (2)	CENTER	5J4773 (6)	2J3506 (6)	5P8248 (6)
D4K2 XL	1577338 (2)	CENTER	3F5108 (7)	4K0367 (7)	
D5	1400983 (2)	CENTER	5J4773 (6)	2J3506 (6)	5P8248 (6)
D5	3G6062 (2)	CENTER	5J4773 (7)	2J3506 (7)	5P8248 (7)
D5	4T3024	CENTER	3F5108 (28)	4K0367 (28)	5P8247 (28)
D5	4T3025	CENTER	3F5108 (7)	4K0367 (7)	5P8247 (7)
D5	9U8057	L / R	5J4773 (4)	2J3506 (4)	5P8248 (4)
D5 LGP	1U2211 (2)	CENTER	5J4773 (9)	2J3506 (9)	5P8248 (9)
D5 LGP	4T2315 (2)	CENTER	5J4773 (10)	2J3506 (10)	5P8248 (10)
D5, D6	4T3030 (2)	CENTER	3F5108 (12)	4K0367 (12)	5P8247 (12)
D5, D6H	4T6659	CENTER	5J4773 (7)	2J3506 (7)	5P8248 (7)
D5H	3G4282 (1-3)	CENTER	5J4773 (7)	2J3506 (7)	5P8248 (7)
D6	1060956 (2)	CENTER	5J4773 (9)	2J3506 (9)	5P8248 (9)
D6	4T2952 (4)	CENTER	5J4773 (5)	2J3506 (5)	5P8248 (5)
D6	4T3008	CENTER	3F5108 (11)	4K0367 (11)	5P8247 (11)
D6	4T3009 (2)	CENTER	4F7827 (12)	2J3506 (12)	5P8248 (12)
D6	4T3010	L / R	5J4773 (4)	2J3506 (4)	5P8248 (4)
D6	4T3011	CENTER	4F7827 (11)	2J3506 (11)	5P8248 (11)
D6	4T3013	CENTER	4F7827 (7)	2J3506 (7)	5P8248 (7)
D6	4T3020 (2)	END	3F5108 (9)	4K0367 (9)	5P8247 (9)

Model	Part No.	Desc.	Bolts Per Edge	Nuts Per Edge	Washers Per Edge
D6	4T6262 (3)	CENTER	5J4773 (7)	2J3506 (7)	5P8248 (7)
D6	7T9977 (3)	CENTER	5J4773 (7)	2J3506 (7)	5P8248 (7)
D6	7T9978	L / R	5J4773 (4)	2J3506 (4)	5P8248 (4)
D6	9W1878 (8)	CENTER	5J4773 (8)	2J3506 (8)	5P8248 (8)
D6, D6 LGP	7T9976	CENTER	5J4773 (7)	2J3506 (7)	5P8248 (7)
D6, D6C, D6H	6Y3840 (2)	CENTER	5J4773 (8)	2J3506 (8)	5P8248 (8)
D6, D7	4T2985 (4)	CENTER	5J4773 (5)	2J3506 (5)	5P8248 (5)
D7	1U1192 (2)	L / R	6F0196 (6)	2J3505 (6)	5P8249 (6)
D7	4T2863 (2)	CENTER	5J4771 (15)	2J3506 (15)	5P8248 (15)
D7	4T2917	CENTER	5J4772 (9)	2J3505 (9)	5P8249 (9)
D7	4T2921	CENTER	5J4772 (7)	2J3505 (7)	5P8248 (7)
D7	4T2922 (2)	L / R	5J4773 (5)	2J3506 (5)	5P8248 (5)
D7	4T2945 (2)	L / R	5J4773 (5)	2J3506 (5)	5P8248 (5)
D7	4T2948 (3)	CENTER	5J4771 (7)	2J3506 (7)	5P8248 (7)
D7	4T2949 (2)	CENTER	5J4771 (15)	2J3506 (15)	5P8248 (15)
D7	4T2989 (3)	CENTER	5J4771 (7)	2J3506 (7)	5P8248 (7)
D7	4T2991	L / R	5J4773 (5)	2J3506 (5)	5P8248 (5)
D7	4T3420 (2)	L / R	5J4772 (5)	2J3505 (5)	5P8249 (5)
D7	4T3421	CENTER	5J4772 (9)	2J3505 (9)	5P8249 (9)
D7	4T5318 (3)	CENTER	6F0196 (6)	2J3505 (6)	5P8249 (6)
D7	9W9794	L / R	5J4772 (5)	2J3505 (5)	5P8249 (5)
D7	9W9796* (3)	CENTER	5J4771 (7)	2J3506 (7)	5P8248 (7)
D7	4T2990	CENTER	5J4773 (7)	2J3506 (7)	
D7	4T2992	L / R	6F0196 (5)	2J3505 (5)	5P8249 (5)
D7	4T2993	CENTER	6F0196 (7)	2J3505 (7)	5P8249 (7)
D7, D7F, D7G	4T2916 (2)	L / R	5J4772 (5)	2J3505 (5)	5P8249 (5)
D7E, D7H, D7R	7T6592	L / R	5J4772 (5)	2J3505 (5)	
D7H	4T3720 (2)	CENTER	5J4773 (6)	2J3506 (6)	5P8248 (6)
D7H 7A	7T6589* (1-3)	CENTER	6F0196 (7)	2J3505 (7)	5P8249 (7)
D7H 7S	7T6678*	CENTER	6F0196 (6)	2J3505 (6)	5P8249 (6)
D7H 7S	7T6936*	L / R	6F0196 (4)	2J3505 (4)	5P8249 (4)
D7R	4T3901	CENTER	6F0196 (7)	2J3505 (7)	
D8	1122472	CENTER	4J9058 (9)	2J3507 (9)	5P8250 (9)
D8	1073476 (2)	CENTER	5J2409 (10)	2J3505 (10)	5P8249 (10)
D8	1073477 (2)	CENTER	5J2409 (14)	2J3505 (14)	5P8249 (14)
D8	1073479 (2)	CENTER	4J9208 (7)	2J3507 (7)	5P8250 (7)
D8	1073483 (2)	CENTER	4J9208 (7)	2J3507 (7)	5P8250 (7)
D8	1U4929	L / R	4J9208 (5)	2J3507 (5)	5P8250 (5)
D8	1U4930	CENTER	4J9058 (6)	2J3507 (6)	5P8250 (6)
D8	1U4931	CENTER	4J9208 (7)	2J3507 (7)	5P8250 (7)
D8	4T2986	CENTER	4J9058 (5)	2J3507 (5)	
D8	4T2994 (3)	CENTER	4J9058 (8)	2J3507 (8)	5P8250 (8)
D8	4T3418 (2)	CENTER	5J2409 (10)	2J3505 (10)	
D8	4T3422 (2)	CENTER	4J9208 (7)	2J3507 (7)	5P8250 (7)
D8	4T6513	CENTER	5J2409 (10)	2J3505 (10)	
D8	9W5232 (2)	CENTER	4J9058 (5)	2J3507 (5)	5P8250 (5)
D8	9W6092 (2)	CENTER	4J9058 (6)	2J3507 (6)	5P8250 (6)
D8	9W9098 (3)	CENTER	4J9058 (8)	2J3507 (8)	5P8250 (8)
D8	1073482	L / R	4J9208 (5)	2J3507 (5)	5P8250 (5)
D8	4T9586	CENTER	4J9058 (11)	2J3507 (11)	5P8250 (11)
D8	9W8657	L / R	4J9208 (6)	2J3507 (6)	5P8250 (6)

Part numbers are used for reference purposes only.

Model	Part No.	Desc.	Bolts Per Edge	Nuts Per Edge	Washers Per Edge
D8	1073474	CENTER	5J2409 (6)	2J3505 (6)	N/A
D8 8A 8S	4T2988 (2)	CENTER	4J9208 (7)	2J3507 (7)	5P8250 (7)
D8 8S	4T3423 (2)	CENTER	4J9208 (6)	2J3507 (6)	5P8250 (6)
D8 8U	4T2987	L / R	4J9208 (6)	2J3507 (6)	5P8250 (6)
D8 8U 8S	4T3417	L / R	4J9208 (5)	2J3507 (5)	5P8250 (5)
D8, D8L	1073480 (2)	CENTER	4J9208 (6)	2J3507 (6)	5P8250 (6)
D8, D9	1122471	L / R	4J9058 (5)	2J3507 (5)	5P8250 (5)
D8, D9	4T6378 (2)	L / R	4J9058 (6)	2J3507 (6)	5P8250 (6)
D8, D9	4T6381	CENTER	4J9058 (9)	2J3507 (9)	5P8250 (9)
D8, D9	6Y5540	L / R	4J9058 (5)	2J3507 (5)	5P8250 (5)
D8, D9	9W6092	CENTER	4J9058 (6)	2J3507 (6)	5P8250 (6)
D8, D9	7T9126	CENTER	4J9208 (9)	2J3507 (9)	5P8250 (9)
D8, D9	7T9125	L / R	4J9058 (5)	2J3507 (5)	5P8250 (5)
D8L, D8N, D9N	9W4396	CENTER	4J9058 (11)	2J3507 (11)	5P8250 (11)
D8L, D8N, D9N	9W4398	L / R	4J9058 (5)	2J3507 (5)	5P8250 (5)
D8R, D8T	4Z9058	CENTER	4J9058 (13)	2J3507 (13)	5P8250 (13)
D9	4T6379 (2)	INTERMEDIATE	4J9258 (4)	2J3507 (4)	5P8250 (4)
D9	4T6387 (2)	END	8J2928 (9)	2J3507 (9)	5P8250 (9)
D9	6Y0311	L / R	4J9208 (8)	2J3507 (8)	5J8250 (8)
D9	6Y0312	L / R	4J9208 (8)	2J3507 (8)	5J8250 (8)
D9	6Y5539 (1)	CENTER	4J9058 (12)	2J3507 (12)	5P8250 (12)
D9	7J2959	L / R	4J9208 (6)	2J3507 (6)	5J8250 (6)
D9	7J2980 (1-3)	CENTER	8J2928 (7)	2J3507 (7)	5P8250 (7)
D9	7T5701	CENTER	4J9058 (15)	2J3507 (15)	5P8250 (15)
D9	7T9779	L / R	6V8360 (5)	3K9770 (5)	4K0684 (5)
D9	7T9782 (2)	CENTER	6V8360 (6)	3K9770 (6)	4K0684 (6)
D9	9W4500 (1-3)	CENTER	4J9258 (7)	2J3507 (7)	5P8250 (7)
D9	9W4507 (2)	CENTER	1J4948 (9)	2J3507 (9)	5P8250 (9)
D9	9W4508	L / R	4J9058 (8)	2J3507 (8)	5P8250 (8)
D9	9W7043	CENTER	4J9258 (12)	2J3507 (12)	5P8250 (12)
D9	6Y5538	CENTER	4J9208 (15)	2J3507 (15)	5P8250 (15)
D9	9W7044	CENTER	4J9058 (15)	2J3507 (15)	5P8250 (15)
D9	9W4502	L / R	8J2928 (8)	2J3507 (8)	5P8250 (8)
D9	4T6448	CENTER	4J9208 (10)	2J3507 (10)	5P8250 (10)
D9 9A	4T6386 (3)	CENTER	8J2928 (7)	2J3507 (7)	5P8250 (7)
D9 9A	4T6388 (2)	END	8J2928 (7)	2J3507 (7)	5P8250 (7)
D9N	7T5702	CENTER	4J9258 (12)	2J3507 (12)	5P8250 (12)
D10	8E2085 (2)	CENTER	5P8823 (6)	3K9770 (6)	4K0684 (6)
D10	8E2086 (2)	END	5P8823 (5)	3K9770 (5)	4K0684 (5)
D10	9W6608 (2)	END	5P8823 (5)	3K9770 (5)	4K0684 (5)
D10	9W6609 (2)	CENTER	5P8823 (6)	3K9770 (6)	4K0684 (6)
D10	9W6615 (3)	CENTER	5P8823 (5)	3K9770 (5)	4K0684 (5)
D10	9W6656 (2)	CENTER	5P8823 (6)	3K9770 (6)	4K0684 (6)
D10	9W6657	L / R	5P8823 (5)		

GRADER BLADES

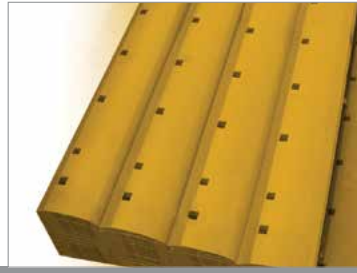

Number in parenthesis () after the part number indicates the quantity of the part per side cutters needed.

Part No.	Blades Size	Bolts	Nuts
8D2786	1/2"x6"x6'	3F5108 (13)	4K0367 (13)
7D4508	5/8"x6"x5'	3F5108 (11)	4K0367 (11)
5D9553	5/8"x6"x6'	3F5108 (13)	4K0367 (13)
5D9554	1/2"x6"x7'	3F5108 (15)	4K0367 (15)
9J3658	5/8" X6" X7'	4F7827 (15)	2J3506 (15)
5D9556	3/4" X 6" X7'	3F5108 (13)	4K0367 (13)
5D9557	3/4" X 6" X7'	3F5108 (15)	4K0367 (15)
5D9562	5/8" X 8" X 6'	3F5108 (13)	4K0367 (13)
9J7701	5/8" X 8" X 6'	4F7827 (13)**	2J3506 (13)
4T2968	5/8" X 8" X 6'	3F5108 (13)	4K0367 (13)
5D9561	5/8" X 8" X 7'	3F5108 (15)	4K0367 (15)
7D1158	5/8" X 8" X 6'	4F7827 (15)**	2J3506 (15)
8J9821	5/8" X 8" X 8'	4F7827 (17)	2J3506 (17)
5D9558	3/4" X 8" X 6'	3F5108 (13)	4K0367 (13)
7D1576	3/4" X 8" X 6'	4F7827 (13)**	2J3506 (13)
4T3007	3/4" X 8" X 6'	3F5108 (13)	4K0367 (13)
5D9559	3/4"x8"x7'	3F5108 (15)	4K0367 (15)
7D1577	3/4"x8"x7'	4F7827 (15)**	2J3506 (15)
4T3036	3/4" X 8" X 7'	3F5108 (15)	4K0367 (15)
4T3032	3/4" X 8" X 7'	4F7827 (15)**	2J3506 (15)
5D9732	3/4" X 8" X 8'	3F5108 (17)	4K0367 (17)
7D1949	3/4" X 8" X 8'	4F7827 (17)**	2J3506 (17)
4T2231	1" X 8" X 6'	4F7827 (13)	2J3506 (13)
7T3499	1" X 8" X 6'	3F5108 (13)	4K0367 (13)
4T2242	1" X 8" X 7'	3F5108 (15)	4K0367 (15)
4T2233	1" X 8" X 7'	4F7827 (15)**	2J3506 (15)
7T3498	1" X 8" X 7'	3F5108 (15)	4K0367 (15)
4T2236	1" X 8" X 8'	4F7827 (17)**	2J3506 (17)
4T6508	1"x10"x7'	4F7827 (15)**	2J3506 (15)
4T6511	1"x10"x8'	4F7827 (17)**	2J3506 (17)
8D2787	1/2"x6"x7'	3F5108 (15)	4K0367 (15)
9J3657	5/8" x16x6'	4F7827 (13)**	2J3506 (13)
7T1626	5/8" x6"x7'	4F7827 (9)**	2J3506 (9)
3G2165	3/4" x8"x2'	4F7827 (4)**	2J3506 (4)
7T1625	3/4" x8"x7'	4F7827 (9)**	2J3506 (9)
4T3037	3/4" x8"x8'	4F7827 (17)**	2J3506 (17)
4T2244	1"x8"x6'	3F5108 (13)	4K0367 (13)
4T8317	1 3/8"x10"x8'	4F7827 (17)**	2J3506 (17)

**For machine 14G, use 5J4773 bolts

CARBON STEEL GRADER BLADES



CTP Part No.	Part No.	Edge Size	Bolts	Nuts
5D9553C	7T1633	5/8"x6"x6'	3F5108 (13)	4K0367 (13)
5D9554C	7T1645	5/8"x6"x7'	3F5108 (15)	4K0367 (15)
5D9556C	N/A	3/4"x6"x6'	3F5108 (13)	4K0367 (13)
5D9557C	N/A	3/4"x6"x7'	3F5108 (15)	4K0367 (15)
5D9558C	7T1634	3/4" X8" X 6'	3F5108 (13)	4K0367 (13)
5D9559C	7T1623	3/4"x8"x7'	3F5108 (15)	4K0367 (15)
5D9561C	7T1643	5/8" X8X 7'	3F5108 (15)	4K0367 (15)
5D9562C	7T1636	5/8" X8X 6'	3F5108 (13)	4K0367 (13)

MOTOR GRADER INSERTS



Part No.	Material	Machine Model
2G7463	PLASTIC	16G
2G7464	PLASTIC	12G, 120G, 130G, 14E, 14G, 140G
2G7465	PLASTIC	120G
8D8024	N/A	16G, 16H, 227
8X4741	BIMETALIC	12H, 120H, 135H, 140H, 160H
9D2252	BIMETALIC	14G, 14H
9D2756	BIMETALIC	120G

EXCAVATOR SIDECUTTERS



Number in parenthesis () after the part number indicates the quantity of the part per side cutters needed.

Part No.		Bolt	Nut	Washer
(LH)	(RH)			
1122488	1122487	N/A	N/A	N/A
2568691	2568690	1D4637 (10)	2J3507 (10)	3K5234 (10)
0964747	0964748	8T0664 (8)	7X0851 (8)	N/A
8J9614	8J9615	6I6371 4F4042 (6)	2J3507(6)	N/A
8J9826	8J9825	8H5772 (10) 7Y1136 (10)	2J3507 (10)	5P8250(10)
9J1856	9J1855	4F7827 (6) 4F3656 (8)	2J3506(6) 1D4720 (8)	N/A

TIPS & ADAPTERS



Reference Chart

Family	Pocket Size	Machine
J200	20 = 2.0"	416, 426, 428, 436, 910, 931, 935, 307, IT12, IT14G
J250	25 = 2.5"	916-930, 936, 941, 943, 951, 953, 205 THRU 214, 225, 229, 311, 312, 320
J300	30 = 3.0"	950,953B THRU 966, E180, 215, 235, 205 THRU 214, 315,320,322
J350	35 = 3.5"	966B, 977, 980, E180, E240, 213B, 215 THRU 229, 320,322,325,330
J400	40 = 4.0"	980G,322,325,330
J450	45 = 4.5"	983, 988, 988B, 225, 229, E300, 235, 325, 330, 345, 350
J460	46 = 4.6"	988F, 988B, 322B, 325B, 330B, 235D, 235L
J550	55 = 5.5"	988G, 992, 235, 245, 345, 350, 375
J600	60 = 6.0"	365B, 385C, 374D, 365C, 345C, 375, 375L
J700	70 = 7.0"	992C, 992D
J800	80 = 8.0"	994

Pin and Retainers for GET's

Pin Part No.	Retainer Part No.	Tip Size
1073308	8E6259	J300
1073378	1078559	J550
1134708	1134709	J700
1139608	1139609	J600
1140358	1140359	J400
1140468	1073469	J460
1167408	1167409	J400
1324762	1495733	J225
1324763	1495733	J250
1324766	1495733	J300
1341808	1341809	J800
1359292	1140359	N/A
1359350	1140359	N/A
1368308	1U2405	N/A
2011238	2011239	N/A
2755982	1320999	N/A
6Y1204	6Y1202	J500
6Y2527	8E6359	J450
6Y3909	4T4707	J500

Part numbers are used for reference purposes only.

Pin Part No.	Retainer Part No.	Tip Size
7T3408	8E8409	J400
8E6208	8E6209	J200
8E6258	8E6259	J250

Cleaner Bars & Stands

Part No.	Description	Wheel Loader
5V4311	CLEANER BAR	815B
4S7928	CLEANER BAR	825,835
3S3225	CL. BAR RETAINER	815,815F,825B, 835
3S3228	CLEANER BAR	834,835,824B,825B/C

Shank Protectors

Part No.	Model	Pin	Lock
6J8814	D8K	6Y3394	8E4743
6Y8960	D11N	6Y1204	6Y1202

Adapter Shanks

Part No.	Nose	Application
8E8418	9U9694	D8, D8L/N/K/R, D9, D9N, D9R, D9H
1U3630		D9L, D10, D11
1038115		D9L, D9R, D10, D11

Bucket Sidebar Protectors

Model	Sidebar Protector	Pin	Retainer ass	Nut
980F, 980G	1358246 (2)	1359292 (4)	1140359 (4)	2J3505
988B/F/G	9J9600 (2)	1359350 (4)	1140359 (4)	8J2933
990, 992C/D/G	1U0740 (2)	1330738 (4)	1078559 (4)	5P8362
966G, 972G	1358246 (4)	1359292 (8)	1140359 (8)	8J2933
385B/C, 980H, 980K	1250800 (2)	8E4708(4)	4T4707(4)	5P8362
320C, 320D	1122489 (2)	1122490 (4)	1320999 (4)	5P8362

Bolt on Corner Adapter

Family	Left	Right	Bolt	Nut
J200	1U2208	1U2209	6F0196	2J3505
J250	3G4258	3G4259	4J9058	8J2933
J300	3G4308	3G4309	6V6535	5P8362
J300	3G4308	3G4309	4J9058	8J2933
J300	3G8308	3G8309	5P8823	5P8362
J350	3G5358	3G5359	5P8823	5P8362
J350	1U1358	1U1359	6V8360	5P8362

Costex Tractor Parts Copyright © 2020. All rights reserved.

2-Bolt on Corner Adapter



Family	Left	Right	Bolt	Bolt	Nut
J250	6I9250	6I9251	4J9058	4F4042	2J3507
J300	8E5308	8E5309	8T9079	6V8360	3K9770
J350	8E5358	8E5359	5P8361	6V6535	3K9770
J400/ J460	6I8244	6I8243	8T9079	6V8360	3K9770

Bolt on Center Adapter - 3 Holes



Family	Model	Part No.	Bolt	Nut	Pin
J300	966C	3G5307	8J2928	8J2933	1073308
J350	977	3G1357	8J2928	8J2933	1140358

Side Pin Teeth



Family	Short	Long	Long Tip	Heavy Duty Abrasion	Heavy Duty Long	Heavy Duty Penetration	Penetration	Penetration Extended	Twin Tiger	Flare (Wide)	Standard Pin	Standard Retainer	Heavy Duty Pin	Heavy Duty Retainer
J200	1U3201	1U3202	1959209	4T2203			1U3209	1U3202V	1358208	1099200	8E6208	8E6209		
J225	6Y6221	6Y3222		6Y6223	8E4222		6Y8229	6Y3222V	1358228	1863010	6Y3228		1374762	1495733
J250	1U3251	1U3252	1681253	9N4253	9N4252		9J4259	1U3252V	1358258	2085254	8E6258	8E6259	1324763	1495733
J300	1U3301	1U3302	1681301	9N4303	9N4302	1359300	9J4309	1835300	1359308	1073300	1073308	8E6259	1324766	1495733
J350	1U3351	1U3352	1681351	9N4353	9N4352	1441358	9J4359	1681359	1359357	1073350	1140358	8E6359	1140358	1140359
J400	7T3401	7T3402	1681401	7T3403	8E4402	1359400	6Y7409	1681409	1359408	1073400			1167408	1167409
J450 J460	9W8451	9W8452	1681451	9N4453	9N4452	1386451	9W8459	1590459	1386458	1073450	6Y2527	8E6359	1140468	1073469
J550	9W8551	9W8552		6Y2553	9N4552	1386522	9W8559	1590559		1073550	1073378	8E5559	1073378	1078559
J600	6I6601	6I6602		6I6603	7Y0602	1359600	7I7609	1590607			1139608	6I6609	1139608	1139609
J700		4T4702		9U9703		1359700	4T4709	1711709					1134708	1134709
J800				6I8803		1359800							1341808	1341809

Tips for Komatsu®

Picture	Type	Application	Part No.	Machine Model	Pin No.
	Point Tiger Long	For use in compact material.	175-78-31230TL	D155AX-5, D155AX-6, D55AX-7	09244-02508
	Ripper Tip	For ripping application on dozers and scarifiers.	141-78-11253	D61EX15, D65WX/EX-12, D65EX-15, D65EX-16, D65EX-17, D65WX-17	09244-02508
	Tooth	Multi-purpose for most basic applications.	423-847-1140	WA380-5, WA380-6, WA380-7	09244-02516
	Tooth Rock Chisel	Best for use on abrasive materials that require good penetration.	205-70-19570RC	PC200, PC210-6, PC210-7, PC210LC-6, PC210LC-7, PC210LC-8	09244-02496
	Tooth Rock Chisel	Best for use on abrasive materials that require good penetration.	207-70-14151RC	PC300LC-6, PC300LC-7, PC300LC-8	09244-02516
	Tooth Tiger Long	Best for use on abrasive materials that require a high level of penetration and resistance to impact.	205-70-19570TL	PC200, PC210-6, PC210-7, PC210LC-6, PC210LC-7, PC210LC-8	09244-02496
	Tooth Tiger Long	Best for use on abrasive materials that require a high level of penetration and resistance to impact.	207-70-14151TL	PC300LC-6, PC300LC-7, PC300LC-8	09244-02516

Bolt on Center Adapter - 2 Holes



Family	Part No.	Bolt	Nut
J200	8E2184	4F3656	4K0367
J200	9J4207	5J4771	2J3506
J250	1U0257	8J2928	8J2933
J300	1U0307	8J2928	8J2933
J300	4T4307	5P8136	8J2933
J300	3G9307	5P8361	5P8362
J350	3G3357	5P8361	5P8362
J350	1U1357	5P8361	5P8362

Blades & end bits for Komatsu®



Cutting Edges

Part No.	Application	Qty Per Machine	Bolt	Nut	Washer
17A-71-45210	D155AX-6, D155AX-7	2	17A-71-12451	17M-71-21530	01643-22460
175-70-26310	D155AX-6, D155AX-7	1	175-71-11463	175-71-11530	01643-02245
134-72-61420	D61EX-15, D61PX-15	2	02090-11265	02290-11219	N/A
144-70-11131	D61PX-15, D65EX-16, D65EX-17, D65EX-15, D65EX-12	2	02090-11270	02290-11219	N/A
13G-72-61410	D61PX-15, D61EX-15, D65EX-17, D65PX-17	1	02090-11265	02290-11219	N/A
13G-72-61420	D61PX-15, D61EX-15, D65EX-17, D65PX-17, D65PX-16, D65EX16	2	02090-11270	02290-11219	N/A
144-920-1120	D65A-6, D65A-7, D65E-7, D65A-8, D65E-8	2	02090-11270	02290-11219	N/A
130-70-41130	D65EX-12, D65EX-15, D65EX-16, D65EX-17	1	02090-11270	02290-11219	N/A
13G-72-63250	D65PX-16, D65WX-17, D65PX-17, D61PX-15	2	02090-11265	02290-11219	N/A



Side Edges

Part No.	Application	Qty Per Machine	Bolt	Nut	Washer
418-815-A110	WA250-6, WA250-5	1	02090-11685	02290-11625	01643-22460
419-815-A120	WA250-6, WA250-5	2	02090-11685	02290-11625	01643-22460
421-838-1110	WA320-1, WA380-5	2, 8	02090-11690	02290-11625	01643-22460
424-815-A130	WA380-6	2	02090-11485	02290-11422	01643-32260
424-815-A140	WA380-6	1	02090-11485	02290-11422	01643-32260



End Bits

Applications	Right Hand Part No.	Left Hand Part No.	Qty Per Machine	Bolt	Nut	Washer
D155A-1, D155AX-5, D155AX-6, D155AX-7	175-70-21136	175-70-21126	1	175-71-11463	175-71-11530	01643-02245
D155AX-6, D65EX-16, D65WX-15, D65EX-15, D65EX-12, D61	175-71-22282	175-71-22272	1	02090-11495	02290-11422	01643-22245
D61PX-15, D65PX-15, D65PX-16, D65EX-16, D65WX-17	14Y-71-11340	14Y-71-11330	1	02090-11270	02290-11219	N/A
D65A-6, D65A-7, D65E-7, D65A-8, D61PX-15, D65AX-12, D65PX-15, D65PX-17	144-70-11190	144-70-11180	1	02090-11270	02290-11219	N/A
D65EX-15, D65EX12	150-70-21346	150-70-21356	1	02090-11280	02290-11219	N/A

Part numbers are used for reference purposes only.

Costex Tractor Parts Copyright © 2020. All rights reserved.

Ripper Shanks



Machine Model	Shank	Protector	Center Ring	Pin and washer	Center Ring	Pin and Washer	Tooth	Center pin	Pin and washer
931, 933, 939, D3, D4C, 135H, 120H	8J5299						1U3209, 1U3201, 9W8209, 1U3202		8E6208 8E6209
943, 953	1U1257						9J4259, 1U3251, 9W8259		8E6258 8E6259
941, 951, 955, 963, 12, 14, 130, 140, 143H, 160H	9J8913 9J6586						4T4302, 6Y0309	8J1433	1368308 1U2405
16, 973, 977, D5, D6	9J8923 9J3139						4T4352, 6Y0359		8E6358 1U2405
D7	9W7382						4T4352, 6Y0359		8E6358 1U2405
D7, D8, D9	7J2459	7J2352 7J2351	7J9600		6J8811		7J3309, 7J3312	7J9600	
D8K	1073485 1073486 8E5346	8E1848		6Y3394 8E4743		6Y3394 8E4743	9W2452, 8E5570, 1140453, 4T5451, 4T5452, 8E5571		6Y3394 8E4743
D8L	8E5342 8E5340	8E1848		6Y3394 8E4743		6Y3394 8E4743	9W2452, 8E5570, 1140453, 4T5451, 4T5452, 8E5571		6Y3394 8E4743
D8N	8E5347 8E5340 8E5346	8E1848		6Y3394 8E4743		6Y3394 8E4743	9W2452, 8E5570, 1140453, 4T5451, 4T5452, 8E5571		6Y3394 8E4743
D9H	1073485 1073486 8E5345	8E1848		6Y3394 8E4743		6Y3394 8E4743	9W2452, 8E5570, 1140453, 4T5451, 4T5452, 8E5571		6Y3394 8E4743
D9L	8E8414	9W8365		6Y3909 4T4707		6Y3909 4T4707	4T4501, 4T4502, 4T4503, 4T5501, 4T5502, 8E5572, 4T5503		6Y3909 4T4707
D9N	8E5339 8E5346	8E1848		6Y3394 8E4743		6Y3394 8E4743	9W2452, 8E5570, 1140453, 4T5451, 4T5452, 8E5571		6Y3394 8E4743
D11, D11N	1049277	9N4621	9W1821		9W1821		9W4551, 9W4552, 6Y3552	9W1821	

Style Ripper Teeth

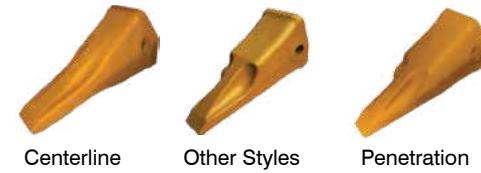

Ripper Teeth

Part No.	Type	Application	Pin	Lock
6Y0309	Penetration	951,955,140,140G	1368308	1140359
9W2451	Centerline-Short	D8-K/L/N/R, D9-H/N/R	6Y3394	8E4743
9W2452	Centerline-Intermediate	D8-K/L/N/R, D9-H/N/R	6Y3395	8E4744
4T5452	Penetrator-Intermediate	D8-K/L/N/R, D9-H/N/R	6Y3396	8E4745
6Y0352	Centerline-Intermediate	D5, D6, D7, 973, 977, 983, 14G, 16G	1140358	1140359
6Y0359	Penetrator-Long	D5, D6, D7, 973, 977, 983, 14G, 16G	1140358	1140359
4T4453	Centerline-Long	D8-K/L/N/R, D9-H/N/R	6Y3394	8E4743
4T4501	Centerline-Short	D9L, D10, D11	6Y1204	6Y1202
4T4502	Centerline-Intermediate	D9L, D10, D11	6Y1204	6Y1202
4T5501	Penetrator-Short	D9L, D10, D11	6Y1204	6Y1202
4T5502	Penetrator-Sharp	D9L, D10, D11	6Y1204	6Y1202
4T5503	Penetrator-Long	D9L, D10, D11	3G0500	N/A
8E8503	Centerline-Long	D9L/R/T, D10-N/R/T, D11	6Y1204	6Y1202
9W4552	Centerline-Intermediate	D11	9N4245	6Y1205
9W4551	Centerline-Short	D11	9N4245	6Y1205
6Y3552	Penetrator-Intermediate	D11	9N4245	6Y1205

Tamping Feet



Part No.	Appl.	Bolt	Nut	Retainer	Base	Wheel Loader
2V7053	WELD-ON				7K6908	815B, 815F
4V0668	WELD-ON				7K7071	825C
4V3851	WELD-ON				7K6908	815, 815F
7K2939	PIN				9S1645	8245/5, 834/5
8K9189	BOLT-ON	8K9163	7H3607	5S0581	7K6908	815, 815F
2V6628	WELD-ON					
8K9171	BOLT-ON	2N5014	7H3609	4D6419		825, 835

Part numbers are used for reference purposes only.

Clean Bar

Part No.	Application	Machine Model	Bolts	Nuts	Washer
1062047	Bolt-On	815B Compactor	3B6753 (8) / 1D4620 (8)	2J3506 (16)	2S0115(32)

Flush Mounted Adapters

Family	Model	Part No.	Position
J200	416, 426, 428, 910, 931, 935	4T1204	Center
J250	930, 936, 941, 943, 951, 953	1U1254	Center
J300	950, 955, 963, 966C	1U1304	Center
J350	966D, 973, 977, 980	1U1354	Center
J400	980	1073404	Center
J460	983, 988	8E0464	Center
J460	983, 988	8E0465	Right
J460	983, 988	8E0466	Left

Weld on Bottom Strap

Family	Part No.	Position
J200	8J7525	Center
J250	3G0169	Center
J300	9J8929	Center
J350	1U1352	Left
J350	1U1350	Center
J350	1U1351	Right

Bolt on Unitooth

Part No.	Family	Bolt	Nut
1358203	J200	4F3656	4K0367
1U1857	J250	8J2928	8J2933
1U1877	J300	8J2928	8J2933
8E1637	J300	8J2928	8J2933
8J6207	J200	5J4771	2J3506
1324720		1592953	8T4778

Shanks and Pins for Motor Graders



Part No.	Description
9F5124	SHANK TOOTH - 3 NOTCH
6Y5230	TOOTH
5B6251	SHANK TOOTH - OUTSIDE NOTCH
5K1459	PIN - TOOTH
5K1458	GROMMET - TOOTH

Costex Tractor Parts Copyright © 2020. All rights reserved.

V-Series Self-Sharpening Teeth



Part No.	Part No.
1U3202V	1681409
6Y3222V	98452V
1U3252V	1590559
1835300	
1681359	

Weld On Double Strap Adapters

Part No.	Part Position	Family
6Y3224	Center	J220
6Y3254	Center	J250
9W1304	Center	J300
3G6304	Center	J300
3G6305	Right	J300
3G6306	Left	J300
6I6354	Center	J350
6I6355	Right	J350
6I6356	Left	J350
6I6404	Center	J400
6I6405	Right	J400
6I6406	Left	J400
1590464	Center	J460
8E3466	Left	J460
8E3464	Center	J460
8E3465	Right	J460
6I6554	Center	J550
6I6604	Center	J600
6I6605	Right	J600
8E9490	Center	J300
6I6554	Center	J550
3G8354	Center	J350
3G8355	Right	J350
3G8356	Left	J350
8E6464	Center	J460
3G9494	Center	J550
1711704	Center	J700
6I8804	Center	J800

Heavy Duty Adapters

Family	Model	Part No.	Position
J350	966	1359356	Left
		1359354	Center
		1359355	Right
J400	980	1258406	Left
		1258404	Center
		1258405	Right
J460	988	1140466	Left
		1140464	Center
		1140465	Right
J550	990, 992	1073556	Left
		1073554	Center
		1073555	Right

TRACK SHOES



Part No.	Description	Machine Model
1265062	SHOE-TRACK 600 MM	320B, 320C, 318C, 317
1265064	SHOE-TRACK 600 MM	325
1265066	SHOE-TRACK 600 MM	330
1P9808	SHOE-TRACK 22"	D7F, D7G
3P0616	SHOE-TRACK MASTER 22"	D7G
3P0617	SHOE-TRACK MASTER 24"	D7G, 571G, 572G
5S0821	SHOE-TRACK 18"	D5, 561C
5S0822	SHOE-TRACK 20"	D5
6I9454	SHOE-TRACK 700MM	320
6Y6286	SHOE-TRACK 22"	D6T
6Y6287	SHOE-TRACK 24"	D6H
6Y6291	SHOE GROUSER 20"	D6C, D6D
6Y6293	SHOE-TRACK 22"	D6D
6Y6295	SHOE-TRACK 24"	D6D
6Y6395	SHOE-TRACK 20"	D6D
6Y6411	SHOE-TRACK 22"	D6C, D6D, 955L/235
6Y8180	SHOE-TRACK TRIPLE 850MM	330
7G6448	SHOE-TRACK 22"	D8T
8E9812	SHOE-TRACK 22"	D4H
9W9351	SHOE-TRACK 800 MM	320

LOADER SEGMENTS

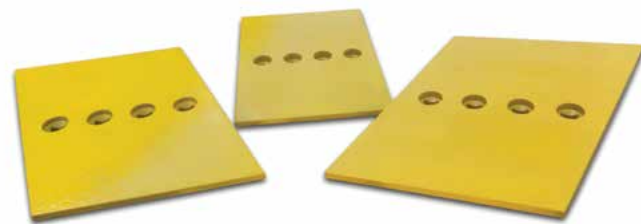

Model Engine Application	Left Hand	Center	Right Hand	Edge Thickness		Bolts	Nuts
				(in)	(mm)		
943		4T6692(5)		0.98	25	1J5607(14)	2J3507(14)
953		4T6692(7)		0.98	25	1J5607(14)	2J3507(14)
963	4T6693	4T6692(5)	4T6693	0.98	25	4F4042(14)	2J3507(14)

Loader Segments (cont.)

Model Engine Application	Left Hand	Center	Right Hand	Edge Thickness		Bolts	Nuts
				(in)	(mm)		
973	4T9124(2)	4T3015(2)	4T9123(2)	1.18	30	6V6535(14)	3K9770(14)
990	4T6762(3)	4T6760	4T6761(3)	1.57	40	5P8823(28)	3K9770(28)
990		4T6760(7)		1.57	40	5P8823(28)	3K9770(28)
910, 914G		1282873(6)		0.75	19	4F7827(12)	2J3506(12)
916, 924F, 926		4T6694(7)		0.98	25	1J5607(14)	2J3507(14)
916, 924F, 926, 920		8E4569(7)		0.98	25	1J5607(14)	2J3507(14)
920, 930, 943	4T6693	4T6694(5)	4T6694(7)	0.98	25	1J5607(14)	2J3507(14)
936, 936E/F, 938F/G		4T6695(7)		0.98	25	1J5607(14)	2J3507(14)
936, 936E/F, 938F/G		1321037(7)		1.38	35	1J5607(14)	2J3507(14)
950, 960 BEF	4T9124(3)	4T3015	4T9123(3)	1.18	30	8T9079(21)	3K9770(21)
950B, 950E, 950F		4T6695(7)		0.98	25	4F4042(14)	2J3507(14)
950G/H/K, 962H		1407601(5)		1.18	30	4F4042(14)	2J3507(14)
950G, 962G		1324715(5)		1.38	35	4F4042(14)	2J3507(14)
960F		4T6695(7)		0.98	25	4F4042(14)	2J3507(14)
960F		4T6699(7)		1.18	30	5P8823(14)	3K9770(14)
963B		4T6696(5)		1.18	30	5P8823(14)	3K9770(14)
966D, 966E	4T9123	4T6697	4T9124	1.18	30	6V6535(14)	3K9770(14)
966D, 966E, 966F/H	3083054	4T6699(5)	3083054	1.18	30	5P8823(14)	3K9770(14)
966G, 970F, 972G		1006666(7)		1.77	45	5P8823(14)	3K9770(14)
966G, 972G	1359296(3)	1359294	1359295(3)	1.57	40	6V6535(14)	3K9770(14)
966G, 972G	1359546(3)	1359544	1359545(3)	2.8	71	6V6535(14)	3K9770(14)
973, 973C		4T6698(7)		1.18	30	5P8823(14)	3K9770(14)
980F	4T7140(3)	4T3015	4T7139(3)	1.18	30	6V6535(14)	3K9770(14)
980G	9W5730(3)	9W5734	9W5737(3)	1.38	35	8T9079(21)	3K9770(21)
980G	1167462(3)	1167460	1167461(3)	1.77	45	8T9079(21)	3K9770(21)
980G		1099019(7)		1.18	30	5P8823(14)	3K9770(14)
980G, 980H	1073492(3)	1073490	1073491(3)	1.77	45	8T9079(21)	3K9770(21)
980G, 980H		1358219(14)		1.77	45	5P8823(14)	3K9770(14)
988B	9W5730(3)	9W5734	9W5737(3)	1.38	35	6V6535(21)	3K9770(21)
988B	1167432(3)	1167460	1167461(3)	1.77	45	6V6535(21)	3K9770(21)

Model Engine Application	Left Hand	Center	Right Hand	Edge Thickness		Bolts	Nuts
				(in)	(mm)		
988B		9W5734(7)		1.38	35	6V6535(21)	3K9770(21)
988B		1073490(7)		1.77	45	6V6535(21)	3K9770(21)
988B		4T6700 (7)		1.18	30	5P8823(14)	3K9770(14)
988F, 988G, 988H	1019437(3)	1019435	1019436(3)	1.57	40	6V6535(21)	3K9770(21)
988F, 988G, 988H	1073538(3)	1073536	1073537(3)	1.77	45	6V6535(21)	3K9770(21)
988F, 988G, 988H	1099082(3)	1099080	1099081(3)	1.77	45	6V6535(21)	3K9770(21)
988F, 988G, 988H		1019435(7)		1.57	40	6V6535(21)	3K9770(21)
988F, 988G, 988H		1073536(7)		1.77	45	6V6535(21)	3K9770(21)
988F, 988G, 988H		1099080(7)		1.77	45	6V6535(21)	3K9770(21)
992, 993K	1076296(3)	1076294	1076295(3)	2.36	60	5P8823(28)	3K9770(28)
IT 12		1282873(6)		0.72	18	4F7827(12)	2J3506(12)
IT 18, IT 28		4T6694(7)		0.98	25	1J5607(14)	2J3507(14)
IT 24F, IT 28F		8E4569(7)		0.98	25	1J5607(14)	2J3507(14)
IT38G		4T6695(7)		0.98	25	1J5607(14)	2J3507(14)
IT62G II		1324715(7)		1.38	35	4F4042(14)	2J3507(14)

SCRAPER CUTTING EDGES



Model	Thickness		Stinger Arrangement		Bolts per Edge	Nuts per Edge
	(In)	(mm)	Center	End		
613, 613C	0.88	22	4T6611	4T6613(2)	4F7827 (15)	2J3506 (15)
621B/E/F, 627B/E/F	0.88	22	4T6568	4T6612(2)	3J2801 (14)	2J3507 (14)
621B/E/F, 627B/E/F	1.12	28	4T2896	4T6380(2)	3J2801 (14)	2J3507 (14)
623B/E/F, J619, J621	0.88	22	4T2887	4T6612(2)	4F4042 (20)	2J3507 (20)
623B/E/F, J619, J621	1.12	28	N/A	4T6380(2)	4F4042 (20)	2J3507 (20)
631D/E, 637D/E	0.88	22	4T6566	4T6614(2)	4F4042 (16)	2J3507 (16)
631D/E, 637D/E	1.12	28	N/A	4T6378(2)	4F4042 (16)	2J3507 (16)
631D/E, 637D/E	1.38	35	9J4369	9W6092(2)	4F4042 (16)	2J3507 (16)
631D/E, 637D/E	1.62	41	9J5899	7J2959(2)	4F4042 (16)	2J3507 (16)

HARDWARE PARTS

ADAPTERS



Part No.	Description
2R8613	ADAPTER
3J7355	ADAPTER
3R2704	ADAPTER
3R5387	ADAPTER
4L8545	ADAPTER
4S6678	ADAPTER
4V6485	ADAPTER
5D9231	ADAPTER
5K6875	ADAPTER
5P1404	ADAPTER
5P2937	ADAPTER
5P3501	ADAPTER
5P5528	ADAPTER
5P6944	ADAPTER
5P9617	ADAPTER

Part No.	Description
6D6489	ADAPTER
6K3457	ADAPTER
6K6967	ADAPTER
6L9777	ADAPTER
6L9781	ADAPTER
6L9952	ADAPTER
7D4903	ADAPTER
7D5363	ADAPTER
8F0390	ADAPTER
8L3282	ADAPTER
8L6557	ADAPTER
8M0755	ADAPTER
9L4007	ADAPTER
9M6522	ADAPTER

BOLTS



Part No.	Description
0302135	BOLT
0310223	BOLT
0312523	BOLT
0314630	BOLT
0930262	BOLT
0S1565	BOLT
0S1570	BOLT
1434891	BOLT
1504741	BOLT
1A0224	BOLT
1K9414	BOLT
2H0191	BOLT
310214	BOLT
3J8281	BOLT
3K3112	BOLT

Part No.	Description
3S0127	BOLT
4B8701	BOLT
4F3650	BOLT
4F3664	BOLT
4F3671	BOLT
5D1972	BOLT
5D9844	BOLT
6K0137	BOLT
6T8521	BOLT
6V1997	BOLT
6V3531	BOLT
6V3823	BOLT
6V4414	BOLT
6V4432	BOLT
6V5221	BOLT

Part No.	Description
6V8132	BOLT
6V8199	BOLT
6V8212	BOLT
6V8918	BOLT
6Y7432	BOLT
7H3579	BOLT
7K4370	BOLT
7X0290	BOLT
7X0296	BOLT
7X0307	BOLT
7X0310	BOLT
7X0314	BOLT
7X0326	BOLT
7X0328	BOLT
7X0333	BOLT
7X0335	BOLT
7X0337	BOLT
7X0341	BOLT
7X0347	BOLT
7X0351	BOLT
7X0356	BOLT
7X0357	BOLT
7X0358	BOLT
7X0372	BOLT
7X0373	BOLT
7X0383	BOLT
7X0384	BOLT
7X0385	BOLT
7X0393	BOLT
7X0396	BOLT
7X0404	BOLT
7X0405	BOLT
7X0407	BOLT
7X0408	BOLT
7X0412	BOLT
7X0434	BOLT
7X0435	BOLT
7X0818	BOLT
7X2488	BOLT
7X2532	BOLT
7X2538	BOLT
7X2549	BOLT
7X2550	BOLT
7X2554	BOLT
7X2556	BOLT
7X2561	BOLT
7X2569	BOLT

Part No.	Description
7X2573	BOLT
7X2574	BOLT
7X2576	BOLT
7X2577	BOLT
7X2581	BOLT
7X2583	BOLT
7X2584	BOLT
7X7925	BOLT
8C3290	BOLT
8C6877	BOLT
8C8451	BOLT
8C8478	BOLT
8M0139	BOLT
8T0281	BOLT
8T0358	BOLT
8T0359	BOLT
8T0360	BOLT
8T0375	BOLT
8T0640	BOLT
8T0650	BOLT
8T0652	BOLT
8T0664	BOLT
8T0668	BOLT
8T0670	BOLT
8T2396	BOLT
8T3647	BOLT
8T4141	BOLT
8T4174	BOLT
8T4779	BOLT
8T4971	BOLT
8T5041	BOLT
8T6624	BOLT
8T8912	BOLT
8T8919	BOLT
8T9043	BOLT
8T9378	BOLT
8T9383	BOLT
8T9396	BOLT
8T9400	BOLT
930265	BOLT
9B7237	BOLT
9F5975	BOLT
9F8122	BOLT
9W9058	BOLT
9X8896	BOLT

BONNETS



Fuel Injection

Part No.	Application
1W9171	3306
6I1327	3306
8S3653	3306
8N2516	3204, 3304, 3402, 3306, 3306B
8N1417	3208, 3304
4N2484	3208, 3406, 3408, 3408B, 3412
4N0209	3304, 3306, 3208
4M0411	3304, 3306, D333, D336
9L6893	3406, 3408, 3408B, 3412, 3412B
1082102	3406B, 3406C

Oil Cooler

Part No.	Application
6N0125	3304, 3306
6N0124	3304, 3306, 3306B
9L5910	3306, 3306B

Oil Cooler Transmission

Part No.	Application
7N3512	3306
8S4304	3306, 3406B, 3406C

CONNECTORS



Part No	Description
0308189	CONNECTOR
0308194	CONNECTOR
1P0268	CONNECTOR
2P1289	CONNECTOR
2P7636	CONNECTOR
2R6276	CONNECTOR
307935	CONNECTOR
308188	CONNECTOR
308196	CONNECTOR
318759	CONNECTOR
321267	CONNECTOR
3J7352	CONNECTOR
4S6680	CONNECTOR

Part No	Description
5P1046	CONNECTOR
5P2948	CONNECTOR
5P2949	CONNECTOR
5P4248	CONNECTOR
5P4402	CONNECTOR
619463	CONNECTOR
6K3607	CONNECTOR
6V8634	CONNECTOR
6V8635	CONNECTOR
6V8636	CONNECTOR
6V8637	CONNECTOR
6V8638	CONNECTOR
6V8639	CONNECTOR

Connectors (cont.)

Part No	Description
6V8640	CONNECTOR
6V8642	CONNECTOR
6V8647	CONNECTOR
6V8714	CONNECTOR
6V8715	CONNECTOR
6V8716	CONNECTOR
7E9898	CONNECTOR

Part No	Description
7W2122	CONNECTOR
8D9088	CONNECTOR
8M0505	CONNECTOR
8M0506	CONNECTOR
9D0884	CONNECTOR
9M4584	CONNECTOR
9S7581	CONNECTOR

Part No.
3B5322
3B5325
3B5329
3F2771
5H9456

Part No.
6F5264
6H5800
9M6505



DOWELS

Part No.	Part No.	Part No.	Part No.
0L2061	2M0122	4N0511	7M8480
0S0130	2M0138	4N0683	7N1902
1044746	2M4537	4N0684	7N2043
1141539	2N5775	4N0955	7N5352
1141541	2P8630	4N1650	7N5683
1155327	2S6091	4N9019	7S4326
1171801	3B2225	4S8537	7S5005
1334952	3B8852	4S8541	7T3109
1499113	3D6509	5B1980	7T5886
1A2036	3E3217	5B5812	7Y4256
1A2223	3F0011	5B5821	8B1312
1A2610	3F0957	5B7652	8B6349
1F1006	3F1526	5H3262	8H9189
1F5151	3F1953	5M3605	8H9208
1F5546	3F3442	5M4606	8K0589
1H0525	3F4746	5M4987	8K6630
1H0974	3F6795	5M7937	8M6521
1M4291	3F8283	5S4033	8M8659
1M5156	3H0703	5S4441	8S3426
1S5440	3H4174	6F0698	8S6814
1S6249	3N2712	6F4161	8T0099
1S7558	3P1681	6F7172	9C6041
1S9292	3P7832	6K5614	9G0832
1S9540	4B8265	6M9155	9H4105
2194458	4D0537	6T5545	9H5546
2390689	4D6472	6V2452	9M0669
2A3348	4F6154	6V3536	9M2001
2A3630	4F6165	6V3537	9M4007
2A3798	4H0254	6V3538	9P7751
2B8162	4H6534	6V3539	9P7752
2D0874	4K7239	7B5415	9W1741
2H1190	4L3395	7M1201	
2H2255	4M3122	7M8479	

GREASE FITTINGS



Grease pumps also available (7H1680I)

Part No.	Description
3B8686	30°
4H3947	30°
7K6462	30°
3B8485	45°
6M7476	45°
9L5125	45°
9R3171	45°
3B8486	60°
3B8487	60°
0306816	90°
1H7922	90°
1L6939	90°
2D1683	90°
2N1287	90°
2N3378	90°
3B8488	90°
3B8998	90°
3B9067	90°
3B9406	90°
3B9408	90°
3K3415	90°
4N1828	90°
5B9916	90°
5K9235	90°
5K9239	90°
5K9240	90°
5K9241	90°
5K9244	90°
6K1972	90°
7K0498	90°
7K1517	90°
7L7262	90°
8M0547	90°
9L5254	90°
9L9045	90°
1F1344	STRAIGHT
1F3278	STRAIGHT
1F7552	STRAIGHT
1H2854	STRAIGHT

Part No.	Description
1K6853	STRAIGHT
1L0480	STRAIGHT
1P9328	STRAIGHT
2D4867	STRAIGHT
2P1314	STRAIGHT
2V4868	STRAIGHT
3B8489	STRAIGHT
3B8490	STRAIGHT
3B8491	STRAIGHT
3B8989	STRAIGHT
3B8990	STRAIGHT
3B8995	STRAIGHT
3B9054	STRAIGHT
3B9400	STRAIGHT
3H0122	STRAIGHT
3K6677	STRAIGHT
4B4550	STRAIGHT
4H2678	STRAIGHT
4M5317	STRAIGHT
4S6399	STRAIGHT
5B0651	STRAIGHT
5B0935	STRAIGHT
5K9238	STRAIGHT
5K9245	STRAIGHT
5K9246	STRAIGHT
5K9248	STRAIGHT
5K9894	STRAIGHT
5K9979	STRAIGHT
6K1019	STRAIGHT
6K6826	STRAIGHT
6K8077	STRAIGHT
6L3616	STRAIGHT
7K1456	STRAIGHT
7K4129	STRAIGHT
8B7121	STRAIGHT
8D0538	STRAIGHT
8F8997	STRAIGHT
8T0336	STRAIGHT

HIGH-HEAD BOLTS



Features of CTP newly designed High-Head Bolts:

- ✓ Thicker than the standard bolt head, adding extra wrenching surface.
- ✓ Washer face eliminates corner drag.
- ✓ Radius under the bolt head increases strength.
- ✓ UNR radiused root bolt thread increases fatigue resistance by reducing the notch effect of conventional UN threads.



Part No.	Description	Part No.	Description
0L0478	CAP SCREW	1D4585	CAP SCREW
0L1178	CAP SCREW	1D4586	CAP SCREW
0L1351	CAP SCREW	1D4590	CAP SCREW
0S0509	CAP SCREW	1D4593	CAP SCREW
0S1566	CAP SCREW	1D4595	CAP SCREW
0S1571	CAP SCREW	1D4599	CAP SCREW
0S1573	CAP SCREW	1D4608	CAP SCREW
0S1585	CAP SCREW	1D4609	CAP SCREW
0S1587	CAP SCREW - OIL COATED	1D4610	CAP SCREW
0S1588	CAP SCREW	1D4612	CAP SCREW
0S1589	CAP SCREW	1D4614	CAP SCREW
0S1591	CAP SCREW	1D4615	CAP SCREW
0S1592	CAP SCREW	1D4616	CAP SCREW
0S1594	CAP SCREW	1D4620	CAP SCREW
0S1595	CAP SCREW	1D4621	CAP SCREW
0S1602	CAP SCREW	1D4624	CAP SCREW
0S1615	CAP SCREW	1D4628	CAP SCREW
0S1616	CAP SCREW	1D4629	CAP SCREW
0S1619	CAP SCREW	1D4630	CAP SCREW
0S1621	CAP SCREW	1D4634	CAP SCREW
0S1625	CAP SCREW	1D4639	CAP SCREW
0S1627	CAP SCREW	1D4640	CAP SCREW
0S1973	CAP SCREW	1D4642	CAP SCREW
0V0269	BOLT	1D4645	CAP SCREW
1A1135	CAP SCREW	1D4647	CAP SCREW
1A1460	CAP SCREW	1D6260	CAP SCREW
1A2029	CAP SCREW	1K4378	BOLT
1A5405	HEX CAP SCREW	1K9420	CAP SCREW
1A5576	CAP SCREW	2705290	BOLT
1A8063	CAP SCREW	2A1538	CAP SCREW
1A8537	CAP SCREW	2B0947	CAP SCREW
1B4367	CAP SCREW	2D3424	CAP SCREW
1B7709	CAP SCREW	2H3856	CAP SCREW
1D4569	CAP SCREW	2H6488	CAP SCREW
1D4574	CAP SCREW	2M3530	HEX CAP SCREW

BUSHINGS



Part No.	Description
0115224	BUSHING
1H7724	BUSHING
2H5547	BUSHING
3B6768	BUSHING
3B7255	BUSHING
3B7721	BUSHING
3B7764	BUSHING

Part No.	Description
4M5317	BUSHING
5B4855	BUSHING
6B4661	BUSHING
8B1931	BUSHING
9F9920	BUSHING

COTTER PINS



Part No.
1J2919
1S0685
1S0686
2H3768
2H3771
3B4605
3B4607
3B4610
3B4611
3B4615
3B4617
3B4618
3B4621

Part No.
3B4622
3B4627
3B4629
3B4631
3B4632
3B4640
3B4643
3B5301
3B5303
3B5316
3B5317
3B5319
3B5320

High-Head Bolts (cont.)

Part No.	Description
3B2968	CAP SCREW
3B6753	CAP SCREW
3E9850	CAP SCREW - ZINC
4I6994	CAP SCREW - ZINC
5B2638	CAP SCREW
5B5473	CAP SCREW
5F9338	CAP SCREW
5L4398	HEX CAP SCREW
6F4991	CAP SCREW
6H1717	CAP SCREW
6J4081	CAP SCREW
6K0953	HEX CAP SCREW
7B3235	CAP SCREW
7F5227	CAP SCREW
7X2555	BOLT

Part No.	Description
7X2562	CAP SCREW - ZINC
7X2563	CAP SCREW - ZINC
7X2565	CAP SCREW
7X2575	CAP SCREW - ZINC
8C6857	BOLT - ZINC
8F3152	CAP SCREW
8S4755	CAP SCREW
8S4756	HEX CAP SCREW
8S9089	CAP SCREW
8S9092	CAP SCREW - OIL COATED
8T9399	CAP SCREW
9F6936	CAP SCREW
9S1322	CAP SCREW
9S1351	CAP SCREW



NUTS

Part No.	Description
2J3505	NUT-HARDENED
2J3506	NUT
2J3507	NUT
3K9770	NUT
2Y5829	NUT
4K0367	NUT
3D8752	NUT
6D5801	NUT
6V7676	NUT
6V7688	NUT
7X0447	NUT

Part No.	Description
7X0451	NUT
7X0452	NUT
8T0389	NUT
8T4778	NUT
9X0941	NUT
6Y7433	NUT TRACK
930320	NUT, SHOE
930321	NUT, SHOE

HEAVY NYLON LOCKNUTS

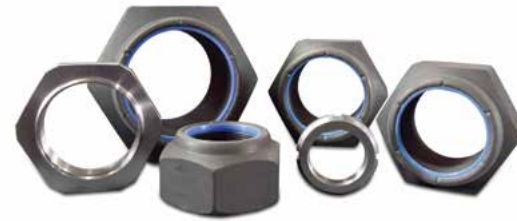

Nylon insert locknuts are used where equipment vibration might loosen the connection. This type of locknut is regularly used for critical applications such as piston rod nuts for hydraulic cylinders. CTP heavy nylon locknuts are made of steel alloy, hardened to RC 28-34 and can withstand temperatures up to 250°F. Regularly used for agricultural, mining, heavy-duty, and off-highway applications our heavy nylon locknuts guarantee strength, durability and reliability.

Part No.	Description
1163513	LOCKNUT
1163516	LOCKNUT
1232060	LOCKNUT
1232112	LOCKNUT
1475835	LOCKNUT
2J0564	LOCKNUT
2J3247	LOCKNUT
2J3950	LOCKNUT
2J7686	LOCKNUT
3G5022	LOCKNUT
3J6899	LOCKNUT
3J9545	LOCKNUT
4J6888	LOCKNUT

Part No.	Description
4J8734	LOCKNUT
5J3488	LOCKNUT
5J5731	LOCKNUT
6J5730	LOCKNUT
7J9250	LOCKNUT
7Y4622	LOCKNUT
7Y4695	LOCKNUT
7Y4956	LOCKNUT
8B7207	LOCKNUT
8B7614	LOCKNUT
9X6018	LOCKNUT



LIFTING EYEBOLTS

Part No.	Description
1P7404	Lifting Eyebolts / Inch
1P7405	Lifting Eyebolts / Inch
1P7407	Lifting Eyebolts / Inch
2D1201	



LOCK NUTS

Part No.	Description
2K7468	LOCK NUT
5D1986	LOCK NUT
6K0545	LOCK NUT
1H4393	LOCK WASHER
3K8909	LOCK WASHER
3E9861	LOCKNUT
3E9862	LOCKNUT

Part No.	Description
3E9863	LOCKNUT
3E9865	LOCKNUT
3F7674	LOCKNUT
6V9189	LOCKNUT
7H8909	LOCKNUT
9B1117	LOCKWASHER

MOTION TRANSFER DEVICES



Rod Ends

Part No.	Description
2J5038	ROD-END
2K5804	ROD-END
4D4064	ROD-END
4D4065	ROD-END
4K4726	ROD END
4M0494	END ROD
4M0495	END ROD
5J5315	END
5K0292	ROD-END
5P6438	ROD END
5P6672	ROD-END
5P9083	ROD END
5V7162	ROD-END
6F7010	END ROD
6L7751	ROD-END
6S6114	ROD-END
6V1033	ROD END
6V8955	ROD END
7H3641	ROD-END
7L4186	END
7X7662	ROD END
7X7874	ROD END
7X7875	ROD END
8C3111	ROD END
8C3392	ROD END
8C7315	ROD END
8K1253	ROD END
8S7048	ROD END
8T4765	ROD END
8T4766	ROD END
8T4815	ROD-END
8T6431	ROD END
9K8757	ROD END
9M7963	ROD-END
9R4760	ROD END

End Yoke



Part No.
1A9252
1M1341
2K0400
2M8340
6F7010
8T4742
9D8632

Ball Joint



Part No.
6K4442
8T4773
9L2685

PINS



Part No.	Description
0310255	PIN
1L5316	PIN
2K8078	PIN
3H1118	PIN
5J3941	PIN
5L5711	PIN
8S7499	PIN



SCREWS

Part No.	Description
0102570	SCREW
4B1221	SCREW
4B1273	SCREW
4B3583	SCREW
5D4697	SCREW
4B3585	SET SCREW
4B3603	SET SCREW
5B9324	SET SCREW

SELF-LOCKING NYLON PATCHED



Part No.	Description
0302135	BOLT
0310219	BOLT
0315085	BOLT
1076826	BOLT
1749638	BOLT
2160029	SCREW
4E5985	BOLT 12 POINT
4V7080	BOLT 12 POINT
5K5552	BOLT
5P4143	BOLT
5P6851	BOLT
6I0302	BOLT
6K0137	BOLT
6K5718	HEX CAP SCREW
7J5639	BOLT
7K4370	BOLT
8N2662	BOLT
8T6473	BOLT

RIVETS



Part No.	Description	Part No.	Description
2N2258	RIVET	7B5054	RIVET
3F1805	RIVET	7B5056	RIVET
4B4311	RIVET	7B5060	RIVET
4B4320	RIVET	7B5062	RIVET
4B4340	RIVET	7B5064	RIVET
4B4341	RIVET	7B5068	RIVET
4B4342	RIVET	7D7301	RIVET
5P6943	RIVET	7K6536	RIVET
6B1369	RIVET	7M8594	RIVET
6B1985	RIVET	9M5732	RIVET
6B4284	RIVET	9M5733	RIVET
7B5050	RIVET		
7B5052	RIVET		

STUDS



Part No.	Description
957928	STUD
1018917	STUD
1061792	STUD
1061793	STUD
1163715	STUD
2264346	STUD
2269404	STUD
2788316	STUD
3049553	STUD
3089259	STUD
3139550	STUD
4186781	STUD
0S0468	STUD
1M6422	STUD
2D8154	STUD
2M2488	STUD
2M8411	STUD
2P1974	STUD
3D0472	STUD
3D0490	STUD
3K1865	STUD
3K3256	STUD
3M0496	STUD
3V4045	STUD
4D4823	STUD
4F1450	STUD
4L6788	STUD
4L8189	STUD
4M8743	STUD
4S6137	STUD
5I6024	STUD
5I7547	STUD
5M1932	STUD
6B9273	STUD
6L4428	STUD
6L7442	STUD
6L8562	STUD
6V1319	STUD
6V1426	STUD
6V1427	STUD
6V1525	STUD

SNAP RINGS



Part No.	Description
1H4142	SNAP RING
1K6984	SNAP RING
1N8620	SNAP RING
2L6965	SNAP RING
3D8358	SNAP RING
4H0094	SNAP RING
5J3864	SNAP RING
6L8797	SNAP RING

WOODRUFF KEYS



Woodruff Keys - Bar

Part No.	Description	Thickness	Length
9T7770	WOODRUFF KEY	3/16	1 7/8
5K5887	WOODRUFF KEY	1/4	2
1D1158	WOODRUFF KEY	1/4	2 1/2
0T0217	WOODRUFF KEY	1/2	4

Woodruff Keys

Part No.	Description	Thickness	Diameter
1B8735	WOODRUFF KEY	3/32	3/8
1B8701	WOODRUFF KEY	3/32	1/2
3H1489	WOODRUFF KEY	3/32	1/2
1B8703	WOODRUFF KEY	3/32	5/8
5H2532	WOODRUFF KEY	1/8	3/8
1B8702	WOODRUFF KEY	1/8	1/2
1B8704	WOODRUFF KEY	1/8	5/8
1B8706	WOODRUFF KEY	1/8	3/4
1B8705	WOODRUFF KEY	5/32	5/8
1B8707	WOODRUFF KEY	5/32	3/4
1B8709	WOODRUFF KEY	5/32	7/8
8F7689	WOODRUFF KEY	5/32	7/8
1B8708	WOODRUFF KEY	3/16	3/4
5H2671	WOODRUFF KEY	3/16	3/4
1B8710	WOODRUFF KEY	3/16	7/8
8M3498	WOODRUFF KEY	3/16	7/8
1B8712	WOODRUFF KEY	3/16	1
1B8715	WOODRUFF KEY	3/16	1 1/8
3K4723	WOODRUFF KEY	7/32	1
2B9373	WOODRUFF KEY	1/4	3/4
1B8736	WOODRUFF KEY	1/4	7/8
1B8714	WOODRUFF KEY	1/4	1
1B8716	WOODRUFF KEY	1/4	1 1/8
1B8719	WOODRUFF KEY	1/4	1 1/4
1B8722	WOODRUFF KEY	1/4	1 1/2
1B8737	WOODRUFF KEY	5/16	1 1/8
1B8721	WOODRUFF KEY	5/16	1 3/8
1B8742	WOODRUFF KEY	5/16	2 3/4
1B8741	WOODRUFF KEY	3/8	1 1/2
1B8743	WOODRUFF KEY	3/8	2 3/4
1B8744	WOODRUFF KEY	3/8	2 3/4
1B8745	WOODRUFF KEY	1/2	2 3/4

WASHERS



Part No.	Description	Part No.	Description
2090962	WASHER	9X8268	WASHER
4B5276	WASHER	4B5059	WASHER
6S3461	WASHER	4B5280	WASHER
8K6273	WASHER		
9X8258	WASHER		

HYDRAULIC SYSTEM



HYDRAULIC PUMPS



Gear Pumps

Part No.	Machine Model
8J2059	225
8J8813	910
3G1686	235B
2387642	267B, 277B, 287B
1262016	322C
1038264	325, 325L
1336912	345B
2P9313	621G
9T1619	631D, 657B, 637D
9T7465	637D, 834B, 988B
9T7414	637G
9T9909	769C, 768C, 771C
9J1295	769C, 771C
6T4257	769D, 771C, 771D
6T3935	771C, 773B/D
3G5868	773B, 775B
2307132	776D, 777D
3T8098	776D, 777D
2305571	777A
1375169	777B, 777D
6E2046	777C
2116626	785C HAA
1363965	854G
2279383	854G
8J4515	931C, 931C LGP
1396084	938G
4T5614	963 LGP
3G9891	966D, 966F
9J5763	980C
3G2858	980C, 980F
8E7538	980F
2356501	980G, 980H
6E4182	988B
3G6856	988F
9T7468	992D
2550625	CS-533E, CP-533E
1T1810	D20D, D250D
8J8809	D3C LGP
3T7897	D4H, D4H LGP

Part No.	Machine Model
3G4661	D5B
1371296	D5G, D5G LGP
3G4768	D6C, D6D
1U1625	D6H
7J4882	D7F
9T6813	D7R TRACK-TYPE
7S7400	D8H
3T8359	D8N
9T9839	D9N
9T8919	IT14B
7J8199	IT28B, 966C
1336911	M325B
1140602	320L
2220110	330B
3119541	330C/CL
1713239	330L
3119542	345B
3799740	992K/854K
2200780	D10T
2213667	D4G/D5G



Piston Pumps

Part No.	Machine Model
4T7426	225
6E0838	426
3G2848	994
6E1412	120G
8J6730	120G, 130G, 140G
6E5072	12G, 140G, 130G, 160G
6E3136	135H, 140H, 160H
1600196	140G, 130G, 160G, 120G
1243027	140G, 130G, 160G, 12G
1694882	140H, 160H
6E3137	140H, 160H
6E3139	14H, 16H
4T2767	16G
1177760	416, 426
9T6857	416, 428
1555109	416C, 426C, 428C
1809588	416D
2246369	420D, 430D, 432D
1003259	426B
1616634	426C, 428C, 436C

Part No.	Machine Model
2402647	725, 730
2244432	735, 740
2191964	769D, 771D, 773D
2615630	777F
1902279	784C, 785 785B
2321835	784C, 785C
6E5650	787B, 789B
1053635	825G, 980G
1527767	834G
2283636	834H, 836H
1689027	924G, 924Gz
1687873	924G, 924H
2419299	950H, 962H
1620770	966G, 972G
1863732	972G
1963807	980G
2093258	980G
2352716	980G, 980H
1U3840	992C, 992D, 994
9T4104	D4H
6E4934	D5H
6E5052	D5H
6E5965	D5M XL, D5M LGP
1576081	D5N XL, LGP
9T3680	D6H, D6H LGP
9T9912	D6H, D6H LGP
1078136	D6M, D6M LGP
1569084	D6N XL, FTC, LGP
1712092	D6R
9T8647	D7H, D8N
9T8346	D8R
1041752	D9R



Vane Pumps

Part No.	Machine Model	Part No.	Machine Model
3G7634	518, 518C	6E2928	953
3G7636	518, 518C	6J6320	12F MTR GRADER
3G7635	528, 528B	1052155	446B
9J5136	621	1U2824	613C
9J5059	772, 773A	9J5075	621B
6E2931	916	3G4602	824C
9J5053	920	6E6476	918F
9J5070	950	6E2927	926E
9J8184	950	1287228	928F

Part numbers are used for reference purposes only.

Costex Tractor Parts Copyright © 2020. All rights reserved.

Vane Pumps (cont.)

Part No.	Machine Model
1003414	928F, 938G
4T0508	930T
3G4097	936 /F/E, G936
6E6659	950B/E/F, 960F
1212501	950F
9J5080	951C
1214019	960F
6E2929	963 LGP
9J8183	966B
9J5049	966C
1214313	966E, 966F
6E6666	966E, 966F
3G7637	977L
9J5064	980B
9J5065	980B
1392383	980G

Part No.	Machine Model
1439722	980G
3G7641	983B
9T1080	D10N
5U0557	D25C
7J0587	D4D, D4P
9J5082	D4E
7J2194	D5
9J8198	D5
9J8190	D6C
9J5058	D7G, D8K, D7F, D9H
9J5050	D8K, 77V, D7G, D9H
3G5810	D9H
9J8277	D9N
3G3895	G936
1070035	PATROL 13K
1214512	R1600/G/H/ 970F

HYDRAULIC MOTORS



The demand for increased energy savings, reduced emissions and reduced noise has lead the industry to create a different mechanism. CTP hydraulic fan motors offer significant advantages over belt and electric fan systems.

- ✓ Fan speed runs independent from engine speed.
- ✓ More precise temperature control.
- ✓ On-demand cooling capability to eliminate power consumption.
- ✓ 3 Reduced noise
- ✓ 3 Reduced emissions

Fan Motors

Part No.	Description	Machine
1799778	Motor Gp	322C, 325L
1915611	Motor Gp	330C
2344638	Motor Gp	330D
1559107	Motor G	330D, 345B
1292413	Motor Gp	824G, 825G, 980G
1618919	Motor Gp	966G/H/K, 972G/H/M
1380529	Pump Gp-Gear	980G
2556805	Motor GP	980H

Drive Motors

Part No.	Machine Model
2807856	236, 246, 252, 262
2807854	216, 226, 232, 242
2807858	236B, 248B

DUMP PUMPS

CTP Dump Pumps are rugged, reliable and interchangeable with many popular brands.

Available in MHC101, MHC102, MHG101 & MHG102 styles.

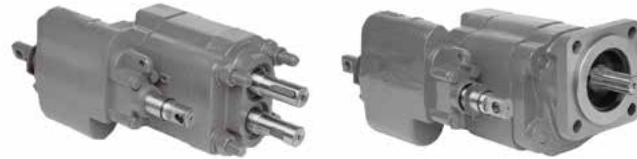

MHG/MHC101

- 3 Piece cast iron construction
- High pressure shaft seals
- Direct acting relief c/w load check
- Pressure balance thrust plates
- Heavy-duty roller bearing
- Two or three line hook-up
- Either shaft rotation
- Optional airshift control
- Factory set relief pressure @ 2000 PSI
- Extended studs for support bracket
- Optional mounting bracket
- Dowelled for higher pressure

MHG/MHC102

- 3 Piece cast iron construction
- High pressure shaft seals
- Direct acting relief c/w load check
- Pressure balance thrust plates
- Heavy-duty roller bearing
- Two or three line hook-up
- Factory set rotation
- Optional airshift control
- Factory set relief pressure @ 2000 PSI
- Dowelled for higher pressure

Model Codes in Stock:

MH101C20
MH102C20L
MH102C20R
MH101C25
MH102C25L
MH102C25R

Available upon Request

MH101G1.5
MH102G1.5L
MH102G1.5R
MH101G2
MH102G2L
MH102G2R

MH101 / MH102 - ORDERING CODES

Dump Pump (Model Codes)	MH	1	0	A	B	C	D
Optional A Mounting	1	Remote Mount					
	2	Direct Mount					
Optional B Flow Range	C	High Flow					
	G	Lower Flow					
Optional C Flow Rate	20	5.10 IN3 - 39 GPM - MH101C & MHC102 ONLY					
	25	6.38 IN3 - 48 GPM - MH101C & MH102C ONLY					
	1.5	2.96 IN3 - 23 GPM - MH101G & MH102G ONLY					
Optional D Flow Range	L	Left Hand		MHC ONLY			
	R	Right Hand		MHC ONLY			
PART#							
	Airshift Kit Available		MC3504DM (MHC) MC3508DM (MHG)				
	Mounting Bracket for MHC101 Available		A11-96-399999				
Sleeve for three line operation			Included with all pumps				

CARTRIDGES



Part No.	VQ Series	GPM	Rotation	Bushing
1U2664	20	8	RH	N
1U2665	20	14	RH	N
3G2720	20	11	LH	N
3G2722	20	5	LH	N
3G2749	20	8	LH	N
3G2751	20	11	RH	N
3G7658	20	14	LH	N
3G7659	20	12	LH	N
4T3196	20	12	RH	N
9T4038†	20	8	LH	N
1555091	25	17	RH	N
1U2652	25	19	LH	N
1U2666	25	17	RH	N
1U2668	25	21	RH	Y
1U3519	25	12	RH	Y
1U3952	25	14	LH	N
3G2195	25	17	RH	Y
3G2196	25	19	RH	Y
3G2200	25	14	RH	Y
3G2717	25	12	LH	Y
3G2718	25	19	LH	Y
3G2752	25	21	LH	N
3G7652	25	19	RH	N
3G7653	25	14	LH	Y
3G7654	25	17	LH	Y
3G7655	25	21	LH	Y
3G7662	25	21	RH	N
3G7663	25	17	LH	N
4T0417†	25	21	RH	N
4T2626†	25	21	LH	N
9J7891	25	14	RH	N
6E2396	32	35	LH	N
1U2667	35	30	LH	N
1U2669	35	38	RH	Y
1U3953	35	38	LH	Y
3G1266	35	30	RH	Y
3G1267	35	25	RH	Y
3G2834	35	25	RH	N
3G2835	35	30	RH	N
3G2837	35	35	LH	N
3G7651	35	35	RH	Y
3G7664	35	38	RH	N
3G7665	35	35	LH	N
3G7666	35	38	LH	N
4T1893	35	35	LH	Y
4T6869	35	25	LH	Y
6E4258	35	25	RH	N
9T2200	35	30	LH	Y
1364815	45	57	-	Y

Part No.	VQ Series	GPM	Rotation	Bushing
1U0532	45	57	-	Y
1U2670	45	47	RH	Y
1U2671	45	60	RH	Y
3G2234	45	60	LH	Y
3G2236	45	42	LH	Y
3G2238	45	42	RH	Y
3G7656	45	50	RH	Y
3G7657	45	57	RH	Y
3G7660	45	50	LH	Y
3G7661	45	45	LH	Y
3G7667	45	57	LH	Y
4T0416†	45	50	RH	Y
4T0422†	45	50	LH	Y
9T5336†	45	50	RH	N
6E2387†		50	LH	N

† HIGH PRESSURE CARTRIDGE

HYDRAULIC PISTON ROTATING GROUPS



Model/ Engine Application	Barrel Part No.	Piston Part No.
345B, 385C, 120H, 143H	1559136	1559112 (9)
120H, 135H, 140H	1588966	2959689 (9) SET
12G, 130G, 140G	9J8660	8J2022 (9)
12G, 14G, D6H	9T7774	9T7765 (9)
14G, 16G, 225, 245	9J2417	1U2738 (9)
D8R, D9R	9T8448	9T8452 (9)
215, 215B	9J3522	8J2037 (9)
225B, 793D	9T3370	9T3371 (7)
307C, 4M40	1949987	1076666 (9) SET
318B	1709959	1858979 (9) SET
318BL	1709960	1858979 (9) SET
320, 320B, 320L	1184053	Included w/ Barrel
320, 320B, 320L	1184054	Included w/ Barrel
320, 320L	518631	518632 (9)
320B, 325B	0874783	0995713 (7)
320B, 322C, 325D	1347134	1475860 (9) SET
320C, 320CL	1733496	1915709 (9) SET
320C, 320CL	1733498	1915709 (9) SET
322C, 325C	1948371	1884210 (9) SET
322C, 325C	1948374	1884210 (9) SET
325, 325L	7Y4209	418834
325, 325L, 330L	1111116	416448 (9) SET
325B	1336777	1475860 (9) SET
330, 330L	514311	518401 (7)
330, 330L	0856259	514171 (9) SET
330C, 345B, 522B	1884097	2835980 (7)
330D, 345C	2478710	2959691 (9) SET
Engine Model/Application	Barrel Part No.	Piston Part No.
336F, 340F, 349D	1884164	3349982 (9) SET

Part numbers are used for reference purposes only.

Costex Tractor Parts Copyright © 2020. All rights reserved.

Hydraulic Piston Rotating Groups (cont.)

Model/ Engine Application	Barrel Part No.	Piston Part No.
345B	1709976	2959687 (9)
350, 350L	718179	718178 (9) SET
350, 350L	718180	718178 (9) SET
416D, 420D, 430D	1960226	6E6151 (9)
416E, 422E, 428E	1683380	1683384 (9)
426, D4	9T3026	9T3018 (9)
426B, D11R	6E4007	6E6151 (9)
446B	9T7757	9T7761 (9) SET
446B, 545C	1165305	1165298 (9)
623F, 623G	9T1687	1656969 (7)
834K, 836K, 962M, D6T	2667836	2334880 (9)
914G, 939C, D4C	1331848	1261400 (9)
938G	9T8250	9T8249 (9)
938H, 962H, 966H, 972H	2560083	1884210 (9) SET
963D, D7E, D8T	2717599	6E4358 (9)
980M, 982M	2861674	1970079 (9)
992, 994	9J8667	4T3122 (9)
924F, 928G, 988F	9T3863	9T3868 (9) SET
D6H, D6H LGP	9T7729	9T7731 (9)
D7R	1410828	9T4180 (9)
627G, D8R	1838446	6E4358
E180, E240	419472	419469 (SET)
E200B, EL200B	0996342	0963989 (9) SET
E180, E240	419473	0963989 (9) SET

Application	Cylinder Grp Part No.	Cylinder As. Part No.	Seal kit
12G, 120G, 140G	3G8069	N/A	2465911
12G, 120G, 140G	3G8070	N/A	2465911
12G, 130G, 140G, 160G	3G4752	N/A	2465914
12G, 130G, 140G, 160G	9T2472	N/A	2384462
12G/H, 130G, 140G/H, 160G	1052094	9T2482	7X2825 / 3769017
12H, 12M, 140H	1317191	N/A	2339204
140G	1309041	N/A	2465916
140G	1309042	N/A	2465916
140H, 140K, 12H, 12K	1324929	1324928	2384462
320L, 325L, 330, 330L, 350L	7Y5100	N/A	2580313
320B/C, 320C LN, 322C, 325C/C L, 345B/B L, 345B LC	2897901	1799765	2159986
320C, 320L, 320B & BL	2897865	N/A	2366368
320L, 325B	7Y4650	N/A	1997416
322, 322L, 320, 320L/N	1185931	N/A	2937500
322C, 322C L, 325C/D, 325C L, 330C, 330C L, 385C, 385C LN	N/A	1884211	1915619
325B L, 325B LN	1184000	1184001	1997416
330, 330L, 330L, 330LN	7Y4926	4I1524	2159990
330D, 330D L, 336D L, 336D2, 336D2 L, 385C, 385C L	2898031	2898032	2316844
336E, 352F, 340D2	3579784	N/A	3338750
416, 416D	2063553	2063552	2342593
416, 428	9T5219	9T5218	2465926
416/B/C/D, 426/B, 428/B/C, 436/B	1070624	9T0665	2465926
416B	N/A	1052365	N/A
416B, 426B, 436B	1302365	1052365	2465929
416B/C	1692967	1065738	2310898
416C	6E1964	1054402	1864327
416C, 426C, 436C	1731927	1722349	2465928
416C, 428, TH560B	N/A	9T4009	2350354
416C, 428C	1268308	1268309	1864327
416C/D	6E0274	N/A	2418924

Application	Cylinder Grp Part No.	Cylinder As. Part No.	Seal kit
416D, 420D, 430D	2060520	2060519	N/A
416D, 420D, 430D	2060522	2060521	N/A
416D, 424D	2063549	N/A	2342593
416D, 424D	2063549	N/A	2342593
416D, 424D	2063628	N/A	2350972
416E, 422E, 428E, 432E, 434E	2107086	3364182	3651283
420D, 416D	1807485	N/A	2857486
420D, 428D, 442D	1917725	1917727	3809484
420D/E, 430E	1923884	N/A	1923884
420E, 428E, 430E, 434E, 442E	2781971	2781972	2332622
422E, 428E, 432E, 434E/F, 442E, 444E	2795556	N/A	3779352
428E, 434E, 442E, 527	2795556	N/A	3779352
844, 844H/K, D8L, D9N,	9T2860	3G8194	3193561 / 3193562
906M, 908H, 420D/H	1851839	9T4009	2350354
920, 930	7J9838	7J9839	2465922
924K, 950F, 960F	6E4892	N/A	2401881
938G, 938G II	1377855	N/A	3367346
938G, 980F	1287678	1287674	2275347
950B	1U1147	3G8792	2442062
950F	3G8786	3G8785	2450585
950G	1250024	1250028	2959890
950G, 950G SERIES II, 962G	1189001	1189004	2281792
953C/D	N/A	3W7515	N/A
962G, 962G II	N/A	1250028	N/A
966D/E/F	3G5497	3G5264	2450605
966D/E/F	3G5495	3G5502	2450581
966D/E/F	3G5496	3G5502	2450581

Application	Cylinder Grp Part No.	Cylinder As. Part No.	Seal kit
966G	1332963	1334048	2281779
966G	1332964	1334048	2281779
966H	2457484	N/A	3133829
980G/H	1151371	N/A	3769012
980H	1125004	1125068	4527462
988B	N/A	4T7587	7X2742
988B, 988F	9J3632	N/A	2450594
D10N, 977L	N/A	9J0669	N/A
D6C	7J8302	7J8301	2422543
D6D, D6D LGP, D6G, D6G2	2J1402	N/A	2442044 / 2440975
D6G2, D6E, D6D, D6F	8J6868	8J6867	2422543 / 2430391
D6H	1U3989	1U4086	2422543
D6H	1U3990	1U4087	2422551
D6N	1526485	3217046	2409538
D6N/XL	3284267	N/A	1864327
D6N/XL, D6M	3217048	3217046	2618566
D6R	1278931	1278932	2292626
D6R, D6R LGP	1294258	N/A	2292626
D7G	1U2135	7J3337	2285271
D8L, D9N	3G5707	N/A	2456837
D8N	9T0140	9T0332	2440959
D8T, D8R	2505861	2388637	3193557
D9R, D9T	1096778	1096783	2456835
R1600H/G, 816F, 966F	6E5024	N/A	2409538

HYDRAULIC CYLINDERS



Application	Cylinder Grp Part No.	Cylinder As. Part No.	Seal kit
322	1913118	2897798	2481174
930	7J9685	7J9686	2465915
930	7J9729	7J9727	2384501
930	7J9730	7J9728	2384501
930	7J9872	7J9868	2410896
950	7J9690	7J9691	2430381
950	7J9695	7J9921	2430381
950	7J9696	7J9922	3402686
100G, 140G, 160G	9J8165	9J8166	2410895
100G, 140G, 160G	8J0028	N/A	2402016
120G, 130G, 140G, 160G	8J0028	N/A	7X2791
120H/K, 135H	6E1754	N/A	2384462
120K, 120H, 135H	1324926	N/A	2384462

HYDRAULIC CYLINDERS FOR BACKHOES & EXCAVATORS



Application	Type	Cylinder Gr. Part No.	Cylinder As. Part No.	Rod As. Part No.	Seal Kit Part No.
320/L, 325/L, 330/L, 350/L	BUCKET	7Y5100	4I1620	7Y5108	2580313
320B/C, 320C LN, 322C, 325C/C L, 345B/B L, 345B LC	BUCKET	2897901	1799765	2897902	2159986
320C	BOOM	2043614	1772574	1772575	2478998

Part numbers are used for reference purposes only.

Costex Tractor Parts Copyright © 2020. All rights reserved.

Hydraulic Cylinders for Backhoes & Excavators (cont.)

Application	Type	Cylinder Gr. Part No.	Cylinder As. Part No.	Rod As. Part No.	Seal Kit Part No.
320C	STICK	2043615	1772598	1772599	2590633
320C, 322B/C, 325C	BUCKET	1346987	1195448	1373700	1764935
320C/L/U	BUCKET	2043696	1772612	1772613	1540744
320L, 325B	STICK	7Y4650	4I1616	1038381	1997416
322/L, 320, 320L/N	BUCKET	1185931	4I8879	4I8880	2937500
322B/C, 325B, 330B, 345B	TILT	1913118	2897798	1913119	2481174
322C, 322C L, 325C/D, 325C L, 330C, 330C L, 385C	BUCKET	2478853	1884211	2478856	1915619
323D, 325D	STICK	2254575	2344509	2898000	2426840
325B L, 325B LN	STICK	1184000	1184001	1038381	1997416
325B, 330B	BOOM	1163578	3119508	7Y4660	1997416
325D L, 330D/L, 340F, 336/D/F/E/L/LN, 340D2, 568	STICK	3751722	3574704	3574713	5185137
330	BOOM	7Y4906	4I0723	7Y4914	2481168
330, 330L, 330LN	STICK	7Y4926	4I1524	1183945	2159990
330C	STICK	2897763	2897764	2898037	2316844
330D, 330D L, 336D L, 336D2, 336D2 L, 385C, 385C L	STICK	2898031	2898032	2898037	2316844
336E, 352F, 340D2	BUCKET	3579784	3579785	3579794	3338750
415F2, 416E, 416F2, 422E, 428E	BOOM	2107074	2764005	2143850	2959891
416, 416D	TILT	2063553	2063552	9T3948	2342593
416, 428	BOOM	9T5219	9T5218	4T7011	2465926
416/B/C/D, 426/B, 428/B/C, 436/B	LIFT	1070624	9T0665	9T0661	1052892
416/C/D, 420D, 424/D, 426C, 428C/D, 432D, 436/C	STEERING	1787190	1306882	1306883	1787189
416/E/F/F2, 420E/F/F2, 430/E/F/F2	STABILIZER	2912681	2912684	2912691	3975181
416/E/F/F2, 420F/F2/E, 422/E/F, 428F, 430/F/E/F2, 432/F/F2, 434/E/F2, 444/E/F/F2	SWING	3818054	3818085	2690386	3779352
416B	STABILIZER	1165354	1052365	1164369	2465929
416B, 426B, 436B	STABILIZER	1302365	1052325	1302367	2465929
416B, 426B, 436B	STABILIZER	1302364	1052365	1302367	2465929
416C	STICK	1692967	1692968	1342659	2310898
416C	BUCKET	6E1964	1054402	6E2109	1864327
416C, 426C, 436C	STABILIZER	1731927	1722349	1722354	2465928
416C, 428C	BUCKET	1268308	1268309	6E1502	1864327
416C/D	BOOM	6E0274	6E0273	6E1522	2418924
416C/D, 420D, 424D, 426C, 428C, 430D, 436C	STEERING	1674265	1690444	1690445	2350352

Application	Type	Cylinder Gr. Part No.	Cylinder As. Part No.	Rod As. Part No.	Seal Kit Part No.
416D, 420D	STICK	2359829	2060502	2359835	2297194
416D, 420D, 424D, 428D, 430D, 432D, 442D	SWING	2781971	2332629	2332631	2332622
416D, 420D, 430D	STABILIZER	2060520	2060519	1722354	2857486
416D, 420D, 430D	STABILIZER	2060522	2060521	1722354	3975181
416D, 424D	LIFT	2063549	2063548	9T0661	2342593
416D, 424D	BOOM	2063628	2063627	6E1522	2350972
416D, 420D, 428D, 432D, 438D, 442D,	BOOM	2063630	2063629	1595848	2350973
416E, 422E, 428E, 432E, 434E	BUCKET	2107086	3364182	2132486	3651283
416E, 422E, 428E, 432E, 434E	BUCKET	2107088	3364182	2132486	3387038
416F2/E/D, 420E/F2, 430E	STABILIZER	2627050	2627052	2332576	2332623
416F2/E/F	STICK	2107078	2143729	2286061	3809470
416F2/IT/F/E, 420/E/F/F2, 430/E/F/F2	STABILIZER	2912682	2912683	2912691	3975181
420D, 416D	STABILIZER	1807485	1833710	1722354	2857486
420D, 428D, 442D	STICK	1917725	1917727	1647176	3809484
420D/E, 430E	TILT	1923884	1923886	1842365	2617175
420E, 428E, 430E, 434E, 442E	SWING	2781971	2781972	2332631	2332622
420E/F, 434E	BOOM	2107076	2767537	2126708	2959893
422E, 428D, 432D, 438D, 442D	STABILIZER	1734565	1266951	1266953	2342595
422E, 428E, 432E, 434E/F, 442E, 444E	SWING	2795556	2795557	2690386	3779352
424D, 428C/D, 432D, 438C/D	SWING	1699530	2283507	1257894	3779352
424D, 428D, 432D, 442D	STICK	2359831	2446869	2359835	2297194
430D	STICK	2058656	1837819	1837808	2456816

HYDRAULIC STEERING CONTROL UNITS



The hydraulic steering control units play an important role in the operator's comfort. At CTP we ensure our steering units deliver perfect control in all kinds of driving conditions.

Some of the advantages of the hydraulic steering control units are:

- ✓ Minimize steering cost by reducing the steering linkage.
- ✓ Provide better comfort to the operator because there is no load reaction on the steering wheel.
- ✓ Offer continuous operation with low input torque.
- ✓ Provide a wide selection of control circuits and meter sizes.

Part No.	Machine Model
1198748	120G, 130G, 926, 950B
2223769	140K, 120H, 160H
1198757	14G, 14G
1198760	14G, 14G
1198752	16G
1186796	416B, 426B, 436
1630059	416C, 420D, 426
1232374	416C, 426C, 436
2477868	416E, 420E, 430E
1427539	426C, 438C
1427549	426C, 436C, 426

Hydraulic Steering Control Units(cont.)

Part No.	Machine Model
1247800	621F, 621S, 623
1198767	814B-F, 815B-F
1198763	836, 988B, 988F
1198749	910, G910, IT12
1198758	926, 936, G926
1198474	928F, 928G, IT2
6C0570	936F, 950F, 966
2304175	938F, 938G, 938, 3126B
1198747	988B, 992C, 988
2741512	CP-533E, CS-533E
1285532	D20D, D250E, D3
1285532	D20D, D250E, D3

HYDRAULIC OIL FILTERS



At CTP we understand that hydraulic filters are a critical component of the hydraulic system. It is essential that they provide the right filtration in order to keep the system cleaned and ensure its efficiency. For this reason we offer quality filters that exceed the highest expectations of performance.

Standard Efficiency	Advanced Efficiency	Ultra High Efficiency	Fire Resistant
4I3948	1843931	1261813	
	1446691	1261815	
0944412			
	9U6984		
1R0719		1328875	
1R0728			4T3130
1R0735	1R0777	1391537	1046931
1R0741	1R0778	1328876	4T3132
1R0746			
1R0722	1R0774	1391536	
	4T6788		
	9T8578	1440832	
	9T6636	1194740	
1262081	1799806		
1R0732		1672009	
	1G8878	1022828	1560214
	3416643	1022828	1560214
9T9054		9T7656	
	1303212	1261814	
	1850337	1261814	
	1081153	1261817	1343014
	9T0973	1261817	1343014
	6E6408	1261818	

Standard Efficiency	Advance Efficiency	Ultra High Efficiency	Fire Resistant
		2075035	
	3283655	3383540	
	518670		

Always consult your maintenance manual of your machine to find the appropriate filter and installation instructions.



FLANGES

Split Flange Half Code 61

Part No.	Split Flange 1/2
1P4574	1/2
1P4576	3/4
1P4577	1"
1P4578	1-1/4
1P4579	1-1/2
1P4582	2"
1P4585	4"
6V0397	Metric Bolts
6V0400	Metric Bolts
8C3205	Metric Bolts
8C3206	Metric Bolts

Split Flange Half Code 62

Part No.	Split Flange 1/2
1244287	3/4
1244288	1
2T3001	1-1/4
2T3000	1-1/2
1244289	2

Thick Flange Half

Part No.	Split Flange 1/2
1P5765	3/4
1P5766	1
1P5767	1-1/4
5P8077	1-1/2

EXCAVATOR COUPLINGS (HYDRAULIC SYSTEM)



Elements also available separately CTP30H-E, CTP50H-E, CTP110H-E, CTP140H-E, CTP160H-E

Part No.	F/ Coupling Specifications			Engine Spcs.	
	Torque (kg-m)	Max. Speed (RPM)	Allowable Temp (°C)		
	NOR	PEAK		Power (Hp)	
CTP30H	40	80	4000	-40°~120°	70~90
CTP50H	80	160	4000	-40°~120°	90~150
CTP110H	110	220	3600	-40°~120°	100~170
CTP140H	160	320	3600	-40°~120°	170~190
CTP160H	160	320	3600	-40°~120°	170~190

Part No.	Description	Machine Model
0990149**	Coupling (50A)	312

** CENTAFLEX MATERIAL

HYDRAULIC HOSES

Temperature ranges between -40° and 212° F

Picture	Hose	Wire Type	Applications	Size range (in)	Pressure (PSI)
	100R1	Single Wire Braid	For use in medium pressure hydraulic applications including machine, tool and agricultural applications using petroleum or water based hydraulic fluids.	1/4 in - 2 in	3000 - 580
	100R2	Double Wire Braid	For medium pressure hydraulic oil lines used in mobile, machine tool and agricultural applications where higher temperature petroleum or water based hydraulic fluids are a factor	1/4 in - 2 in	5000 - 1200
	100R4	Textile with Helical	For low pressure, high temperature return line or suction line for petroleum, oils and water based hydraulic fluids. Vacuum rating 25 in Hg.	3/4 in - 4 in	300 - 35
	100R5	One Wire Braid with Textile Cover	Low and medium pressure lines, power steering, brake lines, turbo oil lines, tilt cab cylinders, transmission coolant and filtration lines. Compatible with petroleum based hydraulic fluids, air, water, gasoline and diesel fuel, lubricating oil and coolants.	1/4 in - 1 in	3000 - 1500
	100R12	4 Wire Braid	High pressure applications subject to surges or flexing such as oil and gas, construction equipment, mining and the high performance industrial market.	3/8 in - 1-1/2 in	4000 All sizes
	100R13	4 Layer Spiral	For very high pressure applications and high impulse hydraulic oil, vegetable oil, poly glycol oil. For construction equipment, mining and the high-performance industrial market.	3/4 in - 1-1/2 in	600 - 4500
	100R15	6 Layer Spiral	Designed to handle sever high pressure hydraulic oils and mineral oils. Perfect for applications where pressure spikes or constant hidrostatic loads are present.	3/4 in - 2 in	6000 - 3600

Part numbers are used for reference purposes only.

Costex Tractor Parts Copyright © 2020. All rights reserved.

100R1 Single Wire Braid



Sold by the inch - 600" minimum order.

Type	Hose Size ID		Max. Working Pressure		Min. Bend Radius	
	in.	mm.	psi	MPa	in.	mm
100R1-03	3/16	05	3625	25.0	3.5	89
100R1-04	1/4	06	3270	22.5	4.0	102
100R1-05	5/16	08	3120	21.5	4.5	114
100R1-06	3/8	10	2615	18.0	5.0	127
100R1-08	1/2	12	2320	16.0	7.0	178
100R1-10	5/8	16	1890	13.0	8.0	203
100R1-12	3/4	19	1530	10.5	9.5	241
100R1-16	1	25	1280	8.8	12.0	305
100R1-20	1 1/4	31	920	6.3	16.5	419
100R1-24	1 1/2	38	730	5.0	20.0	508
100R1-32	2	51	580	4.0	25.0	635

100R1 Hose Assembly

Part No.	Hose	Part No.	Hose
1167734	100R1-4	1946590	100R1-6
2001196	100R1-4	1972679	100R1-6
3N4411	100R1-4	1995278	100R1-6
3N4579	100R1-4	2337186	100R1-6
3N4622	100R1-4	2352470	100R1-6
3N4792	100R1-4	2W4332	100R1-6
3N7229	100R1-4	3N7155	100R1-6
3N7241	100R1-4	3P6151	100R1-6
3N8098	100R1-4	5C6136	100R1-6
3P6048	100R1-4	5N2368	100R1-6
3P7838	100R1-4	6N3876	100R1-6
5D5886	100R1-4	6N3877	100R1-6
6N3879	100R1-4	6N3878	100R1-6
6N4379	100R1-4	6N4376	100R1-6
6N8659	100R1-4	6P5159	100R1-6
7G7105	100R1-4	6P5353	100R1-6
8N1702	100R1-4	7N2638	100R1-6
8V0295	100R1-4	7N3761	100R1-6
9F2638	100R1-4	9L6958	100R1-6
9R6776	100R1-4	1099771	100R1-8
1129434	100R1-6	1272248	100R1-8
1406033	100R1-6	2V8571	100R1-8
1521034	100R1-6	8N1186	100R1-8
1521035	100R1-6	8P7378	100R1-8
1583820	100R1-6	9G2653	100R1-8
1660357	100R1-6	1234079	100R1-10
1728827	100R1-6	2699761	100R1-10

Part No.	Hose	Part No.	Hose
1028391	100R1-12	1N3133	100R1-16
1188062	100R1-12	2G4741	100R1-16
1260196	100R1-12	3P5934	100R1-16
1662791	100R1-12	3W2470	100R1-16
3N4868	100R1-12	6T2787	100R1-16
3N6504	100R1-12	6Y4049	100R1-16
3P2783	100R1-12	8W4961	100R1-16
3W8560	100R1-12	1328315	100R1-20
6Y4056	100R1-12	1504342	100R1-20
6Y4059	100R1-12	6Y4065	100R1-20
7T7665	100R1-12	6Y4067	100R1-20
8N0855	100R1-12	1020427	100R1-24
9C2399	100R1-12	1255364	100R1-24
9W6261	100R1-12	1357911	100R1-24
1250712	100R1-16	1360511	100R1-24
1440119	100R1-16	1360514	100R1-24
1482104	100R1-16	2108159	100R1-24
1746127	100R1-16	8E1290	100R1-24
2031022	100R1-16	8X2799	100R1-24
2031023	100R1-16	9W3702	100R1-24
2065939	100R1-16	8W4910	100R1-32

100R2 Double Wire Braid



Sold by the inch - 600" minimum order.

Type	Hose Size ID		Max. Working Pressure		Min. Bend Radius	
	in.	DIN Dash Size	psi	MPa	in.	mm
100R2-03	3/16	5	6200	41.5	3.5	89
100R2-04	1/4	6	5800	40	4	102
100R2-06	3/8	10	4800	33.1	5	127
100R2-08	1/2	12	4000	27.6	7	178
100R2-10	5/8	16	3630	25	8	203
100R2-12	3/4	19	3120	21.5	9.5	241
100R2-16	1	25	2400	16.5	12	305
100R2-20	1 1/4	31	1820	12.5	16.5	419
100R2-24	1 1/2	38	1310	9	20	508
100R2-32	2	51	1160	8	25	635

100R2 Hose Assembly

Part No.	Hose	Part No.	Hose	Part No.	Hose
907055	100R2-4	1367840	100R2-6	1469036	100R2-8
308172	100R2-4	1469040	100R2-6	7K2839	100R2-8
1010826	100R2-6	9R9005	100R2-6	1360513	100R2-20

100R4 Textile with Helical



Sold by the inch - 600" minimum order.

Type	Hose Size ID		Max. Working Pressure		Min. Bend Radius	
	in.	mm.	psi	MPa	in.	mm
100R4-12	3/4	19	300	2.1	2.5	64
100R4-16	1	25.4	250	1.7	3	76
100R4-20	1 1/4	31.8	200	1.4	4	102
100R4-24	1 1/2	38.1	150	1	5	127
100R4-32	2	50.8	100	0.7	6	152
100R4-40	2 1/2	63.5	62	0.4	7	188
100R4-48	3	76.2	58	0.4	9	229
100R4-64	4	101.6	35	0.2	12	305

100R4 Hose Assembly

Part No.	Hose	Part No.	Hose
1158440	100R4-16	3P6141	100R4-32
1373360	100R4-16	3P7170	100R4-32
6Y2549	100R4-16	6P0685	100R4-32
3P5931	100R4-20	7D4086	100R4-32
6Y4063	100R4-24		
1249318	100R4-32		
2G4479	100R4-32		

100R5 One Wire Braid with Textile Cover



Sold by the inch - 600" minimum order.

Type	Hose Size ID		Max. Working Pressure		Min. Bend Radius	
	in.	mm.	psi	MPa	in.	mm
100R5-04	3/16	4.8	3000	20.7	3	76
100R5-05	1/4	6.4	3000	20.7	3.4	86
100R5-06	5/16	7.9	2250	15.5	4	102
100R5-08	1 3/32	10.3	2000	13.8	4.6	117
100R5-10	1/2	12.7	1750	12.1	5.5	140
100R5-12	5/8	15.9	1500	10.3	6.5	165
100R5-16	7/8	22.2	800	5.5	7.4	187
100R5-20	1 1/8	28.6	625	4.3	9	229
100R5-24	1 3/8	35	500	3.4	10.5	267
100R5-32	1 13/16	46	350	2.4	13.3	337

Part numbers are used for reference purposes only.

100R5 Hose Assembly

Part No.	Hose	Part No.	Hose
3L2207	100R5-4	8K6633	100R5-6
5V1843	100R5-4	8N7140	100R5-6
8W2664	100R5-4	9L5158	100R5-6
9L5098	100R5-4	9N1849	100R5-6
9N3040	100R5-4	9N3041	100R5-6
9Y1116	100R5-4	1180284	100R5-8
1V8365	100R5-5	1274976	100R5-8
2G2477	100R5-5	2002293	100R5-8
3D6931	100R5-5	3D6395	100R5-8
3D8938	100R5-5	4J8743	100R5-8
3D8942	100R5-5	4N4935	100R5-8
3V0037	100R5-5	4N5396	100R5-8
4S7528	100R5-5	6N9255	100R5-8
4S7529	100R5-5	7E6084	100R5-8
4S7560	100R5-5	7J0664	100R5-8
5D7464	100R5-5	9D5458	100R5-8
6J7926	100R5-5	9W1709	100R5-8
6J7929	100R5-5	1095760	100R5-10
6K8231	100R5-5	1Y0683	100R5-10
7D4955	100R5-5	3V5598	100R5-10
7D6096	100R5-5	4N4937	100R5-10
3S8146	100R5-6	4W1309	100R5-10
4P0902	100R5-6	6K6830	100R5-10
6N1047	100R5-6	5V1846	100R5-12
6N3246	100R5-6		

100R12 4 Wire Braid

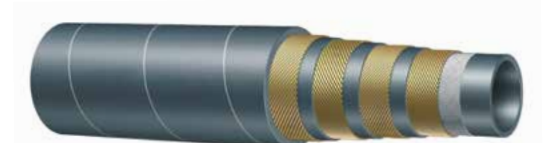

Sold by the inch - 600" minimum order.

Type	Hose Size ID		Max. Working Pressure		Min. Bend Radius	
	in.	mm.	psi	MPa	in.	mm
100R12-06	3/8	10	4100	28.3	2.5	65
100R12-08	1/2	12	4100	28.3	3.5	90
100R12-10	5/8	16	4100	28.3	4	100
100R12-12	3/4	19	4100	28.3	5.1	130
100R12-16	1	25	4100	28.3	11.8	300
100R12-20	1 1/4	31	3050	21	16.5	420
100R12-24	1 1/2	38	2550	17.5	19.7	500
100R12-32	2	51	2550	17.5	25	635

Costex Tractor Parts Copyright © 2020. All rights reserved.

100R12 Hose Assembly

Part No.	Hose	Part No.	Hose
1078142	100R12-6	8K7225	100R12-12
1078147	100R12-6	8K7228	100R12-12
1078150	100R12-6	8P1248	100R12-12
1139326	100R12-6	8W2622	100R12-12
1844457	100R12-6	8W2623	100R12-12
6P6705	100R12-6	8W3183	100R12-12
8W0125	100R12-6	9J0298	100R12-12
8W4196	100R12-6	9S5682	100R12-12
9R1183	100R12-6	9U8544	100R12-12
9W4589	100R12-6	9W2019	100R12-12
1078149	100R12-8	9W5286	100R12-12
1080702	100R12-8	9W9970	100R12-12
1201324	100R12-8	1086981	100R12-16
6Y3474	100R12-8	1086982	100R12-16
6Y3475	100R12-8	1229964	100R12-16
6Y5706	100R12-8	1282569	100R12-16
7T6931	100R12-8	1282570	100R12-16
7T6934	100R12-8	1282571	100R12-16
8W0225	100R12-8	2270218	100R12-16
9C1251	100R12-8	2V5043	100R12-16
9R9198	100R12-8	2V6761	100R12-16
9W9082	100R12-8	3V6259	100R12-16
9W9083	100R12-8	3V7272	100R12-16
1117746	100R12-12	5V4008	100R12-16
1156930	100R12-12	7K8863	100R12-16
1188138	100R12-12	8P3196	100R12-16
1356412	100R12-12	8P4110	100R12-16
1356413	100R12-12	8R7728	100R12-16
1997078	100R12-12	8W2662	100R12-16
1997079	100R12-12	1051512	100R12-20
1Q1372	100R12-12	1348203	100R12-20
3P4836	100R12-12	1747567	100R12-20
4T6224	100R12-12	1859385	100R12-20
4V8370	100R12-12	2091458	100R12-20
6K1936	100R12-12	3P2886	100R12-20
6P1090	100R12-12	3P6956	100R12-20
7G3146	100R12-12	3P6957	100R12-20
7G8208	100R12-12	6T4249	100R12-20
7K0151	100R12-12	7K8862	100R12-20
7T3915	100R12-12	8N9796	100R12-20
7T6483	100R12-12	1357909	100R12-24
7T9340	100R12-12	1V4835	100R12-24
7T9341	100R12-12	3P5345	100R12-24
8E1006	100R12-12	8S8822	100R12-24
8E5660	100R12-12	9W3701	100R12-24
8E9427	100R12-12	8W4907	100R12-32
8E9428	100R12-12		
8E9436	100R12-12		
8J7734	100R12-12		

100R13 4 Wire Spiral



Sold by the inch - 600" minimum order.

Type	Hose Size ID		Max. Working Pressure		Min. Bend Radius	
	in.	mm.	psi	MPa	in.	mm
100R13-12	3/4	19	5100	35.0	9.4	240
100R13-16	1	25	5100	35.0	11.8	300
100R13-20	1 1/4	31	5100	35.0	16.5	420
100R13-24	1 1/2	38	5100	35.0	19.7	500
100R13-32	2	51	5100	35.0	25.2	640

100R13 Hose Assembly

Part No.	Hose	Part No.	Hose
4I1077	100R13-12	1159570	100R13-24
5I4447	100R13-12	1354626	100R13-24
1241037	100R13-16	1354627	100R13-24
874938	100R13-16	1604160	100R13-24
1U2434	100R13-16	2V9106	100R13-24
4I1083	100R13-16		
1538476	100R13-20		

100R15 6 Layer Spiral



Sold by the inch - 600" minimum order.

Type	Hose Size ID		Max. Working Pressure		Min. Bend Radius	
	in.	mm.	psi	MPa	in.	mm
100R15-04	3/16	4.8	3000	20.7	3	76
100R15-05	1/4	6.4	3000	20.7	3.4	86
100R15-06	5/16	7.9	2250	15.5	4	102
100R15-08	1 3/32	10.3	2000	13.8	4.6	117
100R15-10	1/2	12.7	1750	12.1	5.5	140
100R15-12	5/8	15.9	1500	10.3	6.5	165
100R15-16	7/8	22.2	800	5.5	7.4	187
100R15-20	1 1/8	28.6	625	4.3	9	229
100R15-24	1 3/8	35	500	3.4	10.5	267
100R15-32	1 13/16	46	350	2.4	13.3	337

100R15 Hose Assembly

Part No.	Hose	Part No.	Hose
1876058	100R15-12	4I3695	100R15-16
1926790	100R15-12	5I3088	100R15-16
5I4216	100R15-12	6Y4058	100R15-16
5I4490	100R15-12	6Y4061	100R15-16
1158739	100R15-16	1940105	100R15-20
1158749	100R15-16	2026758	100R15-20
1158753	100R15-16	2457308	100R15-20
2048075	100R15-16	2777121	100R15-20
2048164	100R15-16	2181227	100R15-24
2076282	100R15-16	2236915	100R15-24
2391892	100R15-16		

WIPER ROD SEALS



Part No.	Part No.
1211611	2271146
1261885	2271148
1336813	2271150
1336904	2287467
1389739	2313538
1540736	2313539
1540749	2313540
1540767	2330619
1659286	2330625
1659288	2330632
1659291	2332606
1U2708	2332607
2253281	2892930
2253283	2892956
2253284	2J7759
2253285	2J8170
2253287	3081845
2253291	3081880
2253293	3119318
2253294	3124247
2253295	3358966
2253299	3465196
2268202	3465199
2271143	3469382
2271145	3469383

Part numbers are used for reference purposes only.

Part No.	Part No.
3E4103	6J0542
3E4114	6J1879
3E4164	6J1890
3E4166	6J3073
4J0981	7K9791
4J8982	7U4137
4T4802	8J6416
4T4805	8J9934
4T5663	8T0741
5J2274	9J2547
5J6795	9X7333
5J7030	9X7352
5J7032	9X7366
5J7034	9X7367
5J7036	9X7368
5J8016	9X7370
5J8156	
5U3529	
5U3693	

U-CUP SEALS



Part No.	Part No.	Part No.
0963468	1672337	3124245
1052577	1672341	3124245
1211371	1672418	3271055
1289270	1709856	3465201
1540750	1709857	5J0964
1672294	1709859	5J8175
1672300	1709860	5J8225
1672302	1709864	5J8275
1672305	2160003	5J8400
1672307	2160004	5P2940
1672310	2160005	5P4589
1672315	2160008	6J1500
1672322	2160009	6J1889
1672323	2160011	9J1797
1672325	2892946	
1672329	2892946	
1672330	2892948	
1672332	3119317	
1672333	3119317	

Costex Tractor Parts Copyright © 2020. All rights reserved.

POWER TRAIN



BEVEL GEARS & GEAR SETS



Bevel gears and gear sets are:

- ✓ **100% roll tested** against master gears to check for proper match, noise and any small imperfections that may have been created in handling or heat-treating.
- ✓ **Quench pressed** during heat treatment to minimize distortion and maximize close tolerances.
- ✓ **Grounded** with a machine that uses **diamond honing to remove most of the distortion and imperfections** created during heat treatment. Ground gears are quieter and provide longer life.
- ✓ **Shot peening and micro finishing** are used to relieve the stress created in the material of the gear during the forging, cutting and heat treating processes.

Gears

Part No.	Qty. of Teeth	Shaft/Pinion	Machine Model
1P6265	49T	9P9000	D6D, 977L, D6E
1122255	51T	N/A	631, 633
2G5768	58T	1095562	12G, 130G, 140G
2V2006	40T	1V9822	966C, 528
2V3687	38T	7V6790	980C
2V5881	40T	2V5608	518, 930
3V8777	40T	6W1629	613C, 950B, 950E
4D3898	32T	2D3609	12E
4V5393	39T	4V5388	814B, 815B, 816B, 966D
5M7740	58T	9P9000	D6, D6C, 977, 977K
6D0687	32T	N/A	12E, 12F, 120, 14E, 140
6K5625	47T	6K3674	920
6W2900	40T	N/A	D20D, D250D
8D1858	63T	8D2106	16G, 16H
8D2116	63T	1095979	14G, 14H
8D3669	46T	8D4335	621B
8D6491	53T	2G8872	120G
8E7860	29T	6Y5946	D8L, D9N, D9R, D10N, 589
8K6015	47T	6K2085	950, 613
8K9661	55T	N/A	D4D, 955L, 951C
8P1183	47T	8P1182	D5/E/B, 561C
8P6241	29T	3T2273	D8L, D9L, 590
8R8335	45T	9C8669	966F
8R9215	44T	1120742	950F, 960F
8V3135	16T	8V3134	960, 966C

Part No.	Qty. of Teeth	Shaft/Pinion	Machine Model
9C8205	40T	9C8204	815B, 816B, 966D, 966E
9C8219	46T	9C8218	815B, 816B, 966D
9C8277	38T	9C8276	980C, 980F
9H1918	49T	N/A	D8, D8H
9K3413	43T	4K6212	528, 814, 966C
9P1925	35T	9W5150	D6H, D7H, 578
9S9541	49T	9S9541	D6C, D6D special appl.
9V9833	49T	6W8267	992C, 992D

Gear Sets

Part No.	Description	Machine Model
1075608	GEAR SET	416C, 420D, 424D, 426C
1120739	GEAR SET 44:14	1T62G, 950G, 950H, 950, 962G
1189117	GEAR SET	416C/D, 420D, 424D, 426C
9R2479	GEAR SET-BEVEL (10/35)	416, 426
9R5241	GEAR SET-BEVEL (9/37)	D8H, 416, 426, 583H
9R9399	GEAR SET-BEVEL (10/31)	416B, 426B, 428B, 436B
9R9444	GEAR SET BEVEL (11/43)	416, 416B, 426B, 428B
9R9445	GEAR SET BEVEL (15/31)	416B, 426B, 428B, 436B, 438B

CARRIERS



Part No.	Application
1043133	D9N
1107209	325B L
1107228	330B L
1107243	330B
1127308	D9R
1128041	966DE, 966F
1128042	980F, D7R, D8N
1293046	980G
1294300	966G/H, 972G
1864117	416B/C, 416
2105924	416E, 416D
1M4153	D8K, D9G/H
1P9663	977K/L 983
1T0226	571A, 572E, D7E
1T1481	936E, 950B/E
1V1409	910, 920
1V2281	950, 613B

Part No.	Application
1V3335	930
2P4408	D4D, 920, 930
2V5722	966DE, 966F
3P0306	120G, 140G
3P1609	14G/H, 16H
3P2415	980C/F, 826C
3P3103	988G, 980F, D9R
3P3775	D9N, D9L
3T3294	D10N, D10R
3T4007	D6R, D7R, D8N
3T5021	D6R, D7R, D8N
3T5200	D8N, D6H, D7H
4E2166	938F/G
4S5940	D5, 955K
4S5980	N/A
4V8541	950B
4V9823	916, IT18B
5M7875	D6C/G, D7G
5S7023	D5, 955L
5V6177	518, 936
6C0739	215
6G7213	120G, 120H
6P0748	D4C, D3C, 926F
6S3011	910
6T0275	926, 926E
6T3726	D9T
6Y1336	D8N, D8R, D8T
6Y1604	980F/C, 826C
6Y4819	966D
6Y4846	D7R, D8T
6Y7879	966
7G4589	980F, 980C
7G5444	936, 936E
7G5445	962H, 962G
7G5684	D7H
7G7218	980F
7I7728	322B, 325L
7K1848	966
7T1124	D8L
7T3365	D8N
7T8170	D4H, D5C
7Y0228	322L
7Y0241	325
7Y0645	330
7Y0731	330
7Y1432	320, 320B
7Y1433	318B
7Y1751	320

Carriers (cont.)

Part No.	Application
7Y1752	320B
8D3591	315H, 140G/H
8E4024	D3C, 935C, 916
8E4589	D4C, D3C, 926E
8G6335	953
8G7133	963B
8M8677	D6, D7, 977
8R2198	928G
8R4571	950, 950F
8R4821	980C, 980F
8S9070	D7F
9C6027	814F, 815F, 966F
9D8794	773D, 775D
9G1490	D5N, 561N, D5M
9G1491	962G/H
9G9175	D6H, D6R
9K1759	966C
9P3468	D8L, D9T, D9R
9P3663	D8K, D9G, D9H
9P3731	966D, 960F
9P8451	140G, 160G
9R3527	426, 428
9S5267	D6C, D7G
9W0517	950B/F
9W4949	950B
9W4957	936, 950B
9W6046	926, D5C
9W9392	D8N, D9L
9W9396	D8N

CARRIERS FOR KOMATSU®



Part No.	Description	Machine Model
20Y-26-21150	CARRIER	PC200LC-6LE, PC210LC-6K, PC220LC-6LC, PC250LC-6LC
20Y-27-21140	CARRIER	PC240NLC-6K, PC240-6K, PC210-6K, PC210LC-6K
20Y-27-21153	CARRIER	CD110R-1, PC100L-6, PC300-6, PC300-6Z, PC350-6
20Y-27-22170	CARRIER	PC600LC-8E0, PC700LC-8E0, PC650LC-8E0, BR310JG-1
20Y-27-31110	CARRIER	BP500-7-M1, BR380JG-1, PC200-7, PC210LC-7DG
207-26-71570	CARRIER	PC300-7-AA, PC300LC-7L, PC350LC-7, PC360-7, PC350LC-8
705-17-02221	CARRIER	WA200-6, D65WX-16, WA320-6, D41P-6K, D61E-12

DRUMS



Clutch System Application

Part No.	Application
2M6984	594, D9G
2P9037	D8K
2S3443	D6, D6C, 977L
3T1899	D6D, D6E
3T1900	D5B
3T1921	D7G
5G8708	D3C, D4B, D4C, D4D
5S6796	D7F, D7G
6S3398	D3/B, 931/B/C
7M5002	D5, D6, D6B, 561
8H1174	D4/D, 941B, 951, 955/C
8P6495	D6C, D6E
9S7187	D7, D7F
9W6358	955, 955C

Final Drive System Application

Part No.	Application
2B8824	D4C, D4D, 941B, 951
2P9038	D8K, D9K
2S7603	D6C, 977K
3T1898	D6E, D6G
4K1328	966C
4K6736	966, 966C
5K4444	980, 980B
5M1998	D7, D7E, D7G
7B5088	D5, D6B, D7, 977
7K8237	D4D, 941, 950, 951B, 951C
8H2434	D6C, D6E
8P0203	955, 955C
0941509	320, 320C, 320C L, 320L, 320N, 345B, 345B L
7Y0223	320B, 320B L, 320C, 320C L, 325B
7Y0225	320/B/B L, 320C/C L, 320N, 322/C/C L/L, 325/C/L
7Y1646	320, 320L, 320N
7Y1775	320, 320L, 320N

Brake System Application

Part No.	Application
1751928	627F, 3406B
1H8937	D6C LGP 561, 977, 3306
2D1345	12, 12E, 120, 140
4V6040	816B, 966D, 966E, 3306
8V6390	966D/E

SPIDER UNIVERSAL JOINT



Part No.	Description	Engine Model Application
518	9C0397	SPIDER A
518	9C0398	SPIDER A
518	9K1971	SPIDER A
518	9K1976	SPIDER A
528	9K3969	SPIDER A
992	6S0706	SPIDER & BEARING
120B, 140B	2D2978	SPIDER A
120B, 140B	2D3765	SPIDER A
120G, 120H, 12G	5T8739	SPIDER A
120G, 140G	5Y0767	SPIDER & BEARING
12F, 12G, 140G	8D1508	SPIDER A
12F, 14E	6D2529	SPIDER A
12G, 16G, 834B	8K6042	SPIDER A
140B, 120B	2Y4277	SPIDER & BEARING
350B, 944, 988F, D7	6H2577	SPIDER A

Part No.	Description	Engine Model Application
416, 426	9R8715	SPIDER A
416C, 416D, 420	1179887	SPIDER KIT
432D	1388527	SPIDER
515, 528, 950B	7V4077	SPIDER A
518, 926	8V6435	SPIDER A
518C	5V7199	SPIDER A
561D	1K9467	SPIDER A
571G, 772	5V1168	SPIDER & BEARING
613B	7J5242	SPIDER A
613B	7J5245	SPIDER & BEARING
613B	7J5251	SPIDER & BEARING
637G, 773G, 775G, 794, 990	9C3095	SPIDER & BEARING
725, 730, 735, 740, D25	2T3013	SPIDER G
740, 777D/F/G	1725235	SPIDER GP
775B	8Y0809	SPIDER GP
814B, 814F, 815	7V3842	SPIDER & BEARING
854G	8R7036	SPIDER G
924F/G, 928G	1168540	SPIDER & BEARING
928G	1168539	KIT-SPIDER
928H, 930G	1934640	SPIDER & BEARING
928H, 930G, 930K	1912226	SPIDER & BEARING
930R, D5B	5Y0154	SPIDER A
950F, 938G	4E9324	SPIDER G
950H/K, 962H, 966G	1258810	SPIDER GP
966, 966C, 814	7K0442	SPIDER A
966C, 966R	2V7153	SPIDER A

Spider Universal Joint (cont.)

Part No.	Description	Engine Model Application
980K, 980G	1744643	SPIDER KIT
980K/G	1730888	SPIDER
988H, 854K	1060933	SPIDER G
BP	6I0263	SPIDER A
D4, D6, 933, 977	5M0800	SPIDER
D4B	6S6902	SPIDER A
D6G	1S9670	SPIDER A
D7,D8, 938, 988	6H2579	SPIDER A
D8, D9, 980, 988	9V7710	SPIDER ASSY
G936	9C8367	SPIDER A
M316C, M317F, M318D, M322C	8U5853	SPIDER & BEARING
Motor Grader N. 16	4D8212	SPIDER & BEARING
TH417C, TH220B, 450E, 450F	2198794	SPIDER KIT

TRANSMISSION SEAL RINGS

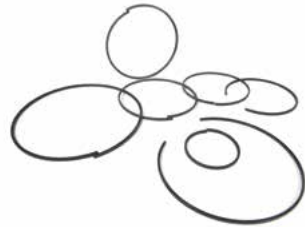

CTP Transmission seals feature:

- ✓ Resistance to extreme temperatures of up to 480°F (250°C)
- ✓ Continuous 24/96 hrs (%) Water Absorption for 5,000/20,000 hrs
- ✓ Its continuous exposure to hot water or vapor does not alter its essential properties
- ✓ 30% glass-reinforced lowers its expansion and increases its flexibility
- ✓ Vapor and corrosion resistance

Part No.
1T1355
1T1356
6G6274

Part No.
6G6275
6P7985
6Y5793

Part No.
6Y5888
6T0248
7G2830
7G4822
7G9922
8E5268

Part No.
8G2194
8P4922
9P7118
9W6990
9W6991

TORQUE CONVERTOR STATORS



Torque Converters are an essential part of your automatic transmission. They not only allow your vehicle to come to a complete stop without stalling the engine, but also provide more torque when accelerating out of a stop, ultimately, giving you more control over your machine's movements. Stators are located at the center of the Torque Converter. They redirect the fluid returning from the turbine before it hits the pump again, increasing the efficiency of the Torque Converter.

Part No.	Description	Machine Application
1480885	STATOR	773B/D, 775D
1T0538	STATOR A	924F, 926
1T0708	STATOR	637, 977K/L, 980, 983
1T1331	STATOR	814, 815, 950F, 960F
1T1397	STATOR	926, D3C, D5C
1T1804	STATOR A	IT28G, 924F, 928G
1T1981	STATOR A	D4H, 517, 518
1T1991	STATOR A	518, 561H, 613C
1T2052	STATOR A	D6H, D7F, D8N
6Y1090	STATOR	966F, 970F, 972H
6Y3151	STATOR	950G, 962H
7T4753	STATOR	527, D5H
8E3726	STATOR	992C, 988F, 836
8P9266	STATOR	D8L, D9L, D10N
9P9517	STATOR	966D, 966E, 966F
9W4702	STATOR	980C, 980G, 980K, 988B

TORQUE CONVERTOR IMPELLERS



Application	Impeller Part No.	Torque Converter Part No.	Turbine Part No.
518	1T1691	1T1984	1T0020
637	1T0901	1T0910	1T0662
814	1T1051	1T1025	1T1053
916	1T1447	1T1449	1T0079
920	1T0841	1T0855	1T0842
930	1T0851	1T0865	1T0020
936	1T1647	1T1503	1T0020
518, 815	1T0406	1T1984	1T0020
613C, 966C	1T1627	N/A	N/A
615C	8P0961	6T1882	8P0953
769C	1T0781	1T1424	1T0782
834B	9W1566	9W1562	2P4470
926L, IT18B	1T1446	1T1448	1T0079
928F	1T1494	1T1949	1T1805
934B	3T5419	3T5227	2P4470
938F	1T1727	1T1950	1T1805
941, 951B/C	1T0018	1T0760	1T0020
950B	1T1438	1T1735	1T1480
950F, 960F	1T1840	1T1841, 1T1939	1T1053
960F	1T1953	1T1939	1T1053
962G, IT 38H	6Y1085	1163825	6Y3149
966D	8P0957	7T7883	8P0953
966D	8P0960	6T1169	8P0953
970F	8E9972	1447659	6Y1089
977K/L, 980B	1T0709	1T1010	1T0662
980C	6P6927	9W6273	2P5680
980F	9W6433	9W6273	N/A
988B	9W1567	9W1564	N/A
988B-3408	3T5102	9W1564	2P5680
D3B, D5, D6C	1T0051	1T0930	1T1993
D4D	1T0022	1T1619	1T0020
D5, D6H, 977H	1T0699	1T1787	1T1993
D5H	7T4754	7T4308	7T4754
D6M, 527, 938G, 966F	6Y1084	1463328	6Y3149
D8, D8H	1T0633	1T0670	1T0221

Part numbers are used for reference purposes only.

Application	Impeller Part No.	Torque Converter Part No.	Turbine Part No.
D8L, D9L, D9N	9P6476	9P4888	8P9265
D9H	1T1399	1T0611	1T0611
D9L, D10N, 988G	9P6477	9P7116	9P9265

Other part no. not included in the list are available. Please contact your sales representative if you have any questions. Part Numbers are used for reference purposes only.

FINAL DRIVE FOR EXCAVATOR



Part No.	Description	Application
3363985	FINAL DRIVE GP	305.5
2081145	MOTOR GP	304CR
1484567	DRIVE ASSY	307B
1484736	DRIVE GP	307C
1026947	DRIVE ASSY	E70B

FINAL DRIVE & SWING COMPONENTS



Planetary drive gears must withstand the high forces of torque generated by the engine and transfer these loads to move the equipment. All CTP swing gears and final drive gears are manufactured to precise tolerances for reliable operation. The manufacturing method includes a heat treatment process that increases bending strength, prevents case crushing and provides exceptional wear resistance for a long service life.

Part No.	Description	No. of Teeth	Use per Machine	Machine
1484632	GEAR-SUN	23	1	318C, 319C, 320C/D/E, 321C
1484732	GEAR-SUN	20	1	318C/E, 319/D, 320C/D/E, 321C/D, 323D/F
1484733	GEAR-PLANET	25	3	318C/E, 319C/D, 320C/D/E, 321C/D/E
6I6583	GEAR-SUN	13	1	318C/E, 319C/D, 320C/E, 322/B, 323D/E/F

Costex Tractor Parts Copyright © 2020. All rights reserved.

Final Drive & Swing Components(cont.)

Part No.	Description	No. of Teeth	Use per Machine	Machine
616585	GEAR-PLANET	44	3/6/12	318C/E, 319C/D, 320C/E, 322/B, 323D/F
1484633	GEAR-PLANET	25	3	318C/E, 319D, 320C/D/E, 321C/D, 323D/F
7Y1427	GEAR-SUN	14	1	320/B/B L, 320B N, 320 N
7Y1428	GEAR-PLANET	32	3	320/B/B L, 320B N, 320 N
7Y1631	GEAR-RING	N/A	1	320/B/B L, 320B N, 320 N
7Y1431	GEAR-PLANET	30	3	320/B/B L, 320B N, 320C/C L, 322/L
1275969	GEAR-SUN	23	1	320/B/B LN/B N/N
7Y1430	GEAR-SUN	17	1	320, 320C
1275970	GEAR-PLANET	25	3	320, 320L, 320N
7Y1643	GEAR-SUN	23	1	320, 320L, 320N
7Y1644	GEAR-PLANET	25	3	320, 320L, 320N
7Y1755	GEAR-RING	73	1	320, 320L, 320N
1484715	GEAR-COUPPLING	55	1 or 2	320, 320L, 320N
1107049	GEAR-SUN	24	1	320B, 322B, 325, 325B
1107051	GEAR-SUN	23	1	320B, 322B, 325, 325B
1107056	GEAR-PLANET	23	3	320B, 322B, 325, 325B
1107053	GEAR-PLANET	23	3	320B, 322B, 325/B, 365B
1107055	GEAR-RING	66	1	320B, 322B, 325/B
7Y0213	GEAR-PLANET	21	3	320B/N, 322B, 325B
7Y0219	GEAR COUPLER	58	1	320B/N, 322B, 325B
7Y0999	GEAR-RING	70	1	320B/N, 325
1695593	GEAR-PLANET	23	3 or 6	320C/D, 322C, 323D, 324D, 325C/D
1695589	GEAR-SUN	24	2	320C/D, 322C, 323D, 324D/E, 325C/D
1695592	GEAR-PLANET	23	3	320C/D, 322C, 323D/E, 324D, 325C/D
1912684	GEAR-PLANET	21	3 or 6	320C/D, 322C, 323D/E, 325C/D, 329D/E
1912683	GEAR-SUN	20	1 or 2	320C/D, 322C, 323D/E, 325C/D, 330F
7Y0221	GEAR-PLANET	23	4	320N
7Y0224	GEAR-PLANET	25	3	320N
7Y0674	GEAR-SUN	23	1	322, 325, 330

Part No.	Description	No. of Teeth	Use per Machine	Machine
1107050	GEAR-SUN	23	1	322BL, 325BL
1912676	GEAR-RING	72	1 or 2	322C
1912675	GEAR-PLANET	20	3 or 7	322C, 324D, 326D/F
7Y0673	GEAR-RING	73	1	325C, 328D, 330C/D
7Y0676	GEAR-PLANET	24	3	325C, 328D, 330C/D
1107216	GEAR-SUN	24	1	325L, 325B
1107233	GEAR-PLANET	26	3	330, 330B
7Y0659	GEAR-PLANET	22	3	330/B/C/D
7Y0663	GEAR-PLANET	20	3	330/B/C/D
1107231	GEAR-SUN	18	1	330B/C/C L/D
1107232	GEAR-SUN	18	1	330B/L

EXCAVATOR GEARS



Part No.	Description	Application
1141414	GEAR GP-BR	215, 320B, 320BL
2003645	GEAR GP-BR	345B
2276081	GEAR GR - SWING BEARING	320C, 320D, 320CL
2276082	GEAR GP-BR	320C, 320D, 323D
2276087	GEAR GR - SWING BEARING	325C, 225D
2276089	GEAR GR - SWING BEARING	330C/C L, 330D/D L, 336D
2276094	GEAR GP-BR	345BII
2291077	GEAR GP-BR	312C, 312CL
2316854	GEAR GR - SWING BEARING	325B
5C0451	GEAR GR - SWING BEARING	215, 215B
7Y0745	GEAR GR - SWING BEARING	325, 325L
7Y1563	GEAR GP - SWING BEARING	320L, 320N
7Y1565	GEAR GP - SWING BEARING	320, 320L, 320N
8K4127	GEAR GR - SWING BEARING	225, 225D, 229

SEALS & GASKETS



MANUFACTURING

At CTP we manufacture gaskets from materials that are engineered to withstand the high pressures and temperatures of today's diesel engines. As an engine gasket supplier we are now an Interface Solutions Inc. Certified Partner producing and assembling gaskets and kits with materials that are 100% asbestos-free and 100% Solvent Free. Ultimately we provide parts with the highest quality standards in our state-of-the-art manufacturing facility with over 60,000 square feet of production space. Our gaskets provide component integration, resulting in durability and reliability, with the quality and value CTP customers have come to expect.

En CTP fabricamos juntas de materiales que soportan las altas presiones y temperaturas de los motores diesel de hoy. Como un surtidor de juntas de motor, ahora somos socios certificados de Interface Solutions Inc. produciendo las juntas y los kits con materiales que son 100% libres de asbestos y 100% libres de solvente. También proveemos piezas de la más alta calidad fabricadas con tecnología avanzada en nuestras instalaciones de más de 60.000 pies cuadrados de espacio de producción. Nuestras juntas permiten la integración de componentes, dando como resultado la durabilidad y confiabilidad que los clientes de CTP esperan.













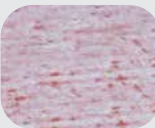

GASKET MATERIALS

What are CTP Gaskets made of? ¿Que contienen las empaquetaduras CTP?

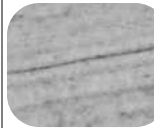
Gaskets are produced from solvent free, environmentally friendly, asbestos free materials. Materials are treated with an anti-stick coating on both sides to better protect the gasket and the machine itself.

Las empaquetaduras CTP son fabricadas con material 100% libre de solventes y asbestos. Estas son tratadas con una capa de material anti-resbalante en ambos lados para proteger la empaquetadura y la máquina al mismo tiempo.

Material	Gasket Type	Material	Application	Maximum Short Duration Temperatures
NCA-45 	Cork Gasket	Cork/synthetic rubber blend	Medium oil resistance of most sealing application: <ul style="list-style-type: none"> Valve Covers Oil Pans Transmission Pans 	up to 200°C (392°F)
CMP-4000 	Paper Gasket	Compressed MicroPore material, combining a unique synthetic fiber matrix and fully cured Nitrile Butadiene rubber binder	Excellent sealability and torque retention properties for OEM and industrial applications.	up to 350°C (650°F)
HFL-171 	Paper Gasket	Fully cured Nitrile Butadiene rubber binder	Heavy-duty and Industrial applications: <ul style="list-style-type: none"> Diesel engine Transmission Refrigeration Piping 	up to 290°C (550°F)
HFL-781 	Paper Gasket	Controlled swell gasket material with Styrene Butadiene and natural rubber binders	Heavy-duty oil sealing applications: <ul style="list-style-type: none"> Diesel engine Oil pans Front covers 	up to 290°C (550°F)
M5201 	Paper Gasket	High-density material with fully cured Nitrile Butadiene rubber binder	Heavy-duty diesel engine applications: <ul style="list-style-type: none"> Oil resistance Fuel resistance 	up to 290°C (550°F)
MP-15 	Paper Gasket	MicroPore with a Nitrile Butadiene binder	Excellent low flange pressure sealability and bolt torque retention for heavy-duty applications: <ul style="list-style-type: none"> Compressors Diesel engines Others 	up to 205°C (400°F)
N-8092 	Paper Gasket	Reinforced Cellulose with Nitrile binder	Excellent crush resistance at high flange pressure for small engine and compressor applications: <ul style="list-style-type: none"> Oil Fuel Water 	up to 180°C (350°F)

Material	Gasket Type	Material	Application	Maximum Short Duration Temperatures
PF-4S 	Paper Gasket	Synthetic fibers, advanced fillers and Nitrile Butadiene binders	Various oil, air, and coolant applications: <ul style="list-style-type: none"> Oil pans Front covers Intake manifolds Rear seals 	up to 290°C (550°F)
RN8011 	Paper Gasket	Low density Cellulose fiber material with high rubber filler content and Nitrile Butadiene rubber binder	Excellent sealing at low flange pressures for oil and water applications: <ul style="list-style-type: none"> Engine Transmission pan gaskets Water pumps Environmental seals 	up to 180°C (350°F)
S-8091 	Paper Gasket	Latent cure Styrene Butadiene bound material with reinforced Cellulose fiber	Excellent sealing for: <ul style="list-style-type: none"> Oil Fuel Low-pressure Steam 	up to 180°C (350°F)
TS-9016 	Paper Gasket	Fully cured Styrene Butadiene rubber binder and a blend of Aramid and Cellulose fibers	Oil and water applications	up to 290°C (550°F)
VB-72 	Paper Gasket	MicroPore with a Nitrile Butadiene binder	Heavy-duty applications: <ul style="list-style-type: none"> Valve body Applications with high fluid pressures and flow rates exposure Erosion Resistance 	up to 290°C (550°F)
EMC-7201 	Metal Gasket	Composite structure of high-density, fully cured Nitrile Butadiene bound gasket facings chemically and mechanically fused to an expanded steel core	High performance diesel engine structural joint applications: <ul style="list-style-type: none"> Gear case Flywheel housings High pressure hydraulic joints 	up to 290°C (550°F)
HTX-900 	Metal Gasket	Graphite-coated, high temperature facing material chemically and mechanically fused to an expanded steel core	High strength, thermal integrity, and anti-stick performance sealing applications: <ul style="list-style-type: none"> Exhaust manifolds Header Collector EGR system gaskets 	up to 760°C (1,400°F)

ABC GASKET PROGRAM



What is CTP's ABC Gasket program about?

The ABC Gasket Kit program is designed to consolidate gasket kits and make it easier for the parts person to order and for the rebuilder himself to quickly identify and organize their seals and gaskets. At the same time, they can be assured that everything they need is included for each particular rebuild. Kits are packaged into sub kits (front set, rear set, lower set, etc.) inside the gasket kit box for easy identification.

Why buy CTP's ABC Gasket Kits?

Everyone likes to keep things simple and organized. We can help you do that while offering you the reliability and premium quality that comes with every CTP product.

THE ABC GASKET KIT PROGRAM OFFERS YOU THE FOLLOWING:



- 1 box instead of 10 boxes.
Todo lo que necesita en una sola caja en vez de diez.



- Kits A are divided and labeled into sub-kits inside the gasket kit box for easy identification.
Los Kits A se dividen y etiquetan en Sub-kits para asegurar una identificación fácil.



- Less shipping costs. (1 box compared to 10 boxes)
Menos costos de envío (1 caja vs 10 cajas).

¿De qué se trata “Kit de Empaquetaduras ABC” de CTP?

El programa de los Kit de Empaquetaduras ABC está diseñado para facilitar al cliente la orden de piezas. Al mismo tiempo facilita la rápida identificación y organización de los sellos y juntas necesarios para la reconstrucción de su motor diesel. Esto asegura al cliente que todas las piezas necesarias para la reconstrucción de su motor están incluidas en una sola caja.

¿Por qué comprar un Kit de Empaquetaduras ABC de CTP?

Sabemos lo importante que es para el cliente mantener las cosas simples y organizadas. Nosotros podemos ayudarle en este aspecto y al mismo tiempo le ofrecemos la confiabilidad y la calidad superior que viene en cada producto CTP.

EL PROGRAMA DE KIT DE EMPAQUETADURAS ABC LE OFRECE LOS SIGUIENTES BENEFICIOS:

- Less warehouse space (1 box compared to 10 boxes).
Ocupa menos espacio en su establecimiento (1 caja vs 10 cajas).
- Faster inventory turnover.
Rotación de inventario más rápida.
- More machine coverage with lower investment in inventory (Each special kit covers a wide range of serial numbers).
Una cobertura más amplia sobre los modelos de motor con una inversión más baja en el inventario (Cada kit cubre una amplia gama de números de serie).
- Simplified part number system (A= , B= , C=).
Un sistema más fácil para la identificación de números de parte (A=, B=, C=).
- All necessary seals and gaskets are included in a kit for a particular rebuild (inframe, out of frame or a head set). You won't have to worry that anything is missing.
Todos los sellos y juntas necesarios para cada reconstrucción están incluidos (In-frame, Out-of-Frame o el set de empaquetadura para la cabeza de los cilindros).

Selecting the right kit for your application / Cómo elegir el kit que necesita:

A = Out of Frame Overhaul Set

Includes all the gaskets and seals required for a complete engine overhaul / *Incluye todas las empaquetaduras y partes necesarias para realizar una reconstrucción completa de su motor.*

B = Inframe Overhaul Set

Includes all the gaskets required for an in-frame engine overhaul / *Incluye todas las empaquetaduras y partes necesarias para realizar una reparación dentro del marco de su motor.*

C = Single Cylinder Head Replacement Set

Includes all the gaskets required for the replacement of a single cylinder head on an engine / *Incluye todas las juntas requeridas para el reemplazo de una sola culata en un motor.*

Other options will be identified with the letters D or E.
Otras opciones se identifican con las letras D o E.

The part number will be made up of: CTP + engine number + consecutive number + A,B,C (D or E suffix if available).
El número de parte está compuesto de la siguiente forma: CTP + Numero de motor + Numero consecutivo + A, B, C (sufijo “D” o “E” también están disponibles).

† Delivery time varies depending on availability of parts. *El tiempo de entrega varía dependiendo de la disponibilidad de las piezas.*

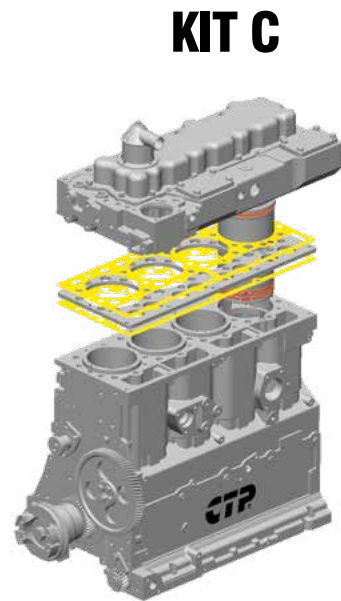
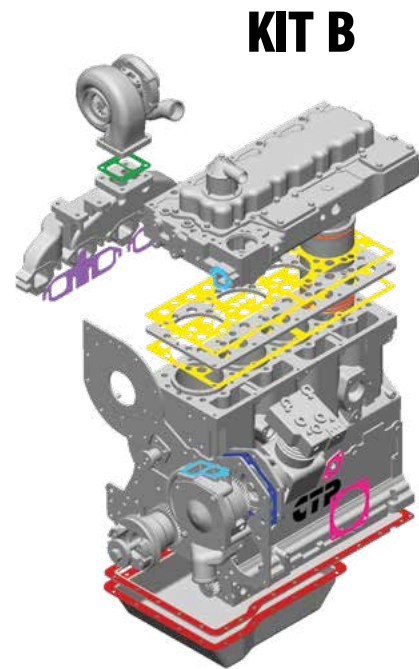
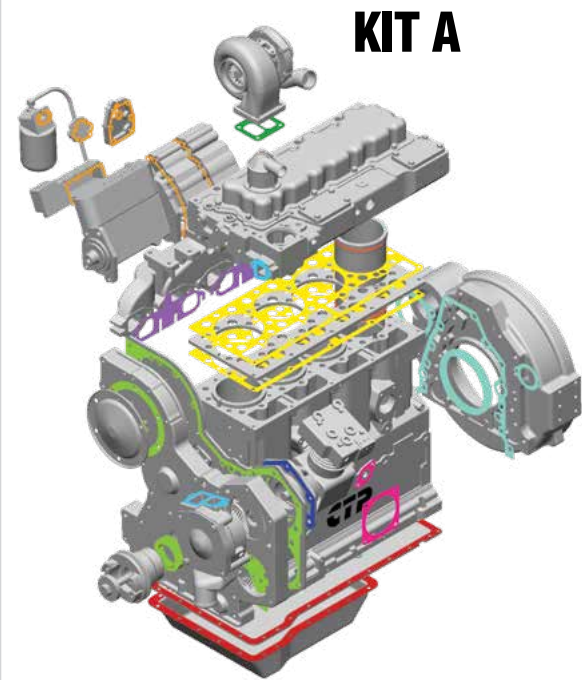

- Air Inlet Manifold Set
- Fuel System Set
- Cylinder Head Kit
- Air Compressor Set
- Front Cover Kit
- Turbo Charger Set
- Oil Cooler and Lines Set
- Water Pump Set
- Rear Cover Kit
- Cylinder Liner Kit
- Lower and Central Structure Kit

Sub Kit	Description	KIT A	KIT B	KIT C
CYLINDER HEAD SET	CONTAINS THE GASKETS AND SEALS TO REINSTALL A SINGLE CYLINDER HEAD. KIT DOES NOT INCLUDE THE FUEL INJECTOR SEALS.	✓	✓	✓
SINGLE CYLINDER LINER	CONTAINS LINER SEALS (# CYLINDERS).	✓	✓	✓
FUEL INJECTOR	CONTAINS FUEL INJECTOR SEALS. (Note: Injector seals are regularly included in the Fuel System Kit.)	✓	✓	✓
CENTRAL AND LOWER STRUCTURE	CONTAINS THE GASKETS AND SEALS TO REINSTALL THE OIL PAN, OIL PUMP, AND BLOCK COVERS.	✓	✓	-
AIR COMPRESSOR SET	CONTAINS THE GASKETS AND SEALS TO REBUILD AND REINSTALL THE AIR COMPRESSOR AND ATTACHING LINES.	✓	✓	-
WATER PUMP SET	CONTAINS THE GASKETS AND SEALS TO REBUILD AND REINSTALL WATER PUMP AND ATTACHING LINES.	✓	✓	-
OIL COOLER AND LINES SET	CONTAINS THE GASKETS AND SEALS TO REINSTALL THE OIL COOLER(S), OIL FILTER BASE AND ATTACHING LINES.	✓	✓	-
TURBOCHARGER SET	CONTAINS THE GASKETS AND SEALS TO REBUILD AND REINSTALL THE TURBO AND ATTACHING LINES. (If required.)	✓	✓	-
AIR INLET MANIFOLD SET	CONTAINS THE GASKETS AND SEALS TO REINSTALL THE AIR INLET MANIFOLD. (Note: Inlet Manifold Seals are regularly included in a Turbocharger Set.)	✓	✓	-
AFTERCOOLER SET	CONTAINS THE GASKETS AND SEALS TO REINSTALL THE AFTERCOOLER. (If required.)	✓	✓	-
FUEL SYSTEM	CONTAINS THE GASKETS AND SEALS TO REINSTALL ENGINE MOUNTED FUEL SYSTEM COMPONENTS. (Note: Injector seals are regularly included in this Kit.)	✓	-	-
FRONT COVER	CONTAINS THE GASKETS AND SEALS TO REINSTALL THE FRONT COVER.	✓	-	-
REAR COVER	CONTAINS THE GASKETS AND SEALS TO REINSTALL THE REAR COVER.	✓	-	-

CTP has developed over 1000 new ABC Gasket kits for different applications including the C-Series engines.

The applications we cover are:

C-7	C-13	3116	3304	3508
C-9	C-15	3126	3306	3512
C-10	C-18	3176	3406	3516
C-11	C-27	3204	3408	3520G
C-12	3114	3208	3412	

Each engine offers different kits depending on the engine arrangement and engine serial of your machine.

The following is just a brief summary of some of the part numbers we have available in stock. For a full listing of our ABC developments you may see our complete ABC Gasket Kit Catalog. Find it on our website at www.costex.com or email us at marketing@costex.com.

C-7

Part Number	Description	Machine Model / Application	Engine Arrangement	Engine Serial No.	Comments
CTPC7001A	Out of Frame OH Gasket Set	C7 ON - HIGHWAY ENGINE	258-9208	WAX20740	Turbocharged Single Head
CTPC7001B	Inframe OH Set				
CTPC7001D	Cylinder Head Repl. Gasket Set				
CTPC7002A	Out of Frame OH Gasket Set	235-9212 239-4566	235-9215	WAX00001-WAX99999 SAP00001-SAP99999 KAL00001-KAL99999	Turbocharged Single Head
CTPC7002B	Inframe OH Set				
CTPC7002C	Cylinder Head Repl. Gasket Set				
CTPC7003A	Out of Frame OH Gasket Set	237-1552 246-9452	237-1587	WAX00001-WAX99999 SAP00001-SAP99999 KAL00001-KAL99999	Turbocharged Single Head
CTPC7003B	Inframe OH Set				
CTPC7003C	Cylinder Head Repl. Gasket Set				
CTPC7004A	Out of Frame OH Gasket Set	237-1569	237-1748	WAX00001-WAX99999 SAP00001-SAP99999 KAL00001-KAL99999	Turbocharged Single Head
CTPC7004B	Inframe OH Set				
CTPC7004C	Cylinder Head Repl. Gasket Set				
CTPC7005A	Out of Frame OH Gasket Set	237-1755	237-1843	WAX00001-WAX99999 SAP00001-SAP99999 KAL00001-KAL99999	Turbocharged Single Head
CTPC7005B	Inframe OH Set				
CTPC7005C	Cylinder Head Repl. Gasket Set				
CTPC7006A	Out of Frame OH Gasket Set	239-4688	239-4680	WAX00001-WAX99999 SAP00001-SAP99999 KAL00001-KAL99999	Turbocharged Single Head
CTPC7006B	Inframe OH Set				
CTPC7006C	Cylinder Head Repl. Gasket Set				
CTPC7007A	Out of Frame OH Gasket Set	239-4688	239-4688	WAX00001-WAX99999 SAP00001-SAP99999 KAL00001-KAL99999	Turbocharged Single Head
CTPC7007B	Inframe OH Set				
CTPC7007C	Cylinder Head Repl. Gasket Set				
CTPC7008A	Out of Frame OH Gasket Set	239-4688	239-4688	WAX00001-WAX99999 SAP00001-SAP99999 KAL00001-KAL99999	Turbocharged Single Head
CTPC7008B	Inframe OH Set				
CTPC7008C	Cylinder Head Repl. Gasket Set				
CTPC7009A	Out of Frame OH Gasket Set	239-4688	239-4688	WAX00001-WAX99999 SAP00001-SAP99999 KAL00001-KAL99999	Turbocharged Single Head
CTPC7009B	Inframe OH Set				
CTPC7009C	Cylinder Head Repl. Gasket Set				

Part Number	Description	Machine Model / Application	Engine Arrangement	Engine Serial No.	Comments
CTPC7010A	Out of Frame OH Gasket Set	237-1844	237-1844	WAX00001-WAX99999 SAP00001-SAP99999 KAL00001-KAL99999	Turbocharged Single Head
CTPC7010B	Inframe OH Set				
CTPC7010C	Cylinder Head Repl. Gasket Set				
CTPC7011A	Out of Frame OH Gasket Set	238-7101	238-7101	WAX00001-WAX99999 SAP00001-SAP99999 KAL00001-KAL99999	Turbocharged Single Head
CTPC7011B	Inframe OH Set				
CTPC7011C	Cylinder Head Repl. Gasket Set				
CTPC7012A	Out of Frame OH Gasket Set	238-7102	238-7102	WAX00001-WAX99999 SAP00001-SAP99999 KAL00001-KAL99999	Turbocharged Single Head
CTPC7012B	Inframe OH Set				
CTPC7012C	Cylinder Head Repl. Gasket Set				
CTPC7013A	Out of Frame OH Gasket Set	238-7120	238-7120	WAX00001-WAX99999 SAP00001-SAP99999 KAL00001-KAL99999	Turbocharged Single Head
CTPC7013B	Inframe OH Set				
CTPC7013C	Cylinder Head Repl. Gasket Set				
CTPC7014A	Out of Frame OH Gasket Set	238-7268	238-7268	WAX00001-WAX99999 SAP00001-SAP99999 KAL00001-KAL99999	Turbocharged Single Head
CTPC7014B	Inframe OH Set				
CTPC7014C	Cylinder Head Repl. Gasket Set				
CTPC7015A	Out of Frame OH Gasket Set	238-7285	238-7285	WAX00001-WAX99999 SAP00001-SAP99999 KAL00001-KAL99999	Turbocharged Single Head
CTPC7015B	Inframe OH Set				
CTPC7015C	Cylinder Head Repl. Gasket Set				
CTPC7016A	Out of Frame OH Gasket Set	238-7305 239-4680	238-7305 239-4680	WAX00001-WAX99999 SAP00001-SAP99999 KAL00001-KAL99999	Turbocharged Single Head
CTPC7016B	Inframe OH Set				
CTPC7016C	Cylinder Head Repl. Gasket Set				
CTPC7017A	Out of Frame OH Gasket Set	239-4582	239-4582	WAX00001-WAX99999 SAP00001-SAP99999 KAL00001-KAL99999	Turbocharged Single Head
CTPC7017B	Inframe OH Set				
CTPC7017C	Cylinder Head Repl. Gasket Set				
CTPC7018A	Out of Frame OH Gasket Set	239-4688	239-4688	WAX00001-WAX99999 SAP00001-SAP99999 KAL00001-KAL99999	Turbocharged Single Head
CTPC7018B	Inframe OH Set				
CTPC7018C	Cylinder Head Repl. Gasket Set				

Part numbers are used for reference purposes only.

Costex Tractor Parts Copyright © 2020. All rights reserved.

Part Number	Description	Machine Model / Application	Engine Arrangement	Engine Serial No.	Comments
CTPC9001A	Out of Frame OH Gasket Set	Industrial		CLJ1-UP CLJ11104-UP	Turbocharged Single Head
CTPC9002A	Out of Frame OH Gasket Set	Industrial		JSC0001-UP KLW0001-UP MBD0001-UP JLW001-UP	Turbocharged Single Head
CTPC9003A	Out of Frame OH Gasket Set	330D 330D L		THX-UP THY-UP	Turbocharged Single Head
CTPC9004A	Out of Frame OH Gasket Set	D6R Series III D6T Track-Type Tractor		THX-UP THY-UP	Turbocharged Single Head
CTPC9005A	Out of Frame OH Gasket Set	D6R Series II Track Type Tractor		4ZF1-UP	Turbocharged Single Head
CTPC9006A	Out of Frame OH Gasket Set	12H MOTOR GRADER	168-7967	4ZF00001- 4ZF99999	Turbocharged Single Head
CTPC9006B	Inframe OH Set				
CTPC9006C	Cylinder Head Repl. Gasket Set				
CTPC9007A	Out of Frame OH Gasket Set	12H MOTOR GRADER	285-6123	4ZF00001- 4ZF99999	Turbocharged Single Head
CTPC9007B	Inframe OH Set				
CTPC9007C	Cylinder Head Repl. Gasket Set				
CTPC9008A	Out of Frame OH Gasket Set	330C	187-0470 235-4129 208-3027 211-5020	4ZF00001- 4ZF99999	Turbocharged Single Head
CTPC9008B	Inframe OH Set				
CTPC9008C	Cylinder Head Repl. Gasket Set				
CTPC9009C	Cylinder Head Repl. Gasket Set	330C	234-2817	4ZF00001- 4ZF99999	Turbocharged Single Head
CTPC9010A	Out of Frame OH Gasket Set	330C	234-2917	4ZF00001- 4ZF99999	Turbocharged Single Head
CTPC9010B	Inframe OH Set				
CTPC9010C	Cylinder Head Repl. Gasket Set				
CTPC9011A	Out of Frame OH Gasket Set	330C	237-0283	4ZF00001- 4ZF99999	Turbocharged Single Head
CTPC9011B	Inframe OH Set				
CTPC9011C	Cylinder Head Repl. Gasket Set				
CTPC9012A	Out of Frame OH Gasket Set	330C	242-0067 253-8366	4ZF00001- 4ZF99999	Turbocharged Single Head
CTPC9012B	Inframe OH Set				
CTPC9012C	Cylinder Head Repl. Gasket Set				
CTPC9013A	Out of Frame OH Gasket Set	470, 475	203-7058	4ZF00001- 4ZF99999	Turbocharged Single Head
CTPC9013C	Cylinder Head Repl. Gasket Set				
CTPC9014A	Out of Frame OH Gasket Set	627G	174-7519	4ZF00001- 4ZF99999	Turbocharged Single Head
CTPC9014B	Inframe OH Set				
CTPC9014C	Cylinder Head Repl. Gasket Set				
CTPC9015A	Out of Frame OH Gasket Set	637G	174-7522	4ZF00001- 4ZF99999	Turbocharged Single Head
CTPC9015B	Inframe OH Set				
CTPC9015C	Cylinder Head Repl. Gasket Set				
CTPC9017C	Cylinder Head Repl. Gasket Set	D6	166-0273	4ZF00001- 4ZF99999	Turbocharged Single Head
CTPC9018A	Out of Frame OH Gasket Set	D6R	166-0273	4ZF00001- 4ZF99999	Turbocharged Single Head
CTPC9018B	Inframe OH Set				
CTPC9018C	Cylinder Head Repl. Gasket Set				
CTPC9020A	Out of Frame OH Gasket Set	D6R	169-3791 290-1145	4ZF00001- 4ZF99999	Turbocharged Single Head
CTPC9020B	Inframe OH Set				
CTPC9020C	Cylinder Head Repl. Gasket Set				

Part Number	Description	Machine Model / Application	Engine Arrangement	Engine Serial No.	Comments
CTPC9021A	Out of Frame OH Gasket Set	D6R	176-5509 176-9269	4ZF00001- 4ZF99999	Turbocharged Single Head
CTPC9021B	Inframe OH Set				
CTPC9021C	Cylinder Head Repl. Gasket Set				
CTPC9022A	Out of Frame OH Gasket Set	D6R	254-5750 254-5751 254-5752 254-5753	4ZF00001- 4ZF99999	Turbocharged Single Head
CTPC9022B	Inframe OH Set				
CTPC9022C	Cylinder Head Repl. Gasket Set				
CTPC9023A	Out of Frame OH Gasket Set	MT745 MT755	177-1414 177-1416 177-1418 179-4956	4ZF00001- 4ZF99999	Turbocharged Single Head
CTPC9023B	Inframe OH Set				
CTPC9023C	Cylinder Head Repl. Gasket Set				
CTPC9025A	Out of Frame OH Gasket Set	MT765	177-1418 179-4958	4ZF00001- 4ZF99999	Turbocharged Single Head
CTPC9025B	Inframe OH Set				
CTPC9025C	Cylinder Head Repl. Gasket Set				
CTPC9026A	Out of Frame OH Gasket Set	330C	187-0470 208-3027 211-5020 235-4129	7AZ00001- 7AZ99999	Turbocharged Single Head
CTPC9026B	Inframe OH Set				
CTPC9026C	Cylinder Head Repl. Gasket Set				
CTPC9029A	Out of Frame OH Gasket Set	330C	237-0283	7AZ00001- 7AZ99999	Turbocharged Single Head
CTPC9029B	Inframe OH Set				
CTPC9029C	Cylinder Head Repl. Gasket Set				
CTPC9030A	Out of Frame OH Gasket Set	D6R	254-5750 254-5752	7AZ00001- 7AZ99999	Turbocharged Single Head
CTPC9030B	Inframe OH Set				
CTPC9030C	Cylinder Head Repl. Gasket Set				
CTPC9031A	Out of Frame OH Gasket Set	C9	203-7056 203-7057	CLJ00001- CLJ99999	Turbocharged Single Head
CTPC9031B	Inframe OH Set				
CTPC9031C	Cylinder Head Repl. Gasket Set				
CTPC9033A	Out of Frame OH Gasket Set	C9	208-2835 208-2840 214-3561 235-8166	CLJ00001- CLJ99999	Turbocharged Single Head
CTPC9033B	Inframe OH Set				
CTPC9033C	Cylinder Head Repl. Gasket Set				
CTPC9034A	Out of Frame OH Gasket Set	C9	208-2837 235-8165	CLJ00001- CLJ99999	Turbocharged Single Head
CTPC9034B	Inframe OH Set				
CTPC9034C	Cylinder Head Repl. Gasket Set				
CTPC9035A	Out of Frame OH Gasket Set	330C	242-0067	SAN00001- SAN99999	Turbocharged Single Head
CTPC9035B	Inframe OH Set				
CTPC9035C	Cylinder Head Repl. Gasket Set				
CTPC9036A	Out of Frame OH Gasket Set	330C	253-8366 253-8367	SAN00001- SAN99999	Turbocharged Single Head
CTPC9036B	Inframe OH Set				
CTPC9036C	Cylinder Head Repl. Gasket Set				
CTPC9038A	Out of Frame OH Gasket Set	D6R	169-3791 254-5753	SAN00001- SAN99999	Turbocharged Single Head
CTPC9038B	Inframe OH Set				
CTPC9038C	Cylinder Head Repl. Gasket Set				
CTPC9039C	Cylinder Head Repl. Gasket Set		261-4290	THX00001- THX99999 THY00001- THY99999	Turbocharged Single Head

Part Number	Description	Machine Model / Application	Engine Arrangement	Engine Serial No.	Comments
CTPC9040C	Cylinder Head Repl. Gasket Set	D6R SERIES III TRACK-TYPE TRACTOR XL,XW	261-4291 261-4294 261-4295 261-4297 287-7574	THX00001- THX99999 THY00001- THY99999	Turbocharged Single Head
CTPC9041C	Cylinder Head Repl. Gasket Set	D6R SERIES III TRACK-TYPE TRACTOR STD, XL, LGP	318-1904 318-1905 355-7356 387-8577 387-8582	THX00001- THX99999	Turbocharged Single Head
CTPC9042C	Cylinder Head Repl. Gasket Set	330D & 330D L EXCAVATION	253-5330 301-3082	THX00001- THX99999	Turbocharged Single Head
CTPC9043A	Out of Frame OH Gasket Set	330D & 330D L EXCAVATION	270-2770 270-2771	THX00001- THX99999	Turbocharged Single Head
CTPC9043B	Inframe OH Set				
CTPC9043C	Cylinder Head Repl. Gasket Set				
CTPC9044A	Out of Frame OH Gasket Set	330D & 330D L EXCAVATION	290-0760	THX00001- THX99999	Turbocharged Single Head
CTPC9044B	Inframe OH Set				
CTPC9044C	Cylinder Head Repl. Gasket Set				
CTPC9045C	Cylinder Head Repl. Gasket Set	330D MATERIAL HANDLER (HCR & FCR)	349-3571	THX00001- THX99999	Turbocharged Single Head
CTPC9046C	Cylinder Head Repl. Gasket Set	330D	391-1073	THX00001- THX99999	Turbocharged Single Head
CTPC9047A	Out of Frame OH Gasket Set	C9 TRUCK ENGINE	248-4695	9DG07691- 9DG99999	Turbocharged Single Head
CTPC9047B	Inframe OH Set				
CTPC9047C	Cylinder Head Repl. Gasket Set				
CTPC9048A	Out of Frame OH Gasket Set	C9 TRUCK ENGINE	249-8276	9DG00419- 9DG99999	Turbocharged Single Head
CTPC9048B	Inframe OH Set				
CTPC9048C	Cylinder Head Repl. Gasket Set				
CTPC9049A	Out of Frame OH Gasket Set	C9 TRUCK ENGINE	249-8311 250-7399 261-5233	9DG00419- 9DG99999	Turbocharged Single Head
CTPC9049B	Inframe OH Set				
CTPC9049C	Cylinder Head Repl. Gasket Set				
CTPC9050A	Out of Frame OH Gasket Set	C9 TRUCK ENGINE	249-8410	9DG00001- 9DG99999	Turbocharged Single Head
CTPC9050B	Inframe OH Set				
CTPC9050C	Cylinder Head Repl. Gasket Set				
CTPC9051A	Out of Frame OH Gasket Set	C9 TRUCK ENGINE	263-0690 281-9719	9DG07691- 9DG99999	Turbocharged Single Head
CTPC9051B	Inframe OH Set				
CTPC9051C	Cylinder Head Repl. Gasket Set				
CTPC9052A	Out of Frame OH Gasket Set	C9 TRUCK ENGINE	267-5876	9DG00001- 9DG99999	Turbocharged Single Head
CTPC9052B	Inframe OH Set				
CTPC9052C	Cylinder Head Repl. Gasket Set				
CTPC9053A	Out of Frame OH Gasket Set	C9 TRUCK ENGINE	269-4395	9DG07691- 9DG99999	Turbocharged Single Head
CTPC9053B	Inframe OH Set				
CTPC9053C	Cylinder Head Repl. Gasket Set				
CTPC9054A	Out of Frame OH Gasket Set	C9 TRUCK ENGINE	284-0128	9DG00001- 9DG99999	Turbocharged Single Head
CTPC9054B	Inframe OH Set				
CTPC9054C	Cylinder Head Repl. Gasket Set				

Part Number	Description	Machine Model / Application	Engine Arrangement	Engine Serial No.	Comments
CTPC9055A	Out of Frame OH Gasket Set	C9 TRUCK ENGINE	286-7789	9DG07691- 9DG99999	Turbocharged Single Head
CTPC9055B	Inframe OH Set				
CTPC9055C	Cylinder Head Repl. Gasket Set				
CTPC9056A	Out of Frame OH Gasket Set	330D L EXCAVATOR	290-0760	THX00001- THX99999	Turbocharged Single Head
CTPC9056B	Inframe OH Set				
CTPC9056C	Cylinder Head Repl. Gasket Set				
CTPC9059A	Out of Frame OH Gasket Set	966M	373-3754	SYE00001- SYE99999	Turbocharged
CTPC9059B	Inframe OH Set				
CTPC9059C	Cylinder Head Repl. Gasket Set				
CTPC9060A	Out of Frame OH Gasket Set	C9	387-1318 387-1322 / 398-3122	REH00001- REH99999	Turbocharged
CTPC9060B	Inframe OH Set				
CTPC9060C	Cylinder Head Repl. Gasket Set				

C-9.3

Part Number	Description	Machine Model / Application	Engine Arrangement	Engine Serial No.	Comments
CTPC9.3001A	Out of Frame OH Gasket Set	966K WHEEL LOADER 972K WHEEL LOADER	365-4046 365-4047	MME01- MMEUP MYE01- MYEUP	Turbocharged
CTPC9.3001B	Inframe OH Set				
CTPC9.3001C	Cylinder Head Repl. Gasket Set				
CTPC9.3002A	Out of Frame OH Gasket Set	D6T	516-1637	SYE00001- SYE99999	Turbocharged
CTPC9.3002B	Inframe OH Set				
CTPC9.3002C	Cylinder Head Repl. Gasket Set				
CTPC9.3003A	Out of Frame OH Gasket Set	C9.3	381-6486	SYE00001- SYE99999	Turbocharged
CTPC9.3003B	Inframe OH Set				
CTPC9.3003C	Cylinder Head Repl. Gasket Set				
CTPC9.3004A	Out of Frame OH Gasket Set	D6T	398-6913 416-8790	SYE00001- SYE99999	Turbocharged
CTPC9.3004B	Inframe OH Set				
CTPC9.3004C	Cylinder Head Repl. Gasket Set				
CTPC9.3005A	Out of Frame OH Gasket Set	C9.3, D7E	398-6914	SYE00001- SYE99999	Turbocharged
CTPC9.3005B	Inframe OH Set				
CTPC9.3005C	Cylinder Head Repl. Gasket Set				
CTPC9.3006A	Out of Frame OH Gasket Set	C9.3	485-9800 516-4820	SYE00001- SYE99999	Turbocharged
CTPC9.3006B	Inframe OH Set				
CTPC9.3006C	Cylinder Head Repl. Gasket Set				

C-9.3 (cont.)

Part Number	Description	Machine Model / Application	Engine Arrangement	Engine Serial No.	Comments
CTPC9.3007A	Out of Frame OH Gasket Set	C9.3	486-4637	SYE00001-SYE99999	Turbocharged
CTPC9.3007B	Inframe OH Set				
CTPC9.3007C	Cylinder Head Repl. Gasket Set				
CTPC9.3008A	Out of Frame OH Gasket Set	C9.3, D6T	516-1635	SYE00001-SYE99999	Turbocharged
CTPC9.3008B	Inframe OH Set	C9.3, D7E	516-4775		
CTPC9.3008C	Cylinder Head Repl. Gasket Set	C9.3 D7E	516-9592 373-3840		
CTPC9.3009A	Out of Frame OH Gasket Set	C9.3	516-9591	SYE00001-SYE99999	Turbocharged
CTPC9.3009B	Inframe OH Set				
CTPC9.3009C	Cylinder Head Repl. Gasket Set				
CTPC9.3010A	Out of Frame OH Gasket Set	C9.3	516-9594	SYE00001-SYE99999	Turbocharged
CTPC9.3010B	Inframe OH Set				
CTPC9.3010C	Cylinder Head Repl. Gasket Set				
CTPC9.3011A	Out of Frame OH Gasket Set	12M, C9	382-4675, 382-4676	SYE00001-SYE99999	Turbocharged
CTPC9.3011B	Inframe OH Set	140M, C9	373-3811 381-6488		
CTPC9.3011C	Cylinder Head Repl. Gasket Set	160M, C9	373-3776		
CTPC9.3012A	Out of Frame OH Gasket Set	12M	486-4643	SYE00001-SYE99999	Turbocharged
CTPC9.3012B	Inframe OH Set				
CTPC9.3012C	Cylinder Head Repl. Gasket Set				
CTPC9.3013A	Out of Frame OH Gasket Set	12M	516-9591	SYE00001-SYE99999	Turbocharged
CTPC9.3013B	Inframe OH Set				
CTPC9.3013C	Cylinder Head Repl. Gasket Set				
CTPC9.3014A	Out of Frame OH Gasket Set	140M	516-9592	SYE00001-SYE99999	Turbocharged
CTPC9.3014B	Inframe OH Set				
CTPC9.3014C	Cylinder Head Repl. Gasket Set				
CTPC9.3015A	Out of Frame OH Gasket Set	160M	381-6486	SYE00001-SYE99999	Turbocharged
CTPC9.3015B	Inframe OH Set				
CTPC9.3015C	Cylinder Head Repl. Gasket Set				
CTPC9.3016A	Out of Frame OH Gasket Set	336F	373-3834	SYE00001-SYE99999	Turbocharged
CTPC9.3016B	Inframe OH Set	336F, 340F	485-9800		
CTPC9.3016C	Cylinder Head Repl. Gasket Set	336F, 340F	516-4820		

Part Number	Description	Machine Model / Application	Engine Arrangement	Engine Serial No.	Comments
CTPC9.3017A	Out of Frame OH Gasket Set	725C	373-3847	SYE00001-SYE99999	Turbocharged
CTPC9.3017B	Inframe OH Set				
CTPC9.3017C	Cylinder Head Repl. Gasket Set				
CTPC9.3018A	Out of Frame OH Gasket Set	966M	373-3745	SYE00001-SYE99999	Turbocharged
CTPC9.3018B	Inframe OH Set				
CTPC9.3018C	Cylinder Head Repl. Gasket Set				

C-10

Part Number	Description	Machine Model / Application	Engine Arrangement	Engine Serial No.	Comments
CTPC10001A	Out of Frame OH Gasket Set	Industrial CPT372 Truck Petroleum Engine		BCX001-UP 1WZ001-UP ZZB001-UP	Turbocharged
CTPC10002A	Out of Frame OH Gasket Set	C-10 TRUCK ENGINE TURBOCHARGER	129-3597	2PN01094-2PN01095	Turbocharged Single Head
CRPC10002B	Inframe OH Set		129-3598	2PN01095-2PN01660	
CTPC10002C	Cylinder Head Repl. Gasket Set		129-3607	2PN01095-2PN01660	
			129-3608	2PN01095-2PN01100	
			129-3609	2PN01095-2PN01100	
			129-3614	2PN00001-2PN03164	
			129-3619	2PN01095-2PN01660	
			129-9721	2PN00001-2PN99999	
			132-4817	2PN01095-2PN01660	
			132-6068	2PN01096-2PN02378	
			132-6069	2PN01098-2PN07341	
			132-6070	2PN01097-2PN07341	
			133-1049	2PN01095-2PN02110	
			133-1051	2PN01095-2PN07341	
			133-1054	2PN01095-2PN01456	
			133-4087	2PN01122-2PN01557	
			133-4117	2PN01111-2PN07341	
			133-4119	2PN01107-2PN07341	
			133-4185	2PN01407-2PN01408	
			133-4189	2PN00001-2PN04110	
			133-7677	2PN01130-2PN07341	
			133-7702	2PN01130-2PN02766	
			133-7704	2PN01110-2PN07341	
			133-7728	2PN00001-2PN02275	
			133-7757	2PN01130-2PN01953	
			133-7797	2PN01114-2PN01121	
			133-7798	2PN01112-2PN01113	
			134-1673	2PN01182-2PN07341	
			134-4849	2PN01133-2PN01837	
			134-4866	2PN01129-2PN07341	
			134-4875	2PN01128-2PN01823	
			134-4877	2PN01164-2PN01320	
			134-4878	2PN00001-2PN01893	
			134-4886	2PN01136-2PN02530	
			134-4914	2PN01139-2PN01140	
			134-4937	2PN00001-2PN07341	
			134-4950	2PN01140-2PN03459	
			134-4951	2PN01140-2PN03029	
			134-4952	2PN01148-2PN01319	
			134-4984	2PN01148-2PN07341	
			134-4985	2PN01148-2PN02795	
			134-4988	2PN01140-2PN01337	
			134-4995	2PN01182-2PN01443	
			134-4996	2PN01182-2PN07341	
			134-4999	2PN01182-2PN07341	
			135-0897	2PN01182-2PN07341	
			135-0898	2PN01131-2PN07341	
			135-0906	2PN01140-2PN07341	

Part Number	Description	Machine Model / Application	Engine Arrangement	Engine Serial No.	Comments
			135-0924	2PN01133-2PN02888	
			135-0928	2PN01133-2PN02650	
			135-0930	2PN01140-2PN07341	
			135-0932	2PN01140-2PN03575	
			135-0936	2PN01140-2PN07341	
			135-0944	2PN01140-2PN02141	
			135-0953	2PN01133-2PN01316	
			135-0982	2PN01135-2PN02825	
			135-0983	2PN01135-2PN01322	
CTPC10002A	Out of Frame OH Gasket Set	C-10 TRUCK ENGINE TURBOCHARGER	135-0988	2PN01182-2PN07341	Turbocharged Single Head
CRPC10002B	Inframe OH Set		135-0990	2PN01182-2PN02320	
CTPC10002C	Cylinder Head Repl. Gasket Set		135-0991	2PN01182-2PN03996	
			135-0992	2PN01446-2PN07341	
			135-0993	2PN01470-2PN07341	
			135-0994	2PN01470-2PN07341	
			135-0995	2PN01470-2PN07341	
			135-0997	2PN01470-2PN07341	
			135-0998	2PN01135-2PN01555	
			135-0999	2PN01135-2PN03457	
			135-1000	2PN01135-2PN02236	
			135-4760	2PN01141-2PN01163	
			135-4766	2PN01148-2PN01227	
			135-4768	2PN01148-2PN01242	
			135-4795	2PN01300-2PN02697	
			135-4796	2PN01300-2PN02697	
			135-4801	2PN01176-2PN07341	
			135-4816	2PN01135-2PN02111	
			135-4834	2PN01300-2PN07341	
			135-4837	2PN01235-2PN07341	
			135-4838	2PN01300-2PN03895	
			135-4839	2PN01300-2PN03471	
			135-4855	2PN01285-2PN01515	
			135-4858	2PN01267-2PN07341	
			135-4860	2PN01260-2PN06013	
			135-4861	2PN01300-2PN07341	
			135-4862	2PN01300-2PN07341	
			135-4863	2PN01300-2PN07341	
			135-4883	2PN01300-2PN02545	
			135-4884	2PN01300-2PN01802	
			135-4886	2PN01300-2PN07341	
			136-0633	2PN01315-2PN01315	
			136-0634	2PN01300-2PN02891	
			136-0639	2PN01255-2PN01772	
			136-0644	2PN01300-2PN03115	
			136-0661	2PN01300-2PN03328	
			136-0662	2PN01300-2PN02884	
			136-0675	2PN01300-2PN03750	
			136-0680	2PN01300-2PN01488	
			136-0682	2PN01300-2PN04266	
			136-0688	2PN01300-2PN99999	
			136-0697	2PN01300-2PN01969	
			136-0718	2PN01300-2PN01552	
			136-0754	2PN01371-2PN01621	
			136-0755	2PN01372-2PN02896	
			136-0768	2PN01369-2PN02192	
			136-0770	2PN01369-2PN07341	
			136-0771	2PN01431-2PN07341	
			136-0772	2PN01443-2PN07341	
			136-0774	2PN00001-2PN01556	
			136-0778	2PN01369-2PN01492	
			136-0780	2PN01369-2PN01434	
			136-0781	2PN01369-2PN01622	
			136-9643	2PN01641-2PN02587	
			136-9649	2PN01380-2PN07341	
			136-9654	2PN01380-2PN03657	
			136-9655	2PN01443-2PN01472	
			136-9665	2PN01443-2PN03884	
			136-9666	2PN01380-2PN03858	
			136-9668	2PN01380-2PN01944	
			136-9669	2PN01380-2PN07341	
			137-1490	2PN01456-2PN02415	
			137-1514	2PN01456-2PN01654	
			137-1524	2PN01571-2PN07341	
			137-1527	2PN01581-2PN07341	
			137-1528	2PN01456-2PN02416	
			137-1534	2PN01456-2PN03280	
			137-1535	2PN01456-2PN03696	
			137-1536	2PN01456-2PN07341	
			137-1539	2PN01456-2PN01569	
			137-1540	2PN01572-2PN01588	
			137-1546	2PN01537-2PN07341	
			137-5327	2PN01589-2PN01704	
			137-5336	2PN01571-2PN01846	
			137-5337	2PN01630-2PN01702	
			137-5340	2PN01645-2PN07341	
			137-5341	2PN01657-2PN01657	

Part Number	Description	Machine Model / Application	Engine Arrangement	Engine Serial No.	Comments
			137-5342	2PN01663-2PN07341	
			137-5343	2PN01487-2PN03304	
			137-5355	2PN01571-2PN07341	
			137-5373	2PN01571-2PN01762	
			137-5384	2PN01670-2PN01675	
			137-5385	2PN01622-2PN01720	
			137-5409	2PN01675-2PN02377	
			137-5410	2PN01675-2PN03117	
			137-5411	2PN01675-2PN01858	
			137-5412	2PN01675-2PN02747	
			137-5417	2PN01675-2PN05659	
			137-5425	2PN01675-2PN05552	
			137-5426	2PN01675-2PN07341	
			137-5437	2PN01720-2PN07341	
CTPC10002A	Out of Frame OH Gasket Set	C-10 TRUCK ENGINE TURBOCHARGER	137-5438	2PN01720-2PN04026	Turbocharged Single Head
CRPC10002B	Inframe OH Set		137-5482	2PN01720-2PN02497	
CTPC10002C	Cylinder Head Repl. Gasket				

C-10 (cont.)

Part Number	Description	Machine Model / Application	Engine Arrangement	Engine Serial No.	Comments
CTPC10008A	Out of Frame OH Gasket Set	C-10 TRUCK ENGINE TURBOCHARGER	141-4239	2PN07341-2PN99999	Turbocharged Single Head
CTPC10008B	Inframe OH Set				
CTPC10008C	Cylinder Head Repl. Gasket Set				
CTPC10009A	Out of Frame OH Gasket Set	C-10 TRUCK ENGINE TURBOCHARGER	141-4250	2PN02522-2PN07341	Turbocharged Single Head
CTPC10009B	Inframe OH Set				
CTPC10009C	Cylinder Head Repl. Gasket Set				
CTPC10010A	Out of Frame OH Gasket Set	C-10 TRUCK ENGINE TURBOCHARGER	142-0615	2PN00001-2PN99999	Turbocharged Single Head
CTPC10010B	Inframe OH Set				
CTPC10010C	Cylinder Head Repl. Gasket Set		143-1194	2PN00001-2PN99999	
CTPC10011A	Out of Frame OH Gasket Set	C-10 TRUCK ENGINE TURBOCHARGER	143-1035	2PN03141-2PN03141	Turbocharged Single Head
CTPC10011B	Inframe OH Set				
CTPC10011C	Cylinder Head Repl. Gasket Set				
CTPC10012A	Out of Frame OH Gasket Set	C-10 TRUCK ENGINE TURBOCHARGER	143-1113	2PN03224-2PN03408	Turbocharged Single Head
CTPC10012B	Inframe OH Set				
CTPC10012C	Cylinder Head Repl. Gasket Set				
CTPC10013A	Out of Frame OH Gasket Set	C-10 TRUCK ENGINE TURBOCHARGER	143-1127	2PN00001-2PN99999	Turbocharged Single Head
CTPC10013B	Inframe OH Set				
CTPC10013C	Cylinder Head Repl. Gasket Set				
CTPC10014A	Out of Frame OH Gasket Set	C-10 TRUCK ENGINE TURBOCHARGER	143-1160	2PN03224-2PN07341	Turbocharged Single Head
CTPC10014B	Inframe OH Set				
CTPC10014C	Cylinder Head Repl. Gasket Set		144-5795	2PN03551-2PN07341	
CTPC10015A	Out of Frame OH Gasket Set	C-10 TRUCK ENGINE TURBOCHARGER	143-1197	2PN03414-2PN99999	Turbocharged Single Head
CTPC10015B	Inframe OH Set				
CTPC10015C	Cylinder Head Repl. Gasket Set				
CTPC10016A	Out of Frame OH Gasket Set	C-10 TRUCK ENGINE TURBOCHARGER	144-5789	2PN03593-2PN07341	Turbocharged Single Head
CTPC10016B	Inframe OH Set				
CTPC10016C	Cylinder Head Repl. Gasket Set				
CTPC10017A	Out of Frame OH Gasket Set	C-10 TRUCK ENGINE TURBOCHARGER	144-5870	2PN03626-2PN07341	Turbocharged Single Head
CTPC10017B	Inframe OH Set				
CTPC10017C	Cylinder Head Repl. Gasket Set				
CTPC10018A	Out of Frame OH Gasket Set	C-10 TRUCK ENGINE TURBOCHARGER	147-7489	2PN00001-2PN99999	Turbocharged Single Head
CTPC10018B	Inframe OH Set				
CTPC10018C	Cylinder Head Repl. Gasket Set				
CTPC10019A	Out of Frame OH Gasket Set	C-10 TRUCK ENGINE TURBOCHARGER	147-7493	2PN00001-2PN99999	Turbocharged Single Head
CTPC10019B	Inframe OH Set				
CTPC10019C	Cylinder Head Repl. Gasket Set				
CTPC10020A	Out of Frame OH Gasket Set	C-10 TRUCK ENGINE TURBOCHARGER	151-2288	2PN06047-2PN07341	Turbocharged Single Head
CTPC10020B	Inframe OH Set				
CTPC10020C	Cylinder Head Repl. Gasket Set				
CTPC10021A	Out of Frame OH Gasket Set	C-10 TRUCK ENGINE TURBOCHARGER	166-9888	3CS01-3CSUP	Turbocharged
CTPC10021B	Inframe OH Set				
CTPC10021C	Cylinder Head Repl. Gasket Set				

Part Number	Description	Machine Model / Application	Engine Arrangement	Engine Serial No.	Comments
CTPC10022A	Out of Frame OH Gasket Set	C-10 TRUCK ENGINE TURBOCHARGER	166-9891	3CS01-3CSUP	Turbocharged
CTPC10022B	Inframe OH Set		166-9892		
CTPC10022C	Cylinder Head Repl. Gasket Set		169-2346	3CS01-3CS17020	
			169-2347	3CS01-3CSUP	
			169-2349	3CS01-3CS17020	
			169-2350	3CS05801-3CSUP	
			169-2352		
			169-2353		
			169-2354		
			169-2355		
			169-2378		
			169-2379	3CS01-3CSUP	
			169-2381		
			169-2382		
			169-2395		
			169-2400		
			169-5162		
			169-9206		
			169-9215	3CS01-3CS16016	
			169-9293		
			169-9314		
			169-9342		
			169-9351		
			169-9376		
			169-9419		
			169-9420		
		169-9484			
169-9485					
169-9488					
170-7753					
171-4936					
171-4938					
171-4967					
171-4971	3CS01-3CSUP				
171-4981					
171-5009					
171-5014					
171-5015					
171-5018					
171-5019					
171-5027					
171-5029					
171-5050					
171-5053					
171-5054					

Part Number	Description	Machine Model / Application	Engine Arrangement	Engine Serial No.	Comments	
			171-5068	3CS01-3CSUP		
			171-5081			
			171-5115			
			171-5129			
			171-5160			
			171-5163			
			171-8212			
			171-8260			
			171-8311			
			171-8332			
			171-8334			
			171-8433			
			171-8447			
			171-8503			
			171-8517			
			172-8947			
			172-8988			
			172-9124			
			173-6283			3CS01-3CSUP
			173-6467			
			174-2666			
			175-1908			
			175-1914			
			175-1936			
			175-9162			
			175-9375			
175-9382						
178-1338						
178-1386						
178-1490						
178-1491						
179-1027						
179-1078						
179-1080						
186-1825						
CTPC10023A	Out of Frame OH Gasket Set	C-10 TRUCK ENGINE TURBOCHARGER	169-2344	3CS01-3CSUP	Turbocharged	
CTPC10023B	Inframe OH Set		169-2363			
CTPC10023C	Cylinder Head Repl. Gasket Set		169-2373	3CS05801-3CS17020		
CTPC10024A	Out of Frame OH Gasket Set	C-10 TRUCK ENGINE TURBOCHARGER	169-2358	3CS05801-3CS17020	Turbocharged	
CTPC10024B	Inframe OH Set					
CTPC10024C	Cylinder Head Repl. Gasket Set					
CTPC10025A	Out of Frame OH Gasket Set	C-10 TRUCK ENGINE TURBOCHARGER	169-9483	3CS01-3CSUP	Turbocharged	
CTPC10025B	Inframe OH Set		171-5032			
CTPC10025C	Cylinder Head Repl. Gasket Set		171-5055			
CTPC10026A	Out of Frame OH Gasket Set	C-10 TRUCK ENGINE TURBOCHARGER	171-4961	3CS01-3CSUP	Turbocharged	
CTPC10026B	Inframe OH Set					
CTPC10026C	Cylinder Head Repl. Gasket Set					
CTPC10027A	Out of Frame OH Gasket Set	C-10 TRUCK ENGINE TURBOCHARGER	171-4962	3CS01-3CSUP	Turbocharged	
CTPC10027B	Inframe OH Set		171-4986			
CTPC10027C	Cylinder Head Repl. Gasket Set		174-2663			
CTPC10028A	Out of Frame OH Gasket Set	C-10 TRUCK ENGINE TURBOCHARGER	171-5017	3CS01-UP	Turbocharged	
						175-1883
CTPC10028B	Inframe OH Set					
CTPC10028C	Cylinder Head Repl. Gasket Set					
CTPC10029A	Out of Frame OH Gasket Set	C-10 TRUCK ENGINE TURBOCHARGER	171-5030	3CS01-UP	Turbocharged	
CTPC10029B	Inframe OH Set					
CTPC10029C	Cylinder Head Repl. Gasket Set					

Part Number	Description	Machine Model / Application	Engine Arrangement	Engine Serial No.	Comments
CTPC10030A	Out of Frame OH Gasket Set	C-10 TRUCK ENGINE TURBOCHARGER	171-5051	3CS01-UP	Turbocharged
CTPC10030B	Inframe OH Set				
CTPC10030C	Cylinder Head Repl. Gasket Set				
CTPC10031A	Out of Frame OH Gasket Set	C-10 TRUCK ENGINE TURBOCHARGER	171-5130	3CS01-UP	Turbocharged
CTPC10031B	Inframe OH Set				
CTPC10031C	Cylinder Head Repl. Gasket Set				
CTPC10032A	Out of Frame OH Gasket Set	C-10 TRUCK ENGINE TURBOCHARGER	177-1203	3CS01-UP	Turbocharged
CTPC10032B	Inframe OH Set		177-1205		
CTPC10032C	Cylinder Head Repl. Gasket Set		178-1547		
			179-0920		
			179-1073		
			179-1150		
			179-1173		
			179-3791		
			179-3939		
			179-4087		
			180-1756		
			180-1817		
			180-1863		
			185-5051		
			187-0304		
			187-7872		
			187-7945		
			187-7946		
			187-7969		
			188-6806		
			189-9513		
			189-9527		
			191-4073		
			191-4179		
			191-4181		
			191-4182		
		191-4267			
191-4391					
192-9377					
192-9495					
192-9537					
192-9661					
197-1150					
198-3550					
201-6365					
202-9298					
202-9569					
206-8221					
CTPC10034A	Out of Frame OH Gasket Set	C-10 TRUCK ENGINE TURBOCHARGER	179-4088	3CS01-3CSUP	Turbocharged
CTPC10034B	Inframe OH Set		184-2878		
CTPC10034C	Cylinder Head Repl. Gasket Set		186-1960		
CTPC10035A	Out of Frame OH Gasket Set	C-10 TRUCK ENGINE TURBOCHARGER	197-1149	3CS01-3CSUP	Turbocharged
CTPC10035B	Inframe OH Set		235-9460		
CTPC10035C	Cylinder Head Repl. Gasket Set				
CTPC10036A	Out of Frame OH Gasket Set	C-10 TRUCK ENGINE TURBOCHARGER	218-9531	3CS01-3CSUP	Turbocharged
CTPC10036B	Inframe OH Set				
CTPC10036C	Cylinder Head Repl. Gasket Set				
CTPC10037A	Out of Frame OH Gasket Set	C-10 TRUCK ENGINE TURBOCHARGER	219-9382	3CS01-3CSUP	Turbocharged
CTPC10037B	Inframe OH Set		219-9419		
CTPC10037C	Cylinder Head Repl. Gasket Set		219-9427		

C-10 (cont.)

Part Number	Description	Machine Model / Application	Engine Arrangement	Engine Serial No.	Comments
CTPC10038A	Out of Frame OH Gasket Set	C-10 TRUCK ENGINE TURBOCHARGER	232-5782 233-8875 239-4529	3CS01-3CSUP	Turbocharged
CTPC10038B	Inframe OH Set				
CTPC10038C	Cylinder Head Repl. Gasket Set				
CTPC10039A	Out of Frame OH Gasket Set	C-10 TRUCK ENGINE TURBOCHARGER	234-8600	3CS01-3CSUP	Turbocharged
CTPC10039B	Inframe OH Set				
CTPC10039C	Cylinder Head Repl. Gasket Set				
CTPC10040A	Out of Frame OH Gasket Set	C-10 TRUCK ENGINE TURBOCHARGER	277-2761	3CS01-3CSUP	Turbocharged
CTPC10040B	Inframe OH Set				
CTPC10040C	Cylinder Head Repl. Gasket Set				

C-11

Part Number	Description	Machine Model / Application	Engine Arrangement	Engine Serial No.	Comments
CTPC11001A	Out of Frame OH Gasket Set	Industrial Petroleum engine 966h, 725, 730, 14M, RM-300		GLS0001-UP B5K001-UP RSX0001-UP	Turbocharged
CTPC11002A	Out of Frame OH Gasket Set	14M MOTOR GRADER	226-9770	RSX00001-RSX99999	Turbocharged Single Head
CTPC11002B	Inframe OH Set			TXE00001-TXE99999	
CTPC11002C	Cylinder Head Repl. Gasket Set				
CTPC11003A	Out of Frame OH Gasket Set	730 ARTICULATED & EJECTOR ARTICULATED TRUCK	227-8353	RSX00001-RSX99999	Turbocharged Single Head
CTPC11003B	Inframe OH Set				
CTPC11003C	Cylinder Head Repl. Gasket Set				
CTPC11004A	Out of Frame OH Gasket Set	966H WHEEL LOADER	234-7848	RSX01317-RSX99999	Turbocharged Single Head
CTPC11004B	Inframe OH Set			RSX00001-RSX99999	
CTPC11004C	Cylinder Head Repl. Gasket Set				
CTPC11005A	Out of Frame OH Gasket Set	966H WHEEL LOADER	234-7850	RSX01317-RSX99999	Turbocharged Single Head
CTPC11005B	Inframe OH Set				
CTPC11005C	Cylinder Head Repl. Gasket Set				
CTPC11006A	Out of Frame OH Gasket Set	966H WHEEL LOADER	349-4468	RSX18010-RSX99999	Turbocharged Single Head
CTPC11006B	Inframe OH Set			TXE00001-TXE99999	
CTPC11006C	Cylinder Head Repl. Gasket Set				
CTPC11007A	Out of Frame OH Gasket Set	C-11 ON HIGHWAY TRUCK	246-9420	KCA00001-KCA99999	Turbocharged Single Head
CTPC11007B	Inframe OH Set				
CTPC11007C	Cylinder Head Repl. Gasket Set				
CTPC11008A	Out of Frame OH Gasket Set	C-11 ON HIGHWAY TRUCK	246-9426, 246-9763, 246-9502, 248-4482, 246-9543, 248-4498, 246-9544, 248-4620, 246-9559, 248-4678, 246-9574, 248-4680, 248-4681, 250-7426, 249-8191, 250-7433,	KCA00001-KCA99999	Turbocharged
CTPC11008B	Inframe OH Set				
CTPC11008C	Cylinder Head Repl. Gasket Set				

Part Number	Description	Machine Model / Application	Engine Arrangement	Engine Serial No.	Comments
CTPC11008A	Out of Frame OH Gasket Set	C-11 ON HIGHWAY TRUCK	249-8365, 250-7440, 250-7321, 250-7480, 250-7332, 250-7482, 250-7364, 251-8854, 251-8855, 253-5824, 254-9447, 254-9581, 256-8949, 256-9089, 256-9265, 256-9266, 258-9134, 258-9136, 258-9137, 258-9138, 258-9257, 258-9258, 258-9287, 260-2682, 260-2684, 260-2702, 260-2752, 260-2777, 260-2788, 260-2825, 261-5316, 261-5347, 261-5465, 261-5489, 264-0736, 264-0826, 264-0871, 264-0872, 264-0907, 264-0937, 264-0943, 264-5647, 266-1804, 267-5920, 267-5937, 267-5939, 269-4337, 271-1128, 271-1257, 273-4482, 273-3132, 277-2907, 279-1646, 279-1863, 281-9745, 281-9945, 289-1646, 289-1653, 289-1955, 289-1983, 289-1984, 289-1986, 292-6147, 292-6206, 292-6207, 292-6241, 292-6246, 293-2490, 294-5883, 295-3577, 297-2051, 297-2152	KCA00001-KCA99999	Turbocharged
CTPC11008B	Inframe OH Set				
CTPC11008C	Cylinder Head Repl. Gasket Set				
CTPC11009A	Out of Frame OH Gasket Set	C-11 ON HIGHWAY TRUCK	246-9672	KCA00001-KCA99999	Turbocharged Single Head
CTPC11009B	Inframe OH Set				
CTPC11009C	Cylinder Head Repl. Gasket Set				
CTPC11010A	Out of Frame OH Gasket Set	C-11 ON HIGHWAY TRUCK	249-8328	KCA00001-KCA99999	Turbocharged Single Head
CTPC11010B	Inframe OH Set				
CTPC11010C	Cylinder Head Repl. Gasket Set				
CTPC11011A	Out of Frame OH Gasket Set	C-11 ON HIGHWAY TRUCK	250-7235 250-7427	KCA00001-KCA99999	Turbocharged Single Head
CTPC11011B	Inframe OH Set				
CTPC11011C	Cylinder Head Repl. Gasket Set				
CTPC11012A	Out of Frame OH Gasket Set	C-11 ON HIGHWAY TRUCK	250-7307 264-0813 281-9661-2337	KCA00001-KCA99999	Turbocharged Single Head
CTPC11012B	Inframe OH Set				
CTPC11012C	Cylinder Head Repl. Gasket Set				
CTPC11013A	Out of Frame OH Gasket Set	C-11 ON HIGHWAY TRUCK	250-7366	KCA00001-KCA99999	Turbocharged Single Head
CTPC11013B	Inframe OH Set				
CTPC11013C	Cylinder Head Repl. Gasket Set				
CTPC11014A	Out of Frame OH Gasket Set	730	2929283	TXE01-UP	Turbocharged
CTPC11014B	Inframe OH Set				
CTPC11014C	Cylinder Head Repl. Gasket Set				

C-12

Part Number	Description	Machine Model / Application	Machine Serial Number	Engine Serial No.	Comments
CTPC12001A	Out of Frame OH Gasket Set	C-12 TRUCK	2281500 / 2348391 2301704 / 2359388 2325767 / 2338822 2338823	MBL1-UP	Turbocharged
CTPC12001B	Inframe OH Set				
CTPC12001C	Cylinder Head Repl. Gasket Set				
CTPC12002A	Out of Frame OH Gasket Set	TRUCK	1998694	2KS01-UP	Turbocharged
CTPC12002B	Inframe OH Set				
CTPC12002C	Cylinder Head Repl. Gasket Set				
CTPC12003A	Out of Frame OH Gasket Set	972G	180-3195	5ED00001-5ED99999	
CTPC12003B	Inframe OH Set				
CTPC12003C	Cylinder Head Repl. Gasket Set				
CTPC12004A	Out of Frame OH Gasket Set	MTC84	172-6946	5ED00001-5ED99999	
CTPC12004B	Inframe OH Set				
CTPC12004C	Cylinder Head Repl. Gasket Set				
CTPC12005A	Out of Frame OH Gasket Set	C-12	203-7099	BDL00001-BDL99999	
CTPC12005B	Inframe OH Set				
CTPC12005C	Cylinder Head Repl. Gasket Set				
CTPC12006A	Out of Frame OH Gasket Set	C-12	205-2511	BDL00001-BDL99999	
CTPC12006B	Inframe OH Set				
CTPC12006C	Cylinder Head Repl. Gasket Set				
CTPC12007A	Out of Frame OH Gasket Set	C-12	206-8412	BDL00001-BDL99999	
CTPC12007B	Inframe OH Set				
CTPC12007C	Cylinder Head Repl. Gasket Set				
CTPC12008A	Out of Frame OH Gasket Set	C-12	228-1354 / 229-4551, 229-4552 / 229-4599, 230-8409	BDL00001-BDL99999	
CTPC12008B	Inframe OH Set				
CTPC12008C	Cylinder Head Repl. Gasket Set				
CTPC12009A	Out of Frame OH Gasket Set	C-12	228-1438 / 230-2020, 228-1439 / 230-8601, 228-1500 / 230-8685, 229-4445 / 231-5468, 229-4447 / 231-5780, 229-4600 / 231-5781, 229-4686 / 232-5696, 230-1965 / 232-5765, 230-1936 / 233-8890, 233-8958	BDL00001-BDL99999	
CTPC12009B	Inframe OH Set				
CTPC12009C	Cylinder Head Repl. Gasket Set				
CTPC12010A	Out of Frame OH Gasket Set	C-12	228-1502	BDL00001-BDL99999	
CTPC12010B	Inframe OH Set				
CTPC12010C	Cylinder Head Repl. Gasket Set				
CTPC12011A	Out of Frame OH Gasket Set	C-12	228-1503	BDL00001-BDL99999	
CTPC12011B	Inframe OH Set				
CTPC12011C	Cylinder Head Repl. Gasket Set				
CTPC12012A	Out of Frame OH Gasket Set	C-12	229-4428 / 231-5537 229-4429 / 231-5550 229-4434 / 231-5620 229-4614 / 231-5626 229-4615 / 231-5732 230-1860 / 231-5791 230-1876 / 232-5544 230-1884 / 232-5545 232-5707 / 232-5708 233-8788 / 233-8855 234-8400 / 235-9400 235-9413 / 235-9414	BDL00001-BDL99999	
CTPC12012B	Inframe OH Set				
CTPC12012C	Cylinder Head Repl. Gasket Set				

Part Number	Description	Machine Model / Application	Machine Serial Number	Engine Serial No.	Comments
CTPC12013A	Out of Frame OH Gasket Set	C-12	229-4550 / 232-5667 229-4766 / 232-5717 232-5426 / 233-8821	BDL00001-BDL99999	
CTPC12013B	Inframe OH Set				
CTPC12013C	Cylinder Head Repl. Gasket Set				
CTPC12014A	Out of Frame OH Gasket Set	C-12	229-4801 / 232-5783 229-4802 / 229-1693 230-1822 / 230-1850 230-1851	BDL00001-BDL99999	
CTPC12014B	Inframe OH Set				
CTPC12014C	Cylinder Head Repl. Gasket Set				
CTPC12015A	Out of Frame OH Gasket Set	C-12	229-4803 / 231-5696 229-4804 / 232-5764 229-4805	BDL00001-BDL99999	
CTPC12015B	Inframe OH Set				
CTPC12015C	Cylinder Head Repl. Gasket Set				
CTPC12016A	Out of Frame OH Gasket Set	C-12	229-4807 229-4808 232-5395	BDL00001-BDL99999	
CTPC12016B	Inframe OH Set				
CTPC12016C	Cylinder Head Repl. Gasket Set				
CTPC12017A	Out of Frame OH Gasket Set	C-12	231-5769	BDL00001-BDL99999	
CTPC12017B	Inframe OH Set				
CTPC12017C	Cylinder Head Repl. Gasket Set				
CTPC12018A	Out of Frame OH Gasket Set	C-12	235-8040 235-8162	BDL00001-BDL99999	
CTPC12018B	Inframe OH Set				
CTPC12018C	Cylinder Head Repl. Gasket Set				
CTPC12019A	Out of Frame OH Gasket Set	C-12	239-4530	BDL00001-BDL99999	
CTPC12019B	Inframe OH Set				
CTPC12019C	Cylinder Head Repl. Gasket Set				
CTPC12020A	Out of Frame OH Gasket Set	C-12	135-4845 139-3490 139-9834 141-4233 141-4236	2KS00304-2KS00343 2KS00001-2KS00321 2KS00326-2KS00349 2KS00001-2KS00327	
CTPC12020B	Inframe OH Set				
CTPC12020C	Cylinder Head Repl. Gasket Set				
CTPC12021A	Out of Frame OH Gasket Set				
CTPC12021B	Inframe OH Set				
CTPC12021C	Cylinder Head Repl. Gasket Set				

C-12(cont.)

Part Number	Description	Machine Model / Application	Machine Serial Number	Engine Serial No.	Comments
			171-8221/171-8384 171-8403/171-8435 171-8523/179-4038 179-4073/180-1848		
CTPC12022A	Out of Frame OH Gasket Set	C-12	166-9519/169-2289 166-9688/169-2292 169-2276/169-2296 169-2280/169-5191 169-2285/169-5192 169-2287/169-5197 169-5198/169-5200 169-5205/169-5206 169-5207/169-9213 169-9226/169-9296 169-9306/169-9309 169-9334/169-9412 169-9413/169-9414 169-9418/169-9470 169-9471/169-9474 170-7914/170-7941	2KS00001-2KS99999	
CTPC12022B	Inframe OH Set				
CTPC12022C	Cylinder Head Repl. Gasket Set				
			169-5154/169-5155 169-5170/169-5171	2KS00010-2KS99999	
CTPC12023A	Out of Frame OH Gasket Set	C-12	166-9521/169-5240 166-9538/169-9227 166-9764/169-9297 169-2444/169-9466	2KS00001-2KS99999	
CTPC12023B	Inframe OH Set				
CTPC12023C	Cylinder Head Repl. Gasket Set		169-2435	2KS00403-2KS99999	
CTPC12024A	Out of Frame OH Gasket Set				
CTPC12024B	Inframe OH Set	C-12	166-9519	2KS00001-2KS99999	
CTPC12024C	Cylinder Head Repl. Gasket Set				
CTPC12025A	Out of Frame OH Gasket Set				
CTPC12025B	Inframe OH Set	C-12	169-2281	2KS00001-2KS99999	
CTPC12025C	Cylinder Head Repl. Gasket Set				
CTPC12026A	Out of Frame OH Gasket Set				
CTPC12026B	Inframe OH Set	C-12	169-2284	2KS00001-2KS99999	
CTPC12026C	Cylinder Head Repl. Gasket Set				
CTPC12023A	Out of Frame OH Gasket Set	C-12	166-9521/169-5240 166-9538/169-9227 166-9764/169-9297 169-2444/169-9466	2KS00001-2KS99999	
CTPC12023B	Inframe OH Set				
CTPC12023C	Cylinder Head Repl. Gasket Set		169-2435	2KS00403-2KS99999	
CTPC12024A	Out of Frame OH Gasket Set				
CTPC12024B	Inframe OH Set	C-12	166-9519	2KS00001-2KS99999	
CTPC12024C	Cylinder Head Repl. Gasket Set				
CTPC12025A	Out of Frame OH Gasket Set				
CTPC12025B	Inframe OH Set	C-12	169-2281	2KS00001-2KS99999	
CTPC12025C	Cylinder Head Repl. Gasket Set				
CTPC12026A	Out of Frame OH Gasket Set				
CTPC12026B	Inframe OH Set	C-12	169-2284	2KS00001-2KS99999	
CTPC12026C	Cylinder Head Repl. Gasket Set				
CTPC12027A	Out of Frame OH Gasket Set				
CTPC12027B	Inframe OH Set	C-12	169-2313	2KS00001-2KS99999	
CTPC12027C	Cylinder Head Repl. Gasket Set				
CTPC12028A	Out of Frame OH Gasket Set				
CTPC12028B	Inframe OH Set	C-12	169-2329	2KS00464-2KS99999	
CTPC12028C	Cylinder Head Repl. Gasket Set		169-9390	2KS00001-2KS99999	

Part Number	Description	Machine Model / Application	Machine Serial Number	Engine Serial No.	Comments
CTPC12029A	Out of Frame OH Gasket Set		169-9212/170-7895		
CTPC12029B	Inframe OH Set	C-12	169-9391	2KS00001-2KS99999	
CTPC12029C	Cylinder Head Repl. Gasket Set		169-9469		
CTPC12030A	Out of Frame OH Gasket Set	C-12	169-9416/169-9479 169-9476/169-9481 169-9477/170-7911 172-8908/172-9076 172-9173/173-6320 173-6493/174-2641 175-1998/175-9151 175-9229/175-9240 175-9269/175-9341 177-1138/177-1331 178-1347/178-1516 179-1188/179-3953 180-2007/184-2763 184-2769/184-2777 184-2805/184-2814 185-4808/185-4930 185-5019/186-1833 186-1948/186-1949 187-0041/187-0174 189-9693/191-4104 191-4148/191-4186 191-4190/191-4200 191-4215/191-4222 191-4274/191-4284 191-4327/191-4343 191-4353/192-9297 192-9314/192-9640 195-4334/197-1273 198-3624/199-8642 199-8696/199-8717 202-9454/205-2555 205-2742/205-2887 212-1759/212-9074 212-9296/214-2940	2KS00001-2KS99999	
CTPC12030B	Inframe OH Set				
CTPC12030C	Cylinder Head Repl. Gasket Set				
CTPC12031A	Out of Frame OH Gasket Set				
CTPC12031B	Inframe OH Set	C-12	169-9475	2KS00001-2KS99999	
CTPC12031C	Cylinder Head Repl. Gasket Set		169-9495		
CTPC12032A	Out of Frame OH Gasket Set				
CTPC12032B	Inframe OH Set	C-12	169-9478	2KS00001-2KS99999	
CTPC12032C	Cylinder Head Repl. Gasket Set				
CTPC12033A	Out of Frame OH Gasket Set		169-9480		
CTPC12033B	Inframe OH Set	C-12	172-8890	2KS00001-2KS99999	
CTPC12033C	Cylinder Head Repl. Gasket Set				
CTPC12034A	Out of Frame OH Gasket Set				
CTPC12034B	Inframe OH Set	C-12	169-9494	2KS00001-2KS99999	
CTPC12034C	Cylinder Head Repl. Gasket Set				
CTPC12035A	Out of Frame OH Gasket Set				
CTPC12035B	Inframe OH Set	C-12	169-9496	2KS00001-2KS99999	
CTPC12035C	Cylinder Head Repl. Gasket Set				
CTPC12036A	Out of Frame OH Gasket Set				
CTPC12036B	Inframe OH Set	C-12	170-7913	2KS00001-2KS99999	
CTPC12036C	Cylinder Head Repl. Gasket Set				
CTPC12037A	Out of Frame OH Gasket Set				
CTPC12037B	Inframe OH Set	C-12	170-7940	2KS00001-2KS99999	
CTPC12037C	Cylinder Head Repl. Gasket Set				

Part Number	Description	Machine Model / Application	Machine Serial Number	Engine Serial No.	Comments
CTPC12038A	Out of Frame OH Gasket Set				
CTPC12038B	Inframe OH Set	C-12	172-8999	2KS00001-2KS99999	
CTPC12038C	Cylinder Head Repl. Gasket Set		187-0379		
CTPC12039A	Out of Frame OH Gasket Set				
CTPC12039B	Inframe OH Set	C-12	174-2780	2KS00001-2KS99999	
CTPC12039C	Cylinder Head Repl. Gasket Set				
CTPC12040A	Out of Frame OH Gasket Set	C-12	187-0300/192-9261 187-7947/198-3511 191-4259/198-3697 202-9356/202-9447 204-2416/205-2633 208-7096/212-9259 212-9286/214-2711 214-2765/214-2769 214-2800/214-2801 214-2818/214-2854 214-2873/214-2876 214-2904/215-5080 215-5113/215-5160 215-5161/215-5173 215-5186/215-5221 215-5222/215-5223 215-5226/215-5238 215-5362/215-5363 215-5364/215-5429 215-5455/215-5487 217-1034/217-1035 217-1069/217-1228 217-1229/217-1304 218-9432/218-9515 219-9353/220-7687 222-9465/222-9478 222-9481/222-9496 222-9565/222-9584 224-0395/224-0402 224-0403/224-0404 224-0420/224-0422 224-0424/224-0428 224-0432/224-0478 224-0480/224-0502 224-0504/224-0508 224-0530/224-0533 224-0542/224-0591 224-0657/224-7919 225-7968/224-7971 225-2049/225-2056 225-9897/225-9919	2KS00001-2KS99999	
CTPC12040B	Inframe OH Set				
CTPC12040C	Cylinder Head Repl. Gasket Set				
CTPC12041A	Out of Frame OH Gasket Set				
CTPC12041B	Inframe OH Set	C12	187-7951	2KS00001-2KS99999	
CTPC12041C	Cylinder Head Repl. Gasket Set				
CTPC12042A	Out of Frame OH Gasket Set	C-12	198-3543/206-8329 198-3739/219-9432 201-6381/219-9437 219-9439/220-7532 220-7533/220-7534 220-7554/220-7558 220-7562/220-7643 220-7683/220-7689 220-7712/220-7746 221-7431/221-7446 222-9589/224-7861	2KS00001-2KS99999	
CTPC12042B	Inframe OH Set				
CTPC12042C	Cylinder Head Repl. Gasket Set				
CTPC12043A	Out of Frame OH Gasket Set		198-3701		
CTPC12043B	Inframe OH Set	C-12	218-9667	2KS00001-2KS99999	
CTPC12043C	Cylinder Head Repl. Gasket Set				
CTPC12044A	Out of Frame OH Gasket Set		201-6461		
CTPC12044B	Inframe OH Set	C-12	202-9374	2KS00001-2KS99999	
CTPC12044C	Cylinder Head Repl. Gasket Set				

Part Number	Description	Machine Model / Application	Machine Serial Number	Engine Serial No.	Comments
CTPC12045A	Out of Frame OH Gasket Set		212-1813		
CTPC12045B	Inframe OH Set	C-12	212-1814	2KS00001-2KS99999	
CTPC12045C	Cylinder Head Repl. Gasket Set		218-9537		
CTPC12046A	Out of Frame OH Gasket Set		215-5225		
CTPC12046B	Inframe OH Set	C-12	215-5255	2KS00001-2KS99999	
CTPC12046C	Cylinder Head Repl. Gasket Set				
CTPC12047A	Out of Frame OH Gasket Set		215-5428		
CTPC12047B	Inframe OH Set	C-12	218-9497	2KS00001-2KS99999	
CTPC12047C	Cylinder Head Repl. Gasket Set				
CTPC12048A	Out of Frame OH Gasket Set		219-9435		
CTPC12048B	Inframe OH Set	C-12	221-7343	2KS00001-2KS99999	
CTPC12048C	Cylinder Head Repl. Gasket Set				
CTPC12049A	Out of Frame OH Gasket Set		221-7203/222-9600 221-7267/222-9609 221-7289	2KS00001-2KS99999	
CTPC12049B	Inframe OH Set	C-12			
CTPC12049C	Cylinder Head Repl. Gasket Set				
CTPC12050A	Out of Frame OH Gasket Set		222-9599/233-8805 224-0269/233-9002 224-0585	2KS00001-2KS99999	
CTPC12050B	Inframe OH Set	C-12			
CTPC12050C	Cylinder Head Repl. Gasket Set				
CTPC12051A	Out of Frame OH Gasket Set		231-5488/233-8973 231-5687/234-8555 231-5723/239-4642 264-0818/299-8588	2KS00001-2KS99999	
CTPC12051B	Inframe OH Set	C-12			
CTPC12051C	Cylinder Head Repl. Gasket Set				
CTPC12052A	Out of Frame OH Gasket Set				
CTPC12052B	Inframe OH Set	C-12	144-5809	9NS00372-9NS99999	
CTPC12052C	Cylinder Head Repl. Gasket Set				

C-13

Part Number	Description	Machine Model / Application	Machine Serial Number	Engine Serial No.	Comments
CTPC13001A	Out of Frame OH Gasket Set				
CTPC13002B	Inframe OH Set	**	**	**	Turbocharged
CTPC13002C	Cylinder Head Repl. Gasket Set				
CTPC13002A	Out of Frame OH Gasket Set				
CTPC13002B	Inframe OH Set	16M MOTOR GRADER	227-5359 231-0876	MHX00001-MHX99999	Turbocharged Single Head
CTPC13002C	Cylinder Head Repl. Gasket Set				
CTPC13003A	Out of Frame OH Gasket Set				
CTPC13003B	Inframe OH Set	329D 345D L 349D L	291-9259	MHX00001-MHX99999	Turbocharged Single Head
CTPC13003C	Cylinder Head Repl. Gasket Set				
CTPC13004A	Out of Frame OH Gasket Set				
CTPC13004B	Inframe OH Set	345C W345C	241-8344 280-3645	MHX00001-MHX99999	Turbocharged Single Head
CTPC13004C	Cylinder Head Repl. Gasket Set				

C-13 (cont.)

Part Number	Description	Machine Model / Application	Machine Serial Number	Engine Serial No.	Comments
CTPC13005A	Out of Frame OH Gasket Set	345D 349D	291-9259	TXF00001- TXF99999	Turbocharged Single Head
CTPC13005B	Inframe OH Set				
CTPC13005C	Cylinder Head Repl. Gasket Set				
CTPC13006A	Out of Frame OH Gasket Set	C-13 ON-HIGHWAY	234-8423, 245-7253, 234-8424, 245-7290, 235-9184, 245-7291, 235-9334, 246-9390, 239-4640, 246-9393, 239-4641, 246-9404, 241-1210, 246-9413, 242-7563, 246-9415, 242-7688, 246-9416, 242-7694, 246-9509, 242-7699, 246-9517, 242-7708, 246-9519, 242-7735, 246-9594, 242-7738, 246-9607, 242-7892, 246-9608, 242-7898, 246-9610, 242-7905, 246-9612, 242-7921, 246-9627, 242-7924, 246-9629, 244-4547, 246-9647, 244-4548, 246-9661, 244-4559, 246-9666, 244-4587, 246-9744, 244-4645, 246-9779, 244-4646, 246-9784, 244-4760, 246-9800, 244-4761, 248-4411, 244-4823, 248-4412, 244-4838, 248-4414, 245-6878, 248-4424, 245-6903, 248-4432, 245-6924, 248-4470, 245-7000, 248-4519, 245-7047, 248-4538, 245-7048, 248-4550, 245-7053, 249-8197, 245-7054, 249-8205, 245-7055, 249-8327, 245-7064, 249-8357, 245-7069, 249-8404, 245-7118, 249-8422, 245-7124, 249-7249, 245-7127, 250-7277, 245-7248, 250-7370, 251-8852, 251-8945, 253-5846, 253-5885, 258-9121, 258-9124, 258-9127, 258-9142, 258-9148, 258-9297, 258-9318, 263-0438, 263-0658, 264-0803, 264-0811, 264-0828, 264-0878, 264-0899, 267-5864, 267-5965	KCB00001- KCB99999	Turbocharged Single Head
CTPC13006B	Inframe OH Set				
CTPC13006C	Cylinder Head Repl. Gasket Set				
CTPC13007A	Out of Frame OH Gasket Set	C-13 ON-HIGHWAY	242-7742 281-9757	KCB00001- KCB99999	Turbocharged Single Head
CTPC13007B	Inframe OH Set				
CTPC13007C	Cylinder Head Repl. Gasket Set				
CTPC13008A	Out of Frame OH Gasket Set	C-13 ON-HIGHWAY	242-7920	KCB00001- KCB99999	Turbocharged Single Head
CTPC13008B	Inframe OH Set				
CTPC13008C	Cylinder Head Repl. Gasket Set				
CTPC13009A	Out of Frame OH Gasket Set	C-13 ON-HIGHWAY	244-4780 244-4803	KCB00001- KCB99999	Turbocharged Single Head
CTPC13009B	Inframe OH Set				
CTPC13009C	Cylinder Head Repl. Gasket Set				
CTPC13010A	Out of Frame OH Gasket Set	C-13 ON-HIGHWAY	250-7471	KCB00001- KCB99999	Turbocharged Single Head
CTPC13010B	Inframe OH Set				
CTPC13010C	Cylinder Head Repl. Gasket Set				
CTPC13011A	Out of Frame OH Gasket Set	C-13 ON-HIGHWAY	258-9140	KCB00001- KCB99999	Turbocharged Single Head
CTPC13011B	Inframe OH Set				
CTPC13011C	Cylinder Head Repl. Gasket Set				

Part Number	Description	Machine Model / Application	Machine Serial Number	Engine Serial No.	Comments
CTPC13012A	Out of Frame OH Gasket Set	C-13 ON-HIGHWAY	258-9296	KCB00001- KCB99999	Turbocharged Single Head
CTPC13012B	Inframe OH Set				
CTPC13012C	Cylinder Head Repl. Gasket Set				
CTPC13013A	Out of Frame OH Gasket Set	C-13 ON-HIGHWAY	258-9300 258-9313	KCB00001- KCB99999	Turbocharged Single Head
CTPC13013B	Inframe OH Set				
CTPC13013C	Cylinder Head Repl. Gasket Set				
CTPC13014A	Out of Frame OH Gasket Set	C-13 ON-HIGHWAY	258-9301 260-2725	KCB00001- KCB99999	Turbocharged Single Head
CTPC13014B	Inframe OH Set				
CTPC13014C	Cylinder Head Repl. Gasket Set				
CTPC13015A	Out of Frame OH Gasket Set	C-13 ON-HIGHWAY	260-2870	KCB00001- KCB99999	Turbocharged Single Head
CTPC13015B	Inframe OH Set				
CTPC13015C	Cylinder Head Repl. Gasket Set				
CTPC13016A	Out of Frame OH Gasket Set	C-13 ON-HIGHWAY	264-0804 264-0805 264-0806 264-0877 284-0179	KCB00001- KCB99999	Turbocharged Single Head
CTPC13016B	Inframe OH Set				
CTPC13016C	Cylinder Head Repl. Gasket Set				
CTPC13017A	Out of Frame OH Gasket Set	C-13 ON-HIGHWAY	267-5956 267-5966 267-6023 269-4289 271-1163	KCB00001- KCB99999	Turbocharged Single Head
CTPC13017B	Inframe OH Set				
CTPC13017C	Cylinder Head Repl. Gasket Set				
CTPC13018A	Out of Frame OH Gasket Set	C-13 ON-HIGHWAY	269-4286	KCB00001- KCB99999	Turbocharged Single Head
CTPC13018B	Inframe OH Set				
CTPC13018C	Cylinder Head Repl. Gasket Set				
CTPC13019A	Out of Frame OH Gasket Set	C-13 ON-HIGHWAY	269-4338	KCB00001- KCB99999	Turbocharged Single Head
CTPC13019B	Inframe OH Set				
CTPC13019C	Cylinder Head Repl. Gasket Set				
CTPC13020A	Out of Frame OH Gasket Set	C-13 ON-HIGHWAY	269-4342 279-1696	KCB00001- KCB99999	Turbocharged Single Head
CTPC13020B	Inframe OH Set				
CTPC13020C	Cylinder Head Repl. Gasket Set				
CTPC13021A	Out of Frame OH Gasket Set	C-13 ON-HIGHWAY	277-2624	KCB00001- KCB99999	Turbocharged Single Head
CTPC13021B	Inframe OH Set				
CTPC13021C	Cylinder Head Repl. Gasket Set				
CTPC13022A	Out of Frame OH Gasket Set	C-13 ON-HIGHWAY	277-2865 277-2872	KCB00001- KCB99999	Turbocharged Single Head
CTPC13022B	Inframe OH Set				
CTPC13022C	Cylinder Head Repl. Gasket Set				
CTPC13023A	Out of Frame OH Gasket Set	C-13 ON-HIGHWAY	277-2868	KCB00001- KCB99999	Turbocharged Single Head
CTPC13023B	Inframe OH Set				
CTPC13023C	Cylinder Head Repl. Gasket Set				
CTPC13024A	Out of Frame OH Gasket Set	C-13 ON-HIGHWAY	279-1862	KCB00001- KCB99999	Turbocharged Single Head
CTPC13024B	Inframe OH Set				
CTPC13024C	Cylinder Head Repl. Gasket Set				
CTPC13025A	Out of Frame OH Gasket Set	C-13 ON-HIGHWAY	289-0863 289-1684	KCB00001- KCB99999	Turbocharged Single Head
CTPC13025B	Inframe OH Set				
CTPC13025C	Cylinder Head Repl. Gasket Set				

Part Number	Description	Machine Model / Application	Machine Serial Number	Engine Serial No.	Comments
CTPC13026A	Out of Frame OH Gasket Set	C-13 ON-HIGHWAY	289-1656 289-1681 289-1773 289-1929	KCB00001- KCB99999	Turbocharged Single Head
CTPC13026B	Inframe OH Set				
CTPC13026C	Cylinder Head Repl. Gasket Set				
CTPC13027A	Out of Frame OH Gasket Set	C-13 ON-HIGHWAY	289-1659	KCB00001- KCB99999	Turbocharged Single Head
CTPC13027B	Inframe OH Set				
CTPC13027C	Cylinder Head Repl. Gasket Set				
CTPC13028A	Out of Frame OH Gasket Set	C-13 ON-HIGHWAY	289-1703	KCB00001- KCB99999	Turbocharged Single Head
CTPC13028B	Inframe OH Set				
CTPC13028C	Cylinder Head Repl. Gasket Set				
CTPC13029A	Out of Frame OH Gasket Set	C-13 ON-HIGHWAY	289-1723	KCB00001- KCB99999	Turbocharged Single Head
CTPC13029B	Inframe OH Set				
CTPC13029C	Cylinder Head Repl. Gasket Set				
CTPC13030A	Out of Frame OH Gasket Set	C-13 ON-HIGHWAY	289-1863	KCB00001- KCB99999	Turbocharged Single Head
CTPC13030B	Inframe OH Set				
CTPC13030C	Cylinder Head Repl. Gasket Set				
CTPC13031A	Out of Frame OH Gasket Set	C-13 ON-HIGHWAY	289-1864	KCB00001- KCB99999	Turbocharged Single Head
CTPC13031B	Inframe OH Set				
CTPC13031C	Cylinder Head Repl. Gasket Set				
CTPC13032A	Out of Frame OH Gasket Set	C-13 ON-HIGHWAY	289-1949	KCB00001- KCB99999	Turbocharged Single Head
CTPC13032B	Inframe OH Set				
CTPC13032C	Cylinder Head Repl. Gasket Set				
CTPC13033A	Out of Frame OH Gasket Set	C-13 ON-HIGHWAY	289-1951 289-1957	KCB00001- KCB99999	Turbocharged Single Head
CTPC13033B	Inframe OH Set				
CTPC13033C	Cylinder Head Repl. Gasket Set				
CTPC13034A	Out of Frame OH Gasket Set	C-13 ON-HIGHWAY	293-2611	KCB00001- KCB99999	Turbocharged Single Head
CTPC13034B	Inframe OH Set				
CTPC13034C	Cylinder Head Repl. Gasket Set				
CTPC13035A	Out of Frame OH Gasket Set	C-13 ON-HIGHWAY	295-3794 297-2034	KCB00001- KCB99999	Turbocharged Single Head
CTPC13035B	Inframe OH Set				
CTPC13035C	Cylinder Head Repl. Gasket Set				
CTPC13036A	Out of Frame OH Gasket Set	C-13 ON-HIGHWAY	297-2268	KCB00001- KCB99999	Turbocharged Single Head
CTPC13036B	Inframe OH Set				
CTPC13036C	Cylinder Head Repl. Gasket Set				
CTPC13037A	Out of Frame OH Gasket Set	C-13 ON-HIGHWAY	289-1965, 292-6300, 297-2194, 297-2303, 302-4997, 302-4998, 302-5001, 302-5016, 302-5044, 302-5050, 302-5051, 302-5052, 302-5053, 302-5054, 302-5077, 305-9620, 305-9632, 305-9637, 305-9639, 305-9640, 305-9680, 305-9682, 305-9685, 305-9701, 305-9704, 305-9706, 305-9724, 305-9725, 305-9766, 305-9767, 305-9769, 305-9790, 305-9791, 305-9792, 305-9812, 305-9813, 305-9825, 305-9826, 305-9830,	KCB00001- KCB99999	Turbocharged Single Head
CTPC13037B	Inframe OH Set				
CTPC13037C	Cylinder Head Repl. Gasket Set				

Part Number	Description	Machine Model / Application	Machine Serial Number	Engine Serial No.	Comments
CTPC13037A	Out of Frame OH Gasket Set	C-13 ON-HIGHWAY	311-9792, 311-9793, 311-9822, 311-9834, 311-9843, 311-9844, 311-9852, 311-9857, 311-9864, 311-9868, 311-9922, 311-9923, 311-9925, 311-9934, 311-9996, 311-9998, 314-4356, 314-4358, 314-4372, 314-4397, 314-4398, 314-4399, 314-4428, 314-4430, 314-4449, 314-4489, 314-4497, 314-4512, 314-4567, 314-4614, 314-4619, 314-4650, 314-4655, 314-4657, 314-4699, 314-4700, 317-0156, 317-0161, 317-0166, 317-0212, 317-0234, 317-0249, 317-0256, 317-0258, 317-0270, 317-0275, 317-0283, 317-0285, 317-0293, 317-0294, 317-0297, 317-0319, 317-0327, 317-0349, 317-0358, 317-0372, 317-0377, 317-0383, 317-0391, 317-0399, 317-0410, 317-0412, 317-0435, 317-0467, 317-0470, 319-4616, 319-4622, 319-4638, 319-4661, 319-4699, 319-4714, 319-4750, 319-4755, 319-4764, 319-4818, 319-4819, 319-4840, 322-4140, 322-4184, 322-4199, 322-4400, 322-4401, 322-4402, 322-4456, 323-4836, 323-4893, 323-4894, 323-4925, 323-4932, 323-4934, 323-4936, 323-4938, 323-4941, 324-8514, 324-8519, 324-8520, 324-8521, 324-8523, 324-8525, 324-8526, 324-8532, 324-8580, 324-8586, 324-8587, 324-8588, 324-8594, 324-8595, 324-8607, 324-8611, 324-8616, 324-8620, 324-8627, 324-8636, 324-8637, 324-8651, 325-2030, 325-2057, 325-2058, 325-2059, 325-2061, 325-2065, 325-2088, 325-2089, 325-2110, 325-2112, 325-2113, 325-2137, 325-2159, 325-2165, 325-2179, 325-2180, 325-2190, 325-2192, 325-2200, 325-2206, 325-2241, 325-2243, 325-2254, 325-2255, 325-2266, 325-2267	KCB00001- KCB99999	Turbocharged Single Head
CTPC13037B	Inframe OH Set				
CTPC13037C	Cylinder Head Repl. Gasket Set				

C-13 (cont.)

Part Number	Description	Machine Model / Application	Machine Serial Number	Engine Serial No.	Comments
CTPC13037A	Out of Frame OH Gasket Set	C-13 ON-HIGHWAY	330-6472, 330-6473, 330-6474, 330-6480, 330-6483, 330-6489, 332-8161, 332-8197, 332-8299, 332-8340, 332-8366, 332-8423, 332-8507, 332-8510, 332-8511, 332-8516, 339-9003, 341-1149, 343-7528, 343-7529	KCB00001-KCB99999	Turbocharged Single Head
CTPC13037B	Inframe OH Set				
CTPC13037C	Cylinder Head Repl. Gasket Set				
CTPC13038A	Out of Frame OH Gasket Set	C-13 ON-HIGHWAY	295-3763, 299-8743, 302-5095, 302-5096, 302-5097, 305-9568, 305-9607, 305-9657, 305-9659, 305-9710, 307-7013, 307-7014, 307-7085, 307-7131, 307-7142, 307-7147, 307-7275, 307-7276, 307-7277, 307-7278, 309-8054, 309-8161, 309-8233, 309-8294, 309-8335, 309-8349, 311-9664, 311-9689, 311-9815, 311-9826, 314-4374, 314-4386, 314-4599, 314-4627, 314-4689, 319-4556, 319-4742, 322-4455, 323-4861, 323-4872, 323-4876, 307-4877, 323-5024, 323-5032, 323-5034, 323-5041, 323-5046, 323-5048, 324-8558, 324-8562, 324-8566, 325-2012, 325-2018, 325-2118, 325-2119, 325-2125, 325-2127, 325-2129, 325-2248, 327-1798, 327-1820, 327-1825, 327-1827, 327-1853, 327-1869, 327-1870, 327-1906, 327-1921, 327-1955, 327-1977, 327-1990, 327-2013, 327-2066, 328-7864, 328-7896, 328-8061, 328-8180, 330-6171, 330-6386, 332-8171, 332-8176, 332-8351, 332-8457, 332-8462, 332-8471, 338-3802, 339-9012, 341-1148	LEE00001-LEE99999	Turbocharged Single Head
CTPC13038B	Inframe OH Set				
CTPC13038C	Cylinder Head Repl. Gasket Set				
CTPC13039A	Out of Frame OH Gasket Set	C-13 ON-HIGHWAY	295-3822	LEE00001-LEE99999	Turbocharged Single Head
CTPC13039B	Inframe OH Set				
CTPC13039C	Cylinder Head Repl. Gasket Set				
CTPC13040A	Out of Frame OH Gasket Set	C-13 ON-HIGHWAY	299-8744, 307-7072, 311-9824, 319-4646, 319-4791, 322-4190, 324-8449, 325-2022, 327-1911, 332-8503	LEE00001-LEE99999	Turbocharged Single Head
CTPC13040B	Inframe OH Set				
CTPC13040C	Cylinder Head Repl. Gasket Set				
CTPC13041A	Out of Frame OH Gasket Set	C-13 ON-HIGHWAY	302-5041, 311-9733, 323-5050, 323-5087	LEE00001-LEE99999	Turbocharged Single Head
CTPC13041B	Inframe OH Set				
CTPC13041C	Cylinder Head Repl. Gasket Set				
CTPC13042A	Out of Frame OH Gasket Set	C-13 ON-HIGHWAY	302-5047, 311-9788, 319-4593, 324-8605, 328-8024, 330-6217, 330-6430	LEE00001-LEE99999	Turbocharged Single Head
CTPC13042B	Inframe OH Set				
CTPC13042C	Cylinder Head Repl. Gasket Set				

Part Number	Description	Machine Model / Application	Machine Serial Number	Engine Serial No.	Comments
CTPC13043A	Out of Frame OH Gasket Set	C-13 ON-HIGHWAY	324-8407	LEE00001-LEE99999	Turbocharged Single Head
CTPC13043B	Inframe OH Set				
CTPC13043C	Cylinder Head Repl. Gasket Set				
CTPC13044A	Out of Frame OH Gasket Set	C-13 ON-HIGHWAY	325-2062	LEE00001-LEE99999	Turbocharged Single Head
CTPC13044B	Inframe OH Set				
CTPC13044C	Cylinder Head Repl. Gasket Set				
CTPC13045A	Out of Frame OH Gasket Set	C-13 INDUSTRIAL	368-4893, 368-4894, 368-4895, 368-4898, 388-2114, 368-4896, 368-4897, 368-4900, 392-5475, 396-9755	LGK01-UP	Turbocharged Single Head
CTPC13045B	Inframe OH Set				
CTPC13045C	Cylinder Head Repl. Gasket Set				
CTPC13046A	Out of Frame OH Gasket Set	349EL	365-3524	TXM00001-TXM99999	Turbocharged Single Head
CTPC13046B	Inframe OH Set				
CTPC13046C	Cylinder Head Repl. Gasket Set		417-2599	M4X00001-M4X99999	
CTPC13047A	Out of Frame OH Gasket Set	349EL	417-2599 / 422-5494, 431-1464 / 442-9567	TXM00001-TXM99999	Turbocharged Single Head
CTPC13047B	Inframe OH Set				
CTPC13047C	Cylinder Head Repl. Gasket Set				
CTPC13048A	Out of Frame OH Gasket Set	349EL	422-5494	TXM00001-TXM99999	Turbocharged Single Head
CTPC13048B	Inframe OH Set				
CTPC13048C	Cylinder Head Repl. Gasket Set				
CTPC13049A	Out of Frame OH Gasket Set	627H	365-3518	M4X00001-M4X99999	Turbocharged Single Head
CTPC13049B	Inframe OH Set				
CTPC13049C	Cylinder Head Repl. Gasket Set				

C-15

Part Number	Description	Machine Model / Application	Engine Serial No.	Comments
CTPC15001A	Out of Frame OH Gasket Set	Industrial & C15-TH35 Petroleum Truck	JRE0001-UP MHP0001-UP	Turbocharged Spacer plated
CTPC15002A	Out of Frame OH Gasket Set	Truck Engine	6NZ1-90822	Turbocharged, Single Head

Part Number	Description	Machine Model / Application	Engine Serial No.	Comments
CTPC15003A	Out of Frame OH Gasket Set	Truck Engine	6NZ1-37112, 6NZ1340-37112, 6NZ20517-37112, 6NZ18292-37112, 6NZ1-21695, 6NZ1-17363, 6NZ17363-37112, 6NZ17363-27285	Turbocharged, Single Head
CTPC15004A	Out of Frame OH Gasket Set	Truck Engine	6NZ1-UP, 6NZ1340-90822, 6NZ13016-90822, 6NZ17363-90822, 6NZ27892-90822, 6NZ44995-90822, 6NZ49772-90822, 6NZ47911-90822, 6NZ1-52184, 6NZ52185-90822, 6NZ59796-90822, 6NZ80923-90822, 6NZ76365-91260	Turbocharged, Single Cylinder Head, Spacer Plate
CTPC15005A	Out of Frame OH Gasket Set	Truck Engine	6NZ92411-UP, 6NZ94000-UP, 6NZ94203-UP, 6NZ91974-UP, 6NZ97215-UP, 9NZ1-UP	Turbocharged, Single Cylinder Head, Spacer Plate
CTPC15009A	Out of Frame OH Gasket Set	Industrial	BEM1-2999, BEM682-UP, BEM3000-UP	Turbocharged, Single Cyl. Head, Spacer Plate
CTPC15010A	Out of Frame OH Gasket Set		6NZ01-UP	Turbocharged
CTPC15011A	Out of Frame OH Gasket Set	C-15 TRUCK ENGINE	6NZ01-UP	
CTPC15012A	Out of Frame OH Gasket Set	C-15 ON - HIGHWAY ENGINE	NXS01-UP	
CTPC15013A	Out of Frame OH Gasket Set	C-15 ON - HIGHWAY ENGINE	NXS01-UP	

C-18

Part Number	Description	Machine Model / Application	Engine Arrangement	Engine Serial No.	Comments
CTPC18001A	Out of Frame OH Gasket Set	D9T	205-8603	RJS01-UP, RHX01-UP	Turbocharger
CTPC18001B	Inframe OH Set				
CTPC18001C	Cylinder Head Repl. Gasket Set				
CTPC18002A	Out of Frame OH Gasket Set	988H WHEEL LOADER	281-6452	RHX01-RHXUP, TXH01-TXHUP	Turbocharger
CTPC18002B	Inframe OH Set				
CTPC18002C	Cylinder Head Repl. Gasket Set				
CTPC18003A	Out of Frame OH Gasket Set	D9T TRACK-TYPE TRACTOR	342-4633	R4L01-R4LUP	Turbocharger
CTPC18003B	Inframe OH Set				
CTPC18003C	Cylinder Head Repl. Gasket Set				
CTPC18004A	Out of Frame OH Gasket Set	C-18 GENERATOR SET	241-2422	STH01-UP	Turbocharger
CTPC18004B	Inframe OH Set				
CTPC18004C	Cylinder Head Repl. Gasket Set				
CTPC18005A	Out of Frame OH Gasket Set	C-18 GENERATOR SET	269-1769	STH01-UP	Turbocharger
CTPC18005B	Inframe OH Set				
CTPC18005C	Cylinder Head Repl. Gasket Set				

Part Number	Description	Machine Model / Application	Engine Arrangement	Engine Serial No.	Comments
CTPC18006A	Out of Frame OH Gasket Set	MARINE ENGINE	328-1564, 328-1565, 328-1566, 328-1567, 328-1568, 328-1569, 328-1570, 328-1571, 328-1572, 328-1579, 328-1581, 328-1588, 328-1601, 328-1600, 328-1602	CYN00001-CYN99999	Turbocharger
CTPC18006B	Inframe OH Set				
CTPC18006C	Cylinder Head Repl. Gasket Set				
CTPC18007A	Out of Frame OH Gasket Set	TRUCK	240-4200 / 240-4201	MDP00001-MDP99999	Turbocharger
CTPC18007B	Inframe OH Set				
CTPC18007C	Cylinder Head Repl. Gasket Set				
CTPC18008A	Out of Frame OH Gasket Set	TRUCK	242-7889 / 242-7890	MDP00001-MDP99999	Turbocharger
CTPC18008B	Inframe OH Set				
CTPC18008C	Cylinder Head Repl. Gasket Set				
CTPC18009A	Out of Frame OH Gasket Set	INDUSTRIAL	254-3824	EJG00001-EJG99999	Turbocharger
CTPC18009B	Inframe OH Set				
CTPC18009C	Cylinder Head Repl. Gasket Set				
CTPC18010A	Out of Frame OH Gasket Set	INDUSTRIAL	367-8506	EJG00001-EJG99999	Turbocharger
CTPC18010B	Inframe OH Set				
CTPC18010C	Cylinder Head Repl. Gasket Set				
CTPC18011A	Out of Frame OH Gasket Set	INDUSTRIAL	325-3283	JDA00001-JDA99999	Turbocharger
CTPC18011B	Inframe OH Set				
CTPC18011C	Cylinder Head Repl. Gasket Set				

C-27

Part Number	Description	Machine Model / Application	Engine Arrangement	Engine Serial No.	Comments
CTPC27001A	Out of Frame OH Gasket Set	844H WHEEL TRACTOR	217-5670	EHX00001-EHX05530	
CTPC27001B	Inframe OH Set				
CTPC27001C	Cylinder Head Repl. Gasket Set				
CTPC27001D	Single Cyl. Head Repl. Gasket Set		271-8633	EHX02921-EHX05550	
CTPC27002A	Out of Frame OH Gasket Set	D10T TRACK-TYPE TRACTOR	212-2744, 271-2219	EHX00001-EHX99999	
CTPC27002B	Inframe OH Set				
CTPC27002C	Cylinder Head Repl. Gasket Set				
CTPC27002D	Single Cyl. Head Repl. Gasket Set				
CTPC27003A	Out of Frame OH Gasket Set	773F OFF-HIGHWAY TRUCK	227-5353, 282-3741, 280-2297	EHX00001-EHX99999	
CTPC27003B	Inframe OH Set				
CTPC27003C	Cylinder Head Repl. Gasket Set				
CTPC27003D	Single Cyl. Head Repl. Gasket Set				

C-27 (cont.)

Part Number	Description	Machine Model / Application	Engine Arrangement	Engine Serial No.	Comments
CTPC27004B	Inframe OH Set	773F OFF-HIGHWAY TRUCK	360-3757	EHX00001-EHX99999	
CTPC27004C	Cylinder Head Repl. Gasket Set				
CTPC27004D	Single Cyl. Head Repl. Gasket Set				
CTPC27005A	Out of Frame OH Gasket Set				
CTPC27005B	Inframe OH Set	990H WHEEL LOADER	217-5670	EHX00001-EHX02560	
CTPC27005C	Cylinder Head Repl. Gasket Set				
CTPC27005D	Single Cyl. Head Repl. Gasket Set				
CTPC27006A	Out of Frame OH Gasket Set	775F OFF-HIGHWAY TRUCK	227-5354	LJX00001-LJX99999	
CTPC27006B	Inframe OH Set				
CTPC27006C	Cylinder Head Repl. Gasket Set				
CTPC27006D	Single Cyl. Head Repl. Gasket Set				
CTPC27007A	Out of Frame OH Gasket Set	775F OFF-HIGHWAY TRUCK	262-3742	LJX00001-LJX99999	
CTPC27007B	Inframe OH Set				
CTPC27007C	Cylinder Head Repl. Gasket Set				
CTPC27007D	Single Cyl. Head Repl. Gasket Set				
CTPC27008C	Cylinder Head Repl. Gasket Set	C27 INDUSTRIAL	351-0216	TWM00001-TWM99999	
CTPC27008D	Single Cyl. Head Repl. Gasket Set				

3114

Part Number	Description	Machine Model / Application	Engine Arrangement	Engine Serial No.	Comments
CTP3114001A	Out of Frame OH Gasket Set	924F WHEEL LOADER	114-4507	97Z01450-97Z99999	Turbocharged Single Head
CTP3114001B	Inframe OH Set			4RR00001-4RR01508	
CTP3114001C	Cylinder Head Repl. Gasket Set			2ZF07483-2ZF99999	
CTP3114002A	Out of Frame OH Gasket Set	924F WHEEL LOADER	114-4507	2FG04650-2FG06187	Turbocharged Single Head
CTP3114002B	Inframe OH Set			97Z02000-97Z99999	
CTP3114002C	Cylinder Head Repl. Gasket Set			4RR01509-4RR99999	

3116

Part Number	Description	Machine Model / Application	Engine Arrangement	Engine Serial No.	Comments
CTP3116001A	Out of Frame OH Gasket Set	325L/LN, 950F, M318 Excavator		4TF12112 4TF49404 7JL00001-UP	Turbocharged Single Head
CTP3116002A	Out of Frame OH Gasket Set	Marine		4KG1-9870 1SK1-2575	Turbocharged Water Aftercooled Single Cyl. Head
CTP3116003A	Out of Frame OH Gasket Set	E240B, E240C, Excavators	9Y-9184	1CK00001-1CK99999	Turbocharged Single Head
CTP3116003B	Inframe OH Set				
CTP3116003C	Cylinder Head Repl. Gasket Set				
CTP3116004A	Out of Frame OH Gasket Set	325B L & 325B LN, Excavators	115-5937	1CK00001-1CK99999	Turbocharged Single Head
CTP3116004B	Inframe OH Set				
CTP3116004C	Cylinder Head Repl. Gasket Set				
CTP3116004D	Single Cyl. Head Repl. Gasket Set				
CTP3116005A	Out of Frame OH Gasket Set	325B L & 325B LN, Excavators	115-5938	4TF29125-4TF99999	Turbocharged Single Head
CTP3116005B	Inframe OH Set				
CTP3116005C	Cylinder Head Repl. Gasket Set				

Part Number	Description	Machine Model / Application	Engine Arrangement	Engine Serial No.	Comments
CTP3116006A	Out of Frame OH Gasket Set		129-8578	1CK00001-1CK99999	Turbocharged Single Head
CTP3116006B	Inframe OH Set				
CTP3116006C	Cylinder Head Repl. Gasket Set				
CTP3116007A	Out of Frame OH Gasket Set		131-3803	1CK00001-1CK99999	Turbocharged Single Head
CTP3116007B	Inframe OH Set				
CTP3116007C	Cylinder Head Repl. Gasket Set				
CTP3116008A	Out of Frame OH Gasket Set	325, 325L, Excavators	6I-2112	1CK00001-1CK99999	Turbocharged Single Head
CTP3116008B	Inframe OH Set				
CTP3116008C	Cylinder Head Repl. Gasket Set				
CTP3116009A	Out of Frame OH Gasket Set		7C-9097	1CK00001-1CK99999	Turbocharged Single Head
CTP3116009B	Inframe OH Set				
CTP3116009C	Cylinder Head Repl. Gasket Set				
CTP3116010A	Out of Frame OH Gasket Set	938F, IT38F, Wheel Loader, Integrated Toolcarrier	133-8829	1CK00001-1CK99999	Turbocharged Single Head
CTP3116010B	Inframe OH Set			4TF28600-4TF99999	
CTP3116010C	Cylinder Head Repl. Gasket Set			98Z17000-98Z99999	
CTP3116011A	Out of Frame OH Gasket Set		112-9039	1CK13442-1CK99999	Turbocharged Single Head
CTP3116011B	Inframe OH Set				
CTP3116011C	Cylinder Head Repl. Gasket Set				
CTP3116012A	Out of Frame OH Gasket Set	950F SERIES II, Wheel Loader	4P-9992	1CK00001-1CK99999	Turbocharged Single Head
CTP3116012B	Inframe OH Set				
CTP3116012C	Cylinder Head Repl. Gasket Set				
CTP3116013A	Out of Frame OH Gasket Set	D5M XL, D5M LGP, Tractor	114-4508	1CK11131-1CK99999	Turbocharged Single Head
CTP3116013B	Inframe OH Set				
CTP3116013C	Cylinder Head Repl. Gasket Set				
CTP3116014A	Out of Frame OH Gasket Set	D6M Track-Type, Tractor Power Shift, Tractor XL	107-4935	1CK11130-1CK99999	Turbocharged Single Head
CTP3116014B	Inframe OH Set			7JS00001-7JS99999	
CTP3116014C	Cylinder Head Repl. Gasket Set				
CTP3116015A	Out of Frame OH Gasket Set	E200B, EL200B, Excavators	7W-6852	1CK00001-1CK99999	Turbocharged Single Head
CTP3116015B	Inframe OH Set			4TF00001-4TF99999	
CTP3116015C	Cylinder Head Repl. Gasket Set				
CTP3116016A	Out of Frame OH Gasket Set	3116, Industrial Engine	101-3130	2WG03022-2WG99999	Turbocharged Single Head
CTP3116016B	Inframe OH Set				
CTP3116016C	Cylinder Head Repl. Gasket Set				
CTP3116017A	Out of Frame OH Gasket Set	3116, Industrial Engine	101-3131	2WG02918-2WG99999	Turbocharged Single Head
CTP3116017B	Inframe OH Set				
CTP3116017C	Cylinder Head Repl. Gasket Set				
CTP3116018A	Out of Frame OH Gasket Set	3116, Industrial Engine	101-3134	2WG02939-2WG99999	Turbocharged Single Head
CTP3116018B	Inframe OH Set				
CTP3116018C	Cylinder Head Repl. Gasket Set				
CTP3116019A	Out of Frame OH Gasket Set	3116, Industrial Engine	107-2777	2WG03126-2WG99999	Turbocharged Single Head
CTP3116019B	Inframe OH Set				
CTP3116019C	Cylinder Head Repl. Gasket Set				
CTP3116020A	Out of Frame OH Gasket Set	3116, Industrial Engine	113-5818	2WG03930-2WG99999	Turbocharged Single Head
CTP3116020B	Inframe OH Set				
CTP3116020C	Cylinder Head Repl. Gasket Set				
CTP3116021A	Out of Frame OH Gasket Set	3116, Industrial Engine	116-2290	2WG04157-2WG99999	Turbocharged Single Head
CTP3116021B	Inframe OH Set				
CTP3116021C	Cylinder Head Repl. Gasket Set				

Part Number	Description	Machine Model / Application	Engine Arrangement	Engine Serial No.	Comments
CTP3116022A	Out of Frame OH Gasket Set	3116, Industrial Engine	120-4105	2WG04446-2WG99999	Turbocharged Single Head
CTP3116022B	Inframe OH Set				
CTP3116022C	Cylinder Head Repl. Gasket Set				
CTP3116023A	Out of Frame OH Gasket Set	3116, Industrial Engine	4P-3507	2WG01254-2WG02034	Turbocharged Single Head
CTP3116023B	Inframe OH Set				
CTP3116023C	Cylinder Head Repl. Gasket Set				
CTP3116024A	Out of Frame OH Gasket Set	3116, Industrial Engine	4P-3707	2WG01403-2WG05952	Turbocharged Single Head
CTP3116024B	Inframe OH Set				
CTP3116024C	Cylinder Head Repl. Gasket Set				
CTP3116025A	Out of Frame OH Gasket Set	3116, Industrial Engine	4P-4711	2WG01660-2WG99999	Turbocharged Single Head
CTP3116025B	Inframe OH Set				
CTP3116025C	Cylinder Head Repl. Gasket Set				
CTP3116026A	Out of Frame OH Gasket Set	3116, Industrial Engine	4P-4918	2WG01361-2WG02475	Turbocharged Single Head
CTP3116026B	Inframe OH Set				
CTP3116026C	Cylinder Head Repl. Gasket Set				
CTP3116027A	Out of Frame OH Gasket Set	3116, Industrial Engine	6I-0867	2WG02062-2WG29534	Turbocharged Single Head
CTP3116027B	Inframe OH Set				
CTP3116027C	Cylinder Head Repl. Gasket Set				
CTP3116028A	Out of Frame OH Gasket Set	3116, Industrial Engine	6I-2320	2WG02571-2WG99999	Turbocharged Single Head
CTP3116028B	Inframe OH Set				
CTP3116028C	Cylinder Head Repl. Gasket Set				
CTP3116029A	Out of Frame OH Gasket Set	3116, Industrial Engine	6I-2321	2WG00001-2WG99999	Turbocharged Single Head
CTP3116029B	Inframe OH Set				
CTP3116029C	Cylinder Head Repl. Gasket Set				
CTP3116030A	Out of Frame OH Gasket Set	3116, Industrial Engine	6I-2322	2WG00001-2WG99999	Turbocharged Single Head
CTP3116030B	Inframe OH Set				
CTP3116030C	Cylinder Head Repl. Gasket Set				
CTP3116031A	Out of Frame OH Gasket Set	3116, Industrial Engine	6I-2323	2WG02571-2WG99999	Turbocharged Single Head
CTP3116031B	Inframe OH Set				
CTP3116031C	Cylinder Head Repl. Gasket Set				
CTP3116032A	Out of Frame OH Gasket Set	3116, Industrial Engine	6I-2324	2WG00001-2WG99999	Turbocharged Single Head
CTP3116032B	Inframe OH Set				
CTP3116032C	Cylinder Head Repl. Gasket Set				
CTP3116033A	Out of Frame OH Gasket Set	3116, Industrial Engine	6I-2325	2WG00001-2WG02825	Turbocharged Single Head
CTP3116033B	Inframe OH Set				
CTP3116033C	Cylinder Head Repl. Gasket Set				
CTP3116034A	Out of Frame OH Gasket Set	3116, Industrial Engine	6I-2326	2WG02749-2WG99999	Turbocharged Single Head
CTP3116034B	Inframe OH Set				
CTP3116034C	Cylinder Head Repl. Gasket Set				
CTP3116035A	Out of Frame OH Gasket Set	3116, Industrial Engine	6I-2327	2WG02627-2WG99999	Turbocharged Single Head
CTP3116035B	Inframe OH Set				
CTP3116035C	Cylinder Head Repl. Gasket Set				
CTP3116036A	Out of Frame OH Gasket Set	3116, Industrial Engine	6I-2328	2WG02608-2WG99999	Turbocharged Single Head
CTP3116036B	Inframe OH Set				
CTP3116036C	Cylinder Head Repl. Gasket Set				
CTP3116037A	Out of Frame OH Gasket Set	AP-1000, Asphalt Pave	7C-9226	2WG00001-2WG99999	Turbocharged Single Head
CTP3116037B	Inframe OH Set				
CTP3116037C	Cylinder Head Repl. Gasket Set				

Part Number	Description	Machine Model / Application	Engine Arrangement	Engine Serial No.	Comments
CTP3116038A	Out of Frame OH Gasket Set	3116, Industrial Engine	7E-7743	2WG00837-2WG99999	Turbocharged Single Head
CTP3116038B	Inframe OH Set				
CTP3116038C	Cylinder Head Repl. Gasket Set				
CTP3116039A	Out of Frame OH Gasket Set	3116, Industrial Engine	9Y-0179	2WG00001-2WG02571	Turbocharged Single Head
CTP3116039B	Inframe OH Set				
CTP3116039C	Cylinder Head Repl. Gasket Set				
CTP3116041A	Out of Frame OH Gasket Set	3116, Industrial Engine	9Y-2756	2WG01302-2WG02541	Turbocharged Single Head
CTP3116041B	Inframe OH Set				
CTP3116041C	Cylinder Head Repl. Gasket Set				
CTP3116042A	Out of Frame OH Gasket Set	3116, Industrial Engine	9Y-6728	2WG00001-2WG02621	Turbocharged Single Head
CTP3116042B	Inframe OH Set				
CTP3116042C	Cylinder Head Repl. Gasket Set				
CTP3116043A	Out of Frame OH Gasket Set	3116, Industrial Engine	9Y-6729	2WG01302-2WG02523	Turbocharged Single Head
CTP3116043B	Inframe OH Set				
CTP3116043C	Cylinder Head Repl. Gasket Set				
CTP3116044A	Out of Frame OH Gasket Set	214B & 214BFT, Excavator Wheel	7W-9478	4TF00001-4TF99999	Turbocharged Single Head
CTP3116044B	Inframe OH Set				
CTP3116044C	Cylinder Head Repl. Gasket Set				
CTP3116045A	Out of Frame OH Gasket Set	213B, Excavator Track Type	9Y-5173	4TF00748-4TF99999	Turbocharged Single Head
CTP3116045B	Inframe OH Set				
CTP3116045C	Cylinder Head Repl. Gasket Set				
CTP3116046A	Out of Frame OH Gasket Set	214B & 214BFT, 224B, Excavator Wheel	7C-1135	4TF00001-4TF99999	Turbocharged Single Head
CTP3116046B	Inframe OH Set				
CTP3116046C	Cylinder Head Repl. Gasket Set				
CTP3116047A	Out of Frame OH Gasket Set	M318, M320, Excavator	118-3600	4TF14681-4TF99999	Turbocharged Single Head
CTP3116047B	Inframe OH Set				
CTP3116047C	Cylinder Head Repl. Gasket Set				
CTP3116048A	Out of Frame OH Gasket Set	320B, 320B L, 320B LN, 320B N & 320B S, Excavator	120-7719	4TF00001-4TF99999	Turbocharged Single Head
CTP3116048B	Inframe OH Set				
CTP3116048C	Cylinder Head Repl. Gasket Set				
CTP3116049A	Out of Frame OH Gasket Set	320, 320L, 320N, 320S, Excavator	6I-2111	4TF04123-4TF99999	Turbocharged Single Head
CTP3116049B	Inframe OH Set				
CTP3116049C	Cylinder Head Repl. Gasket Set				
CTP3116050A	Out of Frame OH Gasket Set		7E-9899	4TF00001-4TF99999	Turbocharged Single Head
CTP3116050B	Inframe OH Set				
CTP3116050C	Cylinder Head Repl. Gasket Set				
CTP3116051A	Out of Frame OH Gasket Set		101-1683	4TF00001-4TF99999	Turbocharged Single Head
CTP3116051C	Cylinder Head Repl. Gasket Set				
CTP3116052A	Out of Frame OH Gasket Set	322 L, 322 LN, 322 N, Excavator	113-1724	4TF11600-4TF99999	Turbocharged Single Head
CTP3116052B	Inframe OH Set				
CTP3116052C	Cylinder Head Repl. Gasket Set				
CTP3116053A	Out of Frame OH Gasket Set	322B L, Excavator	131-3804	98Z16500-98Z99999	Turbocharged Single Head
CTP3116053B	Inframe OH Set				
CTP3116053C	Cylinder Head Repl. Gasket Set				
CTP3116054A	Out of Frame OH Gasket Set	322 L, 322 LN, 322 N, Excavator	133-8856	4TF28174-4TF99999	Turbocharged Single Head
CTP3116054B	Inframe OH Set				
CTP3116054C	Cylinder Head Repl. Gasket Set				

3116 (cont.)

Part Number	Description	Machine Model / Application	Engine Arrangement	Engine Serial No.	Comments
CTP3116056A	Out of Frame OH Gasket Set	325, 325L, 325LN, Excavator	9Y-1932	4TF02055-4TF99999	Turbocharged Single Head
CTP3116056B	Inframe OH Set				
CTP3116056C	Cylinder Head Repl. Gasket Set				
CTP3116057A	Out of Frame OH Gasket Set	CS-583, CS-533, CS-531, CS-563, CP-563, CS-573, Vibratory Compactors	4P-0844	4TF05805-4TF99999	Turbocharged Single Head
CTP3116057B	Inframe OH Set				
CTP3116057C	Cylinder Head Repl. Gasket Set				
CTP3116058A	Out of Frame OH Gasket Set	561M, D5M, D5M LGP, Tractors	114-4508	4TF23390-4TF99999	Turbocharged Single Head
CTP3116058B	Inframe OH Set				
CTP3116058C	Cylinder Head Repl. Gasket Set				
CTP3116059A	Out of Frame OH Gasket Set	613C, Wheel Tractor/Scraper	4P-2400	4TF00001-4TF99999	Turbocharged Single Head
CTP3116059B	Inframe OH Set				
CTP3116059C	Cylinder Head Repl. Gasket Set				
CTP3116060A	Out of Frame OH Gasket Set	928F, Wheel Loader IT28F, Integrated Toolcarrier	7C-9097 6I-2803	4TF08700-4TF99999 98200131-9829999	Turbocharged Single Head
CTP3116060B	Inframe OH Set				
CTP3116060C	Cylinder Head Repl. Gasket Set				
CTP3116061A	Out of Frame OH Gasket Set	147-1753	4TF00001-4TF99999	Turbocharged Single Head	
CTP3116061B	Inframe OH Set				
CTP3116061C	Cylinder Head Repl. Gasket Set				
CTP3116062A	Out of Frame OH Gasket Set	938F, IT38F, Wheel Loader, Integrated Toolcarrier	103-1978	4TF14130-4TF99999	Turbocharged Single Head
CTP3116062B	Inframe OH Set				
CTP3116062C	Cylinder Head Repl. Gasket Set				
CTP3116064A	Out of Frame OH Gasket Set	950F SERIES II, Wheel Loader	106-1758	4TF00114-4TF99999	Turbocharged Single Head
CTP3116064B	Inframe OH Set				
CTP3116064C	Cylinder Head Repl. Gasket Set				
CTP3116065A	Out of Frame OH Gasket Set	950F SERIES II, Wheel Loader	116-7959	4TF20681-4TF99999	Turbocharged Single Head
CTP3116065B	Inframe OH Set				
CTP3116065C	Cylinder Head Repl. Gasket Set				
CTP3116066A	Out of Frame OH Gasket Set	950F SERIES II, Wheel Loader	4P-9992	4TF00114-4TF99999	Turbocharged Single Head
CTP3116066B	Inframe OH Set				
CTP3116066C	Cylinder Head Repl. Gasket Set				
CTP3116067A	Out of Frame OH Gasket Set	950F SERIES II, Wheel Loader	7E-0576	4TF00001-4TF99999	Turbocharged Single Head
CTP3116067B	Inframe OH Set				
CTP3116067C	Cylinder Head Repl. Gasket Set				
CTP3116068A	Out of Frame OH Gasket Set	953C, Track-Type Loader Hydrostatic Drive	116-4803	4TF19620-4TF99999	Turbocharged Single Head
CTP3116068B	Inframe OH Set				
CTP3116068C	Cylinder Head Repl. Gasket Set				
CTP3116069A	Out of Frame OH Gasket Set	953B, Track-Type Loader 3116 Engine	6I-0793	4TF03496-4TF99999	Turbocharged Single Head
CTP3116069B	Inframe OH Set				
CTP3116069C	Cylinder Head Repl. Gasket Set				
CTP3116070A	Out of Frame OH Gasket Set	960F, Wheel Loader	103-1980	4TF10150-4TF99999	Turbocharged Single Head
CTP3116070B	Inframe OH Set				
CTP3116070C	Cylinder Head Repl. Gasket Set				
CTP3116071A	Out of Frame OH Gasket Set	960F, Wheel Loader	123-7734	4TF10150-4TF99999	Turbocharged Single Head
CTP3116071B	Inframe OH Set				
CTP3116071C	Cylinder Head Repl. Gasket Set				
CTP3116072A	Out of Frame OH Gasket Set	963B, Track-Type Loader	114-7159	4TF00001-4TF99999	Turbocharged Single Head
CTP3116072B	Inframe OH Set				
CTP3116072C	Cylinder Head Repl. Gasket Set				

Part Number	Description	Machine Model / Application	Engine Arrangement	Engine Serial No.	Comments
CTP3116073A	Out of Frame OH Gasket Set	963B, Track-Type Loader	117-5187	4TF17400-4TF99999	
CTP3116073B	Inframe OH Set				
CTP3116073C	Cylinder Head Repl. Gasket Set				
CTP3116074A	Out of Frame OH Gasket Set	963C, Track-Type Loader	127-1023	4TF35104-4TF99999	Turbocharged Single Head
CTP3116074B	Inframe OH Set				
CTP3116074C	Cylinder Head Repl. Gasket Set				
CTP3116075A	Out of Frame OH Gasket Set	963B, Track-Type Loader	6I-3528	4TF17400-4TF99999	
CTP3116075B	Inframe OH Set				
CTP3116075C	Cylinder Head Repl. Gasket Set				
CTP3116076A	Out of Frame OH Gasket Set	CS-583, CP-533C, CS-533C, CS-533, CS-531, CP-563C, CS-563C, CS-563, CP-563, CS-573C, CS-583C, CS-573, CS-531C, Vibratory Compactors	111-7718	4TF16569-4TF99999	Turbocharged Single Head
CTP3116076B	Inframe OH Set		111-7717	98204335-9829999	
CTP3116076C	Cylinder Head Repl. Gasket Set		6I-3038	98200001-9829999	
CTP3116077A	Out of Frame OH Gasket Set	114-3674	4TF00001-4TF99999	Turbocharged Single Head	
CTP3116077B	Inframe OH Set				
CTP3116077C	Cylinder Head Repl. Gasket Set				
CTP3116078A	Out of Frame OH Gasket Set	D20D & D250D, Articulated Truck	7E-7907	4TF02055-4TF99999	Turbocharged Single Head
CTP3116078B	Inframe OH Set				
CTP3116078C	Cylinder Head Repl. Gasket Set				
CTP3116079A	Out of Frame OH Gasket Set	114-3675	4TF00001-4TF99999	Turbocharged Single Head	
CTP3116079B	Inframe OH Set				
CTP3116079C	Cylinder Head Repl. Gasket Set				
CTP3116080A	Out of Frame OH Gasket Set	D20D & D250D, Articulated Truck	9Y-8271	4TF02055-4TF99999	Turbocharged Single Head
CTP3116080B	Inframe OH Set				
CTP3116080C	Cylinder Head Repl. Gasket Set				
CTP3116081A	Out of Frame OH Gasket Set	D6M & D6M LGP Track-Type, Tractors	107-4935	4TF00001-4TF99999	Turbocharged Single Head
CTP3116081B	Inframe OH Set				
CTP3116081C	Cylinder Head Repl. Gasket Set				
CTP3116084A	Out of Frame OH Gasket Set	M318, M320, Excavator	118-3600	4TF14681-4TF99999	Turbocharged Single Head
CTP3116084B	Inframe OH Set				
CTP3116084C	Cylinder Head Repl. Gasket Set				
CTP3116085A	Out of Frame OH Gasket Set	322B L & 322B LN, Excavator	120-4815	4TF00001-4TF99999	Turbocharged Single Head
CTP3116085B	Inframe OH Set				
CTP3116085C	Cylinder Head Repl. Gasket Set				
CTP3116086A	Out of Frame OH Gasket Set	928G, IT28G, Wheel Loader, Integrated Toolcarrier	118-0904	6RR00001-6RR9999	Turbocharged Single Head
CTP3116086B	Inframe OH Set				
CTP3116086C	Cylinder Head Repl. Gasket Set				
CTP3116087A	Out of Frame OH Gasket Set	D6M Track-Type, Tractor Power Shift, Tractor XL	124-1564	7JS00001-7JS9999	Turbocharged Single Head
CTP3116087B	Inframe OH Set				
CTP3116087C	Cylinder Head Repl. Gasket Set				
CTP3116088A	Out of Frame OH Gasket Set	D6M Track-Type, Tractor Power Shift, Tractor XL	146-8342	7JS00961-7JS9999	Turbocharged Single Head
CTP3116088B	Inframe OH Set				
CTP3116088C	Cylinder Head Repl. Gasket Set				

Part Number	Description	Machine Model / Application	Engine Arrangement	Engine Serial No.	Comments
CTP3116090A	Out of Frame OH Gasket Set	120H Motor Grader, 3116 Engine	110-8741	98204100-9829999	Turbocharged Single Head
CTP3116090B	Inframe OH Set				
CTP3116090C	Cylinder Head Repl. Gasket Set				
CTP3116093A	Out of Frame OH Gasket Set	120H Motor Grader, 3116 Engine	146-8336	98200001-9829999	Turbocharged Single Head
CTP3116093B	Inframe OH Set				
CTP3116093C	Cylinder Head Repl. Gasket Set				
CTP3116094A	Out of Frame OH Gasket Set	120H Motor Grader, Machine	146-8338	98222034-9829999	Turbocharged Single Head
CTP3116094B	Inframe OH Set				
CTP3116094C	Cylinder Head Repl. Gasket Set				
CTP3116095A	Out of Frame OH Gasket Set	120H Motor Grader, 3116 Engine	146-8341	98222034-9829999	Turbocharged Single Head
CTP3116095B	Inframe OH Set				
CTP3116095C	Cylinder Head Repl. Gasket Set				
CTP3116096A	Out of Frame OH Gasket Set	120H Motor Grader, Machine	7E-3352	98201377-9829999	Turbocharged Single Head
CTP3116096B	Inframe OH Set				
CTP3116096C	Cylinder Head Repl. Gasket Set				
CTP3116097A	Out of Frame OH Gasket Set	135H Motor Grader, 3116 Engine	110-8742	98204100-9829999	Turbocharged Single Head
CTP3116097B	Inframe OH Set				
CTP3116097C	Cylinder Head Repl. Gasket Set				
CTP3116098A	Out of Frame OH Gasket Set	135H Motor Grader, 3116 Engine	146-8344 146-8346	98214200-9829999	Turbocharged Single Head
CTP3116098B	Inframe OH Set				
CTP3116098C	Cylinder Head Repl. Gasket Set				
CTP3116100A	Out of Frame OH Gasket Set	322L, Excavator	113-1724	98204000-9829999	Turbocharged Single Head
CTP3116100B	Inframe OH Set				
CTP3116100C	Cylinder Head Repl. Gasket Set				
CTP3116102A	Out of Frame OH Gasket Set	325, 325L, Excavator, Machine	101-4871	98200001-9829999	Turbocharged Single Head
CTP3116102B	Inframe OH Set				
CTP3116102C	Cylinder Head Repl. Gasket Set				
CTP3116103A	Out of Frame OH Gasket Set	325B L, M325B, Excavator, Machine, Material Handler	131-3803	98200001-9829999	Turbocharged Single Head
CTP3116103B	Inframe OH Set				
CTP3116103C	Cylinder Head Repl. Gasket Set				
CTP3116104A	Out of Frame OH Gasket Set	Challenger 35 & 45, Tractor	108-8301	98204350-9829999	Turbocharged Single Head
CTP3116104B	Inframe OH Set				
CTP3116104C	Cylinder Head Repl. Gasket Set				
CTP3116105A	Out of Frame OH Gasket Set	Challenger 35 & 45, Machine	108-8300	98204350-9829999	Turbocharged Single Head
CTP3116105B	Inframe OH Set				
CTP3116105C	Cylinder Head Repl. Gasket Set				
CTP3116106A	Out of Frame OH Gasket Set	Challenger 35 & 45, Tractor 80 (2032mm) Tractor 60 (1524 mm)	154-6045	98200001-9829999	Turbocharged Single Head
CTP3116106B	Inframe OH Set				
CTP3116106C	Cylinder Head Repl. Gasket Set				

Part Number	Description	Machine Model / Application	Engine Arrangement	Engine Serial No.	Comments
CTP3116107A	Out of Frame OH Gasket Set	613C, Wheel Tractor	118-7663	98200001-9829999	Turbocharged Single Head
CTP3116107B	Inframe OH Set				
CTP3116107C	Cylinder Head Repl. Gasket Set				
CTP3116108A	Out of Frame OH Gasket Set	613C, Wheel Tractor	4P-2400	98200001-9829999	Turbocharged Single Head
CTP3116108B	Inframe OH Set				
CTP3116108C	Cylinder Head Repl. Gasket Set				
CTP3116109A	Out of Frame OH Gasket Set	928F, Wheel Loader	101-7527	98200820-9829999	Turbocharged Single Head
CTP3116109B	Inframe OH Set				
CTP3116109C	Cylinder Head Repl. Gasket Set				
CTP3116110A	Out of Frame OH Gasket Set	928G, Wheel Loader	158-3335	98228633-9829999	Turbocharged Single Head
CTP3116110B	Inframe OH Set				
CTP3116110C	Cylinder Head Repl. Gasket Set				
CTP3116112A	Out of Frame OH Gasket Set	938F, IT38F, Wheel Loader, Integrated Toolcarrier	103-1978	98200001-9829999	Turbocharged Single Head
CTP3116112B	Inframe OH Set				
CTP3116112C	Cylinder Head Repl. Gasket Set				
CTP3116114A	Out of Frame OH Gasket Set	950F SERIES II, Wheel Loader	100-5839 100-7024	98200001-9829999 98200415-9829999	Turbocharged Single Head
CTP3116114B	Inframe OH Set				
CTP3116114C	Cylinder Head Repl. Gasket Set				
CTP3116116A	Out of Frame OH Gasket Set	950F SERIES II, Wheel Loader	106-1756	98202350-9829999	Turbocharged Single Head
CTP3116116B	Inframe OH Set				
CTP3116116C	Cylinder Head Repl. Gasket Set				
CTP3116117A	Out of Frame OH Gasket Set	950F SERIES II, Wheel Loader	112-9039	98214398-9829999	Turbocharged Single Head
CTP3116117B	Inframe OH Set				
CTP3116117C	Cylinder Head Repl. Gasket Set				
CTP3116118A	Out of Frame OH Gasket Set	950F SERIES II, Wheel Loader	116-7958	98208480-9829999	Turbocharged Single Head
CTP3116118B	Inframe OH Set				
CTP3116118C	Cylinder Head Repl. Gasket Set				
CTP3116119A	Out of Frame OH Gasket Set	960F, Wheel Loader	106-4772	98201750-9829999	Turbocharged Single Head
CTP3116119B	Inframe OH Set		108-2294	98202780-9829999	
CTP3116119C	Cylinder Head Repl. Gasket Set				
CTP3116121A	Out of Frame OH Gasket Set	960F, Wheel Loader	112-9040	98200001-9829999	Turbocharged Single Head
CTP3116121B	Inframe OH Set				
CTP3116121C	Cylinder Head Repl. Gasket Set				
CTP3116122A	Out of Frame OH Gasket Set	960F, Wheel Loader	116-7960	98208480-9829999	Turbocharged Single Head
CTP3116122B	Inframe OH Set				
CTP3116122C	Cylinder Head Repl. Gasket Set				
CTP3116123A	Out of Frame OH Gasket Set	6I-3657	98200001-9829999	Turbocharged Single Head	
CTP3116123B	Inframe OH Set				
CTP3116123C	Cylinder Head Repl. Gasket Set				
CTP3116124A	Out of Frame OH Gasket Set	AP-1000, AP-1050, Asphalt Paver	112-1684	98203000-9829999	Turbocharged Single Head
CTP3116124B	Inframe OH Set		104-3000	98200272-9829999	
CTP3116124C	Cylinder Head Repl. Gasket Set				

3116 (cont.)

Part Number	Description	Machine Model / Application	Engine Arrangement	Engine Serial No.	Comments
CTP3116125A	Out of Frame OH Gasket Set	AP-1000, Asphalt Paver	133-4249	98201610-98299999	Turbocharged Single Head
CTP3116125B	Inframe OH Set				
CTP3116125C	Cylinder Head Repl. Gasket Set				
CTP3116126A	Out of Frame OH Gasket Set	AP-1050, Asphalt Paver	61-3039	98200001-98299999	Turbocharged Single Head
CTP3116126B	Inframe OH Set				
CTP3116126C	Cylinder Head Repl. Gasket Set				
CTP3116127A	Out of Frame OH Gasket Set	Caterpillar AP-1050B, Barber-Greene BG-245C, Caterpillar AP-1055B, Barber-Greene BG-2455C, Asphalt Paver	105-4404	98201135-98299999	Turbocharged Single Head
CTP3116127B	Inframe OH Set				
CTP3116127C	Cylinder Head Repl. Gasket Set				
CTP3116128A	Out of Frame OH Gasket Set	Caterpillar AP-1050B, Barber-Greene BG-245C, Caterpillar AP-1055B, Barber-Greene BG-2455C, BG260, Asphalt Paver	133-4245	98216276-98299999	Turbocharged Single Head
CTP3116128B	Inframe OH Set				
CTP3116128C	Cylinder Head Repl. Gasket Set				
CTP3116130A	Out of Frame OH Gasket Set	CB-634C, CB-634, Vibratory Compactor	130-9242	98214252-98299999	Turbocharged Single Head
CTP3116130B	Inframe OH Set				
CTP3116130C	Cylinder Head Repl. Gasket Set				
CTP3116131A	Out of Frame OH Gasket Set	CB-634C, CB-634, Vibratory Compactor	105-6144	98201230-98299999	Turbocharged Single Head
CTP3116131B	Inframe OH Set				
CTP3116131C	Cylinder Head Repl. Gasket Set				
CTP3116132A	Out of Frame OH Gasket Set	CB-634C, Vibratory Compactor	133-4246	98215855-98299999	Turbocharged Single Head
CTP3116132B	Inframe OH Set				
CTP3116132C	Cylinder Head Repl. Gasket Set				
CTP3116135A	Out of Frame OH Gasket Set	CS-563C, CP-563C, CS-583C, Vibratory Compactor	133-4247	98216285-98299999	Turbocharged Single Head
CTP3116135B	Inframe OH Set				
CTP3116135C	Cylinder Head Repl. Gasket Set				
CTP3116136A	Out of Frame OH Gasket Set	1T28F, Integrated Toolcarrier	101-7528	98200820-98299999	Turbocharged Single Head
CTP3116136B	Inframe OH Set				
CTP3116136C	Cylinder Head Repl. Gasket Set				
CTP3116137A	Out of Frame OH Gasket Set	TRUCK	133-2151 101-3149 106-7836 153-9720 121-3213 178-4491	7HS00001-7HS01806 7JL00001-UP 9GK00001-9GK70157 9LN00001-UP 9YN00503-UP 2FR00001-UP	Turbocharged Single Head
CTP3116137B	Inframe OH Set				
CTP3116137C	Cylinder Head Repl. Gasket Set				
CTP3116138A	Out of Frame OH Gasket Set	TRUCK	106-7885 4P-1533 153-9720	9GK00001-9GK70157 2BK00001-UP 9LN00001-UP	Turbocharged Single Head
CTP3116138B	Inframe OH Set				
CTP3116138C	Cylinder Head Repl. Gasket Set				
CTP3116139A	Out of Frame OH Gasket Set	TRUCK	7E-0576 6I-2322 112-9040 133-8829	4TF00001-UP 2WG00001-UP 98200001-UP 1CK00001-UP	Turbocharged Single Head
CTP3116139B	Inframe OH Set				
CTP3116139C	Cylinder Head Repl. Gasket Set				
CTP3116140A	Out of Frame OH Gasket Set	TRUCK	133-1651 101-3146 108-3110 119-7799 117-4665 143-7779	2FR00001-UP 7JL00001-UP 9GK00001-9GK70157 9YN00001-9YN04624 9LN00658-9LN08668 2CW00188-UP	Turbocharged Single Head
CTP3116140B	Inframe OH Set				
CTP3116140C	Cylinder Head Repl. Gasket Set				

Part Number	Description	Machine Model / Application	Engine Arrangement	Engine Serial No.	Comments
CTP3116141A	Out of Frame OH Gasket Set	TRUCK	153-9720 6I-3038 114-2910 6I-2327	9LN00001-UP 98200001-UP 5EN00001-UP 2WG02627-UP	Turbocharged Single Head
CTP3116141B	Inframe OH Set	MACHINE			
CTP3116141C	Cylinder Head Repl. Gasket Set	INDUSTRIAL			
CTP3116142A	Out of Frame OH Gasket Set	TRUCK	7E-0824 6I-2322 7E-2963 112-9040	7SF00001-7SF19179 2WG00001-UP 4PG00587-UP 98200001-UP	Turbocharged Single Head
CTP3116142B	Inframe OH Set	MACHINE			
CTP3116142C	Cylinder Head Repl. Gasket Set	INDUSTRIAL			
CTP3116143A	Out of Frame OH Gasket Set	TRUCK	100-5167 5F-9688 118-9577 143-7779	2BK25081-UP 3RJ00001-UP 7AG00001-UP 2CW00188-UP	Turbocharged Single Head
CTP3116143B	Inframe OH Set				
CTP3116143C	Cylinder Head Repl. Gasket Set				
CTP3116144A	Out of Frame OH Gasket Set	TRUCK	7E-1085 120-4814 7E-2963	7SF00001-UP 4TF00001-UP 4PG00587-UP	Turbocharged Single Head
CTP3116144B	Inframe OH Set	MACHINE			
CTP3116144C	Cylinder Head Repl. Gasket Set	INDUSTRIAL			
CTP3116145A	Out of Frame OH Gasket Set	MACHINE	154-6045 118-0904 7W-6652	98200001-UP 6RR00001-UP 4TF00001-UP	Turbocharged Single Head
CTP3116145B	Inframe OH Set				
CTP3116145C	Cylinder Head Repl. Gasket Set				
CTP3116146A	Out of Frame OH Gasket Set	MACHINE	6C-9319	4TF00001-4TF99999 4TF00001-4TF99999	Turbocharged Single Head
CTP3116146B	Inframe OH Set				
CTP3116146C	Cylinder Head Repl. Gasket Set				

3126

Part Number	Description	Machine Model / Application	Engine Arrangement	Engine Serial No.	Comments
CTP3126001A	Out of Frame OH Gasket Set	962G 938G		6EW001UP 55K001-UP 6JK001-UP	Turbocharged Water Aftercooled
CTP3126002A	Out of Frame OH Gasket Set	Industrial		9ZR03822	Turbocharged Water Cooled Single Head
CTP3126003A	Out of Frame OH Gasket Set	Industrial		BEJ0001-UP	Turbocharged
CTP3126004A	Out of Frame OH Gasket Set	938G, Wheel Loader	135-6437 138-3673	3AK00001-3AK99999	Turbocharged Single Head
CTP3126004B	Inframe OH Set				
CTP3126004C	Cylinder Head Repl. Gasket Set				
CTP3126005A	Out of Frame OH Gasket Set	962G, Wheel Loader	116-8671 143-7058	3AK00117-3AK99999 6JK00001-6JK99999	Turbocharged Single Head
CTP3126005B	Inframe OH Set				
CTP3126005C	Cylinder Head Repl. Gasket Set				
CTP3126006A	Out of Frame OH Gasket Set	525B, Wheel Skidder	148-3017	55K00001-55K99999	Turbocharged Single Head
CTP3126006B	Inframe OH Set				
CTP3126006C	Cylinder Head Repl. Gasket Set				
CTP3126007A	Out of Frame OH Gasket Set	CHALLENGER 55, Agricultural Tractor	154-4515	55K01552-55K99999	Turbocharged Single Head
CTP3126007B	Inframe OH Set				
CTP3126007C	Cylinder Head Repl. Gasket Set				
CTP3126008A	Out of Frame OH Gasket Set	938G, IT38G, Wheel Loader & Integrated Toolcarrier	135-6437 138-3673	55K00001-55K99999 6JK00001-6JK99999	Turbocharged Single Head
CTP3126008B	Inframe OH Set				
CTP3126008C	Cylinder Head Repl. Gasket Set				

Part Number	Description	Machine Model / Application	Engine Arrangement	Engine Serial No.	Comments
CTP3126009A	Out of Frame OH Gasket Set	950G, Wheel Loader	116-8670	55K01620-55K99999	Turbocharged Single Head
CTP3126009B	Inframe OH Set				
CTP3126009C	Cylinder Head Repl. Gasket Set				
CTP3126010A	Out of Frame OH Gasket Set	938G II, IT38G II, Wheel Loader & Integrated Toolcarrier	198-5914	5GG00001-5GG99999 BMA00001-BMA99999	Turbocharged Single Head
CTP3126010B	Inframe OH Set				
CTP3126010C	Cylinder Head Repl. Gasket Set				
CTP3126011A	Out of Frame OH Gasket Set	950G II, Wheel Loader	216-0848	5GG00001-5GG99999	Turbocharged Single Head
CTP3126011B	Inframe OH Set				
CTP3126011C	Cylinder Head Repl. Gasket Set				
CTP3126012A	Out of Frame OH Gasket Set	D5N XL, LGP Track-Type Tractor	188-2033	BMA00001-BMA99999	Turbocharged Single Head
CTP3126012B	Inframe OH Set				
CTP3126012C	Cylinder Head Repl. Gasket Set				
CTP3126013A	Out of Frame OH Gasket Set	D6N XL, D/S, FTC, LGP Track-Type Tractor	191-4479	BMA00001-BMA99999	Turbocharged Single Head
CTP3126013B	Inframe OH Set				
CTP3126013C	Cylinder Head Repl. Gasket Set				
CTP3126014A	Out of Frame OH Gasket Set	3126, Truck Engine (Military)	130-1500	1BW00001-1BW99999	Turbocharged Single Head
CTP3126014B	Inframe OH Set				
CTP3126014C	Cylinder Head Repl. Gasket Set				
CTP3126015A	Out of Frame OH Gasket Set	3126, Truck Engine	116-4558	1WM00094-1WM99999	Turbocharged Single Head
CTP3126015B	Inframe OH Set				
CTP3126015C	Cylinder Head Repl. Gasket Set				
CTP3126016A	Out of Frame OH Gasket Set	3126, Truck Engine	120-6662 121-4321 121-4323 121-4324 121-4325	1WM00095-180 1WM00001-202 1WM00001-137 1WM00001-096 1WM00001-UP	Turbocharged Single Head
CTP3126016B	Inframe OH Set				
CTP3126016C	Cylinder Head Repl. Gasket Set				
CTP3126017A	Out of Frame OH Gasket Set	3126, Truck Engine	121-4326 122-1709 123-0860 123-0865	1WM00001-1WM00202 1WM00124-1WM02022 1WM00141-1WM02029	Turbocharged Single Head
CTP3126017B	Inframe OH Set				
CTP3126017C	Cylinder Head Repl. Gasket Set				
CTP3126018A	Out of Frame OH Gasket Set	3126, Truck Engine	120-8256 120-8257 120-8258 120-8259 120-8260 120-8261	1WM00203-1WM00887	Turbocharged Single Head
CTP3126018B	Inframe OH Set				
CTP3126018C	Cylinder Head Repl. Gasket Set				
CTP3126019A	Out of Frame OH Gasket Set	3126, Truck Engine	120-8262 120-8263 120-8264 120-8265 120-8266 120-8267 120-8271	1WM00203-1WM00887	Turbocharged Single Head
CTP3126019B	Inframe OH Set				
CTP3126019C	Cylinder Head Repl. Gasket Set				
CTP3126020A	Out of Frame OH Gasket Set	3126, Truck Engine	120-8268 120-8269	1WM00203-1WM00887	Turbocharged Single Head
CTP3126020B	Inframe OH Set				
CTP3126020C	Cylinder Head Repl. Gasket Set				
CTP3126021A	Out of Frame OH Gasket Set	3126, Truck Engine	120-8270 125-0551 125-0552 125-0553 125-0554 125-0555	1WM00203-1WM00887	Turbocharged Single Head
CTP3126021B	Inframe OH Set				
CTP3126021C	Cylinder Head Repl. Gasket Set				

Part Number	Description	Machine Model / Application	Engine Arrangement	Engine Serial No.	Comments
CTP3126022A	Out of Frame OH Gasket Set	3126, Truck Engine	125-0556 125-0557 125-0558 125-0559 125-0560 125-0561	1WM00203-1WM00887	Turbocharged Single Head
CTP3126022B	Inframe OH Set				
CTP3126022C	Cylinder Head Repl. Gasket Set				
CTP3126023A	Out of Frame OH Gasket Set	3126, Truck Engine	120-8272	1WM00203-1WM00887	Turbocharged Single Head
CTP3126023B	Inframe OH Set				
CTP3126023C	Cylinder Head Repl. Gasket Set				
CTP3126024A	Out of Frame OH Gasket Set	3126, Truck Engine	125-0562 125-0563 125-0564 125-0565 125-0566	1WM00203-1WM00887	Turbocharged Single Head
CTP3126024B	Inframe OH Set				
CTP3126024C	Cylinder Head Repl. Gasket Set				
CTP3126025A	Out of Frame OH Gasket Set	3126, Truck Engine	125-0567	1WM00203-1WM00887	Turbocharged Single Head
CTP3126025B	Inframe OH Set				
CTP3126025C	Cylinder Head Repl. Gasket Set				
CTP3126026A	Out of Frame OH Gasket Set	3126, Truck Engine	125-0568	1WM00203-1WM00887	Turbocharged Single Head
CTP3126026B	Inframe OH Set				
CTP3126026C	Cylinder Head Repl. Gasket Set				
CTP3126027A	Out of Frame OH Gasket Set	3126, Truck Engine	126-8620	1WM00001-1WM99999	Turbocharged Single Head
CTP3126027B	Inframe OH Set				
CTP3126027C	Cylinder Head Repl. Gasket Set				
CTP3126028A	Out of Frame OH Gasket Set	3126, Truck Engine	126-8621 126-8628	1WM00001-1WM99999	Turbocharged Single Head
CTP3126028B	Inframe OH Set				
CTP3126028C	Cylinder Head Repl. Gasket Set				
CTP3126029A	Out of Frame OH Gasket Set	3126, Truck Engine	126-8622 126-8627 126-8630	1WM00001-1WM99999	Turbocharged Single Head
CTP3126029B	Inframe OH Set				
CTP3126029C	Cylinder Head Repl. Gasket Set				
CTP3126030A	Out of Frame OH Gasket Set	3126, Truck Engine	126-8623 126-8624 126-8625 126-8645 126-8646	1WM00001-1WM99999	Turbocharged Single Head
CTP3126030B	Inframe OH Set				
CTP3126030C	Cylinder Head Repl. Gasket Set				
CTP3126031A	Out of Frame OH Gasket Set	3126, Truck Engine	126-8626	1WM00001-1WM99999	Turbocharged Single Head
CTP3126031B	Inframe OH Set				
CTP3126031C	Cylinder Head Repl. Gasket Set				
CTP3126032A	Out of Frame OH Gasket Set	3126, Truck Engine	126-8629	1WM00001-1WM99999	Turbocharged Single Head
CTP3126032B	Inframe OH Set				
CTP3126032C	Cylinder Head Repl. Gasket Set				
CTP3126033A	Out of Frame OH Gasket Set	3126, Truck Engine	126-8631 126-8632 126-8633 126-8634 126-8635	1WM00001-1WM99999	Turbocharged Single Head
CTP3126033B	Inframe OH Set				
CTP3126033C	Cylinder Head Repl. Gasket Set				
CTP3126034A	Out of Frame OH Gasket Set	3126, Truck Engine	126-8647 126-8648 126-8649 126-8650 126-8654	1WM00001-1WM99999	Turbocharged Single Head
CTP3126034B	Inframe OH Set				
CTP3126034C	Cylinder Head Repl. Gasket Set				
CTP3126035A	Out of Frame OH Gasket Set	3126, Truck Engine	126-8651 126-8652 126-8653 128-5788	1WM00001-1WM99999	Turbocharged Single Head
CTP3126035B	Inframe OH Set				
CTP3126035C	Cylinder Head Repl. Gasket Set				
CTP3126036A	Out of Frame OH Gasket Set	3126, Truck Engine	126-8655 126-8658 126-8659 126-8662	1WM00001-1WM99999	Turbocharged Single Head
CTP3126036B	Inframe OH Set				
CTP3126036C	Cylinder Head Repl. Gasket Set				

3126 (cont.)

Part Number	Description	Machine Model / Application	Engine Arrangement	Engine Serial No.	Comments
CTP3126037A	Out of Frame OH Gasket Set	3126, Truck Engine	126-8656	1WM00001-1WM99999	Turbocharged Single Head
CTP3126037B	Inframe OH Set				
CTP3126037C	Cylinder Head Repl. Gasket Set				
CTP3126038A	Out of Frame OH Gasket Set				
CTP3126038B	Inframe OH Set	3126, Truck Engine	126-8657	1WM00001-1WM99999	Turbocharged Single Head
CTP3126038C	Cylinder Head Repl. Gasket Set				
CTP3126039A	Out of Frame OH Gasket Set				
CTP3126039B	Inframe OH Set	3126, Truck Engine	126-8660	1WM00001-1WM99999	Turbocharged Single Head
CTP3126039C	Cylinder Head Repl. Gasket Set				
CTP3126040A	Out of Frame OH Gasket Set	3126, Truck Engine	126-8664	1WM00001-1WM99999	Turbocharged Single Head
CTP3126040B	Inframe OH Set				
CTP3126040C	Cylinder Head Repl. Gasket Set				
CTP3126041A	Out of Frame OH Gasket Set	3126, Truck Engine	126-8670 127-1838 128-5727	1WM00001-1WM99999	Turbocharged Single Head
CTP3126041B	Inframe OH Set				
CTP3126041C	Cylinder Head Repl. Gasket Set				
CTP3126042A	Out of Frame OH Gasket Set	3126, Truck Engine	126-8671	1WM00001-1WM99999	Turbocharged Single Head
CTP3126042C	Cylinder Head Repl. Gasket Set				
CTP3126043A	Out of Frame OH Gasket Set	3126, Truck Engine	126-8673	1WM00001-1WM99999	Turbocharged Single Head
CTP3126043B	Inframe OH Set				
CTP3126043C	Cylinder Head Repl. Gasket Set				
CTP3126044A	Out of Frame OH Gasket Set	3126, Truck Engine	127-1831	1WM00001-1WM99999	Turbocharged Single Head
CTP3126044B	Inframe OH Set				
CTP3126044C	Cylinder Head Repl. Gasket Set				
CTP3126045A	Out of Frame OH Gasket Set	3126, Truck Engine	127-1866 128-5763	1WM00001-1WM99999	Turbocharged Single Head
CTP3126045B	Inframe OH Set				
CTP3126045C	Cylinder Head Repl. Gasket Set				
CTP3126046A	Out of Frame OH Gasket Set	3126, Truck Engine	127-1868	1WM00001-1WM99999	Turbocharged Single Head
CTP3126046B	Inframe OH Set				
CTP3126046C	Cylinder Head Repl. Gasket Set				
CTP3126047A	Out of Frame OH Gasket Set	3126, Truck Engine	127-6531 127-6570 128-5789	1WM00001-1WM99999	Turbocharged Single Head
CTP3126047B	Inframe OH Set				
CTP3126047C	Cylinder Head Repl. Gasket Set				
CTP3126048A	Out of Frame OH Gasket Set	3126, Truck Engine	127-6563	1WM00001-1WM99999	Turbocharged Single Head
CTP3126048B	Inframe OH Set				
CTP3126048C	Cylinder Head Repl. Gasket Set				
CTP3126049A	Out of Frame OH Gasket Set	3126, Truck Engine	127-6571	1WM00001-1WM99999	Turbocharged Single Head
CTP3126049B	Inframe OH Set				
CTP3126049C	Cylinder Head Repl. Gasket Set				
CTP3126050A	Out of Frame OH Gasket Set	3126, Truck Engine	127-6572 129-3661	1WM00001-1WM99999	Turbocharged Single Head
CTP3126050B	Inframe OH Set				
CTP3126050C	Cylinder Head Repl. Gasket Set				
CTP3126051A	Out of Frame OH Gasket Set	3126, Truck Engine	127-6591 129-3642	1WM00001-1WM99999	Turbocharged Single Head
CTP3126051B	Inframe OH Set				
CTP3126051C	Cylinder Head Repl. Gasket Set				
CTP3126052A	Out of Frame OH Gasket Set		128-5793	1WM00001-1WM99999	Turbocharged Single Head
CTP3126052B	Inframe OH Set				
CTP3126052C	Cylinder Head Repl. Gasket Set				

Part Number	Description	Machine Model / Application	Engine Arrangement	Engine Serial No.	Comments
CTP3126053A	Out of Frame OH Gasket Set		129-1719 129-3653 132-6097 133-7800 134-1608	1WM00001-1WM99999	Turbocharged Single Head
CTP3126053B	Inframe OH Set				
CTP3126053C	Cylinder Head Repl. Gasket Set				
CTP3126054A	Out of Frame OH Gasket Set				
CTP3126054B	Inframe OH Set		129-9741	1WM00001-1WM99999	Turbocharged Single Head
CTP3126054C	Cylinder Head Repl. Gasket Set				
CTP3126055A	Out of Frame OH Gasket Set				
CTP3126055B	Inframe OH Set		131-9250	1WM00001-1WM99999	Turbocharged Single Head
CTP3126055C	Cylinder Head Repl. Gasket Set				
CTP3126056A	Out of Frame OH Gasket Set		132-6100	1WM00001-1WM99999	Turbocharged Single Head
CTP3126056B	Inframe OH Set				
CTP3126056C	Cylinder Head Repl. Gasket Set				
CTP3126057A	Out of Frame OH Gasket Set		133-4122 133-4123	1WM00001-1WM99999	Turbocharged Single Head
CTP3126057B	Inframe OH Set				
CTP3126057C	Cylinder Head Repl. Gasket Set				
CTP3126058A	Out of Frame OH Gasket Set		133-4124 133-4125 133-7686	1WM00001-1WM99999	Turbocharged Single Head
CTP3126058B	Inframe OH Set				
CTP3126058C	Cylinder Head Repl. Gasket Set				
CTP3126059A	Out of Frame OH Gasket Set		134-4825	1WM00001-1WM99999	Turbocharged Single Head
CTP3126059B	Inframe OH Set				
CTP3126059C	Cylinder Head Repl. Gasket Set				
CTP3126060A	Out of Frame OH Gasket Set		134-4827 136-0656	1WM00001-1WM99999	Turbocharged Single Head
CTP3126060B	Inframe OH Set				
CTP3126060C	Multiple Cyl. Head Repl. Gasket Set				
CTP3126061A	Out of Frame OH Gasket Set		134-4829	1WM00001-1WM99999	Turbocharged Single Head
CTP3126061C	Multiple Cyl. Head Repl. Gasket Set				
CTP3126062A	Out of Frame OH Gasket Set		134-4830 135-0878 135-0879 135-0882 135-0885	1WM00001-1WM99999	Turbocharged Single Head
CTP3126062B	Inframe OH Set				
CTP3126062C	Multiple Cyl. Head Repl. Gasket Set				
CTP3126063A	Out of Frame OH Gasket Set		134-4862	1WM00001-1WM99999	Turbocharged Single Head
CTP3126063C	Multiple Cyl. Head Repl. Gasket Set				
CTP3126064A	Out of Frame OH Gasket Set		134-4991 135-4877 137-5490	1WM00001-1WM99999	Turbocharged Single Head
CTP3126064B	Inframe OH Set				
CTP3126064C	Multiple Cyl. Head Repl. Gasket Set				
CTP3126065A	Out of Frame OH Gasket Set		135-0877 135-0887	1WM00001-1WM99999	Turbocharged Single Head
CTP3126065B	Inframe OH Set				
CTP3126065C	Multiple Cyl. Head Repl. Gasket Set				
CTP3126066A	Out of Frame OH Gasket Set		135-0880 135-0883	1WM00001-1WM99999	Turbocharged Single Head
CTP3126066B	Inframe OH Set				
CTP3126066C	Cylinder Head Repl. Gasket Set		135-0886 135-0888 135-0889 135-0890 135-4876	1WM00001-1WM99999	Turbocharged Single Head
CTP3126067A	Out of Frame OH Gasket Set				
CTP3126067B	Inframe OH Set				
CTP3126067C	Cylinder Head Repl. Gasket Set		135-0892	1WM00001-1WM99999	Turbocharged Single Head
CTP3126068A	Out of Frame OH Gasket Set				
CTP3126068B	Inframe OH Set				
CTP3126068C	Cylinder Head Repl. Gasket Set				

Part Number	Description	Machine Model / Application	Engine Arrangement	Engine Serial No.	Comments
CTP3126069A	Out of Frame OH Gasket Set		135-0893	1WM00001-1WM99999	Turbocharged Single Head
CTP3126069B	Inframe OH Set				
CTP3126069C	Cylinder Head Repl. Gasket Set				
CTP3126070A	Out of Frame OH Gasket Set		136-0737	1WM00001-1WM26507	Turbocharged Single Head
CTP3126070C	Cylinder Head Repl. Gasket Set				
CTP3126071A	Out of Frame OH Gasket Set		137-5387	1WM05198-1WM99999	Turbocharged Single Head
CTP3126071B	Inframe OH Set				
CTP3126071C	Cylinder Head Repl. Gasket Set				
CTP3126072A	Out of Frame OH Gasket Set		137-5389 137-5392 139-9941	1WM00001-1WM99999	Turbocharged Single Head
CTP3126072B	Inframe OH Set				
CTP3126072C	Cylinder Head Repl. Gasket Set				
CTP3126073A	Out of Frame OH Gasket Set		137-5391 137-5400 139-9856 139-9868	1WM00001-1WM99999	Turbocharged Single Head
CTP3126073B	Inframe OH Set				
CTP3126073C	Cylinder Head Repl. Gasket Set				
CTP3126074A	Out of Frame OH Gasket Set		137-5401	1WM00001-1WM99999	Turbocharged Single Head
CTP3126074B	Inframe OH Set				
CTP3126074C	Cylinder Head Repl. Gasket Set		137-5402	1WM00001-1WM99999	Turbocharged Single Head
CTP3126075A	Out of Frame OH Gasket Set				
CTP3126075B	Inframe OH Set				
CTP3126075C	Cylinder Head Repl. Gasket Set		137-5450	1WM00001-1WM99999	Turbocharged Single Head
CTP3126076A	Out of Frame OH Gasket Set				
CTP3126076B	Inframe OH Set				
CTP3126076C	Cylinder Head Repl. Gasket Set		137-5451 137-5452 137-5453 137-5455	1WM00001-1WM99999	Turbocharged Single Head
CTP3126077A	Out of Frame OH Gasket Set				
CTP3126077B	Inframe OH Set				
CTP3126077C	Cylinder Head Repl. Gasket Set		137-5476	1WM00001-1WM99999	Turbocharged Single Head
CTP3126078A	Out of Frame OH Gasket Set				
CTP3126078B	Inframe OH Set				
CTP3126078C	Cylinder Head Repl. Gasket Set		138-6035	1WM05709-1WM99999	Turbocharged Single Head
CTP3126079A	Out of Frame OH Gasket Set				
CTP3126079B	Inframe OH Set				
CTP3126079C	Cylinder Head Repl. Gasket Set		139-9779	1WM00001-1WM99999	Turbocharged Single Head
CTP3126080A	Out of Frame OH Gasket Set				
CTP3126080B	Inframe OH Set				
CTP3126080C	Cylinder Head Repl. Gasket Set		139-9858 139-9859 139-9933 139-9945 139-9949	1WM00001-1WM99999	Turbocharged Single Head
CTP3126081A	Out of Frame OH Gasket Set				
CTP3126081B	Inframe OH Set				
CTP3126081C	Cylinder Head Repl. Gasket Set		139-9943	1WM00001-1WM99999	Turbocharged Single Head
CTP3126082A	Out of Frame OH Gasket Set				
CTP3126082B	Inframe OH Set				
CTP3126082C	Cylinder Head Repl. Gasket Set		139-9944 139-9947 141-4290	1WM00001-1WM99999	Turbocharged Single Head
CTP3126083A	Out of Frame OH Gasket Set				
CTP3126083B	Inframe OH Set				
CTP3126083C	Cylinder Head Repl. Gasket Set				

Part Number	Description	Machine Model / Application	Engine Arrangement	Engine Serial No.	Comments
CTP3126084A	Out of Frame OH Gasket Set		139-9950 139-9951 141-4163 141-4291	1WM00001-1WM99999	Turbocharged Single Head
CTP3126084B	Inframe OH Set				
CTP3126084C	Cylinder Head Repl. Gasket Set				
CTP3126085A	Out of Frame OH Gasket Set		139-9997 139-9998 139-9999	1WM00001-1WM99999	Turbocharged Single Head
CTP3126085B	Inframe OH Set				
CTP3126085C	Cylinder Head Repl. Gasket Set		140-0000	1WM00001-1WM99999	Turbocharged Single Head
CTP3126086A	Out of Frame OH Gasket Set				
CTP3126086B	Inframe OH Set				
CTP3126086C	Cylinder Head Repl. Gasket Set		142-0582	1WM00001-1WM99999	Turbocharged Single Head
CTP3126087A	Out of Frame OH Gasket Set				
CTP3126087B	Inframe OH Set				
CTP3126087C	Cylinder Head Repl. Gasket Set		142-0583	1WM00001-1WM99999	Turbocharged Single Head
CTP3126088A	Out of Frame OH Gasket Set				
CTP3126088B	Inframe OH Set				
CTP3126088C	Cylinder Head Repl. Gasket Set		142-0614	1WM00001-1WM99999	Turbocharged Single Head
CTP3126089A	Out of Frame OH Gasket Set				
CTP3126090A	Out of Frame OH Gasket Set				
CTP3126090B	Inframe OH Set				
CTP3126090C	Cylinder Head Repl. Gasket Set				
CTP3126091A	Out of Frame OH Gasket Set		142-0641	1WM00001-1WM99999	Turbocharged Single Head
CTP3126091B	Inframe OH Set				
CTP3126091C	Cylinder Head Repl. Gasket Set				
CTP3126092A	Out of Frame OH Gasket Set		142-0656	1WM00001-1WM99999	Turbocharged Single Head
CTP3126092B	Inframe OH Set				
CTP3126092C	Cylinder Head Repl. Gasket Set				
CTP3126093A	Out of Frame OH Gasket Set		142-0660	1WM00001-1WM99999	Turbocharged Single Head
CTP3126093B	Inframe OH Set				
CTP3126093C	Cylinder Head Repl. Gasket Set				
CTP3126094A	Out of Frame OH Gasket Set		143-1009 143-1048 143-1049	1WM00001-1WM99999	Turbocharged Single Head
CTP3126094B	Inframe OH Set				
CTP3126094C	Cylinder Head Repl. Gasket Set				
CTP3126095A	Out of Frame OH Gasket Set		143-1052	1WM00001-1WM99999	Turbocharged Single Head
CTP3126095B	Inframe OH Set				
CTP3126095C	Cylinder Head Repl. Gasket Set				
CTP3126096A	Out of Frame OH Gasket Set		143-1061	1WM00001-1WM99999	Turbocharged Single Head
CTP3126096B	Inframe OH Set				
CTP3126096C	Cylinder Head Repl. Gasket Set				
CTP3126097A	Out of Frame OH Gasket Set		143-1071 143-9978 143-9979	1WM08697-1WM26507 1WM09630-1WM26507	Turbocharged Single Head
CTP3126097B	Inframe OH Set				
CTP3126097C	Cylinder Head Repl. Gasket Set				
CTP3126098A	Out of Frame OH Gasket Set		143-1073 143-1074 143-1076	1WM08697-1WM26507	Turbocharged Single Head
CTP3126098B	Inframe OH Set				
CTP3126098C	Cylinder Head Repl. Gasket Set				

3126 (cont.)

Part Number	Description	Machine Model / Application	Engine Arrangement	Engine Serial No.	Comments
CTP3126099A	Out of Frame OH Gasket Set		143-1091	1WM08697-1WM26507	Turbocharged Single Head
CTP3126099B	Inframe OH Set		144-0098	1WM09674-1WM26507	
CTP3126099C	Cylinder Head Repl. Gasket Set		144-5776	1WM09906-1WM26507	
CTP3126100A	Out of Frame OH Gasket Set		143-1092 143-1120 143-1121 143-1122	1WM08697-1WM26507	Turbocharged Single Head
CTP3126100B	Inframe OH Set				
CTP3126100C	Cylinder Head Repl. Gasket Set		143-1098	1WM08782-1WM26507	
CTP3126101A	Out of Frame OH Gasket Set		143-1110	1WM08739-1WM26507	Turbocharged Single Head
CTP3126101B	Inframe OH Set		143-1133	1WM09411-1WM26507	
CTP3126101C	Cylinder Head Repl. Gasket Set		143-1134	1WM09411-1WM26507	
CTP3126102A	Out of Frame OH Gasket Set		143-1111	1WM08739-1WM26507	Turbocharged Single Head
CTP3126102B	Inframe OH Set				
CTP3126102C	Cylinder Head Repl. Gasket Set				
CTP3126103A	Out of Frame OH Gasket Set		143-1129	1WM08739-1WM26507	Turbocharged Single Head
CTP3126103B	Inframe OH Set		144-0026	1WM09482-1WM26507	
CTP3126103C	Cylinder Head Repl. Gasket Set		144-0050	1WM09274-1WM26507	
			144-0087	1WM09482-1WM26507	
CTP3126104A	Out of Frame OH Gasket Set		143-1140	1WM08782-1WM26507	Turbocharged Single Head
CTP3126104B	Inframe OH Set		143-1141	1WM08828-1WM26507	
CTP3126104C	Cylinder Head Repl. Gasket Set		143-1154	1WM09774-1WM26507	
			143-9966	1WM09774-1WM26507	
CTP3126105A	Out of Frame OH Gasket Set		143-9965	1WM09774-1WM26507	Turbocharged Single Head
CTP3126105B	Inframe OH Set				
CTP3126105C	Cylinder Head Repl. Gasket Set				
CTP3126106A	Out of Frame OH Gasket Set		144-0025	1WM09482-1WM26507	Turbocharged Single Head
CTP3126106B	Inframe OH Set				
CTP3126106C	Cylinder Head Repl. Gasket Set				
CTP3126107A	Out of Frame OH Gasket Set		144-0029	1WM09482-1WM26507	Turbocharged Single Head
CTP3126107B	Inframe OH Set				
CTP3126107C	Cylinder Head Repl. Gasket Set				
CTP3126108A	Out of Frame OH Gasket Set		144-0032	1WM09482-1WM26507	Turbocharged Single Head
CTP3126108B	Inframe OH Set				
CTP3126108C	Cylinder Head Repl. Gasket Set				
CTP3126109A	Out of Frame OH Gasket Set		144-0033	1WM09482-1WM26507	Turbocharged Single Head
CTP3126109B	Inframe OH Set				
CTP3126109C	Cylinder Head Repl. Gasket Set				
CTP3126110A	Out of Frame OH Gasket Set		144-0039	1WM09273-1WM26507	Turbocharged Single Head
CTP3126110B	Inframe OH Set				
CTP3126110C	Cylinder Head Repl. Gasket Set				
CTP3126111A	Out of Frame OH Gasket Set		144-0042	1WM09273-1WM26507	Turbocharged Single Head
CTP3126111B	Inframe OH Set		144-5775	1WM09906-1WM26507	
CTP3126111C	Cylinder Head Repl. Gasket Set				

Part Number	Description	Machine Model / Application	Engine Arrangement	Engine Serial No.	Comments
CTP3126112A	Out of Frame OH Gasket Set		144-0088	1WM09482-1WM26507	Turbocharged Single Head
CTP3126112B	Inframe OH Set		144-0089	1WM09482-1WM26507	
			144-5786	1WM10192-1WM26507	
			144-5787	1WM09906-1WM26507	
CTP3126112C	Cylinder Head Repl. Gasket Set		144-5787	1WM09906-1WM26507	
CTP3126113A	Out of Frame OH Gasket Set		144-5764	1WM10866-1WM26507	Turbocharged Single Head
CTP3126113B	Inframe OH Set				
CTP3126113C	Cylinder Head Repl. Gasket Set				
CTP3126114A	Out of Frame OH Gasket Set		144-5765	1WM10866-1WM26507	Turbocharged Single Head
CTP3126114B	Inframe OH Set		144-5798	1WM09806-1WM26507	
			144-5837	1WM10038-1WM26507	
			145-1933	1WM10458-1WM26507	
CTP3126114C	Cylinder Head Repl. Gasket Set		145-1933	1WM10458-1WM26507	
CTP3126115A	Out of Frame OH Gasket Set		144-5788	1WM09906-1WM26507	Turbocharged Single Head
CTP3126115B	Inframe OH Set		144-5796	1WM10197-1WM26507	
			144-5856	1WM10038-1WM26507	
			145-1945	1WM10458-1WM26507	
CTP3126115C	Cylinder Head Repl. Gasket Set		145-1945	1WM10458-1WM26507	
CTP3126116A	Out of Frame OH Gasket Set		144-5862	1WM10138-1WM26507	Turbocharged Single Head
CTP3126116B	Inframe OH Set		146-8723	1WM13093-1WM26507	
CTP3126116C	Cylinder Head Repl. Gasket Set		146-8723	1WM13093-1WM26507	
CTP3126117A	Out of Frame OH Gasket Set		144-5866	1WM10138-1WM26507	Turbocharged Single Head
CTP3126117B	Inframe OH Set		144-5867	1WM10138-1WM26507	
			144-5867	1WM10138-1WM26507	
			144-5867	1WM10138-1WM26507	
CTP3126117C	Cylinder Head Repl. Gasket Set		144-5867	1WM10138-1WM26507	
CTP3126118A	Out of Frame OH Gasket Set		144-5886	1WM10765-1WM26507	Turbocharged Single Head
CTP3126118B	Inframe OH Set				
CTP3126118C	Cylinder Head Repl. Gasket Set				
CTP3126119A	Out of Frame OH Gasket Set				
CTP3126119B	Inframe OH Set		144-5900	1WM10306-1WM26507	
CTP3126119C	Cylinder Head Repl. Gasket Set		144-5900	1WM10306-1WM26507	
CTP3126120A	Out of Frame OH Gasket Set		145-1953	1WM10776-1WM26507	Turbocharged Single Head
CTP3126120B	Inframe OH Set				
CTP3126120C	Cylinder Head Repl. Gasket Set				
CTP3126121A	Out of Frame OH Gasket Set				
CTP3126121B	Inframe OH Set		145-1971	1WM11054-1WM26507	
CTP3126121C	Cylinder Head Repl. Gasket Set		145-1971	1WM11054-1WM26507	
CTP3126122A	Out of Frame OH Gasket Set		145-2008	1WM11715-1WM26507	Turbocharged Single Head
CTP3126122B	Inframe OH Set				
CTP3126122C	Cylinder Head Repl. Gasket Set				
CTP3126123A	Out of Frame OH Gasket Set		145-2041	1WM11716-1WM26507	Turbocharged Single Head
CTP3126123B	Inframe OH Set		146-8721	1WM13040-1WM26507	
CTP3126123C	Cylinder Head Repl. Gasket Set		147-7561	1WM00001-1WM26507	
CTP3126124A	Out of Frame OH Gasket Set		145-2079	1WM11486-1WM26507	Turbocharged Single Head
CTP3126124B	Inframe OH Set				
CTP3126124C	Cylinder Head Repl. Gasket Set				

Part Number	Description	Machine Model / Application	Engine Arrangement	Engine Serial No.	Comments
CTP3126125A	Out of Frame OH Gasket Set		145-2092	1WM11425-1WM26507	Turbocharged Single Head
CTP3126125B	Inframe OH Set				
CTP3126125C	Cylinder Head Repl. Gasket Set				
CTP3126126A	Out of Frame OH Gasket Set		145-2140	1WM11914-1WM26507	Turbocharged Single Head
CTP3126126B	Inframe OH Set				
CTP3126126C	Cylinder Head Repl. Gasket Set				
CTP3126127A	Out of Frame OH Gasket Set		145-2159	1WM12066-1WM26507	Turbocharged Single Head
CTP3126127B	Inframe OH Set		146-8700	1WM12819-1WM26507	
CTP3126127C	Cylinder Head Repl. Gasket Set		146-8700	1WM12819-1WM26507	
CTP3126128A	Out of Frame OH Gasket Set		145-2200	1WM12486-1WM26507	Turbocharged Single Head
CTP3126128B	Inframe OH Set				
CTP3126128C	Cylinder Head Repl. Gasket Set				
CTP3126129A	Out of Frame OH Gasket Set		145-2201	1WM12486-1WM26507	Turbocharged Single Head
CTP3126129B	Inframe OH Set		146-8593		
CTP3126129C	Cylinder Head Repl. Gasket Set		146-8632		
			146-8633		
CTP3126130A	Out of Frame OH Gasket Set		146-8614	1WM12818-1WM26507	Turbocharged Single Head
CTP3126130B	Inframe OH Set		146-8664		
CTP3126130C	Cylinder Head Repl. Gasket Set		146-8665		
CTP3126131A	Out of Frame OH Gasket Set		146-8635	1WM12818-1WM26507	Turbocharged Single Head
CTP3126131B	Inframe OH Set		147-6089	1WM00001-1WM26507	
CTP3126131C	Cylinder Head Repl. Gasket Set		147-6100	1WM00001-1WM26507	
CTP3126132A	Out of Frame OH Gasket Set		146-8667 146-8668	1WM12819-1WM26507	Turbocharged Single Head
CTP3126132B	Inframe OH Set		146-8707 146-8708	1WM13040-1WM26507	
CTP3126132C	Cylinder Head Repl. Gasket Set		146-8707 146-8708	1WM13040-1WM26507	
CTP3126133A	Out of Frame OH Gasket Set		146-8709 146-8710 146-8711 146-8712	1WM13040-1WM26507	Turbocharged Single Head
CTP3126133B	Inframe OH Set				
CTP3126133C	Cylinder Head Repl. Gasket Set				
CTP3126134A	Out of Frame OH Gasket Set		146-8713	1WM13040-1WM26507	Turbocharged Single Head
CTP3126134B	Inframe OH Set		146-8748	1WM13093-1WM26507	
CTP3126134C	Cylinder Head Repl. Gasket Set		146-8770 146-8771	1WM00001-1WM26507	
CTP3126135A	Out of Frame OH Gasket Set		146-8749	1WM13093-1WM26507	Turbocharged Single Head
CTP3126135B	Inframe OH Set				
CTP3126135C	Cylinder Head Repl. Gasket Set				
CTP3126136A	Out of Frame OH Gasket Set		146-8769	1WM13132-1WM26507	Turbocharged Single Head
CTP3126136B	Inframe OH Set				
CTP3126136C	Cylinder Head Repl. Gasket Set				
CTP3126137A	Out of Frame OH Gasket Set		147-7401	1WM00001-1WM99999	Turbocharged Single Head
CTP3126137B	Inframe OH Set				
CTP3126137C	Cylinder Head Repl. Gasket Set				

Part Number	Description	Machine Model / Application	Engine Arrangement	Engine Serial No.	Comments
CTP3126138A	Out of Frame OH Gasket Set		147-7442 147-7562	1WM00001-1WM26507	Turbocharged Single Head
CTP3126138B	Inframe OH Set		147-7563 147-7590 147-7594		
CTP3126138C	Cylinder Head Repl. Gasket Set				
CTP3126139A	Out of Frame OH Gasket Set		147-7578 148-8695 148-8696	1WM00001-1WM26507	Turbocharged Single Head
CTP3126139B	Inframe OH Set				
CTP3126139C	Cylinder Head Repl. Gasket Set				
CTP3126140A	Out of Frame OH Gasket Set		147-7595 148-8616 148-8617 148-8697	1WM00001-1WM26507	Turbocharged Single Head
CTP3126140B	Inframe OH Set				
CTP3126140C	Cylinder Head Repl. Gasket Set				
CTP3126141A	Out of Frame OH Gasket Set		148-8661 149-9034	1WM00001-1WM26507	Turbocharged Single Head
CTP3126141B	Inframe OH Set				
CTP3126141C	Cylinder Head Repl. Gasket Set				
CTP3126142A	Out of Frame OH Gasket Set		148-8706	1WM00001-1WM26507	Turbocharged Single Head
CTP3126142B	Inframe OH Set				
CTP3126142C	Cylinder Head Repl. Gasket Set				
CTP3126143A	Out of Frame OH Gasket Set		149-9044	1WM00001-1WM26507	Turbocharged Single Head
CTP3126143B	Inframe OH Set				
CTP3126143C	Cylinder Head Repl. Gasket Set				
CTP3126144A	Out of Frame OH Gasket Set		149-9061	1WM00001-1WM26507	Turbocharged Single Head
CTP3126144B	Inframe OH Set				
CTP3126144C	Cylinder Head Repl. Gasket Set				
CTP3126145A	Out of Frame OH Gasket Set		149-9083	1WM00001-1WM26507	Turbocharged Single Head
CTP3126145B	Inframe OH Set				
CTP3126145C	Cylinder Head Repl. Gasket Set				
CTP3126146A	Out of Frame OH Gasket Set		150-6141	1WM00001-1WM26507	Turbocharged Single Head
CTP3126146B	Inframe OH Set				
CTP3126146C	Cylinder Head Repl. Gasket Set				
CTP3126147A	Out of Frame OH Gasket Set		151-2251	1WM00001-1WM26507	Turbocharged Single Head
CTP3126147B	Inframe OH Set				
CTP3126147C	Cylinder Head Repl. Gasket Set				
CTP3126148A	Out of Frame OH Gasket Set		151-2341	1WM00001-1WM99999	Turbocharged Single Head
CTP3126148B	Inframe OH Set				
CTP3126148C	Cylinder Head Repl. Gasket Set				
CTP3126149A	Out of Frame OH Gasket Set		152-3163	1WM00001-1WM26507	Turbocharged Single Head
CTP3126149B	Inframe OH Set				
CTP3126149C	Cylinder Head Repl. Gasket Set				
CTP3126150A	Out of Frame OH Gasket Set		152-3331	1WM00001-1WM99999	Turbocharged Single Head
CTP3126150B	Inframe OH Set				
CTP3126150C	Cylinder Head Repl. Gasket Set				
CTP3126151A	Out of Frame OH Gasket Set		152-3344 152-3345 153-5864	1WM00001-1WM26507	Turbocharged Single Head
CTP3126151B	Inframe OH Set				
CTP3126151C	Cylinder Head Repl. Gasket Set				

Part numbers are used for reference purposes only.

Costex Tractor Parts Copyright © 2020. All rights reserved.

3126 (cont.)

Part Number	Description	Machine Model / Application	Engine Arrangement	Engine Serial No.	Comments
CTP3126152A	Out of Frame OH Gasket Set		137-5454	4ES00265-4ES99999	Turbocharged Single Head
CTP3126152B	Inframe OH Set				
CTP3126152C	Cylinder Head Repl. Gasket Set				
CTP3126153A	Out of Frame OH Gasket Set		137-5458	4ES00265-4ES99999	Turbocharged Single Head
CTP3126153B	Inframe OH Set				
CTP3126153C	Cylinder Head Repl. Gasket Set	137-5459			
CTP3126154A	Out of Frame OH Gasket Set		151-7122	6PZ00001-6PZ99999	Turbocharged Single Head
CTP3126154B	Inframe OH Set				
CTP3126154C	Cylinder Head Repl. Gasket Set				
CTP3126155A	Out of Frame OH Gasket Set		151-7123	7JZ00001-7JZ99999	Turbocharged Single Head
CTP3126155B	Inframe OH Set				
CTP3126155C	Cylinder Head Repl. Gasket Set				
CTP3126156A	Out of Frame OH Gasket Set		237-4837	7JZ00001-7JZ99999	Turbocharged Single Head
CTP3126156B	Inframe OH Set				
CTP3126156C	Cylinder Head Repl. Gasket Set				
CTP3126157A	Out of Frame OH Gasket Set		156-2278 156-2287 156-2439	7LZ00001-7LZ99999	Turbocharged Single Head
CTP3126157B	Inframe OH Set				
CTP3126157C	Cylinder Head Repl. Gasket Set				
CTP3126158A	Out of Frame OH Gasket Set		156-2280 156-2281 156-2282 156-2285 156-2441	7LZ00001-7LZ99999	Turbocharged Single Head
CTP3126158B	Inframe OH Set				
CTP3126158C	Cylinder Head Repl. Gasket Set				
CTP3126159A	Out of Frame OH Gasket Set		156-2440	7LZ00299-7LZ99999	
CTP3126160A	Out of Frame OH Gasket Set		156-1957	8HW00001-8HW99999	Turbocharged Single Head
CTP3126160B	Inframe OH Set				
CTP3126160C	Cylinder Head Repl. Gasket Set				
CTP3126161A	Out of Frame OH Gasket Set		156-1958	8HW00001-8HW99999	Turbocharged Single Head
CTP3126161B	Inframe OH Set				
CTP3126161C	Cylinder Head Repl. Gasket Set				
CTP3126162A	Out of Frame OH Gasket Set		156-1959	8HW00001-8HW99999	Turbocharged Single Head
CTP3126162B	Inframe OH Set				
CTP3126162C	Cylinder Head Repl. Gasket Set				
CTP3126163A	Out of Frame OH Gasket Set		164-8709	8HW00001-8HW99999	Turbocharged Single Head
CTP3126163B	Inframe OH Set				
CTP3126163C	Cylinder Head Repl. Gasket Set				
CTP3126164A	Out of Frame OH Gasket Set		164-8710	8HW00001-8HW99999	Turbocharged Single Head
CTP3126164B	Inframe OH Set				
CTP3126164C	Cylinder Head Repl. Gasket Set				
CTP3126165A	Out of Frame OH Gasket Set		179-4052	8SZ00001-8SZ99999	Turbocharged Single Head
CTP3126165B	Inframe OH Set				
CTP3126165C	Cylinder Head Repl. Gasket Set				
CTP3126166A	Out of Frame OH Gasket Set		172-9164	5GL00001-5GL99999	Turbocharged Single Head
CTP3126166B	Inframe OH Set				
CTP3126166C	Cylinder Head Repl. Gasket Set	172-9198			

Part Number	Description	Machine Model / Application	Engine Arrangement	Engine Serial No.	Comments
CTP3126167A	Out of Frame OH Gasket Set		143-3322	7AS00001-7AS99999	Turbocharged Single Head
CTP3126167B	Inframe OH Set				
CTP3126167C	Cylinder Head Repl. Gasket Set				
CTP3126168A	Out of Frame OH Gasket Set		146-8758 146-8763 146-8767 153-5825	7AS00001-7AS99999	Turbocharged Single Head
CTP3126168B	Inframe OH Set				
CTP3126168C	Cylinder Head Repl. Gasket Set				
CTP3126169A	Out of Frame OH Gasket Set		146-8759	7AS00001-7AS99999	Turbocharged Single Head
CTP3126169B	Inframe OH Set		146-8761	7AS00001-7AS26507	
CTP3126169C	Cylinder Head Repl. Gasket Set		146-8762 146-8766	7AS00001-7AS99999	
CTP3126170A	Out of Frame OH Gasket Set		146-8768 148-8756 153-5823	7AS00001-7AS99999	Turbocharged Single Head
CTP3126170B	Inframe OH Set				
CTP3126170C	Cylinder Head Repl. Gasket Set				
CTP3126171A	Out of Frame OH Gasket Set		147-6081	7AS00001-7AS00580	Turbocharged Single Head
CTP3126171B	Inframe OH Set		147-7440	7AS00001-7AS00517	
CTP3126171C	Cylinder Head Repl. Gasket Set				
CTP3126172A	Out of Frame OH Gasket Set		149-9013	7AS00001-7AS99999	Turbocharged Single Head
CTP3126172B	Inframe OH Set				
CTP3126172C	Cylinder Head Repl. Gasket Set				
CTP3126173A	Out of Frame OH Gasket Set		150-6053 152-9921 152-9924 154-1054	7AS00001-7AS99999	Turbocharged Single Head
CTP3126173B	Inframe OH Set				
CTP3126173C	Cylinder Head Repl. Gasket Set				
CTP3126174A	Out of Frame OH Gasket Set		150-6067 152-9925 154-1047 154-1059	7AS00001-7AS99999	Turbocharged Single Head
CTP3126174B	Inframe OH Set				
CTP3126174C	Cylinder Head Repl. Gasket Set				
CTP3126175A	Out of Frame OH Gasket Set		150-6088	7AS00001-7AS99999	Turbocharged Single Head
CTP3126175B	Inframe OH Set				
CTP3126175C	Cylinder Head Repl. Gasket Set				
CTP3126176A	Out of Frame OH Gasket Set		152-9930 166-9731	7AS00001-7AS99999	Turbocharged Single Head
CTP3126176B	Inframe OH Set				
CTP3126176C	Cylinder Head Repl. Gasket Set				
CTP3126177A	Out of Frame OH Gasket Set		153-5818 153-5894	7AS00001-7AS99999	Turbocharged Single Head
CTP3126177B	Inframe OH Set				
CTP3126177C	Cylinder Head Repl. Gasket Set				
CTP3126178A	Out of Frame OH Gasket Set		153-5824 153-5828 153-5829 153-5830	7AS00001-7AS99999	Turbocharged Single Head
CTP3126178B	Inframe OH Set				
CTP3126178C	Cylinder Head Repl. Gasket Set				
CTP3126179A	Out of Frame OH Gasket Set		153-5826	7AS00001-7AS99999	Turbocharged Single Head
CTP3126179B	Inframe OH Set		153-5827		
CTP3126179C	Cylinder Head Repl. Gasket Set				
CTP3126180A	Out of Frame OH Gasket Set		153-5860	7AS00001-7AS99999	Turbocharged Single Head
CTP3126180B	Inframe OH Set		154-1033		
CTP3126180C	Cylinder Head Repl. Gasket Set				

Part Number	Description	Machine Model / Application	Engine Arrangement	Engine Serial No.	Comments
CTP3126181A	Out of Frame OH Gasket Set		153-5897	7AS00001-7AS99999	Turbocharged Single Head
CTP3126181B	Inframe OH Set				
CTP3126181C	Cylinder Head Repl. Gasket Set				
CTP3126182A	Out of Frame OH Gasket Set		154-1053 154-1058 154-1062 154-1075	7AS00001-7AS99999	Turbocharged Single Head
CTP3126182B	Inframe OH Set				
CTP3126182C	Cylinder Head Repl. Gasket Set				
CTP3126183A	Out of Frame OH Gasket Set		154-1055 154-1077 154-1078	7AS00001-7AS99999	Turbocharged Single Head
CTP3126183B	Inframe OH Set				
CTP3126183C	Cylinder Head Repl. Gasket Set				
CTP3126184A	Out of Frame OH Gasket Set		154-1056	7AS00001-7AS99999	Turbocharged Single Head
CTP3126184B	Inframe OH Set				
CTP3126184C	Cylinder Head Repl. Gasket Set				
CTP3126185A	Out of Frame OH Gasket Set		154-1057	7AS00001-7AS99999	Turbocharged Single Head
CTP3126185B	Inframe OH Set				
CTP3126185C	Cylinder Head Repl. Gasket Set				
CTP3126186A	Out of Frame OH Gasket Set		154-1060 154-1061 154-1176 154-1182	7AS00001-7AS99999	Turbocharged Single Head
CTP3126186B	Inframe OH Set				
CTP3126186C	Cylinder Head Repl. Gasket Set				
CTP3126187A	Out of Frame OH Gasket Set		154-1063	7AS00001-7AS99999	Turbocharged Single Head
CTP3126187B	Inframe OH Set				
CTP3126187C	Cylinder Head Repl. Gasket Set				
CTP3126188A	Out of Frame OH Gasket Set		154-1064 154-1086 156-2042	7AS00001-7AS99999	Turbocharged Single Head
CTP3126188B	Inframe OH Set				
CTP3126188C	Cylinder Head Repl. Gasket Set				
CTP3126189A	Out of Frame OH Gasket Set		154-1065	7AS00001-7AS99999	Turbocharged Single Head
CTP3126189B	Inframe OH Set		154-1066		
CTP3126189C	Cylinder Head Repl. Gasket Set		154-1067		
CTP3126190A	Out of Frame OH Gasket Set		154-1076	7AS00001-7AS99999	Turbocharged Single Head
CTP3126190B	Inframe OH Set				
CTP3126190C	Cylinder Head Repl. Gasket Set				
CTP3126191A	Out of Frame OH Gasket Set		154-1079 154-1080 154-1081 154-1097	7AS00001-7AS99999	Turbocharged Single Head
CTP3126191B	Inframe OH Set				
CTP3126191C	Cylinder Head Repl. Gasket Set				
CTP3126192A	Out of Frame OH Gasket Set		154-1082	7AS00001-7AS99999	Turbocharged Single Head
CTP3126192B	Inframe OH Set				
CTP3126192C	Cylinder Head Repl. Gasket Set				
CTP3126193A	Out of Frame OH Gasket Set		154-1085	7AS00001-7AS99999	Turbocharged Single Head
CTP3126193B	Inframe OH Set				
CTP3126193C	Cylinder Head Repl. Gasket Set				
CTP3126194A	Out of Frame OH Gasket Set		154-1089 160-3382 173-6236	7AS00001-7AS99999	Turbocharged Single Head
CTP3126194B	Inframe OH Set				
CTP3126194C	Cylinder Head Repl. Gasket Set				

Part Number	Description	Machine Model / Application	Engine Arrangement	Engine Serial No.	Comments
CTP3126195A	Out of Frame OH Gasket Set		154-1093	7AS00001-7AS99999	Turbocharged Single Head
CTP3126195B	Inframe OH Set				
CTP3126195C	Cylinder Head Repl. Gasket Set				
CTP3126196A	Out of Frame OH Gasket Set		154-1094 154-1095	7AS00001-7AS99999	Turbocharged Single Head
CTP3126196B	Inframe OH Set				
CTP3126196C	Cylinder Head Repl. Gasket Set				
CTP3126197A	Out of Frame OH Gasket Set		154-1096 154-1106 154-1108	7AS00001-7AS99999	Turbocharged Single Head
CTP3126197B	Inframe OH Set				
CTP3126197C	Cylinder Head Repl. Gasket Set				
CTP3126198A	Out of Frame OH Gasket Set		154-1098 154-1099 154-1152	7AS00001-7AS99999	Turbocharged Single Head
CTP3126198B	Inframe OH Set				
CTP3126198C	Cylinder Head Repl. Gasket Set				
CTP3126199A	Out of Frame OH Gasket Set		154-1100 154-1102 154-1111	7AS00001-7AS99999	Turbocharged Single Head
CTP3126199B	Inframe OH Set				
CTP3126199C	Cylinder Head Repl. Gasket Set				
CTP3126200A	Out of Frame OH Gasket Set		154-1101 154-1104 154-1109 154-1110	7AS00001-7AS99999	Turbocharged Single Head
CTP3126200B	Inframe OH Set				
CTP3126200C	Cylinder Head Repl. Gasket Set				
CTP3126201A	Out of Frame OH Gasket Set		155-3294 156-2043 156-2045 156-2312	7AS00001-7AS99999	Turbocharged Single Head
CTP3126201B	Inframe OH Set				
CTP3126201C	Cylinder Head Repl. Gasket Set				
CTP3126202A	Out of Frame OH Gasket Set		155-3346 155-3350 155-3360 166-9471	7AS00001-7AS99999	Turbocharged Single Head
CTP3126202B	Inframe OH Set				
CTP3126202C	Cylinder Head Repl. Gasket Set				
CTP3126203A	Out of Frame OH Gasket Set		155-3347 155-3351 155-3359 155-3455	7AS00001-7AS99999	Turbocharged Single Head
CTP3126203B	Inframe OH Set				
CTP3126203C	Cylinder Head Repl. Gasket Set				
CTP3126204A	Out of Frame OH Gasket Set		155-3404 166-9470	7AS00001-7AS99999	Turbocharged Single Head
CTP3126204B	Inframe OH Set				
CTP3126204C	Cylinder Head Repl. Gasket Set				
CTP3126205A	Out of Frame OH Gasket Set		156-2291 156-2305 156-2451 156-2452	7AS00001-7AS99999	Turbocharged Single Head
CTP3126205B	Inframe OH Set				
CTP3126205C	Cylinder Head Repl. Gasket Set				
CTP3126206A	Out of Frame OH Gasket Set		156-2293 156-2299 156-2303 156-2360	7AS00001-7AS99999	Turbocharged Single Head
CTP3126206B	Inframe OH Set				
CTP3126206C	Cylinder Head Repl. Gasket Set				
CTP3126207A	Out of Frame OH Gasket Set		156-2295	7AS00001-7AS99999	Turbocharged Single Head
CTP3126207B	Inframe OH Set				
CTP3126207C	Cylinder Head Repl. Gasket Set				
CTP3126208A	Out of Frame OH Gasket Set		156-2296	7AS00001-7AS99999	Turbocharged Single Head
CTP3126208B	Inframe OH Set				
CTP3126208C	Cylinder Head Repl. Gasket Set				

3126 (cont.)

Part Number	Description	Machine Model / Application	Engine Arrangement	Engine Serial No.	Comments
CTP3126209A	Out of Frame OH Gasket Set				
CTP3126209B	Inframe OH Set		156-2298	7AS00001-7AS99999	Turbocharged Single Head
CTP3126209C	Cylinder Head Repl. Gasket Set				
CTP3126210A	Out of Frame OH Gasket Set		156-2311 156-2313 158-5485 169-9267	7AS00001-7AS99999	Turbocharged Single Head
CTP3126210B	Inframe OH Set				
CTP3126210C	Cylinder Head Repl. Gasket Set				
CTP3126211A	Out of Frame OH Gasket Set		156-2355 156-2454 156-2456 156-2458	7AS00001-7AS99999	Turbocharged Single Head
CTP3126211B	Inframe OH Set				
CTP3126211C	Cylinder Head Repl. Gasket Set				
CTP3126212A	Out of Frame OH Gasket Set		156-2459 157-5395 166-9736	7AS00001-7AS99999	Turbocharged Single Head
CTP3126212B	Inframe OH Set				
CTP3126212C	Cylinder Head Repl. Gasket Set				
CTP3126213A	Out of Frame OH Gasket Set		157-5394	7AS00001-7AS99999	Turbocharged Single Head
CTP3126213B	Inframe OH Set				
CTP3126213C	Cylinder Head Repl. Gasket Set				
CTP3126214A	Out of Frame OH Gasket Set		157-5397 157-5427 157-5456 157-5471	7AS00001-7AS99999	Turbocharged Single Head
CTP3126214B	Inframe OH Set				
CTP3126214C	Cylinder Head Repl. Gasket Set				
CTP3126215A	Out of Frame OH Gasket Set		157-5398 158-5245 158-5532 158-5533	7AS00001-7AS99999	Turbocharged Single Head
CTP3126215B	Inframe OH Set				
CTP3126215C	Cylinder Head Repl. Gasket Set				
CTP3126216A	Out of Frame OH Gasket Set		157-5410 157-5412 158-5403 164-8687	7AS00001-7AS99999	Turbocharged Single Head
CTP3126216B	Inframe OH Set				
CTP3126216C	Cylinder Head Repl. Gasket Set				
CTP3126217A	Out of Frame OH Gasket Set		157-5428	7AS00001-7AS99999	Turbocharged Single Head
CTP3126217B	Inframe OH Set				
CTP3126217C	Cylinder Head Repl. Gasket Set				
CTP3126218A	Out of Frame OH Gasket Set		157-5472 157-5491 158-5154 158-5155	7AS00001-7AS99999	Turbocharged Single Head
CTP3126218B	Inframe OH Set				
CTP3126218C	Cylinder Head Repl. Gasket Set				
CTP3126219A	Out of Frame OH Gasket Set		158-5184 158-5188 158-5386 158-5400	7AS00001-7AS99999	Turbocharged Single Head
CTP3126219B	Inframe OH Set				
CTP3126219C	Cylinder Head Repl. Gasket Set				
CTP3126220A	Out of Frame OH Gasket Set		158-5229	7AS00001-7AS99999	Turbocharged Single Head
CTP3126220B	Inframe OH Set				
CTP3126220C	Cylinder Head Repl. Gasket Set				
CTP3126221A	Out of Frame OH Gasket Set		158-5252 164-8892 164-8894 164-8895	7AS00001-7AS99999	Turbocharged Single Head
CTP3126221B	Inframe OH Set				
CTP3126221C	Cylinder Head Repl. Gasket Set				
CTP3126222A	Out of Frame OH Gasket Set		158-5293 158-5527	7AS00001-7AS99999	Turbocharged Single Head
CTP3126222B	Inframe OH Set				
CTP3126222C	Cylinder Head Repl. Gasket Set				

Part Number	Description	Machine Model / Application	Engine Arrangement	Engine Serial No.	Comments
CTP3126223A	Out of Frame OH Gasket Set				
CTP3126223B	Inframe OH Set		158-5525	7AS00001-7AS99999	Turbocharged Single Head
CTP3126223C	Cylinder Head Repl. Gasket Set				
CTP3126224A	Out of Frame OH Gasket Set		158-5527 158-5530 158-5531 158-5534	7AS00001-7AS99999	Turbocharged Single Head
CTP3126224B	Inframe OH Set				
CTP3126224C	Cylinder Head Repl. Gasket Set				
CTP3126225A	Out of Frame OH Gasket Set		158-5529	7AS00001-7AS99999	Turbocharged Single Head
CTP3126225B	Inframe OH Set				
CTP3126225C	Cylinder Head Repl. Gasket Set				
CTP3126226A	Out of Frame OH Gasket Set		158-5535 158-5536 158-5538 160-2764	7AS00001-7AS99999	Turbocharged Single Head
CTP3126226B	Inframe OH Set				
CTP3126226C	Cylinder Head Repl. Gasket Set				
CTP3126227A	Out of Frame OH Gasket Set		158-5554 160-2801 160-3106 160-3252	7AS00001-7AS99999	Turbocharged Single Head
CTP3126227B	Inframe OH Set				
CTP3126227C	Cylinder Head Repl. Gasket Set				
CTP3126228A	Out of Frame OH Gasket Set		160-2800 160-2803 160-2804 160-2839	7AS00001-7AS99999	Turbocharged Single Head
CTP3126228B	Inframe OH Set				
CTP3126228C	Cylinder Head Repl. Gasket Set				
CTP3126229A	Out of Frame OH Gasket Set		160-2868 160-2884 160-2921 160-2956	7AS00001-7AS99999	Turbocharged Single Head
CTP3126229B	Inframe OH Set				
CTP3126229C	Cylinder Head Repl. Gasket Set				
CTP3126230A	Out of Frame OH Gasket Set		160-3034 160-3263 160-3339 160-3402	7AS00001-7AS99999	Turbocharged Single Head
CTP3126230B	Inframe OH Set				
CTP3126230C	Cylinder Head Repl. Gasket Set				
CTP3126231A	Out of Frame OH Gasket Set		160-3357 164-8703 166-9652 166-9841	7AS00001-7AS99999	Turbocharged Single Head
CTP3126231B	Inframe OH Set				
CTP3126231C	Cylinder Head Repl. Gasket Set				
CTP3126232A	Out of Frame OH Gasket Set		160-3403 160-3453 164-1810 164-1899	7AS00001-7AS99999	Turbocharged Single Head
CTP3126232B	Inframe OH Set				
CTP3126232C	Cylinder Head Repl. Gasket Set				
CTP3126233A	Out of Frame OH Gasket Set		164-1877	7AS00001-7AS99999	Turbocharged Single Head
CTP3126233B	Inframe OH Set				
CTP3126233C	Cylinder Head Repl. Gasket Set				
CTP3126234A	Out of Frame OH Gasket Set		164-1890	7AS00001-7AS99999	Turbocharged Single Head
CTP3126234B	Inframe OH Set				
CTP3126234C	Cylinder Head Repl. Gasket Set				
CTP3126235A	Out of Frame OH Gasket Set		164-1893 166-9546	7AS00001-7AS99999	Turbocharged Single Head
CTP3126235B	Inframe OH Set				
CTP3126235C	Cylinder Head Repl. Gasket Set				
CTP3126236A	Out of Frame OH Gasket Set		164-8631 164-8810 166-9548 166-9835	7AS00001-7AS99999	Turbocharged Single Head
CTP3126236B	Inframe OH Set				
CTP3126236C	Cylinder Head Repl. Gasket Set				

Part Number	Description	Machine Model / Application	Engine Arrangement	Engine Serial No.	Comments
CTP3126237A	Out of Frame OH Gasket Set		164-8688 164-8759 164-8808 166-9550	7AS00001-7AS99999	Turbocharged Single Head
CTP3126237B	Inframe OH Set				
CTP3126237C	Cylinder Head Repl. Gasket Set				
CTP3126238A	Out of Frame OH Gasket Set		164-8896 164-8897 164-8898 164-8899	7AS00001-7AS99999	Turbocharged Single Head
CTP3126238B	Inframe OH Set				
CTP3126238C	Cylinder Head Repl. Gasket Set				
CTP3126239A	Out of Frame OH Gasket Set		166-9456 166-9457 166-9461 166-9462	7AS00001-7AS99999	Turbocharged Single Head
CTP3126239B	Inframe OH Set				
CTP3126239C	Cylinder Head Repl. Gasket Set				
CTP3126240A	Out of Frame OH Gasket Set		166-9464 166-9467 166-9468 166-9469	7AS00001-7AS99999	Turbocharged Single Head
CTP3126240B	Inframe OH Set				
CTP3126240C	Cylinder Head Repl. Gasket Set				
CTP3126241A	Out of Frame OH Gasket Set		166-9466	7AS00001-7AS99999	Turbocharged Single Head
CTP3126241B	Inframe OH Set				
CTP3126241C	Cylinder Head Repl. Gasket Set				
CTP3126242A	Out of Frame OH Gasket Set		166-9472 166-9973 166-9474 166-9481	7AS00001-7AS99999	Turbocharged Single Head
CTP3126242B	Inframe OH Set				
CTP3126242C	Cylinder Head Repl. Gasket Set				
CTP3126344A	Out of Frame OH Gasket Set		178-1577 178-1578 178-1582 178-1583	8YL00001-8YL99999	Turbocharged Single Head
CTP3126344C	Cylinder Head Repl. Gasket Set				
CTP3126345A	Out of Frame OH Gasket Set		178-1591 179-0904 179-0974 179-0982	8YL00001-8YL99999	Turbocharged Single Head
CTP3126345B	Inframe OH Set				
CTP3126345C	Cylinder Head Repl. Gasket Set				
CTP3126346A	Out of Frame OH Gasket Set		179-0963 179-0969	8YL00001-8YL99999	Turbocharged Single Head
CTP3126346B	Inframe OH Set				
CTP3126346C	Cylinder Head Repl. Gasket Set				
CTP3126347A	Out of Frame OH Gasket Set		179-0983 179-0987 179-1011 179-1050	8YL00001-8YL99999	Turbocharged Single Head
CTP3126347B	Inframe OH Set				
CTP3126347C	Cylinder Head Repl. Gasket Set				
CTP3126348A	Out of Frame OH Gasket Set		179-1048 179-1052 184-2797 184-2798 184-2898	8YL00001-8YL99999	Turbocharged Single Head
CTP3126348B	Inframe OH Set				
CTP3126348C	Cylinder Head Repl. Gasket Set				
CTP3126349A	Out of Frame OH Gasket Set		179-1053 179-1067 179-1069 179-1097 179-1112	8YL00001-8YL99999	Turbocharged Single Head
CTP3126349B	Inframe OH Set				
CTP3126349C	Cylinder Head Repl. Gasket Set				
CTP3126350A	Out of Frame OH Gasket Set		179-1085 179-1139 179-1154 179-1191 180-2099	8YL00001-8YL99999	Turbocharged Single Head
CTP3126350B	Inframe OH Set				
CTP3126350C	Cylinder Head Repl. Gasket Set				
CTP3126351A	Out of Frame OH Gasket Set		179-1130 179-1152 179-1157 179-3795 189-9699	8YL00001-8YL99999	Turbocharged Single Head
CTP3126351B	Inframe OH Set				
CTP3126351C	Cylinder Head Repl. Gasket Set				

Part Number	Description	Machine Model / Application	Engine Arrangement	Engine Serial No.	Comments
CTP3126352A	Out of Frame OH Gasket Set		179-1153 188-6673 191-4045 197-1002 197-1003	8YL00001-8YL99999	Turbocharged Single Head
CTP3126352B	Inframe OH Set				
CTP3126352C	Cylinder Head Repl. Gasket Set				
CTP3126353A	Out of Frame OH Gasket Set		179-1193 179-1194 179-1195 179-3868 179-3915	8YL00001-8YL99999	Turbocharged Single Head
CTP3126353B	Inframe OH Set				
CTP3126353C	Cylinder Head Repl. Gasket Set				
CTP3126354A	Out of Frame OH Gasket Set		179-3888	8YL00001-8YL99999	Turbocharged Single Head
CTP3126354B	Inframe OH Set				
CTP3126354C	Cylinder Head Repl. Gasket Set				
CTP3126355A	Out of Frame OH Gasket Set		179-3896	8YL00001-8YL99999	Turbocharged Single Head
CTP3126355C	Cylinder Head Repl. Gasket Set				
CTP3126356A	Out of Frame OH Gasket Set		179-3897	8YL00001-8YL99999	Turbocharged Single Head
CTP3126356C	Cylinder Head Repl. Gasket Set				
CTP3126357A	Out of Frame OH Gasket Set		179-3909	8YL00001-8YL99999	Turbocharged Single Head
CTP3126357B	Inframe OH Set				
CTP3126357C	Cylinder Head Repl. Gasket Set				
CTP3126358A	Out of Frame OH Gasket Set		179-3913	8YL00001-8YL99999	Turbocharged Single Head
CTP3126358C	Cylinder Head Repl. Gasket Set				
CTP3126359A	Out of Frame OH Gasket Set		179-3924 179-3925	8YL00001-8YL99999	Turbocharged Single Head
CTP3126359C	Cylinder Head Repl. Gasket Set				
CTP3126360A	Out of Frame OH Gasket Set		179-3976 185-4825 185-4828 185-4832	8YL00001-8YL99999	Turbocharged Single Head
CTP3126360B	Inframe OH Set				
CTP3126360C	Cylinder Head Repl. Gasket Set				
CTP3126361A	Out of Frame OH Gasket Set		179-4036 185-5025 185-5040 186-1758 186-1831	8YL00001-8YL99999	Turbocharged Single Head
CTP3126361B	Inframe OH Set				
CTP3126361C	Cylinder Head Repl. Gasket Set				
CTP3126362A	Out of Frame OH Gasket Set		180-1755	8YL00001-8YL99999	Turbocharged Single Head
CTP3126362B	Inframe OH Set				
CTP3126362C	Cylinder Head Repl. Gasket Set				
CTP3126363A	Out of Frame OH Gasket Set		180-1865	8YL00001-8YL99999	Turbocharged Single Head
CTP3126363B	Inframe OH Set				
CTP3126363C	Cylinder Head Repl. Gasket Set				
CTP3126364A	Out of Frame OH Gasket Set		180-2262	8YL00001-8YL99999	Turbocharged Single Head
CTP3126364B	Inframe OH Set				
CTP3126364C	Cylinder Head Repl. Gasket Set				
CTP3126365A	Out of Frame OH Gasket Set		184-2799 185-4823 185-4826 185-4843 185-4844	8YL00001-8YL99999	Turbocharged Single Head
CTP3126365B	Inframe OH Set				
CTP3126365C	Cylinder Head Repl. Gasket Set				
CTP3126366A	Out of Frame OH Gasket Set				

3126 (cont.)

Part Number	Description	Machine Model / Application	Engine Arrangement	Engine Serial No.	Comments
CTP3126367A	Out of Frame OH Gasket Set		184-2905 184-2906	8YL00001-8YL99999	Turbocharged Single Head
CTP3126367B	Inframe OH Set		185-4842 185-4861		
CTP3126367C	Cylinder Head Repl. Gasket Set		185-5059		
CTP3126368A	Out of Frame OH Gasket Set		185-4822 185-4830	8YL00001-8YL99999	Turbocharged Single Head
CTP3126368C	Cylinder Head Repl. Gasket Set		185-4834 185-4858		
CTP3126369A	Out of Frame OH Gasket Set		185-4827 185-4831	8YL00001-8YL99999	Turbocharged Single Head
CTP3126369C	Cylinder Head Repl. Gasket Set		185-4841 185-4845 185-4855		
CTP3126370A	Out of Frame OH Gasket Set		185-4846 185-4847	8YL00001-8YL99999	Turbocharged Single Head
CTP3126370B	Inframe OH Set		185-4852 185-4854		
CTP3126370C	Cylinder Head Repl. Gasket Set		185-4856		
CTP3126371A	Out of Frame OH Gasket Set		185-4851	8YL00001-8YL99999	Turbocharged Single Head
CTP3126371C	Cylinder Head Repl. Gasket Set		185-4853		
CTP3126372A	Out of Frame OH Gasket Set			8YL00001-8YL99999	Turbocharged Single Head
CTP3126372B	Inframe OH Set		185-4860		
CTP3126372C	Cylinder Head Repl. Gasket Set				
CTP3126373A	Out of Frame OH Gasket Set		185-4862 185-4864	8YL00001-8YL99999	Turbocharged Single Head
CTP3126373B	Inframe OH Set		187-0395 187-7977		
CTP3126373C	Cylinder Head Repl. Gasket Set		188-6657		
CTP3126374A	Out of Frame OH Gasket Set		185-5021 185-5022	8YL00001-8YL99999	Turbocharged Single Head
CTP3126374B	Inframe OH Set		185-5024		
CTP3126374C	Cylinder Head Repl. Gasket Set				
CTP3126375A	Out of Frame OH Gasket Set		185-5080 186-1737	8YL00001-8YL99999	Turbocharged Single Head
CTP3126375B	Inframe OH Set		186-1768 187-0053		
CTP3126375C	Cylinder Head Repl. Gasket Set		194-2334		
CTP3126376A	Out of Frame OH Gasket Set		185-5081 186-1735	8YL00001-8YL99999	Turbocharged Single Head
CTP3126376B	Inframe OH Set		186-1739 186-1755		
CTP3126376C	Cylinder Head Repl. Gasket Set		186-1832		
CTP3126377A	Out of Frame OH Gasket Set		186-1842 186-1846	8YL00001-8YL99999	Turbocharged Single Head
CTP3126377B	Inframe OH Set		187-0008 187-7975		
CTP3126377C	Cylinder Head Repl. Gasket Set		188-6707		
CTP3126378A	Out of Frame OH Gasket Set		186-1843 186-1849	8YL00001-8YL99999	Turbocharged Single Head
CTP3126378B	Inframe OH Set		187-0042 187-0049		
CTP3126378C	Cylinder Head Repl. Gasket Set		187-7912		
CTP3126379A	Out of Frame OH Gasket Set		186-1859 187-7898	8YL00001-8YL99999	Turbocharged Single Head
CTP3126379B	Inframe OH Set		187-7902 187-7908		
CTP3126379C	Cylinder Head Repl. Gasket Set		187-7910		
CTP3126380A	Out of Frame OH Gasket Set		187-0100 187-0112	8YL00001-8YL99999	Turbocharged Single Head
CTP3126380B	Inframe OH Set		187-0387 194-2434		
CTP3126380C	Cylinder Head Repl. Gasket Set				
CTP3126381A	Out of Frame OH Gasket Set		187-7896 187-7904	8YL00001-8YL99999	Turbocharged Single Head
CTP3126381B	Inframe OH Set		187-7905 187-7906		
CTP3126381C	Cylinder Head Repl. Gasket Set		187-7907		

Part Number	Description	Machine Model / Application	Engine Arrangement	Engine Serial No.	Comments
CTP3126382A	Out of Frame OH Gasket Set		187-7920 188-6960	8YL00001-8YL99999	Turbocharged Single Head
CTP3126382B	Inframe OH Set		191-4312 192-9629		
CTP3126382C	Cylinder Head Repl. Gasket Set		194-2366		
CTP3126383A	Out of Frame OH Gasket Set		187-7922 187-7943	8YL00001-8YL99999	Turbocharged Single Head
CTP3126383B	Inframe OH Set		187-7976 187-7983		
CTP3126383C	Cylinder Head Repl. Gasket Set		187-7984		
CTP3126384A	Out of Frame OH Gasket Set			8YL00001-8YL99999	Turbocharged Single Head
CTP3126384B	Inframe OH Set		187-7973 188-6877		
CTP3126384C	Cylinder Head Repl. Gasket Set				
CTP3126385A	Out of Frame OH Gasket Set		187-7974 187-7978	8YL00001-8YL99999	Turbocharged Single Head
CTP3126385B	Inframe OH Set		187-7979 187-7982		
CTP3126385C	Cylinder Head Repl. Gasket Set		187-7988		
CTP3126386A	Out of Frame OH Gasket Set		187-7985 187-7987	8YL00001-8YL99999	Turbocharged Single Head
CTP3126386B	Inframe OH Set		187-7992 188-6620		
CTP3126386C	Cylinder Head Repl. Gasket Set		188-6637		
CTP3126387A	Out of Frame OH Gasket Set		187-7990 188-6639	8YL00001-8YL99999	Turbocharged Single Head
CTP3126387B	Inframe OH Set		188-6640 188-6641		
CTP3126387C	Cylinder Head Repl. Gasket Set		188-6644		
CTP3126388A	Out of Frame OH Gasket Set		188-6611 188-6642	8YL00001-8YL99999	Turbocharged Single Head
CTP3126388B	Inframe OH Set		191-4164 194-2365		
CTP3126388C	Cylinder Head Repl. Gasket Set		198-3506		
CTP3126389A	Out of Frame OH Gasket Set		188-6622	8YL00001-8YL99999	Turbocharged Single Head
CTP3126389B	Inframe OH Set		194-2407		
CTP3126389C	Cylinder Head Repl. Gasket Set				
CTP3126390A	Out of Frame OH Gasket Set		188-6638 188-6643	8YL00001-8YL99999	Turbocharged Single Head
CTP3126390B	Inframe OH Set		188-6756 188-6866		
CTP3126390C	Cylinder Head Repl. Gasket Set		188-6869		
CTP3126391A	Out of Frame OH Gasket Set			8YL00001-8YL99999	Turbocharged Single Head
CTP3126391B	Inframe OH Set		188-6647 189-9601		
CTP3126391C	Cylinder Head Repl. Gasket Set		194-2339		
CTP3126392A	Out of Frame OH Gasket Set			8YL00001-8YL99999	Turbocharged Single Head
CTP3126392B	Inframe OH Set		188-6659		
CTP3126392C	Cylinder Head Repl. Gasket Set				
CTP3126393A	Out of Frame OH Gasket Set		188-6750 194-2354	8YL00001-8YL99999	Turbocharged Single Head
CTP3126393B	Inframe OH Set		194-2355 194-2394		
CTP3126393C	Cylinder Head Repl. Gasket Set		194-2427		
CTP3126394A	Out of Frame OH Gasket Set		188-6870 194-2315	8YL00001-8YL99999	Turbocharged Single Head
CTP3126394B	Inframe OH Set		197-1183 197-1190		
CTP3126394C	Cylinder Head Repl. Gasket Set		197-1192		
CTP3126395A	Out of Frame OH Gasket Set		188-6871 188-6872	8YL00001-8YL99999	Turbocharged Single Head
CTP3126395B	Inframe OH Set		188-6873 188-6901		
CTP3126395C	Cylinder Head Repl. Gasket Set		192-9334		

Part Number	Description	Machine Model / Application	Engine Arrangement	Engine Serial No.	Comments
CTP3126396A	Out of Frame OH Gasket Set			8YL00001-8YL99999	Turbocharged Single Head
CTP3126396B	Inframe OH Set		188-6976		
CTP3126396C	Cylinder Head Repl. Gasket Set				
CTP3126397A	Out of Frame OH Gasket Set			8YL00001-8YL99999	Turbocharged Single Head
CTP3126397B	Inframe OH Set		191-4046		
CTP3126397C	Cylinder Head Repl. Gasket Set				
CTP3126398A	Out of Frame OH Gasket Set		191-4047 191-4239	8YL00001-8YL99999	Turbocharged Single Head
CTP3126398B	Inframe OH Set		191-4362 192-9654		
CTP3126398C	Cylinder Head Repl. Gasket Set		202-9503		
CTP3126399A	Out of Frame OH Gasket Set			8YL00001-8YL99999	Turbocharged Single Head
CTP3126399B	Inframe OH Set		192-9548 195-4263		
CTP3126399C	Cylinder Head Repl. Gasket Set		195-4264		
CTP3126400A	Out of Frame OH Gasket Set		194-2288 194-2312	8YL00001-8YL99999	Turbocharged Single Head
CTP3126400B	Inframe OH Set		194-2313 194-2314		
CTP3126400C	Cylinder Head Repl. Gasket Set		194-2327		
CTP3126401A	Out of Frame OH Gasket Set		194-2328 194-2415	8YL00001-8YL99999	Turbocharged Single Head
CTP3126401B	Inframe OH Set		195-4099 197-1120		
CTP3126401C	Cylinder Head Repl. Gasket Set		197-1130		
CTP3126402A	Out of Frame OH Gasket Set			8YL00001-8YL99999	Turbocharged Single Head
CTP3126402B	Inframe OH Set		194-2359		
CTP3126402C	Cylinder Head Repl. Gasket Set		195-4261		
CTP3126403A	Out of Frame OH Gasket Set			8YL00001-8YL99999	Turbocharged Single Head
CTP3126403B	Inframe OH Set		194-2412		
CTP3126403C	Cylinder Head Repl. Gasket Set				
CTP3126404A	Out of Frame OH Gasket Set			8YL00001-8YL99999	Turbocharged Single Head
CTP3126404B	Inframe OH Set		194-2413		
CTP3126404C	Cylinder Head Repl. Gasket Set				
CTP3126405A	Out of Frame OH Gasket Set		195-4015 195-4197	8YL00001-8YL99999	Turbocharged Single Head
CTP3126405B	Inframe OH Set		195-4383 197-1079		
CTP3126405C	Cylinder Head Repl. Gasket Set				
CTP3126406A	Out of Frame OH Gasket Set		194-4258	8YL00001-8YL99999	Turbocharged Single Head
CTP3126407A	Out of Frame OH Gasket Set			8YL00001-8YL99999	Turbocharged Single Head
CTP3126407B	Inframe OH Set		195-4127		
CTP3126407C	Cylinder Head Repl. Gasket Set				
CTP3126408A	Out of Frame OH Gasket Set			8YL00001-8YL99999	Turbocharged Single Head
CTP3126408B	Inframe OH Set		195-4129 195-4168		
CTP3126408C	Cylinder Head Repl. Gasket Set				
CTP3126409A	Out of Frame OH Gasket Set			8YL00001-8YL99999	Turbocharged Single Head
CTP3126409C	Cylinder Head Repl. Gasket Set		195-4139		
CTP3126410A	Out of Frame OH Gasket Set		195-4147 195-4151	8YL00001-8YL99999	Turbocharged Single Head
CTP3126410C	Cylinder Head Repl. Gasket Set				

Part Number	Description	Machine Model / Application	Engine Arrangement	Engine Serial No.	Comments
CTP3126411A	Out of Frame OH Gasket Set		195-4258	8YL00001-8YL99999	Turbocharged Single Head
CTP3126412A	Out of Frame OH Gasket Set			8YL00001-8YL99999	Turbocharged Single Head
CTP3126412B	Inframe OH Set		195-4260		
CTP3126412C	Multiple Cyl. Head Repl. Gasket Set				
CTP3126431A	Out of Frame OH Gasket Set		210-4243 221-7598	BKD00001-BKD99999	Turbocharged Single Head
CTP3126431B	Inframe OH Set				
CTP3126431C	Cylinder Head Repl. Gasket Set				
CTP3126432A	Out of Frame OH Gasket Set			8YL00001-8YL99999	Turbocharged Single Head
CTP3126432B	Inframe OH Set		221-7596		
CTP3126432C	Cylinder Head Repl. Gasket Set				
CTP3126433A	Out of Frame OH Gasket Set			8YL00001-8YL99999	Turbocharged Single Head
CTP3126433C	Cylinder Head Repl. Gasket Set		205-2549	BKD00001-BKD99999	Turbocharged Single Head
CTP3126434A	Out of Frame OH Gasket Set			8YL00001-8YL99999	Turbocharged Single Head
CTP3126434B	Inframe OH Set		206-8260	CRP00001-CRP99999	Turbocharged Single Head
CTP3126434C	Cylinder Head Repl. Gasket Set				
CTP3126435A	Out of Frame OH Gasket Set			8YL00001-8YL99999	Turbocharged Single Head
CTP3126435B	Inframe OH Set		212-9238	CRP00001-CRP99999	Turbocharged Single Head
CTP3126435C	Cylinder Head Repl. Gasket Set				
CTP3126436A	Out of Frame OH Gasket Set			8YL00001-8YL99999	Turbocharged Single Head
CTP3126436C	Cylinder Head Repl. Gasket Set		220-7755	DPF00001-DPF99999	Turbocharged Single Head
CTP3126437A	Out of Frame OH Gasket Set			8YL00001-8YL99999	Turbocharged Single Head
CTP3126437B	Inframe OH Set		233-2160	G3E00001-G3E99999	Turbocharged Single Head
CTP3126437C	Cylinder Head Repl. Gasket Set				
CTP3126438A	Out of Frame OH Gasket Set			8YL00001-8YL99999	Turbocharged Single Head
CTP3126438B	Inframe OH Set		254-5878	G3E00001-G3E99999	Turbocharged Single Head
CTP3126438C	Cylinder Head Repl. Gasket Set				
CTP3126439A	Out of Frame OH Gasket Set			8YL00001-8YL99999	Turbocharged Single Head
CTP3126439B	Inframe OH Set		262-3649	G3E00001-G3E99999	Turbocharged Single Head
CTP3126439C	Cylinder Head Repl. Gasket Set				
CTP3126440A	Out of Frame OH Gasket Set			8YL00001-8YL99999	Turbocharged Single Head
CTP3126440B	Inframe OH Set		276-3429	G3E00001-G3E99999	Turbocharged Single Head
CTP3126440C	Cylinder Head Repl. Gasket Set				
CTP3126441A	Out of Frame OH Gasket Set			8YL00001-8YL99999	Turbocharged Single Head
CTP3126441B	Inframe OH Set		283-6603	G3E00001-G3E99999	Turbocharged Single Head
CTP3126441C	Cylinder Head Repl. Gasket Set				
CTP3126442A	Out of Frame OH Gasket Set				

3176

Part Number	Description	Machine Model / Application	Engine Arrangement	Engine Serial No.	Comments
CTP3176001A	Out of Frame OH Gasket Set	Industrial		2AW00223-UP	Turbocharged Watercooled
CTP3176002A	Out of Frame OH Gasket Set				
CTP3176002B	Inframe OH Set	TRUCK	111-2659	9CK01-UP 9CK20359	Turbocharged
CTP3176002C	Cylinder Head Repl. Gasket Set				
CTP3176003A	Out of Frame OH Gasket Set				
CTP3176003B	Inframe OH Set	345B EXCAVATOR	126-0054 173-0355	7ZR00001- 7ZR99999	
CTP3176003C	Cylinder Head Repl. Gasket Set				
CTP3176004A	Out of Frame OH Gasket Set				
CTP3176004B	Inframe OH Set	966G II WHEEL LOADER	214-4619 220-0794	3PD00001- 3PD99999	
CTP3176004C	Cylinder Head Repl. Gasket Set				
CTP3176005A	Out of Frame OH Gasket Set		160-8560	7ZR00001- 7ZR06436	
CTP3176005B	Inframe OH Set	D7R II TRACK-TYPE TRACTOR	248-6391	7ZR00001- 7ZR99999	
CTP3176005C	Cylinder Head Repl. Gasket Set				

3204

Part Number	Description	Machine Model / Application	Engine Arrangement	Engine Model	Engine Serial No.
CTP3204001A	Out of Frame OH Gasket Set				
CTP3204001B	Inframe OH Set	943 TRACK LOADER 215 EXCAVATOR 953 TRACK LOADER	6N-6626	10X05369- UP	
CTP3204001C	Cylinder Head Repl. Gasket Set				
CTP3204002A	Out of Frame OH Gasket Set				
CTP3204002B	Inframe OH Set	D4B / D4C II TRACK-TYPE TRACTOR	7C-7739 9Y-0792 4P-0909	45V60736- 45VUP 45V69350- 45VUP 45V90750- UP, 7YJ1-UP	Turbocharged
CTP3204002C	Cylinder Head Repl. Gasket Set				
CTP3204003A	Out of Frame OH Gasket Set				
CTP3204003B	Inframe OH Set	D4C / D4H / D5C TRACK-TYPE TRACTOR	1N-3610 1N-3608	7YJ01-7YJUP 45V47658- 45VUP	Turbocharged
CTP3204003C	Cylinder Head Repl. Gasket Set				

3208

Part Number	Description	Machine Model / Application	Machine Serial Number	Engine Model	Engine Serial No.	Comments
CTP3208001A	Out of Frame OH Gasket Set					
CTP3208001B	Inframe OH Set	Truck Industrial Marine	613B	3208 NA	32Y1-UP 40S1-UP 51Z1-UP 90N1-UP 29A225-UP 79V5381-UP	Non Turbocharged Engine
CTP3208001C	Multiple Cyl. Head Repl. Gasket Set					
CTP3208001D	Single Cyl. Head Repl. Gasket Set					
CTP3208002A	Out of Frame OH Gasket Set					
CTP3208002B	Inframe OH Set	Truck Industrial Generator Marine		3208T	2Z1-UP 3Z1-UP 30A210-UP	Turbocharged Engine
CTP3208002C	Multiple Cyl. Head Repl. Gasket Set					
CTP3208002D	Single Cyl. Head Repl. Gasket Set					
CTP3208003C	Multiple Cyl. Head Repl. Gasket Set	Industrial Marine		3208 NA	70V1-UP	Non Turbocharged Engine
CTP3208004A	Out of Frame OH Gasket Set					
CTP3208004C	Multiple Cyl. Head Repl. Gasket Set	Marine		3208T	1Z1-UP 75V1-UP	Turbocharged Engine
CTP3208004D	Single Cyl. Head Repl. Gasket Set					
CTP3208005A	Out of Frame OH Gasket Set					
CTP3208005B	Inframe OH Set	**		3208	79V04927- UP	
CTP3208005C	Cylinder Head Repl. Gasket Set					
CTP3208006A	Out of Frame OH Gasket Set					
CTP3208006C	Cylinder Head Repl. Gasket Set	**		3208	1Z01-UP	
CTP3208006D	Single Cyl. Head Repl. Gasket Set					
CTP3208007A	Out of Frame OH Gasket Set					
CTP3208007B	Inframe OH Set	Marine	1W0356	3208	75V09526- UP 75V09712- UP	Turbocharged
CTP3208007C	Multiple Cyl. Head Repl. Gasket Set					
CTP3208007D	Single Cyl. Head Repl. Gasket Set					
CTP3208008A	Out of Frame OH Gasket Set	Marine	8N-3527		75V04263- 75V99999	
CTP3208008B	Inframe OH Set					
CTP3208008C	Multiple Cyl. Head Repl. Gasket Set	Industrial	2W-8219		03Z02551- 03Z99999	
CTP3208008D	Single Cyl. Head Repl. Gasket Set					
CTP3208009A	Out of Frame OH Gasket Set		1W-9808			
CTP3208009B	Inframe OH Set		9N-5997		02Z00001- UP	
CTP3208009C	Multiple Cyl. Head Repl. Gasket Set	3208 Truck				
CTP3208009D	Single Cyl. Head Repl. Gasket Set					
CTP3208010A	Out of Frame OH Gasket Set		1W-7687		51Z00001- UP	
CTP3208010B	Inframe OH Set		9Y-9706		51Z78017- UP	
CTP3208010C	Multiple Cyl. Head Repl. Gasket Set	3208 Truck				
CTP3208010D	Single Cyl. Head Repl. Gasket Set					

3304

Part Number	Description	Machine Model / Application	Engine Arrangement	Engine Serial No.	Comments
CTP3304001A	Out of Frame OH Gasket Set				
CTP3304001B	Inframe OH Set	120G MOTOR GRADER	3P-0134	78P00001- 78P40899	Turbocharged Single Head
CTP3304001C	Cylinder Head Repl. Gasket Set				
CTP3304002A	Out of Frame OH Gasket Set	120G MOTOR GRADER	7N-1528	78P00001- 78P99999	Turbocharged Single Head
CTP3304002B	Inframe OH Set				
CTP3304002C	Cylinder Head Repl. Gasket Set	130G MOTOR GRADER	7N-1526	78P40900- 78P99999	
CTP3304003A	Out of Frame OH Gasket Set				
CTP3304003B	Inframe OH Set	130G MOTOR GRADER	3P-0136	78P00001- 78P40899	Turbocharged Single Head
CTP3304003C	Cylinder Head Repl. Gasket Set		8N-0191	78P40900- 78P99999	
CTP3304004A	Out of Frame OH Gasket Set				
CTP3304004B	Inframe OH Set	130G MOTOR GRADER	1P-6493	78P00001- 78P99999	Turbocharged Single Head
CTP3304004C	Cylinder Head Repl. Gasket Set				
CTP3304005A	Out of Frame OH Gasket Set				
CTP3304005B	Inframe OH Set	518 SKIDDER	2P-6784	78P00001- 78P11062	Turbocharged Single Head
CTP3304005C	Cylinder Head Repl. Gasket Set				
CTP3304006A	Out of Frame OH Gasket Set				
CTP3304006B	Inframe OH Set	518 SKIDDER	4N-3976	78P11063- 78P40899	Turbocharged Single Head
CTP3304006C	Cylinder Head Repl. Gasket Set				
CTP3304007A	Out of Frame OH Gasket Set				
CTP3304007B	Inframe OH Set	518 SKIDDER	7N-1523	78P47088- 78P99999	Turbocharged Single Head
CTP3304007C	Cylinder Head Repl. Gasket Set				
CTP3304008A	Out of Frame OH Gasket Set				
CTP3304008B	Inframe OH Set	920 WHEEL LOADER	2P-6777	78P00001- 78P08214	Turbocharged Single Head
CTP3304008C	Cylinder Head Repl. Gasket Set				
CTP3304009A	Out of Frame OH Gasket Set				
CTP3304009B	Inframe OH Set	920 WHEEL LOADER	4N-3802	78P08215- 78P22209	Turbocharged Single Head
CTP3304009C	Cylinder Head Repl. Gasket Set				

Part Number	Description	Machine Model / Application	Engine Arrangement	Engine Serial No.	Comments
CTP3304010A	Out of Frame OH Gasket Set	920 WHEEL LOADER	7N-1515		
CTP3304010B	Inframe OH Set	930 WHEEL LOADER	7N-1522	78P40900- 78P99999	Turbocharged Single Head
CTP3304010C	Cylinder Head Repl. Gasket Set	D4E TRACTOR POWERSHIFT	7N-1516		
CTP3304011A	Out of Frame OH Gasket Set				
CTP3304011B	Inframe OH Set	930 WHEEL LOADER	2P-6782	78P00001- 78P05303	Turbocharged Single Head
CTP3304011C	Cylinder Head Repl. Gasket Set				
CTP3304012A	Out of Frame OH Gasket Set				
CTP3304012B	Inframe OH Set	930 WHEEL LOADER	4N-3807	78P05304- 78P40899	Turbocharged Single Head
CTP3304012C	Cylinder Head Repl. Gasket Set				
CTP3304013A	Out of Frame OH Gasket Set				
CTP3304013B	Inframe OH Set	941B TRAXCAVATOR	2P-6776	78P00001- 78P07424	Turbocharged Single Head
CTP3304013C	Cylinder Head Repl. Gasket Set				
CTP3304014A	Out of Frame OH Gasket Set				
CTP3304014B	Inframe OH Set	941B TRAXCAVATOR	4N-3801	78P07425- 78P40899	Turbocharged Single Head
CTP3304014C	Cylinder Head Repl. Gasket Set				
CTP3304015A	Out of Frame OH Gasket Set				
CTP3304015B	Inframe OH Set	941B TRAXCAVATOR	7N-1519	78P40900- 78P99999	Turbocharged Single Head
CTP3304015C	Cylinder Head Repl. Gasket Set				
CTP3304016A	Out of Frame OH Gasket Set				
CTP3304016B	Inframe OH Set	950 WHEEL LOADER	2P-6785	78P00001- 78P09706	Turbocharged Single Head
CTP3304016C	Cylinder Head Repl. Gasket Set				
CTP3304017A	Out of Frame OH Gasket Set				
CTP3304017B	Inframe OH Set	950 WHEEL LOADER	4N-3975	78P09707- 78P40899	Turbocharged Single Head
CTP3304017C	Cylinder Head Repl. Gasket Set				
CTP3304018A	Out of Frame OH Gasket Set				
CTP3304018B	Inframe OH Set	950 WHEEL LOADER	7N-1525	78P40900- 78P99999	Turbocharged Single Head
CTP3304018C	Cylinder Head Repl. Gasket Set				
CTP3304019A	Out of Frame OH Gasket Set				
CTP3304019B	Inframe OH Set	951C TRAXCAVATOR	2P-6779	78P00001- 78P40899	Turbocharged Single Head
CTP3304019C	Cylinder Head Repl. Gasket Set				
CTP3304020A	Out of Frame OH Gasket Set				
CTP3304020B	Inframe OH Set	951C TRAXCAVATOR	7N-1521	78P40900- 78P99999	Turbocharged Single Head
CTP3304020C	Cylinder Head Repl. Gasket Set				

3304 (cont.)

Part Number	Description	Machine Model / Application	Engine Arrangement	Engine Serial No.	Comments
CTP3304021A	Out of Frame OH Gasket Set	955L TRAXCAVATOR	2P-6783	78P00001-78P07424	Turbocharged Single Head
CTP3304021B	Inframe OH Set				
CTP3304021C	Cylinder Head Repl. Gasket Set				
CTP3304022A	Out of Frame OH Gasket Set	955L TRAXCAVATOR	4N-3974	78P07425-78P40899	Turbocharged Single Head
CTP3304022B	Inframe OH Set				
CTP3304022C	Cylinder Head Repl. Gasket Set				
CTP3304023A	Out of Frame OH Gasket Set	955L TRAXCAVATOR	7N-1524	78P40900-78P99999	Turbocharged Single Head
CTP3304023B	Inframe OH Set				
CTP3304023C	Cylinder Head Repl. Gasket Set				
CTP3304024A	Out of Frame OH Gasket Set	D4E TRACTOR POWERSHIFT	4N-3799	78P05248-78P34853	Turbocharged Single Head
CTP3304024B	Inframe OH Set				
CTP3304024C	Cylinder Head Repl. Gasket Set				
CTP3304025A	Out of Frame OH Gasket Set	D4E TRACTOR POWERSHIFT	4N-3803	78P22210-78P99999	Turbocharged Single Head
CTP3304025B	Inframe OH Set				
CTP3304025C	Cylinder Head Repl. Gasket Set				
CTP3304026A	Out of Frame OH Gasket Set	D4E TRACTOR POWERSHIFT	4N-3806	78P22210-78P99999	Turbocharged Single Head
CTP3304026B	Inframe OH Set				
CTP3304026C	Cylinder Head Repl. Gasket Set				
CTP3304027A	Out of Frame OH Gasket Set	D4E TRACTOR POWERSHIFT	7N-1517	78P40900-78P99999	Turbocharged Single Head
CTP3304027B	Inframe OH Set				
CTP3304027C	Cylinder Head Repl. Gasket Set				
CTP3304028A	Out of Frame OH Gasket Set	D4E TRACTOR POWERSHIFT	7N-1520	78P40900-78P99999	Turbocharged Single Head
CTP3304028B	Inframe OH Set				
CTP3304028C	Cylinder Head Repl. Gasket Set				
CTP3304029A	Out of Frame OH Gasket Set	MACHINE	1W-4584	12211007-12299999	Turbocharged Single Head
CTP3304029B	Inframe OH Set				
CTP3304029C	Cylinder Head Repl. Gasket Set				
CTP3304030A	Out of Frame OH Gasket Set	MACHINE	4W-3918	10E00815-10E99999	Turbocharged Single Head
CTP3304030B	Inframe OH Set				
CTP3304030C	Cylinder Head Repl. Gasket Set				
CTP3304031A	Out of Frame OH Gasket Set	MACHINE	7N-1131	07Z00001-07Z99999	Turbocharged Single Head
CTP3304031B	Inframe OH Set				
CTP3304031C	Cylinder Head Repl. Gasket Set				
CTP3304031A	Out of Frame OH Gasket Set	MACHINE	8N-3073	07Z00257-07Z99999	Turbocharged Single Head
CTP3304031B	Inframe OH Set				
CTP3304031C	Cylinder Head Repl. Gasket Set				

Part Number	Description	Machine Model / Application	Engine Arrangement	Engine Serial No.	Comments
CTP3304032A	Out of Frame OH Gasket Set	MACHINE	7N-3586	43V10671-43V18853	Turbocharged Single Head
CTP3304032B	Inframe OH Set				
CTP3304032C	Cylinder Head Repl. Gasket Set				
CTP3304033A	Out of Frame OH Gasket Set	D4D / D4E TRACK-TYPE TRACTOR	6A-3021 6A-5543 6A-7358	07R01-07R00462 48V01-48V10235 48V01-48V99999 43V10506-43VUP	Turbocharged
CTP3304033B	Inframe OH Set				
CTP3304033C	Cylinder Head Repl. Gasket Set				
CTP3304034A	Out of Frame OH Gasket Set	D4E TRACTOR-SPECIAL APPLICAT DIRECT DRIVE	2Y-9470 2Y-8608 2Y-9471	46V9547-UP 4YD1-UP 59Z1974-UP	Turbocharged
CTP3304034B	Inframe OH Set				
CTP3304034C	Cylinder Head Repl. Gasket Set				
CTP3304035A	Out of Frame OH Gasket Set	D4E TRACTORS POWER SHIFT / TRACK-TYPE TRACTOR	2Y-6294 2Y-7229	59Z1-UP	Turbocharged
CTP3304035B	Inframe OH Set				
CTP3304035C	Cylinder Head Repl. Gasket Set				
CTP3304036A	Out of Frame OH Gasket Set	D4E TRACK-TYPE TRACTOR	6C-0113	12Z02795-12ZUP	Turbocharged
CTP3304036B	Inframe OH Set				
CTP3304036C	Cylinder Head Repl. Gasket Set				
CTP3304037A	Out of Frame OH Gasket Set	D4E TRACK-TYPE TRACTOR	2Y-8609 2Y-2007	9CB1700-UP 46V04786-46VUP	Turbocharged
CTP3304037B	Inframe OH Set				
CTP3304037C	Cylinder Head Repl. Gasket Set				
CTP3304038A	Out of Frame OH Gasket Set	D4E SR TRACK-TYPE TRACTOR DIRECT DRIVE	132-2010	07Z32317-UP	Turbocharged
CTP3304038B	Inframe OH Set				
CTP3304038C	Cylinder Head Repl. Gasket Set				
CTP3304039A	Out of Frame OH Gasket Set	D5H / D4H / D4H XL D4H LGP Series III TRACK-TYPE TRACTOR D4H LGP Track-Type Tractor Direct Drive	4P-0903	09Z09370-09ZUP	Turbocharged
CTP3304039B	Inframe OH Set				
CTP3304039C	Cylinder Head Repl. Gasket Set				
CTP3304040A	Out of Frame OH Gasket Set	950B / 950E WHEEL LOADER	6N-6878 9Y-1720 5C-8862	09Z00254-09ZUP 09Z07617-09ZUP 12Z01-12ZUP	Turbocharged
CTP3304040B	Inframe OH Set				
CTP3304040C	Cylinder Head Repl. Gasket Set				
CTP3304041A	Out of Frame OH Gasket Set	920 / 930 / 950 WHEEL LOADER	6A-4615 6A-4616 6A-4617	48V01-48V14144	Turbocharged
CTP3304041B	Inframe OH Set				
CTP3304041C	Cylinder Head Repl. Gasket Set				
CTP3304042A	Out of Frame OH Gasket Set	930R / 930T WHEEL LOADER	2Y-9463	59Z1930-UP	Turbocharged
CTP3304042B	Inframe OH Set				
CTP3304042C	Cylinder Head Repl. Gasket Set				

3306

Part Number	Description	Machine Model / Application	Engine Arrangement	Engine Serial No.	Comments	
CTP3306001A	Out of Frame OH Gasket Set	D6D, D6E, D6H, 12G, 12H, 14G, 140G, 528	3X; 4X; 5X; 6X; 9X; 20X; 30X; 31X; 32X; 33X; 8KB; 4RC; 7PC; 8FC; 8VC; 1KD; 2KD; 3ED; 3ZF; 4YF; 5HF; 6CF; 2TG; 3YG; 4LG; 1FJ; 3YJ; 2KD; 2MJ	08Z1-UP 10Z1-UP 13Z1-UP 08TD1-UP	Spacer Plated Turbocharged *For Aftercooled Units Order 1 CTP-5P8772	
CTP3306001B	Inframe OH Set					
CTP3306001C	Cylinder Head Repl. Gasket Set					
CTP3306002A	Out of Frame OH Gasket Set	Industrial	7JB1-UP 5JC1-UP 8JJ1-UP 6PK1-UP 1CZ1-UP 64Z1-UP 85Z1-UP	7JB1-UP 5JC1-UP 8JJ1-UP 6PK1-UP 1CZ1-UP 64Z1-UP 85Z1-UP	Spacer Plated Turbocharged *For Aftercooled Units Order 1 CTP-5P8772 For Units With Expansion Tanks Order 1 CTP-6V0621	
CTP3306002B	Inframe OH Set					
CTP3306002C	Cylinder Head Repl. Gasket Set					
CTP3306003A	Out of Frame OH Gasket Set	D5 D5B 12F 12G 561C 561D	48X1-UP; 49X1296-UP; 89H1-UP; 61M1-UP; 13K1-UP; 85H1-UP; 92J1-UP	44V22231-UP 3N79763-UP	Spacer Plated Non Turbocharged PC Engine	
CTP3306003B	Inframe OH Set					
CTP3306003C	Cylinder Head Repl. Gasket Set					
CTP3306004A	Out of Frame OH Gasket Set	D6D, D7G, 14G, 235, 571F, 572F, 627,	14E, 140G, 528, 571G, 572G, 627B	3X; 4X; 5X; 6X; 19X; 20X; 30X; 31X; 32X; 35N; 64V; 65V; 91V; 92V; 44W; 72W; 72G; 12K; 72V; 81V; 13W; 32K; 62K; 81X; 51S; 78W; 95N; 40U; 14S	3N79763-UP 44V22287-UP 44V22351-UP 44V22403-UP 62Z1-UP	Spacer Plated Turbocharged PC Engine *For Aftercooled Units Order 1 CTP-5P8772
CTP3306004B	Inframe OH Set					
CTP3306004C	Cylinder Head Repl. Gasket Set					
CTP3306005A	Out of Frame OH Gasket Set	D5, D5B, D6C, D6D, 12F, 12G, 120, 561C, 561D	48X1-UP; 9X1-1295 19X1-UP; 20X1-UP 46J1-UP; 47J1-UP 89H1-UP; 61M1-UP 13K1-UP; 32C1-UP 64J1-UP; 85H1-UP 92J1-UP	44V1-22230 44V1-22252 3N1-79762 49V1-24230 47V1-UP 60Z1-UP	Non Spacer Plated PC Engine Non Turbocharged *For Aftercooled Units Order 1 CTP-5P8772	
CTP3306005B	Inframe OH Set					
CTP3306005C	Cylinder Head Repl. Gasket Set					
CTP3306007A	Out of Frame OH Gasket Set	D5B 12G 12H 561D	26X878-UP 21Y878-UP 61M1-UP 3WC1-UP 4ER1-UP 8MN1-UP 54X1-UP	8Z1-UP 10Z1-UP 13Z1-UP 1AF1-UP 3N79763-UP	Spacer Plated D.I. Engine Non Turbocharged *For Aftercooled Units Order 1 CTP-5P8772	
CTP3306007B	Inframe OH Set					
CTP3306007C	Cylinder Head Repl. Gasket Set					
CTP3306008A	Out of Frame OH Gasket Set	Truck	76R273-UP	76R273-UP	Spacer Plate PC Engine Turbocharged *For Aftercooled Units Order 1 CTP-5P8772	
CTP3306008B	Inframe OH Set					
CTP3306008C	Cylinder Head Repl. Gasket Set					
CTP3306009A	Out of Frame OH Gasket Set	Truck	63Z1-UP 5KD1-UP	63Z1-UP 5KD1-UP	D.I. Engine Spacer Plate Turbocharged *For Aftercooled Units Order 1 CTP-5P8772	
CTP3306009B	Inframe OH Set					
CTP3306009C	Cylinder Head Repl. Gasket Set					
CTP3306010A	Out of Frame OH Gasket Set	D6C	10K7953UP 46J869-UP 47J2560-UP 99J1754-UP 69U316-UP 17R465-UP	49V 3N	Non Spacer Plated Turbocharged *For Aftercooled Units Order 1 CTP-5P8772	
CTP3306010B	Inframe OH Set					
CTP3306010C	Cylinder Head Repl. Gasket Set					
CTP3306011A	Out of Frame OH Gasket Set	D6D D7G 571F 571G 572F 572G	3X; 4X; 5X; 6X; 19X; 20X; 30X; 31X; 32X; 35N; 64V; 5V; 91V; 91V; 92V; 44W; 72W; 95N; 16W; 96N; 40U	3N1-77760 3N1-79762 44V1-22286 44V1-22350 47V1-17093	Non Spacer Plated Turbocharged *For Aftercooled Units Order 1 CTP-5P8772	
CTP3306011B	Inframe OH Set					
CTP3306011C	Cylinder Head Repl. Gasket Set					

Part Number	Description	Machine Model / Application	Engine Arrangement	Engine Serial No.	Comments	
CTP3306012A	Out of Frame OH Gasket Set	627 Front 627 Rear 980B	54K1-842; 68M1-789; 50K1-831; 69M1-789; 64M198-381; 91N1-563; 92N1-232; 89P1-2167	3N1	Non Spacer Plated Turbocharged PC Engine *For Aftercooled Units Order 1 CTP-5P8772	
CTP3306012B	Inframe OH Set					
CTP3306012C	Cylinder Head Repl. Gasket Set					
CTP3306013A	Out of Frame OH Gasket Set	627 Front & Rear 627B Front & Rear	14S1-UP 15S1-UP 37V1-UP 38V1-UP	3N1-79762	Non Spacer Plated Turbocharged PC Engine *For Aftercooled Units Order 1 CTP-5P8772	
CTP3306013B	Inframe OH Set					
CTP3306013C	Cylinder Head Repl. Gasket Set					
CTP3306014A	Out of Frame OH Gasket Set	14E 140 528	72G1-1340 12K1-2138 11R1-1690 14U1-430 51S1-67	8Z1-UP 3N1-UP 12Z6564-UP	Non Spacer Plated Turbocharged PC Engine	
CTP3306014B	Inframe OH Set					
CTP3306014C	Cylinder Head Repl. Gasket Set					
CTP3306015A	Out of Frame OH Gasket Set	14E 140G 528	72G; 12K; 96U; 72V; 81V; 51S; 78W; 13W	3N1-79762	Non Spacer Plated Turbocharged PC Engine	
CTP3306015B	Inframe OH Set					
CTP3306015C	Cylinder Head Repl. Gasket Set					
CTP3306017A	Out of Frame OH Gasket Set	980B	89P	3N1	Spacer Plated Turbocharged PC Engine *For Aftercooled Units Order 1 CTP-5P8772	
CTP3306017B	Inframe OH Set					
CTP3306017C	Cylinder Head Repl. Gasket Set					
CTP3306018A	Out of Frame OH Gasket Set	STEIGER		66D12370-26831	Spacer Plated PC Engine Turbocharged *For Aftercooled Units Order 1-CTP-5P8772	
CTP3306019A	Out of Frame OH Gasket Set	STEIGER		66D26831-UP	Non Spacer Plated PC Engine Turbocharged *For Aftercooled Units Order 1-CTP-5P8772	
CTP3306020A	Out of Frame OH Gasket Set	814 815 966C 977K 977L	816	90P1-202; 91P1-527; 57U1-197; 30K1-1624; 76J1-6388; 42J1-3565; 11K1-5050; 48J1-1058	3N 62Z 49V	Non Spacer Plated Turbocharged PC Engine *For Aftercooled Units Order 1-5P8772
CTP3306020B	Inframe OH Set					
CTP3306020C	Cylinder Head Repl. Gasket Set					
CTP3306021A	Out of Frame OH Gasket Set	814 815 966C 977K 977L	816	14R1-UP 15R1-UP 76G, 76J, 30K, 48J1-UP 11K1-UP 14X1-UP 64X1-UP	3N1-79762 49V1-24220	Non Spacer Plated Turbocharged PC Engine *For Aftercooled Units Order 1CTP-5P8772
CTP3306021B	Inframe OH Set					
CTP3306021C	Cylinder Head Repl. Gasket Set					
CTP3306022A	Out of Frame OH Gasket Set	814 815 966C 966D 977K 977L	816	14R1-UP 15R1-UP 76G, 76J, 30K, 48J1-UP 11K1-UP 14X1-UP 64X1-UP	3N79763-UP 44V22485-UP	Spacer Plated Turbocharged PC Engine *For Aftercooled Units Order 1-CTP-5P8772
CTP3306022B	Inframe OH Set					
CTP3306022C	Cylinder Head Repl. Gasket Set					
CTP3306023A	Out of Frame OH Gasket Set	814B, 815B, 816B, 966C, 966D, 966E, 966F, 970F	15Z1-UP; 16Z1-UP 17Z1-UP; 35S1-UP 94X1-UP; 99Y1-UP 15L1-UP; 3XJ1-UP 4YG1-UP; 88G1-UP 9VJ1-UP; 7PL 1-UP 78K1-UP; 9JK 1-UP	8Z1-UP 10Z1-UP 13Z1-UP 8TD1-UP 6NC1-UP	Spacer Plated Turbocharged D.I. Engine *For Aftercooled Units Order 1-CTP-5P8772	
CTP3306023B	Inframe OH Set					
CTP3306023C	Cylinder Head Repl. Gasket Set					

3306 (cont.)

Part Number	Description	Machine Model / Application	Engine Arrangement	Engine Serial No.	Comments
CTP3306024A	Out of Frame OH Gasket Set	D7G, D7H	91V; 92V; 72W, 58F; 4FG; 77Z; 79Z; 80Z; 40U1; 5ZD1	8Z1-UP 3N79763-UP	Spacer Plated Turbocharged D.I. Engine
CTP3306024B	Inframe OH Set	D7G, D7H	91V; 92V; 72W, 58F; 4FG; 77Z; 79Z; 80Z; 40U1; 5ZD1	8Z1-UP 3N79763-UP	Spacer Plated Turbocharged D.I. Engine
CTP3306024C	Cylinder Head Repl. Gasket Set	D7G, D7H	91V; 92V; 72W, 58F; 4FG; 77Z; 79Z; 80Z; 40U1; 5ZD1	8Z1-UP 3N79763-UP	Spacer Plated Turbocharged D.I. Engine
CTP3306025A	Out of Frame OH Gasket Set	Marine		67D1-2863	Non Spacer Plated Turbocharged P.C. Engine
CTP3306025B	Inframe OH Set	Marine		67D1-2863	Non Spacer Plated Turbocharged P.C. Engine
CTP3306025C	Cylinder Head Repl. Gasket Set	Marine		67D1-2863	Non Spacer Plated Turbocharged P.C. Engine
CTP3306026A	Out of Frame OH Gasket Set				
CTP3306026B	Inframe OH Set	Marine		67D2864-UP	Spacer Plated Turbocharged
CTP3306026C	Cylinder Head Repl. Gasket Set	Marine		67D2864-UP	Spacer Plated Turbocharged
CTP3306027A	Out of Frame OH Gasket Set				
CTP3306027B	Inframe OH Set	Marine		84Z1-UP	Spacer Plated Turbocharged
CTP3306027C	Cylinder Head Repl. Gasket Set	Marine		84Z1-UP	Spacer Plated Turbocharged
CTP3306028A	Out of Frame OH Gasket Set				N/A & Turbocharged Spacer Plated *For Units With Expansion Tanks Order 1-CTP-6V0621 *For Units With Long Valve Train, Order 1-CTP-851605 Additional Valve Cover Gasket
CTP3306028B	Inframe OH Set			7Y291 - UP	N/A & Turbocharged Spacer Plated *For Units With Expansion Tanks Order 1-CTP-6V0621 *For Units With Long Valve Train, Order 1-CTP-851605 Additional Valve Cover Gasket
CTP3306028C	Cylinder Head Repl. Gasket Set	Natural Gas		7Y291 - UP	N/A & Turbocharged Spacer Plated *For Units With Expansion Tanks Order 1-CTP-6V0621 *For Units With Long Valve Train, Order 1-CTP-851605 Additional Valve Cover Gasket
CTP3306029A	Out of Frame OH Gasket Set	D25C; D25D; D30C; D30D; D35C; D250B; D250E; D300B; D300D; D330E; D350C; D350D	9Y1-UP; 1HK1-UP; 7Z1-UP; 3AJ1-UP; 2G01-UP; 5WD1-UP; 5N1-UP; 4SD1-UP; 5MG1-UP; 7FN1-UP; 8XC1-UP; 9RF1-UP	13Z1-UP 7JB1-UP	Spacer Plated Turbocharged D.I. Engine *For Aftercooled Units Order 1-CTP-5P8772
CTP3306029B	Inframe OH Set			13Z1-UP 7JB1-UP	Spacer Plated Turbocharged D.I. Engine *For Aftercooled Units Order 1-CTP-5P8772
CTP3306029C	Cylinder Head Repl. Gasket Set			13Z1-UP 7JB1-UP	Spacer Plated Turbocharged D.I. Engine *For Aftercooled Units Order 1-CTP-5P8772
CTP3306030A	Out of Frame OH Gasket Set				Spacer Plated Turbocharged Or Non Turbocharged *For Aftercooled Units Order 1-CTP-5P8772 For Units With Expansion Tanks Order 1-CTP-6V0621
CTP3306030B	Inframe OH Set	Industrial		66D1-UP	Spacer Plated Turbocharged Or Non Turbocharged *For Aftercooled Units Order 1-CTP-5P8772 For Units With Expansion Tanks Order 1-CTP-6V0621
CTP3306030C	Cylinder Head Repl. Gasket Set	Industrial		66D1-UP	Spacer Plated Turbocharged Or Non Turbocharged *For Aftercooled Units Order 1-CTP-5P8772 For Units With Expansion Tanks Order 1-CTP-6V0621
CTP3306031A	Out of Frame OH Gasket Set				Non Spacer Plated Turbocharged Or Non Turbocharged *For Aftercooled Units Order 1-CTP-5P8772
CTP3306031B	Inframe OH Set	Industrial		66D1-UP 62M1-UP MILITARY	Non Spacer Plated Turbocharged Or Non Turbocharged *For Aftercooled Units Order 1-CTP-5P8772
CTP3306031C	Cylinder Head Repl. Gasket Set	Industrial		66D1-UP 62M1-UP MILITARY	Non Spacer Plated Turbocharged Or Non Turbocharged *For Aftercooled Units Order 1-CTP-5P8772
CTP3306032A	Out of Frame OH Gasket Set				Spacer Plated Turbocharged D.I. Engine *For Aftercooled Units Order 1-CTP-5P8772
CTP3306032B	Inframe OH Set	827E Front Rear	627E	6E6 1 - UP; 6G6 1 - UP; 6F6 1 - UP; 6H6 1 - UP	8Z33294-UP 8Z33309-UP
CTP3306032C	Cylinder Head Repl. Gasket Set				8Z33294-UP 8Z33309-UP
CTP3306033A	Out of Frame OH Gasket Set	615 FRONT 615C FRONT 627B FRONT 627B REAR **627E REAR **627F REAR **637D REAR	46Z1-UP; 5TF1-UP; 9XG1-UP; 2XG1-UP; 14S1-UP; 15S1-UP; 37V1-UP; 38V1-UP; 3WJ1-UP; 4YK1-UP; 20W1-UP; 1W1-UP; 22W1-UP; 23W1-UP; 4JB1-UP	8Z1-UP 6NC1-UP	Spacer Plated Turbocharged D.I. Engine *For Aftercooled Units Order 1-CTP-5P8772
CTP3306033B	Inframe OH Set			8Z1-UP 6NC1-UP	Spacer Plated Turbocharged D.I. Engine *For Aftercooled Units Order 1-CTP-5P8772
CTP3306033C	Cylinder Head Repl. Gasket Set			8Z1-UP 6NC1-UP	Spacer Plated Turbocharged D.I. Engine *For Aftercooled Units Order 1-CTP-5P8772
CTP3306034A	Out of Frame OH Gasket Set				
CTP3306034B	Inframe OH Set	235; 235B; 235C; 235D; 350L; E300; E300B; EL300; EL300B	300BL	821-UP 10Z9394-UP 13Z1-UP	Spacer Plated Turbocharged D.I. Engine *For Aftercooled Units Order 1-CTP-5P8772
CTP3306034C	Cylinder Head Repl. Gasket Set			821-UP 10Z9394-UP 13Z1-UP	Spacer Plated Turbocharged D.I. Engine *For Aftercooled Units Order 1-CTP-5P8772

Part Number	Description	Machine Model / Application	Engine Arrangement	Engine Serial No.	Comments
CTP3306035A	Out of Frame OH Gasket Set			63Z1-UP 5KD1-UP 7RJ1-UP 9TL1-UP	Spacer Plated Turbocharged D.I. Engine *For Aftercooled Units Order 1-CTP-5P8772 ENgine
CTP3306035B	Inframe OH Set	Truck		63Z1-UP 5KD1-UP 7RJ1-UP 9TL1-UP	Spacer Plated Turbocharged D.I. Engine *For Aftercooled Units Order 1-CTP-5P8772 ENgine
CTP3306035C	Cylinder Head Repl. Gasket Set	Truck		63Z1-UP 5KD1-UP 7RJ1-UP 9TL1-UP	Spacer Plated Turbocharged D.I. Engine *For Aftercooled Units Order 1-CTP-5P8772 ENgine
CTP3306036A	Out of Frame OH Gasket Set	CH65			Spacer Plated Aftercooled D.I. Engine
CTP3306036B	Inframe OH Set	CH65B CH65C CH65D	7YC1-UP 2ZJ1-UP	8Z1-UP	Spacer Plated Aftercooled D.I. Engine
CTP3306036C	Cylinder Head Repl. Gasket Set	CH65B CH65C CH65D	7YC1-UP 2ZJ1-UP	8Z1-UP	Spacer Plated Aftercooled D.I. Engine
CTP3306037A	Out of Frame OH Gasket Set				
CTP3306037B	Inframe OH Set	235 970	7N-1291 135-3684	13Z00943-UP 13Z36957-UP	
CTP3306037C	Cylinder Head Repl. Gasket Set				
CTP3306038A	Out of Frame OH Gasket Set	621	7W-6847	1AF00001-UP	
CTP3306038B	Inframe OH Set				
CTP3306038C	Cylinder Head Repl. Gasket Set	D6	5Y-1001	1AF00001-UP	
CTP3306039A	Out of Frame OH Gasket Set				
CTP3306039B	Inframe OH Set	966 D6	7N-3601 7N-3599 7N-3602	44V11740-UP 44V12221-UP 44V11794-UP	
CTP3306039C	Cylinder Head Repl. Gasket Set				
CTP3306040A	Out of Frame OH Gasket Set				
CTP3306040B	Inframe OH Set	814 D6	6A-3819	49V00001-UP	
CTP3306040C	Cylinder Head Repl. Gasket Set		7S-4456	49V00001-UP	
CTP3306041A	Out of Frame OH Gasket Set				
CTP3306041B	Inframe OH Set	966G MACHINE	147-1850	13Z01-UP	
CTP3306041C	Cylinder Head Repl. Gasket Set				
CTP3306042A	Out of Frame OH Gasket Set				
CTP3306042B	Inframe OH Set	TRUCK	4P9855	7RJ01-UP	
CTP3306042C	Cylinder Head Repl. Gasket Set				
CTP3306043A	Out of Frame OH Gasket Set	966			
CTP3306043B	Inframe OH Set		106-3145	08Z00001-UP 08Z99999 6NC00001-UP 6NC99999	
CTP3306043C	Cylinder Head Repl. Gasket Set				
CTP3306044A	Out of Frame OH Gasket Set				
CTP3306044B	Inframe OH Set	966	106-3145	13Z30334-UP 13Z99999	
CTP3306044C	Cylinder Head Repl. Gasket Set				
CTP3306045A	Out of Frame OH Gasket Set				
CTP3306045B	Inframe OH Set	966	122-4210	08Z86460-UP 08Z99999 6NC00001-UP 6NC99999	
CTP3306045C	Cylinder Head Repl. Gasket Set				
CTP3306046A	Out of Frame OH Gasket Set				
CTP3306046B	Inframe OH Set	966	6I-2965	08Z68825-UP 08Z73987	
CTP3306046C	Cylinder Head Repl. Gasket Set				
CTP3306047A	Out of Frame OH Gasket Set				
CTP3306047B	Inframe OH Set	966F	6I-2965	R6J00001-UP R6J99999	
CTP3306047C	Cylinder Head Repl. Gasket Set				

3406

Part Number	Description	Machine Model / Application	Machine Serial Number	Engine Model	Engine Serial No.	Comments
CTP3406001A	Out of Frame OH Gasket Set					
CTP3406001B	Inframe OH Set	Truck		3406	92U 5944-UP	
CTP3406001C	Cylinder Head Repl. Gasket Set					
CTP3406002A	Out of Frame OH Gasket Set					
CTP3406002B	Inframe OH Set	980C		3406	70V4683-UP 11N1-1475 81Y1-UP	
CTP3406002C	Cylinder Head Repl. Gasket Set					
CTP3406003A	Out of Frame OH Gasket Set					
CTP3406003B	Inframe OH Set	D8N	9TC1-UP 1XJ1-UP	3406	9TC1-UP 1XJ1-UP	Non Aftercooled With 24 Bolt Flywheel Housin
CTP3406003C	Cylinder Head Repl. Gasket Set					
CTP3406004A	Out of Frame OH Gasket Set					
CTP3406004B	Inframe OH Set	Marine		3406B 3406C	4TB1-3481 4TB3482-UP	With 19 Bolt Flywheel Housing
CTP3406004C	Cylinder Head Repl. Gasket Set					
CTP3406005A	Out of Frame OH Gasket Set					
CTP3406005B	Inframe OH Set	D8N	7TK1-UP	3406	11N7050-UP	Aftercooled With 19 Bolt Flywheel Housing
CTP3406005C	Cylinder Head Repl. Gasket Set					
CTP3406006A	Out of Frame OH Gasket Set					
CTP3406006B	Inframe OH Set		85X1194-UP 86X731-UP 87X587-UP 3HK 1 - UP 8CJ 1 - UP 8JN 1 - UP 5XJ 1 - UP	3406	70V21372-UP 11N1-UP	Spacer Plated Turbocharged Non Aftercooled With 19 Bolt Flywheel Housing
CTP3406006C	Cylinder Head Repl. Gasket Set					
CTP3406007A	Out of Frame OH Gasket Set					
CTP3406007B	Inframe OH Set		824C 825C 826C 980F 980G	3406	70V21372-UP 11N1-UP 41Z1-UP	Spacer Plated Turbocharged Aftercooled With 24 Bolt Flywheel Housing
CTP3406007C	Cylinder Head Repl. Gasket Set					
CTP3406008A	Out of Frame OH Gasket Set					
CTP3406008B	Inframe OH Set	16G 16H	93U2679-UP 6ZJ1-UP	3406	70V36899-UP 11N1449-UP 41Z1-UP	DITA With 24 Bolt Flywheel Housing
CTP3406008C	Cylinder Head Repl. Gasket Set					
CTP3406009A	Out of Frame OH Gasket Set					
CTP3406009B	Inframe OH Set	D8N D8R	5TJ1UP 7XM1-UP 9EM1-UP	3406	11N4939-UP 11N12940-UP 41Z286-UP	Aftercooled With 24 Bolt Flywheel Housing
CTP3406009C	Cylinder Head Repl. Gasket Set					
CTP3406010A	Out of Frame OH Gasket Set					
CTP3406010B	Inframe OH Set	Industrial		3406	2WB1-UP 6TB1-UP	Aftercooled Turbocharged With 19 Bolt Flywheel Housing
CTP3406010C	Cylinder Head Repl. Gasket Set					
CTP3406011A	Out of Frame OH Gasket Set					
CTP3406011B	Inframe OH Set	Truck		3406	92U1-5943	With Oil Feed Thru Studs Aftercooled Turbocharged With 19 Bolt Flywheel Housing
CTP3406011C	Cylinder Head Repl. Gasket Set					
CTP3406012A	Out of Frame OH Gasket Set					
CTP3406012B	Inframe OH Set	245	95V731-UP 82X475-UP 84X475-UP	3406	70V4578-UP	Spacer Plated Turbocharged Aftercooled Turbocharged P.C. or D.I. Engines With 19 Bolt Flywheel Housing
CTP3406012C	Cylinder Head Repl. Gasket Set					
CTP3406013A	Out of Frame OH Gasket Set					
CTP3406013B	Inframe OH Set	Truck		3406C	3ZJ16182-UP 60112 4CK846-UP 5KJ7800-UP	ATAAC (Air to Air Aftercooled) Turbocharged With 19 Bolt Flywheel Housing
CTP3406013C	Cylinder Head Repl. Gasket Set					
CTP3406014A	Out of Frame OH Gasket Set					
CTP3406014B	Inframe OH Set	Industrial		3406A	90U2159-UP 75Z1-UP	Aftercooled Turbocharged With 19 Bolt Flywheel Housing
CTP3406014C	Cylinder Head Repl. Gasket Set					

Part Number	Description	Machine Model / Application	Machine Serial Number	Engine Model	Engine Serial No.	Comments
CTP3406015A	Out of Frame OH Gasket Set					
CTP3406015B	Inframe OH Set	Marine		3406A	92U721-UP	Aftercooled Turbocharged P.C. Engine With 19 Bolt Flywheel Housing
CTP3406015C	Cylinder Head Repl. Gasket Set					
CTP3406016A	Out of Frame OH Gasket Set	Marine		3406A	91U1-484	Aftercooled Turbocharged 19 Bolt Fly wheel Housing With Oil Feed Thru Studs
CTP3406017A	Out of Frame OH Gasket Set	Industrial		3406C	3ER1-UP 1SS1-UP	Aftercooled Turbocharged 24 Bolt Flywheel Housing
CTP3406018A	Out of Frame OH Gasket Set					
CTP3406018B	Inframe OH Set	621B 623B	45P1-UP 46P1-UP	3406 FRONT	70V3145-UP	Spacer Plated Turbocharged Aftercooled Turbocharged P.C. or D.I. Engines With 19 Bolt Flywheel Housing
CTP3406018C	Cylinder Head Repl. Gasket Set					
CTP3406020A	Out of Frame OH Gasket Set					
CTP3406020B	Inframe OH Set	245B 245D	1S,J1-UP 6MF1-UP 4LK1-UP 7ZJ1-UP	3406	70V26356-UP 11N1-UP	Spacer Plated Turbocharged Aftercooled Turbocharged With 19 Bolt Flywheel Housing
CTP3406020C	Cylinder Head Repl. Gasket Set					
CTP3406021A	Out of Frame OH Gasket Set	STEIGER		3406	6TB3571-UP	Spacer Plated Aftercooled D.I. Engine With 19 Bolt Flywheel Housing
CTP3406022A	Out of Frame OH Gasket Set					
CTP3406022B	Inframe OH Set	Natural Gas		3406	4FD1-UP 1RK1-UP	Non Turbocharged Spacer Plated
CTP3406022C	Cylinder Head Repl. Gasket Set					
CTP3406023A	Out of Frame OH Gasket Set					
CTP3406023B	Inframe OH Set	16G 16H	93U1179-UP 2678	3406	70V4105-UP	DITA With 24 Bolt Flywheel Housing
CTP3406023C	Cylinder Head Repl. Gasket Set					
CTP3406024A	Out of Frame OH Gasket Set					
CTP3406024B	Inframe OH Set	621E 623E 627E FRONT	6AB1-UP; 2PD1-UP; 60B1-UP; 6YF1-UP; 7CG1-UP; 1DL1-UP; 6BK1-UP	3406	70V3145-UP 11N1-UP	Spacer Plated Turbocharged Non Aftercooled With 19 Bolt Flywheel Housing
CTP3406024C	Cylinder Head Repl. Gasket Set					
CTP3406025A	Out of Frame OH Gasket Set	Natural Gas		G3406	4FD1-UP 1RK1-UP	Spacer Plated Turbocharged Aftercooled With 24 Bolt Flywheel Housing
CTP3406026A	Out of Frame OH Gasket Set					
CTP3406026B	Inframe OH Set	Truck		3406C	3ZJ60113-UP 8PN1-UP	ATAAC (Air to Air Aftercooled) With 24 Bolt Flywheel Housing With Round Exhaust Ports
CTP3406026C	Cylinder Head Repl. Gasket Set					
CTP3406027A	Out of Frame OH Gasket Set</					

3408 (cont.)

Part Number	Description	Machine Model / Application	Machine Serial Number	Engine Model	Engine Serial No.	Comments
CTP3408002A	Out of Frame OH Gasket Set	Industrial		3408	67U1335-UP	Aftercooled Turbocharged With 24 Bolt Flywheel Housing
CTP3408002B	Inframe OH Set					Aftercooled Turbocharged With 24 Bolt Flywheel Housing
CTP3408002C	Cylinder Head Repl. Gasket Set					Aftercooled Turbocharged With 24 Bolt Flywheel Housing
CTP3408003A	Out of Frame OH Gasket Set	988B	50W1-UP	3408	48W950-UP	Non Aftercooled Turbocharged With 19 Bolt Flywheel Housing
CTP3408003B	Inframe OH Set					Non Aftercooled Turbocharged With 19 Bolt Flywheel Housing
CTP3408003C	Cylinder Head Repl. Gasket Set					Non Aftercooled Turbocharged With 19 Bolt Flywheel Housing
CTP3408004A	Out of Frame OH Gasket Set	768C 769C	2X1-UP 1X1-UP	3408	48W1-UP	Aftercooled Turbocharged With 19 Bolt Flywheel Housing
CTP3408004B	Inframe OH Set					Aftercooled Turbocharged With 19 Bolt Flywheel Housing
CTP3408004C	Cylinder Head Repl. Gasket Set					Aftercooled Turbocharged With 19 Bolt Flywheel Housing
CTP3408005A	Out of Frame OH Gasket Set	D9N	1JD1-UP 6XJ1-UP	3408	48W23086-UP 48W35650-UP	Aftercooled Turbocharged D.I. With 19 Bolt Flywheel Housing
CTP3408005B	Inframe OH Set					Aftercooled Turbocharged D.I. With 19 Bolt Flywheel Housing
CTP3408005C	Cylinder Head Repl. Gasket Set					Aftercooled Turbocharged D.I. With 19 Bolt Flywheel Housing
CTP3408006A	Out of Frame OH Gasket Set	631D FRONT 633D FRONT 637D FRONT	24W1-UP 25W1-UP 26W1-UP 27W1-UP	3408	48W950-UP	Aftercooled Turbocharged With 24 Bolt Flywheel Housing
CTP3408006B	Inframe OH Set					Aftercooled Turbocharged With 24 Bolt Flywheel Housing
CTP3408006C	Cylinder Head Repl. Gasket Set					Aftercooled Turbocharged With 24 Bolt Flywheel Housing
CTP3408006D	Single Cyl. Head Repl. Gasket Set					
CTP3408007A	Out of Frame OH Gasket Set	Marine		3408 3408B	99U585-UP 782	Aftercooled Turbocharged With 24 Bolt Flywheel Housing
CTP3408007B	Inframe OH Set					Aftercooled Turbocharged With 24 Bolt Flywheel Housing
CTP3408007C	Cylinder Head Repl. Gasket Set					Aftercooled Turbocharged With 24 Bolt Flywheel Housing
CTP3408008A	Out of Frame OH Gasket Set	Truck		3408	28V428-UP	Aftercooled Turbocharged With 24 Bolt Flywheel Housing
CTP3408008B	Inframe OH Set					Aftercooled Turbocharged With 24 Bolt Flywheel Housing
CTP3408008C	Cylinder Head Repl. Gasket Set					Aftercooled Turbocharged With 24 Bolt Flywheel Housing
CTP3408009A	Out of Frame OH Gasket Set	631E FRONT 637E FRONT 657E REAR	1N8390-UP 1FB1-659 1JB1-UP 90Z1-UP 91Z1-UP	3408	77M1-UP 48W19968-UP 73W3857-UP	Aftercooled Turbocharged D.I. With 24 Bolt Flywheel Housing
CTP3408009B	Inframe OH Set					Aftercooled Turbocharged D.I. With 24 Bolt Flywheel Housing
CTP3408009C	Cylinder Head Repl. Gasket Set					Aftercooled Turbocharged D.I. With 24 Bolt Flywheel Housing
CTP3408010A	Out of Frame OH Gasket Set	D8L	53Y1-UP 7JC1-UP 7YB1-UP	3408	48W13008-17791 77M1-UP	Non Aftercooled Turbocharged With 19 Bolt Flywheel Housing
CTP3408011A	Out of Frame OH Gasket Set	988F	8YG	3408	48W35089-UP	Aftercooled Turbocharged With 19 Bolt Flywheel Housing
CTP3408011B	Inframe OH Set					Aftercooled Turbocharged With 19 Bolt Flywheel Housing
CTP3408011C	Cylinder Head Repl. Gasket Set					Aftercooled Turbocharged With 19 Bolt Flywheel Housing
CTP3408012A	Out of Frame OH Gasket Set	69D 771D 834B 836C	STR1-UP SSS1-UP 6JR1-UP 7BR1-UP 7FR11-UP	3408	99C1-UP	Aftercooled Turbocharged With 19 Bolt Flywheel Housing HEUI® Engine
CTP3408012C	Cylinder Head Repl. Gasket Set					Aftercooled Turbocharged With 19 Bolt Flywheel Housing HEUI® Engine
CTP3408013A	Out of Frame OH Gasket Set					Aftercooled Turbocharged With 19 Bolt Flywheel Housing HEUI® Engine
CTP3408013C	Cylinder Head Repl. Gasket Set	988F	2ZR1-UP	3408	99C1-UP	Aftercooled Turbocharged With 19 Bolt Flywheel Housing HEUI® Engine
CTP3408014A	Out of Frame OH Gasket Set					Aftercooled Turbocharged With 19 Bolt Flywheel Housing HEUI® Engine
CTP3408014C	Cylinder Head Repl. Gasket Set					Aftercooled Turbocharged With 19 Bolt Flywheel Housing HEUI® Engine
CTP3408015A	Out of Frame OH Gasket Set	**			48W	
CTP3408016A	Out of Frame OH Gasket Set	3408C Marine Auxiliary & Generator Turbocharger	131-5407	3408	1TS00001-1TS99999	Aftercooled Turbocharged Single Head
CTP3408016B	Inframe OH Set					Aftercooled Turbocharged Single Head
CTP3408016C	Cylinder Head Repl. Gasket Set					Aftercooled Turbocharged Single Head
CTP3406016D	Single Cyl. Head Repl. Gasket Set					
CTP3408017A	Out of Frame OH Gasket Set	3408C Marine Auxiliary & Generator Turbocharger	131-5408	3408	1TS00001-1TS99999	Aftercooled Turbocharged Single Head
CTP3408017B	Inframe OH Set					Aftercooled Turbocharged Single Head
CTP3408017C	Cylinder Head Repl. Gasket Set					Aftercooled Turbocharged Single Head
CTP3408017D	Single Cyl. Head Repl. Gasket Set					

Part Number	Description	Machine Model / Application	Machine Serial Number	Engine Model	Engine Serial No.	Comments
CTP3408018A	Out of Frame OH Gasket Set	3408C Marine Auxiliary & Generator Turbocharger	177-3060 177-3061 177-3062 177-3063	3408	1TS00001-1TS99999	Aftercooled Turbocharged Single Head
CTP3408018B	Inframe OH Set					Aftercooled Turbocharged Single Head
CTP3408018C	Cylinder Head Repl. Gasket Set					Aftercooled Turbocharged Single Head
CTP3408018D	Single Cyl. Head Repl. Gasket Set					
CTP3408018A	Out of Frame OH Gasket Set	3408C Marine Auxiliary & Generator Turbocharger	177-3060 177-3061 177-3062 177-3063	3408	1TS00001-1TS99999	Aftercooled Turbocharged Single Head
CTP3408018B	Inframe OH Set					Aftercooled Turbocharged Single Head
CTP3408018C	Cylinder Head Repl. Gasket Set					Aftercooled Turbocharged Single Head
CTP3408018D	Single Cyl. Head Repl. Gasket Set					
CTP3408019A	Out of Frame OH Gasket Set	D9R	139-3291 206-1494 362-6597	3408	48W00001-48W99999	Aftercooled Turbocharged Single Head
CTP3408019B	Inframe OH Set					Aftercooled Turbocharged Single Head
CTP3408019C	Cylinder Head Repl. Gasket Set					Aftercooled Turbocharged Single Head
CTP3408020A	Out of Frame OH Gasket Set	D9R	139-3288	3408	99C00001-99C99999	Aftercooled Turbocharged Single Head
CTP3408020B	Inframe OH Set					Aftercooled Turbocharged Single Head
CTP3408020C	Cylinder Head Repl. Gasket Set					Aftercooled Turbocharged Single Head
CTP3408021A	Out of Frame OH Gasket Set	D9R	163-5784	3408	5XD00001-5XD99999	Aftercooled Turbocharged Single Head
CTP3408021B	Inframe OH Set					Aftercooled Turbocharged Single Head
CTP3408021C	Cylinder Head Repl. Gasket Set					Aftercooled Turbocharged Single Head
CTP3408022A	Out of Frame OH Gasket Set	D9R	163-5785	3408	5XD00001-5XD99999	Aftercooled Turbocharged Single Head
CTP3408022B	Inframe OH Set					Aftercooled Turbocharged Single Head
CTP3408022C	Cylinder Head Repl. Gasket Set					Aftercooled Turbocharged Single Head

3412

Part Number	Description	Machine Model / Application	Machine Serial Number	Engine Model	Engine Serial No.	Comments
CTP3412001A	Out of Frame OH Gasket Set	990B 992C 992D	7HK1-UP 42X1-UP 49Z1-UP 7MJ1-UP	3412	73W1-UP	Aftercooled Turbocharged With 19 Bolt Flywheel Housing
CTP3412001B	Inframe OH Set					Aftercooled Turbocharged With 19 Bolt Flywheel Housing
CTP3412001C	Cylinder Head Repl. Gasket Set					Aftercooled Turbocharged With 19 Bolt Flywheel Housing
CTP3412002A	Out of Frame OH Gasket Set	772B 773B 775B	64W1-UP 63W1-UP 7XJ1-UP	3412	73W1-UP	Aftercooled Turbocharged With 19 Bolt Flywheel Housing
CTP3412002B	Inframe OH Set					Aftercooled Turbocharged With 19 Bolt Flywheel Housing
CTP3412002C	Cylinder Head Repl. Gasket Set					Aftercooled Turbocharged With 19 Bolt Flywheel Housing
CTP3412003A	Out of Frame OH Gasket Set	D10N	2YD1-UP	3412	73W8338-UP	Aftercooled Turbocharged D.I. Engine With 19 Bolt Flywheel Housing
CTP3412003B	Inframe OH Set					Aftercooled Turbocharged D.I. Engine With 19 Bolt Flywheel Housing
CTP3412003C	Cylinder Head Repl. Gasket Set					Aftercooled Turbocharged D.I. Engine With 19 Bolt Flywheel Housing
CTP3412003D	Single Cyl. Head Repl. Gasket Set					
CTP3412004A	Out of Frame OH Gasket Set	D10R 651E 657E	3KR1-UP 4YR1-UP 4XR1-UP 6TR1-UP 5YR1-UP	3412	80M1-UP	Aftercooled Turbocharged HEUI® Engine With 19 Bolt Flywheel Housing
CTP3412004C	Cylinder Head Repl. Gasket Set					Aftercooled Turbocharged HEUI® Engine With 19 Bolt Flywheel Housing
CTP3412004D	Single Cyl. Head Repl. Gasket Set					Aftercooled Turbocharged HEUI® Engine With 19 Bolt Flywheel Housing
CTP3412005A	Out of Frame OH Gasket Set	Industrial	3412 3412C 3412C W/ 4 SEQ TURBOS	38S1-UP 81Z1-UP 2WJ1-UP 1EZ1-UP		Aftercooled Turbocharged Single Head
CTP3412005B	Inframe OH Set					Aftercooled Turbocharged Single Head
CTP3412005C	Cylinder Head Repl. Gasket Set					Aftercooled Turbocharged Single Head
CTP3412005D	Single Cyl. Head Repl. Gasket Set					
CTP3412006A	Out of Frame OH Gasket Set	Marine		3412	60M1-UP 9BR1-UP	Aftercooled Turbocharged With 19 Bolt Flywheel Housing
CTP3412006B	Inframe OH Set					Aftercooled Turbocharged With 19 Bolt Flywheel Housing
CTP3412006C	Cylinder Head Repl. Gasket Set					Aftercooled Turbocharged With 19 Bolt Flywheel Housing

3456

Part Number	Description	Machine Model / Application	Machine Serial Number	Engine Model	Engine Serial No.	Comments
CTP3456001A	Out of Frame OH Gasket Set	988G	133-3840 180-4188 238-1807	3456	7RC01-UP	Aftercooled Turbocharged
CTP3456001B	Inframe OH Set					Aftercooled Turbocharged
CTP3456001C	Cylinder Head Repl. Gasket Set					Aftercooled Turbocharged

3508

Part Number	Description	Machine Model / Application	Machine Serial Number	Engine Model	Engine Serial No.	Comments
CTP3508001A	Out of Frame OH Gasket Set	D11N 776B 777B	74Z1-UP 6JC1UP 4YC1-UP	3508	99W1-UP	Aftercooled Turbocharged
CTP3508001C	Cylinder Head Repl. Gasket Set					Aftercooled Turbocharged
CTP3508001D	Single Cyl. Head Repl. Gasket Set					Aftercooled Turbocharged
CTP3508002A	Out of Frame OH Gasket Set	D11N 776C 777C	4HK1-UP 2KT1-UP 4XJ1-UP	3508	7YG1-UP	Aftercooled Turbocharged
CTP3508002C	Cylinder Head Repl. Gasket Set					Aftercooled Turbocharged
CTP3508002D	Single Cyl. Head Repl. Gasket Set					Aftercooled Turbocharged
CTP3508003A	Out of Frame OH Gasket Set	D11R 776D 777D 854G 992G 5130B	7PZ1-UP 9TR1-UP 9XR1-UP 5ER1-UP 3PR1-UP 1JW1-UP 7HR1-UP 4CS1-UP	3508B	2GR1-UP	Aftercooled Turbocharged HEUI Engine Non Ceramic Dry Exhaust Manifolds
CTP3508003C	Cylinder Head Repl. Gasket Set					Aftercooled Turbocharged HEUI Engine Non Ceramic Dry Exhaust Manifolds
CTP3508003D	Single Cyl. Head Repl. Gasket Set					Aftercooled Turbocharged HEUI Engine Non Ceramic Dry Exhaust Manifolds

3512

Part Number	Description	Machine Model / Application	Engine Arrangement	Engine Serial No.	Comments
CTP3512001A	Out of Frame OH Gasket Set	INDUSTRIAL GENERATOR		49Y1-UP 51Y1-UP 24Z1-UP 65Z1-UP 67Z1-UP	Aftercooled turbocharged with dry exhaust manifolds
CTP3512001C	Multiple Cyl. Head Repl. Gasket Set				Aftercooled turbocharged with dry exhaust manifolds
CTP3512001D	Single Cyl. Head Repl. Gasket Set				Aftercooled turbocharged with dry exhaust manifolds
CTP3512002C	Multiple Cyl. Head Repl. Gasket Set	785D OEM OFF-HIGHWAY TRUCK	278-0555 323-5312 365-9312 365-9313	B7F00001- B7F00328	
CTP3512002D	Single Cyl. Head Repl. Gasket Set	785D OFF-HIGHWAY TRUCK			
CTP3512004A	Out of Frame OH Gasket Set	INDUSTRIAL & VEHICULAR		1LM-UP 2AF-UP 51Y-UP	Aftercooled Turbocharged Multiple Cyl. Head
CTP3512005A	Out of Frame OH Gasket Set	3512	2322508 2322514 2362459	S2L00001- S2L99999	Single Head
CTP3512005B	Inframe OH Set				Single Head
CTP3512005C	Cylinder Head Repl. Gasket Set				Single Head
CTP3512005D	Single Cyl. Head Repl. Gasket Set				
CTP3512006A	Out of Frame OH Gasket Set	MARINE	2W-8868	66Z00665- 66Z99999	Aftercooled Turbocharged Multiple Cyl. Head
CTP3512006B	Inframe OH Set				Aftercooled Turbocharged Multiple Cyl. Head
CTP3512006C	Cylinder Head Repl. Gasket Set				Aftercooled Turbocharged Multiple Cyl. Head
CTP3512006D	Single Cyl. Head Repl. Gasket Set				

3516

Part Number	Description	Machine Model / Application	Engine Arrangement	Engine Serial No.	Comments
CTP3516001A	Out of Frame OH Gasket Set	NATURAL GAS		3RC198-1254 3RC182-UP	Turbocharged Multiple Cyl Head water-air aftercooler
CTP3516002A	Out of Frame OH Gasket Set	NATURAL GAS Generator CSZ		CTL0001-UP	Turbocharged Aftercooled Spacer plated
CTP3516003C	Cylinder Head Repl. Gasket Set	793C OFF-HIGHWAY TRUCK	147-0797 147-0825 196-9173	8WM00001- 8WM99999	
CTP3516003D	Single Cyl. Head Repl. Gasket Set				

3516 (cont.)

Part Number	Description	Machine Model / Application	Engine Arrangement	Engine Serial No.	Comments
CTP3516004C	Cylinder Head Repl. Gasket Set	793C OFF-HIGHWAY TRUCK	147-0825	8WM00129-8WM00140	
CTP3516004D	Single Cyl. Head Repl. Gasket Set				
CTP3516005C	Cylinder Head Repl. Gasket Set	793D OFF-HIGHWAY TRUCK	235-0300	8WM00001-8WM99999	
CTP3516005D	Single Cyl. Head Repl. Gasket Set		373-9863		
CTP3516006A	Out of Frame OH Gasket Set	793D OFF-HIGHWAY TRUCK	288-4348	8WM00001-8WM99999	
CTP3516006B	Inframe OH Set				
CTP3516006C	Cylinder Head Repl. Gasket Set				
CTP3516006D	Single Cyl. Head Repl. Gasket Set				
CTP3516007C	Cylinder Head Repl. Gasket Set	994F WHEEL LOADER	240-7750	8WM00001-8WM99999	
CTP3516007D	Single Cyl. Head Repl. Gasket Set				
CTP3516008A	Out of Frame OH Gasket Set	3516B MARINE	234-2795	S2X00001-S2X99999	
CTP3516008B	Inframe OH Set				
CTP3516008C	Cylinder Head Repl. Gasket Set				
CTP3516008D	Single Cyl. Head Repl. Gasket Set				

3520G

Part Number	Description	Machine Model / Application	Engine Arrangement	Engine Serial No.
CTPG3520001C	Cylinder Head Repl. Gasket Set	G3520C GENERATOR SET	212-4365	GDB00001-GDB99999
	CTPG3520001D		Single Cyl. Head Repl. Gasket Set	319-8117
				313-6082
				RLP00001-RLP99999

D353

Part Number	Description	Machine Model / Application	Engine Arrangement	Engine Serial No.	Comments
CTPD353001A	Out of Frame OH Gasket Set	D9	4N-5998	97U00001-97U07921	
CTPD353001B	Inframe OH Set				
CTPD353001C	Cylinder Head Repl. Gasket Set				
CTPD353002A	Out of Frame OH Gasket Set	INDUSTRIAL	7N-4374	46B06600-46B99999	
CTPD353002B	Inframe OH Set				
CTPD353002C	Cylinder Head Repl. Gasket Set				

GASKET KITS FOR C-SERIES ENGINES



Special Gasket Kits for Engine C-7

Part No.	Application/ Description
2690064	GASKET KIT - TURBOCHARGER
2712910	GASKET KIT - WATER PUMP
2853794	GASKET KIT - AIR COMPRESSOR
2919159	GASKET KIT - WATER PUMP INSTALLATION
2933069	GASKET KIT - WATER PUMP INSTALLATION
2974826	GASKET KIT - AIR COMPRESSOR
2974827	GASKET KIT - FUEL SYSTEM
2974828	GASKET KIT - FRONT STRUCTURE
2974830	GASKET KIT - SINGLE CYLINDER HEAD
2974831	GASKET KIT - WATER PUMP INSTALLATION
2974835	GASKET KIT - CENTRAL & LOWER
2974841	GASKET KIT - SINGLE FUEL INJECTOR
2975350	GASKET KIT - SINGLE CYLINDER HEAD
2975867	GASKET KIT - FRONT STRUCTURE
2975894	GASKET KIT - WATER PUMP INSTALLATION
2975909	GASKET KIT - AIR COMPRESSOR
2976161	GASKET KIT - FUEL SYSTEM
2976163	GASKET KIT - AIR COMPRESSOR
2976379	GASKET KIT - AIR COMPRESSOR
2976380	GASKET KIT - FRONT
2976382	GASKET KIT - WATER PUMP INSTALLATION
2978786	GASKET KIT - FRONT STRUCTURE
2978787	GASKET KIT - SINGLE CYLINDER HEAD
2982108	GASKET KIT - FRONT STRUCTURE
2982111	GASKET KIT - SINGLE CYLINDER
2982112	GASKET KIT - WATER PUMP INSTALLATION
2982438	GASKET KIT - AIR COMPRESSOR
2982733	GASKET KIT - FRONT STRUCTURE

Part No.	Application/ Description
2983818	GASKET KIT - FUEL SYSTEM
3083436	GASKET KIT - WATER PUMP INSTALLATION
3085824	GASKET KIT - FUEL SYSTEM
3086327	GASKET KIT - CENTRAL & LOWER
3086345	GASKET KIT - FUEL SYSTEM
3087293	GASKET KIT - FRONT STRUCTURE
3133975	GASKET KIT - FRONT STRUCTURE
3189645	GASKET KIT - CENTRAL & LOWER
3189646	GASKET KIT - FUEL SYSTEM
3189647	GASKET KIT - FRONT STRUCTURE
3189648	GASKET KIT - TURBOCHARGER
3451909	GASKET KIT - OIL COOLER AND LINES

Special Gasket Kits for Engine C-9

Part No.	Application/ Description
1416584	GASKET KIT - SINGLE CYLINDER HEAD
1548867	GASKET KIT - SINGLE CYLINDER HEAD
2196584	GASKET KIT - SINGLE CYLINDER HEAD
2197629	GASKET KIT - SINGLE CYLINDER HEAD
2221196	GASKET KIT - SINGLE CYLINDER HEAD
2321820	GASKET KIT - FRONT COVER
2894093	GASKET KIT - SINGLE CYLINDER HEAD
2919117	GASKET KIT - SINGLE CYLINDER HEAD
3050788	GASKET KIT - CENTRAL & LOWER
3050789	GASKET KIT - FUEL SYSTEM
3050790	GASKET KIT - FRONT COVER
3050791	GASKET KIT - REAR STRUCTURE
3050792	GASKET KIT - SINGLE CYLINDER HEAD
3050793	GASKET KIT - SINGLE FUEL INJECTOR
3050794	GASKET KIT - TURBOCHARGER INSTALLATION
3050795	GASKET KIT - WATER PUMP INSTALLATION
3067121	GASKET KIT - OIL COOLER & LINES
3071612	GASKET KIT - OIL COOLER & LINES
3071629	GASKET KIT - CENTRAL & LOWER

Part No.	Application/ Description
3073161	GASKET KIT - FUEL SYSTEM
3073163	GASKET KIT - TURBOCHARGER INSTALLATION
3073164	GASKET KIT - CENTRAL & LOWER
3073165	GASKET KIT - SINGLE CYLINDER HEAD
3083417	GASKET KIT - FUEL SYSTEM
3083435	GASKET KIT - FUEL SYSTEM
3136074	GASKET KIT - FUEL SYSTEM
3172171	GASKET KIT - OIL COOLER & LINES
3172224	GASKET KIT - OIL COOLER & LINES
3071629	GASKET KIT - CENTRAL & LOWER
3121241	GASKET KIT - OIL COOLER & LINES
3120208	GASKET KIT - OIL COOLER & LINES
3262044	GASKET KIT - OIL COOLER & LINES
3262045	GASKET KIT - FUEL SYSTEM
3262046	GASKET KIT - FRONT STRUCTURE
3262047	GASKET KIT - OIL COOLER & LINES
3262048	GASKET KIT - SINGLE CYLINDER HEAD
3262059	GASKET KIT - TURBOCHARGER INSTALLATION
3262946	GASKET KIT - OIL COOLER & LINES
3263095	GASKET KIT - AIR COMPRESSOR INSTALLATION
3367994	GASKET KIT - SINGLE CYLINDER HEAD
3509578	GASKET KIT - CENTRAL & LOWER
3383549	GASKET KIT - CENTRAL & LOWER
3383570	GASKET KIT - FUEL SYSTEM
3383571	GASKET KIT - FRONT STRUCTURE
3383577	GASKET KIT - TURBOCHARGER INSTALLATION
3383622	GASKET KIT - REAR STRUCTURE
3509580	GASKET KIT - FUEL SYSTEM
3509621	GASKET KIT - FRONT STRUCTURE
3509622	GASKET KIT - OIL COOLER & LINES
3509623	GASKET KIT - REAR STRUCTURE
3509662	GASKET KIT - WATER PUMP

Special Gasket Kits for Engine C-10

Part No.	Application/ Description
1350239	GASKET KIT - OIL COOLER& LINES
1390616	GASKET KIT - AIR COMPRESSOR
1473781	GASKET KIT - WATER PUMP INSTALLATION
1728176	GASKET KIT - CENTRAL & LOWER
1728178	GASKET KIT - OIL COOLER& LINES
1767000	GASKET KIT - WATER PUMP
1872858	GASKET KIT - FUEL SYSTEM
1933322	GASKET KIT - OIL COOLER& LINES
1933326	GASKET KIT - WATER PUMP
2053615	GASKET KIT - REAR STRUCTURE
2181801	GASKET KIT - FUEL SYSTEM
2197004	GASKET KIT - CYLINDER HEAD
2197005	GASKET KIT - CYLINDER HEAD
2210859	GASKET KIT - TURBOCHARGER INSTALLATION
2245797	GASKET KIT - SINGLE FUEL INJECTOR
2245843	GASKET KIT - FUEL SYSTEM
2266620	GASKET KIT - REAR STRUCTURE
2348913	GASKET KIT - REAR STRUCTURE
2527955	GASKET KIT - CENTRAL & LOWER
3164416	GASKET KIT - SINGLE CYLINDER HEAD
3166709	GASKET KIT - OIL COOLER & LINES
3198077	GASKET KIT - CENTRAL & LOWER
3198081	GASKET KIT - FUEL SYSTEM
3198126	GASKET KIT - SINGLE CYLINDER HEAD
3198127	GASKET KIT - TURBOCHARGER INSTALLATION
3199441	GASKET KIT - OIL COOLER & LINES
3199464	GASKET KIT - CENTRAL & LOWER
3199466	GASKET KIT - FUEL SYSTEM
3199471	GASKET KIT - SINGLE CYLINDER HEAD
3199472	GASKET KIT - TURBOCHARGER INSTALLATION
3215638	GASKET KIT - CENTRAL & LOWER
3234153	GASKET KIT - WATER PUMP INSTALLATION
3234154	GASKET KIT - FUEL SYSTEM
3234159	GASKET KIT - OIL COOLER & LINES
3234174	GASKET KIT - SINGLE CYLINDER HEAD
3235215	GASKET KIT - SINGLE CYLINDER HEAD
3235232	GASKET KIT - WATER PUMP INSTALLATION
7X7975	GASKET KIT - OIL PUMP

Special Gasket Kits for Engine C-11

Part No.	Application/ Description
2655328	GASKET KIT - REAR STRUCTURE
3139670	GASKET KIT - OIL COOLER & LINES
3142521	GASKET KIT - REAR STRUCTURE
3142543	GASKET KIT - SINGLE CYLINDER HEAD
3153221	GASKET KIT - OIL COOLER & LINES
3178084	GASKET KIT - OIL COOLER & LINES
3178354	GASKET KIT - FUEL SYSTEM
3178750	GASKET KIT - SINGLE CYLINDER HEAD
3178751	GASKET KIT - TURBOCHARGER
3179129	GASKET KIT - OIL COOLER & LINES
3179435	GASKET KIT - FUEL SYSTEM
3251561	GASKET KIT - CENTRAL & LOWER
3251564	GASKET KIT - FUEL SYSTEM
3251566	GASKET KIT - FRONT STRUCTURE
3251567	GASKET KIT - OIL COOLER & LINES
3251577	GASKET KIT - SINGLE CYLINDER HEAD
3251636	GASKET KIT - TURBOCHARGER INSTALLATION
3251691	GASKET KIT - WATER PUMP INSTALLATION
3251830	GASKET KIT - SINGLE CYLINDER HEAD
3251853	GASKET KIT - TURBOCHARGER INSTALLATION
3252596	GASKET KIT - FUEL SYSTEM
3268631	GASKET KIT - WATER PUMP INSTALLATION
3268634	GASKET KIT - FUEL SYSTEM
3268677	GASKET KIT - OIL COOLER & LINES
3530280	GASKET KIT - SINGLE CYLINDER HEAD
3530281	GASKET KIT - TURBOCHARGER INSTALLATION

Special Gasket Kits for Engine C-12

Part No.	Application/ Description
1166747	GASKET KIT - COOLER & LINE
1348267	GASKET KIT - OIL COOLER & LINES
1349807	GASKET KIT - OIL COOLER & LINES
1390616	GASKET KIT - AIR COMPRESSOR
1422535	GASKET KIT - OIL COOLER & LINE
1433010	GASKET KIT - WATER PUMP
1473781	GASKET KIT - WATER PUMP INST
1538053	GASKET KIT - PUMP GP-WATER
1728176	GASKET KIT - CENTRAL & LOWER
1728181	GASKET KIT - CENTRAL & LOWER
1872858	GASKET KIT - FUEL SYSTEM
1933318	GASKET KIT - AIR COMPRESSOR
1933322	GASKET KIT - OIL COOLER & LINE
1933326	GASKET KIT - WATER PUMP
2053615	GASKET KIT - REAR STRUCTURE
2181801	GASKET KIT - FUEL SYSTEM
2197006	GASKET KIT - SINGLE CYLINDER HEAD

Part No.	Application/ Description
2197007	GASKET KIT - SINGLE CYLINDER HEAD
2203682	GASKET KIT - REAR STRUCTURE
2210859	GASKET KIT - TURBOCHARGER INSTALLATION
2210860	GASKET KIT - TURBOCHARGER
2245797	GASKET KIT - SINGLE FUEL INJECTOR
2245824	GASKET KIT - FUEL SYSTEM
2245843	GASKET KIT - FUEL SYSTEM
2245876	GASKET KIT - FUEL SYSTEM
2302167	GASKET KIT - FRONT
2302529	GASKET KIT - FRONT
2366611	GASKET KIT - REAR STRUCTURE
2434690	GASKET KIT - OIL COOLER & LINE
2434768	GASKET KIT - FRONT
2434770	GASKET KIT - FUEL SYSTEM
2434780	GASKET KIT - CENTRAL & LOWER
2434784	GASKET KIT - SINGLE CYLINDER HEAD
2434785	GASKET KIT - TURBOCHARGER INSTALLATION
2435142	GASKET KIT - FUEL SYSTEM
2440721	GASKET KIT - CENTRAL & LOWER
2440731	GASKET KIT - SINGLE CYLINDER HEAD
2440732	GASKET KIT - FUEL SYSTEM
2441400	GASKET KIT - CYLINDER HEAD
2441418	GASKET KIT - FRONT
2501273	GASKET KIT - FUEL SYSTEM
2527955	GASKET KIT - CENTRAL & LOWER
2725923	GASKET KIT - CENTRAL & LOWER
3166707	GASKET KIT - FUEL SYSTEM
3166708	GASKET KIT - FRONT STRUCTURE
3166712	GASKET KIT - SINGLE CYLINDER HEAD
3167146	GASKET KIT - CENTRAL & LOWER
3167148	GASKET KIT - TURBOCHARGER INSTALLATION
3167723	GASKET KIT - AIR COMPRESSOR INSTALLATION
3206200	GASKET KIT - TURBOCHARGER INSTALLATION
3220610	GASKET KIT - CENTRAL & LOWER
3220615	GASKET KIT - SINGLE CYLINDER HEAD
3222929	GASKET KIT - SINGLE CYLINDER HEAD
7X7975	GASKET KIT - OIL PUMP

Special Gasket Kits for Engine C-13

Part No.	Application/ Description
2481394	GASKET KIT - SINGLE FUEL INJECTOR
2644675	GASKET KIT - SINGLE CYLINDER HEAD
2644676	GASKET KIT - AIR COMPRESSOR
2655321	GASKET KIT - CENTRAL & LOWER
2655322	GASKET KIT - FUEL SYSTEM
2655323	GASKET KIT - FRONT STRUCTURE
2655324	GASKET KIT - OIL COOLER & LINES

Part No.	Application/ Description
2655325	GASKET KIT - TURBOCHARGER
2655326	GASKET KIT - OIL PUMP
2655327	GASKET KIT - WATER PUMP INSTALLATION
2707966	GASKET KIT - AFTERCOOLER & LINES
2921261	GASKET KIT - SINGLE CYLINDER HEAD
2921263	GASKET KIT - TURBOCHARGER
3136846	GASKET KIT - CENTRAL & LOWER
3136847	GASKET KIT - FUEL SYSTEM
3136848	GASKET KIT - OIL COOLER & LINES
3136850	GASKET KIT - TURBOCHARGER
3136851	GASKET KIT - WATER PUMP INSTALLATION
3136878	GASKET KIT - AFTERCOOLER & LINES
3136879	GASKET KIT - SINGLE CYLINDER HEAD
3136880	GASKET KIT - TURBOCHARGER
3136895	GASKET KIT - AIR COMPRESSOR
3136896	GASKET KIT - FRONT STRUCTURE
3136898	GASKET KIT - FRONT STRUCTURE
3139224	GASKET KIT - OIL COOLER & LINES
3139552	GASKET KIT - WATER PUMP INSTALLATION
3142522	GASKET KIT - WATER PUMP INSTALLATION
3142771	GASKET KIT - WATER PUMP INSTALLATION
3142793	GASKET KIT - TURBORCHARGER
3149899	GASKET KIT - AIR COMPRESSOR
3150121	GASKET KIT - AIR COMPRESSOR
3155080	GASKET KIT - OIL COOLER & LINES
3162520	GASKET KIT - CENTRAL & LOWER
3162521	GASKET KIT - FUEL SYSTEM
3162522	GASKET KIT - FRONT STRUCTURE
3162524	GASKET KIT - OIL COOLER & LINES
3162525	GASKET KIT - REAR STRUCTURE
3162526	GASKET KIT - SINGLE CYLINDER HEAD
3162527	GASKET KIT - TURBOCHARGER INSTALLATION
3162536	GASKET KIT - WATER PUMP INSTALLATION
3188187	GASKET KIT - SINGLE CYLINDER HEAD
3348399	GASKET KIT - CENTRAL AND LOWER
3348400	GASKET KIT - FUEL SYSTEM
3348401	GASKET KIT - FRONT STRUCTURE
3348402	GASKET KIT - OIL COOLER & LINES
3348404	GASKET KIT - REAR STRUCTURE
3348405	GASKET KIT - SINGLE CYLINDER HEAD
3348406	GASKET KIT - TURBOCHARGER INSTALLATION
3348407	GASKET KIT - WATER PUMP INSTALLATION
3349770	GASKET KIT - OIL COOLER & LINES
3359191	GASKET KIT - AIR COMPRESSOR
3359192	GASKET KIT - AIR COMPRESSOR INSTALLATION
3612573	GASKET KIT - SINGLE CYLINDER HEAD

Part numbers are used for reference purposes only.

Costex Tractor Parts Copyright © 2020. All rights reserved.

Special Gasket Kits for Engine C-15

Part No.	Application/ Description
1218170	GASKET GP - BREAK SAVER
1282922	GASKET KIT - WATER PUMP
1386744	GASKET KIT - WATER PUMP REBUILT KIT
1412686	GASKET KIT - AIR COMPRESSOR
1423950	GASKET KIT - AIR COMPRESSOR
1609874	SEAL KIT - SINGLE CYLINDER LINER
1891814	GASKET KIT - OIL COOLER & LINES
1891951	GASKET KIT - FUEL SYSTEM
1895390	GASKET KIT - FUEL INJECTOR
1905978	GASKET KIT - CENTRAL & LOWER
2088350	GASKET KIT - AIR COMPRESSOR
2138603	GASKET KIT - FUEL SYSTEM
2172638	GASKET KIT - FUEL SYSTEM
2220895	GASKET KIT - TURBOCHARGER
2250773	GASKET KIT - FUEL SYSTEM
2341633	GASKET KIT - FRONT STRUCTURE
2341877	GASKET KIT - REAR STRUCTURE
2341904	GASKET KIT - FRONT STRUCTURE
2342986	GASKET KIT - FUEL SYSTEM
2390998	GASKET KIT - FRONT STRUCTURE
2410825	GASKET KIT - TURBOCHARGER
2481394	GASKET KIT - SINGLE FUEL INJECTOR
2486744	GASKET KIT - CYLINDER HEAD
2525655	GASKET KIT - AIR COMPRESSOR
2525656	GASKET KIT - TURBOCHARGER INSTALLATION
2533433	GASKET KIT - CENTRAL & LOWER
2533434	GASKET KIT - FUEL SYSTEM
2533435	GASKET KIT - FRONT STRUCTURE
2533437	GASKET KIT - OIL COOLER & LINES
2533442	GASKET KIT - SINGLE CYLINDER HEAD
2558195	GASKET KIT - FUEL SYSTEM
2572752	GASKET KIT - FRONT STRUCTURE
2572754	GASKET KIT - SINGLE CYLINDER HEAD
2572756	GASKET KIT - CENTRAL & LOWER
2594662	GASKET KIT - FUEL SYSTEM
2763966	GASKET KIT - WATER PUMP INSTALLATION
2800481	GASKET KIT - AIR COMPRESSOR
2853200	GASKET KIT - REAR STRUCTURE
2903986	GASKET KIT - TURBOCHARGER
2969846	GASKET KIT - AIR COMPRESSOR
2969852	GASKET KIT - FRONT STRUCTURE
2969932	GASKET KIT - FUEL SYSTEM
2969933	GASKET KIT - OIL COOLER & LINES
2969949	GASKET KIT - CENTRAL & LOWER
2997436	GASKET KIT - WATER PUMP
3056216	GASKET KIT - CENTRAL & LOWER
3056218	GASKET KIT - FUEL SYSTEM

Part No.	Application/ Description
3056219	GASKET KIT - FRONT STRUCTURE
3056220	GASKET KIT - OIL COOLER & LINES
3056221	GASKET KIT - REAR STRUCTURE
3056222	GASKET KIT - SINGLE CYLINDER HEAD
3056223	GASKET KIT - TURBOCHARGER
3211414	GASKET KIT - AIR COMPRESSOR
3211415	GASKET KIT - CENTRAL & LOWER
3211416	GASKET KIT - FRONT STRUCTURE
3211418	GASKET KIT - SINGLE CYLINDER HEAD
3211447	GASKET KIT - WATER PUMP
3362952	GASKET KIT - FRONT STRUCTURE
3362955	GASKET KIT - OIL COOLER & LINES
3362980	GASKET KIT - TURBOCHARGER
3429546	GASKET KIT - FUEL SYSTEM
3429547	GASKET KIT - WATER PUMP INTALL
3429882	GASKET KIT - SINGLE CYLINDER HEAD
3429891	GASKET KIT - AIR COMPRESSOR INSTALLATION
3429900	GASKET KIT - REAR STRUCTURE
3467526	GASKET KIT - FRONT STRUCTURE
3467527	GASKET KIT - OIL COOLER & LINES
3467528	GASKET KIT - REAR STRUCTURE
3467529	GASKET KIT - SINGLE CYLINDER HEAD
3467530	GASKET KIT - TURBOCHARGER
3467531	GASKET KIT - WATER PUMP
3467532	GASKET KIT - FUEL SYSTEM
3467674	GASKET KIT - REAR STRUCTURE
3467675	GASKET KIT - SINGLE CYLINDER HEAD
3467678	GASKET KIT - FUEL SYSTEM
3483681	GASKET KIT - FRONT STRUCTURE
3483682	GASKET KIT - OIL COOLER & LINES
3483708	GASKET KIT - REAR STRUCTURE
3492885	GASKET KIT - TURBOCHARGER
3492982	GASKET KIT - CENTRAL & LOWER
3492999	GASKET KIT - CENTRAL & LOWER

Special Gasket Kits for Engine C-16

Part No.	Application/ Description
1386744	GASKET KIT - WATER PUMP REBUILT KIT
1609874	SEAL KIT - SINGLE CYLINDER LINER
1891814	GASKET KIT - OIL COOLER & LINES
1895390	GASKET KIT - FUEL INJECTOR
2138621	GASKET KIT - WATER PUMP INSTALLATION
2172638	GASKET KIT - FUEL SYSTEM
2192888	GASKET KIT - AIR COMPRESSOR
2281630	GASKET KIT
2341877	GASKET KIT - REAR STRUCTURE

Part No.	Application/ Description
1609874	GASKET KIT - SINGLE CYLINDER LINER
2410825	GASKET KIT - TURBOCHARGER
2481394	GASKET KIT - SINGLE FUEL INJECTOR
2486744	GASKET KIT - CYLINDER HEAD
2572751	GASKET KIT - AIR COMPRESSOR

Special Gasket Kits for Engine C-18

Part No.	Application/ Description
1386744	GASKET KIT - WATER PUMP REBUILT KIT
1411941	GASKET KIT - SINGLE CYLINDER HEAD
1411943	GASKET KIT - GASKET GP
1891814	GASKET KIT - OIL COOLER & LINES
2138621	GASKET KIT - WATER PUMP INSTALLATION
2322672	GASKET KIT - FRONT STRUCTURE
2341877	GASKET KIT - REAR STRUCTURE
2410825	GASKET KIT - TURBOCHARGER
2481394	GASKET KIT - SINGLE FUEL INJECTOR
2558195	GASKET KIT - FUEL SYSTEM
2572751	GASKET KIT - AIR COMPRESSOR
2572752	GASKET KIT - FRONT STRUCTURE
2572753	GASKET KIT - REAR STRUCTURE
2572754	GASKET KIT - SINGLE CYLINDER HEAD
2572756	GASKET KIT - CENTRAL & LOWER
2588117	GASKET KIT - LINES SEAL
3483295	GASKET KIT - SINGLE CYLINDER HEAD
3493411	GASKET KIT - WATER PUMP INSTALLATION
3493412	GASKET KIT - CENTRAL & LOWER
3493413	GASKET KIT - FUEL SYSTEM
3493414	GASKET KIT - FRONT STRUCTURE
3493415	GASKET KIT - OIL COOLER & LINES
3493416	GASKET KIT - REAR STRUCTURE
3493417	GASKET KIT - SINGLE CYLINDER HEAD
3493424	GASKET KIT - TURBOCHARGER
8T3367	GASKET KIT - WATER PUMP REBUILT KIT

Special Gasket Kits for Engine C-27

Part No.	Application/ Description
3134988	GASKET KIT - FUEL SYSTEM
3135020	GASKET KIT - REAR STRUCTURE
3135452	GASKET KIT - TURBOCHARGER INSTALLATION
3135617	GASKET KIT - SINGLE CYLINDER HEAD
3136412	GASKET KIT - FRONT STRUCTURE
3136413	GASKET KIT - CENTRAL & LOWER
3136478	GASKET KIT - OIL COOLER & LINES
3139004	GASKET KIT - WATER LINES
3139118	GASKET KIT - MULTIPLE CYLINDER HEAD

Part No.	Application/ Description
3179460	GASKET KIT - CENTRAL & LOWER
3179461	GASKET KIT - FUEL SYSTEM
3179465	GASKET KIT - MULTIPLE CYLINDER HEAD
3179466	GASKET KIT - OIL COOLER & LINES
3179467	GASKET KIT - REAR STRUCTURE
3179468	GASKET KIT - SINGLE CYLINDER HEAD
3179469	GASKET KIT - TURBOCHARGER INSTALLATION
3179470	GASKET KIT - WATER LINES
3179471	GASKET KIT - WATER PUMP INSTALLATION
3182333	GASKET KIT - MULTIPLE CYLINDER HEAD
3488374	GASKET KIT - CENTRAL & LOWER
3488375	GASKET KIT - FUEL SYSTEM
3488377	GASKET KIT - OIL COOLER & LINES
3488378	GASKET KIT - SINGLE CYLINDER HEAD
3488379	GASKET KIT - WATER PUMP INSTALLATION
3488395	GASKET KIT - MULTIPLE CYLINDER HEAD

Special Gasket Kits for Engine 3046

Part No.	Application/ Description
2411393	GASKET KIT- FINAL DRIVE

Special Gasket Kits for Engine 3054

Part No.	Application/ Description
2225835	GASKET KIT- BOTTOM
2270186	GASKET KIT - TOP

Special Gasket Kits for Engine 3054E

Part No.	Application/ Description
1739716	GASKET KIT- BOTTOM
2720494	GASKET KIT- BOTTOM

Special Gasket Kits for Engine 3056

Part No.	Application/ Description
1030080	GASKET KIT- BOTTOM
1526731	GASKET KIT

Special Gasket Kits for Engine 3116

Part No.	Application/ Description
1002942	OIL COOLERS & LINES
1002951	SINGLE CYLINDER HEAD
1045833	FUEL SYSTEM
1062822	CYLINDER HEAD
1243686	OIL COOLER & LINES
1246033	FUEL SYSTEM
1246133	SINGLE CYL HEAD
1301306	FRONT STRUCTURE
1301307	OIL COOLER & LINES

Special Gasket Kits for Engine 3116 (cont.)

Part No.	Application/ Description
1301457	SINGLE CYLINDER HEAD
1376568	FUEL SYSTEM
1401093	SINGLE CYLINDER HEAD
1422220	TURBOCHARGER
1422222	OIL COOLER & LINES
1450228	OIL COOLER & LINES
1910759	OIL COOLER & LINES
1966931	OIL COOLER & LINES
2046537	FRONT STRUCTURE
2243871	REAR STRUCTURE
2243973	REAR STRUCTURE
2244323	REAR STRUCTURE
2545676	CYLINDER HEAD
2627133	SINGLE CYLINDER HEAD
2641260	WATER PUMP INSTALLATION
2646898	SINGLE CYL HEAD
2646903	TURBOCHARGER INSTALLATION
2664325	CENTRAL & LOWER
2664362	CENTRAL & LOWER
2665907	CENTRAL & LOWER
2667276	CENTRAL & LOWER
2667283	CENTRAL & LOWER
2667584	CENTRAL & LOWER
2673857	CENTRAL & LOWER
2682932	SINGLE CYLINDER HEAD
2812813	CYLINDER HEAD
2862494	SINGLE CYLINDER HEAD
2878446	FRONT STRUCTURE
2880554	FRONT STRUCTURE
2884735	FRONT STRUCTURE
2885706	FRONT STRUCTURE
3E3278	FRONT STRUCTURE
3E3339	FUEL SYSTEM
3009500	SINGLE CYLINDER HEAD
7X2522	FUEL SYSTEM
7X2524	OIL COOLER & LINES
7X2528	WATER PUMP

Special Gasket Kits for Engine 3126

Part No.	Application/ Description
1422220	GASKET KIT - TURBOCHARGER
2107442	GASKET KIT - OIL COOLER & LINES
2243871	GASKET KIT
2244966	GASKET KIT - FRONT
2305003	GASKET KIT - RS
2421539	GASKET KIT - SFI
2625009	GASKET KIT - SINGLE CYLINDER HEAD

Part No.	Application/ Description
2625080	GASKET KIT - SINGLE CYLINDER HEAD
2627133	GASKET KIT - SCH
2641260	GASKET KIT - WATER PUMP
2664561	GASKET KIT - CENTRAL & LOWER
2666621	GASKET KIT - CENTRAL & LOWER
2690064	GASKET KIT - TURBOCHARGER INSTALLATION
2849745	GASKET KIT - CENTRAL & LOWER
2886375	GASKET KIT - FRONT STRUCTURE

Special Gasket Kits for Engine 3126B

Part No.	Application/ Description
2900468	GASKET KIT - FUEL SYSTEM
2900494	GASKET KIT - OIL COOLER & LINES
3209660	GASKET KIT - TURBOCHARGER INSTALLATION

Special Gasket Kits for Engine 3176

Part No.	Application/ Description
3156662	GASKET KIT - CENTRAL & LOWER
3156671	GASKET KIT - EXTERNAL OIL PUMP
3156672	GASKET KIT - REAR
3156714	GASKET KIT - WATER PUMP INSTALLATION
3190845	GASKET KIT - FUEL SYSTEM
3190846	GASKET KIT - OIL COOLER & LINES
3190847	GASKET KIT - SINGLE CYLINDER HEAD
3190848	GASKET KIT - TURBOCHARGER INSTALLATION
3195381	GASKET KIT - CENTRAL & LOWER
3198081	GASKET KIT - FUEL SYSTEM
3198082	GASKET KIT - FRONT STRUCTURE

Special Gasket Kits for Engine 3176C

Part No.	Application/ Description
2119977	GASKET KIT - FRONT STRUCTURE
2367653	GASKET KIT - CENTRAL & LOWER
2368883	GASKET KIT - OIL COOLER & LINES
3156661	GASKET KIT - CENTRAL & LOWER
3156669	GASKET KIT - FRONT STRUCTURE
3156670	GASKET KIT - OIL COOLER & LINES
3156713	GASKET KIT - TURBOCHARGER INSTALLATION
3156731	GASKET KIT - SINGLE CYLINDER HEAD
3193608	GASKET KIT - TURBOCHARGER INSTALLATION
3193611	GASKET KIT - SINGLE CYLINDER HEAD
3203841	GASKET KIT - CENTRAL & LOWER
3206190	GASKET KIT - OIL COOLER & LINES
3226833	GASKET KIT - FUEL SYSTEM

Special Gasket Kits for Engine 3204

Part No.	Application/ Description
6V2588	GROUP-CYL BLK/OIL PAN
8T2468	CENTRAL & LOWER
6V9882	GROUP-FUEL SYSTEM
8T7981	OIL COOLER & LINES
8C3792	REAR STRUCTURE
6V2501	TURBO MOUNTING
8T2469	FRONT & HSG
8T6734	GROUP-FUEL SYSTEM
7X7707	REAR STRUCTURE
7X2405	SINGLE CYLINDER HEAD

Special Gasket Kits for Engine 3208

Part No.	Application/ Description
1427393	GASKET KIT - TURBOCHARGER INSTALLATION
1427403	GASKET KIT - CENTRAL & LOWER
1433125	GASKET KIT - OIL COOLER & LINES
2039728	GASKET KIT - SINGLE CYLINDER HEAD
2069780	GASKET KIT - AFTERCOOLER & LINES
2347992	GASKET KIT - SINGLE CYLINDER HEAD
2347995	GASKET KIT - MULTIPLE CYLINDER HEAD
2347989	GASKET KIT - SINGLE CYLINDER HEAD
2348001	GASKET KIT - MULTIPLE CYLINDER HEAD
2429882	GASKET KIT - MULTIPLE CYLINDER HEAD

Special Gasket Kits for Engine 3408

Part No.	Application/ Description
1191183	GASKET KIT - POWER SHIFT TRANSMISSION
1308133	GASKET KIT - DIFFERENTIAL AND GEAR
1402859	GASKET KIT - MULTIPLE CYLINDER HEAD
2184365	GASKET KIT - FRONT WHEEL & DRY BREAK
2322943	GASKET KIT - WHEEL/FINAL DRIVE
2323376	GASKET KIT - SINGLE CYLINDER HEAD

Special Gasket Kits for Engine 3412

Part No.	Application/ Description
1394752	GASKET KIT - EXHAUST MANIFOLD
1394758	GASKET KIT - TURBOCHARGER INSTALLATION
1489618	GASKET KIT - OIL COOLER & LINES
1768167	GASKET KIT - AFTERCOOLER & LINES
1768168	GASKET KIT - CENTRAL & LOWER
1768170	GASKET KIT - EXPANSION TANK
1768178	GASKET KIT - MULTIPLE CYLINDER HEAD
1768182	GASKET KIT - SINGLE CYLINDER LINER SEAL KIT
1768184	GASKET KIT - WATER LINES
2157128	GASKET KIT - FUEL SYSTEM

Special Gasket Kits for Engine 3412E

Part No.	Application/ Description
1383622	GASKET KIT - BREAK OIL COOLER LINES
1416586	GASKET KIT - TURBOCHARGER
1416587	GASKET KIT - WATER LINES
1509544	GASKET KIT - CENTRAL & LOWER
1509545	GASKET KIT - FUEL SYSTEM
1509546	GASKET KIT - FRONT STRUCTURE
2212593	GASKET KIT - TURBOCHARGER INSTALLATION
2265975	GASKET KIT - SINGLE CYLINDER HEAD
2410138	GASKET KIT - SINGLE CYLINDER HEAD
2606486	GASKET KIT - POWER SHIFT TRANSMISSION
2637659	GASKET KIT - POWER SHIFT TRANSMISSION
2931009	GASKET KIT - MULTIPLE CYLINDER HEAD
2951108	GASKET KIT - MULTIPLE CYLINDER HEAD
2951109	GASKET KIT - SINGLE CYLINDER HEAD

Special Gasket Kits for Engine G3412

Part No.	Application/ Description
2288898	GASKET KIT - MULTIPLE CYLINDER HEAD
2341985	GASKET KIT - FRONT STRUCTURE
2341986	GASKET KIT - REAR STRUCTURE

Special Gasket Kits for Engine 3512

Part No.	Application/ Description
1299918	GASKET KIT - AUXILIARY WATER PUMP INSTALLATION
1403069	GASKET KIT - AUXILIARY WATER PUMP INSTALLATION
1904176	GASKET KIT - AFTERCOOLER & LINES
2688134	GASKET KIT - AIR COMPRESSOR INSTALLATION
2688136	GASKET KIT - AUXILIARY WATER PUMP
2688142	GASKET KIT - FUEL SYSTEM
2688144	GASKET KIT - FRONT STRUCTURE
2688147	GASKET KIT - EXHAUST MANIFOLD
2688150	GASKET KIT - OIL COOLER & LINES
2688201	GASKET KIT - WATER LINES GR
2850036	GASKET KIT - TURBOCHARGER INSTALLATION
2911303	GASKET KIT - AFTERCOOLER & LINES
2923127	GASKET KIT - REAR STRUCTURE
3052664	GASKET KIT - CENTRAL & LOWER
3053416	GASKET KIT - CENTRAL AND LOWER
3550763	GASKET KIT - SINGLE CYLINDER HEAD

Special Gasket Kits for Engine 3516

Part No.	Application/ Description
2844775	GASKET KIT - AFTERCOOLER & LINES
2409644	GASKET KIT - AFTERCOOLER & LINES
3066827	GASKET KIT - CENTRAL & LOWER
3550775	GASKET KIT - SINGLE CYLINDER HEAD

Special Gasket Kits for Engine 3524

Part No.	Application/ Description
2445643	GASKET KIT -TORQUE CONVERTOR
2445644	GASKET KIT - TRANSMISSION OVERHAUL

Special Gasket Kits for Engine 3508 / 3512 / 3516

Part No.	Application/ Description
1709192	GASKET KIT - EXHAUST MANIFOLD
2409644	GASKET KIT - SINGLE CYLINDER HEAD
3066827	GASKET KIT - SINGLE CYLINDER HEAD
3550776	GASKET KIT - SINGLE CYLINDER HEAD

HEAD GASKETS



Part No.	Engine Model	Part No.	Engine Model
2994645	3044	613066	3406
1070979	3046	2835666	3408
1600161	3054	7E7308	3408
1850885	3054	7N9006	3408
7C3803	3054	7E7312	3412
2400205	3056	2188533	3013C
2228331	3066	1992176	302.5C, 303CR
614689	3114	3227487	3024C
1077832	3116	1529864	3034 MARINE
1753234	3116	1465098	3034, 4.236
2051293	3126	1W7879	3054, 4.236
1193790	3176	2584946	3054, C4.4
7N7386	3304	2228330	3064 MHI
7N8022	3304	1334995	3126, C7
1118015	3306	7W2059	3204, 3208
6N7263	3306	2W8128	3406 Early
8N3658	3306	1873306	3406, C10, C12

Head Gaskets (cont.)

Part No.	Engine Model	Part No.	Engine Model
3590908	3406C, 3406E	4F7004	D315
1539653	3406E	7H6995	D318
1106991	3508, 3512, 3516	8M7684	D320, D311
3628264	3508, 3512, 3516	5M5837	D330, 1670
2219392	C11, C13	1S9397	D339
1873307	C12, 3196	1S4390	D342
2271204	C15	8N4810	D342
3227486	C2.2	7E8026	D343, 1693
3227488	C2.2	7E8027	D346 SPACE PLATE
2253099	C27, C32, 3412E	7E8028	D348
3108520	C4.4	8M2970	D353, G353
2941682	C6.4	3N3220	D379, D398, D399
1871315	C9	1W6440	D9H, D353, D353 E

CRANKSHAFT SEALS



Part No.	Description	Engine Application
1154120	SEAL GP	3126
2223910	SEAL GP - FRONT	3126
7W3200	SEAL GP	3204
7W3202	SEAL GP	3204
7C6660	SEAL GP	3208
2P6224	SEAL GP	3304
9Y9895	SEAL GP - FRONT	3306
2880422	SEAL GP - FRONT	3054, 3056
4W5360	SEAL GP - REAR	3054, 3056
5I7656	SEAL GP - FRONT	3066, 3064
5I7660	SEAL GP - REAR	3066, 3064
2457339	SEAL GP - FRONT	3116, 3126, C7
1154109	SEAL GP - REAR	3116, 3126B, 3126E
2223909	SEAL GP - REAR	3116, 3126B, C7
7C1728	SEAL GP - REAR	3176, C9, C11, C12, C13
2P6226	SEAL GP	3304, 3306
7C4297	SEAL GP - REAR	3306, C9
1138432	SEAL GP - FRONT	3508, 3512, 3516
1694166	SEAL GP - FRONT	C-10, C-13
2264755	SEAL GP - FRONT	C11, C13
1005421	SEAL GP - REAR	C11, C15
4W8133	SEAL GP - FRONT	C15, 3406
4W8134	SEAL GP - REAR	C15, 3407

Part No.	Description	Engine Application
1425867	SEAL GP - FRONT	C15, C18
1425868	SEAL GP - REAR	C15, C18
2854073	SEAL GP - REAR	C-9
2854074	SEAL GP - REAR	C-9
4W2606	SEAL GP	D379/398
4W2607	SEAL GP	D379/398

O-RING KITS



Part No.	Material	Description
CTPSN75	Nitrile O-Ring	30 Sizes / 381 Pieces
CTP0057	Nitrile 75 O-Ring	54 Sizes / 223 Pieces
CTP0157	Silicone O-Ring	54 Sizes / 223 Pieces
CTP0257	Viton O-Ring	54 Sizes / 223 Pieces
CTPMN70	Nitrile 70 O-Ring	O-Ring Kit Metric
4C4782	Nitrile 90 O-Ring	O-Ring Kit
4C4784	Nitrile 90 O-Ring	O-Ring Kit
4C8253	Silicone 70 O-Ring	O-Ring Kit

D-RING KIT



Part No.	Material	Description
4C4784	Nitrile 90 O-Ring	D-Ring Kit

OIL SEALS



Part No.	Part No.	Part No.
1389507	5H9753	7T5617
1B0936	5J9969	8B8255
1J2150	5M9736	8D3902
1N3316	5P0547	8F5340
1T1366	5P0796	8S5575
1U1655	5P3275	8T0392
2H3918	5P7456	8T1362
2H3919	6V1949	8T5416
2N2560	6V7196	9H0223
2P6286	6V7371	9H6079
4F6888	6V9747	9J4957
4N0636	6V9748	9N2539
4N3713	7H7107	9R2499
4W5360	7K2830	9R9402
5H0033	7M8805	

METAL FACE SEALS



Part No.	Engine Model/ Application	Part No.	Engine Model/ Application
0990159	E110B, E312	3144126	797, 793B/C
0990183	311, 312	1C9427	CB 534B/C, CB
0990193	310	4S8984	973C
1090868	345B/C	5K6191	330C L, 330C LN
1090881	330	6T3377	N/A
1090885	322, 325	6T8433	N/A
1141497	320B	6V1915	963
1306889	D10N,	6Y0520	769C, 771D
1326141	330	6Y0857	D9R
1617247	D8T, D9T	7T5125	N/A
1627863	D9R	9G5321	834G
1796863	777D	9G5323	650
1953495	844	9G5349	320

Metal Face Seals (cont.)

Part No.	Engine Model/ Application
9W6630	953, 963
9W6645	920, 930
9W6646	N/A
9W6647	955L, D7G
9W6649	963, D8L
9W6651	D8L, D8N, D9L
9W6666	D4C, D4D, D4E
9W6669	955
9W6672	950B, 966D
9W6674	950B, 966D
9W6675	D6C, D7G
9W6680	D6
9W6684	D7E-F
9W6686	D7G
9W6688	D8H-K, 621
9W6691	D8K, D8H, 621B
9W6699	N/A
9W7207	773B

Part No.	Engine Model/ Application
9W7209	120G
9W7211	944, 950
9W7213	950, 944
9W7215	N/A
9W7216	D4, D5
9W7220	D8H/K
9W7224	D8, 320
9W7225	D9G/K
9W7228	D8H/K
9W7230	D9G
9W7231	D4H, D5H
9W7232	D5C, D5C LPG
9W7233	D10
9W7234	D11N
9W7241	D6C
9W7243	D8K, D9H
9W7332	955L
9W8878	D9R

Part No.	Machine Model	Application
1542919C2	580 K/SK/SL	BOOM
1542923C2	580 K/SK/SL	BUCKET
1542915C2	580 K/SK	N/A
1542915C2	580 K/SK	DIPPER
175251A1	580 L	TILT
1543269C1	580 L	STABILIZER
191747A1	580 L	SWING
122535A1	580 SL	N/A
122535A1	580 SL	SWING
182218A1	580 L	BOOM
131750A2	580 L	BUCKET
234844A1	580 L	DIPPER

CASE IH is a registered trademark of CNH Industrial America LLC.

SEAL KITS FOR SKID LOADERS & EXCAVATORS



SEAL KITS FOR CASE™ MACHINES



Part No.	Machine Model	Application
1543260C1	580 K/SK/SL	LIFT
1543260C1	580 K/SK	SWING
1543256C1	580 K/SK	TILT
1543256C1	580 SL	N/A
1543262C1	580 K/SK	CLAM
1543267C1	580 K/SK/L/SL	EXT. DIPPER
1543267C1	580 SL	CLAM
1543252C1	580 K/SK	HITCH LIFT 3 POINTS
1543250C1	580 K/SK	HITCH TILT 3 POINTS
1543249C1	580 K/SK	HITCH 3 POINTS
G110045	580 K/SK	STEERING
1543275C1	580 K/SK/SL	STABILIZER
1543266C1	580 K/SK	N/A

Skid Loaders

Part No.	Application
1428962	226
1428963	226
1643213	228
1725285	228
1809872	430D
2186822	236B
2309357	430D
2620941	228
2697190	302.5
2698599	302.5
2702668	302.5
2764172	430E
2781970	226
3712760	236B

Excavators 336

Part No.	Application
2590768	336D
3198295	336D
3764333	336D

UNDERCARRIAGE / FRAME & BODY



Part numbers are used for reference purposes only.

FRAME ASSEMBLIES



Sliding Frame Assemblies

Part No.	Description	Machine
2010582	FRAME AS	424D, 428D, 432D, 438D, 442D
2923274	FRAME AS.	422E, 428E, 432E, 434E, 442E, 444E
3223770	FRAME AS.	422F, 422F2, 428F, 428F2, 432F, 444E/F



Swing Frame Assemblies

Part No.	Description	Machine
2366954*	FRAME AS	416D, 420D, 424D, 428D, 432D, 438D
3155384	FRAME AS	422E, 428E, 434E
3161079	FRAME AS	416E, 420E, 422E, 432E, 434E
9R7710	FRAME AS	416D, 420D, 424D, 428D, 432D, 438D

*Part number 2366954 is designed to accept the reinforced pin with 60mm diameter for maximum service life.

BOGIES



Bogie Major

Bin Loc	Part No.	Description	Qty. Per Machine
D8L, 578	8E4236	MIDDLE	4
	8E4235	FRONT	2
	8E4237	REAR	2
D8N, D8R, D8T	3102866	MIDDLE	4
	3102901	FRONT	2
	3102902	REAR	2
D9L	9W0683	MIDDLE	4
	9W7612	FRONT	2
	9W7613	REAR	2

Costex Tractor Parts Copyright © 2020. All rights reserved.

Bogie Major (cont.)

Bin Loc	Part No.	Description	Qty. Per Machine
D9L, D10N, D10R, D10T	7T0375	MIDDLE	4
	1284414	FRONT	2
	1268588	REAR	2
D9N, D9R, D9T	7T5417	MIDDLE	4
	1342679	FRONT	2
	1342680	REAR	2
D11N, D11R, D11T	9W7871	MIDDLE	4
	1287256	FRONT	2
	1287255	REAR	2
D11N, D11R, D11T	9W7871	MIDDLE	4
	1287256	FRONT	2
	1287255	REAR	2



Bogie Minor

Machine Model	Part No.	Description
D10R	1560000	BOGIE MINOR RH
D10R	1560000	BOGIE MINOR LH
D9R	1573106	BOGIE MINOR RH
D9R	1573107	BOGIE MINOR LH
D11R, D11T	2618287	BOGIE MINOR
D11R, D11T	2618288	BOGIE MINOR
D11R, D11T	2618289	BOGIE MINOR LH
D9L, D10N, D10R, D10T	6T1382	BOGIE
D9N, D9R, D9T	7T5420	BOGIE
D8L, D8N, D8R D8R II, D8T, 578	7T8555	BOGIE
D9L, 589	9W0685	BOGIE

*Other part no. not included in the list are available. Please contact your sales representative if you have any questions. Part Numbers are used for reference purposes only



EQUALIZER BARS

Part No.	Application	Part No.	Application
1409698	D8N, D8R	7M0665	D6
1409699	D8L, D9R, D9N	7S9088	D8, D8H
1414690	D7H	8E0743	D5H-LGP
1774651	D9K	8E1340	D5H
2012076	D6H, D6R	8E8789	D6M
2012078	D6H-LGP	8P1865	D7E, D7F
2072683	D11R		
2223676	D9, D10N		
6T1724	D6E		

ROLLERS



Single Flange

Part No.	Application
1231186	245
1787293	345
8E4573	215, 219, 225
8E5745	215B
8E7494	215B, 225
8E4623	215C, 219D, 225D
8E4579	235C/D
8E0830	245B/D, 235D
1634143	315, 315B, 345, 320/B/C/D
1634147	322, 324D, 325B
1634145	322, 325D, 330D L
1791486	325D, 330B, 330D L
1787288	330, 345C, 365B, 374D, 385C
1890475	345C, 350
1855065	375, 385C/B, 390D
1181611	955K, 951BC, D5
1955855	D10T, D10R
1846305	D11R/T
3T4352	D3, D3B/C/G, D4B/C/G
1181608	D4D, D6D
1248237	D4H, D5C/G/H/M/N
1210824	D5B, D5H, D5N, D6, D6B
1181614	D6C, D6R, D6T
1181617	D6D
1205746	D6R
1P9100	D7E
1P8717	D7E, D7F, D7G, D7H
1248250	D7F, D7R
1248253	D7F, D7R
1181623	D7F, D7R
6P4897	D8H, D8K
2460775	D8N
8P5605	D9G, D9H
6Y2950	D9L
1043495	D9R
4I7346	E110, E120B, 311/B, 312/B
0957138	E240
0854973	E300B, EL300B

Double Flange

Part No.	Application
1791491	330B
3T4353	D3B/C/G, D4B/C
3010650	D3K
1248240	D4C/D/E/H, D5G/K/M
1181609	D4E
1181612	D5, D5E
1210827	D5B, D5H, D5N, D6, D6B
1181615	D6, 955
1181618	D6D
1205766	D6H, D6R, D6T
1P9102	D7E, 977L
1248253	D7F, D7R
6P4898	D8H/K, 583H/K, D8
2460779	D8N/R/T
8P5604	D9G/H, 594H
6Y2951	D9L
7T1253	D9N, D9R
1955856	D10N/R/T



Top Rollers

Part No.	Application
8E4576	225SA, FB227, 229, 231
8E5600	315, 318B, 320E, E200B
6Y5323	320S, 325, 330
3004610	345B, 330C
3004611	365B, 374F, 385C/B, 390D/F, 5090B
6Y8168	365B, 375, 375L
6S3609	D3B/C, D4B/C
5A8374	D5, 561
6K9880	D5M, D4H, 939
3T3206	D6, 963
6Y3908	D6M, D5H, 953C, 953B
6Y1781	D6R, D6H, 963
8P6256	D8, D8H, 245, 983
8E0400	D8R, D8N
3P3403	D9, 594
4I7345	E120B

Part numbers are used for reference purposes only.

Mini Excavator Rollers

Part No.	Application	Type
3041890	279C, 289C, 299C	T.F
2668793	302.5, 303, 303.5	C.F
1857280	302.5, 303.5	N/A
1466064	302.5, 303.5	S.F
2668794	303.5CCR, 304E	N/A
1721764	304.5, 305.5	S.F
2657674	304C CR, 305C CR	N/A
2657675	304C CR, 305C CR	N/A
3408957	304CR	C.F
1273807	307, 307B, 308D	S.F
2778576	307, 308, E70B	N/A
1273806	315, 315B, E307	S.F

S.F = Single Flange
C.F = Central Flange



IDLERS

Part No.	Description	Application
CR4094	IDLER	D6D
CR4095	FRONT IDLER GP W/ BRACKETS	D7E/F/G/H
941384	IDLER WHEEL	E240B
1M8867	IDLER A-FRONT	D4, D4C/D, 933F, 955
1028152	IDLER G-FRONT	330
1028155	IDLER G-FRONT	325, 325L
1111729	IDLER GP-TRACK	D8N
1111730	IDLER GP-FRONT	D8N
1156366	IDLER G-FRONT	345/B/C
1253537	IDLER A-TRACK	D10, D10R
1254655	IDLER GP-TRACK	D9N
1592086	IDLER GP-TRACK	D7H, D7R
1846590	IDLER GP-TRACK	D3G
1901534	IDLER GP-TRACK	D4H
1901546	IDLER GP-TRACK	D5H
1901551	IDLER GP-TRACK	D4H
1920224	IDLER GP-TRACK	D7R, D7H
2024296	IDLER GP-TRACK	D6R
2024303	IDLER AS	D6R, D6T
2024304	IDLER GP-TRACK	D6R, D6H



Idlers (cont.)

Part No.	Description	Application
2487143	IDLER GP-TRACK	320C, 315C
3V5131	IDLER AS-FRONT	215 SA, 225B
4E8500	IDLER GR W/ BRACKETS	235C, 235D
4I7337	IDLER GP-FRONT	E311, E110B, E312
5C9558	IDLER GP-FRONT	215B SA, 225
5M5009	IDLER A-TRACK	D6C
8E8907	IDLER AS	215B, 225
9H8489	IDLER SHELL	D7, 973
9S7221	IDLER SHELL	D8H
9W6039	IDLER GP-TRACK	D9L

SPROCKETS & SEGMENTS



Sprockets

Part No.	Application
3T9154	215
7T1311	235
8E6974	250
1028134	315
6Y4898	325
6Y5685	330
8E4686	375
3T9152	215, 225
6C3495	215B
1243296	345B
1419655	365B/C 345B 374D
4V5374	951C
4V5376	951C
6Y1244	D3
8Y0622	D3C
5H9107	D4, 955C
4V4106	D4D, D4E, 941, 941B
4V4107	D4D, D4E, 941, 941B
5S4822	D5
5I9336	D9
0990219	E120B
8E4686	375
8E9805	E320
9C2646	225
0964327	E200B
4I7472	E311, E110B, E312
8E9805	E320

Part No.	Application
0962144	E70B
1R5440	E70B
0959779	EL240B
0994129	EL300

Sprocket Segments



Part No.	Application
6Y3242	953C
6K1430	955K, 955L
6T9538	D10R
6Y2047	D3C, D4C
7G0841	D4H
5S0836	D5B
8E7298	D5G
3145464	D5H
5S0050	D6C, D6D, D6
7G7212	D6H

Part No.	Application
6I8078	D6M
3P1039	D7E/F/G, 977L
9P1898	D7H
2P9510	D8H, D8K
9P4747	D8L
9W0074	D8N, D7H
2P9448	D9G, D9H
7T1246	D9N
3T9049	DC51 A

Sprockets for Mini Excavators

Part No.	Application
1937091	303
1721965	303.5
2645371	303.5
3041870	259B3, 259

Part No.	Application
3041916	299D, 289C, 279C
1404022	302.5C
1309326	307B



SPRING RECOIL

Part No.	Engine / Model Application
9V9408	225, 235
1017880	232, 322BL, 322C, 322L, 325BL, 325C
7V1111	235, 235B, 235C
8K2082	235, 235D
8K4102	235C, 235D, 245, 245B
1686690	311C, 312C, 314C
2394376	311C, 312C, 314C
2487194	311D, 312E, 314E
1028139	312, 315, 317
1880904	312C, 312CL

Part No.	Engine / Model Application
1792993	315C
2394350	315D
1453036	318C
7Y1606	320, 320L, E200
7Y0631	320, 325, 325L
1156427	320B, 320B L
1941231	320C, 321C
1793004	320C, 322C, 325C
2394339	320C, 325C
7I7717	322, 322B, 322L
1764882	322C
2394358	322C
2394369	324D, 324E, 326D
1941244	324D, 325D, 329D
1941220	325C, 330C
4I7401	330, 330L
1309295	330BL, 330C, 350, 350L, 532, 541
1793035	330C
Part No.	Application
2154119	330C, 330DL
2394323	330D, 336E
1941253	336D, 340F, 521B
1156368	345B, 330C
7Y1874	350, 350L
5K2754	933, 941B, D4, D4D
8Y2735	933, D3C, D4G
7K0639	941, 941B, D4, D4D
5K6262	955, 955K
1V7785	955L, 955K
2S7567	977, 977K, 46H, 76H
2V7439	D4E
2V7440	D4E
2V7441	D4E
2V9035	D5, D5B, 951B
3P1465	D5, D5D, D6B
8Y6659	D5C, 939, 939C, D5
8G4958	D5H
3P1459	D6, D6C, D7E
2261340	D6RII, D6T
5H9474	D7, D8
3P1885	D7E
2P9666	D8, D8H
2P9665	D8H, D8K, 583H, 594
7T4616	D8N, D8R, D8T, 583, 587R
3P4434	D9E, D9H, 594, 594H, 943, 953, 953C
0990166	E120B, 311B, 313B
0964269	E200B, EL200B

BRONZE WEAR STRIPS



Part No.	Application	Description
1781685	12H, 120H, 135H, 140H, 143H, 160H	STRIP-WEAR
2534627	14M, 16M	STRIP-WEAR
2534628	14M, 16M	STRIP-WEAR
2761318	12M, 120M, 140M, 160M	STRIP-WEAR
2761319	12M, 120M, 140M, 160M	STRIP-WEAR
5T2925	120G, 120H	STRIP-WEAR
5T8365	12G, 16G, 16H	STRIP-WEAR
5T8366	12, 12G, 14E, 140G, 160G	STRIP-WEAR / OLD PART #5D0134, 4461524
5T8367	12F, 12G, 14E, 120G, 130G, 140G	STRIP-WEAR
6G4372	14G	STRIP-WEAR
6G4524	120G, 130G, 135G, 140G, 143H, 160G, 163H	STRIP-WEAR
6G4525	120G, 130G, 135G, 140G, 143H, 160G, 163H	STRIP-WEAR
8W6324	12, 12E, 12F, 14E, 16	STRIP-WEAR KIT
8X0576	12F, 120G, 130G, 14E, 140G, 160G	STRIP-WEAR KIT

NON-METALLIC STRIPS (NYLON)



Part No.	Application	Description
1289654	120G, 130G, 135G, 140G, 143H, 160G, 163H	NON-METALLIC / SAME SIZE #6G4524
3026331	14M, 16M	NON-METALLIC WEAR STRIPS
3026338	120M, 140M, 160M	NON-METALLIC WEAR STRIPS
3086303	14G	NON-METALLIC / SAME SIZE #6G4372 / OLD PART #1289655
3330960	120G, 130G, 135G, 140G, 143H, 160G, 163H	NON-METALLIC / SAME SIZE #6G4525

Part numbers are used for reference purposes only.

Costex Tractor Parts Copyright © 2020. All rights reserved.

TRACK ADJUSTERS



Application	Adjuster As	Spring Gr	Spring Gr with Plate	
			LH	RH
320, 320-L, 320-N	1028165	7Y1602		
330B, 330B-L	7Y1457	7Y0773		
330B, 330B-L	2979143	2979142		
319D, 319D-L, 319D-LN, 320D, 320D-L, 323D-L	2394390	2394389	2394388	2394387
318C, 320C, 320C-L, 321C	1941257	1941229		1941260
320C, 325C, 320C-L		1792997		
318C, 319C, 320C, 321C	1453029	1453028	1453039	
320, 320 325/B/L		1309292		
320, 320 L, 320N	1225136	1225135		
318B, 320B, 320B-L, 320B-N	1156425	1156424	1156423	1156422
330C, 345B		1156365		
322, 322B L	1028167			



Application	Adjuster As. With Plate Warning	Spring GP
311, 311B, 321, 312B, 312B L, 313B	4I7338	4I7342
320B S, 320 N, 322 L, 325, 325B L, 325, 325B L, 325 L, 325LN	7Y0720, 7Y0721	1309292
322C, 323D S, 324D FM, 324D FMLL, 325, 325C, 325C L, 325D, 325D L, 329D, 329D L	1792998, 2979150	1792997, 1941242
330, 330B L, 330B LN, 330 L, 330 LN	7Y1457	7Y0773
330B L, 330C, 330D, 330D MH, 330 L, 345B, 345B II, 345B L, 345C, 345C L, 345D L, 350/L, 532, 541, 551, 552, TK1051, TK741, TK751, TK752	2979152	1156365
320B S, 320B LL, 322B L/C/L, 324D FM, 325/B/B L, 511, 522, 541, TK711, TK722	1028109	1309292
325D, 325D L, 325D FMLL, 328D LCR, 330C/C L, 330D/D L, 336D / D L	1793043	1793033

Other Available Part Numbers.

Application	Part No.
312B, 315B, 330	1309332
311B, 312, 315, 315L, 317, 317L	1028114
312, 315, 315L, 317	1028117
D6H, D6H LGP	7G5526
311C, 312C, 314C	1686684
324D/E, 326D/F	2394373
322C, 322C L	1941127
322C, 325C/D, 328D, 329D, 330C/D, 335F, 336D/E/F, 340F	2979151
330, 330L	7Y1458

LINK ASSEMBLIES



Model	Part No.	Length	Link LH	Link RH	Bushing	Pin	Master Link LH	Master Link RH
955	1V7077	41	3P7154	3P7153	5S0710	6B5502	3P3044 / 3P3046	3P3043 / 3P3045
211, 213, 215	6T0511	51	9K6628	9K6629	9K4061 / 7K2020	9K4060 / 9K4062	9K0028	9K0029
311B, 312B, 313B, 311, 312	1624303	41	4I7476	4I7475	6I6446 / 0931887	5I6140 / 0990653	4I7478	4I7477
311D, 312D, 312E, 314E, 313D	1764870	43	4I7476	4I7475	1624304	1624305 / 0990653	4I7478	4I7477
312D, 312B, 314C, 314D	1764871	45	4I7476	4I7475	1624304	1624305 / 0990653	4I7478	4I7477
312D, 330D, 330C, 336D	2019118	45	6Y2590	6Y2589	3211463 / 2010828	6Y2751 / 1883066	1187303	1187302
315B, 317B, 318B, 320B, 321C	1941609	45	9W3138	9W3137	1903524 / 1903523	1883064 / 6Y8186	8E8586	8E8585
315C, 317C, 318C, 319D, 320C, 323D	1941608	49	9W3138	9W3137	1903524 / 1903523	1883064 / 6Y8186	8E8586	8E8585
320C, 323D, 325D, 329D	2019116	45	6Y1608	6Y1607	3211462 / 2010826	6Y0851 / 1883065	1151854	1151853
320S, 325B, 325	6Y0854	48	6Y1608	6Y1607	1790693 / 1790695	6Y0850 / 6Y0850	N/A	N/A
322B, 322C, 324D	1959343	47	9W3138	9W3137	1903524 / 1903523	1883064 / 6Y8186	8E8586	8E8585
322C, 324D, 325B, 325C	2131932	48	6Y1608	6Y1607	3211462 / 2010826	6Y0851 / 6Y0850	N/A	N/A
323E, 329D, 329E	2131933	45	6Y1608	6Y1607	3211462 / 2010826	6Y0851 / 6Y0850	N/A	N/A
328D, 330D, 330C, 336D	2019119	49	6Y2590	6Y2589	3211463 / 2010828	6Y2751 / 1883066	1187303	1187302
330, 322B, 324D, 326D, 345D	1959344	51	9W3138	9W3137	1903524 / 1903523	1883064 / 6Y8186	8E8586	8E8585
345C, 349D, 349E, 568	3012287	52	4821224	4821223	2273029 / 2518368	8E4272 / 2532740	N/A	N/A
572G, 977L	3P0958	39	8S2590	8S2589	1M3669	8E4272	2P9654 / 2P9656	2P9653 / 2P9655
D3, D3B, D3C, D4C/B, 935C, 933, 930	6Y1711	36	6Y0936	6Y0935	6Y1717	6B5278	6Y0938 / 6Y0940	6Y0937 / 6Y0939
D3, D3B, D3C, D4C/B, 935C, 933, 931	6Y1713	39	6Y0936	6Y0935	6Y1717	6B5278	6Y0938 / 6Y0940	6Y0937 / 6Y0939
D3C, D3G, D4C, 933	3238757	39	6Y0936	6Y0935	1111522	3039455	6Y0938 / 6Y0940	6Y0937 / 6Y0939
D4	1543657	40	9K6628	9K6629	7T4628	1543664	1V4604 / 1V4606	1V4603 / 1V4605
D4	1V4599	36	9K6628	9K6629	7T4628	1543664	1V4604 / 1V4606	1V4603 / 1V4605
D4	1V7072	36	9K6628	9K6629	9K4061	9K4060	1V4604 / 1V4606	1V4603 / 1V4605
D4	7K2049	36	7K1826	7K1825	7K2019 / 7K2020	4B6166 / 4K3919	N/A	N/A
D5, 561	1543672	39	3P7154	3P7153	7T4636	1607818	3P3044 / 3P3046	3P3043 / 3P3045
D5, 561	1543676	46	3P7154	3P7153	7T4636	1607818	3P3044 / 3P3046	3P3043 / 3P3045
D5, 561, 977	3P5762	46	3P7154	3P7153	5S0710	6B5502	3P3044 / 3P3046	3P3043 / 3P3045
D5, D6, 561, 955	3P5757	39	3P7154	3P7153	5S0710	6B5502	3P3044 / 3P3046	3P3043 / 3P3045

Part numbers are used for reference purposes only.

Costex Tractor Parts Copyright © 2020. All rights reserved.

Link Assemblies (cont.)

Model	Part No.	Length	Link LH	Link RH	Bushing	Pin	Master Link LH	Master Link RH
D5C, D5G	2279976	39	6Y9262	6Y9261	2243959	1607816	6Y9264 / 9G8586	6Y9263 / 9G8585
D5H, D6M	6Y5412	37	6Y9268	6Y9267	6Y0929	1607818	8E0886 / 8E0888	8E0885 / 8E0887
D5H, D6M	6Y5414	46	6Y9268	6Y9267	6Y0929	1607818	8E0886 / 8E0888	8E0885 / 8E0887
D5M, D4H	1080955	41	1080948	1080947	1080944	1080943	1080950 / 1080952	1080949 / 1080951
D5M, D4H, 561H	1080954	44	1080948	1080947	1080944	1080943	1080950 / 1080952	1080949 / 1080951
D5M, D4H, 561H	2282744	44	6Y9262	6Y9261	9G8588	1607816	6Y9264 / 9G8586	6Y9263 / 9G8585
D6	3P5927	41	3P1113	3P1112	4M5991	4M5989	6Y6744 / 6Y6746	6Y6743 / 6Y6745
D6, D6R, D6H, 527	6I9671	41	3788242	3788241	8E7222	1607820	8E7410 / 8E7408	8E7409 / 8E7407
D6D, 955L, D6C	3P1088	36	3P1113	3P1112	4M5991	4M5989	3P1115 / 3P1117	3P1114 / 3P1116
D6D, D6C, 955L	3P1118	36	3P1113	3P1112	3P1109	1607819	3P1115 / 3P1117	3P1114 / 3P1116
D6D, D6E, D6G	3P1120	39	3P1113	3P1112	3P1109	1607819	6Y6744 / 6Y6746	6Y6743 / 6Y6745
D6M, D5H	1061634	47	1061626	1061625	1061618	1547311	1061628 / 1061630	1061627 / 1061629
D6M, D5H	1061636	46	1061626	1061625	1061618	1547311	1061628 / 1061630	1061627 / 1061629
D6M, D5H	1102976	40	1061626	1061625	1061618	1547311	1061628 / 1061630	1061627 / 1061629
D6R, D6H	6I9668	39	3788242	3788241	8E7222	1607820	8E7410 / 8E7408	8E7409 / 8E7407
D6R, D6H	6I9670	40	3788242	3788241	8E7222	1607820	8E7410 / 8E7408	8E7409 / 8E7407
D6R, D6H	8E9037	45	3788242	3788241	8E7222	1607820	8E7408 / 8E7410	8E7407 / 8E7409
D7, 571, 572	3P0955	38	8S2590	8S2589	1M3669	8E4272	2P9654 / 2P9656	2P9653 / 2P9655
D7G	2392230	38	2330386	2330385	2373790	1992794	2554792 / 2554794	2554791 / 2554793
D7R, D7H	1156301	40	6I9240	6I9239	1154924	1154923	6I9242 / 6I9244	6I9241 / 6I9243
D7R, D7H	1156303	41	6I9240	6I9239	1154924	1154923	6I9242 / 6I9244	6I9241 / 6I9243
D7R, D7H	6Y1139	43	9G2418	9G2417	2373790	1992794	9G2420 / 9G2422	9G2419 / 9G2421
D7R, D7H	6Y1141	40	9G2418	9G2417	2373790	1992794	9G2420 / 9G2422	9G2419 / 9G2421
D8, 583	8S0396	41	7S9182	7S9181	2900844	1M1455	7S9602 / 7S9604	7S9601 / 7S9603
D8, 583	9W8937	41	7S9182	7S9181	2P9484	2P9486	7S9602 / 7S9604	7S9601 / 7S9603
D8L	6I8665	45	8E4506	8E4505	6Y3914	1992794 / 9W5588	8E4060 / 8E4458	8E4059 / 8E4457
D8T, D8R	2726010	44	8E4506	8E4505	6Y3914	1992794 / 9W5588	8E4060 / 8E4458	8E4059 / 8E4457
D9, 594	8S1731	39	8E4056	8E4055	2S0253	2M5652	8S0944 / 8E4058	8S0943 / 8E4057
D9L, 589	6Y2887	47	7T7630	7T7629	6Y2141	6Y2146 / 6Y2147	6T2882 / 6T2886	6T2881 / 6T2885
D9R, D9T	1995531	43	9W2744	9W2743	1860781	1995522	2504244 / 2504248	2504243 / 2504247

Undercarriage System

Part No.	Description	System Application	Model / Engine Application
1S6422	PILOT	FRONT IDLER	561, 561B, 951C, 955, 955H, 3304
2V7197	PILOT	MEC. TRACK ADJUSTER	D4D, 3304
2V7198	PILOT A.	FRONT IDLER	D4D LGP, 941, 3304
2V9025	PILOT	FRONT IDLER	D4D, 3304
6A7196	PILOT	FRONT IDLER	215, 215B, 3204

Part No.	Description	System Application	Model / Engine Application
7M1856	PILOT	FRONT IDLER	D6C, 3306
7M1859	PILOT	FRONT IDLER	D6C, 3306
7P7740	PILOT	FRONT IDLER	953, 3204
9H4104	PILOT	FRONT IDLER	D5B, 955, 3306

RIMS & WHEELS



Rim Part No.	Machine	Seal	Ring Lock	Flange	Rim Group
6S4848	910	4K4879	7K3658	8W9591	N/A
7K8758	920	4K4879	4K4881	8W9594	N/A
7V5177	920	2D2565	2D2566	2D2567	7V5178
7V5210	930	2D2565	2D2654	8W9566	N/A
6C0898	936	4K4879	4K4881	8W9576	N/A
4K5851	950	2D2443	2D5272	N/A	1V7445
4K4909	950	4K4879	4K4881	4K4907	4K4908
1842309	120G, 130G	2D2565	2D2654	8W9566	9D5900
8X1160	120H, 135H, 140H	N/A	N/A	N/A	N/A
1233420	12H, 120H	N/A	N/A	N/A	N/A
6G1528	12H, 120H, 140G	4K4879	4K4881	8W9594	N/A
2520098	12H, 12M, 120M, 140M	N/A	N/A	N/A	N/A
N/A	12H, 14H, 16H	4K4879	4K4881	N/A	1426232
2901505	12M, 120M, 140M	N/A	2D2654	8W9566	2901505
2520100	12M, 120M, 160M	N/A	N/A	N/A	N/A
2G5744	130G, 140G	2D2565	2D2566	8W9587	5T8234
6G1527	140M, 160M	N/A	4K4881	8W9582	N/A
1850050	14H	2D2565	2D2654	8W9566	N/A
2899726	160M	N/A	4K4881	8W9594	N/A
2248809	725, 730	N/A	7D7469	2087472	N/A
Rim Assembly	Machine	Seal	Ring Lock	Flange	Rim Group
1396938	740, D350E	N/A	7D7469	5K4865	N/A
1155172	824G, 980G	2D2443	7D7469	4F8925	N/A
3304103	824G, 980G/K	2D2443	7D7469	5K4865	1104603
7K3913	910, 920	4K4879	7K3658	8W9591	1V7344
8R5825	924G, 930G	N/A	N/A	N/A	N/A
2531691	924H, 928H	N/A	4K4881	1718689	N/A
4V2135	926E/F	4K4879	4K4881	8W9594	4V2135
1022131	928G, 930G	4K4879	4K4881	8X9925	N/A
8R3223	928G, 930G	N/A	4K4881	8W9576	N/A
9K5780	930T	4K4879	4K4881	8W9594	N/A
2522161	938G, IT38G	N/A	4K4881	1718689	2522161
1026222	938G/F	4K4879	4K4881	8W9576	1197454
2707829	938H	N/A	4K4881	1718689	N/A
5V2937	950B	3D2824	4K4881	8W9604	N/A
5C9287	950E/B	2D2443	2D5272	1J8387	N/A
2069271	950G, 962H	2D2443	7D7469	2087472	2069278
8R1465	950G, 966G/H, 972G	N/A	7D7469	4F8925	N/A

Rim Part No.	Machine	Seal	Ring Lock	Flange	Rim Group
1312778	950G/H, 962G	N/A	7D7469	1J8387	N/A
3V4404	966C/R	2D2443	2D5272	1J8387	N/A
2069272	966H, 972H	2D2443	7D7469	2087473	N/A
6W4536	980C, 980F	2D2443	7D7469	4F8925	N/A
8V3550	980C, 980F	2D2443	7D7469	5K4865	N/A
1104604	980G, 980H	2D2443	7D7469	5K4865	1104604

Backhoe Wheels

Part No.	Description	Machine
1350786	WHEEL AS - FRONT	416C, 416D
1956348	WHEEL AS - LEFT HAND REAR	432E/F
2026186	WHEEL AS - FRONT	432E, 420F
2713042	WHEEL AS - REAR	420D, 424D
2713050	WHEEL AS - REAR	424D, 428D
9R0315	WHEEL AS - FRONT	416, 428
9R1572	WHEEL AS - FRONT	428C

BACKHOE LOADER PADS



Part No.	Application
1378894	426C, 436C
1378898	428C, 438C
1873825	416D, 420D, 432D, 428D, 424D
1873826	416D, 420D, 432D, 428D, 424D
1873827	416D, 430D, 428C, 438C, 432D
1873828	416D, 430D, 428C, 438C, 432D
1873829	416D, 430D, 428C, 438C, 432D
1921699	426C, 436C
1931681	428C, 438C
1931682	428C, 438C
1931683	428C, 438C
1931684	428C, 438C
1931685	428C, 438C
1931686	428C, 438C
1931687	428C, 438C
1931688	428C, 438C
1931689	428C, 438C
2171577	420E, 428E, 430E, 422E, 432E, 442E, 444E
2188411	420E, 428E, 430E, 422E, 432E, 442E, 444E
2269764	420E, 428E, 430E, 422E, 432E, 442E, 444E
2335169	420E, 428E, 430E, 422E, 432E, 442E, 444E
9R8231	438C, 436B
9R8235	426C, 436C, 428C, 438C
9R9579	426C, 436C, 428C, 438C

TIE RODS & SOCKETS



Rods

Part No.	Description	Application
1313739	ROD-TIE	12H, 120H, 135H, 140H, 143H, 160H, 163H, 854G
9R2601	ROD-TIE	416, 426, 428, 436, 438
9R2842	ROD-TIE LH	416/B, 426/B, 428/B, 436/B, 438/B
9R2843	ROD-TIE RH	416/B, 426/B, 428/B, 436/B, 438/B
1100840	ROD-TIE	416C, 426C, 428C, 436C, 438C, 442D
2292949	ROD-TIE AS LH	416C/D, 420D, 426C, 428C/D, 430D, 436C, 438C
2292950	ROD-TIE AS RH	416C/D, 420D, 426C, 428C/D, 430D, 436C, 438C
2172883	ROD-TIE	416D/E, 420D/E, 430E/F
2074272	ROD-TIE	416D/E, 420D/E
2164459	ROD-TIE	416D/E/F, 420D/E/F, 430D
2099886	ROD-TIE	416D/F, 420D/E/F, 430D/E
2385236	ROD-TIE AS LH	434E, 444E
2385237	ROD-TIE AS RH	434E, 444E
1534941	ROD-TIE	TH103
2097480	ROD-TIE	TH220B, TH330B
2172915	ROD-TIE	TH355B
1987834	ROD-TIE	TH560B, TH580B
1534942	ROD-TIE	TH62
1534943	ROD-TIE	TH82

Rods

Part No.	Description	Application
2768724	SOCKET GP-RH	120M, 140M, 160M
1313736	SOCKET	12G/H, 120G/H, 130G, 140G/H, 160H
1313737	SOCKET AS LH	12G/H, 120G/H, 130G, 140G/H, 160H
1313738	SOCKET AS RH	12G/H, 120G/H, 130G, 140G/H, 160H
2768723	SOCKET GP-LH	12M, 120M
1416138	SOCKET GP	14G
1416136	SOCKET GP	14G, 16G, 16H
1416137	SOCKET GP	14G, 16G, 16H
2746810	SOCKET GP-LH	14M
2746811	SOCKET GP-RH	14M
1365694	SOCKET AS	768C, 769C, 771D
1365695	SOCKET AS	768C, 769C, 771D
9D3706	SOCKET A LH	772, 772B, 773, 773B/E
9D3704	SOCKET A	772/B, 773/E, 776/B/C/D, 777B/C/D

PINS



The internal hardness of the new CTP Pins is thicker to ensure better resistance and longer life. They are manufactured with alloy steel, and are put through an induction hardness procedure that makes the pin more resistant to extreme wear and prevents corrosion. Our pins feature:

- ✓ Induction Harden zone HRC 56 min to depth 1mm
- ✓ Minimum core hardness HRC 22 to 25
- ✓ 0.02 to 0.03mm layer of chrome coating on all surfaces of the pin.
- ✓ Material 42CrMo and 35CrMo

Minimum core hardness HRC 22 to 25

Thicker internal hardness

Layer of chrome coating on all surfaces of the pin

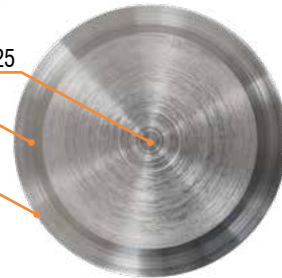

Control Gp - Bucket

Part No.	Machine Model
8W5293	12G, 120G, 160G
2G8613	140G
5V1882	325C, 950B
7K9360	910, 931, 941
4V8657	916, 918F, 924F
8Y7028	918F, 924F
6K8314	920
6K8316	920
6K8542	920
7K5213	920
7K9347	920
7K9348	920
4V2588	926
6K6175	920, 922, 930
1180869	928G, 928HZ
1226393	928G, 928HZ
7K9343	930
7K9345	930
4V3619	936, 938F
4V3625	936, 938F
8G1098	936, 938F, 953
1106167	938F, 938G
2878291	938
6K5513	944, 950
6K7161	950
6K7162	950
6K7164	950
6K7165	950
6K7166	950

Part No.	Machine Model
8K5758	950
5V1511	950B, 950G
3101899	950B/G, 325C
1369371	950G, 962G
4V7099	950G/950H
1369380	950G/H, 962G
7K9513	966
6K8307	966, 966C
6K8308	966, 966C
6K8309	966, 966C
8K5334	966, 966C
1386679	966, 966G
7V6715	966D, 966E, 966F
7V6716	966D, 966E, 966F
1386674	966G
4E3196	966G, 950B
7K9990	980, 980B
3121067	980C, 980F
1V8439	980C/F
1V8949	980C/F/G
1V8957	980C/F/G/H/K
1857219	980G
1302621	980G/K/M
4V2122	988B/F, 992C
1V8031	992
1V8030	992C, 992D
9V3363	IT24F, IT18/B

Boom Gp

Part No.	Machine Model
1243240	120G, 120H, 140H
5T3323	621B, 623B
8J7727	621E, 327E
5T8528	621E, 627E
1V8850	824, 980/F
6K2703	920
1133791	924G
9C8634	928F, IT28F
9V6162	936, 936F, 938, 938F
5K0990	950
5K3499	980, 980C

Linkage Gp

Part No.	Machine Model
4E1065	215C, 219, 235
1441012	312B/C, 320C
1066878	315
1192863	317B L, 317B-LN
0860523	320
0875805	320
0875806	320
0875845	320
7Y6617	320
4I5016	330
7Y2348	320, 320B
7Y2357	320, 320B
1865652	320, 325
1072139	320B, 330C
2343931	320D, 325D
2343930	320D, 323D, 324D
2543053	320D/DL
2543052	320DL
1893922	322, 325
7Y3548	322B
7Y3549	322B
7Y3550	322B
1894148	322B/BL, 330C
2512552	324D, 324D LN
2512558	324D, 330D

Bar Gp

Part No.	Machine Model
8G3733	517, D4K
3W8572	963C
6Y6886	D4H
1090380	D5N, D5M, 561N
2814015	D6R

Mounting Gp

Part No.	Machine Model
1301918	416, 426
9R6162	416, 426
9R6163	416, 426
1590961	416/B/D
2119286	416E, 420E
3G8932	D4H, D6H, D6M
1U0159	D6D, D4H, D5H
1U0612	D6R/H
9P6912	D8L, D9L
9W7991	D8N, D8R
2195735	D8T
2195743	D8T

Part No.	Machine Model
2512557	324D, 330D
4I4804	330, 330BL
4I4805	330, 330BL
1896062	330, 330C, 330BL
1893923	330C, 322C, 325C
2012837	330C/CL
2357636	330D, 330D L
2357642	330D, 330D L
1413476	345B
1413479	345B L
4I6722	345BL, 365BL
2357639	345C
4I5014	350, 350L
2123090	365B
9R4494	416
1545279	416, 430D
9R7696	416B, 416C, 426
1545277	416C/D, 430D
1545278	416C/E, 430D
1545280	416D/E, 430D
2136698	416E
8W6928	770/G, 769D
1684331	988G, 988H

Frame Gp

Part No.	Machine Model
2502398	320N, 320C
1175435	325B, 330B/C/D
5I3371	330, 330B/L
4I4812	330B/BL, 320B/C
2502436	330C
4I4996	345B, 345BL
1300485	416B/C, 426C
9R8579	416, 416B, 416C
9R0237	416, 428
1590960	416/B/C
1300479	416B/C, 426C
2375330	416D, 420D, 424
2368182	416D, 420D, 430
1014020	416D, 420D
3005440	416E, 420E
3288776	416E, 420E
2096855	416E, 420E, 422

Axle Gp

Part No.	Machine Model
2G8620	120G
2G8628	120G
8W6476	120G, 140H
2D5961	12E/F, 14B/C
1303595	12H, 120H, 140H
2G8633	135H
2G8614	14G
2G8629	140G
1107722	16H, 16M
9R9631	416, 416B
1601014	416B, 426B, 428

Guard Gp

Part No.	Machine Model
1301638	416
8K0530	12M, 14H, 160M
3W0630	D6H
9N4622	D7H, D8R

Cylinder & MTG Gp

Part No.	Machine Model
1361711	120H
5T8417	140G/H, 120H
1428791	226B, 242, 242B
4K8225	814, 815, 816
1322553	924G, 930G
4V2115	988BF, 988B

Part No.	Machine Model
6K2704	920
6K6349	920, 930
7K7176	922, 930, 950
5K2432	950
6K7167	950
1044817	950, 951, 955
8J0927	D3B
1245233	D5M, D6M
6Y7471	D6H
1090958	D6M, D6N
1450803	D6M, D6N
6Y6774	D7H, D7H LGP
6Y7474	D7H, D7R
1U0990	D8L, D8N
1112104	D9R
1055448	D11N, D11R

Hitch Gp

Part No.	Machine Model
1243240	120G/H, 140H
5T3323	621B, 623B
8J7727	621E, 327E
5T8528	621E, 627E
1V8850	824, 980/F
6K2703	920
1133791	924G
9C8634	928F, IT28F
9V6162	936/F, 938/F
5K0990	950
5K3499	980, 980C

Bucket Gp

Part No.	Machine Model
9R0437	416, 416B, 426
9R0438	416, 416B, 426

Blade Gp

Part No.	Machine Model
3F6149	D6C
6Y6751	D6H, D6R, D6T
9W2939	D10N, D10R, D11
1303434	D11R
3F6185	D306N

Other Pins also Available

Part No.	Machine Model	Application
9J9598	D6, D5E, D6D	RIPPER GP
9R0423	416B, 426C	STABILIZER GP
1483386	330B	STICK GP
2201019	416	STICK GP
1506308	785D	SUSPENSION GP

Arm Gp

Part No.	Machine Model	Part No.	Machine Model
9R3182	414E, 416, 416B	1114343	416C, 426
1285010	416	1114334	416C, 426C
1305451	416/C/D, 420D, 436C	1326496	416C, 426C
1251037	416C, 420D, 426C	1224954	420D, 426C, 428D

PIVOT PINS



Part No.	Machine
2374872	D8R
2519832	D6R, D6R-III, D6T
3H7164	D8H
4D3462	619C, 140B
6Y7471	D6H, D6H XR, D6R

Part No.	Machine
6Y7474	D7R, D7H, D7H LGP
8E6220	D5H, 527
8E6442	D8N, D8R

RUBBER TRACKS



CTP now stocks a large selection of rubber tracks for mini-excavators, compact track loaders and mini-dozers for nearly all equipment brands such as CAT®, Bobcat®, Takeuchi®, John Deere®, Case®, Komatsu®, Terex®, New Holland®, Volvo®, Hyundai®, and JCB®

Environmental hazards, heat, and friction are the enemy when it comes to rubber track longevity. At CTP, we ensure our rubber tracks are manufactured from only the finest materials and specifically designed to provide excellent performance under a wide range of working conditions. The rubber tracks manufacturing process follows strict ISO 9001 Quality Standards.

Here are some of the several popular sizes available in stock for a large selection of machines and applications:



180mm Width Rubber Track

- Mini-Excavator Rubber Track
- Width: 180mm
- Pitch: 72mm



230mm Width Rubber Track

- Mini-Excavator Rubber Track
- Width: 230mm
- Pitch: 48mm



300mm Width Rubber Track

- Mini-Excavator Rubber Track
- Width: 300mm
- Pitch: 52.5mm
- 300mm Width 52.5mm Pitch Rubber Track (Narrow and Wide Guide Link)



320mm Width Rubber Track

- Mini-Excavator Rubber Track
- Width: 320mm
- Pitch: 86mm



450mm Width Rubber Track

- Compact Track Loader Rubber
- Width: 450mm
- Pitch: 86mm
- 450mm Width 86mm Pitch Rubber Track (C Tread Pattern and Standard Duty Style)



450mm Width Rubber Track

- Compact Track Loader Rubber
- Width: 450mm
- Pitch: 100mm



CATERPILLAR MTL1

- Track Loader Rubber
- Width: 15(in)
- Pitch: 4(in)



CATERPILLAR MTL2

- Track Loader Rubber
- Width: 18(in)
- Pitch: 4(in)

Mini-Excavators

Part No.	Size	Links	Tread Pattern	Comments
180x72x39	180(mm) x 72(mm)	39	P	180mm Wide Conventional Guide
230x48x66	230(mm) x 48(mm)	66	S	230mm Wide Short Pitch Interchangeable Guide
230x48x70	230(mm) x 48(mm)	70	S	230mm Wide Short Pitch Interchangeable Guide
300x52.5Nx80	300(mm) x 52.5(mm)	80	V1	300mm Wide Short Pitch Interchangeable Guide/Narrow Guide Link
300x52.5Wx84	300(mm) x 52.5(mm)	84	V1	300mm Wide Short Pitch Interchangeable Guide/Wide Guide Link
300x52.5Nx86	300(mm) x 52.5(mm)	86	V1	300mm Wide Short Pitch Interchangeable Guide/Narrow Guide Link



STEEL CABLES

Made of high-tensile steel wires resistant to cutting and stretching, allowing for even tension throughout the track.

- Unique steel core design improves rubber bonding
- Special coating improves corrosion resistance
- Even cable placement



3S IRON CORE

- Exclusive External 3S Iron Core
- Greatly reduces vibrations for a smoother ride and less noise
- Significantly reduce risk of detracking



CURBSHIELD

- Edge cutting protection
- Prevent cable and metal bar from damage
- Protect steel bar and rubber adhesion

TREAD PATTERN

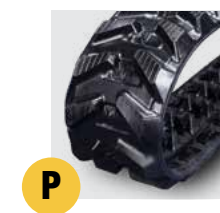

Tread patterns designed for maximum traction, flotation and durability.

Compact Track Loaders

Part No.	Size	Links	Tread Pattern	Comments
B320x86x49	320(mm) x 86(mm)	49	AE	320mm Wide Block Staggered Tread Pattern
B320x86x52	320(mm) x 86(mm)	52	AE	320mm Wide Block Staggered Tread Pattern
T320x86Kx52	320(mm) x 86(mm)	52	AE	320mm Wide Block Staggered Tread Pattern
B320x86x53	320(mm) x 86(mm)	53	AE	320mm Wide Block Staggered Tread Pattern
B450x86Cx52	450(mm) x 86(mm)	52	CE	450mm Wide "C" Pattern Tread Pattern
B450x86Cx55	450(mm) x 86(mm)	55	CE	450mm Wide "C" Pattern Tread Pattern
B450x86Cx56	450(mm) x 86(mm)	56	CE	450mm Wide "C" Pattern Tread Pattern
B450x86SDx60	450(mm) x 86(mm)	60	AE	450mm Wide "C" Pattern Tread Pattern
T450x100Kx48	450(mm) x 100(mm)	48	AE	450mm Wide Block Staggered Tread Pattern
T450x100Kx50	450(mm) x 100(mm)	50	AE	450mm Wide Block Staggered Tread Pattern



STEEL CABLES

Made of high-tensile steel wires resistant to cutting and stretching, allowing for even tension throughout the track

- Unique steel core design improves rubber bonding
- Special coating improves corrosion resistance
- Even cable placement

TRACKGUARD

- Prevents infiltration of water, sand and rocks between the rolling path and iron core
- Increases rolling path durability by 100%

IRON CORE

- Produced from superior steel alloy for a track 15% stronger than the competition's

TREAD PATTERN



Tread patterns designed for maximum traction, flotation and durability.

Compact Track Loaders

Part No.	Size	Links	Tread Pattern	Comments
2208161	18(in) x 4(in)	51 (C-Lug)	MTL2	3 days "Lead Time"
2387664	18(in) x 4(in)	56	MTL2	3 days "Lead Time"
3258624	15(in) x 4(in)	42	MTL1	3 days "Lead Time"
3258625	18(in) x 4(in)	51 (Triple Row)	MTL2	3 days "Lead Time"

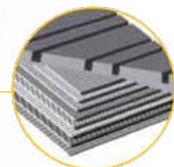

HEAVY-DUTY CARCASS

- Optimized ply for better track alignment and rigidity
- Endless single cure technology for even ply and cable placement
- Heavy-duty synthetic fiber provides rockpuncture resistance

DRIVER LUG

- Optimized drive lug geometry for extended wear and superior performance

TREAD PATTERN



Tread patterns designed for maximum traction, flotation and durability.

RUBBER TRACKS

Part No.	Machine Model										
	AIRMAN	BOBCAT	CASE	CATERPILLAR	DAEWOO	DITCH WITCH	GEHL	HANIX (NISSAN)	HITACHI	HYUNDAI	IHI
180X72X39		MT50 / 52				JT 520, SK 500					
230X48X66	AX 16 / CBL-3	320/D/G/J		301.5	Solar 015		GE 142	H 15A	EX 16	ROBEX 15-5	
	AX 16-2	322/D/G/J		301.6	Solar 15			H 15B PLUS-2	EX 17/-2/2B	ROBEX 15-7	
230X48X70	AX 16-2 N	323		301.8				H 15B-2	FH 16.2	ROBEX 16-7	
	AX 17	E 16		ME 15				N 120-2	FH 17.2		
	AX 17 CGL-2 N								FH 17.2/PLUS		
	AX 17-2 / N			MH 15					HE 15		
	HM 10, HM 15							N 150-2	HM 15		
300X52.5NX80			CX 14/ZTS	301.5 CR	Solar 015 Plus	MX 15			EX 17U	16-9	15NX
			CX 15 STC	301.6 C	Solar 018	MX 182			ZX 17U-2		18J
			CX 16 B	301.8 C	Solar 018VT						18N
			CX 16 SVR								IS 18J
300X52.5NX86		328G	CK 32	MX 35		MX 202	363	H 29A, H 30/A		ROBEX 24Z-9	
		331/D/E/G	CX 27 B			MX 272	GE 342	H 35/A, H36A		ROBEX 27Z-9	
		334/D/G						Minicrane		ROBEX 30	
		E 26						N300-2, N350-2			
300X52.5WX84	AX 35/36 U							S&B 30 0 /-2	EX 35U	ROBEX 35-9	
	AX 36 UCGL							S&B X-1		ROBEX 35Z-9	
B320X86X49			CK 36	303 CR					EX 33		30JX / NX
				MM 35							32J
B320X86X52				MM 35 A							35J/N
				MM 35 B							IS 30JX / NX
B320x86x53				MM 35 T							32J
				MM 40 SR							IS 35G/GX
B450x86Cx52				MX 35							IS 35J
				239							
B450x86Cx55		T190									
		T550									
B450x86Cx56		T570									
		T590									
B450x86SDx60		864/FG/G									
		T200									
B450x86Cx55		T630									
		T650									
B450x86Cx56				445 CT							
				450 CT							
B450x86SDx60											CL 45

Rubber Tracks(cont.)

Part No.	Machine Model										
	JCB	JOHN DEERE	KOBELCO	KOMATSU	KUBOTA	MUSTANG	NEW HOLLAND	NISSAN	TAKEUCHI	TEREX	VOLVO
T320X86KX52							CTL 60 / 65				
T450X100KX48							CTL 70 / 75				
T450X100KX50							CTL 80 / 85				
180X72X39					KX 21				TB 080		
230X48X66						ME 1402 ME 1502	EC 15	150/N N 120-2 N 150-2 N 150-2R N 230-2		TC 15 TC 16 TC 20	EC 15 EC 15 ADJ - WIDTH EC 15XR
230X48X70		17 ZTS	SK 13 SR SK 16 MSR	PC 15 MR PC 15 MRx-1 PC 18 MR2	KX 41-2SC KX 41-2V KX 41-2VC KX 41-3V RX 141 U 15		E 18 B SR TR IV E 18 SR EH 15 B		TB 15F TB 15FR		
300X52.5NX80		27 D	SK 27 SK 27 SR-3 SK 27SR ACE- RA TR 4	PC 15 PC 15 avance R PC 20 R	AR 30 K 028, K 030 KH 030/G/HG KH 033, KX 030 KX 033-1 KX 71-2 KX 91/-2	ME 3402 ME 3602	EC 35 EH 27 B	N 300-2 N 300-2R N 350-2 N 350-2R S&B 300 S&B 300-2 S&B X-1		AR 35 TC 25 TC 35	
300X52.5NX86		35 C, 35 D								TC 37	
300X52.5WX84	803 803 E 803 plus 803 Super 8030ZTS 8032Z		SK30 UR-2		KH 033 KH 101 KH 90 KX 033 KX 101 KX 90 RX 301 RX 302 RX 303	3503					EC 35 ECR 38
B320X86X49	180 T										
B320x86x52	190 T	319 D 323 D CT 322		820 TURBO CK 20/-1 CK 25-1 SK1020 VTS	SVL 75						
B450X86CX55							C 185,C 190 LT 190 C LT 195 B				
B450X86CX56	260 T	329D,333 D CT 332		1020 TURBO CK30-1 CK 35-1							MC 110/B MTC 135c
T320X86KX52						MTL 16/316			TL 130/230		
T450X100KX48						MTL 20/320			TL 140/240		
T450X100KX50						MTL 25/325			TL 150/250		

† CTP Offers a database with all rubber tracked machines ensuring you get the correct rubber track specification for your machine.

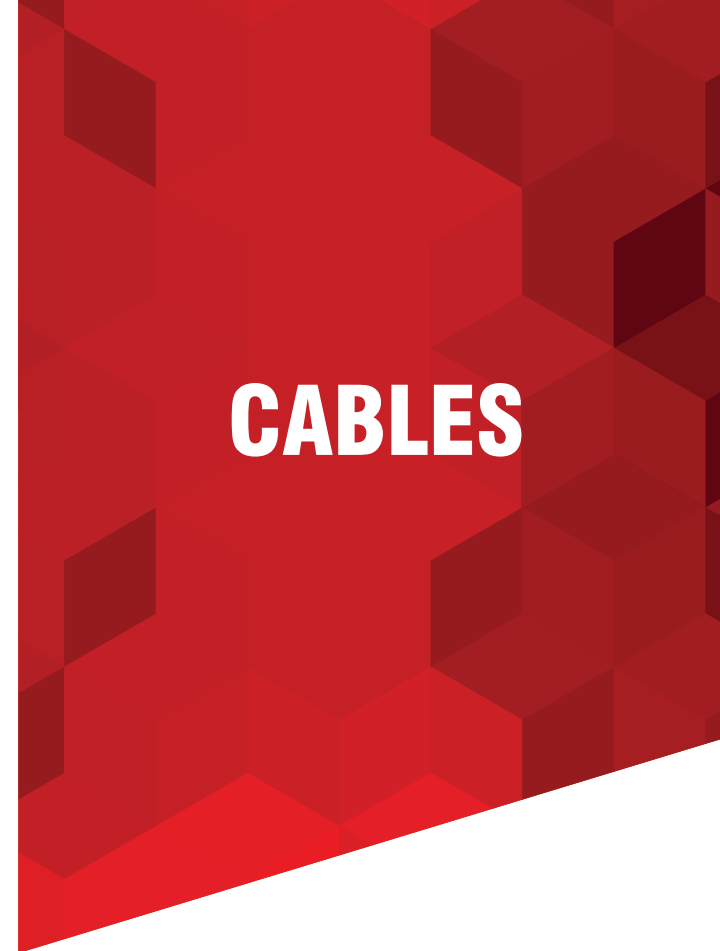

**BRAKING SYSTEM
CABLES**

Part No.	Application	Machine Model
1061858	SERVICE BREAK	950F, 960F
1088100	BREAK GROUP	814F, 815F, 816F, 950F, 960F, 966F, 970F
1445323	CLUTCH & BREAK CONTROL	12H, 120H, 135H, 140H, 143H, 160H, 163H
1479654	PARKING BREAK	950G, 962G, 962G II, IT62G
1630755	PARKING BREAK	416C/D, 420D, 424D, 428C/D, 430D, 432D, 436C, 438C/D, 442D, 446D
3E1804	SERVICE BREAK	834B, 836, 988B, 988F
4D3270	SERVICE BREAK	120B, 140B, 12
4D7345	CLUTCH & BRAKE CONTROL	12, 120B, 140B
4V2157	PARKING BREAK	814B, 815B, 816B, 824C, 825C, 826C, 950B, 966D, 980C
6C1581	SERVICE BREAK	966F, 970F
6D1562	CLUTCH & BRAKE CONTROL	120, 140
7X1799	STEERING & BRAKING SYSTEM	D8N, D8R, D7H & D7H LGP
7X1906	STEERING & BRAKING SYSTEM	D6H, D6H LGP
8D5287	CLUTCH & BRAKE CONTROL	12G, 130G, 140G, 160G
8D5288	CLUTCH & BRAKE CONTROL	14G
9D4635	CLUTCH & BRAKE CONTROL	120G
9U0691	PARKING BREAK	IT18F, IT24F, IT28F, 918F, 924F, 928F, 938F
9X5694	CLUTCH & BRAKE CONTROL	12H, 16H, 120H, 135H, 140H, 160H, 163H

Cables for Electrical & Starting Systems

Part No.	Application	Machine Model
1706929	ELECTRICAL & STARTING SYSTEM	313D2 LGP, 314D LCR, 315C & 315C L, 318D2 L, 320C, 320C L, 320D L, 323D2 L, 324D, 324DL, 325D L, 329D L, 330C L, 336D2 L, 345D, 621K, 623K, 627K
3L8048	ELECTRICAL	D342C, D348, D379A, D379B, D398
7P6682	ELECTRICAL	D4H LGP, D5N, D6R, D6T, 416B, 428B, 815B, 943, 953, 960F, 973C, PM-565

Cables for Lock System

Part No.	Application	Machine Model
1166531	LOCK-TRANSPORT	416B, 426B, 436B
1178774	LOCK-TRANSPORT	416C
1137398	LOCK-TRANSPORT	428B, 438B
1742365	LOCK-TRANSPORT	416C, 426C, 436C

Cables for Fuel System

Part No.	Application	Machine Model
1042128	GOVERNOR	3054
1742297	GOVERNOR	3054B, 3116
2037100	GOVERNOR	3116, 3054
2350128	GOVERNOR	3054C, 3054B, C.4.4
5G2315	GOVERNOR	3204
6T8466	GOVERNOR	3204, 3304
6T8467	GOVERNOR	3304
6T8468	GOVERNOR	3306, 3406C
6T8469	GOVERNOR	3406
8C9586	GOVERNOR	3306, 3306B
9D0148	GOVERNOR	3306, 3306D
9D1611	GOVERNOR	3304, 3306, 120G
9X0391	GOVERNOR	3306, 816F
9X4776	GOVERNOR	3114
9X4857	GOVERNOR	3408
9X5476	GOVERNOR	3408
1311990	GOVERNOR	3126
1641079	GOVERNOR	3054, 3054B, 3114
1766767	GOVERNOR	3126, 3306, 3406C
9X1336	GOVERNOR	3306
9X4219	GOVERNOR	3306, 3406/B

Frame and Body Cables

Part No.	Application	Machine Model
1641183	FRAME GP SWING	416D, 420D
2220844	FRAME GP SWING	416D, 420D

Undercarriage Track Adjuster Cables

Part No.	Application	Machine Model
7G8282	UNDERCARRIAGE TRACK	D7H, D8L/T, D9T/L/R, D10N, D10R, D10T2, D11R/T, PL83, PL87, 583R

Power Train Cables

Part No.	Application	Machine Model
2V7617	TRANSMISSION CTRL.	834B, 988B
7V9142	TRANSMISSION CTRL.	930/R/T
7V9223	TRANSMISSION CTRL.	966C/R
8C5604	TRANSMISSION CTRL.	D3C, D4C, D5C, 931C, 933

Part No.	Application	Machine Model
8D5286	TRANSMISSION CTRL.	12G, 130G, 140G, 160G
8D5289	TRANSMISSION CTRL.	14G
8V8022	TRANSMISSION CTRL.	966C/R
9D4634	TRANSMISSION CTRL.	120G
9D4635	TRANSMISSION CTRL.	120G
9G8630	TRANSMISSION CTRL.	D8L, D9L/N/R, D10N
9G8631	TRANSMISSION CTRL.	D8L, D9L/R, D10N,
1V6350	TRANSMISSION CTRL.	834B, 836, 988B

Operator Cables

Part No.	Application	Machine Model
3V2783	STATION INSTALL	814B, 815B, 816B, 824C, 825C, 826C, 966D, 980C
3V7125	STATION INSTALL	824C, 825C, 826C, 980C/F
4V4835	STATION INSTALL	950B
5V4732	STATION INSTALL	814B, 815B, 950B/E, 966D/E/F
5V4734	STATION INSTALL	814B, 815B, 816B, 950B, 966D/E
6T1313	STATION INSTALL	G936, 936/E/F
6T1314	STATION INSTALL	G936, 936/E/F
7T1971	STATION INSTALL	815B, 824C, 825C, 826C
8V0554	STATION INSTALL	824C, 825C, 826C, 980C/F
9X0391	STATION INSTALL	814F, 815F, 816F, 970F
9D2141	INDICATOR GP	12G, 120G, 130G, 140G, 160G
9X0390	STATION INSTALL	IT18B, IT28B, 916, 926E, 936E/F, 966E
9X1147	STATION INSTALL	IT18B, IT28B, G916, D3C, D4C, D5C, 926E
9X1395	STATION INSTALL	950E
9X5426	STATION INSTALL	950F, 960F
9X5695	STATION INSTALL	950F, 966F
1406705	STATION INSTALL	938G, IT38G
3V7096	STATION INSTALL	824C, 825C, 826C, 980C/F

Work Tools Cables

Part No.	Application	Machine Model
3V9180	WINCH CONTROL	3306

TOOLS & SUPPLIES

CRIMPING TOOL



Use this crimping tool to crimp contact terminals part numbers 1908900 and 1753700.

Part No.	Engine Model/Application
1U5804	CRIMPING TOOL FOR CONNECTORS

To see more about our Terminal Connector Kits go to page 41.

GREASE GUN KIT



The CTP Grease Gun Kit includes:

- ✓ A TWIN-LOCK-System Grease Gun that ensures the grease reaches the lubrication point to avoid dummy lubrication.
La graseira posee un sistema TWIN LOCK que asegura que la grasa alcance el punto de lubricación perfecto para evitar una lubricación falsa.
- ✓ Two different high pressure hoses that connect the grease gun to the lubrication point.
Dos mangueras de presión diferentes que conectan la graseira con el punto de lubricación.
- ✓ An extension tube that allows you to adjust the bent connector to the desired pointing direction.
Un tubo de extensión que permite apuntar el conector en la dirección deseada.
- ✓ An assortment of the 5 most popular sizes of interchangeable fittings.
Un surtido de los 5 tamaños más populares de boquillas.

Part No.	Description
CTP8F9866	GREASE GUN KIT

Part numbers are used for reference purposes only.

GREASE PUMP



Features and Specifications:

- ✓ The gauge of the sheet metal is thicker to giving optimum strength to the structure of the tank.
El espesor del metal es mas grueso para dar más fuerza y resistencia a la estructura del tanque.
- ✓ The piston pump is attached to the tank by four screws and four nuts that are located inside the tank to make it more resistant.
La bomba del pistón esta reforzada con 4 tornillos y 4 tuercas que se encuentran dentro del tanque para que esté más fija.
- ✓ Equipped with rubber gaskets by the piston and by the filler cap to prevent leakage.
Viene con juntas en la sección de la bomba de pistón y en la tapa de llenado para evitar derrame.
- ✓ Piston parts are interchangeable with OEM part numbers.
Las piezas del pistón son intercambiables con las piezas OEM.
- ✓ Pressure can go from 3000 to 5000 psi with just a few strokes.
La presión varia de 3000 hasta 5000 psi.
- ✓ Includes hose and replacement fittings. *Incluye la manguera y las boquillas.*
- ✓ 20 Kgs Capacity. *Capacidad de hasta 20 Kg.*

Part No.	Description
7H1680	GREASE PUMP

STRAP WRENCH



Provides quick, efficient service when removing or installing all spin-on type fuel and oil filters.

Part No.	Engine Model/Application
1853630	WRENCH

To see the listing of Fuel and Oil filters available please see pages 66-67.

TETRAGAUGE (Performs four gauge functions)











Part No.	Hose Length (inch)	Pressure		
		Low	Med.	High
6V7830	36	0-150 psig	0-600 psig	0-5000 psig

Costex Tractor Parts Copyright © 2020. All rights reserved.

Other Tools & Supplies Available

Part No.	Description	
1U7234	FEELER GAUGE	
5F4764	PRY BAR	
1476456	REMOVAL TOOL	
9S9150	CRIMPING TOOL	
1516320	PIN SOCKET REMOVAL TOOL	
BIN32	CORRUGATED BIN 6 1/2" X 10" X 8"	
BIN33	YELLOW METAL BIN	
CTPCU1	CTP CUTTER	
CTPTAPE	MEASURING TAPE WITH CTP LOGO	

Part No.	Description	
HANDWIPE	HAND CLEANER TOWEL (100 UNITS PER BOX)	
CTPTOOL	SMALL MULTI TOOL WITH FLASHLIGHT AND BATTERIES INCLUDED	
ORINGPICK	O-RING PICK (SOLD IN QTY OF 5)	
CTPGAUGE	NUT AND BOLT MEASURING GAUGE	
CTPGAUGE-LD	NUT AND BOLT MEASURING GAUGE FOR LARGE DIAMETERS	
LGAUGE-INCH	NUT AND BOLT MEASURING GAUGE	
LGAUGE-MET	NUT AND BOLT MEASURING GAUGE	
PICKUPTOOL	MAGNETIC PICK UP TOOL	

COLLECTIBLE REPLICAS

CATERPILLAR

NEW MODEL CAT® 390F L HYDRAULIC EXCAVATOR

The latest Commemorative series is of the legendary Cat 390F L Hydraulic excavator in a special gunmetal finish.

Part No. C85547
Scale 1:50



NEW SPECIAL EDITION SPECIAL GUNMETAL FINISH

Packaged in a top-quality; flip-top display package with mirror base and engravable nameplate.

NEW MODEL CAT® 18M3 MOTOR GRADER



A Limited edition special paint scheme of the Cat 18M3 Motor Grader in black onyx finish.

Part No. C85522
Scale 1:50

NEW MODEL CAT® D11T TRACK-TYPE TRACTOR

Commemorative series of the legendary Cat D11T Track-Type Tractor is presented in a rich copper finish.

Part No. C85517
Scale 1:50



Packaged in a top-quality; flip-top display package with mirror base and engravable nameplate.

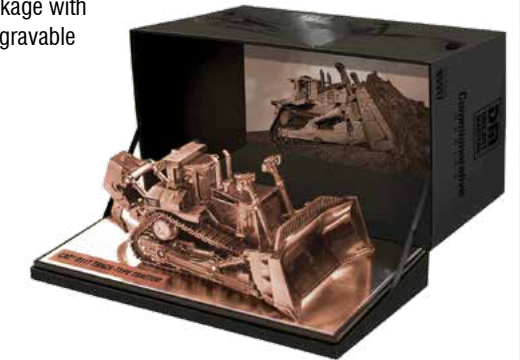

CTP DOZER TRACK-TYPE TRACTOR

This is our brand new CTP Dozer! It's elegant, stunning and perfect to use as desk decor or place it on your display! What are you waiting for? Don't waste any more time and get yours now before they run out!! You can head to the CTP Store or contact your sales representative today!

Part No. CTPDOZER
Scale 1:50



High Line Series

The High Line Series models are housed in full-color-printed metal boxes and nestled in soft foam cushioning.

CAT® D11T TRACK-TYPE TRACTOR



Part No. C85212
Scale 1:50

CAT® D10T TRACK-TYPE TRACTOR



Part No. C85158
Scale 1:50

CAT® D8T TRACK-TYPE TRACTOR



Part No. C85299
Scale 1:50

CAT® D7ET TRACK-TYPE TRACTOR



Part No. C85224
Scale 1:50

CAT® 4M MOTOR GRADER



Part No. C85189
Scale 1:50



CAT® 793F MINING TRUCK



Part No. C85273
Scale 1:50

CAT® 432F2 SIDE SHIFT BACKHOE LOADER



Part No. C85249
Scale 1:50

CAT® 336D L HYDRAULIC EXCAVATOR



Part No. C85241
Scale 1:50

CAT® 613G WHEEL TRACTOR SCRAPER



Part No. C85235
Scale 1:50

CAT® 587T PIPELAYER



Part No. C85272
Scale 1:50

Core Classics

The Core Classics Series models' Packaging is reminiscent of the "plain brown" parts boxes that owners and operators are familiar with.



Accurately scaled operator figure in each model's cabin provides an instant "human scale" reference to the real machine's size.



Part No. C85098 Scale 1:50



Part No. C85214 Scale 1:50



Part No. C85277 Scale 1:50



Part No. C85160 Scale 1:50



Part No. C85280 Scale 1:50



Part No. C85161 Scale 1:50



Part No. C85196 Scale 1:50



Part No. C85027 Scale 1:50



Part No. C85073 Scale 1:50



Part No. C85104 Scale 1:50



Part No. C85223 Scale 1:50



Part No. C85290 Scale 1:50



Part No. C85100 Scale 1:25



Part No. C85030 Scale 1:50



Part No. C85167 Scale 1:32



Part No. C85226 Scale 1:32



Part No. C85238 Scale 1:25

KOMATSU®

D65EX-17 SIGMADOZER WITH RIPPER



Part No. C503245
Scale 1:50

GD655-5 MOTOR GRADER WITH RIPPER



Part No. C503264
Scale 1:50

PC138USLC-11 EXCAVATOR



Part No. C503360
Scale 1:50

D155AX-8 SIGMADOZER WITH RIPPER



Part No. C600325
Scale 1:50

HM400-5 ARTICULATED DUMP TRUCK



Part No. C503347
Scale 1:50

PC360LC-11 EXCAVATOR



Part No. C503361
Scale 1:50

PC210LC-11 EXCAVATOR



Part No. C600326
Scale 1:64

WA500-7 WHEEL LOADER



Part No. C503262
Scale 1:50

PROMOTIONAL MERCHANDISE

APPAREL

Part No.	Description	
CTPSH021	SMALL MEN DRY FIT BLACK POLO	
CTPSH022	MEDIUM MEN DRY FIT BLACK POLO	
CTPSH023	LARGE MEN DRY FIT BLACK POLO	
CTPSH024	X-LARGE MEN DRY FIT BLACK POLO	
CTPSH025	2X-LARGE DRY FIT BLACK POLO	
CTPSH026	3X-LARGE DRY FIT BLACK POLO	
CTPPOL001	X-SMALL WOMEN 3/4 SLEEVE BLACK SHIRT	
CTPPOL002	SMALL WOMEN 3/4 SLEEVE BLACK SHIRT	
CTPPOL003	MEDIUM WOMEN 3/4 SLEEVE BLACK SHIRT	
CTPPOL004	LARGE WOMEN 3/4 SLEEVE BLACK SHIRT	
CTPPOL005	X-LARGE WOMEN 3/4 SLEEVE BLACK SHIRT	
JACKET02	SMALL WATERPROOF JACKET	
JACKET03	MEDIUM WATERPROOF JACKET	
JACKET04	LARGE WATERPROOF JACKET	
JACKET05	X-LARGE WATERPROOF JACKET	
CTPT-SH01	SMALL BLACK CTP T-SHIRT	
CTPT-SH02	MEDIUM BLACK CTP T-SHIRT	
CTPT-SH03	LARGE BLACK CTP T-SHIRT	
CTPT-SH04	X-LARGE BLACK CTP T-SHIRT	
CTPT-SH05	2X-LARGE BLACK CTP T-SHIRT	
CTPT-SH06	3X-LARGE BLACK CTP T-SHIRT	



Part numbers are used for reference purposes only.

Costex Tractor Parts Copyright © 2020. All rights reserved.







Apparel(cont.)

Part No.	Description	
UTSHIRT11	SMALL MEN BLACK T-SHIRT	
UTSHIRT12	MEDIUM MEN BLACK T-SHIRT	
UTSHIRT13	LARGE MEN BLACK T-SHIRT	
UTSHIRT14	X-LARGE MEN BLACK T-SHIRT	
UTSHIRT15	2X-LARGE MEN BLACK T-SHIRT	
UTSHIRT16	3X-LARGE MEN BLACK T-SHIRT	
LTSHIRT11	SMALL WOMEN BLACK T-SHIRT	
LTSHIRT12	MEDIUM WOMEN BLACK T-SHIRT	
LTSHIRT13	LARGE WOMEN BLACK T-SHIRT	
LTSHIRT14	X-LARGE WOMEN BLACK T-SHIRT	
VEST01	MEDIUM REFLECTIVE VEST	
VEST02	LARGE REFLECTIVE VEST	
VEST03	X-LARGE REFLECTIVE VEST	
VEST04	2X-LARGE REFLECTIVE VEST	
REFLT01	SMALL REFLECTIVE SHIRT	
REFLT02	MEDIUM REFLECTIVE SHIRT	
REFLT03	LARGE REFLECTIVE SHIRT	
REFLT04	X-LARGE REFLECTIVE SHIRT	
COVERALL01	SMALL MECHANIC COVERALL	
COVERALL02	MEDIUM MECHANIC COVERALL	
COVERALL03	LARGE MECHANIC COVERALL	
COVERALL04	XL MECHANIC COVERALL	
COVERALL05	2XL MECHANIC COVERALL	
COVERALL06	3XL MECHANIC COVERALL	





GLOVES

Part No.	Description	
CTPGLOVE1	MEDIUM LEATHER GLOVES WITH EXTRA PADDING AND COMFORTABLE GRIP	
CTPGLOVE2	LARGE LEATHER GLOVES WITH EXTRA PADDING AND COMFORTABLE GRIP	
CTPGLOVE3	X-LARGE LEATHER GLOVES WITH EXTRA PADDING AND COMFORTABLE GRIP	
CTPGLOVE4	2X-LARGE LEATHER GLOVES WITH EXTRA PADDING AND COMFORTABLE GRIP	
CTPGLOVE5	3XL LEATHER GLOVES WITH EXTRA PADDING AND COMFORTABLE GRIP	

CAPS

Part No.	Description	
CAP40	BLACK AND RED WITH WHITE CTP LOGO. LIMITED EDITION 40TH ANNIVERSARY	
CAPBYM	BLACK AND YELLOW MESH HAT WITH BLACK CTP LOGO	
CAPBW	BLACK HAT YELLOW STITCHING WITH WHITE CTP LOGO	
CAPCY	CAMOUFLAGE HAT WITH YELLOW CTP LOGO	
CAPGR	GRAY HAT WITH WHITE CTP LOGO	
CTPVISOR	BLACK VISOR WITH YELLOW CTP LOGO	











BAGS

Part No.	Description	
CTPBAG2	YELLOW CTP BEACH BAG	
CTPBAG4	BLACK NYLON CTP BRIEFBAG	
CTPBAG5	PLASTIC CTP BAG (SOLD IN PACKS OF 50)	
CTPBAG6	BLACK CTP CROSSBODY BAG	
CTPBAG7	DUAL BACKPACK AND BRIEFCASE	
CTPBAG8	FOLDABLE BACKPACK	
CTPBAG9	GRAY BACKPACK	
BRIEFCASE	CARRY-ON BRIEFCASE WITH WHEELS	
CTPDUFFEL	BLACK CTP DUFFEL BAG	
TOOLBAG	BLACK CTP TOOL BAG	



OFFICE SUPPLIES

Part No.	Description	
ADM001	YELLOW AND BLACK BIC PEN WITH CTP LOGO (SOLD IN PACKS OF 25)	
CTPPENCIL	BLACK PENCIL WITH CTP LOGO (SOLD IN PACKS OF 8)	
CTPPEN2	EXECUTIVE PEN (BLUE INK)	
CTPPEN3	EXECUTIVE PEN (BLACK INK)	
PAD1	CTP MOUSEPAD	
MAGNIFIER	ACRYLIC DOME MAGNIFIER ZOOM 3X THE SIZE	
STRESSBALL	HAT-SHAPED STRESS BALL	
NOTEBOOK1	CTP NOTEBOOK BLACK COVER	
NOTEPAD	SMALL NOTE PAD FOR MEETINGS	
NOTEPAD2	POCKET SIZE NOTE PAD	

Office Supplies(cont.)

Part No.	Description	
CALC02	CTP YELLOW CALCULATOR	
CTPL01	CTP LETTER OPENER	
KEYCHAIN1	SILVER KEYCHAIN WITH BOTTLE OPENER	
KEYCHAIN3	BLACK MINI FLASHLIGHT KEYCHAIN	
LAN	CTP LANYARDS WITH ADJUSTABLE STRAP	
CTPBADGE	BLACK BADGE HOLDER	
CTPMUG	15 OZ. STAINLESS STEEL TRAVEL MUG	
CUPCOASTER	CUP COASTER	
CTPK00ZIE1	BLACK KOOZIE FOR DRINKS	
CTPK00ZIE2	CAMO KOOZIE FOR DRINKS	



Part No.	Description	
LTAG01	BLACK LEATHER LUGGAGE TAG	
LTAG02	CARAMEL LEATHER LUGGAGE TAG	
LTAG03	PINK LEATHER LUGGAGE TAG	
CTPOVERVIEW	CTP PRODUCT LINE OVERVIEW	
CAL05	DESKTOP CALENDAR	
CALWALL1	WALL CALENDAR	
EASELPAD	EASEL PAD FOR COUNTER DISPLAY. UP TO 40 SHEETS IN CAPACITY	
BRKIT-EN	BROCHURE HOLDER WITH 40 INSERTS (ENGLISH)	
BRKIT-SP	BROCHURE HOLDER WITH 40 INSERTS (SPANISH)	
COUNTER DISPLAY	COUNTER DISPLAY	

Part No.	Description	
DVDEN	CTP TUTORIAL DVD (ENGLISH)	
DVDSP	CTP TUTORIAL DVD (SPANISH)	
COUNTERMAT	CTP LAMINATED COUNTERMAT (DOUBLE-SIDED)	



RAIN GEAR

Part No.	Description	
UMBRELLA	GOLF SIZE UMBRELLA	
CTPPONCHO	CTP REUSABLE PONCHO	



STICKERS

Part No.	Description	
CTPSK002	3"CTP STICKER SOLD IN PACKS OF 250	
CTPSK005	6"CTP WINDOW CLING	
CTPSK006	11" CTP STICKER	





SIGNS

Part No.	Description	
CTPSIGNS	CTP SMALL SIGN	
CTPSIGNL	CTP LARGE SIGN	
LIGHTSIGN	CTP LIGHT SIGN	

GADGETS

Part No.	Description	
USBPEN	16GB USB PEN DRIVE AND LASER POINTERV	
USBKEYCHAIN	16GB USB DRIVE KEYCHAIN	
UTADAPTER	UNIVERSAL TRAVEL ADAPTER WITH DUAL USB	

MISCELLANEOUS ITEMS

Part No.	Description	
GOLFKIT	GOLF KIT INCLUDES: TEES, REPAIR TOOL AND HAT CLIP	
STOOL	BLACK STOOL WITH CTP LOGO	
STOOLSEAT	REPLACEMENT SEAT FOR STOOL	
CTPFLAPS	MUD FLAPS FOR TRUCKS (SOLD IN PAIRS)	

INDEX

A

ABC Gasket Program	168
Actuator Kits	37
Actuators	37
Actuators for Governors	123
Adapters	136
Adapter Shanks	129
Air Compressor Blocks & Crankshafts	43
Air Compressor Governor	43
Air Compressor Miscellaneous Parts	44
Air Compressor Piston & Rings	42
Air Compressors	41
Air Compressors Repair Kits	42
Air Conditioning Compressors	68
Air Filter Indicators	116
Air Filters	115
Air Intake/ Exhaust Clamps	10
Alarms & Horns	68
Alarms	68
Alternators	67
Amber LED	74
Ammeters	50
Apparel	253
Applications we cover:	171
Armatures	69
Arm Group	240
Axle Group - Front	239

B

Backhoe Applications	85
Backhoe Loader	45
Backhoe Loader Pads	237
Backhoe Wheels	237
Bags	255
Ball Joint	141
Bar Group	239
Batteries	69
Bearings	22
Belts & Hoses	26
Belts	26
Belt Tensioner	29
Bevel Gears & Gear Sets	158
Bit Cutters	124
Blade Group	239
Blades & end bits for Komatsu®	131
Bogie Major	229
Bogie Minor	230
Bogies	229
Bolt on Center Adapter - 2 Holes	130
Bolt on Center Adapter - 3 Holes	130
Bolt on Corner Adapter	129
Bolt on Monoblock Teeth	133

Bolts	136
Bonnets	137
Boom Group	239
Brake Discs	39
Brake Lining	38
Brake Lining Disc Kits	38
Brake Pedal Assemblies	38
Brake Pedals	38
Brake System Application	161
Braking System	37
Braking System Cables	245
Bronze Wear Strips	233
Brushes	69
Brushes for Alternators	70
Brushes for Electrical Motor Starters	69
Brush Kits for Starter Motors	70
Bucket Group	239
Bucket Sidebar Protectors	129
Bulldozer Blades	126
Bulldozers & Compactors End Bits	125
Bushings	138

C

C-10, C-11, C-12	220
C-10	176
C-11	180
C-13	183
C-13	221
C-15, C-16	222
C-15	186
C-18, C-27, 3046, 3054, 3054E	223
C-18, C27	187
C-7	171
C-7	218
C-9.3	175
C-9	174
C-9	219
C12	181
Cab Air Filters	118
Cabin & Accessories	45
Cabin Glass	45
Cables	245
Cables for Electrical & Starting Systems	245
Cables for Fuel System	246
Cables for Lock System	246
Camshafts	89
Capillary Switch	80
Caps	254
Carbon Steel Grader Blades	128
Carriers	159
Carriers for Komatsu®	160
Cartridges	147
Caterpillar®	249
CAT® 140H MOTOR GRADER	251
CAT® 18M3 MOTOR GRADER	249
CAT® 272C SKID STEER LOADER	251
CAT® 299C MOTOR GRADER	251
CAT® 320D L HYD. EXCAVATOR	251
CAT® 323D L HYD. EXCAVATOR H.	251
CAT® 330D L HYD. EXCAVATOR	251
CAT® 336D L HYD. EXCAVATOR	250
CAT® 3516 ENGINE GENERATOR	251

CAT® 365C FRONT SHOVEL	251
CAT® 390FL HYDRAULIC EXCAVATOR	249
CAT® 432F2 SIDE SHIFT B. LOADER	250
CAT® 4M MOTOR GRADER	250
CAT® 5110B HYD. EXCAVATOR	251
CAT® 587T PIPELAYER	250
CAT® 613G WHEEL TRACTOR SCRAPER	250
CAT® 725 ARTICULATED DUMP TRUCK	251
CAT® 777D OFF-HIGHWAY TRUCK	251
CAT® 793F MINING TRUCK	250
CAT® 950H WHEEL LOADER	251
CAT® 980G WHEEL LOADER	251
CAT® 994F WHEEL LOADER	251
CAT® CT660 DUMP TRUCK	251
CAT® D10T TRACK-TYPE TRACTOR	250
CAT® D11T TRACK-TYPE TRACTOR	249
CAT® D11T TRACK-TYPE TRACTOR	250
CAT® D7ET TRACK-TYPE TRACTOR	250
CAT® D8T TRACK-TYPE TRACTOR	250
CAT® G3516 GAS ENGINE	251
CAT® P5000 LIFT TRUCK	251
Circuit Breakers	69
Clamps	36
Clean Bar	133
Cleaner Bars & Stands	129
Clutch Discs	39
Clutch System Application	160
Collectible replicas	249
Compact Track Loaders	242
Composite Bearings	22
Cone Bearings	24
Connecting Rod Kits	99
Connecting Rods	98
Connectors	137
Control Group - Bucket	238
Coolant Temperature Regulators	63
Cooling System	59
Cotter Pins	138
Crankshafts	86
Crankshaft Seals	226
Crankshafts for Komatsu®	88
Crimping Tool	247
Crowns and Skirts	92
C Series Head Bolts	103
CTP Dozer Track-Type Tactor	249
Cup Bearings	24
Custom Engines	84
Cutting Edges	131
Cylinder & MTG Group	239
Cylinder Heads	102

D

D-Ring Kit	227
D155AX-8 SIGMADOZER WITH RIPPER	252
D65EX-17 SIGMADOZER WITH RIPPER	252
Diaphragm-type or Mechanical	123
Diesel Engine Components	82
Diesel Fuel Lift Pumps	122
Digital Hour Meters	48
Double Flange	231
Dowels	138
Drive Motors	146

Driving and Traffic Lights	72
Drums	160
Dry Engine Liner	91
Dump Pumps	146

E

Electrical Parts	67
Electrical Pressure Gauges	49
Electrical Temperature Gauges	49
Electrical Terminals	70
End Bits	125
End Bits	131
End Bits Overlay End Bits	126
End Yoke	141
Engine & Air Brake Hose Assemblies	35
Engine Bearings	88
Engine Blocks	84
Engine Ferrules & Seals	114
Engine Hoses	30
Engine Mounts	114
Engine Oil Coolers	59
Engine Oil Pumps	99
Engine Oil Pumps For Komatsu®	102
Engine Valve Rotocoils	113
Engine Valves	104
Enhancing the Operator's Comfort	53
Equalizer Bars	230
Excavator / Material Handler	46
Excavator Couplings	152
Excavator Gears	164
Excavators 336	228
Excavators	46
Excavator Sidecutters	128
Exhaust System	10
Extended Wear Life End Bits	125

F

Fan Drives	63
Fan Motors	146
Filters	115
Final Drive & Swing Components	163
Final Drive for Excavator	163
Final Drive System Application	160
Finish Dozing End Bits	125
Flanges	152
Flow Switch	80
Flush Mounted Adapters	133
Folded Core Radiators	
for Backhoses and Excavator	149
Frame and Body Cables	246
Frame Assemblies	229
Frame Group	239
Friction Discs & Plates for Komatsu®	41
Friction Discs	39
Friction Discs For Komatsu®	41
Fuel Additive	123
Fuel Caps	52
Fuel Injection	119
Fuel Injection	137
Fuel Injection System	119
Fuel Line Assembly	120
Fuel Shutoff Solenoids	77
G3412, 3512	225

G

Gadgets	257
Gasket Kits for C-Series Engines	218
Gasket Materials	166
Gas Springs	50
Gauges	49
GD655-5 Motor Grader with Ripper	252
Gear Pumps	144
Gears	158
Gear Sets	159
General Duty End Bits	125
Gloves	254
Glow Plugs	71
Governor Control Motors	71
Grader Blades	128
Grease Fittings	139
Grease Gun Kit	247
Grease Pump	247
Ground Engaging Tools	124
Group Manifolds	11
Guard Group	239
Guards	63

H

Hardware Parts	136
Head Gaskets	226
Heater Hoses	35
Heat Shields	21
Heavy Duty Adapters	134
Heavy Nylon Locknuts	140
Hi-Torque Clamp	36
High-head Bolts	139
High Performance Valves	105
Hitch Group	239
HM400-5 Articulated Dump Truck	252
Horns	68
Horn Switch	81
Hydraulic Cylinders	148
Hydraulic Hoses	153
Hydraulic Motors	146
Hydraulic Oil Coolers	60
Hydraulic Oil Filters	152
Hydraulic Piston Rotating Groups	147
Hydraulic Pumps	144
Hydraulic Steering Control Units	151
Hydraulic System	144

I

Idlers	231
Ignition Switch	80
Ignition Switches	51
Inframe Overhaul Kits	84
Inframe Overhaul Kits for	
Injectors	119
Inlet & Exhaust Pipes	14
Inte grated Toolcarrier / Compactor	47

K

Kickout and Bucket Positioners	77
Komatsu® Replicas	252

L

Lamp Bulbs	74
Lamp Groups	72
Lamps Assembly Kits	72

LED Lamp Groups	72
Lifters	90
Lifting Eyebolts	140
Lighting	72
Limit Switch	81
Linear Actuators	76
Liner Kits	91
Liners	90
Linkage - Bucket	239
Link Assemblies	235
Liquid Level Switch	80
Loader Segments	34
Lock Nuts	40

M

Magnetic Switches	77
Manifolds	10
Manufacturing	165
Master Clutch Discs	39
Mechanical Pressure Gauges	49
Mechanical Pressure Gauges	49
Metal Face Seals	227
Mini-Excavators	241
Mini Excavator Rollers	231
Mirrors	51
Mirrors for Komatsu ®	52
Miscellaneous Items	257
Moldboard End Bits	126
Motion Transfer Devices	141
Motor Grader	46
Motor Grader Inserts	128
Mounting Group	239
Mufflers	12

N

Needle Bearings	25
Non-Metallic Strips	233
Nozzles	119
Nuts	140

O

O-Ring Kits	227
Office Supplies	255
Oil & Fuel Filters	116
Oil Cooler	137
Oil Coolers	59
Oil Cooler Transmission	137
Oil Seals	227
Other Pins also Available	240
Other Tapered Bearings also Available	25
Other Tools & Supplies	248
Other Warning Lights	75

P

Parts for Braking System	37
PC138USLC-11 Excavator	252
PC210LC-11 Excavator	252
PC360LC-11 Excavator	252
Pedals and Valves	38
Pilots	40
Pin and Retainers for GET's	129
Pins/Hardware Parts	141
Pins/Undercarriage	238
Piston Kits	95
Piston Pins	96

Piston Pumps	145	Snap Rings	143	U-Cup Seals	157
Piston Ring Sets	97	Solenoids	77	Undercarriage/Frame & Body	229
Pistons	92	Spark Plugs	71	Undercarriage System	236
Pivot Pins	240	Specialty Switches	81	Undercarriage Track Adjuster Cables	246
Plates For Komatsu®	41	Speed Sensors	76	V	
Plungers & Barrels	120	Spherical Bearings	23	V-Band Clamp	36
Power Shift Transmission Discs	40	Spherical LED Head	75	V-Band Turbo	36
Power Train	158	Spider Universal Joint	161	V-Series Self-Sharpening Teeth	134
Powertrain Cables	246	Split Flange Half Code 61	152	Valve Guides	105
Pre-Combustion Chambers	104	Split Flange Half Code 62	152	Valve Seat Inserts	106
Premium Inframe Overhaul Kits	85	Spring Recoil	232	Valve Springs	113
Pressure Sensing	81	Sprockets & Segments	232	Vane Air Starter Motors	78
Pressure Sensors	77	Sprockets	232	Vane Pump or Electrical	123
Pressure Transducer	49	Sprocket Segments	232	Vane Pumps	145
Promotional merchandise	253	Sprockets For Mini Excavator	232	Vibratory Compactors	47
Pulleys	30	Standard Fans	62	W	
Push Button Switch	81	Standard Lights	74	WA500-7 WHEEL LOADER	252
R		Starter Motors	78	Warning Lights	74
Radiator Hoses	35	Starter Selenoid Switch	81	Washers	143
Radiator Oil Coolers	60	Starting Motor Solenoids	77	Water Pump Impellers	63
Radiators	60	Steering and Braking System	40	Water Pumps & Components	64
Rain Gear	257	Steering Clutch Discs	40	Weld on Bottom Strap	133
Receiver / Dryer	68	Steps	51	Weld On Double Strap Adapters	134
Remanufactured Fuel Injectors	121	Steps Support	51	Wet Engine Liner	91
Repair Kit	2	Stickers	257	What is the program about?	168
Reversible & Standard Fans	62	Strainers	117	Wheel Loader	47
Reversible Fans	62	Strainers for Caterpillar® machines	117	Why buy CTP's ABC Gasket Kits?	168
Rims & Wheels	237	Strainers for Komatsu® machines	118	Wiper Motors	48
Ripper Shanks	132	Strap Wrench	247	Wiper Rod Seals	157
Ripper Teeth	133	Studs	142	Wire Braid with Textile Cover	155
Rivets	142	Style Ripper Teeth	133	Woodruff Keys - Bar	143
Rod Ends	141	Summary Table of Key Features	58	Woodruff Keys	143
Rollers	230	Swing Frame Assemblies	229	#	
Rotary Switch	80	Switches	80	100R12 4 Wire Braid	155
Rubber Hoses	35	T		100R12 Hose Assembly	156
Rubber Tracks	240	T-Bolt Clamp	36	100R13 4 Wire Spiral	156
S		Tamping Feet	133	100R13 Hose Assembly	156
Scraper Cutting Edges	135	Tapered Roller Bearings	24	100R15 6 Layer Spiral	156
Screws	41	Temperature Sensing	81	100R15 Hose Assembly	157
Sealed Lamps	72	Terminal Connector Kits	70	100R1 Single Wire Braid	154
Seal Kits for Case™ Machines	228	Tetragauge	247	100R2 Double Wire Braid	154
Seal Kits for Skid Loaders	228	Thick Flange Half	152	100R2 HOSE ASSEMBLY	154
Seals & Gaskets	165	Thin Aux. LED with Rectangular Bezel	75	100R4 Hose Assembly	155
Seats	52	Tie Rods & Sockets	238	100R4 Textile with Helical	155
Sea Water Pumps & Components	64	Tips & Adapters	129	100R5 Hose Assembly	155
Self-Locking Nylon Patched	142	Tips for Komatsu®	130	100R5 One	
Semi Solid Solenoids	77	Toggle Switch	80	2-Bolt on Corner Adapter	130
Sensing Switch	81	Tools & Supplies	247	3056, 3116	223
Serpentine Belts	29	Top Rollers	231	3114, 3116	188
Service Groups	120	Torque Converter Oil Coolers	60	3126, 3126B, 3176, 3176C	224
Shank Protectors	129	Torque Converter Impellers	163	3126	192
Shanks and Pins for Motor Graders	133	Torque Converter Stators	162	3176, 3204, 3208	208
Shoe Lining & Bands	39	Track Adjusters	234	3204, 3208, 3408, 3412, 3412E	225
Side Edges	131	Track Shoes	134	3304	209
Side Pin Teeth	130	Track Type Tractor / Dozer	46	3306	211
Signal, Stop Lamps and Lenses	73	Transmission Oil Coolers	60	3406	213
Signs	257	Transmission Seal Rings	162	3408	215
Single Flange	230	Turbochargers	15	3412	216
Single Manifolds	10	Turbochargers for Caterpillar®	15	3456, 3508, 3512, 3516	217
Sleeve Bearings	23	Turbochargers for Komatsu®	20	3516, 3524, 3508, 3512, 3516	226
Sliding Frame Assemblies	229	U		3520G, D353	218

NOTES:

YOUR LOCAL DISTRIBUTOR:



WWW.COSTEX.COM

ANNIVERSARY

