



Air Tables + Faraday Cages
Electrophysiology Systems
Micropipette Fabrication
Optical Instruments
Perfusion Systems
Mounting Systems
Amplifier Systems
Micromanipulation
Igor Pro Software
Light Sources
Microinjection
Microscopes
Translators
Shuttering
Stages

CUSTOMER SERVICE

For phone orders, quotation requests, and technical support:

Phone +1.888.883.0128 (U.S. & Canada)
+1.415.883.0128

Monday – Friday 8:00 am to 5:00 pm Pacific Time

For correspondence by mail:

Sutter Instrument
One Digital Drive
Novato, CA 94949
USA

FAX ORDERS

Fax +1.888.883.0900 (U.S. & Canada)
+1.415.883.0572

24 hours a day, every day

EMAIL

info@sutter.com

WEB SITE

www.sutter.com

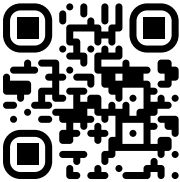

PRICES

Prices are available on our web site at www.sutter.com for purchases made directly from Sutter Instrument for sales in the USA. International prices are typically 10% higher, and all pricing is subject to change without notice. Products are sold FOB Novato (exclusive of transportation, insurance, and applicable taxes). Please contact Sutter Instrument or your local representative for a price quotation.

SHIPPING

Shipping charges are prepaid and added to the invoice. Unless otherwise specified when placing your order, we will use our best judgement in selecting a reliable and economical shipper of our choice.

RETURNS

Items ordered in error may be returned within 30 days of receipt, and are subject to a 15% restocking fee. You are urged to retain the original shipping containers should there be a need to return the item. Please contact Sutter Instrument for a return authorization number.

QUALITY CONTROL

Sutter Instrument takes great pride in meeting the highest possible standards of quality and reliability. Each instrument undergoes rigorous electronic and mechanical testing protocols during the production process. For our micropipette pullers, every instrument is tested to assure its ability to consistently fabricate micropipettes with ultra-fine tips. A series of pipettes is pulled on each instrument and examined with our scanning electron microscope. No other manufacturer offers this level of quality control.

SERVICE & SUPPORT

We hope that our instruments and products continually meet your needs. However, should a problem arise, please contact our technical support staff to discuss the problem. If the instrument requires factory service, we will furnish shipping instructions. Items under warranty will be repaired free of any costs for parts or service. Both delivery and return shipping costs are the responsibility of the owner.

WARRANTY INFORMATION

Sutter Instrument provides a limited warranty on parts and labor for two years from shipping date on all Sutter made products. To be covered under warranty, the instrument must have been operated in accordance with the instructions outlined in the instruction manual and in a manner that would be expected in the normal use of the product. Items not covered under warranty are: consumables, photomultiplier tubes, galvanometers, Uniblitz® shutters, air tables, and other non-Sutter made products. Non-Sutter made products carry the factory warranty of their original manufacturer. Extended warranties on Sutter made products may be purchased for an additional charge. Please contact Sutter for a quotation. Abuse, misuse, or unauthorized repairs will void any warranty.

PAYMENT METHODS

Payments may be made in U.S. dollars in one of the following methods: MasterCard, Visa, American Express, bank draft drawn on a U.S. bank, international money order, bank wire transfer, irrevocable letter of credit (a processing fee will apply).

GENERAL INFORMATION

Every effort has been made to ensure that at the time of printing, the information contained herein is accurate. Please phone Sutter or visit our web site for the latest product specifications and pricing.



50 Years of Sutter Instrument!

In 1974, a partnership was formed between Dale Flaming (a researcher at UCSF working on retinal physiology) and James Wall (head machinist in the Department of Physiology at UCSF). Having difficulty with cell penetration, Dale designed what would be Sutter's first product, the Microelectrode Beveler. Three years later, when having problems getting consistent pipettes small enough to record from retinal cells, Dale designed the P-77, the world's first digitally controlled micropipette puller. The P-77 was the first puller to reliably and reproducibly create pipettes as small as 0.01 microns, a size at the very limit of what could be resolved with a scanning electron microscope. The company was officially incorporated in 1977 to make and sell what most assumed would be a dozen or so pipette pullers. Demand for a pipette puller that could consistently make good microelectrodes was underestimated, and demand continued to grow.

In our first 10 years, Sutter was literally a garage operation. Pullers and bevelers were being completely fabricated and assembled in the founders' garages in the San Francisco Bay Area. In 1982, steadily increasing sales allowed Sutter to lease its first space and hire our first full-time employee, who is still with the company today! Dale Flaming and Jim Wall left their positions at UCSF, began running the company full time, and continued to develop new products.

As Sutter gained employees (most of whom came via word of mouth from research backgrounds), our product portfolio grew. We gained expertise in many kinds of motion control, electronic engineering and modern precision machining techniques. We next expanded into micromanipulators, filter wheels and lightsources. Today we produce nearly every component needed to build a complete electrophysiology rig, as well as the original moving objective 2-photon microscope design, collaboratively built with, and officially licensed from, the Max Plank Institute in Germany.

As we celebrate our 50th anniversary, we still design and manufacture everything in-house at our main office in Novato California, with remote employees in Oregon and New York. Dale Flaming is still very much involved in the day to day operations at the company. We are deeply grateful for the many close working relationships we have had with customers over the years. We will continue to do our best to provide for the needs of the science community, and look forward to many more years of collaboration. Thank you all so much for being our customers for the last 50 years. We deeply appreciate you all!





50 Years of Innovation for the Sciences

BV-10 Micropipette Beveler

Sutter Instrument was founded as a partnership: Dale Flaming, Jim Wall, & Gus Winston

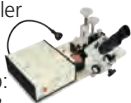

1974

IBM Personal Computer, HepB vaccine

P-80B Micropipette Puller

1981

PCR developed, HIV identified

P-80PC & PC-84 (Sachs) Micropipette Pullers

1983

1977

Sutter Instrument is incorporated, P-77 Micropipette Puller

Apple II, MRI, IVF (1978), Smallpox eradicated (1980)

1982

P-80C Micropipette Puller

Compact disk

1986

MP-85 Micromanipulator

Mir space capsule launched

iPad, self-replicating, synthetic bacterial cells

MP-265 Manipulator

2010

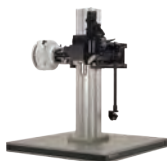

MOM® 2-Photon Microscope

2008

MacBook, Twitter, shingles & rotavirus vaccines

XenoWorks™ Microinjection System

2006

2011

QUAD®, Lightweight Filterwheels

2009

P-1000 Puller; MT-78 Stage; Lambda XL Light Source

2007

3DMS Motorized Stage
iPhone

CRISPR-Cas9, Higgs boson

VF-1™ & VF-5™ Tunable Filter Systems, TLED Light Source, SOM® Microscope

2012



IPA® Integrated Patch Amplifier, SutterPatch® Software

2016

5G, 1st black hole image

Dynamic clamp for dPatch® Amplifier System

2019

2013

Lambda HPX LED Light Source

2017

dPatch® Amplifier System, BOB™ Microscope



2020

Lambda 721 LED Light Source with Optical Beam Combiner

COVID-19 vaccine



Multiphoton microscopy (1990), gene therapy (1990)

P-87 Micropipette Puller, Lambda-10 Filterwheel

1987

World Wide Web

P-2000 Laser Puller is developed on NIH Phase 1 grant

1993



Varicella & hepA vaccines, Dolly the clone sheep (1996), DVD (1997)

MP-285 Micromanipulator

1995

1992

MP-185 Micromanipulator

1st smartphone and text message

1994

MP-300 Micromanipulator (Gnat)

Yahoo!

1998

Lambda 10-2 Filterwheel Controller

Google, ISS launched, quantum computer, stem cells cultured

Facebook

MPC-200 controller, DG-5, Lambda 10-3 & 10-B

2004

MP-225 Micromanipulator, Lambda LS - Xenon light source

2002



Lambda DG-4 Wavelength Switcher, Lambda 10-C Filter Changer

1999

Bluetooth, USB 1.0

2005

SmartShutter®

YouTube, Google Maps, grid cells discovered



2003

MT-2000 Motorized Translator

Skype, Human Genome Project

2001

MT-1000 Microscope Translator and Gantry Stands

Wikipedia, iPod, targeted cancer therapy

NAN™ Microscope

2021

XWI Motorized Injector

2023

2022

XenoWorks™ Joystick redesign, WaveMetrics acquisition, Igor Pro

ChatGPT





INDEX

AMPLIFIER SYSTEMS & SOFTWARE

Introduction	8
dPatch®	10
Low-noise Ultra-fast Digital Patch Clamp Amplifier System	
dPatch FAQ	18
dPatch vs. Brand aX Comparison Chart	19
IPA®/Double IPA®	20
Integrated Patch Amplifiers with Data Acquisition System	
Dendrite™	26
Data Acquisition, Management and Analysis System	
SutterPatch®	32
Data Acquisition, Management and Analysis Software	
WaveMetrics Igor Pro	38
Technical Graphing and Data Analysis Software for Scientists and Engineers	

MICROMANIPULATION

Introduction	42
THREE-AXIS MANIPULATORS	
TRIO™ MPC-165 3-Axis Narrow-Format Micromanipulator System	44
TRIO™ MPC-145 3-Axis 0-90 Diagonal Micromanipulator System	52
TRIO™-245 3-Axis Micromanipulator System	58
MPC-385 System MP-285 Based Multi-Micromanipulator Systems	62
MPC-365 System Narrow-Format MP-865 Based Multi-Micromanipulator Systems	70
MPC-325 MP-225 Based Multi-Micromanipulator Systems	78
Multi-Link™ Position Control Software	84
MP-285 Robotic Micromanipulator	86
MP-225A Motorized Micromanipulator	92
IN VIVO MANIPULATORS	
QUAD® 4-Axis Motorized Micromanipulator	96
TRIO™-235 3-Axis 0-90 Diagonal Micromanipulator System	100
SOLO Single Axis Manipulator Controller	104

MICROMANIPULATION cont'd.

MANUAL	
MP-85 Huxley-Wall Style Micromanipulator	108
MM-33/MP-33A Micromanipulator	112
MM-6 Micropositioner	116
TRANSLATORS, STAGES & MOUNTING SYSTEMS	
MT-1000/MT-2000/MT-2200 Systems Motorized and Manual Translation Systems For Fixed-Stage Microscopes	118
MT-1078/MT-2078/MT-2278 X-Y Translation Systems For Fixed-Stage Microscopes	124
MPC-78/MP-78 Large Moving Platform Stage	130
3DMS 3-Axis Motorized Stage Motorized Stage and Translator Comparison Chart	134
COMPONENTS	
MT-75 Gantry Style Stands	140
MT-70/MT-71 Series Micromanipulator Stands	146
MD SERIES Micromanipulator Platforms	150
BUNDLED SYSTEMS	
BUNDLED CONFIGURATIONS Manipulators, Stages & Platforms	156
MICROPIPETTE FABRICATION	
Introduction	160
PULLERS	
P-2000 Laser-Based Micropipette Puller	162
P-1000 Next Generation Micropipette Puller	166
P-97 Flaming/Brown™ Micropipette Puller	170
P-30 Vertical Micropipette Puller	174
Micropipette Puller Comparison Chart	178
P-1000/P-97 Comparison Chart	179
Filaments/Accessories	180
BEVELER	
BV-10 Microelectrode Beveler	182



MICROPIPETTE FABRICATION cont'd.

BOOKS

Advanced Techniques in Micropipette Fabrication	186
Pipette Cookbook	187
GLASS	
Glass Capillary Tubing	188

MICROSCOPES

Introduction	194
MOM®	196
Movable Objective Microscope®	
BOB™	204
Open-design Upright Microscope	
New NAN™	214
Open-design Upright Microscope	
SOM®	226
Simple Moving Microscope	
DF-Scope™	230
Multiphoton Imaging Package for Olympus BX51WI Microscope	
MCS	234
MOM Computer System and Software	
ScanImage	240
Premium Software and FPGA-Based Acquisition System	
RESSCAN	244
Sutter Resonant Scan Box	
PS-2 / PS-2/LV	248
PMT Power Supplies	

OPTICAL INSTRUMENTS

Introduction	252
Light Source Comparison	254
Filter Wheel Controller Comparison	255
OPTICAL BEAM COMBINERS	
Lambda OBC	256
Optical Beam Combiner	
Lambda 421	260
Optical Beam Combining System	
New Lambda 721	264
Optical Beam Combining System	
LIGHT SOURCES	
Lambda LS	268
Stand-Alone Xenon Arc Lamp and Power Supply	

OPTICAL INSTRUMENTS cont'd.

Lambda HPX-L5	274
High Power LED Light Source With Liquid Lightguide	
Lambda FLED	278
Fluorescent Light Source	
Lambda TLED/TLED+	282
LED Transmitted Light Source	
WAVELENGTH SWITCHERS AND FILTER WHEELS	
Lambda VF-5™/VF-1™	288
Tunable Filter Changers	
Lambda 10-3	292
Optical Filter Changer	
Lambda 10-B	300
Optical Filter Changer	
SHUTTERING	
Lambda SC	306
SmartShutter® Controller	
SmartShutter®	310
Stepper-motor Driven Shutter	
MICROSCOPE ADAPTERS	
Adapter list	314

MICROINJECTION

Introduction	320
New XenoWorks™ Micromanipulator	322
XenoWorks™ Digital Microinjector	326
New XenoWorks™ XWI	
Motorized Microinjector	330
Manual Manual Microinjector	334
PRIME TECH	
PMM6 Piezo Impact Drive	336
HDJ-M3 Hydraulic Microinjector	340
PNJ-T2 Pneumatic Microinjector	342
Applications	344

Air Tables, Perfusion Systems and Custom Products

Air Tables & Faraday Cages	348
Vibration Isolation Systems	
New Equipment Racks	356
Perfusion Systems & Bath Chambers	360
Custom and OEM Products	364

DEALERS

International Dealer Directory	366
--------------------------------	-----

AMPLIFIER SYSTEMS

Sutter Instrument is proud to announce one of the most significant additions to our product lineup in years: a full suite of electrophysiology recording hardware and software.

The dPatch® Digital Patch Amplifier System combines an unmatched sampling rate of up to 5 MHz, with noise performance that supports the quietest single-channel recordings, and digital architecture for the highest signal fidelity and ultra-stable compensation circuitry. The dPatch system is the most advanced amplifier for electrophysiology on the market today.

The IPA® family of Integrated Patch Amplifier Systems enables efficient, low-noise whole-cell recordings. The IPA system, available with one (IPA) or two headstages (Double IPA), combines state-of-the-art amplifier technology with fully integrated D/A and A/D conversion and a high-speed USB interface. Acquisition, data management, and streamlined analysis are performed using the bundled SutterPatch® Data Acquisition and

Analysis Software, built on the foundation of Igor Pro (WaveMetrics, Inc.).

All Sutter Amplifier Systems were designed with the attention to detail our customers expect and appreciate. The faceplates are sculpted and feature recessed connectors. The pipette holder connects to machined aluminum threads designed for the utmost in mechanical stability and improved shielding. Available accessories include expansion panels, which present amplifier back panel connections at the front of a 19" rack, a machined brass ground point, and pipette holders in polycarbonate or quartz, which minimizes thermal expansion.



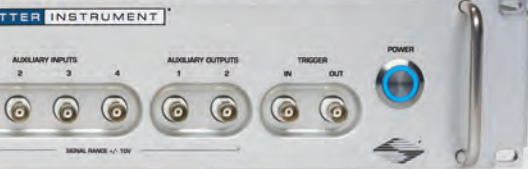



dPatch®

LOW-NOISE ULTRA-FAST DIGITAL PATCH CLAMP AMPLIFIER SYSTEM



(Shown: DPATCH-2)

FEATURES dPatch®

- **New:** Fully-integrated dynamic clamp interface with update rates up to 500 kHz
- Fully integrated single- or dual-headstage patch clamp amplifier and data acquisition system ensures quick and easy setup
- Optimized for single-channel and whole-cell patch clamp recordings in tissue slices, adherent or dissociated cells
- Full computer control provides automated compensation of electrode and whole-cell capacitance
- Voltage and FastFollower™ Current Clamp capability for accurate characterization of cells' electrical activity
- Line frequency reduction in SutterPatch®
- Software lock-in amplifier in SutterPatch® for high-resolution capacitance measurements
- High bandwidth enables characterization of the fastest signals
- Three headstage feedback ranges for single-channel and whole-cell patch clamp recordings
- Comprehensive digital compensation circuitry provides the utmost precision and signal fidelity
- Bundled SutterPatch® software provides a contemporary user interface, versatile data management, intuitive navigation and streamlined data analysis

COMMON APPLICATIONS dPatch®

- Single-channel recordings
- Auditory research and other rapidly changing signals
- Tissue slice recordings
- Cultured cell experiments
- Cell line studies from adherent or dispersed cells
- Optogenetics
- Nanopore and nanogap research



The dPatch® amplifier system was built around a simple idea: What if we built a clean-sheet design that used the latest technology to make the next generation of patch clamp amplifiers? We hired the best hardware and software designers available in the industry, the same engineers who created the leading amplifiers already in the market. We asked them to design the best amplifier system possible, using the very latest in digital architecture, and pair it with a contemporary, easy-to-use, yet powerful software platform.

The resulting design represents a complete rethinking of how to best reduce noise and preserve signal to get the cleanest recordings possible, at a bandwidth that far exceeds anything else on the market. The dPatch amplifier system's digital architecture uses state-of-the-art methods in signal processing, such as field-programmable gate arrays (FPGAs) and Arm Core processors – technologies unavailable when the leading amplifiers in the market were designed well over 20 years ago. The processing power of this design FINALLY enables fully integrated dynamic clamp, as well as digital capacitance and resistance compensation. The included SutterPatch® software facilitates data acquisition, management and analysis with an intuitive and easy to learn interface.

Available in either a single- or dual-headstage configuration, the dPatch amplifier system's architecture makes swapping headstages, or adding a second one to a single-headstage unit, a plug-and-play operation. The two headstages are independently configurable for either voltage clamp or FastFollower™ current clamp.

5 MHz SAMPLING RATE, UP TO 22-BIT RESOLUTION

One unique feature with dPatch is the headstage data sampling system. Each headstage is continually sampled at 5 MHz. Output filtering has thirteen settings between 100 Hz and 1 MHz. A resolution of 18 bits is achieved at 1 MHz. For lower filter settings, automatic downsampling increases resolution while optimizing data rates. At a bandwidth setting of 1 kHz, the dPatch system provides a signal resolution of better than 22 bits.

NO ACTIVE COOLING REQUIRED

Active cooling causes numerous problems that actually create more "noise" in the long run. Active cooling in amplifier headstages use Peltier cells, which cool the electronics for slightly better performance, but generate considerable heat on the opposite side of the cell. The heat generated causes thermal drift which makes it almost impossible to stay patched while doing single-channel work. This is THE MOST COMMON source of what users perceive as "manipulator drift". As a company that makes micromanipulators, we are highly sensitive to the performance of the system within a complete electrophysiology rig.

Active cooling can help get a slightly better noise specification on paper, but in the real world the disadvantages far outweigh the slight gain in specsmanship. One of the development goals of the dPatch headstage was achieving a comparable noise performance at room temperature, without the need for a cooled headstage. In the two resistive feedback modes, the dPatch amplifier is even quieter than any of the competitor systems. In addition, the limited life expectancy of Peltier elements causes reliability concerns that we found unacceptable.

Patent No. 10,393,727



BUILT-IN DATA ACQUISITION SYSTEM MEANS NO THIRD-PARTY COMPUTER INTERFACE

Using a multiplexer-free design, the dPatch provides 8 fully differential analog input channels, 4 analog output channels, and 16 digital outputs (TTL). All I/O channels are sampled continuously (200 kHz for analog inputs, 250 kHz for analog and digital outputs) and available through the user interface.

SUTTERPATCH® SOFTWARE

The dPatch amplifier system, in combination with SutterPatch software, has been engineered to automatically capture and store all amplifier settings, stimulus information and external experiment parameters, and associate them in time with the raw data traces. This includes all amplifier and acquisition settings, as well as timing and progress of the experiment. Fully integrated computer control of the amplifier stages means that the acquisition software is aware of the internal state of the amplifier and digitizer at all times, and can track any changes that may occur. This is independent of whether a change is triggered automatically or initiated by the user.

DYNAMIC CLAMP

The patented digital architecture of the dPatch amplifier system provides an ideal platform for dynamic clamp. The dPatch is powered by a system-on-chip which provides parallel processing across a Field Programmable Gate Array (FPGA) and two high-speed ARM core processors. Several sophisticated dynamic clamp models are implemented within this architecture. In each model, the update of the applied current values occurs without communication between the dPatch and a computer. Depending upon the complexity of the model, update rates of up to 500 kHz can be achieved. (read more on the SutterPatch Software page)

TRACKING OF OTHER EXTERNAL DATA

In addition to status changes in connected hardware that are automatically tracked, the researcher can manually trigger tags to document events like stimulus application using instruments not connected to the amplifier. Information about environmental parameters and a more detailed specification of sample properties can be recorded and stored with the raw data. A total of over 650 metadata attributes are supported. Examples include: animal species, genotype, date/time when a cell sample was prepared, recording solutions, pipette resistance, hardware properties, and detailed information about stimuli applied.

DATA VISUALIZATION AND ANALYSIS

SutterPatch software has been designed to simplify the navigation and analysis of complex datasets. The scope window supports multiple view modes in both two-dimensional and an innovative three-dimensional display. The 3D view is particularly useful during assay development. Built on top of the latest version of the proven Igor Pro platform, SutterPatch combines native Igor Pro functionality with a wealth of features that are tailored to electrophysiology applications. Both the newcomer and the experienced user of patch clamp programs will feel comfortable using SutterPatch software.

Application modules provide focused functionality for particular applications.



Currently Available

- Event Detection Module: A deconvolution algorithm that excels at detecting miniature synaptic events, even on a noisy background
- Action Potential Analysis Module: Phase plane plot, timing and waveform statistics
- Single-Channel Analysis Module: All-points histogram, idealized trace, dwell time, open and closed probability and more
- Camera Module: An easy way to document the identity and condition of the recorded cell

A LABORATORY WORKHORSE

While the dPatch® System is ready for cutting-edge research, its feature set also makes it immediately valuable in any electrophysiological lab setting.

- Three headstage feedback ranges for optimal whole-cell and single-channel recording
- Automated or manual compensation of electrode and whole-cell capacitance
- Series resistance compensation
- Simple cabling, quick and easy set-up
- High dynamic range of digitizer means no need for additional variable gain stages
- Ultra high speed of digitizer means no concerns about inadequate sample rate

The dPatch® Integrated Digital Patch Clamp Amplifier is a computer-controlled single- or dual-headstage system optimized for both single-channel and whole-cell recording applications.

Amplifier

- Hardware architecture enables all data conversion to be performed near the preparation, well away from known noise sources, such as power supplies and high-speed digital circuitry
- Voltage clamp and FastFollower™ True Current Clamp modes with smart switching between modes to avoid current artifacts
- Three choices of headstage feedback elements to optimize both single-channel and whole-cell recording

Feedback Element	Range	Analog Bandwidth	Noise 10 kHz BW	Pipette Capacitance Compensation Range	Series Resistance Range	Cell Capacitance Range
Capacitive	±20 nA	1 MHz	<0.22 pA _{RMS}	20 pF	N/A *	N/A *
500 MΩ	±20 nA	>250 kHz	<0.7 pA _{RMS}	20 pF	100 MΩ	100 pF
50 MΩ	±200 nA	>250 kHz	<2.3 pA _{RMS}	20 pF	10 MΩ	1000 pF

* Capacitive feedback range is optimized for single-channel voltage clamp recordings. Whole-cell compensation and current clamp mode are disabled with this range.



Back panel of dPatch

- Automatic compensation routines for pipette compensation, whole-cell compensation, and series resistance compensation
- Series resistance prediction and correction independently programmable
- 8-pole Bessel filter: 0.1, 0.2, 0.5, 1, 2, 5, 10, 20, 50, 100, 250, 500, 1000 kHz
- Signal processing of filter output to increase resolution and reduce data file size
- Resolution over 22 bits at 1 kHz filter setting
- High dynamic range of analog-to-digital converters eliminates need for variable output gain stages
- Holding potential ± 750 mV
- Current clamp bridge compensation and pipette capacitance compensation
- Slow holding potential tracking compensates for drift during current clamp recordings

Data Acquisition

- Embedded data acquisition system eliminates the need for an external data acquisition board
 - 5 MHz sampling rate per headstage, up to 22-bit resolution
 - 8 Auxiliary analog inputs, 16-bit fully differential, ± 10 V input, each continuously sampled at 200 kHz
 - 4 Analog outputs, 16-bits, ± 10 V output each continuously updated at 250 kHz
 - 16 Digital outputs (TTL) each running at 250 kHz
 - Independent Trigger IN / Trigger OUT for synchronization of external instrumentation
- Single SuperSpeed 3.0 USB connection controls both data acquisition and amplifier settings
- Complex command waveforms
- Data acquisition can be initiated by an onboard microsecond clock or external (TTL) trigger



SutterPatch® Software

- Built on the foundation of Igor Pro (WaveMetrics, Inc.)
- Paradigms and Routines provide complete experimental control of program execution
- Waveform Editor for easy execution of even the most complex stimulus patterns or user-defined templates
- Associated metadata stores all relevant information regarding your experiment
- Specialized data analysis modules and publication quality graphics
- Rapid-response online adaptive AC line-frequency reduction
- Runs on Windows 10 or later (64-bit), or Macintosh OS X 10.11 (El Capitan) or newer versions

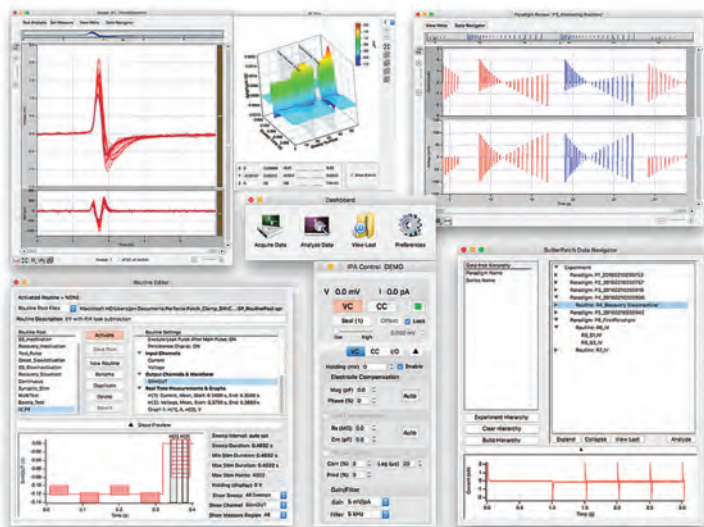

Screen shot of SutterPatch software



Shown: DPATCH-PCH expansion panel



SPECIFICATIONS dPatch®

■ Dimensions

dPatch®: 19 in x 11 in x 3.5 in / 48.2 cm x 28 cm x 9 cm

dPatch® Preamplifier: 7.6 in x 3.5 in x 1.2 in / 19.5 cm x 9 cm x 3 cm

dPatch® Headstage: 3.7 in x 1.1 in x 0.66 in / 9.5 cm x 2.9 cm x 1.7 cm

■ Weight

dPatch®: 15 lbs / 6.8 kg

dPatch® Preamplifier: 15 lbs / 6.8 kg

dPatch® Headstage: 15 lbs / 6.8 kg

■ Electrical

110/240 Volts

50/60 Hertz power line



dPATCH HEADSTAGE DIMENSIONAL DRAWING

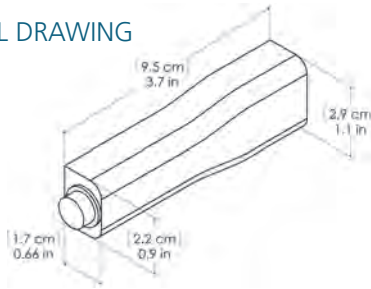

SYSTEM REQUIREMENTS

■ Computer Hardware

Minimum Configuration

Windows 10 or later: 64-bit versions, or

Mac OS X 10.11 (El Capitan) or later

Processor: Dual-core i5

Memory: 8 GB

Solid-state Drive (SSD), 500 GB or greater

Display Resolution: 1024 x 768 (XGA)

1 available USB 3.0 SuperSpeed port

(on the main board, not a PCIx card or similar)

Recommended Configuration for Bandwidths of >50 kHz

Windows 10 or later: 64-bit versions, or

Mac OS X 10.11 (El Capitan) or later

Processor: Dual-core i5

Memory: 16 GB

Solid-state Drive (SSD), 500 GB or greater

Display Resolution: 1920 x 1080 (Full HD)

1 available USB 3.0 SuperSpeed port

(on the main board, not a PCIx card or similar)

SUTTERPATCH® Data Acquisition Management System and Analysis Software: Included with all Sutter Instrument Amplifier Systems



dPatch®

U.S. prices available at www.sutter.com. International prices vary by country. Contact a distributor or Sutter Instrument for a quotation. Prices subject to change without notice..

- **DPATCH** Includes: dPatch® System with one headstage and preamplifier, EH-P170 pipette holder, model cell, screw terminal for digital outputs, rack mounting hardware; SutterPatch® software suite with Igor Pro license
- **DPATCH-2** Includes: dPatch System with two headstages and preamplifiers, two EH-P170 pipette holders, two model cells, screw terminals for digital outputs, rack mounting hardware; SutterPatch® software suite with Igor Pro license

ACCESSORIES dPatch®

- **DPATCH-HS** Headstage & preamplifier for dPatch Amplifier System
- **DPATCH-PCH** dPatch expansion panel

PIPETTE HOLDERS

- **EH-P170** Polycarbonate holder 1.0 mm to 1.7 mm O.D.
- **EH-P170-S** Polycarbonate holder (short shaft) 1.0 mm to 1.7 mm O.D.
- **EH-Q170** Quartz holder 1.0 mm to 1.7 mm O.D.
While polycarbonate is a proven material for patch pipette holders, it undergoes significant thermal expansion. Uneven warming may lead to motion of the pipette tip and is often incorrectly perceived as drift in the micromanipulator. Quartz has a significantly lower thermal expansion coefficient and virtually eliminates thermal drift. Note: Quartz is fragile and may crack or shatter on impact. Treat your quartz electrode holder with the same care you would with any optical component.

ACCESSORIES

- **GP-17** Ground point , accepts banana plugs and clamp wires up to 10 gauge
- **GP-W10** Ground wiring kit (10 assorted cables, 5 alligator clips, assorted clamp rings)
- **RACK-PK** Rack mounting hardware



The Ground Point GP-17 provides reliable, low resistance connections for a star ground configuration, the proven method to avoid ground loops in any electrophysiology setup. Accepts 9 banana plugs + 8 bare wires up to 10 gauge or banana plugs. The GP-17 mounts directly on imperial or metric air table tops with the included 1/4-20 and M6 screws. Made of solid, machined brass with plated banana/clamp connectors.



dPatch® FAQ

Q: How does dPatch compare to other amplifiers on the market?

A: The dPatch uses current state-of-the-art digital architecture. By converting the signal from analog to digital out near the headstage, we preserve the signal integrity as much as is possible. Almost every noise specification of the dPatch exceeds those of all other amplifiers on the market. In addition, the dPatch constitutes a complete patch clamp system, all data acquisition hard-and software are included, and no external hardware is required for dynamic clamp. (See *our Comparison Sheet*)

Q: Why doesn't the dPatch have active cooling?

A: Active cooling causes numerous problems that actually create more "noise" in the long run. The heat generated by Peltier cells cause thermal drift in manipulators, making it almost impossible to stay patched while doing single-channel work. As a company that makes micromanipulators, we are highly sensitive to the performance of the system within a complete electrophysiology rig. Active cooling can help get a slightly better noise specification on paper, but in the real world the disadvantages far outweigh the slight gain in specsmanship (See *the Comparison Sheet*). In addition, the limited life expectancy of Peltier elements causes reliability concerns that we found unacceptable.

Q: Do I need to buy a digitizer or software with the dPatch?

A: No, because the dPatch is inherently a digital design, no additional digitizer is necessary. SutterPatch® software and a license for Igor Pro are included with every dPatch system. The dPatch includes everything you need to start running experiments.

Q: Can I retrofit a second headstage to my single-headstage dPatch system later?

A: Yes, dPatch headstage/preamplifier units are interchangeable and self-contained. All calibration and tuning information is stored directly in the headstage/preamplifier unit and read during startup. That makes adding a second headstage easy.

Q: Do the headstages fit on my existing micromanipulator?

A: All Sutter Instrument headstages come with a standard dovetail fitting. This fitting was jointly introduced by Sutter Instrument and Axon Instruments almost 30 years ago and has since been adopted by most manufacturers of patch clamp amplifiers and micromanipulators. That makes Sutter headstages a drop-in replacement on an existing rig, in most cases without even requiring any adjustment.



dPatch® Ultra-fast Low-noise Digital Patch Clamp Amplifier System vs. Brand aX Low-noise Amplifier

Major Features

Specification	dPatch	Brand aX	Sutter Advantage
Computer Control	YES, fully digital design, controlled by SutterPatch® software	NO, analog knobs and buttons	State-of-the-art design
Data Acquisition	YES, high-speed computer interface integration, SutterPatch software included	NO, requires separate interface and software	12 analog I/O, 16 digital outs
Field Upgradable Software And Firmware	YES	NO	Easy upgrades to keep performance optimized
Built-in Software Lock-in Amplifier	YES	NO	High-resolution membrane capacitance measurements
Integrated Dynamic Clamp Capability	YES	NO	The fastest dynamic clamp for ion channel research
Support For Two Headstages	YES	NO	Headstages with full Plug-and-Play capability
Installation	Simple	Complicated	System is ready to run "out of the box" with a USB 3 computer connection. Grounding problems are minimized.

Whole Cell Voltage Clamp

Specification	dPatch	Brand aX	Sutter Advantage
Feedback Elements	500 MΩ, 50 MΩ	Same	
Noise, 500 MΩ	0.7 pA _{RMS} Range (10 kHz)	1.1 pA _{RMS}	36% lower noise
Noise, 50 MΩ Range (10 kHz)	2.3 pA _{RMS}	3.0 pA _{RMS}	23% lower noise
Bandwidth, Both FB Ranges	250 kHz	50 kHz	5X higher bandwidth
Output Filter Ranges	13 settings from 100 Hz to 1 MHz	5 settings from 1 kHz to 100 kHz	More settings, 10X higher bandwidth
Output Filter Type	8-pole Bessel	4-pole Bessel	8-Pole provides a lower-noise signal
Pipette Cap Compensation Range	20 pF	10 pF	2X compensation range

Single Channel Voltage Clamp

Specification	dPatch	Brand aX	Sutter Advantage
Feedback Element	1 pF / integrator	Same	
Bandwidth	1 MHz	100 kHz	10X higher bandwidth
Noise, 10 kHz	0.22 pA _{RMS}	0.13 pA _{RMS}	No active cooling*
Pipette Cap Compensation Range	20 pF	10 pF	2X compensation range

Current Clamp

Specification	dPatch	Brand aX	Sutter Advantage
Circuit Architecture	FastFollower™ true current clamp	Modified voltage clamp	Produces very accurate membrane voltage waveforms
10 to 90% Rise Time			
R _p = 1 MΩ	2 μs	15 μs	7.5X faster rise time
R _p = 10 MΩ	3 μs	20 μs	6.7X faster rise time
Mode Switching Voltage Clamp to Current Clamp	Special circuitry minimizes glitches	No glitch compensation	Near-zero glitch

* Active cooling causes numerous problems that actually create more "noise" in the long run. The heat generated by Peltier cells cause thermal drift in manipulators, making it almost impossible to stay patched while doing single-channel work. As a company that makes micromanipulators, we are highly sensitive to the performance of the system within a complete electrophysiology rig. Active cooling can help get a slightly better noise specification on paper, but in the real world the disadvantages far outweigh the slight gain in specsmanship. In addition, the limited life expectancy of Peltier elements causes reliability concerns that we found unacceptable.



IPA® and DOUBLE IPA® INTEGRATED PATCH AMPLIFIERS WITH DATA ACQUISITION SYSTEM



FEATURES IPA® / DOUBLE IPA®

- Combination of any two IPA or Double IPA devices enables up to four headstage channels for as many as 16 signals
- Fully integrated patch clamp amplifier and data acquisition system ensures quick and easy setup
- Optimized for whole-cell patch clamp recordings in tissue slices, and adherent or dissociated cells
- Full computer control provides automated compensation of electrode and whole-cell capacitance
- Voltage and current clamp capability for complete characterization of cells' electrical activity
- Bundled SutterPatch® software excels in complete data management, intuitive navigation and streamlined data analysis
- Line frequency reduction in SutterPatch®

COMMON APPLICATIONS IPA® / DOUBLE IPA®

- Tissue slice recordings
- Cultured-cell experiments
- Cell line studies from adherent or dispersed cells
- *In vivo* patch clamp
- Network studies
- Optogenetics



Sutter Instrument introduces the IPA[®] family of Integrated Patch Amplifiers, which enables efficient, low-noise whole-cell recordings. The IPA systems, available in either a single headstage (IPA) or dual headstage (Double IPA) version, combine state-of-the-art amplifier technology with fully integrated D/A and A/D conversion and a high speed USB interface. Acquisition, data management, and streamlined analysis are performed using the bundled SutterPatch[®] Data Acquisition and Analysis Software, built on the foundation of Igor Pro (WaveMetrics, Inc.).

EXTERNAL INPUTS & OUTPUTS

External signals, such as environmental parameters or stimulus information, can be recorded using 4 auxiliary analog input channels. The IPA systems also support the control of peripheral hardware, such as wavelength or solution switchers, with 2 analog and 8 digital (TTL) output channels. As an alternative to the standard breakout cable, an optional Patch Panel provides a tidy way of connecting auxiliary signals on the front of your rack.

SUTTERPATCH[®] SOFTWARE

The IPA system, in combination with SutterPatch software, has been engineered to automatically capture and store all amplifier settings, stimulus information and external experiment parameters and associate them in time with the raw data traces. This includes all amplifier and acquisition settings, as well as timing and progress of the experiment. Fully integrated computer control of the amplifier stages means that the acquisition software is aware of the internal state of the amplifier and digitizer at all times and can track any changes that may occur. This is independent of whether a change is triggered automatically or initiated by the user.

TRACKING OF OTHER EXTERNAL DATA

In addition to status changes in connected hardware that are automatically tracked, the experimenter can manually trigger tags to document events like stimulus application in instruments not connected to the IPA system.

Information about environmental parameters and a more detailed specification of sample properties can be recorded and stored with the raw data. A total of over 600 metadata attributes are supported. Examples include: animal species, strain, genotype, date/time when a cell sample was prepared, recording solutions, pipette resistance, hardware properties, and detailed information about stimuli applied.

DATA VISUALIZATION AND ANALYSIS

SutterPatch software has been designed to simplify the navigation and analysis of complex datasets. The scope window supports multiple view modes in both two-dimensional and an innovative three-dimensional display. The 3D view is particularly useful during assay development. Built on top of the latest version of the proven Igor Pro platform, the SutterPatch program combines native Igor Pro functionality with a wealth of features that are tailored to electrophysiology applications. Both the newcomer and experienced user of patch clamp programs will feel comfortable using SutterPatch software.



Application modules provide focused functionality for particular applications.

- Event Detection Module: A deconvolution algorithm that excels at detecting miniature synaptic events, even on a noisy background
- Action Potential Analysis Module: Phase plane plot, timing and waveform statistics
- Camera Module: An easy way to document the identity and condition of the recorded cell

The IPA® and Double IPA® Integrated Patch Clamp Amplifiers are computer-controlled single- or dual-headstage amplifiers optimized for whole-cell recording applications.

Amplifier

- Voltage clamp and FastFollower™ True Current Clamp modes with smart switching between modes to avoid current artifacts
- Open-Circuit (RMS) noise of 1.4 pA in a 0.1–10 kHz bandwidth
- 500 M Ω headstage feedback resistor provides a maximal range of ± 20 nA
- Fast pipette capacitance compensation and whole-cell compensation
 - Pipette capacitance compensation up to 25 pF
 - Whole-cell compensation: C_m from 1–100 pF; R_s from 1–100 M Ω
- Onboard automatic compensation routines
- Series resistance prediction and correction (0–100 M Ω)
- Four-pole Bessel low-pass filter (cutoff = 0.5–20 kHz)
- Output gain: 0.5–25 mV/pA (voltage clamp); 10–500 mV/mV (current clamp)
- Holding potential ± 1000 mV
- Current clamp bridge compensation and capacitance neutralization
- Slow holding potential tracking can compensate for drift during current clamp recordings

Data Acquisition

- Embedded data acquisition system eliminates the need for an external data acquisition board and facilitates setup
- Single high-speed USB connection controls both data acquisition and amplifier settings
- Up to 6 or 8 input channels (0.1–50 kHz sampling rate per channel)
- Up to 400 kHz aggregate sampling rate
- Multi-amplifier mode: A combination of any two IPA or Double IPA Amplifiers can be connected, providing up to 16 input channels
- Complex command waveforms
- Auxiliary input / output for control of other instrumentation
 - 4 analog input channels (± 10 V)
 - 2 analog output channels (± 10 V)
 - 8 digital output channels (TTL)
- Data acquisition can be initiated by an onboard microsecond clock or external (TTL) trigger



SutterPatch® Software

- Built on the foundation of Igor Pro (WaveMetrics, Inc.)
- Paradigms and Routines provide complete experimental control
- Waveform Editor for easy creation of even the most complex stimulus patterns or user-defined templates
- Associated metadata stores all relevant information regarding your experiment
- Comprehensive data analysis routines and publication quality graphics
- Runs on Windows 10 or later (64-bit) or Mac OS X 10.11 (El Capitan) or later

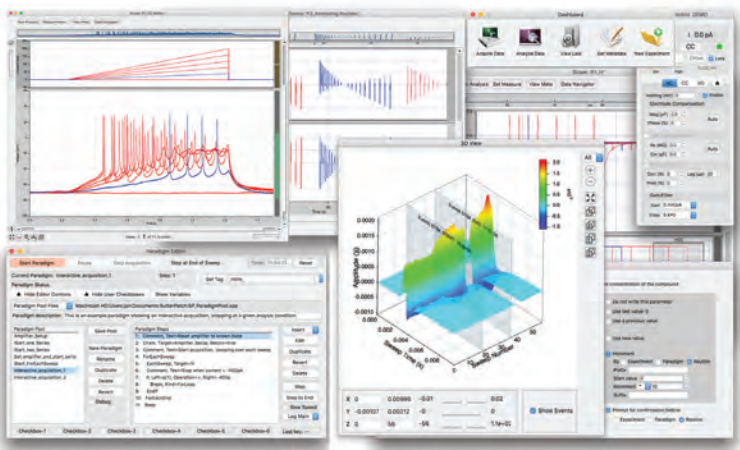

Screen shot of SutterPatch software

Optional IPA Patch Panel

The IPA and Double IPA Amplifiers come standard with an “octopus” breakout cable for auxiliary inputs and outputs, and digital outputs. The optional IPA Patch Panel, machined from 1/2 inch thick billet aluminum stock like the IPA faceplate, brings the auxiliary I/O connections to the front of the rack in a tidy 2U rack mount panel with BNC connectors.

The IPA Patch Panel includes a 2.5 ft (76 cm) connector cable and replaces the standard cable that ships with the IPA system.



IPA-PCH Patch Panel for tidy, convenient connection of peripherals at the front of the rack



SPECIFICATIONS IPA® / DOUBLE IPA®

■ Dimensions

IPA®: 18.8 in x 11.8 in x 1.8 in / 48 cm x 30 cm x 4.5 cm

DOUBLE IPA®: 18.8 in x 11.8 in x 3.5 in / 48 cm x 30 cm x 9 cm

IPA® Headstage: 4.0 in x 1.4 in x 0.75 in / 10 cm x 3.5 cm x 1.9 cm

PATCH PANEL: 18.8 in x 2.0 in x 3.5 in / 48 cm x 5 cm x 9 cm

■ Weight

IPA®: 9 lbs / 4 kg

DOUBLE IPA®: 8.1 lbs / 3.7 kg

PATCH PANEL: 3.5 lbs / 1.6 kg

■ Electrical

110/240 Volts / 50/60 Hertz power line



IPA HEADSTAGE DIMENSIONAL DRAWING

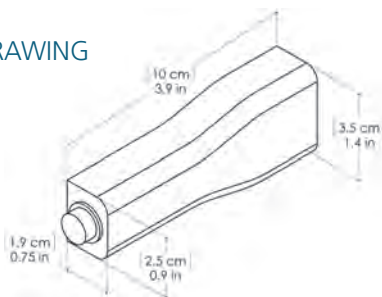

SYSTEM REQUIREMENTS

■ Computer Hardware

Minimum Configuration

Windows 10 (64-bit) or later, or

Mac OS X 10.11 (El Capitan)

Processor: Dual-core i5

Memory: 3 GB

Hard Disk: 500 GB or greater

Display Resolution: 1024 x 768 (XGA)

1 available USB 2.0 High-speed port

Recommended Configuration

Windows 10 (64-bit) or later, or

Mac OS X 10.11 (El Capitan) or later

Processor: Dual-core i5

Memory: 8 GB

Solid-state drive (SSD), 500 GB or greater

Display Resolution: 1920 x 1080 (FULL HD)

1 available USB 2.0 High-speed port

Notes:

USB 3.0 ports are compatible with USB 2.0 High-speed specifications.

Slower USB 2.0 'full-speed' ports, which are sometimes found on older Windows PCs or USB add-in cards, are not supported.



IPA® / DOUBLE IPA®

U.S. prices available at www.sutter.com. International prices vary by country. Contact a distributor or Sutter Instrument for a quotation. Prices subject to change without notice.

- **IPA** Includes: IPA® system with headstage, EH-P170 pipette holder, model cell, "octopus" break-out cable, rack mounting hardware, and SutterPatch® software suite with Igor Pro license.
- **IPA-2** Includes: DOUBLE IPA® system with two headstages, two EH-P170 pipette holders, model cell, "octopus" break-out cable, rack mounting hardware, and SutterPatch software suite with Igor Pro license.

ACCESSORIES IPA® / DOUBLE IPA®

PATCH PANEL

- **IPA-PCH** Patch panel with 8 digital out / 4 aux. in / 2 aux. out BNC connectors, 19" x 2U rack format, D-Sub connecting cable, rack mounting hardware

PIPETTE HOLDERS

- **EH-P170** Polycarbonate pipette holder 1.0 mm to 1.7 mm O.D.
- **EH-P170-S** Polycarbonate pipette holder (short shaft) 1.0 mm to 1.7 mm O.D.
- **EH-Q170** Quartz pipette holder 1.0 mm to 1.7 mm O.D.
While polycarbonate is a proven material for patch pipette holders, it undergoes significant thermal expansion. Uneven warming may lead to motion of the pipette tip and is often incorrectly perceived as drift in the micromanipulator. Quartz has a significantly lower thermal expansion coefficient and virtually eliminates thermal drift. Note: Quartz is fragile and may crack or shatter on impact. Treat your quartz electrode holder with the same care you would with any optical component.

ACCESSORIES

- **GP-17** Ground point
- **GP-W10** Ground wiring kit (10 assorted cables, 5 alligator clips)
- **RACK-PK** Rack mounting hardware



The Ground Point GP-17 provides reliable, low resistance connections for a star ground configuration, the proven method to avoid ground loops in any electrophysiology setup. Accepts 9 banana plugs + 8 bare wires up to 10 gauge or banana plugs. The GP-17 mounts directly on imperial or metric air table tops with the included ¼-20 and M6 screws. Made of solid, machined brass with plated banana/clamp connectors.



DENDRITE™

DATA ACQUISITION, MANAGEMENT AND ANALYSIS SYSTEM



FEATURES DENDRITE™

- Data acquisition with included SutterPatch® software ensures quick and easy setup
- Eight analog inputs
- Four analog outputs
- Eight digital outputs
- Trigger input and output
- Bundled SutterPatch® software excels in complete data management, intuitive navigation and streamlined data analysis
- Online adaptive AC line frequency reduction in SutterPatch® software



The conventional architecture of an electrophysiology system follows a three-tier structure consisting of an amplifier, a computer interface, and data acquisition software. Sutter Instrument's patch clamp amplifier systems, the IPA® Family and the dPatch® Amplifier systems combine these three tiers into convenient, fully integrated packages that include the increasingly popular SutterPatch® Data Acquisition, Management and Analysis Software. The Dendrite™ system meets the needs of customers who want to combine an existing amplifier with the functionality of SutterPatch software.

Featuring eight analog input signals, four analog output lines and eight digital outputs, at a sampling rate of up to 50 kHz, the Dendrite system covers the majority of electrophysiology applications. Independent 16-bit A-D and D-A converters constitute state-of-the-art technology that avoids crosstalk and provides adequate resolution for virtually all use case scenarios. Trigger input and output lines enable coordination with other equipment.

Connection to the computer is conveniently established through a High-speed USB 2.0 connection, and the installation of drivers and SutterPatch software is typically completed within minutes. The Dendrite system accepts input from the majority of patch clamp and other electrophysiology amplifiers that comply with the common standard of +/-10 V signal range. It also controls amplifiers and peripherals that accept analog or digital input according to common standards.

SUTTERPATCH SOFTWARE

The Dendrite and SutterPatch software systems have been engineered to let the user add information about instrument settings, stimulus application and external experiment parameters, and associate them in time with the raw data traces. This includes all acquisition settings, as well as timing and progress of the experiment. In addition, the experimenter can manually trigger tags to document events like stimulus application in instruments not connected to the Dendrite system.

Information about environmental parameters and a more detailed specification of sample properties can be recorded and stored with the raw data. A total of over 600 metadata attributes are supported. Examples include: animal species, genotype, date/time when a cell sample was prepared, recording solutions, pipette resistance, hardware properties, and detailed information about stimuli applied.

DATA VISUALIZATION AND ANALYSIS

SutterPatch software has been designed to simplify the navigation and analysis of complex datasets. The scope window supports multiple view modes in both two-dimensional and an innovative three-dimensional display. The 3D view is particularly useful during assay development. Built on top of the latest version of the proven Igor Pro platform, SutterPatch combines native Igor Pro functionality with a wealth of features that are tailored to electrophysiology applications. Both the newcomer and the experienced user of patch clamp programs will feel comfortable using SutterPatch software.



Data Acquisition

- High-speed USB 2.0 connection controls data acquisition
- Up to 8 analog input channels (± 10 V; 0.1–50 kHz sampling rate per channel)
- 4 analog output channels (± 10 V)
- 8 digital output channels (TTL)
- Up to 400 kHz aggregate sampling rate
- Complex command waveforms
- Data acquisition can be initiated by an onboard microsecond clock or external (TTL) trigger

SutterPatch® Software

- Built on the foundation of Igor Pro (WaveMetrics, Inc.)
- Paradigms and Routines provide complete experimental control of program execution
- Waveform Editor for easy creation of even the most complex stimulus patterns or user-defined templates
- Associated metadata stores all relevant information regarding your experiment
- Specialized data analysis modules and publication-quality graphics
- Rapid-response online adaptive AC line-frequency reduction
- Runs on Windows 10 or later (64-bit), or Macintosh OS X 10.11 (El Capitan)

Application modules provide focused functionality for particular applications.

- Action Potential Analysis Module:
Phase plane plot, timing and waveform statistics
- Event Detection Module:
A deconvolution algorithm that excels at detecting miniature synaptic events, even on a noisy background
- Single-channel Analysis Module:
All-points histogram, idealized trace, duration and amplitude distribution and scatter plot
- Camera Module: An easy way to document the identity and condition of the recorded cell

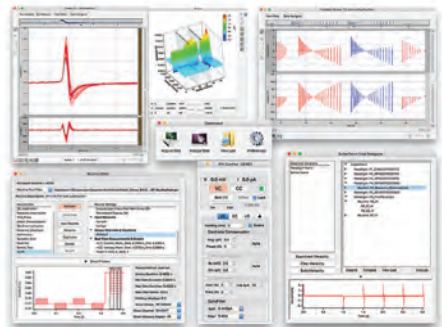

Screenshot of SutterPatch Software



SPECIFICATIONS DENDRITE™

- **Dimensions** 18.8 in x 11.8 in x 1.8 in
48 cm x 30 cm x 4.5 cm
- **Weight** 5 lbs
2.3 kg
- **Electrical** 110/240 Volts
50/60 Hertz power line



SYSTEM REQUIREMENTS

■ Computer Hardware

Minimum Configuration

Windows 10 or later: 64-bit versions, or Mac OS X 10.11 (El Capitan) or later
Processor: Dual-core i5
Memory: 3 GB
Hard Disk: 500 GB or greater
Display Resolution: 1024 x 768 (XGA)
1 available USB 2.0 High-speed port

Recommended Configuration

Windows 10 or later: 64-bit versions, or Mac OS X 10.11 (El Capitan) or later
Processor: Dual-core i5
Memory: 8 GB
Hard Disk: 500 GB or greater
Display Resolution: 1920 x 1080 (Full HD)
1 available USB 2.0 High-speed port

SUTTERPATCH® Data Acquisition Management System and Analysis Software: Included with all Sutter Instrument Amplifier Systems

Notes:

USB 3.0 ports are compatible with USB 2.0 High-speed specifications.

Slower USB 2.0 'full-speed' ports, which are sometimes found on older Windows PCs or USB add-in cards, are not supported.

To check for High-speed USB 2.0 or USB 3.0 on a PC computer running Windows, look in the Control Panel > Device Manager > Universal Serial Bus controllers section for "Enhanced" host controllers. As this does not provide any mapping information to the computer's physical ports, and there can be a mix of USB port versions, you should check individual USB ports for USB 2.0/3.0 High-speed operational performance. As a visual indicator, USB 3.0 ports are often color coded blue.

USB hubs are not supported. USB add-in cards, even if they formally meet High-speed or SuperSpeed specifications, are not recommended. They are often architecturally configured as USB hubs and may lead to intermittent transfer errors that are hard to troubleshoot.

Operating systems installed within virtualization software platforms such as VMware and Parallels are not supported.



DENDRITE™

U.S. prices available at www.sutter.com. International prices vary by country. Contact a distributor or Sutter Instrument for a quotation. Prices subject to change without notice.

- **DENDRITE** Dendrite Data Acquisition, Management and Analysis System with SutterPatch® Software and Igor Pro license

ACCESSORIES DENDRITE™

PATCH PANEL

- **IPA-PCH** Patch panel with 8 digital out / 4 aux. in / 2 aux. out BNC connectors, 19" x 2U rack format, D-Sub connecting cable, rack mounting hardware

PIPETTE HOLDERS

- **EH-P170** Polycarbonate holder 1.0 mm to 1.7 mm O.D.
- **EH-P170-S** Polycarbonate pipette holder (short shaft) 1.0-1.7 mm O.D.
- **EH-Q170** Quartz holder 1.0 mm to 1.7 mm O.D.
While polycarbonate is a proven material for patch pipette holders, it undergoes significant thermal expansion. Uneven warming may lead to motion of the pipette tip and is often incorrectly perceived as drift in the micromanipulator. Quartz has a significantly lower thermal expansion coefficient and virtually eliminates thermal drift.

ACCESSORIES

- **GP-17** Ground point
- **GP-W10** Ground wiring kit (10 assorted cables, 5 alligator clips)
- **RACK-PK** Rack mounting hardware



The Ground Point GP-17 provides reliable, low resistance connections for a star ground configuration, the proven method to avoid ground loops in any electrophysiology setup. Accepts 9 banana plugs + 8 bare wires up to 10 gauge or banana plugs. The GP-17 mounts directly on imperial or metric air table tops with the included 1/4-20 and M6 screws. Made of solid, machined brass with plated banana/clamp connectors.

NAVEPOINT EQUIPMENT RACKS

- **RACK-22U** 22U 2-post open frame rack with casters
- **RACK-42U** 42U 2-post open frame rack with casters
- **RACK-CS-8** 1 U shelf, 8" (210mm) deep with lip
- **RACK-CS-16** 2 U shelf 16" (350mm) deep with lip





SUTTERPATCH®

DATA ACQUISITION, MANAGEMENT AND ANALYSIS SOFTWARE

AMPLIFIER SYSTEMS

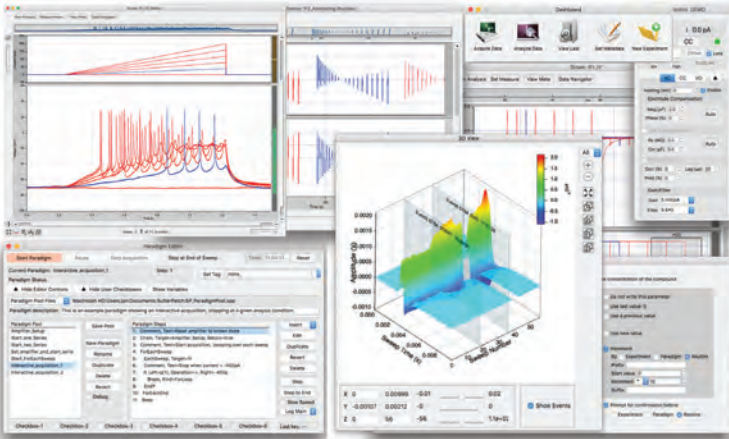

Screen shot of
SutterPatch software

FEATURES SUTTERPATCH®

- Support for all Sutter Instrument amplifier systems, including the dPatch® Digital Patch Clamp Recording System
- Fully-integrated dynamic clamp interface with update rates up to 500 kHz
- Scope Window provides intuitive, efficient navigation through your data
- Routines control data acquisition with or without application of command waveforms
- Line frequency reduction
- Paradigms enable process automation and eliminate operator bias
- The Data Navigator displays the entire experiment in a tree structure
- Real-time and off-line analysis, including mini / synaptic event detection and action potential characterization



SutterPatch® software is a full-featured electrophysiology data acquisition, management and analysis application for Windows or Mac OS computers, backed by our legendary free technical support. SutterPatch comes bundled with all Sutter Instrument Patch Clamp Amplifier Systems. The software controls data acquisition, provides real-time measurements to aid decision making during the experiment, keeps track of all amplifier parameters, records the experimental progress and stores a set of up to 600 metadata parameters. Built within the latest version of Igor Pro by WaveMetrics, Inc., SutterPatch provides immediate access to Igor's powerful scientific and engineering analysis tools. SutterPatch is actively being expanded and developed daily, with the goal of becoming the standard for electrophysiology around the globe.

Version 2 of SutterPatch software adds support for the new dPatch® Digital Patch Amplifier System as well as a multitude of new features and user interface improvements that also apply to the IPA Family of Amplifier Systems. The Membrane Test and Free Run have been upgraded. New triple slider and 2D-matrix controls facilitate compensation adjustments in the Amplifier Control Panel.

Particular emphasis was put into intuitive navigation through large data sets. Controls that are familiar from electrophysiology software or applications in other fields, as well as entirely new approaches make finding a particular section of an experiment very easy.

The structured architecture of the data files was designed to retain the context of every sample within an experiment. With little effort at the beginning of an experiment, a plethora of metadata parameters are recorded – automatically where possible, configured by the user where desired. Each parameter can be reviewed before a Paradigm or Routine is executed.

SutterPatch software comes with a collection of sample Paradigms and Routines that facilitate the configuring of commonly executed experimental scenarios.

SutterPatch provides real-time analysis capability that creates graphs like I-V curves or a time course plot while the experiment is in progress. Up to 8 analysis graphs can be shown, each derived from 16 possible measurements from the input signals. Analyses include mean, slope, rise time, frequency of threshold crossing, etc. This facilitates making decisions about the further course of an experiment.

In addition to real-time analysis, SutterPatch supports further processing after the experiment for the most sophisticated analysis procedures and adds application-specific capabilities on top of the expansive analysis feature set that is native to Igor Pro. Equations and Variables facilitate the use of more complex algorithms in both Routines and Paradigms.



FEATURE HIGHLIGHTS

- Scope Window provides intuitive, efficient navigation through your data
 - Zoom control buttons and sliders
 - Drag along axis to zoom in
 - Mouse wheel zoom
 - Marquee zoom
 - Scroll bars
 - Continuous and snapshot autoscale
 - Sweep, time course and concatenated display
 - Novel 3D display
 - Unique Overview Navigator for panoramic examination of and convenient movement within a data section
 - Paradigm Review window gives quick access to individual Routine Data

- Membrane Test keeps track of cell health and other quality control parameters
 - Waveform types include double pulses, sine and triangle trains and instantaneous RMS noise measurement.
 - Simultaneous display of up to two amplifier or auxiliary input signals and a command waveform.
 - Test pulse parameters fully configurable
 - Pulse averaging
 - Audio monitor

- Routines control data acquisition with or without application of command waveforms
 - Sample Routine Pool with pre-configured Paradigms for many common applications
 - Hard-wired signals from Sutter Instrument hardware and auxiliary input signals are recorded
 - The command signal as applied to the cell is monitored and recorded
 - Analog and digital output signals control peripherals and third-party information
 - Up to 50 Segments per Sweep for utmost flexibility in shaping the most complex command waveforms
 - Preconfigured Segment shapes, such as Sine, Square and Chirp, for easy waveform design
 - Waveform Template enables “playback” of a recorded signal to a cell or applying a mathematical expression as a waveform
 - Measurements provide the basis for real-time analysis and enable decision making in the course of the experiment

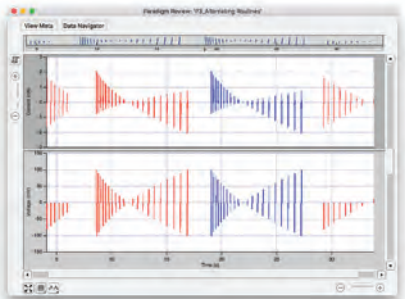
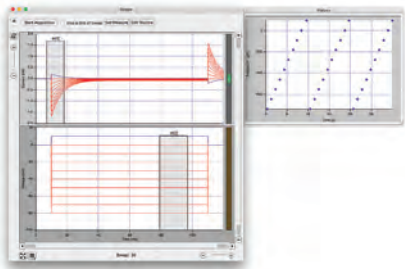



■ Paradigms enable process automation and eliminate operator bias

- Sample Paradigm Pool with pre-configured Paradigms for many common applications
- Configure the amplifier to reproducible standard settings
- Acquisition of Routine sequences enables pre-planned experimentation and minimizes operator bias
- Flow control for interactive or automated decision-making during the experiment
- Chaining Paradigms provides added flexibility
- Automatic creation of Layouts for standardized documentation

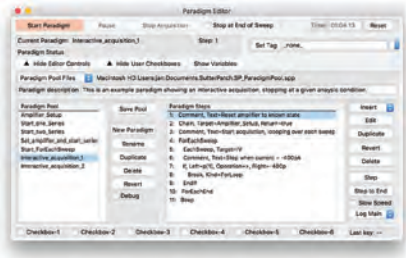

■ The Solution Editor lets you keep track of solutions and compounds, and supports direct control of a solution switcher

- Initial conditions and all solution changes are automatically written to the MetaData
- Analog or digital outputs control all common solution switchers

■ The Data Navigator displays the entire experiment in a tree structure

- Preview of the first acquired signal
- Quick access to Paradigm Review, Reanalysis Scope, Metadata and Routine information

■ Real-time and off-line analyses, including mini/synaptic event detection and action potential characterization

- Measurements configured as part of Routines create real-time graphs
- Virtual signals provide the user with information derived from physical input signals, mathematical equations, signal modification, or any combination thereof. High- and low-pass filters, lock-in amplifier capability and subtraction of a reference sweep are new in version 2.
- Paradigms can access measurements for further real-time analysis
- Equations and variables provide utmost flexibility
- Event detection using a high-performance, deconvolution-based algorithm
- Easily exports data to Microsoft Excel and other spreadsheet programs for compatibility with existing analysis procedures
- A wealth of native Igor Pro analysis features

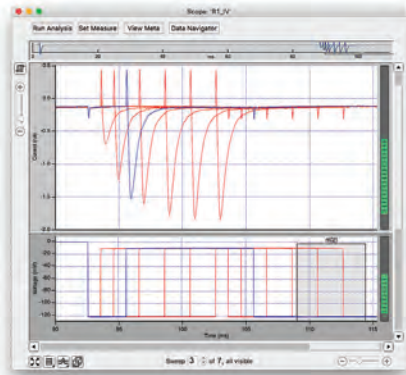

■ Support for IPA multi-amplifier mode

- A combination of any two IPA® or Double IPA® Amplifiers can be connected
- Up to 16 input channels are supported



SYSTEM REQUIREMENTS SUTTERPATCH®

■ Computer Hardware

For IPA Family Systems:

Minimum Configuration

Windows 7 or later: 64-bit versions, or
Mac OS X 10.11 (El Capitan) or later
Processor: Dual-core i5
Memory: 3 GB
Hard Disk: 500 GB or greater
Display Resolution: 1024 x 768 (XGA)
1 available USB 2.0 High-speed port

Recommended Configuration

Windows 10 or later: 64-bit versions, or
Mac OS X 10.11 (El Capitan) or later
Processor: Dual-core i5
Memory: 8 GB
Solid-state drive (SSD), 500 GB or greater
Display Resolution: 1920 x 1080 (Full HD)
1 available USB 2.0 High-speed port

For dPatch® Systems:

Minimum Configuration

Windows 10 or later: 64-bit versions, or
Mac OS X 10.11 (El Capitan) or later
Processor: Dual-core i5
Memory: 6 GB
Solid-state Drive (SSD), 500 GB or greater
Display Resolution: 1024 x 768 (XGA)
1 available USB 3.0 SuperSpeed port
(on the main board, not a PCIx card or similar)

Recommended Configuration for Bandwidths of >50 kHz

Windows 10 or later: 64-bit versions, or
Mac OS X 10.11 (El Capitan) or later
Processor: Dual-core i5
Memory: 16 GB
Solid-state Drive (SSD), 500 GB or greater
Display Resolution: 1920 x 1080 (Full HD)
1 available USB 3.0 SuperSpeed port
(on the main board, not a PCIx card or similar)



SUTTERPATCH®

U.S. prices available at www.sutter.com. International prices vary by country. Contact a distributor or Sutter Instrument for a quotation. Prices subject to change without notice.

■ **SUTTERPATCH** Data Acquisition Management System and Analysis Software

Included with all Sutter Amplifier Systems

Notes:

USB 3.0 ports are compatible with USB 2.0 High-speed specifications.

To check for High-speed USB 2.0 or USB 3.0 SuperSpeed on a PC computer running Windows, look in the Control Panel > Device Manager > Universal Serial Bus controllers section for "Enhanced" host controllers. As this does not provide any mapping information to the computer's physical ports, and there can be a mix of USB port versions, you should check individual USB ports for USB 2.0/3.0 operational performance. As a visual indicator, USB 3.0 ports are often color blue.

USB hubs are not supported. USB add-in cards, even if they formally meet USB 2.0 or 3.0 specifications, are not recommended. They are often architecturally configured as USB hubs and may lead to intermittent transfer errors that are hard to troubleshoot.

Operating systems installed within virtualization software platforms such as VMware and Parallels are not supported.



WAVEMETRICS IGOR PRO

TECHNICAL GRAPHING AND DATA ANALYSIS

SOFTWARE FOR SCIENTISTS AND ENGINEERS

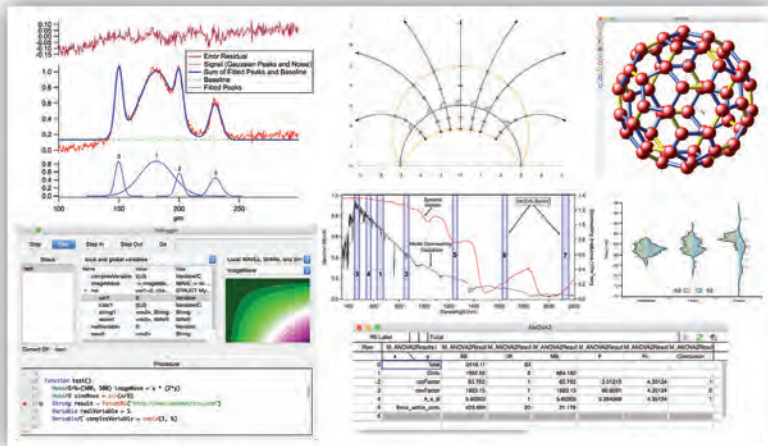

FEATURES IGOR PRO

- Handles large data sets very quickly
- Produces and exports high-resolution, journal quality scientific graphs in EPS and PDF
- Includes a wide range of capabilities for scientific and engineering analysis and simulation
- Easily create custom applications using Igor's built-in programming environment
- Extend Igor's programming language using external code (XOPs) written in C
- Includes extensive image processing tools for image filtering, manipulation and graphing
- Imports data in many formats and can acquire data from hardware devices
- Uses Unicode to support foreign languages and mathematical symbols
- Includes Igor Filter Design Laboratory for interactive design of FIR and IIR digital filters
- Responsive, user-acclaimed technical support



Product Description

Igor Pro is an interactive software environment for experimentation with scientific and engineering data and for the production of publication-quality graphs and page layouts. Igor has been used by tens of thousands of technical professionals since its introduction in 1989.

Igor Pro combines powerful tools with an easy to use, point and click interface for the casual user together and a programming environment for the sophisticated user. Igor Pro's plugin technology extends the built-in functionality with custom tools for data acquisition, instrument control and computational tasks.

The latest Igor Pro 9 release contains hundreds of improvements, including built-in support for HDF5, 24 new functions and 34 new operations.

Igor Pro is an excellent tool for:

- **Graphics Creation** - Igor Pro is first and foremost a publication quality scientific and engineering graphics program, capable of creating visually stunning 3D graphics as well as 2D graphs
- **Data Access** - Scientists and engineers encounter many data formats. Igor Pro provides a variety of import, storage and export capabilities that can handle almost any requirement.
- **Data Storage** - Unlike spreadsheet programs, Igor Pro's data objects won't clutter up your screen. Efficiently organize your data into a hierarchy, just like you would organize files in a hierarchy of folders on your hard drive!
- **Data Manipulation & Math** - Igor Pro provides an extensive library of math and data manipulation routines and Igor's array-oriented arithmetic make complex operations a snap.
- **Image Processing** - Igor Pro contains a full set of operations and functions for scientific image analysis applications.
- **Data Analysis** - Igor provides many analysis capabilities, including curve fitting, peak analysis, signal processing and statistics.
- **Analysis of Function** - Igor includes several operations that work on functions rather than discrete data points, including: plotting of functions, differential equations, numerical integration of functions, root finding and optimization.

Programming

Igor Pro includes a powerful and full-featured structured programming language that you can use for automation of data import, file I/O, analysis, data acquisition, graphing, drawing, printing, and just about anything you can think of.

Igor's full-featured symbolic debugger gives you a powerful tool to get your code working properly by observing it execute one step at a time. You can view multidimensional waves as images and 1D waves in a regular graph. You can also view waves in a table and values edited in place.



IGOR PRO 9

Single-seat licenses and upgrades are available through Sutter Instrument. For multi-seat, student, academic and coursework licenses, please contact WaveMetrics Sales by email or phone: sales@wavemetrics.com; +1 503-620-3001

- **IGOR-9** Igor Pro 9 single-seat license
- **IGOR-9UP** Igor Pro 9 upgrade from version 8; please provide your serial number with the order
- **IGOR-9UP-7** Igor Pro 9 upgrade from version 7 or older; please provide your serial number with the order



MICROMANIPULATION

Sutter began making micromanipulators in 1985 with the MP-85, a refined version of the venerable Huxley-style manipulator. Seeing the potential of stepper motors, Sutter went on to develop the MP-285, our first stepper-driven micromanipulator. Both the MP-285 and MP-225 use stepper motors with a cable drive design. These have been proven over the last 25 years to be very reliable in the field. Both are available with the MPC-200 controller or their original standalone controllers.

More recently, we have developed a new series of manipulators using a lead-screw drive. The 3-axis MP-845 and narrow format MP-865 represent a new family of compact and reliable manipulators that interface with our proven controllers. These new designs offer a more compact footprint which creates additional space for setup and access around your microscope.

These are available with the TRIO™ MPC-100 controller. The narrow format MP-865 is alternatively available with the MPC-200 controller when four or more manipulators are required.

Multiple motorized manipulators can be controlled with the MPC-100 and MPC-200 controllers. The MPC-100 controller is an inexpensive, all-in-one controller capable of operating two of our MP-845 or MP-865 series manipulators. The MPC-200 controller will control two of our MP-285 or MP-225 motorized manipulators and can be **expanded** to run four manipulators off a single ROE-200 input device. These highly flexible solutions allow the user to add components to their system in the future as needed.



The QUAD® adds a motorized 4th axis to the MP-845 to move the pipette coaxially at the desired angle. This choice is perfect for users that need a true diagonal. The compact ROE and controller-in-one is easy to use, has built-in robotic capabilities and a USB port to program more complicated moves.

The TRIO™-235 eliminates the Z-axis in favor of an adjustable diagonal. This X-Y-D design is preferred by some as it makes for a very compact setup. Our TRIO-235 controller is capable of synthesizing an artificial Z-axis, in much the same way our 3-axis manipulators synthesize a diagonal.

Stages, Stands & Translators

Mounting options include manipulator platforms that bolt directly to the frames of the most popular microscopes, and rock-steady, free-standing platforms that support the manipulators by clamping to the table beside the microscope. Our MT-70 stand, originally designed for stable support of the fifteen-pound Huxley manipulator, and the MT-75 gantry-style stand, are perfect free-standing columns for our manipulators. We have also designed the MD series microscope-specific platforms that bolt directly to the bodies of the most popular Olympus, Leica, Nikon, and Zeiss inverted microscopes. These platforms lend themselves to the low-drift recording configuration required when using Sutter manipulators for positioning patch-electrodes onto attached cells in culture.



The 3DMS, 3-Dimensional Motorized Stage, was designed for experiments that require rapid movement of a chamber or culture dish to multiple locations in a compact space. Two axes provide X-Y translation and the third axis provides built-in focusing with sub-micron accuracy. The 3DMS offers robotic programmability of complex motion sequences when used with the MP-285 controller.

A task specific platform for manipulators is the MT-1000 translation system. When coupled with Sutter manipulators, the system forms a slice-patch workstation. The MT-1000 was born out of a technique now common in slice recording that moves the optical pathway while keeping the slice chamber and recording electrodes fixed. The translation system allows the user to move to multiple locations on the tissue at high resolution without disturbing recording electrodes. The MT-1000 workstation encompasses: an X-Y translator designed to move a microscope smoothly and accurately; two MT-75 gantry-type stands for positioning manipulators on one or both sides of the microscope; and a third gantry stand that becomes the fixed support for the chamber. The MT-2000 uses a motorized X-Y translator. In this design, stepper-motor driven lead-screws provide smooth movement of the microscope.

Sutter's large motorized platform stages, the MP-78 and MPC-78, are perfect for multi-site experiments where the microscope cannot be translated, and a wide field of view is necessary. The MT-78-FS large fixed-stage platform provides the same generous mounting surface for experiments dependent on X-Y translation.

Rounding out our company's line of manipulators is the MIM-33 manual micromanipulator, an economical micromanipulator of sufficient resolution and control for impaling xenopus oocytes and other medium-fine manipulation tasks.



TRIO™ MPC-165 System

3-AXIS NARROW-FORMAT MANIPULATOR SYSTEM



(Shown: MPC-165-2 with optional IPA headstage)

FEATURES TRIO™ MPC-100 CONTROLLER

- Controls one or two manipulators
- Sub-micron (less than 100 nm) resolution
- User selectable angle from 0 - 90 degrees via ROE input
- Fast movement with a top speed of 3 mm/sec (while homing)
- Compact, fanless, user-friendly ROE controller preserves bench and rack space
- Push button control of multiple functions - WORK, HOME, LOCK, PULSE and RELATIVE
- DIP switches on ROE select direction of movement produced by turn of ROE knob
- USB interface for computer control

FEATURES MP-865 MECHANICAL

- Mechanically robust construction for high stability
- Precision cross-roller bearings
- Three independent axes - 50 mm travel in X, 12.5 mm in Y and 25 mm in Z
- Carries up to a kilogram
- Suited for *in vitro* and *in vivo* electrophysiological recording
- Universal mounting system for headstage or pipette holder
- Optional MT-73 narrow stand with linear slide and built in rotating base



The MPC-165 System consists of the MPC-100 controller and an MP-865 narrow-format micromanipulator.

Our new MP-865 "narrow format" mechanical is designed specifically for patch-slice work that require multiple pipettes, as well as for other setups where space is limited. We designed the MP-865 to minimize the width, allowing as many manipulators to be grouped together as possible. Travel in the Y-axis is shortened (12.5 mm) because radially oriented manipulators do not require long travel in the traverse axis. Travel in the X-axis has been increased to 50 mm to facilitate fast and easy pipette exchange. Built with the same precision cross-roller bearings and lead-screw as the MP-845 design.

The optional narrow-format tower with linear slide, or rotating base, can be added for mounting the MP-865 mechanical. With the 150 mm throw of the linear slide, the manipulator can be quickly and smoothly retracted out to a location where there is easy access to the pipette for replacement. A rotating base can be used for mounting to large platform stages like the Sutter MT 78, or smaller Sutter MD Series platforms.

The compact design of the TRIO MPC-100 integrated Rotary Optical Encoder (ROE) controller requires minimal bench space; provides quiet, fan-free operation; and is easy to use. No rack mounted controller is required. Position coordinates, in relative or absolute values, are displayed directly on the ROE. The TRIO manipulators use a logarithmic acceleration algorithm that eliminates the need for speed selection. As the knobs on the ROE are turned faster, acceleration ramps up. This allows for smooth and intuitive motion control of electrode position without the need to stop and change speeds or lift your hand from the knobs. A Y-axis lockout function (accessible by DIP switch) is also available, allowing X/Z-only axial movement during HOME and WORK repositioning. Each MPC-100 can control up to two MP-865 manipulators

Five conveniently located buttons control all the functions you will need in normal operation. Press and hold the [WORK] button to quickly store a work position; pressing [WORK] after this will return the manipulator to the same location. [HOME] sends the manipulator to a second position, often set for a point furthest from the microscope, which is useful for rapid pipette exchange. Pressing [SPEED] allows the selection of one of 4 speed ranges. With practice, there is no need to ever change speeds, however, we have included three low speed ranges for those who work at very high magnification. Holding [SPEED] for three-seconds will lock the knobs out, to prevent accidental movement. Display coordinates can toggle between relative and absolute by pressing the [RELATIVE] button; holding the button down will zero the relative coordinates. Finally, [PULSE] activates a pulse movement mode that produces small, rapid bursts of motion that can be advantageous for cell penetration with sharp electrodes. Hold [PULSE] for three-seconds to set or modify the 4th axis angle between 0 and 90 degrees.

Designed with maximum flexibility in mind, a DIP switch on the controller changes the directional movement of the ROE knobs to accommodate the preference of the user. The TRIO comes standard with a universal mounting system suitable for the most popular headstages or pipette holders.

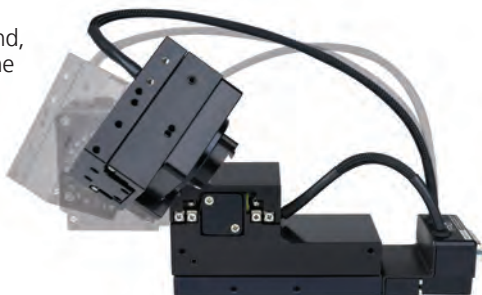



SPECIFICATIONS TRIO MPC-165 SYSTEM

- **Resolution and Full Travel** Minimal microstep size is 46.88 nanometers per microstep
Display has single micron resolution
Full travel is 50 mm in X, 25 mm in Z and 12.5 mm in Y
- **Maximum Speed** 3 mm/sec
- **Long Term Stability** <1.0 micron/4 hr
- **Dimensions** *Controller (TRIO MPC-100):*
6.25 in x 8.0 in x 5.9 in / 15.9 cm x 20.3 cm x 10.2 cm
- **Weight** *Manipulator (MP-865 - aluminum):*
3.5 lbs / 1.6 kg
TRIO MPC-100 Controller:
2.3 lbs / 1.04 kg
- **Electrical** 115/230 Volts
50/60 Hertz power line



MECHANICAL DRAWINGS OF THE MP-865/M

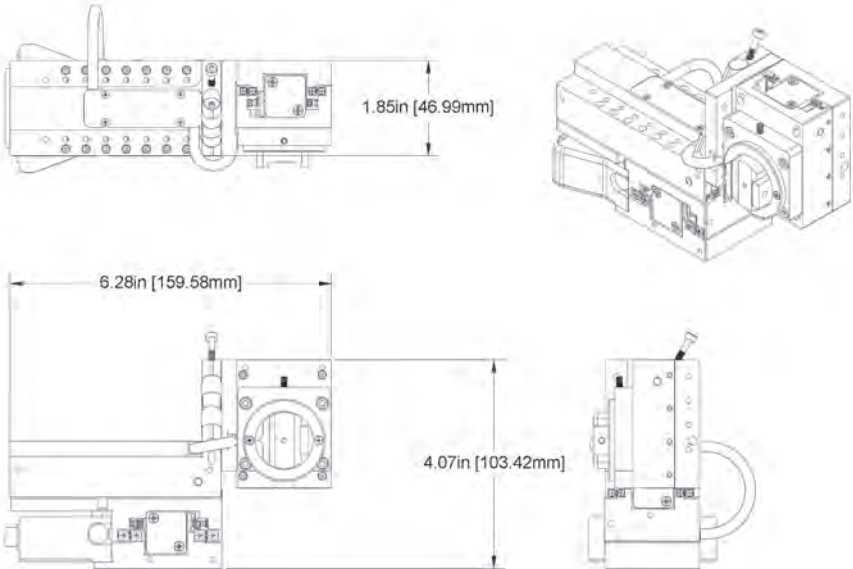



TRIO MPC-165 SYSTEM

U.S. prices available at www.sutter.com. International prices vary by country. Contact a distributor or Sutter Instrument for a quotation. Prices subject to change without notice.

- **MPC-165^{1,2}** One TRIO™ MPC-100 controller, one MP-865/M manipulator mechanical, mounting adapter plate, rod holder, 4 inch dovetail extension, cables, power cord and manual.
 - **MPC-165-2^{1,2}** MPC-165 with two MP-865/M mechanicals.
-

COMPONENTS TRIO MPC-165 SYSTEM

- **MP-865/M³** The MP-865 manipulator mechanical alone. Includes mounting adapter plate, rod holder, 4 inch dovetail extension, and cable to connect manipulator to controller.
-

ACCESSORIES TRIO MPC-165 SYSTEM

- **MT-73⁴** Narrow format stand with linear slide
- **MT-74** Narrow format stand (no linear slide)
- **MAG-MT74** Magnetic feet for MT-74 (set of two)
- **265RBI⁵** Rotating base for MP-865
- **M100106** Flat side panel for MPC-200 controller (each)
- **MP-RISER-0.5⁶** 1/2 inch riser
- **MP-RISER-1.0⁶** 1 inch riser
- **MP-CLIP⁷** Rod holder (for rod OD 6.25 mm or larger)
- **MP-ROD** Rod holder (for rod OD 6.25 mm or larger)
- **EHOLDER** Micropipette holder – 1.0-1.5 mm glass

¹ Indicate right- or left-handed setup when ordering.

² Order with a translator or moving stage and receive a discount.

³ Indicate right- or left-handed setup when ordering

⁴ Suitable for upright scopes

⁵ Useful with Sutter MD stand and large platform stages such as the MT-87-FS, MP-78 and MPC-78

⁶ Risers can be combined to achieve desired height

⁷ Suitable for multi-electrode probes



(Shown: Height-adjustable MT-73 stand)



(Shown: 265RBI rotating base)



MOUNTING SYSTEMS

U.S. prices available at www.sutter.com. International prices vary by country. Contact a distributor or Sutter Instrument for a quotation. Prices subject to change without notice.

MT-1004 Systems

Includes the MT-500 manual X-Y translator, MT-150 chamber column, two MT-74 micromanipulator columns (without linear slide)

- **MT-1004/Y51'** MT-1004 for the Olympus BX51WI
- **MT-1004/Y53'** MT-1004 for the Olympus BX53/63
- **MT-1004/Y71'** MT-1004 for the Olympus IX71
- **MT-1004/Z25'** MT-1004 for the Zeiss Axioskop 2 FS
- **MT-1004/Z45'** MT-1004 for the Zeiss Axio Examiner
- **MT-1004/N65'** MT-1004 for the Nikon FN1
- **MT-1004/L30'** MT-1004 for the Leica DMLFS
- **MT-1004/L35'** MT-1004 for the Leica DM6000 FS

MT-2004 Systems

Includes the MT-800 motorized X-Y translator, MP-285A controller and ROE, MT-150 chamber column, two MT-74 micromanipulator columns (without linear slide), cables, and manual

- **MT-2004/Y51'** MT-2004 for the Olympus BX51WI
- **MT-2004/Y51/FD^{1,2}** MT-2004 with focus drive for the Olympus BX51WI
- **MT-2004/Y53'** MT-2004 for the Olympus BX53/63
- **MT-2004/Z25'** MT-2004 for the Zeiss Axioskop 2 FS
- **MT-2004/Z45'** MT-2004 for the Zeiss Axio Examiner
- **MT-2004/N65'** MT-2004 for the Nikon FN1
- **MT-2004/L30'** MT-2004 for the Leica DMLFS
- **MT-2004/L35'** MT-2004 for the Leica DM6000 FS

MT-2204 Systems

Includes the MT-800 motorized X-Y translator, MPC-200 controller, ROE-200, MT-150 chamber column, two MT-74 micromanipulator columns (without linear slide), cables, and manual

- **MT-2204/Y51'** MT-2204 for the Olympus BX51WI
- **MT-2204/Y51/FD^{1,2}** MT-2204 with focus drive for the Olympus BX51WI
- **MT-2204/Y53'** MT-2204 for the Olympus BX53/63
- **MT-2204/Z25'** MT-2204 for the Zeiss Axioskop 2 FS
- **MT-2204/Z45'** MT-2204 for the Zeiss Axio Examiner
- **MT-2204/N65'** MT-2204 for the Nikon FN1
- **MT-2204/L30'** MT-2204 for the Leica DMLFS
- **MT-2204/L35'** MT-2204 for the Leica DM6000 FS

¹ Please specify chamber type when ordering.

² Please contact Sutter for availability of focus drive on other microscope makes & models



(Shown: MPC-365 with optional MT-73 stand and dPatch® headstage)

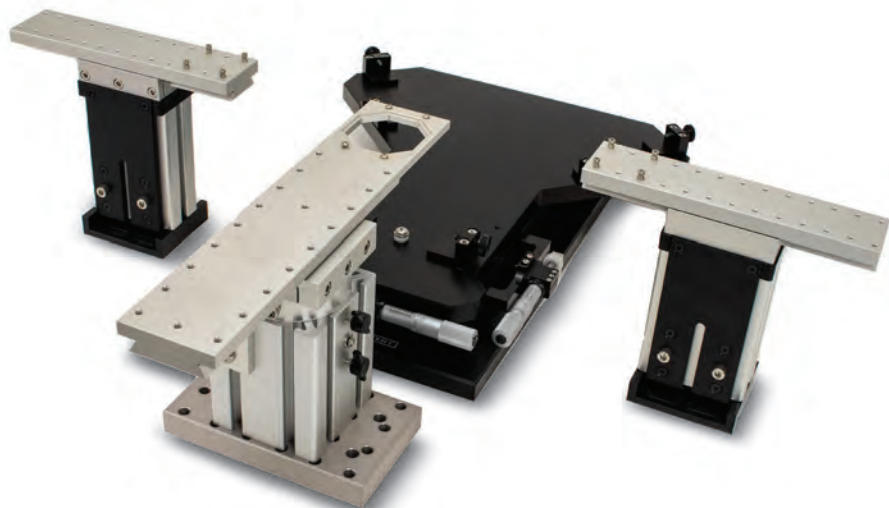

(Shown: MT-1004 system)





TRIO™ MPC-145 System

3-AXIS 0-90 DIAGONAL MICROMANIPULATOR SYSTEM



(Shown: TRIO MPC-145-2 with optional dPatch® headstage)

FEATURES TRIO™ MPC-100 CONTROLLER

- Controls one or two manipulators
- Sub-micron (less than 100 nm) resolution
- User selectable angle from 0 - 90 degrees via ROE input
- Fast movement with a top speed of 3 mm/sec (while homing)
- Compact, fanless, user-friendly, ROE controller preserves bench and rack space
- Push button control of multiple functions – WORK, HOME, LOCK, PULSE, RELATIVE, SPEED & ANGLE
- DIP switches on ROE select direction of movement produced by turn of ROE knob
- USB interface for computer control

FEATURES MP-845 MECHANICAL

- Now also available in thermally stable stainless steel
- Mechanically robust construction for high stability
- Precision cross-roller bearings
- Three independent axes – 25 mm orthogonal travel in X, Y and Z
- Carries up to a kilogram
- Suited for *in vivo* and *in vitro* electrophysiological recording
- Universal mounting system for headstage or pipette holder



The MPC-145 System consists of the MPC-100 controller and an MP-845 micromanipulator.

The new MP-845 micromanipulator features construction based on the lead screw design of the TRIO-245, but with the addition of precision cross-roller bearings for even tighter tolerances. A 25 pin connector insures future compatibility with our other controllers. Available in aluminum or stainless steel (see Stainless MP-845 tab above) the MP-845 is a highly stable 3-axis manipulator with 25 mm of travel on each axis. The TRIO MPC-100 controller gives the MP-845 a synthetic 4th axis that can be set in software to any angle between 0 and 90 degrees for diagonal movement. Based on a lead-screw design with a smaller overall size and footprint than most manipulators, the MP-845 is ideal for applications that require 2 pipettes in one setup or for setups where space is limited.

The compact design of the integrated Rotary Optical Encoder (ROE) controller requires minimal bench space; provides quiet, fan-free operation; and is easy to use. No rack mounted controller is required. Position coordinates, in relative or absolute values, are displayed directly on the ROE. The TRIO MPC-100 uses a logarithmic acceleration algorithm that eliminates the need for speed selection. As the knobs on the ROE are turned faster, acceleration ramps up. This allows for smooth and intuitive motion control of electrode position without the need to stop and change speeds or lift your hand from the controller. When not moving, the motors are powered down, reducing electrical noise in the system to unmeasurable levels which keeps the motors cool to eliminate thermal drift.

Five conveniently located buttons control all the functions you will need in normal operation. Press and hold the [WORK] button to quickly store a work position; pressing [WORK] after this will return the manipulator to the same location. [HOME] sends the manipulator to a second position, often set for a point furthest from the microscope, which is useful for rapid pipette exchange. Pressing [SPEED] allows the selection of one of 4 speed ranges. With practice, there is no need to ever change speeds, however, we have included three low speed ranges for those who work at very high magnification. Holding [SPEED] for three-seconds will lock the knobs out, to prevent accidental movement. Display coordinates can toggle between relative and absolute by pressing the [RELATIVE] button; holding the button down will zero the relative coordinates. Finally, [PULSE] activates a pulse movement mode that produces small, rapid bursts of motion that can be advantageous for cell penetration with sharp electrodes. Hold [PULSE] for three-seconds to set or modify the 4th axis angle between 0 and 90 degrees.

Designed with maximum flexibility in mind, a DIP switch on the controller changes the directional movement of the ROE knobs to accommodate the preference of the user. A Y-axis lockout function (accessible by DIP switch) is also available, allowing X/Z-only axial movement during HOME and WORK repositioning. The TRIO comes standard with a universal mounting system suitable for the most popular headstages or pipette holders.



The MP-845 manipulator is now also available in stainless steel! The standard version of the MP-845 has virtually no drift in its motor and bearing assemblies. The last remaining hurdle is that of thermal drift caused by the expansion and contraction of the aluminum body of the manipulator. By utilizing a stainless steel with very low coefficient of expansion, the MP-845S is simply the lowest drift manipulator available on the market. The added mass of the stainless steel body has the additional benefit of dampening out vibration, giving the stainless steel MP-845S the silkiest movement of any manipulator.

Because low expansion stainless steels do have some ferric content, the stainless MP-845S is PVD coated in titanium nitride, giving it its distinctive gold color. This coating will ensure that the stainless TRIO will resist corrosion caused by exposure to salt solutions in a lab environment.



(TRIO MP-845S)

SPECIFICATIONS TRIO™ MPC-145 SYSTEM

- **Travel** *MP-845/MP-845S: 25 mm on X, Y and Z axes*
- **Long Term Stability**
 Aluminum
 <1.0 micron in 4 hours
 Stainless Steel
 <0.5 micron in 24 hours
- **Control Box Dimensions** *TRIO MPC-100:*
6.25 in x 8 in x 5.9 in (15.9 cm x 20.3 cm x 10.2 cm)
- **Weight**
MP-845 Manipulator (aluminum):
 3.5 lbs (1.6 kg)
MP-845 Manipulator (Stainless Steel):
 7.7 lbs (3.5 kg)
TRIO MPC-100 Controller:
 2.3 lbs (1.04 kg)
- **Electrical** 115/230 Volts
50/60 Hertz power line





TRIO™ MPC-145 SYSTEMS

U.S. prices available at www.sutter.com. International prices vary by country. Contact a distributor or Sutter Instrument for a quotation. Prices subject to change without notice.

ALUMINUM

- **MPC-145** One TRIO MPC-100 controller, one MP-845 manipulator mechanical, mounting adapter plate, rod holder, hinged headstage mount, 4 inch dovetail extension, manipulator connecting cables, power cord and manual (please specify right- or left-handed)
- **MPC-145-2** TRIO MPC-145 with two MP-845 manipulator mechanicals (please specify right- or left-handed)

STAINLESS STEEL

- **MPC-145S** One MP-845S manipulator mechanical in stainless steel, one TRIO MPC-100 controller, mounting adapter plate, rod holder, hinged headstage mount, 4 inch dovetail extension, manipulator connecting cables, power cord and manual (please specify right- or left-handed)
- **MPC-145S-2** TRIO MPC-145 with two stainless steel MP-845S mechanicals (please specify right- or left-handed)

FIXED STAGE PLATFORM

- **MT-78-FS** Fixed platform stage with imperial/standard holes, chamber insert and gantry supports
- **MT-78-FS/M6** Same as above with M6 tapped holes

MANIPULATOR COLUMNS

- **MT-75** Standard gantry stand 8.7 to 13.4 in (22.1 to 33.9 cm)
- **MT-75S** Short gantry stand 6.7 to 9.6 in (16.9 to 24.4 cm)
- **MT-75T** Tall gantry stand 10.7 to 15.4 in (27.1 to 39.1 cm)
- **MT-75XT** Extra tall gantry stand 14.7 to 18.5 in (37.4 to 47 cm)

For detailed information on mounting our micromanipulators, refer to the Mounting Systems section or phone for assistance.

COMPONENTS TRIO™ MPC-145 SYSTEMS

For those customers wishing to add a second manipulator

- **MP-845-M** MP-845 manipulator mechanical alone - Includes mounting adapter plate, rod holder, 4" dovetail extension, hinged headstage mount and cable to connect manipulator to controller.
- **MP-845-S-M** MP-845 stainless steel manipulator mechanical alone - Includes mounting adapter plate, rod holder, 4 inch dovetail extension, hinged headstage mount and cable to connect manipulator to controller.



ACCESSORIES TRIO™ MPC-100 / MPC-145

- **285204** 4 inch dovetail extension
- **265210**¹ Mounting adapter plate
- **225RBI** Rotating base for TRIO
- **221165** Z-axis vertical extension
- **BR-AW** Rod clamp for XenoWorks® injectors (for rod OD 2 to 4 mm)
- **BR-AW-L** Long rod clamp for XenoWorks injectors (for rod OD 2 to 4 mm)
- **MP-RISER-0.5**² 1/2 inch riser
- **MP-RISER-1.0**² 1 inch riser
- **MP-CLIP**³ Rod holder (for rod OD 1 to 4 mm)
- **MP-ROD** Rod holder (for rod OD 6.25 mm or larger)
- **EHOLDER** Micropipette holder – 1.0-1.5 mm glass

¹ For use with MT and MD series stands and platforms, or any surface with 1 inch or 25 mm centered holes

² Risers can be combined to achieve desired height.

³ Suitable for multi-electrode probes.

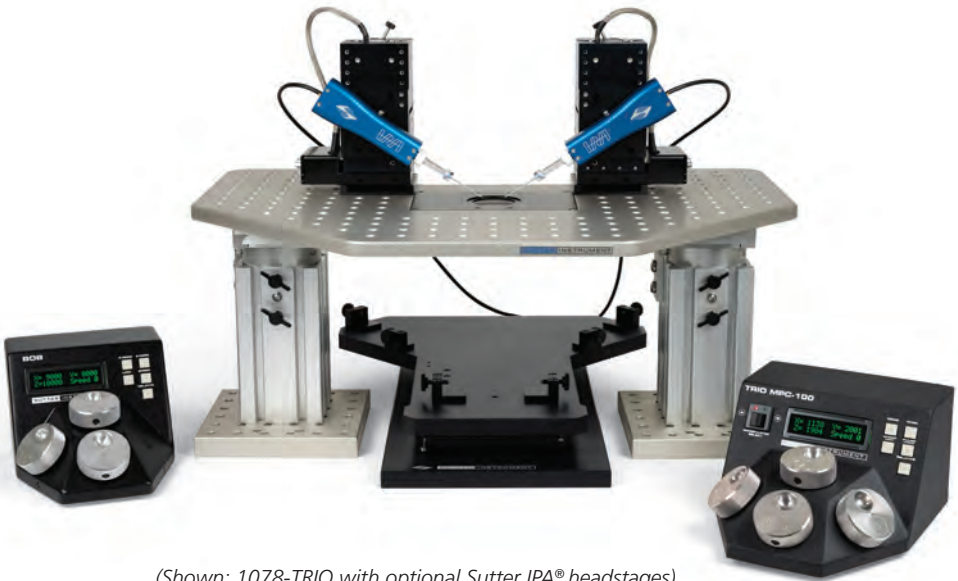

(Shown: 1078-TRIO with optional Sutter IPA® headstages)



TRIO™ BUNDLED SYSTEMS

U.S. prices available at www.sutter.com. International prices vary by country. Contact a distributor or Sutter Instrument for a quotation. Prices subject to change without notice.

MICROSCOPE MODELS - Use this scope suffix when ordering

Z25	Zeiss Axioskop 2 FS	Y51	Olympus BX51WI
Z45	Zeiss Axio Examiner	Y53	Olympus BX53/63
N65	Nikon FN1		
L30	Leica DM LFS		
L35	Leica DM6000 FS, DM6 FS		

BUNDLED SYSTEMS

SAN FRANCISCO

MANUAL – MT-1000 with manual X-Y translator, micromanipulators

Includes 2 motorized TRIO micromanipulators, one MPC-100 controller, one MT-500 manual X-Y translator, one MT-150 chamber column, two micromanipulator stands (without linear slide)

- **1000-TRIO-(scope suffix)** With TRIO MPC-145-2
- **1000-TRIO-S-(scope suffix)** With TRIO MPC-145S-2 stainless steel

MOTORIZED - MT-2800 with motorized X-Y translator, micromanipulators

Includes TRIO MPC-145-2 system with 2 motorized micromanipulators, the MT-800 motorized X-Y translator, BOB controller, one MT-150 chamber column, two micromanipulator stands (without linear slide)

- **2800-TRIO-(scope suffix)** With TRIO MPC-145-2
- **2800-TRIO-S-(scope suffix)** With TRIO MPC-145S-2 stainless steel

ALCATRAZ

MANUAL – MT-1078 with manual X-Y translator, micromanipulators

Includes motorized TRIO micromanipulators, one MPC-100 controller, the MT-500 manual X-Y translator, one MT-78-FS fixed stage platform and insert

- **1078-TRIO-(scope suffix)¹** With TRIO MPC-145-2
- **1078-TRIO-S-(scope suffix)¹** With TRIO MPC-145S-2 stainless steel

MOTORIZED - MT-2878 with motorized X-Y translator, micromanipulators

Includes TRIO MPC-145-2 system with 2 motorized micromanipulators, the MT-800 motorized X-Y translator, BOB controller, one MT-78-FS fixed stage platform and insert

- **2878-TRIO-(scope suffix)¹** With TRIO MPC-145-2
- **2878-TRIO-S-(scope suffix)¹** With TRIO MPC-145S-2 stainless steel

¹ Specify insert type when ordering



TRIO™-245 3-AXIS DIAGONAL MICROMANIPULATOR SYSTEM



(TRIO-245 shown with Sutter IPA® headstage (not included))

FEATURES TRIO™-245

- Three independent axes – 25 mm orthogonal travel in X, Y and Z
- Software-based Diagonal axis in any user selectable angle (0 - 90 degrees)
- Sub-micron (less than 100 nm) resolution
- Fast movement with a top speed of 3 mm/sec (while homing)
- Mechanically robust construction for high stability
- Compact, fanless, user-friendly, ROE controller preserves bench and rack space
- Carries up to a kilogram
- Push button control of multiple functions – WORK, HOME, LOCK, PULSE, RELATIVE, SPEED & ANGLE
- Suited for *in vivo* and *in vitro* electrophysiological recording
- Universal mounting system for headstage or pipette holder
- DIP switches on ROE select direction of movement produced by turn of ROE knob
- USB interface for computer control



The TRIO™-245 from Sutter Instrument is a highly stable 3-axis manipulator with 25 mm of travel on each axis. The TRIO's synthetic 4th axis can be set in software as any angle between 0 and 90 degrees for diagonal movement. Based on a lead-screw design with a smaller overall size and footprint than most manipulators, the TRIO-245 is ideal for setups where space is limited.

The TRIO-245 controller employs a combination of state-of-the-art software and mechanical design that eliminates the need for the motor to remain powered on during recording, thus eliminating the heating effects of the motors and giving us the electrically quietest manipulators in the industry. This stability ensures that Sutter manipulators will not drift in the middle of experiments.

The compact design of the integrated Rotary Optical Encoder (ROE) controller requires minimal bench space; provides quiet, fan-free operation; and is easy to use. No rack mounted controller is required. Position coordinates, in relative or absolute values, are displayed directly on the ROE. The TRIO manipulators use a logarithmic acceleration algorithm that eliminates the need for speed selection. As the knobs on the ROE are turned faster, acceleration ramps up. This allows for smooth and intuitive motion control of electrode position without the need to stop and change speeds or lift your hand from the knobs. A Y-axis lockout function (accessible by DIP switch) is also available, allowing X/Z-only axial movement during HOME and WORK repositioning.

Five conveniently located buttons control all the functions you will need in normal operation. Press and hold the WORK button to quickly store a work position; pressing WORK after this will return the manipulator to the same location. HOME sends the manipulator to a second position, often set for a point furthest from the microscope, which is useful for rapid pipette exchange. Pressing SPEED allows the selection of one of 4 speed ranges. With practice, there is no need to ever change speeds, however, we have included three low speed ranges for those who work at very high magnification. Holding SPEED for three seconds will lock the knobs out, to prevent accidental movement. Display coordinates can toggle between relative and absolute by pressing the RELATIVE button; holding the button down will zero the relative coordinates. Finally, PULSE activates a pulse movement mode that produces small, rapid bursts of motion that can be advantageous for cell penetration with sharp electrodes. Hold PULSE for three seconds to set or modify the 4th axis angle between 0 and 90 degrees.

Designed with maximum flexibility in mind, a DIP switch on the controller changes the directional movement of the ROE knobs to accommodate the preference of the user. The TRIO comes standard with a universal mounting system suitable for the most popular headstages or pipette holders.



SPECIFICATIONS TRIO™-245

- **Travel** 25 mm on X, Y and Z axes
- **Long Term Stability** <1 micron in 2 hours
- **Control Box Dimensions** 5.5 in x 7.5 in x 4 in (14 cm x 19 cm x 10.2 cm)
- **Weight** 3.5 lbs (1.6 kg)
- **Electrical** 115/230 Volts
50/60 Hertz power line





TRIO™-245

U.S. prices available at www.sutter.com. International prices vary by country. Contact a distributor or Sutter Instrument for a quotation. Prices subject to change without notice.

TRIO™-245

BASIC SYSTEM

Basic systems include the manipulator, controller, rod holder, 4 inch dovetail extension, mounting adapter plate, Z-axis vertical extension, cables, and power supply

- **TRIO-245-L**
- **TRIO-245-R**

3-axis manipulator (X,Y and Z) – left-handed setup
3-axis manipulator (X,Y and Z) – right-handed setup

- **MT-78-FS**

FIXED STAGE PLATFORM

Fixed platform stage with imperial/standard holes, chamber insert and gantry supports
Same as above with M6 tapped holes

- **MT-78-FS/M6**

MANIPULATOR COLUMNS

- **MT-75** Standard gantry stand 8.7 to 13.4 in (22.1 to 33.9 cm)
- **MT-75S** Short gantry stand 6.7 to 9.6 in (16.9 to 24.4 cm)
- **MT-75T** Tall gantry stand 10.7 to 15.4 in (27.1 to 39.1 cm)
- **MT-75XT** Extra tall gantry stand 14.7 to 18.5 in (37.4 to 47 cm)

For detailed information on mounting our micromanipulators, refer to the Mounting Systems section or phone for assistance.

ACCESSORIES TRIO™-245

- **285204** 4 inch dovetail extension
- **285210¹** Mounting adapter plate
- **225RBI** Rotating base for TRIO
- **221165** Z-axis vertical extension
- **BR-AW** Rod clamp for XenoWorks® injectors (for rod OD 2 to 4 mm)
- **BR-AW-L** Long rod clamp for XenoWorks injectors (for rod OD 2 to 4 mm)
- **MP-CLIP²** Rod holder (for rod OD 1 to 4 mm)
- **MP-ROD** Rod holder (for rod OD 6.25 mm or larger)
- **MP-RISER-0.5³** 1/2 inch riser
- **MP-RISER-1.0³** 1 inch riser
- **EHOLDER** Micropipette holder – 1.0-1.5 mm glass

¹ For use with MT and MD series stands and platforms, or any surface with 1 inch or 25 mm centered holes

² Suitable for multi-electrode probes.

³ Risers can be combined to achieve desired height.



MPC-385 SYSTEM

MP-285 BASED

MULTI-MICROMANIPULATOR SYSTEMS

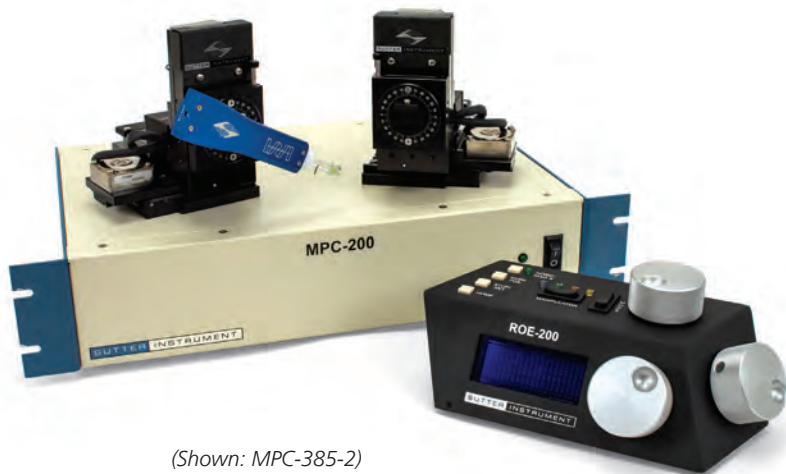

(Shown: MPC-385-2)

FEATURES MPC-385 SYSTEM

- Quietest electronics in the industry. Optimized for single channel recording.
- Single controller and ROE will run two stepper motor drive manipulators
- Self-detecting, daisy-chain capability allows control of four manipulators from one ROE-200
- User-friendly interface: single button access to all major functions
- Easily configurable virtual 4th axis set without external computer
- Accelerated Mode for fast, manual manipulator movement
- Easy toggle selection of Mode (speed/resolution, pulsed diagonal, Accelerated Mode)
- Display indicates X, Y, Z coordinates, Mode, active manipulator
- Robotic HOME and WORK Position moves for easy automated pipette exchange
- Faster robotic moves than previous versions
- Definable 4th axis for coaxial pipette movement, angle selected by DIP switches
- Simple USB interface
- Toggle switch selects which manipulator is connected to input device
- LED and display indicate active manipulator
- Ultra-low drift, ultra-smooth movement
- Low-drift mechanical stability



Neurobiological experiments are becoming more complex. Many require multiple manipulators with control units that quickly become space and/or cost prohibitive. The MPC-200 is the solution you have been asking for. A single controller capable of running 2 manipulators! Sutter Instrument has taken the simplicity of the MP-225 controller and expanded it to run two manipulators from a single controller/ROE. The MPC-200 works with our world-renowned mechanicals, the MP-285 (MPC-385), MP-225 (MPC-325) or narrow format MP-865 (MPC-365).

If two manipulators aren't enough, a second controller can be daisy-chained to allow the single ROE-200 to move up to four manipulators. Thus the system can be easily expanded to control highly sophisticated experiments.

The Sutter MPC-200 is electrically quiet. Unique to the MPC-200 is our multi-unit controller which employs linear output circuitry to minimize electrical noise. Sutter adds additional manipulators to the same controller without requiring potentially noisy chopper drives.

In all of our manipulators, the 4th axis can be set up and changed without the need to connect an external computer and download and configure software. A separate configuration is allowed for each output on this manipulator controller. If desired, each manipulator can approach the preparation at a different angle from the horizontal. The 4th axis can be configured between the X and Z axes or the Y and Z axes (useful when manipulator is rotated 90 degrees relative to the preparation).

Faster automated pipette exchange

The MPC-200 has faster "Home" and "Work Position" moves for quicker pipette exchange. Automation is set up and run via the same interface used in the MP-225 controller; however, the speeds of the automated movement are much faster.

Accelerated manual mode

For users who prefer manual pipette exchange we have added "Accelerated Mode" to the ROE. Using Accelerated Mode, the user can make quick manual moves in and out of a setup. Accelerated Mode amplifies the speed attainable in a manual move by smoothly accelerating to the maximum speed during sustained, fast turns of the ROE. Accelerated movement ends as soon as the user stops turning the knob. This mode can be fully disabled for those who feel the need for direct control of the pipette.

MP-285 MICROMANIPULATOR

One of the first in our line of precision motorized micromanipulators, the MP-285 mechanical offers advanced features found in manipulators costing thousands more. Custom engineered stepping motors, precision cross-roller bearing slides and



proprietary worm gear capstan drives form the basis of the watch-like mechanical system. Pipette holders and headstages are securely mounted to the MP-285 with one of our several unique and rigid mounting systems.

The extremely low backlash of the MP-285 removes traditional drawbacks of “open loop” technology and eliminates drift. This allows submicron resolution down to 0.2 microns in the coarse range and down to 63 nanometers in the fine range. With over 1 inch of motorized travel on all three axes, and a user designated 4th axis, the MP-285 allows tremendous range of motion while maximizing resolution.

Additional components can be added at any time, allowing the user to develop a system tailored to his or her particular needs. The controller is self-detecting so there is no need for manual configuration of the components.



SPECIFICATIONS MPC-385 SYSTEM

- **Resolution and Full Travel** Minimal microstep size is 62.5 nanometers per microstep. Display has single micron resolution. Full travel is 25 mm in each axis.
- **Maximum Speed** MP-285 *mechanical*
5 mm/sec.
- **Long Term Stability** <1.0 micron in 4 hours

DIMENSIONS

- **Controller** 15.75 in x 10.75 in x 3.5 in
40 cm x 27.3 cm x 9 cm
- **ROE** 10 in x 6 in x 4 in
25.4 cm x 15.2 cm x 10.2 cm

WEIGHT

- **Controller** 6.5 lbs
3 kg
- **ROE** 3.5 lbs
1.6 kg
- **Electrical** 115/230 Volts
50/60 Hertz power line





MPC-385 SYSTEM

U.S. prices available at www.sutter.com. International prices vary by country. Contact a distributor or Sutter Instrument for a quotation. Prices subject to change without notice.

- **MPC-385¹** One MP-285 manipulator mechanical, one MPC-200 controller and one ROE-200. Also includes mounting adapter plate, rod holder, hinged headstage mount, 4 inch dovetail extension, manipulator and ROE connecting cables, power cord and manual.
- **MPC-385-2¹** MPC-385 with two MP-285 mechanicals.
- **MPC-385-3¹** MPC-385 with three MP-285 mechanicals, and two MPC-200 controllers.
- **MPC-385-4¹** MPC-385 with four MP-285 mechanicals, and two MPC-200 controllers.

¹ Indicate right- or left-handed set-up when ordering



MPC-385 SYSTEM COMPONENTS

U.S. prices available at www.sutter.com. International prices vary by country. Contact a distributor or Sutter Instrument for a quotation. Prices subject to change without notice.

- **MPC-200-ROE** Consists of the MPC-200 controller and ROE-200. This "system" is made available at a special price for those who wish to use previously purchased Sutter manipulators with the newer controller system or to use the MPC-200-ROE to control other devices. Includes cable to connect ROE to controller, power cord and manual.
- **MPC-200** Controller box alone. Purchase this if you intend to daisy-chain two controllers to one ROE-200. In this configuration, up to 4 manipulators can be controlled by a single ROE-200.
NOTE:
This is not a standalone device. In order to function, the MPC-200 must be connected to a second MPC-200 with ROE-200 attached or be connected to its own ROE-200. Includes daisy-chain cable, power cord and manual.
- **ROE-200** This is the ROE alone. Provides user input to one or more MPC-200 controllers. This component is intended for users who have an existing four-manipulator MPC-200 system with a single ROE-200 and wish to split it into two independent two-manipulator systems. Includes cable to connect ROE to controller.
- **MP-285/M'** MP-285 manipulator mechanical alone - Includes mounting adapter plate, rod holder, 4" dovetail extension, hinged headstage mount and cable to connect manipulator to controller.

¹ Indicate right- or left-handed set up when ordering



MPC-385 SYSTEM ACCESSORIES

U.S. prices available at www.sutter.com. International prices vary by country. Contact a distributor or Sutter Instrument for a quotation. Prices subject to change without notice.

- **285204** 4 inch dovetail extension
- **285210¹** Mounting adapter plate
- **285RBI** Rotating base for MP-285
- **285300** Right angle adapter
- **285305** Z-axis vertical extension
- **285310** Z-axis horizontal extension
- **285HEA** Hinged headstage mount
- **M100106** Flat side for controller (each)
- **BR-AW** Rod clamp for XenoWorks[®] injectors (for rod OD 2 mm to 4 mm)
- **BR-AW-L** Long rod clamp for XenoWorks injectors (for rod OD 2 to 4 mm)
- **MP-CLIP²** Rod holder (for rod OD 1 to 4.5 mm)
- **MP-ROD** Rod holder (for rod OD 6.25 mm or larger)
- **EHOLDER** Micropipette holder – 1.0-1.5 mm glass

For detailed information on mounting our micromanipulators, refer to the Mounting Systems section or phone Sutter for assistance.

¹ For use with MT and MD series stands and platforms, or any surface with 1 inch or 25 mm centered holes.

² Suitable for multi-electrode probes.





MPC-365 SYSTEM

NARROW-FORMAT MP-865 BASED MULTI-MICROMANIPULATOR SYSTEMS



(MT-73 stand and dPatch® headstage not included)

FEATURES MPC-365 SYSTEM

- Quietest electronics in the industry. Optimized for single channel recording.
- Single controller and ROE will run two stepper motor drive manipulators
- Self-detecting, daisy-chain capability allows control of four manipulators from one ROE-200
- User-friendly interface: single button access to all major functions
- Easily configurable virtual 4th axis set without external computer
- Accelerated Mode for fast, manual manipulator movement
- Easy toggle selection of Mode (speed/resolution, pulsed diagonal, Accelerated Mode)
- Display indicates X, Y, Z coordinates, Mode, active manipulator
- Robotic HOME and WORK Position moves for easy automated pipette exchange
- Faster robotic moves than previous versions
- Definable 4th axis for coaxial pipette movement, angle selected by DIP switches
- Simple USB interface
- Toggle switch selects which manipulator is connected to input device
- LED and display indicate active manipulator
- Ultra-low drift, ultra-smooth movement
- Low-drift mechanical stability



Neurobiological experiments are becoming more complex. Many require multiple manipulators with control units that quickly become space and/or cost prohibitive. The MPC-200 is the solution you have been asking for. A single controller capable of running 2 manipulators! Sutter Instrument has taken the simplicity of the MP-225 controller and expanded it to run two manipulators from a single controller/ROE. The MPC-200 works with our world-renowned mechanicals, the MP-285 (MPC-385), MP-225 (MPC-325) or narrow format MP-865 (MPC-365).

If two manipulators aren't enough, a second controller can be daisy-chained to allow the single ROE-200 to move up to four manipulators. Thus the system can be easily expanded to control highly sophisticated experiments.

The Sutter MPC-200 is electrically quiet. Unique to the MPC-200 is our multi-unit controller which employs linear output circuitry to minimize electrical noise. Sutter adds additional manipulators to the same controller without requiring potentially noisy chopper drives.

In all of our manipulators, the 4th axis can be set up and changed without the need to connect an external computer and download and configure software. A separate configuration is allowed for each output on this manipulator controller. If desired, each manipulator can approach the preparation at a different angle from the horizontal. The 4th axis can be configured between the X and Z axes or the Y and Z axes (useful when manipulator is rotated 90 degrees relative to the preparation).

Faster automated pipette exchange

The MPC-200 has faster "Home" and "Work Position" moves for quicker pipette exchange. Automation is set up and run via the same interface used in the MP-225 controller; however, the speeds of the automated movement are much faster.

Accelerated manual mode

For users who prefer manual pipette exchange we have added "Accelerated Mode" to the ROE. Using Accelerated Mode, the user can make quick manual moves in and out of a setup. Accelerated Mode amplifies the speed attainable in a manual move by smoothly accelerating to the maximum speed during sustained, fast turns of the ROE. Accelerated movement ends as soon as the user stops turning the knob. This mode can be fully disabled for those who feel the need for direct control of the pipette.

MP-865 MICROMANIPULATOR

Our new MP-865 "narrow format" mechanical is designed specifically for patch-slice work that require more than 2 or 3 pipettes, as well as for other setups where space is limited. We designed the MP-865 to minimize the width, allowing as many



manipulators to be grouped together as possible. Travel in the Y-axis is shortened (12.5 mm) because radially oriented manipulators do not require long travel in the traverse axis. Travel in the X-axis has been increased to 50 mm to facilitate fast and easy pipette exchange.

The optional narrow-format stand and linear slide or rotating base is available for mounting the MP-865 mechanical. With the 150 mm throw of the linear slide, the manipulator can be quickly and smoothly retracted out to a location where there is easy access to the pipette for replacement. A rotating base can be used for mounting to large platform stages like the Sutter MT-78, or smaller Sutter MD Series platforms.

Additional components can be added at any time, allowing the user to develop a system tailored to his or her particular needs. The controller is self-detecting so there is no need for manual configuration of the components.

FEATURES MP-365 MECHANICAL

- Mechanically robust construction for high stability
- Precision cross-roller bearings
- Three independent axes - 50 mm travel in X, 12.5 mm in Y and 25 mm in Z
- Carries up to a kilogram
- Suited for *in vitro* and *in vivo* electrophysiological recording
- Universal mounting system for headstage or pipette holder
- Optional MT-73 narrow stand with linear slide and built in rotating base



SPECIFICATIONS MPC-365 SYSTEM

- **Resolution and Full Travel** Minimal microstep size is 46.88 nanometers per microstep
Display has single micron resolution
Full travel is 50 mm in X, 25 mm in Z and 12.5 mm in Y
- **Maximum Speed** MP-265 *mechanical*
3 mm/sec.
- **Long Term Stability** <1.0 micron in 4 hours

DIMENSIONS

- **MPC-200 Controller** 15.75 in x 10.75 in x 3.5 in
40 cm x 27.3 cm x 9 cm
- **ROE-200** 10 in x 6 in x 4 in
25.4 cm x 15.2 cm x 10.2 cm

WEIGHT

- **MP-865 (aluminum)** 3.5 lbs
1.6 kg
- **MPC-200 Controller** 6.5 lbs
3 kg
- **ROE-200** 3.5 lbs
1.6 kg
- **Electrical** 115/230 Volts
50/60 Hertz power line





MPC-365 SYSTEM

U.S. prices available at www.sutter.com. International prices vary by country. Contact a distributor or Sutter Instrument for a quotation. Prices subject to change without notice.

- **MPC-365¹** One MP-865 manipulator mechanical, one MPC-200 controller and one ROE-200. Also includes mounting adapter plate, rod holder, hinged headstage mount, 4 inch dovetail extension, manipulator and ROE connecting cables, power cord and manual
- **MPC-365-2¹** ROE-200 with MPC-200 and (2) MP-865 mechanicals
- **MPC-365-3¹** ROE-200 with (2) MPC-200 controllers and (3) MP-865 mechanicals
- **MPC-365-4¹** ROE-200 with (2) MPC-200 controllers and (4) MP-865 mechanicals
- **MPC-365-5¹** ROE-200 with (2) MPC-200 controllers and (5) MP-865 mechanicals
- **MPC-365-6¹** ROE-200 with (2) MPC-200 controllers and (6) MP-865 mechanicals

¹ Indicate right- or left-handed set-up when ordering



MPC-365 SYSTEM COMPONENTS

U.S. prices available at www.sutter.com. International prices vary by country. Contact a distributor or Sutter Instrument for a quotation. Prices subject to change without notice.

■ MPC-200

Controller box alone. Purchase this if you intend to daisy-chain two controllers to one ROE-200. In this configuration, up to 4 manipulators can be controlled by a single ROE-200.

NOTE:

This is not a standalone device. In order to function, the MPC-200 must be connected to a second MPC-200 with ROE-200 attached or be connected to its own ROE-200. Includes daisy-chain cable, power cord and manual.

■ ROE-200

This is the ROE alone. Provides user input to one or more MPC-200 controllers. This component is intended for users who have an existing four-manipulator MPC-200 system with a single ROE-200 and wish to split it into two independent two-manipulator systems. Includes cable to connect ROE to controller.

■ MP-865/M¹

MP-285 manipulator mechanical alone. Includes mounting adapter plate, rod holder, 4 inch dovetail extension, and cable to connect manipulator to controller.

¹ Indicate right- or left-handed set up when ordering



MPC-365 SYSTEM ACCESSORIES

U.S. prices available at www.sutter.com. International prices vary by country. Contact a distributor or Sutter Instrument for a quotation. Prices subject to change without notice.

- **MT-73¹** Narrow-format stand with linear slide
- **MT-74** Narrow-format stand (no linear slide)
- **MAG-MT74** Magnetic feet for MT-74 (set of two)
- **265RBI²** Rotating base
- **M100106** Flat side panel for MPC-200 controller (each)
- **MP-RISER-0.5³** 1/2 inch riser
- **MP-RISER-1.0³** 1 inch riser
- **MP-CLIP⁴** Rod holder (for rod OD 1 to 4.5 mm)
- **MP-ROD** Rod holder (for rod OD 6.25 mm or larger)
- **EHOLDER** Micropipette holder – 1.0-1.5 mm glass

For detailed information on mounting our micromanipulators, refer to the Mounting Systems section or phone Sutter for assistance.

¹ Suitable for upright microscopes.

² Useful with Sutter MD stand and large platform stages such as the MT-78-FS, MP-78 and MPC-78.

³ Risers can be combined to achieve desired height.

⁴ Suitable for multi-electrode probes.





MPC-325

MP-225 BASED

MULTI-MICROMANIPULATOR SYSTEMS

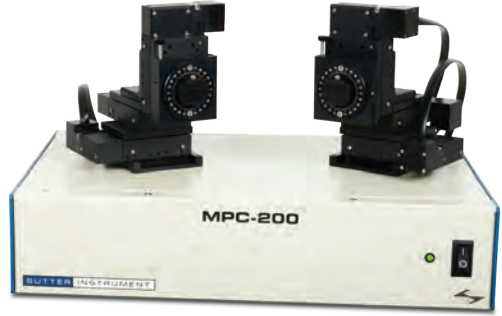

FEATURES MPC-325

- Quietest electronics in the industry. Optimized for single channel recording.
- Single controller and ROE will run two stepper motor drive manipulators
- Self-detecting, daisy-chain capability allows control of four manipulators from one ROE-200
- User-friendly interface: single button access to all major functions
- Easily configurable virtual 4th axis set without external computer
- Accelerated Mode for fast, manual manipulator movement
- Easy toggle selection of Mode (speed/resolution, pulsed diagonal, Accelerated Mode)
- Display indicates X, Y, Z coordinates, Mode, active manipulator
- Robotic HOME and WORK Position moves for easy automated pipette exchange
- Faster robotic moves than previous versions
- Definable 4th axis for coaxial pipette movement, angle selected by DIP switches
- Simple USB interface
- Toggle switch selects which manipulator is connected to input device
- LED and display indicate active manipulator
- Ultra-low drift, ultra-smooth movement
- Low-drift mechanical stability



The MPC-325 System consists of the MPC-200 controller and one to four MP-225 micromanipulators.

MPC-200 Controller and ROE

Neurobiological experiments are becoming more complex. Many require multiple manipulators with control units that quickly become space and/or cost prohibitive. The MPC-200 is the solution you have been asking for. A single controller capable of running 2 manipulators! Sutter Instrument has taken the simplicity of the MP-225 controller and expanded it to run two manipulators from a single controller/ROE. The MPC-200 works with our world-renowned mechanicals, the MP-285 (MPC-385), MP-225 (MPC-325) or narrow format MP-865 (MPC-365).

If two manipulators aren't enough, a second controller can be daisy-chained to allow the single ROE-200 to move up to four manipulators. Thus the system can be easily expanded to control highly sophisticated experiments.

The Sutter MPC-200 is electrically quiet. Unique to the MPC-200 is our multi-unit controller which employs linear output circuitry to minimize electrical noise. Sutter adds additional manipulators to the same controller without requiring potentially noisy chopper drives.

In all of our manipulators, the 4th axis can be set up and changed without the need to connect an external computer and download and configure software. A separate configuration is allowed for each output on this manipulator controller. If desired, each manipulator can approach the preparation at a different angle from the horizontal. The 4th axis can be configured between the X and Z axes or the Y and Z axes (useful when manipulator is rotated 90 degrees relative to the preparation).

Faster automated pipette exchange

The MPC-200 has faster "Home" and "Work Position" moves for quicker pipette exchange. Automation is set up and run via the same interface used in the MP-225 controller; however, the speeds of the automated movement are much faster.

Accelerated manual mode

For users who prefer manual pipette exchange we have added "Accelerated Mode" to the ROE. Using Accelerated Mode, the user can make quick manual moves in and out of a setup. Accelerated Mode amplifies the speed attainable in a manual move by smoothly accelerating to the maximum speed during sustained, fast turns of the ROE. Accelerated movement ends as soon as the user stops turning the knob. This mode can be fully disabled for those who feel the need for direct control of the pipette.

The MP-225 manipulator represents an economical alternative to the MP-285 and MPC-365. In 2002, production and design changes allowed us to produce this motorized manipulator as a more affordable alternative to the industry standard MP-285. The mechanical design utilizes a miniature stepper motor and integral anti-backlash gear head. Pre-loaded ball bearing slides provide smooth movement throughout the 25 mm of travel. The methodology for mounting pipette holders and headstages used with the MP-285 has been maintained in the MP-225 to allow for cross compatibility.

Additional component pieces can be added at any time, allowing the user to develop a system tailored to his or her particular needs. The controller is self-detecting so there is no need for manual configuration of the components.



SPECIFICATIONS MPC-325

- **Resolution and Full Travel** Minimal microstep size is 62.5 nanometers per microstep
Display has single micron resolution
Full travel is 25 mm in each axis
- **Maximum Speed** MP-225 *mechanical*
3 mm/sec.
- **Long Term Stability** <1.0 micron in 2 hours

DIMENSIONS

- **MPC-200 Controller** 15.75 in x 10.75 in x 3.5 in
40 cm x 27.3 cm x 9 cm
- **ROE-200** 10 in x 6 in x 4 in
25 cm x 15 cm x 10.2 cm

WEIGHT

- **MPC-200 Controller** 6.5 lbs
3 kg
- **ROE-200** 3.5 lbs
1.6 kg
- **Electrical** 115/230 Volts
50/60 Hertz power line





MPC-325

U.S. prices available at www.sutter.com. International prices vary by country. Contact a distributor or Sutter Instrument for a quotation. Prices subject to change without notice.

- **MPC-325¹** One MP-325 manipulator mechanical, one MPC-200 controller and one ROE-200. Also includes mounting adapter plate, rod holder, hinged headstage mount, 4 inch dovetail extension, manipulator and ROE connecting cables, power cord and manual
- **MPC-325-2¹** MPC-325 and (2) MP-225 mechanicals
- **MPC-325-3¹** MPC-325 with (2) MPC-200 controllers and (3) MP-225 mechanicals
- **MPC-325-4¹** MPC-325 with (2) MPC-200 controllers and (4) MP-225 mechanicals

¹ Indicate right- or left-handed set-up when ordering



MPC-325 COMPONENTS

U.S. prices available at www.sutter.com. International prices vary by country. Contact a distributor or Sutter Instrument for a quotation. Prices subject to change without notice.

- **MPC-200-ROE** Consists of the MPC-200 controller and ROE-200. This "system" is made available at a special price for those who wish to use previously purchased Sutter manipulators with the newer controller system or to use the MPC-200-ROE to control other devices. Includes cable to connect ROE to controller, power cord and manual.
- **MPC-200** Controller box alone. Purchase this if you intend to daisy-chain two controllers to one ROE-200. In this configuration, up to 4 manipulators can be controlled by a single ROE-200.
NOTE:
This is not a standalone device. In order to function, the MPC-200 must be connected to a second MPC-200 with ROE-200 attached or be connected to its own ROE-200. Includes daisy-chain cable, power cord and manual.
- **ROE-200** This is the ROE alone. Provides user input to one or more MPC-200 controllers. This component is intended for users who have an existing four-manipulator MPC-200 system with a single ROE-200 and wish to split it into two independent two-manipulator systems. Includes cable to connect ROE to controller.
- **MP-285/M¹** MP-285 manipulator mechanical alone - Includes mounting adapter plate, rod holder, 4 inch dovetail extension, hinged headstage mount and cable to connect manipulator to controller.
- **MP-225/M¹** MP-225 manipulator mechanical alone - Includes mounting adapter plate, rod holder, 4 inch dovetail extension, hinged headstage mount and cable to connect manipulator to controller.

¹ Indicate right- or left-handed set up when ordering



MPC-325 ACCESSORIES

U.S. prices available at www.sutter.com. International prices vary by country. Contact a distributor or Sutter Instrument for a quotation. Prices subject to change without notice.

- **285204** 4 inch dovetail extension
- **285210¹** Mounting adapter plate
- **285RBI** Rotating base
- **285300** Right angle adapter
- **285305** Z-axis vertical extension
- **285310** Z-axis horizontal extension
- **BR-AW** Rod clamp for XenoWorks® injectors (for rod OD 2 mm to 4 mm)
- **BR-AW-L** Long rod clamp for XenoWorks injectors (for rod OD 2 to 4 mm)
- **MP-CLIP²** Rod holder (for rod OD 1 to 4.5 mm)
- **MP-ROD** Rod holder (for rod OD 6.25 mm or larger)
- **285HEA** Hinged headstage mount
- **M100106** Flat side for controller (each)
- **MP-RISER-0.5³** 1/2 inch riser
- **MP-RISER-1.0³** 1 inch riser
- **EHOLDER** Micropipette holder – 1.0-1.5 mm glass

For detailed information on mounting our micromanipulators, refer to the Mounting Systems section or phone Sutter for assistance.

¹ For use with MT and MD series stands and platforms, or any surface with 1 inch or 25 mm centered holes

² Suitable for multi-electrode probes.

³ For MP-225 mechanical only. Risers can be combined to achieve desired height.



MULTI-LINK™

POSITION CONTROL SOFTWARE FOR MPC-200

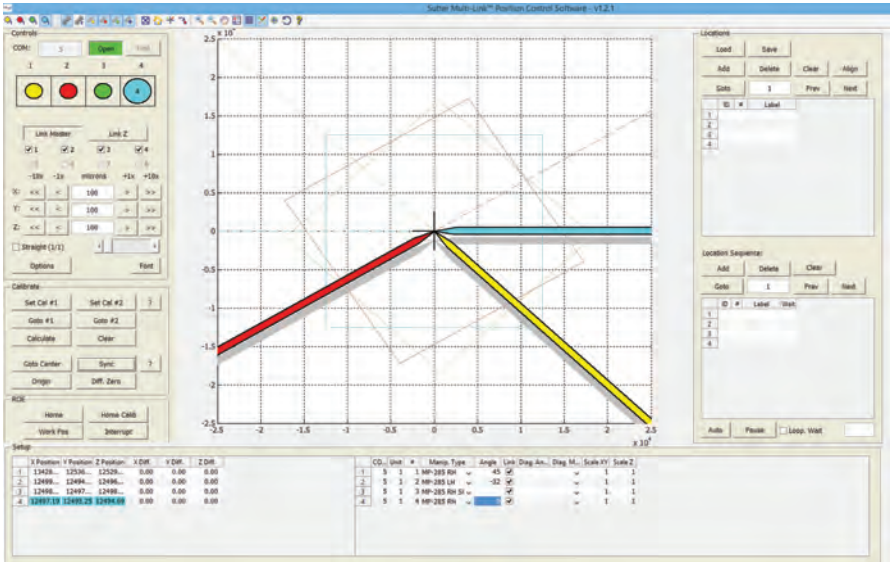

FEATURES MULTILINK™

- Selectable linking of one, two or more manipulators and translator
- Unlimited memorized positions
- Simultaneous control via ROE and computer GUI
- Positional information mirrored between GUI and ROE
- Pipettes are color coordinated to selected manipulator LED on ROE
- Supports mounting of manipulators at ANY mounting angle in the X-Y plane
- Extended version controls up to 8 manipulators
- Backwards compatible with all existing MPC-200 controllers
- Price: FREE! Available on our Technical Support/Software page at www.sutter.com



The Multi-Link™ Position Control Software is a standalone program that interfaces with our MPC-200 manipulator controllers. Multi-Link™ is an intuitive GUI that uses the MPC-200 driver Sutter developed for the NIH freeware μ Manager. It operates any Sutter Instrument device that can be connected to the MPC-200, including: manipulators, motorized microscopes (MOM and SOM), the MT-800 translator (with or without focus drive), and the MPC-78 platform stage (with or without focus drive) and the 3DMS stage.

The most powerful aspect of the Multi-Link software is the ability to link the movement of multiple devices together. The lead pipette can be used to direct the movement of a microscope translator (objective/camera), or the translator can function as the leader and thereby keep the pipettes in the field of view. The leading device can be controlled through the manual input knobs of the ROE-200 or the computer GUI via a mouse or other PC interface.

Multi-Link easily memorizes multiple working locations and can rapidly switch between them. The user simply moves the microscope to a region of interest and clicks to save the location. Turning on "Link" will then coordinate all linked devices (usually manipulators) with moves made by the microscope via a motorized translator. Switching between memorized positions will bring all linked devices to that location. Link, intuitive and easy to use, will allow users to bring all their pipettes to a working location in seconds! The memory positions available in the Multi-Link software allow for most of the same robotic functionality found in our MP-285. Memorized locations can be repeated in looped operation.

While all features found in the ROE-200 have been replicated in Multi-Link, full functionality of the ROE is retained, allowing movement of any connected device by turning the knobs on the ROE or by clicking and dragging the pipettes in software. Moves made in the GUI update the positional information displayed on the ROE, and moves made with the ROE-200 are updated in Multi-Link.

ADDITIONAL FEATURES

Accurately linked moves require "Calibration". A calibration protocol within the software automatically determines the mounting angle of each manipulator in the X-Y plane, so that Linked movement of the pipette will always be accurate. With two simple moves, the software automatically determines the mounting angle of each pipette with respect to the objective/camera.

The ROE-200 always displays the coordinates in an absolute scale, from 0 μm to 25000 μm . Multi-Link displays coordinates in either absolute or relative scale. Press one button to set the relative origin in all three axes and move in a positive or negative direction with respect to the relative origin. Multi-Link can also multiply the coordinates by a user-defined Scaling factor. The Scaling factor allows the user to match the position information displayed in Multi-Link to that of third-party and/or home-made stages, translators, focusing knobs, or other stepper motor devices.

One of the most innovative features of Multi-Link is the GUI representation of all manipulated pipettes. In addition to being a great teaching tool, the GUI allows a user to visualize the relative position of all pipettes in an experiment. Zoom out to see the location of each pipette at each memorized location, even when these positions are outside the microscope's field of view. Drag the virtual pipettes from one memorized position to another and the manipulators will move the real pipettes in real-time.

All the features of the Multi-Link software, from Link to the virtual pipette GUI, will increase the success rate of your experiments and save time. Another outstanding feature of this software is the price. Sutter is including this software at no charge with all MPC-200 systems. The software is also available as a FREE download for those with existing MPC-200 systems!



MP-285 ROBOTIC MICROMANIPULATOR



(Shown with optional dPatch® headstage)

FEATURES MP-285

- Quietest electronics in the industry. Optimized for single channel recording.
- Highly stable for experiments intolerant of pipette drift
- Sub-micron resolution and integrated coarse positioning
- 1 inch of motorized travel on all three axes
- Virtual 4th axis with user-selected angle for axial drive
- Adjustable speed and resolution allows optimization for your experimental setup
- Programmable robotics for complex motion sequences
- Continuous display (in microns) of axes positions
- Switch between continuous or single step movement
- Absolute and relative origins
- Convenient HOME function allows pipettes to be quickly repositioned
- Assignable axes permit any orientation of the manipulator
- Easy-to-read vacuum fluorescent display
- Remote computer control via serial interface
- Compact design easily adaptable to your setup
- Universal mounting system for headstage or pipette holder
- Optional mounting adapters (see price list)



One of the first in our line of precision motorized micromanipulators, the MP-285 is affordable yet offers advanced features found in manipulators costing thousands more. Custom engineered stepping motors, precision cross-roller bearing slides and proprietary worm gear capstan drives form the basis of the watch-like mechanical system. The controller provides power to the stage motors with a quiet linear power supply to minimize electrical noise radiation in your setup. Pipette holders and headstages are securely mounted to the MP-285 with one of our several unique and rigid mounting systems.

The MP-285 was designed to meet a wide variety of positioning needs for the scientific community and is suitable for patch clamp experiments, extracellular recording, microinjection, intra-cellular recording and precision robotic positioning applications. An outstanding feature of this system is the unique definable 4th axis for diagonal advancement of the pipette. You select the angle, then activate the 4th axis. As with the other three axes, you may move with adjustable coarse or ultrafine resolution, select the movement speed, and move continuously or in single step increments. To quickly reposition the pipette, simply select the HOME function. Axes positions are continuously shown in relative and absolute scales, and are easily readable on the vacuum fluorescent display.

The extremely low backlash of the MP-285 removes traditional drawbacks of “open loop” technology and eliminates drift. This allows submicron resolution down to 0.2 microns in the coarse range and down to 40 nanometers in the fine range. With over 1 inch of motorized travel on all three axes, and a user designated 4th axis, the MP-285 allows tremendous range of motion while maximizing resolution.

In all our manipulators, the 4th axis can be set up and changed without the need to connect an external computer and download and configure software. Unlike other designs, the virtual 4th axis in the MP-285 can comprise any two axes — conventional X-Z to approach along the pipette axis, Y-Z used when the manipulator is rotated 90 degrees, and you can even set up a virtual diagonal in the X-Y plane: useful when the manipulator is set up as a 3DMS (3D movable stage) and one wants to quickly move along the diagonal between two points on a horizontal specimen.

Available with a table-top or rack-mounted controller, our manipulator fits in seamlessly with your other components while the compact design and assignable axes of the MP-285 allow you to easily integrate it into your setup at any orientation. To add to its practicality, the rotary optical encoder (ROE), assures a comfortable experimentation environment, customized to the scientist. Turning one of three 2-inch knobs produces a movement along one axis proportional to the amount and speed of the turn. Buttons allow the activation of “4th axis”, change of movement resolution, “Home” return function, and toggle between continuous pulse movements.

For users who require repeatable motion sequences, the MP-285 features easily programmed robotic control from the keypad, or via a remote computer. The system can store up to 500 position instructions, including pauses, and will execute the instruction set once, continuously, or in reverse.

As always, our technical support team is available to address your concerns and answer all questions before, and after your purchase.



SPECIFICATIONS MP-285

- **Travel** 1 inch
25 mm on all three axes
- **Resolution** Low: 0.2 $\mu\text{m}/\text{step}$
High: 0.04 $\mu\text{m}/\text{step}$
- **Maximum Speed** 2.9 mm/sec
- **Long Term Stability** <1.0 micron in 4 hours
- **Drive Mechanism** Precision worm gear capstan drive
- **Serial Interface** RS-232, 9600 baud
(1 start bit, 8 data bits, 1 stop bit)
- **Dimensions** *Mechanical:*
4.5 in x 6 in x 6.25 in
11 cm x 15 cm x 16 cm
Controller:
16 in x 10.75 in x 3.75 in
40.6 cm x 27.3 cm x 9.6 cm
- **Weight** *Manipulator:*
3.85 lbs / 1.7 kg
Controller:
10 lb 11 oz / 4.5 kg
- **Electrical** 115/230 Volts
50/60 Hertz power line





MP-285

U.S. prices available at www.sutter.com. International prices vary by country. Contact a distributor or Sutter Instrument for a quotation. Prices subject to change without notice.

- **MP-285/R** Includes manipulator, rack mount controller unit, rotary optical encoder, cables, rod holder, hinged headstage mount, 4 inch dovetail extension, mounting adapter plate, choice of input device, power cord, and manual
- **MP-285/T** Includes manipulator, table top controller unit, rotary optical encoder, cables, rod holder, hinged headstage mount, 4 inch dovetail extension, mounting adapter plate, choice of input device, power cord, and manual

When ordering the MP-285, the handedness must be specified. Please list as separate item with no cost.

Select the manipulator handedness

Right-handed setup

RIGHT

Left-handed setup

LEFT

If you have any questions regarding the part numbering system, please contact Sutter Instrument Company directly.

ACCESSORIES MP-285

- **285204** 4 inch dovetail extension
- **285210¹** Mounting adapter plate
- **285RBI** Rotating base for MP-285
- **285300** Right angle adapter
- **285305** Z-axis vertical extension
- **285310** Z-axis horizontal extension
- **BR-AW** Rod clamp for XenoWorks[®] injectors (for rod OD 2 mm to 4 mm)
- **BR-AW-L** Long rod clamp for XenoWorks injectors (for rod OD 2 mm to 4 mm)
- **285HEA** Hinged headstage mount
- **M100106** Flat side panel for controller (each)
- **MP-CLIP²** Rod holder (for rod OD 1 to 4.5 mm)
- **MP-ROD** Rod holder (for rod OD 6.25 mm or larger)
- **EHOLDER** Micropipette holder – 1.0-1.5 mm glass

For detailed information on mounting our micromanipulators, refer to the Mounting Systems section or phone Sutter for assistance.

¹ For use with MT and MD series stands and platforms, or any surface with 1 inch or 25 mm centered holes.

² Suitable for multi-electrode probes.



MANIPULATOR DRAWINGS MP-285

MICROMANIPULATION

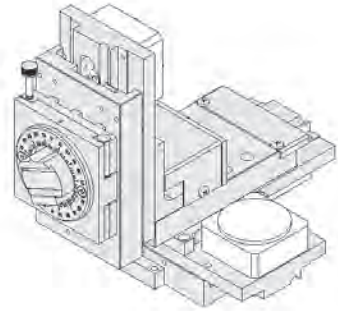
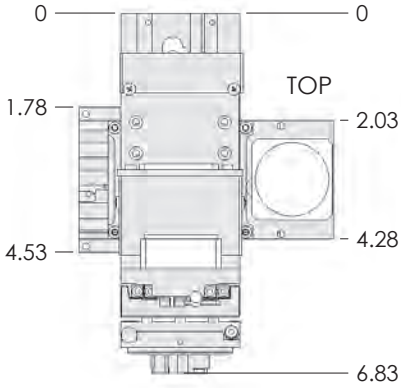

*ALL MEASUREMENTS ARE IN INCHES

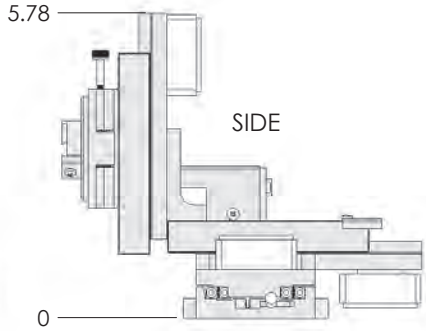
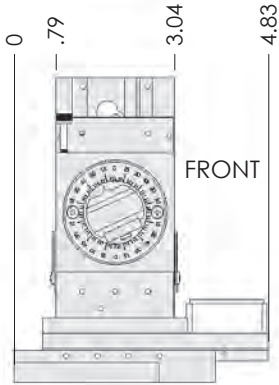



MECHANICAL DRAWINGS OF OPTIONAL ROTATING BASE (285RBI OR 225RBI)

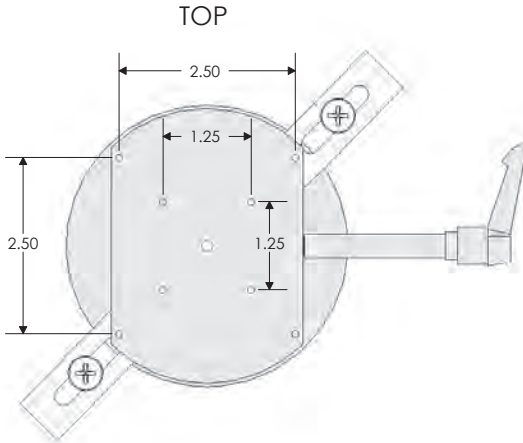

*ALL MEASUREMENTS ARE IN INCHES

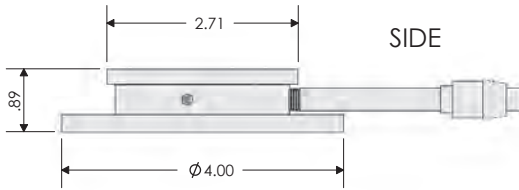



MP-225A MOTORIZED MICROMANIPULATOR



FEATURES MP-225A

- Highly stable for experiments intolerant of pipette drift
- Submicron (125 nm) minimal resolution for fine movement
- Convenient toggle wheel selects resolution/speed of movement
- New logarithmic mode automatically adjusts speed
- 25 mm of motorized travel on all three axes
- 4th axis for coaxial movement of pipette, any angle from 0-90 can be selected on ROE
- Programmable Home position for pipette exchange
- Programmable Work position near recording location
- Absolute or Relative position display in microns
- DIP switches on ROE to customize direction of movement produced by turn of ROE knob
- Modularized, compact design easily adaptable to your setup
- Universal mounting system for headstage or pipette holder
- Mounting adapters included with manipulator



In 2002, we created the MP-225 controller and motorized manipulator as a cost effective option for those who didn't need all the features of the industry standard MP-285. While the MP-225 feature set is less comprehensive than the MP-285's, it includes the most popular features with an efficient user interface. The MP-225 was designed primarily for positioning patch and intracellular recording pipettes. We have retained and refined the features most desired for this type of work.

In 2021, we've updated the MP-225 controller design, now called the MP-225A, by integrating the ROE and rack mounted controller box into a single unit to save you valuable space. This extended version of the popular rotary optical encoder (ROE) is the sole input device available with the MP-225A. The MP-225A mechanical continues to use a cable driven mechanical design that utilizes a miniature stepper motor and integral anti backlash gear head. Pre-loaded ball bearing slides provide smooth movement throughout the 25 mm of travel. The methodology for mounting pipette holders and headstages used with the MP-285 has been maintained in the MP-225A to allow for cross compatibility.

A newly added RELATIVE mode allows the user to zero the display at any point, showing travel distance from that point onward.

In addition to the fixed speeds, the MP-225A now has an option to use a logarithmic acceleration algorithm, which allows speed control proportional to the input speed. As the knobs on the ROE are turned faster, acceleration ramps up. This allows for smooth and intuitive motion control of electrode position without the need to stop and change speeds or lift your hand from the controller. When not moving, the motors will power down, reducing electrical noise in the system to unmeasurable levels while also keeping the motors cool to eliminate thermal drift.

The display on the ROE gives position location and, like the MP-285, the MP-225A manipulator has a synthetic 4th axis for diagonal advancement of the pipette; any angle from 0-90 degrees may be selected on the controller. Speed and resolution of movements are easily selected with a multiple position thumbwheel, allowing fast/coarse movement and slow/ultra-fine movement in 10 increments. Two commonly used robotic movements have been incorporated for user convenience: a single button press can initiate a move to a Home position for pipette exchange or to a user defined Work position to quickly relocate the pipette near the recording location.

As always, our technical support team is available to address your particular needs and answer all questions before and after your purchase.



SPECIFICATIONS MP-225A

- **Travel** 1 in – 25 mm on all three axes
- **Resolution** 125 nm/microstep
- **Maximum Speed** 2.0 mm/sec
- **Long Term Stability** <1.0 micron in 2 hours
- **Drive Mechanism** Integral miniature stepper motor with anti-backlash gearhead
- **Dimensions**

<i>Mechanical:</i>	<i>ROE Controller:</i>
4 in x 5.5 in x 6 in	9.25 in x 4.5 in x 3 in
10 cm x 15 cm x 15.5 cm	23.5 cm x 14.43 cm x 7.62 cm
- **Weight**

<i>Manipulator:</i>	<i>ROE Controller:</i>
2.95 lbs / 1.3 kg	3 lbs 12 oz / 1.7 kg
- **Electrical**

115/230 Volts
50/60 Hertz power line



MECHANICAL DRAWINGS MP-225

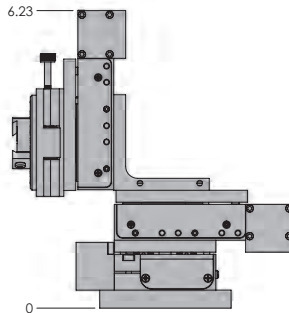
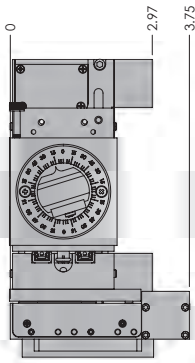
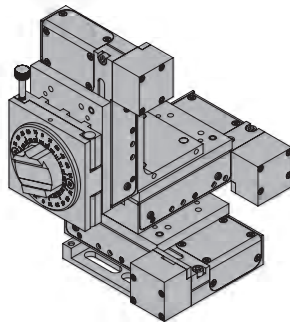
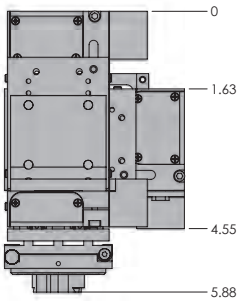



MP-225A

U.S. prices available at www.sutter.com. International prices vary by country. Contact a distributor or Sutter Instrument for a quotation. Prices subject to change without notice.

MOTORIZED MICROMANIPULATOR

- **MP-225A¹** Includes manipulator, extended ROE, cables, rod holder, 4 inch dovetail extension, mounting adapter plate, screws, hex wrench, power cord and manual

ACCESSORIES MP-225A

- **285204** 4 inch dovetail extension
- **285210²** Mounting adapter plate
- **225RBI** Rotating base
- **285300** Right angle adapter
- **285305** Z-axis vertical extension
- **285310** Z-axis horizontal extension
- **285SHEA** Hinged headstage mount
- **M100106** Flat side panel for controller (each)
- **BR-AW** Rod holding clamp for XenoWorks[®] injectors (rod OD 2-4 mm)
- **BR-AW-L** Long rod holding clamp for XenoWorks[®] injectors (for rod OD 2-4 mm)
- **MP-RISER-0.5³** 1/2 inch riser
- **MP-RISER-1.0³** 1 inch riser
- **MP-CLIP⁴** Rod holder (for rod OD 1.0-4.5 mm)
- **MP-ROD** Rod holder (rod OD 6.25 mm or larger)
- **EHOLDER** Micropipette holder – 1.0-1.5 mm glass

For detailed information on mounting our micromanipulators, refer to the Mounting Systems section or phone for assistance.

¹ Indicate right- or left-handed set-up when ordering.

² For use with MT and MD series stands and platforms, or any surface with 1 inch or 25 mm centered holes.

³ Risers can be combined to achieve desired height.

⁴ Suitable for multi-electrode probes.



QUAD®

4-AXIS

MOTORIZED MICROMANIPULATOR



FEATURES QUAD®

- Four independent axes — 30 mm travel in diagonal for coaxial pipette movement, 25 mm travel in X, Y and Z
- Sub-micron 100 nm resolution
- True diagonal assures coaxial movement
- Quiet mode eliminates electrical noise
- Display indicates coordinates in relative or absolute
- User-friendly, fanless compact controller with ROE preserves bench space
- Push button control of multiple functions — WORK, HOME, LOCK, PULSE, and RELATIVE
- Robotic Home and Work position moves for easy automated pipette exchange
- Suited for *in vivo* electrophysiological recording
- USB interface for computer control



The QUAD® motorized micromanipulator is easy to use and features four independent axes. Each axis has a 25 mm range of motion, a digital display of position and an ROE control. The compact, intuitive controller takes up minimal bench space, is fan free and is easy to use. Three axes provide the X, Y, Z-orthogonal motion typical of most motorized micromanipulators. In the QUAD, Sutter introduces a true fourth axis to move the electrode coaxially at exactly the desired angle of approach. The fourth axis has 30 mm of travel that significantly extends the range of travel for the system.

The QUAD has an intuitive ROE interface. The ROE inputs for each axis allow facile manual control of electrode position. Five conveniently located buttons control all of the basic functions that you will need in normal operation. Press and hold the WORK button to quickly store a work position; press WORK again and the manipulator will return to the same location. HOME sends the manipulator to an initial location that is useful for changing electrodes. When you are ready to begin collecting data, the motor drive, electronics can be suppressed by pressing LOCK. Display coordinates can be zeroed at any location by pressing RELATIVE; go back to absolute coordinates by pressing RELATIVE again. Finally, PULSE activates a pulse movement mode that produces small, rapid bursts of motion that can be advantageous for sharp electrode cell penetration.



SPECIFICATIONS QUAD®

- **Travel** 30 mm on diagonal 4th axis
25 mm on X, Y and Z axes
- **Long Term Stability** <1.0 micron in 4 hours
- **Control Box Dimensions** 5.5 in x 7.5 in x 4 in
14 cm x 19 cm x 10.2 cm
- **Weight** 2.2 lbs
1.0 kg
- **Electrical** 115/230 Volts
50/60 Hertz power line



MECHANICAL DRAWINGS QUAD®

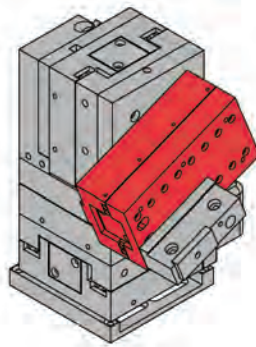
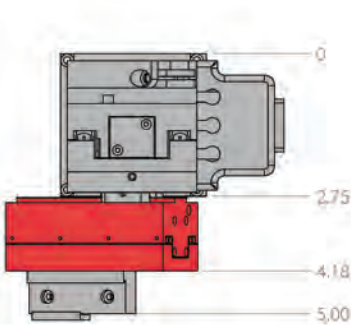

** All measurements are in inches

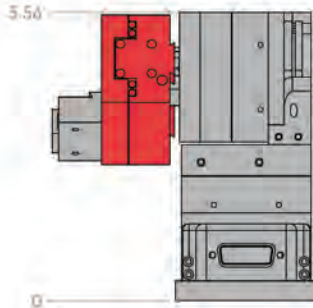
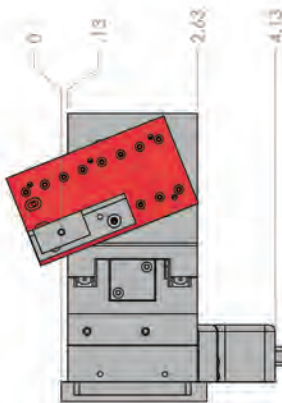

**QUAD®**

U.S. prices available at www.sutter.com. International prices vary by country. Contact a distributor or Sutter Instrument for a quotation. Prices subject to change without notice.

QUAD**BASIC SYSTEM**

Includes the manipulator, controller, rod holder, 4 inch dovetail extension, mounting adapter plate, Z-axis vertical extension, cables, and power supply

- **QUAD-L¹** QUAD 4-axis manipulator with ROE controller – left-handed setup
- **QUAD-R¹** QUAD 4-axis manipulator with ROE controller – right-handed setup

FIXED STAGE PLATFORM

Fixed platform stage with imperial/standard holes, chamber insert and gantry supports

- **MT-78-FS** Same as above with M6 tapped holes
- **MT-78-FS/M6**

MANIPULATOR COLUMNS

Standard gantry stand 8.7 to 13.4 in (22.1 to 33.9 cm)

- **MT-75** Short gantry stand 6.7 to 9.6 in (16.9 to 24.4 cm)
- **MT-75S** Tall gantry stand 10.7 to 15.4 in (27.1 to 39.1 cm)
- **MT-75T** Extra tall gantry stand 14.7 to 18.5 in (37.4 to 47 cm)
- **MT-75XT**

MICROINJECTION COLUMNS

MT-81 stand with 8 inch dovetail

- **MT-81-DOV8²**
- **MT-81-DOV12²** MT-81 stand with 12 inch dovetail

ACCESSORIES QUAD®

U.S. prices available at www.sutter.com. International prices vary by country. Contact a distributor or Sutter Instrument for a quotation. Prices subject to change without notice.

- **285204** 4 inch dovetail extension
- **225RBI** Rotating base for TRIO
- **221165** Z-axis vertical extension
- **BR-AW** Rod clamp for XenoWorks® injectors (for rod OD 2 to 4 mm)
- **BR-AW-L** Long rod clamp for XenoWorks injectors (for rod OD 2 to 4 mm)
- **MP-RISER-0.5³** 1/2 inch riser
- **MP-RISER-1.0³** 1 inch riser (for rod OD 2 to 4 mm)
- **MP-CLIP⁴** Rod holder (for rod OD 1 to 4.5 mm)
- **MP-ROD** Rod holder (for rod OD 6.25 mm or larger)
- **EHOLDER** Micropipette holder – 1.0 to 1.5 mm glass

¹ Manipulator will be preconfigured as a convenience. Customer can change orientation as needed.

² Useful for low profile stereoscopes and microinjection

³ Risers can be combined to achieve desired height

⁴ Suitable for multi-electrode probes

For detailed information on mounting our micromanipulators, refer to the Mounting Systems section or phone for assistance.

TRIO™-235**3-AXIS****0-90 DIAGONAL MICROMANIPULATOR SYSTEM**

(TRIO-235 shown with Sutter IPA® headstage (not included))

FEATURES TRIO™-235

- Three independent axes – 25 mm orthogonal travel in X, Y and Z
- Software-based "Z-axis"
- Sub-micron (less than 100 nm) resolution
- Fast movement with a top speed of 3 mm/sec (while homing)
- Mechanically robust construction for high stability
- Compact, fanless, user-friendly, ROE controller preserves bench and rack space
- Carries up to a kilogram
- Push button control of multiple functions – WORK, HOME, LOCK, PULSE, RELATIVE, SPEED & ANGLE
- Suited for *in vivo* and *in vitro* electrophysiological recording
- Universal mounting system for headstage or pipette holder
- DIP switches on ROE select direction of movement produced by turn of ROE knob
- USB interface for computer control



Ideal for *in vivo* work, the TRIO™-235, replaces the Z-axis with an adjustable diagonal axis. This configuration pairs a traditional X and Y-axis with a diagonal axis that can be adjusted in angle with a set screw. The diagonal features 50 mm of travel, with 25 mm of travel in the X and Y-axes. We have added software to create a synthetic "Z-axis" by combining the diagonal and X-axes which is the reverse of how we create a synthetic diagonal axis on our other manipulators. The TRIO-235 features a precision bearing and lead-screw design.

The TRIO-235 controller employs a combination of state-of-the-art software and mechanical design that eliminates the need for the motor to remain powered on during recording, thus eliminating the heating effects of the motors and giving us the electrically quietest manipulators in the industry. This stability ensures that Sutter manipulators will not drift in the middle of experiments.

The compact design of the integrated Rotary Optical Encoder (ROE) controller uses minimal bench space; provides quiet, fan-free operation; and is easy to use. No rack mounted controller is required. Position coordinates, in relative or absolute values, are displayed directly on the ROE. The TRIO manipulators use a logarithmic acceleration algorithm that eliminates the need for speed selection. As the knobs on the ROE are turned faster, acceleration ramps up. This allows for smooth and intuitive motion control of electrode position without the need to stop and change speeds or lift your hand from the knobs. A Y-axis lockout function (accessible by DIP switch) is also available, allowing X/Diagonal-only axial movement during HOME and WORK repositioning.

Five conveniently located buttons control all the functions you will need in normal operation. Press and hold the WORK button to quickly store a work position; pressing WORK after this will return the manipulator to the same location. HOME sends the manipulator to a second position, often set for a point furthest from the microscope, which is useful for rapid pipette exchange. Pressing SPEED allows the selection of one of 4 speed ranges. With practice, there is no need to ever change speeds; however, we have included three low speed ranges for those who work at very high magnification. Holding SPEED for three-seconds will lock the knobs out, to prevent accidental movement. Display coordinates can toggle between relative and absolute by pressing the RELATIVE button; holding the button down will zero the relative coordinates. Finally, PULSE activates a pulse movement mode that produces small, rapid bursts of motion that can be advantageous for cell penetration with sharp electrodes. Hold PULSE for three-seconds to set or modify the angle the diagonal axis is positioned at. This allows the controller to calculate the synthetic "Z-Axis".

Designed with maximum flexibility in mind, a DIP switch on the controller changes the directional movement of the ROE knobs to accommodate the preference of the user. The TRIO-235 comes standard with a universal mounting system suitable for the most popular headstages or pipette holders.



SPECIFICATIONS TRIO™-235

- **Travel** 25 mm on X and Y / 50 mm on diagonal
- **Long Term Stability** <1.0 micron in 4 hours
- **Control Box Dimensions** 5.5 in x 8 in x 4 in (14 cm x 20.4 cm x 10.2 cm)
- **Weight Mechanical** 2.8 lbs (1.3 kg)
- **Weight Controller** 2.2 lbs (1.0 kg)
- **Electrical** 115/230 Volts
50/60 Hertz power line





TRIO™-235

U.S. prices available at www.sutter.com. International prices vary by country. Contact a distributor or Sutter Instrument for a quotation. Prices subject to change without notice.

TRIO™-235

BASIC SYSTEM

Includes the manipulator, controller, rod holder, 4 inch dovetail extension, mounting adapter plate, Z-axis vertical extension, cables, and power supply

- **TRIO-235** 3-axis manipulator (X,Y and diagonal) and controller

FIXED STAGE PLATFORM

- **MT-78-FS** Fixed platform stage with imperial/standard holes, chamber insert and gantry supports
- **MT-78-FS/M6** Same as above with M6 tapped holes

MANIPULATOR COLUMNS

- **MT-75** Standard gantry stand 8.7 to 13.4in (22.1 to 33.9 cm)
- **MT-75S** Short gantry stand 6.7 to 9.6 in (16.9 to 24.4 cm)
- **MT-75T** Tall gantry stand 10.7 to 15.4 in (27.1 to 39.1 cm)
- **MT-75XT** Extra tall gantry stand 14.7 to 18.5 in (37.4 to 47 cm)

MICROINJECTION COLUMNS

- **MT-81-DOV8¹** MT-81 stand with 8 inch dovetail
- **MT-81-DOV12¹** MT-81 stand with 12 inch dovetail

For detailed information on mounting our micromanipulators, refer to the Mounting Systems section or phone for assistance.

ACCESSORIES TRIO™-235

- **285204** 4 inch dovetail extension
- **265210²** Mounting adapter plate
- **225RBI** Rotating base for TRIO
- **221165** Z-axis vertical extension
- **BR-AW** Rod clamp for XenoWorks® injectors (for rod OD 2 to 4 mm)
- **BR-AW-L** Long rod clamp for XenoWorks injectors (for rod OD 2 to 4 mm)
- **MP-RISER-0.5³** 1/2 inch riser
- **MP-RISER-1.0³** 1 inch riser
- **MP-CLIP⁴** Rod holder (for rod OD 1 to 4.5 mm)
- **MP-ROD** Rod holder (for rod OD 6.25 mm or larger)
- **EHOLDER** Micropipette holder – 1.0 to 1.5 mm glass

¹ Useful for low profile stereoscopes and microinjection.

² For use with MT and MD series stands and platforms, or any surface with 1 inch or 25 mm centered holes

³ Risers can be combined to achieve desired height.

⁴ Suitable for multi-electrode probes.

SOLO SINGLE AXIS MANIPULATOR CONTROLLER



(Shown with SOLO-50)

FEATURES SOLO

- Control any single axis from Sutter stepper motor manipulator collection
- 25 mm or 50 mm length of travel
- Absolute and Relative modes
- User defined WORK and HOME positions in Absolute mode
- Pulse mode
- USB connectivity

APPLICATIONS SOLO

- Can be used with a single axis micromanipulator to design a focus drive for your researcher-made microscope
- Can be used to add a 4th axis to a 3-axis Sutter manipulator
- Ideal for *in vivo* experiments



The SOLO is an extremely easy to operate single axis controller capable of running any single axis from Sutter's line of stepper motor manipulators. The compact design of the SOLO controller requires minimal bench space and provides quiet, fan-free operation.

The SOLO controller features user defined HOME and WORK positions. Press and hold the WORK button to quickly store a Work position; press WORK again and the manipulator will return to the same location. HOME sends the manipulator to an initial location or any user defined position. Position coordinates, in relative or absolute values, are displayed directly on the ROE. A PULSE button activates a discrete 3 micron movement of the axis.

Speed of movement is determined by how fast the ROE knob is turned. We have added three distinct speeds to give the user extreme control over movement. The combination of three speeds and the knob speed control makes the SOLO an ideal, ultra-reliable controller for sub-micron movement.

Single axes are available in lengths of 25 mm or 50 mm. The SOLO is suitable for *in vivo* experiments that require only one motorized axis. Additionally, this single axis controller can be used as a sub-micron focusing system as seen in the Sutter SOM and BOB microscopes. Or add a fourth axis to your existing Sutter manipulator to create a true four-axis motorized *in vivo* and *in vitro* manipulator (such as the QUAD).

USB connectivity and open source commands, along with built-in features such as WORK & HOME positions, and Pulse mode, make this single axis controller the ideal device for the do-it-yourself scientist.



SPECIFICATIONS SOLO

- **Control Box Dimensions** 5.5 in x 5.1 in x 3.2 in
14 cm x 13 cm x 8.1 cm
- **Weight** *Controller:*
1.2 lbs
0.53 kg
- **Long Term Stability** < 1.0 micron in 4 hours
- **Electrical** 115/230 Volts
50/60 Hertz power line





SOLO

U.S. prices available at www.sutter.com. International prices vary by country. Contact a distributor or Sutter Instrument for a quotation. Prices subject to change without notice.

SINGLE AXIS MANIPULATOR CONTROLLER

- **SOLO-25MM** SOLO controller and single axis with 25 mm travel
- **SOLO-50MM** SOLO controller and single axis with 50 mm travel

Adapters are available to connect your Sutter single axis manipulator to many instruments. Phone Sutter for details.

ACCESSORIES SOLO

For 25 mm axis

- **SO-ST25** Stereotaxic adapter for Kopf/Stoelting

For 50 mm and 70 mm axis

- **SO-ST** Stereotaxic adapter for Kopf/Stoelting

For ALL

- **285204** 4 inch dovetail extension
- **MP-CLIP¹** Rod holder (for rod OD 1 to 4.5 mm)
- **MP-ROD** Rod holder (for rod OD 6.25 mm or larger)
- **EHOLDER** Micropipette holder – 1.0 to 1.5 mm glass

¹ Suitable for multi-electrode probes.

MP-85 HUXLEY-WALL STYLE MICROMANIPULATOR

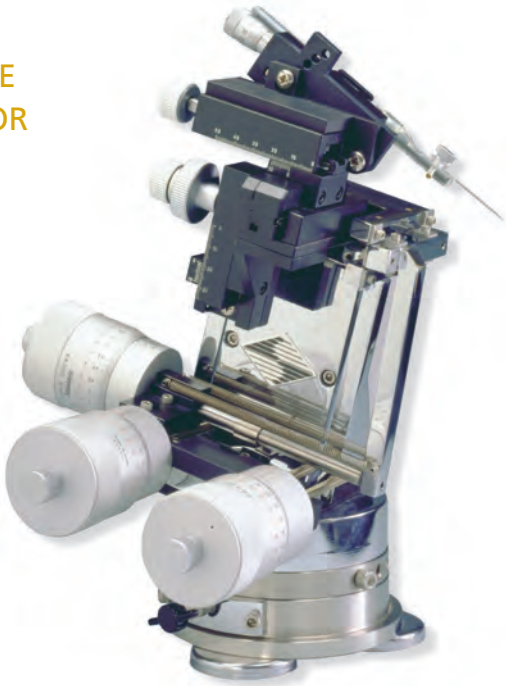

(Shown with optional spacer, wedge and magnetic feet)

FEATURES MP-85

- Dual springing of the moment arms to insure zero backlash and zero torsion
- The micromanipulator is mounted on a precision rotating base featuring a positive stop and lock
- The coarse movement is an all cross-roller bearing design consisting of coarse X, Y, and Z with an additional fine X motion
- The micromanipulator can be ordered in either a right- or left-handed version

OPTIONS MP-85

- Fifteen degree stackable wedges for tilting the manipulator
- A set of three magnetic feet for increased stability
- One inch thick, chrome plated, solid brass spacer



The classic micromanipulator, developed by Sir Andrew Huxley many years ago, is still considered by many investigators to be the finest manual micromanipulator available. The MP-85 offers the advantage of a very large range of movement with its built-in coarse manipulator and precise submicron movement with the fine controls. Coarse positioning is achieved with a three axis manipulator mounted on top. The ultrafine positioning is accomplished with the large micrometers mounted on the base. These micrometers provide smooth, precise movement through a 10:1 reduction mechanism.

The brass and stainless steel construction of the MP-85 makes for a very heavy and solid micromanipulator with excellent damping properties. This exceptionally stable design is ideal for patch clamp recording, intracellular recording, or any other application that is intolerant of drift.

The MP-85 is chrome-plated and anodized to prevent corrosion. The J.R. Wall designed rotating base is machined from solid, stainless steel with a brass spindle; a thin Teflon washer provides for the bearing surface.

Please contact Sutter Instrument for any additional information on the suitability and use of the MP-85 micromanipulator for your specific application.



SPECIFICATIONS MP-85

- **Coarse X-axis Tilt** 0 to 45 degrees
in 15 degree increments
- **Coarse Resolution** 0.1 mm on all axes
- **Fine X resolution** 0.01 mm
- **Ultrafine (Huxley) Resolution** 0.2 μm
- **Huxley Excursion** ~2 mm maximum in each axis
- **Dimensions** 10 in x 10 in x 12 in
25.4 cm x 25.4 cm x 30.5 cm
- **Weight** *Manipulator:*
15 lbs
7 kg



MP-85

U.S. prices available at www.sutter.com. International prices vary by country. Contact a distributor or Sutter Instrument for a quotation. Prices subject to change without notice.

MICROMANIPULATOR

- **MP-85/R** Right-handed — Includes manipulator, coarse movement MM-33 micromanipulator, and rotating base
- **MP-85/L** Left-handed — Includes manipulator, coarse movement MM-33 micromanipulator, and rotating base

ACCESSORIES MP-85

- **Holder/MP85** Headstage adapter
- **RBI** Rotating base for MP-85
- **MAG-85** Magnetic feet (set of 3)
- **85AX200¹** Headstage adapter for MP-85
- **X850600** 15 degree wedges (each)
- **X850700** 1 inch increment spacer
(No more than three recommended)
- **X700115** MP-85 to MT stand adapter plate

¹ Suitable for Sutter IPA®, dPatch®, Axopatch 200 and Heka EPC-10.



MM-33 MICROMANIPULATOR



MM-33/R



MM-33A/L



MM-33A/L open profile

FEATURES MM-33

- Compact design allows use in tight environments
- Rack and pinion drive gives stable movement with minimal backlash
- Cross-loaded roller bearings for smooth, low friction movement
- Vertical axis lock

OPTIONS MM-33

- Rotating base allows horizontal rotation and vertical tilting
- Magnetic feet
- Tilting mount for fine X-axis



Successfully used in conjunction with our other micromanipulators, the MM-33 is available separately for those in need of a small, practical instrument in applications not requiring submicron accuracy.

The MM-33 is the right choice for tight environments which require maximum versatility within a small space. A vertical lock is added to secure the vertical axis in position. The optional rotating base and tiltable X-axis provide even further flexibility.

Stainless steel cross-loaded roller bearings are designed to offer low friction and smooth linear motion with a minimum of side play. The pre-loaded rollers are set at 90 degrees to the hardened steel guides insuring constant contact and accuracy. This precise rack and pinion drive gives stable, drift-free movement with minimal backlash. The controls are placed one above the other which makes for less hand movement and easier positioning. The scales for all axes are calibrated in 0.10 mm increments and the fine micrometer adjustment for the X-axis thrust is calibrated at 0.01 mm with estimates to 5 μ m.

The optional rotating base extends the utility of the MM-33 by providing two additional rotating planes. The rotation in the horizontal plane (approximately 120 degrees) has a positive stop, quick release mechanism for fast insertion and removal of pipettes. The second rotating axis allows the MM-33 to be tilted in a vertical plane from 0 to 70 degrees. The optional tiltable X-axis allows the fine axis to be tilted up to 45 degrees. This option should be ordered at the time of purchase since the modifications require factory installation.



(Shown: MM-33A/L)



INDIVIDUAL EXCURSIONS ARE AS FOLLOWS:

X-axis coarse movement: 37 mm

X-axis fine movement: 10 mm

Y-axis horizontal movement: 20 mm

Z-axis vertical movement: 20 mm



(Shown: MM-33/R)



MM-33

U.S. prices available at www.sutter.com. International prices vary by country. Contact a distributor or Sutter Instrument for a quotation. Prices subject to change without notice.

MICROMANIPULATOR

- **MM-33/R¹** Right-handed micromanipulator with vertical lock (with 1/2 inch rod clamps)
- **MM-33/L¹** Left-handed micromanipulator with vertical lock (with 1/2 inch rod clamps)
- **MM-33A/R** Right-handed micromanipulator with tilting mount for fine X-axis, vertical lock, rotating base, and two base clamps
- **MM-33A/L** Left-handed micromanipulator with tilting mount for fine X-axis, vertical lock, rotating base, and two base clamps

ACCESSORIES MM-33

- **MM-33000²** Right-handed tilting mount for fine X-axis
- **MM-33001²** Left-handed tilting mount for fine X-axis
- **MM-33002** Rotating base with two base clamps
- **MM-33005²** Stationary mounting base
- **MM-33006** Rod mounting bracket for use with stands
- **H102905** 12 mm rod clamp
- **H102910** 1/2 inch rod clamp
- **H102925** Electrode holder
- **MAG-33²** Magnetic feet for rotating base (set of 3)
- **X330105** Base clamps (2) for clamping rotating base

¹ 12 mm rod clamps available upon request

² Must be ordered with the MM-33 since this option is factory installed

only.



MM-6 MICROPOSITIONER

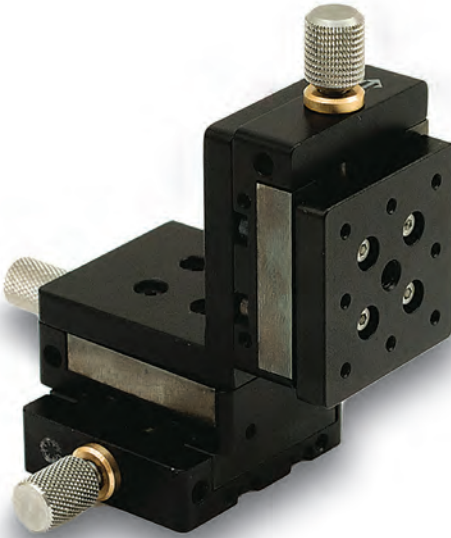

The MM-6 micropositioner is light weight, accurate, compact device designed to eliminate many research and design problems, especially in the case of space limitations. Hardened steel precision pre-loaded ball bearing slides and high resolution thumbscrew movement assure smooth motion, precision, and excellent load bearing capacity.

The black anodized aluminum body is made with a one-piece base and three piece construction. The top plate is designed around an M2 thread size on a 10 mm square hole pattern and central M4 tapped hole. The MM-6 is available in single, double, or triple stages. Adding stages is an easy job and requires no special tools. Triple stages come with an angle bracket to attach the Z-axis. The travel of the stage is 0.26 in (6.5 mm) and the base is easily adapted to most surfaces.



SPECIFICATIONS MM-6

- **Baseplate Dimensions** 1.4 in x 1.2 in x 0.6 in
35 mm x 30 mm x 15 mm
- **Travel** 0.26 in
6.5 mm
- **Resolution** 1.0 μm
- **Maximum Load** Horizontal:
6.5 lbs
3 kg
Vertical:
1 lb
0.5 kg

MM-6

U.S. prices available at www.sutter.com. International prices vary by country. Contact a distributor or Sutter Instrument for a quotation. Prices subject to change without notice.

MICROMANIPULATOR

- **MM-6 X** Single stage
- **MM-6 XY** Double stage
- **MM-6 XYZ** Triple stage



MT-1000 / MT-2000 / MT-2200 SYSTEMS

MOTORIZED AND MANUAL TRANSLATION SYSTEMS FOR FIXED-STAGE MICROSCOPES

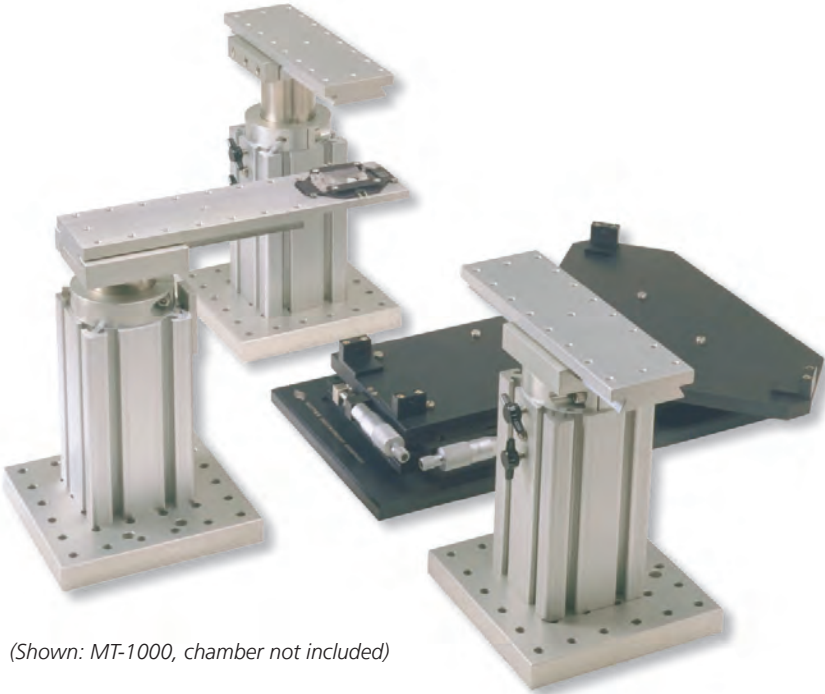

(Shown: MT-1000, chamber not included)

FEATURES MT-1000 / MT-2000 / MT-2200

- 22 mm of travel in X & Y
- 40 nm resolution displayed in submicrons (MP-285)
- 62.5 nm resolution displayed in microns (MPC-200)
- Highly stable for experiments intolerant of drift
- Easy to read vacuum fluorescent display
- Adjustable speed and resolution allows optimization for your experimental setup
- Programmable robotics for complex motion sequences (MP-285)
- Continuous display of axes positions
- Convenient HOME function allows microscope to be quickly repositioned



The MT-1000 / MT-2000 / MT-2200 systems consist of a microscope translator and three independent stands. Two MT-75 stands used for each manipulator and a similar stand, the MT-150 holds the tissue chamber. The classic design features freestanding columns that provide rock solid mounting for the tissue recording chamber and multiple micromanipulators. Many prefer this methodology as it maximizes working room for adjusting the microscope and changing pipettes. Furthermore, the independent stand design minimizes movement-related cross talk between manipulators.

The MT-1000 uses a manual translator. At the core of the MT-1000 translator systems is the MT-500 X-Y manual translation table. It is designed to allow movement of a microscope's optics with respect to the fixed stage(s). This methodology was developed by electrophysiologists recording from tissue slice preparations. The translator allows visualization and/or imaging of multiple tissue locations while maintaining multiple stable recordings from the preparation. Such a system is also useful for experiments on cells in culture where one wishes to monitor several cells not in the same field of view, e.g., recording from pre and post synaptic neurons in culture and/or imaging one cell while recording from or stimulating another.

The MT-2000 / MT-2200 systems use a motorized translator. At the core of the MT-2000 / MT-2200 system is the MT-800 stepper-motor driven X-Y translation table. The motors can be operated either by the popular MP-285 manipulator controller (MT-2000) or the dual manipulator controller MPC-200 (MT-2200). A two-axis rotary optical encoder (ROE) accepts user input to the motorized translator and can be placed in any convenient location in your setup. Either controller gives the user smooth, high-resolution control of motion. The MP-285 controller offers extensive on-board robotic functionality and a serial computer interface for PC control. The MPC-200 controller offers a USB computer interface for PC control. Systems using the MP-285 controller are called MT-2000 while systems using the MPC-200 controller are designated MT-2200.

Our controller design has allowed Sutter to easily add a focus drive to the MT-2000 / MT-2200. The Sutter focus drive employs a direct-coupled stepper motor for lock-step focus movement and adjustable end of travel sensors to limit the travel of the microscope objective to a safe range for the setup. In the focus drive version, MT-2000/FD and MT-2200/FD, the ROE input device has inputs for X, Y and Z focus.

MT-500 manual translators and MT-800 motorized translators are currently available for the Olympus BX-51WI, Nikon FN1, Zeiss Examiner, Zeiss Axioskop 2 FS and the Leica DM6000FS. Focus drives are available for the Olympus BX51WI. Other microscopes can be supported.



SPECIFICATIONS

MT-1000 / MT-2000 / MT-2200 SYSTEMS

■ Baseplate Dimensions	8 in x 15.25 in x 2.25 in 200 mm x 375 mm x 55 mm
■ Maximum Travel	22 mm
■ Minimal Microstep Size	50 nm (MP-285 controller) 78 - 125 nm (MPC-200 controller)
■ Minimal Display Resolution	50 nm (MP-285 controller) 1 micron (MPC-200 controller)
■ Maximum Load	110 lbs 50 kg
■ Weight	35 lbs 16 kg
■ Controller Weight	11 lbs 4.5 Kg





MT-1000 / MT-2000 / MT-2200

U.S. prices available at www.sutter.com. International prices vary by country. Contact a distributor or Sutter Instrument for a quotation. Prices subject to change without notice.

COMPLETE SYSTEMS

MT-1000

Includes the MT-500 manual X-Y translator, MT-150 chamber column, two MT-75 micromanipulator columns (without linear slide)

- **MT-1000/Y51¹** MT-1000 for the Olympus BX51WI
- **MT-1000/Y53¹** MT-1000 for the Olympus BX53/63
- **MT-1000/Y71¹** MT-1000 for the Olympus IX71
- **MT-1000/Z25¹** MT-1000 for the Zeiss Axioskop 2 FS
- **MT-1000/Z45¹** MT-1000 for the Zeiss Axio Examiner
- **MT-1000/N65¹** MT-1000 for the Nikon FN1
- **MT-1000/L30¹** MT-1000 for the Leica DMLFS
- **MT-1000/L35¹** MT-1000 for the Leica DM6000 FS

MT-2200

Includes the MT-800 motorized X-Y translator, MPC-200 controller and ROE, MT-150 chamber column, two MT-75 micromanipulator columns (without linear slide), cables and manual

- **MT-2200/Y51¹** MT-2200 for the Olympus BX51WI
- **MT-2200/Y53^{1,2}** MT-2200 for the Olympus BX53/63
- **MT-2200/Z25¹** MT-2200 for the Zeiss Axioskop 2 FS
- **MT-2200/Z45¹** MT-2200 for the Zeiss Axio Examiner
- **MT-2200/N65¹** MT-2200 for the Nikon FN1
- **MT-2200/L30¹** MT-2200 for the Leica DMLFS
- **MT-2200/L35¹** MT-2200 for the Leica DM 6000 FS

MT-2000

Includes the MT-800 motorized X-Y translator, MP-285 controller and ROE, MT-150 chamber column, two MT-75 micromanipulator columns (without linear slide), cables and manual

- **MT-2000/Y51¹** MT-2000 for the Olympus BX51WI
- **MT-2000/Y53¹** MT-2000 for the Olympus BX53/63
- **MT-2000/Z25¹** MT-2000 for the Zeiss Axioskop 2 FS
- **MT-2000/Z45¹** MT-2000 for the Zeiss Axio Examiner
- **MT-2000/N65¹** MT-2000 for the Nikon FN1
- **MT-2000/L30¹** MT-2000 for the Leica DMLFS
- **MT-2000/L35¹** MT-2000 for the Leica DM 6000 FS

¹ Please specify chamber type when ordering.

² Please contact Sutter for availability of focus drive on other microscope makes & models.



MT-1000 / MT-2000 / MT-2200

U.S. prices available at www.sutter.com. International prices vary by country. Contact a distributor or Sutter Instrument for a quotation. Prices subject to change without notice.

COMPONENTS

MANUAL X-Y TRANSLATOR

- **MT-500/Y50** Manual Translator for Olympus BX50WI
- **MT-500/Y51** Manual Translator for Olympus BX51WI
- **MT-500/Y53** Manual Translator for Olympus BX53/63
- **MT-500/Y71** Manual Translator for Olympus IX71
- **MT-500/N65** Manual Translator for Nikon FN1
- **MT-500/L30** Manual Translator for Leica DMLFS
- **MT-500/L35** Manual Translator for Leica DM6000 FS
- **MT-500/Z20** Manual Translator for Zeiss Axioskop FS
- **MT-500/Z25** Manual Translator for Zeiss Axioskop 2 FS
- **MT-500/Z45** Manual Translator for Zeiss Axio Examiner

MOTORIZED X-Y TRANSLATOR WITH MPC-200 CONTROLLER AND ROE

- **MT-820/Y51** Translator for Olympus BX51WI
- **MT-820/Y53** Translator for Olympus BXB53/63
- **MT-820/Z25** Translator for Zeiss Axioskop 2 FS
- **MT-820/Z45** Translator for Zeiss Axio Examiner
- **MT-820/N65** Translator for Nikon FN1
- **MT-820/L30** Translator for Leica DMLFS
- **MT-820/L35** Translator for Leica DM6000 FS

MOTORIZED X-Y TRANSLATOR WITH MP-285 CONTROLLER AND ROE

- **MT-800/Y51** Translator for Olympus BX51WI
- **MT-800/Y53** Translator for Olympus BX53/63
- **MT-800/Z25** Translator for Zeiss Axioskop 2 FS
- **MT-800/Z45** Translator for Zeiss Axio Examiner
- **MT-800/N65** Translator for Nikon FN1
- **MT-800/L30** Translator for Leica DMLFS
- **MT-800/L35** Translator for Leica DM6000 FS



MT-1000 / MT-2000 / MT-2200

U.S. prices available at www.sutter.com. International prices vary by country. Contact a distributor or Sutter Instrument for a quotation. Prices subject to change without notice.

CHAMBER COLUMN

- **MT-150/W20** Chamber column for Warner Series 20 (octagon)
- **MT-150/W20R** Chamber column for Warner Series 20 (round)
- **MT-150/ALA35** Chamber column for ALA 35 mm chamber
- **MT-150/ALA-MS** Chamber column for ALA MS
- **MT-150/CUST** Chamber column for non-standard recording chamber
- **MT-150/PT** Chamber column for petri dish or lid
- **MT-150/AUTO** Chamber column for Automate round stage adapter

MANIPULATOR COLUMNS

- **MT-75** Standard gantry stand 8.7 to 13.4 in (22.1 to 33.9 cm)
- **MT-75S¹** Short gantry stand 6.7 to 9.6 in (16.9 to 24.4 cm)
- **MT-75T** Tall gantry stand 10.7 to 15.4 in (27.1 to 39.1 cm)
- **MT-75XT** Extra tall gantry stand 14.7 to 18.5 in (37.4 to 47 cm)
- **MT-75/LS¹** Standard gantry stand with linear slide
- **MT-75S/LS¹** Short gantry stand with linear slide
- **MT-75T/LS** Tall gantry stand with linear slide
- **MT-75XT/LS¹** Extra tall gantry stand with linear slide

¹ Useful for most upright scopes & Axiovert 25 inverted scope with low stage plate.

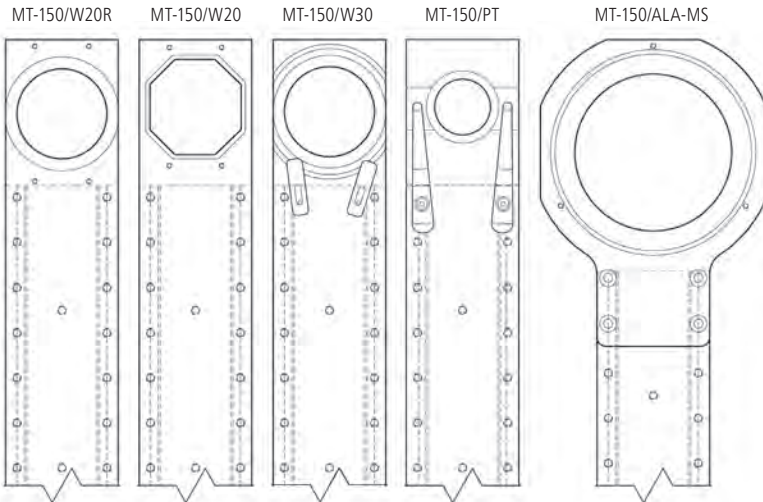



MT-1078 / MT-2078 / MT-2278 X-Y TRANSLATION SYSTEM FOR FIXED-STAGE MICROSCOPES

MICROMANIPULATION

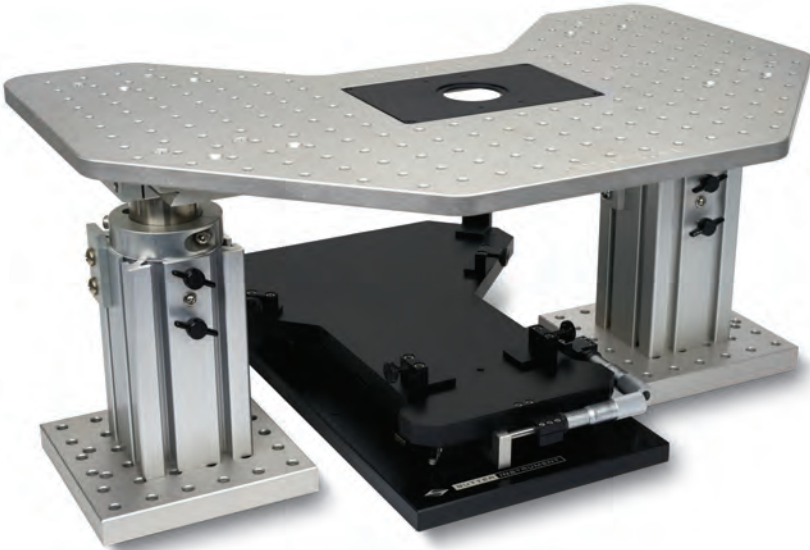

(Shown: MT-1078/Y51)

FEATURES MT-1078 / MT-2078 / MT-2278

- Motorized or manual X-Y translation
- Stable support and solid design
- Open design allows easy access to specimen and microscope
- Highly stable for experiments intolerant of drift
- Accommodates a variety of stage inserts
- Compatible with Nikon, Olympus, Zeiss and Leica upright and inverted microscopes
- Suitable for:
Multi-site electrophysiology where there is a need for a single large stage



The MT-1078 / MT-2078 / MT-2278 systems consist of a X-Y translator and a large fixed stage. The MT-78-FS is designed for users who prefer a large platform stage for their experiments. The stage provides solid, stable support and ample space to attach manipulators and other instruments as needed. The rigid aluminum top plate sits firmly on two MT-75 gantry style stands. These stands provide height adjustment and sturdy attachment to the user's vibration tables.

At the core of the MT-1078 is a manual X-Y translation table, the MT-500. The translator is designed to allow movement of a microscope's optics with respect to the fixed stage. The translator allows visualization and/or imaging of multiple tissue locations while maintaining multiple stable recordings from the preparation.

The MT-2078 / MT-2278 systems use a motorized translator. At the core of the MT-2000/MT-2200 system is the MT-800 stepper-motor driven X-Y translation table. The motors can be operated either by the popular MP-285 manipulator controller (MT-2078) or the dual manipulator controller MPC-200 (MT-2278). A rotary optical encoder (ROE) accepts user input to the motorized translator and can be placed in any convenient location in your setup. Either controller gives the user smooth, high-resolution control of motion. The MP-285 controller offers extensive on-board robotic functionality and a serial computer interface for PC control.

The MPC-200 controller offers a USB computer interface for PC control. Systems using the MP-285 controller are called MT-2078 while systems using the MPC-200-ROE controller are designated MT-2278. In the center of the MT-78-FS top plate is a 4x6 inch milled pocket that will accommodate a variety of aluminum or stainless steel (ferromagnetic) stage inserts, designed to secure various commercial tissue chambers, Petri dishes or slide holders. Custom can also be provided. The ferromagnetic insert allows small magnetic devices such as perfusion lines, ground electrodes and small manipulators to be mounted near the dish.

The MT-500 manual translator and the MT-800 motorized translator are currently available for the Olympus BX-51WI, Nikon FN1, Zeiss Examiner, Zeiss Axioskop 2 FS and the Leica DM6000FS. Focus drives are available for the Olympus BX51WI. Other microscopes can be supported.



SPECIFICATIONS

MT-1078 / MT-2078 / MT-2278

■ Baseplate Dimensions	8 in x 15.25 in x 2.25 in 200 mm x 375 mm x 55 mm
■ Maximum Travel	1 in 25 mm
■ Resolution	0.0002 in 5 μ m
■ Maximum Load	70 lbs 32 kg
■ Weight	35 lbs 16 kg



*(MT-1078 shown with MPC-385-2.
Headstages and microscope not included)*



MT-1078 / MT-2078 / MT-2278

U.S. prices available at www.sutter.com. International prices vary by country. Contact a distributor or Sutter Instrument for a quotation. Prices subject to change without notice.

COMPLETE SYSTEMS

MT-1078

Includes the MT-500 manual X-Y translator, and MT-78-FS fixed stage platform

- **MT-1078/Y51¹** MT-1078 for the Olympus BX51WI
- **MT-1078/Y53¹** MT-1078 for the Olympus BX53/63
- **MT-1078/Y71¹** MT-1078 for the Olympus IX71
- **MT-1078/Z25¹** MT-1078 for the Zeiss Axioskop 2 FS
- **MT-1078/Z45¹** MT-1078 for the Zeiss Axio Examiner
- **MT-1078/N65¹** MT-1078 for the Nikon FN1
- **MT-1078/L30¹** MT-1078 for the Leica DMLFS
- **MT-1078/L35¹** MT-1078 for the Leica DM6000 FS

MT-2278

Includes the MT-800 motorized X-Y translator, MPC-200 controller and ROE, MT-78-FS fixed stage platform, cables and manual

- **MT-2278/Y51¹** MT-2278 for the Olympus BX51WI
- **MT-2278/Y53¹** MT-2278 for the Olympus BX53/63
- **MT-2278/Z25¹** MT-2278 for the Zeiss Axioskop 2 FS
- **MT-2278/Z45¹** MT-2278 for the Zeiss Axio Examiner
- **MT-2278/N65¹** MT-2278 for the Nikon FN1
- **MT-2278/L30¹** MT-2278 for the Leica DMLFS
- **MT-2278/L35¹** MT-2278 for the Leica DM6000 FS

MT-2078

Includes the MT-800 motorized X-Y translator, MP-285 controller and ROE, MT-78-FS fixed stage platform, cables and manual

- **MT-2078/Y51¹** MT-2078 for the Olympus BX51WI
- **MT-2078/Y53¹** MT-2078 for the Olympus BX53/63
- **MT-2078/Z25¹** MT-2078 for the Zeiss Axioskop 2 FS
- **MT-2078/Z45¹** MT-2078 for the Zeiss Axio Examiner
- **MT-2078/N65¹** MT-2078 for the Nikon FN1
- **MT-2078/L30¹** MT-2078 for the Leica DMLFS
- **MT-2078/L35¹** MT-2078 for the Leica DM6000 FS

¹Please specify chamber type when ordering.

²Please contact Sutter for availability of focus drive on other microscope makes & models



ACCESSORIES MT-1078 / MT-2078 / MT-2278

U.S. prices available at www.sutter.com. International prices vary by country. Contact a distributor or Sutter Instrument for a quotation. Prices subject to change without notice.

PLATFORM CHAMBER INSERTS

- **X040500¹** Warner Series 20 (round) for PM platform — aluminum
- **X040503¹** Warner Series 20 (round) for PM platform — stainless
- **X040505¹** Warner Series 20 (octagonal) for P & PH — aluminum
- **X040507¹** Warner Series 20 (octagonal) for P & PH — stainless
- **X040510¹** 50 mm round — aluminum
- **X040512¹** 50 mm round — stainless steel
- **X040497¹** Blank insert — aluminum
- **X040498¹** Blank insert — stainless steel
- **SI-SLIDE¹** Insert with slide holders
- **SI-PETRI** Insert for petri dish and slides
- **SI-W30¹** Warner Series 30 platform insert — aluminum
- **SI-W30ST¹** Warner Series 30 platform insert — stainless steel
- **SI-ALA-MS¹** ALA MS series insert — aluminum
- **SI-CUSTOM²** Custom stage insert

¹ One insert included with MT-1078 / MT-2078 / MT-2278 at no charge

² Call Sutter Instrument for details

INSERT DRAWINGS

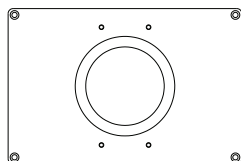

X040500, X040503

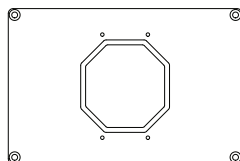

X040505, X040507

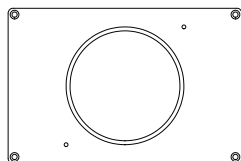

SI-W30, SI-W30-ST

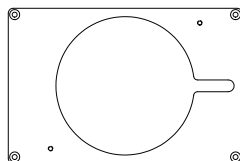

SI-ALA-MS

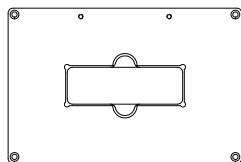

SI-SLIDE

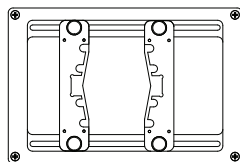

SI-PETRI



COMPONENTS MT-1078 / MT-2078 / MT-2278

U.S. prices available at www.sutter.com. International prices vary by country. Contact a distributor or Sutter Instrument for a quotation. Prices subject to change without notice.

INDIVIDUAL COMPONENTS

- **MT-78-FS¹** Fixed platform stage with imperial/standard holes, chamber insert and gantry supports
- **MT-78-FS/M6¹** Same as above with M6 tapped holes
- **MT-78-CS¹** Platform stage with 12.5 mm manual micrometer movement, chamber insert, and gantry supports
- **MT-78-CS/M6¹** Same as above with M6 tapped holes

MANUAL X-Y TRANSLATOR

- **MT-500/Y50** Manual Translator for Olympus BX50WI
- **MT-500/Y51** Manual Translator for Olympus BX51WI
- **MT-500/Y53** Manual Translator for Olympus BX53/63
- **MT-500/Y71** Manual Translator for Olympus IX71
- **MT-500/N65** Manual Translator for Nikon FN1
- **MT-500/L30** Manual Translator for Leica DMLFS
- **MT-500/L35** Manual Translator for Leica DM6000 FS
- **MT-500/Z20** Manual Translator for Zeiss Axioskop 2 FS
- **MT-500/Z25** Manual Translator for Zeiss Axioskop 2 FS
- **MT-500/Z45** Manual Translator for Zeiss Axio Examiner

MOTORIZED X-Y TRANSLATOR WITH MPC-200 CONTROLLER AND ROE

- **MT-820/Y51** Translator for Olympus BX51WI
- **MT-820/Y53** Translator for Olympus BXB53/63
- **MT-820/N65** Translator for Nikon FN1
- **MT-820/L30** Translator for Leica DMLFS
- **MT-820/L35** Translator for Leica DM6000 FS
- **MT-820/Z25** Translator for Zeiss Axioskop 2 FS
- **MT-820/Z45** Translator for Zeiss Axio Examiner

MOTORIZED X-Y TRANSLATOR WITH MP-285 CONTROLLER AND ROE

- **MT-800/Y51** Translator for Olympus BX51WI
- **MT-800/Y53** Translator for Olympus BX53/63
- **MT-800/N65** Translator for Nikon FN1
- **MT-800/L30** Translator for Leica DMLFS
- **MT-800/L35** Translator for Leica DM6000 FS
- **MT-800/Z25** Translator for Zeiss Axioskop 2 FS
- **MT-800/Z45** Translator for Zeiss Axio Examiner

¹ Useful for most upright scopes and the Axiovert 25 inverted scope with low stage plate. Please specify chamber type when ordering (Page 100).



MPC-78 / MP-78

LARGE MOVING PLATFORM STAGE

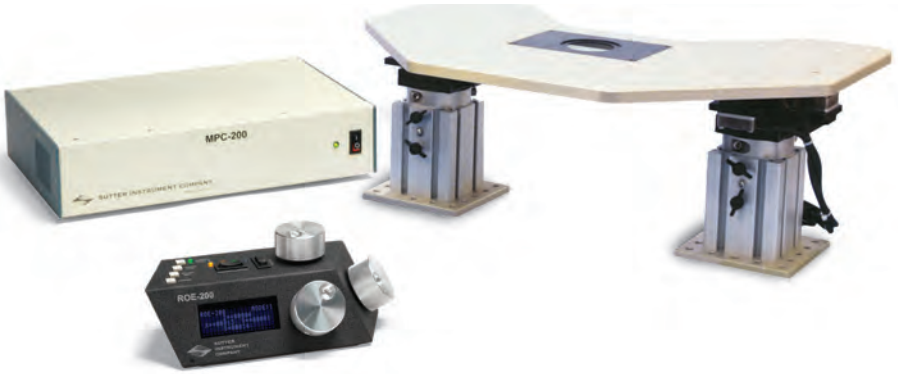

FEATURES MPC-78 / MP-78

- Stable support and solid design
- 25 mm motorized travel in X & Y
- 40 nm or 62.5 nm resolution (depending on controller)
- Convenient HOME function allows stage to be quickly repositioned
- Can be operated with MPC-200 or MP-285 controllers
- Easy to read vacuum fluorescent display
- Accommodates a variety of stage inserts
- Compatible with Nikon, Olympus, Zeiss and Leica upright and inverted microscopes
- Suitable for:
 - Multi-site, two-photon, electrophysiology
 - Multi-site, inverted (or other large microscope) electrophysiology



The MPC-78 / MP-78 Large Moving Stage is available for patch slice or *in vivo* experiments where the microscope body cannot be moved to view different fields of view. This is most common in two-photon experiments where the excitation beam path must enter a fixed microscope. In order to visit wide-spaced fields of view, and potentially position pipettes at wide-spaced locations, the preparation and any associated manipulators must move together on a large stage.

The MPC-78 / MP-78 was introduced at the 2007 Imaging Structure and Function in the Nervous System course at Cold Spring Harbor labs. The stage was very well received. The MPC-78 / MP-78 is also appropriate for use with inverted microscopes or other scopes that are larger and not easily translated.

The MPC-78 version uses our MPC-200 multi-manipulator controller. Connecting the stage to one port leaves the second port open for a Sutter MP-285, MP-865, or MP-225 manipulator. A simple switch on the ROE-200 allows you to easily control the stage or manipulator. A second MPC-200 controller can be daisy-chained to allow operation of a more complex system from one ROE-200.

The MP-78 version is operated by the MP-285 controller, providing onboard programming capability along with control via a serial interface.

The cast aluminum top plate has an attractive shape with an extensive 1/4-20 threaded hole pattern on 1-inch centers. This hole pattern is appropriate for mounting Sutter MP-285 or MP-225 manipulator mechanicals using the mounting adapter plates that come with these devices. Optional rotating bases (285RB1) are also compatible and add flexibility. Finally, the MP-865 mechanical can be mounted on its narrow linear slide.

The large-stage platforms provide solid, stable support and ample space to attach manipulators and other instruments as needed. The rigid aluminum top plate sits firmly on two of our well-known MT-75 gantry-style stands. These stands provide height adjustment and sturdy attachment to the user's vibration table. Multiple degrees of freedom accommodate a variety of microscope and instrument arrangements.

In the center of the top plate is a 4 X 6 inch milled pocket that will accommodate a variety of aluminum stage inserts, designed to secure various commercial tissue chambers or slide holders. Custom aluminum inserts can also be provided. An available magnetic stainless steel insert carries commercial chambers or can be provided with a simple large, through hole for mounting a custom chamber. The magnetic insert allows small magnetic devices (perfusion lines, ground electrodes, small manipulators) to be mounted easily near the dish.



SPECIFICATIONS MPC-78 LARGE MOVING STAGE PLATFORM

■ Baseplate Dimensions	8 in x 15.25 in x 2.25 in 200 mm x 375 mm x 55 mm
■ Maximum Travel	1 in 25 mm
■ Resolution	0.625 $\mu\text{m}/\text{step}$ Displayed in microns
■ Maximum Load	110 lbs 50 kg
■ Weight	35 lbs 16 kg
■ Interface	USB



SPECIFICATIONS MP-78 LARGE MOVING STAGE PLATFORM

■ Baseplate Dimensions	8 in x 15.25 in x 2.25 in 200 mm x 375 mm x 55 mm
■ Maximum Travel	1 in 25 mm
■ Resolution	Low: 0.2 $\mu\text{m}/\text{step}$ High: 0.04 $\mu\text{m}/\text{step}$ Displayed in submicrons
■ Maximum Load	110 lbs 50 kg
■ Weight	35 lbs 16 kg
■ Interface	RS-232, 9600 baud (1 start bit, 8 data bits, 1 stop bit)





MPC-78 / MP-78

U.S. prices available at www.sutter.com. International prices vary by country. Contact a distributor or Sutter Instrument for a quotation. Prices subject to change without notice.

INDIVIDUAL COMPONENTS

- **MPC-78¹** Moving platform stage plate with motorized gantry supports and imperial/standard holes, MP-200 controller (USB interface) and ROE, chamber insert, cables, manual
- **MPC-78/M6¹** Same as MPC-78 except M6 tapped holes
- **MP-78¹** Moving platform stage plate with motorized gantry supports and imperial/standard holes, MP-285 controller (serial interface) and ROE, chamber insert, cables, manual
- **MP-78/M6¹** Same as MP-78 except with M6 tapped holes

ACCESSORIES MPC-78 / MP-78

MP-78 and MPC-78 CHAMBER INSERTS (Diagrams on page 100)

- **X040500³** Warner Series 20 (round) for PM platform – aluminum
- **X040503³** Warner Series 20 (round) for PM platform – stainless
- **X040505³** Warner Series 20 (octagonal) for P & PH – aluminum
- **X040507³** Warner Series 20 (octagonal) for P & PH – stainless
- **X040510³** 50mm round – aluminum
- **X040512³** 50mm round – stainless steel
- **X040497³** Blank insert – aluminum
- **X040498³** Blank insert – stainless steel
- **SI-SLIDE³** Insert with slide holders
- **SI-PETRI** Insert for petri dish and slides
- **SI-W30³** Warner Series 30 platform insert – aluminum
- **SI-W30ST³** Warner Series 30 platform insert – stainless steel
- **SI-ALA-MS³** ALA MS series insert – aluminum
- **SI-CUSTOM⁴** Custom stage insert

¹ Please specify chamber type when ordering.

² Other microscope makes and models may be available. Order with M6 or standard tapped holes.

³ One insert included with MP-78 or MPC-78 at no charge

⁴ Call Sutter Instrument for details



3DMS 3-AXIS MOTORIZED STAGE



(Shown: 3DMS-200, with 3DMS-W20 stage bracket)

FEATURES 3DMS

- Variety of stage bracket options provide increased flexibility
- Highly stable for experiments intolerant of pipette drift
- Sub-micron resolution and integrated coarse positioning
- 1 inch of motorized travel on all three axes
- Adjustable speed and resolution allows optimization for your experimental setup
- When used with the MP-285 controller, programmable robotics for complex motion sequences
- Continuous display (in microns) of axes positions
- Switch between continuous or single step movement
- Absolute and relative origins
- Remote computer control
- Compact design easily adaptable to your setup



Many imaging experiments require the ability to move to multiple locations in a chamber or in a tissue culture dish. Large motorized stages accomplish this, but generally make the microscope into a single-use, motorized imaging station. The form factor of motorized stages usually precludes positioning other equipment such as manipulators at the same microscope.

Now, a simple attachment converts a standard Sutter MP-285 manipulator into the 3-Dimensional Motorized Stage. The 3DMS manipulator and stage attachment can be either mounted on an MT-75 gantry stand next to an upright microscope, or on an MD series stand attached to the body of an inverted microscope. The compact size allows manipulators and other equipment to be used simultaneously.

Refocusing is often required at the different X-Y locations when images are automatically acquired. Normally this requires a motorized focus drive to be added to the microscope. Because the 3DMS is a three-axis manipulator, focusing (vertical movement of the stage) is already built in. Surprisingly, this relatively small package still allows for 25 mm of movement in X, Y and Z axes with sub-micron precision.

A variety of stage brackets are available to fit the needs of your experiment. Please consult our technical staff for further information.





SPECIFICATIONS 3DMS

- **Travel** 1 inch
25 mm on all three axes
- **Resolution (with MP-285 Controller)** Low: 0.2 $\mu\text{m}/\text{step}$
High: 0.04 $\mu\text{m}/\text{step}$
- **Maximum Speed** 2.9 mm/sec
- **Long Term Stability** <10 nm/hour at 24 deg C
- **Drive Mechanism** Precision worm gear capstan drive
- **Serial Interface** RS-232, 9600 baud
(1 start bit, 8 data bits, 1 stop bit)
- **Dimensions** *Mechanical:*
4.5 in x 6 in x 6.25 in
11 cm x 15 cm x 16 cm
Controller:
4 in x 16 in x 12.25 in
10 cm x 40.5 cm x 31 cm
- **Weight** *Manipulator:*
3.85 lb
1.7 kg
Controller:
10 lb 11 oz
4.5 kg
- **Electrical** 115/230 Volts
50/60 Hertz power line



MECHANICAL DRAWINGS STAGE BRACKETS

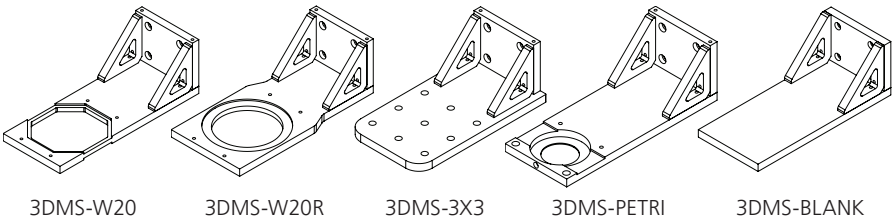



3DMS SYSTEMS

U.S. prices available at www.sutter.com. International prices vary by country. Contact a distributor or Sutter Instrument for a quotation. Prices subject to change without notice.

- **3DMS-100** Includes TRIO™ MPC-100 controller, 3-axis motorized stage for microscope, stage bracket, and ROE user interface
- **3DMS-285¹** Includes rack mount MP-285 controller, 3-axis motorized stage for microscope, stage bracket, and ROE user interface
- **3DMS-200¹** Includes rack mount MPC-200 controller, 3-axis motorized stage for microscope, stage bracket, and ROE user interface

ACCESSORIES 3DMS

STAGE BRACKETS

When ordering the 3DMS, the stage bracket must be specified. Please list as a separate item at no cost. Additional stage brackets can be purchased as needed.

- **3DMS-W20²** Stage bracket for Warner Series 20 octagonal (P & PH)
- **3DMS-W20R²** Stage bracket for Warner Series 20 round (PM)
- **3DMS-3X3²** Stage bracket with 3X3 M6 tapped holes
- **3DMS-PETRI²** Stage bracket for Petri dish and slides
- **3DMS-BLANK²** Stage bracket – blank
- **3DMS-CUSTOM** Stage bracket – custom design
- **3DMS/M** 3-axis motorized stage mechanical only
- **M100106** Flat side panel for controller (each)

¹ Please specify stage bracket when ordering.

² One stage bracket included with 3DMS-200 or 3DMS-285 at no charge.

MOTORIZED MICROSCOPE STAGE AND TRANSLATOR COMPARISON CHART



	MT-2000 / 2078 MT-2200 / 2278	MP-78 MPC-78	3DMS
DESCRIPTION	Microscope translator and table mounted stands and/or fixed stage for multi-patch	Large moving platform stage	3-dimensional motorized stage
USES	Multi-electrode recording and imaging in slices or other preparations	Simultaneous 2-Photon Imaging and electrophysiology	Multi-site imaging of samples smaller than 25 mm x 25 mm
FEATURES	25 mm X and Y optical train movement via manual or motorized microscope translators. Accomplishes high magnification microscopy/ electrophysiology at multiple sites in a sample. Manipulators and tissue sample can be on separate stands or on a single large fixed stage.	Tissue sample or whole animal and multiple manipulators are supported on a large, moving stage. 25 mm travel in X and Y allow the user to move to multiple sites in brain or other tissue for electrode placement and simultaneous 2-photon imaging. The large moving stage is also useful for inverted microscope or other applications where moving the microscope is not convenient or easily accomplished.	Built-in Z focus drive, compact form factor, compatible with upright or inverted microscopes, 25 mm travel in X, Y, and Z. Adjustable speed and resolution allows optimization for your experimental setup. Absolute and relative origins. Programmable robotics for complex motion sequences when used with MP-285 controller.

Features

Travel

25 mm in X, Y, and Z

22 mm in X and Y

Focus

Built-in

Option for Olympus BX51WI¹

Control

ROE or PC

ROE or PC

ROE or PC

Interface

With MPC-200

USB

USB

USB

With MP-285A

Serial & USB

Serial & USB

Serial & USB

With TRIO™ MPC-100²

USB

¹ Please contact Sutter for availability on other microscope makes and models

² Only available with 3DMS





MT-75 SERIES GANTRY STYLE MICROMANIPULATOR STAND

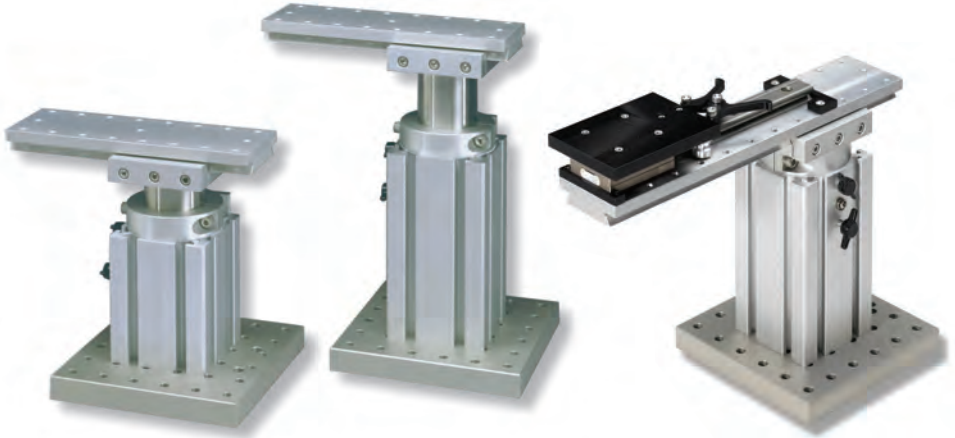

FEATURES MT-75 SERIES

- Adjustable vertical and horizontal axes
- Up to 360 degrees of rotation
- Suitable for upright and inverted microscopes
- Quick lock mechanism allows for easy positioning
- Solid construction provides stable mounting
- Optional linear slide provides smooth and easy movement for pipette replacement



For ultimate flexibility in positioning micromanipulators or other devices adjacent to your microscope, look to the MT-75 series stands. These unique gantry systems offer adjustable vertical and horizontal axes and up to 360 degrees of rotation. Your manipulator or other device will mount to the 3/4 in. thick aluminum cantilever which is dovetailed for secure positioning. The cantilever assembly is mounted on a heavy 2 in. diameter stainless steel post. The post is supported within the same extruded aluminum tower used in our MT-70 stands. The tower can be center mounted or edge mounted to the base-plate for an additional degree of positioning freedom.

A quick lock mechanism allows easy unlocking and rotation of the post/cantilever assembly up to 320 degrees, then rotation back to the same positive stop position and locking in place (e.g. insertion and removal of microelectrodes from headstages). Remove the positive stop and you have a full 360 degree rotation. A Teflon washer contributes to the smooth rotation of the system.

The solid aluminum baseplate has through-holes on 1 inch (25mm) centers for mounting onto tables. The cantilever has eighteen 1 inch spaced 10-32 holes along the edges. The MT-75/LS manipulator mount provides additional flexibility of movement. In multiple manipulator setups, rotational movement for pipette replacement is often not possible. Using a long linear rail, the manipulator can be quickly and smoothly moved to a location where there is easy access to the pipette for replacement. After replacement, the manipulator can be slid back into a fixed stop that defines the working position.

Vertical positioning is achieved with an aluminum collar which securely locks onto the steel post to fix the height of the system. These systems are very stiff, deflecting approximately 2 μm per 25 mm rise with a 1.5 kg load at the end of the cantilever.

The linear slide system can also be added to existing MT-75 stands by ordering the MT-7004 linear slide cantilever alone.



SPECIFICATIONS

MT-75 SERIES

- **Baseplate Dimensions** 6 in x 6 in x .75 in
153 mm x 153 mm x 19 mm
- **Cantilever Dimensions** 2.5 in x 8 in x .75 in
64 mm x 204 mm x 19 mm
- **Total Stand Height** *MT-75:*
Adjustable
8.71 in to 12.25 in
221 mm to 311 mm
MT-75S:
Adjustable
6.71 in to 7.25 in
170 mm to 184 mm
- **Weight** *MT-75:*
11 lbs 7 oz
5.2 kg
MT-75S:
9 lbs 14 oz
4.5 kg
MT-75T:
13 lbs
5.9 kg



MT-75 GANTRY STYLE STAND SELECTION GUIDE

For use with an inverted microscope. Independent tower solution when not using our MD manipulator or stage platforms.

For use with an upright microscope mounted on a translator.

For use with an upright microscope without a translator.

MT-75T

MT-75

MT-75S

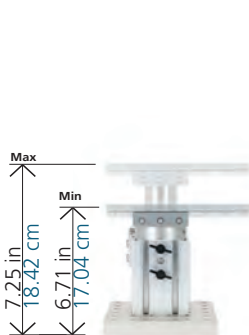
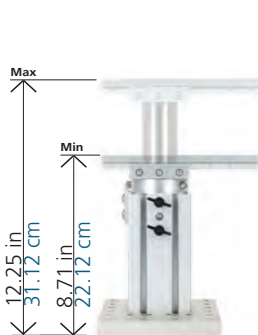
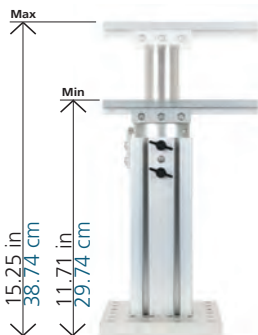

BASEPLATE OPTIONS

SQUARE

6 in x 6 in x 0.75 in
15.2 cm x 15.2 cm x 1.9 cm

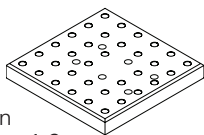

NARROW

3 in x 5 in x 0.75 in
7.6 cm x 12.7 cm x 1.9 cm

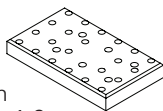

THIN

5 in x 5 in x 0.3 in
12.7 cm x 12.7 cm x 0.76 cm

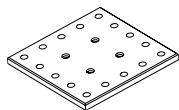

MT-75T MT-75 MT-75S

BASEPLATE	VERTICAL DIMENSIONS					
	Min	Max	Min	Max	Min	Max
SQUARE OR NARROW	11.71 in 29.74 cm	15.25 in 38.74 cm	8.71 in 22.12 cm	12.25 in 31.12 cm	6.71 in 17.04 cm	7.25 in 18.42 cm
THIN	11.26 in 28.60 cm	14.80 in 37.59 cm	8.26 in 20.98 cm	11.80 in 29.97 cm	6.26 in 15.90 cm	6.80 in 17.27 cm

The MT-75 stands come standard with the square baseplate. The narrow or thin baseplate can be substituted at the time of ordering at no additional charge.



MT-75 SERIES

U.S. prices available at www.sutter.com. International prices vary by country. Contact a distributor or Sutter Instrument for a quotation. Prices subject to change without notice.

MT-75 SERIES

- **MT-75** Standard gantry stand 8.7 to 13.4in (22.1 to 33.9 cm)
- **MT-75S¹** Short gantry stand 6.7 to 9.6 in (16.9 to 24.4 cm)
- **MT-75T** Tall gantry stand 10.7 to 15.4 in (27.1 to 39.1 cm)
- **MT-75XT** Extra tall gantry stand 14.7 to 18.5 in (37.4 to 47 cm)
- **MT-75/LS¹** Standard gantry stand with linear slide
- **MT-75S/LS¹** Short gantry stand with linear slide
- **MT-75T/LS** Tall gantry stand with linear slide
- **MT-75XT/LS** Extra tall gantry stand with linear slide

MT-81 MICROINJECTION SERIES

- **MT-81-DOV8²** MT-81 stand with 8 inch dovetail
- **MT-81-DOV12²** MT-81 stand with 12 inch dovetail

¹ Useful for most upright scopes and the Axiovert 25 inverted scope with low stage plate.

² Useful for low profile stereoscopes and microinjection.



(Shown: MT-81-DOV8.
Suitable for microinjection)

ACCESSORIES MT-75 SERIES

- **MT-7004** Linear slide cantilever (no stand)
- **MAG-MT** Magnetic feet (set of 4)
- **X700080³** Thin baseplate – 5 in x 5 in x 0.3 in thick
- **X700095³** Narrow baseplate – 3 in x 5 in x 0.75 in thick
- **X700100³** Square baseplate – 6 in x 6 in x 0.75 in thick
- **X750090³** 12 inch dovetail

³ Can be substituted at time of ordering with MT-75 stands at no additional charge.





MT-70 & MT-71 SERIES MICROMANIPULATOR STANDS



FEATURES MT-70 / MT-71

- Solid extrusion provides sturdy, stable mounting
- Accommodates a variety of special layouts
- Individual components provide a variety of mounting options
- Suitable for upright and inverted microscopes
- Adjustable height cantilever available



The MT-70 series of stands are sturdy, stable, and extremely versatile for mounting components for a variety of research applications. They were designed for placing our heavy Huxley-style micromanipulators adjacent to any microscope. We found them to be so useful and adaptable that we also use them for mounting other items such as optical components.

The stands are based on a rigid extruded aluminum tower which is available in 3 inch increments up to 12 inches. The tower is mounted on a sturdy 3/4 in thick aluminum baseplate and then fitted with a 5/16 in thick aluminum mounting platform. These systems are configurable as fixed height stands or, in the MT-71 series, have an adjustable height cantilevered side platform for added versatility. The tower can be center or edge mounted to the baseplate for accommodating various spatial layouts. Rows of 1 inch and 25 mm centered clearance holes are provided in the baseplate for attachment to tables. The mounting platforms have tapped 1/4-20 mounting holes on 1 inch centers.

The stands are available in sets, or you can order individual components separately to meet your specific requirements. Custom heights can be made to order for an additional fee. To securely fasten our MP-85 Huxley style manipulator to the mounting plates, please order the manipulator adapter plate at the time of purchase. Larger baseplates or mounting plates are available upon special order.



SPECIFICATIONS MT-70 / MT-71 SERIES

- **Baseplate Dimensions** 6 in x 6 in x .75 in
153 mm x 153 mm x 19 mm
- **Mounting Plate Dimensions** 5 in x 5 in x 5/16 in
128 mm x 128 mm x 8 mm
- **Total Stand Height** Depending on configuration
4 1/16 in to 13 1/16 in
104 mm to 333 mm
- **Weight** Depending on configuration
3 lbs 11 oz to 8 lbs 5 oz
1.7 kg to 3.8 kg

MECHANICAL DRAWINGS MT-70-3

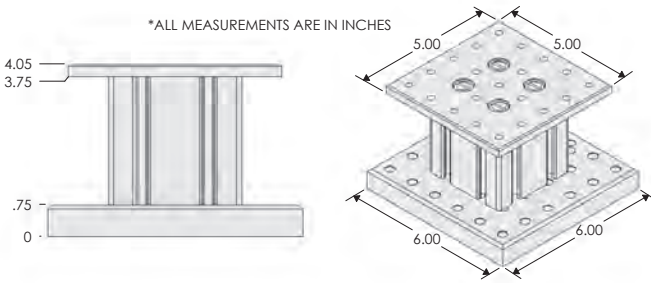

MECHANICAL DRAWINGS MT-71-6

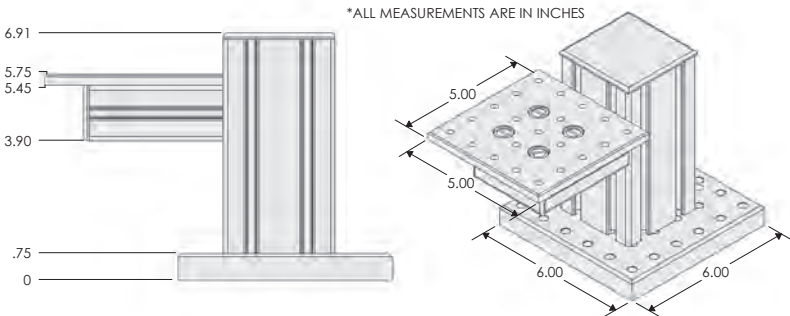



MT-70 / MT-71 SERIES

U.S. prices available at www.sutter.com. International prices vary by country. Contact a distributor or Sutter Instrument for a quotation. Prices subject to change without notice.

MT-70 SERIES

- **MT-70-3** 3 inch tower, baseplate, mounting platform and fastening hardware
- **MT-70-6** Same as above with 6 inch tower
- **MT-70-9** Same as above with 9 inch tower
- **MT-70-12** Same as above with 12 inch tower

(Custom tower lengths available: Call for pricing)

MT-71 SERIES

- **MT-71-3** 3 inch tower, baseplate, mounting platform and fastening hardware
- **MT-71-6** Same as above with 6 inch tower
- **MT-71-9** Same as above with 9 inch tower
- **MT-71-12** Same as above with 12 inch tower

(Custom tower lengths available: Call for pricing)

ACCESSORIES MT-70 / MT-71 SERIES

- **MT-7001** Cantilever mounting assembly
- **MAG-MT** Magnetic feet (set of 4)
- **X700080** Thin baseplate — 5 in x 5 in x 0.3 in thick
- **X700095** Narrow baseplate — 3 in x 5 in x 0.75 in thick
- **X700100** Square baseplate — 6 in x 6 in x 0.75 in thick
- **X700102** Mounting plate — 5 in x 5 in x 0.3 in thick
- **X700115** MP-85 adapter plate



MD SERIES MICROMANIPULATOR PLATFORMS



FEATURES MD SERIES

- Creates a stable matrix of ¼-20 or M6 holes on one or both sides of a mechanical stage
- Open design allows easy access to specimen and microscope
- Mounts directly on microscope, preserving valuable optical bench space
- Independent platform separate from specimen
- Allows for flexible mounting of all Sutter motorized manipulators



We've designed a series of Microscope Dependent (MD) stands for those who wish to use a Sutter Instrument manipulator in conjunction with an inverted microscope.

The typical MD stand is a manipulator platform that bolts directly to the frame of an inverted microscope. Stands are available in either single-sided or double-sided versions for the most common inverted microscopes made by Nikon, Olympus, Leica, and Zeiss. These platforms lend themselves to the absolutely drift-free recording configuration required when using the manipulators to position patch-electrodes to record from attached cells in culture.

To mount the MP-285 to an MD stand, you also need either the X285210 mounting adapter plate (for orthogonal mounting), or the 285RBI rotating base that allows for non-orthogonal mounting and rotation of the entire manipulator (note: the X285210 mounting plate is included with each MP-285 and MP-225). New mounting options and adapters for new microscopes are being added frequently. Please see our web site for new additions, current mechanical drawings, and dimensions.

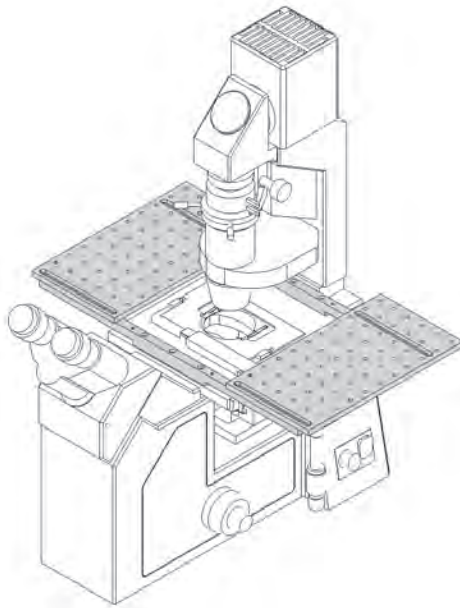



MECHANICAL DRAWINGS MD-SERIES

MICROMANIPULATION

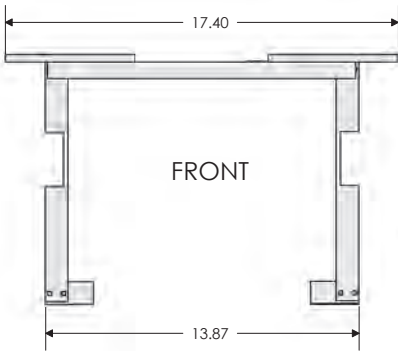

*ALL MEASUREMENTS ARE IN INCHES

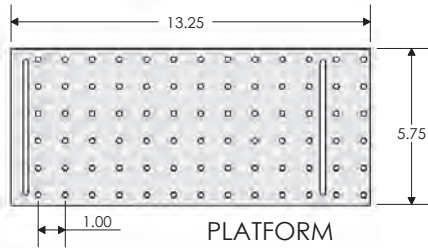
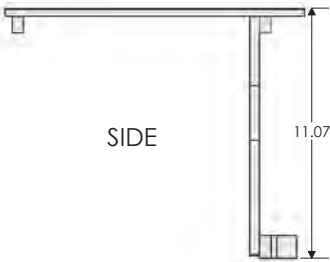
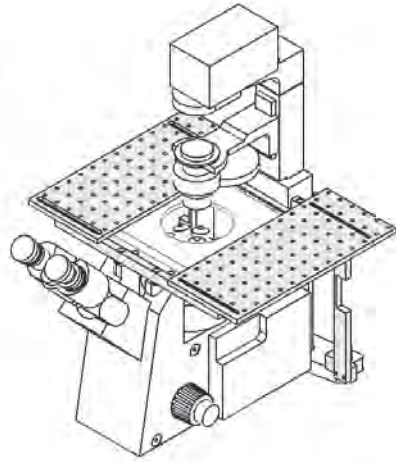

(Dimensions vary by scope)



MD-SERIES

U.S. prices available at www.sutter.com. International prices vary by country. Contact a distributor or Sutter Instrument for a quotation. Prices subject to change without notice.

MD part numbers have top plates with an imperial hole pattern (1/4-20 on 1 inch centers) and our MDM part numbers indicate a metric hole pattern (M6 tapped holes on 25 mm centers). The last digit of the MD and MDM part number identifies a single-sided universal platform (-1), single-sided positional (-1L, -1R), or a double-sided platform (-2). If you do not see a metric top plate for your microscope, please phone Sutter as it may be available.

Nikon

MD-50 SERIES

Nikon Diaphot 200/300 and Nikon TE 200/300

MD-50-1 Single-sided
MD-50-2 Double-sided

Nikon TMD

MD-51-1 Single-sided
MD-51-2 Double-sided

Nikon TE-2000

MD-52-1 Single-sided
MD-52-2 Double-sided
MD-52-1/UP Single-sided for scopes with Stage Up
MD-52-2/UP Double-sided for scopes with Stage Up

Nikon TE-2000 (metric tap)

MDM-52-1 Single-sided
MDM-52-2 Double-sided
MDM-52-1/UP Single-sided for scopes with Stage Up
MDM-52-2/UP Double-sided for scopes with Stage Up

Nikon Ti

MD-54-1L Single-sided left
MD-54-1R Single-sided right
MD-54-2 Double-sided
MD-54-1/M Single-sided for scopes with motorized stage
MD-54-2/M Double-sided for scopes with motorized stage
MD-54-1/UP Single-sided for scopes with Stage Up
MD-54-2/UP Double-sided for scopes with Stage Up
MD-54-1/MUP Single-sided for scopes with Stage Up — motorized
MD-54-2/MUP Double-sided for scopes with Stage Up — motorized

Nikon Ti (metric tap)

MDM-54-1L Single-sided left
MDM-54-1R Single-sided right
MDM-54-2 Double-sided
MDM-54-1/M Single-sided for scopes with motorized stage
MDM-54-2/M Double-sided for scopes with motorized stage
MDM-54-1/UP Single-sided for scopes with Stage Up
MDM-54-2/UP Double-sided for scopes with Stage Up
MDM-54-1/MUP Single-sided for scopes with Stage Up — motorized
MDM-54-2/MUP Double-sided for scopes with Stage Up — motorized

Nikon Ti2

MD-55-1L Single-sided left
MD-55-1R Single-sided right
MD-55-2 Double-sided

Nikon Ti2 (metric tap)

MDM-55-1L Single-sided left
MDM-55-1R Single-sided right
MDM-55-2 Double-sided
MD-SPACER-15 15 mm spacer for Nikon Ti2 with motorized stage (set of 4)



MD-SERIES

U.S. prices available at www.sutter.com. International prices vary by country. Contact a distributor or Sutter Instrument for a quotation. Prices subject to change without notice.

Nikon

Nikon TS-2

MD-56-1L

Single-sided left

MD-56-1R

Single-sided right

MD-56-2

Double-sided

Nikon TS-2 (metric tap)

MDM-56-1L

Single-sided left

MDM-56-1R

Single-sided right

MDM-56-2

Double-sided

Nikon TS-2R

MD-57-1/L

Single-sided left

MD-57-1/R

Single-sided right

MD-57-2

Double-sided

Nikon TS-2R (metric tap)

MDM-57-1

Single-sided

MDM-57-2

Double-sided t

Leica

Leica DMIRB

MD-60-1L

Single-sided left

MD-60-1R

Single-sided right

MD-60-2

Double-sided

Leica DMIL

MD-61-1

Single-sided

MD-61-2

Double-sided

Leica DMI 4000/5000/6000

MD-62-1L

Single-sided left

MD-62-1R

Single-sided right

MD-62-2

Double-sided

Leica DMi 8

MD-63-1/L

Single-sided left

MD-63-1/R

Single-sided right

MD-63-2

Double-sided

MD-63-1L/M

Single-sided left for scopes with motorized stage

MD-63-1R/M

Single-sided right for scopes with motorized stage

MD-63-2/M

Double-sided for scopes with motorized stage

Leica DMi 8 (metric tap)

MDM-63-1L

Single-sided left

MDM-63-1R

Single-sided right

MDM-63-2

Double-sided

MDM-63-1L/M

Single-sided left for scopes with motorized stage

MDM-63-1R/M

Single-sided right for scopes with motorized stage

MDM-63-2/M

Double-sided for scopes with motorized stage

MD-50 SERIES – continued

MD-60 SERIES



MD-SERIES

U.S. prices available at www.sutter.com. International prices vary by country. Contact a distributor or Sutter Instrument for a quotation. Prices subject to change without notice.

Olympus

Olympus IX 50/70

MD-80-1 Single-sided
MD-80-2 Double-sided

Olympus IX 50/70 (metric tap)

MDM-80-1 Single-sided
MDM-80-2 Double-sided

Olympus IX 51/71/81

MD-81-1 Single-sided
MD-81-2 Double-sided

Olympus IX 51/71/81 (metric tap)

MDM-81-1 Single-sided
MDM-81-2 Double-sided

Olympus IX 51/71/81 with zero drift stage

MD-81-1ZDC Single-sided
MD-81-2ZDC Double-sided

Olympus IX 53/73

MD-73-1 Single-sided
MD-73-2 Double-sided

Olympus IX 53/73 (metric tap)

MDM-73-1 Single-sided
MDM-73-2 Double-sided

Olympus IX 83

MD-83-1 Single-sided
MD-83-2 Double-sided

Olympus IX 83 (metric tap)

MDM-83-1 Single-sided
MDM-83-2 Double-sided

Zeiss

Axiovert 100/135

MD-90-1 Single-sided
MD-90-2 Double-sided

Axiovert 200 / Axio Observer

MD-91-1 Single-sided
MD-91-2 Double-sided

Axiovert 200 / Axio Observer (metric tap)

MDM-91-1 Single-sided
MDM-91-2 Double-sided

Axiovert 25

MD-92-1 Single-sided
MD-92-2 Double-sided

MD-80 SERIES

MD-90 SERIES

ELECTROPHYSIOLOGY SYSTEMS BUNDLED CONFIGURATIONS



(Shown: 1078-385-N65. Headstages and microscope not included)

FEATURES BUNDLED SYSTEMS

- Discounted pricing offers savings and value
- Classic electrophysiology designs available through a single system configuration
- Each bundled system comes with 2 manipulators
- Easy toggle selection of active component
- Single ROE input device controls manipulators and motorized components providing ease of operation
- All features of manipulators, stages and translators are retained
- Systems with platforms include rotating bases for mounting manipulators
- Simple USB interface



MANIPULATOR / STAGE / PLATFORM BUNDLED SYSTEMS

Over the last 20 years, electrophysiology rigs have developed around several platforms. In all, the central concept is that manipulators and the sample are fixed in one frame, and the microscope is fixed in a second frame. These two separate frames of reference are then moved with respect to each other in order to locate cells. Sutter Instrument is now offering several systems, or "Big Kits", that include dual manipulators with either manipulator stands and scope translator or large moving stage and a dual manipulator system. By specifying and offering the Big Kit systems, Sutter is able to extend significant price savings over the same components purchased separately.

Sutter San Francisco... the classic moving scope design with manual translator and three columns and two manipulators. Developed by labs at UCSF and later adopted throughout the Bay area, the U.S., and the world. This method allows for easy hand access to controls on the scope and manipulators, for pipette exchange and other adjustments.

Sutter Alcatraz... another well proven design, relies on a manual scope translator but uses a single large fixed plate stage rather than separate stands for manipulators. Many electrophysiologists want the ability to add additional manipulators or other devices that a single large platform allows.

Both the *San Francisco* and the *Alcatraz* are available with a motorized or manual translator.

Sutter Long Island... intended specifically for multi-pipette electrophysiology on two-photon microscopes. Designed in conjunction with Northwestern University and first used for the CSHL Imaging course. The large moving stage can easily hold an *in vivo* or slice preparation and two or more manipulators. The scope is allowed to be fixed to the table top, which is required for scopes attached to two-photon sources. This same design is also good for systems where the scope has become too large to move easily, as in spinning disc confocals and large camera systems. The stage and manipulator systems have been used on many two-photon and other scopes including those from Intelligent Imaging Innovations, Zeiss, Olympus and Leica. This configuration is also used by many researchers in custom built two-photon microscopes.

Software compatibility: Motorized translation and motorized stage systems are compatible with a wide range of commercial and freeware imaging software platforms including Intelligent Imaging Innovations' Slidebook, Scan Image, MicroManager and Sutter's MCS - MOM Computer System. Please contact Sutter for current listing of software suites that are compatible with our products.



CHOOSING THE RIGHT BUNDLED SYSTEM



Three Towers

SAN FRANCISCO¹

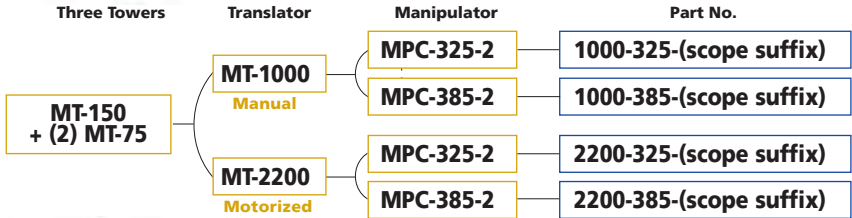

Fixed Platform Stage

ALCATRAZ¹

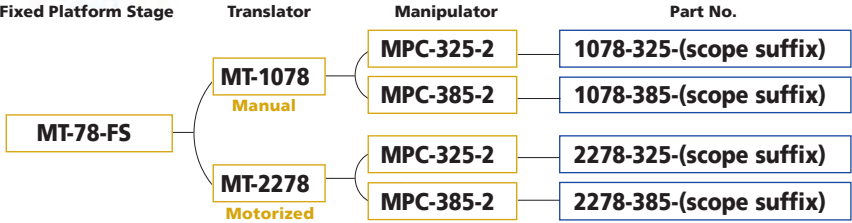

Motorized Platform Stage

LONG ISLAND²

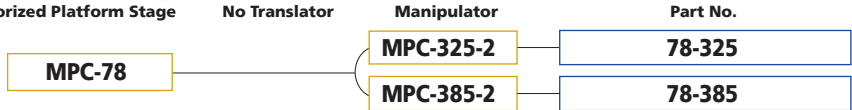

¹ Supported microscopes. Others may be available. Please call Sutter for details.

Z25 Zeiss Axioskop 2 FS

L30 Leica DM LFS

Z45 Zeiss Axio Examiner

L35 Leica DM6000 FS, DM6 FS

Y51 Olympus BX51WI

N65 Nikon FN1

Y51-FD Olympus BX51WI (includes focus drive)

Y53 Olympus BX53/63

² The Long Island has no translator and is appropriate when the microscope must be stationary.



BUNDLED SYSTEMS

U.S. prices available at www.sutter.com. International prices vary by country. Contact a distributor or Sutter Instrument for a quotation. Prices subject to change without notice.

MICROSCOPE MODELS - Use this scope suffix when ordering

Z25	Zeiss Axioskop 2 FS	Y51	Olympus BX51WI
Z45	Zeiss Axio Examiner	Y53	Olympus BX53/63
N65	Nikon FN1		
L30	Leica DMLFS		
L35	Leica DM6000 FS		

SAN FRANCISCO

MT-1000 with manual X-Y translator, micromanipulators

- **1000-325-(scope suffix)** With two MP-225 manipulators
- **1000-385-(scope suffix)** With two MP-285 manipulators

MT-2200 with motorized X-Y translator, micromanipulators

- **2200-325-(scope suffix)** With two MP-225 manipulators
- **2200-385-(scope suffix)** With two MP-285 manipulators

ALCATRAZ

MT-1078 with manual X-Y translator, micromanipulators

- **1078-325-(scope suffix)¹** With two MP-225 manipulators
- **1078-385-(scope suffix)¹** With two MP-285 manipulators

MT-2278 with motorized X-Y translator, micromanipulators

- **2278-325-(scope suffix)¹** With two MP-225 manipulators
- **2278-385-(scope suffix)¹** With two MP-285 manipulators

LONG ISLAND

MT-78 with motorized platform stage, and micromanipulators

- **78-325¹** With two MP-225 manipulators
- **78-385¹** With two MP-285 manipulators

¹ Specify stage insert type when ordering.

MICROPIPETTE FABRICATION

After the founding product, the BV-10 Micropipette Beveler, the P-77 Puller was Sutter Instrument's second product to market. With 50 years of continual development, we have long been the undisputed leader in micropipette pullers.

Forming glass micropipettes at a nanoscale demands precision and sophisticated controls. From years of continued refinement of the micropipette puller, Sutter pullers represent the state-of-the-art in micropipette fabrication. From the ease

of use of the P-1000 touch screen display, to the P-2000, one of the only pullers available that can fabricate pipettes from pure quartz tubing, Sutter's pullers have become the world standard.

The P-1000 is the latest evolution of the Flaming/Brown™ Style micropipette puller. This puller extends the features of the P-97 by incorporating a color touch screen and integrating new technology that simplifies programming. Unique features such as the safe heat mode, diagnostic testing,

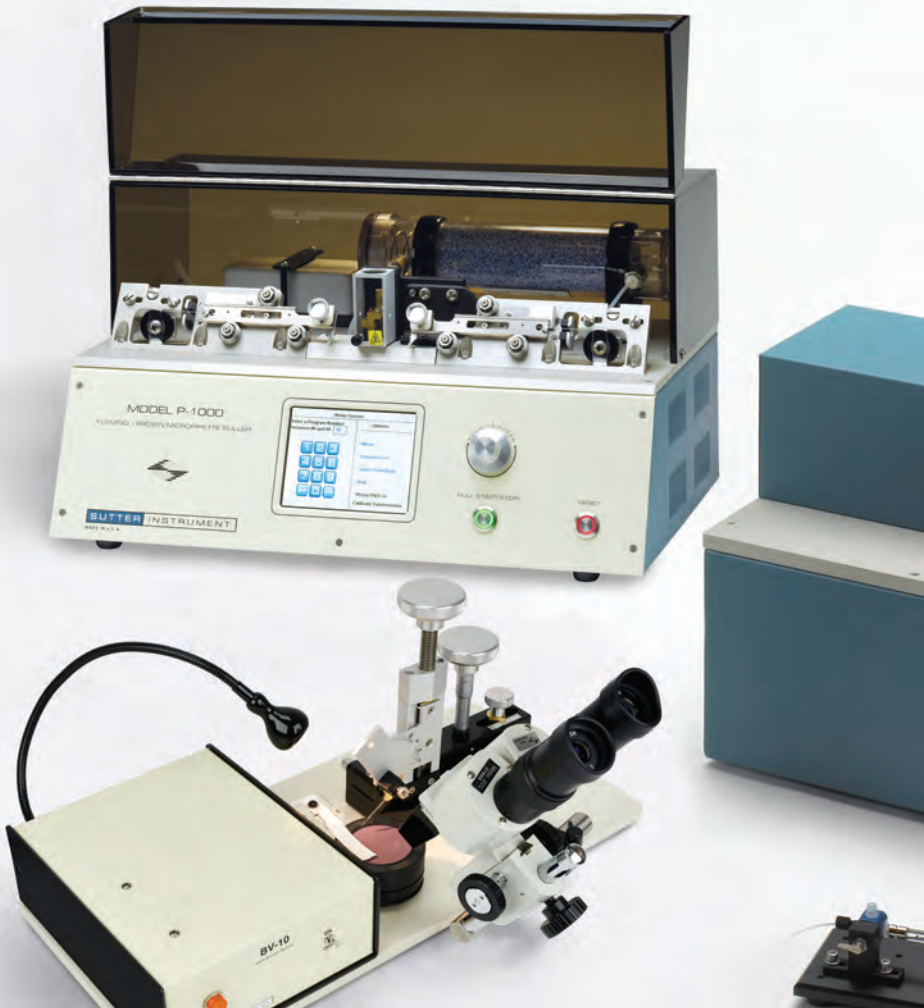

line repeat mode, and jaw temperature sensor assist in creating the ideal pipette morphology. The pre-installed Sutter Pipette Cookbook, glossary and help topics, make it easy to access the extensive library of programs. Both pullers offer: microprocessor controlled programmability, constant current power supply, a self-contained precision air delivery system, and a patented velocity sensing system. These design elements have led to significant improvements in pipette reproducibility when compared to other micropipette pullers.

The current state-of-the-art in micropipette puller technology is the P-2000. It incorporates the mechanical design and programmability of the Flaming/Brown™ pullers, but uses a CO₂ laser as the heat source. With the addition of the laser,

quartz tubing can now be pulled along with other lower melting point glass compositions. Quartz pipettes have helped eliminate some technical barriers in electrophysiological studies and have enhanced microinjection procedures as well as near field scanning microscopy.

The P-30 is Sutter's lowest priced and simplest puller, based upon a National Institutes of Health (NIH) design from the 1950s. As a vertical puller, it is intended for basic micropipette fabrication, sharp electrode, and microinjection work.

The BV-10 micropipette beveler continues to be the state-of-the-art in micropipette beveling technology. For precision beveling of pipette tip diameters from fractions of a micron to tens of microns, it is the system of choice.

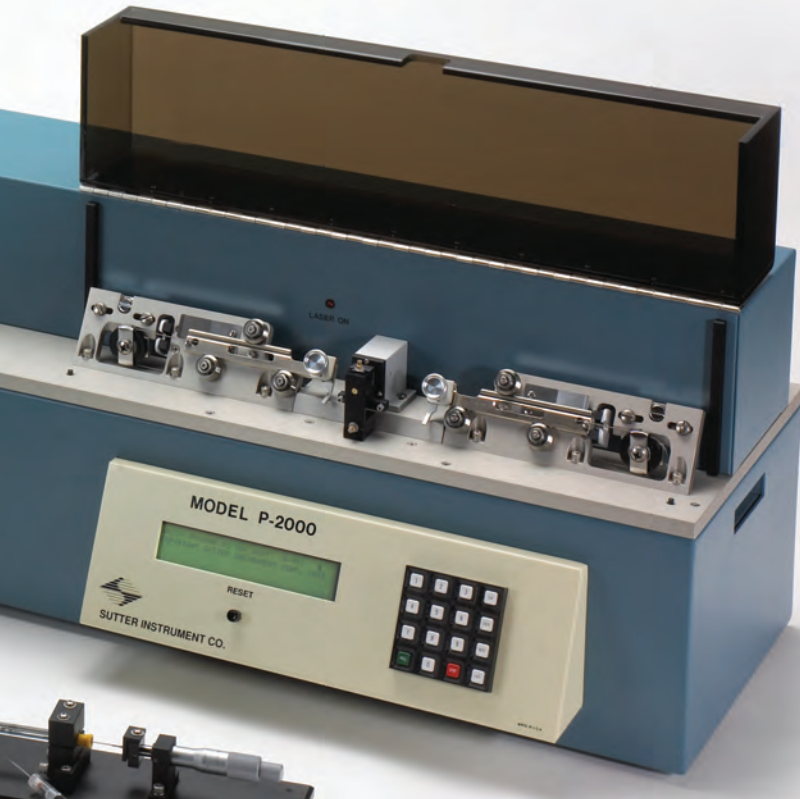



P-2000 LASER-BASED MICROPIPETTE PULLER



FEATURES P-2000

- Capable of pulling quartz, borosilicate and aluminosilicate glass
- Fully programmable — including heating filament characteristics
- The laser has no melting point limit as with conventional metal filaments, and therefore, cannot be burned out
- Pulls electrodes with tip diameters that are less than 0.03 μm
- Optimized velocity sensing circuit for maximized sensitivity and reproducibility
- Operating life of the CO_2 laser is expected to be in excess of ten years with normal use, after which the laser can be refurbished by Sutter Instrument for a fee
- Individual programs can be write-protected in order to secure them from inadvertent changes
- The total time that the heat is on during the pull is displayed for improved program development and troubleshooting
- A date and time stamp is displayed to show when the program was written and/or the last time a program was changed
- The P-2000/F is ideal for applications such as nanospray and NSOM
- Preprogrammed sample programs for intra-cellular and patch pipettes. The P-2000/F is also comes with an NSOM tip program

Patent No.4,600,424



The P-2000 micropipette puller represents a significant advance in the technology of fabrication of micropipettes, optical fiber probes, and nanospray tips. The P-2000 integrates a CO₂ laser-based heat source with the technology derived from our extensive experience with conventional pullers. This system offers capabilities unmatched by other pullers.

While the P-2000 is suitable for working with most conventional glasses, its primary advantage is the ability to work with quartz glass (fused silica). Quartz offers superior material properties for a variety of research applications. Quartz is stronger than other glasses and can facilitate penetration through tough tissues which would normally break conventional pipettes¹. For applications requiring a low noise glass, users will find that quartz is the lowest noise glass available^{2,3}. Quartz contains none of the metals used in conventional glasses⁴. Optically, quartz is virtually free from fluorescence when illuminated.

A CO₂ laser was selected as the heat source for the P-2000 for several reasons: 1) the nominal emission wavelength of the laser approximates the resonant frequency of the SiO₂ lattice in glass. Thus, quartz and other conventional glasses can be melted when the appropriate laser power is supplied; 2) laser heat is clean and leaves no metal residue on the pipette as do conventional heating filaments; 3) laser heat can be turned off instantly, leaving no residual filament heat; 4) the user can program the amount and distribution of heat supplied to the glass; 5) laser heat source means there are no filaments to burn out or replace.

The P-2000 can store up to 100 separate programs, with each program consisting of up to 8 command lines. Programmable parameters include; laser power level, scan width, trip velocity, delay/laser-on time, and hard pull strength.

One important consideration for the use of the P-2000 is the diameter of the glass used. The P-2000/G is designed to produce even heating on glass up to 1.2 mm in outside diameter. Larger diameter glass can be used with the P-2000/G (up to 1.5 mm quartz and 1.8 mm conventional glass), but the performance is best with glass that is 1.2 mm diameter or less.

The P-2000/F is designed specifically for small diameter glass (outer diameter in the range of 0.125 mm to 0.6 mm), such as optical fiber and fused silica capillary, commonly used for the manufacture of nanospray tips. The P-2000/F is built with special fiber puller bars and is optically aligned so it is optimized for small diameter material.

As with larger diameter glass, a wide range of tip sizes and taper geometries can be produced with the P-2000/F and small diameter glass. We have drawn optical fiber tips ranging from less than 10 nm to more than 5 μm. Please consult our technical staff for further information.

^{1, 2, 3, 4} References listed on the next page.



COMMON APPLICATIONS P-2000

P-2000/G

- Patch clamp — single-channeled and whole-cell recordings
- Intracellular recording
- Nanoprobe research
- SECM

P-2000/F

- Nanospray mass spectrometry
- NSOM
- Tapering optical fibers

SPECIFICATIONS P-2000

- **Dimensions** 30 in x 14.25 in x 13.25 in
76 cm x 36 cm x 33.5 cm
- **Weight** 90 lbs
41 kg
- **Electrical** 115/230 Volts
50/60 Hertz power line



■ CLASS I LASER PRODUCT

REFERENCES P-2000

1. Munoz, J.L. and Coles, J. Quartz micropipettes for intracellular voltage microelectrodes and ion selective microelectrodes. *Journal of Neuroscience Methods*: 22:57-64, 1987.
2. Rae, J.L. and Levis, R. A. A method for exceptionally low noise single channel recordings. *European Journal of Physiology - Pflügers Archive*: 420:618-620, 1992.
3. Levis, R. A. and Rae, J. L. The use of quartz patch pipettes for low noise single channel recording. *Biophysical Journal*: 65:1666-1677, 1993.
4. Zuazaga, C. and Steinacker, A. Patch-clamp recording of ion channels: Interfering effects of patch pipette glass. *News in Physiological Science*: 5:155-59, 1990.



P-2000

U.S. prices available at www.sutter.com. International prices vary by country. Contact a distributor or Sutter Instrument for a quotation. Prices subject to change without notice.

- **P-2000/G** Laser-based puller, outfitted for use with glass GREATER than 0.6 mm OD
- **P-2000/F** Laser-based puller, outfitted for use with glass LESS than 0.6 mm OD

(Pullers include a glass stop, sample box of Q100-70-7.5 glass, mirrored tile and manual)

ACCESSORIES P-2000

- **FPS** Spacer for special procedures
- **GS-I¹** Glass stop (Imperial)
- **GLA¹** Glass loading aid
- **GC-I** Glass clamps with grips for P-2000/G (set of 2)
- **GC-P2000-F** Glass clamps with grips for P-2000/F (set of 2)
- **CTS** Ceramic tile for scoring glass
- **PET** Pipette examining tile
- **BX10²** Pipette storage box (holds 10)
4 3/4 in x 3 5/8 in x 3/4 in
- **BX20²** Pipette storage box (holds 20)
7 in x 3 5/8 in x 3/4 in
- **O730350** Mirrored tile
- **PR³** Protective ruler (used with P-2000/F)
- **PBS** Puller bar hard stop

¹ Installs on either puller bar

² Minimum order of any 2 boxes

³ Allows user to burn coating off HPLC tubing without damaging tubing. Acts as a guide to allow repeatable location control of burn site.



Protective Ruler

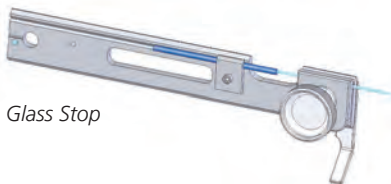

Glass Stop

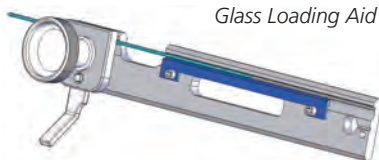

Glass Loading Aid



P-1000 NEXT GENERATION MICROPIPETTE PULLER

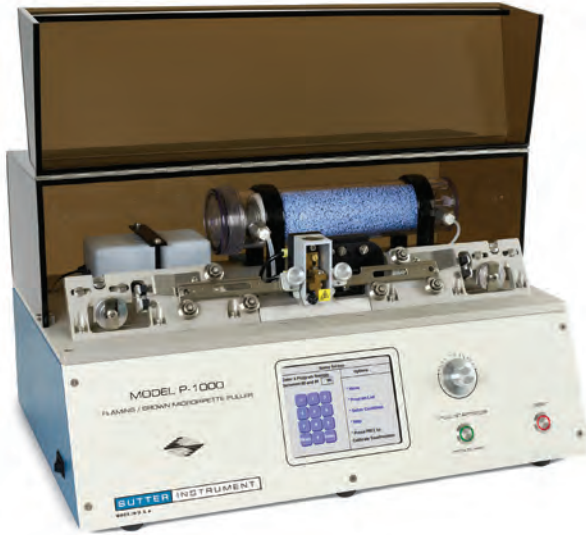

FEATURES P-1000

- Color touch screen display
- Safe heat mode to protect and extend filament life
- Pipette Cookbook program directory
- Pre-heat mode improves stability
- Line repeat mode simplifies multi-line programming
- Help topics and error detection
- Glossary defines micropipette and puller terminology
- Copy & paste function for writing new programs
- Jaw temperature sensor helps define ideal pulling conditions
- Record of last two pull results
- Ramp test more easily accessed and is stored and referenced within each program. Helps to establish program heat settings and protect filament.
- Two symmetrical pipettes with each pull
- Self-contained air supply with filtration system and humidity control chamber
- Memory storage for up to 100 programs
- Two cooling modes: Time and Delay



Developed through years of experience with the Flaming/Brown style micropipette pullers and infused with leading edge technology, Sutter is proud to introduce the P-1000 micropipette puller. The most obvious new feature is the color touchscreen display that provides an intuitive and full-featured interface.

The extensive library of programs found in the popular Sutter Cookbook has been incorporated into the P-1000 puller and is available to the user via the touchscreen display. You need only specify the glass, filament, and type of pipette you require and a suitable program will be identified and available for installation. This takes the guesswork out of pipette pulling and simplifies programming.

The Pre-heat mode actively heats and controls the jaw temperature and assures that the jaws have reached a specific temperature before the glass is pulled. This can increase the stability of the program from pull to pull. Copy and paste functions assure that programs can be easily written and the line repeat mode simplifies multi-line programming. A safe heat mode is an additional feature that helps the user avoid using heat settings that might damage or burn out the filament. When the safe heat mode is turned on, the puller will "check" the installed heat and alert the user when a given heat value is too low or too high in relation to the ramp value. User notes can be added to each program for annotating important information.

New features for the P-1000 include: diagnostic testing of all puller components, built-in error detection of air pressure loss or filament burnout, easy access to ramp test, measurement of jaw temperature, and access to previous pull results with the heat on times for each cycle of the program. In addition, help topics are pre-loaded to assist with on-site troubleshooting and the built-in glossary includes text, pictures, and diagrams explaining the terms used in micropipette fabrication. A rotary dial is offered as an alternative to the keypad for numerical entry.

Every Sutter Instrument P-1000 Micropipette Puller undergoes a stringent quality control procedure. Finished pullers are run in for 48 hours to expose any issues that might lead to premature failure. During the run-in process, the pull cycle is triggered over 2800 times. After this, seven pipettes are pulled and examined in a scanning electron microscope to ensure good quality pipettes are being made. Only after passing all these tests, the puller is shipped to the customer. We perform this test on every single P-1000 Puller we sell to guarantee the quality. Our other pullers, micromanipulators, light sources, imaging products, microscopes and amplifier systems undergo similarly demanding quality control procedures before they ship to you.

With over 100 collective years of experience, our product managers are always available by phone or email to help you program your Sutter puller to help you get the pipettes you want. No other micropipette manufacturer has as much experience and expertise.



COMMON APPLICATIONS P-1000

- Patch pipettes
- Sharp electrodes
- Pronuclear injection
- Zebrafish injection
- Insect Egg microinjection
- Aspiration pipettes

SPECIFICATIONS P-1000

- **Dimensions** 21 in x 14 in x 12 in
53 cm x 36 cm x 30 cm
- **Weight** 41 lbs
18.59 kg
- **Electrical** 115/230 Volts
50/60 Hertz power line



P-1000

U.S. prices available at www.sutter.com. International prices vary by country. Contact a distributor or Sutter Instrument for a quotation. Prices subject to change without notice.

- **P-1000** Flaming/Brown™ type micropipette puller, glass stop, manual, hard copy of Sutter Pipette Cookbook. Each puller comes with a FB255B filament and a sample box of BF100-50-10, BF150-110-10, and BF150-86-10 glass. Sutter pre-programs the P-1000 with a 2.5 mm x 2.5 mm box filament (FB255B) unless an alternative filament is requested.



ACCESSORIES P-1000

- **FPS** Fire polishing spacer
- **GS-M** Glass stop (Metric)
- **GC-M** Glass clamps with grips (Metric set of 2)
- **CTS** Ceramic tile for scoring glass
- **PET** Pipette examining tile
- **BX10¹** Pipette storage box (holds 10) 4 3/4 in x 3 5/8 in x 3/4 in
- **BX20¹** Pipette storage box (holds 20) 7 in x 3 5/8 in x 3/4 in
- **V400103** Replacement Drierite (1 lb)
- **V400105** Drierite-w/Cobalt Chloride (5 lb)
- **X870700** Drierite Tube Assembly-Complete, w/ports
- **M100210** Replacement Puller Dust Cover

BOX FILAMENTS

- **FB215B** 2.0 mm square box filament, 1.5 mm wide
- **FB220B** 2.0 mm square box filament, 2.0 mm wide
- **FB230B** 2.0 mm square box filament, 3.0 mm wide
- **FB255B** 2.5 mm square box filament, 2.5 mm wide
- **FB245B¹** 2.5 mm square box filament, 4.5 mm wide
- **FB315B** 3.0 mm square box filament, 1.5 mm wide
- **FB320B** 3.0 mm square box filament, 2.0 mm wide
- **FB330B** 3.0 mm square box filament, 3.0 mm wide

TROUGH FILAMENTS

- **FT315B** 1.5 mm wide trough filament
- **FT320B** 2.0 mm wide trough filament
- **FT330B** 3.0 mm wide trough filament
- **FT345B** 4.5 mm wide trough filament

CUSTOM FILAMENT

- **FILAMENT** Custom platinum/iridium filament
(phone Sutter for assistance)

¹ Minimum order of any 2 boxes

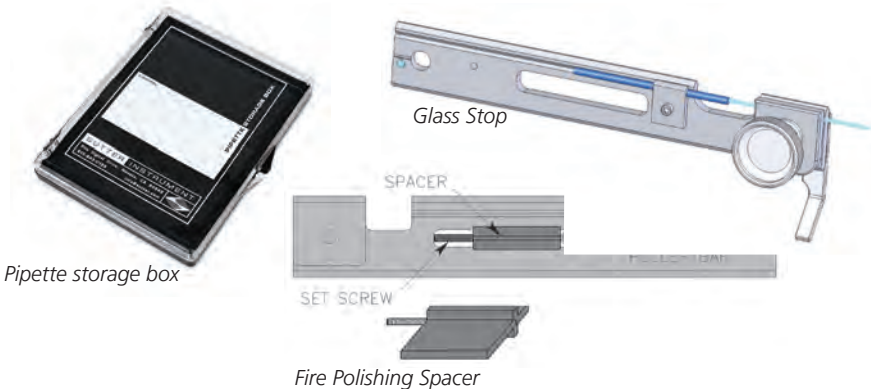



P-97 FLAMING/BROWN™ MICROPIPETTE PULLER



FEATURES P-97

- Environmental chamber for humidity control
- Programmable air pressure
- Memory storage for up to 100 programs
- Write protection and date stamp for each program
- Two symmetrical pipettes with each pull
- Two cooling modes: time and delay
- Pre-programmed sample programs for intracellular and patch pipettes. Special programming on request
- Ramp test to establish program heat settings when a new filament or glass is introduced
- Vacuum fluorescent display
- Constant current power supply for filament and pull solenoid
- Looping pull cycle for fabrication of patch type micropipettes
- Self-contained air supply with filtration system and humidity control
- Consistent and reliable electrodes with tip diameters less than 0.1 μm
- Control over the time and pressure at which the air is delivered
- Optimized velocity sensing circuit for maximized sensitivity and reproducibility
- Quality control, SEM photograph of a tip pulled with each puller; criterion is tip measurement less than 0.1 μm and typically is $\sim 0.06 \mu\text{m}$



The P-97 Flaming/Brown type micropipette puller is ideal for fabricating micropipettes, patch pipettes and microinjection needles. While retaining many of the features of earlier models, the P-97 offers improvements in mechanical, electronic and software design. The result is better control of the pulling process and a higher degree of reproducibility. The P-97 combines a proven mechanical system with a sophisticated, programmable microprocessor controller. This programmable control of the pulling parameters allows the investigator to design application specific pipettes from a wide range of glass compositions and sizes.

A number of other features have been incorporated in the design of the P-97. Most apparent is the environmental chamber which surrounds the heating filament. This environmental chamber is designed to minimize the effect of changing humidity on the reproducibility of pulled pipettes. A 25% increase in power over the P-87 allows for the use of larger heating filaments, larger diameter glass and multi-barreled glass. The metal jaws that clamp the heating filament have also been redesigned to minimize heat retention. A gas delivery mode switch provides for extended cooling for large diameter and multi-barreled glass. A spring-loaded clamping mechanism has been added for easier loading of glass. A vacuum fluorescent display has been added that allows easy viewing.

Software improvements on the P-97 include a display of the total heat-on time to assist in program development and troubleshooting. Up to 100 programs can now be written and stored in memory, which makes the P-97 suitable for multiple users. These programs can now be write-protected, adding security to prevent programs from being changed or altered inadvertently. The display shows the last date and time the program was written or edited. In addition, the air pressure is included as a programmable parameter.

Every Sutter Instrument P-97 Micropipette Puller undergoes a stringent quality control procedure. Finished pullers are run in for 48 hours to expose any issues that might lead to premature failure. During the run-in process, the pull cycle is triggered over 2800 times. After this, seven pipettes are pulled and examined in a scanning electron microscope to ensure good quality pipettes are being made. Only after passing all these tests, the puller is shipped to the customer. We perform this test on every single P-97 Puller we sell to guarantee the quality. Our other pullers, micromanipulators, light sources, imaging products, microscopes and amplifier systems undergo similarly demanding quality control procedures before they ship to you.

With over 100 collective years of experience, our product managers are always available by phone or email to help you program your Sutter puller to help you get the pipettes you want. No other micropipette manufacturer has as much experience and expertise.

* Patent No. 4,600,424



COMMON APPLICATIONS P-97

- Patch pipettes
- Sharp electrodes
- Pronuclear injection
- Zebrafish injection
- Insect egg microinjection
- Aspiration pipettes

SPECIFICATIONS P-97

- **Dimensions** 21 in x 16 in x 12 in
53 cm x 40.6 cm x 30 cm
- **Weight** 50 lbs
23 kg
- **Electrical** 115/230 Volts
50/60 Hertz power line



REFERENCES P-97

These references describe the Flaming/Brown™ series of pullers and contain valuable information applicable to the P-97.

1. Brown, K.T. and Flaming, D.G. *Neurosciences Journal*: 2:813-827, 1977.
2. Flaming, D.G. and Brown, K.T., *Journal of Neuroscience Methods*: 6:91-102, 1982.
3. Brown, K.T. and Flaming, D.G., *Advanced Micropipette Techniques for Cell Physiology*. John Wiley and Sons. Great Britain, 1986.

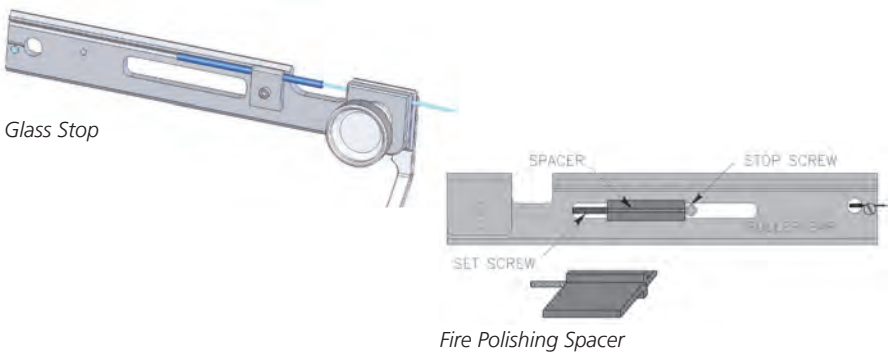

**P-97**

U.S. prices available at www.sutter.com. International prices vary by country. Contact a distributor or Sutter Instrument for a quotation. Prices subject to change without notice.

- **P-97** Flaming/Brown™ type micropipette puller, glass stop, manual, hard copy of Sutter Pipette Cookbook. Each puller comes with a FB255B filament and a sample box of BF150-110-10, BF100-50-10, and BF150-86-10 glass. Sutter pre-programs the P-97 with a 2.5 mm box filament unless an alternative filament is requested.

ACCESSORIES P-97

- **FPS** Fire polishing spacer
- **GS-M¹** Glass stop (Metric)
- **GC-M¹** Glass clamps with grips (Metric set of 2)
- **CTS** Ceramic tile for scoring glass
- **PET** Pipette examining tile
- **BX10²** Pipette storage box (holds 10) 4 3/4 in x 3 5/8 in x 3/4 in
- **BX20²** Pipette storage box (holds 20) 7 in x 3 5/8 in x 3/4 in
- **V400103** Replacement Drierite (1 lb)
- **V400105** Drierite-w/Cobalt Chloride (5 lb)
- **X870700** Drierite Tube Assembly-Complete, w/ports
- **M100210** Replacement Puller Dust Cover

BOX FILAMENTS

- **FB215B** 2.0 mm square box filament, 1.5 mm wide
- **FB220B** 2.0 mm square box filament, 2.0 mm wide
- **FB230B** 2.0 mm square box filament, 3.0 mm wide
- **FB255B** 2.5 mm square box filament, 2.5 mm wide
- **FB245B¹** 2.5 mm square box filament, 4.5 mm wide
- **FB315B** 3.0 mm square box filament, 1.5 mm wide
- **FB320B** 3.0 mm square box filament, 2.0 mm wide
- **FB330B** 3.0 mm square box filament, 3.0 mm wide

TROUGH FILAMENTS

- **FT315B** 1.5 mm wide trough filament
- **FT320B** 2.0 mm wide trough filament
- **FT330B** 3.0 mm wide trough filament
- **FT345B** 4.5 mm wide trough filament

CUSTOM FILAMENT

- **FILAMENT** Custom platinum/iridium filament (phone Sutter for assistance)

¹ Installs on either puller bar. Order Metric for serial numbers that include a "M" and Imperial for all others.

² Minimum order of any 2 boxes

P-30 VERTICAL MICROPIPETTE PULLER



FEATURES P-30

- Pulls electrodes with tip diameters down to 0.3 μm , consistently and reliably
- A micrometer allows precise reproducibility of trip point settings in producing fine microelectrodes
- Full three digit digital controls for accurate setting of heat and pull values
- Constant current power supplies for filament and pull solenoid
- Enclosed front to reduce variability caused by drafts
- Dual (manually) switched heat settings for patch pulling or two different types of micropipettes
- All working parts are made from corrosion resistant material
- Two heating assemblies available: platinum/iridium (recommended) or Nichrome coil
- Built-in RFI filter and dual voltage/dual frequency operation
- Rubber padded jaws to minimize breakage of capillary tubing
- Designed to take up minimal bench space
- Slope of the front panel aids in preventing glass from entering cabinet/solenoid mechanism



The model P-30 vertical micropipette puller is designed for the fabrication of basic micropipettes and patch-type pipettes. It will pull micropipettes with tip diameters as small as 0.3 μm and moderate taper lengths (6 mm to 10 mm). By using an included patching attachment, the P-30 will pull a patch-type pipette. But, for those needing very short tapers, high cone angles, and advanced reproducibility, one should consider the P-97 or the P-1000 micropipette pullers. Using thin or standard walled capillaries, the P-30 will generate suitable pipettes for microinjection studies. The P-30 is also ideal for student laboratories and other situations which call for an economical, reliable pipette pulling device.

The P-30 is available with either a platinum/iridium or a Nichrome filament. The Nichrome filament is suitable for many applications and is not prone to damage. The platinum filament is more efficient at heating and cooling, and, although it is more prone to damage than the Nichrome filament, the platinum filament is recommended for thick wall and aluminosilicate glass and applications requiring shorter taper lengths.



COMMON APPLICATIONS P-30

- C. elegans
- Xenopus
- Drosophila microinjection

SPECIFICATIONS P-30

- **Dimensions** 18 in x 10 in x 9 in
46 cm x 25 cm x 23 cm
- **Weight** 35 lbs
16 kg
- **Electrical** 115/230 Volts
50/60 Hertz power line



P-30

U.S. prices available at www.sutter.com. International prices vary by country. Contact a distributor or Sutter Instrument for a quotation. Prices subject to change without notice.

- **P-30/P** Vertical micropipette puller with platinum/iridium filament
- **P-30/N** Vertical micropipette puller with Nichrome filament

Each puller comes with a sample box of BF100-50-10 glass, and manual. The P-30/P also comes with an additional filament.



ACCESSORIES P-30

- **P-30-NFL/M¹** Nichrome filament block assembly
- **P-30-PFL/M¹** Platinum/iridium filament block assembly
- **PET** Pipette examining tile
- **BX10²** Pipette storage box (holds 10)
4 3/4 in x 3 5/8 in x 3/4 in
- **BX20²** Pipette storage box (holds 20)
7 in x 3 5/8 in x 3/4 in

FILAMENTS P-30

- **PF30T15** 1.5 mm wide trough filament
- **PF30T20** 2.0 mm wide trough filament
- **PF30T30** 3.0 mm wide trough filament
- **PF30N³** Nichrome filament (3 turns) (*BEFORE SN# P30-680*)
- **PF30N-4³** Nichrome filament (4 turns) (*AFTER SN# P30-679*)

¹ Only necessary when changing filament configuration

² Minimum order of any 2 boxes

³ P-30/N pullers (serial number lower than P-30-680) came with a P30N filament installed. You can now select either the P30N or P30N-4 filament. With the P30N-4 you can 1) use lower heat settings, 2) pull longer tapers (2-3 cm) and 3) use aluminosilicate glass. If you need to pull very short tapers, the P30N is recommended.



MICROPIPETTE PULLER COMPARISON CHART

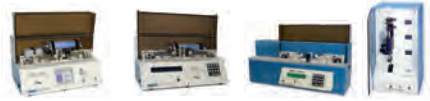

Features	P-1000	P-97	P-2000	P-30
Heat Source				
Platinum Filament with Safe Heat Mode	■			
Platinum Filament		■		
CO ₂ Laser			■	
Platinum or Nichrome Filament				■
Glass Type				
Borosilicate and Aluminosilicate	■	■	■	■
Quartz Glass or Fiber ¹			■	
Max. Glass Size (OD)				
4 mm	■	■		
2 mm				■
1.65 mm Quartz, 1.8mm Borosilicate			■	
Tip Size				
0.06 μ–3 μ	■	■		
0.01 μ–5 μ			■ (Fiber)	
0.03 μ–5 μ			■ (Glass)	
0.30 μ–2 μ				■
Max. Taper Length				
1 cm				■
1.8 cm			■	
2 cm	■	■		
Program Lines				
8		■	■	
1 Stage or 2 Stage with manual adjustment				■
4 plus Line Repeat Mode	■			
Type of Cooling				
Compressed Dry Air with Humidity Control Chamber	■	■		
NA (Laser On/Off)			■	
None				■
Usable Pipettes/Pull	2	2	2	1

1. Outer diameters < 600 μm require P-2000/F.



P-1000 / P-97 COMPARISON CHART



Features	P-1000	P-97	Notes
Tip Size Range	0.06 μm –3 μm	0.06 μm –3 μm	Two identical pipettes with the same taper length and same tip size.
Taper Length Range	3 mm–15 mm	3 mm–15 mm	For longer or shorter tapers, contact Sutter Technical Support.
Two Identical Pipettes	Yes	Yes	To make overall length identical, please purchase and install the optional Glass Stop (part # GS) onto your puller bar.
Program Looping	Yes	Yes	4–5 loops is ideal for thick walled glass, while 2–3 loops is ideal for thin walled glass.
Multi-line Programming	Yes	Yes	The P-1000 has an additional feature “Line Repeat” (see below).
Humidity Control Chamber	Yes	Yes	This chamber is purged with dry air before and after the pull to remove humidity and control for the ambient conditions in the lab.
100 Program Spots	Yes	Yes	Ideal for labs with multiple users.
Two Cooling Modes: Time & Delay	Yes	Yes	Delay mode is recommended when making patch pipettes with thick walled glass.
Program Lock	Yes	Yes	On the P-1000, the PROGRAM LOCK feature is on the Menu Screen of the program.
Safe Heat Mode	Yes	No	The SAFE HEAT mode helps prevent filament burn-out.
Pipette Cookbook	Yes	No	The PIPETTE COOKBOOK can be used to search for a program that is appropriate for the filament installed in your puller, the glass dimension you are using, and your application.
Programming Touch Screen Display	Yes	No	The color TOUCH SCREEN DISPLAY provides an intuitive interface that allows more information to be displayed.
Temperature Sensor	Yes	No	The JAW TEMPERATURE SENSOR helps define ideal pulling conditions.
Pre-heat Mode	Yes	No	The ThermoLock™ technology in the PRE-HEAT mode assures that the jaws have reached a specific temperature before the glass is pulled. This can increase the stability of the program from pull to pull.
Copy & Paste Function	Yes	No	The COPY & PASTE feature simplifies writing and editing a program.
Line Repeat	Yes	No	The LINE REPEAT feature simplifies writing multi-line programs.
Ramp Test Specific to Each Program	Yes	No	The RAMP TEST VALUE is linked and specific to each program.
Diagnostics	Yes	No	The DIAGNOSTIC feature can be used to check the Heat, Pull, Velocity Sensor, and Air/Cooling System functions of the puller.
Error Messages & Warnings	Yes	No	The P-1000 will alert the user if a system error occurs when pulling a pipette (filament burn-out, air leak, failed to melt glass, etc).
Pull Results	Yes	No	The PULL RESULTS feature displays the heat-on times line by line for the last two pulls.
Glossary	Yes	No	The GLOSSARY is a built-in dictionary of terms associated with the pipette puller.



FILAMENTS / ACCESSORIES



There is a minimum purchase of 4 filaments.

Appropriate filament selection depends on your research application, but a general guideline for filaments is as follows:

Box Filaments are recommended for small to large diameter borosilicate glass, double barreled, or aluminosilicate glass. Box filaments are particularly suitable for patch pipettes, slice preparations, and for sharp electrodes and microinjection pipettes where gradual parallel walls would aid cell penetration. When using a box filament, the size of the square box should be approximately 1.0 mm to 1.5 mm larger than the outside diameter of the glass that you will be using.

For IVF and ICSI applications, a 2.5 mm x 4.5 mm box filament (FB245B) is recommended. For pronuclear injection work, we recommend a 2.5 mm x 2.5 mm box filament (FB255B). Call for more specific advice or to request a combination of settings, filaments, and glass for your application.

Trough Filaments are excellent general purpose filaments and are recommended for creating longer slice patch pipettes and sharp electrodes. The trough filament is not ideal for making patch pipettes or when using glass over 1.2 mm OD. If very short tapers are required for patch electrodes or for microinjection, a 2.5 mm or 3mm box filament is recommended.

Sutter pre-programs the P-1000 and P-97 with a 2.5 mm x 2.5 mm box filament unless an alternative filament is requested.

For either shape of filament (box or trough), increasing the filament width tends to increase the length of the pipette taper. If there are specific questions as to the filament type needed, please call and our technical support staff will guide you in your choice.



BOX FILAMENTS

P-1000, P-97, P-87, P80PC, P80C, PC-84, P-77B

FB215B	2.0 mm square box filament, 1.5 mm wide
FB220B	2.0 mm square box filament, 2.0 mm wide
FB230B	2.0 mm square box filament, 3.0 mm wide
FB255B	2.5 mm square box filament, 2.5 mm wide
FB245B¹	2.5 mm square box filament, 4.5 mm wide
FB315B	3.0 mm square box filament, 1.5 mm wide
FB320B	3.0 mm square box filament, 2.0 mm wide
FB330B	3.0 mm square box filament, 3.0 mm wide

TROUGH FILAMENTS

P-1000, P-97, P-87, P80PC, P80C, PC-84, P-77B

FT315B	1.5 mm wide trough filament
FT320B	2.0 mm wide trough filament
FT330B	3.0 mm wide trough filament
FT345B	4.5 mm wide trough filament

P-30 FILAMENTS

PF30T15	1.5 mm wide trough filament
PF30T20	2.0 mm wide trough filament
PF30T30	3.0 mm wide trough filament
PF30N²	Nichrome filament (3 turns) (<i>BEFORE SN# P30-680</i>)
PF30N-4²	Nichrome filament (4 turns) (<i>AFTER SN# P30-679</i>)

P-77A LOOP FILAMENTS

(Serial number 160 and above)

FL315A	3.0 mm loop filament, 1.5 mm wide
FL320A	3.0 mm loop filament, 2.0 mm wide
FL325A	3.0 mm loop filament, 2.5 mm wide
(Serial number below 160)	
FL315X	3.0 mm loop filament, 1.5 mm wide
FL320X	3.0 mm loop filament, 2.0 mm wide
FL325X	3.0 mm loop filament, 2.5 mm wide

ACCESSORIES

FILAMENT	Custom platinum/iridium filament
FPS	Fire polishing spacer (P-2000, P-97, P-87)
FS1875	Platinum/iridium sheet, 18 mm x 75 mm x 0.05 mm (40 μ)
CTS	Ceramic tile for scoring glass (large tips 20-200 microns)
BX10	Pipette storage box (holds 10) 4 3/4 in x 3 5/8 in x 3/4 in
BX20	Pipette storage box (holds 20) 7 in x 3 5/8 in x 3/4 in

¹ For P-87, please contact Sutter.

² P-30/N pullers (serial number lower than P-30-680) came with a P30N filament installed. You can now select either the P30N or P30N4 filament. With the P30N4 you can 1) use lower heat settings, 2) pull longer tapers (2-3 cm) and 3) use aluminosilicate glass. If you need to pull very short tapers, the P30N is recommended.

BV-10 MICROELECTRODE BEVELER

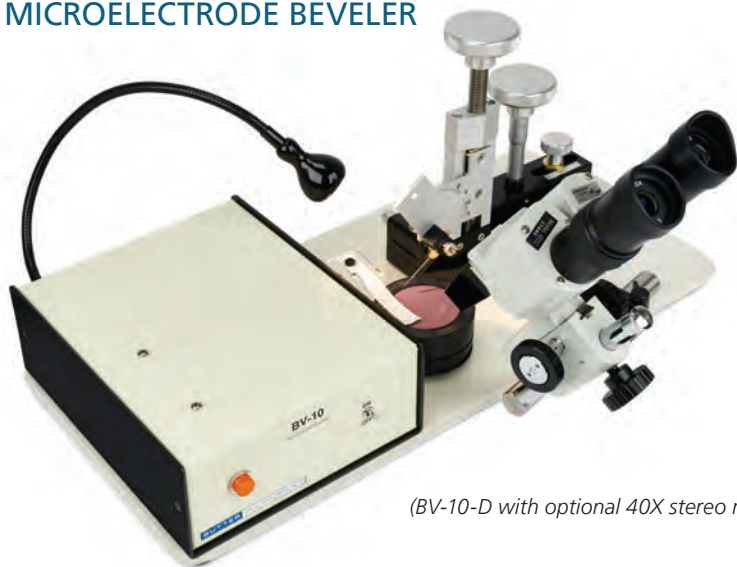

(BV-10-D with optional 40X stereo microscope)

FEATURES BV-10

- Vibration-free, magnetically coupled beveling surface
- Abrasive surface optically flat to a half wave (250 nm)
- Finest abrasive surface commercially available
- Synchronous clock motor insures stable rotation rate
- 7 pound steel baseplate adds additional dampening
- Integrated LED lamp
- Robust micromanipulator controls bevel angle and advancement

COMMON APPLICATIONS BV-10

- Deep brain injections
- ES cell and ICSI procedures
- CRISPR
- C. elegans injections
- Fish and insect egg injections



Elegant and simple to use, the BV-10 offers precision beveling of micropipette tips between 0.1 and 100 μm . The unique abrasive plate drive system is vibration free for greater control of the beveling process. Beveling can be accomplished very rapidly and produces consistent tip diameters using the techniques as described by Brown and Flaming, *Science*, August 1974, Vol. 185.

Intracellular recording electrodes can benefit from beveling because of:

- A reduction in the tip diameter by creation of the sharp point on the electrode
- A lowered electrical resistance of the electrode due to the larger cross sectional area of the lumen.

This greatly facilitates penetrating and holding very small or difficult cells. Microinjection needles also benefit from beveling by promoting entry into cells with minimal damage while at the same time enhancing the flow of material through the needle.

The basic beveling system consists of a stationary pedestal, optically flat to a half wave (250 nm), surface mounted on a heavy baseplate. This serves as a bearing for an abrasive coated glass grinding plate, which is also flat to half a wave. The flat abrasive plate is coupled to a low vibration, slow-speed motor by means of magnetic fields to provide a wobble-free flat grinding surface. The abrasive plates are fabricated with a proprietary process which insures a consistent abrasive coating.

A 2-axis micromanipulator holds the pipette to be beveled and permits controlled advancement onto the abrasive surface. The bevel angle and speed of advancement are adjustable. An LED lamp with a gooseneck enhances the beveling operation by providing sharp illumination of the abrasive plate and pipette.

The basic system is completed with two abrasive plates of your choice, a wick with holder (for wet beveling), pedestal oil, degreasing fluid, and manual.

Two options are available for monitoring the beveling process, an 40X stereo microscope and an electrode impedance meter. Depending on your research application, one or both of these options may be desirable. For all micropipette applications, the swing mounted microscope enhances your control of pipette advancement onto the abrasive plate and allows for viewing of the beveling operation (scope resolution is not sufficient for viewing the actual bevel except in the case of very large tips). For microelectrode applications, the impedance meter is used to monitor the tip resistance during the beveling operation. The meter is an analog design, offering three resistance ranges (0-10, 0-100, 0-500 MOhm). Measurements are made at 12 Hz to minimize capacitive contributions to the impedance measured and provide a near-true DC resistance value. A rapid roll-off is used to reduce 50/60 Hz interference, allowing operation in a laboratory environment without screening.



SPECIFICATIONS BV-10

- **Bevel Range** 0.1 μm through 100 μm finished electrodes depending on abrasive plate used
- **Grinding Surface Variation** Less than 1.0 μm
- **Grinding Speed** 60 RPM
- **Bevel Angle Range** 5–90 degrees — adjustable
- **Micromanipulator** Course drive: 0.075 in / dial revolution
Fine drive: 0.0004 in / dial revolution
- **Dimensions Speed** 19 in x 9 in x 8 in
48 cm x 22 cm x 20 cm
- **Weight** Approx. 30 lbs / 14 kg
- **Electrical** 100/120 or 200/240 Volts
50/60 Hz power line



OPTIONS

40X stereo microscope

Impedance meter for real-time measurement of tip impedance



(Shown: BVM-CE)



BV-10

U.S. prices available at www.sutter.com. International prices vary by country. Contact a distributor or Sutter Instrument for a quotation. Prices subject to change without notice.

BV-10

- **BV-10-B¹**
- **BV-10-C**
- **BV-10-D**
- **BV-10-E**

- **BV-10-N**

SYSTEM

- Micropipette beveler basic system
- BV-10-B with electrode impedance meter
- BV-10-B with 40X stereo microscope
- BV-10-B with impedance meter and 40X stereo microscope
- BV-10-B with 40X stereo microscope for NSOM, nano-ESI

¹ Includes BV-10 beveler, micromanipulator, reference wick, reference wick holder, pedestal oil, degreaser, manual, and two abrasive plates of your choice.

ACCESSORIES BV-10

- **BVM-CE** Electrode impedance meter with active and reference lead
- **BV-10S** 40X stereo microscope
- **104C** Diamond abrasive plate – coarse (5.0 μm to 50 μm tip sizes)
- **104D** Diamond abrasive plate – fine (2.0 μm to 20 μm tip sizes)
- **104E** Diamond abrasive plate – very fine (0.7 μm to 2.0 μm tip sizes)
- **104F** Diamond abrasive plate – extra fine (0.2 μm to 1.0 μm tip sizes)
- **007** Degreaser (bottle)
- **008** Beveler pedestal oil
- **O740124** 20X eyepiece
- **O740130** Reticle grid for BV-10S scope
5 mm scale / 100 divisions

REPLACEMENT PARTS BV-10

- **101** 6-inch reference lead (body to meter)
- **102** 2-inch active lead (platinum to pipette)
- **X050300** Reference wick
- **M100019** Reference wick holder
- **H906100** Drive belt
- **PEDESTAL** Pedestal plates (top and bottom)

MICROPIPETTE TECHNIQUES

ADVANCED MICROPIPETTE TECHNIQUES FOR CELL PHYSIOLOGY

KENNETH T. BROWN

University of California at
San Francisco

DALE FLAMING

Sutter Instrument Company,
Novato, CA



Fine glass micropipettes are extensively used in intra- and extracellular physiology as a means of recording electrical activity in cells and as channels for injecting a variety of substances for experimental purposes. In 1973, the authors began a course of systematic studies designed to help them improve the capabilities and efficiency of intracellular research using the micropipette technique. Here, they present for the first time their theory of how micropipette tips are formed, their methods of reducing tip size, and the implications of their work for research on small cells of all kinds, especially cells within the central nervous system. This text not only incorporates this new work, but reviews and analyzes existing publications on micropipette methodology, including patch-clamping, in order to present as complete an account as possible of how micropipettes can be used efficiently and effectively in a wide variety of experimental situations. The information presented here should prove helpful to anyone performing research with micropipettes, from a graduate student conducting a first project to the most experienced investigator.

CONTENTS

Early Methods of Fabricating Micropipettes

The Flaming/Brown™ Micropipette Puller:
Its Background, Design and Underlying Principles

Techniques for Examining and Measuring
Micropipette Tips by Scanning Electron
Microscopy

Evaluation of Flaming/Brown Micropipette Puller

A Theory of Micropipette Tip Formation:
Quantitative Prediction and Validation of the
Effects of Capillary Wall Thickness Upon Tip Size

Effects of a Fused Internal Fiber (Omega Dot)
Upon Micropipette Tips

Minimizing Tip Size With Borosilicate Tubing

Beveling Micropipette Tips: Techniques and
Applications

Filling Micropipettes: Techniques and Solutions

Advancing Micropipettes Through Tissues and
Into Cells

Ancillary Techniques for Conducting Intracellular
Research

Evaluation of Improved Intracellular Recording
Techniques in Vertebrate Photoreceptors

Evaluation of Tubing Designs for Intracellular
Work

The Structure Properties of Glasses for
Fabricating Micropipettes

Dual-Channel Micropipettes

The Burgeoning Field of Patch Clamping

Extension of the Flaming/Brown Micropipette
Puller to Patch Clamping and Conveniently
Handling Aluminosilicate Glass

References

Appendices

PIPETTE COOKBOOK

P-97 & P-1000
MICROPIPETTE PULLERS



The Pipette Cookbook was written to help our customers quickly set up programs for pulling the types of pipettes they need. Specifically written for the P-97 and P-1000 pullers, the Pipette Cookbook offers tutorials on maintenance, setup and basic repairs on Sutter pipette pullers. The cookbook is divided into sections based on both application and pipette morphology. We offer this as a free download! Stop by the Sutter Instrument booth at a scientific meeting to pick up your printed copy. As always, please call or email if you need additional help getting your puller adjusted to pull the types of pipettes you need. You can also visit Sutter's YouTube Channel for videos on maintaining your puller: www.youtube.com/c/SutterInstrument

BOOKS

U.S. prices available at www.sutter.com. International prices vary by country. Contact a distributor or Sutter Instrument for a quotation. Prices subject to change without notice.

- **BOOK-1** *Advanced Micropipette Techniques
For Cell Physiology*
- **BOOK-2** *Pipette Cookbook*



GLASS CAPILLARY TUBING



Sutter Instrument Company, in addition to the finest micropipette pullers available, offers a wide selection of high quality capillary glasses in various sizes and materials. Though there are many types and sizes of capillary glass available, we have carefully selected only those that pass our strict criteria for precision and quality.

We offer capillary glass tubing in three different compositions; quartz, borosilicate and aluminosilicate. Each composition has its own unique properties and the selection will be determined by your application and your puller's capabilities. Please refer to the Pipette Cookbook for recommendations on which glass to consider for specific applications. It should also be noted that quartz glass (fused silica) can only be pulled using the P-2000 laser-based micropipette puller.

FILAMENT GLASS

Filamented glass has a small rod of glass annealed to the inner wall and this rod (filament of glass) creates the capillary action required to back-fill the pipette with solution. If the resulting pipette tip is under 1 μ l and being used for microinjection or recording, we recommend "filamented-glass." The filament in the glass not only provides capillary action for quick filling of the micropipette, it also helps to reduce the incidence of air bubbles when introducing solution into the pipette. If you have any additional concerns, please contact Sutter for technical support.

FIRE POLISHING

All borosilicate and aluminosilicate capillary glass offered by Sutter Instrument has fire-polished ends. This process eliminates any sharp edges, making it easier to insert into holders, and does not affect the electrical or mechanical properties of the glass. Unpolished glass capillary is available upon request.

CUSTOM PIPETTES

Sutter Instrument can make custom pipettes and microtools not commonly available from other pipette manufacturers. For example, we make custom pre-pulled beveled pipettes for microinjection. The custom pipettes are considered non-sterile and are manufactured for research applications and non-human use. Please contact Sutter Instrument for further details.

BOROSILCATE (CORNING 7740)

The most commonly used glass is borosilicate. Sutter Instrument offers only TYPE I-CLASS A borosilicate as described by ASTM Standard 3.1.2¹. This glass softens at 821 degrees Celsius and, as it is pulled, maintains its ratio of inside diameter to outside diameter over the total taper length. Borosilicate softens at a lower temperature than our other glasses and has a wider working range. These unique properties allow for a greater variety of shapes used in microelectrodes, patch pipettes, microinjection needles and, in the case of solid rod, chromosome dissection tools.

ALUMINOSILICATE (SCHOTT 8252)

Aluminosilicate softens at a higher temperature (935 degrees Celsius) than borosilicate and is workable over a much narrower range. It has a tendency to continuously thin out as it is drawn which allows extremely fine tips with very short tapers. For example, we have pulled aluminosilicate tips in the 20 – 30 nanometer range with taper lengths of 5 mm to 6 mm. Its resistivity is several orders of magnitude higher than borosilicate, thus reducing leakage currents when used in ion-selective micropipettes. Aluminosilicate is harder than borosilicate which results in a pipette that is more suitable for penetrating tough tissues.

QUARTZ (HERAEUS HSQ300)

The finest and purest glass available is quartz. It is superior to all other glasses in its mechanical, electrical and optical qualities. It has the lowest dielectric constant, the lowest loss factor and the highest volume resistivity making it ideal for investigators needing extremely low noise recording conditions. Its chemical purity virtually eliminates leakage of ions² and by using quartz in single channel patch clamp recordings the lowest background noise levels have been achieved³. Due to its high melting point, it cannot be pulled on conventional pullers, but can be easily pulled with the Sutter CO₂ laser-based P-2000 micropipette puller.

SIZES

Sutter Instrument capillary glass can be broadly divided into 2 categories based on the ratio of the inner diameter (I.D.) to the outer diameter (O.D.). Thick-walled capillaries are those having an approximate I.D. to O.D. ratio of 1:2, while thin-walled capillaries have an I.D. to O.D. ratio near 3:4. All other factors being equal, thicker walled capillaries produce pipettes with longer tapers and smaller tips, making them better suited for intracellular microelectrodes. Additionally, pipette capacitance decreases as the wall thickness increases so thicker walled capillaries contribute less capacitive noise during patch-clamp recording. Thinner walled capillary glass allows for larger tip openings which make it ideal for microinjection applications and low resistance microelectrodes.

¹ ASTM Designation E438-90 - April 1990.

² Zuazaga C., Steinacker A. Patch-clamp recording of ion channels: Interfering effects of patch pipette glass. *News in Physiological Sciences: International Union of Physiological Sciences and the American Physiological Society*: 5:155-158, August 1990.

³ Rae, James L., Levis Richard A. A Method for exceptionally low noise single channel recordings. *Pflügers Archive; European Journal of Physiology*:420:618-620, Springer-Verlag 1992.



THICK / STANDARD WALLED BOROSILICATE GLASS

WITH FILAMENT

catalog number	outside diameter	inside diameter	overall length	pieces per package
BF100-50-7.5	1.00 mm	0.50 mm	7.5 cm	225
BF100-50-10	1.00 mm	0.50 mm	10 cm	225
BF100-50-15	1.00 mm	0.50 mm	15 cm	225
BF100-58-10	1.00 mm	0.58 mm	10 cm	250
BF100-58-15	1.00 mm	0.58 mm	15 cm	250
BF120-60-10	1.20 mm	0.60 mm	10 cm	225
BF120-69-7.5	1.20 mm	0.69 mm	7.5 cm	250
BF120-69-10	1.20 mm	0.69 mm	10 cm	250
BF120-69-15	1.20 mm	0.69 mm	15 cm	250
BF150-75-7.5	1.50 mm	0.75 mm	7.5 cm	225
BF150-75-10	1.50 mm	0.75 mm	10 cm	225
BF150-86-7.5	1.50 mm	0.86 mm	7.5 cm	250
BF150-86-10	1.50 mm	0.86 mm	10 cm	250
BF150-86-15	1.50 mm	0.86 mm	15 cm	250
BF200-100-10	2.00 mm	1.00 mm	10 cm	225
BF200-116-10	2.00 mm	1.16 mm	10 cm	250
BF200-116-15	2.00 mm	1.16 mm	15 cm	250

WITHOUT FILAMENT

catalog number	outside diameter	inside diameter	overall length	pieces per package
B100-20-10 ¹	1.00 mm	0.20 mm	10 cm	225
B100-50-10	1.00 mm	0.50 mm	10 cm	225
B100-50-15	1.00 mm	0.50 mm	15 cm	225
B100-58-10	1.00 mm	0.58 mm	10 cm	250
B100-58-15	1.00 mm	0.58 mm	15 cm	250
B114-53-10NP ²	1.14 mm	0.53 mm	10 cm	225
B120-69-8	1.20 mm	0.69 mm	8 cm	250
B120-69-10	1.20 mm	0.69 mm	10 cm	250
B120-69-15	1.20 mm	0.69 mm	15 cm	250
B150-86-7.5	1.50 mm	0.86 mm	7.5 cm	250
B150-86-10	1.50 mm	0.86 mm	10 cm	250
B150-86-15	1.50 mm	0.86 mm	15 cm	250
B200-116-10	2.00 mm	1.16 mm	10 cm	250
B200-116-15	2.00 mm	1.16 mm	15 cm	250

¹ The ends are not fire-polished. Special order minimum of 2.

² Nanoinjection glass. Ends are not fire-polished.



HEAVY POLISHED THICK / STANDARD AND THIN WALLED GLASS¹

WITH FILAMENT

catalog number	outside diameter	inside diameter	overall length	pieces per package
BF150-86-7.5HP	1.50 mm	0.86 mm	7.5 cm	250
BF150-86-10HP	1.50 mm	0.86 mm	10 cm	250
BF150-110-7.5HP	1.50 mm	1.10 mm	7.5 cm	225
BF150-110-10HP	1.50 mm	1.10 mm	10 cm	225

WITHOUT FILAMENT

catalog number	outside diameter	inside diameter	overall length	pieces per package
B100-30-7.5HP	1.00 mm	0.30 mm	7.5 cm	225
B100-50-7.5HP	1.00 mm	0.50 mm	7.5 cm	225
B150-86-7.5HP	1.50 mm	0.86 mm	7.5 cm	250
B150-86-10HP	1.50 mm	0.86 mm	10 cm	250
B150-110-7.5HP	1.50 mm	1.10 mm	7.5 cm	225
B150-110-10HP	1.50 mm	1.10 mm	10 cm	225

¹ Useful for added protection of gaskets and wire in headstages.

THIN WALLED BOROSILICATE GLASS

WITH FILAMENT

catalog number	outside diameter	inside diameter	overall length	pieces per package
BF100-75-10	1.00 mm	0.75 mm	10 cm	225
BF100-78-10	1.00 mm	0.78 mm	10 cm	250
BF100-78-15	1.00 mm	0.78 mm	15 cm	250
BF120-94-8	1.20 mm	0.94 mm	8 cm	250
BF120-94-10	1.20 mm	0.94 mm	10 cm	250
BF120-94-15	1.20 mm	0.94 mm	15 cm	250
BF150-110-7.5	1.50 mm	1.10 mm	7.5 cm	225
BF150-110-10	1.50 mm	1.10 mm	10 cm	225
BF150-117-10	1.50 mm	1.17 mm	10 cm	250
BF150-117-15	1.50 mm	1.17 mm	15 cm	100
BF150-120-10	1.50 mm	1.20 mm	10 cm	250
BF165-120-7.5	1.65 mm	1.20 mm	7.5 cm	225
BF165-120-10	1.65 mm	1.20 mm	10 cm	225
BF200-156-10	2.00 mm	1.56 mm	10 cm	250
BF200-156-15	2.00 mm	1.56 mm	15 cm	100

WITHOUT FILAMENT

catalog number	outside diameter	inside diameter	overall length	pieces per package
B100-75-10	1.00 mm	0.75 mm	10 cm	225
B100-75-15	1.00 mm	0.75 mm	15 cm	225
B120-90-8	1.20 mm	0.90 mm	8 cm	225
B120-90-10	1.20 mm	0.90 mm	10 cm	225
B120-90-15	1.20 mm	0.90 mm	15 cm	225
B150-110-7.5	1.50 mm	1.10 mm	7.5 cm	225
B150-110-10	1.50 mm	1.10 mm	10 cm	225
B150-117-10	1.50 mm	1.17 mm	10 cm	250
B200-156-10	2.00 mm	1.56 mm	10 cm	250
B200-156-15	2.00 mm	1.56 mm	15 cm	100



MULTI-BARREL BOROSILICATE¹ GLASS

WITH FILAMENT

catalog number	number of barrels	outside/inside diameter	overall length	pieces per package
2BF100-50-10	2 barrels	1.00/0.50	10 cm	75
2BF100-75-10	2 barrels	1.00/0.75	10 cm	75
2BF150-86-10	2 barrels	1.50/0.86	10 cm	100
2BF150-86-15	2 barrels	1.50/0.86	15 cm	100
3BF100-50-10	3 barrels	1.00/0.50	10 cm	75
3BF100-75-10	3 barrels	1.00/0.75	10 cm	75
3BF120-69-10	3 barrels	1.20/0.69	10 cm	100
3BF120-69-15	3 barrels	1.20/0.69	15 cm	100

WITHOUT FILAMENT

catalog number	number of barrels	outside/inside diameter	overall length	pieces per package
3B100-75-10	3 barrels	1.00/0.75	10 cm	75
4B100-75-10	4 barrels	1.00/0.75	10 cm	75

¹ Multibarrel borosilicate requires a custom filament. Please contact Sutter Instrument for more information when ordering.

QUARTZ GLASS

WITH FILAMENT

catalog number	outside diameter	inside diameter	overall length	pieces per package
QF100-50-7.5	1.00 mm	0.50 mm	7.5 cm	100
QF100-50-10	1.00 mm	0.50 mm	10 cm	100
QF100-60-7.5	1.00 mm	0.60 mm	7.5 cm	100
QF100-60-10	1.00 mm	0.60 mm	10 cm	100
QF100-70-7.5	1.00 mm	0.70 mm	7.5 cm	100
QF100-70-10	1.00 mm	0.70 mm	10 cm	100
QF100-70-15	1.00 mm	0.70 mm	15 cm	100
QF120-60-7.5	1.20 mm	0.60 mm	7.5 cm	100
QF120-60-10	1.20 mm	0.60 mm	10 cm	100
QF120-90-10	1.20 mm	0.90 mm	10 cm	100
QF150-75-7.5	1.50 mm	0.75 mm	7.5 cm	100
QF150-75-10	1.50 mm	0.75 mm	10 cm	100

WITHOUT FILAMENT

catalog number	outside diameter	inside diameter	overall length	pieces per package
Q100-30-7.5	1.00 mm	0.30 mm	7.5 cm	100
Q100-30-15	1.00 mm	0.30 mm	15 cm	100
Q100-50-7.5	1.00 mm	0.50 mm	7.5 cm	100
Q100-50-10	1.00 mm	0.50 mm	10 cm	100
Q100-70-7.5	1.00 mm	0.70 mm	7.5 cm	100
Q100-70-10	1.00 mm	0.70 mm	10 cm	100
Q114-53-10NP*	1.14 mm	0.53 mm	10 cm	100
Q120-40-7.5	1.20 mm	0.40 mm	7.5 cm	100
Q120-60-7.5	1.20 mm	0.60 mm	7.5 cm	100
Q120-90-7.5	1.20 mm	0.90 mm	7.5 cm	100
Q120-90-10	1.20 mm	0.90 mm	10 cm	100
Q150-50-7.5	1.50 mm	0.50 mm	7.5 cm	100
Q150-75-7.5	1.50 mm	0.75 mm	7.5 cm	100
Q150-75-10	1.50 mm	0.75 mm	10 cm	100
Q150-110-10	1.50 mm	1.10 mm	10 cm	100
Q165-115-10	1.65 mm	1.15 mm	10 cm	100



* The ends are not fire-polished. Nanoinjection glass.

SOLID QUARTZ ROD

catalog number	outside diameter	inside diameter	overall length	pieces per package
QR-100-7.5	solid	1.00 mm	7.5 cm	100
QR-100-10	solid	1.00 mm	10 cm	100
QR-100-15	solid	1.00 mm	15 cm	100

QUARTZ THETA GLASS

catalog number	outside diameter	inside diameter	overall length	pieces per package
QT120-90-7.5	1.20/0.9 mm	0.15 mm	7.5 cm	50

MULTI-BARREL GLASS

catalog number	number of barrels	outside/inside diameter	overall length	pieces per package
7Q033-16-10	7 barrel	1.00/[.33/.16 ea]	10 cm	50

ALUMINOSILCATE GLASS

WITH FILAMENT

catalog number	outside diameter	inside diameter	overall length	pieces per package
AF100-64-10	1.00 mm	0.64 mm	10 cm	100
AF120-77-10	1.20 mm	0.77 mm	10 cm	100
AF120-87-10	1.20 mm	0.87 mm	10 cm	100
AF150-100-10	1.50 mm	1.00 mm	10 cm	100

WITHOUT FILAMENT

catalog number	outside diameter	inside diameter	overall length	pieces per package
A100-64-10	1.00 mm	0.64 mm	10 cm	100
A120-77-10	1.20 mm	0.77 mm	10 cm	100
A120-87-10	1.20 mm	0.87 mm	10 cm	100
A150-100-10	1.50 mm	1.00 mm	10 cm	100

BOROSILICATE THETA GLASS

catalog number	outside diameter	inside diameter	overall length	pieces per package
BT-150-10	1.50/1.17 mm	0.165 mm	10 cm	100

SOLID BOROSILICATE ROD

catalog number	outside diameter	inside diameter	overall length	pieces per package
BR-100-10	solid	1.00 mm	10 cm	250
BR-100-15	solid	1.00 mm	15 cm	250

MICROSCOPES

When the Movable Objective Microscope® (MOM®) was being developed at Max Planck Institute, Winfried Denk turned to Sutter for its experience in precision machining and 3D stepper-motor control to prototype the first two-photon moving objective microscope. The Sutter MOM rapidly grew to be the standard for two-photon in vivo microscopy. The open frame structure of this scope gives it unsurpassed flexibility, allowing for a range of configurations. In the last two years, this open frame has fostered near continuous development of the three-photon, 3P-MOM. We have made modifications to the excitation path to allow the usage of a new scan and

tube lens with longer transmission and modified our short path detector to better collect scattered photons.

Building on the successful design of the MOM, Sutter has recently introduced the SOM®, simple moving microscope. In the SOM, Sutter followed the lead of customers who requested a low-cost, robotic microscope with the versatility



of the MOM. The SOM was designed with electrophysiology in mind and is an appropriate platform for in vivo or brain slice preparations with little or no modification. The SOM uses the popular MP-285 as its mechanical base, and Sutter has designed a variety of adapters for video cameras, objective flippers, and illumination sources.

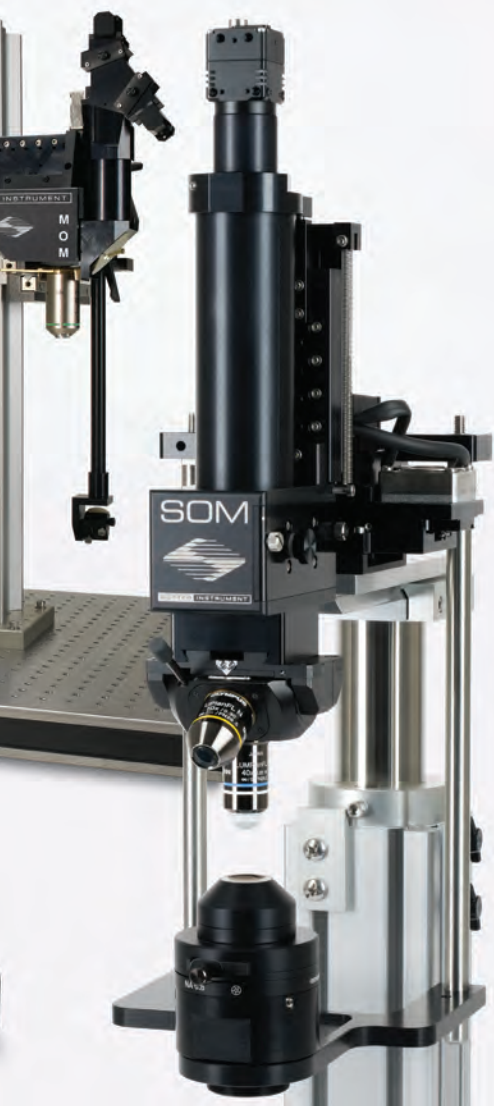

The DF-Scope™ is another customer-inspired microscope design. Rather than a complete microscope, this package adds multiphoton imaging capability to the ubiquitous Olympus BX51WI upright microscope. Many laboratories already have BX51WI microscopes for use in electrophysiology and epifluorescent imaging experiments. The DF-Scope package provides the necessary optics and electronics for the BX51WI to be used for multiphoton imaging (with the addition of a Ti:Sapphire laser and scanning software). The design incorporates subassemblies from the MOM including resonant and galvo scan boxes and controllers, detector paths, PMTs, PMT power supplies, scan lens, and tube lens.

Our latest offering, the BOB open-design upright microscope, incorporates the Olympus vertical illuminator and objectives. By simplifying the microscope to its bare essentials, we've created a much more flexible and open system that can be used for a variety of applications.

Rounding out Sutter's microscope line is a growing list of standalone accessories for two-photon and other microscopes. Components available as standalone include MCS, the MScan software suite with PC workstation and data acquisition cards, RESSCANNER, an ultra-quiet resonant scan box and controller that is available as a MOM upgrade or a generic version that can be used in home built scopes, PS-2 and PS-2/LV, two different dual power supplies for PMTs, and a small selection of Hamamatsu PMTs.

MOM® MOVABLE OBJECTIVE MICROSCOPE®



(Shown with optional trinocular head and CCD camera. Objective not included)

FEATURES MOM®

- Objective moves 22 mm in X, Y and Z
- Objective rotates about optical axis for imaging of non-horizontal surfaces and volumes
- Customizable open platform design
- Cambridge Technology XY scanners
- Two or four channel detector system with Hamamatsu PMTs and preamplifiers
- Sutter PS-2 / PS-2 LV dual channel PMT power supply
- Two- or three-photon compatible scan lens and tube lens
- "New" Light Block keeps visual stimuli, photostimuli and ambient light out of detector path
- National Instrument and Vidrio Technologies data acquisition systems

COMMON APPLICATIONS MOM®

- *In vivo* two-photon imaging
- *In vivo* three-photon imaging
- Electrophysiological recording and imaging (culture, large *in vivo* preparations, etc.)
- Non-horizontal surface microscope
- Simultaneous retinal stimulation and two-photon microscope*
- Whole animal imaging
- Immunology
- Embryology

* *Eyecup scope-optical recordings of light stimulus-evoked fluorescence signals in the retina*" Euler et al, Pflugers Arch, 2008



The Movable Objective Microscope® (MOM®) is a two- or three-photon microscope capable of imaging deep within living specimens when combined with an appropriate laser. The Sutter MOM was the first scope to provide 3-dimensional objective movement and rotation allowing the specimen to remain horizontal and stationary. Many highly regarded imaging laboratories around the world use the Sutter MOM and we constantly work with our customers to adapt the design for their changing needs.

MOM Opto-mechanical Design

The MOM consists of two independent microscopes. The wide-field half of the microscope consists of an Olympus vertical illuminator, Sutter Xenon arc lamp and camera mount to provide standard epifluorescence. The two-photon side of the microscope provides the optical pathway for guiding the excitation laser light from the table up into the scanning galvanometric mirrors and then expanding the beam through the scan lens and directing into the back of the objective. Following two-photon excitation, the emitted photons are directed by a dichroic mirror immediately above the objective into the detection pathway. The main body of the microscope moves backwards on a rail system allowing easy access to the specimen prior to imaging.

The objective translates in X, Y and Z as well as rotates around the X axis. Two moving mirrors allow the microscope to maintain efficient delivery of the excitation light to the back aperture of the objective regardless of movement or orientation. The X, Y and Z movements used are the same as that in our MP-285 micromanipulator so you know the movements are smooth, fine in scale, drift-free and highly reproducible. These movements permit Z-stacks and mosaic images of large regions of tissue to be recorded without the need for a moving stage.

The horizontal light path allows for rotation of the objective away from the standard vertical position. As a result of this rotation, the MOM can easily be converted from an upright to an inverted microscope and the objective positioned from 0 to 180 degrees. This positional freedom permits the imaging of non-horizontal surfaces and volumes.

MOM Scanning Systems

During the last 10 years, scanning systems for multiphoton microscopes have changed in several ways. Large aperture, high NA objectives became available and thus required larger aperture scanners. Resonant scanner technology allowed faster imaging. Two-photon scopes now include both resonant-galvo and resonant galvo-galvo systems. The Sutter MOM developed in parallel with these changes and new technology can be bolted into older, existing scopes with minimal changes. Many original scopes with 3 mm galvo scanners have been upgraded to either 6 mm galvo scanners or resonant/galvo scanners. As an example, the Vidrio RMR scanner (a resonant galvo-galvo scanner system) can be purchased as part of any new MOM system or retrofit into existing MOM scopes.



Imaging Software

Starting in 2011, Sutter began offering the MOM[®] Computer System and Software (MCS). Before this software package was developed, most users relied on ScanImage or MPscope to generate scanned images. Customers valued the fact that the MOM would operate with open source freewares, however, there seemed to also be a market for a commercial package. MCS continues to offer a simple, easy to use package available at a price that compares with other commercial and freeware packages. MScan 3.0, the latest version, is Windows 10 compatible. A recent publication takes advantage of the long (1-2 hour) data files that can be captured in the MCS proprietary data file structure. (reference Kuhn, 2020).

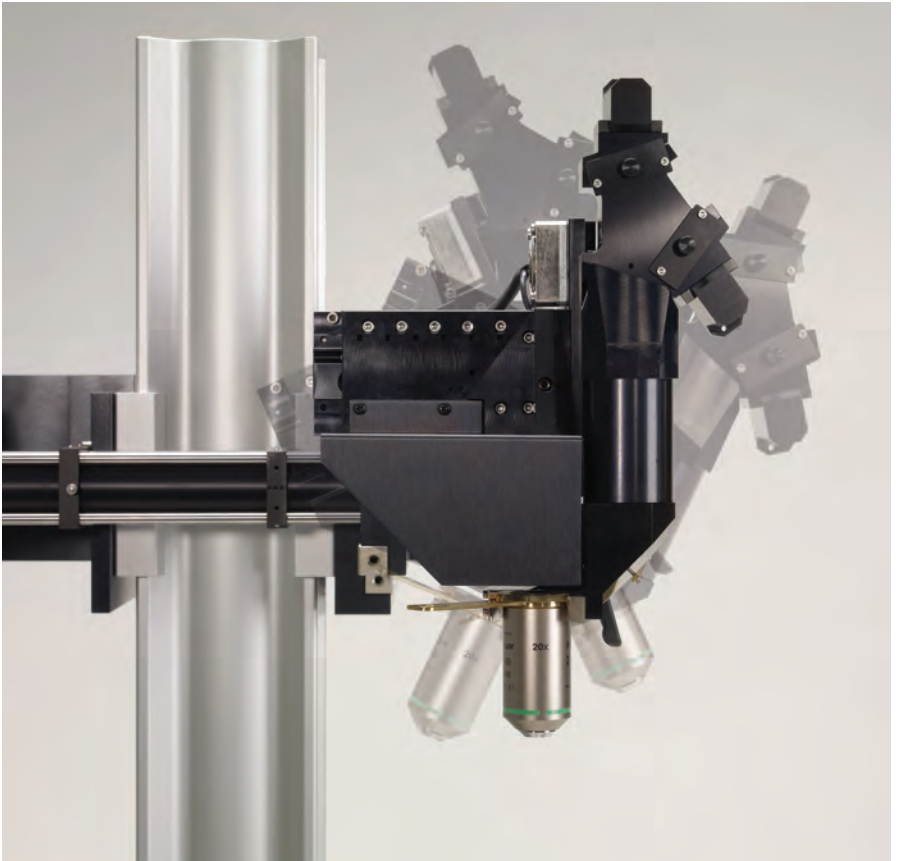

The MOM is both an inverted and upright microscope with 0° to 180° rotation



The MOM® has always been compatible with ScanImage freeware, the two-photon imaging software developed by Karel Svoboda and collaborators. One of the reasons the MOM platform exists in its present form is the strong support from the ScanImage community. In 2014, Vidrio became the principle vehicle for support and new development of ScanImage. Sutter is happy to make Vidrio ScanImage Premium available to customers who wish premium support and the latest features. ScanImage Basic is available as an entry level system with a year of support included. ScanImage freeware is still available but does not include support. Sutter provides packages that include the necessary data acquisition hardware to couple the MOM and other scanning microscopes to ScanImage Premium, ScanImage Basic or the freeware version. We also sell Vidrio's hardware line including ScanImage ready computers, the vDAQ acquisition system and the RMR scanner.

*2-channel**4-channel**Short path (2-channel)**Wide path*

Sutter MOM packages include all of the equipment (less the laser and objective) needed for a complete imaging system.

- Scan lens and tube lens appropriate for two- or three-photon imaging
- Cambridge Technology XY galvanometric (3 mm or 6 mm) or resonant scanners (resonant-galvo or resonant galvo-galvo systems both with 5 mm mirrors).
- Hamamatsu photomultiplier tubes (PMTs): R6357 multialkali or H10770PA-40 (GaAsP) products. (Other PMTs are available, Sutter is an authorized reseller for Hamamatsu).
- Power supplies for PMTs: Sutter PS-2 (dual channel high-voltage power supply for conventional PMTs) or Sutter PS-2/LV (dual channel low-voltage power supply for H10770PA-40 or other PMTs with built in high voltage). Power supplies can be ordered with remote turn on/shut off for PMT gating.
- Hamamatsu, Sigmam or FEMTO pre-amplifiers.
- Data acquisition: National Instruments PXI FPGA, Vidrio vDAQ, or National Instruments PC based Multifunction I/O.
- Conoptics Pockels Cells for laser intensity control.



Forget multiphoton! The new Sutter 3P-MOM® is ready to go for deep-tissue, three-photon imaging.

Despite the intense interest in three-photon microscopy over the last two years, this is still a relatively nascent field. Neurobiologists doing two-photon imaging and microscope manufacturers building two-photon microscopes have been eager to make the jump into the technology that will allow experimenters to image deeper into the brain, probably close to twice the sub millimeter depth of the best two-photon recordings. We all hoped we could just dial the laser up to 1300 nm and start imaging deeper. After all, Chris Xu made it look so easy!

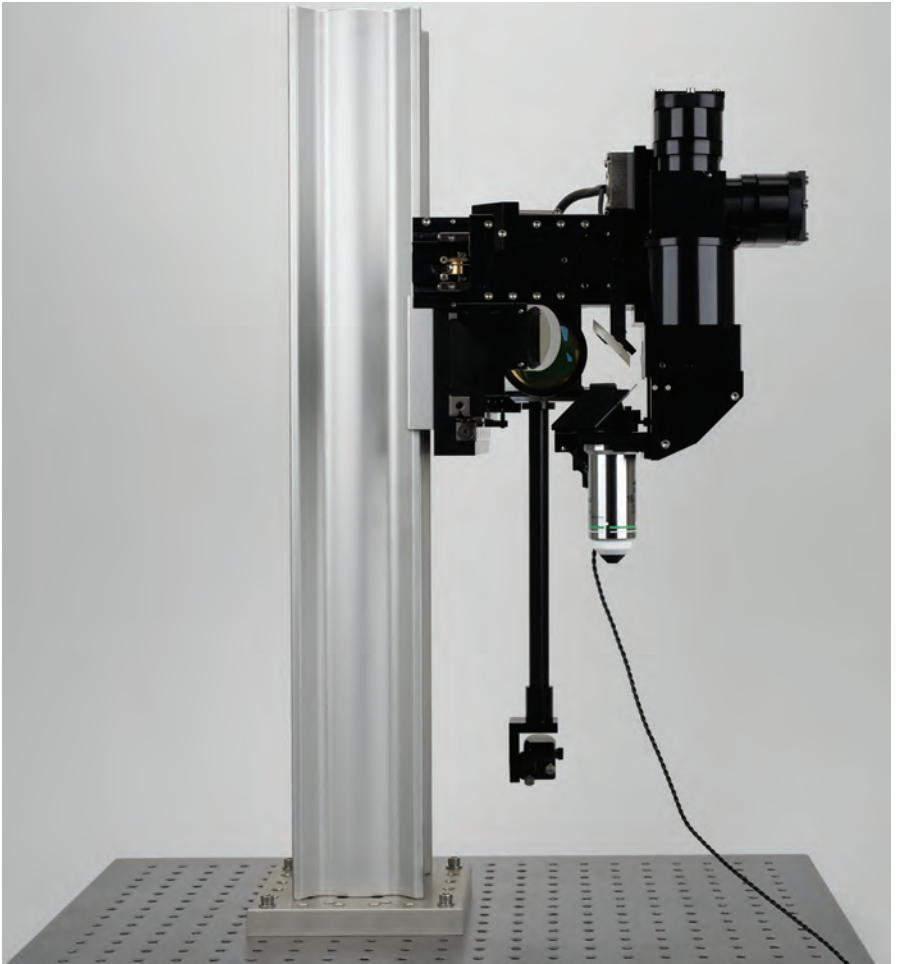



Three-photon microscopy is in about the same status as two-photon microscopy was in the late '90s. There were a small number of labs doing the necessary work to establish the field. Most made their own microscopes and commercialized systems were not well suited to doing functional imaging *in vivo*.

Today, with respect to three-photon microscopy, there are several handfuls of labs that are establishing the field, using largely either homemade microscopes or adapting existing two-photon scopes. There does not seem to yet be a huge market for de novo commercial platforms, possibly because the technique is more challenging than two-photon and possibly because three-photon requires a completely different excitation source than two-photon with more power concentrated in narrower, taller pulses. In this developing field, Sutter's Microscope division is exactly where you would expect and want us to be. We are already working with a significant portion of the labs developing three-photon microscopy. Most started with our two-photon MOM® design and have converted them to three-photon platforms either on their own or with our assistance. Sutter now can incorporate those changes into any existing Sutter 2P-MOM. The most important change is to convert the scan and tube lenses to better transmit IR to beyond 1700 nm. We have also collaborated to develop a more efficient version of one of our detector paths to do a better job of collecting emission from even deeper focal depths.

In the last two years we have quoted and built a number of three-photon MOMs as well as a few that were designed to be "three-photon ready". We have collaborated with several labs to convert existing 2P-MOMs into 3P platforms.

We are excited to be fully involved in this developing field. Let us help you see what the challenges and benefits of three-photon imaging can be. Whether you are just entering the field of multiphoton imaging or are an experienced two-photon imager who wishes access to deeper and lower-noise images that three-photon excitation can bring, please contact us.



FG-MOM-LB-WIDE (shown installed on wide path detector, blocks external light sources from entering detector path).



SPECIFICATIONS MOM® AND CONTROLLER

- **Travel** 22 mm on all three axes
- **Resolution** MP-285 controller
Low: 0.2 $\mu\text{m}/\text{step}$
High: 0.04 $\mu\text{m}/\text{step}$
MPC-200 controller
0.0625 $\mu\text{m}/\text{step}$
- **Maximum Speed** MP-285 controller
2.9 mm sec
MPC-200 controller
5.0 mm/sec
- **Long Term Stability** 1-2 $\mu\text{m}/\text{hour}$
- **Drive Mechanism** Precision worm gear capstan drive
- **Communication** MP-285: RS-232 Serial
MPC-200: USB
- **Electrical** 115/230 Volts
50/60 Hertz power line

LAMBDA LS 300W XENON ARC LAMP

- **Lamp Life** 1,000 hours (500 hour warranty)
Longer life depends on application
- **Electrical** 115/230 Volts
50/60 Hertz power line

PS-2/PS-2LV PMT POWER SUPPLY

- **Electrical** 115/230 Volts
50/60 Hertz power line

MDR-3 / MDR-6 / MDR-R SCAN DRIVE CONTROLLER

- **Electrical** 115/230 Volts
50/60 Hertz power line





MOM®

U.S. prices available at www.sutter.com. International prices vary by country. Contact a distributor or Sutter Instrument for a quotation. Prices subject to change without notice.

MOM®

BASIC SYSTEM FOR 2- and 3-PHOTON MICROSCOPY

Includes Movable Objective Microscope®, 2-channel detector with PMTs, preamps and PS-2 power supply, XY scanners with drive electronics, wide field fluorescence unit including vertical illuminator, Lambda LS 300 Watt Xenon Arc lamp, LLG and light guide adapter, C-mount for wide field camera, data acquisition system.

- **MOM-3MM¹** MOM System with 6 mm XY scanners
- **MOM-RES-MCS¹** MOM System with Resonant scanners GaAsP PMTs and MScan 3.0 software
- **MOM-RES-SIP¹** MOM System with Resonant scanners GaAsP PMTs and ScanImage Premium
- **MOM-RMR-SIP¹** MOM System with Vidrio RMR scanners, GaAsP PMTs, vDAQ acquisition system and ScanImage Premium
- **MOM-3P¹** MOM System with 3P scan and tube lens, 3P detector path, 6 mm galvo scanners, and ScanImage Premium

ACCESSORIES MOM®

- **MOM-SETUPKIT-M** Basic table optics for laser routing
- **MOM-ALIGNTOOL²** MOM alignment tool
- **MOM-LB-WIDE** Light blocking cover excludes ambient and other light from detector path
- **MOM-3P-CONVERSION** 3P compatible scan lens and tube lens. Price depends on current MOM configuration, Call Sutter For Details
- **MOM-3P-SHORTPATH** Call Sutter For Details

¹ Final pricing depends on detector path selected and does not include several devices necessary for a complete 2-photon microscope (i.e. Ti:Sapphire laser, objective, camera, trinocular head, table mount optics). Please phone Sutter for details.

² Useful tool for aligning the laser in MOM scopes, especially those with resonant scanners.



BOB™ OPEN-DESIGN UPRIGHT MICROSCOPE

MICROSCOPES



FEATURES BOB™

- Optional motorized or fixed XY stage, or motorized translator
- Open-design microscope with motorized focus
- Quickly configurable based on experimental needs
- Optimized to allow *in vivo* and *in vitro* experimentation on one setup
- Designed for use with Olympus objective lenses
- Free Multi-Link™ software coordinates movement with micropipette positioning of MPC-200
- Oblique Coherent Contrast (OCC) or Differential Interference Contrast (DIC)
- Epi-fluorescent illumination



The Sutter BOB™ – designed to eliminate the conventional microscope frame – is a simple, open-design upright microscope platform ideal for slice electrophysiology, wide field functional imaging, two-photon retinal imaging, photostimulation and new techniques just being developed! A microscope, in its simplest form, is an objective and a tube lens. Other components of most modern microscopes are designed to serve specific functions: different types of experiments, methods of illumination and means of signal detection.

Replacing the microscope frame with an optical rail builds in the ability to adjust the overall height of the microscope, unheard of in conventional microscope designs. Work on slices in January, do *in vivo* experiments in March. The BOB microscope is a compact, single assembly that mounts to the “blue rail” with one massive, stable connection. Focusing is motorized and incorporated between the focus arm and the optical rail.

Fluorescence epi-illumination is built into the basic BOB via an Olympus vertical illuminator. LED transmitted light illumination uses the Olympus Oblique Coherent Contrast (OCC) condenser. Sutter’s TLED and TLED controller form the trans-illumination light source. The TLED controller is capable of being triggered with a digital signal eliminating the need for shutters and adding the ability to photostimulate from the trans location. In experiments where transmitted light is not desired, the LED, condenser focus mechanism and OCC condenser are easily removed as a single assembly. Additionally, the transmitted light path is shorter than in other frames, allowing the microscope body to sit significantly lower than a conventional microscope. When the microscope is shorter, there is more stability and increased ergonomics for ease of use.

The Sutter BOB, when configured with an optional motorized XY stage or translator with MPC-200 controller, takes full advantage of our free Multi-Link™ software program for micromanipulator positioning. During whole-cell patch recording in slices, it is common to search a large area of the slice to find appropriate neurons. If the BOB is configured with Multi-Link, after you find your target, Multi-Link will then retrieve your recording and stimulation pipettes to the same field of view so that you can begin recording immediately. If later you need to stimulate a region outside the current field of view, Multi-Link can release the recording pipette and allow you to reposition the objective and stimulating pipette(s) to the new stimulation region.

APPLICATIONS:

- Patch Clamp Electrophysiology
- In vivo*, *in vitro*, and slice
- Whole-cell imaging
- Intracellular imaging
- Material Science



SPECIFICATIONS BOB™

- **Dimensions** 9.1 in x 10.8 in x 20.4 in
23.1 cm x 27.5 cm x 51.9 cm
- **Weight** *BOB:*
23.9 lbs
10.8 kg
BOB-TL:
29.3 lbs
13.3 kg
- **Electrical** 115/230 Volts
50/60 Hertz power line





BOB™

U.S. prices available at www.sutter.com. International prices vary by country. Contact a distributor or Sutter Instrument for a quotation. Prices subject to change without notice.

BOB systems *with* fluorescence

- **BOB-FL** BOB microscope with epi-illuminator
- **BOB-FLTRTL** BOB with epi-illuminator, trinocular head, transmitted light
- **BOB-FLTRL2** BOB with epi-illuminator, trinocular head, dual transmitted light
- **BOB-FLTR** BOB with epi-illuminator, trinocular head
- **BOB-FLTL** BOB with epi-illuminator, transmitted light
- **BOB-FLTL2** BOB with epi-illuminator, dual transmitted light

BOB systems *without* fluorescence

- **BOB** BOB microscope
- **BOB-TRTL** BOB with trinocular head, transmitted light
- **BOB-TRTL2** BOB with trinocular head, dual transmitted light
- **BOB-TR** BOB with trinocular head
- **BOB-TL** BOB with transmitted light
- **BOB-TL2** BOB with dual transmitted light

CONFIGURE YOUR BOB™ MICROSCOPE

STEP 1: Use this chart to determine the BOB system suited to your requirements

BOB SYSTEMS WITH FLUORESCENCE

FEATURES	Trinocular head or camera mount	Transmitted light	Add a second wavelength to transmitted light
BOB-FL	Camera	No	No
BOB-FLTL	Camera	Yes	No
BOB-FLTL2	Camera	Yes	Yes
BOB-FLTR	Trinocular Head	No	No
BOB-FLTRTL	Trinocular Head	Yes	No
BOB-FLTRTL2	Trinocular Head	Yes	Yes

BOB SYSTEMS WITHOUT FLUORESCENCE

BOB	Camera	No	No
BOB-TL	Camera	Yes	No
BOB-TL2	Camera	Yes	Yes
BOB-TR	Trinocular Head	No	No
BOB-TRTL	Trinocular Head	Yes	No
BOB-TRTL2	Trinocular Head	Yes	Yes



CONFIGURE YOUR BOB™ MICROSCOPE

STEP 2: Choose your objective(s)

The BOB uses a standard Olympus turret. You can select from this list, use your own objectives, or choose from one below. Objectives in GREEN with footnote are recommended for electrophysiology.

- **OBJ-Y522** 4X – UPLFLN4X;U PLAN FLUORITE 4X OBJECTIVE;
NA 0.13, WD 17 mm
- **OBJ-Y524** 10X – UPLFLN10X2;U PLAN FLUORITE 10X OBJECTIVE;
NA 0.3, WD 10 mm
- **OBJ-Y587** 40X – LUMPLFLN40X/W;U M PLAN FLN 40X/W
NA0.8 WD 3.3 mm,IR,ECO
- **OBJ-Y592** 60X – LUMPLFLN60X/W; U M PLAN FLN 60X/W
NA1.0 WD 2.0 mm,IR,ECO
- **OBJ-Y672** 60X – LUMFLN60X/W;LUMFLN60X/W
NA1.1WD 1.5 mm 25 ANGLE,IR.CC,ECO



CONFIGURE YOUR BOB™ MICROSCOPE

STEP 3: For models with **TL** in the part number: Choose a condenser.

- **OCC** Oblique contrast condenser
- **DIC-40X[†]** DIC system components for 40X objective
- **DIC-40XIR[†]** IR DIC system components for 40X objective
- **DIC-60X[†]** DIC system components for 60X objective
- **DIC-60XIR[†]** IR DIC system components for 60X objective

[†] For DIC models, select the one that matches the highest power of your selected objectives.

CONFIGURE YOUR BOB™ MICROSCOPE

STEP 4: For models with **TR** in the part number: Choose a filter cube(s) and a light source.

FILTER CUBES

- **CUBE-GFP** Filter Cube – GFP
- **CUBE-CY3** Filter Cube – CY3
- **CUBE-YFP** Filter Cube – YFP
- **CUBE-DAPI** Filter Cube – DAPI
- **CUBE-A635** Filter Cube – ALEXA 635
- **CUBE-MCH** Filter Cube – mCHERRY

LIGHT SOURCES

Not necessary if you already have a light source with a liquid light guide.

- **HPX-L5** Lambda HPX-L5 High powered LED light source
- **LS-OF30** Lambda LS with 300 Watt ozone free lamp
- **LB-421** Lambda 421 Optical Beam Combiner (Select 4 wavelengths)
- **LB-721** Lambda 721 Optical Beam Combiner (Select 4 wavelengths)
- **L-OBC** Lambda OBC Optical Beam Combiner (Please contact Sutter to discuss your configuration)
- **FLED-BOB** Lambda FLED LED light source for BOB
- **FLED-DC-BOB** Dual channel Lambda FLED LED light source for BOB

LIGHT SOURCE ADAPTER

- **LG-Y51** Liquid light guide adapter for light source



CONFIGURE YOUR BOB™ MICROSCOPE

STEP 5: Select a stage and translator as needed.

LONG ISLAND

MOTORIZED LARGE PLATFORM STAGE

- **MPC-88^{1,2}** Moving platform stage plate with motorized gantry supports, MPC-200 controller and ROE, cables and manual
- **MPC-88-M6^{1,2}** Same as MPC-88 except with M6 tapped holes
- **MPB-88¹** Moving platform stage plate with motorized gantry supports, BOB controller, cables
- **MPB-88-M6¹** Same as MP-88 except with M6 tapped holes
- **MP-88¹** Moving platform stage plate with motorized gantry supports, MP-285 controller and ROE, cables and manual
- **MP-88/M6¹** Same as MP-88 except with M6 tapped holes

SAN FRANCISCO

MOTORIZED TRANSLATOR AND STANDS

Includes a motorized X-Y translator, a controller, two micromanipulator stands, MT-150 chamber stand, and cables.

- **MT-2000/BOB** Motorized translator with MP-285 controller, ROE, and stands
- **MT-2200/BOB²** Motorized translator with MPC-200 controller, ROE, and stands
- **MT-2800/BOB** Motorized translator with BOB controller, ROE, and stands

NEW: MOTORIZED TRANSLATOR AND AND POST-STYLE STANDS

Includes a motorized X-Y translator, a controller, MT-150 chamber stand, two post-style manipulator columns, cables and manual.

- **MT-2095/BOB** Motorized translator, MP-285 controller, and post-style columns
- **MT-2295/BOB²** Motorized translator, MPC-200 controller, and post-style columns
- **MT-2895/BOB** Motorized translator, BOB controller, ROE, and post-style columns

METRIC

- **MT-2095M/BOB** Motorized translator, MP-285 controller, and post-style columns for metric table
- **MT-2295M/BOB²** Motorized translator, MPC-200 controller, and post-style columns for metric table
- **MT-2895M/BOB** Motorized translator, BOB controller, ROE, and post-style columns for metric table

¹ Please specify chamber type when ordering.

² If you are planning on using our free Multi-Link Software, you will need to purchase a stage or translator with the MPC-200 controller.



CONFIGURE YOUR BOB™ MICROSCOPE

STEP 5 continued: Select a stage and translator as needed.

ALCATRAZ

MOTORIZED TRANSLATOR AND FIXED PLATFORM STAGE

Includes a motorized X-Y translator, controller, cables, and fixed platform stage.

- **MT-2089/BOB** Motorized translator with MP-285 controller, ROE, and fixed platform stage
- **MT-2289/BOB¹** Motorized translator with MPC-200 controller, ROE, and fixed platform stage
- **MT-2889/BOB** Motorized translator with BOB controller, ROE, and fixed platform stage

MOTORIZED TRANSLATOR ONLY (no stand or platform)

Includes a motorized X-Y translator, controller, and cables.

- **MT-800/BOB** Motorized translator with MP-285 controller, and ROE
- **MT-820/BOB¹** Motorized translator with MPC-200 controller, and ROE
- **MT-880/BOB** Motorized translator with BOB controller, and ROE

¹ If you are planning on using our free Multi-Link Software, you will need to purchase a stage and translator with the MPC-200 controller.

CONFIGURE YOUR BOB™ MICROSCOPE

STEP 6: Select other accessories as needed.

CAMERA

- **CAM-EL** ELECTRO, Cooled 1.4MP CCD Camera
- **CAM-PR** PRIME 95B, Back illuminated CMOS Camera
- **CAM-BSI** PRIME BSI, High-res scientific CMOS Camera



ACCESSORIES BOB™

MP-88 / MPC-88 CHAMBER INSERTS

- **X040500**¹ Warner Series 20 (round) — aluminum
- **X040503**¹ Warner Series 20 (round) — stainless steel
- **X040505**¹ Warner Series 20 (octagonal) — aluminum
- **X040507**¹ Warner Series 20 (octagonal) — stainless steel
- **X040510**¹ 50 mm round — aluminum
- **X040512**¹ 50 mm round — stainless steel
- **X040497**¹ Blank insert — aluminum
- **X040498**¹ Blank insert — stainless Steel
- **SI-SLIDE**¹ Insert with slide holder
- **SI-PETRI** For petri dish and slides
- **SI-W30**¹ Warner Series 30 platform — aluminum
- **SI-W30ST**¹ Warner Series 30 platform — stainless steel
- **SI-ALA-MS**¹ ALA MS series insert — aluminum
- **SI-CUSTOM** Custom stage insert

POST-STYLE MANIPULATOR COLUMNS

- **MT-95** Post-style manipulator column – 6 in
- **MT-95-M6** Post-style manipulator column – 6 in (metric table)

¹ No charge when ordered with MP-88 or MPC-88.



(Shown: BOB-FLRTL)

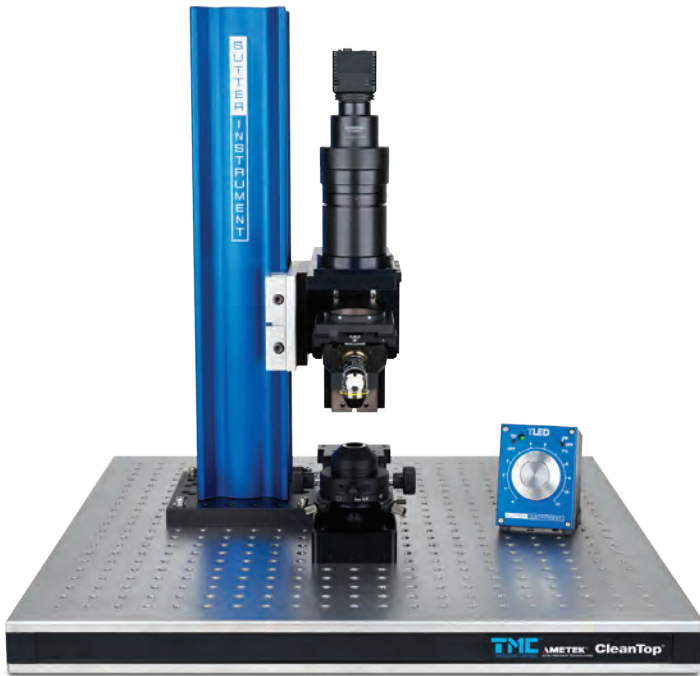

(Shown: BOB-TL)

NAN™

OPEN-DESIGN UPRIGHT MICROSCOPE

New



(Shown: NAN-12 with MP-865 micromanipulators)

FEATURES NAN™

- Optional with manual or motorized translator, or motorized XY Stage
- Open-design microscope with motorized focus
- Quickly configurable based on experimental needs
- Optimized to allow *in vivo* and *in vitro* experimentation on one setup
- Designed for use with Olympus objective lenses
- Free Multi-Link™ software coordinates movement with micropipette positioning of MPC-200
- Oblique Coherent Contrast (OCC) or Differential Interference Contrast (DIC)
- Epi-fluorescent illumination



The Sutter NAN™ — A focusing nosepiece microscope designed for electrophysiology. The microscope frame has been reimagined around our highly-stable adjustable MT-70 manipulator gantry stands; this design choice allows for many possible configurations to match the ever-expanding applications in the field of electrophysiology.

The NAN is manually height adjustable, with a range of 75 mm, which allows a single microscope to be coarsely re-positioned in Z within a few moments to switch between slice work or in vivo. There are two overall height variants of NAN, determined by the nosepiece that is selected. The focusing nosepiece, with 25 mm of motorized travel, can be configured with either a single objective nosepiece (Sutter made) or an Olympus 2-position swinging nosepiece. The height of the gantry stands is 15.25 cm (6") or 22.86 cm (9") for the single nosepiece or 2-position swinging nosepiece, respectively.

The epi level can be configured with a single filter cube or a complete Olympus epi-illuminator.



(Shown: NAN-12)



The transmitted light system is available with a single white light LED or dual white light and IR LED. LED transmitted light illumination uses the Olympus Oblique Coherent Contrast (OCC) condenser, or IR-DIC components for the available contrast methods. The LED(s) are driven by the TLED controller and are capable of being triggered with a digital signal. This eliminates the need for shutters, and adds the ability to photostimulate from the trans location. In experiments where transmitted light is not desired, the LED, condenser focus mechanism and condensing optics are easily removed as a single assembly. Additionally, the transmitted light path is shorter than in other systems, allowing the microscope body to sit significantly lower than a conventional microscope. When the microscope is shorter, there is more stability, increased ergonomics, and ease of use.

The NAN™ can be configured with trinocular eyepieces for visualization, or alternatively, with a tube lens and C-mount if only a camera is desired.



(Shown: NAN-21 with MPC-78 Stage)



An important detail to consider with the NAN is whether to translate the microscope, or move the sample and manipulators together on a large platform stage, or finally, translate the microscope but mount the sample and manipulators on a fixed platform stage. For the XY motion, all combinations of manual and motorized motion are available with the NAN. Here are the three general configurations:

- Manual or motorized translator with manipulators mounted on individual gantry stands
- Manual or motorized translator with manipulators mounted on a large platform stage
- Motorized XY platform stage with the microscope fixed to the tabletop

In order to complete the Electrophysiology “rig” we can also offer an abundant list of accessories, including the epi-fluorescence light source, manipulators, and amplifier systems. Call Sutter or visit www.sutter.com to configure a complete NAN rig that includes all part numbers and components. An example of the epi-fluorescence source is the FLED-DC which is a 2 channel LED system that is directly mounted to the epi-port of the microscope. If more than two fluorescent channels are required, then the Lambda 721 is a highly configurable LED light source with up to 7 channels. Sutter also offers equipment racks and air tables if you need those as well.

APPLICATIONS:

Patch Clamp Electrophysiology
In vivo, *in vitro*, and slice
Whole-cell imaging
Intracellular imaging
Material Science



SPECIFICATIONS NAN™

- **Dimensions** 16.5 in x 5.11 in x 13.1 in
42 cm x 13 cm x 33.3 cm
- **Weight** NAN-11:
39.7 lbs
18 kg



(Shown: NAN-12 with MP-865 micromanipulators)



NAN™

U.S. prices available at www.sutter.com. International prices vary by country. Contact a distributor or Sutter Instrument for a quotation. Prices subject to change without notice.

NAN systems *with* a single objective nosepiece

- **NAN-11** Single filter cube, Tube lens, White light LED transmitted
- **NAN-12** Olympus RFA, Tube lens, White light LED transmitted
- **NAN-13** Olympus RFA, Eyepieces, White light LED transmitted
- **NAN-14** Single filter cube, Eyepieces, White light LED transmitted

NAN systems *with* Olympus 2 position nosepiece

- **NAN-15** Single filter cube, Tube lens, White light LED transmitted
- **NAN-16** Olympus RFA, Tube lens, White light LED transmitted
- **NAN-17** Olympus RFA, Eyepieces, White light LED transmitted
- **NAN-18** Single filter cube, Eyepieces, White light LED transmitted
- **NAN-19** Single filter cube, Tube lens, White light IR LED transmitted
- **NAN-20** Olympus RFA, Tube lens, White light IR LED transmitted
- **NAN-21** Olympus RFA, Eyepieces, White light IR LED transmitted
- **NAN-22** Single filter cube, Eyepieces, White light IR LED transmitted

CONFIGURE YOUR NAN™ MICROSCOPE

STEP 1: Use this chart to determine the NAN system suited to your requirements

NAN SYSTEMS WITH SINGLE OBJECTIVE NOSEPIECE

FEATURES	Olympus Epi or Single CUBE	Trinoc or Tube Lens (no eyepieces)	Transmitted Light
NAN-11	Single FL CUBE	Tube Lens Only	White Light LED
NAN-12	Olympus RFA	Tube Lens Only	White Light LED
NAN-13	Olympus RFA	Trinoc	White Light LED
NAN-14	Single FL CUBE	Trinoc	White Light LED

NAN SYSTEMS WITH OLYMPUS 2-POSITION SWINGING NOSEPIECE

NAN-15	Single FL CUBE	Tube Lens	White Light LED
NAN-16	Olympus RFA	Tube Lens	White Light LED
NAN-17	Olympus RFA	Trinoc	White Light LED
NAN-18	Single FL CUBE	Trinoc	White Light LED
NAN-19	Single FL CUBE	Tube Lens	White Light LED+IR
NAN-20	Olympus RFA	Tube Lens	White Light LED+IR
NAN-21	Olympus RFA	Trinoc	White Light LED+IR
NAN-22	Single FL CUBE	Trinoc	White Light LED+IR



CONFIGURE YOUR NAN™ MICROSCOPE

STEP 2: Choose your objective(s)

The NAN uses a standard Olympus turret. You can select from this list, use your own objectives, or choose from one below. Objectives in GREEN with footnote are recommended for electrophysiology.

- **OBJ-Y522** 4X – UPLFLN4X;U PLAN FLUORITE 4X OBJECTIVE;
NA 0.13, WD 17 mm
- **OBJ-Y524** 10X – UPLFLN10X2;U PLAN FLUORITE 10X OBJECTIVE;
NA 0.3, WD 10 mm
- **OBJ-Y587** 40X – LUMPLFLN40X/W;U M PLAN FLN 40X/W
NA0.8 WD 3.3 mm,IR,ECO
- **OBJ-Y592** 60X – LUMPLFLN60X/W; U M PLAN FLN 60X/W
NA1.0 WD 2.0 mm,IR,ECO
- **OBJ-Y672** 60X – LUMFLN60X/W;LUMFLN60X/W
NA1.1WD 1.5 mm 25 ANGLE,IR.CC,ECO



CONFIGURE YOUR NAN™ MICROSCOPE

STEP 3: Select the condenser that matches the highest power of your selected selected objectives.

- **OCC** Oblique contrast condensor
- **DIC-40X** DIC system components for 40X objective
- **DIC-40XIR** DIC system components for 40X objective and IR
- **DIC-60X** DIC system components for 60X objective
- **DIC-60XIR** DIC system components for 60X objective and IR

CONFIGURE YOUR NAN™ MICROSCOPE

STEP 4: Choose a filter cube(s) and a light source.

FILTER CUBES

- **CUBE-GFP** Filter Cube – GFP
- **CUBE-CY3** Filter Cube – CY3
- **CUBE-YFP** Filter Cube – YFP
- **CUBE-DAPI** Filter Cube – DAPI
- **CUBE-A635** Filter Cube – ALEXA 635
- **CUBE-MCH** Filter Cube – mCHERRY

LIGHT SOURCES

- **HPX-L5** Lambda HPX-L5 High powered LED light source
- **LS-OF30** Lambda LS with 300 Watt ozone free lamp
- **LB-721** Lambda 721 - Seven channel LED light source
- **FLED-Y** Lambda FLED for Olympus RFA
- **FLED-DC-Y** Dual channel Lambda FLED

LIGHT SOURCE ADAPTER

- **LG-Y51** Liquid light guide adapter for Olympus RFA



CONFIGURE YOUR NAN™ MICROSCOPE

STEP 5: Select a stage and translator as needed.

LONG ISLAND

MOTORIZED LARGE PLATFORM STAGE

- **MPC-78^{1*}** Moving platform stage plate with motorized gantry supports, MPC-200 controller and ROE, cables and manual
- **MPC-78-M6^{1*}** Same as MPC-78 except with M6 tapped holes
- **MPB-78¹** Moving platform stage plate with motorized gantry supports, NAN controller, cables
- **MPB-78-M6¹** Same as MP-78 except with M6 tapped holes
- **MP-78¹** Moving platform stage plate with motorized gantry supports, MP-285 controller and ROE, cables and manual
- **MP-78/M6¹** Same as MP-78 except with M6 tapped holes

¹ Please specify chamber type when ordering.

MOTORIZED TRANSLATOR AND STANDS

Includes a motorized X-Y translator, a controller, two micromanipulator stands, MT-150 chamber stand, and cables.

- **MT-2000/NAN** Motorized translator with MP-285 controller, ROE, MT-150 chamber column, two MT-75 micromanipulator columns (without linear slide)
- **MT-2200/NAN** Motorized translator with MPC-200 controller, ROE, MT-150 chamber column, two MT-75 micromanipulator columns (without linear slide)
- **MT-1000/NAN** MT-500 manual X-Y translator, MT-150 chamber column, two MT-75 micromanipulator columns (without linear slide), SOLO controller for Z focus

MOTORIZED TRANSLATOR AND AND POST-STYLE STANDS

Includes a motorized X-Y translator, a controller, MT-150 chamber stand, two post-style manipulator columns, cables and manual.

- **MT-2078/NAN** Motorized translator with MP-285 controller, ROE, and fixed platform stage
- **MT-2278/NAN** Motorized translator with MPC-200 controller, ROE, and fixed platform stage
- **MT-2878/NAN** Motorized translator with NAN controller, ROE, and fixed platform stage
- **MT-1078/NAN** Manual translator with MT-78-FS fixed platform stage, and SOLO controller for Z focus



CONFIGURE YOUR NAN™ MICROSCOPE

STEP 6: Select other accessories as needed.

CAMERA

- **CAM-EL** ELECTRO, Cooled 1.4MP CCD Camera
- **CAM-PR** PRIME 95B, Back illuminated CMOS Camera
- **CAM-BSI** PRIME BSI, High-res scientific CMOS Camera



ACCESSORIES NAN™

MICROSCOPES

MP-78 / MPB-78 / MPC-78 CHAMBER INSERTS

- **X040500'** Warner Series 20 (round) — aluminum
- **X040503'** Warner Series 20 (round) — stainless steel
- **X040505'** Warner Series 20 (octagonal) — aluminum
- **X040507'** Warner Series 20 (octagonal) — stainless steel
- **X040510'** 50 mm round — aluminum
- **X040512'** 50 mm round — stainless steel
- **X040497'** Blank insert — aluminum
- **X040498'** Blank insert — stainless Steel
- **SI-SLIDE'** Insert with slide holder
- **SI-PETRI** For petri dish and slides
- **SI-W30'** Warner Series 30 platform — aluminum
- **SI-W30ST'** Warner Series 30 platform — stainless steel
- **SI-ALA-MS'** ALA MS series insert — aluminum
- **SI-CUSTOM** Custom stage insert

POST-STYLE MANIPULATOR COLUMNS

- **MT-95** Post-style manipulator column – 6 in
- **MT-95-M6** Post-style manipulator column – 6 in (metric table)

¹ No charge when ordered with MP-78, MPB-78 or MPC-78.



SOM® SIMPLE MOVING MICROSCOPE



(Shown with optional camera.
Objectives not included)

FEATURES SOM®

- Simple moving microscope based on an MP-285 / MPC-385 motorized micromanipulator
- X, Y and Z axes of manipulator used to position the microscope over the sample and focus. No need for large translators or moving stages.
- Optimized to allow *in vivo* and *in vitro* experimentation on one setup
- Standard configuration accepts RMS thread objectives. Contact Sutter for additional options.
- Free Multi-Link™ software coordinates movement with micropipette positioning of MPC-200
- Transmitted IR and EPI fluorescent imaging modes
- Flexible excitation port easily allows addition of secondary sources for photostimulation
- MPC-200 controller with USB interface and open source commands



The Son of MOM® (SOM®) is a small, simple microscope designed to allow a single experimental setup to be used for both *in vivo* and *in vitro* experimentation. As in our two-photon Movable Objective Microscope® (MOM®), positioning over the sample and focusing is accomplished robotically. This removes the need for the large translators and stages that normally limit the available space beneath the objective for *in vivo* experimentation. For example, the SOM will allow whole-cell patch recordings from neurons *in vivo* on one day followed by multi-cell recordings in slices on the next.

The SOM opens up experimental possibilities that otherwise might be limited by the ever growing space constraints in modern laboratories. The SOM is designed to take full advantage of our free Multi-Link™ software program for micromanipulator positioning.

For instance, during whole-cell patch recording in slices it is commonly necessary to search over a large area of tissue to find neurons appropriate to your experiment. With the SOM, you simply translate over your sample to search for your target. The software programs will then retrieve your recording and stimulation pipettes so that you can begin recording immediately. Moreover, if you then find you need to stimulate a region outside of the current objective's field of view, the programs will allow you to lock the position of your recording pipette and reposition the objective and stimulating pipette(s) to their required positions.

An optional Oblique Coherent Contrast (OCC) condenser that is illuminated with an LED is also available. The condenser translates with the microscope in the X & Y axes, which allows for consistent illumination during re-positioning of the SOM over the sample.

How it Works:

The SOM is designed to take advantage of the high-quality images that can be obtained with a simple IR LED-based transmitted light source combined with an IR capable CCD camera. This combination is sufficient for the majority of *in vitro* electrophysiology needs. The SOM is also designed with a two-position filter cube to allow for identification of fluorescently-tagged cells for recording or for photostimulation. If you populate both of the filter cube positions, one of the filter sets will need to pass IR to allow for transmitted light imaging. As many filter combinations will pass IR, transmitted light imaging can generally be done in either of the two filter positions

The fluorescence excitation port of the microscope has C-mount threading as well as mounting holes for standard cage components. This allows for customization by the user to various experimental needs. For instance, multiple light sources can be coupled to the excitation port with small cage assemblies.



COMMON APPLICATIONS SOM®

- *In vivo* and *in vitro* electrophysiology
- Wide field imaging (fluorescent dyes, genetic fluorescent proteins, intrinsic fluorescent signals)
- Surface inspection
- Imaging on many sample types including: tissue slices, *Drosophila*, zebra fish, mice, and much larger animal models

SPECIFICATIONS SOM®

- **Travel** 25 mm on all three axes
- **Resolution** MP-285 controller
Low: 0.2 $\mu\text{m}/\text{step}$
High: 0.04 $\mu\text{m}/\text{step}$
MPC-200 controller
0.0625 $\mu\text{m}/\text{step}$
- **Maximum Speed** MP-285 controller
2.9 mm/sec
MPC-200 controller
5.0 mm/sec
- **Drive Mechanism** Precision worm gear capstan drive
- **Communication** MP-285: RS-232 Serial
MPC-200: USB
- **Electrical** 115/230 Volts
50/60 Hertz power line



(Shown: SOM-T, 2 QUAD® Manipulators, TLED+ Light Source, P-1000 Puller)



SOM®

U.S. prices available at www.sutter.com. International prices vary by country. Contact a distributor or Sutter Instrument for a quotation. Prices subject to change without notice.

SOM®

■ SOM-T

BASIC SYSTEM

SOM Microscope system with MPC-200 controller and ROE, mounted on tall (MT-75T) tower.

■ SOM-XT

SOM Microscope system with MPC-200 controller and ROE, mounted on extra tall (MT-75XT) tower.

ACCESSORIES SOM®

■ SOM-COND

SOM OCC condensor with TLED

■ OBJ-Y522

OBJECTIVES

4X - UPLFLN4X;U PLAN FLUORITE
4X OBJECTIVE,NA 0.13, WD 17 mm

■ OBJ-Y524

10X - UPLFLN10X2;U PLAN FLUORITE
10X OBJECTIVE;NA 0.3, WD 10 mm

■ OBJ-Y587

40X - LUMPLFLN40X/W;U M PLAN FLN
40X/W NA0.8 WD3.3 mm,IR,ECO

■ OBJ-Y592

60X - LUMPLFLN60X/W; U M PLAN FLN
60X/W NA1.0 WD2.0 mm,IR,ECO

■ OBJ-Y672

60X - LUMFLN60X/W;LUMFLN
60X/W NA1.1WD1.5 mm 25 ANGLE,IR.CC,ECO

■ TLED-CT

LIGHT SOURCES

Lambda TLED for transmitted light with C-mount for SOM



The DF-Scope™ is a customer-inspired, multiphoton, imaging package for the ubiquitous BX51WI upright microscope. Many laboratories already have BX51WI microscopes for use in electrophysiology and epifluorescent imaging experiments. The DF-Scope package provides the necessary optics and electronics for the BX51WI to be used for multiphoton imaging (with the addition of a Ti:Sapphire laser). The design incorporates subassemblies from our MOM® (Movable Objective Microscope®) system including resonant and galvo scan boxes and controllers, detector paths, PMTs, PMT power supplies, scan lenses and tube lenses.

A hallmark of multiphoton imaging is that all of the light emitted by the sample is known to be from the focal volume as a result of the nonlinear excitation of the fluorophore. High sensitivity photomultiplier tubes (PMTs) are used to collect as many of these photons as is possible in order to reconstruct the scanned image. The DF-Scope design allows for two detector paths to gather more emitted light, one above the sample and one below. If using a thin sample, like a brain slice, we recommend the lower (sub-stage) detectors to increase signal detection. Additional signal will be available at the trans detector path. This substage detector assembly is designed to work with a variety of Olympus condensers.

NOTE: The DF-Scope design requires an Olympus BX51WI and the following Olympus parts: WI-ARMAD, 5-UR710LP and U-M619.



COMMON APPLICATIONS DF-SCOPE™

- Deep tissue imaging
- Slice imaging and SFCC recording
- Retinal ex-plant imaging
- Imaging on many sample types including: tissue slices, Drosophila, zebra fish, mice, etc.

SPECIFICATIONS DF-SCOPE™

- **Front panel Controls/Indicators** Main power switch for entire unit
Discrete controls / indicator for each
On / Off Switch
10 turn potentiometer to set high voltage/gain
LED display
- **Voltage and Current of rear panel outputs** PS-2 PMT High Voltage output:
0 VDC to -1250 VDC,
current 0.6 mA
PS-2 / LV PMT Module output:
constant +15 VDC as well as control Vref supplied by module
Preamp/Auxiliary power outputs:
+/-12 VDC, 200 mA per side
+/-5 VDC, 200 mA per side
- **Dimensions** 16 in x 11 in x 3.5 in
41 cm x 28 cm x 9 cm
- **Weight** 6.5 lbs
3 kg
- **Electrical** 115/230 Volts
50/60 Hertz power line





DF-SCOPE™

U.S. prices available at www.sutter.com. International prices vary by country. Contact a distributor or Sutter Instrument for a quotation. Prices subject to change without notice.

DF-Scope™

Multiphoton Imaging package for Olympus BX51WI Microscope

Includes Sutter-designed custom scanner mount with scan lens, tube lens and two position mirror mount to choose between two-photon and widefield operation, XY scanners with drive electronics, special Olympus-made, wide-field fluorescence unit that incorporates two-photon detector pathway, two channel detector with PMTs, preamps and PS-2 power supply and data acquisition system.

- **DF-3MM** DF-Scope package with 3 mm scanners
- **DF-6MM** DF-Scope package with 6 mm scanners
- **DF-RES** DF-Scope package with Resonant scanners, MCS Computer System and MScan 2.0 software

ACCESSORIES DF-SCOPE™

- **MOM-DETCT-S1-M** MOM® short path #1 detector
- **DF-LOWER** DF-Scope lower detector mounting
- **PS-2** PMT power supply and mating connectors for all outputs (suitable for RG357 or like PMT's)
- **PS-2/LV** Includes PMT power supply, power cord and mating connectors for all outputs (Suitable for H10770 or like PMTs with built-in high voltage power supply).
- **O040368** PMT amplifier C7319
- **LB-SC** Lambda SC control unit, serial and USB cables, power cord and manual
- **IQ25-SA** 25 mm *SmartShutter*® with stand alone housing
- **MOM-SETUPKIT-M** Basic table optics for laser routing
- **MOM-BEAMSPLITTER** MOM Beam Splitter
- **MPC-78/Y51/FD¹** MPC-78 with focus drive for the Olympus BX51WI
- **MP-78/Y51/FD¹** MP-78 with focus drive for the Olympus BX51WI

¹ When ordering please specify ¼-20 or M6 tapped holes, and chamber insert (see page 100).



MCS

MOM COMPUTER SYSTEM AND SOFTWARE

MICROSCOPES

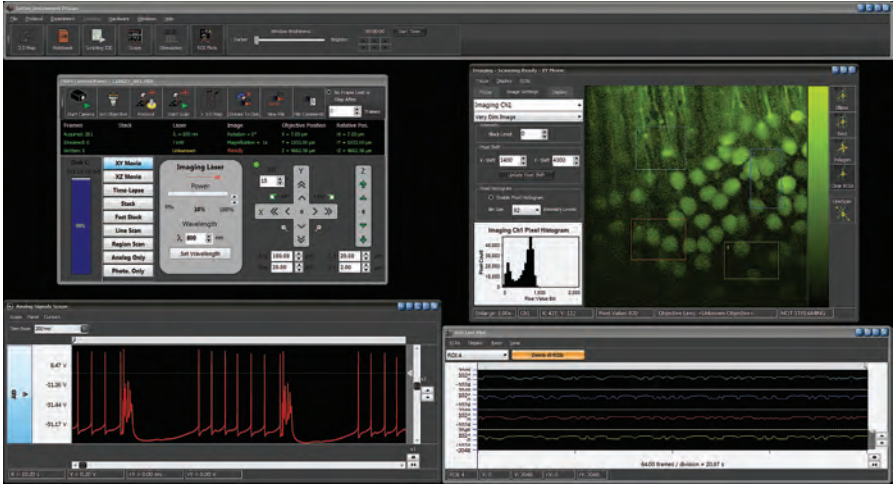

FEATURES MCS

The MCS is especially designed for:

- Multichannel, high-speed, functional optical imaging
- Resonant scanning capable with imaging rates to 30 frames per second
- Scanning microscopy combined with simultaneous, camera-based, behavioral monitoring
- Prolonged, multi-hour experiments
- Photostimulation while imaging through the same optical pathway ("photostimaging")
- Large-scale, high-resolution, deep tissue mapping
- Two-photon microscopy and concurrent electrophysiology with computer-controlled placement of electrodes by Sutter micro-manipulators

COMMON APPLICATIONS MCS

- Two-photon imaging
- Deep tissue imaging
- Neurophysiology
- Immunology
- Embryology



The MOM® Computer System (MCS) includes the acquisition software package MScan 3.0 and MView 3.0 data analysis software. MScan seamlessly combines two-photon imaging, with photostimulation, behavioral monitoring, and electrophysiology. While designed expressly for use with the Sutter MOM, it is also compatible with other two-photon platforms. The MCS is designed to take on complex experiments in deep-tissue intravital imaging. Its intuitive user interface, is easy to learn and easy to use. The MCS and MOM together form a formidable tool to understand the most complex issues in neuroscience, immunology or oncology. Importantly, you will find in MCS the same standard of technical excellence and customer support that are the hallmark of all Sutter Instrument products.

The MScan 3.0 software simplifies the many tasks inherent in a complicated imaging experiment. MScan 3.0 is extensively multithreaded to take advantage of multicore processors, ensuring high performance, reliability and a responsive user interface.

MView 3.0, the MCS program for data analysis, can be downloaded freely from Sutter's website. As well as allowing for complex analysis, MView will also allow data output in formats suitable for analysis on other platforms.

MScan and MView are free-standing, Windows native software applications, assuring optimal performance and eliminating dependence on other, 3rd party supporting software (ex. MatLab). The MCS platform scales readily, and easily supports a multiuser environment where data are acquired on one, shared microscope, but can be analyzed via MView on any number of other, independent workstations – no dongles.

MCS includes a Windows 10 workstation, fully integrated with its National Instruments data acquisition boards, a USB 2.0 camera and a USB controlled MPC-200. The National Instruments boards included are a PCI-6110 board for scanner control, a PCIe-6353 board for timing of imaging and control of photostimulation and laser power. Finally, a PCIe-6321 board provides for electrophysiology functions. MCS is delivered as a fully functional, turnkey system with all data acquisition hardware and software pre-installed and pre-tested within the workstation



■ IMAGING FEATURES

- 4 imaging channels with independent gains and user-adjustable pixel duration
- Bidirectional line scan with sub-pixel line offset adjustment
- User or TTL triggered

■ IMAGING MODES

- XY movie
- XZ movie
 - Requires z-piezo nanopositioner
- Timelapse
- Stack
- Fast stack
 - Requires z-piezo nanopositioner
- Line scan
- Region scan
 - User-designated collections of points, lines, rectangles, ellipses or polygons
- Photostimulation scan
 - User-designated collections of points, lines, rectangles, ellipses or polygons

■ MCS DATA FILES

- Proprietary data format allows long (1-2 hour) functional imaging from behaving animals, sophisticated meta-data in file header

■ BEHAVIORAL CAMERA

- Records synchronized imaging of animal behavior during extended functional imaging (see Kuhn et al reference)

■ FUNCTIONAL IMAGING

- Real-time display of averaged intensities of regions of interest (ROIs) in scrolling plot

■ XYZ CONTROL OF OBJECTIVE PLACEMENT RELATIVE TO FIXED SAMPLE

- Requires Sutter Instrument MPC-200

■ 3-D MAP WINDOW

- Stores multispectral frames or stacks in a 25 nm x 25 nm x 25 mm 3-D world in objective coordinates

■ PHOTOSTIMULATION

- Localized photostimulation without imaging using same optical path

■ PHOTOSTIMAGING

- Sequential photostimulation and imaging through the same optical pathway

■ TARGETED PATCH-CLAMPING

- Support for Sutter Instrument micromanipulator and amplifiers

■ ANALOG INPUTS

- 8 analog channels, up to 250 kHz continuous acquisition rate

■ INTEGRATED DEVELOPMENT ENVIRONMENT

- Rich object model to control hardware, fully compatible with ActiveX Automation



SPECIFICATIONS

MCS MOM® COMPUTER SYSTEM

■ Dimensions

CPU:
20.5 in x 8.25 in x 20 in
52 cm x 21 cm x 51 cm
Monitor:
26 in x 10 in x 19 in
67 cm x 24 cm x 48 cm

■ Weight

CPU:
31 lbs
14 kg
Monitor:
15 lbs
7 kg

■ Electrical

115/230 Volts
50/60 Hertz power line





MCS SYSTEM

U.S. prices available at www.sutter.com. International prices vary by country. Contact a distributor or Sutter Instrument for a quotation. Prices subject to change without notice.

- **MOM-MCS¹** System includes preinstalled MScan 3.0 software, Windows 10 workstation, data acquisition boards, Includes One USB 2.0 camera (can be used for behavior or basic wide field sample location)

¹Must be used with MOM® systems equipped with MOM-DAQ, MPC-200 and ROE-200

COMPONENTS MCS

- **MOM-DAQ** MOM® data acquisition system (includes NI 6110E PCI board)
- **MPC-200-ROE** Includes MPC-200 controller and ROE-200
- **CAM-USBE** USB 2.0 camera camera (if both wide field and behavior cameras are desired)

NOTE: The MOM-MCS communicates with the MPC-200 controller via the USB port for control of X, Y, and Z movement. It is not compatible with the MP-285 controller. Please contact Sutter for more information.





SCANIMAGE SOFTWARE AND FPGA-BASED ACQUISITION SYSTEM

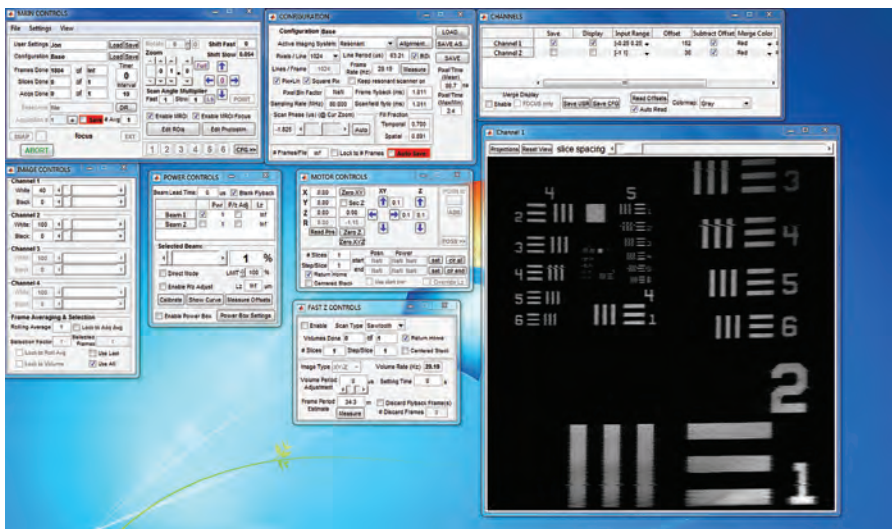

FEATURES SCANIMAGE

- Supports linear galvanometer and resonant scanning hardware
- Provides support for resonant, galvanometer, galvanometer triple scanner combination
- Precise experimental synchronization between imaging, physiology and behavior with user defined triggers and internal clock signals
- Full support for simultaneous imaging and photostimulation applications requiring parallel scanner paths
- Multi-region of interest mode provides targeted sequential imaging and photostimulation
- Multiple arbitrary line scanning
- Continuous volume imaging with fast piezo support (PI, nPoint)
- Step and settle volume imaging with piezos or Optotune
- FPGA based continuous, gap-free data acquisition for real-time image processing and future closed loop data processing
- MatLab interface offers user scripting and custom analysis capabilities with a full hardware control API exposed for automating experiments
- Integration with WaveSurfer enables synchronized electrode recording and general data recording



ScanImage is imaging software for scanning microscopes developed by Karel Svoboda and coworkers (Pologruto et al, 2003) and judiciously maintained by members of the Svoboda lab, first at Cold Spring Harbor Lab and then at Janelia Farms, HHMI. It is hard to over estimate the influence of this software in the field of two-photon scanning microscopy.

ScanImage was designed to be a freely available open source program and its early maintenance was “easily” supported. However, as ScanImage became increasingly popular and as new versions were required to cover changes in operating systems and hardware drivers, it soon became obvious that a high level of maintenance could not be sustained based on the “freeware model”. Ultimately, ScanImage support and development has become a commercial enterprise and Vidrio is the new face of ScanImage.

Two-photon microscope development at Sutter Instrument has been closely tied to ScanImage software for years. In addition to the MOM® *in vivo* two-photon scope, Sutter has many products that are used by two-photon microscopists using ScanImage including our stepper motor drive XYZ controllers, galvo and resonant scanner systems, PMTs and PMT power supplies. We are grateful to have had a mutual, continuing connection to ScanImage and the ScanImage community for over ten years.

Sutter provides hardware that operates seamlessly with all versions of ScanImage. Products can be purchased ala carte or as a bundled system with ScanImage Premium or SI 5.



COMMON APPLICATIONS SCANIMAGE

- Two-photon imaging
- Deep tissue imaging
- Complex neurophysiology experimentation control



SCANIMAGE

U.S. prices available at www.sutter.com. International prices vary by country. Contact a distributor or Sutter Instrument for a quotation. Prices subject to change without notice.

SCANIMAGE PREMIUM

BUNDLED SYSTEMS¹

Includes SIP-SOFT, RESSCAN-MOM or RESSCAN-GEN, preconfigured NI-FLEX RIO data acquisition system, and two FEMTO DHPCA-100 fast preamps with power supplies.

■ **RES-MOM-SIP**

Resonant Scanner for Sutter MOM® w/ ScanImage Premium software

■ **RES-GEN-SIP**

Resonant Scanner for 60 mm cage based microscope w/ ScanImage Premium software

SCANIMAGE 5

BUNDLED SYSTEMS¹

Includes RESSCAN-MOM or RESSCAN-GEN, preconfigured NI-FLEX RIO data acquisition system, and two FEMTO DHPCA-100 fast preamps with power supplies.

■ **RES-MOM-SI5**

Resonant Scanner for Sutter MOM w/ SI 5

■ **RES-GEN-SI5**

Resonant Scanner for 60 mm cage based microscope w/ SI 5

COMPONENTS

■ **RESSCAN-MOM**

Resonant Scanner for Sutter MOM — Standalone

■ **RESSCAN-GEN**

Resonant Scanner for 60 mm cage based microscope — Standalone

■ **SIP-SOFT**

ScanImage Premium software

■ **DAQ-FPGA**

Basic National Instruments Flex-RIO Data Acquisition system compatible with SI 5 freeware and ScanImage Premium software

■ **O040335**

FEMTO DHPCA-100 preamplifier

■ **O040337**

FEMTO power supply

¹Please note, ScanImage Premium Bundles are not turnkey packages. You will need to supply an appropriate computer with MATLAB® software installed. MATLAB® is a product of MathWorks.



RESSCAN SUTTER RESONANT SCAN BOX



(Shown: RESSCAN-MOM)

FEATURES RESSCAN

- Can easily be added to existing MOM® systems
- Can be used as a component for customers building their own scope
- Compatible with MScan, as well as many freeware and commercial software packages
- Full frame scanning at up to 30 frames per second
- Whisper quiet resonant scanners
- Flexible hardware works with a variety of systems
- Turn-key or bundled options available



The Sutter Resonant Scan box (RESSCAN) is a general purpose resonant scan box using the industry standard Cambridge Technologies CRS 8 kHz resonant scanner for fast X scanning and a second Cambridge galvo scanner (6215 5 mm) for Y axis scanning. The scan box is whisper quiet and the package allows full frame scanning at up to 30 frames per second (actual values are software dependent). Unlike other resonant systems designed to be used with proprietary hardware and/or software, the Sutter resonant scan box and its connections to the outside world are intentionally generic.

Two versions of the scan box are currently available:

- RESSCAN-MOM — a version that fits in the standard scanner location in the MOM and can be purchased either with a new MOM® or used to field convert an existing MOM.
- RESSCAN-GEN — a generic version compatible with 60 mm cage systems. This version of the resonant scan box was designed for the Janelia Farms MIMMs scope, but will work with any scope with a scan pathway designed around a 60 mm optical cage.

The resonant scan box controller (MDR-R) connects to and drives the resonant scan box and provides the exact inputs and outputs supplied by Cambridge Technologies scanner controller cards (SYNC and ZOOM for the CRS scanner and Position for the slow Y scanner). This is helpful for those who have existing software that runs with other scopes using Cambridge Resonant scanners.

The Sutter resonant scanner system can be purchased in several configurations. Those who wish a ready-to-use, turnkey Resonant scanner system, complete with software, should purchase either RES-MOM-MCS or RES-GEN-MCS. If you wish to use your RESSCAN with ScanImage Premium, you should purchase either RES-MOM-SIP or RES-GEN-SIP.

Alternatively, you may wish to take advantage of the standard connections on the controller to use the Sutter scanner system with existing freeware (Helioscan, MP Scope, or SI 5), third party commercial software (3I Slidebook) or software of your own design. Sutter carries stand alone NI FLEX RIO data acquisition packages to use with SI 5.



SPECIFICATIONS RESSCAN

■ Dimensions

Resonant Scan Box:
5 in x 4 in x 2 in
13 cm x 10 cm x 5 cm
Controller:
16 in x 11 in x 3.5 in
41 cm x 28 cm x 9 cm

■ Weight

Resonant Scan Box:
2.0 lbs
1 kg
Controller:
6.5 lbs
3 kg

■ Electrical

115/230 Volts
50/60 Hertz power line

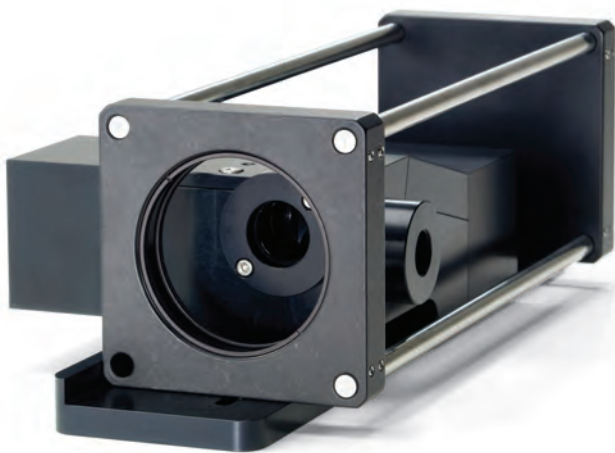

(Shown: Generic resonant scanner)



RESCAN

U.S. prices available at www.sutter.com. International prices vary by country. Contact a distributor or Sutter Instrument for a quotation. Prices subject to change without notice.

RESCAN

BASIC SYSTEM

Resonant Scan Box for Sutter MOM® or Researcher-built Microscope

Includes: Cambridge CRS 8 kHz Resonant Scanner and 6215 5 mm Galvo Scanner in Sutter-designed, quiet, sealed enclosure; MDR-R controller for both scanners with power supply, SYNC output and ZOOM and Y position inputs; power cord and cables to connect to Resonant Scan Box, and mounting adapter for Sutter MOM or standard 60 mm cage (drawings available).

- **RESCAN-MOM** Resonant Scanner for Sutter MOM — Stand Alone
- **RESCAN-GEN** Resonant Scanner for 60 mm cage based microscope — Stand Alone

SCANIMAGE PREMIUM BUNDLED VERSION¹

In addition to the stand alone resonant scan box (RESCAN-MOM or RESCAN-GEN) ScanImage bundles also include ScanImage Premium software, preconfigured NI-FLEX RIO data acquisition system, and two FEMTO DHPA-100 fast preamps.

- **RES-MOM-SIP** Resonant Scanner for Sutter MOM — ScanImage Premium Bundle version
- **RES-GEN-SIP** Resonant Scanner for 60 mm cage-based microscope — ScanImage Premium Bundle version

¹ Please note, ScanImage Premium Bundles are not turnkey packages. You will need to supply an appropriate computer with MATLAB® software installed. MATLAB® is a product of MathWorks.



PS-2 / PS-2/LV PMT POWER SUPPLIES



FEATURES PS-2 / PS-2/LV

- Dual power supplies, discrete gain, on/off controls and high voltage displays for each PMT connected
- Rear panel has +/-12 VDC (two outlets) and +/-5 VDC (two outlets)
- Mating connectors supplied for high and low voltage outputs
- Low noise linear power for all low voltages and for driving high voltage supplies



The PS-2 and PS-2/LV are Sutter PMT power supplies sold with the Sutter MOM®. They are also available to those who need dual power supplies for either their own scanning microscope or other projects that need PMT power supplies. The PS-2 is a dual high voltage supply specifically designed to be used with the Hamamatsu R6357 multi alkali PMT, but applicable to other similar PMTs. The PS-2/LV was originally designed to be used with the Hamamatsu H10770PA-40 PMT Module, but is applicable to many other similar PMT modules that have the high voltage supply built into the device and only require a low voltage supply and a control voltage to set gain.

The PS-2 and PS-2/LV have additional outputs for running preamplifiers and other associated circuitry. Both are dual supplies with discrete on/off switches, gain controls and voltage displays for the two PMTs attached. These two models are manually controlled, which is convenient for those designing their own scopes; there is no need to worry about PC control of various parameters. Just plug in the PMT and power up!

To keep generated noise at a minimum, linear power supplies are used to generate all low voltages and to power the high voltage supplies.

APPLICABLE PMTs

PS-2

Hamamatsu R6357, R3896, R3811

PS-2/LV

Hamamatsu H10770PA-40, H10770PB-40, H10770PA-50 as well as gated modules like H11706-40 and H11526-110

Please call Sutter for applicability of the PS-2 and PS-2/LV to other PMTs and PMT modules.

HAMAMATSU PMTs

Sutter Instrument is an authorized reseller for Hamamatsu. We have been using Hamamatsu PMTs and PMT modules in the Sutter MOM scope since 2006 and also offer various Hamamatsu PMTs for sale as individual components.

We keep a small inventory of PMTs and PMT modules, provide PMT testing, cabling and mounting solutions and we also provide several Sutter designed PMT power supplies. Please contact Sutter for a list and pricing of the Hamamatsu PMTs that we carry, or to find out if we can help you design a PMT into a custom instrument.



SPECIFICATIONS PS-2 / PS-2/LV

- **Front panel Controls/Indicators**
 - Main power switch for entire unit
 - Discrete controls/indicator for each On/Off Switch
 - 10 turn potentiometer to set high voltage/gain
 - LED display showing high voltage 0 V to 1250 V

- **Voltage and Current of rear panel outputs**
 - PS-2 PMT High Voltage output:
 - 0 VDC to -1250 VDC,
 - current 0.6 mA
 - PS-2 / LV PMT Module output:
 - constant +15 VDC as well as control Vref supplied by module
 - Preamp / Auxiliary power outputs:
 - +/-12 VDC, 200 mA per side
 - +/-5 VDC, 200 mA per side

- **Dimensions**
 - 16 in x 11 in x 3.5 in
 - 41 cm x 28 cm x 9 cm

- **Weight**
 - 6.5 lbs
 - 3 kg

- **Electrical**
 - 115/230 Volts
 - 50/60 Hertz power line





PS-2 / PS-2/LV

U.S. prices available at www.sutter.com. International prices vary by country. Contact a distributor or Sutter Instrument for a quotation. Prices subject to change without notice.

- **PS-2** Includes PMT power supply, power cord and mating connectors for all outputs (Suitable for RG357 or like PMTs).

- **PS-2/LV** Includes PMT power supply, power cord and mating connectors for all outputs (Suitable for H10770 or like PMTs with built-in high voltage power supply).

OPTICAL INSTRUMENTS

Precise mechanical movement and well engineered electronics have always been hallmarks of Sutter Instrument products. Over twenty years ago, our entrance into the optical products market capitalized on these attributes when we set out to produce a reliable, fast, electronically quiet, computer controlled filter wheel. The result was the Lambda 10, which met all of our original performance goals, and proved itself as a very rugged and reliable instrument.

The success of the Lambda 10 led to the development of a new generation of wavelength switching products, and one of the widest ranges of accessories in the industry. Our current design, the Lambda 10-3 controller, allows for the use of three filter wheels without the expense of additional controllers. The Lambda 10-B has also been added as a lower cost alternative for those who do not require all the features of the Lambda 10-3. Both of these controllers can be coupled to our

original filter wheel, as well as our latest line of wheels which have been designed for 25 mm as well as larger diameter filters.

Taking advantage of the latest in thin-film filter technology, Sutter has incorporated tunable filters into a single and 5-position filter changer, the Lambda VF-1™ and Lambda VF-5™, providing access to any center bandpass from 338 nm to 900 nm in nanometer increments.

When the Lambda 10 was first introduced, most imaging systems could not keep up with its 55 msec switching time. As technology has advanced in the field of imaging, demand has increased for



faster wavelength switching speed. Sutter Instrument has responded with an integrated illumination system capable of switching wavelengths in less than 0.5 msec.

As demands for higher throughput and lower exposure times have increased, the need for a stand-alone high power light source was met with the Lambda LS. This integrated 175 (or 300) Watt xenon arc lamp, cold mirror, and power supply system is available in an efficient single cabinet design. Our lamp product family was recently expanded with the Lambda XL, which uses electrodeless bulb technology to produce a highly stable, long lifetime light source. Now the TLED and HPX LED light sources represent the latest generation of solid-state microscope illumination.

Sutter Instrument developed and designed the SmartShutter® to address the need for a robust and reliable shutter to serve as a component in our imaging line or as a stand-alone solution for optical applications. The SmartShutter offers the most sophisticated shutter control available. Microprocessor control of the stepper-motor allows the user to optimize

movement for speed or smoothness, produce a variable aperture, and achieve open/close times of 8 msec from trigger. The SmartShutter is compatible with the Lambda 10-3, Lambda 10-B/IQ, and Lambda SC controllers.

Customization of our optical product line for unique applications has become a specialty for Sutter Instrument. New technology has been incorporated in various custom and OEM filterwheels. For example, for systems using a large number of filter wheels, Sutter Instrument developed an RS-485 serial bus to allow up to 16 controllers to share a single serial port on a host computer. Sutter Instrument has also developed sensor and motor technology for a system of filter wheels running at liquid helium temperatures for use with astronomical telescopes. Please contact us directly for more information about custom filter changing devices.





LIGHT SOURCE COMPARISON CHART

This chart of light source options and capabilities will assist you in selecting the product best suited to your application. Sutter product managers are happy to discuss your particular technical requirements in order to ensure you receive the best light source for your research needs. Please contact Sutter for further assistance.

Light Source		Fluorescent Microscopy	Calcium Imaging	FURA	Optogenetics	Transmitted Light	PHASE	DIC	Hyper Spectral Imaging	Ultra High Speed Wavelength Selection	High Speed Wavelength Selection	Wavelength Selection
Lambda OBC	LED	■	■	■	■					■	■	■
Lambda 421 / Lambda 721 Lambda 821	LED	■	■	■	■					■	■	■
Lambda LS	Xenon	■	■	■	■						■	■
Lambda HPX	LED	■			■							
Lambda HPX-L5	LED	■			■							
Lambda TLED/TLED+	white LED				■	■	■	■				
Lambda FLED	LED	■	■		■							
Lambda FLED-DC	LED	■	■	■	■					■	■	■
Filter Wheel	N/A	■	■	■	■						■	■



FILTER WHEEL CONTROLLER COMPARISON CHART

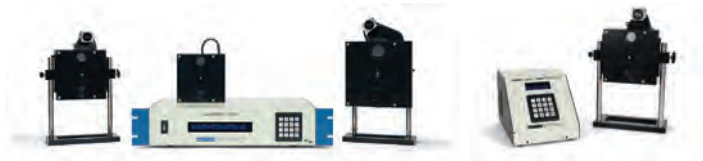

Features	Lambda 10-3	Lambda 10-B
Maximum # of Wheels	3	1
Maximum # of Shutters	3 ¹	2 ¹
Shutter Type		
SmartShutter®	■	■
Uniblitz®	■	■
Filter Diameter (mm)		
12/25/32/50 ²	■	■
Minimum Switching Time³ (ms)		
40 ms — 25 mm wheel	■	■
50 ms — 32 mm wheel	■	■
31 ms — 4-position 25 mm	■	■
Power Supply	Chopper	Chopper
Computer Interface		
Serial	■	■
Parallel	■	
USB	■	■
TTL In/Out	Yes	Yes

1. The Lambda 10-3 can be used to drive up to 3 filter wheels and 2 shutters, or 3 shutters and 2 filter wheels. The Lambda 10-B, two shutters or one wheel and one shutter.
2. The controller automatically detects the installed hardware.
3. Minimum switching time between adjacent filters depends on the filter load. The given values are for a load of 2 filters.



LAMBDA OBC OPTICAL BEAM COMBINER



(Shown: LB-OBC-LLG)

FEATURES LAMBDA OBC

- Up to 4 channel ultra high-speed LED light source (<25 μ sec)
- LLG or direct mount connection options for all common microscopes
- Capable of combining any combination of LEDs or any liquid light guide delivered light sources
- Easy to reconfigure
- LEDs driven by our proven FLED controllers

COMMON APPLICATIONS LAMBDA OBC

- Fluorescent microscopy
- Calcium imaging
- FURA
- Optogenetics
- High-speed wavelength selection



Patent No. 8,988,779



The Lambda OBC (optical beam combiner) is a new, patented, concept for combining separate light sources with different spectra into a single common output beam. Each separate light source is collimated before entering the optical path through a bandpass filter. The filters for each light source also function as mirrors that reflect the collimated beams from the previous light sources. In the diagram below the optical paths are outlined for each position including the reflections that occur:

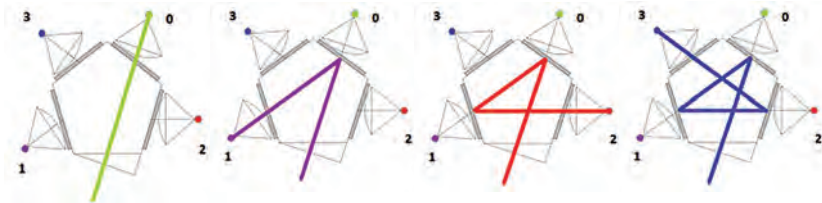

Optical path for each light source position from 0 through 3. The position number of the light sources are labeled based on the number of total reflections.

Traditionally, combining more than two light sources required the use of a dichroic ladder. Dichroic mirrors, which switch from transmission to reflection at one point in the spectrum, allow the combining of separate light sources, provided that those sources do not have overlapping wavelengths. The downside of this approach is that light sources cannot be easily changed.

Dichroic ladders also demand careful attention to the order in which the light sources are introduced into the optical path to avoid having the light blocked by the next dichroic in line. Typically, additional bandpass filters must be added in front of each light source before the dichroic, to select the desired range of wavelengths for each source. Each filter and dichroic used in the ladder decreases the total light output of the system.

The Pentagon shape of the Lambda OBC was designed to keep the size of the beam combiner small and the optical path short and efficient. Thin-film bandpass filters, such as Semrock's STR, reflect greater than 90% of out-of-band light. If the band pass of each light source does not overlap, it is possible to use the filters for both attenuation and reflection of the light from the other sources. By arranging the filters and sources into a pentagon, we could combine four light sources in a compact design with lower losses than previously achievable. As an added benefit, the last position in the optical train does not require any filter, since no other input reflects from that position. This input can be used with any sort of light source if you are aware of the possible losses if there are filters in use that overlap this light source. The fifth side of the pentagon becomes the output for the combined sources. The filters are easily exchangeable and are installed on small sliders inside the core of the pentagon. Filters and associated light sources can be arranged in any order around the pentagon.



Notes:

- The light from position #0 goes directly to the device output without being reflected. This position might be preferred for the source with the greatest desired output.
- The filter for the fourth light source is not used as a reflective surface and could be omitted if a broad-band source were desired.
- In configurations with fewer than 4 light sources, sources should be filled from lowest to highest number of reflections to ensure the greatest light output.
- The optical path for each input is tilted by 18 degrees relative to the filter for that port. This will cause a small shift in the band pass toward shorter wavelengths. While it would be ideal to have a coating optimized for this application, we have found that stock -STR filters can be used if you correct for the shift in the band pass when selecting the filters. This lends itself to combining narrow-band sources such as LEDs and lasers with a broad-band sources such as arc lamps or white light LEDs. In the case of LEDs, wavelengths can be shuttered at the speed of the individual source. Sutter Instrument HPX and FLED products can switch in 10-25 microseconds respectively. The Lambda OBC is designed for ultimate flexibility and expandability. Should your illumination needs change over time, a simple configuration change and possibly additional filters can produce an entirely different output.

SPECIFICATIONS OBC

- **Output Range** (330 nm to 960 nm) Depending the LED's selected for use
- **Shuttering** Turn ON/OFF time: <25 μ s
- **Noise/Short Term Stability** 0.01 %
- **LED Life** >50,000 hours
- **Dimensions**
 - Control Box – FLED:*
4 in x 3.25 in x 4.1 in
10.2 cm x 8.3 cm x 10.2 cm
 - Lambda OBC – with 4 LEDs:*
9.65 in x 9.25 in x 3 in
24.5 cm x 23.5 cm x 7.5 cm
- **Weight**
 - Control Box – FLED:*
2.2 lbs
1 kg
 - Lambda OBC – with 4 LEDs:*
4.7 lbs
2.13 kg
- **Electrical** 120/240 Volts
50/60 Hertz power line



LAMBDA OBC

U.S. prices available at www.sutter.com. International prices vary by country. Contact a distributor or Sutter Instrument for a quotation. Prices subject to change without notice.

OPTICAL BEAM COMBINER

Includes Lambda OBC optical beam combining pentagon that accommodates up to 4 LED modules (purchased separately).

- **LB-OBC-N** Lambda Optical Beam Combiner for Nikon
- **LB-OBC-Y** Lambda Optical Beam Combiner for Olympus
- **LB-OBC-Z** Lambda Optical Beam Combiner for Zeiss
- **LB-OBC-L** Lambda Optical Beam Combiner for Leica
- **LB-OBC-C** Lambda Optical Beam Combiner for C-mount
- **LB-OBC-LLG** Lambda Optical Beam Combiner with
3 mm series 380 liquid light guide

CONTROLLER FOR LED MODULES

One Lambda FLED controller is needed for each LED ordered (part numbers OBC-XXX). Up to 4 controllers can be used with the Optical Beam Combiner.

- **FLED-E** Lambda FLED Controller (one needed for each LED module).

LED MODULES FOR LAMBDA OBC

The LED modules consist of the LED and the appropriate Semrock®-STR excitation filter for the output of the LED. Four LED modules can be installed in the Optical Beam Combiner at one time, however, the purchase of additional LED modules adds versatility to the system as you can reconfigure the Lambda OBC by substituting wavelengths as needed for your application.

- **OBC-340** LED, 340 nm for Optical Beam Combiner
- **OBC-365** LED, 365 nm for Optical Beam Combiner
- **OBC-385** LED, 385 nm for Optical Beam Combiner
- **OBC-410** LED, 410 nm for Optical Beam Combiner
- **OBC-440** LED, 440 nm for Optical Beam Combiner
- **OBC-460** LED, 460 nm for Optical Beam Combiner
- **OBC-480** LED, 480 nm for Optical Beam Combiner
- **OBC-506** LED, 506 nm for Optical Beam Combiner
- **OBC-530** LED, 530 nm for Optical Beam Combiner
- **OBC-561** LED, 561 nm for Optical Beam Combiner
- **OBC-590** LED, 590 nm for Optical Beam Combiner
- **OBC-617** LED, 617 nm for Optical Beam Combiner
- **OBC-630** LED, 630 nm for Optical Beam Combiner
- **OBC-660** LED, 660 nm for Optical Beam Combiner
- **OBC-740** LED, 740 nm for Optical Beam Combiner
- **OBC-810** LED, 810 nm for Optical Beam Combiner
- **OBC-850** LED, 850 nm for Optical Beam Combiner
- **OBC-940** LED, 940 nm for Optical Beam Combiner
- **OBC-W5** LED, White Light for Optical Beam Combiner



LAMBDA 421

OPTICAL BEAM COMBINING SYSTEM



(Shown: Lambda 421)

FEATURES LAMBDA 421

- Versatile 4-channel Ultra high-speed LED light source
- Wide variety of available LED's between 340-900 nm
- Unique optical design allows for simple spectral flexibility

COMMON APPLICATIONS LAMBDA 421

- Fluorescent microscopy
- Optogenetics
- Calcium imaging
- High-speed wavelength selection
- FURA

Patent No. 8,988,779



The Lambda 421 beam combiner is a new, patented, concept for combining separate light sources with different spectra into a single common output beam. Each separate light source is collimated before entering the optical path through a bandpass filter. The filters for each light source also function as mirrors that reflect the collimated beams from the previous light sources. In the diagram below the optical paths are outlined for each position including the reflections that occur:

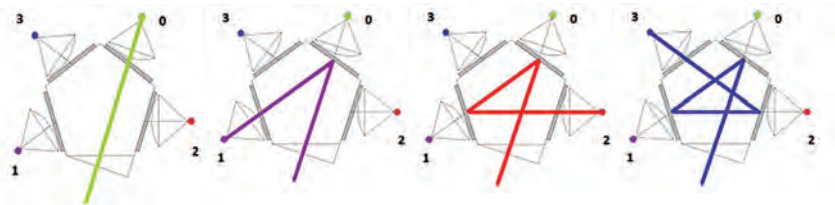

Optical path for each light source position from 0 through 3. The position number of the light sources are labeled based on the number of total reflections.

Traditionally, combining more than two light sources required the use of a dichroic ladder. Dichroic mirrors, which switch from transmission to reflection at one point in the spectrum, allow the combining of separate light sources, provided that those sources do not have overlapping wavelengths. The downside of this approach is that light sources cannot be easily changed.

Dichroic ladders also demand careful attention to the order in which the light sources are introduced into the optical path to avoid having the light blocked by the next dichroic in line. Typically, additional bandpass filters must be added in front of each light source before the dichroic, to select the desired range of wavelengths for each source. Each filter and dichroic used in the ladder decreases the total light output of the system.

The Lambda 421 was designed to keep the size of the beam combiner small and the optical path short and efficient. Thin-film bandpass filters, such as Semrock's STR, reflect greater than 90% of out-of-band light. If the band pass of each light source does not overlap, it is possible to use the filters for both attenuation and reflection of the light from the other sources. By arranging the filters and sources into a pentagon, we were able to combine four light sources in a compact design with lower losses than previously achievable. As an added benefit, the last position in the optical train does not require any filter, since no other input reflects from that position. This input can be used with any sort of light source as long as you are aware of the possible losses if there are filters in use that overlap this light source. The fifth side of the pentagon becomes the output for the combined sources. The filters are easily exchangeable and are installed on small sliders inside the core of the pentagon. Filters and associated light sources can be arranged in any order around the pentagon.



Notes:

- The light from position #0 goes directly to the device output without being reflected. This position might be preferred for the source with the greatest desired output.
- The filter for the fourth light source is not used as a reflective surface and could be omitted if a broad-band source were desired.
- In configurations with fewer than 4 light sources, sources should be filled from lowest to highest number of reflections to ensure the greatest light output.
- The optical path for each input is tilted by 18 degrees relative to the filter for that port. This will cause a small shift in the band pass toward shorter wavelengths. While it would be ideal to have a coating optimized for this application, we have found that stock -STR filters can be used if you correct for the shift in the band pass when selecting the filters. This lends itself to combining narrow-band sources such as LEDs and lasers with a broad-band sources such as an arc lamps or white light LEDs. In the case of LEDs, wavelengths can be shuttered at the speed of the individual source. Sutter Instrument HPX and TLED products can switch in 1 0-25 microseconds respectively, making the Lambda 421 one of, if not the fastest wavelength switcher on the market. The Lambda optical beam combiner is designed for flexibility and expandability. Should your illumination need change over time a simple configuration change and possibly additional filters can produce an entirely different output.

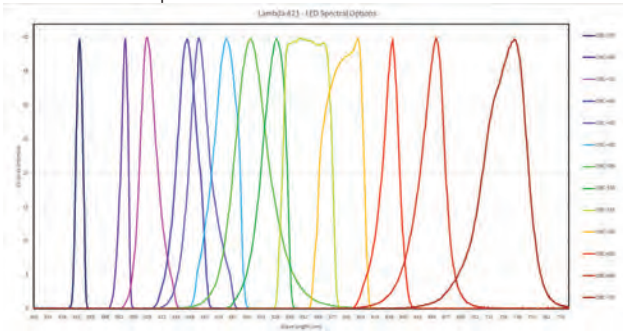

Lambda 421 - LED Spectra Options

SPECIFICATIONS LAMBDA 421

- **Output Range** (330 nm to 960 nm) Depending the LED's selected for use
- **Shuttering** Turn ON/OFF time: <25 μs
- **Noise/Short Term Stability** 0.01 %
- **LED Life** >50,000 hours
- **Control Box Dimensions** 15.75 in x 11 in x 7.5 in
40 cm x 27.9 cm x 19.05 cm
- **Weight** 17.8 lbs
8.07 kg
- **Electrical** 120/240 Volts
50/60 Hertz power line





LAMBDA 421

U.S. prices available at www.sutter.com. International prices vary by country. Contact a distributor or Sutter Instrument for a quotation. Prices subject to change without notice.

LAMBDA 421 OPTICAL BEAM COMBINER AND CONTROLLER

Includes controller, LED unit with liquid light guide, cables, and power cord. The instrument accepts up to 4 LED modules (listed below) and can easily be reconfigured. The LED modules consist of the LED and the appropriate Semrock®-STR excitation filter for the output of the LED.

- **LB-421** Lambda 421 Optical Beam Combiner and controller

LED MODULES FOR LAMBDA 421

- **OBC-340** LED, 340 nm for Optical Beam Combiner
- **OBC-365** LED, 365 nm for Optical Beam Combiner
- **OBC-385** LED, 385 nm for Optical Beam Combiner
- **OBC-410** LED, 410 nm for Optical Beam Combiner
- **OBC-440** LED, 440 nm for Optical Beam Combiner
- **OBC-460** LED, 460 nm for Optical Beam Combiner
- **OBC-480** LED, 480 nm for Optical Beam Combiner
- **OBC-506** LED, 506 nm for Optical Beam Combiner
- **OBC-530** LED, 530 nm for Optical Beam Combiner
- **OBC-561** LED, 561 nm for Optical Beam Combiner
- **OBC-590** LED, 590 nm for Optical Beam Combiner
- **OBC-617** LED, 617 nm for Optical Beam Combiner
- **OBC-630** LED, 630 nm for Optical Beam Combiner
- **OBC-660** LED, 660 nm for Optical Beam Combiner
- **OBC-740** LED, 740 nm for Optical Beam Combiner
- **OBC-810** LED, 810 nm for Optical Beam Combiner
- **OBC-850** LED, 850 nm for Optical Beam Combiner
- **OBC-940** LED, 940 nm for Optical Beam Combiner
- **OBC-W5** LED, White Light for Optical Beam Combiner

Mounting adapters for Nikon, Zeiss, Leica and Olympus microscopes are available. Please call Sutter Instrument for pricing and further information. Also, please see the Microscope Adapters section of this catalog.



LAMBDA 721

OPTICAL BEAM COMBINING SYSTEM

New



FEATURES LAMBDA 721

- Easy to change the spectral output of the light source
- Any LED cube can be placed in any of 7 positions without concern for the order
- Wavelength selection and beam reflection using Semrock® STR Filters

COMMON APPLICATIONS LAMBDA 721

- Fluorescent microscopy
- Calcium imaging
- FURA
- Optogenetics
- High-speed wavelength selection

Patent No. 8,988,779



The Lambda 721 is a new concept for combining up to 7 separate LED cubes with different spectra into a single common output beam. The LED cubes contain the LED, collimating optics, and a filter. These LED cubes are easily exchanged and installed with no tools required. Each LED cube is collimated before entering the optical path through the bandpass filter. The filters for each LED cube also function as mirrors that reflect the collimated beams from the previous light sources. In the diagram below the optical paths are outlined for each position including the reflections that occur:

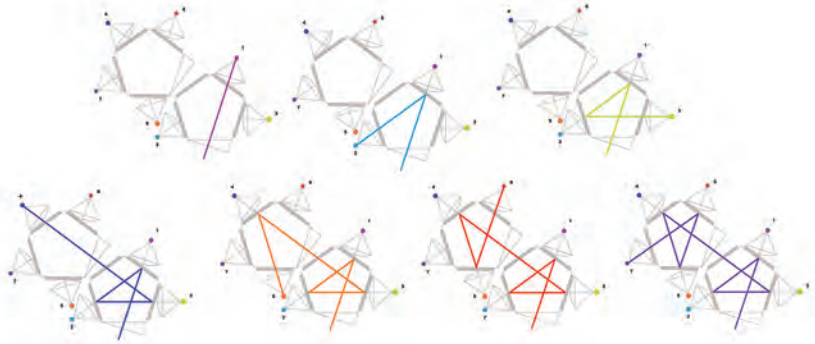

Optical path for each light source position from 0 through 7

Traditionally, combining more than two light sources required the use of a dichroic ladder. Dichroic mirrors, which switch from transmission to reflection at one point in the spectrum, allow the combining of separate light sources, provided that those sources do not have overlapping wavelengths. The downside of this approach is that light sources cannot be easily changed.

Dichroic ladders also demand careful attention to the order in which the light sources are introduced into the optical path to avoid having the light blocked by the next dichroic in line. Typically, additional bandpass filters must be added in front of each light source before the dichroic, to select the desired range of wavelengths for each source. Each filter and dichroic used in the ladder decreases the total light output of the system.

The Lambda 721 was designed to keep the size of the beam combiner small and the optical path short and efficient. Thin-film bandpass filters, such as Semrock's STR, reflect greater than 90% of out-of-band light. If the band pass of each light source does not overlap, it is possible to use the filters for both attenuation and reflection of the light from the other sources. By arranging the filters and sources into a double pentagon, we were able to combine seven light sources in a compact design with lower losses than previously achievable. As an added benefit, the last position in the optical train does not require any filter since no other input reflects from that position. This position can be used with LED's that have broad spectral output, such as the 561 nm LED, and may allow the excitation of more than single channel of fluorescence from a single LED. (raw spectra available upon request)



Notes:

- The light from position #1 goes directly to the device output without being reflected. This position might be preferred for the source with the greatest desired output.
- The filter for the seventh light source is not used as a reflective surface and could be used with LED cubes with broader outputs.
- In configurations with fewer than 7 light sources, sources should be filled from lowest to highest number of reflections to ensure the greatest light output.
- This filter is installed at 18° angle-of-incidence to the collimated beam of the LED cube. This will cause a small shift in the band pass toward shorter wavelengths. While it would be ideal to have a coating optimized for this application, we have found that stock -STR filters can be used if you correct for the shift in the band pass when selecting the filters.
- The Lambda optical beam combiner is designed for flexibility and expandability. Should your illumination need change over time a simple configuration change and possibly additional filters can produce an entirely different output.



(Pen shown for scale)

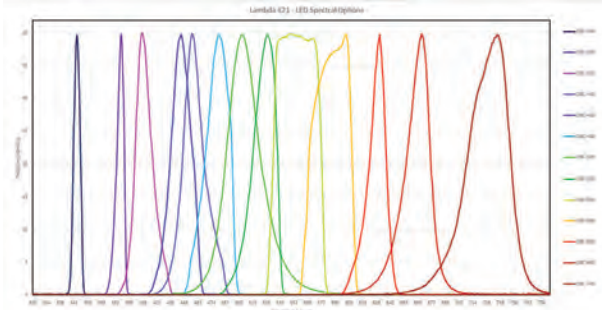

Lambda 721 - LED Spectra Options

SPECIFICATIONS LAMBDA 721

■ Output Range	(330 nm to 960 nm) Depending the LED's selected for use
■ Shuttering	Turn ON/OFF time: <4 μs
■ Noise/Short Term Stability	0.01 %
■ LED Life	>50,000 hours
■ Control Box Dimensions	7 in x 19 in x 10.5 in 17.7 cm x 48.25 cm x 26.5 cm
■ Weight	23 lbs 10.45 kg
■ Electrical	120/240 Volts 50/60 Hertz power line





LAMBDA 721

U.S. prices available at www.sutter.com. International prices vary by country. Contact a distributor or Sutter Instrument for a quotation. Prices subject to change without notice.

LAMBDA 721 OPTICAL BEAM COMBINER AND CONTROLLER

Includes Lambda 721 with liquid light guide, cables, and power cord. The instrument accepts up to 7 LED cubes (listed below) and can easily be reconfigured. The LED cube consist of the LED, collimating optics and the appropriate Semrock®-STR excitation filter for the output of the LED.

- **LB-721** Lambda 721 Optical Beam Combiner and controller with 3 mm Liquid Light Guide (Please order filter cubes separately)
- **LB-721-SMA** Lambda 721 Optical Beam Combiner and controller with SMA fiber (Please order filter cubes separately)

LED MODULES FOR LAMBDA 821

- **721CUBE-340** LED cube with optics and filter, 340 nm
- **721CUBE-365** LED cube with optics and filter, 365 nm
- **721CUBE-385** LED cube with optics and filter, 385 nm
- **721CUBE-405** LED cube with optics and filter, 405 nm
- **721CUBE-410** LED cube with optics and filter, 410 nm
- **721CUBE-420** LED cube with optics and filter, 420 nm
- **721CUBE-440** LED cube with optics and filter, 440 nm
- **721CUBE-460** LED cube with optics and filter, 460 nm
- **721CUBE-480** LED cube with optics and filter, 480 nm
- **721CUBE-480NB** LED cube with optics and NARROW BAND filter, 480 nm
- **721CUBE-506** LED cube with optics and filter, 506 nm
- **721CUBE-506NB** LED cube with optics and NARROW BAND filter, 506 nm
- **721CUBE-530** LED cube with optics and filter, 530 nm
- **721CUBE-561** LED cube with optics and filter, 561 nm
- **721CUBE-590** LED cube with optics and filter, 590 nm
- **721CUBE-617** LED cube with optics and filter, 617 nm
- **721CUBE-630** LED cube with optics and filter, 330 nm
- **721CUBE-660** LED cube with optics and filter, 440 nm
- **721CUBE-740** LED cube with optics and filter, 740 nm
- **721CUBE-810** LED cube with optics and filter, 810 nm
- **721CUBE-850** LED cube with optics and filter, 850 nm
- **721CUBE-940** LED cube with optics and filter, 940 nm

Collimating adapters for Nikon, Zeiss, Leica and Olympus microscopes are available. Please call Sutter Instrument for pricing and further information. Also, please see the Microscope Adapters section of this catalog.



LAMBDA LS

STAND-ALONE XENON ARC LAMP AND POWER SUPPLY



*(Shown with optional light
guide and lens tube)*

FEATURES LAMBDA LS

- Xenon lamps provide light levels which exceed those of standard microscope fluorescence lamps
- Equipped with a cold mirror to eliminate IR heating of downstream optical components
- Compact standalone lamp housing power supply enclosure
- Pre-aligned bulb eliminates common focusing problems
- Integrated hour meter for convenient monitoring of lamp life
- Modular construction allows use of optional liquid light guide for flexible direction of light output
- Easily accommodates Sutter Instrument filter wheels or *SmartShutter*[®] within the body of the lamp.
- Can be coupled via a liquid light guide to many standard microscopes (Nikon, Zeiss, Leica and Olympus). Microscope coupling requires special adapters (not included). Please see the Microscope Adapter section in this catalog.



The Lambda LS is a standalone lighting system consisting of a xenon arc lamp, lamp housing, cold mirror and power supply in a single enclosure. The Lambda LS is designed to be used with a liquid light guide which transmits remarkably flat, intense, illumination to the optical train of the user's microscope or other instrumentation. The lamp's cabinet accommodates a standard Sutter Instrument filter wheel that slides easily in and out of a slot in the light path. If desired, a second filterwheel can be mounted on the outside of the cabinet. When used with appropriate adapters, the light guide output is compatible with most common microscope systems.

Unlike the arc lamps used with most fluorescence microscopes, the xenon bulb is pre-aligned using a parabolic mirror and does not require alignment, focusing or collimation. In the standard configuration, the Lambda LS bulb is capable of producing light output from 330 nm to a cutoff of 650 nm determined by the cold mirror. An optional enhanced UV bulb produces output much lower into the UV (cut off near 200 nm). As with any UV generating light source, the optional bulb generates significant quantities of ozone and must be used in an adequately ventilated environment.

The Lambda LS utilizes a compact design, which places power supply, lamp house, arc lamp and cold mirror in a single enclosure. This system eliminates a common failure associated with standard arc lamp designs: when using a remote power supply aging may lead to a decreased ability to light the lamp due to loss of the insulating characteristics of the lengthy high-tension line. As with all our equipment, the power supply has been designed to minimize electrical noise that can be picked up by physiological recording equipment.

The liquid light guide can be coupled to the illumination port of most microscopes using an adapter which can be purchased separately. Please refer to the "Microscope Adapters" section for further information. Extended output ranges are possible with various cold mirror and light guide combinations. Phone Sutter to discuss your specific application requirements.



COMMON APPLICATIONS LAMBDA LS

- Fluorescent microscopy
- Calcium imaging
- FURA
- Optogenetics
- High-speed wavelength selection

SPECIFICATIONS LAMBDA LS

- **Output Range** 330 nm to 650 nm — Ozone free
200 mm to 650 mm — Full spectrum
(Note: full spectrum produces ozone)
- **Lamp Type** 175 or 300 Watt Xenon
(pre-aligned to produce
collimated output)
- **Radiant Output** 2.5 Watts (175 W lamp)
4.5 Watts (300 W lamp)
(broadband, full beam)
- **Lamp Life** 1000 hours (Bulb warranted for 500 hours.
Longer life depends on application.
Expected life is 1000 hours)
- **Power Consumption** 175 Watts or 300 Watts
- **Dimensions** 10.5 in x 9.5 in x 10 in
26.7 cm x 24.1 cm x 25.4 cm
- **Weight** 10.5 lbs
4.8 kg
- **Electrical** 120/240 Volts
50/60 Hertz power line



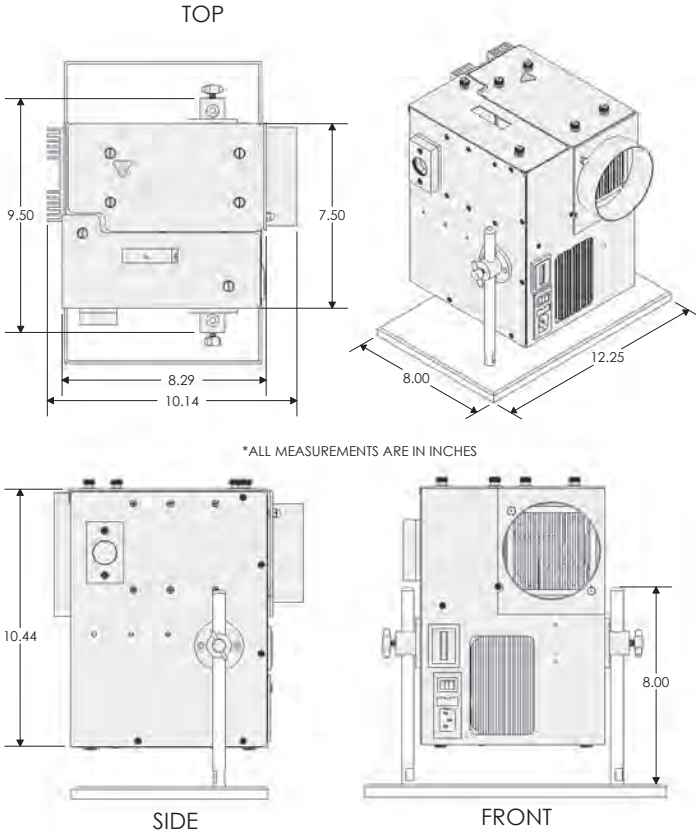

(There is additional depth when second filterwheel is attached)



LAMBDA LS

U.S. prices available at www.sutter.com. International prices vary by country. Contact a distributor or Sutter Instrument for a quotation. Prices subject to change without notice.

LAMBDA LS BASIC SYSTEM

Includes a xenon lamp, cold mirror, power supply and lamp housing, support base with mounting rods, drop-in filter holder and manual.

- **LS-OF30** Lambda LS with 300 Watt **ozone free** lamp
- **LS-FS30¹** Lambda LS with 300 Watt **full spectrum** lamp
- **LS-OF17** Lambda LS with 175 Watt **ozone free** lamp
- **LS-OF30R²** Lambda LS with 300 Watt **ozone free** lamp and cold mirror that reflects to 780 nm
- **LS-OF30IR³** Lambda LS with 300 Watt **ozone free** lamp and cold mirror that reflects to 1100 nm
- **LS-FS30UV^{1,4}** Lambda LS with 300 Watt **full spectrum** lamp and cold mirror that reflects to 275 nm

¹ Note: Full spectrum bulbs produce ozone. Please be certain that you have ventilation. Contact Sutter for details.

² Order with LLG/380

³ Order with LLG/2000 or LLG/380

⁴ Order with LLG/250

FILTER WHEELS & SHUTTER

- **LB10-NWIQ/LS** 10 position 25 mm filter wheel with SmartShutter®
- **LB10-NW¹** 10 position 25 mm filter wheel (can be mounted inside Lambda LS or outside if used as a second wheel)
- **IQ-25/LS** 25 mm SmartShutter for mounting in Lambda LS

¹ Will need to purchase additional controller if using as a second wheel.



LAMBDA LS

U.S. prices available at www.sutter.com. International prices vary by country. Contact a distributor or Sutter Instrument for a quotation. Prices subject to change without notice.

ACCESSORIES

- **LLG** Liquid light guide and coupling adapter (2 meters, 3 mm dia.), C-mount, lens and lens tube
- **LLG/380¹** Liquid light guide and coupling adapter (2 meters, 3 mm dia.), C-mount, lens and lens tube
- **LLG/2000²** Liquid light guide and coupling adapter (2 meters, 3 mm dia.), C-mount, lens and lens tube
- **LLG/250³** Liquid light guide (2 meters, 3 mm dia.), C-mount, lens and lens tube
- **LLGPLUS⁴** Liquid light guide (2 meters, 3 mm dia.), heatsink, C-mount, lens and lens tube
- **LLGPLUS/380⁴** Liquid light guide (2 meters, 3 mm dia.), heatsink, C-mount, lens and lens tube
- **LLGPLUS/2000⁴** Liquid light guide (2 meters, 3 mm dia.), heatsink, C-mount, lens and lens tube
- **DROP-IN** Drop-in filter holder (25 mm)
- **O777655⁵** Replacement 3 mm light guide (300 series)
- **O777651⁶** Replacement 3 mm light guide (380 series)

Mounting adapters for Nikon, Zeiss, Leica and Olympus microscopes are available. Please see the Microscope Adapter list at the end of this section.

¹ Supports transmission into near IR.

² Supports transmission into near IR. No output below 420 nm

³ Supports transmission into near UV.

⁴ Extends the lifetime of the LLG when the Lambda LS is used without a SmartShutter®.

⁵ Maximum UV transmission.

⁶ Allows light input into near IR

BULBS¹

- **O661176** Ozone free 175 Watt xenon bulb (attenuated output below 340 nm)
- **O661301** Ozone free 300 Watt xenon bulb (attenuated output below 340 nm)
- **O661300²** Full spectrum 300 Watt xenon bulb

¹ Please note that the bulbs do not include the outer blue housing.

² Full spectrum bulbs produce ozone. Please be certain that you have ventilation. Contact Sutter for details.



LAMBDA HPX-L5

HIGH POWER LED LIGHT SOURCE WITH LIQUID LIGHTGUIDE

OPTICAL INSTRUMENTS



FEATURES LAMBDA HPX-L5

- Vibration-free coupling via liquid light guide
- Dimming via PWM or current control
- Lifetime >50,000 hours
- Front mounted connectors for ease of access
- TTL and Analog controls
- Integral shuttering
- White light and UV combination available

COMMON APPLICATIONS LAMBDA HPX-L5

- Fluorescent microscopy
- Optogenetics



The Lambda HPX-L5 was created as a liquid light guide coupled version of the HPX, our newest high power LED light source. The liquid light guide allows for LED cooling via an internal heatsink with a whisper fan. This requires less maintenance than the liquid-cooled direct mount version. Designed around a single 90 W 3 mm LED die, the Lambda HPX-L5 provides light output comparable to a 150 W Xenon arc lamp when using the same light guide. The Lambda HPX-L5 is optimized for coupling to an optional 5 mm liquid light guide, and off-the-shelf microscope adapter. The HPX-L5 is expected to retain 95% of its original output at 5,000 hours, and 80% after 10,000 hours.

Because LEDs exhibit color shift with current change, the Lambda HPX was designed to dim the LED using either PWM or current control. PWM will be preferable for most applications, and allows the LED to run cooler. PWM switching is at 28 kHz, high enough for use with most high-speed cameras. For those with applications intolerant of any pulsed output, dimming via current control is also available. PWM and Current information are conveniently displayed on the front panel display, and are manually selectable via control knobs. Integral shuttering time is 10 microseconds to turn on or off. TTL input and output allows for triggering from either software or directly from another device such as a camera or digital IO board. PWM can also be controlled externally via analog input. Active temperature monitoring ensures that the LED life will be maximized.

Light output is in the visible spectrum from 430 nm to 700 nm. Special order units are available with 630 nm, 530 nm, 460 nm, and 405 nm wavelength specific LEDs. The Lambda HPX-L5 can also be combined with our FLED to create a two-channel system with any combination of wavelengths.



SPECIFICATIONS LAMBDA HPX-L5

- **Output Range** White light (430 nm to 700 nm)
- **Shuttering** Turn on time: 10 μ s
Turn off time: 10 μ s
- **LED Life** 60,000 hours
- **Noise/Short Term Stability** 0.02%
- **PWM Frequency** 28 kHz
- **Input/Output** TTL & Analog
- **Standard White LEDs** Cool White
- **Optional LEDs** 405 nm, 460 nm, 530 nm, and 630 nm
- **Dimming** PWM or Current Control
- **Dimensions**
Control Box:
12.25 in x 9 in D 5.25 in
311 mm x 229 mm x 133 mm
Head (attaches to scope):
2.5 in x 3 in x 5 in
64 mm x 76 mm x 127 mm
Length of cabling between Head and Control Box:
4 ft
1.2 m
- **Weight** 8.8 lbs
4 kg
- **Electrical** 120/240 Volts
50/60 Hertz power line
150 Watts max.





LAMBDA HPX-L5

U.S. prices available at www.sutter.com. International prices vary by country. Contact a distributor or Sutter Instrument for a quotation. Prices subject to change without notice.

LAMBDA HPX-L5

Includes the Lambda HPX-L5 LED light source, liquid light guide, and power cables (select one wavelength when ordering).

■ HPX-L5¹

Lambda HPX-L5 High Powered LED light source

AVAILABLE WAVELENGTHS

- **WC-HPX-L5** LED, Cool White
- **460-HPX-L5** LED, 460 nm
- **530-HPX-L5** LED, 530 nm
- **630-HPX-L5** LED, 630 nm

LAMBDA HPX-L5UV

Includes the Lambda HPX-L5UV LED light source, liquid light guide, and cables.

■ HPX-L5UV¹

Lambda HPX-L5UV LED light source

AVAILABLE WAVELENGTHS

■ 405-HPX-L5

LED, 405 nm

LAMBDA HPX-L5DC²

Includes the Lambda HPX-L5 LED light source with cool white LED, Lambda FLED with UV LED, liquid light guide, and cables.

■ HPX-L5DC-Y¹

Lambda HPX and FLED for Olympus

■ HPX-L5DC-N¹

Lambda HPX and FLED for Nikon

■ HPX-L5DC-Z¹

Lambda HPX and FLED for Zeiss

■ HPX-L5DC-L¹

Lambda HPX and FLED for Leica

ACCESSORIES LAMBDA HPX-L5

■ 0777648

Liquid light guide (2 meters, 5 mm diameter)

■ TRIGGER³

USB trigger box

¹ You will need a mounting adapter for your microscope

² Suitable for additional DAPI channel.

³ Compatible with Micro-Manager software

Mounting adapters for Nikon, Zeiss, Leica and Olympus microscopes are available. Please see the Microscope Adapter list at the end of this section.



LAMBDA FLED FLUORESCENT LIGHT SOURCE

OPTICAL INSTRUMENTS

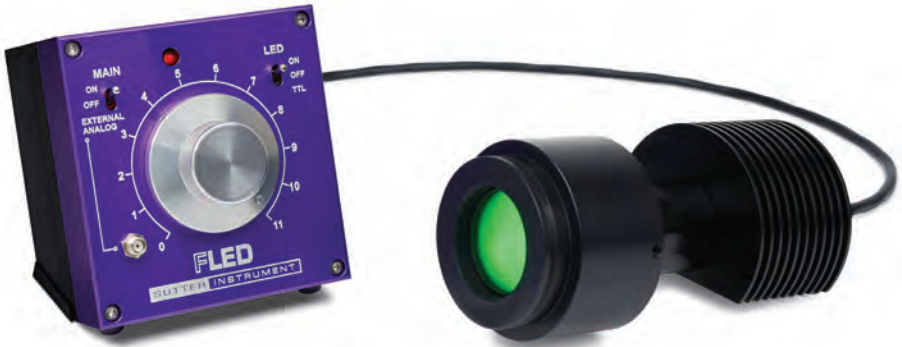

FEATURES LAMBDA FLED

- >50,000 hour lifetime
- <25 µsecs On-Off time
- TTL control (with polarity switch)
- Very stable output
- Compact stand-alone design
- Easy installation

COMMON APPLICATIONS LAMBDA FLED

- Fluorescent microscopy
- Ultra high-speed wavelength selection (FLED-DC)



The Lambda FLED was designed as a high-power LED driver for fluorescence microscopy. Based on our proven TLED+ design, the FLED has been optimized for single-channel, high-current LEDs used as excitation light sources.

The basic system consists of an LED mounted on a special black-anodized aluminum heat sink and a controller. The controller is CNC machined from solid aluminum billet, and powered by a rugged modular universal power supply. The FLED provides intensity control and on-off control via a toggle switch or TTL logic. The on-off time is less than 25 μ secs when using TTL control. In addition to digital input control, the Lambda FLED has an analog input to modulate the LED intensity. The Lambda FLED is expected to have stable output that will last more than 50,000 hours.

The Lambda FLED can be ordered with several different wavelength-specific LEDs that range from 365 nm to 940 nm. Please call us if you require a wavelength is not listed.

Our dual channel Lambda FLED option combines two high power LEDs into a single light path. The FLED-DC allows the use of two channels for fluorescence imaging. Both channels are driven by individual FLED controllers and can be triggered, also individually, by a TTL signal. For greater than two LEDs in a setup, please see our Lambda 421 or Lambda OBC.

Product	Wavelength options (nm)*	External Control
FLED	340, 365, 385, 410, 440, 460, 480, 506, 530, 561, 590, 630, 660, 740, 850, 940	Digital (BNC) / Analog (SMA)

* other wavelengths available upon request

Each Lambda FLED system includes an optical mounting adapter for the excitation port of the microscope and detailed installation instructions. Mounting adapters are designed to fit most models of Nikon, Olympus, Zeiss and Leica microscopes. Custom adapters are available at an additional cost.



SPECIFICATIONS LAMBDA FLED

- **Output Range** White light (400 nm to 700 nm)
- **LED Life** >50,000 hours
- **Noise/Short Term Stability** 0.01%
- **Control Box Dimensions** FLED 4 in x 3.25 in x 4.1 in
10.2 cm x 8.3 cm x 10.2 cm
- **Weight** 2.2 lbs
1 kg
- **Electrical** 120/240 Volts
50/60 Hertz power line
75 Watts max



ACCESSORIES LAMBDA FLED

- **TRIGGER¹** USB trigger box

¹ Compatible with Micro-Manager software

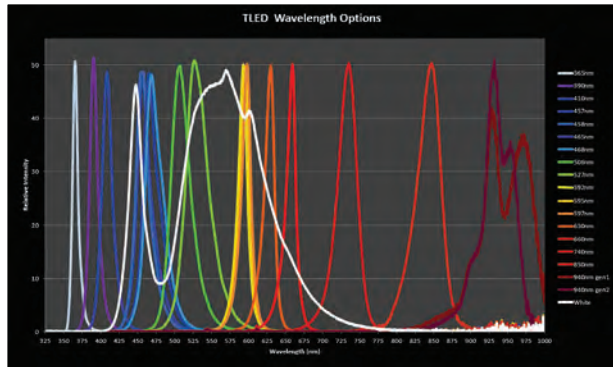



LAMBDA FLED

U.S. prices available at www.sutter.com. International prices vary by country. Contact a distributor or Sutter Instrument for a quotation. Prices subject to change without notice.

LAMBDA FLED

Single Channel LED Light Source

Includes Lambda FLED light source, FLED controller and power supply. Please select one wavelength when ordering.

- **FLED-N** Lambda FLED for Nikon
- **FLED-N25¹** Lambda FLED for Nikon TE200/E300, Diaphot 200/300
- **FLED-N50** Lambda FLED for Nikon AZ100
- **FLED-Y** Lambda FLED for Olympus
- **FLED-Z** Lambda FLED for Zeiss
- **FLED-L** Lambda FLED for Leica
- **FLED-C²** Lambda FLED with C-mount

AVAILABLE WAVELENGTHS³ (in nm)

340, 365, 385, 410, 440, 460, 480, 506,
530, 561, 590, 630, 660, 740, 850, 940

LAMBDA FLED-DC

Dual Channel LED Light Source

Includes Lambda FLED light source, 2 FLED controllers, and power supplies. Please select two wavelengths of your choice.

- **FLED-DC-N** Dual Channel Lambda FLED and 2 controllers for Nikon
- **FLED-DC-Y** Dual Channel Lambda FLED and 2 controllers for Olympus
- **FLED-DC-Z** Dual Channel Lambda FLED and 2 controllers for Zeiss
- **FLED-DC-L** Dual Channel Lambda FLED and 2 controllers for Leica
- **FLED-DC-C** Dual Channel Lambda FLED and 2 controllers with C-mount

AVAILABLE WAVELENGTH COMBINATIONS³ (in nm)

340, 365, 385, 410, 440, 460, 480, 506,
530, 561, 590, 630 660, 740, 850, 940, White

¹ Replaces the epi-illuminator.

² Suitable for SOM microscope.

³ Other wavelengths and wavelength combinations may be available. Custom mounting adapters available on all models at an additional cost. Contact Sutter for further details.



LAMBDA TLED / TLED+

LED TRANSMITTED LIGHT SOURCE



FEATURES LAMBDA TLED / TLED+

- >50,000 hour lifetime
- <25 μ secs On-Off time
- TTL control (with polarity switch)
- Very stable output
- Compact standalone design
- Easy installation

COMMON APPLICATIONS LAMBDA TLED / TLED+

- Transmitted light
- Phase Contrast
- Differential Interface Contrast (DIC)



The Lambda TLED and TLED+ are standalone LED light sources that can be used with the transmitted light path of a microscope or in other applications with similar requirements.

This basic system consists of an LED mounted on a special black-anodized aluminum heat sink and a controller. The Lambda TLED and TLED+ controllers are powered by a rugged modular universal power supply. The controllers provide intensity control and on-off control via a toggle switch or TTL logic. The on-off time is $<25 \mu\text{s}$ when using TTL control. In addition to digital input control, the Lambda TLED+ has analog input to modulate the LED intensity. The Lambda TLED and TLED+ are expected to have stable output that will last in excess of 50,000 hours.

The Lambda TLED and TLED+ can be ordered with a high-output white light LED, making it a suitable light source for contrast methods, including Phase, and Differential Interference Contrast (DIC).

As an alternative to the standard white-light LED, we have several options available including an IR-LED which is suitable for experiments requiring IR-DIC. Please contact Sutter for details.

Our dual channel Lambda TLED+ option combines two high power LEDs into a single light path. The TLED-DC includes a 460 nm LED for stimulation, while the second channel passes the phosphor emission from a white light LED. The white light channel can be used to access spectra between 510 nm to 630 nm and is suitable for a variety of applications. Both channels are driven by individual TLED+ controllers and can be triggered, also individually, by a TTL signal. Alternate wavelength configurations are available.

Each Lambda TLED/TLED+ system includes an optical mounting adapter for the microscope and detailed installation instructions. Mounting adapters are designed to fit most models of Nikon, Olympus, Zeiss and Leica microscopes. Custom adapters for the Lambda TLED/TLED+ are available at an additional cost.

The TLED-FT is a powerful and compact array of 9 LEDs used to deliver a homogenized beam of light to the sample. Useful for illuminating a 96 well plate, the TLED-FT is available in blue, green, red and white light configurations. The TLED controller provides stable, adjustable light intensity by switch or TTL. Ideal for optogenetics, and transparent samples.

The TLED-RL is a ring light illuminator for stereo microscopes with lenses up to 65 mm in outside diameter. The ring light is composed of a circular assembly of many white light LEDs that provides even and direct illumination of the sample.



SPECIFICATIONS LAMBDA TLED / TLED+

- **Output Range** White light (400 nm to 700 nm)
- **LED Life** >50,000 hours
- **Noise/Short Term Stability** 0.01%
- **Control Box Dimensions**

TLED	3 in x 3.5 in x 4.1 in
	7.6 cm x 8.9 cm x 10.2 cm
TLED+	4 in x 3.25 in x 4.1 in
	10.2 cm x 8.3 cm x 10.2 cm
- **Weight**

2.2 lbs
1 kg
- **Electrical**

120/240 Volts
50/60 Hertz power line
75 Watts max



ACCESSORIES LAMBDA TLED / TLED+

- **TRIGGER¹** USB trigger box

¹ Compatible with Micro-Manager software



(Shown: TLED-FT)





LAMBDA TLED / TLED+

U.S. prices available at www.sutter.com. International prices vary by country. Contact a distributor or Sutter Instrument for a quotation. Prices subject to change without notice.

TLED

Includes Lambda TLED light source, TLED controller, white light LED, and power supply.

- **TLED-N** Lambda TLED for Nikon
- **TLED-N40** Lambda TLED for Nikon E400/E600
- **TLED-N50** Lambda TLED for Nikon AZ100
- **TLED-N65** Lambda TLED for Nikon FN1
- **TLED-Y** Lambda TLED for Olympus
- **TLED-Z** Lambda TLED for Zeiss
- **TLED-L** Lambda TLED for Leica
- **TLED-C** Lambda TLED with C-mount

TLED+

Includes Lambda TLED+ light source, TLED+ controller, white light LED, and power supply.

- **TLEDPLUS-N** Lambda TLED+ for Nikon
- **TLEDPLUS-N25¹** Lambda TLED+ for Nikon TE200/300, Diaphot 200/300
- **TLEDPLUS-Y** Lambda TLED+ for Olympus
- **TLEDPLUS-Z** Lambda TLED+ for Zeiss
- **TLEDPLUS-L** Lambda TLED+ for Leica
- **TLEDPLUS-C** Lambda TLED+ with C-mount

TLED-RGB

Includes Lambda TLED-RGB light source, TLED controller and power supply.

- **TLED-RGB-N** Lambda TLED-RGB for Nikon
- **TLED-RGB-Y** Lambda TLED-RGB for Olympus
- **TLED-RGB-L** Lambda TLED-RGB for Leica

TLED-FT²

Includes Lambda TLED-FT light array, TLED controller and power supply.

- **TLED-FT** Lambda TLED-FT Light array

TLED-RL

Includes Lambda TLED-RL light source, TLED controller and ring light.

- **TLED-RL** Lambda TLED-RL reflected light illuminator

** Custom mounting adapters are available for all models at an additional cost. Contact Sutter for details.*

¹ Replaces the epi-illuminator.

² Please specify either blue, green, red or white light LEDs when ordering..



LAMBDA VF-5™ / VF-1™ / TUNABLE FILTER CHANGERS

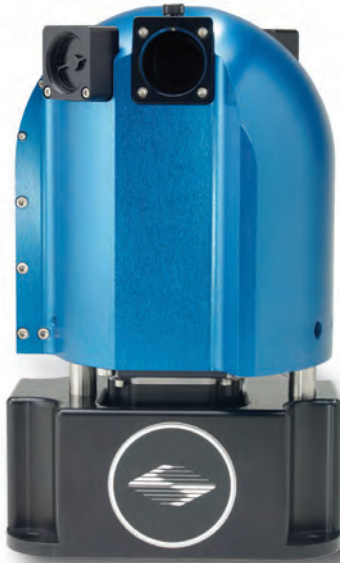

(Shown: Lambda VF-5)

FEATURES LAMBDA VF-5 / VF-1

- Supported by the Lambda 10-3 (with special programming)
- Patented white light output capability
- Wavelength range as wide as 338 nm to 900 nm
- Access any center-wavelength in nanometer increments
- Images pass through filters making it suitable for both excitation and emission
- Easily switch between flurophore combinations
- Optional liquid light guide offers absolute vibration isolation
- All the advantages of thin-film technology – high transmission, steep spectral edges, high out-of-band blocking
- Polarization independence (s and p nearly identical)



Sutter Instrument has developed several filter changers specially designed for wavelength selection over a wide spectral range to any given nanometer value. The Lambda VF-5™, and Lambda VF-1™, employ the innovative VersaChrome® thin-film filter technology from Semrock® to provide outstanding bandpass characteristics such as high transmission (close to 100%), steep edges and out-of-band blocking. Since these filters pass an image, they are equally suitable for emission and excitation paths.

How It Works

A specific wavelength within the wide spectral range of each filter is obtained by adjusting the angle of incidence from 0 to 60 degrees. This tuning causes little or no change in spectral performance of the filter regardless of the state of polarization of the light passing through the filter. The current VersaChrome series has 7 filters covering 338 nm to 900 nm. By simply selecting the desired center-wavelength on the controller, users can select any combination of filters for the Lambda VF-5 (which holds up to 5 filters) or any single filter in the series for the Lambda VF-1.

The controller for these new tunable filter changers is a special version of our Lambda 10-B. Users can select the desired center wavelength in 1 nm increments from the keypad, or via the serial or USB ports. This allows control of the Lambda VF instruments with minimal changes to existing software supporting the popular Lambda 10-B controller. A sequence of wavelengths can be stored in the controller and the TTL input can then be used to trigger selection of the wavelengths in the sequence step-to-step. The firmware includes filter-specific data for each of the VersaChrome filters in the series.

The Lambda VF-5

Along with the ability to select any wavelength in the range covered by any combination of 5 VersaChrome filters, the Lambda VF-5 has a patented white-light output mode that allows the user to access the full spectral output of the excitation light source when it is required. White-light output is achieved by capturing the rejected light from the VersaChrome filter at a 45 degree angle and then combining the two beams on the output side of the VF-5. If this configuration is desired, it requires an additional custom light guide and SmartShutter® system.

When using the Lambda VF-5 for emission applications, we suggest installation of the 5 filters with the longer center-wavelengths covering from 430 nm to 800 nm. For excitation applications, we suggest installing the 5 filters with the shortest wavelengths covering 338 nm to 620 nm. For special applications, any combination of 5 filters could be installed in the Lambda VF-5. The compact Lambda VF-1 accepts any single filter in the series. The single VersaChrome filter installed in the Lambda VF-1 can be changed as needed.

VersaChrome® is a registered trademark of Semrock®, an IDEX company



The Lambda VF-1

The Lambda VF-1™ accepts any single filter in the series, which can be exchanged with other filters as needed. This model offers faster switching times as well as a more compact and affordable system. When used with the Lambda VF-1, the controller is able to also control a separate filter wheel or *SmartShutter*®.

* Patent # 8,733,978, B2



(Shown: Lambda VF-1)



COMMON APPLICATIONS LAMBDA VF-5 / VF-1

- Fluorescent microscopy
- Calcium imaging
- FURA
- Optogenetics
- Hyperspectral imaging wavelength selection

SPECIFICATIONS LAMBDA VF-5 / VF-1

- **Lambda VF-1™**
2.8 in x 2.8 in x 4.4 in
7 cm x 7 cm x 11 cm
3.3 lbs
1.5 kg
- **Lambda VF-5™**
9.4 in x 6 in x 5 in
23.8 cm x 15.2 cm x 12.7 cm
11.7 lbs
5.3 kg
- **Controller**
15.75 in x 11 in x 4 in
40 cm x 28 cm x 10.2 cm
2.6 lbs
1.1 kg
- **Electrical**
120/240 Volts
50/60 Hertz power line
75 Watts max





LAMBDA VF-5 / VF-1

U.S. prices available at www.sutter.com. International prices vary by country. Contact a distributor or Sutter Instrument for a quotation. Prices subject to change without notice.

BASIC SYSTEM

- **VF-1¹** Includes the Lambda VF-1™, a single VersaChrome® filter, Lambda 10-B control unit, serial and USB cables, power cable and manual
- **VF-5¹** Includes the Lambda VF-5™, five VersaChrome® filters, Lambda 10-B control unit, serial and USB cables, power cable and manual

¹ Please select filter(s) when ordering.

VERSACHROME® FILTERS¹ – ORIGINAL SERIES

- **O573380** Tunable filter, 380–338 nm with 16 nm bandwidth
- **O573440** Tunable filter, 440–388 nm with 16 nm bandwidth
- **O573490** Tunable filter, 490–429 nm with 15 nm bandwidth
- **O573550** Tunable filter, 550–487 nm with 15 nm bandwidth
- **O573620** Tunable filter, 620–547 nm with 14 nm bandwidth
- **O573700** Tunable filter, 700–615 nm with 13 nm bandwidth
- **O573800** Tunable filter, 800–699 nm with 12 nm bandwidth

¹ The ranges described above are the designed performance values for the VersaChrome coatings. The Semrock® catalog tuning ranges will be narrower due to different criteria.

ACCESSORIES

- **O629950** Male-to-male C-mount adapter for mounting SmartShutter® to Lambda VF-5 / VF-1
- **VF5-WL** Lambda VF-5™ white light kit
- **VF5-EMMSN-ADAP** Emission adapter

VersaChrome® is a registered trademark of Semrock®





LAMBDA 10-3 OPTICAL FILTER CHANGER



FEATURES LAMBDA 10-3

- As fast as 40 msec between adjacent filters (10 position wheel)
- As fast as 30 msec between adjacent filters (4 position wheel)
- Can control three wheels and two shutters, or two wheels and three shutters
- Can accommodate *SmartShutter*[®] and *Uniblitz*[®] shutter
- 7 speed settings to optimize movement
- Command set compatible with Lambda 10-2
- Automatically detects installed hardware
- Serial, parallel and USB interfaces
- Can control a variety of 25 mm, 32 mm and 50 mm wheels
- Chopper drives
- Universal power supply

COMMON APPLICATIONS LAMBDA 10-3

- Fluorescent microscopy
- Calcium imaging
- FURA
- Optogenetics
- High-speed wavelength selection



The Lambda 10-3 is the latest generation of Sutter's high performance filter wheel changers. The controller now offers faster switching times, synchronous independent control of 3 filter wheels and 2 shutters (or 2 filter wheels and 3 shutters), and expanded communication interface options. Recent advances in motor technology allow the Lambda 10-3 to achieve switching times of 40 msec between adjacent filters. In addition, the controller commands can now be accessed via USB, serial, parallel, and keypad interfaces.

The Lambda 10-3 controls a variety of standard Sutter filter wheels including the popular 10 position 25 mm wheel, a lighter 4 position 25 mm wheel, a 10 position 32 mm wheel, 5 position 50 mm wheel, and a compact belt-drive 4 position wheel. The embedded controllers automatically detect the equipment installed and the source of the external commands, so there are no jumper wires or switches to set. There are seven speed settings available to optimize the rate of movement in accordance with the load of the wheel. The Lambda 10-3 can operate up to 40 msec switching time with the traditional 25 mm filter wheel as well as our newer, high-speed 32 mm version. The 4 position wheel (LB10-NWHS4) provides additional speed and can achieve switching times of less than 33 msec. Nearly all of our filter wheels employ a direct drive system. This design eliminates problems with belt slippage and backlash, assuring that our wheels are exceptionally robust.

Each wheel will accommodate filters from 1 mm to 9 mm in thickness, allowing multiple filters to be used in each position. For instance, this allows users to insert a neutral density filter along with an interference filter in a single position. We have designed the body of the filter wheel with a trap to eliminate light scatter. For added stability, non-emission filter wheels come with a sturdy support stand and 12 inch rods. In addition to filter wheels, the Lambda 10-3 controller supports our patented stepper-motor controlled *SmartShutter*[®] as well as the Uniblitz[®] shutter. Either shutter can be mounted directly onto the wheel, providing a compact wheel/shutter package for systems with mounting constraints.

Both shuttered and non-shuttered filter wheels can be installed directly on the microscope in a number of locations: excitation, emission, Infinity path, and the trinocular head. Up to two excitation and/or neutral density filter wheels can be used with the Lambda LS xenon light source and liquid light guide, in vibration sensitive systems. The *SmartShutter* can be mounted independently from the wheel in any location in the light path (including the Lambda LS and Lambda DG-4/DG-5), and driven in a standalone configuration by the Lambda 10-3 controller. The microscope specific adapters necessary for any configuration of wheels and shutter are listed in the Microscope Adapters section of the catalog.



The Lambda 10-3 commands are a superset of the Lambda 10-2, thus integrating all previously available features into the new design. Additional commands are incorporated to access the third wheel as well as the special *SmartShutter*® features. These configurations can be programmed through the keypad making it easy to use the previous shutter commands to access the *SmartShutter* specific functions such as the neutral density or the 'soft' shutter mode.

Filter selection can be made directly from the keypad or from a computer via the serial, parallel, or USB port. The controller determines the shortest route to the selected filter and an acceleration/deceleration algorithm minimizes vibrations during the movement of the wheel. Internal sensors ensure correct filter positioning and current filter position is displayed on the front panel. The serial port accepts RS-232 level signals through a DB-9 connector. USB input is made through a standard connector and can be directly connected to a PC USB port.

The universal power supply will automatically switch to accommodate the line voltage – no user adjustment is required. An optional liquid light guide is available for applications requiring absolute vibration isolation, and/or spatial illumination uniformity.

GETTING FASTER FILTER SWITCHING TIMES WITH MANY FILTERS INSTALLED

The Sutter filter wheel systems have always been optimized for fast switching of a lightly loaded wheel. When many thick filters are installed, the added mass requires an increase in the time required to switch from one filter to another. Switching times improve significantly with filters made on a thin substrate that do not require a thick layer of additional glass to obtain the desired blocking. Semrock® has the required coating technology to offer filters with substrates down to 2 mm in thickness.

We have now taken the additional step of designing a special threaded ring that Semrock can install in place of their typical plain filter cells. Filters mounted in these rings can be threaded directly into the body of our filter wheels when our standard filter cups have been removed. Semrock filters actually weigh less than the filter cup and retaining ring normally used to mount filters in the Sutter wheels. Thus, if you remove our filter cups and mount the new threaded filters directly in the wheel, even a fully loaded wheel will be able to run at speeds that previously could only be used with just 2 filters installed.

The STR Semrock filters are available in both 25 mm and 32 mm versions and should be purchased directly from Semrock. If you are installing these filters in a Sutter wheel that has filter cups, you will need to remove the cup from the position you intend to use to mount the threaded filter. Contact Sutter for details. When installing the new threaded filters, you will want to use the new wrench designed for this purpose.



SPECIFICATIONS LAMBDA 10-3

- **Control Box Dimensions** 15.75 in x 11 in x 4 in
40 cm x 28 cm x 10.2 cm
- **Weight** 20 lbs
11 kg
- **Electrical** 120/240 Volts
50/60 Hertz power line
75 Watts max



MECHANICAL DRAWINGS LAMBDA 10-NWIQ

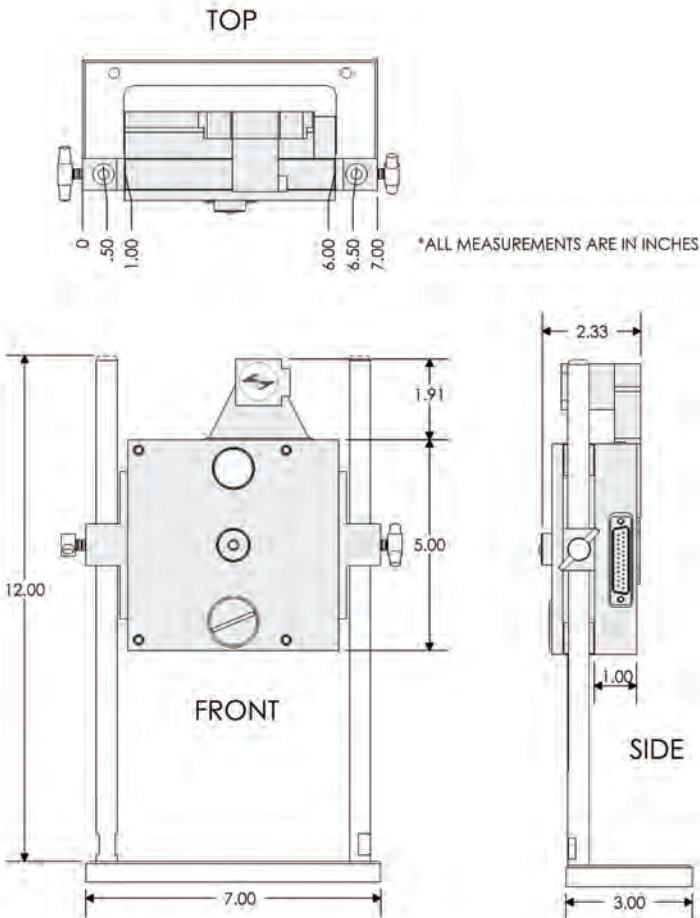

(Shown with optional Smart Shutter®)



LAMBDA 10-3

U.S. prices available at www.sutter.com. International prices vary by country. Contact a distributor or Sutter Instrument for a quotation. Prices subject to change without notice.

CONTROLLER

■ LB10-3

Includes one Lambda 10-3 controller unit, serial, parallel and USB cables, power cable and manual

WHEELS

■ LB10-NW

25 mm Filter Wheels — 10-position

10-position 25 mm filter wheel without shutter

■ LB10-NWIQ

10-position 25 mm filter wheel with *SmartShutter*[®]

■ LB10-NWS

10-position 25 mm filter wheel with Uniblitz[®] shutter

■ LB10-NWE

10-position 25 mm filter wheel set up for emission

25 mm Filter Wheels — 4-position

■ LB10-WHS4

4-position 25 mm filter wheel without shutter

■ LB10-WHS4IQ

4-position 25 mm filter wheel with *SmartShutter*

■ LB10-WHS4E

4-position 25 mm filter wheel set up for emission

Thin Filter Wheels — 10-position

■ LB10-TW¹

10-position 25 mm thin wheel without shutter

■ LB10-TWIQ¹

10-position 25 mm thin wheel with *SmartShutter*

■ LB10-TWE¹

10-position 25 mm thin wheel set up for emission

25 mm Dual Filter Wheels

■ LB10-WD

Back to back mounting of two 25 mm filter wheels without shutter. No drop-in filter holders

■ LB10-WDIQ

Back to back mounting of two 25 mm filter wheels with *SmartShutter* and one slide-in filter holder

■ LB10-WDS

Back to back mounting of two 25 mm filter wheels with one Uniblitz shutter and one slide-in filter holder

32 mm Filter Wheels — 10-position

■ LB10-W32

10-position 32 mm filter wheel without shutter

■ LB10-W32IQ

10-position 32 mm filter wheel with *SmartShutter*

■ LB10-W32S

10-position 32 mm filter wheel with Uniblitz shutter

■ LB10-W32-Y73¹

32 mm emission wheel for Olympus IX73/83

50 mm Filter Wheel — 5-position

■ LB10-W50

5-position 50 mm filter wheel without shutter

Specialty Wheels

■ LB10-W12

10-position 12.5 mm filter wheel without shutter

■ LB4-W

Belt drive 4-position 25 mm filter wheel without shutter

■ LB10-NWE-N29B

10-position 25 mm emission for bottom port of Nikon Ti

■ LB10-NWE-Z40²

10-position 25 mm emission for Zeiss Axio Observer

■ LB5-W32E-Y73

5-position 32 mm emission wheel for Olympus IX73/83

■ LB5-W32E-N31

5-position 32 mm emission wheel for Nikon Ti2

■ LB6-W32E-Y73

6-position 32 mm emission wheel for Olympus IX73/83

■ LB6-W32E-N31

6-position 32 mm emission wheel for Nikon Ti2

¹ Includes emission adapter

² Left port only



LAMBDA 10-3

U.S. prices available at www.sutter.com. International prices vary by country. Contact a distributor or Sutter Instrument for a quotation. Prices subject to change without notice.

SMARTSHUTTER®

- **IQ12-SA** 12.5 mm *SmartShutter* with standalone housing
- **IQ12-AN** 12.5 mm hard anodized *SmartShutter*
- **IQ25-SA**¹ 25 mm *SmartShutter* with standalone housing
- **IQ25-W**² 25 mm *SmartShutter* with housing to fit filter wheel
- **IQ25-WU** 25 mm *SmartShutter* to retrofit non-shuttered filter wheel
- **IQ25-LS** 25 mm *SmartShutter* with housing to fit Lambda LS
- **IQ25-DG** 25 mm *SmartShutter* with housing to fit Lambda DG-4/DG-5
- **IQ35-W** 35 mm *SmartShutter* with housing to fit filter wheel
- **IQ35-SA** 35 mm *SmartShutter* with standalone housing
- **IQ50-SA** 50 mm *SmartShutter* with standalone housing

Mounting adapters for Nikon, Zeiss, Leica and Olympus microscopes are available. Please see the Microscope Adapters section of the catalog or contact Sutter Instrument for pricing and further information.

¹ Where vignetting may be an issue, we recommend the 35mm shutter.

² For upgrading a 25 mm filter wheel with existing Uniblitz® shutter to *SmartShutter*.



LAMBDA 10-3

U.S. prices available at www.sutter.com. International prices vary by country. Contact a distributor or Sutter Instrument for a quotation. Prices subject to change without notice.

CABLES AND ACCESSORIES

- **F5WITCH** Foot switch with BNC connector –
Changes state of shutter with foot press as long as foot press is maintained
- **F5TOGGLE** Foot switch with BNC connector –
Alternates open/close with each foot press
- **CIQ-2** One 25-pin connector to two 9-pin connectors
(Allows connection of one standalone *SmartShutter*[®] to controller)
- **SLIDE-IN¹** Slide-in filter holder for 25 mm wheel
- **DROP-IN²** Drop-in filter holder for 25 mm wheel
- **DROP-IN/32** Drop-in filter holder for LB10-W32IQ
- **X100120** 25 mm filter cup
- **X100145³** 25 mm angled filter spacer
- **X100150** 25 mm spacer
- **X100160** 25 mm retaining ring
- **X100122** 32 mm filter cup
- **X100152** 32 mm spacer
- **X100162** 32 mm retaining ring
- **X100124** 50 mm filter cup
- **X100126** 50 mm short filter cup
- **X100154** 50 mm spacer
- **X100164** 50 mm retaining ring
- **LLG** Liquid light guide (2 meters, 3 mm diameter) C-mount,
lens, and lens tube
- **SHUTTER** 25 mm replacement shutter for Uniblitz[®] shutter
(not an upgrade)
- **W620005** 9-pin male/female serial cable
- **W620007** 15-pin shielded cable for standard filter wheel
- **W620009** 25-pin cable for wheels with *SmartShutter*
- **W621520** USB cable
- **X100111** 35 mm replacement Uniblitz shutter (not an upgrade)
- **X100208** 8 inch guide rod for stand (each)
- **X100210** 12 inch guide rod for stand (each)
- **X100212** 22 inch guide rod for stand (each)
- **X100560** 25 mm spanner wrench
- **X100555** 25 mm thin wheel spanner wrench
- **X100565** 32 mm spanner wrench
- **X100558** 32 mm thin wheel spanner wrench
- **X100567** 50 mm spanner wrench

¹ Slide-in filter holders are for wheels **with** a shutter.

² Drop-in filter holders are for wheels **without** a shutter.

³ Two spacers are required for each filter position.



OEM WHEELS AVAILABLE

For OEM applications, the Lambda 10-3 can readily be modified to meet your specific requirements. By utilizing the 10-3 controller to drive customized wheels, we can provide an economical solution to your OEM design specification. To date we have made custom 2-, 3-, 4-, 5-, 10- and 12-position wheels and have designed for 50 mm, 32 mm and 25 mm filters. Our technical staff will be happy to discuss with you special application requirements.

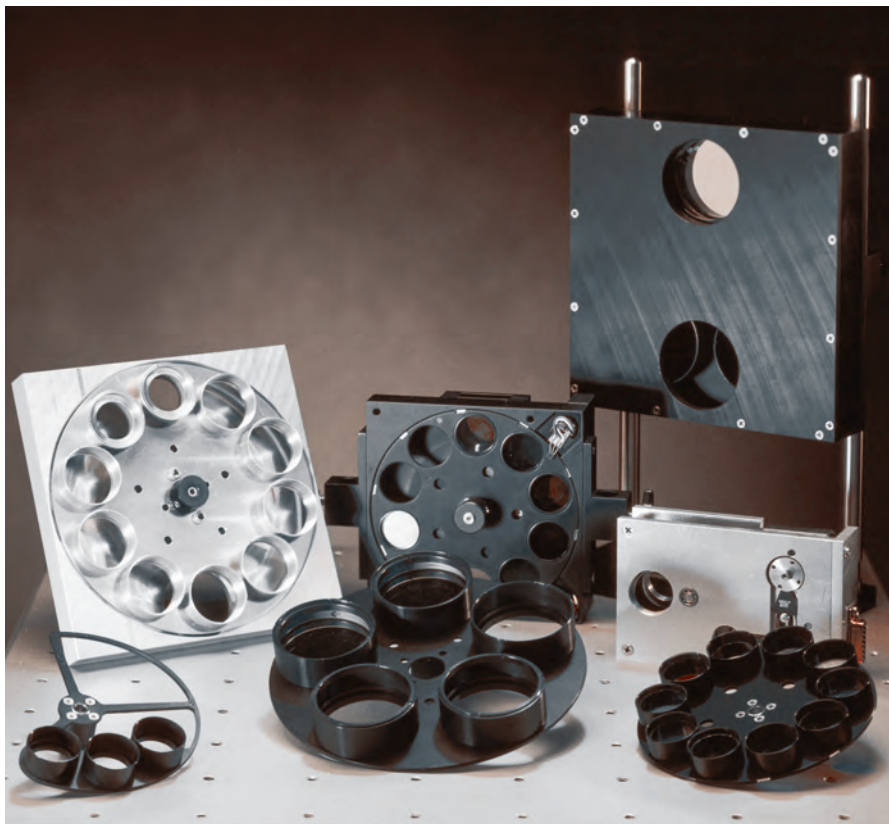



LAMBDA 10-B OPTICAL FILTER CHANGER



(Shown with LB10-NW1Q)

FEATURES LAMBDA 10-B

- As fast as 40 msec between adjacent filters (10-position wheel)
- As fast as 30 msec between adjacent filters (4-position wheel)
- As fast as 28 msec with a fully loaded wheel using STR filter from Semrock®
- Serial and USB interfaces
- Can control a variety of 25 mm, 32 mm, and 50 mm wheels
- Controls one wheel and one optional shutter, or two *SmartShutter*®
- Can accommodate *SmartShutter* and *Uniblitz*® shutter
- Chopper drives
- Universal power supply

COMMON APPLICATIONS LAMBDA 10-B

- Fluorescent microscopy
- Calcium imaging
- FURA
- Optogenetics
- High-speed wavelength selection



The Lambda 10-B is a high performance, microprocessor-controlled filter wheel for imaging applications requiring a single filter wheel. The latest release in Sutter's optical filter changer product line, the Lambda 10-B, uses recent advances in motor technology to achieve switching times of 40 msec between adjacent filters. When used with the high-speed 4-position wheels, the Lambda 10-B achieves switching times of less than 31 msec. It features both USB and serial port interfaces as well as keypad control. The Lambda 10-B is capable of controlling both the *SmartShutter*[®] as well as the *Uniblitz*[®] shutter. The Lambda 10-B is a low-cost alternative and ideal for imaging applications requiring a single filter wheel.

The Lambda 10-B can operate with switching times as brief as 40 msec with our standard 25 mm filter wheel as well as our 32 mm wheel. The user can select from seven speeds, allowing the speed to be adjusted in accordance with the load of the wheel. Except for the 4-position compact wheel, our filter wheels employ a direct drive system – a feature that prevents belt slippage or backlash. An optional shutter installation is also available.

Filter selection can be made directly from the keypad or from a computer via the serial or USB port. The Lambda 10-B controller determines the shortest route to the selected filter and an acceleration/deceleration algorithm minimizes vibrations during the movement of the wheel. The current filter position is displayed on the front panel. Internal sensors monitor the position of the filter wheel to insure that the correct filter is in place. The drive uses switching mode current regulation, which is more economical than the linear supply of the Lambda 10-2. Although this is not a problem with most imaging applications, the Lambda 10-2 may be more appropriate for systems where electrophysiology is performed.

Both serial and USB input ports are provided to allow complete and easy control from a remote computer. The serial port accepts RS232 level signals through a DB-9 connector. USB input is made through a standard connector and can be directly connected to a USB port. The Lambda 10-B's USB port interface supports multiple USB devices simultaneously, allowing a user to run in tandem as many units as USB ports. The universal power supply will automatically switch to accommodate local line voltage.

OPTIONS:

The basic system for the Lambda 10-B includes our popular 10-position 25 mm filter wheel. A significant advantage of the Lambda 10-B controller is that it can accommodate a variety of Sutter filter wheels to suit your particular requirements. The controller will automatically detect and determine the model of wheel installed and adjust for the number of positions and filter size.

Our 32 mm wheel was designed to remedy the problem of vignetting that may occur with a 25 mm filter format in certain microscope systems, and can achieve the same 40 msec switching times as our 25 mm wheel. For applications requiring a larger aperture opening, there is a 5-position 50 mm filter wheel. If additional speed is



required, we offer a high-speed, 4-position 25 mm wheel which is capable of achieving 31 msec switching times between adjacent filters. An optional liquid light guide is available for applications requiring absolute vibration isolation, and/or spatial uniformity independent of wavelength. The Lambda 10-B is also capable of controlling either the SmartShutter® or the Uniblitz shutter.

GETTING FASTER FILTER SWITCHING TIMES WITH MANY FILTERS INSTALLED

The Sutter filter wheel systems have always been optimized for fast switching of a lightly loaded wheel. When many thick filters are installed, the added mass requires an increase in the time required to switch from one filter to another. Switching times improve significantly with filters made on a thin substrate that do not require a thick layer of additional glass to obtain the desired blocking. Semrock® has the required coating technology to offer filters with substrates down to 2 mm in thickness.

We have now taken the additional step of designing a special threaded ring that Semrock can install in place of their typical plain filter cells. Filters mounted in these rings can be threaded directly into the body of our filter wheels when our standard filter cups have been removed. Semrock filters actually weigh less than the filter cup and retaining ring normally used to mount filters in the Sutter wheels. Thus, if you remove our filter cups and mount the new threaded filters directly in the wheel, even a fully loaded wheel will be able to run at speeds that previously could only be used with just 2 filters installed.

The STR Semrock filters are available in both 25 mm and 32 mm versions and should be purchased directly from Semrock. If you are installing these filters in a Sutter wheel that has filter cups, you will need to remove the cup from the position you intend to use to mount the threaded filter. Contact Sutter for details. When installing the new threaded filters, you will want to use the new wrench designed for this purpose.

SPECIFICATIONS LAMBDA 10-B

- **Control Box Dimensions** 6 in x 8.25 in x 5.25 in
15.2 cm x 21 cm x 13.3 cm
- **Weight** 2.6 lbs
1.1 kg
- **Electrical** 120/240 Volts
50/60 Hertz power line
75 Watts max





LAMBDA 10-B

U.S. prices available at www.sutter.com. International prices vary by country. Contact a distributor or Sutter Instrument for a quotation. Prices subject to change without notice.

CONTROLLER

- **LB10-B/IQ¹** Lambda 10-B control unit, serial and USB cables, power cord and manual

WHEELS

- **LB10-NW** 25 mm Filter Wheels — 10-position
10-position 25 mm filter wheel without shutter
- **LB10-NWIQ** 10-position 25 mm filter wheel with *SmartShutter*[®]
- **LB10-NWS** 10-position 25 mm filter wheel with Uniblitz[®] shutter
- **LB10-NWE** 10-position 25 mm filter wheel set up for emission

- **LB10-WHS4** 25 mm Filter Wheels — 4-position
4-position 25 mm filter wheel without shutter
- **LB10-WHS4IQ** 4-position 25 mm filter wheel with *SmartShutter*
- **LB10-WHS4E** 4-position 25 mm filter wheel set up for emission

- **LB10-TW¹** Thin Filter Wheels — 10-position
10-position 25 mm thin wheel without shutter
- **LB10-TWIQ¹** 10-position 25 mm thin wheel with *SmartShutter*
- **LB10-TWE¹** 10-position 25 mm thin wheel set up for emission

- **LB10-W32** Filter Wheels — 10-position
10-position 32 mm filter wheel without shutter
- **LB10-W32IQ** 10-position 32 mm filter wheel with *SmartShutter*
- **LB10-W32S** 10-position 32 mm filter wheel with Uniblitz shutter
- **LB10-W32-Y73²** 32 mm emission wheel for Olympus IX73/83

- **LB10-W50** 50 mm Filter Wheel — 5-position
5-position 50 mm filter wheel without shutter

- **LB10-W12** Specialty Wheels
10-position 12.5 mm filter wheel without shutter
- **LB4-W** Belt drive 4-position 25 mm filter wheel without shutter

- **LB10-NWE-N29B** 10-pos. 25 mm emission for bottom port of Nikon Ti
- **LB10-NWE-Z40³** 10-position 25 mm emission for Zeiss Axio Observer
- **LB5-W32E-Y73** 5-position 32 mm emission wheel for Olympus IX73/83
- **LB5-W32E-N31** 5-position 32 mm emission wheel for Nikon Ti2

¹ CIQ-2 cable provided when ordered with standalone shutter.

² Includes emission adapter.

³ Left port only.



LAMBDA 10-B

U.S. prices available at www.sutter.com. International prices vary by country. Contact a distributor or Sutter Instrument for a quotation. Prices subject to change without notice.

SMARTSHUTTER®

- **IQ12-SA** 12.5 mm *SmartShutter*® with standalone housing
- **IQ12-AN** 12.5 mm hard anodized *SmartShutter*
- **IQ25-SA¹** 25 mm *SmartShutter* with standalone housing
- **IQ25-W²** 25 mm *SmartShutter* with housing to fit filter wheel
- **IQ25-WU** 25 mm *SmartShutter* to retrofit non-shuttered filter wheel
- **IQ25-LS** 25 mm *SmartShutter* with housing to fit Lambda LS
- **IQ25-DG** 25 mm *SmartShutter* to fit in Lambda DG-4/DG-5
- **IQ35-W** 35 mm *SmartShutter* with housing to fit filter wheel
- **IQ35-SA** 35 mm *SmartShutter* with standalone housing
- **IQ50-SA** 50 mm *SmartShutter* with standalone housing

ACCESSORIES

- **FSWITCH** Foot switch with BNC connector – Changes state of shutter with foot press as long as foot press is maintained
- **FSTOGGLE** Foot switch with BNC connector – Alternates open/close with each foot press
- **CIQ-2** One 25 pin connector to two 9 pin connectors (Connects up to 2 standalone shutters to *SmartShutter*)
- **SLIDE-IN³** Slide-in filter holder for 25 mm wheel
- **DROP-IN⁴** Drop-in filter holder for 25 mm wheel
- **DROP-IN/32** 32 mm drop-in filter holder for LB10-W32IQ
- **X100120** 25 mm filter cup
- **X100145⁵** 25 mm angled filter spacer
- **X100150** 25 mm spacer
- **X100160** 25 mm retaining ring
- **X100122** 32 mm filter cup
- **X100152** 32 mm spacer
- **X100162** 32 mm retaining ring
- **X100124** 50 mm filter cup
- **X100126** 50 mm short filter cup
- **X100154** 50 mm spacer
- **X100164** 50 mm retaining ring
- **LLG** Liquid light guide (2 meters, 3 mm diameter), C-mount, lens, and lens tube
- **SHUTTER** 25 mm replacement shutter for Uniblitz® shutter (not an upgrade)

¹ Where vignetting may be an issue, we recommend the 35 mm shutter.

² For upgrading a 25 mm filter wheel with existing Uniblitz® shutter to *SmartShutter*.

³ Slide-in filter holders are for wheels **with** a shutter.

⁴ Drop-in filter holders are for wheels **without** a shutter.

⁵ Two spacers are required for each filter position.



LAMBDA 10-B

U.S. prices available at www.sutter.com. International prices vary by country. Contact a distributor or Sutter Instrument for a quotation. Prices subject to change without notice.

ACCESSORIES – continued

- **W620005** 9-pin male/female serial cable
- **W620007** 15-pin shielded cable for standard filter wheel
- **W621512** 25-pin cable for wheels with *SmartShutter*
- **W621520** USB cable
- **X100111** 35 mm replacement Uniblitz shutter (not an upgrade)
- **X100208** 8 inch guide rod for stand (each)
- **X100210** 12 inch guide rod for stand (each)
- **X100212** 22 inch guide rod for stand (each)
- **X100560** 25 mm spanner wrench
- **X100555** 25 mm thin wheel spanner wrench
- **X100565** 32 mm spanner wrench
- **X100558** 32 mm thin wheel spanner wrench
- **X100567** 50 mm spanner wrench

SHUTTER MOUNTING POST

Stainless steel 1/2 in diameter. One end is 1/4-20 (M6) tapped hole. Other end is #8-32 (M4) removable threaded stud. Can be used with 25 mm *SmartShutter*, or 35 mm when used with the PMA-IQ35.

- **O620120** 1 in/25 mm long post
- **O620122** 1.5 in/38 mm long post
- **O620123** 2 in/50 mm long post
- **PMA-IQ35** 35 mm post mount adapter

POST HOLDER

- **O620125** 1 in/25 mm holder, spring loaded thumbscrew for mounting post
- **O620130** 2 in/50 mm holder, spring loaded thumbscrew for mounting post
- **O620134** 4 in/100 mm holder, spring loaded thumbscrew for mounting post
- **O620136** 6 in/152 mm holder, spring loaded thumbscrew for mounting post

POST BASE PLATE

- **O620143** 1 in x 2.3 in x .375 in base plate. Suitable for Imperial or Metric tables, posts, and post holders
- **O620140** 2 in x 3 in x .375 in base plate. Suitable for Imperial or Metric tables, posts, and post holders

POST COLLAR

- **O620150** Slip-on collar, 1 in OD x 0.5 in ID

Mounting adapters for Nikon, Zeiss, Leica and Olympus microscopes are available. Please call Sutter Instrument for pricing and further information. Also, please see the Microscope Adapters section of this catalog.



LAMBDA SC SMARTSHUTTER® CONTROLLER



(Shown with IQ35-SA and stand)

FEATURES SMARTSHUTTER

- Robust design
- Life tested to 100 million cycles
- Modular repairable design
- Opening time 8 msec from trigger (for 25 mm and 35 mm versions)
- Continuous operation frequencies as high as 40 Hz
- Standalone or use with Sutter filter wheel
- Mountable in Lambda LS and Lambda DG-4 / DG-5

FEATURES LAMBDA SC

- Microprocessor based controller
- Serial, USB and TTL interfaces
- User can produce a variable aperture by selecting the degree of shutter opening
- "Soft" action mode provides minimum vibration
- TTL activation of the shutter can be set to high, low, or Toggle on rising/falling edge
- Programmable delay and exposure intervals of up to 5 hours with millisecond resolution
- Commands can run continuously or loop a specified number of times
- Programmable delayed sync out
- Universal power supply



The Lambda SC is a full-featured micro-processor controlled shutter driver for the *SmartShutter*[®]. It supports the same shutter command set used for our other Lambda controllers and offers enhanced performance through additional modes of operation. The additional operating modes allow programmable control over the exposure time, the delay between exposures, the number of exposures, the mode of triggering and the mode of shutter operation. The Lambda SC utility program allows computer control and configuration of multiple SC controllers through serial or USB ports.

In the Lambda 10 family of filter wheel controllers, shutter timing is controlled directly by the time of occurrence of commands or TTL input. In most cases, the system software used with these controllers has provisions for controlling the timing of the shutter. The Lambda SC shutter controller may be used in applications that would benefit from enhanced control options built into the controller. A convenient toggle switch on the front panel has three positions: OPEN (shutter will open regardless of other inputs), CLOSED (shutter will close regardless of other inputs) and AUTO. In the AUTO position, the controller can be operated remotely from a computer through the USB port, or opened and closed using a logic level input.

In the free running mode, the shutter will open and close repeatedly. The time between closing and reopening can either be directly timed, or set as an interval for the entire cycle. Delay and exposure intervals can be set by the user for up to 5 hours with millisecond resolution. This mode can be set to continuously run or loop for a specific number of cycles. The mode is initiated from power up, or a trigger pulse, and can be interrupted by using a stop command.

Because the *SmartShutter* incorporates a microprocessor controlled motor/wiper design, the trajectory of each move can be controlled and the motion of the blade optimized for speed or for smoothness. When speed is the most important condition, the user can select the fast mode. If the modest amount of vibration in the fast mode is objectionable and speed is not important, the “soft” mode can be selected, moving the blade slower through the overall travel.

The neutral density mode results in a partial opening of the *SmartShutter*. Any one of the 144 steps from a fully closed to fully open can be selected. Using this variable aperture opening along with a liquid light guide acts to spatially homogenize the light to produce a uniform spatial illumination that’s independent of the geometry of the input illumination.

The *SmartShutter* can be coupled to the illumination ports of most microscopes using an adapter which can be purchased separately. Please refer to the “Microscope Adapters” section for further information. An optical black coating option for the shutter blade is available to eliminate reflection. Please phone Sutter for details.



SPECIFICATIONS LAMBDA SC

- **Dimensions** 8.5 in x 5.25 in x 2 in
21.6 cm x 13.5 cm x 5 cm
- **Weight** 1.7 lbs
0.77 kg
- **Electrical** 120/240 Volts
50/60 Hertz power line
75 Watts max



LAMBDA SC

U.S. prices available at www.sutter.com. International prices vary by country. Contact a distributor or Sutter Instrument for a quotation. Prices subject to change without notice.

CONTROLLER

- **LB-SC** Includes one Lambda SC control unit, serial and USB cable, power cord and manual

SMARTSHUTTER

- **IQ12-SA** 12.5 mm *SmartShutter*® with standalone housing
- **IQ12-AN** 12.5 mm hard anodized *SmartShutter*
- **IQ25-SA¹** 25 mm *SmartShutter* with standalone housing
- **IQ25-W²** 35 mm *SmartShutter* with housing to fit filter wheel
- **IQ25-WU** 35 mm *SmartShutter* with housing to fit filter wheel
- **IQ25-LS** 25 mm *SmartShutter* with housing to fit Lambda LS
- **IQ25-DG** 25 mm *SmartShutter* to fit in Lambda DG-4 / DG-5
- **IQ35-W** 35 mm *SmartShutter* with housing to fit filter wheel
- **IQ35-SA** 35 mm *SmartShutter* with standalone housing
- **IQ50-SA** 50 mm *SmartShutter* with standalone housing

¹ Where vignetting may be an issue, we recommend the 35mm shutter.

² For upgrading a 25 mm filter wheel with existing Uniblitz® shutter to *SmartShutter*®



LAMBDA SC

U.S. prices available at www.sutter.com. International prices vary by country. Contact a distributor or Sutter Instrument for a quotation. Prices subject to change without notice.

CABLES AND ACCESSORIES

- **FSWITCH** Foot switch with BNC connector –
Changes state of shutter with foot press as long as foot press is maintained
- **FSTOGGLE** Foot switch with BNC connector –
Alternates open/close with each foot press
- **W620005** 9-pin male/female *SmartShutter*® (no wheel)
- **W621520** USB cable

SHUTTER MOUNT POSTS

Stainless steel 1/2 in diameter. One end is 1/4-20 (M6) tapped hole. Other end is #8-32 (M4) removable threaded stud. Can be used with 25 mm *SmartShutter*, or 35 mm when used with the PMA-IQ35.

- **O620120** 1 in / 25 mm long post
- **O620122** 1.5 in / 38 mm long post
- **O620123** 2 in / 50 mm long post
- **O620124** 3 in / 76 mm long post
- **O620117** 4 in / 100 mm long post
- **O620119** 8 in / 203 mm long post
- **PMA-IQ35** 35 mm post mount adapter

POST HOLDER

- **O620125** 1 in / 25 mm holder & spring loaded thumbscrew for post
- **O620130** 2 in / 50 mm holder & spring loaded thumbscrew for post
- **O620134** 4 in / 100 mm holder & spring loaded thumbscrew for post
- **O620136** 6 in / 152 mm holder & spring loaded thumbscrew for post

POST BASE PLATE

Suitable for Imperial or Metric tables, posts, and post holders.

- **O620143** 1 in x 2.3 in x 3/8 in base plate.
- **O620140** 2 in x 3 in x 3/8 in base plate.

POST COLLAR

- **O620150** Slip-on collar, 1 in OD x 0.5 in ID

Mounting adapters for Nikon, Zeiss, Leica and Olympus microscopes are available. Please call Sutter Instrument for pricing and further

information. Also, please see the Microscope Adapters section of this catalog.



SMARTSHUTTER®

STEPPER-MOTOR DRIVEN SHUTTER

OPTICAL INSTRUMENTS



(Shown with LB10-B/IQ controller)

FEATURES SMARTSHUTTER®

- Robust design
- Life tested to 100 million cycles
- Modular repairable design
- Opening time 8 msec from trigger (for 25 mm and 35 mm versions)
- Continuous operation frequencies as high as 40 Hz
- Standalone or use with Sutter filter wheel
- Mountable in Lambda LS, Lambda DG-4 / DG-5, and Lambda XL
- Microprocessor based controller
- "Soft" action mode provides minimum vibration
- Selection partial opening function for neutral density
- Serial, USB and TTL interfaces
- Manual input via keypad (on LB10-B/IQ)
- Universal power supply
- Patent No. 7,253,575





The *SmartShutter*[®] is designed to complement our growing line of optical products and sets a new standard for shutter performance and reliability. In the traditional shutter design there are two or more “leaves” that rub against each other. Given time, the blades will wear down, bind, and the shutter will fail to open. The *SmartShutter* is designed with only one moving part, which virtually eliminates the effects of wear and markedly improves performance. In the traditional shutter design there is an additional issue of the leaves binding in extreme temperature conditions. To solve this problem our shutter blade has the ability to perform well under very high temperature conditions, extending the life of the shutter.

The *SmartShutter* incorporates a new high-performance motor drive and precision stepper-motor to provide added control and durability. Traditional shutters use a solenoid actuator requiring a high initial opening voltage for rapid opening of the shutter. This can overheat or burn out the coil of the shutter if the shutter is opened too frequently. With our microprocessor controlled motor/wiper design, we can control the trajectory of each move and optimize the motion of the blade for speed or for smoothness. The *SmartShutter*, in either the 25 mm or 35 mm version, operates with open/close times of 8 msec from the command (3 msec from the start of motion). Since our robust design does not rely on over-driving the windings, we can achieve continuous operation at certain frequencies up to 40 Hz for the 25 mm version, and 20 Hz for the 35 mm model. While the 25 mm *SmartShutter* can run at frequencies up to 40 Hz, some repetition rates may excite undesirable resonances that interfere with proper operation. A small adjustment in frequency will normally correct this.

Because the shutter blade is stopped by the action of the motor rather than mechanical stops, *SmartShutter* units tested for over 100 million cycles show no sign of failure. The standard *SmartShutter* blade is made of untreated aluminum. Non-reflective coatings are available upon request and are not recommended for use with arc lamps.

The microprocessor-based controller provides exceptional versatility and is adaptable to various modes of operation and function. The *SmartShutter* can be programmed for a variety of movement profiles or to produce a variable aperture by determining the degree of shutter opening. When used in our Lambda LS xenon light source and coupled with a liquid light guide, the shutter acts as a programmable neutral density filter. In addition, while the impulse of our shutter is minimal, a “soft” action mode can be selected to decrease vibration.

The LB10-B/IQ controller for the *SmartShutter* is capable of driving up to two shutters. To support this function a TTL input is supplied for remote triggering of the shutter, as well as a TTL output to support remote triggering of external devices such as a camera. The controller can also be operated locally (manually) from the controller keypad or remotely from a computer through either the USB or serial port.

A dedicated single shutter controller, the Lambda SC is also available and provides a USB port, serial port, TTL in and TTL sync out. The Lambda SC allows programmable control over the exposure time, and the delay between trigger and shutter opening.

Originally designed to be integrated into our 25 mm and 32 mm filter wheels, housings are also available for standalone units and for use in our Lambda LS, Lambda XL, and Lambda DG-4/DG-5 optical products. The standard *SmartShutter* blade is made of untreated aluminum. Non-reflective coatings are available upon request and are not recommended for use with arc lamps. The modularity of the *SmartShutter* assures that repairs, should they be necessary, are simple and economical.



SMARTSHUTTER®

U.S. prices available at www.sutter.com. International prices vary by country. Contact a distributor or Sutter Instrument for a quotation. Prices subject to change without notice.

CONTROLLER

■ **LB10-B/IQ¹**

Lambda 10-B control unit, serial and USB cables, power cord and manual

■ **LB-SC**

Includes one Lambda SC control unit, serial and USB cable, power cord and manual

SMARTSHUTTER

■ **IQ12-SA**

12.5 mm *SmartShutter*® with standalone housing

■ **IQ12-AN**

12.5 mm hard anodized *SmartShutter*

■ **IQ25-SA¹**

25 mm *SmartShutter* with standalone housing

■ **IQ25-W²**

25 mm *SmartShutter* with housing to fit filter wheel

■ **IQ25-WU**

25 mm *SmartShutter* to retrofit non-shuttered filter wheel

■ **IQ25-LS**

25 mm *SmartShutter* with housing to fit Lambda LS

■ **IQ25-DG**

25 mm *SmartShutter* to fit in Lambda DG-4 / DG-5

■ **IQ35-W**

35 mm *SmartShutter* with housing to fit filter wheel

■ **IQ35-SA**

35 mm *SmartShutter* with standalone housing

■ **IQ50-SA³**

50 mm *SmartShutter* with standalone housing

¹ Where vignetting may be an issue, we recommend the 35 mm shutter.

² For upgrading a 25 mm filter wheel with existing Uniblitz® shutter to *SmartShutter*.

³ Compatible with Lambda SC controller.

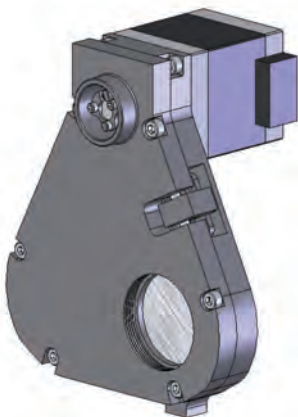

(Shown: IQ25-SA.
Visit our website for images of other shutters.)



SMARTSHUTTER®

U.S. prices available at www.sutter.com. International prices vary by country. Contact a distributor or Sutter Instrument for a quotation. Prices subject to change without notice.

CABLES AND ACCESSORIES

- **FSWITCH** Foot switch with BNC connector – Changes state of shutter with foot press as long as foot press is maintained
- **FSTOGGLE** Foot switch with BNC connector – Alternates open/close with each foot press
- **CIQ-2** One 25-pin connector to two 9-pin connectors (Connects up to 2 standalone shutters to LB10-B/IQ controller)
- **W621520** USB cable
- **W620005** 9-pin male/female SmartShutter® (no wheel)

SHUTTER MOUNT POSTS

Stainless steel 1/2 in diameter. One end is 1/4-20 (M6) tapped hole. Other end is #8-32 (M4) removable threaded stud. Can be used with 25 mm SmartShutter, or 35 mm when used with the PMA-IQ35.

- **O620120** 1 in / 25 mm long post
- **O620122** 1.5 in / 38 mm long post
- **O620123** 2 in / 50 mm long post
- **O620124** 3 in / 76 mm long post
- **O620117** 4 in / 100 mm long post
- **O620119** 8 in / 203 mm long post
- **PMA-IQ35** 35 mm post mount adapter

POST HOLDER

- **O620125** 1 in / 25 mm holder & spring loaded thumbscrew for post
- **O620130** 2 in / 50 mm holder & spring loaded thumbscrew for post
- **O620134** 4 in / 100 mm holder & spring loaded thumbscrew for post
- **O620136** 6 in / 152 mm holder & spring loaded thumbscrew for post

POST BASE PLATE

Suitable for Imperial or Metric tables, posts, and post holders.

- **O620143** 1 in x 2.3 in x 3/8 in base plate.
- **O620140** 2 in x 3 in x 3/8 in base plate.

POST COLLAR

- **O620150** Slip-on collar, 1 in OD x 0.5 in ID

Mounting adapters for Nikon, Zeiss, Leica and Olympus microscopes are available. Please call Sutter Instrument for pricing and further information. Also, please see the Microscope Adapters section of this catalog.

MICROSCOPE ADAPTERS



ORDERING INFORMATION

It is advisable to contact Sutter Instrument to discuss your adapter needs prior to purchasing. All prices are U.S. prices. Pricing in other countries may vary.

LAMBDA FILTERWHEELS

Excitation adapters (suffix EC) include all components necessary for mounting our filter wheels between the microscope lamp housing and excitation port. Please select adapters with a prefix of 10 for wheels with a 25 mm aperture, and a prefix of 32 for wheels with a 32 mm aperture.

LAMBDA 421 / 721 / OBC

Lambda 421, 721, and OBC Beam Combining Systems only require a light guide adapter (prefix LG).

LAMBDA LS and LAMBDA HPX-L5

It is recommended that these instruments be used with the optional Liquid Light Guide and a light guide adapter (prefix LG).

LAMBDA DG-4/DG-5 PLUS (discontinued)

The Lambda DG-4/DG-5 PLUS will only require a light guide adapter (prefix LG).

LARGE FORMAT LIGHT GUIDE ADAPTERS

The large format light guide adapter (suffix LF) is necessary when a demagnification lens is present in the emission path to eliminate vignetting in the camera. This adapter is also recommended for those customers wishing to eliminate vignetting in the eyepiece.

LAMBDA VF-5™, VF-1™, VF-10, and VF-1™ Edge

Please phone Sutter to discuss your microscope and/or mounting requirements.

SmartShutter®

The SmartShutter® can be mounted on the microscope excitation and transmitted light ports using our standard adapters.

For easy reference: IQ25 Excitation - use adapters that begin with **10**

IQ35 Excitation - use adapters that begin with **32**

IQ25 & IQ35 Transmitted light - use adapters ending with **TL**

OPTICAL DECKS

Optical deck platforms are used to access the infinity space of the Olympus IX3 microscope and provide a mounting surface for optical and other elements. The Sutter 32 mm filterwheel (part# LB10-W32-Y73) can be mounted directly onto the deck.



MICROSCOPE ADAPTERS

SUTTER

TLED/TLED+/FLED

SMA-LED¹

Lambda VF-5/VF-1

10-X20-EM

Lambda 421 / 721 / OBC

LG-Y51

SMA Fiber Adapter for TLED, TLED+ or FLED

EMISSION

Light guide adapter

¹ Fits both emission ports

OLYMPUS

IX-70 / IX-50 (Y70) *Please contact Sutter to discuss your needs.*

BX-50 / BX-60 (Y50)

10-Y50-EC

32-Y50-EC

10-Y50-EM

LG-Y50

LG-Y50-LF

25-Y50-TL

35-Y50-TL

EXCITATION

EXCITATION – 32 mm

EMISSION

LIGHT GUIDE

LIGHT GUIDE – Large Format

TRANSMITTED – 25 mm

TRANSMITTED – 35 mm

BX-51 / BX-61 (Y51)

10-Y51-EC

32-Y51-EC

10-Y51-EM

LG-Y51

LG-Y51-LF

25-Y51-TL

35-Y51-TL

SMA-Y51

EXCITATION

EXCITATION – 32 mm

EMISSION

LIGHT GUIDE

LIGHT GUIDE – Large Format

TRANSMITTED – 25 mm

TRANSMITTED – 35 mm

FIBER COLLIMATING

BX-53 / BX-63 (Y53)

10-Y53-EC

32-Y53-EC

10-Y53-EM

10-Y53-IEM

LG-Y53

LG-Y53-LF

25-Y53-TL

35-Y53-TL

EXCITATION

EXCITATION – 32 mm

EMISSION

EMISSION – Infinity

LIGHT GUIDE

LIGHT GUIDE – Large Format

TRANSMITTED – 25 mm

TRANSMITTED – 35 mm

IX-70 / IX50 (Y70)

Please contact Sutter for details

IX-51 / IX71 / IX-81 (Y71)

10-Y71-EC

32-Y71-EC

10-Y71-EM

10-Y71-SU

LG-Y71¹

LG-Y71-LF

25-Y71-TL

35-Y71-TL

EXCITATION

EXCITATION – 32 mm

EMISSION

STAGE UP (IX71 only)

LIGHT GUIDE

LIGHT GUIDE – Large Format

TRANSMITTED – 25 mm

TRANSMITTED – 35 mm



MICROSCOPE ADAPTERS

OLYMPUS

(CONTINUED)

IX-73 / IX-83 (Y73)

10-Y73-EC

32-Y73-EC

10-Y73-EM

LG-Y73¹

LG-Y73-LF

25-Y73-TL

35-Y73-TL

Y73-UD²

EXCITATION

EXCITATION – 32 mm

EMISSION

LIGHT GUIDE

LIGHT GUIDE – Large Format

TRANSMITTED – 25 mm

TRANSMITTED – 35 mm

UP/DOWN SCOPE ADAPTER

¹ Replaces the epi-illuminator

² Contact Sutter for details

OPTICAL DECKS

OD-Y73-7

OD-Y73-15

OD-Y73-R

OD-Y73-L

OPTICAL DECK – NARROW

OPTICAL DECK – WIDE

RIGHT SIDE EXTENSION – 5" x 9"

LEFT SIDE EXTENSION – 5" x 5"

NIKON

TMD (N10)

TS100 (N15)

DIAPHOT 200/300 (N20)

OPTIPHOT (N30)

Please contact Sutter to discuss your needs.

TE200/300 (N25)

10-N25-EC

32-N25-EC

10-N25-EM

35-N25-TL¹

10-N25-QB

LG-N25²

EXCITATION

EXCITATION – 32 mm

EMISSION (needs 1x relay lens)

TRANSMITTED – 35 mm

BOTTOM (QUANTUM)

LIGHT GUIDE

TE2000 (N27)

10-N27-EC

32-N27-EC

10-N27-EM

35-N27-TL

LG-N27²

LG-N27-LF

10-N27-SU³

EXCITATION

EXCITATION – 32 mm

EMISSION

TRANSMITTED – 35 mm

LIGHT GUIDE

LIGHT GUIDE – Large Format

STAGE UP

Ti (N29)

10-N29-EC

32-N29-EC

10-N29-EM

35-N29-TL

EXCITATION

EXCITATION – 32 mm

EMISSION

TRANSMITTED – 35 mm

¹ Please contact Sutter to discuss solutions and early model Nikon scope adapters.

² Replaces the epi-illuminator

³ Places wheel in infinity path below the dichroic cassette



MICROSCOPE ADAPTERS

NIKON (CONTINUED)

Ti (N29) (CONTINUED)

LG-N29¹

LG-N29-LF

10-N29-SU²

10-N29-SB³

MA-N29⁴

LIGHT GUIDE

LIGHT GUIDE – Large Format

STAGE UP

STAGE UP – Bracket only

MOSAIC

Ti2 (N31)

10-N31-EC

32-N31-EC

10-N31-EM

35-N31-TL

LG-N31¹

LG-N31-LF

LG-N31-SF

10-N31-SB³

EXCITATION

EXCITATION – 32 mm

EMISSION

TRANSMITTED – 35 mm

LIGHT GUIDE

LIGHT GUIDE – Large Format

LIGHT GUIDE – Small Format

STAGE UP – Bracket only

E400 & E600 (N40)

10-N40-EC⁵

32-N40-EC⁵

10-N40-EM

LG-N40⁶

LG-N40-R⁷

EXCITATION

EXCITATION – 32 mm

EMISSION

LIGHT GUIDE

LIGHT GUIDE

AZ 100 (N50)

LG-N50

LIGHT GUIDE

FN1 (N65)

10-N65-EC

32-N65-EC

10-N65-EM

LG-N65-LF

EXCITATION

EXCITATION – 32 mm

EMISSION

LIGHT GUIDE – Large Format

E800 & E1000 (N80)

10-N80-EC

32-N80-EC

10-N80-EM

LG-N80

EXCITATION

EXCITATION – 32 mm

EMISSION

LIGHT GUIDE

50i / 80i / 90i / Ni(N85)

10-N85-EC

32-N85-EC

10-N85-EM⁸

10-N85-IN⁹

LG-N85

LG-N85-LF

35-N85-TL

EXCITATION

EXCITATION – 32 mm

EMISSION

EMISSION – INFINITY

LIGHT GUIDE

LIGHT GUIDE – Large Format

TRANSMITTED – 35 mm

¹ Replaces the epi-illuminator

² For use with infinity path emission wheel applications only.

Not applicable for any other applications.

³ For use in conjunction with standard Nikon 70 mm stage up kit (MED53200)

⁴ For use with combination of Mosaic and TIRF attachment

⁵ We will need to know which epi-illuminator you have

⁶ For use with sliding dichroic illuminator

⁷ For use with rotating dichroic illuminator

⁸ Compatible with trinocular head that uses the Y-T photo tube.

All others need infinity emission adapter.

⁹ Puts filter wheel in emission infinity path



MICROSCOPE ADAPTERS

ZEISS

AXIOSKOP 2 & 2 FS (Z25)

10-Z25-EC	EXCITATION
10-Z25-EM¹	EMISSION
35-Z25-TL	TRANSMITTED – 35 mm
LG-Z25	LIGHT GUIDE

AXIOVERT 35 and 100 series (Z30)

10-Z30-EC	EXCITATION
LG-Z30²	LIGHT GUIDE
10-Z30-KP	KELLER PORT
10-Z30-KP-M	KELLER PORT (100M SCOPE)
10-Z30-SP	SIDE PORT
10-Z30-TH	TRINOCULAR HEAD
10-Z30-TH-M	TRINOCULAR HEAD (135M SCOPE)

AXIOVERT 200 (Z35)

10-Z35-EC	EXCITATION
32-Z35-EC	EXCITATION – 32 mm
10-Z35-EM	EMISSION (side port on left)
10-Z35-EM-M	EMISSION – motorized
35-Z35-TL	TRANSMITTED – 35 mm
10-Z35-KP	KELLER PORT
LG-Z35	LIGHT GUIDE
LG-Z35-LF	LIGHT GUIDE – Large Format

AXIO OBSERVER (Z40)

10-Z40-EC	EXCITATION
32-Z40-EC	EXCITATION – 32 mm
10-X10-EM³	EMISSION (adapter only)
10-X20-EM	EMISSION (with relay optical system)
LG-Z40²	LIGHT GUIDE
LG-Z40-LF	LIGHT GUIDE – Large Format
25-Z40-TL	TRANSMITTED – 25 mm
35-Z40-TL	TRANSMITTED – 35 mm
SMA-240	FIBER COLLIMATING

AXIO IMAGER (Z45)

AXIO EXAMINER

10-Z45-EC	EXCITATION
32-Z45-EC	EXCITATION – 32 mm
10-X10-EM³	EMISSION (adapter only)
10-X20-EM	EMISSION (with relay optical system)
LG-Z45	LIGHT GUIDE
LG-Z45-LF	LIGHT GUIDE – Large Format
25-Z45-TL	TRANSMITTED – 25 mm
	TRANSMITTED – 35 mm

AXIOPLAN 2 (Z50)

Please contact Sutter to discuss your needs

¹ Please specify standard or ergonomic trinocular head

² Replaces the epi-illuminator

³ Will need to be used with a relay optical system



MICROSCOPE ADAPTERS

LEICA

DMR (L10)
10-L10-EC EXCITATION
32-L10-EC EXCITATION – 32 mm
10-L10-EM EMISSION
LG-L10 LIGHT GUIDE

DMIRB & DMIRE2 (L20)
10-L20-EC EXCITATION
32-L20-EC EXCITATION – 32 mm
10-L20-EM¹ EMISSION
LG-L20¹ LIGHT GUIDE
LG-L20-LF LIGHT GUIDE – Large Format

DM 4000/5000/6000 (L30)
10-L30-EC EXCITATION
32-L30-EC EXCITATION – 32 mm
10-L30-EM EMISSION
LG-L30 LIGHT GUIDE
LG-L30-LF LIGHT GUIDE – Large Format

DM 6000 FS (L35)
10-L35-EC EXCITATION
32-L35-EC EXCITATION – 32 mm
10-L35-EM EMISSION
LG-L35 LIGHT GUIDE
LG-L35-LF LIGHT GUIDE – Large Format

DMI 4000/5000/6000 (L40)
10-L40-EC EXCITATION
32-L40-EC EXCITATION – 32 mm
10-L40-EM EMISSION
35-L40-TL TRANSMITTED – 35 mm
LG-L40² LIGHT GUIDE
LG-L40-LF LIGHT GUIDE – Large Format

Dmi8
10-L45-EC EXCITATION
32-L45-EC EXCITATION – 32 mm
10-L45-EM EMISSION
35-L45-TL TRANSMITTED – 35 mm
LG-L45 LIGHT GUIDE
LG-L45-LF LIGHT GUIDE – Large Format

OTHER ADAPTERS

YOKOGAWA CSU-X1(J15)
10-J15-EM³ EMISSION
10-J30-EM EMISSION – 3 degree angle

CARV (J20)

CARV II *Please contact Sutter to discuss your needs.*

¹ Please specify standard or ergonomic trinocular head

² Replaces the epi-illuminator

³ Fits both emission ports

MICROINJECTION

XenoWorks™ is a modular microinjection system designed to meet a wide variety of application needs. Our experience with precision motor control has culminated in this state-of-the-art system.

The XenoWorks Micromanipulator uses a classic inverted joystick design for excellent ergonomics, intuitively linking the user with the micropipette. Combined with our smooth, responsive stepper-motor drives, the XenoWorks Manipulator provides exceptional mechanical stability, sensitivity, and range of movement.

The XenoWorks Digital Microinjector was designed for precision manipulation of cells via an easy-to-use interface. The Digital Microinjector employs two pressure ports, one for holding suspended cells, and a second channel is available for both high-pressure injection and gentle positive/negative pressure for transfer of embryonic stem cells. Both injection duration and pressure are easily selectable using rotary knobs on the remote interface. The built-in compressor removes the need for an external pressure supply.

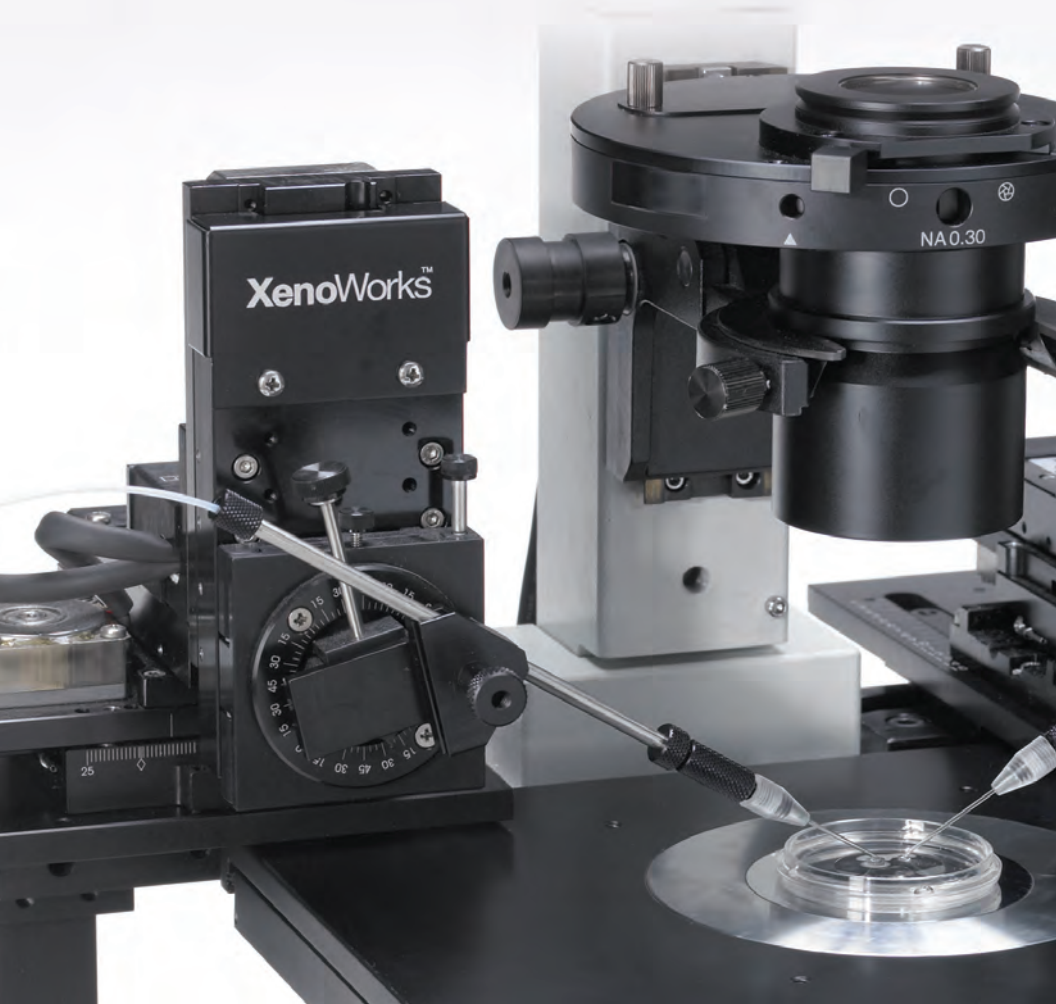

APPLICATIONS

- Pronuclear microinjection of DNA into mouse zygote
- Embryonic stem cell transfer into blastocysts
- Somatic cell nuclear transfer (ES cell)
- Clustered regularly interspaced short palindromic repeats (CRISPR)
- Adherent cell microinjection
- Drosophila injection
- C. elegans injection
- Zebrafish injection
- Contact Sutter for suitability of XenoWorks for applications not listed here





New

XENOWORKS™ MICROMANIPULATOR

MICROINJECTION



FEATURES XENOWORKS™ MICROMANIPULATOR

- Joystick and controller integrated into a single unit eliminates the need for a separate component.
- Inverted joystick with adjustable height and tension for optimal ergonomics
- Exceptionally smooth and responsive micropipette movement
- Diagonal mode operation for axial pipette movements
- One-click, axial 'Pulse' operation helps penetrate tough membranes
- User-defined "Home" position and "Work" positions for fast micropipette exchange
- User-defined limits for travel along Z-axis and X-axis
- Locks for X- and Y-axes permit pure movements along Y- and X-axes
- 25 mm of travel in all three axes
- Touch declutch mechanism
- 8 speeds from coarse to ultra-fine
- USB computer interface for external programmable control



The XenoWorks™ Micromanipulator has been designed around our hugely successful MP-285 electrophysiology micromanipulator mechanical, with the addition of a smooth-moving, adjustable, inverted joystick. Because the motor drive is based on an electrophysiology design, the XenoWorks Micromanipulator is extremely stable and resistant to ambient vibration. This stability also makes this manipulator an ideal platform for use in conjunction with the PrimeTech PMM6, PMM-4G or PMM-150FU Piezo Impact Drive, for applications such as mouse nuclear transfer and intracytoplasmic sperm injection.

The redesigned XenoWorks joystick controller offers an unprecedented level of user comfort during operation. The controller circuitry is fully integrated into the joystick, fanless and completely silent. The use of an inverted, height-adjustable joystick user interface in conjunction with the functionally shaped base allows the operator to rest their hands and forearms on the bench surface, providing ease of use and added ergonomics. The function keys and declutch mechanism can be located and activated by touch, removing the need to look away from the microscope, which will save time. Other time saving features are the user-defined Home position, two user-defined Work positions, and the Setup function, which centers the manipulator in all axes.

Lock functions for both the X and Y axis allow restricting movement to only two dimensions for maximum control during injections. The Z-Floor memory position is used to prevent the pipette from colliding with the bottom of the dish, while the equivalent function for the X axis is useful for repetitive injections into a line of eggs. The newly introduced Diagonal mode enables motion in the axis of the pipette. Combining diagonal mode with the new Pulse motion facilitates penetrating specimens with a resilient cuticle.

To eliminate guesswork, the status of all functions and motions is put out in the convenient LED display.

The XenoWorks joystick is designed to allow the user to immediately develop an intuitive feel that makes it easy to precisely control position. Movement of the joystick is directly converted to a proportional movement of the manipulator. Speed control, center of travel, and programmable positions are right at your fingertips. One unique feature of the joystick is the declutch mechanism that allows for rapid repositioning of the joystick without moving the pipette. The declutch ring is also used as a modifier key, which gives individual buttons additional functions. Combining this advanced joystick with the proven Sutter manipulator technology creates an ideal system for efficient microinjection.





SPECIFICATIONS

XENOWORKS™ MICROMANIPULATOR

MICROINJECTION

■ **Travel** 25 mm on all three axes

■ **Maximum Resolution** 125 nm/microstep

■ **Maximum Speed** 3.25 mm/s

Speed Setting	X & Y Axis (per swing of joystick)	Z Axis (per rotation of knob)
	C	15.9 mm
1	4.1 mm	800 μm
2	1.1 mm	400 μm
3	500 μm	200 μm
4	250 μm	100 μm
5	125 μm	50 μm
6	100 μm	30 μm
7	50 μm	10 μm

- **Joystick Controller Features**
- Inverted joystick
 - Adjustable height and tension
 - Independent control of X, Y, and Z movement
 - 2 user-defined Work positions
 - 1 user-defined Home position
 - Setup function
 - Touch declutch
 - Z-floor axis limit
 - Y-axis lock
 - X-axis lock
 - X-axis limit
 - Diagonal Mode
 - 8 Speed settings
 - Pulse Mode, 3μm diagonal advance

■ **Dimensions** *Mechanical drive:*
112 mm x 185 mm x 145 mm

Joystick Controller:
289 mm x 235 mm x 244 mm

■ **Electrical** 120/240 Volts
50/60 Hertz power line





XENOWORKS™ MICROMANIPULATOR

U.S. prices available at www.sutter.com. International prices vary by country. Contact a distributor or Sutter Instrument for a quotation. Prices subject to change without notice.

- **XWML** XenoWorks™ Micromanipulator (Left) Includes: 3 axis motor drive (left-hand configuration), motor drive base plate, joystick controller, connecting cables, and manual
- **XWMR** XenoWorks Micromanipulator (Right) Includes: 3 axis motor drive (right-hand configuration), motor drive base plate, joystick controller, connecting cables, and manual
- **XWJOY** XenoWorks Joystick Controller, power supply, and manual; for use with existing XenoWorks or MPC-285/M mechanicals

XENOWORKS MICROSCOPE ADAPTERS

- **BR-L20** Leica DMIRB/E/IRE2 adapter
- **BR-L30** Leica DMIL adapter
- **BR-L40** Leica DMI 4/5/6000/8 adapter (double-sided)
- **BR-N10** Nikon TMD adapter
- **BR-N25** Nikon TE200/300 adapter
- **BR-N27** Nikon TE2000 adapter
- **BR-N29** Nikon Ti adapter
- **BR-N29-M** Nikon Ti adapter for scopes with motorized stage
- **BR-Y50** Olympus IX50/70 adapter
- **BR-Y51** Olympus IX51/71/81 adapter
- **BR-Y51-FL** Olympus IX51/71/81 adapter with ZDC autofocus, left
- **BR-Y51-FR** Olympus IX51/71/81 adapter with ZDC autofocus, right
- **BR-Y73** Olympus IX53/73/83 adapter
- **BR-Y73-2** Olympus IX53/73/83 adapter (2 sides)
- **BR-Z30** Zeiss Axiovert 100/135 adapter
- **BR-Z40** Zeiss Axiovert 200, Axio Observer adapter
- **BR-Z50** Zeiss Axiovert A1 adapter
- **BR-CUST** Custom microscope adapter, e.g., for aftermarket microscope stage or accessories; contact Sutter for details.

ACCESSORIES

- **BR-AW** Rod holding clamp (for rod OD 2-4mm)
- **MT-81-DOV8¹** MT-81 stand with 8 inch dovetail
- **MT-81-DOV12¹** MT-81 stand with 12 inch dovetail
- **MAG-MT** Magnetic feet (set of 4)
- **BR-HEA-CV²** Swing gate conversion for MP-285 / MP-225

¹ Useful with stereo or dissection scopes.

² Factory installation required. No charge when ordered with manipulator.



(Shown: MT-81-DOV8)



XENOWORKS™ **DIGITAL MICROINJECTOR**



FEATURES **XENOWORKS™ DIGITAL MICROINJECTOR**

- Built-in compressor with remote user interface
- Two independent pressure channels
- Negative and positive pressure
- Two injection modes: pulse and continuous
- Four functions: Hold, Transfer, Inject, Clear
- Transfer channel provides compensation pressure for high pressure injection
- Five range settings for transfer/compensation pressure
- Rotary controls for continuous pressure adjustment
- ON-OFF key for Hold channel
- Standby mode for transfer/compensation channel
- USB port



The XenoWorks™ Digital Microinjector is designed for transgenic mammal workstations, and adherent cell, *C. elegans*, *drosophila*, zebrafish, *xenopus* and sea urchin injections. It is capable of holding oocytes and embryos while simultaneously providing a separate pressure channel for pronuclear microinjection of DNA or the gentle control of embryonic stem cells as they are transferred into blastocysts. The microinjector employs two independent pressure channels: Hold and Inject/Transfer, which are controlled via the remote user interface.

The hold port is a self-contained vacuum channel for gentle suspension-cell holding and can be switched on and off as needed. The responsive rotary control is used to dial the pressure up or down according to the degree of hold required.

The injector/transfer port is a second channel for delivering both high-pressure for femtoliter to microliter volume injections, and gentle positive/negative pressure for embryonic stem (ES) cell transfer. The transfer channel has five range settings to optimize the system to each application and user preference. It also includes a Clear function which can be used if the pipette gets clogged. Two modes of injection, Continuous or Pulse, in combination with a balance pressure, are available on this channel. In the Continuous mode, the inject pressure is applied to the micropipette tip for as long as the hand- or foot-switch is held down. In the Pulse mode, the inject pressure is applied for a precisely timed duration, which can be set in 0.01 second increments. Both injection duration and pressure are easily selectable using rotary controls on the remote interface. Injections are executed using the inject key on the remote interface or the footswitch.

Optimal ergonomics are again a prime consideration. The remote interface unit provides access to all keys and rotary controls necessary to manipulate the parameters of the two pressure channels, while the separate compressor controller can be positioned away from the microscope to eliminate vibration.

In addition to pronuclear injection, the XenoWorks Digital Microinjector can be used for a variety of intracellular and extracellular applications including adherent and suspended cell microinjection.



SPECIFICATIONS

XENOWORKS™ DIGITAL MICROINJECTOR

- Hold Function** *Hold pressure:*
-350 to +350 hPa in 1 hPa increments
- Inject Function** *Inject modes:* Continuous or Pulse
Inject pressure: 0 to 5600 hPa in 7 hPa increments
Compensation pressure: Adjustable in 1 hPa increments
Inject time: 0 to 10 seconds in 0.01 sec increments
Clear pressure: 6700 hPa (97 psi)
Inject command: Remote interface or foot switch
- Transfer Function** *Transfer pressure:*
-175 to +175 hPa (Range setting 1) in 1 hPa increments
Adjustable using range setting dial
- Maximum Injection Pressure** 5600 hPa (80 psi)
- Controls** Tactile keys, rotary optical encoders
3 x 7 segment LED display
- Micropipette Holder** *Rod Diameter:*
4 mm
Compatible with:
1 mm capillary glass
(1.2 mm and 1.5 mm available upon request)
2.4 m ETFE tubing (2 additional sets included)
- Electrical** 115/230 Volts
50-60 Hertz power line
- Dimensions** *Compressor module:*
407 mm x 440 mm x 150 mm
User interface module
164 mm x 123 mm x 70 mm
- Weight** *Compressor module:*
1504 g
User interface module:
42 g





XENOWORKS™ DIGITAL MICROINJECTOR

U.S. prices available at www.sutter.com. International prices vary by country. Contact a distributor or Sutter Instrument for a quotation. Prices subject to change without notice.

■ BRE

XenoWorks™ Digital Microinjector. Includes: compressor module, footswitch, remote user interface, 2 micropipette holders with 2.4 m ETFE tubing and fittings, spare tubing, connecting cables, and manual

ACCESSORIES

- **BR-DT** XenoWorks digital tubing kit
- **BR-OIL** XenoWorks oil for injector (100 ml)
- **BR-MH** XenoWorks micropipette holder
- **BR-MH1.0** Micropipette replacement tip (1.0 mm OD glass)
- **BR-MH1.2** Micropipette replacement tip (1.2 mm OD glass)
- **BR-MH1.5** Micropipette replacement tip (1.5 mm OD glass)
- **V001104** 1/16 in clear ferrule for tubing
- **V300450** 1.0 - 1.2 mm O-ring (package of 6)
- **V300455** 1.5 mm O-ring (package of 6)
- **V400105** Drierite-w/Cobalt Chloride (5 lb)
- **X870700** Drierite Tube Assembly-Complete, w/ports



(Remote user interface)



XENOWORKS™ XWI MOTORIZED MICROINJECTOR

New



FEATURES XENOWORKS™ XWI MOTORIZED MICROINJECTOR

- Multiple modes of operation: manual, automatic, and USB control
- Ergonomic controller for comfortable operation
- Diverse applications ranging from *in-vitro* fertilization to stereotaxic injection
- Footswitch triggering of programmed injections
- Accurate and reproducible injection and aspiration
- Minimum micropipette tip size of 4 μ m
- High resolution and dynamic range
- Remote operation to minimize vibration
- Automated injection volumes from 1 nL to 500 μ L
- Can be used with needles pulled from 1.0 – 1.2 mm capillaries
- Real-time injection volume readout



The Xenoworks™ XWI motorized microinjector is a versatile hydraulic microinjector designed for use in microinjection workflows, as well as in stereotaxic and other tissue injections. The XWI uses a stepper motor linear actuator to drive a piston accurately and reproducibly against a column of hydraulic fluid, producing reliable fluid motion in an injection pipette. The full stroke of the XWI actuator is 500 μ L, allowing the injector to be used for many injections before the fluid reservoir must be refilled.

For microinjection workflows, manual operation of the injector using the rotary encoder on the controller gives users direct control over injection and aspiration. The injection rate in manual operation mode spans three orders of magnitude, with fluid displacement rates varying from 3.1 μ L/revolution to 70 nL/revolution in five discrete steps. Separation of the injector mechanical from its controller allows users to control the injector without introducing vibrations into their preparations.

Manual operation of the XWI is suited for numerous applications including:

- Pronuclear Injection
- Generation of holding force
- Nuclear transfer
- Preimplantation genetic testing
- Embryonic stem cell injection
- Xenopus Oocyte injection
- Embryo injections
- Polar body biopsy
- Blastocyst Injection
- Single-cell picking

For stereotaxic and other tissue injections, the XWI has a programmable automatic mode with injection and aspiration rates between 1 nL/s and 10 μ L/s. Unlike other nanoliter injectors, the XWI can be easily configured for use with injection pipettes fabricated from glass capillaries with outer diameters between 1.0 and 1.2 mm, regardless of inner diameter. The micropipette holder of the XWI can be mounted to commercially available stereotaxic frames with stock adaptors. For other tissue injections, the micropipette holder can easily be held in one hand while the controller is operated either by the other hand, or the included footswitch. Alternatively, the micropipette holder fits stock rod holders of most micromanipulators and can be mounted on any Sutter Instrument micromanipulator. Use of a glass, rather than metal, microinjection needle minimizes damage to the target tissue while simultaneously improving targeting and specificity. It does this by allowing for the use of needles with small outer diameters and bore diameters as small as 4 μ m. In automatic mode, the XWI can be programmed to inject between 1 nL and 500 μ L of solution in a single programmed injection.

Automatic operation of the XWI microinjector is suited for any application where a pneumatic, hydraulic, or syringe pump injector might be used including:

- Stereotaxic injection
- Nerve injection
- (Xeno)transplantation
- Subretinal injection
- Intravitreal injection
- Intrathecal and spinal cord injection
- Round window and semicircular canal injection
- Cerebrospinal fluid (CSF) sampling
- Controlled dispensing of fluids

The XWI motorized microinjector can also be controlled by a computer via USB with user-designed software, using freely available Sutter Instrument drivers and software development kits.



SPECIFICATIONS

XENOWORKS™ XWI MOTORIZED MICROINJECTOR

- **Full Stroke Volume** 500 μ L
- **Piston Resolution** 275 pL (*Manual Mode*)
1 nL (*Automatic Mode*)
- **Injection Rates** 70 nL/Rev – 3.1 μ L/Rev (*Manual Mode*)
 ± 1 nL/s - ± 10 μ L/s (*Automatic Mode*)
- **Features**
 - Manual and automatic operation modes
 - Versatile applications
 - Rotary encoder interface
 - High resolution
 - Large volumetric operating range
 - Realtime volume readout
 - Footswitch operation
 - Ergonomic design
- **Dimensions**
Injector Mechanical:
255 mm x 35 mm x 35 mm
Controller:
1140 mm x 130 mm x 80 mm
- **Electrical**
115/230 Volts
50-60 Hertz power line





XENOWORKS™ XWI MOTORIZED MICROINJECTOR

U.S. prices available at www.sutter.com. International prices vary by country. Contact a distributor or Sutter Instrument for a quotation. Prices subject to change without notice.

■ XWI

Xenoworks™ Motorized Microinjector Includes: Hydraulic injector body, ROE controller, footswitch, microtool holder, injection and filling tubing, connecting cables, and manual.

ACCESSORIES

■ XWI-MH

XWI microtool holder with O-Rings, gaskets for 1.0 – 1.2 mm OD pipettes.

■ XWI-FILL

Filling kit for Xenoworks Motorized Microinjector.

■ XWI-AT

Spare injection tubing and fittings for Xenoworks Motorized Microinjector.

■ FC770

Fluorinert, 100 mL

■ BR-OIL

Light mineral oil, suitable for mouse embryo cell culture



MANUAL MICROINJECTOR

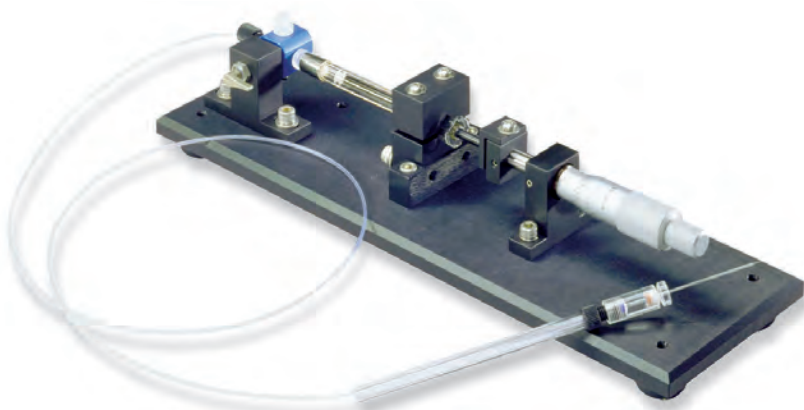

The Manual Injector is a manual syringe driver for pneumatic or hydraulic control of injection needles or holding pipettes. It is suitable for injecting volumes in the nanoliter to microliter range. It is also widely used as a fluid control device for applications requiring sensitive manual control of the displacement of microneedle contents. The system is constructed from the highest quality parts. The base assembly is black anodized aluminum. A non-rotating Mitutoyo micrometer provides the drive to the gas-tight syringe¹. A precision 3-way valve provides a convenient method for filling the fluid line and clearing air bubbles from the line. Teflon tubing, chromatography connectors and a pipette holder² complete the system.

The injection resolution is dependent on the volume of the syringe that is installed, as outlined in the table below. For example, with a 25 μl syringe installed, one complete rotation of the micrometer (25 divisions) yields a displacement equivalent to a volume of 267 nl and turning the micrometer one division (0.001 in) yields 10.6 nl.

SYRINGE VOLUME	VOLUME PER REVOLUTION	VOLUME PER DIVISION
10 μl	106 nl	4.2 nl
25 μl	267 nl	10.6 nl
50 μl	529 nl	21.2 nl
100 μl	1.06 μl	42.3 nl
250 μl	2.65 μl	105.8 nl
500 μl	5.29 μl	211.7 nl
1000 μl	10.58 μl	423.4 nl

¹ Please specify the syringe volume that you will be using. For animal IVF applications, 500 μl and 1000 μl syringes are commonly used.

² Unless specified otherwise, a pipette holder for 1 mm outside diameter glass will be supplied. The diameter of the pipette holder is 0.25 inches (6.4 mm). For micromanipulators that cannot accept this size holder, an adapter is optionally available. Please contact us for further information.



SPECIFICATIONS MANUAL MICROINJECTOR

- **Dimensions** 12 in x 3.75 in x 4 in
30 cm x 9.5 cm x 10 cm
- **Weight** 2.5 lbs
1 kg

MANUAL MICROINJECTOR

U.S. prices available at www.sutter.com. International prices vary by country. Contact a distributor or Sutter Instrument for a quotation. Prices subject to change without notice.

- **MANUAL** Manual injector with non-rotating micrometer, 3-way valve, precision 50 μ l gas-tight syringe, teflon tubing, connectors and MI-10010 pipette holder assembly for 1.0 mm capillary tubing*

* Other syringe volumes, and pipette holder sizes are available upon request.

ACCESSORIES MANUAL MICROINJECTOR

- **MI-10010** Pipette holder assembly for 1.0 mm OD glass (includes holder and mounting rod)
- **MI-10012** Pipette holder assembly for 1.2 mm OD glass (includes holder and mounting rod)
- **MI-10015** Pipette holder assembly for 1.5 mm OD glass (includes holder and mounting rod)
- **BR-OIL** Oil for injector (100 ml)
- **V200050** Teflon tubing
- **V001180¹** 10 μ l gas-tight syringe
- **V001181** 25 μ l gas-tight syringe
- **V001182** 50 μ l gas-tight syringe
- **V001183** 100 μ l gas-tight syringe
- **V001184** 250 μ l gas-tight syringe
- **V001185** 500 μ l gas-tight syringe
- **V001186¹** 1000 μ l gas-tight syringe
- **V300450** 1.0–1.5 mm O-Ring (Package of 6)
- **V300455** 1.5 mm O-Ring (Package of 6)
- **V001104** 1/16 in. clear ferrule for tubing

¹ Requires special assembly and parts when ordered separately. Please contact Sutter.



PRIME TECH PMM6 PIEZO IMPACT DRIVE



FEATURES PMM6

- Smooth, controlled penetration of micropipette tips through cellular membranes
- Inertial force from piezo-electric control minimizes damage of biomembranes
- Touch screen display
- Smaller piezo drive unit is adjustable on pipette mounting rod
- 3 Modes: Standard, Piezo ICSI, and Expert
- 8 memory program positions
- Compact design



Microinjection demands precise and delicate penetration of cellular membranes. Prime Tech's popular PMM-150FU and PMM-4G Piezo Impact Drives have set the industry standard for easy operation and reproducible results. Building on that expertise, Prime Tech has developed and is now proud to announce their new PMM6 Piezo Impact Drive.

The PMM6 builds upon a new, smaller, piezo-drive unit which delivers:

- more effective and gentler coupling between the piezo cell and the micropipette tip
- user-adjustable driving force

The updated user-interface is optimized for ease of use and includes:

- A touch-screen to ease operations and display the settings of the current program
- 3 programmable operating modes – Standard, Piezo-ICSI, and Expert – allowing each user to balance simplicity of operation with precise control, according to their specific needs,

With its new designs, features and functions, Prime Tech's PMM6 delivers:

- Precision microinjection that is "Gentle for both Oocyte and Operator"
- User friendly operation for both the beginner and the expert!

The PMM6 system comprises:

Piezo Drive unit [MB-D-2]

The new and improved MB-D-2 drive unit mounts easily to the manipulator and pipette holder, has greater durability and performance, and performs injections more gently.

Interface Module [TS-1]

The TS-1 touch screen interface displays the settings for the user's chosen operating mode and provides remote controlled operation of the MB-D-2 or MB-U-2 piezo drive-unit. Its compact size means users can move and place the TS-1 for their comfort and ease of use. Settings can be selected individually, or an on/off switch can be used to control the entire unit.

Controller [PMAS-CT6]

The PMAS-CT6 controller accepts user-commands from the TS-1 Interface Module and powers and precisely supervises operation of the connected MB-D-2 or MB-U-2 piezo-drive-unit.

Foot switch [OP-16]

The dual-pedal foot switch provides convenient, 'hands free' and 'vibration free' command of the piezo drive unit and switching between two pre-set operating modes such as 'Zona Pellucida' and 'Membrane'.

The PMM6 is designed for multiple micromanipulation applications including:

- ICSI
- Enuclation
- Nuclear Transfer
- ES Cell Injection
- Assisted Hatching



SPECIFICATIONS PMM6

- **Piezo Impact Drive Unit (MB-D-2)**
 - Moving range: ~5 mm
 - Traveling resolution: ~0.1 μ m
 - Traveling speed: 0.04 mm/s max
- **Operation Box**
 - Touch screen display
 - 3 modes of operation: Standard, Piezo-ICSI, Expert
 - Expert mode has 8 program positions
 - 1/2 + 2/3 power options
- **Foot Switch**
 - Mode A/B selection
 - Activation of Piezo
- **Dimensions**
 - Controller:*
 - 9.5 in x 13 in x 5.5 in
 - 240 mm x 340 mm x 140 mm
 - Operation Box:*
 - 4 in x 6.3 in x 2.4 in
 - 100 mm x 160 mm x 60 mm
 - Foot Switch:*
 - 5.5 in x 5.5 in x 1.5 in
 - 145 mm x 145 mm x 38 mm
- **Weight**
 - Controller:*
 - 11 lbs
 - 5 kg
 - Piezo Drive Unit:*
 - 0.3 lbs
 - 125 g
 - Operation Box:*
 - 1.2 lbs
 - 530 g
 - Foot Switch:*
 - 1.8 lbs
 - 820 g
- **Electrical**
 - AC supply of 100-240 Volts
 - 50/60Hz, 50 mA
- **Temperature**
 - Operates at 5° to 40° C
 - Avoid high humidity





PMM6

U.S. prices available at www.sutter.com. International prices vary by country. Contact a distributor or Sutter Instrument for a quotation. Prices subject to change without notice.

■ **PMM6**

Includes: controller, operation box,
piezo impact drive unit and foot switch

Available from Sutter in the Western Hemisphere.

Please contact Sutter for other international destinations.



PRIMETECH HDJ-M3 HYDRAULIC MICROINJECTOR



FEATURES HDJ-M3

- A large plunger knob that is extremely light to the touch means that you can operate the HDJ-M3 with a single finger
- Flexible layout accommodates multiple connector configurations
- Airtight, with Luer connector and O-ring means that you can expect leakage-free microinjection

DESCRIPTION HDJ-M3

The HDJ-M3 microinjector from PrimeTech is a manual water/oil type pressure injector. The HDJ-M3 will allow you to inject spermatozoa, DNA and/or other solutions into somatic cells, unfertilized eggs or embryos. Manual operation with HDJ-M3 allows maximum sensitivity and optimized performance during micromanipulation.

HDJ-M3 is compatible with other models in the PMM Series, including the PMM-150FU unit.



SPECIFICATIONS HDJ-M3

- **Syringe Volume** 1.9 ml Screw
Pitch: 0.05 mm
Stroke: 20 mm
- **Dimensions** 2.75 in (W) x 7.2 in (D) x 3.5 in (H)
70 mm (W) x 182.5 mm (D) x 90 mm (H)
- **Weight** 1.9 lbs
0.88 kg

HDJ-M3

U.S. prices available at www.sutter.com. International prices vary by country. Contact a distributor or Sutter Instrument for a quotation. Prices subject to change without notice.

- **HDJ-M3** Hydraulic Microinjector

*Available from Sutter in the Western Hemisphere.
Please contact Sutter for other international destinations.*



PRIMETECH PNJ-T2 PNEUMATIC MICROINJECTOR

MICROINJECTION



FEATURES PNJ-T2

- PNJ-T2 is optimized for use with PMM systems
- Low-maintenance systems
- Highly responsive pneumatic control

DESCRIPTION PNJ-T2

The PNJ-T2 pneumatic microinjector from PrimeTech is optimized for use with the PMM piezo impact drives. The PNJ-T2 has a smooth motion and positive feel. The pneumatic system requires little maintenance compared to hydraulic units.

Suitable for a wide range of applications.



SPECIFICATIONS PNJ-T2

■ Syringe Volume	5.0 ml Screw Pitch: 2.0 mm Diaphragm Travel: 16 mm
■ Dimensions	2.9 in (W) x 6.55 in (D) x 3.5 in (H) 73 mm (W) x 166.6 mm (D) x 90 mm (H)
■ Weight	2.05 lbs 0.93 kg

PNJ-T2

U.S. prices available at www.sutter.com. International prices vary by country. Contact a distributor or Sutter Instrument for a quotation. Prices subject to change without notice.

■ **PNJ-T2** Pneumatic Microinjector

*Available from Sutter in the Western Hemisphere.
Please contact Sutter for other international destinations.*



APPLICATIONS

The configuration of any micro-injection system will depend upon the application for which it is used. Some common applications and system configurations are:

Stem Cell Transfer into Blastocysts

Animals, usually mice, can be engineered with a specific gene function reduced or knocked out altogether by introducing genetically altered embryonic stem cells into the cavity of a blastocyst so that the stem cells contribute to the embryo. The resulting live animal is a chimera of both genotypes. Subsequent selective interbreeding of manipulated animals results in pure-bred gene “knock-outs” or “knock-downs” and can be used for subsequent gene function studies. This operation requires two micromanipulators, one for holding the blastocyst and one for transferring the cells. Both holding and transfer functions require gentle positive and negative pressure for which the **Digital Microinjector** is ideal.

Suggested system configuration:

- 1 x Micromanipulator (Right) XWMR
- 1 x Micromanipulator (Left) XWML
- 1 x Digital Microinjector BRE
- 2 x Microscope Adapter





Zygote Pronuclear DNA Microinjection

The microinjection of DNA into the pronucleus of a newly-fertilized mammalian egg is now a common and highly efficient method of creating transgenic offspring.

Pronuclear microinjection was first described in the mouse, but now many different transgenic animals have been created in this way. Because the micropipette used for injection has an internal diameter typically less than one micron, relatively high pressure (>3000 hPa) is required to inject the DNA solution. Two micromanipulators are required, one to hold the zygote and one to inject the DNA. Gentle negative pressure is used on the holding side, while pulses of high pressure are used to inject 1–2 pL of DNA solution into the pronucleus. The **XenoWorks® Digital Microinjector** is ideal for this application, having simultaneous holding and high-pressure injecting capabilities.

Suggested system configuration:

- 1 x Micromanipulator (Right) XWMR
- 1 x Micromanipulator (Left) XWML
- 1 x Digital Microinjector BRE
- 2 x Microscope Adapter





Microinjection of Cultured, Adherent Cells

Cultured cell lines such as 3T3, CHO and HeLa can be microinjected while attached to a Petri dish. The procedure is best viewed through phase-contrast optics; a single micromanipulator and a single high-pressure microinjection channel are required. The tip of a sharp (inner diameter less than 1 micron) micropipette is brought down on top of a single cell and a pulse of high (100–1000 hPa) pressure applied. The cell membrane is ruptured and the cell can be seen to inflate slightly. Volumes injected are typically less than 5% of the cell volume. Success rates vary widely depending upon the type and volume of compound injected, the culture conditions and the cell line used. The high-pressure function of the **Digital Microinjector** and the smooth, fine control of the micromanipulator are particularly well-suited to this application.

Suggested system configuration:

- 1 x Micromanipulator (Right) WXMR
- 1 x Digital Microinjector BRE
- 1 x Microscope Adapter

Please contact Sutter Instrument for help and advice with these and any other microinjection needs.





AIR TABLES & FARADAY CAGES VIBRATION ISOLATION SYSTEMS

AIR TABLES, PERFUSION SYSTEMS, AND CUSTOM PRODUCTS



FEATURES AIR TABLES & FARADAY CAGES

- Provides a stable, level basis for your experimental setup
- Active air suspension maintains leveling
- Vertical and horizontal vibration isolation
- Available with metric or imperial tapped hole pattern
- Optional Faraday cage for low-noise electrophysiology applications
- Optional casters facilitate relocation and cleanup after a spill
- Optional accessories to meet your individual needs



Physiological experiments, such as electrophysiological recordings and imaging experiments, are susceptible to environmental factors that introduce noise to the signals. Predominant noise sources are mechanical vibrations and, in the case of electrophysiology, electromagnetic interference (EMI). The cleanest way of dealing with noise of any modality is to avoid it at the source rather than attempting to remove it from a noisy signal after the fact. This strategy avoids the risk of introducing filter artifacts or other unwanted effects. Air tables and Faraday cages are proven ways to eliminate noise caused by vibration and electromagnetic fields, respectively. Sutter Instrument now offers a series of vibration isolation tables from TMC with feature sets tailored for scientists who perform electrophysiological recordings, including patch clamp, microinjections, or imaging experiments that require the utmost stability.

Each air table comes with a state-of-the-art stainless steel, magnetic breadboard tabletop in either metric (M6 tapped holes on 25 mm centers) or imperial (1/4-20 tapped holes on 1" centers) versions. Custom configurations and additional options are available on request. Please contact Sutter to discuss your specific requirements.

Electrophysiology and Microinjection Workstations

Patch clamp and other electrophysiological techniques share the same requirements for vibration isolation with most microinjection techniques. The AT-3036 Air Table will meet the needs of most electrophysiology and microinjection applications, providing excellent vibration isolation across the entire relevant spectrum. A perimeter enclosure prevents one from accidentally pushing the tabletop and carries a practical sliding shelf just above the work surface for easy access to control devices. Optional padded armrests conveniently attach to the front guardrail and provide support for the researcher who prefers using the eyepieces of the microscope over camera-and-monitor operation. If more space is required, e.g., if voluminous imaging equipment needs to be installed for combined patch clamp and imaging experiments, the AT-3648 Air Table offers additional room for these complex applications.

Options and Accessories

A set of retractable casters helps move the table during relocation, or facilitates clean-up in the event of a spill. For most electrophysiology applications, the Faraday cage with wire mesh roll-up door is strongly recommended. An optional overhead u-shaped rear shelf is available for the cage to accommodate the components of a gravity perfusion set-up or to provide storage for items that need to be easily accessible during the experiment.

Optical Tables

Imaging experiments, such as two-photon microscopy using Sutter's MOM® Moveable Objective Microscope®, typically require larger vibration isolation tables, but rarely need electromagnetic shielding. Three configurations of optical tables are available for these types of experiments: the models AT-48, AT-58 and AT-510. Each version is available as a standalone table or with casters.

Applications

- Electrophysiology
- Cellular and subcellular microinjection
- Photomicroscopy
- Videomicroscopy



SPECIFICATIONS AIR TABLES

All Air Tables come with a state-of-the-art stainless, magnetic breadboard tabletop in either metric (M6 tapped holes on 25-mm centers) or imperial (1/4-20 on 1-in centers) versions. Custom sizes, configurations, or additional options are available upon request. Please contact Sutter for details.

AIR SUPPLY

Source	Compressor (Sutter AT-COMP-xxx or equivalent), house air or air cylinder
Pressure	> 30 psi to max. 80 psi, depending on payload
Quality	Dry, oil-free (in-line filter comes installed)
Fittings	1/4 inch press-lock (quick-fit), or threading for 1/8 or 1/4 in NPT fittings (adapters included)

PATCH CLAMP / ELECTROPHYSIOLOGY AND MICROINJECTION AIR TABLES

Model	AT-3036	AT-3648
■ Dimensions¹	36 in x 30 in x 28.5 in 91 cm x 76 cm x 72 cm	48 in x 36 in x 28.5 in 122 cm x 91 cm x 72 cm
■ Load Capacity²	500 lbs / 227 kg	700 lbs / 318 kg
■ Table Top Thickness	2 in / 5 cm	2 in / 5 cm
■ Table Construction	Honeycomb core with magnetic, stainless steel top layer	
■ Table Hole Pattern³	M6 on 25 mm centers or 1/4-20 on 1 inch centers	
■ Faraday Height	40 in / 102 cm	40 in / 102 cm
■ Faraday Cage Cable Pass-through	Three circular openings with diameters of 2 in / 5 cm	
■ Sliding Shelf Width	8 in / 20 cm	8 in / 20 cm

IMAGING / OPTICAL AIR TABLES

Model	AT-48	AT-58	AT-510
■ Dimen.¹	96 in x 48 in x 36 in 244 cm x 122 cm x 91 cm	96 in x 59 in x 36 in 244 cm x 150 cm x 91 cm	120 in x 59 in x 36 in 305 cm x 150 cm x 91 cm
■ Load Capacity²	1500 lbs / 680 kg	1800 lbs / 590 kg	1200 lbs / 544 kg
■ Table Top Thickness	8 in / 20 cm	8 in / 20 cm	8 in / 20 cm
■ Table Const.	Plated steel honeycomb core		
■ Table Hole Pattern³	M6 on 25 mm centers or 1/4-20 on 1 inch centers		

¹Width x depth x height. Height to top of table surface.

²A high center of gravity may reduce the load capacity.

³Smooth top layer available on request.



AIR TABLES

U.S. prices available at www.sutter.com. International prices vary by country. Contact a distributor or Sutter Instrument for a quotation. Prices subject to change without notice.

STANDARD AIR TABLES

AT-3036

30 in x 36 in x 2 in thick (75 cm x 90 cm x 5 cm thick) table top, perimeter enclosure, and sliding side shelf

- **AT-3036-ST** 30 in x 36 in Air Table, 1/4-20 threaded top
- **AT-3036-M6** 30 in x 36 in Air Table, M6 tapped hole top
- **AT-3036-ST-F** 30 in x 36 in Air Table, 1/4-20 threaded top, and Faraday cage with roll-up door
- **AT-3036-M6-F** 30 in x 36 in Air Table, M6 tapped hole top, and Faraday cage with roll-up door

AT-3648

Includes 36 in x 48 in x 2 in thick (90 cm x 120 cm x 5 cm thick) table top, perimeter enclosure, and sliding side shelf

- **AT-3648-ST** 36 in x 48 in Air Table, 1/4-20 threaded top
- **AT-3648-M6** 36 in x 48 in Air Table, M6 tapped hole top
- **AT-3648-ST-F** 36 in x 48 in Air Table, 1/4-20 threaded top, and Faraday cage with roll-up door
- **AT-3648-M6-F** 36 in x 48 in Air Table, M6 tapped hole top, and Faraday cage with roll-up door





AIR TABLES

U.S. prices available at www.sutter.com. International prices vary by country. Contact a distributor or Sutter Instrument for a quotation. Prices subject to change without notice.

OPTICAL AIR TABLES

AT-48

Includes 4 ft x 8 ft x 8 in thick (122 cm x 244 cm x 20 cm thick) table top and legs

- **AT-48-ST** 4 ft x 8 ft Air Table, 1/4-20 threaded top
- **AT-48-M6** 4 ft x 8 ft Air Table, M6 tapped hole top
- **AT-48-ST-C** 4 ft x 8 ft Air Table, 1/4-20 threaded top, and casters
- **AT-48-M6-C** 4 ft x 8 ft Air Table, M6 tapped hole top, and casters

AT-58

Includes 5 ft x 8 ft x 8 in thick (152 cm x 244 cm x 20 cm thick) table top and legs

- **AT-58-ST** 5 ft x 8 ft Air Table, 1/4-20 threaded top
- **AT-58-M6** 5 ft x 8 ft Air Table, M6 tapped hole top
- **AT-58-ST-C** 5 ft x 8 ft Air Table, 1/4-20 threaded top, and casters
- **AT-58-M6-C** 5 ft x 8 ft Air Table, M6 tapped hole top, and casters

AT-510

Includes 5 ft x 10 ft x 8 in thick (152 cm x 305 cm x 20 cm thick) table top and legs

- **AT-510-ST** 5 ft x 10 ft Air Table, 1/4-20 threaded top
- **AT-510-M6** 5 ft x 10 ft Air Table, M6 tapped hole top
- **AT-510-ST-C** 5 ft x 10 ft Air Table, 1/4-20 threaded top, and casters
- **AT-510-M6-C** 5 ft x 10 ft Air Table, M6 tapped hole top, and casters





ACCESSORIES

U.S. prices available at www.sutter.com. International prices vary by country. Contact a distributor or Sutter Instrument for a quotation. Prices subject to change without notice.

FOR ALL AIR TABLES

- **AT-ARM** Padded arm rests (set of 2)
- **AT-CASTER** Casters for non-optical air tables (set of 4)
- **AT-COMP-110** Air compressor – 110 V, 60 Hz
- **AT-COMP-220** Air compressor – 220 V, 50 Hz
- **GP-17** Ground point
- **GP-W10** Ground wiring kit, 10 assorted cables, 5 alligator clips, assorted clamp rings

FOR AT-3036 30 IN X 36 IN AIR TABLE

- **AT-30-OSF** U-shaped shelf (for Faraday cage)
- **AT-30-FC¹** Faraday cage
- **AT-30-ONT²** OnTrak™ pre-installed, roll-off option

FOR AT-3648 36 IN X 48 IN AIR TABLE

- **AT-36-OSF** U-shaped shelf (for Faraday cage)
- **AT-36-FC¹** Faraday cage
- **AT-36-ONT²** OnTrak™ pre-installed, roll-off option



The Ground Point GP-17 provides reliable, low resistance connections for a star ground configuration, the proven method to avoid ground loops in any electrophysiology setup. Accepts 9 banana plugs + 8 bare wires up to 10 gauge or banana plugs. The GP-17 mounts directly on imperial or metric air table tops with the included 1/4-20 and M6 screws. Made of solid, machined brass with plated banana/clamp connectors.

² Must use with perimeter enclosure (included in metric or imperial AT-3036 or AT-3648). Phone Sutter for information on options or configurations.

³ Tables ship pre-installed on isolator frame. Must order with optional casters



ACCESSORIES - CONTINUED

U.S. prices available at www.sutter.com. International prices vary by country. Contact a distributor or Sutter Instrument for a quotation. Prices subject to change without notice.

FARADAY CAGES – BENCH TOP

Standalone cage with stainless steel base plate. Breadboards with threaded or tapped holes sold separately. Cages with cut-out base plates available upon request. Phone Sutter for detail.

- **AT-3036-FCB** Faraday cage, 30 in x 36 in solid stainless steel
- **AT-3048-FCB** Faraday cage, 30 in x 48 in solid stainless steel
- **AT-3648-FCB** Faraday cage, 36 in x 48 in solid stainless steel
- **AT-MOUNT-ST** Mounting kit for standalone cage – imperial
- **AT-MOUNT-M6** Mounting kit for standalone cage – metric

NAVEPOINT EQUIPMENT RACKS

Standalone cage with stainless steel base plate. Breadboards with threaded or tapped holes sold separately. Cages with cut-out base plates available upon request. Phone Sutter for detail.

- **NP-22U** 22U 2-post open frame rack with casters
- **NP-42U** 42U 2-post open frame rack with casters
- **NP-CS-8** 1 U shelf, 8" (210 mm) deep with lip
- **NP-CS-16** 1 U shelf 16" (350 mm) deep with lip



EQUIPMENT RACKS

New

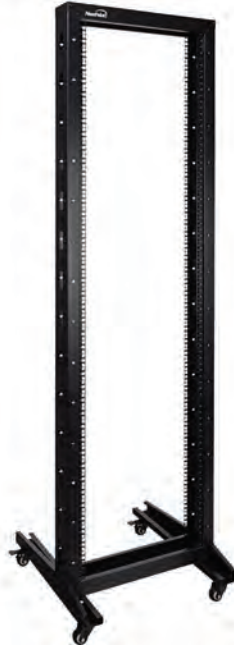

FEATURES EQUIPMENT RACKS

- Constructed of heavy-duty Cold Rolled Steel with a classic Black Powder Coated finish, this rack delivers excellent utility and durability to get your job done right
- The product comes flat-packed and is compliant with: CE, DIN 41494, EIA/ECA-310-E, IEC-60297-3-100, RoHS
- Maximum weight capacity 330 lbs
- 42U rack measurements: 23.75"L x 23.5"W x 81.75"H
- 22U rack measurements: 23.75"L x 23.5"W x 47"H

Sutter now offers equipment racks from NavePoint in both 22U and 42U configurations.

The NavePoint 2-post open frame equipment rack is the perfect solution to mount your large or small rack mount electrophysiology equipment in limited spaces. It's accommodating, open design is compatible with most standard 19-inch rackmount equipment and offers easy access to cables and equipment and unobstructed airflow. Enjoy the versatility of either floor mounting your rack or installing the supplied casters. This rack is self-squaring using bolt down provisions and can support stationary loads up to 330 lbs. The package includes all required hardware for assembly (bolted construction with square-punched cage nut style holes).



SPECIFICATIONS EQUIPMENT RACKS

Model	22U	42U
■ Color	Black	Black
■ Material	Cold Rolled Steel	Cold Rolled Steel
■ Coating	Powder Coat	Powder Coat
■ Interior Rail Threading	Cage Nuts	Cage Nuts
■ Compliance	CE Compliant, DIN 41494 Compliant, EIA/ECA-310-E Compliant, IEC-60297-3-100 Compliant RoHS Compliant	
■ Construction	Bolted Assembly	Bolted Assembly
■ Weight Capacity	330 lbs (150Kg)	330 lbs (150Kg)
■ External Width	23.5 in (59.7 cm)	23.5 in (59.7 cm)
■ External Height	47 in (119.4 cm)	81.75 in (207.6 cm)
■ External Depth	23.75 in (60.3 cm)	23.75 in (60.3 cm)

EQUIPMENT RACKS

U.S. prices available at www.sutter.com. International prices vary by country. Contact a distributor or Sutter Instrument for a quotation. Prices subject to change without notice.

NAVEPOINT EQUIPMENT RACKS

Standalone cage with stainless steel base plate. Breadboards with threaded or tapped holes sold separately. Cages with cut-out base plates available upon request. Phone Sutter for detail.

- **RACK-22U** 22U 2-post open frame rack with casters
- **RACK-42U** 42U 2-post open frame rack with casters
- **RACK-CS-8** 1 U shelf, 8" (210 mm) deep with lip
- **RACK-CS-16** 2 U shelf 16" (350 mm) deep with lip



PERFUSION SYSTEMS AND BATH CHAMBERS

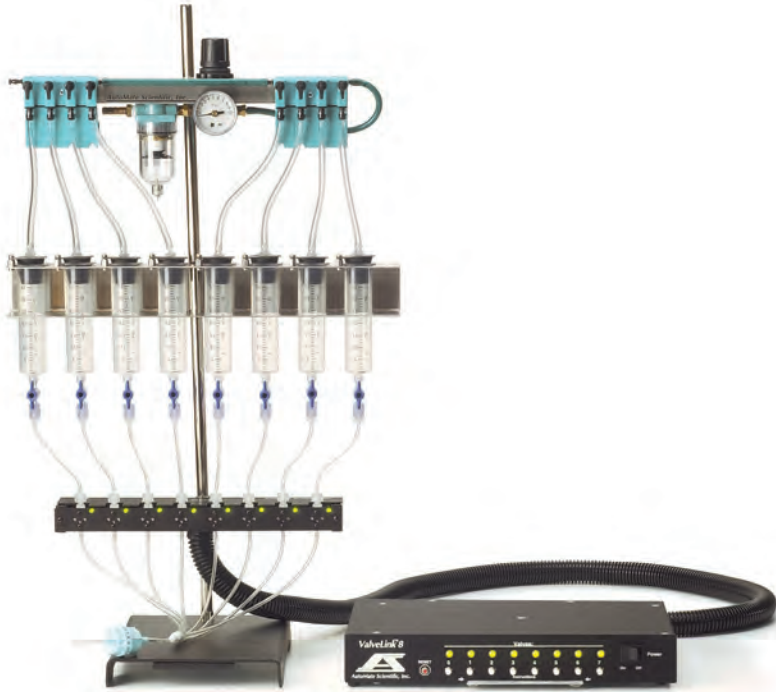

(Shown: AM-PS8-PR Perfusion System)

FEATURES PERFUSION SYSTEMS

- Reliable solution exchange for tissue oxygenation or pharmacology experiments
- 1, 4 or 8 fluid reservoirs
- Available for room temperature operation, inline-heated, or with both inline and bath chamber heating
- ValveLink8.3® and ThermoClamp Controllers compatible with SutterPatch® Software
- High reliability through low-maintenance pinch valves
- Electrically quiet circuitry for valve switching and temperature control



An electrophysiology setup is not complete without a perfusion system. Depending on your application, the objective could be as simple as keeping the preparation alive by supplying oxygenated saline, or as complex as applying a wide range of concentrations of an ion channel modulator, complete with positive and negative controls to obtain a high-quality concentration-response curve. In addition, experiments with mammalian cells or tissues frequently require elevated temperature.

Sutter Instrument now offers the popular perfusion systems and bath chambers made by AutoMate Scientific. Our standard product portfolio consists of perfusion systems with one, four or eight reservoirs, with the option of room temperature operation, inline heating, or a heated bath chamber in addition to inline heating. The standard bath chambers are compatible with either the Sutter platform stages, or with the MT-150 chamber column. Solution switching can be controlled by SutterPatch® software for complete integration into your data acquisition and analysis workflow. Manual operation, as well as control through other patch clamp software, or through digital (TTL) or analog signals from other sources is also possible.

The AutoMate Scientific ValveLink8.3® Controller avoids vibrations produced by switching solutions by hand. Low-noise circuitry and low-maintenance pinch valves switch in 20 ms and contribute to problem-free operation. Liquids never touch the valves. All AutoMate Scientific valves include an individual indicator LED. The aluminum enclosure keeps the valves dry from spills and provides Luer lock ports for syringe reservoirs.

All perfusion systems include syringe reservoirs (140 mL for the one-channel systems, 60 mL each for the four- and eight-channel systems), 2-way stopcocks, a ringstand with reservoir mounts, tubing, Luer connectors and a manifold where applicable.

In addition to the standard perfusion systems which cover the most frequently required configurations, a high degree of customization is possible. Please contact Sutter Instrument for a configuration that meets your particular requirements.



SPECIFICATIONS PERFUSION SYSTEMS

■ ValveLink8.3®

- Low noise & low voltage valve control
Designed for electrophysiology.
- ValveGuard™ technology detects bad valves
- Run experiments automatically – even unattended
- Manual push buttons
- Red/green LED indicators
- 1.5 A, 12 VAC supply included (specify 110 V or 220 V)
- Dimensions: 9.28" x 1.6" x 5.13"
- Weight: 3 lbs. (1.4 kg.)
- Eight TTL inputs directly activate 8 valves or control 16 valves with only four digital outputs
- Analog input selects 8 valves
- Analog out "event marker" to record all valve activity
- Push buttons, TTL, analog and USB inputs ALL work simultaneously
- Capable of switching valves in 1 millisecond
- Automatic networking of up to eight ValveLink8.3 units, connected to a USB hub and PC to create a single 64-channel controller.
- Capable of powering 12 W (1 A) valves and 24 W (2 A) total

■ Pinch valves for reduced maintenance

- Easiest valves to clean and switch tubing
- Liquids never touch the valves
- 20 ms switching
- 1/32" I.D. silicone tube passes through, and is pinched closed by solenoid activation
- Individual indicator LEDs
- Aluminum enclosure keeps the valves dry from spills and offers Luer lock ports for syringe reservoirs

■ ThermoClamp-3.1® or ThermoClamp-3.2®

- Auto-tuning PID (Proportional Integral Derivative) temperature control accurate to <math><1.0^{\circ}\text{C}</math> (often $\pm 0.1^{\circ}\text{C}</math>) with fuzzy logic$
- Extremely low noise (analog heating) designed for electrophysiology
- Over-temperature protection
- Three types of user-configurable thermal runaway protection (patent pending) with fuzzy logic constraints
- Smart voltage setpoint: digital, analog (BNC) or automatic
- Separate displays for both temperatures (control sensor and safety sensor)
- Constant USB/serial data stream output
- Automatic heater failure detection and prevention
- Utilization of the safety sensor as secondary input for feedback control
- Includes power supply, bath and safety sensors
- Analog temperature output (100 mV/°C)
- Ambient to 50°C
- Dimensions: 11.5" x 2" x 7"
- Weight: 4 lbs. (1.8 kg.)



SPECIFICATIONS PERFUSION SYSTEMS

■ **Inline heater** (Heated Perfusion Pencil®)

- Combination inline heater plus multi-channel focal drug delivery
- Luer lock tube connections
- Steady 37°C at 5 mL/min flow rates through both the bath line and tip
- Designed for physiology research – No metal anywhere in the flow path
- Low noise for electrophysiology
- Internal and external grounding plus electrical isolation between liquids and heating elements

■ **Heated QuickStage™ Bath Chamber**

- Integrated spill channel
- Magnetic stainless steel tool platform holds your tubes and electrodes for the next experiment
- Release two thumb nuts to change coverslips and clean the entire stack
- Four heated and three unheated chambers available
- Adapters for 35 mm Petri dishes from Nunc, WillCo, Falcon, In Vitro, Corning, Mattek
- Standard 24 mm x 40 mm #1 thickness coverslip



ValveLink® Controller

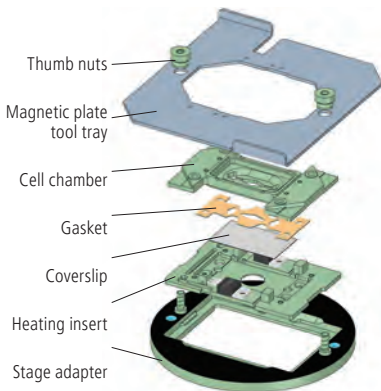

QuickStage™ Recording Chamber – Assembly View



StageHands™ Magnetic Tool Holders

Perfusion Systems and Chamber trademarks belong to AutoMate Scientific.



PERFUSION SYSTEMS

U.S. prices available at www.sutter.com. International prices vary by country. Contact a distributor or Sutter Instrument for a quotation. Prices subject to change without notice.

PERFUSION SYSTEMS

Standard configurations come with a chamber insert for either the Sutter Instrument MT/MP-78 and -88 stages, or the MT-150/AUTO gantry stand. Other inserts are available on request. Please specify microscope stage and chamber when placing an order.

Single-reservoir Perfusion Systems

140 mL reservoir on a ringstand, 2-way Luer stopcock, Tygon tubing with Luer-lock fittings, horizontal perfusion chamber

- **AM-PS1** Single-reservoir Perfusion System, gravity feed, unheated
- **AM-PS1-INL** Single-reservoir Perfusion System, gravity feed, inline-heated
- **AM-PS1-FULL** Single-reservoir Perfusion System, gravity feed, inline-heated, heated bath chamber

Four-channel Perfusion Systems

ValveLink8.3® 4-ch. Pinch Valve Perfusion System, mounting, cables, ringstand set, 4-into-1 manifold, flow controller, 4 x 60 ml syringes, stopcocks, pinch fittings, 2-way Luer stopcocks, Tygon tubing with Luer-lock fittings, horizontal perfusion chamber, BNC cables and grounding kit

- **AM-PS4** 4-channel Perfusion System, gravity feed, unheated
- **AM-PS4-PR** 4-channel Perfusion System, pressurized, Perfusion Pencil with 250 µL removable tip
- **AM-PS4-INL** 4-channel Perfusion System, pressurized, inline-heated Perfusion Pencil with 250 µL removable tip
- **AM-PS4-FULL** 4-channel Perfusion System, pressurized, inline-heated Perfusion Pencil with 250 µL removable tip, heated bath chamber

Eight-channel Perfusion Systems

ValveLink8.3® 8-ch. Pinch Valve Perfusion System, mounting, cables, ringstand set, 8-into-1 manifold, flow controller, 8 x 60 ml syringes, stopcocks, pinch fittings, 2-way Luer stopcocks, Tygon tubing with Luer-lock fittings, horizontal perfusion chamber, BNC cables and grounding kit.

- **AM-PS8** 8-channel Perfusion System, gravity feed, unheated
- **AM-PS8-PR** 8-channel Perfusion System, pressurized, Perfusion Pencil with 250 µL removable tip
- **AM-PS8-INL** 8-channel Perfusion System, pressurized, inline-heated Perfusion Pencil with 250 µL removable tip
- **AM-PS8-FULL** 8-channel Perfusion System, pressurized, inline-heated Perfusion Pencil with 250 µL removable tip, heated bath chamber



ACCESSORIES

U.S. prices available at www.sutter.com. International prices vary by country. Contact a distributor or Sutter Instrument for a quotation. Prices subject to change without notice.

ACCESSORIES

- **AM-01-17** ValveLink rack mounting brackets (to std. 19" rack) with 6-32 x 1/8" screws
- **AM-01-173** Rack mounting brackets – ThermoClamp®-3.1 to standard 19 in rack
- **AM-01-57** Rack mounting brackets – ThermoClamp®-3.2 to standard 19 in rack
- **AM-01-19** BNC-ValveLink8.3® cable – 4 BNC plugs to DB-9
- **AM-01-20** Full BNC-ValveLink8.3® cable – 8 BNC plugs to DB-9
- **AM-04-100** 100 µm Removable Tip for Perfusion Pencil®
- **AM-04-250** 250 µm Removable Tip for Perfusion Pencil®
- **AM-04-360** 360 µm Removable Tip for Perfusion Pencil®
- **AM-220** 220 V Power and CE upgrade
- **AM-SH-1** StageHands Magnetic tool holder
- **AM-GPUMP** 2-channel peristaltic pump and tubing

COMPONENTS

ValveLink®

- **AM-17-PP-24** ValveLink8.3® 4-ch. Pinch Valve Perfusion System, ValveLink8.3® controller = 4+4 solutions (expandable), 4 Pinch Valves, mounting, cables, ringstand set, 4-into-1 manifold, 1/16" tubing, flow controller, 4 x 60 ml syringes, stopcocks, pinch fittings
- **AM-17-PP-54** ValveLink8.3® 8-ch. Pinch Valve Perfusion System, ValveLink8.3® controller = 8 solutions, 8 Pinch Valves, mounting, cables, ringstand set, 8-into-1 manifold with flow control, 1/16" tubing, 8 x 60 ml syringes, stopcocks, pinch fittings

QuickStage

- **AM-QSH-LS-TT-ZK** QuickStage heated large slice chamber (upright), ToolTray, ThermoClamp®-3.1 Controller
- **AM-QSU-H-TT-ZK** QuickStage unheated horizontal perfusion chamber, ToolTray

Thermodclamp® Inline Solution Heater

- **AM-03-11-LL** ThermoClamp®-3.1 Controller, 1-channel heated Perfusion Pencil® with bath sensor
- **AM-03-14-250** ThermoClamp®-3.1 Controller, 4-channel heated Perfusion Pencil® with 250 µm tip & bath sensor
- **AM-03-18-250** ThermoClamp®-3.1 Controller, 8-channel heated Perfusion Pencil® with 250 µm tip & bath sensor

Compressors

The pressurized perfusion systems (all 4- and 8-channel systems other than the gravity feed models AM-PS4 and AM-PS8) require a compressed gas. A popular source is air from a silent, industry grade compressor.

- **AT-COMP-110** Air compressor - 110V, 60 Hz
- **AT-COMP-110** Air compressor - 220V, 50 Hz



CUSTOM AND OEM PRODUCTS

Customization of our optical product line for unique applications has become a specialty for Sutter Instrument. Our production facilities include in-house electronic design, circuit board layout, embedded systems programming, and state-of-the-art CNC machining and turning centers for volume production of precision mechanical components. This expertise gives Sutter the ability to provide timely, cost-effective engineering and manufacturing solutions for Original Equipment Manufacturers (OEMs).

The proven performance and reliability of our optical filter wheel systems has made them a desirable choice for a range of OEM applications. Examples of custom designs include 5-position and 10-position wheels with 2 inch filters, 12-position arrays, compact belt-driven filterwheels, cryogenic and high vacuum filterwheels, rotating polarizers, an RS-485 serial bus allowing 16 controllers to share a single serial port on a host computer, and mounting adapters for a wide range of microscopes. Sutter currently has several significant OEM contracts and will continue to establish new OEM relationships. Please contact Sutter for more information about custom filter changing devices.

SAMPLE OEM PROJECT

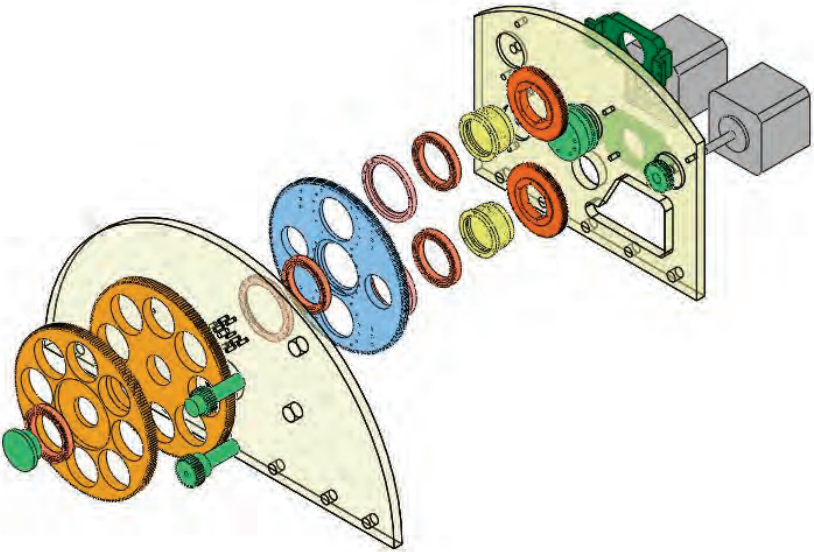

A sample design project shown above: A cryogenic dual wheel with twin adjustable rotating polarizers for use in infrared astronomy.





INTERNATIONAL DEALERS

A complete listing of international distributors and resellers in more than 43 countries is available on our web site at www.sutter.com. Customers worldwide are welcome to purchase our products directly; however, for overseas sales, Sutter recommends that you purchase through one of our local distributors.

COUNTRIES WHERE SUTTER HAS DISTRIBUTOR REPRESENTATION

ARGENTINA	HUNGARY	PUERTO RICO
AUSTRALIA	INDIA	QATAR
AUSTRIA	ISRAEL	ROMANIA
BAHRAIN	ITALY	SINGAPORE
BRAZIL	JAPAN	SLOVENIA
BULGARIA	JORDAN	SOUTH KOREA
CANADA	KUWAIT	SPAIN
CHILE	LITHUANIA	SWEDEN
CHINA	MEXICO	SWITZERLAND
DENMARK	NETHERLANDS	TAIWAN
FINLAND	NEW ZEALAND	TURKEY
FRANCE	NORWAY	UNITED ARAB EMIRATES
GERMANY	POLAND	UNITED KINGDOM
GREECE	PORTUGAL	YEMEN

CUSTOMER SERVICE

For phone orders, quotation requests, and technical support:

Phone +1.888.883.0128 (U.S. & Canada)
+1.415.883.0128

Monday – Friday 8:00 am to 5:00 pm Pacific Time

For correspondence by mail:

Sutter Instrument
One Digital Drive
Novato, CA 94949
USA

FAX ORDERS

Fax +1.888.883.0900 (U.S. & Canada)
+1.415.883.0572

24 hours a day, every day

EMAIL

info@sutter.com

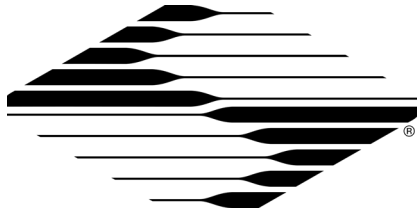

www.sutter.com

