



TAYLOR PRODUCTS

Gauge Catalog



"Your Gauge Company Since 1947"

Table Of Contents

Gauges	
Junior Above Ground LP Gauges	Page 1
Junior Below Ground LP Gauges	Page 2
Junior Motorfuel LP Gauges	Page 3
Senior Above Ground LP Gauges	Page 4
3/4" Threaded LP Gauges	Page 5
1" Threaded LP Gauges	Page 6
1 1/4" Threaded LP Gauges	Page 7
Vertical Cylinder LP Gauges	Page 8
Lift Truck LP Gauges	Page 9
Senior NH3 Gauges	Page 10
N-Serve SS Gauges	Page 11
Junior NH3 Gauges	Page 12
Flow Indicator	Page 13
RoadMaster Mobile Applications	Page 14-15
Master Gauges	Page 16-17
The Eliminator™	Page 18
Rotary Gauges	Page 19
Monitors	
Will Call Monitor, Reed Switches, Sender, & Storage Tank Monitor Parts	Page 20
Stationary Tank Monitor & HE-2 Conversion Kit	Page 21
Ordering Information	
Gauge Ordering Information	Page 22
Gauge Reference Information	Page 23
Dials	
LP Dials for Above Ground & Motor Fuel	Page 24
LP Dials for Motor Fuel & Lift Truck	Page 25
LP Dials For Lift Truck & Vertical	Page 26
LP Dials for Vertical, Under Ground, & Glue-On	Page 27
LP Dial for Glue-On, Visible "4" & RoadMaster	Page 28
RoadMaster & Master	Page 29
Master & NH3	Page 30
NH3 Dials	Page 31
Dial Ordering Information	
Visible "2" & Visible "4"	Page 32
Master Dials	Page 33
Dial Installation	
Glue-On Replacement & Visible "4"	Page 34
Visible "4" & Master Dials	Page 35
Master Dials	Page 36
Miscellaneous	
Broken Screw Kit & Notes	Page 37

Junior Above Ground LP Gauges

Float Gauges are designed to indicate the liquid level contents of LP-Gas Containers. These gauges mount in a Junior flanged coupling with a 2 1/32" [51,5] diameter bolt circle.

Junior gauges are supplied standard with Buna-N gasket and four zinc-plated steel mounting screws (1/4"-28 X 7/8"). These gauges are available in top, side or end, and angle mounting for above ground tanks. **Note:** *Torque mounting bolts evenly to 20 to 50 in-lb. [2,3 to 5,6 Nm]*

Junior LP Standard Sizes										
Item Number	Part Number	"H"	Tank Diameter	Head Type	Mount	Case Quantity	Replacement Dials			
							Drop-In Dial	Drop-In R3D Dial	Tabbed Dial	Tabbed R3D Dial
130299	JA124IP	1/2"	24"	Alum.	Top	50 Pcs.	130012	130022	130021	130082 *
130305	JA154IP	1/2"	30"	Alum.	Top	50 Pcs.	130012	130022	130021	130082 *
130310	JA192JP	1/2"	37"	Alum.	Top	50 Pcs.	130012	130023	130021	130082 *
130315	JA206IP	1/2"	41"	Alum.	Top	50 Pcs.	130012	130022	130021	130082 *
130301	JC124B	1/2"	24"	Alum.	45°	50 Pcs.	130012	130022	130021 *	130082
130303	JC154A	1/2"	30"	Alum.	45°	50 Pcs.	130012	130022	130021 *	130082
130307	JC190B	1/2"	37"	Alum.	45°	50 Pcs.	130012	130022	130021 *	130082
130312	JC210B	1/2"	41"	Alum.	45°	50 Pcs.	130012	130022	130021 *	130082
130316	JD080D	1/2"	24"	Alum.	End	50 Pcs.	130012	130022	130021 *	130082
130318	JD100F	1/2"	30"	Alum.	End	50 Pcs.	130012	130022	130021 *	130082
130320	JD120D	1/2"	37"	Alum.	End	50 Pcs.	130012	130022	130021 *	130082
130322	JD140C	1/2"	41"	Alum.	End	50 Pcs.	130012	130022	130021	130082 *

"H" = Distance from tank surface to center of thread.

*Denotes Standard Dial

Junior Gauge Parts		
Item Number	Part Number	Case Quantity
130118	Jr. Gauge Screw	50 Pcs.
130121	Jr. Gauge Gasket Buna-N	50 Pcs.
130134	Jr. Gauge Gasket Teflon	1 Pc.
130101	Jr. Gauge Head Only	1 Pc.



"Serving the Industry Since 1947"



"Custom Sizes Available"

Float Gauges are designed to indicate the liquid level contents of LP-Gas Containers. These gauges mount in a Junior flanged coupling with a 2 1/32" [51,5] diameter bolt circle.

Junior gauges are supplied standard with Buna-N gasket and four zinc-plated steel mounting screws (1/4"-28 X 7/8").

Note: *Torque mounting bolts evenly to 20 to 50 in-lb. [2,3 to 5,6 Nm]*

Junior LP Standard Sizes										
Item Number	Part Number	"H"	Tank Diameter	Head Type	Mount	Case Quantity	Replacement Dials			
							Drop-In Dial	Drop-In R3D Dial	Tabbed Dial	Tabbed R3D Dial
131572	JB302AP	18 1/4"	24"	Alum.	Top	50 Pcs.	130011	130024	N/A	130083 *
131550	JB340A	22"	24"	Alum.	Top	50 Pcs.	130011 *	130024	N/A	130083
131574	JB332AP	18 1/4"	30"	Alum.	Top	50 Pcs.	130011	130024	N/A	130083 *
131551	JB370C	22"	30"	Alum.	Top	50 Pcs.	130011	130024	N/A	130083 *
133861	JB370GP	18 1/4"	37"	Alum.	Top	50 Pcs.	130011	130024	N/A	130083 *
131552	JB404D	22"	37"	Alum.	Top	50 Pcs.	130011	130024 *	N/A	130083
133862	JB382BP	18 1/4"	41"	Alum.	Top	50 Pcs.	130011	130024	N/A	130083 *
131553	JB424C	22"	41"	Alum.	Top	50 Pcs.	130011	130024 *	N/A	130083

"H" = Distance from tank surface to center of thread.

*Denotes Standard Dial

Junior Gauge Parts		
Item Number	Part Number	Case Quantity
130118	Jr. Gauge Screw	50 Pcs.
130121	Jr. Gauge Gasket Buna-N	50 Pcs.
130134	Jr. Gauge Gasket Teflon	1 Pc.
130101	Jr. Gauge Head Only	1 Pc.



Junior Motorfuel LP Gauges

Float Gauges are designed to indicate the liquid level contents of LP-Gas Containers. These gauges mount in a Junior flanged coupling with a 2 1/32" [51,5] diameter bolt circle.

Junior gauges are supplied standard with Buna-N gasket and four zinc-plated steel mounting screws (1/4"-28 X 7/8"). These gauges are available in top, side or end, and angle mounting for motorfuel tanks. **Note:** *Torque mounting bolts evenly to 20 to 50 in-lb. [2,3 to 5,6 Nm]*

Junior LP Standard Sizes								
Item Number	Part Number	"H"	Tank Diameter	Head Type	Mount	Case Quantity	Replacement Dials	
							Drop-In Dial	Tabbed Dial
130247	10CC	-3/8"	10"	Aluminum	Side, End	50 Pcs.	136000	136005
130248	12CC	-3/8"	12"	Aluminum	Side, End	50 Pcs.	136000	136005
130250	14CC	-3/8"	14"	Aluminum	Side, End	50 Pcs.	136000	136005
130251	16CC	-3/8"	16"	Aluminum	Side, End	50 Pcs.	136000	136005
130252	18CC	-3/8"	18"	Aluminum	Side, End	50 Pcs.	136000	136005
130253	20CC	-3/8"	20"	Aluminum	Side, End	50 Pcs.	136000	136005
130254	22CC	-3/8"	22"	Aluminum	Side, End	50 Pcs.	136000	136005
130255	24CC	-3/8"	24"	Aluminum	Side, End	50 Pcs.	136000	136005
130249	12AC	-3/8"	12"	Aluminum	45° Angle	50 Pcs.	136000	136005
130256	14AC	-3/8"	14"	Aluminum	45° Angle	50 Pcs.	136000	136005
130257	16AC	-3/8"	16"	Aluminum	45° Angle	50 Pcs.	136000	136005
130258	18AC	-3/8"	18"	Aluminum	45° Angle	50 Pcs.	136000	136005
130259	20AC	-3/8"	20"	Aluminum	45° Angle	50 Pcs.	136000	136005
130260	22AC	-3/8"	22"	Aluminum	45° Angle	50 Pcs.	136000	136005
130261	24AC	-3/8"	24"	Aluminum	45° Angle	50 Pcs.	136000	136005

"H" = Distance from tank surface to center of thread.

Junior Gauge Parts		
Item Number	Part Number	Case Quantity
130118	Jr. Gauge Screw	50 Pcs.
130121	Jr. Gauge Gasket Buna-N	50 Pcs.
130134	Jr. Gauge Gasket Teflon	1 Pc.
130101	Jr. Gauge Head Only	1 Pc.



"Serving the Industry Since 1947"



"Custom Sizes Available"

Float Gauges are designed to indicate the liquid level contents of LP-Gas Containers. These gauges mount in a Senior flanged coupling with a 2 1/2" [63,5] diameter bolt circle.

Senior gauges are supplied standard with Buna-N gasket and four zinc-plated steel mounting screws (5/16"-24 X 7/8"). These gauges are available in top, side or end, and angle mounting for above ground tanks. A Visible "4" Dial is available.

Note: Torque mounting bolts evenly to 30 to 60 in-lb. [3,4 to 6,8 Nm]

Senior LP Standard Sizes										
Item Number	Part Number	"H"	Tank Diameter	Head Type	Mount	Case Quantity	Replacement Dials			
							Drop-In Dial	Drop-In R3D Dial	Tabbed Dial	Tabbed R3D Dial
130324	SA130A	1"	24"	Alum.	Top	50 Pcs.	130009	130023	130037 *	403594
130326	SA160A	1"	30"	Alum.	Top	50 Pcs.	130009	130023	130037 *	403594
130328	SA194A	1"	37"	Alum.	Top	50 Pcs.	130009	130023	130037 *	403594
130330	SA214A	1"	41"	Alum.	Top	50 Pcs.	130009	130023	130037 *	403594
130332	SC130B	1"	24"	Alum.	45°	50 Pcs.	130012	130022	130037 *	403594
130334	SC160A	1"	30"	Alum.	45°	50 Pcs.	130012	130022	130037 *	403594
130336	SC194D	1"	37"	Alum.	45°	50 Pcs.	130012	130022	130037 *	403594
130338	SC214C	1"	41"	Alum.	45°	50 Pcs.	130012	130022	130037	403594 *
130340	SD080D	1"	24"	Alum.	End	50 Pcs.	130012 *	130022	130037	403594
130342	SD100C	1"	30"	Alum.	End	50 Pcs.	130012	130022	130037 *	403594
130344	SD120G	1"	37"	Alum.	End	50 Pcs.	130012	130022	130037 *	403594
130346	SD140A	1"	41"	Alum.	End	50 Pcs.	130012	130022	130037 *	403594

"H" = Distance from tank surface to center of thread.

*Denotes Standard Dial

Senior Gauge Parts		
Item Number	Part Number	Case Quantity
130119	Sr. Gauge Screw	50 Pcs.
130120	Sr. Gauge Screw - Phillips	50 Pcs.
130122	Sr. Gauge Gasket Buna-N	50 Pcs.
130130	Sr. Gauge Gasket Teflon	1 Pc.
130131	Sr. Gauge Gasket Spirotallic	1 Pc.
130104	Sr. Gauge Head Only	1 Pc.



3/4" Threaded LP Gauges



Float Gauges are designed to indicate the liquid level contents of LP-Gas Containers. These gauge mount in a 3/4" tank coupling.

The UA series gauges are only for top mount applications in an aboveground tank. These come standard with a 3/4" threaded zinc head with a 2" hex wrenching flat and junior tabbed dial. **Note:** *Torque head evenly to 50 to 100 ft-lbs. [68 to 136 Nm].*

3/4" Threaded Domestic Standard Sizes										
Item Number	Part Number	"H"	Tank Diameter	Head Type	Mount	Case Quantity	Replacement Dials			
							Drop-In Dial	Drop-In R3D Dial	Tabbed Dial	Tabbed R3D Dial
131640	UA130A	1"	24"	3/4" Zinc	Top	50 Pcs.	130012	130022	130052 *	N/A
131645	UA160A	1"	30"	3/4" Zinc	Top	50 Pcs.	130012	130022	130052 *	N/A
131650	UA194A	1"	37"	3/4" Zinc	Top	50 Pcs.	130012	130022 *	130052	N/A
131655	UA210A	1"	41"	3/4" Zinc	Top	50 Pcs.	130012 *	130022	130052	N/A

3/4" Horizontal Standard Sizes										
Item Number	Part Number	"H"	Tank Diameter	Head Type	Mount	Case Quantity	Replacement Dials			
							Drop-In Dial	Drop-In R3D Dial	Tabbed Dial	Tabbed R3D Dial
131670	UD080A	1"	24"	3/4" Zinc	End	50 Pcs.	N/A	N/A	130043 *	N/A
131671	UD080B	1"	30"	3/4" Zinc	End	50 Pcs.	N/A	N/A	130043 *	N/A
131674	UD120A	1"	37"	3/4" Zinc	End	50 Pcs.	N/A	N/A	130043 *	N/A
131673	UD140A	1"	41"	3/4" Zinc	End	50 Pcs.	N/A	N/A	130043 *	N/A

"H" = Distance from tank surface to center of thread.

*Denotes Standard Dial



"Serving the Industry Since 1947"

"Custom Sizes Available"

Float Gauges are designed to indicate the liquid level contents of LP-Gas Containers. These gauges mount in a 1" tank coupling.

The HA series gauges are only for top mount applications in an above ground tank. These come standard with a 1" threaded brass head with a 2" hex wrenching flat. **Note: Torque head evenly to 75 to 150 ft.-lbs. [102 to 200 Nm].**

1" Threaded Domestic Standard Sizes

Item Number	Part Number	"H"	Tank Diameter	Head Type	Mount	Case Quantity	Replacement Dials			
							Drop-In Dial	Drop-In R3D Dial	Tabbed Dial	Tabbed R3D Dial
131589	HA130AP	1"	24"	1" Brass	Top	50 Pcs.	130012	130022	130021	130082 *
131591	HA156AP	1"	30"	1" Brass	Top	50 Pcs.	130012	130022	130021	130082 *
131592	HA160AP	1"	30"	1" Brass	Top	50 Pcs.	130012	130022	130021	130082 *
131594	HA162AP	1"	31.5"	1" Brass	Top	50 Pcs.	130012	130022	130021	130082 *
131595	HA194AP	1"	37"	1" Brass	Top	50 Pcs.	130012	130022	130021	130082 *
131661	HA210AP	1"	41"	1" Brass	Top	50 Pcs.	130012	130022	130021	130082 *

1" Threaded Vertical Cylinder Standard Sizes

Item Number	Part Number	"H"	Tank Size	Head Type	Mount	Case Quantity	Replacement Dials			
							Drop-In Dial	Drop-In R3D Dial	Tabbed Dial	Tabbed R3D Dial
131608	HA180AP	1"	200 Lb.	1" Brass	Top	50 Pcs.	130006	130039	130047	130038 *
131619	HA254JP	1"	420 Lb.	1" Brass	Top	50 Pcs.	130014	132765	N/A	130084 *

"H" = Distance from tank surface to center of thread.

*Denotes Standard Dial



1 1/4" Threaded LP Gauges

Float Gauges are designed to indicate the liquid level contents of LP-Gas Containers. These gauges mount in a 1 1/4" tank coupling.

The TA series gauges are only for top mount applications in an above ground tank. These come standard with a 1 1/4" threaded brass head with a 2" hex wrenching flat. **Note:** *Torque head evenly to 100 to 200 ft.-lbs. [136 to 270 Nm].*

1 1/4" Threaded Domestic Standard Sizes										
Item Number	Part Number	"H"	Tank Diameter	Head Type	Mount	Case Quantity	Replacement Dials			
							Drop-In Dial	Drop-In R3D Dial	Tabbed Dial	Tabbed R3D Dial
131600	TA130AP	1"	24"	1 1/4" Brass	Top	50 Pcs.	130012	130022	130021	130082 *
131604	TA156AP	1"	30"	1 1/4" Brass	Top	50 Pcs.	130012	130022 *	130021	130082
131605	TA160AP	1"	30"	1 1/4" Brass	Top	50 Pcs.	130012	130022	130021	130082 *
131609	TA164AP	1"	32"	1 1/4" Brass	Top	50 Pcs.	130012	130022	130021 *	130082
131610	TA194AP	1"	37"	1 1/4" Brass	Top	50 Pcs.	130012	130022	130021	130082 *
131615	TA210AP	1"	41"	1 1/4" Brass	Top	50 Pcs.	130012	130022	130021	130082 *

1 1/4" Threaded Vertical Cylinder Standard Sizes										
Item Number	Part Number	"H"	Tank Size	Head Type	Mount	Case Quantity	Replacement Dials			
							Drop-In Dial	Drop-In R3D Dial	Tabbed Dial	Tabbed R3D Dial
131611	TA180AP	1"	200 Lb.	1 1/4" Brass	Top	50 Pcs.	130006	130039	130047 *	130038
131616	TA254NS	1"	420 Lb.	1 1/4" Brass	Top	50 Pcs.	130014	132765	N/A	130084 *

"H" = Distance from tank surface to center of thread.

*Denotes Standard Dial



Float Gauges are designed to indicate the liquid level contents of LP-Gas Containers. These gauges mount in a Junior flanged, 1" or 1 1/4" tank coupling.

The JA series gauges are only for top mount applications in a vertical cylinder. These come standard with Buna-N gasket and four zinc-plated steel mounting screws (1/4"-28 X 7/8"). **Note:** *Torque mounting bolts evenly to 20 to 50 ft.-lbs. [2,3 to 5,6 Nm]*

The HA series gauges are only for top mount applications in a vertical cylinder. These come standard with a 1" threaded brass head with a 2" hex wrenching flat. **Note:** *Torque head evenly to 75 to 150 ft.-lbs. [102 to 200 Nm].*

The TA series gauges are only for top mount applications in a vertical cylinder. These come standard with a 1 1/4" threaded brass head with a 2" hex wrenching flat. **Note:** *Torque head evenly to 100 to 200 ft.-lbs. [136 to 270 Nm]*

Junior Vertical Cylinder Standard Sizes

Item Number	Part Number	"H"	Tank Size	Head Type	Mount	Case Quantity	Replacement Dials			
							Drop-In Dial	Drop-In R3D Dial	Tabbed Dial	Tabbed R3D Dial
131545	JA176B	1/2"	200 Lb.	Alum.	Top	50 Pcs.	130006	130039	130047	130038 *
131540	JA250J	1/2"	420 Lb.	Alum.	Top	50 Pcs.	130014	132765	N/A	130084 *

1" Threaded Vertical Cylinder Standard Sizes

Item Number	Part Number	"H"	Tank Size	Head Type	Mount	Case Quantity	Replacement Dials			
							Drop-In Dial	Drop-In R3D Dial	Tabbed Dial	Tabbed R3D Dial
131608	HA180AP	1"	200 Lb.	1" Brass	Top	50 Pcs.	130006	130039	130047	130038 *
131619	HA254JP	1"	420 Lb.	1" Brass	Top	50 Pcs.	130014	132765	N/A	130084 *

1 1/4" Threaded Vertical Cylinder Standard Sizes

Item Number	Part Number	"H"	Tank Size	Head Type	Mount	Case Quantity	Replacement Dials			
							Drop-In Dial	Drop-In R3D Dial	Tabbed Dial	Tabbed R3D Dial
131611	TA180AP	1"	200 Lb.	1 1/4" Brass	Top	50 Pcs.	130006	130039	130047 *	130038
131616	TA254NS	1"	420 Lb.	1 1/4" Brass	Top	50 Pcs.	130014	132765	N/A	130084 *

"H" = Distance from tank surface to center of thread.

*Denotes Standard Dial



Lift Truck LP Gauges



Float Gauges are designed to indicate the liquid level contents of LP-Gas Containers. These gauges mount in a Junior flanged, a 3/4" or a 1 1/4" tank coupling.

These gauges are for 20 Lb, 33 Lb., and 43 Lb. Lift Truck cylinders. The JU, TU, and UU series are Universal and will read either vertically or horizontally. The JA series are for vertical cylinders only. The JD060A and TU060A are for horizontal cylinders only. A 3/4" zinc head is optional on the UU series.

Lift Truck Standard Sizes								
Item Number	Part Number	"H"	Tank Size	Head Type	Mount	Case Quantity	Replacement Dials	
							Drop-In Dials	Tabbed Dials
131506	JU086B	1/2"	20 Lb.	Aluminum	Side, End	50 Pcs.	130002 *	N/A
131507	UU086B	1"		3/4" Snap-On	Side, End	50 Pcs.	130033 *	403582
131520	TU086B	1"		1 1/4" Brass	Side, End	50 Pcs.	130002 *	N/A
131512	JU160B	1/2"	33 Lb.	Aluminum	Side, End	50 Pcs.	130013	130081 *
131513	UU160B	1"		3/4" Snap-On	Side, End	50 Pcs.	130033	403582 *
131499	UU160E	1"		3/4" Zinc	Side, End	50 Pcs.	130033	130081 *
131530	TU160B	1"		1 1/4" Brass	Side, End	50 Pcs.	130013	130081 *
131516	JU212A	1/2"	43 Lb.	Aluminum	Side, End	50 Pcs.	130004	130051 *
131517	UU212A	1"		3/4" Snap-On	Side, End	50 Pcs.	130033	403582 *
131535	TU212A	1"		1 1/4" Brass	Side, End	50 Pcs.	130004	130048 *

Vertical Mount Standard Sizes								
Item Number	Part Number	"H"	Tank Size	Head Type	Mount	Case Quantity	Replacement Dials	
							Drop-In Dials	Tabbed Dials
131510	JA086A	1/2"	20 Lb.	Aluminum	Vertical	50 Pcs.	130009 *	N/A
131514	JA166A	1/2"	33 Lb.	Aluminum	Vertical	50 Pcs.	130009 *	N/A
131518	JA216A	1/2"	43 Lb.	Aluminum	Vertical	50 Pcs.	130009 *	N/A

Horizontal Mount Standard Sizes								
Item Number	Part Number	"H"	Tank Size	Head Type	Mount	Case Quantity	Replacement Dials	
							Drop-In Dials	Tabbed Dials
131508	JD060A	1/2"	20, 33,	Aluminum	Horizontal	50 Pcs.	130012	130021 *
131525	TD060A	1"	43 Lb.	1 1/4" Brass	Horizontal	50 Pcs.	130012 *	130021

"H" = Distance from tank surface to center of thread.

*Denotes Standard Dial

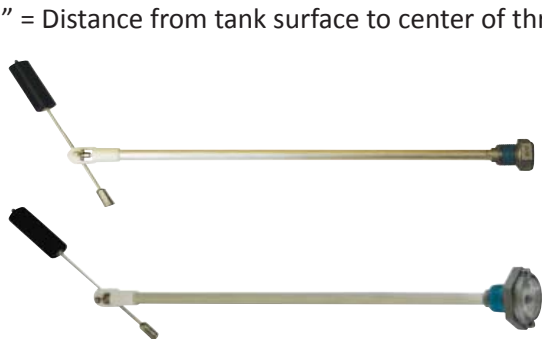

"Serving the Industry Since 1947"

"Custom Sizes Available"

Float Gauges are designed to indicate the liquid level contents of Anhydrous-Ammonia(NH3) Containers. These gauges mount in a Senior flanged coupling with a 2 1/2" [51,5] diameter bolt circle.

Senior gauges are supplied standard with Buna-N gasket and four zinc-plated steel mounting screws (5/16"-24 X 7/8"). These gauges are available in top, side or end, and angle mounting for above ground tanks. A Visible "4" Dial is available.

Note: Torque mounting bolts evenly to 30 to 60 in-lb. [3,4 to 6,8 Nm]

Senior NH3 Standard Sizes								
Item Number	Part Number	"H"	Tank Diameter	Head Type	Mount	Case Quantity	Replacement Dials	
							Drop-In Dials	Tabbed Dials
130431	AA130A	1"	24"	Aluminum	Top	40 Pcs.	130018 *	130041
140433	AA160A	1"	30"	Aluminum	Top	40 Pcs.	130018 *	130041
130435	AA194A	1"	37"	Aluminum	Top	40 Pcs.	130018	130041 *
130437	AA214E	1"	41"	Aluminum	Top	40 Pcs.	130018	130041 *
130425	AA240A	1"	46"	Aluminum	Top	40 Pcs.	130018	130041 *
130426	AA250A	1"	48"	Aluminum	Top	40 Pcs.	130018	130041 *
130440	AC130A	1"	24"	Aluminum	45° Angle	40 Pcs.	130018 *	130041
130443	AC160A	1"	30"	Aluminum	45° Angle	40 Pcs.	130018 *	130041
130444	AC194A	1"	37"	Aluminum	45° Angle	40 Pcs.	130018 *	130041
130447	AC214B	1"	41"	Aluminum	45° Angle	40 Pcs.	130018	130041 *
130449	AC240A	1"	46"	Aluminum	45° Angle	40 Pcs.	130018	130041 *
130450	AD080B	1"	24"	Aluminum	Side, End	40 Pcs.	130018 *	130041
130452	AD100D	1"	30"	Aluminum	Side, End	40 Pcs.	130018 *	130041
130455	AD120E	1"	37"	Aluminum	Side, End	40 Pcs.	130018	130041 *
130457	AD140A	1"	41"	Aluminum	Side, End	40 Pcs.	130018	130041 *
130427	AD150A	1"	46"	Aluminum	Side, End	40 Pcs.	130018	130041 *
130459	AD160J	1"	48"	Aluminum	Side, End	40 Pcs.	130018	130041 *

"H" = Distance from tank surface to center of thread.

*Denotes Standard Dial

Senior Gauge Parts		
Item Number	Part Number	Case Quantity
130119	Sr. Gauge Screw	50 Pcs.
130120	Sr. Gauge Screw - Phillips	50 Pcs.
130122	Sr. Gauge Gasket Buna-N	50 Pcs.
130130	Sr. Gauge Gasket Teflon	1 Pc.
130131	Sr. Gauge Gasket Spirotallic	1 Pc.
130104	Sr. Gauge Head Only	1 Pc.



N-Serve SS Gauges

Float Gauges are designed to indicate the liquid level contents of N-Serve Containers. These gauges mount in a Senior flanged coupling with a 2 1/2" [51,5] diameter bolt circle.

Senior gauges are supplied standard with Buna-N gasket and four zinc-plated steel mounting screws (5/16"-24 X 7/8"). These gauges are available in top, side or end, and angle mounting for above ground tanks. A Visible "4" Dial is available.

Note: Torque mounting bolts evenly to 30 to 60 in.-lb. [3,4 to 6,8 Nm] for Buna-N and Teflon Gaskets. Torque mounting bolts evenly to 115-125 in.-lb. for Spirotallic gasket.

Senior N-Serve SS Standard Sizes								
Item Number	Part Number	"H"	Tank Diameter	Head Type	Mount	Case Quantity	Replacement Dials	
							Drop-In Dials	Tabbed Dials
290000	AA41SS	41"	24"	Stainless Steel	Top	25 Pcs.	N/A	130041 *
290001	AA46SS	46"	30"	Stainless Steel	Top	25 Pcs.	N/A	130041 *

"H" = Distance from tank surface to center of thread.

*Denotes Standard Dial

Senior Gauge Parts		
Item Number	Part Number	Case Quantity
130119	Sr. Gauge Screw	50 Pcs.
130120	Sr. Gauge Screw - Phillips	50 Pcs.
130122	Sr. Gauge Gasket Buna-N	50 Pcs.
130130	Sr. Gauge Gasket Teflon	1 Pc.
130131	Sr. Gauge Gasket Spirotallic	1 Pc.
130104	Sr. Gauge Head Only	1 Pc.



"Serving the Industry Since 1947"

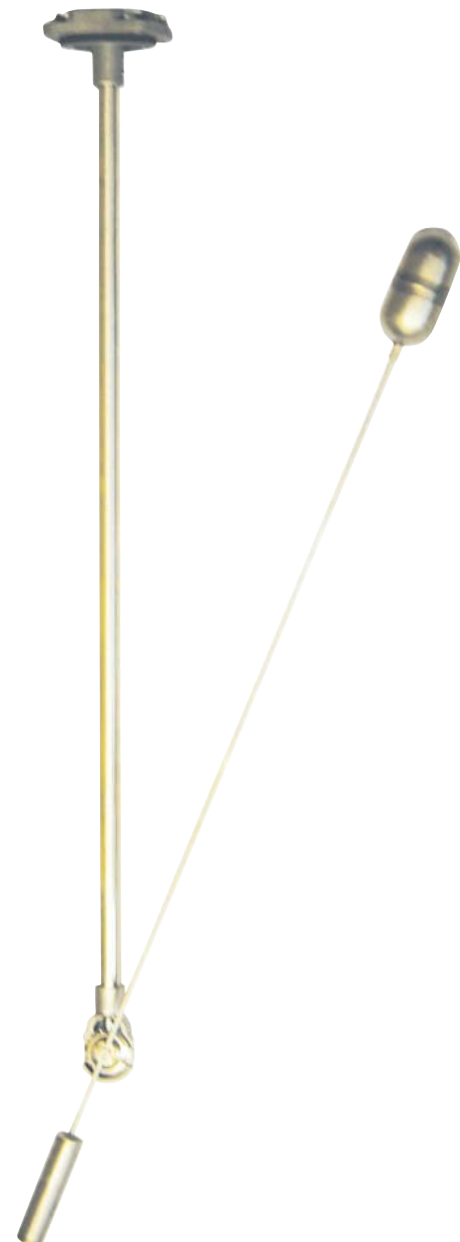

"Custom Sizes Available"

Float Gauges are designed to indicate the liquid level contents of Anhydrous-Ammonia(NH3) Containers. These gauges mount in a junior flanged coupling with a 2 1/32" [51,5] diameter bolt circle.

Junior gauges are supplied standard with Buna-N gasket and four zinc-plated steel mounting screws (1/4"-28 X 7/8"). These gauges are available in top, side or end, and angle mounting for above ground tanks. **Note:** *Torque mounting bolts evenly to 20 to 50 in-lb. [2,3 to 5,6 Nm]*

Junior NH3 Standard Sizes								
Item Number	Part Number	"H"	Tank Diameter	Head Type	Mount	Case Quantity	Replacement Dials	
							Drop-In Dials	Tabbed Dials
130400	BA124A	1/2"	24"	Aluminum	Top	50 Pcs.	130029 *	130049
130402	BA154A	1/2"	30"	Aluminum	Top	50 Pcs.	130029 *	130049
130403	BA214B	1/2"	41"	Aluminum	Top	50 Pcs.	130029	130049 *

"H" = Distance from tank surface to center of thread.

*Denotes Standard Dial

Junior Gauge Parts		
Item Number	Part Number	Case Quantity
130118	Jr. Gauge Screw	50 Pcs.
130121	Jr. Gauge Gasket Buna-N	50 Pcs.
130134	Jr. Gauge Gasket Teflon	1 Pc.
130101	Jr. Gauge Head Only	1 Pc.



Flow Indicator

Indicates direction of flow of LP-Gas or Anhydrous Ammonia(NH3) in piping at working pressures up to 500 psig [34 Bar]. The indicator must be installed in piping tees.

The head, center shaft, support tube, bearings and vane in these indicators are made of 300 Series stainless steel. Magnets are nickel-plated Alnico, and the threaded mounting adapters are forged steel. The hermetically sealed dial has a large 4" dial face capable of showing flow in both directions or the absence of flow. **Note: Torque mounting bolts to 140 to 150 in-lb.**

Flow Indicator Standard Sizes			
Item Number	Part Number	Pipe Size	Complete Assembly Includes
130050	5520-2 Complete	2"	5520-2 Flapper, 5520R Dial, 5305 2" Adapter, Screws , Spirotallic Gasket.
130055	5520-2 1/2 Complete *	2 1/2"	5520-2 1/2 Flapper, 5520R Dial, 5305 2" Adapter, Screws, Spirotallic Gasket.
130060	5520-3 Complete **	3"	5520-3 Flapper, 5520R Dial, 5305 2" Adapter, Screws, Spirotallic Gasket.

* Requires a 2 1/2" X 2" Hex Bushing - Sold Separately ** Requires a 3" X 2" Hex Bushing - Sold Separately

Flow Indicator Parts		
Item Number	Part Number	Case Quantity
130046	5520R Dial *	1 Pc.
130065	5520-2 Flapper Only	1 Pc.
130070	5520-2 1/2 Flapper Only	1 Pc.
130075	5520-3 Flapper Only	1 Pc.
130131	Sr. Spirotallic Gasket	1 Pc.
403631	SS Cap Screws	1 Pc.
130045	5520T Dial *	1 Pc.
118405	5305 2" MNPT X Sr. Head Adaptor	1 Pc.

* Includes Dial, Bezel, Bracket and Screws.



130050



130046

Replacement Dial Ordering Information



Old Style Head



130045

Bracket mounts on top and is secured by two screws on the side of head.



New Style Head



130046

Bracket mounts on top and is secured with dial screws.



5520-2	L Dimension = 3 13/16"
5520-2 1/2	L Dimension = 5 5/16"
5520-3	L Dimension = 5 15/16"

L Dimension is the distance from gasket surface to the end of the flapper.

The RM Series RoadMaster gauges were designed to withstand the vibration and shock inherent in mobile service. Their service life in over-the-road, transports and bobtails, carrying liquids from LP-Gas to Anhydrous Ammonia(NH3), is unsurpassed. These gauges allow a continuous reading between 5% and 95% of tank contents.

The RM Series RoadMaster gauges are to be installed in the side or end of mobile tanks at the centerline. They are equipped with a spring controlled shock absorber on the float arm which substantially reduces the stress that quickly destroys conventional gauges. Angle mounting gauges are also available.

The standard model mounts in an 8 bolt adaptor and incorporates a 4" [100 mm] dial with an available 8" [200 mm] dial. When necessary, the dials are easily replaceable.

The RM Series RoadMaster gauges are designed for working pressures ranging from atmospheric to 450 [31 Bar] psig.

Note: Refer to Gauge Instructions for mounting bolt torque specifications.

RoadMaster Standard Sizes			
Item Number	Part Number	Tank Diameter	Case Quantity
131825	RM1425	56"	1 Pc.
131830	RM2030	66"	1 Pc.
131833	RM1833	72"	1 Pc.
131834	RM1834	74"	1 Pc.
131836	RM1836	78"-79"	1 Pc.
131832	RM2437	80"	1 Pc.
131838	RM2438	82"-84"	1 Pc.
131840	RM2440	85"-86"	1 Pc.
131941	RM2941	87"	1 Pc.
131841	RM1841	88"	1 Pc.
131842	RM2942	90"	1 Pc.
131245	RM3245	96"	1 Pc.

RoadMaster Options	
Suffix	Description
SS	Adds Stainless Steel Counter-Weight
X	Straddle Mount
Y	Includes Adapter To Fit A 2" Opening

Examples:

RM1836SS - A RM1836 with all Stainless Steel construction

RM1836X - A RM1836 for a Straddle Mount

RM1836Y - A RM1836 to fit a 2" opening

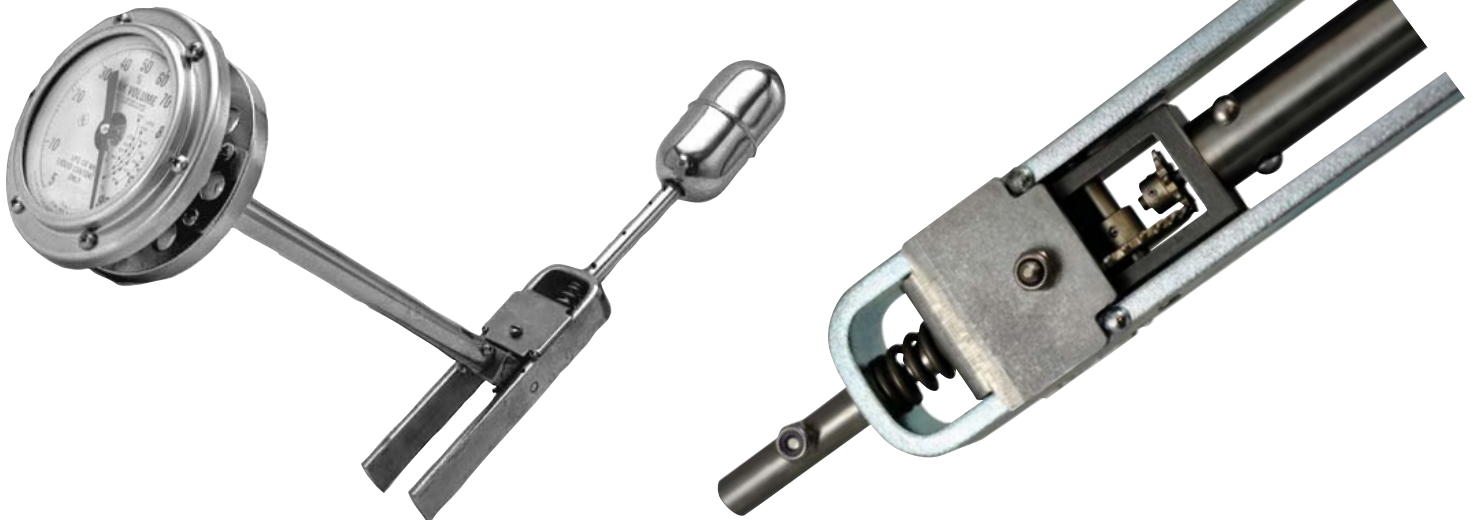

RoadMaster Parts		
Item Number	Part Number	Case Quantity
130040	Spirotallic Gasket	1 Pc.
118425	5331 - 2 1/2" X 8 Bolt Flange Adaptor	1 Pc.
118428	5330 Weld In 8-Bolt Flange Adaptor	1 Pc.
131812	Straddle Mount Adapter w/Screws & Gasket	1 Pc.
131845	RoadMaster Dial Bracket Kit	1 Pc.
131839	RoadMaster Dial Assembly Complete	1 Pc.
131820	RoadMaster R3D Dial Assembly Complete	1 Pc.
130093	Stud Bolt & Nut Kit (not shown)	1 Pc.
131823	RoadMaster Angle Bracket Kit	1 Pc.
131821	RoadMaster Fluorescent Dial Only	1 Pc.
131822	RoadMaster R3D Fluorescent Dial Only	1 Pc.
131824	RoadMaster Dial Crystal	1 Pc.
131819	RoadMaster Crystal Gasket	1 Pc.



131823
Angle Bracket



131839

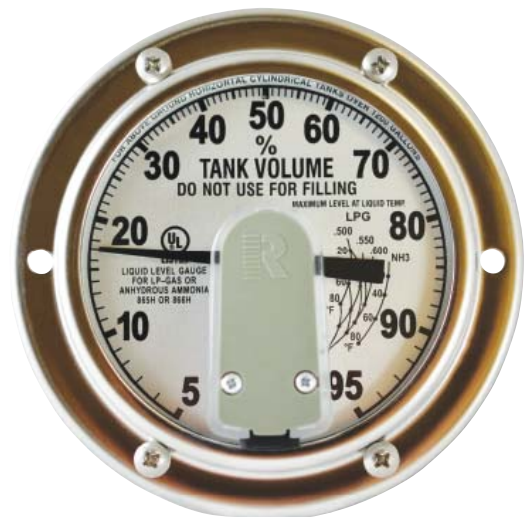

131820



131821



131822

The Master Series™ liquid-level gauges are designed to indicate the liquid level contents of LP-Gas and Anhydrous Ammonia(NH3) in stationary-storage tanks.

The Master Series™ are available in two basic models:

Model A - Stainless Steel Senior head which mounts to a 2" MNPT x Senior adaptor.

Model B - Stainless Steel head which mounts to a 2 1/2" X 8-Bolt flange adaptor.

Both models incorporate a 8" [100 mm] dial with an available 4" [200 mm] dial. When necessary, the dials are easily replaceable. Standard mounting is end or top mounting. These gauges can be special ordered with angle or straddle mounts. The model A comes standard with cap screws and a Senior spirotallic gasket. The model B comes with a stud and nut kit and spirotallic gasket.

The Master Series™ gauges are designed for working pressures ranging from atmospheric to 450 [31 Bar] psig. **Note:** Refer to Gauge Instructions for mounting bolt torque specifications.

Master Standard Sizes								
Item Number	Part Number	Tank Diameter	Tank Opening	Model Type	Mount	Case Quantity	Old LP-Gas Number	Old NH3 Number
138000	ME2434A	72"	2"	A	Side, End	1 Pc.	MD240A	DD240B
138005	ME2434B		2 1/2"	B	Side, End	1 Pc.	MD240B	DD240A
138010	ME2738A	82"	2"	A	Side, End	1 Pc.	MD270B	DD270D
138015	ME2738B		2 1/2"	B	Side, End	1 Pc.	MD270A	DD270G
138020	ME2839A	84"	2"	A	Side, End	1 Pc.	MD280B	DD280G
138025	ME2839B		2 1/2"	B	Side, End	1 Pc.	MD280C	DD280C
138030	ME3245A	96"	2"	A	Side, End	1 Pc.	MD320C	DD320F
138035	ME3245B		2 1/2"	B	Side, End	1 Pc.	MD320A	DD320B
138040	ME3650A	104"-108"	2"	A	Side, End	1 Pc.	MD360B	DD360A
138045	ME3650B		2 1/2"	B	Side, End	1 Pc.	MD360C	DD360B
138050	ME3862A	130"	2"	A	Side, End	1 Pc.	ME430A	DD430B
138055	ME3862B		2 1/2"	B	Side, End	1 Pc.	MD380F	DD380F

Master Gauge Parts		
Item Number	Part Number	Model Type
130040	Spirotallic Gasket	B
118405	5305 2" MNPT X Sr. Head Adaptor	A
118425	5331 2 1/2" X 8 Bolt Flange Adaptor	B
118428	5330 Weld In 8 Bolt Flange Adaptor	B
130206	Master Gasket & Centralizer	B
131812	Straddle Mount Adapter w/Screws & Gasket	B



118428



118425



131812



118405

Old Style Master Gauge Parts		
Item Number	Part Number	Model Type
130130	Sr. Teflon Gasket	A
130119	Sr. Gauge Screw	A
130205	Master Dial 2-Bkt Kit	A & B
130035	Master Dial LP or NH3 2-Bkt Pre 08	A & B
130036	4102 LP Only Dial 2-Bkt Pre 08	A & B
130030	4607 NH3 Only Dial 2-Bkt Pre 08	A & B
130078	Master R3D Dial LP or NH3 2-Bkt Pre 08	A & B
130076	Master R3D Sender & Cable	A & B
130088	Master Fluorescent Dial LP & NH3 2-BKT	A & B
130094	Master R3D Fluorescent Dial LP & NH3 2-BKT	A & B
130127	Master Dial Screws 1032-1 (2 Req.)	A & B
130219	Master Gauge Bolts (8 Req.)	B

* These screws come in packages of 50 Pcs.

Old Style Heads



Model A



2-Bracket Model B

New Style Master Gauge Parts		
Item Number	Part Number	Model Type
130131	Sr. Spirotallic Gasket	A
130095	Model A Head Strap Post 07	A
403631	Sr. Cap Screw	A
130098	Master Dial 3-Bkt Kit	B
130090	Master Dial LP or NH3 3-Bkt Post 07	B *
130091	4102 LP Only Dial 3-Bkt Post 07	B *
130092	4607 NH3 Only Dial 3-Bkt Post 07	B *
130034	Master R3D Dial LP or NH3 3-Bkt Post 07	B *
130076	Master R3D Sender & Cable	A & B
130089	Master Fluorescent Dial LP & NH3 3-BKT	B *
130099	Master R3D Fluorescent Dial LP & NH3 3-BKT	B *
130093	Master Stud Bolt and Nut Kit (8)	B
130201	Master Glass Crystal & Gaskets -8"	A & B
130199	Master Lexan Crystal -8"	A & B #
130198	Gasket For Master Lexan Crystal -8" (2 Req.)	A & B #

* These Dials have 3 blank holes to mount on a Model B only. If you need a Dial for a Model A than you must specify Model A when ordering.

Must be ordered together.

New Style Heads



Model A



3-Bracket Model B

The Eliminator™ direct-reading float gauge is a direct replacement for 1" NPT rotary-type dip-tube gauges in LP-Gas and NH₃ storage tanks.

These Gauges are designed for larger tanks up to 96" [2134 mm] in diameter. The Eliminator™ is not intended for use in filling tanks - its use is restricted to tanks with fixed liquid level gauges, used to determine when the maximum fill level has been reached.

Eliminator Standard Sizes

Item Number	Part Number	Tank Diameter	Case Quantity
131900	EL4442	42"	1 Pc.
131901	EL6046	46"	1 Pc.
131902	EL6048	48"	1 Pc.
131903	EL6056	56"	1 Pc.
131906	EL6060	60"	1 Pc.
131909	EL7266	66"	1 Pc.
131912	EL7272	72"	1 Pc.
131914	EL8474	74"	1 Pc.
131916	EL8476	76"	1 Pc.
131919	EL8479	79"	1 Pc.
131920	EL8480	80"	1 Pc.
131921	EL8481	81"	1 Pc.
131922	EL8482	82"	1 Pc.
131923	EL8484	84"	1 Pc.
131925	EL8486	86"	1 Pc.
131926	EL8487	87"	1 Pc.
131930	EL9696	96"	1 Pc.

* Any Eliminator installed in a mobile tank greater than 60" is excluded from the Taylor Gauge Limited Warranty and cannot be reworked.



130100

Eliminator Dial

Item Number	Part Number
130100	Eliminator Dial Assy

How To Do The Conversion

1. After the storage tank has been evacuated, remove the rotary gauge from the 1" NPT opening at the centerline of the head. Clean and re-tap the female threads.
2. Remove the two screws from the bezel. Put the bezel, screws and dial chamber aside for the moment. Remove the four mounting screws holding the gauge head to the adapter.
3. Insert the lower portion of the replacement gauge, including the float bulb, float arm, gear housing and counterbalance, into the tank opening.
4. Apply three wraps of 1/2" [12 mm] wide Teflon tape, or other suitable thread sealant, to the 1" NPT threads on the steel adapter through which the gauge support passes.
5. Screw the adapter into the tank opening to achieve a leak-tight joint, and align the gauge mounting holes in the horizontal plane.
6. Using the gasket and four mounting screws supplied, attach the gauge to the adapter finger tight. Be sure the gauge is right side up, the bracket tab for locating dial chamber should be on the right. Torque the mounting screws evenly to 140/150 lb. in., [16,4 Nm] using a cross pattern.
7. Reattach the 4" dial chamber and bezel to the Senior™ gauge head brackets using the two screws supplied.
8. If you end up with the dial chamber upside down, you cannot solve the problem by rotating the bracket. You must rotate the entire gauge 180°.

Rotary Gauges

Fisher® brand rotary gauges can be used on stationary or mobile tanks to visually indicate the amount of LP- Gas or Anhydrous Ammonia (NH3) in the container. They are also used in filling the tank to the proper liquid level. On mobile applications and some large stationary storage tanks, hangers are recommended to support the horizontal length of the dip tube.

The Gauge is operated by opening the small bleed orifice when the tube is in the vapor space of the tank. Moving the pointer on the dial causes the end of the tube to move until it contacts liquid in the container. At that point, discharge from the bleed orifice turns from vapor to liquid and the rotary gauge dial gives the volume percentage of liquid in the tank.

J31 Series - consists of heavy duty gauges that minimize vibration effects (swaying, bouncing) by a long (68-inches) (1,73 meters) stem tube extension. Gauges fit 1-inch (25,4 mm) female coupling container connections.

All gauges have stem and dip tubes with an extra large inside diameter. This assures that the correct liquid level can be obtained quickly. A P323 dial is included with the LP version and a P324 is included with the NH3 version.

A nylon packing sleeve and a friction ring for the pointer indicator gives smooth rotation and long service life. Steel and stainless steel materials resist rust or corrosion.

LP Rotary Gauges				
Item Number	Part Number	Case Quantity	Length	
			Inches	Millimeters
121120	J31L-1	1 Pc.	68	1727
121125	J31L-2	1 Pc.	69 - 92	1753 - 2337
121130	J31L-3	1 Pc.	93 - 108	2362 - 2743
121135	J31L-3L	1 Pc.	109 - 140	2769 - 3556

NH3 Rotary Gauges				
Item Number	Part Number	Case Quantity	Length	
			Inches	Millimeters
121122	J31A-1	1 Pc.	68	1727
121127	J31A-2	1 Pc.	69 - 92	1753 - 2337
121132	J31A-3	1 Pc.	93 - 108	2362 - 2743
121137	J31A-3L	1 Pc.	109 - 140	2769 - 3556

Each Gauge Must be bent before installation.

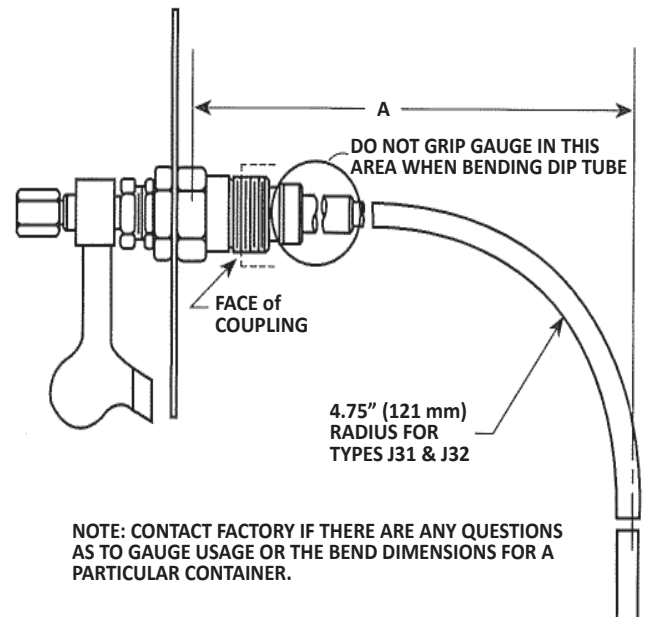

Rotary Gauge Parts			
Item Number	Part Number	Description	Case Quantity
122915	P322	Under 1200 Gal. Dial	1 Pc.
122916	P323	LP Dial	1 Pc.
122920	P324	NH3 Dial	1 Pc.
128217	T10971-000A2	Cap & Disc Assy.	1 Pc.
128139	T10887-19232	Dial Indicator	1 Pc.
128209	T10964-24152	Indicator Set Screw	1 Pc.

Shipping Notice:

The J31-1 and J31-2 ship UPS.

The J31-3 and J31-3L will be shipped via motor freight.

The J31-3 if shipped UPS gets an additional oversize charge.



Will Call Monitor Gauge

Item Number	Part Number	Description	Case Quantity
136100	3620	Will Call Monitor 3620 w/20' Cable	1 Pc.
136105	00294-50"	50' Cable Extension Kit (not shown)	1 Pc.

Extendable with 50' Cable Extension Kit.

Easy to read display activated by push button.

Mounting bracket and AAA batteries included.

Complete with 20' Cable ready to connect to any R3D Remote Ready Dial.



3620

Reed Switches

Item Number	Part Number	Description	Case Quantity
130110	9750-05	15-25% Switch	1 Pc.
130111	9750-07	25-30% Switch	1 Pc.



130111

Sender

Item Number	Part Number	Description	Case Quantity
136530	P2537	0-90 Ohms Sender	1 Pc.



136530

Storage Tank Monitor Parts

Item Number	Part Number	Description	Fits	Case Quantity
136120	R6315-12	4-20 mA Liquid-Level Transmitter	Master & RoadMaster R3D Dials	1 Pc.
136121	146S-1	Intrinsic Safety Barrier	For R6315-12	1 Pc.
130076	9701-54	Master R3D Sender & Cable	Master & RoadMaster R3D Dials	1 Pc.

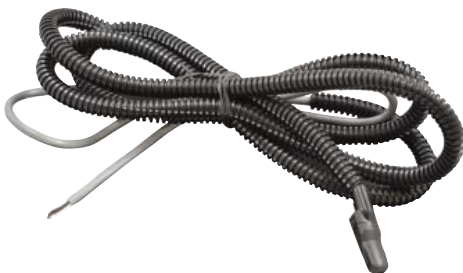

130076



R6315-12

Stationary Tank Monitor

The 94442A Stationary Tank Monitor (STM) is used for measuring LPG level in a tank. It can be installed indoors or outdoors at a convenient location that can be up to 1000 feet from the tank. A level sender is also included which must be installed in the float gauge located on the tank. The LPG tank does not have to be emptied or purged to install the sender. Its' universal design fits any gauge that has an R3D dial which allows you to check the LPG level at the tank.



136619

Monitors 2 LPG Tank Levels (Sensor for second tank optional).

State-of-the-art intelligent microprocessor based electronics.

Hi/Lo alarm set points programmable using built-in pushbuttons.

Analog Output for each channel, 0-5 VDC standard, 4-20 mA optional.

RS232 Serial Interface for direct connection to PC/RTU or PLC.

NEMA 4 enclosure suitable for outdoor use.

One LPG sensor included to fit float gauge with Junior tabbed dial.

Will work with any gauge that has an R3D dial installed.

Large LCD readout indicating Level, Low Set Point and High set Point for each channel.

One Form "C" (NC-C-NO) contact available for each channel. Contact rating 120 VAC @ 3 Amps.

Operates on 12 to 24 VDC power and a 120 VAC wall transformer is included for AC operation.

Stationary Tank Monitor & Cables			
Item Number	Part Number	Description	Case Quantity
136619	S T M 94442A	Includes Monitor, R3D Dial w/ Sender, & AC Adapter	1 Pc.
403557	TM-GSUO5R	R3D 5' Monitor Cable (not shown)	1 Pc.
136105	00294-50'	50' Cable Extension Kit (not shown)	1 Pc.
136125	SIG420	STM 4-20mA Signal Conditional For R6315-12 (Tank To 136619)	1 Pc.
136130	ISO420-1	STM 4-20mA Signal Isolator For R6315-12 (136619 To PLC)	1 Pc.
136135	STM-48V	STM -48V Power Supply Adapter	1 Pc.

HE-2 Conversion Kit



Old Style STM Obsolete

The 0-1000 Ohm 2-Wire Sender is obsolete for the old style 136619 (shown at left). If your 0-1000 dial fails you can still use the monitor with the HE-2 Kit upgrade. All you need is the HE-2 Kit and an R3D dial installed in your existing float gauge.



136603 - HE-2 Kit

3 To 2 Wire for Analog

Order by Gauge Code - Stamped on the Head of any Gauge

Simply order Taylor Visible Gauges by the Gauge Code, and an exact duplicate of the gauge from which the code was taken will be delivered. All Junior and Senior Gauges produced since 1964 have the Taylor code stamped on the top of the head. For all Gauges produced since 2008 the sides of the heads are stamped. For other gauges, and pressure vessel gauge needs, see below.



Old Style.

New Style.

Notes where Gauge Code is located.

If Above Code is Not Available, Specify:

1. TYPE OF SERVICE - LP-Gas or Anhydrous Ammonia(NH3).
2. GAUGE SIZE (or Head Type) - Specify JUNIOR SIZE, SENIOR SIZE, VISIBLE "4", 3/4" THREADED, 1" THREADED, 1 1/4" THREADED, ROADMASTER OR Master Gauge Model (4 Bolt or 8 Bolt).

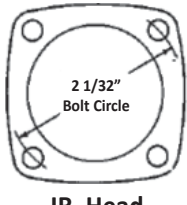

JR. Head

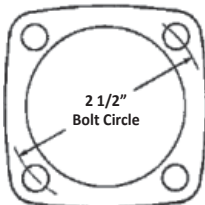

SR. Head

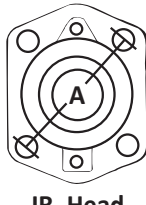

JR. Head
A = 2 1/32"

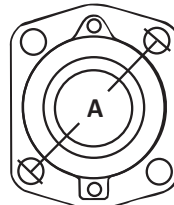

SR. Head
A = 2 1/2"

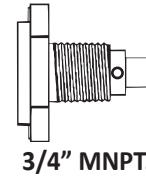

3/4" MNPT.

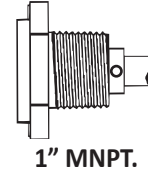

1" MNPT.

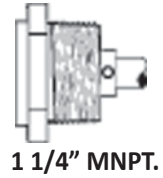

1 1/4" MNPT.

3. TYPE MOUNTING - Top, Side, End, or Angle (if angle, specify angle above horizontal center line).

Mounting Location

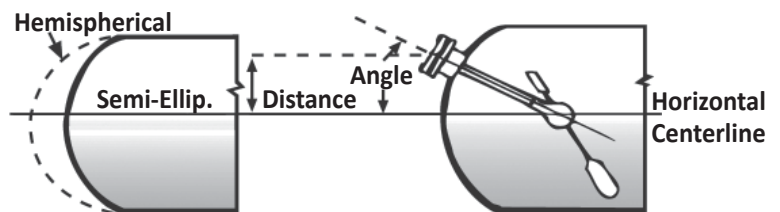
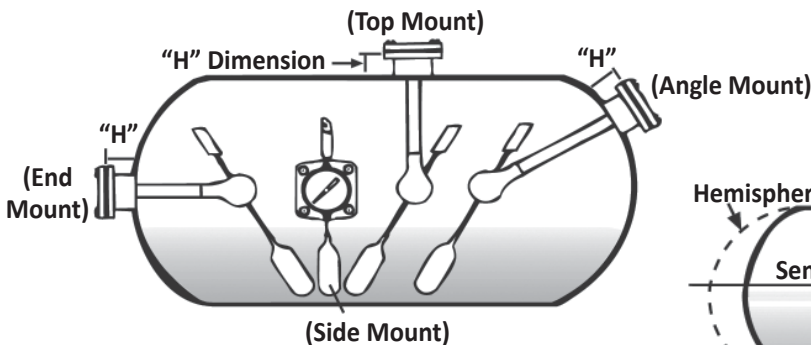

4. GIVE FOLLOWING DIMENSIONS:

H = Distance from tank surface to gasket surface.
D = Inside diameter of tank or cylinder.

5. FOR VERTICAL CYLINDERS ONLY:

X = Distance from center of adaptor to nearest inside wall.
O = Cylinder height.
H = Distance from tank surface to gasket surface.

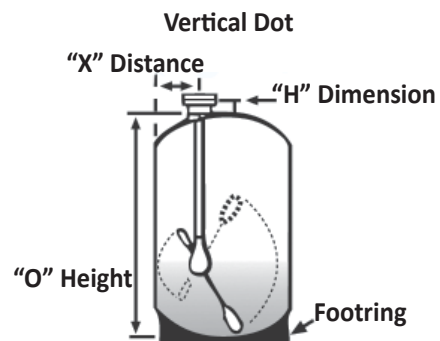

NH3 Tanks	
Prefix	Gauge Description
AA	Sr. NH3 Top Mount
AB	Sr. NH3 Below Mount
AC	Sr. NH3 Angle Mount
AD	Sr. NH3 End Mount
BA	Jr. NH3 Top Mount
BB	Jr. NH3 Below Mount
BC	Jr. NH3 Angle Mount
BD	Jr. NH3 End Mount
CA	Sr. NH3 Visible "4" Top Mount
CB	Sr. NH3 Visible "4" Below Mount
CC	Sr. NH3 Visible "4" Angle Mount
CD	Sr. NH3 Visible "4" End Mount

LP Tanks	
Prefix	Gauge Description
HA	1" Brass LP Top Mount
HC	1" Brass LP Angle Mount
HD	1" Brass LP End Mount
JA	Jr. LP Top Mount
JB	Jr. LP Below Mount
JC	Jr. LP Angle Mount
JD	Jr. LP End Mount
JU	Jr. Universal Mount
SA	Sr. LP Top Mount
SB	Sr. LP Below Mount
SC	Sr. LP Angle Mount
SD	Sr. LP End Mount
TA	1 1/4" Brass Top Mount
TC	1 1/4" Brass Angle Mount
TD	1 1/4" Brass End Mount
TU	1 1/4" Brass Universal Mount
UA	3/4" Brass Top Mount
UD	3/4" Brass End Mount
UU	3/4" Snap-On Universal Mount
UU	3/4" Zinc Universal Mount
VA	Sr. LP Visible "4" Top Mount
VB	Sr. LP Visible "4" Below Mount
VC	Sr. LP Visible "4" Angle Mount
VD	Sr. LP Visible "4" End Mount

LP or NH3 Mobile & Storage	
Prefix	Gauge Description
EL	1" Eliminator End Mount
DA	Master NH3 Top Mount "Obsolete" Use MT
DD	Master NH3 End Mount "Obsolete" Use ME
MA	Master LP Top Mount "Obsolete" Use MT
MD	Master LP End Mount "Obsolete" Use ME
ME	Master LP or NH3 End Mount
MT	Master LP or NH3 Top Mount
RM	RoadMaster End Mount

Motor Fuel Tanks	
Suffix	Gauge Description
__A	Recessed (-3/8") Upper 45° Angle Mount With Direct Reading Dial
__AB	Recessed (-3/8") Lower 45° Angle Mount With Direct Reading Dial
__ABC	Recessed (-3/8") Lower 45° Angle Mount With Converta-Visible Dial
__ABN	Non-Recessed (+5/16") Lower 45° Angle Mount With Direct Reading Dial
__ABNC	Non-Recessed (+5/16") Lower 45° Angle Mount With Converta-Visible Dial
__AC	Recessed (-3/8") Upper 45° Angle Mount With Converta-Visible Dial
__AN	Non-Recessed (+5/16") Upper 45° Angle Mount With Direct Reading Dial
__C	End Mount With Direct Reading Dial
__CC	End Mount With Converta-Visible Dial
__L	Recessed (-3/8") Lower 45° Angle Mount With Direct Reading Dial
__LN	Non-Recessed (+5/16") Lower 45° Angle Mount With Converta-Visible Dial
__T	Recessed (-3/8") Top Mount With Direct Reading Dial
__TC	Recessed (-3/8") Top Mount With Converta-Visible Dial
__TN	Non-Recessed (+5/16") Top Mount With Direct Reading Dial



130012 - 2701 CV Dial
Guide Hole @ 94%
Percentages 5 - 94
Above Ground



130009 - 2701 CV Dial
Guide Hole @ 5%
Percentages 5 - 94
Above Ground



130022 - 2701 R3D Dial
Guide Hole @ 5%
Percentages 5 - 94
Above Ground



130023 - 2701 R3D Dial
Guide Hole @ 30%
Percentages E-90
Above Ground



130021 - 2701 CV Dial
Jr. Tabbed
Percentages 5 - 94
Above Ground



130082 - 2701 R3D Dial
Jr. Tabbed
Percentages 5 - 94
Above Ground



130037 - 2201 CV Dial
Sr. Tabbed
Percentages 5 - 94
Above Ground



403594 - 2701 R3D Dial
Sr. Tabbed
Percentages 5 - 94
Above Ground



136000 - CV50 Dial
Guide Hole @ LP
Fractional E-3/4
Motor Fuel



136005 - CV50 Dial
Jr. Tabbed
Fractional E-3/4
Motor Fuel



130043 - E - F Dial
Jr. Tabbed
Fractional E - F
Lift Truck



130031 - 2713 CV Dial 33 1/2#
Guide Hole @ 45%
Percentages 10 - 45
Lift Truck



130013 - 2733U CV Dial 33 1/2#
Guide Hole @ 7%
H = 13-40% V = 7-20%
Lift Truck



130033 - 7533U CV Dial 33 1/2#
Guide Hole @ 13%
V = 5-20% H = 13-40%
Lift Truck



130081 - 2733U Dial 33 1/2#
Jr. Tabbed
V = 7-20% H = 13-40%
Lift Truck



403582 - 33 1/2# Dial
Snap-On
V = 7-20% H = 13-40%
Lift Truck



130042 - 2766 CV Dial 40#
Guide Hole @ 60%
Percentages 5 - 60
Lift Truck



130017 - 2710 CV Dial 43 1/2#
Guide Hole @ 35%
Percentages 8-35
Lift Truck



130004 - 2743U CV Dial 43 1/2#
 Guide Hole @ 5%
 V = 13-40% H = 5-15%
 Lift Truck



130052 - E - F Dial
 Jr. Tabbed
 Fractional E-3/4
 Lift Truck



130051 - 43 1/2# Dial
 Jr. Tabbed
 V = 7-17% H = 13-40%
 Lift Truck



130006 - 2722 CV Dial
 Guide Hole @ 85%
 Percentages 5 - 85
 200# Vertical



130007 - 2722 CV Dial
 Guide Hole @ 5%
 Percentages 5 - 85
 200# Vertical



130039 - 2722 R3D Dial
 Guide Hole @ 5%
 Percentages 5 - 85
 200# Vertical



130038 - 2722 R3D Dial
 Jr. Tabbed
 Percentages 5 - 85
 200# Vertical



130014 - 2765 CV Dial
 Guide Hole @ 80%
 Percentages 10 - 80
 420# Vertical



132765 - 2765 R3D Dial
 Guide Hole @ 15%
 Percentages 10 - 80
 420# Vertical



130084 - 2765 R3D Dial
Jr. Tabbed
Percentages 10 - 80
420# Vertical



130019 - 2721 CV Dial
Guide Hole @ 12%
Percentages 12 - 85
420# Vertical



130008 - 2746 CV Dial
Guide Hole @ 10%
Percentages 8 - 68
Vertical



130011 - 2700 CV Dial
Guide Hole @ 94%
Percentages 5 - 94
Under Ground



130026 - 2700 CV Dial
Guide Hole @ 5%
Percentages 5 - 94
Under Ground



130024 - 2700 R3D Dial
Guide Hole @ 5%
Percentages 5 - 94
Under Ground



130028 - 2700 R3D Dial
Guide Hole @ 30%
Percentages 5 - 94
Under Ground



130083 - 2700 R3D Dial
Jr. Tabbed
Percentages 5 - 94
Under Ground



130005 - 2201 Dial
Jr. Universal
Percentages 5-94
Glue-On Replacement



130010 - 2201 Dial
Sr. Universal
Percentages 5 - 94
Glue-On Replacement



130053 - 2201 R3D Dial
Sr. Universal
Percentages 5 - 94
Glue-On Replacement



136610 - Direct Read Dial
Fits any Old Style Taylor Gauge
Fits any Jr. Tabbed Gauge
Percentages 5 - 95



130020 - 5511T Dial
Mounts on Old Style Head
LP Only
Visible 4"



130085 - 5511R Dial
Mounts on New Style Head
LP Only
Visible 4"



130087 - 2778R
Mounts on New Style Head
LP or NH3
Visible 4"



130045 - 5520T
Mounts on Old Style Head
Flow Indicator
Visible 4"



130046 - 5520R
Mounts on New Style Head
Flow Indicator
Visible 4"



131839 - RoadMaster Dial
Mounts to RoadMaster
LP or NH3
Visible 4"



**131820 - RoadMaster R3D Dial
Mounts to RoadMaster
LP or NH3
Visible 4"**



**131821 - RoadMaster Dial
Mounts to RoadMaster
LP or NH3
Visible 4" Fluorescent**



**131822 - RoadMaster R3D Dial
Mounts to RoadMaster
LP or NH3
Visible 4" Fluorescent**



**130035 - Master Dial
Mounts to 2 Bracket Heads
LP or NH3
8" Master**



**130090 - Master Dial
Mounts to 3 Bracket Heads
LP or NH3
8" Master**



**130036 - 4102 Master Dial
Mounts to 2 Bracket Heads
LP Only
8" Master**



**130091 - 4102 Master Dial
Mounts to 3 Bracket Heads
LP Only
8" Master**



**130078 - R3D Master Dial
Mounts to 2 Bracket Heads
LP or NH3
8" R3D Master**



**130034 - R3D Master Dial
Mounts to 3 Bracket Heads
LP or NH3
8" R3D Master**



130078 - R3D Master Dial
Mounts to 2 Bracket Heads
LP or NH3
8" R3D Master



130034 - R3D Master Dial
Mounts to 3 Bracket Heads
LP or NH3
8" R3D Master



130088 - Master Dial
Mounts to 2 Bracket Heads
LP or NH3
8" Fluorescent Master



130089 - Master Dial
Mounts to 3 Bracket Heads
LP or NH3
8" Fluorescent Master



130094 - R3D Master Dial
Mounts to 2 Bracket Heads
LP or NH3
8" Fluorescent Master



130099 - R3D Master Dial
Mounts to 3 Bracket Heads
LP or NH3
8" Fluorescent Master



130018 - 2208 CV NH3 Dial
Guide Hole @ 93%
Percentages 5 - 95
Above Ground



130029 - 2208 CV NH3 Dial
Guide Hole @ 5%
Percentages 5 - 95
Above Ground



130049 - 2208 NH3 Dial
Jr. Tabbed Heads
Percentages 5 - 95
NH3 Only



130041 - 2209 NH3 Dial
Sr. Tabbed
Percentages 5 - 95
Above Ground



130016 - 2208 NH3 Dial
Jr. Universal
Percentages 5 - 95
Glue-On Replacement



130015 - 2208 NH3 Dial
Sr. Universal
Percentages 5 - 95
Glue-On Replacement



130025 - 5553T NH3 Dial
Mounts on Old Style Head
Percentages 5 - 95
Above Ground



130086 - 5553R NH3 Dial
Mounts on New Style Head
Percentages 5 - 95
Above Ground



130030 - 4607 Master Dial
Mounts to 2 Tabbed Heads
NH3 Only
8" Master



130092 - 4607 Master Dial
Mounts to 3 Tabbed Heads
NH3 Only
8" Master



130035 - Master Dial
Mounts to 2 Tabbed Heads
LP or NH3
8" Master



130090 - Master Dial
Mounts to 3 Tabbed Heads
LP or NH3
8" Master

Visible "2" Dials

The Visible "2" dials come in a variety of styles and sizes. The Direct Read dials are available in Drop-In, Jr. Tabbed, Sr. Tabbed, and Glue-On Replacement (Jr. & Sr.). The R3D Dials are Hall Effect compatible and are available in Drop-In, Jr. Tabbed and Sr. Tabbed.

Note: The Drop-In dials fit Jr. & Sr. Old Style heads and have locating tabs on the back of the dial that position the dial in the head of the gauge. Glue-On Replacement dials will work with any Jr. or Sr. gauge ever built.



Drop-In



Style A

The large hole on the back lines up with the 94% mark on the front of the dial.



R3D Drop-In



Style B

The large hole on the back lines up with the 5% mark on the front of the dial.



Jr. Tabbed



Sr. Tabbed



R3D Jr. Tabbed



R3D Sr. Tabbed



Jr. Glue-On



Sr. Glue-On



Jr. Glue-On



Sr. Glue-On



Old Style Jr.



Old Style Sr.



New Style Jr.



New Style Sr.

Visible "4" Dials

The Visible "4" dials come in two styles. If you have the Old Style Head then you need a dial with the "T" suffix. If you have the New Style Head then you need a dial with the "R" suffix.



"T" Old Style Head



The following dials are available for the Old Style Head.
5520T, 5511T, and 5553T



"R" New Style Head



The following dials are available for the New Style Head.
5520R, 5511R, 5553R, and 2778R

Master Dials

The Master dials come in two styles. If you have the Old Style Head with 2 brackets then you need a dial with the “T” suffix. If you have the New Style Head with 3 brackets then you need a dial with the “R” suffix.



“T” Old Style Head



The following dials are available for the Old Style Head.
4102T, 4607T, and Combo”T”
130036, 130030, and 130035



“R” New Style Head

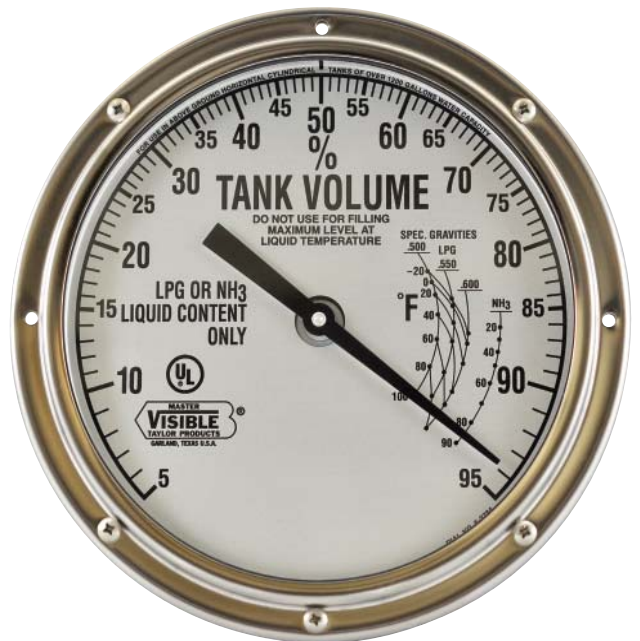

The following dials are available for the New Style Head.
4102R, 4607R, and Combo”R”
130091, 130092, and 130090

Jr. & Sr. Glue-On Dial Instructions *

1. Determine dial orientation.
2. Break out lens, remove pointer, and bend over stem.
3. Glue on the new dial.



1. Before Installation



2. Ready To Glue



3. After Installation

*** Refer to Dial Kit Instruction Sheet For Complete Instructions, Warnings and Cautions.**

Visible "4" Instructions

These Instructions are for the following dials - 5520T, 5511T, and 5553T.

These dials come the factory pre-assembled and are attached by placing the dial and bracket assembly over the head and tightening the two screws (Figure 1) to clamp the dial to the gauge head (Figure 2).



Complete Dial Assembly
Front View



Complete Dial Assembly
Back View

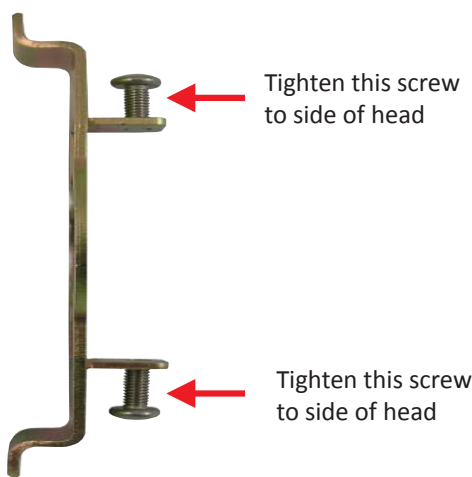

Figure 1



Figure 2



Figure 3

Visible "4" Instructions

These Instructions are for the following dials - 2778R, 5520R, 5511R , and 5553R.

These dials will come the factory pre-assembled and need to be disassembled prior to installation.

1. Remove the two screws that attach the bezel (Figure 1) to the bracket. This will allow the bezel and dial to be removed from the bracket assembly.
2. Use the two small screws that are in the bracket to attach the bracket to the gauge head (Figure 2). NOTE the orientation of the notch that must be at the "3 O'clock position".
3. After the bracket is attached to the dial head, push the dial into the bracket and attach the bezel with the two screws that you originally removed (Figure 3).



Complete Dial Assembly
Front View



Complete Dial Assembly
Back View



Figure 1

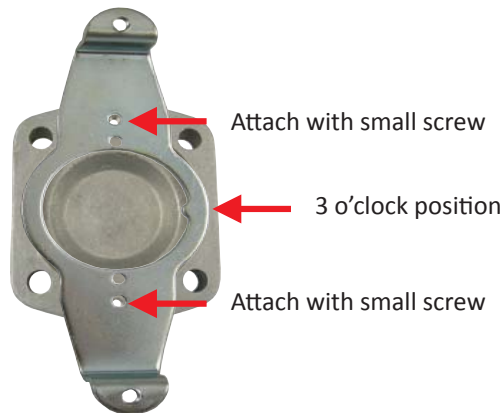

Figure 2



Figure 3

New Style 3 Bracket Master Instructions

1. Remove dial screws from brackets on the gauge head.
2. Match the 3 holes on the dial up with 3 brackets.
3. Replace the 3 screws that you removed in step 1 and tighten them down.



Old Style 2-Bracket Master Instructions

These dials will come from the factory pre-assembled and needs to be disassembled prior to installation.

1. Remove the four screws and nuts that attach the brackets (Figure 1) to the dial. This will allow the brackets to be installed on the gauge head.
2. Use the two small screws that are in the bracket to attach the brackets to the gauge head (Figure 2).
3. After the brackets are attached to the gauge head, make sure that the 50% mark on the dial and top on the head matches up and attach the dial to brackets with the 4 screws and nuts that you originally removed (Figure 3).

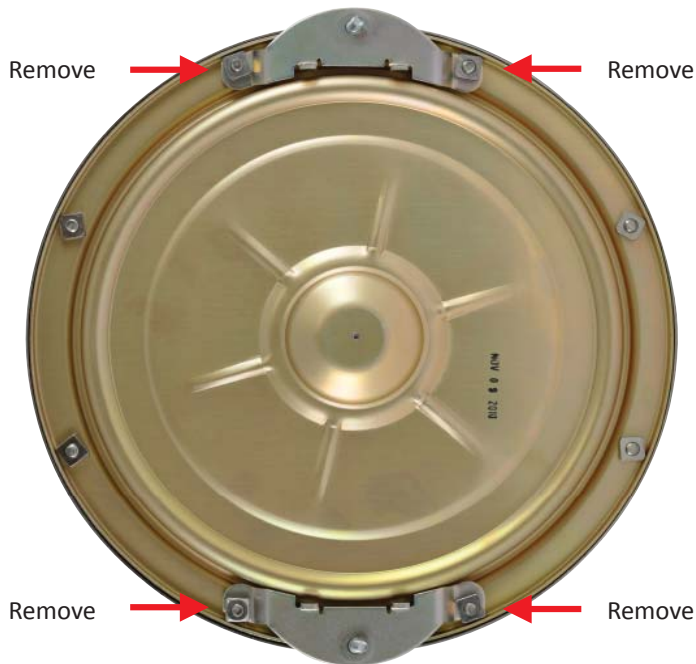

Figure 1



Figure 2



Figure 3

Broken Screw Kit			
Item Number	Part Number	Description	Case Quantity
130054	Jr. & Sr. Broken Screw Kit	Includes Blocks, Bolts, Drills, Taps & Instructions	1 Pc.



130054

Notes:



Your Distributor Is: