



PIPE TOOLS & VISES  
SINCE 1896

[www.reedmfgco.com](http://www.reedmfgco.com)



*CUTTERS & CUTTER WHEELS / LARGE DIAMETER PIPE TOOLS / PLASTIC PIPE TOOLS / WATER SERVICES TOOLS & MACHINES / GROOVERS, POWER DRIVES, THREADERS & DIES / VISES / WRENCHES / GENERAL PIPE WORKING TOOLS*

*THE PROFESSIONAL'S  
**FIRST CHOICE***

Quality. Service. Performance.



# ✓ WHY REED?

## BENEFITS FOR REED CUSTOMERS & COMMUNITY

PIPE TOOLS & VISES  
SINCE 1896



(L-R) Scott Wright (5th generation), Ralph Wright (4th - Chairman Emeritus - deceased), and Mark Wright (5th)



Reed Manufacturing has been producing fine tools for worldwide professional trades since its founding, in 1896, by Carl Reed. The company was purchased in 1902 by Reuben Wright with money he made selling water and hardware during the 1849 California Gold Rush, followed by successful timber businesses in Wisconsin, Michigan, and Western Pennsylvania. The company continues to be operated by his descendants: fifth generation members of the Wright family. Mark Wright and Scott Wright serve as President, Manufacturing & Product Development and President, Sales & Finance, respectively. At Reed in several roles for more than 25 years each, Mark and Scott uphold the family traditions of product innovation, highest quality pipe tools, great customer service, a cutting edge factory and extra value to customers.

Five generations of Wrights have also provided a great place to work and exceptional contributions to the community. Reed Manufacturing is a big supporter of the Erie County United Way (\$2,974 per capita for 2014), the Second Harvest Food Bank along with WQLN Public Television, among others. Additionally, Reed Associates are encouraged to give back to the community through gifts of money and service.

### BEST EVER!

### REED ASSOCIATES



L to R - Debbie Sulecki, Jeff Esmont, Pat Reinke



L to R - Patty Soderberg, Mike Pruzinsky, Bill Stevens, Hector Angel Andrade, Todd Gilpatrick, Tom Fess, LaVerna Ritchie, Steve Angermeier, Marnie Caldwell



L to R - Minnie Franz, Joyce Carr, Julie Machinski, Tim Donohue, Gene Lachman, Brian Gunderson, Gou-Dong "Jason" Cao, Carrie Applequist, Wan-Xin Werstler, Yousef Hamdan



Hartmut Lutz



Matt Harvey

The secret of Reed's continuing, increasing success can be attributed to its corporate culture of excellence and the quality of its Associates, who are individually committed to exceptional performance and service. Reed engineers developed many of the most innovative and effective tools in the industry – such as the Quick Release™ Tubing Cutter, the Hinged Cutter™, the Rotary™ Cutter and the Universal Pipe Cutter. Many of these tools have been copied by others, but through continuous improvements and everyday dedication to quality workmanship, Reed products remain the finest in the world.

The goals of each Reed Associate are to ship 95% of orders within three business days, to provide immediate, informed responses to customer inquiries and to produce 100% error-free work. Reed works diligently to cultivate relationships with dependable distributors to reach the end-user market. Selling through traditional, local distributors is the best avenue to strengthen ties with Reed tool users. The strong links in the customer service chain – from product development and manufacturing, through order processing and inquiry fulfillment, to distribution – make Reed a leader in customer satisfaction. Reed identifies the best people to provide the best quality tools which results in the best service available.

**BEST Service** + **BEST Quality** + **BEST People** = **The LOWEST TOTAL COST**



PIPE TOOLS & VISES  
SINCE 1896

**WE ARE  
DEDICATED  
TO EARNING &  
KEEPING YOUR  
BUSINESS.**

**Reach us at:**

**Phone**

**800.666.3691** (US/Canada) or **814.452.3691**  
7:30 am - 5:30 pm U.S. Eastern Time

**Fax**

**800.456.1697** (US/Canada) or **814.455.1697**

**Email**

**reedsales@reedmfgco.com**

**Shipping Address**

1425 West 8th Street  
Erie, Pennsylvania 16502 USA

**Mailing Address**

P.O. Box 1321  
Erie, Pennsylvania 16512 USA

**www.reedmfgco.com**



**REED MISSION STATEMENT P. 30**  
**REED LIFETIME WARRANTY P. 80**



**CUTTERS & CUTTER WHEELS**

<b>NEW</b> Cutter Wheels .....	7 - 9
Quick Release™ Tubing Cutters (for metal).....	11
Tubing Cutters.....	11
Tubing Cutters for Stainless Steel.....	11
Telescoping Tubing Cutters.....	12
Mini Tubing Cutters.....	12
C Cutters.....	12
Repair Kits.....	13
2" Pipe Cutters.....	13
Deburring Tools (for metal).....	13
Soil Pipe Cutters.....	14
Saw It® Pneumatic Saw.....	15
Power Hack Saw Blades.....	15
Universal Pipe Cutters.....	16 - 17
Filter-Regulator-Lubricator.....	17
Hinged Cutters™.....	18
<b>NEW</b> Hinged Cutters™ with Helper Handle.....	18
<b>NEW</b> Low Clearance Rotary™ Cutters.....	19
Rotary™ Cutters.....	19
Pipe Descalers.....	20
Pipe Reamer (for steel).....	20

**LARGE DIAMETER PIPE TOOLS**..... 22 - 23



**PLASTIC PIPE TOOLS**

Quick Release™ Tubing Cutters for Plastic.....	25
Scissor Shears.....	25
Ratchet Shears.....	26
Plastic Pipe Saws.....	26
Internal Pipe Cutters.....	27
Plastic Pipe Fitting Reamers.....	27
<b>NEW</b> Solutions Kits.....	28
PE Scraper.....	28
Flare Tools for PE Water Service Lines.....	28
<b>NEW</b> Deburring Tools for Plastic.....	29
PEX Crimpers.....	29
Bevelers (for PVC).....	30
<b>NEW</b> Drill-Powered Bevelers (for PVC/CPVC).....	30
Universal Pipe Cutters for PE.....	31
Rapid Cut & Bevel™ Machines.....	31
PLAS In-Line Rotary™ Cutters (for PE/PVC).....	32
PLAS Hand-Over-Hand Rotary™ Cutters (for PE/PVC).....	32
Guillotine Pipe Cutters (for PE).....	33
PE Squeeze-Off Tools.....	34 - 35
Grounding Accessory.....	35
Static Discharge Alarm.....	35
Plastic Pipe Joiners (for PVC).....	36

### 3 WATER SERVICES TOOLS & MACHINES 37

<b>NEW</b> Feed Tap™ Drilling Machines.....	38
Direct Tapping Machine.....	39
Drilling Machines.....	40 - 41
Combination Drilling/Tapping Machines.....	42
PVC/PE Drilling Machines.....	42 - 43
<b>NEW</b> Power Units for Tapping/Drilling.....	43
PE Water Service Shut-Off Tool.....	44
Standing Shut-Off Tool.....	44
Copper Shut-Off Tools.....	44
Flare Tools.....	45
Rerounding Tools.....	45
Brass Hammer.....	45
Round It® Straightener/Rerounders.....	45
<b>NEW</b> Fiberglass Probe Rod.....	46
Meter Pit Pump.....	46
Manhole Hooks.....	46
<b>NEW</b> Drill-Powered Hydrostatic Test Pump.....	47
Electric Hydrostatic Test Pumps.....	47
Hydrostatic Test Pumps.....	47
Valve & Curb Keys.....	48
Ratcheting Valve Keys.....	48
<b>NEW</b> Valve Operators.....	49
Valve & Curb Keys Matrix.....	49
Meter Box & Curb Box Lid Keys.....	49

### 4 GROOVERS, POWER DRIVES, THREADERS & DIES 50

Combo Roll Groover.....	51
Portable Roll Groovers.....	51
5301PD Power Drives.....	52
Ground Fault Interrupter.....	52
<b>NEW</b> Threading Machines.....	53
Machine Cart.....	53
700PD Power Drives.....	54
<b>NEW</b> 700APD Pneumatic Power Drives.....	54
701PD Power Drives.....	55
601PD Power Drives.....	55
Oilers.....	56
Threadguard Cutting Oil.....	56
R12+ Segmental Dies.....	57
R12+ Dropheads.....	57
R12+ Threader Sets.....	57
<b>NEW</b> Universal Dies.....	58
Universal Die Head.....	58
Enclosed Ratchet Threader Sets.....	59
Enclosed Dropheads.....	59
Adjustable Guide Threader Sets.....	60
Block Dies.....	60

### 5 VISES 61

Tripod Vises.....	62 - 63
<b>NEW</b> Pipe Jacks.....	63
Chain Vises.....	64
Field Pipe Vise.....	64
Yoke Pipe Vises.....	64
Utility Workshop Vises.....	65
Mid-Line Vises.....	65
Combination Bench & Pipe Vises.....	65
Brass Vise Jaw Caps.....	66
Pipe Welding Vise.....	66

### 6 WRENCHES 68

Pipe Wrenches.....	69
60" Pipe Wrench Parts.....	69
Aluminum Pipe Wrenches.....	69
Chain Tongs.....	70
Chain Wrenches.....	70
Strap Wrenches.....	70
Adjustable Wrenches.....	71
Comfort Grip - Adjustable Wrenches.....	71
Torque Wrenches for Cast Iron Soil Pipe.....	71
Thru-Bolt™ Ratchet Wrenches & Sockets (Standard & Metric)....	72
Thru-Bolt™ Larger Ratchet Wrench & Sockets.....	73
<b>NEW</b> Square Drive Ratchet Wrenches.....	73
<b>NEW</b> Extended Sockets.....	73
<b>NEW</b> Thru-Bolt™ 4-in-1 Ratchet Wrench.....	74
<b>NEW</b> Thru-Bolt™ Dual Socket Ratchet Wrenches.....	74
Basin Wrenches.....	75
One Hand Meter Wrenches.....	75
Comfort Grip - One Hand Meter Wrench.....	75
Operator's Wrench.....	76
Valve Packing Wrenches.....	76
Valve Wheel Wrenches.....	76
Smooth Jaw Wrenches.....	77
Hydrant Wrenches.....	77
Ratcheting Hydrant Wrench.....	77

### 7 GENERAL PIPE WORKING TOOLS 78

Mechanical Hot Tapping Machines.....	79
Tubing Benders.....	79
Stud Punch.....	80
Multi-Purpose Pipe Joiner.....	81
Torpedo Level.....	81
Hack Saw & Blades.....	81
Water Pump Pliers.....	82
Positive Grip Pliers.....	82
Threaded Rod Cutters.....	82



# SPECIAL FEATURES

PIPE TOOLS & VISES  
SINCE 1896

Throughout the catalog, various symbols are used to help the reader identify key points:



**Reed Exclusive Tool** – The tool is unique, available only from Reed, offers operational cost savings or safety features, and at least one advantage to buying Reed.



**Reed Exclusive Features** – The tool has special features available only from Reed. These meaningful features are advantages to buying Reed.



**Reed Exclusive Sizes** – The tool is available in certain capacities only from Reed. These unique capacities are advantages to buying Reed.



**Reed Best Ever** – The tool has been improved over all previous versions. These continuous improvements are advantages to buying Reed.



**Reed Online Video Training** – Numerous tools offer training videos through the Reed website or YouTube.



**Reed Metric Sizes** – The tool has metric-only sizing. However, Reed offers a wide variety of other tools to fit metric pipe since most tools suit a range of sizes.



Next to many of the tools in this catalog, there is a brief statement headed by the term: "**WHY REED?**" This statement explains why that particular Reed tool is superior to any other on the market, and can be used with confidence to compare Reed products with the competition.



**New Tools** are indicated by **NEW** symbol, while models added to the Reed line are highlighted in charts in **red ink**. To Reed, "**NEW**" means the tool was introduced within the last 12 months.



**Reed Extra Value** – The tool offers extra cost savings over the previous Reed version – or the competitors'.



**Truck Freight Required** – These tools require truck freight due to size or weight.

## REED - REGISTERED & TRADEMARKED

**Clean Cut®**

**Cutter Wheel Headquarters™**

**Feed Tap™**

**Hinged Cutter™**

**Hole Master®**

**Quality First®**

**Quick Release™ Cutter**

**Rapid Cut & Bevel™**

**Rotary™ Cutter**

**Round It®**

**Saw It®**

**Thru-Bolt™**

## HOW TO FIND REED DISTRIBUTORS

**BUY NOW »**

LOCAL OR ONLINE

To find the nearest **Reed distributor**, visit **WHERE TO BUY** on [www.reedmfgco.com](http://www.reedmfgco.com).

There is a section for **FIND A DISTRIBUTOR** which uses a zip code/postal code search to identify nearby stocking distributors. There is also **SHOP ONLINE DISTRIBUTORS** which links to vetted, stocking Reed distributors that also run online retailer websites.

Alternatively, contact Reed Sales or a Reed Regional Manager or Manufacturer's Representative to find a distributor.

# REPLACEMENT WHEELS

## FOR EVERY PIPE & PIPE CUTTER

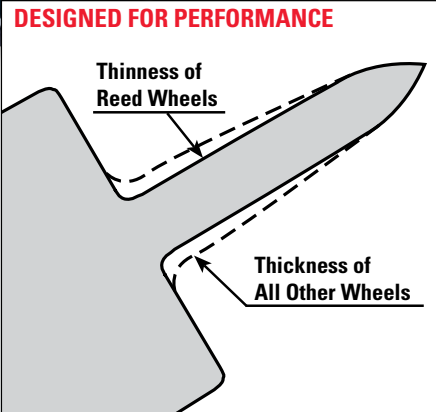

**BE ON THE CUTTING EDGE WITH REED!**

Back



Front

The most popular types of genuine Reed cutter wheels (P. 7) are also sold in convenient, two-pack display bags for quick and easy showroom purchases.

### ✓ **WHY REED? CUTTER WHEELS ARE BETTER...**

All Reed cutter wheels are made from high shock-resistant tool steel, while competitive wheels are made from carbon steel or still lower quality tool steel. By using this higher quality raw material, Reed cutter wheels can be made thinner and can therefore cut pipe more easily and leave less burr. Also, because of their higher quality, certified material, only Reed wheels can be heat-treated for the perfect balance between hardness and toughness to make the wheels resist breakage and last longer.

Reed pioneered the development of wheels for plastic pipe and today has the widest variety and highest quality wheels for various types and wall thicknesses of plastic pipe and tubing.

Reed offers the largest cutter wheel line for all types of pipe, tubing and conduit. Reed wheels are the best value for use in Reed cutters, or in the cutters of any other manufacturer.

**CUTTER WHEEL INTERCHANGEABILITY CHARTS P. 7-9**



[www.reedmfgco.com](http://www.reedmfgco.com)



**PIPE TOOLS & VISES  
SINCE 1896**



## Reed 2-Pack Replacement Cutter Wheels

Item Code	Reed Catalog No.	Std. Pack	Reed Cutter	Blade Exposure**		Application
				inches	mm	
<b>FOR TUBING CUTTERS - METAL, 2-PACK</b>						
63375	2PK-SLRCW	1	TC50SL; TC75SL; TC1SL; TC50SLR; TC75SLR; TC1SLR	0.116	2.9	Copper (K, L & M); CTS CPVC
63612	2PK-2RBS	1	2-1; 2-1Q; 2-4WG; 2-3; 2-3Q; 2-4; 5401TMSO	0.300	7.6	Steel; Stainless Steel
63613	2PK-2RBHD	1	2-1; 2-1Q; 2-4WG; 2-3; 2-3Q; 2-4; 5401TMSO	0.296	7.5	HD for Steel; Stainless Steel
63655	2PK-OSS	1	TC1Q; TC1.6Q; TC2Q; T10; T15; T20	0.160	4.1	Stainless Steel
63659	2PK-OCSSST-2	1	TC1.6Q; TC1.6RGT; TC2Q; TC2QRGT	0.281	7.1	CSST
63660	2PK-O	1	TC1Q; TC1.6Q; TC2Q; T10; T15; T20; RT15T1; RT15T2; RT15T3; RTC1.1; RTC1.4	0.180	4.6	Copper; Aluminum; Brass; Steel
63661	2PK-32633	1	MC1	0.127	3.2	Copper; Aluminum; Brass; Steel
63662	2PK-75015	1	TC11; TC17	0.125	3.2	Copper; Aluminum; Brass; Steel
63663	2PK-75046	1	TC11; TC17	0.125	3.2	Copper; Aluminum; Brass; Steel; Stainless Steel
63665	2PK-30-40	1	TC3Q; TC4Q; TC5Q; TC6Q; TC8Q	0.250	6.4	Copper; Aluminum; Brass; Steel
63666	2PK-345T	1	MC2; MC2GRIP	0.146	3.7	Copper; Aluminum; Brass
63670	2PK-R2558	1	TC3Q; TC4Q; TC5Q; TC6Q; TC8Q	0.188	4.8	Muffler Systems Tubing
63671	2PK-30-40SS	1	TC3Q; TC4Q; TC5Q; TC6Q; TC8Q	0.160	4.1	Stainless Steel
63690	2PK-73505	1	TC14; TC166; MC3	0.170	4.3	Copper; Aluminum; Brass; Steel
63691	2PK-73515	1	TC14; TC166	0.170	4.3	Stainless Steel Only
<b>FOR TUBING CUTTERS - PLASTIC, 2-PACK</b>						
64180	2PK-OP2	1	TC1Q; TC1.6Q; TC2Q; T10; T15; T20	0.275	7.0	ABS; PE; PEX; PP; PEX/AL/PEX
64184	2PK-1-2PVC	1	TC1Q; TC1.6Q; TC2Q; T10; T15; T20	0.160	4.1	PVC; CPVC; PVDS
64190	2PK-30-40P	1	TC3Q; TC4Q; TC5Q; TC6Q	0.343	8.7	ABS; PE; PP
64194	2PK-3-6PVC	1	TC3Q; TC4Q; TC5Q; TC6Q	0.377	9.6	3"-6" PVC; 4" Heavy Wall; CPVC

## Reed Replacement Cutter Wheels

Item Code	Reed Catalog No.	Std.* Pack	Reed Cutter	Blade Exposure**		Application
				inches	mm	
<b>FOR TUBING CUTTERS - METAL</b>						
03375	SLRCW	12	TC50SL; TC75SL; TC1SL; TC50SLR; TC75SLR; TC1SLR	0.116	2.9	Copper (K, L & M); CTS CPVC
03655	OSS	12	TC1Q; TC1.6Q; TC2Q; T10; T15; T20	0.160	4.1	Stainless Steel
03657	3T23	4	T23	0.125	3.2	Copper; Aluminum; Brass; Steel
03659	OCSSST-2	12	TC1.6Q; TC1.6RGT; TC2Q; TC2QRGT	0.281	7.1	CSST
03660	O	12	TC1Q; TC1.6Q; TC2Q; T10; T15; T20; RT15T1; RT15T2; RT15T3; RTC1.1; RTC1.4	0.180	4.6	Copper; Aluminum; Brass; Steel
03661	32633	12	MC1	0.127	3.2	Copper; Aluminum; Brass; Steel
03662	75015	12	TC11; TC17	0.125	3.2	Copper; Aluminum; Brass; Steel
03663	75046	12	TC11; TC17	0.125	3.2	Copper; Aluminum; Brass; Steel; Stainless Steel
03665	30-40	12	TC3Q; TC4Q; TC5Q; TC6Q; TC8Q	0.250	6.4	Copper; Aluminum; Brass; Steel
03666	345T	12	MC2; MC2GRIP	0.146	3.7	Copper; Aluminum; Brass
03668	R4546	6	MC2; MC2GRIP	0.161	4.1	Steel; Stainless Steel
03670	R2558	12	TC3Q; TC4Q; TC5Q; TC6Q; TC8Q	0.188	4.8	Muffler Systems Tubing
03671	30-40SS	12	TC3Q; TC4Q; TC5Q; TC6Q; TC8Q	0.250	6.4	Stainless Steel
03690	73505	12	TC14; TC166; MC3	0.170	4.3	Copper; Aluminum; Brass; Steel Tubing
03691	73515	12	TC14; TC166	0.170	4.3	Stainless Steel Only
<b>FOR TUBING CUTTERS - PLASTIC</b>						
★ 04159	TC56QPP-R	6	TC5Q; TC6Q; TC8Q	0.744	18.9	Aquatherm® PP-R
04180	OP2	12	TC1Q; TC1.6Q; TC2Q; T10; T15; T20	0.275	7.0	ABS; PE; PEX; PP; PEX/AL/PEX
04184	1-2PVC	12	TC1Q; TC1.6Q; TC2Q; T10; T15; T20	0.280	7.1	ABS; PVC; CPVC; PVDF
04190	30-40P	12	TC3Q; TC4Q; TC5Q; TC6Q	0.343	8.7	ABS; PE; PP
04192	680PVC	4	TC6Q; TC8Q	0.575	14.6	PVC-Standard & Heavy Wall; CPVC
04194	3-6PVC	12	TC3Q; TC4Q; TC5Q; TC6Q	0.377	9.6	ABS; 3"-6" PVC; 4" Heavy Wall; CPVC
04198	6QP	4	TC4Q; TC5Q; TC6Q; TC8Q	0.550	14.0	Thick Wall PE
04199	80P	4	TC6Q; TC8Q	0.750	19.1	ABS; PE; PP
<b>FOR PIPE CUTTERS</b>						
03612	2RBS	12	2-1; 2-4WG; 2-3; 2-4; 5301PD; 5401TMSO	0.300	7.6	Steel; Stainless Steel
03613	2RBHD	12	2-1; 2-4WG; 2-3; 2-4; 5301PD; 5401TMSO	0.296	7.5	HD for Steel; Stainless Steel
03624	2RBCI	4	2-1; 2-4WG; 2-3; 2-4	0.172	4.4	Cast Iron
03616	3RG	4	4-1; 4-3; 4-4; 4-4WG	0.172	4.4	Steel; Stainless Steel
03617	3RGCI	4	4-1; 4-3; 4-4; 4-4WG	0.172	4.4	Cast Iron; Ductile Iron
03532	R1032/S	6	5301PD; 5401TMSO	0.450	11.4	Steel; Stainless Steel; Schd 80

★ NEW

\* Cutter wheels sold to distributors in standard package quantities only.

\*\* Blade Exposure determines wall thickness capacity of cutter wheel.



## Reed Replacement Cutter Wheels

Item Code	Reed Catalog No.	Std.* Pack	Reed Cutter	Blade Exposure**		Application
				inches	mm	
<b>FOR HINGED CUTTERS</b>						
03502	HS21/2	4	H21/2	0.312	7.9	Steel; Stainless Steel
03504	HS4	4	H4; LCRC4	0.320	8.1	Steel; Stainless Steel
03505	HS14	4	H4	0.275	7.0	Steel; Stainless Steel; Cast Iron; Ductile Iron
03506	HS6	4	H6	0.390	9.9	Steel; Stainless Steel; Copper
03507	HS16-8	4	H6; H8	0.350	8.9	Steel; Stainless Steel; Cast Iron; Ductile Iron
03508	HS8-12	4	H8; H12	0.450	11.4	Steel; Stainless Steel
03510	HX21/2	4	H21/2	0.383	9.7	Steel; Stainless Steel; Schd 80
03512	HX4	4	H4; LCRC4	0.383	9.7	Steel; Stainless Steel; Schd 80
03514	HX6	4	H6	0.476	12.1	Steel; Stainless Steel; Schd 80
03516	HX8	4	H8; H12	0.567	14.4	Steel; Stainless Steel; Schd 80
03518	HXX8	4	H8; H12	0.682	17.3	Steel; Stainless Steel; Schd 100
03522	HI4	4	H4; LCRC4	0.258	6.6	Cast Iron; Ductile Iron
03524	HI6	4	H6; H8; H12	0.410	10.4	Cast Iron; Ductile Iron
03525	H6PSE5	4	H6; H8; H12	0.400	10.2	Steel; Cast Iron; Ductile Iron
03624	2RBCI	4	H21/2	0.172	4.4	Cast Iron; Ductile Iron

### FOR ROTARY™ CUTTERS

03530	RCS8-36	4	LCRC8; LCRC12; LCRC16; RC20; RC24; RC30; RC36; RC42S	0.635	16.1	Steel; Stainless Steel
03535	RC18-30	4	LCRC8; LCRC12; LCRC16; RC20; RC24; RC30; RC36	0.500	12.7	Cast Iron; Ductile Iron (manual)
03550	RCX	4	LCRC8; LCRC12; LCRC16; RC20; RC24; RC30; RC36; RC42S	0.800	20.3	Heavy Wall Steel; Stainless Steel

**REQUIRES: ONE SET (8) OF RC8-30XR ROLLERS (93222) WHEN USING RCX WHEELS**

## Reed Replacement Cutter Wheels, by Manufacturer

Manufacturer Cutter No.	Manufacturer Wheel	Reed Cat. No.	Item Code	Std. Pack*	Blade Exposure**		Application
					inches	mm	
<b>RIDGID®</b>							
50	M-50	R2558	03670	12	0.188	4.8	Muffler Systems Tubing
10; 15; 20	E-1240	OSS	03655	12	0.160	4.1	Stainless Steel
10; 15; 20	E-1240	O	03660	12	0.180	4.6	Steel
10; 15; 20	F-158	O	03660	12	0.180	4.6	Copper; Aluminum
101; 103; 104; 105; 118; 150; 150L; 131; 132; 151; 152; 153; 205	E-3469	345T	03666	12	0.146	3.7	Copper; Aluminum; Brass
105; 150; 150L; 131; 132; 151; 152; 153; 205	E-4546	R4546	03668	6	0.161	4.1	Steel; Stainless Steel
131P; 132P; 151P; 152P; 153P; 205P	E-2155	R2155	04185	6	0.295	7.5	PE; PP-Standard & Heavy Wall
131P; 132P; 151P; 152P; 153P; 205P	E-5272	R5272	04186	6	0.295	7.5	PVC; ABS-Standard Wall
134P; 136P; 154P; 156P	E-702	680PVC	04192	4	0.575	14.6	PVC- Standard & Heavy Wall; CPVC
134P; 136P; 154P; 156P	E-2157	60P	04198	4	0.550	14.0	Thick Wall PE
136P; 156P	E-2880	80P	04199	4	0.750	19.1	ABS; PE; PP
1A; 2A; 42A; 202; 300; 360; 820; 364; 732; 300; 535	E-1032S	R1032/S	03532	6	0.450	11.4	Steel; Stainless Steel; Schd 80
1A; 2A; 42A; 202; 360; 820; 364; 732	F-514	2RBS	03612	12	0.300	7.6	Steel; Stainless Steel
1A; 2A; 42A; 202; 360; 820; 364; 732	F-3	2RBHD	03613	12	0.296	7.5	HD for Steel; Stainless Steel
1A; 2A; 42A; 202; 360; 820; 364; 733	F-3S	2RBHD	03613	12	0.296	7.5	HD for Steel; Stainless Steel
1A; 2A; 42A; 206; 360; 820; 364; 732	F-119	2RBCI	03624	4	0.172	4.4	Cast Iron
30; 40; 106; 108; 109; 133; 134; 136; 154; 156	E-2191	30-40	03665	12	0.250	6.4	Copper; Aluminum; Brass; Steel
30; 40; 106; 108; 109; 133; 134; 136; 154; 156	E-2558	30-40	03665	12	0.250	6.4	Copper; Aluminum; Brass; Steel
30; 40; 106; 108; 109; 133; 134; 154; 136; 156	E-2558	R2558	03670	12	0.188	4.8	Muffler Systems Tubing
30P; 40P; 106; 108; 109P; 133P; 134P; 136P; 154P; 156P	E-5299	3-6PVC	04194	12	0.377	9.6	3"-6" PVC; 4" Heavy Wall
30P; 40P; 106; 108; 109P; 133P; 134P; 154P; 136P; 156P	E-5299	30-40P	04190	12	0.343	8.7	ABS; PE; PP
30P; 40P; 133P; 134P; 136P; 154P; 156P	E-2156	30-40P	04190	12	0.343	8.7	ABS; PE; PP
3S; 4S; 44S; 466S; 466C; 466HWS; 468C; 468S; 468HWS; 472C; 472S; 472HWS; 764; 1224	F-229	3RG	03616	4	0.399	10.1	Steel; Stainless Steel
3S; 4S; 44S; 466S; 466C; 466HWS; 468C; 468S; 468HWS; 472C; 472S; 472HWS; 764	F-229S	3RG	03616	4	0.399	10.1	Steel; Stainless Steel
3S; 4S; 44S; 466S; 466C; 466HWS; 468C; 764 468S; 468HWS; 472C; 472S; 472HWS	F-515	3RG	03616	4	0.399	10.1	Steel; Stainless Steel
42A; 202; 360; 820; 364; 732	E-1032	R1032/S	03532	6	0.450	11.4	Steel; Stainless Steel; Schd 80
466; 468; 472	E-1962	3RGC1	03617	4	0.285	7.2	Cast Iron; Ductile Iron
466C; 466S; 466HWS; 468C; 468S; 468HWS; 472C; 472S; 472HWS	E-3186	R3186	03526	4	0.680	17.3	Steel; Ductile Iron Heavy Wall



## Cutter Wheel Conversions

Manufacturer Cutter No.	Manufacturer Wheel	Reed Cat. No.	Item Code	Std. Pack*	Blade Exposure**		Application
					inches	mm	
<b>ARMSTRONG®</b>							
1T; 2T; 2TA		2RBS	03612	12	0.300	7.6	Steel; Stainless Steel
1T; 2T; 2TA		2RBHD	03613	12	0.296	7.5	HD for Steel; Stainless Steel
4A		3RG	03616	4	0.399	10.1	Steel; Stainless Steel
4A		3RGCI	03617	4	0.285	7.2	Cast Iron; Ductile Iron
<b>GASTITE®</b>							
RT15T1; RT15T3; RT15T2; T15T1; T15T2		O	03660	12	0.180	4.6	Copper; Aluminum; Brass; Steel; CSST
<b>IMPERIAL EASTMAN</b>							
127-F/FA/FB; TC1050; 227-FA	S32633	32633	03661	12	0.127	3.2	Copper; Aluminum; Brass
TC1000; TC1020; 374; 312-FC/FB; 274-FC/FB; 174-F	S75015	75015	03662	12	0.125	3.2	Copper; Aluminum; Brass; Steel
TC1000; TC1020; 374; 312-FC/FB; 274-FC/FB; 174-F	S75046	75046	03663	12	0.125	3.2	Copper; Aluminum; Brass; Steel; Stainless Steel
<b>LENOX®</b>							
21010-TC11/8; 21011-TC13/8; 21012-TC13/4	21017-TCW158C	O	03660	12	0.180	4.6	Copper; Aluminum; Brass; Steel
21010-TC11/8; 21012-TC13/4; 21011-TC13/8; 21013-TC25/8	21015-TCW158SS	OSS	03655	12	0.160	4.1	Brass; Stainless Steel
21013-TC25/8	21016-TCW158P	1-2PVC	04184	12	0.280	7.1	PVC; Plastic
<b>SWAGelok®</b>							
MS-TC-308	MS-TCW-308	OSS	03655	12	0.160	4.1	Stainless Steel
<b>WHEELER REX®</b>							
95041	8050	HS4	03504	4	0.320	8.1	Steel; Stainless Steel
95041	8078	HS4	03504	4	0.320	8.1	Steel; Stainless Steel
95061	8052	HS6	03506	4	0.390	9.9	Steel; Stainless Steel
95081; 95121	8054	HS8-12	03508	4	0.450	11.4	Steel; Stainless Steel
	8002	HX21/2	03510	4	0.383	9.7	Steel; Stainless Steel; Schd 80
95041	8051	HI4	03522	4	0.258	6.6	Cast Iron; Ductile Iron
95061; 95081; 95121	8053	HI6	03524	4	0.410	10.4	Cast Iron; Ductile Iron
95061; 95081; 95121	8076	H6PSE5	03525	4	0.400	10.2	Steel; Cast Iron; Ductile Iron
	8839	RCS8-36	03530	4	0.635	16.1	Steel; Stainless Steel
	8838	RCI8-30	03535	4	0.500	12.7	Cast Iron; Ductile Iron
9590	8001	2RBHD	03613	12	0.296	7.5	HD for Steel; Stainless Steel
	8004	3RG	03616	4	0.399	10.1	Steel; Stainless Steel
	8016	3RG	03616	4	0.399	10.1	Steel; Stainless Steel
9290; 9291	8012	OSS	03655	12	0.160	4.1	Stainless Steel
9290; 9291	8015	O	03660	12	0.180	4.6	Copper; Aluminum; Brass; Steel
	8021	30-40	03665	12	0.250	6.4	Copper; Aluminum; Brass; Steel
9490	8025	30-40	03665	12	0.250	6.4	Copper; Aluminum; Brass; Steel
	8034	345T	03666	12	0.146	3.7	Copper; Aluminum; Brass
	8045	R4546	03668	6	0.161	4.1	Steel; Stainless Steel
90735; 90728; 90750	8071	73505	03690	12	0.170	4.3	Copper; Aluminum; Brass; Steel
	8065	OP2	04180	12	0.275	7.0	ABS; PE; PEX; PP; PEX/AL/PEX
	8036	30-40P	04190	12	0.343	8.7	ABS; PE; PP
	8037	3-6PVC	04194	12	0.377	9.6	3"-6" PVC; 4" Heavy Wall; CPVC

\* Cutter wheels sold to distributors in standard package quantities only.

\*\* Blade Exposure determines wall thickness capacity of cutter wheel.



**Reed has the widest variety of high-quality wheels  
for more cutters and more brands than any other manufacturer!**



# CUTTERS & CUTTER WHEELS

SECTION

1

Cutter Wheels

Quick Release™ Tubing Cutters

Tubing Cutters

Tubing Cutters for Stainless Steel

Telescoping Tubing Cutters

Mini Tubing Cutters

C Cutters

Repair Kits

2" Pipe Cutters

Deburring Tools

Soil Pipe Cutters

Saw It® Pneumatic Saw

Power Hack Saw Blades

Universal Pipe Cutters

Filter-Regulator-Lubricator

Hinged Cutters™

Hinged Cutters™ with Helper Handle **NEW**

Low Clearance Rotary™ Cutters **NEW**

Rotary™ Cutters

Pipe Descalers

Pipe Reamer

**Hinged Cutters™ are a Reed invention and remain an excellent tool for manual cuts on steel, stainless steel, ductile and cast iron. Handle swing is 90° to 110° with just 4 inch clearance on the back side of the pipe.**



PIPE TOOLS & VISES  
SINCE 1896

## QUICK RELEASE™ TUBING CUTTERS

### FEATURES

- Quick Release™ is a **Reed invention** and still the industry standard.
- Features include quick release, quick advance and manual advance, along with the **ball detent wheel pin**.
- **Built-in reamer** and spare cutter wheel in the knob on TC1Q, TC1.6Q and TC2Q.
- Simple cutter wheel change permits use on a wide variety of pipe/tubing types.

Quick Release™ Tubing Cutters are the best tracking, easiest cutting tubing cutters available. Cut copper, aluminum, light wall steel and stainless steel tubing. With alternate wheels they will cut a wide variety of plastic pipe and tubing. Reed also offers the R2558 wheel for muffler systems tubing. **TC1Q**, **TC1.6Q** and **TC2Q** sliding bars are die-cast zinc aluminum for great strength. These three sizes also feature a built-in reamer and spare cutter wheel in the knob. Long-proven **TC3Q** and larger models with steel sliding bars withstand professional workloads over the long haul.

Catalog No.	Item Code	O.D. Capacity		Length		Weight		Wheel
		actual O.D. in	actual O.D. mm	in	mm	lbs	kg	
TC1Q*	03410	1/8 - 1 5/16	3 - 33	6	152	0.6	0.3	0
TC1.6Q*	03416	1/4 - 1 5/8	6 - 42	6.5	165	0.8	0.4	0
TC2Q*	03420	1/4 - 2 5/8	6 - 63	8	203	1.2	0.5	0
TC3Q	03430	3/8 - 3 1/2	10 - 90	11	279	2.5	1.1	30-40
TC3Q2558	03439	3/8 - 3 1/2	10 - 90	11	279	2.5	1.1	R2558
TC4Q	03440	1 7/8 - 4 1/2	48 - 114	12	305	2.8	1.3	30-40
TC5Q2558	03459	2 1/2 - 5	63 - 125	13	330	3.0	1.4	R2558
TC6Q	03460	4 - 6 5/8	102 - 168	15	381	3.9	1.8	30-40
TC6Q2558	03469	4 - 6 5/8	102 - 168	15	381	3.9	1.8	R2558
TC8Q	04158	6 1/4 - 10	159 - 254	26	660	8.0	3.6	30-40

\*Spare "O" Cutter Wheel in Knob.

CUTTER WHEELS ON P. 7 - 9

QUICK RELEASE™ CUTTERS FOR PLASTIC ON P. 25



### ✓ WHY REED?

Quick Release™ cutter is a Reed invention and still the industry standard! First used by Reed, the ball detent wheel pin makes cutter wheel change easy. No other cutter on the market tracks or cuts as fast.

## TUBING CUTTERS

### FEATURES

- **Large, ergonomic grip knob** for hand comfort during use.
- **Internal reamer** in T10 and T15 grip knob for operator convenience.
- For lighter weight, T20 features aluminum construction.

Tubing cutters are a simple, durable design. Each has a screw feed with a large grip knob to make it easier to tighten the cutter. **T10** and **T15** are zinc alloy construction with a built-in reamer for convenient cutting then deburring. **T20** is larger but light due to its aluminum construction. It features a fold-out reamer. Wide rollers on all three models yield a square cut while thin cutter wheel profile ensures a quick, clean cut.

Catalog No.	Item Code	O.D. Capacity		Weight		Cutter Wheel**		
		actual O.D. in	actual O.D. mm	lbs	kg	Copper	PE	PVC
T10	03483	1/8 - 1	3 - 25	0.9	0.4	0	OP2	1 - 2PVC
T15	03485	3/16 - 1 1/4	4 - 32	1.3	0.6	0	OP2	1 - 2PVC
T20*	03487	5/8 - 2 1/8	15 - 54	1.5	0.7	0	OP2	1 - 2PVC

\*\*Ships with wheel for copper. To cut PE or PVC pipe, order recommended cutter wheel separately.

\*AWWA Approved for Tapping Contest.

CUTTER WHEELS ON P. 7 - 9

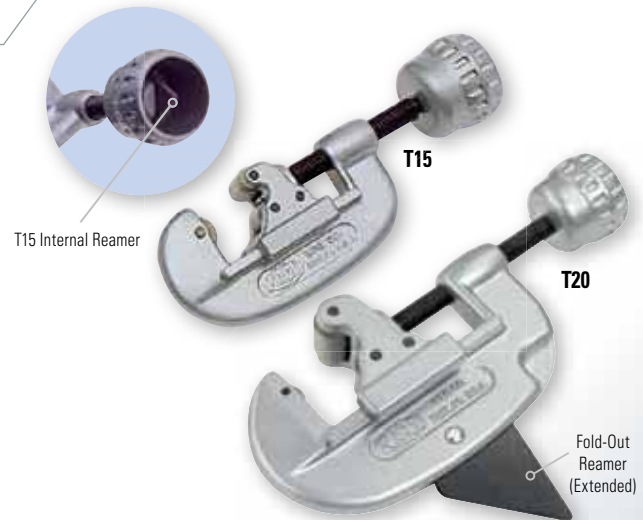

## TUBING CUTTERS FOR STAINLESS STEEL

### FEATURES

- **Specialized** steel cutter wheels are **designed** for toughness and heat dissipation.
- **Ergonomic** grip knob on T10SS, T15SS and T20SS cutters.
- Telescoping TC11SS is a great choice for **tight spaces**.

Reed "SS" tubing cutters are equipped with special cutter wheels for stainless steel to yield optimal cutting and long service life. **T10SS**, **T15SS** and **T20SS** feature a large knob for firm grip and easy turning and tightening. The T10SS and T15SS have a reamer built into the grip knob while the **TC11SS** and the T20SS include a fold-out reamer.

Catalog No.	Item Code	Capacity		Cutter Wheel	Weight	
		actual O.D. in	actual O.D. mm		lbs	kg
T10SS	03476	1/8 - 1	3 - 25	OSS	0.9	0.4
T15SS	03477	3/16 - 1 1/4	4 - 32	OSS	1.4	0.6
T20SS	03479	5/8 - 2 1/8	15 - 54	OSS	1.5	0.7
TC11SS*	03481	1/8 - 1 1/8	3 - 28	75046*	0.7	0.3

\*Includes spare cutter wheel.

CUTTER WHEELS ON P. 7 - 9

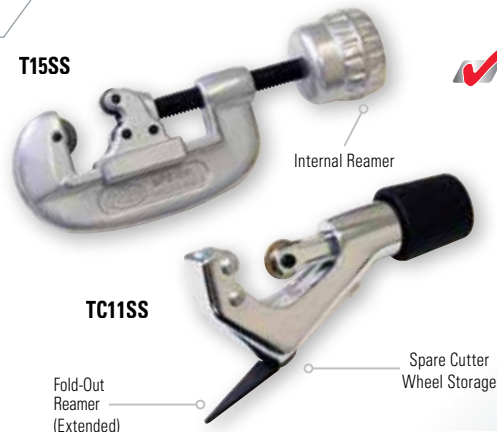

### ✓ WHY REED?

Only Reed offers such a wide variety of professional-quality cutters with wheels for stainless installed. No more extra cost and hassle of early replacement of the first wheel!

## TELESCOPING TUBING CUTTERS

### FEATURES

- Great choice for **tight spaces**, where more than a mini cutter is needed.
- Grooved roller permits close-to-flare cuts.
- **Easily cut** copper, brass, aluminum or steel tubing.

Telescoping Tubing Cutters are a good choice for tight spaces as their feed screw telescopes to advance the cutter wheel to the pipe. This means the cutters remain a consistent size throughout the cut and do not require extra space. **TC11** with strong, aluminum alloy body and nickel-chrome finish, makes a clean, square cut. Cutter has telescoping feed screw, fold-out reamer, grooved rollers and a spare cutting wheel. **TC14** and **TC166** telescoping tubing cutters move smoothly and offer a pencil reamer. TC14 features a spare cutter wheel.

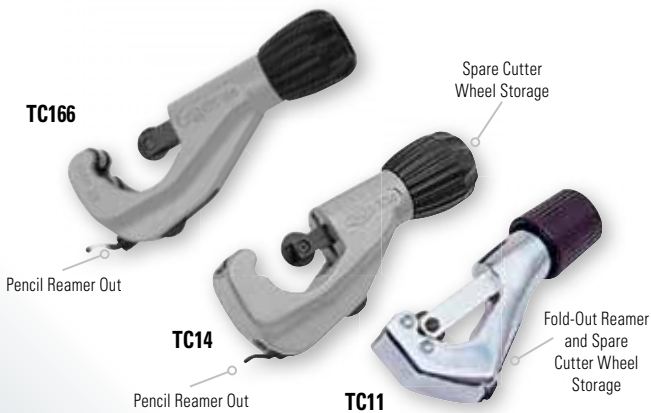

Catalog No.	Item Code	O.D. Capacity		Weight		Cutter Wheel**	Heavy-Duty Wheel
		actual O.D. in	actual O.D. mm	lbs	kg		
TC11	03480	1/8 - 1 1/8	3 - 28	0.7	0.3	75015	75046
TC14*	03475	1/4 - 1 3/8	6 - 35	1.1	0.5	73505	73515
TC166*	03465	1/4 - 1 3/8	6 - 42	1.2	0.5	73505	73515

\*Reamer replacement blade #94437 (10 pk) or #03473 (single).

\*\*Ships with regular wheel. Order heavy-duty wheels separately.

CUTTER WHEELS ON P. 7 - 9

## MINI TUBING CUTTERS

### FEATURES

- For use in **extremely tight places** due to minimal swing needed.
- Smooth, rounded body contour for **comfortable grip**.

Mini cutters can be used on copper, steel, stainless steel and aluminum tubing in confined spaces. **MC2**, **MC2GRIP** and **MC3** have zinc die castings for long service life and are painted with durable silver epoxy for corrosion protection. Large high-torque knobs on the MC2GRIP and MC3 provide easy feeding. **MC1** needs only 1 1/4" radial clearance, features smallest cutting diameter in the industry and uses a fine screw thread for easy tightening.



### ✓ WHY REED?

MC2 is heavy-duty – the strongest mini cutter available. MC2GRIP includes a larger, high-torque feed. Larger, deeply knurled knob allows easier tightening.

Catalog No.	Item Code	O.D. Capacity		Weight		Cutter Wheel	Cutter Swing Inches
		actual O.D. in	actual O.D. mm	lbs	kg		
MC1	03470	1/8 - 5/8	3 - 15	0.2	0.1	32633	1 1/4
MC2	03490	1/8 - 15/16	3 - 24	0.3	0.1	345T	1 11/16
MC2GRIP	03493	1/8 - 15/16	3 - 24	0.4	0.2	345T	1 11/16
MC3	03495	1/8 - 1 1/8	3 - 28	0.4	0.2	73505	1 7/8

CUTTER WHEELS ON P. 7 - 9

## C CUTTERS

### FEATURES

- Compact c-shape means **no handle swing** space is required.
- The **spring-loaded cutter** self-feeds on copper and CTS CPVC.

Everyone needs a handy cutter (or two) like Reed's C Cutter. This easy-to-grip cutter easily snaps on to copper tubing for a quick, clean cut. Just turn the cutter in the direction of the arrow and the cut will be complete in seconds. Consistent pressure is maintained as the tool is turned around the tubing. Each cutter fits just one popular size of copper tubing.



Catalog No.	Item Code	Pipe Diameter		Weight		Application
		in-nom.	actual O.D. mm	lbs	kg	
TC50SLR*	03404	1/2	15.9	0.5	0.2	Copper K, L & M; CTS CPVC
TC50SL	03405	1/2	15.9	0.5	0.2	Copper L & M; CTS CPVC
TC75SLR*	03406	3/4	22.2	0.5	0.2	Copper K, L & M; CTS CPVC
TC75SL	03407	3/4	22.2	0.5	0.2	Copper L & M; CTS CPVC
TC1SLR*	03408	1	28.6	0.6	0.3	Copper K, L & M; CTS CPVC
TC1SL	03409	1	28.6	0.6	0.3	Copper L & M; CTS CPVC

### \*EXCLUSIVE FEATURE

NOTE: SLRCW is the only replacement cutter wheel for C Cutters. Installed in the SLR models and suited for all C Cutters, it is Reed cutter wheel quality for Copper K, L & M and CTS CPVC.



PIPE TOOLS & VISES  
SINCE 1896

## REPAIR KITS

### FEATURES

- Great choice for distributor repair counters or contractor maintenance departments.

Simple field repairs can be handled with **1-2 PARTS** and **3-4-6 PARTS** kits which are plastic bags containing the most popular parts for Quick Release™ Cutters. Common spare parts for T10, T15 and T20 cutters are contained in **T10-T15-T20 PARTS** kit. **RPR KIT** in sectioned toolbox includes a wide variety of Quick Release™ and other tubing cutter parts, along with blades for shears for plastic.

Catalog No.	Item Code	Weight	
		lbs	kg
1-2 PARTS	03009	2.2 oz	0.1
3-4-6 PARTS	03010	3.3 oz	0.1
RPR KIT	03011	5.5 lbs	2.5
T10-T15-T20 PARTS	03014	3.0 oz	0.1

Repair cutters on-site  
for less lost time!

RPR KIT

3-4-6 PARTS

1-2 PARTS

## 2" PIPE CUTTERS

### FEATURES

- **Short handle** allows for work in close quarters.
- The wide rollers help **create square cuts**.
- **Clean, easy cuts** on steel, stainless steel or cast iron pipe.
- Leaves **no burr**, which is great for threading jobs.

Reed offers a variety of pipe cutters, both with and without guides. Standard cutters without guides feature strong malleable iron frames. These cutters work on steel, stainless steel or cast iron pipe, depending on the installed cutter wheels. The thin profile, sharp cutter wheels allow shorter handles for work in smaller spaces. The **2-3** pipe cutter with three wheels (and no rollers) means more cutting surface and less handle swing. Exclusive guide bars on **2-4WG** are the best way to get a square cut on pipe since the bars hold the cutter square to the pipe during the cutting process. Guide bars also help secure the cutter to smooth stainless steel and corroded pipe.

Catalog No.	Item Code	Pipe Capacity		Style	Length		Weight		Cutter Wheel*
		in-nom.	O.D. mm		in	mm	lbs	kg	
2-3	03305	1/8 - 2	10 - 63	3 Wheel	15.8	400	6.8	3.1	2RBS
2-1	03320	1/8 - 2	10 - 63	1 Wheel	15.8	400	6.9	3.1	2RBS
2-4	03335	1/2 - 2	21 - 63	4 Wheel	14.3	362	6.8	3.1	2RBS
2-4WG*	03338	1/2 - 2	21 - 63	4 Wheel with Guides	14.3	362	7.2	3.3	2RBS

\*EXCLUSIVE

\*2RBC1 wheels available for cast iron. 2RBHD heavy-duty wheels available for steel and stainless steel.

CUTTER WHEELS ON P. 7 - 9

Replacement Wheel Pins available for Ridgid® cutters: 1-A, 2-A, 42-A, 202, 2000A. Order Reed pin R34780 #93320 5/pk. to replace Ridgid® pin No. 34780 (Old #F-9).

NOTE: To cut easy and fast, Pipe Cutters use Reed's thin profile, high quality tool steel cutter wheels.

### ✓ WHY REED?

Guide bars on 2-4WG are exclusive to Reed and the best way to get a square cut on stainless steel and corroded pipe. The guides make the cutter more stable on the pipe, thus reducing motion wear on the wheels.



EXCLUSIVE FEATURE

### ✓ WHY REED?

With rollers on the side away from the operator and the cutter wheel closer, Reed Pipe Cutters are easy to line up with the cut-off mark. Wheel change is quick as the ring on the top of the wheel pin makes it convenient to find and center the pin through the second hole.

Convert 2-1 and 2-3 back and forth simply by changing wheels and rollers.

## DEBURRING TOOLS

### FEATURES

- Long-lasting, hardened tool steel deburring blade.

Eliminate internal burrs in copper, steel and aluminum tubing. **DEBO** has an aluminum handle and handy pocket slip. **DEB3** has a plastic body and two spare blades store in its handle, giving this tool extra value. Both have unlimited pipe capacity.

Catalog No.	Item Code	Pipe Capacity	Weight	
			lbs	kg
DEBO	04434	unlimited	0.05	0.02
DEB3*	04437	unlimited	0.1	0.05

\*Reamer replacement blade #94437 (10 pk) or #03473 (single).

DEBURRING TOOLS FOR PLASTIC ON P. 29



DEB3

DEBO





## SOIL PIPE CUTTERS

### FEATURES

- Great for gray water applications.
- Reed **innovations** have improved upon the original cutter.
- Soil Pipe Cutters apply chain pressure to snap the pipe.
- **Captured screw** in SC49 resists breakage.

The fastest way to cut cast iron soil pipe, clay pipe and small diameter concrete pipe is with a chain pipe cutter. Reed's design provides stronger jaws and more durable adjusting screws compared to the competition. Some parts are even interchangeable.† Reed soil pipe cutters are available in a single stroke **SC59** model and a ratcheting **SC49** model for close quarter work. Multiple use 1/2" male ratchet wrench ships with SC49 models. No-Hub® Roller Kit is standard on all models.

For cutting ductile iron pipe, Reed recommends **HINGED CUTTERS™ ON P. 18** and **LOW CLEARANCE ROTARY™ CUTTERS ON P. 19**.

### RATCHET

Catalog No.	Item Code	Pipe Capacity**		Length		Weight	
		in-nom.	actual O.D. mm	in	mm	lbs	kg
SC49-6*	08049	1 1/2 - 6	160	26	660	17.6	8.0
SC49-8*	08050	1 1/2 - 8	212	26	660	19.4	8.8
SC49-10*	08051	1 1/2 - 10	268	26	660	21.2	9.6
SC49-12*	08052	1 1/2 - 12	317	26	660	23.0	10.5
SC49-15*	08053	1 1/2 - 15	403	26	660	24.8	11.3

### SINGLE STROKE

SC59-6	08059	1 1/2 - 6	160	43	1,092	23.8	10.8
SC59-8	08060	1 1/2 - 8	212	43	1,092	25.6	11.6
SC59-10	08061	1 1/2 - 10	268	43	1,092	27.4	12.5
SC59-12	08062	1 1/2 - 12	317	43	1,092	29.2	13.3
SC59-15	08063	1 1/2 - 15	403	43	1,092	31.0	14.1

\*Male Ratchet Wrench (#40208) included with all SC49 cutters.

#### \*\*Maximum Pipe Capacities (determined by maximum pressure applied):

- Extra heavy cast iron soil pipe ..... 2-4" (62-125 mm)
- Service weight cast iron soil pipe ..... 2-8" (62-212 mm)
- Concrete pipe ..... 4-6" (125-160 mm)
- No-Hub® cast iron soil pipe ..... 1 1/2"-8" (38-212 mm)
- Clay pipe ..... 2-15" (62-403 mm)

Extension chains available to increase capacity of smaller cutters.

† NOTE: Jaw sets and cutter chains are interchangeable with Wheeler-Rex® models. Pressure Screw Assembly available offering heavy-duty replacement parts for current and prior Reed models, along with Wheeler-Rex® 490. Order #98046 for Reed SC49 models and Wheeler-Rex® 490 series; use #98047 for Reed SC59 models.

### ACCESSORIES

Catalog No.	Item Code	Description
SCEXT	40336	10" Chain Extension with 8 Pitches at 1.25" per Pitch
TW516	02298	3/16" Torque Wrench
TW38	02300	3/8" Torque Wrench

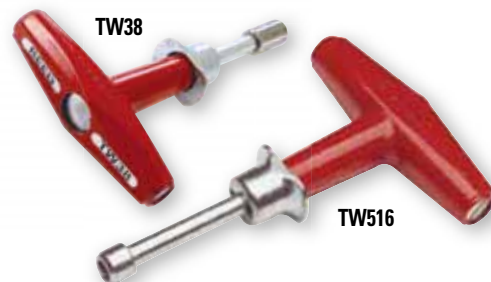

TORQUE WRENCHES are featured in full ON P. 71  
SCFR WRENCH ON P. 73

### WHY REED?

First introduced by Reed, the captured screw makes the SC49 close-quarter soil pipe cutters both easy to use and less costly. The screw does not have to be manipulated into place which reduces screw and cutter breakage.





PIPE TOOLS & VISES  
SINCE 1896

## SAW IT® PNEUMATIC SAW

### FEATURES

- Saw It® pneumatic saw is a good choice for plastic and steel cuts and a great cutting tool for **hard-to-reach places**.
- **Immediate shut down** when throttle is released.
- Saw It Vise and Saw It Blade Guides should be added for **extra stability**.

Saw It is a pneumatic powered reciprocating saw. Used with Power Hack Saw Blades (sold separately), Saw It cuts steel, stainless steel, PVC (including C900), PE and PP. As a safety feature, a trigger lock prevents accidental "on" if the trigger is bumped or pressed unintentionally. Saw It needs 6" clearance beyond the pipe to accommodate blade movement. The Saw It must have a means to hold it in place and the recommended **Saw It Vise** (sold separately) provides stability and safety for the cut. Optional **Blade Guides** provide directional guidance for the saw and greatly reduce blade wobble.

Maximum capacity is blade and blade guide dependent. Saw It cuts up to 24" diameter pipe when used with the Saw It Vise and a 12" chain extension. Saw It cuts up to 20" (500 mm) diameter pipe when used with recommended SAWITBG30 blade guide. Pneumatic saws are less likely to ignite materials than gas-powered saws and even some electrical-powered saws. However, the Saw It is **not recommended** for gas lines.

Saw It Vise fits 4" - 12" diameter pipe. When a 6" or 12" chain extension is added, the vise capacity increases to 18" or 24" respectively.

Catalog No.	Item Code	Description	Capacity		Maximum Power	Air Consumption	Weight	
			in-nom.	mm-nom.			lbs	kg
SAWITSD	07615	Saw It® with Safety Deadman Switch	up to 24" max.	up to 610 max.	1.5 HP, 1100 watts	50 cfm @ 90 psi 1.4 cu. m/min. @ 6.2 BAR	19.1	8.7

**NOTE: Always use a filter-regulator-lubricator (FRL) with Reed pneumatic tools.** Reed offers FRL #97591. **FILTER -REGULATOR -LUBRICATOR ON P. 17**  
**POWER HACK SAW BLADES** sold separately.

### ACCESSORIES

#### SAW IT® BLADE GUIDES

Catalog No.	Item Code	Fits	Capacity
SAWITBG21	04602	21" Long Blades	Up to 12" Pipe
SAWITBG30	04603	30" Long Blades	Up to 20" Pipe

#### SAW IT® VISE

Catalog No.	Item Code	Description	Capacity		Weight	
			in-nom.	actual O.D. mm	lbs	kg
SAWITVISE	04600	Vise with 42" Chain	4" - 12"	114 - 324	14.0	6.4

#### CHAIN EXTENSIONS FOR SAW IT® VISE

Item Code	Description
40628	6" Chain Extension Plus Pin
40629	12" Chain Extension Plus Pin

## POWER HACK SAW BLADES

### FEATURES

- Greater blade height for reduced deflection.
- Bi-metal construction for safety.
- Fit Saw It® Pneumatic Saws, along with saws by Widder®, Fein® and Spitznas®.

For speed, straightness of cut, long life and safety, these bi-metal blades are the best choice for the Reed Saw It® and heavy-duty power hack saws made by Widder®, Fein® and Spitznas®. The extra blade depth (1 3/8") and the Matrix® high-speed steel (HSS) cutting edge allow a straighter cut. Bi-metal blade construction reduces the tendency of solid HSS blades to shatter. Wavy set and high tooth hardness for longer life. Blades cut steel, stainless steel, copper, aluminum and harder plastics like PVC and ABS.

Catalog No.	Item Code	Teeth Per Inch	Length/Width/Thickness		Std. Pkg.
			in-nom.	mm	
Z814	04478	14	8 x 1 3/8 x .062	200 x 35 x 1.6	10
Z1014	04479	14	10 x 1 3/8 x .062	250 x 35 x 1.6	10
Z1214	04494	14	12 x 1 3/8 x .062	300 x 35 x 1.6	10
Z1614	04495	14	16 x 1 3/8 x .062	400 x 35 x 1.6	10
Z2114	04496	14	21 x 1 3/8 x .062	533 x 35 x 1.6	10
Z2414	04497	14	24 x 1 3/8 x .062	600 x 35 x 1.6	10
Z3014	04498	14	30 x 1 3/8 x .062	760 x 35 x 1.6	10
Z1608	04499	8	16 x 1 3/8 x .062	400 x 35 x 1.6	10
Z2108	04597	8	21 x 1 3/8 x .062	533 x 35 x 1.6	10

**NOTE: Blade length should be at least 6" more than the O.D. of the pipe.**

SAWITSD and SAWITVISE with SAWITBG21 and Z2114



BEST EVER!

ONLINE VIDEO TRAINING



SAWITVISE



Great for work on process piping with little clearance!



SAWITBG21

Z1614

Z1214



SAWITSD on steel with Z2114

14 TPI (teeth per inch) work best on at least 1/8" wall thickness. 8 TPI work best on walls at least 3/16" thick. Choose 8 teeth per inch for softer materials like plastic.

UPC cutting PE



UPC636A on ductile iron



## UNIVERSAL PIPE CUTTERS

### FEATURES

- Cut **large diameter** ductile or cast iron, clay, concrete, steel, PVC or PE pipe.
- Basic unit can be adapted to a **variety** of uses, depending on blade selected.
- **UPC836APE** and **UPC848APE** are designed specifically for PE.

These lightweight, easy-to-use Universal Pipe Cutters (UPC) are available to cut 6" - 48" (150-1300 mm) ductile iron, cast iron, clay, concrete, steel, PVC or PE pipe. The cutters are pneumatic. The lower cost **UPC616A** uses the same motor as the others, but does not include connecting frames for larger capacities. The **UPC616A** is shipped in a steel toolbox with a three-gallon, formed-steel water tank. The **UPC636A** and **UPC648A** come in a steel toolbox with a six-gallon, stainless steel water tank and cart. Every UPC ships with an FRL Filter-Regulator-Lubricator.

### PNEUMATIC

Catalog No.	Item Code	Pipe Diameter		Gross Weight*	
		in-nom.	actual O.D. mm	lbs	kg
UPC616A	07512	6 - 16	150 - 450	98	44.5
UPC636A	07510	6 - 36	150 - 1000	128	58.2
UPC648A	07511	6 - 48	150 - 1300	133	60.5
UPC836APE*	07517	8 - 36	200 - 1000	101	45.9
UPC848APE*	07518	8 - 48	200 - 1300	106	48.2

\***EXCLUSIVE** - Complete details about **UPC836APE AND UPC848APE ON P. 31**

\***GROSS WEIGHT** includes all components plus packaging. **UPC Cutting Frame** weighs just 28 lbs (12.7 kg).

**MUST ORDER REQUIRED BLADES SEPARATELY.**

### UPC PNEUMATIC POWER REQUIREMENTS

Horsepower = 1.7 H.P. generated by UPC

Maximum R.P.M. = 3675

Air Consumption = 50 cu. ft./min. (1.4 cu. m/min.)

Pressure = 90 P.S.I. Maximum (6 BAR)

Shut-Off = 3/4" Ball Valve

Air Supply Fittings = 3/4" Dixon "Air King" Coupling

### ACCESSORIES

Accessory	Item Code
Air-Line Oil	97583
Arbor Locknut	97543
Arbor Wrench	97590
Blade Guard 8" Assembly	07509
Chain Hooks	97546
Diamond Blade Sharpening Stone	97595
Filter for the FRL	47506
Hex Key Set	40156
Motor Grease, 2 oz.	97588
Release Pins	97545
Water Tank Hose System	97581
Wedges	97589

### SERVICE

UPC motor reconditioning/refurbishing is available. Complete UPC cutters can also be reconditioned/refurbished.

**BEFORE shipping items, contact Reed by phone, fax or email for a return authorization number.**

All items should arrive freight prepaid at the Reed factory. Quotes, including any labor charges, will be issued upon inspection of the unit.

### ✓ WHY REED?

The Reed UPC is *lightweight; cuts fast; requires only 12" (300 mm) clearance around the pipe; provides a square cut virtually every time; and can be operated underwater. It is by far the safest, easiest and fastest power cutter to setup, operate and maintain, which nets a low operating cost.*



UPC636A







PIPE TOOLS & VISES  
SINCE 1896

### UNIVERSAL PIPE CUTTER BLADE SELECTION CHART

Reed provides a complete line of UPC saw blades for efficient cutting of PVC, PE, steel, cast and ductile iron, clay or concrete pipe. See chart below for the various blades to match job requirements. Blades sold separately from UPC units.

**CAUTION:** When cutting steel, ductile iron or cast iron, the UPC can produce sparks. When cutting steel pipe with the steel "DIA" blades, sparks are expected. Because of the sparks, the UPC cannot be used for cold cuts. When cutting PE, the UPC may cause a build-up of static electricity. Do not use the UPC saw in-line on potentially explosive or otherwise dangerous situations. The line must be verified as completely purged of any flammable vapor or liquid.

Catalog No.	Item Code	Description	Pipe Diameter	Pipe Material
UPCARB4	97510	4" BLADES cut up to 2 <sup>3</sup> / <sub>32</sub> " (18.3 mm) wall thickness	6" (150 mm)	PVC
UPCBPVC	97511	PVC Bevel Cutter 1 1/4" blade thickness, 15° bevel	6" - 48" (150-1300 mm)	PVC
UPCARB6	97514	6" BLADES cut up to 1 2 <sup>3</sup> / <sub>32</sub> " (43.7 mm) wall thickness	8" - 48" (200-1300 mm)	PVC
UPCSTEEL4	97519	4" carbide-tipped BLADES cut up to 1/2" (12.7 mm) wall thickness	6" - 8" (150-200 mm)	Steel
		4" carbide-tipped BLADES cut up to 2 <sup>3</sup> / <sub>32</sub> " (18.3 mm) wall thickness	6" - 8" (150-200 mm)	PE
UPCSTEEL6	97520	6" carbide-tipped BLADES cut up to 1/2" (12.7 mm) wall thickness	8" - 48" (200-1300 mm)	Steel
		6" carbide-tipped BLADES cut up to 1 2 <sup>3</sup> / <sub>32</sub> " (43.7 mm) wall thickness	8" - 48" (200-1300 mm)	PE
UPCPE8	97521	8" BLADES cut up to 2 2 <sup>3</sup> / <sub>32</sub> " (69 mm) wall thickness	26" - 48" (660-1300 mm)	PE
UPDIA4C	97528	4" BLADES cut up to 2 <sup>3</sup> / <sub>32</sub> " (18.3 mm) wall thickness	6" (150 mm)	Cast Iron, Pit Cast, Ductile Iron Clay, Concrete
UPDIA6C	97524	6" BLADES cut up to 1 2 <sup>3</sup> / <sub>32</sub> " (43.7 mm) wall thickness	8" - 48" (200-1300 mm)	Cast Iron, Pit Cast, Ductile Iron Clay, Concrete

PIPE DESCALERS ON P. 20

UPDIA6C

UPDIA4C

UPCARB4

UPCARB6

UPCPE8

UPCBPVC

UPCSTEEL6

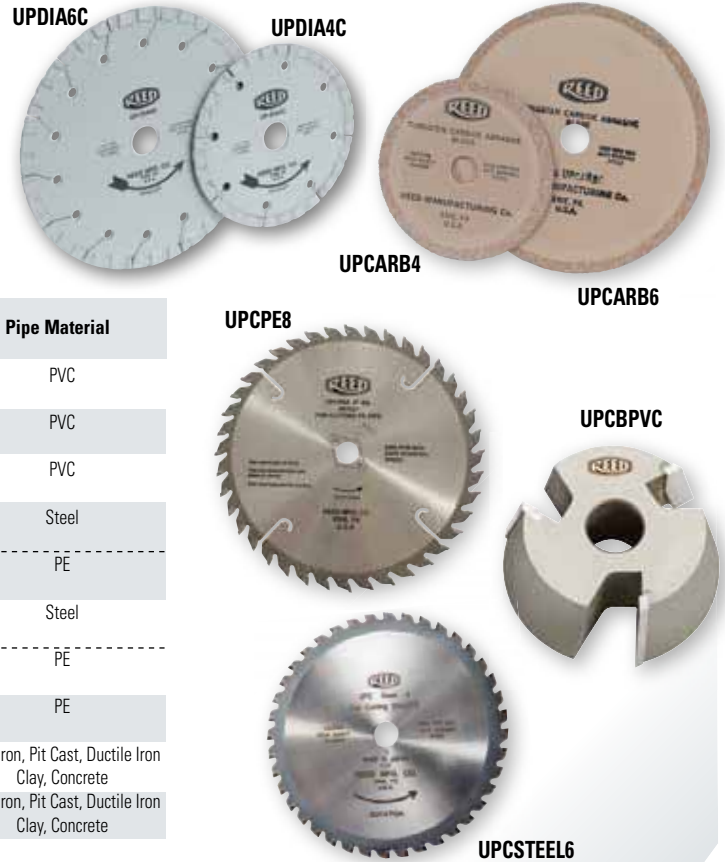

### FILTER-REGULATOR-LUBRICATOR

#### FEATURES

- Maximize tool efficiency by using clean air.

An FRL (filter-regulator-lubricator) appliance is key to preparing clean air for use in pneumatic system tools. Use of prepared air allows tools and equipment to operate with maximum effectiveness and efficiency. Always use an FRL with Reed pneumatic tools such as the Saw It®, Rapid Cut & Bevel™ Machines and Universal Pipe Cutters. **Failure to use an FRL may result in premature motor failure and will negate warranty.**

Catalog No.	Item Code	Description	Weight	
			lbs	kg
FRL	97591	Filter-Regulator-Lubricator Unit	12.5	5.7



TAKE A LOOK...

CUTTERS FOR LARGER DIAMETER PLASTIC PIPE P. 31 - 33

ONLINE VIDEO TRAINING



H4S in use

EXCLUSIVE SIZES

90° - 110° SWING

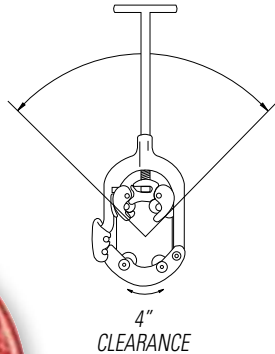

4" CLEARANCE

H4S

## HINGED CUTTERS™

### FEATURES

- A **Reed invention** that needs only 4" (102 mm) of clearance around pipe.
- Can be **used anywhere** - in the ditch, underwater, overhead, in racks of pipe!
- **Efficient** handle swing of only 90° to 110°.

Four wheels cut steel, stainless steel, cast and ductile iron with only 90° to 110° handle swing. Only 4" (102 mm) clearance required around pipe. Strong guide fingers ensure perfect wheel alignment for square cuts. A closed 360° frame forces all energy into cutting the pipe for maximum efficiency and productivity. There is no shower of sparks in this cold cut. This is the only hinged cutter that tracks every time and the only one recommended for ductile iron, steel and stainless steel to Schedule 100. This tool is a Reed invention.

Catalog No.	Item Code	Pipe Capacity		Length		Weight	
		in-nom.	actual O.D. mm	in	mm	lbs	kg
H21/2S*	03110	1 - 2 1/2	32 - 76	17	419	7.2	3.3
H21/2I*	03112	1 - 2 1/2	32 - 76	17	419	7.2	3.3
H21/2X*	03114	1 - 2 1/2	32 - 76	17	419	7.2	3.3
H4S	03120	2 - 4	60 - 125	22	559	12.8	5.8
H4I	03122	2 - 4	60 - 125	22	559	12.8	5.8
H4X	03124	2 - 4	60 - 125	22	559	12.8	5.8
H6S	03130	4 - 6	114 - 182	28	711	19.4	8.8
H6I	03132	4 - 6	114 - 182	28	711	19.4	8.8
H6X	03134	4 - 6	114 - 182	28	711	19.4	8.8
H8S	03140	6 - 8	168 - 240	32	813	24.4	11.1
H8I	03142	6 - 8	168 - 240	32	813	24.4	11.1
H8X	03144	6 - 8	168 - 240	32	813	24.4	11.1
H8XX	03146	6 - 8	168 - 240	32	813	24.4	11.1
H12S	03150	8 - 12	219 - 356	34	864	34.9	15.9
H12I	03152	8 - 12	219 - 356	34	864	34.9	15.9
H12X	03154	8 - 12	219 - 356	34	864	34.9	15.9
H12XX	03156	8 - 12	219 - 356	34	864	34.9	15.9

### \*EXCLUSIVE SIZES

NOTE: S= for steel; I= for cast and ductile iron; X= for schedule 80 steel; XX= for schedule 100 steel. Wheels for same size cutters are interchangeable. Reed cutter wheels are recommended for Hinged Cutters™. Reed wheels are made from high shock-resistant tool steel on computerized (CNC) machines and then precisely heat-treated. This allows for a thinner profile yet stronger blade, so they:

- Cut easier and faster, especially stainless steel and ductile pipe
- Last much longer
- Allow for shorter cutter handle for work in tight spaces
- Provide the best value

CUTTER WHEELS ON P. 7 - 9

PIPE DESCALERS ON P. 20

Replacement Wheel Pins for Ridgid® cutters: 3S, 4S, 6S, 44S, 466, 468, 472. Order Reed pin R34790 #93322 5/pk. to replace Ridgid® pin No. 34790 (Old #F-14).

### ✓ WHY REED?

Hinged Cutters™ are a Reed invention! They are lighter, track better for square cuts, and require less clearance, yet provide better torque so the cut is made faster and with less effort. Can be used anywhere - in the ditch, underwater, in noise-free zones, overhead, in racks of pipes, etc.

## HINGED CUTTERS™ WITH HELPER HANDLE

### FEATURES

- Helper handle allows two people to make a **team effort** for fast, tough cuts.
- Great choice for **cutting well casing and other vertical pipe**.
- **Efficient** handle swing of only 90° to 110°.

Special Hinged Cutters™ with an extra helper handle save time as two operators use team effort for fast work on tough applications or harsh conditions. Helper handle "HH" models are ideal for cuts on vertical pipe such as well casing or process piping. Hinged Cutters™ feature four wheels to cold cut steel, stainless steel, cast and ductile iron with only 90° to 110° handle swing. Strong guide fingers ensure perfect wheel alignment for square cuts. A closed 360° frame on the hinged cutter forces all energy into cutting the pipe for maximum efficiency and productivity.

Catalog No.	Item Code	Pipe Capacity		Assembled Length		Weight	
		in-nom.	actual O.D. mm	in	mm	lbs	kg
★ H6SHH	03138	4 - 6	114 - 182	51	1295	21.8	9.9
★ H8SHH	03148	6 - 8	168 - 240	58	1473	23.6	10.7
★ H12SHH	03158	8 - 12	219 - 356	63	1600	36.5	16.6

★ NEW

CUTTER WHEELS ON P. 7 - 9



Ridgid® is a registered trademark of Ridgid, Inc. and is not associated with Reed Manufacturing Company.



PIPE TOOLS & VISES  
SINCE 1896

## LOW CLEARANCE ROTARY™ CUTTERS

### FEATURES

- The low profile design of these cutters requires only **5" (127 mm) clearance**.
- Pipe **snaps off squarely** once the operator completes the cut.

Cold cut large diameter steel, most stainless steel, ductile and cast iron pipe in close quarters. The low profile design of the LCRC models needs only 5" clearance for up to 18" pipe diameter. Yoke design improvements make cutters more durable in high stress conditions. Each cutter is supplied with a slip-on handle that is used to turn the cutter around the pipe in one direction. The handle is also used to tighten the cutter every half revolution.

Catalog No.	Item Code	Pipe Capacity			Length		Weight	
		Steel	Cast Iron & Ductile	actual O.D. mm	in	mm	lbs	kg
		in-nom.	in-nom.					
★ LCRC4I*	03306		2 - 4	60 - 125	19	483	12	5.5
★ LCRC4S*	03307	2 - 4		60 - 125	19	483	12	5.5
LCRC8S*	03309	6 - 8		159 - 246	58	1473	41	18.6
LCRC8I*	03308		6 - 8	159 - 246	58	1473	41	18.6
LCRC8X*	03311	6 - 8 Heavy Wall and Stainless Steel		159 - 246	58	1473	41	18.6
LCRC12S*	03313	10 - 14		266 - 358	61	1549	50	22.7
LCRC12I*	03312		10 - 12	266 - 358	61	1549	50	22.7
LCRC12X*	03314	10 - 14 Heavy Wall and Stainless Steel		266 - 358	61	1549	50	22.7
LCRC16S*	03317	16 - 18		368 - 462	66	1664	60	27.3
LCRC16I*	03316		14 - 16	368 - 462	66	1664	60	27.3
LCRC16X*	03318	16 - 18 Heavy Wall and Stainless Steel		368 - 462	66	1664	60	27.3

★ **NEW - Coming mid-2014**  
★ **EXCLUSIVE**

## ROTARY™ CUTTERS

### FEATURES

- Pipe **snaps off squarely** once the operator completes the cut.
- Excellent for **cold cuts**.

Cold cut large diameter steel, most stainless steel, ductile and cast iron pipe in close quarters. Modest clearance needed for all models (see chart at right). Each cutter is supplied with a slip-on handle that is used to turn the cutter around the pipe in one direction. The handle is also used to tighten the cutter every half revolution.

Best manual cutters for ductile iron. With good leverage from long handle, pipe snaps off squarely before wheel penetrates halfway through pipe. Cutters have heavy-duty frames.

All sizes use the same cutter wheels: either RCS8-36 for steel/stainless steel and RC18-30 for ductile and cast iron. RCX wheels cut up to <sup>25</sup>/<sub>32</sub>" wall thickness for steel pipe.

Catalog No.	Item Code	Pipe Capacity			Length		Weight	
		Steel**	Cast Iron & Ductile	actual O.D. mm	in	mm	lbs	kg
		in-nom.	in-nom.					
RC20S*	03240	20 - 22		476 - 572	106	2680	89	40.5
RC20I*	03242		18 - 20	476 - 572	106	2680	89	40.5
RC24S*	03250	24 - 26		584 - 660	111	2807	107	48.6
RC24I*	03252		22 - 24	584 - 660	111	2807	107	48.6
RC30S*†	03260	28 - 34		698 - 864	96	2438	283	128.6
RC30I*†	03262		30	698 - 864	96	2438	283	128.6
RC36S*†	03264	32 - 36		813 - 915	96	2438	295	134.1
RC36I*†	03263		30	813 - 915	96	2438	295	134.1
RC42S*	03265	40 - 42		1016 - 1067	108	2743	325	147

★ **EXCLUSIVE**

\*\*For heavy wall steel and stainless steel, order four RCX cutter wheels (#03550) and also order eight RC8-30XR rollers (#93222).

NOTE: S= for steel; I= for cast and ductile iron. Wheels for same size cutters are interchangeable. Reed cutter wheels are recommended for Rotary™ Cutters and Low Clearance Rotary™ Cutters. Reed wheels are made from high shock-resistant tool steel on computerized (CNC) machines and then precisely heat-treated. This allows for a thinner profile yet stronger blade, so they:

- Cut easier and faster, especially stainless steel and ductile pipe
- Last much longer
- Provide the best value

CUTTER WHEELS ON P. 7 - 9  
PIPE DESCALERS ON P. 20

### † CONVERSION KITS

Catalog No.	Item Code	Converts
RC30CONV	03267	RC36 to RC30
RC36CONV	03268	RC30 to RC36

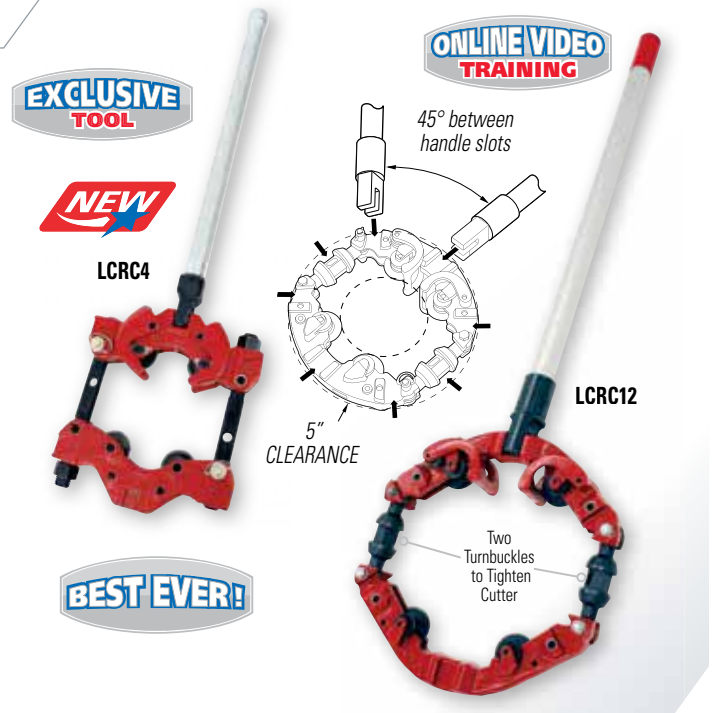

### ✓ WHY REED?

Rotary™ cutters are a Reed invention! Reed Rotary™ cutters cut pipe safely, easily, quickly and at a low cost. Provide a square cut and can be used in close quarters anywhere – in the ditch, underwater, in noise-free zones, overhead, in racks of pipes, etc. Reed Rotary™ cutters last for decades.

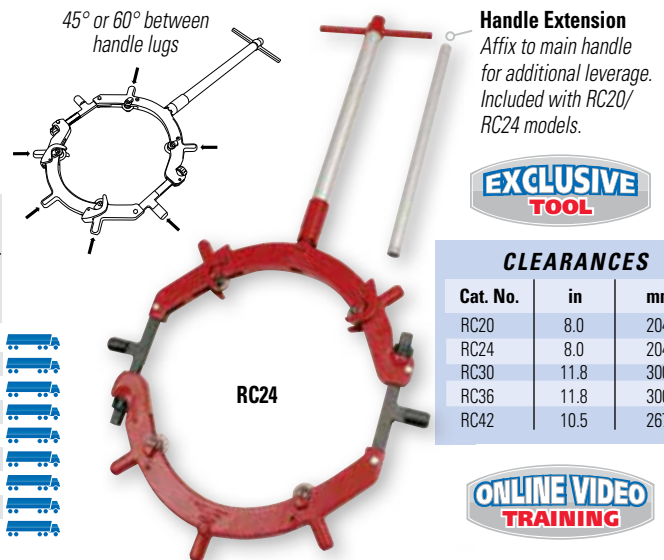

### CLEARANCES

Cat. No.	in	mm
RC20	8.0	204
RC24	8.0	204
RC30	11.8	300
RC36	11.8	300
RC42	10.5	267





DS12  
in use

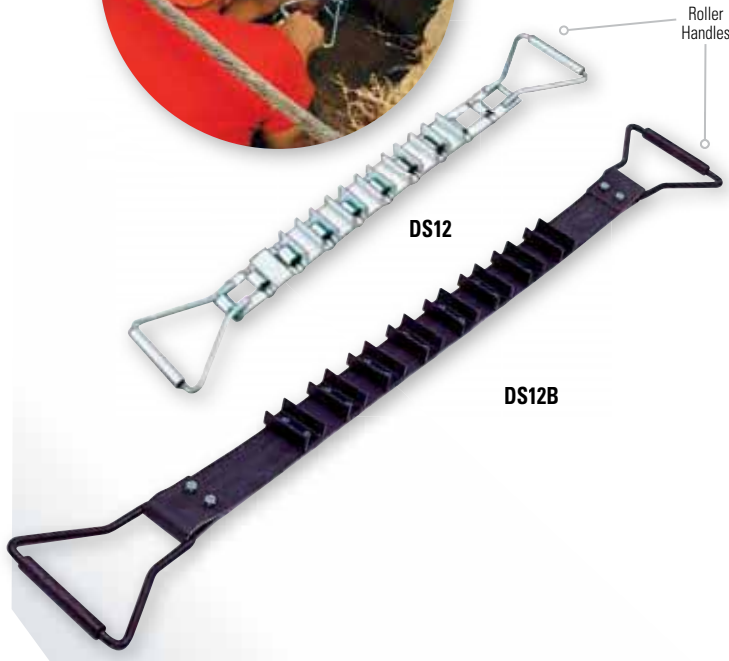

## PIPE DESCALERS

### FEATURES

- **Much faster** and **far more effective** than chisels, chains or files.
- Needs only 2" of clearance around the pipe.
- For removing tough dirt and debris quickly, choose the **sharp scrapers** of the DS12 and DS36 chain descalers.

Wide, tough scrapers remove scale, dirt and corrosion quickly from the pipe surface to allow more effective cutting, joining, gasket/valve seating or other operations. Pipe descalers are faster and more effective than chisels, chains or files and need only 2" of clearance around the pipe. Use them to clean pipe before cutting or water tapping or drilling. Roller handles allow smooth movement in use. DS12 and DS36 chain descalers are made entirely of steel that is zinc-plated for corrosion resistance and toughness. The sharp metal scrapers dig in fast to remove dirt and debris. They are welded on for long life and can be sharpened. Also, Reed produces a heavy-duty power transmission belting pipe descender, DS12B. Its handles and scrapers are blackened for good rust protection. Belt descender benefits include lower cost and lighter weight than all-metal descalers, longer length to ease back strain during use and high-profile scrapers to reduce dirt clogs. Reed offers a replacement belt (for DS12B only) with scrapers attached; simply bolt the new belt onto the handles.

Catalog No.	Item Code	Type	Pipe Capacity		Length		Weight	
			in-nom.	mm	in	mm	lbs	kg
DS12	08000	Steel Chain	3 - 12	70 - 300	32	810	5.7	2.6
DS36	08006	Steel Chain	3 - 36	70 - 910	44	1110	8.2	3.7
DS12B	08008	Belt	3 - 12	70 - 300	50	1257	4.2	1.9

### REPLACEMENT BELT

Catalog No.	Item Code	Description	Length		Weight	
			in	mm	lbs	kg
DS12BRB	98008	Replacement belt fits REED DS12B or Wheeler-Rex® 1300	45	1143	3.0	1.4

### ✓ WHY REED?

This Reed invention has two pawls for faster action and for work in tight places – requires half the handle swing space of competitive reamers.

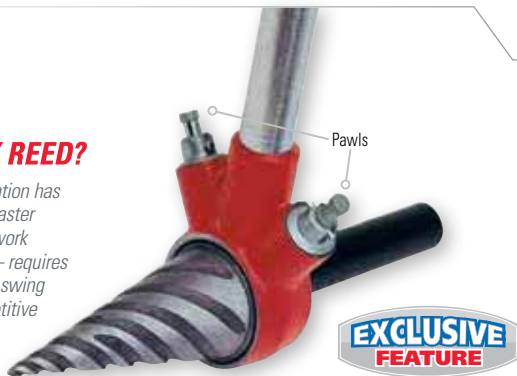

2-71

## PIPE REAMER

### FEATURES

- Self-feeding, spiral reamer **starts easily** into pipe.

Pipe Reamer is used to deburr steel pipe before threading. Cone is made from tool steel and hardened for maximum life. Unique cutting edge makes this spiral reamer self-feeding and easy to start and operate.

Catalog No.	Item Code	Pipe Capacity		Weight	
		in-nom.	actual I.D. mm	lbs	kg
2-71	06060	1/8 - 2	7 - 53	6.7	3.0

# REED

## ENVIRONMENTAL STEWARDSHIP



www.NewWindEnergy.com

Reed is always mindful of using practical and environmentally-friendly options for literature and packaging.

The paper used for this catalog is sourced from managed forests. A web press, powered by wind power, is used. The ink is heat-set and 99.9% of all VOC's (volatile organic compounds) are destroyed in a dryer sequence used by Reed's printing partner, Knepper Press. For more information, visit [www.knepperpress.com/environmentally-green-printer](http://www.knepperpress.com/environmentally-green-printer).



PIPE TOOLS & VISES  
SINCE 1896



CNC Lathe



CNC Surface Grinder



*CNC technology is widely used for milling and machining components in Reed's product line.*

CNC Vertical Mill

# REED

## MANUFACTURING TECHNOLOGY

Leading-edge processes and state-of-the-art equipment infused with old world craftsmanship have been and remain the standard at Reed Manufacturing for over 100 years. The results of this century of commitment are unparalleled professional trade products offering quite possibly the world's best quality, service and value. Products made to exacting specifications, products made to last for a lifetime, and products with a full lifetime warranty.



# LARGE DIAMETER PIPE TOOLS

## ROTARY™ CUTTERS

42" (1067 mm) P. 19

Reed's large diameter pipe tools meet and exceed the demands of the toughest projects — and are made to last for years. These tools provide unique solutions and save the contractor money on the job. Maximum capacities are shown here. For more detailed information on any of these heavy-duty, specialized tools, turn to the catalog page numbers listed.

RIDE Colombia

For Steel, Ductile or Cast Iron



### UNIVERSAL PIPE CUTTERS

48" (1300 mm) P. 16, 31

For PE



### PLAS IN-LINE ROTARY™ CUTTERS

28" (800 mm) P. 32

### CHAIN TONGS

18" (457 mm) P. 70

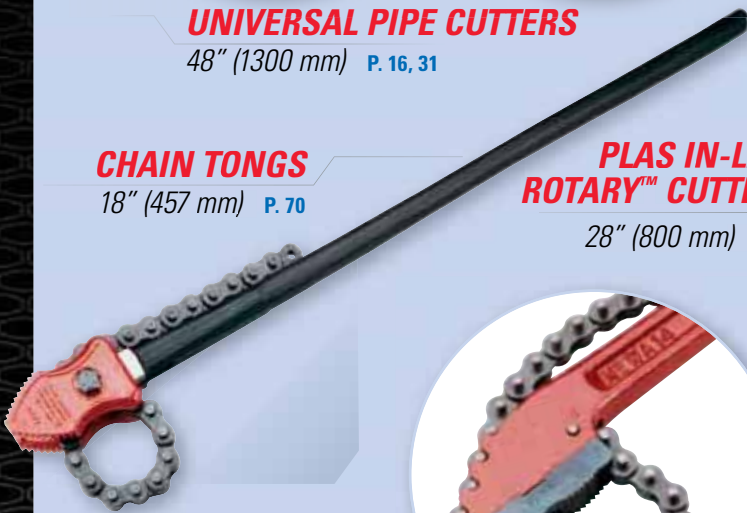

### CHAIN WRENCHES

18" (457 mm) P. 70



### PIPE DESCALERS

36" (910 mm) P. 20



### STRAP WRENCHES

12" (324 mm) P. 70





**GUILLOTINE PIPE CUTTERS**

12" (350 mm) P. 33

**PE SQUEEZE-OFF TOOLS**

8" (219 mm) P. 34

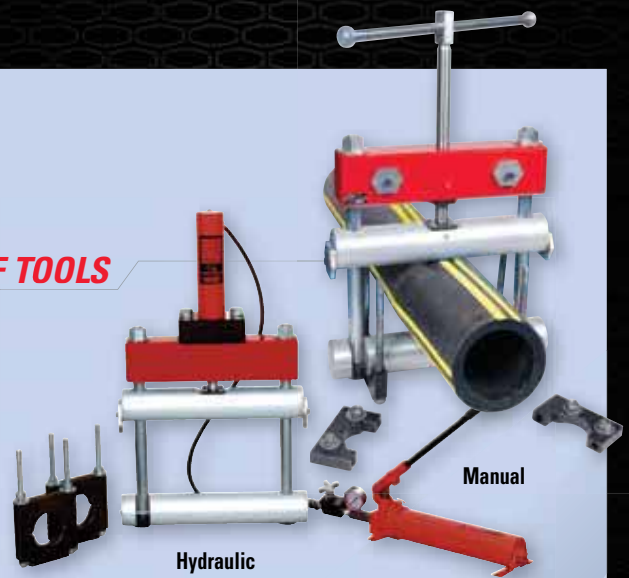

Hydraulic

Manual

**QUICK RELEASE™ TUBING CUTTERS**

10" (254 mm) P. 11, 25

**CHAIN VISES**

12" (335 mm) P. 64



BEST EVER!

**SAW IT®**

24" (610 mm) P. 15



**RAPID CUT & BEVEL™ MACHINES**

24" (610 mm) P. 31

**FIELD PIPE VISE**

20" (500 mm) P. 64



**YOKE PIPE VISES**

12" (335 mm) P. 64



**HINGED CUTTERS™**

12" (356 mm) P. 18

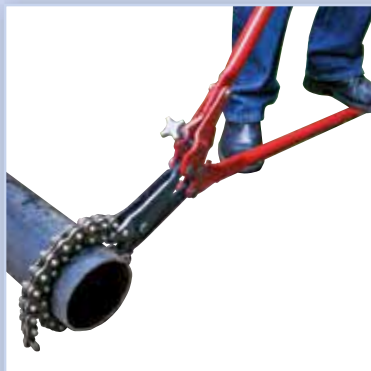

**SOIL PIPE CUTTERS**

15" (403 mm) P. 14

**THRU-BOLT™ LARGER RATCHET WRENCH & SOCKETS**

17" (432 mm) Handle & 1 5/8" Socket P. 73



# PLASTIC PIPE TOOLS

SECTION

# 2

Quick Release™ Tubing Cutters for Plastic

Scissor Shears

Ratchet Shears

Plastic Pipe Saws

Internal Pipe Cutters

Plastic Pipe Fitting Reamers

Solutions Kits **NEW**

PE Scraper

Flare Tools for PE Water Service Lines

Deburring Tools for Plastic **NEW**

PEX Crimpers

Bevelers

Drill-Powered Bevelers **NEW**

Universal Pipe Cutters for PE

Rapid Cut & Bevel™ Machines

PLAS In-Line Rotary™ Cutters

PLAS Hand-Over-Hand Rotary™ Cutters

Guillotine Pipe Cutters

PE Squeeze-Off Tools

Grounding Accessory

Static Discharge Alarm

Plastic Pipe Joiners

**PPR300 Plastic Pipe Fitting Reamer shown with operator-supplied drill on Schedule 40 3" PVC pipe fitting. Drill powers the reamer to effectively clean-out the original fitting and cement residue allowing for reuse of the fitting.**





PIPE TOOLS & VISES  
SINCE 1896

## QUICK RELEASE™ TUBING CUTTERS FOR PLASTIC

### FEATURES

- **Best tracking**, easiest cutting tubing cutters available.
- With a simple wheel change, Quick Release™ cutters can be used for a variety of plastic or metal pipe.
- Replace worn cutter wheels for faster and easier cuts.

Reed Quick Release™ tubing cutters are the industry standard; most recommended by plastic pipe companies and most imitated by other manufacturers. Quick Release™ tubing cutters for plastic are the best cutters for small, medium and large diameter work and feature sliding bars now with magnesium for added strength. They cut clean and square with very little burr. Additionally, field reports indicate that Quick Release™ Tubing Cutters with Reed OP2 or 30-40P cutter wheels are well-suited for use on ABS pipe.

Catalog No.	Item Code	Capacity		Length		Weight		Wheel	Material Cut
		actual O.D. in	actual O.D. mm	in	mm	lbs	kg		
TC1QP*	04110	1/8 - 1 5/16	3 - 33	6	152	0.6	0.3	OP2	PE, PP, ABS, PEX
TC1QPVC*	04114	1/8 - 1 5/16	3 - 33	6	152	0.6	0.3	1-2PVC	PVC, CPVC, ABS
TC1.6QP*	04116	1/4 - 1 1/2	6 - 42	6.5	165	0.8	0.4	OP2	PE, PP, ABS, PEX
TC1.6QPVC*	04118	1/4 - 1 1/2	6 - 42	6.5	165	0.8	0.4	1-2PVC	PVC, CPVC, ABS
TC2QP*	04120	1/4 - 2 5/8	6 - 63	8	203	1.2	0.5	OP2	PE, PP, ABS, PEX
TC2QPVC*	04124	1/4 - 2 5/8	6 - 63	8	203	1.2	0.5	1-2PVC	PVC, CPVC, ABS
TC3QP	04130	3/8 - 3 1/2	10 - 90	11	279	2.5	1.1	30-40P	PE, PP, ABS
TC3QPVC	04134	3/8 - 3 1/2	10 - 90	11	279	2.5	1.1	3-6PVC	PVC, CPVC, ABS
TC3Q6QP	04138	3/8 - 3 1/2	10 - 90	11	279	2.5	1.1	6QP	THICK PE
TC4QP	04140	1 1/8 - 4 1/2	48 - 114	12	305	2.8	1.3	30-40P	PE, PP, ABS
TC4QPVC	04144	1 1/8 - 4 1/2	48 - 114	12	305	2.8	1.3	3-6PVC	PVC, CPVC, ABS
TC4Q6QP	04148	1 1/8 - 4 1/2	48 - 114	12	305	2.8	1.3	6QP	.55 THICK PE
TC5QP*	04150	2 1/2 - 5	63 - 125	13	330	3.0	1.4	30-40P	PE, PP, ABS
TC5QPVC*	04154	2 1/2 - 5	63 - 125	13	330	3.0	1.4	3-6PVC	4" C900
TC6QP	04160	4 - 6 5/8	102 - 168	15	381	3.9	1.8	30-40P	PE, PP, ABS
TC6QPVC	04164	4 - 6 5/8	102 - 168	15	381	3.9	1.8	3-6PVC	PVC, ABS
TC6Q680PVC	04125	4 - 6 5/8	102 - 168	15	381	3.9	1.8	680PVC	PVC-HVY WALL
TC6Q6QP	04168	4 - 6 5/8	102 - 168	15	381	3.9	1.8	6QP	.55 THICK PE
TC6Q8QP	04123	4 - 6 5/8	102 - 168	15	381	3.9	1.8	8QP	.75 THICK PE
TC8QP*	04170	6 1/4 - 10	159 - 254	26	660	8.0	3.6	8QP	ABS, PE, PP, PVC**
TC8QPL*	04171	6 1/4 - 10	159 - 254	26	660	8.0	3.6	8QP	.75 THICK PE
TC8Q680PVC*	04172	6 1/4 - 10	159 - 254	26	660	8.0	3.6	680PVC	PVC-NYLON

### \*EXCLUSIVE SIZES

\*Features spare cutter wheel in knob. TC1QP, TC1QPVC, TC1.6QP, and TC1.6QPVC have spare "O" wheel. TC2QP has "OP2" wheel, TC2QPVC has "O" wheel.

\*\*TC8QP comes with a cradle and parting blade for cutting thick plastic pipe. The parting blade can cut to a depth of 1 1/2 inches (38.1 mm) on plastic pipe.

NOTE: To cut Aquatherm® PP-R pipe, order Cutter Wheel #04159 with the TC5Q, TC6Q or TC8Q cutter.

QUICK RELEASE™ TUBING CUTTERS (for metal) ON P. 11  
CUTTER WHEELS ON P. 7 - 9

## SCISSOR SHEARS

### FEATURES

- Ideal for cutting thin wall and small diameter plastic, rubber or nylon tubing.
- Choose an industrial-grade, non-stick blade or stainless steel blade for corrosion resistance.
- For safety and ease of operation, use Scissor Shears with **blade on bottom**.

Scissor Shears squeeze together for fast cutting of small diameter PE, PEX, thin wall PVC pipe, rubber or nylon tubing. Rotate scissor shears around tubing while squeezing handles together for the best cut. All models feature ribbed handles for more secure hold along with fiberglass strengthened nylon construction. Blade design maintains its sharp edge for long life and exact cuts. **SC1** and **SC125** industrial-grade blades are non-stick coated with a surface lubricant which lets blades slice smoothly through cut area. **SC1SS** features stainless steel blade which stays sharper and lasts longer when cutting harder plastics like thin wall PVC.

Catalog No.	Item Code	Capacity		Length		Weight	
		actual O.D. in	actual O.D. mm	in	mm	lbs	kg
SC1SS	04169	1.3	32	8.25	210	0.3	0.1
SC1	04174	1.3	32	8.25	210	0.3	0.1
SC125	04178	1.7	42	8.5	216	0.3	0.1

### REPLACEMENT BLADES

Catalog No.	Item Code	Description
SC1B	94170	High Carbon Steel Blade fits SC1, SC1SL, SC1SS
SC1BSS	94187	Stainless Steel Blade fits SC1, SC1SL, SC1SS
SC125B	94169	High Carbon Steel Blade fits SC125, SC125SL

NOTE: Scissor Shears are **NOT RECOMMENDED** to cut PVC or CPVC for solvent cement weld connections. Instead use QUICK RELEASE™ TUBING CUTTERS FOR PLASTIC ABOVE.



### ✓ WHY REED?

Quick Release™ tubing cutters were invented by Reed and cover capacities up to 10" (254 mm). First used by Reed, the ball detent wheel pin makes cutter wheel change easy. Reed has the best cutter wheels specifically designed for all plastic applications.

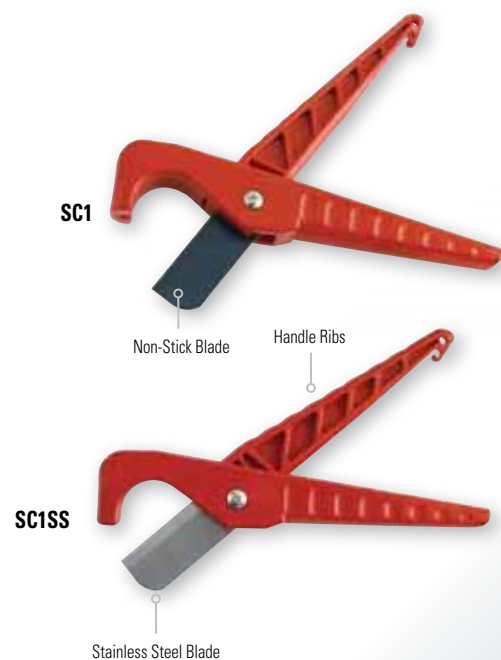

## RATCHET SHEARS

### FEATURES

- Ratchet Shears are **ideal for cutting** PE, PP, PEX, ABS and thin wall PVC.
- **Smoothest** ratchet action for easiest cuts.
- Replace or resharpen blades for longer tool life and faster cuts.

Ratchet shears with hardened steel blades are ideal for cutting PE, PP, PEX, ABS and thin wall PVC pipe. **RSP1** also cuts PVDF. One-hand models **RS1** and **RS1PLT** offer a 7-step ratchet mechanism for best mechanical advantage and smoothest operation. RS1PLT is unique with a corrosion-resistant, nickel-plated, steel blade. Pointed blade in one-hand model RSP1 helps start the cut in tough plastics like thin wall PVC or rigid PP and helps avoid bounce in thin wall material. The two-hand **RS2** features 2" capacity, extra wide, v-style jaws for easy alignment and square cuts, and long handles for leverage on tough-to-cut pipe. **RS7290** has 2" capacity and one-hand style to keep user's other hand free to work with pipe. All Reed ratchet shears cut pipe used in gas, water, plumbing and industrial applications. All blades can be easily sharpened or replaced, enhancing performance and saving money. These tools are not disposable and perform better, longer and for less money over the tool's lifetime.

### ✓ WHY REED?

Broader base and 7-step ratcheting mechanism on RS1/RS1PLT models mean square cuts are easily attained with minimal clearance.

### EXCLUSIVE FEATURE



Catalog No.	Item Code	Capacity		Length		Weight	
		actual O.D. in	actual O.D. mm	in	mm	lbs	kg
RS1	04176	1.66	42	8.3	210	0.8	0.4
RS1PLT*	04175	1.66	42	8.3	210	0.8	0.4
RS2	04177	2.4	63	17.0	440	2.8	1.3
RS7290	04182	2.4	63	13.25	337	2.4	1.1
RSP1	04276	1.66	42	8.75	222	0.9	0.4

\*EXCLUSIVE FEATURE

### REPLACEMENT BLADES

Catalog No.	Item Code	Description
RS1B	94175	RS1 Hardened Steel Blade
RS1BPLT	94180	RS1PLT Nickel-plated Steel Blade
RS2B	94176	RS2 Hardened Steel Blade
RS7290B	94555	Blade fits Reed RS7290 and Wheeler® 7290
RSP1B	94276	RSP1 Stainless Steel Blade

NOTE: Ratchet Shears are **NOT RECOMMENDED** to cut PVC or CPVC for solvent cement weld connections. Instead use **QUICK RELEASE™ CUTTERS FOR PLASTIC ON P. 25**

## PLASTIC PIPE SAWS

### FEATURES

- Cuts ABS, CPVC, PVC including C900 and larger diameter plastic such as 6" and 8" sewer pipe.
- Ergonomic-designed handle on PPS20 and PPS24 with large radius contours for hand comfort.
- Die cast design of handle on PPS12 and PPS18 makes blade change fast and easy.

Reed Plastic Pipe Saws are specifically designed to cut plastic pipe. The composition of plastic pipe, especially PVC, tends to be very abrasive, hence, saws designed to cut only wood become dull very quickly. It is therefore necessary to make saws with the proper profile, set and hardness to most effectively cut plastic pipe. PPS saws respond to this need while offering a competitive price and replaceable blades. Low profile **PPS12** and **PPS18** can reach into small spaces. Plus, their tooth design, set and hardness simplify cuts on ABS and PVC pipe. **PPS20** and **PPS24** feature 11 teeth per inch (more than average) and a unique pattern to create a bite that does not chatter on plastic or wood in the push or pull of the saw blade. This same tooth spacing makes these fast cutting. Reed plastic pipe saws cut Schedules 40 and 80 PVC, C900, CPVC and ABS, along with wood. PPS24 also cuts HDPE.



Catalog No.	Item Code	Pipe Capacity		Length		Weight	
		in-nom.	actual O.D. mm	in	mm	lbs	kg
PPS12	04512	3	75	16	426	0.6	0.3
PPS18	04510	4	100	22	560	0.7	0.3
PPS20	04720	6	150	20	508	1.0	0.5
PPS24	04724	8	200	24	610	1.1	0.5

### REPLACEMENT BLADES

Catalog No.	Item Code	Description
PPS18B	94510	PPS18 Blade
PPS12B	94512	PPS12 Blade
PPS20B	94720	PPS20 Blade
PPS24B	94724	PPS24 Blade



PIPE TOOLS & VISES  
SINCE 1896

## INTERNAL PIPE CUTTERS

### FEATURES

- Conveniently cut from the inside (i.e. drain pipes or sprinkler drops, etc) using a standard 3/8" drill (not included).
- Exclusive, adjustable guide on IC1SL and IC3/4SL doubles as a **depth gauge**.
- Abrasive or saw toothed blade option.

Reed Internal Pipe Cutters cut pipe from the inside: below floor level or in the ceiling in new construction, around pools, and for replacement of closet flanges. Heat-treated steel, saw-toothed blades on the **IC1S**, **IC1SL** and **IC3/4SL** make for fast cutting. The **IC1A** comes with an abrasive blade for areas where the blade may come in contact with concrete or other hard surfaces which would destroy a saw tooth blade. All internal pipe cutters fit in a standard 3/8" drill (not included). During use, flats on the larger cutters keep the cutter from slipping in the jaws of the drill while a lock washer on the smaller cutters keeps the blades from slipping. All saw-toothed internal pipe cutter models cut plastic pipe aggressively and can cut wood for sink lugs. IC1SL and IC3/4SL feature an exclusive, adjustable guide that doubles as a depth gauge. The IC3/4SL is exclusive in its 3/4" pipe diameter.

Catalog No.	Item Code	Blade Type	Blade Diameter		Blade Cutting Depth		Shaft Size	Weight	
			in	mm	in	mm		lbs	kg
IC1A	04500	abrasive	1.53	38.8	.50	13.0	4"	0.2	0.1
IC1S	04501	saw tooth	1.26	32.0	.38	9.6	4"	0.2	0.1
IC1SL*	04505	saw tooth	1.26	32.0	.38	9.6	7"	0.7	0.3
IC3/4SL*	04507	saw tooth	0.75	19.0	.13	3.18	6"	0.4	0.2

\*EXCLUSIVE

### REPLACEMENT BLADES

Catalog No.	Item Code	Description
IC1RA	04502	Abrasive Blades for IC1
IC1RS	04503	Saw Tooth Blades for IC1
IC3/4RS	04508	Saw Tooth Blades for IC3/4

### ✓ WHY REED?

SL models offer exclusive, adjustable guide and depth gauge making it easier to cut from inside pipe where other tools won't go.



## PLASTIC PIPE FITTING REAMERS

### FEATURES

- Clean leftover pipe and solvent cement residue from PVC, CPVC or ABS fittings.
- **Reduce labor time and materials costs** by reusing the fittings.
- Available in 7 sizes and fit into standard 1/2" drills (not included).
- Sturdy kits keep reamers organized and clean.

Money-saving reamers are designed to clean out the old or broken pipe and leftover solvent cement from a fitting so the fitting can be reused. In this era of green living and recycling, try these reamers on PVC, CPVC or ABS to save time and material costs. Plastic Pipe Fitting Reamers fit into 1/2" electric or cordless drills. PPR reamers work great for vent lines, drain lines and water lines. PPR carbide cutting insert provides a cutting edge on each side. Rotate before replacement and receive three bonus cutting edges.



Cat. No.	Item Code	Description	Shaft Size	Weight	
				lbs	kg
PPR75	04521	Reams 3/4" Sch. 40 PVC, CPVC & ABS Fittings	1/4" hex	0.12	0.05
PPR100	04522	Reams 1" Sch. 40 PVC, CPVC & ABS Fittings	1/4" hex	0.14	0.06
PPR125	04523	Reams 1 1/4" Sch. 40 PVC, CPVC & ABS Fittings	3/8" hex	0.30	0.13
PPR150	04524	Reams 1 1/2" Sch. 40 PVC, CPVC & ABS Fittings	3/8" hex	0.40	0.18
PPR200	04525	Reams 2" Sch. 40 PVC, CPVC & ABS Fittings	3/8" hex	0.60	0.27
PPR300	04526	Reams 3" Sch. 40 PVC, CPVC & ABS Fittings	3/8" hex	1.20	0.52
PPR400	04527	Reams 4" Sch. 40 PVC, CPVC & ABS Fittings	3/8" hex	2.00	0.89
PPR4	04528	Kit with PPR150, PPR200, PPR300, PPR400 in a hard plastic case	-	7.60	3.50
PPR5	04520	Kit with PPR125, PPR150, PPR200, PPR300 and PPR400 in a hard plastic case	-	7.80	3.50
PPR6	04529	Kit with PPR75, PPR100, PPR150, PPR200, PPR300 and PPR400 in a hard plastic case	-	7.90	3.60

NOTE: PPR Fitting Reamers are **NOT RECOMMENDED** for use on pressurized systems or gas vent systems.



**NEW**  
**ONLINE VIDEO TRAINING**

## SOLUTIONS KITS

### FEATURES

- All the tools needed to **ensure a perfect joint**, every time.
- Works for plastic pipe such as PVC, CPVC, PP, ABS and PE.
- Cutter provides quick, square and clean cut on plastic pipe.

These kits contain tools required to install a perfect joint every time to prevent failures between pipe and fitting. Quick Release™ Cutter produces a square, clean cut which is imperative for proper, even stab depth into fittings and for reducing leak potential. DEB4 and DEB1 deburring tools produce even, consistent chamfer ensuring proper fitting penetration depth. And, at the same time, allow the solvent cement to move to the correct part of the pipe (side) for greater surface area solvent weld. The IC1SL Internal Pipe Cutter (in some kits) yields a uniform internal cut in hard-to-reach places where a tubing cutter will not fit. All tools are contained in a durable, hard plastic case.

Catalog No.	Item Code	Description	Weight	
			lbs	kg
★ TC2PPDEB1-2SK	04142	TC2QPVC, DEB11PS & DEB1-2IPS with case	5.6	2.5
TC3PPSK	04151	TC3QPVC, DEB4 & DEB11PS with case	6.9	3.1
TC3-636SK	04155	TC3QPVC, DEB4 & IC1SL with case	6.9	3.1
TC4-636SK	04156	TC4QPVC, DEB4 & IC1SL with case	7.1	3.2
★ TC2PPSK	04157	TC2QPVC, DEB4 & DEB11PS with case	5.6	2.5

★ **NEW**

## PE SCRAPER

### FEATURES

- One tool does a range of pipe 2" - 6".
- Takes 2 minutes to attach to pipe and scrape 6" PE.
- Creates a **uniformly** scraped surface.
- Works well even on out-of-round pipe.

PE Scraper prepares the outside diameter of PE pipe for electrofusion by removing the oxidized layer and contaminates. Spring-loaded blade keeps consistent pressure on the pipe for a smooth finished surface. This blade tension means the blade does not skip. Updates include smoother-riding ball bearing wheels and a revolving handle which allow the scraper to be rotated in one continuous motion. Also, new roller chain tensioning system allows for more forgiveness on out-of-round pipe. PE Scraper can be used on the edge of the pipe or anywhere along the pipe with sufficient 6" (150 mm) clearance for turning the tool around the pipe.

Catalog No.	Item Code	Pipe Capacity		Weight	
		in-nom.	actual O.D. mm	lbs	kg
PESCRAPER2*	04631	2 - 6	60 - 168	3.1	1.4

\*Available late 2014



PESCRAPER2  
in use

**ONLINE VIDEO TRAINING**

PESCRAPER2

**BEST EVER!**

## FLARE TOOLS FOR PE WATER SERVICE LINES

### FEATURES

- Flare water service lines easily with this **innovative** and **inexpensive** tool.

Flare Tools for PE Water Service Lines form a permanent cold flare with ten easy revolutions to connect PE 160 psi water service tubing (SDR 9), using inexpensive, standard AWWA flare fittings for CTS tubing. These tools flare medium and high density PE.

Catalog No.	Item Code	CTS Tubing	Weight	
		in-nom.	lbs	kg
SFPE3/4*	04200	3/4	1.9	0.9
SFPE1*	04202	1	2.2	1.0

\*EXCLUSIVE



SFPE3/4

SFPE3/4 in use

**EXCLUSIVE TOOL**



PIPE TOOLS & VISES  
SINCE 1896

## DEBURRING TOOLS FOR PLASTIC

### FEATURES

- DEB1 offers **knurled grip** for slip-resistance and durable aluminum body for longevity.
- **Deburr and chamfer** in the same rotation using DEB4 or DEB1.
- Suitable for PVC, CPVC, PE, ABS and PP.
- Three sizes of pipe accommodated per DEB1 which produces a 15° chamfer.

Reed offers several deburring tool styles for plastic pipe. Selection depends on capacity and style preference.

**Patented DEB1** tools deburr and chamfer to pipe manufacturers' standards in seconds. Plastic pipe joints get proper fit from smooth, chamfered ends delivered by DEB1 models. Use for PVC, CPVC, ABS, PE and PP pipe. Find three sizes in one tool for iron pipe size, copper tube size or metric sizes. **DEB1IPS-INT** is a double-ended tool to deburr both inner and outer diameters. All DEB1 models have internal pipe guides, knurled grip for slip-resistance and a sharpenable and replaceable blade.

One easy revolution of Reed exclusive **DEB4** deburrs and produces a 15° chamfer in seconds. It fits comfortably in one's hand for a secure grip. The resulting chamfered pipe end permits solvent to be spread evenly for pipe joining. Aluminum die-cast DEB4 features a hardened steel blade that is reversible, sharpenable and replaceable. Fits six nominal pipe sizes of PVC, CPVC and ABS up through 4" diameter. **DEB2** deburrs inner and outer edges of PVC, CPVC, ABS, PP and PE pipe through 2" diameter. Made from steel, the cone design allows for use on even the smallest pipe, including 1/8" diameter.

### DEB1 SERIES\*

Catalog No.	Item Code	Nominal Pipe Capacity	Application	Pipe	Weight	
					lbs	kg
DEB1IPS*	04650	1/2", 3/4", 1" O.D.	PVC, CPVC, PE, ABS, PP	IPS	0.4	0.2
DEB1CTS*	04652	1/2", 3/4", 1" O.D.	PVC, CPVC, PE, ABS, PP	CTS	0.4	0.2
DEB1-2IPS*	04654	1 1/4", 1 1/2", 2" O.D.	PVC, CPVC, PE, ABS, PP	IPS	0.9	0.4
★ <b>DEB1M*</b>	04655	20, 25, 32 mm O.D.	PVC, CPVC, PE, ABS, PP	metric	0.4	0.2
★ <b>DEB1-2CTS*</b>	04656	1 1/4", 1 1/2", 2" O.D.	PVC, CPVC, PE, ABS, PP	CTS	0.9	0.4
★ <b>DEB1IPS-INT*</b>	04670	1/2", 3/4", 1" I.D./O.D.	PVC, CPVC, PE, ABS, PP	IPS	0.6	0.3

\*EXCLUSIVE

\*PATENTED DESIGN.

NOTE: IPS is for use on iron pipe size and CTS is for use on copper tube size.

### DEB2 & DEB4

Catalog No.	Item Code	Nominal Pipe Capacity						Weight		
		in	1 1/4	1 1/2	2	2 1/2	3	4	lbs	kg
DEB2	04436	up to 2" (60 mm)						0.2	0.09	
DEB4*	04430	actual O.D. mm	42	50	63	75	90	114	0.7	0.32

\*EXCLUSIVE

DEBURRING TOOLS (for metal) ON P. 13



## PEX CRIMPERS

### FEATURES

- **Crimps rings** easily, giving good connections.
- Crimpers are the right tools for PEX systems because they **properly seal** the rings without distortion.
- Each Reed copper ring crimper includes a go/no-go gauge and an Allen wrench.

PEX Crimpers squeeze the copper rings used on PEX brass fittings. PEX systems are used for potable water lines, radiant heat, snow melt and ice rink systems, among other applications. The design of these PEX crimpers eliminates tool marks and distortion on the rings. The tools crimp rings easily, making PEX installation a breeze. For one-hand use on 1/2" and 3/4" PEX, consider the **PEXOH12** or **PEXOH34**.

Catalog No.	Item Code	Description	Handle Length*	Weight	
				lbs	kg
PXCR12S	04900	1/2" capacity	8 3/4"	3.0	1.4
PXCR34S	04903	3/4" capacity	9"	3.0	1.4
PXCR1M	04904	1" capacity	11 1/2"	4.0	1.8
PXCR1234M	04910	1/2" and 3/4" capacity	11"	4.3	1.9
PEXOH12	04920	1/2" capacity, one-hand style	8 1/2"	2.5	1.1
PEXOH34	04925	3/4" capacity, one-hand style	9"	2.6	1.2

\*Handle length does not include head.

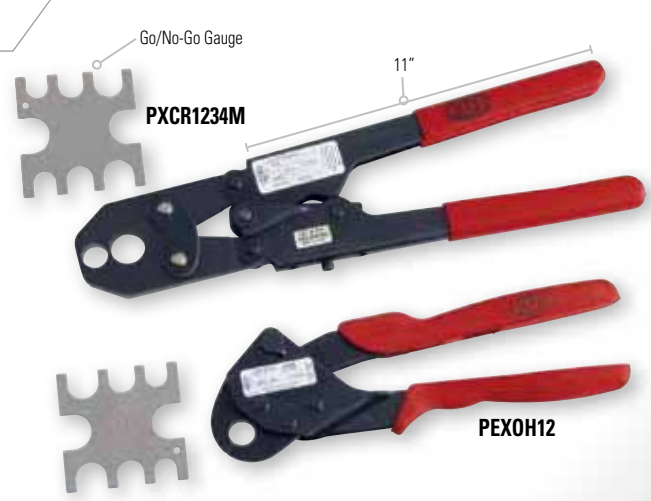



BT1 in use



Thumb Screw Adjustment

BT2 in use

### ✓ WHY REED?

Much faster, safer, and far more effective than a file or power saw as it reduces the possibility of injury and leaks after joining pipe.

## BEVELERS

### FEATURES

- Beveler only needs a few turns around PVC pipe to safely make the smooth 15° bevel.
- Strong, reinforced aluminum frame for **durability**.
- Adjusts to **bevel multiple sizes** with one tool.

With a strong aluminum alloy frame, effective roller locking and good tool life, a Beveler produces a smooth 15° bevel on all types of plastic pipe, including gasketed PVC and C900 PVC in about one minute. Depending on wall thickness, the bevel can be up to 1 1/2" long. Beveler is easily adjusted for different pipe sizes and thicknesses, with no part changes. Bevel blade can be sharpened or replaced.

Catalog No.	Item Code	Pipe Capacity		Weight	
		in-nom.	actual O.D. mm	lbs	kg
BT1	04395	1 1/2 - 8	40 - 200	3.0	1.4
BT2	04398	1 1/2 - 12	40 - 300	6.1	2.8

NOTE: If pipe is not stationary, a Reed pipe vise is recommended.

### REPLACEMENT BLADES

Catalog No.	Item Code	Description
BT1B	94388	Bevel Blade for BT1 and BT2
BT1SB	94386	Support Blade for BT1 and BT2

## DRILL-POWERED BEVELERS

### FEATURES

- Quickly chamfers pipe using drill power, eliminating user fatigue when making multiple cuts/chamfers.
- Deburrs inside and outside simultaneously in just seconds.
- Produces smooth, consistent chamfer on PVC and CPVC, eliminating leak channels that can be caused by improper bevel.

The Drill-Powered Beveler attaches to an electric or cordless drill (not included) to bevel both the inner and outer diameters of plastic pipe. PVC and CPVC pipe joints require a bevel and Reed's PB series bevelers create a smooth, consistent, factory-style, 15° bevel in seconds. These drill-powered bevelers are available in a kit consisting of 2", 3" and 4" sizes or individually by size.



PB4 in use



PB4



Catalog No.	Item Code	Description	Weight	
			lbs	kg
★ <b>PBKIT</b>	04660	Kit with 2", 3" and 4" Bevelers with case	6.6	3.0
★ <b>PB2</b>	04662	for 2" plastic pipe	0.4	0.2
★ <b>PB3</b>	04663	for 3" plastic pipe	0.5	0.2
★ <b>PB4</b>	04664	for 4" plastic pipe	0.7	0.3

★ **NEW - Coming mid-2014**

# REED

## MISSION STATEMENT

Reed will develop a growing market position in the pipe tool industry by providing the most innovative and the highest quality tools, the best customer service, the lowest total cost and the greatest value to distributors and tool users.



**REED DELIVERS VALUE WORLDWIDE... GUARANTEED!**

Reed seeks to utilize very effective personnel, the most modern, cost-effective equipment, and total quality management concepts in order to achieve challenging objectives. Reed also seeks to provide a great place to work, to be environmentally responsible and to be a good corporate citizen.



PIPE TOOLS & VISES  
SINCE 1896

## UNIVERSAL PIPE CUTTERS FOR PE

### FEATURES

- Special arbor, blades and blade guard for PE.
- Includes all the parts for successful PE cuts.

Reed's pneumatic-powered Universal Pipe Cutters (UPC) for PE are available to cut 8" - 48" nominal diameter (200-1300 actual O.D. mm) PE pipe. Both kits ship in a steel toolbox and include a UPC cutter, a filter-regulator-lubricator, UPCSTEEL6 and UPCPE8 blades. The UPCPE8 blade will cut large diameter PE pipe with a wall thickness up to 2 23/32" (69 mm). To cut 6" - 8" PE pipe, the UPCSTEEL4 blade must be purchased separately.

Catalog No.	Item Code	Pipe Diameter		Gross Weight*	
		in-nom.	actual O.D. mm	lbs	kg
UPC836APE*	07517	8 - 36	200 - 1000	101	45.9
UPC848APE*	07518	8 - 48	200 - 1300	106	48.2

\*EXCLUSIVE

\*GROSS WEIGHT includes all components plus packaging.  
#07517 and #07518 units do not require a water tank and one is not supplied.



### UNIVERSAL PIPE CUTTER BLADES FOR PE

Catalog No.	Item Code	Description	Pipe Diameter	Pipe Material
UPCSTEEL4	97519	4" BLADES cut up to 23/32" (18.3 mm) PE wall thickness	6 - 8 in 150 - 200 mm	PE
UPCSTEEL6	97520	6" BLADES cut up to 1 23/32" (43.7 mm) PE wall thickness	8 - 48 in 200 - 1300 mm	PE
UPCPE8	97521	8" BLADES cut up to 2 23/32" (69 mm) wall thickness	26 - 48 in 660 - 1300 mm	PE

UNIVERSAL PIPE CUTTERS ON P. 16 - 17, including UPC for PVC.



UPCSTEEL6

UPCPE8



## RAPID CUT & BEVEL™ MACHINES

### FEATURES

- Safely produce a clean, straight cut and bevel PVC or PE pipe in one pass.
- Faster than manual cutters and safer than chop saws.
- Lightweight, pneumatic powered machines.
- Set-up, cut and bevel takes about 1 minute per pipe diameter inch.

Portable to the jobsite and used above ground, in water or in trenches. It takes about one minute per pipe diameter inch for set-up, cut and bevel. RCB412 is for 4" - 12" pipe and RCB624 has a longer chain and additional yoke to get around larger pipe up to 24" diameter. Save time and money with accurate, fast cutting and beveling on plastic pipe.

Catalog No.	Item Code	Pipe Capacity		Weight	
		in-nom.	actual O.D. mm	lbs	kg
RCB412**	07700	4 - 12	114 - 335	26.0	12.0
RCB624**	07706	6 - 24	168 - 610	29.5	13.4

\*PATENTED

\*EXCLUSIVE

NOTES: Air compressor is required, but not included. Operator will need an air compressor rated @ 60 cfm (30 l/s) and 90 psi, (6 bar) 600 kPa.  
Always use a filter-regulator-lubricator (FRL) with Reed pneumatic tools. Reed offers FRL #97591. FILTER-REGULATOR-LUBRICATOR ON P. 17  
MAXIMUM WALL THICKNESS: 1 1/2" (38.1 mm) for PVC.  
1 1/4" (31.75 mm) for PE (LDPE, MDPE, HDPE) including: SDR 7 up to 10"; up to 16" SDR 9; up to 18" SDR 11; up to 24" SDR 13.5. To cut thicker PE, use Reed's UNIVERSAL PIPE CUTTERS FOR PE.

### CONVERSION KIT

Catalog No.	Item Code	Description	Weight	
			lbs	kg
RCBKIT1	07702	Converts RCB412 to RCB624	9.9	4.5

RCB412 in use

RCB412



### WHY REED?

Proprietary tool cuts and bevels in-line and square on even large plastic pipe up to 24" (610 mm).

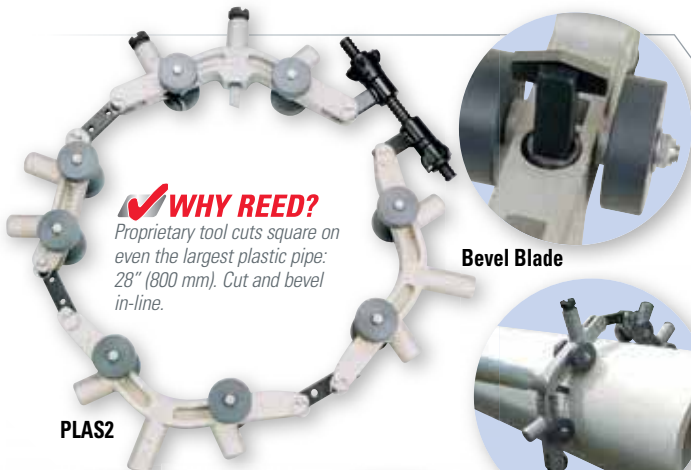

**✓ WHY REED?**  
Proprietary tool cuts square on even the largest plastic pipe: 28" (800 mm). Cut and bevel in-line.

Bevel Blade

PLAS2

PLAS1 works great for C900 water pipe.

ONLINE VIDEO TRAINING

EXCLUSIVE TOOL

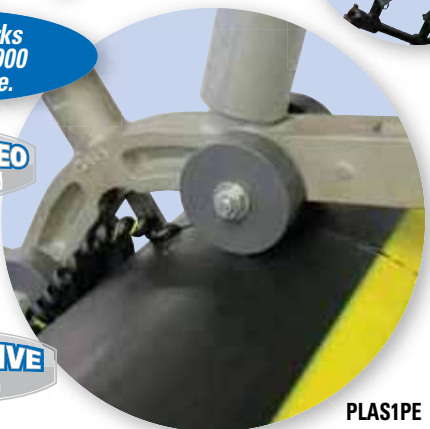

PLAS1

PLAS1PE

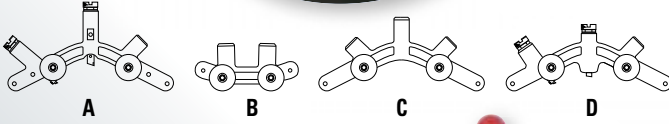

## PLAS IN-LINE ROTARY™ CUTTERS

### FEATURES

- **Clean and safe!** No chips to clog valves and apertures.
- Only 6" - 8" clearance needed to turn PLAS around pipe.
- Cuts out-of-round pipe because of **spring loaded nuts**.
- Inexpensive tool to make a cut for a tie-in or pipe break and then get the line back in use. **Reduce overall labor costs!**

PLAS In-Line Rotary™ Cutters are excellent for cutting PVC or PE pipe in trench or above ground. Each PLAS rotary cutter needs just 6" to 8" (153 - 203 mm) clearance around the pipe, making them easy to operate in trench and with lower prep costs. Outboard rollers keep the cutter aligned on pipe, ensuring a square cut every time. Carbide-tipped blades for PVC are long-lasting and penetrate up to a 2" wall thickness.\* Each PVC cutter also can produce, in-line with the cut, a 15° bevel on both sides of the cut. In addition, Reed has developed a hardened, tool steel blade to cut PE pipe. The curved blade drives chips out of the way, making PE cuts much easier. PLAS In-Line Rotary Cutters can retrofit for PE by purchasing PLASPEB blade #94485 separately.

Catalog No.	Item Code	Pipe Capacity		Application*	Sections Used	Weight	
		in-nom.	actual O.D. mm			lbs	kg
PLAS1*	04470	6 - 12	160 - 335	PVC	A, B, C	52	23.6
PLAS1PE*	04474	6 - 12	160 - 335	PE	A, B, C	52	23.6
PLAS2*	04475	14 - 18	355 - 500	PVC	B, C (2), D	57	25.9
PLAS2PE*	04477	14 - 18	355 - 500	PE	B, C (2), D	57	25.9
PLAS3*	04480	14 - 24	355 - 630	PVC	B, C (3), D	62	28.2
PLAS3PE*	04483	14 - 24	355 - 630	PE	B, C (3), D	62	28.2
PLAS4*	04485	14 - 28	355 - 800	PVC	B, C (4), D	68	30.9
PLAS4PE*	04487	14 - 28	355 - 800	PE	B, C (4), D	68	30.9

\*EXCLUSIVE

NOTE: 04470, 04475, 04480, 04485 ship with cutting blade for PVC. Models 04474, 04477, 04483, 04487 ship with cutting blade for PE. Blades are interchangeable.

\*PLAS CUTTERS WILL CUT PVC AND PE PIPE. SPECIFIC LIMITATIONS FOR PE ARE AS FOLLOWS: 2" (50.8 mm) wall thickness PE - up to 14" pipe, 1 1/2" (38.1 mm) wall thickness PE - up to 18" pipe, 1" (25.4 mm) wall thickness PE - up to 28" pipe.

## PLAS HAND-OVER-HAND ROTARY™ CUTTERS

### FEATURES

- **Attached handles** permit fast hand-turning – about half the cutting time of a regular PLAS cutter.
- Leaves a **disposable remnant** (not dust or chips) that is easy to recycle.
- Simple to transport and fast to use on PE and PVC.

Exclusive to Reed, PLAS Hand-over-Hand Rotary™ Cutters excel at cutting 4" to 12" (110 - 336 mm) diameter PVC or PE pipe in trench or above ground. They feature attached handles which permit fast hand-turning. Once the cutter is positioned around the pipe, the operator turns it for one revolution, feeds the cut-off tool closer to the pipe, and continues turning/feeding as needed. These OH models require 11" (280 mm) clearance around the pipe. Attached handles means there is no need to reposition a handle after each turn, compared to a regular PLAS (above). The built-in handle convenience equals no loose parts. Like PLAS Cutters above, outboard rollers keep the cutter aligned on pipe, ensuring a square cut every time. The tool's carbide-tipped blades for PVC are long-lasting and penetrate up to a 2" wall thickness. Each PVC cutter also can produce, in-line with the cut, a 15° bevel on both sides of the cut. In addition, Reed offers a hardened, tool steel blade to cut PE pipe. The curved blade drives chips out of the way, making PE cuts much easier.

Catalog No.	Item Code	Pipe Capacity		Application*	Sections Used	Weight	
		in-nom.	actual O.D. mm			lbs	kg
PLASOH*	04463	4 - 8	106 - 240	PVC	E (2)	21	9.6
PLASOHPE*	04464	4 - 8	106 - 240	PE	E (2)	21	9.6
PLASOH12PE*	04468	4 - 12	106 - 335	PE	E (2), B (1)	52	23.6
PLASOH12*	04469	4 - 12	106 - 335	PVC	E (2), B (1)	52	23.6

\*EXCLUSIVE

NOTE: 04463, 04469 ship with cutting blade for PVC. Models 04464, 04468 ship with cutting blade for PE. Blades are interchangeable.

\*PLAS CUTTERS WILL CUT PVC AND PE PIPE. SPECIFIC LIMITATIONS FOR PE ARE AS FOLLOWS: 2" (38.1 mm) wall thickness PE - up to 12" pipe.

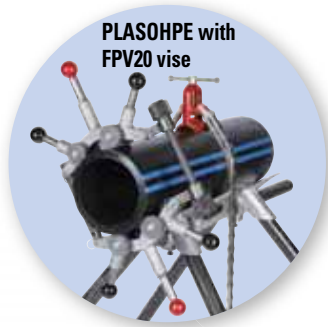

PLASOHPE with FPV20 vise

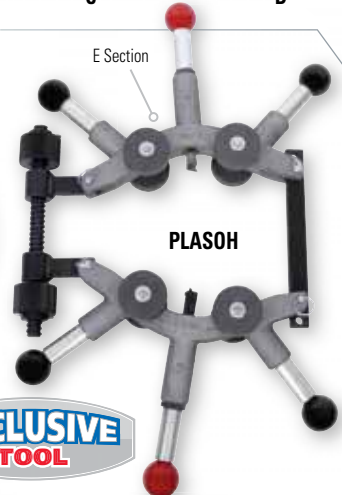

E Section

PLASOH

EXCLUSIVE TOOL



PLASOH using PLASPVCB blade



PLASOH Hand-Over-Hand in use





PIPE TOOLS & VISES  
SINCE 1896

## GUILLOTINE PIPE CUTTERS

### FEATURES

- **Squarest cut** available for PE due to strong frames and unique blade design.
- Saves facing cost: no facing needed for electrofusion, less needed for butt-fusion.
- Requires minimal clearance, only 4" - 6" (102 - 152 mm) around pipe.
- **Clean and safe!** No chips to clog valves and apertures.
- Many **high quality cuts**, with durable non-stick coated, tool steel blade.

Robust Guillotine Pipe Cutters are designed to cut PE pipe thicker than SDR17 within 1/8" (3 mm) of square on medium and high-density pipe. **HPC12** is designed for DIPS and IPS PE pipe from SDR17 to SDR9.3. Brass bushings in HPC12 crosshead feed assembly yield smooth feed and more consistent blade alignment. The accurate cuts from Reed Guillotine Cutters mean no facing is needed for electrofusion and only minimal facing for butt fusion joints. Durable, non-stick coated blade makes many square cuts with no chips to clog valves and small openings. Slight taper on blade allows an easy start to the cut, and holds form for a nice, straight cut. Blades are easy to sharpen or replace.

*NOTE: Reed strongly recommends use of the **GROUNDING ACCESSORY ON P. 35** with Guillotine Cutters. Use a grounding accessory as a precaution against static build-up. Dissipate the charge and minimize the possibility of ignition.*

Catalog No.	Item Code	Capacity		Length		Weight	
		in-nom.	actual O.D. mm	in	mm	lbs	kg
HPC4	04604	2 - 4	63 - 125	19	482	15.6	7.1
HPC8	04608	3 - 8	90 - 225	30	750	35.0	15.9
HPC12	04612	4 - 12	114 - 350	51	1295	100.0	45.5

### REPLACEMENT BLADES

Catalog No.	Item Code	Description
HPC4B	40329	HPC4 Blade
HPC8B	40027	HPC8 Blade
HPC12B	94903	HPC12 Blade

*NOTE: HPCs cut PE only and will not cut PVC or PP (polypropylene) pipe, such as Aquatherm®.*



HPC12 in use



HPC8

EXCLUSIVE FEATURE

ONLINE VIDEO TRAINING



HPC8 in use

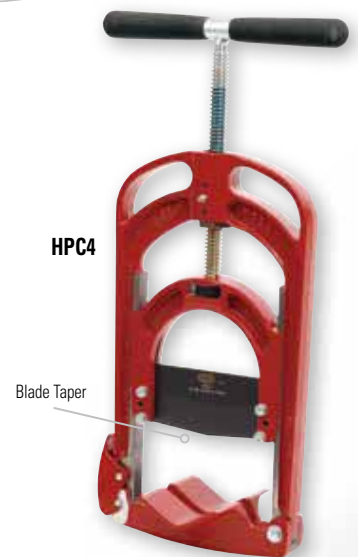

HPC4

Blade Taper

### ✓ WHY REED?

Because of the crosshead and blade design, all HPCs produce a much straighter cut with minimal blade wear. Safer than abrasive saws because no PE chip residue remains in the pipe that may later clog valves.



## PE SQUEEZE-OFF TOOLS

### FEATURES

- Robust aluminum bars on PES2 and larger models reduce tool weight for **easier handling**.
- Positive stops **prevent damage** caused by over-clamping.
- Easy to use in line because of swing bar and **no loose parts**.
- PES1 built-in stops and "C" shape allow easy movement on and off pipe.
- **With the proper stops**, PES2, PES4, PES6 and PES8 also work for metric pipe.
- Double-bar design on PES2-2 models gives two squeeze points in a row which provide better shut-off and **extra protection** against leaks, all in one tool.
- Wide variety of stops for all Reed PE squeeze-off tools.

Reed offers the best designed tools for stopping flow in 1/2" up to 8" PE pipe. Different models handle a wide range of pipe sizes and applications. Sliding bar handles make work in tight places easier and increase leverage for tightening. Fine-pitched thread on feed screw allows for a controlled, low-effort squeeze. Grease fittings at friction points make operation smoother and extend tool life. Aluminum bars are anodized or painted for protection from the elements. All PE squeeze-off tools use positive stops to prevent damage caused by over-clamping. Multiple size/SDR settings on one pair of stops provide quick, convenient over-squeeze protection for standard pipe sizes.

*NOTE: Reed strongly recommends use of the **GROUNDING ACCESSORY ON P. 35** with PE Squeeze-Off Tools. Use a grounding accessory as a precaution against static build-up. Dissipate the charge and minimize the possibility of ignition.*

**EXCLUSIVE FEATURES**



Catalog No.	Item Code	Capacity		Pipe/SDR Stops		Length		Weight	
		in-nom.	actual O.D.	# of Stops	Stops	in	mm	lbs	kg
PES1IPS*	04290	1/2 - 1	.84" - 1.32"	3	94295	11	280	6.5	3.0
PES1CTS*	04292	1/2 - 1	.63" - 1.13"	3	94296	11	280	6.5	3.0
PES2IPS	04302	1/2 - 2	.84" - 2.38"	6	98079	12	305	11.6	5.3
PES2CTS	04304	1/2 - 2	.63" - 2.13"	6	98078	12	305	11.6	5.3
PES4	04306	2 - 4	2.38" - 4.50"	7	98094	20	508	38.6	17.5
PES2-2IPS	04322	1/2 - 2	.84" - 2.38"	6	98079	12	305	11.6	5.3
PES2-2CTS	04324	1/2 - 2	.63" - 2.13"	6	98078	12	305	11.6	5.3
PES2SDR17	04702	1/2 - 2	.84" - 2.38"	6	98123	12	305	11.5	5.3
PES2METRIC	04703	-	20 - 63 mm	6	98124	12	305	11.6	5.3
PES4SDR17	04704	2 - 4	2.38" - 4.50"	6	98122	20	508	38.6	17.5
PES4METRIC	04705	-	75 - 110 mm	6	98121	20	508	38.6	17.5

\*All steel construction.

## HYDRAULIC & MANUAL, LARGE DIAMETER

### FEATURES

- Hydraulic PES6H features self-contained hydraulic pump.
- Manual PES6M and PES8M are lower-price and lighter-weight than the hydraulic models, making them practical for carry-in jobs, infrequent use or budget-minded work crews.
- PES8H handles large diameters with ease due to its included, separate hydraulic hand pump that allows the operator to work the pump from a convenient surface.

Catalog No.	Item Code	Capacity		Power Source	Pipe/SDR Stops		Length		Gross Weight*	
		in-nom.	actual O.D. mm		# of Stops	Stops (pair of each)	in	mm	lbs	kg
PES8M	04308	3 - 8	89 - 219	Manual	12	98319 & 98320	28	711	148	67.3
PES8H	04309	3 - 8	89 - 219	Hydraulic	12	98319 & 98320	28	711	227	103.2
PES6H	04312	3 - 6	89 - 168	Hydraulic	10	98356 & 98320	32	812	141	64.1
PES6M	04313	3 - 6	89 - 168	Manual	10	98356 & 98320	28	711	92	41.8

*NOTE: PE Squeeze-Off Tools conform to ASTM F1041 and F1563.*

*\*GROSS WEIGHT includes all components plus packaging.*

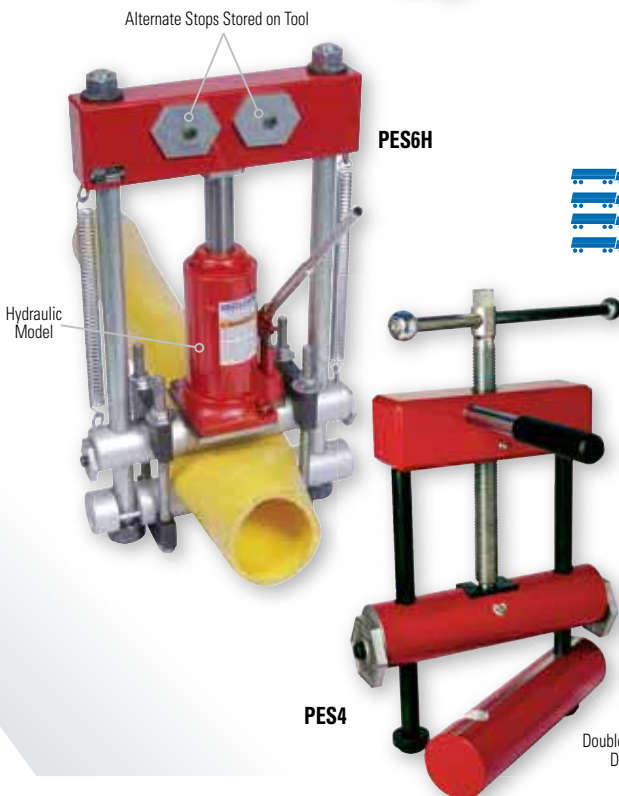



PIPE TOOLS & VISES  
SINCE 1896

**FLOW CONTROL VALVE**

Item Code	Description
94317	Flow Control Valve Kit for PES8H

**CONVERSION KITS**

Use easy-to-adjust stops to convert PE Squeeze-Off Tool PES2 models from CTS to IPS or vice versa.

Stops	Item Code	Converts
CTS	98078	PES2IPS to PES2CTS
IPS	98079	PES2CTS to PES2IPS

**REPLACEMENT & ALTERNATE STOPS**

Sold in pairs, replacement and alternate stops come in a variety of CTS and IPS sizes. Visit [www.reedmfgco.com/en/cts-ips-stops](http://www.reedmfgco.com/en/cts-ips-stops) for complete details.

**CUSTOM & METRIC STOPS**

Custom stops available for PES2 models with a minimum of 20 tools per custom stop. Metric stops are available for the PES2, PES4, PES6 and PES8 models, with no minimum quantity. Visit [www.reedmfgco.com/en/metric-stops](http://www.reedmfgco.com/en/metric-stops) for details on metric stops.



**✓ WHY REED?**

Reed automatically provides multiple pipe/SDR stops in one tool. Also, all parts store on the tool, making it self-contained.

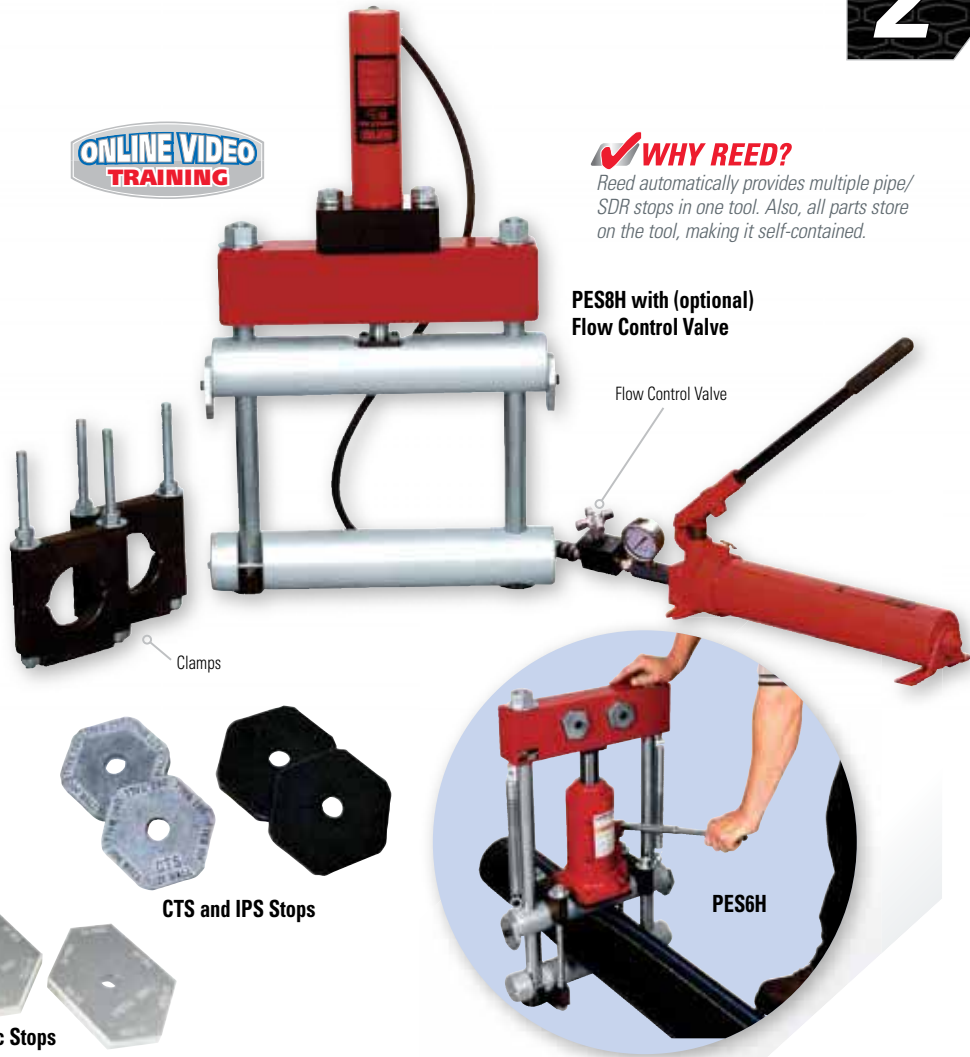

PES8H with (optional) Flow Control Valve

Flow Control Valve

Clamps

CTS and IPS Stops

Metric Stops

PES6H

**GROUNDING ACCESSORY**

**FEATURES**

- Ground the work area to increase safety for the operator.

The Static Electricity Grounding Accessory (PEGR) provides a path to ground for any static charge. Because static can build up on plastic pipe, even for water services, there is a possibility of a spark discharge of sufficient energy to cause ignition if the proper air/gas mixture is present. Use of a static electricity grounding accessory is a precaution that can dissipate the charge and minimize the possibility of ignition. Reed strongly recommends use of this grounding accessory with PE Squeeze-Off Tools and Guillotine Pipe Cutters in all gas applications.

Catalog No.	Item Code	Weight	
		lbs	kg
PEGR	04619	1.5	0.7

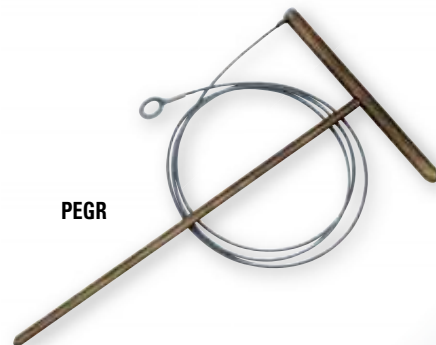

PEGR

**STATIC DISCHARGE ALARM**

**FEATURES**

- Be aware of static in the work area by use of a discharge alarm.

Static Discharge Alarm warns of static build-up. Static build-up can lead to possible pinholing of PE pipe resulting from electrical forces discharging through the pipe wall during squeezing or cutting. Static discharge alarm features test circuit and low battery warning. Plastic case included. Use with Grounding Accessory.

Catalog No.	Item Code	Dimensions	Weight	
			lbs	kg
STDA1	04620	1 3/8" X 3 1/4" X 5 1/2"	0.6	0.3



STDA1

**GASKETED**

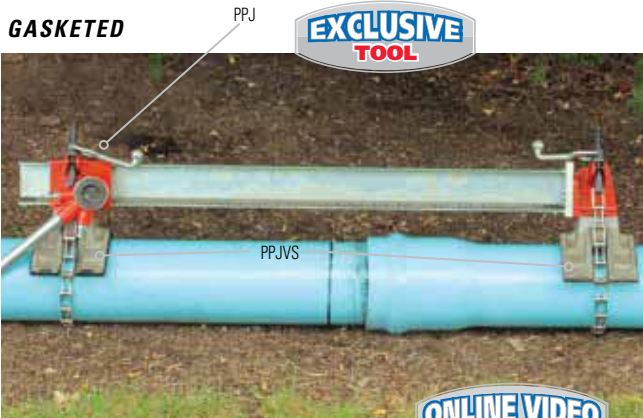

NOTE: PPJVS sold separately from PPJ.

**✓ WHY REED?**  
Easy-to-use design for one person operation with no leaks.

**SOLVENT CEMENT**

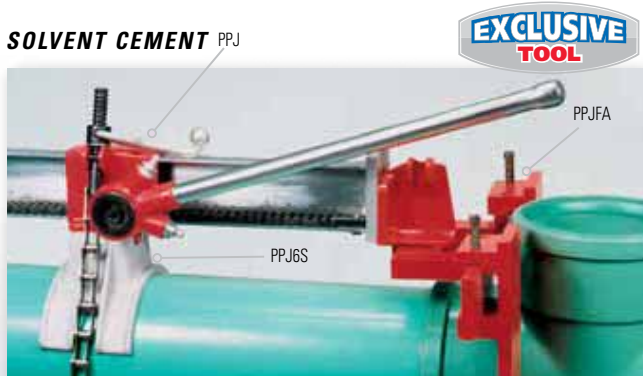

NOTE: Fitting attachment (PPJFA) and saddles sold separately from PPJ.

## PLASTIC PIPE JOINERS

**FEATURES**

- Join or separate **gasketed PVC pipe** using the PPJ and PPJVS universal saddles.
- Efficiently connect 4" - 12" (114 - 324 mm) PVC **solvent cement** joints using the PPJ and individually sized saddles.†
- PPJFA Fitting Attachment is required for **solvent cement** branch connections only.

With 28-to-1 leverage, it is easy for one person to join PVC pipe up to 16" gasketed or up to 12" solvent cement joints, using a Reed Plastic Pipe Joiner.

**FOR GASKETED PIPE:** The Plastic Pipe Joiner can connect and separate 4" - 16" IPS and cast iron size gasketed pipe. Components required for joining gasketed pipe include the Plastic Pipe Joiner (**PPJ**) and V-shaped saddles (**PPJVS**).

**FOR SOLVENT CEMENT CONNECTIONS:** The Plastic Pipe Joiner connects solvent cement joints on all pipe schedules, IPS and water pipe from 4" - 12". For solvent cement connections, individually sized saddles must be ordered together with the **PPJ** Plastic Pipe Joiner. **PPJFA** fitting attachments are sold separately and only required for branch attachments.

NOTE: Connection saddles for gasketed pipe or solvent cement connections must be purchased separately.

### GASKETED PIPE

Catalog No.	Item Code	Pipe Capacity		Weight	
		in-nom.	actual O.D. mm	lbs	kg
PPJ*	04446	—	—	44.0	20.0
PPJVS**	04441	4 - 16	114 - 434	8.0	3.6

\*EXCLUSIVE  
\*One pair of saddles.

### SOLVENT CEMENT CONNECTION

Catalog No.	Item Code	O.D. Capacity		Weight	
		in-nom.	actual O.D. mm	lbs	kg
PPJ*	04446	—	—	44.0	20.0
PPJFA*	04439	4 - 12	114 - 324	39.0	17.7

\*EXCLUSIVE  
**SADDLES FOR SOLVENT CEMENT CONNECTION**† (sold in pairs)

Catalog No.	Item Code	O.D. Capacity		Weight	
		actual O.D. in	actual O.D. mm	lbs	kg
PPJ4S	04442	4.5	114	4.0	1.8
PPJ6S	04444	6.6	168	4.5	2.0
PPJ8S	04447	8.8	224	6.0	2.7
PPJ10S	04448	10.8	273	7.0	3.2
PPJ12S	04449	12.8	324	7.0	3.2

# REED ASSOCIATIONS



# WATER SERVICES TOOLS & MACHINES

SECTION

3

Feed Tap™ Drilling Machines **NEW**  
Direct Tapping Machine  
Drilling Machines  
Combination Drilling/Tapping Machines  
PVC/PE Drilling Machines  
Power Units for Tapping/Drilling **NEW**  
PE Water Service Shut-Off Tool  
Standing Shut-Off Tool  
Copper Shut-Off Tools  
Flare Tools  
Rerounding Tools  
Brass Hammer  
Round It® Straightener/Rerounders  
Fiberglass Probe Rod **NEW**  
Meter Pit Pump  
Manhole Hooks  
Drill-Powered Hydrostatic Test Pump **NEW**  
Electric Hydrostatic Test Pumps  
Hydrostatic Test Pumps  
Valve & Curb Keys  
Ratcheting Valve Keys  
Valve Operators **NEW**  
Meter Box & Curb Box Lid Keys



Make easy work of drilling jobs by adding a Reed power drive to a tapping or drilling machine. Reed's lightweight 601PD Power Drive pairs well with the DM2100 Drilling Machine for installing corporation stops on water mains.

**BEST EVER!**

**FT2000UNIV**



**FT2000UNIV**  
on Ductile Iron

Works great with electric or cordless drills.



**FTSC875**

Manual Feed Control



**FTP2000UNIV**  
on C900 PVC

**NEW**

Independent, controlled feed makes this the preferred tool for PVC taps.



**FTPSAA & PL688** attaching to coupling nut

**PL688**

**CRPD25**

**FTPSAA**

**FTAA**

## FEED TAP™ DRILLING MACHINES

### FEATURES

- Superior performance and life of the carbide-tipped Heavy-Duty Shell Cutters on cast and ductile iron.
- Preferred tool for PVC and PE taps using manual power and PL Series Shell Cutters.
- Coupon Retaining Pilot Drill Bit with proven technology provides consistent results.
- All units are shipped in an impact-resistant, compact case.

Reed's Feed Tap™ drills through PVC, PE, cast iron and ductile iron while under pressure. The compact design, featuring a separate feed for advancing the heavy-duty shell cutter into the pipe, allows the user to easily complete the tap using an electric or cordless drill, right angle drill for cast and ductile iron, or even a 7/16" wrench (drill/wrench not included) with manual power for plastics. The independent feed control advances the shell cutter for tapping PVC pipe as recommended by Uni-Bell PVC Pipe Association. The **FTB** Feed Tap consists of the base unit which allows the user to purchase shell cutters and corporation adapters separately, as needed. A complete kit is sold as **FT2000UNIV**. The kit contains both a coupon retaining drill bit, CRPD25 and two sets of coupon retaining magnets. Plastic Pipe only **FTP2000UNIV** is used for manual drilling operations with Reed's proven PVC/PE Shell Cutters. The **FTP2000UNIV** comes complete with all corporation adapters, shell cutters, adapters and a ratchet wrench with socket to cover 3/4" to 2" services in PVC and PE. Each machine ships with a sturdy carrying case.

Catalog No.	Item Code	Description	Gross Weight*	
			lbs	kg
FTB	09160	Feed Tap™ Base Machine	22.5	10.2
FT2000UNIV	09165	Complete Feed Tap™ Kit 3/4" - 2"	34.0	15.5
FT2000CC110	09161	AWWA/110 Comp Feed Tap™ Kit 3/4" - 2"	31.5	14.3
FT2000	09162	AWWA Feed Tap™ Kit 3/4" - 2"	27.8	12.6
FT2000110	09163	110 Comp Feed Tap™ Kit 3/4" - 2"	28.0	12.7
FT2000NPT	09164	NPT Feed Tap™ Kit 3/4" - 2"	26.5	12.0
FT2000CCNPT	09166	AWWA/110 Comp 3/4" - 1" NPT 1 1/2" - 2" Feed Tap™ Kit	28.7	13.0
FT1000CC110	09167	AWWA/110 Comp Feed Tap™ Kit 3/4" - 1"	24.4	11.1
★ <b>FTP2000UNIV</b>	09168	Complete Plastic Pipe Only Feed Tap Kit 3/4" - 2"	36.0	16.4

★ **NEW**

\*GROSS WEIGHT includes all components plus packaging.

NOTE: Feed Tap™ is designed to be used with corporation stops and bronze gate valves up to 2".

To tap through a 2" iron body gate valve, one 1" NPT female x 2" NPT male bushing is **REQUIRED**. Feed Tap™ **not** to be used on gas lines.

MECHANICAL HOT TAPPING MACHINE ON P. 79 is recommended for steel pipe.

## ACCESSORIES

### CORPORATION ADAPTERS

Catalog No.	Item Code	Description	Weight	
			lbs	kg
FT75CC110	09170	3/4" AWWA and 110 Comp	.60	.27
FT100CC110	09171	1" AWWA and 110 Comp	.55	.25
FT150	09172	1 1/2" AWWA	1.20	.55
FT200	09174	2" AWWA	1.40	.64
FT150110	09173	1 1/2" 110 Comp	1.35	.61
FT200110	09175	2" 110 Comp	1.40	.64
DMCA100IPS*	98499	1" IPS	.80	.40
FT75NPT	99117	3/4" NPT	.45	.20
FT100NPT	99118	1" NPT	.45	.20
FT150NPT	99109	1 1/2" NPT	.80	.36
FT200NPT	99112	2" NPT	.80	.36

\*Requires #09171 adapter.

NOTE: No BSPT adapters available.

### HEAVY-DUTY SHELL CUTTERS

Cut up to 2" deep and fit most standard arbors and competitive machines. Recommended for cast and ductile iron. The attachment thread is 1/2" - 20. Each tooth has carbide inserts which long outlast bi-metal teeth.

Catalog No.	Item Code	Shell Cutter Size Inches*	Weight	
			lbs	kg
FTSC688	99132	1 1/16"	.09	.04
FTSC875	99134	7/8"	.15	.07
FTSC1438	99137	1 7/16"	.41	.19
FTSC1750	99138	1 3/4"	.57	.26

\*Check manufacturer's fitting specifications for proper hole diameter.

### MISCELLANEOUS

Catalog No.	Item Code	Description
FTPLAA	04423	Adapter used with 1 1/2" & 2" PVC/PE Shell Cutters
DMP716	04428	Ratchet Wrench
L716	04429	7/16" Socket
FTAA	09113	Arbor Assembly used with 1 7/16" & 1 3/4" FTSC Shell Cutters
FTPSAA	94198	Adapter used with 3/4" & 1" PVC/PE Shell Cutters
CRPD25	99129	3/4" diameter Carbide Tipped Coupon Retaining Drill Bit

TAPPING COMPOUND ON P. 39

PVC/PE "PL SERIES" SHELL CUTTERS ON P. 43 recommended for PVC and PE.



PIPE TOOLS & VISES  
SINCE 1896

## DIRECT TAPPING MACHINE†

### FEATURES

- Drill and tap water mains while they remain **under pressure**.
- **Lightweight yet strong**, corrosion-resistant aluminum frames are easy to carry and set-up.
- **Modular design** allows fast and simple conversion to drilling machine.

Reed's Direct Tapping Machine is used to drill and tap water mains while under pressure, then to install 3/4" or 1" corporation stops in a 2-step operation. It covers a range of 4" - 48" cast or ductile iron and C900 PVC with the use of saddles and chain extensions (saddles sold separate). The **TM1100** tapping machine features a flip clamp feed system. Anodized and epoxy-painted aluminum frames provide a lightweight yet sturdy machine for tough in-ditch applications. The swing valve allows easy change-out from drill tap to corporation insertion tool without main shutdown. Tapping machine uses Reed DT series drill taps.

Catalog No.	Item Code	Size Inches	Pipe Diameter		Gross Weight*	
			in-nom.	actual O.D. mm	lbs	kg
TM1100	09300	3/4 - 1	4 - 48	100 - 1300	101.8	46.3

\*GROSS WEIGHT includes all components, box and packaging. TM1100 unit alone weighs 40.4 lbs / 21 kg  
SMOOTH JAW WRENCHES ON P. 77  
†Spec Booklet available #01071



ONLINE VIDEO  
TRAINING

TM1100



TM1100  
in use

## ACCESSORIES

### DRILL TAPS

**DT75** and **DT100** drill taps perform fast with six cutting edges for clean threads and leakproof connections. Have a sharper point for easiest starting. The unique three-flute design of **DT75P** and **DT100P** drill taps bore into the pipe with less effort than other drill tap designs and ensures that the coupon and cuttings are retained. This saves the operator time and effort because there is less clean-up.

Catalog No.	Item Code	Drill Size Inches	Thread*	Pipe Material	Weight	
					lbs	kg
DT75*	04390	3/4	CC	Cast/Ductile	1.1	0.5
DT100	04391	1	CC	Cast/Ductile	1.3	0.6
DT75P	04396	3/4	CC	C900 PVC	1.0	0.5
DT100P	04397	1	CC	C900 PVC	1.4	0.6

\*AWWA Approved for Tapping Contest.  
\*Drill taps with NPT and BSPT threads not available.



DT75



### ✓ WHY REED?

### ✓ WHY REED?

DT75 has been used by the AWWA Tapping Competition winning teams for over 15 years!

The unique three-flute design of DT75P/DT100P bores into the pipe with less effort than other drill tap designs and ensures that the coupon and cuttings are retained.

### TAPPING SADDLES\*

Catalog No.	Item Code	Description
TS4	98442	4" Saddle
TS6	98439	6" Saddle
TS8	98440	8" Saddle
TS10	98441	10" Saddle
TS12	98438	12" Saddle
TS16	98443	16" Saddle
TS18	98444	18" Saddle
TS20	98445	20" Saddle
TS24	98446	24" Saddle
TS36	98447	36" Saddle
TS42	98448	42" Saddle
TS48	98449	48" Saddle

\*Also fit Mueller® machines.



TS6



DT75P

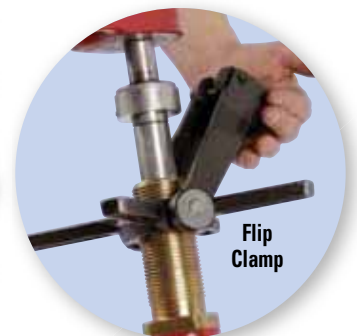

Flip  
Clamp

### TAPPING COMPOUND

Choose from a thick, spreadable compound or a thinner grease to squeeze onto the work area.

Catalog No.	Item Code	Description
TMTC	98425	16 oz. (.45 kg) Resealable Can
TMTC8	99139	8 oz. Bottle

### ✓ WHY REED?

Food-grade compound that **does not** contaminate water, making this compound environmentally friendly.



### ✓ WHY REED?

Reed's Tapping Machine is a better value than the competition and is made in the USA. TM1100 ships with all necessary parts, including the corp insertion tools. Plus, by ordering the saddles and drill taps separately, one only needs to purchase the right sizes for the job. Additionally, the Direct Tapping Machine can be converted to a drilling machine for up to 2" saddle taps, thus saving money over the purchase of an additional machine.†





DM2100

† Spec Booklet available #01071

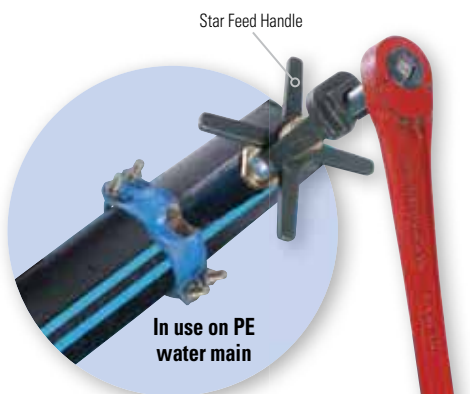

D688



PL1438

NOTE: For shell cutters and hole cutters, attachment thread is 5/8" - 18.

Slot for Easy Coupon Removal



HDHS1438

## DRILLING MACHINES†

### FEATURES

- Drilling Machines have a **flip clamp feed** mechanism requiring little adjustment.
- These machines are more compact, thus requiring less clearance than competitors'.
- **Modular design** allows fast and simple conversion to a Direct Tapping Machine.

Drilling Machines cut or drill through the pipe wall of cast iron, ductile iron, C900 PVC and PE water mains via the corporation stop inserted into the service saddle while under pressure. They use Reed D series drill bits or hole cutters. The **DM2100B** drilling machine consists of the base unit, which allows the customer to purchase separately individual corporation adapters, drill or hole cutter adapters, along with necessary drills or hole cutters. With shell cutters and necessary adapters, these units can also be used on C900 PVC pipe. **DM2100110** drilling machine is for use with Mueller® 110 compression corporation stops. **DM2100CCNPT** is a combination of 3/4" and 1" AWWA CC thread and 1 1/2" and 2" NPT thread adapters. **DM2100UNIVERSAL** drilling machine has the base and accessories to work for AWWA and NPT threads up to 2".

Catalog No.	Item Code	Size	Gross Weight**	
			lbs	kg
DM2100B	09301	DM2100 Base Machine	49.5	22.5
DM1100	09302	3/4" - 1	53.0	24.1
DM1100NPT	09305	3/4" - 1 NPT	53.0	24.1
DM1100BSPT	09307	1/2" - 1 BSPT	53.0	24.1
DM2100BSPT	09308	3/4" - 2 BSPT	55.5	25.2
DM2100	09312	3/4" - 2	55.5	25.2
DM2100NPT*	09315	3/4" - 2 NPT	55.5	25.2
DM2100110*	09317	3/4" - 2 110 Compression	55.5	25.2
DM2100CCNPT	09318	3/4" - 1 AWWA 1 1/2" - 2 NPT	55.5	25.2
DM2100UNIVERSAL	09321	3/4" - 2 AWWA & NPT	60.0	27.3

\*Extended boring bar (#99390) needed for 2" iron body gate valves.

\*\*GROSS WEIGHT includes all components plus packaging. Drilling Machine unit alone weighs 13.3 lbs / 6.0 kg. Drilling Machines **not** to be used on gas lines.

SMOOTH JAW WRENCHES ON P. 77

### ACCESSORIES SELECTION CHART ON P. 41

#### D SERIES DRILL BITS

Drill bits are designed for use with Reed drilling machines and Mueller® E5/D5 only; both of which use saddles. These spiral drills are made from strong, high-speed steel, and are heat-treated for longer life. They are black oxide coated for corrosion resistance, and are much easier cutting than other drills as the spiral motion clears chips away from the cut. Recommended for cast iron and cement-lined ductile iron.

Catalog No.	Item Code	Drill Size in	Nom. Corp. Size in**	Weight	
				lbs	kg
D688	04380	11/16	3/4"	0.3	0.1
D875	04381	7/8	1"	0.5	0.2
D938	04382	15/16	1"	0.6	0.3

\*Check manufacturer's fitting specifications for proper hole diameter.

#### PVC/PE SHELL CUTTERS\*

Shells cut through service saddles on PVC and PE. They also fit Mueller PL-2® machines.

Catalog No.	Item Code	Shell Size in.	Nom. Corp. Size in.**	Weight	
				lbs	kg
PL688	04385	11/16	3/4"	0.2	0.1
PL875	04386	7/8	1"	0.2	0.1
PL1438	04387	1 1/16	1 1/2"	0.5	0.2
PL1750	04392	1 3/4	2"	0.7	0.3

\*See P. 43 for more details.

\*\*Check manufacturer's fitting specifications for proper hole diameter.

#### HEAVY-DUTY CARBIDE-TIPPED HOLE CUTTERS

For use with Reed DM2100 Series Drilling Machines, these cutters provide more cuts into mains than standard hole cutters. Thicker shell walls and bigger carbides are the heavy-duty features that help withstand many cuts. These are the best choice for cutting cast iron and cement-lined ductile iron.

Catalog No.	Item Code	Hole Cutter Size in.	Nom. Corp. Size in.	Weight	
				lbs	kg
HDHS1438	04354	1 1/16	1 1/2"	0.4	0.2
HDHS1750	04355	1 3/4	2"	0.5	0.2
HDHS1875	04356	1 7/8	2"	0.6	0.3





PIPE TOOLS & VISES  
SINCE 1896

**PILOT DRILL**

Catalog No.	Item Code	Size	Weight	
			lbs	kg
HSPD	04561	4 3/8" x 1/4" for HDHS Series	0.1	0.05

**ADAPTERS FOR DRILLS, HOLE CUTTERS & SHELL CUTTERS**

Catalog No.	Item Code	Fits Size	Weight	
			lbs	kg
DMHSA*	08413	1 1/2" & 2" Shell & Hole Cutters	0.4	0.2
HSASC	98457	3/4" & 1" Shell Cutter Adapter	0.5	0.2
DMDA75	98461	3/4" for D688	0.4	0.2
DMDA100	98462	1" for D875 & D938	0.5	0.2
DMCA75EXT	98481	3/4" Extended	0.4	0.2
DMCA100EXT	98482	1" Extended	0.7	0.3
DMA PVCEXT	98489	3/4" & 1" PVC Extended	0.6	0.3
DMA PVC	94150	3/4" & 1" PVC Shell	0.5	0.2

\*DMHSA (#08413) is included with purchase of any new 2100 Series Drilling or Combination Machine.

**CORPORATION ADAPTERS**

Catalog No.	Item Code	Fits Size	Weight	
			lbs	kg
DMCA75	08423	3/4" AWWA	2.2	1.0
DMCA100	08424	1" AWWA	2.2	1.0
DMCA150	08425	1 1/2" AWWA	1.0	0.5
DMCA200	08426	2" AWWA	1.1	0.5
DMCA110150	08431	1 1/2" Mueller® 110 Comp	1.3	0.6
DMCA110200	08432	2" Mueller® 110 Comp	1.3	0.6
DMCA150NPT	08428	1 1/2" NPT	0.8	0.4
DMCA200NPT	08429	2" NPT	0.8	0.4
DMCA125BSPT	08434	1 1/4" BSPT	2.2	1.0
DMCA150BSPT	08435	1 1/2" BSPT	0.8	0.4
DMCA200BSPT	08436	2" BSPT	0.8	0.4
DMCA100IPS	98499	1" IPS	0.8	0.4

**BORING BARS**

Catalog No.	Item Code	Description
DM1100BB	99304	Boring Bar
DM11BBEXT	99390	Extended Boring Bar for 2" Gate Valves

**SELECTION CHART**

Select the proper cutter for the proper type of pipe.

Catalog No.	Item Code	Size Inches	Type of Water Main		
			PE/PVC	Cast Iron	Cement-Lined Ductile

**D SERIES DRILL BITS**

D688	04380	11/16		X	X
D875	04381	7/8		X	X
D938	04382	15/16		X	X

**PVC/PE SHELL CUTTERS**

PL688	04385	11/16	X		
PL875	04386	7/8	X		
PL1438	04387	17/16	X		
PL1750	04392	13/4	X		

**HEAVY-DUTY CARBIDE-TIPPED HOLE CUTTERS**

HDHS1438	04354	1 7/16		X	X
HDHS1750	04355	1 3/4		X	X
HDHS1875	04356	1 7/8		X	X



DMHSA



DMCA75



DMCA200

DMCA110200

DMCA200NPT



DM2100  
in use

**WHY REED?**

Heavy-duty Drilling Machine is compact and lightweight to make up to 2" saddle taps. Reed offers many different options to meet individual customer needs.



### ✓ WHY REED?

Reed's machines assemble as a drilling machine or a direct tapping machine. Offers 10%+ cost savings versus the purchase of two separate machines.

## COMBINATION DRILLING/TAPPING MACHINES†

### FEATURES

- **Modular design** allows fast and simple conversion back and forth from tapping to drilling machine.
- Flip clamp feed mechanism requires little adjustment, **saving time** for the operator.
- Compact design requires less digging as radius = 32" which is less than competitive models.

Combination Drilling/Tapping Machines are easier to use, save operating time and are a better value than any other machine. The CDTM models are tapping machines with the necessary components for conversion to drilling machines. The **CDTM1100** is a TM1100 with components for converting to a DM1100. The **CDTM2100** is a TM1100 with components for converting to a DM2100. All these combination models feature Reed's flip clamp. They utilize Reed DT series drill taps, D series drill bits, heavy-duty hole cutters and PVC/PE shell cutters. Drill taps, drill bits and hole cutters must be purchased separately. NPT adapters also available.

Catalog No.	Item Code	Description	Pipe Diameter		Gross Weight*	
			in-nom.	actual O.D. mm	lbs	kg
CDTM1100	09304	3/4" - 1" Tap & Drill	4 - 48 Tap	100 - 1200	114.4	52.0
CDTM2100	09314	3/4" - 1" Tap 3/4" - 2" Drill	4 - 48 Tap	100 - 1200	116.5	53.0
CDTM2100110	09323	CDTM2100 with 110 Adapters 3/4" - 1" Tap, 3/4" - 2" Drill	4 - 48 Tap	100 - 1200	116.5	53.0

\*GROSS WEIGHT includes all components plus packaging.  
TAPS, BITS, CUTTERS AND ADAPTERS ON P. 39 - 41  
SMOOTH JAW WRENCHES ON P. 77

### CONVERSION KITS†

Catalog No.	Item Code	Converts
CDTM1CONV	09306	TM1100 to CDTM1100
CDTM2CONV	09316	TM1100 to CDTM2100
CDTM210CONV	09322	TM1100 to CDTM2100110

† Spec Booklet available #01071

## PVC/PE DRILLING MACHINES†

### FEATURES

- Drill through the pipe wall while the system is **under pressure**.
- Drill feed rate can handle PVC, C900 and PE wall thicknesses up to 1 1/8".
- Steel parts are plated or powder epoxy coated for **corrosion resistance**.
- New, **one-piece**, stainless steel boring bar assemblies easier.

The PVC/PE Drilling Machine is used to cut through the pipe wall via the corporation stop inserted into the service saddle while under pressure. The **DMPVC** drilling machine consists of the base unit and corporation (corp) adapters in a carrying case. PVC/PE shell cutters are sold separately. **DMPVCBASE** drilling machine consists of the base unit in a storage tube, allowing the customer to purchase necessary corp adapters and shell cutters. **DMPVC3/4** and **DMPVC1** kits include one shell cutter, one corp adapter, DMPVCBASE and a storage tube. **DMPVC COMPLETE** ships in a plastic toolbox and includes the DMPVCBASE along with corp adapters and PVC/PE shell cutters for both 3/4" and 1" drilling projects. NPT to CC corp adapter converters, and a 7/16" socket wrench complete the set.

Catalog No.	Item Code	Size Inches	Weight	
			lbs	kg
DMPVC	04402	3/4 - 1	8.4	3.8
DMPVCBASE	04401	3/4 - 1	3.7	1.7
DMPVC COMPLETE	04404	3/4 - 1	11.0	5.0
DMPVC3/4	04418	3/4	4.0	1.8
DMPVC1	04420	1	4.0	1.8

† Spec Booklet available #01071  
PVC/PE SHELL CUTTERS ON P. 43





PIPE TOOLS & VISES  
SINCE 1896

**ACCESSORIES**

**PVC/PE SHELL CUTTERS**

**FEATURES**

- **Tool steel** is heat-treated for optimum toughness and wear resistance.
- Flute design offers easy cutting and **constant coupon retention**.

PVC/PE Shell Cutters are for use with Reed's DM1100, DM2100 and DMPVC series drilling machines plus the Feed Tap™ machines. They cut through the PVC or PE wall via the corporation stop and the service saddle. Now made from tool steel and heat-treated to maintain sharper cutting edges and longer life of the shell cutter. They are capable of cutting PVC and up to 1 1/8" wall thickness on C900 PVC water pipe or high density PE (HDPE) pipe. **PL688** and **PL875** also fit Mueller PL-2® machines.

Catalog No.	Item Code	Shell Size in.	Nom. Corp. Size in.	Weight	
				lbs	kg
PL688	04385	1 1/16"	3/4"	0.2	0.1
PL875	04386	7/8"	1"	0.2	0.1
PL1438*	04387	1 7/16"	1 1/2"	0.5	0.2
PL1750*	04392	1 3/4"	2"	0.7	0.3

\*Used only with DRILLING MACHINES ON P. 40 or FEED TAP™ ON P. 38

**CORPORATION ADAPTERS**

Catalog No.	Item Code	Fits Size	Weight	
			lbs	kg
DMCA75PVC	04426	3/4" AWWA	1.5	0.7
DMCA100PVC	04427	1" AWWA	1.1	0.5
DM175CONV	98472	3/4" NPT - AWWA Converter	0.4	0.2
DM100CONV	98473	1" NPT - AWWA Converter	0.6	0.3

**POWER UNITS FOR TAPPING/DRILLING**

**FEATURES**

- Add power to your drilling and tapping and eliminate the labor of hand-cranking.

Power units fit the DM1100, DM2100, TM1100, CDTM1100 and CDTM2100 machines including all variations. Economical **601PDTAP** power tapping/drilling machine is a portable electric machine which is lightweight and a good value. Its plated metal bar reinforces the plastic handle to protect the housing from excess torque. 601PDTAP can be used on any tap machine with a 1 3/16" square end boring bar. The **700PDTMPDA** (electric) or **700APDTMPDA** (pneumatic) power tapping/drilling machines are heavy-duty workhorses designed for constant, everyday use. Units consist of the selected power drive and a TMPDA adapter which fits a 1 3/16" square end boring bar that is common on popular drilling and tapping machines. The operator manually turns the star feed on the tapping or drilling machine while the power drive adapter turns the boring bar.

Catalog No.	Item Code	Description	Weight	
			lbs	kg
601PDTAP	05246	601PD Tap/Drill with Adapter*	17	7.7
★ <b>700APDTMPDA</b>	05266	700APD (pneumatic) and TMPDA Adapter	50	22.7
700PDTMPDA	05276	700PD and TMPDA Adapter	34	15.5

★ **NEW**

\* 601PDTAP adapter *NOT* sold separately.

**ACCESSORIES**

Catalog No.	Item Code	Description	Weight	
			lbs	kg
PDGFI	05277	Ground Fault Interrupter	0.7	0.3
TMPDA	08430	1 3/16" Power Drive Adapter Only for 700PD/700APD	4.0	1.8

GROUND FAULT INTERRUPTER ON P. 52  
POWER DRIVES ON P. 54 - 55



PL688

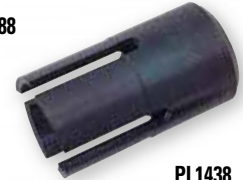

PL1438

**✓ WHY REED?**

These shell cutters easily bore through even the heaviest wall PVC/PE pipe and retain the coupon and most cuttings.



601PDTAP

700PDTMPDA

Plated Metal Bar



TMPDA



601PDTAP with TM1100



700PDTMPDA with DM1100



## PE WATER SERVICE SHUT-OFF TOOL

### FEATURES

- "One size fits all" emergency shut-off tool **squeezes shut** PE water lines.
- Shut-off tool is zinc-plated for corrosion resistance.

PE Water Service Shut-Off Tool is designed for emergency shut-off of PE water services. Front end of shut-off tool features a snap hinge device that can be taken apart quickly to allow work in confined areas. Knurled grip catches and holds the pipe. Open end has latch to hold tool closed until the repair is made.

Catalog No.	Item Code	Pipe Capacity		Length		Weight	
		in-nom.	actual O.D. mm	in	mm	lbs	kg
PES01	04300	3/4 - 1	19 - 25	18	457	2.7	1.2



## STANDING SHUT-OFF TOOL

### FEATURES

- **Stop the flow** of water in 3/4" to 1" PE plastic tubes.
- Long, **30-inch handles** allow both clamping leverage and reach into pits.

Reed's Standing Shut-Off Tool compresses 3/4" to 1" PE plastic tubes to stop the flow of water. The shut-off tool uses 30" handles to develop a clamping force in a manner similar to a pair of bolt cutters. The long handles make for easy shut-off from above the ditch with a chain (not included\*) to hold the tool closed. Not intended for gas service lines.

Catalog No.	Item Code	Pipe Capacity		Length		Weight	
		in-nom.	actual O.D. mm	in	mm	lbs	kg
SS01C	04281	3/4 - 1	19 - 25	43.5	1105	17.7	8.0

\*9 3/4" Chain #99055 may be ordered separately.  
PE SQUEEZE-OFF TOOLS ON P. 34 - 35



## COPPER SHUT-OFF TOOLS

### FEATURES

- Work best on copper service lines, which are softer copper than inside, residential lines.
- **No loose parts** to get lost.
- Handle can be positioned in two different spots for **leverage options**.
- Handle and screw of both are zinc plated for corrosion protection.
- CS02 aluminum castings are hard anodized for long service life.

Copper Shut-Off Tools are designed to shut-off and reshape 3/4" through 2" Type K copper tubing. The tool swings open to go around the pipe. Fine threads on the screw provide smooth, easy tightening. Sliding bar handle is used to increase leverage for turning and to permit work in tight places. The handle can be positioned in two different spots, depending on where there is clearance. The bottom open area of the shut-off tool is used to reround the tubing to allow 80-90% return of flow. All parts are corrosion protected for long service life. Grease fittings for lubrication yield long tool life and easy operation.

Catalog No.	Item Code	Tube Capacity		Weight	
		in	mm	lbs	kg
CS01	08200	3/4 - 1	19 - 25	7.9	3.6
CS02	08202	1 1/4 - 2	32 - 51	13.0	5.9





PIPE TOOLS & VISES  
SINCE 1896

## FLARE TOOLS

### FEATURES

- Quality flaring tools for use on Type K soft copper tubing.

Hardened and tempered steel flare tools make 45° flares on Type K soft copper water service tubing. Flare tools have larger pilots and finger grip areas for safety. Use with HAM3 brass hammer for safety.

### FLARE TOOLS

Catalog No.	Item Code	Copper Tube Size	Weight	
			lbs	kg
HF3/4*	06071	3/4"	1.0	0.5
HF1	06072	1"	1.5	0.7
HF1 1/2	06077	1 1/2"	3.2	1.5
HF2	06078	2"	4.9	2.2

\*AWWA Approved for Tapping Contest.

### PRESSURE-RELIEVING HAMMER FLARES

With precision channels drilled from the tool's end to its side, they allow flaring even when water is in the service line. Use only on Type K soft copper water service tubing, with brass hammers for safety.

Catalog No.	Item Code	Copper Tube Size	Length		Weight	
			in	mm	lbs	kg
PRHF3/4	06073	3/4"	7.5	191	2.0	0.9
PRHF1	06074	1"	7.5	191	2.3	1.0

### ✓ WHY REED?

Safety first! Reed always recommends brass hammers with Flare Tools, Pressure Relieving Hammer Flares and Rerounding Tools.



## REROUNDING TOOLS

### FEATURES

- Compression fittings rely on round copper tubing and these tools help restore a round shape to the tubing.

Catalog No.	Item Code	Copper Tube Size	Length		Weight	
			in	mm	lbs	kg
RR 3/4	06081	3/4"	6	152	0.7	0.3
RR1	06082	1"	6.5	165	1.3	0.6
RR1 1/2	06084	1 1/2"	8	203	2.8	1.3
RR2	06085	2"	9	229	5.4	2.5



## BRASS HAMMER

Soft-faced brass hammer is designed for the safe use of Flare Tools and Rerounding Tools as the brass head absorbs some of the striking shock. It pairs well with flaring tools used on Type K soft copper tubing.

Catalog No.	Item Code	Length		Weight	
		in	mm	lbs	kg
HAM3*	06088	14.5	368.3	2.8	1.3

\*AWWA Approved for Tapping Contest.



## ROUND IT® STRAIGHTENER/REROUNDERS

### FEATURES

- Take the trouble out of handling copper rolls by using Reed Round It® tools for straightening and rerounding.
- Provides the needed leverage to guide tube into position for fit-ups.
- Tools will quickly pay for themselves in material, labor and time savings.

Time-and-material saving CSR2 Round It® Straightener/Rerounder handles 1 1/2" and 2" K annealed copper. Grips the end of a coil so uncoiling is easy; rerounds oval tubing anywhere along its length so a cutter will track or the fitting will seal properly. Provides safe grip when flaring, and guides copper into alignment for easier fit-ups. RCR3/4 and RCR1 tools are especially useful when tubing is wet for a solid grip when straightening and fitting up. RCR341 offers all the same features as both RCR1 and RCR3/4 and includes jaws for either size tubing. The long-handled RCR rerounders are beneficial when extra leverage is needed.

Catalog No.	Item Code	Nominal Capacity	Length		Weight	
			in	mm	lbs	kg
CSR2	08220	1 1/2" & 2"	38	965	22.0	10.0
RCR3/4	08226	3/4"	18	457	4.5	2.0
RCR1	08227	1"	18	457	4.5	2.0
RCR341	08228	3/4" & 1"	18	457	5.5	2.5



CSR2 in use



XTRA VALUE

## TAKE A LOOK AT WRENCHES DESIGNED FOR WATER SERVICE P. 72-77



FSPR4

### FIBERGLASS PROBE ROD

#### FEATURES

- Safely locate pipe or utility lines.

Reed Fiberglass Probe Rods are certified non-conductive. The four foot soil probe has a metal tip and offers comparable strength and durability to other fiberglass probe rods in the industry.

Catalog No.	Item Code	Description	Weight	
			lbs	kg
★ FSPR4 ★ NEW	02960	Fiberglass Soil Probe Rod 4 ft.	0.7	0.3



MP175-6

### METER PIT PUMP

#### FEATURES

- **Rugged**, yet light-weight PVC construction.
- Quickly **removes standing water** in meter pits.

Reed offers a handy solution for flooded meter pits. Quickly pull water out of pits making them more serviceable, visible and safer. Includes a six foot hose that simply screws into the meter pit pump. This handy pump should be standard equipment on every service truck. And, meter pit pump may be used on a fire hydrant to drain the water for repair work.

Catalog No.	Item Code	Description	Capacity ounces/stroke	Weight	
				lbs	kg
MP175-6	02327	1 3/4" x 36" Manual Pump with 6 ft. Hose	35	2.0	0.9

### REPLACEMENT HOSE

Catalog No.	Item Code	Description	Weight	
			lbs	kg
HOSE175-6	42326	1 3/4" x 6 ft. (1829 mm) Replacement Hose	0.8	0.4



MH30

MH26

### MANHOLE HOOKS

#### FEATURES

- Open manhole covers with ease choosing from three different hook lengths.
- Handle to head hooks are offered in same plane or 90-degree rotation plane.

Manhole hooks are forged of 5/8" hex high carbon steel. Handle fits large hand. **MH30** has rotated handle and rocker head to more easily enter notch in stubborn covers. Points are 1/2" wide for cover openings. Reed manhole hooks are powder painted for corrosion protection.

Catalog No.	Item Code	Handle to Hook Relationship	Length		Weight	
			in	mm	lbs	kg
MH26	02301	Same plane	26	650	3.3	1.5
MH30	02302	Hook 90° to handle*	30	760	4.0	1.8
MH36	02303	Same plane	36	900	4.3	2.0

\*EXCLUSIVE FEATURE

#### ✓ WHY REED?

Red powder coating insulates handle from hot sun for greater comfort.





PIPE TOOLS & VISES  
SINCE 1896

## DRILL-POWERED HYDROSTATIC TEST PUMP

### FEATURES

- Powered by a 1/2" electric or cordless 18V drill (not included).
- Lightweight since the power source is separate.
- No drop cord needed when used with a cordless drill.

Use of a cordless drill for power keeps weight off this hydrostatic test pump, making it lightweight and portable. Included high pressure hose allows for filling the system and features quick disconnect. This 15 foot hose allows the pump to be set in a convenient location instead of being held next to the worksite. **DPHTP500** uses a 1/2" chuck on an electric or cordless drill 18V or higher, capable of 1500 RPM (drill not included). These pumps are designed for pressure testing both residential and commercial water systems.

Catalog No.	Item Code	Power Source	Capacity				Weight	
			gal/min	l/min	psi	bar	lbs	kg
★ <b>DPHTP500</b>	08177	Drill-powered	1.3	4.5	500	34	8.5	3.9

★ **NEW**

### REPLACEMENT HOSE

Catalog No.	Item Code	Description
EHTPOUTHOSE	08172	15 ft. (4.6 m) High Pressure Output Hose



## ELECTRIC HYDROSTATIC TEST PUMPS

### FEATURES

- Smooth running, quiet 3/4 HP motor available in 110V or 220V.
- Includes a 15 foot (4.6 m) EHTPOUTHOSE high pressure hose for filling the system.
- EHTP500C and EHTP500CE include protective cage.

Electric Hydrostatic Test Pumps are designed for pressure testing water systems such as water meters, plumbing lines, pressure vessels, solar systems and sprinkler systems, in both residential and commercial buildings. The output pressure is easily adjusted by turning a knob and watching the attached gauge. A built-in bypass allows for automatic water recirculation once the set pressure is reached. The hose-to-pump connection features a quick disconnect with built-in check valve, which allows for convenient setup and portability. Durable pump has stainless steel piston and brass cylinder for long pump life. Replacement seal kits available to sustain pump efficiency.

Catalog No.	Item Code	Power Source	Capacity				Weight	
			gal/min	l/min	psi	bar	lbs	kg
EHTP500	08170	110V, single phase 50/60 HZ	2	7	500	34	37.5	17.0
EHTP500E	08171	220V, single phase 50/60 HZ	2	7	500	34	37.5	17.0
EHTP500C	08175	110V, single phase 50/60 HZ	2	7	500	34	48.0	21.8
EHTP500CE	08176	220V, single phase 50/60 HZ	2	7	500	34	48.0	21.8

### REPLACEMENT HOSE

Catalog No.	Item Code	Description
EHTPOUTHOSE	08172	15 ft. (4.6 m) High Pressure Output Hose



## HYDROSTATIC TEST PUMPS

### FEATURES

- Economical yet reliable.
- Consider manual pumps for infrequent use.

Reed's **HTP300** and **HTP1000** are designed to test water meters, plumbing lines, pressure vessels, solar systems and sprinkler systems, in both residential and commercial buildings. The units are portable and can be used to test modest irrigation lines. Pump operation requires the user to first fill the system that needs to be tested. Next, the user raises the system pressure by actuating the pump handle. Finally, the user closes the pump's ball valve at the desired pressure. The user determines leakage based on dropping pressure as indicated by the pump's pressure gauge. The pump has a relief valve that reduces the likelihood of over-pressuring the system. Hoses are sold separately.

Catalog No.	Item Code	Capacity	Weight	
			lbs	kg
HTP300	08150	300 psi	8.6	3.9
HTP1000	08160	1000 psi	8.6	3.9

### HOSES

Catalog No.	Item Code	Description
HTPINHOSE	08152	10 ft. Input Hose
HTPOUTHOSE	08154	10 ft. Output Hose



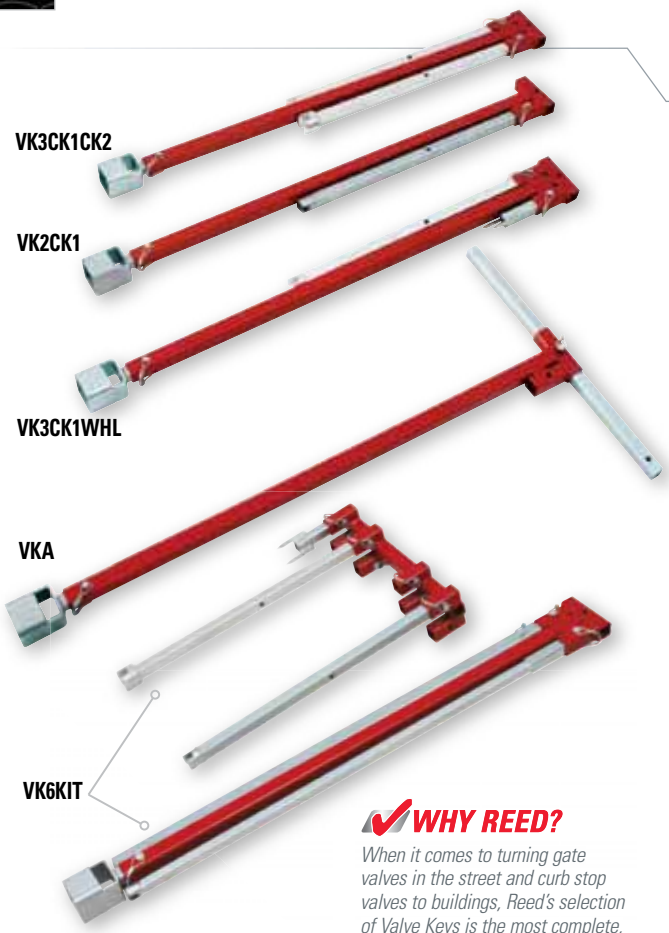

## VALVE & CURB KEYS

### FEATURES

- **Compact size** fits in crowded utility trucks, behind pickup seats or in car trunks.
- A Reed VK2 or VK3 saves the space, expense and handling of 1 or 2 other single purpose keys.
- **Wide choice** of attachable tools allows users to customize to their systems.
- As a **safety feature**, Reed valve keys bend before they break.

Reed Valve Keys are built for strength and durability. Upper shafts are made from heavy-gauge, mechanical steel tubing. Curb key ends are machined from solid steel. Valve keys have a telescoping design. When telescoped in, they are under 4 feet long and fit easily in small utility trucks, behind pickup seats and in car trunks. When telescoped out, lengths of 5 feet to 7 feet are possible. **VKEXT** shaft is available to further extend the keys. VKEXT is an extension bar with three positions that can be used on most Reed valve keys for up to 6 feet (1829 mm) of extra reach. For greater control and versatility, a variety of tools can be used on the end of T handles to turn curb stops. Optional clip-on tools can be used to turn small valve wheels, curb box rods and Buffalo box lids. Reed customers can choose valve keys according to the needs of their systems. **VK6KIT** is great for water and sewer utility companies to have on service trucks for emergencies.

Catalog No.	Item Code	Description	Closed Length		Weight	
			in	mm	lbs	kg
VKA	02340	Adjustable Valve Key for Mains	45.5	1156	14.4	6.5
VK2CK1	02346	Main Valve Key + 1" Curb Key	45.5	1156	14.4	6.5
VK2CK2	02347	Main Valve Key + 2" Curb Key	45.5	1156	14.5	6.6
VK3CK1WHL	02353	Main Valve Key + 1" Curb Key + valve wheel 2 prong tool	45.5	1156	15.3	7.0
VK3CK1ROD	02356	Main Valve Key + 1" Curb Key + 3/8" slotted tool for curb box rods	45.5	1156	18.7	8.5
VK3CK1CK2	02357	Main Valve Key + 1" Curb Key + 2" Curb Key	45.5	1156	18.4	8.4
VK3CK1EXT	02358	Main Valve Key + 1" Curb Key + Extension shaft for additional 6' reach	45.5	1156	25.7	11.7
VK6KIT	02368	Kit contains parts to make all VK2 and VK3 variations, using the VK3 upper shaft. VK6KIT contains 32340 (8) and (1) each 92339, 92347, 92342, 92346, 92345, 92349, 92358, 92360*	45.5	1156	42.5	19.3
VKEXT	92358	Valve Key Extension, 6 ft. extra reach	72.0	1829	11.3	5.1

\*Refer to **MATRIX ON P. 49** for item descriptions.

### ✓ WHY REED?

When it comes to turning gate valves in the street and curb stop valves to buildings, Reed's selection of Valve Keys is the most complete, rugged and compact around.

### KEY CHOICES

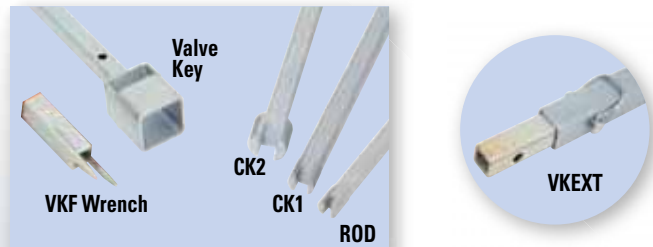

NOTE: Key ends fit regular Valve & Curb Keys only.

## RATCHETING VALVE KEYS

### FEATURES

- Ratchet handle operation reduces back strain and operator fatigue compared with using traditional valve keys.
- Closed size of under 4 foot long means they fit in crowded utility trucks, behind pickup seats or in car trunks.

Ratcheting Valve Keys are great for water utilities. Back-saving ratchet handle allows work in one's comfort zone. Under 4 feet long when telescoped in, Reed valve keys fit well in today's smaller utility trucks, behind pickup seats or in car trunks.

Catalog No.	Item Code	Description	Closed Length		Weight	
			in	mm	lbs	kg
VKRCK1	02349	Main Valve Key + 1" Curb Key & Ratchet Handle	45.5	1156	20.1	9.1
VKREXT	02350	Main Valve Key + Ext & Ratchet Handle	45.5	1156	26.2	11.9

NOTE: Valve & Curb Keys (top of page) do not fit the ratcheting handle. However, some **VALVE & CURB KEY ADD-ONS FROM MATRIX ON P. 49** do fit. The ones that fit Ratcheting Valve Keys are marked with a red asterisk (\*) in the top line of the Matrix.

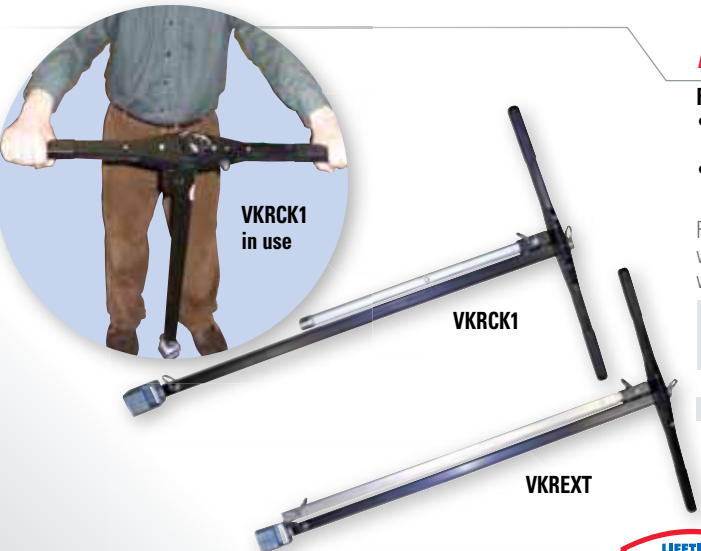





PIPE TOOLS & VISES  
SINCE 1896

## VALVE OPERATORS

### FEATURES

- **Power alternative** to hand turning valves.
- Individuals working alone can **isolate a leak** by shutting multiple valves easily with this time-saving tool.
- Uses Valve Keys with 1" square shafts.
- Truck does not need to be in close proximity to valve since the tool is portable.
- **Inexpensive** when compared to other valve exercising methods.

A Valve Operator provides power to make valve turns easy. This portable and economical tool is great for preventive maintenance. **VOK700PD** power drive uses electricity to drive the **VOKCLUTCH**. The **VOK700APD** power drive uses compressed air to drive the **VOKCLUTCH**. The clutch applies up to 150 ft-lbs of torque and disengages when torque exceeds preset value. The **VOKCLUTCH** accepts 1" square shafts. The Valve Key extends from 4 to 9 feet and recommended operation is at chest height for best leverage.

Catalog No.	Item Code	Description	Gross Weight*	
			lbs	kg
VOKCLUTCH	05281	Spring-Loaded Valve Key Clutch	8.9	4.0
VOK700PD	05288	Kit includes 700PD power drive, VOKCLUTCH, 2" valve key (#92339) and valve key extension (#92358)	63.8	29.0
<b>VOK700APD</b>	05289	Kit includes 700APD power drive, VOKCLUTCH, 2" valve key (#92339) and valve key extension (#92358)	79.3	36.0

★ **VOK700APD**

★ **NEW**

\*GROSS WEIGHT includes all components plus packaging.

KEY CHOICES ON P. 48 fit the Valve Operator. The selected key plus #92341 handle and #32340 pins are generally required.



Power alternative to hand turning valves!

VOK700PD in use

## VALVE & CURB KEYS MATRIX

Catalog No.	Item Code	Pin/Key Options										Closed Length		Open Length*		Weight				
		32340 PIN	92337 VKR LOWER	92339 LOWER	92340 43.25" UPPER	92342 43.25" UPPER	92343 VKR UPPER	92346 HDL9/16K	92347 HDL3/4K	92341 HDL	92345 HDL RODKY	92356 VK RATCHET	92349 VKF WRENCH	92358 EXT	in	mm	ft	meters	lbs	kg
VKA	02340	X								X				45.5	1156	6' 8"	2.03	14.4	6.5	
VK2CK1	02346	X	X	X			X							45.5	1156	6' 8"	2.03	14.4	6.5	
VK2CK2	02347	X	X	X			X							45.5	1156	6' 8"	2.03	14.5	6.6	
VKRCK1	02349	X	X				X	X			X			45.5	1156	6' 7"	2.01	20.1	9.1	
VKREXT	02350	X	X				X				X	X		45.5	1156	12' 6"	3.81	26.2	11.9	
VK3CK1WHL	02353	X	X	X	X		X				X		X	45.5	1156	6' 8"	2.03	15.3	7.0	
VK3CK1ROD	02356	X	X	X	X	X	X		X					45.5	1156	6' 8"	2.03	18.7	8.5	
VK3CK1CK2	02357	X	X	X	X	X	X							45.5	1156	6' 8"	2.03	18.4	8.4	
VK3CK1EXT	02358	X	X	X	X	X	X				X	X		45.5	1156	12' 7"	3.84	25.7	11.7	
VK6KIT	02368	X	X	X	X	X	X	X	X	X	X	X	X	45.5	1156	12' 7"	3.84	42.5	19.3	

\*As sold, without any extra extensions.

\* Also fit Ratcheting Valve Keys.



92343 VKR Upper Shaft



92356 VKR Ratchet



92349 VKF Wrench

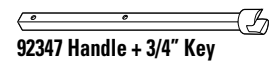

92347 Handle + 3/4" Key

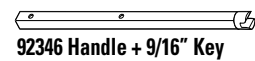

92346 Handle + 9/16" Key

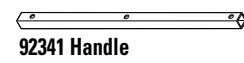

92341 Handle

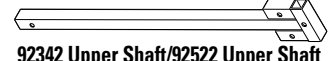

92342 Upper Shaft/92522 Upper Shaft

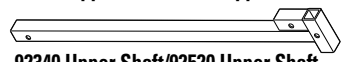

92340 Upper Shaft/92520 Upper Shaft

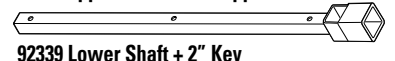

92339 Lower Shaft + 2" Key



92345 Handle + Rod Key (one piece, expand with #92358)



92358 Extension Shafts



92337 VKR Lower Shaft

## METER BOX & CURB BOX LID KEYS

### FEATURES

- Reed's broad line saves searches for the right key.
- Tough, **rust-resistant** materials give long life.

Reed Meter Box and Curb Box Lid Keys open many styles of meter pit lids and curb box lids. Reed pentagon meter key capacities include standard waterworks pentagon bolts and plugs, as well as the large pentagon bolts made by both Mueller® and Ford®. Careful design and production ensure the Reed pentagon and skeleton keys fit many brands of lids and bolts. Reed meter box and curb box lid keys all have a turn and lift feature, allowing tool users to open a lid, lock onto it, and lift the lid off with a single motion. All Reed meter box and curb box lid keys are made of strong, plated ductile iron to inhibit rust.

Catalog No.	Item Code	Description	Length		Weight	
			in	mm	lbs	kg
MKF2	02364	Ford® Lg. & Std. Pentagons	5.5	140	0.9	0.4
MKF324	02367	24" T w/ Std., Slotted Pentagon	24.5	622	2.4	1.1
MKDT	02375	Ductile T Skeleton	7.0	178	0.8	0.4
MKH10820	02380	Mueller® 2 Lg. & 1 Std. Pentagon	5.0	127	1.2	0.5

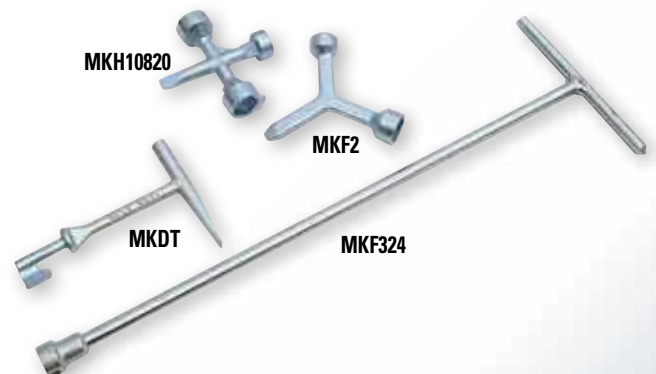

SECTION

# 4

# GROOVERS, POWER DRIVES, THREADERS & DIES

Combo Roll Groover

Portable Roll Groovers

5301PD Power Drives

Ground Fault Interrupter

Threading Machines **NEW**

Machine Cart

700PD Power Drives

700APD Pneumatic Power Drives **NEW**

701PD Power Drives

601PD Power Drives

Oilers

Threadguard Cutting Oil

R12+ Segmental Dies

R12+ Dropheads

R12+ Threader Sets

Universal Dies **NEW**

Universal Die Head

Enclosed Ratchet Threader Sets

Enclosed Dropheads

Adjustable Guide Threader Sets

Block Dies

**RGCOMBO2 Combo Roll Groover makes consistent depth, smooth groove. Shown grooving in the air on 6" Schedule 40 steel pipe.**



PIPE TOOLS & VISES  
SINCE 1896

## COMBO ROLL GROOVER

### FEATURES

- Perform **both power and manual** roll grooves with ease.
- May be used "in air" or with 5301PD Power Drive.
- **Built to last!**

Combo Roll Groover is a 2-in-1 service tool that yields cost savings of time and money by allowing a complete change in minutes from power machine operation to manual work or back. **Patented RGCOMBO2** forms standard rolled grooves in steel, stainless steel (SS) and aluminum pipe from 1 1/4" - 6". The formed grooves comply with the specifications required for mechanical coupling systems. The only adjustment required is for the depth of the groove.

Catalog No.	Item Code	Pipe Material	Power Source	Pipe Capacity		Gross Weight*	
				in-nom.	mm	lbs	kg
RGCOMBO2**	09200	Sch. 10 - 40 for Steel, SS, Aluminum	Power or Manual	1 1/4" - 6"	32 - 152	31.4	14.3

\*GROSS WEIGHT includes all components plus packaging.

\*\*PATENTED

### SELECTION CHART

Select the roll groover for the proper type of pipe.

Catalog No.	Item Code	Power Source*	Tool Weight		Pipe Capacity		Type of Pipe			
			lbs	kg	in-nom.	mm	SS	Steel	Al	PVC
RG6S	08500	Power	22.7	10.3	1 1/4" - 6" Sch. 5S to 40	32 - 152	X	X	X	X
RG26S	08510	Manual	19.1	8.7	2" - 6" Sch. 5S to 10S 2" - 3" Sch. 40	51 - 152 51 - 76	X	X	X	X
RGCOMBO2	09200	Power or Manual	27.5	12.5	1 1/4" - 6" Sch. 10 to 40	32 - 152	X	X	X	

\*5301PD POWER DRIVE ON P. 52 is the recommended power source.



RGCOMBO2

### ✓ WHY REED?

Combo Roll Groover has compact, lightweight design with built-in handle for improved mounting and transporting. All gears enclosed in the casting minimize debris entering tool. Consistent tracking makes this tool great to use time after time.

2-in-1 groovers feature reliable, effortless tracking!



RGCOMBO2 in use



RGCOMBO2 with 5301PDCOMP



Two wrenches ship with RGCOMBO2. There's a straight handle for power grooving and an angled handle for easier, more efficient manual grooving.

## PORTABLE ROLL GROOVERS

### FEATURES

- Finger-adjust depth screw and gauge on RG6S for **quick, accurate** and repeatable groove depths.
- **Angled rollers** on RG26S keep the groover on the pipe and in-line.
- RG26S ratchet wrench is easy to use in tight places.

Reed Portable Roll Groovers are compact, durable tools for use at installation sites. **RG6S** roll groover is designed to be powered by Reed 5301PD power drive. RG6S has heavy-duty, sealed bearings and a steel body to withstand the punishment of severe grooving applications, including use on Schedule 40 pipe. Finger-adjust depth screw and gauge provide quick adjustment and accurate, repeatable groove depths. No bulky adjusting wrenches required. **RG26** roll groover manually grooves in-place pipe and pipe too short for powered groovers. It is easily carried and positioned with a convenient handle. Screw knob on top of unit makes for easy depth adjustments. Included ratcheting handle is used for feeding and turning.

Catalog No.	Item Code	Pipe Material	Power Source	Pipe Capacity		Gross Weight*	
				in-nom.	mm	lbs	kg
RG6S	08500	Steel, SS, PVC, Aluminum	Power	1 1/4" - 6" Sch. 5S to 40	32 - 152	26.6	12.1
RG26S	08510	Steel, SS, PVC, Aluminum	Manual	2" - 6" Sch. 5S to 10S 2" - 3" Sch. 40	51 - 152 51 - 76	20.0	9.1

\*GROSS WEIGHT includes all components plus packaging.

NOTE: Grooves will comply with dimensional specifications published by ANSI/AWWA C-606 and mechanical coupling manufacturers.

HYDROSTATIC TEST PUMPS ON P. 47  
5301PD POWER DRIVES ON P. 52



RG6S

### ✓ WHY REED?

Combines the compact RG6S design for long life with sealed, heavy-duty bearings and up to 6" capacity.



RG6S with 5301PDCOMP

### ✓ WHY REED?

Angled rollers keep the groover on the pipe and in-line: **will not "walk off" pipe**. It uses heavy-duty bearings, hardened and ground shafts, and rollers mounted in a ductile iron housing for durability. Ratchet wrench is convenient to use in tight spaces.



RG26S in use on steel pipe



RG26S



**EXCLUSIVE  
FEATURE**

**240V Models  
Available**

5301PD is CSA Approved for Canada!

**ONLINE VIDEO  
TRAINING**

Workspace on Housing



**5301PDCOMP**

Catalog No.	Item Code	Capacity		Description	Gross Weight*	
		in-nom.	actual O.D. mm		lbs	kg
5301PD	05301	1/8 - 2 Pipe 1/4 - 2 Bolt**	10.3 - 60.3 Pipe 6 - 50 Bolt**	Power Drive 38 RPM, 120V with Footswitch only	93	43
5301PD57RPM	05302	1/8 - 2 Pipe 1/4 - 2 Bolt**	10.3 - 60.3 Pipe 6 - 50 Bolt**	Power Drive 57 RPM, 120V with Footswitch only	93	43
5301PDCOMP	05303	1/8 - 2 Pipe 1/4 - 2 Bolt**	10.3 - 60.3 Pipe 6 - 50 Bolt**	Power Drive Complete*** 38 RPM, 120V, NPT Dies	208	95
5301PD57RPMCMP	05304	1/8 - 2 Pipe 1/4 - 2 Bolt**	10.3 - 60.3 Pipe 6 - 50 Bolt**	Power Drive Complete*** 57 RPM, 120V, NPT Dies	208	95
5301PD240	05321	1/8 - 2 Pipe 1/4 - 2 Bolt**	10.3 - 60.3 Pipe 6 - 50 Bolt**	Power Drive 38 RPM, 240V with Footswitch only	93	43
5301PDCOMP240B	05322	1/8 - 2 Pipe 1/4 - 2 Bolt**	10.3 - 60.3 Pipe 6 - 50 Bolt**	Power Drive Complete*** 38 RPM, 240V, BSPT Dies	208	95
5301PDCOMP240	05323	1/8 - 2 Pipe 1/4 - 2 Bolt**	10.3 - 60.3 Pipe 6 - 50 Bolt**	Power Drive Complete*** 38 RPM, 240V, NPT Dies	208	95

\*GROSS WEIGHT includes all components plus packaging.

\*\* Bolt dies not currently available from Reed.

\*\*\*COMPLETE units contain Power Drive, Footswitch, Tripod, Carriage with Lever, Pipe Cutter, Reamer, R811 Universal Die Head, Transporter, Oiler, 1 gallon Threadguard Cutting Oil and one set each High Speed Steel Universal Dies: 1/2" - 3/4" and 1" - 2" NPT or BSPT, depending on model.

COMBO ROLL GROOVERS ON P. 51

PORTABLE ROLL GROOVERS ON P. 51



**5301PD**

**Transporter  
with 5301PD**

### ACCESSORIES

Catalog No.	Item Code	Description	Weight	
			lbs	kg
5301PDTP	05305	5301PD Tripod	26.0	11.8
5301PDTRANSPRTR	05306	5301PD Transporter	28.0	12.7
5301PDCARRIAGE	05307	5301PD Carriage	16.0	7.3
5301PDREAMER	05308	5301PD Reamer	6.8	3.1
5301PDCUTTER	05309	5301PD Cutter	8.5	3.9

COMBO ROLL GROOVERS ON P. 51

PORTABLE ROLL GROOVERS ON P. 51

OILERS ON P. 56

THREADGUARD CUTTING OIL ON P. 56

UNIVERSAL DIE HEAD ON P. 58

UNIVERSAL DIES ON P. 58

### ✓ WHY REED?

Flat top of housing is ideal for placing tools. 5301PD includes long-lasting high speed steel (HSS) dies, not alloy dies. All steel oiler (not plastic) with 60" (not 54") hose included with complete units.

## GROUND FAULT INTERRUPTER

### FEATURES

- Stay safe and use a GFI.

The PDGFI Ground Fault Interrupter can be used with any Reed power drive or power threader. When drilling/tapping live pipe or actuating a valve with the potential for water to be present, the PDGFI is recommended.

**PDGFI**



Catalog No.	Item Code	Description	Weight	
			lbs	kg
PDGFI	05277	Ground Fault Interrupter 20 VAC, 50/60Hz, 15 AMPERES, 1800 WATTS	0.8	0.4



PIPE TOOLS & VISES  
SINCE 1896

## THREADING MACHINES

### FEATURES

- **Self-oiler** feature allows operator to concentrate on the pipe work.
- **Open work space** features a large, integral oil reservoir and an easy-to-remove chip collection tray.
- Three-spoke handwheel easily moves the carriage and starts the dies for threading.

Reed's 1/2 horsepower, electric-motor-driven **5401TMSO** Threading Machine centers and chucks pipe and conduit and rotates it while cutting, reaming and threading operations are performed. Its through head oiling system features a self-priming pump that generously floods the pipe with oil while threading. Threading capacity for bolt is 1/4" - 2" and for pipe is 1/8" - 2" nominal. Plenty of carriage clearance to allow easy cleanup and removal of cuttings and chips. Handy three-spoke handwheel with a gear and rack system easily moves the carriage and starts the dies onto the pipe for threading. System includes\*\*\* threading machine with footswitch, legs, die head and dies (NPT or BSPT) and cutting oil.

Catalog No.	Item Code	Description	Capacity in-nom.	Gross Weight*		Icons
				lbs	kg	
5401TMSO	05365	Threading Machine 1/2 HP***, 120V single phase 60Hz, NPT Dies	Pipe: 1/8" - 2" Bolt: 1/4" - 2"*** depending on dies	175	79.4	
★ 5401TMSOENPT	05368	Threading Machine 1/2 HP***, 240V single phase 60Hz, NPT Dies	Pipe: 1/8" - 2" Bolt: 1/4" - 2"*** depending on dies	175	79.4	
★ 5401TMSOEBSP	05369	Threading Machine 1/2 HP***, 240V single phase 60Hz, BSPT Dies	Pipe: 1/8" - 2" Bolt: 1/4" - 2"*** depending on dies	175	79.4	

★ **NEW**

\*GROSS WEIGHT includes all components plus packaging.

\*\*Bolt dies not currently available from Reed.

\*\*\*COMPLETE units include Threading Machine, Footswitch, Legs, R811 Universal Die Head, 1 gallon Threadguard Cutting Oil, and one set each High Speed Steel Universal Dies: 1/2" - 3/4" and 1" - 2" NPT or BSPT, depending on model.

THREADGUARD CUTTING OIL ON P. 56

UNIVERSAL DIE HEAD ON P. 58

UNIVERSAL DIES ON P. 58

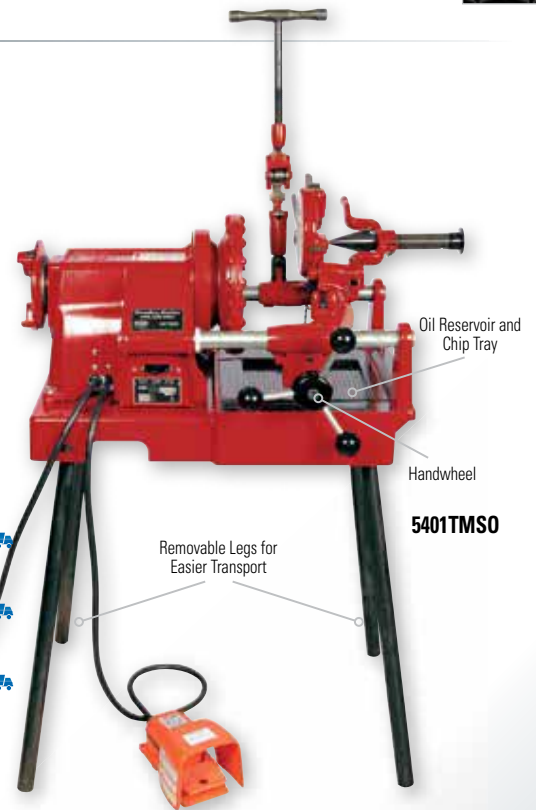

## MACHINE CART

### FEATURES

- Crank handle **raises and lowers** caster to change cart movement.
- **Anti-tip bar** mechanism for safety when transporting machines.
- Heavy-duty steel (not plastic) storage tray for durability.

Reed's **5401CRT** cart makes transport of the threading machine easy. The heavy-duty cart is fabricated from steel tubing. The cart handles slide in to keep them out of the way when space is an issue. It has an exclusive feature caster which is on the same end of the cart as the handles. The caster's crank handle allows the cart to be moved up and down so that, if desired, the cart can be pushed around instead of lifted and pushed like a wheelbarrow. The cart also features an anti-tip front bar mechanism and a heavy-duty steel (not plastic) storage tray. The cart fits the Reed 5401TMSO Threading Machine or Ridgid® 300 Compact, 1224, 1233, 1822, 535, or 535A/585 Manual. **Assembly required** of cart.

Catalog No.	Item Code	Height		Width		Length		Weight	
		in	mm	Inches	mm	in	mm	lbs	kg
5401CRT	06670	27.5	698.5	26	660.4	40 (Handles in) 57 (Handles out)	1016 (Handles in) 1448 (Handles out)	72	32.7

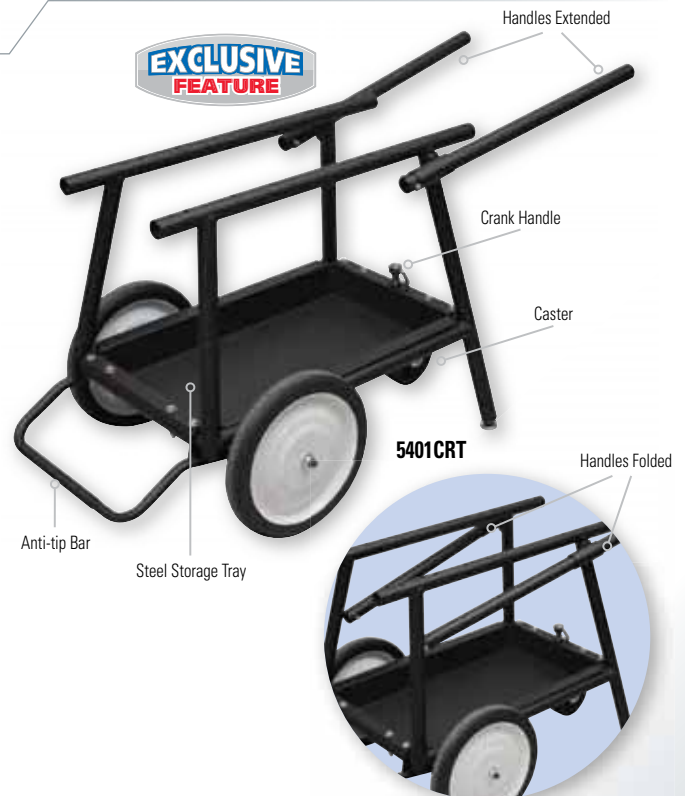



### ✓ WHY REED?

Reed 700PD comes with a **FREE** safety arm – 10% extra value over the competition! The vinyl-coated handle provides better electrical safety. Flexible pigtail cord retainer extends cord life and prevents pull-out. The neoprene sealed switch keeps dirt out and prolongs switch life.



700PD is approved for US and CSA Canada specs!



## 700PD POWER DRIVES

### FEATURES

- Heavy-duty 700PD **workhorse** is designed for constant, daily use.
- **FREE safety arm** included.
- Vinyl-coated handle provides better electrical safety to the user.
- Neoprene **sealed switch** helps keep dirt out and prolongs switch life.

Reed's **700PD** Power Drive is a portable, electric-motor-driven, heavy-duty power drive which provides power for threading pipe and conduit up to 2" (50 mm) in diameter. It uses Reed R12+ Segmental Dies and Dropheads or Ridgid® brand 12R dies and dropheads. The 700PD comes with a **FREE** safety arm. The vinyl-coated handle provides better electrical safety. The sealed switch keeps dirt out which prolongs switch life. The 700PD is ½ horsepower, double insulated, turns at 28 RPM no load and uses electrical forward/reverse switch. Reed's 700PD is approved for US and CSA Canadian standards. The 700PD can be used to power hot tapping and drilling machines by adding Reed's TMPDA Power Drive Adapter. It can also be used to power Reed Valve Operators in conjunction with the VOKCLUTCH.

**700PD POWER DRIVE** Ships with Free Safety Arm!

Catalog No.	Item Code	Capacity		Description	Gross Weight*	
		in-nom.	actual O.D. mm		lbs	kg
700PD	05270	1/8 - 2	10.3 - 60.3	Power Drive & Safety Arm, 120V, 60 Hz	41	18.4
700PDSET	05272	1/2 - 2 NPT	21.3 - 60.3	Power Drive & Safety Arm, 120V, 60 Hz, six R12+ Dropheads for 1/2" - 2" NPT	67	30.5

\*GROSS WEIGHT includes all components plus packaging.  
[R12+ DROPHEADS AND SEGMENTAL DIES ON P. 57](#)  
[POWER UNITS FOR TAPPING/DRILLING ON P. 43](#)  
[OILERS ON P. 56](#)  
[VALVE OPERATORS ON P. 49](#)

### SAFETY ARM

Catalog No.	Item Code	Description	Weight	
			lbs	kg
700V	05275	Replacement Safety Arm for 700PD & 700APD Power Drives	7	3.2

700PD and Oiler on Tripod



## 700APD PNEUMATIC POWER DRIVES

### FEATURES

- **Pneumatic-powered** and useful for threading pipe in an environment where electric shock or sparks from an electric tool are hazardous.
- May also be used for power tapping or valve exercising.

Due to its pneumatic power source, Reed's **700APD** Power Drive can be used in environments where electric shock or sparks from an electric tool are hazardous. Portable and heavy-duty, the 700APD provides power for threading pipe and conduit up to 2" (50 mm) diameter. The included **700V** Safety Arm absorbs the forces generated during threading and frees up the operator to oil the dies. Its 4 HP pneumatic motor turns at 28 RPM no load. Reed's 700APD has a maximum torque of 400 lb-ft. and uses Reed R12+ Segmental Dies and Dropheads.

Catalog No.	Item Code	Capacity		Air Consumption	Description	Gross Weight*	
		in-nom.	actual O.D. mm			lbs	kg
★ <b>700APD</b>	05260	1/8 - 2	10.3 - 60.3	80 CFM @ 90 psi 2.4 cu. m/min @ 6.2 Bar	Pneumatic Power Drive & Safety Arm, 28 RPM, 4 HP motor	56	25.5
★ <b>700APDSET</b>	05262	1/2 - 2 NPT	21.3 - 60.3	80 CFM @ 90 psi 2.4 cu. m/min @ 6.2 Bar	Pneumatic Power Drive & Safety Arm, 28 RPM, 4 HP motor with six Dropheads for 1/2" - 2" NPT	83	37.7

★ **NEW**

\*GROSS WEIGHT includes all components plus packaging.  
**NOTE: Always use a filter-regulator-lubricator (FRL) with Reed pneumatic tools.** Reed offers FRL #97591.  
[FILTER - REGULATOR - LUBRICATOR ON P. 17](#)  
[R12+ DROPHEADS & SEGMENTAL DIES ON P. 57](#)  
[POWER UNITS FOR TAPPING/DRILLING ON P. 43](#)  
[VALVE OPERATORS ON P. 49](#)

### POWER DRIVE UNIT WEIGHT

A measure of the tool weight the operator must support.

Catalog No.	Item Code	Weight	
		lbs	kg
601PD	05240	15	6.8
701PD	05250	16	7.3
700PD	05270	31	14.3
700APD	05260	46	20.9

Ridgid® is a registered trademark of Ridgid, Inc. and is not associated with Reed Manufacturing Company.



PIPE TOOLS & VISES  
SINCE 1896

## 701PD POWER DRIVES

### FEATURES

- At less than 16 pounds, it's the **lightest threading machine** for R12+ or 12R style dropheads.
- Lightweight and **easy to transport** from level to level on large or high-rise jobs.

**701PD** Power Drive automates the threading process for pipe 1/8" through 2" (3-50 mm). 701PD is the lightest threading power drive machine at 15.9 pounds (7.2 kg) available for industry-standard R12+ or 12R style dropheads. 701PD comes with a free safety arm and is equipped with a gearshift that backs the machine off the work twice as fast at 60 RPM. **701V** Safety Arm absorbs the forces generated when threading and frees up the operator to oil the dies during threading. Gearing gives this compact power drive plenty of torque to thread 2" pipe.

**701PD POWER DRIVE** Ships with Free Safety Arm!

Catalog No.	Item Code	Capacity		Description	Gross Weight*	
		in-nom.	actual O.D. mm		lbs	kg
701PD	05250	1/8 - 2	10.3 - 60.3	Power Drive & Safety Arm, 115V	23.5	10.7
701PD W/BOX	05251	1/8 - 2	10.3 - 60.3	Power Drive & Safety Arm, 115V, with Box	43.1	19.6
701PDE**	05252	1/8 - 2	10.3 - 60.3	Power Drive & Safety Arm, 230V	23.5	10.7
701PDSET2 W/Box	05253	1/2 - 2	21.3 - 60.3	Power Drive & Safety Arm, 115V, six R12+ Dropheads for 1/2" - 2" NPT	69.7	31.7
701PDSET2	05254	1/2 - 2	21.3 - 60.3	Power Drive & Safety Arm, 115V, six R12+ Dropheads for 1/2" - 2" NPT, with Box	50.1	22.8

\*GROSS WEIGHT includes all components plus packaging.

\*\*R12+ BSPT dies not available.

R12+ DROPHEADS AND DIES ON P. 57

### ACCESSORIES

Catalog No.	Item Code	Description	Weight	
			lbs	kg
701V	05255	Replacement Safety Arm for 701PD Power Drive	7.5	3.4
701BOX	95252	Toolbox (fits 701PD & Dropheads)	19.6	8.9



### ✓ WHY REED?

Reed 701PD is lighter, faster, safer, and a 20% less expensive alternative to the Ridgid® 700 (with arm) and uses R12+ or 12R style dropheads. The FREE 701V safety arm stabilizes the power drive firmly in both forward and reverse. 701PD has speeds of 25 RPM forward and 60 RPM reverse. Great for overhead work due to its lightweight and safety arm.



701PD W/BOX

701PD, OLBUCKET1 and R450+

OILERS ON P. 56



## 601PD POWER DRIVES

### FEATURES

- The **lightest power drive** on the market.
- Safety arm and carrying case included.
- A great alternative to hand-threading.

**601PD** Power Drive weighs only 15.4 pounds, yet delivers plenty of torque for threading through 1 1/4" pipe. A safety arm is always included, as is a carrying case. No load forward speed is 25 RPM, with a fast reverse switch that allows 60 RPM backoff to expedite jobs. The REVERSE button on the power drive is used to properly and quickly remove the threader drophead or die head from the pipe that has just been threaded. (There is no threading done in the REVERSE position.) An entire power drive kit weighs from 30 to 32 pounds, making the 601PD the easiest machine to get to gas pipe and other on-site jobs. 601PD power drive uses R11 Enclosed Dropheads.

**601V** Safety Arm absorbs the forces generated when threading and frees up the operator to oil the dies during threading.

**601PD POWER DRIVE** Ships with Free Safety Arm!

Catalog No.	Item Code	Capacity		Description	Gross Weight*	
		in-nom.	actual O.D. mm		lbs	kg
601PD	05240	1/4 - 1 1/4	13.7 - 42.2	Power Drive & Safety Arm, 115V with Case	25.0	11.4
601PDKIT1	05244	1/2 - 1	21.3 - 33.4	Power Drive & Safety Arm, 115V, three R11 Dropheads for 1/2" - 1" NPT, with Case	30.0	13.6
601PDKIT1-1/4	05245	1/2 - 1 1/4	21.3 - 42.2	Power Drive & Safety Arm, 115V, four R11 Dropheads for 1/2" - 1 1/4" NPT, with Case	32.0	4.5

\*GROSS WEIGHT includes all components plus packaging.

R11 ENCLOSED DROPHEADS ON P. 59

POWER UNITS FOR TAPPING/DRILLING ON P. 43

### SAFETY ARM

Catalog No.	Item Code	Description	Weight	
			lbs	kg
601V	05242	Replacement Safety Arm for 601PD Power Drives	5.7	2.6



601V Safety Arm

601PD



Eliminate hand-threading with this portable, lightweight machine!

### OLBUCKT1



## OILERS

### FEATURES

- **Ruggedness** of Reed's metal drip pan/chip tray is superior to competitors' plastic pans.
- Sturdy nozzle made from **solid aluminum** (not from thin tubing).

Reed Oilers effectively deliver threading oil as the gun-and-trigger approach makes it easy to pump oil directly on the work. The rugged and completely portable Reed **OLBUCKT1** comes with a 20-gauge steel bucket and steel drip pan/chip tray along with oil gun, a 60" industrial-grade hose and one gallon of dark oil. Drip pan/chip tray is durable metal and outlasts competitor's plastic pans. The oiler system double-filters and recirculates oil as the chip tray catches the big waste pieces and the filter strains out any small particles. Oil gun features a sturdy nozzle made from turned aluminum. **OLBUCKT1** ships with one gallon of Reed Threadguard dark cutting oil. **OLKIT1** includes the oil gun, hose, cap, clamp and seal.

*NOTES: Approximately one gallon of oil in the bucket is required to meet the minimum fill line for hose penetration. USE REED DARK OR CLEAR THREADGUARD CUTTING OIL FOR BEST RESULTS. Please recycle or dispose of used threading oil according to the regulations of user's own state or country.*

Catalog No.	Item Code	Weight	
		lbs	kg
OLBUCKT1*	06150	21.0	9.5
OLKIT1	06158	2.5	0.9

\*Includes 1 Gallon of Oil, #06120.

### ACCESSORIES

Item Code	Description
06120	Dark Cutting Oil - Gallon
97370*	60" Hose (1524 mm)
97375*	Metal Drip Pan/Chip Tray - 20 gauge sheet steel
97376*	Metal Bucket - 20 gauge sheet steel
97380	Oil Pan Strainer
97395*	Oil Gun

\*Interchangeable with similar parts on Ridgid® oilers.

### ✓ WHY REED?

Much stronger and longer-lasting than oilers with plastic drip pans/chip trays. 60" (not 54") hose maximizes user convenience. Both features eliminate downtime and save money.



OLKIT1



Metal Drip Pan

Metal Bucket



## THREADGUARD CUTTING OIL

### FEATURES

- Successful hand and machine threading depends on this **quality cutting oil**.
- **Quart-size available** in both clear and dark oil.
- Clear oil is not prone to staining.

Reed Threadguard Cutting Oil was developed by thousands of actual work-condition tests by Reed and oil company laboratories. It is specifically formulated for cooling the work, prolonging die life, and increasing cutting speed for both machine and hand threading.

### DARK OIL

Catalog No.	Item Code	Size	Weight	
			lbs	kg
OOD	06118	Quart	2.0	0.9
OGD	06120	Gallon*	8.2	3.7
O55GD	06124	55 Gallon	465.0**	211.4**

### CLEAR OIL

OQC	06110	Quart	2.0	0.9
OGC	06112	Gallon*	7.9	3.6
O55GC	06116	55 Gallon	465.0**	211.4**

\*24 or more gallon bottles must ship by truck freight.

\*\*GROSS WEIGHT



OGD

OOD

OGC

OQC

### ✓ WHY REED?

Higher lubricity for longer die life and faster cutting speed.





PIPE TOOLS & VISES  
SINCE 1896

## R12+ SEGMENTAL DIES

### FEATURES

- R12+ Segmental Dies are made of high speed steel which **lengthens die life**.
- Precision manufactured by modern CNC machines.

Reed knows how to cut a good thread and high speed steel (HSS) R12+ Segmental Dies show this with cutting edges manufactured in-house by precision CNC machinery. The segmental die design enables smooth chip flow and easy cutting. R12+ Segmental Dies are replaceable parts for Reed R12+ Dropheads, as well as the following Ridgid® dropheads: 12-R, 00-R, 111-R, 0-R, 11-R, 30A and 31A threaders. Segmental dies are sold in full sets of four numbered dies. Use with Reed Threadguard Cutting Oil for better and faster threads and longer die life.

### R12+ SEGMENTAL DIES

Catalog No.	Item Code	Size	Material Threaded	Weight	
				lbs	kg
R12DN1/2	05606	1/2" NPT	Steel & Stainless Steel	0.2	0.1
R12DN3/4	05608	3/4" NPT	Steel & Stainless Steel	0.2	0.1
R12DN1	05610	1" NPT	Steel & Stainless Steel	0.3	0.1
R12DN1 1/4	05612	1 1/4" NPT	Steel & Stainless Steel	0.3	0.1
R12DN1 1/2	05614	1 1/2" NPT	Steel & Stainless Steel	0.5	0.2
R12DN2	05616	2" NPT	Steel & Stainless Steel	0.5	0.2

THREADGUARD CUTTING OIL ON P. 56

R12DN1

### ✓ WHY REED?

Reed offers high speed steel (HSS) dies for the price of competitor's alloy dies: a 10%+ cost savings. Reed R12+ series is made in USA. HSS dies last longer than alloy dies, especially if used with power drives.

Reed provides over 100+ years of quality die-making expertise.



## R12+ DROPHEADS

### FEATURES

- R12+ Dropheads ship with **longer lasting**, high speed steel dies whereas competitor uses alloy dies.

R12+ Dropheads ship completely assembled and ready to use with HSS segmental dies already in place. R12+ Dropheads can be used manually with the R12RRHC ratchet ring and handle or with 700PD, 700APD and 701PD. R12+ dropheads are interchangeable with Ridgid® 12-R dropheads and can also be utilized in the Ridgid® 700 power drive.

Catalog No.	Item Code	Size	Material Threaded	Weight	
				lbs	kg
DHR12 1/2NPT	05626	1/2" NPT	Steel & Stainless Steel	3.6	1.6
DHR12 3/4NPT	05628	3/4" NPT	Steel & Stainless Steel	3.6	1.6
DHR12 1NPT	05630	1" NPT	Steel & Stainless Steel	4.2	1.9
DHR121 1/4NPT	05632	1 1/4" NPT	Steel & Stainless Steel	4.7	2.1
DHR121 1/2NPT	05634	1 1/2" NPT	Steel & Stainless Steel	5.1	2.3
DHR12 2NPT	05636	2" NPT	Steel & Stainless Steel	5.4	2.5



DHR121 1/2NPT

### ✓ WHY REED?

Reed's dropheads are designed for improved chip flow and easier cutting. Reed's dropheads are more than 10% less expensive than Ridgid® 12-R dropheads with HSS dies.



## R12+ THREADER SETS

### FEATURES

- Choose the number of dropheads needed for an NPT set.

R12+ Drophead Threader Sets include complete dropheads in sizes from 1/2" to 2" NPT threads. Each drophead threader set has a ratchet ring and handle. In addition, the Reed R12+ ratcheting ring R12RRHC accepts all Ridgid® 12-R dropheads. All drophead threader sets thread steel pipe. Only the "BOX" model includes a metal toolbox with pegs for the dropheads. Extra **R12BOX** boxes available separately.

Catalog No.	Item Code	Size	Dropheads Included	Weight	
				lbs	kg
R12NPT-3	05712	1/2" to 1" NPT	3	16.4	7.5
R12NPT-4	05714	1/2" to 1 1/4" NPT	4	21.1	9.6
R12NPT-5	05716	1" to 2" NPT	4	24.4	11.1
R12NPT-6	05720	1/2" to 2" NPT	6	31.6	14.4
R12NPT-6-BOX	05721	1/2" to 2" NPT with R12BOX	6	52.6	23.9

### ACCESSORIES

Catalog No.	Item Code	Description	Weight	
			lbs	kg
R12BOX	05715	Box Only with 6 Drophead Slots	21.0	9.5
R12RRHC	05638	Ratchet Ring & Handle	5.0	2.3



R12RRHC



R12NPT-6-BOX



NOTE: Most Reed R12+ threader sets **DO NOT** include the R12 box. It can be ordered separately as #05715.



R12NPT-6





UHN1-2



Reed provides over 100+ years of quality die-making expertise.

**✓ WHY REED?**

Reed Universal Dies are made in the USA, lab tested and proven, then field tested and approved by threading specialist contractors and industrial users. Years of on-going lab and field tests have shown Reed Universal Dies give clean threads and long die life.



UBD1-2-375

## UNIVERSAL DIES

### FEATURES

- Reed Universal Dies give **clean threads** and **long die life** as proven by years of field and lab testing.
- Bevel dies add a chamfer to the outside edge of pipe for welding purposes.
- Combo set UBD1-2-COMBO includes both 45° and 37.5° bevel dies.

Reed used its 100+ years of die-making experience to select the best materials, methods and CNC production for its Universal Dies. These dies fit Reed's 5301PD power drive, Ridgid® 300, 300 Compact, 535, 535 Automatic, 1215, 1822-1, 1224 plus the Reed R811 Universal Die Head. Bevel dies add a chamfer to the outside edge of steel/stainless steel pipe for welding purposes. A bevel die set comes with 1 cutting segment and 3 guide segments.

Reed offers alloy, high speed steel (HSS) and HSS for stainless steel universal dies in NPT or BSPT geometries. All three provide excellent threads. Alloy dies are the most economical. HSS dies last longer than alloy dies because HSS universal dies withstand high temperature without losing hardness. This feature allows them to cut faster than the alloy at room temperature. HSS for stainless steel dies are designed specially for stainless steel pipe. Use with Reed Threadguard Cutting Oil for better and faster threads and longer die life.

### UNIVERSAL DIES

Catalog No.	Item Code	Size	Die Material	Standard Package	Weight	
					lbs	kg
UAN1/2-3/4	05805	1/2 - 3/4" NPT	Alloy	4	1.5	0.7
UAN1-2	05810	1 - 2" NPT	Alloy	4	1.3	0.6
UHN1/2-3/4	05815	1/2 - 3/4" NPT	HSS	4	1.5	0.7
UHN1-2	05820	1 - 2" NPT	HSS	4	1.3	0.6
UHS1/2-3/4	05825	1/2 - 3/4" NPT	HSS for Stainless	4	1.5	0.7
UHS1-2	05830	1 - 2" NPT	HSS for Stainless	4	1.3	0.6
UHB1/2-3/4	05865	1/2 - 3/4" BSPT	HSS	4	1.4	0.6
UHB1-2	05870	1 - 2" BSPT	HSS	4	1.3	0.6

### UNIVERSAL BEVEL DIES

Catalog No.	Item Code	Size Inches	Bevel Angle	Die Material	Standard Package	Weight	
						lbs	kg
★ <b>UBD1-2-375</b>	05875	1 - 2	37.5°	HSS	4	1.4	0.6
★ <b>UBD1-2-450</b>	05877	1 - 2	45°	HSS	4	1.4	0.6
★ <b>UBD1-2-COMBO</b>	05879	1 - 2	37.5° and 45°	HSS	4	1.4	0.6
★ <b>NEW</b>							

5301PD POWER DRIVE ON P. 52  
 THREADING MACHINES ON P. 53  
 THREADGUARD CUTTING OIL ON P. 56

## UNIVERSAL DIE HEAD

### FEATURES

- R811 die head holds any NPT, BSPT thread or bevel angle Reed Universal Dies.
- Works on machines with **through head oiling** capabilities.

R811 Universal Die Head uses universal dies from Reed, Ridgid®, Wheeler-Rex®, Berkley and some private brands. R811 fits Reed's 5301PD Power Drive and Ridgid® machine models 300, 535 and 1822. The R811 universal die head offers easy-to-adjust size selection with manual open/close operation, along with die lubrication slots. R811 does not include universal dies; order them separately.

Catalog No.	Item Code	Capacity		Weight	
		in-nom.	actual O.D. mm	lbs	kg
R811	05380	1/8 - 2	10.3 - 60.3	12.5	5.7

5301PD POWER DRIVE ON P. 52  
 THREADING MACHINES ON P. 53



R811



PIPE TOOLS & VISES  
SINCE 1896

## ENCLOSED RATCHET THREADER SETS

### FEATURES

- High quality dies and dropheads made on CNC machines.
- Dies are alloy steel; heads are malleable iron.
- Sets are the **lightest drophead sets** available, size for size.

For the Enclosed Ratchet Threader Sets, precise dies and dieheads are manufactured on CNC machines. Sets contain dropheads and handle in a compact, reinforced plastic carrying case. Dropheads are available from 1/4" to 2" NPT. Dropheads in these sets fit Reed's 601PD power drive. Dropheads up through 1 1/4" are interchangeable with Ridgid® 11-R and R200, Super-Ego® 600, Virax® 1362, Rothenberger™ Super Cut hand ratchet threaders and Supertronic portable power threaders.

Catalog No.	Item Code NPT	Range Inches	Heads Included	Weight	
				lbs	kg
DH82-5	05198	3/4 - 1 1/4	3	10.9	5.0
DH82-4	05200	1/2 - 1 1/4	4	12.2	5.5
DH82-3	05201	3/8 - 1 1/4	5	13.4	6.1
DH81-2	05202	1/4 - 1	5	12.7	5.8
DH81-3	05203	3/8 - 1	4	10.2	5.1
DH81-4	05204	1/2 - 1	3	10.1	4.6
DH84-4	05222	1/2 - 2	6	22.8	10.4
DH84-5	05223	3/4 - 2	5	21.5	9.8
DH84-6	05224	1 - 2	4	20.0	9.1
DH84-7	05225	1 1/4 - 2	3	18.2	8.3



### ✓ WHY REED?

No alignment problems as dies are enclosed within each drophead. These complete dropheads are less expensive than models requiring individual segment replacement.

DH81-2



## ENCLOSED DROPHEADS

### FEATURES

- Affordable, **ready-to-use** dropheads have the dies in-line every time making them quick to grab and use.
- **Low-cost**, disposable, compact, high-quality dies.

Enclosed Dropheads for NPT fit the Reed 601PD power drive and are interchangeable with Ridgid® 11-R and R200 (through 1 1/4"), Super Ego® 600, Virax® 1362, Rothenberger™ Super Cut hand ratchet threaders and Supertronic portable power threaders. Separate replacement die segments are not available for these disposable, enclosed dropheads because of the low cost of a complete head. Use R11SC ratchet ring and handle with 1/4" - 1 1/4" dropheads. R20SC ratchet ring and handle works with all R11 dropheads, including 1 1/2" and 2", provided that the R20 ADAPTER is used with the smaller 1/4" - 1 1/4" enclosed dropheads.

Catalog No.	Item Code	Description	Weight	
			lbs	kg
R11 1/4NPT	05210	1/4" NPT Drophead	1.2	0.5
R11 3/8NPT	05211	3/8" NPT Drophead	1.2	0.5
R11 1/2NPT	05212	1/2" NPT Drophead	1.3	0.6
R11 3/4NPT	05213	3/4" NPT Drophead	1.4	0.6
R11 1NPT	05214	1" NPT Drophead	1.9	0.9
R11 1 1/4NPT	05215	1 1/4" NPT Drophead	2.0	0.9
R15 1 1/2NPT	05226	1 1/2" NPT Drophead	3.7	1.7
R20 2NPT	05227	2" NPT Drophead	3.4	1.5



R15 1 1/2NPT

R20 ADAPTER

R20SC

R11SC with R11 3/8NPT

## ACCESSORIES

Catalog No.	Item Code	Description	Weight	
			lbs	kg
R11SC	05230	Ratchet Ring & Handle for R11 1/4" - 1 1/4" Dropheads	3.7	1.7
R20SC	05231	Ratchet Ring & Handle for R11 1 1/2" - 2" Dropheads	5.4	2.5
R20 ADAPTER	05234	Adapts R11 1/4" - 1 1/4" Dropheads to R20SC	0.6	0.3

601PD POWER DRIVES ON P. 55



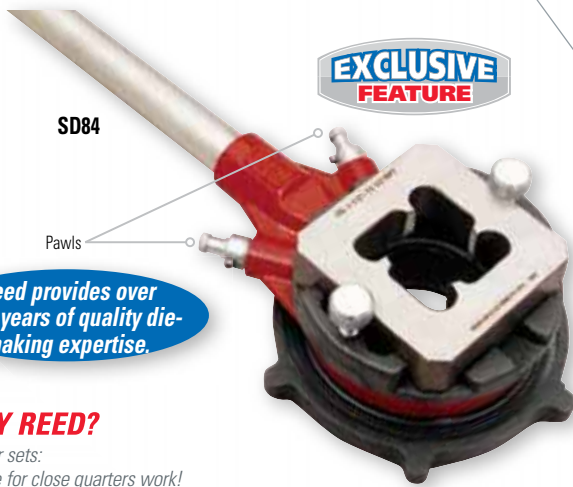

Reed provides over 100+ years of quality die-making expertise.

## ADJUSTABLE GUIDE THREADER SETS

### FEATURES

- **Economical and convenient** because it's only necessary to have a die for each pipe size, not a die and a head.

The Reed adjustable guide system and solid block dies make these the most economical, most convenient and most versatile threader sets on the market. Because the adjustable guide system adjusts to different sizes of pipe, it is only necessary to have a die for each pipe size, not a die plus a head. Other threader sets which require a die and a head for each size take up considerably more room in the toolbox or truck. Further, with two pawls, handle swing is faster on the adjustable guide threader sets – half that of one pawl competitive sets, and best for close quarter work. Adjustable Guide Threader Sets work well on coated pipe because the diehead can fit over the coating and then be tightened down into place. So, there is no need to peel back the coating before threading. This speeds up the job and permits maximum retention of the protective coating to extend pipe life. Adjustable Guide Threader Sets use Reed Block Dies for easy cutting and precise threading. Block dies may also be used as pipe thread chasers to clean-up the threads and remove debris.

### ✓ WHY REED?

Reed threader sets:

- Best choice for close quarters work!
- Threads pipe out of wall with as little as 1" pipe showing.
- 15%-20% less expensive for a full set versus Ridgid® 12-R sets.
- Reed block dies thread both stainless steel and carbon steel, using the same die.

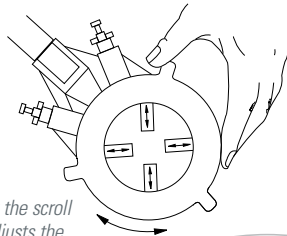

Simply turning the scroll plate easily adjusts the guide fingers over standard or coated pipe to center the die every time.



### SERIES SD81 USES OS (2" X 2") DIES

Catalog No.	Item Code	Range Inches	Dies Included	Weight	
				lbs	kg
SD81-4*	05105	1/2 - 1	3	6.8	3.1

### SERIES SD84 FULL RANGE 1/2" - 2" - USES 2S (4" X 4") DIES

SD84-4*	05151	1/2 - 2	6	29.1	13.2
SD84-5*	05149	3/4 - 2	5	26.1	11.9
SD84-6*	05147	1 - 2	4	23.2	10.6
SD84-7*	05145	1 1/4 - 2	3	19.8	9.0

\*EXCLUSIVE

## BLOCK DIES

### FEATURES

- Reed's block dies thread both carbon steel and stainless steel with **no die change required**.
- Produce the most **precise thread** of any die.
- Block dies are made from hardened and tempered tool steel for **toughness and wearability**.

Only Reed solid block dies have wide throats and extra-fine threads that actually pull the die onto the pipe, even if the burr is large. CNC-milled from solid tool steel, solid block dies are available in NPT threads. Chasers do not have to be individually set. Reed chasers are machined as a unit (not bolted in place) for perfect alignment. Lower cost and less weight are two more good reasons to use Reed solid block dies compared to systems requiring die changes. Use with Reed Threadguard Cutting Oil for better and faster threads and longer die life.

### NPT - SOLID DIES FOR STEEL / STAINLESS STEEL

Catalog No.	Item Code	Size	Block Size Inches	Stocks That Dies Fit	Weight	
					lbs	kg
OSP1/8*	05400	1/8	2 X 2	S81, SD81, 81	71D	0.6 0.3
OSP1/4*	05402	1/4	2 X 2	S81, SD81, 81	71D	0.6 0.3
OSP3/8*	05404	3/8	2 X 2	S81, SD81, 81	71D	0.6 0.3
OSP1/2*	05406	1/2	2 X 2	S81, SD81, 81	71D	0.5 0.2
OSP3/4*	05408	3/4	2 X 2	S81, SD81, 81	71D	0.5 0.2
OSP1*	05410	1	2 X 2	S81, SD81, 81	71D	0.5 0.2
1SP1/4*	05462	1/4	2 1/2 X 2 1/2	S82, SD82, 82	72, 72D	0.9 0.4
1SP3/8*	05464	3/8	2 1/2 X 2 1/2	S82, SD82, 82	72, 72D	0.9 0.4
1SP1/2*	05466	1/2	2 1/2 X 2 1/2	S82, SD82, 82	72, 72D	0.9 0.4
1SP3/4*	05468	3/4	2 1/2 X 2 1/2	S82, SD82, 82	72, 72D	0.9 0.4
1SP1*	05470	1	2 1/2 X 2 1/2	S82, SD82, 82	72, 72D	0.9 0.4
1SP1 1/4*	05472	1 1/4	2 1/2 X 2 1/2	S82, SD82, 82	72, 72D	0.7 0.3
2SP1/2*	05524	1/2	4 X 4	S84, SD84, 84	-	3.0 1.4
2SP3/4*	05526	3/4	4 X 4	S84, SD84, 84	-	2.9 1.3
2SP1*	05528	1	4 X 4	S84, SD84, 84	-	3.4 1.5
2SP1 1/4*	05530	1 1/4	4 X 4	S84, SD84, 84	-	3.2 1.5
2SP1 1/2*	05532	1 1/2	4 X 4	S84, SD84, 84	-	3.0 1.4
2SP2*	05534	2	4 X 4	S84, SD84, 84	-	2.6 1.2

\*EXCLUSIVE

THREADGUARD CUTTING OIL ON P. 56



2SP1 1/2



### ✓ WHY REED?

The Reed block die is machined as a unit to ensure perfect threads and to eliminate the danger of inserting a chaser into the wrong slot.

# VICES

## SECTION 5

*Tripods Vises*

*Pipe Jacks* **NEW**

*Chain Vises*

*Field Pipe Vise*

*Yoke Pipe Vises*

*Utility Workshop Vises*

*Mid-Line Vises*

*Combination Bench & Pipe Vises*

*Brass Vise Jaw Caps*

*Pipe Welding Vise*



*Designed for durability and stability, Reed's R450+ Tripod has a 6" pipe diameter capacity. Patented bowtie jaws provide extra value since they can be rotated before replacement.*

## TRIPOD VISES

### FEATURES

- **Patented**, reversible double-sided bowtie jaws.
- **Very sturdy** due in part to the overlapping hinges on the lower tray and the adjustable tray clamp.

Reed Tripod Vises are among the strongest pipe vises available. R450 and R470 series tripods are manufactured with heavy gauge steel, overlapping hinges, and the best adjustable tray clamp, not a set screw, to keep the lower tray assembly and entire portable workbench tight - even after many hours of use! The heavy-duty design permits use with pipe up to 6" diameter. Tripods fold into a compact shape, have a padded handle grip at the balance point, and boast the lightest weight for the easiest portability of all well-known tripods. **R470+** offers the same great features as Reed's **R450+**, but **R470+** provides a 60 percent larger top tray and a 45° cranking handle. All Reed R450 and R470 series tripods offer double-sided, **patented** "bowtie jaws" for 15% extra value versus purchase of a second jaw set. Reverse the jaws for an extra face and save the cost of buying a replacement set as soon.

Exclusive double-faced jaws on the **R450P** and **R470P** offer one neoprene side for plastic pipe/soft metals and the other regular jaw for metal pipe. Neoprene jaws provide protection against damaging plastic pipe and soft metal pipe. Jaws are easily rotated from plastic pipe to metal pipe position to protect against damage and to maximize productivity.

**R40+** yoke vise with 2 1/2" pipe capacity is built on the same, sturdy tripod vise platform. Double-sided jaws allow for reversal before replacement.

Catalog No.	Item Code	Vise Style	Pipe Capacity		Folded Length		Weight	
			in-nom.	actual O.D. mm	in	mm	lbs	kg
R450+	02306	Chain	1/8 - 6	10 - 178	44	1118	36.3	16.5
R470+	09402	Chain	1/8 - 6	10 - 178	44	1118	42.0	19.1
R450P	04457	Chain	1/8 - 6	10 - 178	44	1118	36.3	16.5
R450C*	04458	Chain	1/8 - 6	10 - 178	44	1118	37.4	17.0
R470P	04459	Chain	1/8 - 6	10 - 178	44	1118	42.0	19.1
R450GB*†	02307	Chain	1/8 - 4	10 - 114	44	1118	27.6	12.5
R450EXPORT	02312	Chain	1/8 - 6	10 - 178	44	1118	36.3	16.5
R40+	02311	Yoke	1/8 - 2 1/2	10 - 75	51	1295	39.1	17.8
R40EXPORT	02313	Yoke	1/8 - 2 1/2	10 - 75	51	1295	39.1	17.8

\*EXCLUSIVE

†NSN# 5120-00-293-1108

Ask for Reed/Ridgid® interchangeable parts list for Ridgid® 450 and 40.

## CLEAN ROOM TRIPOD

The R450C Clean Room Tripod comes with reversible, stainless steel, bowtie jaws with regular jaw teeth on one side and rubber-coated jaws on the other side. The tripod has an anodized aluminum base for corrosion resistance, along with a clear polymer slip tube to inhibit marring the pipe. (The slip tube covers the chain, but is easily removed.) Chain lubricant is food grade, not petroleum based.

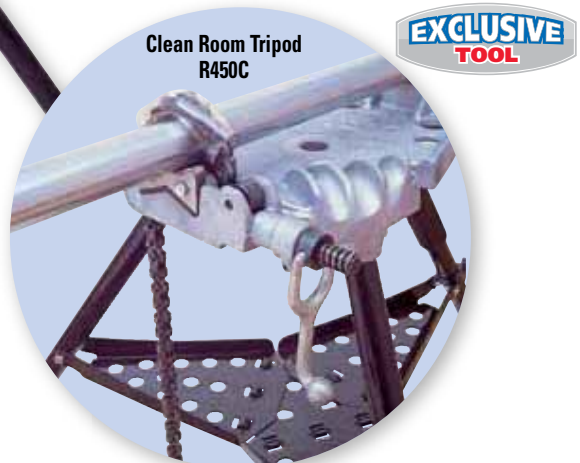

EXCLUSIVE TOOL

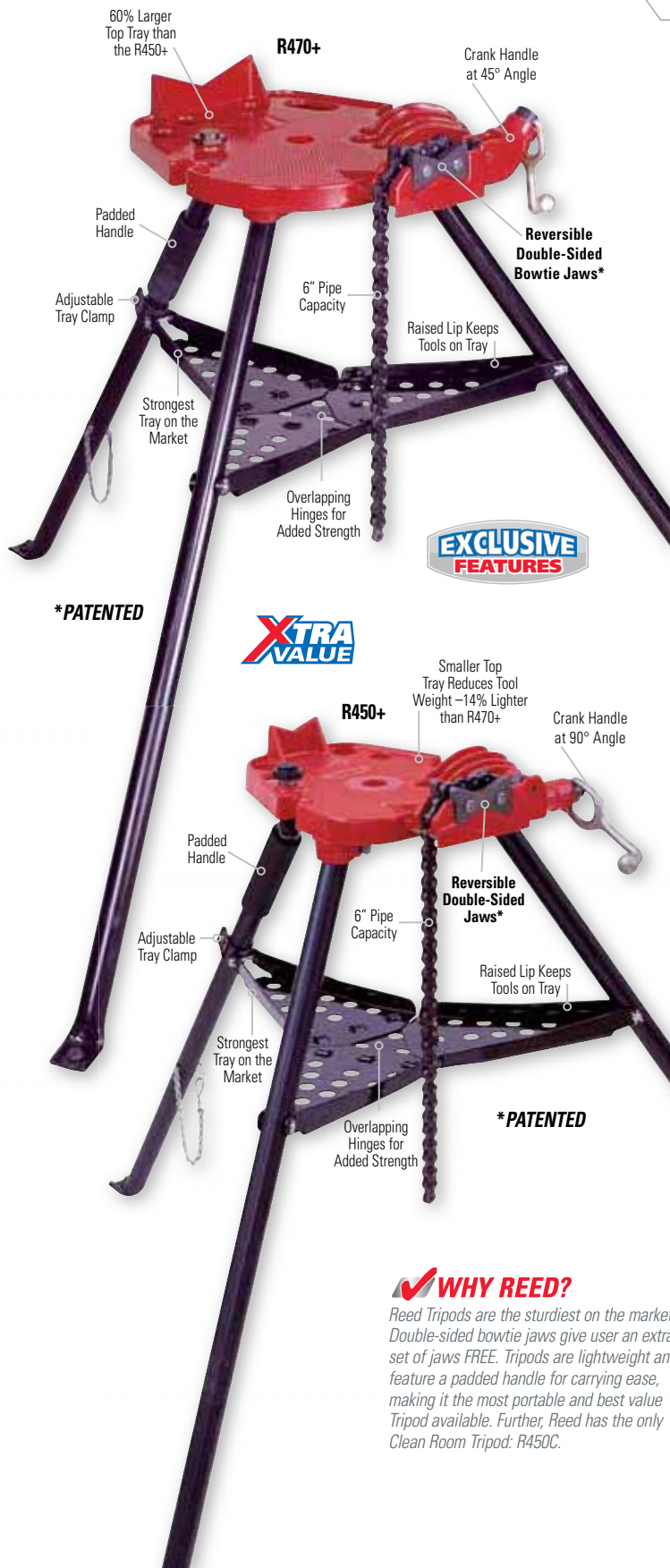

60% Larger Top Tray than the R450+

R470+

Crank Handle at 45° Angle

Padded Handle

Reversible Double-Sided Bowtie Jaws\*

Adjustable Tray Clamp

6" Pipe Capacity

Raised Lip Keeps Tools on Tray

Strongest Tray on the Market

Overlapping Hinges for Added Strength

EXCLUSIVE FEATURES

\*PATENTED

XTRA VALUE

R450+

Smaller Top Tray Reduces Tool Weight -14% Lighter than R470+

Crank Handle at 90° Angle

Padded Handle

Reversible Double-Sided Jaws\*

Adjustable Tray Clamp

6" Pipe Capacity

Raised Lip Keeps Tools on Tray

Strongest Tray on the Market

Overlapping Hinges for Added Strength

\*PATENTED

### ✓ WHY REED?

Reed Tripods are the sturdiest on the market. Double-sided bowtie jaws give user an extra set of jaws FREE. Tripods are lightweight and feature a padded handle for carrying ease, making it the most portable and best value Tripod available. Further, Reed has the only Clean Room Tripod: R450C.



PIPE TOOLS & VISES  
SINCE 1896

VICES



## MORE ABOUT TRIPODS...

**R450+:** patented, double-sided, steel bowtie jaws (450J) for up to 6" metal pipe; chain vises are best for holding both standard and irregular shapes

**R470+:** patented, double-sided, steel bowtie jaws for up to 6" metal pipe; 60% larger top tray than R450+ and 45 degree crank handle

**R450P & R470P:** for plastic pipe up to 6"; one patented, neoprene jaw (450PJ) set for plastic/soft metal; one side of double-sided bowtie jaw for metal pipe

**R450C:** patented stainless steel jaws, with rubber on one side; anodized (not painted) aluminum base for corrosion protection; clear slip tube over chain; food grade lubricant; good for clean room use

**R450GB:** aluminum legs for weight-critical field uses; up to 4" pipe capacity, no ceiling jack screw also lowers weight for easier portability

**R450EXPORT:** unassembled R450+ designed for low cost international shipment

**R40+:** two-sided lower jaws for up to 2 1/2" metal pipe; best Tripod for high torque applications like hand or power drive threading

**R40EXPORT:** unassembled R40+ designed for low cost international shipment



## PIPE JACKS

### FEATURES

- 1" safety zone created by patented internal safety stop to protect against operator injuries.
- Three head options available.
- JFV folds for portability and storage.

Convenient adjusting screw and a hardened steel locking ring are two features that make these pipe jacks last for many years of use. Patented internal safety stop on the pipe jacks creates a 1" safety zone and prevents injuries to hands and fingers. JFV Folding Pipe Jack offers same great features plus legs fold for compact storage and easier portability. Roller head jack JH2R has extra wide bearing for great strength and tool life. Roller head jacks are preferred when circumstances call for the pipe to be turned for fabrication such as welding or roll grooving. Lower cost, v-head JHV is suitable for most ordinary pipe support needs. Adjusting screw gives proper working height. Outer surfaces are powder painted or zinc phosphate plated to resist corrosion. Ball transfer head JTA attaches to Ridgid® and Sumner® models while all Reed heads and bases interchange with Sumner® and Greenlee®.

Catalog No.	Item Code	Description	Height Adj.		Weight Capacity		Pipe Capacity		Weight	
			in	mm	lbs	kg	in	mm	lbs	kg
JHV*	06350	V-Head High Jack	28 - 49	711-1245	2000	909	1/8 - 36	3 - 914	22.8	10.4
JH2R*	06352	Roller Head High Jack	28 - 49	711-1245	2000	909	1 1/4 - 24	32 - 610	25.0	11.4
JFV	06370	Folding V-Head Pipe Jack	28 - 49	711-1245	2500	1135	1/8 - 24	3 - 610	25.0	11.4

★ JFV  
★ NEW

\*6 or more pieces in any combination must ship by truck freight.

### ALTERNATE HEADS

The 1,000 lb (454 kg) capacity ball transfer attachment (JTA) with replaceable ball casters bolts to either side of v-head models. Note that use of the JTA head decreases the overall weight capacity of the jack. V-HEAD and ROLLER HEAD options are interchangeable on any of the three pipe jacks Reed offers.

Catalog No.	Item Code	Description	Weight Capacity		Pipe Capacity		Weight	
			lbs	kg	in	mm	lbs	kg
JTA	06351	Ball Transfer Head (pair)	1000	455	3/8 - 12	10 - 300	4.6	2.1
V-HEAD	96371	V-Head	2000 or 2500		1/8 - 36	3 - 914	6.4	2.9
ROLLER HEAD	96372	Roller Head	2000 or 2500		1/4 - 24	32 - 610	9.9	4.5

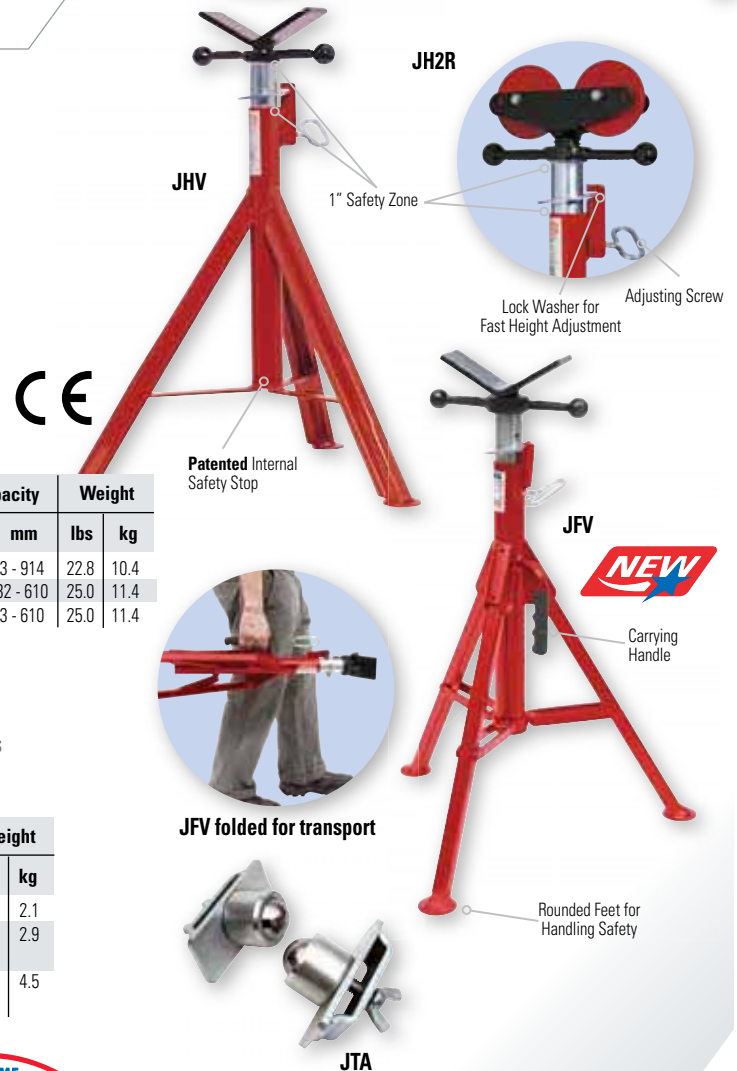

**EXCLUSIVE SIZE**



CV4

**✓ WHY REED?**

Reed chain vises save money because they come standard with three-sided jaws. Only Reed has a 12" capacity chain vise.



**XTRA VALUE**

**EXCLUSIVE FEATURES**

## CHAIN VISES

### FEATURES

- **Three-sided jaws** are standard on Reed chain vises, giving the user extra value.

Chain Vises permit the holding of irregular shapes and provide an excellent cost-for-capacity value. Reed chain vises are the fastest to use: two turns to open or close. These chain vises are the strongest available and the hardened tool steel jaws are triple-faced. This permits two rotations before jaw replacement, providing extra value with three total jaw face sets.

To make conversion to a Reed vise simpler, **CV4RHP** features mounting holes to fit spots already drilled for a Ridgid® vise.

Catalog No.	Item Code	Pipe Capacity		Weight	
		in-nom.	actual O.D. mm	lbs	kg
CV2	02510	1/8 - 2 1/2	10 - 75	9.3	4.2
CV4	02520	1/8 - 4	10 - 114	14.6	6.6
CV4RHP*	02525	1/8 - 4	10 - 114	14.6	6.6
CV5	02530	1/8 - 5	10 - 141	15.5	7.0
CV6	02540	1/4 - 6	14 - 168	28.4	12.9
CV8	02550	1/2 - 8	21 - 219	46.3	21.0
CV12*	02560	3/4 - 12	25 - 335	111.0	50.5



**\*EXCLUSIVE SIZE**

\*Features drilled holes to fit Ridgid® vise hole pattern.

## FIELD PIPE VISE

### FEATURES

- **Designed for heavy-duty**, pre-trench or field work.
- Perfect for supporting work during cutting operations using Reed Hinged Cutters, Rotary™ Cutters and the Universal Pipe Cutter.

Field Pipe Vise holds pipe up to 20" (500 mm) pipe diameter. More pipe capacity than other vises and 2,000 lb (909 kg) vise capacity, yet weighs only 22 lbs (10 kg) without legs and backbone. Super choice for pre-trench work and above ground cuts. Excellent flexibility achieved in height and length of vise appropriate to application as customer may cut own pipe for legs and backbone. Alternatively, order **FPVBLS** for user convenience.

Catalog No.	Item Code	Pipe Capacity		Weight	
		in-nom.	actual O.D. mm	lbs	kg
FPV20*	06027	2 - 20	50 - 500	22	10

### LEGS & BACKBONE

Catalog No.	Item Code	Description	Weight	
			lbs	kg
FPVBLS	96014	Legs (40" each) and Backbone (6 ft. long)	50.0	22.7

\*To create legs and backbone, use 1 1/2" nominal diameter Sch. 40 steel pipe.



FPV20 and FPVBLS

Large Diameter Pipe? No Problem.

## YOKE PIPE VISES

### FEATURES

- Best choice for all pipe work because there are **four points of contact** for the jaws to grip the pipe.
- Reed yoke vises are **very solidly built**, and provide the powerful grip required for demanding pipe fitting and threading operations.

Yoke Pipe Vises permit the strongest jaw-to-jaw gripping of pipe for high-torque applications like threading. Reed yoke vises are made of ductile or malleable iron and have hardened, high carbon steel jaws for toughness and long life. These yoke vises easily convert from right- to left-hand operation and back, making it simple to work around obstructions or to accommodate right- or left-hand user preference.

Catalog No.	Item Code	Pipe Capacity		Weight	
		in-nom.	actual O.D. mm	lbs	kg
R0	02420	1/8 - 2	10 - 60	6.7	3.0
R1	02430	1/8 - 2 1/2	10 - 75	9.8	4.5
R2	02440	1/8 - 3 1/2	10 - 102	16.3	7.4
R3	02450	1/8 - 4 1/2	10 - 127	25.0	11.4
64	02460	1/4 - 6	14 - 168	49.0	22.3
65*	02470	1 - 8	32 - 219	80.0	36.4
66*	02480	1 1/2 - 12	48 - 335	168.0	76.4



**\*EXCLUSIVE**

**✓ WHY REED**

Double-faced lower jaws on R Series vises allow reversal before replacement.



R1

**EXCLUSIVE FEATURES**

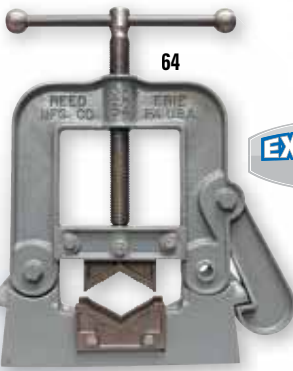

64

**EXCLUSIVE SIZES**



R Series Jaws

**✓ WHY REED**

Only Reed makes yoke vises in 8" and 12" capacities.





PIPE TOOLS & VISES  
SINCE 1896

VICES



## UTILITY WORKSHOP VISES

### FEATURES

- Vise features a **swivel base** for flexibility.
- **Good value**, reliable model for the price.
- Rubber washers on the handle reduce finger pinching injuries.

Heavy-duty design strengthens this ideal utility workshop vise. Cast vises with pipe jaws, anvil and horn feature a swivel base with positive locking in addition to replaceable, hardened steel, serrated jaw facings for user convenience. **26B** is the strongest vise of the utility vise line; consider it for larger workloads. These quality vises are imported.

Catalog No.	Item Code	Throat Depth*		Jaw Width		Jaws Open <sup>Ω</sup>		Weight	
		in	mm	in	mm	in	mm	lbs	kg
24 1/2C**	01522	2 1/2	64	4 1/2	115	4	102	18.0	8.2
25 1/2C**	01532	3	76	5 1/2	140	5	127	27.0	12.3
26 1/2C**	01542	3 3/8	86	6 1/2	165	6	152	41.0	18.6
26B**	01545	4 3/16	120	6	150	6	152	60.0	27.3

\*See illustration

Ω See illustration

\*\*3 or more pieces in any combination must ship by truck freight.

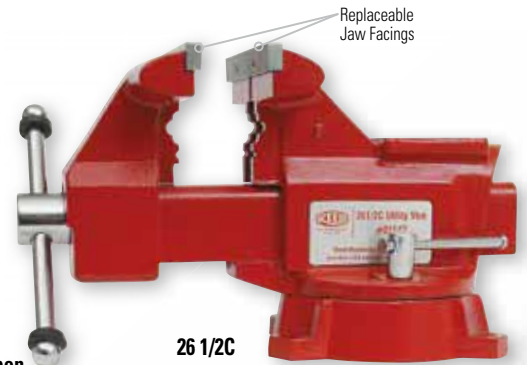

26 1/2C

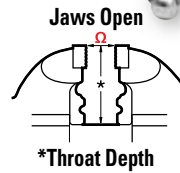

Swivel-base models feature positive-locking base.

## MID-LINE VISES

### FEATURES

- Mid-level pricing for a **well-made, durable vise**.
- The vise screw and nut are enclosed to keep out dirt, and they are permanently lubricated.
- Rubber washers on the handle reduce finger pinching injuries.

Mid-line vises are of strength and price between the Combination Vise and Utility Vise. Design features a machined work surface. The main screw and nut are totally enclosed to keep out dirt and eliminate wear. Straight line pull through the bar and the body greatly reduces wear on main vise nut. Mid-line vises are imported and have replaceable, hardened steel jaw facings and replaceable pipe jaws which are serrated and heat-treated. The base swivels 360° and has two swivel base locking clamps with toothed engagement.

Catalog No.	Item Code	Throat Depth*		Jaw Width		Jaws Open <sup>Ω</sup>		Pipe Capacity in-nom.	Weight	
		in	mm	in	mm	in	mm		lbs	kg
704**	01385	3.45	88	4	102	4.5	114	1/2 - 2	36.0	16.4
705**	01387	3.75	95	5	127	5.5	140	1/4 - 2 1/2	47.0	21.4
706**	01389	4.10	104	6	152	5.7	146	1/4 - 3 1/2	61.0	27.7

\*See illustration

Ω See illustration

\*\*3 or more pieces in any combination must ship by truck freight.

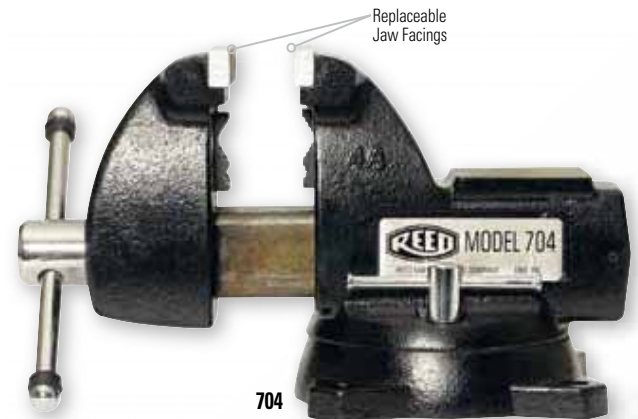

704

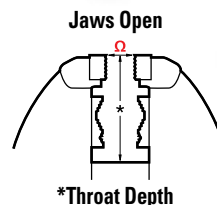

Swivel-base models feature positive-locking base.

### ✓ WHY REED?

Vises have enclosed screw assembly for all-weather protection.

## COMBINATION BENCH & PIPE VISES

### FEATURES

- **Top-of-the line vise** for maximum durability.
- **Deepest throat** of all Reed bench vises.

Designed to provide decades of service, these cast Combination Bench & Pipe Vises carry Reed's lifetime warranty. Steel pipe jaws made of heat-treated, hardened steel are double-sided to reverse jaws once before replacement. Jaw facings are replaceable, too. This yields long jaw life. Combination vises are designed with maximum throat depth for greater clamping action to hold large parts. Forged steel, geared clamp bolt on swivel base maintains positive lock to avoid slippage under heavy pressure.

Catalog No.	Item Code	Throat Depth*		Jaw Width		Jaws Open <sup>Ω</sup>		Pipe Capacity in-nom.	Weight	
		in	mm	in	mm	in	mm		lbs	kg
2CA	01360	5 3/8	137	4 1/2	114	5	127	1/8 - 3 1/2	60.0	27.3
3CA	01370	6 1/4	159	5	127	6	152	1/8 - 4 1/2	95.0	43.2
4CA	01380	7 1/8	181	6	152	10	254	1/8 - 6	157.0	71.4

\*See illustration

Ω See illustration

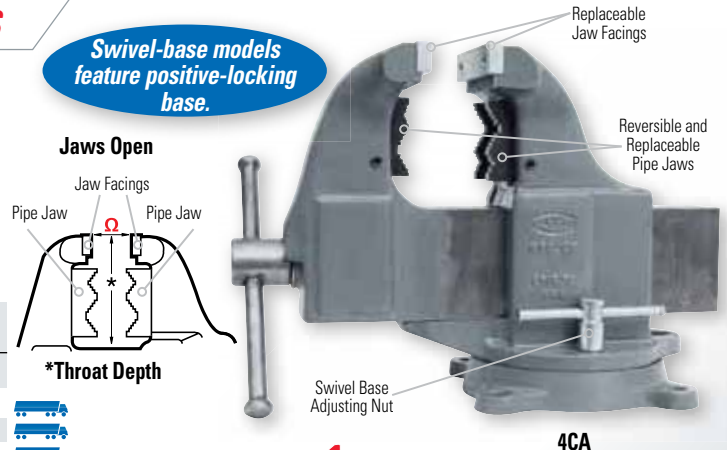

4CA

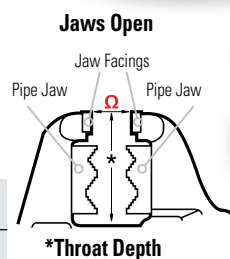

Swivel-base models feature positive-locking base.

### ✓ WHY REED?

Only Reed has backed up its bench vises with a Lifetime Warranty for over 100+ years.



Ridgid® is a registered trademark of Ridgid, Inc. and is not associated with Reed Manufacturing Company.

www.reedmfgco.com

Ears

VC4 on  
4CA vise

## BRASS VISE JAW CAPS

### FEATURES

- Universal jaw facings fit simply by bending back the "ears."

Protect fine work in vises with universal serrated jaw facings by using Brass Vise Jaw Caps. Convert any Reed vise jaw facing to a smooth surface with proper size brass caps. Caps available for 4"-6" jaw width. As universal caps, these also fit vises by Wilton®, among others.

Catalog No.	Item Code	Jaw Width		Weight	
		in	mm	lbs	kg
VC4	01570	4"	102	1.0	0.5
VC5	01580	5"	127	1.8	0.8
VC6	01590	6"	152	2.7	1.2

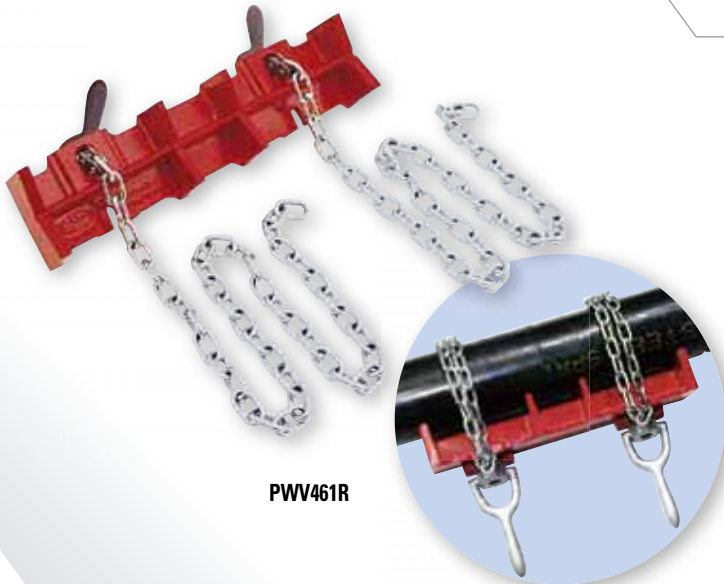

PWV461R

## PIPE WELDING VISE

### FEATURES

- Portable vise for welding projects.

Reed Pipe Welding Vise offers positive alignment for the most common pipe welding needs. Ductile iron **PWV461R** vise has machined surfaces that ensure correct meeting of straight pipe. Screws and chains allow easy, firm clamping.

Catalog No.	Item Code	Capacity		Length		Weight	
		in-nom.	actual O.D. mm	in	mm	lbs	kg
PWV461R	02491	1/2 - 8	21 - 225	15	381	16.4	7.5

# REED

## AROUND THE JOBSITE & AROUND THE WORLD

Serving the world of hard-working tradesmen and women from our Erie, Pennsylvania location since 1896, Reed Manufacturing is still family-owned and operated, producing quality pipe tools and vises. Sold worldwide exclusively through local distributors, Reed tools are the first choice of professionals everywhere.





PIPE TOOLS & VISES  
SINCE 1896

# REED DISTRIBUTION

*Reed sells only through traditional distributors, and for very good reasons.*

*Good distributors add value for users of Reed tools in these important ways:*

*Etna Supply Co.  
Grand Rapids, MI*



*Supertech Group  
UAE*



*Jobsite Supply  
San Diego, CA*



*NEXT Supply  
Mississauga, ON  
Canada*



*Northwest Supply Co., Northport, AL*

*Fort Worth Bolt & Tool  
Fort Worth, TX*

## LOCAL STOCK

Local distributors, both in the U.S. and worldwide, provide readily available stock for Reed tool users. Local distributors help to avoid costly delays when tools are needed immediately to get the job done right!

✓ **WHY REED?** Reed ships over 95% of its orders complete within three working days, with same-day expediting if necessary; very low prepaid freight requirements, with no minimum orders, standard packs or drop ship penalties that slow service and add costs. All Reed products are marketed through traditional distributors: NO BIG BOXES/MASS MERCHANTS.

## PRODUCT INFORMATION

Local distributors provide information and arrange demonstrations on both existing and new, quality tools.

✓ **WHY REED?** Reed has developed new, problem-solving products each and every year for over 100 years.

## PROBLEM SOLVING

Local distributors provide problem-solving efforts like product recommendations, order expediting, and replacement part identification on Reed tools. Distributors also can arrange visits by factory representatives.

✓ **WHY REED?** Reed factory and field service personnel are by far the most responsive in the industry to distributor and tool user requests. Reed people do not feel that a sale is successfully concluded unless the transaction is smooth and error-free, and the final customer is completely satisfied.



*RIDE Colombia  
Bogotá, Colombia*



*Dixie Construction  
Atlanta, GA*



# WRENCHES

SECTION

# 6

Pipe Wrenches

Aluminum Pipe Wrenches

Chain Tongs

Chain Wrenches

Strap Wrenches

Adjustable Wrenches

Comfort Grip - Adjustable Wrenches

Torque Wrenches for Cast Iron Soil Pipe

Thru-Bolt™ Ratchet Wrenches & Sockets

Thru-Bolt™ Larger Ratchet Wrench & Sockets

Square Drive Ratchet Wrenches **NEW**

Extended Sockets **NEW**

Thru-Bolt™ 4-in-1 Ratchet Wrench **NEW**

Thru-Bolt™ Dual Socket Ratchet Wrenches **NEW**

Basin Wrenches

One Hand Meter Wrenches

Comfort Grip - One Hand Meter Wrench

Operator's Wrench

Valve Packing Wrenches

Valve Wheel Wrenches

Smooth Jaw Wrenches

Hydrant Wrenches

Ratcheting Hydrant Wrench



The versatile RF10 Operator's Wrench includes a hook-end to turn VO-size valve wheels and also sports a regular pipe wrench at the opposite end. It's a great tool to keep handy through one's shift.



PIPE TOOLS & VISES  
SINCE 1896

## PIPE WRENCHES HEAVY-DUTY

### FEATURES

- Designed to withstand the heaviest demands.
- **Solid steel pin** in the heel jaw strengthens Reed's wrenches.

Reed Pipe Wrenches are the most popular pipe wrench style. High-tensile ductile iron handle and hardened, forged alloy steel parts are designed to withstand the heaviest demands. Offset pipe wrenches have similar construction and provide longer swing and better access to hard-to-reach places.

### STRAIGHT

Catalog No.	Item Code	Pipe Capacity		Length		Weight	
		in-nom.	actual O.D. mm	in	mm	lbs	kg
RW8	02120	1/8 - 1	10 - 35	8	203	1.0	0.4
RW10	02130	1/8 - 1 1/2	10 - 49	10	254	1.9	0.8
RW12	02140	1/8 - 2	10 - 61	12	305	2.9	1.3
RW14*	02150	1/4 - 2	14 - 61	14	356	3.6	1.6
RW18	02160	1/4 - 2 1/2	14 - 77	18	457	6.1	2.8
RW24	02170	1/4 - 3	14 - 90	24	610	9.9	4.5
RW36	02180	1/4 - 5	14 - 141	36	914	15.6	7.1
RW48	02190	1 1/2 - 6	48 - 167	48	1219	32.7	14.9

### 45° OFFSET

RW010	02220	1/8 - 1 1/2	10 - 49	10	254	1.7	0.8
RW014	02230	1/4 - 2	14 - 61	14	356	3.5	1.6

\*AWWA Approved for Tapping Contest.

### ✓ WHY REED?

No minimum order quantities or standard package requirements on wrenches or parts.



STRAIGHT



OFFSET

Reed pipe wrench parts are interchangeable with most major, heavy-duty U.S. brands (including Ridgid®) of straight, 45° offset and end wrenches from 18" - 48". Parts available include hook jaw, heel jaw and pin, coil and flat spring, and nut.

## 60" PIPE WRENCH PARTS

### FEATURES

- **Alloy steel** replacement parts meet the most demanding applications.
- Direct replacement parts for the Ridgid® 60" iron pipe wrench.
- Heel jaw fits both hook and handle.
- Forged alloy steel hook jaws are hardened and tempered for **toughness and wearability**.

Catalog No.	Item Code	Description	Replaces Ridgid® Part No.	Weight	
				lbs	kg
RW60B	92169	Hook Jaw Assembly	31770	12.5	5.7
RW60C	92179	Heel Jaw & Pin	31775	1.2	0.5

RW60C



## ALUMINUM PIPE WRENCHES HEAVY-DUTY

### FEATURES

- Light and strong.
- **Titanium-aluminum** alloy handle is heat-treated for maximum strength.
- Offset wrenches provide **longer swing** and **better access** to hard-to-reach places.

Reed aluminum pipe wrenches offer tighter tolerances for a snugger wrench, "beefier" housing for a stronger wrench, and textured paint for a better grip. Offset aluminum wrenches have similar construction to RW series wrenches with forged, alloy steel hook jaw and heel jaw, along with longer swing for hard-to-reach places.

### STRAIGHT

Catalog No.	Item Code	Pipe Capacity		Length		Weight	
		in-nom.	actual O.D. mm	in	mm	lbs	kg
ARW10	02093	1/8 - 1 1/2	10 - 49	10	254	1.1	0.5
ARW14	02095	1/4 - 2	14 - 61	14	356	2.1	1.0
ARW18	02097	1/4 - 2 1/2	14 - 77	18	457	3.5	1.6
ARW24	02099	1/4 - 3	14 - 90	24	610	5.7	2.6
ARW36	02101	1/4 - 5	14 - 141	36	914	10.9	5.0
ARW48	02102	1 1/2 - 6	48 - 167	48	1200	18.5	8.4

### 90° OFFSET

ARW014	02202	1/4 - 2	14 - 61	14	350	1.9	0.9
ARW018	02204	1/4 - 2 1/2	14 - 77	18	450	3.2	1.5



STRAIGHT

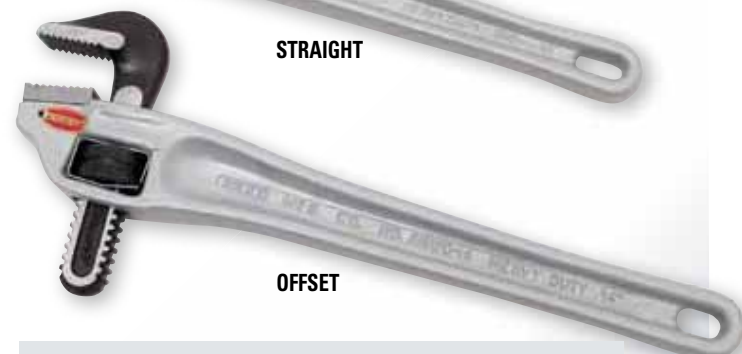

OFFSET

Reed aluminum pipe wrench parts are interchangeable with most major U.S. brands (including Ridgid®) of straight, 90° offset and end wrenches from 18" - 48". Parts available include hook jaw, heel jaw and pin, coil and flat spring, and nut.

Ridgid® is a registered trademark of Ridgid, Inc. and is not associated with Reed Manufacturing Company.



## CHAIN TONGS HEAVY-DUTY

### FEATURES

- Long-lasting chain tongs for all types of pipe fitting jobs from oil field to general work.

Durable Chain Tongs consist of solid, full-length handles of forged steel and strong, flat link chains. Hardened steel jaws are replaceable and interchangeable with major brands, including Ridgid®. As with Reed and other brands, single- and double-end chain tongs require different chains, jaws and bolts.

### DOUBLE-END

Catalog No.	Item Code	Pipe Capacity		Length		Chain Length		Breaking Strain lbs	Weight	
		in-nom.	actual O.D. mm	in	mm	in	mm		lbs	kg
R229	06329	1/4 - 2 1/2	14 - 75	27	686	18	445	13,800	10	4.5
R231	06331	3/4 - 4	27 - 114	37	940	23	572	17,600	19	8.6
R233	06333	1 - 6	33 - 168	44	1118	32	813	20,000	29	13.2
R235	06335	1 1/2 - 8	48 - 219	51	1283	41	1029	22,000	34	15.5
R237	06337	2 - 12	60 - 324	65	1638	56	1410	31,000	59	26.8

### SINGLE-END

	R215	06315	4 - 18	114 - 457	88	2235	75	1892	56,000	149	67.7
---	------	-------	--------	-----------	----	------	----	------	--------	-----	------





## CHAIN WRENCHES HEAVY-DUTY

### FEATURES

- Useful for all types of pipe fitting, from waterworks to industrial to oil and gas.
- Chain wrenches provide safe, reliable and **high torque**.
- Reed offers **more sizes** than any competitor with chain wrenches to fit from 1/8" all the way up to 18" diameters.

Use a chain wrench to turn any shape in close quarters. Dual reversible (and therefore more economical) jaws permit ratchet action in either direction without removing the chain wrench from the pipe. Reed's unique in-line handle and jaw design allows the user to rest the wrench on the pipe while placing the chain in the chain slots.

Catalog No.	Item Code	Pipe Capacity		Handle Length		Max. O.D.		Chain Tensile Strength lbs	Weight	
		in-nom.	actual O.D. mm	in	mm	in	mm		lbs	kg
WA14	02040	1/8 - 2	10 - 60	14	362	4.6	117	5,500	3.2	1.5
WA18	02050	1/4 - 2 1/2	14 - 75	18	445	5	127	9,150	6.0	2.7
WA24	02060	1/4 - 3	14 - 90	24	610	5.8	147	9,150	8.4	3.8
WA36	02070	1/2 - 4 1/2	21 - 127	33	832	7.1	180	14,350	16.4	7.5
WA48*	02080	1 - 6	33 - 168	44	1118	8.5	216	20,500	29.4	13.4
WA60*	02090	1 1/2 - 8	48 - 225	46	1175	11	279	23,700	47.0	21.4
 WA72*	02092	2 1/2 - 12	73 - 324	46	1175	13	330	29,150	80.0	36.4
 WA84*	02094	2 1/2 - 18	73 - 457	46	1175	18	457	29,150	90.0	40.9

\*EXCLUSIVE SIZE

### ✓ WHY REED?

Reed chain wrenches offer by far the most sizes and are longer lasting with up to twice as many chain slots as any competitive tool. This spreads the force across more chain slots and provides greater operator safety.

## STRAP WRENCHES

### FEATURES

- **Gripping power** without scratching or deforming plastic or polished metal pipe.
- Ductile iron handle and **extremely strong polyester strap** yield a durable wrench.

Use strap wrenches on plastic pipe, filters, or any slick or smooth surface. Strap wrenches work well on irregular shapes, too. Reed's extra-strong, coated-polyester strap provides slip resistance and durability along with protecting plastic or polished metal pipe from scratches or deformities. **SW12A30** and **SW18A48** have extra-long straps for increased leverage on large diameters.

Catalog No.	Item Code	Pipe Capacity		Tube Capacity		Handle Length		Weight	
		in-nom.	actual O.D. mm	actual O.D. in	actual O.D. mm	in	mm	lbs	kg
SW12A	02248	1/8 - 2	10 - 63	3 1/2	90	12	305	1.6	0.7
SW12A30	02247	1/8 - 5	10 - 127	7 1/2	190	12	305	1.7	0.8
SW18A	02249	1 - 5	33 - 127	6	150	18	458	2.6	1.2
SW18A48	02255	1 - 12	33 - 305	12	300	18	458	2.9	1.3
SW24A	02250	2 - 12	60 - 324	14	350	24	610	5.1	2.3





PIPE TOOLS & VISES  
SINCE 1896

## ADJUSTABLE WRENCHES

### FEATURES

- Triple-coated nickel-chrome exterior finish to resist rust.
- Precision-ground jaw slides make for the **smoothest action**.

With hardened and tempered, forged alloy steel handles, phosphorous bronze springs and a triple-coated nickel-chrome exterior finish, Reed Adjustable Wrenches are constructed of the finest materials available. Precise, parallel jaw surfaces ensure good grip of nuts. 22° 30' angle allows for closest quarter work on hex nuts. Slip-resistant handle, lower cost, blackened adjustable wrenches of the same construction are also available.

### CHROME

Catalog No.	Item Code	Capacity		Length		Weight	
		in-nom.	actual O.D. mm	in	mm	lbs	kg
CW4	02199	7/16	13	4	114	0.1	0.05
CW6	02201	3/4	20	6	152	0.3	0.1
CW8	02203	7/8	25	8	203	0.5	0.2
CW10	02205	1 1/8	30	10	254	0.8	0.4
CW12*	02207	1 5/16	35	12	305	1.4	0.6
CW15	02209	1 7/16	40	15	381	2.7	1.2
CW18	02211	2 1/16	50	18	457	4.7	2.1
CW24	02218	2 1/2	63	24	610	7.9	3.6

### BLACKENED

CWB6	02212	3/4	20	6	152	0.3	0.1
CWB8	02213	7/8	25	8	203	0.5	0.2
CWB10	02214	1 1/8	30	10	254	0.8	0.4
CWB12	02215	1 5/16	35	12	305	1.4	0.6
CWB15	02216	1 7/16	40	15	381	2.7	1.2
CWB18	02217	2 1/16	50	18	457	4.7	2.1

\*AWWA Approved for Tapping Contest.



**✓ WHY REED?**  
Jaw slides are precision ground to provide smooth action.

## COMFORT GRIP – ADJUSTABLE WRENCHES

### FEATURES

- Same precision as Reed's adjustable wrenches with an **added grip** for more secure handhold.
- To increase **ergonomics**, Reed comfort grips are thicker and harder than most.

Use the best adjustable wrenches in new ways: a plastic dip coating gives ergonomic advantages of greater comfort and less hand fatigue. The plastic grip is also stickier than the steel handle, which combines with the larger diameter to make these wrenches easier to grip while working. Parallel jaw surfaces ensure good grip of nut. 22° 30' angle allows for closest quarter work on hex nuts.

Catalog No.	Item Code	Capacity		Length		Weight	
		in-nom.	actual O.D. mm	in	mm	lbs	kg
CW6GRIP	02906	3/4	20	6	152	0.3	0.1
CW8GRIP	02908	7/8	25	8	203	0.5	0.2
CW10GRIP	02910	1 1/8	30	10	254	1.0	0.5
CW12GRIP	02912	1 5/16	35	12	305	1.5	0.7

NOTE: These are comfort grips only, they are not made for electrical insulation.



**✓ WHY REED?**  
Reed puts a thicker, harder, more comfortable, longer lasting coating on the smoothest, most exact adjustable wrenches available.

## TORQUE WRENCHES FOR CAST IRON SOIL PIPE

### FEATURES

- Ratcheting action is fast and maximum torque is preset.
- Guaranteed accurate to ±10%.

Torque Wrenches for Cast Iron Soil Pipe are engineered to provide recommended torque on No-Hub® soil pipe connections/fitting clamps. Torque wrenches can also loosen clamp screws and are designed for hand comfort. Ratcheting action is fast and maximum torque is preset. It releases with a click when reached for secure, leak free joints.

Catalog No.	Item Code	Hex Size	Torque		Length		Weight	
			inch pounds	Newton meter	in	mm	lbs	kg
TW516	02298	5/16"	60	6.8	6	152	0.9	0.4
TW38	02300	3/8"	80	9.0	5.8	148	0.9	0.4

SOIL PIPE CUTTERS ON P. 14

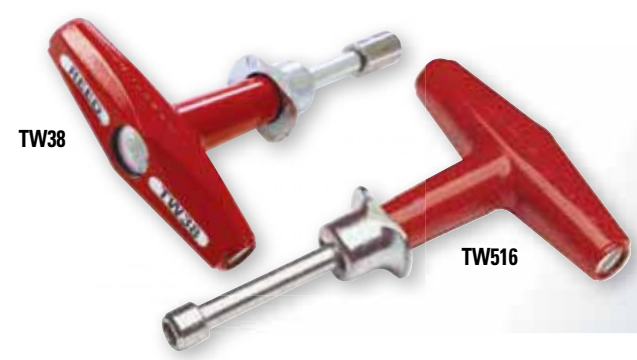



L564 and L20

**✓ WHY REED?**

L564 features a "quick release" button along with an adjustable handle for hard-to-reach spots.



L515 Set



L564

L150

L51



L500 and L17 on Service Saddle

**✓ WHY REED?**

The Reed Thru-Bolt™ ratchet handles and sockets substantially reduce the time required to tighten or remove nuts so assembly time and cost are cut considerably.



L511M

## THRU-BOLT™ RATCHET WRENCHES & SOCKETS - STANDARD/INCH SIZES

**FEATURES**

- Reed offers individual sockets, handles and complete sets.

Reed Thru-Bolt™ ratchet wrenches work faster than pipe wrenches or adjustable wrenches for tightening or loosening nuts on long, threaded bolts of service saddles, repair clamps, flanges, mechanical couplings, etc. Individual ratchet wrench handles are available, made with traditional malleable iron or lower cost steel stampings. Individual sockets made of strong, cast ductile iron are available, as well as whole sets, and fit all ratchet wrench handles listed mid-page.

DUAL SOCKET RATCHET WRENCHES ON P. 74

LARGER RATCHET WRENCH & SOCKETS ON P. 73

**THRU-BOLT™ UTILITY SETS\***

Catalog No.	Item Code	Handle	Sockets	Weight	
				lbs	kg
L511	02284	L500	7/8", 15/16", 1 1/8", 1 1/4" and corp.	6.8	3.1
L514	02286	L564	3/4", 7/8", 15/16", 1 1/16", 1 1/8", 1 1/4" with adjustable angle handle	9.5	4.3
L515	02285	L500	3/4", 7/8", 15/16", 1 1/16", 1 1/8", 1 1/4" and corp.	8.9	4.0

\*Sets include steel storage case

**INDIVIDUAL HEX SOCKETS-INCHES**

Catalog No.	L10	L12	L14	L15	L16	L17	L18	L20	L25
Item Code	02264	02265	02266	02267	02268	02269	02270	02271	02272
Hex Size	5/8" *	3/4"	7/8"	15/16"	1"	1 1/16"	1 1/8"	1 1/4"	Corp.

\*MegaLug® coupling bolts

**RATCHET WRENCH HANDLES (FOR BOTH STANDARD & METRIC)**

**FEATURES**

- Choose from malleable iron cast handles or lower cost, steel stamped handles.
- "Quick release" socket retention permit fast socket changes.
- L564 features an adjustable handle for hard-to-reach spots.

Catalog No.	Item Code	Type		Handle Length		Weight	
		Handle	Socket Retention	in	mm	lbs	kg
L50	02258	Cast	Retaining Ring	11	280	1.5	0.7
L51	02259	Cast	Retaining Ring	13	330	1.7	0.8
L500	02260	Cast	Quick Release	13	330	1.7	0.8
L150	02261	Stamped	Retaining Ring	11	280	1.4	0.6
L151	02262	Stamped	Retaining Ring	13	330	1.7	0.8
L564	02263	Cast Adjustable	Quick Release	16	420	3.5	1.6

## THRU-BOLT™ RATCHET WRENCHES & SOCKETS - METRIC SIZES

**FEATURES**

- Individual metric sockets, handles and complete sets are available.

Reed Thru-Bolt™ ratchet wrenches work faster than pipe wrenches or adjustable wrenches for tightening or loosening nuts on long, threaded bolts of service saddles, repair clamps, flanges, mechanical couplings, etc. Individual ratchet wrench handles are available, made with traditional malleable iron or lower cost steel stampings. In addition to whole sets, individual sockets made of strong, cast ductile iron are available and the sockets fit all Ratchet Wrench Handles listed mid-page.

**THRU-BOLT™ METRIC UTILITY SETS\***

Catalog No.	Item Code	Handle	Sockets	Weight	
				lbs	kg
L511M	02243	L500	22 mm, 24 mm, 27 mm, 30 mm, 32 mm	6.8	3.1
L514M	02245	L564	19 mm, 22 mm, 24 mm, 27 mm, 30 mm, 32 mm with adjustable angle handle	9.5	4.3
L515M	02246	L500	17 mm, 19 mm, 22 mm, 24 mm, 27 mm, 30 mm, 32 mm	8.9	4.0

\*Sets include steel storage case

**INDIVIDUAL HEX SOCKETS-METRIC**

Catalog No.	M17	M19	M22	M24	M27	M30	M32
Item Code	02274	02275	02276	02277	02278	02279	02280
Hex Size	17 mm	19 mm	22 mm	24 mm	27 mm	30 mm	32 mm





PIPE TOOLS & VISES  
SINCE 1896

WRENCHES

6

## THRU-BOLT™ LARGER RATCHET WRENCH & SOCKETS

### FEATURES

- Sizes from 1 7/16" up to 1 5/8".
- L152 ratchet wrench handles the largest sockets.

For larger hardware found on 30" - 36" diameter pipe, the **L152** is the Thru-Bolt™ ratchet wrench suited to the job. **L26** fits mechanical joints with 1 5/8" hex bolts. **L23** and **L24** sockets fit bolts used on repair clamps, tapping sleeves and other bolt-on pipe apparatus for 30" - 36" diameter pipe.

### HANDLE

Catalog No.	Item Code	Type		Handle Length		Weight	
		Handle	Socket Retention	in	mm	lbs	kg
L152	02670	Stamped	Retaining Ring	17	432	2.5	1.1

### INDIVIDUAL HEX SOCKETS-INCHES

Catalog No.	Item Code	Hex Bolt Size	Weight	
			lbs	kg
L23	02680	1 7/16"	1.0	0.4
L24	02682	1 1/2"	1.1	0.5
L26	02684	1 5/8"	1.1	0.5



## SQUARE DRIVE RATCHET WRENCHES

### FEATURES

- Made to fit only one size of square part/bolt.
- Ratchet wrench reverses by use of the directional pawl or lever.

Square drive (female) ratchet wrenches are great for ratcheting line-up clamps for welding steel pipe and for other process piping needs. The ratchet and reverse features speed up jobs. Both heavy-duty cast handles and value stamped handles available.

### HEAVY-DUTY LINE

Catalog No.	Item Code	Type		Handle Length		Weight	
		Handle	Square Size	in	mm	lbs	kg
L16-7/8	02292	Cast	7/8"	16.4	420	4.3	2.0
L16-1	02291	Cast	1"	16.4	420	4.4	2.0
RWR13/16	40383	Cast	13/16"	19.5	495	5.2	2.4

### VALUE LINE

★ L104-7/8	02671	Stamped	7/8"	16.4	420	2.5	2.0
★ L104-1	02672	Stamped	1"	16.4	420	2.4	2.0
★ NEW							

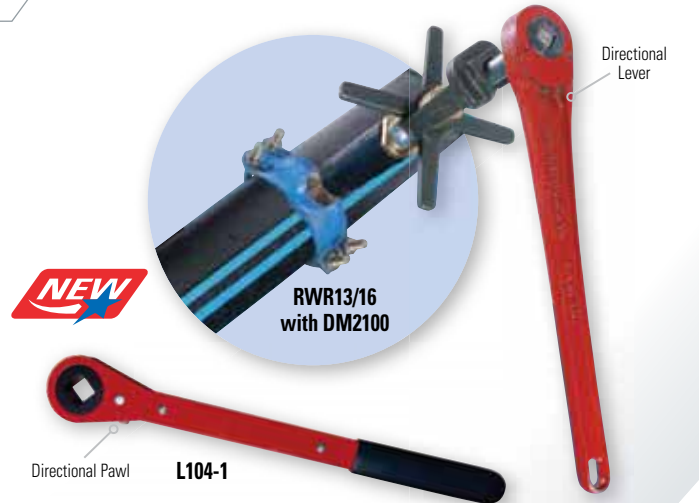

## EXTENDED SOCKETS

### FEATURES

- Extended length (6" and 6 1/2") **impact grade** sockets.
- EDSK5 includes all five extended sockets in a heavy-duty case.

For hard-to-reach deep well bolts, Reed offers Extended Sockets that are made of tool steel and are impact grade. Use extended sockets to tighten hex nuts on repair clamps, mechanical joint fittings and saddles. Drive them with a 1/2" square drive power impact wrench or hand tighten. Finish on sockets provides corrosion-resistance.

Catalog No.	Item Code	Hex Size	Finish	Length	Weight	
					lbs	kg
EDS12	02622	3/4"	Blackened	6 1/2"	1.5	0.7
EDS14	02624	7/8"	Blackened	6 1/2"	1.6	0.7
EDS17	02626	1 1/16"	Zinc Phosphate	6"	1.5	0.7
EDS18	02628	1 1/8"	Zinc Phosphate	6"	1.5	0.7
EDS20	02630	1 1/4"	Zinc Phosphate	6"	1.5	0.7

Catalog No.	Item Code	Description	Weight	
			lbs	kg
★ EDSK5	02640	Kit with 3/4", 7/8", 1 1/16", 1 1/8" & 1 1/4" extended sockets in a hard plastic case	7.8	3.5

★ NEW

### ACCESSORY

Catalog No.	Item Code	Description	Overall Length		Handle Length		Weight	
			in	mm	in	mm	lbs	kg
SCFR	40208	1/2" Male Square Drive Ratchet Wrench	15	381	13	330	1.9	0.9



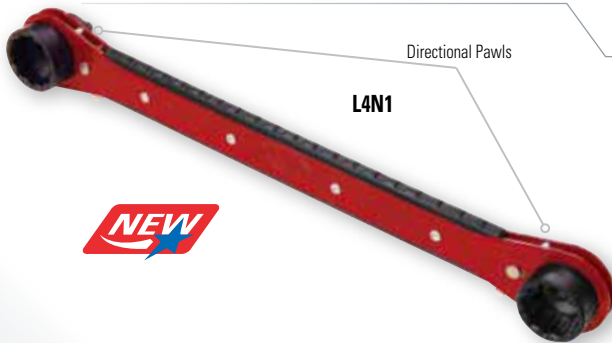

L4N1

Directional Pawls



## THRU-BOLT™ 4-IN-1 RATCHET WRENCH

### FEATURES

- Carry one wrench for **all** your jobs.
- Sockets are designed to stay on the handle, meaning **no loose sockets**.
- Rugged yet smooth grip handle construction.

Reed's **L4N1** Thru-Bolt™ ratchet wrench features four sockets on one wrench in a popular dog bone configuration. The sockets stay on the handle, meaning no loose sockets. L4N1 offers rugged construction of its smooth grip handle with a forward/reverse pawl. Use just one tool to work on mechanical joints and restraints, repair clamps, service saddles, gas/water couplings, flange bolts, friction clamps, hydrant break flanges and some bonnet bolts. Additionally, tightening nuts on long bolts or all-thread rod is never a problem with Reed's Thru-Bolt™ sockets which work by letting the bolt pass completely through the socket and arm head so nuts can be worked on any threaded length. Thru-bolt sockets replace the need for separate regular and deep sockets. The L4N1 wrench is made in USA.

Catalog No.	Item Code	Sockets	Application	Handle Length		Weight	
				in	mm	lbs	kg
★ L4N1	02690	1 1/4" & 1 1/16"	Mechanical joints and restraints, repair clamps, service saddles	17	432	2.5	1.1
		1 1/8" & 1 1/16"	Gas and water industry couplings, repair clamps, service saddles, flange bolts				
		1 1/16" & 15/16"	Flange bolts, friction clamps, hydrant break flange and some bonnet bolts				



L2017

LHM2275

LDSSET



**✓ WHY REED?**  
One wrench with two sockets means no lost sockets.

## THRU-BOLT™ DUAL SOCKET RATCHET WRENCHES HEAVY-DUTY

### FEATURES

- Combines two popular socket sizes into one tool.
- **Rugged construction** of handle and ratchet mechanism.
- Thru-bolt™ design works on nuts on any threaded length.

Dual Socket Ratchet Wrenches fit the most popular water works fasteners for mechanical joints, flange bolts, repair clamps, service saddles and sleeves. Each wrench also offers a handy switch on the head for safe action reversal. Ratchet wrenches are faster to use than pipe wrenches or adjustable wrenches. Thru-bolt sockets work by letting the bolt pass completely through the socket and arm head. Thru-bolt sockets replace the need for separate deep sockets. **LDSSET** features three popular dual socket ratchet wrenches in a convenient storage case. **LHM2275** has red sockets to identify this tool as suitable for Hymax™ reducer couplings. **L2017ERG** features an ergonomic handle grip.

Catalog No.	Item Code	Sockets	Application	Handle Length		Weight	
				in	mm	lbs	kg
LDSSET	02222	LHM2275, L2017 & L1815	see individual wrenches	-	-	9.0	4.1
LHM2275	02225	3/4" & 7/8" 19 mm + 22 mm	Hymax™ Reducer Couplings	13	330	2.2	1.0
L2017	02251	1 1/4" & 1 1/16"	Mechanical Joints & Restraints, Repair Clamps Service Saddles	13	330	2.4	1.1
L1817	02252	1 1/8" & 1 1/16"	Gas & Water Industry Couplings, Repair Clamps, Service Saddles, Flange Bolts	13	330	2.4	1.1
L1815	02253	1 1/8" & 15/16"	Flange Bolts, Friction Clamps, Hydrant Break Flange & Some Bonnet Bolts	13	330	2.3	1.0
★ L2017ERG	02665	1 1/4" & 1 1/16"	Mechanical Joints & Restraints, Repair Clamps Service Saddles	13	330	2.6	1.2

★ NEW

## THRU-BOLT™ DUAL SOCKET RATCHET WRENCHES VALUE LINE

### FEATURES

- Economical wrenches combine two popular socket sizes into one tool.
- **Colored-coded handles** for quick recognition.

Reed's value line of Dual Socket Ratchet Wrenches fit the most popular water works fasteners for mechanical joints, flange bolts, repair clamps, service saddles and sleeves. Each wrench also offers a handy switch on the head for safe action reversal. Ratchet wrenches are faster to use than pipe wrenches or adjustable wrenches. Thru-bolt sockets work by letting the bolt pass completely through the socket and arm head so nuts can be worked on any threaded length. Thru-bolt sockets replace the need for separate deep sockets.

Catalog No.	Item Code	Sockets	Application	Handle Length		Weight	
				in	mm	lbs	kg
LVDSSET	02930	LV1815, LV2017 & LVHM2275	Kit contains one of each: LV1815, LV2017 & LVHM2275	-	-	8.9	4.0
LV2017	02950	1 1/4" & 1 1/16"	Mechanical joints and restraints, repair clamps, service saddles - BLUE handle	13	330	2.4	1.1
LV1815	02952	1 1/8" & 15/16"	Flange bolts, friction clamps, hydrant break flange and some bonnet bolts - GREEN handle	13	330	2.5	1.1
LVHM2275	02954	3/4" & 7/8" and 19 mm & 22 mm	Hymax™ Reducer Couplings - YELLOW handle	13	330	2.3	1.0

LVDSSET

LV2017





PIPE TOOLS & VISES  
SINCE 1896

WRENCHES

6

## BASIN WRENCHES

### FEATURES

- Forged jaws are spring-loaded for **one-hand ratcheting**.

Basin Wrenches are designed for use under sinks and in other tight quarters. They feature long-lasting, hardened, forged jaws which are spring-loaded for one-hand ratcheting. Heads move up to 90° to hold pipe. For easier reach, popular **BW125** basin wrench telescopes from 10" - 17" as does **BW190** which grips larger fittings. Lightweight, economical **BW11** basin wrench features a solid hex bar. These quality tools are imported.

Catalog No.	Item Code	Capacity		Length		Weight	
		in-nom.	actual O.D. mm	in	mm	lbs	kg
BW125	11601	3/8 - 1 1/4	10 - 30	10 - 17	250 - 425	1.8	0.8
BW11	11611	1 1/4	31.8	11	279.4	1.3	0.6
BW190	11620	1 7/8	48.3	10 - 17	250 - 425	1.9	0.9



## ONE HAND METER WRENCHES

### FEATURES

- The **original** and **still the best** for working in tight places.
- **Use one hand** to place and seat the wrench on meter nuts.
- **Spring-loaded jaws quickly grip** many shapes and hold the work securely.

One Hand Wrenches are a Reed invention and feature a strong, forged steel, one-piece handle. Jaws grip any shape: meter nuts, round pipe or parts of fittings, without adjustment. One Hand Wrenches work like a pipe wrench and provide better grip than pliers due to the spring-loaded jaws. Securely and immediately tighten and loosen without removing wrench from pipe. Saves time loosening nut due to ratchet action jaws, unlike a pipe wrench which cannot ratchet on a hex or octagon fitting.

Catalog No.	Item Code	Capacity-Fittings		Pipe Capacity		Length		Weight	
		in	mm	in-nom.	actual O.D. mm	in	mm	lbs	kg
MW 3/4*	02289	1/8 - 3/4	17 - 33	3/8 - 1	17 - 33	11	267	1.2	0.5
MW1 1/4*	02281	3/8 - 1 1/4	27 - 48	3/4 - 1 1/2	27 - 48	16	394	3.1	1.4

\*EXCLUSIVE SIZES

EXCLUSIVE SIZES

MW1 1/4



MW3/4

**✓ WHY REED?**

Ratchets for fast one-hand operation in hard-to-reach places. No adjustment necessary.

## COMFORT GRIP – ONE HAND METER WRENCH

### FEATURES

- **Special hand grip** provides ergonomic advantages of comfort and less hand fatigue.

Comfort Grip model has the same great attributes as the One Hand Meter Wrenches, but with a comfort hand grip for ergonomic advantage. Reed One Hand Meter Wrenches (with or without a comfort grip) are the best for working in tight places, including meter pits.

Catalog No.	Item Code	Capacity-Fittings		Pipe Capacity		Length		Weight	
		in	mm	in-nom.	actual O.D. mm	in	mm	lbs	kg
MW1 1/4GRIP*	02386	3/8 - 1 1/4	27 - 48	3/4 - 1 1/2	27 - 48	16	394	3.3	1.5

\*EXCLUSIVE SIZE

NOTE: These are comfort grips only. These grips are not made for electrical insulation.



MW1 1/4GRIP

EXCLUSIVE SIZE





RF10

Keep this lightweight 2-in-1 wrench handy all day!

RF10  
in use

## OPERATOR'S WRENCH

### FEATURES

- **Two tools in one;** serves as a pipe wrench and a valve wheel wrench.
- Lightest operator's wrench available – carry it all day long.
- Smooth valve wheel wrench openings **protect hands** from sharp burrs.

Double-ended **RF10** Operator's Wrench has forged alloy steel pipe wrench jaws on one end and a 0 size valve wheel wrench hook on the opposite end. Cast alloy steel RF10 is designed for gripping pipe, test plugs or bull plugs. Hook end assists in opening and closing valves while length of operator's wrench provides for needed leverage. The hook end fits hand valve wheels (up to  $\frac{5}{8}$ " rims) without gouging the wheel. OSHA inspectors can assess penalties for using a pipe wrench on a valve wheel rim as wrench teeth can leave sharp burrs on the wheel rim, which result in hand injuries. Use of the RF10 operator's wrench prevents these problems. Handle is painted with chemical-resistant powder coating.

Catalog No.	Item Code	Pipe Capacity		Length		Weight	
		in-nom.	actual O.D. mm	in	mm	lbs	kg
RF10	02121	$\frac{1}{8}$ - 1	10 - 33	10	254	1.2	0.5

## VALVE PACKING WRENCHES

### FEATURES

- Adjustable wrench end for hex/packing nuts with the other end for O-style valve wheels.
- **Combines two tools** needed for regular maintenance and valve operation.

Valve Packing Wrenches are combination tools that help maintain valves without stripping the nuts or gouging the wheel rims. One end is an adjustable wrench while the other end provides leverage to turn valve wheels with up to  $\frac{5}{8}$ " thick rims. They fit 0 size valve wheels. The adjustable wrench end is great for hex nuts including packing nuts on valve stems. Slides and jaws are precisely machined. Valve packing wrenches are lightweight for easy portability.

Catalog No.	Item Code	Pipe Capacity		Length		Weight	
		in-nom.	actual O.D. mm	in	mm	lbs	kg
A8V0*	02808	$\frac{15}{16}$ "	23.8	8.4	213	0.6	0.3
A10V0*	02810	1 $\frac{1}{8}$ "	28.5	11	267	0.9	0.4
A12V0*	02812	1 $\frac{7}{16}$ "	36.5	12.4	315	1.5	0.7

\*EXCLUSIVE

## VALVE WHEEL WRENCHES

### FEATURES

- **Protect valve wheels** from damage and burrs by leveraging force on the outer rim.
- VWALP1 and VWALP2 are made of aluminum for low spark potential.
- **Reed designs are safer** because handle bending gives warning of excess load.

Valve Wheel Wrenches grip the rims of hand valve wheels securely and provide leverage for opening and closing. These wrenches are the solution for handling hard-to-open valves. Choose a wrench based on the hook opening. The hooks work without gouging the wheel rim. OSHA inspectors can assess penalties for using a pipe wrench on a valve wheel rim as wrench teeth can leave sharp burrs on the wheel rim, which result in hand injuries. **VWALP1** and **VWALP2** valve wheel wrenches have low spark potential due to aluminum-magnesium alloy construction. Design and construction of Reed's valve wheel wrenches permit the wrench to bend before breaking, thus warning users of valve turning overload.

Catalog No.	Item Code	Style	Material	Hook Opening		Length		Weight	
				in	mm	in	mm	lbs	kg
VW0	02830	Double-end	Forged Steel	$\frac{1}{2}$ & $\frac{21}{32}$	13 & 17	8	203	1.0	0.5
VW1	02831	Single-end	Forged Steel	1	25	15	381	2.4	1.1
VW2	02832	Single-end	Forged Steel	1 $\frac{5}{16}$	33	22	559	4.8	2.2
VW10	02834	Double-end	Forged Steel	$\frac{11}{16}$ & 1	18 & 25	10	254	1.6	0.7
VWALP1	02851	Single-end	Aluminum	1 $\frac{3}{8}$	35	14	356	2.2	1.0
VWALP2	02852	Single-end	Aluminum	1 $\frac{3}{4}$	44	18	457	4.0	1.8



VWALP1

VW2

VW10

VW0



PIPE TOOLS & VISES  
SINCE 1896

## SMOOTH JAW WRENCHES

### FEATURES

- Large capacity wrenches that **will not mar** chrome, brass or other fittings.
- The smooth jaws are **gentle on finished and visible surfaces**.
- RCORP is strong with all forged steel construction.

Reed offers large capacity Smooth Jaw Wrenches for geometric and delicate work. The **R110HEX** hex wrench works for hex-shaped fittings on meters, drains, spuds and chrome valves, without damage from teeth. The **RSPUD** smooth jaw wrench is for square, hex or octagonal shapes where toothed pipe wrenches are not a good option. Both are heavy-duty, made from ductile iron with forged steel hook jaws and offer larger capacity than adjustable wrenches. Reed's **RCORP** smooth jaw wrench fits up to 2" corp stops and opens to a generous maximum of 4 1/2". A coarse adjustment thread and a large thumbscrew provide quick, easy adjustments for the numerous size changes encountered during jobs. Ford Meter Box® and A.Y. McDonald®, along with other brass fittings manufacturers, recommend a smooth jaw wrench when tightening corp stops, either into the pipe or tapping saddle, or for tightening the service line connection on any waterworks brass valve or fitting.

Catalog No.	Item Code	Maximum Actual Opening		Length		Weight	
		in	mm	in	mm	lbs	kg
R110HEX	02111	2 5/8	67	10	254	1.6	0.7
RSPUD	02112	2 5/8	67	11	279	2.6	1.2
RCORP	02114	4 1/2	114	18	457	4.4	2.0



## HYDRANT WRENCHES

### FEATURES

- Suitable for pentagon nuts and square hydrant nuts.

The **HW** forged steel and economical **HWB** cast ductile iron hydrant wrenches have spanners for either pin or lug style hose couplings. Hydrant wrenches are zinc-chromate plated for corrosion-resistance. The **HWS45** is a Storz® style wrench for hydrants and 4" and 5" Storz® fittings. HWS45 has a ductile iron head and a steel handle. The head and threaded handle adjust to fit standard sizes of pentagon and square hydrant nuts. A spanner hook is part of the head casting, which loops out to grab lugs on the Storz® style fittings, allowing the whole hydrant wrench to turn these fittings for maximum leverage.

Catalog No.	Item Code	Pentagon		Square		Length		Weight	
		in-nom.	actual O.D. mm	in-nom.	actual O.D. mm	in	mm	lbs	kg
HWB	02283	1 3/4	45	1 1/4	31	20.0	500	4.5	2.0
HW	02295	1 3/4	45	1 1/4	31	20.0	500	4.0	1.8
HWS45	02390	1 3/4	45	1 1/4	31	20.5	517	4.9	2.2



**✓ WHY REED?**  
Solid bar stock handle on HW/HWB is both strong and knurled for more secure gripping for critical field applications.

## RATCHETING HYDRANT WRENCH

### FEATURES

- **Save valuable time** with wrench's ratchet action and quick-adjusting socket.

Stubborn hydrant nuts beware, Reed's Ratcheting Hydrant Wrench features a long-handle and an adjustable, snug-fitting socket for tackling pentagon or square nuts. Make loosening or tightening easier with the good leverage provided by the long handle. Socket adjusts quickly with the thumb screw feature. Ratchet action makes this wrench faster to operate than non-ratchet models during emergencies or for general maintenance like flushing. **HWFR** fits pentagon nuts or square nuts. Reduce valuable time on hydrant work by using a Ratcheting Hydrant Wrench.

Catalog No.	Item Code	Pentagon		Square		Overall Length		Handle Length		Weight	
		in-nom.	actual O.D. mm	in-nom.	actual O.D. mm	in	mm	in	mm	lbs	kg
HWFR	02397	1 3/4	42	1 1/4	32	18	457	13	330	4.4	2.0

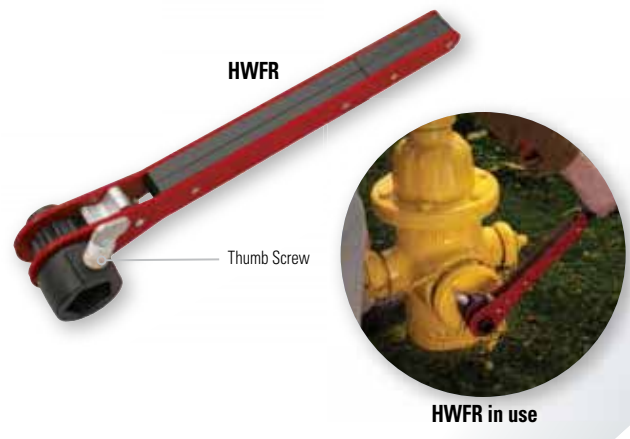

# GENERAL PIPE WORKING TOOLS

SECTION

7

*Mechanical Hot Tapping Machines*

*Tubing Benders*

*Stud Punch*

*Multi-Purpose Pipe Joiner*

*Torpedo Level*

*Hack Saw & Blades*

*Water Pump Pliers*

*Positive Grip Pliers*

*Threaded Rod Cutters*



*DM3MECH Mechanical Hot Tapping Machine hot taps steel pipe using a Reed bi-metal hole saw.*



PIPE TOOLS & VISES  
SINCE 1896

## MECHANICAL HOT TAPPING MACHINES

### FEATURES

- Hot tap up to 4" valves on steel, copper or plastic pipe.
- Pressure rated 300 psi for ambient temperatures or 125 psi for steam systems.

Hot tap using the **DM3MECH** Mechanical Hot Tapping Machine. With the right hole saw, drill and cut into steel, copper or plastic pipe for up to 4" valves. DM3MECH contains the base machine, along with  $\frac{1}{16}$ " Hex Arbor,  $\frac{1}{4}$ " Drill Bit, Hole Saws  $\frac{5}{8}$ ",  $\frac{7}{8}$ ",  $1\frac{1}{8}$ ",  $1\frac{3}{8}$ ",  $1\frac{3}{4}$ ",  $2\frac{1}{4}$ ",  $3\frac{1}{4}$ ", Allen wrenches and toolbox. **DM3MECHB** is the base machine in a toolbox only, without hole saws or arbor. Mechanical Hot Tapping Machines require a  $\frac{1}{2}$ " drill motor, valves and fittings (not included). Versatile DM3MECH tapping machine is conveniently housed in a heavy plastic toolbox.

Catalog No.	Item Code	Valve Size	Weight	
			lbs	kg
DM3MECH	08350	$\frac{3}{4}$ " - 4"	12.0	5.5
DM3MECHB	08351	$\frac{3}{4}$ " - 4"	10.0	4.5

NOTE: User adds fittings and valves according to the application.  
Pressure Rating for ambient (room) temperature liquid systems: 300 psi.  
Pressure Rating for steam systems: 125 psi.  
**NOT RECOMMENDED** for ammonia or other caustic systems. The seals do not support it.

### ACCESSORIES

DB25	43507	$\frac{1}{4}$ " Pilot Drill Bit
CRPD25	99129	$\frac{1}{4}$ " Carbide-tipped Coupon Retaining Pilot Drill Bit

### HOLE SAWS

Catalog No.	Item Code	Description
BMHS10	43500	$\frac{5}{8}$ " diameter, $1\frac{1}{2}$ " cut depth
BMHS14	43501	$\frac{7}{8}$ " diameter, $1\frac{1}{2}$ " cut depth
BMHS18	43502	$1\frac{1}{8}$ ", diameter, $1\frac{1}{2}$ " cut depth
BMHS22	43503	$1\frac{3}{8}$ ", diameter, $1\frac{1}{2}$ " cut depth
BMHS28	43504	$1\frac{3}{4}$ ", diameter, $1\frac{1}{2}$ " cut depth
BMHS36	43505	$2\frac{1}{4}$ ", diameter, $1\frac{1}{2}$ " cut depth
BMHS52	43506	$3\frac{1}{4}$ ", diameter, $1\frac{1}{2}$ " cut depth



DM3MECH



### WHY REED?

A great deal on a versatile tapping machine that is priced well for the market.

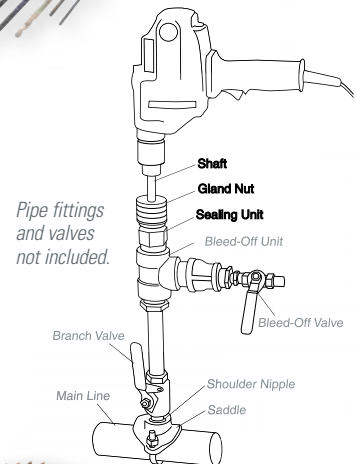

Pipe fittings and valves not included.



BMHS52



BMHS36



BMHS14

## TUBING BENDERS

### FEATURES

- Used for bending steel, stainless steel, copper, aluminum and other metal tubing of bending temper.
- TB3456 covers four sizes with one tool.

Reed Tubing Benders, in popular sizes, are ideal for bending soft metal tubes of copper, steel, stainless steel and aluminum. The tubing benders should not, however, be used on extremely thin or hard-tempered material. All metal parts are chrome plated for corrosion resistance. Starting at a 90° angle, ergonomic round offset handles allow bends up to 180°. Calibrated angle markings appear every 15°, with separate gauge marks for right (R), left (L), and normal (O). **TB3456** Quad Bender is ideal for plumbing and HVAC applications because there are four sizes in one tool.

Catalog No.	Item Code	Tube Capacity		Bend Radius	Weight	
		actual O.D. in*	mm		lbs	kg
TB04	02745	$\frac{1}{4}$	-	$\frac{9}{16}$	1.0	0.5
TB06	02746	$\frac{3}{8}$	-	$\frac{15}{16}$	2.0	0.9
TB08	02747	$\frac{1}{2}$	-	$1\frac{1}{2}$	3.5	1.6
TB12	02749	$\frac{3}{4}$	-	3	7.0	3.2
TB3456**	02742	$\frac{1}{8}$ , $\frac{1}{4}$ , $\frac{5}{16}$ , $\frac{3}{8}$	3.2, 6.5, 7.9, 9.5	$\frac{15}{16}$	1.9	0.9

\* $\frac{1}{4}$ " =  $\frac{1}{8}$ " nominal  $\frac{3}{8}$ " =  $\frac{1}{4}$ " nominal  $\frac{1}{2}$ " =  $\frac{3}{8}$ " nominal  
\*\* For annealed tubing



TB12

TB06

TB3456





## STUD PUNCH

### FEATURES

- Aluminum head makes for **lightweight tool**.
- Handle design allows **maximum leverage**.

Reed offers the most common size of stud punch for metal studs found in plumbing and electrical work. Give fast punches for running wires or lines through metal studs without pre-drilling. Punches 20 gauge steel and thinner steel. **STP710** features two cutting edges. For punches made with the STP710 and other 1 11/32" holes, use **GR1.3** plastic grommets to protect pipe and wire from the metal edges.

Catalog No.	Item Code	Punch Size		Length		Weight	
		actual in	mm	in	mm	lbs	kg
STP710	06465	1 11/32	34.1	21.0	533.4	6.6	3.0

### PLASTIC GROMMETS

Catalog No.	Item Code	Punch Size		Length		Weight*	
		actual in	mm	in	mm	lbs	kg
GR1.3	06475	1 11/32	34.1	1.8	44	0.9	0.4

\*100 Count

# REED

## LIFETIME WARRANTY

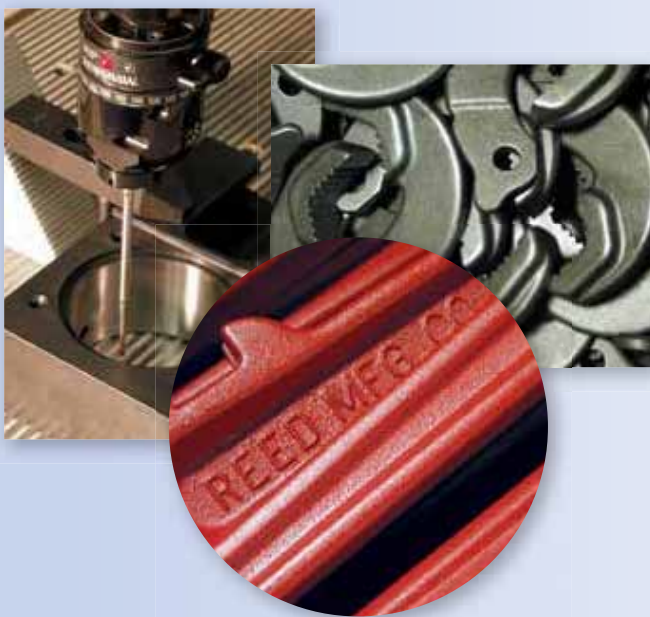

Reed Hand Tools are for the professional trade and are warranted against all failure due to defects in workmanship and materials for the **normal life of the tool**.

**FAILURES DUE TO MISUSE, ABUSE, OR NORMAL WEAR AND TEAR ARE NOT COVERED BY THIS WARRANTY.**

Power units for Universal Pipe Cutters, Saw It®, Rapid Cut & Bevel™ machines, hydrostatic test pumps, and threading power drives are warranted for a period of one year from date of purchase. Hydraulic pumps for PE Squeeze-Off tools have a one year warranty from date of purchase.

**NO PARTY IS AUTHORIZED TO EXTEND ANY OTHER WARRANTY. NO WARRANTY FOR MERCHANTABILITY OR FITNESS FOR A PARTICULAR PURPOSE SHALL APPLY.**

No warranty claims will be allowed unless the product in question is received freight prepaid at the Reed factory. All warranty claims are limited to repair or replacement, at the option of the company, at no charge to the customer. **REED IS NOT LIABLE FOR ANY DAMAGE OF ANY SORT, INCLUDING INCIDENTAL AND CONSEQUENTIAL DAMAGES.** Some states do not allow the exclusion or limitation of incidental or consequential damages, so the above exclusion may not apply.

This warranty gives you specific legal rights, and you may also have other rights which vary from state to state.





PIPE TOOLS & VISES  
SINCE 1896

## MULTI-PURPOSE PIPE JOINER

### FEATURES

- Join gasketed pipe up to 14" nominal diameter.

The **PJ414** utilizes a basic lever-and-chain approach to join medium and large gasketed pipe and fittings up to 14" size. It works for PVC, ductile iron, clay tile, cast iron soil pipe and concrete pipe. Use two PJ414's for heavier pipe. Uses 1/4" proof coil chain rated at 1600 lbs (727 kg). PJ414 comes complete with two 12' (3.7 m) lengths of chain, two grab hooks, plus a 2-piece extendable handle of over 4 feet that allows for a variety of applications.

Catalog No.	Item Code	Capacity		Weight	
		in-nom.	actual O.D. mm	lbs	kg
PJ414	08080	4 - 14	102 - 355	34.0	15.5

NOTES: Not for use with solvent cement joining of plastic pipe.  
Double wrap chain around PVC for best grip.

PLASTIC PIPE JOINERS ON P. 36

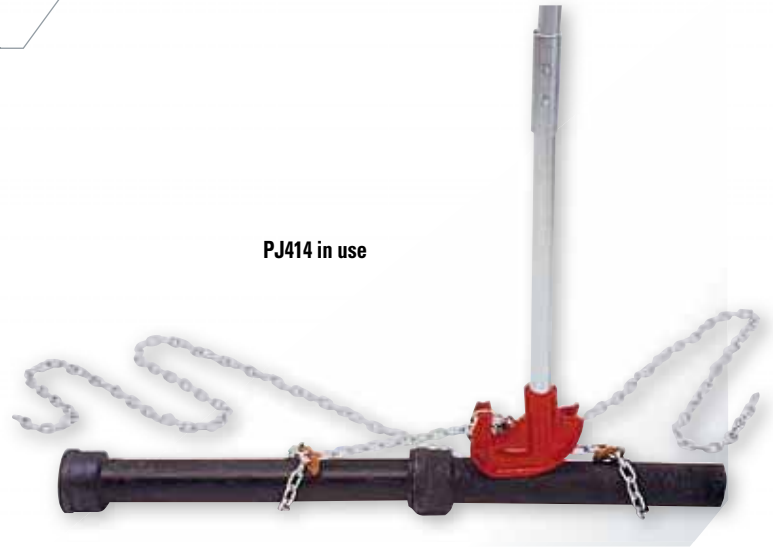

## TORPEDO LEVEL

### FEATURES

- 9-inch level with **pitch** measurements.
- **Magnetic base** to sit flat and secure during levelling work.

Sturdy plastic, frame with magnetic base and working edges precision ground flat to sit flat. V-groove edge allows level to sit on pipe. Easy-to-read as white frames surround the yellow vials for contrast. Top view window for convenience. Vials read level, plumb and 45°. Vial indicates pitch at 1/8", 1/4" or 3/8" per foot without adjustments.

Catalog No.	Item Code	Material	Size-Inches	Weight	
				lbs	kg
LV9PM	06212	Plastic	5/8 X 1 1/4 X 9	0.3	0.1

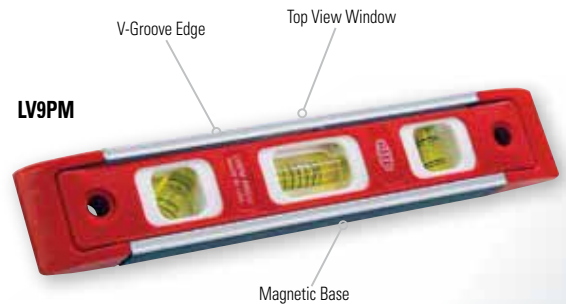

## HACK SAW & BLADES

### FEATURES

- Bi-metal blades provide best performance on steel pipe.
- **Tensioning knob** for adjustments and quick blade changes.
- Four permanent mounting pins permit both straight cutting and 45° angle for flush cutting.
- Room to store spares blades in frame.

This versatile, high end hack saw and its replacement blades are adaptable to cut a wide variety of materials including steel, copper and plastic pipe. **HK1228** is a high-tension style hack saw. Bi-metal blades have a high speed steel cutting edge and are electron-beam welded to alloy steel back, with wavy set. When used with high-tension frames, bi-metal blades provide best performance. Blades and hack saw frames are interchangeable with Stanley®, Lenox®, Starrett®, M.K. Morse® and Ridgid®, among others.

### HACK SAW

Catalog No.	Item Code	Description	Blade	Throat Depth Inches	Weight	
					lbs	kg
HK1228	04489	High Tension Hack Saw	Bi-Metal Blade	4 3/4	1.8	0.8

### BI-METAL BLADES

Catalog No.	Item Code	Teeth per Inch	Length/Width/Thickness		Std. Pkg.	Weight	
			in-nom.	mm		lbs	kg
BH18	04491	18	12 x 1/2 x .025	300 x 13 x 0.6	10	0.5	0.2
BH24	04492	24	12 x 1/2 x .025	300 x 13 x 0.6	10	0.5	0.2
BH32	04493	32	12 x 1/2 x .025	300 x 13 x 0.6	10	0.5	0.2

NOTE: Coarse teeth (less teeth per inch) are to be used for softer materials like aluminum, brass or low carbon steels. The larger spaces between teeth keep them from clogging with metal fragments. Finer teeth are to be used on tougher or slightly harder materials like alloy, tool steels and some stainless steels.





WPP10

## WATER PUMP PLIERS

### FEATURES

- Designed for **one-hand operation**.
- Built-in stop prevents hand injuries.

Water Pump Pliers have a forged, slip joint design for one-hand operation. Pipe-wrench-style milled teeth, traditional 32° angle nose and zinc plating which inhibits corrosion. Water pump pliers are large enough to handle 1 1/2" slip nuts on traps and have maximum capacity of 2" nominal. Handles are always parallel, even with jaws fully extended.

Catalog No.	Item Code	Pipe Capacity		Length		Weight	
		in-nom.	actual O.D. mm	in	mm	lbs	kg
WPP10	02650	2" pipe 1 1/2" slip nuts	63	10	254	0.9	0.4



PGP10

PGP12

## POSITIVE GRIP PLIERS

### FEATURES

- Offset head design **reaches into tight areas** and allows for **better leverage**.
- Top and bottom jaw "v" shape permits pliers to grip a wide variety of shapes.
- **Superior fastener** surpasses traditional nut and bolt tightness issues.

Positive Grip Pliers offer a combination of jaw design, offset head, handle and tongue-and-groove design. They only require downward pressure on the handle, no squeezing, once pliers are engaged. Smooth tongue-and-groove action makes these the most effective pliers on the market for one-hand operation. **Patented** rib prevents finger pinching. Positive grip pliers are forged from high quality, high carbon steel and fully heat-treated for long life.

Catalog No.	Item Code	Pipe Capacity		Length		Weight	
		in-nom.	actual O.D. mm	in	mm	lbs	kg
PGP10	02655	1	35	9.5	245	0.7	0.3
PGP12	02656	2	63	12	305	1.5	0.7



TRC2D

TRC1S

TRCD3/8

## THREADED ROD CUTTERS

### FEATURES

- Mounting hole in lower handle for a permanent mounting option.
- Heat-treated dies for **durability**.
- **Comfort grip** on upper handle.

Threaded Rod Cutters give a fast, clean cut on soft steel threaded rod and eliminate the need for grinding or filing. Threaded rod is commonly used on construction sites to secure pipe, conduit, duct work and other construction elements. Head is made of forged alloy steel while cutting dies are heat-treated for strength. Powder-coated, painted handle features a drilled hole on the lower handle for permanent mounting to a benchtop or other surface. Tools feature a comfort handle grip on the upper handle. **TRC2D** features two cutting spots for 1/2" or 3/8" and long handle for greater leverage. The **TRC1S**, with a single cutting space, ships with 3/8" dies and can be outfitted with optional dies for 1/4" and 5/16" rod.

Catalog No.	Item Code	Description	Weight	
			lbs	kg
TRC1S	04760	Ships with 3/8" dies	9	4.1
TRC2D	04761	Ships with dies for 1/2" and 3/8" threaded rod	16	7.3

### DIES FOR THREADED ROD CUTTERS

Catalog No.	Item Code	Description	Weight	
			lbs	kg
TRCD1/4	04765	1/4" die set	0.2	0.1
TRCD5/16	04766	5/16" die set	0.2	0.1
TRCD3/8	04767	3/8" die set	0.2	0.1
TRCD1/2*	04768	1/2" die set	0.3	0.1

\*1/2" dies only fit TRC2D.



PIPE TOOLS & VISES  
SINCE 1896



## REED EDUCATION & TRAINING

- *Online video training*
- *Site visits for live demonstrations*
- *Devoted, in-person, local sales support*
- *Daily support by phone/email from knowledgeable inside sales associates*
- *Annual factory training*

### *Goes Above & Beyond*

Reed Manufacturing believes in the importance of continuing education and training. Reed offers in-depth, on-site training to end-users and distributor sales teams. Live demonstrations ensure that tool users obtain the comfort level needed to be efficient with Reed tools. Demonstrations also give tool users a chance to provide valuable feedback to Reed for product needs and improvement ideas.

To provide our customers with the best service and freshest knowledge, Reed Regional Managers, Manufacturer's Representatives, and Reed Associates receive annual factory training, along with bimonthly e-news updates. The Product Development department engineers, senior Regional Managers, and Reed management give hands-on tool training and marketing sessions annually to keep the whole Reed team up-to-date on established and new products. New Regional Managers are formally trained one-on-one, in-house over a 4-5 week period, to learn the tools thoroughly.

Reed people know the products inside and out. They assemble and disassemble tools in addition to working with the tools in simulated and field situations. The Reed sales team understands tool applications and takes their knowledge to tool users and recommends how to achieve the best results with Reed pipe tools and vises. Reed's trained salespeople, located across the world, along with our website including online training videos and instruction manuals, extend the training beyond Reed's Erie, Pennsylvania headquarters.

[www.reedmfgco.com](http://www.reedmfgco.com)

*To request a tool demonstration or consultation, check SALES CONTACTS online, email [reedsales@reedmfgco.com](mailto:reedsales@reedmfgco.com) or call 800.666.3691 (US/Canada) or 814.452.3691 (International).*

# TRADITIONAL VALUES & **CUTTING EDGE SOLUTIONS**



**Reed Manufacturing Company Headquarters  
Erie, Pennsylvania USA**



PIPE TOOLS & VISES  
SINCE 1896



1425 West 8th Street • Erie, Pennsylvania 16502 USA  
[reedsales@reedmfgco.com](mailto:reedsales@reedmfgco.com) • Phone: **800.666.3691** or **814.452.3691**

© 2014-01005