

SMB

FENCE EDITION CATALOGUE

2007

FOR ALL YOUR ELECTRIC FENCING SOLUTIONS

HORSE RAIL

SPEEDRITE

PARMAK

DARE

HALLMAN

**WE'VE GOT THE FENCE SYSTEM FOR
YOU...HAVE YOU GOT THE LIVESTOCK?**



SERVING YOU...SINCE 1968



Prices Effective March 1, 2007

NEW PRODUCTS SHOWCASE

COME SEE WHAT'S **NEW!**

OVER 50 NEW ITEMS ADDED TO OUR FENCING LINE



speedrite™ *ELECTRIC FENCING & ACCESSORIES*



Parmak

ELECTRIC FENCING & ACCESSORIES

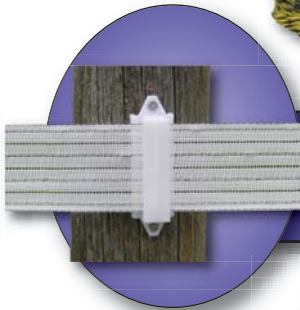

Tape Rail Fencing *4" WIDE FENCE TAPE*

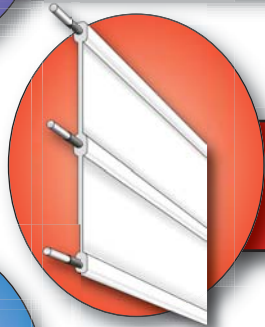

HORSERAIL™

THE COMPLETE HORSERAIL SYSTEM



Gripples®

JOINER & TENSIONER



Fence Insulators

SPEEDRITE™ & DARE

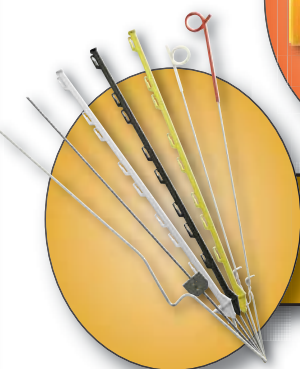

Fence Posts

STEP-IN, BENT & PIGTAIL

SPEEDRITE ENERGIZERS

Speedrite – No-Nonsense electric fence solutions for the serious farmer.

Since 1938 Speedrite has produced powerful and robust electric fencing products. Products proven to perform in the harshest conditions and toughest environments. Our No-nonsense attitude to developing hardworking electric fencing systems has carved a worldwide reputation for performance and durability – a reputation built on 65 years of honesty, quality, and innovation.

Speedrite low-impedance energizers combine massive power and technology to produce hard-working performance. Proven to work in even the toughest of environments, Speedrite energizers power through areas of thick over-growth. State of the art componentry and programming technology means Speedrite energizers deliver a high quality pulse onto the fence – providing maximum energy as it is needed. All Speedrite energizers come with an industry leading warranty.



Maximum Power Factor 360 km / 220 miles

Max Output Energy: 37 J Max Stored Energy: 54 J
 Power Consumption: 52 W Power Source: 230 V / 110 V
 Suitable for up to: 500+ acres / 200+ ha

#36000R UPC 9-414731 37632-6

Designed for large properties with extensive electric fencing systems and for those that want maximum power to cater for extreme livestock pressure. The 36000R maintains high voltage and easily powers through seasonal growth in the toughest conditions.

- High powered, low impedance, mains energizer
- Remote control capable
- Suitable for all types of livestock
- LED display shows output voltage
- **Remote Control Fault Finder included**
- Energizer senses the voltage on the fence and automatically adjusts the output pulse to maximise livestock control
- Slotted wire terminals for easy wire connection
- Low voltage terminal to allow bi-polar fence construction

\$1899.99



Maximum Power Factor 200 km / 125 miles

Max Output Energy: 22 J Max Stored Energy: 34 J
 Power Consumption: 33 W Power Source: 230 V / 110 V
 Suitable for up to: 275 acres / 120 ha

#20000R UPC 9-414731 37620-3

Introducing the new Speedrite 20000R. Uncompromising power with new remote control and fault finding technology ensures safe and reliable control of your precious livestock. Designed for large farms with multi wire fences the Speedrite 20000R offers superior livestock control and is now available with a low voltage terminal to safely handle all types of livestock.

- High powered, low impedance, mains energizer
- **Remote control capable (Remote Control Fault Finder purchased separately)**
- Suitable for all types of livestock
- LED display shows output voltage
- Energizer senses the voltage on the fence and automatically adjusts the output pulse to maximise livestock control
- Slotted wire terminals for easy wire connection
- Low voltage terminal to allow bi-polar fence construction

\$1499.99



Maximum Power Factor 120 km / 75 miles

Max Output Energy: 14.5 J Max Stored Energy: 20 J
 Power Consumption: 20 W Power Source: 230 V / 110 V
 Suitable for up to: 180 acres / 75 ha

#12000R UPC 9-414731 37612-8

Introducing the new Speedrite 12000R. Uncompromising power with new remote control and fault finding technology ensures safe and reliable control of your precious livestock. Designed for large farms with multi wire fences the Speedrite 12000R offers superior livestock control and is now available with a low voltage terminal to safely handle all types of livestock.

- High powered, low impedance, mains energizer
- **Remote control capable (Remote Control Fault Finder purchased separately)**
- Suitable for all types of livestock
- Energizer senses the voltage on the fence and automatically adjusts the output pulse to maximise livestock control
- Slotted wire terminals for easy wire connection
- Low voltage terminal to allow bi-polar fence construction

\$1249.99



SPEEDRITE ENERGIZERS



#9800 UPC 9-414731 37879-5

A powerful mid-ranged energizer, ideal for medium to large sized farms. Suitable for the control of all types of animals.

- High and low output terminals
- Three indicator lights:
 - Red indicates electrical supply is present
 - Orange indicates pulse and that the main energizer module is working correctly
 - White indicates fence loading

Maximum Power Factor 95km / 60 miles

Max Output Energy: 9.4 J Max Stored Energy: 14 J
 Power Consumption: 15 W Power Source: 230 V / 110 V
 Suitable for up to: 170+ acres / 70+ ha

\$685.99



#5800 UPC 9-414731 37880-1

Designed for medium sized farms. Suitable for the control of all types of animals.

- High and low output terminals
- Three indicator lights:
 - Red indicates electrical supply is present
 - Orange indicates pulse and that the main energizer module is working correctly
 - White indicates fence loading

Maximum Power Factor 53 km / 35 miles

Max Output Energy: 5.3 J Max Stored Energy: 7.5 J
 Power Consumption: 10 W Power Source: 230 V / 110 V
 Suitable for up to: 100+ acres / 40+ ha

\$484.99



#Delta 3 UPC 9-414731 37873-3

Specifically designed for small to mid-sized farms of up to 40 acres. Has the capacity to power through vegetation and maintain high pulse strength. Suitable for the control of all types of animals.

- Pulse lights indicate output voltage
- Optimized energy and voltage performance
- Large fence terminals for easy installation
- Rugged construction

Maximum Power Factor 25 miles

Max Output Energy: 2.5 J Max Stored Energy: 4.1 J
 Power Consumption: 4.4 W Power Source: 230 V / 110 V
 Suitable for up to: 40 acres / 16 ha

\$299.99



#Delta 2 UPC 9-414731 37872-6

Designed for small farms with limited fence energizing requirements. Suitable for the control of cattle and horses in small numbers.

- Pulse lights indicate output voltage
- Optimized energy and voltage performance
- Large fence terminals for easy installation
- Rugged construction

Maximum Power Factor 10 miles

Max Output Energy: 1.0 J Max Stored Energy: 1.7 J
 Power Consumption: 2.6 W Power Source: 230 V / 110 V
 Suitable for up to: 15 acres / 6 ha

\$173.50



#Delta 1 UPC 9-414731 37871-9

Suitable for smaller farms including wire around barns, implement sheds and stables.

- Pulse lights indicate output voltage
- Optimized energy and voltage performance
- Large fence terminals for easy installation
- Rugged construction

Maximum Power Factor 5 miles

Max Output Energy: 0.5 J Max Stored Energy: 0.8 J
 Power Consumption: 4.4 W Power Source: 230 V / 110 V
 Suitable for up to: 7 acres / 3 ha

\$137.50



SPEEDRITE BATTERY ENERGIZERS



#9000 UPC 9-414731 37881-8

A heavy duty solution for large farms and large remote areas where electricity is not available. Provides high performance under extreme conditions. Suitable for control of all types of animals.

- Heavy duty energizer designed for large solar assisted applications and where fence is subject to heavy growth conditions.
- High and low output terminals
- Two pulse speed options
- Pulse light indicates pulse and fence loading
- Light sensor reduces battery consumption at night
- Power level selection – high for training animals and low for battery conservation

\$875.75

Maximum Power Factor 90km / 55 miles

Max Output Energy: 9 J Max Stored Energy: 13.5 J
 Recommended Solar Panel: 2 x 42W Power Source: 12, 24 or 36V
 Suitable for up to: 160 acres / 65 ha



#5000 UPC 9-414731 37882-5

Designed for large farms and harsh conditions. Suitable for the control of all types of animals.

- Heavy duty energizer designed for specialized solar assisted applications
- High and low output terminals
- Two pulse speed options
- Pulse light indicates pulse and fence loading
- Light sensor reduces battery consumption at night
- Power level selection – high for training animals and low for battery conservation

\$689.95

Maximum Power Factor 50km / 30 miles

Max Output Energy: 5 J Max Stored Energy: 7 J
 Recommended Solar Panel: 42W Power Source: 12, 24 or 36V
 Suitable for up to: 95 acres / 39 ha



#Delta 3B UPC 9-414731 37868-9

Designed for medium sized farms where electricity is not available. Suitable for the control of all types of animals.

- Pulse lights indicate output voltage. Variable power output option
- Battery protection technology
- Adjustable pulse speed including light sensor options
- Check battery charge level with the turn of a switch
- Rugged design

\$381.95

Maximum Power Factor 25 miles

Max Output Energy: 2.5 J Max Stored Energy: 4.1 J
 Recommended Solar Panel: 22W Power Source: 12V
 Suitable for up to: 40 acres / 16 ha



#Delta 2B UPC 9-414731 37869-6

Designed for small sized farms where electricity is not available. Suitable for small numbers of livestock and horses.

- Pulse lights indicate output voltage. Variable power output option
- Battery protection technology
- Adjustable pulse speed including light sensor options
- Check battery charge level with the turn of a switch
- Rugged design

\$279.95

Maximum Power Factor 10 miles

Max Output Energy: 1 J Max Stored Energy: 1.7 J
 Recommended Solar Panel: 11W Power Source: 12V
 Suitable for up to: 15 acres / 6 ha



#Delta 1B UPC 9-414731 37870-2

Suitable for semi-permanent or portable fences.

- Pulse lights indicate output voltage. Variable power output option
- Battery protection technology
- Adjustable pulse speed including light sensor options
- Check battery charge level with the turn of a switch
- Rugged design

\$199.99

Maximum Power Factor 5 miles

Max Output Energy: 0.5 J Max Stored Energy: 0.8 J
 Recommended Solar Panel: 5W Power Source: 12V
 Suitable for up to: 7 acres / 3 ha



SPEEDRITE BATTERY ENERGIZERS



Maximum Power Factor 4 km / 2.5 miles

Max Output Energy 0.25 J Max Stored Energy: 0.30 J

Power Source: 12V Battery Life: 3 years
Suitable for up to: 5.5 acres / 2.2 ha

\$355.95

S250 UPC 9-14731 100921-0

The Speedrite S250 integrated solar energizer is a new generation energizer with an integrated solar panel. The most powerful energizer in its class, the S250 delivers high performance even in low sunlight. Fully portable with steel and wood post fixing options, this energizer features a stylish, impact resistant case and optional security code settings to deter theft. The S250 is suitable for strip grazing and the containment of livestock in small to medium sized areas and offers rugged portability as well as delivering exceptional power output and performance.

- High output low impedance electric fence energizer
- Includes rechargeable internal sealed 12 V 7 Ah battery
- LCD indicator with built in voltmeter
- High or low energy output option
- Night time battery save mode to optimize battery performance
- Battery care system to protect battery from over discharging
- Power save software that optimizes output performance / battery use during periods of low sunlight
- Up to 21 days operation without sunlight
- 4.2 watt solar panel – the largest in its class
- New laminated impact resistant solar panel. Tough weather and UV resistant case
- Unique post mounting system for steel posts and wooden posts
- All in one unit with integrated carry handle for portability.



SG3

This advanced 9V utility energizer is a powerful and versatile unit. Designed for longer lengths of fence, it is ideal for securing areas for medium-term time frames, as well as intensive strip grazing. The more powerful battery means less changing of batteries.



Battery Life
400 days

Battery Life
450 days

- Low or high power output option
- LCD displaying output voltage
- Light sensor reduces consumption at night
- Pulse indicator light, low battery indicator
- Powered by integral 9V or external 12V battery
- Fully waterproof electronic casing

Maximum Power Factor 4 Km / 2.5 miles

Max Output Energy: 0.3 J Max Stored Energy: 0.45 J
Power Source: 9V/12V Suitable for up to: 5.5 acres / 1.4 ha



SG1

This 9V utility energizer is ideal for medium lengths of fence. Fully self-contained, this unit is suitable for strip grazing or securing problem areas on a medium term basis. Includes the same features as the SG3

Maximum Power Factor 2 Km / 1.25 miles

Max Output Energy: 0.15 J Max Stored Energy: 0.24 J
Power Source: 9V/12V Suitable for up to: 2.8 acres / 0.7 ha



Battery Life
40 days

\$143.95

\$197.99



Battery Life
80 days

AN90 UPC 9-414731 37741-5

The AN90 is the most powerful dedicated stripgrazing unit available. Ideal for longer lengths of portable fence.

- Two pulse speed option and indicator light
- Clips directly onto wire for strip grazing
- Internally powered by 4 x 1.5V D cell batteries or external 12V battery
- No conversion required for wet battery
- Optional tread in stand available

Maximum Power Factor 2 Km / 1.25 miles

Max Output Energy: 0.12 J Max Stored Energy: 0.16 J
Power Source: 6V/12V Suitable for up to: 2.8 acres / 0.7 ha



AN45 UPC 6-49998 02100-2

The AN45 is ideal for use on short lengths of portable fence. Includes the same features as the popular AN90.

Maximum Power Factor 1 Km / 0.65 miles

Max Output Energy: 0.04 J Max Stored Energy: 0.05 J
Power Source: 6V/12V Suitable for up to: 1.4 acres / 0.35 ha

HALLMAN FENCERS

See our *Hallman* line of CSA approved, low impedance energizers. Economy class and serviceable, with a **24 month warranty** from date of sale, including lightning damage. *These fencers have electrically grounded transformers to minimize tinkle voltage.*

GUARD VOLTAGE: Lowest effective guard voltage for long haired animals = 2000 V
 Lowest effective guard voltage for short haired animals = 700 V

Model Number	No Load Voltage	Type	½ mi.	1 mi.*	2 mi.	3 mi.	5 mi.	10 mi.	30 mi.	50 mi.
DETER-300:	5200 V	DC	4400	3000	1700	1200	840	N/A	N/A	N/A
BATTERY SAVER:	4500 V (Hi)	DC	9100	8300	7400	6700	5400	3800	1800	1200
	4200 V (Lo)		5200	5100	4450	3800	3500	2100	1000	N/A
SOLAR-12:	2000 V	DC	6100	5800	5210	4300	3500	2400	1150	N/A
SOLAR-6:	5200 V	DC	4360	2920	2200	1680	1220	840	N/A	N/A
SHUR SHOCK:	2400 V	AC	6300	6100	5800	5600	4700	3800	1800	1200
STOCKMAN:	4500 V	AC	11500	10300	8300	6800	5700	4000	2100	1500
TRIDENT:	6000 V (Hi)	AC	9300	9000	8900	8700	8700	7600	5200	4500
	3000 V (Med)		4300	4800	5000	5000	4500	3700	3500	3000
	1200 V (Lo)		2000	2000	2000	2000	2000	2000	2000	2000

* 100,000 ohm, .015uF. Above ratings based on well insulated, single wire fence.



170-070 - Trident 6950 9 Joule

UPC 7-75348 06950-6

\$399.99

- 110 Volt AC Energizer
- 9300 Guard Volts Output
- 3 Terminals can be used simultaneously for 3 different fields and voltage settings
- 3 separate fence systems of up to 50 miles each

These ratings are based on clean fence, no obstructions.

- We recommend the Trident for areas of 40 to 100 Acres
- Features a flashing operating light.



170-050 - Stockman 6000 1.5 Joule

UPC 7-75348 06000-8

\$199.99

- 110 Volt AC Energizer
- 4000 Guard Volts Output at 10 miles of fence
- 8300 Guard Volts Output at 2 miles of fence

These ratings are based on a clean well constructed fence

- We recommend the Stockman for areas of 10 to 40 Acres
- Features a flashing operating light.
- This is a good performing fencer, with a pulse rate of 60 per minute. Great for predator control.



170-055 - Stockman Extra 6050 1.5 Joule

UPC 7-75348 06050-3

\$224.99

- 110 Volt AC Energizer
- Same features and performance as the Stockman. This fencer comes equipped with a fence condition indicator that shows the user at a glance whether there is a problem with the fence installation.

HALLMAN FENCERS

170-030 - Shur Shock 2800 2 Joule UPC 7-75348 02800-8 **\$159.99**



- 110 Volt AC Low Impedance Energizer
- 3800 Guard Volts Output at 10 miles of fence
- 5800 Guard Volts Output at 2 miles of fence

These ratings are based on a clean well constructed fence

- Effective for up to 25 miles of clean fence
- Features a flashing operating light.
- A good quality fencer, the Shur Shock will easily do the job for a field of up to 20 acres with moderate weed load.

170-035 - Shur Shock Extra 2850 2 Joule UPC 7-75348 02850-3 **\$179.99**



- 110 Volt AC Low Impedance Energizer
- Same features and performance as the Shur Shock. This fencer comes equipped with a fence condition indicator that shows the user at a glance whether there is a problem with the fence installation.

Battery Fencers

170-060 - Battery Saver 1.5 Joule UPC 7-75348 06900-1 **\$199.99**



- 12 Volt DC Low Impedance Fence Controller
- High performance fencer will except some vegetation
- Photo cell extends operation to 120 days with night time power on low, 62 days on high setting. Photo cell automatically reduces nighttime pulse rate for battery conservation.
- Over-ride switch maintains daytime pulse rate for nocturnal predator control

These claims are based on fully charged 12 Volt deep cycle battery

- We recommend this energizer for up to 20 acres.

170-040 - Deter 300 Battery 0.1 Joule UPC 7-75348 03000-1 **\$159.99**



- 6 Volt DC Low Impedance Current Pulse
- Up to 8 weeks battery life
- Uses 6 volt Alkaline Lantern Batteries (*not included*)
- Up to 4000 Guard Volts on small acreage
- A low cost fencer alternative
- We recommend this energizer for fields of 5 to 10 acres.

170-020 - Deter 200 Battery 0.1 Joule UPC 7-74996 02705-6 **\$89.99**



- Battery Energizer
- Uses 4 D cell Alkaline Flashlight Batteries (*not included*)
- Will power fence up to 4 weeks, 24 hours a day
- Ideal for the circuit rider when you need a corral to let your horse have their freedom for the night. Also good for guarding your possessions from creatures while camping.
- 1 year warranty

HALLMAN SOLAR FENCERS



170-090 - Solar6 6985 0.1 Joule **UPC 7-75348 06985-8** **\$309.99**

- 6 Volt DC Low Impedance Solar Powered Fence Controller
- The Hallman Solar 6 delivers up to 4000 Guard Volts
- Solar Panel and 6 Volt Gel Cell battery included
- Fencer is powered by the sun by day and battery at night
- Battery will operate fencer up to 7 days in darkness
- High quality gelled electrolyte battery included
- 24 month warranty on fencer, 12 month warranty on battery
- We recommend this fencer for 5 to 10 acres

170-091 - 6 Volt Battery **UPC 7-74996 05279-3** **\$49.99**

- 6 Volt gel cell battery for solar fencer



180-010 - Shock Reducer **UPC 7-75348 02315-7** **\$84.99**

- This shock reducer is safely and successfully used with Hallman and many other brands of energizers as long as they bear the CSA or UL mark. It will reduce the power on the output terminals:
 - On High: by approximately 50% of the fencers normal output
 - On Med: by approximately 35% of the fencers normal output
 - On Low: by approximately 17% of the fencers normal output
- We do not recommend using the Shock Reducer with a high output fencer such as the Hallman Trident #170-070
- Ideal for use in dairy operations with cow trainers
- Ideal for use in poultry operations for bird control with feeders

170-100 - Dare O.K. Corral Kit 2700 **UPC 0-38923 02700-2** **\$296.99**



- Ideal for trail riding, horse shows, etc. Quick, Easy set-up
- Battery fence charger with 30 day continuous service life
- Powered by two D-cell batteries (*not included*)
- Durable compact carry bag attaches to most saddles
- Includes:

1 fence charger	12 fiberglass posts
25 insulators	2 gate hooks & hardware
1 262' roll of poly wire	4 corner stakes & tie-downs
1 fence tester	1 jumper cable
1 24" ground rod / hanger	1 roll flagging tape
1 Complete Instructions	

PARMAK ENERGIZERS



#P-RM-1 RANGE MASTER UPC 0-54711 02550-0

The most technically advanced Parmak fencer.

Suitable for the control of all types of animals.

- Digital meter shows voltage on fence - accurate within 100 volts
- Ultra-high visibility multi-color LED lights show condition of fence
- Audible and visible "Shut Down Alarm" sounds when fencer is not functioning
- Rugged high impact ABS housing
- Color coded fence and ground terminals

Maximum Power Factor 160km / 100 miles

Max Output Energy: 12 J Power Source: 110-120 V
 UL Listed Low Impedance
 2 Year Warranty For Indoor Installation

\$399.99

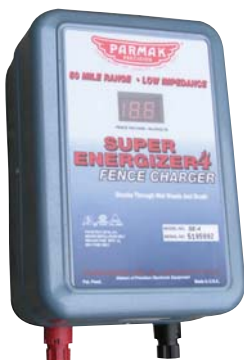

#P-SE4 SUPER ENERGIZER 4 UPC 0-54711 02514-2

Outstanding Parmak model with proven performance.

- Low impedance designed specifically for large pastures
- For single or multi-wire high-tensile fence
- Advanced solid state circuitry
- Parmak's exclusive built-in performance meter
- Ideal for controlled grazing of livestock and predator control
- Double fuse protection with built-in lightning arrester

Maximum Power Factor 80 km / 50 miles

Max Output Energy: 9.1 J Power Source: 110-120 V
 UL Listed Low Impedance
 1 Year Warranty For Indoor Installation

\$184.99



#P-MARK7 MAXI-POWER UPC 0-54711 02512-8

The all new Mark 7, low impedance fencer gives you the stock holding power that you have always wanted.

- For single or multi-wire high-tensile fence
- Advanced solid state circuitry
- Parmak's exclusive built-in performance meter
- Ideal for livestock or predator control
- Double fuse protection with built-in lightning arrester

Maximum Power Factor 48 km / 30 miles

Max Output Energy: 6 J Power Source: 110-120 V
 UL Listed Low Impedance
 1 Year Warranty For Indoor Installation

\$161.99



#P-FM FIELD MASTER UPC 0-54711-02516-6

Designed for small to medium pastures.

Suitable for the control of cattle and horses in small numbers.

- Advanced solid state circuitry
- Shocks through wet weeds and brush
- Built-in operational light
- Double fuse protection with built-in lightning arrester

Maximum Power Factor 24 km / 15 miles

Max Output Energy: 3 J Power Source: 110-120 V
 UL Listed Low Impedance
 1 Year Warranty For Indoor Installation

\$135.99

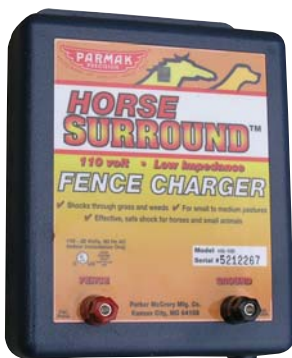

#P-HS-100 HORSE SURROUND UPC 0-54711 02575-3

Suitable for horses, pets, & other smaller animals. Ideal for controlling and training horses.

- Advanced solid state circuitry
- Shocks through wet weeds & brush
- Built-in dual flashing operational light
- 100% American made

Maximum Power Factor 24 km / 15 miles

Max Output Energy: 1.5 J Power Source: 110-120 V
 UL Listed Low Impedance
 1 Year Warranty For Indoor Installation

\$89.99

PARMAK BATTERY & SOLAR ENERGIZERS



#P-MAG12 MAGNUM 12 UNIT ONLY **UPC 0-54711 23113-0**
A heavy duty solution for medium to large farms and remote areas where electricity is not available.

- 12 volt advanced solid state circuitry
- Performance meter that shows condition of the fence
- Low impedance for maximum power and longer life
- Compact design
- Weatherproof, portable - outdoor model
- Use with 12 volt storage battery; complete with battery clamps
- Ideal for livestock or predator control
- Provides up to 3 months of continuous operation between battery charges

Maximum Power Factor 48km / 30 miles

Max Output Energy: 2.7 J Power Source: 12 V
 UL Listed Low Impedance
 1 Year Warranty For Outdoor Installation

\$131.99



#P-EM-200 SURROUND EM **UPC 0-54711 02580-7**
Safe, effective, shock designed for animals that are sensitive to electric shock like horses, dogs and other short haired animals. Control & train your horses, dogs, or other animals. Approved by leading equestrians.

- Advanced solid state circuitry
- Shocks through wet weeds & brush
- Built-in flashing operational light
- Weatherproof for outdoor installation

Maximum Power Factor Small Pastures

Max Output Energy: 1.6 J Power Source: 12 V
 UL Listed Low Impedance

\$94.95



#P-DF-LI-OU DELUXE FIELD **UPC 0-54711 02113-7**
New, compact 6 volt fencer designed for livestock control in small to medium pastures.

- New, compact, lightweight design
- 100% solid-state with increased shock output
- Compact design, weatherproof, portable - outdoor model
- Built-in operational light
- Use a Ray-o-vac #641 or equivalent 6-volt battery
- Shocks through wet weeds and brush

Maximum Power Factor 40km / 25 miles

Max Output Energy: 1.4 J Power Source: 6 V
 UL Listed Low Impedance
 1 Year Warranty For Outdoor Installation

\$111.49



#P-MAG12-SP MAGNUM 12 SOLAR PAK **UPC 0-54711 23111-6**
Featuring the latest state-of-the-art solar panel with superior charging power the Magnum 12 Solar-Pak eliminates battery recharging, thereby saving you time and money.

- Performance meter that shows condition of the fence
- No operating costs
- Complete with 12 volt rechargeable battery
- Weatherproof, portable, outdoor model

Maximum Power Factor 48km / 30 miles

Max Output Energy: 3 J Power Source: 12 V Solar
 UL Listed Low Impedance
 2 Year Warranty For Outdoor Installation

\$454.99



#P-DF-SP-LI DELUXE FIELD SOLAR PAK **UPC 0-54711 02111-3**
America's first solar-powered electric fencer is now low impedance and features an exclusive built-in performance meter .

- Weatherproof, outdoor model
- Sealed, rechargeable 6 volt battery
- Will operate for 21 days in total darkness
- New, more powerful solar panel

Maximum Power Factor 40km / 25 miles

Max Output Energy: 1.4 J Power Source: 6 V
 UL Listed Low Impedance
 1 Year Warranty For Outdoor Installation

\$269.99

FENCE MANAGEMENT TOOLS

Part No.	UPC No.	Retail Price
speedrite™ by TRU-TEST® DIGITAL VOLTMETER		
S-ST010	9-414731 374797	65.50

speedrite™ DIGITAL VOLTMETER is highly accurate voltmeter for testing the most extensive fencing systems. Powered by a 9 volt battery with a life of 12 - 18 months. Tough, durable and reliable, the compact pocket sized digital voltmeter has solid state circuitry, automatic on/off and reads from 100 to 9,900 volts. Simply insert ground stake into the ground, then hook over fence.



S-ST010

DARE DIGITAL VOLTMETER		
180-095	0-38923 02411-7	52.49

DARE DIGITAL VOLTMETER for electric fence. Reads up to 9,999 volts. Extremely sensitive and accurate. Powered by a 9 volt battery supplied. Has an easy to use ground probe attached and automatic on/off. Leather pouch included.



180-095

speedrite™ by TRU-TEST® FENCEALERT		
S-ST0301	9-414731 103779	26.15

speedrite™ FENCEALERT warning light should be placed on every electric fence that is passed during the hours of darkness, especially alongside roads, lane ways and around buildings. The FENCEALERT provides an instant warning of low or intermittent voltage and hence, animals escaping. Low voltage warning light. Starts working when your fence stops. No ground lead required. Up to 5 years battery life. Can be seen for up to a mile.



S-ST0301

DARE ELECTRIC FENCE PULSE INDICATOR		
180-111	0-38923 02221-2	46.29

DARE ELECTRIC FENCE PULSE INDICATOR has a fluorescent lamp encased in vinyl tube. Attaches permanently to electric fence wire. Check the fence at night from a distance. Uses little power. Simply install this unit on end of your fence where you can see it from your house or barn. If flashing you know your fence is still charged. Gives you peace of mind, without following your entire fence. Clip red lead onto fence. Black lead to ground stake.



180-111

FENCE MANAGEMENT TOOLS

Part No.	UPC No.	Retail Price
----------	---------	--------------

DARE FIVE-O-LITE FENCE TESTER

180-110	0-38923 01360-9	13.69
---------	-----------------	-------

DARE FIVE-O-LITE FENCE TESTER is a graduated electric fence tester that actually show how many volts are at the charger or on the fence line. Voltages are plainly marked on the case - 625, 950, 2,000, 3,300 and 5000 volts. Take a reading on your fencer, then check fence. If reading is the same, fence is okay.



180-110

speedrite™ by TRU-TEST® DIRECTIONAL FAULT FINDER

S-ST101	9-414731 102680	157.00
---------	-----------------	--------

speedrite™ DIRECTIONAL FAULT FINDER is a combined voltage and current meter that allows you to rapidly find faults/shorts on your electric fence. Large backlight. Bold current indicator arrows. Simultaneous voltage and current reading. Audible current indicator. Robust, impact and water resistant case. Integrated belt carry clip. No earth lead needed. Low battery indicator. Replaceable 9 volt battery.



S-ST101

S-ST102

speedrite™ by TRU-TEST® FAULT FINDER/REMOTE CONTROL

S-ST102	9-414731 102680	250.00
---------	-----------------	--------

speedrite™ DIRECTIONAL FAULT FINDER/REMOTE CONTROL Same as above but is also a remote control for the R36 000, R20 000 and R12 000 electric fencer. Turn off your electric fence to perform repairs from anywhere in the field. No more running back to the fencer from the back end of your field to turn off the power for repairs.

DARE SINGLE LITE FENCE TESTER

180-100	0-38923 00460-7	4.55
---------	-----------------	------

DARE SINGLE LITE FENCE TESTER is essential to making spot checks in the field. Tells wether fence is working and helps locate faults such as 'opens', 'shorts', and partial grounds. Lamp protected by resistor.



180-100

DARE VOLTAGE SPIKE PROTECTOR

180-112	0-38923 00219-0	10.35
---------	-----------------	-------

DARE VOLTAGE SPIKE PROTECTOR A must for every 110-V fence controller. Reduces effects from electrical surge through power line, a common cause of controller damage. Use on grounded circuits only.



180-112

DARE ELECTRIC FENCE FUSED PLUG

180-116	0-38923 01624-2	3.69
---------	-----------------	------

DARE ELECTRIC FENCE FUSED PLUG Two one amp fuses protect controller on 110-V power. (Fuses not included.)



180-116

DARE ONE AMP FUSE

180-060	0-38923 01890-1	1.99
---------	-----------------	------

DARE ONE AMP FUSE to fit most types of electric fence controllers. Dimensions 1/4" x 1-1/4" AGC - 1 amp. Pack of 5 blister card.



180-060

FENCE TRANSFORMERS/POST POUNDER PARTS

KOLTEC	Part No.	UPC No.	Retail Price
 <p>170-280</p>	170-250	7-74996 01885-0	CIRCUIT BOARDS – Replacement boards for Koltec fencers. 79.99 USC10 Board – 1/case, 1 lb.
	170-260	7-74996 01886-7	USC20 Board – 1/case, 1 lb. 129.99
	170-261	7-74996 02661-9	Transformer USC 10 & 20. 89.10
	170-262	7-74996 02662-6	Transformer USC 12. 129.99
	170-265	7-74996 02663-3	EC1000 Circuit Board. 59.99
	170-270	7-74996 01887-4	USC12 Board – 1/case, 1 lb. 119.99
	170-275	7-74996 02664-0	EC2000 Circuit Board. 69.99
	170-280	0-38923 01892-5	Three Prong Timer Interrupter. 13.10

POST POUNDER PARTS

Pound 5000	6-49998 05000-2	Driver Spring.	129.29
Pound 5220	6-49998 05220-4	Bit 6 Finger Head.	26.79
Pound 5260	6-49998 05260-0	Bit 4 Finger Head.	36.49
Pound 5720	6-49998 05720-9	Chain Link Kit Handle.	11.95
Pound 5730	6-49998 05730-8	25P Handle Brac. – 4 Bolt.	17.69
Pound 5740	6-49998 05740-7	V20 Handle Brac. – 2 Bolt.	20.79
Pound 5754	6-49998 05754-4	Valve Clevis Handle Bracket.	30.19



Pound 5220



Pound 5260



Pound 5720



Pound 5730



Pound 5740



Pound 5754

LIGHTNING STRIKE PROTECTION

We recommend Lightning Protection for energizers, regardless of what make or model, to reduce your energizer repair bills. A properly installed lightning protection system will help to eliminate costly energizer repairs. Our 180-030 Dare Lightning Choke used in conjunction with 180-115 Dare Lightning Arrestor Kit should help to protect your energizer. Please see diagram on page #96. **Note: Make sure your ground on the lightning arrestor has more capacity than ground on energizer.*

Part No.	UPC No.	Retail Price
DARE LIGHTNING CHOKE		
180-030	0-38923 02454-4	15.75

DARE LIGHTNING CHOKE is designed to reduce the impact of lightning travelling the fence line to the controller. Complete with mounting screws, stand off insulators and instructions.



180-030

LIGHTNING STRIKE PROTECTION

Part No.	UPC No.	Retail Price
DARE LIGHTNING ARRESTOR KIT		
180-115	0-38923 02477-3	9.49

DARE LIGHTNING ARRESTOR KIT Heavy duty, farm tested and proven, electric fence lightning arrester. Complete with wire clamp, ground rod clamp and mounting screws. When installing the arrester kit you must use separate ground rods from fence energizer. Make sure your arrester ground is at least 50 feet from the closest ground on energizer.

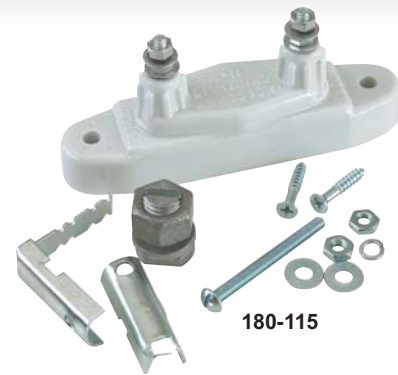

speedrite™ by TRU-TEST® LIGHTNING ARRESTOR		
S-SA003	9-415793 400301	9.25

speedrite™ LIGHTNING ARRESTOR Porcelain arrester used in line with fence. Protect your energizer from lightning strikes.



LACME LIGHTNING ARRESTOR		
180-025	3-41516 66710-2	21.39

LACME LIGHTNING ARRESTOR diverts lightning strike through 2 poles faced towards each other far enough apart no to interfere with energizer power voltage.

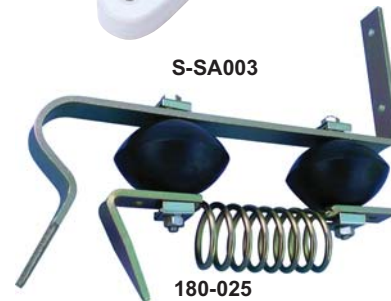

KOLTEC LIGHTNING ARRESTOR		
180-020	7-74996 02065-5	15.29

KOLTEC LIGHTNING ARRESTOR



DARE LIGHTNING PROTECTOR KIT		
180-113	0-38923 01860-4	5.89

DARE LIGHTNING PROTECTOR KIT contains one lightning protector (fence-line fuse) and one ground clamp. Not for high tensile fence.



MAX-TEN 200 PLUS WIRE



Part No.	UPC No.	Description	Retail Price
12-1/2 GAUGE HIGH TENSILE WIRE			
110-020	6-49998 08244-7	Class 3 galvanized, minimum 200,000 PSI, minimum 2000 lbs. breaking load, 4000 ft. , 105 lbs.	119.99
110-025		Same as above. Economy Wire.	105.95
110-030	6-49998 08224-9	Class 3 galvanized, minimum 200,000 PSI, minimum 2000 lbs. breaking load, 2000 ft. , 53 lbs.	63.99
110-035		Same as above. Economy Wire.	54.95
110-010	7-74996 02396-0	Class 3 galvanized, minimum 200,000 PSI, minimum 2000 lbs. breaking load, 1000 ft. , 27 lbs.	34.99



Part No.	UPC No.	Description	Retail Price
16 GAUGE HIGH TENSILE SPIDER WIRE			
110-060	6-49998 08284-3	Class 3 galvanized, minimum 200,000 PSI, 4000 ft. , 43 lbs.	96.99
110-070	6-49998 08280-5	Class 3 galvanized, minimum 200,000 PSI, 2000 ft. , 22 lbs.	56.99

LOW CARBON WIRE

110-080	7-74996 01858-4	14 Gauge, 1/4 mile, (1320 feet) Plastic spool (80 rod) 22 lbs. per spool, 2 spools per case.	23.95
110-082	6-72285 14025-4	14 Gauge, 1/4 mile (1320 feet) Wood spool. High Grade Galvanizing 3X greater life...3X more galvanizing that 110-080	42.99
110-081	7-74996 05269-4	14 Gauge, 200 foot spool	5.95
110-091	0-95832 04604-3	16 Gauge, 1/4 mile. (1320 feet) Steel spool 4 spools per case	20.95



110-080



110-082



110-081



110-091

ELECTRIC FENCING WIRE

Part No.	UPC No.	Retail Price
BAYGUARD® BY PARMAK HEAVY DUTY ELECTRIC FENCE WIRE		
110-140	0-55709 00123-0	107.24
800 meters/2624 ft., yellow/black, 4 rolls/case, 33 lbs./case.		
110-120	0-55709 00122-3	53.99
400 meters/1312 ft., yellow/black, 6 rolls/case, 32 lbs./case.		
110-110	0-55709 00121-6	29.05
200 meters/656 ft., yellow/black, 12 rolls/case, 32 lbs./case.		
110-130	0-55709 00679-2	53.99
400 meters/1312 ft., bright white, 6 rolls/case, 32 lbs./case.		
110-135	0-55709 00678-5	29.05
200 meter roll, (656 ft) bright white, 12 rolls/case, 32 lbs./case.		

BAYGUARD® HEAVY DUTY ELECTRIC FENCE WIRE for permanent or temporary pasture and rotational grazing. 3 Aluminum conductors for maximum shocking power - Conducts electricity 50X greater than stainless steel wire. High contrast yellow and black colors. 3 Reinforced PVC coated fiberglass cords give high strength plus low stretch and sag properties. Bayguard conductor wires are 0.159" (.4mm) compared to many products constructed of 0.008" (.2mm) conductor wires. UV stabilized for excellent weathering. 110-140 wire is wound on a ReelEasy™ Spool for use with optional Reel Easy™ handle. **5 Year UV Warranty.**

speedrite™ by TRU-TEST® ULTRAWIRE FOR ELECTRIC FENCE

S-SP041	9-414731 101379	78.50
400 meters/1312 ft., red/white,		
S-SP040	9-415793 321002	45.75
200 meters/656 ft., red/white,		

speedrite™ ULTRAWIRE ELECTRIC FENCE WIRE products feature 6 tin plated copper strands as the conductor. This is one of the most conductive materials known to man and it's the ULTRA product's low resistance that enables such high voltage readings at the end of strip grazing lengths. 60 Times more conductive than standard polywire. Ultra violet stabilized polyethylene yarn.

Using a larger energizer will not greatly increase the amount of shock (volts) at the end of a strip grazing section. If the resistance remains the same then so will the voltage. This can be likened to a rancher trying to increase the flow of water, to a trough at the end of a 1 mile section of pipe by using a larger pump. Increased water flow will only be achieved by lowering the resistance, or in other words by using a larger diameter pipe.

REMEMBER you need at least 3000 volts to successfully control animals, this is recognized as the industry standard.

The "effective voltage" is the voltage experienced by an animal when it touched the fence. There is often a difference between a voltmeter reading and what an animal experiences when it touches the fence. At the end of a fence (or at the end of a length of polywire) a voltmeter may record a high voltage. However, the voltmeter does not load the fence when it records the voltage. If an animal touches the fence at the same place, it creates a significant load on the fence. The larger the load, the more important the resistance that the energizer must overcome to deliver a shock to the animal. As a consequence the voltage felt by the animal is always less than the voltage on the voltmeter, especially as you move further from the energizer. By using Speedrite ULTRA products you can lower the fence resistance, resulting in higher effective voltage.

speedrite™ by TRU-TEST® 9 STRAND ELECTRIC FENCE WIRE

S-SP211	6-91346 10130-0	57.50
400 meters/1312 ft., white,		

speedrite™ 9 STRAND ELECTRIC FENCE WIRE has higher strength and conductivity than conventional polywire. Recommended for temporary and semi-permanent fencing. High twist cord with excellent strength and durability and 9 strands of stainless steel wire for high corrosion resistance. UV stabilized for longer life. Available in bright white.



ELECTRIC FENCING WIRE

Part No.	UPC No.	Retail Price
speedrite™ by TRU-TEST® POLIWIRE ELECTRIC FENCE WIRE		
S-SP010	9-415793 320104	51.00
500 meters/1650 ft., orange,		
S-SP011	9-415793 320111	51.00
500 meters/1650 ft., white,		
S-SP012	9-415793 320128	19.60
200 meters/660 ft., orange,		
S-SP013	9-415793 320135	19.60
200 meters/660 ft., white,		

speedrite™ POLYWIRE ELECTRIC FENCE WIRE products for economic strip grazing feature 6 strands of highly durable stainless steel conductors. High twist cord has excellent strength and durability. UV stabilized for longer life. Available in highly visible orange or bright white.

BAYGUARD® BY PARMAK

SUPER HEAVY DUTY PLATINUM SERIES® 4X4 WIRE

110-101	0-54711 00961-6	64.99
400 meters/1312 ft., 6 rolls/case,		
110-102	0-54711 00960-9	33.99
200 meters/656 ft., 6 rolls/case,		

BAYGUARD® SUPER HEAVY DUTY PLATINUM SERIES® 4X4 WIRE for permanent or temporary pasture and rotational grazing. 4 Aluminum conductors for maximum shocking power - Conducts electricity 75X greater than stainless steel wire. 4 Reinforced PVC coated fiberglass cords provide the strongest wire available. Excellent weathering - 7 year UV warranty. High visibility reflective silver color. Available in a 200 or 400 M roll. **Full 7 Year UV Warranty.**

KOLTEC AND OTHER POLY FENCING WIRE

110-111	7-74996 00195-1	24.49
250 meter White and Yellow Wire.		
110-180	8-71295 60054-7	3.49
100 meter orange polywire, .50 lbs./roll.		
110-190	7-74996 01891-1	6.95
250 meter polywire, 1 lb./roll.		



S-SP012



110-101 — 400M
110-102 — 200M



110-111



110-180



110-190

ELECTRIC FENCING SPOOLS

Part No.	UPC No.	Retail Price
KOLTEC POLY FENCING SPOOL		
180-120	7-74996 01892-8	27.95
Fence reel w/susp. Hook, KO21/1, 1/case, 1.5 lbs. each.		



180-120

BAYGUARD® BY PARMAK ReelEasy™ POLY FENCING SPOOL		
180-155	7-74996 02670-1	7.70
ReelEasy™ Empty reel cartridge		



180-155

BAYGUARD® BY PARMAK ReelEasy™ CARTRIDGE HANDLE COMBINATION		
180-156	7-74996 02671-8	48.39
ReelEasy™ Cartridge and handle combination. Lightweight & durable electric fence reel with pop on/off cartridge. Easy to unwind and rewind. Can be hung from fence or bolted to post. Rugged construction. The ideal way to store and use portable fencing.		



180-156

BAYGUARD® BY PARMAK ReelEasy™ POLY FENCING SPOOL HANDLE		
180-157	7-74996 02674-9	3.99
ReelEasy™ Drive handle only		



180-157

speedrite™ by TRU-TEST® POLY FENCING SPOOL		
S-SR001	9-415793 800101	65.25
Jumbo Reel (can hold 3300' of Poliwire or 1320' of Politape)		
S-SR003	9-415793 800309	62.95
Maxi Reel (can hold 1650' of Poliwire or 660' of Politape)		
S-SR005	9-415793 800507	37.75
Mini Reel (can hold 660' of Poliwire or 330' of Politape)		
S-SR015	9-415793 801504	37.95
Econo Reel (can hold 1650' of Poliwire or 660' of Politape)		

speedrite™ POLY FENCING SPOOL has a heavy duty steel frame, a fully insulated drum and self locking ratchet.



S-SR001



S-SR003



S-SR005



S-SR015

ELECTRIC FENCING SPOOLS

Part No.	UPC No.	Retail Price
speedrite™ by TRU-TEST® GEARED POLY FENCING SPOOL		
S-SR020	9-415793 800118	70.75

GEARED POLY FENCING REEL (can hold 1650' of Poliwire or 660' of Politape)

speedrite™ O'BRIENS GEARED POLY FENCING SPOOL has a 3 to 1 gearing ratio. Free wheeling handle position for unwinding. No-kick handle. Wire guide eliminates tangling. Worlds number 1 Geared Reel



S-SR020

speedrite™ by TRU-TEST® REPLACEMENT BOBBIN GEARED REEL		
S-805551	9-414731 113747	35.25
REPLACEMENT BOBBIN GEARED REEL (can hold 1650' of Poliwire or 660' of Politape)		



S-805551

speedrite™ by TRU-TEST® REPLACEMENT BOBBIN JUMBO REEL		
S-SR002	9-414731 375404	31.25
REPLACEMENT BOBBIN JUMBO REEL (can hold 3300' of Poliwire or 1320' of Politape)		



S-SR002

speedrite™ by TRU-TEST® REPLACEMENT BOBBIN ECONO REEL		
S-SR0091	9-414731 800910	35.25
REPLACEMENT BOBBIN ECONO REEL (can hold 1650' of Poliwire or 660' of Politape)		



S-SR0091

speedrite™ by TRU-TEST® REPLACEMENT BOBBIN MINI REEL		
S-SR0081	9-414731 800811	18.30
REPLACEMENT BOBBIN MINI REEL (can hold 660' of Poliwire or 330' of Politape)		



S-SR0081

POLY FENCING ROPE

Part No.	UPC No.	Retail Price
----------	---------	--------------

DARE 7MM BRAIDED POLY ELECTRIC FENCE EQUI-ROPE®

110-200	7-74996 05273-1	88.99
---------	-----------------	-------

7mm x 200 meters/656 ft., 2 per carton, 25 lb per case

DARE 7MM POLY ELECTRIC FENCE EQUI-ROPE® is a premium braided HDPE & polyester mix rope with 12 strands of stainless steel wire for strength and conductivity. Approx. 9/32" in diameter. White. 1,592 lbs. average breaking strength.

DARE 6MM BRAIDED POLY ELECTRIC FENCE EQUI-ROPE®

110-201	7-74996 05274-8	56.49
---------	-----------------	-------

6mm x 180 meters/600 ft., 2 per carton, 14 lb per case

DARE 6MM POLY ELECTRIC FENCE EQUI-ROPE® is a braided heavy duty polyethylene rope with 7 strands of stainless steel wire for strength and conductivity. Approx. 1/4" in diameter. White. 628 lbs. average breaking strength.

DARE 4MM BRAIDED POLY ELECTRIC FENCE EQUI-ROPE®

110-202	7-74996 05275-5	40.99
---------	-----------------	-------

6mm x 180 meters/600 ft., 2 per carton, 14 lb per case

DARE 6MM POLY ELECTRIC FENCE EQUI-ROPE® is a braided heavy duty polyethylene rope with 3 strands of stainless steel wire for strength and conductivity. Approx. 1/4" in diameter. White. 628 lbs. average breaking strength.

BAYGUARD® BY PARMAK 1/4" TWISTED PREMIUM GRADE POLY FENCE ROPE

110-203	7-74996 07019-3	72.49
---------	-----------------	-------

1/4" x 200 meters/656 ft.,

BAYGUARD® 1/4" TWISTED PREMIUM GRADE POLY ELECTRIC FENCE ROPE is a white high visibility rope with 1 yellow and 1 black monofilament. High strength with over 995 lbs. breaking point with 6 tinned copper conductors. Low impedance conductors - 0.064 ohm/m resistance. For temporary or permanent pastures and rotational grazing. **Full 3 Year UV Warranty.**

BAYGUARD® BY PARMAK

1/4" TWISTED STANDARD GRADE POLY FENCE ROPE

110-204	7-74996 07020-9	49.99
---------	-----------------	-------

1/4" x 200 meters/656 ft.,

BAYGUARD® 1/4" TWISTED STANDARD GRADE POLY ELECTRIC FENCE ROPE is an economical white fibrillated polyethylene rope with good strength with 850 lbs. break strength and 6 stainless steel conductors. **Full 1 Year UV Warranty.**

speedrite™ by TRU-TEST® ULTRABRAID ELECTRIC FENCE ROPE

S-SP036	9-415793 320456	57.50
---------	-----------------	-------

200 meters/660 ft., red/white,

speedrite™ ULTRABRAID ELECTRIC FENCE ROPE features ultra high conductivity and delivers maximum energy transfer. 40 Times more conductive than conventional poly-wire. Ultra low resistance of 100 ohm/km (160 ohm/mile). Designed for long lengths of temporary or semi-permanent fencing. Tight braided yarn for high strength and maximum flexibility. Contrasting colours for excellent visibility. UV stabilized for longer life.



POLY FENCING TAPE

Part No.	UPC No.	Retail Price
----------	---------	--------------

DARE 1-1/2" POLY ELECTRIC FENCE TAPE

110-1710	7-74996 05271-7	81.59
----------	-----------------	-------

1-1/2" wide x 200 meters/656 ft., 6 per carton, 40 lb per case

DARE ELECTRIC FENCE POLY TAPE is ideal for temporary pastures and rotational grazing. Highly visible, lightweight and easy to use. Woven of white UV resistant polyethylene and 15 strands of stainless steel conductor wires. Install with tape insulators only. Includes a tape buckle for joints. Lightweight and portable, easy to join and splice.

DARE 1/2" POLY ELECTRIC FENCE TAPE

110-169	7-74996 05270-0	34.59
---------	-----------------	-------

1/2" wide x 200 meters/656 ft., 6 per carton, 13 lb per case

DARE ELECTRIC FENCE POLY TAPE is ideal for temporary pastures and rotational grazing. Highly visible, lightweight and easy to use. Woven of white UV resistant polyethylene and 5 strands of stainless steel conductor wires. Install with tape insulators only. Includes a tape buckle for joints. Lightweight and portable, easy to join and splice.

BAYGUARD® BY PARMAK HV POLY ELECTRIC FENCE EQUI-TAPE®

110-171	0-54711 00661-3	79.99
---------	-----------------	-------

7/8" (23 mm) wide x 150 meters/492 ft., bright white.

Wire is wound on a ReelEasy™ Spool for use with optional Reel Easy™ handle.

110-170	0-55709 00680-8	66.99
---------	-----------------	-------

1/2" (13 mm) wide x 200 meters/656 ft., 4 rolls/case, 24 lbs/case. bright white.

Wire is wound on a ReelEasy™ Spool for use with optional Reel Easy™ handle.

110-160	0-55709 00129-2	66.99
---------	-----------------	-------

1/2" (13 mm) wide x 200 meters/656 ft., 4 rolls/case, 24 lbs/case. high vis. yellow/black, Wire is wound on a ReelEasy™ Spool for use with optional Reel Easy™ handle.

110-150	0-55709 00171-1	29.99
---------	-----------------	-------

1/2" (13 mm) wide x 100 meters/328 ft., 6 rolls/case, 18 lbs/case. high vis. yellow/black, Wire is wound on a metal spool.

BAYGUARD® HIGH VISIBILITY POLY ELECTRIC FENCE EQUI-TAPE® is PVC coated fiberglass which gives this tape high strength plus low stretch and sag properties. High conductivity (low resistance) aluminum wires for superior conductivity compared to stainless steel wire. Fire resistant unlike many competitive brands. BAYGUARD conductor wires are .0159" (.4mm) compared to many competitive products constructed of .008" (.2mm) conductor wires. UV stabilized. Easy to install. **5 Year UV Warranty.**



110-169

110-160



110-150

110-170

TAPE JOINERS & TENSIONERS

Part No.	UPC No.	Retail Price
----------	---------	--------------

180-160	0-38923 02804-7	3.89
---------	-----------------	------

Tape buckle for 1/2" Tape. Package of 5

180-165	0-38923-02892-4	4.59
---------	-----------------	------

Tape Buckle for 1-1/2" Tape. 2 Pak

180-170	0-38923-02809-2	7.69
---------	-----------------	------

End Tensioner for 1-1/2" Tape. 2 Pak

180-175	0-38923-02810-8	9.79
---------	-----------------	------

Corner Tensioner for 1-1/2" Tape

180-176	0-38923-04093-3	6.29
---------	-----------------	------

3 Way Tensioner for 1-1/2" Tape



180-165



180-170



180-175



180-176



180-160

POLY FENCING TAPE

Part No.	UPC No.	Retail Price
----------	---------	--------------

speedrite™ by TRU-TEST® ULTRATAPE ELECTRIC FENCE TAPE

S-SP052	9-415793 320364	96.80
400 meters/1320 ft., red/white,		
S-SP050	9-415793 320357	49.70
200 meters/660 ft., red/white,		

speedrite™ ULTRATAPE ELECTRIC FENCE TAPE features ultra high conductivity and delivers maximum energy transfer. 60 Times more conductive than conventional poly-tape. Ultra low resistance of 65 ohm/km (105 ohm/mile). Designed for long lengths of temporary or semi-permanent fencing. Special woven construction for extra strength and durability. Contrasting colours for excellent visibility. UV stabilized for longer life.

MATELEVAGE ELECTRIC FENCE TAPE

110-176	7-74996 05873-3	59.99
1/2" x 200 meters/656 ft., blue/white, 4 rolls/case, 24 lbs/case.		

MATELEVAGE ELECTRIC FENCE TAPE is ideal for permanent pastures and rotational grazing. The grouped arrangement of the conductors guarantees instant reelectrification in case of a failure on one wire. Perfect resistance in bad weather conditions. Treated against UV. Highly visible.

speedrite™ by TRU-TEST® POLITAPE ELECTRIC FENCE TAPE

S-SP017	9-415793 320173	61.50
400 meters/1320 ft., highly visible orange,		
S-SP014	9-415793 320142	61.50
400 meters/1320 ft., bright white,		
S-SP018	9-415793 320180	32.75
200 meters/660 ft., highly visible orange,		
S-SP016	9-415793 320166	32.75
200 meters/660 ft., bright white,		

speedrite™ POLITAPE ELECTRIC FENCE TAPE for economic strip grazing. Highly visible tape with excellent durability. Ideal for temporary fence. UV stabilized for longer life. White tape has 6 strands of durable stainless steel wire for conductivity. Orange tape has 5 strands of durable stainless steel wire.



EQUINE FENCE TAPE & ROPE

Part No.	UPC No.	Retail Price
----------	---------	--------------

DARE 1-1/2" POLY ELECTRIC FENCE TAPE

110-1710	7-74996 05271-7	81.59
----------	-----------------	-------

1-1/2" wide x 200 meters/656 ft., 6 per carton, 40 lb per case

DARE ELECTRIC FENCE POLY TAPE is ideal for temporary pastures and rotational grazing. Highly visible, lightweight and easy to use. Woven of white UV resistant polyethylene and 15 strands of stainless steel conductor wires. Install with tape insulators only. Includes a tape buckle for joints. Lightweight and portable, easy to join and splice.

speedrite™ by TRU-TEST® MAXITAPE ELECTRIC FENCE TAPE

S-SP022	9-414731 10178-2	117.75
---------	------------------	--------

1-1/2" wide x 200 meters/656 ft.

speedrite™ MAXITAPE ELECTRIC FENCE TAPE has 10 strands of highly durable stainless steel wire. UV stabilized for longer life. Suitable for all electric fencing requiring high visibility including horses, ostrich and emu.

DARE 1/2" POLY ELECTRIC FENCE TAPE

110-169	7-74996 05270-0	34.59
---------	-----------------	-------

1/2" wide x 200 meters/656 ft., 6 per carton, 13 lb per case

DARE ELECTRIC FENCE POLY TAPE is ideal for temporary pastures and rotational grazing. Highly visible, lightweight and easy to use. Woven of white UV resistant polyethylene and 5 strands of stainless steel conductor wires. Install with tape insulators only. Includes a tape buckle for joints. Lightweight and portable, easy to join and splice.

BAYGUARD® BY PARMAK 7/8" HV POLY ELECTRIC FENCE EQUI-TAPE®

110-171	0-54711 00661-3	79.99
---------	-----------------	-------

7/8" (23mm) wide x 150 meters/492 ft.,

BAYGUARD® HV POLY ELECTRIC FENCE EQUI-TAPE® is PVC coated fiberglass which gives this tape high strength plus low stretch and sag properties. High conductivity (low resistance) aluminum wire conductors. Fire resistant unlike many competitive brands. BAYGUARD conductor wires are .0159" (.4mm) compared to many competitive products constructed of .008" (.2mm) conductor wires. UV stabilized. 5 Year UV Warranty.

DARE 7MM BRAIDED POLY ELECTRIC FENCE EQUI-ROPE®

110-200	7-74996 05273-1	88.99
---------	-----------------	-------

7mm x 200 meters/656 ft., 2 per carton, 25 lb per case

DARE 7MM POLY ELECTRIC FENCE EQUI-ROPE® is a premium braided HDPE & polyester mix rope with 12 strands of stainless steel wire for strength and conductivity. Approx. 9/32" in diameter. White. 1,592 lbs. average breaking strength.

DARE 6MM BRAIDED POLY ELECTRIC FENCE EQUI-ROPE®

110-201	7-74996 05274-8	56.49
---------	-----------------	-------

6mm x 180 meters/600 ft., 2 per carton, 14 lb per case

DARE 6MM POLY ELECTRIC FENCE EQUI-ROPE® is a braided heavy duty polyethylene rope with 7 strands of stainless steel wire for strength and conductivity. Approx. 1/4" in diameter. White. 628 lbs. average breaking strength.

DARE 4MM BRAIDED POLY ELECTRIC FENCE EQUI-ROPE®

110-202	7-74996 05275-5	40.99
---------	-----------------	-------

6mm x 180 meters/600 ft., 2 per carton, 14 lb per case

DARE 6MM POLY ELECTRIC FENCE EQUI-ROPE® is a braided heavy duty polyethylene rope with 3 strands of stainless steel wire for strength and conductivity. Approx. 1/4" in diameter. White. 628 lbs. average breaking strength.



EQUINE FENCE ROPE & WIRE

Part No.	UPC No.	Retail Price
----------	---------	--------------

BAYGUARD® BY PARMAK

1/4" TWISTED PREMIUM GRADE POLY FENCE ROPE

110-203	7-74996 07019-3	72.49
---------	-----------------	-------

1/4" x 200 meters/656 ft.,

BAYGUARD® 1/4" TWISTED PREMIUM GRADE POLY ELECTRIC FENCE ROPE is a white high visibility rope with 1 yellow and 1 black monofilament. High strength with over 995 lbs. breaking point with 6 tinned copper conductors. Low impedance conductors - 0.064 ohm/m resistance. For temporary or permanent pastures and rotational grazing. **Full 3 Year UV Warranty.**

BAYGUARD® BY PARMAK

1/4" TWISTED STANDARD GRADE POLY FENCE ROPE

110-204	7-74996 07020-9	49.99
---------	-----------------	-------

1/4" x 200 meters/656 ft.,

BAYGUARD® 1/4" TWISTED STANDARD GRADE POLY ELECTRIC FENCE ROPE is an economical white fibrillated polyethylene rope with good strength with 850 lbs. break strength and 6 stainless steel conductors. **Full 1 Year UV Warranty.**

BAYGUARD® BY PARMAK

SUPER HEAVY DUTY PLATINUM SERIES® 4X4 WIRE

110-101	0-54711 00961-6	64.99
---------	-----------------	-------

400 meters/1312 ft., 6 rolls/case,

110-102	0-54711 00960-9	33.99
---------	-----------------	-------

200 meters/656 ft., 6 rolls/case,

BAYGUARD® SUPER HEAVY DUTY PLATINUM SERIES® 4X4 WIRE for permanent or temporary pasture and rotational grazing. 4 Aluminum conductors for maximum shocking power - Conducts electricity 75X greater than stainless steel wire. 4 Reinforced PVC coated fiberglass cords provide the strongest wire available. Excellent weathering - 7 year UV warranty. High visibility reflective silver color. Available in a 200 or 400 M roll. **Full 7 Year UV Warranty.**

ON LINE STRAINER

140-030D	7-74996 06518-2	3.99
----------	-----------------	------

A rope-tensioning device applied without cutting the rope., Extra wide slot especially for rope., .33 lbs., 100/ctn. Plastic.

DARE ONE WAY ROUNDUP LATCH™

180-240	0-38923 03258-7	19.95
---------	-----------------	-------

DARE One Way RoundUp Gate Latch. **Easy one handed operation for opening and closing.**

DARE TWO WAY ROUNDUP LATCH™

180-245	0-38923 03260-0	24.95
---------	-----------------	-------

DARE Two Way RoundUp Gate Latch

"The Original Ring Latch"™

DARE One Way ROUNDUP LATCH™ works on wood, tube, galvanized metal, chain link, ornamental and more. Slef latching one handed operation, locks securely with or without padlock. This gate latch is easy to operate, secure self latching, one handed operation. Patent #6,017,068. Reinforced zinc chromated rings. Professional powder coated finish. Reinforced 10-Guage steel. Applications include farm & ranch gates, garden gates, residential gates, dog kennels, corrals, hunting/fishing leases and barn doors. **Easy one handed operation for opening and closing.**

110-203



110-204

110-101 — 400M
110-102 — 200M



140-030D



180-245



EQUINE FENCE TAPE

Part No.	UPC No.	Retail Price
4" TAPE RAIL EQUINE FENCE		
110-211	8-35923 00329-2	84.99

4" x 100 meters/330 ft.,

THE TOP LINE ELECTRIC FENCE.

This tape rail has been designed to be highly visible and easy to erect.

The tape is constructed with 4 unique conductive twines. Each twine contains 3 tinned copper wires. The twisted construction means that the tape can be highly strained without the worry of breaking the conductive filaments. The tinned copper wires gives the Tape Rail a conductivity similar to 2.5mm galvanized fence wire.

The Tape Rail system has a full range of quality accessories listed below. This allows construction utilizing either steel or wood. If using steel posts, specially designed protective caps should be used to protect your livestock.

Tape Rail Dispensing. If constructing the fence by yourself, the box can be used as a dispensing unit. Tie the box to the strainer post using some wire. Alternatively you can place the box on the centre spindle of a common wire spinner. Simply pull the tape through the slit on the box.

Post spacings should be 5 meters apart. In high wind areas, post spacing may need to be reduced. It is important to make sure the tape is strained sufficiently so wind does not flutter the tape. If the tape moves in the wind, increase the strain on the tape.

While the tape is strained make sure the retaining clip is held in the cog. If the spring releases during straining the tape will unwind like a giant spring.

Once the tape has been strained tightly from both ends, the strainer should be returned to vertical position.

Electrical connection is made to the insulated strainer utilizing split bolt line clamps and underground cable. "Cut off" switches should be used to electrically isolate sections of the fence.



110-211

INSULATED RATCHET STRAINER FOR 4" TAPE RAIL FENCE

110-214	8-35923 00109-0	21.95
---------	-----------------	-------

2 Pack

Insulated Ratchet Strainer for 4" Tape Rail Fence is used to strain the tape. This should be used from both ends to guarantee an even strain along distances up to 300 meters.

Pull the tape through the slit of the cog and pull hand tight. Cut excess tape away. Turn the strainer to the horizontal position while straining with spanner. Make sure while straining that the tape is centered on the strainer to prevent the tape from being damaged by either side of the cog.



110-214

TAPE RAIL INLINE CONNECTOR

110-215	8-35923 00332-2	26.95
---------	-----------------	-------

Tape Rail inline connector joins Tape Rail. Wind the tape from both sides around individual plates and then clamp together utilizing bolts and nuts supplied.



110-215

TAPE RAIL INSULATOR

110-212	8-35923 00327-8	26.95
---------	-----------------	-------

Tape Rail insulator for T-posts and wood posts.



110-212

HORSERAIL FENCING

Part No.	UPC No.	Retail Price
HORSECOTE™ COATED HIGH TENSILE FENCE WIRE		
110-240	7-74996 04584-9	215.95

12-1/2" gauge wire., 1320'/400m., 68 lbs/30kg., White.

HORSECOTE™ COATED HIGH TENSILE FENCE WIRE is a plastic coated wire that is quickly becoming the coated wire of choice by both horse owners and fencing contractors. It is very easy to use, needs little maintenance, is cost-effective, easy to install and versatile. The molecularly bonded premium grade polyethylene plastic is reinforced by a 12.5 gauge high tensile fence wire, which has an ASTM classification for physical barrier fencing, that has a minimum breaking strength of 1650 lbs. It can handle animal impact and cold weather construction/expansion without permanent elongation. The large diameter of 0.3" is easier for animals to see, and this size helps reduce the chance of injury. 10 Year Limited Warranty.

HOTCOTE™ COATED HIGH TENSILE FENCE WIRE		
110-245	7-74996 04585-6	244.75

12-1/2" gauge wire., 1320'/400m., 68 lbs/30kg., White.

HOTCOTE™ COATED HIGH TENSILE FENCE WIRE has the same properties as the above wire but can be electrified. The black plastic core is conductive and comes to the surface in 3 narrow lines.

PONYRAIL™ COATED HIGH TENSILE FENCE RAIL		
110-300	6-49998 03835-2	314.99

750'/230m., 68 lbs/30kg., White.

PONYRAIL™ COATED HIGH TENSILE FENCE RAIL. The 1" Ponyrail is an economical choice that does not sacrifice quality. The Ponyrail system is best used with our Horsecote and Hotcote wire fences. Ponyrail is both safe for the horse and rider and can be used to make attractive arenas.

HORSERAIL™ COATED HIGH TENSILE FENCE RAIL

110-310-W	7-74996 07164-0	4" wide, 2 wire, 660 ft. roll, White.	434.31
110-311-W	7-74996 07165-7	4" wide, 2 wire, 330 ft. roll, White.	231.63
110-310-BL	7-74996 07166-4	4" wide, 2 wire, 660 ft. roll, Black.	434.31
110-311-BL	7-74996 07167-1	4" wide, 2 wire, 330 ft. roll, Black.	231.63
110-310-BR	7-74996 07168-8	4" wide, 2 wire, 660 ft. roll, Brown.	434.31
110-311-BR	7-74996 07169-5	4" wide, 2 wire, 330 ft. roll, Brown.	231.63
110-320-W	7-74996 07170-1	5" wide, 3 wire, 660 ft. roll, White.	579.09
110-321-W	7-74996 07171-8	5" wide, 3 wire, 330 ft. roll, White.	311.26
110-320-BL	7-74996 07173-2	5" wide, 3 wire, 660 ft. roll, Black.	579.09
110-321-BL	7-74996 07174-9	5" wide, 3 wire, 330 ft. roll, Black.	311.26
110-320-BR *	7-74996 07175-6	5" wide, 3 wire, 660 ft. roll, Brown.	579.09
110-321-BR *	7-74996 07176-3	5" wide, 3 wire, 330 ft. roll, Brown.	311.26
110-330-W	7-74996 07177-0	6" wide, 3 wire, 660 ft. roll, White.	665.95
110-331-W *	7-74996 07178-7	6" wide, 3 wire, 330 ft. roll, White.	332.98
110-330-BL *	7-74996 07179-4	6" wide, 3 wire, 660 ft. roll, Black.	665.95
110-331-BL *	7-74996 07180-0	6" wide, 3 wire, 330 ft. roll, Black.	332.98
110-330-BR *	7-74996 07181-7	6" wide, 3 wire, 660 ft. roll, Brown.	665.95
110-331-BR *	7-74996 07182-4	6" wide, 3 wire, 330 ft. roll, Brown.	332.98

HORSERAIL™ COATED HIGH TENSILE FENCE RAIL. The Horserail is available in 4", 5" and 6" widths and is a popular choice for horserail fencing. This is because of it's strength, flexibility, safety and competitive cost. It is available in three colours - white, brown and black - and is designed to be easily installed using the unique buckling and tensioning system. Horserail is competitively priced and comes with a "No Problems" Warranty.

4" 2 WIRE HORSE RAIL IS STRONGER THAN 4" 3 WIRE HORSE RAIL DUE TO ITS HEAVIER CONSTRUCTION

* signifies that item is not in-stock



THE COMPLETE HORSE RAIL SYSTEM...IN A CLASS OF ITS OWN

HORSERAIL FENCING

Part No.	UPC No.		Retail Price
HORSERAIL™ ORIGINAL 1 PC SPOOLER			
110-312-W *	7-74996 07183-1	4" wide, 1 pc. construction, White,	12.06
110-312-BL *	7-74996 07219-7	4" wide, 1 pc. construction, Black,	12.06
110-312-BR *	7-74996 07184-8	4" wide, 1 pc. construction, Brown,	12.06
110-322-W *	7-74996 07185-5	5" wide, 1 pc. construction, White,	13.16
110-322-BL *	7-74996 07186-2	5" wide, 1 pc. construction, Black,	13.16
110-322-BR *	7-74996 07187-9	5" wide, 1 pc. construction, Brown,	13.16
110-332-W *	7-74996 07188-6	6" wide, 1 pc. construction, White,	14.26
110-332-BL *	7-74996 07189-3	6" wide, 1 pc. construction, Black,	14.26
110-332-BR *	7-74996 07191-6	6" wide, 1 pc. construction, Brown,	14.26

HORSERAIL™ ORIGINAL 1 PC SPOOLER quick, practical and designed for safety. No stripping, no crimping or notching and no exposed wires. The spooler has a clean look, a neat appearance and is safe for horses. The spooler is designed as a simple and economical way to tension the rail. The recommended method of attaching and joining the rail is the innovative Horserail Buckle System.

HORSERAIL™ 2 PC SPOOLER			
110-313-W	7-74996 07192-3	4" wide, 2 pc. construction, White,	16.45
110-313-BL	7-74996 07193-0	4" wide, 2 pc. construction, Black,	16.45
110-313-BR	7-74996 07194-7	4" wide, 2 pc. construction, Brown,	16.45
110-323-W	7-74996 07195-4	5" wide, 2 pc. construction, White,	17.55
110-323-BL	7-74996 07196-1	5" wide, 2 pc. construction, Black,	17.55
110-323-BR *	7-74996 07197-8	5" wide, 2 pc. construction, Brown,	17.55
110-333-W	7-74996 07198-5	6" wide, 2 pc. construction, White,	18.64
110-333-BL *	7-74996 07199-2	6" wide, 2 pc. construction, Black,	18.64
110-333-BR *	7-74996 07200-5	6" wide, 2 pc. construction, Brown,	18.64

HORSERAIL™ 2 PC SPOOLER has the same function as the ORIGINAL 1 PC SPOOLER but provides the convenience of spooler placement after the initial rail assembly.

HORSERAIL™ FLAT BRACKET			
110-314-W	7-74996 07201-2	4" wide, Flat mounting bracket, White,	1.32
110-314-BL	7-74996 07202-9	4" wide, Flat mounting bracket, Black,	1.32
110-314-BR	7-74996 07203-6	4" wide, Flat mounting bracket, Brown,	1.32
110-324-W	7-74996 07204-3	5" wide, Flat mounting bracket, White,	1.42
110-324-BL	7-74996 07205-0	5" wide, Flat mounting bracket, Black,	1.42
110-324-BR *	7-74996 07206-7	5" wide, Flat mounting bracket, Brown,	1.42
110-334-W	7-74996 07207-4	6" wide, Flat mounting bracket, White,	1.64
110-334-BL *	7-74996 07208-1	6" wide, Flat mounting bracket, Black,	1.64
110-334-BR *	7-74996 07209-8	6" wide, Flat mounting bracket, Brown,	1.64

HORSERAIL™ FLAT BRACKET for installing fence in most situations.

HORSERAIL™ 90° INSIDE BRACKET			
110-318-W	7-74996 07210-4	4" wide, 90° Inside Mounting Bracket, White,	3.29
110-318-BL	7-74996 07211-1	4" wide, 90° Inside Mounting Bracket, Black,	3.29
110-318-BR	7-74996 07212-8	4" wide, 90° Inside Mounting Bracket, Brown,	3.29
110-328-W	7-74996 07213-5	5" wide, 90° Inside Mounting Bracket, White,	3.84
110-328-BL	7-74996 07214-2	5" wide, 90° Inside Mounting Bracket, Black,	3.84
110-328-BR *	7-74996 07215-9	5" wide, 90° Inside Mounting Bracket, Brown,	3.84
110-338-W	7-74996 07216-6	6" wide, 90° Inside Mounting Bracket, White,	4.39
110-338-BL *	7-74996 07217-3	6" wide, 90° Inside Mounting Bracket, Black,	4.39
110-338-BR *	7-74996 07218-0	6" wide, 90° Inside Mounting Bracket, Brown,	4.39

HORSERAIL™ 90° INSIDE BRACKET allows 90° tune while keeping posts on the outside of the riding area for optimum horse and rider safety. Unique design blends into the overall look of the rail and allows the rail to be tensioned even at this acute angle. Made of heavy gauge metal and fastened with two 3/8" lag screws. Double coated...hot dipped galvanized and powder coated. Unmatched warranty. If it breaks we will replace it.

* signifies that item is not in-stock

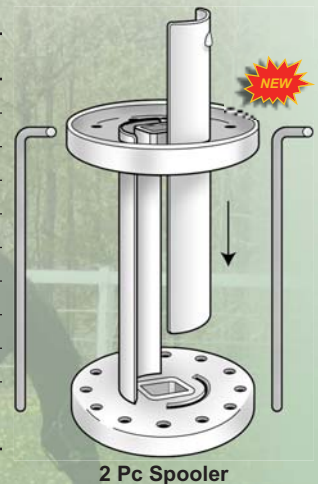
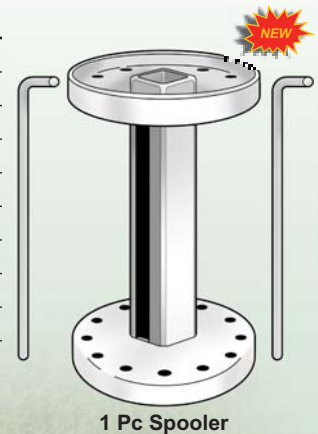

HORSERAIL FENCING

Part No.	UPC No.		Retail Price
HORSERAIL™ TOP BRACKET			
110-319-W	7-74996 07220-3	4" wide, Top Bracket, White,	1.42
110-319-BL *	7-74996 07221-0	4" wide, Top Bracket, Black,	1.42
110-319-BR *	7-74996 07222-7	4" wide, Top Bracket, Brown,	1.42
110-329-W *	7-74996 07223-4	5" wide, Top Bracket, White,	1.54
110-329-BL *	7-74996 07224-1	5" wide, Top Bracket, Black,	1.54
110-329-BR *	7-74996 07225-8	5" wide, Top Bracket, Brown,	1.54
110-339-W *	7-74996 07226-5	6" wide, Top Bracket, White,	1.75
110-339-BL *	7-74996 07227-2	6" wide, Top Bracket, Black,	1.75
110-339-BR *	7-74996 07228-9	6" wide, Top Bracket, Brown,	1.75

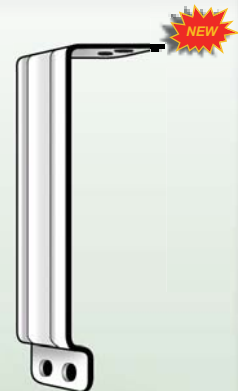

Top Bracket

HORSERAIL™ TOP BRACKET is used where you want the rail to be level with the top of the post.

$\frac{3}{8}$ " Lag Screw length for brackets determined by post density

Dense Southern Yellow Pine	3"	Notes: 1. pre-drill $\frac{1}{4}$" diameter hole 2. when in doubt - use a longer length screw or use a carriage bolt through the post 3. hot dipped galvanized washer - optional 4. small amount of grease on lag screw assists installation
Softer Red & White Pine	3 $\frac{1}{2}$ "	
Cedar/Lodge Pole, Ponderosa	4"	

HORSERAIL™ T-BUCKLE			
110-317-W *	7-74996 07229-6	4" wide, T-Buckle, White,	10.42
110-317-BL *	7-74996 07230-2	4" wide, T-Buckle, Black,	10.42
110-317-BR *	7-74996 07232-6	4" wide, T-Buckle, Brown,	10.42
110-327-W *	7-74996 07233-3	5" wide, T-Buckle, White,	11.51
110-327-BL *	7-74996 07234-0	5" wide, T-Buckle, Black,	11.51
110-327-BR *	7-74996 07235-7	5" wide, T-Buckle, Brown,	11.51
110-337-W *	7-74996 07236-4	6" wide, T-Buckle, White,	13.16
110-337-BL *	7-74996 07237-1	6" wide, T-Buckle, Black,	13.16
110-337-BR *	7-74996 07238-8	6" wide, T-Buckle, Brown,	13.16

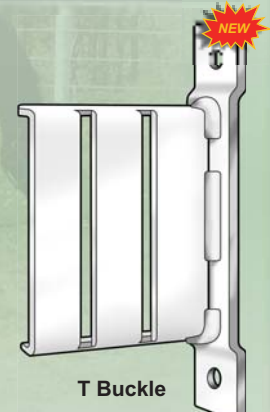

T Buckle

HORSERAIL™ T-BUCKLE is designed to be used at T-Junctions as an alternative to attaching buckles and post brackets.

HORSERAIL™ ATTACHING BUCKLE			
110-315-W	7-74996 07239-5	4" wide, Attaching Buckle, White,	9.32
110-315-BL	7-74996 07240-1	4" wide, Attaching Buckle, Black,	9.32
110-315-BR	7-74996 07241-8	4" wide, Attaching Buckle, Brown,	9.32
110-325-W	7-74996 07242-5	5" wide, Attaching Buckle, White,	9.87
110-325-BL	7-74996 07243-2	5" wide, Attaching Buckle, Black,	9.87
110-325-BR *	7-74996 07244-9	5" wide, Attaching Buckle, Brown,	9.87
110-335-W	7-74996 07245-6	6" wide, Attaching Buckle, White,	10.42
110-335-BL *	7-74996 07246-3	6" wide, Attaching Buckle, Black,	10.42
110-335-BR *	7-74996 07247-0	6" wide, Attaching Buckle, Brown,	10.42



Attaching Buckle

HORSERAIL™ ATTACHING BUCKLE is designed to eliminate the hassles of joining rails and attaching them to end posts. The buckles provide a strong, low maintenance solution for railing connections.

* signifies that item is not in-stock

THE COMPLETE HORSERAIL SYSTEM...IN A CLASS OF ITS OWN

HORSE RAIL FENCING

Part No.	UPC No.		Retail Price
HORSE RAIL™ JOINING BUCKLE			
110-316-W	7-74996 07248-7	4" wide, Joining Buckle, White,	9.32
110-316-BL	7-74996 07249-4	4" wide, Joining Buckle, Black,	9.32
110-316-BR	7-74996 07250-0	4" wide, Joining Buckle, Brown,	9.32
110-326-W	7-74996 07251-7	5" wide, Joining Buckle, White,	9.87
110-326-BL	7-74996 07252-4	5" wide, Joining Buckle, Black,	9.87
110-326-BR *	7-74996 07253-1	5" wide, Joining Buckle, Brown,	9.87
110-336-W	7-74996 07254-8	6" wide, Joining Buckle, White,	10.42
110-336-BL *	7-74996 07255-5	6" wide, Joining Buckle, Black,	10.42
110-336-BR *	7-74996 07256-2	6" wide, Joining Buckle, Brown,	10.42

HORSE RAIL™ JOINING BUCKLE is designed to eliminate the hassles of joining rails and attaching them to end posts. The buckles provide a strong, low maintenance solution for railing connections.

HORSE RAIL™ BENDING TOOL

110-310-BND	7-74996 07257-9	4" wide, Bending Tool, White,	16.45
110-320-BND	7-74996 07258-6	5" wide, Bending Tool, Black,	16.45
110-330-BND	7-74996 07259-3	6" wide, Bending Tool, Brown,	16.45

HORSE RAIL™ BENDING TOOL is designed to properly bend Horserail rails to be joined with a joining buckle.

HORSE RAIL™ ORANGE SPLIT TUBING

110-210	7-74996 01897-3	4" wide, Bending Tool, White,	.23/ft.
---------	-----------------	-------------------------------	---------

HORSE RAIL™ ORANGE SPLIT TUBING is designed to create a highly visible fence from an ordinary high tensile fence.

HORSE RAIL™ NAILS FOR BRACKETS

110-282	6-49998 05109-2	Nails for spur rail bracket	.03
---------	-----------------	-----------------------------	-----

PONY RAIL™ STAPLES

140-140	6-49998 09685-7	1" x 2" Flat Top Staple.	.27 each
---------	-----------------	--------------------------	----------

* signifies that item is not in-stock

THE COMPLETE HORSE RAIL SYSTEM...IN A CLASS OF ITS OWN

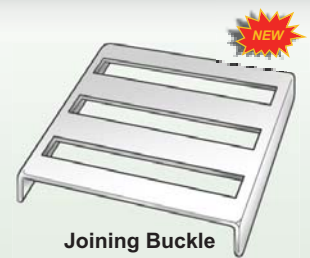

DROPPERS

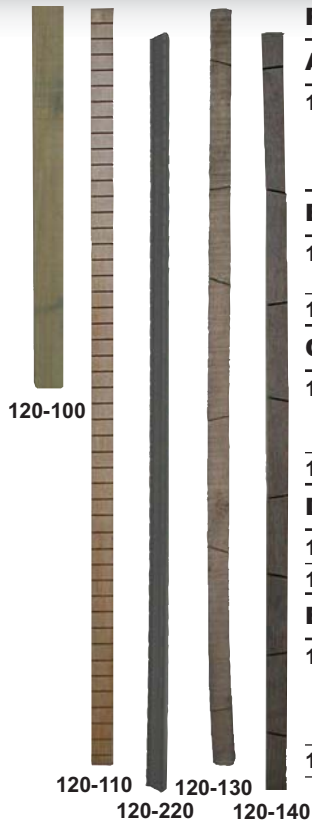

Part No.	UPC No.	Description	Retail Price
A. 24" TWITCH STICK			
120-100	6-49998 01000-6	Used for twitching or tensioning the brace wire, manufactured from hardwood and pressure treated. Won't shear off or slide out of brace wire. CAA treated. 3 lbs. each, 15/bundle.	1.80
B. MULTI-GROOVE DROPPERS			
120-110	6-49998 01055-6	Cut from select hardwood, notched every inch and stress tested 49" Multi-Groove – 3 lbs. each, 25/bundle.	4.25
120-220	6-49998 01150-8	Same as above. Poly Dropper	4.49
C. MULTI-GROOVE DROPPER CLIP			
140-260	6-49998 09105-0	Class 111 galvanized low carbon steel wire clips. Used for attaching multi-groove droppers to fence wires to prevent horizontal wire separation.	.10
140-261	6-49998 09107-4	Same as above. Box of 1000, 14-1/4 lbs.	101.90
D. POLY DROPPER CLIP			
140-280	6-49998 09115-9	Poly Dropper Clip.	.10
140-281	6-49998 99117-3	Same as above. Box of 1000.	102.40
E. ANGLE GROOVE DROPPERS			
120-130	6-49998 01038-9	Angle Grooves come in either six or eight cut. The pre-cut grooves are alternated in different directions to self-lock. No clips are needed. 6 Angle Groove Dropper – 3.2 lbs., 25/bundle.	3.99
120-140	6-49998 01026-6	Same as above. 8 Angle Groove Dropper – 3.2 lbs., 25/bundle.	3.99



140-260



140-280

SPINNING JENNY. WIRE PAYOUT TOOL

Part No.	UPC No.	Description	Retail Price
130-010	7-74996 01860-7	For pay out of wire. 20 lbs.	90.00
130-011	7-74996 03425-6	Spinning Jenny Rental.	3/day
130-012	7-74996 02635-0	Spinning Jenny Parts Box.	25.99
130-015	7-74996 02639-8	Spinning Jenny Wing-Nut.	.45
130-018	7-74996 02641-1	Spinning Jenny Wheel only.	65.99
130-019	7-74996 02642-8	Spinning Jenny Peg only.	13.75



130-010



130-012



130-018



130-019

FENCING

Part No.	UPC No.	Description	Retail Price
CRIMP TOOLS			
130-110	0-38923 02154-3	For full strength splices, tie-off and superior electrical connections, crimping sleeves do the best job. The 4 hole model is for 16 thru 9 gauge wire. Agitite 4 Hole Crimp Tool – 7.2 lbs., 5/ctn., 1.0 cu. ft.	82.39
130-100	6-49998 03164-3	Same as above. Micropress 4 Hole Crimp Tool – 6 lbs.	359.99
130-121	7-74996 03426-3	Crimp Tool Rental.	4/day
130-125	6-49998 03190-2	Eze Pull Pliers (4-in-One).	195.95
WIRE VISE PULLER & GRIPPLE TENSIONER			
130-090	6-49998 03440-8	Used to pull wire through the wire vises especially for the initial tension. 5.50 lbs.	62.99
130-095	0-38923 02885-6	Gripple tension tool.	82.39
WIRE CUTTER AND PLIERS			
130-130	0-38923 02290-8	Wire cutting pliers with hardened jaws capable of cutting high carbon wire. 1 lb., 5/ctn., .25 cu. ft.	21.24
130-132	0-38923 03001-6	General purpose fence pliers	11.99
130-133	0-38923 02999-0	Round nose fence pliers	9.99
S-SF1709	9-414731 376906	Heavy Duty Combo Pliers 6/ctn	
WIRE TWISTING TOOL			
130-080	0-38923 01707-2	Used for tightly fastening multi-groove droppers and for loosely wrapping the electric post clip. .3 lbs., 10/ctn., .03 cu. ft.	2.99
STRAINER HANDLES			
130-050	0-38923 01701-0	Used for tightening or releasing wire tension using in-line strainers. Dare Handle – 1.2 lbs., 5/ctn., .09 cu. ft.	6.69
130-050A	7-74996 03437-9	Same as above. SMB Handle	4.99
130-060	6-49998 03300-5	Same as above. Kiwi Handle – .75 lbs., 24/case.	7.29
130-055	0-38923 02770-5	Handle for Plastic Tighteners	7.35
130-055M	7-74996 06513-7	Handle for Metal Tighteners	7.35
S-SA017	9-415793 401704	Handle for S-SA016	13.99
POST POUNDER			
130-091	6-49998 03450-7	The One man post pounder allows accurate driving of the Electric Fence Post while keeping it square to the guide wire.	49.80



FENCE STRAINERS

Part No.	UPC No.	Description	Retail Price
WIRE PULLING & TENSIONING TOOLS			
130-020	6-49998 03250-3	Wire pulling and tensioning tool that uses wire grips. S.A. Donalds – 6 lbs.	121.49
130-030	6-49998 03270-1	Same as above. Hayes – 6.75 lbs.	105.95
130-040	7-74996 06514-4	Maasdam Wire Grip. 1000 lb	29.50
130-041	7-74996 06515-1	McKluskey Wire Grip (Wire Dog)	39.75
130-045	7-74996 06516-8	Klein Wire Grip. 1200 lb	81.75
IN-LINE STRAINER			
140-010	7-74996 04982-3	State-of-the-art wire-tensioning device .62 lbs., 50/ctn.	2.59
140-011	7-74996 02643-5	Same as above. Box of 50.	116.99
IN-LINE STRAINER WITH CLIP			
140-020	7-74996 04981-6	Same as above, but has a spring clip to positively engage the flapper while tensioning. .64 lbs., 50/ctn.	2.99
140-021	7-74996 02644-2	Same as above. Box of 50.	134.39
140-040	0-38923 02910-5	Metal Self Locking Strainer.	2.79
S-SA100-50	9-414731 113037	Uninsulated Spring Clip Wire Strainer BY SPEEDRITE	3.90
ON-LINE STRAINER			
140-025	6-49998 09352-8	A wire-tensioning device applied without cutting the wire. .33 lbs., 100/ctn. Metal.	3.49
S-SA016	9-415793 401506	Same as above. BY SPEEDRITE 25/ctn. Metal	3.90
140-030	7-74996 01861-4	Same as above. Plastic.	2.59
140-030D	7-74996 06518-2	Same as above. Plastic. Wider Groove For Use With Rope	3.99
140-032	7-74996 02646-6	Pins for On-Line.	.05
140-033	7-74996 02647-3	Clips for On-Line.	.20
140-050	0-38923 02806-1	Plastic On-Line Strainer for Poly. 5 Pak	9.99
TENSION INDICATOR SPRING			
140-070	7-74996 01864-5	Used to determine the proper wire tension, while maintaining full strength of the wire.	7.49
140-080	6-49998 09155-5	Same as above. Kiwi Ten. Ind. Spring. 1.29 lbs., 24/ctn.	7.89

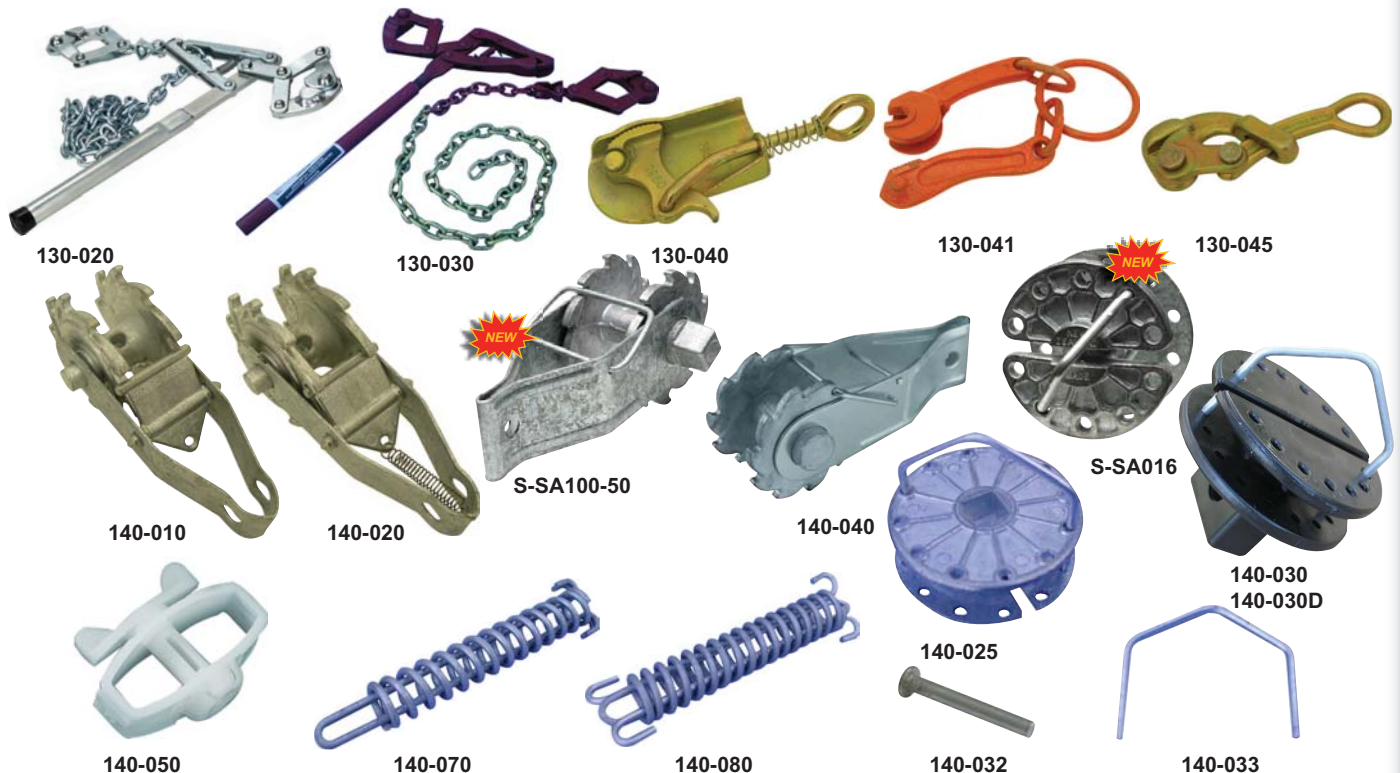

CRIMP SLEEVES AND JOINTERS



GRIPPLE JOINER & TENSIONER

GripPle is a unique wire joining and tensioning system, consisting of the GripPle Joiner and Tensioner and the GripPle Tensioning Tool.

At the heart of the system is the internally acclaimed, award winning GripPle Joiner and Tensioner. The unique GripPle design gives strength and durability, both essential requirements for outdoor use in extreme climatic conditions. GripPles have a 100% zinc alloy outer casing. Inside there are two precision serrated, hardened steel rollers which act as a locking mechanism. The rollers, supported by two stainless steel springs, allow the GripPle to be re-tensioned or reused as required.

The second component of the system, the GripPle Tensioning Tool takes up the wire tension when installing or during seasonal maintenance.

The real benefit of using the GripPle is its ease of use - simply push the wire through the GripPle. Pass a length of at least 50mm of wire through the other side of the GripPle; this will help future adjustments and re-tensioning.

Once the GripPle is in position, and tension is applied, the rollers lock automatically onto the wire. Wire tension can be increased at any time by simply pulling more through the GripPle. To remove the GripPle, cut the wire and pull the ends through. The GripPle is now ready to use again.

The GripPle's clever design allows installations and repairs to be secured in seconds. This saves time, money and materials.

System Benefits

- Easy to Use - simple push-fit means no bending or twisting of awkward wires and no more cuts and grazes to hands
- Versatile - there is a GripPle Joiner and Tensioner to suit all types of wire, including stainless steel, high tensile and barbed wire
- Re-tensionable - the GripPle Joiner and Tensioner can be re-tensioned season after season, restoring original tension to the fence
- Maximizes the life of the wire - the wire maintains its straightness and strength - there is no bending or twisting to weaken the wire
- Durable - GripPle Joiner and Tensioners are made from zinc for maximum corrosion resistance
- Fast Repairs - GripPle Joiner and Tensioners are ideal for maintaining and replacing damaged sections of wire

Model	Plain Wire		Barbed Wire		Working Load	
	mm	Gauge	mm	Gauge	Kg	Lb
Small	1.00 - 2.00	14 - 17 ga			220	450
Medium	2.00 - 3.25 mm Mild Steel	12 - 13 ga	2 X 1.70 mm Mild Steel	15.5 ga	350	700
	2.00 - 2.85 mm High Tensile Steel					
Large	4 mm Mild Steel		2 X 2.50 mm Mild Steel	12.5 ga	150	350
Maxi	2.50 - 4.00 mm High Tensile Steel	8 - 11 ga			600	1400

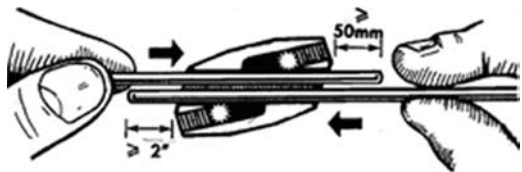

	Part No.	UPC No.	Description	Retail Price
GRIPPLES				
	140-231	0-38923 02881-8	Small GripPle for 14-17 Gauge Wire. 20/Pak	34.99
	140-232	0-38923 02882-5	Medium GripPle for 12-13 Gauge Wire. 20/Pak	38.99
	140-233	0-38923 02883-2	Large GripPle for 7-11 Gauge Wire. 10/Pak	27.99
	140-234	0-38923 02884-9	Maxi GripPle Fits 8-11 Gauge Wire. 10/Pak	35.99

CRIMP SLEEVES AND JOINTERS

Part No.	UPC No.	Description	Retail Price
CRIMPING SLEEVE			
<i>Splicing of 12-1/2" gauge wire can be accomplished with three crimped sleeves, which withstand up to 1800 lbs. tension. Two sleeves required for end post attachment. Also used for attaching In-Line Strainers, and tying in electric jumper wires.</i>			
140-160	6-49998 09610-3	Same as above. Ag-Tite 16 GA – 100/pkg., .25 lbs./pkg., 75 pkg./case.	15.19/pkg.
140-170	6-49998 09685-1	Same as above. Ag. Long Sleeve. 12-1/2 GA – 100/pkg., .5 lbs./pkg., 75 pkg./case.	25.69/pkg.
140-200	6-49998 09820-2	Same as above. Ag.-Tite 12-1/2 GA – 100/pkg., .50 lbs./pkg., 50 pkg./case.	18.49/pkg.
140-220	6-49998 09640-0	Same as above. Ag. 10-11 GA – 50/bag, .75 lbs./bag, 50 bags/case.	24.99/pkg.
140-230	6-49998 09845-5	Same as above. Ag. 9 GA – 50/bag, .1 lb./bag, 50 bags/case.	26.49/pkg.
WIRE JOINTERS			
140-240	0-38923 02106-2	A fast, simple "no-knot" method of joining wires. Withstands up to 1800 lbs. of tension. .04 lbs., 100/ctn., .16 cu. ft. Per ea.	4.99
130-070	6-49998 03420-0	Wire Release Tool.	31.99
140-250	0-38923 02105-5	Wire Vise. For anchoring wire to an end post. This device has a one-way grabbing action that allows wire to be tensioned when pulled through the centre. For 12.5 Gauge wire	3.99
140-251	7-74996 05276-2	Wire vise for 10, 11, & 12.5 Gauge wire.	3.99
140-255	0-38923 03098-9	Braid Rope Joiner	6.99
AGTITE ELECTRIC FENCE TAPS			
140-180	6-49998 01510-0	Electric Fence Taps – 12-1/2 GA., 25/pack.	8.49



140-170



140-200

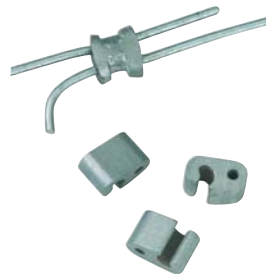

140-180



130-070



140-220



140-230



140-250



140-251



140-240



140-255

JOINTERS, BRACE PINS & STAPLES

Part No.	UPC No.	Description	Retail Price
CONNECTORS			
140-300	0-38923 02101-7	Split Bolt. Used to connect hook-up or grounding wire to fence. 9.45 Package of 10., 10 pkgs./ctn., 4 lbs./ctn., .16 cu. ft.	
140-301	0-38923 02476-6	Split Bolt Individual.	.95
140-330	7-74996 01903-1	L-Clamp. Positive clamping action, galvanized. 25/bag.	ea. .60
140-305	6-49998 01500-1	Heavy-Duty Line Clamp	1.29
S-SA052	9-415793 405207	Heavy Duty Line Clamp <i>by TRU-TEST®</i>	1.40
140-335	0-38923 02805-4	Pulse Connector. 2/Pak	4.14
BRACE PINS. H.D.G.			
140-090	6-49998 09135-7	Hot dipped galvanized bracing pins come in two different sizes, 5" and 10". These pins are just the right diameter to slip into a 3/8" hole, for easy installation. 10" Pins – .03 lbs., 100/case.	.65
140-100	6-49998 09140-1	Same as above. 5" Pins – .01 lbs., 100/case.	.35
ELECTRO GALVANIZED STAPLES			
140-130	6-49998 09670-3	2" galvanized barbed staple. Per lb.	1.69
140-131	6-49998 09672-7	2" galvanized barbed staple. 50 lb.	57.45
140-132	6-49998 09676-5	2" galvanized barbed staple. 10 lb.	22.99
140-133	7-74996 06517-5	2" knurled staple. 50 lb. Box	57.45
140-134	7-74996 07260-9	2" fish hook barbed staple. Class III galvanized. High quality.	75.75



GROUND RODS & EARTH ANCHORS

Part No.	UPC No.	Description	Retail Price
GROUND ROD CLAMP			
140-340	6-49998 01640-4	Connect ground wire to ground rod. Used for rods up to 3/4" 25/pkg., 16 oz.	1.99
speedrite™ by TRU-TEST® GROUND CLAMP			
S-SA112	9-414731 378573	UL Approved Ground Rod Clamp	2.75
GROUND ROD			
140-350	7-74996 01904-8	Hot dip galvanized. 3/4" x 8', 5/bundle, 12 lbs.	18.49
140-360	7-74996 01905-5	Same as above. 3/4" x 6', 5/bundle, 9 lbs.	16.59
140-370	6-49998 01634-3	Same as above. 1/2" x 6', 5/bundle, 7.50 lbs.	11.69
140-380	6-49998 01636-7	Same as above. 1/2" x 8', 5/bundle, 5.50 lbs.	15.79
EARTH ANCHORS			
180-250J	7-74996 04413-2	3 x 20 earth anchor	3.69
180-255J	7-74996 04414-9	3 x 28 earth anchor	3.99
180-260J	7-74996 04415-6	4 x 38 earth anchor	6.39
180-269J	0-85312 62551-6	6 x 46 earth anchor	10.19
180-270J	7-74996 01909-3	6 x 58 earth anchor	10.39
180-271	0-38923 02396-7	Duck Bill Earth Anchor	9.49

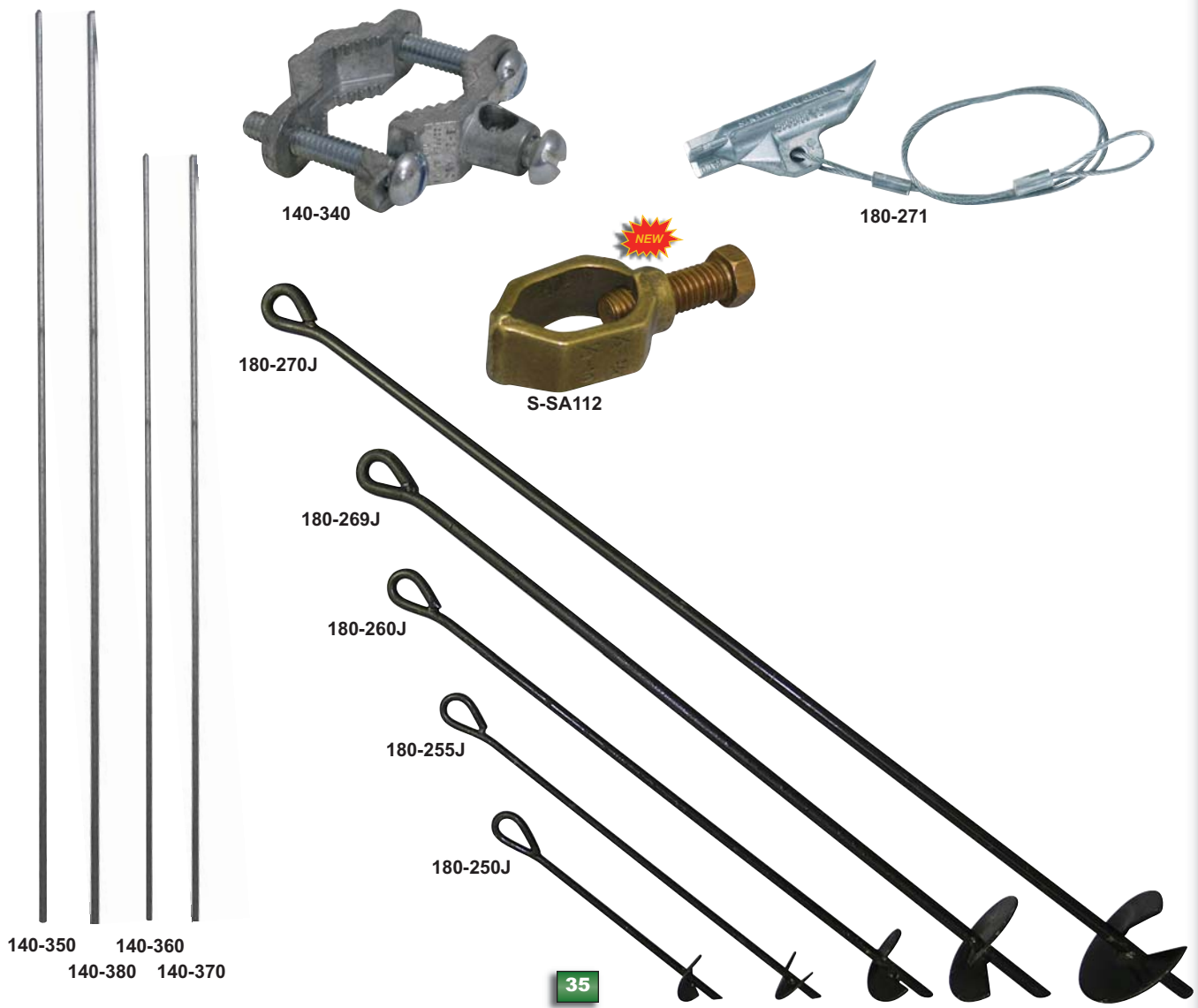

ELECTRIC FENCE ACCESSORIES

Part No.	UPC No.	Description	Retail Price
----------	---------	-------------	--------------

DARE FLOODGATE CONTROLLER

180-210	0-38923 02209-0		15.59
---------	-----------------	--	-------

Restricts the flow of current to specific sections of fence that may be shorted by rising water or heavy weed growth. Prevents shorted wire from grounding entire fence. Also as an "ENERGY LIMITER"

speedrite™ by TRU-TEST® FLOODGATE CONTROLLER

S-SA038	9-415793 403807		35.25
---------	-----------------	--	-------

Limits energy loss from heavy growth or flooding. Fully sealed from insects and the elements.

DARE 20' SLINKY GATE

180-200	0-38923 02222-9		16.29
180-201	7-74996 02675-6	Spring only.	8.79

Stretches to fit gate opening up to 20 feet. Retracts to keep gate off ground when open. Electrified when closed, neutral when open. Highly visible and effective. SLINKY GATE assembly consists of: One Rub'RGate handle, one large galvanized spring, two pinlock style wood post insulators with galvanized nails, two pinlock style T-Post insulators, one anchor/activator, one fence line clamp/tap and complete schematic instructions. Equipped to fit wood or T-Post openings.

speedrite™ by TRU-TEST® SPRING GATE

S-SA044	9-415793 404408	16' Spring Gate	20.95
S-SA0448M	9-414731 101171	24' Spring Gate	27.50
S-RSGSXL	9-414731 376883	24' Spring Only for S-SA0448M	7.90

Heavy duty galvanized spring. Highly visible for maximum stock control.

speedrite™ by TRU-TEST® TAPE GATE

S-SA043	9-415793 404309	16' Tape Gate	20.95
---------	-----------------	---------------	-------

Wide, highly visible tape. 16' of 1-5/8" wide gate tape.

KOLTEC GATE HANDLE

180-230	7-74996 01930-7		2.29
---------	-----------------	--	------

Strong gate handle that can withstand heavy loads. Will not crush when driven over by tractor. Incorporates strong spring that cannot be overstrained.

DARE GATE HANDLE

180-231	0-38923 01793-5		4.99
---------	-----------------	--	------

OLD IRONSIDES® gate handle has a safety hook and body formed as one...from 7/8" diameter steel pipe. Spring mechanism consists of 4-1/4" long compression spring fastened to a 5/16" diameter eyebolt. All metal parts are permanently assembled using 20 tons of force. No flimsy snap-on/push-on fasteners used anywhere. Large insulated grip measures 5-1/8" long with a 2-1/4" diameter flange for extra shock protection, Molded of a soft flexible material that will not chip, crack or break when abused. Performs in any climate. Metal parts plated to resist rust. Molded grip contains carbon black to deter UV rays.

DARE GATE HANDLE

180-220	0-38923 00503-1	50 per box	1.75
---------	-----------------	------------	------

OLD FAITHFUL™ High quality, hi-impact styrene long and trouble free life. Measures 4-3/4" between flanges. All metal parts plated. Heavy stamped steel hook. Enclosed spring stretches 3-1/2" to keep wire taut. **Red.**



180-210



S-SA038



180-200



180-201



S-SA044

S-SA0448M



S-RSGSXL



S-SA043



180-230



180-231



180-220

ELECTRIC FENCE ACCESSORIES

Part No.	UPC No.	Description	Retail Price
----------	---------	-------------	--------------

DARE GATE HANDLE

180-221	0-38923 01247-3	50 per box	2.85
---------	-----------------	------------	------

RUB'RGATE® Don't be shocked - be safe - with RUB'RGATE electric fence spring gate handle. RUB'RGATE soft pliable rubber outer case internally reinforced with semi-rigid, non-conductive vinyl inner tube. This provides a firm grip and acts as an extra layer of insulation. Generous, sensibly spaced flanges allow plenty of hand room. Large, heavy stamped steel plated safety hook. Enclosed spring stretches 3-1/2" to keep wire taut. **Hard hat yellow.**



180-221



180-232

SPIRAL GATE HANDLE

180-232	7-74996 00216-3		5.39
---------	-----------------	--	------

Spiral Gate Handle.



180-235

KIWI GATE HANDLE

180-235	6-49998 09130-2		8.89
---------	-----------------	--	------

Kiwi Gate Latch.

speedrite™ by TRU-TEST® GATE HANDLE

S-SA042	9-414731 103069		3.45
---------	-----------------	--	------

speedrite™ GATE HANDLE has large flanges for a positive grip. Heavy duty, non-stretch spring. High strength, non-twisting hook.



S-SA042

speedrite™ by TRU-TEST® NO-KICK HANDLE

S-SA013	9-415793 401308		2.25
---------	-----------------	--	------

speedrite™ NO-KICK HANDLE is a dual purpose self insulated gate handle and live wire handling device. Clips onto belt or coat pocket. Clips onto fence preventing handle from falling off.



S-SA013

DOUBLE GATE HANDLE

150-555	7-74996 00214-9		1.39
---------	-----------------	--	------



150-555

DARE ELECTRIC FENCE SWITCH

180-190	0-38923 02211-3	Single Throw Switch	9.99
180-180	0-38923 02199-4	Double Throw Switch	11.89

For outdoor use on electric fence. Install several in each electric fence for convenience and safety. Switch off areas to allow repairs. Use to change polarity of fence wires.

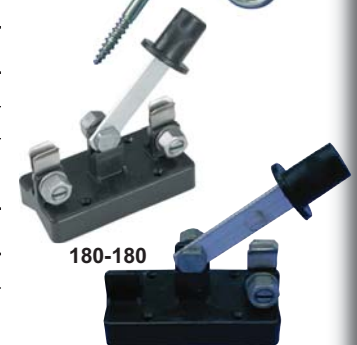

180-180

180-190

speedrite™ by TRU-TEST® GATE & ACTIVATOR PLATE

S-SA040	9-415793 401308		5.00
---------	-----------------	--	------

speedrite™ GATE ANCHOR & ACTIVATOR PLATE is an anchor for gate handle. Easily mounts using 2 nails on a wood post. Galvanized and stainless metal fittings for maximum life. 180 degree swivel for easy access.



S-SA040

speedrite™ by TRU-TEST® TAPE GATE BUCKLES

S-SA062	9-415793 406204		1.95
---------	-----------------	--	------

speedrite™ TAPE GATE BUCKLE is galvanized for maximum life. Positive locking to prevent tape from slipping. 10/pack



S-SA062

MORE ACCESSORIES & SOLAR PANELS

Part No.	UPC No.	Description	Retail Price
----------	---------	-------------	--------------

speedrite™ by TRU-TEST® SWIVEL CUT-OUT SWITCH

S-SA064	9-415793 406402		11.75
----------------	-----------------	--	-------

speedrite™ SWIVEL CUT-OUT SWITCH has a positive connection - leaving you in no doubt as to its action. Long lasting path - eliminating possibility of shorting, especially necessary for use with high powered energizers. Total handle disconnection option. Flush mount - for ease of roundpost attachment avoiding distortion. Easily visible on/off positions. Self-cleaning stainless steel fittings for non-corrosive contact.



S-SA064

DARE ELECTRIC FENCE WARNING SIGN

180-040	0-38923 02921-1		3.44
----------------	-----------------	--	------

Plastic Warning Signs. Pak of 3



180-040

speedrite™ by TRU-TEST® ELECTRIC FENCE WARNING SIGN

S-SA046	9-415793 404606		3.25
----------------	-----------------	--	------

speedrite™ Plastic Warning Signs



S-SA046

MISCELLANEOUS

180-070	0-88183 00247-6	Ground Marking Paint with inverted tip.	9.25
180-185	7-74996 69350-7	Rotary Switch	12.99
180-320	0-38923 01896-3	Driveway Marker	1.99

SOLAR PANEL

180-080	7-74996 01932-1	10 Watt. Crystalline Solar Panel.	248.99
180-079	7-74996 02667-1	5 Watt. Solar Panel.	157.79

speedrite™ by TRU-TEST® SOLAR PANEL

S-808188	9-414731 379440	40 Watt (No Mounting Bracket Included)	654.25
S-808186	9-414731 379426	10 Watt (Mounting Bracket Included)	277.95

speedrite™ 40W SOLAR PANEL provides fast charging of batteries through superior conversion efficiency of sunlight to electrical current. Premium, high efficient polycrystalline panels. Rugged aluminum framing. Diodes and regulators are used to prevent overcharging of batteries.

40 Watt For use with: VIPER 5000 12V energizer (1 X 40 Watt solar panel)
12 V, deep cycle 120 amp hour battery

10 Watt For use with: Delta 1B 12V energizer
12 V, 12 amp hour battery

speedrite™ by TRU-TEST® 40W SOLAR PANEL MOUNTING BRACKET

S-808189	9-414731 379457		104.50
-----------------	-----------------	--	--------

speedrite™ 40W SOLAR PANEL MOUNTING BRACKET



180-185



180-070

180-320



S-808188



180-079

180-080

LEAD-OUT WIRE & INSULTUBE

Part No.	UPC No.	Description	Retail Price
ELECTRIC LEAD-OUT WIRE			
150-510	6-49998 04400-1	This is a 12-1/2 gauge, heavy galvanized, soft wire with a thick medium density polyethylene coating for use with high, voltage low impedance chargers. 50 ft./roll , 2.5 lbs./roll.	9.95
150-520	6-49998 04403-2	Same as above. 100 ft./roll , 5 lbs./roll.	19.90
150-530	6-49998 04406-3	Same as above. 250 ft./roll , 12.50 lbs./roll.	49.50
150-540	6-49998 04409-4	Same as above. 500 ft./roll , 25 lbs./roll.	98.75
S-SC005	9-414731 375138	12-1/2 gauge double insulated 165'roll , BY SPEEDRITE	51.00
S-SC007	9-414731 375145	12-1/2 gauge double insulated 328'roll , BY SPEEDRITE	94.00
150-002	7-74996 04400-2	82' double lead-out wire	37.49
150-003	7-74996 04401-9	330' double lead-out wire	149.99
150-004	7-74996 04402-6	165' double lead-out wire	74.99
INSULTUBE			
150-480	6-49998 04420-9	Multi-purpose polyethylene tubing fits readily over 12-1/2 gauge wire. Tough, flexible and ultra-violet-ray resistant. 50' Insultube – 1.50 lbs/roll.	11.25
150-490	6-49998 04423-0	Same as above. 500' Insultube – 15 lbs./roll.	112.49
150-500	6-49998 03844-4	White insultube for Hotcote fencing – 100' .	22.99
4" TUBE INSULATOR			
150-000	6-49998 04040-9	The 4" tube line post tube insulator has fins on either side that lock when stapled, preventing the insulator from sliding out from under the staple. Pkg. of 200 , 2.25 lbs./pkg., 10 pkg./case.	13.99
150-010	7-74996 02345-8	Same as above. Each	.09
150-011	6-49998 04045-4	Same as above. Bulk Pak of 2000	139.99
150-001	0-38923 01973-1	4" sq. Tube Insulation. Pkg. of 50	4.15
150-005	6-49998 03843-5	4" Hotcote Insulation. Pkg. of 100	14.99
WRAPAROUNDS			
150-370	6-49998 04005-8	Tubular medium-density polyethylene provides total insulation, .70 ea and a non-rusting aluminum insert prevents fence wire from cutting through the insulation under high strain. Has one flat side for seating end post. 20" Wraps –	
150-380	6-49998 04015-7	Same as above. 24" Wraps –	.80 ea
150-390	6-49998 04020-1	Same as above. 30" Wraps –.	1.05 ea



WOOD POST INSULATORS

Part No.	UPC No.	Retail Price
----------	---------	--------------

DARE BLACK WIDOW™ ELECTRIC FENCE INSULATOR

150-070	0-38923 01938-0	2.23
---------	-----------------	------

High density black linear polyethylene for sunlight resistance. Operates well in any climate in any part of the world. 45 degrees slot accepts any fence wire and holds it in place. BLACK WIDOW™ ...a very good insulator.

25/bag, 20 bags/ctn., 10 lbs./ctn., 1.02 cu. ft.



DARE SNUG® 1728 INSULATOR

150-080	0-38923 02070-6	2.69
---------	-----------------	------

SNUG® 1728 INSULATOR for wood posts. Extends wire 1" from post. Flexible base fits round and flat sided posts. Single headed nails supplied, easily removed. Molded of high density polyethylene with UV inhibitors.

25/bag, 20 bags/ctn., 14 lbs./ctn., 1.02 cu. ft. (Complete with nails)



DARE SNUG® SWP INSULATOR

150-090	0-38923 01911-3	3.44
---------	-----------------	------

SNUG® SWP INSULATOR for wood posts. Extends wire 2" from post. Heavier and tougher than others. Insulator rests on 3/4" nail surface. Won't tear or crack loose. Flexible base fits round or flat sided posts. Molded of high density polyethylene with UV inhibitors for all weather durability.

25/bag, 20 bags/ctn., 23 lbs./ctn., 1.78 cu. ft. (Complete with nails)



DARE WOODDEX® 5WP/10 INSULATOR

150-100	0-38923 01915-1	4.71
---------	-----------------	------

WOODDEX® 5WP/10 FOR WOOD POSTS. Extends wire 5" from post. Excellent for hogging down over old field fence. 3" od Wooddex rests on 30d nail. Strong and sturdy. Molded of high density polyethylene with UV inhibitors.

10/bag, 25 bags/ctn., 26 lbs./ctn., 1.78 cu. ft (Complete with nails)



DARE WOOD POST TAPE INSULATOR

150-110	0-38923 02403-2	7.84
---------	-----------------	------

For polytape up to 1 1/2" wide. Insulators grip tape tightly to prevent whipping and sawing. Heavy tape holder unlocks to aid installation. Molded of all-weather high density polyethylene.

25/bag, 10 bags/ctn., 13 lbs./ctn., 1.02 cu. ft



DARE WOOD POST TAPE INSULATOR EXTENDED

150-115	0-38923 02913-6	13.12
---------	-----------------	-------

For polytape up to 1 1/2" wide. Extends tape 3 1/2" from post. (Nails included)

150-115W	0-38923 02986-0	13.12
----------	-----------------	-------

Same as above in white. For polytape up to 1 1/2" wide. Extends tape 3 1/2" from post.

25/bag, 10 bags/ctn., 13 lbs./ctn., 1.02 cu. ft (Nails included)



DARE STAPLE INSULATOR

150-150	0-38923 01964-9	9.22
---------	-----------------	------

PERMATEMP STAPLE INSULATOR for wood posts. Designed to be used with high tensile permanent electric fence. Can be installed after wire is strung. Molded of highest quality polypropylene with carbon black for superior UV resistance. Performs in any climate. (Type III galvanized 2" staple included.)

50/bag, 10 bags/ctn., 15 lbs./ctn., .38 cu. ft.



WOOD POST INSULATORS

Part No.	UPC No.	Retail Price
speedrite™ by TRU-TEST® WOOD POST PINLOCK INSULATOR		
S-SI027	9-415793 200277	10.90

speedrite™ WOOD POST PINLOCK INSULATOR has a large shield to prevent arcing. Easily attaches with with nails or staples. Self-locking pin attached by a lead.

25/bag,



speedrite™ by TRU-TEST® WOOD POST CLAW INSULATOR		
S-SI0291	9-415793 202912	9.25

speedrite™ WOOD POST CLAW INSULATOR has a large shield to prevent arcing. Easily attaches with with nails or staples. Heavy duty claw fittings for maximum strength.

25/bag,



speedrite™ by TRU-TEST® WOOD POST/TEE POST PINLOCK INSULATOR		
S-SI037	9-414731 102697	12.55

speedrite™ DUAL PURPOSE WOOD POST/TEE POST PINLOCK INSULATOR fits 1-5/16" - 1.33 posts. A combination insulator that can be nailed onto wood posts or attached to T-posts.

25/bag,



speedrite™ by TRU-TEST® WOOD POST INSULATOR		
S-STI3164	9-414731 102697	6.75

speedrite™ WOOD POST INSULATOR nails onto wood posts. Can be used with any nail. U.V. stabilized for long life.

25/bag,



DARE PORCELAIN LINE INSULATOR		
150-120	0-38923 02609-8	4.58

PORCELAIN LINE INSULATOR Produced from specialty formulated electrical porcelain for superior dielectric and mechanic strength. Standard size porcelain line insulator. (No fittings of nails included)

25/pkg., 20 pkgs./ctn., 40 lbs./ctn., .72 cu. ft. (No fittings or nails included)



DARE WASHER FOR PORCELAIN INSULATOR		
150-126	7-74996 02651-0	1.10

Washer for Porcelain Insulator. Pkg. of 10.

DARE WIRE CLIP FOR PORCELAIN INSULATOR		
150-130	0-38923 01855-0	6.20

Wire Clip to fasten wire to insulator. Pkg. of 100.



DARE DOUBLE HEADED NAILS WITH POLY WASHERS		
150-127	0-38923 01857-4	11.17

DOUBLE HEADED NAILS WITH POLY WASHERS. Handy retail pack of 100 nails and washers.

(Without porcelain knobs) Nail size 10d.



WOOD POST INSULATORS

Part No.	UPC No.	Retail Price
----------	---------	--------------

DARE SNUG® HT INSULATOR

150-140	0-38923 01958-8	7.05
---------	-----------------	------

SNUG® HT INSULATOR for wood posts. Designed for high tensile use - perfect for temporary fencing. Large diameter flange prevents arcing. Heavy fingers carry wire 3/4" from post. Molded of high density polyethylene with carbon black for UV resistance. Performs in any climate.

25/bag, 20 bags/ctn., 27 lbs./ctn., 1.78 cu. ft.



DARE SNUG® HT INSULATOR

150-145	0-38923 02530-5	5.94
---------	-----------------	------

Same as above. In white.

25/bag, 20 bags/ctn., 27 lbs./ctn., 1.78 cu. ft.



DARE RING INSULATOR

150-030	7-74996 01867-6	5.85
---------	-----------------	------

BLACK SCREW IN RING INSULATOR for corners, ends and line posts. Angled slot securely holds wire and rope up to 3/8". Black. 25/pkg., 1 lb./pkg.

150-030W	7-74996 06519-9	5.06
----------	-----------------	------

WHITE SCREW IN RING INSULATOR. 10/pkg., 1 lb./pkg.

150-031	7-74996 05277-9	15.99
---------	-----------------	-------

RING INSULATOR. 100 per pail.



DARE PINLOCK INSULATOR

150-060	0-38923 02308-0	10.24
---------	-----------------	-------

PINLOCK INSULATOR FOR WOOD POSTS. Heavy cross sections withstand the pressure of high tensile fencing. When pin is removed, wire can be taken out of insulator. Large flange prevents "shorts" and arcing. Molded of high density polyethylene with carbon black for superior UV resistance. Performs in any climate. Used on wood posts. Can be nailed or stapled to post.

25/bag, 20 bags/ctn., 22 lbs./ctn., 1.78 cu. ft.



ROUND POST INSULATORS

speedrite™ by TRU-TEST® MULTI-FIT ROD POST INSULATOR

S-808022	9-414731 378870	10.90
----------	-----------------	-------

speedrite™ MULTI-FIT ROD POST INSULATOR fits 1/4" - 5/8" rods.

25/bag,



speedrite™ by TRU-TEST® LARGE ROD POST INSULATOR (RP14)

S-SI0301	7-74996 02657-2	7.85
----------	-----------------	------

speedrite™ LARGE ROD POST INSULATOR fits 3/8" to 3/4" rods. U.V. stabilized for longer life.

20/bag,



ROUND POST INSULATORS

Part No.	UPC No.	Retail Price
KOLTEC FENCE TAPE INSULATOR		
150-050	7-74996 01869-0	8.95

FENCE TAPE INSULATOR holds tape up to 40 mm wide.

25/pkg., 1 lb./pkg.



DARE UNIVERSAL INSULATOR FASTENER (J BOLT)		
150-470	0-38923 01854-3	3.39

Will fit any insulator - porcelain or plastic. Plated steel J bolt with wingnut for attaching line insulator to any type of steel post - round, angle or T.

25 bags, 20 bags/ctn., 13 lbs./ctn., .19 cu. ft.



DARE WESTERN® SCREW-TIGHT		
150-330	0-38923 01852-9	5.17

WESTERN® SCREW-TIGHT for round posts. Fits 1/4" to 9/16" diameter posts and 5/8" fiberglass T-posts. Extends wire 1" from post. Installs without tools. High density polyethylene with UV inhibitors. Yellow.

DESIGNED TO PERFORM WITH SOLID STATE ELECTRIC FENCE SHOCKERS

25/bag, 20 bags/ctn., 23 lbs./ctn., 1.78 cu. ft.



DARE LARGE WESTERN® FOR 7/8" SUCKER RODS		
150-335	7-74996 05278-6	13.49

LARGE WESTERN® FOR SUCKER RODS and other oversized round posts. Fits 1/4" to 7/8" dia and 5/8" fiberglass T-posts. Holds all wire, polywire, polyrope, and polytape up to 1 1/2" wide.

25/bag, 10 bags/ctn., 23 lbs./ctn., 1.78 cu. ft.



DARE POLYTAPE INSULATORS		
150-340	0-38923 02406-3	8.67

Fits 1/4" to 9/16" diameter post. For any fence tape up to 1-1/2" wide. Insulators grip tape tightly to prevent whipping and sawing. Heavy tape holder unlocks to aid installation. Molded of all-weather high density polyethylene. Yellow.

25/bags, 10 bags/ctn., 14 lbs./ctn., 1.56 cu. ft.

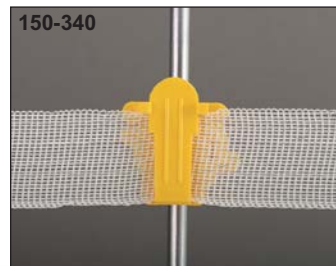

TEE POST INSULATORS

DARE WESTERN® SCREW TIGHT FOR TEE POSTS & 3/4" SUCKER RODS		
150-270	0-38923 02233-5	9.33

WESTERN® SCREW TIGHT FOR TEE POSTS & SUCKER RODS adjusts to fit:







- T posts, steel - small, medium & large, with or without studs.
- T posts, fiberglass - medium & large sizes only.
- Sucker rods - 3/4" diameter only.
- U posts - small, 1-1/8" wide.
- Small garden U posts - 1-1/8" wide.

Insulator opens to attach anywhere on post. Yellow.

25/bag, 10 bags/ctn., 20 lbs./ctn., 1.78 cu. ft.



TEE POST INSULATORS

Part No.	UPC No.	Retail Price	
DARE SUPER SNUG®			
150-240	0-38923 01905-2	3.69	150-240 
<p>SUPER SNUG® T posts. Fits 1.25 & 1.33 lb/ft T Large flange prevents arcing. Solid wire holders take heavy barbed, electric fence wire and polywire. Snaps on and around post. Molded of high density polyethylene with UV inhibitors for all weather performance. Extends wire 1" from post.</p> <p>25/bag, 20 bags/ctn., 19 lbs./ctn., 1.78 cu. ft.</p>			
DARE EXTRA LENGTH SNUG®			
150-250	0-38923 01907-6	5.32	150-250 
<p>EXTRA LENGTH SNUG® T posts. Extends wire 2" from face of post. Yellow.</p> <p>25/bag, 10 bags/ctn., 13 lbs./ctn., 1.56 cu. ft.</p>			
DARE REVERSED TEE POST INSULATOR EXTENDER			
150-255	0-38923 02831-3	9.75	150-255 
<p>REVERSED T POST INSULATOR EXTENDER Holds wire 3" from backside of T-post. Snaps on and around post - insulator faces backwards.</p> <p>25/bag, 20 bags/ctn., 13 lbs./ctn., 1.56 cu. ft.</p>			
DARE EXTENDED LENGTH SNUG®			
150-260	0-38923 01909-9	9.75	150-260 
<p>EXTENDED LENGTH SNUG® for T-posts. Extends wire 5" from face of post. Use to hog down sagging field fence.</p> <p>25/bag, 10 bags/ctn., 18 lbs./ctn., 2.54 cu. ft.</p>			
DARE ELFIN® EXTENDER			
150-073	7-74996 06520-5	7.65	150-073 
<p>ELFIN® WITH ESSEX BRACKET FOR T-POST, U-POST, & CHAIN LINK FENCE. Extends wire 5" from old fence. Fits either side of chain link, studded T & U-posts. Consists of heavy steel bracket with Elfin® insulator and tie wire. All metal parts plated to resist rust.</p> <p>10/bag,</p>			
DARE TEE POST TAPE INSULATOR			
150-280	0-38923 02404-9	7.03	150-280 
<p>TEE POST TAPE INSULATOR for polytape up to 1-1/2" wide. Fits 1.25 & 1.33 lb./ft. T posts.</p> <p>25/bag, 10 bags/ctn., 10 lbs./ctn., 1.56 cu. ft.</p>			
150-280W	0-38923 02982-2	7.03	
<p>Same as above. In white.</p> <p>25/bag, 10 bags/ctn., 10 lbs./ctn., 1.56 cu. ft.</p>			

TEE POST INSULATORS

Part No.	UPC No.	Retail Price
----------	---------	--------------

DARE TEE POST TAPE INSULATOR

150-285	0-38923 02915-0	11.48
---------	-----------------	-------

TEE POST TAPE INSULATOR EXTENDER. Extends wire 31/2" from post. Fits 1.25 & 1.33 lb/ft T-posts. For polytape up to 1-1/2" wide.

25/bag, 10 bags/ctn., 10 lbs./ctn., 1.56 cu. ft.



DARE TEE POST TOP'R® SAFETY TOP AND ELECTRIC FENCE INSULATOR

150-290	0-38923 02046-1	7.73
---------	-----------------	------

TEE POST TOP'R® SAFETY TOP AND ELECTRIC FENCE INSULATOR. Fits all T-posts and can be nailed on top of wood posts. Protects horses and other valuable livestock from sharp, jagged T-post tops. Large heavy-duty cap/insulator can be installed with wire holders facing front, back, right or left. Holds wire, polywire, polyrope, and polytape up to 1-1/2" wide. Molded of high density polyethylene with UV inhibitors for all weather performance.

10/bag, 20 bags/ctn., 38 lbs./ctn., 3.08 cu. ft.



DARE PINLOCK INSULATOR FOR TEE POSTS

150-310	0-38923 02523-7	8.73
---------	-----------------	------

PIN LOCK INSULATOR FOR T-POSTS. Fits 1.25 & 1.33 lb/ft T-posts. Heavy cross sections withstand the pressure of high tensile fencing. Large flange prevents 'shorts' and arcing. Molded of high density polyethylene with carbon black for superior UV resistance. Performs in any climate. Black.

25/bag, 20 bags/ctn., 22 lbs./ctn., 1.78 cu. ft.

SUITABLE FOR HIGH TENSILE FENCING



speedrite™ by TRU-TEST® PINLOCK INSULATOR FOR TEE POSTS

S-SI035	While quantities last.	8.75
---------	------------------------	------

T-post snap on insulator.

20/bag,



speedrite™ by TRU-TEST® TEE POST INSULATOR TP9

S-STI3163		5.95
-----------	--	------

speedrite™ TEE POST INSULATOR can be used with all types of wire. Specially designed to hold most electrified tape flat. U.V. stabilized for longer life.

25/bag,



speedrite™ by TRU-TEST® Y POST INSULATOR





S-SI025SP	9-414731 111149	6.75
-----------	-----------------	------

speedrite™ Y POST INSULATOR has a large shield to prevent arcing. Self locking pins attached by leads.

25/bag,



CORNER POST INSULATORS

Part No.	UPC No.	Retail Price	
DARE HIGH STRAIN CORNER & END ASSEMBLY			
150-460	0-38923 01882-6	17.92	
<p>HIGH STRAIN CORNER AND END ASSEMBLY. Performs superbly from any wood post or tree - as a corner - for straight line fencing. Consists of 3/8" diameter hi-carbon steel bracket, 1752 insulator and self-locking nut. #1708 clip may be required when used for straight line fencing. All metal parts are zinc plated.</p> <p>10/pkg., 5 pkgs./ctn., 17 lbs./ctn., .37 cu. ft.</p>			
DARE HIGH STRAIN CORNER & END INSULATOR			
150-430	0-38923 01752-2	5.69	
<p>HIGH STRAIN CORNER AND END INSULATOR. Molded of high strength engineering grade polymer. Able to withstand the constant pressure of high tensile fence wire. Use for corners, ends, dips, and rises. All weather. Black.</p> <p>10/pkg.</p>			
DARE DOUBLE U END AND CORNER INSULATOR			
150-400	0-38923 02842-9	8.94	
<p>DOUBLE U END AND CORNER INSULATOR. Designed with heavy cross sections to withstand the pull of high tensile wire. Molded of an engineering grade polymer. All weather. Black.</p> <p>10/bag, 20 bags/ctn., 20 lbs./ctn., 1.02 cu. ft.</p>			
DARE REGULAR DUTY CORNER INSULATOR			
150-450	0-38923 01932-8	2.17	
<p>REGULAR DUTY CORNER INSULATOR. Use with polywire and 14 to 19 Ga. electric fence wire. Molded of high density polyethylene with carbon black for superior UV resistance. Large flanged corner insulator with heavy center section. Has flexible tabs that speed installation. Performs in any climate. Black. Not for high tensile fence.</p> <p>10/bag, 25 bags/ctn., 7.5 lbs./ctn., .72 cu. ft.</p>			
DARE BLACK EGG INSULATOR			
150-442	7-74996 02659-6	.49	
<p>Black Egg Insulator Individual</p>			
DARE WHITE EGG INSULATOR			
150-442W	7-74996 04589-4	.65	
<p>White Egg Insulator Individual</p>			

CORNER POST INSULATORS

Part No.	UPC No.	Retail Price
----------	---------	--------------

speedrite™ by TRU-TEST® WHITE END HI-STRAIN CORNER INSULATOR

S-SI018	9-415793 200185	1.70 ea.
----------------	-----------------	----------

speedrite™ WHITE END HI-STRAIN CORNER INSULATOR is built of high quality materials for rugged, long life design.

25/bag,

S-SI018



speedrite™ by TRU-TEST® BLACK END STRAIN CORNER INSULATOR

S-SI031	9-415793 200314	.80 ea.
----------------	-----------------	---------

speedrite™ BLACK END STRAIN CORNER INSULATOR is molded from long life U.V. stabilized, premium grade materials. Deep grooves prevent twisting under tension. Long leakage paths to prevent arcing. Recommended for medium strain and semi-permanent applications only.

25/bag,

S-SI031



DARE PORCELAIN CORNER INSULATOR

150-420	0-38923 02613-5	3.92
----------------	-----------------	------

PORCELAIN CORNER INSULATOR. Regular duty porcelain corner and end post insulator.

10/pkg., 25 pkgs./ctn., 35 lbs./ctn., .72 cu. ft.

150-420



DARE PORCELAIN CORNER INSULATOR

150-421	0-38923 02617-3	7.53
----------------	-----------------	------

PORCELAIN CORNER INSULATOR. Horse shoe style.

10/pkg.

150-421



DARE PORCELAIN LINE INSULATOR

150-121	7-74996 05311-0	1.15
----------------	-----------------	------

PORCELAIN LINE INSULATOR. Small porcelain insulator with lag bolt. Use for lines and corners.

150-121



DARE PORCELAIN LINE INSULATOR

150-122	7-74996 05312-7	2.15
----------------	-----------------	------

PORCELAIN LINE INSULATOR. Large porcelain insulator with lag bolt. Heavy duty. Use for lines and corners.

150-122



ELECTRIC FENCE POSTS

Part No.	UPC No.	Description	Retail Price
speedrite™ by TRU-TEST® PIGTAIL FENCE POST			
S-806445	9-414731 113938		3.75

speedrite™ PIGTAIL FENCE POST has a white powder coated finish for visibility and long life. Extra long tubing for ease of handling. Robotic weld for strength. Durable crimped foot design. 6 mm galvanized spring steel. Bundle of 10. 32" Height **NEW!**

WHITE PIGTAIL FENCE POST

120-210	7-74996 06521-2		1.95
---------	-----------------	--	------

WHITE PIGTAIL FENCE POST had a galvanized finish for longer life. Spring steel construction springs back to straight position after being bent. Bundle of 10. 32" Height **NEW!**

DARE STEP IN POST

120-200B	0-38923 02400-1	48" Dare Step in Poly Post, Black	2.79
120-200W	0-38923 02791-0	48" Dare Step in Poly Post, White	2.79
120-200Y	0-38923 02197-6	48" Dare Step in Poly Post, Yellow	2.79

DARE STEP IN POST has strong H sections. 8 wire holders. Large step in pad. Oversize metal spike. 48" overall length. 50/ctn., 38 lbs./ctn., 4.6 cu. ft.

ELECTRIC FENCE POSTS

BFP	7-74996 00333-7		2.20
-----	-----------------	--	------

BENT ELECTRIC FENCE POST 3/8" x 4" Bent Steel Fence Post. Shipped in bundles of 10. Weight 1.386 lbs. each.

EFP	7-74996 00433-4		2.25
-----	-----------------	--	------

ELECTRIC FENCE POST 3/8" x 4" Steel Fence Post. Shipped in bundles of 10. Weight 1.59 lbs. each.

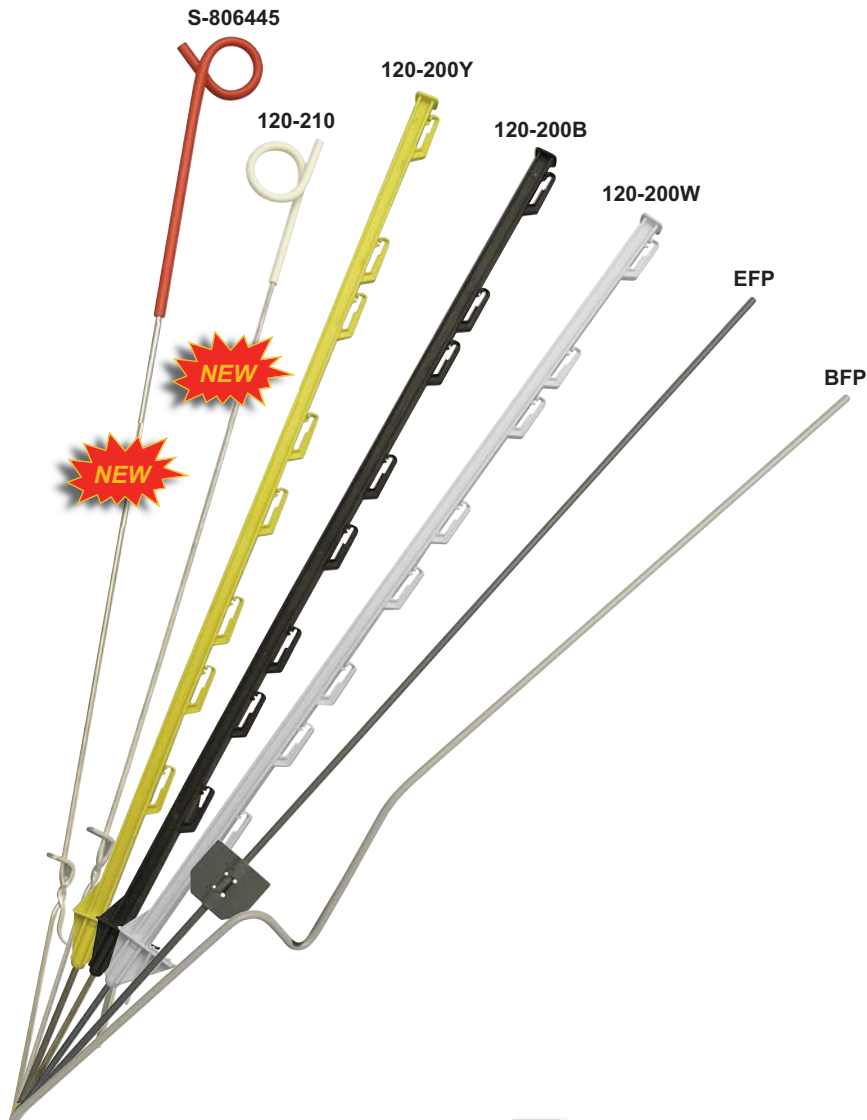

FARM SUPPLIES CATALOGUE



AVAILABLE FROM:

