

SHURE[®]

LEGENDARY
PERFORMANCE™

Conferencing and Discussion Systems

CU 6110 Central Unit

USER GUIDE



Table of Contents

Table of Contents	2	Connecting to SW 6000.....	21
Important	3	Connecting an emergency signal.....	22
Important Safeguards	3	Using the Interactive Menu	22
Labels.....	4	Overview	22
Note for Power Connections.....	4	Navigate through the menu	22
Power Disconnect.....	4	Web Browser Setup and Control	23
Compliance	5	CU 6110 Setup (browser)	23
Cleaning	5	CU 6110 Mic. Control (browser)	39
Repacking	5	Using Web browser in PC.....	41
Warranty	5	Using Web browser in iPad.....	41
Your DCS 6000 Conference System	6	Operation Modes	42
The DCS 6000 system with CU 6110	6	Operation Mode.....	42
System components	7	Delegate Interrupt Mode	43
Central equipment etc.....	7	AM 6040 Ambient Microphone Unit	43
Interpreter equipment.....	7	Troubleshooting	44
Conference units and ch. selectors.....	7	Firmware Update	46
Accessories.....	7	Technical Specifications	48
Getting Started	8	System Specification	48
Setting up the system the first time	8	CU 6110 Specifications	48
Connecting a PC	8	Connection Details	49
General Guidelines	9	Accessories	50
Installation	9	External Control Protocol	51
Cabling guidelines	9	General Protocol Behavior	51
Max. number of units to be connected	10	TCP/IP socket connection.....	51
Using only one DCS-LAN chain.....	10	Test connection to CU via Putty.....	51
Using multiple DCS-LAN chains.....	12	Cmd structure (External to CU 6110).....	52
Connection using JB 6104 Junction Box.....	12	Cmd structure (CU 6110 to External).....	52
CU 6110 Central Unit	13	Seat numbering.....	52
Overview	13	CU 6110 reply to commands	52
Feature License.....	13	Retrieving system status	53
User controls & connectors.....	13	Voting control (only CU 6110).....	53
Simplified Audio Schematic	14	Voting results.....	53
Connecting Units	15	Microphone Control	55
Connecting Conference Unit	15	External Commands to CU 6110	55
Connecting a PC.....	16	CU 6110 Commands to External	59
Connecting a PC and an iPad.....	16	Audio Control	62
Connecting an audio recorder.....	16	External Commands to CU 6110	62
Connecting an audio mixer.....	17	Commands from CU 6110 to External	64
Connecting interpretation units	18	Voting Control	66
Using wireless language distribution.....	19	External Commands to the CU 6110.....	66
Using RP 6004 Repeater.....	20	CU 6110 Commands to External	67
Using PS 6001 DCS-LAN Power Kit	20		

Important

Important Safeguards

- 1 **Read these instructions** - All the safety and operating instructions should be read before the apparatus or system is operated.
- 2 **Keep these instructions** - The important safety instructions and operating instructions should be retained for future reference.
- 3 **Heed all warnings** - All warnings on the apparatus and in the operating instructions should be adhered to.
- 4 **Follow all instructions** - All instructions for installation or use/operating should be followed.
- 5 **Do not use this apparatus near water** - Do not use this apparatus in a water or moistures environment - for example, near a bathtub, washbowl, kitchen sink, or laundry tub, in a wet basement, near a swimming pool, in an unprotected outdoor installation, or any area which is classified as a wet location.
- 6 **Warning: To reduce the risk of fire or electric shock, do not expose this apparatus to rain or moisture and no objects filled with liquids, such as vases, should be placed on this apparatus.**
- 7 **Clean only with dry cloth** - Unplug the apparatus from the outlet before cleaning. Do not use liquid cleaners or aerosol cleaners.
- 8 **Do not block any ventilation openings. Install in accordance with the manufacturer's instructions** - Openings in the enclosure, if any, are provided for ventilation and to ensure reliable operation of the apparatus and to protect it from overheating. These openings must not be blocked or covered. This apparatus should not be placed in a built-in installation unless proper ventilation is provided or the manufacturer's instructions have been adhered to.
- 9 **Do not install near any heat sources such as radiators, heat registers, stoves, air ducts, or other apparatus (including amplifiers) that produce heat.**
- 10 **Do not install the unit in a place exposed to direct sunlight, excessive dust or humidity, mechanical vibration or shock.**
- 11 **To avoid moisture condensations do not install the unit where the temperature may rise rapidly.**
- 12 **Do not defeat the safety purpose of the polarized or ground-type plug.** A polarized plug has two blades with one wider than the other. A grounding type plug has two blades and a third grounding prong. The wider blade or the third prong is provided for your safety. If the provided plug does not fit into your outlet, consult an electrician for replacement of the obsolete outlet.
- 13 **Protect the power cord from being walked on or pinched particularly at plug, convenience receptacles, and the point where they exit from the apparatus.**
- 14 **Only use attachments/accessories specified by the manufacturer.** Any mounting of the apparatus should follow the manufacturer's instructions, and should use a mounting accessory recommended by the manufacturer.
- 15 **Use only with the cart, stand, tripod, bracket or table specified by the manufacturer, or sold with the apparatus.**
When a cart is used, use caution when moving the cart/apparatus combination to avoid injury from tip-over - Quick stops, excessive force, and uneven surfaces may cause the appliance and cart combination to overturn.
- 16 **Unplug this apparatus during lighting storms or when unused for long periods of time.** - Not applicable when special functions are to be maintained, such as evacuation systems.
- 17 **Refer all servicing to qualified service personnel. Servicing is required when the apparatus has been damaged in any way, such as power-supply cord or plug**



is damaged, liquid has been spilled or objects have fallen into the apparatus, the apparatus has been exposed to rain or moisture, does not operate normally, or has been dropped.

- 18 Replacement Parts** - When replacement parts are required, be sure the service technician has used replacement parts specified by the manufacturer or having the same characteristics as the original part.
- Unauthorized substitutions may result in fire, electric shock or other hazards.
- 19 Safety Check** - Upon completion of any service or repairs to this apparatus, ask the service technician to perform safety checks to determine that the apparatus is in proper operating condition.
- 20 Overloading** - Do not overload outlets and extension cords as this can result in a risk of fire or electric shock.
- 21 Power Sources** - This apparatus should be operated only from the type of power source indicated on the marking label. If you are not sure of the type of power supply you plan to use, consult your appliance dealer or local power company. For apparatuses intended to operate from battery power, or other sources, refer to the operating instructions.
- 22 Power Lines** - An outdoor system should not be located in the vicinity of overhead power lines or other electric light or power circuits, or where it can fall into such power lines or circuits. When installing an outdoor system, extreme care should be taken to keep from activating such power lines or circuits, as contact with them might be fatal.
- 23 Object and Liquid Entry** - Never push objects of any kind into this apparatus through openings as they may touch dangerous voltage points or short-out parts that could result in a fire or electric shock.

Never spill liquid of any kind on the apparatus. Should any liquid or solid object fall into the cabinet, unplug the unit and have it checked by qualified personnel before operating it further.

Labels



“Lightning Flash Symbol” with the lightning flash with arrowhead symbol within an equilateral triangle, is

intended to alert the user to the presence of un-insulated “dangerous voltage” within the product enclosure that may be of sufficient magnitude to constitute a risk of shock to persons.



“Exclamation Point Symbol” with the exclamation point within an equilateral triangle is intended to alert the user to the presence of important operating and maintenance (servicing) instructions in the literature accompanying the product.

Note for Power Connections

Check that the voltage of your local power supply is within the operating voltage of the unit. If a voltage conversion is required, consult your DIS dealer or qualified personnel.

Set the Power switch to ‘Off’ if it is not used for several days.

Important: The equipment must be connected to earth (ground)

The wires in the main lead supplied with the equipment are colored in accordance with the following codes:

- Green-and-yellow Earth (Ground)
- Blue Neutral
- Brown Live

The green-and-yellow wire must be connected to the terminal in the plug marked with the letter E or with the safety earth symbol or marked with green-and-yellow color.

The blue wire must be connected to the terminal marked with the letter N or marked with black color.

The brown wire must be connected to the terminal marked with the letter L or marked with red color.

Power Disconnect

Apparatuses with or without On/Off switches have power supplied to the apparatus whenever the power cord is inserted into the power source; however, the apparatus is operational only when the On/Off switch is in the On position. The power cord is the main power disconnect for all apparatuses

Compliance

The equipment is intended to be used in professional audio applications.

Note: This device is not intended to be connected directly to a public internet network.

EMC conformance to Environment E2: Commercial and Light Industrial.

Testing is based on the use of supplied and recommended cable types.

The use of other than shielded (screened) cable types may degrade EMC performance.

Changes or modifications not expressly approved by Shure Incorporated could void your authority to operate this equipment.

This Class B digital apparatus complies with Canadian ICES-003. Cet appareil numérique de la classe B est conforme à la norme NMB-003 du Canada.

Authorized under the verification provision of FCC Part 15B.

Please follow your regional recycling scheme for batteries, packaging, and electronic waste.

Information to the user

This equipment has been tested and found to comply with the limits for a Class B digital device, pursuant to Part 15 of the FCC Rules. These limits are designed to provide reasonable protection against harmful interference in a residential installation.

This equipment generates uses and can radiate radio frequency energy and, if not installed and used in accordance with the instructions, may cause harmful interference to radio communications. However, there is no guarantee that interference will not occur in a particular installation. If this equipment does cause harmful interference to radio or television reception, which can be determined by turning the equipment off and on, the user is encouraged to try to correct the interference by one or more of the following measures:

- Reorient or relocate the receiving antenna.
- Increase the separation between the equipment and the receiver.
- Connect the equipment to an outlet on a circuit different from that to which the receiver is connected.
- Consult the dealer or an experienced radio/TV technician for help.

Cleaning

To keep the cabinet in its original condition, periodically clean it with a soft cloth. Stubborn stains may be removed with a cloth lightly

dampened with a mild detergent solution. Never use organic solvents such as thinners or abrasive cleaners since these will damage the cabinet

Repacking

Save the original shipping cardboard box and packing material; they will become handy if you ever have to ship the unit. For maximum

protection, re-pack the unit as originally packed from the factory.

Warranty

The units are minimum covered by 24 months warranty against defects in materials or workmanship.

Your DCS 6000 Conference System

The DCS 6000 system with CU 6110

DCS 6000 Digital Conference System is a system to be used at meetings, where a number of people are addressing the 'Floor' in a structured manner. The audio from the Conference units can be heard in the built in loudspeakers in the units.

The system does also allow for simultaneous interpretation for international conferences where multiple languages are used.

To enable all participants to understand the proceedings, interpreters can simultaneously translate the speaker's language as required. These interpretations are distributed through the connected Conference units and delegates can select the language of their choice and listen to it through headphones.

DCS 6000 Digital Conference System comprises of one CU 6110 Central Unit and a number of Conference Units, Gooseneck Microphones and other accessories depending on the system configuration.

The DCS 6000 system used with CU 6110 has the following main features:

- Fully digital
- Excellent sound quality
- "State of the Art" fully digital integrated interpretation, discussion and voting system offering interpretation, language distribution, conference microphone and voting facilities with attendance check with Chip Card™
- Digital transmission of audio from/to the Conference unit to/from the central unit using a unique digital DATA and AUDIO bus named DCS-LAN
- Control of up to 3800 conference units. This number does not include Channel Selectors, Repeaters etc. In practical use there are no limits for the number of Channel Selectors in a system
- Delegate and Interpreter units are powered and controlled by the CU 6110 Central Unit, which drives up to app. 50 units with the PS CU power supply
- EX 6010 Extension Unit or PS 6001 DCS-LAN Power Kit is available if more units are required
- Delayed switching on of power to the four DCS-LAN chains, to minimize the total 'in-rush' current on the Mains supply
- Designed for 31 interpreted channels and 8 open microphones
- Audio scrambling of the audio to avoid eavesdropping
- Designed in a standard 1HE 19" cabinet
- TCP/IP connection on CU 6110 for external operation of the system using a PC or control system such as AMX® or Crestron®
- Functionality on the CU 6110 depends on the Feature License uploaded into the unit
- Firmware in Delegate units, Interpreter Units, Central Units etc. is upgradeable
- Operated either stand alone or from a PC using the CU browser or using SW 6000 software
- Added functionality and comprehensive features provided by SW 6000 software package running on PC

The SW 6000 is an optional software package, which expands the functionality of the DCS 6000 system. The software runs on standard computer technology (Standard PC with Windows 7, Server 2008 etc.).

Main features of the SW 6000 are:

- Microphone management
- Mimic panel operation
- Interpretation management
- Voting management
- Message handling
- Agenda handling
- Data stored on SQL data base
- Web service interface available for easy links to external applications
- Multi language user interfaces
- Supports different User types with different priorities, user interfaces and control possibilities

System components

The CU 6110 Central Unit supports all available units in the DCS 6000 series:

Central equipment etc.

EX 6010	Extension Unit
PS 6001	DCS-LAN Power Kit consisting of one PS CU and one PI 6000
PS CU	Power Supply
PI 6000	DCS-LAN Power Inserter
RC 6000	Redundancy Controller
AO 6004	Audio Output box
AO 6008	Audio Output box
RP 6004	Repeater for four chains
JB 6104	Junction Box with 4 outputs

Interpreter equipment

IS 6132 P	Interpreter Unit
LS 6132 P	Interpreter Loudspeaker

Conference units and ch. selectors

DC 6990 P	Conference Unit (portable) with touch screen with two built-in channel selector, Chip-card and 5 voting buttons, configurable as Delegate, Dual Delegate or Chairman.
DC 6120 P	Conference Unit (portable)
DC 6190 P	Conference Unit (portable) with two built-in channel selectors
DM 6680 P	Conference Unit (portable) with voting
CM/DM 6080 F	Conference Unit (flush mounted) with built-in channel selectors

DM 6620 F	Conference Unit (flush mounted) with, Chip-card and 5 voting buttons
CM/DM 6680 F	Conference Unit (flush mounted) with one built-in channel selector, Chip-card and 5 voting buttons
MU 6040 C/D	Microphone Unit for use with FD/FC front plate with Loudspeaker, Microphone and Buttons. Available in Delegate (D) and Chairman (C) version
MU 6042 D	Dual Microphone Unit for use with FD/FC front plate with Loudspeaker, Microphone and two delegate Buttons
DV 6501 F	Voting Unit
AM 6040	Ambient Microphone Unit
CS 6340 FV/H	Channel Selector (flush mounted)

Accessories

In addition to the unit a number of accessories are available like:

- Storage Boxes
- GM 6523 Gooseneck Microphone, 40 cm
- GM 6524 Gooseneck Microphone, 50 cm
- GM 6525 Gooseneck Microphone, 63 cm
- DH 6021 Delegate Headphone
- DH 6223 Stethoscope Headphone
- DH 6225 Ear Clip Headphone

For detailed instruction in how to use the above units, please refer to the User Manuals for the relevant products.

Getting Started

Setting up the system the first time

When setting up the system for the first time please follow the instruction given in this section in sequence.

1. Unpack the CU 6110 Central Unit and connect the power cord to the CU Power Supply and connect the cable from the power supply to the CU 6110.

Please refer to section [‘CU 6110 Central Unit’](#) for details.

2. Place all units at the positions, where they are to be used observing the unit type.
3. Connect the GM Gooseneck Microphone to the units. If needed fix the gooseneck microphones to the units with the tool delivered with the CU 6110.
4. Connect the units to one or two of the DCS-LAN connectors on the CU 6110 using EC 6001-xx Cat5e extension cables in suitable length observing that the cables are not bended to a radius less than 15 mm.

Please refer to section ‘

General Guidelines’ for details.

5. Connect power to the PS CU Power Supply. The light indication in the power switch on the CU 6110 will light red.
6. Activate the power switch on the CU 6110 and the light indication in the button will light green. After about 15 seconds, the display in the CU will be visible and the LED's in the conference units will flash until the units are registered (less than 60 seconds).
7. Check that the units are working by activation the ‘Speak’ button.
8. Adjust the ‘Loudspeaker volume’ to a desired level using the interactive menu on the front of the CU 6110.

Please refer to the section [‘Using the Interactive Menu’](#) for details.

Connecting a PC

When connecting a PC direct to the CU 6110 please follow the instruction given in this section in sequence.

1. Connect the PC and the CU 6110 with a standard LAN cable
2. Turn ‘On’ power to both units
3. On the PC check that the network setting is set to ‘Obtain an IP address automatically’:
 - a. Navigate to ‘Control Panel * Network and Sharing Center * Change adapter settings * Local Area Connection’.
 - b. Select ‘Properties’
 - c. Select ‘Internet Protocol Version 4 (TCP/IPv4)’
 - d. Click ‘Properties’
 - e. Change setting to ‘Obtain an IP address automatically’

4. Using the interactive menu on the CU 6110 navigate to:
 - a. ‘LAN setup * Acquire IP adr.’
 - b. Select ‘Dynamic’.
5. Using the interactive menu on the CU 6110 navigate to:
 - a. LAN setup * IP address setup * IP address * Actual IP address
 - b. Note the IP address
6. Open the internet browser in the PC
7. Type in the internet browser: ‘http://IP-address’, where ‘IP address’ is the address noted from the CU 6110
8. The CU 6110 browser interface will open.

Please refer to section [‘Web Browser Setup and Control’](#) for details about using the CU 6110 web browser.

General Guidelines

Installation

The CU 6110 is suitable for either tabletop or 19-inch rack-mounted use. Four feet (for tabletop use) and two mounting brackets (for rack mounting) are supplied.

When installing in a 19" rack the supplied 19" brackets shall be fixed to the front side of the CU 6110 Central Unit by unscrewing the crews holding the top and button cover and then fix the brackets using the same screws.

Important: Use the two 10 mm length self-threading screws closest to the front and the 8 mm length threaded screw furthest from the front.

Cabling guidelines

The Conference Units are connected to the CU 6110 Central Unit using shielded CAT5e (F/UTP or U/FTP) cables and the following guidelines have to be observed:

- The conference units are daisy chain connected to the central unit
- The number of units, which can be connected to CU 6110, depends on length of the feeding cable and the length of the cable between each unit.

If the feeding cables are short and the cables between the units are short, more units can be connected than if the feeding cable is long and/or the cables are long between the units.

- Maximum cable length in one chain is 200 m (before inserting RP 6004 Repeater in a chain). This includes interconnection cables between the units.
- Maximum cable length in one chain when using RP 6004 Repeaters and Cat5e cables is 680 m.
- Cables must be AWG24 if the number of units in the tables in section 'Max. number of units to be connected' is to be used. AWG26 cables

The unit has a low noise built-in fan taking air in at the left side of the unit and blowing the hot air out at the right side. That allows units in 19" racks to be stacked close with other units without extra room for cooling air between them. Please check that other units in the rack will allow this.

Connect the CU 6110 to the various DCS 6000 units using shielded CAT5e (F/UTP or U/FTP) cables following the guidelines in the next chapter.

The operation and installation of the various DCS 6000 units is found in the User Manuals for the specific units.

will not allow as many units. DIS cables series EC 6001-xx are all AWG 24.

- It is desirable that the square of the feeding cables are as big as possible to minimize the voltage drop in the cables. Cat5e cables are delivered in various gauges:

The following table shows the Diameter/square for various AWG types:

Type	Diameter	Square
AWG22	0.64 mm	0.32 mm ²
AWG23/1	0.57 mm	0.25 mm ²
AWG24	0.53 mm	0.22 mm ²
AWG26	0.42 mm	0.14 mm ²

Although the DCS-LAN chain output connectors have a 125 W supply, this 125 W power is not all available with long cables, as there will be a power drop in the feeding cable from the CU 6110 Central Unit to the units connected.

Please consult the next sections for details about the number of units, which can be connected depending on the cable length.

Max. number of units to be connected

The following tables show the maximum number of units, which can be connected to a CU 6110 Central Unit.

In the tables the 'Feeding Cable' is defined as the cable between the CU 6110 and the first Unit and

Using only one DCS-LAN chain

The following tables show the maximum number of units, which can be connected to one DCS-LAN chain output when only one DCS-LAN chain is in use.

DC 6120 P, DC 6190 P, DM 6680 P Conference Units

Length of Feeding Cable	Length of inter connecting Cable	Total cable length	Max. number of units
10 m	1 m	51 m	42
30 m	1 m	67 m	38
50 m	1 m	83 m	34
100 m	1 m	122 m	23
150 m	1 m	165 m	16
10 m	2 m	88 m	40
30 m	2 m	98 m	35
50 m	2 m	108 m	30
100 m	2 m	140 m	21
150 m	2 m	178 m	15

Figure 0-A

DC 6990 P Conference Unit

Length of Feeding Cable	Length of inter connecting Cable	Total cable length	Max. number of units
10 m	1 m	35 m	26
30 m	1 m	53 m	24
50 m	1 m	70 m	21
100 m	1 m	112 m	13
150 m	1 m	158 m	9
10 m	2 m	58 m	25
30 m	2 m	72 m	22
50 m	2 m	86 m	19
100 m	2 m	124 m	13
150 m	2 m	166 m	9

Figure 0-B

CM/DM 6080 F / DM 6620 F Chairman/Delegate

Length of Feeding Cable	Length of inter connecting Cable	Total cable length	Max. number of units
10 m	1 m	39 m	30
30 m	1 m	56 m	27
50 m	1 m	73 m	24
100 m	1 m	115 m	16
150 m	1 m	160 m	11
10 m	2 m	64 m	28
30 m	2 m	78 m	25
50 m	2 m	94 m	23
100 m	2 m	130 m	16
150 m	2 m	170 m	11

Figure 0-C

the 'Interconnecting Cable' is defined as the cable connecting two conference unit. Feeding cables and interconnection cables must be minimum AWG24 if the number of units in the tables is to be used.

CM/DM 6680 F Chairman/Delegate Units

Length of Feeding Cable	Length of inter connecting Cable	Total cable length	Max. number of units
10 m	1 m	36 m	27
30 m	1 m	53 m	24
50 m	1 m	70 m	21
100 m	1 m	113 m	14
150 m	1 m	159 m	10
10 m	2 m	58 m	25
30 m	2 m	72 m	22
50 m	2 m	88 m	20
100 m	2 m	126 m	14
150 m	2 m	166 m	9

Figure 0-D

MU 6040 C/D and MU 6042 D

Length of Feeding Cable	Cable length between each MU 6040	Total cable length	Max. number of MU 6040
10 m	2 m	168 m	80
30 m	2 m	178 m	75
50 m	2 m	188 m	70
100 m	2 m	200 m	51
150 m	2 m	200 m	26
100 m	1 m	151 m	52
150 m	1 m	191 m	42

Figure 0-E With no Audio in the loudspeaker

Note: The numbers are valid with no audio in loudspeaker or no loudspeaker connected to each unit. If loudspeakers are used, then use the figures for DC 6120 P or DC 6190 P.

IS 6132 P Interpreter Units

Length of Feeding Cable,	Length of inter-connecting Cables,	Max. number of units All ON ½ ON 1/3 ON
10m	2 m	54 x x
30m	2 m	49 57 60
50m	2 m	44 51 x
100m	2 m	35 40 x
150m	2 m	25 30 x

Figure 0-F IS 6132 P Interpreter Units connected. The numbers are with no loudspeakers connected.

Note: The number of units is dependent of how many interpreter sets there are per booth (or language), as there only can be one set switched ON per language (channel).

Note: The numbers are valid with no audio in loudspeaker or no loudspeaker connected to each unit. If loudspeakers are used, then use the figures for DC 6120 P or DC 6190 P.

IS 6132 P Units and JB 6104

Length of Feeding Cable	Length of cable between booths	Number of booths	Number of IS 6132/ booths	Number of LS 6132 P/ booths
10 m	5 m	19	4	0
10 m	5 m	12	4	4
30 m	5 m	17	4	0
30 m	5 m	10	4	4
50 m	5 m	15	4	0
50 m	5 m	9	4	4
100 m	5 m	11	4	0
100 m	5 m	7	4	4
150 m	5 m	8	4	0
150 m	5 m	5	4	4

Figure 0-G IS 6132 P Units and JB6104 and with/without LS 6132 P Loudspeaker connected.

CS 6340 F Channel Selector

Length of Feeding Cable	Length of Inter-connecting cable	Total cable length	Max. number of units
30 m	1 m	122 m	93
50 m	1 m	129 m	80
100 m	1 m	163 m	64
150 m	1 m	196 m	47
10 m	1,5 m	144 m	90
30 m	1,5 m	156 m	85
50 m	1,5 m	149 m	80
100 m	1,5 m	189 m	60
150 m	1,5 m	200 m	33
10 m	2 m	174 m	83
30 m	2 m	182 m	77
50 m	2 m	188 m	70
100 m	2 m	200 m	51
150 m	2 m	200 m	26

Figure 0-H CS 6340 F Channel Selector w/back light on

Using multiple DCS-LAN chains

The following table shows the maximum number of units, which can be connected to the DCS-LAN using multiple chain outputs simultaneously.

Note: If only one chain is used the information in section 'Using only one DCS-LAN chain' must be used.

DC 6120 P, DC 6190 P or DM 6680 P Conference Units

Length of Feeding Cable	Length of inter connecting Cable	Total cable length	Max. number of units using two outputs
10 m	1 m	2x32 m	2x23
30 m	1 m	2x51 m	2x22
50 m	1 m	2x70 m	2x21
100 m	1 m	2x117 m	2x18
150 m	1 m	2x164 m	2x15
10 m	2 m	2x54 m	2x23
30 m	2 m	2x72 m	2x22
50 m	2 m	2x88 m	2x20
100 m	2 m	2x132 m	2x17
150 m	2 m	2x176 m	2x14

Figure 0-I

DC 6990 P Conference Units

Length of Feeding Cable	Length of inter connecting Cable	Total cable length	Max. number of DC 6990 P using two outputs
10 m	1 m	2x34 m	2x15
30 m	1 m	2x43 m	2x14
50 m	1 m	2x62 m	2x13
100 m	1 m	2x110 m	2x11
150 m	1 m	2x158 m	2x9
10 m	2 m	2x36 m	2x14
30 m	2 m	2x54 m	2x13
50 m	2 m	2x90 m	2x12
100 m	2 m	2x118 m	2x10
150 m	2 m	2x164 m	2x8

Figure 0-J

Connection using JB 6104 Junction Box

This following table's shows conference units connected to JB 6104 Junction Boxes with 3 m cables between each Junction Box.

Important:

- * Connect only one unit to each output of a JB 6104
- * Use maximum 10 m cable from JB 6104 to the conference unit

DC 6120 P, DC 6190 P or DM 6680 P Conference Units, two units per box

Length of Feeding Cable	Length of Cable between each JB 6104	Total cable length	Number of JB 6104 (two outputs in use)	Max. number of DC 61xxP
10 m	3 m	61 m	18	36
30 m	3 m	75 m	16	32
50 m	3 m	89 m	14	28
100 m	3 m	127 m	10	20
150 m	3 m	168 m	7	14

Figure 0-K DC 6120 P, DC 6190 P or DM 6680 P Conference Unit connected using JB 6104 Junction Box, using only two outputs connection two unit

DC 6120 P, DC 6190 P or DM 6680 P Conference Units, four units per box

Length of Feeding Cable	Length of Cable between each JB 6104	Total cable length	Number of JB 6104 (four outputs in use)	Max. number of DC 61xxP
10 m	3 m	40 m	11	44
30 m	3 m	57 m	10	40
50 m	3 m	74 m	9	36
100 m	3 m	115 m	6	25
150 m	3 m	159 m	4	16

Figure 0-L DC 6120 P, DC 6190 P or DM 6680 P Conference Unit connected using JB 6104 Junction Box, using all four outputs connecting four unit

CU 6110 Central Unit

Overview

The CU 6110 Central Unit for the DCS 6000 is the heart of the system. One CU 6110 is needed in each DCS 6000 system.

Feature License

The CU 6110 Central Unit has as standard basic functionality:

- Conference Units max. 50
- Interpretation Channels max. 4
- Vox, voice activating No
- Voting No

The unit count above includes DC, DM, CM and DV units. Dual Delegate units count for 2 units.

By obtaining feature licenses, the functionality can be expanded to include further features like:

- Conference Units max. 100
max. 500
max. 1000
max. 3800
- Interpreter Channels max. 8
max. 16
max. 31
- Voting option
- VOX, Voice Activation

The Feature License key is a file delivered from your authorized DIS Partner and can be uploaded in the CU using the build in browser. For details about uploading the Feature license, please refer to section '[CU 6110 Setup \(browser\)](#)'

This manual describes all features available.

User controls & connectors

The CU 6110 is suitable for either table-top or 19-inch rack-mounted use. Four feet (for table top use) and two mounting brackets (for rack mounting) are supplied.

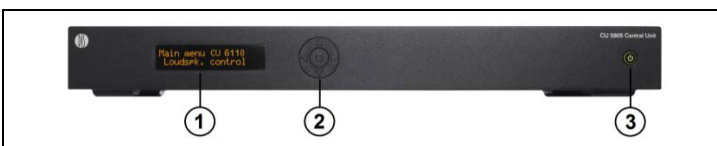

Figure 0-A Front view of CU 6110

1. **Menu display** – A 2x20 character OLED-display is used as an interactive display for configuring the system.
2. **Menu buttons** – 5-button keypad for configuring the unit in combination with the display (1).
3. **Mains on/off switch** – After switching the mains on, the central unit starts up and the display (1) will light-up after app. 15 seconds. Any connected EX 6010 Extension Units will automatically be powered up. The indication in the switch is lighting Green, when power is switched 'On'. A red light indicates that power is connected to the central unit, but the unit is not switched 'On' (Standby).

If power is removed due to a main power failure, the unit will maintain the power state when main power is re-established.

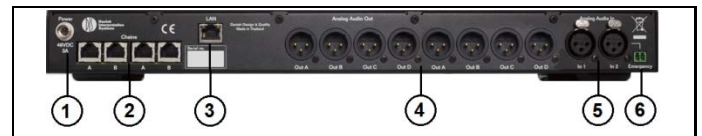

Figure 0-B Back view of CU 6110

1. **Power Supply input** – Connection of the external PS CU Power Supply (48V/3A). The power supply is provided together with the CU 6110.



Figure 0-C PS CU Power Supply

2. **Chain outputs** – Four RJ45 connectors for connecting Conference Unit. The connection and protocol is called DCS-LAN.

Important: The 'Chain' outputs are only for connecting Conference Units or other DCS-LAN compatible equipment.

Connecting a LAN (TCP/IP) connection from a third part device to this output may damage both the third part device and the CU 6110.

3. **LAN (TCP/IP) connector** – A RJ45 connector for connection to local area network (LAN). This connector is used to connection to the built in web application or for connection to SW 6000 or a control system like AMX® or Crestron®.
4. **Audio output A, B, C, D, E, F & H** – Eight male XLR3 connectors for connection of PA systems, Audio Mixers, Audio Recorders or Language Distribution System etc.
5. **Audio input In 1 & In 2** – Two female XLR3 connectors for extra audio inputs. 'In 1' and 'In 2' is used to connect auxiliary symmetrical audio signals such as a wireless microphone to the floor language.

'In 2' is also used for connection of an 'Emergency Evacuation Message (EEM)' audio signal.

6. **Emergency switch connector** – A terminal block socket for a single, 'normally open' switch. When the switch is closed, the audio signal on the 'In 2' connector is distributed on all output channels and loudspeakers, overriding all other audio inputs.

Note: There is no volume control available for setting the EEM volume on 'In 2'. The volume has to be set at the equipment generating the "Emergency Evacuation Message (EEM)" audio signal.

Simplified Audio Schematic

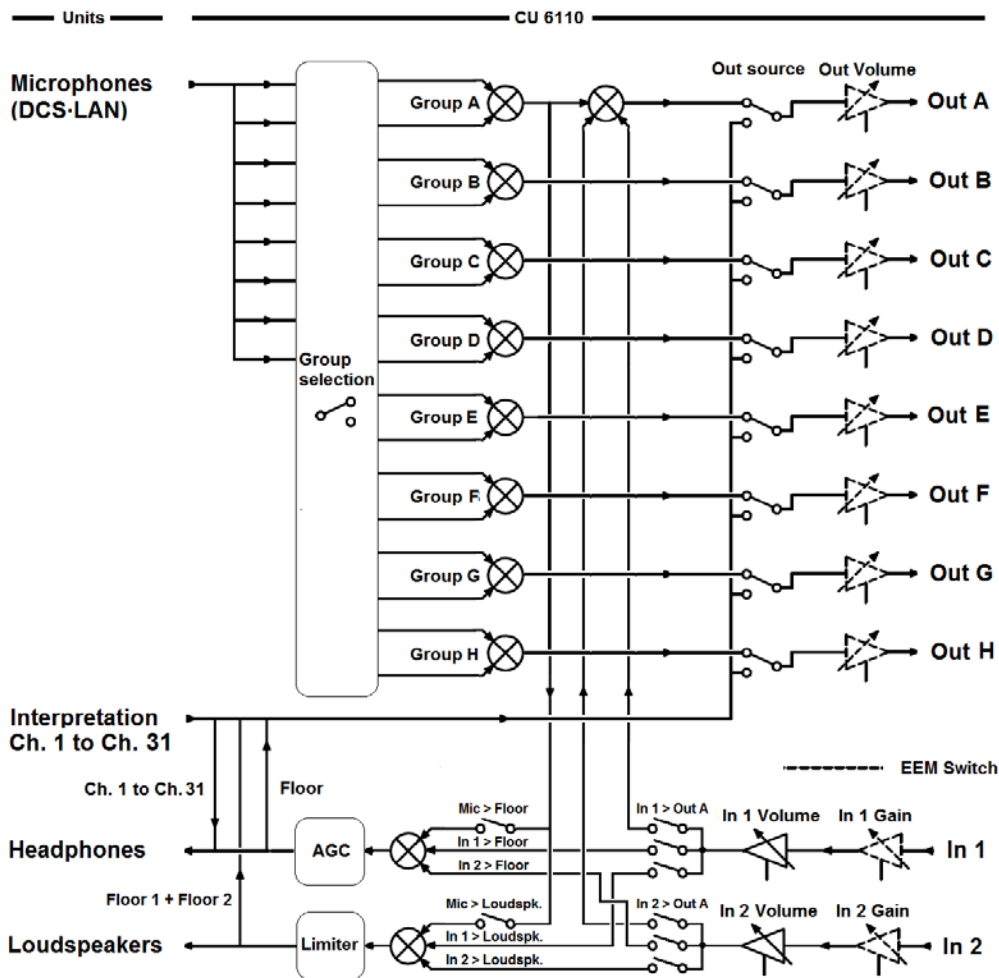

Figure 0-A

CU 6110 Central Unit Audio Schematic

Connecting Units

This chapter gives an overview of typical system connections using the CU 6110 Central Unit:

combinations of the schematics are however not only possible, but very common used.

Although the schematics are typical and are intended to give a general overview,

Connecting Conference Unit

The DCS 6000 Conference Units are connected to the CU 6110 using EC 6001-xx Cat5e cables. This is the basic connection of the system.

Refer to section 'Using multiple DCS-LAN chains' when using four chains.

All four of the DCS-LAN chain connectors on the CU 6110 can be used for connecting any Conference Unit or other units.

Please refer to section 'Using only one DCS-LAN chain' for information about the number of units which can be connected using one chain.

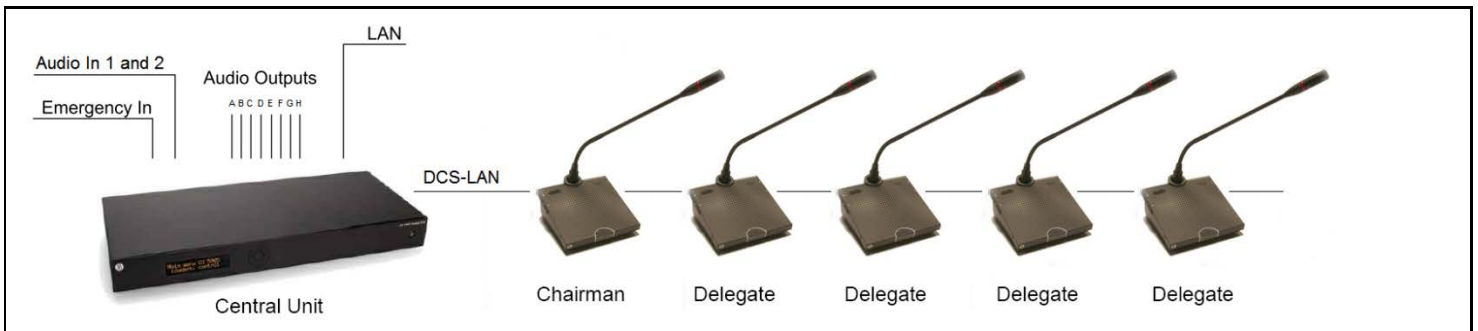

Figure 0-A Connecting DCS 6000 conference units.

When using JB 6104 Junction boxes, the conference units can be connected and disconnected without interrupting the conference.

Please refer to the 'User Manual JB 6104' for further details.

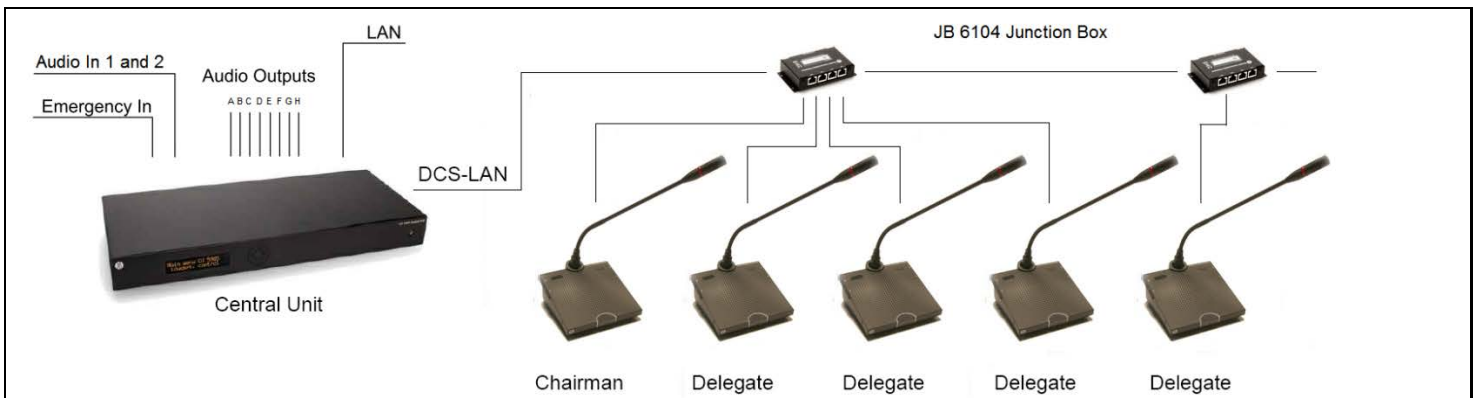

Figure 0-B Connecting DCS 6000 conference units using JB 6104 Junction Boxes.

Connecting a PC

The CU 6110 is connected to the Conference Units using EC 6001-xx Cat5e cables and is connected to a PC with a LAN cable.

Opening the browser in the PC gives the option of configuring the system and controlling the Conference units from the PC. Please refer to section *'Web Browser Setup and Control'* for more information.

Hint: On older PC's to setup a fixed IP address on both the PC and the CU might be needed.

Note: Depending on the type of PC a 'Crossed' LAN cable has to be used.
Instead of using a 'Crossed' LAN cable, a LAN Router can be inserted.

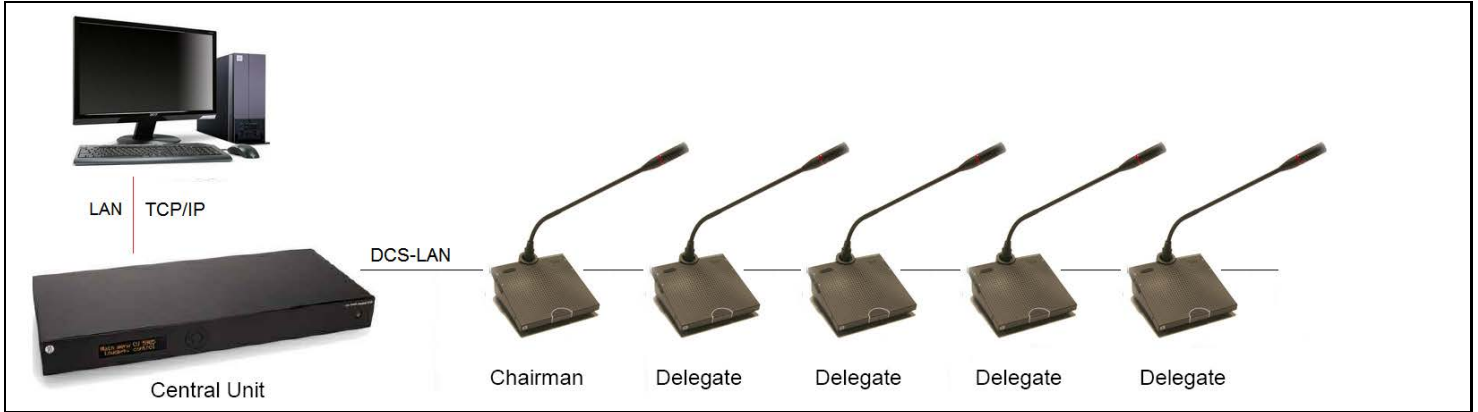

Figure 0-C Connecting the DCS 6000 Digital Conference System to a PC

Connecting a PC and an iPad

The CU 6110 is connected to the Conference Units using EC 6001-xx Cat5e cables.

A wireless access point with built-in router is used for connection to the CU 6110 and the PC. The iPad is connected wireless.

Opening the browser in the PC or on the iPad gives the option of configuring the system and

controlling the Conference units from the PC and/or iPad.

Please refer to section *'Web Browser Setup and Control'* for more information.

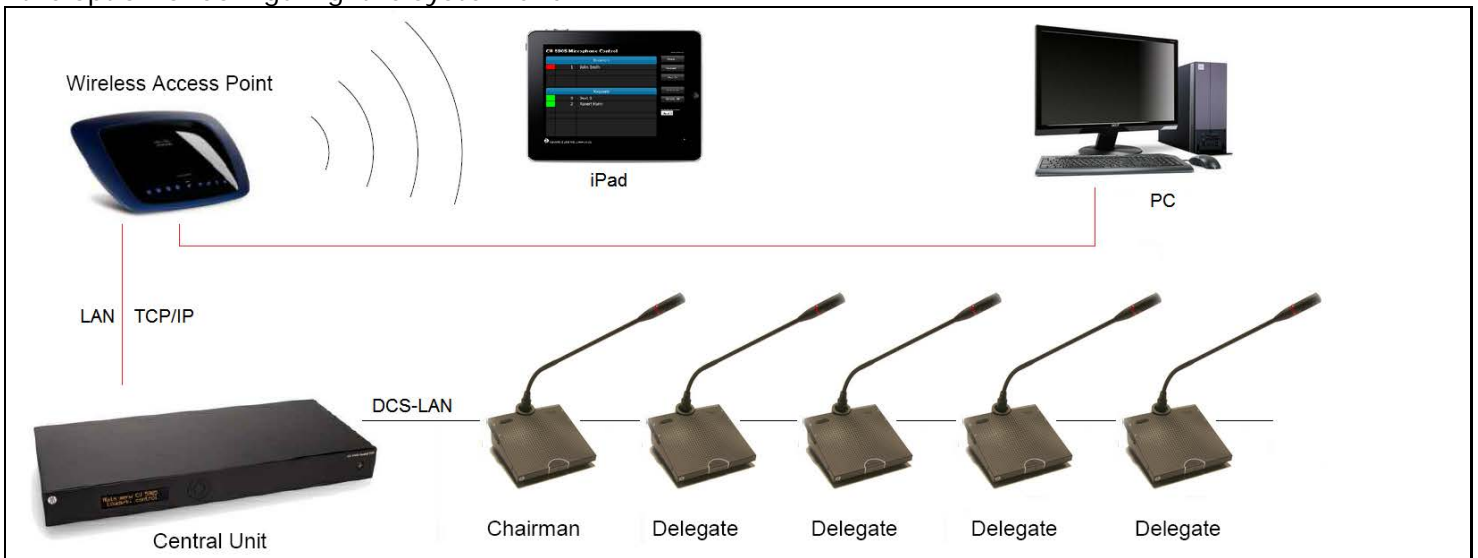

Figure 0-D Connecting the DCS 6000 Digital Conference System to a PC and an iPad

Connecting an audio recorder

The CU 6110 is connected to the Conference Units using EC 6001-xx Cat5e cables.

This configuration is used when 'Floor' audio or audio from one or more microphones is required to be recorded.

Use the 'Group' selection for the eight outputs and select the seats for each group. Refer to section 'Please refer to section Web Browser Setup and Control' item #8 for more information.

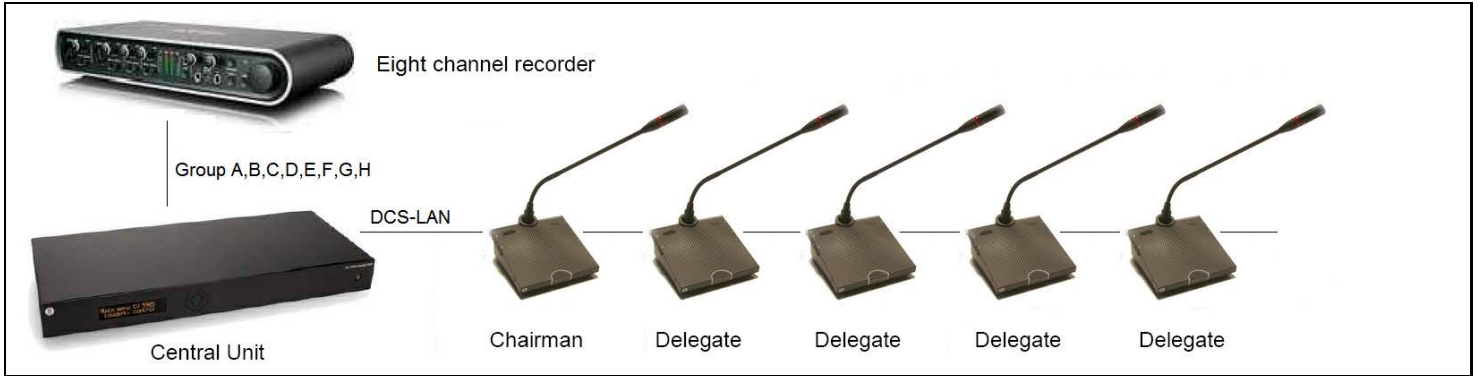

Figure 0-E Connecting the DCS 6000 Digital Conference System to an audio recorder.

Connecting an audio mixer

The CU 6110 is connected to the Conference Units using EC 6001-xx Cat5e cables.

This configuration is used when the volume from one or more microphones is required to be controlled separately or equalization is needed. One or more Outputs are connected to the external mixer, where the control or equalization is done.

The audio from the audio mixer is then send back to the CU using the 'Audio In 1 or 2' input.

Use the 'Group' selection for the eight outputs and make seat selection for each group. Refer to section 'Web Browser Setup and Control' item #8.

Important: If 'Out A' is also send to the mixer the following settings must to be done:

'CU 6110 Setup * Audio * Loudspeaker Control * Microphone -> Loudspeaker' shall be set to 'Off'.

'In 1 or 2 -> Out. A' shall be un-selected in the selection 'CU 6110 Setup * Audio * Input/Output Control * Audio In 1 or 2'.

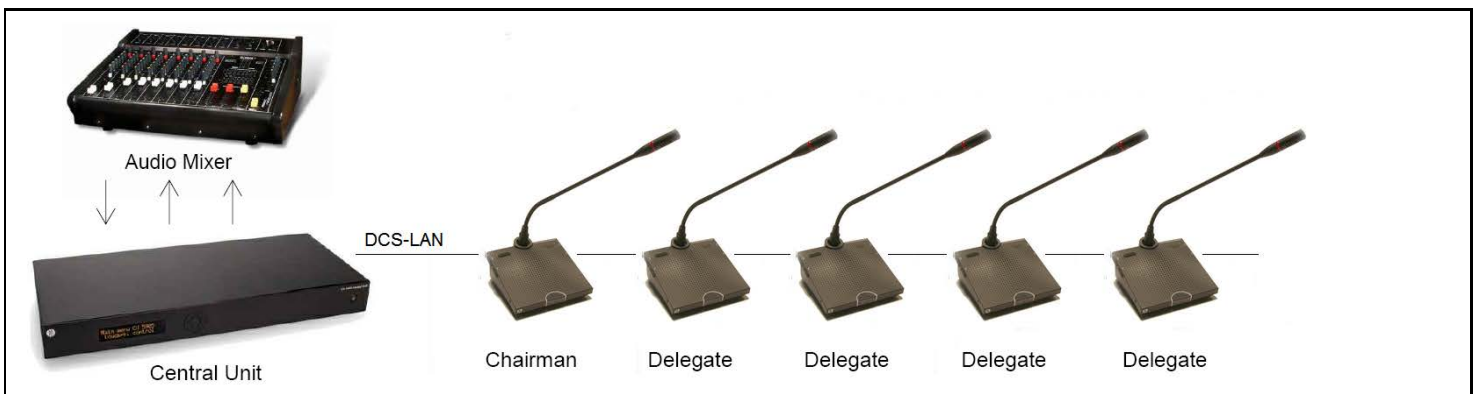

Figure 0-F Connecting the DCS 6000 Digital Conference System to an audio mixer.

Connecting interpretation units

The CU 6110 is connected to the Conference Units using EC 6001-xx Cat5e cables.

All four the DCS-LAN chain connectors on the CU 6110 can be used for connecting the Conference Units.

In this example one or more Interpreter Booth with Interpreter Units and DH 6021 Headphone is connected to the units.

Audio from the Interpreter Units can then be heard in the headphones connected to the Chairman and Delegate Units.

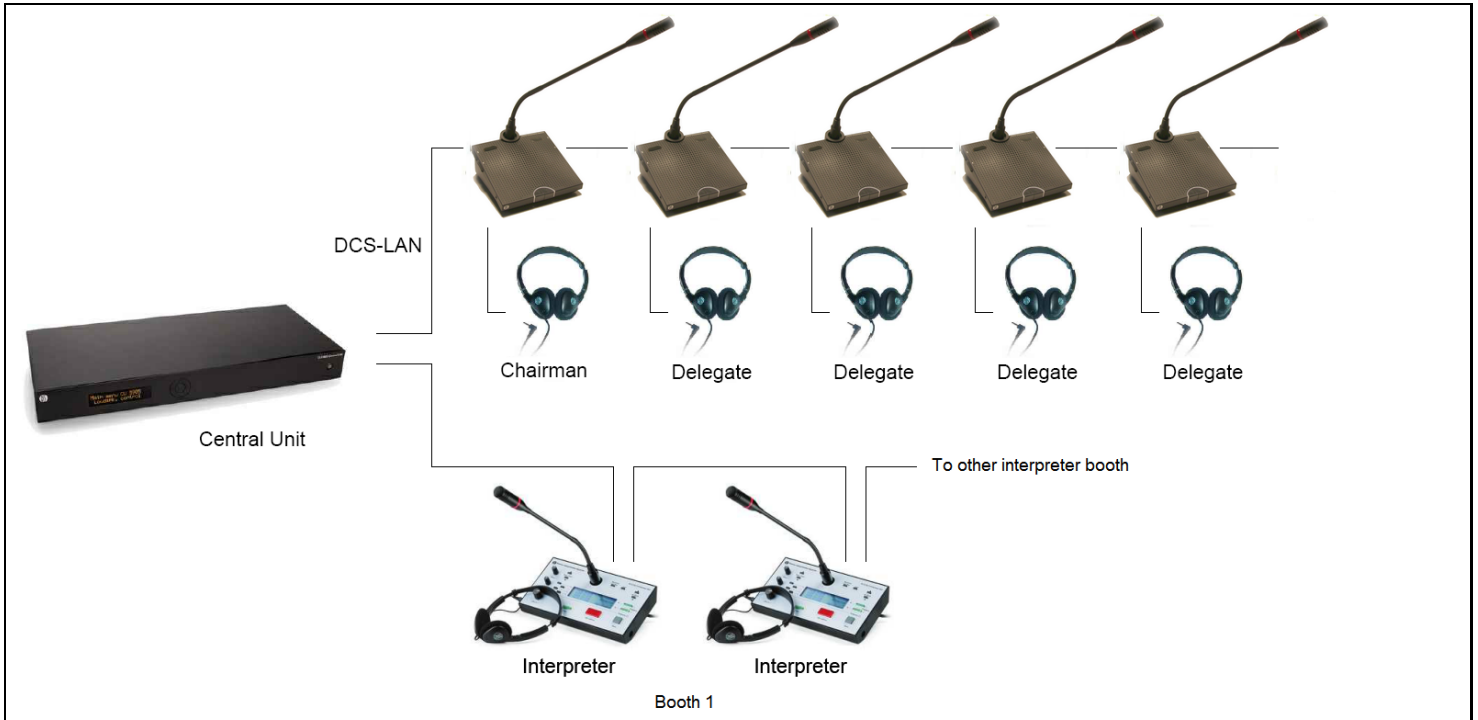

Figure 0-G DCS 6000 Digital Conference System with interpretation functionality.

Using wireless language distribution

The CU 6110 is connected to the Conference Units using EC 6001-xx Cat5e cables. All four DCS-LAN connectors on the CU 6110 can be used for connecting Conference Units.

In this example one or more Interpreter Booth with Interpreter Units and DH 6021 Headphone is connected to the units. Audio from the Interpreter Units can then be heard in the headphones

connected to the Chairman and Delegate Units and wired Channel Selectors.

A wireless language distribution system like 'DCS 6000 Digital Infrared Language System' can then be connected to the Audio Out connectors (A, B, C, D, E, F, G & H), where the source to the outputs are configured as 'Floor' and the interpreter channels. Refer to section 'Web Browser Setup and Control' item #8.

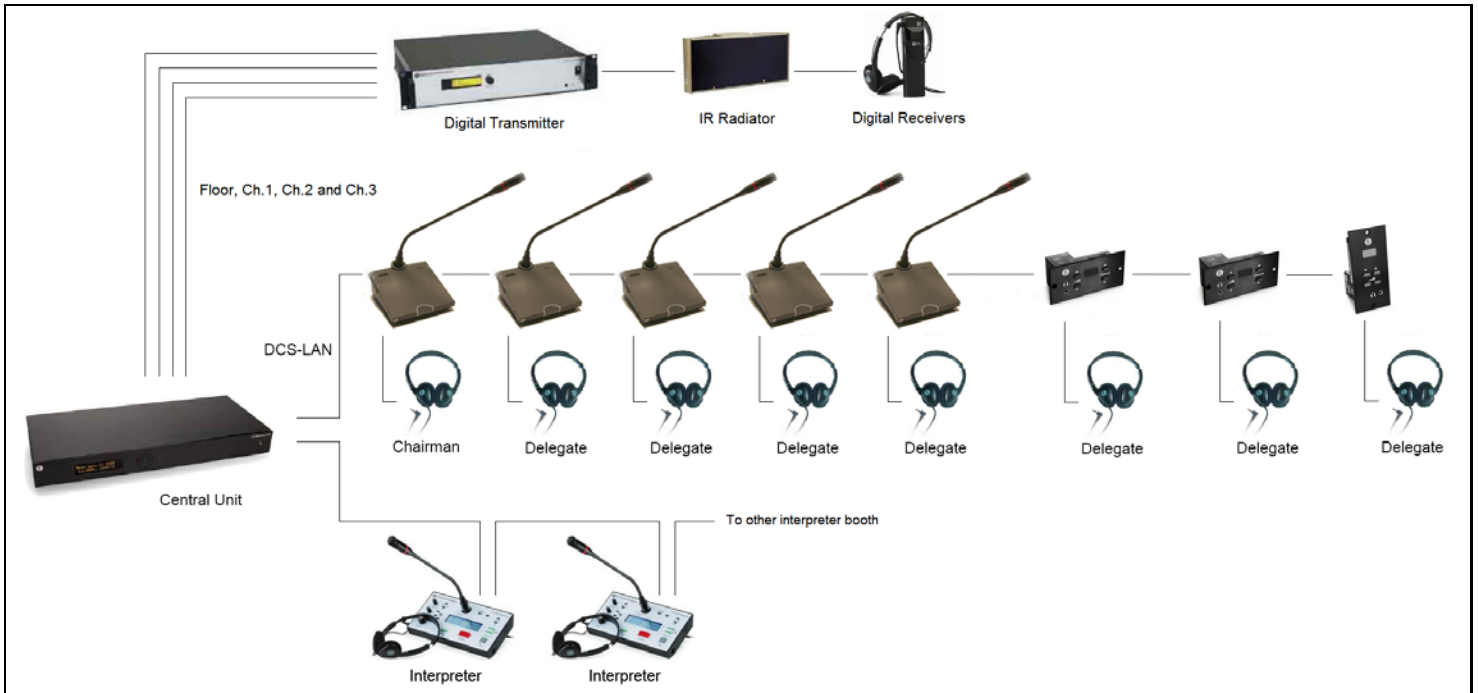

Figure 0-H DCS 6000 Digital Conference System with interpretation and wireless distribution, Floor, Ch.1 to Ch.7

Using RP 6004 Repeater

RP 6004 Repeater can be used to extend the maximum cable length from the central unit of the unit furthest away.

The maximum cable length is 200 m in one chain, but when using RP 6004 Repeater that maximum cable length can be expanded to 680m.

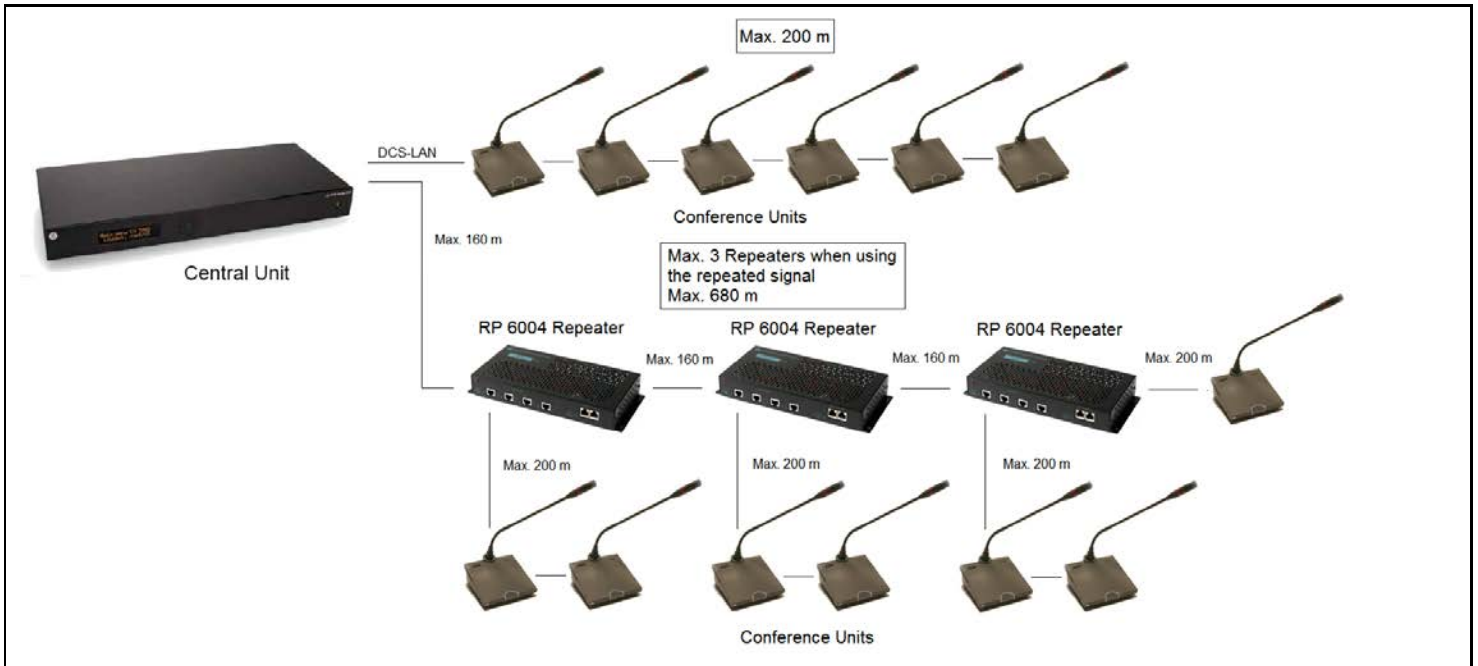

Figure 0-I DCS 6000 Digital Conference System with RP 6004 Repeater.

Using PS 6001 DCS-LAN Power Kit

The PS 6001 is a kit consisting of a PS CU Power Supply and a PI 6000 Power Inserted. The kit can be inserted in the DCS-LAN chains at any point, where additional power is needed.

Figure 0-J show that one RP 6004 and four PS 6001 Power Kits equals one EX 6010.

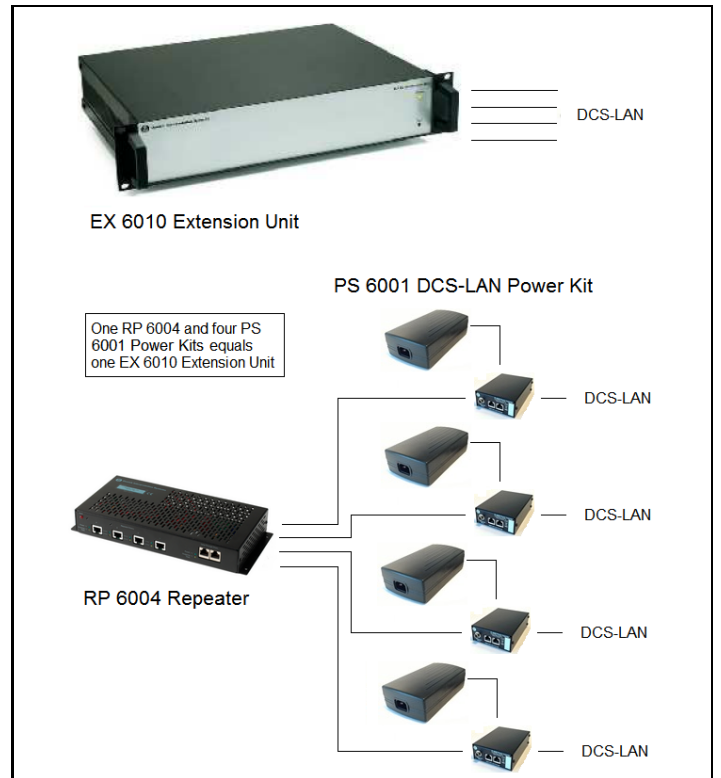

Figure 0-J DCS 6000 Digital Conference System with PS 6001.

Connecting to SW 6000

Figure 0-K is a basic installation with only one PC. SW 6000 is installed on a PC and connected to the CU 6110 using TCP-IP. The PC can be used either by a Chairman or a Technician.

Figure 0-L is a more advanced setup, where each user has a PC with SW 6000 conference user application (CUA).

Please refer to the SW 6000 User Manuals for more information.

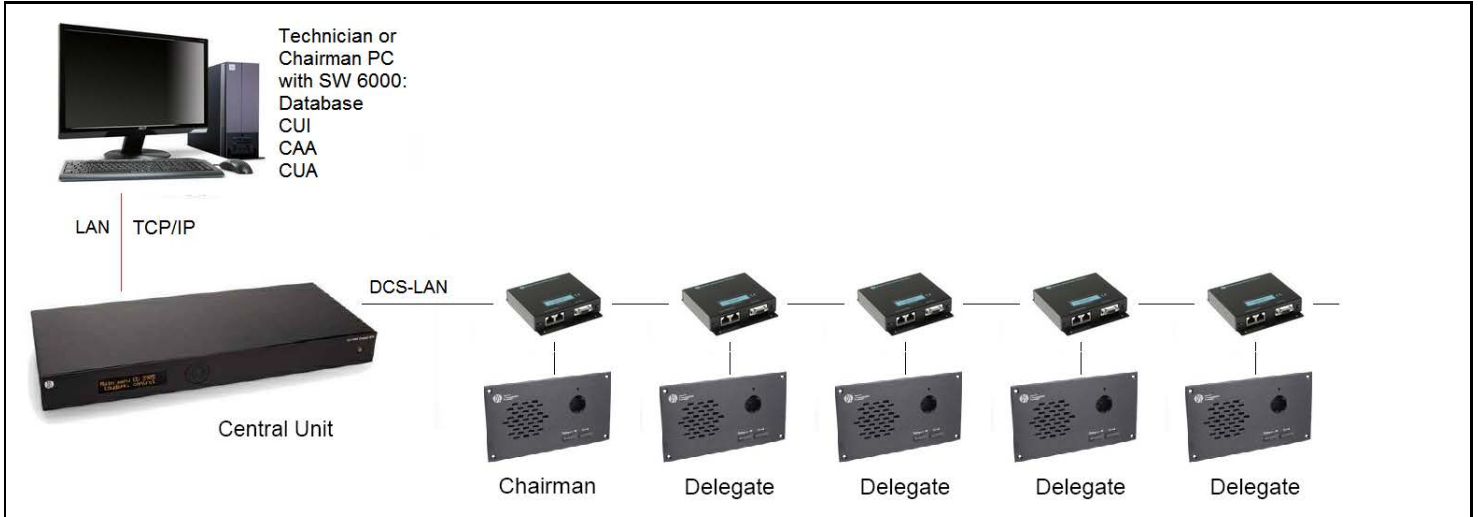

Figure 0-K DCS 6000 Digital Conference System with basic SW 6000 setup

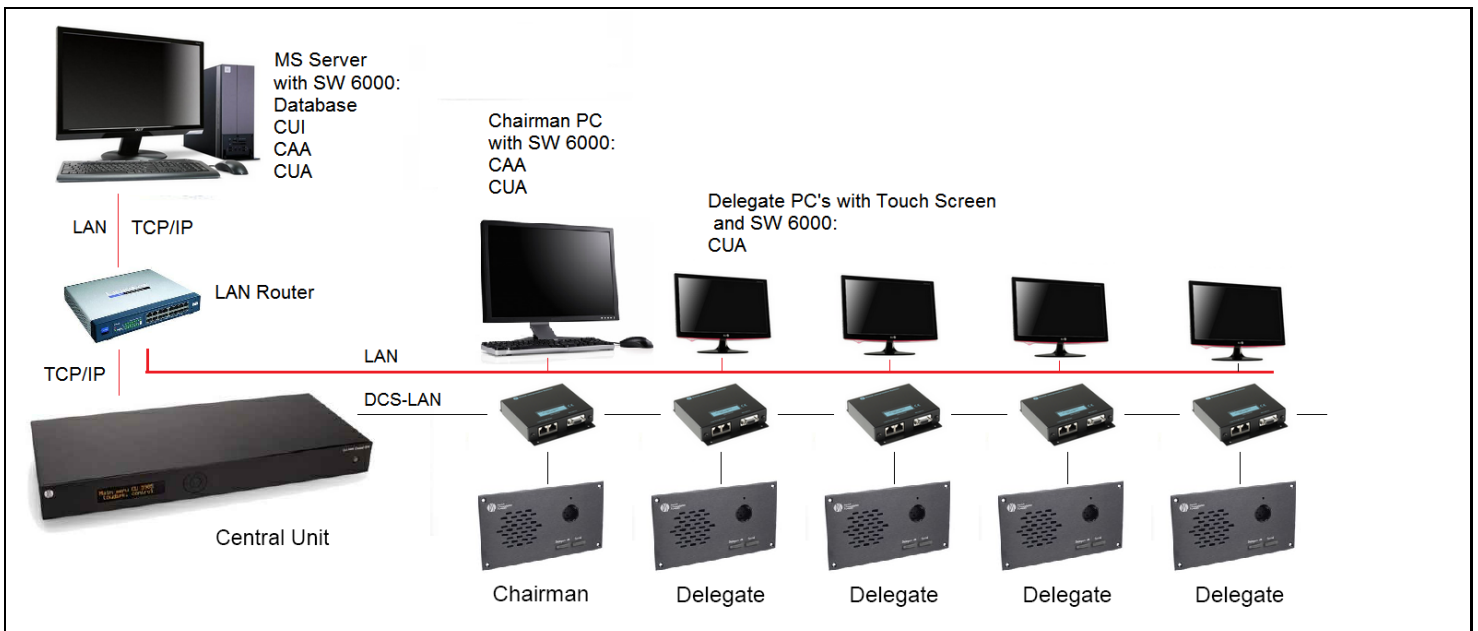

Figure 0-L DCS 6000 Digital Conference System with advanced SW 6000 setup

Connecting an emergency signal

To use the emergency signal function, a switch (normally-open) must be connected to the emergency switch connector. When the switch is closed an "Emergency Evacuation Message (EEM)" audio signal present on the 'In 2' input is

distributed to all output channels, overriding all other audio inputs.

Important: The level of the signal must be controlled externally.

Using the Interactive Menu

Overview

The major configurations and operation options of the CU 6110 can be set via an interactive menu, using the 2x20 character OLED display and the 5-button keypad.

'Figure 5.3 A' gives an overview of the menu structure, however for a general description of the settings in the menu refer to the section [Web Browser Setup and Control](#) where all CU 6110 settings are explained.

Figure 0-A Menu overview

Navigate through the menu

Navigation in the menu and changing parameters is done by activation the 5-button keypad:

- Cycle through the menu items (Blue marking) with the four 'arrow' buttons (Left-Right, Up-Down).
- Navigate to a settable option (Green marking).
- Cycle through the available values for a settable option using the 'arrow' buttons Up-Down.

Press the 'Enter' button in the center to accept the value. Pressing the Enter button concludes the selection made, and at the same time it indicates a confirmation of the possible changes made within the selection.

Please note that some changes are applied immediately but might not be saved. Saving of those settings to the memory of the CU 6110 will be done within 15-30 seconds.

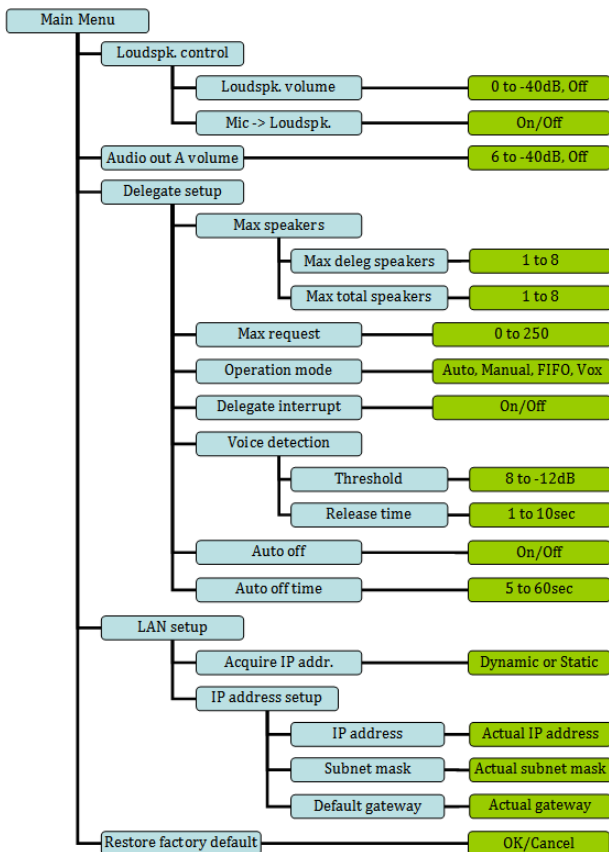

Web Browser Setup and Control

CU 6110 Setup (browser)

All configurations and operation options of the CU 6110 can be set using a web browser in a PC, tablet or iPad. When the 'IP address' or 'Host Name' is typed into the browser the connection to the CU will be established and the 'CU 6110 Setup' screen will open in the browser.

Important: The 'CU 6110 Web Browser Control' has been tested with the following browsers:
IE8/9+, Firefox 10+, Safari and Chrome
 Other browsers might work but have not been tested. Version of IE prior to v8 will not work.

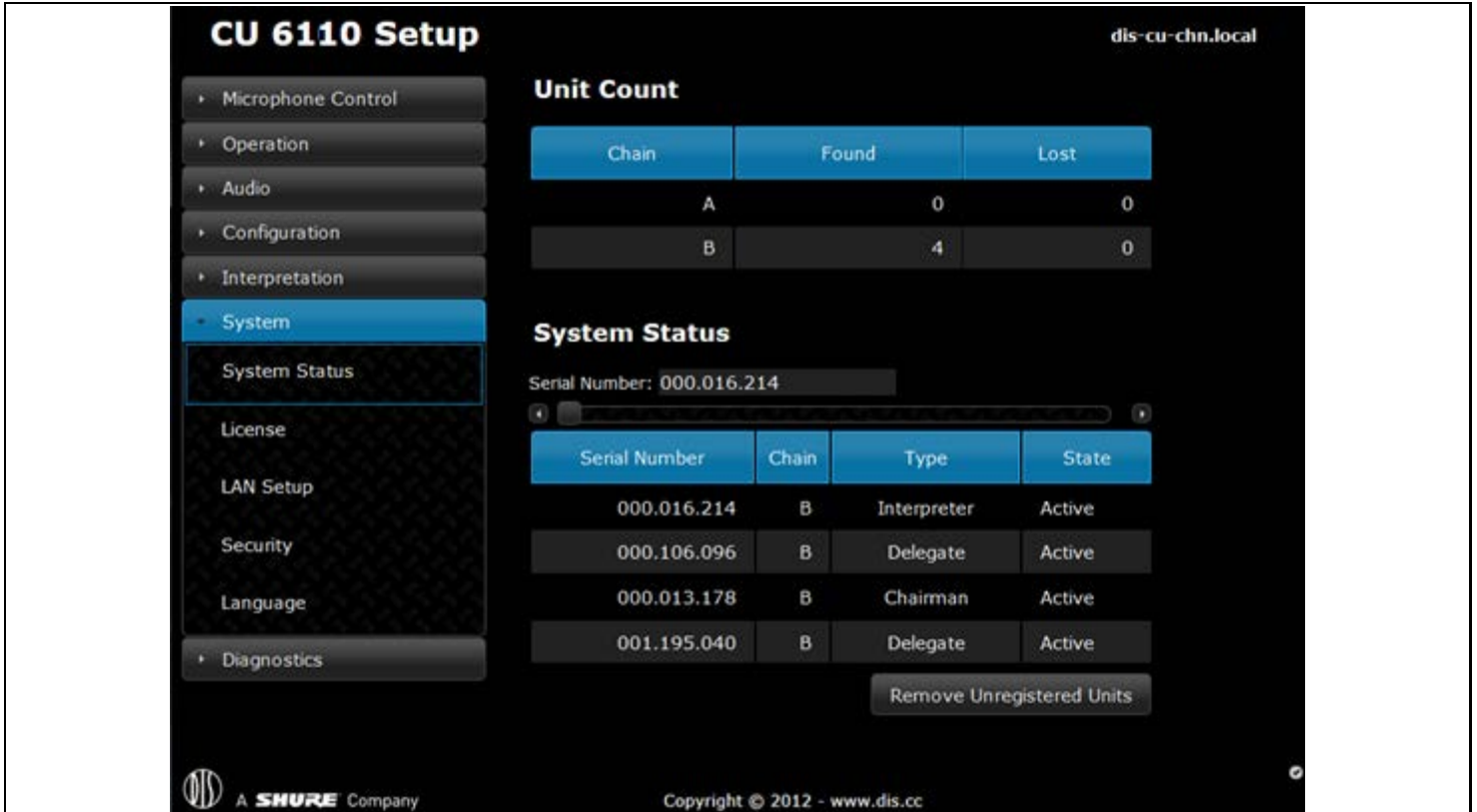

Figure 0-A CU 6110 Setup

The next tables show all menu items in the browser menu and a detailed description of the settings available.

#	Menu	Settings	Description
	<ul style="list-style-type: none"> ▸ Microphone Control ▸ Operation ▸ Audio ▸ Configuration ▸ Interpretation ▸ System ▸ Diagnostics 		<p>There are seven menu options in the browser control. The first menu option switches to the Microphone Control screen. Please refer to section 'CU 6110 Mic. Control (browser)' for details.</p> <p>The last six options select sub-menus for configuring and setting up the CU 6110.</p>

#	Menu	Settings	Description																													
	<ul style="list-style-type: none"> System System Status License LAN Setup Security Language 	<p>Unit Count</p> <table border="1"> <thead> <tr> <th>Chain</th> <th>Found</th> <th>Lost</th> </tr> </thead> <tbody> <tr> <td>A</td> <td>0</td> <td>0</td> </tr> <tr> <td>B</td> <td>4</td> <td>0</td> </tr> </tbody> </table> <p>System Status</p> <p>Serial Number: 000.016.214</p> <table border="1"> <thead> <tr> <th>Serial Number</th> <th>Chain</th> <th>Type</th> <th>State</th> </tr> </thead> <tbody> <tr> <td>000.016.214</td> <td>B</td> <td>Interpreter</td> <td>Active</td> </tr> <tr> <td>000.106.096</td> <td>B</td> <td>Delegate</td> <td>Active</td> </tr> <tr> <td>000.013.178</td> <td>B</td> <td>Chairman</td> <td>Active</td> </tr> <tr> <td>001.195.040</td> <td>B</td> <td>Delegate</td> <td>Active</td> </tr> </tbody> </table> <p>Remove Unregistered Units</p>	Chain	Found	Lost	A	0	0	B	4	0	Serial Number	Chain	Type	State	000.016.214	B	Interpreter	Active	000.106.096	B	Delegate	Active	000.013.178	B	Chairman	Active	001.195.040	B	Delegate	Active	<p>Unit Count –</p> <p>Shows the number of connected units on each chain.</p> <p>Unit Status –</p> <p>Shows the connected Conference units with Serial Number and Type of units. The 'State' field shows if a unit is 'Active' (connected) or 'Lost' (not connected) or 'Unregistered' (the unit has been present earlier).</p> <p>If a unit is shown as 'Locked' the unit is not compatible with the DCS 6000 System</p>
Chain	Found	Lost																														
A	0	0																														
B	4	0																														
Serial Number	Chain	Type	State																													
000.016.214	B	Interpreter	Active																													
000.106.096	B	Delegate	Active																													
000.013.178	B	Chairman	Active																													
001.195.040	B	Delegate	Active																													
	<ul style="list-style-type: none"> System System Status License LAN Setup Security Language 	<p>License</p> <p>Basic functionality available. No feature license installed</p> <p>Browse... GO</p> <hr/> <p>License</p> <p>File DCS License CU 001.218.032.xml uploaded. Size : 711 bytes.</p> <p>License file upload successfully Restarting</p> <hr/> <p>License</p> <p>Serial Number : 001.218.032 Microphones : 500 IS Channels : 16 Voting : Yes VoiceActivity : Yes</p> <p>Browse... No file selected. GO</p>	<p>License –</p> <p>Used for upload Feature License for expand the features in the CU.</p> <p>After selecting the update file of type 'xml' click the 'Go' button and the update process is started.</p> <hr/> <p>When the License file is uploaded the CU will reset</p> <hr/> <p>After the CU has restarted the license information is shown</p>																													

#	Menu	Settings	Description	
	<ul style="list-style-type: none"> System System Status License LAN Setup Security Language 	<p>LAN Setup</p> <p>CU hostname: dis-cu</p> <p>MAC Address: E4:67:BA:00:00:04</p> <p>IP configuration: <input type="button" value="Dynamic"/> <input type="button" value="Static"/></p> <p>IP address: 192.168.10.110</p> <p>Subnet mask: 255.255.255.0</p> <p>Gateway address: 192.168.10.1</p> <p><input type="button" value="Apply Changes"/></p>	<p>LAN Setup</p> <p>CU hostname: dis-cu</p> <p>MAC Address: E4:67:BA:00:00:04</p> <p>IP configuration: <input type="button" value="Dynamic"/> <input checked="" type="button" value="Static"/></p> <p>IP address: 192.168.10.110</p> <p>Subnet mask: 255.255.255.0</p> <p>Gateway address: 192.168.10.1</p> <p><input type="button" value="Apply Changes"/></p>	<p>CU hostname –</p> <p>A host name can be assigned to the CU 6110. This name can be used to connect to the CU 6110 with a browser instead of using the IP-address.</p> <p>After a hostname is assigned, type the following in the browser:</p> <p>http://'hostname'.local</p> <p>where 'hostname' is to be replaced with the assigned name.</p> <p>IP configuration –</p> <p>Select 'Dynamic' if the CU is connected to a network with DHCP server. Otherwise select 'Static' and assign a fixed IP address to the CU. Default IP configuration is "Dynamic".</p> <p>Select 'Apply Changes' to save changes made.</p> <p>The actual IP address can always be found in this screen or using the interactive menu on the CU 6110:</p> <p>LAN setup * IP address setup * IP address * Actual IP address.</p>
	<ul style="list-style-type: none"> System System Status License LAN Setup Security Language 	<p>Password Setup</p> <p>User name: []</p> <p>Password: []</p> <p><input type="button" value="Change Password"/></p>	<p>Password Setup –</p> <p>Used for setting 'User name/Password' for browser connection.</p>	



#	Menu	Settings	Description																																
	<ul style="list-style-type: none"> System System Status License LAN Setup Security Language 	<p>Language</p> <p>Browser Interface Language:</p> <table border="1"> <tr><td>English</td><td>македонски</td></tr> <tr><td>Dansk</td><td>български</td></tr> <tr><td>Svenska</td><td>Srpski</td></tr> <tr><td>Norsk</td><td>Српски</td></tr> <tr><td>Icelandic</td><td>Crnogorski</td></tr> <tr><td>Francais</td><td>Црногорски</td></tr> <tr><td>Deutsch</td><td>Shqip</td></tr> <tr><td>Español</td><td>Ελληνική</td></tr> <tr><td>Português</td><td>中文(简体)</td></tr> <tr><td>Italiano</td><td>中文(繁體)</td></tr> <tr><td>русский</td><td>日本語</td></tr> <tr><td>Polski</td><td>한국인</td></tr> <tr><td>Hrvatski</td><td>ภาษาไทย</td></tr> <tr><td>Bosanski</td><td>Tiếng Việt</td></tr> <tr><td>Slovenski</td><td>اللغة العربية</td></tr> <tr><td></td><td>فارسی</td></tr> </table>	English	македонски	Dansk	български	Svenska	Srpski	Norsk	Српски	Icelandic	Crnogorski	Francais	Црногорски	Deutsch	Shqip	Español	Ελληνική	Português	中文(简体)	Italiano	中文(繁體)	русский	日本語	Polski	한국인	Hrvatski	ภาษาไทย	Bosanski	Tiếng Việt	Slovenski	اللغة العربية		فارسی	<p>Language –</p> <p>Selecting the browser interface language. English language is default.</p>
English	македонски																																		
Dansk	български																																		
Svenska	Srpski																																		
Norsk	Српски																																		
Icelandic	Crnogorski																																		
Francais	Црногорски																																		
Deutsch	Shqip																																		
Español	Ελληνική																																		
Português	中文(简体)																																		
Italiano	中文(繁體)																																		
русский	日本語																																		
Polski	한국인																																		
Hrvatski	ภาษาไทย																																		
Bosanski	Tiếng Việt																																		
Slovenski	اللغة العربية																																		
	فارسی																																		
	<ul style="list-style-type: none"> Interpretation Interpreter Channels Language Setup Booth Setup Auto Floor Interpreter Lock 	<p>Interpretation Setup</p> <p>Interpretation Channels: 16</p> <p>Channel Display:</p> <p>Number Abbreviation</p>	<p>Interpretation Setup –</p> <p>Used to set the number of Interpreter Channels in use (0 to 31).</p> <p>When set to value '0' no interpretation channels are present in the system. Only 'Floor' sound will be present</p> <p>Channel 0 will always give the original audio (floor).</p> <p>Channel Display –</p> <p>Used to switch the showing in the channel selectors displays in conference units between Language Abbreviation and Channel Number.</p>																																

#	Menu	Settings	Description																																								
	<ul style="list-style-type: none"> Interpretation Interpreter Channels Language Setup Booth Setup Auto Floor Interpreter Lock 	<p>Language Setup</p> <table border="1"> <thead> <tr> <th>Channel</th> <th>Language</th> </tr> </thead> <tbody> <tr><td>1</td><td>Afrikaans</td></tr> <tr><td>2</td><td>English</td></tr> <tr><td>3</td><td>Arabic</td></tr> <tr><td>4</td><td>Armenian</td></tr> <tr><td>5</td><td>Azerbaijan</td></tr> <tr><td>6</td><td>Basque</td></tr> <tr><td>7</td><td>Belarusian</td></tr> <tr><td>8</td><td>Bengali</td></tr> <tr><td>9</td><td>Bulgarian</td></tr> <tr><td>10</td><td>Burmese</td></tr> <tr><td>11</td><td>Cantonese</td></tr> <tr><td>12</td><td>Catalan</td></tr> <tr><td>13</td><td>Chinese</td></tr> <tr><td>14</td><td>Corsican</td></tr> <tr><td>15</td><td>Croatian</td></tr> <tr><td>16</td><td>Czech</td></tr> </tbody> </table>	Channel	Language	1	Afrikaans	2	English	3	Arabic	4	Armenian	5	Azerbaijan	6	Basque	7	Belarusian	8	Bengali	9	Bulgarian	10	Burmese	11	Cantonese	12	Catalan	13	Chinese	14	Corsican	15	Croatian	16	Czech	<p>Language setup –</p> <p>The “Language setup” menu shows the number of channels according to the ‘Interpreter Channels’ settings.</p> <p>The language for each channel can be selected used the drop down list.</p>						
Channel	Language																																										
1	Afrikaans																																										
2	English																																										
3	Arabic																																										
4	Armenian																																										
5	Azerbaijan																																										
6	Basque																																										
7	Belarusian																																										
8	Bengali																																										
9	Bulgarian																																										
10	Burmese																																										
11	Cantonese																																										
12	Catalan																																										
13	Chinese																																										
14	Corsican																																										
15	Croatian																																										
16	Czech																																										
	<ul style="list-style-type: none"> Interpretation Interpreter Channels Language Setup Booth Setup Auto Floor Interpreter Lock 	<p>Booth Setup</p> <table border="1"> <thead> <tr> <th>Booth</th> <th>Channel</th> </tr> </thead> <tbody> <tr><td>1</td><td>Afrikaans</td></tr> <tr><td>2</td><td>English</td></tr> <tr><td>3</td><td>Arabic</td></tr> <tr><td>4</td><td>Armenian</td></tr> <tr><td>5</td><td>Azerbaijan</td></tr> <tr><td>6</td><td>Basque</td></tr> <tr><td>7</td><td>Belarusian</td></tr> <tr><td>8</td><td>Bengali</td></tr> <tr><td>9</td><td>Bulgarian</td></tr> <tr><td>10</td><td>Burmese</td></tr> <tr><td>11</td><td>Cantonese</td></tr> <tr><td>12</td><td>Catalan</td></tr> <tr><td>13</td><td>Chinese</td></tr> <tr><td>14</td><td>Corsican</td></tr> <tr><td>15</td><td>Croatian</td></tr> <tr><td>16</td><td>Czech</td></tr> <tr><td>17</td><td></td></tr> <tr><td>18</td><td></td></tr> <tr><td>19</td><td></td></tr> </tbody> </table>	Booth	Channel	1	Afrikaans	2	English	3	Arabic	4	Armenian	5	Azerbaijan	6	Basque	7	Belarusian	8	Bengali	9	Bulgarian	10	Burmese	11	Cantonese	12	Catalan	13	Chinese	14	Corsican	15	Croatian	16	Czech	17		18		19		<p>Booth Setup –</p> <p>The “Booth Setup” shows a list of Booth (1 to 128).</p> <p>The Interpretation Channels can now be assigned to the Booth. More Booths can be assigned the same channel.</p> <p>As default Booth 1 is assigned Channel 1 , Booth 2 assigned Channel 2 etc.</p>
Booth	Channel																																										
1	Afrikaans																																										
2	English																																										
3	Arabic																																										
4	Armenian																																										
5	Azerbaijan																																										
6	Basque																																										
7	Belarusian																																										
8	Bengali																																										
9	Bulgarian																																										
10	Burmese																																										
11	Cantonese																																										
12	Catalan																																										
13	Chinese																																										
14	Corsican																																										
15	Croatian																																										
16	Czech																																										
17																																											
18																																											
19																																											

#	Menu	Settings	Description
	<ul style="list-style-type: none"> ▼ Interpretation Interpreter Channels Language Setup Booth Setup <li style="border: 1px solid black;">Auto Floor Interpreter Lock 	<p>Auto Floor</p> <p>Auto Floor:</p> <p><input checked="" type="button" value="On"/> <input type="button" value="Off"/></p>	<p>Auto Floor –</p> <p>When set to ON a language channel with no interpretation will have the Floor sound.</p>
	<ul style="list-style-type: none"> ▼ Interpretation Interpreter Channels Language Setup Booth Setup Auto Floor <li style="border: 1px solid black;">Interpreter Lock 	<p>Interpreter Lock</p> <p>Interpreter Lock:</p> <p><input type="button" value="No Lock"/></p> <p><input type="button" value="A Interrupt A"/></p> <p><input type="button" value="A Interrupt B"/></p> <p><input type="button" value="A Interrupt A+B"/></p> <p><input checked="" type="button" value="Complete"/></p>	<p>Interpreter Lock –</p> <p>The Interlock settings are used to setup the interlock between the Interpretation channels.</p> <p>The settings are:</p> <p>Complete Lock</p> <p>An interpreter cannot switch on his microphone to any occupied interpreter channel. This is the default setting.</p> <p>No Lock</p> <p>An interpreter turning on his microphone to any occupied interpreter channel, will turn of the interpreter occupying the channel.</p> <p>A interrupt A</p> <p>An interpreter turning on his microphone on an A-channel will interrupt another interpreter using his A channel</p> <p>A interrupt B</p> <p>An interpreter turning on his microphone on an A-channel will interrupt another interpreter using his B channel, but will not interrupt an interpreter using his A channel.</p> <p>A interrupt A+B</p> <p>An interpreter turning on his microphone on an A-channel will interrupt another interpreter using his A or B channel.</p>

#	Menu	Settings	Description																
	<p>Configuration</p> <ul style="list-style-type: none"> Delegate Setup Unit to Seat Relation Factory Defaults 	<p>Delegate Setup</p> <p>Seat Number: 8</p> <table border="1"> <thead> <tr> <th>Seat Number</th> <th>Delegate Name</th> <th>Microphone Attenuation</th> <th>Priority</th> </tr> </thead> <tbody> <tr> <td>8</td> <td>John Smith</td> <td>0</td> <td>1</td> </tr> <tr> <td>9</td> <td>Calvin Klein</td> <td>0</td> <td>5</td> </tr> <tr> <td>1</td> <td>Seat 1</td> <td>0</td> <td>5</td> </tr> </tbody> </table>	Seat Number	Delegate Name	Microphone Attenuation	Priority	8	John Smith	0	1	9	Calvin Klein	0	5	1	Seat 1	0	5	<p>Delegate Setup -</p> <p>All units connected are shown in this list with a 'Seat Number' and a 'Delegate name'.</p> <p>When a unit is connected for the first time, it will be assigned the next 'Seat Number' and assigned a 'Delegate Name' in the format 'Seat x', where 'x' is the assigned seat number. The assigned 'Delegate Name' can be changed to show the actual name of the delegate placed in the seat.</p> <p>Microphone Attenuation -</p> <p>Used to lower the Microphone level the selected unit.</p> <p>Speak Priority -</p> <p>Each unit can be assigned an individual speak priority from 0 to 5.</p> <p>As default a Chairman Unit has speak priority 5 and a Delegate Unit has speak priority 1.</p>
Seat Number	Delegate Name	Microphone Attenuation	Priority																
8	John Smith	0	1																
9	Calvin Klein	0	5																
1	Seat 1	0	5																
		<p>Delegate Setup</p> <div style="border: 1px solid black; padding: 5px;"> <p>Delegate Setup</p> <p>Seat Range: 1 - 9</p> <p>Reset Names: <input type="checkbox"/></p> <p>Microphone Attenuation: ---</p> <p>Speak Priority: ---</p> <p>Apply</p> </div> <p>Seat Number: 8</p> <table border="1"> <thead> <tr> <th>Seat Number</th> <th>Delegate Name</th> <th>Microphone Attenuation</th> <th>Priority</th> </tr> </thead> <tbody> <tr> <td>8</td> <td>John Smith</td> <td>0</td> <td>1</td> </tr> <tr> <td>9</td> <td>Calvin Klein</td> <td>0</td> <td>5</td> </tr> <tr> <td>1</td> <td>Seat 1</td> <td>0</td> <td>5</td> </tr> </tbody> </table>	Seat Number	Delegate Name	Microphone Attenuation	Priority	8	John Smith	0	1	9	Calvin Klein	0	5	1	Seat 1	0	5	<p>Activating the 'Arrow Down' button in the right upper corner reveals a window with options to change settings for a range of seats.</p> <p>The 'Reset Names' button delete all assigned delegate names in the selected seat range.</p>
Seat Number	Delegate Name	Microphone Attenuation	Priority																
8	John Smith	0	1																
9	Calvin Klein	0	5																
1	Seat 1	0	5																

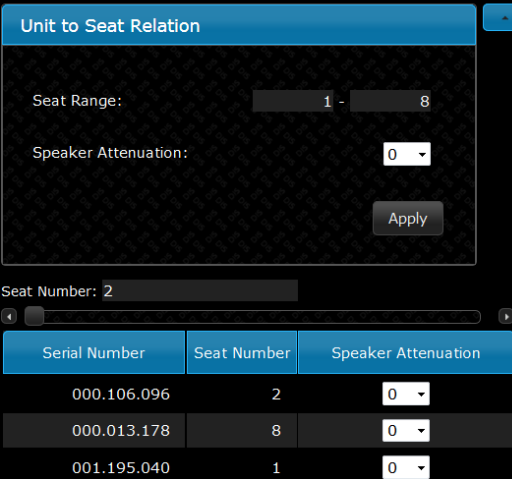
#	Menu	Settings	Description																								
	<ul style="list-style-type: none"> Configuration Delegate Setup Unit to Seat Relation Factory Defaults 	<p>Unit to Seat Relation</p> <p>Seat Number: 1</p> <table border="1"> <thead> <tr> <th>Serial Number</th> <th>Seat Number</th> <th>Speaker Attenuation</th> <th>Left Button</th> </tr> </thead> <tbody> <tr> <td>000.106.096</td> <td>1</td> <td>0</td> <td>---</td> </tr> <tr> <td>000.013.178</td> <td>2</td> <td>0</td> <td>---</td> </tr> <tr> <td>001.195.040</td> <td>3</td> <td>0</td> <td>Reply</td> </tr> </tbody> </table>	Serial Number	Seat Number	Speaker Attenuation	Left Button	000.106.096	1	0	---	000.013.178	2	0	---	001.195.040	3	0	Reply	<p>Unit to Seat Relation –</p> <p>All units connected are shown in this list with ‘Serial Number’ and ‘Seat Number’.</p> <p>When a unit is connected for the first time, it will be assigned the next available ‘Seat Number’</p> <p>The ‘Seat Number’ can be changed as required. If the changed seat number is already applied to a seat, the seat number will simply be shifted. The ‘Seat Number’ is a numerical in the range 1 to 65535.</p> <p>When the mouse cursor is moved to a seat number field, the red light ring in the microphone in the corresponding Conference unit is flashing until the cursor is moved to another field or ‘Submit Changes’ has been activated. This feature makes it easy to re-number the units.</p> <p>Speaker Attenuation –</p> <p>is used to lower the output level of the loudspeaker or turn it off.</p> <p>Left button –</p> <p>Left button on some conference units is a ‘Function button’. If the unit feature setting of the function, the choices will be shown in a drop down list. When setting the function of a function button, the physical button on the unit should be exchanged to match the selection in the drop down list.</p>								
Serial Number	Seat Number	Speaker Attenuation	Left Button																								
000.106.096	1	0	---																								
000.013.178	2	0	---																								
001.195.040	3	0	Reply																								
		<p>Unit to Seat Relation</p> <p>Seat Number: 2</p> <table border="1"> <thead> <tr> <th>Serial Number</th> <th>Seat Number</th> <th>Speaker Attenuation</th> <th></th> </tr> </thead> <tbody> <tr> <td>000.106.096</td> <td>2</td> <td>0</td> <td></td> </tr> <tr> <td>000.013.178</td> <td>8</td> <td>0</td> <td></td> </tr> <tr> <td>001.195.040</td> <td>1</td> <td>0</td> <td></td> </tr> <tr> <td>000.033.178</td> <td>78</td> <td>0</td> <td>✘</td> </tr> <tr> <td>001.194.040</td> <td>9</td> <td>0</td> <td>✘</td> </tr> </tbody> </table>	Serial Number	Seat Number	Speaker Attenuation		000.106.096	2	0		000.013.178	8	0		001.195.040	1	0		000.033.178	78	0	✘	001.194.040	9	0	✘	<p>Disconnected Units</p> <p>If units are disconnected they are marked with a yellow indication in the list. The units can be removed from the list either individually or all by clicking the yellow button next to the title.</p>
Serial Number	Seat Number	Speaker Attenuation																									
000.106.096	2	0																									
000.013.178	8	0																									
001.195.040	1	0																									
000.033.178	78	0	✘																								
001.194.040	9	0	✘																								

#	Menu	Settings	Description												
		<p>Unit to Seat Relation</p>  <table border="1"> <thead> <tr> <th>Serial Number</th> <th>Seat Number</th> <th>Speaker Attenuation</th> </tr> </thead> <tbody> <tr> <td>000.106.096</td> <td>2</td> <td>0</td> </tr> <tr> <td>000.013.178</td> <td>8</td> <td>0</td> </tr> <tr> <td>001.195.040</td> <td>1</td> <td>0</td> </tr> </tbody> </table>	Serial Number	Seat Number	Speaker Attenuation	000.106.096	2	0	000.013.178	8	0	001.195.040	1	0	<p>Activating the 'Arrow Down' button in the right upper corner reveals a window with options to change settings for a range of seats.</p>
Serial Number	Seat Number	Speaker Attenuation													
000.106.096	2	0													
000.013.178	8	0													
001.195.040	1	0													
	<ul style="list-style-type: none"> Configuration <ul style="list-style-type: none"> Delegate Setup Unit to Seat Relation Factory Defaults 	<p>Reset to Factory Defaults</p> 	<p>Reset to Factory Defaults –</p> <p>When the reset button is activated, the settings in the CU 6110 are reset to factory default.</p> <p>When doing this from a browser, the IP and security settings aren't changed.</p> <p>To reset IP settings and security settings, use 'Factory defaults' on the interactive menu on the CU 6110.</p>												
	<ul style="list-style-type: none"> Audio <ul style="list-style-type: none"> Loudspeaker Control Input Control Output Control Group Setup Ambient Microphone 	<p>Loudspeaker Control</p> 	<p>Loudspeaker Control –</p> <p>The 'Loudspeaker Volume' is setting the volume of the built-in loudspeakers in the Conference units.</p>												

#	Menu	Settings	Description																
	<ul style="list-style-type: none"> Audio Loudspeaker Control Input Control Output Control Group Setup Ambient Microphone 	<p>Input Control</p> <p>Audio In 1 Gain: <input type="button" value="0 dB"/> <input type="button" value="10 dB"/></p> <p>Audio In 2 Gain: <input type="button" value="0 dB"/> <input type="button" value="10 dB"/></p> <p>Audio In 1 Volume: Off <input type="button" value="v"/> <input type="range"/></p> <p>Audio In 2 Volume: -10 <input type="button" value="v"/> <input type="range"/></p> <table border="1"> <thead> <tr> <th></th> <th>Loudspeaker</th> <th>Floor</th> <th>Out A (Group)</th> </tr> </thead> <tbody> <tr> <td>Audio In 1</td> <td><input checked="" type="checkbox"/></td> <td><input checked="" type="checkbox"/></td> <td><input checked="" type="checkbox"/></td> </tr> <tr> <td>Audio In 2</td> <td><input type="checkbox"/></td> <td><input type="checkbox"/></td> <td><input type="checkbox"/></td> </tr> <tr> <td>Mic (Group A)</td> <td><input checked="" type="checkbox"/></td> <td><input checked="" type="checkbox"/></td> <td><input type="checkbox"/></td> </tr> </tbody> </table>		Loudspeaker	Floor	Out A (Group)	Audio In 1	<input checked="" type="checkbox"/>	<input checked="" type="checkbox"/>	<input checked="" type="checkbox"/>	Audio In 2	<input type="checkbox"/>	<input type="checkbox"/>	<input type="checkbox"/>	Mic (Group A)	<input checked="" type="checkbox"/>	<input checked="" type="checkbox"/>	<input type="checkbox"/>	<p>Input Control –</p> <p>The Gain of 'Audio In 1 & 2' can be set to '0 dB' or '10 dB'. When set to '10 dB' the input signal is amplified 10 db.</p> <p>The 'Audio In 1 & 2 Volume' is used to set the volume of the input signal.</p> <p>'Audio In 1 & 2' can be routed to the 'Loudspeakers', 'Floor' (headphones) in the Conference units as well as to 'Out. A' output using the selection buttons.</p> <p>'Audio In 1 or 2' will only be present at 'Out. A' if 'Group' is selected as the source to the 'Out A' output, where it will be mixed with the 'Group A' signal. See next menu point.</p> <p>The audio from the conference microphones, which are selected in 'Group A' can be routed to the Loudspeaker and/or Floor.</p>
	Loudspeaker	Floor	Out A (Group)																
Audio In 1	<input checked="" type="checkbox"/>	<input checked="" type="checkbox"/>	<input checked="" type="checkbox"/>																
Audio In 2	<input type="checkbox"/>	<input type="checkbox"/>	<input type="checkbox"/>																
Mic (Group A)	<input checked="" type="checkbox"/>	<input checked="" type="checkbox"/>	<input type="checkbox"/>																

#	Menu	Settings	Description										
	<ul style="list-style-type: none"> Audio Loudspeaker Control Input Control Output Control Group Setup Ambient Microphone 	<p>Audio Output</p> <table border="1"> <thead> <tr> <th></th> <th>Out A</th> <th>Out B</th> <th>Out C</th> <th>Out D</th> </tr> </thead> <tbody> <tr> <td>Source</td> <td>Group</td> <td>Group</td> <td>Group</td> <td>Group</td> </tr> </tbody> </table> <p>Output Control</p> <p>Audio Out Volume A: Off</p> <p>Audio Out Volume B: 0</p> <p>Audio Out Volume C: 0</p> <p>Audio Out Volume D: 0</p> <p>Group Floor 2 Floor 1 Floor Ch. 1 Ch. 2 Ch. 3 Ch. 4 Ch. 5 Ch. 6 Ch. 7 Ch. 8 Ch. 9 Ch. 10 Ch. 11 Ch. 12 Ch. 13 Ch. 14 Ch. 15 Ch. 16</p>		Out A	Out B	Out C	Out D	Source	Group	Group	Group	Group	<p>Audio Output –</p> <p>The 'Source' can be selected for each of the eight outputs (the graphics is only showing four of the eight outputs). The choices using the dropdown menu are:</p> <p>Group, Floor, Floor 1, Floor 2 or any of the interpreter channels.</p> <p>When 'Group' is selected for 'Out A', the 'Group A' is the source and similar for the three other outputs.</p> <p>The 'Floor or Interpreter Channel' selection is used either for recording of the interpreted languages or for connection to a wireless language distribution system.</p> <p>The 'Floor 1 or Floor 2' selection is used when connection to external PA system.</p> <p>If 'Floor, Floor 1, Floor 2 or any of the interpreter channels' is selected for an output (Out A, B, C, D, E, F, G or H) the corresponding group is disabled in the 'Group Setup'.</p> <p>The 'Audio Out Volume' can be set for each of the eight audio outputs (A, B, C, D, E, F, G and H).</p>
	Out A	Out B	Out C	Out D									
Source	Group	Group	Group	Group									

#	Menu	Settings	Description																				
	<ul style="list-style-type: none"> Audio Loudspeaker Control Input Control Output Control Group Setup Ambient Microphone 	<p>Group Setup</p> <p>Seat Number: 1</p> <table border="1"> <thead> <tr> <th>Seat Number</th> <th>Group A</th> <th>Group B</th> <th>Group C</th> <th>Group D</th> </tr> </thead> <tbody> <tr> <td>1</td> <td><input checked="" type="checkbox"/></td> <td><input type="checkbox"/></td> <td><input checked="" type="checkbox"/></td> <td><input type="checkbox"/></td> </tr> <tr> <td>2</td> <td><input checked="" type="checkbox"/></td> <td><input type="checkbox"/></td> <td><input checked="" type="checkbox"/></td> <td><input type="checkbox"/></td> </tr> <tr> <td>8</td> <td><input checked="" type="checkbox"/></td> <td><input type="checkbox"/></td> <td><input checked="" type="checkbox"/></td> <td><input type="checkbox"/></td> </tr> </tbody> </table>	Seat Number	Group A	Group B	Group C	Group D	1	<input checked="" type="checkbox"/>	<input type="checkbox"/>	<input checked="" type="checkbox"/>	<input type="checkbox"/>	2	<input checked="" type="checkbox"/>	<input type="checkbox"/>	<input checked="" type="checkbox"/>	<input type="checkbox"/>	8	<input checked="" type="checkbox"/>	<input type="checkbox"/>	<input checked="" type="checkbox"/>	<input type="checkbox"/>	<p>Group Setup –</p> <p>The Conference units can be assigned individually to eight groups (<u>the graphics is only showing four of the eight groups</u>).</p> <p>‘Group A’ is always used as the source to the built-in loudspeakers. A unit can be selected in ‘Group A’ and/or in one of the other three groups. If a unit is not selected in ‘Group A’ the audio from this unit cannot be available in the built-in loudspeakers.</p> <p>The ‘Group’ facility is used if separate microphones are required to be recorded or if external equalization or volume control is required.</p> <p>Note: A microphone can only be present in ‘Group A’ and in <u>one other group</u>.</p>
Seat Number	Group A	Group B	Group C	Group D																			
1	<input checked="" type="checkbox"/>	<input type="checkbox"/>	<input checked="" type="checkbox"/>	<input type="checkbox"/>																			
2	<input checked="" type="checkbox"/>	<input type="checkbox"/>	<input checked="" type="checkbox"/>	<input type="checkbox"/>																			
8	<input checked="" type="checkbox"/>	<input type="checkbox"/>	<input checked="" type="checkbox"/>	<input type="checkbox"/>																			
		<p>Group Setup</p> <div style="border: 1px solid black; padding: 5px; margin-bottom: 10px;"> <p>Group Setup</p> <p>Seat Range: 1 - 8</p> <p>Groups: A B C D</p> <p>Apply</p> </div> <p>Seat Number: 1</p> <table border="1"> <thead> <tr> <th>Seat Number</th> <th>Group A</th> <th>Group B</th> <th>Group C</th> <th>Group D</th> </tr> </thead> <tbody> <tr> <td>1</td> <td><input checked="" type="checkbox"/></td> <td><input type="checkbox"/></td> <td><input checked="" type="checkbox"/></td> <td><input type="checkbox"/></td> </tr> <tr> <td>2</td> <td><input checked="" type="checkbox"/></td> <td><input type="checkbox"/></td> <td><input checked="" type="checkbox"/></td> <td><input type="checkbox"/></td> </tr> <tr> <td>8</td> <td><input checked="" type="checkbox"/></td> <td><input type="checkbox"/></td> <td><input checked="" type="checkbox"/></td> <td><input type="checkbox"/></td> </tr> </tbody> </table>	Seat Number	Group A	Group B	Group C	Group D	1	<input checked="" type="checkbox"/>	<input type="checkbox"/>	<input checked="" type="checkbox"/>	<input type="checkbox"/>	2	<input checked="" type="checkbox"/>	<input type="checkbox"/>	<input checked="" type="checkbox"/>	<input type="checkbox"/>	8	<input checked="" type="checkbox"/>	<input type="checkbox"/>	<input checked="" type="checkbox"/>	<input type="checkbox"/>	<p>Activating the ‘Arrow Down’ button in the right upper corner reveals a window with options to change settings for a range of seats (<u>the graphics is only showing four of the eight outputs</u>).</p>
Seat Number	Group A	Group B	Group C	Group D																			
1	<input checked="" type="checkbox"/>	<input type="checkbox"/>	<input checked="" type="checkbox"/>	<input type="checkbox"/>																			
2	<input checked="" type="checkbox"/>	<input type="checkbox"/>	<input checked="" type="checkbox"/>	<input type="checkbox"/>																			
8	<input checked="" type="checkbox"/>	<input type="checkbox"/>	<input checked="" type="checkbox"/>	<input type="checkbox"/>																			

#	Menu	Settings	Description
	<ul style="list-style-type: none"> Audio Loudspeaker Control Input Control Output Control Group Setup Ambient Microphone 	<p>Ambient Microphone Setup</p> <p>Ambient Microphone Enable: <input type="button" value="On"/> <input type="button" value="Off"/></p> <p>Ambient microphone level: 0 ▾ </p>	<p>Ambient Microphone –</p> <p>Used to enable/disable a connected AM 6040 Ambient Microphone Unit.</p> <p>When 'enabled', the Ambient Noise Microphone is active.</p> <p>When 'Audio In 1 or 2' is routed to 'Loudspeaker' and 'Audio In Volume' is set to a value between 40dB and 0dB the microphone will be disabled.</p> <p>If 'Audio In 1 or 2' is not routed to 'Loudspeaker' or 'Audio In Volume' is set to off, the microphone will stay disabled until enabled.</p> <p>Please refer to section 'AM 6040 Ambient Microphone' for more details about using an ambient microphone.</p>
	<ul style="list-style-type: none"> Operation Operation Mode Microphone Parameters Voice Detection 	<p>Operation Mode</p> <p>Operation mode: <input type="button" value="Auto"/> <input type="button" value="Auto + Reply"/> <input checked="" type="button" value="Manual"/> <input type="button" value="Manual + Reply"/> <input type="button" value="VOX"/> <input type="button" value="VOX + Reply"/> <input type="button" value="FIFO"/></p> <p>Delegate interrupt mode: <input type="button" value="Not Allowed"/> <input checked="" type="button" value="Lower"/> <input type="button" value="Same Lower"/></p>	<p>Operation mode –</p> <p>Used for switching between the operation modes. Please refer to the section 'Operation Modes'.</p> <p>Delegate interrupt mode –</p> <p>Used to set the 'Delegate Interrupt Mode'. Please refer to section 'Delegate Interrupt Mode'.</p>

#	Menu	Settings	Description
	<ul style="list-style-type: none"> ▾ Operation Operation Mode Microphone Parameters Voice Detection 	<p>Microphone Parameters</p> <p>Max speakers: Delegates: 2 ▾ Total: 3 ▾</p> <p>Max requests: 30 ▾</p> <p>Max replies: 30 ▾</p>	<p>Delegate Setup –</p> <p>The number of 'Max speakers: Total' defines the maximum number of participants, which can speak at the same time. This includes both delegate and chairman units.</p> <p>The number of 'Max speakers: Delegates' defines the maximum number of Delegates, who are allowed to speak at the same time.</p> <p>Please observe that a Chairman Unit can always be switched ON as long as the number set in 'Max. Speakers: Total' are not exceeded.</p> <p>'Maximum requests' defines how many delegates requesting to speak who can be inserted into the 'Request' list.</p> <p>'Maximum replies' defines how many delegates requesting to reply who can be inserted into the 'Reply' list.</p>

#	Menu	Settings	Description
	<ul style="list-style-type: none"> Operation Operation Mode Microphone Parameters Voice Detection 	<p>Voice Activation</p> <p>Voice detection threshold: 0</p> <p>Voice detection release time: 4</p> <p>Book Drop Feature: <input type="checkbox"/> On <input checked="" type="checkbox"/> Off</p> <p>Last Mic Stays Open: <input type="checkbox"/> On <input checked="" type="checkbox"/> Off</p> <p>Auto Off</p> <p>Microphone Auto Off: <input type="checkbox"/> On <input checked="" type="checkbox"/> Off</p> <p>Automatic Off Time: 5</p>	<p>Voice Activation –</p> <p>Those settings determines the behavior of the system when working in VOX mode</p> <p>The 'Voice detection threshold' can be set to values ranging from '-12 to '8' in steps of '1'. The default value is '0'. Setting to a lower value makes the microphone more sensitive.</p> <p>The 'Voice detection release time' can be set to values from 1 to 10 seconds in 0.5 sec step.</p> <p>This setting is used for setting the time from the delegate stops talking until the microphone turns off. The default value is 4 sec.</p> <p>When "Book Drop" Feature is enabled a short 'unwanted' noise will only make the microphone to open a few seconds.</p> <p>"Last Mic Stays Open" feature is used when the DCS 6000 system is used for video or audio conferences where equipment with echo-canceling feature is in use.</p> <p>Auto Off –</p> <p>When 'Microphone Auto Off' is set to 'On' a Conference unit will automatic turn off the microphone when the delegate stops talking. The time is determined by the 'Auto Off time' setting.</p> <p>The 'Automatic Off Time' sets the time from the delegate stops speaking until the microphone turns off. The value can be set from 5 to 60 seconds in 5 second steps. The default value is 5 sec.</p> <p>When the system is set to VOX mode Auto Off settings are disabled.</p>

#	Menu	Settings	Description
	 A screenshot of a web browser interface. At the top, there is a blue header bar with the text 'Diagnostics' and a small downward-pointing arrow to its left. Below this header, the word 'Report' is centered on a dark background with a subtle repeating pattern.		Report – If a report is needed for factory diagnostic purposes. The report can be printed using an installed printer on the PC or saved to a html file.

Figure 0-B CU 6110 Browser Setup

CU 6110 Mic. Control (browser)

The microphone control screen is selected by clicking the 'Microphone Control' button in the 'CU 6110 Setup' screen.

Figure 0-D shows the screens available with a description of the functionality for each screen.



Figure 0-C CU 6110 Setup, Browser Menu

#	Screen	Description																																	
	<table border="1"> <tr> <th colspan="3">Speakers (1)</th> </tr> <tr> <td>2</td> <td>Frank Summers (Chairman)</td> <td>Speak ...</td> </tr> <tr> <td></td> <td></td> <td>Reply ...</td> </tr> <tr> <td></td> <td></td> <td>Request ...</td> </tr> <tr> <th colspan="3">Replies (2)</th> </tr> <tr> <td>1</td> <td>John Smith</td> <td>Next On</td> </tr> <tr> <td>3</td> <td>Nanna West</td> <td>All Del. Off</td> </tr> <tr> <th colspan="3">Requests (1)</th> </tr> <tr> <td>3</td> <td>Nanna West</td> <td>All Rep. Off</td> </tr> <tr> <td></td> <td></td> <td>All Req. Off</td> </tr> <tr> <td></td> <td></td> <td>Operation mode: Manual + Reply</td> </tr> </table>	Speakers (1)			2	Frank Summers (Chairman)	Speak ...			Reply ...			Request ...	Replies (2)			1	John Smith	Next On	3	Nanna West	All Del. Off	Requests (1)			3	Nanna West	All Rep. Off			All Req. Off			Operation mode: Manual + Reply	<p>The microphone control page gives the option of switching On/Off microphone and depending on 'Operation mode' setting microphones into the 'Request to speak' queue.</p> <p>Speak ... – Request ... – Request ... –</p> <p>Brings the lists of delegates with status of each of the delegates. See #25, #26 and #27 later in this table.</p> <p>Next On –</p> <p>Pressing the 'Next On' button turns on the first request on the request list</p> <p>All Del. Off –</p> <p>Pressing the 'All Del Off' button turns off all delegate microphones</p> <p>All Req. Off –</p> <p>Pressing the 'All Rep. Off' button empties the 'Reply' list.</p> <p>All Req. Off –</p> <p>Pressing the 'All Req. Off' button empties the 'Requests' list.</p> <p>Operation mode –</p> <p>Drop down menu used to switch between the operation modes. Please refer to the section 'Operation Modes'.</p>
Speakers (1)																																			
2	Frank Summers (Chairman)	Speak ...																																	
		Reply ...																																	
		Request ...																																	
Replies (2)																																			
1	John Smith	Next On																																	
3	Nanna West	All Del. Off																																	
Requests (1)																																			
3	Nanna West	All Rep. Off																																	
		All Req. Off																																	
		Operation mode: Manual + Reply																																	

#	Screen	Description																		
	<div style="border: 1px solid black; padding: 5px;"> <div style="background-color: #0070C0; color: white; padding: 2px; text-align: center; margin-bottom: 5px;">Speakers (1) ▲</div> <table border="1" style="width: 100%; border-collapse: collapse;"> <tr> <td style="width: 20px; background-color: red;"></td> <td style="width: 20px; text-align: center;">2</td> <td>Frank Summers (Chairman)</td> </tr> <tr> <td style="background-color: #808080;"></td> <td></td> <td></td> </tr> <tr> <td style="background-color: #808080;"></td> <td></td> <td></td> </tr> </table> <div style="background-color: #0070C0; color: white; padding: 2px; text-align: center; margin-bottom: 5px;">Replies (2) ▲</div> <table border="1" style="width: 100%; border-collapse: collapse;"> <tr> <td style="width: 20px; background-color: #808080;"></td> <td style="width: 20px; text-align: center;">1</td> <td>John Smith</td> </tr> <tr> <td style="width: 20px; background-color: #808080;"></td> <td style="width: 20px; text-align: center;">3</td> <td>Nanna West</td> </tr> </table> <div style="background-color: #0070C0; color: white; padding: 2px; text-align: center; margin-bottom: 5px;">Requests (1) ▲</div> <table border="1" style="width: 100%; border-collapse: collapse;"> <tr> <td style="width: 20px; background-color: green;"></td> <td style="width: 20px; text-align: center;">3</td> <td>Nanna West</td> </tr> </table> <div style="margin-top: 10px; font-size: small;"> Operation mode: Manual + Reply ▼ </div> </div>		2	Frank Summers (Chairman)								1	John Smith		3	Nanna West		3	Nanna West	<p>Speakers –</p> <p>Shows the list of active speakers. The number of list lines are defined by the setting in 'Max. Total Speakers'.</p> <p>A speaker is turned off by clicking the speaker name.</p> <p>Requests – Replies –</p> <p>Shows the lists of delegates requesting to speak/request to reply.</p> <p>An delegate is turned on by clicking the speaker name in the lists.</p> <p>A delegate in the list is removed from the list by activating the Request .../Reply ... button and clicking the name in the list.</p>
	2	Frank Summers (Chairman)																		
	1	John Smith																		
	3	Nanna West																		
	3	Nanna West																		
	<div style="border: 1px solid black; padding: 5px;"> <div style="background-color: #0070C0; color: white; padding: 2px; text-align: center; margin-bottom: 5px;">Delegate Microphones(Speak) ◀</div> <table border="1" style="width: 100%; border-collapse: collapse;"> <tr> <td style="width: 20px; background-color: #808080;"></td> <td style="width: 20px; text-align: center;">1</td> <td>John Smith</td> </tr> <tr> <td style="width: 20px; background-color: #808080;"></td> <td style="width: 20px; text-align: center;">2</td> <td>Nanna West (Chairman)</td> </tr> <tr> <td style="width: 20px; background-color: red;"></td> <td style="width: 20px; text-align: center;">3</td> <td>Frank Summer</td> </tr> </table> </div>		1	John Smith		2	Nanna West (Chairman)		3	Frank Summer	<p>Delegate Microphones (Speak) –</p> <p>Shows the list of seats with delegates and chairmen. Clicking a name will turn on the microphone.</p> <p>If a unit is disconnected the seat will be greyed out and cannot be activated.</p>									
	1	John Smith																		
	2	Nanna West (Chairman)																		
	3	Frank Summer																		
	<div style="border: 1px solid black; padding: 5px;"> <div style="background-color: #0070C0; color: white; padding: 2px; text-align: center; margin-bottom: 5px;">Delegate Microphones(Reply) ◀</div> <table border="1" style="width: 100%; border-collapse: collapse;"> <tr> <td style="width: 20px; background-color: #808080;"></td> <td style="width: 20px; text-align: center;">1</td> <td>John Smith</td> </tr> <tr> <td style="width: 20px; background-color: #808080;"></td> <td style="width: 20px; text-align: center;">2</td> <td>Nanna West (Chairman)</td> </tr> <tr> <td style="width: 20px; background-color: red;"></td> <td style="width: 20px; text-align: center;">3</td> <td>Frank Summer</td> </tr> </table> </div>		1	John Smith		2	Nanna West (Chairman)		3	Frank Summer	<p>Delegate Microphones (Reply) –</p> <p>Shows the list of delegates. Clicking a delegate name will place the delegate in the reply queue. A delegate speaking cannot be place in the reply queue.</p> <p>If a unit is disconnected the seat will be greyed out and cannot be activated.</p>									
	1	John Smith																		
	2	Nanna West (Chairman)																		
	3	Frank Summer																		
	<div style="border: 1px solid black; padding: 5px;"> <div style="background-color: #0070C0; color: white; padding: 2px; text-align: center; margin-bottom: 5px;">Delegate Microphones(Request) ◀</div> <table border="1" style="width: 100%; border-collapse: collapse;"> <tr> <td style="width: 20px; background-color: #808080;"></td> <td style="width: 20px; text-align: center;">1</td> <td>John Smith</td> </tr> <tr> <td style="width: 20px; background-color: #808080;"></td> <td style="width: 20px; text-align: center;">2</td> <td>Nanna West (Chairman)</td> </tr> <tr> <td style="width: 20px; background-color: red;"></td> <td style="width: 20px; text-align: center;">3</td> <td>Frank Summer</td> </tr> </table> </div>		1	John Smith		2	Nanna West (Chairman)		3	Frank Summer	<p>Delegate Microphones (Requests) –</p> <p>Shows the list of delegates.. Clicking a delegate name will place the delegate in the request queue. A Chairman will not be placed in the request queue.</p> <p>If a unit is disconnected the seat will be greyed out and cannot be activated.</p>									
	1	John Smith																		
	2	Nanna West (Chairman)																		
	3	Frank Summer																		

Figure 0-D CU 6110 Microphone Control

Using Web browser in PC

Opening the 'CU 6110 Setup' in one window and the 'CU 6110 Microphone Control' in another window or tab makes it easy to switch between the two screens. To get Full Screen mode press F11.

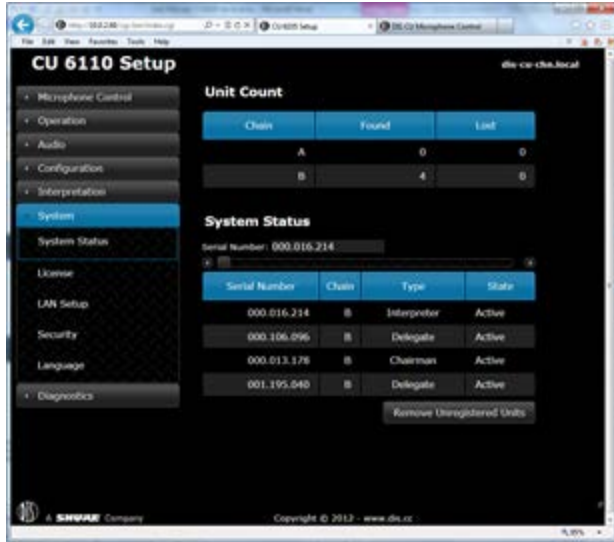

Figure 0-E CU6110 Setup Tab selected



Figure 0-F CU6110 Microphone Control Tab selected

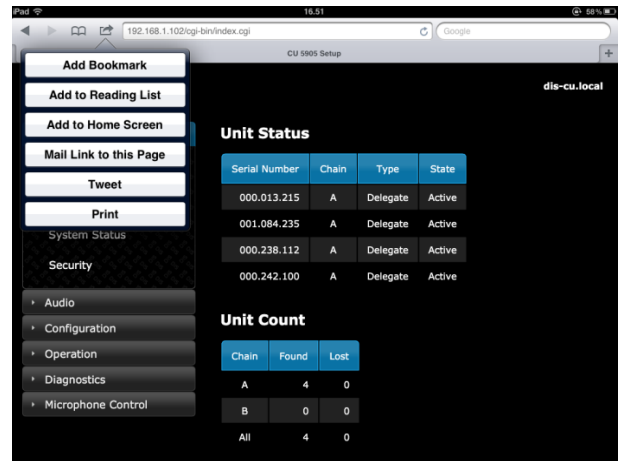

Figure 0-G Select 'Add to Home Screen'

Click the 'Add' button and a shortcut to the 'CU 6110 Setup' is placed on the desktop on the iPad.

Click 'Microphone Control' and in the similar way make a shortcut for this screen as well. The two shortcuts can now be activated separately opening the screens in 'full screen mode'.



Figure 0-H CU 6110 Browser shortcuts on the desktop

Using Web browser in iPad

Making shortcuts on the desktop for 'CU 6110 Setup' and the 'CU 6110 Microphone Control' makes it easy to start the required browser. The screen will start in 'full screen mode'.

Open the CU 6110 Browser application using the 'Safari' iPad. Then select 'Add to Home' browser on the select 'Add to screen':



Operation Modes

Operation Mode

The "Operation Mode" determines the behavior of the microphone system.

- **Auto** (or Automatic) mode allows for the Conference units to be switched on immediately upon activating the 'Speak' button.

This is indicated by a red light in the 'Speak' lamp and in the light ring in the gooseneck microphone. Activating the 'Speak' button again will turn the microphone off.

A Chairman Unit can be considered as always being in Auto or VOX mode.

- **Manual** mode features a request list, where 'Delegates' are inserted in a queue upon activating the 'Speak' button. This is confirmed by a steady green light in the 'Request' indication in the delegate unit. It is possible to cancel the request by activating the button again.

The delegate unit can only be switched 'On' using the CU 6110 browser interface on a PC/iPad or from SW 6000 or from a control system like AMX ® or Crestron ®. This will be indicated by red light in the 'Speak' lamp in the Conference unit. At this point the delegate can switch off the microphone by activating the 'Speak' button.

Note: Manual mode is normally never selected/used on CU 6110 if a Browser, AMX ®, Crestron ® or other "Control Facility" is not connected.

- **FIFO** is an automated mode. The Conference unit functions in the same way as in 'automatic' mode as long as the number of turned on delegate units is less or equal to the selected maximum speakers.

When the max. number is reached, the next delegates activating their 'Speak' button will be placed in the request queue until the maximum requests is reached. The green 'Request' lamp in the delegate unit in top of the queue will flash slowly indicating that this unit is the next to be switched 'On'.

The green 'Request' lamp in the other delegate unit in the queue will light up steadily.

When one of the units speaking is switched 'Off', the first delegate unit in the queue is automatically switched 'On'.

This mode will normally be used with only 1 as 'Max delegate speakers'. Chairman units will

always be turned on directly if the value set for 'Max Total Speakers' is not reached.

- **VOX**, voice activation mode allows for the Conference units to be switched on automatically when a delegate is speaking in the microphone or by activating the 'Speak' button.

This is indicated by a red light in the 'Speak' lamp in the Conference unit. Activating the microphone 'Speak' button again will turn the microphone off.

When a delegate stops speaking the microphone turns off automatically after a short period. This period is controlled by the 'Release Time' setting (see section 'Web Browser Setup and Control') where default is 4 seconds.

The microphone can also be turned off by activating the 'Speak' button. A Chairman Unit can be considered as always being in Auto or VOX mode.

Reply functionality

This functionality is used by a delegate or chairman who wants to indicate that he want to give a comment to the present speaker(s).

The functionality can be used both in Manual, Automatic and VOX modes, but not in FIFO, where the reply button is disabled.

Most DCS 6000 conference units have a 'Function' button, which as default is configured with 'Mute' Functionality. When using Reply functionality, the Function button shall be configured as 'Reply' button. It means that a user (Chairman or Delegate) can have either Mute or Reply, but not both.

Reply List Management

A unit goes into reply by pressing the 'Reply' button on the delegate unit or on the CUA if SW 6000 is used.

A unit is switched on by a user with 'Microphone Control' privileges (if in Manual mode) or using the MIC button (if in Auto mode).

If a delegate currently speaking presses the Reply button nothing happens.

A delegate cannot be present in the Speakers list and Reply list at the same time. A Reply is always removed from Reply list, when the microphone is switched on.

If no-one is speaking the Reply button can still be activated.

'Manual + Reply' mode

The delegate enters into the 'Reply List' by pressing the Reply button on his user interface. He might already be on the 'Request List' after having activated his Mic button, as a delegate can be present in both lists at the same time.

Replies enters the list in the order the reply buttons are activated, the first one on top. If multiple reply options are used (SW 6000 option), the replies are shown in the Reply list sorted on priority, highest priority on top.

'Max. number of Replies' is 255

Functionality in short:

- Whenever a microphone is turned ON (except turned ON from the Request list):
 - Entry of this microphone in the Reply list is removed
 - Entry of this microphone in the Request list is maintained
 - Other entries in both lists are maintained
- Whenever a microphone is turned ON from the Request list:
 - Entry of this microphone in the Request list is removed
 - Whole Reply list is emptied
 - Other entries in the Request list are maintained

'Automatic + Reply' and 'VOX + Reply' mode

The delegate enters into the 'Reply List' by pressing the Reply button on his user interface.

When the microphone is turned on the entry is removed from the 'Reply List'.

Delegate Interrupt Mode

The "Delegate Interrupt" setting determines the behavior of the delegate Conference units.

- **None** When "None" is selected and the number of open Delegate units has reached the number specified in the setting "Max. Delegate Speakers" no more delegate microphone can

be opened. Pressing the microphone buttons will not turn on the microphone but 3 flashes in the green LED will indicate, that the maximum number has been reached.

It is similar for Chairman units if the number of open units (Chairman and Delegate) has reached the number specified in the setting "Max. Total Speakers".

- **Lower** If however "Lower" is selected a chairman will interrupt (switch off) the first switched on delegate unit if the number of open units (Chairman and Delegate) has reached the number specified in the setting "Max. Total Speakers".
- **Lower+Same** If "Lower+Same" is selected a delegate unit will interrupt (switch off) the first switched on delegate unit if the number of delegate units has reached the number specified in the setting "Max. Delegate Speakers".

Similar a chairman will interrupt (switch off) the first switched ON delegate unit if the number of open units (Chairman and Delegate) has reached the number specified in the setting "Max. Total Speakers", and if no delegate unit is switched ON the first switched ON Chairman unit will be switched OFF.

AM 6040 Ambient Microphone Unit

The purpose of an ambient microphone unit is to provide sound from a meeting room/conference hall, when there is no delegate/chairman using their microphones.

Transmission of ambient noise rather than transmitting no sound at all is a desirable feature from listeners attending the meeting via headphones. The ambient noise indicates to the listeners, that there is no speaking activity going on, and this information is very nice to have, when interpreters are doing interpretation, and the speaker stops speaking.

Troubleshooting

In this chapter a simple fault-finding guide is given.

This is intended to be used to remedy the consequences of incorrect installation. If more serious faults or problems arise the installer should contact a qualified technician.

The light rings in the microphone in the units are constantly flashing	<ul style="list-style-type: none"> ▪ Check the cables as the digital communication from the central unit to the Conference units is not established. ▪ Check that all the connectors on all cables are firmly inserted in the DCS-LAN sockets on the units ▪ Check that the feeding cables from the Conference units are inserted in the 'DCS-LAN' chain connectors on the CU 6110.
The 'Del. Off' button in the chairman unit does not switch off delegate units	<ul style="list-style-type: none"> ▪ Check if the unit is configured as a chairman unit ▪ Check if the units which are not switched of are configured as chairman units, as chairman units are not switched off by the 'Del. Off' button.
The audio from an interpreter unit cannot be heard in the headphone in delegate or chairman units	<ul style="list-style-type: none"> ▪ Check the headphone volume control on the units ▪ Check the channel selection on the Conference units ▪ Check the plug from the headphone is firmly inserted in the headphone socket ▪ Check that the light ring on the microphone on the interpreter unit is lighting and that the gooseneck microphone is firmly inserted in the microphone socket
There is no audio in the built-in loudspeakers	<ul style="list-style-type: none"> ▪ Check the 'Loudspeaker Volume' setting using either the interactive menu on the CU or using the browser control. ▪ Check using the browser control that the setting 'CU 6110 Setup * Audio * Loudspeaker Control * Microphone -> Loudspeaker' is set to 'On'. ▪ Check using the browser control the settings in 'CU 6110 * Audio * Audio Output * Group Setup' that the seats are selected in 'Group A'. 'Group A' is always used as the source for the built-in loudspeakers. If a unit is not selected in 'Group A' the audio from this unit will not be heard in the built-in loudspeakers.
The is no audio in the built-in loudspeakers from one or more delegate or chairman units	<ul style="list-style-type: none"> ▪ Check using the browser control in 'CU 6110 * Audio * Audio Output * Group Setup' that this seat is selected in 'Group A'. 'Group A' is always used as the source for the built-in loudspeakers. If a unit is not selected in 'Group A' the audio from this unit will not be heard in the built-in loudspeakers.
A microphone cannot be turned 'On'	<ul style="list-style-type: none"> ▪ Check the settings 'Max Delegate Speaker' and 'Max Total Speakers'. ▪ Check the 'Operation Mode'.

The CU 6110 browser application will not open in a PC or iPad	<ul style="list-style-type: none"> ▪ Check the IP address using the interactive menu on the CU: 'LAN setup/IP address setup/IP address'. Use this IP address in the browser ▪ Check that the CU 6110 is connected to the same network as the PC ▪ Check the LAN cables
The CU 6110 browser application will not open in iPad	<ul style="list-style-type: none"> ▪ Check the IP address using the interactive menu on the CU: 'LAN setup * IP address setup * IP address'. Use this IP address in the browser. ▪ Check that the iPad is connected to the correct wireless access point ▪ Check that the CU 6110 is connected to the same network as the wireless access point
The Interpreter Units does not work	<ul style="list-style-type: none"> ▪ The channel setup on each interpreter unit is not setup. Use a combination of b-B buttons to configure. For detail please consult the 'User Manual IS 6132 P'

Firmware Update

If firmware update of the CU 6110 Central Unit is needed for maintenance, this is done using the browser interface.

Type the 'IP address' or 'Host Name' followed by '/cgi-bin/update.cgi' into the browser as shown in Figure 0-A. The CU 6110 Update window is then shown:

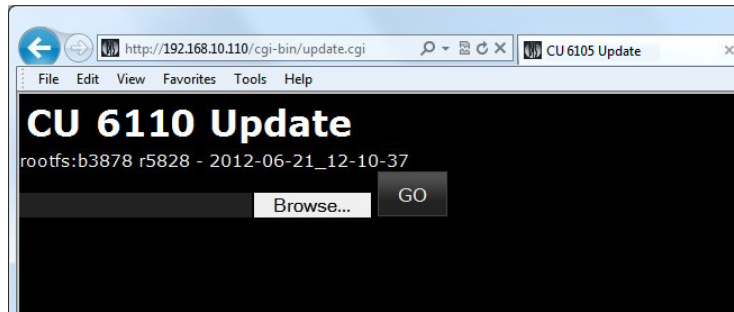

Figure 0-A Browsing for update file

Copy the update file to the PC and locate the file using the 'Browse' button. The update file has the format 'cu_6105_xxxxxx.dis'. If maintenance update is needed the update file is delivered from your support source.

After selecting the update file click the 'Go' button and the update process is started:

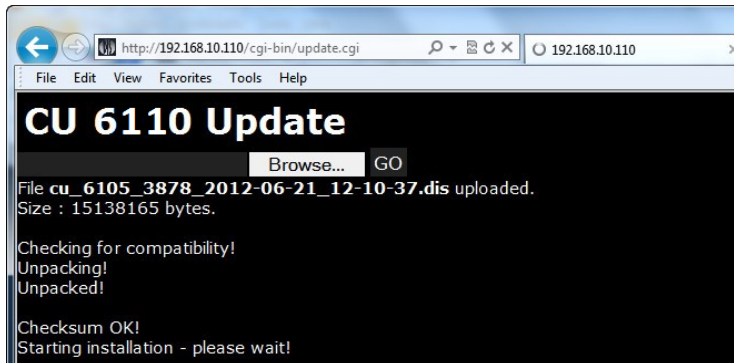

Figure 0-B Update file is uploaded

The update process will take several minutes. During the update process information is typed on the screen. When the process is finished the word 'Success' is typed:

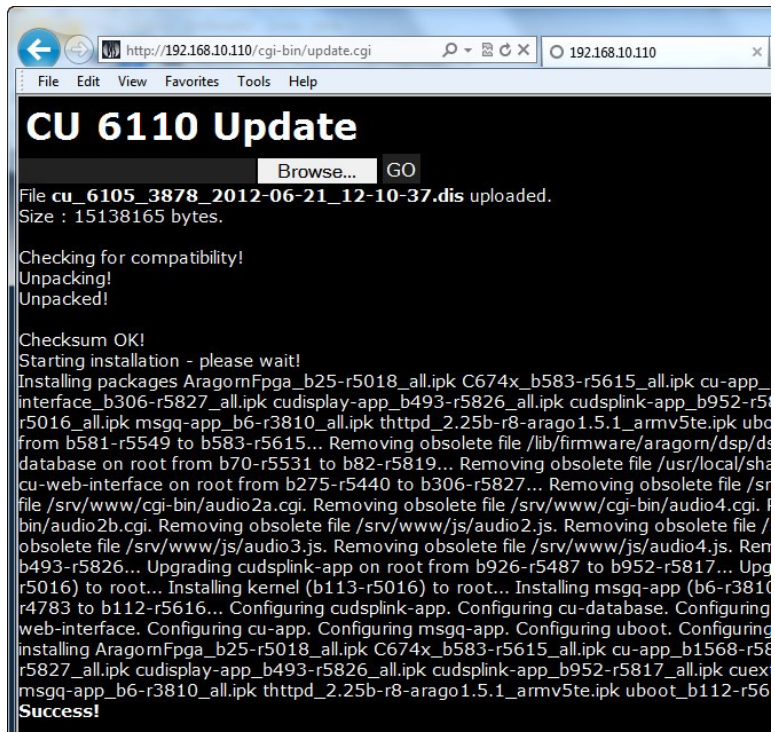

Figure 0-C Update is finalized

Technical Specifications

System Specification

Overall system characteristics

The microphone system conforms to IEC 60914, the international standard for Conference systems.

System Audio Performance

Audio quality 24 bit audio @ 32 kHz sampling frequency

Measured from the audio input of a Conference unit to the headphone output of a Conference unit:

Audio frequency response 125 Hz - 15 kHz

Total harmonic distortion at 1 kHz < 0.1%

Dynamic range > 80 dB

Weighted signal-to-noise ratio > 85 dB(A)

Cabling and System Limits

Cable type (min. specification) Cat5e, AWG 24, shielded

Maximum cable length in one chain 200 m

System Environmental Conditions

Working condition Fixed, stationary or transportable

Temperature range

To guarantee specified performance... 5 Deg C. to 40 Deg C.

Storage temperature -20 Deg C. to 60 Deg C

Maximum relative humidity < 80%

Approvals

EMC emission According to harmonized standard EN 55103-1 and FCC rules part 15, complying with the limits for a class B digital devices

EMC immunity According to harmonized standard EN 55103-2

EMC approvals Affixed with the CE mark

ESD According to harmonized standard EN 55103-2

Mains harmonics According to harmonized standard EN 55103-1

Environmental requirements Contains no banned substances as specified in UAT-0480/100 (e.g. no cadmium or asbestos)

Specifications are subject to change without notice

CU 6110 Specifications

Analog Section

Audio output signal type electronically balanced

Nominal output level 0 dBm at nominal input

Max. output level 4.9V RMS ~ +16 dBm

Audio input signal type electronically balanced

Nominal input level (switchable) 0 dBm or -10 dBm
(0.775V RMS or 0.245V RMS)

Max. input level +15 dBm (4.5V RMS)

Analog Audio in impedance 50-100 kohm

Connectors

Chain – Conference units (DCS-LAN) 4xRJ45

Audio output connectors 8 pieces XLR3 male

Audio input connector 2 pieces XLR3 female

LAN (TCP/IP) 1 piece RJ45

EEM 1 contact closure input

General

Power consumption 22W/48V (150W max.)

Supply voltage for units 122W/48V

Weight 2.8 kg

Dimensions (W x H x D) 427 (483) x 44.4 x 186 mm

Dimension in bracket is including 19" brackets

System performance

Max. number of Conference units 500

Max. number of interpreter units 128

Max. number of languages 16

Max number of open microphones 8

Accessories supplied

- PS CU Power Supply incl. mains cable
- Terminal block for EEM connector
- 19" brackets for installing in 19" standard racks
- USB memory stick with 'User Manual'

PS CU Power Supply

Main Voltage	.. 100-240V, 50-60 Hz nominal
Max. consumption 175 W
Total supply power 144W (power factor: >0.9)
Input current max. 4A@115V AC max. 2A@230V AC
In-rush current max. 40A@115V max. 80A@230V
Standby consumption <0,5W (no load)

Supply voltage for CU 48V/3A @ 40 deg C (De-rate linearly to 50% @ 60 deg C)
Efficiency typical 87%
Weight935 g
Dimensions (W x H x D)99 x 52 x 180 mm
Approvals	... CE, KC, CCC, cULus, TÜV

Specifications are subject to change without notice.

Connection Details

Mains

Blue	Neutral
Brown	Live
Green/Yellow	Earth (Ground)

DCS-LAN Chain

The DCS 6000 system uses shielded Cat5e, Cat6 or Cat7 F/UTP or U/FTP cables with shielded RJ45 connectors.

EIA 568-B wiring shall be used.

Important: The names of Cat5/6/7 cable type have changed.

Old name	New name
FTP	F/UTP
STP	U/FTP
UTP	U/UTP

Important: Use only F/UTP or U/FTP (shielded) cables and shielded RJ45 connectors and not U/UTP cable, which are unshielded.

How to wire a Cat5e (EIA 568-B) cable to a RJ45 con.:

Pin	Function	Connector #1	Connector #2
1	In-going +	ORG/WHT	ORG/WHT
2	In-going -	ORG	ORG
3	+48V	GRN/WHT	GRN/WHT
4	0V	BLU	BLU
5	0V	BLU/WHT	BLU/WHT
6	+48V	GRN	GRN
7	Outgoing -	BRN/WHT	BRN/WHT
8	Outgoing +	BRN	BRN

Important: If other color codes are used then the four pairs are connected as follows:

- Pair 2: Pin 1 & 2
- Pair 3: Pin 3 & 6
- Pair 1: Pin 4 & 5
- Pair 4: Pin 7 & 8

The phase of the pairs must be correct and the wiring spec. as stated in Cat5e (EIA 568-B) have to be followed.

Note: Cat6 and Cat7 cables can normally only be terminated in sockets (female) and not in cable plugs.

Cat6 and Cat7 can thus only be used for feeding cables terminating in wall outlets or patch panels.

Analog Audio Out

XLR3 male

Pin	Signal	Cable type
1	Earth	2 x 0.25 mm2 shielded.
2	Signal +	
3	Signal -	

Analog Audio In

XLR3 female

Pin	Signal	Cable type
1	Earth	2 x 0.25 mm2 shielded.
2	Signal +	
3	Signal -	

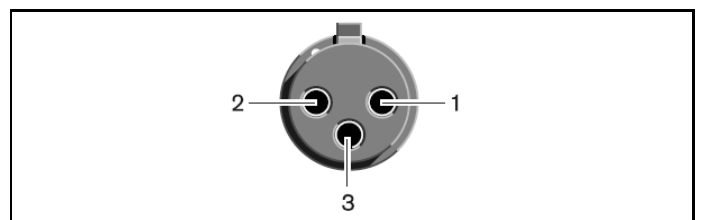

Emergency switch

Terminal block

Connect the emergency switch to pin 1 and 2.

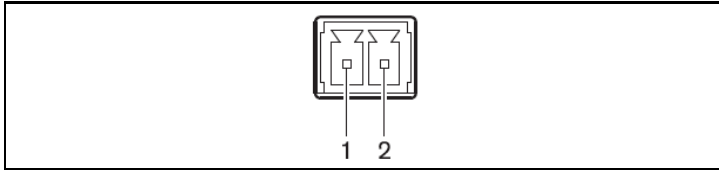

Accessories

Gooseneck Microphones

GM 6523..... Gooseneck Microphone, 40 cm

GM 6524 Gooseneck Microphone, 50 cm

GM 6525 Gooseneck Microphone, 63 cm

Cat5e Connection Cables (AWG24)

EC 6001-0.5 Connection Cable 0.5 m

EC 6001-01 Connection Cable 1 m

EC 6001-02 Connection Cable 2 m

EC 6001-05 Connection Cable 5 m

EC 6001-10 Connection Cable 10 m

EC 6001-20 Connection Cable 20 m

EC 6001-50 Connection Cable 50 m

Headphones

DH 6021Stereo headphones

Expansion units

JB 6104 Junction Box with 4 outputs

EX 6010 Extension Unit

PS CU Power Supply

PS 6001 DCS-LAN Power Kit

PI 6000Power Inserter

RC 6000Redundancy Controller

RP 6004 Repeater/Splitter for four chains

External Control Protocol

The DCS 6000 Digital Conference System features an Ethernet connection with the purpose of providing an interface for controlling and monitoring of the system. By setting up a simple (raw) TCP/IP socket connection to the CU 6110 Central Unit control options are available.

This document describes the TCP/IP raw socket protocol for communicating with the DCS 6000 Conference System. This protocol provides a short set of commands, enabling a third part control application to monitor and/or control system status of a DCS 6000 Conference System.

Some examples of functionally available using the protocol:

- Setting a microphone in speak or in request
- Retrieving a list of seats available in the system
- Starting/stopping a voting session

This "simple to use" interface supports applications developed by customers, so the protocol is deliberately kept simple to avoid complexity.

The External Control protocol offers a mean for supplementing the control functionality available through the DCS 6000 Browser interface and the CU 6110 interactive display, however some commands and settings available in the browser interface and on the CU 6110 interactive display are not available using the 'External Control Protocol'

Customer applications can include but are not limited to AMX ® or Crestron ® room control systems, PC or micro controller based applications e.g. for button mimics and camera control applications.

General Protocol Behavior

TCP/IP socket connection

A TCP/IP socket connection to the CU 6110 must be established for the External Control protocol to become available. Configuration of the CU 6110 connection to the Ethernet must be defined from the CU interactive front plate control/Browser interface, and an IP address for the CU 6110 must be assigned in the network.

Choose either a static IP address or an IP address assigned through DHCP. It is convenient to ensure, that the CU 6110 ends up with the same IP address at each start up.

For using *hostname.local* on Windows, the Bonjour protocol distributed by Apple needs to be installed on Windows.

Knowing the IP address, the only additional information required for setting up a TCP/IP connection is the Port Number:

Port Number = 3142

Test connection to CU via Putty

If the CU 6110 is assigned IP address 192.168.1.100, the external application must connect the TCP/IP socket to the address 192.168.1.100:3142.

Knowing the IP address of the CU 6110 a connection can be set up using a simple terminal program like Putty ®.

1. Download at www.putty.org
2. Start Putty.
3. Insert IP address and Port Number.
4. Select 'Raw' for the Connection Type.
5. Press 'Open' to establish connection to the CU. Control is now possible.
6. Give command 'help' to see a list of commands available.

Cmd structure (External to CU 6110)

To control the CU an External Control sends commands to CU 6110 included in command lines. Command lines are build up in a very simple manner:

```
<command><SP><data><CR>
<command><SP><data><LF>
<SP>           Space - 0x20 = 32
<CR>          Carriage return - 0x0D = 13
<LF>          Line Feed - 0x0A = 10
```

Command lines are terminated by Carriage Return <CR> or Line Feed <LF> or both. In order to be able to communicate with Windows systems, Linux systems or other systems, the CU understands both types of command line terminations.

Notice also that there is a space between the command and data. If a command does not carry any data, space is possible but not required.

The CU is not sensitive to upper/lower case.

Example:

```
mic_on 212<CR>
```

Turn on microphone a seat 212. Command = 'mic_on', data = '212'. The 'mic_on' command carries a seat number as data.

Cmd structure (CU 6110 to External)

Command lines out of the CU 6110 are just as simple:

```
<command><SP><data><CR><LF>
<SP>           Space - 0x20 = 32
<CR>          Carriage return - 0x0D = 13
<LF>          Line Feed - 0x0A = 10
```

Again, to satisfy most systems, the CU terminates command lines by including both <CR> and <LF>.

Seat numbering

Conference units are identified by means of seat numbers. Each Conference Unit is assigned a seat number. This is done automatically for all Conference Units, when they are connected to the CU 6110. The CU 6110 Browser interface is used to change seat numbering if desired.

Seat numbers must be in the range from 1 to 65535.

CU 6110 reply to commands

Generally, a command from external application is replied to by the CU. But, reply to a command is produced only if actions are taken by the CU due to the command.

Example: When a 'mic_on' command results in a microphone being turned on, the CU replies with a 'mic_on' command. On the other hand, if a 'mic_on' command does not lead to turning on a microphone, the CU does not produce any reply.

There can be several reasons for the CU to reject turning on a microphone:

- The microphone is already turned on
- The microphone is no longer connected to the system.

-Speak list is already full ('max_speakers'), and delegate interrupt is not 'on'.

Retrieving system status

The CU supports streaming of status. When an External Control issues a 'mic_status', 'audio_status', 'reply_status' or 'voting_status' command, the CU responds by sending the status. Hereby, it is possible for an External Control to synchronize with the CU status.

Voting control (only CU 6110)

The external control interface features control of voting sessions and attendance check sessions in the Central Unit. This feature is available only for CU 6110 – not for CU5905. And only if the feature license 'Voting' is uploaded in the CU 6110.

Voting configurations

Two different configurations must be considered:

- CU 6110 controlled by SW 6000
- CU 6110 not controlled by SW 6000 (standalone)

Retrieve voting sessions

No matter which configuration applies, it is possible for an external controller to request a list of voting sessions - using the command 'voting_status'. The CU will reply by returning the list of voting sessions currently applicable (either SW 6000 defined voting sessions or build-in voting sessions).

SW 6000 controlled

SW 6000 supports a number of voting sessions.

Via the external control protocol, it is possible to make two requests:

- Start one of the SW 6000 defined voting sessions
- Start SW 6000 default voting session

Standalone

The CU features 4 build-in voting sessions in standalone mode:

- 3-button voting
- 3-button secret voting
- 5-button voting
- 5-button secret voting

Voting results

During voting sessions the CU delivers interim voting results, unless the session is secret.

At completion of a voting session, the CU delivers final voting results. Also at completion of an attendance check the CU delivers final attendance check result.

SW 6000 controlled

With SW 6000 attached to the CU, voting results are defined in SW 6000. Up to 9 voting results can be defined.

Standalone

The CU 6110 supports 3- and 5-button voting.

3-button voting sessions the following alternatives apply:

- 1 'Yes'
- 2 'Abstain'
- 3 'No'

5-button voting sessions the following alternatives apply:

- 1 '+ +'
- 2 '+'
- 3 '0'
- 4 '-'
- 5 '- -'

Example: Voting

Assume, that the CU 6110 is not controlled by SW 6000

```

ExtCtrl          CU
----->
voting_status
----->
<-----
voting_configuration 1 3-button voting
voting_configuration 2 3-button secret voting
voting_configuration 3 5-button voting
voting_configuration 4 5-button secret voting
voting_status_done
<-----
----->
start_voting 1
----->
<-----
voting_started 1
<-----
<-----
interim_voting_result 1 0 Yes
interim_voting_result 2 0 Abstain
interim_voting_result 3 0 No
<-----
<-----
                                vote (Yes)
                                <-----
<-----
interim_voting_result 1 1 Yes
interim_voting_result 2 0 Abstain
interim_voting_result 3 0 No
<-----
----->
stop_voting
----->
<-----
voting_stopped
<-----
<-----
final_voting_result 1 1 Yes
final_voting_result 2 0 Abstain
final_voting_result 3 0 No
<-----

```

Microphone Control

External Commands to CU 6110

Turn on microphone

mic_on <seat no><CR>

Instruct the CU to turn on microphone at seat_no.

If the CU turns on the microphone, it will reply with a '**mic_on**' command. And, if the microphone appeared in the request list, it is taken out of the request list, which makes the CU issue a '**mic_request_off**' command as well.

Turn off microphone

mic_off <seat no><CR>

Instruct the CU to turn off microphone at seat_no.

If the CU turns off the microphone, it replies with a '**mic_off**' command.

Turn off all delegate microphones

mic_all_delegates_off<CR>

Instruct the CU to turn off all delegate microphones.

A Chairman is not turned off.

The CU responds to the command by issuing a '**mic_off**' command for each microphone which is turned off.

Place microphone in reply list

mic_reply_on <seat no><CR>

Insert microphone into reply list.

If the CU inserts the unit into the reply list, it replies with a '**mic_reply_on**' command.

Remove microphone from reply list

mic_reply_off <seat no><CR>

Remove microphone from reply list.

If the CU removes the unit from the reply list, it replies with a '**mic_reply_off**' command.

Clear reply list

mic_all_reply_off<CR>

Clear the reply list.

The CU responds by issuing a '**mic_reply_off**' command for each microphone that is removed from the reply list.

Set next microphone in the request list on

mic_next_request_on<CR>

Turns on first microphone from the request list on.

If a microphone is turned on, the CU sends a '**mic_on**' command and a '**mic_request_off**' command.

Turn on microphone from request list**mic_on_from_request xCR>**

Turns on microphone x from the request list.

If a microphone is turned on, the CU sends a '**mic_on**' command and a '**mic_request_off**' command.**Place microphone in request list****mic_request_on <seat no><CR>**

Insert microphone into request list.

If the CU inserts the unit into the request list, it replies with a '**mic_request_on**' command.**Remove microphone from request list****mic_request_off <seat no><CR>**

Remove microphone from request list.

If the CU removes the unit from the request list, it replies with a '**mic_request_off**' command.**Clear request list****mic_all_requests_off<CR>**

Clear the request list.

The CU responds by issuing a '**mic_request_off**' command for each microphone that is removed from the request list.**Set next microphone on****mic_next_on<CR>**

Turns on first microphone from the reply list. If the reply list is empty the first microphone in the request list is turned on..

If a microphone is turned off, the CU sends a '**mic_off**' command.If a microphone is turned on, the CU sends a '**mic_on**' command and a '**mic_reply_off**' or '**mic_request_off**' command.**Set max total speakers****max_total_speakers <max total speakers><CR>**

Maximum number of speakers allowed to speak.

<max total speakers> Can be set to "1" to "8"The CU responds by sending a '**max_total_speakers**' command.**Set max delegate speakers****max_speakers <max speakers><CR>**

Maximum number of delegates allowed to speak.

<max speakers> Can be set to "1" to "8"The CU responds by sending a '**max_speakers**' command.

Set max replies**max_replies <max replies><CR>**

Maximum number of delegates allowed in the reply list.

<max replies> Can be set to "0" to "250".

The CU responds by sending a '**max_replies**' command.**Set max requests****max_requests <max requests><CR>**

Maximum number of delegates allowed in the request list.

<max requests> Can be set to "0" to "250".

The CU responds by sending a '**max_requests**' command.**Set operation mode****mic_mode <mode><CR>**

Set system operation mode.

<mode> Can be set to "auto" (Automatic), "fifo" (First-in-first-out), "manual" (Manual), "vox" (Voice Active), "auto+reply" (Automatic+Reply), "manual+reply" (Manual+Reply) and "vox+reply" (Voice Active + Reply)

The CU responds by sending a '**mic_mode**' command.**Set interrupt mode****mic_interrupt <mode><CR>**

Set ability to interrupt. Defines, whether microphones should interrupt or not.

For CU 59XX <mode> Can be "on" (microphones interrupt) and "off" (microphones do not interrupt)

For CU 6110 <mode> Can be "Same", "Lower" and "Off"

The CU responds by sending a '**mic_interrupt**' command.**Set Mic priority****mic_priority <seat_number> <priority><CR>**

This command sets the priority of a microphone.

<seat_number>: The microphone to adjust

<priority>: The desired priority. Possible values: 0 to 5, where 0 is the lowest priority and 5 is the highest priority.

The CU responds to this command by returning a '**mic_priority**' message.**Retrieve microphone status****mic_status<CR>**

Ask the cu to deliver status of the system (microphones in speak, and microphones in request list).

The CU responds by sending microphone system status. The status is a list of commands from the CU:

```

mic_status
seat_state                (for all units in the system)
mic_priority              (for all units in the system)
mic_interrupt
mic_on                    (for all units in speakers list)
mic_request_on            (for all units in request list)
max_replies
mic_reply_on
mic_mode
max_total_speakers
max_speakers
max_requests
mic_status_done

```

Retrieve reply status

reply_status<CR>

Ask the cu to deliver status of the reply configuration.

The CU responds by sending reply system status. The status is a list of commands from the CU:

```

reply_status
reply_configuration <reply#> <priority> <color> <label>
reply_status_done

```

Help

help<CR>

help <command><CR>

Help information is available listing all commands supported by the CU. If a command is included in the help command, details on that command is returned.

Note: The help command results in a number of command lines returned from the CU. The command is intended for use in a simple console.

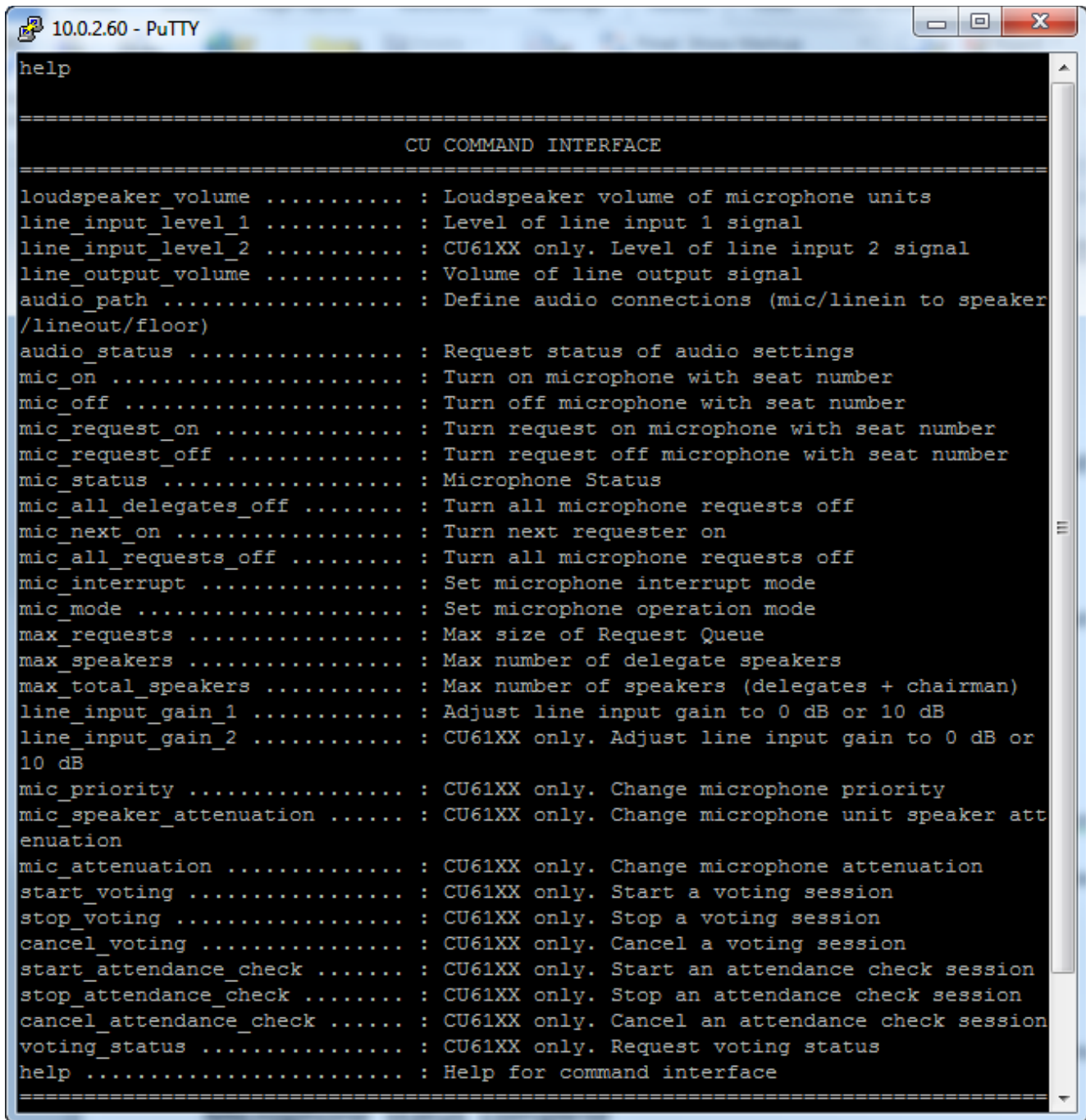

```

help
=====
                        CU COMMAND INTERFACE
=====
loudspeaker_volume ..... : Loudspeaker volume of microphone units
line_input_level_1 ..... : Level of line input 1 signal
line_input_level_2 ..... : CU61XX only. Level of line input 2 signal
line_output_volume ..... : Volume of line output signal
audio_path .....        : Define audio connections (mic/linein to speaker
/lineout/floor)
audio_status .....       : Request status of audio settings
mic_on .....             : Turn on microphone with seat number
mic_off .....            : Turn off microphone with seat number
mic_request_on .....     : Turn request on microphone with seat number
mic_request_off .....    : Turn request off microphone with seat number
mic_status .....         : Microphone Status
mic_all_delegates_off ... : Turn all microphone requests off
mic_next_on .....        : Turn next requester on
mic_all_requests_off .... : Turn all microphone requests off
mic_interrupt .....      : Set microphone interrupt mode
mic_mode .....           : Set microphone operation mode
max_requests .....       : Max size of Request Queue
max_speakers .....       : Max number of delegate speakers
max_total_speakers ..... : Max number of speakers (delegates + chairman)
line_input_gain_1 .....  : Adjust line input gain to 0 dB or 10 dB
line_input_gain_2 .....  : CU61XX only. Adjust line input gain to 0 dB or
10 dB
mic_priority .....       : CU61XX only. Change microphone priority
mic_speaker_attenuation .. : CU61XX only. Change microphone unit speaker att
enuation
mic_attenuation .....    : CU61XX only. Change microphone attenuation
start_voting .....       : CU61XX only. Start a voting session
stop_voting .....        : CU61XX only. Stop a voting session
cancel_voting .....      : CU61XX only. Cancel a voting session
start_attendance_check ... : CU61XX only. Start an attendance check session
stop_attendance_check ... : CU61XX only. Stop an attendance check session
cancel_attendance_check ... : CU61XX only. Cancel an attendance check session
voting_status .....      : CU61XX only. Request voting status
help .....               : Help for command interface
=====

```

CU 6110 Commands to External

Microphone on

mic_on <seat no> <name> <CR>

A microphone is turned on.

<seat no>: The seat number

<name>: The *seat name* or *delegate name*.

The *seat name* is name that can be edited by the web interface when the CU is standalone.

The *delegate name* is the name of the person logged in at this seat when SW 6000 is connected.

The *seat name* can be edited using the web interface. When SW 6000 is connected *seat names are not in use*.

Microphone off

`mic_off <seat no><CR>`

A microphone is turned off.

Microphone in reply list

`mic_reply_on <seat no> <reply position> <reply #> <name> <CR>`

A microphone is inserted into reply list.

<seat no>: The seat number

<reply position> informs about the position in the reply list.

<reply #> informs about the reply number in the reply configuration

<name>: The *seat name* or *delegate name*.

The *seat name* is name that can be edited by the web interface when the CU is standalone.

The *delegate name* is the name of the person logged in at this seat when SW 6000 is connected.

The *seat name* can be edited using the web interface. When SW 6000 is connected *seat names are not in use*.

Microphone out of reply list

`mic_reply_off <seat no><CR>`

A microphone is removed from reply list.

Microphone in request list

`mic_request_on <seat no> <request position> <name> <CR>`

A microphone is inserted into request list.

<seat no>: The seat number

<request position> informs about the position in the request list.

<name>: The *seat name* or *delegate name*.

The *seat name* is name that can be edited by the web interface when the CU is standalone.

The *delegate name* is the name of the person logged in at this seat when SW 6000 is connected.

The *seat name* can be edited using the web interface. When SW 6000 is connected *seat names are not in use*.

Microphone out of request list

`mic_request_off <seat no><CR>`

A microphone is removed from request list.

Max total speakers

`max_total_speakers <max total speakers><CR>`

Maximum number of speakers allowed to speak.

<max total speakers> "1" to "8"

Max delegate speakers**max_speakers** <max speakers><CR>

Maximum number of delegates allowed to speak.

<max speakers> "1" to "8"

Max replies**max_replies** <max replies><CR>

Maximum number of delegates allowed in the reply list.

<max replies> "0" to "250".

Max requests**max_requests** <max requests><CR>

Maximum number of delegates allowed in the request list.

<max requests> "0" to "250".

Operation mode**mic_mode** <mode><CR>

System operation mode.

<mode> "auto" (Automatic), "fifo" (First-in-first-out), "manual" (Manual) and "vox" (Voice Active)

Interrupt mode**mic_interrupt** <mode><CR>

Ability for microphones to interrupt.

For CU 59XX: <mode> "on" (microphones interrupt) and "off" (microphones do not interrupt)

For CU 6110: <mode> "Same" (microphones interrupt other microphones with same or lower priority), "Lower" (microphones interrupt other microphones with lower priority) and "off" (microphones do not interrupt other microphones)

Mic priority**mic_priority** <seat_number> <priority><CR>

This message indicates the priority of a microphone.

<seat_number>: The microphone that was adjusted

<priority>: The priority. Possible values: 0 to 5, where 0 is the lowest priority and 5 is the highest priority

Seat State**seat_state** <seat number> <seat state> <name><CR>

Information about a seat.

This information is sent from the CU to an external control application in the following situations:

- When a delegate logs in
- When a delegate logs out
- When the seat name is modified

- When the external control application requests microphone status (**mic_status**).
- When a microphone unit becomes lost or found

<seat number> The seat number identification of a microphone unit. An integer ranging from 1 to 65535.

<seat state> The current state of the seat. This can be "active" or "passive"

<name> The *seat name* or *delegate name*. If a *delegate name* is available for the seat number then the *delegate name* is provided. Otherwise the *seat name* is provided.

Example:

```
seat_number 12 active John Jones<CR>
```

This command informs about seat number 12, which is active and has the name 'John Jones' attached.

Microphone status complete

```
mic_status_done<CR>
```

Informs, that complete system status has been sent.

Command error

```
command_error <error text><CR>
```

The CU has received an unknown command.

<error text> is a text explaining the fault case.

Example:

```
command_error unknown command<CR>
```

```
command_error syntax error<CR>
```

Audio Control

External Commands to CU 6110

Set loudspeaker volume

```
loudspeaker_volume <volume><CR>
```

Set the volume of loudspeakers for all Conference units.

<volume> The volume of the loudspeakers ranging from -41 to 0. The value -41 indicates Off, whereas values from -40 to 0 indicates attenuation in dB.

The CU responds to this command by returning a '**loudspeaker_volume**' command.

Set line input 1 level

```
line_input_level_1 <level><CR>
```

Adjust the level of line input signal.

<level> The level of line input 1 ranges from -41 to 0. The value -41 indicates Off, whereas values from -40 to 0 indicates attenuation in dB.

The CU responds to this command by returning a '**line_input_level_1**' command.

Set line input 2 level**line_input_level_2** <level><CR>

Adjust the level of line input signal.

<level> The level of line input 2 ranges from -41 to 0. The value -41 indicates Off, whereas values from -40 to 0 indicates attenuation in dB.

The CU responds to this command by returning a 'line_input_level_2' command.

Set line input 1 gain**line_input_gain_1** <gain><CR>

Adjust input gain of the line in 1 input.

<gain>: 0 or 10

Gain can be set to 0 dB or 10 dB. 0 dB will not add any gain to the line input whereas 10 dB will add 10 dB gain to the line input.

The CU responds to this command by a line_input_gain_1 message.

Set line input 2 gain**line_input_gain_2** <gain><CR>

Adjust input gain of the line in 2 input.

<gain>: 0 or 10

Gain can be set to 0 dB or 10 dB. 0 dB will not add any gain to the line input whereas 10 dB will add 10 dB gain to the line input.

The CU responds to this command by a line_input_gain_2 message.

Set line output volume (A-H)**line_output_volume** <output> <volume><CR>

Adjust the level of line output signal.

<output> Indicates which output is being controlled. Possible values: 'A', 'B', 'C', 'D', 'E', 'F', 'G', 'H'.

Note: CU 59XX and CU6105 support A to D. CU6110 supports A to H.

<volume> The volume of line output ranges from -41 to 0. The value -41 indicates Off, whereas values from -40 to 0 indicates attenuation in dB.

The CU responds to this command by returning a 'line_output_volume' command.

Define audio path**audio_path** <path> <on/off><CR>

This command defines audio connections in the system.

<path> Indicates which connection is being controlled. Possible values: 'mic_to_speaker', 'mic_to_floor', 'linein_1_to_speaker', 'linein_1_to_lineout_A', 'linein_1_to_floor', 'linein_2_to_speaker', 'linein_2_to_lineout_A', 'linein_2_to_floor'.

Note: CU 59XX do not support the linein_2 values.

<on/off> Indicates, whether the audio is being routed from microphones/lineinput_1 to speakers/lineoutput/floor.

The CU responds to this command by returning an **'audio_path'** command.

Set Individual Speaker Attenuation

This command is only available on CU 6110

mic_speaker_attenuation <seat_number> <Attenuation><CR>

This command sets the speaker attenuation of a microphone.

<seat_number>: The microphone to adjust

<Attenuation>: The desired speaker attenuation. Possible values: 0 to 7.

0 to 6 will attenuate 0 to 6 dB. 7 is speaker off.

The CU responds to this command by returning a **'mic_speaker_attenuation'** message.

Set Individual Microphone Attenuation

This command is only available on CU 6110

mic_attenuation <seat_number> <Attenuation><CR>

This command sets the attenuation of a microphone.

<seat_number>: The microphone to adjust

<Attenuation>: The desired microphone attenuation. Possible values: 0 to 6 dB, where 0 is the lowest attenuation and 6 is most attenuation.

The CU responds to this command by returning a **'mic_attenuation'** message

Request audio status

audio_status<CR>

System audio status.

The CU responds to this command by returning a list of commands for the Audio settings:

line_output_volume	(for all outputs)
audio_path	(for all paths)
line_input_level	(for all inputs)
line_input_gain	(for all inputs)
mic_speaker_attenuation	(for all units)
mic_attenuation	(for all units)
loudspeaker_volume	
audio_status_done	

Commands from CU 6110 to External

Loudspeaker volume

loudspeaker_volume <volume><CR>

Volume of loudspeakers for all Conference units.

<volume> The volume of the loudspeakers ranging from -41 to 0. The value -41 indicates Off, whereas values from -40 to 0 indicates attenuation in dB.

Line input 1 level

line_input_level_1 <level><CR>

Level of line input 1 signal.

<level> The level of line input 1 ranges from -41 to 0. The value -41 indicates Off, whereas values from -40 to 0 indicates attenuation in dB.

Line input 2 level

line_input_level_2 <level><CR>

Level of line input 2 signal.

<level> The level of line input 2 ranges from -41 to 0. The value -41 indicates Off, whereas values from -40 to 0 indicates attenuation in dB.

Line input 1 gain

line_input_gain_1 <gain><CR>

Adjust input gain of line in 1 input.

<gain>: 0 or 10

Gain can be set to 0 dB or 10 dB. 0 dB will not add any gain to the line input whereas 10 dB will add 10 dB gain to the line input.

Line input 2 gain

Only available on CU 6110

line_input_gain_2 <gain><CR>

Adjust input gain of line in 2 input.

<gain>: 0 or 10

Gain can be set to 0 dB or 10 dB. 0 dB will not add any gain to the line input whereas 10 dB will add 10 dB gain to the line input.

Line output level (A-D)

line_output_level <output> <level><CR>

Adjust the level of line output signal.

<output> Indicates which output is being controlled. Possible values: 'A', 'B', 'C', 'D', 'E', 'F', 'G', 'H'.

Note: On CU 59XX and CU6105 'A' to 'D' are possible. CU6110 deliver 'A' to 'H'.

<level> The level of line output ranges from -41 to 0. The value -41 indicates Off, whereas values from -40 to 0 indicates attenuation in dB.

Define audio path

audio_path <path> <on/off><CR>

This command defines audio connections in the system.

<path> Indicates which connection is being controlled. Possible values: 'mic_to_speaker', 'mic_to_floor', 'linein_1_to_speaker', 'linein_1_to_lineout_A', 'linein_1_to_floor', 'linein_2_to_speaker', 'linein_2_to_lineout_A', 'linein_2_to_floor'.

Note: CU 59XX do not support the linein_2 values.

<on/off> Indicates, whether the audio is being routed from microphones/lineinput_1 to speakers/lineoutput_A/floor.

Individual Speaker Attenuation

`mic_speaker_attenuation <seat_number> <Attenuation><CR>`

Indicates the speaker attenuation of a microphone. Only available on CU 6110.

<seat_number> The microphone that has been adjusted

<Attenuation>: The desired speaker attenuation. Possible values: 0 to 7.

0 to 6 will attenuate 0 to 6 dB. 7 is speaker off.

Individual Microphone Attenuation

`mic_attenuation <seat_number> <Attenuation><CR>`

This message indicates the attenuation of a microphone. This message is only available on CU 6110.

<seat_number>: The microphone that has been adjusted.

<Attenuation>: The microphone attenuation. Possible values: 0 to 6 dB, where 0 is the lowest attenuation and 6 is most attenuation.

Audio status complete

`audio_status_done<CR>`

This command terminates audio status streaming.

Voting Control

External Commands to the CU 6110**Start a voting session**

`start_voting <voting_session_id><CR>`

Starts a voting session in the CU

<voting_session_id>: Identification of the voting configuration to start.

The CU replies with **'voting_started'**, if a voting session is started.

SW 6000 controlled

The **voting_session_id** defines which voting configuration to run. A list of configurations can be requested by command **'voting_status'**.

If no **voting_session_id** is specified, the default SW 6000 voting configuration is requested.

Standalone

voting_session_id defines the build-in voting configurations:

'1' 3-button voting

'2' 3-button secret voting

'3' 5-button voting

'4' 5-button secret voting

If no **voting_session_id** is specified, the configuration '1' is requested.

Stop a voting session

`stop_voting<CR>`

Used to stop an ongoing voting session in the CU. If the voting session is stopped, the CU replies with **'voting_stopped'**.

Cancel a voting session**cancel_voting<CR>**

Used to cancel an ongoing voting session in the CU. If the voting session is cancelled, the CU replies with **'voting_cancelled'**.

Start attendance check session**start_attendance_check<CR>**

Used to start an attendance check session in the CU. If an attendance check session is started, the CU replies with **'attendance_check_started'**.

Stop an attendance check session**stop_attendance_check<CR>**

This command is used to stop an ongoing attendance check session in the CU. If the attendance check session is stopped, the CU replies with **'attendance_check_stopped'**.

Cancel an attendance check session**cancel_attendance_check<CR>**

Used to cancel an ongoing attendance check session in the CU. If the attendance check session is cancelled, the CU replies with **'attendance_check_cancelled'**.

Request voting status**voting_status<CR>**

Used to request voting status. The result is a list of available voting configurations. The CU replies to this command by returning the commands:

```

voting_configuration 1 <configuration_label>
...
voting_configuration <n> <configuration_label>
voting_status_done

```

CU 6110 Commands to External**A voting session is started****voting_started<CR>****A voting session is stopped****voting_stopped<CR>****A voting session is cancelled****voting_cancelled<CR>****Interim voting results****interim_voting_result <result_id><interim_result><result_text><CR>**

During a voting session the CU informs about interim voting results. When new votes are cast, the CU distributes interim voting results. This command informs about one of the interim voting results.

<result_id> With SW 6000 connected values [1 to 9] corresponding to the 9 result columns in the SW 6000 'Voting Configurations'. For a standalone CU 6105 this is the button numbers [1 to 5].

<interim_result> interim voting result. With SW 6000 this is the result for the 9 result columns. For a standalone CU this is the number of votes given on the specified button.

<result_text> Text related to the result. With SW 6000 this is the labels for the 9 result columns. For a standalone CU this voting button labels.

Final voting results

final_voting_result <result_id><final_result><result_text><CR>

At completion of a voting session the CU distributes final voting results. This command informs about final voting result for one of the voting alternatives.

<result_id> identification of result. With SW 6000 connected values [1 to 9] corresponding to the 9 result columns in the SW 6000 'Voting Configurations'. For a standalone CU 6105 this is the button numbers [1 to 5].

<final_result> With SW 6000 this is the result for the 9 result columns. For a standalone CU 61cc this is the number of votes given on the specified button.

<result_text> Text related to the result.

An attendance check session is started

attendance_check_started<CR>

An attendance check session is stopped

attendance_check_stopped<CR>

An attendance check session is cancelled

attendance_check_cancelled<CR>

Interim Attendance check result

interim_attendance_check_result <interim_result><CR>

Used by the CU to inform about the interim attendance check result.

<interim_result> contains the interim attendance check result.

Final Attendance check result

final_attendance_check_result <final_result><CR>

Used by the CU to inform about the final attendance check result.

<final_result> contains the interim attendance check result.

For a standalone system it indicates how many delegates have pressed the 'attendance' button.

Voting Configuration

voting_configuration <voting_configuration_id><voting_configuration_name><CR>

Identifies a voting configuration.

<voting_configuration_id> is an integer identifying the voting configuration.

<voting_configuration_name> is a name for the configuration.

Voting Status complete

voting_status_done<CR>

Informs that voting status streaming is complete.



www.shure.com

United States, Canada, Latin America, Caribbean:

Shure Incorporated
5800 West Touhy Avenue
Niles, IL 60714-4608
USA

Phone: +1 847 600 2000
Fax: +1 847 600 1212 (USA)
Fax: +1 847 600 6446
Email: info@shure.com

Europe, Middle East, Africa:

Shure Europe GmbH
Jakob-Dieffenbacher-Str. 12
75031 Eppingen
Germany

Phone: +49 (0) 7262-9249-100
Fax: +49 (0) 7262-9249-114
Email: info@shure.de

Asia, Pacific:

Shure Asia Limited
22/F, 625 King's Road
North Point, Island East,
Hong Kong

Phone: (+852) 2893-4290
Fax: (+852) 2893-4055
Email: info@shure.com.hk