

# Stationary Battery Systems

## Test & Monitoring Equipment

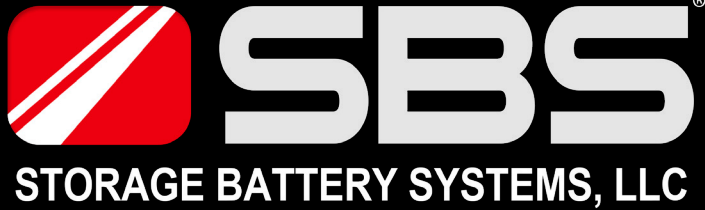



**Storage Battery Systems, LLC (SBS) has been providing Power Solutions™ since 1915.**

SBS strives to provide superior products and service while maintaining consistent quality and continuity.

## SERVICES

SBS will design and size your system per IEEE standards based on your specific requirements. SBS can provide the following services using fully-trained and experienced personnel, ensuring fast completion and high quality:

- Install, set up and test new stationary battery systems; decommission and recycle old stationary battery systems
- Provide preventative maintenance services for stationary battery systems
- Capacity/discharge test stationary battery systems per IEEE standards
- Conduct customized training classes

### Installations

- SBS will decommission and recycle your old battery system and install, set up and test your new system
- SBS has been installing stationary batteries for over 30 years and has the experience and capabilities to do this type of work anywhere in the world

### Preventative Maintenance (PM)

- SBS can be contracted to do routine maintenance, such as quarterly or annual PMs
- Both IEEE standards and NERC standard PRC-005-2 reference battery testing/maintenance guidelines, and battery manufacturers also publish testing requirements to ensure warranty compliance – SBS will test and provide detailed reports that will comply with these requirements

### Load Tests

- SBS can perform load tests based around your requirements or IEEE/NERC guidelines
- If necessary, SBS can provide temporary power so that the system does not have to be shut down
- After the load test is completed, SBS will provide complete reports that comply with NERC standard PRC-005-2

### Training

SBS offers customized battery training courses on topics related to DC power that are designed around your needs and requirements:

- SBS can train at our corporate office in Menomonee Falls, WI or on-site at your company
- SBS offers individual or group training sessions
- Popular topics include *Battery 101* and *Maintenance and Testing*
- SBS can train your technicians during an actual installation, PM or load test

**Contact SBS today for all your stationary battery service and testing needs.**

# Table of Contents

## Stationary Batteries

1-6 • Flooded Lead Acid Batteries  
*20 year low maintenance designs*

7-8 • Nickel Cadmium Batteries  
*For extreme applications*

9-19 • Valve Regulated Lead Acid Batteries  
*Compact design and sealed = little/no maintenance*



Pg. 1-6



Pg. 7-8



Pg. 9-19

## Racks, Spill Containment & Enclosures

20-22 • Standard and Seismic Battery Racks

23-24 • Spill Containment Systems

25-28 • Custom DC Enclosures

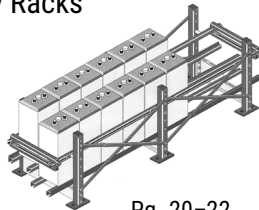

Pg. 20-22

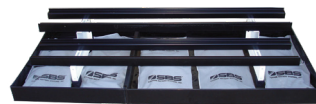

Pg. 23-24



Pg. 25-28

## Chargers

29-31 • Float Chargers

32 • Portable Maintenance Chargers



Pg. 29-31



Pg. 32



Pg. 32

## Test and Monitoring Equipment

33-36 • Digital Hydrometers / Density Meters

37-38 • Battery Resistance Tester

39-46 • Constant Current DC Load Banks

47-48 • Hydrogen Gas Monitoring System

49-52 • Active Battery Monitoring System



Pg. 33-36



Pg. 37-38



Pg. 39-46



# STT Series Low Maintenance Tubular Flooded Batteries

OPzS 6 & 12 Volt Blocks (55–330 Ah)

SBS has been selling tubular lead-selenium vented batteries for nearly 20 years. SBS was the first company to actively introduce this technology to the US market.

The combination of the tubular positive plates and the lead selenium/low antimony alloy provides the best possible combination in lead acid plate technology.

The battery world favors tubular positive plates for flooded, gel and AGM applications. STT batteries are manufactured in accordance with OPzS DIN 40736 standards.

## Lead Selenium/Low Antimony

By utilizing a small amount of selenium in the grid alloy, a dense fine grain structure is produced. This alloy is extremely corrosion-resistant and virtually eliminates inter-granular corrosion which is one of the most common causes of cell failure. A lead selenium cell combines the advantages of both lead calcium and lead antimony cells while exhibiting none of the disadvantages.

## Tubular Positive Plate Advantages

Due to increased positive plate surface area, tubular plates have more electrical capacity than flat plates of comparable size and weight.

With positive plate shedding eliminated, tubular batteries also provide up to a 30% longer service life compared to flat plate batteries.

Perhaps most importantly to stationary applications, the tubular positive grid does not require horizontal bars, which virtually eliminates positive plate growth and therefore post seal leaks and jar cracking. As a result, in applications which require a long service life, tubular plate batteries provide the best and most reliable power.

## Features

- 20 year design life at 77° F
- Watering intervals: 1–3 years
- Leak-proof post seal
- High cycle life:
  - 1200+ cycles @ 80% DOD
  - 2000+ cycles @ 60% DOD
- 100%+ capacity upon delivery
- No positive plate growth damage
- Tank formed plates
- Safe: zero voltage exposed to personnel
- Flip-top, easy-fill, flame arrestor vent caps
- Withstands high temperature applications better than lead-calcium batteries
- **Typically in stock and ready to ship!**

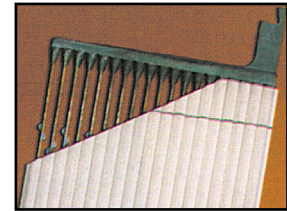

## Applications

- Switchgear/Substations
- Power Generation
- Microwave Relay Sites
- Telecommunications
- Solar/Photovoltaic
- Oil and Gas



## Construction

Positive Plate	Tubular plate with selenium/low antimony alloy (0.34" thick)
Negative Plate	Pasted flat radial structure
Separation	Microporous combined with corrugated separator
Case Material	Styrene-acrylonitrile (SAN), impact resistant
Cover Material	Styrene-acrylonitrile (SAN)
Specific Gravity	1.240 S.G. @ 77° F
Post Design	Leak-proof with brass insert
Intercells	Fully insulated flexible copper cables (uninsulated bars optional)
Vent Caps	Flip-top flame arrestor with dust cap
Temp. Range	-4° to 131° F (68° to 77° F recommended)
Float Voltage	2.23 V/cell
Equalize Voltage	2.33–2.40 V/cell



**Option:** taller posts available upon request (shown below)



Shown with and without removable protective caps

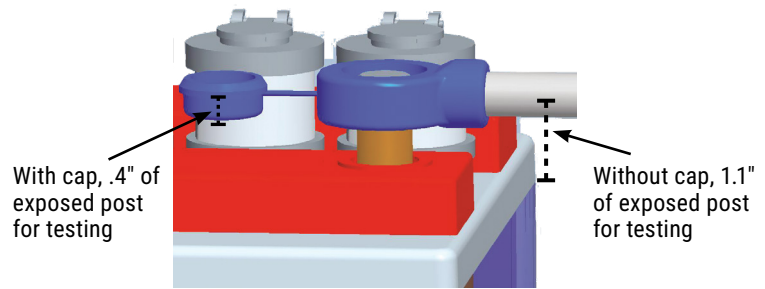

With cap, .4" of exposed post for testing

Without cap, 1.1" of exposed post for testing

### Technical Data

Part No.	OPzS DIN Std. 30736	8 hr. Ah Rate	Voltage (V)	Battery Dimensions L x W x H (in.)	Weight w/ Electrolyte (lb.)	Electrolyte Weight (lb.)	Electrolyte (Gallons)	Short Circuit Current (Amps)
STT12V50	12V 1 OPzS 50	55	12	10.7 x 8.08 x 15.1	86.0	23.8	2.3	620
STT12V100	12V 2 OPzS 100	110	12	10.7 x 8.08 x 15.1	107	22.5	2.2	1260
STT12V150	12V 3 OPzS 150	165	12	15.0 x 8.08 x 15.1	149	31.7	3.1	1780
STT6V200	6V 4 OPzS 200	220	6	10.7 x 8.08 x 15.1	101	24.2	2.3	2240
STT6V250	6V 5 OPzS 250	275	6	15.0 x 8.08 x 15.1	130	31.9	3.1	2660
STT6V300	6V 6 OPzS 300	330	6	15.0 x 8.08 x 15.1	144	30.4	2.9	3040

### Performance Data

Constant current discharge in Amperes to 1.75 V/cell at 77° F

Part No.	1 min.	15 min.	30 min.	1 hr.	1.5 hr.	2 hr.	3 hr.	5 hr.	6 hr.	8 hr.	24 hr.
STT12V50	75.0	54.3	40.2	27.3	21.3	17.8	13.6	9.50	8.39	6.85	2.67
STT12V100	150	109	80.3	54.6	42.6	35.5	27.2	19.0	16.8	13.7	5.34
STT12V150	225	163	121	81.9	64.0	53.3	40.9	28.5	25.2	20.6	8.01
STT6V200	300	217	161	109	85.3	71.1	54.5	38.0	33.6	27.5	10.6
STT6V250	375	272	201	137	107	88.8	67.9	47.6	41.9	34.2	13.3
STT6V300	450	327	241	164	128	107	81.4	57.1	50.4	41.0	16.0

### Standard STT Kit Includes

- Intercell-connector cables
- Jumper cable(s)
- Flip-top flame arrestor vent caps
- No-oxide grease
- Cell numbers
- Brass wire brush
- Utility funnel
- Installation & Operation Manual

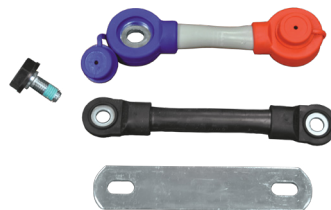

Insulated flexible intercell connectors standard. Optional accessories on pages 5 and 6.



Flip-top, easy-fill, flame arrestor vent caps

SBS reserves the right to change specifications and designs without notice.

Illustrations, data, dimensions and weights given in this brochure are for guidance only and cannot be held binding on the company.

# STT Series Low Maintenance Tubular Flooded Batteries

OPzS 2 Volt Cells (110–3,585 Ah)

SBS has been selling tubular lead-selenium vented batteries for nearly 20 years. SBS was the first company to actively introduce this technology to the US market. The combination of the tubular positive plates and the lead selenium/low antimony alloy provides the best possible combination in lead acid plate technology. The battery world favors tubular positive plates for flooded, gel and AGM applications. STT batteries are manufactured in accordance with OPzS DIN 40736 standards.

## Lead Selenium/Low Antimony

By utilizing a small amount of selenium in the grid alloy, a dense fine grain structure is produced. This alloy is extremely corrosion-resistant and virtually eliminates inter-granular corrosion which is one of the most common causes of cell failure. A lead selenium cell combines the advantages of both lead calcium and lead antimony cells while exhibiting none of the disadvantages.

## Tubular Positive Plate Advantages

Due to increased positive plate surface area, tubular plates have more electrical capacity than flat plates of comparable size and weight. With positive plate shedding eliminated, tubular batteries also provide up to a 30% longer service life compared to flat plate batteries.

Perhaps most importantly to stationary applications, the tubular positive grid does not require horizontal bars, which virtually eliminates positive plate growth and therefore post seal leaks and jar cracking. As a result, in applications which require a long service life, tubular plate batteries provide the best and most reliable power.

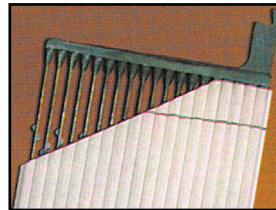

## Features

- 20 year design life at 77° F
- Watering intervals: 1–3 years
- Leak-proof post seal
- High cycle life:
  - 1200+ cycles @ 80% DOD
  - 2300+ cycles @ 60% DOD
- 100%+ capacity upon delivery
- No positive plate growth damage
- Tank formed plates
- Safe: zero voltage exposed to personnel
- Flip-top, easy-fill, flame arrestor vent caps
- Withstands high temperature applications better than lead-calcium batteries
- **Many in stock and ready to ship!**

## Applications

- Switchgear/Substations
- Power Generation
- Microwave Relay Sites
- Telecommunications
- Solar/Photovoltaic
- Oil and Gas

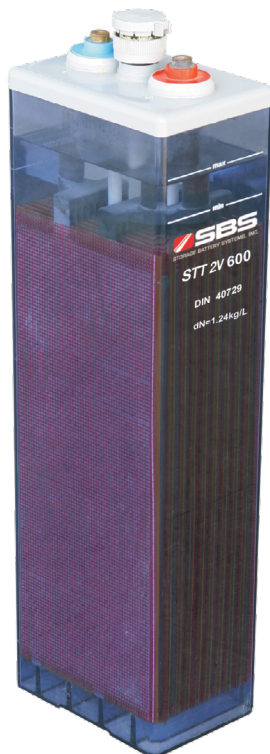

Option: taller posts available upon request (shown below)

With std. cable, .33" of exposed post for testing

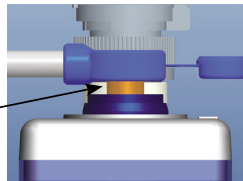

With optional bar, .5" of exposed post for testing

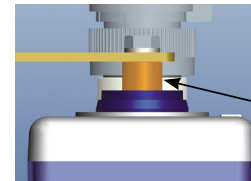

## Construction

Positive Plate	Tubular plate with selenium/low antimony alloy (0.34" thick)
Negative Plate	Pasted flat radial structure
Separation	Microporous combined with corrugated separator
Case Material	Styrene-acrylonitrile (SAN), impact resistant
Cover Material	Styrene-acrylonitrile (SAN)
Specific Gravity	1.240 S.G. @ 77° F
Post Design	Leak-proof with brass insert
Intercells	Fully insulated flexible copper cables (uninsulated bars optional)
Vent Caps	Flip-top flame arrestor with dust cap
Temp. Range	-4° to 131° F (68° to 77° F recommended)
Float Voltage	2.23 V/cell
Equalize Voltage	2.33–2.40 V/cell

## Technical Data

Part No.	OPzS DIN Std.	8 hr. Ah Rate	Voltage (V)	Cell Dimensions L x W x H (in.)	Weight w/ Electrolyte (lb.)	Electrolyte Weight (lb.)	Electrolyte (Gallons)	# of Poles	Short Circuit Current (Amps)
STT2V100	2 OPzS 100	110	2	4.06 x 8.11 x 16.1	28.8	12.3	1.2	2	1240
STT2V150	3 OPzS 150	165	2	4.06 x 8.11 x 16.1	34.2	11.1	1.1	2	1860
STT2V200	4 OPzS 200	220	2	4.06 x 8.11 x 16.1	39.6	9.90	1.0	2	2380
STT2V250	5 OPzS 250	275	2	4.89 x 8.11 x 16.1	46.2	11.0	1.1	2	3000
STT2V300	6 OPzS 300	330	2	5.71 x 8.11 x 16.1	55.0	13.2	1.3	2	3500
STT2V350	5 OPzS 350	395	2	4.89 x 8.11 x 20.7	61.6	14.3	1.4	2	3300
STT2V420	6 OPzS 420	475	2	5.71 x 8.11 x 20.7	73.7	17.6	1.7	2	3900
STT2V490	7 OPzS 490	550	2	6.54 x 8.11 x 20.7	85.8	22.0	2.1	2	4950
STT2V600	6 OPzS 600	660	2	5.71 x 8.11 x 27.6	102	26.4	2.6	2	4500
STT2V700	7 OPzS 700	755	2	8.27 x 7.52 x 27.6	132	37.5	3.8	4	5350
STT2V800	8 OPzS 800	865	2	8.27 x 7.52 x 27.6	141	35.2	3.4	4	6200
STT2V900	9 OPzS 900	975	2	8.27 x 9.18 x 27.6	161	44.1	4.5	4	6950
STT2V1000	10 OPzS 1000	1090	2	8.27 x 9.18 x 27.6	170	44.0	4.3	4	7750
STT2V1200	12 OPzS 1200	1310	2	8.27 x 10.9 x 27.6	203	52.8	5.1	4	8850
STT2V1375	11 OPzS 1375	1605	2	8.27 x 10.9 x 33.5	244	77.1	7.8	4	8500
STT2V1500	12 OPzS 1500	1755	2	8.27 x 10.9 x 33.5	247	66.0	6.4	4	9000
STT2V1750	14 OPzS 1750	2047	2	8.35 x 15.7 x 32.6	296	78.0	7.5	6	10350
STT2V2000	16 OPzS 2000	2340	2	8.35 x 15.7 x 32.6	330	88.0	8.5	6	12600
STT2V2250	22 OPzS 2250	2630	2	8.35 x 19.2 x 32.6	405	130	13.1	8	16200
STT2V2500	20 OPzS 2500	2920	2	8.35 x 19.2 x 32.6	418	110	10.6	8	14450
STT2V3000	24 OPzS 3000	3585	2	8.35 x 22.7 x 32.6	495	136	13.2	8	18800

## Performance Data

Constant current discharge in Amperes to 1.75 V/cell at 77° F

Part No.	1 min.	15 min.	30 min.	1 hr.	1.5 hr.	2 hr.	3 hr.	5 hr.	6 hr.	8 hr.	24 hr.
STT2V100	150	109	80.3	54.6	42.6	35.5	27.2	19.0	16.8	13.7	5.34
STT2V150	225	163	121	81.9	64.0	53.3	40.9	28.5	25.2	20.6	8.01
STT2V200	300	217	161	109	85.3	71.1	54.5	38.0	33.6	27.5	10.6
STT2V250	375	272	201	137	107	88.8	67.9	47.6	41.9	34.2	13.3
STT2V300	450	327	241	164	128	107	81.4	57.1	50.4	41.0	16.0
STT2V350	450	307	246	186	151	128	98.7	69.0	60.0	49.3	19.0
STT2V420	540	369	296	224	181	153	118	82.8	71.1	59.3	22.8
STT2V490	630	430	345	261	212	179	138	96.6	84.0	68.8	26.6
STT2V600	690	456	393	313	258	218	170	117	103	82.5	31.9
STT2V700	805	533	459	365	300	255	200	137	120	94.5	37.2
STT2V800	920	609	524	417	343	291	228	157	137	108	42.5
STT2V900	1035	684	590	470	387	329	256	176	155	122	47.9
STT2V1000	1150	760	656	522	430	365	284	196	172	136	53.2
STT2V1200	1380	913	787	626	515	438	341	235	206	164	63.8
STT2V1375	1458	937	820	666	566	492	391	277	245	201	74
STT2V1500	1620	1022	894	726	617	537	426	302	267	219	82.2
STT2V1750	1890	1118	978	793	674	588	470	337	298	256	95.0
STT2V2000	2160	1277	1118	907	771	672	537	385	341	293	109
STT2V2250	2454	1533	1341	1089	927	806	643	454	401	329	123
STT2V2500	2700	1703	1490	1210	1030	895	714	504	445	365	137
STT2V3000	3240	2042	1789	1451	1236	1071	854	605	534	448	164

## Standard STT Kit Includes

- Intercell-connector cables
- Jumper cable(s)
- Flip-top flame arrestor vent caps
- No-oxide grease
- Cell numbers
- Brass wire brush
- Utility funnel
- Installation & Operation Manual



Flip-top, easy-fill, flame arrestor vent caps

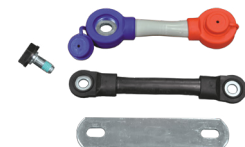

Insulated flexible intercell connectors standard. Optional accessories on pages 5 and 6.

SBS reserves the right to change specifications and designs without notice.

Illustrations, data, dimensions and weights given in this brochure are for guidance only and cannot be held binding on the company.



# Bi-Directional Recombination Vent Plug

For Stationary Flooded/Vented Batteries

**Significantly reduces/eliminates watering intervals and increases safety in poorly-ventilated areas**

## Principle of Operation

Operation of lead acid batteries results in the electrolysis of water. Electrolysis reduces the amount of water in the electrolyte, which in turn requires the battery to be watered more frequently, increasing maintenance requirements. Hydrogen and oxygen are also naturally created as part of this process and these gases can accumulate and become explosive.

The SBS recombination vent caps help to prevent the gases generated through electrolysis from escaping. Inside the cap is a catalyst (rare earth element) which reacts with hydrogen and oxygen and converts the gases into water vapor. This is an exothermic process and heat is generated during this recombination process.

As the battery stops gassing and the cap cools, water vapor condenses on the walls of the plug and will flow back into the battery, thus 98% of the hydrogen/oxygen gas mixture generated during charging will be recombined and converted back to water. This process effectively eliminates the flow of gases from the battery into the atmosphere.

SBS recombination vent caps significantly improve safety, preventing (under normal conditions) the flow of gas into the immediate surroundings and eliminating the risk of ignition, as well as reducing the need for water refilling.

The system is economical from both an installation and maintenance perspective.



## Features

- Reduces the frequency of water refilling (12–15 years topping-up interval)
- Reduction of maintenance and service costs
- Increases safety since explosive gases are not released from cell under normal operation
- Protects against flashback
- Lifetime of more than 20 years

## Bi-Directional Valve

In order to achieve the most effective gas recombination plug, a special catalyst system using a bi-directional valve is integrated to automatically regulate the pressure inside the plug.

In order to maintain the safe operation of the system, a flame arrester is mounted over the valve in the plug in the form of a ceramic flame screen. With this design the vent plug gas emissions are minimal and safe for the surrounding environment.

The design of the recombination plug increases the safety of the battery in areas with limited ventilation while maintaining the level of gas recombination at the highest possible level.

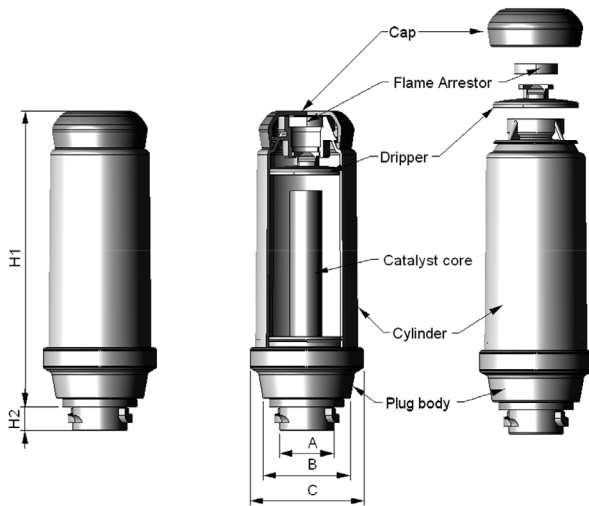

## Construction and Technical Data

Part No.	Cell Capacity (Ah)	Max Charging Voltage (V/cell)	Dimensions				
			Diameter in Inches (mm)			Height in Inches (mm)	
			A	B	C	H1	H2
RECOM-BD-500AH	up to 500*	2.4 ± 1%	0.98 (25)	1.57 (40)	2.09 (53)	5.20 (132)	0.43 (11)
RECOM-BD-3000AH	above 501*	2.4 ± 1%	0.98 (25)	1.57 (40)	2.09 (53)	5.20 (132)	0.43 (11)

\*Will not fit on STT12V50 or STT12V100 batteries

# Battery System Accessories

## Hydrometers and Accessories

Part No.	Description
Z1G	Hydrometer with glass float (1.100-1.320 scale)
HY-HOLDER	Hydrometer holder with drip cup
1353	Thermometer w/SG correction factor table (-20° to 130° F)
STRAP-6FT	6 ft. lifting strap (for P/Ns STT2V100 through STT2V490)
STRAP-8FT	8 ft. lifting strap (for P/N STT2V600 and larger)



Z1G



1353



STRAP-8FT

## STT Solid Intercell Connectors

Part No.	Description
SBS12V50/100-BB	Solid intercell connector for STT12V50/100 - 3.5" x 1"
SBS12V150-BB	Solid intercell connector for STT12V150 - 4.25" x 1"
SBS6V200Z-BB	Solid intercell connector for STT6V200 - 5.5" x 1"
SBS6V250/300-BB	Solid intercell connector for STT6V250/350 - 8.5" x 1"
SBS100/150/200	Solid intercell connector for STT2V100/150/200 - 6" x 1.25"
SBS250/350	Solid intercell connector for STT2V250/350 - 6.75" x 1.25"
SBS300/420/600	Solid intercell connector for STT2V300/420/600 - 7.5" x 1.25"
SBS490	Solid intercell connector for STT2V490 - 8.5" x 1.25"
STT2V800-3000	Contact SBS for details



Lead/tin plated copper bar

## STT Termination Plates

Part No.	Description
7158740100-600	L termination plate for STT2V100-600 - 4" x 2.5" x 1.25"
7158740800	L termination plate for STT2V800 - 4.75" x 4" x 4"
7158741000	L termination plate for STT2V1000 - 6" x 4" x 4"
7158741500	L termination plate for STT2V1200-1500 - 7" x 4" x 4"
7158742000	L termination plate for STT2V1750-2000 - 10.25" x 4" x 4"
7158742500	L termination plate for STT2V2500 - 14.5" x 4" x 4"
7158743000	L termination plate for STT2V3000 - 18" x 4" x 4"



## ANSI-Approved Eye Wash Stations

Part No.	Description
7500	16 gallon gravity fed eyewash
7603	Portable air pressure operated eyewash with 15 gallon tank



7500



7603

# Pocket Plate NiCd Batteries

Flooded Nickel Cadmium Cells (8–1680 Ah)



KB Series  
(Multi-Cell Block)

Nickel Cadmium pocket plate batteries are the most reliable and rugged batteries available today. They can withstand, to a great extent, any type of abuse like overcharge, deep discharge, even accidental reverse charge, and can be stored in any state of charge.

Pocket plate batteries are manufactured in 3 series (L, M, and H) based on their performance capabilities. They are available in 1.2V single cells (KP-Series) and in 1.2V, 2.4V and 3.6V multi-cell blocks (KB-Series).

SBS's pocket plate batteries are supplied with the electrolyte, intercell connectors, related hardware and accessories required for normal operation and maintenance.



KP Series  
(Single Cell)

## Features

- Long float life: 25 years
- Highest reliability among all battery systems
- Operating temp. of: -4° to 131° F (Storage: -22° to 113° F)
- Low maintenance
- No shedding/loss of plate material
- Quick charge capability
- Very resistant to electrical and mechanical abuse
- Flame-arresting vent protection
- Long shelf life
- No emission of corrosive gases
- Good charge retention

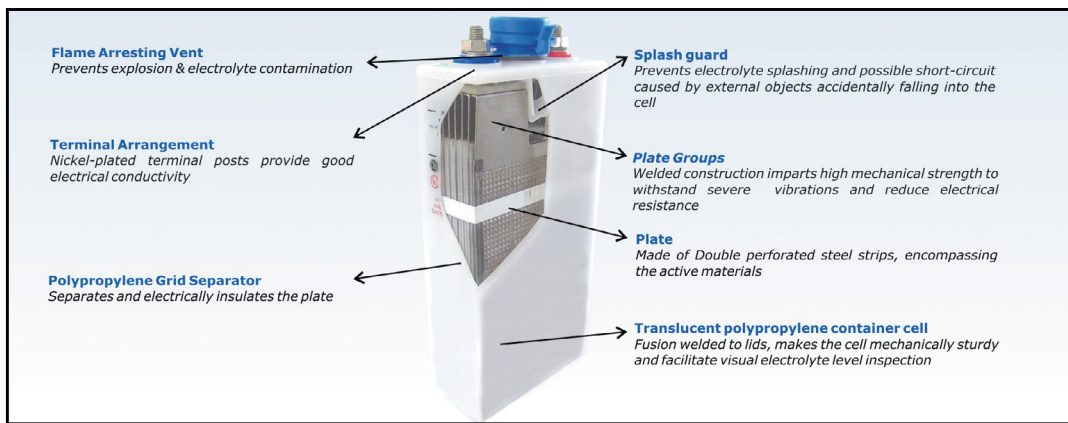

## Technical Data

Pocket Plate Cell Series	Capacity Range (Ah)	Plate Information	Plate Thickness	Typical Back-Up	Typical Applications
Low Rate - Long Duration KPL / KBL	8 – 1680	Thick plates to provide a large capacity reserve for a long duration	5 mm	3 hr. or more	Oil & gas, railway signaling, telecom, power plants, emergency lighting, photovoltaic, fire alarms
Medium Rate KPM / KBM	10 – 1460	Optimized plate thickness which is ideal for medium discharge performance and durations	3 mm	30 min. to 3 hr. or mixed loads	Switchgear protection, UPS, emergency lighting, instrumentation and process control
High Rate KPH / KBH	9 – 990	Thin plates to provide an excellent high rate discharge performance	2 mm	Below 30 min	UPS, generator starting

Use link below for detailed battery information.

NICKEL CADMIUM BATTERIES



# HV Series Valve Regulated Pocket Plate NiCd Batteries

Ultra Low Maintenance Nickel Cadmium Cells (7–1680 Ah)



1.2V Cell

2.4V Block

Valve regulated pocket plate batteries were designed to meet the needs of applications requiring the traditional high reliability of nickel cadmium pocket plate cells without the need to top-up with water. The VRPP battery works on the oxygen recombination principle and therefore has a much reduced water consumption. The level of recombination of these cells is 85–95%. Normal vented type cells will have only a 30–35% recombination efficiency. When the VRPP cells are properly float charged (between 1.40–1.42 V/cell) they will not need to be topped off with water for nearly 20 years. If the levels do become low during the life of the battery there are provisions to add water to the cells.

The VRPP batteries are available in 1.2V single cells or 2.4V, 3.6V or 4.8V multi-cell blocks. Available in medium rate (HVM Series) and low rate (HVL Series), all batteries are supplied with the electrolyte, intercell connectors, related hardware and accessories required for normal operation and maintenance.

## Features

- Long float life: 25 years
- High cycle life: 2000 cycles @ 20% DOD
- Reliable and predictable performance
- Operating temp.: -4° to 131° F (Storage: -22° to 113° F)
- Low maintenance
- Minimal gassing
- Very resistant to electrical and mechanical abuse
- No sudden failure due to internal corrosion
- Good performance at low temperatures

## Operating Notes

- Float voltage range: 1.43 V/cell
- Max. equalize voltage: 1.45 V/cell
- Current limit: 10% of  $C_5$  ( $C_5 = 5$  hr. Ah Rate)

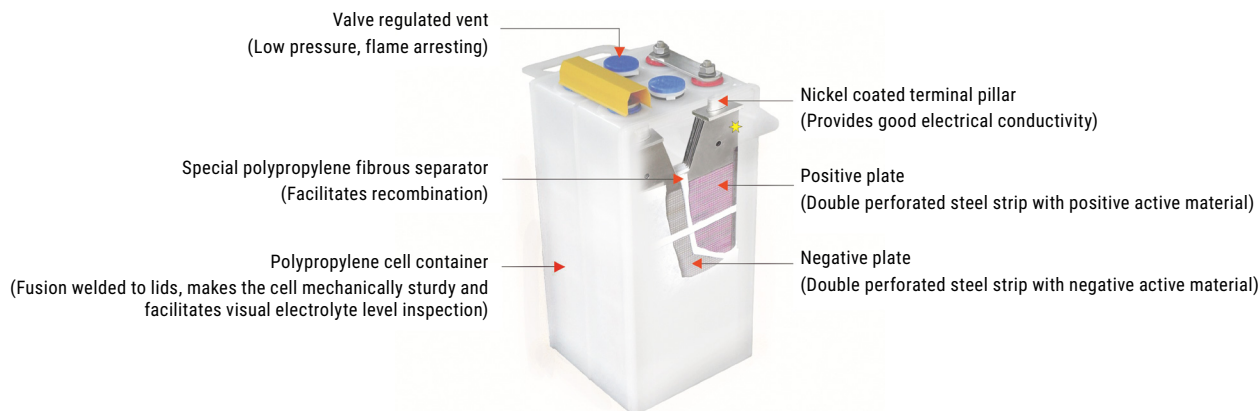

## Technical Data

Pocket Plate Cell Series	Capacity Range (Ah)	Plate Information	Plate Thickness	Typical Back-Up	Typical Applications
Low Rate - Long Duration HVL	7–1340	Thick plates to provide a large capacity reserve for a long duration	5 mm	3 hr. or more	Oil & gas, railway signaling, telecom, power plants, emergency lighting, photovoltaic, fire alarms
Medium Rate HVM	15–1680	Optimized plate thickness which is ideal for medium discharge performance and durations	3 mm	30 min. to 3 hr. or mixed loads	Switchgear protection, UPS, emergency lighting, instrumentation and process control

Use link below for detailed battery information.

# AGM VRLA Modular Battery Systems

100–400 Ah Battery Systems



### Applications

- Telecom
- Utility
- Oil and Gas
- Solar/Photovoltaic
- UPS
- Emergency Lighting
- Railways

The 2 Volt AGM batteries can be mounted vertically or horizontally in a seismic modular rack. When ordered with the modular racks, this system will come complete with an insulated cable kit as well as removable Plexiglas shields making this a very safe system. SBS typically stocks 48 and 125 Vdc AGM systems complete with modular rack kits which include the intercell connectors.

### Features

- 15–20 year design life at 77° F
- Cycle life: 1200 cycles at 80% DOD at 77° F
- 100% capacity upon delivery
- Maintenance free – no watering required
- No corrosive fumes – special battery room not required
- Seismic modular racking available
- Tank formed plates provide consistent and stable voltages
- Extra space in jars for grid growth to enhance battery life
- Can be installed vertically or horizontally
- UL Listed – UL file no. MH19767
- AGM-100 and AGM-150 battery systems are typically in stock

### Construction

Positive Plate	Flat plate with lead-calcium/tin grid alloy
Negative Plate	Flat plate with lead-calcium grid alloy
Separator	Absorbent glass mat (AGM)
Container	UL 94 HB plastic resin (flame retardant UL 94 V0 optional)
Safety Valve	Self resealing, pressure regulated and explosion proof
Terminals	High conductivity lead-plated, with brass insert
Modular Racking	Seismic rated, acid resistant, epoxy coated
Temp. Range	5° to 130° F (68° to 77° F recommended)
Float Voltage	2.25 V/cell
Equalize Voltage	2.35 V/cell
Plexiglas Shields	Included with rack kit
Intercell Connectors	Fully insulated cables (included with modular rack kit)

### Technical Data

Part No.	8 hr. Ah Rate to 1.75 V/cell	Nominal Voltage (V)	L x D x H (in.)	Weight (lb.)	Internal Resistance (mOhms)	Terminal Type
AGM-100	100	2	6.69 x 2.83 x 8.35	13.2	1.40	M6
AGM-150	150	2	6.69 x 3.86 x 8.35	18.7	1.10	M6
AGM-200	200	2	6.69 x 4.33 x 13.8	30.0	1.03	M8
AGM-250	250	2	6.69 x 4.33 x 13.8	32.0	1.00	M8
AGM-300	300	2	6.69 x 5.91 x 13.8	41.2	0.90	M8
AGM-400	400	2	8.27 x 6.89 x 13.8	56.2	0.70	M8

For flame retardant covers add 'FR' after part number (Example: AGM-150-FR).

## Performance Data

Constant current discharge in Amperes to 1.75 V/cell at 77° F

Part No.	1 min.	15 min.	30 min.	45 min.	1 hr.	2 hr.	3 hr.	5 hr.	8 hr.	10 hr.	20 hr.	24 hr.
AGM-100	166	126	85.3	66.6	54.7	33.8	25.7	17.7	12.5	10.1	5.40	4.64
AGM-150	249	188	128	99.8	82.1	50.7	38.6	26.6	18.7	15.2	8.04	6.91
AGM-200	350	270	186	144	118	74.2	55.3	37.8	25.0	21.7	11.3	10.1
AGM-250	400	309	213	164	134	84.8	63.2	43.2	31.2	24.8	12.9	11.5
AGM-300	500	386	266	205	168	106	79.0	54.0	37.5	31.0	16.1	14.4
AGM-400	650	502	346	267	218	138	103	70.2	50.1	40.3	20.9	18.7

## Seismic Modular Racks for 48 Vdc Systems

Battery Type	Part No.	L x D x H (in.)	Layout
AGM-100	24xAGM100-RACK	21 x 8.0 x 58	4W x 6H
AGM-150	24xAGM150-RACK	25 x 8.0 x 58	4W x 6H
AGM-200	24xAGM200-RACK	27 x 13 x 57	4W x 6H
AGM-250	24xAGM250-RACK	27 x 13 x 57	4W x 6H
AGM-300	24xAGM300-RACK	33 x 13 x 58	4W x 6H
AGM-400	24xAGM400-RACK	43 x 13 x 58	4W x 6H

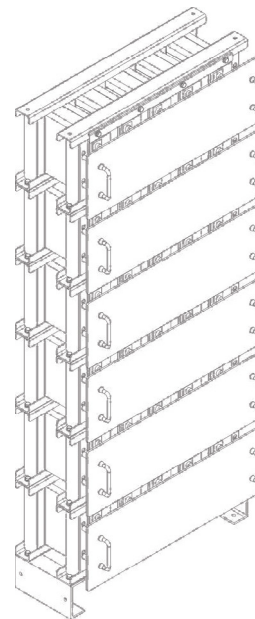

## Seismic Modular Racks for 125 Vdc Systems

Battery Type	Part No.	L x D x H (in.)	Layout
AGM-100	60xAGM100-RACK	50 x 8.0 x 58	10W x 6H
AGM-150	60xAGM150-RACK	60 x 8.0 x 57	10W x 6H
AGM-200	60xAGM200-RACK	64 x 13 x 57	10W x 6H
AGM-250	60xAGM250-RACK	64 x 13 x 57	10W x 6H
AGM-300	60xAGM300-RACK	80 x 13 x 57	10W x 6H
AGM-400	60xAGM400-RACK	107 x 13 x 58	10W x 6H

Other system voltages and rack layouts available upon request.



Insulated intercell connectors come standard with AGM type racks. (If solid, uninsulated bars are required see E-AGM Series.)

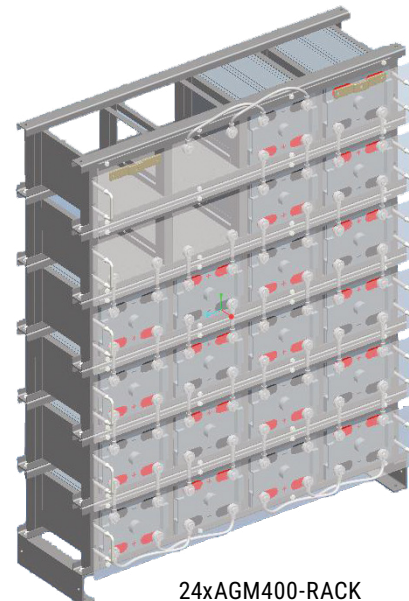

24xAGM400-RACK



# E-AGM VRLA Modular Battery Systems

200–3,000 Ah Battery Systems



The E-AGM 2 Volt batteries have a similar design as the classic AGM batteries, however they are built in cases that are taller and thinner allowing a more compact footprint especially in larger Ah systems. **These batteries must be ordered with the horizontal seismic modular 'EOS' racks**, and these systems include solid intercell connectors as well as removable Plexiglas covers.

### Features

- 15–20 year design life at 77° F
- Cycle life at 77° F
  - 1200 cycles @ 80% DOD
  - 2250 cycles @ 50% DOD
- 100% capacity upon delivery
- Maintenance free – no watering required
- No corrosive fumes – special battery room not required
- Seismic modular racking
- Tank formed plates provide consistent and stable voltages
- Extra space in jars for grid growth to enhance battery life
- UL Listed - UL file no. MH19767
- E-AGM- 200–600 Ah battery systems are typically in stock

### Construction

Positive Plate	Flat plate with lead-calcium/tin grid alloy
Negative Plate	Flat plate with lead-calcium grid alloy
Separator	Absorbent glass mat (AGM)
Container	UL 94 HB plastic resin (flame retardant UL 94 V0 optional)
Safety Valve	Self resealing, pressure regulated and explosion proof
Terminals	High conductivity lead-plated, with brass insert
Modular Racking	Seismic rated, acid resistant, epoxy coated
Temp. Range	5° to 130° F (68° to 77° F recommended)
Float Voltage	2.25 V/cell
Equalize Voltage	2.35 V/cell
Mounting Orientation	Horizontal only
Plexiglas Shields	Included with rack kit
Intercell Connectors	Lead plated copper bars (included with modular rack kit)

### Applications

- Telecom
- Utility
- Oil and Gas
- Solar/Photovoltaic
- UPS
- Emergency Lighting
- Railways

### Technical Data

Part No.	8 hr. Ah Rate to 1.75 V/cell	Nominal Voltage (V)	L x D x H (in.)	Weight (lb.)	Internal Resistance (mOhms)	Terminal Type
E-AGM-200	200	2	3.72 x 7.26 x 14.7	29.7	0.67	M8
E-AGM-300	300	2	4.84 x 7.26 x 14.7	40.7	0.47	M8
E-AGM-400	400	2	6.54 x 7.26 x 14.7	53.9	0.35	M8
E-AGM-500	500	2	7.66 x 7.26 x 14.7	64.9	0.33	M8
E-AGM-600	600	2	8.78 x 7.26 x 14.7	77.0	0.28	M8
E-AGM-800	800	2	6.06 x 9.02 x 22.3	115	0.21	M8
E-AGM-1000	1000	2	7.32 x 9.02 x 22.3	137	0.18	M8
E-AGM-1200	1200	2	8.86 x 9.02 x 22.3	165	0.17	M8
E-AGM-1500	1500	2	10.5 x 9.02 x 22.3	203	0.14	M8
E-AGM-2000	2000	2	13.8 x 9.17 x 22.3	267	0.11	M8
E-AGM-3000	3000	2	19.6 x 14.3 x 14.7	385	0.10	M8

For flame retardant covers add 'FR' after part number (Example: E-AGM-200-FR).

### Performance Data

Constant current discharge in Amperes to 1.75 V/cell at 77° F

Part No.	1 min.	15 min.	30 min.	45 min.	1 hr.	2 hr.	3 hr.	5 hr.	8 hr.	10 hr.	20 hr.	24 hr.
E-AGM-200	280	218	161	133	112	71.5	53.0	36.4	25.0	21.0	11.4	9.66
E-AGM-300	420	328	242	199	168	107	79.5	54.7	37.5	31.5	17.1	14.5
E-AGM-400	560	437	323	265	224	143	106	72.9	50.0	42.0	22.7	19.3
E-AGM-500	700	546	403	331	280	179	133	91.1	62.5	52.5	28.4	24.2
E-AGM-600	840	655	484	398	336	214	159	109	75.0	63.0	34.1	29.0
E-AGM-800	1120	874	645	530	448	286	212	146	100	84.0	45.5	38.7
E-AGM-1000	1400	1092	807	663	561	357	265	182	125	105	56.9	48.3
E-AGM-1200	1680	1311	968	795	673	429	318	219	150	126	68.2	58.0
E-AGM-1500	2100	1638	1210	994	841	536	398	273	188	158	85.3	72.5
E-AGM-2000	2800	2185	1614	1326	1121	715	530	364	250	210	114	96.6

### Seismic Modular Racks for 48 Vdc Systems

Battery Type	Part No.	L x D x H (in.)
E-AGM-200	24xEOS200-RACK	35 x 17 x 42
E-AGM-300	24xEOS300-RACK	35 x 17 x 50
E-AGM-400	24xEOS400-RACK	35 x 17 x 59
E-AGM-500	24xEOS500-RACK	35 x 17 x 66
E-AGM-600	24xEOS600-RACK	35 x 17 x 73
E-AGM-800	24xEOS800-RACK	42 x 25 x 57
E-AGM-1000	24xEOS1000-RACK	42 x 25 x 64
E-AGM-1200	24xEOS1200-RACK	42 x 25 x 73
E-AGM-1500	24xEOS1500-RACK	65 x 25 x 57
E-AGM-2000	24xEOS2000-RACK	66 x 25 x 70



Racks include pos. and neg. termination plates with cover

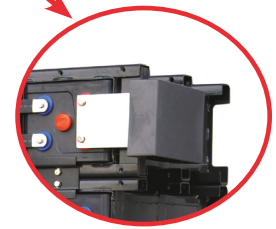

24xEOS800-RACK

### Seismic Modular Racks for 125 Vdc Systems

Battery Type	Part No.	L x D x H (in.)
E-AGM-200	60xEOS200-RACK	85 x 17 x 42
E-AGM-300	60xEOS300-RACK	85 x 17 x 50
E-AGM-400	60xEOS400-RACK	85 x 17 x 59
E-AGM-500	60xEOS500-RACK	85 x 17 x 66
E-AGM-600	60xEOS600-RACK	85 x 17 x 73
E-AGM-800	60xEOS800-RACK	107 x 25 x 57
E-AGM-1000	60xEOS1000-RACK	107 x 25 x 64
E-AGM-1200	60xEOS1200-RACK	107 x 25 x 73
E-AGM-1500	60xEOS1500-RACK	163 x 25 x 57
E-AGM-2000	60xEOS2000-RACK	165 x 25 x 70

Fully-insulated system includes:

- Plexiglas shields
- Termination plate covers
- Solid intercell bar with polarity caps

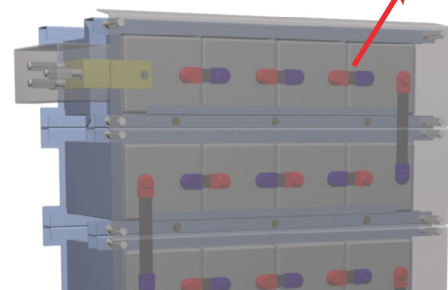
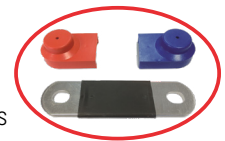

Other system voltages and rack layouts available upon request.

# GEL VRLA Modular Battery Systems

200–2,000 Ah Battery Systems



The GEL Series 2 Volt batteries are constructed with a low gravity gel suspended electrolyte to give superior long-duration and deep-discharge performance, as well as predictable service life in telecom and renewable energy applications. These batteries must be ordered with the horizontal seismic modular 'EOS' Racks and these systems include solid intercell connectors as well as removable Plexiglas covers.

### Features

- 15 year design life at 77° F
- High cycle life at 77° F
  - 1500+ cycles @ 80% DOD
  - 3500+ cycles @ 20% DOD
- 100% capacity upon delivery
- Maintenance free – no watering required
- No corrosive fumes – special battery room not required
- Seismic modular racking
- Tank formed plates provide consistent and stable voltages
- Extra space in jars for grid growth to enhance battery life

Construction	
Positive Plate	Flat plate with lead-calcium/tin grid alloy
Negative Plate	Flat plate with lead-calcium grid alloy
Separator	Microporous glass separator
Container	UL 94 HB ABS plastic (flame retardant UL 94 V0 optional)
Electrolyte	Fixed as gel
Safety Valve	Self resealing, pressure regulated and explosion proof
Terminals	High conductivity lead-plated, with brass insert
Modular Racking	Seismic rated, acid resistant, epoxy coated
Temp. Range	5° to 130° F (68° to 77° F recommended)
Float Voltage	2.25 V/cell
Equalize Voltage	2.35 V/cell
Mounting Orientation	Vertical or Horizontal
Plexiglas Shields	Included
Intercell Connectors	Lead plated copper bars (part of modular rack kit)

### Applications

- Telecom
- Utility
- Oil and Gas
- Solar/Photovoltaic
- Emergency Lighting
- Railways

Technical Data						
Part No.	8 hr. Ah Rate to 1.75 V/cell	Nominal Voltage (V)	L x D x H (in.)	Weight (lb.)	Internal Resistance (mOhms)	Terminal Type
GEL-200	200	2	3.72 x 7.26 x 14.7	31.9	0.66	M8
GEL-300	300	2	4.84 x 7.26 x 14.7	42.7	0.48	M8
GEL-400	400	2	6.54 x 7.26 x 14.7	58.3	0.34	M8
GEL-500	500	2	7.66 x 7.26 x 14.7	68.9	0.33	M8
GEL-600	600	2	8.78 x 7.26 x 14.7	82.5	0.28	M8
GEL-800	800	2	6.06 x 9.02 x 22.3	116.0	0.22	M8
GEL-1000	1000	2	7.32 x 9.02 x 22.3	138.2	0.18	M8
GEL-1200	1200	2	8.86 x 9.02 x 22.3	166.1	0.17	M8
GEL-1500	1500	2	10.5 x 9.02 x 22.3	204.6	0.15	M8
GEL-2000	2000	2	13.8 x 9.17 x 22.3	268.4	0.11	M8

For flame retardant covers add 'FR' after part number (Example: GEL-200-FR).



## Performance Data

Constant Current Discharge in Amperes to 1.75 V/cell at 77° F

Part No.	5 min.	15 min.	30 min.	1 hr.	2 hr.	3 hr.	5 hr.	6 hr.	8 hr.	10 hr.	24 hr.	48 hr.	100 hr.
GEL-200	290.4	246.0	171.0	114.0	70.8	52.5	36.5	32.1	25.0	21.3	9.8	5.1	2.7
GEL-300	435.6	369.0	256.5	171.0	106.2	78.7	54.7	48.1	38.0	31.9	14.7	7.6	4.0
GEL-400	580.8	492.0	342.0	228.0	141.5	105.0	72.9	64.1	50.0	42.6	19.6	10.1	5.3
GEL-500	726.0	615.0	427.0	285.0	176.9	131.2	91.2	80.2	63.0	53.2	24.4	12.6	6.7
GEL-600	871.2	738.0	512.9	342.0	212.3	157.5	109.4	96.2	75.0	63.8	29.3	15.2	8.0
GEL-800	967.7	821.1	612.1	441.0	291.9	215.3	146.7	126.9	100.0	83.2	38.7	20.6	11.2
GEL-1000	1210	1026	765.1	551.2	364.9	369.2	182.5	157.8	125.0	103.5	48.1	25.7	14.0
GEL-1200	1450	1231	917.2	660.8	437.8	323.0	220.1	190.7	150.0	125.1	58.1	31.0	16.9
GEL-1500	1815	1540	1148	826.8	547.3	403.7	272.4	235.5	188.0	154.5	71.7	38.3	20.8
GEL-2000	2419	2053	1530	1103	729.7	538.3	363.2	314.1	250.0	205.9	95.7	51.0	27.8

## Seismic Modular Racks for 48 Vdc Systems

Battery Type	Part No.	L x D x H (in.)
GEL-200	24xEOS200-RACK	35 x 17 x 42
GEL-300	24xEOS300-RACK	35 x 17 x 50
GEL-400	24xEOS400-RACK	35 x 17 x 59
GEL-500	24xEOS500-RACK	35 x 17 x 66
GEL-600	24xEOS600-RACK	35 x 17 x 73
GEL-800	24xEOS800-RACK	42 x 25 x 57
GEL-1000	24xEOS1000-RACK	42 x 25 x 64
GEL-1200	24xEOS1200-RACK	42 x 25 x 73
GEL-1500	24xEOS1500-RACK	65 x 25 x 57
GEL-2000	24xEOS2000-RACK	66 x 25 x 70



## Seismic Modular Racks for 125 Vdc Systems

Battery Type	Part No.	L x D x H (in.)
GEL-200	60xEOS200-RACK	85 x 17 x 42
GEL-300	60xEOS300-RACK	85 x 17 x 50
GEL-400	60xEOS400-RACK	85 x 17 x 59
GEL-500	60xEOS500-RACK	85 x 17 x 66
GEL-600	60xEOS600-RACK	85 x 17 x 73
GEL-800	60xEOS800-RACK	107 x 25 x 57
GEL-1000	60xEOS1000-RACK	107 x 25 x 64
GEL-1200	60xEOS1200-RACK	107 x 25 x 73
GEL-1500	60xEOS1500-RACK	163 x 25 x 57
GEL-2000	60xEOS2000-RACK	165 x 25 x 70

Other system voltages and rack layouts available upon request.

### Fully-insulated system includes:

- Plexiglas shields
- Termination plate covers
- Solid intercell bar with polarity caps

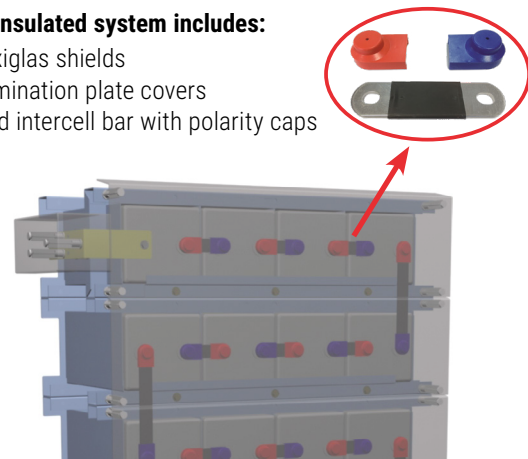

# VRZ Series Tubular Gel VRLA Batteries

200–3,000 Ah (2 Volt Cells)



The VRZ-Series batteries have tubular positive plates and a gelled electrolyte making them the highest quality valve-regulated battery design available. The VRZ batteries are ideal for applications which call for maximum life and maintenance-free operation.

Insulated flexible intercell connectors standard. Other accessories on page 6.



## Construction

Positive Plate	Tubular plate with calcium-tin alloy
Negative Plate	Flat plate grid
Separation	Microporous combined with corrugated separator
Case and Cover	ABS
Electrolyte	Fixed as gel
Post Design	Leak-proof with brass insert
Intercells	Fully insulated, flexible copper cables
Temp. Range	30° to 130° F (68° to 77° F recommended)
Float Voltage	2.25 V/cell
Equalize Voltage	2.35 V/cell

## Features

- 15 – 20 year design life at 77°F
- Maintenance-free operation
- Gel tubular plate technology
- Leak-proof post seal
- High cycle life:
  - 1500+ cycles @ 80% DOD
- Flame retardant ABS cover standard
- Safe – fully-insulated connections
- Built per OPzV DIN standards
- UL Listed - UL file no. MH19767

## Applications

- Telecom
- Industrial
- Reserve Power
- Utility
- Solar

## Technical Data

Part No.	OPzV DIN Std.	8 hr. Ah Rate	Voltage (V)	Cell Dimensions L x W x H (in.)	Total Weight (lb.)	I.R. (mOhms)
VRZ-200	4 OPzV 200	200	2	4.06 x 8.11 x 15.3	39.7	1.20
VRZ-250	5 OPzV 250	250	2	4.89 x 8.11 x 15.3	48.5	1.10
VRZ-300	6 OPzV 300	300	2	5.71 x 8.11 x 15.3	57.3	1.00
VRZ-350	5 OPzV 350	350	2	4.89 x 8.11 x 19.9	63.9	0.90
VRZ-420	6 OPzV 420	420	2	5.71 x 8.11 x 19.9	75.0	0.80
VRZ-490	7 OPzV 490	500	2	6.54 x 8.11 x 19.9	86.0	0.73
VRZ-600	6 OPzV 600	600	2	5.71 x 8.11 x 26.8	101	0.62
VRZ-800	8 OPzV 800	800	2	8.27 x 7.52 x 26.8	142	0.50
VRZ-1000	10 OPzV 1000	1000	2	8.27 x 9.17 x 26.8	173	0.45
VRZ-1200	12 OPzV 1200	1200	2	8.27 x 10.8 x 26.8	205	0.40
VRZ-1500	12 OPzV 1500	1500	2	8.27 x 10.8 x 32.7	254	0.30
VRZ-2000	16 OPzV 2000	2000	2	8.42 x 15.7 x 31.8	342	0.25
VRZ-2500	20 OPzV 2500	2500	2	8.35 x 19.2 x 31.8	432	0.20
VRZ-3000	24 OPzV 3000	3000	2	8.35 x 20.7 x 31.8	512	0.18

## Performance Data

Constant current discharge in Amperes to 1.75 V/cell @ 77° F

Part No.	15 min.	30 min.	45 min.	1 hr.	2 hr.	3 hr.	5 hr.	8 hr.	10 hr.	20 hr.	24 hr.
VRZ-200	210	152	121	105	68.6	51.9	35.1	25.0	20.8	11.7	10.1
VRZ-250	263	190	151	131	85.8	64.9	43.9	31.3	26.0	14.6	12.6
VRZ-300	315	228	182	158	103	77.9	52.7	37.5	31.2	17.6	15.1
VRZ-350	343	257	208	184	119	90.0	60.9	43.8	35.6	20.5	17.6
VRZ-420	412	308	250	220	142	108	73.1	52.5	42.7	24.6	21.2
VRZ-490	480	359	291	257	166	126	85.3	62.5	49.8	28.7	24.7
VRZ-600	526	416	347	313	200	152	104	75.0	60.9	35.0	30.1
VRZ-800	702	554	463	418	266	202	139	100	81.2	46.7	40.2
VRZ-1000	877	693	579	522	333	253	174	125	102	58.4	50.2
VRZ-1200	1052	832	695	626	400	304	209	150	122	70.1	60.2
VRZ-1500	1157	970	844	781	492	377	257	188	152	87.4	75.2
VRZ-2000	1543	1293	1125	1041	656	503	343	250	203	117	100
VRZ-2500	1928	1617	1407	1302	820	628	428	313	253	146	125
VRZ-3000	2314	1940	1688	1562	984	754	514	375	304	175	150

# UPS Series VRLA Batteries

For High Rate UPS Applications

The SBS UPS Series battery is suitable for all critical power UPS applications including UL924 emergency lighting. Designed with high-density thin plate technology, the UPS battery will deliver up to 30% additional watts per cell than the typical UPS battery of equal footprint.

All jars are flame-retardant ABS (UL94) as standard at no additional cost. The UPS series VRLA battery ensures your optimum longevity, reliability and availability. SBS offers complete replacement services, IEEE testing and redundant battery strings in cabinets or on rack system.

## Features

- Premium high-rate UPS batteries
- Design life: up to 10 years in float service at 77° F
- Wide operating temperature: -10° to 140° F; optimal 68° to 77° F
- Maintenance free – no water top-up required throughout service life
- Transports via surface, water and air as “non-hazardous”
- No corrosive fumes – special battery room not required
- Flame retardant covers
- Can be mounted both in horizontal and vertical orientation



## Technical Data

Part No.	Voltage (V)	Watts/Cell*	Ah Rate**	Length (In.)	Width (In.)	Height (In.)	Terminal Type (Bolt)
UPS12-35WFR	12	35	9	5.95	2.56	3.90	.250 tab
UPS12-100WFR	12	92.8	27	6.46	4.92	6.89	T12
UPS12-150WFR	12	150.0	35	7.68	5.12	6.57	T6
UPS12-210WFR	12	225.1	55	9.02	5.43	7.99	T6
UPS12-300WFR	12	324.6	82	10.20	6.61	8.31	T6
UPS12-350WFR	12	370.3	95	12.00	6.61	8.27	T6
UPS12-400WFR	12	430.4	110	12.81	6.69	8.50	T8
UPS12-540WFR	12	539.0	155	13.19	6.77	10.94	T8
UPS6-700WFR	6	681.0	210	12.7	7.00	9.10	T8

\*15 Min. rate to 1.67 V/cell @ 77° F

\*\*Nominal 20 hr. rate to 1.80 V/cell @ 77° F

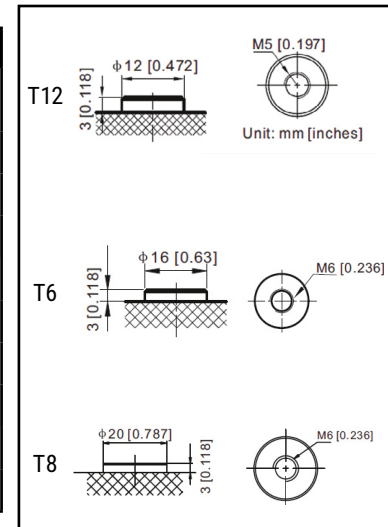

## Comparative UPS Battery Part Numbers

SBS Part No.	C&D MR-Series	C&D Dynasty-Series	EnerSys HX-Series	Deka/Unigy HR-Series
UPS12-35WFR			12HX35	
UPS12-100WFR		UPS12-100FR	12HX100	
UPS12-150WFR	UPS12-150MR		12HX135/150	U1HR1500
UPS12-210WFR	UPS12-210MR	UPS12-200FR	12HX205	45HR2000
UPS12-300WFR	UPS12-300MR	UPS12-270FR	12HX300	24HR3000
UPS12-350WFR	UPS12-350MR	UPS12-310FR	12HX350	27HR3500
UPS12-400WFR	UPS12-400MR	UPS12-370FR	12HX400	31HR4000
UPS12-540WFR	UPS12-490/540MR	UPS12-475FR	12HX505/540	31HR5000
UPS6-700WFR	UPS6-620MR	UPS6-620FR	6HX800	

## Applications

- UPS
- Telecommunications
- Emergency Lighting
- Utility
- Oil and Gas
- Railways
- Starting/Generator

## Certifications & Standards

- UL Listed - UL file no. MH19767
- ISO 9001 certified
- ISO 14000 certified

# S Series (AGM) & G Series (Gel) VRLA Batteries

30–225 Ah (6 & 12 Volt Blocks)

The sealed construction of the SBS VRLA series battery allows trouble-free, safe operation in any position. There is no need to add electrolyte since gases generated during charging are recombined in a unique "Oxygen Cycle."



Optional insulated cables available



S Series (AGM)



G Series (Gel)

### Construction

Plates	Lead-tin-calcium alloy
Separator (S-Series)	Microporous glass fiber (AGM)
Case Material (S-Series)	ABS
Separator (G-Series)	Microporous glass fiber (Gelled)
Case Material (G-Series)	ABS UL 94 V0 Flame Retardant
Float Voltage	2.25 V/cell
Equalize Voltage	2.35 V/cell
Temp. Range	5° to 130° F (68° to 77° F recommended)

### Features

- Maintenance-free operation
- Low self discharge (long shelf life)
- Spill-proof construction
- Wide operating temperature
- 100% memory-free
- Non-restricted for air transportation
- UL Listed - UL file no. MH19767
- Design life of 5 – 10 years in float service

### Technical Data

Part No.*	8 hr. Ah Rate	20 hr. Ah Rate	Voltage (V)	Battery Dimensions L x W x H (in.)	Weight (lb.)	I.R. (mOhms)
<b>S Series AGM Batteries:</b>						
ST-S-12330	33	35	12	7.68 x 5.12 x 7.01	24.7	11.0
ST-S-12400	37	41	12	7.76 x 6.50 x 6.69	29.1	10.0
ST-S-12550	54	59	12	8.98 x 5.39 x 9.06	39.0	7.5
ST-S-12750	74	80	12	10.24 x 6.61 x 8.43	50.7	6.6
ST-S-12900	88	96	12	12.05 x 6.61 x 9.06	60.6	5.0
ST-S-12V120	100	107	12	12.99 x 6.81 x 8.66	69.5	4.9
ST-S-6V150	143	156	6	10.02 x 7.09 x 9.96	46.7	3.0
ST-S-6V195	190	208	6	12.05 x 6.61 x 8.98	61.6	1.4
ST-S-6V225GC	194	214	6	10.24 x 7.09 x 9.96	67.3	1.4
<b>G Series Gel Batteries:</b>						
ST-G-12550	44	50	12	9.02 x 5.43 x 8.31	36.6	9.0
ST-G-12750	61	70	12	10.2 x 6.61 x 8.43	50.7	7.9
ST-G-12900	74	85	12	12.01 x 6.61 x 8.38	59.8	6.8
ST-G-12V100	85	96	12	13.0 x 6.81 x 8.58	68.4	5.9

\*Additional models available. Please contact SBS for more information.

### Applications

- Utility (switchgear)
- Telecom
- UPS systems
- Emergency lighting
- Alarm systems

### AGM Advantages (S Series)

- Competitively priced
- Superior high rate discharge performance
- Commonly used in standby applications

### Gel Advantages (G Series)

- Best for cyclic applications
- High temperature tolerance
- Excellent for long/deep discharge
- Flame retardant case standard



# VRLA Battery Rack Configurations

For 30-225 Ah 6 & 12 Volt S, G and UPS Series Batteries

The SBS VRLA racks have adjustable rails allowing them to hold top terminal 6 or 12 volt VRLA batteries ranging from 30 to 225 Ah (100 to 800 Wpc). The heavy duty yet light frame makes them easy to move and install.

## Features

- When ordered with batteries includes cables and jumper(s)
- -Z4 racks seismically certified to Zone 4 UBC standards
- Powder coated with ASA 61 Gray, corrosion-resistant, epoxy powder
- All welded construction with 7 GA frame and rails
- Floor mounting brackets included with all racks
- Ship pre-assembled for fast installation
- Adjustable rails with 3" lip

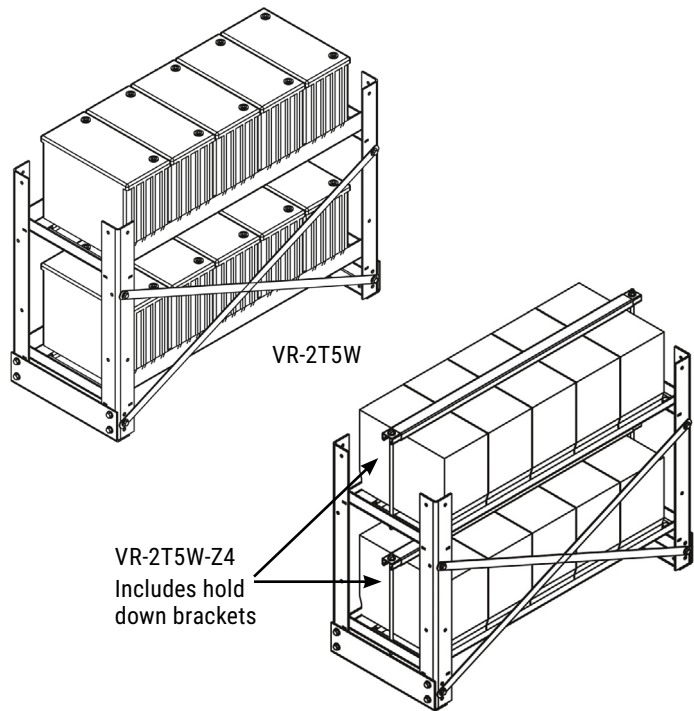

## Seismic Zone 4 Certified

The VRLA rack rails have 3" high lips. Batteries that are shorter than 7" high do not require the '-Z4' hold down bracket option for seismic Zone 4 applications.

When a seismic rack is required for VRLA batteries taller than 7" high the '-Z4' option should be ordered and a hold down bracket kit will be provided with the rack.

Technical Data				
Part No.	Description	Batteries (6 or 12V)	Dimensions W x D x H (in.)	Weight (lb.)
VR-1T4W	1 tier x 4 batt.	4	31.5 x 16.3 x 28.3	30
VR-1T4W-Z4	1 tier x 4 batt.	4	31.5 x 16.3 x 28.3	36
VR-2T4W	2 tier x 4 batt.	8	31.5 x 16.3 x 28.3	40
VR-2T4W-Z4	2 tier x 4 batt.	8	31.5 x 16.3 x 28.3	46
VR-2T5W	2 tier x 5 batt.	10	40.5 x 16.3 x 28.3	50
VR-2T5W-Z4	2 tier x 5 batt.	10	40.5 x 16.3 x 28.3	56
VR-4T5W	4 tier x 5 batt.	20	40.5 x 16.3 x 67.5	98
VR-4T5W-Z4	4 tier x 5 batt.	20	40.5 x 16.3 x 67.5	104

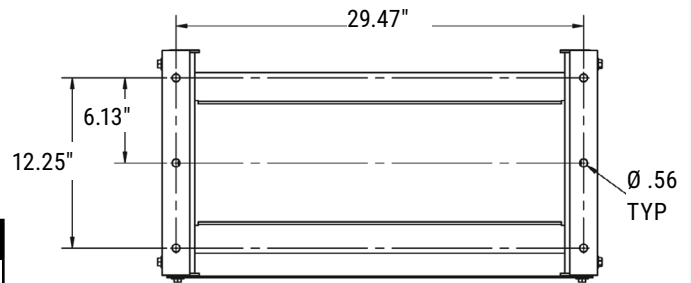

Bottom view - mounting footprint for 31.5"W racks

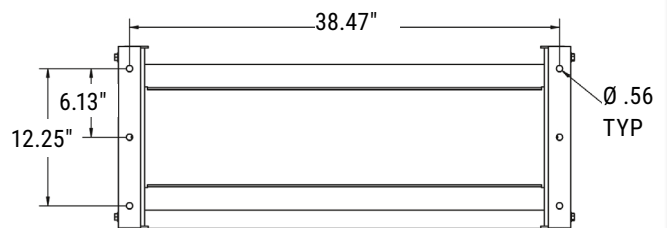

Bottom view - mounting footprint for 40.5"W racks

# PL Series & AFT Series VRLA Front Terminal Batteries

55–225 Ah\* (12 Volt) Thin Plate Pure Lead and Lead-Calcium Batteries



PL Series

AFT Series

The SBS thin plate pure lead PL Series and the lead-calcium AFT Series are front terminal AGM VRLA batteries designed for mounting in cabinets or 19" or 23" relay racks.

The PL Series battery is designed for critical applications that require the longest and most reliable life possible. They are lighter, energy dense, and can handle high temperatures better than the AFT Series battery. The SBS Pure Lead batteries also have a 2 year shelf life at 77° F.

## Construction

Series	AFT	PL
Plates	Lead-calcium-tin alloy	Thin plate pure lead
Casing Material	ABS jar/cover (FR UL94V-0 optional)	ABS jar/cover (FR UL94V-0 standard)
Float Voltage	2.25 V/cell	2.27 V/cell
Equalizing Voltage	2.35 V/cell	up to 2.40 V/cell
Temp. Range	5° to 130° F	-40° to 149° F
Capacity at 32° F	86%	86%
Design life at 77° F	up to 10 years	up to 15 years
Storage time at 77° F	6 months	2 years

## Features

- Long float life
- Designed to fit on 19" or 23" relay racks
- Excellent high rate discharge performance
- Copper alloy terminal inserts
- Leak-free terminal seal
- 100% initial capacity
- Non-hazardous cargo for ground, sea and air transportation
- Handles for easy handling
- UL Listed - UL file no. MH19767

## Additional PL Features/Advantages

- Pure lead positive plates for longest life
- UL94V-0 flame retardant jar/cover standard
- Up to 2 year shelf life at 77° F
- Fast charging acceptance

## Technical Data

Part No.*	8 hr. Ah Rate	10 hr. Ah Rate	Voltage (V)	Dimensions L x W x H (in.)	19" or 23" Rack	Weight (lb.)	I.R. (mOhms)
12AFT110	100	103	12	15.50 x 4.33 x 11.20	19" or 23"	76.1	4.3
12AFT150	145	150	12	21.69 x 4.33 x 11.30	19" or 23"	103	3.0
12PLH100FT	96	101	12	15.63 x 4.25 x 11.30	19" or 23"	68.3	4.5
12PLH150FT	144	152	12	22.12 x 4.92 x 10.24	23"	101	3.6
12PLH190FT	182	192	12	22.10 x 4.92 x 12.60	23"	128	3.0

## Applications

- Telecommunications
- UPS
- Utility
- Renewable
- Railway
- Emergency lighting

## Performance Data

Constant current discharge data in Amperes to 1.75 V/cell at 77° F

Part No.*	10 min.	15 min.	20 min.	30 min.	45 min.	1 hr.	2 hr.	3 hr.	5 hr.	8 hr.	10 hr.	20 hr.
12AFT110	185	158	136	103	77.6	60.9	36.0	26.1	17.4	12.5	10.3	5.53
12AFT150	278	237	209	159	117.	94.1	53.9	39.2	26.1	18.1	15.2	8.02
12PLH100FT	221	179	148	108	77.7	60.9	34.4	25.5	17.4	12.0	10.1	5.26
12PLH150FT	323	266	224	167	123	97.9	54.6	39.7	26.5	17.9	15.2	8.07
12PLH190FT	390	324	264	196	144	115	66.6	48.4	32.3	22.7	19.2	10.1

\*Additional models available. Please contact SBS for more information.

# Relay Rack Systems

Relay Racks, Trays and Pre-Wired Systems

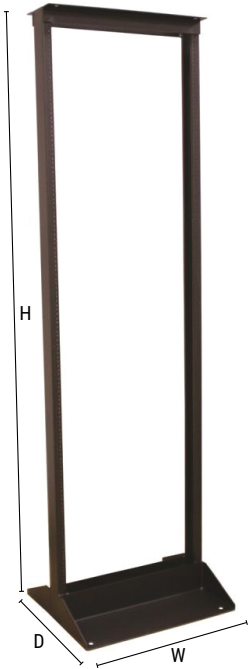

## Relay Racks

- 19" and 23" rack configurations
- All steel construction
- Black powder coat finish

## Relay Rack Ordering Information

Part No.	Size	Dimensions H x W x D (in.)	Weight (lb.)
94384	19"	84 x 20.3 x 20	66
94784	23"	84 x 24.3 x 20	70

## 19" Standard Battery Tray

- 350 lb. capacity
- Designed for front access or monobloc style batteries
- Black powder coat finish

## Standard Tray Ordering Information

Part No.	Size	Inside Dimensions W x D (in.)
91304	19"	17.2 x 19.0



Standard 19" Tray

## 23" Heavy Duty Battery Tray

- 650 lb. capacity
- Designed for front access or monobloc style batteries
- Welded heavy gauge steel construction
- Black powder coat finish

## Heavy Duty Tray Ordering Information

Part No.	Size	Inside Dimensions W x D (in.)
91302	23"	20.39 x 22.25



Heavy Duty 23" Tray

## Pre-Wired Relay Racks

- 19" or 23" pre-wired racks
- 650 lb. capacity per tray
- Two pole quick disconnect per string
- 850A busbar capacity
- Black powder coat finish



## Pre-Wired Rack Part Number Configuration

91255 -				
1	2	3	4	5
1. Base Model No.	2. No. of Trays	3. Cable Size	4. Lug Hole Size	5. Strings per Tray
<b>91254</b> (19" x 84"H)	1-5	02 = #2	A = #10	1 = One String
or		04 = #4	B = 1/4"	2 = Two Strings
<b>91255</b> (23" x 84"H)		20 = 2/0	C = 5/16"	
		40 = 4/0		

The battery racks utilize our HD-Series Battery Trays which are optimized for the use of any front access battery. These racks come pre-wired with an Ultra Flexible MTW-style cable which terminates each battery string to the DC Junction Box located at the top of the rack.

For added safety, each tray is equipped with a 2-pole quick disconnect on each battery string for isolating individual strings during system maintenance. Just add batteries and intercell connectors for an effective solution for adding additional run time to any system.

# Standard Battery Racks

*Zone 0 (Non-Seismic) Racks in Many Configurations*

Our SBS standard racks have been designed for all types of stationary battery models. These easy-to-use racks are strong, have a flexible design, and are acid-proof. Their light, small frame makes them easy to install, move and store.

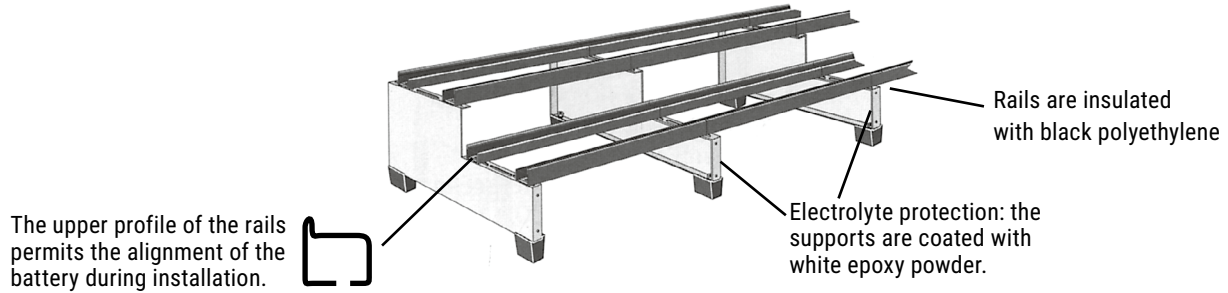

2-Tier racks  
11.22" or  
14.17" wide

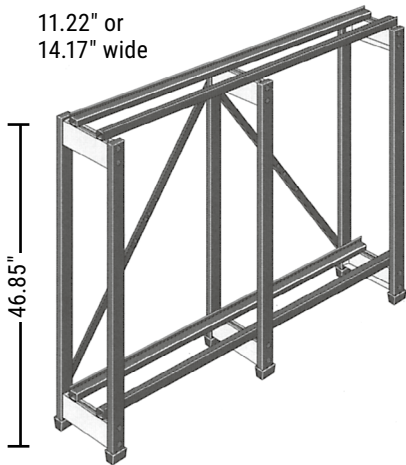

1-Tier racks  
8.46" or 11.42" wide



2-Step racks  
16.93" or 22.83" wide

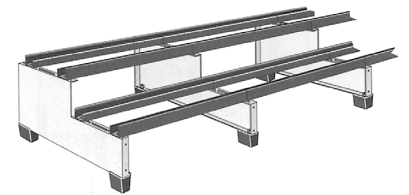

2-Step/2-Tier racks  
19.69" or  
25.59" wide

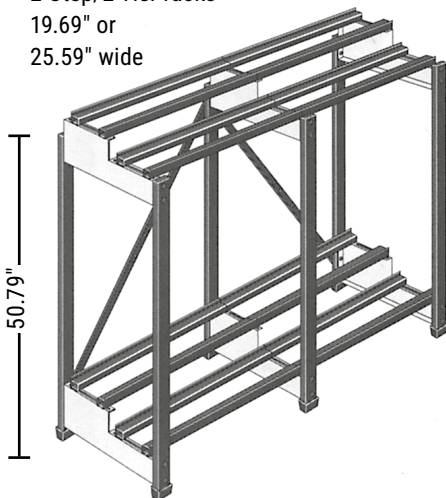

3-Step racks  
25.39" or 34.25" wide

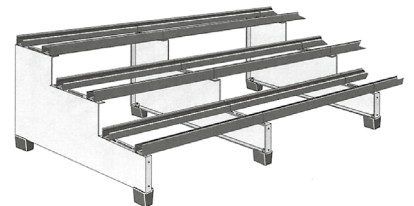

Please contact SBS for information on the different rack lengths and designs available.



# Seismic Battery Racks

Zone 1 – 4 Racks, Most Available from Stock

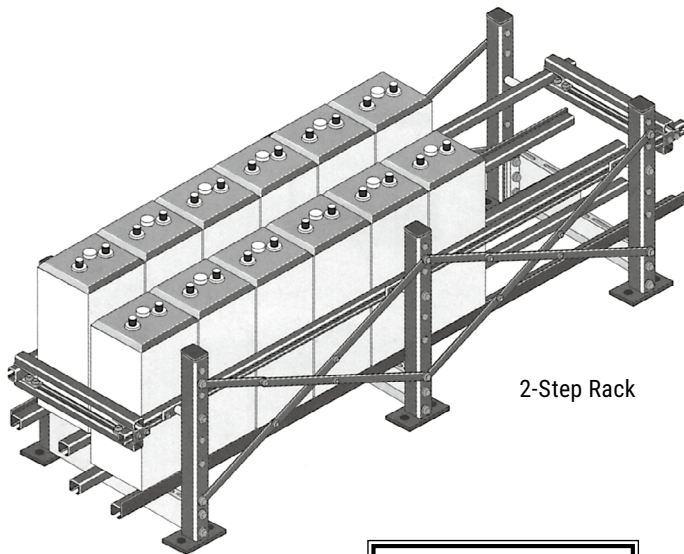

2-Step Rack

SBS has many different seismic rack designs available to meet almost all seismic rack requirements. We offer adjustable racks, racks designed specifically for our batteries, and racks that can be used with other manufacturers' batteries. We can custom-design racks when needed.

SBS seismic racks are either certified, or built to Seismic Zone 4 IBC/UBC standards.

### Available styles

- 2-Step
- 2-Tier
- 2-Step/2-Tier
- 1-Row (1-Tier)
- 2-Row
- Custom

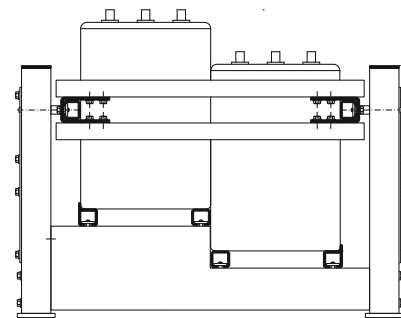
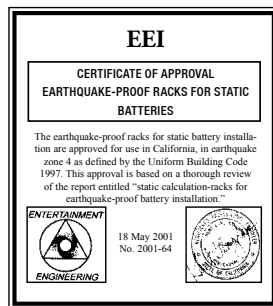

2-Step Rack Profile

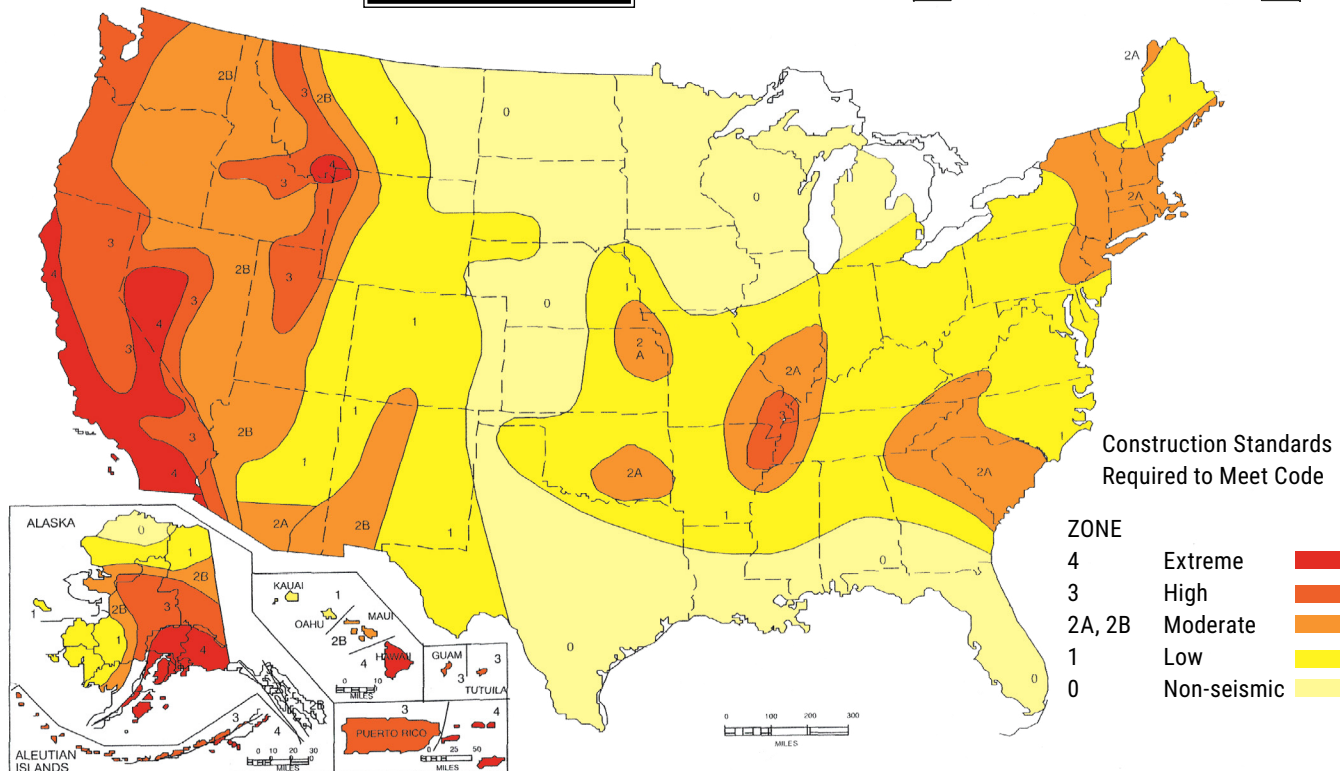

# Spill Containment Systems

High Density Polyethylene Pans and Neutralizing Pillows

The Uniform Fire Code (UFC) Article 64, Section 104.d and 104.e requires lead acid battery installations with more than 100 gallons of electrolyte be equipped with a "liquid-tight" spill-control barrier system. It also requires an approved method, capable of neutralizing a spill from the largest lead acid battery.

In response to these new requirements, SBS offers a spill containment system solution. SBS's system is quick and easy to install with new battery racks.

## Features

- Welded 5/16" thick HDPE pans in multiple sizes
- 12" x 12" Flame retardant acid absorbing/neutralizing pillows (10" x 10" NiCd pillows available as an option)
- Complies with EPA, OSHA, and Uniform Fire Code 64
- Acid tight, 4" tall barrier protects from corrosion
- Quick and easy installation
- Cost effective solution to electrolyte spills
- Custom sizes available

## How Our System Works

- SBS stocks different size spill pans that can be placed together in multiple combinations to form different spill containment system lengths and widths.
- We provide pillows and connectors that hold the pans together.
- Your rack will fit inside our spill containment system. If you are mounting the racks to the floor, you drill through the pans where needed and silicone the bolt and hole to provide a 100% leak-proof system.

SPILL CONTAINMENT SYSTEMS

12 in. Wide Spill Containment Systems			23 in. Wide Spill Containment Systems			25 in. Wide Spill Containment Systems		
Part No.	Size L x W x H (in.)	# of Pillows	Part No.	Size L x W x H (in.)	# of Pillows	Part No.	Size L x W x H (in.)	# of Pillows
SC23-12P2	23 x 12 x 4	2	SC37-23P6	37 x 23 x 4	6	SC23-25P4	23 x 25 x 4	4
SC28-12P2	28 x 12 x 4	2	SC42-23P6	42 x 23 x 4	6	SC28-25P4	28 x 25 x 4	4
SC34-12P3	34 x 12 x 4	3	SC49-23P8	49 x 23 x 4	8	SC34-25P6	34 x 25 x 4	6
SC46-12P4	46 x 12 x 4	4	SC50-23P8	50 x 23 x 4	8	SC46-25P8	46 x 25 x 4	8
SC51-12P4	51 x 12 x 4	4	SC54-23P8	54 x 23 x 4	8	SC51-25P8	51 x 25 x 4	8
SC57-12P5	57 x 12 x 4	5	SC62-23P10	62 x 23 x 4	10	SC57-25P10	57 x 25 x 4	10
SC62-12P5	62 x 12 x 4	5	SC67-23P10	67 x 23 x 4	10	SC62-25P10	62 x 25 x 4	10
SC68-12P5	68 x 12 x 4	5	SC75-23P12	75 x 23 x 4	12	SC68-25P10	68 x 25 x 4	10
SC74-12P6	74 x 12 x 4	6	SC79-23P12	79 x 23 x 4	12	SC74-25P12	74 x 25 x 4	12
SC84-12P7	84 x 12 x 4	7	SC84-23P14	84 x 23 x 4	14	SC84-25P14	84 x 25 x 4	14
SC90-12P7	90 x 12 x 4	7	SC92-23P14	92 x 23 x 4	14	SC90-25P14	90 x 25 x 4	14
SC96-12P8	96 x 12 x 4	8	SC96-23P16	96 x 23 x 4	16	SC96-25P16	96 x 25 x 4	16
SC102-12P8	102 x 12 x 4	8	SC104-23P16	104 x 23 x 4	16	SC102-25P16	102 x 25 x 4	16
SC107-12P9	107 x 12 x 4	9	SC109-23P18	109 x 23 x 4	18	SC107-25P18	107 x 25 x 4	18
SC114-12P10	114 x 12 x 4	10	SC121-23P20	121 x 23 x 4	20	SC114-25P20	114 x 25 x 4	20
SC119-12P10	119 x 12 x 4	10	SC126-23P20	126 x 23 x 4	20	SC119-25P20	119 x 25 x 4	20
SC125-12P10	125 x 12 x 4	10	SC134-23P22	134 x 23 x 4	22	SC125-25P20	125 x 25 x 4	20
SC130-12P10	130 x 12 x 4	10	SC138-23P22	138 x 23 x 4	22	SC130-25P20	130 x 25 x 4	20
SC136-12P11	136 x 12 x 4	11	SC142-23P22	142 x 23 x 4	22	SC136-25P22	136 x 25 x 4	22
SC148-12P12	148 x 12 x 4	12	SC151-23P24	151 x 23 x 4	24	SC148-25P24	148 x 25 x 4	24
SC159-12P13	159 x 12 x 4	13	SC168-23P28	168 x 23 x 4	28	SC159-25P26	159 x 25 x 4	26
SC164-12P13	164 x 12 x 4	13	SC176-23P30	176 x 23 x 4	30	SC164-25P26	164 x 25 x 4	26
SC170-12P14	170 x 12 x 4	14	SC180-23P30	180 x 23 x 4	30	SC170-25P28	170 x 25 x 4	28
SC198-12P17	198 x 12 x 4	17	SC193-23P32	193 x 23 x 4	32	SC198-25P34	198 x 25 x 4	34
SC221-12P19	221 x 12 x 4	19	SC217-23P36	217 x 23 x 4	36	SC221-25P38	221 x 25 x 4	38



SC67-28P10 - Example System

**Above system consists of:**

- A: Qty. 1     42" x 28" x 4" pan
- B: Qty. 1     25" x 28" x 4" pan
- C: Qty. 1     27" connector
- D: Qty. 10    12" x 12" pillows

28 in. Wide Spill Containment Systems			34 in. Wide Spill Containment Systems			42 in. Wide Spill Containment Systems		
Part No.	Size L x W x H (in.)	# of Pillows	Part No.	Size L x W x H (in.)	# of Pillows	Part No.	Size L x W x H (in.)	# of Pillows
SC37-28P6	37 x 28 x 4	6	SC37-34P9	37 x 34 x 4	9	SC23-42P6	23 x 42 x 4	6
SC42-28P6	42 x 28 x 4	6	SC42-34P9	42 x 34 x 4	9	SC28-42P6	28 x 42 x 4	6
SC49-28P8	49 x 28 x 4	8	SC49-34P12	49 x 34 x 4	12	SC34-42P9	34 x 42 x 4	9
SC50-28P8	50 x 28 x 4	8	SC50-34P12	50 x 34 x 4	12	SC46-42P12	46 x 42 x 4	12
SC54-28P8	54 x 28 x 4	8	SC54-34P12	54 x 34 x 4	12	SC51-42P12	51 x 42 x 4	12
SC62-28P10	62 x 28 x 4	10	SC62-34P15	62 x 34 x 4	15	SC57-42P15	57 x 42 x 4	15
SC67-28P10	67 x 28 x 4	10	SC67-34P15	67 x 34 x 4	15	SC62-42P15	62 x 42 x 4	15
SC75-28P12	75 x 28 x 4	12	SC75-34P18	75 x 34 x 4	18	SC68-42P15	68 x 42 x 4	15
SC79-28P12	79 x 28 x 4	12	SC79-34P18	79 x 34 x 4	18	SC74-42P18	74 x 42 x 4	18
SC84-28P14	84 x 28 x 4	14	SC84-34P21	84 x 34 x 4	21	SC84-42P21	84 x 42 x 4	21
SC92-28P14	92 x 28 x 4	14	SC92-34P21	92 x 34 x 4	21	SC90-42P21	90 x 42 x 4	21
SC96-28P16	96 x 28 x 4	16	SC96-34P24	96 x 34 x 4	24	SC96-42P24	96 x 42 x 4	24
SC104-28P16	104 x 28 x 4	16	SC104-34P24	104 x 34 x 4	24	SC102-42P24	102 x 42 x 4	24
SC109-28P18	109 x 28 x 4	18	SC109-34P27	109 x 34 x 4	27	SC107-42P27	107 x 42 x 4	27
SC121-28P20	121 x 28 x 4	20	SC121-34P30	121 x 34 x 4	30	SC114-42P30	114 x 42 x 4	30
SC126-28P20	126 x 28 x 4	20	SC126-34P30	126 x 34 x 4	30	SC119-42P30	119 x 42 x 4	30
SC134-28P22	134 x 28 x 4	22	SC134-34P33	134 x 34 x 4	33	SC125-42P30	125 x 42 x 4	30
SC138-28P22	138 x 28 x 4	22	SC138-34P33	138 x 34 x 4	33	SC130-42P30	130 x 42 x 4	30
SC142-28P22	142 x 28 x 4	22	SC142-34P33	142 x 34 x 4	33	SC136-42P33	136 x 42 x 4	33
SC151-28P24	151 x 28 x 4	24	SC151-34P36	151 x 34 x 4	36	SC148-42P36	148 x 42 x 4	36
SC168-28P28	168 x 28 x 4	28	SC168-34P42	168 x 34 x 4	42	SC159-42P39	159 x 42 x 4	39
SC176-28P30	176 x 28 x 4	30	SC176-34P45	176 x 34 x 4	45	SC164-42P39	164 x 42 x 4	39
SC180-28P30	180 x 28 x 4	30	SC180-34P45	180 x 34 x 4	45	SC170-42P42	170 x 42 x 4	42
SC193-28P32	193 x 28 x 4	32	SC193-34P48	193 x 34 x 4	48	SC198-42P50	198 x 42 x 4	50
SC217-28P36	217 x 28 x 4	36	SC217-34P54	217 x 34 x 4	54	SC221-42P56	221 x 42 x 4	56

# Battery & Charger Enclosures

Custom-Built NEMA 1, 3R and 12 Enclosures

SBS designs and builds custom DC enclosures for battery systems and/or chargers. A typical cabinet integrates batteries, racking and chargers into an indoor (NEMA 1 or 12) or outdoor (NEMA 3R) rated enclosure. There are many different options and accessories available, making every system unique and built to your site-specific needs.

## Typical Industry Standards

- NEMA Type 1, 3R, 12
- UL Listed Type 1, 3R, 12
- CSA Type 1, 3R, 12
- IEC 60529



## Typical Features

- ANSI-61 gray powder coated finish
- Carbon steel (0.104 – 0.125")
- Continuously welded and ground smooth seams
- Lifting eyes for easy handling
- Concealed door hinges
- Key / Padlocking handle
- 3-point locking mechanism
- Body stiffeners
- Oil resistant gasket
- Ground stud on door
- Print pocket provided on door
- Provision for mounting LED light

## Accessories and Options

- Grill and washable filter kit
- Fan kit (includes grill and filter)
- Rain hood (for outdoor NEMA 3R applications)
- Door-activated LED lighting
- NEMA 12 vents and fan kit
- Subpanel
- Heater with built-in thermostat
- Floor stand kit (6" or 12" stands available)
- Drip shield
- Viewing window
- Batteries (Flooded LA, VRLA or NiCd)
- Battery rack and rack installation
- Spill containment
- Battery charger and charger installation
- DC cabling

**NEMA Type 1** – Enclosures are for indoor use to provide a degree of protection to personnel against access to hazardous parts and to provide a degree of protection of the equipment inside the enclosure against ingress of solid foreign objects (falling dirt). ***This is a basic indoor cabinet that will include venting for batteries.***

**NEMA Type 3R** – Enclosures are for indoor or outdoor use to provide a degree of protection to personnel against access to hazardous parts; to provide a degree of protection of the equipment inside the enclosure against ingress of solid foreign objects (falling dirt); to provide a degree of protection with respect to harmful effects on the equipment due to the ingress of water (rain, sleet, snow); and that will be undamaged by the external formation of ice on the enclosure. ***This is a typical outdoor cabinet that will require rain hoods for the vents.***

**NEMA Type 12** – Enclosures are for indoor use to provide a degree of protection to personnel against access to hazardous parts; to provide a degree of protection of the equipment inside the enclosure against ingress of solid foreign objects (falling dirt and circulating dust, lint, fibers, and flyings); and to provide a degree of protection with respect to harmful effects on the equipment due to the ingress of water (dripping and light splashing). ***This cabinet will require NEMA 12 vents and/or cooling fans.***



# Tips for Designing Enclosures

- What equipment will be installed inside the enclosure? Only a charger? A battery/rack? A battery/rack and charger? Will other equipment such as spill containment or a DC disconnect switch be mounted inside the enclosure?
- After the equipment is decided upon, the details of that equipment must be determined. If the batteries are known, the next step is to determine the rack type and size, and, if required, the spill containment size. If a charger is being installed, what is the cabinet style/size? This is all necessary information for determining the minimum length, width and height of the enclosure.
- There may be multiple ways to configure the cabinet, so consider all possible options. For instance, if a battery, rack and charger are required the system can be designed using a 2-step rack with the charger mounted above, or with a 2-tier rack with the charger mounted to the side of the rack. Depending on the equipment being installed, one solution may be a more logical choice than the other.
- A rack measuring 47.24" L x 23" D cannot be installed in a 48" L x 24" D enclosure. The dimensions of the cabinets are the outside dimensions, so it is important to take into account the thickness of the material and body stiffeners that are attached to the sides and back of the cabinet for support, fans that take up internal length, etc.

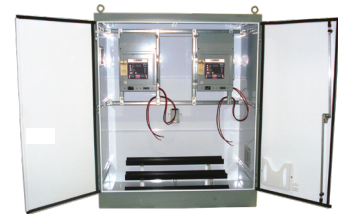
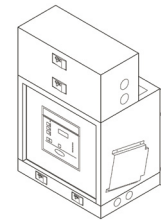
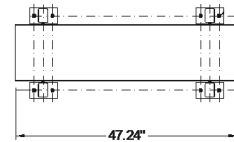
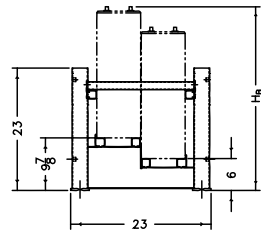

## Length and Depth (Width) Considerations:

- For the length, if a fan is required, factor in 3" of extra space per side or 6" total.  
*Example: a 45" L rack will need an extra 3" per side or a minimum cabinet length of 51" L (round up to 60" L).*  
If a fan is not required, 1" of space per side is acceptable, so a 48" L cabinet could work.
- For the depth, factor in 1" of extra space for the front and back or 2" total.  
*Example: a 22" D rack will safely fit into a 24" D cabinet.*
- If a spill containment system is being installed, use the tray dimensions, rather than the rack dimensions, and the same rules above apply.

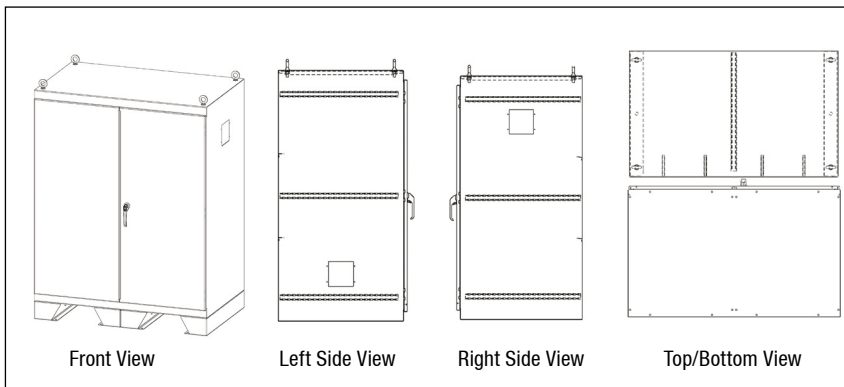

## Height Considerations:

Chargers need room to breathe and batteries need extra room above for maintenance (watering and testing). To calculate the minimum height of the cabinet, use this general information/formula:

$$\text{Minimum Cabinet Height} = \text{Rack height (to top of rail)} + \text{Battery height} + \text{Space above battery (12" ideal)} + \text{Charger height} + \text{6" (for space above charger)}$$

*Example: Rack height = 10" Battery height = 19" Charger = 25"*

*Minimum enclosure height = 10" + 19" + 12" + 25" + 6" = 72" (use 72" H cabinet minimum)*

Note: if there is a situation where the above rules cause an issue, contact SBS for possible rack/cabinet customizations.

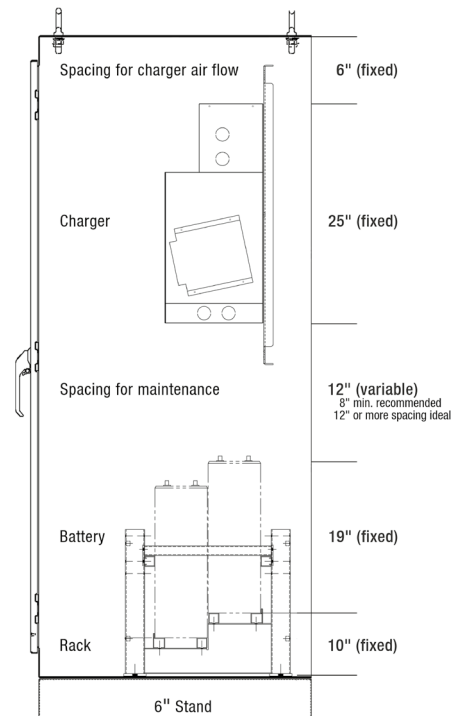

# Common Battery Enclosure Sizes

## Technical Data

Part No.	No. of Doors	Length (in.) [w/ rain hoods]	Width/Depth (in.)	Height (in.) [w/ 6" legs & eye bolts]	Vent/Fan Size (in.)
SBS-603624STD	1 door	36 [45]	24	60 [67.75]	6
SBS-723624STD	1 door	36 [44]	24	72 [79.75]	6
SBS-723636STD	1 door	36 [45]	36	72 [79.75]	6
SBS-903636STD	1 door	36 [45]	36	90 [97.75]	6
SBS-724824STD	1 door	48 [57]	24	72 [79.75]	6
SBS-724836STD	1 door	48 [57]	36	72 [79.75]	6
SBS-726024STD	1 door	60 [69]	24	72 [79.75]	6
SBS-726036STD*	1 door	60 [69]	36	72 [79.75]	6
SBS-907224STD*	2 door	72 [81]	24	90 [97.75]	6
SBS-907236STD*	2 door	72 [81]	36	90 [97.75]	6
SBS-8611230STD*	3 door	112 [121]	30	86 [93.75]	10
SBS-8614930STD*	4 door	149 [158]	30	86 [93.75]	10

\*These models typically use two sets of legs.



Single door cabinet



Two door cabinet



Three door cabinet

## Standard/Typical Accessories

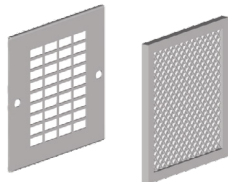

**NEMA1 grille & washable aluminum filter kit** - Stainless steel grill with thumb screws. Available in 6" and 10" sizes.



**Charger subpanel and charger installation** - Full or half size subpanels can be installed inside the enclosure to mount the charger and other equipment. This feature is common when a charger is pre-installed inside an enclosure. The subpanel typically mounts to the sides of the cabinets and can telescope towards the front or back of the cabinet.

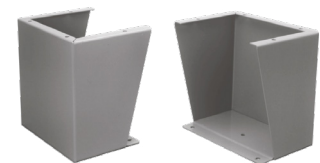

**Floor stand kit** (required for NEMA Type 3R applications) - Kit includes two stands. Larger cabinets require two kits (4 stands). Stands measuring 6"H are standard and 12" stands are optional.

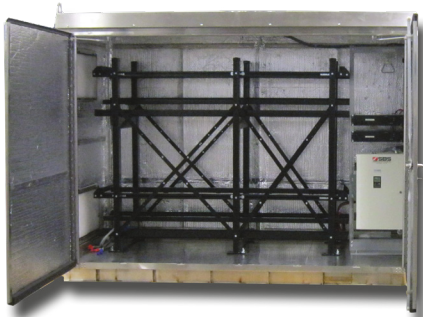

**Rack assembly and installation** - SBS will assemble and mount the battery rack inside the cabinet so once the enclosure is set in place it can be loaded with the batteries. To permanently mount the rack, the floor stand kit is required.



**DC cabling** - SBS will supply and connect the DC cables to the charger and provide the proper cable, lugs and insulating covers needed to connect to the supplied battery.

# Battery Enclosure Options

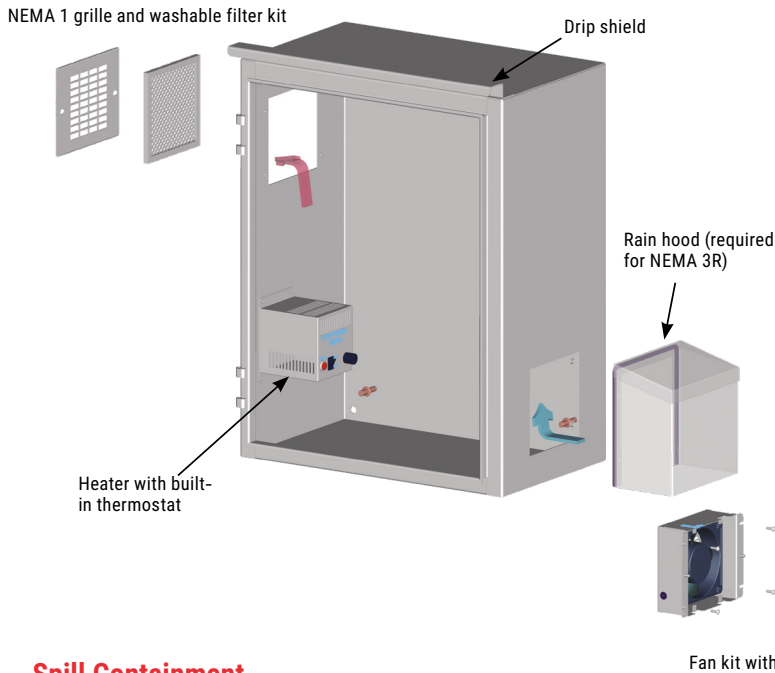

## NEMA Type 3R and 12 Applications

- **Rain hoods** - When added to the standard grille/filter kit or to the fan/grille/filter kit, these will prevent rain, sleet, snow or water from being drawn into the enclosure. Rain hoods are necessary for outdoor NEMA Type 3R applications.
- **Drip shield** - Protects door hardware against dripping water and settling dust.
- **NEMA Type 12 grille and washable filter kit** - Housing and grille are made of heat resistant ABS-FR black material.
- **NEMA Type 12 fan kit with grille and filter** - Housing and grille are made of heat resistant ABS-FR black material. 110 Vac 60Hz or 230 Vac 50/60Hz input available.

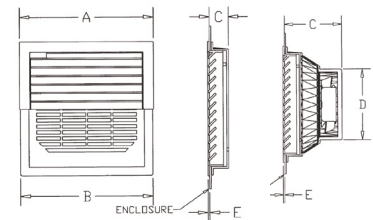

## Spill Containment

- SBS spill containment system can be pre-installed under our standard or seismic rack. They can be supplied with or without acid-absorbing and neutralizing pillows.

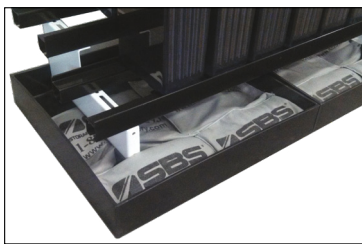

## Thermal Management/Venting

- **Heater with built-in thermostat** - Models available with either 120 Vac 60Hz or 230 Vac 50/60Hz input from 125–800 Watts. Brushed aluminum housing, thermostat range is 0 to 100° F, fan blows heat upwards, switch for auto or fan setting. UL recognized component.
  - **Fan kit with grille and filter** - This kit is designed to bring outside air into the enclosure from the bottom and force the hot air out of the top of the other side. In a battery application the fan will also help to force built up hydrogen gas out. The fan kit increases the venting efficiency and reduces the temperature inside of the cabinet to the outside ambient temperature. 110 Vac 60Hz or 230 Vac 50/60Hz input options available.
- **Thermostat for fan** - Set point range of 30 to 140° F. Normally Open (NO) contact to operate switch. Switch capacity: 10Amp 120 – 250 Vac resistive load, 1Amp 120 – 250 Vac inductive load, 1.25Amp 24 Vdc 35mm DIN rail mounted.



## Other Options

- **Viewing window** - 13" x 8" x 0.25" polycarbonate window typically used for viewing charger without opening the cabinet door(s). NEMA Type 1, 3R or 12.
- **Door activated LED light** - Overhead light turns on when the cabinet door is opened. 120 Vac input option includes AC receptacle and 110–277 Vac input option does not include AC receptacle.
- **Stainless steel** - SS cabinets and accessories available for marine/offshore/coastal environments. Stainless steel provides improved resistance to salt, some acids and high temperatures.
- **Hydrogen detector** - SBS-H2 hydrogen detector can be installed inside cabinet and can operate fan when 1% or greater hydrogen levels are detected. 2nd form C contact can be connected to your alarm/SCADA system.



Note: All AC wiring must be completed on-site by a licensed electrician. SBS does not perform any AC wiring.

# AT Series Battery Chargers

## Stationary Battery Float Chargers



The AT10 and AT30 series chargers offer a combination of advanced technology microprocessor control and performance engineered modular construction which make them easy to set up, operate, and maintain. Single phase units (AT10) are available from 12–130 Vdc and rated from 6 to 100 Amps. Three phase units (AT30) are available from 12–130 Vdc and rated from 25 to 1000 Amps.

### Standard Features

- Local LEDs and common form “C” alarm contact for AC and DC fail, high and low Vdc, positive and negative ground fault
- 1% digital LED meter for Vdc, Adc, timer hours & alarm settings
- 1% or less ripple with battery connected (unfiltered model)
- Manual or automatic 0–255 hour equalize timer
- Seismic Zone 4 analyzed/qualified
- ANSI 61 gray powder coated finish
- AC and DC breakers
- 30 year design life
- Current limit from 50% to 110%
- High DC voltage shutdown
- Reverse polarity protection
- NEMA and IEEE compliant
- UL and CSA listed

### Applications

- Substations/Switchgear
- Power Generation
- Telecommunications
- UPS
- Microwave Relay Sites

CHARGERS



### Common Available Options

- Filtered charger: 30mVrms filtering with battery connected\*
- Battery eliminator: 30mVrms filtering without battery connected\*
- Individual Form C alarm contacts/relays
- Medium or High rated AC & DC breakers
- Ground pad with compression terminal
- Lightning arrestor
- Fungus proofing/tropicalization
- Static proofing

\*100 Vrms for 130V DC models

### AT Accessory Ordering Information

Part No.	Description
EJ5033-00	Temp. compensation probe assembly w/ 25 ft. cable
EJ5033-01	Temp. compensation probe assembly w/ 50 ft. cable
EJ5033-02	Temp. compensation probe assembly w/ 100 ft. cable
EJ5033-03	Temp. compensation probe assembly w/ 200 ft. cable
EJ5037-01	Comm. kit using Modbus or DNP3 Protocols - 12 Vdc
EJ5037-02	Comm. kit using Modbus or DNP3 Protocols - 24 Vdc
EJ5037-03	Comm. kit using Modbus or DNP3 Protocols - 48 Vdc
EJ5037-04	Comm. kit using Modbus or DNP3 Protocols - 130 Vdc
EJ5226-XX	Ethernet gateway for Modbus or DNP3
EJ5126-00	Forced load sharing cable - 15 ft.
EJ5126-01	Forced load sharing cable - 25 ft.
EJ5126-02	Forced load sharing cable - 50 ft.
EJ5017-05	Fan control contactor - 10A @ 120/240 Vac - 48 Vdc
EJ5017-06	Fan control contactor - 10A @ 120/240 Vac - 130 Vdc
EJ5017-15	Fan control contactor - 20A @ 120/240 Vac - 48 Vdc
EJ5017-16	Fan control contactor - 20A @ 120/240 Vac - 130 Vdc
EI0191-00	Drip shield assembly for 586/594 cabinet
EI0191-01	Drip shield assembly for 5017 cabinet
EI0191-02	Drip shield assembly for 5018 cabinet
EI0192-00	44"H floor stand for 586/594/5017 cabinet
EI0192-02	60"H floor stand for 586/594/5017 cabinet
EI0193-00	19/23/24" Relay rack brackets for 586/594 cabinet
EI0193-01	19" Relay rack brackets for 5017 cabinet
EI0193-02	23/24" Relay rack brackets for 5017 cabinet
EI0193-03	23/24" Relay rack brackets for 5018 cabinet
EI5008-00	Wall mounting kit for 5018 cabinet
Contact SBS	NEMA 4/12 enclosure
Contact SBS	Export packaging
JH0003-XX	Approval or As-Built drawings
Many other options are available; contact SBS for details	

### Cabinet Information

Cabinet Style	Dimensions (in.) W x D x H (H*)	Wall Mount	Floor Mount	Rack Mount
586	16.3 x 10.3 x 15.4 {22.7*}	Std.	Opt.	Opt.
594	19.5 x 12.8 x 17.8 {25.0*}	Std.	Opt.	Opt.
5017	19.3 x 16.0 x 26.8	Std.	Opt.	Opt.
5018	20.9 x 16.8 x 38.0	Opt.	Std.	Opt.
5030	30.0 x 19.2 x 54.3	N/A	Std.	N/A
163	42.3 x 25.1 x 62.6	N/A	Std.	N/A
198	58.0 x 30.0 x 80.0	N/A	Std.	N/A

\*Height with penthouse  
 Std. = Standard  
 Opt. = Available as option  
 N/A = Not available



# AT10 6-25 Amps Single-Phase

## Group 1 Ordering Code (For AT10 Single Phase Chargers 6-25A)

	A	B	C	D	E	F	G	H	J	K	L
Your Code	AT10										

Description	Code	Feature
A	AT10	AT10 Series
B Nominal DC Output Voltage	012	12 Vdc
	024	24 Vdc
	048	48 Vdc
	130	130 Vdc
C Nominal DC Output Current	006	6 Adc
	012	12 Adc
	016	16 Adc
	020	20 Adc
	025	25 Adc
D Filtering	U	Unfiltered
	F	Filtered
	E	Eliminator
E AC Input Voltage (Standard)	240	120/208/240V, 60 Hz*
	480	480V, 60 Hz
	220	220V, 50/60 Hz
E AC Input Voltage (Custom)	416	380/416V, 50/60 Hz

Description	Code	Feature
	AT10	AT10 Series
F Circuit Breaker Rating	S	Standard
	M	Medium
	H	High
G Aux Relay Board	AUX	Installed
	XXX	Not Supplied
H Ground Pad	G	Installed
	X	Not Supplied
J Lightning Arrestor	L	Installed
	X	Not Supplied
K Fungus Proofing	F	Installed
	X	Not Supplied
L Static Proofing	S	Installed
	X	Not Supplied

\*Wired for 240 Vac unless otherwise specified, re-tappable in field. Consult SBS for additional options and pricing.

12 Vdc		
Ampere Rating	Cabinet Style	Shipping Weight
6	586	83
12	586	87
16	586	92
20	586	118
25	586	100
30	5017	184
40	5017	189
50	5017	194
75	5018	199
100	5018	225

24 Vdc		
Ampere Rating	Cabinet Style	Shipping Weight
6	586	99
12	586	109
16	586	115
20	586	119
25	586	136
30	5017	259
40	5017	267
50	5017	342
75	5018	355
100	5018	360

# AT10 30-100 Amps Single-Phase

## Group 2 Ordering Code (For AT10 Single Phase Chargers 30-100A)

	A	B	C	D	E	F	G	H	J	K	L	M	N	P
Your Code	AT10													

Description	Code	Feature
A	AT10	AT10 Series
B Nominal DC Output Voltage	012	12 Vdc
	024	24 Vdc
	048	48 Vdc
	130	130 Vdc
C Nominal DC Output Current	030	30 Adc
	040	40 Adc
	050	50 Adc
	075	75 Adc
	100	100 Adc
D Filtering	U	Unfiltered
	F	Filtered
	E	Eliminator
E AC Input Voltage Group 2 ratings cannot be re-tapped in field	120	120V, 60 Hz
	208	208V, 60 Hz
	240	240V, 60 Hz
	480	480V, 60 Hz
	220	220V, 50/60 Hz
	380	380V, 50/60 Hz
416	416V, 50/60 Hz	

Description	Code	Feature
	AT10	AT10 Series
F AC Circuit Breaker	S	Standard AIC
	M	Medium AIC
	H	High AIC
	O	No Breaker
	F	Installed
G AC Input Fuses	X	Not Supplied
	S	Standard AIC
H DC Circuit Breaker	M	Medium AIC
	H	High AIC
	O	No Breaker
	F	Installed
J DC Fuses	X	Not Supplied
	A	Installed
K Aux Relay Board	X	Not Supplied
	G	Installed
L Ground Pad	X	Not Supplied
	L	Installed
M Lightning Arrestor	X	Not Supplied
	F	Installed
N Fungus Proofing	X	Not Supplied
	S	Installed
P Static Proofing	X	Not Supplied

48 Vdc		
Ampere Rating	Cabinet Style	Shipping Weight
6	586	105
12	586	120
16	594	155
20	594	170
25	594	180
30	5017	217
40	5017	225
50	5017	250
75	5018	433
100	5018	450

130 Vdc		
Ampere Rating	Cabinet Style	Shipping Weight
6	586	130
12	594	155
16	594	215
20	594	225
25	594	265
30	5017	285
40	5018	340
50	5018	375
75	5018	482
100	N/A	N/A

# AT30 25-1000 Amps Three-Phase

Ordering Code (For AT30 Three Phase Chargers)														
	A	B	C	D	E	F	G	H	J	K	L	M	N	P
Your Code	AT30													

Description	Code	Feature
<b>A</b>	<b>AT30</b>	<b>AT30 Series</b>
<b>B</b> Nominal DC Output Voltage	012	12 Vdc
	024	24 Vdc
	048	48 Vdc
	130	130 Vdc
<b>C</b> Nominal DC Output Current	See Ratings Table Below	
<b>D</b> Filtering	U	Unfiltered
	F	Filtered
	E	Eliminator
<b>E</b> AC Input Voltage* (3 Phase)	208	208 Vac, 60 Hz
	240	240 Vac, 60 Hz
	480	480 Vac, 60 Hz
	220	220V, 50/60 Hz
	380	380V, 50/60 Hz
	416	416V, 50/60 Hz
<b>F</b> AC Circuit Breaker	S	Standard AIC
	M	Medium AIC
	H	High AIC
	O	No AC Breaker

Description	Code	Feature
<b>G</b> High KAIC AC Input Fuses	F	Installed
	X	Not Supplied
<b>H</b> DC Circuit Breaker	S	Standard AIC
	M	Medium AIC
	H	High AIC
	O	No AC Breaker
<b>J</b> High KAIC DC Output Fuses	F	Installed
	X	Not Supplied
<b>K</b> Auxiliary Relay Board	A	Installed
	X	Not Supplied
<b>L</b> Ground Pad	G	Installed
	X	Not Supplied
<b>M</b> Lightning Arrestor	L	Installed
	X	Not Supplied
<b>N</b> Fungus Proofing	F	Installed
	X	Not Supplied
<b>P</b> Static Proofing	S	Installed
	X	Not Supplied

\*Contact SBS for other AC input voltages not listed.

Ampere Rating	12 Vdc		24 Vdc		48 Vdc		130 Vdc	
	Cabinet Style	Shipping Weight	Cabinet Style	Shipping Weight	Cabinet Style	Shipping Weight	Cabinet Style	Shipping Weight
25	-	-	-	-	-	-	5018	370
30	-	-	-	-	-	-	5018	380
40	-	-	-	-	-	-	5018	390
50	5018	260	5018	280	5018	310	5018	400
75	5018	330	5018	340	5018	390	5018	490
100	5018	380	5018	390	5018	500	5030	650
125	5030	450	5030	540	5030	550	5030	740
150	5030	550	5030	580	5030	600	5030	750
200	5030	590	5030	610	5030	660	5030	820
250	5030	610	5030	650	5030	720	163	1130
300	5030	650	5030	690	5030	760	163	1330
400	-	-	163	1150	163	1100	163	1580
500	-	-	163	1300	163	1350	198	2150
600	-	-	163	1530	198	1600	198	2650
800	-	-	198	2020	198	2020	198	3250
1000	-	-	198	2440	198	2400	198	4200

Note: For 260 Vdc models contact SBS for SCR charger information

Consult SBS for additional options and pricing.

CHARGERS

# Portable Chargers

Maintenance Chargers For Lead Acid and Nickel Cadmium Batteries



## Portable Single Cell Charger: BB0442-01

- Boost charge a single cell without removing it from service (even while system is online)
- Provides a charge to a replacement cell prior to installation
- Input and output cables are stored inside the case when not in use
- Lightweight built-in carrying case with handle

### Input (AC)

- 6 ft., 120 Vac, 3-prong cord
- Input to output isolation is 2kV
- Input current less than 0.5 Ampere

### Output (DC)

- Selectable 1.8V (NiCd) or 2.6V (Lead Acid)
- Adjustable output voltage  $\pm 5\%$
- Output AC ripple is below 1%
- Selectable current limited at 3, 6 or 10 Amps

### Specifications

Part No.	DC Output (Amps)	DC Output (Volts)	AC Input (Volts)	AC Input Frequency	Dimensions L x D x H (in.)	Weight (lb.)
BB0442-01	3/6/10	1.8/2.6	120	60 Hz	12.3 x 6.8 x 4.5	12.0



## Universal Maintenance Charger: BB0443-XX

- Charges 20-140 Vdc battery systems
- AC input accepts 120, 208, 240 or 480 Vac at 60 Hz, single phase
- Filtered output as a battery eliminator allows the charger to operate without battery
- Output ripple:
  - 200mVrms without battery
  - 30mVrms with battery
- Current limit adjustable from 10-110%
- Mounted on a hand truck
- Input and output circuit breakers
- 2% analog AC ammeter
- 1% digital DC ammeter

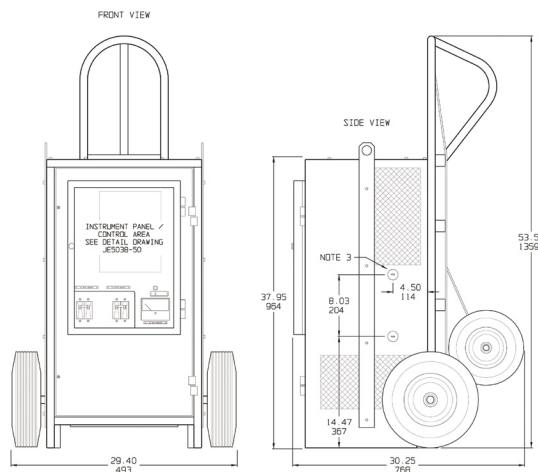

### Specifications

Part No.	DC Output (Amps)	DC Output (Volts)	AC Input (Volts)	AC Input Frequency	Dimensions L x D x H (in.)	Weight (lb.)
BB0443-00	25	20-140	120/208 240/480	60 Hz	29.4 x 30.3 x 53.5	290
BB0443-01	50	20-140	120/208 240/480	60 Hz	29.4 x 30.3 x 53.5	390

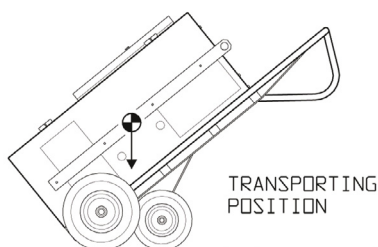

# SBS-2003 Digital Hydrometer / Density Meter

Digital Specific Gravity Tester with Bluetooth Downloading Capabilities



Specific gravity testing is easy and efficient with the SBS-2003. Simply insert the nozzle into the battery and depress the finger pump, which draws a few drops of sulfuric acid (H<sub>2</sub>SO<sub>4</sub>) through the tube. Within three seconds the measured refractive index is converted into a temperature-compensated specific gravity reading. The specific gravity, temperature and cell count are then displayed. After testing is completed, you can transfer the data to your computer via Bluetooth and download results into an Excel report.

Combining a light weight and durable design with easy maintenance, field-replaceable spare parts and a large data storage memory, the SBS-2003 is suitable for use with lead acid batteries.

## Benefits

- Measures specific gravity, ambient temperature and count
- Automatic temperature compensation to 77° F (or 25° C)
- Time savings: 5 times faster than conventional methods
- Stores up to 1000 readings
- Wirelessly transfers testing data to provided software to create an Excel report

## Features

- Able to record temperature in Fahrenheit or Celsius
- ±0.002 accuracy
- LCD display
- IP64 water resistant

## Applications

- Utility
- UPS
- Data Centers
- Telecom
- Material Handling

## Cost Savings Example

SBS field studies show that using the SBS-2003 is five times faster than using a standard glass hydrometer and thermometer.

If you spend 60 minutes testing specific gravities every month in 20 sites, this totals 60 minutes x 20 sites x 12 months per year = 14,400 minutes divided by 60 minutes = 240 labor hours per year.

Since we can reduce this time by 500%, 240 hours divided by 5 = 48 hours total time with the SBS-2003.

That's a savings of 192 hours per year. Multiplied by \$45.00 per hour labor cost with benefits: 192 x \$45.00 = \$8,640.00 of savings per year.

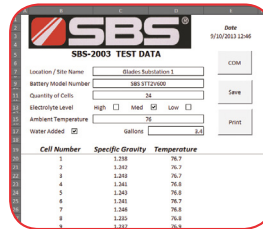

Data Archive/  
Export into Excel

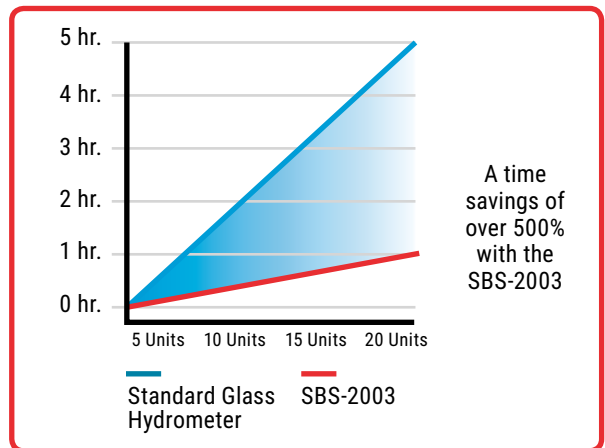

Video available at [www.sbsbattery.com/videos](http://www.sbsbattery.com/videos)



## Hydrometer/Resistance Tester Package 3 Steps for Easy Data Management & Storage

When combined with our SBS-6500 battery diagnostic tester, the SBS-2003 provides an all-in-one solution for your battery testing needs.

1. Press the 'SG Upload' button on the SBS-6500 resistance tester.
2. Follow prompts for the 3-step data transfer from the SBS-2003 hydrometer. The hydrometer will then upload all of its specific gravity readings into the SBS-6500.
3. Select the readings string to view and it inserts the SG information into the string. The combined SG and SBS-6500 readings will be integrated into a single report for battery analysis.



SBS-6500  
Battery Analyzer



SBS-2003  
Hydrometer

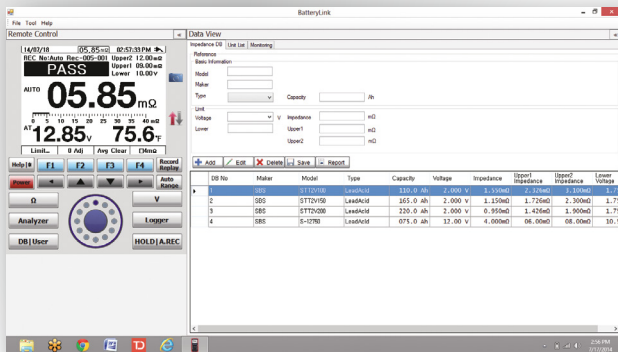

Specific gravity readings will be integrated into the SBS-6500 data/readings.

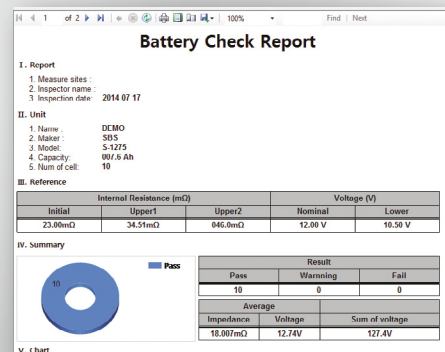

Now all data for each battery is in one, easy-to-read spreadsheet. The generated report will include the downloaded specific gravity readings.



### SBS-2003 Includes

- Main unit
- Instruction manual
- Excel template software
- Three (3) filling tubes
- 9V battery
- Adjustable hand strap
- Hard case

### Specifications

Method of Detection	Specific gravity; light refraction method
Temperature	Measuring: 5 to 40° C (41 to 104° F)
S.G. Range	1.000–1.400
Measuring Time	Within 3 seconds
Power Supply	(1) DC9V alkaline battery
Calibration	Distilled or de-ionized water
Accuracy	Specific gravity: ±0.002 @ 10 to 30° C (50 to 86° F) Temperature: ±1° C @ 10 to 30° C (1.8° F @ 50 to 86° F)
Size	2.75" D x 1.75" W x 8.25" H; 10.75 oz.
Filling Tube	9.5" L x 1/8" diameter

### Ordering Information

Part No.	Description
SBS-2003	Specific gravity tester (°F and °C)

### Accessory Ordering Information

Part No.	Description
2002/3-SPR-PRT-KIT	Spare parts kit includes: O-ring, sample chamber w/ rubber pump, (3) 9" filling tubes
2002/3-TUBE	9" filling tube for SBS-2003
2002/3-HOL	Holster w/ belt for SBS-2003
SBS-TE CASE	Soft case for hydrometer

# SBS-3500 Digital Hydrometer / Density Meter

Digital Specific Gravity Tester with Downloading Capabilities for NiCd or Lead Acid Batteries

The SBS-3500 uses oscillating U-tube technology to measure specific gravity and temperature of lead acid or nickel cadmium batteries within seconds. The unit is able to take readings between the range of 0.0000 to 3.0000. With the ability to communicate wirelessly to a printer or computer via the integrated IrDA interface, testing results can be uploaded into an easy-to-read report.

## Features

- Measures specific gravity, ambient temperature and count
- Tests both lead acid and nickel cadmium batteries
- Time savings: 5 times faster than conventional methods
- $\pm 0.001$  accuracy
- Automatic temperature compensation
- Compact, lightweight design enabling one-hand measurement
- Stores up to 100 sample IDs for easy sample identification
- Stores up to 1024 measurements including time stamps and sample IDs
- Infrared data interface for data exchange
- LCD display



## SBS-3500 Includes

- Main unit
- Instruction manual
- IR computer link and driver
- 7" filling tube
- Carrying case

## Ordering Information

Part No.	Description
SBS-3500	Specific gravity tester ( $^{\circ}$ F and $^{\circ}$ C)

## Accessory Ordering Information

Part No.	Description
SBS-3500-TUBE	7" filling tube for SBS-3500
SBS-3500-PUMP	Replacement hand pump for SBS-3500

## Specifications

Method of Detection	Specific gravity; oscillating tube method
Temperature	Measuring: 0 to 40 $^{\circ}$ C (32 to 104 $^{\circ}$ F) Ambient: -10 to 50 $^{\circ}$ C (14 to 122 $^{\circ}$ F) Storage: -20 to 70 $^{\circ}$ C (-4 to 158 $^{\circ}$ F)
S.G. Range	0.0000-3.0000
Measuring Time	Within 3 seconds
Power Supply	(2) AA batteries
Calibration	With dry air or pure water
Accuracy	$\pm 0.001$ ; temperature: 0.2 $^{\circ}$ C (0.4 $^{\circ}$ F)
Size	5.5" L x 5.4" W x 1" H, 12.2 oz.
Filling Tube	7" L



## Applications

- Utility
- UPS
- Data Centers
- Telecom
- Material Handling
- Battery Manufacturing

# SBS-3510 Digital Hydrometer / Density Meter

Digital Specific Gravity Tester with Downloading Capabilities for NiCd or Lead Acid Batteries

The SBS-3510 uses oscillating U-tube technology to measure specific gravity and temperature of lead acid or nickel cadmium batteries within seconds. The unit is able to take readings between the range of 0.0000 to 3.0000. With the ability to communicate wirelessly to a printer or computer via the integrated Bluetooth interface, testing results can be uploaded into an easy-to-read report.

Unlike other digital hydrometers on the market, the measuring cell can be replaced if damage occurs. This design feature eliminates the need to replace the entire unit should the measuring cell become damaged.

Maintaining the digital hydrometer through proper maintenance is essential to long lasting service life and accuracy. SBS recommends a maintenance interval of at least once a year. SBS is able to meet all digital service needs.

## Features

- Measures specific gravity, ambient temperature and count
- Tests both lead acid and nickel cadmium batteries
- Time savings: 5 times faster than conventional methods
- ± 0.001 accuracy
- Automatic temperature compensation
- Compact, lightweight design enabling one-hand measurement
- Stores up to 100 sample IDs for easy sample identification
- Stores up to 1024 measurements including time stamps and sample IDs
- Bluetooth interface for data exchange
- Ability to connect with the SBS-6500 impedance tester via Bluetooth for integrated data and reporting
- LCD display



Measuring Cell



SBS-3510

SBS-6500

## SBS-3510 Includes

- Main unit
- Instruction manual
- Built-In Bluetooth
- 7" filling tube
- Carrying case

## Applications

- Utility
- UPS
- Data Centers
- Telecom
- Material Handling
- Battery Manufacturing

## Ordering Information

Part No.	Description
SBS-3510	Specific gravity tester (°F and °C)

## Accessory Ordering Information

Part No.	Description
SBS-3510-Tube-Long	23.6" filling tube
SBS-3510-TUBE	90 degree bent filling tube
SBS-3510-Cell-Boot	Rubber housing measuring cell
SBS-3510-Boot	Rubber housing operating panel
SBS-3510-Wriststrap	Spare wristband
SBS-3510-Carrystrap	Set carrying straps
SBS-3510-Bluetooth-USB	Bluetooth USB adapter
SBS-3510-Printer	Printer CMP-20BT Bluetooth/RS232C

## Specifications

Method of Detection	Specific gravity; oscillating tube method
Temperature	Measuring: 32 to 104° F (0 to 40° C) Ambient: 14 to 122° F (-10 to 50° C) Storage: -4 to 158° F (-20 to 70° C)
S.G. Range	0.0000-3.0000
Measuring Time	Within 3 seconds
Power Supply	(3) 1.5V AA (LR6) batteries
Calibration	With dry air or pure water
Accuracy	±0.001; temperature: 0.4° F (0.4° C)
Size	5.5" L x 5.4" W x 1" H, 12.2 oz.
Filling Tube	7" L

# SBS-6500 Battery Tester

Assists with IEEE/NERC Compliance

The SBS-6500 is a multipurpose impedance and voltage tester. Readings of cells and intercell connectors are taken within seconds using the included pin probes (or optional clamp probes). The SBS-6500 can be programmed with site names, battery details and pass/warning/fail alarm set points for ohmic measurements (pass/fail for voltage). All data is retained in the meter's internal memory for easy on-site access. With a computer and the included software, the SBS-6500 generates custom graphical reports for historical trending and comparisons.

The SBS-6500 pairs with our SBS-2003 digital hydrometer to import specific gravity readings from the SBS-2003 into the SBS-6500. With this data merge, the SBS-6500 will store and generate reports with voltage, ohmic, temperature and gravity readings.

Contains  
Data logger,  
SG Bluetooth  
Upload and  
USB PC  
Integration  
Software



## Benefits

- Quickly records and stores ohmic, voltage and temperature of strings, cells and intercell connectors
- Instantly retests and recalls readings on-site
- Pin probe or clamp probe compatible
- User-friendly software and easy-to-navigate menu
- Convenient battery string and parameter set up via unit or software
- Organizes data by name and parameters for each battery string (up to 300 strings)
- Optional ability to download specific gravity readings wirelessly from SBS-2003 hydrometer
- Meets IEEE and NERC maintenance recommendations for stationary battery systems

## Data Storage:

**300 battery strings  
x 250 cells per string x  
4 tests per year over a  
period of 25 years =  
7.5 million records**

## Applications

- Telecom
- Utility
- Oil and Gas
- Solar/Photovoltaic
- UPS
- Emergency Lighting
- Railways



## Functions

- Tests and records impedance, voltage and temperature readings of cells and intercell connectors
- On-screen pass/warning/fail indication during testing based on set parameters
- Stores and displays all historical data on handheld unit
- Communicates with computer and software via USB port
- Generates and displays battery string's test report and comparison data

## Features

- Versatile: tests flooded lead acid, VRLA, NiCd, Li-ion and NiMH batteries and strings
- Automatically measures and stores data within seconds
- Voltage testing range of 0-100 Vdc
- IEC 6101-1 CAT II 300V Safety Standard
- Built-in NiMH battery with unit charging cord
- Large 3.8" LCD backlit display

## Specifications

Size and Weight	4.2" W x 2.2" D x 8.3" H; 2.6 lb.
Storage	7,500,000 records
Ah Measurement Range	5-6000 Ah, 0-100 Vdc
Voltage Measurement	Resolution: 0.001V Accuracy: ±0.1%
Resistance Measurement	Range: 1 mΩ to 400Ω Resolution: 0.001 mΩ Accuracy: ±1.0%
Display	3.8" LCD, 320 x 240 backlit screen
Communication Interface	USB, Bluetooth w/ SBS-2003
Software	SBS-6500 Battery Management Software
Software Format	MS Windows
Power Supply	Rechargeable NiMH battery pack
Operation Time	8 hours
Operation Temperature	14° to 122° F



Video available at [www.sbsbattery.com/videos](http://www.sbsbattery.com/videos)

INTERNAL RESISTANCE TESTER



## Hydrometer & Resistance Tester Data Merge

When combined with our SBS-2003 hydrometer, the SBS-6500 provides an all-in-one solution for your battery testing needs. The hydrometer downloads specific gravity data directly into the SBS-6500 for viewing or reporting. When a report is created with the SBS-6500 software, correlating voltage, temperature, impedance and specific gravity data readings will be together in a single report.



SBS-2003  
Hydrometer



SBS-6500 Tester

## Battery Management Software (Included)

- Interface for loading string and alarm data to and from tester
- Exports into Excel and PDF formats for easy incorporation into custom reports
- Creates graphs and reports for battery analysis and trending

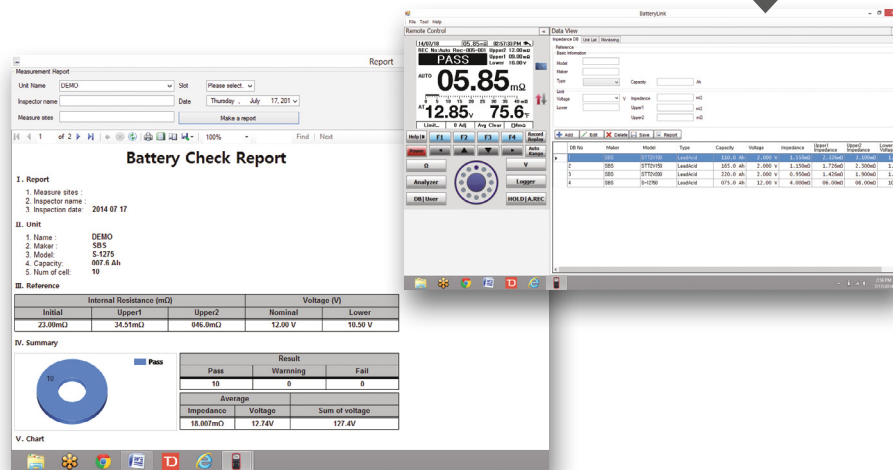

## SBS-6500 Includes

- Main unit
- Pin probes
- Instruction manual
- Quick start guide
- Software
- USB cable
- Unit charging cable
- NiMH battery
- Adjustable carrying strap
- Carrying case



Clamp Probes (optional)  
P/N 6500-CLAMP-PROBE

### Ordering Information

Part No.	Description
SBS-6500	Battery tester

### Accessory Ordering Information

Part No.	Description
SBS-2003	Specific gravity tester
6500-CLAMP-PROBE	Clamp probe leads
6500-PIN-PROBE	Replacement pin probe leads
6500-PIN	Replacement pin set for 6500-PIN-PROBES
6500-BATT	Spare NiMH battery for SBS-6500

# SBS-8400 Battery Capacity Tester with Monitoring

10–300 Vdc, 0–120 Amp Constant Current Load Bank with Individual Cell Monitoring Capabilities



The SBS-8400 is a versatile and fully programmable, constant current discharge load bank with detailed data acquisition and display capabilities. The unit features a user-friendly touch screen menu and a complete built-in data monitoring/acquisition system when paired with wireless modules and software.

Unlike basic load banks, the SBS-8400 is a high-tech solution for easy, efficient collection of data and generation of records for archiving.

## Benefits

- Automatically discharges batteries unmanned without danger of over-discharging
- Individual cell monitoring capabilities via wireless modules
- Can be used on a variety of systems with lead acid and/or nickel cadmium batteries
- Test parameters are adjustable during test without stopping test
- Automatically protects and saves data from an unexpected test stop/end
- Easy to navigate unit menu and computer software
- Download data after discharge to USB drive
- Generates custom reports for trending, records and reporting with included software
- Can be slaved with other load banks to increase amp draw up to 720 Amps



Touch Screen Menu

## Features

- Wide voltage and current range: 10–300 Vdc / 0–120 Amps
- Wireless module connection that measures and records individual cell voltages
- 5.7 in. LCD touch screen
- 30 parameter presets that can be adjusted during testing
- Selectable discharge mode: constant current (amps) / power (kW)
- 4 adjustable stop points and multiple alarm designs to control the process intelligently
  - Low system voltage: 0–250 Vdc
  - Discharge time: 0–99 Hour 99 Min.
  - Discharge capacity: 0–9999 Ah
  - Low cell voltage: 0–15.00 V
- View test data in real time on screen or with computer via RS232

## Applications

- Telecommunications
- Utility
- UPS
- Battery manufacturing
- Industrial maintenance
- Critical power
- Data center



Example of how the wireless modules would be installed on a 48 Vdc system consisting of qty. (24) 2 volt cells

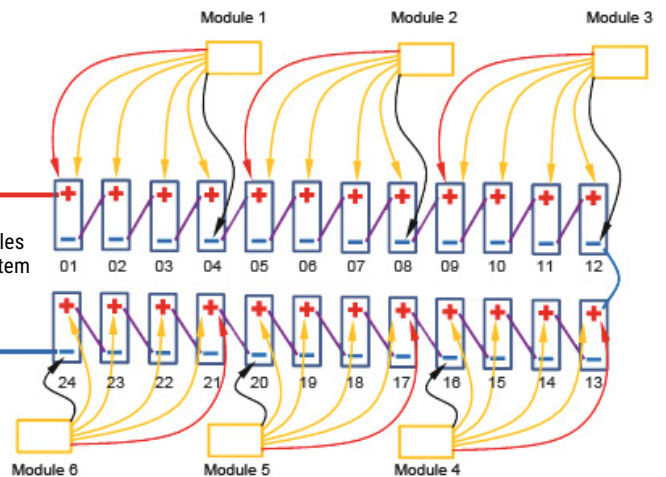

Video available at [www.sbsbattery.com/videos](http://www.sbsbattery.com/videos)

Specifications	
DC Volt Range	10–300 Vdc
DC Current Range	10–15 / 150–300 Vdc: 0–60 Amps 15–150 Vdc: 0–120 Amps
Accuracy and Resolution	±1.0%, 0.1 Amp
Display	5.7" LCD Color Touch Screen
Power Supply	110 Vac, 60 Hz
Communications Port	USB / RS232
Internal Memory	8MB Flash
Size (main unit)	9.0" x 14.5" x 27.0"; 53 lb.
Size (with case/acc.)	12.5" x 23.0" x 31.0"; 93 lb.

**Includes**

- Main unit
- Instruction manual
- Computer analysis software
- 6 ft. DC cable set (pos. & neg.)
- 3 ft. AC cable
- RS232 wire
- Case with wheels



Portable case included

**Computer Analysis Software**

- User-friendly and easy to navigate
- Data downloading and analyzing through real-time communication or USB memory devices
- Software interface includes: battery voltages curve and bar chart, group voltage curve, current curve, capacities histogram data form, etc.
- Generate custom and detailed Excel reports with USB and software

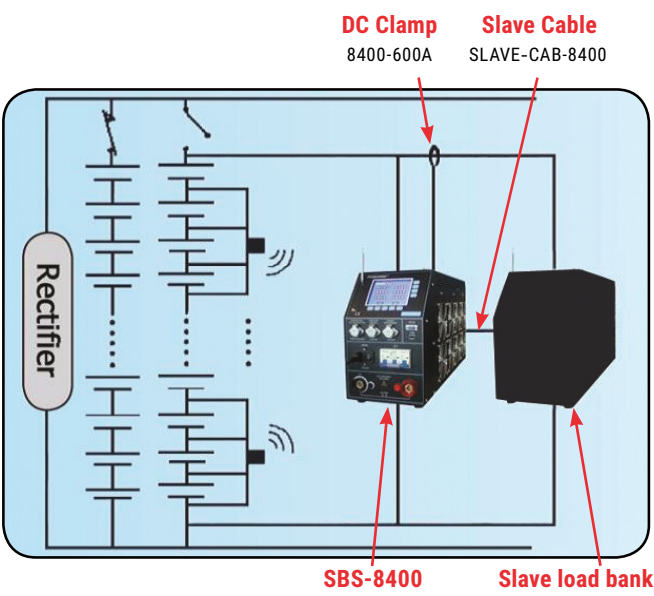
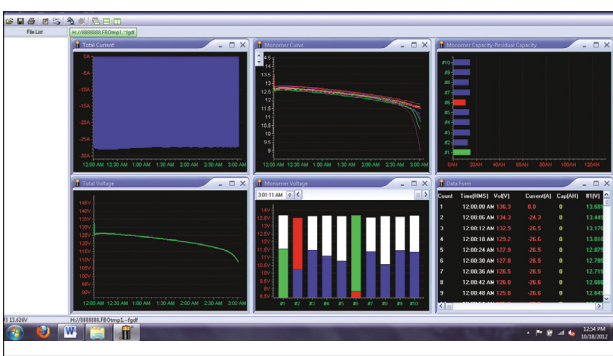

**Paralleling Load Banks**

The SBS-8400 has a 0–120 Amp current range; however, it is possible to parallel additional compatible load banks with the SBS-8400 to increase the current.

With the optional P/N 8400-600A DC clamp the user can discharge up to 720 Amps and the SBS-8400 will monitor the total DC current being drawn by up to two (2) additional load banks in parallel.

Accessory Ordering Information	
Part No.	Description
MODULE-1.2/2-25	1.2/2V Wireless module kit w/ case Qty. 25 (+2 spare)*
MODULE-1.2/2-30	1.2/2V Wireless module kit w/ case Qty. 30 (+2 spare)*
MODULE-2/6/12-15	2/6/12V Wireless module kit w/ case Qty. 15 (+2 spare)*
MODULE-2/6/12-30	2/6/12V Wireless module kit w/ case Qty. 30 (+2 spare)*
8400-600A	600 DC Current Clamp
SLAVE-CAB-8400>8400	Paralleling Cable, SBS-8400 to SBS-8400/SBS-4815
SLAVE-CAB-8400>S	Paralleling Cable, SBS-8400 to S-Series
SLAVE-CAB-8400>(2)S	Paralleling Cable, SBS-8400 to (2)S-Series
BCT110/220-1000	750 Watt Voltage Transformer 110/220 Vac 50/60 Hz
Pelican case upgrade available	

Ordering Information	
Part No.	Description
SBS-8400	0–300 Vdc, 0–120 Amp load bank

\*Module details on pages 41-42

# SBS Wireless Modules

Individual Cell Monitors (Accessory for Compatible Battery Capacity Testers)

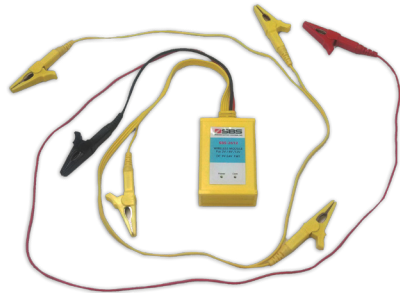

During capacity testing, the wireless modules measure each cell's voltage and wirelessly send the data back to the paired load bank. All voltage values are displayed on the load bank's LCD screen and listed in the test report, which is created with the computer software. Wireless modules make it easy to locate failed or problematic cells in the battery bank.

## Features

- Real-time cell voltage measurement during discharge test
- Advanced technology that wirelessly communicates readings between modules and load bank
- Wide range for 1.2/2V or 2/6/12V battery applications
- One module supports voltage measurements for up to 4 cells
- Supports monitoring up to 120 cells/batteries in a single test
- Protective storage included

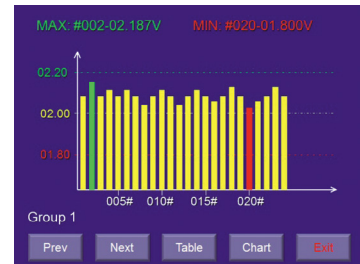

Voltage bar chart on load bank screen

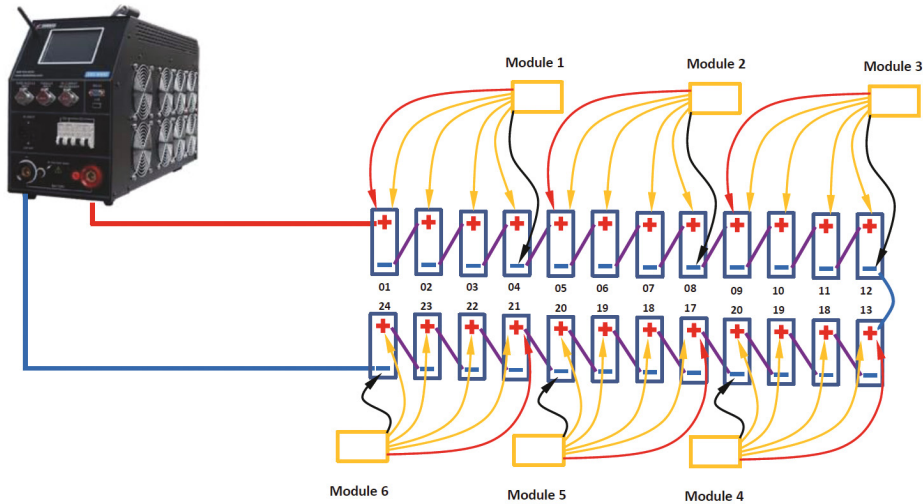

## Specifications

Type	SBS-2/6/12	SBS-1.2/2
Support Cell Voltage	2/6/12V	1.2/2V
Wires	Six (1 Red, 1 Black, 4 Yellow)	Five (4 Red, 1 Black)
Power Supply Wire	Red & Black Operating Voltage: 5-24 V Max. Voltage: <400V	Red No. 1 & Black Operating Voltage: 3.5-20 V Max. Voltage: <60V
Measure Voltage Range	0-16 V for each channel	0-5 V for each channel
Accuracy and Resolution	±0.5%, 0.01 V	±0.5%, 0.01 V
Dimensions / Weight	3.9 x 2.6 x 1.3 in. (100 x 65 x 32 mm) / 0.66 lb. (0.3 kg)	
Operation Temp. / Storage Temp. / Humidity	23° to 122° F (-5° to 50° C) / -40° to 158° F (-40° to 70° C) / 5% - 95% RH	

WIRELESS MODULES



## Connection Drawings

**SBS-2/6/12**  
For Lead Acid Battery Monitoring

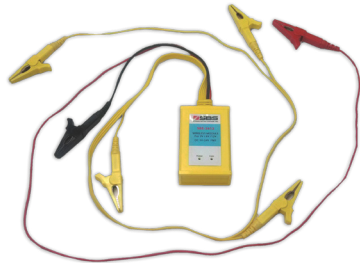

**SBS-1.2/2**  
For Single-Cell Monitoring



**Monitoring 2Volt Cells with 2/6/12V Module**

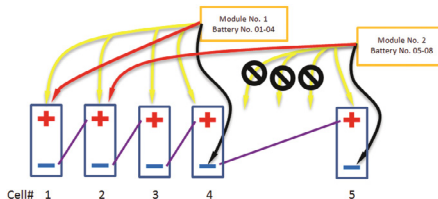
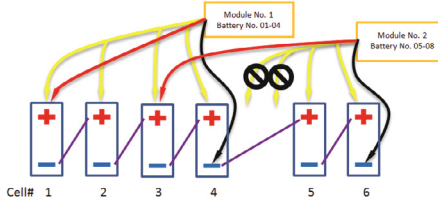
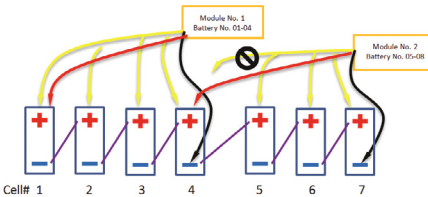
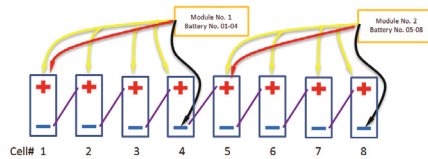

**Monitoring 6 or 12V Blocks with 2/6/12V Module**

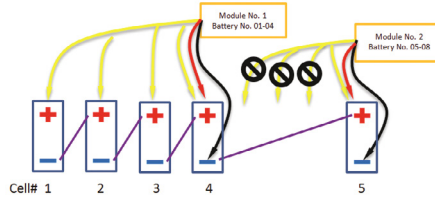
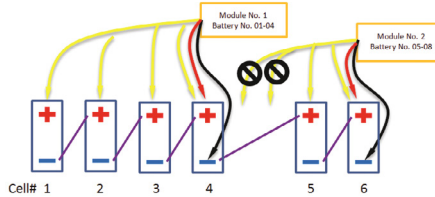
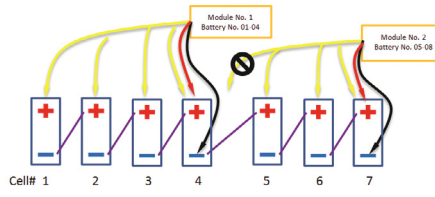
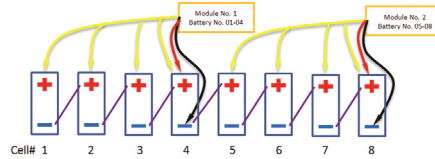

**Monitoring 1.2 or 2V Cells with 1.2/2V Module**

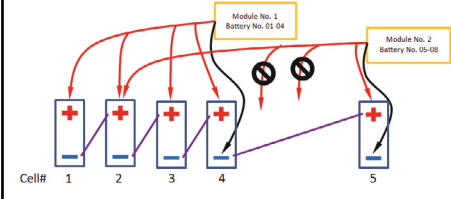
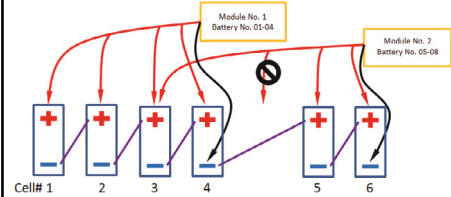
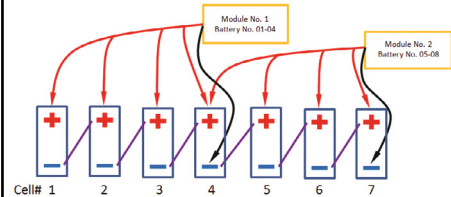
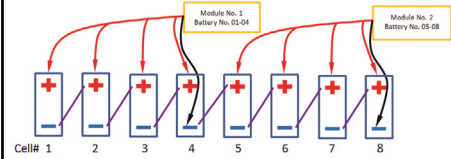

### Wireless Load Bank Module Kits Ordering Information

Battery Type	DC Voltages of Systems to be Tested	Module Package(s) Required (Part No.)	Qty. of Modules (+2 spares)
Lead Acid Only (2/6/12V)	12-125 Vdc	MODULE-2/6/12-15	15
	12-250 Vdc	MODULE-2/6/12-30	30
NiCd/Single Cell LA Only (1.2/2V)	12-125 Vdc	MODULE-1.2/2-25	25
	12-250 Vdc	MODULE-1.2/2-30	30

# Battery Capacity Testers

24–250 Vdc, 0–300 Amp Series of Constant Current Load Banks

The only way to know if your stationary batteries will perform to specification is to test them regularly.

NERC standard PRC-005-2 requires that vented lead acid and nickel cadmium (NiCd) systems be discharge tested every six (6) years and valve regulated lead acid (VRLA) batteries every three (3) years. IEEE recommends load testing stationary flooded/vented lead acid and NiCd stationary batteries every five (5) years and VRLA batteries every 12–18 months.

The SBS constant current load banks are an affordable way to perform easy and accurate IEEE450 (vented lead acid), IEEE1106 (NiCd) and IEEE1188 (VRLA) load tests.

These units are quick and easy to set up. They display the voltage, current and Ah removed from the string during the test. Since this is a constant current load bank, the user also does not have to adjust the current during the test.

These load banks come standard with multiple adjustable stop points and built-in protection to ensure that the batteries are never damaged due to over-discharge.

## Features

- Many unit options with wide voltage and current range
- Automatically discharges batteries unmanned without danger of over-discharging
- Continuously holds the current set throughout the test
- LCD screen displays real time voltage, discharge current and capacity/Ah removed
- Test parameters are adjustable during test without stopping test
- 3 adjustable stop points for built-in protection
  - End system voltage
  - Discharge time
  - Discharge capacity (Ah)
- Units can be slaved with the SBS-8400 and/or other load banks to increase amp draw

## Built-in Protection

- Audible alarm
- Warning on LCD screen
- High temperature shutdown
- High voltage shutdown
- Overload protection

DC LOAD BANKS

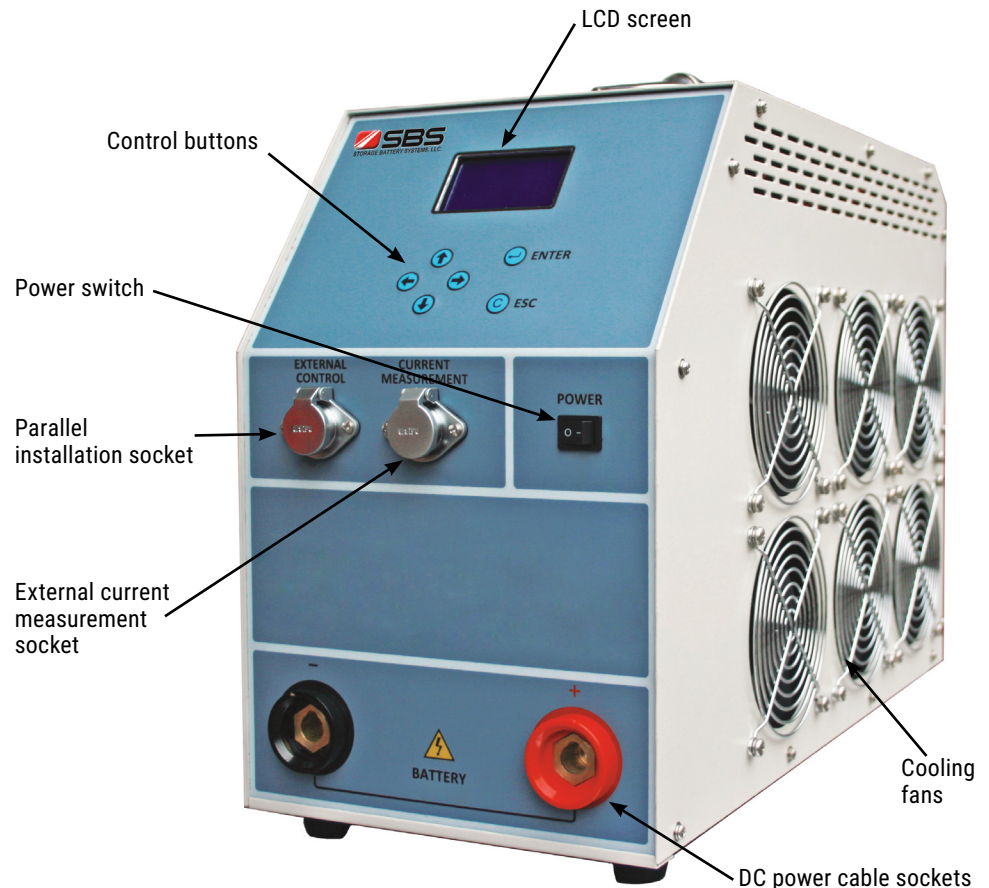

SBS-4830S



Video available at [www.sbsbattery.com/videos](http://www.sbsbattery.com/videos)



SBS-1110S



**Includes**

- Main unit
- Instruction manual
- 9 ft. DC cables
- Carrying case with wheels

**DC Clamp** P/N: 8400-600A  
**Slave Cable** P/N: SLAVE-CAB-8400>S

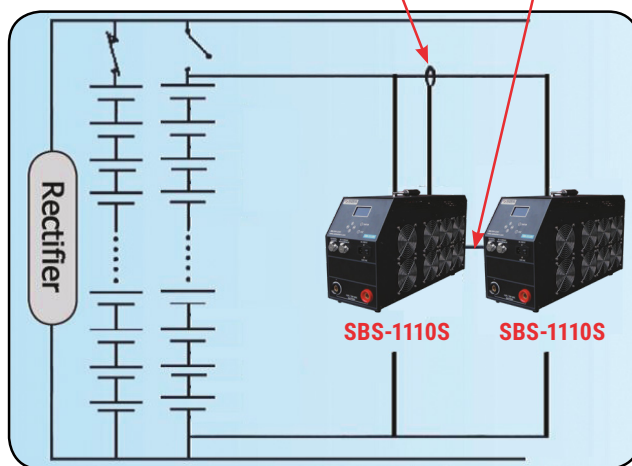

With the optional P/N 8400-600A DC clamp the user can parallel additional load banks of the same voltage range to increase discharge current.

**Ordering Information**

Part No.	Description
SBS-4830S	24 Vdc 0-150 Amp / 48 Vdc 0-300 Amp Constant Current Load Bank
SBS-1110S	125 Vdc 0-100 Amp Constant Current Load Bank
SBS-1230S	125 Vdc 0-300 Amp Constant Current Load Bank
SBS-2206S	250 Vdc 0-60 Amp Constant Current Load Bank
SBS-2415S	250 Vdc 0-150 Amp Constant Current Load Bank

**Accessory Ordering Information**

Part No.	Description
8400-600A	600 DC Current Clamp
SLAVE-CAB-8400>S	Paralleling Cable, S-Series to S-Series/SBS-8400/SBS-4815
SLAVE-CAB-8400>(2)S	Paralleling Cable, S-Series to (2) S-Series/SBS-8400/SBS-4815
BCT110/220-1000	750 Watt Voltage Transformer 110/220 Vac 50/60 Hz
Pelican case upgrade available for select models	

**Technical Data**

Display	LCD (128 x 64 pixels)
Input	During discharge: real time voltage / current / test time / capacity discharged (Ah) User can set: end system voltage / test time / capacity discharged (Ah)
Test Type	Unit holds the set current throughout the test
Protection	Overheat / Overload / Over voltage protection with audible alarm and screen warning
Power Supply	SBS-4830S uses DC power supply (from tested battery) 125 and 250 Vdc units use AC power supply (110 Vac 60 Hz)
DC Cables	Included, 9 ft. long

**Specifications**

Part No.	DC Voltage Range	DC Current Range (Amps)	Dimensions L x W x H (in.)	Weight (lb.)
SBS-4830S	20-40 Vdc 40-60 Vdc	0-150 A 0-300 A	26 x 9 x 16	40
SBS-1110S	90-150 Vdc	0-100 A	25 x 9 x 15	44
SBS-1230S	90-150 Vdc	0-300 A	36 x 9 x 25	110
SBS-2206S	190-265 Vdc	0-60 A	26 x 9 x 16	40
SBS-2415S	196-300 Vdc	0-150 A	36 x 9 x 25	110

# SBS-4815CT Battery Capacity Tester with Monitoring

24/48 Vdc, 0–150 Amp Constant Current Load Bank with Individual Cell Monitoring



## Applications

- Telecom
- Forklifts, Golf Carts & AGVs
- Power Plants
- Oil Companies

The SBS-4815CT is a fully programmable and portable constant current load bank with detailed data acquisition and display capabilities.

Built-in memory continuously records discharge data including: overall system voltage, current and individual cell voltages (when modules are installed).

## Benefits

- Can be powered from DC or AC power supply
- Weighs only 21 lb.; designed for portability
- Can be slaved with other load banks of the same voltage to increase discharge current



## Features

- Voltage and current range: 20–60 Vdc / 0–150 Amps
- 5.7" LCD touch screen
- 4 adjustable stop points and multiple alarm designs to control the process intelligently
- Wireless modules that measure and record individual cell voltages during testing
- View test data in real time on screen or with computer via RS232
- Download data after discharge to USB drive
- Computer software for capacity evaluation and report generation

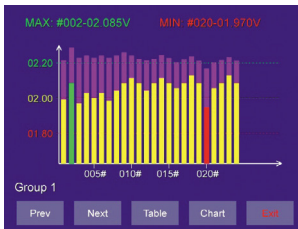

Data		Memory 78%	
DataFile	01/08	Type	Discharge
		Capacity	0500AH
		TestCurr	125.0A
		TestCap	400AH
		TestTime	03H10M
		BattLow	01.80V
		GroupLow	043.5V
		BattSum	024#
		GroupSum	002G
		StopType	BattLow

Buttons: Up, Down, USB, RS232, Exit

## Internal Memory

- Automatically protects and saves data from an unexpected test stop/end
- Menu interface provides data management operations for parameter settings, test results review, and download by RS232 or USB device to the computer software



## Analytical Software

- Powerful analytical software calculates test results and reports cell/battery conditions and capacity
- Software interface displays detailed graphs and charts
- Ability to export raw data into customized Excel reports



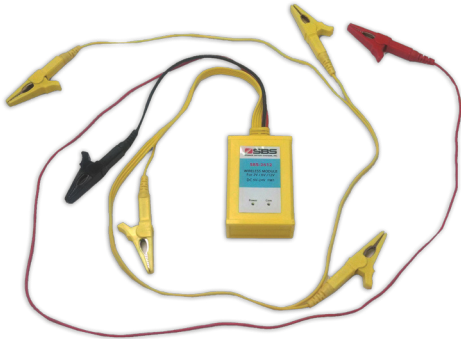

**Wireless Modules**

- Included for collection of cell voltage data during testing
- Advanced technology that wirelessly communicates readings between modules and load bank
- For 2/6/12V batteries
- One module supports voltage measurements for up to 4 cells
- Easily locate failed cells in battery and estimate actual capacity of each cell

**Discharge Protection**

Stop Point	Setting Range
Low System Voltage	0–60.0V
Discharge Time	0–99 Hour 99 Min.
Discharge Capacity	0–9999 Ah
Cell Low Voltage	0–15.00V

**Alerts**

Malfunction	LCD Prompt	Warning Beep
Input Over Voltage	✓	✓
Reverse Polarity	✓	✓
Overload	✓	✓
Overheat	✓	✓



**Includes**

- Main unit
- Instruction manual
- Wireless 2/6/12 Volt modules (qty. 6 +1 spare)
- Computer analysis software
- DC test (power) cables
- 3 ft. AC power cable
- RS232 wire
- Carrying case with wheels

**Parallel Operation**

The SBS-4815CT has a 0–150 Amp current range; however it is possible to parallel additional load banks of the same voltage range with the SBS-4815CT to increase current draw.

With the optional P/N 8400-600A DC clamp the user can discharge up to 750 Amps and the SBS-4815CT will monitor the total DC current being drawn by up to three load banks in parallel.

**Ordering Information**

Part No.	Description
SBS-4815CT	Battery discharge and capacity tester

**Accessory Ordering Information**

Part No.	Description
8400-600A	600 DC Current Clamp
SLAVE-CAB-8400>8400	Paralleling Cable, SBS-4815 to SBS-4815/8400
SLAVE-CAB-8400>S	Paralleling Cable, SBS-4815 to S-Series
SLAVE-CAB-8400>(2)S	Paralleling Cable, SBS-4815 to (2)S-Series
BCT110/220-1000	750 Watt Voltage Transformer 110/220 Vac 50/60 Hz

Pelican case upgrade available

**Specifications**

DC Volt Range	20–60 Vdc
DC Current Range	20–40 Vdc: 0–75 Amps 40–60 Vdc: 0–150 Amps
Accuracy & Resolution	±0.5%, 0.1 Amp
Display	5.7" LCD Color Touch Screen
DC Power Supply	20–60V
AC Power Supply	120 Vac, 50/60 Hz
Communications Port	USB / RS232
Internal Memory	8MB Flash
Main Tester Size	16.25 x 9.0 x 9.0 in.
Carrying Case Size	20.5 x 19.7 x 15 in.
Weight	21 lb. (main tester only) 62 lb. (tester, accessories, case)

# SBS-H2 Hydrogen Gas Detector

## Complete Hydrogen Detection System



### Includes

- Main control
- Hydrogen sensor
- 25 ft. cable

### Applications

- Substations
- Battery rooms
- Uninterruptible power supply (UPS)
- Battery cabinet systems
- Battery charging areas
- Hydrogen fueled back-up power systems

The SBS-H2 Hydrogen Detector is a hydrogen detection system with visual and audible alarms and 1% and 2% hydrogen relays.

The system comes complete with the main control, a highly accurate hydrogen gas sensor and a 25 ft. cable. This unit can be powered with AC and/or DC power and can be mounted directly to a wall or to an electrical box, making it extremely versatile and very user-friendly.

The SBS-H2 includes relays for remote connection to alarm/monitoring systems and for control of external relays or an exhaust fan.

### Benefits

- Protects life, property and company profits
- Ideal for remote locations
- Fail safe mode in event of loss of power
- Up to three (3) sensors can be installed to main control to meet space coverage requirements

### Features

- Universal power inputs: 110/220 Vac and/or 12–48 Vdc input
- Strobe light for visual alerts
- Sensor status indicator LEDs on the main control
- Modular design for optimal placement of sensor(s)
- NRTL/C Certified: UL Std. No 61010-1 & CAN/CSA-C22.2 No. 61010-1-12

### Installation

- Wall or 2-gang junction box mountable
- Mechanical relays are easily accessible:
  - Warning 1% relay, 15 A @ 120 Vac; 10 A @ 277 Vac; 10 A @ 28 Vdc
  - Alarm 2% relay, 0.5 A resistive @ 28 Vdc, 0.5 A @ 125 Vac
- Redundant power supply capability; dual AC and/or DC power supply connections (DC power supply will operate as backup power source)
- Indicator LEDs can be tested by pushing the red "TEST" button
- Sensors can be tested in the field with the P/N H2-TESTKIT

### Main Control Mounting and Power Options



Wall-mountable



2-Gang Junction Box  
Hardwired AC and/or DC  
(optional)



18 AWG AC Cord (optional)

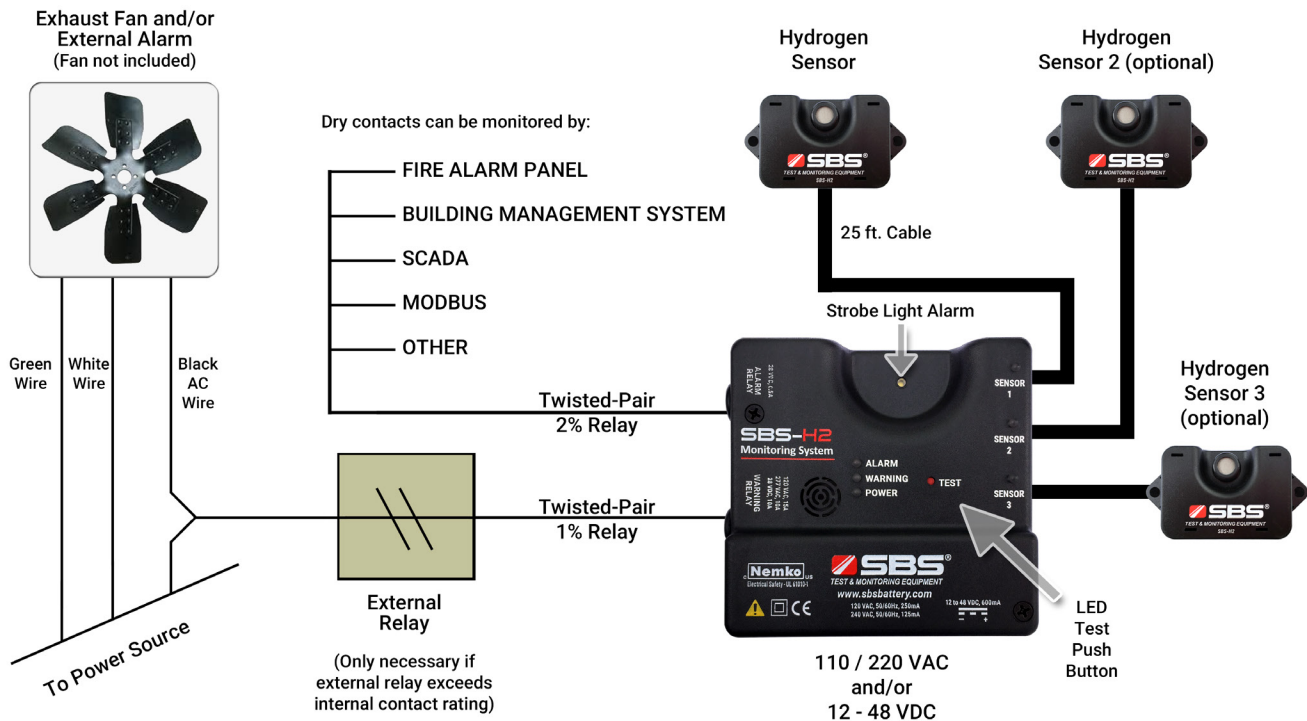

**Warning Settings:** Should the concentration of hydrogen gas in the air surrounding the sensor reach 1% by volume, the “1% Warning” yellow LED will light up on the main control of the unit. In addition, the 1% internal relay will energize and can be used to activate an external exhaust fan or a building management/alarm system (via SCADA Modbus).

**Alarm Settings:** Should the hydrogen gas concentration reach 2% by volume, the “2% Alarm” red LED will light up, the strobe will flash and an audible alarm will sound. In addition, the 2% internal relay will energize and can be used to activate a building management/alarm system (via SCADA/Modbus).

**Ordering Information**

Part No.	Description
SBS-H2	Hydrogen detector with (1) sensor and 25 ft. cable

**Accessory Ordering Information**

Part No.	Description
H2-SENSOR-25FT	Additional hydrogen sensor with 25 ft. cable
H2-SENSOR-50FT	Additional hydrogen sensor with 50 ft. cable
H2-SENSOR-100FT	Additional hydrogen sensor with 100 ft. cable
H2-TESTKIT	Test kit (includes 1% and 2% hydrogen, regulator, tubing and case) <b>Note: cannot ship via air freight</b>
H2-JB	4 11/16" x 4 11/16" 2-gang junction box
E190399	AC Cord 110 V, 10 A, 10 ft. with plug

**Specifications**

1% Hydrogen	Dry contacts rated 10A/25 Vac
2% Hydrogen	Dry contacts rated .5A/28 Vdc
Power source	110/220 Vac, 50/60 Hz and/or 12-48 Vdc (9-58 Vdc operating voltage)
Temperature	Sensor rating of -4° F to 176° F (-20° C to 80° C)
Size	4.7" L x 4.7" W x 1.2" D (main control)

**Available Accessories**



Test Kit



Additional Hydrogen Sensor with 25 ft., 50 ft. or 100 ft. Cable



2-Gang Junction Box (Hardwired AC and/or DC)

# EquaLink Battery Monitoring

Active Battery Management System with Voltage Balancing

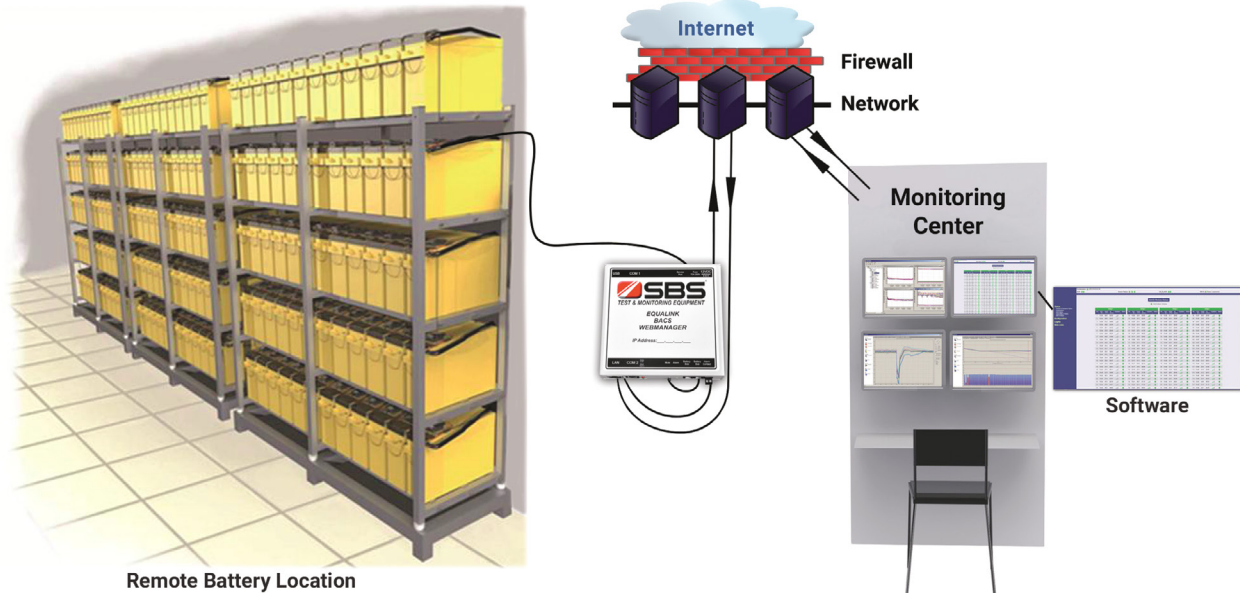

Remote Battery Location

EquaLink is an Ethernet-based battery management system which monitors the voltage, internal resistance and temperature of each battery in a stationary battery system.

Through a patented Balancing process, EquaLink actively regulates the float charging current of each battery ensuring that all batteries charge at the optimal voltage. Continuously monitoring and balancing the individual charging/float voltage of each battery enables the full capacity of the entire battery system to be available at all times.

**EquaLink Battery Management System actively manages batteries to increase reliability and extend life, whereas other battery monitoring systems simply monitor batteries as they deteriorate.**

## How It Works

EquaLink reads individual battery voltages and compares them to the battery system's overall voltage. Each EquaLink module controls the amount of float current passing through the battery to regulate the voltage to the optimum value. This constant monitoring and Balancing of the individual charging voltages helps guarantee the availability of the battery system at all times.

Due to its proprietary Balancing process, EquaLink surpasses other battery monitoring systems, having the ability to monitor and actively regulate battery voltage to within 0.001 volts of the system's average float charging voltage.

EquaLink's Balancing prevents overcharging and undercharging, ensuring maximum capacity and service life.

EquaLink has the ability to monitor current, ambient/room temperature, humidity, hydrogen gas and electrolyte levels. Through available Form C contacts/relays, EquaLink can also monitor electrical equipment such as UPSs, inverters, transfer switches, generators and air conditioning systems.

EquaLink is designed for lead acid batteries (flooded/wet, VRLA, gel, AGM, etc.) as well as some Ni-Cd, battery applications. EquaLink is easy to set up and configure.

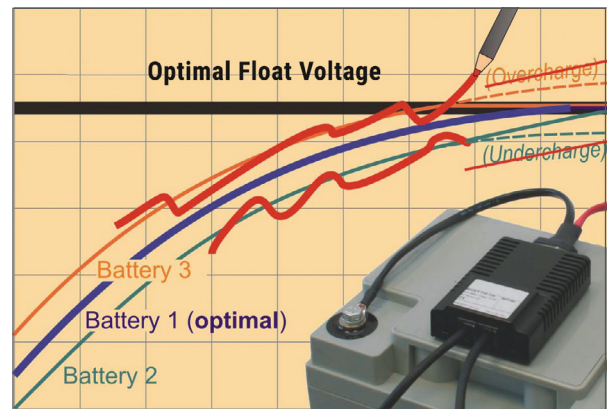

- Battery 3's voltage (top) is capped at the charge end voltage by removing current to prevent overcharging and gassing
- Battery 2 is supplied extra current until the optimal float charging voltage is obtained
- Battery 1 is held at the correct voltage and is performing ideally



## Benefits

- Individual voltage regulation (Balancing)
  - Avoid overcharging batteries
  - Avoid undercharging batteries
- Extend the life of the system
- Increase battery capacity
- Detect stratification
- Prevent thermal runaway
- Eliminate/reduce maintenance
  - Cost and time savings
  - NERC PRC-005 compliance
  - Battery swaps
- Receive warnings in advance via alarm
- User-friendly browser interface and software included

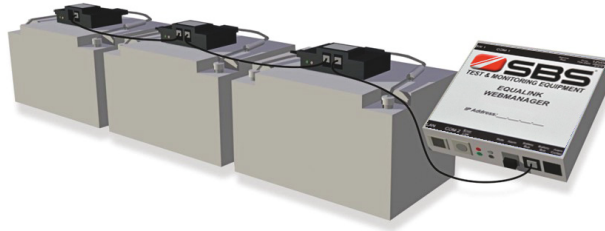

UPS: ● OK    Sensor: ● Disabled    BACS: ● OK    GSMModem: ● Disabled

BACS Module Status

● BACS Status: Charging

String Equaling Demo String #1 48 VDC						
No.	Volt [V]	Temp. [°C]	Ri [mΩ]	Equalize	Status	
1	2.26	14.5	1.59		●	
2	2.26	14.8	1.67		●	
3	2.26	14.8	1.55		●	
4	2.26	14.7	1.54		●	
5	2.26	14.5	1.55		●	
6	2.26	14.1	1.55		●	
7	2.26	14.5	1.53		●	
8	2.26	14.5	1.51		●	
9	2.26	14.5	1.55		●	
10	2.26	14.5	1.67		●	
11	2.26	15.0	1.61		●	
12	2.26	14.3	1.64		●	
13	2.26	15.5	1.64		●	
14	2.26	15.2	1.60		●	
15	2.26	15.8	1.63		●	
16	2.26	16.0	1.63		●	
17	2.26	15.0	1.63		●	
18	2.26	16.5	1.58		●	
19	2.26	14.5	1.51		●	
20	2.26	15.1	1.61		●	
21	2.26	14.5	1.56		●	
22	2.26	14.5	1.65		●	
23	2.26	14.0	1.45		●	
24	2.26	14.7	1.45		●	
Σ Voltage 54.29 V						
2.26 [V] Target Voltage						
0 [A] Current    0.00 [KW] Real Power						

Module info		Battery info		Miscellaneous	
Module type	C40	Manufacturer	Storage Battery Systems	Voltage Low/High	1.75 V/2.41 V
Hardware Version	03.03	Type	Flooded Tubular Lead Acid	Temperature Low/High	0°C/35°C
Software Version	03.03.04	Capacity(C10)	110 Ah	Resistance Min/Max	1.03 mΩ/2.38 mΩ
Number of Blocks	24	Installation Date	04.08.2015	Equalizing Range Min/Max	2.0485 V/2.41 V
Number of Strings	1	Phone Number	2629461342	Firmware Version	CS141-SNMP V1.46.69 161212
Contact Person	Wayne Eaton	Location	Menomonee Falls WI	Discharge Counter	0
IP Address	192.168.200.74	Mac Address	00-30-d6-16-03-6c	Page generated	13.01.2017 13:57:24

## Equalink System Components

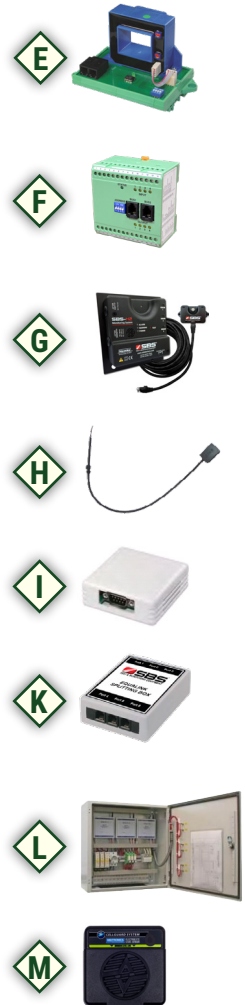
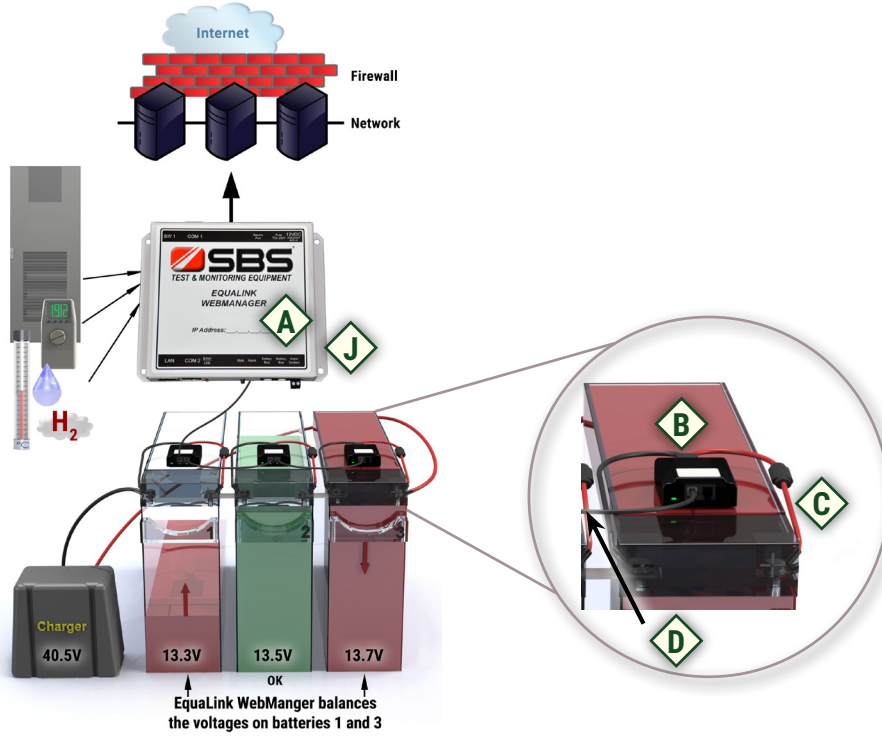

### System Components (Included)

A	WebManager	Battery system's central control unit, connects to modules
B	Modules	One module per battery for individual battery data collection
C	Voltage Measuring Cable	Attaches module to battery
D	Communication Bus Cable	Links system components together

### System Accessories (Optional)

E	DC Current Sensor	Measures and records overall system DC current
F	Auxiliary Alarm & Control Interface	For monitoring other equipment through WebManager
G	Hydrogen Gas Detector	1% Warning and 2% Alarm relays (EQ-AUX required)
H	External Temperature Sensor	For use when module not installed directly on battery
I	Ambient Temperature Sensor	Measures and records room temperature
J	Mounting Kit	Wall mounting plate/DIN rail mounting kit
K	Splitter Box	Splitter for optimization of communication cable wiring
L	Control Cabinet	Customizable
M	Electrolyte Level Sensor	For monitoring electrolyte level at each cell

### WebManager

The WebManager acts as the battery system's central control unit. It gathers, evaluates, and (on its internal flash memory) stores all pertinent system information.

### Interfaces/Display

- (3) RS232
- (2) RJ10 Communication bus cable outputs
- (1) RJ45 10/100 Mbit Ethernet
- (3) LED (Manager status, device alarm, Equalink alarm)
- (1) Buzzer with mute button
- (1) Dry Form C output contact

## Modules

Equalink battery modules are capable of taking precise measurements of individual battery voltage, internal resistance and, through an integrated sensor, surface temperature. These measurements are essential to making analyses of the batteries in any given system.

Equalink transfers data through the communication bus cable system to the Equalink WebManager.

There are 4 different types of Equalink modules: 12 Volt, 2 Volt, 6 Volt and 8 Volt. The module can be mounted on the top or side of each battery.

Specifications				
Model	BM-C20	BM-C40	BM-C30	BM-C23
Voltage	12 V	2 V	6 V	8 V
AH Range	7-600 AH	7-5000 AH	7-600 AH	7-900 AH
Voltage Measuring/ Balancing Range	9.7-17 V	1.25-3.2 V	4.8-8.0 V	9.7-21.0 V
IR Range	0.5-60 mOhm	0.02-60 mOhm	0.5-6 mOhm	0.5-60 mOhm
Balancing Power (Current)	0.15A	0.9A	0.3A	0.12A
Current Consumption	15-20 mA (<1 mA sleep mode)		35-40 mA (<1 mA sleep mode)	

## Voltage Measuring Cables

The Equalink voltage measuring cable assembly attaches the module to the battery. It connects to both the positive and negative battery posts and measures individual battery data.

## Communication Bus Cables

The Equalink communication bus cables link the WebManager to the modules and select accessories (current sensor, auxiliary bus interface, splitter box).

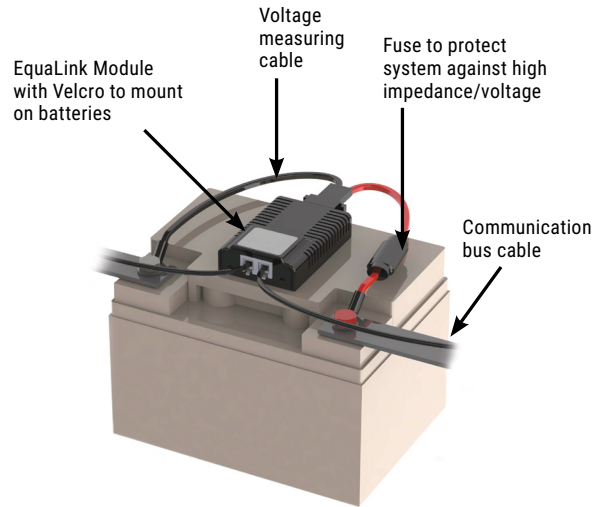

Equalink Order Code						
		A	B		C	D
<i>Example*</i>	<i>BM-</i>	<i>125-</i>	<i>60</i>	<i>x</i>	<i>2V</i>	<i>.01</i>
Your Code	BM-			x		
		Code	Feature			
A	Nominal DC System Voltage	12-	12 Vdc			
		24-	24 Vdc			
		48-	48 Vdc			
		125-	125 Vdc			
		250-	250 Vdc			
		XXX-	Other XXX Vdc			
B	Number of Individual Batteries to Monitor	XXX	Enter number of batteries (blocks or cells)			
C	Battery Voltage	2V	2 V Cells			
		4V	4 V Blocks			
		6V	6 V Blocks			
		12V	12 V Blocks			
		D	Input Power	.01	120 Vac/12 Vdc	
		.02	18-72 Vdc			
		.03	120-370 Vdc			

Available Options	
Part Number	Description
BM-ELSENSOR	Electrolyte Level Sensor
BM-CT400A	DC Current Sensor, 400Amp
BM-CT1000A	DC Current Sensor, 1000Amp
BM-CT2000A	DC Current Sensor, 2000Amp
BM-AUX	Terminal Relay Controller, 4 digital inputs & 4 relay outputs
SBS-H2	Hydrogen Gas Detector (BM-AUX also required)
BM-REM-TEMP-9	External Temperature Sensor for Module, 9"L
BM-REM-TEMP-35	External Temperature Sensor for Module, 35"L
BM-SPLIT	1 x 5 RJ10 Splitter Box
BM-AMB-TEMP	Ambient Room Temperature Sensor

**\*Example part number BM-125-60x2V.01 represents: 125Vdc system consisting of sixty (60) 2 Volt cells. WebManager to run on 120 Vac input power.**



**STORAGE BATTERY SYSTEMS, LLC**  
 N56 W16665 Ridgewood Dr.  
 Menomonee Falls, WI 53051

## SBS Recommended Testing Schedule Based on IEEE & NERC PRC-005

■ - Meets the minimum requirements of NERC PRC-005-2\*  
 ● or ■ - Meets IEEE Recommendations\*

Vented / Flooded Lead Acid Batteries (VLA)	Test Equipment	IEEE 450-2010			
		Monthly	Quarterly	Yearly	5 Years
Visually inspect batteries, rack, charger, room.		●	●	■	
Record battery system float voltage and current at battery terminals.	SBS-600	●	●	■	
Record charger output voltage and current. Correct if needed.	SBS-600	●	■	■	
Check electrolyte levels. Fill with distilled water to 'max' line if necessary.		●	■	■	
Record pilot cell(s) or block(s) voltage, electrolyte temperature and specific gravity <sup>†</sup> .	SBS-2003	●			
Record voltage of ALL cells/blocks.	SBS-600, SBS-6500		●		
Record specific gravity of 10% of the cells <sup>†</sup> .	SBS-2003, SBS-2500, SBS-3500		●		
Record temperature of 10% of the cells.	SBS-2003		●		
Record specific gravity of ALL cells <sup>†</sup> .	SBS-2003, SBS-2500, SBS-3500			●	
Record the internal resistance value of ALL cells/blocks.	SBS-6500		■	■	
Record temperature of ALL cells/blocks.	SBS-6500			●	
Record internal resistance value of ALL cell-to-cell and terminal connections.	SBS-6500			■	
Conduct load test two years after installation and then every five years. When the system's capacity falls below 90% load test annually.	SBS-8400, SBS-1230, SBS-1110				■

<sup>†</sup>Specific gravity should be temperature-corrected to 77°F.

Nickel Cadmium Batteries	Test Equipment	IEEE 1106-2005			
		Quarterly	Semi-Yearly	Yearly	5 Years
Visually inspect batteries, rack, charger, room.		●	●	■	
Record battery system float voltage and current at battery terminals.	SBS-600	●	■	■	
Record charger output voltage and current. Correct if needed.	SBS-600	■	■	■	
Check electrolyte levels. Fill with distilled water to 'max' line if necessary.		■	■	■	
Record voltage of ALL cells/blocks.	SBS-600, SBS-6500		●	●	
Record temperature of 10% of the cells.	SBS-6500	●	●	●	
Record the internal resistance value and temperature of ALL cells/blocks.	SBS-6500			●	
Record internal resistance value of ALL cell-to-cell and terminal connections.	SBS-6500			■	
Conduct load test two years after installation and then every five years. When excessive capacity loss is noticed load test annually.	SBS-8400				■

Valve Regulated Lead Acid Batteries (VRLA)	Test Equipment	IEEE 1188-2005			
		Monthly	Quarterly	Yearly	2 Years
Visually inspect batteries, rack, charger, room.		●	●	■	
Record battery system float voltage and current at battery terminals.	SBS-600	●	●	■	
Record charger output voltage and current. Correct if needed.	SBS-600	●	■	■	
Record voltage and temperature of ALL cells/blocks at the negative terminal.	SBS-6500		●	●	
Record the internal resistance value of ALL cells/blocks.	SBS-6500		■	■	
Record internal resistance value of ALL cell-to-cell and terminal connections.	SBS-6500			■	
Conduct load test after initial installation and then every two years or 25% of expected battery life.	SBS-8400				■

\*The above testing schedules are based on SBS's interpretations of both IEEE and NERC PRC-005-2. This information should be used for guidance purposes only and SBS can't be held responsible if the information is incorrect or if other parties interpret the information differently.