

# Citywide **COMPUTER AIDED DESIGN and DRAFTING (CADD) Standards** 2016 Edition



# TABLE OF CONTENTS

<b>TABLE OF CONTENTS</b> .....	i
<b>INTRODUCTION</b> .....	vii
<b>PREFACE</b> .....	viii
<b>ACKNOWLEDGEMENT</b> .....	ix
<b>CITYWIDE DRAFTING</b> .....	1
<b>PART 1 CADD STANDARDS</b> .....	1
1.1 General .....	1
1.2 Development Criteria.....	1
1.3 Citywide CADD Program.....	2
City Engineer .....	2
Citywide CADD Standards .....	2
Engineering Application Support .....	2
CADD Users.....	2
1.4 Department of Information Technology .....	2
1.5 Information Control Procedures .....	2
Requesting Electronic Data .....	2
Exchange of Electronic Data/Interim Submittals .....	3
Transmitting Electronic Data to the Citywide .....	3
1.6 CADD Final Deliverables .....	3
CADD File Specifications.....	3
City Standard Seed Files and Resource Files .....	3
City Dimension Styles .....	11
File Naming Convention .....	11
1.7 Geographic Information System .....	11
1.8 CADD Transmittal .....	11
1.9 Survey Files.....	11

	Survey Files Deliverables.....	11
	Survey Files Submittal.....	12
	<b>PART 2 GENERAL DRAFTING STANDARDS .....</b>	<b>13</b>
2.1	Symbols .....	13
2.2	Abbreviations.....	13
2.3	Classification of Drawings .....	13
	Final Drawings .....	13
	Addendum Drawings.....	13
	Construction Drawings.....	13
	Change Order Drawings.....	14
	Red-lines.....	14
	As-Built Drawings .....	14
2.4	Mylar Plotting Materials.....	14
2.5	Size .....	14
2.6	Drawing Sheets.....	15
2.7	Drafting Practices .....	15
2.8	Scale .....	16
2.9	Lettering .....	18
	Size .....	18
	Freehand Lettering.....	18
	Transparent Transfer Tape Lettering .....	18
	Reading Direction.....	18
	Other Guidelines .....	18
2.10	Line Work.....	18
	Line Widths .....	19
	Line Spacing.....	19
	Line Patterns.....	19

	Line Usage.....	19
	Line Terminations .....	20
2.11	Views .....	21
2.12	Callouts .....	21
	Sections and Details.....	21
	Equipment and Piping.....	22
2.13	Notes.....	22
	General Notes.....	23
	Construction Notes.....	23
2.14	Signing and Sealing: .....	23
2.15	Other Conventions .....	23
	North Orientation.....	23
	Key Plan .....	23
	Cover Sheet Warning Scale .....	24
	Unnecessary Information .....	24
	General Drawing Information .....	24
	Drawing Changes .....	24
	Centerline Coordinates - Station and Elevation .....	25
2.16	Sequence of Drawings.....	25
2.17	Discipline Specifics .....	27
	Cover Sheet.....	27
	General Drawings.....	27
2.18	Microfilm Reproduction.....	28
2.19	Standard Details .....	28
2.20	Special Facilities Plan Check.....	28
Figure 2-1	Standard Abbreviations Sheet 1 of 4 .....	29
Figure 2-1	Standard Abbreviations Sheet 2 of 4 .....	30

Figure 2-1	Standard Abbreviations Sheet 3 of 4.....	31
Figure 2-1	Standard Abbreviations Sheet 4 of 4 .....	32
Figure 2-2	CIP Sample Border .....	33
Figure 2-2	CIP Sample Border Project Title Block Breakdown .....	34
Figure 2-3	Reading Direction .....	35
Figure 2-4	Line Patterns and Widths .....	36
Figure 2-5	Column Lines and Balloons.....	37
Figure 2-6	Dimensioning.....	38
Figure 2-7	Section Callout.....	39
Figure 2-8	Detail Callout.....	40
Figure 2-9	Standard Detail Callout.....	41
Figure 2-10	Equipment and Piping Callouts .....	42
Figure 2-11	View Notes and Leaders .....	43
Figure 2-12	North Arrow Direction .....	44
Figure 2-13	Plan and Profile Sheet Sample.....	45
Figure 2-13a.1	Sewer / Water / Storm Drain Small Project Cover Sheet.....	46
Figure 2-13a.2	Sewer / Water / Storm Drain Large Cover Sheet 1 of 2.....	47
Figure 2-13a.3	Sewer / Water / Storm Drain Large Cover Sheet 2 of 2.....	48
Figure 2-13b.1	Roadway Cover Sheet.....	49
Figure 2-13c.1	AEP Project Cover Sheet 1 of 2 .....	50
Figure 2-13c.2	AEP Project Cover Sheet 2 of 2 .....	51
Figure 2-13d.1	PUD Building Project Sheet 1 of 2 .....	52
Figure 2-13d.2	PUD Building Project Sheet 2 of 2 .....	53
Figure 2-13e.1	PUD Pipeline Project Sheet 1 of 2 .....	54
Figure 2-13e.2	PUD Pipeline Project Sheet 2 of 2 .....	55
Figure 2-13f	PUD Buildings / Pipeline Projects.....	56
Figure 2-13g	Traffic Signal Installation Cover Sheet.....	57
Figure 2-13h	Traffic Control Plans Cover Sheet .....	58
Figure 2-14	Addendum Format Sheet 1 .....	59

Figure 2-14a	Addendum Format Sheet 2.....	49
Figure 2-14b	Addendum Format Sheet 3.....	49
Figure 2-14c	Addendum Format Sheet 4.....	49
PART 3 PUBLIC & PRIVATE DEVELOPMENT .....		63
3.1	Private Development & Public Improvement (Private Contract).....	63
	General Standards and Procedures.....	63
	Grading and Public Improvement Plan Templates for Private Contracts ..	63
	Typical Sheets for Grading and Public Improvement Plans.....	63
	Drawing Numbering.....	64
3.2	Public Improvement & Facilities .....	64
	Improvement Plans.....	64
	Discipline Specifics .....	64
	Cover Sheet .....	64
	General Drawings.....	64
	Civil Drawings.....	70
	Landscaping/Irrigation.....	75
	Architectural Drawings .....	75
	Structural Drawings .....	78
	Mechanical Drawings.....	81
	Electrical Drawings .....	84
	Instrumentation Drawings .....	88
3.3	Numbering Systems.....	91
	Equipment Numbering.....	91
	Equipment Schedules .....	93
	Pipe Line Numbering .....	93
	Valve Numbering.....	94
	Cable Numbering .....	94

	Instrument and Loop Numbering .....	95
	Drawing Numbering.....	96
Figure 3-1	DSD Cover Sheet Sample.....	98
Figure 3-2	CIP Sample Border Project Title Block Breakdown .....	99
Figure 3-2	Piping & Instrumentation Diagram Symbols and Legend Sheet 1 Sample .....	100
Figure 3-2	Piping & Instrumentation Diagram Symbols and Legend Sheet 2 Sample .....	101
Figure 3-3	Piping & Instrumentation Diagram Sheet Sample .....	102
<b>PART 4 STANDARD AND PROCEDURE FOR IMPROVEMENT PLANS (CityProjects)</b> .....		103
SECTION I COVER SHEET & TITLE BLOCK.....		104
COVER SHEET DESCRIPTION.....		105
COVER SHEET TITLE BLOCK DESCRIPTION.....		107
PLAN SHEET TITLE BLOCK DESCRIPTION .....		110
SECTION II COMMON SEWER & WATER DESCRIPTION .....		113
COMMON SEWER AND WATER EXAMPLES .....		114
PLAN VIEW .....		114
PROFILE VIEW .....		121
SECTION III SEWER DESCRIPTION .....		123
PLAN VIEW .....		124
PROFILE VIEW .....		126
SECTION IV WATER DESCRIPTION.....		131
PLAN VIEW .....		132
PROFILE VIEW .....		134
SECTION V MISCELLANEOUS PLAN SHEETS .....		137
<b>PART 5 LEVELS</b> .....		157
<b>PART 6 CADD TEXT AND SYMBOLS STANDARDS</b> .....		173

# INTRODUCTION

These Citywide Computer Aided Design and Drafting (CADD) Standards have been developed with the following objectives:

1. Enhance the level of graphic consistency. Provide consistent and uniform symbols and abbreviations in the Contract Documents to minimize confusion in the interpretation of the Contract Documents.
2. Maintain an acceptable level of quality and clarity in the contract drawings.
3. Supply information to the Design Consultants, Design-Builders and all Contractors relating to the design and drafting methods.

For updates and changes to these standards refer to the Citywide CADD Standards Committee's operating procedure. Approved updates and changes will be promptly integrated and published onto the City's Official Website for public accessibility at

<https://www.sandiego.gov/publicworks/edocref/drawings>.

These standards are not intended to serve as a design textbook, nor as a substitute for professional design experience. Furthermore, these do not address procedural issues or organizational responsibilities. The primary intent is to address graphic issues and establish drafting standards for design drawings and plans.



## PREFACE

The purpose and intent of this document is to provide the necessary information for the design team to prepare a complete set of improvement plans in accordance with these standards and procedures.

While it is intended that these standards and procedures cover most project types with regards to preparing plans for a project, there may be unique situations or circumstances not covered in these standards. The Project Manager shall obtain approval from the Senior Civil Engineer approving the plans for any deviations from these standards.

Additional information not specifically covered in these standards may be required on the plans when such information is necessary for a clear and concise set of plans.

The plans shall be prepared under the direction of the Project Manager and shall be based upon an aerial survey or physical survey in accordance with the Department's standard operating procedures, Text and Symbol Standards and County of San Diego Aerial Conditions and Specifications.

**NOTE:** For the procedures and examples described on the following pages, the Department's "Text and Symbol Standards" should be referred to for text size, weight or symbol to be used.

For those procedures that do not include an example, their written description is self-explanatory.

# **ACKNOWLEDGEMENT**

This edition is the product of an extensive team effort by the Citywide CADD Standards Committee including City Engineers and Surveyors, CADD Users, Engineering Applications Support, and Department of Information Technology (IT).

Following is a list of staff members who contributed to the completion of this edition:

## **DEVELOPMENT SERVICES**

Sara Dastgheibi, Berric Doringo, Chester Dowling, Efren Landeros, Elham Lotfi, John Montesdeoca and Thien-Long Tran

## **PUBLIC UTILITIES**

Staci Domasco, Danny Manglicmot, Julio Prado, Richard Stevens and Thinkh Tran

## **PUBLIC WORKS**

Kris Asgharzadeh, Diana Bergen, Byron Burnham, Ramesis Bustamante, John Butcher, Cindyrose Catapia, Luis Chavez, Maria Cunningham, Catherine Dungca, Edgar Edusada, Wendy Gamboa, Christopher Hackney, Robert Hagan, Sadegh Jahadi, Angelita Jaro, Mart Ramirez, Aras Rekani, Eva Zuniga, Nathaniel Scott (Chairperson) and Corson Smith

## **TRANSPORTATION & STORM WATER**

Alan Gomez and James Nabong

# CITYWIDE DRAFTING

## PART 1 CADD STANDARDS

### 1.1 General

Although the City of San Diego uses the Bentley MicroStation as its basic CADD graphics engine, coupled with Intergraph Engineering Application programs for engineering design and drawing production, if approved by the City, Design Consultants may use other industry standard CADD systems such as AutoCAD to produce hard copy or PDF files which can be transmitted appropriately to the Project Manager as submittals. However, for compatibility reasons, all electronic CADD files submittals to the City that will be uploaded into the City's CADD file management system must be created in MicroStation and conform to the requirements set forth in these standards.

If approved by the City, AutoCAD drawing files can be accepted and uploaded into the City's CADD systems provided that it complies with the following criteria:

1. Can convert from dwg to dgn files.
2. Element attributes should be recognized by the Systems.
3. Comply to the City's CADD Standards.
4. Free of any problems translating from Autocad to Microstation.
5. Possible corrupted files are not acceptable.

The terminology used in these standards follows the customary usage for MicroStation systems, recognizing that other CADD systems use different terms for similar concepts.

The City intends to use the current MicroStation tag data function to collect data electronically for use with the Drawing Management System. The MicroStation drawing file will also be used to collect data for the City's Geographic Information System.

### 1.2 Development Criteria

These standards have been developed based on the following criteria:

1. Hierarchical computer directory structure that allows groups of files from various sources to be easily incorporated into the overall directory structure.
2. Data separation using level, color, line weight and style within each design file to organize different types of information.
3. Engineering discipline separation using reference files to overlay information for interdisciplinary coordination.
4. Logical names for device/directory in attaching reference files, cell libraries and font libraries to design files so that they can be transported among systems without modification.
5. Well organized transmittal and acceptance procedures.

6. Uniformity in major aspects of CADD design such as units of measurement, text size and font, border and title block data.

## **1.3 Citywide CADD Program**

The Citywide CADD Program lead by the City Engineer or designee involves the Citywide CADD Standards Committee, CADD Users, and Department of Information Technology (IT).

### **1.3.1 City Engineer**

The City Engineer or designee approves policies and standards to be used on engineering plans, forms the Citywide CADD Standards Committee, and sets the duration and appointment of Committee Chairperson and Members.

### **1.3.2 Citywide CADD Standards**

Under the direction of the City Engineer, the Citywide CADD Standards Committee coordinates and resolves CADD related topics and issues.

### **1.3.3 Engineering Application Support**

The Engineering Application/Software support's responsibility is to advise the committee on technical items such as software/hardware upgrades and if needed prepare technical reports or white papers on existing or upcoming technology that may benefit the CADD Program.

### **1.3.4 CADD Users**

Each CADD User for the City of San Diego is responsible for compliance with the CADD Standards whether they are creating drawings or reviewing plans prepared by the Design Consultants.

## **1.4 Department of Information Technology**

The role of the Department of Information Technology is to manage and leverage license cost and maintenance for Citywide CADD Program. The IT Section will prepare and present the annual budget allocation for each participating department which will be included in the department's IT Budget.

## **1.5 Information Control Procedures**

The following procedures apply to the acquisition, exchange, and submittal of CADD-related files.

### **1.5.1 Requesting Electronic Data**

Requests for updated information must be directed to the City CIP Project Manager or designee administering the Design Consultant's contract.

## **1.5.2 Exchange of Electronic Data/Interim Submittals**

The exchange or transmittal of electronic data from Design Consultant to Design Sub Consultant is not permitted. Electronic data distribution must be through the appropriate City staff.

When required, the Project Manager contacts the Design Consultant to request interim submittals of the latest design data for transmittal to other affected projects. Prior to disseminating interim submittals, the City CADD Coordinator reviews the electronic data for compliance with these standards.

## **1.5.3 Transmitting Electronic Data to the Citywide**

Electronic submittals must be addressed to the City Project Manager administering the Design Consultant's contract. Transmittal requirements are described in detail in Section 1.8

## **1.6 CADD Final Deliverables**

For legal purposes, the primary deliverable for engineering drawings is Mylar plots with original or electronic signatures and seals. Delivery of all the final corresponding electronic data files used in the creation of the design drawings is required. CADD files created during design and construction of City facilities will be used by the City over the life of those facilities. Therefore, the Design Consultant shall ensure that the design files enable the City, with reasonable effort, to retrieve, use, and modify the CADD files during operation, maintenance, and modification of the facilities.

CADD file final deliverables must be as-built to reflect actual constructed conditions. Files determined by the Project Manager to be not in compliance with the City CADD standards are to be returned to the Design Consultant for correction and re-submission at no additional cost to the City. Electronic files submitted shall be error free as determined by running the file through Axiom File Fixer or other equal means. The City shall not accept corrupted files.

### **1.6.1 CADD File Specifications**

If approved by the City, Design Consultants may generate drawings using any CADD application. However, the files must be delivered in a format compatible with current City standards and must meet the criteria in Section 1.1.

### **1.6.2 City Standard Seed Files and Resource Files**

The MicroStation XM CADD standard files are now accessed through ProjectWise via a managed workspace.

#### **1. Seed Files**

- a) SD 2d.dgn – 2D Nad 83 coordinate based file with working units in Survey Feet
- b) SD 2dm.dgn – 2D Nad 83 coordinate based file with working units in metric
- c) SD 3d.dgn – 3D Nad 83 coordinate based file with working units in Survey Feet

- d) SD 3dm.dgn - 3D Nad 83 coordinate based file with working units in metric
- e) SD Arch 2D.dgn – Architectural based file with working units in feet and inches containing separate models with Water sheet border for various scales.
- f) SD Survey.dgn – Developed for and used by the Survey group. This seed files contains several different models for different needs.

## **2. Cell Libraries**

- a) SD Details.cel – standard City details
- b) SD Existing.cel – Existing public structures
- c) SD Notes.cel – Most used notes
- d) SD Proposed.cel – Proposed public structures
- e) SD Traffic Features.cel – Existing, salvaged, and proposed traffic features
- f) SD Traffic Eq.cel - Existing, salvaged, and proposed traffic equipment
- g) SD Traffic Legend.cel - traffic legends
- h) SD Traffic Notes & Details.cel – Most used traffic notes
- i) State Sign.cel – Caltrans signs

## **3. Color Tables**

- a) SD BW.tbl – Gray scale color ranges uses colors 232 to 239
- b) SD Color.tbl – City defined colors range uses colors 0 to 8 and gray scale color range uses colors 232 to 239

## **4. Level Structure**

- a) SD Level.csv – Contains all standard City named levels and can be imported into any file as needed.

## **5. Symbols**

- a) SD Font.rsc – Font Resource file containing both MicroStation and true type fonts
- b) SD Line Style.rsc – Common line styles for public structures. Use with scale factor = 40
- c) SD Traffic Line Style.rsc – Commonly used Caltrans traffic striping. Use with scale factor = 1

Seed File Configurations Working Units Survey Feet is governed by a customized units.def file.

Seed File	Coordinate System	Working Units/Accuracy	Global Origin	Models	Level Structure	City Dimension Styles	Color Table
SD 2d.dgn	NAD 83, CA State Plane, Zone 6	Survey Feet/.1234*	-1665251.6353, -1772251.6353	Default	627 named levels – SD Level.csv	Yes	SD Color.tbl
SD 3dm.dgn	NAD 83, CA State Plane, Zone 6	Meters/.1234	-1742251.6352, -337251.6352, 214748.3648	Default	627 named levels – SD Level.csv	Yes	SD Color.tbl
SD Arch 2D.dgn	None	Feet , Inches/1/8"	0:0,0:0	21 for different scales	627 named levels – SD Level.csv	City plus Arch. scales	SD Color.tbl
SD Survey.dgn	See Survey Seed File Table						

**SD Survey.dgn (Developed for Survey Section use only)**

<b>Models</b>	<b>Coordinate System</b>	<b>Working Units/Accuracy</b>	<b>Global Origin</b>	<b>Level Structure</b>	<b>City Dimension Styles</b>	<b>Color</b>
3D – SD SEED	NAD 83, CA State Plane, Zone 6	Survey Feet/.1234*	-6165251.6353, -1772251.6353, 214748.3601	627 named levels – SD Level.csv	Yes	SD Color.tbl
3D – 40 SCALE	NAD 83, CA State Plane, Zone 6	Survey Feet/.1234*	-6165251.6353, -1772251.6353, 214748.3601	627 named levels – SD Level.csv	Yes	SD Color.tbl
3D – DTM CITY	NAD 83, CA State Plane, Zone 6	Survey Feet/.1234*	-6165251.6353, -1772251.6353, 214748.3601	627 named levels – SD Level.csv	Yes	SD Color.tbl
3D – FIELD	NAD 83, CA State Plane, Zone 6	Survey Feet/.1234*	-6165251.6353, -1772251.6353, 214748.3601	627 named levels – SD Level.csv	Yes	SD Color.tbl



Models	Coordinate System	Working Units/Accuracy	Global Origin	Level Structure	City Dimension Styles	Color
3D – FIELD DTM	NAD 83, CA State Plane, Zone 6	Survey Feet/.1234*	-6165251.6353, -1772251.6353, 214748.3601	627 named levels – SD Level.csv	Yes	SD Color.tbl
3D – MAPPING	NAD 83, CA State Plane, Zone 6	Survey Feet/.1234*	-6165251.6353, -1772251.6353, 214748.3601	627 named levels – SD Level.csv	Yes	SD Color.tbl
3D – MAPPING – DTM	NAD 83, CA State Plane, Zone 6	Survey Feet/.1234*	-6165251.6353, -1772251.6353, 214748.3601	627 named levels – SD Level.csv	Yes	SD Color.tbl
2D – ROW	NAD 83, CA State Plane, Zone 6	Survey Feet/.1234*	-6165251.6353, -1772251.6353	627 named levels – SD Level.csv	Yes	SD Color.tbl

<b>Models</b>	<b>Coordinate System</b>	<b>Working Units/Accuracy</b>	<b>Global Origin</b>	<b>Level Structure</b>	<b>City Dimension Styles</b>	<b>Color</b>
2D - LAYOUT	NAD 83, CA State Plane, Zone 6	Survey Feet/.1234*	-6165251.6353, -1772251.6353	627 named levels – SD Level.csv	Yes	SD Color.tbl
3D – DTM – METRIC	NAD 83, CA State Plane, Zone 6	Meters/.1234	-1742251.6352, -337251.6352, 214748.3648	627 named levels – SD Level.csv	Yes	SD Color.tbl
3D – FIELD – METRIC	NAD 83, CA State Plane, Zone 6	Meters/.1234	-1742251.6352, -337251.6352, 214748.3648	627 named levels – SD Level.csv	Yes	SD Color.tbl
3D – MAPPING - METRIC	NAD 83, CA State Plane, Zone 6	Meters/.1234	-1742251.6352, -337251.6352, 214748.3648	627 named levels – SD Level.csv	Yes	SD Color.tbl

<b>Models</b>	<b>Coordinate System</b>	<b>Working Units/Accuracy</b>	<b>Global Origin</b>	<b>Level Structure</b>	<b>City Dimension Styles</b>	<b>Color</b>
2D – ROW – METRIC	NAD 83, CA State Plane, Zone 6	Meters/.1234	-1742251.6352, -337251.6352	627 named levels – SD Level.csv	Yes	SD Color.tbl
2D – INDEX	NAD 83, CA State Plane, Zone 6	Survey Feet/.1234*	-6165251.6353, -1772251.6353	627 named levels – SD Level.csv	Yes	SD Color.tbl
2D – SHEET	NAD 83, CA State Plane, Zone 6	Survey Feet/.1234*	-6165251.6353, -1772251.6353	627 named levels – SD Level.csv	Yes	SD Color.tbl

Models	Coordinate System	Working Units/Accuracy	Global Origin	627 named levels – SD Level.csv	City Dimension Styles	Color
2D – SHEET METRIC	NAD 83, CA State Plane, Zone 6	Meters/.1234	-1742251.6352, -337251.6352	627 named levels – SD Level.csv	Yes	SD Color.tbl
2D – LOCAL COORD - CUSTOM	NAD 83, CA State Plane, Zone 6	Survey Feet/.1234*	0.0000,0.0000	627 named levels – SD Level.csv	Yes	SD Color.tbl
3D – LOCAL COORD - CUSTOM	NAD 83, CA State Plane, Zone 6	Survey Feet/.1234*	0.0000, 0.0000, 0.0000	627 named levels – SD Level.csv	Yes	SD Color.tbl
3D – NAD27 – CUSTOM	NAD 27, CA State Plane, Zone 6	Survey Feet/.1234*	-1535251.6352, -35251.6352, 214748.3648	627 named levels – SD Level.csv	Yes	SD Color.tbl
2D – NAD27 – CUSTOM	NAD 27, CA State Plane, Zone 6	Survey Feet/.1234*	-1535251.6352, -35251.6352	627 named levels – SD Level.csv	Yes	SD Color.tbl
2D – SHEET – OCE	NAD 83, CA State Plane, Zone 6	Survey Feet/.1234*	-6165251.6353,- 1772251.6353	627 named levels – SD Level.csv	Yes	SD Color.tbl

\*Working Units Survey Feet is governed by a customized **units.def** file

### **1.6.3 City Dimension Styles**

City dimension styles are defined in each seed file to facilitate the placement of dimension element at the correct size governed by the anticipated plot scale. All styles have predefined settings for geometry, units, text, and symbols.

City10, City20, City40, City80, City100, and City160 dimension styles have extension lines turned ON. City10EX, City20EX, City40EX, City80EX, City100EX, and City160EX dimension styles have extension lines turned OFF.

### **1.6.4 File Naming Convention**

Naming conventions vary by Department. Check with the Project Manager.

## **1.7 Geographic Information System**

Integration with Geographic Information System (GIS)

Currently, information is entered manually into the City of San Diego GIS database from AS-Built drawings, various Project Systems or information gathered from Field. To aid the current manual process of integrating CADD and GIS, CADD drawing files must adhere to these standards. Requirements and changes to the City's current CADD Standards/Specifications will be presented to the various CADD Program entities when the processes and procedures for integration between the CADD and GIS are finalized.

## **1.8 CADD Transmittal**

Electronic data transmittals from the Design Consultant shall be compatible with the City's current computer operating system. These transmittals shall also be subject to the City's applicable Administrative Regulations and the City's security system scans. The Project Manager shall determine the method of data exchange and coordinate the CADD transmittal.

## **1.9 Survey Files**

All Computer Aided Drafting (CAD) work must be done in accordance with Citywide CADD Standards and must be in City seed files (.job, .txt, .dgn, .alg, .raw, .fwd, .dtm, .pdf, .docx, .xlsx, .tif, and .jpg).

All survey files shall be prepared in accordance with the City of San Diego's Citywide CADD Standards and shall adhere to City's Microstation level and attribute structure.

### **1.9.1 Survey Files Deliverables**

The survey file deliverable will be either one Master .dgn file containing all xref's in geospatially referenced (and attached) models or one Master dgn with all xref's geospatially referenced (and attached) as dgn files. Resource files will be provided by the City Project Manager or designee to Design Consultant if requested.

Survey files must include, but not limited to, the following items. Additional requirements shall be provided per consultant agreement or contract documents.

- a. Street center line and (record width) right-of-way lines

- b. Project geometry (.alg) files (this will be generated for use in InRoads)
- c. 3D surface model (.dtm, break line and spot elevation) file
- d. Spot elevations of the new utility main at each intersection, midblock and for any change in grade
- e. Monuments
- f. Curb lines (top curb and gutter)
- g. All other appurtenances including but not limited to water valves, meters, vaults, manholes, fire hydrants, utility boxes, cleanouts and poles

Survey information shall be used to produce red-lines and as-built drawings as described in Sections 2.3.5 "Red-lines" and 2.3.6 "As-Built Drawings"

### **1.9.2 Survey Files Submittal**

Survey files shall be submitted in accordance with Section 1.8 "CADD Transmittal" and Citywide CADD Standards. Survey files, proposed drawings, red-line and as-built drawings shall be submitted on a CD/DVD to the City Project Manager or designee. These files and drawings shall also be posted at the following ftp site:

<ftp://ftp.sannet.gov/IN/SURVEYS/>

After the documents have been posted in the ftp site, a confirmation email which includes the hyperlink to the website shall be sent to the City Project Manager or designee and [SurveyReview@sandiego.gov](mailto:SurveyReview@sandiego.gov).

All survey work and submittals which reveal non-compliance with the requirements of the Citywide CADD Standards shall be corrected and re-submitted by the Design Consultant at no additional cost to the City.

## **PART 2 GENERAL DRAFTING STANDARDS**

### **2.1 Symbols**

The preparation of clear drawings requires strict adherence to a standard nomenclature. A system of standard symbols for component identification also makes coordination and communication between design disciplines and construction trade groups more effective.

The symbols to be used are those established by the American National Standards Institute (ANSI), the Instrument Society of America (ISA), and other nationally-recognized organizations.

### **2.2 Abbreviations**

These standards do not encourage reliance on abbreviations to convey information on drawings. However, space limitations mandate use of abbreviations in certain situations. Abbreviations used in these standards conform to ANSI as much as possible. A comprehensive list of standard abbreviations used by the City is presented in Figure 2-1.

Abbreviations must be used carefully. Important rules are:

1. Avoid abbreviations with more than one common meaning.
2. An abbreviation used on one drawing must have the same meaning on all the drawings.
3. A word abbreviated once on a drawing must be abbreviated everywhere on the drawing.
4. Use abbreviations only to avoid excessive clutter or busyness on drawings.

Abbreviations that are not defined in the GREENBOOK or WHITEBOOK must be defined on the Plans.

### **2.3 Classification of Drawings**

Drawings are classified by the purpose they serve in the design (e.g., 30%, 60%, 100%, and Final) and construction process.

#### **2.3.1 Final Drawings**

These are the complete signed and stamped drawings ready to print and bind in one contract document for prospective bidders. They are sometimes referred to as "Camera Ready."

#### **2.3.2 Addendum Drawings**

Addendum drawings are issued by a formal process between the advertisement and bid opening. Addendum drawings may change, add, or remove some of the work of the previously issued drawings. (See Figure 2-14)

#### **2.3.3 Construction Drawings**

When the contract is awarded, addendum drawings are incorporated onto the final drawings to form the construction drawings.

### **2.3.4 Change Order Drawings**

Change order drawings cover changes made during construction. These drawings become part of the construction drawings after the change order is signed by the City and the Contractor.

### **2.3.5 Red-lines**

Plans with annotations of changes made during construction in red to reflect the actual product built during construction whether concealed or visible. This information must be transferred to the CADD file as As-built drawings.

### **2.3.6 As-Built Drawings**

The CADD drawings prepared from the approved Red-lines to reflect the actual product built.

Procedures for as-built drawings are described in the following documents:

1. As-Builts for CIP Projects: Refer to Standard Operating Procedure
2. As-Builts for Engineering Permits & Subdivisions (Non-CIP): Refer to Standard Operating Procedure

The as-built drawings must be delivered within 60 days after final substantial completion date of construction or in accordance with the contract between the City and Consultant (if applicable).

## **2.4 Mylar Plotting Materials**

Four-mil Mylar is used for all drawings. Drawings submitted on Mylar must be prepared with ink, or electrostatic toner to assure permanent legibility.

The entire drawing must be prepared on the upper side of the sheet. Placing certain portions on the underside of the sheet is not acceptable.

Mylar drawings with stick-on materials, scuff marks, creases, marks on the back or indentations are not acceptable to the City.

## **2.5 Size**

Drawings are prepared in accordance with ANSI Standard Y14.1-1995. ANSI standard sheet sizes are shown in Table 2-1.

D-sized sheets are required for camera ready drawings and are also appropriate for some addendum drawings. Other addendum drawings are better shown on A-sized sheets. Change order and other drawings prepared during construction may use A, B, C or D sheets. Changes must be made in the electronic CADD files. E-sized sheet is not acceptable.



<b>Table 2-1 ANSI Standard Drawing Sheet Sizes</b>				
<b>ANSI</b>	<b>Size (Inches)</b>		<b>Margin (Inches)</b>	
Designation	Width	Length	Width	Length
A	8.5	11.0	0.25	.038
B	11.0	17.0	0.38	.062
C	17.0	22.0	0.75	.050
D	22.0	34.0	0.50	1.00
E	34.0	44.0	1.00	0.5

## 2.6 Drawing Sheets

All drawings must use the standard border applicable to their Department/Division and sheet size. A sample border is shown in Figure 2-2. The border serves several purposes:

1. Identifies the drawing with the appropriate department.
2. Provides information used by the City to archive drawings.
3. Identifies the Design Consultant and staff responsible for preparing the drawing.
4. Provides other basic information (title, scale, revisions, etc.) in a consistent location and format for use in the City document management system.

Sample sheets are attached starting at Figure 2-13.

## 2.7 Drafting Practices

Drawings prepared for City Projects must be uncluttered, legible and easy to understand. Drawings must have a high degree of consistency. This section presents scaling, lettering, lining, notation and dimensioning techniques and practices that all disciplines must follow.

General guidelines are:

1. Eliminate Repetitive Details: When several items have common details, show the common detail once.

2. Eliminate Unnecessary Lines: Only those lines necessary to convey the design must be used.
3. Use Abbreviations Sparingly: Abbreviations may be used only where they are required to save space. Abbreviations must be defined, clear, and easily understood.
4. Use Symbols Frequently: Symbols reduce drafting time, increase legibility and conserve space.
5. Use Tabulations Appropriately: Tables consolidate related data into one location which normally might be scattered in many locations.

## 2.8 Scale

As a general rule, use the smallest possible scale to show a view without obscuring vital details. Scales must be selected with the following requirements in mind:

1. Maintain clarity when notes and dimensions are added to drawings.
2. Maintain legibility when drawings are reduced to half size.
3. Maintain readability when files are microfilmed for archival purposes.
4. The scales listed in Table 2-2 are recommended; however, they may be varied to accommodate the need of a particular drawing.
5. The use of distorted scales (different horizontal and vertical scales) is acceptable for profile drawings.

The rules listed below must be followed to show the scale of a drawing:

6. When multiple views on a drawing are not to the same scale, the appropriate scale must be centered below the view.
7. When the entire drawing is to the same scale, the scale must be shown on the sheet.
8. When an entire drawing (such as a diagram, a schematic or an isometric drawing) is not to scale, "No Scale" must be noted in the title block. If only one view on the drawing is not to scale, the notation "No Scale" must be placed below the view in question.
9. The notation "NTS" (not to scale) must only be used for specific dimensions within a drawing that are not to scale.
10. For plan and profile drawings, the vertical and horizontal scales must have a 1:10 ratio. That is, if the vertical scale is 1 inch = 4 feet, then the horizontal scale must be 1 inch = 40 feet. Similarly, a 1 inch = 10 feet vertical scale corresponds to a 1 inch = 100 feet horizontal scale.
11. For PDF format, drawing files must be required to be converted into 100% true scale format in which the print queue settings will determine the required paper size which in turn determines the desired scale.

<b>Table 2-2</b>	
<b>Typical Drawing Scales, All Disciplines</b>	
<b>Scale</b>	<b>Drawing Type</b>
1 inch = 100 feet    1 inch = 200 feet 1 inch = 80 feet 1 inch = 40 feet    1 inch = 400 feet 1 inch = 20 feet 1 inch = 10 feet    1 inch = 1000 feet	General Plan Views, Site Civil, Civil Sections, Yard Piping, etc.
1 inch = 4 feet, vertical and 1 inch = 40 feet, horizontal or 1 inch = 10 feet, vertical and 1 inch = 100 feet, horizontal	Profile Views
1/6 inch = 1 foot 1/8 inch = 1 foot 3/16 inch = 1 foot 1/4 inch = 1 foot 3/8 inch = 1 foot 1/2 inch = 1 foot 3/4 inch = 1 foot 1 inch = 1 foot	Sections, Details, A&E Plans
1-1/2 inch = 1 foot 3 inches = 1 foot	Enlarged Sections, Details

## 2.9 Lettering

Drawings must be prepared using a CADD system. MicroStation Font 1 is the basic text font per the Citywide CADD Standards. Other fonts may be used in certain situations. The following information is provided to assist in preparing drawings that may be drawn manually.

Drawings must use simple letters and figures without embellishments. The following are general guidelines for lettering.

### 2.9.1 Size

Lettering on full size D sheets must never be less than 1/8-inch in height.

### 2.9.2 Freehand Lettering

Freehand lettering is acceptable as long as it matches the style and size required of mechanical (CADD) lettering. A lettering guide or preprinted underlay must be used to ensure straight lines and uniform letter sizes.

### 2.9.3 Transparent Transfer Tape Lettering

Transparent transfer tape is not acceptable.

### 2.9.4 Reading Direction

Normally, all letters and figures must be readable from either the bottom or right edge of the sheet. The guide for reading is as follows:

1. Horizontal lettering must read from left to right.
2. Vertical lettering must read from bottom to top.
3. Diagonals must read from left to right, bottom to top up to 120°, top to bottom above 120° (see Figure 2-3).

### 2.9.5 Other Guidelines

1. All lettering must be upper case.
2. Fractions are set to be vertically written (e.g. 1/2, 1-1/2).
3. Font 1/newft 1 shows "1" with base or flag.

## 2.10 Line Work

Lines and lettering must be of adequate size and weight to produce legible half-size reproductions. Lines must be sufficiently thick to print well and make readable photocopies. Line work must be smooth, black, firm, equally spaced, of uniform weight and density throughout the drawings, and ends must be clearly defined. Line work must adhere to the following guidelines (see Figure 2-4 for detail of the line pattern and width):

## 2.10.1 Line Widths

Line widths must vary to distinguish certain features as follows:

1. Extra heavy lines (MicroStation line weight 4) must be used for main process lines on schematics.
2. Heavy lines (MicroStation line weight 3) must be used for emphasis for basic outlining features of new facilities. Examples are baseline, construction layout lines, and the outline of objects. Heavy lines must also be used on secondary process lines on schematics, double-line piping, flange outlines and on cutting plane lines.
3. Medium weight lines (MicroStation line weight 2) must be used for proposed construction and right-of-way, match lines, single-line drawings, flanges and equipment.
4. Fine lines (MicroStation line weight 1) must be used for topography, outline of existing and future facilities and other less important details, centerlines, phantom lines, column lines (see Figure 2-5), dimension lines, leader lines and hidden lines for new and existing facilities.
5. Dashed lines must be used for hidden lines and also to distinguish existing from proposed work.

## 2.10.2 Line Spacing

Line spacing is one-half the text height.

## 2.10.3 Line Patterns

Line patterns must be selected from the eight basic ones:

1. Solid
2. Dotted
3. Long Dash
4. Medium Dash
5. Short Dash
6. Dash Dot
7. Dash Dot Dot
8. Long Dash Short Dash

## 2.10.4 Line Usage

Centerline and column lines must extend 1/4-inch beyond a view, or farther if necessary, for indicating dimensions. Do not extend them into the space between views or continue them from one view to the next. End column lines with column-line balloons (3/8 inch-diameter circles).

1. In general, if an object has dimensions which are too long to be shown at the scale being used, the object must be broken and the dimensions indicated across the break. Scattering of dimensions across the sheet must be avoided if at all possible.

2. The overall dimension and string dimensions must be located far enough away from the object drawing to ensure uniformity and clarity, in addition to providing space for future notations.
3. Where several closely spaced parallel lines occur (i.e., pavements, gutters, curbs, medians), place dimensions between the parallel lines without using arrows. Enlarged details must be used where dimensioning is congested or crowded.
4. Leader or callout lines are usually drawn at an angle of 30 degrees to 60 degrees whenever possible, with an arrowhead at the drawing feature being annotated and no terminator at the note.

Leader lines must start at the note with a short line (1/8-inch minimum) parallel to the note's base. Leader lines are then angled before terminating at the appropriate feature with a line terminator. When the note is to the right of the object, the leader line must start with the first word of the note. When the note is to the left of the object, the leader line must start with the last word of the note. Leader lines in the same area must be parallel. Avoid leader lines that are:

- Horizontal or vertical
- At the same angle as cross-hatching
- At very small angles to the terminating surface
- Parallel to extension or dimension lines
- Curved
- Crossed
- Too long

5. Cutting-plane lines must extend beyond the view and end with horizontally bisected circles (1/2-inch diameter on one end and arrowhead at the other end of the cutting-plane line).

## 2.10.5 Line Terminations

Line terminators are used on dimension lines, leader lines and cutting-plane lines. The type of line terminator used depends on the feature to be emphasized and on available space. Line terminators may be one of the following:

1. Arrowheads are used to terminate dimension and leader lines. If a dimension is required inside a space less than 3/8-inch, external dimension lines and arrowheads may be used (see Figure 2-6).
2. Slashes are used to terminate dimension lines inside a space less than 3/8-inch. Slashes are approximately 1/8-inch long.
3. Loops are used to terminate leader lines at reinforcing steel bars, electrical wires, piping, and schematic lines. Their approximate radius is 1/16-inch, and they start and stop one radius from the line identified.

## 2.11 Views

Usually, a drawing requires at least two views to adequately describe an area. Complex areas may need several views, including auxiliary views and sections. Some simple areas may require only one view wherein the specification will adequately describe the rest of it.

Views must be oriented within the format so as not to crowd each other, the border or other data. The placement of auxiliary views must be in proper relation to main views and be complete enough only to explain the detail which made the view necessary. Break lines, tabular identities of similar items and short word descriptions are permissible as long as clarity is not impaired. These guidelines must be followed in placing the views:

1. The main plan view must be placed in the drawing's upper left corner. If there is more than one plan view, views must be arranged at the top of the drawing in sequence from left to right.
2. Sections, details, elevations and schematics (in that order) must be placed directly below the main plan view when space is available; otherwise they must be placed to the right. Sections and details must be displayed in sequential order, always moving from left to right. Whenever possible, views that relate to one another must be grouped on the same drawing.
3. View notes must be located 1/4-inch between the lettering and the drawing and must be left-justified.
4. Allow 4 to 6 inches between views to insert notes and dimensions, and 2-1/2 inches at the borders.

## 2.12 Callouts

This section describes the formats and layout guidelines for callouts on the drawings.

### 2.12.1 Sections and Details

If possible, sections and details must be on the same drawing where called out. When shown on a different drawing, place section views to the right of plan views. If a drawing shows only sections and details, sections take precedence, and are shown in sequential order from the drawing's top left corner.

When showing a section cut through a plan, refer to Figure 2-7 for the proper arrowheads to show the direction of the cut, the bubble identifying the section letter and the number of the drawing where the section is located.

Figure 2-8 shows a detail callout. The standards for pen size and thickness of arrow must be followed.

Figure 2-9 shows standard detail callouts.

## 2.12.2 Equipment and Piping

Equipment and piping callouts must follow Figure 2-10. Equipment and pipe callouts are placed in differently shaped blocks. Criteria for drawing pipes as single or double lines are shown in Table 2-3.

<b>Table 2-3</b>				
<b>Criteria for Showing Pipe as Single or Double Line</b>				
<b>Pipe Diameter, In.</b>	<b>Drawing Scale</b>			
	<b>1/8</b>	<b>1/4</b>	<b>3/8</b>	<b>1/2</b>
2	S	S	S	S
3	S	S	S	O
4	S	S	O	D
5	S	S	D	D
6	S	O	D	D
8	S	D	D	D
10	S	D	D	D
12	O	D	D	D
14 and larger	D	D	D	D

Note: S = Single line  
 O = Design Consultant Choice  
 D = Double Line

## 2.13 Notes

Two types of notes can appear on drawings: general notes which apply to all drawings, and construction notes which apply to specific features on a specific drawing. The following sections explain the difference.



### **2.13.1 General Notes**

General notes convey information common to the components of an entire drawing, process area, or discipline, or to all the drawings in a package. General notes are typically presented on the cover sheet(s).

General notes must be placed in a column on the left side of a drawing with single-spaced lines within each note, double-spaced between notes, and must be left-justified.

### **2.13.2 Construction Notes**

Construction notes show information pertaining to specific drawing features. Lines within each note must be single-spaced lines within each note, double-spaced between notes, and must be left-justified. See Figure 2-11 for further detail.

## **2.14 Signing and Sealing:**

Refer to the following Standard Operating Procedures (SOP):

- Signing and Sealing Plans & Specifications Standard Operating Procedure
- Electronic (digital) Signature Standard Operating Procedures

## **2.15 Other Conventions**

### **2.15.1 North Orientation**

General Plans such as maps and site plans must always include a north arrow. The project north orientation may be used to show the buildings and other structures squarely on the drawing sheet. In such drawings, the relationship between true north and project north must be as shown in Figure 2-12. The north arrow may point in any direction within plus or minus 90° of vertical.

The same orientation must be maintained for all plans in a series of similar sheets, regardless of discipline. If a plan view does not fit vertically on a drawing sheet, it can be rotated counterclockwise by as much as 90°. If the same orientation is not possible for certain plans within a set, place the note "Plan Orientation Different from Plan Layout" 1/4-inch below the north arrow.

On plan and profile sheets where the lowest elevation of the sewer, storm drain, and water mains are shown at the left side of each sheet, stationing is from left to right.

The north arrow shall be located near the title block in the lower right corner.

### **2.15.2 Key Plan**

A key plan is a small scale layout of the overall site showing by cross-hatching the context of a drawing of a small portion of the site which otherwise might be difficult to identify. Key plans, if necessary, are placed in the lower right corner of a drawing. Key plans must be no larger than 4 inches square.

### **2.15.3 Cover Sheet Warning Scale**

The standard border for the Cover sheet provides a 1-inch bar to warn that a drawing may not be at its original full-size scale.

### **2.15.4 Unnecessary Information**

Do not repeat dimensions except as necessary to relate one drawing or view clearly to another and only if there is no other way to identify location or orientation.

Do not repeat room names or numbers, door or window numbers or material identification. Show these on a larger scale detail or plan.

Do not render elevations, show shadows, or draw all the bricks, shingles or siding. A small area of texture or hatching at corners or a simple detail showing pattern and direction tells everything necessary. Cross hatching need not cover an entire wall or area in plan.

Do not draw interior elevations in which walls are blank.

Do not detail casework except for very unusual features. Draw elevations only and call out dimensions when necessary.

Do not use the term "By Others." Use "By Owner" or "NIC," meaning "Not In Contract."

### **2.15.5 General Drawing Information**

Use multiple partial plans with match lines on projects if complexity demands it.

Provide only the kinds of information which relate clearly to the specifications. Designate items by generic names, not trade names, i.e., Gypsum Board, not Sheetrock.

Call out specific details of materials such as hardwood species, aluminum finish, or gypsum only when they cannot be clearly identified or described in schedules and specifications.

The accuracy of elements within a CADD drawing file depends on the use of proper drawing techniques and on the working units used in creating the file. There is a misconception that if a drawing is created digitally, it is precise and accurate. In fact, there are varying levels of accuracy. Because of the obvious legal implications involved in the accuracy of the Contract Documents, the accuracy requirements (both legal and contractual) for each project must be understood and followed by each project team member. Additionally, the City intends to use these drawings as a component of its geographical informational system (GIS). The layering structure and attention to procedures is therefore important in that regard as well.

### **2.15.6 Drawing Changes**

Changes made to drawings during design do not lead to any revision notations on the border. The Construction Change/Addendum Table on the border is for formal changes made by addendum during the bid phase, change orders made during construction, and for recording as-built information.

A change is noted by describing it in the Construction Change/Addendum Table, clouding the revised area on the drawing, and placing the revision letter or number in a triangle adjacent to the clouded area. When the next revision is made to the drawing, the previous cloud(s) and letter(s) remain and a new cloud and next sequential letter is applied.

### **2.15.7 Centerline Coordinates - Station and Elevation**

In conformance with industry and local standards, buried pipelines are dimensioned on the Contract Drawings using stationing and invert elevations. Recognizing that this dimensioning system is not precise when slopes and horizontal bends are combined, the pipe fabricator must convert the invert data to a pipe centerline station and elevation coordinate system. For this purpose, the following definitions are used:

1. The horizontal location of the intersection of the pipe centerlines at bends is defined as equal to that of the corresponding invert lines on the plan view.
2. The vertical elevation of the intersection of the pipe centerlines at bends is defined as equal to the invert elevation at intersection of the invert lines plus the pipe inside radius.

Further recognizing that this conversion can have a minor effect upon final as-built pipe invert elevations, the pipe fabricator must provide precise invert elevations and pipe slopes for setting each pipe section and fitting.

Whenever centerline dimensions are given on the contract drawings, they govern.

## **2.16 Sequence of Drawings**

Drawings are arranged in the volume of contract drawings according to the following:

### **1. General Drawings**

- Cover Sheet
- Overall Site Plan
- List of Drawings
- General and Project Notes
- Abbreviations and Symbols
- Traffic Control Plan or Project Notes
- Design Criteria
- Flow Diagram
- Hydraulic Profile

After the General Drawings, drawings are sequenced first by area, second by discipline within the area, and third by sheet sequence within the discipline. Subjects within the disciplines are arranged according to the following:

### **2. Demolition Drawings**

### **3. Civil Drawings**

- Civil Plans
- Plans and Profiles
- Civil Details
- Cathodic Protection Plans and Details

### **4. Landscaping /Irrigation Drawings**

- Irrigation Plans
- Irrigation Details
- Landscaping Planting Schedule
- Landscaping Plans
- Landscaping Details

### **5. Architectural Drawings**

- Architectural Plans, Sections and Elevations
- Architectural Details
- Architectural Schedules

### **6. Structural Drawings**

- General Notes and Design Criteria
- Structural Plans and Sections
- Structural Details

### **7. Mechanical Drawings**

- Mechanical Plans and Sections
- Mechanical Details
- Equipment Schedules
- HVAC Schematics
- HVAC Plans and Sections
- HVAC Details
- HVAC Equipment Schedules
- Plumbing Schematics
- Plumbing Floor Plans
- Plumbing Details
- Fire Protection Floor Plans
- Fire Protection Details

### **8. Electrical Drawings**

- Electrical Plans
- Electrical Details
- Electrical Schedules
- Electrical Diagrams

## **9. Instrumentation Drawings**

Piping and Instrumentation Diagrams  
Loop Diagrams  
Logic Diagrams  
Instrument Installation Details

## **10. Traffic Control Drawings**

Traffic Control Index and Notes  
Traffic Control Plans  
Traffic Control Details  
Resurfacing/Striping Plans  
Resurfacing/Striping Details

### **2.17 Discipline Specifics**

This section elaborates on the content of the drawings produced by the various disciplines.

#### **2.17.1 Cover Sheet**

The standard cover sheet is shown in Figure 2-13. The Design Consultant places the vicinity and location maps on the cover sheet. The name of the consultant, design consultant's declaration, and block for stamp are also included on this sheet. The Discipline code for this sheet is G-1.

#### **2.17.2 General Drawings**

General drawings present information which relates to the overall project, not to any single discipline. They are numbered in sequence. The number of general drawings depends on the size of the project. Information on sheets must be combined when possible. These drawings carry a "G" number, in the following sequence.

##### **2.17.2.1 Overall Site Plan**

Drawing numbered G-2 follows G-1 in every project. It shows the entire project site. If the project site is too large to be shown with the necessary level of detail, the overall site plan may be used as a key map.

1. Individual structures or process units must be identified. If the scale is small enough to prevent adequate size lettering, a structure or process numbering index must be used.
2. The grid system must be shown on this plan along with the basis of bearing and any adjustment to plan north.
3. The benchmark reference is also shown on this plan.
4. The boundary of the property is shown with bearings and distances or coordinates.

## **2.18 Microfilm Reproduction**

Drawings must be capable of producing acceptable prints when enlarged from 35mm microfilm records. Special attention must be given to avoid the following problems that cause poor microfilm quality:

1. Inconsistent line weight and density
2. Lettering that is fuzzy or too small
3. Incomplete erasures from changes
4. Smudges, dirt, stains, wrinkles and creases resulting from careless handling
5. Insufficient space between lines and letters
6. Over drafting, such as excessive cross hatching and shading
7. Drawings made to excessively small scales

## **2.19 Standard Details**

For water and recycled water system, refer to Books 3 and 7.

For wastewater treatment plant and large pump station facilities, refer to Clean Water Program Guidelines, Volume IV, Section A3.

Standard details can be obtained from the City of San Diego, Public Utilities Department.

## **2.20 Special Facilities Plan Check**

Improvement plans for special facilities such as large water (18-inch and larger), sewer pump stations and metering stations are submitted to Development Services Department (DSD) and routed to the appropriate operating division (responsible for maintenance) for review and comments. Sewer pump stations and metering stations shall be prepared in accordance with the City of San Diego's Sewer Design Guide, DSD gives final approval of the plans once all disciplines are satisfied. This plan check process information can be obtained from DSD.

## FIGURES

Figure 2-1 Standard Abbreviations

ABBREVIATION	MEANING	ABBREVIATION	MEANING	ABBREVIATION	MEANING	ABBREVIATION	MEANING
A/C	AIR CONDITIONING	BLK	BLACK, BLOCK	COMPT	COMPARTMENT	EF	EACH FACE, EXHAUST FAN
A	AMPERE, ANODE	BLKG	BLOCKING	CONC	CONCRETE	EG	EXHAUST GRILLE, EXISTING GRADE,
AB	ANCHOR BOLT, ANODE BED	BLT	BOLT	COND	CONDENSER, CONDUIT		EDGE OF GUTTER
ABAND	ABANDON	BM	BEAM, BENCH MARK	CONN	CONNECTION, CONNECTOR	EGL	ENERGY GRADE LINE
ABAND'D	ABANDONED	BO	BLOW-OFF ASSEMBLY	CONST	CONSTRUCTION	EJ	EXPANSION JOINT
ABBR	ABBREVIATIONS	BOD	BIOCHEMICAL OXIGEN DEMAND	CONT	CONTINUED, CONTINUOUS, CONTROL	EL	ELEVATION
ABS	ABSOLUTE,	BOP	BOTTOM OF PIPE	CONTR	CONTRACTOR	ELB	ELBOW
	ACRYLONITRILE-BUTADIENE-STYRENE	BOT	BOTTOM	COORD	COORDINATE	ELEC	ELECTRICAL, ELECTRONIC
AC	ACTIVATED CARBON, ASPHALT CONCRETE,	BP	BYPASS	CP	CATHODIC PROTECTION, CONCRETE PIPE	EMER	EMERGENCY
	ALTERNATING CURRENT, ASBESTOS CEMENT	BRK	BRICK	CPLG	COUPLING	EMH	ELECTRIC MANHOLE
ACB	AIR CIRCUIT BREAKER	BS	BUTT STRAP, BOND STATION	CPVC	CHLORINATED POLYVINYL CHLORIDE	E-NET	ETHERNET
ACFL	ACCESS FLOOR	BSMT	BASEMENT	CRT	CATHODIC RAY TUBE	ENCL	ENCLOSURE
ACK	ACKNOWLEDGE	BTWN	BETWEEN	CS	CAST STEEL, CARBON STEEL,	ENG	ENGINE
ACP	ASPHALT CONCRETE PAVEMENT	BTU	BRITISH THERMAL UNIT		CONTROL SWITCH	ENTR	ENTRANCE
ADJ	ADJUSTABLE	BVC	BEGIN VERTICAL CURVE	CT	CERAMIC TILE, CURRENT TRANSFORMER	EP	EXPLOSION PROOF, EDGE OF PAVEMENT
AFF	ABOVE FINISH FLOOR	BW ELEV	BOTTOM OF WALL ELEVATION	C TO C	CENTER TO CENTER	EQ	EQUATION, EQUAL
AG	ABOVE GRADE			CTF	CUT TO FIT IN FIELD	EQUIP	EQUIPMENT
AHD	AHEAD	C & G	CURB AND GUTTER	CTR	CENTER	E SHTDWN	EMERGENCY SHUTDOWN
AI	ANALOG INPUT	C	CONDUIT, COPPER	CTSK	COUNTERSUNK	ESMT	EASEMENT
AJB	ANODE JUNCTION BOX	CAB	CABINET, CRUSHED AGGREGATE BASE	CTV	CABLE TELEVISION	ETM	ELAPSE TIME METER
AL	ALUMINUM	CAP	CORRUGATED ALUMINUM PIPE,	CTX	COAL TAR EPOXY	EVC	END VERTICAL CURVE
ALT	ALTERNATE		CAPACITOR, CAPACITY	CU	CUBIC	EW	EACH WAY, EYEWASH
AM	AUTO/MANUAL	CAT	CATALOG	CV	CHLORINATOR VENT AND DETECTOR	EXC	EXCAVATION
AMB	AMBIENT	CATV	CABLE TELEVISION		LINE, CONTROL VALVE, CONE VALVE	EXH	EXHAUST
AMP	AMPERE	CB	CATCH BASIN, CHALK BOARD, CUT BACK,	CYL	CYLINDER	EXIST	EXISTING
ANN	ANNUNCIATOR		CIRCUIT BREAKER			EXP JT	EXPANSION JOINT
ANSI	AMERICAN NATIONAL STANDARDS	CD	CHEMICAL DRAIN			EXT	EXTERIOR, EXTENSION
	INSTITUTE	CEM	CEMENT	db	DECIBELS	EXTD	EXTRUDED
AO	ANALOG OUTPUT	CER	CERAMIC	DBL	DOUBLE		
APPROX	APPROXIMATE	CF	CURB FACE	DC	DIRECT CURRENT		
APVD	APPROVED	CFM	CUBIC FEET PER MINUTE	DCS	DISTRIBUTED CONTROL SYSTEM		
ARCH	ARCHITECTURAL	CFS	CUBIC FEET PER SECOND	DE	DRESSER END		
ASME	AMERICAN SOCIETY OF	CHKD PL	CHECKERED PLATE	DET	DETAIL		
	MECHANICAL ENGINEERS	CHNG	CHANGE	DF	DOUGLAS FIR		
ASSEM	ASSEMBLY	CI	CAST IRON	DFT	DRY FILM THICKNESS		
ASTM	AMERICAN SOCIETY FOR	CICL	CAST IRON CEMENT LINED PIPE	DI	DUCTILE IRON, DISCRETE INPUT		
	TESTING AND MATERIALS	CIP	CAST IRON PIPE,	DIA	DIAMETER		
AT	ACOUSTICAL TILE		CAPITAL IMPROVEMENT PLAN	DIAG	DIAGONAL, DIAGRAM		
ATM	ATMOSPHERE	CIPP	CAST IN PLACE PIPE	DIAPH	DIAPHRAGM		
AUTO	AUTOMATIC	CJ	CONSTRUCTION JOINT	DIFF	DIFFERENTIAL		
AUX	AUXILIARY	CKT	CIRCUIT	DIP	DUCTILE IRON PIPE		
AV	AIR VALVE	CKV	CHECK VALVE	DISC	DISCONNECT		
AVAR	AIR VACUUM AND AIR RELEASE	CL	CENTERLINE, CHLORINATOR, CHAIN LINK,	DISCH	DISCHARGE		
AVG	AVERAGE		CLEARANCE, CLASS	DISP	DISPENSER		
AWG	AMERICAN WIRE GAGE	CLF	CURRENT LIMITING FUSE	DISTR	DISTRIBUTION		
AWT	ADVANCED WASTE TREATMENT	CLG	CEILING	DN	DOWN		
AWWA	AMERICAN WATER WORKS ASSOCIATION	CLR	CLEAR	DO	DISSOLVED OXYGEN, DISCRETE OUTPUT		
AXFMR	AUTO-TRANSFORMER	CM	CENTIMETER	DPDT	DOUBLE POLE, DOUBLE THROW		
		CMC	CEMENT MORTAR COATING	DPST	DOUBLE POLE, SINGLE THROW		
BAT	BATTERY	CMH	COMMUNICATIONS MANHOLE	DR	DOOR, DRAIN		
BC	BEGIN CURVE, BOLT CIRCLE,	CML	CEMENT MORTAR LINED	DS	DRENCH SHOWER AND EYEWASH, DOWN SPOUT,		
	BETWEEN CENTERS	CMLCS	CEMENT MORTAR LINED		DISCONNECT SWITCH		
BCR	BEGIN CURVE RETURN		AND COATED STEEL	DWG	DRAWING		
BDRY	BOUNDARY	CMP	CORRUGATED METAL PIPE	DWY	DRIVEWAY		
BE	BEVEL END	CMU	CONCRETE MASONRY UNIT				
BF	BLIND FLANGE	CNCTRC	CONCENTRIC	E	EAST, ELECTRICAL		
BFP	BACK FLOW PREVENTER	CND	CONDUIT	EA	EACH		
BFV	BUTTERFLY VALVE	CNTRL	CONTROL	EB	EXPANSION BOLT (ANCHOR)		
BHP	BRAKE HORSEPOWER	CO	CONDUIT ONLY, CUT OFF	EC	END CURVE		
BIL	BASIC IMPULSE LEVEL	COAX	COAXIAL CABLE	ECC	ECCENTRIC		
BK	BACK	COL	COLUMN	ECR	END CURB RETURN		
BKR	BREAKER	COMB	COMBINATION				
BLDG	BUILDING	COMM	COMMUNICATION				
		COMPR	COMPRESSOR				

NOTES: SOME ABBREVIATIONS MAY NOT BE USED IN THIS CONTRACT.  
FOR INSTRUMENT IDENTIFICATION LETTERS SEE ANSI/ISA-S5.1, TABLE 1.

A-1

STANDARD ABBREVIATIONS (A-E)			
CITY OF SAN DIEGO, CALIFORNIA		WATER WBS	0-00000
PUBLIC WORKS DEPARTMENT		SEWER WBS	0-00000
SHEET OF SHEETS			
FOR CITY ENGINEER	DATE	PROJECT MANAGER	
PRINT NAME	TRCE#	PROJECT ENGINEER	
DESCRIPTION	BY	APPROVED	DATE
ORIGINAL	xx/xx		
CONTRACTOR	DATE STARTED		XXXXX-01-D
INSPECTOR	DATE COMPLETED		



Figure 2-1 Standard Abbreviations

ABBREVIATION	MEANING	ABBREVIATION	MEANING	ABBREVIATION	MEANING	ABBREVIATION	MEANING
F	DEGRESS FAHRENHEIT, FLANGE	GND	GROUND	KVAR	KILOVAR	MTC	MECHANICAL-TYPE COUPLING
FA	FIRE ALARM	GPD	GALLONS PER DAY	KW	KILOWATT	MTD	MOUNTED, MULTIPLE TELEPHONE DUCT
FAB	FABRICATED	GPM	GALLONS PER MINUTE	KWH	KILOWATT HOUR	MTG	MOUNTING
FAT	FACTORY ACCEPTANCE TEST	GRC	GRADE BREAK, GRADE CHANGE	L/P	LOW POINT	MTR	METERING STATION
FB	FLAT BAR, FLOOR BEAM, FIELD BOOK	GRTG	GRATING	L/R	LOCAL/REMOTE	MTS	SAN DIEGO METROPOLITAN TRANSIT SYSTEM
FBC	FURNISHED BY CITY	GSP	GALVANIZED STEEL PIPE	L	LITER, LENGTH, LEFT	MULT	MULTIPLE
FBE	FUSION BONDED EPOXY	GV	GATE VALVE	LA	LIGHTNING ARRESTER	MV	MEDIUM VOLTAGE
FC	FLEXIBLE COUPLING, FAIL CLOSE, FOOT CANDLE	GVBP	GATE VALVE WITH BYPASS	LB	POUND	mV	MILLIVOLTS
FCA	FLANGE COUPLING ADAPTER	GYP	GYP SUM	LCP	LOCAL CONTROL PANEL	N	NORTH, NEUTRAL
FCO	FLOOR CLEANOUT	H/A	HAND/AUTO	LEL	LOWER EXPLOSIVE LEVEL	NA	NON-AUTOMATIC, NOT APPLICABLE
FD	FLOOR DRAIN	H/P	HIGH POINT	LF	LINEAR FEET, LINE FILTER	NBS	NATIONAL BUREAU OF STANDARDS
FDN	FOUNDATION	HB	HOSE BIBB	LG	LENGTH, LONG	NC	NORMALLY CLOSED
FDR	FEEDER	HDR	HEADER	LL	LIVE LOAD	NCTD	NORTH COUNTY TRANSIT DISTRICT
FEXT	FIRE EXTINGUISHER	HEX	HEXAGONAL	LOC	LOCAL, LOCATION	NDL	NEEDLE VALVE
FF	FLAT FACE, FAR FACE, FINISH FLOOR	Hg	MERCURY	LONG	LONGITUDINAL	NEC	NATIONAL ELECTRICAL CODE
FG	FINISHED GRADE	HGL	HYDRAULIC GRADE LINE	LOS	LOCK OUT STOP	NEMA	NATIONAL ELECTRICAL MANUFACTURING ASSOCIATION
FH	FIRE HYDRANT	HGR	HANGER	LP	LOW PRESSURE, LIGHTING PANEL	NEUT	NEUTRAL
FHMB	FLAT HEAD MACHINE BOLT	HGT	HEIGHT	LR	LONG RADIUS, LOCAL/REMOTE	NF	NEAR FACE
FIG	FIGURE	HH	HAND HOLE	LSP	LANDSCAPING SPRINKLER SYSTEM	NFPA	NATIONAL FIRE PROTECTION ASSOCIATION
FIN	FINISHED	HI	HIGH	LT	LIGHT, LEFT	NG	NATURAL GRADE
FIX	FIXTURE	HMW	HIGH MOLECULAR WEIGHT	LTG	LIGHTING	NIC	NOT IN CONTRACT
FL	FLOWLINE, FLOOR	HOA	HAND/OFF/AUTOMATIC	LTS	LIGHTS	NO	NORMALLY OPEN, NUMBER
FLA	FULL LOAD AMPS	HOR	HAND/OFF/REMOTE, HORIZONTAL	LV	LOW VOLTAGE	NOM	NOMINAL
FLEX	FLEXIBLE	HP	HORSEPOWER, HIGH PRESSURE	LVL	LEVEL	NOS	NUMBERS
FLG	FLANGE	HR	HOUR	LWL	LOW WATER LEVEL	NPS	NOMINAL PIPE SIZE (FORMERLY I.P.S.)
FLUOR	FLUORESCENT	HTG	HEATING	LWR	LOWER	NPT	NATIONAL PIPE THREAD
FM	FORCE MAIN	HV	HORIZONTAL AND VERTICAL CONTROL POINT, HIGH VOLTAGE	LYT	LAYOUT	NRS	NON-RISING STEM
FMH	FLEXIBLE METAL HOSE	HZ	HERTZ	M/W	WATER METER	NS	NEAR SIDE
FO	FAIL OPEN, FIBER OPTIC (CABLE)	I/O	INPUT/OUTPUT	M	METER, MALE (PIPE THREAD)	NTS	NOT TO SCALE
FOB	FLAT ON BOTTOM	IA	INSTRUMENT AIR	mA	MILLIAMPS	OC	OVER-CROSSING, ON CENTER, OPEN/CLOSE
FOC	FACE OF CONCRETE	ID	INSIDE DIAMETER, IDENTIFICATION	MA	MANUAL/AUTO	OCA	OPEN/CLOSE/AUTO
FOM	FACE OF MASONRY	IE	INVERT ELEVATION	MACH	MACHINE	OCB	OIL CIRCUIT BREAKER
FOR	FORWARD	IF	INSIDE FACE	MAG	MAGNETIC	OCR	OPEN/CLOSE/REMOTE
FOS	FACE OF STUDS	IL	INDICATING LAMP	MAN	MANUAL	OD	OUTSIDE DIAMETER, OVERALL DIMENSION
FOT	FLAT ON TOP	IN	INCH	MATL	MATERIAL	OE	OUTSIDE EDGE
FOW	FACE OF WALL	INC	INCANDESCENT	MAX	MAXIMUM	OF	OUTSIDE FACE
FPM	FEET PER MINUTE	INSTR	INSTRUMENT	MCC	MOTOR CONTROL CENTER	OH	OVERHEAD
FPS	FEET PER SECOND	INSUL	INSULATION OR INSULATED	MDM	MEDIUM	OL	OVERLOAD RELAY, OUTLET
FR	FRAME	INTR	INTERIOR	MECH	MECHANICAL	OPER	OPERATOR
FRP	FIBERGLASS REINFORCED PLASTIC	INVT	INVERT ELEVATION	MET	METAL	OPNG	OPENING
FS	FAR SIDE, FINISHED, SURFACE, FORGED STEEL, FACTOR OF SAFETY, FIRE SERVICE FEET, FOOT, FIELD TOP	IP	IRON PIPE	MFR	MANUFACTURER	OPP	OPPOSITE
FT	FOOTING	IPS	IRON PIPE SIZE	MGD	MILLION GALLONS PER DAY	ORD	OVERFLOW ROOF DRAIN
FTG	FUTURE	IRR	IRRIGATION	MH	MANHOLE	OS & Y	OUTSIDE STEM AND YOKE
FUT	FUTURE	ISA	INSTRUMENT SOCIETY OF AMERICA	MIL	MILITARY, 1/1,000 INCH	OUT	OUTPUT
FV	FULL VOLTAGE	JB	JUNCTION BOX	MIN	MINIMUM, MINUTE	OVFL	OVERFLOW
FVNR	FULL VOLTAGE NON REVERSING	JC	JUNCTION CHAMBER	MISC	MISCELLANEOUS	OVHD	OVERHEAD
FW	FIELD WELD	JT	JOINT	MJ	MECHANICAL JOINT	OZ	OUNCE
FWD	FORWARD	K	KILO	MK	MARK		
FWY	FREEWAY	KA	KILO AMPERES	MMI	MAN MACHINE INTERFACE		
FX	FUSION EPOXY	KCM	KILO CIRCULAR MILLS	MO	MOTOR OPERATED, MASONRY OPENING		
G/B	GALVANIZED BOLT	KG	KILOGRAM	MOD	MODIFY, MODIFIED		
GA	GAGE, GAUGE	KM	KILOMETER	MON	MONUMENT		
GAF	GALVANIZED AFTER FABRICATION	KV	KILOVOLT	MOT	MOTOR		
GAL	GALLON	KVA	KILOVOLT AMPERES	MOV	MOTOR OPERATED VALVE		
GALV	GALVANIZED			MS	MANUAL SWITCH		
GALVI	GALVANIZED IRON			MSL	MEAN SEA LEVEL		
GEN	GENERAL, GENERATOR			MT	MOUNT		
GFA	GROOVED FLANGED ADAPTER						
GIS	GEOGRAPHICAL INFORMATION SYSTEM						
GL	GLASS, GLOBE VALVE						

NOTE: SOME ABBREVIATIONS MAY NOT BE USED IN THIS CONTRACT

A-2

<b>STANDARD ABBREVIATIONS (F-0)</b>			
CITY OF SAN DIEGO, CALIFORNIA		WATER WBS	0-00000
PUBLIC WORKS DEPARTMENT		SHEET WBS	0-00000
SHEET OF SHEETS			
FOR CITY ENGINEER	DATE	PROJECT MANAGER	
PRINT NAME	TRC#	PROJECT ENGINEER	
DESCRIPTION	BY	APPROVED	DATE
ORIGINAL	xx/xx		
CONTRACTOR	DATE STARTED	XXXXX-01-D	
INSPECTOR	DATE COMPLETED		

Figure 2-1 Standard Abbreviations

ABBREVIATION	MEANING	ABBREVIATION	MEANING	ABBREVIATION	MEANING	ABBREVIATION	MEANING
P/S	POLE AND SHELF	RC	REINFORCED CONCRETE	SO	SIDE OUTLET		
PE/BS	PLAIN END, BUTT STRAP	RCP	REINFORCED CONCRETE PIPE	SOD	SPECIFIED IN OTHER DIVISIONS		
P	POLE, PAGE, PIPE, PHASE, PLASTIC	RCCP	REINFORCED CONCRETE CYLINDER PIPE	SOL	SOLENOID		
PA	PLANT AIR, PUBLIC ADDRESS	RCSC	REINFORCED CONCRETE STEEL CYLINDER	SP	SPARE, STATIC PRESSURE		
PAVMT	PAVEMENT	RD	ROOF DRAIN, ROAD	SPDT	SINGLE POLE DOUBLE THROW		
PC	PORTLAND CEMENT, POINT OF CURVATURE, PERSONAL COMPUTER	RE-STL	REINFORCING STEEL	SPECF	SPECIFIED		
PCM	PROCESS CONTROL MODULE	RE	REFERENCE ELECTRODE	SPECS	SPECIFICATIONS		
PCSC	PRESTRESSED CONCRETE	REC	RECTIFIER	SPK	SPEAKER		
	STEEL CYLINDER	RECPT	RECEPTACLE	SPST	SINGLE POLE SINGLE THROW		
PD	PLANT DRAIN	RED	REDUCER	SQ	SQUARE		
PE	PLAIN END, POLYETHYLENE	REF	REFERENCE	SR	SHORT RADIUS		
PED	PEDESTRIAN	REG	REGULATING STATION	SS	STAINLESS STEEL		
PF	POWER FACTOR	REINF	REINFORCEMENT		SELECTOR SWITCH, START/STOP		
PG	PIPE GROUND	REOD	REQUIRED	SSB	STAINLESS STEEL BOLT		
PH	PHASE, POT HOLE	RESIL	RESILIENT	ST PR	STATIC PRESSURE		
pH	HYDROGEN ION CONCENTRATION	REV	REVISION, REVERSE	STA	STATION		
PI	POINT OF INTERSECTION, PRESSURE INDICATOR	RF	ROOF, RAISED FACE	STD	STANDARD		
PI&D	PIPING & INSTRUMENT DIAGRAM	RFG	ROOFING	STL	STEEL		
PL, P/L	PLATE, PROPERTY LINE, PLACE, PLUG VALVE	RGS	RIGID GALVANIZED STEEL	STM	STEAM		
	PROGRAMMABLE LOGIC CONTROLLER	RH	RELATIVE HUMIDITY	STR	STRAIGHT		
PLC	PLANT	RIO	REMOTE I/O	STRD	STRANDED		
PLT	PNEUMATIC	RM	ROOM	STRUCT	STRUCTURAL OR STRUCTURE		
PNEU	PANEL	RND	ROUND	SUCT	SUCTION		
PNL	PANELBOARD	RO	ROUGH OPENING	SV	SOLENOID VALVE, SAFETY VALVE, SUPPLY VENT		
PNLBD	PAINT	ROFC	RATE OF FLOW CONTROL STATION	SW	SWITCH		
PNT	POSITION	ROM	READ ONLY MEMORY	SWBD	SWITCHBOARD		
POS	POWER POLE, POLYPROPYLENE, POWER PANEL	RPM	REVOLUTIONS PER MINUTE, REINFORCED PLASTIC MORTAR	SWGR	SWITCHGEAR		
PP	POUNDS PER DAY	RR	RAILROAD	SYM	SYMBOL		
PPD	POUNDS PER HOUR	RS	RISING STEM, RIGID STEEL	SYMM	SYMMETRICAL		
PPH	PARTS PER MILLION	RT	RIGHT	SYS	SYSTEM		
PPM	PRECAST	RTD	RESISTANCE TEMPERATURE DETECTOR				
PRCST	PREFABRICATED	RTN	RETURN				
PREFAB	PRESSURE	RTP	REINFORCED THERMOSETTING PLASTIC				
PRESS	PRIMARY	RTU	REMOTE TELEMETRY UNIT				
PRI	PRESSURE RELIEF VALVE	RW	RETAINING WALL				
PRV	POINT OF REVERSE VERTICAL CURVE	S/W	SIDEWALK				
PRVC	PRESSURE SWITCH, POWER SUPPLY, PUMPING STATION	SE/CJ	SPOT END, CARNEGIE JOINT				
PS	POUNDS PER SQUARE FOOT	S	SOUTH, SINK, SEWER				
PSF	POUNDS PER SQUARE INCH	SA	SAMPLE LINE, STATUS ANNUNCIATOR				
PSI	POUNDS PER SQUARE INCH ABSOLUTE	SAMA	SCIENTIFIC APPARATUS MAKERS ASSOCIATION				
PSIA	POUNDS PER SQUARE INCH GAGE	SAT	SITE ACCEPTANCE TEST				
PSIG	PRESSURE TRANSMITTER	SBR	STYRENE BUTADIENE RUBBER				
PT	POTENTIAL TRANSFORMER	SCD	SCREWED				
PTFE	POLYTETRAFLUOROETHYLENE (TEFLON)	SCFM	STANDARD CUBIC FEET PER MINUTE				
PV	PLUG VALVE	SCHD	SCHEDULE				
PVC	POLYVINYL CHLORIDE	SCRW	STEEL CYLINDER ROD WRAPPED				
PVMT	PAVEMENT	SD&AE	SAN DIEGO & ARIZONA EASTERN RAILROAD				
PW	POTABLE WATER, PART WINDING (MOTOR STARTER)	SDR	STORM DRAIN				
PWR	POWER	SD	CITY OF SAN DIEGO				
QT	QUARRY TILE	SDRSD	SAN DIEGO REGIONAL STANDARD DRAWING				
QTY	QUANTITY	SDSD	CITY OF SAN DIEGO STANDARD DRAWING				
R/W, ROW	RIGHT OF WAY	SDTI	SAN DIEGO TROLLEY INC.				
R	RISER, RATE OR SLOPE, RIGHT, RADIUS	SEC	SECONDARY, SECONDS				
RAM	RANDOM ACCESS MEMORY	SECT	SECTION				
		SEL SW	SELECTOR SWITCH				
		SEQ	SEQUENCE				
		SER	SERIES				
		SHT	SHEET				
		SHT DN	SHUT DOWN				
		SIG	SIGNAL				
		SL	SLOPER, SLOPE LENGTH, SURVEY LINE, SLUICE VALVE				
		SLDG	SLIDING				

NOTE: SOME ABBREVIATIONS MAY NOT BE USED IN THIS CONTRACT.

A-3

<b>STANDARD ABBREVIATIONS (P-S)</b>			
CITY OF SAN DIEGO, CALIFORNIA		WATER WBS	0-00000
PUBLIC WORKS DEPARTMENT		SEWER WBS	0-00000
SHEET OF SHEETS			
FOR CITY ENGINEER	DATE	PROJECT MANAGER	
PRINT NAME	TICE#	PROJECT ENGINEER	
DESCRIPTION	BY	APPROVED	DATE
ORIGINAL	xx/xx		
CONTRACTOR	DATE STARTED	XXXXX-01-D	
INSPECTOR	DATE COMPLETED		

Figure 2-1 Standard Abbreviations

ABBREVIATION	MEANING	ABBREVIATION	MEANING
T & B	TOP AND BOTTOM	VSD	VARIABLE SPEED DRIVE
T/C	THERMOCOUPLE	VTR	VENT THROUGH ROOF
T & G	TONGUE AND GROOVE	W/	WITH
T	TREAD OF STAIR, TOP, TOILET, THICKNESS	W/O	WITHOUT
TACH	TACHOMETER	W	WEST, WATTS, WIRE, WATER
TAN	TANGENTIAL, TANGENT	WB	WELDED BELL
TB	TACK BOARD, TERMINAL BOARD	WC	WATER COLUMN
TBD	TO BE DETERMINED	WD	WOOD
TBE	THREAD BOTH ENDS	WI	WROUGHT IRON
TBM	TEMPORARY BENCH MARK	WM	WATER METER
TBS	TEST BOND STATION	WP	WEATHERPROOF, WATER PROOFING, WALL PLUG
TC	TOP OF CURB, TIMED CLOSED, TOP OF CONCRETE, THERMOCOUPLE	WS	WATER SURFACE, WELDED SPIGOT
TDOD	TIME DELAY ON DE-ENERGIZE	WSP	WELDED STEEL PIPE
TDOE	TIME DELAY ON ENERGIZE	WSTP	WATER STOP
TEL	TELEPHONE	WT	WEIGHT
TELCO	TELEPHONE UTILITY	WTR	WATER
TEMP	TEMPERATURE, TEMPORARY	WWF	WELDED WIRE FABRIC
TERM	TERMINAL	WWM	WELDED WIRE MESH
TF	TOP OF FOOTING	XCVR	TRANSEIVER
THK	THICK, THICKNESS	XFMR	TRANSFORMER
THRD	THREADED	XING	CROSSING
TK	TANK	XMTR	TRANSMITTER
TO	TIMED OPEN	XSEC	CROSS SECTION
TOE	THREAD ONE END	YD	YARD
TOL	THREADED OUTLET	YR	YEAR
TP	TELEPHONE POLE OR TELEGRAPH POLE	Z	ZERO OR ZONE, IMPEDENCE
TS	TIME SWITCH, TRANSITION STRUCTURE, TEMP SWITCH, TEST STATION	ZN	ZINC
TSPR	TWISTED SHIELDED PAIR	ZO	ZINC ORTHOPHOSPHATE
TURB	TURBIDITY		
TV	TELEVISION		
TW	TOP OF WALL, THERMOMETER WELL		
TYP	TYPICAL		
UBC	UNIFORM BUILDING CODE		
UC	UNDER-CROSSING		
UG	UNDERGROUND		
UL	UNDERWRITERS LABORATORY		
UMC	UNIFORM MECHANICAL CODE		
UNK	UNKNOWN		
UPC	UNIFORM PLUMBING CODE		
V	VALVE, VALVE STATION, VERTICAL, VENT, VOLT		
VA	VOLT/AMPS		
VAC	VACUUM		
VAP PRF	VAPOR PROOF		
VAR	VARIABLE		
VB	VALVE BOX		
VC	VERTICAL CURVE, VICTAULIC COUPLING		
VCP	VITRIFIED CLAY PIPE		
VD	VOLTAGE DROP		
VERT	VERTICAL		
VFD	VARIABLE FREQUENCY DRIVE		
VIB	VIBRATION		
VIC	VICTAULIC		
VOL	VOLUME		

NOTE: SOME ABBREVIATIONS MAY NOT BE USED IN THIS CONTRACT

A-4

STANDARD ABBREVIATIONS (T-Z)					
CITY OF SAN DIEGO, CALIFORNIA PUBLIC WORKS DEPARTMENT SHEET OF SHEETS				WATER WBS 0-00000	SEWER WBS 0-00000
APPROVED BY FOR CITY ENGINEER _____ DATE _____		DRAWN BY PROJECT MANAGER _____		CHECKED BY PROJECT ENGINEER _____	
PRINT NAME	BY	APPROVED	DATE	FILMED	
ORIGINAL	xx/xx				
					000-0000 CSDS COORDINATE
					0000-0000 CSDS COORDINATE
					XXXXX-01-D
CONTRACTOR _____		DATE STARTED _____			
INSPECTOR _____		DATE COMPLETED _____			

Figure 2-2 CIP Sample Border

C-1

PROJECT TITLE  
STREET NAME  
STREET TO STREET

CITY OF SAN DIEGO, CALIFORNIA  
PUBLIC WORKS DEPARTMENT  
SHEET OF SHEETS

FOR CITY ENGINEER	DATE			
PRINT NAME	TICE#			
DESCRIPTION	BY	APPROVED	DATE	FILMED
ORIGINAL	xx/xx			

CONTRACTOR \_\_\_\_\_ DATE STARTED \_\_\_\_\_  
INSPECTOR \_\_\_\_\_ DATE COMPLETED \_\_\_\_\_

WATER WBS	0-00000
SEWER WBS	0-00000
PROJECT MANAGER	_____
PROJECT ENGINEER	_____
000-0000	COORDINATE
0000-0000	COORDINATE
XXXXX-01-D	

PROJECT NAME

Figure 2-2 CIP Sample Border Project Title Block Breakdown

- 1 COVER SHEET TITLE BLOCK – PROJECT TITLE FOR CIP PROJECTS SHALL BE THE SAME AS THE TITLE OF THE PROJECT IN THE C.I.P. BUDGET BOOK
- 2 DISCIPLINE DESIGNATORS – OPTIONAL, AS SHOWN ON THE COVER SHEET
- 3 SHEET XX OF YY SHEET – XX REPRESENTS THE INDIVIDUAL SHEET AND YY REPRESENTS THE TOTAL NUMBER OF SHEETS
- 4 WORK BREAKDOWN STRUCTURE (WBS) – OBTAIN AND PLACE THE (WBS)(S) IN THE APPROPRIATE BLOCK AS SHOWN
- 5 PROJECT MANAGER – NAME OF THE PROJECT MANAGER  
PRIVATE PROJECT PLANS: NA
- 6 PROJECT ENGINEER – NAME OF THE PROJECT ENGINEER  
PRIVATE PROJECT PLANS: NA
- 7 CCS27 COORDINATE – (NAD 27) THE COVER SHEET SHALL CALL OUT "SEE EACH SHEET" ON THIS BLOCK  
PRIVATE PROJECT PLANS: THESE NUMBERS ARE DETERMINED DURING PLAN CHECK BASED ON PTS MAP LAYERS
- 8 CCS83 COORDINATE – (NAD 83) THE SHEET COVER SHEET SHALL CALL OUT "SEE EACH SHEET" ON THIS BLOCK  
PRIVATE PROJECT PLANS: THESE NUMBERS ARE DETERMINED DURING PLAN CHECK BASED ON PTS MAP LAYERS
- 9 DRAWING NUMBER – OBTAIN FROM MAPS AND RECORDS IN DEVELOPMENT SERVICES
- 10 DEPUTY CITY ENGINEER – DEPUTIZED CITY ENGINEER WHO IS IN CHARGE OF THE PROJECT (DIGITAL SIGNATURE) SIGNS ON BEHALF OF THE CITY
- 11 REGISTRATION: LEAVE BLANK IF IN-HOUSE DESIGN
- 12 REGISTRATION: DEPUTY CITY ENGINEER'S RCE NUMBER
- 13 DESCRIPTION BLOCK – "ORIGINAL" BLOCK FOR DESIGN PROJECT, ADDENDUM "A", "B", ETC AND CONSTRUCTION CHANGE "1", "2", ETC., FOR CHANGES MADE DURING CONSTRUCTION, WHEN DOING AS-BUILTS, USE A TRIANGLE WITH A NUMBER INSIDE (SEE AS-BUILT PROCEDURES SECTION OF THIS MANUAL)
- 14 CHANGES MADE TO DRAWINGS DURING DESIGN DO NOT LEAD TO ANY REVISION NOTATIONS ON THE BORDER, THE DRAWING STATUS BLOCK IS FOR FORMAL CHANGES BY ADDENDUM DURING THE BID PHASE, CONSTRUCTION CHANGES DURING CONSTRUCTION, AND FOR RECORDING AS-BUILTS INFORMATION PROJECT ENGINEER AND DRAFTER'S INITIALS WHO REVIEWED AND PREPARED THE AS-BUILT
- 15 DRAWN BY – WHEN ENTERING INITIALS, PLACE CITY DESIGN ENGINEER FIRST, THEN DRAFTER'S INITIALS OR THE INITIALS OF THE CONSULTANT'S COMPANY
- 16 APPROVED – THIS SECTION IS SIGNED WHEN ADDENDA AND CONSTRUCTION CHANGES ARE APPROVED BY THE DEPUTY CITY ENGINEER, AND THE AS-BUILT WILL BE SIGNED BY THE RESIDENT ENGINEER.
- 17 DATE – DATED BY THE DEPUTY CITY ENGINEER OR STAFF UNDER THEIR DIRECTION WHEN CHANGES ARE APPROVED
- 18 FILMED – WHEN THE PLANS ARE SUBMITTED TO MAPS AND RECORDS, THEY ARE FILMED AND DATED
- 19 FIELD INSPECTOR – PRINT NAME OF THE RESIDENT ENGINEER AFTER APPROVING AS-BUILTS, RESIDENT ENGINEER TO SIGN THE AUTHORIZATION FORM.
- 20 AS-BUILT INFORMATION – NAME OF CONTRACTOR, INSPECTOR AND THE DATES OF WHEN THE PROJECT STARTED AND ENDED
- 21 ENGINEERS STAMP – DIGITAL SEAL/STAMP (SIGNATURE WITH ELECTRONIC SIGNATURE AUTHORIZATION FORM), CONSULTANT IN CHARGE OF WORK MUST BE WET/ORIGINAL ONLY ON MYLARS
- 22 PRIVATE PROJECT PLANS: SEAL/STAMP MUST BE WET/ORIGINAL ONLY ON MYLARS
- 23 ADD THE MANUFACTURER(S) OF ALL MATERIALS, INCLUDING REHAB.  
PRIVATE PROJECT PLANS: NA
- 24 SPECIFICATIONS NO. – OBTAIN FROM CONTRACT PROCESSING  
PRIVATE PROJECT PLANS: NA
- 25 AS-BUILT INFORMATION FOR MATERIALS – REFER TO AS-BUILT PROCEDURES SECTION IN THIS MANUAL  
PRIVATE PROJECT PLANS: NA
- 26 PROGRAM IDENTIFICATION –
- 27 SCALE WARNINGS –
- 28 CHANGE – LINE WOULD HAVE THE LETTER (A, B, C, ETC.) SURROUNDED BY A TRIANGLE, WITH EACH LETTER A DIFFERENT SET OF CHANGES THROUGHOUT THE COURSE OF CONSTRUCTION. FOR PROCEDURES, REFER TO APPENDIX A, STANDARDS AND PROCEDURES FOR IMPROVEMENT PLANS.
- 29 DATE OF THE ADDENDUM AND/OR CONSTRUCTION CHANGE APPROVAL
- 30 AFFECTED OR ADDED SHEET NUMBERS – A CHANGE IS NOTED BY LISTING THE SHEET NUMBER(S)
- 31 APPROVAL NO. – NOT APPLICABLE FOR CIP PROJECTS
- 32 PRIVATE PROJECT PLANS: ASSIGNED APPROVAL NO. UPON PLAN REVIEW FOR PTS TRACKING PURPOSES

**Example 1: General Cover Sheet**

1: PLANS FOR THE CONSTRUCTION OF PROJECT TITLE COVER SHEET

2: G-1

3: CITY OF SAN DIEGO, CALIFORNIA  
PUBLIC WORKS DEPARTMENT  
SHEET XX OF YY SHEETS

4: WATER WBS 0-00000  
SEWER WBS 0-00000

5: PROJECT MANAGER

6: PROJECT ENGINEER

7: SEE SHEETS  
CCS27 COORDINATE

8: SEE SHEETS  
CCS83 COORDINATE

9: XXXXX-01-D

10: APPROVED: FOR CITY ENGINEER DATE

11: PRINT DCE NAME RCE#

12: SUBMITTED BY: CHECKED BY:

13: DESCRIPTION BY APPROVED DATE FILMED

14: ORIGINAL xx/xx xx

15: AS-BUILT xx/xx xx

16: CONTRACTOR DATE STARTED

17: INSPECTOR DATE COMPLETED

18: XXXXX-01-D

**Example 2: Specific Cover Sheet**

1: PLANS FOR THE CONSTRUCTION OF SEWER & WATER GROUP XYZ COVER SHEET

2: G-1

3: CITY OF SAN DIEGO, CALIFORNIA  
PUBLIC WORKS DEPARTMENT  
SHEET OF SHEETS

4: WATER WBS 0-00000  
SEWER WBS 0-00000

5: PROJECT MANAGER

6: PROJECT ENGINEER

7: 0000-0000  
CCS27 COORDINATE

8: 0000-0000  
CCS83 COORDINATE

9: XXXXX-00-D

10: APPROVED: FOR CITY ENGINEER DATE

11: PRINT NAME RCE#

12: SUBMITTED BY: CHECKED BY:

13: DESCRIPTION BY APPROVED DATE FILMED

14: ORIGINAL xx/xx xx

15: AS-BUILT xx/xx xx

16: CONTRACTOR DATE STARTED

17: INSPECTOR DATE COMPLETED

18: XXXXX-00-D

19: AS-BUILT INFORMATION

20: MATERIALS MANUFACTURER

21: PIPE CL 235 (WATER) -

22: PIPE SDR 35 (SEWER) -

23: GATE VALVES -

24: FIRE HYDRANTS -

25: SEWER MANHOLES -

26: REHABILITATE SEWER MANHOLES -

27: REHABILITATE SEWER MAIN -

28: CONSTRUCTION CHANGE / ADDENDUM

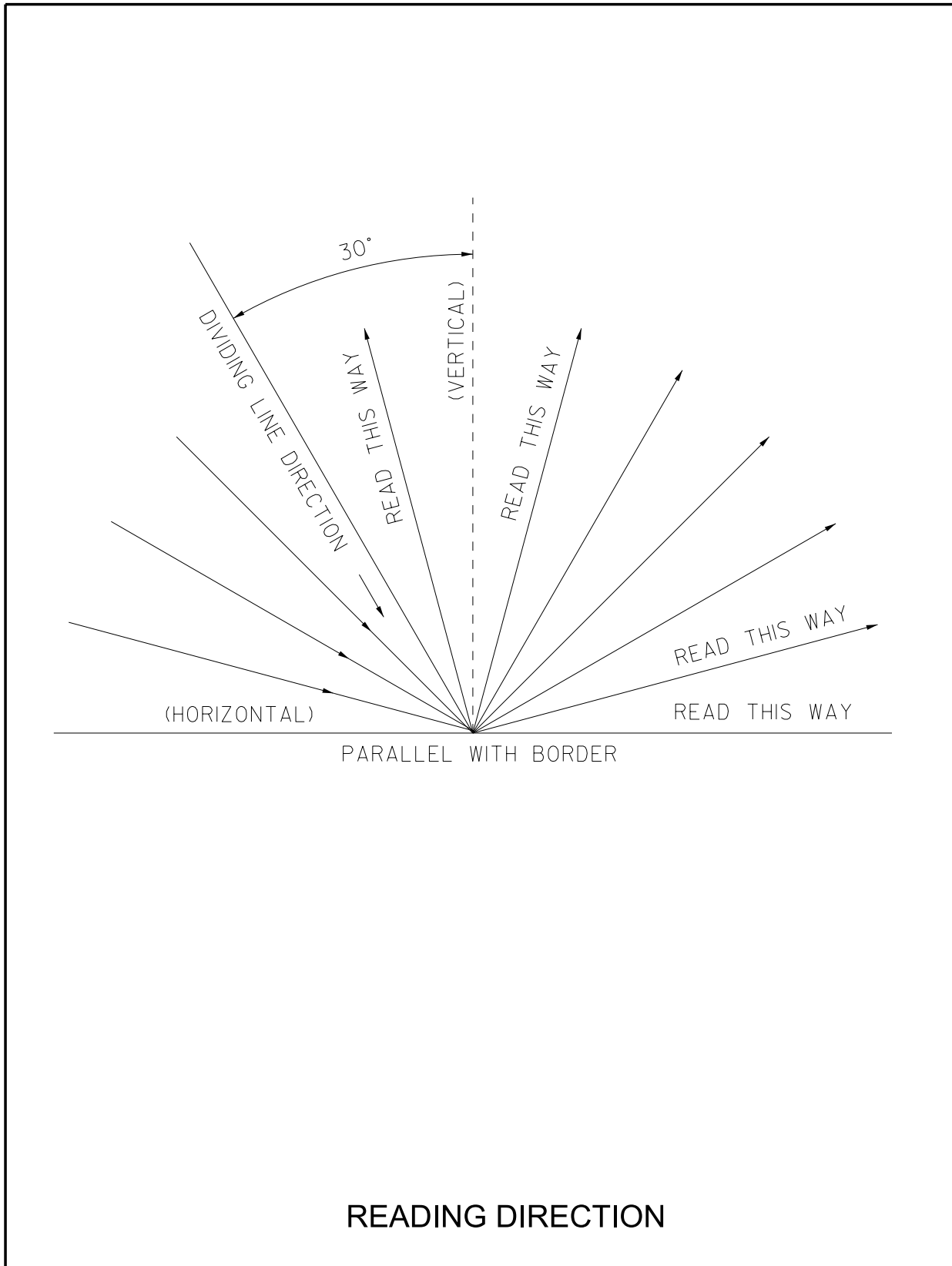
29: CHANGE DATE AFFECTED OR ADDED SHEET NUMBERS APPROVAL NO.

30: WARNING

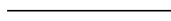



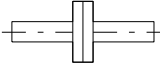
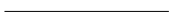





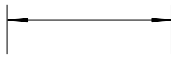

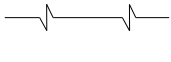


31: IF THIS BAR DOES NOT MEASURE 1" THEN DRAWING IS NOT TO SCALE.

32: The City of SAN DIEGO Public Works

**Figure 2-3 Reading Direction**

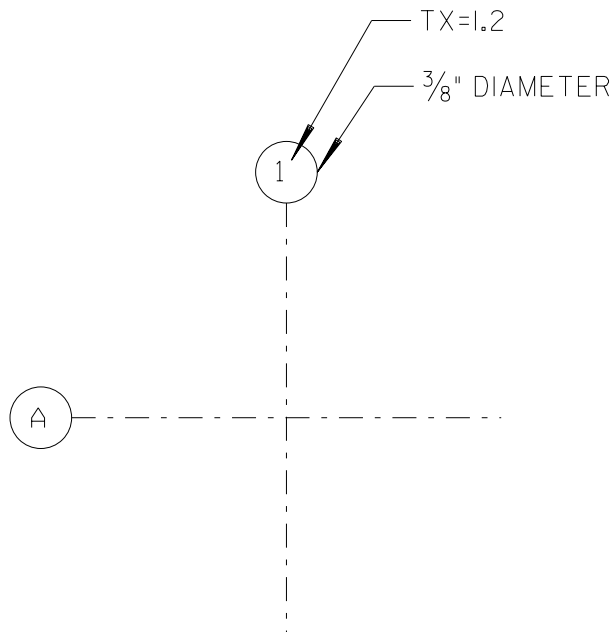


**Figure 2-4 Line Patterns and Widths**

NAME	PATTERN	WIDTH	PEN SIZE
SCHEMATIC MAIN PROCESS		EXTRA HEAVY	3
SCHEMATIC SECONDARY PROCESS		HEAVY	2
CUTLINE-PROPOSED FACILITIES		HEAVY	2
CUTTING PLANE LINE		HEAVY	2
DOUBLE LINE PIPING FLANGE		HEAVY	2
MATCH LINE		MEDIUM	1
SINGLE LINE FLANGE		MEDIUM	1
EQUIPMENT	VARIABLES	MEDIUM	1
OUTLINE EXISTING FACILITIES		FINE	000
OUTLINE FUTURE FACILITIES		FINE	000
HIDDEN LINE PROPOSED FACILITIES		FINE	000
HIDDEN LINE EXISTING FACILITIES		EXTRA FINE	0000
DIMENSION LINES		EXTRA FINE	0000
LEADER LINE (CALLOUT LINE)		EXTRA FINE	0000
LONG BREAKING LINE		EXTRA FINE	0000
CENTERLINE, COLUMN LINE, STRUCTURE OUTLINE		EXTRA FINE	0000
PHANTOM LINE		FINE	0000
		EXTRA FINE	0000

**LINE PATTERNS AND WIDTHS**

**Figure 2-5 Column Lines and Balloons**



USE A CENTERLINE AS A COLUMN LINE.  
EXTEND THE LINE  $\frac{1}{4}$ " BEYOND THE VIEW AT BOTH  
ENDS, AND TERMINATE IT AT THE TOP OR THE  
LEFT SIDE WITH A COLUMN LINE BALLON.

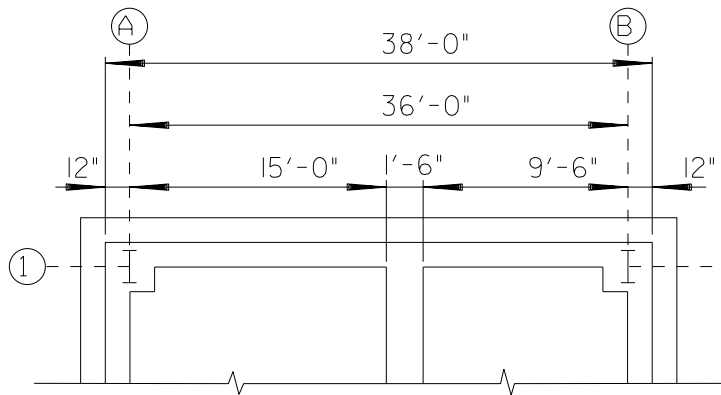
STARTING AT THE TOP LEFT AND MOVING RIGHT,  
SEQUENTIALLY LETTER COLUMN LINE BALLONS  
ACROSS THE TOP OF THE PAGE. AGAIN STARTING  
AT THE TOP LEFT, SEQUENTIALLY NUMBER THE  
BALLONS DOWN THE LEFT SIDE TO THE BOTTOM  
OF THE PAGE.

## COLUMN LINES AND BALLOONS

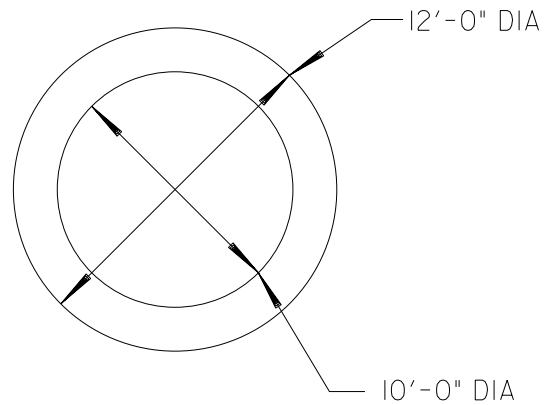
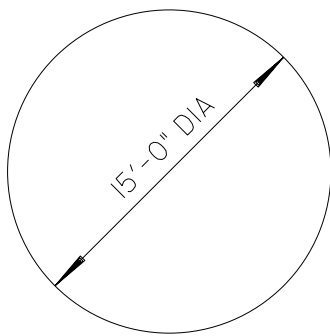


**Figure 2-6 Dimensioning**

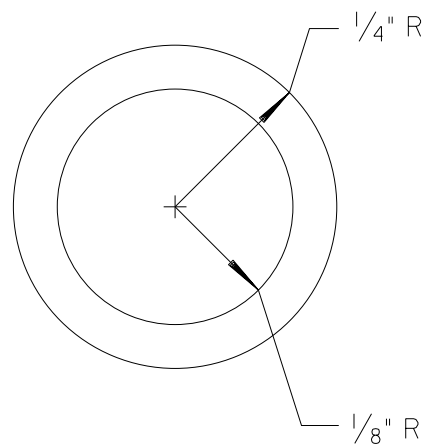
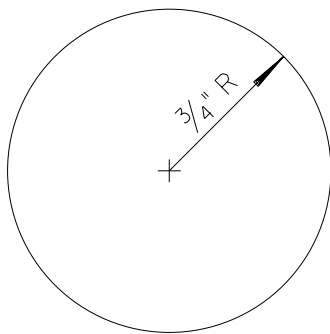
DIMENSIONING DRAWINGS



DIMENSIONING DIAMETERS

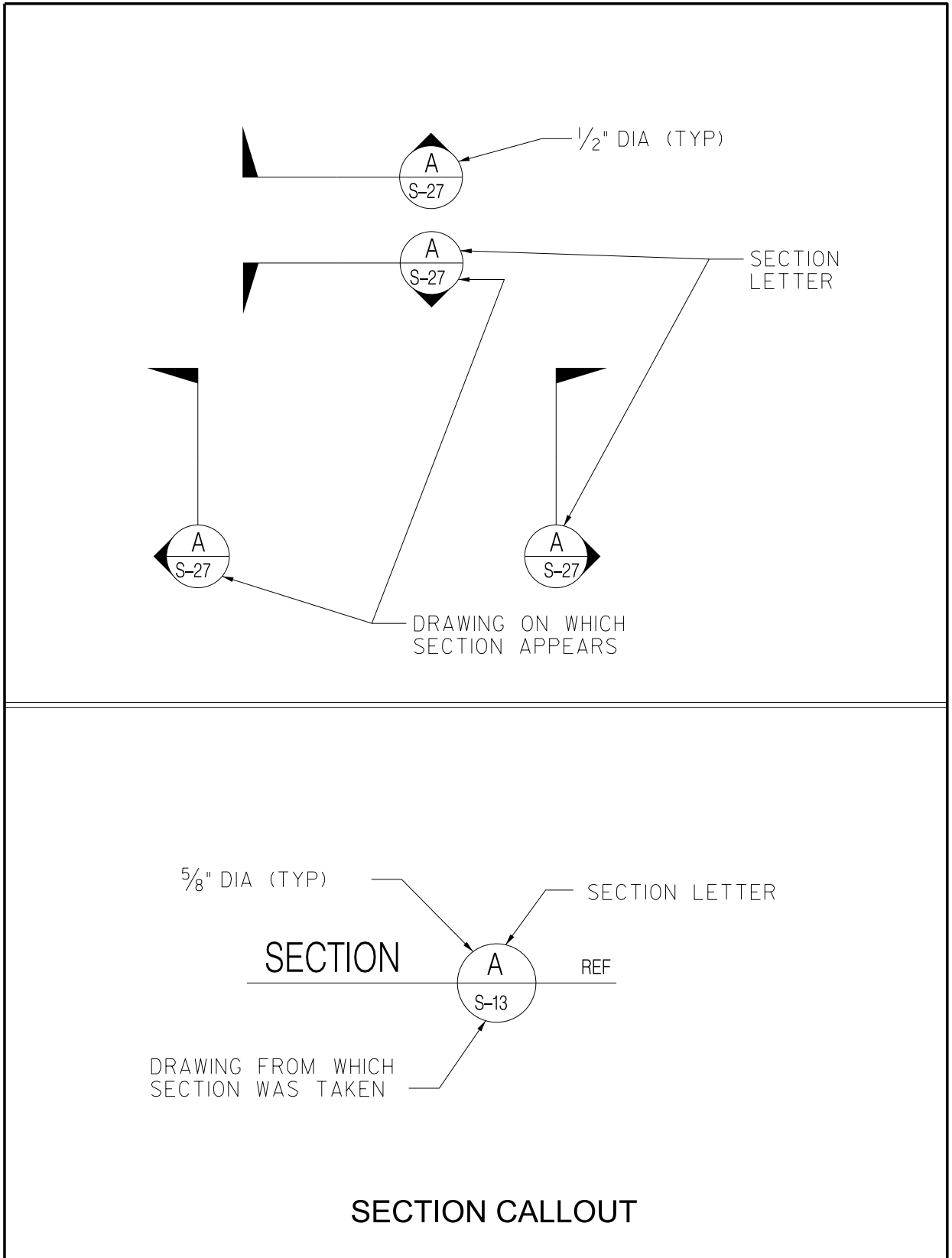


DIMENSIONING RADI

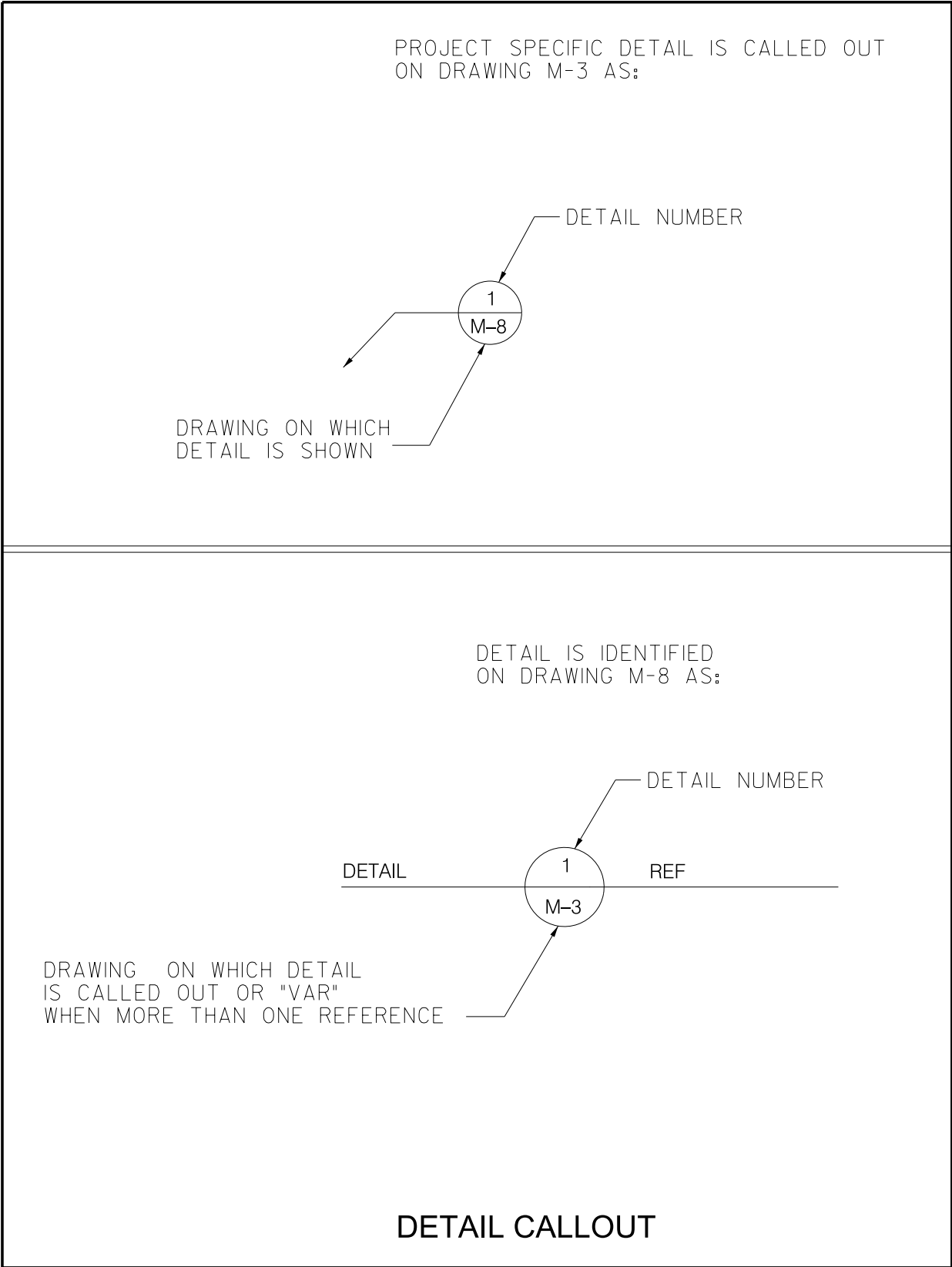


**DIMENSIONING**

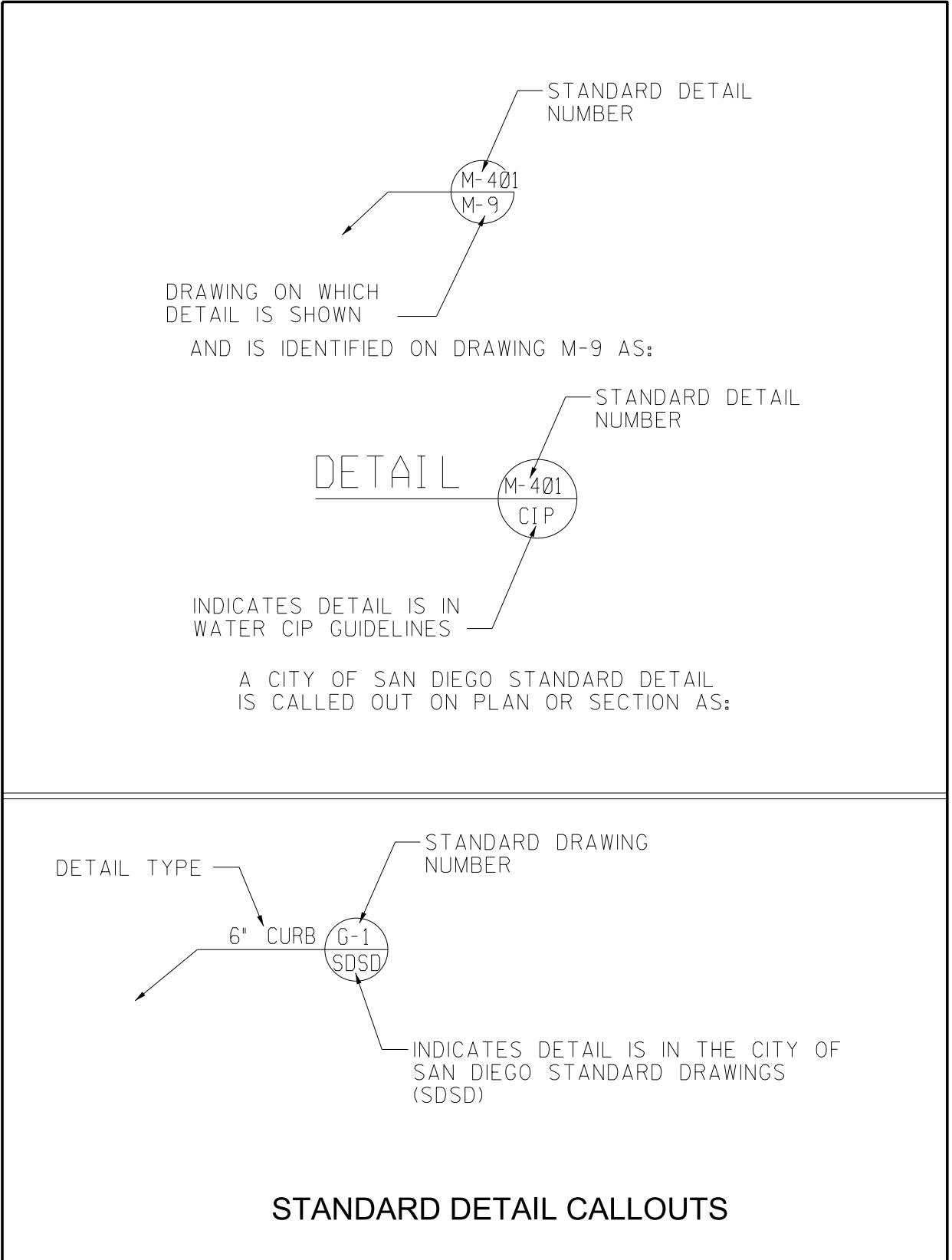
**Figure 2-7 Section Callout**



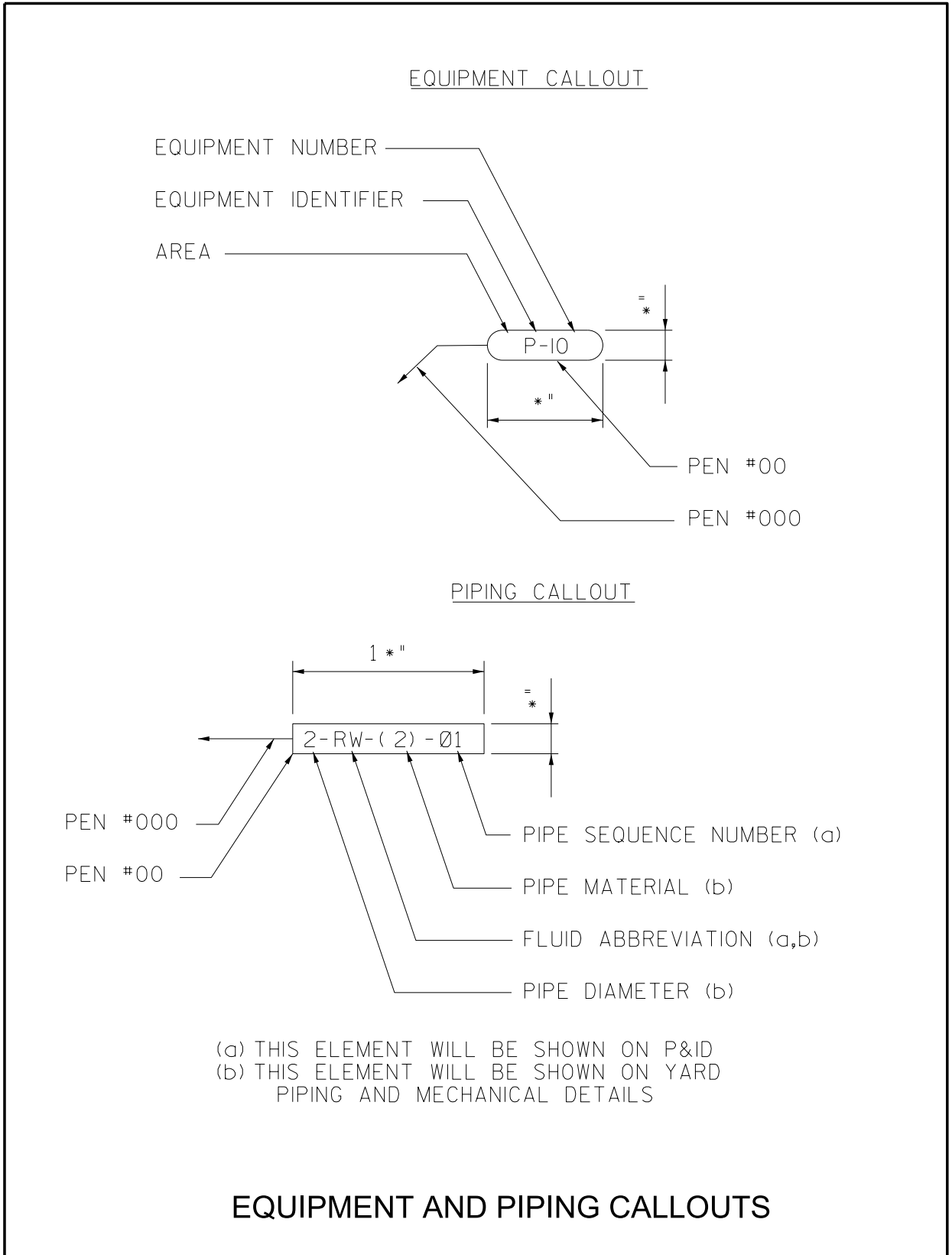
**Figure 2-8 Detail Callout**



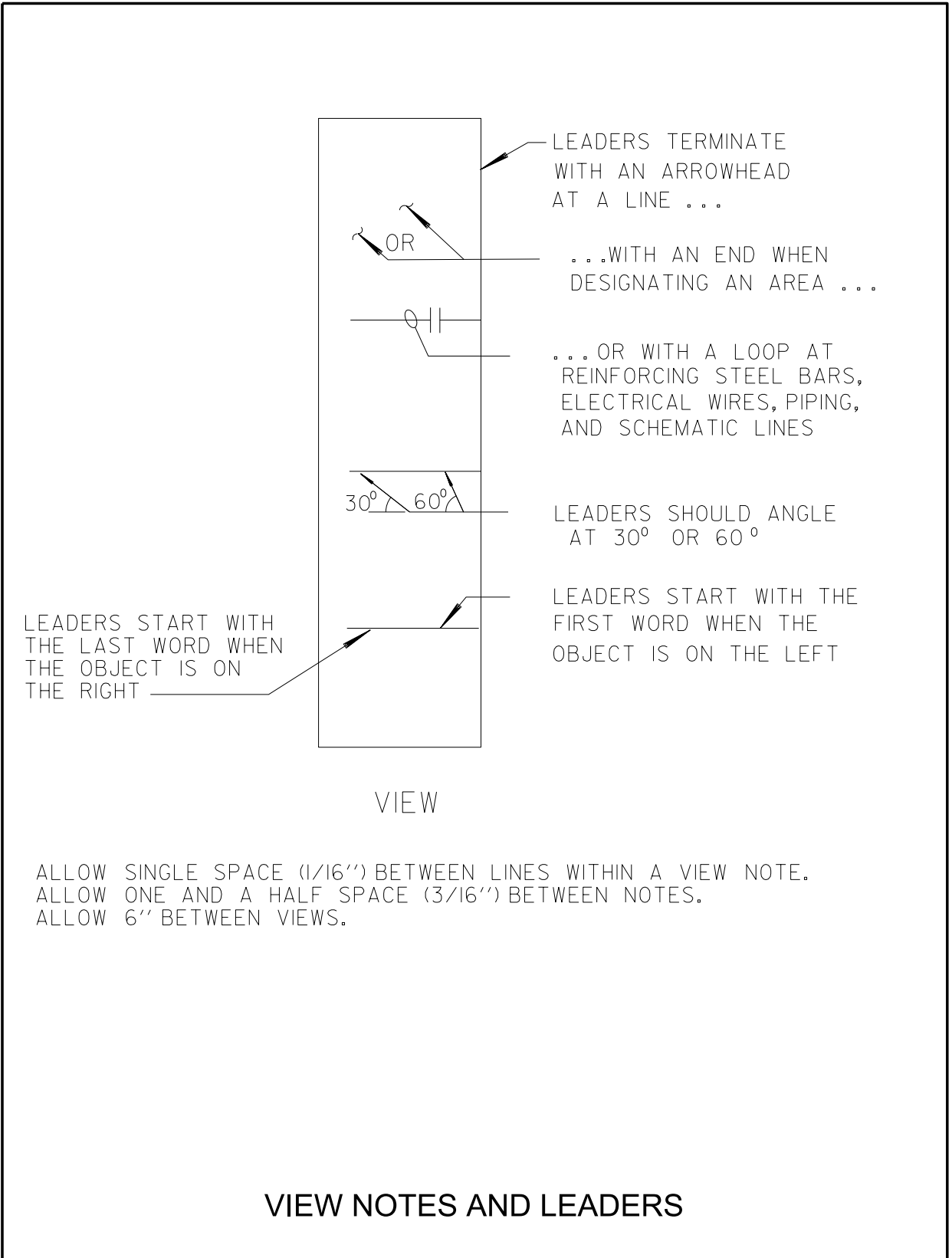
**Figure 2-9 Standard Detail Callouts**



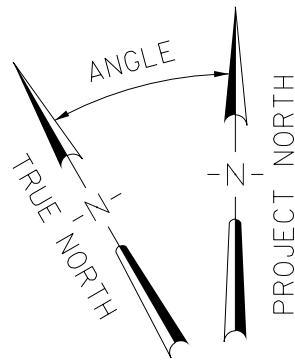
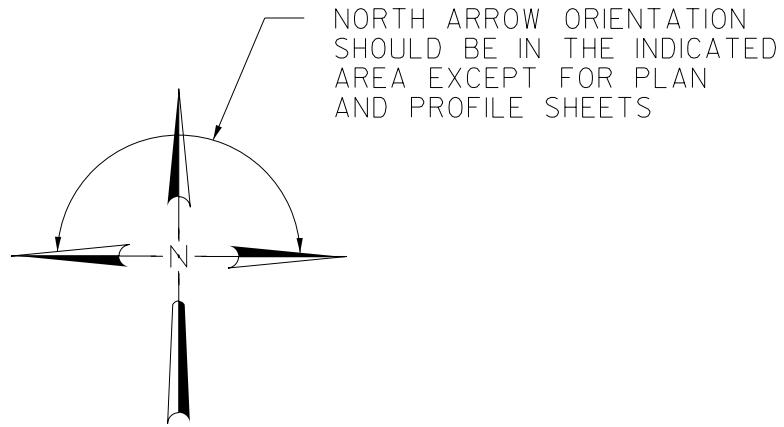
**Figure 2-10 Equipment and Piping Callouts**



**Figure 2-11 View Notes and Leaders**

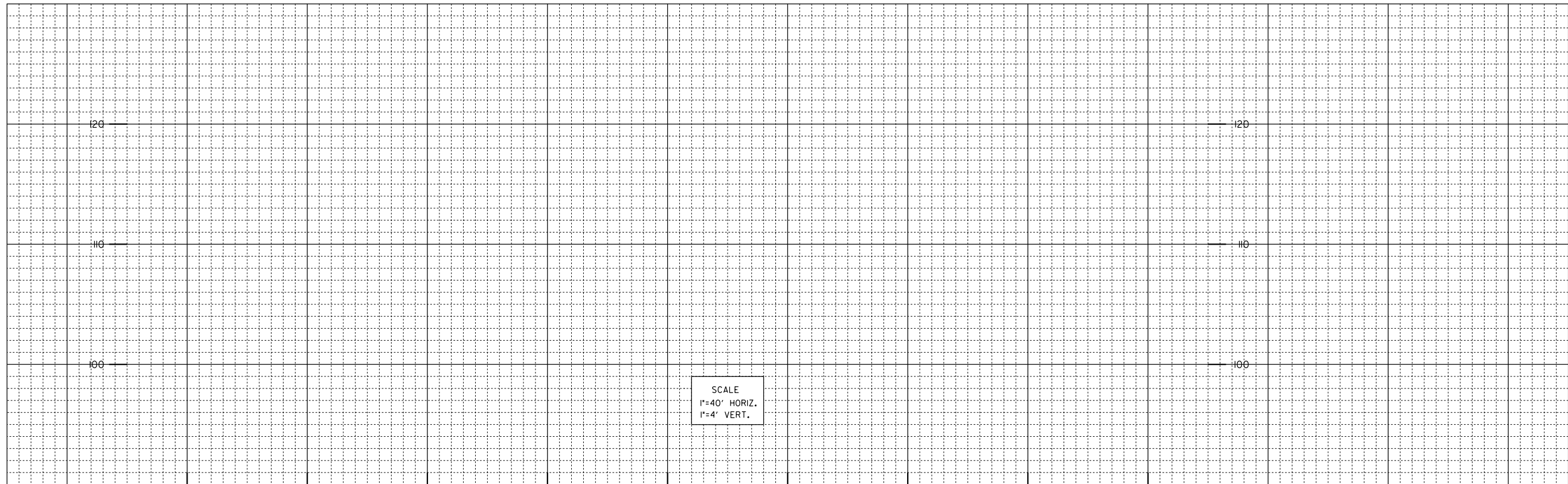


**Figure 2-12 North Arrow Direction**



**NORTH ARROW DIRECTION**

Figure 2-13 Plan and Profile Sheet Sample



+00

**REFERENCE:**

WATER:  
SEWER:  
STORM DRAIN:  
GAS:  
ELECTRIC:  
CABLE TV:  
TELEPHONE:  
IMPROVEMENTS:  
100' SCALE/FIELD BOOK:  
THOMAS BROS.:  
HGL:

**RETIREMENTS:**

0" - MATERIAL - 0' - 1900  
0" - MATERIAL - 0' - 1900  
MH - 4X3 - 0 - 1900  
FH (2-PORT) - 0  
FH (3-PORT) - 0  
4" LATERAL - 0 - MATERIAL - 1900  
6" LATERAL - 0 - MATERIAL - 1900  
1" SERVICE - 0 - MATERIAL - 1900  
2" SERVICE - 0 - MATERIAL - 1900

C-99

PROJECT TITLE  
STREET NAME  
STREET TO STREET

CITY OF SAN DIEGO, CALIFORNIA  
PUBLIC WORKS DEPARTMENT  
SHEET OF SHEETS

WATER  
WBS 0-00000  
SEWER  
WBS 0-00000

FOR CITY ENGINEER \_\_\_\_\_ DATE \_\_\_\_\_

PRINT NAME \_\_\_\_\_ TITLE# \_\_\_\_\_

DESCRIPTION BY APPROVED DATE FILMED

ORIGINAL xx/xx

SEE SHEETS

SEE SHEETS

CONTRACTOR \_\_\_\_\_ DATE STARTED \_\_\_\_\_

INSPECTOR \_\_\_\_\_ DATE COMPLETED \_\_\_\_\_

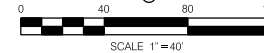
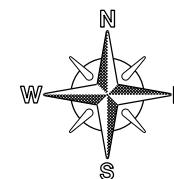
PROJECT MANAGER

PROJECT ENGINEER

SEE SHEETS

SEE SHEETS

XXXXX-01-D



STREET NAME



Figure 2-13a.1 Sewer/Water/Storm Drain Small Project Cover Sheet

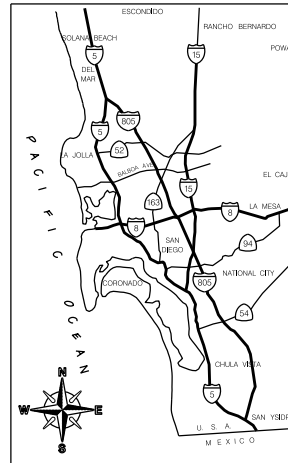
# PROJECT TITLE

### SHEET INDEX

SHEET NO.	DISCIPLINE CODE	TITLE	LIMITS	PIPE		LENGTH (FT)
				SIZE (IN)	MATERIAL	
1	G-1	COVER SHEET				
2	C-1	NAME STREET	NAME STREET TO NAME AVENUE	-	-	000.00
3	C-2	NAME AVENUE	NAME ROAD TO NAME BOULEVARD	-	-	000.00
4	C-3	NAME ROAD	NAME STREET TO NAME AVENUE	-	-	000.00
5	C-4	NAME BOULEVARD	NAME ROAD TO NAME BOULEVARD	-	-	00.00
STREET RESURFACING				TOTAL SEWER		
CURB RAMP LOCATION				TOTAL WATER		
CITY FORCES						
MISC DETAILS						
*PERMANENT STORM WATER BEST MANAGEMENT PRACTICES (BMP) -STANDARD DEVELOPMENT PROJECTS						
*PERMANENT STORM WATER BEST MANAGEMENT PRACTICES (BMP) -PRIORITY DEVELOPMENT PROJECTS						
T-1 TRAFFIC PLANS						

### WORK TO BE DONE

CONSTRUCTION OF SEWER AND WATER GROUP XXX CONSISTS OF THE INSTALLATION OF ...



VICINITY MAP NOT TO SCALE

### DISCIPLINE CODE

- G GENERAL
- D DEMOLITION
- C CIVIL
- L LANDSCAPE
- A ARCHITECTURAL
- S STRUCTURAL
- M MECHANICAL
- E ELECTRICAL
- I INSTRUMENTATION
- T TRAFFIC CONTROL

### LEGEND

IMPROVEMENTS	REFERENCE	SYMBOL
TRENCH RESURFACING	SDG-107, SDG-108	
SEWER MAIN	SDS-101, SDS-110 (TYPE C)	
SEWER MANHOLE/PVC LINED	SDS-106, SDS-107, SDS-108, SDM-113, SDS-120, M-3, SM-07	
REHAB. EX. SEWER MANHOLE	SEE PLANS & SPECS	
SEWER MAIN REHAB.	SEE PLANS & SPECS	
4" SEWER LATERAL WITH C.O. UNLESS OTHERWISE SPECIFIED	SDS-102, SDS-103, SDS-104, SDS-105, SDS-110 (TYPE C), SDS-118	
REPLUMB SEWER LATERAL WITH C.O.	SDS-102, SDS-103, SDS-104, SDS-105, SDS-110 (TYPE C), SDS-118	
SEWER LATERAL CONNECTION	SEE PLANS & SPECS	
REHAB SEWER LATERAL (LINED) WITH C.O.	SEE PLANS & SPECS	
SERVICE LATERAL CONNECTION TO REHABILITATED SEWER	SEE PLANS & SPECS	
SEWER PUMP INCLUDING REPLUMB SEWER LATERAL WITH C.O.	SDS-102, SDS-103, SDS-104, SDS-105, SDS-110 (TYPE C), SDS-118	
TUNNEL SEWER REPLUMB LATERAL WITH C.O.	SDS-102, SDS-103, SDS-104, SDS-105	
CONCRETE PROTECTION FOR EXIST SEWER PIPE	SDS-116	
PIPE SUPPORT FOR UNDERCUT AC WATER MAIN	SDW-162	
CONCRETE ENCASEMENT	SDS-112	
ABANDON EX MANHOLE	SM-08	
SLURRY FILL ABANDONED SEWER MAIN	SEE PLANS & SPECS	
CUTTING AND PLUGGING ABANDONED WATER MAIN	WP-03	
SURVEY MONUMENT	M-10, M-10A, M-10B	
WATER MAIN & APPURTENANCES	SDM-105, SDW-110, SDW-151, SDW-161	
VALVES WITH CAPS AND WELLS	SDW-109, SDW-152, SDW-153, WV-05	
FIRE SERVICE CONNECTION & ASSEMBLY	SDM-105, SDW-109, SDW-118, SDW-152, SDW-153	
6" FIRE HYDRANT ASSEMBLY & MARKER 2-PORT UNLESS SPECIFIED AS 3-PORT	SDM-105, SDW-104, SDW-109, SDW-152, SDW-153	
1" WATER SERVICE UNLESS OTHERWISE SPECIFIED	SDM-105, SDW-107, SDW-134, SDW-135, SDW-136, SDW-137, SDW-138, SDW-149, SDW-150, WS-03	
WATER SERVICE TRANSFER	SDW-149, SDW-150	
BLOW-OFF ASSEMBLY	SDM-105, SDW-106, SDW-143, SDW-144, SDW-145, SDW-146, WB-05,	
AIR & VACUUM VALVE	SDM-105, SDW-117, SDW-158, SDW-159, SDW-160	
HIGHLIGHTING BY CONTRACTOR	SDW-170, SDW-171, SDW-172, SDW-173	

### CONTRACTOR'S RESPONSIBILITIES

- PURSUANT TO SECTION 4216 OF THE GOVERNMENT CODE, AT LEAST 2 WORKING DAYS PRIOR TO EXCAVATION, YOU MUST CONTACT THE REGIONAL NOTIFICATION CENTER (E.G. UNDERGROUND SERVICE ALERT OF SOUTHERN CALIFORNIA) AND OBTAIN AN INQUIRY IDENTIFICATION NUMBER.
- NOTIFY SDG&E AT LEAST 10 WORKING DAYS PRIOR TO EXCAVATING WITHIN 10' OF SDG&E UNDERGROUND HIGH VOLTAGE TRANSMISSION POWER LINES, (I.E., 69 KV & HIGHER)
- LOCATE AND RECONNECT ALL SEWER LATERALS. LOCATIONS AS SHOWN ON THE PLANS ARE APPROXIMATE ONLY. LATERAL RECORDS ARE AVAILABLE TO THE CONTRACTOR AT THE WATER DEPARTMENT, 2797 CAMINITO CHOLLAS. LOCATE THE IMPROVEMENTS THAT WILL BE AFFECTED BY LATERAL REPLACEMENTS.
- EXCAVATE AROUND WATER METER BOX (CITY PROPERTY SIDE) TO DETERMINE IN ADVANCE, THE SIZE OF EACH SERVICE BEFORE TAPPING MAIN.
- CITY FORCES, WHEN SPECIFIED OR SHOWN ON THE PLANS, WILL MAKE PERMANENT CUTS & PLUGS AND CONNECTIONS.
- KEEP EXISTING MAINS IN SERVICE IN LIEU OF HIGH-LINING, UNLESS OTHERWISE SPECIFIED SHOWN ON PLANS.
- THE LOCATIONS OF EXISTING BUILDINGS AS SHOWN ON THE PLAN ARE APPROXIMATE.
- STORM DRAIN INLETS SHALL REMAIN FUNCTIONAL AT ALL TIMES DURING CONSTRUCTION.
- UNLESS OTHERWISE NOTED AS PREVIOUSLY POTHOLED (PH), ELEVATIONS SHOWN ON THE PROFILE FOR EXISTING UTILITIES ARE BASED ON A SEARCH OF THE AVAILABLE RECORD INFORMATION ONLY AND ARE SOLELY FOR THE CONTRACTOR'S CONVENIENCE. THE CITY DOES NOT GUARANTEE THAT IT HAS REVIEWED ALL AVAILABLE DATA. THE CONTRACTOR SHALL POTHOLE ALL EXISTING UTILITIES EITHER SHOWN ON THE PLANS OR MARKED IN THE FIELD IN ACCORDANCE WITH THE SPECIFICATIONS SECTION 5-UTILITIES.
- EXISTING UTILITY CROSSING AS SHOWN ON THE PLANS ARE APPROXIMATE AND ARE NOT REPRESENTATIVE OF ACTUAL LENGTH AND LOCATION OF CONFLICT AREAS. SEE PLAN VIEW.
- ALL ADVANCE METERING INFRASTRUCTURE (AMI) DEVICES ATTACHED TO THE WATER METER OR LOCATED IN OR NEAR WATER METER BOXES, COFFINS, OR VAULTS SHALL BE PROTECTED AT ALL TIMES IN ACCORDANCE WITH THE CONTRACT DOCUMENTS.

### CONSTRUCTION STORM WATER PROTECTION NOTES

- TOTAL SITE DISTURBANCE AREA (ACRES) \_\_\_\_\_  
HYDROLOGIC UNIT / WATERSHED \_\_\_\_\_  
HYDROLOGIC SUBAREA NAME & NO. \_\_\_\_\_
- THE CONTRACTOR SHALL COMPLY WITH THE REQUIREMENTS OF THE  
 WPCP  
THE PROJECT IS SUBJECT TO MUNICIPAL STORM WATER PERMIT NO. R9-2013-0001 AS AMENDED BY R9-2015-0001 AND R9-2015-0100  
 SWPPP  
THE PROJECT IS SUBJECT TO MUNICIPAL STORM WATER PERMIT NO. R9-2013-0001 AS AMENDED BY R9-2015-0001 AND R9-2015-0100 AND CONSTRUCTION GENERAL PERMIT ORDER 2009-0009-DWO AS AMENDED BY ORDER 2010-0014-DWO AND 2012-0006-DWO  
TRADITIONAL RISK LEVEL  1  2  3  
LUP RISK TYPE  1  2  3
- CONSTRUCTION SITE PRIORITY  
 ASBS  HIGH  MEDIUM  LOW

### MONUMENTATION/SURVEY NOTES

THE CONTRACTOR SHALL BE RESPONSIBLE FOR SURVEY MONUMENTS AND/OR VERTICAL CONTROL BENCHMARKS WHICH ARE DISTURBED OR DESTROYED BY CONSTRUCTION. A LICENSED LAND SURVEYOR OR LICENSED CIVIL ENGINEER AUTHORIZED TO PRACTICE LAND SURVEYING IN THE STATE OF CALIFORNIA SHALL FIELD LOCATE, REFERENCE, AND/OR PRESERVE ALL HISTORICAL OR CONTROLLING MONUMENTS PRIOR TO ANY EARTHWORK, DEMOLITION OR SURFACE IMPROVEMENTS. IF DESTROYED, A LICENSED LAND SURVEYOR SHALL REPLACE SUCH MONUMENT(S) WITH APPROPRIATE MONUMENTS. WHEN SETTING SURVEY MONUMENTS USED FOR RE-ESTABLISHMENT OF THE DISTURBED CONTROLLING SURVEY MONUMENTS AS REQUIRED BY SECTIONS 6730.2 AND 8710 OF THE BUSINESS AND PROFESSIONS CODE OF THE STATE OF CALIFORNIA, A CORNER RECORD OR RECORD OF SURVEY, AS APPROPRIATE, SHALL BE FILLED WITH THE COUNTY SURVEYOR. IF ANY VERTICAL CONTROL IS TO BE DISTURBED OR DESTROYED, THE CITY OF SAN DIEGO FIELD SURVEY SECTION SHALL BE NOTIFIED IN WRITING AT LEAST 7 DAYS PRIOR TO CONSTRUCTION. THE CONTRACTOR SHALL BE RESPONSIBLE FOR THE COST OF REPLACING AND VERTICAL CONTROL BENCHMARKS DESTROYED BY THE CONSTRUCTION.

### ABBREVIATIONS

ABAND	ABANDON	EL, ELEV	ELEVATION	OVHD	OVER HEAD
ABAND'D	ABANDONED	ELEC	ELECTRIC	PVC	POLYVINYL CHLORIDE
AC	ASBESTOS CEMENT PIPE	EX, EXIST	EXISTING	PROP	PROPOSED
AHD	AHEAD	E/O	EAST OF	RED	REDUCER
ASSY	ASSEMBLY	F	FLANGE	RT	RIGHT
BFV	BUTTERFLY VALVE	FH	FIRE HYDRANT	S	SURVEY LINE
BK	BACK	FS	FIRE SERVICE	SD&AE	SAN DIEGO & ARIZONA EASTERN RAILROAD
BTWN	BETWEEN	GV	GATE VALVE	SDTI	SAN DIEGO TROLLEY INC.
CATV	CABLE TV	HDPE	HIGH-DENSITY POLYETHYLENE	SO	STUB OUT
CI	CAST IRON PIPE	HP	HIGH PRESSURE	S/O	SOUTH OF
C	CENTER LINE	IE	INVERT ELEVATION	SWR	SEWER
COND	CONDUIT	LT	LEFT	TEL	TELEPHONE
CONT	CONTINUED	MJ	MECHANICAL JOINT	UNK	UNKNOWN
CONTR	CONTRACTOR	MTS	SAN DIEGO METROPOLITAN	VC	VITRIFIED CLAY PIPE
DB	DIRECT BURIED	WTR	WATER METER	WTR	WATER
DI	DUCTILE IRON	MTO	MULTIPLE TELEPHONE DUCT	WTR	WATER
EB	ENCASED BURIED	N/O	NORTH OF	W/O	WEST OF

### EXISTING STRUCTURES

EX WATER MAIN & VALVES		EX GROUND LINE (PROFILE)	
EX WATER METER		EX TRAFFIC SIGNAL	
EX FIRE HYDRANT		EX STREET LIGHT	
EX SEWER MAIN & MANHOLES		GAS MAIN	
EX DRAINS		ELEC. COND., TEL. COND., CATV	
EX PAVEMENT (PROFILE)		RAILROAD, TROLLEY TRACKS	

\* IF NO CONSULTANT ON THIS PROJECT; DELETE ENGINEER'S RESPONSIBILITIES.

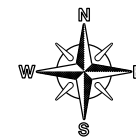
DELETE THIS NOTE AFTER REVIEWING THE TASK BELOW

### DECLARATION OF RESPONSIBLE CHARGE

\* I HEREBY DECLARE THAT I AM THE ENGINEER OF WORK FOR THIS PROJECT THAT I HAVE EXERCISED RESPONSIBLE CHARGE OVER THE DESIGN OF THE PROJECT AS DEFINED IN SECTION 6703 OF THE BUSINESS AND PROFESSIONS CODE AND THAT THE DESIGN IS CONSISTENT WITH CURRENT STANDARDS. I UNDERSTAND THAT THE CHECK OF PROJECT DRAWINGS AND SPECIFICATIONS BY THE CITY OF SAN DIEGO IS CONFINED TO A REVIEW ONLY AND DOES NOT RELIEVE ME, AS ENGINEER OF WORK, OF MY RESPONSIBILITIES FOR PROJECT DESIGN.

(ENGINEER'S NAME)

DATE



KEY MAP NO SCALE

### FIELD DATA

BENCHMARK:  
FIELD NOTES:  
DATUM: MEAN SEA LEVEL  
STREETS REQUIRING 12" TRENCH CAP:  
\*STREET NAMES\*

G-1

### PLANS FOR THE CONSTRUCTION OF PROJECT TITLE COVER SHEET

CITY OF SAN DIEGO, CALIFORNIA PUBLIC WORKS DEPARTMENT SHEET OF SHEETS		WATER WBS 0-00000 SEWER WBS 0-00000
FOR CITY ENGINEER	DATE	PROJECT MANAGER
PRINT DCE NAME	TICE#	PROJECT ENGINEER
DESCRIPTION	BY	APPROVED
DATE	FILED	SEE SHEETS
ORIGINAL	xx/xx	CS27 COORDINATE
		SEE SHEETS
		CS31 COORDINATE
CONTRACTOR	DATE STARTED	XXXX-01-D
INSPECTOR	DATE COMPLETED	

PROJECT TITLE (FOR SMALL PROJECT ONLY)

Figure 2-13a.2 Sewer/Water/Storm Drain Large Cover Sheet 1 of 2

# PROJECT TITLE

## CONTRACTOR'S RESPONSIBILITIES

- PURSUANT TO SECTION 4216 OF THE GOVERNMENT CODE, AT LEAST 2 WORKING DAYS PRIOR TO EXCAVATION, YOU MUST CONTACT THE REGIONAL NOTIFICATION CENTER (E.G. UNDERGROUND SERVICE ALERT OF SOUTHERN CALIFORNIA) AND OBTAIN AN INQUIRY IDENTIFICATION NUMBER.
- NOTIFY SDG&E AT LEAST 10 WORKING DAYS PRIOR TO EXCAVATING WITHIN 10' OF SDG&E UNDERGROUND HIGH VOLTAGE TRANSMISSION POWER LINES, (I.E., 69 KV & HIGHER)
- LOCATE AND RECONNECT ALL SEWER LATERALS. LOCATIONS AS SHOWN ON THE PLANS ARE APPROXIMATE ONLY; LATERAL RECORDS ARE AVAILABLE TO THE CONTRACTOR AT THE WATER DEPARTMENT, 2797 CAMINITO CHOLLAS. LOCATE THE IMPROVEMENTS THAT WILL BE AFFECTED BY LATERAL REPLACEMENTS.
- EXCAVATE AROUND WATER METER BOX (CITY PROPERTY SIDE) TO DETERMINE IN ADVANCE, THE SIZE OF EACH SERVICE BEFORE TAPPING MAIN.
- CITY FORCES, WHEN SPECIFIED OR SHOWN ON THE PLANS, WILL MAKE PERMANENT CUTS & PLUGS AND CONNECTIONS.
- KEEP EXISTING MAINS IN SERVICE IN LIEU OF HIGH-LINING, UNLESS OTHERWISE SPECIFIED SHOWN ON PLANS.
- THE LOCATIONS OF EXISTING BUILDINGS AS SHOWN ON THE PLAN ARE APPROXIMATE.
- STORM DRAIN INLETS SHALL REMAIN FUNCTIONAL AT ALL TIMES DURING CONSTRUCTION.
- UNLESS OTHERWISE NOTED AS PREVIOUSLY POTHOLED (PH), ELEVATIONS SHOWN ON THE PROFILE FOR EXISTING UTILITIES ARE BASED ON A SEARCH OF THE AVAILABLE RECORD INFORMATION ONLY AND ARE SOLELY FOR THE CONTRACTOR'S CONVENIENCE. THE CITY DOES NOT GUARANTEE THAT IT HAS REVIEWED ALL AVAILABLE DATA; THE CONTRACTOR SHALL POTHOLE ALL EXISTING UTILITIES EITHER SHOWN ON THE PLANS OR MARKED IN THE FIELD IN ACCORDANCE WITH THE SPECIFICATIONS SECTION 5-UTILITIES.
- EXISTING UTILITY CROSSING AS SHOWN ON THE PLANS ARE APPROXIMATE AND ARE NOT REPRESENTATIVE OF ACTUAL LENGTH AND LOCATION OF CONFLICT AREAS. SEE PLAN VIEW.
- ALL ADVANCE METERING INFRASTRUCTURE (AMI) DEVICES ATTACHED TO THE WATER METER OR LOCATED IN OR NEAR WATER METER BOXES, COFFINS, OR VAULTS SHALL BE PROTECTED AT ALL TIMES IN ACCORDANCE WITH THE CONTRACT DOCUMENTS.

## CONSTRUCTION STORM WATER PROTECTION NOTES

- TOTAL SITE DISTURBANCE AREA (ACRES) \_\_\_\_\_  
HYDROLOGIC UNIT / WATERSHED \_\_\_\_\_  
HYDROLOGIC SUBAREA NAME & NO. \_\_\_\_\_
- THE CONTRACTOR SHALL COMPLY WITH THE REQUIREMENTS OF THE  
 WPCP  
THE PROJECT IS SUBJECT TO MUNICIPAL STORM WATER PERMIT NO. R9-2013-0001 AS AMENDED BY R9-2015-0001 AND R9-2015-0100  
 SWPPP  
THE PROJECT IS SUBJECT TO MUNICIPAL STORM WATER PERMIT NO. R9-2013-0001 AS AMENDED BY R9-2015-0001 AND R9-2015-0100 AND CONSTRUCTION GENERAL PERMIT ORDER 2009-0009-DWQ AS AMENDED BY ORDER 2010-0014-DWQ AND 2012-0006-DWQ  
TRADITIONAL RISK LEVEL  2  3  
LUP: RISK TYPE  2  3
- CONSTRUCTION SITE PRIORITY  
 ASBS  HIGH  MEDIUM  LOW

## ABBREVIATIONS

ABAND	ABANDON	EL, ELEV	ELEVATION	OVHD	OVER HEAD
ABAND'D	ABANDONED	ELEC	ELECTRIC	PVC	POLYVINYL CHLORIDE
AC	ASBESTOS CEMENT PIPE	EX, EXIST	EXISTING	PROP	PROPOSED
AHD	AHEAD	E/O	EAST OF	RED	REDUCER
ASSY	ASSEMBLY	F	FLANGE	RT	RIGHT
BFV	BUTTERFLY VALVE	FH	FIRE HYDRANT	S	SURVEY LINE
BK	BACK	FS	FIRE SERVICE	SD&AE	SAN DIEGO & ARIZONA EASTERN RAILROAD
BTWN	BETWEEN	GV	GATE VALVE	SDTI	SAN DIEGO TROLLEY INC.
CATV	CABLE TV	HOPE	HIGH-DENSITY POLYETHYLENE	SO	STUB OUT
CI	CAST IRON PIPE	HP	HIGH PRESSURE	S/O	SOUTH OF
C	CENTER LINE	IE	INVERT ELEVATION	SWR	SEWER
COND	CONDUIT	LT	LEFT	TEL	TELEPHONE
CONT	CONTINUED	MJ	MECHANICAL JOINT	UNK	UNKNOWN
CONTR	CONTRACTOR	MTS	SAN DIEGO METROPOLITAN	VC	VITRIFIED CLAY PIPE
DB	DIRECT BURIED	MTS	TRANSIT SYSTEM	WM	WATER METER
DI	DUCTILE IRON	MTD	MULTIPLE TELEPHONE DUCT	WTR	WATER
EB	ENCASED BURIED	N/O	NORTH OF	W/O	WEST OF

## EXISTING STRUCTURES

EX WATER MAIN & VALVES	— — — — —
EX WATER METER	— — — — —
EX FIRE HYDRANT	— — — — —
EX SEWER MAIN & MANHOLES	— — — — —
EX DRAINS	— — — — —
EX PAVEMENT (PROFILE)	— — — — —
EX GROUND LINE (PROFILE)	— — — — —
EX TRAFFIC SIGNAL	— — — — —
EX STREET LIGHT	— — — — —
GAS MAIN	— — — — —
ELEC. COND., TEL. COND., CATV	— — — — —
RAILROAD, TROLLEY TRACKS	— — — — —

## SHEET INDEX

SHEET NO.	DISCIPLINE CODE	TITLE	LIMITS	PIPE		LENGTH (FT)
				SIZE (IN)	MATERIAL	
1	G-1	COVER SHEET				
2	G-2	KEY MAP				
3	C-1	NAME STREET	NAME STREET TO NAME AVENUE	-	-	000.00
4	C-2	NAME AVENUE	NAME ROAD TO NAME BOULEVARD	-	-	000.00
WATER						
5	C-3	NAME ROAD	NAME STREET TO NAME AVENUE	-	-	000.00
6	C-4	NAME BOULEVARD	NAME ROAD TO NAME BOULEVARD	-	-	00.00
STREET RESURFACING				TOTAL SEWER		
CURB RAMP LOCATION				TOTAL WATER		
CITY FORCES						
MISC DETAILS						
*PERMANENT STORM WATER BEST MANAGEMENT PRACTICES (BMP) -STANDARD DEVELOPMENT PROJECTS						
*PERMANENT STORM WATER BEST MANAGEMENT PRACTICES (BMP) -PRIORITY DEVELOPMENT PROJECTS						
T-1 TRAFFIC PLANS						

## DISCIPLINE CODE

G	GENERAL
D	DEMOLITION
C	CIVIL
L	LANDSCAPE
A	ARCHITECTURAL
S	STRUCTURAL
M	MECHANICAL
E	ELECTRICAL
I	INSTRUMENTATION
T	TRAFFIC CONTROL

\* PROJECT SHOULD CHOOSE FROM STANDARD AND PRIORITY, AS APPLICABLE TO THE PROJECT.  
**DELETE THIS NOTE AFTER REVIEWING THE TASK ABOVE**

## MONUMENTATION SURVEY NOTES

THE CONTRACTOR SHALL BE RESPONSIBLE FOR SURVEY MONUMENTS AND/OR VERTICAL CONTROL BENCHMARKS WHICH ARE DISTURBED OR DESTROYED BY CONSTRUCTION. A LICENSED LAND SURVEYOR OR LICENSED CIVIL ENGINEER AUTHORIZED TO PRACTICE LAND SURVEYING IN THE STATE OF CALIFORNIA SHALL FIELD LOCATE, REFERENCE, AND/OR PRESERVE ALL HISTORICAL OR CONTROLLING MONUMENTS PRIOR ANY EARTHWORK, DEMOLITION OR SURFACE IMPROVEMENTS. IF DESTROYED, A LICENSED LAND SURVEYOR SHALL REPLACE SUCH MONUMENT(S) WITH APPROPRIATE MONUMENTS. WHEN SETTING SURVEY MONUMENTS USED FOR RE-ESTABLISHMENT OF THE DISTURBED CONTROLLING SURVEY MONUMENTS AS REQUIRED BY SECTIONS 6730.2 AND 8771 OF THE BUSINESS AND PROFESSIONS CODE OF THE STATE OF CALIFORNIA, A CORNER RECORD OR RECORD OF SURVEY, AS APPROPRIATE, SHALL BE FILLED WITH THE COUNTY SURVEYOR. IF ANY VERTICAL CONTROL IS TO BE DISTURBED OR DESTROYED, THE CITY OF SAN DIEGO FIELD SURVEY SECTION SHALL BE NOTIFIED IN WRITING AT LEAST 7 DAYS PRIOR TO CONSTRUCTION. THE CONTRACTOR SHALL BE RESPONSIBLE FOR THE COST OF REPLACING AND VERTICAL CONTROL BENCHMARKS DESTROYED BY THE CONSTRUCTION.

\* IF NO CONSULTANT ON THIS PROJECT, DELETE ENGINEER'S RESPONSIBILITIES.  
**DELETE THIS NOTE AFTER REVIEWING THE TASK BELOW**

## DECLARATION OF RESPONSIBLE CHARGE

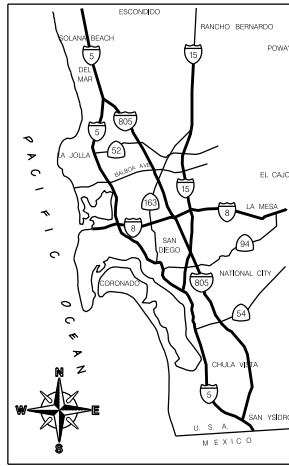
\* I HEREBY DECLARE THAT I AM THE ENGINEER OF WORK FOR THIS PROJECT THAT I HAVE EXERCISED RESPONSIBLE CHARGE OVER THE DESIGN OF THE PROJECT AS DEFINED IN SECTION 6703 OF THE BUSINESS AND PROFESSIONS CODE AND THAT THE DESIGN IS CONSISTENT WITH CURRENT STANDARDS. I UNDERSTAND THAT THE CHECK OF PROJECT DRAWINGS AND SPECIFICATIONS BY THE CITY OF SAN DIEGO IS CONFINED TO A REVIEW ONLY AND DOES NOT RELIEVE ME, AS ENGINEER OF WORK, OF MY RESPONSIBILITIES FOR PROJECT DESIGN.

(ENGINEER'S NAME) \_\_\_\_\_ DATE \_\_\_\_\_

The City of **SAN DIEGO** Public Works

## WORK TO BE DONE

CONSTRUCTION OF SEWER AND WATER GROUP XXX CONSISTS OF THE INSTALLATION OF ...



VICINITY MAP  
NOT TO SCALE

## LEGEND

IMPROVEMENTS	REFERENCE	SYMBOL
TRENCH RESURFACING	SDG-107, SDG-108	— — — — —
SEWER MAIN	SDS-101, SDS-110 (TYPE C)	— — — — —
SEWER MANHOLE/PVC LINED	SDS-106, SDS-107, SDS-108, SDS-113, SDS-120, M-3, SM-07	— — — — —
REHAB. EX. SEWER MANHOLE	SEE PLANS & SPECS	— — — — —
SEWER MAIN REHAB.	SEE PLANS & SPECS	— — — — —
4" SEWER LATERAL WITH C.O. UNLESS OTHERWISE SPECIFIED	SDS-102, SDS-103, SDS-104, SDS-105, SDS-110 (TYPE C), SDS-118	— — — — —
REPLUMB SEWER LATERAL WITH C.O.	SDS-102, SDS-103, SDS-104, SDS-105, SDS-110 (TYPE C), SDS-118	— — — — —
SEWER LATERAL CONNECTION	SEE PLANS & SPECS	— — — — —
REHAB SEWER LATERAL (LINED) WITH C.O.	SEE PLANS & SPECS	— — — — —
SERVICE LATERAL CONNECTION TO REHABILITATED SEWER	SEE PLANS & SPECS	— — — — —
SEWER PUMP INCLUDING REPLUMB SEWER LATERAL WITH C.O.	SDS-102, SDS-103, SDS-104, SDS-105, SDS-110 (TYPE C), SDS-118	— — — — —
TUNNEL SEWER REPLUMB LATERAL WITH C.O.	SDS-102, SDS-103, SDS-104, SDS-105	— — — — —
CONCRETE PROTECTION FOR EXIST SEWER PIPE	SDS-116	— — — — —
PIPE SUPPORT FOR UNDERCUT AC WATER MAIN	SDW-162	— — — — —
CONCRETE ENCASEMENT	SDS-112	— — — — —
ABANDON EX MANHOLE	SM-08	— — — — —
SLURRY FILL ABANDONED SEWER MAIN	SEE PLANS & SPECS	— — — — —
CUTTING AND PLUGGING ABANDONED WATER MAIN	WP-03	— — — — —
SURVEY MONUMENT	M-10, M-10A, M-10B	— — — — —
WATER MAIN & APPURTENANCES	SDM-105, SDW-110, SDW-151, SDW-161	— — — — —
VALVES WITH CAPS AND WELLS	SDW-109, SDW-152, SDW-153, WV-05	— — — — —
FIRE SERVICE CONNECTION & ASSEMBLY	SDM-105, SDW-109, SDW-118, SDW-152, SDW-153	— — — — —
6" FIRE HYDRANT ASSEMBLY & MARKER 2-PORT UNLESS SPECIFIED AS 3-PORT	SDM-105, SDW-104, SDW-109, SDW-152, SDW-153	— — — — —
1" WATER SERVICE UNLESS OTHERWISE SPECIFIED	SDM-105, SDW-107, SDW-134, SDW-135, SDW-136, SDW-137, SDW-138, SDW-149, SDW-150, WS-03	— — — — —
WATER SERVICE TRANSFER	SDW-149, SDW-150	— — — — —
BLOW-OFF ASSEMBLY	SDM-105, SDW-106, SDW-143, SDW-144, SDW-145, SDW-146, WB-05,	— — — — —
AIR & VACUUM VALVE	SDM-105, SDW-117, SDW-158, SDW-159, SDW-160	— — — — —
HIGHLINING BY CONTRACTOR	SDW-170, SDW-171, SDW-172, SDW-173	— — — — —

REVISE LEGEND ON PROJECT THEN DELETE THIS NOTE.

## FIELD DATA

BENCHMARK:  
FIELD NOTES:  
DATUM: MEAN SEA LEVEL  
STREETS REQUIRING 12" TRENCH CAP:  
\*STREET NAMES\*

## PLANS FOR THE CONSTRUCTION OF PROJECT TITLE COVER SHEET

CITY OF SAN DIEGO, CALIFORNIA		WATER WBS	0-00000
PUBLIC WORKS DEPARTMENT		SEWER WBS	0-00000
SHEET OF SHEETS			
FOR CITY ENGINEER	DATE	APPROVED BY	PROJECT MANAGER
PRINT DCE NAME	TICE#	PROJECT ENGINEER	
DESCRIPTION	BY	APPROVED	DATE
ORIGINAL	xx/xx		
		SEE SHEETS	
		SEE SHEETS	
		DATE STARTED	XXXX-01-D
		DATE COMPLETED	

AS-BUILT INFORMATION	
MATERIALS	MANUFACTURER
PIPE CL 235 (WATER)	-
PIPE SDR 35 (SEWER)	-
GATE VALVES	-
FIRE HYDRANTS	-
SEWER MANHOLES	-
REHABILITATE SEWER MANHOLES	-
REHABILITATE SEWER MAIN	-

CONSTRUCTION CHANGE / ADDENDUM			
CHANGE	DATE	AFFECTED OR ADDED SHEET NUMBERS	APPROVAL NO.

WARNING  
IF THIS BAR DOES NOT MEASURE 1" THEN DRAWING IS NOT TO SCALE.

PROJECT TITLE

G-2

KEY MAP

PLANS FOR THE CONSTRUCTION OF  
PROJECT TITLE  
KEY MAP

CITY OF SAN DIEGO, CALIFORNIA  
PUBLIC WORKS DEPARTMENT  
SHEET OF SHEETS

WATER WBS 0-00000  
SEWER WBS 0-00000

FOR CITY ENGINEER \_\_\_\_\_ DATE \_\_\_\_\_  
PRINT DCE NAME \_\_\_\_\_ TITLE# \_\_\_\_\_

DESCRIPTION	BY	APPROVED	DATE	FILED
ORIGINAL	xx/xx			

CONTRACTOR \_\_\_\_\_ DATE STARTED \_\_\_\_\_  
INSPECTOR \_\_\_\_\_ DATE COMPLETED \_\_\_\_\_

XXXXX-02-D



Figure 2-13b.1 Roadway Cover Sheet

# PROJECT TITLE

### CONTRACTOR'S RESPONSIBILITIES

- PURSUANT TO SECTION 4216 OF THE CALIFORNIA GOVERNMENT CODE, AT LEAST 2 WORKING DAYS PRIOR TO EXCAVATION, YOU MUST CONTACT THE REGIONAL NOTIFICATION CENTER (E.G., UNDERGROUND SERVICE ALERT OF SOUTHERN CALIFORNIA) AND OBTAIN AN INQUIRY IDENTIFICATION NUMBER.
- NOTIFY SDG&E AT LEAST 10 WORKING DAYS PRIOR TO EXCAVATING WITHIN 10' OF SDG&E UNDERGROUND HIGH VOLTAGE TRANSMISSION POWER LINES, (I.E., 69 KV & HIGHER)

### CONSTRUCTION STORM WATER PROTECTION NOTES

- TOTAL SITE DISTURBANCE AREA (ACRES) \_\_\_\_\_  
HYDROLOGIC UNIT/ WATERSHED \_\_\_\_\_  
HYDROLOGIC SUBAREA NAME & NO. \_\_\_\_\_
- THE CONTRACTOR SHALL COMPLY WITH THE REQUIREMENTS OF THE  
 WPCP  
THE PROJECT IS SUBJECT TO MUNICIPAL STORM WATER PERMIT NO. R9-2013-0001 AS AMENDED BY R9-2015-0001 AND R9-2015-0100  
 SWPPP  
THE PROJECT IS SUBJECT TO MUNICIPAL STORM WATER PERMIT NO. R9-2013-0001 AS AMENDED BY R9-2015-0001 AND R9-2015-0100 AND CONSTRUCTION GENERAL PERMIT ORDER 2009-0009-DW0 AS AMENDED BY ORDER 2010-0014-DW0 AND 2012-0006-DW0  
TRADITIONAL RISK LEVEL  1  2  3  
LUP: RISK TYPE  1  2  3
- CONSTRUCTION SITE PRIORITY  
 ASBS  HIGH  MEDIUM  LOW

### MONUMENTATIONSURVEY NOTES

THE CONTRACTOR SHALL BE RESPONSIBLE FOR SURVEY MONUMENTS AND/OR VERTICAL CONTROL BENCHMARKS WHICH ARE DISTURBED OR DESTROYED BY CONSTRUCTION. A LICENSED LAND SURVEYOR OR LICENSED CIVIL ENGINEER AUTHORIZED TO PRACTICE LAND SURVEYING IN THE STATE OF CALIFORNIA SHALL FIELD LOCATE, REFERENCE, AND/OR PRESERVE ALL HISTORICAL OR CONTROLLING MONUMENTS PRIOR ANY EARTHWORK, DEMOLITION OR SURFACE IMPROVEMENTS. IF DESTROYED, A LICENSED LAND SURVEYOR SHALL REPLACE SUCH MONUMENT(S) WITH APPROPRIATE MONUMENTS. WHEN SETTING SURVEY MONUMENTS USED FOR RE-ESTABLISHMENT OF THE DISTURBED CONTROLLING SURVEY MONUMENTS AS REQUIRED BY SECTIONS 6130.2 AND 8771 OF THE BUSINESS AND PROFESSIONS CODE OF THE STATE OF CALIFORNIA, A CORNER RECORD OR RECORD OF SURVEY, AS APPROPRIATE, SHALL BE FILLED WITH THE COUNTY SURVEYOR. IF ANY VERTICAL CONTROL IS TO BE DISTURBED OR DESTROYED, THE CITY OF SAN DIEGO FIELD SURVEY SECTION SHALL BE NOTIFIED IN WRITING AT LEAST 7 DAYS PRIOR TO CONSTRUCTION. THE CONTRACTOR SHALL BE RESPONSIBLE FOR THE COST OF REPLACING AND VERTICAL CONTROL BENCHMARKS DESTROYED BY THE CONSTRUCTION.

### ABBREVIATIONS

ABAND	ABANDON	EB	ENCASED BURIED	OVHD	OVER HEAD
ABAND'D	ABANDONED	EL, ELEV	ELEVATION	PROP	PROPOSED
BTWN	BETWEEN	ELEC	ELECTRIC	\$	SURVEY LINE
CATV	CABLE TV	EX, EXIST	EXISTING	SD&AE	SAN DIEGO & ARIZONA EASTERN RAILROAD
C	CENTER LINE	FH	FIRE HYDRANT	SDTI	SAN DIEGO TROLLEY INC.
COND	CONDUIT	FS	FIRE SERVICE	SWR	SEWER
CONT	CONTINUED	HP	HIGH PRESSURE	TEL	TELEPHONE
CONTR	CONTRACTOR	IE	INVERT ELEVATION	UNK	UNKNOWN
DB	DIRECT BURIED	MTD	MULTIPLE TELEPHONE DUCT	WM	WATER METER
DI	DUCTILE IRON	MTS	SAN DIEGO METROPOLITAN TRANSIT SYSTEM	WTR	WATER

### EXISTING STRUCTURES

EX WATER VALV E	---	●	---	
EX WATER METER	---	⊠	---	
EX FIRE HYDRANT	○	●		
EX SEWER MAIN & MANHOLES	---	⊠	---	
EX DRAINS	==			
EX PAVEMENT (PROFILE)	////			
EX GROUND LINE (PROFILE)	////			
EX TRAFFIC SIGNAL	OK TS			
EX STREET LIGHT	+	SL		
GAS MAIN	---			
ELEC. COND., TEL. COND., CATV	---	E	T	C
RAILROAD, TROLLEY TRACKS				

\* IF NO CONSULTANT ON THIS PROJECT; DELETE ENGINEER'S RESPONSIBILITIES.

DELETE THIS NOTE AFTER REVIEWING THE TASK BELOW

\* I HEREBY DECLARE THAT I AM THE ENGINEER OF WORK FOR THIS PROJECT THAT I HAVE EXERCISED RESPONSIBLE CHARGE OVER THE DESIGN OF THE PROJECT AS DEFINED IN SECTION 6703 OF THE BUSINESS AND PROFESSIONS CODE AND THAT THE DESIGN IS CONSISTENT WITH CURRENT STANDARDS. I UNDERSTAND THAT THE CHECK OF PROJECT DRAWINGS AND SPECIFICATIONS BY THE CITY OF SAN DIEGO IS CONFINED TO A REVIEW ONLY AND DOES NOT RELIEVE ME, AS ENGINEER OF WORK, OF MY RESPONSIBILITIES FOR PROJECT DESIGN.

(ENGINEER'S NAME) DATE

### SHEET INDEX

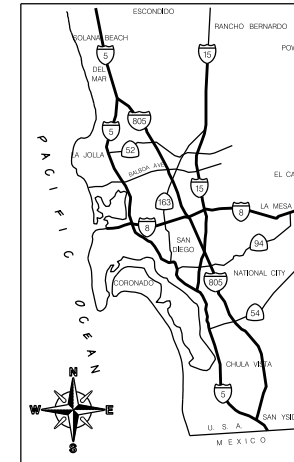
SHEET NO.	DISCIPLINE CODE	TITLE	LIMITS
1	G-I	COVER SHEET	
2	C-I	CIVIL	NAME ROAD TO NAME BOULEVARD
		CURB RAMP LOCATION	
		MISC DETAILS	
		*PERMANENT STORM WATER BEST MANAGEMENT PRACTICES (BMP) -STANDARD DEVELOPMENT PROJECTS	
		*PERMANENT STORM WATER BEST MANAGEMENT PRACTICES (BMP) -PRIORITY DEVELOPMENT PROJECTS	
	T-I	TRAFFIC PLANS	

### DISCIPLINE CODE

- G GENERAL
- D DEMOLITION
- C CIVIL
- L LANDSCAPE
- A ARCHITECTURAL
- S STRUCTURAL
- M MECHANICAL
- E ELECTRICAL
- I INSTRUMENTATION
- T TRAFFIC CONTROL

### WORK TO BE DONE

THE IMPROVEMENTS CONSIST OF THE FOLLOWING WORK TO BE DONE ACCORDING TO THESE PLANS AND THE STANDARD SPECIFICATIONS AND THE STANDARD DRAWINGS OF THE CITY OF SAN DIEGO.



VICINITY MAP  
NOT TO SCALE

### LEGEND

IMPROVEMENTS	STANDARD DRAWINGS	SYMBOL
SIDEWALK	SDG-109, SDW-155, SDG-156, G-10	=====
CURB AND GUTTER	SDG-151, TYPE H	=====
CURB INLET	SDD-116, TYPE B-1	⊠
STORM DRAIN CLEANOUT	D-9, TYPE A	⊠
NO. 3-1/2 PULLBOX	CALTRANS ES-8	⊠

FOR ADDITIONAL SYMBOLS SEE RESURFACING, CURB RAMP AND TRAFFIC CONTROL SHEETS.  
REVISE LEGEND ON PROJECT THEN DELETE THIS NOTE.

### TRAFFIC CONTROL NOTES:

THE CONTRACTOR SHALL, PER SECTION X-XX.X OF THE CONTRACT SPECIAL PROVISIONS, PREPARE TRAFFIC CONTROL WORKING DRAWINGS AND SUBMIT THEM TO THE RESIDENT ENGINEER. THE WORKING DRAWINGS WILL BE SENT TO THE ENGINEERING TRAFFIC CONTROL SECTION FOR REVIEW AND APPROVAL. THE CONTRACTOR SHALL ALLOW A MINIMUM OF 20 WORKING DAYS FOR REVIEW OF THE WORKING DRAWINGS. UPON APPROVAL OF THE TRAFFIC CONTROL PLAN, THE ENGINEERING TRAFFIC CONTROL SECTION WILL ISSUE A TRAFFIC CONTROL PLAN (TCP) PERMIT. WORK SHALL NOT BEGIN IN THE PUBLIC RIGHT OF WAY WITHOUT THE APPROVED TCP PERMIT.

### STREET CLASSIFICATION

STREET NAME: \_\_\_\_\_  
STREET CLASSIFICATION, ADT=XXXXXX

### REFERENCE:

MAP NO. & DRAWING NO.

### FIELD DATA

BENCHMARK: NEBP STREET NAME AND STREET NAME

ELEV.=XXX

FIELD NOTES:

BASIS OF BEARINGS / COORDINATES:

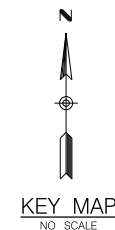
GPS X TO GPS X NXX XX'XX"E, HD XXX.X FT

CCS 83 (EPOCH XXX FEET)

DATUM: MEAN SEA LEVEL

REFERENCES:

MAP XXX



KEY MAP  
NO SCALE

G-1

AS-BUILT INFORMATION		PLANS FOR THE CONSTRUCTION OF	
MATERIALS	MANUFACTURER	PROJECT TITLE	
-	-	PROJECT TITLE	
-	-	COVER SHEET	
-	-		
-	-		
CONSULTANT		CITY OF SAN DIEGO, CALIFORNIA	
SPEC. NO.		PUBLIC WORKS DEPARTMENT	
		SHEET OF SHEETS	
		WBS 0-00000	
		APPROVED BY: _____	
		DATE: _____	
		PROJECT MANAGER: _____	
		PROJECT ENGINEER: _____	
		SEE SHEETS	
		CCS87 COORDINATE	
		SEE SHEETS	
		CCS81 COORDINATE	
CONTRACTOR _____		DATE STARTED _____	
INSPECTOR _____		DATE COMPLETED _____	
		XXXXX-01-D	

CONSTRUCTION CHANGE / ADDENDUM			
CHANGE	DATE	AFFECTED OR ADDED SHEET NUMBERS	APPROVAL NO.

WARNING  
IF THIS BAR DOES NOT MEASURE 1" THEN DRAWING IS NOT TO SCALE.



PROJECT TITLE (FOR ROADWAY PROJECTS)

# PROJECT TITLE

### CONTRACTOR'S RESPONSIBILITIES

- PURSUANT TO SECTION 4216 OF THE CALIFORNIA GOVERNMENT CODE, AT LEAST 2 WORKING DAYS PRIOR TO EXCAVATION, YOU MUST CONTACT THE REGIONAL NOTIFICATION CENTER (E.G., UNDERGROUND SERVICE ALERT OF SOUTHERN CALIFORNIA) AND OBTAIN AN INQUIRY IDENTIFICATION NUMBER.
- NOTIFY SDG&E AT LEAST 10 WORKING DAYS PRIOR TO EXCAVATING WITHIN 10' OF SDG&E UNDERGROUND HIGH VOLTAGE TRANSMISSION POWER LINES, (I.E., 69 KV & HIGHER)

### CONSTRUCTION STORM WATER PROTECTION NOTES

- TOTAL SITE DISTURBANCE AREA (ACRES) \_\_\_\_\_  
HYDROLOGIC UNIT / WATERSHED \_\_\_\_\_  
HYDROLOGIC SUBAREA NAME & NO. \_\_\_\_\_
- THE CONTRACTOR SHALL COMPLY WITH THE REQUIREMENTS OF THE
  - WPCP  
THE PROJECT IS SUBJECT TO MUNICIPAL STORM WATER PERMIT NO. R9-2013-0001 AS AMENDED BY R9-2015-0001 AND R9-2015-0100
  - SWPPP  
THE PROJECT IS SUBJECT TO MUNICIPAL STORM WATER PERMIT NO. R9-2013-0001 AS AMENDED BY R9-2015-0001 AND R9-2015-0100 AND CONSTRUCTION GENERAL PERMIT ORDER 2009-0009-DW0 AS AMENDED BY ORDER 2010-0014-DW0 AND 2012-0006-DW0  
TRADITIONAL: RISK LEVEL 1  2  3   
LUP: RISK TYPE 1  2  3
- CONSTRUCTION SITE PRIORITY
  - ASBS  HIGH  MEDIUM  LOW

### MONUMENTATIONSURVEY NOTES

THE CONTRACTOR SHALL BE RESPONSIBLE FOR SURVEY MONUMENTS AND/OR VERTICAL CONTROL BENCHMARKS WHICH ARE DISTURBED OR DESTROYED BY CONSTRUCTION. A LICENSED LAND SURVEYOR OR LICENSED CIVIL ENGINEER AUTHORIZED TO PRACTICE LAND SURVEYING IN THE STATE OF CALIFORNIA SHALL FIELD LOCATE, REFERENCE, AND/OR PRESERVE ALL HISTORICAL OR CONTROLLING MONUMENTS PRIOR ANY EARTHWORK, DEMOLITION OR SURFACE IMPROVEMENTS. IF DESTROYED, A LICENSED LAND SURVEYOR SHALL REPLACE SUCH MONUMENT(S) WITH APPROPRIATE MONUMENTS. WHEN SETTING SURVEY MONUMENTS USED FOR RE-ESTABLISHMENT OF THE DISTURBED CONTROLLING SURVEY MONUMENTS AS REQUIRED BY SECTIONS 6730.2 AND 8771 OF THE BUSINESS AND PROFESSIONS CODE OF THE STATE OF CALIFORNIA, A CORNER RECORD OR RECORD OF SURVEY, AS APPROPRIATE, SHALL BE FILLED WITH THE COUNTY SURVEYOR. IF ANY VERTICAL CONTROL IS TO BE DISTURBED OR DESTROYED, THE CITY OF SAN DIEGO FIELD SURVEY SECTION SHALL BE NOTIFIED IN WRITING AT LEAST 7 DAYS PRIOR TO CONSTRUCTION. THE CONTRACTOR SHALL BE RESPONSIBLE FOR THE COST OF REPLACING AND VERTICAL CONTROL BENCHMARKS DESTROYED BY THE CONSTRUCTION.

### ABBREVIATIONS

ABAND	ABANDON	ELEC	ELECTRIC	OVHD	OVER HEAD
ABAND'D	ABANDONED	EX, EXIST	EXISTING	PVC	POLYVINYL CHLORIDE
AC	ASBESTOS CEMENT PIPE	E/O	EAST OF	PROP	PROPOSED
AHD	AHEAD	F	FLANGE	RED	REDUCER
ASSY	ASSEMBLY	FH	FIRE HYDRANT	RT	RIGHT
BFV	BUTTERFLY VALVE	FS	FIRE SERVICE	\$	SURVEY LINE
BK	BACK	GV	GATE VALVE	SD&AE	SAN DIEGO & ARIZONA EASTERN RAILROAD
BTWN	BETWEEN	HDPE	HIGH-DENSITY POLYETHYLENE	SDTI	SAN DIEGO TROLLEY INC.
CATV	CABLE TV	HP	HIGH PRESSURE	SO	STUB OUT
CI	CAST IRON PIPE	IE	INVERT ELEVATION	S/O	SOUTH OF
C	CENTER LINE	LT	LEFT	SWR	SEWER
COND	CONDUIT	LUP	LINEAR UNDERGROUND PROJECT	TEL	TELEPHONE
CONT	CONTINUED	MJ	MECHANICAL JOINT	UNK	UNKNOWN
CONTR	CONTRACTOR	MTS	SAN DIEGO METROPOLITAN TRANSIT SYSTEM	VC	VITRIFIED CLAY PIPE
DB	DIRECT BURIED	MTD	MULTIPLE TELEPHONE DUCT	WM	WATER METER
DI	DUCTILE IRON	N/O	NORTH OF	WTR	WATER
EB	ENCASED BURIED			W/O	WEST OF
EL, ELEV	ELEVATION				

### EXISTING STRUCTURES

EX WATER MAIN & VALVES	---	⊙	---
EX WATER METER	---	⊠	---
EX FIRE HYDRANT	---	⊙	---
EX SEWER MAIN & MANHOLES	---	⊠	---
EX DRAINS	---	---	---
EX PAVEMENT (PROFILE)	---	---	---
EX GROUND LINE (PROFILE)	---	---	---
EX TRAFFIC SIGNAL	---	⊙	TS
EX STREET LIGHT	---	+	SL
GAS MAIN	---	---	---
ELEC. COND., TEL. COND., CATV	---	-E-	-T-
RAILROAD, TROLLEY TRACKS	---	---	---

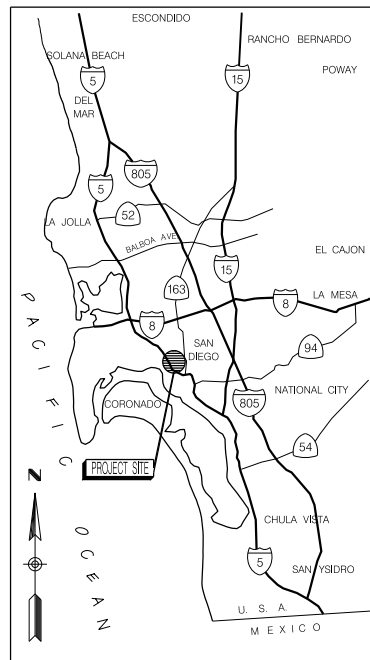
### SHEET INDEX

SHEET NO.	DISCIPLINE CODE	TITLE
1	G-1	COVER SHEET
2	G-2	KEY MAP
CURB RAMP LOCATION		
MISC DETAILS		
* PERMANENT STORM WATER BEST MANAGEMENT PRACTICES (BMP) -STANDARD DEVELOPMENT PROJECTS		
* PERMANENT STORM WATER BEST MANAGEMENT PRACTICES (BMP) -PRIORITY DEVELOPMENT PROJECTS		
T-1		TRAFFIC PLANS

\* PROJECT SHOULD CHOOSE FROM STANDARD AND PRIORITY, AS APPLICABLE TO THE PROJECT.  
DELETE THIS NOTE AFTER REVIEWING THE TASK ABOVE

### DISCIPLINE CODE

G	GENERAL
D	DEMOLITION
C	CIVIL
L	LANDSCAPE
A	ARCHITECTURAL
S	STRUCTURAL
M	MECHANICAL
E	ELECTRICAL
I	INSTRUMENTATION
T	TRAFFIC CONTROL



VICINITY MAP  
NOT TO SCALE

AS-BUILT TABLE TO BE REVISE BASED ON PROJECT REQUIREMENTS. DELETE TABLE IF NOT APPLICABLE.

### LEGAL DESCRIPTION:

### SITE ADDRESS

### ASSESSOR'S NUMBER

### PROJECT DATA

CONDITION OF SOIL (UNDISTURBED, COMPACT, OR LOSE FILL):  
LANDSCAPE AREA SQUARE FOOTAGE:  
TOTAL AREA OF DISTURBANCE:  
LISTING OF DEFERRED SUBMITTALS:

### FIELD DATA

BENCHMARK: NEBP STREET NAME AND STREET NAME  
ELEV.=XXX  
FIELD NOTES:  
BASIS OF BEARINGS / COORDINATES:  
GPS X TO GPS X NXX XX'XX"E, HD XXX.X FT  
CCS 83 (EPOCH XXX FEET)  
DATUM: MEAN SEA LEVEL  
REFERENCES:  
MAP NO. XXX & DRAWING NO.  
TOPOGRAPHY SOURCE:

### OWNER

CITY OF SAN DIEGO  
525 B STREET  
SUITE XXX  
SAN DIEGO CA, 92101  
PHONE NUMBER 619-XXX-XXXX  
PROJECT MANAGER NAME

### PROJECT TEAM

LIST NAME AND PHONE OF ALL DESIGN PROFESSIONALS INCLUDING ENGINEERS, ARCHITECTS, DESIGNERS.

\* IF NO CONSULTANT ON THIS PROJECT; DELETE ENGINEER'S RESPONSIBILITIES.  
DELETE THIS NOTE AFTER REVIEWING THE TASK BELOW

### DECLARATION OF RESPONSIBLE CHARGE

\* I HEREBY DECLARE THAT I AM THE ENGINEER OF WORK FOR THIS PROJECT THAT I HAVE EXERCISED RESPONSIBLE CHARGE OVER THE DESIGN OF THE PROJECT AS DEFINED IN SECTION 6703 OF THE BUSINESS AND PROFESSIONS CODE AND THAT THE DESIGN IS CONSISTENT WITH CURRENT STANDARDS. I UNDERSTAND THAT THE CHECK OF PROJECT DRAWINGS AND SPECIFICATIONS BY THE CITY OF SAN DIEGO IS CONFINED TO A REVIEW ONLY AND DOES NOT RELIEVE ME, AS ENGINEER OF WORK, OF MY RESPONSIBILITIES FOR PROJECT DESIGN.

(ENGINEER'S NAME) \_\_\_\_\_ DATE \_\_\_\_\_

AS-BUILT INFORMATION		PLANS FOR THE CONSTRUCTION OF PROJECT TITLE COVER SHEET	
MATERIALS	MANUFACTURER	CITY OF SAN DIEGO, CALIFORNIA PUBLIC WORKS DEPARTMENT SHEET OF SHEETS	
-	-	WBS 0-00000	
-	-	FOR CITY ENGINEER _____ DATE _____	
-	-	PROJECT MANAGER _____	
-	-	PROJECT ENGINEER _____	
CONSULTANT		APPROVED BY _____ DATE _____	
SPEC. NO.		PROJECT NO. _____	
COMPANY NAME		DESCRIPTION	
COMPANY ADDRESS		BY _____ APPROVED _____ DATE _____ FILED _____	
COMPANY PHONE		ORIGINAL _____ xx/xx	
COMPANY FAX		000-0000	
COMPANY EMAIL		0000-0000	
CONTRACTOR		DATE STARTED _____	
INSPECTOR		DATE COMPLETED _____	
		19905-01-D	

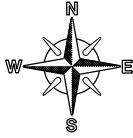
CONSTRUCTION CHANGE / ADDENDUM			
CHANGE	DATE	AFFECTED OR ADDED SHEET NUMBERS	APPROVAL NO.

WARNING  
0 1  
IF THIS BAR DOES NOT MEASURE 1" THEN DRAWING IS NOT TO SCALE.



AEP PROJECT TITLE

G-1



KEY MAP  
NOT TO SCALE

G-2

PROJECT TITLE				
KEY MAP				
CITY OF SAN DIEGO, CALIFORNIA PUBLIC WORKS DEPARTMENT SHEET OF SHEETS				WBS <u>0-00000</u>
APPROVED FOR CITY ENGINEER _____	DATE _____	DRAWN BY _____	PROJECT MANAGER _____	PROJECT ENGINEER _____
PRINT DC# NAME _____	BY _____	APPROVED _____	DATE _____	FILMED _____
ORIGINAL	xx/xx			
CONTRACTOR _____			DATE STARTED _____	PROJECT ENGINEER _____
INSPECTOR _____			DATE COMPLETED _____	19905-02-D

KEY MAP

# PROJECT TITLE

### CONTRACTOR'S RESPONSIBILITIES

- PURSUANT TO SECTION 4216 OF THE CALIFORNIA GOVERNMENT CODE, AT LEAST 2 WORKING DAYS PRIOR TO EXCAVATION, YOU MUST CONTACT THE REGIONAL NOTIFICATION CENTER (E.G., UNDERGROUND SERVICE ALERT OF SOUTHERN CALIFORNIA) AND OBTAIN AN INQUIRY IDENTIFICATION NUMBER.
- NOTIFY SDG&E AT LEAST 10 WORKING DAYS PRIOR TO EXCAVATING WITHIN 10' OF SDG&E UNDERGROUND HIGH VOLTAGE TRANSMISSION POWER LINES (I.E., 69 KV & HIGHER)

### SHEET INDEX

SHEET NO.	DISCIPLINE CODE	TITLE
1	G-1	COVER SHEET
2	G-2	KEY MAP
CURB RAMP LOCATION		
MISC DETAILS		
* PERMANENT STORM WATER BEST MANAGEMENT PRACTICES (BMP) -STANDARD DEVELOPMENT PROJECTS		
* PERMANENT STORM WATER BEST MANAGEMENT PRACTICES (BMP) -PRIORITY DEVELOPMENT PROJECTS		
T-1		TRAFFIC PLANS

### LEGAL DESCRIPTION:

### SITE ADDRESS

### ASSESSOR'S NUMBER

### PROJECT DATA

OCCUPANCY CLASSIFICATION(S):  
 NUMBER OF STORIES (EXISTING & PROPOSED):  
 HEIGHT OF BUILDING (EXISTING & PROPOSED):  
 FLOOR AREA AND FLOOR AREA RATIO:  
 TOTAL NEW FLOOR AREA ADDED:  
 TOTAL EXISTING FLOOR AREA TO REMAIN PER STORY:  
 CONDITION OF SOIL (UNDISTURBED, COMPACT, OR LOOSE FILL):  
 LANDSCAPE AREA SQUARE FOOTAGE:  
 TOTAL AREA OF DISTURBANCE:  
 LISTING OF DEFERRED SUBMITTALS:  
 FIRE PROTECTION REQUIREMENTS:  
 APPLICABLE CODES:

### WORK TO BE DONE

INSERT THE PROJECT'S COMPLETE SCOPE OF WORK, INCLUDING ALL EXISTING AND PROPOSED IMPROVEMENTS. CLEARLY IDENTIFY PARTIAL APPROVALS, SUCH AS FOUNDATIONS, SUBSTRUCTURE, AND SHELL BUILDINGS (THIS IS REFERRED AS DESCRIPTION OF WORK OR SCOPE OF WORK)

### LEGEND

IMPROVEMENTS      STANDARD DRAWINGS      SYMBOL

FOR BMP LEGEND SEE SHEET NO. XX.  
 FOR GRADING LEGEND SEE SHEET NO. XX.  
 FOR IRRIGATION LEGEND SEE SHEET NO. XX.  
 FOR LANDSCAPING LEGEND SEE SHEET NO. XX.  
 FOR ADDITIONAL SYMBOLS SEE CURB RAMP AND TRAFFIC CONTROL SHEETS.

### CONSTRUCTION STORM WATER PROTECTION NOTES

- TOTAL SITE DISTURBANCE AREA (ACRES) \_\_\_\_\_  
 HYDROLOGIC UNIT/ WATERSHED \_\_\_\_\_  
 HYDROLOGIC SUBAREA NAME & NO. \_\_\_\_\_
- THE CONTRACTOR SHALL COMPLY WITH THE REQUIREMENTS OF THE  
 WPCP  
 THE PROJECT IS SUBJECT TO MUNICIPAL STORM WATER PERMIT NO. R9-2013-0001 AS AMENDED BY R9-2015-0001 AND R9-2015-0100  
 SWPPP  
 THE PROJECT IS SUBJECT TO MUNICIPAL STORM WATER PERMIT NO. R9-2013-0001 AS AMENDED BY R9-2015-0001 AND R9-2015-0100 AND CONSTRUCTION GENERAL PERMIT ORDER 2009-0009-DWQ AS AMENDED BY ORDER 2010-004-DWQ AND 2012-0006-DWQ  
 TRADITIONAL RISK LEVEL  1  2  3  
 LUP RISK TYPE  1  2  3
- CONSTRUCTION SITE PRIORITY  
 ASBS  HIGH  MEDIUM  LOW

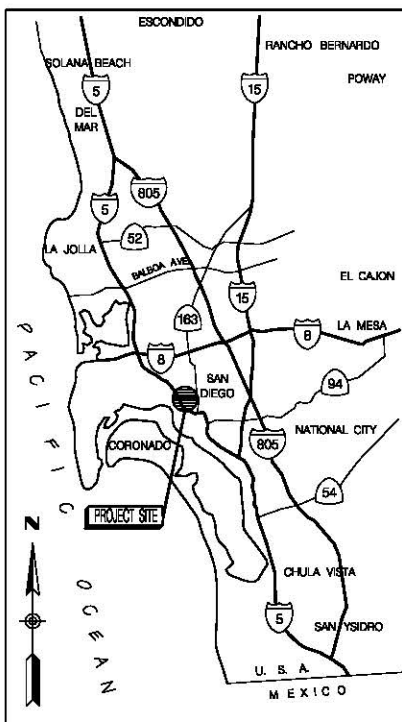
### MONUMENTATION/SURVEY NOTES

THE CONTRACTOR SHALL BE RESPONSIBLE FOR SURVEY MONUMENTS AND/OR VERTICAL CONTROL BENCHMARKS WHICH ARE DISTURBED OR DESTROYED BY CONSTRUCTION. A LICENSED LAND SURVEYOR OR LICENSED CIVIL ENGINEER AUTHORIZED TO PRACTICE LAND SURVEYING IN THE STATE OF CALIFORNIA SHALL FIELD LOCATE, REFERENCE, AND/OR PRESERVE ALL HISTORICAL OR CONTROLLING MONUMENTS PRIOR ANY EARTHWORK, DEMOLITION OR SURFACE IMPROVEMENTS. IF DESTROYED, A LICENSED LAND SURVEYOR SHALL REPLACE SUCH MONUMENT(S) WITH APPROPRIATE MONUMENTS. WHEN SETTING SURVEY MONUMENTS USED FOR RE-ESTABLISHMENT OF THE DISTURBED CONTROLLING SURVEY MONUMENTS AS REQUIRED BY SECTIONS 6730.2 AND 8771 OF THE BUSINESS AND PROFESSIONS CODE OF THE STATE OF CALIFORNIA, A CORNER RECORD OR RECORD OF SURVEY, AS APPROPRIATE, SHALL BE FILLED WITH THE COUNTY SURVEYOR. IF ANY VERTICAL CONTROL IS TO BE DISTURBED OR DESTROYED, THE CITY OF SAN DIEGO FIELD SURVEY SECTION SHALL BE NOTIFIED IN WRITING AT LEAST 7 DAYS PRIOR TO CONSTRUCTION. THE CONTRACTOR SHALL BE RESPONSIBLE FOR THE COST OF REPLACING AND VERTICAL CONTROL BENCHMARKS DESTROYED BY THE CONSTRUCTION.

\* PROJECT SHOULD CHOOSE FROM STANDARD AND PRIORITY, AS APPLICABLE TO THE PROJECT.  
**DELETE THIS NOTE AFTER REVIEWING THE TASK ABOVE**

### DISCIPLINE CODE

- G GENERAL
- D DEMOLITION
- C CIVIL
- L LANDSCAPE
- A ARCHITECTURAL
- S STRUCTURAL
- M MECHANICAL
- E ELECTRICAL
- I INSTRUMENTATION
- T TRAFFIC CONTROL



VICINITY MAP

### FIELD DATA

BENCHMARK: NEBP STREET NAME AND STREET NAME  
 ELEV.=XXX  
 FIELD NOTES:  
 BASIS OF BEARINGS / COORDINATES:  
 GPS X TO GPS X NXX XX'XX"E, HD XXX.X FT  
 CCS 83 (EPOCH XXX FEET)  
 DATUM: MEAN SEA LEVEL  
 REFERENCES:  
 MAP NO. XXX & DRAWING NO.  
 TOPOGRAPHY SOURCE:

### OWNER

CITY OF SAN DIEGO  
 525 B STREET  
 SUITE XXX  
 SAN DIEGO CA, 92101  
 PHONE NUMBER 619-XXX-XXXX  
 PROJECT MANAGER NAME

### PROJECT TEAM

LIST NAME AND PHONE OF ALL DESIGN PROFESSIONALS INCLUDING ENGINEERS, ARCHITECTS, DESIGNERS.

### ZONING

CONSTRUCTION TYPE:  
 BUILDING TYPE:  
 DISCRETION APPROVALS:  
 BUILDING CODE YEAR:  
 EXISTING USE OF BUILDING:  
 PROPOSED USE OF BUILDING:

\* IF NO CONSULTANT ON THIS PROJECT; DELETE ENGINEER'S RESPONSIBILITIES.  
**DELETE THIS NOTE AFTER REVIEWING THE TASK BELOW**

### DECLARATION OF RESPONSIBLE CHARGE

\* I HEREBY DECLARE THAT I AM THE ENGINEER OF WORK FOR THIS PROJECT THAT I HAVE EXERCISED RESPONSIBLE CHARGE OVER THE DESIGN OF THE PROJECT AS DEFINED IN SECTION 6703 OF THE BUSINESS AND PROFESSIONS CODE AND THAT THE DESIGN IS CONSISTENT WITH CURRENT STANDARDS. I UNDERSTAND THAT THE CHECK OF PROJECT DRAWINGS AND SPECIFICATIONS BY THE CITY OF SAN DIEGO IS CONFINED TO A REVIEW ONLY AND DOES NOT RELIEVE ME, AS ENGINEER OF WORK, OF MY RESPONSIBILITIES FOR PROJECT DESIGN.

ENGINEER'S NAME \_\_\_\_\_ DATE \_\_\_\_\_ **G-1**

PLANS FOR THE CONSTRUCTION OF  
 PROJECT TITLE  
 COVER SHEET

CONSTRUCTION CHANGE / ADDENDUM			
CHANGE	DATE	AFFECTED OR ADDED SHEET NUMBERS	APPROVAL NO.

**WARNING**  
  
 IF THIS BAR DOES NOT MEASURE 1" THEN DRAWING IS NOT TO SCALE.



CONSULTANT	
COMPANY NAME	
COMPANY ADDRESS	
COMPANY PHONE	
COMPANY FAX	
COMPANY EMAIL	

CITY OF SAN DIEGO, CALIFORNIA PUBLIC UTILITIES DEPARTMENT SHEET OF SHEETS					WBS 0-0000
APPROVED FOR CITY ENGINEER	DATE	SUBMITTED BY		PROJECT MANAGER	
PRINT DCE NAME	RCS#	DRAWN BY		PROJECT ENGINEER	
DESCRIPTION	BY	APPROVED	DATE	FILMED	
ORIGINAL	XX/XX				000-0000 CS827 COORDINATE
					0000-0000 CS883 COORDINATE
CONTRACTOR	DATE STARTED	INSPECTOR		DATE COMPLETED	XXXXX-XX-D



G-2

KEY MAP

PROJECT TITLE  
KEY MAP

CITY OF SAN DIEGO, CALIFORNIA  
PUBLIC UTILITIES DEPARTMENT  
SHEET OF SHEETS

WBS 0-00000

APPROVED FOR CITY ENGINEER \_\_\_\_\_ DATE \_\_\_\_\_  
PROJECT MANAGER \_\_\_\_\_

DESCRIPTION	BY	APPROVED	DATE	FILED	PROJECT ENGINEER
ORIGINAL	xx/xx				000-0000
					0000-0000
					0000-0000

CONTRACTOR \_\_\_\_\_ DATE STARTED \_\_\_\_\_  
INSPECTOR \_\_\_\_\_ DATE COMPLETED \_\_\_\_\_

XXXXX-XX-D



# PROJECT TITLE

### CONTRACTOR'S RESPONSIBILITIES

- PURSUANT TO SECTION 4216 OF THE GOVERNMENT CODE, AT LEAST 2 WORKING DAYS PRIOR TO EXCAVATION, YOU MUST CONTACT THE REGIONAL NOTIFICATION CENTER (E.G. UNDERGROUND SERVICE ALERT OF SOUTHERN CALIFORNIA) AND OBTAIN AN INQUIRY IDENTIFICATION NUMBER.
- NOTIFY SDG&E AT LEAST 10 WORKING DAYS PRIOR TO EXCAVATING WITHIN 10' OF SDG&E UNDERGROUND HIGH VOLTAGE TRANSMISSION POWER LINES, (I.E., 69 KV & HIGHER)
- LOCATE AND RECONNECT ALL SEWER LATERALS. LOCATIONS AS SHOWN ON THE PLANS ARE APPROXIMATE ONLY; LATERAL RECORDS ARE AVAILABLE TO THE CONTRACTOR AT THE WATER DEPARTMENT, 2797 CAMINITO CHOLLAS. LOCATE THE IMPROVEMENTS THAT WILL BE AFFECTED BY LATERAL REPLACEMENTS.
- EXCAVATE AROUND WATER METER BOX (CITY PROPERTY SIDE) TO DETERMINE IN ADVANCE, THE SIZE OF EACH SERVICE BEFORE TAPPING MAIN.
- CITY FORCES, WHEN SPECIFIED OR SHOWN ON THE PLANS, WILL MAKE PERMANENT CUTS & PLUGS AND CONNECTIONS.
- KEEP EXISTING MAINS IN SERVICE IN LIEU OF HIGH-LINING, UNLESS OTHERWISE SPECIFIED SHOWN ON PLANS.
- THE LOCATIONS OF EXISTING BUILDINGS AS SHOWN ON THE PLAN ARE APPROXIMATE.
- STORM DRAIN INLETS SHALL REMAIN FUNCTIONAL AT ALL TIMES DURING CONSTRUCTION.
- UNLESS OTHERWISE NOTED AS PREVIOUSLY POTHOLED (PH), ELEVATIONS SHOWN ON THE PROFILE FOR EXISTING UTILITIES ARE BASED ON A SEARCH OF THE AVAILABLE RECORD INFORMATION ONLY AND ARE SOLELY FOR THE CONTRACTOR'S CONVENIENCE. THE CITY DOES NOT GUARANTEE THAT IT HAS REVIEWED ALL AVAILABLE DATA; THE CONTRACTOR SHALL POTHOLE ALL EXISTING UTILITIES EITHER SHOWN ON THE PLANS OR MARKED IN THE FIELD IN ACCORDANCE WITH THE SPECIFICATIONS SECTION 5-UTILITIES.
- EXISTING UTILITY CROSSING AS SHOWN ON THE PLANS ARE APPROXIMATE AND ARE NOT REPRESENTATIVE OF ACTUAL LENGTH AND LOCATION OF CONFLICT AREAS. SEE PLAN VIEW.
- ALL ADVANCE METERING INFRASTRUCTURE (AMI) DEVICES ATTACHED TO THE WATER METER OR LOCATED IN OR NEAR WATER METER BOXES, COFFINS, OR VAULTS SHALL BE PROTECTED AT ALL TIMES IN ACCORDANCE WITH THE CONTRACT DOCUMENTS.

### CONSTRUCTION STORM WATER PROTECTION NOTES

- TOTAL SITE DISTURBANCE AREA (ACRES) \_\_\_\_\_  
HYDROLOGIC UNIT / WATERSHED \_\_\_\_\_  
HYDROLOGIC SUBAREA NAME & NO. \_\_\_\_\_
- THE CONTRACTOR SHALL COMPLY WITH THE REQUIREMENTS OF THE  
 WPCP  
THE PROJECT IS SUBJECT TO MUNICIPAL STORM WATER PERMIT NO. R9-2013-0001 AS AMENDED BY R9-2015-0001 AND R9-2015-0100  
 SWPPP  
THE PROJECT IS SUBJECT TO MUNICIPAL STORM WATER PERMIT NO. R9-2013-0001 AS AMENDED BY R9-2015-0001 AND R9-2015-0100 AND CONSTRUCTION GENERAL PERMIT ORDER 2009-0009-DWO AS AMENDED BY ORDER 2010-0014-DWO AND 2012-0006-DWO  
TRADITIONAL RISK LEVEL  1  2  3  
LUP: RISK TYPE  1  2  3
- CONSTRUCTION SITE PRIORITY  
 ASBS  HIGH  MEDIUM  LOW

### ABBREVIATIONS

ABAND	ABANDON	EL, ELEV	ELEVATION	OVHD	OVER HEAD
ABAND'D	ABANDONED	ELEC	ELECTRIC	PVC	POLYVINYL CHLORIDE
AC	ASBESTOS CEMENT PIPE	EX, EXIST	EXISTING	PROP	PROPOSED
AHD	AHEAD	E/O	EAST OF	RED	REDUCER
ASSY	ASSEMBLY	F	FLANGE	RT	RIGHT
BFV	BUTTERFLY VALVE	FH	FIRE HYDRANT	S	SURVEY LINE
BK	BACK	FS	FIRE SERVICE	SD&AE	SAN DIEGO & ARIZONA EASTERN RAILROAD
BTWN	BETWEEN	GV	GATE VALVE	SDTI	SAN DIEGO TROLLEY INC.
CATV	CABLE TV	HOPE	HIGH-DENSITY POLYETHYLENE	SO	STUB OUT
CI	CAST IRON PIPE	HP	HIGH PRESSURE	S/O	SOUTH OF
C	CENTER LINE	IE	INVERT ELEVATION	SWR	SEWER
COND	CONDUIT	LT	LEFT	TEL	TELEPHONE
CONT	CONTINUED	MJ	MECHANICAL JOINT	UNK	UNKNOWN
CONTR	CONTRACTOR	MTS	SAN DIEGO METROPOLITAN	VC	VITRIFIED CLAY PIPE
DB	DIRECT BURIED	MTS	TRANSIT SYSTEM	WM	WATER METER
DI	DUCTILE IRON	MTD	MULTIPLE TELEPHONE DUCT	WTR	WATER
EB	ENCASED BURIED	N/O	NORTH OF	W/O	WEST OF

### EXISTING STRUCTURES

EX WATER MAIN & VALVES	---
EX WATER METER	---
EX FIRE HYDRANT	○
EX SEWER MAIN & MANHOLES	---
EX DRAINS	---
EX PAVEMENT (PROFILE)	////
EX GROUND LINE (PROFILE)	
EX TRAFFIC SIGNAL	○
EX STREET LIGHT	+
GAS MAIN	---
ELEC. COND., TEL. COND., CATV	-E- -T- -C-
RAILROAD, TROLLEY TRACKS	

### SHEET INDEX

SHEET NO.	DISCIPLINE CODE	TITLE	LIMITS	PIPE		LENGTH (FT)
				SIZE (IN)	MATERIAL	
1	G-1	COVER SHEET				
2	G-2	KEY MAP				
3	C-1	NAME STREET	NAME STREET TO NAME AVENUE	-	-	000.00
4	C-2	NAME AVENUE	NAME ROAD TO NAME BOULEVARD	-	-	000.00
WATER						
5	C-3	NAME ROAD	NAME STREET TO NAME AVENUE	-	-	000.00
6	C-4	NAME BOULEVARD	NAME ROAD TO NAME BOULEVARD	-	-	00.00
STREET RESURFACING				TOTAL SEWER		
CURB RAMP LOCATION				TOTAL WATER		
CITY FORCES						
MISC DETAILS						
*PERMANENT STORM WATER BEST MANAGEMENT PRACTICES (BMP) -STANDARD DEVELOPMENT PROJECTS						
*PERMANENT STORM WATER BEST MANAGEMENT PRACTICES (BMP) -PRIORITY DEVELOPMENT PROJECTS						
T-1 TRAFFIC PLANS						

### DISCIPLINE CODE

G	GENERAL
D	DEMOLITION
C	CIVIL
L	LANDSCAPE
A	ARCHITECTURAL
S	STRUCTURAL
M	MECHANICAL
E	ELECTRICAL
I	INSTRUMENTATION
T	TRAFFIC CONTROL

\* PROJECT SHOULD CHOOSE FROM STANDARD AND PRIORITY, AS APPLICABLE TO THE PROJECT.  
DELETE THIS NOTE AFTER REVIEWING THE TASK ABOVE

### MONUMENTATION SURVEY NOTES

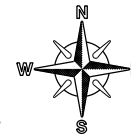
THE CONTRACTOR SHALL BE RESPONSIBLE FOR SURVEY MONUMENTS AND/OR VERTICAL CONTROL BENCHMARKS WHICH ARE DISTURBED OR DESTROYED BY CONSTRUCTION. A LICENSED LAND SURVEYOR OR LICENSED CIVIL ENGINEER AUTHORIZED TO PRACTICE LAND SURVEYING IN THE STATE OF CALIFORNIA SHALL FIELD LOCATE, REFERENCE, AND/OR PRESERVE ALL HISTORICAL OR CONTROLLING MONUMENTS PRIOR ANY EARTHWORK, DEMOLITION OR SURFACE IMPROVEMENTS. IF DESTROYED, A LICENSED LAND SURVEYOR SHALL REPLACE SUCH MONUMENT(S) WITH APPROPRIATE MONUMENTS. WHEN SETTING SURVEY MONUMENTS USED FOR RE-ESTABLISHMENT OF THE DISTURBED CONTROLLING SURVEY MONUMENTS AS REQUIRED BY SECTIONS 6730.2 AND 8771 OF THE BUSINESS AND PROFESSIONS CODE OF THE STATE OF CALIFORNIA, A CORNER RECORD OR RECORD OF SURVEY, AS APPROPRIATE, SHALL BE FILLED WITH THE COUNTY SURVEYOR. IF ANY VERTICAL CONTROL IS TO BE DISTURBED OR DESTROYED, THE CITY OF SAN DIEGO FIELD SURVEY SECTION SHALL BE NOTIFIED IN WRITING AT LEAST 7 DAYS PRIOR TO CONSTRUCTION. THE CONTRACTOR SHALL BE RESPONSIBLE FOR THE COST OF REPLACING AND VERTICAL CONTROL BENCHMARKS DESTROYED BY THE CONSTRUCTION.

\* IF NO CONSULTANT ON THIS PROJECT; DELETE ENGINEER'S RESPONSIBILITIES.  
DELETE THIS NOTE AFTER REVIEWING THE TASK BELOW

### DECLARATION OF RESPONSIBLE CHARGE

\* I HEREBY DECLARE THAT I AM THE ENGINEER OF WORK FOR THIS PROJECT THAT I HAVE EXERCISED RESPONSIBLE CHARGE OVER THE DESIGN OF THE PROJECT AS DEFINED IN SECTION 6703 OF THE BUSINESS AND PROFESSIONS CODE AND THAT THE DESIGN IS CONSISTENT WITH CURRENT STANDARDS. I UNDERSTAND THAT THE CHECK OF PROJECT DRAWINGS AND SPECIFICATIONS BY THE CITY OF SAN DIEGO IS CONFINED TO A REVIEW ONLY AND DOES NOT RELIEVE ME, AS ENGINEER OF WORK, OF MY RESPONSIBILITIES FOR PROJECT DESIGN.

(ENGINEER'S NAME) \_\_\_\_\_ DATE \_\_\_\_\_



KEY MAP  
NO SCALE

### FIELD DATA

BENCHMARK:  
FIELD NOTES:  
DATUM: MEAN SEA LEVEL  
STREETS REQUIRING 12" TRENCH CAP:  
\*STREET NAMES\*

REVISE LEGEND ON PROJECT THEN DELETE THIS NOTE.

### LEGEND

IMPROVEMENTS	REFERENCE	SYMBOL
TRENCH RESURFACING	SDG-107, SDG-108	---
SEWER MAIN	SDS-101, SDS-110 (TYPE C)	---
SEWER MANHOLE/PVC LINED	SDS-106, SDS-107, SDS-108, SDS-113, SDS-120, M-3, SM-07	○
REHAB. EX. SEWER MANHOLE	SEE PLANS & SPECS	○
SEWER MAIN REHAB.	SEE PLANS & SPECS	○
4" SEWER LATERAL WITH C.O. UNLESS OTHERWISE SPECIFIED	SDS-102, SDS-103, SDS-104, SDS-105, SDS-110 (TYPE C), SDS-118	○
REPLUMB SEWER LATERAL WITH C.O.	SDS-102, SDS-103, SDS-104, SDS-105, SDS-110 (TYPE C), SDS-118	○
SEWER LATERAL CONNECTION	SEE PLANS & SPECS	○
REHAB SEWER LATERAL (LINED) WITH C.O.	SEE PLANS & SPECS	○
SERVICE LATERAL CONNECTION TO REHABILITATED SEWER	SEE PLANS & SPECS	○
SEWER PUMP INCLUDING REPLUMB SEWER LATERAL WITH C.O.	SDS-102, SDS-103, SDS-104, SDS-105, SDS-110 (TYPE C), SDS-118	○
TUNNEL SEWER REPLUMB LATERAL WITH C.O.	SDS-102, SDS-103, SDS-104, SDS-105	○
CONCRETE PROTECTION FOR EXIST SEWER PIPE	SDS-116	---
PIPE SUPPORT FOR UNDERCUT AC WATER MAIN	SDW-162	---
CONCRETE ENCASEMENT	SDS-112	---
ABANDON EX MANHOLE	SM-08	---
SLURRY FILL ABANDONED SEWER MAIN	SEE PLANS & SPECS	---
CUTTING AND PLUGGING ABANDONED WATER MAIN	WP-03	---
SURVEY MONUMENT	M-10, M-10A, M-10B	---
WATER MAIN & APPURTENANCES	SDM-105, SDW-110, SDW-151, SDW-161	---
VALVES WITH CAPS AND WELLS	SDW-109, SDW-152, SDW-153, WV-05	---
FIRE SERVICE CONNECTION & ASSEMBLY	SDM-105, SDW-109, SDW-118, SDW-152, SDW-153	---
6" FIRE HYDRANT ASSEMBLY & MARKER 2-PORT UNLESS SPECIFIED AS 3-PORT	SDM-105, SDW-104, SDW-109, SDW-152, SDW-153	---
1" WATER SERVICE UNLESS OTHERWISE SPECIFIED	SDM-105, SDW-107, SDW-134, SDW-135, SDW-136, SDW-137, SDW-138, SDW-149, SDW-150, WS-03	---
WATER SERVICE TRANSFER	SDW-149, SDW-150	---
BLOW-OFF ASSEMBLY	SDM-105, SDW-106, SDW-143, SDW-144, SDW-145, SDW-146, WB-05,	---
AIR & VACUUM VALVE	SDM-105, SDW-117, SDW-158, SDW-159, SDW-160	---
HIGHLINING BY CONTRACTOR	SDW-170, SDW-171, SDW-172, SDW-173	---

G-1

PLANS FOR THE CONSTRUCTION OF  
PROJECT TITLE  
COVER SHEET

CITY OF SAN DIEGO, CALIFORNIA PUBLIC UTILITIES DEPARTMENT SHEET OF SHEETS		WATER WBS 0-00000 SEWER WBS 0-00000
FOR CITY ENGINEER _____ DATE _____	DATE _____	PROJECT MANAGER _____
PRINT DCE NAME _____	TRCE# _____	PROJECT ENGINEER _____
DESCRIPTION BY APPROVED DATE FILMED		SEE SHEETS
ORIGINAL xx/xx		COORDINATE
		SEE SHEETS
		COORDINATE
CONTRACTOR _____	DATE STARTED _____	XXXXX-01-D
INSPECTOR _____	DATE COMPLETED _____	

AS-BUILT INFORMATION	
MATERIALS	MANUFACTURER
PIPE CL 235 (WATER)	-
PIPE SDR 35 (SEWER)	-
GATE VALVES	-
FIRE HYDRANTS	-
SEWER MANHOLES	-
REHABILITATE SEWER MANHOLES	-
REHABILITATE SEWER MAIN	-

CONSTRUCTION CHANGE / ADDENDUM			
CHANGE	DATE	AFFECTED OR ADDED SHEET NUMBERS	APPROVAL NO.

WARNING  
0 1  
IF THIS BAR DOES NOT MEASURE 1" THEN DRAWING IS NOT TO SCALE.





**CONTRACTOR'S RESPONSIBILITIES**

- PURSUANT TO SECTION 4216 OF THE GOVERNMENT CODE, AT LEAST 2 WORKING DAYS PRIOR TO EXCAVATION, YOU MUST CONTACT THE REGIONAL NOTIFICATION CENTER (E.G. UNDERGROUND SERVICE ALERT OF SOUTHERN CALIFORNIA) AND OBTAIN AN INQUIRY IDENTIFICATION NUMBER.
- NOTIFY SDG&E AT LEAST 10 WORKING DAYS PRIOR TO EXCAVATING WITHIN 10' OF SDG&E UNDERGROUND HIGH VOLTAGE TRANSMISSION POWER LINES. (I.E., 69 KV & HIGHER)
- LOCATE AND RECONNECT ALL SEWER LATERALS. LOCATIONS AS SHOWN ON THE PLANS ARE APPROXIMATE ONLY. LATERAL RECORDS ARE AVAILABLE TO THE CONTRACTOR AT THE WATER DEPARTMENT, 2797 CAMINITO CHOLLAS. LOCATE THE IMPROVEMENTS THAT WILL BE AFFECTED BY LATERAL REPLACEMENTS.
- EXCAVATE AROUND WATER METER BOX (CITY PROPERTY SIDE) TO DETERMINE IN ADVANCE, THE SIZE OF EACH SERVICE BEFORE TAPPING MAIN.
- CITY FORCES, WHEN SPECIFIED OR SHOWN ON THE PLANS, WILL MAKE PERMANENT CUTS & PLUGS AND CONNECTIONS.
- KEEP EXISTING MAINS IN SERVICE IN LIEU OF HIGH-LINING, UNLESS OTHERWISE SPECIFIED SHOWN ON PLANS.
- THE LOCATIONS OF EXISTING BUILDINGS AS SHOWN ON THE PLAN ARE APPROXIMATE.
- STORM DRAIN INLETS SHALL REMAIN FUNCTIONAL AT ALL TIMES DURING CONSTRUCTION.
- UNLESS OTHERWISE NOTED AS PREVIOUSLY POTHOLED (PH), ELEVATIONS SHOWN ON THE PROFILE FOR EXISTING UTILITIES ARE BASED ON A SEARCH OF THE AVAILABLE RECORD INFORMATION ONLY AND ARE SOLELY FOR THE CONTRACTOR'S CONVENIENCE. THE CITY DOES NOT GUARANTEE THAT IT HAS REVIEWED ALL AVAILABLE DATA. THE CONTRACTOR SHALL POTHOLE ALL EXISTING UTILITIES EITHER SHOWN ON THE PLANS OR MARKED IN THE FIELD IN ACCORDANCE WITH THE SPECIFICATIONS SECTION 5-UTILITIES.
- EXISTING UTILITY CROSSING AS SHOWN ON THE PLANS ARE APPROXIMATE AND ARE NOT REPRESENTATIVE OF ACTUAL LENGTH AND LOCATION OF CONFLICT AREAS. SEE PLAN VIEW.
- ALL ADVANCE METERING INFRASTRUCTURE (AM) DEVICES ATTACHED TO THE WATER METER OR LOCATED IN OR NEAR WATER METER BOXES, COFFINS, OR VAULTS SHALL BE PROTECTED AT ALL TIMES IN ACCORDANCE WITH THE CONTRACT DOCUMENTS.

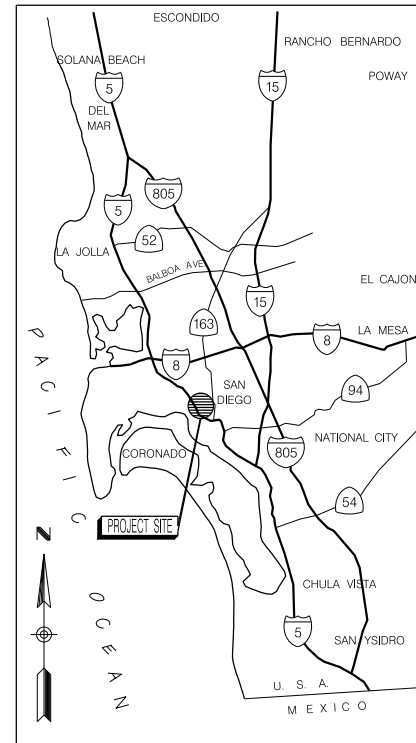
# PROJECT TITLE

**SHEET INDEX**

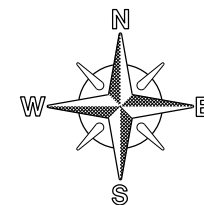
SHEET NO.	DISCIPLINE CODE	TITLE
1	G-1	COVER SHEET
2	C-2	-
3	C-3	-
4	C-1	-
5	C-2	-

DISCIPLINE CODE FOR CONTINUATION SEE SHEET 2

- G GENERAL
- D DEMOLITION
- C CIVIL
- L LANDSCAPE
- A ARCHITECTURAL
- S STRUCTURAL
- M MECHANICAL
- E ELECTRICAL
- I INSTRUMENTATION
- T TRAFFIC CONTROL



VICINITY MAP



LOCATION MAP NOT TO SCALE

**WORK TO BE DONE**

INSERT THE PROJECT'S COMPLETE SCOPE OF WORK, INCLUDING ALL EXISTING AND PROPOSED IMPROVEMENTS. CLEARLY IDENTIFY PARTIAL APPROVALS, SUCH AS FOUNDATIONS, SUBSTRUCTURE, AND SHELL BUILDINGS (THIS IS REFERRED AS DESCRIPTION OF WORK OR SCOPE OF WORK)

**STANDARD SPECIFICATIONS:**

1. STANDARD SPECIFICATIONS FOR PUBLIC WORKS CONSTRUCTION, 2015 EDITION (GREENBOOK), DOCUMENT NO. PWPI070116-01, 2015, INCLUDING THE CITY OF SAN DIEGO SUPPLEMENT, DOCUMENT NO. PWPI070116-02, 2015

2. 2015 STANDARD SPECIAL PROVISIONS FOR SIGNALS, LIGHTING AND ELECTRICAL SYSTEMS OF THE CITY OF SAN DIEGO.

3. CALIFORNIA MANUAL ON UNIFORM TRAFFIC CONTROL DEVICES (FHWA'S MUTCD, 2009 EDITION, WITH REVISIONS 1 AND 2 AS AMENDED FOR USE IN CALIFORNIA), DOCUMENT NO. PITS070112-06, MAY 2012.

4. STATE OF CALIFORNIA, DEPARTMENT OF TRANSPORTATION, STANDARD SPECIFICATIONS, DOCUMENT NO. PITS070112-04.

**STANDARD DRAWINGS:**

1. CITY OF SAN DIEGO STANDARD DRAWINGS, DOCUMENT NO. PWPI070116-03, 2016.

2. STATE OF CALIFORNIA, DEPARTMENT OF TRANSPORTATION, STANDARD PLANS, DOCUMENT NO. PITS070112-05, 2010.

**LEGEND**

IMPROVEMENTS      STANDARD DRAWINGS      SYMBOL

**LEGAL DESCRIPTION:**

**SITE ADDRESS**

**ASSESSOR'S NUMBER**

**PROJECT DATA**

- OCCUPANCY CLASSIFICATION(S):
- NUMBER OF STORIES (EXISTING & PROPOSED):
- HEIGHT OF BUILDING (EXISTING & PROPOSED):
- FLOOR AREA AND FLOOR AREA RATIO:
- TOTAL NEW FLOOR AREA ADDED:
- TOTAL EXISTING FLOOR AREA TO REMAIN PER STORY:
- CONDITION OF SOIL (UNDISTURBED, COMPACT, OR LOSE FILL):
- LANDSCAPE AREA SQUARE FOOTAGE:
- TOTAL AREA OF DISTURBANCE:
- LISTING OF DEFERRED SUBMITTALS:
- FIRE PROTECTION REQUIREMENTS:
- APPLICABLE CODES:

**FIELD DATA**

BENCHMARK: NEBP STREET NAME AND STREET NAME  
ELEV.=XXX

**FIELD NOTES:**

BASIS OF BEARINGS / COORDINATES:  
GPS X TO GPS X NXX XX'XX"E, HD XXX.X FT  
CCS 83 (EPOCH XXX FEET)

DATUM: MEAN SEA LEVEL

**REFERENCES:**

MAP NO. XXX & DRAWING NO.  
TOPOGRAPHY SOURCE:

**ZONING**

- CONSTRUCTION TYPE:
- BUILDING TYPE:
- DISCRETION APPROVALS:
- BUILDING CODE YEAR:
- EXISTING USE OF BUILDING:
- PROPOSED USE OF BUILDING:

\* IF NO CONSULTANT ON THIS PROJECT; DELETE ENGINEER'S RESPONSIBILITIES.  
**DELETE THIS NOTE AFTER REVIEWING THE TASK BELOW**

**DECLARATION OF RESPONSIBLE CHARGE**

\* I HEREBY DECLARE THAT I AM THE ENGINEER OF WORK FOR THIS PROJECT THAT I HAVE EXERCISED RESPONSIBLE CHARGE OVER THE DESIGN OF THE PROJECT AS DEFINED IN SECTION 6703 OF THE BUSINESS AND PROFESSIONS CODE AND THAT THE DESIGN IS CONSISTENT WITH CURRENT STANDARDS. I UNDERSTAND THAT THE CHECK OF PROJECT DRAWINGS AND SPECIFICATIONS BY THE CITY OF SAN DIEGO IS CONFINED TO A REVIEW ONLY AND DOES NOT RELIEVE ME, AS ENGINEER OF WORK, OF MY RESPONSIBILITIES FOR PROJECT DESIGN.

**MONUMENTATION SURVEY NOTES**

THE CONTRACTOR SHALL BE RESPONSIBLE FOR SURVEY MONUMENTS AND/OR VERTICAL CONTROL BENCHMARKS WHICH ARE DISTURBED OR DESTROYED BY CONSTRUCTION. A LICENSED LAND SURVEYOR OR LICENSED CIVIL ENGINEER AUTHORIZED TO PRACTICE LAND SURVEYING IN THE STATE OF CALIFORNIA SHALL FIELD LOCATE, REFERENCE, AND/OR PRESERVE ALL HISTORICAL OR CONTROLLING MONUMENTS PRIOR ANY EARTHWORK, DEMOLITION OR SURFACE IMPROVEMENTS. IF DESTROYED, A LICENSED LAND SURVEYOR SHALL REPLACE SUCH MONUMENT(S) WITH APPROPRIATE MONUMENTS. WHEN SETTING SURVEY MONUMENTS USED FOR RE-ESTABLISHMENT OF THE DISTURBED CONTROLLING SURVEY MONUMENTS AS REQUIRED BY SECTIONS 6730.2 AND 871 OF THE BUSINESS AND PROFESSIONS CODE OF THE STATE OF CALIFORNIA, A CORNER RECORD OR RECORD OF SURVEY, AS APPROPRIATE, SHALL BE FILLED WITH THE COUNTY SURVEYOR. IF ANY VERTICAL CONTROL IS TO BE DISTURBED OR DESTROYED, THE CITY OF SAN DIEGO FIELD SURVEY SECTION SHALL BE NOTIFIED IN WRITING AT LEAST 7 DAYS PRIOR TO CONSTRUCTION. THE CONTRACTOR SHALL BE RESPONSIBLE FOR THE COST OF REPLACING AND VERTICAL CONTROL BENCHMARKS DESTROYED BY THE CONSTRUCTION.

(ENGINEER'S NAME) \_\_\_\_\_ DATE \_\_\_\_\_

G-1

**PLANS FOR THE CONSTRUCTION OF PROJECT TITLE COVER SHEET**

SPEC. NO.		CITY OF SAN DIEGO, CALIFORNIA PUBLIC UTILITIES DEPARTMENT SHEET OF SHEETS		WBS 0-00000	
APPROVED FOR CITY ENGINEER _____ DATE _____		DATE _____		SUBMITTED BY _____ PROJECT MANAGER _____	
PRINT DOC NAME _____		RCE# _____		CHECKED BY _____ PROJECT ENGINEER _____	
DESCRIPTION	BY	APPROVED	DATE	FILMED	
ORIGINAL	xx/xx				000-0000 CCS27 COORDINATE
					0000-0000 CCS83 COORDINATE
CONTRACTOR _____		DATE STARTED _____		DATE COMPLETED _____	
INSPECTOR _____				XXXXX-XX-D	

CONSTRUCTION CHANGE / ADDENDUM			
CHANGE	DATE	AFFECTED OR ADDED SHEET NUMBERS	APPROVAL NO.

**WARNING**  
0 1  
IF THIS BAR DOES NOT MEASURE 1" THEN DRAWING IS NOT TO SCALE.



BUILDINGS / PIPELINE TITLE

# PROJECT TITLE TRAFFIC SIGNAL INSTALLATION

CONTRACTOR'S RESPONSIBILITIES

- PURSUANT TO SECTION 4216 OF THE GOVERNMENT CODE, AT LEAST 2 WORKING DAYS PRIOR TO EXCAVATION, YOU MUST CONTACT THE REGIONAL NOTIFICATION CENTER (E.G. UNDERGROUND SERVICE ALERT OF SOUTHERN CALIFORNIA) AND OBTAIN AN INQUIRY IDENTIFICATION NUMBER.
- NOTIFY SD&E AT LEAST 10 WORKING DAYS PRIOR TO EXCAVATING WITHIN 10' OF SD&E UNDERGROUND HIGH VOLTAGE TRANSMISSION POWER LINES. (I.E., 69 KV & HIGHER)
- THE LOCATIONS OF EXISTING BUILDINGS AS SHOWN ON THE PLAN ARE APPROXIMATE.
- UNLESS OTHERWISE NOTED AS PREVIOUSLY POTHOLED (PH), ELEVATIONS SHOWN ON THE PROFILE FOR EXISTING UTILITIES ARE BASED ON A SEARCH OF THE AVAILABLE RECORD INFORMATION ONLY AND ARE SOLELY FOR THE CONTRACTOR'S CONVENIENCE. THE CITY DOES NOT GUARANTEE THAT IT HAS REVIEWED ALL AVAILABLE DATA. THE CONTRACTOR SHALL POTHOLE ALL EXISTING UTILITIES EITHER SHOWN ON THE PLANS OR MARKED IN THE FIELD IN ACCORDANCE WITH THE SPECIFICATIONS SECTION 5-1.
- EXISTING UTILITY CROSSING AS SHOWN ON THE PLANS ARE APPROXIMATE AND ARE NOT REPRESENTATIVE OF ACTUAL LENGTH AND LOCATION OF CONFLICT AREAS. SEE PLAN VIEW.

SHEET INDEX

SHEET NO.	DISCIPLINE CODE	TITLE	LIMITS OF WORK
1	G-1 ( GENERAL )	COVER SHEET	
2	E-1 (ELECTRICAL)		

WORK TO BE DONE

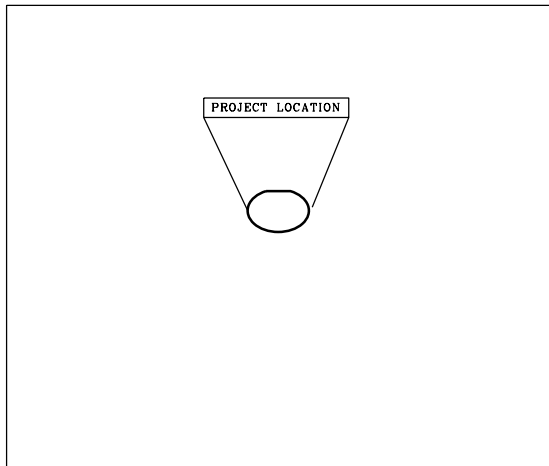
CONSTRUCTION CONSISTS OF THE INSTALLATION OF NEW TRAFFIC SIGNAL AND STREET LIGHTING SYSTEMS - FIRST ST @ SECOND ST

LEGEND

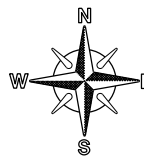
IMPROVEMENTS	REFERENCE	SYMBOL
NEW EQUIPMENT	AS SHOWN	
REMOVED AND SALVAGED EQUIPMENT	AS SHOWN	
2"-3" CONDUIT	SDG-116, 117 & 118	
NO. 5/6 PULL BOX	CALTRANS ES-8	
CURB RAMP TYPE 'A' & B	SDG-132	
EXISTING CONDITIONS IN LIGHTER HALF-TONE		
PROPOSED CONDITIONS IN DARKER FULL-TONE		
<u>SIGN AND PAVEMENT MARKINGS:</u>		
REMOVE CONFLICTING STRIPING, LEGEND OR MARKING BY GRINDING.	AS SHOWN	
PROPOSED STRIPING	AS SHOWN	
PROPOSED TYPE IV ARROW	CALTRANS A24A	
PROPOSED STRIPING PER CALTRANS DETAILS	AS SHOWN	

CONSTRUCTION STORM WATER PROTECTION NOTES

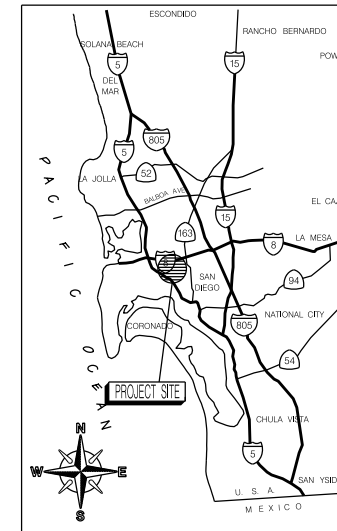
- TOTAL SITE DISTURBANCE AREA (ACRES) \_\_\_\_\_  
HYDROLOGIC UNIT/ WATERSHED \_\_\_\_\_  
HYDROLOGIC SUBAREA NAME & NO. \_\_\_\_\_
- THE CONTRACTOR SHALL COMPLY WITH THE REQUIREMENTS OF THE  
 WPCP  
 THE PROJECT IS SUBJECT TO MUNICIPAL STORM WATER PERMIT NO. R9-2013-0001 AS AMENDED BY R9-2015-0001 AND R9-2015-0100  
 SWPPP  
 THE PROJECT IS SUBJECT TO MUNICIPAL STORM WATER PERMIT NO. R9-2013-0001 AS AMENDED BY R9-2015-0001 AND R9-2015-0100 AND CONSTRUCTION GENERAL PERMIT ORDER 2009-0009-DWQ AS AMENDED BY ORDER 2010-0014-DWQ AND 2012-0006-DWQ  
 TRADITIONAL: RISK LEVEL 1  2  3   
 LUP: RISK TYPE 1  2  3
- CONSTRUCTION SITE PRIORITY  
 ASBS  HIGH  MEDIUM  LOW



- DISCIPLINE CODE
- G GENERAL
  - D DEMOLITION
  - C CIVIL
  - L LANDSCAPE
  - A ARCHITECTURAL
  - S STRUCTURAL
  - M MECHANICAL
  - E ELECTRICAL
  - I INSTRUMENTATION
  - T TRAFFIC CONTROL



KEY MAP  
NO SCALE



VICINITY MAP  
NOT TO SCALE

GENERAL NOTES:

- PULL BOXES AND CONDUIT:
  - PULL BOXES ARE NO. 6, UNLESS OTHERWISE NOTED ON THIS PLAN.
  - ALL CONDUIT DEPTH SHALL BE A MINIMUM OF 18" BELOW THE PAVEMENT SURFACE OR 3" BELOW THE BOTTOM OF THE PAVEMENT, WHICH EVER IS GREATER.
  - CONDUIT SHALL BE 3" DIAMETER, UNLESS OTHERWISE NOTED IN THE CONDUCTOR TABLE OR AS SHOWN ON THIS PLAN.
- LOCATIONS OF ALL UNDERGROUND UTILITIES ARE APPROXIMATE. THE CONTRACTOR SHALL DETERMINE THE EXACT LOCATIONS AND VERIFY ALL CONDITIONS ON THE JOB SITE.
- THE CONTRACTOR SHALL, PER SECTION 601-2.1.1 & 601-2.1.3 OF THE STANDARD SPECIFICATIONS FOR PUBLIC WORKS CONSTRUCTION ("WHITEBOOK"), PREPARE TRAFFIC CONTROL WORKING DRAWINGS AND SHALL CALL THE FIELD ENGINEERING TRAFFIC CONTROL SECTION AT (858) 498-4741 FOR AN APPOINTMENT TO APPLY FOR A TRAFFIC CONTROL PLAN (TCP) PERMIT. THE CONTRACTOR SHALL ALLOW A MINIMUM OF TWO (2) WORKING DAYS PRIOR TO STARTING WORK OR FIVE (5) WORKING DAYS FOR STREET CLOSURES. UPON APPROVAL OF THE TRAFFIC CONTROL PLAN, THE FIELD ENGINEERING TRAFFIC SECTION WILL ISSUE THE TCP PERMIT, WORK SHALL NOT BEGIN IN THE PUBLIC ROADWAY WITHOUT THE TCP PERMIT.
- ALL TRAFFIC SIGNAL POLE FOUNDATIONS SHALL HAVE A 3" CONDUIT INSTALLED TO THE ADJACENT PULL BOX AND THE CONTROLLER FOUNDATION SHALL HAVE A SPARE 3" CONDUIT STUBBED OUT TO THE ADJACENT PULL BOX FOR FUTURE USE.
- LOCATIONS, POSITIONING, AND INSTALLATION OF SIGNAL EQUIPMENT, LOOP DETECTORS, TRAFFIC SIGNS, TRAFFIC STRIPING, PAVEMENT AND CURB MARKINGS:
  - THE CONTRACTOR, WITH THE APPROVAL OF THE CITY RESIDENT ENGINEER, IS RESPONSIBLE FOR LOCATING, MARKING THE LAYOUT, AND INSTALLATION OF ALL SIGNAL AND LIGHTING EQUIPMENT.
  - THE CONTRACTOR, WITH THE APPROVAL OF THE CITY RESIDENT ENGINEER, IS RESPONSIBLE FOR LOCATING, MARKING THE LAYOUT, AND INSTALLATION OF ALL LOOP DETECTORS, TRAFFIC SIGNS (EXCEPT "G" SERIES STREET NAME SIGNS), TRAFFIC STRIPING, PAVEMENT AND CURB MARKINGS.
  - THE CONTRACTOR SHALL OBTAIN APPROVAL FOR THE ITEMS NOTED IN 5a AND 5b PRIOR TO INSTALLATION.
  - AS SHOWN ON THIS PLAN, CONTRACTOR SHALL INSTALL 6" DIAMETER TYPE E LOOP DETECTORS, WITH 10' SPACING, AND CENTERED IN THE TRAVEL PORTION OF EACH LANE (UNLESS OTHERWISE NOTED).
  - THE CONTRACTOR SHALL NOT PERFORM ANY PARKING REMOVAL, UNTIL A MINIMUM OF FIFTEEN (15) WORKING DAYS AFTER THE LOCATION APPROVAL.
  - THE CONTRACTOR IS RESPONSIBLE FOR THE REMOVAL OF ALL CONFLICTING STRIPING AND PAVEMENT MARKINGS BY SANDBLASTING/GRINDING (METHOD TO BE DETERMINED BY THE RESIDENT ENGINEER).
- IT IS THE CONTRACTOR'S RESPONSIBILITY TO ENSURE INTERSECTION WIRING IS PER POLARA NAVIGATOR PUSHBUTTON SPECIFICATIONS AND TO PROGRAM THE NEWLY INSTALLED PUSHBUTTONS. (SEE SPECIFICATIONS).
- LOCATION AND ELEVATION IMPROVEMENTS TO BE MET BY "WORK TO BE DONE" SHALL BE CONFIRMED BY FIELD MEASUREMENTS PRIOR TO CONSTRUCTION OF NEW WORK.

STREET CLASSIFICATION:

STREET NAME:	ADT
1. FIRST ST	3,180
2. SECOND ST	25,745

FIELD DATA

BENCHMARK:  
FIELD NOTES:  
DATUM: MEAN SEA LEVEL  
STREETS REQUIRING 12" TRENCH CAP:  
•STREET NAMES•

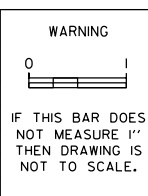
G-1

NAME OF ENGINEER, TRAFFIC ENGINEER \_\_\_\_\_ DATE \_\_\_\_\_

**PLANS FOR THE CONSTRUCTION OF  
PROJECT TITLE  
TRAFFIC SIGNAL INSTALLATION  
COVER SHEET**

SPEC. NO. XXXX	CITY OF SAN DIEGO, CALIFORNIA PUBLIC WORKS DEPARTMENT SHEET X OF X SHEETS	WBS X-XXXXX			
APPROVED BY: FOR CITY ENGINEER _____ DATE _____ SENIOR CIVIL ENGINEER _____ PRINT DCE NAME _____ RCE# _____	CHECKED BY: PROJECT ENGINEER _____	CHECKED BY: PROJECT MANAGER _____			
DESCRIPTION	BY	APPROVED	DATE	FILMED	PROJECT ENGINEER
ORIGINAL	xx				000-0000 CCS27 COORDINATE
					0000-0000 CCS83 COORDINATE
CONTRACTOR _____	INSPECTOR _____	DATE STARTED _____	DATE COMPLETED _____		XXXXX-X-1D

CONSTRUCTION CHANGE / ADDENDUM			
CHANGE	DATE	AFFECTED OR ADDED SHEET NUMBERS	APPROVAL NO.



PROJECT TITLE

Figure 2-13h Traffic Control Plans Cover Sheet

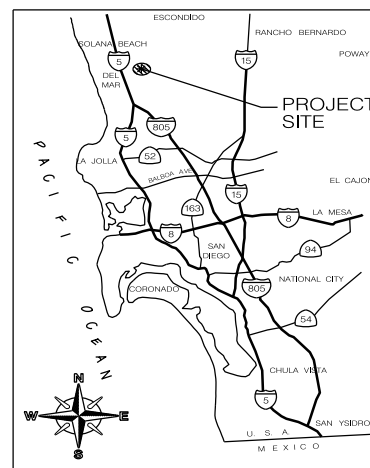
# PROJECT NAME TRAFFIC CONTROL PLANS

TRAFFIC CONTROL NOTES:

- VALIDATION. THIS TRAFFIC CONTROL PLAN IS NOT VALID UNTIL WORK DATES ARE APPROVED. THE CONTRACTOR SHALL, PER SECTION 601-2.11 OF THE "WHITEBOOK", CALL THE ENGINEERING TRAFFIC CONTROL SECTION AT (858) 495-4741 TO OBTAIN A PERMIT. THE CONTRACTOR MUST CALL A MINIMUM OF TWO (2) WORKING DAYS PRIOR TO STARTING WORK, OR FIVE (5) WORKING DAYS WHEN THE WORK WILL AFFECT A TRAFFIC SIGNAL.
- STANDARDS. THIS TRAFFIC CONTROL PLAN SHALL CONFORM TO THE MOST RECENTLY ADOPTED EDITION OF EACH OF THE FOLLOWING MANUALS:
  - CALTRANS MANUAL OF TRAFFIC CONTROLS FOR CONSTRUCTION AND MAINTENANCE WORK ZONES;
  - STANDARD SPECIFICATIONS FOR PUBLIC WORKS CONSTRUCTION ("GREENBOOK") AND CITY OF SAN DIEGO SUPPLEMENT AMENDMENTS;
  - STANDARD SPECIFICATIONS FOR PUBLIC WORKS CONSTRUCTION ("WHITEBOOK") AND CITY OF SAN DIEGO SUPPLEMENT AMENDMENTS.
- NOTIFICATIONS. THE CONTRACTOR SHALL NOTIFY THE FOLLOWING AFFECTED AGENCIES A MINIMUM OF FIVE (5) WORKING DAYS PRIOR TO ANY EXCAVATION, CONSTRUCTION OR TRAFFIC CONTROL:
 

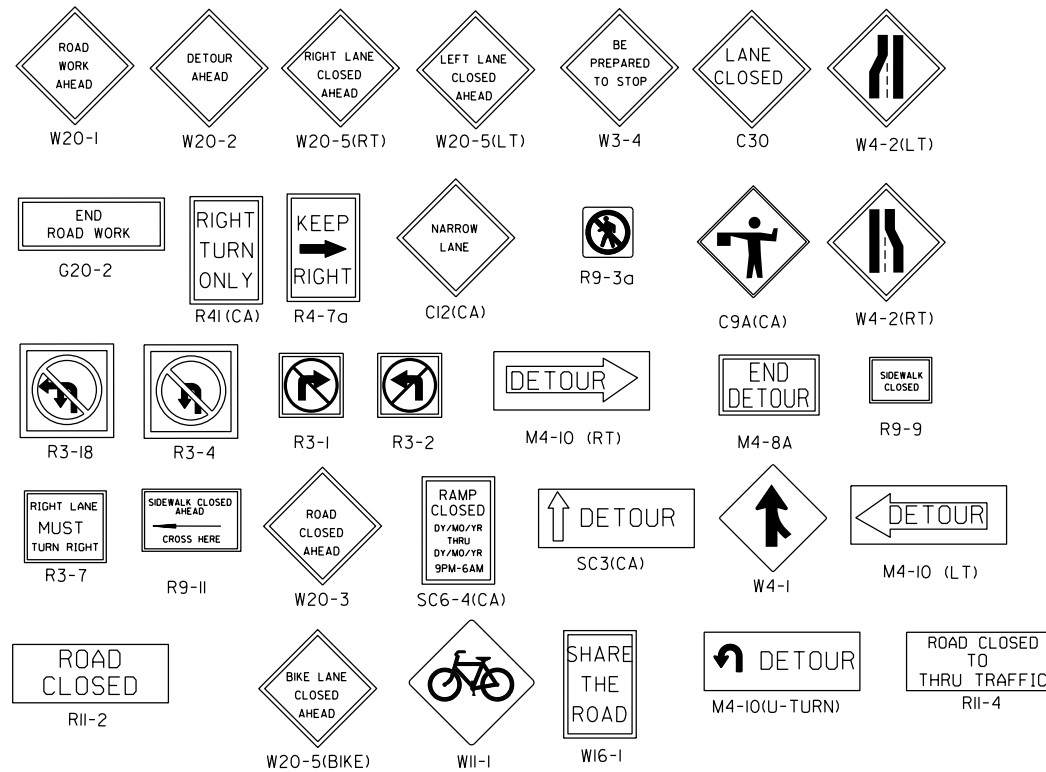
FIRE DEPARTMENT DISPATCH	(STREET OR ALLEY CLOSURE)	(858) 573-1300
POLICE DEPARTMENT TRAFFIC	(STREET OR ALLEY CLOSURE)	(858) 495-7800
UNDERGROUND SERVICE ALERT	(ANY EXCAVATION)	(800) 422-4133
WASTE MANAGEMENT DEPT.	(REFUSE COLLECTION)	(858) 694-7000
STREET DIVISION/ELECTRICAL	(TRAFFIC SIGNALS)	(619) 527-7500
SAN DIEGO TRANSIT	(BUS STOPS)	(619) 238-0100 x424
MTDB	(TAXI ZONES)	(619) 595-7030

THE CONTRACTOR SHALL NOTIFY PROPERTY OWNERS AND TENANTS A MINIMUM OF FIVE (5) WORKING DAYS PRIOR TO CLOSURE OF DRIVEWAYS. THE CONTRACTOR SHALL POST SIGNS NOTIFYING THE PUBLIC A MINIMUM OF FIVE (5) WORKING DAYS PRIOR TO CLOSURE OF STREETS.
- POSTING NO PARKING SIGNS. THE CONTRACTOR SHALL POST "TOW-AWAY/NO PARKING" SIGNS TWENTY-FOUR (24) HOURS IN ADVANCE FOR TEMPORARY PARKING REMOVAL. SIGNS SHALL INDICATE SPECIFIC DAYS, DATES, AND TIMES OF RESTRICTIONS.
- EXCAVATIONS. EXCEPT AS SHOWN ON THE PLANS, TRENCHES SHALL BE BACKFILLED OR TRENCH-PLATED AT THE END OF EACH WORK DAY. AN ASPHALT RAMP SHALL BE PLACED AROUND EACH TRENCH PLATE TO PREVENT THE PLATE FROM BEING DISLODGED. UPON COMPLETION OF EXCAVATION BACKFILL, THE CONTRACTOR SHALL PROVIDE A SATISFACTORY SURFACE FOR TRAFFIC. WHEN CONSTRUCTION OPERATIONS ARE NOT ACTIVELY IN PROGRESS, THE CONTRACTOR SHALL MAINTAIN ALL TRAVEL LANES OPEN TO TRAFFIC, EXCEPT AS SHOWN ON THE PLANS.
- RESTORATION OF TRAFFIC CONTROL DEVICES. THE CONTRACTOR SHALL REPAIR OR REPLACE TRAFFIC CONTROL DEVICES (INCLUDING TRAFFIC SIGNS, STRIPING, PAVEMENT MARKERS, PAVEMENT MARKINGS, LEGENDS, CURB MARKINGS, LOOP DETECTORS, TRAFFIC SIGNAL EQUIPMENT, ETC.) DAMAGED OR REMOVED AS A RESULT OF OPERATIONS AND NOT DESIGNATED FOR REMOVAL, REPAIRS AND REPLACEMENTS SHALL BE EQUAL TO EXISTING IMPROVEMENTS. LOOP DETECTORS SHALL BE REPLACED WITHIN THREE (3) WORKING DAYS OF COMPLETION OF UNDERGROUND WORK.
- CHANGES IN WORK. THE RESIDENT ENGINEER WILL OBSERVE THESE TRAFFIC CONTROL PLANS IN OPERATION AND RESERVES THE RIGHT TO MAKE CHANGES AS THE FIELD CONDITIONS WARRANT. SUCH CHANGES SHALL SUPERSEDE THESE PLANS.
- FOR WORK NOT COVERED BY THESE TRAFFIC CONTROL PLANS, THE CONTRACTOR SHALL, PER SECTION 7-10.2.2 OF THE CONTRACT SPECIAL PROVISIONS, PREPARE TRAFFIC CONTROL WORKING DRAWINGS AND SUBMIT THEM TO THE RESIDENT ENGINEER. THE CONTRACTOR SHALL ALLOW A MINIMUM OF TWENTY (20) WORKING DAYS FOR REVIEW OF THE WORKING DRAWINGS. UPON APPROVAL OF THE TRAFFIC CONTROL PLAN, THE ENGINEERING TRAFFIC CONTROL SECTION WILL ISSUE A TRAFFIC CONTROL PLAN (TCP) PERMIT FOR THIS WORK.



VICINITY MAP  
NOT TO SCALE

TRAFFIC CONTROL SIGNS (TYP)



NOTE: ALL SIGNS ARE STANDARD SIZE

TRAFFIC CONTROL 85TH PERCENTILE SPEED

STREET NAME \_\_\_\_\_ XX MPH

TABLE 1  
RECOMMENDED SIGN SPACING FOR ADVANCE WARNING SIGN SERIES

APPROACH SPEED (MPH)	MINIMUM DISTANCE IN FEET BETWEEN SIGNS AND FROM LAST SIGN TO TAPER	MAXIMUM DEVICE SPACING IN FEET	MINIMUM TAPER LENGTHS FOR LANE WIDTHS •		
			10 FT	11 FT	12 FT
25	150-200	25	105	115	125
30	200-300	30	150	165	180
35	250-400	35	205	225	245
40	350-500	40	265	295	320
45	500-750	45	450	495	540
50	500-1000	50	500	550	600
55+	500-1500	50	550	605	660

• L=WS<sup>2</sup>/60 FOR SPEED OF 40 MPH OR LESS; L=WS FOR SPEED GREATER THAN 40 MPH. TAPER LENGTHS SHOWN ARE ROUNDED TO NEAREST 5 FEET.

TABLE 2  
RECOMMENDED TAPER LENGTH AND DEVICE SPACING FOR CHANNELIZING TAPERS

APPROACH SPEED (MPH)	TAPER LENGTH (L) •	SPACING OF CONES ALONG TAPER (FEET) ±	NOTE:
			TAPER FORMULA
25	125	25	L = S x W for speeds greater than 40 mph
30	180	30	
35	245	35	L = $\frac{W \times S^2}{60}$ for speeds of 40 mph or less
40	320	40	
45	540	45	
50	600	50	
50+	660	50	

• BASED ON 12-FOOT WIDE LANE. THIS COLUMN IS ALSO APPROPRIATE FOR LANE WIDTHS LESS THAN 12 FEET

LEGEND

- DELINEATOR OR CONE •
- SIGN ↓
- TRAFFIC DIRECTIONAL ARROW ↗
- WORKING AREA [Hatched Box]
- FLASHING ARROW BOARD [Flashing Arrow]
- BARRICADE [I-Bar]
- PFB (PORTABLE FLASHING BEACON) ⚡

NAME (DEPUTY CITY ENGINEER) _____	DATE _____	T-1
PROJECT NAME TRAFFIC CONTROL PLANS		
CITY OF SAN DIEGO, CALIFORNIA PUBLIC WORKS DEPARTMENT SHEET T1 OF TX SHEETS		#BS X-XXXX
APPROVED BY FOR CITY ENGINEER (SENIOR TRAFFIC ENG.) PRINT NAME _____	DATE _____	PROJECT MANAGER PRINT NAME _____
DESCRIPTION	BY	APPROVED
ORIGINAL	xx	
CONTRACTOR _____	DATE STARTED _____	XXXXX-T1-D
INSPECTOR _____	DATE COMPLETED _____	

PROJECT NAME TRAFFIC CONTROL

# SEWER GROUP XYZ

## CONTRACTOR'S RESPONSIBILITIES

- PURSUANT TO SECTION 4216 OF THE GOVERNMENT CODE, AT LEAST 2 WORKING DAYS PRIOR TO EXCAVATION, YOU MUST CONTACT THE REGIONAL NOTIFICATION CENTER (E.G. UNDERGROUND SERVICE ALERT OF SOUTHERN CALIFORNIA) AND OBTAIN AN INQUIRY IDENTIFICATION NUMBER.
- NOTIFY SDG&E AT LEAST 10 WORKING DAYS PRIOR TO EXCAVATING WITHIN 10' OF SDG&E UNDERGROUND HIGH VOLTAGE TRANSMISSION POWER LINES, (I.E., 69 KV & HIGHER)
- LOCATE AND RECONNECT ALL SEWER LATERALS. LOCATIONS AS SHOWN ON THE PLANS ARE APPROXIMATE ONLY. LATERAL RECORDS ARE AVAILABLE TO THE CONTRACTOR AT THE WATER DEPARTMENT, 2797 CAMINITO CHOLLAS. LOCATE THE IMPROVEMENTS THAT WILL BE AFFECTED BY LATERAL REPLACEMENTS.
- EXCAVATE AROUND WATER METER BOX (CITY PROPERTY SIDE) TO DETERMINE IN ADVANCE, THE SIZE OF EACH SERVICE BEFORE TAPPING MAIN.
- CITY FORCES, WHEN SPECIFIED OR SHOWN ON THE PLANS, WILL MAKE PERMANENT CUTS & PLUGS AND CONNECTIONS.
- KEEP EXISTING MAINS IN SERVICE IN LIEU OF HIGH-LINING, UNLESS OTHERWISE SPECIFIED SHOWN ON PLANS.
- THE LOCATIONS OF EXISTING BUILDINGS AS SHOWN ON THE PLAN ARE APPROXIMATE.
- STORM DRAIN INLETS SHALL REMAIN FUNCTIONAL AT ALL TIMES DURING CONSTRUCTION.
- UNLESS OTHERWISE NOTED AS PREVIOUSLY POTHOLED (PH), ELEVATIONS SHOWN ON THE PROFILE FOR EXISTING UTILITIES ARE BASED ON A SEARCH OF THE AVAILABLE RECORD INFORMATION ONLY AND ARE SOLELY FOR THE CONTRACTOR'S CONVENIENCE. THE CITY DOES NOT GUARANTEE THAT IT HAS REVIEWED ALL AVAILABLE DATA. THE CONTRACTOR SHALL POTHOLE ALL EXISTING UTILITIES EITHER SHOWN ON THE PLANS OR MARKED IN THE FIELD IN ACCORDANCE WITH THE SPECIFICATIONS SECTION 5-UTILITIES.
- EXISTING UTILITY CROSSING AS SHOWN ON THE PLANS ARE APPROXIMATE AND ARE NOT REPRESENTATIVE OF ACTUAL LENGTH AND LOCATION OF CONFLICT AREAS. SEE PLAN VIEW.
- ALL ADVANCE METERING INFRASTRUCTURE (AM) DEVICES ATTACHED TO THE WATER METER OR LOCATED IN OR NEAR WATER METER BOXES, COFFINS, OR VAULTS SHALL BE PROTECTED AT ALL TIMES IN ACCORDANCE WITH THE CONTRACT DOCUMENTS.

## CONSTRUCTION STORM WATER PROTECTION NOTES

- TOTAL SITE DISTURBANCE AREA (ACRES): \_\_\_\_\_  
HYDROLOGIC UNIT/ WATERSHED: \_\_\_\_\_  
HYDROLOGIC SUBAREA NAME & NO.: \_\_\_\_\_
- THE CONTRACTOR SHALL COMPLY WITH THE REQUIREMENTS OF THE  
 WPCP  
THE PROJECT IS SUBJECT TO MUNICIPAL STORM WATER PERMIT NO. R9-2013-0001 AS AMENDED BY R9-2015-0004 AND R9-2015-0100  
 SWPPP  
THE PROJECT IS SUBJECT TO MUNICIPAL STORM WATER PERMIT NO. R9-2013-0001 AS AMENDED BY R9-2015-0004 AND R9-2015-0100 AND CONSTRUCTION GENERAL PERMIT ORDER 2009-0009-DWQ AS AMENDED BY ORDER 2010-0014-DWQ AND 2012-0006-DWQ  
TRADITIONAL RISK LEVEL  1  2  3  
LUP RISK TYPE  1  2  3
- CONSTRUCTION SITE PRIORITY  
 ASBS  HIGH  MEDIUM  LOW

## ABBREVIATIONS

ABAND	ABANDON	EL, ELEV	ELEVATION	OVHD	OVER HEAD
ABAND'D	ABANDONED	ELEC	ELECTRIC	PVC	POLYVINYL CHLORIDE
AC	ASBESTOS CEMENT PIPE	EX, EXIST	EXISTING	PROP	PROPOSED
AHD	AHEAD	E/O	EAST OF	RED	REDUCER
ASSY	ASSEMBLY	F	FLANGE	RT	RIGHT
BFV	BUTTERFLY VALVE	FS	FIRE SERVICE	S	SURVEY LINE
BK	BACK	FS	FIRE SERVICE	SDA&E	SAN DIEGO ARIZONA & EASTERN RAILROAD
BTWN	BETWEEN	GV	GATE VALVE	SOTI	SAN DIEGO TROLLEY INC.
CATV	CABLE TV	HDPE	HIGH-DENSITY POLYETHYLENE	SO	STUB OUT
CI	CAST IRON PIPE	HP	HIGH PRESSURE	S/O	SOUTH OF
C	CENTER LINE	IE	INVERT ELEVATION	SWR	SEWER
COND	CONDUIT	LT	LEFT	TEL	TELEPHONE
CONT	CONTINUED	MJ	MECHANICAL JOINT	UNK	UNKNOWN
CONTR	CONTRACTOR	MTS	SAN DIEGO METROPOLITAN TRANSIT SYSTEM	VC	VITRIFIED CLAY PIPE
DB	DIRECT BURIED	MTD	MULTIPLE TELEPHONE DUCT	WM	WATER METER
DI	DUCTILE IRON	N/O	NORTH OF	WTR	WATER
EB	ENCASED BURIED			W/O	WEST OF

## EXISTING STRUCTURES

EX WATER MAIN & VALVES	---
EX WATER METER	---
EX FIRE HYDRANT	---
EX SEWER MAIN & MANHOLES	---
EX DRAINS	---
EX PAVEMENT (PROFILE)	---
EX GROUND LINE (PROFILE)	---
EX TRAFFIC SIGNAL	---
EX STREET LIGHT	---
GAS MAIN	---
ELEC. COND., TEL. COND., CATV	---
RAILROAD, TROLLEY TRACKS	---

\* IF NO CONSULTANT ON THIS PROJECT; DELETE ENGINEER'S RESPONSIBILITIES.  
**DELETE THIS NOTE AFTER REVIEWING THE TASK BELOW**

## DECLARATION OF RESPONSIBLE CHARGE

\* I HEREBY DECLARE THAT I AM THE ENGINEER OF WORK FOR THIS PROJECT THAT I HAVE EXERCISED RESPONSIBLE CHARGE OVER THE DESIGN OF THE PROJECT AS DEFINED IN SECTION 6703 OF THE BUSINESS AND PROFESSIONS CODE AND THAT THE DESIGN IS CONSISTENT WITH CURRENT STANDARDS. I UNDERSTAND THAT THE CHECK OF PROJECT DRAWINGS AND SPECIFICATIONS BY THE CITY OF SAN DIEGO IS CONFINED TO A REVIEW ONLY AND DOES NOT RELIEVE ME, AS ENGINEER OF WORK, OF MY RESPONSIBILITIES FOR PROJECT DESIGN.

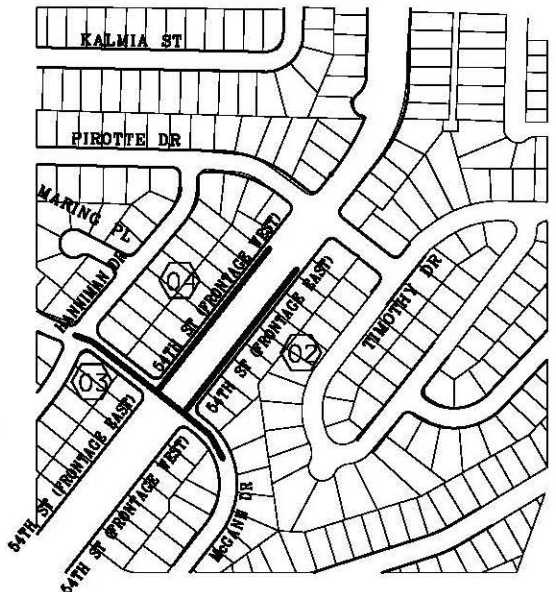
(ENGINEER'S NAME) \_\_\_\_\_ DATE \_\_\_\_\_

## SHEET INDEX

SHEET NO.	DISCIPLINE CODE	TITLE	LIMITS	PIPE		LENGTH (FT)
				SIZE (IN)	MATERIAL	
1	G-1	COVER SHEET				
SEWER						
3	C-2	MCGANN DR	HANNIMAN DR TO STA. 6+49.71	8"	PVC	549.71
4	C-3	NAME ROAD	NAME STREET TO NAME AVENUE	-	-	000.00
5	C-4	STREET RESURFACING				
6	C-5	CURB RAMP LOCATION				
7	C-6	CITY FORCES				
8	C-7	MISC DETAILS				
9	C-8	PERMANENT STORM WATER BEST MANAGEMENT PRACTICES (BMP) - STANDARD DEVELOPMENT PROJECTS				
10	C-9	54TH ST (FRONTAGE EAST)	HANNIMAN DR TO STA 6+15.10	8"	PVC	915.10
	T-1	TRAFFIC PLANS				
				TOTAL SEWER		
				TOTAL WATER		

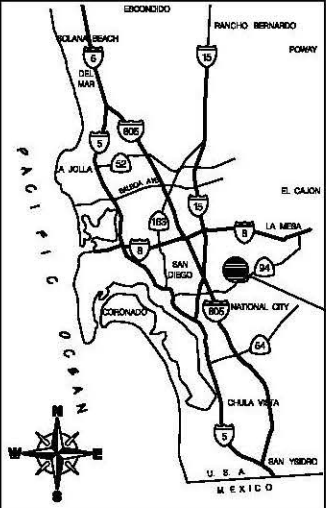
## DISCIPLINE CODE

- G GENERAL
- D DEMOLITION
- C CIVIL
- L LANDSCAPE
- A ARCHITECTURAL
- S STRUCTURAL
- M MECHANICAL
- E ELECTRICAL
- I INSTRUMENTATION
- T TRAFFIC CONTROL



## WORK TO BE DONE

CONSTRUCTION OF SEWER GROUP XYZ CONSISTS OF THE INSTALLATION OF ...



## VICINITY MAP

NOT TO SCALE

## FIELD DATA

- BENCHMARK: \_\_\_\_\_
- FIELD NOTES: \_\_\_\_\_
- DATUM: MEAN SEA LEVEL
- STREETS REQUIRING 12" TRENCH CAP: \_\_\_\_\_
- \*STREET NAMES\*

## MONUMENTATIONSURVEY NOTES

THE CONTRACTOR SHALL BE RESPONSIBLE FOR SURVEY MONUMENTS AND/OR VERTICAL CONTROL BENCHMARKS WHICH ARE DISTURBED OR DESTROYED BY CONSTRUCTION. A LICENSED LAND SURVEYOR OR LICENSED CIVIL ENGINEER AUTHORIZED TO PRACTICE LAND SURVEYING IN THE STATE OF CALIFORNIA SHALL FIELD LOCATE, REFERENCE, AND/OR PRESERVE ALL HISTORICAL OR CONTROLLING MONUMENTS PRIOR ANY EARTHWORK, DEMOLITION OR SURFACE IMPROVEMENTS. IF DESTROYED, A LICENSED LAND SURVEYOR SHALL REPLACE SUCH MONUMENT(S) WITH APPROPRIATE MONUMENTS. WHEN SETTING SURVEY MONUMENTS USED FOR RE-ESTABLISHMENT OF THE DISTURBED CONTROLLING SURVEY MONUMENTS AS REQUIRED BY SECTIONS 6730.2 AND 8771 OF THE BUSINESS AND PROFESSIONS CODE OF THE STATE OF CALIFORNIA. A CORNER RECORD OR RECORD OF SURVEY, AS APPROPRIATE, SHALL BE FILLED WITH THE COUNTY SURVEYOR. IF ANY VERTICAL CONTROL IS TO BE DISTURBED OR DESTROYED, THE CITY OF SAN DIEGO FIELD SURVEY SECTION SHALL BE NOTIFIED IN WRITING AT LEAST 7 DAYS PRIOR TO CONSTRUCTION. THE CONTRACTOR SHALL BE RESPONSIBLE FOR THE COST OF REPLACING AND VERTICAL CONTROL BENCHMARKS DESTROYED BY THE CONSTRUCTION.

## LEGEND

IMPROVEMENTS	REFERENCE	SYMBOL
TRENCH RESURFACING	SDG-107, SDG-108	---
SEWER MAIN	SDS-104, SDS-110 (TYPE C)	---
SEWER MANHOLE/PVC LINED	SDS-106, SDS-107, SDS-108, SDW-113, SDS-120, M-3, SM-07	---
REHAB. EX. SEWER MANHOLE	SEE PLANS & SPECS	REHAB
SEWER MAIN REHAB.	SEE PLANS & SPECS	---
4" SEWER LATERAL WITH C.O. UNLESS OTHERWISE SPECIFIED	SDS-102, SDS-103, SDS-104, SDS-105, SDS-110 (TYPE C), SDS-118	---
REPLUMB SEWER LATERAL WITH C.O.	SDS-102, SDS-103, SDS-104, SDS-105, SDS-110 (TYPE C), SDS-118	---
SEWER LATERAL CONNECTION	SEE PLANS & SPECS	---
REHAB SEWER LATERAL (LINED) WITH C.O.	SEE PLANS & SPECS	---
SERVICE LATERAL CONNECTION TO REHABILITATED SEWER	SEE PLANS & SPECS	---
SEWER PUMP INCLUDING REPLUMB SEWER LATERAL WITH C.O.	SDS-102, SDS-103, SDS-104, SDS-105, SDS-110 (TYPE C), SDS-118	---
TUNNEL SEWER REPLUMB LATERAL WITH C.O.	SDS-102, SDS-103, SDS-104, SDS-105	---
CONCRETE PROTECTION FOR EXIST SEWER PIPE	SDS-116	---
PIPE SUPPORT FOR UNDERCUT AC WATER MAIN	SDW-162	---
CONCRETE ENCASEMENT	SDS-112	---
ABANDON EX MANHOLE	SM-08	---
SLURRY FILL ABANDONED SEWER MAIN	SEE PLANS & SPECS	---
CUTTING AND PLUGGING ABANDONED WATER MAIN	WP-03	---
SURVEY MONUMENT	M-10, M-10A, M-10B	---
WATER MAIN & APPURTENANCES	SDM-105, SDW-110, SDW-151, SDW-161	---
VALVES WITH CAPS AND WELLS	SDW-109, SDW-152, SDW-153, WV-05	---
FIRE SERVICE CONNECTION & ASSEMBLY	SDM-105, SDW-109, SDW-118, SDW-152, SDW-153	---
6" FIRE HYDRANT ASSEMBLY & MARKER 2-PORT UNLESS SPECIFIED AS 3-PORT	SDM-105, SDW-104, SDW-109, SDW-152, SDW-153	---
7" WATER SERVICE UNLESS OTHERWISE SPECIFIED	SDW-105, SDW-107, SDW-134, SDW-135, SDW-136, SDW-137, SDW-138, SDW-149, SDW-150, WS-03	---
WATER SERVICE TRANSFER	SDW-149, SDW-150	---
BLOW-OFF ASSEMBLY	SDM-105, SDW-106, SDW-143, SDW-144, SDW-145, SDW-146, WB-05,	---
AIR & VACUUM VALVE	SDM-105, SDW-117, SDW-158, SDW-159, SDW-160	---
HIGHLIGHTING BY CONTRACTOR	SDW-170, SDW-171, SDW-172, SDW-173	---
FOR ADDITIONAL SYMBOLS SEE RESURFACING, CURB RAMP AND TRAFFIC CONTROL SHEETS.		IF APPLICABLE

G-1

## PLANS FOR THE CONSTRUCTION OF SEWER GROUP XYZ COVER SHEET

SPEC. NO.	CITY OF SAN DIEGO, CALIFORNIA PUBLIC WORKS DEPARTMENT SHEET 01 OF XX SHEETS	WATER WBS 0-0000	SEWER WBS 0-00000
APPROVED FOR CITY ENGINEER	DATE	PROJECT MANAGER	DRAWN BY
PRINT NAME	DATE	PROJECT ENGINEER	DATE
DESCRIPTION	BY	APPROVED	DATE
ORIGINAL	XX/XX		
ADDENDUM A	XX/XX	XX/YY	XX/YY
CONTRACTOR	DATE STARTED	DATE COMPLETED	XXXX-01-D

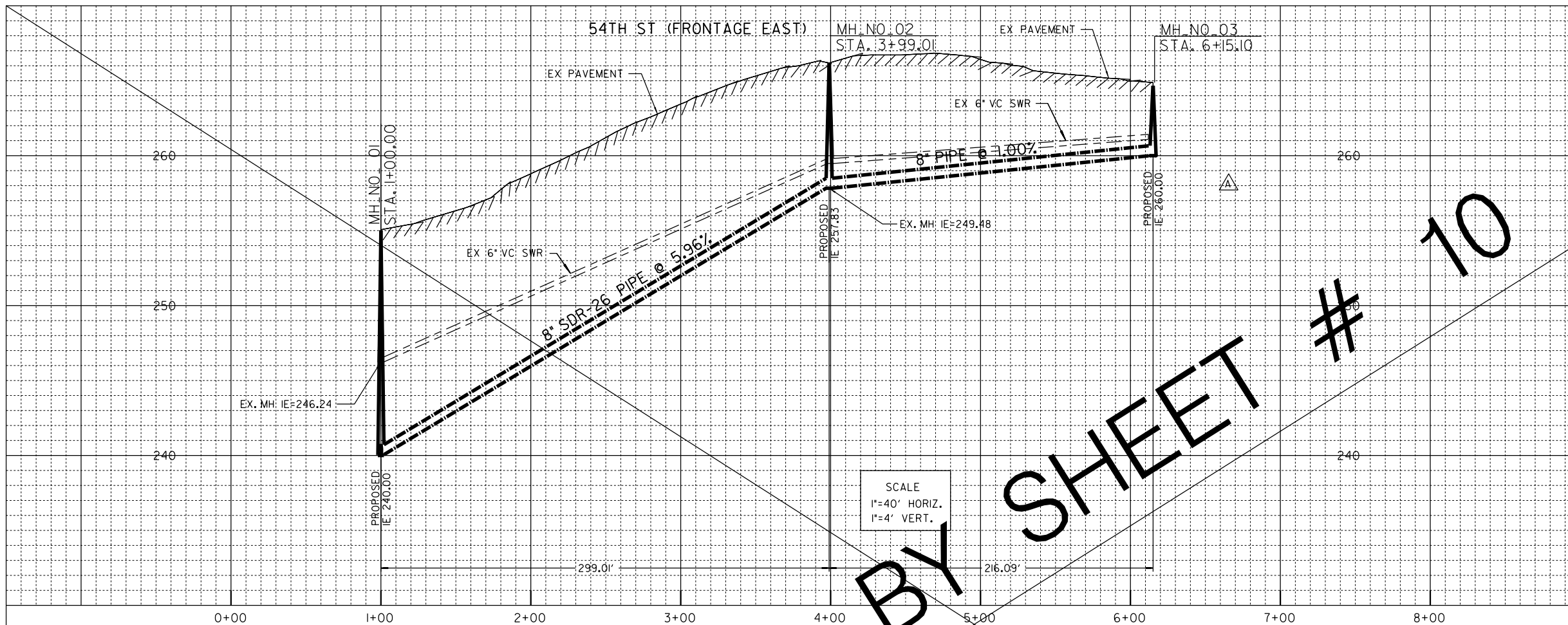
CONSTRUCTION CHANGE / ADDENDUM			
CHANGE	DATE	AFFECTED OR ADDED SHEET NUMBERS	APPROVAL NO.
A	XX/XX	01, 02, 03, 10	

WARNING  
IF THIS BAR DOES NOT MEASURE 1" THEN DRAWING IS NOT TO SCALE.



## ADDENDUM A

ADD NEW SHEET TO SHEET INDEX



POB 1+00.00 1845395.45 6305902.21  
 STRAIGHT 299.01 38' 09" 44.28"  
 PI 3+99.01 1845630.55 6306086.96  
 STRAIGHT 216.09 38' 11" 41.52"  
 POE 6+15.10 1845800.38 6306220.58

ESTIMATED ARCHAEOLOGICAL MONITORING LIMITS  
 (INCLUDES MAIN, LATERALS, AND OTHER TRENCHING ACTIVITIES)

BEGINNING STATION	ENDING STATION	APPROXIMATE LF
STA. 1+00	STA. 6+15.10	515.10

ESTIMATED PALEONTOLOGICAL MONITORING LIMITS  
 (INCLUDES MAIN, LATERALS, AND OTHER TRENCHING ACTIVITIES)

BEGINNING STATION	ENDING STATION	APPROXIMATE LF
STA. 1+00.00	STA. 3+70.00	270.00

ACTUAL LIMITS SHALL BE DETERMINED BY THE PI/MONITOR(S) PRIOR TO CONSTRUCTION AND SHALL BE CONSISTENT WITH THE MITIGATION AND MONITORING PROGRAM (MMRP) FOR THE PROJECT.

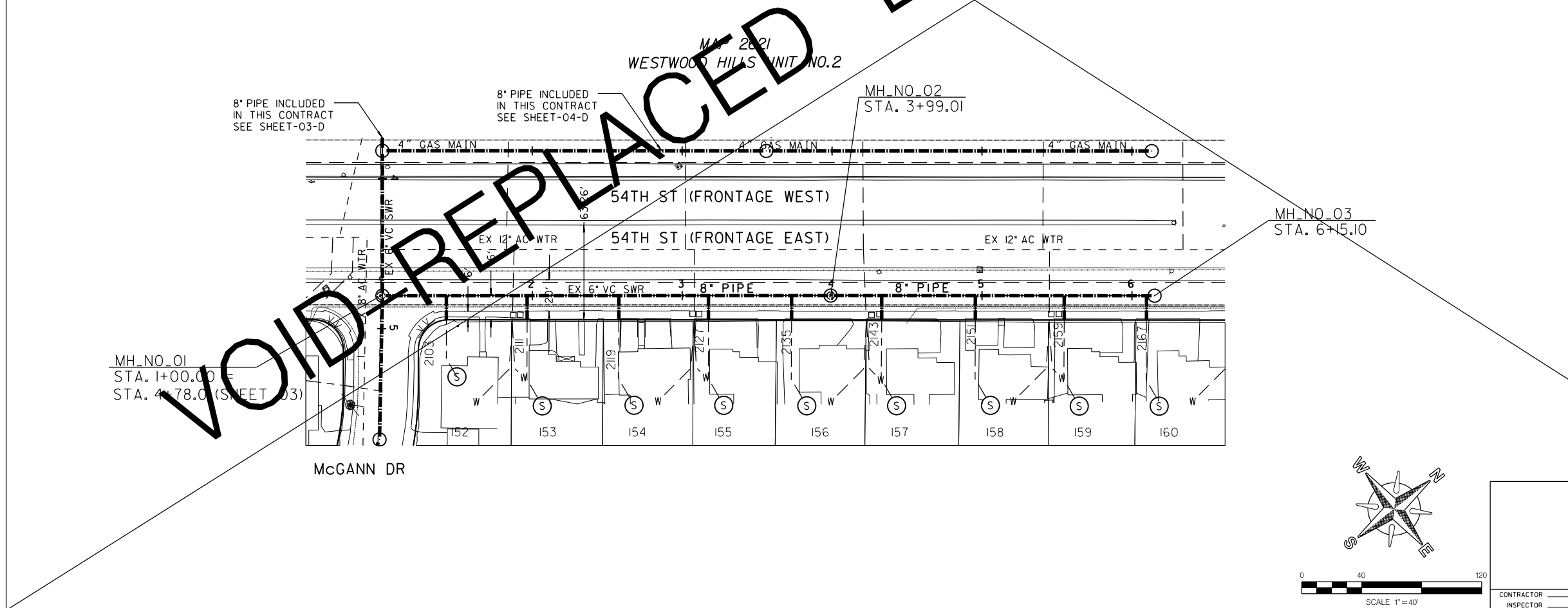
CONTRACTOR'S NOTE:  
 USE EXTREME CAUTION WHEN WORKING  
 DUE TO LOW OVERHEAD UTILITY LINES.

REFERENCE:

WATER: 7768-L  
 SEWER: 7193-L, 7768-L, 6394-B  
 STORM DRAIN: NONE  
 GAS: 16147-118800  
 ELECTRIC: 16147-118800  
 CABLE TV: 202-1743  
 TELEPHONE: N/A  
 IMPROVEMENTS: 7768-L  
 100' SCALE/FIELD BOOK: J20S, K20S, K2IS  
 THOMAS BROS.: I270 A-7, I290 A-1, B-2

RETIREMENTS:

6" - VC - 512' - 1950  
 MH - 4X3 - 1 - 1950  
 4" LATERAL - 9' - VC - 1950

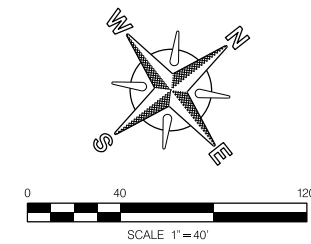


C-1

SEWER GROUP XYZ  
 54TH ST (FRONTAGE EAST)  
 McGANN DR TO STA 6+15.10

CITY OF SAN DIEGO, CALIFORNIA  
 PUBLIC WORKS DEPARTMENT  
 SHEET 02 OF XX SHEETS

APPROVED FOR CITY ENGINEER	DATE	PROJECT MANAGER
PRINT NAME	PC#	PROJECT ENGINEER
DESCRIPTION	BY	APPROVED
ORIGINAL	XX/XX	
ADDENDUM A	XX/XX	XX/YY
		XX/YY
		XX/YY
		XX/YY
CONTRACTOR INSPECTOR	DATE STARTED	XXXXX-02-D
	DATE COMPLETED	



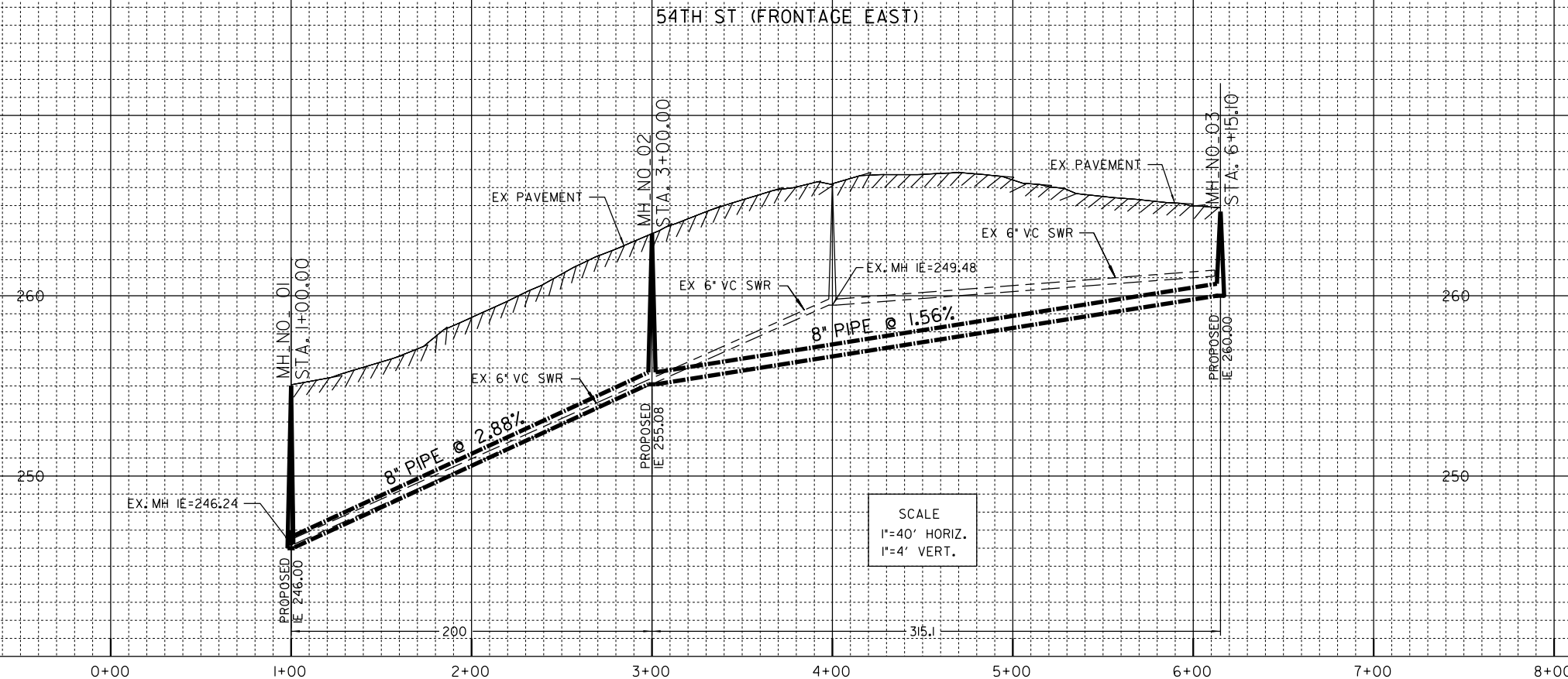
54TH ST (FRONTAGE EAST)

POB 1+00.00 1845395.45 6305902.21  
 STRAIGHT 200.00 38° 09'44.28"  
 PI 3+00.00 1845630.55 6306086.96  
 STRAIGHT 315.10 38° 11'41.52"  
 POE 6+15.10 1845800.38 6306220.58

ESTIMATED ARCHAEOLOGICAL MONITORING LIMITS  
 (INCLUDES MAIN, LATERALS, AND OTHER TRENCHING ACTIVITIES)

BEGINNING STATION	ENDING STATION	APPROXIMATE LF
STA. 1+00	STA. 6+15.10	515.10

ACTUAL LIMITS SHALL BE DETERMINED BY THE PI/MONITOR(S) PRIOR TO CONSTRUCTION AND SHALL BE CONSISTENT WITH THE MITIGATION AND MONITORING PROGRAM (MMP) FOR THE PROJECT.



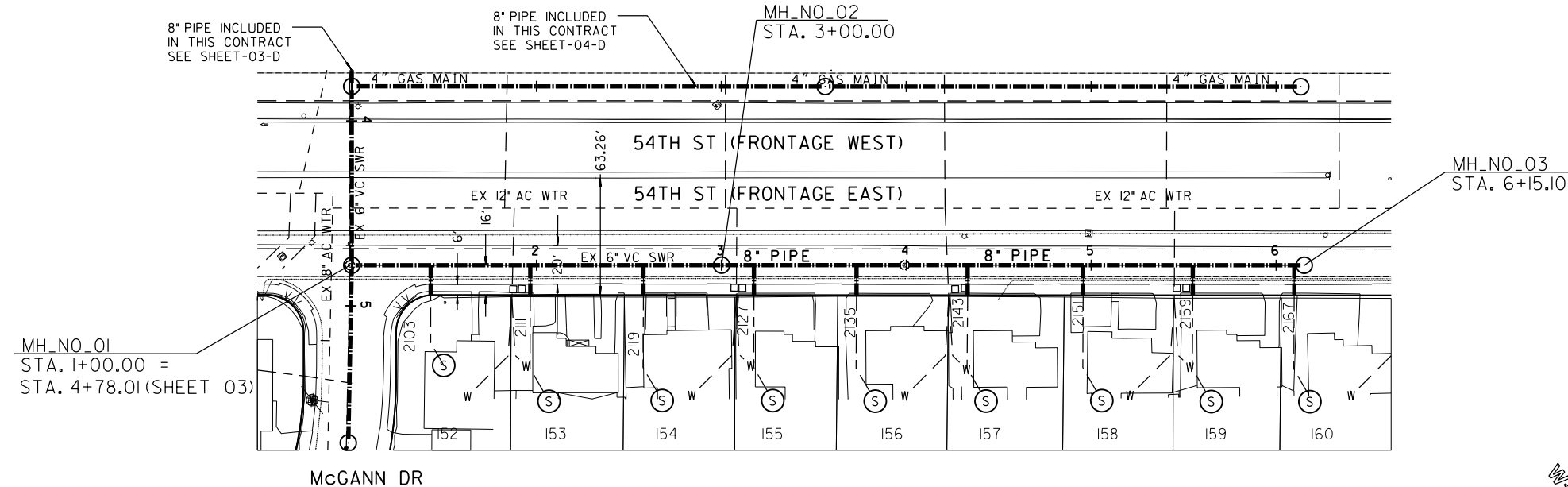
SCALE  
 1"=40' HORIZ.  
 1"=4' VERT.

CONTRACTOR'S NOTE:  
 USE EXTREME CAUTION WHEN WORKING  
 DUE TO LOW OVERHEAD UTILITY LINES.

REFERENCE:  
 WATER: 7768-L  
 SEWER: 7193-L, 7768-L, 6394-B  
 STORM DRAIN: NONE  
 GAS: 16147-118800  
 ELECTRIC: 16147-118800  
 CABLE TV: 202-1743  
 TELEPHONE: N/A  
 IMPROVEMENTS: 7768-L  
 100' SCALE/FIELD BOOK: J20S, K20S, K2IS  
 THOMAS BROS.: I270 A-7, I290 A-1, B-2

RETIREMENTS:  
 6" - VC - 512' - 1950  
 MH - 4X3 - 1 - 1950  
 4" LATERAL - 9 - VC - 1950

MAP 2621  
 WESTWOOD HILLS UNIT NO.2



MH\_NO\_01  
 STA. 1+00.00 =  
 STA. 4+78.01 (SHEET 03)

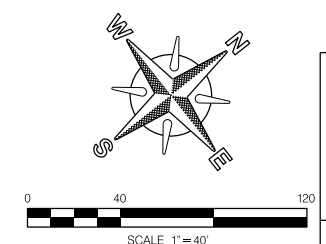
MH\_NO\_03  
 STA. 6+15.10

C-9

SEWER GROUP XYZ  
 54TH ST (FRONTAGE EAST)  
 McGANN DR TO STA 6+15.10

CITY OF SAN DIEGO, CALIFORNIA  
 PUBLIC WORKS DEPARTMENT  
 SHEET 10 OF XX SHEETS

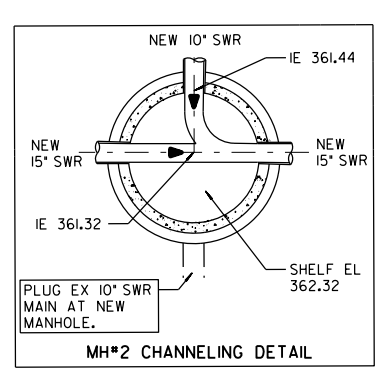
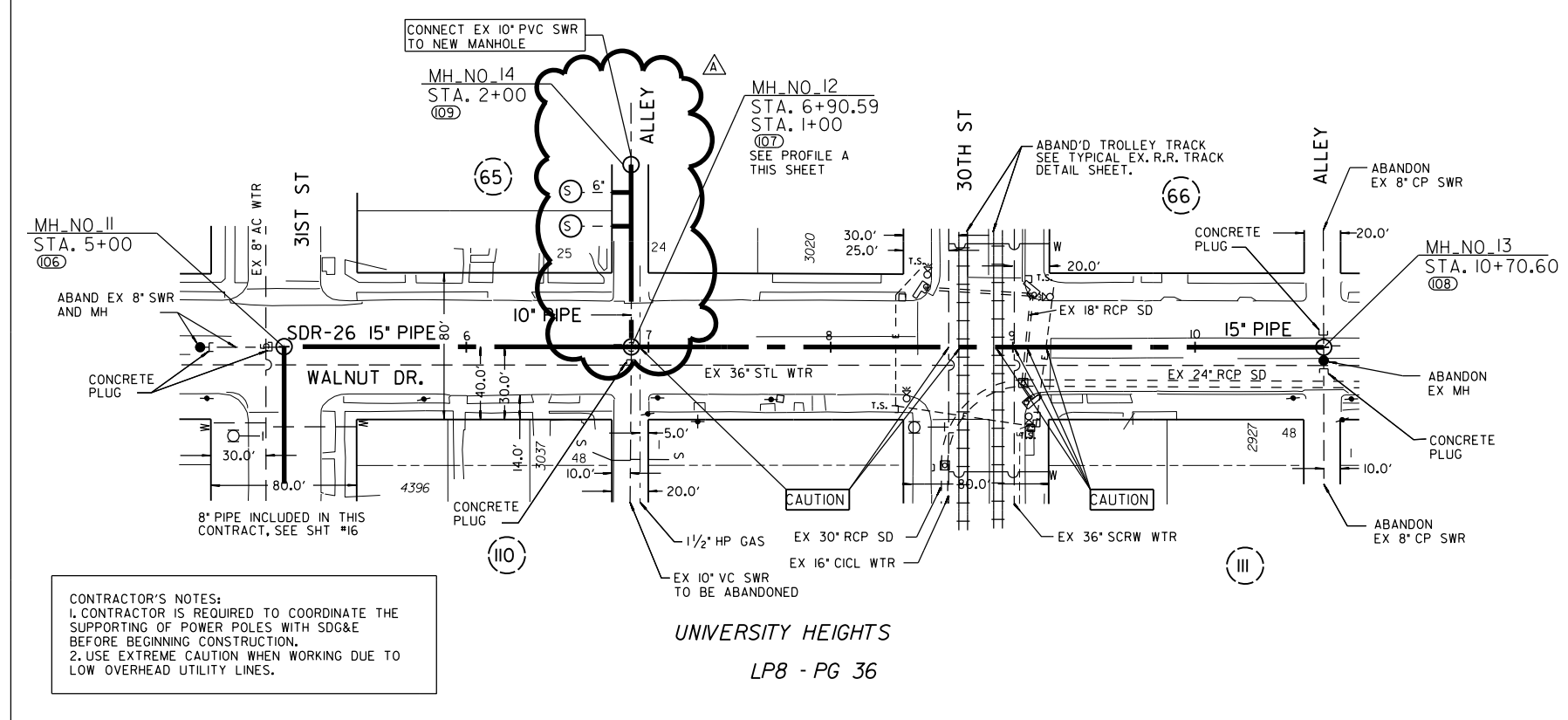
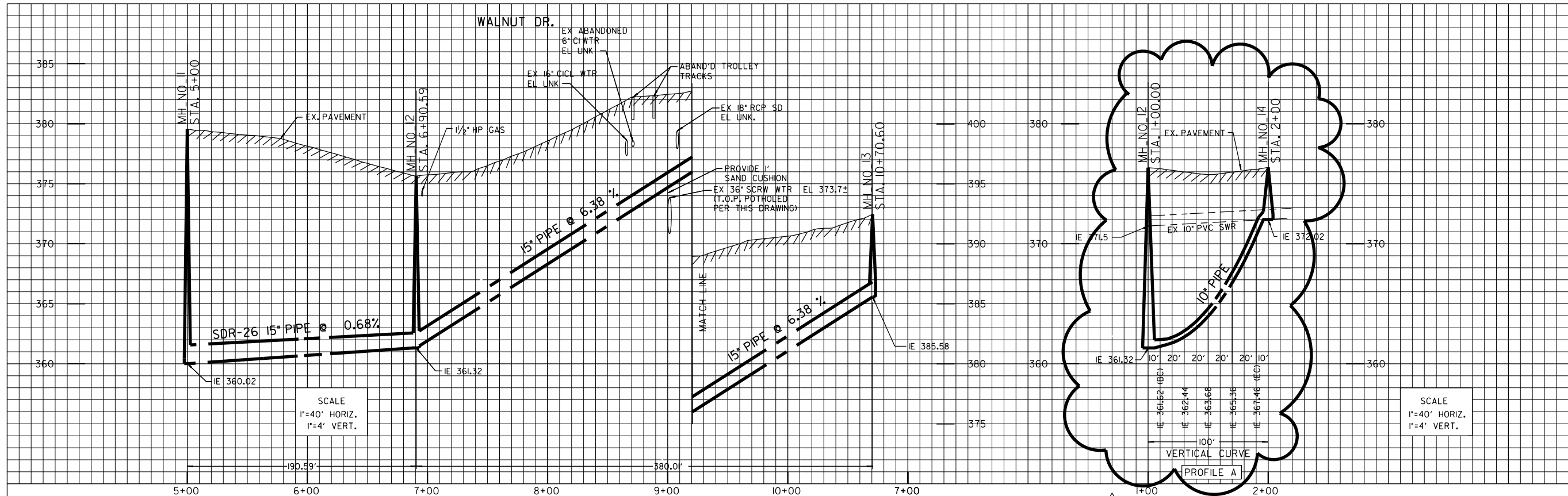
APPROVED FOR CITY ENGINEER	DATE	PROJECT MANAGER
PRINT NAME	RCE#	PROJECT ENGINEER
DESCRIPTION	BY	APPROVED
ORIGINAL	XX/XX	
ADDENDUM A	XX/XX	XX/YY
		DATE FILMED
		DATE
		FILED
		202-1743
		CCSB3 COORDINATE
		6304407-1842444
		CCSB3 COORDINATE
CONTRACTOR	DATE STARTED	XXXXX-10-D
INSPECTOR	DATE COMPLETED	



54TH ST (FRONTAGE EAST)



Figure 2-14c Addendum Format Sheet 4

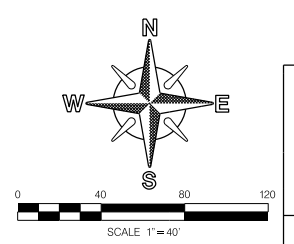


REFERENCE:  
 WATER: 12345-6-D, 23456-7-D  
 SEWER: 12345-6-D  
 STORM DRAIN: 12345-6-D  
 FIELD BOOK: 214-1719, G2IS  
 THOMAS BROS.1250

RETIREMENTS:  
 100' - 10" PVC - 1999  
 45' - 8" VC - 1975  
 MH - 3 - 1962  
 4" LATERAL - 1- 1962  
 6" LATERAL - 1- 1962

CONTRACTOR'S NOTES:  
 1. CONTRACTOR IS REQUIRED TO COORDINATE THE SUPPORTING OF POWER POLES WITH SDG&E BEFORE BEGINNING CONSTRUCTION.  
 2. USE EXTREME CAUTION WHEN WORKING DUE TO LOW OVERHEAD UTILITY LINES.

UNIVERSITY HEIGHTS  
 LP8 - PG 36



SEWER GROUP 000			
WALNUT DR./ALLEY IN BLOCK 65			
31ST STREET TO ALLEY BLK NO. 66			
CITY OF SAN DIEGO, CALIFORNIA		WATER	0-00000
PUBLIC WORKS DEPARTMENT		SEWER	0-00000
SHEET OF SHEETS		DATE	
FOR CITY ENGINEER	DATE	PROJECT MANAGER	
PRINT DCE NAME	TRC#	PROJECT ENGINEER	
DESCRIPTION	BY	APPROVED	DATE
ORIGINAL	XX/XX		
ADDENDUM A	XX/YY		
CONTRACTOR		DATE STARTED	08-08-08
INSPECTOR		DATE COMPLETED	08-08-08
		19905-01-D	

ADDENDUM A

WALNUT DR.

## **PART 3 PUBLIC & PRIVATE DEVELOPMENT**

### **3.1 Private Development & Public Improvement (Private Contract)**

#### **3.1.1 General Standards and Procedures**

Plans must be routed to the Development Services Department (DSD) for plan check and approval to ensure consistency.

The planning functions for private developments are generally required of the land developer from conditions of a development permit (i.e., tentative map resolution, Site Development Permit, Coastal Development Permit, Neighborhood Development Permit, etc.). Any questions of these aspects must be directed to the Project Manager assigned to the submitted project in DSD.

The applicable disciplines from DSD review the project for compliance with the development permit conditions, design standards, and all applicable regional standard drawings.

In general, the City follows the GREENBOOK and the City of San Diego Supplement, WHITEBOOK.

For additional submittal requirements to DSD, refer to the following website: <https://www.sandiego.gov/development-services/devprocess/site/submitreq>

#### **3.1.2 Grading and Public Improvement Plan Templates for Private Contracts**

Minor public improvements are to be prepared on a Construction Plan (form DS-3179) as outlined in DSD's Information Bulletin 165. Major public improvements and grading projects are to be prepared on D-Sheet format. Format requirements for all templates may be obtained from the following web site; <http://www.sandiego.gov/development-services/industry/information/standtemp.shtml>. A sample of the D-Sheet template may be found in Figure 3-1.

All plans must be prepared according to these standards and the templates found at DSD's website. Other drawing formats are not acceptable.

#### **3.1.3 Typical Sheets for Grading and Public Improvement Plans**

Grading and Public Improvement Plans on D-Sheets must include the following applicable sheets (but not limited to):

- Title Sheet
- Notes and Details
- Grading Plan
- Improvement Plan (Plan and Profile)
- Erosion Control Plan
- Signing/Striping/Curb Utilization Plan

- Shoring Plan
- Planting/Landscape/Irrigation Plan
- Traffic Signal Plan
- Traffic Control Plan

### **3.1.4 Drawing Numbering**

Each grading and improvement project for private contracts on D-Sheets are assigned a five-digit number by the Engineering Maps and Records Section of DSD. Every construction drawing carries the project number, a sequential number within the set, and the drawing size designation "D" in the lower right-hand corner of the title block.

For example:

20905 - 1 - D

Project No. 20905

Sequential Sheet No.01

Drawing Size DesignationD

## **3.2 Public Improvement & Facilities**

### **3.2.1 Improvement Plans**

### **3.2.2 Discipline Specifics**

This section elaborates on the content of the drawings produced by the various disciplines.

#### **3.2.2.1 Cover Sheet**

The standard cover sheet is shown in Figure 3-1. The Design Consultant places the vicinity and location maps on the cover sheet. The name of the consultant, engineer's declaration, and block for stamp is also included on this sheet. The Discipline code for this sheet is D-1.

#### **3.2.2.2 General Drawings**

General drawings present information which relates to the overall project, not to any single discipline. They are numbered in sequence. The number of general drawings depends on the size of the project. Information on sheets must be combined when possible. These drawings carry a "D" number, in the following sequence.

#### **A. Overall Site Plan**

Drawing numbered D-2 follows D-1 in every project. It shows the entire project site. If the project site is too large to be shown with the necessary level of detail, the overall site plan may be used as a key map.

1. Individual structures or process units must be identified. If the scale is small enough to prevent adequate size lettering, a structure or process numbering index must be used.

2. The grid system must be shown on this plan along with the basis of bearing and any adjustment to plan north.
3. The benchmark reference is also shown on this plan.
4. The boundary of the property is shown with bearings and distances or coordinates.
5. Treatment plant drawings can be classified according to Table 3-1. Unassigned area numbers are available to make the system flexible.

**Table 3-1**

**AREA NUMBERING SYSTEM**

No.	Area	No.	Area
1	Influent Pump Station	51	Operations & Maintenance Building
2	Influent Metering	52	Unassigned
3	Unassigned	53	Unassigned
4	Unassigned	54	Unassigned
5	Headworks	55	Chemical Building
6	Unassigned	56	Unassigned
7	Unassigned	57	Unassigned
8	Unassigned	58	Unassigned
9	Unassigned	59	Unassigned
10	Primary Sedimentation Tanks	60	Odor Control Facilities
11	Intermediate Pump Station	61	Unassigned

No.	Area	No.	Area
12	Flow Equalization	62	Unassigned
13	Unassigned	63	Unassigned
14	Unassigned	64	Unassigned
15	Aeration Basins	65	Utility System
16	Unassigned	66	Electrical Substation
17	Unassigned	67	HVAC System
18	Unassigned	68	Unassigned
19	Unassigned	69	Unassigned
20	Secondary Clarifiers	70	Energy Recovery Building
21	Secondary Effluent Splitter Box	71	Unassigned
22	Coagulation & Flocculation Structure	72	Unassigned
23	Unassigned	73	Unassigned
24	Unassigned	74	Unassigned
25	Effluent Drop Structure	75	Dissolved Air Floatation Thickeners
26	Waste Backwash Tank	76	Unassigned
27	Unassigned	77	Unassigned

No.	Area	No.	Area
28	Unassigned	78	Unassigned
29	Unassigned	79	Unassigned
30	Chlorine Contact Tank	80	Digesters
31	Effluent Control Structure	81	Unassigned
32	Effluent Junction Box	82	Unassigned
33	Effluent Drop Structure	83	Unassigned
34	Unassigned	84	Unassigned
35	Chlorination Building	85	Sludge Dewatering
36	Unassigned	86	Unassigned
37	Unassigned	87	Unassigned
38	Unassigned	88	Unassigned
39	Unassigned	89	Unassigned
40	De chlorination Facility	90	Sludge Drying
41	Unassigned	91	Unassigned
42	Unassigned	92	Unassigned
43	Unassigned	93	Unassigned
44	Unassigned	94	Unassigned

No.	Area	No.	Area
45	Sludge Pumping	95	Sludge Composting
46	Unassigned	96	Unassigned
47	Chemical Building	97	Unassigned
48	Unassigned	98	Unassigned
48	Unassigned	98	Unassigned
49	Unassigned	99	Unassigned
50	Administration Building	100	Unassigned

Numbering of facilities (e.g. valves and valve vaults, etc.) between treatment plants, pumping stations, etc., shall be based on area designations for the originating facility. For example, numbering of facilities on the sludge force main between Point Loma Wastewater Treatment Plant and another project site would be based on the area designation for Point Loma sludge Pumping Station.

## **B. List of Drawings**

This drawing shows the list of design drawings with sheet numbers and drawing numbers identified.

## **C. General and Project Notes**

The purpose of the Construction Notes on the Plans is only to highlight or bring attention to unique or special aspects, construction details, or to cross reference the special provisions.

Special provisions or other contract terms and conditions for Capital Improvement Projects shall not be shown on drawings.

This quality issue is especially important with Consultant designed projects, and need to be understood at the beginning of the design development process. By the time it is in the Contract Processing phase it is too late to make major changes.

## **D. Abbreviations and Symbols**

This sheet lists all the abbreviations and symbols used on the drawings. It follows the general and project notes.

## **E. Design Criteria**

This sheet lists the design criteria for the project. (This sheet may not be required for the construction package.)

## **F. Flow Diagram**

This schematic drawing shows where the liquids flow and how the major equipment and major valves are arranged. Major mechanical equipment is shown and labeled; major valves and instruments are shown but are not labeled. Flow diagrams are used for pumping plant facilities.

## **G. Pump Curve**

For a pump station project, the pump curve must be included to describe the relation between the flow rate and head for each pump. The pump curve is a graph presentation drawing which characterizes pumps.

## **H. Hydraulic Profile**

For a water pump plant, the hydraulic profile must include the steady-state hydraulic grade line (working pressure), the maximum surge hydraulic grade line, and the minimum surge hydraulic grade line. The hydraulic profile must start from the pump plant and end at the reservoir. High and low water levels inside the suction forebay and ending reservoir must also be identified. Design data including flow rate, pipe diameter and Hazen-Williams coefficient used in developing the profile must be identified as notes.

For water and wastewater treatment plants, the hydraulic profile must show water level elevation throughout the treatment process from plant influent to effluent. Levels at peak and average flow rates must be depicted. Inverts and soffits of hydraulic elements and weir crest elevations shall be called out and depicted accurately, and widths and lengths shall be called out below each profile.

Add notes to clarify how many influent screens and tanks of each process are out of service for each profile condition show. Add notes, similar to the profile elevation call outs, below each process unit to indicate the applicable process unit flow rates for each of the profiles.

Submit detailed hydraulic profile calculations to the project manager for inclusion in City Records.

## **I. Traffic Control Notes and Index**

Unlike the previous general drawings, this sheet is always numbered T-1 in contracts where it is used. It lists contractor requirements for general control of traffic at the site and indexes any plan sheets used to define specific traffic controls. Additional traffic control plans are numbered T-2, etc. (These sheets are discarded at As-Built stage.)



### 3.2.3 Civil Drawings

Civil drawings are classified as follows:

#### **A. Site Plan**

Refer to Section 3.2.2 A.

#### **B. Horizontal Control and Paving Plans**

Each sheet may have a key index at the lower right corner with hatching to indicate the plan location on the site. The following must be shown on these drawings:

1. The grid system with the grid reference at the perimeter.
2. Existing structures/improvements with easy-to-identify join lines at the interface. New improvements must be shown solid to stand apart from existing structures which are to be shown dashed or screened.
3. Dimensions and coordinates of structures, roads and all surface features. Two coordinates are necessary to locate each structure.
4. The various paving types clearly distinguishable to separate one from the other.
5. Centerlines of point intersection (PI), curve data, road dimensions, etc., in sufficient quantity to locate all improvements without the need for calculations.
6. Cross-referencing of sections and details associated with the paving.
7. Catch basins, manhole, and other utility structures.
8. Parking and striping with dimensions or coordinates, and traffic signs.
9. Fences, with coordinates.
10. Notes.

#### **C. Grading and Drainage Plans**

Each sheet of the plans may have a key index at the lower right corner with hatching to indicate the plan location on the site. The following must appear on these drawings:

1. The grid system with the grid reference at the perimeter.
2. Existing structures, contours and elevations shown screened or dashed.

3. New contour lines and elevations of new improvements shown solid to stand out and be legible.
4. Control points needed in addition to those of structures and pavement, shown with dimensions or coordinates.
5. Drainage pattern with flow lines and ridges.
6. Labeled transitions.
7. Cross-referencing to sections or details associated with the grading.
8. Notes.

#### **D. Yard Piping Plans**

Each sheet of the plans may have a key index in the lower right corner with hatching to indicate the plan location on the site. The following appear on these drawings:

1. The grid system with the grid reference at the perimeter.
2. Existing piping and structures dashed or screened.
3. New improvements with solid lines.
4. New piping showing coordinates, size, material and fluid to be conveyed.
5. Existing piping, showing size, materials and fluid to be conveyed.
6. Cross-referencing to profiles, sections and details associated with yard piping.
7. Any temporary piping needed to maintain plant operations during construction.
8. Any work by others which affects the yard piping.
9. Invert elevations on gravity lines six inches and smaller which do not have a profile.
10. Test stations and other cathodic protection equipment, as necessary.
11. Notes.

## **E. Section Drawings**

Section drawings include the following:

1. Screened horizontal and vertical guide lines at 100-foot and 10-foot intervals, respectively.
2. Existing ground lines and structures.
3. New grade lines and structures.
4. Depth of existing soil removal and reworking (to provide structural fill for new improvements).
5. Extent and thickness of special materials such as select fill and gravel.
6. Fencing.
7. Subsurface drains (if required).
8. Space limitations and other unusual constraints.
9. Right of way (if required).
10. Notes.

## **F. Profile Drawings**

Profile drawings include the following:

1. A profile identifier for each profile and reference plan numbers.
2. Existing ground lines.
3. New grade lines.
4. New pipe centerline and appurtenances such as meters, manholes, coupling, valves, etc.
5. Stations along horizontal distances to all pipe angle points, pipe appurtenances, tie-in, inlets, outlets and any other items necessary for fabrication and installation.
6. All pipe crossings, pipe function, material, size, and elevation, including electrical and communications duct banks.
7. All slopes.
8. Pipe class or strength, coating and lining requirements.

9. For storm drain, Q and hydraulic grade for each reach, as well as invert elevations.
10. Flow data (Q,V,d/D) for Trunk Sewers.
11. Concrete encasements where needed.
12. Casing where needed and casing data.
13. Special pipe supports where needed.
14. Manway, meter box or vault, valve box or vault.
15. Curb inlet opening.
16. Notes.

## **G. Detail Drawings**

These drawings are used as needed to clearly show design details.

## **H. Demolition Plans**

These drawings may have a key index at the lower right hand corner with hatching to indicate the plan location on the site. Demolition drawings show the following:

1. The grid system with the grid reference at the perimeter.
2. Existing conditions.
3. Items requiring removal with circled numbers keyed to the notes.
4. Large areas or structures requiring removal with hatched lines for ease of identification.
5. Items to be protected with squared numbers keyed to the notes.
6. Items to be salvaged and relocated with circled number within a square box keyed to notes.

## **I. Plan and Profile Drawings**

These drawings apply to pipelines within the public right-of-way and plans outside a facility site. Plan and profile sheets must adhere to the following guidelines:

1. The drawings must consist of two parts: the top part, a profile; and the bottom part, a plan view.

2. The vertical and horizontal reference lines for the profile must be selected to minimize distortions and maximize clarity. Reference lines must be screened or of light weight so as not to interfere with the information to be communicated.
3. The profile must show the elevations and stationing and the existing ground line over the pipe line, a finished grade if applicable, the top and bottom of the pipe, all lines crossing the new pipeline and special conditions such as concrete encasement or steel casing for boring.
4. In addition, the profile shows manways/manholes, meter box or vault, valve box or vault, and other appurtenant items. Also, shown are the class of pipe, the length of the pipe, the slope of pipe between grade changes, and degree if changing direction.
5. Station lines must be shown at manways/manholes, elbows, grade breaks and horizontal bends with centerline elevations and slopes between them.
6. The plan must show existing contours, existing improvements dashed or screened so as to stand out from the new improvements which are solid lines.
7. Plans must show stations for the manholes, elbows and other appurtenances to correspond with the profile stationing.
8. The plan must show right-of-way and temporary construction easements.
9. The plan must show referencing to sections and details shown on other sheets or on the same sheet.
10. In addition to stationing, the plan must show pipeline coordinates and bearings to allow location from survey monuments. Identify the pipeline by name.
11. The plan must also show special conditions to alert the contractor for construction requirements which may be out of the ordinary, such as cathodic protection equipment, such as rectifiers, test suction, isolating flanges, etc., on plan view.
12. Provide hydraulic data for the pipeline on the profile.
13. Pipeline stationing always increases from left to right across each plan and profile drawing and continue through curves.
14. Each plan view must have a north arrow. These stationing criteria are to be satisfied regardless of the resulting orientation of the north arrow on the plan view. The second criterion can, however, be disregarded for site piping around such projects as pumping stations or reservoirs. In these cases the direction of the north arrow must generally match the facility plan sheet.

15. Call out horizontal points of intersection (HPIs) on the plan and vertical points of intersection (VPIs) and combined angles on the profile.
16. Show and station the centerline of the pipe on the plan view and at VPIs in the profile for all pipes larger than 40 inches.
17. Provide a survey control drawing to include basis of bearing, coordinates, benchmarks, coordinates of critical locations, and coordinates at survey points. Show and identify any control points that also appear within the areas covered by the plan and profiles sheets.
18. For a larger area projects that are need to be cut show match line with reference number or letter and a sheet number where it is referred to.

Figure 2-13 is an example of a blank plan and profile sheet.

### **3.2.4 Landscaping/Irrigation**

Use the symbols from the City's Standard Drawings.

### **3.2.5 Architectural Drawings**

Whether or not a separate set of architectural drawings is planned, a building code analysis of any building and site is performed and included in the set of drawings.

When a separate set of architectural drawings is planned, the following drawing classifications are the minimum components of the set:

1. Building Code Analysis
2. General Notes, Materials Legend, Architectural Abbreviations
3. Plans, Sections and Elevations
4. Door, Window, Louver and Finish Schedules and Details
5. Standard Details

#### **A. Building Code Analysis**

The building code analysis includes the following:

1. Design Code used (e.g., IBC (International Building Code, current adopted Edition.)
2. Any other applicable codes or references used (e.g., NFPA 101)

3. The following minimum information must appear on the drawings with respect to the code analysis:
  - Occupancy Group(s) and actual floor area(s)
  - Type of Construction
  - Location on Property (relativity of all buildings on site)
  - Actual versus allowable floor areas
  - Is area increase required?
  - Are alarms required?
  - Diagram existing provisions
  - Fire Resistive Construction Requirements, both as a result of construction type and of special occupancy requirements
  - Exiting Loads and Diagrams for any building in which the public is allowed

## **B. General Notes, Materials Legend and Architectural Abbreviations**

The general notes, materials legend and abbreviations include the following:

1. General notes must not contain specification information.
2. A legend identifying the graphic symbols used and textures shown in the plans, sections and details to identify various materials if specific to the architectural discipline and not shown elsewhere.
3. Any special abbreviations used specific to the architectural discipline and not shown elsewhere.

## **C. Plans, Sections, and Elevations**

Plans, sections and elevations include the following:

1. Drawings must contain sizes and materials. Specifications must describe the materials and installation methods.
2. Materials must be called out on drawings in the same terminology as they are specified. Avoid repetition and duplication of information found on other discipline drawings.
3. When drawings of other disciplines are referenced, the specific drawing or detail must be noted.

4. When match lines are used, they must be located in the same place on the drawings of all disciplines.
5. Wherever possible, draw all plans at the same scale.
6. Show information only once. Dimensions shown on small-scale plans must not appear on large-scale plans or vice versa.
7. All disciplines must use the same orientation for their plans.

#### **D. Door, Window, Louver, and Finish Schedule and Details**

The use of standard formats for door, window, louver and finish schedules helps ensure consistency of the documents.

#### **E. Details**

These drawings are used as needed to clearly show design details.

#### **F. Minimum Information Required on Architectural Drawings**

The following information appears on architectural drawings as a minimum requirement regardless of policy, even if shown on other discipline drawings:

1. Plan dimensions, starting with building out-to-out measured at outside face of walls. Plan dimensions include wall locations and thicknesses, all openings through slabs (but located and sized on structural), door, window and louver opening dimensions and locations, interior partition dimensioned locations and thicknesses, and centerline locations of all beams, columns, pilasters and piers.
2. Rooms must be named and numbered; doors, windows and louvers must be designated by number or letter.
3. Show and locate all fire extinguisher cabinets and devices.
4. Show size and location of all architecturally relevant items such as tack or marker boards, built-in cabinets or millwork, lockers, etc.
5. If not shown on structural drawings, show stair width, number and height of risers, number and length of treads, overall dimensions and landing sizes.
6. Show all slab penetrations including sumps and floor drains (but location dimensions must appear on structural plans).
7. Show structural separations and similar features. Reference details.



8. If existing structures are relevant (i.e., part of same facility) or critical (i.e., sufficiently near to possibly impact construction efforts) show these facilities with phantom lines; note as existing.
9. Roof slopes must be shown and called out, and elevations at high and low points provided.
10. Sections and details needed must be provided unless covered by note or reference (as to standard/typical details or other discipline drawings). Sections are sufficient to cover unique conditions without being repetitious. Sections must show interface conditions between architectural and other disciplines, drawn at a scale to clearly show required information and referencing to details.
11. Details are generally used to enlarge non-typical features, which must be drawn at a larger scale.
12. Detailed materials, components and features are clearly indicated.
13. Additional information includes ladders, stairs, handrails, grating (by material and thickness), access covers (also by material and thickness), access hatches and scuttles (by material and size) and doors, windows and louvers.

### **3.2.6 Structural Drawings**

Structural drawings may be classified in three groups: the structural general notes and design criteria drawing, the standard/typical details drawing(s), and the design drawings.

#### **A. Structural General Notes and Design Criteria**

This drawing shall be the first structural drawing. The structural general notes and design criteria drawing(s) include the following:

1. Reference Codes, Standards, and Design Loads
  - Design code used (e.g., IBC (International Building Code, current adopted Edition)
  - Reference standards used (e.g., American Welding Society D1.4)
  - Geotechnical report reference, with soils bearing and lateral pressures
  - Assumed live loads used in design, including hydraulic forces if applicable
  - Seismic zone and seismic coefficients used (or wind forces if govern)
  - Any other applicable codes or references used as needed

2. Materials and Materials Standards

- Concrete strength used in design (may vary for different uses)
- Reinforcing steel grade and ASTM designation
- Structural steel grade and ASTM designation (as applicable)
- Aluminum alloy/stainless steel alloy (if used/where applicable)
- Grating section properties/materials/coatings/manufacturer
- Metal decking depth/gage/section properties/manufacturer (if used)
- Anchor bolt material by ASTM for cast-in-place anchor bolts
- Drilled in concrete anchors (epoxy or wedge) by manufacturer
- Any materials to be galvanized – by ASTM “G-XX” designation
- All other materials used by manufacturers or equal, or by ASTM designation

3. Notes, Legend, Abbreviations

- Additional general notes may be added as deemed appropriate by the Design Consultant. These can include notes regarding coordination with other discipline drawings, verification of existing conditions, construction safety orders, verification of equipment sizes and anchorage with approved vendor shop drawings, etc.
- A legend identifying the graphic symbols used and textures shown in the sections to identify various materials.
- Any special abbreviations used specific to the structural discipline not shown elsewhere.

## **B. Standard/Typical Details**

The use of well-established, time-proven standard/typical details, refined and improved over time as needed to reflect current materials and methods ensures a more consistent approach to drawing presentation. The standard/typical detail drawings must follow the drawing or drawings above as the next in numerical sequence. The division of information between standard/typical details and design drawings use the following guidelines:

1. Standard/typical details include any frequently occurring detail for which a standard exists. These details may be included on the full-size standard/typical details drawings, or in 8-1/2 x 11-inch format, bound into the specifications or included as a separate volume of the Bid Documents.

2. When used, each typical detail is referenced at least once on the plans. The typical details must be appropriate for, and coordinated with, the design drawings.
3. Standard/typical details can be any condition occurring more than once. Examples include ladders, grating, access covers, metal stairs, concrete stairs, handrails, connection details (such as steel beam to concrete, steel beam to steel beam or column, etc.), concrete embedment such as frames, and all similar detail information that may apply to one or more locations or more than one structure.

### **C. Design Drawings**

The structural design drawings prepared must include the plans, sections, elevations, and detail drawings containing all job-specific information. In general, the structural drawings show all information needed to build the complete structure, or show where it can be found.

Avoid repetition and duplication of information found on other discipline drawings. The structural drawings need not repeat the wall opening dimensions provided for windows and doors shown on the architectural drawings, although the openings must appear on the structural drawings.

The following information must appear on the structural drawings as a minimum requirement regardless of policy, even if shown on other discipline drawings:

1. All plan dimensions, starting with building out-to-out measured at outside face of walls. Plan dimensions include all wall locations and thickness, locations of edge of slab or change in elevation, size and location of all openings through slabs, and centerline locations of all beams, columns, pilasters, piers and similar structural features. These locations are tied to key functional elements within the structure by centerline location such as a large diameter pipe or manifold within the structure, pump or pumps locations, pipe or vessel support saddles, or similar features in each direction.
2. Unless size is dictated by vendor-specific information, show size and location of all equipment pads and piers.
3. Show stair width, rise, run, and overall dimensions and landing sizes, unless the same information is shown on architectural drawings.
4. Locate all slab high and low points, including sumps and floor drains, by dimension or note.
5. Locate all construction, contraction and expansion joints, structural separations and similar features.
6. If existing structures are relevant (i.e., part of same facility) or critical (i.e., sufficiently near to possibly impact construction efforts), show these facilities with phantom lines; note as existing, and provide plan reference dimensions.

7. Show all elevations and slopes. This includes bottom of footing elevation, invert elevation of all fill concrete, and all top-of-concrete elevations at high and low points, slabs, and landings. Where slope is provided, it must be noted as uniform between high point and low point elevations.
8. For large diameter pipes passing through walls, or large horizontal vessels, provide centerline or invert dimensions.
9. Where steel members are used, top-of-steel dimensions are provided and noted high point, low point, or typical.
10. Sections and details needed are provided unless covered by note or reference. Sections are concise representations of wall and slab conditions drawn at a scale to clearly show reinforcing steel, joints, wall type and thickness. Avoid showing information occurring beyond the section cut.
11. If complex wall penetrations occur and are not shown on architectural drawings, and wall openings such as doors, windows, louvers, etc. are needed, draw wall elevations and note/reference accordingly.
12. Details are generally used to enlarge non-typical features which must be drawn at a larger scale. A detail referenced from the plan shall appear as an enlarged plan view, and a detail referenced from a section shall appear as an enlarged section. If other views are required, they may be developed from this principal view.
13. Clearly indicate detailed materials, components, and features. Materials such as metal decking are shown, including depth, gage, section properties, material and finish, and required welding. Clearly show embedded hardware. Wherever possible, use schedules to present information.
14. Additional information is often associated with the architectural drawings, but those features are identified on structural drawings for this work. These include ladders, stairs, handrails, grating (by material and thickness), access covers (also by material and thickness), access hatches and scuttles (by manufacturer's model number, material, and size) and doors, windows and louvers.

### **3.2.7 Mechanical Drawings**

Mechanical drawings are classified as follows:

#### **A. Area Drawings**

Area drawings must show all the equipment inside and outside facility structures. Area drawings also show the routing and location of piping systems to ensure clearances between all components. Develop area drawings using the following guidelines:

1. System component identification in accordance with Subsection 2.12 of this manual. Piping callouts include size, fluid and piping material.
2. Show all piping, including process piping.
3. Illustrate existing piping and future piping and equipment shown on the drawing according to the line styles on Figure 3-2.
4. Show insulation on short sections and note the class within the insulation outline.
5. Add symbols for valve or in-line components to scale. Motor and air actuators are outlined to show clearances and orientation.
6. Terminal dimensions are not shown at the connection of piping to vendor furnished equipment.
7. Pipe supports, anchors, and instrumentation taps are shown and identified but not dimensioned.
8. High and low point vents and drains are noted if no system isometric is provided.
9. Place a key map at the lower right-hand corner of each sheet of the plans to indicate how the facility is divided into areas and by cross-hatching to show the particular area that the drawing covers. Each sheet of the plans adjoining another area must have a match line and the number of the adjacent drawing. Any piping continuing from one area to another is identified at this line.
10. Draw plan views for each main floor level. When required, partial plans may be used. One longitudinal and one transverse section along with additional partial sections are generally all that are required.

In addition, the following are shown on area drawings:

- Column centerlines, outlines and designations
  - General outlines of building exterior walls
  - Doors, hatchways, elevators, stairs, platforms and ladders
  - Piping and ductwork
  - Centerlines of rails and outline of cranes and monorails necessary to show clearances and hook limits
  - Outlines of all equipment in adequate detail to indicate clearance and space requirements
11. Minimum headroom clearance is 7 feet 6 inches or per current CBC.

12. Valve handwheels are oriented for best operation, keeping them out of passageways while retaining easy operability.

## **B. Utility Drawings**

Utility drawings are prepared using separate levels on architectural/structural backgrounds in accordance with Citywide Drafting/CADD Standards.

HVAC drawings show at least floor plans and roof plans (if roof-mounted equipment is involved). Single line ductwork and piping shall be shown for small systems, with ample room for installation. Double-line ductwork and piping are shown for large, complex systems with multiple disciplines occupying the same space. Critically important sections and details of installation, schematics of piping, air flow, and controls must also be presented. In addition, the design drawings include details of seismic supports, bracing and restraints.

American Society of Heating, Ventilating, and Air Conditioning, Inc. (ASHRAE) drafting nomenclature, symbols, and abbreviations are used. For all buildings subject to California Energy Commission (CEC) Energy Efficiency Standards compliance, the design drawings include design criteria based on ASHRAE/CEC weather data for the job location, all required architectural, mechanical, and electrical Title 24 compliance forms, completely filled out, signed and stamped by the respective discipline professional engineers, duly registered in the state of California.

The HVAC equipment included in the design is presented on the equipment schedules showing unit manufacturer and model numbers, service, location, type, design calculations, nominal capacity, electrical rating, optional equipment and features, and method of control.

Plumbing drawings show at least floor plans and roof plans (if roof-mounted equipment is involved). All toilet rooms show connections to the site utility drawings. Piping is routed to a location five feet from the building and is continued on the civil drawings. Critically important sections and details of installation, and schematics of piping, must also be presented. In addition, the design drawings include details of seismic supports, bracing and restraints.

The Uniform Plumbing Code (UPC) and American Society of Plumbing Engineers (ASPE) details, drafting nomenclature, symbols, and abbreviations are used. For all buildings subject to California Energy Commission (CEC) Energy Efficiency Standard compliance, the design drawings include design criteria based on ASHRAE/CEC data and Title 24 compliance forms, completely filled out, signed and stamped by the respective discipline professional engineers, duly registered in the state of California.

Fire protection drawings show at least floor plans showing fire system components.

National Fire Protection Association (NFPA) details, drafting nomenclature, symbols and abbreviations are used.

The fire protection equipment included in the design is presented on the equipment schedules showing unit manufacturer and model numbers, service, location, type, design calculations and nominal capacity.

### **C. Isometric Drawings**

Isometric drawings provide clarity to piping layouts. They are helpful when a pipe stress analysis is required.

### **D. System Flow Diagrams**

System flow diagrams are schematic drawings that show operational relationships between various components and define the design variables for the major modes of operation.

### **E. Major Equipment and Valve Schedule**

The equipment schedule shows all the major equipment categorized using the abbreviations shown in Table 3-2, including equipment numbers, service, and equipment data. The valve schedule must show all major valves, including valve number, type of valve, and valve size.

### **F. Piping Schedule**

The piping schedule includes the following information regarding piping and fittings:

- Materials
- Schedule or wall thickness
- Pressure ratings
- Types of joints
- Fittings
- Testing requirements
- Cleaning requirements

## **3.2.8 Electrical Drawings**

Electrical drawings are classified as follows:

### **A. Symbol Lists, Abbreviations and General Notes**

This drawing shows all the symbols and abbreviations used, as well as general notes giving special instructions to the contractor.

### **B. Site/Plot Plan**

These drawings incorporate the following:

1. Arrangement of structures and roadways.
2. Underground distribution system including location of pullboxes, manholes and ducts.
3. Location of switchgear, motor control centers (MCCs), power panels, main control board, and major local control panels.

4. Area/parking lighting. The area/parking lighting plan is to be drawn on a separate sheet to avoid confusion with power and control plans.
5. Location of power service, utility substation and in-plant substations.
6. Key plan and orientation arrow.
7. Drawing references for each structure.

### **C. Overall Single Line Diagrams**

This drawing is required for large and complex projects and must present the following:

1. A simplified single-line diagram showing the interconnections of all distribution switchgear, power transformers, distribution boards, MCCs, all major electrical equipment, emergency generators, and power panels.
2. Each equipment single-line diagram is referenced to a drawing where this equipment's single-line diagram shows in detail.
3. Identification of all major electrical equipment.
4. Identification of all power cable and conduits.
5. Sizes of all major electrical components and loads.

### **D. Single Line Diagrams**

These drawings show the makeup and development of all medium voltage switchgear and power distribution to 4160V and 480V loads. These drawings incorporate the following:

1. Power service and revenue meter connections.
2. Main circuit breakers or fused disconnect switches for the main power entrance, power distribution, and motor control centers.
3. Motor loads complete with corresponding horsepower sizes, branch circuit breaker or fused disconnect switches, motor starters, branch circuit conductors, miscellaneous devices and components such as local disconnecting means, speed controllers, power factor correcting capacitors, etc.
4. Miscellaneous electrical loads complete with corresponding circuit breakers, starters, contactors, disconnects, etc.



5. Single-line diagrams for panel or motor control centers must show:
  - Total connected loads including existing, proposed and future loads
  - Approximate maximum demand
  - Future additional loads
  - Bus ampacities
  - Bus bracing
  - Circuit numbers
6. Identification of all panels, motor control centers, feeders, subfeeders, branch circuit conductors and all loads.
7. Substation transformers complete with all protective equipment such as circuit breakers, disconnect switches, surge arresters, grounding resistors, protective relays, etc.
8. Electrical interlocks.
9. All instrumentation.
10. All local vendor furnished control panels with three-phase branch circuits to loads shown with all overcurrent devices, starters, feeder sizes and loads.

## **E. Schematic Diagrams**

These diagrams show the following:

1. Control scheme for each electrical load
2. Interlocks between equipment controls
3. Locations of control components
4. Connections of electrical protective devices
5. Wire termination interphase points
6. Control power sources
7. Identification of all components

## **F. Electrical Equipment Elevations**

Unless a specific situation arises in which it is important to show the elevation of a piece of electrical equipment, the only equipment elevation required is that of the main switchgear. This drawing shows the following:

1. Underground pull section.

2. The service section showing the main metering socket, CTs and PTs, and the main circuit breaker.
3. The distribution sections showing the number of distribution sections required. The location of the breakers in the distribution sections is left up to the electrical equipment vendors.
4. Future expansion is shown in dashed lines.
5. This drawing shows approximate dimensions for each section and an overall height.
6. Notes regarding the approval of the electrical utility company prior to manufacturing are also shown.

## **G. Power and Control Plans**

These drawings show the following:

1. Physical locations and identification of electrical loads, control and process instrumentation devices.
2. Identification of power and control conduit runs.
3. Special routing of conduits.
4. Signal conduit runs.
5. Callouts to enlarged plans and details for special situations.
6. Components such as disconnect switches, lockout-stops, manual switches, cathodic protection rectifiers, pressure switches, solenoids, level switches, temperature switches, miscellaneous instruments, special control devices and panels, etc.

## **H. Conduit and Cable Schedules**

These drawings show all conduits and cables for power and controls, with the following information:

- Conduit/cable number
- From
- To
- Via
- Cable specification
- Voltage
- Insulation type
- Grounding conductor size
- Remarks

A separate schedule must be developed for instrumentation trunking cables.

No lighting branch circuits are shown on the above schedules.

### **I. Lighting Plans**

1. Physical locations of all lighting fixtures
2. Locations and identification of lighting control switches
3. Power conduit homeruns
4. Fixture identifications and number
5. Location of lighting power panels
6. Lighting fixture circuit numbers
7. heights of fixtures
8. Special junction or splice boxes

### **J. Receptacle Plans**

These drawings show:

1. Physical locations of all receptacles
2. Power conduit homeruns
3. Locations of receptacle power panels
4. Receptacle circuit numbers
5. Special types of receptacles
6. All other details necessary to convey the intent of the design to the electrical contractor

## **3.2.9 Instrumentation Drawings**

Instrumentation drawings are classified as follows:

### **A. Piping and Instrument Diagram (P&ID)**

This drawing depicts schematically the basic equipment and the process that takes place within a facility. The P&ID shows pumps and connecting pipes, and the instruments used for controlling and monitoring the process.

The SCADA flow, pressure sensor, and measuring device must be indicated in the drawing.

The P&ID is a combined effort of various disciplines (mechanical process, piping, instrumentation and electrical) to ensure that the plant process is represented in a clear and logical sequence.

The P&ID is the foundation document used for understanding the process, and when used with other supporting documents, it provides the tool for troubleshooting and maintaining the facility.

Layout - The P&ID format, symbols, line work, notation and title block follow the standards provided in this chapter. The P&ID is mainly schematic. It may follow the layout when possible, but the process flows from left to right.

Symbols and Line Conventions - Instrument and equipment symbols are per the symbols and legend sheet shown in Figure 3-2. When additional symbols not shown in the legend sheet are required, use ANSI/ISA S5.1 standard symbols.

Instruments are represented by a bubble containing a functional identification and a loop sequential number identification. The functional identification may be two, three, or four letters (see Figure 3-2 and subsection 3.3.6). The loop sequence is normally a three-digit number, or four-digit for large facilities.

Instrument signal lines may enter or leave the instrument bubble at any angle, preferably horizontally or vertically. Arrowheads are used as required to clarify the direction of flow on process, electrical or pneumatic lines. Crossing line work follows the rule that horizontal lines break when crossing vertical lines, except that instrument lines or process lines of lesser importance break when crossing larger lines.

Equipment Identification - Process equipment, e.g. pumps, compressors, etc. are identified alphanumerically as described in subsection 3.3.1, with capacity in English units, located directly below the equipment symbol. Figure 3-2 shows a sample P&ID.

## **B. Process Flow Diagrams**

For larger and more complex facilities, a process flow diagram is prepared. This type of drawing precedes the P&ID and provides a simplified version of the process. Its main purpose is to depict the relationship among the large equipment and process lines. The flow diagram also contains a matrix listing the mass balance data for each process line; i.e., flow rate, pressure, etc. The matrix and process lines are cross-referenced numerically to facilitate identification.

## **C. Loop Diagrams**

Instrument loop diagrams are provided for each instrument loop. The loop diagram follows the format in ANSI/ISA S5.4. The loop diagram is an extension of the P&ID. It is a valuable tool during construction, checkout, startup, operation, and maintenance of a process plant. The loop diagram is laid out with the field instrument on the left and the electrical (or pneumatic) lines progressing right as they go through junction

boxes, cabinets, and panels to the final connection point. The loop diagrams are coordinated with the power and control plans described in subsection 3.3.6 at Sheet 95.

Instrument symbols and tag numbers correspond with those shown on the P&IDs. Every connection point is identified by terminal numbers, wire and cable number, and whether the signal is analog or on-off digital. Additionally, the diagram includes the I/O address of every wire connected to the PLC or DCS as applicable. The loop is identified in the title block with the instrument loop number shown on the P&ID.

For wastewater treatment plant and large pump station facilities refer to PUD's web site.

## **D. Logic Diagrams**

Logic diagrams are prepared for complex control logic sequences that cannot be described by logic descriptions. The logic diagrams are intended for the use of the PLC or DCS programmer and for the technician in troubleshooting a control problem. Logic diagrams are per ANSI/ISA S5.2, Binary logic Diagrams for Process Operations. The logic symbols in this standard may be used in combination with block symbols entailing a complex operation or vendor equipment whose logic is still unknown.

Worded descriptions may accompany the logic diagram for clarification and better understanding.

## **E. Instrument Data Sheets**

Instrument data sheets per ISA-S20 must be prepared for each instrument provided in the project. The data sheet lists the process, mechanical, and electrical requirements of the instrument. The data sheets, in addition to providing valuable engineering information, are intended for procurement of the instrument. A bill of material or instrument index is not a substitute for the instrument data sheet since many features of the instrument covered in the data sheet are not covered in the bill of material. The instrument data sheet is filled out in its entirety and refers to the instrument tag number shown on the P&ID. The specification forms provided by ISA-S20 cover 28 types of instruments. If a data sheet form is not found in ISA-S20, a user-modified version may be supplied.

The instrument data sheets are sequentially numbered to facilitate referencing. They are identified with the project title and revision number.

## **F. Control Panel Layouts**

The control panel layout drawing must contain four basic items: the front panel elevation, the interior panel elevation, a nameplate tabulation, and a component list. The front and interior elevations are drawn at an appropriate scale to provide clear detail of every feature shown. Overall dimensions are provided. Panel door hinge locations are also indicated. If a cabinet stand is provided it is also dimensioned. The nameplate list contains the panel name and equipment number. The nameplate is to be located on the top center of the panel. If the component list is too lengthy to fit on the drawing, it is included in the specifications and referred to on the drawing by note.

## G. Instrument Installation Details

Typical installation details for each type of instrument must be provided in a diagrammatic fashion. A sequential identification number is used for each type of installation to be referred to in other project drawings. In addition, the tag numbers of the instruments the installation covers are listed. Refer to Book 3, Standard and Guide Details, Water Department Capital Improvements Program for typical instrument installation details.

### 3.3 Numbering Systems

This section describes the numbering system to be used for drawings and components of systems. Components include equipment, piping, valves, motors, circuit breakers, controls, protective devices, instruments, alarms, wire, and all other devices necessary to make up a complete system which may be functionally tested and operated.

#### 3.3.1 Equipment Numbering

The purpose of equipment numbering is to uniquely identify each piece of equipment in the facility. The equipment number consists of three elements: process area, equipment ID, and a sequence number.

01 - C - 01

Where:

01	=	Area Identifier
C	=	Equipment Identifier
01	=	Sequential Numbers

#### 1. First Element (Area Identifier)

The area identifier is a two digit number according to the numbering system explained in the Clean Water Program Guidelines, Volume III, Section A1.4.

#### 2. Second Element (Equipment Identifier)

The equipment or package identifier is an alpha designator. Mechanical and electrical equipment identifiers are found in Table 3-2. Instrumentation is identified by ISA nomenclature.

#### 3. Third Element (Equipment Sequential Number)

The equipment sequential number is a two-digit number used to identify specific equipment in a process area.

The sequence for equipment numbers must be assigned following the direction of flow.

**Table 3-2**  
**Mechanical and Electrical Equipment Identifiers**

<b>Letter Designator</b>	<b>Group Description</b>
A	Mixing Equipment
AF	Air Filters
AHU	Air Handling Units
AS	Acoustic Silencers
B	Boilers
C	Compressors
CAC	Computer Room Air Conditioners
D	Dewatering Equipment
E	Engines
F	Fans, Blowers
FCV	Flow Control Valves
G	Gates
H	Heat Exchangers
HV	Manual, Check Valves
LP	Lighting Panel
MCC	Motor Control Centers
O	Conveyors
P	Pumps
PCV	Pressure Control Valves
PP	Power Panels
T	Tanks
TCV	Temperature Control Valves
V	Valves
Y	Expansion Joints

<b>Table 3-2 Mechanical and Electrical Equipment Identifiers</b>	
<b>Letter Designator</b>	<b>Group Description</b>
ME	Miscellaneous Equipment

### 3.3.2 Equipment Schedules

Major pieces of equipment may be listed on schedules when the contract requires multiple units. Schedules refer to locations on drawings and in the specifications where more complete information is given.

Schedules on the drawings must list:

1. Equipment number
2. Equipment name, type and size
3. Type of service
4. Drawing where shown in plan
5. Specification section

### 3.3.3 Pipe Line Numbering

The purpose of pipe numbering is to uniquely identify each pipe in the facility. Each pipe number consists of four elements. The first element represents the pipe size in inches. The second element identifies the fluid flowing in the pipe. The third element represents the material of the pipe and type of fittings as a group. The fourth element represents the sequential number.

10 - RW - (29) - 01

Where:

10 = Piping Size<sup>(a)</sup>  
 RW = Fluid Abbreviation<sup>(a,b)</sup>  
 (29) = Piping Material<sup>(a)</sup>  
 01 = Sequential Number<sup>(b)</sup>

(a) This element must be used on piping callouts on mechanical drawings.

(b) This element must be used on piping callouts on P&ID drawings.

When the sequential number is used, these guidelines must be followed:

1. Assign a separate number to each line.
2. Assign a single number to all drains or vents from one piece of equipment.
3. Assign a separate number to each drain and vent line from different pieces of similar equipment. If manifold together, assign one number to an entire manifold.



4. Assign a bypass pipe the same number as the inlet and outlet headers if the bypass line has a single valve. However, if the bypass line has two valves, assign a separate number to the pipe between valves.
5. Assign a separate number to each pipe on multiple pipes between two pieces of equipment.
6. Assign a separate number to each header.
7. Assign the same number as the main piping run up to the isolation valve on a branch of the main run.
8. Assign a separate number for each significant temperature and pressure change in the line.
9. Assign separate numbers for each material class.
10. Assign separate numbers when a pipe changes sizes.

### 3.3.4 Valve Numbering

Valves must be identified for type and must be numbered according to the ISA system. Only instrument air valves are excluded.

For example, the first manual valve for fluid abbreviation RW would be:

01 - HV - 01

Where:

01 = Area Identifier  
 HV = Manual Valve  
 01 = Sequential Number

### 3.3.5 Cable Numbering

Power, control and signal cables are each assigned a unique identification number. Power cable is identified using the following system:

MCC2 - 4 - A

Where:

MCC2 = Denotes MCC number 2  
 4 = Denotes circuit number 4  
 A = Suffix for special cases. AA@ for continuation of cable on secondary side of transformer  
 X = Denotes spare conduit

Control and signal cable are identified using the following system:

3 - S - 2

Where:

3 = Area Identifier  
 S = Type of Cable - "C" for control cable; "S" for signal cable  
 2 = Sequential number

### 3.3.6 Instrument and Loop Numbering

Each instrument must be designated by an alphanumeric number consisting of functional identification letters and a loop number. For functional identification letters, see Piping and Instrumentation Diagram Symbols and Legend, Figures 3-2 and 3-3. These guidelines must be followed in numbering instruments and loops.

1. Identify an instrument according to its function. For example, a differential-pressure recorder used for flow measurement must be functionally identified as "FR"; a pressure indicator and a pressure-actuated switch connected to the output of a pneumatic level transmitter must be functionally identified as "LI" and "LS", respectively.
2. Select the first letter of the functional identification according to the measured or initiating variable, not the manipulated variable. For example, a control valve which varies flow in response to a level controller must be functionally identified as "LCV" not "FCV."
3. Use the succeeding letters of the functional identifiers to designate one or more readout or passive functions and/or output functions. A modifying letter may be in addition to one or more succeeding letters. Modifying letters may modify either a first letter or succeeding letters. For example, "TDAL" contains two modifiers; the "D" changes the measured variable "T" into a new variable, "temperature differential." The letter "L" restricts the readout function "A" to represent a low alarm only.
4. The sequence of the functional identifier begins with one letter which designates the measured or initiating variable. Readout or passive letters may follow in any order with output functional letters following these in sequence except that output letter "C" (control) precedes output letter "V" (valve), i.e., "PCV," a pressure control valve. When modifying letters are used, interpose them so that they immediately follow the letters they modify.
5. Symbolize a multiple function device by showing a bubble for each measured variable, output and function. For example, a temperature controller with an integral switch is symbolized by two tangent bubbles: one functionally identified as "TC" and the other as "TSH." The instrument is functionally identified as "TC/TSH" in the specifications.
6. The number of functional letters used for any one instrument must not exceed four. The number of functional letters must be kept to a minimum by arranging the functional letters into subgroups or by omitting the "I" (indicate) if an instrument both indicates and records the same measured variable. All letters in the functional identifiers must be upper case.
7. Each instrument loop must have a unique number not assigned to any other loop at the facility. Each instrument in a loop must have the same loop number.

8. An instrument common to two or more loops must carry the identification of the loop considered predominant.

9. Loop numbering is serial, using a single sequence of numbers regardless of the loop function. For example, loops in area 4 would be numbered:

TIC -4001  
FRC -4002  
LIC - 4003

10. If a loop has more than one instrument with the same function, a suffix is appended to the loop number according to the following:

- (1) Use only an upper case letter
- (2) Alternate letters and numbers for further loop subdivisions

For example, the primary elements for a multipoint pressure recorder would be:

PE - 25A  
PE - 25B  
PE - 25C

11. Instrument accessories such as purge meters, air sets, and seal pots that are not explicitly shown on a drawing, but which need a designation for other purposes must be tagged according to their function using the same loop identification as the instruments they directly serve. For example, an orifice flange union associated with orifice plate "FE-7" must be tagged "FX-7."

### 3.3.7 Drawing Numbering

For example:

19905 - 01 - D  
Project No.                      19905  
Sequential Sheet No.        01  
Drawing Size Designation    D

The Design Consultant assigns internal sheet numbers by the discipline involved. Within each discipline, sheets are numbered sequentially by subject in the order listed below.

Subject

- Plans
- Sections
- Elevations
- Details
- Schedules

An example is:

M - 13

Where:

M=Mechanical Discipline Drawing

13=Sheet 13 of the Mechanical Drawings

Discipline designators are shown in Table 3-3.

<b>Table 3-3 Discipline Designators</b>	
<b>Discipline</b>	<b>Prefix</b>
General	G
Demolition	D
Civil	C
Landscape	L
Architectural	A
Structural	S
Mechanical	M
Electrical	E
Instrumentation	I
Traffic Control	T

Figure 3-1 DSD Cover Sheet Sample

### GENERAL NOTES

- APPROVAL OF THESE PLANS BY THE CITY ENGINEER DOES NOT AUTHORIZE ANY WORK TO BE PERFORMED UNTIL A PERMIT/ A NOTICE TO PROCEED HAS BEEN ISSUED.
- THE APPROVAL OF THIS PLAN OR ISSUANCE OF A PERMIT BY THE CITY OF SAN DIEGO DOES NOT AUTHORIZE THE SUBMITTER AND OWNER TO VIOLATE ANY FEDERAL, STATE OR CITY LAWS, ORDINANCES, REGULATIONS, OR POLICES, INCLUDING, BUT NOT LIMITED TO, THE FEDERAL ENGINEERING SPECIES ACT OF 1975 AND AMENDMENTS THERE TO (16 USC SECTION 1531 ET SEQ.).
- THE CONTRACTOR SHALL BE RESPONSIBLE FOR SURVEY MONUMENTS AND/OR VERTICAL CONTROL BENCHMARKS WHICH ARE DISTURBED OR DESTROYED BY CONSTRUCTION. A LAND SURVEYOR MUST FIELD LOCATE, REFERENCE, AND/OR PRESERVE ALL HISTORICAL OR CONTROLLING MONUMENTS PRIOR TO ANY EARTHWORK. IF DESTROYED, A LAND SURVEYOR SHALL REPLACE SUCH MONUMENTS WITH APPROPRIATE MONUMENTS, A CORNER RECORD OR RECORD OF SURVEY, AS APPROPRIATE, SHALL BE FILED AS REQUIRED BY THE PROFESSIONAL LAND SURVEYORS ACT, SECTION 8717 OF THE BUSINESS AND PROFESSIONS CODE OF THE STATE OF CALIFORNIA. IF ANY VERTICAL CONTROL IS TO BE DISTURBED OR DESTROYED, THE CITY OF SAN DIEGO FIELD SURVEY SECTION MUST BE NOTIFIED, IN WRITING, AT LEAST 15 DAYS PRIOR TO THE CONSTRUCTION. THE CONTRACTOR WILL BE RESPONSIBLE FOR THE COST OF REPLACING ANY VERTICAL CONTROL BENCHMARKS DESTROYED BY THE CONSTRUCTION.
- IMPORTANT NOTICE: SECTION 4216 OF THE GOVERNMENT CODE REQUIRES A DIG ALERT IDENTIFICATION NUMBER BE ISSUED BEFORE A "PERMIT TO EXCAVATE" WILL BE VALID. FOR YOUR DIG ALERT ID NUMBER, CALL UNDERGROUND SERVICE ALERT, TOLL FREE 1-800-422-4133, TWO DAYS BEFORE YOU DIG.
- CONTRACTOR SHALL IMPLEMENT AN EROSION AND SEDIMENT CONTROL PROGRAM DURING THE PROJECT GRADING AND/OR CONSTRUCTION ACTIVITIES. THE PROGRAM SHALL MEET ALL APPLICABLE REQUIREMENTS OF THE STATE WATER RESOURCE CONTROL BOARD AND THE CITY OF SAN DIEGO MUNICIPAL CODE AND STORM WATER STANDARDS MANUAL.
- "PUBLIC IMPROVEMENT SUBJECT TO DISBURSE OF DAMAGE": IF REPAIR OR REPLACEMENT OF SUCH PUBLIC IMPROVEMENTS IS REQUIRED, THE OWNER SHALL OBTAIN THE REQUIRED PERMITS FOR WORK IN THE PUBLIC RIGHT-OF-WAY SATISFACTORY TO THE PERMITTING AGENCY.
- ALL EXISTING AND/OR PROPOSED PUBLIC UTILITY SYSTEM AND SERVICE FACILITIES SHALL BE INSTALLED UNDERGROUND IN ACCORDANCE WITH SECTION 144.0400 OF THE MUNICIPAL CODE.
- PRIOR TO ANY DISTURBANCE TO THE SITE, EXCLUDING UTILITY MARK-OUTS AND SURVEYING, THE CONTRACTOR SHALL MAKE ARRANGEMENTS FOR A PRE-CONSTRUCTION MEETING WITH THE CITY OF SAN DIEGO FIELD ENGINEERING DIVISION (FSD) 627-3200.
- DEVIATIONS FROM THESE SIGNED PLANS WILL NOT BE ALLOWED UNLESS A CONSTRUCTION CHANGE IS APPROVED BY THE CITY ENGINEER OR THE CHANGE IS REQUIRED BY THE CITY INSPECTOR.
- AS-BUILT DRAWINGS MUST BE SUBMITTED TO THE RESIDENT ENGINEER PRIOR TO ACCEPTANCE OF THIS PROJECT BY THE CITY OF SAN DIEGO.
- AN AS-GRADED GEOTECHNICAL REPORT AND A SET OF THE REGRADE GRADING PLANS SHALL BE SUBMITTED AT AREA 3 ON THE 3RD FLOOR OF DEVELOPMENT SERVICES WITHIN 30 CALENDAR DAYS OF THE COMPLETION OF GRADING. AN ADDITIONAL SET SHALL BE PROVIDED TO THE RESIDENT ENGINEER OF THE FIELD ENGINEERING DIVISION AT 9450 ACED DR.
- THE AREA WHICH IS DEFINED AS A NON GRADING AREA AND WHICH IS NOT TO BE DISTURBED SHALL BE STAIRED PRIOR TO START OF THE WORK. THE PERMIT APPLICANT AND ALL OF THEIR REPRESENTATIVES OR CONTRACTORS SHALL COMPLY WITH THE REQUIREMENTS FOR PROTECTION OF THIS AREA AS REQUIRED BY ANY APPLICABLE AGENCY. ISSUANCE OF THE CITY'S GRADING PERMIT SHALL NOT RELIEVE THE APPLICANT OR ANY OF THEIR REPRESENTATIVES OR CONTRACTORS FROM COMPLYING WITH ANY STATE OR FEDERAL REQUIREMENTS BY AGENCIES INCLUDING BUT NOT LIMITED TO CALIFORNIA REGIONAL WATER QUALITY CONTROL BOARD, CALIFORNIA DEPARTMENT OF FISH AND GAME, COMPLIANCE MAY INCLUDE OBTAINING PERMITS, OTHER AUTHORIZATIONS, OR COMPLIANCE WITH MANDATES BY ANY APPLICABLE STATE OR FEDERAL AGENCY.
- CONTRACTOR SHALL REMOVE AND REPLACE ALL UTILITY BODIES SERVING AS HANDHOLES THAT ARE NOT IN "AS-NEW" CONDITION IN PROPOSED SIDEWALK DIMENSIONED BODIES, OR THOSE THAT ARE NOT IN COMPLIANCE WITH CURRENT CODE SHALL BE REMOVED AND REPLACED WITH NEW BODIES, INCLUDING WATER, SEWER, TRAFFIC SIGNALS, STREET LIGHTS, BICYCLE-SIGNAL, COX, ETC. ALL NEW METAL LIDS SHALL BE SLIP RESISTANT (PROTRUSION FACTOR >= 1.00) AND INSTALLED FLUSH WITH PROPOSED SIDEWALK GRADE. IF A SLIP RESISTANT METAL LID IS NOT COMMERCIALY AVAILABLE FOR THAT USE, NEW BODIES AND LIDS SHALL BE INSTALLED.

## GRADING PLANS FOR: PROJECT NAME

### OWNER/APPLICANT

OWNER/APPLICANT NAME  
OWNER/APPLICANT COMPLETE ADDRESS  
OWNER/APPLICANT PHONE NUMBER

### REFERENCE DRAWINGS

REFERENCE DRAWING DESCRIPTION DRAWING NUMBER

### SITE ADDRESS

INCLUDE COMPLETE ADDRESS IF APPLICABLE

### TOPOGRAPHY SOURCE

TOPO SOURCE COMPANY WITH COMPLETE ADDRESS  
TOPO SOURCE METHOD (I.E. A.L.T.A., PHOTOGRAMMETRY, ETC.)  
TOPO SOURCE DATE (MUST BE < 3 YEARS AGO)

### BENCHMARK

THIS BENCHMARK MUST BE TAKEN FROM THE CITY OF SAN DIEGO VERTICAL CONTROL BOOK

### TOTAL DISTURBED AREA

TOTAL SITE DISTURBED AREA IN ACRES IS REQUIRED FOR STORM WATER PURPOSES

### GRADING QUANTITIES

GRADED AREA \_\_\_\_\_ XXXX [ACRES] MAX. CUT DEPTH \_\_\_\_\_ [FT]  
CUT QUANTITIES \_\_\_\_\_ XXXX [CY] MAX. CUT SLOPE RATIO (2:1MAX) \_\_\_\_\_  
FILL QUANTITIES \_\_\_\_\_ XXXX [CY] MAX. FILL DEPTH \_\_\_\_\_ [FT]  
IMPORT/EXPORT \_\_\_\_\_ XXXX [CY] MAX. FILL SLOPE RATIO (2:1MAX) \_\_\_\_\_

### ASSESSORS PARCEL NUMBER

AS STATED ON RECORDED DOCUMENT

### EXISTING LEGAL DESCRIPTION

AS STATED ON RECORDED DOCUMENT IF SUBDIVISION/CONSOLIDATION IS NOT INCLUDED  
RENDER PROPOSED LEGAL DESCRIPTION HEARING A TEST

### PROPOSED LEGAL DESCRIPTION

PROVIDE PROPOSED LEGAL DESCRIPTION WITH A PROVISION FOR A MAP NUMBER TO BE AS-BUILT OR ADDED AS PART OF A CONSTRUCTION CHANGE.

### SHEET INDEX

SHEET DESCRIPTION SHEET RANGE

### PRIVATE WATER AND WASTEWATER

THE PRIVATE WATER/SEWER SYSTEM IS DESIGNED IN ACCORDANCE WITH THE CALIFORNIA PLUMBING CODE AND IS SHOWN ON THESE PLANS AS "FORMATION ONLY". A SEPARATE PLUMBING PERMIT IS REQUIRED FOR CONSTRUCTION AND INSPECTION OF THE SYSTEM.

### TRAFFIC CONTROL NOTE

(DELETE IF GREATER THAN 5000 SQ FT)

THE CONTRACTOR SHALL SUBMIT A TRAFFIC CONTROL PLAN (11"X17") FOR APPROVAL PRIOR TO STARTING WORK. THE PLAN SHOULD BE SUBMITTED TO THE TRAFFIC CONTROL PERMIT COORDINATOR, 3RD FLOOR, ROOM 302, LAND DEVELOPMENT REVIEW DIVISION, DEVELOPMENT SERVICES CENTER, 1222 FIRST AVENUE, SAN DIEGO (619-446-5500). CONTRACTOR SHALL OBTAIN A TRAFFIC CONTROL PERMIT A MINIMUM OF TWO (2) WORKING DAYS PRIOR TO STARTING WORK, AND A MINIMUM OF FIVE (5) DAYS IF WORK WILL AFFECT A BUS STOP OR AN EXISTING TRAFFIC SIGNAL, OR IF WORK WILL REQUIRE A ROAD OR ALLEY CLOSURE.

### GRADING & GEOTECHNICAL SPECIFICATIONS

- ALL GRADING SHALL BE DONE UNDER OBSERVATION AND TESTING BY A QUALIFIED CIVIL ENGINEER OR GEOTECHNICAL ENGINEER AND, IF REQUIRED, BOTH A QUALIFIED CIVIL ENGINEER OR GEOTECHNICAL ENGINEER AND AN ENGINEERING GEOLOGIST. ALL GRADING MUST BE PERFORMED IN ACCORDANCE WITH APPLICABLE CITY ORDINANCE AND THE RECOMMENDATIONS AND SPECIFICATIONS SET FORTH IN THE SOILS REPORT OR GEOLOGICAL/GEOENGINEERING INVESTIGATION ENTITLED:
 

(PROJECT FILE)	FOR	(PROJECT FILE)
PREPARED BY _____	(COMPANY NAME)	DATED: (MM/DD/YYYY)
- ALL FILL MATERIAL SHALL BE COMPACTED TO A MINIMUM OF 90% OF THE MAXIMUM DRY DENSITY AS DETERMINED BY THE MOST RECENT VERSION OF A.S.T.M. D-1557 OR AN APPROVED ALTERNATE STANDARD.
- AT THE COMPLETION OF THE GRADING OPERATIONS FOR THE EARTHWORK SHOWN ON THIS PLAN, AN AS-GRADED SOILS REPORT OR, IF REQUIRED, AN AS-GRADED SOILS AND GEOTECHNICAL REPORT WILL BE PREPARED IN ACCORDANCE WITH THE MOST RECENT EDITION OF THE CITY OF SAN DIEGO TECHNICAL GUIDELINES FOR GEOTECHNICAL REPORTS. THE FINAL "AS-GRADED" GEOTECHNICAL REPORT WILL BE SUBMITTED TO THE FIELD ENGINEERING SECTION OF PUBLIC WORKS AND A SECOND COPY TO THE GEOLOGY SECTION OF THE DEVELOPMENT SERVICES DEPARTMENT WITHIN 15 DAYS OF THE COMPLETION OF GRADING. WHERE GEOLOGIC INSPECTION IS INDICATED IN THE PERMIT OR PROJECT PLANS, REPORTS OR SPECIFICATIONS, THE FINAL REPORT MUST ALSO BE REVIEWED AND SIGNED BY A CALIFORNIA CERTIFIED ENGINEERING GEOLOGIST.
- IF THE GEOTECHNICAL CONSULTANT OF RECORD IS CHANGED FOR THE PROJECT, THE WORK SHALL BE STOPPED UNTIL THE REPLACEMENT HAS AGREED IN WRITING TO ACCEPT THE RESPONSIBILITY WITHIN THE AREA OF THEIR TECHNICAL COMPETENCE FOR APPROVAL UPON COMPLETION OF THE WORK. IT SHALL BE THE DUTY OF THE PERMITTEE TO NOTIFY THE CITY ENGINEER AND THE LAND REGULATION SECTION OF THE DEVELOPMENT SERVICES DEPARTMENT IN WRITING OF SUCH CHANGE PRIOR TO THE RECOMMENCEMENT OF GRADING.
- THESE GRADING PLANS HAVE BEEN REVIEWED BY THE UNDERSIGNED AND FOUND TO BE IN CONFORMANCE WITH THE RECOMMENDATIONS AND SPECIFICATIONS CONTAINED IN THE REFERENCED GEOTECHNICAL REPORT(S) PREPARED FOR THIS PROJECT.
 

(SIGNATURE)	R.C.E. OR G.E.	DATE
ENGINEER'S NAME _____		
(SIGNATURE)	C.E.G.	DATE
GEOLOGIST'S NAME _____		
- FOR SOIL FILE SEE CITY RECORDS - XXXXXX

### DECLARATION OF RESPONSIBLE CHARGE

I HEREBY DECLARE THAT I AM THE ENGINEER OF WORK FOR THIS PROJECT, THAT I HAVE EXERCISED RESPONSIBLE CHARGE OVER THE DESIGN OF THE PROJECT AS DEFINED IN SECTION 6705 OF THE BUSINESS AND PROFESSIONS CODE, AND THAT THE DESIGN IS CONSISTENT WITH CURRENT STANDARDS.

I UNDERSTAND THAT THE CHECK OF PROJECT DRAWINGS AND SPECIFICATIONS BY THE CITY OF SAN DIEGO IS CONFINED TO A REVIEW ONLY AND DOES NOT RELIEVE ME, AS ENGINEER OF WORK, OF MY RESPONSIBILITIES FOR PROJECT DESIGN.

COMPANY NAME \_\_\_\_\_  
COMPANY ADDRESS \_\_\_\_\_  
COMPANY PHONE \_\_\_\_\_  
COMPANY FAX \_\_\_\_\_  
COMPANY EMAIL \_\_\_\_\_

NAME \_\_\_\_\_ R.C.E. NO. XXXXXX EXP. XX-XX-XX DATE \_\_\_\_\_

### POST-CONSTRUCTION PERMANENT BMP OPERATION & MAINTENANCE PROCEDURE DETAILS

STORM WATER MANAGEMENT AND DISCHARGE CONTROL MAINTENANCE AGREEMENT APPROVAL:

\_\_\_\_\_ (SIGNATURE) \_\_\_\_\_ (PRINT NAME)  
BMP RESPONSIBLE PARTY DESIGNER, PROPERTY OWNER / HOA / CITY / OTHER

BMP DESCRIPTION	INSPECTION FREQUENCY	MAINTENANCE FREQUENCY	MAINTENANCE METHOD	SHEET NUMBER(S)
SITE DESIGN				
EROSION CONTROL				
TREATMENT CONTROL				

### CONSTRUCTION CHANGE TABLE

CHANGE	DATE	EFFECTED OR ADDED SHEET NUMBERS	APPROVAL NO.	WARNING
				0 1/2 1

REMOVE THIS NOTE AFTER INSTRUCTIONS WITHIN THE IMPROVEMENT FORMAT SHEET ( ? ) HAVE BEEN READ IN THEIR ENTIRETY.

### STREET DATA TABLE

STREET NAME	CLASSIFICATION	SPEED (MPH)	ADT (VEHICLES)	R/W (FT)

### PLANS FOR THE CONSTRUCTION OF PROJECT NAME

BRIEF LEGAL DESCRIPTION

CITY OF SAN DIEGO, CALIFORNIA  
SHEET # OF XX SHEETS

I/O NO. PROJECT NO. \_\_\_\_\_

FOR CITY ENGINEER	DATE	V.I.M.
DESCRIPTION	DATE	DATE
ORIGINAL	XXX	
AS-BUILTS		

CONTRACTOR DATE STARTED \_\_\_\_\_  
INSPECTOR DATE COMPLETED \_\_\_\_\_

1-D

Figure 3-2 CIP Sample Border Project Title Block Breakdown

- 1 COVER SHEET TITLE BLOCK - PROJECT TITLE FOR CIP PROJECTS SHALL BE THE SAME AS THE TITLE OF THE PROJECT IN THE C.I.P. BUDGET BOOK
- 2 DISCIPLINE DESIGNATORS - OPTIONAL, AS SHOWN ON THE COVER SHEET
- 3 SHEET XX OF YY SHEET - XX REPRESENTS THE INDIVIDUAL SHEET AND YY REPRESENTS THE TOTAL NUMBER OF SHEETS
- 4 WORK BREAKDOWN STRUCTURE (WBS) - OBTAIN AND PLACE THE (WBS)(S) IN THE APPROPRIATE BLOCK AS SHOWN
- 5 PROJECT MANAGER - NAME OF THE PROJECT MANAGER  
PRIVATE PROJECT PLANS: NA
- 6 PROJECT ENGINEER - NAME OF THE PROJECT ENGINEER  
PRIVATE PROJECT PLANS: NA
- 7 CCS27 COORDINATE - (NAD 27) THE COVER SHEET SHALL CALL OUT "SEE EACH SHEET" ON THIS BLOCK  
PRIVATE PROJECT PLANS: THESE NUMBERS ARE DETERMINED DURING PLAN CHECK BASED ON PTS MAP LAYERS
- 8 CCS83 COORDINATE - (NAD 83) THE SHEET COVER SHEET SHALL CALL OUT "SEE EACH SHEET" ON THIS BLOCK  
PRIVATE PROJECT PLANS: THESE NUMBERS ARE DETERMINED DURING PLAN CHECK BASED ON PTS MAP LAYERS
- 9 DRAWING NUMBER - OBTAIN FROM MAPS AND RECORDS IN DEVELOPMENT SERVICES
- 10 DEPUTY CITY ENGINEER - DEPUTIZED CITY ENGINEER WHO IS IN CHARGE OF THE PROJECT (DIGITAL SIGNATURE) SIGNS ON BEHALF OF THE CITY  
REGISTRATION: LEAVE BLANK IF IN-HOUSE DESIGN  
REGISTRATION: DEPUTY CITY ENGINEER'S RCE NUMBER
- 11 DESCRIPTION BLOCK - "ORIGINAL" BLOCK FOR DESIGN PROJECT, ADDENDUM "A", "B", ETC AND CONSTRUCTION CHANGE "1", "2", ETC., FOR CHANGES MADE DURING CONSTRUCTION, WHEN DOING AS-BUILTS, USE A TRIANGLE WITH A NUMBER INSIDE (SEE AS-BUILT PROCEDURES SECTION OF THIS MANUAL)
- 12 CHANGES MADE TO DRAWINGS DURING DESIGN DO NOT LEAD TO ANY REVISION NOTATIONS ON THE BORDER, THE DRAWING STATUS BLOCK IS FOR FORMAL CHANGES BY ADDENDUM DURING THE BID PHASE, CONSTRUCTION CHANGES DURING CONSTRUCTION AND FOR RECORDING AS-BUILTS INFORMATION PROJECT ENGINEER AND DRAFTER'S INITIALS WHO REVIEWED AND PREPARED THE AS-BUILT
- 13 DRAWN BY - WHEN ENTERING INITIALS, PLACE CITY DESIGN ENGINEER FIRST, THEN DRAFTER'S INITIALS OR THE INITIALS OF THE CONSULTANT'S COMPANY
- 14 APPROVED - THIS SECTION IS SIGNED WHEN ADDENDA AND CONSTRUCTION CHANGES ARE APPROVED BY THE DEPUTY CITY ENGINEER, AND THE AS-BUILT WILL BE SIGNED BY THE RESIDENT ENGINEER.
- 15 DATE - DATED BY THE DEPUTY CITY ENGINEER OR STAFF UNDER THEIR DIRECTION WHEN CHANGES ARE APPROVED
- 16 FILMED - WHEN THE PLANS ARE SUBMITTED TO MAPS AND RECORDS, THEY ARE FILMED AND DATED
- 17 FIELD INSPECTOR - PRINT NAME OF THE RESIDENT ENGINEER AFTER APPROVING AS-BUILTS, RESIDENT ENGINEER TO SIGN THE AUTHORIZATION FORM.
- 18 AS-BUILT INFORMATION - NAME OF CONTRACTOR, INSPECTOR AND THE DATES OF WHEN THE PROJECT STARTED AND ENDED
- 19 ENGINEER'S STAMP - DIGITAL SEAL/STAMP (SIGNATURE WITH ELECTRONIC SIGNATURE AUTHORIZATION FORM), CONSULTANT IN CHARGE OF WORK MUST BE WET/ORIGINAL ONLY ON MYLARS
- 20 PRIVATE PROJECT PLANS: SEAL/STAMP MUST BE WET/ORIGINAL ONLY ON MYLARS
- 21 ADD THE MANUFACTURER(S) OF ALL MATERIALS, INCLUDING REHAB.
- 22 PRIVATE PROJECT PLANS: NA
- 23 SPECIFICATIONS NO. - OBTAIN FROM CONTRACT PROCESSING  
PRIVATE PROJECT PLANS: NA
- 24 AS-BUILT INFORMATION FOR MATERIALS - REFER TO AS-BUILT PROCEDURES SECTION IN THIS MANUAL  
PRIVATE PROJECT PLANS: NA
- 25 PROGRAM IDENTIFICATION -
- 26 SCALE WARNINGS -
- 27 CHANGE - LINE WOULD HAVE THE LETTER (A, B, C, ETC.) SURROUNDED BY A TRIANGLE, WITH EACH LETTER A DIFFERENT SET OF CHANGES THROUGHOUT THE COURSE OF CONSTRUCTION, FOR PROCEDURES, REFER TO APPENDIX A, STANDARDS AND PROCEDURES FOR IMPROVEMENT PLANS.
- 28 DATE OF THE ADDENDUM AND/OR CONSTRUCTION CHANGE APPROVAL
- 29 AFFECTED OR ADDED SHEET NUMBERS - A CHANGE IS NOTED BY LISTING THE SHEET NUMBER(S)
- 30 APPROVAL NO. - NOT APPLICABLE FOR CIP PROJECTS
- 31 PRIVATE PROJECT PLANS: ASSIGNED APPROVAL NO. UPON PLAN REVIEW FOR PTS TRACKING PURPOSES

**COVER SHEET**

PLANS FOR THE CONSTRUCTION OF  
PROJECT TITLE  
COVER SHEET

CITY OF SAN DIEGO, CALIFORNIA  
PUBLIC WORKS DEPARTMENT  
SHEET XX OF YY SHEETS

WATER WBS 0-00000  
SEWER WBS 0-00000

APPROVED BY: \_\_\_\_\_ DATE: \_\_\_\_\_  
FOR CITY ENGINEER: \_\_\_\_\_ RCE#: \_\_\_\_\_  
PRINT DCE NAME: \_\_\_\_\_

DESCRIPTION	BY	APPROVED	DATE	FILMED
ORIGINAL	xx/xx	xx		
AS-BUILT	xx/xx	xx		

CONTRACTOR: \_\_\_\_\_ DATE STARTED: \_\_\_\_\_  
INSPECTOR: \_\_\_\_\_ DATE COMPLETED: \_\_\_\_\_

XXXXX-01-D

---

**AS-BUILT INFORMATION**

PLANS FOR THE CONSTRUCTION OF  
SEWER & WATER GROUP XYZ  
COVER SHEET

CITY OF SAN DIEGO, CALIFORNIA  
PUBLIC WORKS DEPARTMENT  
SHEET OF SHEETS

WATER WBS 0-00000  
SEWER WBS 0-00000

APPROVED BY: \_\_\_\_\_ DATE: \_\_\_\_\_  
FOR CITY ENGINEER: \_\_\_\_\_ RCE#: \_\_\_\_\_  
PRINT DCE NAME: \_\_\_\_\_

DESCRIPTION	BY	APPROVED	DATE	FILMED
ORIGINAL	xx/xx	xx		
AS-BUILT	xx/xx	xx		

CONTRACTOR: \_\_\_\_\_ DATE STARTED: \_\_\_\_\_  
INSPECTOR: \_\_\_\_\_ DATE COMPLETED: \_\_\_\_\_

XXXXX-00-D

CONSTRUCTION CHANGE / ADDENDUM			
CHANGE	DATE	AFFECTED OR ADDED SHEET NUMBERS	APPROVAL NO.

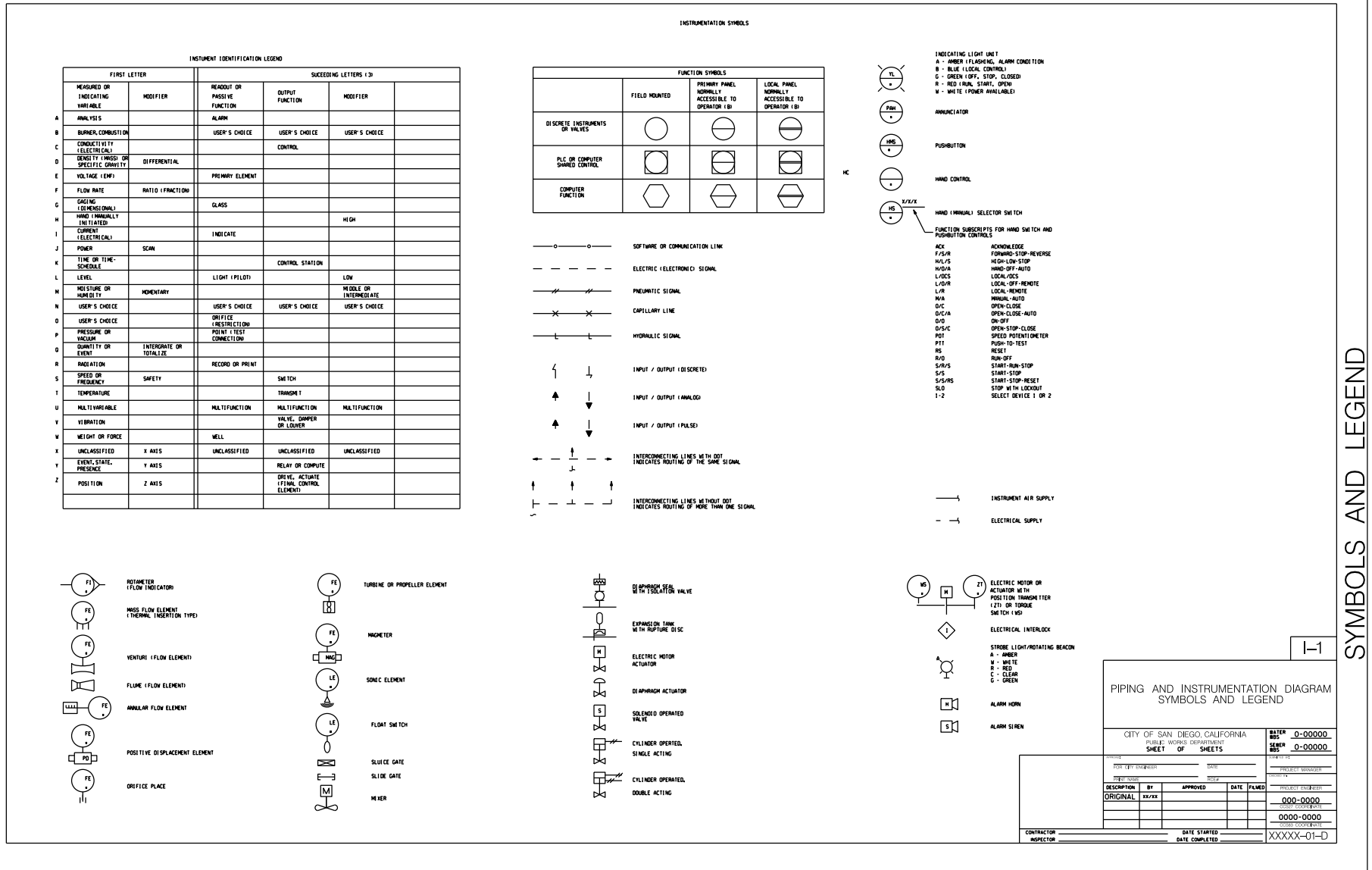
WARNING

0 1/2 1

IF THIS BAR DOES NOT MEASURE 1" THEN DRAWING IS NOT TO SCALE.



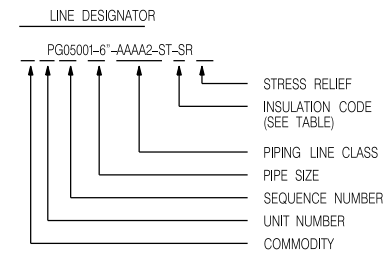
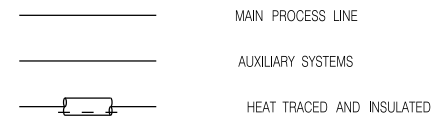
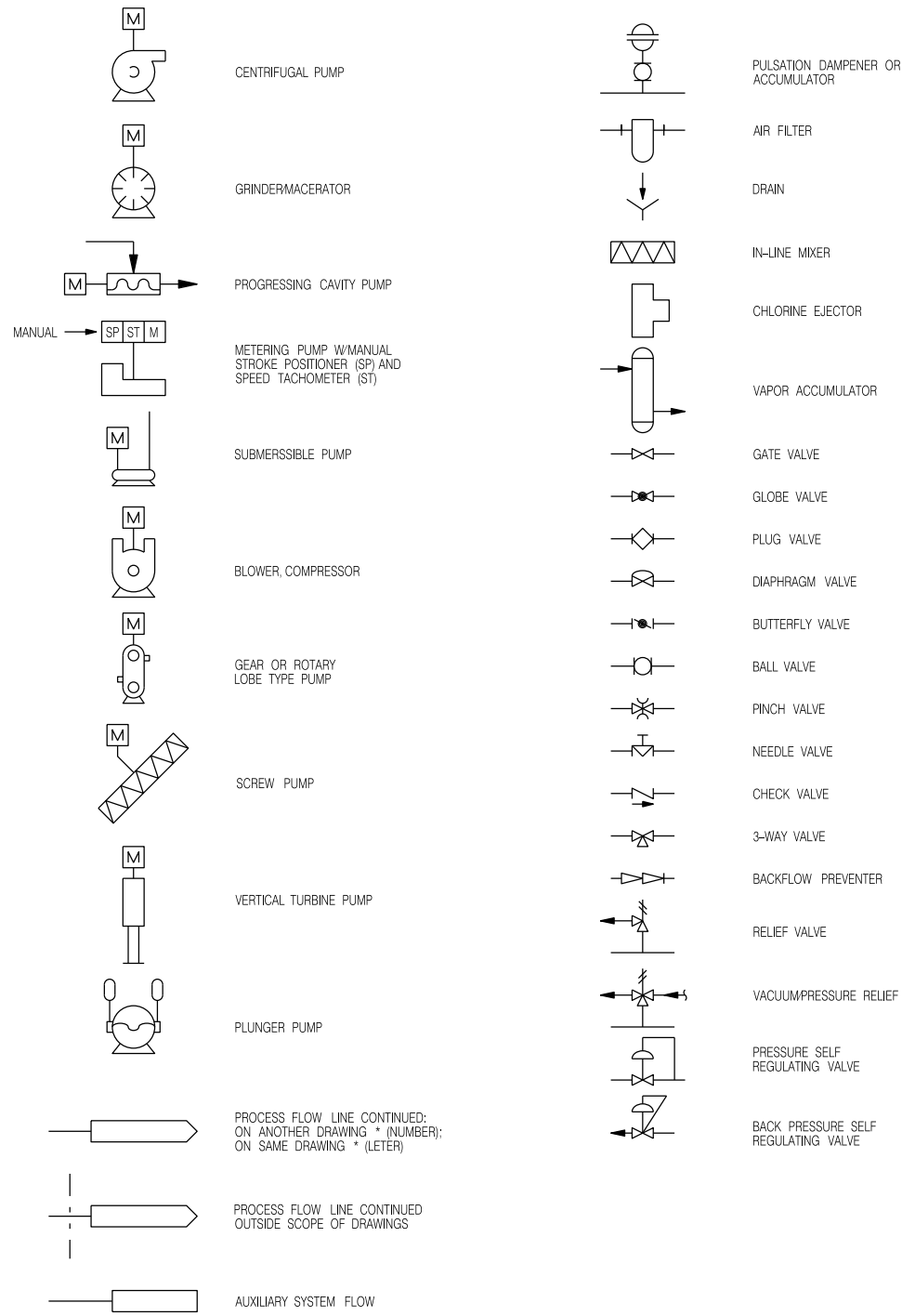
Figure 3-2 Piping & Instrumentation Diagram Symbols and Legend Sheet 1 Sample



SYMBOLS AND LEGEND

Figure 3-2 Piping & Instrumentation Diagram Symbols and Legend Sheet 2 Sample

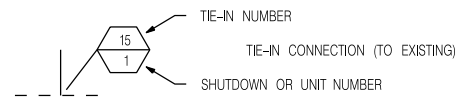
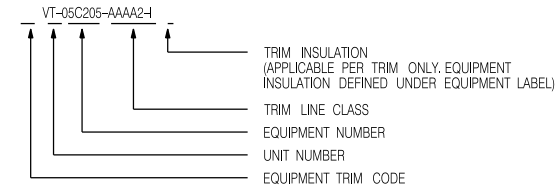
EQUIPMENT SYMBOLS



INSULATION TABLE

TYPE OF INSULATION	HOT	COLD
PROCESS CONTROL	I	IC
ENERGY CONSERVATION	IE	ICE
PERSONNEL PROTECTION	P	PC
ELECTRIC TRACED	ET	NA
STEAM TRACED	ST	NA
GLYCOL TRACED	GT	NA
NOISE ABATEMENT	A	AC
FIRE PROTECTION	F	ICF
TRACED FOR FREEZE PROTECTION	ETFSTFGTF	NA

EQUIPMENT TRIM DESIGNATOR



\* FURNISHED WITH EQUIPMENT



MISCELLANEOUS ABBREVIATIONS

AS	AIR SUPPLY
AVT	AUTOMATIC VENT TRAP
BD	BLOWDOWN
BF	BLIND FLANGE
BL	BATTERY LIMIT
CAD	CLOSED AMIN DRAIN
CBD	CONTINUOUS BLOWDOWN
CD	CLOSED DRAIN
CH-O	CHAIN OPERATED
CSC	CAR SEAL CLOSED
CSC	CAR SEAL OPEN
CWR	COOLING WATER RETURN
CWS	COOLING WATER SUPPLY
DC	DRAIN CONNECTION
EBD	EMERGENCY BLOWDOWN VALVE
ESD	EMERGENCY SHUTDOWN
FC	FAIL CLOSED
FO	FAIL OPEN
HC	HOSE CONNECTION
HOA	MANUAL STATION FOR SELECTION OF HAND (ON) - OFF - AUTOMATIC MODE OF OPERATION
IBD	INTERMITTENT BLOWDOWN
LC	LOCK CLOSED
LO	LOCK OPEN
ML	MANUAL LOADING
NC	NORMALLY CLOSED
NO	NORMALLY OPEN
OD	OPEN DRAIN
P	PERSONNEL PROTECTION
PO	PUMP OUT
QO	QUICK OPENING
SC	SAMPLE CONNECTION OR SPRING CLOSSES
SO	STEAM OUT OR SPRING OPENS
TSO	TIGHT SHUT OFF
VB	VACUUM BREAKER
WC	WATER COLUMN

I-2

PIPING AND INSTRUMENTATION DIAGRAM SYMBOLS AND LEGEND

CITY OF SAN DIEGO, CALIFORNIA  
PUBLIC WORKS DEPARTMENT  
SHEET OF SHEETS

DESCRIPTION	BY	APPROVED	DATE	FILED
ORIGINAL	xx/xx			

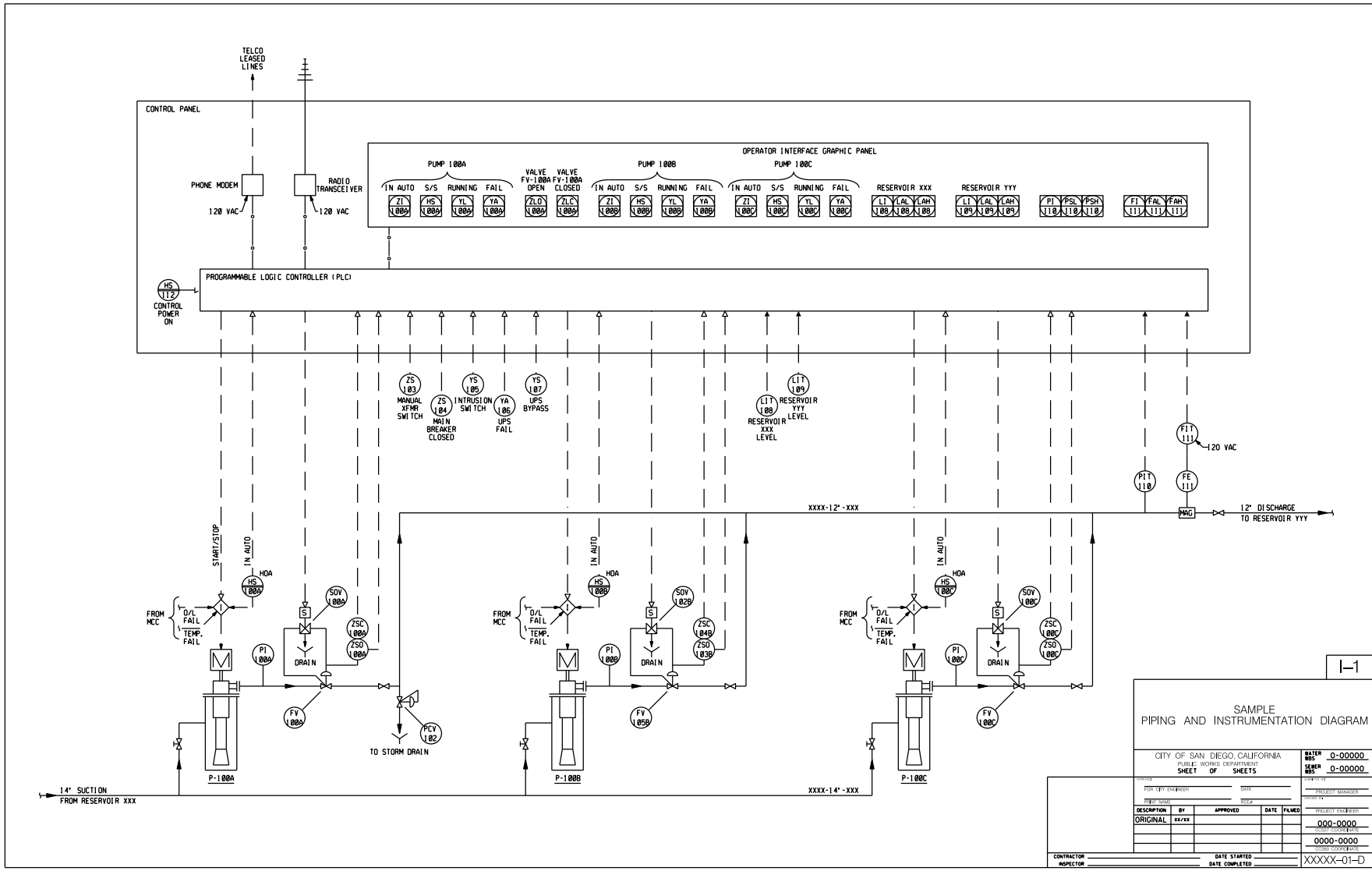
CONTRACTOR \_\_\_\_\_ DATE STARTED \_\_\_\_\_  
INSPECTOR \_\_\_\_\_ DATE COMPLETED \_\_\_\_\_

XXXXX-01-D

SYMBOLS AND LEGEND



Figure 3-3 Piping & Instrumentation Diagram Sheet Sample



PIPING AND INSTRUMENTATION DIAGRAM

SAMPLE PIPING AND INSTRUMENTATION DIAGRAM	
CITY OF SAN DIEGO, CALIFORNIA PUBLIC WORKS DEPARTMENT	
SHEET OF SHEETS	SHEET NO. 0-00000 SERIES NO. 0-00000
DATE: _____	PROJECT MANAGER: _____
BY: _____	DATE: _____
APPROVED: _____	DATE: _____
DESCRIPTION: _____	DATE: _____
ORIGINAL: _____	DATE: _____
CONTRACTOR: _____	DATE STARTED: _____
INSPECTOR: _____	DATE COMPLETED: _____

**PART 4**  
**STANDARD AND PROCEDURES**  
**FOR IMPROVEMENT PLANS**  
**(CITY PROJECTS)**

**SECTION I**

**COVER SHEET**

**&**

**TITLE BLOCK**

## COVER SHEET DESCRIPTION

1. **PROJECT TITLE** - Edit title of project at top of sheet and right hand border.
2. **WORK TO BE DONE** – Shall match the Scope of work in the Contract Documents (Specifications).
3. **LEGEND** – Shall include a list of some bid items and a listing of the standard drawings which will apply to construction. Delete those symbols on the Legend, which do not pertain to your project.
4. **EXISTING STRUCTURES** – This list includes symbols for existing water, sewer, storm drains and their appurtenances, existing surfaces, and various public utilities. This list covers most existing conditions and generally requires no change.
5. **TITLE BLOCK** – Refer to pages 110 and 111 for procedures.
6. **SHEET INDEX** – Fill out the information as listed in the first row of this table.  
If Rehabilitated Sewer Main is not part of the plans, add note to refer to the Contract Document Appendix and list the total length of sewer main to be Rehabilitated.  
For sewer pipe length, do not subtract diameter of manholes.
7. **DISCIPLINE CODE** - Delete the codes that do not apply to your project.
8. **BENCHMARK, FIELD NOTES, & DATUM** – Can be found within the survey files (electronic copy or hardcopy).
9. **STREETS REQUIRING 12" TRENCH CAP**– List the streets that require 12" Trench Cap.
10. **VICINITY MAP** – The project site shall be pointed out. Each vicinity map will have a north arrow and "No Scale."
11. **KEY MAP** – Use different symbols to delineate the type of mains being installed. (water, sewer, storm drain, rehab sewer main or storm drain) Include sheet numbers next to the alignment. Each key map shall have a north arrow, and a "No Scale."
12. **CONTRACTOR'S RESPONSIBILITIES** – Any special notes pertaining to the overall project shall be placed here. Delete the notes that do not apply to the project. Additional notes shall be approved by the Senior Engineer approving the plans.
13. **ABBREVIATIONS** – This list shall include any abbreviations included in the drawings.
14. **DECLARATION OF RESPONSIBLE CHARGE** – To be signed and dated by consultant. Delete declaration note if consultant is not responsible for project design.
15. **STORM WATER PROTECTION** – Enter the following information based on Storm Water Requirements: Disturbance Area, Hydrologic Unit/Watershed, Hydrologic Subarea/No. WPCP or SWPPP, Risk Level/Type and Construction Site priority.
16. **COVER SHEET DESIGN**– There are two Cover Sheet Designs, the single page Cover Sheet and the two page Cover Sheet. The single page Cover Sheet can be used on majority of the projects. For larger or more complicated projects, the two page Cover Sheet is also available.

**CONTRACTOR'S RESPONSIBILITIES**

- PURSUANT TO SECTION 4216 OF THE GOVERNMENT CODE, AT LEAST 2 WORKING DAYS PRIOR TO EXCAVATION, YOU MUST CONTACT THE REGIONAL NOTIFICATION CENTER (E.G. UNDERGROUND SERVICE ALERT OF SOUTHERN CALIFORNIA) AND OBTAIN AN INQUIRY IDENTIFICATION NUMBER.
- NOTIFY SDG&E AT LEAST 10 WORKING DAYS PRIOR TO EXCAVATING WITHIN 10' OF SDG&E UNDERGROUND HIGH VOLTAGE TRANSMISSION POWER LINES, (I.E., 69 KV & HIGHER)
- LOCATE AND RECONNECT ALL SEWER LATERALS. LOCATIONS AS SHOWN ON THE PLANS ARE APPROXIMATE ONLY; LATERAL RECORDS ARE AVAILABLE TO THE CONTRACTOR AT THE WATER DEPARTMENT, 2797 CAMINITO CHOLLAS. LOCATE THE IMPROVEMENTS THAT WILL BE AFFECTED BY LATERAL REPLACEMENTS.
- EXCAVATE AROUND WATER METER BOX (CITY PROPERTY SIDE) TO DETERMINE IN ADVANCE, THE SIZE OF EACH SERVICE BEFORE TAPPING MAIN.
- CITY FORCES, WHEN SPECIFIED OR SHOWN ON THE PLANS, WILL MAKE PERMANENT CUTS & PLUGS AND CONNECTIONS.
- KEEP EXISTING MAINS IN SERVICE IN LIEU OF HIGH-LINING, UNLESS OTHERWISE SPECIFIED SHOWN ON PLANS.
- THE LOCATIONS OF EXISTING BUILDINGS AS SHOWN ON THE PLAN ARE APPROXIMATE.
- STORM DRAIN INLETS SHALL REMAIN FUNCTIONAL AT ALL TIMES DURING CONSTRUCTION.
- UNLESS OTHERWISE NOTED AS PREVIOUSLY POTHOLED (PH), ELEVATIONS SHOWN ON THE PROFILE FOR EXISTING UTILITIES ARE BASED ON A SEARCH OF THE AVAILABLE RECORD INFORMATION ONLY AND ARE SOLELY FOR THE CONTRACTOR'S CONVENIENCE. THE CITY DOES NOT GUARANTEE THAT IT HAS REVIEWED ALL AVAILABLE DATA; THE CONTRACTOR SHALL POTHOLE ALL EXISTING UTILITIES EITHER SHOWN ON THE PLANS OR MARKED IN THE FIELD IN ACCORDANCE WITH THE SPECIFICATIONS SECTION 5-UTILITIES.
- EXISTING UTILITY CROSSING AS SHOWN ON THE PLANS ARE APPROXIMATE AND ARE NOT REPRESENTATIVE OF ACTUAL LENGTH AND LOCATION OF CONFLICT AREAS. SEE PLAN VIEW.
- ALL ADVANCE METERING INFRASTRUCTURE (AMI) DEVICES ATTACHED TO THE WATER METER OR LOCATED IN OR NEAR WATER METER BOXES, COFFINS, OR VAULTS SHALL BE PROTECTED AT ALL TIMES IN ACCORDANCE WITH THE CONTRACT DOCUMENT.

**CONSTRUCTION STORM WATER PROTECTION NOTES**

- TOTAL SITE DISTURBANCE AREA (ACRES) \_\_\_\_\_  
HYDROLOGIC UNIT / WATERSHED \_\_\_\_\_  
HYDROLOGIC SUBAREA NAME & NO. \_\_\_\_\_
- THE CONTRACTOR SHALL COMPLY WITH THE REQUIREMENTS OF THE  
 WPCP  
THE PROJECT IS SUBJECT TO MUNICIPAL STORM WATER PERMIT NO. R9-2013-0001 AS AMENDED BY R9-2015-0001 AND R9-2015-0100  
 SWPPP  
THE PROJECT IS SUBJECT TO MUNICIPAL STORM WATER PERMIT NO. R9-2013-0001 AS AMENDED BY R9-2015-0001 AND R9-2015-0100 AND CONSTRUCTION GENERAL PERMIT ORDER 2009-0009-DW0 AS AMENDED BY ORDER 2010-0014-DW0 AND 2012-0006-DW0  
TRADITIONAL RISK LEVEL  1  2  3  
LUP: RISK TYPE  1  2  3

3. CONSTRUCTION SITE PRIORITY  
 ASBS  HIGH  MEDIUM  LOW

**ABBREVIATIONS**

ABAND	ABANDON	EL, ELEV	ELEVATION	OVHD	OVER HEAD
ABAND'D	ABANDONED	ELEC	ELECTRIC	PVC	POLYVINYL CHLORIDE
AC	ASBESTOS CEMENT PIPE	EX, EXIST	EXISTING	PROP	PROPOSED
AHD	AHEAD	E, EAST	EAST OF	RED	REDUCER
ASSY	ASSEMBLY	F	FLANGE	RT	RIGHT
BFV	BUTTERFLY VALVE	FH	FIRE HYDRANT	S	SURVEY LINE
BK	BACK	FS	FIRE SERVICE	SD&AE	SAN DIEGO & ARIZONA EASTERN RAILROAD
BTWN	BETWEEN	GV	GATE VALVE	SDTI	SAN DIEGO TROLLEY INC.
CATV	CABLE TV	HDPE	HIGH-DENSITY POLYETHYLENE	SO	STUB OUT
CI	CAST IRON PIPE	HP	HIGH PRESSURE	S/O	SOUTH OF
C	CENTER LINE	IE	INVERT ELEVATION	SWR	SEWER
COND	CONDUIT	LT	LEFT	TEL	TELEPHONE
CONT	CONTINUED	MJ	MECHANICAL JOINT	UNK	UNKNOWN
CONTR	CONTRACTOR	VC	VITRIFIED CLAY PIPE	W	WATER
DB	DIRECT BURIED	MTS	METROPOLITAN TRANSIT SYSTEM	WM	WATER METER
DI	DUCTILE IRON	MTD	MULTIPLE TELEPHONE DUCT	WTR	WATER
EB	ENCASED BURIED	N/O	NORTH OF	W/O	WEST OF

**EXISTING STRUCTURES**

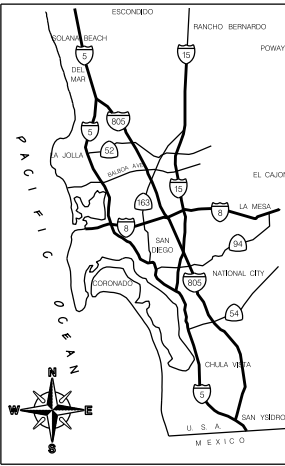
EX WATER MAIN & VALVES	
EX WATER METER	
EX FIRE HYDRANT	
EX SEWER MAIN & MANHOLES	
EX DRAINS	
EX PAVEMENT (PROFILE)	
EX GROUND LINE (PROFILE)	
EX TRAFFIC SIGNAL	
EX STREET LIGHT	
GAS MAIN	
ELEC. COND., TEL. COND., CATV	
RAILROAD, TROLLEY TRACKS	

4

# PROJECT TITLE

**SHEET INDEX**

SHEET NO.	DISCIPLINE CODE	TITLE	LIMITS	PIPE		LENGTH (FT)
				SIZE (IN)	MATERIAL	
1	G-1	COVER SHEET				
2	C-1	NAME STREET	NAME STREET TO NAME AVENUE	-	-	000.00
3	C-2	NAME AVENUE	NAME ROAD TO NAME BOULEVARD	-	-	000.00
SEWER						
4	C-3	NAME ROAD	NAME STREET TO NAME AVENUE	-	-	000.00
5	C-4	NAME BOULEVARD	NAME ROAD TO NAME BOULEVARD	-	-	00.00
WATER						
REHABILITATED SEWER MAIN PART OF CONTRACT DOCUMENTS						
STREET RESURFACING				TOTAL SEWER		
CURB RAMP LOCATION				TOTAL WATER		
CITY FORCES						
MISC DETAILS						
•PERMANENT STORM WATER BEST MANAGEMENT PRACTICES (BMP) -STANDARD DEVELOPMENT PROJECTS						
•PERMANENT STORM WATER BEST MANAGEMENT PRACTICES (BMP) -PRIORITY DEVELOPMENT PROJECTS						
T-1		TRAFFIC PLANS				



VICINITY MAP  
NOT TO SCALE

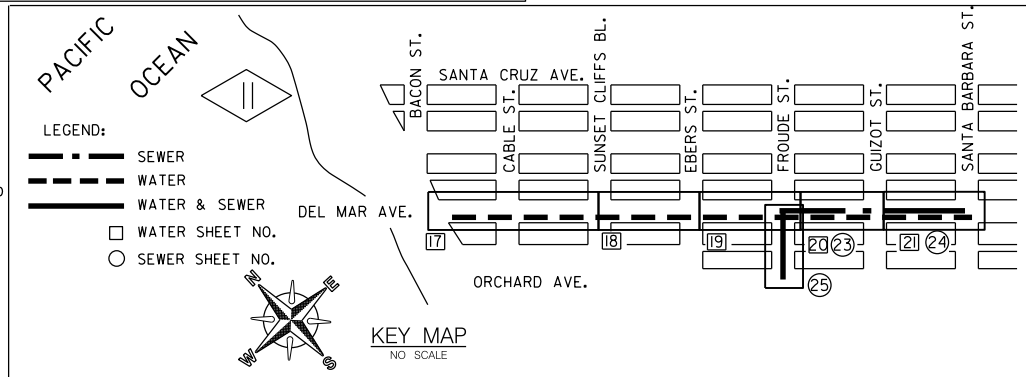
**DISCIPLINE CODE**

G	GENERAL
D	DEMOLITION
C	CIVIL
L	LANDSCAPE
A	ARCHITECTURAL
S	STRUCTURAL
M	MECHANICAL
E	ELECTRICAL
I	INSTRUMENTATION
T	TRAFFIC CONTROL

7

10

\* PROJECT SHOULD CHOOSE FROM STANDARD AND PRIORITY, AS APPLICABLE TO THE PROJECT.  
**DELETE THIS NOTE AFTER REVIEWING THE TASK ABOVE**



KEY MAP  
NO SCALE

11

\* IF NO CONSULTANT ON THIS PROJECT; DELETE ENGINEER'S RESPONSIBILITIES.  
**DELETE THIS NOTE AFTER REVIEWING THE TASK BELOW**

**DECLARATION OF RESPONSIBLE CHARGE**

\* I HEREBY DECLARE THAT I AM THE ENGINEER OF WORK FOR THIS PROJECT THAT I HAVE EXERCISED RESPONSIBLE CHARGE OVER THE DESIGN OF THE PROJECT AS DEFINED IN SECTION 6703 OF THE BUSINESS AND PROFESSIONS CODE AND THAT THE DESIGN IS CONSISTENT WITH CURRENT STANDARDS. I UNDERSTAND THAT THE CHECK OF PROJECT DRAWINGS AND SPECIFICATIONS BY THE CITY OF SAN DIEGO IS CONFINED TO A REVIEW ONLY AND DOES NOT RELIEVE ME, AS ENGINEER OF WORK, OF MY RESPONSIBILITIES FOR PROJECT DESIGN.

KEY MAP  
NO SCALE

**FIELD DATA**

BENCHMARK:  
FIELD NOTES:  
DATUM: MEAN SEA LEVEL  
STREETS REQUIRING 12" TRENCH CAP:  
•STREET NAMES•

14

8

9

**LEGEND**

IMPROVEMENTS	REFERENCE	SYMBOL
TRENCH RESURFACING	SDG-107, SDG-108	
SEWER MAIN	SDS-101, SDS-110 (TYPE C)	
SEWER MANHOLE/PVC LINED	SDS-106, SDS-107, SDS-108, SDS-113, SDS-120, M-3, SM-07	
REHAB. EX. SEWER MANHOLE	SEE PLANS & SPECS	
SEWER MAIN REHAB.	SEE PLANS & SPECS	
4" SEWER LATERAL WITH C.O. UNLESS OTHERWISE SPECIFIED	SDS-102, SDS-103, SDS-104, SDS-105, SDS-110 (TYPE C), SDS-118	
REPLUMB SEWER LATERAL WITH C.O.	SDS-102, SDS-103, SDS-104, SDS-105, SDS-110 (TYPE C), SDS-118	
SEWER LATERAL CONNECTION	SEE PLANS & SPECS	
REHAB SEWER LATERAL (LINED) WITH C.O.	SEE PLANS & SPECS	
SERVICE LATERAL CONNECTION TO REHABILITATED SEWER	SEE PLANS & SPECS	
SEWER PUMP INCLUDING REPLUMB SEWER LATERAL WITH C.O.	SDS-102, SDS-103, SDS-104, SDS-105, SDS-110 (TYPE C), SDS-118	
TUNNEL SEWER REPLUMB LATERAL WITH C.O.	SDS-102, SDS-103, SDS-104, SDS-105	
CONCRETE PROTECTION FOR EXIST SEWER PIPE	SDS-116	
PIPE SUPPORT FOR UNDERCUT AC WATER MAIN	SDW-162	
CONCRETE ENCASUREMENT	SDS-112	
ABANDON EX MANHOLE	SM-08	
SLURRY FILL ABANDONED SEWER MAIN	SEE PLANS & SPECS	
CUTTING AND PLUGGING ABANDONED WATER MAIN	WP-03	
SURVEY MONUMENT	M-10, M-10A, M-10B	
WATER MAIN & APPURTENANCES	SDM-105, SDW-110, SDW-151, SDW-161	
VALVES WITH CAPS AND WELLS	SDW-109, SDW-152, SDW-153, WV-05	
FIRE SERVICE CONNECTION & ASSEMBLY	SDM-105, SDW-109, SDW-118, SDW-152, SDW-153	
6" FIRE HYDRANT ASSEMBLY & MARKER 2-PORT UNLESS SPECIFIED AS 3-PORT	SDM-105, SDW-104, SDW-109, SDW-152, SDW-153	
1" WATER SERVICE UNLESS OTHERWISE SPECIFIED	SDM-105, SDW-107, SDW-134, SDW-135, SDW-136, SDW-137, SDW-138, SDW-149, SDW-150, WS-03	
WATER SERVICE TRANSFER	SDW-149, SDW-150	
BLOW-OFF ASSEMBLY	SDM-105, SDW-106, SDW-143, SDW-144, SDW-145, SDW-146, WB-05,	
AIR & VACUUM VALVE	SDM-105, SDW-117, SDW-158, SDW-159, SDW-160	
HIGHLIGHTING BY CONTRACTOR	SDW-170, SDW-171, SDW-172, SDW-173	

G-1

**PLANS FOR THE CONSTRUCTION OF PROJECT TITLE COVER SHEET**

CITY OF SAN DIEGO, CALIFORNIA PUBLIC WORKS DEPARTMENT SHEET OF SHEETS		WATER WBS 0-00000 SEWER WBS 0-00000
FOR CITY ENGINEER	DATE	PROJECT MANAGER
PRINT DCE NAME	TICE#	PROJECT ENGINEER
DESCRIPTION	BY	APPROVED
ORIGINAL	xx/xx	DATE
		DATE
		DATE
CONTRACTOR	DATE STARTED	XXXXX-01-D
INSPECTOR	DATE COMPLETED	

5

**AS-BUILT INFORMATION**

MATERIALS	MANUFACTURER
PIPE CL 235 (WATER)	-
PIPE SDR 35 (SEWER)	-
GATE VALVES	-
FIRE HYDRANTS	-
SEWER MANHOLES	-
REHABILITATE SEWER MANHOLES	-
REHABILITATE SEWER MAIN	-

CONSTRUCTION CHANGE / ADDENDUM			
CHANGE	DATE	AFFECTED OR ADDED SHEET NUMBERS	APPROVAL NO.

**WARNING**  
IF THIS BAR DOES NOT MEASURE 1" THEN DRAWING IS NOT TO SCALE.



PROJECT TITLE (FOR SMALL PROJECT ONLY)

## **COVER SHEET TITLE BLOCK DESCRIPTION**

1. **COVER SHEET TITLE BLOCK** - Project title for CIP projects shall be the same as the title of the project in the CIP budget book.
2. **DISCIPLINE DESIGNATORS** – Project should be the same as from the discretionary and the title on the top of the D-sheet.
3. **SHEET XX OF YY SHEET** - XX represents the individual sheet and YY represents the total number of sheets including any drawings.
4. **WORK BREAKDOWN SYSTEM (WBS) NUMBER** - Obtain and place the number(s) in the appropriate block as shown for water and sewer as applicable.
5. **PROJECT MANAGER** - Name of the Project Manager.
6. **PROJECT ENGINEER** - Name of the Project Engineer.
7. **CCS27 COORDINATE** - (NAD 27): The sheet cover sheet shall call out "SEE EACH SHEET" shall be placed in this location.
8. **CCS83 COORDINATE** - (NAD 83): The sheet cover sheet shall call out "SEE EACH SHEET" shall be placed in this location.
9. **DRAWING NUMBER** - Contact Development Services Department's Maps and Records section for the D-sheet number. To request a "Drawing Number" email [DSD DrawingnumberReq@sanidiego.gov](mailto:DSD_DrawingnumberReq@sanidiego.gov) and provide the Project's W.B.S. Number, cost Center Number, Project Engineer's name and Project Title.
10. **FOR CITY ENGINEER** - Deputized City Engineer who is in Charge of the Project (Digital Signature) signs on behalf of the City Engineer.
11. **DESCRIPTION BLOCK** - "ORIGINAL" block for design project, CHANGE "1", "2", etc. in triangle, for changes made during construction and ADDENDUM "A", "B", etc. in triangle for changes made during advertising of projects. When doing as-builts, use a triangle with a number inside (see As-Built Procedures Section).
12. **DRAWN BY** - when entering initials, place design engineer first, then drafter's initials or the initials of the consultant's company.
13. **APPROVED** - This section is filled when changes are made to the original drawing. Signatures by the Deputy City Engineer or staff under their direction.
14. **DATE** - Dated by the Deputy City Engineer or staff under their direction when changes are approved.

15. **FILMED** - When the plans are submitted to DSD Maps and Records Section, they are filmed and dated.
16. **FIELD INSPECTOR** - Signature of the Resident Engineer.
17. **AS-BUILT INFORMATION** - Name of contractor, Inspector and the dates of when the project started and completed.
18. **ENGINEERS STAMP** - Digital seal/stamp (Signature with electronic signature authorization form). Consultant in charge of work must stamp and sign (wet/original only) mylars.
19. **SPECIFICATIONS NO.** - Obtain from Standards and Contract Documents Section.
20. **AS-BUILT INFORMATION FOR MATERIALS** - Refer to as-built procedures.
21. **CHANGE** - Place a triangle with a letter (A, B, C, etc.) representing each sequential change during advertising and a number (1, 2, 3, etc.) representing each sequential change during construction.
22. **AFFECTED OR ADDED SHEET NUMBERS** - A change is noted by listing the sheet number(s) updated, deleted or added.
23. **DEPARTMENT** - Department name managing the project.

**PLANS FOR THE CONSTRUCTION OF  
SEWER & WATER GROUP XYZ  
COVER SHEET**

CITY OF SAN DIEGO, CALIFORNIA  
PUBLIC WORKS DEPARTMENT  
SHEET OF SHEETS

WATER WBS 0-00000  
SEWER WBS 0-00000

APPROVED FOR CITY ENGINEER \_\_\_\_\_ DATE \_\_\_\_\_  
PRINT DCE NAME \_\_\_\_\_ RCE# \_\_\_\_\_

DESCRIPTION	BY	APPROVED	DATE	FILMED
ORIGINAL	xx/xx			
AS-BUILTS	xx	xx		

RESERVED FOR ENGINEER OF RECORD STAMP

CONTRACTOR \_\_\_\_\_ DATE STARTED \_\_\_\_\_  
INSPECTOR \_\_\_\_\_ DATE COMPLETED \_\_\_\_\_

PROJECT MANAGER \_\_\_\_\_  
PROJECT ENGINEER \_\_\_\_\_  
SEE SHEETS \_\_\_\_\_  
CCS27 COORDINATE \_\_\_\_\_  
SEE SHEETS \_\_\_\_\_  
CCS83 COORDINATE \_\_\_\_\_  
XXXXXX-01-D

I HEREBY DECLARE THAT I AM THE ENGINEER OF WORK FOR THIS PROJECT THAT I HAVE EXERCISED RESPONSIBLE CHARGE OVER THE DESIGN OF THE PROJECT AS DEFINED IN SECTION 6703 OF THE BUSINESS AND PROFESSIONS CODE AND THAT THE DESIGN IS CONSISTENT WITH CURRENT STANDARDS. I UNDERSTAND THAT THE CHECK OF PROJECT DRAWINGS AND SPECIFICATIONS BY THE CITY OF SAN DIEGO IS CONFINED TO A REVIEW ONLY AND DOES NOT RELIEVE ME, AS ENGINEER OF WORK, OF MY RESPONSIBILITIES FOR PROJECT DESIGN.

COMPANY NAME \_\_\_\_\_  
COMPANY ADDRESS \_\_\_\_\_  
COMPANY PHONE \_\_\_\_\_  
COMPANY FAX \_\_\_\_\_  
COMPANY EMAIL \_\_\_\_\_

NAME \_\_\_\_\_ R.C.E. NO. XXXXX EXP. XX-XX-XX DATE \_\_\_\_\_

**PLANS FOR THE CONSTRUCTION OF  
SEWER & WATER GROUP XYZ  
COVER SHEET**

CITY OF SAN DIEGO, CALIFORNIA  
PUBLIC WORKS DEPARTMENT  
SHEET OF SHEETS

WATER WBS 0-00000  
SEWER WBS 0-00000

APPROVED FOR CITY ENGINEER \_\_\_\_\_ DATE \_\_\_\_\_  
PRINT NAME \_\_\_\_\_ RCE# \_\_\_\_\_

DESCRIPTION	BY	APPROVED	DATE	FILMED
ORIGINAL	xx/xx			
AS-BUILTS	xx	xx		

RESERVED FOR ENGINEER OF RECORD STAMP

CONTRACTOR \_\_\_\_\_ DATE STARTED \_\_\_\_\_  
INSPECTOR \_\_\_\_\_ DATE COMPLETED \_\_\_\_\_

PROJECT MANAGER \_\_\_\_\_  
PROJECT ENGINEER \_\_\_\_\_  
SEE SHEETS \_\_\_\_\_  
CCS27 COORDINATE \_\_\_\_\_  
SEE SHEETS \_\_\_\_\_  
CCS83 COORDINATE \_\_\_\_\_  
XXXXXX-01-D

CONSTRUCTION CHANGE / ADDENDUM		
CHANGE	AFFECTED OR ADDED SHEET NUMBERS	APPROVAL NO.

**WARNING**  
IF THIS BAR DOES NOT MEASURE 1" THEN DRAWING IS NOT TO SCALE.

The City of **SAN DIEGO** Public Works

AS-BUILT INFORMATION	
MATERIALS	MANUFACTURER
PIPE CL 235 (WATER)	-
PIPE SDR 35 (SEWER)	-
GATE VALVES	-
FIRE HYDRANTS	-
SEWER MANHOLES	-
REHABILITATE SEWER MANHOLES	-
REHABILITATE SEWER MAIN	-



## **PLAN SHEET TITLE BLOCK DESCRIPTION**

1. **PROJECT TITLE** – Underline the type of infrastructure being replaced on the first line of each sheet, either Sewer or Water. No underlining needed for sewer or water only or other type of projects.
2. **STREET NAME(S) / ALLEY BLK NO. (S)** - Pertaining to street / alley layout for each individual sheet. First Street to Twelfth Street should be spelled out.
3. **LIMITS OF WORK** – Use Street to Street limits. (Ash St to Beech St, N/O of B St, W/O Sixth Ave, etc.) If streets limits are unavailable, use stationing limits.
4. **SHEET XX OF YY SHEETS** – **XX** represents the individual sheet, and **YY** represents the total number of sheets including any consultant drawings. Traffic Control Plans are not included in total number of sheets.
5. **WORK BREAKDOWN SYSTEM (WBS) NUMBER** – Obtain and place the number(s) in the appropriate block as shown.
6. **PROJECT MANAGER/** - Name of the Project Manager.
7. **PROJECT ENGINEER** - Name of the Project Engineer.
8. **CCS27 COORDINATE** - (NAD 27): Use the most southwesterly coordinates from the 100' scale map pertaining to street layout for each individual sheet.
9. **CCS83 COORDINATE** - (NAD 83): Use the most southwesterly coordinates from the 100' scale map pertaining to street layout for each individual sheet.
10. **DRAWING NUMBER** - Contact Development Services Department's Maps and Records section for the D-sheet number. To request a "Drawing Number" email [DSD\\_DrawingnumberReq@sandiego.gov](mailto:DSD_DrawingnumberReq@sandiego.gov) and provide the W.B.S. Number, Cost Center Number, Project Engineer's name and project title.
11. **DESCRIPTION BLOCK** - "ORIGINAL" block for design project, CHANGE "1", "2", etc. in triangle, for changes made during construction and ADDENDUM "A", "B", etc. in triangle for changes made during advertising of projects. When doing as-builts, use a triangle with a number inside (see As-Built Procedures Section).
12. **DRAWN BY** - when entering initials, place design engineer first, then drafter's initials or the initials of the consultant's company.
13. **APPROVED** - This section is filled when changes are made to the original drawing. Signatures by the Duty City Engineer or staff under their direction.
14. **DATE** - Dated by the Deputy City Engineer or staff under their direction when changes are approved.
15. **FILMED** - When the plans are submitted to Maps and Records, they are filmed and dated. Filled out by Maps & Records after the completion of the project. (This portion is filled out by the drafter after plans have been picked up at Maps & Records. Maps & Records personnel will never fill this out on .dgn file).

16. **FIELD INSPECTOR** - Signature of the Resident Engineer.
17. **AS-BUILT INFORMATION** - Name of contractor, Inspector and the dates of when the project started and completed.
18. **CHANGE** - Place a triangle with a letter (A, B, C, etc.) representing each sequential change during advertising and a number (1, 2, 3, etc.) representing each sequential change during construction.
19. **CHANGE DESCRIPTION** - Place a triangle with a letter (A, B, C, etc.), brief description of changes made and "ADDENDUM" with the letter representing the change made during project advertising.
20. **ADDENDUM** - An Addendum is a change to plans or contract that is issued during advertising before the bid opening and the project is awarded. Show the changes from the Addendum on the plans by lining out features that will be removed and adding new features. Nothing shall be deleted from the plans at this stage. If required, cross out the entire sheet and add a new sheet for the change. Place graphic "clouds" around the area of change along with a lettered Delta cell. Place the Addendum Cell in the appropriate location on the Title Block.

**CONSTRUCTION CHANGE** - A Construction Change is a change to the plans that is issued after the project is awarded. This change is large enough that the Resident Engineer requires instructions from the Project Engineer, and usually results in a change in the design and the project cost. Show the changes from the Construction Change on the plans by lining out features that will be removed and adding the new design. Nothing shall be deleted from the plans at this stage. If required, cross out the entire sheet and add a new sheet for the change. Place graphic "clouds" around the area of change along with a lettered Delta cell. Place the Construction Change Cell in the appropriate location on the Title Block.

# PLAN VIEW SHEET TITLE BLOCK DETAIL

1 SEWER & WATER GROUP 000  
2 STREET NAME / ALLEY BLK 00  
3 LIMITS OF WORK  
4

CITY OF SAN DIEGO, CALIFORNIA PUBLIC WORKS DEPARTMENT SHEET OF SHEETS					WATER WBS 0-00000 SEWER WBS 0-00000
APPROVED: _____ FOR CITY ENGINEER _____ DATE _____					SUBMITTED BY: _____ PROJECT MANAGER _____
PRINT DCE NAME _____ RCE# _____					CHECKED BY: _____ PROJECT ENGINEER _____
DESCRIPTION	BY	APPROVED	DATE	FILMED	000-0000 CCS27 COORDINATE
ORIGINAL	XX/XX				
AS-BUILTS	XX	XX/XX			000-0000 CCS83 COORDINATE
CONTRACTOR _____			DATE STARTED _____		XXXXX-01-D
INSPECTOR _____			DATE COMPLETED _____		

11
5  
6  
7  
8  
9  
10  
17
18
19
20
12
13
14
15  
16

**SECTION II**

**COMMON SEWER**

**&**

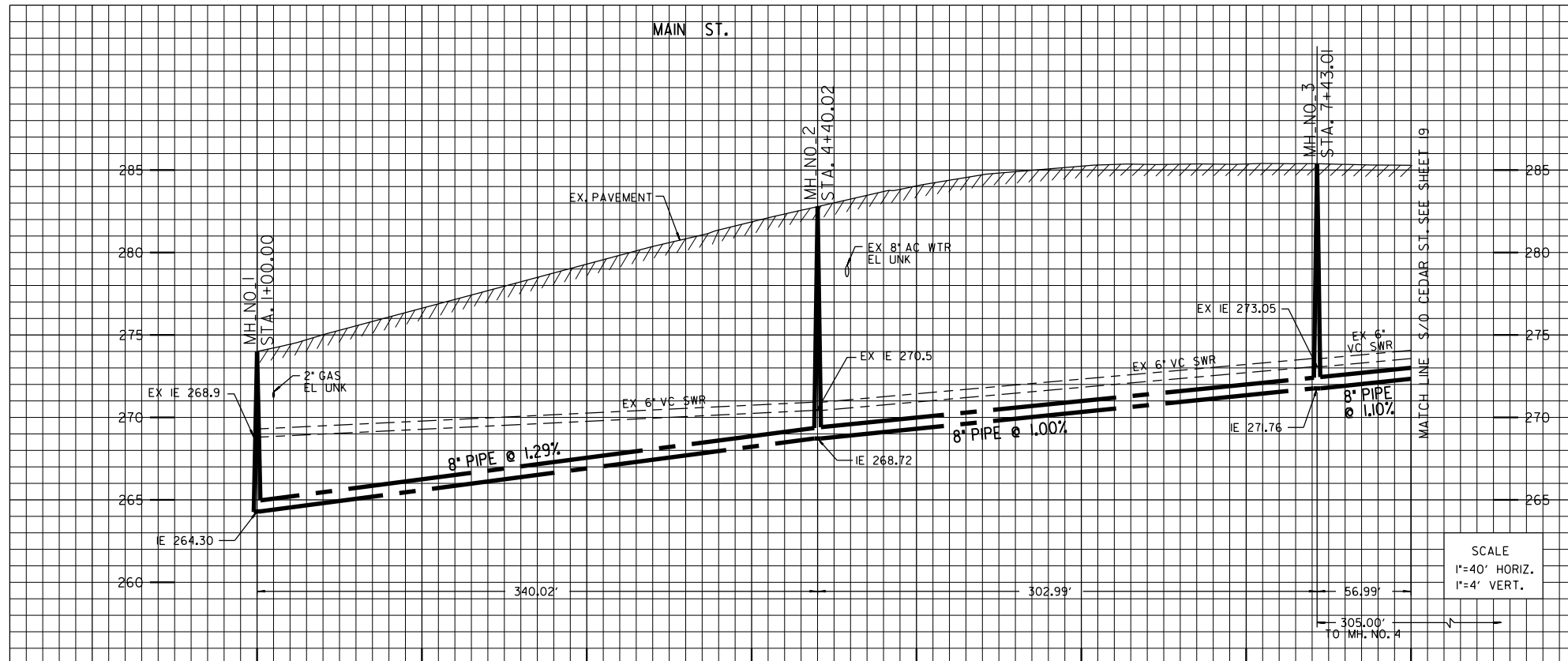
**WATER DESCRIPTION**

## **COMMON SEWER AND WATER EXAMPLES**

### **PLAN VIEW**

1. **REFERENCES** – Are located above the title block. List all As-Built references that pertain to each sheet.
2. **RETIREMENTS** – Fill out the information:  
Size & Material of Pipe - Total Length of Pipe - Manholes - Year Installed (if a year cannot be found after researching, then make an educated guess).  
Size of Lateral / Service - Quantity - Material - Date  
Fire Hydrants - Indicate the number of 2-port or 3-port fire hydrants being removed and / or replaced. Include all mains and appurtenances replaced or abandoned by the contractor.
3. **NORTH ARROW & SCALE with GRAPHIC BAR**– Shall be located near title block with scale of drawing underneath. Otherwise, place north arrow in noticeable location. **\*Note:** Personalized north arrows are allowed within limits of accuracy used to produce the arrow. The arrow must include an “N” for north. (There are agencies that use south arrows.) Keep the style and size to a minimum.
4. **RIGHT MARGIN** – Street name, which should match the title block of the corresponding sheet, is located here according to the example and the text standards.
5. **SUBDIVISION NAME** – Is located outside the clip reference boundary of the plan view.
6. **SUBDIVISION MAP NUMBER** – Is located outside the clip reference boundary of the plan view.
7. **BLOCK NUMBER** – Is located above or below lot lines and within the block it is identifying.
8. **Right-of-Way LINES** – Are located per field survey, subdivision maps, reference drawings or assessor maps. **Note:** assessor’s parcel maps are not legal maps and are only the source of “last resort.”
9. **ADDRESSES** – To be located within the lot lines, usually perpendicular to the street (Right-of-Way).
10. **LOT LINES** – Obtain from parcel, subdivision, record of survey or assessors maps.
11. **LOT NUMBERS** – Obtain from subdivision, parcel and assessors maps. Locate numbers parallel to the street (Right-of-Way).
12. **OWNERSHIP LINE** – To be used only if showing ownership of more than one lot and can be obtained from the assessor maps.
13. **PROPERTY SPLITS** – Obtain from assessor’s maps. Draw ownership line to indicate ownership.
14. **EASEMENT LINES** – Are shown in its appropriate location along with the legal drawing number showing the width and location of the easement. If you have to acquire an easement, then follow the procedure in the Easement Research Section of the Design Guide.
15. **STREET ALIGNMENT** – Whenever possible, align streets on D-sheets so that survey stationing in the plan view is in a direct projection to the stationing in the profile view.

16. **STREET NAME** – Is located within the R/W (Right-of-Way) area. First Street to Twelfth Street should be spelled out. Add call out (paper street) if street is not a travel way.
17. **CENTER LINE** – Is usually located in the center of the legal right-of-way, which can differ from center of pavement. Check record maps for openings and vacations (closures), which can result in an “off-center” centerline.
18. **EXISTING STRUCTURES** – Including Abandoned Structures that are in the vicinity of the proposed alignment shall be included on the drawings. These can all be determined from your research. They shall be labeled and designated with an arrow. Only City owned utilities (WTR, SWR, SD) are called out with existing.
19. **LATERALS, SERVICES & FIRE SERVICES OF EXISTING UTILITIES** – Are to be shown on the plans even though the Greenbook specifies that the contractor assumes a lateral / service to each lot for each utility.
20. **LEADER LINES** – Shall be used when information cannot be placed next to the object designated. Try not to use LONG leader lines if possible. Leader lines shall not cross other leader lines, text or dimensions.
21. **DIMENSIONS** – All streets, alleys, and curb widths, existing, abandoned, and proposed utilities are to be dimensioned. The electrical, telephone, and cable TV utilities need only be dimensioned if a reliable offset has been found on the utility as-built or utility map. They shall appear in a noticeable location and be dimensioned clearly. Try to keep dimensions away from areas where there may be several callouts or cautions designated. Dimensions lines should not cross over other text or dimensions. At least one dimension shall be tied to the curb line and all others can be tied to the Right-Of-Way line. Dimensions shall be rounded off to the nearest whole number.  
For example: 44.75' = 45'
22. **SHEET LIMITS FOR PROPOSED PIPE – OPTION A**  
**MATCH LINE (SEWER)** – The proposed pipe shall have limits at the beginning and ending of a sheet at 50 or 100-foot stationing whenever possible. For example 5+00, 7+50. If this is not possible, the break may occur at the nearest 10 foot station. Example 7+40, 8+60. Match lines shall be used where the 50' or 100' stations occur. The match line shall be weight 3, style 0 and be perpendicular to the proposed alignment. Include text indicating the location of the continued proposed pipe. The text size shall be 5.6 and a weight of 2.  
For example: **MATCH LINE STA. 5+00 SEE SHEET 20.**  
**OPTION B (sewer only) – See Sewer Description Section.**
23. **ESTIMATED ARCHAEOLOGICAL / PALEONTOLOGICAL MONITORING TABLE** – Provide beginning and end station numbers and approximate linear footage of estimated limits for archaeological and paleontological monitoring.
24. **HORIZONTAL ALIGNMENT REPORT** – Horizontal alignment report generated from Microstation.



23

ESTIMATED ARCHAEOLOGICAL MONITORING LIMITS  
(INCLUDES MAIN, LATERALS, AND OTHER TRENCHING ACTIVITIES)

BEGINNING STATION	ENDING STATION	APPROXIMATE LF
STA. ----	STA. ----	---
STA. ----	STA. ----	---
STA. ----	STA. ----	---

ESTIMATED PALEONTOLOGICAL MONITORING LIMITS  
(INCLUDES MAIN, LATERALS, AND OTHER TRENCHING ACTIVITIES)

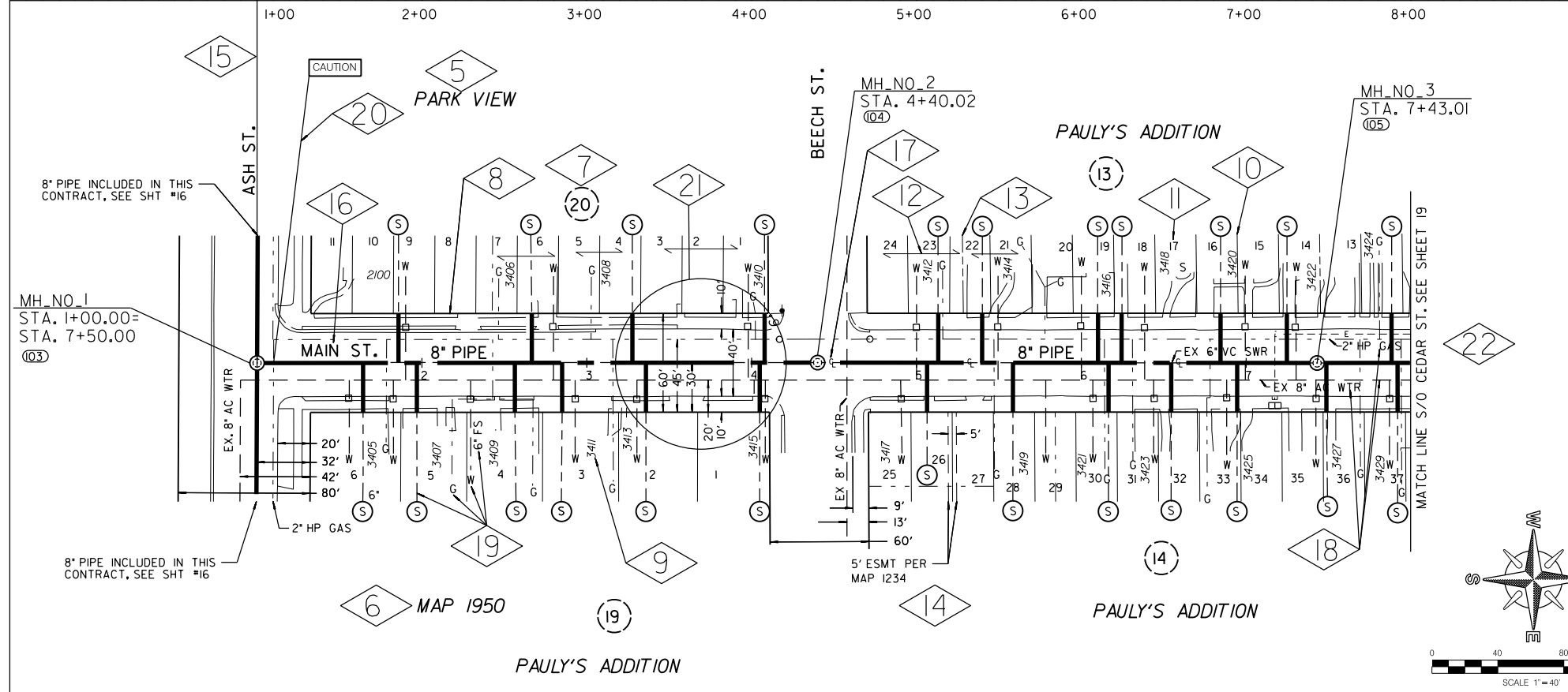
BEGINNING STATION	ENDING STATION	APPROXIMATE LF
STA. ----	STA. ----	---
STA. ----	STA. ----	---
STA. ----	STA. ----	---

ACTUAL LIMITS SHALL BE DETERMINED BY THE PI/MONITOR(S) PRIOR TO CONSTRUCTION AND SHALL BE CONSISTENT WITH THE MITIGATION AND MONITORING PROGRAM (IMRP) FOR THE PROJECT.

24

Report Results

Horizontal Alignment Report  
 \*Project Name: w3c3lc Alignment: 31stcl  
 Pt # Station Point Northing (Y) Easting (X)  
 100 0+00.0000 POB 1841765.9677 6291783.3775  
 Tangent= 74.5711 Bearing=S 0° 00' 00.0000" E  
 101 0+74.5711 PI 1841691.3966 6291783.3775  
 101 0+74.5711 PI 1841691.3966 6291783.3775  
 Tangent= 21.9819 Bearing=S 30° 15' 39.2491" W  
 102 0+96.5530 POE 1841672.4100 6291772.3000



1

REFERENCE:  
 WATER: 12345-6-D, 23456-7-D  
 SEWER: 12345-6-D  
 STORM DRAIN: 12345-6-D  
 FIELD BOOK: 214-1719, G215  
 THOMAS BROS. 1250

2

RETIREMENTS:  
 6" VC - 750' - 1954  
 MH - 4X3 - 3 - 1954  
 4" LATERAL - 22- VC - 1954  
 6" LATERAL - 1- VC - 1954

4

C-99

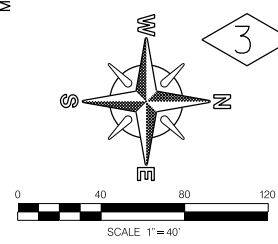
SEWER & WATER GROUP 000  
 MAIN STREET  
 ASH STREET TO SO CEDAR ST.

CITY OF SAN DIEGO, CALIFORNIA  
 PUBLIC WORKS DEPARTMENT  
 SHEET OF SHEETS

WATER WBS	0-00000
SEWER WBS	0-00000

FOR CITY ENGINEER \_\_\_\_\_ DATE \_\_\_\_\_ PROJECT MANAGER \_\_\_\_\_  
 PRINT DCE NAME \_\_\_\_\_ PROJECT ENGINEER \_\_\_\_\_  
 DESCRIPTION BY APPROVED DATE FILMED  
 ORIGINAL XX/XX \_\_\_\_\_  
 000-0000  
 0000-0000  
 19905-01-D

CONTRACTOR \_\_\_\_\_ DATE STARTED \_\_\_\_\_  
 INSPECTOR \_\_\_\_\_ DATE COMPLETED \_\_\_\_\_



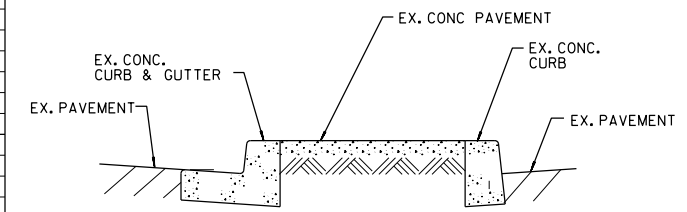
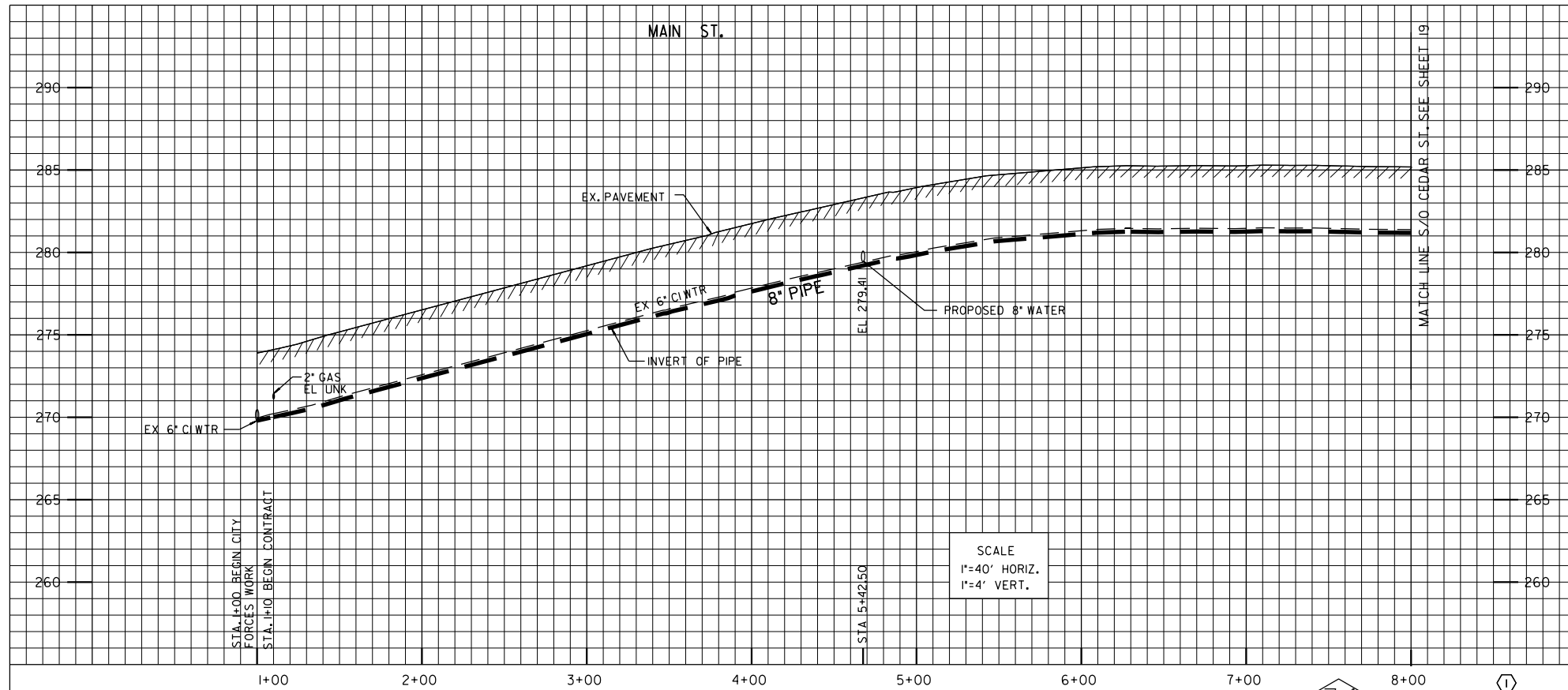
3

MAIN STREET

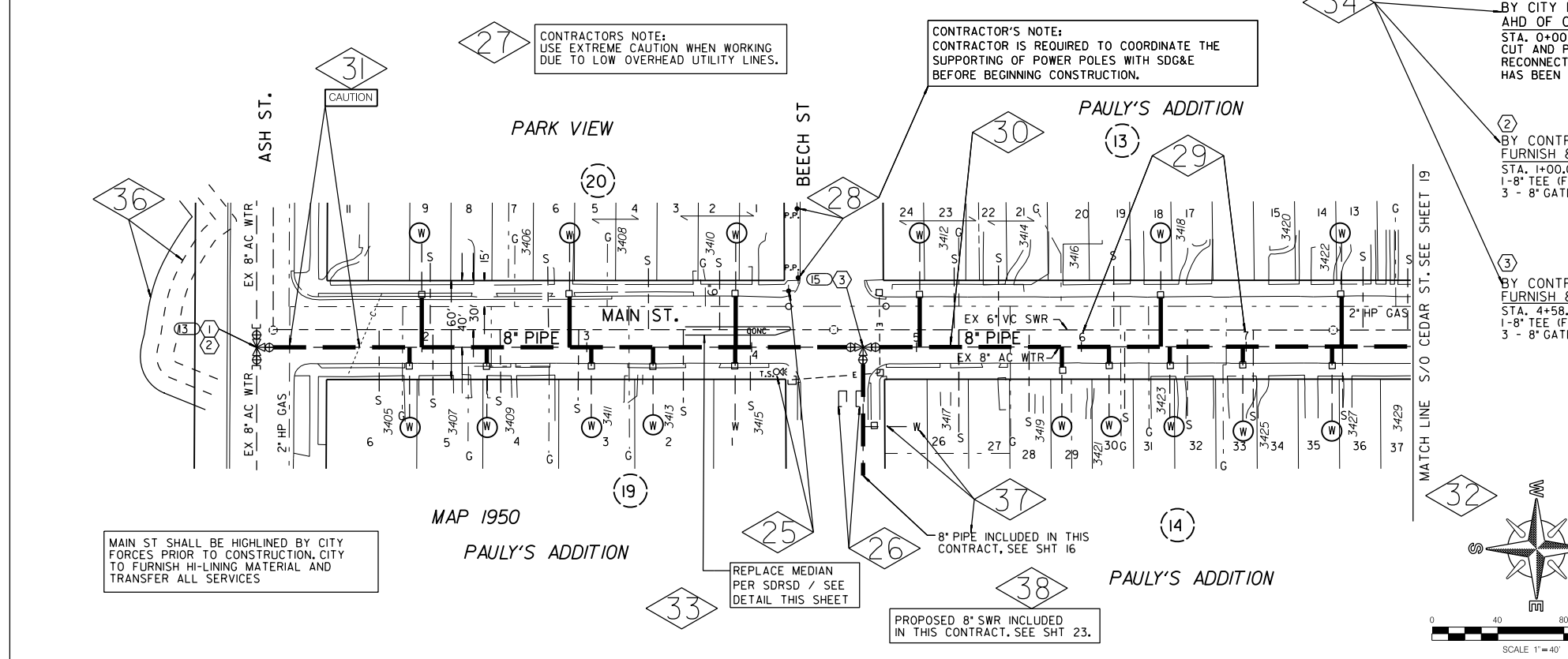
25. **STREET LIGHTS & TRAFFIC LIGHTS** – Are located in appropriate location and referred to as shown in the symbols section.
26. **TRAFFIC ACTUATORS / SENSORS/DETECTORS** – Are located in the appropriate location and referred to as shown in the symbols section. Refer to General Service's Communication / Electrical drawings and reference for locations of detectors.
27. **LOW OVERHEAD UTILITY LINES** – Use the appropriate contractor note, when the utility lines are 15' or less above the proposed trench. Overhead power lines do not need to be shown on the plan view.
28. **POWER POLE AND / OR TELEPHONE POLE** – Should be shown on the plan view. If they are close to a manhole, use the appropriate contractor's note.  
For Example: **Contractor is required to coordinate the supporting of power polls with SDG&E before beginning construction.**
29. **STATIONING LINE** – Shall be along the proposed pipeline at 100' intervals and continue to the end of the alignment. Stationing begins at Station 1+00 to avoid negative stationing if design changes beyond the proposed alignment.
30. **PROPOSED PIPE** – Draft proposed pipe onto drawing according to symbol standards. Show the size of pipe above the proposed pipe, example: **12" PIPE**. Sewer & Water pipe size greater than 24 Inches, show the outside dimension of the pipe on the plan view.
31. **CAUTION CALLOUTS** – Shall be shown when the proposed pipe trench crosses any utilities. Label the crossing utility with a **CAUTION** callout and a leader line to each crossing point. Advanced notices: Use contractor's note when crossing gas mains 4" or larger.
32. **SHEET LIMITS FOR PROPOSED PIPE**  
**MATCH LINE (WATER)** – The proposed pipe shall have limits at the beginning and ending of a sheet at 50 or 100-foot stationing whenever possible. For example 5+00, 7+50. If this is not possible, the break may occur at the nearest 10'station. Example 7+40, 8+60. Match lines shall be used where the 50' or 100' stations occur. The match line shall be weight 3, style 0 and be perpendicular to the proposed alignment. Include text indicating the location of the continued proposed pipe. The text size shall be 5.6 and a weight of 2.  
For example: **MATCH LINE STA. 5+00 SEE SHEET 20.**
33. **CONSTRUCTION / CAUTION NOTES** – (if any) shall be placed in an appropriate location on the plans.
34. **WATER CONSTRUCTION NOTES** - Shall be provided by the Project Engineer and placed in an organized manner on the plans.
35. **MEDIANS** – Shall be shown along with cross section detail drawing, and/or call out for a standard drawing that pertains to the median being trenched.
36. **CONTOUR LINES** – Are usually turned off on the final plot for clarity. They may be left on with the approval of the Senior Engineer.



37. **STREET INTERSECTIONS SHOWN ON MORE THAN ONE STREET** – When an intersection includes a proposed part of the contract which is being built on another sheet, show it as proposed work, modify clip boundary or turn off the proposed lateral / service symbols (circles) for those laterals / services which are to be installed on the other sheet so that the project engineer will not count them twice in the project cost estimate.  
For example: **8" PIPE INCLUDED IN THIS CONTRACT. SEE SHEET 16.**
38. **SEWER & WATER COMBINED** – For clarity the proposed sewer and water shall not be shown on the same sheet, except where short sections of either utility are being proposed, but show sheet number for work to be done in the same area.  
For example: **8" WATER INCLUDED IN THIS CONTRACT. SEE SHEET 23.**
39. **ADDENDUM** – An Addendum is a change to plans or contract that is issued during advertising before the bid opening and the project is awarded. Show the changes from the Addendum on the plans by lining out features that will be removed and adding new features. Nothing shall be deleted from the plans at this stage. If required, cross out the entire sheet and add a new sheet for the change. Place graphic "clouds" around the area of change along with a lettered Delta cell. Place the Addendum Cell in the appropriate location on the Title Block and add a brief description with the Addendum letter below the Title Block in the border area.
- CONSTRUCTION CHANGE** – A Construction Change is a change to the plans that is issued after the project is awarded. This change is large enough that the Resident Engineer requires instructions from the Project Engineer, and usually results in a change in the design and the project cost. Show the changes from the Construction Change on the plans by lining out features that will be removed and adding the new design. Nothing shall be deleted from the plans at this stage. If required, cross out the entire sheet and add a new sheet for the change. Place graphic "clouds" around the area of change along with a lettered Delta cell. Place the Construction Change Cell in the appropriate location on the Title Block.
40. **RAILROAD, TROLLEY TRACKS** – Shall be shown on the plan view if they cross the proposed pipe. For details of tracks, refer to Tracks in City Streets drawing. Also show buried roadways if encountered.



CONCRETE MEDIAN  
NOT TO SCALE



CONTRACTOR'S NOTE:  
USE EXTREME CAUTION WHEN WORKING  
DUE TO LOW OVERHEAD UTILITY LINES.

CONTRACTOR'S NOTE:  
CONTRACTOR IS REQUIRED TO COORDINATE THE  
SUPPORTING OF POWER POLES WITH SDG&E  
BEFORE BEGINNING CONSTRUCTION.

① BY CITY FORCES  
AHD OF CONTRACTOR  
STA. 0+00 - 10+11 LT & RT  
CUT AND PLUG EX 8" AC WTR  
RECONNECT AFTER NEW MAIN  
HAS BEEN ACCEPTED.

② BY CONTRACTOR  
FURNISH & INSTALL  
STA. 1+00,00  
1-8" TEE (F)  
3 - 8" GATE VALVES (F,MJ) AHD, LT, RT

③ BY CONTRACTOR  
FURNISH & INSTALL  
STA. 4+58,07  
1-8" TEE (F)  
3 - 8" GATE VALVES (F,MJ) BK, AHD, RT

REFERENCE:  
WATER: 12345-6-D, 23456-7-D  
SEWER: 12345-6-D  
STORM DRAIN: 12345-6-D  
FIELD BOOK: 214-1719, G21W  
THOMAS BROS. 1250

RETIREMENTS:  
8" AC - 700' - 1957  
1" SERVICE - 15 - COPPER - 1957

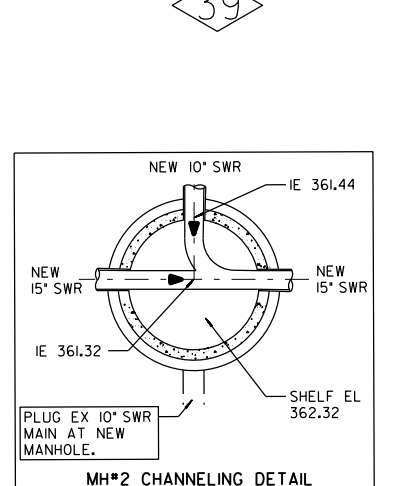
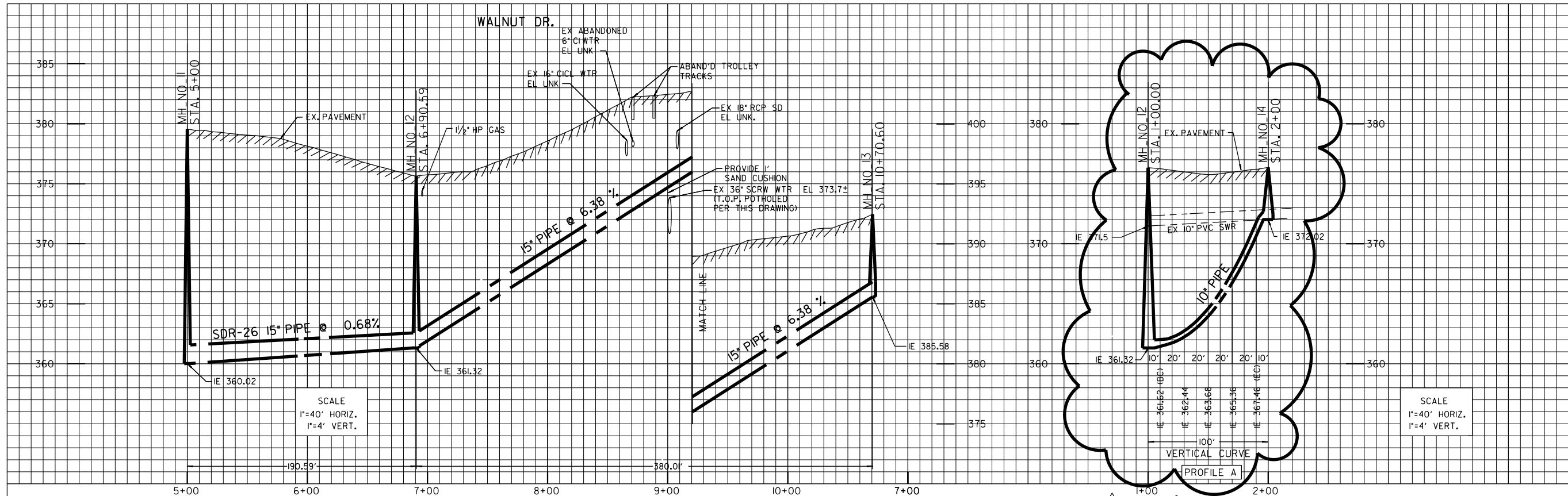
MAIN ST SHALL BE HIGHLINED BY CITY  
FORCES PRIOR TO CONSTRUCTION, CITY  
TO FURNISH HI-LINING MATERIAL AND  
TRANSFER ALL SERVICES

REPLACE MEDIAN  
PER SDRSD / SEE  
DETAIL THIS SHEET

PROPOSED 8" SWR INCLUDED  
IN THIS CONTRACT, SEE SHT 23.

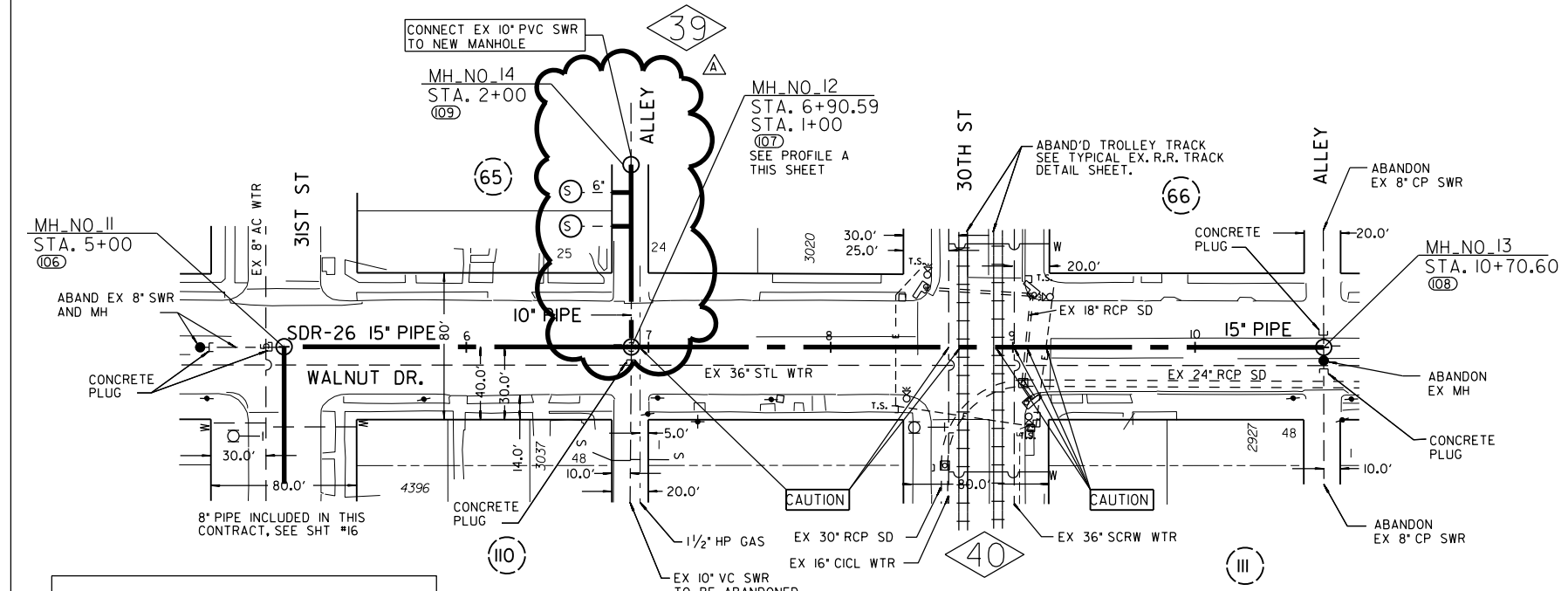
SEWER & WATER GROUP 000			
MAIN STREET			
ASH STREET TO S/O CEDAR ST.			
CITY OF SAN DIEGO, CALIFORNIA		WATER	0-00000
PUBLIC WORKS DEPARTMENT		SEWER	0-00000
SHEET OF SHEETS		DATE	
FOR CITY ENGINEER	DATE	PROJECT MANAGER	
PRINT DCE NAME	REGISTRATION NUMBER	PROJECT ENGINEER	
DESCRIPTION	BY	APPROVED	DATE
ORIGINAL	XX/XX		
		000-0000	
		0000-0000	
		19905-01-D	
CONTRACTOR	DATE STARTED	DATE COMPLETED	
INSPECTOR			

MAIN STREET



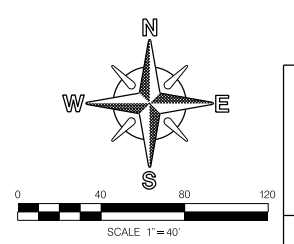
REFERENCE:  
 WATER: 12345-6-D, 23456-7-D  
 SEWER: 12345-6-D  
 STORM DRAIN: 12345-6-D  
 FIELD BOOK: 214-1719, G2IS  
 THOMAS BROS. J250

RETIREMENTS:  
 100' - 10" PVC - 1999  
 45' - 8" VC - 1975  
 MH - 3 - 1962  
 4" LATERAL - 1 - 1962  
 6" LATERAL - 1 - 1962



CONTRACTOR'S NOTES:  
 1. CONTRACTOR IS REQUIRED TO COORDINATE THE SUPPORTING OF POWER POLES WITH SDG&E BEFORE BEGINNING CONSTRUCTION.  
 2. USE EXTREME CAUTION WHEN WORKING DUE TO LOW OVERHEAD UTILITY LINES.

UNIVERSITY HEIGHTS  
 LP8 - PG 36



SEWER GROUP 000				WATER WBS	0-00000
WALNUT DR./ALLEY IN BLOCK 65				SEWER WBS	0-00000
31ST STREET TO ALLEY BLK NO. 66					
CITY OF SAN DIEGO, CALIFORNIA				DATE	
PUBLIC WORKS DEPARTMENT				PROJECT MANAGER	
SHEET OF SHEETS				PROJECT ENGINEER	
DESCRIPTION	BY	APPROVED	DATE	FILMED	
ORIGINAL	XX/XX				000-0000
ADDENDUM A	XX/YY				0000-0000
CONTRACTOR XXXXXXXXXX				DATE STARTED	08-08-08
INSPECTOR XXXXXXXXXX				DATE COMPLETED	08-08-08
					19905-01-D

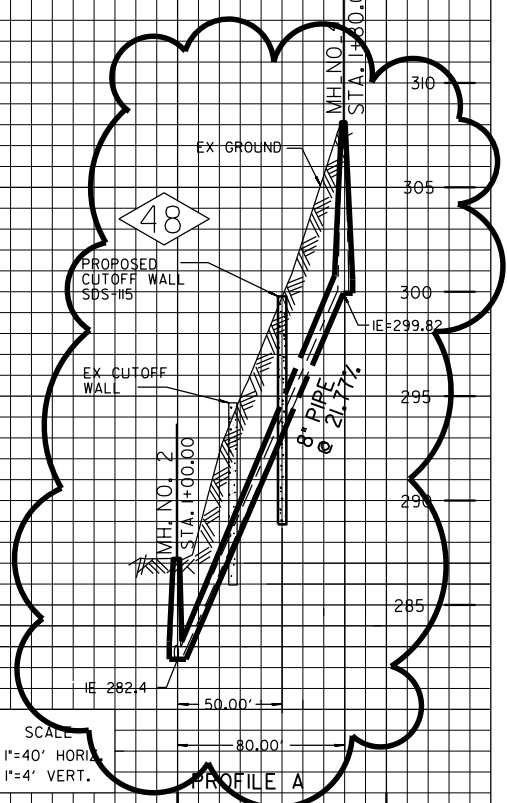
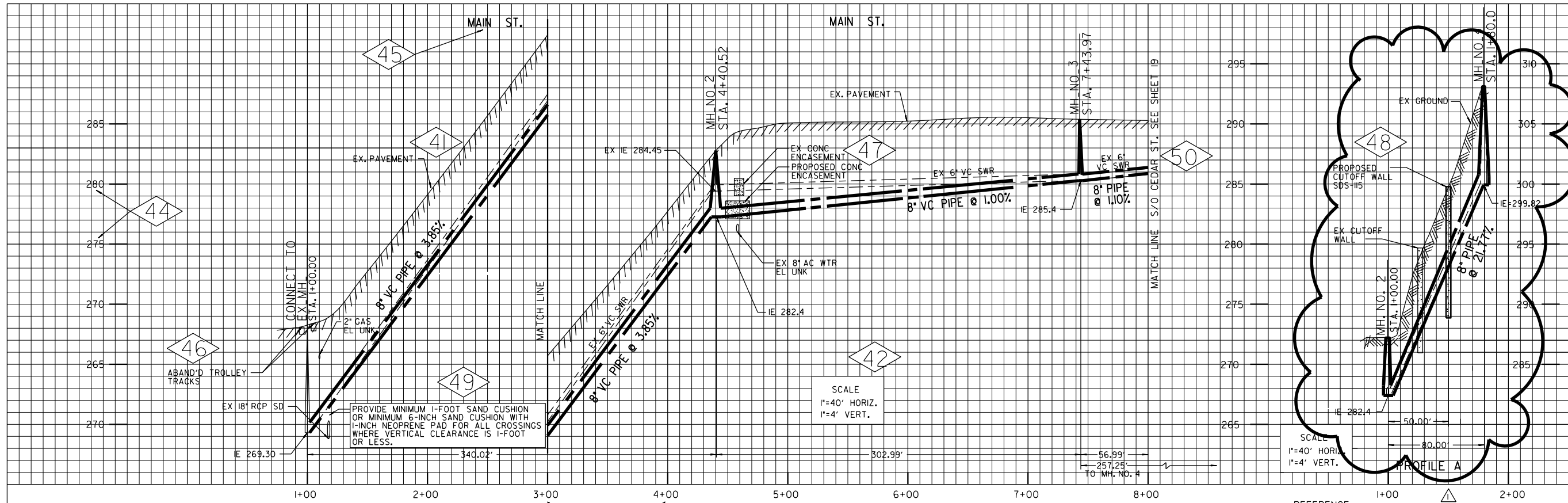
▲: ADDITIONAL 100' OF SEWER MAIN (PROFILE A) **39** ADDENDUM A

WALNUT DR.

## **PROFILE VIEW**

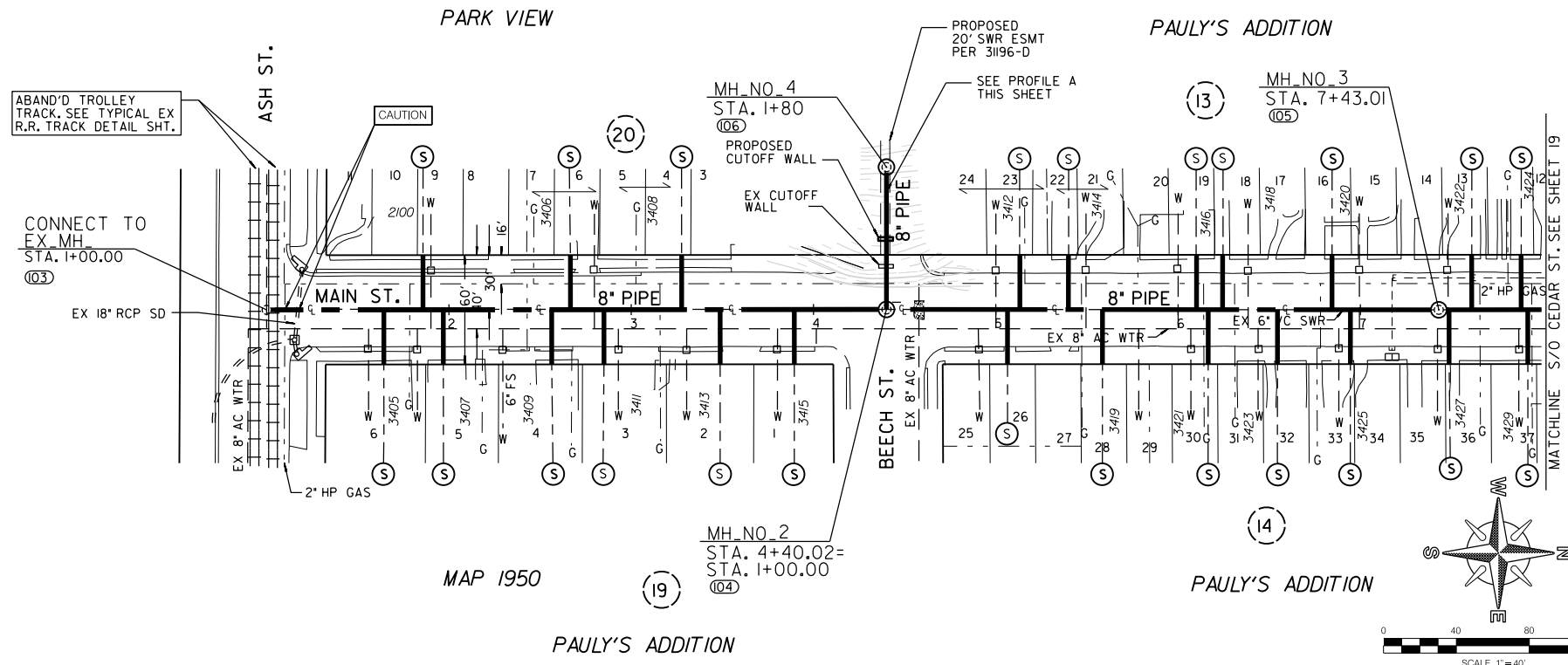
41. **EXISTING SURFACE** – Use the correct pattern for the type of surface, for example use the ground or pavement pattern.
42. **SCALE BLOCK** – Shall be located within the profile grid; include the horizontal and vertical scales. A Scale Block shall be placed within the limits of each alignment shown on the profile view.
43. **STATIONING OF SURVEY LINE** – Use the Department Profile Preferences to generate the stationing of survey line.
44. **ELEVATION NUMBERS** – Use the Department Profile Preferences to generate elevation numbers. If there is not enough room to place elevations on both sides of profile, or if showing only a short section of pipe then they can be placed on one side. For profiles longer than half the sheet, the elevations may be staggered on each side of the profile.
45. **STREET NAME(S)** The street name in which work is being performed shall also be located near the top of the grid.
46. **RAILROAD, TROLLEY TRACKS** – Shall be shown on the profile view if they cross the proposed pipe. For details of tracks, refer to Tracks in City Streets drawing. Also show buried roadways if encountered.
47. **ENCASEMENTS, CRADLES, ETC.** – Shall be called out on both plan and profile views and shall follow the Regional Standard Drawings.
48. **CONCRETE CUTOFF WALL** – Are typically used in areas with steep slopes and for erosion protection of the pipe. For requirements and dimensions, refer to the Sewer Design Guide.
49. **CONTRACTORS NOTES** – See the Project Engineer for the notes.
50. **SHEET LIMITS FOR PROPOSED PIPE – OPTION A**  
**MATCH LINE (SEWER)** – The proposed pipe shall have limits at the beginning and ending of a sheet at 50 or 100-foot stationing whenever possible. For example, 5+00, 7+50. If this is not possible, the break may occur at the nearest 10-foot station. Example, 7+40, 8+60. Match lines shall be used where the 50 or 100-foot stations occur. The match line shall be weight 3, style 0 and be perpendicular to the proposed alignment. Include text indicating the location of the continued proposed pipe. The text size shall be 5.6 and a weight of 2.  
For example: **MATCH LINE STA. 6+00 SEE SHEET 9.**

**OPTION B (sewer only) – See Sewer Description Section.**



REFERENCE:  
 WATER: 12345-6-D, 23456-7-D  
 SEWER: 12345-6-D  
 STORM DRAIN: 12345-6-D  
 FIELD BOOK: 214-1719, G21  
 THOMAS BROS. J250

RETIREMENTS:  
 780' - 6" VC - 1966  
 MH - 3 - 4X3 - 3 - 1966  
 4" LATERAL - 23 - VC - 1966



**C-29**

**SEWER & WATER GROUP 000**  
**MAIN STREET**  
 ASH STREET TO SO CEDAR ST.

CITY OF SAN DIEGO, CALIFORNIA PUBLIC WORKS DEPARTMENT SHEET OF SHEETS		WATER WBS 0-00000 SEWER WBS 0-00000
FOR CITY ENGINEER	DATE	PROJECT MANAGER
PRINT DCE NAME	RCE#	PROJECT ENGINEER
DESCRIPTION	BY	APPROVED
ORIGINAL	XX/XX	DATE
CONSTRUCTION CHANGES	XX/YY	FILED
0000-0000 COORDINATE		0000-0000 COORDINATE
CONTRACTOR XXXXXXXXXX	DATE STARTED 08-08-08	19905-01-D
INSPECTOR XXXXXXXXXX	DATE COMPLETED 08-08-08	

# CONSTRUCTION CHANGES

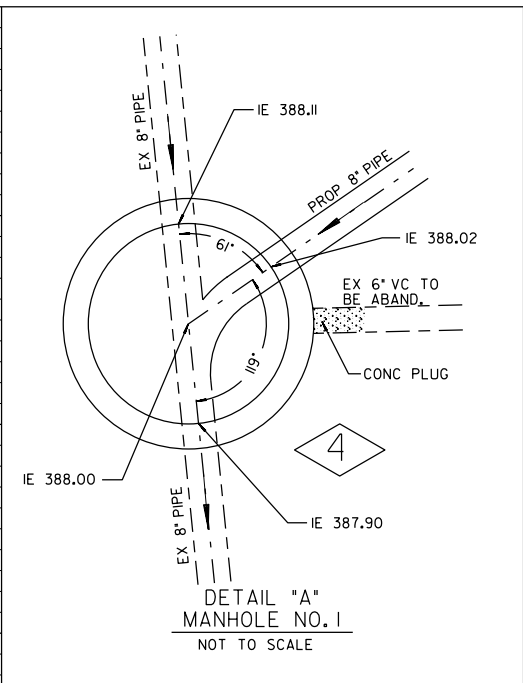
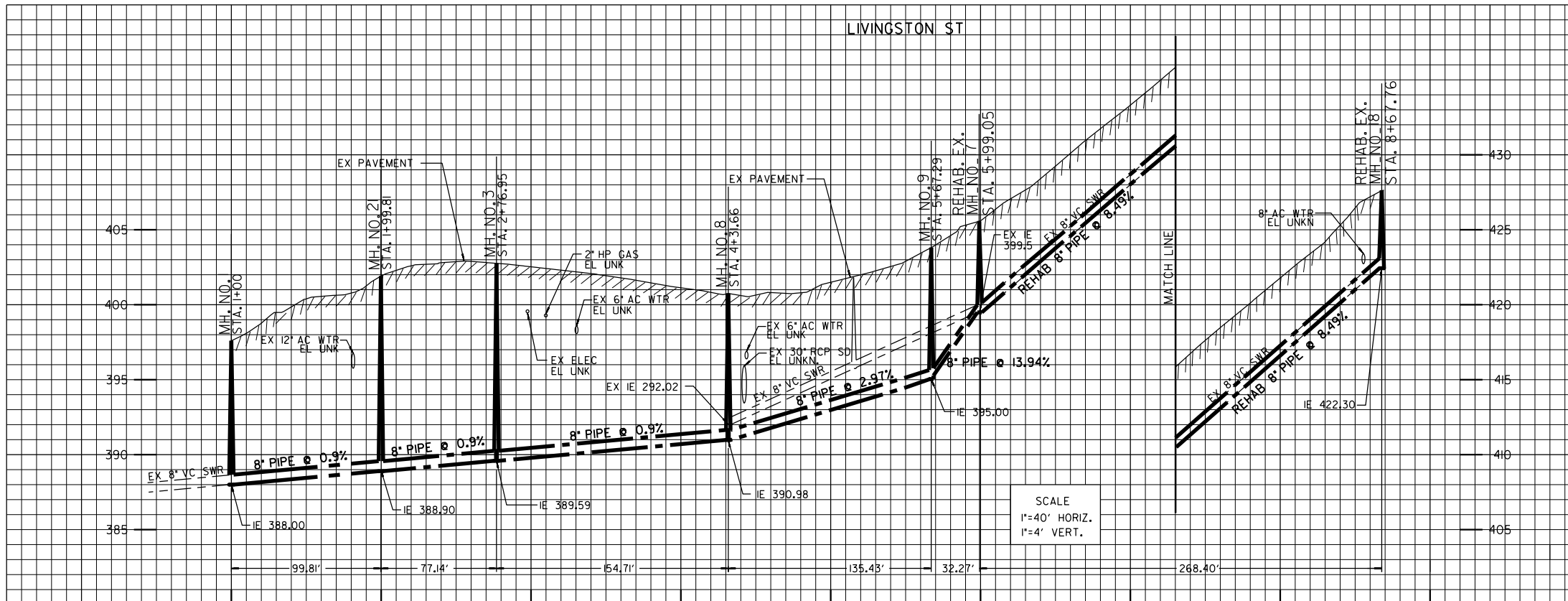
## **SECTION III**

### **SEWER DESCRIPTION**

## **SEWER DESCRIPTION**

### **PLAN VIEW**

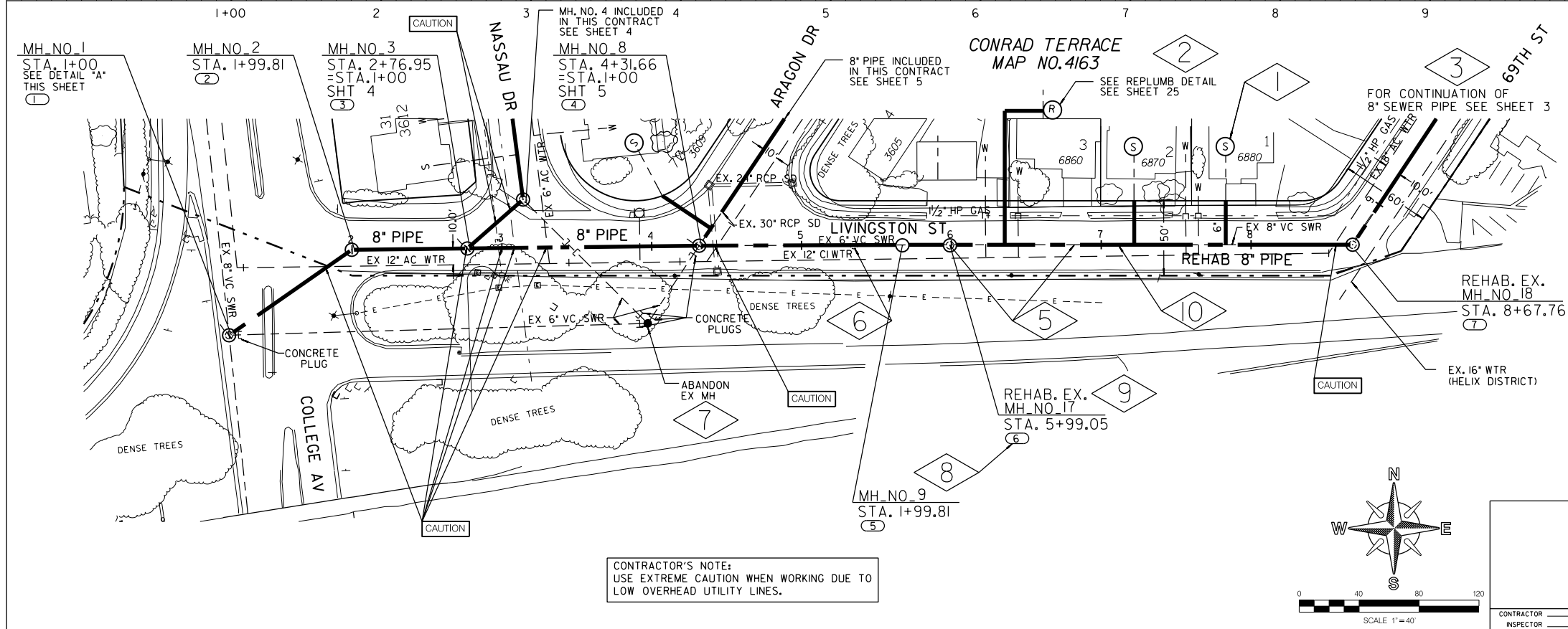
1. **PROPOSED SEWER LATERALS** – Size of circle and text shall be per symbol standards. Circles shall be placed in a uniform line whenever possible. Label sewer laterals 6-inches and larger next to the sewer lateral at the curb location or on the lateral line shown vertically.
2. **PROPOSED REPLUMB SEWER LATERALS** – Add a callout to refer to the detail drawing of the proposed alignment.
3. **SHEET LIMITS FOR PROPOSED PIPE – OPTION B**  
**MANHOLE-to- MANHOLE (SEWER)** – The proposed pipe shall begin at a proposed manhole and end at the nearest proposed manhole towards the end of the sheet layout limits. All proposed manholes in-between the sheet limits shall be shown. Start the next sheet with the same proposed manhole as shown at the end of the previous sheet. Include text indicating the next or previous sheet, which continues the proposed pipe alignment. The text size shall be 5.6 and a weight of 2.  
For example: **“SEE SHEET 20 FOR CONT. OF 8” SEWER,” or “FOR CONTINUATION OF 8” SEWER SEE SHEET 20.”**
4. **SEWER MANHOLES, CHANNELING, SPECIAL DESIGN** – May require the engineer to design special channeling in the manhole, or modify the Standard Drawings. Show the following for special designs: direction of flow, radius of curve, manhole number, station, inlet and outlet pipe and their sizes, section lines, stub outs, shelf elevation (inboard and outboard) and any special notes. The detail shall be placed on the plan or profile view determined by the engineer.
5. **PLAN VIEW SEWER MANHOLES** – Show all existing sewer mains and manholes.
6. **REMOVAL OF EXISTING SEWER MAINS & MANHOLES** – No callout is required for the removal of an existing sewer main & manhole. The Specifications state that the manhole shall be removed along the trench line of the proposed pipe.
7. **ABANDONMENT OF SEWER MAIN AND MANHOLES** – For abandoning existing sewer main outside of trench limits, call out “ABANDON EX” \_ “ SWR ” also, show and call out for concrete plugs. For existing manholes to be abandoned outside of trench limits, the appropriate symbol and call out “ABANDON EX. MH.” shall be used.
8. **PROPOSED MANHOLE WITH POINT NUMBERS CALLOUT** – Represents the Northing and Easting Coordinates that is displayed on the Coordinate Index Table on each sheet and shall be placed as the last line of the construction note.
9. **PROPOSED MANHOLE CALLOUT** – Sewer manholes will be located according to the plan view manhole locations.
10. **REHABILITATED SEWER MAIN THAT IS ATTACHED OR BETWEEN THE PROPOSED SEWER MAIN REPLACEMENT** – Rehabilitated Sewer Main should be shown on the Plan and Profile views.



CONTRACTOR'S NOTE  
 I. PROPOSED WATER MAIN ON LIVINGSTON ST PART OF THIS CONTRACT. SEE SHT 20.

REFERENCE:  
 WATER: 12345-6-D, 23456-7-D  
 SEWER: 12345-6-D  
 STORM DRAIN: 12345-6-D  
 FIELD BOOK: 214-1719, G21  
 THOMAS BROS. J250

RETIREMENTS:  
 767' - 6" VC - 1971  
 MH - 4X3 - 5 - 1971  
 4" LATERAL - 3 - VC - 1971



CONTRACTOR'S NOTE:  
 USE EXTREME CAUTION WHEN WORKING DUE TO LOW OVERHEAD UTILITY LINES.

SEWER GROUP 000	
LIVINGSTON ST	
COLLEGE AVE TO 69TH ST.	
CITY OF SAN DIEGO, CALIFORNIA PUBLIC WORKS DEPARTMENT SHEET OF SHEETS	WATER WBS 0-00000 SEWER WBS 0-00000
FOR CITY ENGINEER _____ DATE _____ PRINT DCE NAME _____ TRC# _____	PROJECT MANAGER _____ PROJECT ENGINEER _____
DESCRIPTION BY APPROVED DATE FILED	0000-0000 COORDINATE
ORIGINAL xx/xx	0000-0000 COORDINATE
CONTRACTOR _____ INSPECTOR _____	DATE STARTED _____ DATE COMPLETED _____
	19905-01-D

LIVINGSTON ST



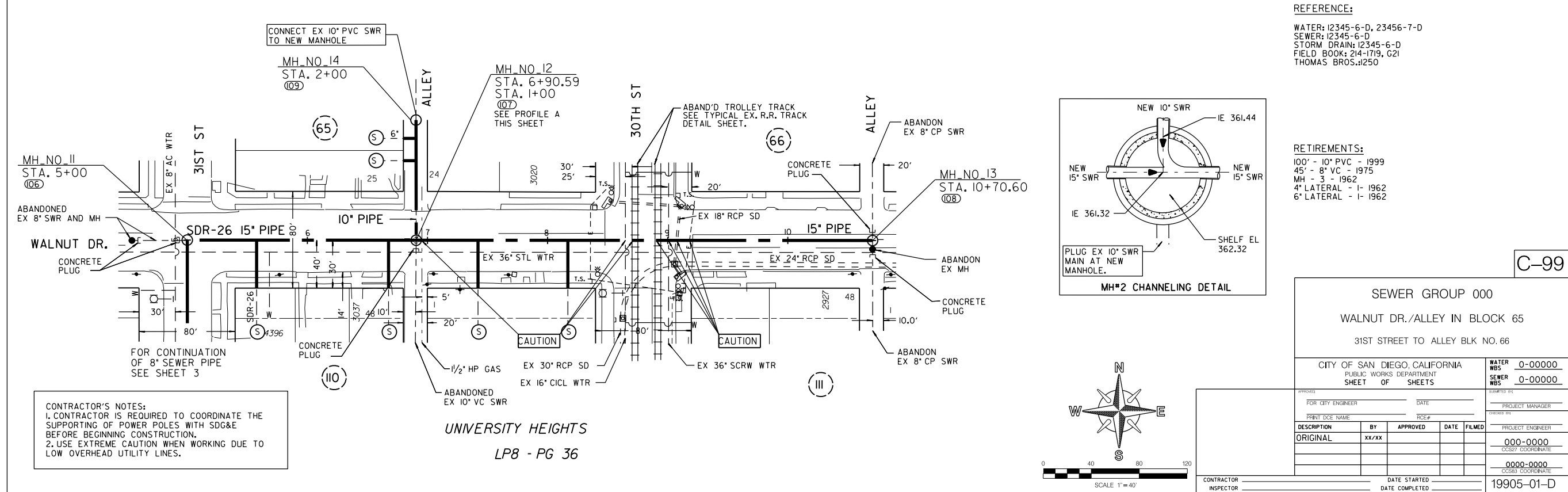
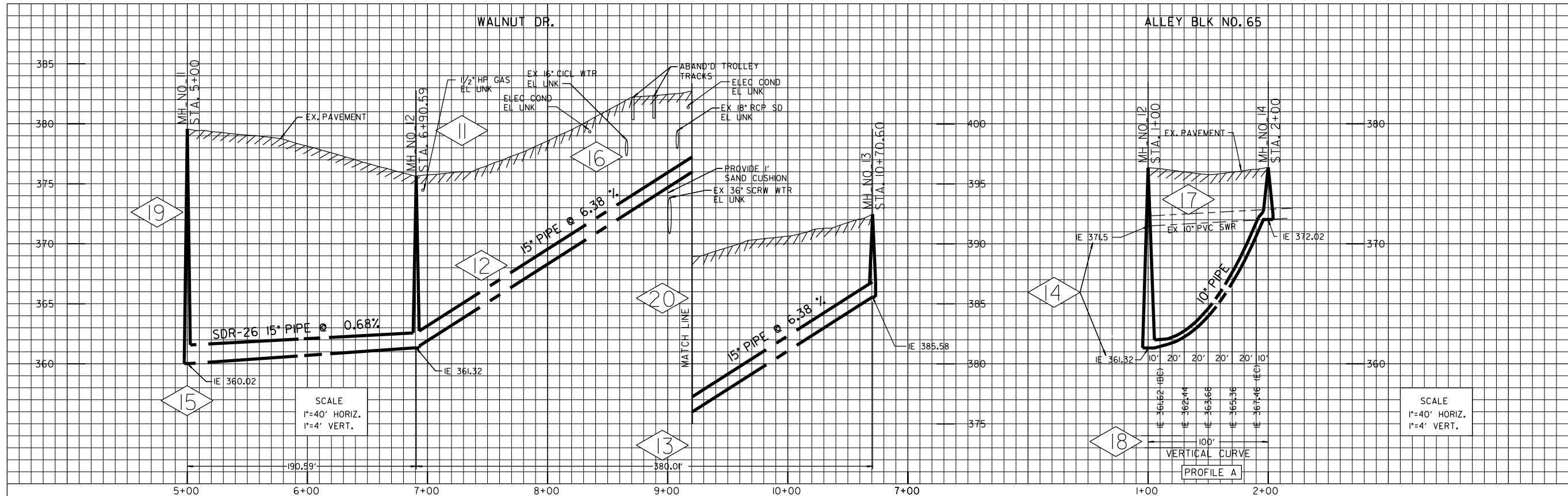
## **PROFILE VIEW**

11. **PROPOSED MANHOLE CALLOUT** – For proposed sewer manholes to be located according to the plan view manhole locations.
12. **PROPOSED SEWER PIPE** – The size and slope of the pipe are to be called out either above or below the proposed pipe. The size and slope of the pipe need not be repeated between the manhole distances if they are the same, otherwise they shall be shown for each distance.  
For example: **REHAB 6" PIPE @ 2.00%, 15" PIPE @ 2.00%, SDR-26 15" PIPE @ 0.68%**
13. **LENGTH OF PIPE** – The horizontal length being shown between the centers of the manholes and below the proposed pipe using dimension lines. The true length of pipe is used when curved lines represent the alignment of a pipe. Place dimensions between proposed manholes on the profile view towards the bottom of the profile grid. Also, if Match Lines are used, place dimensions between manholes where the alignment extends to preceding and/or following sheets.
14. **INVERT ELEVATIONS AT MANHOLES** – Are to be shown only at the center of the manhole for sewer mains 15" and smaller. All incoming pipes to a manhole need not be shown in the profile view.  
**NOTE:** Call out invert elevation of EX MH on the profile view. The information will be used for Capitalization of the group job.
15. **SEWER ALIGNMENT (PROFILE)** – Should be shown downstream to upstream starting from the left side of the sheet. This is because sewers are constructed laying pipe upgrade per the Green Book (Pipe Laying). The profile of the sewer will take precedence over the direction of the north arrow.
16. **EXISTING STRUCTURES** – That are crossed by the proposed pipe or to be connected to the proposed pipe shall be shown. The crossing utilities shall be placed accurately based on as-built drawings or obtained from potholing. Sewer elevations may be interpolated between manholes and labeled as calculated elevations. Otherwise, if no elevation is known then "**EL UNK**" shall be called out.
17. **EXISTING SEWER MAIN REPLACED IN-PLACE (HORIZ.)** – If the existing sewer is being replaced in-place horizontally, then the existing sewer shall be shown in the profile along with the proposed sewer.
18. **VERTICAL CURVES** – Shall show the changes in elevations at the deflection of the pipe and the horizontal distance between each change in elevation.
19. **SHEET LIMITS FOR PROPOSED PIPE – OPTION B**  
**MANHOLE -to- MANHOLE (SEWER)** – The proposed pipe shall begin at a proposed manhole and end at the nearest proposed manhole towards the end of the sheet layout limits. All proposed manholes in-between the sheet limits shall be shown. Start the next sheet with the same proposed manhole as shown at the end of the previous sheet. Text is not needed to show the next or previous sheet because it is shown on the plan view.
20. **VERTICAL BREAKS** - The proposed pipe and existing pavement / ground shall break at an even station. If this is not possible, the break may occur at the nearest 10-foot station. The match line shall be weight 3, style 0. The text size shall be 5.6 and a weight of 2.  
For example: **MATCH LINE**.

Option:

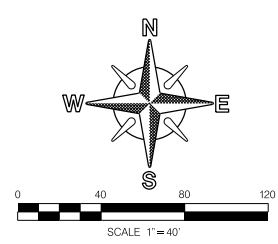
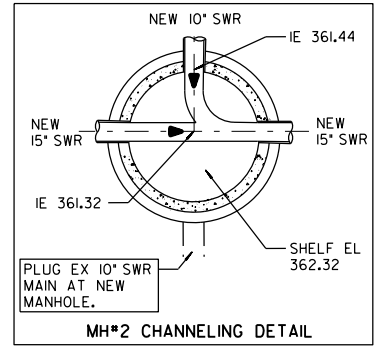
Vertical Scale of 1"= 4' should be used continuous throughout the plans.

When the grade of the alignment is such that it exceeds the lower or upper limits of the profile grid, vertical breaks may be used. If several vertical breaks occur on the profile view, a modified scale can be used. For clarity, the profile view may be modified using 1"= 8' vertical scale. Project alignments should remain at the same profile vertical scale, from beginning station to ending station.



REFERENCE:  
 WATER: 12345-6-D, 23456-7-D  
 SEWER: 12345-6-D  
 STORM DRAIN: 12345-6-D  
 FIELD BOOK: 214-1719, G21  
 THOMAS BROS. J250

RETIREMENTS:  
 100' - 10\"/>



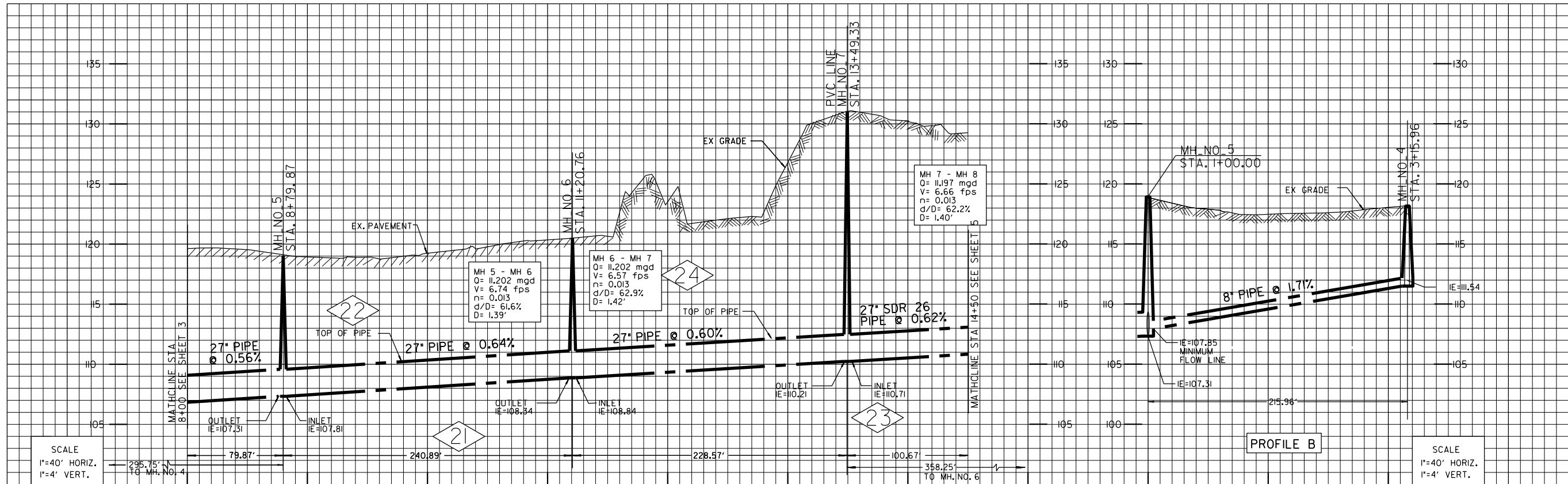
CONTRACTOR'S NOTES:  
 1. CONTRACTOR IS REQUIRED TO COORDINATE THE SUPPORTING OF POWER POLES WITH SDG&E BEFORE BEGINNING CONSTRUCTION.  
 2. USE EXTREME CAUTION WHEN WORKING DUE TO LOW OVERHEAD UTILITY LINES.

UNIVERSITY HEIGHTS  
 LP8 - PG 36

SEWER GROUP 000 WALNUT DR./ALLEY IN BLOCK 65 31ST STREET TO ALLEY BLK NO. 66	
CITY OF SAN DIEGO, CALIFORNIA PUBLIC WORKS DEPARTMENT SHEET OF SHEETS	WATER WBS 0-00000 SEWER WBS 0-00000
FOR CITY ENGINEER _____ DATE _____ PRINT DCE NAME _____ TRC# _____	PROJECT MANAGER _____ PROJECT ENGINEER _____
DESCRIPTION BY APPROVED DATE FILED ORIGINAL xx/xx	000-0000 COORDINATE 0000-0000 COORDINATE
CONTRACTOR _____ DATE STARTED _____ INSPECTOR _____ DATE COMPLETED _____	19905-01-D

WALNUT DR.

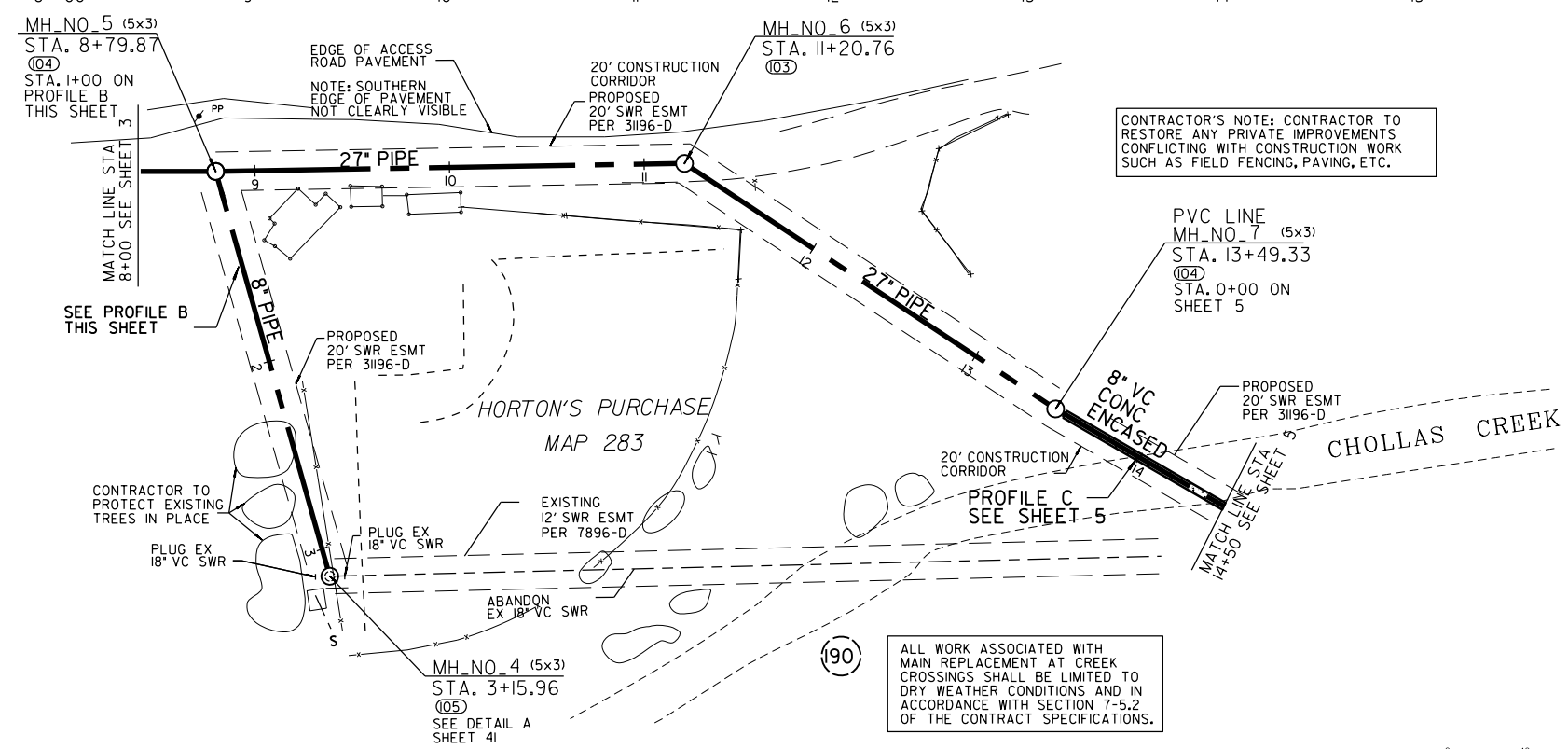
21. **TRUNK SEWER MAINS** – These pipes have special conditions to be considered during design. Trunk Sewers are those where the pipe diameter is larger than 15 inches. Refer to the Sewer Design Guide.
22. **T.O.P. (TOP OF PIPE)** – Used for Trunk Sewer Mains.
23. **INVERT ELEVATIONS FOR SEWER MAINS 18-INCHES AND LARGER:** Invert elevations for the inflow and outflow of the manhole are to be shown, calculate the drop in accordance with the Metropolitan Wastewater Department Sewer Design Guide, Section 2.3.6.  
  
**NOTE:** Call out invert elevation of EX MH on the profile view. The information will be used for Capitalization of the group job.
24. **HYDRAULIC DATA** – Used for Trunk Sewer Mains (18" Diameter and larger). Refer to the Sewer Design Guide for proper information needed on the profile.



PROFILE B

SCALE  
1"=40' HORIZ.  
1"=4' VERT.

SCALE  
1"=40' HORIZ.  
1"=4' VERT.

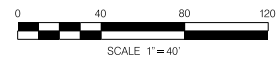


CONTRACTOR'S NOTE: CONTRACTOR TO RESTORE ANY PRIVATE IMPROVEMENTS CONFLICTING WITH CONSTRUCTION WORK SUCH AS FIELD FENCING, PAVING, ETC.

ALL WORK ASSOCIATED WITH MAIN REPLACEMENT AT CREEK CROSSINGS SHALL BE LIMITED TO DRY WEATHER CONDITIONS AND IN ACCORDANCE WITH SECTION 7-5.2 OF THE CONTRACT SPECIFICATIONS.

REFERENCE:  
WATER: 12345-6-D, 23456-7-D  
SEWER: 12345-6-D  
STORM DRAIN: 12345-6-D  
FIELD BOOK: 214-1719, G21S  
THOMAS BROS. 1250

RETIREMENTS:  
500' - 18" VC - 1965  
MH - 4X3 - 1 - 1965



**C-99**

**CHOLLAS VALLEY TRUNK SEWER PHASE II EASEMENT**  
SUNSHINE LITTLE LEAGUE FIELDS  
STA 8+00 TO STA 14+50  
STA 1+00 TO STA 3+15.96

CITY OF SAN DIEGO, CALIFORNIA  
PUBLIC WORKS DEPARTMENT  
SHEET OF SHEETS

DESCRIPTION	BY	APPROVED	DATE	FILMED
ORIGINAL	XX/XX			

CONTRACTOR \_\_\_\_\_ DATE STARTED \_\_\_\_\_  
INSPECTOR \_\_\_\_\_ DATE COMPLETED \_\_\_\_\_

19905-01-D

EASEMENT

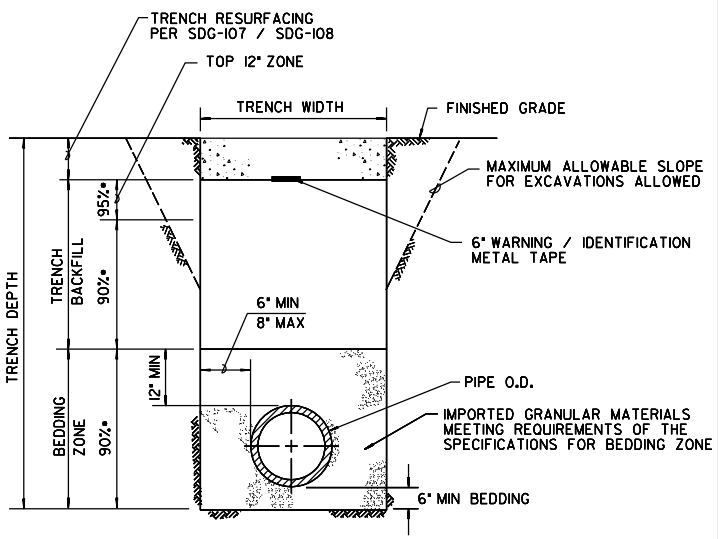
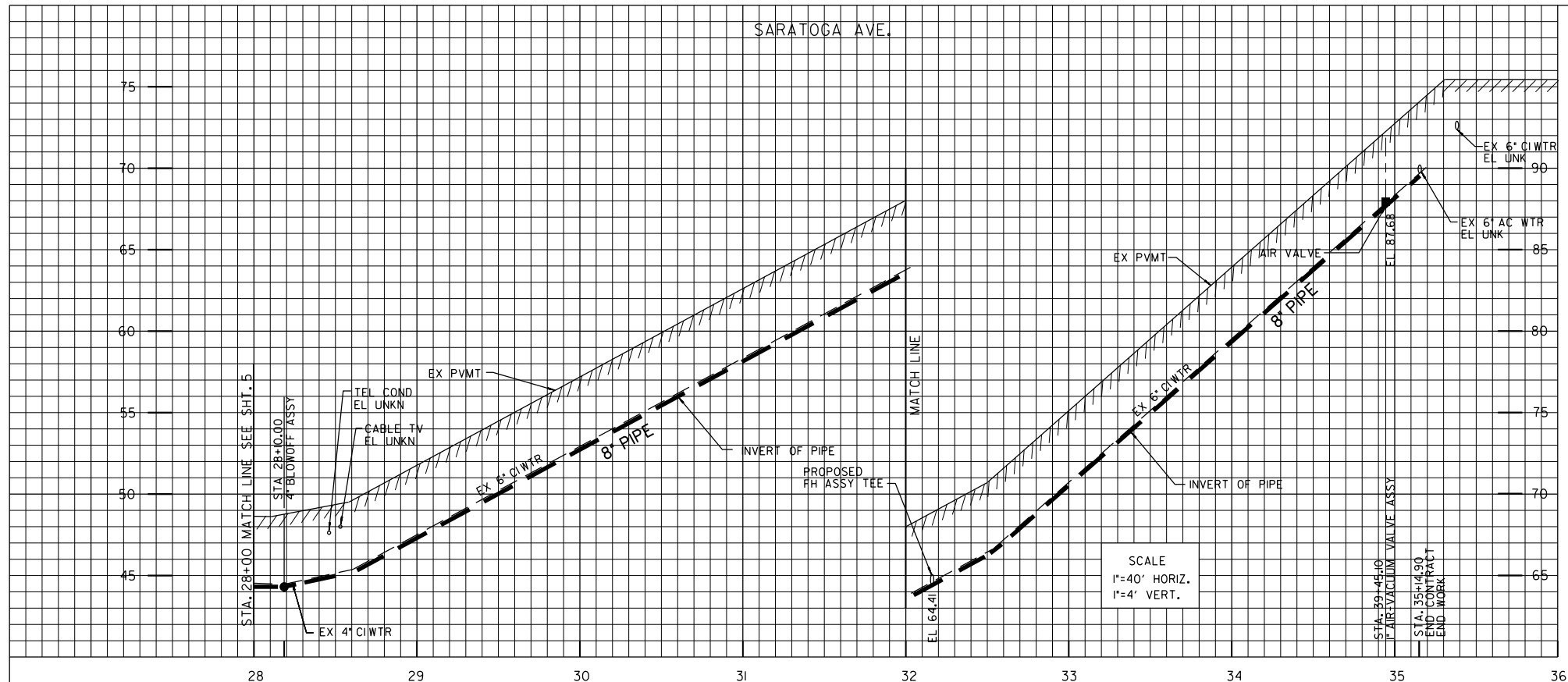
## **SECTION IV**

### **WATER DESCRIPTION**

## **WATER DESCRIPTION**

### **PLAN VIEW**

1. **PROPOSED WATER SERVICES** – Size of circle and text shall be per symbol standards. Circles shall be placed in a uniform line whenever possible. Water services larger than 1” will be labeled next to the service line at the curb location shown vertically.
2. **STIFF - EXISTING WATER SERVICES** – Label each existing water service on the plan view. Verify the water service through field check.
3. **PROPOSED REDUCERS** – Are shown when connecting to a pipe of a different diameter.
4. **EXISTING REDUCERS** – Are not to be shown unless connecting into one or if one is required to be removed. See Symbol Standards Section.
5. **HIGHLINING NOTE** – If no highlining is required, then a note similar to the following: “The existing water mains, fire hydrants and services on this sheet are to be kept in service during construction” shall be used.
6. **CALL OUT FOR PROPOSED WATER INSTALLATIONS** – Shall be provided by the Project Engineer, placed in an organized manner on the plans, and shall be sequentially numbered per each sheet. Fittings shall be designated in the following order according to the direction of the survey line: BK (back), AHD (ahead), LT (left), RT (right).
7. **CALL OUT FOR CITY FORCES / CONTRACTOR WORK** – Use appropriate cell to designate work to be done by City Forces or the Contractor.
8. **PROPOSED WATER WITH POINT NUMBERS CALLOUT** – This point number represents the northing and easting coordinates that is displayed on the Coordinate Index Table on each sheet and shall be placed as the last line of the construction note.
9. **PRESSURE ZONE** – Show the pressure zone boundaries and call out the names of the zones, where applicable. The pressure zones can be found on the water gate book pages for the project area.
10. **NON-STANDARD DETAILS** – should be placed on a specific sheet or on a separate detail sheet.
11. **BLOW-OFFS** – Use the proper symbol and callout on the plan view. Refer to the Water Department Design Guide for locations.
12. **AIR VALVES** – Use the proper symbol and callout on the plan view. Refer to the Water Department Design Guide for locations.



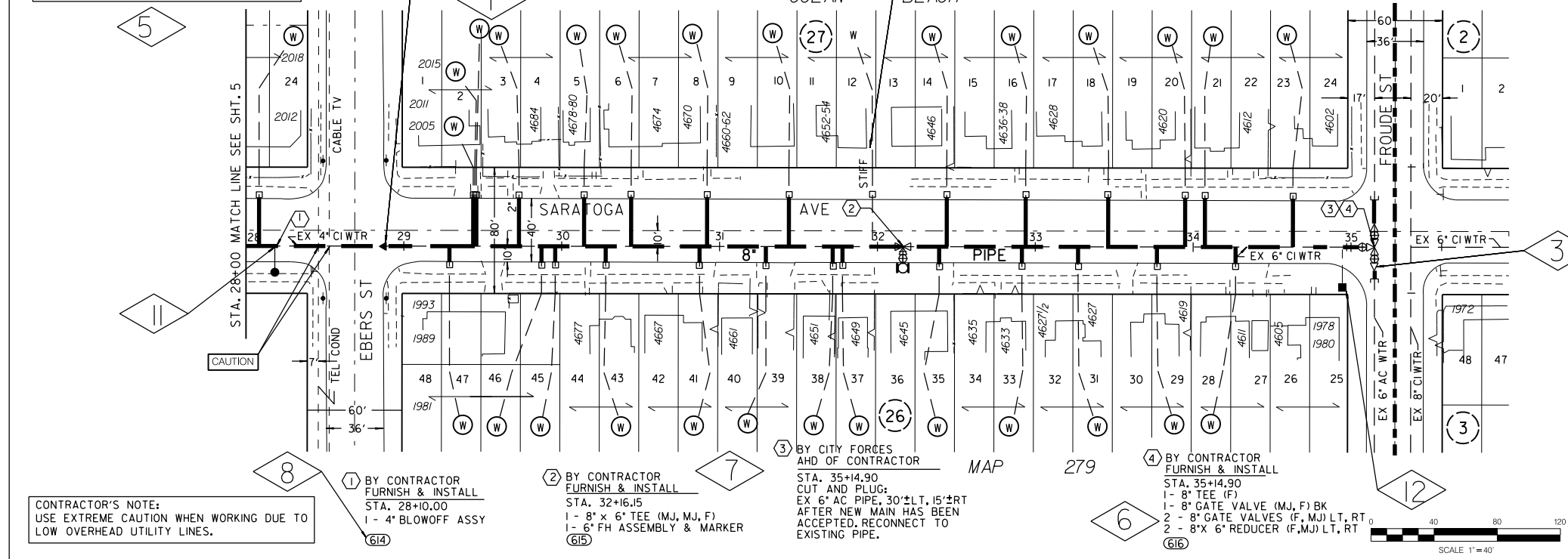
NOTE:  
1. (\*) INDICATES MINIMUM RELATIVE COMPACTION.

**PIPE BEDDING AND TRENCH BACKFILL FOR WATER MAINS**  
NOT TO SCALE

REFERENCE:  
WATER: 12345-6-D, 23456-7-D  
SEWER: 12345-6-D  
STORM DRAIN: 12345-6-D  
FIELD BOOK: 214-1719, G21  
THOMAS BROS. J250

RETIREMENTS:  
715' - 6\"/>

NOTE:  
SARATOGA AVE. TO BE HIGHLINED BY CITY FORCES PRIOR TO CONSTRUCTION. CITY TO FURNISH ALL HIGHLINING MATERIALS AND MAKE ALL CONNECTIONS.



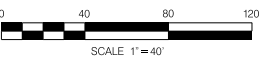
CONTRACTOR'S NOTE:  
USE EXTREME CAUTION WHEN WORKING DUE TO LOW OVERHEAD UTILITY LINES.

① BY CONTRACTOR FURNISH & INSTALL  
STA. 28+10.00  
1 - 4\"/>

② BY CONTRACTOR FURNISH & INSTALL  
STA. 32+16.15  
1 - 8\"/>

③ BY CITY FORCES AHD OF CONTRACTOR  
STA. 35+14.90  
CUT AND PLUG:  
EX 6\"/>

④ BY CONTRACTOR FURNISH & INSTALL  
STA. 35+14.90  
1 - 8\"/>



<b>SEWER &amp; WATER GROUP 000</b>			
SARATOGA AVE.			
EBERS STREET TO FROUDE STREET			
CITY OF SAN DIEGO, CALIFORNIA		WATER WBS	0-00000
PUBLIC WORKS DEPARTMENT		SEWER WBS	0-00000
SHEET OF SHEETS		DATE	
FOR CITY ENGINEER	DATE	PROJECT MANAGER	
PRINT DCE NAME	TITLE#	PROJECT ENGINEER	
DESCRIPTION	BY	APPROVED	DATE
ORIGINAL	XX/XX		
CONTRACTOR	DATE STARTED	19905-01-D	
INSPECTOR	DATE COMPLETED		

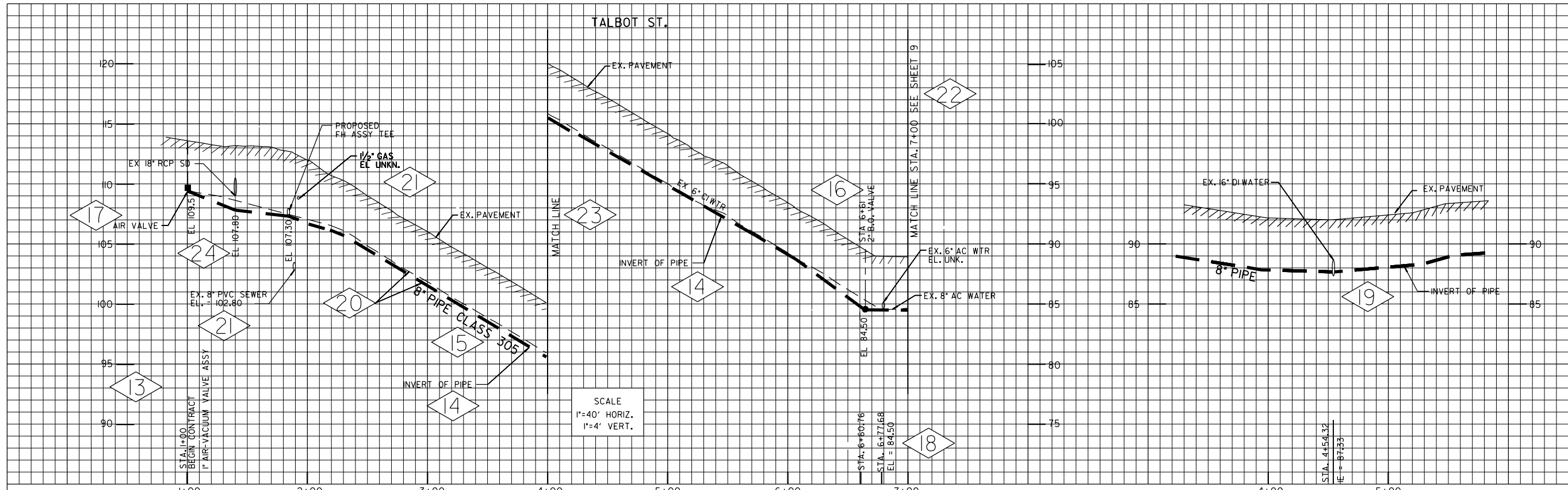
SARATOGA AVE.



## **PROFILE VIEW**

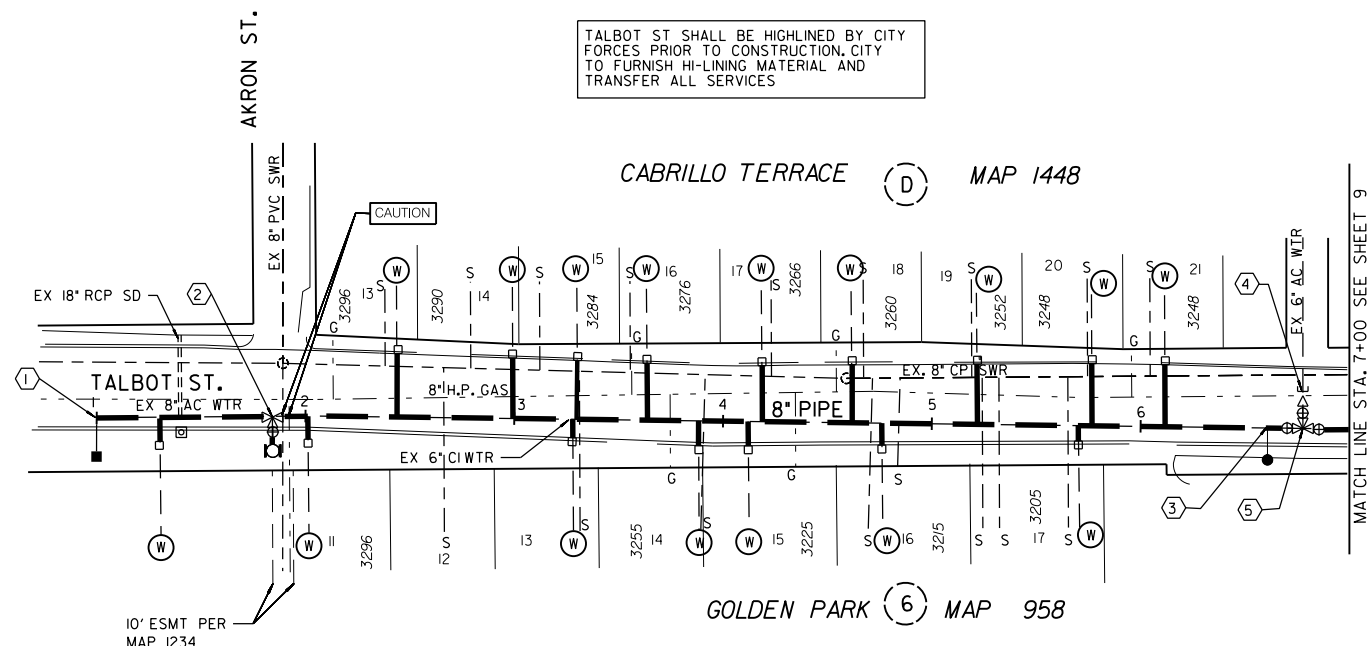
13. **WATER STATION CALLOUT** – Use appropriate cell to designate station call-outs. Examples of where to use the station callouts are: at the beginning and ending of contract work, City forces, Air & Vacuum, blow-off valves, Tees, Crosses, etc.
  - **BEGIN AND END CONTRACT WORK**- Shall have a station callout and either the words **BEGIN** or **END CONTRACT**. This is typically used only on proposed water installations by the Contractor.
  - **BEGIN AND END CITY FORCE WORK** – Shall have a station callout and either the words **BEGIN** or **END WORK**. This is typically used only on proposed water installations by City Forces.
14. **INVERT OF WATER PIPE** – Place callout “INVERT OF PIPE” with leader to the proposed pipe.
  - For a pipe diameter of less than 12 inches, only the pipe invert need be shown.
  - For pipes 12 inches in diameter and larger, the pipe invert and the top of the pipe should be shown.
15. **PROPOSED WATER PIPE** – Any class of pipe other than CL 235 should be called out. For example: **8” PIPE CLASS 305**.
16. **BLOW-OFFS** – Use the proper symbol and callout with stationing and elevation on the profile view. Refer to the Water Department Design Guide for locations.
17. **AIR VALVES** – Use the proper symbol and callout with stationing and elevation on the profile view. Refer to the Water Department Design Guide for locations.
18. **PROPOSED TEES / CROSSES** - Call out the station and proposed invert elevation of the Tee or Cross. The elevations at that point need only be carried out to one decimal point.
19. **PERPENDICULAR WATER MAINS** - When connecting the proposed water main to an existing / proposed the water main it should tie in at the center line of the pipe not the invert of the pipe.
20. **REPLACING IN-PLACE (WATER)** – When replacing in-place, the existing pipe shall be shown at its proper elevation on the profile (if known).
21. **EXISTING UTILITIES** – Existing Utilities that are crossed by the proposed pipe or connected to the proposed pipe shall be shown. The elevation for each will be called out if known from as-built drawings or if the elevation was obtained from potholing. Otherwise if no elevation is known, then **EL UNK** shall be specified. EL UNK shall be the callout for all outside utility companies. We are responsible for locating their utilities for the Contractor.

22. **SHEET LIMITS FOR PROPOSED PIPE**  
**MATCH LINE (WATER)** – The proposed pipe shall have limits at the beginning and ending of a sheet at 50 or 100-foot stationing whenever possible. For example, 5+00, 7+50. If this is not possible, the break may occur at the nearest 10-foot station. Example, 7+40, 8+60. Match lines shall be used where the 50 or 100-foot stations occur. The match line shall be weight 3, style 0. Include text indicating the location of the continued proposed pipe. The text size shall be 5.6 and a weight of 2.  
For example: **MATCH LINE STA. 7+00 SEE SHEET 9.**
23. **VERTICAL BREAKS** - The proposed pipe and existing pavement / ground shall break at an even station. If this is not possible, the break may occur at the nearest 10-foot station. The match line shall be weight 3, style 0. The text size shall be 5.6 and a weight of 2.  
For example: **MATCH LINE.**
24. **VERTICAL DEFLECTIONS (GRADE BREAK) FOR PROPOSED TRANSMISSION WATER MAINS** – Are designated at any deflection of the pipe at the joints. Abrupt vertical grade breaks resulting in upward thrust should be avoided. The elevations at that point need only be carried out to one decimal point.



SCALE  
1"=40' HORIZ.  
1"=4' VERT.

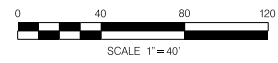
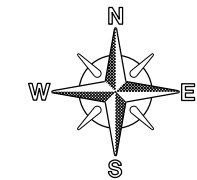
TALBOT ST SHALL BE HIGHLINED BY CITY FORCES PRIOR TO CONSTRUCTION. CITY TO FURNISH HI-LINING MATERIAL AND TRANSFER ALL SERVICES



- ① BY CONTRACTOR FURNISH & INSTALL:  
STA. 1+00.00  
1 - 1" AIR & VACUUM VALVE ASSY  
(616)
- ② BY CONTRACTOR FURNISH & INSTALL:  
STA. 1+84.19  
1 - 8" X 6" TEE (M, J, M, F)  
1 - 6" FH ASSEMBLY & MARKER  
(617)
- ③ BY CONTRACTOR FURNISH & INSTALL:  
STA. 6+60.76  
FURNISH & INSTALL:  
1 - 2" B.O. ASSY  
(618)
- ④ BY CITY FORCES AHD OF CONTRACTOR  
STA. 6+77.68 40'± LF  
CUT & PLUG EX 6" AC WTR  
RECONNECT AFTER NEW MAIN HAS BEEN ACCEPTED.
- ⑤ BY CONTRACTOR FURNISH & INSTALL:  
STA. 6+77.68  
1 - 8" TEE (F)  
3 - 8" GATE VALVES (F, MJ) BK, AHD, LT  
1 - 8" X 6" REDUCER, 40' LT  
40' - 8" CLASS 200 PIPE, LT  
(619)

REFERENCE:  
WATER: 12345-6-D, 23456-7-D  
SEWER: 12345-6-D  
STORM DRAIN: 12345-6-D  
GAS: 11-271  
ELECTRIC: 210-1725A  
CABLE TV: 210-1725  
TELEPHONE: MAP 1220  
IMPROVEMENTS: 1234-L  
100' SCALE FIELD BOOK: 214-1719, G21  
THOMAS BROS. 1250  
HGL: 256

RETIREMENTS:  
577' - 6" CI - 1941  
FH (2-PORT) - 1  
1" - 16 - COPPER



C-99			
SEWER & WATER JOB 000 TALBOT ST. ARKON STREET TO ALLEY BLOCK D			
CITY OF SAN DIEGO, CALIFORNIA PUBLIC WORKS DEPARTMENT SHEET OF SHEETS		WATER WBS 0-00000	SEWER WBS 0-00000
FOR CITY ENGINEER	DATE	PROJECT MANAGER	
PRINT DCE NAME	TRCE#	PROJECT ENGINEER	
DESCRIPTION	BY	APPROVED	DATE FILMED
ORIGINAL	XX/XX		
		000-0000 COORDINATE	
		0000-0000 COORDINATE	
CONTRACTOR		DATE STARTED	
INSPECTOR		DATE COMPLETED	
		19905-01-D	

TALBOT ST.

## **SECTION V**

### **MISCELLANEOUS PLAN SHEETS**

## **MISCELLANEOUS PLAN SHEETS**

1. **WORK BY CITY FORCES** –
  - Show right-of-way (street) lines, street names, address hundred block numbers, existing and proposed water mains and fire hydrants.
  - Call out the appropriate locations, edit the numbers to reflect what work needs to be done (see construction notes).
  - For FH symbols use the cells, but for the proposed FH cell change the weight to 4 so the Fire Department can distinguish the difference.
  - Show the pressure zone boundaries and call out the names of the zones, where applicable. The pressure zones can be found on the water gate book pages for the project area.
  - Fill out the table for materials to be supplied by Contractor to City Force.
  - Fill out the table for Thrust/Anchor for 16" and Larger Water Mains.
2. **SEWER ABANDONMENT SHEET** – Call out the I.E. and the rim of the manholes to be abandoned, length, size, type of material of pipe and show the locations of the concrete plugs. The information will be used for Capitalization of the group job.
3. **REHABILITATED SEWER MAIN SHEET** – Call out the I.E. and the rim of the manholes and the length, size of the sewer mains to be rehabilitated. No need to provide profile view, if the following situations apply:
  - Stand-alone Rehabilitated Sewer Main – Information in Contract Documents or Rehab Sheet in the plans.
  - Rehabilitated Sewer Main is attached to Proposed Sewer Main Replacement – Shown in the plans.
  - In case Rehabilitated Sewer Main is between Proposed Sewer Main Replacement, Rehabilitated Sewer Main should be shown on the Plan and Profile views.
4. **CURB RAMP SHEET** – Call out the locations of the proposed curb ramps and list the type of curb ramps in the table.
5. **STREET RESURFACING SHEET** – Show the areas of resurfacing/slurry and list the limits in the table.
6. **REPLUMB DETAIL SHEET** – The detail drawing of each property location to be replumbed, and should be enlarged enough to see the proposed lateral alignment.

7. **PERMANENT STORM WATER BEST MANAGEMENT PRACTICES STANDARD DEVELOPMENT PROJECTS**
  - 1 The Site Map is a copy of the Grading Plan with the incorporation of the Site Design and Source Control BMPs as described in Nos. 2 and 3 below.
  - 2 LID/Site Design BMP Checklist can be found in Form I-5 on this sheet. Incorporate and label the site design BMPs marked "YES" on the Site Map.
  - 3 Source Control BMP Checklist can be found in Form I-4 on this sheet. Incorporate and label the source control BMPs marked "YES" on the Site Map.
8. **PERMANENT STORM WATER BEST MANAGEMENT PRACTICES PRIORITY DEVELOPMENT PROJECTS**
  - 1 Information can be found on the Cover Sheet of the Storm Water Quality Management Plan (SWQMP).
  - 2 LID/Site Design BMP Checklist can be found in Form I-5 of the Storm Water Quality Management Plan (SWQMP).
  - 3 Source Control BMP Checklist can be found in Form I-4 of the Storm Water Quality Management Plan (SWQMP).
  - 4 Summary of PDP Structural BMPs can be found in Form I-6 of the Storm Water Quality Management Plan (SWQMP).
  - 5 Operation and Maintenance of BMPs can be found in Attachment 3: Structural BMP Maintenance Plan of the Storm Water Quality Management Plan (SWQMP).
  - 6 This should match the DMA exhibit in Attachment 1A of the Storm Water Quality Management Plan (SWQMP). The DMA Exhibit is generally prepared on one sheet or multiple sheets.
  - 7 This should match the legend on the DMA exhibit in Attachment 1A of the Storm Water Quality Management Plan (SWQMP).
  - 8 Refer to the sheet number/numbers of the BMP Map.
9. **TRAFFIC CONTROL** – Call out the project name for the traffic control plans. Add the name(s) of the street(s) where traffic control will be placed with the 85<sup>th</sup>% speed.
10. **TRAFFIC SIGNAL INSTALLATION** – Call out the project name, complete the Storm Water Protection notes, update the Key Map and add the street name(s) with the current ADT values under Street Classification.
11. **FIRE DEPARTMENT INFORMATION SHEET** – This is showing an example of information that the Fire Department wants when submitting the Fire Protection Review for the project area by the engineer.
12. **ADDENDUM SAMPLE SHEET** – An Addendum is a change to plans or contract that is issued during advertising before the bid opening and the project is awarded. Show the changes from the Addendum on the plans by lining out features that will be removed and adding new features. Nothing shall be deleted from the plans at this stage. If required, cross out the entire sheet and add a new sheet for the change. Place graphic "clouds" around the area of change along with a lettered Delta cell. Place the Addendum Cell in the appropriate location on the Title Block and add a brief description with the Addendum letter below the Title Block in the border area. See format for cover sheet, deleted and added sheets.
13. **AS-BUILT SAMPLE SHEETS** – See standard operating procedures for as-builts and sample sheets.

THRUST/ANCHOR TABLE FOR 16" AND LARGER WATER MAINS							
SHEET NO.	PIPE STATIONING	TYPE OF BLOCK	TYPE OF APPURTENANCE	DESIGN PRESSURE	TOTAL THRUST (lb)	ASSUMED SOIL CAPACITY	MINIMUM BEARING AREA (sq. ft.), SEE NOTE 3 BELOW OR VOLUME OF BLOCK (cu. ft.)
2	0+00.00	THRUST	16"x16" BEND	123 LB/SQ. IN.	41,392	1000 LB/SQ. FT.	41 SQ. FT.
3	0+00.00	THRUST	16"x12" TEE	117 LB/SQ. IN.	27,845	1000 LB/SQ. FT.	28 SQ. FT.
4	0+00.00	THRUST	16"x12" CROSS	78 LB/SQ. IN.	28,706	1000 LB/SQ. FT.	29 SQ. FT.
5	0+00.00	THRUST	16" END CAP	93 LB/SQ. IN.	22,133	1000 LB/SQ. FT.	22 SQ. FT.

• THE SPECIFIC WEIGHT OF CONCRETE IS 140LB/CU.FT. SAFETY FACTOR = 1.5

NOTES:  
 1. FOR ADDITIONAL THRUST BLOCK, ANCHOR BLOCKS DETAILS AND NOTES SEE SDW-151.  
 2. REFER TO SPECIFICATIONS SECTION 306-L2J4 FOR ADDITIONAL REQUIREMENTS.  
 3. FOR ESTIMATING THE CY QUANTITY FOR THRUST BLOCKS, THE DEPTH OF THE THRUST BLOCKS SHALL BE HALF OF THE TRENCH WIDTH PLUS 12" EMBEDMENT.

CONTRACTOR FURNISH MATERIALS FOR CITY FORCE WORK						
SHT NO.	12" TEE	12" VALVE	12" X 10" REDUCER	12" BLIND FLANGE	8" BLIND FLANGE	12" CLASS 200 PIPE
3	1	2	1	1		20'
4	1	2			1	20'

LEGEND

- EXISTING WATER MAIN
- PROPOSED WATER MAIN
- PRESSURE ZONE

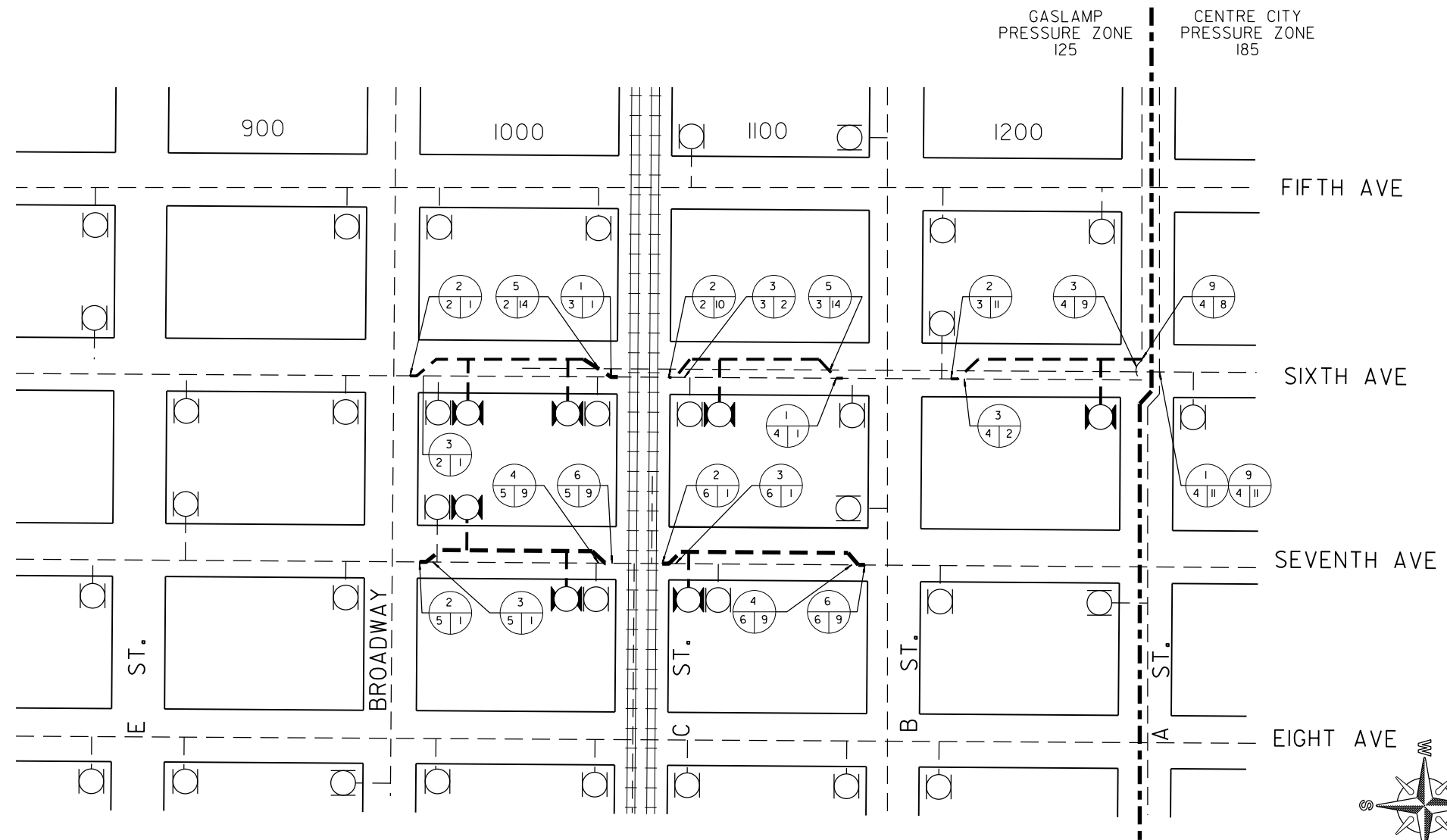
- FIRE HYDRANT TO REMAIN IN SERVICE DURING CONSTRUCTION
- ⊠ PROPOSED FIRE HYDRANT

- ⊙ CITY FORCES NOTE NUMBER (THIS SHEET)
- ⊙ CITY FORCES NOTE NUMBER (PLAN & PROFILE SHT.)
- PLAN & PROFILE 'D' SHEET NUMBER

- BC --- BEFORE CONTRACTOR
- AC --- AFTER CONTRACTOR

WORK BY CITY FORCES

- 1 BC - CLOSE EX VALVE (REPLACE IF NEEDED)  
AC - OPEN EX VALVE
- 2 BC - CUT & PLUG  
AC - RECONNECT
- 3 BC - CUT AND PLUG FOR ABANDONMENT BY CONTRACTOR
- 4 AC - CUT AND PLUG FOR ABANDONMENT BY CONTRACTOR
- 5 AC - CONNECTION
- 6 AC - CUT AND PLUG AND RECONNECT
- 7 AC - CUT AND ABANDON
- 8 AC - INSTALL
- 9 BC - INSTALL



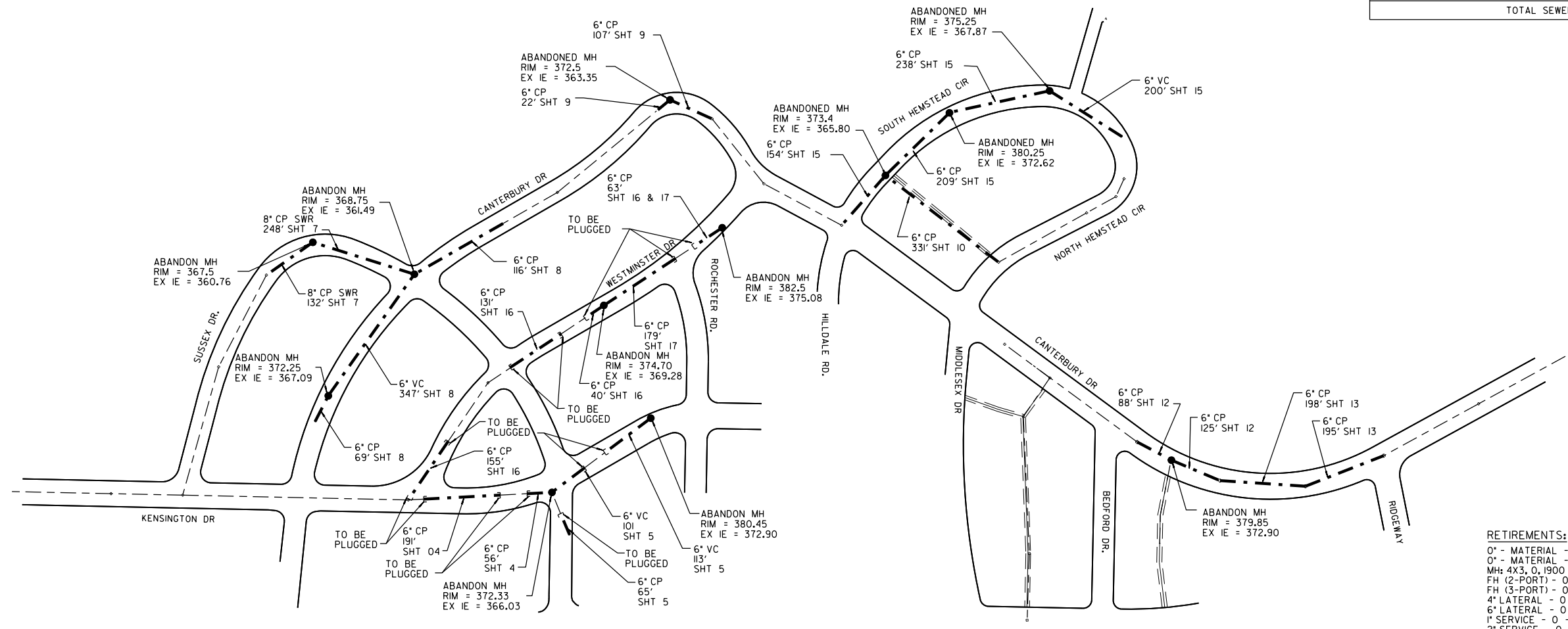
WATER GROUP 000 WORK BY CITY FORCES		C-99
CITY OF SAN DIEGO, CALIFORNIA PUBLIC WORKS DEPARTMENT SHEET OF SHEETS		WATER WBS 0-00000 SEWER WBS 0-00000
FOR CITY ENGINEER _____ DATE _____	PROJECT MANAGER _____	
PRINT DCE NAME _____	PROJECT ENGINEER _____	
DESCRIPTION	BY	APPROVED
ORIGINAL	XX/XX	
		DATE
		FILMED
CONTRACTOR _____	DATE STARTED _____	19905-01-D
INSPECTOR _____	DATE COMPLETED _____	

WORK BY CITY FORCES

SEWER & WATER ABANDONMENT

WATER MAIN TO BE ABANDONED				
NO	LOCATION	SIZE OF PIPE	MATERIAL	LENGTH FT
1	-	-	-	-
2	-	-	-	-
3	-	-	-	-
TOTAL WATER MAIN TO BE ABANDONED				-

SEWER MAIN TO BE ABANDONED				
NO	LOCATION	SIZE OF PIPE	MATERIAL	LENGTH FT
1	-	-	-	-
2	-	-	-	-
3	-	-	-	-
4	-	-	-	-
5	-	-	-	-
6	-	-	-	-
TOTAL SEWER MAIN TO BE ABANDONED				-



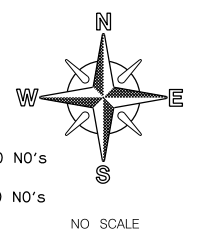
**RETIREMENTS:**  
 0' - MATERIAL - 0' - 1900  
 0' - MATERIAL - 0' - 1900  
 MH: 4X3, 0, 1900  
 FH (2-PORT) - 0  
 FH (3-PORT) - 0  
 4" LATERAL - 0 - (MATERIAL) - 1900  
 6" LATERAL - 0 - (MATERIAL) - 1900  
 1" SERVICE - 0 - (MATERIAL) - 1900  
 2" SERVICE - 0 - (MATERIAL) - 1900

2

C-99

**LEGEND**

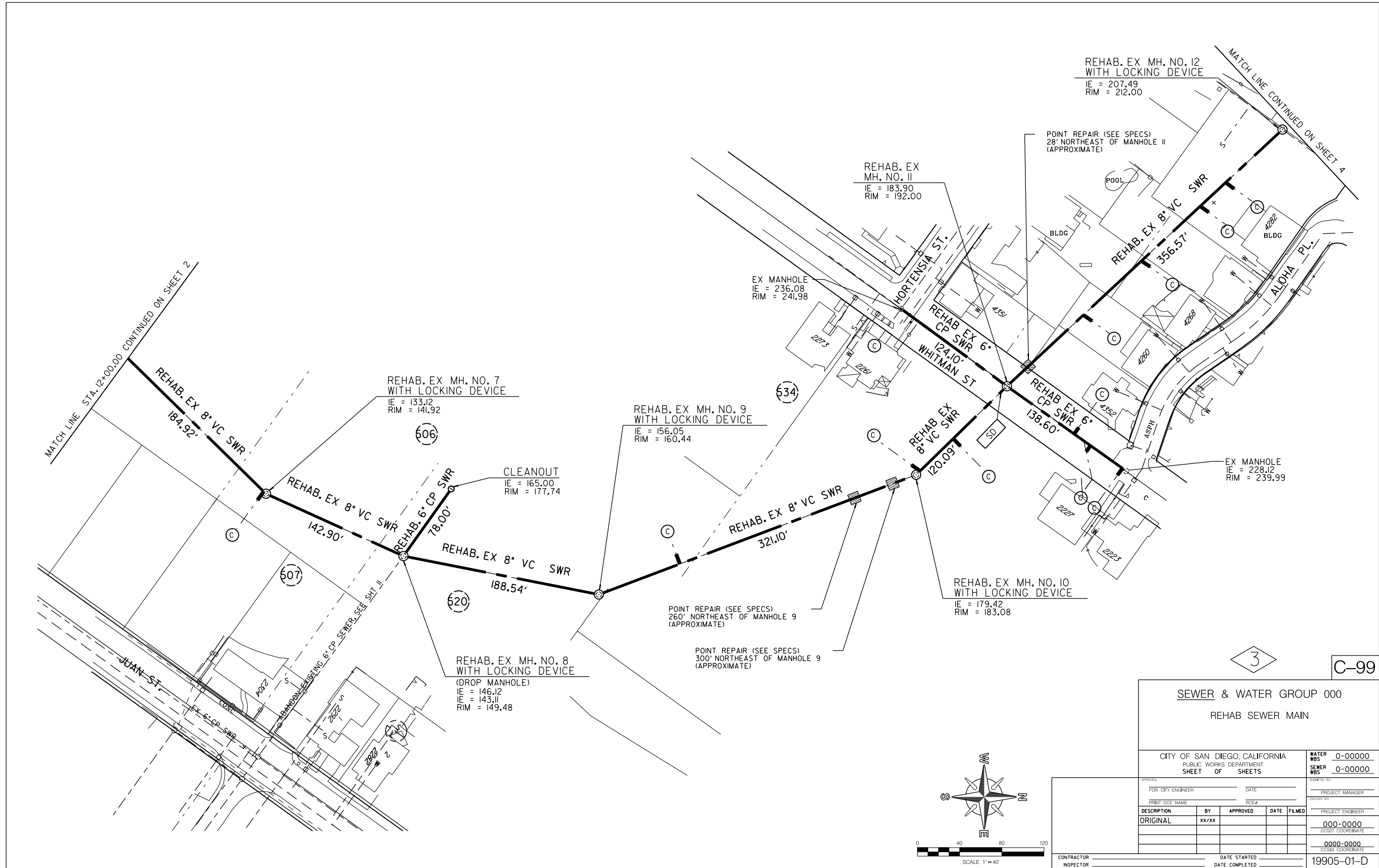
NO	WATER MAIN TO BE ABANDONED NO's
NO	SEWER MAIN TO BE ABANDONED NO's
---	WATER MAIN TO BE ABANDONED
---	SEWER MAIN TO BE ABANDONED
---	EXISTING WATER MAIN
---	EXISTING SEWER MAIN
[●]	ABANDON EX MANHOLE



<b>SEWER &amp; WATER GROUP 000</b>	
SEWER & WATER ABANDONMENT	
CITY OF SAN DIEGO, CALIFORNIA PUBLIC WORKS DEPARTMENT SHEET OF SHEETS	
APPROVED FOR CITY ENGINEER _____ DATE _____ PRINT DCE NAME _____ TITLE# _____ DESCRIPTION BY APPROVED DATE FILMED ORIGINAL xx/xx	WATER WBS 0-00000 SEWER WBS 0-00000 PROJECT MANAGER _____ PROJECT ENGINEER _____ SEE SHEETS CCS27 COORDINATE SEE SHEETS CCS31 COORDINATE XXXXX-XX-D
CONTRACTOR _____ INSPECTOR _____	DATE STARTED _____ DATE COMPLETED _____



REHAB SEWER MAIN



REHAB. EX MH. NO. 12  
WITH LOCKING DEVICE  
IE = 207.49  
RIM = 212.00

REHAB. EX MH. NO. 11  
IE = 183.90  
RIM = 192.00

REHAB. EX MH. NO. 7  
WITH LOCKING DEVICE  
IE = 133.12  
RIM = 141.92

REHAB. EX MH. NO. 9  
WITH LOCKING DEVICE  
IE = 156.05  
RIM = 160.44

CLEANOUT  
IE = 165.00  
RIM = 177.74

REHAB. EX MH. NO. 10  
WITH LOCKING DEVICE  
IE = 179.42  
RIM = 183.08

REHAB. EX MH. NO. 8  
WITH LOCKING DEVICE  
(DROP MANHOLE)  
IE = 146.12  
IE = 143.11  
RIM = 149.48

POINT REPAIR (SEE SPECS)  
260' NORTHEAST OF MANHOLE 9  
(APPROXIMATE)

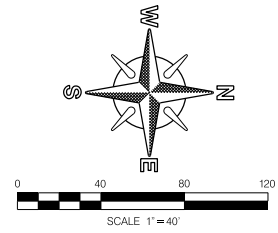
POINT REPAIR (SEE SPECS)  
300' NORTHEAST OF MANHOLE 9  
(APPROXIMATE)

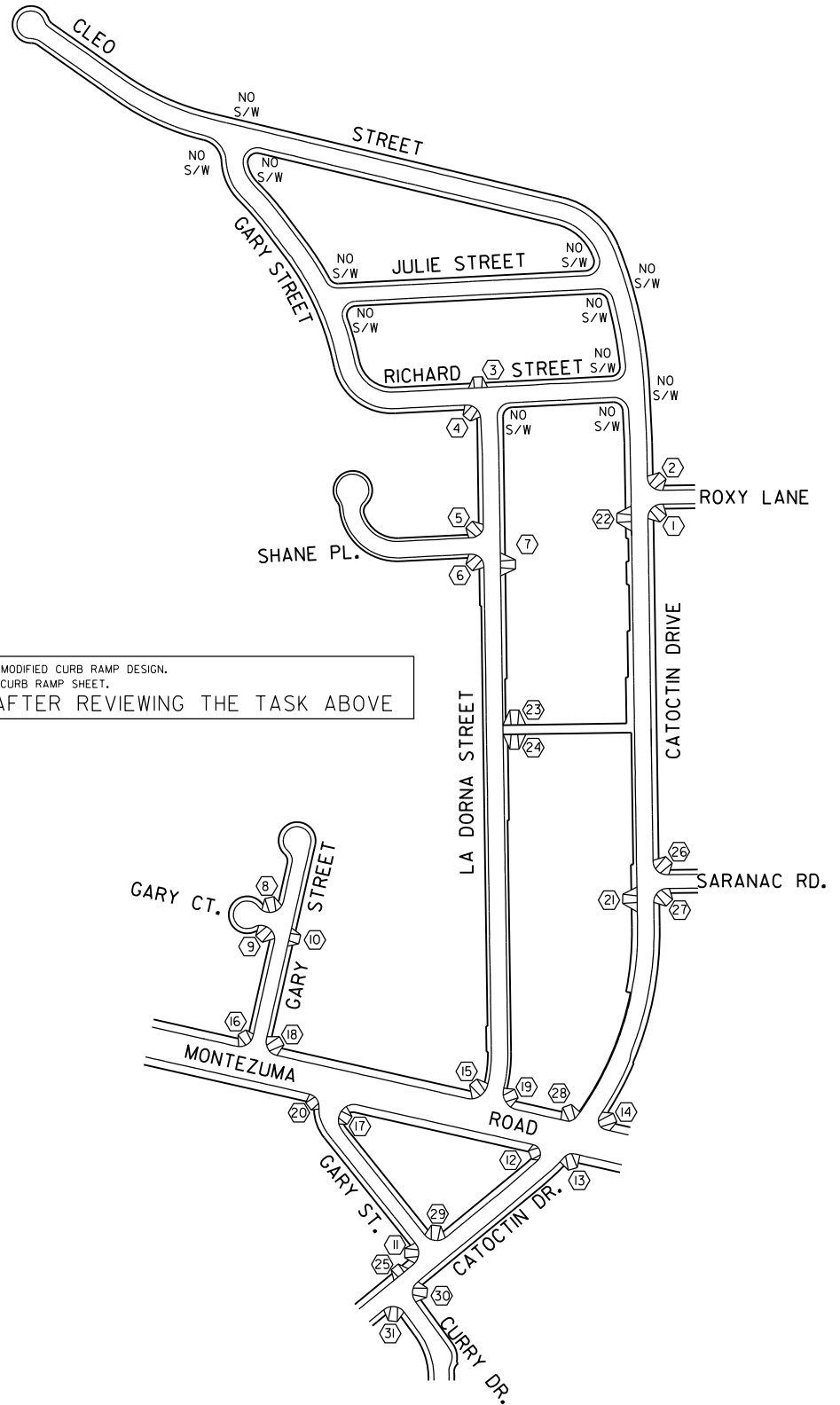
POINT REPAIR (SEE SPECS)  
28' NORTHEAST OF MANHOLE 11  
(APPROXIMATE)

3

C-99

SEWER & WATER GROUP 000			
REHAB SEWER MAIN			
CITY OF SAN DIEGO, CALIFORNIA		WATER WBS	0-00000
PUBLIC WORKS DEPARTMENT		SEWER WBS	0-00000
SHEET OF SHEETS		DATE	
FOR CITY ENGINEER	DATE	PROJECT MANAGER	
PRINT DCE NAME	TRC#	PROJECT ENGINEER	
DESCRIPTION	BY	APPROVED	DATE
ORIGINAL	XX/XX		
CONTRACTOR	DATE STARTED	19905-01-D	
INSPECTOR	DATE COMPLETED		



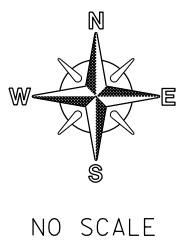


\* PROVIDE DETAILS ON PLAN TO SHOW MODIFIED CURB RAMP DESIGN.  
 \* CREATE A NEW SHEET FOR MODIFIED CURB RAMP SHEET.  
 DELETE THIS NOTE AFTER REVIEWING THE TASK ABOVE

CURB RAMP NOTES TABLE									
LOCATION NO.	RAMP TYPE	NEW	REPLACEMENT	HISTORIC STAMPS	TRUNCATED DOME MATERIAL		CONSTRAINTS	COMMENTS / MODIFICATIONS	
					• STAINLESS STEEL	• OTHER			
1	A	X							
2	A	X							
3	CI								
4	CI								
5	CI								
6	CI								
7	CI								
8	CI								
9	CI								
10	A								
11	A		X					REPLACE EXISTING SUB-STANDARD	
12	CI		X					REPLACE EXISTING SUB-STANDARD	
13	CI		X					REPLACE EXISTING SUB-STANDARD	
14	CI		X					REPLACE EXISTING SUB-STANDARD	
15	CI		X					REPLACE EXISTING SUB-STANDARD	
16	CI		X					REPLACE EXISTING SUB-STANDARD	
17	CI		X					REPLACE EXISTING SUB-STANDARD	
18	CI		X					RETROFIT EX. STANDARD CURB RAMP WITH TRUNCATED DOME	
19	CI		X					RETROFIT EX. STANDARD CURB RAMP WITH TRUNCATED DOME	
20	CI		X					RETROFIT EX. STANDARD CURB RAMP WITH TRUNCATED DOME	
21	CI								
22	CI								
23	D	X							
24	D	X							
25	A								
26	---							NEW EXISTING CURB RAMP - NO ACTION	
27	---							NEW EXISTING CURB RAMP - NO ACTION	
28	---							NEW EXISTING CURB RAMP - NO ACTION	
29	---							NEW EXISTING CURB RAMP - NO ACTION	
30	---							NEW EXISTING CURB RAMP - NO ACTION	
31	---							NEW EXISTING CURB RAMP - NO ACTION	

• THE DETECTABLE WARNING TILES SHALL BE PER THE CITY'S APPROVED MATERIALS LIST

NOTE:  
 CONTRACTOR TO NOTIFY SURVEYING 30 DAYS PRIOR TO REMOVAL OF SIDEWALK FOR CURB RAMP CONSTRUCTION TO RELOCATE ANY SURVEY MARKERS.



LEGEND	
Ⓢ CURB RAMP NO's	T EX TREE
• EX UTILITY POLE	† EX STREET SIGN
○ EX FIRE HYDRANT	◦ EX STREET LIGHT
□ EX CURB RAMP	

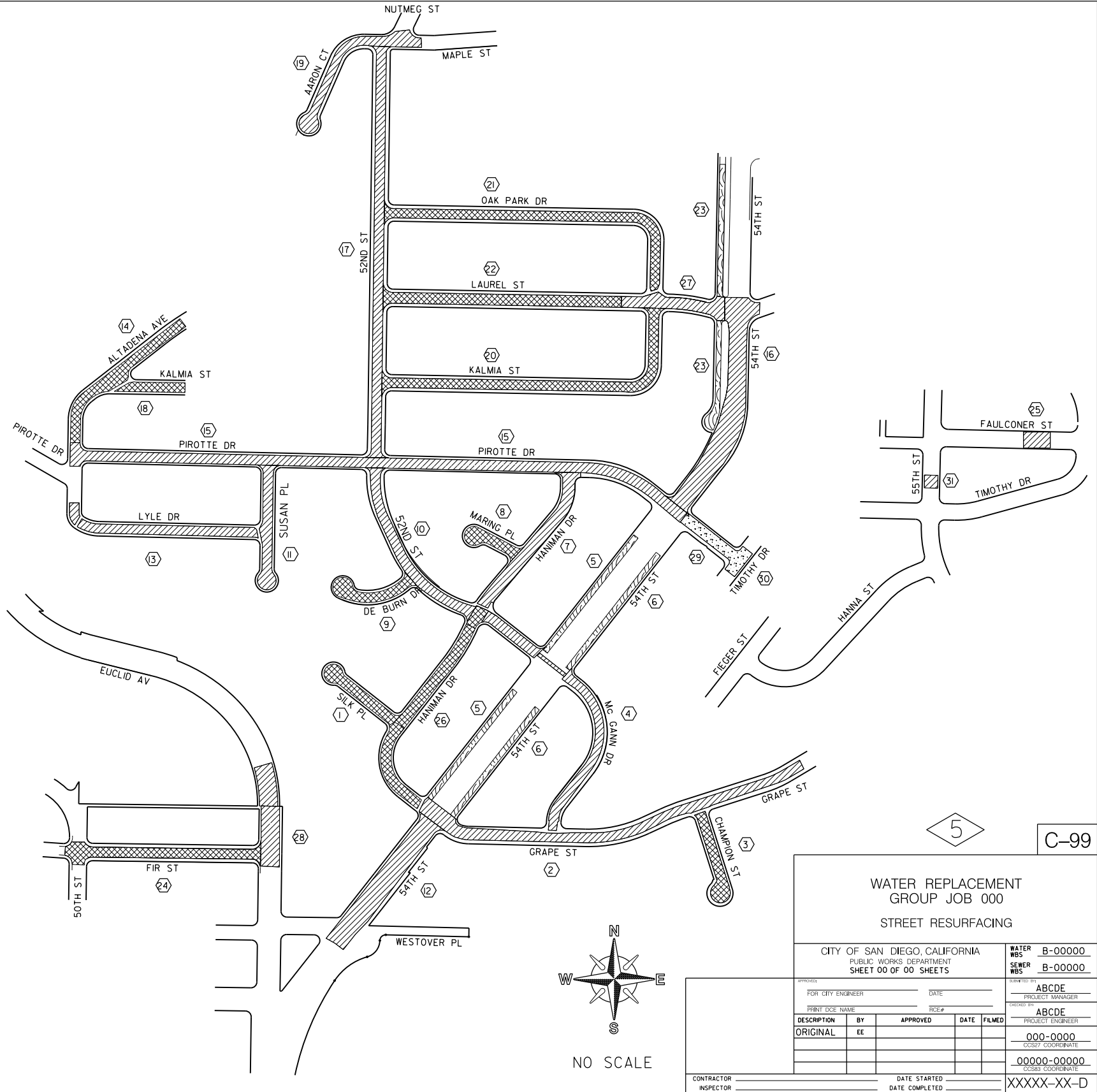
PROPOSED CURB RAMP PER STANDARD DRAWINGS:	
DETECTABLE WARNING TILES	SDG-130
GENERAL CURB RAMP NOTES	SDG-131
GENERAL CURB RAMP NOTES & SUPPLEMENTAL DETAILS	SDG-132
CURB RAMP A & B	SDG-133
DUAL CURB RAMP	SDG-134
CURB RAMP - TYPE C1 & C2	SDG-135
CURB RAMP - TYPE C1 & C2 & MORE DETAILS	SDG-136
CURB RAMP - TYPE D	SDG-137
GENERAL CURB RAMP	SDG-138
ISLAND AND PASSAGEWAY DETAILS	SDG-139
CURB RAMP BARRICADE	SDG-140
EX STAMP/IMPRESSION PLACEMENT	SDG-115

PROJECT TITLE CURB RAMP LOCATION				
CITY OF SAN DIEGO, CALIFORNIA PUBLIC WORKS DEPARTMENT SHEET OF SHEETS				
WATER WBS 0-00000	SEWER WBS 0-00000			
FOR CITY ENGINEER _____ DATE _____	PROJECT MANAGER _____			
PRINT DCE NAME _____	PROJECT ENGINEER _____			
DESCRIPTION	BY	APPROVED	DATE	FILED
ORIGINAL	xx/xx			
CONTRACTOR _____		DATE STARTED _____		19905-01-D
INSPECTOR _____		DATE COMPLETED _____		

CURB RAMP LOCATION

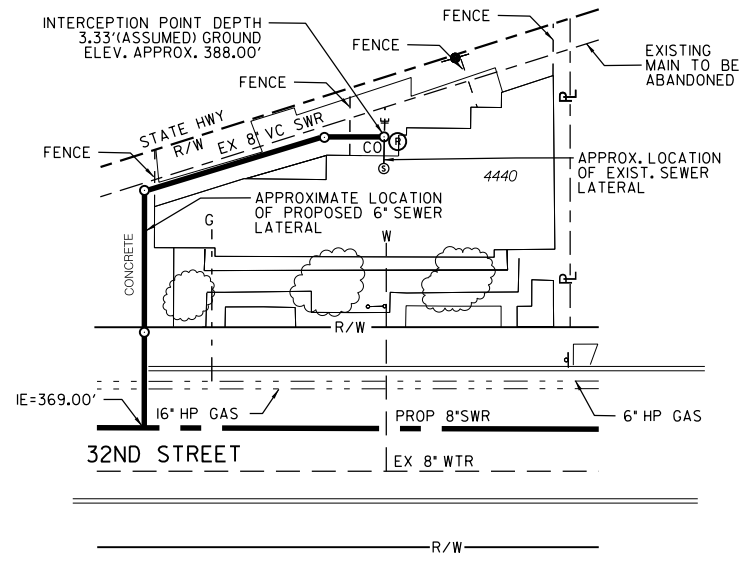
LEGEND	
	APPROXIMATE LOCATION OF SLURRY SEAL (TYPE III)
	APPROXIMATE LOCATION OF SLURRY SEAL (TYPE I OVER TYPE III)
	APPROX. LIMITS OF RESURFACE AC OVERLAY
	APPROX. LIMITS OF CONCRETE PAVEMENT
	LOCATION PER PAVING SCHEDULE NOTES (THIS SHEET)
	COLD MILLING ASPHALT CONCRETE PAVEMENT; SDG-106

PAVING SCHEDULE NOTES					
NO.	LOCATION	RESTORATION REQUIRED	LENGTH	WIDTH	APPROX. AREA
1	SILK PL	OVERLAY	305'	35	10675
2	GRAPE ST	SLURRY	1635'	35	57225
3	CHAMPION ST	OVERLAY	345'	35	12075
4	Mc GANN DR	SLURRY	1023'	35	35805
5	54TH FRONTAGE WEST ST	SLURRY TYPE I OVER TYPE III	1031'	20	20620
6	54TH FRONTAGE EAST ST	SLURRY TYPE I OVER TYPE III	1029'	20	20580
7	HANIMAN DR	SLURRY	225'	35	7875
8	MARING PL	OVERLAY	190'	35	6650
9	DE BURN DR	OVERLAY	292'	35	10220
10	52ND ST	SLURRY	670'	35	23450
11	SUSAN PL	SLURRY	190'	35	6650
12	54TH ST	SLURRY	570'	70	39900
13	LYLE DR	SLURRY	954'	35	33390
14	ALTADENA AVE	OVERLAY	636'	35	22260
15	PIROTTE DR	SLURRY	2132'	35	74620
16	54TH ST	SLURRY	870'	60	52200
17	52ND ST	SLURRY	1448'	35	50680
18	KALMIA ST	OVERLAY	292'	35	10220
19	AARON CT	SLURRY	578'	30	17340
20	KALMIA ST	OVERLAY	1130'	35	39550
21	OAK PARK DR	OVERLAY	1142'	35	39970
22	LAUREL ST	OVERLAY	835'	35	29225
23	54TH ST	SLURRY TYPE I OVER TYPE III	971'	20	19420
24	FIR ST	OVERLAY	600'	35	21000
25	FAULCONER ST	SLURRY	44'	35	1540
26	HANIMAN DR	OVERLAY	825'	35	28875
27	LAUREL ST	SLURRY	473'	35	16555
28	EUCLID AV	SLURRY	310'	57	17670
29	PIROTTE DR	CONC PAVEMENT	233'	33	7689
30	TIMOTHY DR	CONC PAVEMENT	98'	33	3224
31	55TH ST	SLURRY	10'	35	350
TOTAL AREA OF SLURRY SEAL TYPE I OVER TYPE III					60,620 SF
TOTAL AREA OF OVERLAY AC					230,720 SF
TOTAL AREA OF SLURRY SEAL TYPE III					435,250 SF
TOTAL AREA OF CONCRETE PAVEMENT					10,923 SF
TOTAL AREA OF CROSS GUTTER					5,920 SF



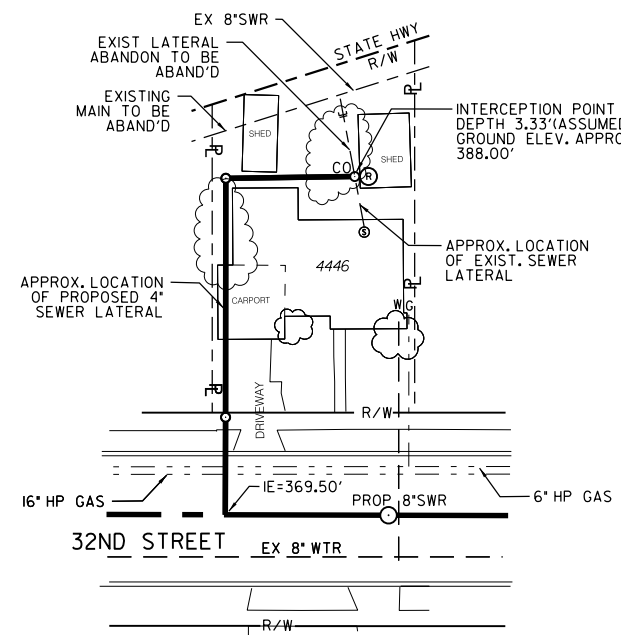
SAMPLE ONLY FOR STREET RESURFACING PLAN

STREET RESURFACING



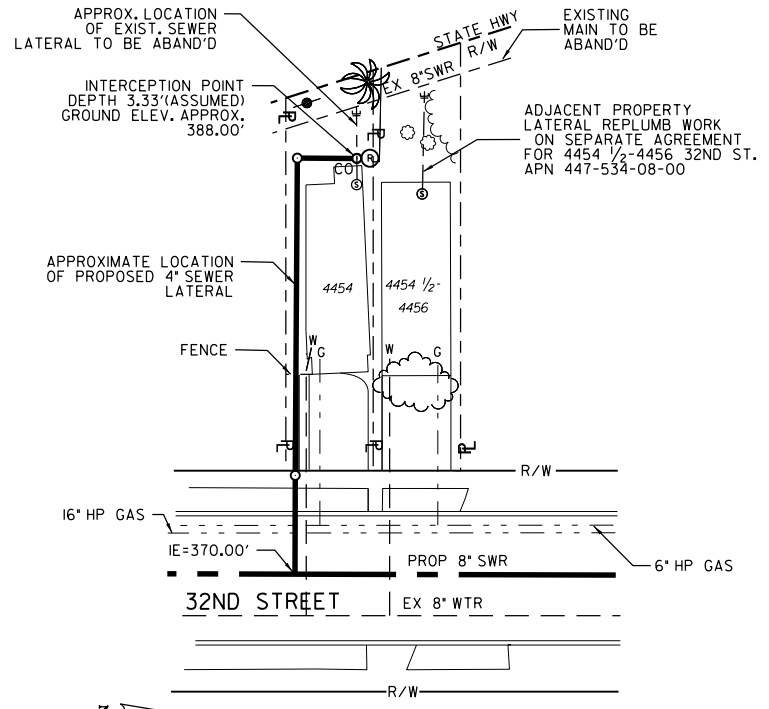
NO SCALE

(SEWER LATERAL REPLUMB WORK)  
ADDRESS: 4440 32ND STREET  
SEE SHEET NO. 9



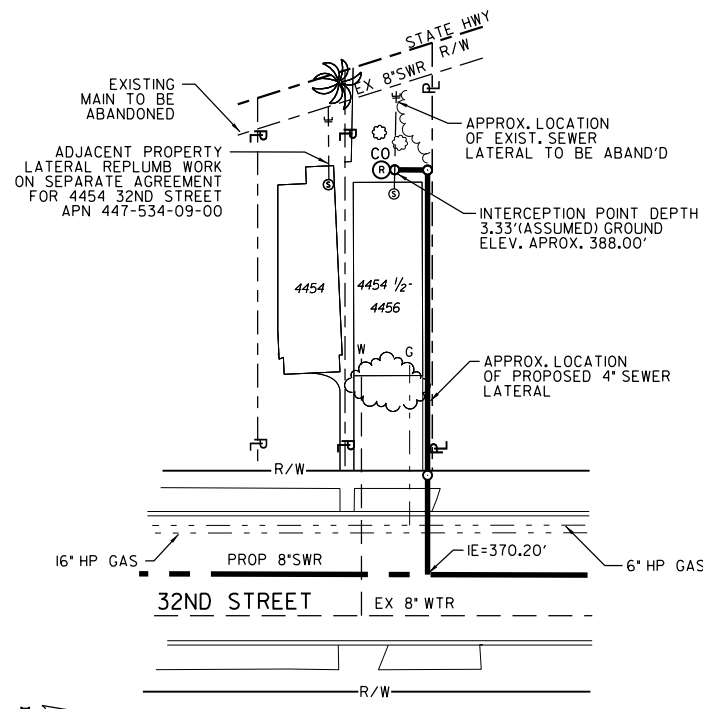
NO SCALE

(SEWER LATERAL REPLUMB WORK)  
ADDRESS: 4446 32ND STREET  
SEE SHEET NO. 9



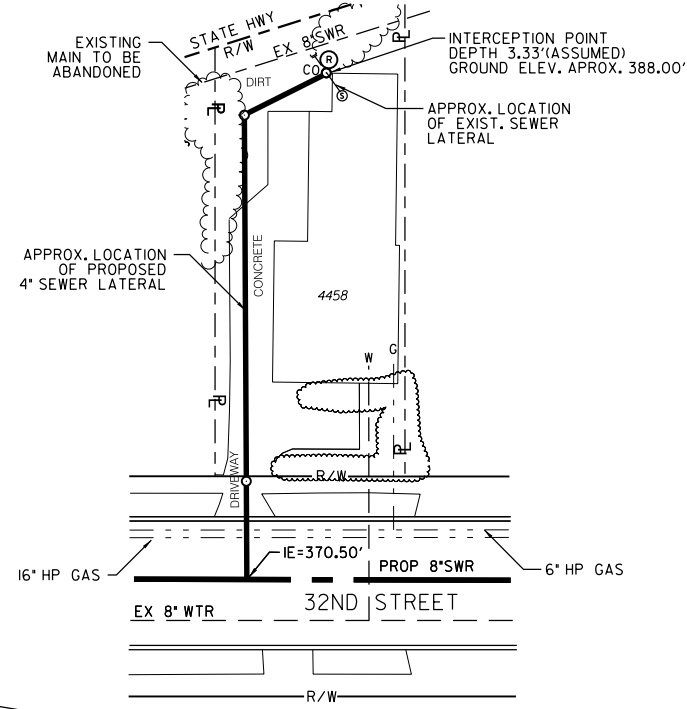
NO SCALE

(SEWER LATERAL REPLUMB WORK)  
ADDRESS: 4454 32ND STREET  
SEE SHEET NO. 9



NO SCALE

(SEWER LATERAL REPLUMB WORK)  
ADDRESS: 4454 1/2 - 4456 32ND STREET  
SEE SHEET NO. 9



NO SCALE

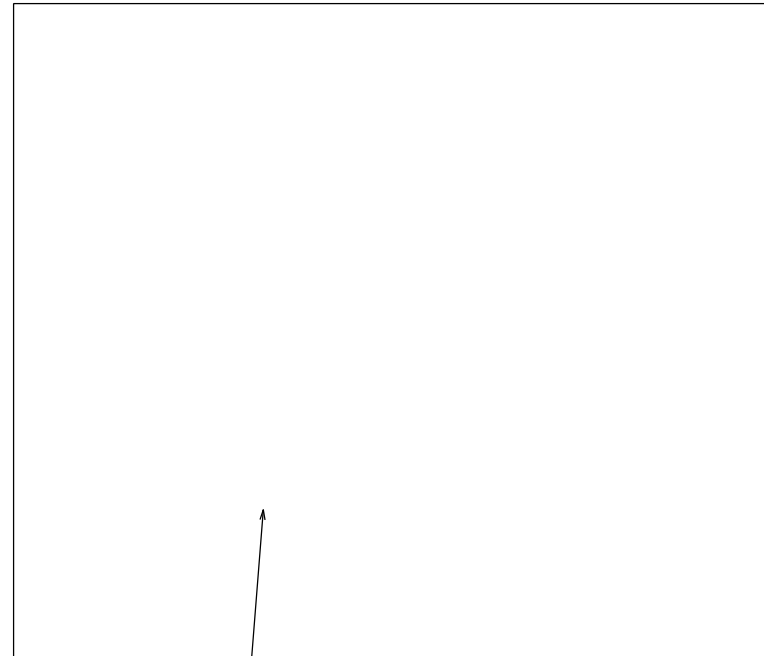
(SEWER LATERAL REPLUMB WORK)  
ADDRESS: 4458 32ND STREET  
SEE SHEET NO. 9

6

C-99

SEWER GROUP JOB 000			
REPLUMB DETAILS			
CITY OF SAN DIEGO, CALIFORNIA		WATER WBS	0-00000
PUBLIC WORKS DEPARTMENT		SEWER WBS	0-00000
SHEET OF SHEETS			
FOR CITY ENGINEER	DATE	PROJECT MANAGER	
PRINT DCE NAME	TRC#	PROJECT ENGINEER	
DESCRIPTION	BY	APPROVED	DATE
ORIGINAL	XX/XX		
CONTRACTOR		DATE STARTED	19905-01-D
INSPECTOR		DATE COMPLETED	

REPLUMB DETAILS



SITE MAP

1

2

3

TO DESIGNER/PPM:  
INDICATE ON PLAN WHERE SITE DESIGN  
AND SOURCE CONTROL BMPs ARE BEING  
INCORPORATED INTO THE DESIGN.  
(ADD MORE SHEETS AS NEEDED)

SOURCE CONTROL BMP CHECKLIST FOR STANDARD PROJECTS		FORM I-4		
ALL DEVELOPMENT PROJECTS MUST IMPLEMENT SOURCE CONTROL BMP's SC-1 THROUGH SC-6 AND, REFER TO CHAPTER 4 AND APPENDIX E OF THE BMP DESIGN MANUAL FOR INFORMATION TO IMPLEMENT BMP's AS SHOWN IN THIS CHECKLIST.				
NOTE: ALL SELECTED BMPs MUST BE SHOWN ON THE CONSTRUCTION PLANS.				
SOURCE CONTROL REQUIREMENT	APPLIED(?)?			
SC-1 PREVENTION OF ILLICIT DISCHARGES INTO THE MS4	<input type="checkbox"/> YES	<input type="checkbox"/> NO	<input type="checkbox"/> N/A	
SC-2 STORM DRAIN STENCILING OR SIGNAGE	<input type="checkbox"/> YES	<input type="checkbox"/> NO	<input type="checkbox"/> N/A	
SC-3 PROTECT OUTDOOR MATERIALS STORAGE AREAS FROM RAINFALL, RUN-ON, RUNOFF, AND WIND DISPERSAL	<input type="checkbox"/> YES	<input type="checkbox"/> NO	<input type="checkbox"/> N/A	
SC-4 PROTECT MATERIALS STORED IN OUTDOOR WORK AREAS FROM RAINFALL, RUN-ON, RUNOFF, AND WIND DISPERSAL	<input type="checkbox"/> YES	<input type="checkbox"/> NO	<input type="checkbox"/> N/A	
SC-5 PROTECT TRASH STORAGE AREAS FROM RAINFALL, RUN-ON, RUNOFF, AND WIND DISPERSAL	<input type="checkbox"/> YES	<input type="checkbox"/> NO	<input type="checkbox"/> N/A	
SC-6 BMPs BASED ON POTENTIAL SOURCES OF RUNOFF POLLUTANTS	<input type="checkbox"/> YES	<input type="checkbox"/> NO	<input type="checkbox"/> N/A	
ON-SITE STORM DRAIN INLETS	<input type="checkbox"/> YES	<input type="checkbox"/> NO	<input type="checkbox"/> N/A	
INTERIOR FLOOR DRAINS AND ELEVATOR SHAFT SUMP PUMPS	<input type="checkbox"/> YES	<input type="checkbox"/> NO	<input type="checkbox"/> N/A	
INTERIOR PARKING GARAGES	<input type="checkbox"/> YES	<input type="checkbox"/> NO	<input type="checkbox"/> N/A	
NEED FOR FUTURE INDOOR AND STRUCTURAL PEST CONTROL	<input type="checkbox"/> YES	<input type="checkbox"/> NO	<input type="checkbox"/> N/A	
LANDSCAPE / OUTDOOR PESTICIDE USE	<input type="checkbox"/> YES	<input type="checkbox"/> NO	<input type="checkbox"/> N/A	
POOLS, SPAS, PONDS, DECORATIVE FOUNTAINS, AND OTHER WATER FEATURES	<input type="checkbox"/> YES	<input type="checkbox"/> NO	<input type="checkbox"/> N/A	
FOOD SERVICE	<input type="checkbox"/> YES	<input type="checkbox"/> NO	<input type="checkbox"/> N/A	
REFUSE AREAS	<input type="checkbox"/> YES	<input type="checkbox"/> NO	<input type="checkbox"/> N/A	
INDUSTRIAL PROCESSES	<input type="checkbox"/> YES	<input type="checkbox"/> NO	<input type="checkbox"/> N/A	
OUTDOOR STORAGE OF EQUIPMENT OR MATERIALS	<input type="checkbox"/> YES	<input type="checkbox"/> NO	<input type="checkbox"/> N/A	
VEHICLE / EQUIPMENT REPAIR AND MAINTENANCE	<input type="checkbox"/> YES	<input type="checkbox"/> NO	<input type="checkbox"/> N/A	
FUEL DISPENSING AREAS	<input type="checkbox"/> YES	<input type="checkbox"/> NO	<input type="checkbox"/> N/A	
LOADING DOCKS	<input type="checkbox"/> YES	<input type="checkbox"/> NO	<input type="checkbox"/> N/A	
FIRE SPRINKLER TEST WATER	<input type="checkbox"/> YES	<input type="checkbox"/> NO	<input type="checkbox"/> N/A	
MISCELLANEOUS DRAIN OR WASH WATER	<input type="checkbox"/> YES	<input type="checkbox"/> NO	<input type="checkbox"/> N/A	
PLAZAS, SIDEWALKS, AND PARKING LOTS	<input type="checkbox"/> YES	<input type="checkbox"/> NO	<input type="checkbox"/> N/A	
SC-6A: LARGE TRASH GENERATING FACILITIES	<input type="checkbox"/> YES	<input type="checkbox"/> NO	<input type="checkbox"/> N/A	
SC-6B: ANIMAL FACILITIES	<input type="checkbox"/> YES	<input type="checkbox"/> NO	<input type="checkbox"/> N/A	
SC-6C: PLANT NURSERIES AND GARDEN CENTERS	<input type="checkbox"/> YES	<input type="checkbox"/> NO	<input type="checkbox"/> N/A	
SC-6D: AUTOMOTIVE-RELATED USES	<input type="checkbox"/> YES	<input type="checkbox"/> NO	<input type="checkbox"/> N/A	
DISCUSSION / JUSTIFICATION FOR ALL "NO" ANSWER SHOWN ABOVE:				

SITE DESIGN AND SOURCE CONTROL BMP OPERATION AND MAINTENANCE PROCEDURE					
O&M RESPONSIBLE PARTY DESIGNEE:					
BMP DESCRIPTION	INSPECTION FREQUENCY	MAINTENANCE FREQUENCY	MAINTENANCE METHOD	QUANTITY	SHEET NUMBER
SITE DESIGN ELEMENTS DESCRIPTION:					
SOURCE CONTROL ELEMENTS DESCRIPTION:					

**STORM WATER NOTE:**

I. THIS PROJECT IS SUBJECT TO MUNICIPAL CODE SECTION 4303 AND ORDER NO. R9-2013-0001 AS AMENDED BY R9-2015-0001 AND R9-2015-0100

SITE DESIGN BMP CHECKLIST FOR STANDARD PROJECTS		FORM I-5		
ALL DEVELOPMENT PROJECTS MUST IMPLEMENT SITE DESIGN BMP's SD-1 THROUGH SD-8. REFER TO CHAPTER 4 AND APPENDIX E OF THE BMP DESIGN MANUAL FOR INFORMATION TO IMPLEMENT BMP's SHOWN IN THIS CHECKLIST.				
NOTE: ALL SELECTED BMPs MUST BE SHOWN ON THE CONSTRUCTION PLANS.				
SOURCE CONTROL REQUIREMENT	APPLIED(?)?			
SD-1 MAINTAIN NATURAL DRAINAGE PATHWAYS AND HYDROLOGIC FEATURES	<input type="checkbox"/> YES	<input type="checkbox"/> NO	<input type="checkbox"/> N/A	
SD-2 CONSERVE NATURAL AREAS, SOILS, AND VEGETATION	<input type="checkbox"/> YES	<input type="checkbox"/> NO	<input type="checkbox"/> N/A	
SD-3 MINIMIZE IMPERVIOUS AREA	<input type="checkbox"/> YES	<input type="checkbox"/> NO	<input type="checkbox"/> N/A	
SD-4 MINIMIZE SOIL COMPACTION	<input type="checkbox"/> YES	<input type="checkbox"/> NO	<input type="checkbox"/> N/A	
SD-5 IMPERVIOUS AREA DISPERSION	<input type="checkbox"/> YES	<input type="checkbox"/> NO	<input type="checkbox"/> N/A	
SD-6 RUNOFF COLLECTION	<input type="checkbox"/> YES	<input type="checkbox"/> NO	<input type="checkbox"/> N/A	
SD-7 LANDSCAPING WITH NATIVE OR DROUGHT TOLERANT SPECIES	<input type="checkbox"/> YES	<input type="checkbox"/> NO	<input type="checkbox"/> N/A	
SD-8 HARVESTING AND USING PRECIPITATION	<input type="checkbox"/> YES	<input type="checkbox"/> NO	<input type="checkbox"/> N/A	
DISCUSSION / JUSTIFICATION FOR ALL "NO" ANSWER SHOWN ABOVE:				

FORMS I-4 AND I-5 SHALL BE COMPLETELY FILLED OUT.  
DELETE THIS NOTE AFTER REVIEWING THE TASK ABOVE

7

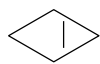
C-99

PROJECT TITLE	
BMP MAP FOR STANDARD PROJECT	
CITY OF SAN DIEGO, CALIFORNIA PUBLIC WORKS DEPARTMENT SHEET OF SHEETS	#BS 0-00000
FOR CITY ENGINEER _____ DATE _____	APPROVED BY _____ PROJECT MANAGER _____
PRINT DCE NAME _____	PROJECT ENGINEER _____
DESCRIPTION BY APPROVED DATE FILED	COORDINATE
ORIGINAL xx/xx	000-0000 CCSD COORDINATE
	0000-0000 CCSD COORDINATE
CONTRACTOR _____ DATE STARTED _____	INSPECTOR _____ DATE COMPLETED _____
	XXXXX-XX-D

BMP MAP FOR STANDARD PROJECT

**STORM WATER REQUIREMENTS:**

1. THIS PROJECT IS SUBJECT TO MUNICIPAL CODE SECTION 4303 AND ORDER NO. R9-2013-0001 AS AMENDED BY R9-2015-0001 AND R9-2015-0100.
2. ALL WORK RELATED TO POST-CONSTRUCTION STORMWATER QUALITY SHALL BE IN ACCORDANCE WITH THE STORM WATER QUALITY MANAGEMENT PLAN ENTITLED, PROJECT NAME/ WBS OR IO: \_\_\_\_\_  
PROJECT ADDRESS: \_\_\_\_\_  
PREPARED BY: \_\_\_\_\_  
DATE PREPARED: \_\_\_\_\_
3. POST-CONSTRUCTION BMPs ARE REQUIRED, SEE SHEET(S) \_\_\_\_\_

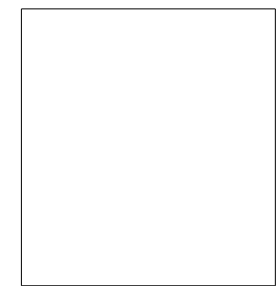


**POST-CONSTRUCTION BMP CERTIFICATION:**

AS THE PROFESSIONAL IN RESPONSIBLE CHARGE FOR THE DESIGN OF THIS PROJECT, I CERTIFY THAT I HAVE INSPECTED ALL CONSTRUCTED LOW IMPACT DEVELOPMENT (LID) SITE DESIGN, SOURCE CONTROL, HYDROMODIFICATION MANAGEMENT, AND TREATMENT CONTROL BMPs REQUIRED PER THE STORM WATER STANDARDS MANUAL AND CONTRACT REQUIREMENTS; AND THAT SAID BMPs HAVE BEEN CONSTRUCTED IN COMPLIANCE WITH THE APPROVED PLANS AND ALL APPLICABLE SPECIFICATIONS, PERMITS, ORDINANCES AND SAN DIEGO REGIONAL MS4 PERMIT.

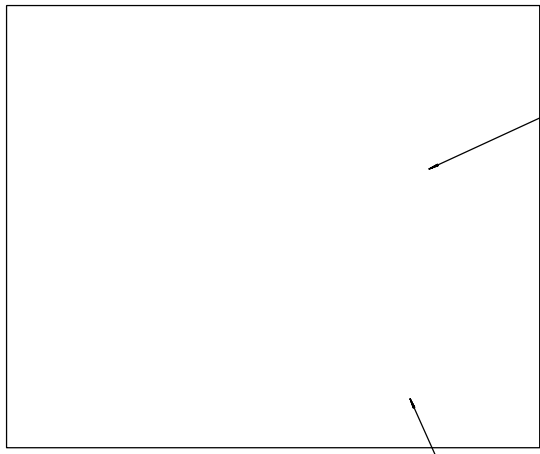
I UNDERSTAND THAT THIS BMP CERTIFICATION STATEMENT DOES NOT CONSTITUTE AN OPERATION AND MAINTENANCE VERIFICATION.

SIGNATURE: \_\_\_\_\_  
DATE OF SIGNATURE: \_\_\_\_\_  
PRINTED NAME: \_\_\_\_\_  
TITLE: \_\_\_\_\_  
PHONE NO.: \_\_\_\_\_



SITE DESIGN, SOURCE CONTROL AND POLLUTANT CONTROL BMP OPERATION & MAINTENANCE PROCEDURE						
O&M RESPONSIBLE PARTY DESIGNEE:						
BMP DESCRIPTION	INSPECTION FREQUENCY	MAINTENANCE FREQUENCY	MAINTENANCE METHOD	QUANTITY	INCLUDED IN O&M MANUAL	SHEET NUMBER
SITE DESIGN ELEMENTS					YES	NO
DESCRIPTION:						
SOURCE CONTROL ELEMENTS					YES	NO
DESCRIPTION:						
POLLUTANT CONTROL BMP(S)					YES	NO
DESCRIPTION:						
HMP FACILITY (IF SEPARATE)					YES	NO
DESCRIPTION:						
HMP EXEMPT						

TO DESIGNER:  
INFORMATION IN THIS COLUMN CAN BE FOUND AT THE O&M SECTION OF THE STORM WATER QUALITY MANAGEMENT PLAN (SWQMP)



SITE MAP

TO DESIGNER/PROJECT MANAGER:  
SHOW SUFFICIENT DETAILS, CROSS-SECTIONS AND NOTES FOR LID SITE DESIGN FEATURES, SOURCE CONTROL AND POLLUTANT CONTROL BMPs. SHOW LIMITS AND AREA OF EACH DMA AND IDENTIFY BMP FOR EACH DMA. PROVIDE THE INFORMATION ON A SEPARATE SHEET. REFER TO THE 2016 STORM WATER MANUAL FOR GUIDANCE. (ADD MORE SHEETS AS NEEDED)

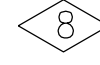
TO DESIGNER:  
SIGNATURE AND STAMP OF ENGINEER OF WORK IS REQUIRED IF A SEPARATE CONSULTANT IS DESIGNING THE BMPs.

**DECLARATION OF RESPONSIBLE CHARGE**

I HEREBY DECLARE THAT I AM THE ENGINEER OF WORK AND THAT I HAVE EXERCISED RESPONSIBLE CHARGE OVER THE DESIGN OF THE PERMANENT STORM WATER BMPs AS DEFINED IN SECTION 6703 OF THE BUSINESS AND PROFESSIONS CODE AND THAT THE DESIGN IS CONSISTENT WITH CURRENT STANDARDS. I UNDERSTAND THAT THE CHECK OF PROJECT DRAWINGS AND SPECIFICATIONS BY THE CITY OF SAN DIEGO IS CONFINED TO A REVIEW ONLY AND DOES NOT RELIEVE ME, AS ENGINEER OF WORK, OF MY RESPONSIBILITIES FOR PROJECT DESIGN.

NAME \_\_\_\_\_ R.C.E. NO. XXXXX \_\_\_\_\_ EXP. XX-XX-XX \_\_\_\_\_ DATE \_\_\_\_\_

**LEGEND:**



PROJECT TITLE		C-99	
BMP MAP FOR PRIORITY DEVELOPMENT PROJECT			
CITY OF SAN DIEGO, CALIFORNIA PUBLIC WORKS DEPARTMENT SHEET OF SHEETS		WBS 0-00000	
APPROVED BY	FOR CITY ENGINEER	DATE	PROJECT MANAGER
PRINT DCE NAME	DATE	PROJECT ENGINEER	PROJECT #
DESCRIPTION	BY	APPROVED	DATE
ORIGINAL	xx/xx		
CONTRACTOR		DATE STARTED	00000-01-D
INSPECTOR		DATE COMPLETED	

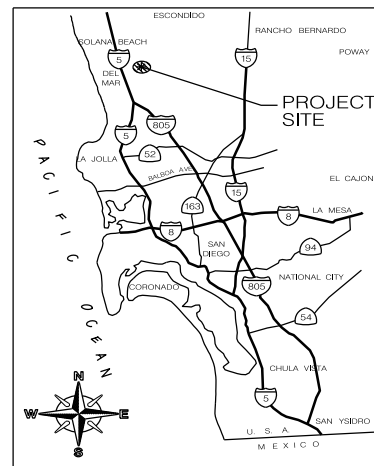
BMP MAP (COVER SHEET)

TRAFFIC CONTROL NOTES:

- VALIDATION. THIS TRAFFIC CONTROL PLAN IS NOT VALID UNTIL WORK DATES ARE APPROVED. THE CONTRACTOR SHALL, PER SECTION 601-2.11 OF THE "WHITEBOOK", CALL THE ENGINEERING TRAFFIC CONTROL SECTION AT (858) 495-4741 TO OBTAIN A PERMIT. THE CONTRACTOR MUST CALL A MINIMUM OF TWO (2) WORKING DAYS PRIOR TO STARTING WORK, OR FIVE (5) WORKING DAYS WHEN THE WORK WILL AFFECT A TRAFFIC SIGNAL.
- STANDARDS. THIS TRAFFIC CONTROL PLAN SHALL CONFORM TO THE MOST RECENTLY ADOPTED EDITION OF EACH OF THE FOLLOWING MANUALS:
  - CALTRANS MANUAL OF TRAFFIC CONTROLS FOR CONSTRUCTION AND MAINTENANCE WORK ZONES;
  - STANDARD SPECIFICATIONS FOR PUBLIC WORKS CONSTRUCTION ("GREENBOOK") AND CITY OF SAN DIEGO SUPPLEMENT AMENDMENTS;
  - STANDARD SPECIFICATIONS FOR PUBLIC WORKS CONSTRUCTION ("WHITEBOOK") AND CITY OF SAN DIEGO SUPPLEMENT AMENDMENTS.
- NOTIFICATIONS. THE CONTRACTOR SHALL NOTIFY THE FOLLOWING AFFECTED AGENCIES A MINIMUM OF FIVE (5) WORKING DAYS PRIOR TO ANY EXCAVATION, CONSTRUCTION OR TRAFFIC CONTROL:
 

FIRE DEPARTMENT DISPATCH	(STREET OR ALLEY CLOSURE)	(858) 573-1300
POLICE DEPARTMENT TRAFFIC	(STREET OR ALLEY CLOSURE)	(858) 495-7800
UNDERGROUND SERVICE ALERT	(ANY EXCAVATION)	(800) 422-4133
WASTE MANAGEMENT DEPT.	(REFUSE COLLECTION)	(858) 694-7000
STREET DIVISION/ELECTRICAL	(TRAFFIC SIGNALS)	(619) 527-7500
SAN DIEGO TRANSIT	(BUS STOPS)	(619) 238-0100 x424
MTDB	(TAXI ZONES)	(619) 595-7030

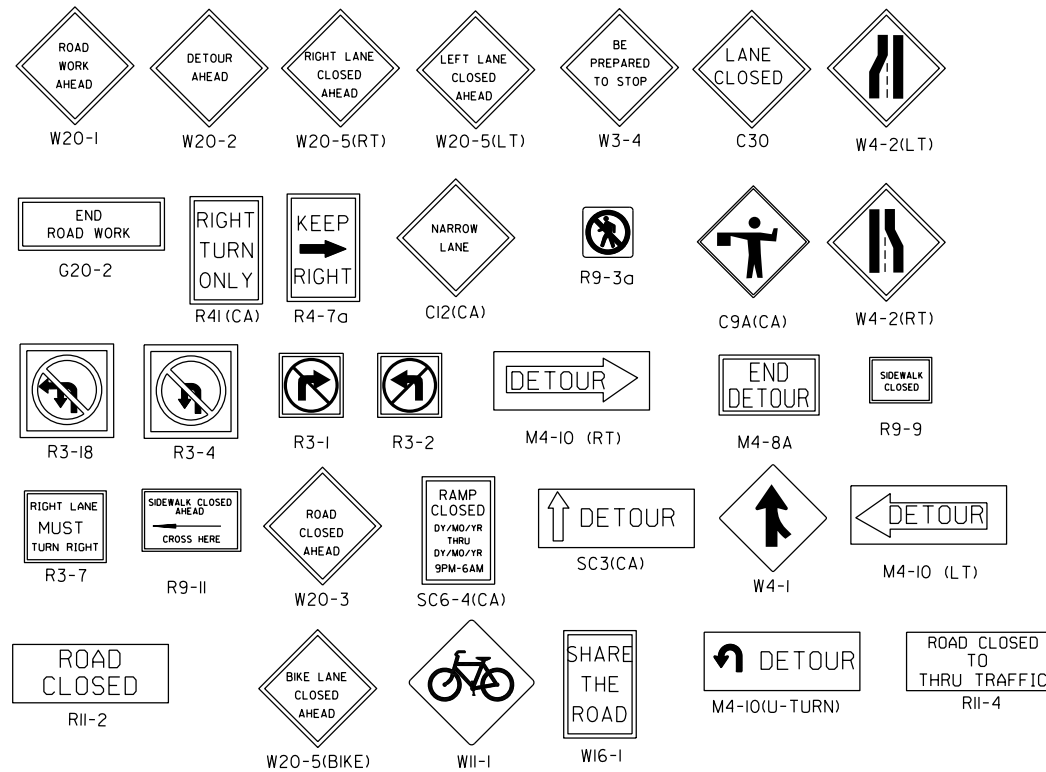
THE CONTRACTOR SHALL NOTIFY PROPERTY OWNERS AND TENANTS A MINIMUM OF FIVE (5) WORKING DAYS PRIOR TO CLOSURE OF DRIVEWAYS. THE CONTRACTOR SHALL POST SIGNS NOTIFYING THE PUBLIC A MINIMUM OF FIVE (5) WORKING DAYS PRIOR TO CLOSURE OF STREETS.
- POSTING NO PARKING SIGNS. THE CONTRACTOR SHALL POST "TOW-AWAY/NO PARKING" SIGNS TWENTY-FOUR (24) HOURS IN ADVANCE FOR TEMPORARY PARKING REMOVAL. SIGNS SHALL INDICATE SPECIFIC DAYS, DATES, AND TIMES OF RESTRICTIONS.
- EXCAVATIONS. EXCEPT AS SHOWN ON THE PLANS, TRENCHES SHALL BE BACKFILLED OR TRENCH-PLATED AT THE END OF EACH WORK DAY. AN ASPHALT RAMP SHALL BE PLACED AROUND EACH TRENCH PLATE TO PREVENT THE PLATE FROM BEING DISLODGED. UPON COMPLETION OF EXCAVATION BACKFILL, THE CONTRACTOR SHALL PROVIDE A SATISFACTORY SURFACE FOR TRAFFIC. WHEN CONSTRUCTION OPERATIONS ARE NOT ACTIVELY IN PROGRESS, THE CONTRACTOR SHALL MAINTAIN ALL TRAVEL LANES OPEN TO TRAFFIC, EXCEPT AS SHOWN ON THE PLANS.
- RESTORATION OF TRAFFIC CONTROL DEVICES. THE CONTRACTOR SHALL REPAIR OR REPLACE TRAFFIC CONTROL DEVICES (INCLUDING TRAFFIC SIGNS, STRIPING, PAVEMENT MARKERS, PAYMENT MARKINGS, LEGENDS, CURB MARKINGS, LOOP DETECTORS, TRAFFIC SIGNAL EQUIPMENT, ETC.) DAMAGED OR REMOVED AS A RESULT OF OPERATIONS AND NOT DESIGNATED FOR REMOVAL, REPAIRS AND REPLACEMENTS SHALL BE EQUAL TO EXISTING IMPROVEMENTS. LOOP DETECTORS SHALL BE REPLACED WITHIN THREE (3) WORKING DAYS OF COMPLETION OF UNDERGROUND WORK.
- CHANGES IN WORK. THE RESIDENT ENGINEER WILL OBSERVE THESE TRAFFIC CONTROL PLANS IN OPERATION AND RESERVES THE RIGHT TO MAKE CHANGES AS THE FIELD CONDITIONS WARRANT. SUCH CHANGES SHALL SUPERSEDE THESE PLANS.
- FOR WORK NOT COVERED BY THESE TRAFFIC CONTROL PLANS, THE CONTRACTOR SHALL, PER SECTION 7-10.2.2 OF THE CONTRACT SPECIAL PROVISIONS, PREPARE TRAFFIC CONTROL WORKING DRAWINGS AND SUBMIT THEM TO THE RESIDENT ENGINEER. THE CONTRACTOR SHALL ALLOW A MINIMUM OF TWENTY (20) WORKING DAYS FOR REVIEW OF THE WORKING DRAWINGS. UPON APPROVAL OF THE TRAFFIC CONTROL PLAN, THE ENGINEERING TRAFFIC CONTROL SECTION WILL ISSUE A TRAFFIC CONTROL PLAN (TCP) PERMIT FOR THIS WORK.



VICINITY MAP  
NOT TO SCALE

# PROJECT NAME TRAFFIC CONTROL PLANS

## TRAFFIC CONTROL SIGNS (TYP)



NOTE: ALL SIGNS ARE STANDARD SIZE

TRAFFIC CONTROL 85TH PERCENTILE SPEED

STREET NAME \_\_\_\_\_ XX MPH

TABLE 1  
RECOMMENDED SIGN SPACING FOR ADVANCE WARNING SIGN SERIES

APPROACH SPEED (MPH)	MINIMUM DISTANCE IN FEET BETWEEN SIGNS AND FROM LAST SIGN TO TAPER	MAXIMUM DEVICE SPACING IN FEET	MINIMUM TAPER LENGTHS FOR LANE WIDTHS •		
			10 FT	11 FT	12 FT
25	150-200	25	105	115	125
30	200-300	30	150	165	180
35	250-400	35	205	225	245
40	350-500	40	265	295	320
45	500-750	45	450	495	540
50	500-1000	50	500	550	600
55+	500-1500	50	550	605	660

• L = WS<sup>2</sup> / 60 FOR SPEED OF 40 MPH OR LESS; L = WS FOR SPEED GREATER THAN 40 MPH. TAPER LENGTHS SHOWN ARE ROUNDED TO NEAREST 5 FEET.

TABLE 2  
RECOMMENDED TAPER LENGTH AND DEVICE SPACING FOR CHANNELIZING TAPERS

APPROACH SPEED (MPH)	TAPER LENGTH (L) •	SPACING OF CONES ALONG TAPER (FEET) ±	NOTE:
			TAPER FORMULA
25	125	25	L = S x W for speeds greater than 40 mph
30	180	30	
35	245	35	L = $\frac{W \times S^2}{60}$ for speeds of 40 mph or less
40	320	40	
45	540	45	
50	600	50	
50+	660	50	

• BASED ON 12-FOOT WIDE LANE. THIS COLUMN IS ALSO APPROPRIATE FOR LANE WIDTHS LESS THAN 12 FEET

LEGEND

- DELINEATOR OR CONE •
- SIGN ↓
- TRAFFIC DIRECTIONAL ARROW ↔
- WORKING AREA ▨
- FLASHING ARROW BOARD ⚡
- BARRICADE I
- PFB (PORTABLE FLASHING BEACON) ⊞

NAME (DEPUTY CITY ENGINEER) _____	DATE _____	T-1
PROJECT NAME TRAFFIC CONTROL PLANS		
CITY OF SAN DIEGO, CALIFORNIA PUBLIC WORKS DEPARTMENT SHEET T1 OF TX SHEETS		#BS X-XXXX
APPROVED BY FOR CITY ENGINEER (SENIOR TRAFFIC ENG.) PRINT NAME _____	DATE _____	PROJECT MANAGER PRINT NAME _____
DESCRIPTION	BY	APPROVED
ORIGINAL	xx	
CONTRACTOR _____	DATE STARTED _____	XXXXX-T1-D
INSPECTOR _____	DATE COMPLETED _____	

PROJECT NAME TRAFFIC CONTROL

# PROJECT TITLE TRAFFIC SIGNAL INSTALLATION

### CONTRACTOR'S RESPONSIBILITIES

1. PURSUANT TO SECTION 4216 OF THE GOVERNMENT CODE, AT LEAST 2 WORKING DAYS PRIOR TO EXCAVATION, YOU MUST CONTACT THE REGIONAL NOTIFICATION CENTER (E.G. UNDERGROUND SERVICE ALERT OF SOUTHERN CALIFORNIA) AND OBTAIN AN INQUIRY IDENTIFICATION NUMBER.
2. NOTIFY SDG&E AT LEAST 10 WORKING DAYS PRIOR TO EXCAVATING WITHIN 10' OF SDG&E UNDERGROUND HIGH VOLTAGE TRANSMISSION POWER LINES (I.E., 69 KV & HIGHER)
3. THE LOCATIONS OF EXISTING BUILDINGS AS SHOWN ON THE PLAN ARE APPROXIMATE.
4. UNLESS OTHERWISE NOTED AS PREVIOUSLY POTHOLED (PH), ELEVATIONS SHOWN ON THE PROFILE FOR EXISTING UTILITIES ARE BASED ON A SEARCH OF THE AVAILABLE RECORD INFORMATION ONLY AND ARE SOLELY FOR THE CONTRACTOR'S CONVENIENCE. THE CITY DOES NOT GUARANTEE THAT IT HAS REVIEWED ALL AVAILABLE DATA. THE CONTRACTOR SHALL POTHOLE ALL EXISTING UTILITIES EITHER SHOWN ON THE PLANS OR MARKED IN THE FIELD IN ACCORDANCE WITH THE SPECIFICATIONS SECTION 5-1.
5. EXISTING UTILITY CROSSING AS SHOWN ON THE PLANS ARE APPROXIMATE AND ARE NOT REPRESENTATIVE OF ACTUAL LENGTH AND LOCATION OF CONFLICT AREAS. SEE PLAN VIEW.

### SHEET INDEX

SHEET NO.	DISCIPLINE CODE	TITLE	LIMITS OF WORK
1	G-1 (GENERAL )	COVER SHEET	
2	E-1 (ELECTRICAL)		

### WORK TO BE DONE

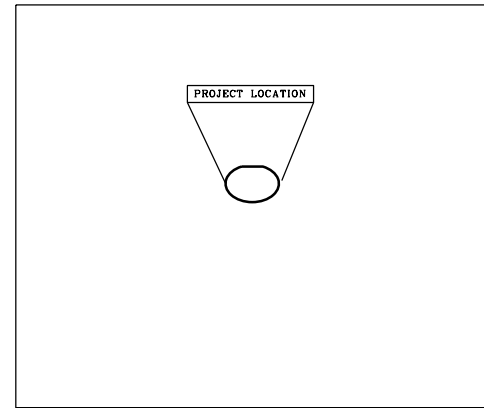
CONSTRUCTION CONSISTS OF THE INSTALLATION OF NEW TRAFFIC SIGNAL AND STREET LIGHTING SYSTEMS - FIRST ST @ SECOND ST

### LEGEND

IMPROVEMENTS	REFERENCE	SYMBOL
NEW EQUIPMENT	AS SHOWN	
REMOVED AND SALVAGED EQUIPMENT	AS SHOWN	
2'-3' CONDUIT	SDG-116, 117 & 118	
NO. 5/6 PULL BOX	CALTRANS ES-8	
CURB RAMP TYPE 'A' & B	SDG-132	
EXISTING CONDITIONS IN LIGHTER HALF-TONE		
PROPOSED CONDITIONS IN DARKER FULL-TONE		
<b>SIGN AND PAVEMENT MARKINGS:</b>		
REMOVE CONFLICTING STRIPING, LEGEND OR MARKING BY GRINDING.	AS SHOWN	
PROPOSED STRIPING	AS SHOWN	
PROPOSED TYPE IV ARROW	CALTRANS A24A	
PROPOSED STRIPING PER CALTRANS DETAILS	AS SHOWN	

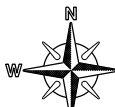
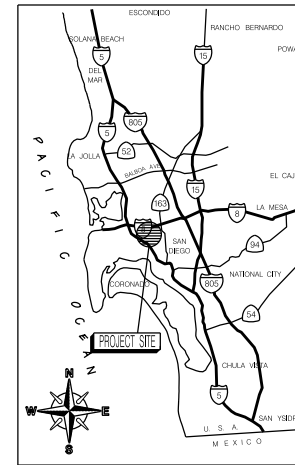
### CONSTRUCTION STORM WATER PROTECTION NOTES

1. TOTAL SITE DISTURBANCE AREA (ACRES) \_\_\_\_\_  
HYDROLOGIC UNIT / WATERSHED \_\_\_\_\_  
HYDROLOGIC SUBAREA NAME & NO. \_\_\_\_\_
2. THE CONTRACTOR SHALL COMPLY WITH THE REQUIREMENTS OF THE
  - WPCP  
THE PROJECT IS SUBJECT TO MUNICIPAL STORM WATER PERMIT NO. R9-2013-0001 AS AMENDED BY R9-2015-0001 AND R9-2015-0100
  - SWPPP  
THE PROJECT IS SUBJECT TO MUNICIPAL STORM WATER PERMIT NO. R9-2013-0001 AS AMENDED BY R9-2015-0001 AND R9-2015-0100 AND CONSTRUCTION GENERAL PERMIT ORDER 2009-0009-DWQ AS AMENDED BY ORDER 2010-004-DWQ AND 2012-0006-DWQ  
TRADITIONAL RISK LEVEL 1  2  3   
LUP: RISK TYPE 1  2  3
3. CONSTRUCTION SITE PRIORITY  
 ASBS  HIGH  MEDIUM  LOW



### DISCIPLINE CODE

- G GENERAL
- D DEMOLITION
- C CIVIL
- L LANDSCAPE
- A ARCHITECTURAL
- S STRUCTURAL
- M MECHANICAL
- E ELECTRICAL
- I INSTRUMENTATION
- T TRAFFIC CONTROL



KEY MAP  
NO SCALE

VICINITY MAP  
NOT TO SCALE

### GENERAL NOTES:

- 1 PULL BOXES AND CONDUIT:
  - 1a PULL BOXES ARE NO. 6, UNLESS OTHERWISE NOTED ON THIS PLAN.
  - 1b ALL CONDUIT DEPTH SHALL BE A MINIMUM OF 18" BELOW THE PAVEMENT SURFACE OR 3' BELOW THE BOTTOM OF THE PAVEMENT, WHICHEVER IS GREATER.
  - 1c CONDUIT SHALL BE 3" DIAMETER, UNLESS OTHERWISE NOTED IN THE CONDUCTOR TABLE OR AS SHOWN ON THIS PLAN.
- 2 LOCATIONS OF ALL UNDERGROUND UTILITIES ARE APPROXIMATE. THE CONTRACTOR SHALL DETERMINE THE EXACT LOCATIONS AND VERIFY ALL CONDITIONS ON THE JOB SITE.
- 3 THE CONTRACTOR SHALL, PER SECTION 601-2.1J & 601-2.1.3 OF THE STANDARD SPECIFICATIONS FOR PUBLIC WORKS CONSTRUCTION ("WHITEBOOK"), PREPARE TRAFFIC CONTROL WORKING DRAWINGS AND SHALL CALL THE FIELD ENGINEERING TRAFFIC CONTROL SECTION AT (858) 498-4741 FOR AN APPOINTMENT TO APPLY FOR A TRAFFIC CONTROL PLAN (TCP) PERMIT. THE CONTRACTOR SHALL ALLOW A MINIMUM OF TWO (2) WORKING DAYS PRIOR TO STARTING WORK OR FIVE (5) WORKING DAYS FOR STREET CLOSURES. UPON APPROVAL OF THE TRAFFIC CONTROL PLAN, THE FIELD ENGINEERING TRAFFIC SECTION WILL ISSUE THE TCP PERMIT. WORK SHALL NOT BEGIN IN THE PUBLIC ROADWAY WITHOUT THE TCP PERMIT.
- 4 ALL TRAFFIC SIGNAL POLE FOUNDATIONS SHALL HAVE A 3" CONDUIT INSTALLED TO THE ADJACENT PULL BOX AND THE CONTROLLER FOUNDATION SHALL HAVE A SPARE 3" CONDUIT STUBBED OUT TO THE ADJACENT PULL BOX FOR FUTURE USE.
- 5 LOCATIONS, POSITIONING, AND INSTALLATION OF SIGNAL EQUIPMENT, LOOP DETECTORS, TRAFFIC SIGNS, TRAFFIC STRIPING, PAVEMENT AND CURB MARKINGS:
  - 5a THE CONTRACTOR, WITH THE APPROVAL OF THE CITY RESIDENT ENGINEER, IS RESPONSIBLE FOR LOCATING, MARKING THE LAYOUT, AND INSTALLATION OF ALL SIGNAL AND LIGHTING EQUIPMENT.
  - 5b THE CONTRACTOR, WITH THE APPROVAL OF THE CITY RESIDENT ENGINEER, IS RESPONSIBLE FOR LOCATING, MARKING THE LAYOUT, AND INSTALLATION OF ALL LOOP DETECTORS, TRAFFIC SIGNS (EXCEPT "G" SERIES STREET NAME SIGNS), TRAFFIC STRIPING, PAVEMENT AND CURB MARKINGS.
  - 5c THE CONTRACTOR SHALL OBTAIN APPROVAL FOR THE ITEMS NOTED IN 5a AND 5b PRIOR TO INSTALLATION.
  - 5d AS SHOWN ON THIS PLAN, CONTRACTOR SHALL INSTALL 6" DIAMETER TYPE E LOOP DETECTORS, WITH 10' SPACING, AND CENTERED IN THE TRAVEL PORTION OF EACH LANE (UNLESS OTHERWISE NOTED).
  - 5e THE CONTRACTOR SHALL NOT PERFORM ANY PARKING REMOVAL, UNTIL A MINIMUM OF FIFTEEN (15) WORKING DAYS AFTER THE LOCATION APPROVAL.
  - 5f THE CONTRACTOR IS RESPONSIBLE FOR THE REMOVAL OF ALL CONFLICTING STRIPING AND PAVEMENT MARKINGS BY SANDBLASTING/GRINDING (METHOD TO BE DETERMINED BY THE RESIDENT ENGINEER).
- 6 IT IS THE CONTRACTOR'S RESPONSIBILITY TO ENSURE INTERSECTION WIRING IS PER POLARA NAVIGATOR PUSHBUTTON SPECIFICATIONS AND TO PROGRAM THE NEWLY INSTALLED PUSHBUTTONS. (SEE SPECIFICATIONS).
- 7 LOCATION AND ELEVATION IMPROVEMENTS TO BE MET BY "WORK TO BE DONE" SHALL BE CONFIRMED BY FIELD MEASUREMENTS PRIOR TO CONSTRUCTION OF NEW WORK.

### STREET CLASSIFICATION:

STREET NAME:	ADT
1. FIRST ST	3,180
2. SECOND ST	25,745

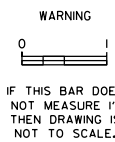
G-1

### FIELD DATA

**BENCHMARK:**  
FIELD NOTES:  
DATUM: MEAN SEA LEVEL  
STREETS REQUIRING 12" TRENCH CAP:  
\*STREET NAMES\*

NAME OF ENGINEER/TRAFFIC ENGINEER _____		DATE _____	
PLANS FOR THE CONSTRUCTION OF PROJECT TITLE TRAFFIC SIGNAL INSTALLATION COVER SHEET			
SPEC. NO. XXXX	CITY OF SAN DIEGO, CALIFORNIA PUBLIC WORKS DEPARTMENT SHEET X OF X SHEETS		WBS X-XXXXX
APPROVED BY _____	DATE _____	PROJECT MANAGER _____	PROJECT ENGINEER _____
FOR CITY ENGINEER SENIOR CIVIL ENGINEER PRINT DCE NAME	DATE XXXXX RCE#	PROJECT MANAGER PROJECT ENGINEER	PROJECT ENGINEER
DESCRIPTION	BY	APPROVED	DATE
ORIGINAL	xx		
CONTRACTOR _____			DATE STARTED _____
INSPECTOR _____			DATE COMPLETED _____
			000-0000 CCS27 COORDINATE 0000-0000 CCS30 COORDINATE XXXXX-X-D

CONSTRUCTION CHANGE / ADDENDUM			
CHANGE	DATE	AFFECTED OR ADDED SHEET NUMBERS	APPROVAL NO.



PROJECT TITLE



# FIRE DEPARTMENT INFORMATION SHEET

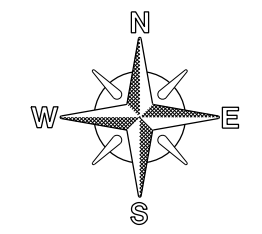
## LEGEND

- LEGEND
- EXISTING WATER MAIN
  - PROPOSED WATER MAIN
  - 4000 HUNDRED BLOCKS
  - EXISTING FIRE HYDRANT
  - PROPOSED FIRE HYDRANT

AREA TO BE HIGHLINED IN PHASES

- PHASE 1
- PHASE 2

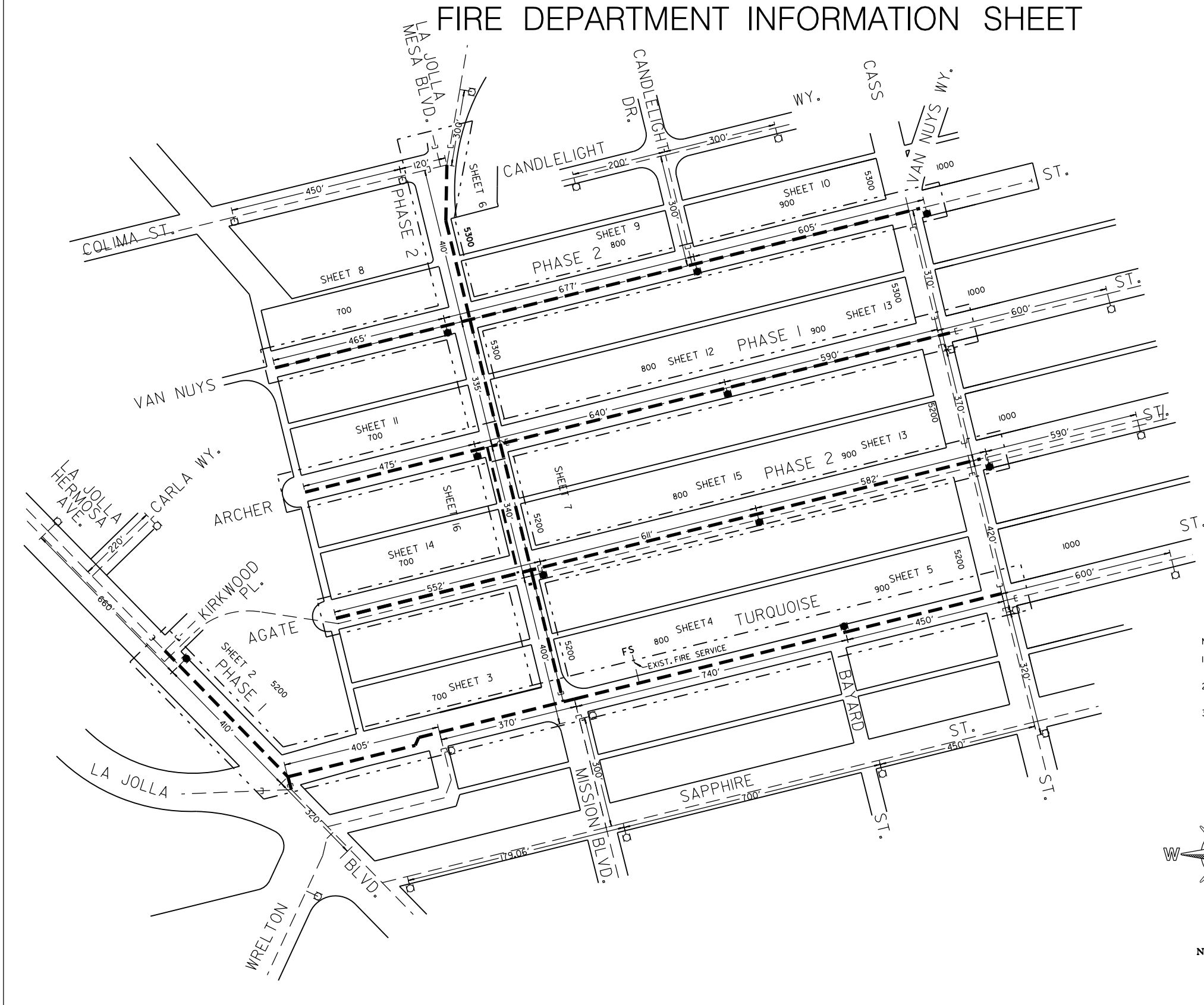
- NOTE:
- 1) ALL FIRE SERVICES SHALL BE HIGHLINED WITH DUAL 2-2" HIGHLINE.
  - 2) THERE WILL BE A MAXIMUM DELAY OF 30 DAYS BETWEEN CONSTRUCTION OF EACH HIGHLINE PHASE.
  - 3) NO STRUCTURES SHALL BE MORE THAN 1000 FEET FROM A "LIVE" FIRE HYDRANT AT ANY TIME DURING CONSTRUCTION. THE DISTANCES SHALL BE MEASURED USING STREETS, PRIVATE ROADS, OR OTHER ROUTES DRIVEN BY EMERGENCY VEHICLES.



NO SCALE

9

FIRE DEPT. INFORMATION SHEET  
WATER MAIN REPLACEMENT  
GROUP 000



**CONTRACTOR'S RESPONSIBILITIES**

- PURSUANT TO SECTION 4216 OF THE GOVERNMENT CODE, AT LEAST 2 WORKING DAYS PRIOR TO EXCAVATION, YOU MUST CONTACT THE REGIONAL NOTIFICATION CENTER (E.G. UNDERGROUND SERVICE ALERT OF SOUTHERN CALIFORNIA) AND OBTAIN AN INQUIRY IDENTIFICATION NUMBER.
- NOTIFY SDG&E AT LEAST 10 WORKING DAYS PRIOR TO EXCAVATING WITHIN 10' OF SDG&E UNDERGROUND HIGH VOLTAGE TRANSMISSION POWER LINES, (I.E., 69 KV & HIGHER)
- LOCATE AND RECONNECT ALL SEWER LATERALS. LOCATIONS AS SHOWN ON THE PLANS ARE APPROXIMATE ONLY. LATERAL RECORDS ARE AVAILABLE TO THE CONTRACTOR AT THE WATER DEPARTMENT, 2797 CAMINITO CHOLLAS. LOCATE THE IMPROVEMENTS THAT WILL BE AFFECTED BY LATERAL REPLACEMENTS.
- EXCAVATE AROUND WATER METER BOX (CITY PROPERTY SIDE) TO DETERMINE IN ADVANCE, THE SIZE OF EACH SERVICE BEFORE TAPPING MAIN.
- CITY FORCES, WHEN SPECIFIED OR SHOWN ON THE PLANS, WILL MAKE PERMANENT CUTS & PLUGS AND CONNECTIONS.
- KEEP EXISTING MAINS IN SERVICE IN LIEU OF HIGH-LINING, UNLESS OTHERWISE SPECIFIED SHOWN ON PLANS.
- THE LOCATIONS OF EXISTING BUILDINGS AS SHOWN ON THE PLAN ARE APPROXIMATE.
- STORM DRAIN INLETS SHALL REMAIN FUNCTIONAL AT ALL TIMES DURING CONSTRUCTION.
- UNLESS OTHERWISE NOTED AS PREVIOUSLY POTHOLED (PH), ELEVATIONS SHOWN ON THE PROFILE FOR EXISTING UTILITIES ARE BASED ON A SEARCH OF THE AVAILABLE RECORD INFORMATION ONLY AND ARE SOLELY FOR THE CONTRACTOR'S CONVENIENCE. THE CITY DOES NOT GUARANTEE THAT IT HAS REVIEWED ALL AVAILABLE DATA. THE CONTRACTOR SHALL POTHOLE ALL EXISTING UTILITIES EITHER SHOWN ON THE PLANS OR MARKED IN THE FIELD IN ACCORDANCE WITH THE SPECIFICATIONS SECTION 5-UTILITIES.
- EXISTING UTILITY CROSSING AS SHOWN ON THE PLANS ARE APPROXIMATE AND ARE NOT REPRESENTATIVE OF ACTUAL LENGTH AND LOCATION OF CONFLICT AREAS. SEE PLAN VIEW.
- ALL ADVANCE METERING INFRASTRUCTURE (AND DEVICES ATTACHED TO THE WATER METER OR LOCATED IN OR NEAR WATER METER BOXES, COFFINS, OR VAULTS SHALL BE PROTECTED AT ALL TIMES IN ACCORDANCE WITH THE CONTRACT DOCUMENTS.

**CONSTRUCTION STORM WATER PROTECTION NOTES**

- TOTAL SITE DISTURBANCE AREA (ACRES) \_\_\_\_\_  
HYDROLOGIC UNIT/ WATERSHED \_\_\_\_\_  
HYDROLOGIC SUBAREA NAME & NO. \_\_\_\_\_
- THE CONTRACTOR SHALL COMPLY WITH THE REQUIREMENTS OF THE  
 WPCP  
 THE PROJECT IS SUBJECT TO MUNICIPAL STORM WATER PERMIT NO. R9-2013-0001 AS AMENDED BY R9-2015-0001 AND R9-2015-0100  
 SWPPP  
 THE PROJECT IS SUBJECT TO MUNICIPAL STORM WATER PERMIT NO. R9-2013-0001 AS AMENDED BY R9-2015-0001 AND R9-2015-0100 AND CONSTRUCTION GENERAL PERMIT ORDER 2009-0009-DW0 AS AMENDED BY ORDER 2010-0014-DW0 AND 2012-0006-DW0  
 TRADITIONAL RISK LEVEL  2  3   
 LUP RISK TYPE  2  3
- CONSTRUCTION SITE PRIORITY  
 ASBS  HIGH  MEDIUM  LOW

**ABBREVIATIONS**

ABAND	ABANDON	EL, ELEV	ELEVATION	OYHD	OVER HEAD
ABAND'D	ABANDONED	ELEC	ELECTRIC	PVC	POLYVINYL CHLORIDE
AC	ASBESTOS CEMENT PIPE	EX, EXIST	EXISTING	PROP	PROPOSED
AHD	AHEAD	E/O	EAST OF	RED	REDUCER
ASSY	ASSEMBLY	FH	FLANGE	RT	RIGHT
BFV	BUTTERFLY VALVE	FS	FIRE HYDRANT	S	SURVEY LINE
BK	BACK	FS	FIRE SERVICE	SDA&E	SAN DIEGO ARIZONA & EASTERN RAILROAD
BTWN	BETWEEN	GV	GATE VALVE	SDTI	SAN DIEGO TROLLEY INC.
CATV	CABLE TV	HP	HIGH-DENSITY POLYETHYLENE	SO	STUB OUT
CI	CAST IRON PIPE	HP	HIGH PRESSURE	S/O	SOUTH OF
C	CENTER LINE	IE	INVERT ELEVATION	SWR	SEWER
COND	CONDUIT	LT	LEFT	TEL	TELEPHONE
CONT	CONTINUED	MJ	MECHANICAL JOINT	UNK	UNKNOWN
CONTR	CONTRACTOR	MTS	SAN DIEGO METROPOLITAN TRANSIT SYSTEM	VC	VITRIFIED CLAY PIPE
DB	DIRECT BURIED	MTD	MULTIPLE TELEPHONE DUCT	WM	WATER METER
DI	DUCTILE IRON	N/O	NORTH OF	WTR	WATER
EB	ENCASED BURIED			W/O	WEST OF

**EXISTING STRUCTURES**

EX WATER MAIN & VALVES	---
EX WATER METER	---
EX FIRE HYDRANT	○
EX SEWER MAIN & MANHOLES	---
EX DRAINS	---
EX PAVEMENT (PROFILE)	///
EX GROUND LINE (PROFILE)	///
EX TRAFFIC SIGNAL	○
EX STREET LIGHT	+
GAS MAIN	---
ELEC. COND., TEL. COND., CATV	---
RAILROAD, TROLLEY TRACKS	---

\* IF NO CONSULTANT ON THIS PROJECT; DELETE ENGINEER'S RESPONSIBILITIES.  
**DELETE THIS NOTE AFTER REVIEWING THE TASK BELOW**

**DECLARATION OF RESPONSIBLE CHARGE**

\* I HEREBY DECLARE THAT I AM THE ENGINEER OF WORK FOR THIS PROJECT THAT I HAVE EXERCISED RESPONSIBLE CHARGE OVER THE DESIGN OF THE PROJECT AS DEFINED IN SECTION 6703 OF THE BUSINESS AND PROFESSIONS CODE AND THAT THE DESIGN IS CONSISTENT WITH CURRENT STANDARDS. I UNDERSTAND THAT THE CHECK OF PROJECT DRAWINGS AND SPECIFICATIONS BY THE CITY OF SAN DIEGO IS CONFINED TO A REVIEW ONLY AND DOES NOT RELIEVE ME, AS ENGINEER OF WORK, OF MY RESPONSIBILITIES FOR PROJECT DESIGN.

ENGINEER'S NAME: \_\_\_\_\_ DATE: \_\_\_\_\_

**WARNING**

IF THIS BAR DOES NOT MEASURE 1" THEN DRAWING IS NOT TO SCALE.

# SEWER GROUP XYZ

**SHEET INDEX**

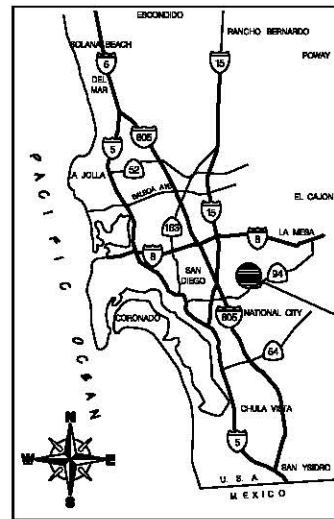
SHEET NO.	DISCIPLINE CODE	TITLE	LIMITS	PIPE		LENGTH (FT)
				SIZE (IN)	MATERIAL	
1	G-1	COVER SHEET				
SEWER						
3	C-2	MCGANN DR	HANNIMAN DR TO STA. 6+49.71	8"	PVC	549.71
4	C-3	NAME ROAD	NAME STREET TO NAME AVENUE			000.00
5	C-4	STREET RESURFACING				
6	C-5	CURB RAMP LOCATION				
7	C-6	CITY FORCES				
8	C-7	MISC DETAILS				
9	C-8	PERMANENT STORM WATER BEST MANAGEMENT PRACTICES (BMP) -STANDARD DEVELOPMENT PROJECTS				
10	C-9	54TH ST (FRONTAGE EAST)	HANNIMAN DR TO STA 6+15.10	8"	PVC	515.10
	T-1	TRAFFIC PLANS				
				TOTAL SEWER		
				TOTAL WATER		

**DISCIPLINE CODE**

- G GENERAL
- D DEMOLITION
- C CIVIL
- L LANDSCAPE
- A ARCHITECTURAL
- S STRUCTURAL
- M MECHANICAL
- E ELECTRICAL
- I INSTRUMENTATION
- T TRAFFIC CONTROL



**WORK TO BE DONE**  
 CONSTRUCTION OF SEWER GROUP XYZ  
 CONSISTS OF THE INSTALLATION OF ...



**VICINITY MAP**  
NOT TO SCALE

**FIELD DATA**

BENCHMARK: \_\_\_\_\_  
 FIELD NOTES: \_\_\_\_\_  
 DATUM: MEAN SEA LEVEL  
 STREETS REQUIRING 12" TRENCH CAP: \_\_\_\_\_  
 \*STREET NAMES\*

**MONUMENTATION/SURVEY NOTES**

THE CONTRACTOR SHALL BE RESPONSIBLE FOR SURVEY MONUMENTS AND/OR VERTICAL CONTROL BENCHMARKS WHICH ARE DISTURBED OR DESTROYED BY CONSTRUCTION. A LICENSED LAND SURVEYOR OR LICENSED CIVIL ENGINEER AUTHORIZED TO PRACTICE LAND SURVEYING IN THE STATE OF CALIFORNIA SHALL FIELD LOCATE, REFERENCE, AND/OR PRESERVE ALL HISTORICAL OR CONTROLLING MONUMENTS PRIOR ANY EARTHWORK, DEMOLITION OR SURFACE IMPROVEMENTS. IF DESTROYED, A LICENSED LAND SURVEYOR SHALL REPLACE SUCH MONUMENT(S) WITH APPROPRIATE MONUMENTS. WHEN SETTING SURVEY MONUMENTS USED FOR RE-ESTABLISHMENT OF THE DISTURBED CONTROLLING SURVEY MONUMENTS AS REQUIRED BY SECTIONS 6730.2 AND 6710 OF THE BUSINESS AND PROFESSIONS CODE OF THE STATE OF CALIFORNIA, A CORNER RECORD OR RECORD OF SURVEY, AS APPROPRIATE, SHALL BE FILLED WITH THE COUNTY SURVEYOR. IF ANY VERTICAL CONTROL IS TO BE DISTURBED OR DESTROYED, THE CITY OF SAN DIEGO FIELD SURVEY SECTION SHALL BE NOTIFIED IN WRITING AT LEAST 7 DAYS PRIOR TO CONSTRUCTION. THE CONTRACTOR SHALL BE RESPONSIBLE FOR THE COST OF REPLACING AND VERTICAL CONTROL BENCHMARKS DESTROYED BY THE CONSTRUCTION.

**IMPROVEMENTS**

- TRENCH RESURFACING
- SEWER MAIN
- SEWER MANHOLE/PVC LINED
- REHAB. EX. SEWER MANHOLE
- SEWER MAIN REHAB.
- 4" SEWER LATERAL WITH C.O. UNLESS OTHERWISE SPECIFIED
- REPLUMB SEWER LATERAL WITH C.O.
- SEWER LATERAL CONNECTION
- REHAB SEWER LATERAL (LINED) WITH C.O.
- SERVICE LATERAL CONNECTION TO REHABILITATED SEWER
- SEWER PUMP INCLUDING REPLUMB SEWER LATERAL WITH C.O.
- TUNNEL SEWER REPLUMB LATERAL WITH C.O.
- CONCRETE PROTECTION FOR EXIST SEWER PIPE
- PIPE SUPPORT FOR UNDERCUT AC WATER MAIN
- CONCRETE ENCASUREMENT
- ABANDON EX MANHOLE
- SLURRY FILL ABANDONED SEWER MAIN
- CUTTING AND PLUGGING ABANDONED WATER MAIN
- SURVEY MONUMENT
- WATER MAIN & APPURTENANCES
- VALVES WITH CAPS AND WELLS
- FIRE SERVICE CONNECTION & ASSEMBLY
- 6" FIRE HYDRANT ASSEMBLY & MARKER 2-PORT UNLESS SPECIFIED AS 3-PORT
- F WATER SERVICE UNLESS OTHERWISE SPECIFIED
- WATER SERVICE TRANSFER
- BLOW-OFF ASSEMBLY
- AIR & VACUUM VALVE
- HIGHLIGHTING BY CONTRACTOR

**LEGEND**

REFERENCE	SYMBOL
SDG-107, SDG-108	---
SDS-104, SDS-110 (TYPE C)	---
SDS-106, SDS-107, SDS-108, SDW-113, SDS-120, M-3, SM-07	○
SEE PLANS & SPECS	○
SEE PLANS & SPECS	○
SDS-102, SDS-103, SDS-104, SDS-105, SDS-110 (TYPE C), SDS-118	P.L. --- (S)
SDS-102, SDS-103, SDS-104, SDS-105, SDS-110 (TYPE C), SDS-118	P.L. --- (R)
SEE PLANS & SPECS	P.L. --- (C)
SEE PLANS & SPECS	P.L. --- (L)
SEE PLANS & SPECS	P.L. --- (C)
SDS-102, SDS-103, SDS-104, SDS-105, SDS-110 (TYPE C), SDS-118	P.L. --- (P)
SDS-102, SDS-103, SDS-104, SDS-105	P.L. --- (T)
SDS-116	---
SDW-162	---
SDS-112	---
SM-08	---
SEE PLANS & SPECS	---
WP-03	---
M-10, M-10A, M-10B	---
SDM-105, SDW-110, SDW-151, SDW-161	---
SDW-109, SDW-152, SDW-153, WV-05	---
SDM-105, SDW-109, SDW-118, SDW-152, SDW-153	P.L. --- (F)
SDM-105, SDW-104, SDW-109, SDW-152, SDW-153	---
SDM-105, SDW-107, SDW-134, SDW-135, SDW-136, SDW-137, SDW-138, SDW-149, SDW-150, WS-03	P.L. --- (W)
SDW-149, SDW-150	P.L. --- (T)
SDM-105, SDW-106, SDW-143, SDW-144, SDW-145, SDW-146, WB-05	B.O.
SDM-105, SDW-117, SDW-158, SDW-159, SDW-160	A.V.
SDW-170, SDW-171, SDW-172, SDW-173	IF APPLICABLE

G-1

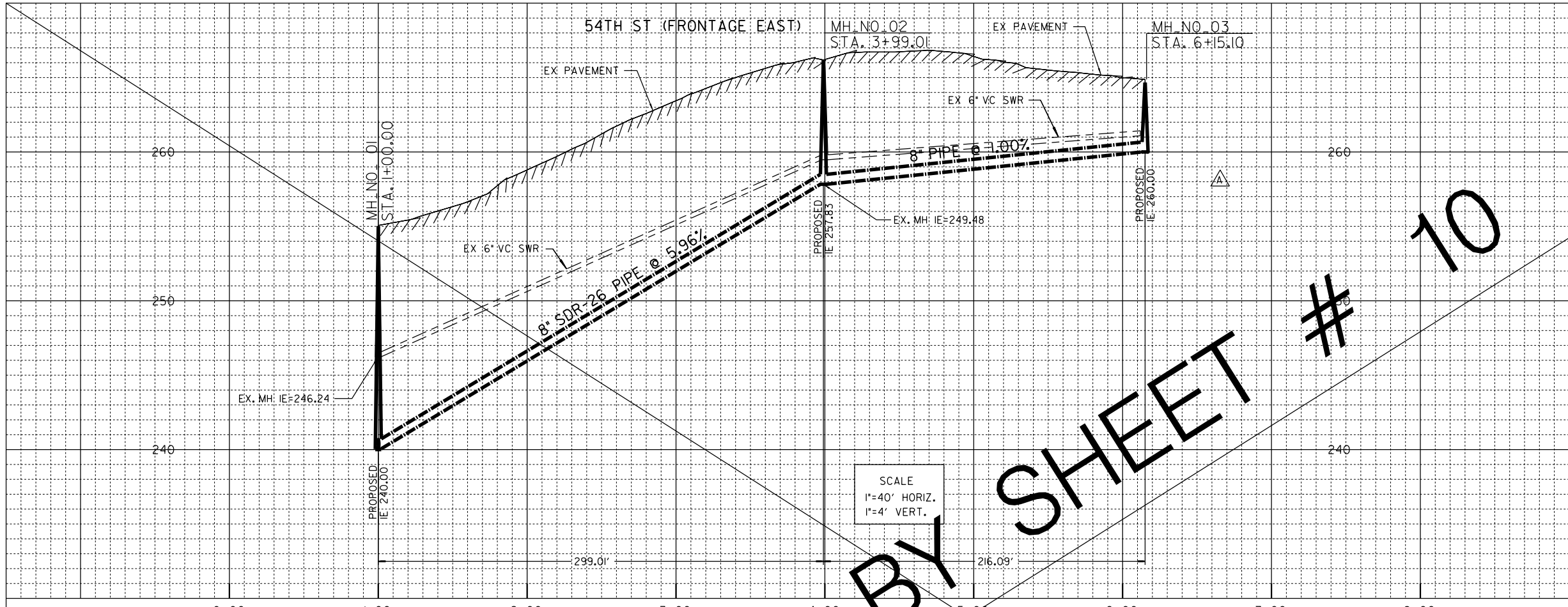
**PLANS FOR THE CONSTRUCTION OF SEWER GROUP XYZ COVER SHEET**

CITY OF SAN DIEGO, CALIFORNIA PUBLIC WORKS DEPARTMENT SHEET 01 OF XX SHEETS		WATER WBS 0-00000 SEWER WBS 0-00000
APPROVED FOR CITY ENGINEER	DATE	SUBMITTED BY
PRINT NAME	RCS#	CREATED BY
DESCRIPTION	BY	APPROVED
ORIGINAL	XX/XX	DATE
ADDENDUM A	XX/XX	XX/YY
	XX/YY	
CONTRACTOR	DATE STARTED	PROJECT ENGINEER
INSPECTOR	DATE COMPLETED	SEE SHEETS
		06827 COORDINATE
		SEE SHEETS
		06883 COORDINATE
		XXXX-01-D

ADD NEW SHEET TO SHEET INDEX

**ADDENDUM A**

SEWER GROUP XYZ



POB 1+00.00 1845395.45 6305902.21  
 STRAIGHT 299.01 38' 09" 44.28"  
 PI 3+99.01 1845630.55 6306086.96  
 STRAIGHT 216.09 38' 11" 41.52"  
 POE 6+15.10 1845800.38 6306220.58

ESTIMATED ARCHAEOLOGICAL MONITORING LIMITS  
 (INCLUDES MAIN, LATERALS, AND OTHER TRENCHING ACTIVITIES)

BEGINNING STATION	ENDING STATION	APPROXIMATE LF
STA. 1+00	STA. 6+15.10	515.10

ESTIMATED PALEONTOLOGICAL MONITORING LIMITS  
 (INCLUDES MAIN, LATERALS, AND OTHER TRENCHING ACTIVITIES)

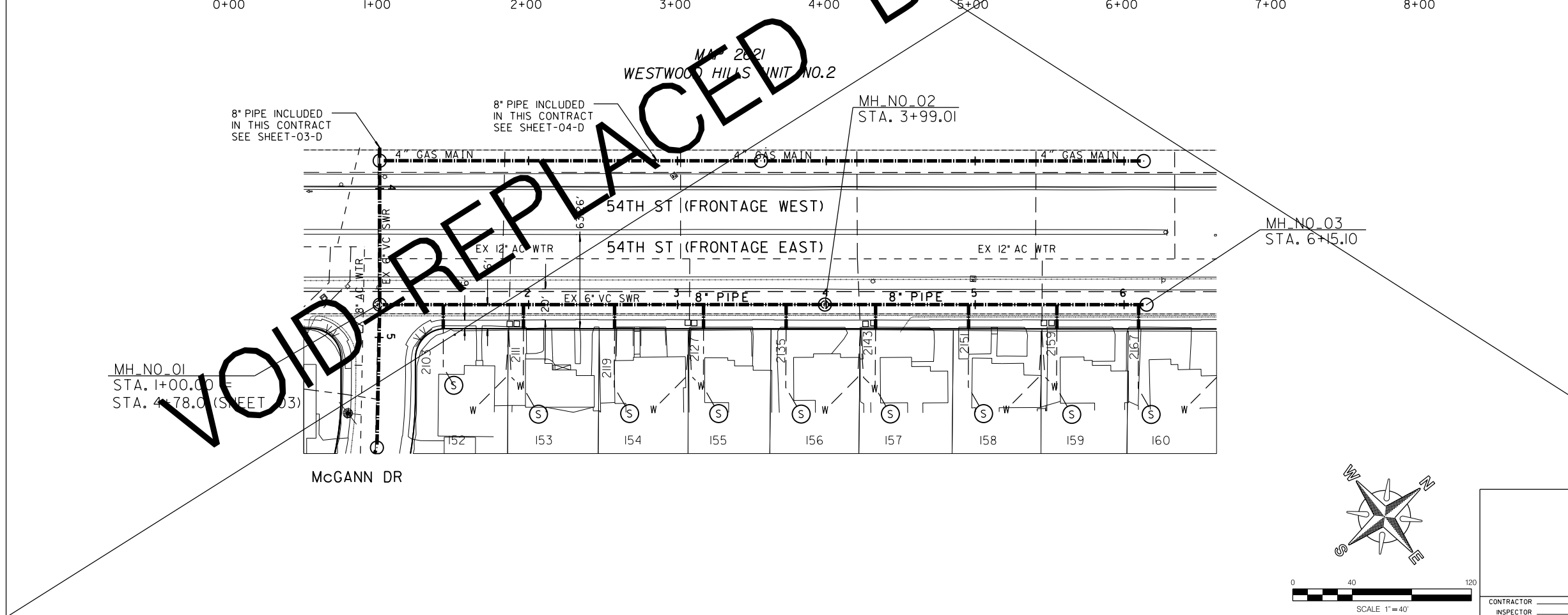
BEGINNING STATION	ENDING STATION	APPROXIMATE LF
STA. 1+00.00	STA. 3+70.00	270.00

ACTUAL LIMITS SHALL BE DETERMINED BY THE PI/MONITOR(S) PRIOR TO CONSTRUCTION AND SHALL BE CONSISTENT WITH THE MITIGATION AND MONITORING PROGRAM (MMRP) FOR THE PROJECT.

CONTRACTOR'S NOTE:  
 USE EXTREME CAUTION WHEN WORKING  
 DUE TO LOW OVERHEAD UTILITY LINES.

REFERENCE:  
 WATER: 7768-L  
 SEWER: 7193-L, 7768-L, 6394-B  
 STORM DRAIN: NONE  
 GAS: 16147-118800  
 ELECTRIC: 16147-118800  
 CABLE TV: 202-1743  
 TELEPHONE: N/A  
 IMPROVEMENTS: 7768-L  
 100' SCALE/FIELD BOOK: J20S, K20S, K21S  
 THOMAS BROS.: 1270 A-7, 1290 A-1, B-2

RETIREMENTS:  
 6" - VC - 512' - 1950  
 MH - 4X3 - 1 - 1950  
 4" LATERAL - 9' - VC - 1950

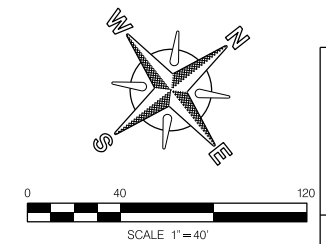


C-1

**SEWER GROUP XYZ**  
 54TH ST (FRONTAGE EAST)  
 McGANN DR TO STA 6+15.10

CITY OF SAN DIEGO, CALIFORNIA PUBLIC WORKS DEPARTMENT SHEET 02 OF XX SHEETS		WATER WBS B-00000 SEWER WBS B-00000
APPROVED FOR CITY ENGINEER _____ DATE _____ PRINT NAME _____ RCE# _____		PROJECT MANAGER _____ PROJECT ENGINEER _____
DESCRIPTION	BY	APPROVED
ORIGINAL	XX/XX	
ADDENDUM A	XX/XX	XX/YY
DATE STARTED _____		DATE COMPLETED _____
CONTRACTOR INSPECTOR _____		DATE COMPLETED _____

6304407-1842444  
 CCS83 COORDINATE  
 XXXXX-02-D



VOID REPLACED BY SHEET # 10

54TH ST (FRONTAGE EAST)

POB 1+00.00 1845395.45 6305902.21  
 STRAIGHT 200.00 38° 09'44.28"  
 PI 3+00.00 1845630.55 6306086.96  
 STRAIGHT 315.10 38° 11'41.52"  
 POE 6+15.10 1845800.38 6306220.58

ESTIMATED ARCHAEOLOGICAL MONITORING LIMITS  
 (INCLUDES MAIN, LATERALS, AND OTHER TRENCHING ACTIVITIES)

BEGINNING STATION	ENDING STATION	APPROXIMATE LF
STA. 1+00	STA. 6+15.10	515.10

ACTUAL LIMITS SHALL BE DETERMINED BY THE PI/MONITOR(S) PRIOR TO CONSTRUCTION AND SHALL BE CONSISTENT WITH THE MITIGATION AND MONITORING PROGRAM (MMP) FOR THE PROJECT.

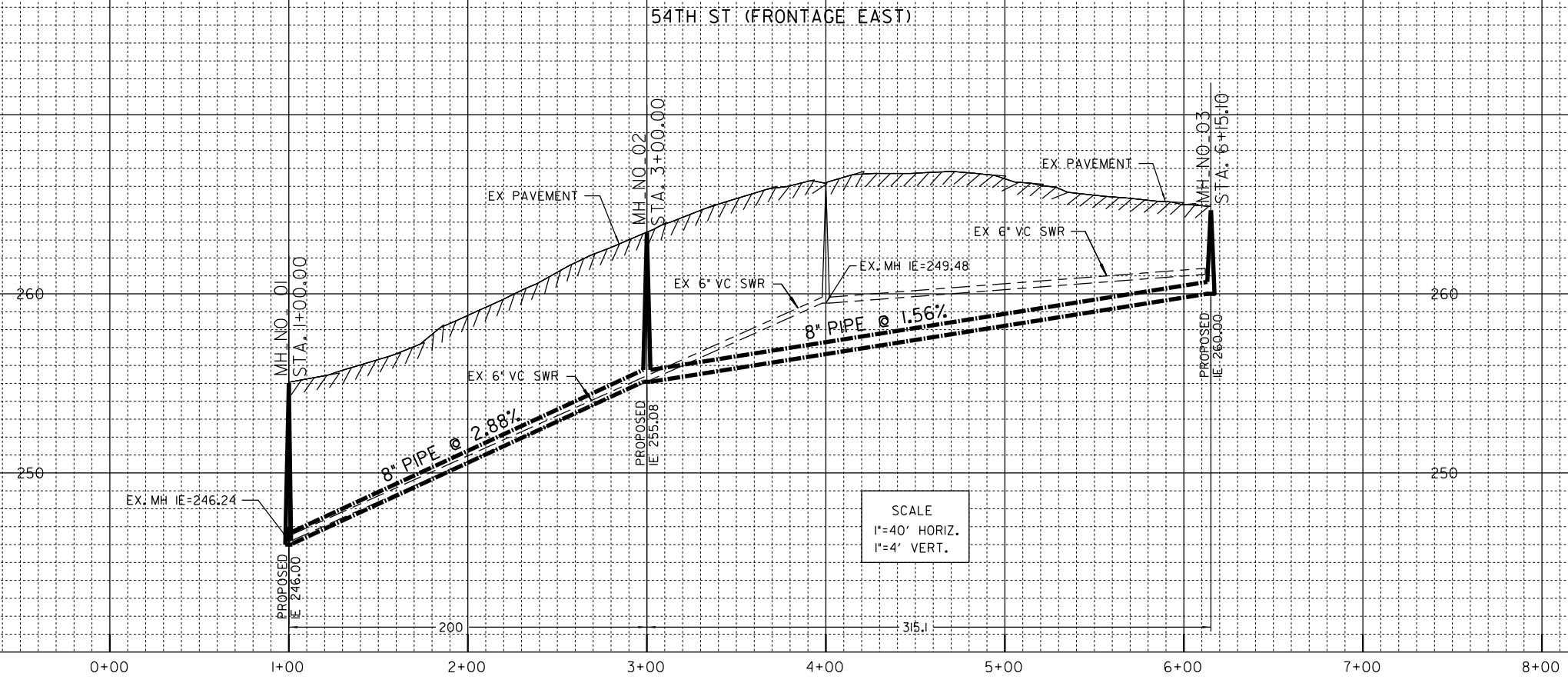
CONTRACTOR'S NOTE:  
 USE EXTREME CAUTION WHEN WORKING  
 DUE TO LOW OVERHEAD UTILITY LINES.

REFERENCE:

WATER: 7768-L  
 SEWER: 7193-L, 7768-L, 6394-B  
 STORM DRAIN: NONE  
 GAS: 16147-118800  
 ELECTRIC: 16147-118800  
 CABLE TV: 202-1743  
 TELEPHONE: N/A  
 IMPROVEMENTS: 7768-L  
 100' SCALE/FIELD BOOK: J20S, K20S, K2IS  
 THOMAS BROS.: I270 A-7, I290 A-1, B-2

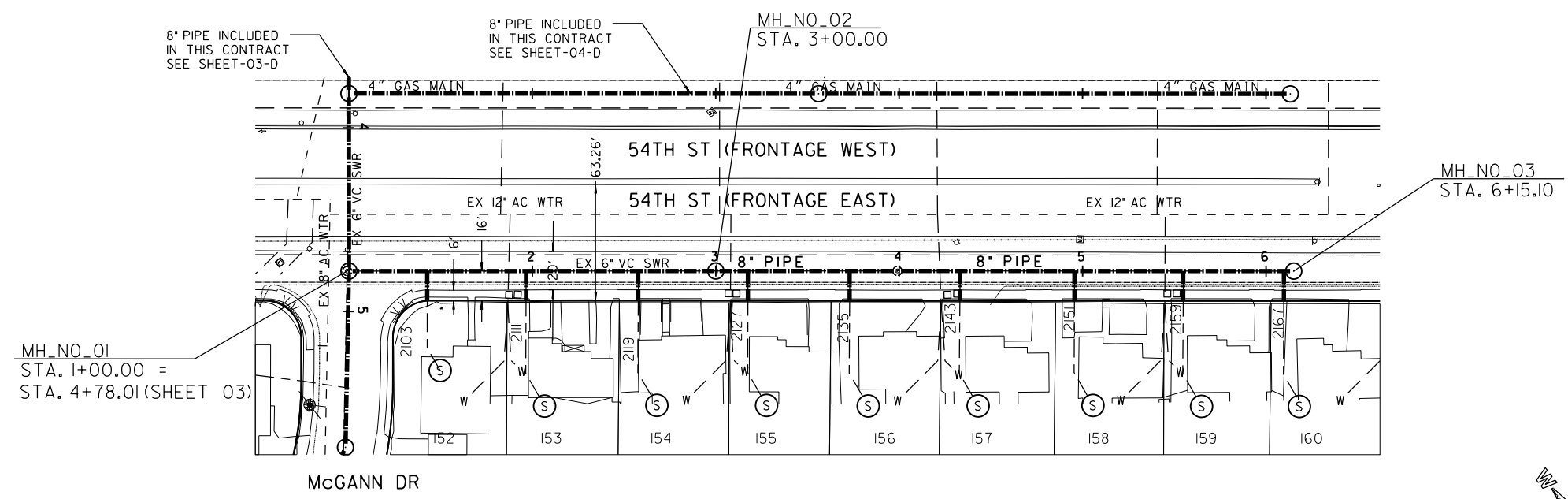
RETIREMENTS:

6" - VC - 512' - 1950  
 MH - 4X3 - 1 - 1950  
 4" LATERAL - 9 - VC - 1950



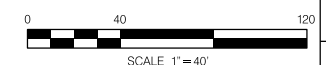
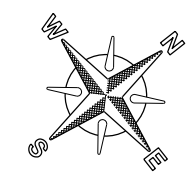
SCALE  
 1"=40' HORIZ.  
 1"=4' VERT.

MAP 2621  
 WESTWOOD HILLS UNIT NO.2



MH\_NO\_01  
 STA. 1+00.00 =  
 STA. 4+78.01 (SHEET 03)

MH\_NO\_03  
 STA. 6+15.10



C-9

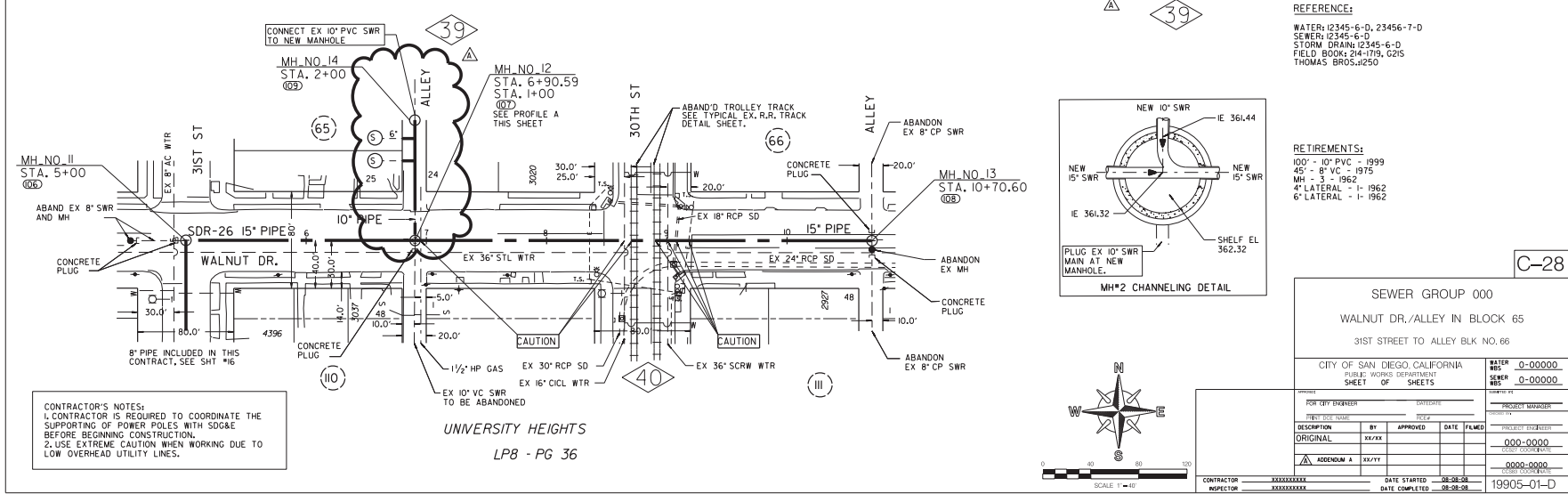
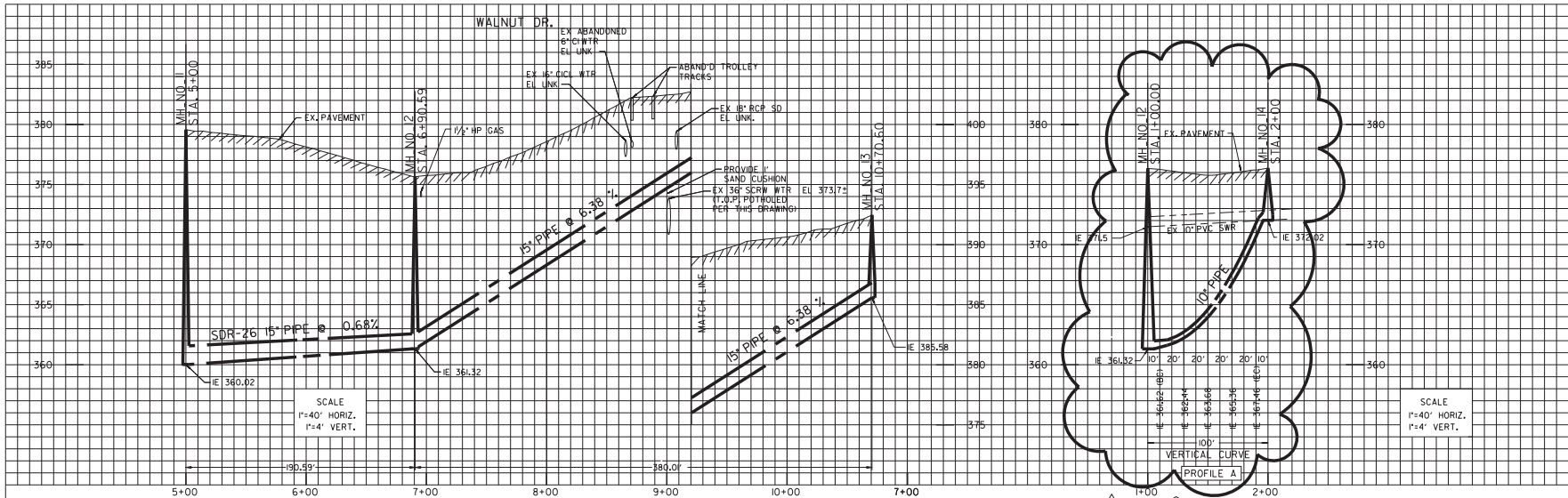
SEWER GROUP XYZ  
 54TH ST (FRONTAGE EAST)  
 McGANN DR TO STA 6+15.10

CITY OF SAN DIEGO, CALIFORNIA  
 PUBLIC WORKS DEPARTMENT  
 SHEET 10 OF XX SHEETS

APPROVED FOR CITY ENGINEER	DATE	PROJECT MANAGER
PRINT NAME	RCE#	PROJECT ENGINEER
DESCRIPTION	BY	APPROVED
ORIGINAL	XX/XX	DATE
ADDENDUM A	XX/XX	XX/YY
		DATE FILMED

CONTRACTOR INSPECTOR \_\_\_\_\_ DATE STARTED \_\_\_\_\_ DATE COMPLETED \_\_\_\_\_

54TH ST (FRONTAGE EAST)



REFERENCE:  
 WATER: 12345-6-D, 23456-7-D  
 SEWER: 12345-6-D  
 STORM DRAIN: 12345-6-D  
 FIELD BOOKS 244-119, 1205  
 THOMAS BROS. 1250

RETIREMENTS:  
 100' - 10" PVC - 1999  
 45' - 8" VC - 1975  
 MH - 3 - 1962  
 4" LATERAL - 1 - 1962  
 6" LATERAL - 1 - 1962

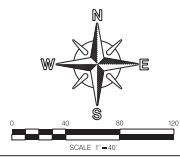
C-28

SEWER GROUP 000 WALNUT DR./ALLEY IN BLOCK 65 31ST STREET TO ALLEY BLK NO. 66	
CITY OF SAN DIEGO, CALIFORNIA PUBLIC WORKS DEPARTMENT SHEET OF SHEETS	MASTER RES 0-00000 SEWER RES 0-00000
DESIGNED BY: [ ] DATE: [ ]	DRAWN BY: [ ] DATE: [ ]
CHECKED BY: [ ] DATE: [ ]	APPROVED BY: [ ] DATE: [ ]
ORIGINAL	000-0000
ADDENDUM A	0000-0000
CONTRACTOR: [ ]	DATE STARTED: 08-08-08
INSPECTOR: [ ]	DATE COMPLETED: 08-08-08
19905-01-D	

WALNUT DR.

CONTRACTOR'S NOTES:  
 1. CONTRACTOR IS REQUIRED TO COORDINATE THE SUPPORTING OF POWER POLES WITH SDG&E BEFORE BEGINNING CONSTRUCTION.  
 2. USE EXTREME CAUTION WHEN WORKING DUE TO LOW OVERHEAD UTILITY LINES.

UNIVERSITY HEIGHTS  
 LP8 - PG 36



39 ADDENDUM A

# MISSION CENTER CANYON SEWER B AND ACCESS PATH

## UNDERGROUND UTILITIES

AT LEAST THREE (3) WORKING DAYS PRIOR TO EXCAVATION, THE CONTRACTOR SHALL REQUEST A MARKOUT OF UNDERGROUND UTILITIES BY CALLING THE BELOW LISTED REGIONAL NOTIFICATION CENTER FOR AN INDUSTRY IDENTIFICATION NUMBER: UNDERGROUND SERVICE ALERT (U.S.A.) 1-800-422-4133

## CONTRACTOR'S RESPONSIBILITIES

- IT SHALL BE THE CONTRACTOR'S RESPONSIBILITY TO LOCATE AND RECONNECT ALL SEWER LATERALS. LOCATIONS AS SHOWN ON THE PLANS ARE APPROXIMATE ONLY. LATERAL RECORDS ARE AVAILABLE TO THE CONTRACTOR AT THE WATER DEPARTMENT, 2197 CAMINITO CHOLLAS. IT SHALL BE THE CONTRACTOR'S RESPONSIBILITY TO LOCATE THE IMPROVEMENTS THAT WILL BE AFFECTED BY LATERAL REPLACEMENTS. ALL IMPROVEMENTS DISTURBED BY CONTRACTOR SHALL BE REPLACED IN KIND TO ORIGINAL CONDITION OR BETTER.
- THE LOCATION OF EXISTING BUILDINGS AS SHOWN ON THE PLAN ARE APPROXIMATE.
- STORM DRAIN INLETS ARE TO REMAIN FUNCTIONAL / OPERATIONAL AT ALL TIMES DURING CONSTRUCTION.
- UNLESS OTHERWISE NOTED AS PREVIOUSLY POTHOLED (PH), ALL ELEVATIONS SHOWN ON THE PROFILE FOR EXISTING UTILITIES ARE BASED ON A SEARCH OF THE AVAILABLE RECORD INFORMATION ONLY AND ARE SOLELY FOR THE CONTRACTOR'S CONVENIENCE. THE CITY IN NO WAY GUARANTEES OR WARRANTS THAT IT HAS REVIEWED ALL AVAILABLE DATA. IT IS THE CONTRACTOR'S RESPONSIBILITY TO POTHOLE ALL EXISTING UTILITIES (EITHER SHOWN ON THE PLANS OR MARKED IN THE FIELD) IN ACCORDANCE WITH THE SPECIFICATIONS (SECTION 5-I)
- CONTRACTOR SHALL NOTIFY THE RESIDENT ENGINEER IMMEDIATELY IF A ONE FOOT VERTICAL SEPARATION (FROM OUTSIDE PIPE WALL TO OUTSIDE PIPE WALL) BETWEEN SEWER AND WATER MAINS CANNOT BE MAINTAINED.
- CONTRACTOR SHALL NOTIFY THE RESIDENT ENGINEER IMMEDIATELY IF A FOUR FOOT HORIZONTAL SEPARATION (FROM OUTSIDE PIPE WALL TO OUTSIDE PIPE WALL) BETWEEN SEWER AND WATER MAINS CANNOT BE MAINTAINED.
- CONTRACTOR SHALL NOTIFY THE RESIDENT ENGINEER IMMEDIATELY IF A 6-INCH VERTICAL SEPARATION (FROM OUTSIDE PIPE WALL TO OUTSIDE PIPE WALL) BETWEEN UTILITIES OTHER THAN SEWER AND WATER CANNOT BE MAINTAINED.
- EXISTING UTILITY CROSSING ARE NOT REPRESENTATIVE OF ACTUAL LENGTH OF CONFLICT AREA (SEE PLAN VIEW)

## ABBREVIATIONS

ABAND	ABANDON	CSS	COASTAL SAGE SCRUB	OVHD	OVER HEAD
ABAND'D	ABANDONED	DB	DIRECT BURIED	PEP	PLANT ESTABLISHMENT PERIOD
AC	ASBESTOS CEMENT	EB	ENCASED BURIED	PLS	PURE LIVE SEED
	PIPE	EL, ELEV	ELEVATION	PVC	POLYVINYL CHLORIDE
AHD	AHEAD	ELEC	ELECTRIC	PROP	PROPOSED
ASSY	ASSEMBLY	EVC	END VERTICAL CURVE	RED	REDUCER
BFM	BONDED FIBER MATRIX	EX, EXIST	EXISTING	REVEG	REVEGETATION
BK	BACK	F	FLANGE	RT	RIGHT
BMP	BEST MANAGEMENT PRACTICES	GV	GATE VALVE	S	SURVEY LINE
BTWN	BETWEEN	HDPE	HIGH-DENSITY POLYETHYLENE	SO	STUB OUT
BVC	BEGIN VERTICAL CURVE	HP	HIGH PRESSURE	SPECS	SPECIFICATIONS
CATV	CABLE TV	IE	INVERT ELEVATION	SWR	SEWER
CI	CAST IRON PIPE	LT	LEFT	TEL	TELEPHONE
G	CENTER LINE	MJ	MECHANICAL JOINT	TPOB	TRUE POINT OF BEGINNING
COND	CONDUIT	MTD	MULTIPLE TELEPHONE DUCT	UNK	UNKNOWN
CONT	CONTINUED			VC	VITRIFIED CLAY PIPE
CONTR	CONTRACTOR			WM	WATER METER
				WTR	WATER

## EXISTING UTILITIES

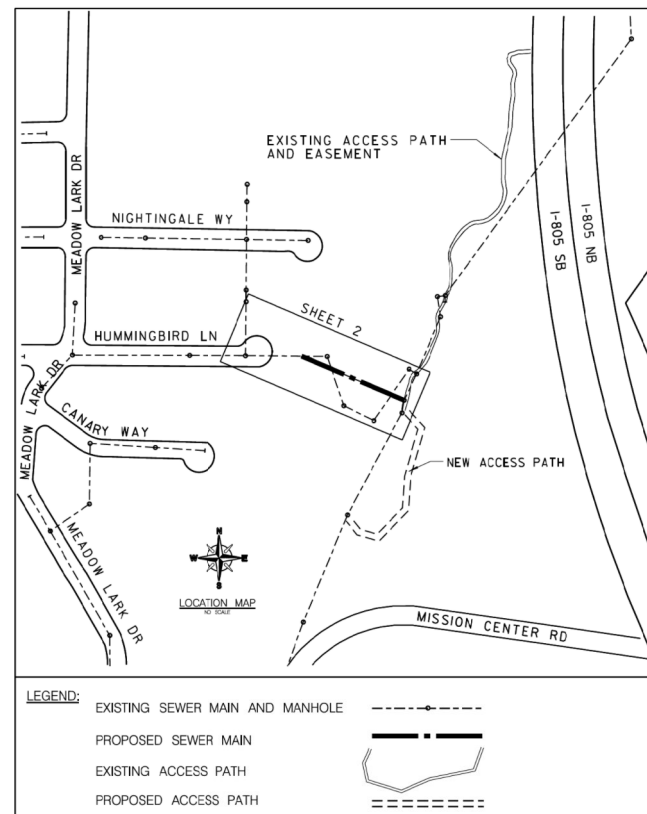
EX WATER MAIN & VALVES	-----+-----
EX WATER METER	-----□-----
EX FIRE HYDRANT	○---+
EX SEWER MAIN & MANHOLES	-----○-----
EX DRAINS	=====
EX PAVEMENT (PROFILE)	//////
EX GROUND (PROFILE)	
EX STREET LIGHT	SL
GAS MAIN	-----T-----
ELEC. COND., TEL. COND., CATV	---E---T---C---
ELEC. POWER POLE	⊕

## LIMITS OF WORK

SHEET NO.	DISCIPLINE CODE	STREET	LIMITS	PIPE		LENGTH (FT)
				SIZE (IN)	MATERIAL	
1	G-1	COVER SHEET	SEWER			
2	C-1	HUMMINGBIRD LN TO MISSION CENTER CANYON	FROM STA 1+00 TO 4+38.40 (LONGITUDINAL AXIS)	8	SEWER	338.40
3	C-2	SEWER MAIN ABANDONMENT				
4	C-3	MISSION CENTER CANYON ACCESS PATH	FROM STA 1+00 TO 6+52.71			
5	C-4	DETAILS				
6	L-1	PIPELINE REVEGETATION PLAN				
7	L-2	ACCESS PATH REVEGETATION PLAN				
8	L-3	PIPELINE REVEGETATION PLAN				

## DISCIPLINE CODE

- G GENERAL
- D DEMOLITION
- C CIVIL
- M MECHANICAL
- E ELECTRICAL
- I INSTRUMENTATION
- L LANDSCAPE



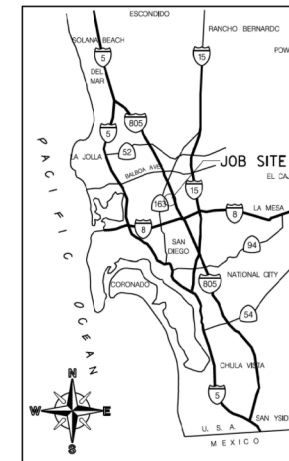
## WORK TO BE DONE

CONSTRUCTION CONSISTS OF THE INSTALLATION OF NEW 8-INCH SEWER MAIN AND CANYON ACCESS PATH, ABANDON EXISTING 8" VC SEWER MAIN AND SEWER MANHOLES OUTSIDE OF PROPOSED ALIGNMENT, TRENCH SHORING, REVEGETATION, ENVIRONMENTAL MONITORING, AND ALL OTHER WORK AND APPURTENANCES IN ACCORDANCE WITH THE SPECIFICATIONS AND THESE DRAWINGS.

BENCHMARK: NEBP CHANTILLY AVE. & ELYSSEE ST.  
FIELD NOTES: MCCORMICK, 226-1722, 7/26/05, W.O. 140081  
DATUM: MEAN SEA LEVEL

ACCESS EASEMENT (CITY OF SAN DIEGO DRAWING 20890-B)  
MISSION CENTER CANYON SEWER 'B' EASEMENT (CITY OF SAN DIEGO DRAWING 20903-B)

STREETS REQUIRING 9" TRENCH CAP: NONE



VICINITY MAP  
NO SCALE

## LEGEND

IMPROVEMENTS	STANDARD DRAWINGS	SYMBOL
SEWER MAIN	SDS-100, SDS-101, SDS-108, SDS-110 (TYPE C)	-----○-----
SEWER MANHOLE/PVC LINE	M-3, SM-03, SM-04, SDM-113, SM-07 SDS-107	-----○-----
REHAB. (PVC LINE) AND RECHANNEL EX. SEWER MANHOLE	SEE PLANS & SPECS	-----○-----
EX MANHOLES TO BE ABANDONED	SM-08	-----○-----
CUTTING AND PLUGGING ABANDONED SEWER/WATER MAIN	WP-03	E-----
SURVEY MONUMENT	M-10	△
CUTOFF WALL	SDS-115	⊥

FOR ADDITIONAL SYMBOLS SEE DETAILS, REVEGETATION AND BMP POLLUTION CONTROL SITE PLANS.

WHERE THIS AS-BUILT DRAWING INDICATES THE PRESENCE OF UTILITIES NOT OWNED OR OPERATED BY THE CITY OF SAN DIEGO, SUCH INDICATIONS MERELY REFLECT A NOTED ENCOUNTER WITH THOSE UTILITIES DURING THE COURSE OF PROJECT CONSTRUCTION. THE CITY OF SAN DIEGO MAKES NO WARRANTIES OR REPRESENTATIONS WITH RESPECT TO THE ACCURACY OF THIS INFORMATION AND NO SUBSEQUENT USERS MAY RELY THEREON FOR ANY PURPOSE WHATSOEVER.

G-1

## MISSION CENTER CANYON SEWER B AND ACCESS PATH COVER SHEET

AS-BUILT INFORMATION	
MATERIALS	MANUFACTURER
PIPE SDR 35 (SEWER)	S&J SUPPLY
SEWER MANHOLES	OLD CASTLE
CONCRETE PAVERS	ARMOR FLEX CONTECH SUPPLY CONSTRUCTION PRODUCTS



CITY OF SAN DIEGO, CALIFORNIA		WATER	00000
SHEET 01 OF 08 SHEETS		SEWER	B-00432
APPROVED BY: <i>W. Team</i>	DATE: 6/7/2010	DESIGNED BY:	CATHERINE DUNGCA
FOR CITY ENGINEER		ASSOCIATE ENGINEER	
DESCRIPTION	BY	APPROVED	DATE
ORIGINAL	MN/CE		
AS-BUILT PER CITY INSPECTOR	INITIALS OF INSPECTOR	DATE	
		7-15-12	
CONTRACTOR: HTA ENGINEERING	DATE STARTED: 1-8-2011	COORDINATE:	
INSPECTOR: IGOR LEVIN	DATE COMPLETED: 2-9-2012		34705-01-D

## AS-BUILT

MISSION CENTER CANYON SEWER B & ACCESS PATH

- ① COVER SHEET TITLE BLOCK - PROJECT TITLE FOR CIP PROJECTS SHALL BE THE SAME AS THE TITLE OF THE PROJECT IN THE C.I.P. BUDGET BOOK
- ② DISCIPLINE DESIGNATORS - OPTIONAL, AS SHOWN ON THE COVER SHEET
- ③ SHEET XX OF YY SHEET - XX REPRESENTS THE INDIVIDUAL SHEET AND YY REPRESENTS THE TOTAL NUMBER OF SHEETS
- ④ WORK BREAKDOWN STRUCTURE (WBS) - OBTAIN AND PLACE THE (WBS)(S) IN THE APPROPRIATE BLOCK AS SHOWN
- ⑤ PROJECT MANAGER - NAME OF THE PROJECT MANAGER  
PRIVATE PROJECT PLANS: NA
- ⑥ PROJECT ENGINEER - NAME OF THE PROJECT ENGINEER  
PRIVATE PROJECT PLANS: NA
- ⑦ CCS27 COORDINATE - (NAD 27) THE COVER SHEET SHALL CALL OUT "SEE EACH SHEET" ON THIS BLOCK  
PRIVATE PROJECT PLANS: THESE NUMBERS ARE DETERMINED DURING PLAN CHECK BASED ON PTS MAP LAYERS
- ⑧ CCS83 COORDINATE - (NAD 83) THE SHEET COVER SHEET SHALL CALL OUT "SEE EACH SHEET" ON THIS BLOCK  
PRIVATE PROJECT PLANS: THESE NUMBERS ARE DETERMINED DURING PLAN CHECK BASED ON PTS MAP LAYERS
- ⑨ DRAWING NUMBER - OBTAIN FROM MAPS AND RECORDS IN DEVELOPMENT SERVICES
- ⑩ DEPUTY CITY ENGINEER - DEPUTIZED CITY ENGINEER WHO IS IN CHARGE OF THE PROJECT (DIGITAL SIGNATURE) SIGNS ON BEHALF OF THE CITY
- ⑪ REGISTRATION: LEAVE BLANK IF IN-HOUSE DESIGN
- ⑫ REGISTRATION: DEPUTY CITY ENGINEER'S RCE NUMBER
- ⑬ DESCRIPTION BLOCK - "ORIGINAL" BLOCK FOR DESIGN PROJECT, ADDENDUM "A", "B", ETC AND CONSTRUCTION CHANGE "1", "2", ETC., FOR CHANGES MADE DURING CONSTRUCTION. WHEN DOING AS-BUILTS, USE A TRIANGLE WITH A NUMBER INSIDE (SEE AS-BUILT PROCEDURES SECTION OF THIS MANUAL)
- ⑭ CHANGES MADE TO DRAWINGS DURING DESIGN DO NOT LEAD TO ANY REVISION NOTATIONS ON THE BORDER. THE DRAWING STATUS BLOCK IS FOR FORMAL CHANGES BY ADDENDUM DURING THE BID PHASE, CONSTRUCTION CHANGES DURING CONSTRUCTION, AND FOR RECORDING AS-BUILTS INFORMATION PROJECT ENGINEER AND DRAFTER'S INITIALS WHO REVIEWED AND PREPARED THE AS-BUILT
- ⑮ DRAWN BY - WHEN ENTERING INITIALS, PLACE CITY DESIGN ENGINEER FIRST, THEN DRAFTER'S INITIALS OR THE INITIALS OF THE CONSULTANT'S COMPANY
- ⑯ APPROVED - THIS SECTION IS SIGNED WHEN ADDENDA AND CONSTRUCTION CHANGES ARE APPROVED BY THE DEPUTY CITY ENGINEER, AND THE AS-BUILT WILL BE SIGNED BY THE RESIDENT ENGINEER.
- ⑰ DATE - DATED BY THE DEPUTY CITY ENGINEER OR STAFF UNDER THEIR DIRECTION WHEN CHANGES ARE APPROVED
- ⑱ FILMED - WHEN THE PLANS ARE SUBMITTED TO MAPS AND RECORDS, THEY ARE FILMED AND DATED
- ⑲ FIELD INSPECTOR - PRINT NAME OF THE RESIDENT ENGINEER AFTER APPROVING AS-BUILTS. RESIDENT ENGINEER TO SIGN THE AUTHORIZATION FORM.
- ⑳ AS-BUILT INFORMATION - NAME OF CONTRACTOR, INSPECTOR AND THE DATES OF WHEN THE PROJECT STARTED AND ENDED
- ㉑ ENGINEERS STAMP - DIGITAL SEAL/STAMP (SIGNATURE WITH ELECTRONIC SIGNATURE AUTHORIZATION FORM). CONSULTANT IN CHARGE OF WORK MUST BE WET/ORIGINAL ONLY ON MYLARS
- ㉒ PRIVATE PROJECT PLANS: SEAL/STAMP MUST BE WET/ORIGINAL ONLY ON MYLARS
- ㉓ ADD THE MANUFACTURER(S) OF ALL MATERIALS, INCLUDING REHAB.  
PRIVATE PROJECT PLANS: NA
- ㉔ SPECIFICATIONS NO. - OBTAIN FROM CONTRACT PROCESSING  
PRIVATE PROJECT PLANS: NA
- ㉕ AS-BUILT INFORMATION FOR MATERIALS - REFER TO AS-BUILT PROCEDURES SECTION IN THIS MANUAL  
PRIVATE PROJECT PLANS: NA
- ㉖ PROGRAM IDENTIFICATION -
- ㉗ SCALE WARNINGS -
- ㉘ CHANGE - LINE WOULD HAVE THE LETTER (A, B, C, ETC.) SURROUNDED BY A TRIANGLE, WITH EACH LETTER A DIFFERENT SET OF CHANGES THROUGHOUT THE COURSE OF CONSTRUCTION. FOR PROCEDURES, REFER TO APPENDIX A, STANDARDS AND PROCEDURES FOR IMPROVEMENT PLANS.
- ㉙ DATE OF THE ADDENDUM AND/OR CONSTRUCTION CHANGE APPROVAL
- ㉚ AFFECTED OR ADDED SHEET NUMBERS - A CHANGE IS NOTED BY LISTING THE SHEET NUMBER(S)
- ㉛ APPROVAL NO. - NOT APPLICABLE FOR CIP PROJECTS
- ㉜ PRIVATE PROJECT PLANS: ASSIGNED APPROVAL NO. UPON PLAN REVIEW FOR PTS TRACKING PURPOSES

G-1

### PLANS FOR THE CONSTRUCTION OF PROJECT TITLE COVER SHEET

SPEC. NO.	CITY OF SAN DIEGO, CALIFORNIA PUBLIC WORKS DEPARTMENT SHEET XX OF YY SHEETS	WATER WBS 0-00000 SEWER WBS 0-00000	
APPROVED: FOR CITY ENGINEER _____ DATE _____		SUBMITTED BY: _____ PROJECT MANAGER _____	
PRINT DCE NAME _____ RCE# _____		CREATED BY: _____ PROJECT ENGINEER _____	
DESCRIPTION	BY	APPROVED	DATE
ORIGINAL	XX/XX	XX	
AS-BUILT	XX/XX	XX	
CONTRACTOR _____		DATE STARTED _____	
INSPECTOR _____		DATE COMPLETED _____	
		XXXXX-01-D	

G-1

### PLANS FOR THE CONSTRUCTION OF SEWER & WATER GROUP XYZ COVER SHEET

SPEC. NO.	CITY OF SAN DIEGO, CALIFORNIA PUBLIC WORKS DEPARTMENT SHEET OF SHEETS	WATER WBS 0-00000 SEWER WBS 0-00000	
APPROVED: FOR CITY ENGINEER _____ DATE _____		SUBMITTED BY: _____ PROJECT MANAGER _____	
PRINT NAME _____ RCE# _____		CREATED BY: _____ PROJECT ENGINEER _____	
DESCRIPTION	BY	APPROVED	DATE
ORIGINAL	XX/XX		
CONTRACTOR _____		DATE STARTED _____	
INSPECTOR _____		DATE COMPLETED _____	
		XXXXX-00-D	

COMPANY NAME \_\_\_\_\_  
 COMPANY ADDRESS \_\_\_\_\_  
 COMPANY PHONE \_\_\_\_\_  
 COMPANY FAX \_\_\_\_\_  
 COMPANY EMAIL \_\_\_\_\_

MATERIALS		MANUFACTURER
PIPE CL 235 (WATER)		-
PIPE SDR 35 (SEWER)		-
GATE VALVES		-
FIRE HYDRANTS		-
SEWER MANHOLES		-
REHABILITATE SEWER MANHOLES		-
REHABILITATE SEWER MAIN		-

CONSTRUCTION CHANGE / ADDENDUM			APPROVAL NO.
CHANGE	DATE	AFFECTED OR ADDED SHEET NUMBERS	

WARNING  
  
 IF THIS BAR DOES NOT MEASURE 1" THEN DRAWING IS NOT TO SCALE.

**PART 5**  
**LEVELS**



# Architectural Levels

Level Name	Description	Color	Style	Weight
ABLDGE BLOCK WALL	Arch Building Elevation Concrete Block Wall	0	0	0
ABLDGE BRICK WALL	Arch Building Elevation Brick Wall	0	0	0
ABLDGE CABINETS LOCKERS	Arch Building Elevation Cabinets and Lockers	0	0	1
ABLDGE CEILINGS	Arch Building Elevation Ceilings	0	0	0
ABLDGE COLUMNS	Arch Building Elevation Columns	0	0	1
ABLDGE DIMEN	Arch Building Elevation Arch Building Elevationitectural Dimensions	5	0	1
ABLDGE DOORS	Arch Building Elevation Doors Systems	0	0	1
ABLDGE ELEC	Arch Building Elevation Electrical Lights and Wiring	3	0	1
ABLDGE ELEV	Arch Building Elevation Elevator shafts	0	0	1
ABLDGE EQUIPT MACH	Arch Building Elevation Equipment or Machines	2	0	1
ABLDGE ESCAL	Arch Building Elevation Escalators and Moving Walks	0	0	1
ABLDGE FINISH FLOOR	Arch Building Elevation Finish Floor	0	0	0
ABLDGE FIREPLACE	Arch Building Elevation Fireplace	0	0	0
ABLDGE FLOOR JOIST	Arch Building Elevation Floor Joist	0	0	0
ABLDGE FOUNDATION	Arch Building Elevation Foundation	0	0	1
ABLDGE FURNISHINGS	Arch Building Elevation Furnishings	5	0	1
ABLDGE GLASS WALL	Arch Building Elevation Glass Block Wall	0	0	0
ABLDGE GYPSUM	Arch Building Elevation Gypsum Board	0	0	0
ABLDGE HANDRAILS	Arch Building Elevation Handrails	0	0	0
ABLDGE HVAC	Arch Building Elevation HVAC Ductwork and Diffusers	0	0	0
ABLDGE INSUL	Arch Building Elevation Insulation	3	0	0
ABLDGE LAM BEAM	Arch Building Elevation Laminated Beam	0	0	0
ABLDGE LAPPED SIDING	Arch Building Elevation Lapped Wood Siding	0	0	0
ABLDGE LOUVERS	Arch Building Elevation Louvers	0	0	0
ABLDGE MOISTURE BARRIER	Arch Building Elevation Moisture Barrier	0	0	0
ABLDGE NOTES	Arch Building Elevation Arch Building Elevationitectural Notes	0	0	1
ABLDGE PLUMB	Arch Building Elevation Plumbing	0	0	2
ABLDGE PLUMB FIX	Arch Building Elevation Plumbing Fixtures	0	0	1
ABLDGE PLYWOOD FLOOR	Arch Building Elevation Plywood Floor	0	0	0
ABLDGE PLYWOOD SHEAT	Arch Building Elevation Plywood Sheathing	0	0	0
ABLDGE RENOV REMAIN	Arch Building Elevation Arch Building Elevationitectural Renovation Remain	0	0	2
ABLDGE RENOV REMOVE	Arch Building Elevation Arch Building Elevationitectural Renovation Remove	0	0	2
ABLDGE ROOF FELT AND FLASH	Arch Building Elevation Roof Felt and Flashing	0	0	0
ABLDGE ROOF TILES	Arch Building Elevation Roofing Tile	0	0	0
ABLDGE ROOF TRUSS	Arch Building Elevation Wood Roof Truss	0	0	0
ABLDGE ROOM NUM	Arch Building Elevation Room Names and Numbers	0	0	1
ABLDGE SHEATHING WALL	Arch Building Elevation Wall Sheathing	0	0	0
ABLDGE SHINGLES	Arch Building Elevation Shingles	0	0	0
ABLDGE SLAB	Arch Building Elevation Slab on Grade	0	0	0
ABLDGE SPEC CONSTR	Arch Building Elevation Special Construction	0	0	0
ABLDGE STAIRS	Arch Building Elevation Stairs	0	0	1
ABLDGE STUCCO	Arch Building Elevation Stucco Finish	0	0	0
ABLDGE WINDOWS	Arch Building Elevation Windows Systems	0	0	0

# Architectural Levels

Level Name	Description	Color	Style	Weight
ABLDGE WOOD FRAME WALL	Arch Building Elevation Wood Frame Walls	0	0	0
ABLDGE WOOD VINYL SIDING	Arch Building Elevation Wood or Vinyl Siding	0	0	0
ABLDGP BEAM CL	Arch Building Plan Beam Centerline	3	4	0
ABLDGP BEAM EDGE	Arch Building Plan Beam Edge	0	0	0
ABLDGP BLOCK WALL	Arch Building Plan Concrete Block Wall	0	0	0
ABLDGP BRICK WALL	Arch Building Plan Brick Wall	0	0	0
ABLDGP CABINET LOCKER	Arch Building Plan Cabinets and Lockers	0	0	1
ABLDGP CEILINGS	Arch Building Plan Ceilings	0	0	0
ABLDGP COLUMNS	Arch Building Plan Columns	0	0	1
ABLDGP DIMENS	Arch Building Plan Arch Building Planitectural Dimensions	5	0	1
ABLDGP DOORS	Arch Building Plan Doors	0	0	1
ABLDGP ELEC CELLS	Arch Building Plan Electrical	3	2	1
ABLDGP ELEC HEATING	Arch Building Plan Electrical Heating Systems	3	7	1
ABLDGP ELEV SHAFT	Arch Building Plan Elevator shafts	0	0	1
ABLDGP EQUIPT OR MACH	Arch Building Plan Equipment or Machines	0	0	1
ABLDGP ESCAL	Arch Building Plan Escalators and Moving Walks	0	0	1
ABLDGP FURNISH	Arch Building Plan Furnishings	0	0	1
ABLDGP GLASS BLOCK WALL	Arch Building Plan Glass Block Wall	0	0	0
ABLDGP HANDRAILS	Arch Building Plan Handrails	0	0	0
ABLDGP HVAC DUCT	Arch Building Plan HVAC Ductwork	0	0	0
ABLDGP LOUVERS	Arch Building Plan Louvers	0	0	0
ABLDGP NOTES	Arch Building Plan Arch Building Planitectural Notes	0	0	1
ABLDGP PLUMB	Arch Building Plan Plumbing	0	0	2
ABLDGP PLUMB FIX	Arch Building Plan Plumbing Fixtures	0	0	1
ABLDGP RENOVA REMAIN	Arch Building Plan Arch Building Planitectural Renovation Remain	0	0	2
ABLDGP RENOVA REMOVE	Arch Building Plan Arch Building Planitectural Renovation Remove	0	0	2
ABLDGP ROOM NUM	Arch Building Plan Room Names and Numbers	0	0	1
ABLDGP SPEC CONSTR	Arch Building Plan Special Construction	0	0	0
ABLDGP STAIRS	Arch Building Plan Stairs	0	0	1
ABLDGP TEL	Arch Building Plan Telephone Cables	5	5	1
ABLDGP WALLS	Arch Building Plan Walls	0	0	1
ABLDGP WINDOW	Arch Building Plan Windows	0	0	0
ASITEE DECKS	Arch Site Elevation Decks with stairs	0	0	1
ASITEE DRAIN	Arch Site Elevation Site Drains	0	0	0
ASITEE FOOTING	Arch Site Elevation Footings	0	0	1
ASITEE PILES	Arch Site Elevation Piles and Caissons	0	0	1
ASITEE PLANTS CELL	Arch Site Elevation Trees, Shrubs, and Plants	3	0	1
ASITEE REBAR	Arch Site Elevation Rebar and Reinforcement	0	3	1
ASITEE RETAINING	Arch Site Elevation Retaining Walls	0	0	0
ASITEE STAIRS	Arch Site Elevation Outdoor Stairs	0	0	3
ASITEP DECKING	Arch Site Plan Floating Dock Decking	0	0	1
ASITEP DECKS	Arch Site Plan Decks with stairs	0	0	1
ASITEP DRAIN	Arch Site Plan Site Drains	1	3	1
ASITEP FLOAT DOCK	Arch Site Plan Floating Dock Flotation Base	0	0	1
ASITEP FOOTING	Arch Site Plan Footings	0	3	1

## Architectural Levels

Level Name	Description	Color	Style	Weight
ASITEP FOOTPRINT	Arch Site Plan Building Footprint	0	0	3
ASITEP GANGWAY	Arch Site Plan Gangway	0	0	2
ASITEP HANDRAIL	Arch Site Plan Handicap Ramp Handrail	0	0	0
ASITEP IRRIGATION	Arch Site Plan Irrigation	0	0	0
ASITEP PAVING	Arch Site Plan Paving	0	0	1
ASITEP PILES	Arch Site Plan Piles and Caissons	0	0	1
ASITEP RAMP	Arch Site Plan Handicap Ramp	0	0	1
ASITEP REBAR	Arch Site Plan Rebar and Reinforcement	0	3	1
ASITEP RET WALL	Arch Site Plan Retaining Walls	0	0	0
ASITEP SIDEWALK	Arch Site Plan Sidewalks	0	0	1
ASITEP STAIRS	Arch Site Plan Outdoor Stairs Concrete	0	0	1
ASITEP TREE	Arch Site Plan Trees, Shrubs, and Plants	3	0	1

## Boundary Levels

Level Name	Description	Color	Style	Weight
BDRY CL EX 6	Boundary Center Line Of Right Of Way Existing	3	4	0
BDRY CL PROP 6	Boundary Center Line Of Right Of Way Proposed	3	4	2
BDRY CL TXT EX 6	Boundary Center Line Text	3	0	1
BDRY CNCL DST	Boundary Council District	0	0	5
BDRY CNTY	Boundary County Boundary	17	CNTY_BND Y	5
BDRY COM PLNG	Boundary Community Planning	0	0	5
BDRY CT 5	Boundary CalTrans Right of Way	3	6	4
BDRY CT ABUT 5	Boundary CalTrans Abutters Rights	3	CAL_ABUT T_RT S	2
BDRY CT TXT 5	Boundary CalTrans Right of Way Text	3	6	4
BDRY CTY	Boundary City Boundary	53	CITY_BND Y	4
BDRY ESMT AVIG EX 7	Boundary Easement Aviation Existing	3	3	0
BDRY ESMT AVIG PROP 7	Boundary Easement Aviation Proposed	3	0	3
BDRY ESMT DRN EX 7	Boundary Easement Drainage Existing	5	3	0
BDRY ESMT DRN PROP 7	Boundary Easement Drainage Proposed	5	0	3
BDRY ESMT GE EX 7	Boundary Easement SDGE Existing	4	3	0
BDRY ESMT GE PROP 7	Boundary Easement SDGE Proposed Acquisition	4	0	3
BDRY ESMT GU EX 7	Boundary Easement General Utility Existing	0	3	0
BDRY ESMT GU PROP 7	Boundary Easement General Utility Proposed Acquisition	0	0	3
BDRY ESMT I/E EX 7	Boundary Easement Ingress/ Egress Existing	50	3	0
BDRY ESMT I/E PROP 7	Boundary Easement Ingress/ Egress Proposed Acquisition	50	0	3
BDRY ESMT LINE EX	Boundary Easement Line Existing	0	0	0
BDRY ESMT OS EX 7	Boundary Easement Open Space Existing	36	3	0
BDRY ESMT OS PROP 7	Boundary Easement Open Space Proposed Acquisition	36	0	3

# Boundary Levels

Level Name	Description	Color	Style	Weight
BDRY ESMT POINT EX 7	Boundary Easement Point Existing	4	0	0
BDRY ESMT PT NUM 54	Boundary Easement Point Number	4	0	0
BDRY ESMT SLP EX 7	Boundary Easement Slope Existing	7	3	0
BDRY ESMT SLP PROP 7	Boundary Easement Slope Proposed Acquisition	7	0	3
BDRY ESMT SWR EX 7	Boundary Easement Sewer Existing	2	3	0
BDRY ESMT SWR PROP 7	Boundary Easement Sewer Proposed Acquisition	2	0	3
BDRY ESMT TC EX 7	Boundary Easement Temporary Construction Area Proposed	23	0	3
BDRY ESMT TEL EX 7	Boundary Easement Telco Existing	6	3	0
BDRY ESMT TEL PROP 7	Boundary Easement Telco Proposed Acquisition	6	0	3
BDRY ESMT TXT 7	Boundary Easement Text	4	0	0
BDRY ESMT WTR EX 7	Boundary Easement Water Existing	1	3	0
BDRY ESMT WTR PROP 7	Boundary Easement Water Proposed Acquisition	1	0	3
BDRY INTL	Boundary International Boundaries	19	INTL	5
BDRY LEASE EX 4	Boundary Lease Existing	3	6	1
BDRY LEASE POINT EX 4	Boundary Lease Point Existing	3	6	1
BDRY LEASE PROP 4	Boundary Lease Proposed	3	6	3
BDRY LEASE PT NUM 54	Boundary Lease Point Number	4	0	0
BDRY LEASE TXT	Boundary Lease Text	4	0	0
BDRY LL EX 4	Boundary Property Line	4	0	0
BDRY LL TXT EX 4	Boundary Lot Line	4	0	0
BDRY LS TXT EX 4	Boundary Lot Split	4	6	0
BDRY MEAS TXT	Boundary Dimension and Measurement Text	0	6	3
BDRY MHTL	Boundary Mean High Tide Line	0	MHTL	2
BDRY PARK EX 51	Boundary Park Recreation Boundary Existing	102	1	2
BDRY PARK PROP 51	Boundary Park Recreation Boundary Proposed	102	0	3
BDRY PARK PT NUM 54	Boundary Park Point Number	4	0	0
BDRY PARK TXT	Boundary Park Text	4	0	0
BDRY PT NUM 54	Boundary Point Number	0	0	0
BDRY REC TXT 5	Boundary Record Data Text	0	0	0
BDRY RP EX 6	Boundary Radius Point Existing	3	2	0
BDRY RP PROP 6	Boundary Radius Point Proposed	3	2	0
BDRY RP TXT	Boundary Radius Point Text	3	2	0
BDRY RW EX 5	Boundary Right Of Way Existing	6	0	3
BDRY RW PROP 5	Boundary Right Of Way Proposed	1	0	3
BDRY RW TXT EX 5	Boundary Right Of Way Existing	6	0	3
BDRY SCHL DIST	Boundary School District	0	0	5
BDRY STRT DED EX 5	Boundary Street Dedication Existing	1	0	0
BDRY STRT DED PROP 5	Boundary Street Dedication Proposed	1	0	3
BDRY STRT VAC EX 5	Boundary Street Vacation Existing	0	0	0
BDRY STRT VAC PROP 5	Boundary Street Vacation Proposed	0	0	3
BDRY SUB EX 4	Boundary Subdivision Boundary	5	6	4
BDRY TXT	Boundary Text	0	0	0
BDRY WTR PRES ZN	Boundary Water Pressure Zone	0	0	5
BDRY ZIP	Boundary Zip Code	0	0	5

## Cable TV Levels

Level Name	Description	Color	Style	Weight
CATV CELL EX 43	Cable TV Structure Cells Existing	6	0	1
CATV LINE EX 43	Cable TV Line Existing	6	CATV	1
CATV PNT NUM EX 56	Cable TV Point Number Existing	6	0	1
CATV TXT EX 43	Cable TV Text Existing	6	0	1

## Electric Levels

Level Name	Description	Color	Style	Weight
E CELL EX	Electric Structure Cell Existing	3	0	0
E CELL PROP	Electric Structure Cell Proposed	3	0	0
E LINE EX 40	Electric Line Existing	3	ELEC	0
E LINE PROP	Electric Line Proposed	3	ELEC	0
E PNT NUM EX 56	Electric Point Number Existing	3	0	1
E TXT EX 40	Electric Text Existing	3	0	1
E TXT PROP	Electric Text Proposed	3	0	3

## Gas Levels

Level Name	Description	Color	Style	Weight
GAS CELL EX 41	Gas Structure Cells Existing	4	0	0
GAS MAIN EX 41	Gas Main Existing	4	6	0
GAS PNT NUM EX 56	Gas Point Number Existing	4	0	0
GAS TXT EX 41	Gas Text	4	0	0

## Instrumentation Levels

Level Name	Description	Color	Style	Weight
INSTR BRDR	Instrumentation Border	0	0	0
INSTR CONST ELMT OBJT LN	Instrumentation Construction Elements and Object Lines	3	0	0
INSTR CONST MTCH LN FOR OPZ FL	Instrumentation Construction Match Lines for OPZ Files	3	6	4
INSTR CONST PT	Instrumentation Construction Points	7	0	10
INSTR DIM LL AROW TXT	Instrumentation Dimensioning with Leader Lines Arrowheads and Text	7	0	1
INSTR ELEC 120VAC INSTR DEV TAG CO TXT	Instrumentation Elec 120VAC Instrumentation Device Tag Callout Text (power required)	5	0	2
INSTR ELEC 120VAC VEND INSTR DEV TAG CO TXT	Instrumentation Elec 120VAC Vendor Instrumentation Device Tag Callout Text (power required)	53	0	2
INSTR ELEC 120VAC VEND WIRE CONDT FTNG JBOX	Instrumentation Elec 120VAC Vendor Wire and Conduit Fittings Junction Box (power required)	53	0	2
INSTR ELEC 120VAC WIRE CONDT FTNG JBOX	Instrumentation Elec 120VAC Wire and Conduit Fittings Junction Box (power required)	5	0	2
INSTR ELEC 24VDC ALM INSTR DEV TAG CO TXT	Instrumentation Elec 24VDC Alarm Instrumentation Device Tag Callout Text	51	0	2
INSTR ELEC 24VDC ALM WIRE CONDT FTNG JBOX	Instrumentation Elec 24VDC Alarm Wire and Conduit Fittings Junction Box	51	0	2

# Instrumentation Level

Level Name	Description	Color	Style	Weight
INSTR ELEC 24VDC INSTR DEV TAG CO TXT	Instrumentation Elec 24VDC Instrumentation Device Tag Callout Text	3	0	2
INSTR ELEC 24VDC VEND INSTR DEV TAG CO TXT	Instrumentation Elec 24VDC Vendor Instrumentation Device Tag Callout Text	115	0	2
INSTR ELEC 24VDC VEND WIRE CONDT FTNG JBOX	Instrumentation Elec 24VDC Vendor Wire and Conduit Fittings Junction Box	115	0	2
INSTR ELEC 24VDC WIRE CONDT FTNG JBOX	Instrumentation Elec 24VDC Wire and Conduit Fittings Junction Box	3	0	2
INSTR ELEC 4 20MA ALRM INSTR DEV TAG CO TXT	Instrumentation Elec 4-20mA Alarm Instrumentation Device Tag Callout Text	15	0	2
INSTR ELEC 4 20MA ALRM WIRE CONDT FTNG JBOX	Instrumentation Elec 4-20mA Alarm Wire and Conduit Fittings Junction Box	15	0	2
INSTR ELEC 4 20MA INSTR DEV TAG CO TXT	Instrumentation Elec 4-20mA Instrumentation Device Tag Callout Text	1	0	2
INSTR ELEC 4 20MA VEND INSTR DEV TAG CO TXT	Instrumentation Elec 4-20mA Vendor Instrumentation Device Tag Callout Text	49	0	2
INSTR ELEC 4 20MA VEND WIRE CONDT FTNG JBOX	Instrumentation Elec 4-20mA Vendor Wire and Conduit Fittings Junction Box	49	0	2
INSTR ELEC 4 20MA WIRE CONDT FTNG JBOX	Instrumentation Elec 4-20mA Wire and Conduit Fittings Junction Box	1	0	2
INSTR ELEC MISC INSTR DEV TAG CO TXT	Instrumentation Elec Misc Instrumentation Device Tag Callout Text (use for 3D model)	11	0	2
INSTR ELEC MISC WIRE CONDT FTNG JBOX	Instrumentation Elec Misc Wire and Conduit Fittings Junction Box (use for 3D model)	11	0	2
INSTR ELEC TC INST DEV TAG CO TXT	Instrumentation Elec TC Instrumentation Device Tag Callout Text	2	0	2
INSTR ELEC TC VEND INST DEV TAG CO TXT	Instrumentation Elec TC Vendor Instrumentation Device Tag Callout Text	50	0	2
INSTR ELEC TC VEND WIRE CONDT FTNG JBOX	Instrumentation Elec TC Vendor Wire and Conduit Fittings Junction Box	50	0	2
INSTR ELEC TC WIRE CONDT FTNG JBOX	Instrumentation Elec TC Wire and Conduit Fittings Junction Box	2	0	2
INSTR ELMT OBJ LN	Instrumentation Elements and Object Lines	0	0	1
INSTR GEN TXT LGD SCH GN WP	Instrumentation General Text Legends Schedules Gen. Notes and Working Points	4	0	1
INSTR GRID COLMN CO BBL TXT	Instrumentation Grid and Column Callout Bubbles w/Text	5	0	1
INSTR GRID LN COLMN CL	Instrumentation Grid Lines and Column Centerlines	5	4	0
INSTR HYD SYM	Instrumentation Hydraulic Symbolology	111	0	2
INSTR AIR FTNG	Instrumentation Air Fittings	10	0	1
INSTR AIR MN HD	Instrumentation Air Main Header (by piping)	10	0	0
INSTR AIR SUB HD PIPNG	Instrumentation Air Sub-Header Piping	10	0	5
INSTR AIR SUP ELPS SYM INSTL DTL CO SYM LL TXT	Instrumentation Air Supply Ellipse Symbol Installation Detail CO Symbol Leader Lines Text	10	0	2
INSTR SUPRT INSTL DET CO SYM LL TEXT	Instrumentation Supports Installation Detail Callout Symbols Leader Lines Text	60	6	2
INSTR MTCH LN	Instrumentation Match Lines	0	6	10
INSTR PLAT ELEV CO LL TXT	Instrumentation Platforms Elevation Callouts Leader Lines and Text	12	0	1
INSTR PLAT GRAT CHKR PLT EARTH CONC SND SYM	Instrumentation Platform Grating Checker Plate Earth Concrete Sand Symbolology	12	0	0
INSTR PLT SHP	Instrumentation Plot Shape	5	0	0
INSTR PNMAT INSTR DEV TAG CO TXT	Instrumentation Pneumatic Instrumentation Device Tag Callout Text	70	0	2

## Instrumentation Level

Level Name	Description	Color	Style	Weight
INSTR PRO CONN INSTR DEV TAG CO TXT	Instrumentation Process Connection Instrumentation Device Tag Callout Text	6	0	2
INSTR REV CLD	Instrumentation Revision Clouds	6	0	2
INSTR REV DLTA	Instrumentation Revision Deltas	6	0	2
INSTR RUB STMP	Instrumentation Rubber Stamps	3	0	0
INSTR SEC DTL ELEV CO SYM TXT	Instrumentation Section Detail and Elevation Callout Symbols w/Text	0	0	1
INSTR TB	Instrumentation Title Block	4	0	0
INSTR TBL CHRT	Instrumentation Tables and Charts	0	0	0

## Irrigation Levels

Level Name	Description	Color	Style	Weight
IRR CELL EX	Irrigation Cell Existing	1	0	0
IRR CELL PROP	Irrigation Cell Proposed	1	0	0
IRR DRP IRR EX	Irrigation Drip Existing	1	3	1
IRR DRP IRR PROP	Irrigation Drip Proposed	1	3	1
IRR LINE EX	Irrigation Line Existing	1	3	1
IRR LINE PROP	Irrigation Line Proposed	1	3	1
IRR PNT NUM EX 56	Irrigation Point Number Existing	1	0	1
IRR TXT EX	Irrigation Text Existing	1	0	1
IRR TXT PROP	Irrigation Text Proposed	1	0	1
IRR WRG EX	Irrigation Wiring Existing	1	3	1
IRR WRG PROP	Irrigation Wiring Proposed	1	3	1

## Landscape Levels

Level Name	Description	Color	Style	Weight
L CELL EX	Landscape Cell Existing	0	0	0
L CELL PROP	Landscape Cell Proposed	0	0	0
L LINE EX	Landscape Line Existing	0	0	0
L LINE PROP	Landscape Line Proposed	0	0	0
L PNT NUM EX 56	Landscape Point Number Existing	2	0	0
L TXT EX	Landscape Text Existing	2	0	0
L TXT PROP	Landscape Text Prop	2	0	0
L VEG CELL EX	Landscape Vegetation Cell Existing	2	0	0
L VEG LINE EX	Landscape Vegetation Line Existing	2	0	0

## Mechanical Levels

Level Name	Description	Color	Style	Weight
M DBL PIPE EX	Mechanical Double Line Pipe Fitting and Valve Existing	3	0	3
M DBL PIPE PROP	Mechanical Double Line Pipe Fitting and Valve Proposed	3	2	3
M SING PIPE EX	Mechanical Single Line Pipe Fitting and Valve Existing	4	0	6
M SING PIPE PROP	Mechanical Single Line Pipe Fitting and Valve Proposed	4	2	6
M STRUCTURES CELLS EX	Mechanical Structures Cells Existing	0	0	1
M STRUCTURES CELLS PROP	Mechanical Structures Cells Proposed	0	2	1
M STRUCTURES EX	Mechanical Structures Existing	0	0	1
M STRUCTURES PROP	Mechanical Structures Proposed	0	2	1
M TXT EX	Mechanical Text Existing	6	0	1
M TXT PROP	Mechanical Text Proposed	6	0	3

## Recycled Water Levels

Level Name	Description	Color	Style	Weight
RW AIR RELS VALV EX	Recycled Water Air Release Valve Existing	15	0	1
RW AIR RELS VALV PROP	Recycled Water Air Release Valve Proposed	15	0	2
RW BO EX	Recycled Water Blow Off Valve Existing	15	0	1
RW BO PROP	Recycled Water Blow Off Valve Proposed	15	0	2
RW CELL EX	Recycled Water Structures Cell Existing	15	0	1
RW CELL PROP	Recycled Water Structures Cell Proposed	15	0	2
RW GRND MON WELL EX	Recycled Water Ground Monument Well Existing	15	0	1
RW GRND MON WELL PROP	Recycled Water Ground Monument Well Proposed	15	0	2
RW MAIN EX	Recycled Water Main Existing	15	3	1
RW MAIN PROP	Recycled Water Main Proposed	15	0	9
RW MAIN TRANS EX	Recycled Water Mains Transmission Existing	15	3	1
RW MAIN TRANS PROP	Recycled Water Mains Transmission Proposed	15	0	9
RW MH EX	Recycled Water Manhole Existing	15	0	1
RW MH PROP	Recycled Water Manhole Proposed	15	0	2
RW MTR EX	Recycled Water Meter Existing	15	3	1
RW MTR PROP	Recycled Water Meter Proposed	15	0	2
RW PT NUM 56	Recycled Water Point Number	1	0	0
RW RED EX	Recycled Water Reducer Existing	15	0	1
RW RED PROP	Recycled Water Reducer Proposed	15	0	2
RW RIS EX	Recycled Water Riser Existing	15	0	1
RW RIS PROP	Recycled Water Riser Proposed	15	0	2
RW SERV EX	Recycled Water Service Existing	15	3	1
RW SERV PROP	Recycled Water Service Proposed	15	0	2
RW TEE EX	Recycled Water Tee Existing	15	0	1
RW TEE PROP	Recycled Water Tee Proposed	15	0	2
RW TEXT EX	Recycled Water Text Existing	15	3	1
RW TEXT PROP	Recycled Water Text Proposed	15	0	3
RW VALV EX	Recycled Water Valve Existing	15	0	1
RW VALV PROP	Recycled Water Valve Proposed	15	0	2
RW VLT EX	Recycled Water Vault Existing	15	0	1



## Storm Drain Levels

Level Name	Description	Color	Style	Weight
SD BD CELL EX 30	Storm Drain Brow Ditch Existing	0	0	0
SD CELL EX 30	Storm Drain Structures Cell Existing	0	0	0
SD CELL PROP	Storm Drain Structures Cell Proposed	0	0	0
SD FLD CHAN EX 30	Storm Drain Flood Channel	0	0	0
SD FLD CHAN PROP 30	Storm Drain Flood Channel	0	channel	5
SD HW EX 30	Storm Drain Headwall	0	0	1
SD HW PROP 30	Storm Drain Headwall	0	0	5
SD IE EX 30	Storm Drain Invert Elevation	0	0	1
SD IE PROP 30	Storm Drain Invert Elevation	0	0	2
SD LINE EX 30	Storm Drain Line	0	0	0
SD MAIN EX 30	Storm Drain Main Existing	0	0	1
SD MAIN PROP	Storm Drain Main Proposed	0	SD	5
SD MH EX 30	Storm Drain Manhole Existing	0	0	0
SD MH PROP 30	Storm Drain Manhole Proposed	0	0	5
SD PT NUM 56	Storm Drain Point Number	0	0	0
SD SLT DRN EX	Storm Drain Slotted Drain	0	3	0
SD SLT DRN PROP	Storm Drain Slotted Drain	0	SD	5
SD SW DRN EX 30	Storm Drain Sidewalk Underdrain	0	3	0
SD SW DRN PROP 30	Storm Drain Sidewalk Underdrain	0	SD	5
SD SWL EX 30	Storm Drain Swale	0	3	0
SD SWL PROP 30	Storm Drain Swale	0	pditch	5
SD TXT EX 30	Storm Drain Text Existing	0	0	1
SD TXT PROP	Storm Drain Text Proposed	0	0	5
SD XGUT EX 30	Storm Drain Cross Gutter	0	3	0
SD XGUT PROP 30	Storm Drain Cross Gutter	0	0	5

## Surface Feature Levels

Level Name	Description	Color	Style	Weight
SF AC BRM CELL EX 16	Surface Ac Berm Cell Existing	0	0	0
SF AC BRM EX 16	Surface Ac Berm Existing	0	0	0
SF AC BRM FL CELL EX 16	Surface Ac Flowline Cell Existing	0	0	0
SF AC BRM FL EX 16	Surface Ac Flowline Existing	0	0	0
SF BK RC CELL EX 16	Surface Back Of Rolled Curb Cell Existing	0	0	0
SF BK RC EX 16	Surface Back Of Rolled Curb Existing	0	0	0
SF BLDG CD FF EX 17	Surface Building Center Door & Finish Floor	0	0	0
SF BLDG CELL EX 17	Surface Building Cell	0	0	0
SF BLDG EX 17	Surface Building Line	0	0	0
SF BLDG TXT EX 17	Surface Building Text	0	0	0
SF BRDG CELL EX 39	Surface Bridge Cell Abutment	0	0	0
SF BRDG EX 39	Surface Bridge Abutment	0	0	0
SF CONT MAJ EX 12	Surface Contours Major Existing	2	0	2
SF CONT MAJ PROP 12	Surface Contours Major Proposed	1	0	4
SF CONT MIN EX 10	Surface Contours Minor Existing	1	2	0

## Surface Feature Levels

Level Name	Description	Color	Style	Weight
SF CONT MIN PROP 10	Surface Contours Minor Proposed	2	2	1
SF CONT TXT EX 13	Surface Contour Major Text Existing	0	0	1
SF CONT TXT PROP 13	Surface Contour Major Text Proposed	0	0	0
SF DTM LINE 1	Surface DTM Line 1	0	0	0
SF DTM LINE 2	Surface DTM Line 2	0	0	0
SF DTM POINT 1	Surface DTM Point 1	0	0	0
SF DTM POINT 2	Surface DTM Point 2	0	0	0
SF DTM PT NUM 56	Surface Text Dtm Point Number	0	0	0
SF DTM TXT	Surface Text Digital Terrain Model	0	0	0
SF EDG CONC CELL EX 16	Surface Edge Of Concrete Cell	0	0	0
SF EDG CONC EX 16	Surface Edge Of Concrete	0	0	0
SF EX GRD	Surface Existing Ground	0	0	0
SF EX PAV EX 16	Surface Existing Pavement	0	0	0
SF FNC DTM EX 15	Surface Fence DTM Points Existing	0	0	0
SF FNC DTM LINES EX 15	Surface Fence DTM Lines Existing	0	0	0
SF FNC LINES EX 15	Surface Fence Non-DTM Lines Existing	0	0	0
SF FNC NON DTM EX 15	Surface Fence Lines Non DTM Existing	0	0	0
SF FNC PNT NUM EX 56	Surface Fence Point Number Existing	0	0	0
SF FNC PROP 15	Surface Fence Proposed	0	0	0
SF FNC TXT	Surface Fence Text	0	0	0
SF GB AC CELL EX 16	Surface Grade Break Ac Cell Existing	0	0	0
SF GB AC EX 16	Surface Grade Break Ac Existing	0	0	0
SF GB CONC CELL EX 16	Surface Grade Break Concrete Cell Existing	0	0	0
SF GB CONC EX 16	Surface Grade Break Concrete Existing	0	0	0
SF GB DAYLT CELL EX 16	Surface Daylight Cell Existing	7	0	0
SF GB DAYLT EX 16	Surface Daylight Existing	7	0	0
SF GB DAYLT PROP 16	Surface Daylight Proposed	7	0	1
SF GB DRT CELL EX 16	Surface Grade Break Dirt Cell Existing	7	0	0
SF GB DRT EX 16	Surface Grade Break Dirt Existing	7	0	0
SF GB GRS CELL EX 16	Surface Grade Break Grass Cell Existing	2	0	0
SF GB GRS EX 16	Surface Grade Break Grass Existing	2	0	0
SF GB PNT NUM EX 56	Surface Grade Break Point Number Existing	6	0	0
SF GB RPRP CELL EX 16	Surface Rip Rap Cell Existing	0	0	0
SF GB RPRP EX 16	Surface Rip Rap Existing	0	0	0
SF GB TOE CELL EX 16	Surface Toe Of Slope Cell Existing	7	0	0
SF GB TOE EX 16	Surface Toe Of Slope Existing	7	0	0
SF GB TOP CELL EX 16	Surface Top Of Slope Cell Existing	6	0	0
SF GB TOP EX 16	Surface Top Of Slope Existing	6	0	0
SF GB TXT	Surface Grade Break Text	0	0	0
SF GB URP CELL EX 16	Surface Unimpr Road Or Path Cell Existing	7	0	0
SF GB URP EX 16	Surface Unimpr Road Or Path Existing	7	0	0
SF GUT CELL EX 16	Surface Gutter Cell Existing	6	0	0
SF GUT EX 16	Surface Gutter Existing	6	0	0
SF LIP CELL EX 16	Surface Lipline Cell Existing	0	0	0
SF LIP EX 16	Surface Lipline Existing	0	0	0
SF SAWCUT PROP	Surface Sawcut Proposed	2	2	1
SF SCHEDULE 'J'	Surface Asphalt Paving Proposed	237	0	0
SF AC PATCH	Surface Asphalt Repair Proposed	237	0	0

## Surface Feature Levels

Level Name	Description	Color	Style	Weight
SF MISC EX 52	Surface Sign Statue Nonbuilding Structures Mailbox	0	0	0
SF MISC LN EX 52	Surface Miscellaneous Line	0	0	0
SF MISC PT EX 52	Surface Miscellaneous Point	0	0	0
SF MISC PT NUM 56	Surface Miscellaneous Point Number	0	0	0
SF MISC TXT	Surface Miscellaneous Text	0	0	0
SF MOW ST CELL EX 16	Surface Mow Strip Cell Existing	0	0	0
SF MOW ST EX 16	Surface Mow Strip Existing	0	0	0
SF MOW ST PROP 16	Surface Mow Strip Proposed	0	0	1
SF PR OR CD CELL EX 14	Surface Pedestrian Ramp/ Center Of Driveway Existing	0	0	0
SF RAIL CELL EX 45	Surface Rail Train & Trolley Cell Existing	5	0	0
SF RAIL EX 45	Surface Rail Train & Trolley Existing	5	0	0
SF RAIL TXT EX 45	Surface Rail Text	5	0	0
SF SND LN 19	Surface Sounding Line	1	0	0
SF SND PT CELL 19	Surface Sounding Point	1	0	0
SF SPT EL EX 14	Surface Spot Elevation Improved & Unimproved Existing	0	0	0
SF SW CONC CELL EX 16	Surface Sidewalk Cell Existing	0	0	0
SF SW CONC EX 16	Surface Sidewalk Existing	0	0	0
SF SW CONC PROP 16	Surface Sidewalk Proposed	0	0	1
SF TCF CELL EX 16	Surface Top of Curb at Face Cell Existing	0	0	0
SF TCF EX 16	Surface Top of Curb at Face Existing	0	0	0
SF TRIANG1 EX 55	Surface Triangles 1	3	0	0
SF TRIANG2 EX 55	Surface Triangles 2	2	0	0
SF TRIANG3 EX 55	Surface Triangles 3	6	0	0
SF UTIL POLE ACH DEAD EX 40	Surface Utility Pole Anchor and Deadman	6	0	0
SF UTIL POLE UN EX 40	Surface Utility Pole with Underground	3	0	0
SF FNC PROP 15	Surface Fence Proposed	3	0	1
SF FNC TXT	Surface Fence Text	0	0	1
SF GB AC PROP 16	Surface Grade Break AC Proposed	3	0	1
SF GB CONC PROP 16	Surface Grade Break Concrete Proposed	3	0	1
SF GB TXT	Surface Grade Break Text	0	0	1
SF PR OR CD CELL PROP 14	Surface Pedestrian Ramp/Center of Driveway Existing	3	0	1

## Sheet Information Levels

Level Name	Description	Color	Style	Weight
SHTINF BORDER TITLE	Sheet Information Borders and Titles	3	0	0
SHTINF CELL	Sheet Information Cells	0	0	0
SHTINF DETAIL CELLS	Sheet Information Details Cells	0	0	0
SHTINF DIMEN	Sheet Information Dimension	0	0	1
SHTINF Iplot ORG SHAPES	Sheet Information Iplot Organizer Shapes	7	0	0
SHTINF LINE	Sheet Information Lines	0	0	0
SHTINF MAJOR GRID	Sheet Information Major Grid	4	0	0
SHTINF MINOR GRID	Sheet Information Minor Grid	2	0	0
SHTINF NORTH SCALE	Sheet Information North Arrows and Scale	0	0	1
SHTINF REF BDRY	Sheet Information Reference Boundaries	0	0	1
SHTINF TXT EX 62	Sheet Information Text or Notes	0	0	1

## Structural Levels

Level Name	Description	Color	Style	Weight
STR CONSTRT JT PROP	Structural ConStructuraluction Joint Proposed	8	0	0
STR DIM PROP	Structural Dimension Proposed	7	0	1
STR FOOTPRINT PROP	Structural Footprint Proposed	1	0	0
STR FRAMING PROP	Structural Framing Proposed	0	0	3
STR GRATE PROP	Structural Grating Proposed	4	0	0
STR GRID CL PROP	Structural Grid Line and Centerline Proposed	1	4	0
STR HID LINE PROP	Structural Hidden Line Proposed	3	3	1
STR LAD MET STRTRAP PROP	Structural Ladders Metal Structuralap Proposed	4	0	1
STR LAYOUT PROP	Structural Layout Proposed	2	0	1
STR LEADER LINE PROP	Structural Leader Line Proposed	6	0	1
STR MISTRC PROP	Structural Misc Proposed	2	0	0
STR RAILING PROP	Structural Railing Proposed	4	6	0
STR REBAR PROP	Structural Rebar Proposed	5	0	3
STR REBAR REQ PROP	Structural Rebar when required Proposed	5	3	0
STR TXT PROP	Structural Text Proposed	6	0	0

## Survey Levels

Level Name	Description	Color	Style	Weight
SUR BL CELL EX 8	Survey Base Line Cell	3	0	0
SUR BL EX 8	Survey Base Line	3	6	0
SUR BL PT NUM EX 54	Survey Base Line Point Number	3	0	1
SUR BL TXT EX 8	Survey Base Line Text	3	0	1
SUR CALC 8	Survey Calculated Point	0	0	0
SUR CALC PN 54	Survey Calculated Point Number	0	0	0
SUR CALC TXT	Survey Calculated Point Text	0	0	0
SUR CHK EX 8	Survey Check Shot	4	0	0
SUR CNT EX 8	Survey Control	0	0	0
SUR CNT PT NUM EX 54	Survey Control Point Number	0	0	0
SUR CNT TXT EX 8	Survey Control Text	0	0	0
SUR DEF EX 57	Survey Default Level	4	0	0
SUR GRD EX 60	Survey Coordinate Grid	0	0	0
SUR GRD TXT EX 60	Survey Coordinate Label	0	0	0
SUR MON EX 8	Survey Record and Found Monumentation	0	0	1
SUR MON PT NUM EX 54	Survey Record Monumentation Point Number	0	0	1
SUR MON TXT EX 8	Survey Record Monumentation Text	0	0	1
SUR TRAV CELL EX 8	Survey Traverse Cell	2	3	0
SUR TRAV EX 8	Survey Traverse Line	2	2	0

## Sewer Levels

Level Name	Description	Color	Style	Weight
SWR CELL EX 22	Sewer Cell Existing	2	0	1
SWR CELL PROP27	Sewer Cell Proposed	2	0	3
SWR IE EX 25	Sewer IE Existing	4	0	0
SWR LAT EX 23	Sewer Lateral Existing	2	EXSM	1
SWR LAT IE EX 23	Sewer Lateral IE Existing	4	0	0
SWR LAT PROP 27	Sewer Lateral Proposed	2	PSM	9
SWR MAIN EX 22	Sewer Main Existing	2	EXSM	1
SWR MAIN PROP 27	Sewer Main Proposed	2	PSM	9
SWR PT NUM 56	Sewer Point Number	2	0	0
SWR TXT EX 25	Sewer Text Existing	2	0	2
SWR TXT PROP 29	Sewer Text Proposed	2	0	3

## Telephone Levels

Level Name	Description	Color	Style	Weight
TEL CELL EX 42	Telephone Structure Cell Existing	6	0	0
TEL FIB OPT CELL EX	Telephone Fiber Optic Cell Existing	6	0	0
TEL LINE EX 42	Telephone Line Existing	6	TEL	0
TEL PNT NUM EX 56	Telephone Point Number Existing	6	0	0
TEL TXT EX 42	Telephone Text Existing	6	0	0

## Traffic Levels

Level Name	Description	Color	Style	Weight
TRAF CELL EX	Traffic Structure Cell Existing	3	0	0
TRAF CELL PROP	Traffic Structure Cell Proposed	3	0	0
TRAF PNT NUM EX 56	Traffic Point Number Existing	0	0	1
TRAF STR CELL EX 34	Traffic Striping Cell Existing	0	0	0
TRAF STR CL EX 36	Traffic Striping Centerline Existing	234	0	3
TRAF STR CL PROP	Traffic Striping Centerline Proposed	0	0	9
TRAF STR DBL YEL DSHD EX 34	Traffic Striping Double Yellow Dashed Existing	234	0	3
TRAF STR DBL YEL DSHD PROP	Traffic Striping Double Yellow Dashed Proposed	0	0	9
TRAF STR DBL YEL SLD EX 34	Traffic Striping Double Yellow Solid Existing	234	0	3
TRAF STR DBL YEL SLD PROP	Traffic Striping Double Yellow Solid Proposed	0	0	9
TRAF STR DSHD WHT EX 34	Traffic Striping Dashed White Existing	234	0	3
TRAF STR DSHD WHT PROP	Traffic Striping Dashed White Proposed	0	0	9
TRAF STR DSHD YEL EX 34	Traffic Striping Dashed Yellow Existing	234	0	3
TRAF STR DSHD YEL PROP	Traffic Striping Dashed Yellow Proposed	0	0	9
TRAF STR LINE EX 34	Traffic Striping Line Existing	0	0	0
TRAF STR SLD WHT EX 34	Traffic Striping Solid White Existing	234	0	3
TRAF STR SLD WHT PROP	Traffic Striping Solid White Proposed	0	0	9

## Traffic Levels

Level Name	Description	Color	Style	Weight
TRAF STR SLD YEL EX 34	Traffic Striping Solid Yellow Existing	234	0	3
TRAF STR SLD YEL PROP	Traffic Striping Solid Yellow Proposed	0	0	9
TRAF TXT EX	Traffic Text Existing	0	0	1
TRAF TXT PROP	Traffic Text Proposed	0	0	3
TRAF PT SIGN PROP	Traffic Post Sign Proposed	3	0	3
TRAF SIG COND EX	Traffic signal conduit existing	234	4	3
TRAF SIG COND PROP	Traffic signal conduit proposed	2	4	4
TRAF SIG DET EX	Traffic signal detector conductor existing	234	0	3
TRAF SIG DET PROP	Traffic signal detector conductor proposed	2	0	1
TRAF CROSSWALK PROP	Traffic Continental Crosswalk	235	0	1
TRAF RED CURB PROP	Traffic Painting Curb Red	3	4	4

## Water Distribution Levels

Level Name	Description	Color	Style	Weight
WDIST CHANNEL EX 20	Water Distrib. Channel Existing	1	0	1
WDIST CHANNEL PROP 26	Water Distrib. Channel Proposed	1	0	3
WDIST CONNECT EX 20	Water Distrib. Connection Existing	1	0	1
WDIST CONNECT PROP 26	Water Distrib. Connection Proposed	1	0	3
WDIST CORP STOP EX 20	Water Distrib. Corp Stop Existing	1	0	1
WDIST CORP STOP PROP 26	Water Distrib. Corp Stop Proposed	1	0	3
WDIST DAM EX 20	Water Distrib. Dam Existing	1	0	1
WDIST DAM PROP 26	Water Distrib. Dam Proposed	1	0	3
WDIST FILTR PLANT EX 20	Water Distrib. Filtration Plant Existing	1	0	1
WDIST FILTR PLANT PROP 26	Water Distrib. Filtration Plant Proposed	1	0	3
WDIST LAKE EX	Water Distrib. Lake	1	7	0
WDIST PNT NUM EX 56	Water Distribution Point Number Existing	1	3	1
WDIST PUMP EX 20	Water Distrib. Pump Existing	1	0	1
WDIST PUMP PROP 26	Water Distrib. Pump Proposed	1	0	3
WDIST PUMP STA EX 20	Water Distrib. Pump Station Existing	1	0	1
WDIST PUMP STA PROP 26	Water Distrib. Pump Station Proposed	1	0	3
WDIST RAW RESVR EX 21	Water Distrib. Raw Reservoir Existing	1	0	1
WDIST RAW RESVR PROP 26	Water Distrib. Raw Reservoir Proposed	1	0	3
WDIST RESVR EX 20	Water Distrib. Reservoir Existing	1	0	1
WDIST RESVR PROP 26	Water Distrib. Reservoir Proposed	1	0	3
WDIST STRM EX 19	Water Distrib. Stream Existing	1	stream	0
WDIST TANK EX 20	Water Distrib. Tank Existing	1	0	1
WDIST TANK PROP 26	Water Distrib. Tank Proposed	1	0	3
WDIST TEST STA EX 20	Water Distrib. Test Station Existing	1	0	0
WDIST TEST STA PROP 26	Water Distrib. Test Station Proposed	1	0	3
WDIST TUNNEL EX 20	Water Distrib. Tunnel Existing	1	0	1
WDIST TUNNEL PROP 26	Water Distrib. Tunnel Proposed	1	0	3
WDIST TXT EX 20	Water Distrib. Text Existing	1	3	1
WDIST TXT PROP 20	Water Distrib. Text Proposed	1	3	1
WDIST WELL EX 20	Water Distrib. Well Existing	1	0	1
WDIST WELL PROP 26	Water Distrib. Well Proposed	1	0	3

## Water Levels

Level Name	Description	Color	Style	Weight
WTR CELL EX 20	Water Structure Cell Existing	0	0	0
WTR CELL PROP 26	Water Structure Cell Proposed	0	0	0
WTR MAIN EX 20	Water Main Existing	1	EXWM	1
WTR MAIN PROP 26	Water Main Proposed	1	PWM	9
WTR PNT NUM EX 56	Water Point Number Existing	1	0	1
WTR SERV EX 21	Water Service Existing	1	EXWM	1
WTR SERV PROP 26	Water Service Proposed	1	PWM	9
WTR TXT EX 24	Water Text Existing	1	0	1
WTR TXT PROP 28	Water Text Proposed	1	0	3

**PART 6**  
**CADD TEXT**  
**AND**  
**SYMBOLS STANDARDS**



CADD  
TEXT AND SYMBOL  
SECTION

Revised 06/2013

## CADD TEXT STANDARDS – COVER & PLAN SHEETS

### FONTS

1 = newft1

23 = ITALICS

43 = LOW\_RES\_FILLED

DESCRIPTION	FONT	SIZE	WEIGHT
TITLE	43	35	1
R. MARGIN	43	20	1
DRAWING NUMBER	43	8.0	1
TITLE BLOCK	43	8.0	1
PROJECT LIMITS MAP		5.6	2
W.B.S. NUMBER		4.8	
SHEET INDEX DATA		4.0	
CONTRACTOR RESPONSIBILITES		4.0	
WORK TO BE DONE DESCRIPTION	43	4.0	1

### NOTE:

TEXT SIZES ARE BASED ON 40' MAPPING

FOR 20' SCALE DIVIDE TEXT SIZE BY 2

FOR 10' SCALE DIVIDE TEXT SIZE BY 4

Revised 04 /2015

## CADD TEXT STANDARDS – PROPOSED

---

### FONTS

1 = newft1

23 = ITALICS

43 = LOW\_RES\_FILLED

DESCRIPTION	FONT	SIZE	WEIGHT
<i>SUBDIVISION NAME</i>	<i>23</i>	<i>8.0</i>	<i>3</i>
<i>MAP NUMBER</i>	<i>23</i>	<i>8.0</i>	<i>3</i>
BLOCK NUMBER	1	7.0	3
STREET NAME	1	7.0	3
LOT NUMBER	1	4.8	1
HORZ-VERT. SCALE (PROFILE VIEW)	1	4.8	1
SCALE (PLAN VIEW)	1	4.8	1
REFERENCES / RETIREMENTS	1	4.8	1
SHEET-OF-SHEETS (TITLE BLOCK)	1	4.8	1
LAMBERT COORDINATES (TITLE BLOCK)	1	4.8	1
DIMENSIONS	1	4.8	1
EXISTING (UTILITY DESCRIPTIONS)	1	4.8	1
<i>ADDRESSES</i>	<i>23</i>	<i>4.8</i>	<i>1</i>

Revised 04 /2015

## CADD TEXT STANDARDS – PROPOSED

### FONTS

1 = newft1

23 = ITALICS

43 = LOW\_RES\_FILLED

DESCRIPTION	FONT	SIZE	WEIGHT
PROJECT NAME (TITLE BLOCK)	43	8.0	1
STREET NAME (TITLE BLOCK)	43	7.0	1
LIMITS OF STREET (TITLE BLOCK)	43	5.6	1
PIPE SIZE / SLOPE	1	7.0	3
MH NO. CALLOUT	1	7.0	2
PROFILE STATIONS	1	5.6	2
PROFILE GRID ELEVATIONS	1	5.6	2
MATCH LINE	1	5.6	2
CAUTION CALL-OUT	43	4.8	1
MANHOLE DIMENSIONS (PROFILE)	1	4.8	1
PLAN STATIONS	1	4.8	1
CALLOUT FOR SEWER STUB-OUT	1	4.8	1
NOTES (OTHER THAN COVER SHEET)	1	4.8	1

Revised 04 /2015

## CADD TEXT STANDARDS – PROPOSED

---

### FONTS

1 = newft1

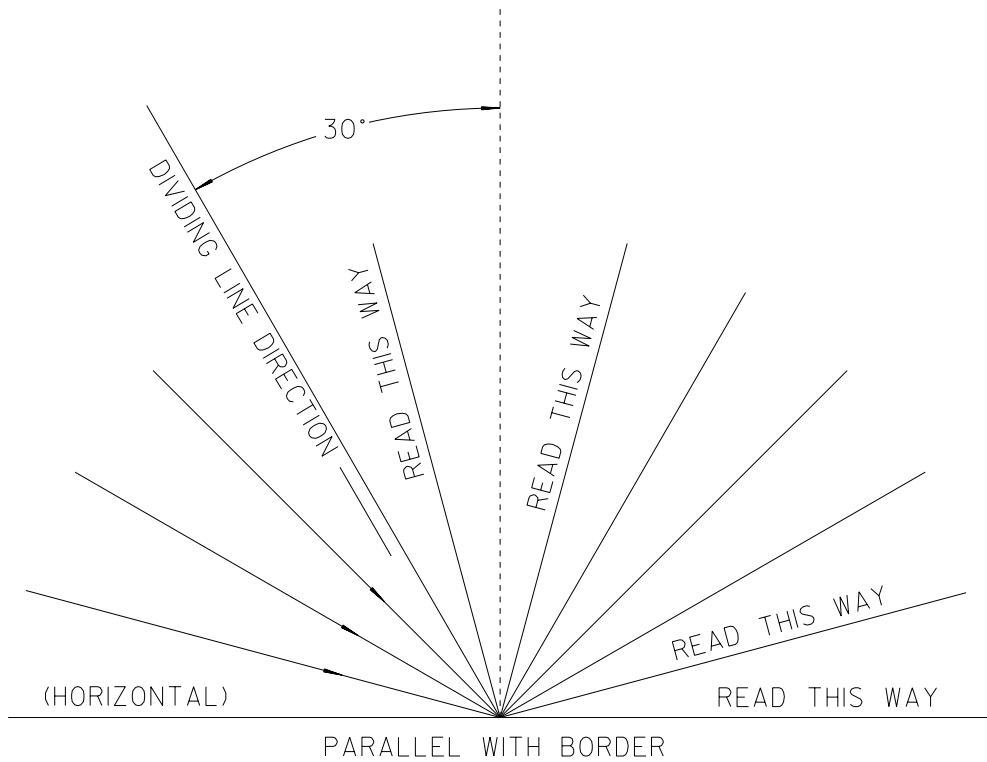
23 = ITALICS

43 = LOW\_RES\_FILLED

DESCRIPTION	FONT	SIZE	WEIGHT
CONSTRUCTION NOTE TITLE (WATER)	I	5.6	I
CONSTRUCTION NOTE (WATER)	I	4.8	I
ELEVATION (PROFILE WATER)	I	4.8	I
"INVERT OF PIPE" (WATER & SEWER)	I	4.8	I

Revised 04 /2015

# CADD TEXT STANDARD FOR READING DIRECTION



Revised 10 /2015

CADD  
SYMBOL STANDARDS  
SECTION

Revised 10 /2015

## EXISTING UTILITIES CADD SYMBOLS


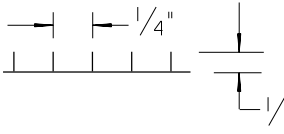
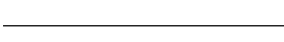

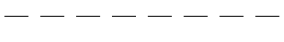

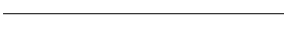

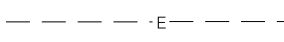
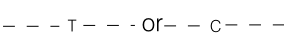
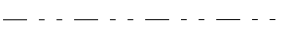
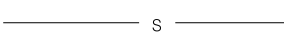
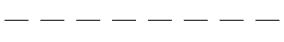

NOTE:

IN THIS SECTION ALL TEXT SIZE SHALL BE 4.8 (TX=4.8)  
AND TEXT WEIGHT SHALL BE 1 (WT=)1, UNLESS OTHERWISE NOTED.

Revised 10 /2015

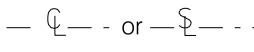
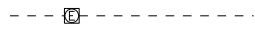
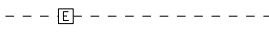
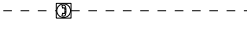
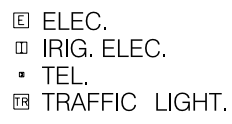
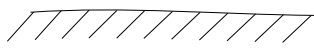

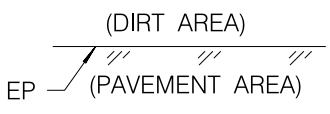

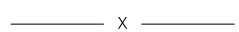
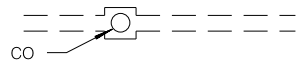
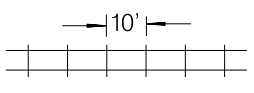


## CADD SYMBOL STANDARDS FOR EXISTING UTILITIES

SYMBOL	DESCRIPTION	CELL, LINE STYLE, PATTERN	LINE WEIGHT
	PRESSURE ZONE BOUNDARY	3	1
	STATE R /W LINE	0	3
	PROPERTY LINE ALONG STREET OR ALLEY R /W	0	3
	SUBDIVISION BOUNDARY LINE	6	3
	EASEMENT LINE	3	0
	PROPERTY SPLITS	6	0
	LOT LINE	0	0
	CURB LINE	0	0
	UNDERGROUND ELEC. (1/8" DASHES, TEXT 3.2)	P	0
	UNDERGROUND TEL. "T" or CABLE T.V. "C" (1/32" DASHES TEXT 3.2)	P	0
	GAS MAIN	6	0
	STEAM LINE (TEXT 3.2)	P	0
	EX WATER	3	1
	EX SEWER	7	1

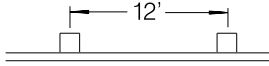
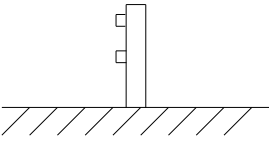










Revised 10 /2015

## CADD SYMBOL STANDARDS FOR EXISTING UTILITIES

SYMBOL	DESCRIPTION	CELL, LINE STYLE, PATTERN	LINE WEIGHT
	CENTER OR SURVEY LINE (BASELINE)	C	0
	ELEC. MH OR HANDHOLD (HH)	C	0
	TRANSFORMER	C	0
	TELEPHONE MH. OR HANDHOLD (HH)	C	0
	ELEC. OR PHONE PULLBOX	C	0
	EXISTING PAVEMENT	P	1
	EXISTING GROUND LINE	P	1
	EDGE OF PAVEMENT (PLAN VIEW)	P	1
	FUEL LINE (TEXT 3.2)	P	0
	FENCE - PIPE, WIRE, WOOD, ETC. (TEXT 3.2)	P	0
	STORM DRAIN - SCALE TO SIZE (TEXT 3.2)	3	0
	RAILROAD, STREET CAR TRACKS OR TROLLEY - SCALE TO SIZE	0	0

Revised 10 /2015

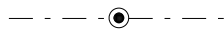
## CADD SYMBOL STANDARDS FOR EXISTING UTILITIES

SYMBOL	DESCRIPTION	CELL, LINE STYLE, PATTERN	LINE WEIGHT
	GUARD RAIL - BARRICADE (1/16" BOX)	C	0
	GUARD RAIL - BARRICADE PROFILE (1/16" BOX)	C	0
	TRAFFIC LIGHT ACTUATOR	C	0
	TRAFFIC LIGHT ACTUATOR-BAR SCALE TO SIZE (TEXT 3.2)	P	0
	TRAFFIC CONTROL BOX	C	0
	TRAFFIC LIGHT	C	0
	STREET LIGHT	C	0
	POWER POLE	C	0
	TELEPHONE POLE	C	0
	OVERHEAD ELECTRICAL, CABLE TV OR TELEPHONE. CALL OUT ON PLANS IF LESS THAN 15' HIGH	0	0
	OWNERSHIP LINE FOR LOTS	C	0
	EX. SURVEY CONTROL MONUMENT	C	0

Revised 10 /2015

# CADD SYMBOL STANDARDS FOR EXISTING UTILITIES

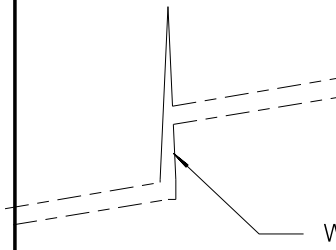
SYMBOL	DESCRIPTION	CELL, LINE STYLE, PATTERN	LINE WEIGHT
--------	-------------	------------------------------------	----------------



EXISTING DROP MANHOLE-PLAN VIEW

C

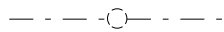
0



EXISTING DROP MANHOLE-PROFILE VIEW

C

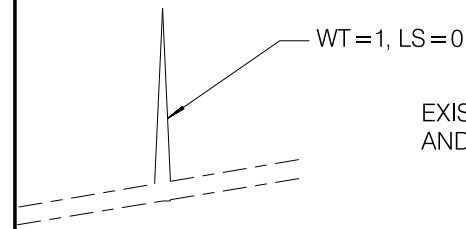
0



EXISTING MANHOLE-PLAN VIEW  
AND SEWER MAIN

C

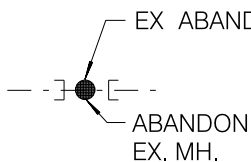
0



EXISTING MANHOLE-PROFILE VIEW  
AND SEWER MAIN

C

0



EX ABANDONED MANHOLE OR  
ABANDON EX MANHOLE

C

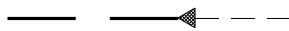
0



PLUG EXISTING SEWER

0

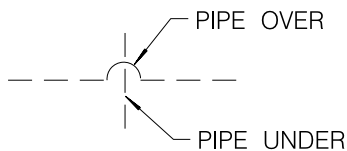
0



EXISTING REDUCER  
NOTE: EX. RED. TO BE SHOWN ONLY  
WHEN CONNECTING NEW PIPE TO  
EX RED.

C

1




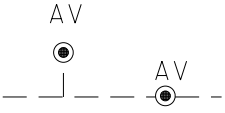
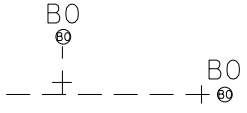
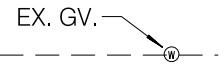



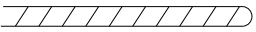

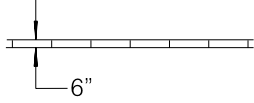
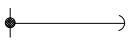
CROSSING OF LINES (NOT CONNECTING)

0

1




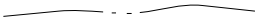

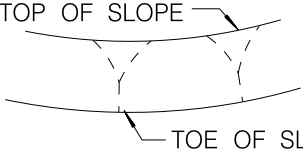
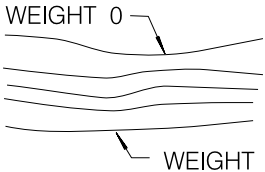
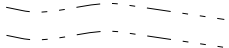
Revised 10 /2015

# CADD SYMBOL STANDARDS FOR EXISTING UTILITIES

SYMBOL	DESCRIPTION	CELL, LINE STYLE, PATTERN	LINE WEIGHT
	WATER METER BOX	C	0
	EX AIR VALVE EX WATER MAIN	C	0
	EX. BLOW-OFF EX WATER MAIN	C	0
	EX. GATE VALVE	C	6
	EX. FIRE HYDRANT	C	0
	CATCH BASIN, DRAIN INLET, DRAW TO SCALE. REFER TO SDRSD FOR TYPE A, B, C, ETC)	C	0
	DIRT MEDIAN	0	1
	ISLAND	0	0
	BILL BOARD (DRAW TO SCALE, CALL OUT ON PLANS)	0	0
	BERM (ASPHALT)	0	0
	POWER POLE W/CABLE SUPPORT	C	0

Revised 10 /2015

## CADD SYMBOL STANDARDS FOR EXISTING UTILITIES

SYMBOL	DESCRIPTION	CELL, LINE STYLE, PATTERN	LINE WEIGHT
	TRACKS – INDICATE IF ABANDONED AND REFER TO DETAIL ON SHT. X . SHOW DETAIL ON X. SHOW TO SCALE. (PROFILE)	P	0
	BUSHES, TREES. INCLUDE SIZE OF TRUNK FOR TREES IN CONFLICT AREA (TEXT 3.2)	C	0
	MARSH OR SWAMP	P	0
	TOP OF LEVEE (CALL OUT ON PLANS)	0	0
	CENTER LINE OF DITCH OR STREAM (CALL OUT ON PLANS)	0	0
 TOP OF SLOPE TOE OF SLOPE	EXISTING EMBANKMENT, DASHED	0&2	1
 WEIGHT 0 WEIGHT 2	BODIES OF WATER LAKES, PONDS (CALL OUT ON PLANS)	0	0&2
	BODIES OF WATER, SMALL STREAMS (CALL OUT ON PLANS)	6	0

Revised 10 /2015


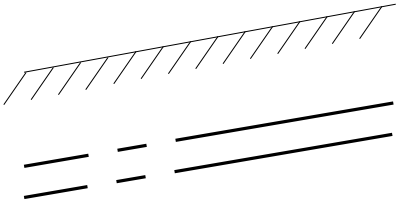
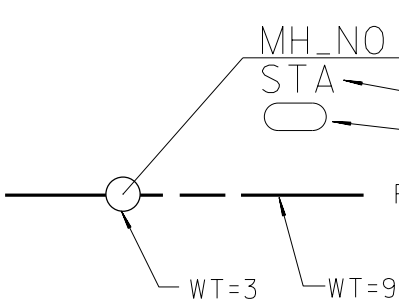
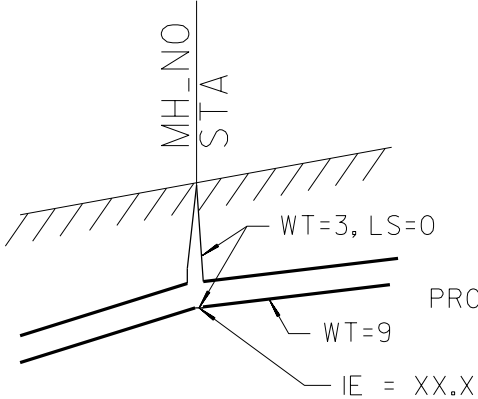
## PROPOSED UTILITIES CADD SYMBOLS

NOTE:

IN THIS SECTION ALL TEXT SIZE SHALL BE 4.8 (TX=4.8)  
AND TEXT WEIGHT SHALL BE 1 (WT=)1, UNLESS OTHERWISE NOTED.

Revised 10 /2015


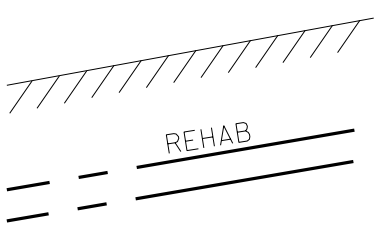
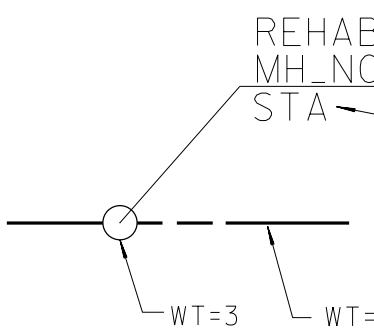
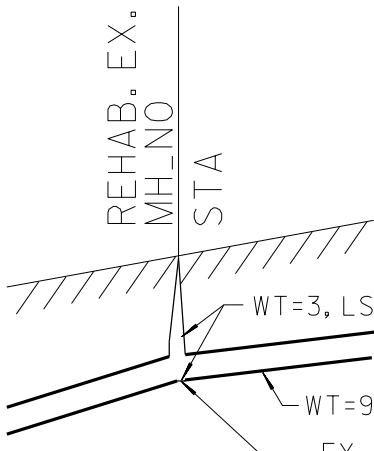
# CADD SYMBOL STANDARDS FOR PROPOSED UTILITIES (STORM & SANITARY)

SYMBOL	DESCRIPTION	CELL, LINE STYLE, PATTERN	LINE WEIGHT
	PROPOSED SEWER MAIN, PLAN VIEW	P	9
	PROPOSED SEWER MAIN, PROFILE VIEW	P	9
	PROPOSED MANHOLE PLAN VIEW	C	3
	PROPOSED MANHOLE PROFILE VIEW	C	3

Rev. 110



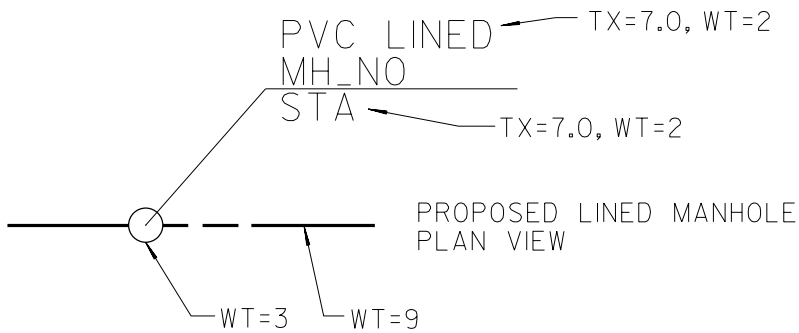
# CADD SYMBOL STANDARDS FOR PROPOSED UTILITIES (REHABILITATION)

SYMBOL	DESCRIPTION	CELL, LINE STYLE, PATTERN	LINE WEIGHT
	PROPOSED REHABILITATION SEWER MAIN, PLAN VIEW	P	9
	PROPOSED REHABILITATION SEWER MAIN, PROFILE VIEW	P	9
	PROPOSED REHABILITATED MANHOLE PLAN VIEW	C	3
	PROPOSED REHABILITATED MANHOLE	C	3

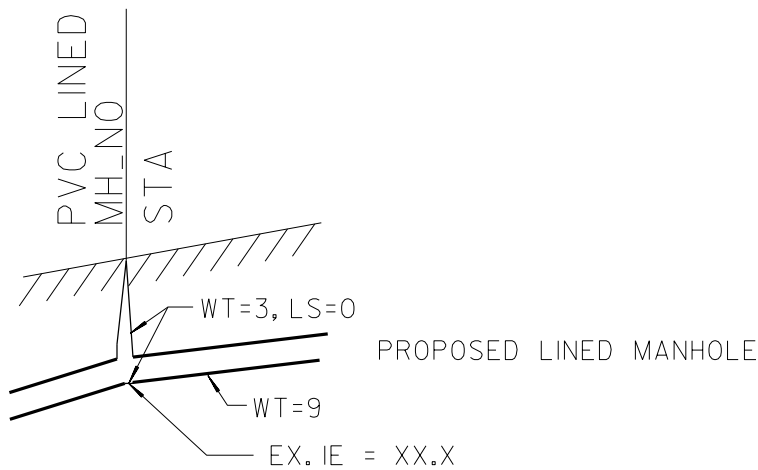
Revised 10 /2015

# CADD SYMBOL STANDARDS FOR PROPOSED UTILITIES

SYMBOL	DESCRIPTION	CELL, LINE STYLE, PATTERN	LINE WEIGHT
--------	-------------	------------------------------------	----------------



C      3



C      3

Revised 10 /2015

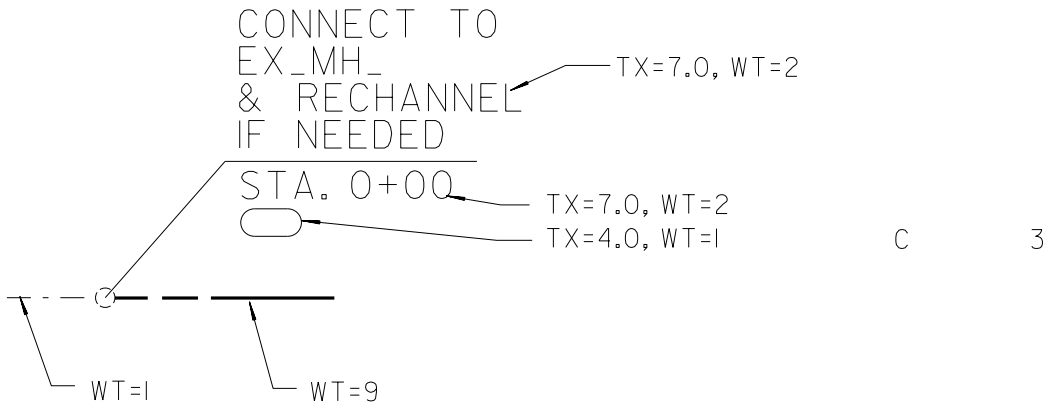
# CADD SYMBOL STANDARDS FOR PROPOSED UTILITIES

SYMBOL	DESCRIPTION	CELL, LINE STYLE, PATTERN	LINE WEIGHT
	<p>CONNECT TO EX. MH_ STA</p> <p>TX=7.0, WT=2</p> <p>TX=7.0, WT=2</p> <p>WT=1</p> <p>WT=9</p>	C	3
	<p>CONNECT TO EX. MH_ STA</p> <p>WT=1, LS=0</p> <p>WT=9</p> <p>EX. IE = XX.X</p>	C	3
	<p>MH_NO_</p> <p>STA. 0+00</p> <p>STA. 0+00</p> <p>SEE SHEET</p> <p>TX=7.0, WT=2</p> <p>TX=7.0, WT=2</p> <p>WT=1</p> <p>WT=9</p>	C	3

Revised 10 /2015

# CADD SYMBOL STANDARDS FOR PROPOSED UTILITIES

SYMBOL	DESCRIPTION	CELL, LINE STYLE, PATTERN	LINE WEIGHT
--------	-------------	------------------------------------	----------------



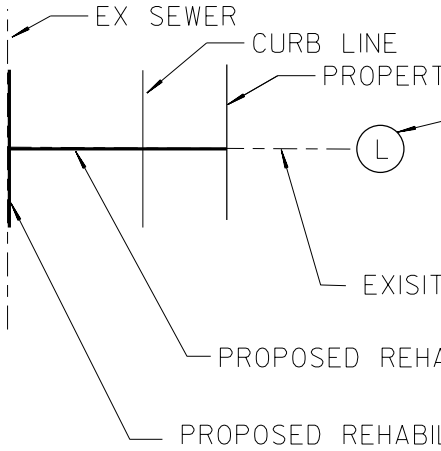
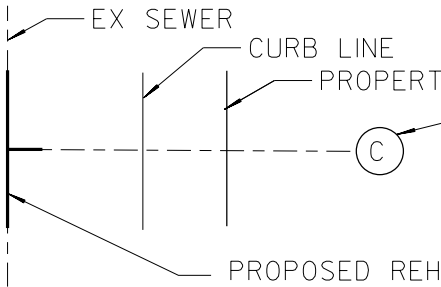
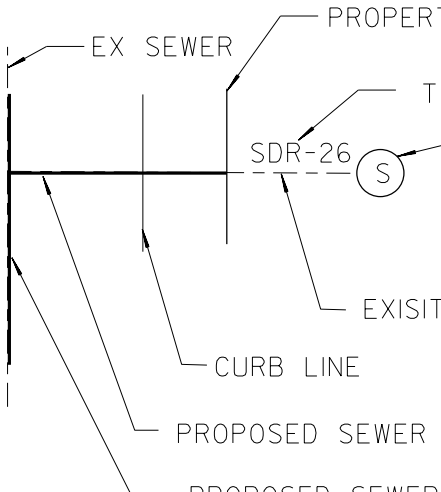
Revised 10 /2015

# CADD SYMBOL STANDARDS FOR PROPOSED UTILITIES

SYMBOL	DESCRIPTION	CELL, LINE STYLE, PATTERN	LINE WEIGHT
	<p>EX SEWER</p> <p>CURB LINE</p> <p>PROPERTY LINE (R/W)</p> <p>SEWER LATERAL TX=4.8, WT=1 5/16" CIRCLE</p> <p>EXISTING SEWER LATERAL (LC=7, WT=1, CO=2)</p> <p>PROPOSED SEWER LATERAL (LC=0, WT=9, CO=2)</p> <p>PROPOSED SEWER</p>	C	3
	<p>REPLUMB SEWER LATERAL WITH C.O. TX=4.8, WT=1 5/16" CIRCLE</p> <p>PROPOSED SEWER LATERAL (LC=0, WT=9, CO=2)</p>	C	3
	<p>SEWER PUMP INCLUDING REPLUMB SEWER LATERAL WITH C.O. TX=4.8, WT=1 5/16" CIRCLE</p> <p>PROPOSED SEWER LATERAL (LC=0, WT=9, CO=2)</p>	C	3
	<p>TUNNEL SEWER REPLUMB LATERAL WITH C.O. (LINED) WITH C.O. TX=4.8, WT=1 5/16" CIRCLE</p> <p>PROPOSED SEWER LATERAL (LC=0, WT=9, CO=2)</p>	C	3
	<p>SEWER LATERAL CONNECTION TX=4.8, WT=1 5/16" CIRCLE</p> <p>PROPOSED SEWER/ PIPE BURST SEWER</p>	C	3

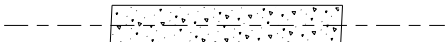

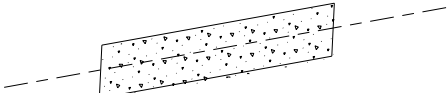
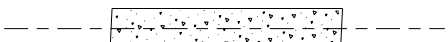





Revised 10 /2015

# CADD SYMBOL STANDARDS FOR PROPOSED UTILITIES

SYMBOL	DESCRIPTION	CELL, LINE STYLE, LINE PATTERN WEIGHT	LINE WEIGHT
	<p>EX SEWER</p> <p>CURB LINE</p> <p>PROPERTY LINE (R/W)</p> <p>REHAB SEWER LATERAL (LINED) WITH C.O. TX=4.8, WT=1 5/16" CIRCLE</p> <p>EXISTING SEWER LATERAL (LC=7, WT=1, CO=2)</p> <p>PROPOSED REHAB SEWER LATERAL</p> <p>PROPOSED REHABILITATED SEWER</p>	C	3
	<p>EX SEWER</p> <p>CURB LINE</p> <p>PROPERTY LINE (R/W)</p> <p>SERVICE LATERAL CONNECTION TX=4.8, WT=1 5/16" CIRCLE</p> <p>PROPOSED REHABILITATED SEWER</p>	C	3
	<p>EX SEWER</p> <p>PROPERTY LINE (R/W)</p> <p>TX=4.8, WT=1</p> <p>SDR-26</p> <p>SEWER LATERAL TX=4.8, WT=1 5/16" CIRCLE</p> <p>EXISTING SEWER LATERAL (LC=7, WT=1, CO=2)</p> <p>CURB LINE</p> <p>PROPOSED SEWER LATERAL (15' DEEP OR GREATER)</p> <p>PROPOSED SEWER MAIN SDR-26 (15' DEEP OR GREATER)</p>	C	3

Revised 10 /2015

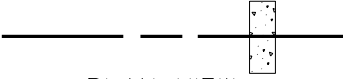
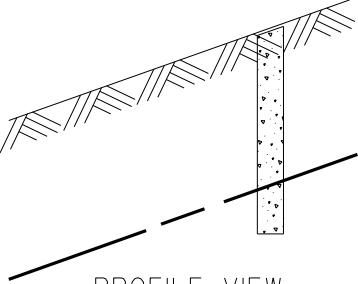
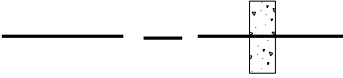
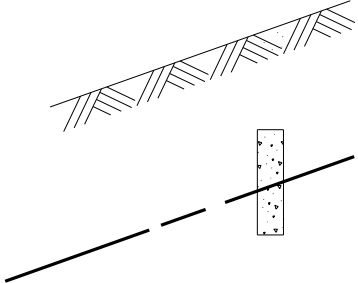
# CADD SYMBOL STANDARDS FOR PROPOSED UTILITIES

SYMBOL	DESCRIPTION	CELL, LINE STYLE, PATTERN	LINE WEIGHT
 PLAN VIEW	CONCRETE ENCASEMENT/ CONCRETE SUPPORT	P	0
  PROFILE VIEW	CONCRETE ENCASEMENT/ CONCRETE SUPPORT	P	0
 PLAN VIEW	CONCRETE CRADLE	P	0
  PROFILE VIEW	CONCRETE CRADLE	P	0
 PLAN VIEW	CONCRETE BACKFILL / CONCRETE PROTECTION	P	0
  PROFILE VIEW	CONCRETE BACKFILL / CONCRETE PROTECTION	P	0

REFER TO THE STANDARD DRAWING FOR  
PUBLIC WORKS CONSTRUCTION FOR PROPER SIZES

Revised 10 /2015

# CADD SYMBOL STANDARDS FOR PROPOSED UTILITIES

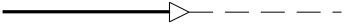


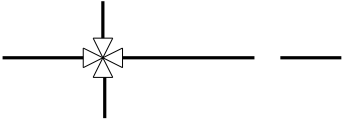

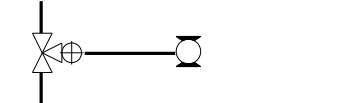

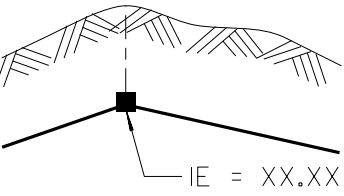
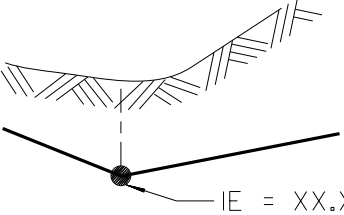
SYMBOL	DESCRIPTION	CELL, LINE STYLE, PATTERN	LINE WEIGHT
 PLAN VIEW	CONCRETE CUTOFF WALL	P	0
 PROFILE VIEW	CONCRETE CUTOFF WALL	P	0
 PLAN VIEW	CONCRETE ANCHOR	P	0
 PROFILE VIEW	CONCRETE ANCHOR	P	0

REFER TO THE STANDARD DRAWING FOR  
PUBLIC WORKS CONSTRUCTION FOR PROPER SIZES

Revised 10 /2015



# CADD SYMBOL STANDARDS FOR PROPOSED UTILITIES

SYMBOL	DESCRIPTION	CELL, LINE STYLE, LINE PATTERN WEIGHT
	PROPOSED REDUCER	C      1
	PROPOSED WATER MAIN	P      9
	PROPOSED VALVE	C      1
	PROPOSED CROSS, TEE, BEND, ETC.	C      1
	PROPOSED AIR VALVE ASSEMBLY	C      1
	PROPOSED FIRE HYDRANT	C      1
	PROPOSED BLOW-OFF, INLINE OR DEADEND.	C      1
	PROPOSED AIR VALVE ASSEMBLY	C      1
	PROPOSED BLOW-OFF FOR WATER MAINS.	C      1

Revised 10 /2015

# CADD SYMBOL STANDARDS FOR PROPOSED UTILITIES

SYMBOL	DESCRIPTION	CELL, LINE STYLE, PATTERN	LINE WEIGHT
<p>①</p> <p>BY CITY FORCES AHD OF CONTRACTOR</p> <p>STA 1+00.00 CUT IN: 1- 12" X 8" TEE (F) 2 - 12" VALVES (F, MJ) BK, AHD 1- 8" VALVE (F, MJ) RT</p>	<p>CONSTRUCTION NOTE BY CONTRACTOR FOR PROPOSED WATER</p>	C	I
<p>①</p> <p>BY CITY FORCES AHD OF CONTRACTOR</p> <p>STA 1+00.00 CUT AND PLUG: EX 12" PVC WTR RECONNECT AFTER NEW MAIN HAS BEEN ACCEPTED.</p>	<p>CONSTRUCTION NOTE BY CITY FORCES FOR PROPOSED WATER</p>	C	I
<p>①</p> <p>BY CONTRACTOR FURNISH AND INSTALL</p> <p>STA 1+00.00 1- 12" X 6" TEE (MJ, MJ, F) 1- 6" FH ASSY AND MARKER</p>	<p>CONSTRUCTION NOTE FOR CONTRACTOR FURNISH AND INSTALL FIRE HYDRANT ASSEMBLY.</p>	C	I
<p>①</p> <p>BY CONTRACTOR FURNISH AND INSTALL</p> <p>STA 1+00.00 1- 4" AIR/VACUUM VALVE ASSY, LT</p>	<p>CONSTRUCTION NOTE FOR CONTRACTOR FURNISH AND INSTALL 4" AIR/VACUUM VALVE ASSEMBLY.</p>	C	I

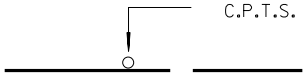
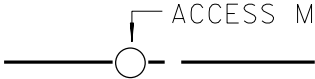
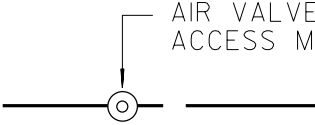
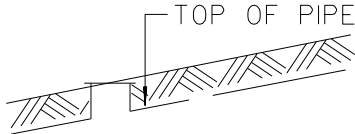
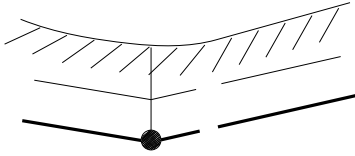
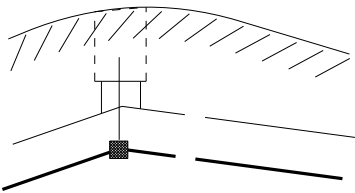
Revised 10 /2015

# CADD SYMBOL STANDARDS FOR PROPOSED UTILITIES

SYMBOL	DESCRIPTION	CELL, LINE STYLE, PATTERN	LINE WEIGHT
	<p>WATER SERVICE TX=4.8, WT=1 5/16" CIRCLE</p>	C	3
	<p>WATER SERVICE TRANSFER TX=4.8, WT=1 5/16" CIRCLE</p>	C	3
	<p>FIRE SERVICE TX=4.8, WT=1 5/16" CIRCLE</p>	C	3
	<p>6" FIRE HYDRANT ASSEMBLY</p>	C	3
	<p>KILLED WATER SERVICE</p>	0	1
	<p>STIFF WATER SERVICE</p>	0	1

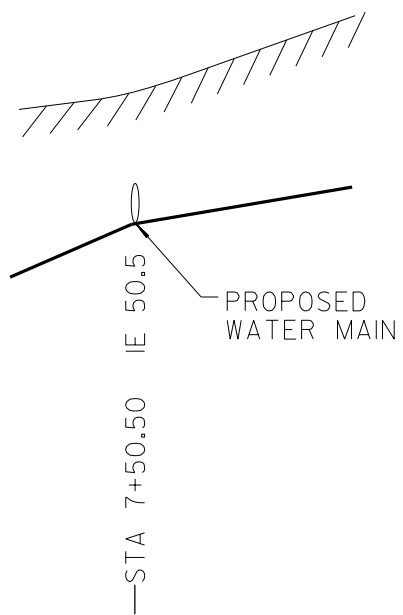
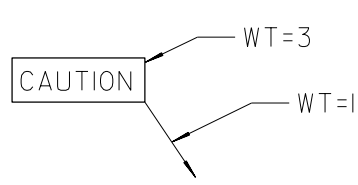
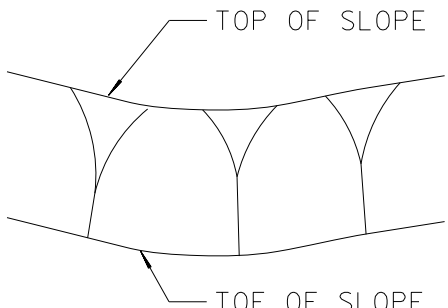
Revised 10 /2015

## CADD SYMBOL STANDARDS FOR PROPOSED UTILITIES

SYMBOL	DESCRIPTION	CELL, LINE STYLE, PATTERN	LINE WEIGHT
<p><b>SYMBOLS USED ON MAJOR (24" OR LARGER) WATER MAINS SHOWN BELOW</b></p>			
 <p style="text-align: center;">C.P.T.S.</p>	<p>CATHODIC PROTECTION TEST STATION (1/16" CIRCLE) TX=3.2</p>	C	0
 <p style="text-align: center;">ACCESS MH</p>	<p>PROPOSED ACCESS MANHOLE PLAN VIEW (5/32" CIRCLE)</p>	C	3
 <p style="text-align: center;">AIR VALVE IN ACCESS MH</p>	<p>PROPOSED AIR VALVE IN ACCESS MH PLAN VIEW (1/16" CIRCLE IN A 5/32" CIRCLE)</p>	C	3
 <p style="text-align: center;">TOP OF PIPE</p>	<p>PROPOSED ACCESS MANHOLE PROFILE</p>	0	0
	<p>PROPOSED BLOW-OFF, PROFILE (1/8" DOT)</p>	C	0
	<p>PROPOSED AIR VALVE IN ACCESS MANHOLE, PROFILE (1/8" SOLID SQUARE)</p>	C	0

Revised 10 /2015

# CADD SYMBOL STANDARDS FOR PROPOSED UTILITIES

SYMBOL	DESCRIPTION	CELL, LINE STYLE, PATTERN	LINE WEIGHT
	<p>PROPOSED PERPENDICULAR WTR. MAIN W/ STATION AND ELEVATION TX=4.8</p>	C	1
	<p>CAUTION CALL-OUT TX=5.6, WT=2</p>	C	
	<p>PROPOSED EMBANKMENT PLAN FOR CONSTRUCTION</p>	O&2	1 0

Revised 10 /2015

# INDEX

- Addendum Drawings, 13, 14
- As-builts, 3, 24, 25, 107, 110, 115, 126, 134,
- As-Builts, 12, 14, 69, 108, 111, 114, 139
- Building(s), 65, 66, 67, 68, 75, 76, 78
- building(s), 23, 75, 76, 77, 80, 82, 83
- CADD, 1, 2, 3, 11, 12, 14, 18, 24, 83
- Change Order, 14, 24
- Construction Drawings, 13, 14
- Cover, 14, 23, 24, 25, 27, 64, 78, 80, 81, 82, 90, 91, 105, 107, 139
- Demolition, 25, 73, 97
- Diagrams, 26, 27, 69, 76, 84, 85, 86, 89, 90
- Drafting, 1, 11, 13, 15, 16, 28, 83
- Drawings, 2, 3, 11, 12, 13, 14, 15, 16, 18, 19, 21, 22, 23, 24, 25, 26, 27, 28, 63, 64, 65, 68, 69, 70, 71, 72, 73, 75m, 76, 77, 78, 80, 81, 82, 83, 84, 85, 87, 88, 91, 93, 96, 97, 105, 107, 110, 114, 115, 117, 121, 124, 126, 134
- Engineer, 1, 2, 64, 83, 105, 107, 108, 110, 111, 117, 118, 121, 124
- Equipment, 4, 19, 22, 26, 69, 71, 74, 79, 80, 81, 82, 83, 84, 85, 86, 87, 88, 89, 90, 91, 92, 93, 94
- File, 1, 2, 3, 4, 5, 10, 11, 12, 14, 16, 24, 25, 26, 105, 110
- General, 1, 13, 16, 17, 18, 19, 22, 23, 24, 25, 26, 27, 63, 74, 68, 69, 75, 76, 78, 79, 80, 82, 84, 97, 117
- Information, 1, 2, 11, 12, 13, 14, 15, 18, 23, 24, 27, 28, 63, 64, 74, 76, 77, 78, 79, 80, 81, 84, 87, 90, 93, 105, 108, 111, 114, 115, 126, 129, 138, 139
- Landscaping, 26, 75
- Lettering, 15, 18, 21, 27, 28, 64
- Lines, 11, 12, 13, 14, 15, 18, 19, 20, 21, 22, 23, 24, 25, 28, 70, 71, 72, 73, 74, 77, 78, 80, 82, 87, 89, 114, 115, 117, 124, 126, 135, 138
- Microfilm, 16, 28
- Mylar, 3, 16, 108
- Plans, 3, 13, 14, 17, 23, 24, 26, 27, 28, 63, 64, 68, 69, 70, 71, 93, 74, 75, 76, 79, 80, 82, 83, 85, 87, 88, 90, 96, 105, 108, 110, 111, 115, 117, 118, 127, 132, 138, 139
- Red-lines, 12, 14
- Scale, 4, 5, 6, 11, 15, 16, 17, 19, 22, 23, 24, 27, 28, 64, 77, 78, 81, 82, 90, 105, 110, 114, 121, 127
- Signing, 23, 63
- Size, 2, 11, 14, 15, 16, 18, 21, 24, 27, 64, 71, 72, 76, 77, 78, 79, 80, 81, 82, 84, 85, 86, 87, 93, 94, 96, 114, 115, 117, 121, 124, 126, 132, 135, 138
- Specifications, 3, 11, 21, 23, 24, 76, 79, 87, 90, 93, 95, 105, 108, 124
- Specifics, 27, 64
- Standard, 1, 2, 3, 4, 11, 12, 13, 14, 15, 18, 21, 23, 24, 25, 27, 28, 63, 64, 75, 77, 78, 79, 80, 83, 89, 90, 91, 105, 108, 114, 117, 121, 124, 132, 139
- Styles, 4, 5, 6, 7, 8, 9, 10, 11, 84
- Symbols, 4, 11, 13, 16, 25, 68, 75, 76, 79, 82, 83, 84, 89, 90, 95, 105, 117, 118, 138



Public Works Department

**PROJECT IMPLEMENTATION DIVISION  
STANDARDS & CONTRACT  
DOCUMENTS SECTION**

525 B STREET STE. 750  
SAN DIEGO, CA 92101

**DOCUMENT NUMBER: PWPI092816-04**