

# AKOUSTIS<sup>®</sup>

**RFMi**  
A BRAND OF AKOUSTIS

REVOLUTIONIZING  
THE RF FILTER INDUSTRY







# TABLE OF CONTENTS

## Technology, Solutions, & Market Features

Technology .....	3-5
XBAW® .....	3-5
Solutions .....	6-7
BAW .....	6
Ceramic .....	6
SAW .....	7
XTAL .....	7
Market Features .....	8

## Product by Market

WiFi .....	9-10
 BAW Filters .....	9
BAW Filters for WiFi Band .....	9
DR Filters for WiFi .....	9-10
LTCC Filters and Diplexer for WiFi .....	10
SAW Filters for WiFi Band .....	10
Telecom & Mobile .....	11-23
 BAW Filters .....	11
LTE Band BAW Filter 1.1 x 0.9 mm .....	11
DR and LTCC LTE Band Filters .....	11-12
DR Filters for GNSS Bands .....	12
Dual LTE Band SAW Filters 1.5 x 1.1 mm .....	12
IF and Other SAW Filters .....	13-15
LTCC Filters .....	16
LTE Band SAW Duplexers 1.6 x 1.2 mm .....	16
LTE Band SAW Duplexers 1.8 x 1.4 mm .....	16-17
LTE Band SAW Filters 1.1 x 0.9 mm .....	17-18
LTE Band SAW Filters 1.4 x 1.1 mm .....	19
SAW By-Pass Filter .....	19
SAW Low Pass Filters .....	19
SAW Notch Filters .....	19
SMD LTE Band SAW Filters 3 x 3 mm .....	19-21
VCXO (Voltage Controlled Crystal Oscillators) .....	21
XO (Crystal Oscillators) .....	21-22
OCXO (Oven Controlled Crystal Oscillators) .....	23

<b>Automotive</b>	<b>24-31</b>
315 MHz Range BCM/RKE SAW Filters	24
433.92 MHz Range BCM/RKE SAW Filters	24-25
DR Filters	25
IF and Other SAW Filters	25-26
ISM Band SAW Diplexers	26
LTCC Filters	26
SAW Filters and Diplexers for GNSS Bands	27-28
SAW Notch Filters	29
SAW Resonators	29-30
XTC-TCXO Series (AEC-Q200)	30
XVT-VCTCXO (AEC-Q200)	31
<b>IoT</b>	<b>32-38</b>
470-519 MHz (China LoRa Band) SAW Filters	32
800 MHz Range ISM Band SAW Filters	32-33
900 MHz Range ISM Band SAW Filters	33-34
915 MHz DR Filters (High Power Handling)	34
LTCC Filters	34
SAW Notch Filters	34
SAW Resonators	35-36
Sub-500 MHz ISM Band SAW Filters	36-38
<b>Defense</b>	<b>39</b>
 BAW Filters	39
<b>Medical/Healthcare</b>	<b>40</b>
SAW Resonators	40
<b>General</b>	<b>41-56</b>
XTC-TCXO Series	41
XTL-XTAL Series	41
XTS (Temperature Sensing Crystal Resonators)	41
XVT-VCTCXO Series	42
TCXO (Temperature Compensated Crystal Oscillators)	42-46
XFL (Crystal Filters)	46
XTAL (Crystal Resonators)	46-53
VCTCXO (Voltage Controlled Temperature Compensated Crystal Oscillator)	54
RXM7000 / RXM7001	55
TRC103	56

## XBAW<sup>®</sup>



### XBAW<sup>®</sup> Technology

#### Optimizing Filter Solutions for The Future Of Connectivity

- XBAW<sup>®</sup> is a patented **MEMS-based** technology optimized to address the most stringent frequency selectivity requirements with superior resonator characteristics ideally suited for frequencies in the range of 2 to 7GHz.
- Demonstrated differentiated filter performance by leveraging proprietary MEMS-based process flow on a 6" Si-substrate (scalable to 8") with a unique wafer process and flexible with respect to piezo material synthesis/composition. This process is compatible with chip, wire-bond, wafer-level packaging (WLP) and allows design-of-experiments (DOE) to explore piezo quality influence on RF filter performance.

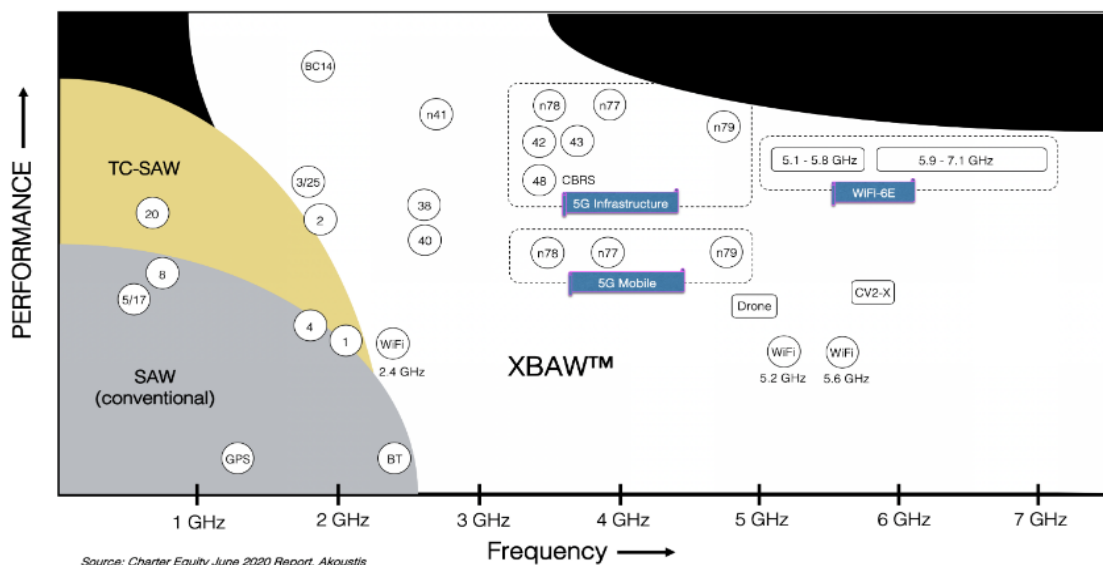

### Why High Purity AlN Piezoelectric

- Acoustic properties maintained over wide thickness range enabling high frequency applications
  - Consistently low rocking curve FWHM
  - Consistently high sound velocity measured
- Enhanced crystal quality drives 40x narrower XRD FWHM (0.028° vs. 1.26°)
- Single crystal AlN provides enhanced piezoelectric properties (d33,e33)
- Demonstrated power handling > 10W @ 3.7GHz



## Technology Benefits

Our XBAW® technology uses Akoustis' patented MEMS-based technology to optimize selective connectivity in the 5G and WiFi 6E space.

- Enhanced material properties and optimized resonator with better FOM ( $k_2 * Q$ ) enables differentiated filter performance at frequencies in range 2 to 7GHz
- High acoustic velocity & thermal conductivity resulting in improved power handling
- Higher  $k_2$  (coupling) enables larger bandwidth filters
- MEMS-based process flow on a 6" Si-substrate with unique wafer process and flexible with respect to piezo material synthesis/ composition
- Compatible with multiple packaging technologies to enable compact footprint



### THERMAL PERFORMANCE

Improved power handling  
Increased heat removal

### HIGH PURITY PIEZOELECTRIC

High-frequency performance  
Tunable stress  
Flexible doping

### HIGH $kt^2$ COUPLING

Ultra-wide bandwidth

### PACKAGING TECHNOLOGY

Compact solution size  
Standard SMT process  
Wafer level packaging

### MEMS BASED PROCESS FLOW

Enable integration  
Unique & flexible  
Low cost platform



### MOBILE BENEFITS

- Improved power handling
- High performance > 3GHz coexist
- Wideband



### WIFI BENEFITS

- Improved power handling
- High performance 5GHz coexist
- Wideband
- Compact footprint



### MASSIVE MIMO & SMALL CELL BENEFITS

- uFilter with high power handling
- High performance > 3GHz coexist
- SMT manufacturability

## Differentiated Solutions



XBAW® technology has been developed to address industry's toughest challenges with respect to power handling, co-existence in 2 to 7GHz frequency range, and need for wider bandwidth filtering solutions. XBAW® technology is designed for compatibility with various packaging technologies to enable compact footprints and compatibility to standard SMT processes for lowest cost of manufacturing. All these technology benefits result in best-in-class RF filter performance for a wide array of Wi-Fi & 5G infrastructure & mobile and defense applications.



## Industry Challenges

Next generation connectivity architectures are demanding solutions that support high-frequency, ultra-wideband, and high-power coexistence RF filter. Years of R&D have uniquely positioned us to handle the industry's challenges and push the boundaries of what's possible bringing you the highest quality filter solutions in the market.

### Mobile

- High Power User Equipment (HPUE) requires Band 41 RF front-end chains to put out 3dB additional power in order to achieve better cell coverage. In the future, carriers could require 5G n41, n78, n77 and n79 to have a similar requirement thus posing a challenge to existing low power filter solutions.
- HPUE power requirements are expected to extend to the new 5G spectrum operating in the 2.5 to 5GHz range.
- 5G RF front-end needs to operate at frequencies higher than traditional sub 2.7GHz
- 5G frequencies have wider bandwidth requirements compared to existing LTE bands
- RF filters need to meet stringent bandwidth, co-existence & power handling requirements

### WiFi

- Proliferation of higher-order MU-MIMO driving number of RF filter placements
- Larger bandwidth filtering needs with 802.11ax WiFi 6 and WiFi 6E and emerging WiFi 7
- Need for compact footprint compared to bulky ceramic options
- Need for higher frequency extending to 7.125 GHz filtering options

### Telecom

- Proliferation of higher-order massive MIMO with active antennas driving number of RF filter placements and need for compact footprint compared to bulky cavity options
- A higher need for cost-effective & high-volume SMT manufacturing
- Wider bandwidth filtering requirements
- Higher power handling requirements 1-10W average
- Need for higher frequency, ultra-wideband filtering options meeting stringent spectral masks

# SOLUTIONS

## BAW

The XBAW® RF BAW filter products are designed for high-frequency, high-power, and ultra-wide-band operations. Their flexible applications include 5G mobile connectivity and infrastructure products, WiFi access points for commercial and consumer purposes, phased array antenna applications, and other markets that require RF filters.

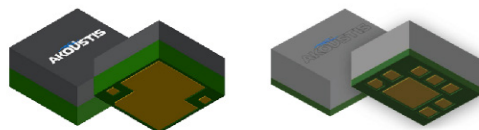

## Ceramic

RFMi offers a wide range of high-performance Ceramic Dielectric Resonator Filters (DR filters) featuring low IL, high Q and very low amplitude and group delay variations. In addition, RFM offers selected high performance Low Temperature Cofired Ceramic Filters and Diplexers (LTCC Filters and Diplexers) with small size, low IL and very low amplitude and group delay variation.

The applications are for 5 GHz and 2.4 GHz WiFi router and networking, DSRC (V2V and V2X), GNSS (GPS, Glonass, Beidou and Galileo), LTE and 5G BTS and small cells.

- CDR: Ceramic Dielectric Resonator Filters
- CF: LTCC Filters and Diplexers





## SAW

With a long heritage from RFM, the pioneer in SAW and Low Power RF technologies, RFMi supplies (Surface Acoustic Wave) SAW Filters (including Band Pass Filters and Band Reject Filters or Notch Filters, for both RF Filtering and IF Filtering applications), SAW Duplexers, SAW Diplexers and SAW Resonators, giving RF engineers a broad range of SAW components from the leading global manufacturer of Electronic Frequency Components.

RFMi SAW technology is industry-leading for small size, high performance, high reliability, low cost and quick time-to-market. Most of our SAWs use (Surface Mount) SMT packages. They are hermetically sealed, RoHS compliant, AEC-Q200 qualified, made in IATF16949 certified factories, and support PPAP for automotive applications. We have one of the broadest SAW portfolios with frequencies from around 30MHz to around 3.7GHz, for LTE bands, ISM bands, GPS and GNSS bands and other frequency bands.

Our state-of-the-art production facilities produce SAW components for high-volume and high-reliability markets, such as Automotive, Telecom Infrastructures, Access Points and Terminals, Industrial and Consumer IoT, Health Care and Medical applications, etc.

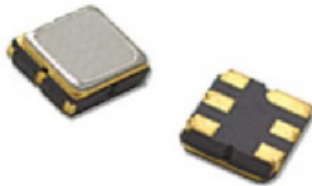

## Xtal

RFMi offers the whole family of Crystal Products for Industrial, Automotive, Telecom, Consumer, Health care and other markets, targeting a wide range of applications such as IoT, AMR (Automated Meter Reading), RFID, T-Box, GNSS (GPS, Glonass, Beidou and Galileo), Medical Monitor, WiFi (e.g., Wifi-6) access point and terminals, 5G and other LTE BTS and mobile devices, etc.

- XTL: Crystal Resonator
- XTC: TCXO (Temperature-Compensated Crystal Oscillator)
- XVT: VCTCXO (Voltage-Controlled Temperature-Compensated Crystal Oscillator)
- XTS: TSX (Temperature Sensing XTAL Resonator)
- XFL: Crystal Filter
- XO: Crystal Oscillator
- XVC: VCXO (Voltage-Controlled Crystal Oscillator)
- XOC: OCXO (Oven-Controlled Crystal Oscillator)

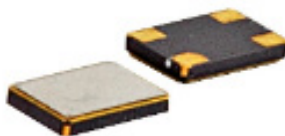

# MARKET FEATURES

## WiFi

IEEE 802.11 standard, including WiFi 6, 6E and upcoming 7, that utilize unlicensed wireless spectrum covering the 2.4GHz, 5GHz and extended 6GHz bands for fixed access points (Routers, Gateways, Hubs, Extenders, etc) and mobile (smartphone, VR/AR, laptops, wearables, tablets, etc).

## Telecom & Mobile

Cellular 5G (fifth generation) is the next generation mobile network, delivering increased speed, lower latency and improved reliability versus older generation networks supporting licensed spectrum mobile and network infrastructure applications.

## Automotive

RKE and BCM, Infotainment systems, GPS/GNSS for navigation, telematics, tracking and ADAS, etc.

## IoT

Internet of Things connectivity for non-mobile phones, high reliability professional applications for factory automation, smart homes, smart buildings, smart cities, precision agriculture, etc. Support industry standards like LoRa<sup>®</sup>, Sigfox<sup>®</sup>,

## Defense

Defense industry provide governments with military capabilities across the naval, land, aerospace, and electronic systems domains in support of current and future defense and military requirements for military communications, radar, electronic warfare applications.

## Medical/Healthcare

MICS, WMTS and MBAN band applications for medical implant, telecare and telehealth, patient monitoring, etc.

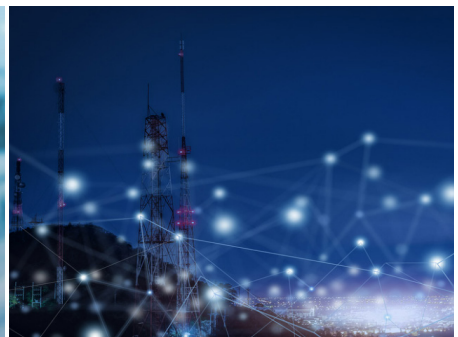
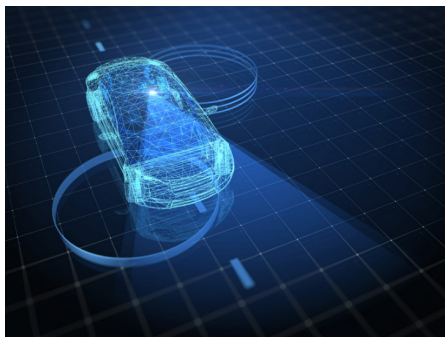



## BAW Filters

Part No.	Description	Center Freq. (MHz)	BW (MHz)	IL (dB)	Size (mm)
A10155	5.5 GHz WiFi 6E Coexistence BAW Filter	5502.5	665	1.7	3.5 x 3.5 x 1.4
A10156	5.6 GHz WiFi 6E Coexistence BAW Filter	5600	725	1.6	3.5 x 3.5 x 1.41
A10165	6.5 GHz WiFi 6E Coexistence BAW Filter	6535	1180	1.7	3.5 x 3.5 x 1.74
A10252	5.2 GHz WiFi Coexistence BAW Filter	5250	160	1.3	2.5 x 2.0 x 1.0
A10256	5.6 GHz WiFi Coexistence BAW Filter	5665	345	1.6	2.5 x 2.0 x 1.0
A10266	6.6 GHz WiFi 6E Coexistence BAW Filter	6600	1020	2.3	3.5 x 3.5 x 1.72
AKF-1252	5.2 GHz RF BAW Filter	5250	160	1.7	2.5 x 2.0 x 1.0
AKF-1256	5.6 GHz RF BAW Filter	5665	345	1.9	2.5 x 2.0 x 1.0

## BAW Filters for WiFi Band

Part No.	Frequency (MHz)	Max IL (dB)	BW (MHz)	Size (mm)
BF2000L	2442.000	3.2	79	1.1 x 0.9
BF2000LA	2442.000	2.5	79	1.1 x 0.9
BF2003KM	2442.000	2.3	79	1.4 x 1.1
BF2001G	5250.000	2	160	2.5 x 2.0

## DR Filters for WiFi

Part No.	Frequency (MHz)	Max IL (dB)	BW (MHz)	Size (mm)
CDR3003	5235.000	3	180	8.4 x 4.05
CDR4000	5235.000	2.5	180	8.7 x 4.27 x 3.0
CDR3004	5240.000	2.1	200	3.25 x 2.58 x 1.85
CDR4001	5240.000	2	200	3.25 x 2.58 x 1.85
CDR3005	5245.000	2	190	8.46 x 4.05 x 3.0
CDR3006	5250.000	2.5	160	8.6 x 4.05 x 3.0
CDR4002	5500.000	2.5	700	4.20 x 2.7 x 1.7
CDR3007	5665.000	2	370	8.46 x 3.45 x 3.0

## DR Filters for WiFi (cont.)

Part No.	Frequency (MHz)	Max IL (dB)	BW (MHz)	Size (mm)
CDR3008	5670.000	2.1	380	3.25 x 2.58 x 1.85
CDR4003	5670.000	2	380	3.25 x 2.58 x 1.85
CDR3009	5697.000	2.5	360	8.6 x 3.45 x 3.0
CDR4004	5697.000	2.5	360	8.6 x 3.6 x 3.0
CDR3010	5710.000	2.5	445	8.6 x 3.45 x 3.0
CDR4006	6240.000	1.3	380	13.0 x 3.5 x 3.5
CDR4007	6245.000	2	360	13.0 x 3.5 x 3.5
CDR4005	6667.000	2.5	1135	4.2 x 2.28 x 1.7
CDR6006	5522.000	2.5	745	4.2 x 2.85 x 1.7
CF1006	5787.500	3	125	8.7 x 3.8

## LTCC Filters & Diplexer for WiFi

Part No.	Frequency (MHz)	Max IL (dB)	BW (MHz)	Size (mm)
CF1011	2450	2.5	100	1.6 x 0.8
CF1005	2450/5425	0.9/1.1	100/1050	1.6 x 0.8
CF1017	5410	2	1050	2.0 x 1.25
CF1018-A	2450/5500	0.6/1.5	100/700	1.6 x 0.8

## SAW Filters for WiFi Band

Part No.	Frequency (MHz)	Max IL (dB)	BW (MHz)	Size (mm)
SF2527KM	2441.750	3.9	83.5	1.4 x 1.1
SF2124E	2441.800	4	83.5	3.0 x 3.0
SF2124K	2441.800	2.6	83.5	1.4 x 1.1
SF2627K	2442.000	2.8	82	1.4 x 1.1
SF2512K	2442.000	3.5	84	1.4 x 1.1
SF2512KM	2442.000	3.5	84	1.4 x 1.1
SF2513LA	2442.000	2.2	79	1.1 x 0.9
SF2516LM	2442.000	1.8	79	1.1 x 0.9
SF2516LA	2442.000	1.8	79	1.1 x 0.9
SF2686L	2441.750	2.6	83.5	1.1 x 0.9



## BAW Filters

Part No.	Description	Center Freq. (MHz)	BW (MHz)	IL (dB)	Size (mm)
A10149	4.9 GHz 5G Coexistence BAW Filter	4850	100	1.8	2.5 x 2.0 x 0.8
A10235	3.5 GHz Coexistence BAW Filter	3500	200	1.3	2.5 x 2.0 x 0.8
A10335	3.5 GHz 5G Coexistence BAW Filter	3450	300	1.2	2.5 x 2.0 x 0.8
AKF-1336	3.6 GHz CBRS Bandpass BAW Filter	3625	150	1.5	2.5 x 2.0 x 0.8

## LTE Band BAW Filter 1.1 x 0.9 mm

Band	Part No.	Fc (MHz)	BW (MHz)	IL (dB)	AEC-Q200	MSL
B40 TRX	BF2004LA	2350	100	2.3	Yes	1

## DR & LTCC LTE Band Filters

Part No.	Description	F0 (MHz)	BW (MHz)	IL (dB)	Size (mm)
CDR1005	DR Filter, B17 up	713	6	3	11.4 x 10.8 x 4.4
CDR1006	Low Pass DR Filter	1325	750	1.5	5.8 x 4.35 x 2.85
CDR1000	High Pass DR Filter	1945	410	2	5.6 x 5.07 x 2.85
CDR1001	DR Filter, B36	1970	40	3.5	11.4 x 6.4 x 4.2
CDR1002	DR Filter, LTE Band	2176	12	2	12.0 x 8.0 x 4.6
CDR2010	DR Filter, Sub 6G/ 5th G	2437	70	4	15.9 x 4.8 x 4.4
CDR2011	DR Filter, Sub 6G/ 5th G	2450	100	1.3	3.5 x 1.7 x 1.6
CDR1003	DR Filter, B41	2587.5	220	2.5	15.9 x 6.9 x 4.3
CDR2000	DR Filter, Sub 6G/ 5th G	2595	160	1.5	15.0 x 6.3 x 4.4
CDR1004	DR Filter, B41	2600	204	2	15.9 x 6.5 x 4.3
CDR2012	DR Filter, Sub 6G/ 5th G	3250	300	2	7.4 x 4.62 x 3.0
CDR2001	DR Filter, Sub 6G/ 5th G	3450	300	2	15.9 x 5.1 x 4.4
CDR2002	DR Filter, Sub 6G/ 5th G	3450	100	2	15.8 x 4.8 x 4.4
CDR2003	DR Filter, Sub 6G/ 5th G	3500	200	2	15.9 x 6.2 x 4.4
CDR2004	DR Filter, Sub 6G/ 5th G	3500	200	2.5	4.4 x 3.6 x 1.8

## DR & LTCC LTE Band Filters (cont.)

Part No.	Description	F0 (MHz)	BW (MHz)	IL (dB)	Size (mm)
CDR2013	DR Filter, Sub 6G/ 5th G	3550	300	1.5	7.45 x 4.23 x 3
CDR2008	DR Filter, Sub 6G/ 5th G	3570	100	1.5	15.9 x 6.3 x 4.4
CDR2005	B42,B43	3600	400	2.2	15.8 x 4.8 x 4.4
CF1007	LTCC, B42,B43	3600	400	1.5	2.0 x 1.25
CDR2006	B43	3700	200	2	15.9 x 6.2 x 4.4
CDR2007	B43	3700	200	2.5	4.16 x 3.6 x 1.8
CDR2009	DR Filter, Sub 6G/ 5th G	4700	200	1.5	15.9 x 4.5 x 4.4
CDR2014	DR Filter, Sub 6G/ 5th G	4700	600	1.6	2.85 x 2.95 x 1.6
CDR2015	DR Filter, Sub 6G/ 5th G	4950	80	4	14 x 2.9 x 2.3

## DR Filters for GNSS Bands

Part No.	Frequency (MHz)	Max IL (dB)	BW ( MHz)	Size (mm)	Bands
CDR9001	1100	2	290	13.94 x 8.10	L5+L2+E5+B2+G3
CDR6007	1201	2.5	71	6.6 x 6.09 x 2.05	L5+B2+G3+E5+L2
CDR6000	1223	2	50	6.6 x 6.05	L2
CDR6008	1230	2	140	8.4 x 5.35 x 2.8	Lower Band
CDR6001	1240	3	60	11.2 x 9.7	L2+G2
CDR6005	1577.42	5	2	9.0 x 7.5	L1
CDR6003	1581	1	80	6.5 x 4.64	L1+B1+G1+E1+SAR
CDR9000	1685	1.6	180	8.40 x 3.60	B1+L1

## Dual LTE Band SAW Filters 1.5 x 1.1 mm

Band	RX/TX	Part No.	Fc (MHz)	BW (MHz)	IL (dB)	AEC-Q200	MSL
3 and 1	RX	SF2579JM	1842.5/2140	75/60	3.6/3.0	No	1
39 and 34	RX	SF2578JM	1900/2017.5	40/15	2.0/2.5	No	1

## IF & Other SAW Filters

Part No.	F0 (MHz)	BW (MHz)	IL (dB)	Size (mm)	Comments
SF2503A	37.800	5.00	20.20	13.3 x 6.5	
SF2242B	40.000	5.00	12.00	5.0 x 7.0	
SF2149A	46.080	5.00	10.00	13.3 x 6.5	TD-SCDMA
SF2624B	46.200	4.20	14.00	5.0 x 7.0	Balanced
SF2185A	70.000	9.00	12.00	13.3 x 6.5	IF Filter
SF2185A-1	70.000	9.10	11.00	13.3 x 6.5	IF Filter
SF2227A	70.000	6.00	9.00	13.3 x 6.5	
SF2228A	70.000	4.00	9.50	13.3 x 6.5	
SF2229A	70.000	0.80	12.00	13.3 x 6.5	
SF2230A	70.000	18.70	15.00	13.3 x 6.5	
SF2257A	70.000	0.80	11.50	13.0 x 6.5	
SF2267A	70.000	1.26	12.00	13.3 x 6.5	
SF2270A	70.000	2.30	8.20	13.3 x 6.5	
SF2310A	70.000	11.77	13.00	13.3 x 6.5	IF Filter
PX1004	82.200	0.03	4.00	13.3 x 6.5	IS-54 TDMA
PX1004-1	82.200	0.05	5.50	13.3 x 6.5	
PX1002	86.850	0.02	4.00	13.3 x 6.5	IS-54 TDMA
SF2131B	92.160	20.00	10.00	7.0 x 5.0	TD-SCDMA
SF2069A-2	96.000	5.00	15.00	13.3 x 6.5	TD-SCDMA
SF2085A	96.000	30.00	19.00	13.3 x 6.5	IF Filter
SF2483A	104.200	1.60	6.50	9.0 x 7.0	Cable TV
SF1056A	110.592	1.15	10.00	13.3 x 6.5	DECT
SF2059B-1	137.500	1.00	9.10	5.0 x 7.0	Orbcomm
SF2377B	137.500	1.80	3.50	5.0 x 7.0	
SF2190B	138.000	60.00	21.00	5.0 x 7.0	Sat Receiver
SF2148B	138.240	20.00	10.50	5.0 x 7.0	LTE/TD-SCDMA
SF2045A	140.000	10.00	11.00	13.3 x 6.5	IF Filter
SF2140A-1	140.000	20.00	11.00	13.3 x 6.5	WCDMA/D-SCDMA IF
SF2181D	140.000	25.00	9.00	3.8 x 3.8	IF Filter
SF2182D	140.000	40.00	15.00	3.8 x 3.8	IF Filter
SF2189A	140.000	30.00	13.00	13.3 x 6.5	IF Filter
SF2308A	140.000	12.00	10.75	13.3 x 6.5	IF Filter
SF2120C	149.000	2.00	2.50	5.0 x 5.0	Orbcomm
SF2289C	155.000	8.00	6.50	5.0 x 5.0	IF Filter
SF2063A	156.000	9.00	18.00	13.3 x 6.5	Wibro
SF2064A	156.000	10.00	18.00	13.3 x 6.5	Wimax

## IF & Other SAW Filters (cont.)

Part No.	F0 (MHz)	BW (MHz)	IL (dB)	Size (mm)	Comments
SF2157A	156.000	20.00	12.00	13.3 x 6.5	IF Filter
SF2147D	157.000	20.00	8.50	3.8 x 3.8	CDMA2000
SF2351C	161.000	22.00	12.00	5.0 x 5.0	GPS
SF2320C	163.000	8.00	6.50	5.0 x 5.0	
SF2170D	165.000	20.00	10.00	3.8 x 3.8	CDMA2000
SF2178A	168.000	20.00	13.50	13.3 x 6.5	Wimax
SF2274C	169.000	6.00	2.85	5.0 x 5.0	
SF2067B	172.800	8.84	12.50	7.0 x 5.0	WCDMA
SF2304B	175.000	0.90	10.00	SMP-03	ViaSat
SF2139D	177.000	20.00	9.00	3.8 x 3.8	CDMA2000
SF2332B	183.600	1.26	10.50		
SF2223D	184.320	30.00	12.00	SM3838-8	
SF2671E	190.000	4.50	7.00		Sat Receiver
SF2219A	193.600	0.39	9.00	SMP53-S	
SF2220C	193.600	0.11	7.00	SM5050-8	
SF2221A	193.600	1.00	9.00	SM1154-14	
SF1092A	199.000	0.20	7.00	19.0 x 6.5	GSM/EDGE
SF2141B	210.380	1.20	11.00	7.0 x 5.0	CDMA
SF1091A	211.000	0.90	8.00	13.3 x 6.5	GSM/EDGE
SF2244A	225.000	4.00	12.00	SM53-S	Repeater
SF2222C	228.000	6.20	3.00	SM5050-8	
SF2685C	231.250	12.00	3.50	5.0 x 5.0	Wireless Gateway
SF2243A	233.000	4.00	12.00	SM53-S	Repeater
SF2055A	240.050	0.30	5.00	11.5 x 4.0	PHS
SF2301D	241.000	0.16	8.00	SM3838-8	
SF2335E-1	243.950	0.26	4.50	SM30330-6	PHS
SF2335E-2	243.950	0.26	4.50	SM3030-6	PHS
SF2331B	246.000	0.60	6.50	7.0 x 5.0	
SF2621E	265.550	0.26	4.00	3.0 x 3.0	Wireless Microphone
SF2621E-1	265.500	0.26	4.00	3.0 x 3.0	Wireless Microphone
SF1131B	266.000	2.20	12.00	7.0 x 5.0	GPS
SF2336B	266.000	0.20	6.50	7.0 x 5.0	Wireless Headset
SF1189B-1	280.000	17.97	10.00	5.0 x 5.0	Wireless Access
SF2172C	280.000	18.00	11.00	5.0 x 5.0	IF Filter
SF2262B	294.500	22.00	20.00	5.0 x 7.0	Compass
SF2088C	295.000	30.00	13.00	5.0 x 5.0	IF Filter



## IF & Other SAW Filters (cont.)

Part No.	F0 (MHz)	BW (MHz)	IL (dB)	Size (mm)	Comments
SF1120B	298.740	2.20	12.00	7.0 x 5.0	GPS
SF2629E	302.825	3.00	4.00	3.0 x 3.0	Base Station
SF2670C	370/390	20	3	5.0 x 5.0	Fixed Mobile
SF2630E	382.825	3.00	4.00	3.0 x 3.0	Base Station
SF2659D	446.000	4.50	4.00	3.8 x 3.8	Two Way Radio
SF2672C	480.000	54.00	15.00	5.0 x 5.0	Land Mobile
SF2695D	525.000	24.00	3.00	3.8 x 3.8	TV brocast
SF2696D	550.000	24.00	3.00	3.8 x 3.8	TV brocast
SF2697D	576.000	24.00	3.00	3.8 x 3.8	TV brocast
SF2683K	689.500	53.00	6.00	1.4 x 1.1	TV brocast
SF2675E	770.000	12.00	3.00	3.0 x 3.0	Land Mobile
SF2207E	800.000	20.00	3.00	3.0 x 3.0	Public Safety Radio Systems
SF2667E	1835.000	20.00	3.00	3.0 x 3.0	
SF2396E-1_TD	1870.000	20.00	5.00	3.0 x 3.0	
SF2397E-1_TD	1880.000	40.00	5.00	3.0 x 3.0	
SF2398E-1_TD	1890.000	60.00	5.00	3.0 x 3.0	
SF2400E-1_TD	1890.000	100.00	7.00	3.0 x 3.0	
SF2399E-1_TD	1900.000	80.00	7.00	3.0 x 3.0	
SF2410E-1_TD	1940.000	200.00	10.00	3.0 x 3.0	
SF2402E-1_TD	2010.000	40.00	5.00	3.0 x 3.0	
SF2403E-1_TD	2020.000	60.00	5.00	3.0 x 3.0	
SF2404E-1_TD	2030.000	80.00	7.00	3.0 x 3.0	
SF2405E-1_TD	2085.000	100.00	7.00	3.0 x 3.0	
SF2407E-1_TD	2120.000	40.00	5.00	3.0 x 3.0	
SF2409E-1_TD	2120.000	80.00	5.00	3.0 x 3.0	
SF2406E-1_TD	2130.000	20.00	5.00	3.0 x 3.0	
SF2408E-1_TD	2130.000	60.00	5.00	3.0 x 3.0	
SF2679K	2185.000	30.00	3.50	1.4 x 1.1	Satellite Communication
SF2669K	2449.710	16.50	4.25	1.4 x 1.1	Big LEO MSS
SF2681K	2595.000	50.00	2.50	1.4 x 1.1	Fixed Satellite

## LTCC Filters

Part No.	Frequency (MHz)	Max IL (dB)	BW (MHz)	Size (mm)
CF1023	1952.500	1.1	145	1.6 x 0.8
CF1015	3550.000	1.3	500	1.6 x 0.8
CF1007	3600.000	1.5	400	2.0 x 1.25
CF1008	3750.000	2.25	900	2.0 x 1.25

## LTE Band SAW Duplexers 1.6 x 1.2 mm

Band	Part No.	Fc (MHz)	BW (MHz)	IL (dB)	AEC-Q200	MSL
1	SF2693QM_TD	1950/2140	60	2.0/2.3	No	1
3	SF2694QM_TD	1747.5/1842.5	74.7	2.6/3.3	No	1
5	SF2691QM_TD	836.5/881.5	25	1.8/2.3	No	1
7	SF2690QM_TD	2535/2655	70	3.2/2.8	No	1
8	SF2692QM_TD	897.5/942.5	34.7	3.5/3.2	No	1

## LTE Band SAW Duplexers 1.8 x 1.4 mm

Band	Part No.	Fc (MHz)	BW (MHz)	IL (dB)	AEC-Q200	MSL
1	SF2535NA	1950/2140	59.04	2.2	Yes	1
1	SF2535N	1950/2140	60	2.6		3
1	SF2580NM	1950/2140	60	2.2		1
1	SF2580N	1950/2140	60	2.3		3
2	SF2583NA	1880/1960	59.04	3.3	Yes	1
2	SF2584NM	1880/1960	59.04	3.3		1
3	SF2536NA	1747.5/1842.5	74.7	3.3	Yes	1
3	SF2585NA	1747.5/1842.5	74.7	3.6	Yes	1
4	SF2586NA	1733/2133	45	2.2	Yes	1
4	SF2587NM	1733/2133	45	2.3		1
5	SF2537NA	836.5/881.5	25	2.3	Yes	1
5	SF2537N	836.5/881.5	25	2.1		3
5	SF2588NM	836.5/881.5	25	2.2		1
7	SF2590NA	2535/2655	70	2.9	Yes	1
8	SF2538NA	897.5/942.5	30.2	3.6	Yes	1
8	SF2538N	897.5/942.5	35	3.6		3
8	SF2591NM	897.5/942.5	34.52	3.6		1
8	SF2592NM	897.5/942.5	30.2	3.4		1

## LTE Band SAW Duplexers 1.8 x 1.4 mm (cont.)

Band	Part No.	Fc (MHz)	BW (MHz)	IL (dB)	AEC-Q200	MSL
8	SF2592N	897.5/942.5	35	3.4		3
12	SF2595NA	707.5/737.5	17	2.35	Yes	1
13	SF2596NA	782/751	10	2.5	Yes	1
14	SF2597NA	763/793	10	3.6	Yes	1
17	SF2598N	710/740	12	2.35		3
20	SF2599NA	847/806	29.5	3	Yes	1
21	SF2600NM	1455.4/1503.4	15	1.9		1
25	SF2601NA	1882.5/1962.5	65/64.04	4.2	Yes	1
26	SF2602NA	831.5/876.5	34.52	3.1	Yes	1
28A	SF2603NA	718/773	30	2.9	Yes	1
28B	SF2604NA	733/788	30	3.6	Yes	1
66	SF2605NA	1745/2155	69.04/89.04	3.3	Yes	1

## LTE Band SAW Filters 1.1 x 0.9 mm

Band	RX/TX	Part No.	Fc (MHz)	BW (MHz)	IL (dB)	AEC-Q200	MSL
1	RX	SF2529LA	2140	60	2.7	Yes	1
1	RX	SF2529LM	2140	60	2.5	No	1
1	RX	SF2529L	2140	60	3	No	3
1	TX	SF2607LA	1950	60	2.5	Yes	1
1	TX	SF2607L	1950	60	2.5	No	3
2	RX	SF2609LM*	1960	60	4	No	1
2	RX	SF2610LA	1960	60	4	Yes	1
2	RX	SF2610LM	1960	60	4	No	1
2	RX	SF2610L	1960	60	4	No	3
2	TX	SF2613LM	1880	60	2	No	1
3	RX	SF2530LA	1842.5	75	4	Yes	1
3	RX	SF2530LM	1842.5	75	4	No	1
3	RX	SF2530L	1842.5	75	4	No	3
3	TX	SF2539LA	1747.5	75	3	Yes	1
4	TX	SF2543LA	1732.5	45	2.2	Yes	1
5	TX	SF2545LM	836.5	25	2.3	No	1
5	RX	SF2531LA	881.5	25	2.5	Yes	1
5	RX	SF2531LM	881.5	25	2.3	No	1
5	RX	SF2560LM*	881.5	25	2	No	1
7	RX	SF2546L	2665	70	3.3	No	3

## LTE Band SAW Filters 1.1 x 0.9 mm (cont.)

Band	RX/TX	Part No.	Fc (MHz)	BW (MHz)	IL (dB)	AEC-Q200	MSL
7	RX	SF2548L	2655	70	3	No	3
8	RX	SF2532LA	942.5	35	3.2	Yes	1
8	RX	SF2549L	942.5	35	2	No	3
8	TX	SF2550LA	897.5	34.2	2.9	Yes	1
8	RX	SF2551L	942.5	35	3.2	No	3
12	TX	SF2554LA	707.5	17	2.5	Yes	1
12/17	RX	SF2552LA	737.5	17	2.4	Yes	1
12/17	RX	SF2553L*	737.5	17	2.5	No	3
13	RX	SF2555L	751	10	2.5	No	3
13	TX	SF2556LA	782	10	2.3	Yes	1
14	RX	SF2557LM	763	10	3	No	1
17	TX	SF2558LM	710	12	1.8	No	1
20	RX	SF2561LA	806	30	3.8	Yes	1
20	TX	SF2648LM	847	30	2.5	No	1
26	RX	SF2562L	876.5	30	3.8	No	3
26	RX	SF2563LM*	876.5	30	3.3	No	1
28	RX	SF2564LA	773	30	3	Yes	1
28	RX	SF2565LA	788	30	2.8	Yes	1
28	RX	SF2566L	780.5	45	3	No	3
28	TX	SF2567L	725.5	45	3	No	3
29	RX	SF2568LM	722.5	11	2.5	No	1
30	RX	SF2569LM	2355	10	2.9	No	1
38	RX	SF2570L	2595	50	2.5	No	3
38	TX	SF2571L	2595	50	2.5	No	3
39	RX	SF2572L	1900	40	2	No	3
40	RX	SF2573L	2350	100	2.8	No	3
40	TX	SF2574L	2350	100	3.8	No	3
41	TRX	SF2657K	2593	194	3.2	No	3
41	TRX	SF2533LA	2595	120	3.2	Yes	3
41	RX	SF2575L	2605	100	3.8	No	1
41	TRX	SF2576L	2605	100	4	No	
66	RX	SF2577LA	2155	90	2.8	Yes	

\* Balanced

## LTE Band SAW Filters 1.4 x 1.1 mm

Band	RX/TX	Part No.	Fc (MHz)	BW (MHz)	IL (dB)	AEC-Q200	MSL
3	TX	SF2651K	1746.5	73	5	No	3
3	RX	SF2652K	1839.5	69	6	No	3
41	TRX	Sf2681K	2595	50	2.5	No	3
41	TRX	SF2657K	2593	194	4.3	No	3
66	RX	SF2679K	2185	30	3.5	No	3

## SAW By-Pass Filter

Part No.	F0 (MHz)	BW (MHz)	IL (dB)	Size (mm)
SF2542L	1650	2100	0.5	1.1 x 0.9

## SAW Low Pass Filter

Part No.	Notch F0 (MHz)	Rejection (dB)	Passband IL (dB)	Package
SF2518K	700	12	3.5	SM1411-5
SF2505K	739.5	15	7	SM1411-5
SF2519K	827.5	15	3.2	SM1411-5

## SAW Notch Filters

Part No.	Notch F0 (MHz)	Notch BW (MHz)	Notch Rejection (dB)	Passband IL (dB)	Package
SF2622E	733/760	30/10	10/14	2	SM3030-8

## SMD LTE Band SAW Filters 3 x 3 mm

Band	Part No.	Fc (MHz)	BW (MHz)	IL (dB)
B1 Up	SF2224E	1950	60	4
B1 Down	SF2225E	2140	60	3.5
B2 Up	SF2036E	1880	60	4
B2 Down	SF2001E	1960	60	4
B3 Up	SF2133E	1747.5	75	4.1
B4 Down	SF2226E	2132.5	45	3.7

## SMD LTE Band SAW Filters 3 x 3 mm

Band	Part No.	Fc (MHz)	BW (MHz)	IL (dB)
B5 Up	SF1182B	836.5	25	3
B5 Down	SF1183E	881.5	25	3
B7 Up	SF2158E	2535	70	3.6
B7 Down	SF2258E	2657	70	3.6
B8 Up	SF2391E	897.5	35	3.5
B8 Down	SF2002E	942.5	35	3
B8 Down	SF2002B-2	942.5	35	4
B10 Up	SF2133E	1747.5	75	4.1
B10 Up	SF2133E-3	1747.5	75	4.5
B10 Down	SF2225E	2140	60	3.5
B11 Down	SF2164E	1484.3	40	4.5
B12 Up	SF2200E	707	18	3
B13 Up	SF2315E-1	782	10	3.4
B14 Up	SF2467E	793	10	2.5
B14 Down	SF2658E	763	10	3
B15 Up	SF2204E	1900	40	3.5
B16 Up	SF2202E	2017.5	15	4
B16 Down	SF2240E	2595	40	4
B20 Up	SF2478E	845	12	3
B20 Up	SF2197E	847	30	4.5
B20 Down	SF2198E	806	30	4.5
B24 Up	SF2236E	1642.5	35	3.5
B24 Up	SF2236E-1	1642.5	35	3.7
B24 Down	SF2275E	1542.5	35	4.2
B24 Down	SF2275E-1	1542	34	3
B25 Up	SF2233E	1882.5	65	3.5
B26 Up	SF2368E	831.5	35	4.2
B26 Down	SF2369E	876.5	35	4
B27 Up	SF2674E	815.5	19	3
B27 Up	SF2214E	815	20	3.5
B27 Down	SF2673E	861	19	3.5
B28 Up	SF2126E	725.5	45	4
B30 Down	SF2372E	2355	10	3.9
B33	SF2204E	1900	40	3.5
B34	SF2202E-1	2017.5	15	4.5
B35	SF2036E	1880	60	4
B36	SF2001E	1960	60	4

## SMD LTE Band SAW Filters 3 x 3 mm (cont.)

Band	Part No.	Fc (MHz)	BW (MHz)	IL (dB)
B38	SF2241E	2595	50	3.8
B39	SF2204E	1900	40	3.5
B40	SF2173E	2350	100	4.2
B41	SF2345E-1	2593	194	5

## VXCO (Voltage Controlled Crystal Oscillators)

Part No.	F0 (MHz)	Supply Voltage (V)	F0 Stability	Temp. Range	Case Style/ Size (mm)	AEC -Q200
XVC5001-1	30.72	3.3	+/-25 ppm	-40C to +85C	SM7050-6	Yes
XVC5002	122.88	3.3	+/-50 ppm	-40C to +85C	SM7050-6	
XVC5003	100.00	3.3	+/-25 ppm	-40C to +85C	SM7050-6	Yes
XVC5004	27	4.5	+/-25 ppm	-20C to +70C	SM7050-6	Yes
XVC5005	122.880	3.3	+/-20 ppm	-40C to +85C	14.2 x 9.3	
XVC6000	122.88	3.3	+/-50 ppm	-40C to +85C	SM7050-6	
XVC6001	122.88	5.0	+/-25 ppm	-40C to +85C	14x9 x 5.5	
XVC6002B	81.36	3.3	+/-100 ppm	-40C to +85C	SM7050-6	

## XO (Crystal Oscillators)

Part No.	F0 (MHz)	Supply Voltage (V)	F0 Tolerance	Temp. Range	Case Style/ Size (mm)	AEC -Q200
XO1000BSS	12	3.3	+/-50 ppm	-40C to +85C	SM7050-4	
XO3001-1	125	3.3	+/-80 ppm	-40C to +85C	SM7050-4	
XO3004	26.00	1.8	+/-20 ppm	-20C to +70C	SM2520-4	
XO6000	156.3	3.3	+/-30 ppm	-40C to +85C	SM5032-6	
XO6001	156	3.3	+/-50 ppm	-40C to +105C	SM7050-6	
XO6002	156.25	3.3	+/-50 ppm	-40C to +85C	SM3225-4	
XO6003	156.25	3.3	+/-50 ppm	-40C to +105C	SM7050-6	
XO6004	311	3.3	+/-20 ppm	-30C to +85C	SM7050-6	
XO6005	200.00	3.3	+/-20 ppm	-10C to +60C	SM7050-6	
XO6006	133.26	3.3	+/-50 ppm	-40C to +85C	SM3225-6	
XO6007	133.00	3.3	+/-30 ppm	-40C to +85C	SM2520-4	
XO6008	125.00	3.3	+/-30 ppm	-40C to +85C	SM7050-6	
XO6009	125.00	3.3	+/-25 ppm	-40C to +85C	SM5032-4	
XO6010	125	3.3	+/-25 ppm	-40C to +85C	SM3225-4	

## XO (Crystal Oscillators) (cont.)

Part No.	F0 (MHz)	Supply Voltage (V)	F0 Tolerance	Temp. Range	Case Style/ Size (mm)	AEC -Q200
XO6011	100	3.3	+/-50 ppm	-40C to +85C	SM3225-6	
XO6012	80	3.3	+/-20 ppm	-20C to +70C	SM7050-4	
XO6013	50	3.3	+/-50 ppm	-40C to +85C	SM7050-4	
XO6014	25	3.3	+/-20 ppm	-10C to +70C	SM5032-4	
XO6015	25	1.2	+/-25 ppm	-40C to +85C	SM5032-4	
XO6016	25	1.2	+/-30 ppm	-40C to +85C	SM3225-4	
XO6017	16	5.0	+/-30 ppm	-40C to +85C	SM5032-4	
XO6018	13	3.3	+/-25 ppm	-40C to +85C	SM7050-4	
XO8000	12	1.8	+/-50 ppm	-20C to +70C	SM2520-4	
XO8001	100	3.3	+/-30 ppm	-40C to +85C	SM2520-4	
XO9012	13	3.3	+/-30 ppm	-40C to +85C	SM3225-4	
XO9012G	32.768KHz	3	+/-25 ppm	-40C to +85C	SM2520-4	
XO9013	12.0	3.3	+/-25 ppm	-40C to +85C	SM2016-4	
XO9014G	24	1.8	+/-50 ppm	-40C to +125C	SM2520-4	Yes
XO9015G	12	1.7-3.6	+/-50 ppm	-20C to +70C	SM2520-4	
XO9016B	12	3.3	+/-50 ppm	-40C to +105C	SM7050-4	
XO9017Q	300	1.8	+/-25 ppm	-40C to +85C	SM5032-8	
XO9018P	15	3.3	+/-20 ppm	-40C to +85C	SM3225-4	Yes
XO9019P	25	3.3	+/-25 ppm	-30C to +85C	SM3225-4	
XO9020P	40	3.3	+/-50 ppm	-40C to +85C	SM3225-4	
XO9020Q	40	3.3	+/-50 ppm	-40C to +85C	SM5032-4	
XO9021Q	200	3.3	+/-25 ppm	-40C to +105C	SM5032-4	
XO9022P	24	1.8	+/-30 ppm	-40C to +105C	SM3225-4	
XO9023P	27	3.3	+/-100 ppm	-40C to +125C	SM3225-4	
XO9024B	2	3.3	+/-25 PPM	-40C to +85C	SM7050-4	
XO9025P	25	3.3	+/-25 PPM	-40C to +85C	SM3225-4	
XO9026B	125	3.3	+/-50 ppm	-40C to +100C	SM7050-4	
XO9027P	29	1.8	+/-50 ppm	-40C to +85C	SM3225-4	
XO9028B	67	3.3	+/-50 ppm	-40C to +85C	SM7050-4	
XO9029G	20	1.62-3.63	+/-30 ppm	-40C to +85C	SM2520-4	
XO9030H	25	1.6-3.6	+/-30 ppm	-40C to +85C	SM2016-4	
XO9031G	24	1.8	+/-30 ppm	-40C to +85C	SM2520-4	
XO9032Q	125	3.3	+/-25 PPM	-40C to +105C	SM5032-6	
XO9033P	10	3.3	+/-30 ppm	-40C to +85C	SM3225-4	
XO9034P	213	3.3	+/-25 PPM	-40C to +85C	SM3225-6	
XO9035G	125	3.3	+/-35 ppm	-40C to +125C	SM2520-4	Yes



## OCXO (Oven Controlled Crystal Oscillators)

Part No.	F0 (MHz)	Power Supply Voltage (V)	F0 Tolerance @ +25c	F0 Stability vs. Temp	Temp Range	Size (mm)
XOC9000	80	12	+/-300 ppb	+/-50 ppb	-20C to +70C	25.4 x 25.4 x 12.7
XOC9001	100	12	+/-300 ppb	+/-50 ppb	-20C to +70C	25.4 x 25.4 x 12.7
XOC9002	125	12	+/-300 ppb	+/-50 ppb	-20C to +70C	25.4 x 25.4 x 12.7
XOC9003	10	3	+/-500 ppb	+/-20 ppb	-40C to +85C	9.7 x 7.5 x 4.1
XOC9003-1	10		+/-500 ppb	+/-20 ppb	-40C to +85C	9.7 x 7.5 x 4.1
XOC9004	20	3	+/-500 ppb	+/-20 ppb	-40C to +85C	9.7 x 7.5 x 4.1
XOC9005	25	3.3	+/-500 ppb	+/-20 ppb	-40C to +85C	9.7 x 7.5 x 4.1
XOC9006	10	3.3	+/-500 ppb	+/-5 ppb	-40C to +85C	25.4 x 22.1 x 11
XOC9007	20	3.3	+/-500 ppb	+/-5 ppb	-40C to +85C	25.4 x 22.1 x 11
XOC9008	31	3.3	+/-500 ppb	+/-5 ppb	-40C to +85C	25.4 x 22.1 x 11
XOC9009	13	3.3	+/-200 ppb	+/-30 ppb	-40C to +85C	14.3 x 9.3 x 6.5
XOC9010	25	3.3	+/-200 ppb	+/-30 ppb	-40C to +85C	14.3 x 9.3 x 6.5
XOC9011	30.7	3.3	+/-200 ppb	+/-30 ppb	-40C to +85C	14.3 x 9.3 x 6.5

## 315 MHz Range BCM RKE SAW

Part No.	F0 (MHz)	IL (dB)	BW (MHz)	Size (mm)
RF3624D	314.45	2.7	1.06	3.8 x 3.8
SF2443H	314.45	2	1.3	2.0 x 1.6
SF2248E-1	314.45	2.5	1.3	3.0 x 3.0
SF2248D	314.45	2.5	1.3	3.8 x 3.8
SF2323E	314.67	2.7	1.1	3.0 x 3.0
SAFCC314MSM0T33R12	314.85	3	1.9	3.0 x 3.0
RF3417E-1	314.90	2.5	0.525	3.0 x 3.0
RF3417D	315.00	2.5	0.5	3.8 x 3.8
RF3417E	315.00	2.5	0.525	3.0 x 3.0
SF2248E	315.00	2.5	0.6	3.0 x 3.0
RF1417D	315.00	2.5	0.5	3.8 x 3.8
RF1402D	315.00	3.7	1	3.8 x 3.8
SAFBC315MSP0T00	315.00	3	1	3.0 x 3.0
RF1211D	315.00	2.5	0.5	3.8 x 3.8
RF1211C	315.00	5	0.8	5.0 x 5.0
RF1439E	315.00	2.5	0.85	3.0 x 3.0
SAFDC315MSP0T95R12	315.00	2.5	1	3.0 x 3.0
SAFDC315MSM0T33R12	315.00	3	0.6	3.0 x 3.0
RF3626E	315.00	3	0.77	3.0 x 3.0
RF3626D	315.00	3	1.06	3.8 x 3.8
RF1415D	315.00	3.5	0.8	3.8 x 3.8

## 433.92 MHz Range BCM/RKE SAW Filters

Part No.	F0 (MHz)	IL (dB)	BW (MHz)	Size (mm)
RF3391D	433.42	3.5	0.5	3.8 x 3.8
RF1391C	433.42	5	1.26	5.0 x 5.0
RF1391C-1	433.42	5	0.5	5.0 x 5.0
SF2439D	433.50	4	3	3.8 x 3.8
SAFDC433MPE5X32R12	433.58	2.6	0.65	3.0 x 3.0
SAFBC433MPB0X00	433.92	2.7	433.0	3.0 x 3.0
SAFDC433MPB0X90R12	433.92	2.7	0.3	3.0 x 3.0
SAFBC433MPB0X00R12	433.92	2.7	0.3	3.0 x 3.0
SAFBC433MSP0T11R12	433.92	2.8	1	3.0 x 3.0
RF3404E	433.92	3.5	0.6	3.0 x 3.0

## 433.92 MHz Range BCM/RKE SAW Filters

Part No.	F0 (MHz)	IL (dB)	BW (MHz)	Size (mm)
RF3404D	433.92	2.5	0.5	3.8 x 3.8
RF1404D	433.92	2.5	0.5	3.8 x 3.8
RF1404C	433.92	4	0.65	5.0 x 5.0
RF3446E	433.92	3	0.96	3.0 x 3.0
RF1400D	433.92	3	1	3.8 x 3.8
RF3709E	433.92	2.9	1.07	3.0 x 3.0
SF2444H	433.92	2	1.3	2.0 x 1.6
SF2176E-1	433.92	3.5	1.6	3.0 x 3.0
SF2176E	433.92	3.5	1.6	3.0 x 3.0
SF2136E	433.92	3.3	1.74	3.0 x 3.0
RF3709D	433.92	3.5	1.1	3.8 x 3.8
RF1172C	433.92	5	0.5	5.0 x 5.0
RF1401D	433.92	3.8	1	3.8 x 3.8
SAFDC434MPE3X32R12	434.30	3.3	0.2	3.0 x 3.0
RF1396C	434.42	5	0.5	5.0 x 5.0
RF3625E	434.42	2.9	1.2	3.0 x 3.0
RF3396E	434.42	2.5	0.85	3.0 x 3.0
RF3396D	434.42	2.5	0.85	3.8 x 3.8

## DR Filters

Part No.	Frequency (MHz)	Max IL (dB)	BW (MHz)	Size (mm)
CDR5000	5825.000	1.5	200	8.6 x 3.35 x 2.9
CDR5001	5887.500	2.5	75	8.6 x 3.2 x 3.0

## IF & Other SAW Filters

Part No.	F0 (MHz)	BW (MHz)	IL (dB)	Size (mm)	Comments
SF2039B	72.540	3.70	12.50	7.0 x 5.0	SDARS
SF2039B-2	72.540	3.70	12.50	7.0 x 5.0	SDARS
SF2039B-3	72.540	3.70	12.50	7.0 x 5.0	SDARS
SF1140B	75.000	4.20	13.00	7.0 x 5.0	SDARS
SF1140B-2	75.000	4.20	13.00	7.0 x 5.0	SDARS
SF1141B	75.000	12.70	16.00	7.0 x 5.0	SDARS
SF1141B-2	75.000	12.70	16.00	7.0 x 5.0	SDARS

## IF & Other SAW Filters

Part No.	F0 (MHz)	BW (MHz)	IL (dB)	Size (mm)	Comments
SF1141B-4	75.000	12.70	16.00	7.0 x 5.0	SDARS
SF2037C	76.000	3.80	12.00	5.0 x 5.0	SDARS
SF2038C	76.000	12.50	12.00	5.0 x 5.0	SDARS
SF2037B	76.500	3.80	12.00	7.0 x 5.0	SDARS
SF2037B-2	76.500	3.80	12.50	7.0 x 5.0	SDARS
SF2037B-3	76.500	3.80	12.00	7.0 x 5.0	SDARS
SF2038B	76.500	12.50	12.00	7.0 x 5.0	SDARS
SF2038B-2	76.500	12.50	12.00	7.0 x 5.0	SDARS
SF2038B-3	76.500	12.50	12.00	7.0 x 5.0	SDARS
SF2040B	80.460	3.70	12.00	7.0 x 5.0	SDARS
SF2040B-2	80.460	3.70	12.00	7.0 x 5.0	SDARS
SF2040B-3	80.460	3.70	12.00	7.0 x 5.0	SDARS
SF2026B	114.815	6.30	15.00	7.0 x 5.0	SDARS
SF2060B	115.000	12.50	16.20	5.0 x 7.0	SDARS
SF2060B-1	115.000	12.50	16.20	5.0 x 7.0	SDARS
SF2138B-1	144.000	12.50	16.50	7.0 x 5.1	SDARS
SF2025B	259.861	12.71	15.50	7.0 x 5.0	SDARS
SF1142B	315.000	4.20	14.00	7.0 x 5.0	SDARS
SF1143B	315.000	12.70	17.00	7.0 x 5.0	SDARS
SF2516LA	2332.500	25	7.00	1.1 x 0.9	SDARS
SF2526L-1	2332.500	25.00	8.00	1.1 x 0.9	SDARS
SF2698E	2345.000	50.00	4.00	3.0 x 3.0	SDARS

## ISM Band SAW Diplexers

Part No.	F0 (MHz)	IL (dB)	BW (MHz)	Size (mm)
SF2281D	313.15/314	4.5	0.2	3.8 x 3.8
SF2283D	433.2/434.6	5.8	0.2	3.8 x 3.8

## LTCC Filters

Part No.	Frequency (MHz)	Max IL (dB)	BW (MHz)	Size (mm)
CF1019-A	5788.000	3.2	125	2.5 x 2.0
CF1020	5787.500	3.2	75	2.5 x 2.0

## SAW Filters & Diplexers for GNSS Bands

Part No.	Frequency (MHz)	Max IL (dB)	BW (MHz)	Size (mm)	Bands
SF2474H	1176	3.3	40	2.0 x 1.6	L5 + E5a
SF2388E	1176.45	4.3	20	3.0 x 3.0	L5 + E5a
SF2689L	1176.45	2.0	20	1.1 x 0.9	L5 + E5a
SF2430E	1189	6	48	3.0 x 3.0	L5 + B2 + G3 + E5
SF2504L	1189	2.5	50	1.1 x 0.9	L5 + B2 + G3 + E5
SF2211E	1200	4	40	3.0 x 3.0	G3
SF2522K	1202	4	72	1.4 x 1.1	L2 + L5 + B2 + G3 + E5
SF2522KM	1202	4	72	1.4 x 1.1	L2 + L5 + B2 + G3 + E5
SF2426E	1214.5	4.5	47	3.0 x 3.0	L2 + G3
SF2429E	1214.5	4.5	47	3.0 x 3.0	L2 + G3
SF2166E	1218	4.5	40	3.0 x 3.0	B3 + E6
SF2434E	1222.5	5	54	3.0 x 3.0	E5b + L2 + G2
SF2434E-1	1223	3.5	54	3.0 x 3.0	E5b + L2 + G2
SF2644L	1223	2.8	52	1.1 x 0.9	L2 + G2
SF2395E	1224	5.5	108	3.0 x 3.0	L5 + E5 + L2 + G2
SF2395H	1224	3.3	52	2.0 x 1.6	L2 + G2
SF2208E	1227	1.3	20	3.0 x 3.0	L2
SF2427H	1227.6	2.5	20	2.0 x 1.6	L2
SF2193E	1228	4.7	20	3.0 x 3.0	L2
SF2428E	1234.5	4	40	3.0 x 3.0	L2 + G2
SF2460H	1254.15	5.2	68.7	2.0 x 1.6	L2 + E6
SF2186E	1268.52	3.2	20.46	3.0 x 3.0	B3
SF2275E-1	1542	3	34	3.0 x 3.0	L band EU
SF2275E	1542.5	4.2	35	3.0 x 3.0	L band EU
SF2442E-1	1565.5	3.7	81	3.0 x 3.0	L-band + L1 + G1
SF2680H	1565.5	31.0	5	2.0 x 1.6	E1 + L1
SF2393E	1570	4.2	80	3.0 x 3.0	SAR + L1 + B1 + E1 + G1
SF1186K-5	1575.42	1.6	2	1.4 x 1.1	L1
SF1186G-2	1575.42	1.9	2	2.5 x 2.0	L1
SF1186E-1	1575.42	4	2	3.0 x 3.0	L1
SF1186B-2	1575.42	3.5	2	3.0 x 3.0	L1
SF1186E-2	1575.42	3.5	2	3.0 x 3.0	L1
SF1186G	1575.42	2.2	2	2.5 x 2.0	L1
SF1186H	1575.42	2.2	2	2.0 x 1.6	L1
SF1186H-2	1575.42	1.6	2	2.0 x 1.6	L1
SF1186H-3	1575.42	1.8	2	2.0 x 1.6	L1
SF1186K-2	1575.42	1.7	2	1.4 x 1.1	L1

## SAW Filters & Diplexers for GNSS Bands (cont.)

Part No.	Frequency (MHz)	Max IL (dB)	BW (MHz)	Size (mm)	Bands
SF1186K-3	1575.42	1.5	2	1.4 x 1.1	L1
SF1186B-3	1575.42	3.5	10	3.0 x 3.0	L1
SF2353E	1582.4	2	46.61	3.0 x 3.0	L1 + B1 + E1 + G1
SF2463H	1582.4	2	46.7	2.0 x 1.6	L1 + B1 + E1 + G1
SF2508LA	1582.469	2.8	46.834	1.1 x 0.9	L1 + B1 + E1 + G1
SF2510L	1582.47	2.5	46.84	1.1 x 0.9	L1 + B1 + E1 + G1
SF2666LA	1582.47	1.3	46.84	1.1 x 0.9	L1 + B1 + E1 + G1
SF2510LM	1582.47	2.5	46.84	1.1 x 0.9	L1 + B1 + E1 + G1
SF2461E	1582.5/1189	6.5	47/50	3.0 x 3.0	L1, L5
SF2462E	1582.5/1223	4.8/5.0	47/52	3.0 x 3.0	L1, L3
SF2316E-3	1583	3	46	3.0 x 3.0	L1 + B1 + E1 + G1
SF2316H	1583	2.1	46.79	2.0 x 1.6	L1 + B1 + E1 + G1
SF2324K-3	1583	2.1	46.79	1.4 x 1.1	L1 + B1 + E1 + G1
SF2481E	1583	2	57 notch	3.0 x 3.0	L1 + B1 + E1 + G1
SF2541LM	1585.653	2.1	40.47	1.1 x 0.9	L1 + G1
SF2540L	1585.655	1.7	40.47	1.1 x 0.9	L1 + G1
SF2540LM	1585.655	2	40.466	1.1 x 0.9	L1 + G1
SF2165E	1586.36	4.5	40	3.0 x 3.0	L1 + G1
SF2385H	1587.5	2.5	57	2.0 x 1.6	L1 + B1 + E1 + G1
SF2297K	1588.655	2.5	34.47	1.4 x 1.1	L1 + G1
SF2316E	1588.655	2.5	35	3.0 x 3.0	L1 + G1
SF2316E-1	1588.655	2.5	34.47	3.0 x 3.0	L1 + G1
SF2316H-1	1588.655	2.7	34.47	2.0 x 1.6	L1 + G1
SF2316K	1588.655	2.5	34.47	1.4 x 1.1	L1 + G1
SF2316K-1	1588.655	2.5	34.47	1.4 x 1.1	L1 + G1
SAFBC1G-58KA0F36R12	1589.5025	2.5	32.25	3.0 x 3.0	L1 + G1
SF2252E	1590	4	59	3.0 x 3.0	L1 + B1 + E1 + G1
SF2217K	1591	3.5	35	1.4 x 1.1	L1 + G1
SF2265E	1592	3.2	36	3.0 x 3.0	L1 + G1
SF2251E	1600	5	40	3.0 x 3.0	L1 + G1
SF2249E	1602	4	11	3.0 x 3.0	G1
SF2216K	1603	4	12	1.4 x 1.1	G1
SF2250E	1615	4.6	20	3.0 x 3.0	L Band
SF2250E-1	1615	4.6	20	3.0 x 3.0	L Band
SF2191E	1620.75	2.8	11.5	3.0 x 3.0	L Band

## SAW Notch Filters

Part No.	Notch F0 (MHz)	Notch BW (MHz)	Notch Rejection (dB)	Passband IL (dB)	Package
SF2481E	1583	57	14	3	SM3030-8
SF2511K	2332.5	25	25	3.5	SM1411-5

## SAW Resonators

Part No.	F0 (MHz)	Max IL (MHz)	F0 Tolerance (+/- KHz)	Passband IL (dB)
RO2131D	314.37	2.5	50	3.8 x 3.8
SARCC314M37BXL1R05	314.37	2.2	50	3.0 x 3.0
SARCC314M99BXL4R12	314.995	2.2	50	3.0 x 3.0
RO3073A	315	2.2	75	5.0 x 3.5
RO3073A-6	315	2.2	50	5.0 x 3.5
RO3073E-1	315	2.4	50	3.0 x 3.0
SARCC315M00BXP4R12	315	2.2	100	3.0 x 3.0
SARBC315M00BXL0R12	315	2.2	50	3.0 x 3.0
RO3073A-14	315	2.2	100	5.0 x 3.5
RO3073E	315	2.4	75	3.0 x 3.0
RO3073E-11	315	2.4	75	3.0 x 3.0
RO3073E-14	315	2.4	100	3.0 x 3.0
RO3073D	315	2.5	75	3.8 x 3.8
RO3073A-1	315	2.2	50	5.0 x 3.5
RO3073A-11	315	2.2	75	5.0 x 3.5
RO3073A-10	315.05	2.2	75	5.0 x 3.5
RO3073A-4	315.05	2.2	75	5.0 x 3.5
RO3073A-16	315.05	2.2	80	5.0 x 3.5
RO3208A	315.5	2.4	75	5.0 x 3.5
RO3112A	433.42	1.6	75	5.0 x 3.5
RO3112C	433.42	1.5	75	5.0 x 5.0
RO3112E	433.42	2.5	75	3.0 x 3.0
RO3112D	433.42	2.5	75	3.8 x 3.8
RO3101E-4	433.86	2.2	75	3.0 x 3.0
RO3101A	433.92	2.2	75	5.0 x 3.5
RO3101C-11	433.92	2.5	75	5.0 x 5.0
RO3101C-1	433.92	2.5	50	5.0 x 5.0
RO3101A-1	433.92	2.2	50	5.0 x 3.5

## SAW Resonators (cont.)

Part No.	F0 (MHz)	Max IL (MHz)	F0 Tolerance (+/- KHz)	Passband IL (dB)
RO3101A-2	433.92	2.2	30	5.0 x 3.5
RO3101E	433.92	2.2	75	3.0 x 3.0
RO3101E-1	433.92	2.2	50	3.0 x 3.0
RO3101E-11	433.92	2.2	75	3.0 x 3.0
RO3101E-14	433.92	2.2	100	3.0 x 3.0
SARBC433M92BXL0R12	433.92	2.5	50	3.0 x 3.0
RO3101A-12	433.92	1.7	50	5.0 x 3.5
RO3101A-11	433.92	2.2	75	5.0 x 3.5
RO3101E-20	433.92	2.2	75	3.0 x 3.0
RO3101A-14	433.92	2.2	100	5.0 x 3.5
RO3101D	433.92	2.5	75	3.8 x 3.8
RO3101D-1	433.92	2.5	50	3.8 x 3.8
RO3101A-20	433.92	2.2	75	5.0 x 3.5
RO3101C	433.92	2.5	75	5.0 x 5.0
SARCC433M93BXL4R05	433.935	2.5	50	3.0 x 3.0
SARBC433M95BXL0R12	433.95	2.5	50	3.0 x 3.0
RO3023A-1	433.97	4	50	5.0 x 3.5
RO3303E	434.15	2.2	50	3.0 x 3.0
SARCC434M29BXL1R12	434.29	2.5	50	3.0 x 3.0

## XTC-TCXO Series (AEC-Q200)

XTC Series	Frequency Range	Tol/Spec as received	Tol/Spec over temperature	Size (mm)
XTC-G-SERIES-2520	10.000-52.000 MHz	+/-0.5 to +/-1.0ppm @25C+/-3C	+/-0.5 to +/-5.0ppm @-40C to +85C,+105C,+125C	2.5 x 2.0
XTC-H-SERIES-2016	10.000-52.000 MHz	+/-0.5 to +/-1.0ppm @25C+/-3C	+/-0.5 to +/-5.0ppm @-40C to +85C,+105C,+125C	2.0 x 1.6
XTC-P-SERIES-3225	10.000-60.000 MHz	+/-0.5 to +/-1.0ppm @25C+/-3C	+/-0.5 to +/-5.0ppm @-40C to +85C,+105C,+125C	3.2 x 2.5



## XVT-VCTCXO (AEC-Q200)

XTC Series	Frequency Range	Tol/Spec as received	Tol/Spec over temperature	Size (mm)
XVT-G-SERIES-2520	10.000-52.000 MHz	+/-0.5 to +/-1.0ppm @25C+/-3C	+/-0.5 to +/-5.0ppm @-40C to +85C,+105C,+125C	2.5 x 2.0
XVT-H-SERIES-2016	10.000-52.000 MHz	+/-0.5 to +/-1.0ppm @25C+/-3C	+/-0.5 to +/-5.0ppm @-40C to +85C,+105C,+125C	2.0 x 1.6
XVT-P-SERIES-3225	10.000-60.000 MHz	+/-0.5 to +/-1.0ppm @25C+/-3C	+/-0.5 to +/-5.0ppm @-40C to +85C,+105C,+125C	3.2 x 2.5

## 470-519 MHz (China LoRa Band) SAW Filters

Part No.	F0 (MHz)	IL (dB)	BW (MHz)	Size (mm)
SF2432D	475.00	10	3.2	3.8 x 3.8
SF2423D	480.00	20	3	3.8 x 3.8
SF2437D	480.00	20	3.5	3.8 x 3.8
SF2421D	485.00	10	4	3.8 x 3.8
SF2416D	490.00	20	4	3.8 x 3.8
SF2419D	495.00	10	3.5	3.8 x 3.8
SF2419E	495.00	10	3.5	3.0 x 3.0
SF2433D	500.00	20	2.8	3.8 x 3.8
SF2424D	505.00	10	4.1	3.8 x 3.8
SF2431D	505.00	10	3.2	3.8 x 3.8
SF2438D	509.00	18	3	3.8 x 3.8
SF2237D	515.00	8	3.5	3.8 x 3.8

## 800 MHz Range ISM Band SAW Filters

Part No.	F0 (MHz)	IL (dB)	BW (MHz)	Size (mm)
SF2411E	862.00	2	16	3.0 x 3.0
SF2660E	864.00	3.7	1	3.0 x 3.0
SF2314E	866.50	3	7	3.0 x 3.0
SF2413E	866.50	3.8	7	3.0 x 3.0
SF2520K	866.50	3	7	1.4 x 1.1
SF2389E	868.30	4.2	1.5	3.0 x 3.0
SF2364C	868.30	4.2	1.5	5.0 x 5.0
SF2364E	868.30	4.2	0.78	3.0 x 3.0
RF3336C	868.35	4	0.5	5.0 x 5.0
RF3336E	868.35	4	0.5	3.0 x 3.0
RF3336D	868.35	4	0.5	3.8 x 3.8
SF2425E	868.60	3.5	1.3	3.0 x 3.0
RF1407D	868.60	4.2	1.2	3.8 x 3.8
RF3319D	868.95	4	0.5	3.8 x 3.8
RF3319E	868.95	4	0.8	3.0 x 3.0
SF2479E	869.00	3.5	14	3.0 x 3.0
SF2137E	869.00	4	2	3.0 x 3.0
SF2137D	869.00	4	2	3.8 x 3.8

## 800 MHz Range ISM Band SAW Filters (cont.)

Part No.	F0 (MHz)	IL (dB)	BW (MHz)	Size (mm)
SF2415E	869.00	3.7	2	3.0 x 3.0
SF2422E	869.00	3.5	2	3.0 x 3.0
SF2137E-1	869.00	3.5	2	3.0 x 3.0
SF2415E-1	869.00	4.5	2	3.0 x 3.0
SF2137E-2	869.00	3	2	3.0 x 3.0
SF2631K	869.00	3	2	1.4 x 1.1
SF2280D	869.21	3	0.025	3.8 x 3.8
SF2280E	869.21	4	0.19	3.0 x 3.0
SF2370H	869.23	5	1.85	2.0 x 1.6
SF2371E	869.23	3.4	1.85	3.0 x 3.0
SF2371H	869.23	3.4	1.85	2.0 x 1.6
RF1411D	869.26	4.5	0.7	3.8 x 3.8
SF2380E	869.50	3.5	13	3.0 x 3.0
SF2380E	869.50	3.5	13	3.0 x 3.0
SF2390E	869.60	3.4	2	3.0 x 3.0
RF1385D	869.85	8	0.6	3.8 x 3.8

## 900 MHz Range ISM Band SAW Filters

Part No.	F0 (MHz)	IL (dB)	BW (MHz)	Size (mm)
SF2441H	908.42	4	19	2.0 x 1.6
SF2150E	915.00	3.7	10	3.0 x 3.0
SF2053E	915.00	5	12.5	3.0 x 3.0
SF2049E	915.00	3.5	26	3.0 x 3.0
SF2049E-1	915.00	3.5	26	3.0 x 3.0
SF2093E	915.00	3.5	26	3.0 x 3.0
SF2098E	915.00	4	26	3.0 x 3.0
SF2521K	915.00	2.5	26	1.4 x 1.1
RF2040E	915.00	3	26	3.0 x 3.0
SF2098H	915.00	3	26	2.0 x 1.6
SF2687L	915.00	4	26	1.1 x 0.9
SF2201E	916.45	3.5	4	3.0 x 3.0
RF3181E	916.50	4	0.75	3.0 x 3.0
SF2328H	918.00	3.5	6	2.0 x 1.6
SF2382H	920.60	2	1.8	2.0 x 1.6

## 900 MHz Range ISM Band SAW Filters (cont.)

Part No.	F0 (MHz)	IL (dB)	BW (MHz)	Size (mm)
SF2259H	921.50	3	13	2.0 x 1.6
SF2294E	922.50	4.2	5	3.0 x 3.0
SF2346H	924.38	3	6.9	2.0 x 1.6
SF2412E	925.00	3.8	10	3.0 x 3.0
SF2378E	925.20	3.5	5.8	3.0 x 3.0

## 915 MHz DR Filters (High Power Handling)

Part No.	F0 (MHz)	IL (dB)	BW (MHz)	Size (mm)
CDR7000	915.00	26	2.5	11.4 x 8.95 x 4.33
CDR7001	915.00	26	2.5	8.2 x 7.05 x 2.9

## LTCC Filters

Part No.	Frequency (MHz)	Max IL (dB)	BW (MHz)	Size (mm)
CF1022	868.500	Low pass	91	2.5 x 1.0
CF1021	915.000	Low pass	26	2.0 x 1.25

## SAW Notch Filters

Part No.	Notch F0 (MHz)	Notch BW (MHz)	Notch Rejection (MHz)	Passband (mm)	Package
SF2379E	742	27	15	5	SM3030-6
SF2485E	868	2	20	6	SM3030-8
SF2472E	869	2	20	2.5	SM3030-6
SF2471E	915	12	14	2.5	SM3030-6
SF2489E	916.5	3.5	25	2.5	SM3038-8

## SAW Resonators

Part No.	F0 (MHz)	Max IL (dB)	F0 Tolerance (+/- KHz)	Size (mm)
RO3104E	303.825	2	75	3.0 x 3.0
RO3104C	303.825	2	75	5.0 x 5.0
RO3104E-1	303.825	2	50	3.0 x 3.0
RO3104D	303.825	2	75	3.8 x 3.8
RO3104D-1	303.825	2	50	3.8 x 3.8
RO3104A	303.825	2	75	5.0 x 3.5
RO3104A-1	303.825	2	50	5.0 x 3.5
RO3104C-1	303.825	2	50	5.0 x 5.0
RO3150E	304	2	75	3.0 x 3.0
SARBC304M30BXL0R12	304.3	2.2	50	3.0 x 3.0
RO3132A	312	2.2	75	5.0 x 3.5
RO3118E	318	2.2	75	3.0 x 3.0
RO3118E-1	318	2.2	50	3.0 x 3.0
RO3118D	318	2	75	3.8 x 3.8
RO3118A	318	2	75	5.0 x 3.5
RO3118A-1	318	2	50	5.0 x 3.5
RO3316E	319.508	2	75	3.0 x 3.0
RO3075E	345	2.2	100	3.0 x 3.0
RO3075E-1	345	2.2	50	3.0 x 3.0
RO3103A	418	2	75	5.0 x 3.5
RO3103D	418	2	75	3.8 x 3.8
RO3103E	418	2	75	3.0 x 3.0
RO3103A-1	418	2	50	5.0 x 3.5
RO3164E	868.35	2	200	3.0 x 3.0
RO3164E-3	868.35	2	75	3.0 x 3.0
RO3164E-2	868.35	2	100	3.0 x 3.0
RO3164D-2	868.35	2	100	3.8 x 3.8
RO3164A-1	868.35	2	150	5.0 x 3.5
RO3164E-1	868.35	2	150	3.0 x 3.0
RO3164D	868.35	2	200	3.8 x 3.8
RO3164D-1	868.35	2	150	3.8 x 3.8
RO3164A	868.35	2	200	5.0 x 3.5
RO3164C	868.35	2.5	200	5.0 x 5.0
RO3156E-3	868.95	2	70	3.0 x 3.0
RO3156E	868.95	2	200	3.0 x 3.0

## SAW Resonators (cont.)

Part No.	F0 (MHz)	Max IL (dB)	F0 Tolerance (+/- KHz)	Size (mm)
RO3156E-1	868.95	2	150	3.0 x 3.0
RO3156E-2	868.95	2	100	3.0 x 3.0
RO3156D	868.95	2.5	200	3.8 x 3.8
RO3156D-1	868.95	2.5	150	3.8 x 3.8
RO3156D-2	868.95	2.5	100	3.8 x 3.8
RO3156A	868.95	2	200	5.0 x 3.5
RO3156A-1	868.95	2	150	5.0 x 3.5
RO3156A-2	868.95	2	100	5.0 x 3.5
RO4102E	915.00	9	250	3.0 x 3.0
RO3144D	916.5	2.5	200	3.8 x 3.8
RO3144D-2	916.5	2.5	100	3.8 x 3.8
RO3144D-1	916.5	2.5	150	3.8 x 3.8
RO3144E-1	916.5	1.6	150	3.0 x 3.0
RO3144E-2	916.5	1.6	100	3.0 x 3.0
RO3144E-3	916.65	1.6	100	3.0 x 3.0
RO3144E	916.5	1.6	200	3.0 x 3.0
RO3144A-2	916.5	2.5	100	5.0 x 3.5
RO3144A	916.5	2.5	200	5.0 x 3.5
RO3144A-1	916.5	2.5	150	5.0 x 3.5
RO3156A-3	868.95	2	75	5.0 x 3.5
RO3320E	1500	4	50	3.0 x 3.0

## Sub-500 MHz ISM Band SAW Filters

Part No.	F0 (MHz)	IL (dB)	BW (MHz)	Size (mm)
SF2247C	169.00	2.8	6	5.0 x 5.0
SF2507C	169.40	3	0.5	5.0 x 5.0
SF2678E	169.40	3	0.5	3.0 x 3.0
SF2367B	169.44	4.5	0.08	5.0 x 7.0
SF2365C	169.44	6	0.075	5.0 x 5.0
RF3624D	314.45	2.7	1.06	3.8 x 3.8
SF2443H	314.45	2	1.3	2.0 x 1.6
SF2248E-1	314.45	2.5	1.3	3.0 x 3.0
SF2248D	314.45	2.5	1.3	3.8 x 3.8

## Sub-500 MHz ISM Band SAW Filters (cont.)

Part No.	F0 (MHz)	IL (dB)	BW (MHz)	Size (mm)
SF2323E	314.67	2.7	1.1	3.0 x 3.0
SAFCC314MSM0T33R12	314.85	3	1.9	3.0 x 3.0
RF3417E-1	314.90	2.5	0.525	3.0 x 3.0
RF3417D	315.00	2.5	0.5	3.8 x 3.8
RF3417E	315.00	2.5	0.525	3.0 x 3.0
SF2248E	315.00	2.5	0.6	3.0 x 3.0
RF1417D	315.00	2.5	0.5	3.8 x 3.8
RF1402D	315.00	3.7	1	3.8 x 3.8
SAFBC315MSP0T00	315.00	3	1	3.0 x 3.0
RF1211D	315.00	2.5	0.5	3.8 x 3.8
RF1211C	315.00	5	0.8	5.0 x 5.0
RF1439E	315.00	2.5	0.85	3.0 x 3.0
SAFDC315MSP0T95R12	315.00	2.5	1	3.0 x 3.0
SAFDC315MSM0T33R12	315.00	3	0.6	3.0 x 3.0
RF3626E	315.00	3	0.77	3.0 x 3.0
RF3626D	315.00	3	1.06	3.8 x 3.8
RF1415D	315.00	3.5	0.8	3.8 x 3.8
RF3391D	433.42	3.5	0.5	3.8 x 3.8
RF1391C	433.42	5	1.26	5.0 x 5.0
RF1391C-1	433.42	5	0.5	5.0 x 5.0
SF2439D	433.50	4	3	3.8 x 3.8
SAFDC433MPE5X32R12	433.58	2.6	0.65	3.0 x 3.0
SAFBC433MPB0X00	433.92	2.7	0.3	3.0 x 3.0
SAFDC433MPB0X90R12	433.92	2.7	0.3	3.0 x 3.0
SAFBC433MPB0X00R12	433.92	2.7	0.3	3.0 x 3.0
SAFBC433MSP0T11R12	433.92	2.8	1	3.0 x 3.0
RF3404E	433.92	3.5	0.6	3.0 x 3.0
RF1404D	433.92	2.5	0.5	3.8 x 3.8
RF3404D	433.92	2.5	0.5	3.8 x 3.8
RF3446E	433.92	3	0.96	3.0 x 3.0
RF1404C	433.92	4	0.65	5.0 x 5.0
RF1400D	433.92	3	1	3.8 x 3.8
RF3709E	433.92	2.9	1.07	3.0 x 3.0
SF2444H	433.92	2	1.3	2.0 x 1.6
SF2176E-1	433.92	3.5	1.6	3.0 x 3.0
SF2176E	433.92	3.5	1.6	3.0 x 3.0

## Sub-500 MHz ISM Band SAW Filters (cont.)

Part No.	F0 (MHz)	IL (dB)	BW (MHz)	Size (mm)
SF2136E	433.92	3.3	1.74	3.0 x 3.0
RF3709D	433.92	3.5	1.1	3.8 x 3.8
RF1172C	433.92	5	0.5	5.0 x 5.0
RF1401D	433.92	3.8	1	3.8 x 3.8
SAFDC434MPE3X32R12	434.30	3.3	0.2	3.0 x 3.0
RF1396C	434.42	5	0.5	5.0 x 5.0
RF3625E	434.42	2.9	1.2	3.0 x 3.0
RF3396E	434.42	2.5	0.85	3.0 x 3.0
RF3396D	434.42	2.5	0.85	3.8 x 3.8





## BAW Filters

Part No.	Description	Center Freq. (MHz)	BW (MHz)	IL (dB)	Size (mm)
AKF-1938	3.83 GHz Bandpass BAW Filter	3830	100	1.8	2.5 x 2.0 x 0.8
AKF-1950	5 GHz UAS BAW Filter	5060.5	150	2.0	2.5 x 2.0 x 0.8

## SAW Resonators

Part No.	F0 (MHz)	Max IL (dB)	F0 Tolerance (+/- KHz)	Size (mm)
RO3300E	403.55	2	75	3.0 x 3.0
RO3120C	403.55	2	75	5.0 x 5.0

## XTC-TCXO Series

XTC Series	Frequency Range	Tol/Spec as received	Tol/Spec over temperature	Size (mm)
XTC-G-SERIES-2520	10.000-52.000 MHz	+/-0.5 to +/-1.0ppm @25C+/-3C	+/-0.5 to +/-3.0ppm @-30C, -40C to +85C	2.5 x 2.0
XTC-H-SERIES-2016	10.000-52.000 MHz	+/-0.5 to +/-1.0ppm @25C+/-3C	+/-0.5 to +/-3.0ppm @-30C, -40C to +85C	2.0 x 1.6
XTC-P-SERIES-3225	10.000-60.000 MHz	+/-0.5 to +/-1.0ppm @25C+/-3C	+/-0.5 to +/-3.0ppm @-30C, -40C to +85C	3.2 x 2.5

## XTL-XTAL Series

XTL Series	Frequency Range	Tol/Spec over temperature	Size (mm)
XTL-G-SERIES-2520	16.000-80.000 MHz	+/-3 to +/-30ppm @25C+/-3C	2.5 x 2.0
XTL-H-SERIES-2016	16.000-96.000 MHz	+/-3 to +/-50ppm @25C+/-3C	2.0 x 1.6
XTL-J-SERIES-1612	24.000-96.000 MHz	+/-3 to +/-50ppm @25C+/-3C	1.6 x 1.2
XTL-P-SERIES-3225	16.000-80.000 MHz	+/-3 to +/-30ppm @25C+/-3C	3.2 x 2.5
XTL-Q-SERIES-1210	32.000-76.800 MHz	+/-3 to +/-50ppm @25C+/-3C	1.2 x 1.0

## XTS (Temperature Sensing Crystal Resonators)

Part No.	F0 (MHz)	Load Capacitance	F0 Tolerance @ +25C	F0 Stability vs. Temp	Temp. Range	Case Style/Size
XTS4200	26	7 pF	+/-10ppm	-12 to +/-10ppm	-30C to +105C	SM2520-4
XTS4201	26	8 pF	+/-10ppm	-30 to +40ppm	-40C to +105C	SM2016-4
XTS4202	38.4	7 pF	+/-10ppm	+/-12ppm	-30C to +85C	SM1612-4
XTS4203	26	7 pF	+/-10ppm	+/-16ppm	-40C to +85C	SM2016-4

## XVT-VCTCXO Series

XVT Series	Frequency Range	Tol/Spec as received	Tol/spec over temperature	Size (mm)
XVT-G-SERIES-2520	10.000-52.000 MHz	+/-0.5 to +/-1.0ppm @25C+/-3C	+/-0.5 to +/-3.0ppm @-30C, -40C to +85C	2.5 x 2.0
XVT-H-SERIES-2016	10.000-52.000 MHz	+/-0.5 to +/-1.0ppm @25C+/-3C	+/-0.5 to +/-3.0ppm@-30C, -40C to +85C	2.0 x 1.6
XVT-P-SERIES-3225	10.000-60.000 MHz	+/-0.5 to +/-1.0ppm @25C+/-3C	+/-0.5 to +/-3.0ppm@-30C, -40C to +85C	3.2 x 2.5

## TCXO (Temperature Compensated Crystal Oscillators)

Part No.	F0 (MHz)	Supply Voltage (V)	F0 Tolerance @ +25C	F0 Stability vs. Temp	Temp. Range	Case Style/ Size	AEC -Q200
XTC2011	32	3.3	+/-1.0ppm	+/-1.5ppm	-30C to +75C	SM2520-4	
XTC4000	38.4	2.8	+/-1.0ppm	+/-1.0ppm	-30C to +85C	SM2016-6	
XTC4001	38.4	1.8	+/-1.0ppm	+/-0.5ppm	-30C to +85C	SM1612-4	
XTC4002	49.152	3.3	+/-1.0ppm	+/-3.0ppm	-40C to +85C	SM7050-4	
XTC4003	30.72	3.3	+/-0.5ppm	+/-0.5ppm	-20C to +70C	SM5032-4	
XTC4004	32.768KHz	3.3	+/-1.5ppm	+/-5.0ppm	-40C to +85C	SM3225-4	
XTC4004P	32.768KHz	3.3	+/-1.5ppm	+/-5.0ppm	-40C to +85C	SM3225-4	
XTC4004P-1	32.768KHz	2-3.465	+/-3.0ppm	+/-5.0ppm	-40C to +85C	SM3225-4	
XTC4006	40	2.5		+/-2.5ppm	-40C to +105C	SM2520-4	
XTC4007	32	3.0	+/-1.0ppm	+/-1.0ppm	-40C to +85C	SM2016-6	
XTC4008.C	32	3.3	+/-1.0ppm	+/-2.0ppm	-30C to +85C	SM2520-4	
XTC4008	32	3.3	+/-1.0ppm	+/-2.0ppm	-30C to +85C	SM2520-4	
XTC4008-1.C	32.0	3	+/-1.0ppm	+/-1.0ppm	-40C to +85C	SM2520-4	
XTC4008-1	32	3	+/-1.0ppm	+/-1.0ppm	-40C to +85C	SM2520-4	
XTC4009	37	3	+/-1.0ppm	+/-2.5,+/-10.0ppm	-40C to +105C	SM2016-6	Yes
XTC4010	48.0	3.0	+/-2.0ppm	+/-2.5,+/-10.0ppm	-40C to +105C	SM2016-6	
XTC4010-1	48.0	3.0	+/-1.5ppm	+/-5.0ppm	-40C to +105C	SM2016-6	
XTC4011	37	3.3	+/-2.0ppm	+/-10.0ppm	-40C to +85C	SM1612-4	
XTC4012	38.40	3	+/-0.5ppm	+/-0.5ppm	-30C to +85C	SM2016-6	
XTC4013	50.00	3	+/-1.0ppm	+/-2.5ppm	-40C to +85C	SM2520-4	

## TCXO (Temperature Compensated Crystal Oscillators) (cont.)

Part No.	F0 (MHz)	Supply Voltage (V)	F0 Tolerance @ +25C	F0 Stability vs. Temp	Temp. Range	Case Style/ Size	AEC-Q200
XTC4014.C	31	3.0	+/-1.0ppm	+/-1.0ppm	-40C to +85C	SM2016-6	
XTC4014	31	3.0	+/-1.0ppm	+/-1.0ppm	-40C to +85C	SM2016-6	
XTC4015	52.0	2	+/-1.0ppm	+/-1.0ppm	-30C to +85C	SM2016-6	
XTC4016	30	3.6	+/-0.5ppm	+/-2.0ppm	-40C to +85C	SM2520-4	
XTC4017	31	3.0	+/-1.0ppm	+/-5.0ppm	-40C to +85C	SM2520-4	
XTC4018.C	26.0	2.8	+/-1.0ppm	+/-0.5ppm	-40C to +85C	SM2520-4	
XTC4018	26	3	+/-1.0ppm	+/-0.5ppm	-40C to +85C	SM2520-4	Yes
XTC4018G-1	26	1.7-3.3	+/-1.0ppm	+/-0.5ppm	-40C to +85C	SM2520-4	Yes
XTC4019	12.5	3.3	+/-1.0ppm	+/-2.0ppm	-40C to +85C	SM2520-4	
XTC4020	100.000	5	+/-1.0ppm	+/-1.0ppm	-20C to +70C	14x9	
XTC4021	20	3.30	+/-1.0ppm	+/-0.28ppm	-40C to +85C	SM7050-4	
XTC4022	32.768KHz	3.30	+/-1.5ppm	+/-5.0ppm	-40C to +85C	2.1x1.3	
XTC7006	26.0	3	+/-2.0ppm	+/-0.5ppm	-30C to +85C	SM3225-4	
XTC7006G	26.0	3	+/-2.0ppm	+/-0.5ppm	-30C to +85C	SM2520-4	Yes
XTC7006G-2	26.000000	3.00	+/-2.0ppm	+/-0.5,+/-2.5ppm	-40C to +85C	SM2520-4	Yes
XTC7006G-3	26.000000	2	+/-2.0ppm	+/-0.5,+/-2.5ppm	-40C to +85C	SM2520-4	Yes
XTC7006G-4	26.000000	3.30	+/-2.0ppm	+/-0.5,+/-2.5ppm	-40C to +85C	SM2520-4	Yes
XTC7006G-5	26.000	2.6	+/-2.0ppm	+/-0.5,+/-2.5ppm	-40C to +85C	SM2520-4	Yes
XTC7006G-5.C	26.000	2.59	+/-2.0ppm	+/-0.5,+/-2.5ppm	-40C to +85C	SM2520-4	
XTC7006H	26.000	3	+/-1.0ppm	+/-1.0ppm	-40C to +85C	SM2117-4	Yes
XTC7006H-1	26.000	2.8	+/-1.0ppm	+/-1.0ppm	-40C to +85C	SM2117-6	
XTC7008G	40.000	2.80	+/-1.0ppm	+/-1.0ppm	-10C to +55C	SM2520-4	Yes
XTC7009G	16	3	+/-2.0ppm	+/-0.5,+/-2.0ppm	-40C to +85C	SM2520-4	Yes
XTC7011	23	3	+/-2.0ppm	+/-0.5ppm	-30C to +85C	SM2520-4	Yes
XTC7012	38	1.8	+/-2.0ppm	+/-5.0ppm	-40C to +85C	SM3225-4	Yes
XTC7014B	19	3.30	+/-0.5ppm	+/-0.28ppm	-40C to +85C	SMP-03	Yes
XTC7015G	27	1.8	+/-2.0ppm	+/-0.5ppm	-30C to +85C	SM2520-4	Yes
XTC7018G	32	2.6	+/-1.0ppm	+/-1.0ppm	-10C to +55C	SM2520-4	Yes
XTC7023G	20	2.8	+/-2.0ppm	+/-2.0ppm	-30C to +85C	SM2520-4	Yes
XTC7024.C	24	3	+/-1.0ppm	+/-2.0ppm	-20C to +70C	SM3225-4	

## TCXO (Temperature Compensated Crystal Oscillators) (cont.)

Part No.	F0 (MHz)	Supply Voltage (V)	F0 Tolerance @ +25C	F0 Stability vs. Temp	Temp. Range	Case Style/ Size	AEC-Q200
XTC7024	24	3.0	+/-2.0ppm	+/-2.0ppm	-20C to +70C	SM3225-4	Yes
XTC7028G	32	3.3	+/-0.5ppm	+/-0.5ppm	-40C to +85C	SM2520-4	Yes
XTC7030G	32	3.30	+/-1.0ppm	+/-2.0ppm	-30C to +85C	SM2520-4	Yes
XTC7031	32	3.3	+/-1.0ppm	+/-2.5ppm	-30C to +85C	SM2016-4	Yes
XTC7032	100	3.3	+/-1.0ppm	+/-2.5ppm	-30C to +85C	SM3225-4	
XTC7033	24	3	+/-1.0ppm	+/-2.0ppm	-30C to +85C	SM2520-4	
XTC7034	25	3.3	+/-1.0ppm	+/-2.0ppm	-30C to +85C	SM2520-4	
XTC7035.C	32.768KHz	1.8	+/-1.5ppm	+/-5.0ppm	-40C to +85C	SM3225-4	
XTC7035	32.768KHz	1.8	+/-1.5ppm	+/-5.0ppm	-40C to +85C	SM3225-4	
XTC7036	26	2.7	+/-1.0ppm	+/-0.5ppm	-40C to +85C	SM2520-4	Yes
XTC7037.C	32.000	3.30	+/-1.0ppm	+/-1.0,+/-1.5ppm	-40C to +85C	SM3225-4	
XTC7037	32.000	3	+/-1.0ppm	+/-1.0,+/-1.5ppm	-30C to +85C	SM3225-4	
XTC7038.C	31.250	3.30	+/-2.0ppm	+/-1.0,+/-1.5ppm	-40C to +85C	SM3225-4	
XTC7038	31	3.3	+/-2.0ppm	+/-1.0,+/-1.5ppm	-40C to +85C	SM3225-4	
XTC7039	38.4000	2.6	+/-0.5ppm	+/-2.0ppm	-40C to +85C	SM2016-4	
XTC7040	38.40	3.1	+/-0.5ppm	+/-2.0ppm	-40C to +85C	SM2016-4	
XTC7041	38.40	3	+/-0.5ppm	+/-0.5ppm	-40C to +85C	SM2016-4	
XTC7042	26.00	2.7	+/-1.0ppm	+/-0.5ppm	-40C to +85C	SM2016-4	Yes
XTC7042-1	26.00	2.6	+/-1.0ppm	+/-0.5,+/-2.5,+/-10.0ppm	-40C to +105C	SM2016-4	Yes
XTC7043	48.00	2.7	+/-1.0ppm	+/-0.5,+/-3.0ppm	-40C to +85C	SM2016-4	Yes
XTC7044.C	38.40	3.3	+/-1.0ppm	+/-2.0ppm	-40C to +85C	SM2520-4	
XTC7044	38.40	3.3	+/-1.0ppm	+/-2.0ppm	-40C to +85C	SM2520-4	
XTC7045.C	24	3.0	+/-0.5ppm	+/-1.0ppm	-10C to +75C	SM2520-4	
XTC7045G	24.0000	3	+/-0.5ppm	+/-1.0ppm	-10C to +75C	SM2520-4	
XTC7046	48	3	+/-2.0ppm	+/-4.0ppm	-40C to +85C	SM2520-4	Yes
XTC7047	40	3.0	+/-1.0ppm	+/-1.0ppm	-30C to +85C	SM3225-4	
XTC7047-1	40	3.30	+/-1.0ppm	+/-1.0ppm	-30C to +85C	SM3225-4	
XTC7047.C	40	3	+/-1.0ppm	+/-1.0ppm	-30C to +85C	SM3225-4	
XTC7048	15	3	+/-1.0ppm	+/-0.5ppm	-20C to +75C	SM3225-4	

## TCXO (Temperature Compensated Crystal Oscillators) (cont.)

Part No.	F0 (MHz)	Supply Voltage (V)	F0 Tolerance @ +25C	F0 Stability vs. Temp	Temp. Range	Case Style/ Size	AEC-Q200
XTC7049	50.0	3	+/-2.0ppm	+/-0.28ppm	-40C to +85C	SM7050-10	
XTC7050H	38.400	1.8	+/-1.5ppm	+/-2.0ppm	-40C to +85C	SM2016-6	
XTC7051	80	3.3	+/-1.0ppm	+/-0.28ppm	-40C to +85C	14x9	
XTC7052H	39	1.7-3.7	+/-1.0ppm	+/-2.0ppm	-40C to +85C	SM2016-6	
XTC7053H	26	1.8-3.6	+/-1.0ppm	+/-2.0ppm	-40C to +85C	SM2016-6	
XTC7054G	40	3	+/-1.0ppm	+/-2.0ppm	-40C to +85C	SM2520-4	
XTC7055P	36	3	+/-1.0ppm	+/-2.0ppm	-30C to +85C	SM3225-4	
XTC7056G	38.4	3.3	+/-1.0ppm	+/-2.0ppm	-40C to +85C	SM2520-4	
XTC7057H	40	3.30	+/-1.0ppm	+/-2.0ppm	-40C to +85C	SM2016-6	
XTC7058G	12	3.3	+/-1.0ppm	+/-2.5ppm	-40C to +85C	SM2520-4	
XTC7059H	16	2.8	+/-1.0ppm	+/-2.0ppm	-30C to +85C	SM2016-6	Yes
XTC7060Q	16	3.3	+/-1.0ppm	+/-2.5ppm	-40C to +85C	SM5032-4	
XTC7061P	39	3.3	+/-0.5ppm	+/-2.0ppm	-40C to +85C	SM3225-4	
XTC7062H	32	3.3	+/-1.0ppm	+/-0.5,+/-1.0ppm	-40C to +85C	SM2016-6	Yes
XTC7063Q	50	3.3	+/-2.0ppm	+/-2.5ppm	-40C to +85C	SM5032-4	
XTC7064G	12	3.3	+/-1.0ppm	+/-2.5ppm	-40C to +85C	SM2520-4	
XTC7065P	25	3.300	+/-1.0ppm	+/-2.5ppm	-30C to +85C	SM3225-4	
XTC7066P	33	3.3	+/-1.0ppm	+/-2.5ppm	-30C to +85C	SM3225-4	
XTC7067Q	24	3.0	+/-2.0ppm	+/-2.5ppm	-30C to +85C	SM5032-4	
XTC7068P	32.00	1.68-3.63	+/-1.0ppm	+/-2.5ppm	-40C to +85C	SM3225-4	
XTC7069H	12.00	3.3	+/-2.0ppm	+/-2.5ppm	-40C to +85C	SM2016-6	
XTC7070H	52.0	1.80	+/-1.5ppm	+/-2.0ppm	-40C to +105C	SM2016-6	
XTC7071H	26.0	1.80	+/-2.0ppm	+/-0.5,+/-3.0ppm	-40C to +85C	SM2016-6	
XTC7072H	49.0	1.80	+/-2.0ppm	+/-0.5ppm	-30C to +85C	SM2016-6	
XTC7073Q	50	3.3	+/-1.0ppm	+/-0.28ppm	-40C to +85C	SM5032-4	
XTC7074G	15	3-3.3	+/-1.0ppm	+/-1.0ppm	-10C to +60C	SM2520-4	
XTC7075Q	32	3.3	+/-1.0ppm	+/-5.0ppm	-40C to +85C	SM5032-10	
XTC7076H	33.6	2.8	+/-1.0ppm	+/-0.5ppm	-40C to +85C	SM2016-6	
XTC7077H	40.0	1.8	+/-1.0ppm	+/-0.5ppm	-30C to +85C	SM2016-6	
XTC7078G	24	1.7-3.3	+/-1.0ppm	+/-0.5ppm	-40C to +85C	SM2520-4	

## TCXO (Temperature Compensated Crystal Oscillators) (cont.)

Part No.	F0 (MHz)	Supply Voltage (V)	F0 Tolerance @ +25C	F0 Stability vs. Temp	Temp. Range	Case Style/ Size	AEC-Q200
XTC7079G	25	3.3	+/-1.0ppm	+/-2.5ppm	-30C to +75C	SM2520-4	
XTC7080P	10	3	+/-1.0ppm	+/-1.0ppm	0C to +55C	SM3225-4	
XTC7081P	26	2	+/-1.0ppm	+/-2.0ppm	-40C to +85C	SM3225-4	
XTC7082G	48.0000	1.8	+/-1.0ppm	+/-2.5ppm	-40C to +85C	SM2520-4	
XTC7083P	43	3.3	+/-1.0ppm	+/-2.5ppm	-30C to +85C	SM3225-4	
XTC7084H	39	3.3	+/-1.0ppm	+/-2.0ppm	-30C to +85C	SM2016-6	
XTC7085H	16	3.3	+/-2.0ppm	+/-2.0ppm	-40C to +85C	SM2016-6	
XTC7086Q	40	3.3	+/-1.0ppm	+/-0.28ppm	-40C to +85C	SM5032-4	
XTC7087H	40	1.8-3.3	+/-2.0ppm	+/-20.0ppm	-40C to +125C	SM2016-6	Yes
XTC7088H	32	1.8	+/-1.0ppm	+/-1.5ppm	-40C to +85C	SM2016-6	
XTC7089P	24.576	3.3	+/-2.0ppm	+/-2.5ppm	-40C to +75C	SM3225-4	

## XFL (Crystal Filters)

Part No.	F0 (MHz)	IL (dB)	Passband	Temp. Range	Case Style	AEC-Q200
XFL8001	76.8	3	+/-4KHz	-40C to +85C	SM5070-6	Yes
XFL8008B	22	3	+/-3.75KHz	-20C to +70C	SM5070-6	
XFL8009B	21	3	+/-7.5KHz	-20C to +70C	SM5070-6	
XFL8010B	38.9	4	+/-3.75KHz	-20C to +70C	SM5070-6	
XFL8011B	39	3	+/-7.5KHz	-20C to +70C	SM5070-6	

## XTAL (Crystal Resonator)

Part No.	F0 (MHz)	Load Capacitance	F0 Tolerance @ +25C	F0 Stability vs. Temp	Temp. Range	Case Style/ Size	AEC-Q200
XTL1002	10.00000	12 pF	+/-20ppm	+/-20ppm	-20C to +70C	SM5032-4	Yes
XTL1003-1	14.	13.5 pF	+/-10ppm	+/-20ppm	-20C to +70C	SM5032-4	Yes
XTL1004-1	13.56	10 pF	+/-10ppm	+/-10ppm	-10C to +60C	SM3225-4	Yes
XTL1008	26.00	16 pF	+/-10ppm	+/-30ppm	-40C to +85C	SM3225-4	Yes
XTL1009	8.00	12 pF	+/-30ppm	+/-30ppm	-10C to +60C	SM5032-4	Yes
XTL1010	12.00	12 pF	+/-30ppm	+/-30ppm	-10C to +60C	SM5032-4	



## XTAL (Crystal Resonator) (cont.)

Part No.	F0 (MHz)	Load Capacitance	F0 Tolerance @ +25C	F0 Stability vs. Temp	Temp. Range	Case Style/ Size	AEC-Q200
XTL1011	26.00 000	9 pF	+/-30ppm	+/-30ppm	-20C to +75C	SM3225-4	Yes
XTL1014	48.53	8 pF	+/-30ppm	+/-30ppm	-40C to +85C	SM2520-4	Yes
XTL1015	49	10 pF	+/-30ppm	+/-30ppm	-40C to +85C	SM2520-4	Yes
XTL1016	49	12 pF	+/-30ppm	+/-30ppm	-40C to +85C	SM2520-4	Yes
XTL1020	13	15 pF	+/-20ppm	+/-10ppm	-40C to +85C	SM5032-4	Yes
XTL1020P	13	15 pF	+/-15ppm	+/-20ppm	-40C to +85C	SM3225-4	Yes
XTL1021	16.000	12 pF	+/-10ppm	+/-20ppm	-40C to +85C	SM5032-4	Yes
XTL1021-1	16	9 pF	+/-20ppm	+/-30ppm	-40C to +85C	SM3225-4	Yes
XTL1021G	16.00	12 pF	+/-10ppm	+/-10ppm	-10C to +60C	SM2520-4	Yes
XTL1021G-1	16.00	12 pF	+/-10ppm	+/-10ppm	-20C to +70C	SM2520-4	
XTL1021P	16.00	12 pF	+/-10ppm	+/-20ppm	-40C to +85C	SM3225-4	Yes
XTL1022	24	10 pF	+/-10ppm	+/-10ppm	-20C to +60C	SM2520-4	
XTL1023	26.000	9 pF	+/-10ppm	+/-10ppm	-20C to +75C	SM2016-4	Yes
XTL1024	40.00	8 pF	+/-10ppm	+/-10ppm	-20C to +75C	SM1612-4	Yes
XTL1025	27.1	12 pF	+/-30ppm	+/-30ppm	-20C to +70C	SM5032-4	Yes
XTL1026	13.6	12 pF	+/-30ppm	+/-30ppm	-20C to +70C	SM5032-4	
XTL1027	26	12 pF	+/-20ppm	+/-20ppm	-20C to +80C	SM5032-4	
XTL1029	14	16 pF	+/-30ppm	+/-100ppm	-40C to +85C	SM3225-4	Yes
XTL1030	24	7 pF	+/-30ppm	+/-50ppm	-40C to +125C	SM3225-4	Yes
XTL1031	38	10 pF	+/-10ppm	+/-10ppm	-20C to +75C	SM3225-4	Yes
XTL1031P-1	38	10 pF	+/-10ppm	+/-15ppm	-40C to +85C	SM3225-4	
XTL1032	13	9 pF	+/-30ppm	+/-60ppm	-40C to +125C	SM5032-4	Yes
XTL1032P	13	9 pF	+/-30ppm	+/-60ppm	-40C to +125C	SM3225-4	Yes
XTL1033	16	12 pF	+/-10ppm	+/-30ppm	-30C to +105C	SM3225-4	Yes
XTL1034	24.00 000	10 pF	+/-10ppm	-20,+14ppm	-40C to +105C	SM3225-4	Yes
XTL1035	26.00	13 pF	+/-10ppm	+/-25ppm	-40C to +85C	SM3225-4	Yes
XTL1036	9.84 375	6 pF	+/-15ppm	+/-15ppm	-10C to +60C	SM6035-4	Yes
XTL1037	12	18 pF	+/-50ppm	+/-50ppm	-10C to +60C	11x4.6	Yes
XTL1038	4.75 469	6 pF	+/-30ppm	+/-30ppm	-20C to +70C	11.3x4.5	Yes

## XTAL (Crystal Resonator) (cont.)

Part No.	F0 (MHz)	Load Capacitance	F0 Tolerance @ +25C	F0 Stability vs. Temp	Temp. Range	Case Style/ Size	AEC-Q200
XTL1039	25.000	20 pF	+/-30ppm	+/-50ppm	0C to +70C	11.3x4.5	Yes
XTL1040	16.0	20 pF	+/-30ppm	+/-50ppm	-20C to +75C	SM3225-4	Yes
XTL1041	12	18 pF	+/-20ppm	+/-50ppm	-20C to +75C	SM3225-4	
XTL1042	27	16 pF	+/-50ppm	+/-30ppm	-10C to +85C	SM3225-4	Yes
XTL1043	14	16 pF	+/-50ppm	+/-30ppm	-10C to +85C	SM3225-4	Yes
XTL1044	25	16 pF	+/-30ppm	+/-30ppm	-20C to +85C	SM3225-4	Yes
XTL1045	8	16 pF	+/-50ppm	+/-30ppm	-10C to +85C	SM5032-4	Yes
XTL1046	16.000 00	8 pF	+/-30ppm	+/-50ppm	-40C to +85C	SM3225-4	Yes
XTL1047	20.000	8 pF	+/-10ppm	+/-25ppm	-40C to +85C	SM3225-4	Yes
XTL1047P	20.000 0000	8 pF	+/-10ppm	+/-25ppm	-40C to +85C	SM3225-4	
XTL1048	48	12 pF	+/-10ppm	+/-20ppm	-40C to +105C	SM2016-4	Yes
XTL1049	28	10 pF	+/-20ppm	+/-40ppm	-40C to +85C	SM3225-4	Yes
XTL1049-1	28	10 pF	+/-10ppm	+/-10ppm	-20C to +75C	SM3225-4	Yes
XTL1050	24	12 pF	+/-30ppm	+/-50ppm	-40C to +125C	SM3225-4	Yes
XTL1051	48.000	11.2 pF	+/-10ppm	+/-20ppm	-40C to +105C	SM3225-4	Yes
XTL1052	27	12 pF	+/-30ppm	+/-50ppm	-40C to +125C	SM3225-4	Yes
XTL1053	33	12 pF	+/-30ppm	+/-50ppm	-40C to +95C	SM3225-4	Yes
XTL1054	16	8 pF	+/-30ppm	+/-50ppm	-40C to +125C	SM3225-4	Yes
XTL1060	26	10 pF	+/-10ppm	+/-10ppm	-20C to +85C	SM2520-4	
XTL1061	32	10 pF	+/-10ppm	+/-20ppm	-40C to +85C	SM2016-4	Yes
XTL1062	8.0	8 pF	+/-50ppm	+/-150ppm	-40C to +150C	SM3225-4	Yes
XTL1063	24.0	10 pF	+/-10ppm	+/-10ppm	-20C to +70C	SM3225-4	
XTL2000	33	9 pF	+/-20ppm		-40C to +85C	3.2x1.5	
XTL2001	26	9 pF	+/-10ppm	+/-10ppm	-20C to +75C	SM2016-4	
XTL2002	48	9.9 pF	-1,+5ppm	-15,+13ppm	-40C to +105C	SM1210-4	
XTL2003	76.800 0	9.16 pF	+/-4ppm	-12,+14ppm	-40C to +150C	SM1210-4	

## XTAL (Crystal Resonator) (cont.)

Part No.	F0 (MHz)	Load Capacitance	F0 Tolerance @ +25C	F0 Stability vs. Temp	Temp. Range	Case Style/ Size	AEC-Q200
XTL2004	96	9.9 pF	+/-12ppm	+/-16ppm	-40C to +150C	SM2016-4	
XTL2006	80	8 pF	+/-10ppm	+/-15ppm	-30C to +85C	SM2016-4	
XTL2007	54	15.5 pF	+/-3ppm	+/-14ppm	-40C to +105C	SM2520-4	
XTL2008	60	7 pF	+/-10ppm	+/-15ppm	-30C to +90C	SM2016-4	
XTL2009	60	6 pF	+/-20ppm	+/-30ppm,+/-70ppm	-40C to +125C	SM2016-4	Yes
XTL2010	40.000 000	6 pF	+/-20ppm	+/-30ppm,+/-70ppm	-40C to +125C	SM2016-4	Yes
XTL2012	48.00	10 pF	+/-10ppm	+/-20ppm	-40C to +85C	SM2520-4	Yes
XTL2013	48	10.7 pF	+/-8ppm	-14,+16ppm	-40C to +100C	SM2016-4	Yes
XTL2014	26.0	9 pF	+/-10ppm	+/-20ppm	-40C to +85C	SM2016-4	Yes
XTL2015	27	12 pF	+/-20ppm	+/-20ppm	-20C to +70C	SM3225-4	
XTL2016	25	12 pF	+/-20ppm	+/-20ppm	-40C to +85C	SM3225-4	
XTL2016-1	25	12 pF	+/-20ppm	+/-20ppm	-20C to +70C	SM3225-4	
XTL2017	24	12 pF	+/-10ppm	+/-20ppm	-40C to +105C	SM3225-4	Yes
XTL2017-1	24	18 pF	+/-10ppm	+/-20ppm	-40C to +105C	SM3225-4	Yes
XTL2018	27	8 pF	+/-20ppm	+/-30ppm	-40C to +105C	SM3225-4	Yes
XTL2019	16	12 pF	+/-10ppm	+/-30ppm	-30C to +105C	SM2520-4	
XTL2020	26	8 pF	+/-10ppm	+/-50ppm	-40C to +125C	SM2016-4	Yes
XTL2021	10	10 pF	+/-10ppm	+/-30ppm	-40C to +85C	SM5032-4	
XTL2022	27	10 pF	+/-10ppm	+/-20ppm	-40C to +85C	SM3225-4	
XTL2023	40	10 pF	+/-10ppm	+/-20ppm	-40C to +85C	SM2520-4	
XTL2024	32.7 68KHz	12.5 pF	+/-20ppm		-40C to +85C	3.2x1.5	
XTL2025	38.00	8 pF	+/-10ppm	+/-20ppm	-40C to +85C	SM2016-4	
XTL2026	32.7 68KHz	12.5 pF	+/-20ppm		-40C to +85C	SM2012-2	
XTL2026-1	32.7 68KHz	12.5 pF	+/-20ppm		-40C to +85C	SM2012-2	Yes

## XTAL (Crystal Resonator) (cont.)

Part No.	F0 (MHz)	Load Capacitance	F0 Tolerance @ +25C	F0 Stability vs. Temp	Temp. Range	Case Style/ Size	AEC-Q200
XTL2027P	28.63 6363	20 pF	+/-10ppm	+/-30ppm	-40C to +105C	SM3225-4	Yes
XTL2028H	48	18 pF	+/-10ppm	+/-10ppm	-20C to +70C	SM2016-4	
XTL2029P	28.63 636	18 pF	+/-10ppm	+/-30ppm	-40C to +105C	SM3225-4	Yes
XTL2030Q	8	12 pF	+/-30ppm	+/-50ppm	-40C to +85C	SM5032-4	Yes
XTL2031H	50	7 pF	+/-10ppm	+/-20ppm	-40C to +85C	SM2016-4	
XTL2032G	26	12 pF	+/-10ppm	+/-20ppm	-40C to +105C	SM2520-4	Yes
XTL2033H	30	8 pF	+/-15ppm	+/-50ppm	-40C to +85C	SM2016-4	
XTL2034G	12	12 pF	+/-10ppm	+/-30ppm	-40C to +85C	SM2520-4	
XTL2035H	24	20 pF	+/-30ppm	+/-30ppm	-30C to +85C	SM2016-4	
XTL2036G	16	8 pF	+/- 100ppm	+/-100ppm	-40C to +125C	SM2520-4	Yes
XTL2036H	16	8 pF	+/- 100ppm	+/-100ppm	-40C to +125C	SM2016-4	Yes
XTL2037J	32.7 68KHz	12.5 pF	+/-20ppm		-40C to +85C	SM1610-2	
XTL2038H	24	10 pF	+/-20ppm	+/-20ppm	-40C to +85C	SM2016-4	
XTL2039G	25	10 pF	+/-10ppm	+/-10ppm	-20C to +70C	SM2520-4	
XTL2040G	20	18 pF	+/-10ppm	+/-10ppm,+/- 15ppm	-20C to +95C	SM2520-4	
XTL2041J	37.4	12 pF	+/-10ppm	+/-10ppm	-30C to +85C	SM1612-4	
XTL2042G	16.384	10 pF	+/-10ppm	+/-20ppm	-20C to +75C	SM2520-4	
XTL2043G	22.5 792	18 pF	+/-10ppm	+/-20ppm	-20C to +75C	SM2520-4	
XTL2044J	26	6 pF	+/-30ppm	+/-35ppm	-40C to +125C	SM1612-4	Yes
XTL2045G	27	6 pF	+/-30ppm	+/-35ppm	-40C to +125C	SM2520-4	
XTL2045H	27	6 pF	+/-30ppm	+/-35ppm	-40C to +125C	SM2016-4	
XTL2046Q	8	20 pF	+/-20ppm	+/-30ppm	-40C to +85C	SM5032-4	
XTL2047P	40	12 pF	+/-10ppm	+/-18ppm	0C to +60C	SM3225-4	
XTL2048P	32.7 68Khz	12.5 pF	+/-20ppm		-40C to +125C	SM3215-2	Yes
XTL2049P	32.7 68KHz	6 pF	+/-20ppm		-40C to +125C	SM3215-2	Yes

## XTAL (Crystal Resonator) (cont.)

Part No.	F0 (MHz)	Load Capacitance	F0 Tolerance @ +25C	F0 Stability vs. Temp	Temp. Range	Case Style/ Size	AEC-Q200
XTL2050P	10	9 pF	+/-30ppm	+/-30ppm	-20C to +70C	SM3225-4	
XTL2051G	48	12 pF	+/-50ppm	+/-100ppm	-40C to +125C	SM2520-4	Yes
XTL2051P	48	12 pF	+/-50ppm	+/-100ppm	-40C to +125C	SM3225-4	Yes
XTL2052G	24	12 pF	+/-50ppm	+/-100ppm	-40C to +125C	SM2520-4	Yes
XTL2052P	24	12 pF	+/-50ppm	+/-100ppm	-40C to +125C	SM3225-4	Yes
XTL2053G	12	12 pF	+/-50ppm	+/-100ppm	-40C to +125C	SM2520-4	Yes
XTL2050P	10	9 pF	+/-30ppm	+/-30ppm	-20C to +70C	SM3225-4	
XTL2051G	48	12 pF	+/-50ppm	+/-100ppm	-40C to +125C	SM2520-4	Yes
XTL2051P	48	12 pF	+/-50ppm	+/-100ppm	-40C to +125C	SM3225-4	Yes
XTL2052G	24	12 pF	+/-50ppm	+/-100ppm	-40C to +125C	SM2520-4	Yes
XTL2052P	24	12 pF	+/-50ppm	+/-100ppm	-40C to +125C	SM3225-4	Yes
XTL2053P	12	12 pF	+/-50ppm	+/-100ppm	-40C to +125C	SM3225-4	Yes
XTL2054P	32	9 pF	+/-20ppm	+/-30ppm	-40C to +85C	SM3225-4	
XTL2055P	27	10 pF	+/-10ppm	+/-20ppm	-40C to +105C	SM3225-4	
XTL2056G	25	20 pF	+/-20ppm	+/-20ppm	-20C to +85C	SM2520-4	
XTL2057	10	20 pF	+/-30ppm	+/-30ppm	-40C to +85C	HC49SMD	
XTL2058	25	20 pF	+/-30ppm	+/-30ppm	-40C to +85C	HC49SMD	
XTL2059P	50	10 pF	+/-10ppm	+/-20ppm	-40C to +85C	SM3225-4	
XTL2060P	27	20 pF	+/-30ppm	+/-30ppm	-40C to +85C	SM3225-4	
XTL2061P	32.7 68KHz	7 pF	+/-20ppm		-40C to +85C	SM3215-2	
XTL2062H	25	8 pF	+/-10ppm	+/-50ppm	-40C to +125C	SM2016-4	
XTL2063H	48	7 pF	+/-10ppm	+/-20ppm,+/-15ppm,+/-40ppm	-40C to +105C	SM2016-4	Yes
XTL2064H	40	12 pF	+/-10ppm	+/-10ppm	-30C to +85C	SM2016-4	

## XTAL (Crystal Resonator) (cont.)

Part No.	F0 (MHz)	Load Capacitance	F0 Tolerance @ +25C	F0 Stability vs. Temp	Temp. Range	Case Style/ Size	AEC-Q200
XTL2065P	16	8 pF	+/-50ppm	+/-200ppm	-40C to +150C	SM3225-4	Yes
XTL2066G	19.2	10 pF	+/-10ppm	+/-10ppm	-30C to +85C	SM2520-4	
XTL2067H	24	10 pF	+/-15ppm	+/-20ppm	-40C to +85C	SM2016-4	
XTL2068P	16	9 pF	+/-10ppm	+/-20ppm	-40C to +85C	SM3225-4	
XTL2069L	32	6 pF	+/-10ppm	+/-20ppm	-20C to +70C	SM1210-4	
XTL2069L-1	32	12.5 pF	+/-10ppm	+/-20ppm	-40C to +105C	SM1210-4	
XTL2070P	19.2	12 pF	+/-30ppm	+/-30ppm	-20C to +85C	SM3225-4	
XTL2071P	25	20 pF	+/-30ppm	+/-30ppm	-20C to +85C	SM3225-4	
XTL2072P	50	18 pF	+/-10ppm	+/-15ppm	-40C to +85C	SM3225-4	
XTL2073M	14.74 56	16 pF	+/-10ppm	+/-10ppm	-10C to +60C	SM4025-4	
XTL2073M-1	14.7 456	16 pF	+/-10ppm	+/-10ppm	-20C to +70C	SM4025-4	
XTL2074P	14.7 456	16 pF	+/-10ppm	+/-10ppm	-20C to +70C	SM3225-4	
XTL2075G	24.576	12 pF	+/-10ppm	+/-30ppm	-40C to +85C	SM2520-4	
XTL2076G	24.576	10 pF	+/-10ppm	+/-30ppm	-40C to +85C	SM2520-4	
XTL2077G	32	12 pF	+/-10ppm	+/-20ppm	-40C to +85C	SM2520-4	
XTL2077G-1	32	8 pF	+/-10ppm	+/-20ppm	-40C to +85C	SM2520-4	Yes
XTL2077G-2	32	8 pF	+/-10ppm	+/-15ppm,+/- 20ppm	-40C to +85C	SM2520-4	
XTL2078P	40	10 pF	+/-10ppm	+/-15ppm	-40C to +85C	SM3225-4	
XTL2079	11.05	7 pF	+/-30ppm	+/-50ppm	-10C to +70C	HC49SMD	
XTL2079-1	11.0 592	7 pF	+/-30ppm	+/-30ppm	-40C to +85C	HC49SMD	
XTL2080H	32	8 pF	+/-10ppm	+/-10ppm	-20C to +70C	SM2016-4	
XTL2081P	25	12 pF	+/-20ppm	+/-50ppm	-40C to +125C	SM3225-4	Yes
XTL2082H	37.4	10 pF	+/-7ppm	+/-13ppm	-30C to +85C	SM2016-4	
XTL2083P	21.94 8717	12 pF	+/-10ppm	+/-30ppm	-40C to +85C	SM3225-4	
XTL2084P	40	8 pF	+/-15ppm	+/-50ppm	-40C to +125C	SM3225-4	
XTL2085	4.096	18 pF	+/-30ppm	+/-30ppm	-40C to +85C	HC49SMD	
XTL2086J	24	8 pF	+/-15ppm	+/-30ppm	-40C to +85C	SM1612-4	

## XTAL (Crystal Resonator) (cont.)

Part No.	F0 (MHz)	Load Capacitance	F0 Tolerance @ +25C	F0 Stability vs. Temp	Temp. Range	Case Style/ Size	AEC-Q200
XTL2087J	48	12 pF	+/-15ppm	+/-30ppm	-40C to +85C	SM1612-4	
XTL2088J	32	6 pF	+/-10ppm	+/-19ppm	-30C to +85C	SM1612-4	
XTL2089J	32	6 pF	+/-10ppm	+/-24ppm	-40C to +105C	SM1612-4	
XTL2090P	32	12 pF	+/-10ppm	+/-10ppm	-20C to +70C	SM3225-4	
XTL2091P	30	12 pF	+/-10ppm	+/-10ppm	-20C to +70C	SM3225-4	
XTL2092	3.579545	18 pF	+/-10ppm	+/-10ppm	-20C to +70C	HC49SMD	
XTL2093	12	20 pF	+/-10ppm	+/-10ppm	-20C to +70C	HC49SMD	
XTL2094H	40	8 pF	+/-10ppm	+/-20ppm	-40C to +100C	SM2016-4	Yes
XTL2094H-1	40	8 pF	+/-10ppm	+/-30ppm	-40C to +125C	SM2016-4	Yes
XTL2094H-2	40	8 pF	+/-10ppm	+/-20ppm, +/-25ppm, +/-70ppm	-40C to +125C	SM2016-4	Yes
XTL2095J	37.4	16 pF	+/-20ppm	+/-30ppm	-40C to +105C	SM1612-4	Yes
XTL2096P	16	16 pF	+/-15ppm	+/-20ppm	-40C to +85C	SM3225-4	
XTL2097H	32	8 pF	+/-10ppm	+/-10ppm	-20C to +85C	SM2016-4	
XTL2098H	50	6 pF	+/-25ppm	+/-35ppm	-40C to +125C	SM2016-4	Yes

## VCTCXO (Voltage Controlled Temperature Compensated Crystal Oscillator)

Part No.	F0 (MHz)	Supply Voltage (V)	F0 Tolerance @ +25C	F0 Stability vs. Temp	Temp. Range	Case Style/ Size	AEC-Q200
XVT9003-2	19.2	3.0	+/-2.0 ppm	+/-1.0 ppm	-40C to +85C	SM3225-4	
XVT9005	32	2.8	+/-1.0 ppm	+/-2.0 ppm	-30C to +85C	SM3225-4	
XVT9009	20	3.3	+/-2.0 ppm	+/-0.5 ppm	-40C to +85C	SM7050-10	Yes
XVT9014	26	3.3	+/-2.0 ppm	+/-250 ppb	-20C to +70C	SM5032-4	Yes
XVT9015Q	19.2	2.8	+/-1.0 ppm	+/-0.2ppm	-40C to +85C	SM5032-10	
XVT9016G	18.8	1.8	+/-1.0 ppm	+/-1.0 ppm	-10C to +55C	SM2520-4	Yes
XVT9030	16.4	3	+/-2.0 ppm	+/-0.5 ppm	-40C to +85C	SM5032-4	

## VCTCXO (Voltage Controlled Temperature Compensated Crystal Oscillator) (cont.)

Part No.	F0 (MHz)	Supply Volt- age (V)	F0 Tolerance @ +25C	F0 Stability vs. Temp	Temp. Range	Case Style/ Size	AEC- Q200
XVT9031	26	2.8	+/-1.5 ppm	+/-0.5 ppm	-30C to +85C	SM2520-4	
XVT9032	19	2.8	+/-1.0 ppm	+/-0.5 ppm	-30C to +85C	SM2520-4	
XVT9033	20	3.3	+/-1.0 ppm	+/-1.0 ppm	-30C to +85C	SM5032-4	
XVT9034Q	16.3840	3.3	+/-1.0 ppm	+/-2.5 ppm	-30C to +85C	SM5032-4	
XVT9035Q	19	3.1	+/-2.0 ppm	+/-1.5 ppm	-30C to +75C	SM5032-4	
XVT9036P	20	3.0	+/-1.0 ppm	+/-2.5 ppm	-30C to +75C	SM3225-4	
XVT9037P	13	3.3	+/-1.5 ppm	+/-2.5 ppm	-30C to +85C	SM3225-4	
XVT9038B	19	2.9	+/-2.0 ppm	+/-0.25 ppm	-5C to +85C	SM7050-4	
XVT9039G	25.0	3.3	+/-1.0 ppm	+/-1.5 ppm	-20C to +70C	SM2520-4	
XVT9040P	30.0	3	+/-0.5 ppm	+/-1.5 ppm	-30C to +85C	SM3225-4	
XVT9041G	48	1.8	+/-1.0 ppm	+/-2.5 ppm	-40C to +85C	SM2520-4	
XVT9042B	40.0	3.3		+/-0.28 ppm	-40C to +85C	SM7050-10	
XVT9043B	10.00000	3.3	+/-1.5 ppm	+/-0.28 ppm	-40C to +85C	SM7050-4	
XVT9044G	38.40000	3.0	+/-1.0 ppm	+/-1.0 ppm	-30C to +85C	SM2520-4	
XVT9045G	19.20000	3.3	+/-0.5 ppm	+/-1.0 ppm	-40C to +85C	SM2520-4	
XVT9045P	19.200	2.9	+/-0.5 ppm	+/-0.5 ppm	-30C to +80C	SM3225-4	
XVT9046Q	13	2.8	+/-1.0 ppm	+/-2.0 ppm	-20C to +75C	SM5032-4	



# RXM7000

## GPS, GLONASS, Beidou and Galileo Front-End Module

### Features

- Low supply voltage: 1.8 / 2.8 V typ.
- Low current consumption:
  - 3.0 / 3.7 mA typ. (at  $V_{DD} = 1.8 / 2.8$  V,  $V_{CTL} = 1.8$  V)
  - 0.1  $\mu$ A typ. (at  $V_{DD} = 1.8 / 2.8$  V,  $V_{CTL} = 0$  V (Stand-by mode))
- High gain: 15.5 / 16.0dB typ. (at  $V_{DD} = 1.8 / 2.8$  V,  $V_{CTL} = 1.8$  V,  $f = 1575$  MHz, 1559~1591 MHz)+

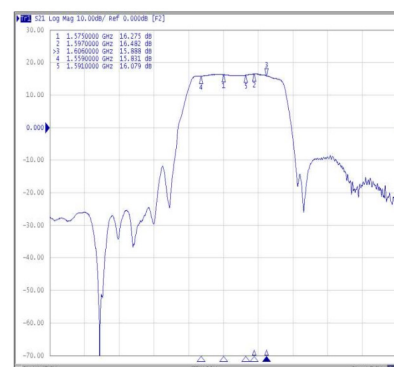
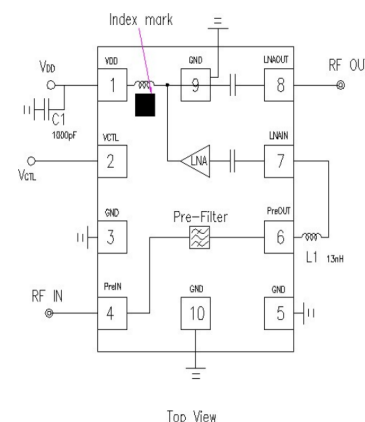

# RXM7001

## GPS L5 Front-End Module

### Features

- AEC-100, MSL-1 Low
- Supply voltage: 1.8 / 2.8 V typ. Low
- Current consumption:
  - 3.0 / 3.7 mA typ. (at  $V_{DD} = 1.8 / 2.8$  V,  $V_{CTL} = 1.8$  V)
  - 0.1  $\mu$ A typ. (at  $V_{DD} = 1.8 / 2.8$  V,  $V_{CTL} = 0$  V (Stand-by mode))
- High gain: 17 / 17.5dB typ. (at  $V_{DD} = 1.8 / 2.8$  V,  $V_{CTL} = 1.8$  V,  $f = 1176.45$  MHz, 1164~1189 MHz)
- Low noise figure: 2 / 1.85db typ. (at  $V_{DD} = 1.8$  V,  $f = 1176.45$  MHz)

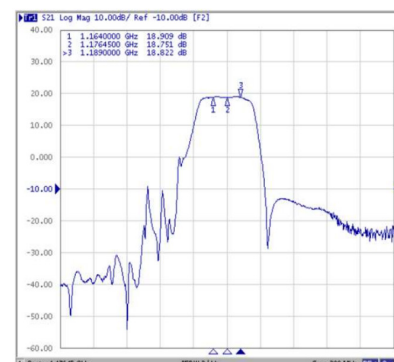

# TRC103

## PLL-Based, Single or Multi-Channel Transceiver

Frequency	Power	Data Rate	Modulation	Interface	Size (mm)
868-960	+10 dBm	115 kbps	OOK/ASK/FSK	SPI	5 x 5

### Features

- Ultra-low Receiver Current Consumption @ 3.0mA
- High Rx Sensitivity: -112dBm Typical (FSK)
- High Data Rate (programmable): 32kbps OOK, 115 kbps (FSK)
- Programmable Transmit Power: +11 dBm
- Programmable 32-Bit Sync Byte
- Integrated PLL, IF and Baseband Circuitry
- Programmable 64-Byte TX/RX FIFO
- Standard SPI Interface
- Integrated Crystal Oscillator: 12.8 MHz
- Programmable Clock Output Frequency
- Integrated RSSI – Digital
- Integrated Packed CRC
- Integrated Data Whitening
- Integrated Manchester Encoding/Decoding
- Operating Voltage: 2.1 to 3.6V
- Very few external components required
- Small size plastic package

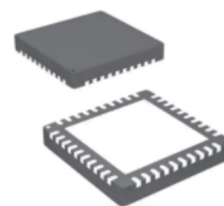





9805-A Northcross Center Suite  
Huntersville, NC 28078



4100 Midway Road, Suite 1155  
Carrollton, Texas 75007

Phone: 1.704.997.5734  
Fax: 1.704.997.5735



Phone: 1.972.256.8478

sales@akoustis.com  
foundry@akoustis.com



US: salesamerica@rfmi.co  
EMEA: salesemea@rfmi.co  
AS: salesasia@rfmi.co

akoustis.com



rfmi.co

akoustis.com/sales-locations/



mouser.com  
digikey.com

**TRADEMARKS:** Akoustis, the Akoustis logo, the stylized "U," XBAW, the XBAW logo, RFMi, and the RFMi logo are trademarks or registered trademarks of Akoustis Technologies, Inc. and its subsidiaries (collectively, "Akoustis") in the United States and/or other countries.

**INFORMATION AND PRICING SUBJECT TO CHANGE:** The specifications and availability of the components described in this publication are subject to change without notice. Every effort has been made to ensure the accuracy of this publication. However, Akoustis does not assume responsibility for inaccuracies or changes.

**SPECIFICATIONS:** "Typical" specifications are based on measurements made on representative samples. These values may vary from lot to lot and are not guaranteed. They are provided only as a reference for the circuit designer.

**REGULATORY APPROVALS:** Many products utilizing the products described in this publication require approval by the government of the destination country prior to sale. Buyers of these components assume all responsibility for compliance, testing and authorization by the appropriate government agencies.

**WARRANTIES:** Akoustis makes no warranty, representation, or guarantee regarding the suitability of these products for any particular purpose. None of these devices are intended for surgical implants or any other application that may provide life support or other critical function necessary for the support or protection of life, property, or business interests. The user assumes responsibility for use of any of these products in any such application. Akoustis shall not be liable for losses due to failure of any of these devices beyond the Akoustis commercial warranty, limited to the original purchase price.

**PATENTS:** Many of the devices described in this publication are patented. Akoustis does not convey any license under its patent rights or the rights of others.

©2022, 2021 Akoustis, Inc. and its subsidiaries, All Rights Reserved

Published June 2022