

SPARE PARTS CATALOGUE







Reborn Everyday With Hot Water

Racold is India's most trusted brand of water heaters from the house of Ariston, with a portfolio of premium quality products that cover the entire spectrum of water heating solutions.

At Racold, our products are a testimony of our commitment towards understanding our consumer's needs. This drives every innovation, while our products continue to deliver efficiency and eco-friendly benefits.

Being the leader in the water heater industry since the last five decades, Racold is a brand synonymous with breakthrough innovation, quality water heating solutions and complete customer satisfaction.



Quality in sales and aftersales services

Our constant strive to achieve customer satisfaction does not end with the sale and installation of the product. We have standardised customer management processes to provide our consumers with immediate and precise support.

We have over 500 authorised and trained service technicians ready to provide installation support, repairs and AMC for all; Electric, Solar and Heat Pump Water Heaters projects.

We also offer annual maintenance contracts which cover all servicing needs of the projects, so consumers can use our solutions minus the hassle of maintenance.

With over 176 service franchise outlet pan India and an efficient call centre in Pune which equips the customer with various touch points; from email to WhatsApp to online registration. Our service network is well equipped with knowledge of our installation configuration, thus providing the customer with 360° solutions.

Our Service Guidelines:

- Always use Racold Genuine spare parts and accessories.
- Always get professional help from installer/electrician/plumber for dry heating issues and pre selection checks.
- We recommend annual maintenance contract for your water heater ranging from 1-3 years.

For AMC and warranty details on range, contact your nearest service center.

SPARE PARTS INDEX

- ▷ PRONTO RANGE
- ▷ ETERNO RANGE
- ▷ ANDRIS RANGE
- ▷ CDR AND CLASSICO
- ▷ GAS WATER HEATER
- ▷ ALPHA PRO
- ▷ ALPHA
- ▷ OMEGA MAX 8
- ▷ DOMESTIC HEAT PUMP
- ▷ COMMERCIAL SOLAR WATER HEATER
- ▷ COMMERCIAL HEAT PUMP
- ▷ ELECTRIC & SOLAR WATER HEATER PLUMBING
SPARE PARTS
- ▷ ELECTRIC WATER HEATER OLD

ELECTRIC WATER HEATER



PRONTO
Spare Parts

**PRONTO NEO
PRONTO STYLO
PRONTO STYLO ECO SENSE
PRONTO NEO DURONOX
PRONTO STYLO DURONOX**



Spare Part Code	Description
65161754	HP ASSLY 1 Ltr NEW 12 hole
65161888	HP ASSLY PR-III_NP 12 HOLE (87MM)
65161889	HP ASSLY PR-VI_NP 12 HOLE



Spare Part Code	Description
65161538	HP 304L 1 Ltr NEW 8 hole
65161755	HP ASSLY PR-III_NP 8 HOLE (87MM)
65161756	HP ASSLY PR-VI_NP 8 HOLE



Spare Part Code	Description
65161541	HE ASSY 3KW NEW



Spare Part Code	Description
65161211	HE ASSY 3KW PRONTO
65161212	HE ASSY 4.5KW PRONTO
65161213	HE ASSY 3.2KW ER-II



Spare Part Code	Description
0507166	CUT-OUT 7" INSTANT PR-I-IV
0507055	THERMOSTAT 7" INSTANT PR-I-IV



Spare Part Code	Description
65161181	SS 304 INN CONT PR - III 8 HOLE
65161829	SS 316L INN TANK PR III DURONOX 8 HOLE



Spare Part Code	Description
065160184	CLAMP INNER CONTAINER



Spare Part Code	Description
65161722	CLAMP INNER CONTAINER PRONTO-3L NP



Spare Part Code	Description
065160491	MIDDLE BKT FOR PRONTO



Spare Part Code	Description
65161721	CLAMP INNER CONTAINER PRONTO-1L NP



Spare Part Code	Description
65161759	TUBE RING BLUE PRONTO-NP
65161760	TUBE RING RED PRONTO-NP



Spare Part Code	Description
65161180	SS 304 INN CONT PR - I 12 HOLE
65161819	SS INNCONT PR-III (12 HOLES) 304L
65161830	SS 316L INNER TANK PR III DURONOX 12 HOLE



Spare Part Code	Description
0508197	LAMP COVER RED
0508198	LAMP COVER BLUE



Spare Part Code	Description
3802840	PLUNGER, CUT-OUT RESET
65161739	PUSH PL CASING BUTTON NP
65161726	DISC CUTOOUT RESET PR-III_NP



Spare Part Code	Description
65161540	GASKET HEATING ELEMENT PRONTO



Spare Part Code	Description
65161727	TEMPLATE DISPLAY STICKER PRONTO NEO
65161728	TEMPLATE DISPLAY STICKER PRONTO STYLO



Spare Part Code	Description
65161182	SS 304 INN CONT PR - VI - 8 HOLE
65161820	ISS INN CONT PR-VI (12 HOLES) 304L



Spare Part Code	Description
65161761	WIRE HARNESS PRONTO 4.5KW_NP
65161762	WIRE HARNESS PRONTO 3KW_NP
65161827	INST-WIRE HARNESS RED 3 & 4.5KW
65161183	WIRE HARNESS 3KW_N_PRONTO
65161184	WIRE HARNESS 4.5KW_N_PRONTO



Spare Part Code	Description
65161719	SAFETY VALVE BRASS PRONTO_NP
0507624	Pressure Release Valve W/H -OLD



Spare Part Code	Description
65161720	SOCKET BRASS FORGED(OUT) PRONTO_NP
0508167	BRASS COUPLING NUT WITH HOLE



Spare Part Code	Description
65161725	SUPPORT CUTOUT LOCKING STRIP_NP



Spare Part Code	Description
65161539	SS 202 HE HOLDING CLAMP_PRESTO



Spare Part Code	Description
65161891	SECTOR RING PRONTO - 6 LTR



Spare Part Code	Description
65161731	6LTR NP INN(INJECTED PUF) 8 hole
65161929	6LTR NP INN(INJECTED PUF) 12 hole



Spare Part Code	Description
65161752	WASHER SS M6 PRONTO NP
65161753	SELF TAP. SCREW 1/4 X 9.5MM



Spare Part Code	Description
65161729	HP GASKET RUBBER PR-I NP 12 hole
65161890	HP GASKET RUBBER PR-III/VI NP 12 hole



Spare Part Code	Description
65161730	SEAL GASKET RUBBER PR-III/VI NP 8 HOLE (HEATER PLATE GASKET)



Spare Part Code	Description
65161732	LAMP HOLDER PRONTO 2 NP



Spare Part Code	Description
65161749	LAMP PL. REFLECTOR TRANSPARENT PRONTO NP



Spare Part Code	Description
65161723	POWER SUPPLY CABLE 48.2X1000 (3KW) PR NP
65161724	POWER SUPPLY CABLE 80.2X1000 (4.5KW)PR NP



Spare Part Code	Description
65161740	PL FRONT COVER PR NEO-1L IV
65161742	PL FRONT COVER PR NEO-3L IV
65161744	PL FRONT COVER PR NEO-6L IV



Spare Part Code	Description
65161733	PL BACK COVER PR NEO/STYLO-1L IV
65161735	PL BACK COVER PR NEO/STYLO-3L IV
65161737	PL BACK COVER PR NEO/STYLO-6L IV



Spare Part Code	Description
65161828	INST-PCB PRONTO STYLO ES



Spare Part Code	Description
65161741	PL FRONT COVER PR NEO-1L WH
65161743	PL FRONT COVER PR NEO-3L WH
65161745	PL FRONT COVER PR NEO-6L WH



Spare Part Code	Description
65161746	PL FRONT COVER PR STYLO-1L WH-TAN PAINT
65161747	PL FRONT COVER PR STYLO-3L WH-TAN PAINT
65161748	PL FRONT COVER PR STYLO-6L WH-TAN PAINT



Spare Part Code	Description
65161734	PL BACK COVER PR NEO/STYLO-1L WH
65161736	PL BACK COVER PR NEO/STYLO-3L WH
65161738	PL BACK COVER PR NEO/STYLO-6L WH

ELECTRIC WATER HEATER



ETERNO
Spare Parts

ETERNO 2
ETERNO INTELLO
ETERNO SWIFT



Spare Part Code	Description
65161956	CABLE CONTROL ETERNO INTELLO

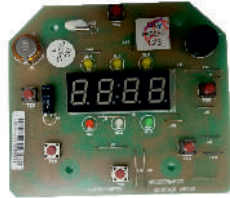

Spare Part Code	Description
615161957	HMI DISPLAY PCB ETERNO INTELLO



Spare Part Code	Description
615161958	MAIN PCB ETERNO INTELLO



Spare Part Code	Description
65161953	HEATING ELEMENT ENAMEL 2KW NEW (ER2 NEW / INTELLO)
65180015-IN	ANODE 165MM



Spare Part Code	Description
65161293	HEATING ELEMENT ASSLY ENAMEL 2KW (OLD)



Spare Part Code	Description
65161955	WIRE HARNESS ETERNO INTELLO
65161861	WIRE HARNESS ETERNO 2
65161862	WIRE HARNESS ETERNO 3KW SWIFT



Spare Part Code	Description
65161961	HEATING ELEMENT ASSLY ENAMEL 3KW NEW(SWIFT)
993014-IN	ANODE 230MM



Spare Part Code	Description
65161334	CUT OUT SAFETY T'STAT 105 CAPILLARY NP
65161333	THERMOSTAT FUNC T'STAT 75 CAPILLARY NP



Spare Part Code	Description
65161315	TUBE RING AL/ER BLUE NP
65161314	TUBE RING AL/ER RED NP



Spare Part Code	Description
65161303	RUBBER GASKET
65161960	RUBBER GASKET

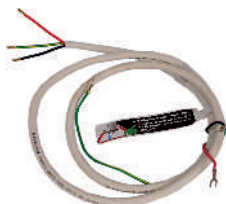

Spare Part Code	Description
65161304	P.S. CABLE 2KW WH NP(PLUG-1M)
65161707	P.S. CABLE 2KW AL/ER COMMON
65161959	P.S. CABLE ER/ INTELLO/NXT/SWIFT



Spare Part Code	Description
0869116	COMMON SAFETY VALVE

ELECTRIC WATER HEATER

ANDRIS
Spare Parts

Andris Lux
Andris Lux Plus
Andris R



Spare Part Code	Description
65190744	HEATING ELE. 2000W (15 & 25 LTR)
65190755	HEATING ELE. 2000W (10 LTR)



Spare Part Code	Description
65190207	MOUNTING BRACKET COMMON



Spare Part Code	Description
65190745	THERMOSTAT (15 & 25)
65190756	THERMOSTAT (10 LTR)



Spare Part Code	Description
65190748	Andris-KNOB (REGULATION) 10-15-25 LUX IV



Spare Part Code	Description
65190747	PLASTIC COVER 10 -15LTR LUX IV
65190753	PLASTIC COVER 25LTR LUX IV



Spare Part Code	Description
65190752	Andris-KNOB (REGULATION) 10-15-25 LUX WH



Spare Part Code	Description
65190751	PL. COVER 10-15 LUX LTR WH
65190754	PL. COVER 25 LUX LTR WH
65190758	PL. COVER 10-15 LUX PLUS LTR WH
65190760	PL. COVER 25 LUX PLUS LTR WH



Spare Part Code	Description
65115147	Andris-FLANGE GASKET



Spare Part Code	Description
65190759	KNOB (REGULATION) 10-15-25 LUX PLUS WH



Spare Part Code	Description
504342	SAFETY VALVE WITH LEVER 7.5 BAR COMMON



Spare Part Code	Description
65103768	ANODE D21,3 L110 M5 10-15 LUX & PLUS
65103793	ANODE D21,3 L110 M5 10-LUX & PLUS
65150069	ANODE D25,5 L105 M5 25 LTR LUX & PLUS



Spare Part Code	Description
65190746	SCREW COVER 10-15-25-LUX IV
65190750	SCREW COVER 10-15-25-LUX IV
65190757	SCREW COVER 10-15-25-LUX PLUS



Spare Part Code	Description
573266	VN-ANDRIS-CABLE CLAMP COMMON

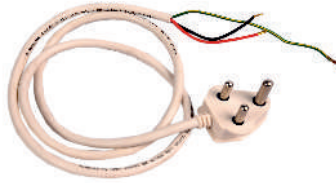

Spare Part Code	Description
65190749	ANDRIS-POWER CABLE COMMON



Spare Part Code	Description
65113408	VN-ANDRIS-CONFECTION DIELECTRIC JOINTS 12 (2PCS)
65190158	ANDRIS-INSTALLATION KIT



SARE PART CODE	DESCRIPTION
65190475	ANDRIS-WIRING



Spare Part Code	Description
65161314	RED AND BLUE PIPE RING 10-15-25
65161315	



Spare Part Code	Description
65190765	ANDRIS-KNOB (REGULATION) 10-15-25 R WH



Spare Part Code	Description
65190761	HE. ELE. 2000W 230V 10 LTR R WH
65190766	HE. ELE. 2000W 230V 15-25 LTR R WH
65190508	FLANGE



Spare Part Code	Description
65190762	THERMOSTAT 10 LTR R
65190745	THERMOSTAT 15 LTR R
65190767	THERMOSTAT 25 LTR R



Spare Part Code	Description
65190764	ANDRIS-PLASTIC COVER 10-15 R
65190768	ANDRIS-PLASTIC COVER 25 R



Spare Part Code	Description
65114656	ANDRIS-FLANGE SCREW M6X12



Spare Part Code	Description
65190469	ANDRIS-FLANGE GASKET WITH 4 HOLES



Spare Part Code	Description
993000	ANDRIS-SCREW COVER 10-15-25-R PLUS
65190763	ANDRIS-SCREW COVER

ELECTRIC WATER HEATER

CLASSICO & CDR

Spare Parts



Spare Part Code	Description
65161948	FLANGE 10-15-25



Spare Part Code	Description
0508028 0508065	INS COVER SET INS COVER SET



Spare Part Code	Description
65161334	CUT OUT SAFETY T'STAT 105 CAPILLARY_NP
65161333	THERMOSTAT FUNC T'STAT 75 CAPILLARY_NP



Spare Part Code	Description
65161497	ASSEMBLED H.E. 2KW CDR OLD



Spare Part Code	Description
65161949 65191947	H.E. 2KW CDR PRESS FLG COMMON FOR CDR PUF & CLASSICO SEAL GASKET FOR COPPER HE



Spare Part Code	Description
65161308	WALL MTG BKT SMALL GRAY_NP

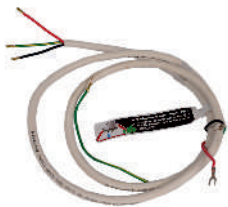

Spare Part Code	Description
65161304	P.S. CABLE 2KW WH_NP(PLUG-1M)



Spare Part Code	Description
0869116	COMMON SAFETY VALVE



Spare Part Code	Description
65161315 65161314	TUBE RING AL/ER BLUE_NP TUBE RING AL/ER RED_NP

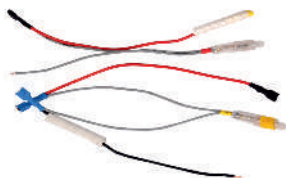

Spare Part Code	Description
65161531	WIRE HARNESS ASSY CDP 2KW_NP



Spare Part Code	Description
65161259	MG ANODE D=21.3MM L=110MM



Spare Part Code	Description
65161950	NUT AND BOLT

GAS WATER HEATER



GAS WATER HEATER

Spare Parts

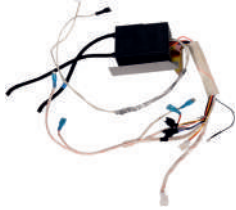

Spare Part Code	Description
65160913	GAS-SPP-NATURE FLUE LED TEMP DIGITAL PCB
65160915	GAS-SPP-NATURE FLUE LED TEMP NON DIGITAL PCB

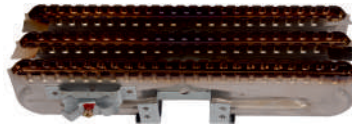

Spare Part Code	Description
65160917	GAS-SPP-LN LP5 EXY - I BURNER GRP LPG



Spare Part Code	Description
065160276	FLAME SENSOR



Spare Part Code	Description
65160914	GAS-SPP-LN.LP 5C-10 HEAT EXG(NTC)
65160910	GAS-SPP-HEAT EXCHANGER 5L WITH DISPLAY



Spare Part Code	Description
65160921	GAS-SPP-5LTR GAS VALVE BODY GROUP LPG

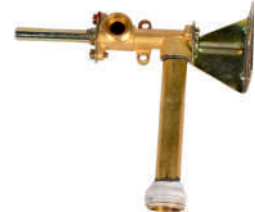

Spare Part Code	Description
65160922	GAS-SPP-LN LP 5LY-I WATER VALVE GROUP



Spare Part Code	Description
0999441	GAS-SPP-POWER SWITCH 5LTR

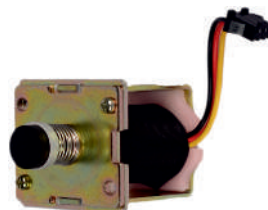

Spare Part Code	Description
0999430	GAS-SPP-SOLONOID GAS VALVE

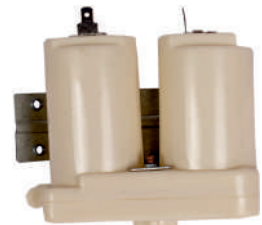

Spare Part Code	Description
0999416	GAS-SPP-BATTERY BOX



Spare Part Code	Description
0999313	GAS-SPP-SAFETY THERMOSTAT 5L

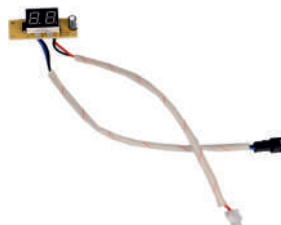

Spare Part Code	Description
0999318	GAS-SPP-TEMPERATURE DISPLAY 5L
0999420	GAS-SPP-TEMP DIGITAL PCB 5



Spare Part Code	Description
65160920	GAS-SPP-LN LP 5L WATER SWITCH

DOMESTIC SOLAR WATER HEATER



ALPHA PRO

Spare Parts



Spare Part Code	Description
65161800	SS PIPE 3/4" X 100MM DRAIN
65161801	SSPIPE 3/4" X 230MM OUTLET



Spare Part Code	Description
65161802	FLOW LIMITER FLOAT VALVE ASSY



Spare Part Code	Description
65161803	ADAPTOR PLUG CLAMP



Spare Part Code	Description
65161804	CAPS OUTER FOR DRAIN AND OUTER PIPE



Spare Part Code	Description
65161805	PLASTIC PIPE NYLON INLET



Spare Part Code	Description
65161806	NYLON VENT PIPE



Spare Part Code	Description
65161807	PLUG NYLON ADAPTOR



Spare Part Code	Description
65161808	O-RING SEAL ID 9 X 1.8



Spare Part Code	Description
65161809	SEALING GASKET FOR INNER



Spare Part Code	Description
65161810	SOLAR PLUG HE D58



Spare Part Code	Description
65161811	SEALING GASKET FOR OUTER



Spare Part Code	Description
65161812	SOLAR COVER INSPECTION



Spare Part Code	Description
65161813	METAL TANK ASSLY ETC 100L
65161814	METAL TANK ASSLY ETC 150L
65161815	METAL TANK ASSLY ETC 200L
65161816	METAL TANK ASSLY ETC 250L
65161817	METAL TANK ASSLY ETC 300L



Spare Part Code	Description
65161841	STAND ETC 100L D380
65161842	STAND ETC 150L D380
65161843	STAND ETC 200L D380
65161844	STAND ETC 250L D380
65161845	STAND ETC 300L D380
65161847	STAND ETC 500L D380



Spare Part Code	Description
65161835	SEAL GASKET PLUG TYPE HE D380



Spare Part Code	Description
65161702	STAND ARC ETC 200L, 250L & 300L
65161715	STAND ARC ETC 100L & 150L
65161846	STAND ARC ETC 500L D470



Spare Part Code	Description
65161837	RIVET COPPER TUBULER D 2.8MM



Spare Part Code	Description
65161832	ALFA PRO BACK UP KIT PLUG TYPE 2KW
65161833	ALFA PRO BACK UP KIT PLUG TYPE 3KW



Spare Part Code	Description
65161838	SEAL GASKET OUTER PUF



Spare Part Code	Description
65161839	SS FLOAT CAPSULE



Spare Part Code	Description
65161840	TUBE SILICON INLET



Spare Part Code	Description
65161836	LOCK NUT FOR SILICON TUBE



Spare Part Code	Description
65161834	CAPS PLUG TYPE HE D380



Spare Part Code	Description
65161664	VACUUM TUBE 58 X 1800-3 TGT

DOMESTIC SOLAR WATER HEATER



ALPHA
Spare Parts



Spare Part Code	Description
65161712	SOL. STAND ETC 100L D412
65161713	SOL. STAND ETC 150L D412
65161714	SOL. STAND ETC 200L D412
65161703	SOL. STAND ETC 250L D412
65161704	SOL. STAND ETC 300L D412
65161779	SOL. STAND ETC 500L



Spare Part Code	Description
65161715	SOL. STAND ARC ETC 100L & 150L D412
65161702	SOL. STAND ARC ETC 200L-250L- 300L DIA 412
65161846	SOL. STAND ARC ETC - 500L



Spare Part Code	Description
65161709	SOLAR TANK ETC 100L (D412) ALPHA
65161710	SOLAR TANK ETC 150L (D412) ALPHA
65161711	SOLAR TANK ETC 200L (D412) ALPHA
65161700	SOLAR TANK ETC 250 L (D412) ALPHA
65161701	SOLAR TANK ETC 300 L (D412) ALPHA
65161780	SOLAR TANK ETC 500L (D470) ALPHA



Spare Part Code	Description
570069-IN	NUT M6



Spare Part Code	Description
65161570	SOLAR FLANGE WITH ANODE (2)



Spare Part Code	Description
0508356	MS CLAMP



Spare Part Code	Description
65161697	SOLAR GROMMET VTC DIA 58 (RED COLOUR INNER)



Spare Part Code	Description
65161763	SOLAR GROMMET OUTER VTC D58



Spare Part Code	Description
65161696	SOLAR GROMMET INSPECTION COVER SOL METAL DOME (2)



Spare Part Code	Description
65161643	SOLAR VACCUME TUBE 47MM DIA- 1800L ETC
0999392	SOLAR VACCUME TUBE 47MM DIA- 1800L ETC



Spare Part Code	Description
65161681	SOLAR VACCUME TUBE 58 MMDIA- 2100L ALPHA

DOMESTIC SOLAR WATER HEATER

OMEGA MAX 8

Spare Parts



Spare Part Code	Description
065160260	SOLAR-EPDM WASHER COLLECTOR



Spare Part Code	Description
065160261	SOLAR-BRASS END CAP 34 BSP



Spare Part Code	Description
065160263	SOLAR- BRASS COUPLER COLLECTOR



Spare Part Code	Description
065160528	SOLAR SPRING STEEL CLIP - SOLAR



Spare Part Code	Description
65161006	SOLAR SAFATY VALVE FOR COMMERTIAL SY



Spare Part Code	Description
65160871	SOLAR Z COUPL FOR 40 DEG 300375500
65161618	SOLAR COUPLING -Z 500L-2540D



Spare Part Code	Description
065160529	SOLAR SS HORIZONTAL PIPE 300L
065160532	SOLAR SS HORIZONTAL PIPE 375L
065160533	SOLAR SS HORIZONTAL PIPE 500L
065161196	SOLAR SS HORIZONTAL PIPE 300L
065161617	SOLAR SS HORIZONTAL PIPE 500L



Spare Part Code	Description
65161223	SOLAR TANK 100L 8BAR SS
65161224	SOLAR TANK 200L 8BAR SS
65161233	SOLAR TANK 250L 8BAR SS
65161226	SOLAR TANK 300L 8BAR SS
65161227	SOLAR TANK 100L 0BAR SS
65161228	SOLAR TANK 200L 0BAR SS
65161229	SOLAR TANK 250L 0BAR SS
65161230	SOLAR TANK 300L 0BAR SS



Spare Part Code	Description
65161232	SOLAR HYD KIT OMEGA 2540D 8B SL200L
65161233	SOLAR HYD KIT OMEGA 2540D 8B SL250L
65161234	SOLAR HYD KIT OMEGA 2540D 8B SL300L
65161235	SOLAR HYD KIT OMEGA 2540D 0B SL100L
65161236	SOLAR HYD KIT OMEGA 2540D 0B SL200L
65161237	SOLAR HYD KIT OMEGA 2540D 0B SL250L
65161238	SOLAR HYD KIT OMEGA 2540D 0B SL300L
65161260	SOLAR HYD KIT OMEGA 40 D 8 BAR-100LTR



Spare Part Code	Description
65161207	SOLAR SS HORIZONTAL PIPE 8 BAR 200L
65161617	SOLAR STAINLESS STEEL PIPE HORZ EXTEN 500L_5C
65161625	SOLAR SS PIPE HORI 200L MALE SOCK



Spare Part Code	Description
065160026	OLD SOL COL MAIN
65161243	SOL COL OMG VERSION-2
65161535	SOL COL OMG VERSION-3
65161222	SOL COL SUPP. OMG NEW ULT (YELLOW PKG) V2
065160697	SOL COL SUPPLEMENTARY OMG
65161575	SOL COL 1"

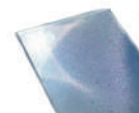

Spare Part Code	Description
65160878	SOLAR GLASS ASSEMBLY(NEW)
65160924	SOLAR GLASS NEW
65161716	SOLAR GLASS ASSLY BODY STEP 2 COLLECTOR
65160925	SOLAR GLASS OLD
65161583	SOLAR GLASS ASSEMBLY OLD
65161579	SOLAR GLASS 2070X1000X4MM IIT

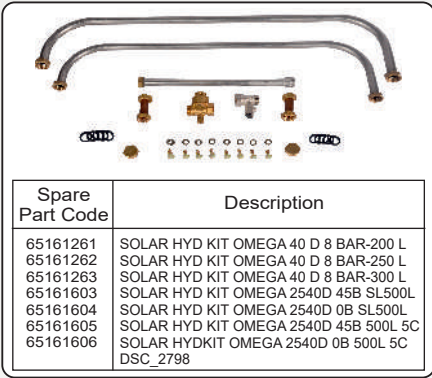

Spare Part Code	Description
65161261	SOLAR HYD KIT OMEGA 40 D 8 BAR-200 L
65161262	SOLAR HYD KIT OMEGA 40 D 8 BAR-250 L
65161263	SOLAR HYD KIT OMEGA 40 D 8 BAR-300 L
65161603	SOLAR HYD KIT OMEGA 2540D 45B SL500L
65161604	SOLAR HYD KIT OMEGA 2540D 0B SL500L
65161605	SOLAR HYD KIT OMEGA 2540D 45B 500L 5C
65161606	SOLAR HYDKIT OMEGA 2540D 0B 500L 5C DSC_2798

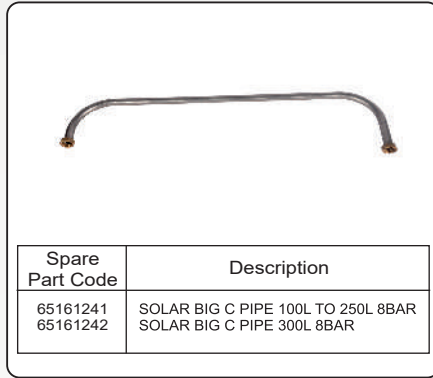

Spare Part Code	Description
65161241	SOLAR BIG C PIPE 100L TO 250L 8BAR
65161242	SOLAR BIG C PIPE 300L 8BAR

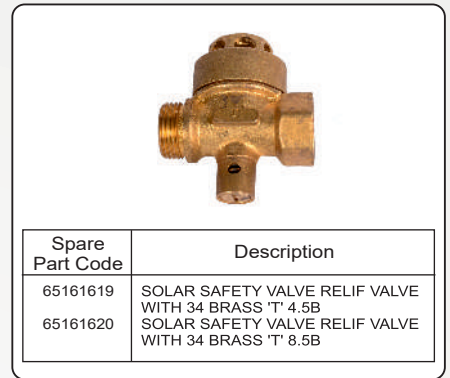

Spare Part Code	Description
65161619	SOLAR SAFETY VALVE RELIF VALVE WITH 34 BRASS 'T' 4.5B
65161620	SOLAR SAFETY VALVE RELIF VALVE WITH 34 BRASS 'T' 8.5B

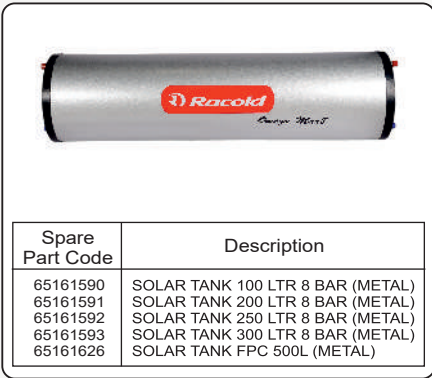

Spare Part Code	Description
65161590	SOLAR TANK 100 LTR 8 BAR (METAL)
65161591	SOLAR TANK 200 LTR 8 BAR (METAL)
65161592	SOLAR TANK 250 LTR 8 BAR (METAL)
65161593	SOLAR TANK 300 LTR 8 BAR (METAL)
65161626	SOLAR TANK FPC 500L (METAL)

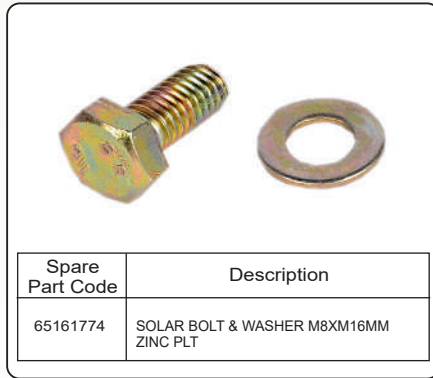

Spare Part Code	Description
65161774	SOLAR BOLT & WASHER M8XM16MM ZINC PLT

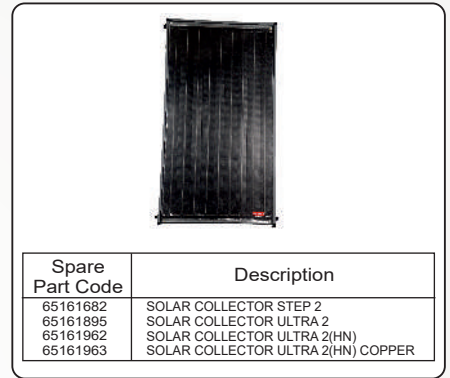

Spare Part Code	Description
65161682	SOLAR COLLECTOR STEP 2
65161895	SOLAR COLLECTOR ULTRA 2
65161962	SOLAR COLLECTOR ULTRA 2(HN)
65161963	SOLAR COLLECTOR ULTRA 2(HN) COPPER

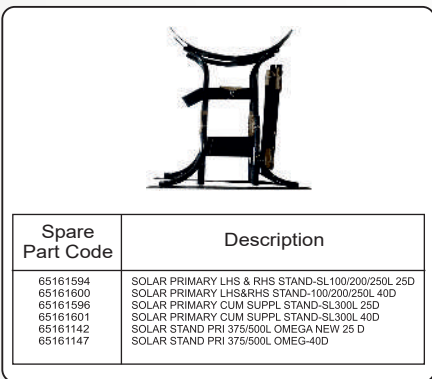

Spare Part Code	Description
65161594	SOLAR PRIMARY LHS & RHS STAND-SL100/200/250L 25D
65161600	SOLAR PRIMARY LHS&RHS STAND-100/200/250L 40D
65161596	SOLAR PRIMARY CUM SUPPL STAND-SL300L 25D
65161601	SOLAR PRIMARY CUM SUPPL STAND-SL300L 40D
65161142	SOLAR STAND PRI 375/500L OMEGA NEW 25 D
65161147	SOLAR STAND PRI 375/500L OMEGA-40D

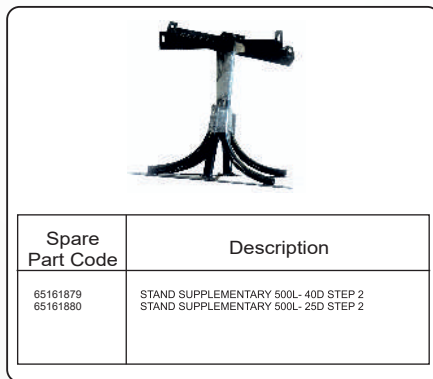

Spare Part Code	Description
65161879	STAND SUPPLEMENTARY 500L- 40D STEP 2
65161880	STAND SUPPLEMENTARY 500L- 25D STEP 2

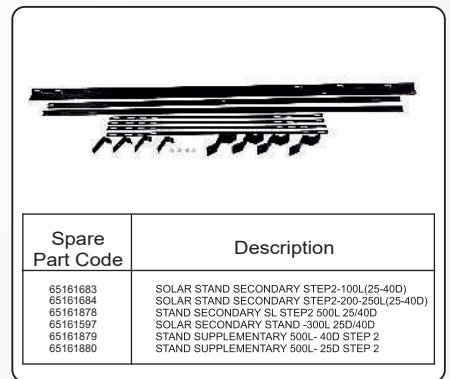

Spare Part Code	Description
65161883	SOLAR STAND SECONDARY STEP2-100L(25-40D)
65161884	SOLAR STAND SECONDARY STEP2-200-250L(25-40D)
65161878	STAND SECONDARY SL STEP2 500L 25/40D
65161597	SOLAR SECONDARY STAND -300L 25D/40D
65161879	STAND SUPPLEMENTARY 500L- 40D STEP 2
65161880	STAND SUPPLEMENTARY 500L- 25D STEP 2

DOMESTIC WATER HEATER



DOMESTIC HEAT PUMP (65L / 80L) Spare Parts



Spare Part Code	Description
65151370-IN	BEZEL PANEL



Spare Part Code	Description
65151371-IN	CONTROL PANEL COVE



Spare Part Code	Description
65151717-IN	FRANKIE 1 ENGLISH DISPLAY



Spare Part Code	Description
65151373-IN	CONTROL BOX MONOBLOCK



Spare Part Code	Description
65151375-IN	FILTER



Spare Part Code	Description
65151376-IN	RIGHT SIDE PLASTIC OF MONOBLOCK



Spare Part Code	Description
65151377-IN	E LOGO PLASTIC



Spare Part Code	Description
65151378-IN	FAN BRACKET



Spare Part Code	Description
65151380-IN	FAN LAMINA DIA 2366



Spare Part Code	Description
65151382-IN	AIR OUTLET CASE



Spare Part Code	Description
65151713-IN	LEFT PLASTIC OF FRANKIE1 INDIA



Spare Part Code	Description
976687-IN	NEW SATETY VALVE 12 7.5B HAN



Spare Part Code	DESCRIPTION
65151384-IN	HEATING ELEMENT 2200W



Spare Part Code	DESCRIPTION
65150277-IN	ANODE C.I.L120



Spare Part Code	DESCRIPTION
65150069-IN	ANODE D25.5145



Spare Part Code	DESCRIPTION
573266-IN	CABLE CLIP



Spare Part Code	DESCRIPTION
65151385-IN	PLASTIC COVER OF POWER CABLE



Spare Part Code	DESCRIPTION
65150952-IN	GASKET FOR 5 BOLTS



Spare Part Code	DESCRIPTION
65151387-IN	MEDIUM HP INTEGRATED



Spare Part Code	DESCRIPTION
65151455-IN	POWER CABLE WITH PLUG FOR SGHP



Spare Part Code	DESCRIPTION
65151389-IN	DRY-FILTER



Spare Part Code	DESCRIPTION
65151390-IN	PCB SWHP-WIRE BOX



Spare Part Code	DESCRIPTION
65151392-IN	COMPRESSOR WHP00930BSV-H3BU



Spare Part Code	DESCRIPTION
65151391-IN	MEDIUM HP INTEGRATED WIRE PCB



Spare Part Code	DESCRIPTION
65151393-IN	ACCUMULATOR



Spare Part Code	DESCRIPTION
65151395-IN	COMPRESSOR CAPACITOR



Spare Part Code	DESCRIPTION
65151397-IN	NTC EVAPORATOR AND AIR



Spare Part Code	DESCRIPTION
65151398-IN	AIR TEMPERATURE SENSOR



Spare Part Code	DESCRIPTION
65151399-IN	COMPRESSOR WIRE



Spare Part Code	DESCRIPTION
65151400-IN	COMPRESSOR PROTECTOR WIRE



Spare Part Code	DESCRIPTION
65151401-IN	HMI WIRE



Spare Part Code	DESCRIPTION
65151402-IN	HMI CONNECT WIRE MONO



Spare Part Code	DESCRIPTION
65151714-IN	FRANKIE 1 ENGLISH REMOTE



Spare Part Code	DESCRIPTION
65151404-IN	SCREW HOLE COVER



Spare Part Code	DESCRIPTION
65151405-IN	HEATER ELEMENT WIRE



Spare Part Code	DESCRIPTION
65151406-IN	ACTIVE ANODE WIRE



Spare Part Code	DESCRIPTION
65151407-IN	SIGNAL CONNECTION WIRE



Spare Part Code	DESCRIPTION
65151408-IN	MAIN-INTERCONNECT PCB GROUND WIRE

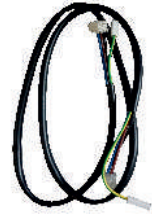

Spare Part Code	DESCRIPTION
65151409-IN	POWER CONNECTION WIRE



Spare Part Code	DESCRIPTION
65151410-IN	INTERCONNECT PCB GROUND WIRE



Spare Part Code	DESCRIPTION
65151715-IN	F1 ENGLISH STICKER OF DISPLAY



Spare Part Code	Description
65151379-IN	DC FAN MOTOR



Spare Part Code	DESCRIPTION
65151386-IN	MAIN PCB BOARD 65/80

DOMESTIC WATER HEATER

DOMESTIC HEAT PUMP
(150L / 200L)
Spare Parts



Spare Part Code	DESCRIPTION
65152005-IN	MAIN PCB BOARD 150/200



Spare Part Code	DESCRIPTION
65151636-IN	DISPLAY PCB 200
65152216-IN	DISPLAY PCB 150



Spare Part Code	Description
65151543-IN	HP-SAFETY VALVE 34-150L & 200L



Spare Part Code	Description
65152215-IN	HP-POWER CABLE FOR INDIAN-150L
65151549-IN	HP-POWER CABLE WITH ELCB-200L



Spare Part Code	Description
573266-IN	CABLE CLAMP-150L & 200L



Spare Part Code	Description
65151544-IN	HP-NTC BOARD FRANKIE4-150L & 200L



Spare Part Code	Description
65151548-IN	HP-F4 ANODE D21900-150L
65152025-IN	HP-MG ANODES EXTRUSION ANODE 22500-200L



Spare Part Code	Description
65151540-IN	HP-5 POLES TERMINAL BLOCK -150L & 200L



Spare Part Code	Description
65151538-IN	HP-2 POLES TERMINAL BLOCK -150L & 200L



Spare Part Code	Description
65151541-IN	HP-SECOND THERMOSTAT 30A -150L & 200L



Spare Part Code	Description
65150323-IN	HP-T&P SAFETY VALVE-150L & 200L



Spare Part Code	Description
65152021-IN	HP-WIRING SENSOR WIRE F4ENTRY 200L-200Ln
65152020-IN	HP-WIRING SENSOR WIRE F4ENTRY 150-150Ln



Spare Part Code	DESCRIPTION
65152022-IN	HP-WIRING CABLE CONTROLLER CONNECTING WIRE-150L & 200LM



Spare Part Code	DESCRIPTION
65152014-IN	HP-CABLE FILTER OUTLET WIRE F4ENTRY 200L-200L



Spare Part Code	Description
65151628-IN	HP-SIGNAL AIR CONNECTION WIRE J3-150L & 200L



Spare Part Code	Description
65151603-IN	HP-GROMMET BLIND D11-150L & 200L



Spare Part Code	Description
65151562-IN	HP-SIGNAL WIRE 4M INDOOR TO OUTDO-150L & 200L



Spare Part Code	Description
65152011-IN	HP-WIRING COMPRESSOR WIRE F4ENTRY-150L & 200L



Spare Part Code	Description
65152015-IN	HP-WIRING H.E WIRE F4ENTRY-150L



Spare Part Code	Description
65152016-IN	HP-WIRING H.E WIRE F4ENTRY-200L



Spare Part Code	Description
65151563-IN	HP-POWER WIRE INDOOR TO OUTDOOR F-150L & 200L



Spare Part Code	DESCRIPTION
65152006-IN	HEATING ELEMENT 1800W 220V



Spare Part Code	DESCRIPTION
65151537-IN	FILTER 16A

COMMERCIAL

COMMERCIAL WATER HEATER Spare Parts



Spare Part Code	Description
65161917	CONTROL PANEL BOX



Spare Part Code	Description
65161918	HEAT-ADJ. CONTROL UNIT TEMPERATURE (2)



Spare Part Code	Description
65161919	RELAY CONTROL PANEL



Spare Part Code	Description
65161920	SENSOR FOR CONTROLLER



Spare Part Code	Description
65161921	CONTROL UNIT PANEL SET



Spare Part Code	Description
65161566	SOLAR ELECTRICAL KIT 2KW AUTOCLAVIC FLNG NEW (OLD CODE-065160593)



Spare Part Code	Description
65161567	SOLAR ELECTRICAL KIT 3KW AUTOCLAVIC FLNG NEW- (OLD CODE-065160734)



Spare Part Code	Description
65161931	NON RETURN VALVE ASSLY ALPHA PRO-1X1
65161938	NON RETURN VALVE ASSLY ALPHA PRO-3X4



Spare Part Code	Description
65161792	ROCKWOOL - COLLECTOR - SW



Spare Part Code	Description
65161015	CONTROL PANEL BOX



Spare Part Code	Description
65161932	ANTI-SCALING SYSTEMS MODEL D-INSTANT
65161933	ANTI-SCALING SYSTEMS MODEL S-EWH
65161934	ANTI-SCALING SYSTEMS MODEL M-EWH
65161935	ANTI-SCALING SYSTEMS MODEL-SOLAR



Spare Part Code	Description
65161619	SAFETY VALVE / RELIEF VALVE 4.5 BAR
65161920	SAFETY VALVE / RELIEF VALVE 8.5 BAR
65161679	
65161680 (OLD)	



Spare Part Code	Description
65161965	BALL WALL 50MM
65161983	BALL WALL 40MM
65161969	BALL WALL 32MM
65161972	BALL WALL 25MM
65161976	BALL WALL 20MM



Spare Part Code	Description
65161966	CHECK VALVE 50MM
65161970	CHECK VALVE 32MM
65161973	CHECK VALVE 25MM



Spare Part Code	Description
65161967	SS 304 L-Y STRAINER 50MM
65161983	SS 304 L-Y STRAINER 40MM
65161969	SS 304 L-Y STRAINER 25MM



Spare Part Code	Description
65161975	AUTO AIRVENT 25 MM
65161979	AUTO AIRVENT 20 MM



Spare Part Code	Description
65161977	SAFETY VALVE 25 MM
65161978	SAFETY VALVE 20 MM



Spare Part Code	Description
65161968	FLOW METER ANALOG 50MM



Spare Part Code	Description
65161980	FLOW BALANCING VALVE 20 MM



Spare Part Code	Description
65161981	TEMP. GAUGE 15 MM



Spare Part Code	Description
65161982	PRESSURE GAUGE ISOLATION VALVE 15 MM



Spare Part Code	Description
65161985	EXAPNTION VALVE



Spare Part Code	Description
65161986	PRESSURE SWITCH



Spare Part Code	Description
65161984	CIRCULATION PUMP



Spare Part Code	Description
065160520	SOLAR BR ELBOW BIG 3/4" SOLAR



Spare Part Code	Description
065160268	SOLAR- BRASS T WH NEW



Spare Part Code	Description
65161202	SOLAR 3/4" TO 3/4" MALE CONNECTOR



Spare Part Code	Description
065160259	SOLAR HOSE CLIP SOLAR WH



Spare Part Code	Description
65161616	SOLAR ADAPTER MALE 1" TO 3/4"
065160438	SOLAR BRASS ADAPTER SOLAR 3/4"



Spare Part Code	Description
65161586	SOLAR 3/4" TO 3/4" MALE CONNECTOR



Spare Part Code	Description
65161576	SOLAR BRASS END CAP 1"

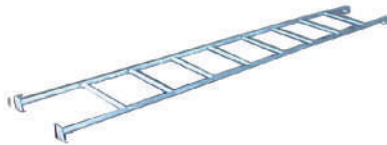

Spare Part Code	Description
65161571	SOLAR LADDER



Spare Part Code	Description
65161577	SOLAR BRASS COUPLING 1"
065160733	SOLAR BR. ADAPTOR 1" MALE THREADED



Spare Part Code	Description
65161574	SOLAR FEEDER TANK 5L



Spare Part Code	Description
65161203	SOLAR 3/4 TO 1/2 MALE CONNECTOR



Spare Part Code	Description
65161774	SOLAR BOLT & WASHER M8XM16MM ZINC PLT



Spare Part Code	Description
65161797	SAFETY VALVE PLASTIC HOUSING 0.8BAR



Spare Part Code	Description
65161798	SAFETY VALVE BRASS HOUSING 0.8BAR



Spare Part Code	Description
0508414	SOLAR AIR RELEASE VALVES - SOLAR (2)



Spare Part Code	Description
65161940	SOLAR PUMP



Spare Part Code	Description
65161083	SOLAR SOLAR TEMP PROBE FOR LIQ (STLDESL)
65161084	SOLAR SOLAR TEMP PROBE FOR LIQ (STLDESL)



Spare Part Code	Description
65161151	SOLAR SOLAR DIFF TEMP SENSOR THERMOWEL 11"
65161152	SOLAR SOLAR DIFF TEMP SENSOR THERMOWEL 7"



Spare Part Code	Description
65161793	Racold Commercial Sticker



Spare Part Code	Description
065160588	SOLAR HE WITH THERMOSTAT 3KW FOR SOL (OLD CODE-065160492,65160797)
65161256	SOLAR HEATING ELEMENT RD FLNG 2 KW (OLD CODE 65160796)



Spare Part Code	Description
65161006	Safety Valve



Spare Part Code	Description
65161568	SOLAR ELECTRICAL KIT 2KW SQ FLNG NEW (OLD CODE 065160189)
65161569	SOLAR ELECTRICAL KIT 3KW SQ FLNG NEW (OLD CODE 065160591)



Spare Part Code	Description
65161572	RELIF VALVE3-4-9PY0999817



Spare Part Code	Description
65161893	REDUCER 1/2" X 3/4"

COMMERCIAL WATER HEATER

COMMERCIAL HEAT PUMP

Spare Parts



Spare Part Code	Description
65152845	HP-SWITCH PRESSURE HIGH



Spare Part Code	Description
65152847	HP-SWITCH LOW PRESSURE



Spare Part Code	Description
65152848	HP-EXPANS. VALVE HP



Spare Part Code	Description
65152849	HP-FILTER HP



Spare Part Code	Description
65152850	HP-PRESSURE GAUGE HP



Spare Part Code	Description
65152851	HP-4-WAY VALVE HP



Spare Part Code	Description
65152852	HP-PUMP CIRCULATION



Spare Part Code	Description
65152853	HP-COMPRESSOR CAPACITOR



Spare Part Code	Description
65152854	HP-FAN CAPACITOR

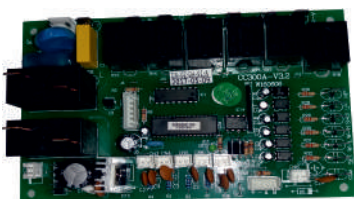

Spare Part Code	Description
65152855	HP-P.C.B.(CONTROL BOARD) (MAIN) HP 6KW/11KW

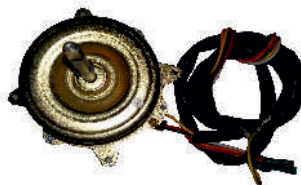

Spare Part Code	Description
65152857	HP-FAN MOTOR



Spare Part Code	Description
65152859	HP-SENSOR RETURN WATER



Spare Part Code	Description
65152860	HP-SENSOR EVAPORATOR



Spare Part Code	Description
65152861	HP-REMOTE CONTROL HP



Spare Part Code	Description
65152863	HP-4-WAY VALVE HP1



Spare Part Code	Description
65152864	HP-WATER FILTER HP



Spare Part Code	Description
65152865	HP-EXPANS. VALVE HP1



Spare Part Code	Description
65152866	HP-FAN CAPACITOR HP1



Spare Part Code	Description
65152867	HP-RELAY HP



Spare Part Code	Description
65152868	HP-COMPRESSOR CAPACITOR HP1



Spare Part Code	Description
65152870	HP-3 DIGIT POWER SOURCE TERMINAL



Spare Part Code	Description
65152872	HP-EXPANS. VALVE HP2



Spare Part Code	Description
65152874	HP-SENSOR EVAPORATOR HP1



Spare Part Code	Description
65152875	HP-SENSOR HOT WATER HP1



Spare Part Code	Description
65152876	HP-SENSOR RETURN WATER HP1

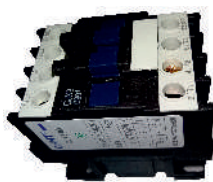

Spare Part Code	Description
65152879	HP-RELAY COMPRESSOR



Spare Part Code	Description
65152880	HP-RELAY FAN



Spare Part Code	Description
65152881	HP-REMOTE CONTROL HP1



Spare Part Code	Description
65152869 65152871	HP3 FAN MOTOR



Spare Part Code	Description
573266-IN	CABLE CLIP



Spare Part Code	Description
65152846 65152862 65152873	COMPRESSOR



Spare Part Code	Description
65152856 65152877	TRANSFORMER HP TRANSFORMER HP1



Spare Part Code	Description
65152858	SENSOR HOT WATER



Spare Part Code	Description
65152882	FAN MOTOR



Spare Part Code	Description
65152878	MAIN PCB CONTROL BOARD 21KW/44KW



Spare Part Code	Description
65153256 65153257	FAN BLADE

ELECTRIC & SOLAR WATER HEATER PLUMBING

Spare Parts



Spare Part Code	Description
65161896	VALVE BALL 1/2" UPVC



Spare Part Code	Description
65161897	VALVE BALL 3/4" UPVC



Spare Part Code	Description
65161900	VALVE BALL 1/2" BRASS PN 40
65161901	VALVE BALL 3/4" BRASS PN 40



Spare Part Code	Description
65161902	PLUG END 1/2"



Spare Part Code	Description
65161904	SEAL RUBBER HOSE CLIP 1/2"



Spare Part Code	Description
65161905	GAS PIPE SURAKSHA IS 9573 (1998)



Spare Part Code	Description
65161906	NOZZLE BARRAL NIPPLE



Spare Part Code	Description
65161908	TEFLON TAPE



Spare Part Code	Description
65161907	NOZZLE ANGLE COCK 1/2"



Spare Part Code	Description
65161898	VALVE BALL 1/2" CPVC



Spare Part Code	Description
65161899	VALVE BALL 3/4" CPVC



Spare Part Code	Description
65161901	VALVE BALL 3/4" BRASS PN 40

ELECTRIC WATER HEATER (OLD)

Spare Parts



Spare Part Code	Model	Available in
65160750	CD Glass wool (V)	1.5 kW
65160748		2 kW
0507117		3 kW



Spare Part Code	Model	Available in
65160746	CD Glass wool (V)	1.5 kW
65160747		2 kW
65160749		3 kW



Spare Part Code	Model	Available in
65160739	CD Glass wool (H)	2 kW LL*
65160741		3 kW LL*



Spare Part Code	Model	Available in
65160738	CD Glass wool (H)	2 kW
65160745		3 kW
65160744		3 kW SL*



Spare Part Code	Model	Available in
65160754	ER Old (V)	2 kW



Spare Part Code	Model	Available in
65160761	ER15 HFM/CD 15H	2 kW
65160759	ER15 HWM	2 kW
65160762	ER25/35 HFM	2 kW
65160760	ER25/35 HWM	2 kW
65160751	CD 70/100 H PUF	3 kW



Spare Part Code	Model	Available in
65160771	ER II	3 kW
65160770	PT 71/76	3 kW
65160772	PT 71/76	4.5 kW



Spare Part Code	Model	Available in
0816092	Platinum 300 V	3 kW



Spare Part Code	Model	Available in
65160766	ER I/FR I	1+3 kW
65160769	ER II S	4.5 kW
65160767	ER II	3.2kW



Spare Part Code	Model	Available in
65160773	AL 6/10(V)/ER 10(V)	3 kW
65160774	ER 10 (V)	2 kW
65160775	AL10 (H)	3 kW



Spare Part Code	Model	Available in
65160776	ER 10 Old (V)	3 kW



Spare Part Code	Model	Available in
0507315	Ariston 15	2 kW
0507316	Ariston 25 (Old)	2 kW

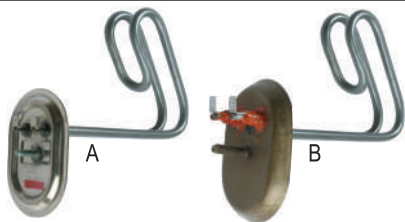

Spare Part Code	Model	Available in
A 0503120	Ti-tech 15/25	2 kW
B 0999474	Ariston 15/25	1.2 kW
B 0999475	New	1.5 kW



Spare Part Code	Model	Available in
65160743	Altro 10 H (Old)	3.2 kW
65160740	CD 25 H	2 kW
65160742	CD 35 H	3 kW



Spare Part Code	Model	Available in
65160753	Eterno & CD PUF 70/100 (V)	2 kW
65160752		3 kW



Spare Part Code	Model	Available in
65160784	AL/ER 15,25 HWM	2 kW
65160787	AL/ER 35,50 HWM	2 kW
65160789/90	ER 15 25,35 HFM	2 kW
65160763	PRIMO 35, 50	2 kW



Spare Part Code	Model	Available in
65160755 (Anode)	Altro (V)	2 kW (8W/CM ²)
65160946	15/25/35 & 50	2 kW (8W/CM ²)
65160756 (Anode)	Eterno (V)	2 kW (6W/CM ²)
65160947	15/25/35	2 kW (6W/CM ²)



Spare Part Code	Model	Available in
65160888	AL/ER 15,25,35 V	2 kW
65160792 (Anode)		2 kW



Spare Part Code	Model	Available in
65160890/91	AL/ER 15,25,35	2 kW RHS
65161678	HWM	2 kW LHS
65161677 (Anode)	AL/ER 15,25,35	2 kW RHS
65160794/95 (Anode)	HWM	2 kW LHS



Spare Part Code	Model	Available in
65160889	ER 15,25,35	2 kW
65160793 (Anode)	HFM	2 kW



Spare Part Code	Model	Available in
65160957 (Anode)	PRIMO 15, 25	2 kW
65160895 (Anode)	PRIMO 35, 50	2 kW



Spare Part Code	Model	Available in
0869134	Flange	
65161099	Platinum 50 V	2 kW



Spare Part Code	Model	Available in
65160887	Platinum 50 H	2 kW
65160781	Platinum 70,100 V	3.2 kW



Spare Part Code	Model	Available in
65160780	Platinum 70,100 H	3.2 kW



Spare Part Code	Model	Available in
0507041 0507042	ER I/ER II/FR I	Thermal Cutout Thermostat



Spare Part Code	Model	Available in
65100412-IN	Altro/Eterno (H)	9"
65102908-IN	New AL/ER 10 V	9"
993215-IN	AL 50 (V)	11"
65107054-IN	ER/CD/AL 25/35 V	11"



Spare Part Code	Model	Available in
0816720	Platinum 150, 200 V	3.2 kW



Spare Part Code	Model	Available in
065160044	Old CD (V/H)	11" Thermostat
065160045	Perla	11" Cut-out
0507055	Instant Water Heaters	7" Thermostat
0507166		7" Cut-out



Spare Part Code	Model	Available in
65103326	Magnesium	110 mm
65180015	Anode	165 mm
65161259		110 mm
99301401		230 mm



Thermostat		Cut out	
Spare Part Code	Model	Available in	
65160970	PRIMO 15, 25	-	
0999325	PRIMO 35, 50	-	
65160971	PRIMO 15, 25	-	
0999324	PRIMO 35, 50	-	



Thermostat with Cut out

Spare Part Code	Model	Available in
0820801	Ariston/Rhyme /Ti-tech	--



Spare Part Code	Model
65109003-IN	AL/ER Storage (7 Bar)
0869116	AL/ER Storage (8 Bar)



Spare Part Code	Model
0507148	NR Gasket for Heater plate
0507215	NR Gasket for Heater plate PT 71/76
0507480	Gasket for ER I/ER II
0508104	Heater plate Gasket PR I/PR II
0508238	Heater plate Gasket PR III/PR IV
65161303	NR Gasket for NP



Spare Part Code	Model
0507147	NR Gasket for QNT Flange
0507433	NR Gasket for CD/ER Heating Element
0508024	Gasket for Altro & Eterno Heating Element
0507306	Gasket for Ariston/Rhyme Heating Element
0508352	Gasket for Auto Calvic Flange Heating Element



Code	Discription
0999353	1 Feet (1/2" x 30 cm)
0017845	1 1/2 Feet (1/2" x 45 cm)
0999345	2 Feet (1/2" x 60 cm)
0999354	3 Feet (1/2" x 90 cm)
65161533	4 Feet (1/2" x 120 cm)



Code	Discription
65161942	1 Feet (1/2" x 30 cm) Set
65161621	1 1/2 Feet (1/2" x 45 cm) Set
65161622	2 Feet (1/2" x 60 cm) Set
65161944	3 Feet (1/2" x 90 cm) Set
65161943	4 Feet (1/2" x 120 cm) Set

Complete Range of Water Heating Solutions

With our complete range of water heating solutions and path breaking innovations, you can trust us to always bring you the best.

While our single largest successfully executed installation has achieved the capacity of 2,00,000 liters per day, our range of products extend across capacities starting from 1 liter to several lakh liters.





Reborn Everyday With Hot Water



An
ISO 9001 : 2008
Certified Company



Customer care number:
1860 425 2288 / 8600256000 / 9243 2222 88



customer.care@racold.com



9422600140 / 9243700100



Marketed by:

Ariston Thermo India Private Limited, 2nd Floor, Eastern Wing, Nyati Unitree,
Nagar Road, Yerwada, Pune – 411006, Maharashtra, India.

Tel: (020) 6725 7600 www.racold.com

Ariston Thermo Spa, Viale Aristide Merloni 45, 60044, Fabriano (AN) - Italy.

Tel: +39 0732 6011 www.aristonthermo.com



Winner of
National Energy
Conservation Awards
Highest Number of Times