

# The Water Professional's Catalog



- Worldwide Distribution
- Single-Source Supplier
- Nationwide Support When you Need It
- Experts in Water Treatment Technology

The information is provided only for convenience and comparison purposes, and is based on data believed to be correct at the date of publication. Actual performance may vary. Watts reserves the right to change the information and products from time to time without notice. Particular conditions, methods and use of our products are beyond our control. Users themselves must determine, through testing or otherwise, the suitability of products for particular applications, whether the information provided is applicable to their circumstances, whether the product's specifications and performance are compatible with their use environment and other equipment, and compliance with applicable laws and regulations. **THE INFORMATION IN THIS PUBLICATION MAKES NO WARRANTY OR PERFORMANCE GUARANTEE, EXPRESS OR IMPLIED, INCLUDING BUT NOT LIMITED TO THE WARRANTY OF MERCHANTABILITY OR FITNESS FOR A PARTICULAR PURPOSE.**

Fleck® is a registered trademark of Pentair, Inc.

Aquamatic® is a registered trademark of Pentair, Inc.

Vortech™ is a trademark of Enpress LLC

GreensandPlus™ is a trademark of Hungerford & Terry, Inc.

Mighty Pure® is a registered trademark of Atlantic Ultraviolet Corporation

Sanitron® is a registered trademark of Atlantic Ultraviolet Corporation

ONE Cartridge Tank® is a registered trademark of Enpress LLC

<b>Terms and Conditions</b> .....	3
<b>Return Goods Policy</b> .....	4
<b>Scale Control Systems</b> .....	5
E-Treat Water Conditioning System with Scale Prevention .....	6
ScaleNet Anti-Scale Systems .....	7-8
<b>Water Softeners</b> .....	9
<b>Residential</b>	
Water Softeners with Watts ProSense™ Valves .....	9
Water Softeners with Watts 1000 Valves .....	10
Dual-Media Water Softeners with Watts W100 Valves .....	11
Tri-Plex Water Conditioning Systems with Watts W100 Valves .....	12
Twin Tank-Dual Chamber Water Conditioners With 9100 Valves .....	13
Water Softeners with Watts W100 Valves .....	14
Water Softeners with Watts W100T Twin Alternating Valves .....	15
Water Softeners with Watts W110 Valves .....	16
Water Softeners with Fleck 7000 Valves .....	17
Water Softeners with Fleck 5600 Valves .....	18
Water Softeners with Fleck 2510 Valves .....	19
Water Softeners with Fleck 2750 Valves .....	19
Water Softeners with Fleck 9100 Valves .....	20
Water Softeners with Fleck 9000 Valves .....	21
<b>Commercial</b>	
Water Softeners with Watts 1 1/2" Valves .....	22
Water Softeners with Fleck 2850 Valves .....	23
Water Softeners with Fleck 9500 Valves .....	24
Water Softeners with Watts 2" Valves .....	25
Water Softeners with Fleck 2900 Valves .....	26
Heavy Duty Water Softeners with Watts 3" Valves .....	27
Water Softeners with Fleck 3900 Valves .....	28
Heavy-Duty Steel Tank Water Softeners with Fleck Valves .....	29-30
<b>Media Filtration Systems</b> .....	31
Automatic Backwashing with Micro Z .....	31
Automatic Backwashing Filox and GreensandPlus Filters .....	32
Non-Backwashing Carbon Filters .....	33
Automatic Backwashing Carbon Filters .....	34-36
Filter Media Properties and Conditions for Operation .....	36
Automatic Backwashing Systems without Media .....	37-38
<b>Drinking Water Systems</b> .....	39
Drinking Water Selection Guide .....	39
Under Counter Quick-Twist (QT) Proprietary Cartridge Systems .....	40
Under Counter Quick-Change (QC) Proprietary Cartridge Systems .....	41
Standard Cartridge Systems .....	42
Counter Top Cartridge Systems .....	42
Top Quality Designer Faucets .....	43-44

<b>Reverse Osmosis Systems</b> .....	<b>45</b>
RO System Selection Guide.....	45
<b>Residential</b>	
Quick-Change (QC) Proprietary Cartridge Systems .....	46
QT-Plus Series Quarter-Turn Proprietary Cartridge Systems .....	47
Certified Standard Cartridge One Piece Manifold Systems .....	48
Standard Cartridge Half-Turn Housing Systems .....	49
Series 315, 415 & 525 Certified Standard Cartridge Systems .....	50
Permeate Pump, GTS Series Standard Cartridge Systems .....	51
Water Kits or Booster Pump Kits for Residential RO Systems .....	52
Top Quality Designer Faucets .....	53
<b>Light Commercial</b>	
Reverse Osmosis LC Series .....	54
Reverse Osmosis R12 Series .....	55
Reverse Osmosis R13 Series .....	56
Reverse Osmosis R4X40 Series .....	57
<b>Heavy Duty Commercial</b>	
Reverse Osmosis R14 Wall Mount Series .....	58
Reverse Osmosis R14 Series .....	59
Reverse Osmosis R24 Series .....	60
Reverse Osmosis R44 Series .....	61
Reverse Osmosis R48 Series .....	62
<b>Ultraviolet (UV)</b> .....	<b>63</b>
Watts UV Systems, Lamps, Quartz Sleeves, Ballasts.....	64
Atlantic UV Systems, Lamps, Quartz Sleeves, Ballasts.....	64
Trojan UV Systems, Lamps, Quartz Sleeves.....	65
Flow-Max UV Plus Systems, Lamps, Quartz Sleeves, Ballasts .....	65
HSFS Filter System and Components .....	65
<b>Cartridge Filtration Systems</b> .....	<b>66</b>
Big Bubba Non-Metallic Filter Housing Systems.....	66-67
One Cartridge Tank Filtration Systems.....	68-73
Flow-Max Stainless Cartridge Systems.....	74
Flow-Max Bag Filters .....	80
<b>Components</b> .....	<b>81</b>
Resins and Media .....	81-87
<b>Cartridges</b>	
Carbon Cartridges .....	88
Sediment Cartridges .....	98
Specialty Cartridges .....	114
<b>Tanks</b>	
Steel Tanks .....	119
Fiberglass Tanks .....	120
Stainless Steel Jackets .....	124
DI Tanks, Fittings, Hose, Drop-In Screens .....	125
Tank Manifold Assemblies .....	126
Bladder and Storage Tanks .....	127
Distributors .....	130
Brine Tanks .....	134
Fittings, Tubing, Flow Restrictors .....	138
Valves .....	154
Filter Housings .....	175
Chemical Feed , Test Kits, Meters .....	191
RO Components .....	201

For the purposes of these terms and conditions the "Seller" is the applicable Watts Water Technologies entity named in any purchase, credit or invoice documents.

**FREIGHT TERMS:** CONSULT YOUR PRODUCT PRICE CATALOG FOR SPECIFIC FREIGHT TERMS.

**TERMS OF SALE:** ALL SALES ARE F.O.B. SHIPPING POINT.

**PAYMENT TERMS:** The invoices are due and payable thirty (30) days from the date of invoice. Consult your product price catalog for any other specific payment terms. Should the account balance exceed any established credit limit, liability for payment additionally extends to the entire balance. Seller has the right to reduce the credit limit and/or withdraw Applicant credit under the Credit Agreement at any time without prior notice, except as otherwise provided by law. Seller reserves the right to revoke credit or demand full payment if Applicant fails to pay when due or, if in the sole discretion of Seller, there has been an adverse change in buyers ability to repay credit extended by Seller, whereupon Seller shall have the right to demand payment or other assurance which is deemed adequate and Seller is hereby authorized to file any lien available to vendors and/or applicators of Products in the manner provided by applicable law notwithstanding the terms of invoices or other documents or the existence of an event of Default. Buyer shall make all claims for billing adjustments/errors in writing within 20 business days from the invoice date. Claims not received within the time specified are waived by the buyer. Default by Applicant under this or any other agreement between Applicant and Seller shall be a default under all agreements. Seller does not waive its rights by accepting late payments. Applicant agrees to pay reasonable attorney fees and cost of collection.

**BUYER'S TERMS AND CONDITIONS:** Any conflicting statements or terms listed on Buyer's purchase orders, invoice, confirmations or other Buyer generated documents ("Buyer Documents") are negated by submission of these Credit Application Terms and Conditions ("Terms and Conditions") and the issuance of credit by Seller. All different or additional terms and conditions contained in any Buyer Documents are hereby rejected by Seller. Seller's performance of any contract is expressly made conditional on Buyer's agreement to Seller's terms and conditions, unless otherwise specifically agreed to in writing by Seller. Commencement of performance and/or delivery shall be for Buyer's convenience only and shall not be deemed or construed to be acceptance of Buyer's terms and conditions, or any of them. If a contract is not earlier formed by mutual agreement in writing, acceptance of any goods or services shall be deemed acceptance of the Terms and Conditions stated herein.

**SECURITY AGREEMENT:** Buyer grants Seller a purchase money security interest in the items sold hereunder whether including, but not limited to, equipment, inventory, fixtures and/or general intangibles shipped by Seller at any time, including all accessions to and replacements thereto, and all proceeds thereof (collectively, the "Collateral") to secure the payment of the purchase price of such Collateral. Buyer grants Seller a limited power of attorney to file one or more financing statements signed by Seller on behalf of Buyer and authorizes Seller to use a copy of this agreement as an exhibit to any financing statement. Buyer agrees to cooperate fully with Seller in executing any additional documents, instruments, financing statements or amendments thereto as Seller may request to perfect or continue the security interest created by this agreement.

**STOCKING WHOLESALE MINIMUM CHARGE:** Consult your product price catalog for specific stocking wholesaler minimum charges.

**SPECIAL PRODUCTS:** ORDERS FOR SPECIAL OR MODIFIED PRODUCTS ARE NON-CANCELABLE.

**LIMITED WARRANTY:** Seller shall provide its then-current standard written warranty for the Product purchased which contains the sole remedies for breach of warranty. SUCH WARRANTY IS GIVEN EXPRESSLY AND IS THE ONLY WARRANTY GIVEN BY SELLER WITH RESPECT TO THE PRODUCTS. SELLER MAKES NO OTHER WARRANTIES, EXPRESS OR IMPLIED. TO THE FULL EXTENT PERMITTED BY LAW, SELLER HEREBY SPECIFICALLY DISCLAIMS ALL OTHER WARRANTIES, EXPRESS OR IMPLIED, INCLUDING BUT NOT LIMITED TO THE IMPLIED WARRANTIES OF MERCHANTABILITY AND FITNESS FOR A PARTICULAR PURPOSE.

**LIMITATION OF LIABILITY:** IN NO EVENT SHALL SELLER BE LIABLE, IN CONTRACT, TORT, STRICT LIABILITY, OR UNDER ANY OTHER LEGAL THEORY, FOR INCIDENTAL, INDIRECT, SPECIAL OR CONSEQUENTIAL DAMAGES, REGARDLESS OF WHETHER IT WAS INFORMED ABOUT THE POSSIBILITY OF SUCH DAMAGES, AND IN NO EVENT SHALL SELLER'S LIABILITY EXCEED AN AMOUNT EQUAL TO THE SALES PRICE OF THE PRODUCTS. THE FOREGOING LIMITATIONS SHALL APPLY TO THE FULL EXTENT PERMITTED BY LAW.

THE BUYER ASSUMES ALL RESPONSIBILITY FOR THE FINAL SELECTION, TESTING AND VALIDATION OF PRODUCTS PURCHASED FROM SELLER AND THE FITNESS OF SUCH PRODUCTS FOR THE BUYER'S APPLICATION.

**RETURNED GOODS MINIMUM CHARGE:** NO MATERIAL SHALL BE RETURNED TO SELLER WITHOUT AUTHORIZATION. When credit is issued it will be at the price charged, or prevailing price if lower, less handling charges based on costs of reconditioning, boxing, etc. Restocking charges will apply. Consult your product price catalog for specific returned goods charges.

**MISCELLANEOUS:** Prices and terms are subject to change without notice and supersede all previous quotations. Seller reserves the right to change or modify product design or construction without prior notice and without incurring any obligation to make such changes or modifications to products previously or subsequently sold. In the event that any of the provisions of this agreement shall be held to be invalid or unenforceable in whole or in part, those provisions to the extent enforceable and all other provisions shall nevertheless continue to be valid and enforceable as though the invalid or unenforceable parts had not been included in this document.

**GOVERNING LAW/ DISPUTES:** This agreement shall be governed by the laws of the Commonwealth of Massachusetts without giving effect to its conflict or choice of law rules. All disputes under these terms and conditions shall be resolved by courts located in the Commonwealth of Massachusetts. The parties agree and consent to the exclusive jurisdiction and venue of the federal and state courts in the Commonwealth of Massachusetts, and Buyer waives any jurisdiction or venue defense otherwise available.

**ENTIRE AGREEMENT:** This agreement contains the entire agreement between the Buyer and Seller with respect to the subject matter contained herein and supersedes any other prior agreements, whether in written or oral form. The terms and conditions contained herein may not be changed except in writing signed by an officer of Seller.

Initial: \_\_\_\_\_ Date: \_\_\_\_\_

## RETURN GOODS POLICY

1. Customers who wish to return merchandise must provide the following information:  
1) Contact name; 2) Company name; 3) Customer Number; 4) Products to be returned and reason for the return; 5) Customer's P. O. number, under which the goods were purchased (if issued); 6) Watts invoice number, under which the goods were purchased.
2. Requests for returns must be approved by the Return Goods Administrator, and only the RGA Administrator shall issue Return Goods Authorizations.
3. No products may be returned, nor shall credits be processed until written approval has been issued by the Watts RGA Administrator. Please note RGA numbers on the shipping label for proper processing, and include a copy of the RGA form inside the shipping carton to receive prompt attention.
4. Goods returned for credit or refund, including goods returned for inspection under warranty, must be shipped to the warehouse by prepaid transportation. No "collect" shipments will be accepted.
5. Products not stocked, will not be accepted for credit.
6. Drop Ship product will not be accepted for return/credit without prior approval from our Supplier.
7. Only sellable goods may be returned as long as they are in original shipping cartons, unmarked.
8. All returns for goods placed by verbal order will be subjected to a 25% restocking fee.
9. Custom products, such as water softeners, backwashing filters, filtration systems, commercial equipment and other custom products may not be returned.
10. Equipment, which has been installed, may not be returned under any circumstances.
11. Authorized credits will be issued at the price paid, less a twenty-five (25) percent restocking charge plus repackaging costs (if necessary).
12. Merchandise older than three (3) months from purchased date, may not be returned (non warranty related).
13. Watts reserves the right to refuse returns at its sole discretion.

### FREIGHT: Shipments are F.O.B. our dock.

1. **Visual damage:** Note on the Bill of Lading (B.O.L.) the damage and the extent of damage. Contact the freight company and start the process to file a claim. Damage not noted is considered a delivery free and clear by the freight company.
2. **Concealed damage:** There is a 15 calendar day claim period for any concealed damage. Freight should be inspected at time of delivery to include any suspected damages. Contact the freight company and start the process to file a claim.
3. **Shortages:** All shortages should be reported within 5 days of receipt. If shortages are known at time of receipt, this must be indicated on the B.O.L.

### Important:

If customers claim returns are due to company error, the burden of proof is the customer's responsibility. If the matter cannot be resolved by telephone, customer may elect to return merchandise by prepaid freight for inspection, so the matter may be further investigated. Shipping errors must be reported within 5 days after receipt of product.

If company agrees Watts is in error, return freight costs will be credited or refunded to customer.

Signature \_\_\_\_\_ Date \_\_\_\_\_

***Please sign, date and return with the Credit Application. Thank you!***

## ScaleNet™ Scale Control Systems

*Calcium scale in pipes and plumbing equipment often increases energy costs and can lead to expensive repairs to appliances such as hot water heaters, ice machines, coffee makers, and dishwashers. On the other hand, calcium is important to human health, and supplements are often recommended if this important mineral is totally reduced or absent from a person's diet.*

*Water quality professionals now have a revolutionary product for fighting scale and retaining the benefits of calcium in water: ScaleNet™. With ScaleNet there's no salt, no backwash, no scale, and no electricity to worry about. This environmentally-friendly solution eliminates sodium discharge by using **Template Assisted Crystallization (TAC) technology** to transform dissolved hardness minerals into harmless, inactive microscopic crystal particles. These particles make their way through plumbing systems without latching on to pipes, inside fixtures, valves, or heating elements. Scientifically tested for performance, ScaleNet provides scale control results backed by years of successful field applications and independent studies. ScaleNet from Watts is the intelligent choice in scale prevention.*

### Features

- No salt or chemicals required
- Economical and efficient
- Upflow design for better flow rates
- No backwashing and zero discharge
- Virtually maintenance free
- Consistent scale control performance
- Wide range of commercial applications
- Uses environmentally friendly "green" technology
- Long-lasting media needs no regeneration

### Benefits

- Eliminates the need for scale prevention chemicals or salt
- Eliminates de-scaling chemical costs
- Reduces labor costs and downtime
- Increases operating efficiencies
- Extends life of capital equipment
- Reverses existing scale problems
- Provides immediate ROI through energy savings

### NOTICE

Independent scientific testing has confirmed that TAC technology provides scale reduction of 95+%. Testing was conducted under protocol based on DVGW W512 test to assess control of scale formation. Results may vary and performance is based on water hardness levels, flow rate, and other factors.

## DID YOU KNOW?

Independent scientific testing has confirmed that TAC technology provides scale reduction of over 95%.

### The Problem!

Calcium creates scale in pipes, on appliances and other plumbing surfaces which can lead to higher heating and energy costs and expensive repairs.



Untreated Pipe

### The Solution!!

Watts ScaleNet® Anti-Scale Systems transform dissolved hardness minerals into harmless, inactive microscopic crystal particles which are so small they are easily rinsed away by the water flow.



ScaleNet Treated Pipe

## E-Treat Water Conditioning System with Scale Prevention

The Watts E-Treat® Water Conditioning System combines the revolutionary scale prevention capabilities of ScaleNet with a coconut shell-activated carbon filter designed to improve water taste. The E-Treat's filter reduces unpleasant odors, chlorine, and organic substances typically found in drinking water. Treated water enables easier rinsing and reduced water usage in addition to improved taste.

*Here's how the E-Treat and ScaleNet systems work:*

### Step #1 (Main Tank)

Water enters the system and flows down through a two cubic foot bed of coconut shell-activated carbon. This initial water treatment process improves water quality by reducing bad tastes, foul odors, chlorine, and organic substances through adsorption.

### Step #2 (Inner Tank & Contact Chamber)

At the same time, water flows upward through the inner tank and through our highly-effective ScaleNet anti-scale media. The ScaleNet TAC technology pre-emptively attracts hardness minerals and converts them into harmless particles that won't stick to pipes and components.

### Installation and Media/Carbon Replacement

E-Treat® water conditioning systems are typically installed where water enters the house for whole house water treatment. Pipe connections are 1" (25mm) in diameter. The anti-scale media is designed to provide whole house water conditioning for up to five years, based on hardness and chlorine levels. We recommend replacing the activated carbon every two years for optimum performance.



ETREATWCS

### Specifications

- Maximum flow rate: 12 gallons per minute
- Maximum temperature 120°F (60°C)
- Minimum temperature 40°F (4°C)
- Maximum hardness: sizing is based on maximum hardness of 25 grains per gallon
- pH range 6.0 to 9.0
- Pressure: Maximum pressure is 125 psi; 8.75 bar (minimum pressure is 20 psi 1.4 bar)
- Tank sizes: Outer tank is 13" x 65". Inner tank is 9" x 30" (outer tank is black)
- Flow pattern: In the outer tank the flow is downward. In the inner tank the flow is up-flow
- Certification: Anti-scale media is NSF/ANSI Standard 61 Certified for material safety
- By-pass valve is included.
- System comes with 2 cu. ft. of coconut shell carbon and 4 liters of anti-scale media
- A five-micron pre-filter is required if sediment is present in the water
- Hydrogen sulfide, iron, and manganese pretreatment required
- Maximum chlorine 4 ppm
- Maximum silica 10 ppm
- Maximum iron 0.3 ppm
- Maximum manganese 0.05 ppm
- Maximum copper none allowed
- Oil and grease should not be present

### NOTICE

Failure to install the proper pretreatment will cause the scale control media to be ineffective.

### ⚠ WARNING

Do not use where water is microbiologically unsafe or with water of unknown quality without adequate disinfection before or after the unit. System must be maintained according to manufacturer's instructions. Pre-treatment for sediment, iron, hydrogen sulfide, manganese, hydrocarbons and copper may be required depending on conditions. Install systems in applications with new copper pipe after six weeks of water use.

### IMPORTANT

The non-electric, "in / out" valve used with E-Treat Systems is designed to be used in both up-flow and down-flow installations. E-Treat Systems are down-flow through the bed of carbon and up-flow through the anti-scale media. Labels are provided; however facing the valve, looking directly into the ports of the valve, the inlet is on the LEFT.

ScaleNet® Application Practices (Refer to bottom of Page 7)



## ScaleNet Anti-Scale Systems

### Residential Applications

#### Specifications

- Minimum pressure 15 PSI (1.03 bar)
- Maximum pressure 125 PSI (8.75 bar)
- Minimum operating temperature 34°F (1.1°C)
- Maximum operating temperature 120°F (60°C)
- Water pH range 6.0 to 9.0
- Maximum feed water hardness is 25 grains per gallon
- Maximum chlorine < 2 ppm, de-chlorination recommended
- Maximum copper none allowed
- Maximum iron .3 ppm
- Maximum manganese .05 ppm
- Maximum silica 10 ppm
- Hydrogen sulfide and phosphates should not be present
- Oil and grease should not be present
- Residential systems are designed for intermittent flow
- For continuous flow use commercial systems

#### NOTICE

Do not exceed specified flow rates. Failure to install the proper pretreatment will cause the scale control media to be ineffective.

**Note:** Bypass not included. Order KC11V3006 separately if a bypass is desired.



Top View with optional bypass



MODEL NO.	TANK SIZE (IN.)	TANK TYPE	PIPE SIZE (IN.)	MEDIA LITERS	SERVICE FLOW (GPM)	FLOOR SPACE L X W X H (IN.)	SHIP WEIGHT (LBS)
M8408-RES	8 x 35	Vortech	1	2.0	10	11 x 11 x 42	30
M8409-RES	9 x 35	Vortech	1	3.0	12	12 x 12 x 42	32
M8410-RES	10 x 54	Vortech	1	4.0	15	13 x 13 x 61	37
M8412-RES	12 x 52	Vortech	1	5.0	20	15 x 15 x 59	45
M8413-RES	13 x 54	Vortech	1	7.5	25	15 x 15 x 61	51

#### WARNING

Do not use where water is microbiologically unsafe or with water of unknown quality without adequate disinfection before or after the unit. System must be maintained according to manufacturer's instructions. Pre-treatment for sediment, iron, hydrogen sulfide, manganese, hydrocarbons and copper may be required depending on conditions. Install systems in new homes with copper pipe after six weeks of water use.

#### ScaleNet® Cartridges

PART NUMBER	SIZE	FLOW (MAX.)
SNC2510	2.5"x 10"	1 gpm
SNC2520	2.5"x 20"	2 gpm
SNC4510	4.5"x 10"	3 gpm
SNC4520	4.5"x 20"	4 gpm

#### ScaleNet® Application Practices

Systems using ScaleNet technology prevent hard water scale formation inside the plumbing system at influent hardness levels of 25 grains per gallon of calcium carbonate and less. Due to variances in water chemistry, certain aesthetic conditions external of the plumbing system may not be attained.

ScaleNet is designed for the treatment of potable water that meets the requirements of the current USEPA Safe Drinking Water Act. The addition of soaps, chemicals, or cleaners, before or after ScaleNet treatment, may reverse its anti-scale treatment effects and/or create water with a heavy residue or spotting potential. Any adverse conditions caused by the addition of soaps, chemicals, or cleaners is the sole responsibility of the end user.

New copper lines need to be passivated before placing unit into service. Copper usually originates from new copper plumbing upstream of the ScaleNet system. All new copper plumbing before the system should be allowed to passivate by operating under normal conditions for a period of four weeks prior to starting up the system. This will allow the copper surfaces to be fully flushed and develop a natural protective surface. To further minimize any problems with excess copper, avoid applying excess flux on the inner surfaces of the pipe and use a low-corrosivity, water-soluble flux listed under the ASTM B813 standard. ScaleNet is not designed for use on closed loop systems.

## ScaleNet Anti-Scale Systems

### Commercial Application

#### Specifications

- Minimum pressure 15 PSI (1.03 bar)
- Maximum pressure 125 PSI (8.75 bar)
- Minimum operating temperature 34°F (1.1°C)
- Maximum operating temperature 120°F (60°C)
- Water pH range 6.0 to 9.0
- Maximum feed water hardness is 75 grains per gallon.
- Maximum chlorine < 2 ppm, de-chlorination recommended
- Maximum copper none allowed
- Maximum iron .3 ppm
- Maximum manganese .05 ppm
- Maximum silica 10 ppm
- Hydrogen sulfide and phosphates should not be present
- Oil and grease should not be present

#### NOTICE

Do not exceed specified flow rates. A flow control device will be required for applications where flow rates may exceed the maximum specified flow rate. Failure to install the proper pretreatment will cause the scale control media to be ineffective.

**Note:** Bypass not included. Order KC11V3006 separately if a bypass is desired.



WQA Certified against NSF/ANSI Standard 61 and 372 for Lead Free.



MODEL NO.	TANK SIZE (IN.)	TANK TYPE	PIPE SIZE (IN.)	MEDIA LITERS	SERVICE FLOW (GPM)	FLOOR SPACE L X W X H (IN.)	SHIP WEIGHT (LBS)
M8407-COM	7 x 44	Standard	1	2.5	10	10 x 10 x 51	30
M8408-COM	8 x 44	Standard	1	3	12	11 x 11 x 51	32
M8409-COM	9 x 48	Standard	1	4	16	12 x 12 x 42	35
M8410-COM	10 x 54	Standard	1	5	20	13 x 13 x 61	37
M8412-COM	12 x 52	Standard	1	7.5	30	15 x 15 x 59	45
M8414-COM	14 x 65	Standard	2*	12.5	50	20 x 20 x 79	77
M8416-COM	16 x 65	Standard	2*	19	75	20 x 20 x 79	138

\*Units with 2" plumbing have a bottom inlet and top outlet. Dimensions listed do not include outlet plumbing.

#### ⚠ WARNING

Commercial systems are designed for long runs and high usage. Maximum hardness is 75 grains per gallon at specified flow rates. Do not use where water is microbiologically unsafe or with water of unknown quality without adequate disinfection before or after the unit. System must be maintained according to manufacturer's instructions. Pre-treatment for sediment, iron, hydrogen sulfide, manganese, hydrocarbons and copper may be required depending on conditions. Install systems in applications with new copper pipe after six weeks of water use.

#### ScaleNet® Cartridges

PART NUMBER	SIZE	FLOW (MAX.)
SNC2510	2.5"x 10"	1 gpm
SNC2520	2.5"x 20"	2 gpm
SNC4510	4.5"x 10"	3 gpm
SNC4520	4.5"x 20"	4 gpm

#### ScaleNet® Application Practices

Systems using ScaleNet technology prevent hard water scale formation inside the plumbing system at influent hardness levels of 75 grains per gallon of calcium carbonate and less. Due to variances in water chemistry, certain aesthetic conditions external of the plumbing system may not be attained.

ScaleNet is designed for the treatment of potable water that meets the requirements of the current USEPA Safe Drinking Water Act. The addition of soaps, chemicals, or cleaners, before or after ScaleNet treatment, may reverse its anti-scale treatment effects and/or create water with a heavy residue or spotting potential. Any adverse conditions caused by the addition of soaps, chemicals, or cleaners is the sole responsibility of the end user.

New copper lines need to be passivated before placing unit into service. Copper usually originates from new copper plumbing upstream of the ScaleNet system. All new copper plumbing before the system should be allowed to passivate by operating under normal conditions for a period of four weeks prior to starting up the system. This will allow the copper surfaces to be fully flushed and develop a natural protective surface. To further minimize any problems with excess copper, avoid applying excess flux on the inner surfaces of the pipe and use a low-corrosivity, water-soluble flux listed under the ASTM B813 standard. ScaleNet is not designed for use on closed loop systems.

## Water Softeners

*Watts water softeners are designed for water conditioning professionals who demand the highest quality, reliability, and value. Our water softeners include only top-quality components, come fully complete, and feature metered control valves for greater efficiency using trusted technology. Our large selection of water softeners range from unique, space-saving, low-profile designs to larger commercial systems for greater demand applications.*

### DID YOU KNOW?

Water softeners on a tankless water heater that would normally experience 20 grains of mineral content per gallon saves a homeowner 34% on repair and replacement costs.

## Water Softeners with ProSense™ Valves

ProSense water softening systems combine the high efficiency advantages of a twin alternating unit with water quality sensors. As the resin bed exhausts, two sensors monitor its exhaustion rate. At the same time the turbine meter in the control valve is feeding water volume data into the controller. The controller compares the exhaustion rate against the water volume used and, at each regeneration cycle, recalculates the water hardness value in the programming. Combining a meter with resin exhaustion sensor technology, ProSense series water softeners solve the efficiency issues created by changing water hardness.

### Features & Benefits

- Resin Exhaustion Sensors To Monitor Water Quality
- Meter For Greater Efficiency
- Sophisticated Electronics To Calculate Water Hardness Automatically
- Twin Alternating For 24/7 Soft Water
- 4 Sizes To Choose From

### Specifications

VALVE	PROSENSE
Electrical	120 Volt 60 Hz standard
Valve Body	Xyron
Distributor	1.05" O.D.
Types	Resin Sensor and Turbine Meter Combination
Connection	¾" and 1" MNPT Noryl® Standard
Mineral Tank	Corrosion resistant FRP
Brine Tank	Fully Assembled Polyethylene
Media	High Capacity Cation Resin

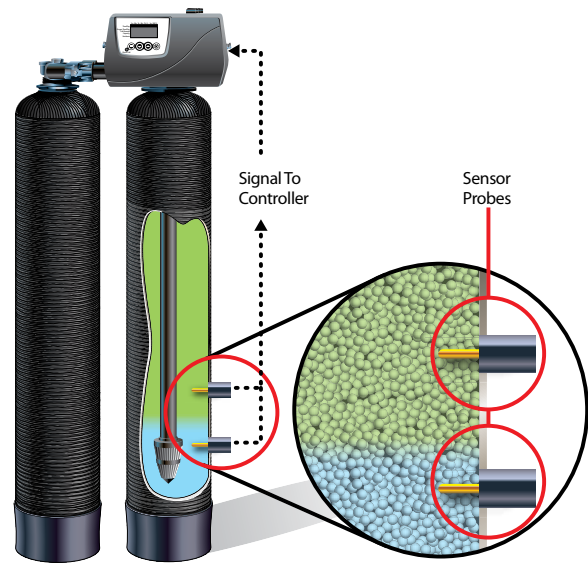

ProSense Twin Series

### ADVANCED SENSOR TECHNOLOGY

- Superior monitoring with non-corrosive 18-karat gold-plated sensor probes
- Replaces traditional metered and time clock controls

### ECO-FRIENDLY

- Fewer regeneration and rinse cycles conserve water and regenerant

### 24/7 MONITORING

- Automatically adjusts to changing water conditions
- A continuous supply of quality water is always available

### UPFLOW REGENERATION

- Improves efficiency and eliminates resin bed compaction

MODEL NO.	CAPACITY (MAX.)	PIPE SIZE (IN.)	MINERAL TANK		BRINE TANK		FLOW RATE & PRESSURE			SHIP WT. (LBS.)
			TANK SIZE	RESIN FT3	SIZE (IN)	SALT FILL	SERVICE (GPM)	DROP (PSI)	BKW (GPM)	
<b>ProSense Series Softeners</b>										
M2056-PRO	22,000	3/4 and 1	8 x 44	0.75	18 x 36	350	9-11	15-25	1.5	150
M2058-PRO	30,000	3/4 and 1	9 x 48	1	18 x 36	350	13-19	15-25	2.0	180
M2059-PRO	45,000	3/4 and 1	10 x 54	1.5	18 x 36	350	14-21	15-25	2.4	250
M2060-PRO	60,000	3/4 and 1	12 x 48	2	18 x 36	350	15-21	15-25	3.5	330

## Water Softeners with Watts 1000 Valves

High efficiency water softeners, designed to use less salt and water to conserve resources and reduce costs.

### Smart<sup>n</sup> Soft™

#### Advantages

- Metered control valve and “smart brining” conserves salt and water
- Resin tanks use the patented Vortech™ distribution system to conserve water by reducing backwash duration
- Systems come with safety float valves to prevent brine water overflow
- Full product line for a wide range of flow rates and requirements



W1000 Series

Featuring Watts 1000 Control Valves With “Smart Brining”

#### Watts® 1000 Control Valves

Softeners with Watts proprietary valves are now available, offering unsurpassed performance and greater efficiency.

- Regenerates based on water usage
- Smart brining
- Less salt!
- Less water!
- Continuous flow rates to 21 GPM
- Peak flow rates to 27 GPM
- LED status lights
- Advanced diagnostics
- Ideal for tanks up to 16”



#### Two Step Water Treatment

##### Step #1 Reduces

- Chlorine
- Tastes
- Odors
- Organics

##### Step #2 Removes

- Calcium
- Magnesium
- Iron\*

\* Some pre-treatment may be required.

MODEL NO.	CAPACITY (MAX)	PIPE SIZE (IN)	MINERAL TANK			BRINE TANK		FLOW RATE & PRESSURE			SHIP WT (LBS)
			TANK SIZE	RESIN FT3	CARBON FT3	SIZE	SALT FILL	SERVICE (GPM)	DROP (PSI)	BKW (GPM)	

#### Single Chamber Softeners with Watts 1000 Control Valves

WWS100	30,000	1	9x48	1	None	18X36	350	15.2	15	2.0	110
WWS150	45,000	1	10x54	1.5	None	18X36	350	16.4	15	2.4	130
WWS200	60,000	1	12x52	2	None	18X36	350	20.5	15	3.5	190

#### Dual Chamber Softeners (Resin and GAC) with Watts 1000 Control Valves

WWSDC100-50	30,000	1	10X54	1	0.5	18X36	350	15.2	15	2.0	143
WWSDC150-100	45,000	1	13X54	1.5	1	18X36	350	16.4	15	5.0	157
WWSDC150-150	45,000	1	13X65	1.5	1.5	18X36	350	16.4	15	5.0	170

#### Dual Chamber Softeners (Resin and Catalytic Carbon for Chloramines) with Watts 1000 Control Valves

WWSDC100-50C	30,000	1	10X54	1	0.5	18X36	350	15.2	15	2.4	143
WWSDC150-100C	45,000	1	13X54	1.5	1	18X36	350	16.4	15	5.0	157

## Dual-Media Water Softeners with Watts W100 Valves

Water softener and carbon filter in one compact design for whole house water treatment!

The Watts® Dual Media Water Softener and Filter utilizes Vortech™ patented distributor technology to maximize media efficiency with two separate media chambers in one tank.

1. Activated Carbon for pre-treatment designed to reduce chloramines\*, chlorine, taste, odors and extends ion exchange resin life.
2. High Efficiency Ion Exchange Resin for increased efficiency and to enhance performance with high iron content water.

### Features & Benefits

- Combines two technologies in one single tank
- One control valve and mineral tank to reduce costs
- Carbon and resin are in separate chambers
- Proper contact time is provided by using two chambers
- No media migration with carbon and resin separated
- Carbon can be replaced without replacing the resin
- Lower pressure drop, compared to twin tank systems
- Vortech™ tank technology for higher backwash rates
- No gravel under bedding to reduce costs and weight
- Space saving, single tank design
- Vortech™ tanks are NSF standard certified
- Made in USA

### Specifications

VALVE	CK-10 METERED VALVE
Pipe fittings	3/4" / 1" sockets and 1" MNPT elbows provided
Resin	1, 1.5 or 2 cu. ft. ion exchange resin
Media	0.5, 1.0 or 1.5 cu. ft. granular activated carbon
Mineral tank	Vortech, corrosion resistant FRP
Distributor	1.05" O.D.
Electrical	120 volt, 60 Hz, standard

### Reduces

- ✓ Hardness
- ✓ Chloramines\*
- ✓ Chlorine
- ✓ Taste
- ✓ Odors
- ✓ Iron\*\*

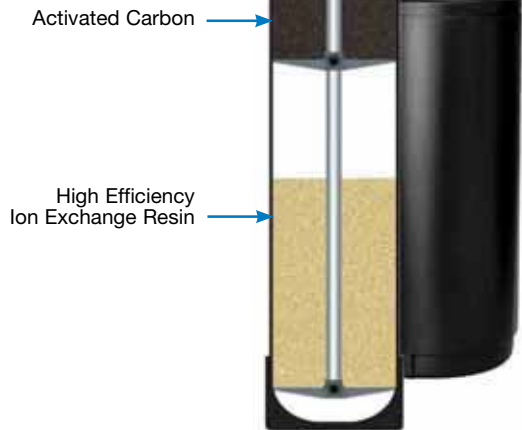

Dual-Media and Brine Tank



### Standard Mineral Tank

Standard tanks use gravel under bedding, which adds weight and cost. Also, re-bedding is more difficult, should riser tubes pull out of the gravel bed.



### Vortech™ Mineral Tank

No gravel under bedding is required, reducing weight and cost. Also, riser tubes are permanently attached, so they cannot pull out during re-bedding.

## Dual Chamber Water Softeners (Resin and GAC) with Watts W100 Control Valves

MODEL NO.	CAPACITY (MAX)	PIPE SIZE (IN)	MINERAL TANK			BRINE TANK		FLOW RATE & PRESSURE			SHIP WT (LBS)
			TANK SIZE	RESIN FT3	CARBON FT3	SIZE	SALT FILL	SERVICE (GPM)	DROP (PSI)	BKW (GPM)	
M3011-W100SM-CR	30,000	1	10x54	1	.5	18x36	350	12-16	15-25	2.7	110
M3011GW100SM-CR	30,000	1	10x54	1	.5	18x36	350	12-16	15-25	2.7	110
M3013CK10SMCR10	45,000	1	13x54	1.5	1	18x36	350	15-20	15-25	4	150
M3013CKDHSMCR10	45,000	1	13x54	1.5	1	18x36	350	15-20	15-25	4	150
M3013CK10SMCR15	45,000	1	13x65	1.5	1.5	18x36	350	15-20	15-25	4	170
M3013CKDHSMCR15	45,000	1	13x65	1.5	1.5	18x36	350	15-20	15-25	4	170
M3015CK10SMCR10	60,000	1	13x65	2	1	18x36	350	15-20	15-25	4	190
M3015CKDHSMCR10	60,000	1	13x65	2	1	18x36	350	15-20	15-25	4	190

**Note:** All units come with W100 valve, by-pass, 1" PVC elbow tails & coconut shell carbon. Brine tanks come with safety float valve.

\*When catalytic carbon is used.  
\*\*Pre-treatment may be required.

## Tri-Plex Water Conditioning Systems with W100 Valves

Multi-Stage water treatment systems for consumers who demand the "best".

Multi-Stage Water Treatment System In a Single Tank To Save Space and Money!

### Our metered control valve

Regenerates in an up-flow pattern based on water usage to conserve water and reduce salt requirements.

### Pre-Filter

Our Micro Z filter media is used for pre-filtration to remove particles, five micron and up. Micro Z outperforms sand and multimedia to increase particulate removal.

### KDF®

This important step enhances the performance of activated carbon (below) and for the well water option, aids in the reduction of iron and hydrogen sulfide.

### Activated Carbon

Activated carbon is used for pre-treatment to improve water quality by reducing bad tastes, foul odors, chlorine and organic substances through adsorption.

### High Efficiency Ion Exchange Resin

Fine mesh resin is used for increased efficiency to remove water hardness, Calcium, Magnesium and improve performance in high Iron content water.

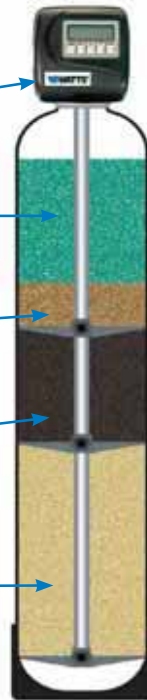

W100 Series

### Innovative Design

If you want the most from your investment, Tri-Plex water conditioners are for you! There's nothing else like them anywhere!

### Reduces:

- Water hardness
- Calcium
- Magnesium
- Sediment
- Chlorine
- Bad tastes
- Foul odors
- Heavy metals (KDF)
- Scale
- Damage to appliances due to scale build-up
- Spots on dishes & glassware.
- Soap build-up on shower walls and bath tubs

### Other Benefits:

- Soap savings 50% or more because soap and detergents work better in soft water
- Softer, brighter laundry
- Refreshing shower water and no chlorine damage to hair
- Smoother shave with softened water
- Reduced energy costs by scale elimination

### Components

Tri-Plex water conditioning systems come with the W100SM metered valve, which features up-flow regeneration to conserve water and increase salt efficiency. Tri-Plex conditioners also use three chamber 10" x 60" Vortech® mineral tanks, (with safety float valves) and come with a 1" by-pass valve.

### Media Replacement

Media replacement may be completed using the extraction tool, designed for Tri-Plex water conditioning systems (see bottom photo). Micro Z is typically not replaced because the media is refreshed during backwash. We recommend replacement of the activated carbon and KDF every 1-2 years, depending on chlorine levels.

### Resin Replacement

Resin life is dramatically extended due to pre-treatment by activated carbon and KDF. With Tri-Plex conditioners, resin life may be extended indefinitely with adequate carbon pre-treatment.

### Hardness

Tri-Plex systems are recommended for hardness levels up to 25 grains per gallon.



D91EXT Extraction Tool

### Tools

MODEL NO.	DESCRIPTION
D91EXT	Extraction Tool
D91INT	Adapter Removal Tool

## Three Chamber Softeners (MicroZ/KDF, GAC, and Resin) with Watts W100 Control Valves

MODEL NO.	CAPACITY (MAX)	PIPE SIZE (IN)	MINERAL TANK			BRINE TANK		FLOW RATE & PRESSURE			SHIP WT (LBS)
			TANK SIZE	RESIN FT3	CARBON FT3	SIZE	SALT FILL	SERVICE (GPM)	DROP (PSI)	BKW (GPM)	
M3011-W100SM5CZ	30,000	3/4 and 1	10x60	1	.5	18x36	350	9-13	15-25	7.5	150
M3011-W100SM8CZ	30,000	3/4 and 1	10x60	1	.5	18x36	350	9-13	15-25	7.5	150

**Note:** Pipe connections are 1".

## Twin Tank-Dual Chamber Water Conditioners with 9100 Valves

*Reduces water hardness, chlorine, tastes and odors 24/7!*

### Features & Benefits

- Designed for applications when continuous water conditioning is required or desired
- Innovative twin alternating dual chamber system works continuously, 24/7
- Systems regenerate immediately, so soft water is available upon demand
- Soft water is provided when the second tank is being regenerated
- Carbon pre-treatment dramatically extends resin life to reduce costs
- Vortech® tanks, used for superior performance
- Metered valve for greater efficiency and reduced water consumption
- Refreshing shower water without hardness
- Softer, brighter laundry
- Reduced soap usage and costs
- No mineral deposits on dishes and glassware
- No chemical damage to hair
- Smoother shave with soft water

### Vortech® Tanks

- Large surface area for lower pressure drop.
- Low pressure drop for higher flow.
- Angled slots for greater lift during backwash.
- No gravel under bedding is required.
- Distributor plates are “self cleaning”.
- Backwash duration is reduced.
- Less water for backwash is required.
- Riser tubes are permanently attached.
- Made in the U.S.A.
- NSF certified.

### Media

<b>CARBON</b>	TYPE	Coconut Shell
	SIZE	12 x 40 Mesh
	Cubic Feet	0.5
<b>RESIN</b>	TYPE	High Capacity Cation
	SIZE	16 x 40 Mesh
	Cubic Feet	1.0

### Reduces

- ✓ Calcium
- ✓ Magnesium
- ✓ Iron\*
- ✓ Water hardness
- ✓ Chlorine
- ✓ Chloramines
- ✓ Organic matter

\*Additional treatment may be required.



Twin Dual Grey

### Metered Valve For Greater Efficiency

Our “9100” control valve is metered for greater efficiency and reduced salt usage, because regeneration of the softener resin is based on 100% water consumption before switching to your second tank!

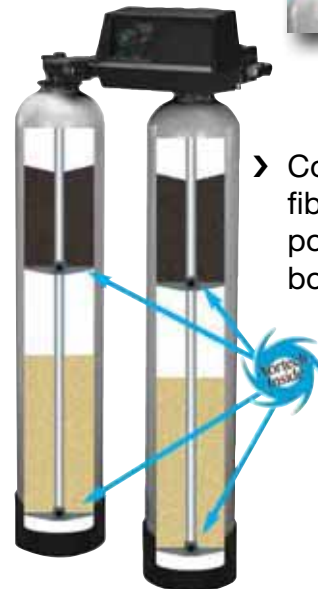

› Corrosion-free fiber-reinforced polymer valve body.

Twin Tank-Dual Chamber

## Twin Tank Softener with 9100 Electromechanical Metered Control Valves and Carbon

MODEL NO.	CAPACITY (MAX)	PIPE SIZE (IN)	MINERAL TANK			BRINE TANK		FLOW RATE & PRESSURE			SHIP WT (LBS)
			TANK SIZE	RESIN FT3	CARBON FT3	TANK SIZE	SALT FILL	SERVICE (GPM)	DROP (PSI)	BKW (GPM)	
M3011-9100SM-CR	30,000	1	10x54	1	.5	18x40	400	14-21	15-25	2	215

## Water Softeners with Watts W100 Valves

### Features & Benefits

- Spot-free glassware and dishes
- No mineral deposits on bathtubs and shower stalls
- Brighter, softer laundry
- Less reliance on water softening products
- Dramatic reduction in soap usage
- Manageable hair because shampoo works better
- Pipes remain free of calcium scale build-up
- Extended life of appliance and reduced energy costs because scale is virtually eliminated

### Complete System

The models listed below are complete systems including:

- W100 high flow, metered valve
- Standard or Vortech® mineral tank (no gravel needed)
- 18" x 36" black brine tank
- Float valve to prevent brine overflow
- By-pass valve

Model selection is typically based on water hardness, water usage, water source and other factors.



### Metered Valve For Greater Efficiency

W100 Metered valves are metered for greater efficiency and reduced salt usage, because regeneration of the softener resin is based on water consumption. Push button settings provide ease-of-use.



Vortech Tank and Brine Tank

MODEL NO.	CAPACITY (MAX.)	PIPE SIZE (IN.)	MINERAL TANK		BRINE TANK		FLOW RATE & PRESSURE			SHIP WT. (LBS)
			TANK SIZE	RESIN FT3	SIZE	SALT FILL	SERVICE (GPM)	DROP (PSI)	BKW (GPM)	

### Water Softeners with Watts W100 Control Valves and Vortech Tanks

M3011-W100SM	30,000	1	9x48	1	18x36	350	9-12	15-25	2.2	110
M3013-W100SM	45,000	1	10x54	1.5	18x36	350	12-16	15-25	2.7	130
M3015-W100SM	60,000	1	12x52	2	18x36	350	15-20	15-25	3.2	190
M3017-W100SM	90,000	1 1/4 -1 1/2	13x65	3	18x36	350	18-23	15-25	4.2	240
M3019-W100SM	120,000	1 1/4 -1 1/2	16x65	4	24x41	600	19-25	15-25	7.5	320
M3021-W100SM	210,000	1 1/4 -1 1/2	21x62	7	24x41	600	22-30	15-25	11	585

### Water Softeners with Watts W100 Control Valves and Standard Tanks

M3011-CK10SM	30,000	1	9x48	1	18x36	350	9-12	15-25	2.2	110
M3013-CK10SM	45,000	1	10x54	1.5	18x36	350	12-16	15-25	2.7	130
M3015-CK10SM	60,000	1	12x52	2	18x36	350	15-20	15-25	3.5	190



## Water Softeners with W100T Twin Alternating Valves

*Ideal softeners when soft water is required 24/7, without interruption.*

Suitable for residential and light commercial applications ranging from 20,000 to 210,000 grains of hardness removal capacity, at flow rates to 24 GPM.

### Features & Benefits

- Great flow rates
- Top quality components
- Models for capacities to 210,000 grains
- Corrosion resistant W100T control valve
- Brine tanks with grid plate for maximum brine storage
- High flow bypass valve is included
- Safety brine valve with air check



W100T Twin Alternating Series

### Specifications

VALVE	W100T TWIN ALTERNATING
Valve body	Corrosion Resistant Poly
Pipe Size	1" and 1.25" x 1.5"
Types	Metered
Bypass	Included
Mineral Tank	Corrosion resistant FRP. NSF
Brine Tank	Polyethylene; fully assembled
Media	Cation resin; high capacity

### Twin Alternating Water Softeners with W100T Metered Control Valves

MODEL NO.	CAPACITY (MAX.)	PIPE SIZE (IN.)	MINERAL TANK		BRINE TANK		FLOW RATE & PRESSURE			SHIP WT. (LBS.)
			TANK SIZE	RESIN FT3	SIZE	SALT FILL	SERVICE (GPM)	DROP (PSI)	BKW (GPM)	
M2058-W100T	30,000	1	9 x 48	1	18 x 40	400	13-19	15-25	2.2	230
M2059-W100T	45,000	1	10 x 54	1.5	18 x 40	400	14-21	15-25	2.7	290
M2060-W100T	60,000	1	12 x 52	2	18 x 40	400	15-21	15-25	3.2	420
M2063-W100T	75,000	1	13 x 54	2.5	18 x 40	400	15-21	15-25	4.2	460
M2066-W100T	90,000	1	14 x 65	3	18 x 40	400	17-22	15-25	5.3	500
M2069-W100T	120,000	1	16 x 65	4	18 x 40	400	17-24	15-25	7.5	650
M2070-W100T	150,000	1 1/4 x 1 1/2	18 x 65	5	24 x 41	600	18-25	15-25	10	890
M2072-W100T	210,000	1 1/4 x 1 1/2	21 x 62	7	24 x 50	800	20-27	15-25	12	1160

## Water Softeners with Watts W110 Valves

### Reliability Meets Serviceability

Our water softeners with W110 series control valves combine the reliability you've come to expect from Watts with the ease of service you've come to deserve. The timer motor and circuit board are replaceable without tools and a flat head screw driver is all that is needed to access the rest of the components. A one piece seal and spacer assembly makes rebuilding this control valve a snap!

#### Features & Benefits

- Ease of Service
- Flexible Programming
- Entire valve can be serviced with a flat head screw driver
- Models for capacities to 120,000 grains
- User friendly Watts W110 control valves
- Brine tanks with grid plate for maximum brine storage
- High flow poly by-pass valve is included
- Safety brine valve with air check



W110 Series

#### Specifications

VALVE	WATTS W110 TOP MOUNT VALVE
Valve body	Glass reinforced Noryl®
Pipe Size	1" MNPT
Types	Metered
Bypass	Included
Mineral Tank	Corrosion resistant FRP. NSF
Brine Tank	Tank Polyethylene; fully assembled
Media	High capacity cation resin

### Metered Models (W110 Valve)

MODEL NO.	CAPACITY (MAX.)	PIPE SIZE (IN.)	MINERAL TANK		BRINE TANK		FLOW RATE & PRESSURE			SHIP WT. (LBS.)
			TANK SIZE	RESIN FT <sup>3</sup>	TANK SIZE	SALT FILL	SERVICE (GPM)	DROP (PSI)	BKW (GPM)	
M3011-W110	30,000	1	9 x 48	1	18 x 40	400	12	15	2	110
M3013-W110	45,000	1	10 x 54	1.5	18 x 40	400	12	15	2.4	130
M3015-W110	60,000	1	12 x 52	2	18 x 40	400	13	15	3.5	190
M3017-W110	90,000	1	14 x 65	3	18 x 40	400	14	15	5	230
M3019-W110	120,000	1	16 x 65	4	18 x 40	400	15	15	7	310

**Note:** Brine tanks come with safety float valve.

## Water Softeners With Fleck 7000 Valves

### Features & Benefits

- 1-1/4" valve for high flow / backwash rates
- Easy to program Fleck 7000 valves
- Variable brining is standard
- Variable reserve is standard
- Quick connect fittings (some connections)
- Models for capacities to 210,000 grains
- Top quality components are used
- Brine tanks with grid plate for maximum saturation of brine
- 1-1/4" distribution system (standard)
- Safety brine valve with air check
- Reliable optical electronics eliminates micro switch positioning

### Specifications

VALVE	FLECK 7000 WITH SE ELECTRONICS
Valve body	Glass reinforced Noryl® (1-1/4")
Valve type	Electronic - metered
Pipe size	1" - 1-1/2"
Bypass	Bypass included (MNPT)
Mineral tanks	Corrosion resistant FRP. NSF.
Brine tanks	Polyethylene; fully assembled
Media	Cation resin; high capacity



7000 Series

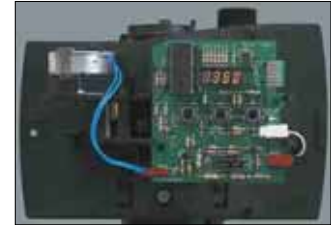

Fleck Control

### Easy To Program!

7000 Series electronic softeners are easy to program and are highly reliable, plus manual operation is possible should power be disrupted!



## Water Softeners with Fleck 7000 Metered Control Valves

MODEL NO.	CAPACITY (MAX.)	PIPE SIZE (IN.)	MINERAL TANK		BRINE TANK		FLOW RATE & PRESSURE			SHIP WT. (LBS.)
			TANK SIZE	RESIN FT3	SIZE	SALT FILL	SERVICE (GPM)	DROP (PSI)	BKW (GPM)	
M3011-70	30,000	1	9 x 48	1	18 x 40	400	15.2	15	2	110
M3013-70	45,000	1	10 x 54	1.5	18 x 40	400	16.4	15	2.4	130
M3015-70	60,000	1	12 x 52	2	18 x 40	400	20.5	15	3.5	190
M3017-70	90,000	1 1/4 - 1 1/2	14 x 65	3	18 x 40	400	21.9	15	5	240
M3019-70	120,000	1 1/4 - 1 1/2	16 x 65	4	18 x 40	400	23.4	15	7	320
M3021-70	210,000	1 1/4 - 1 1/2	21 x 62	7	24 x 41	600	25.0	15	11	585

**Note:** Brine tanks and mineral tanks are almost as standard. Other options are available. Please specify when ordering. Connectors available: 1", 1-1/4", 1-1/2", NPT.

### NOTICE

Flow rates listed above are based on pressure drop only. Selecting a system based on pressure drop alone does not guarantee that the system will provide adequately softened water. System selection should be based on resin quantity, capacity required, feed water analysis, and application requirements.

## Water Softeners with Fleck 5600 Valves

### Features & Benefits

- Top quality components
- Fully assembled, ready for installation
- Models for capacities to 60,000 grains
- User friendly Fleck 5600 control valves
- Brine tanks with grid plate for maximum saturation of brine
- Stainless steel by-pass valve is included
- Safety brine valve with air check

### Specifications

VALVE	FLECK 5600 TOP MOUNT VALVE
Valve body	Glass reinforced Noryl®
Pipe Size	¾"
Types	Time clock and metered
Bypass	Included (stainless steel)
Mineral Tank	Corrosion resistant FRP. NSF
Brine Tank	Polyethylene; fully assembled
Media	High capacity cation resin



5600 Series

MODEL NO.	CAPACITY (MAX.)	PIPE SIZE (IN.)	MINERAL TANK		BRINE TANK		FLOW RATE & PRESSURE			SHIP WT. (LBS)
			TANK SIZE	RESIN FT3	SIZE	SALT FILL	SERVICE (GPM)	DROP (PSI)	BKW (GPM)	

### Water Softeners with 5600 Electromechanical Time Clock Control Valves

M2010	30,000	3/4	9x48	1	18x40	400	9-11	15-25	2.0	110
M2012	45,000	3/4	10x54	1.5	18x40	400	10-13	15-25	2.4	130
M2014	60,000	3/4	12x52	2	18x40	400	12-15	15-25	3.5	190

### Water Softeners with 5600 Electromechanical Metered Control Valves

M1248	22,500	3/4	8x44	0.75	14x34	225	9-11	15-25	1.5	70
M3011	30,000	3/4	9x48	1	18x40	400	9-11	15-25	2.0	110
M1286	30,000	3/4	10x35	1	Cabinet	225	9-11	15-25	2.4	110
M3013	45,000	3/4	10x54	1.5	18x40	400	10-13	15-25	2.4	130
M3015	60,000	3/4	12x52	2	18x40	400	12-15	15-25	3.5	190

### NOTICE

Flow rates listed above are based on pressure drop only. Selecting a system based on pressure drop alone does not guarantee that the system will provide adequately softened water. System selection should be based on resin quality, capacity required, feed water analysis, and application requirements. Softeners listed above are assembled and include by-pass valve and safety float valve to prevent brine overflow.

MODEL NO.	CAPACITY (MAX.)	PIPE SIZE (IN.)	MINERAL TANK		BRINE TANK		FLOW RATE & PRESSURE			SHIP WT. (LBS)
			TANK SIZE	RESIN FT3	SIZE	SALT FILL	SERVICE (GPM)	DROP (PSI)	BKW (GPM)	

### Same Day Water Softeners with 5600 Valves for Quick Shipment

M2010-SD*	30,000	3/4	9x48	1	18x40	400	9-11	15-25	2.0	110
M3011-SD	30,000	3/4	9x48	1	18x40	400	9-11	15-25	2.0	110
M3013-SD	45,000	3/4	10x54	1.5	18x40	400	10-13	15-25	2.4	130
M3015-SD	60,000	3/4	12x52	2	18x40	400	12-15	15-25	3.5	190

\*Regeneration is timeclock initiated.

### NOTICE

Flow rates listed above are based on pressure drop only. Selecting a system based on pressure drop alone does not guarantee that the system will provide adequately softened water. System selection should be based on resin quality, capacity required, feed water analysis, and application requirements.



## Water Softeners with Fleck 2510 Valves



2510 Series

MODEL NO.	CAPACITY (MAX.)	PIPE SIZE (IN.)	MINERAL TANK		BRINE TANK		FLOW RATE & PRESSURE			SHIP WT. (LBS)
			TANK SIZE	RESIN FT3	SIZE	SALT FILL	SERVICE (GPM)	DROP (PSI)	BKW (GPM)	

### Water Softeners With 2510 Electromechanical Time Clock Control Valves

M2012D	45,000	3/4	10x54	1.5	18x40	400	10-13	15-25	2.4	135
M2012D-1	45,000	1	10x54	1.5	18x40	400	10-13	15-25	2.4	135
M2014D	60,000	3/4	12x52	2	18x40	400	12-15	15-25	3.5	195

### Water Softeners With 2510 Electromechanical Metered Control Valves

M2010E	30,000	3/4	9x48	1	18x40	400	9-11	15-25	2.0	110
M2012E	45,000	3/4	10x54	1.5	18x40	400	10-13	15-25	2.4	135
M2014E	60,000	3/4	12x52	2	18x40	400	12-17	15-25	3.5	195

## Water Softeners with Fleck 2750 Valves

Ideal for commercial applications with capacities to 120,000 grains.

LC-100 series softeners with Fleck 2750 brass control valves are our best selling light commercial softeners because they are ideal, considering price and performance!

#### Features & Benefits

- Top quality components
- Models for capacities to 120,000 grains
- User friendly Fleck 2750 control valves
- Brine tanks with grid plate for maximum saturation of brine (some models)
- Safety brine valve with air check

#### Specifications

VALVE	FLECK 2750 SXT OR NXT TOP MOUNT VALVE
Valve body	Brass
Pipe size	1"
Types	Time clock and metered
By-pass	None
Mineral tanks	Corrosion resistant FRP. NSF.
Brine tanks	Polyethylene; fully assembled
Media	Cation resin; high capacity



2750 Series

MODEL NO.	CAPACITY (MAX.)	PIPE SIZE (IN.)	MINERAL TANK		BRINE TANK		FLOW RATE & PRESSURE			SHIP WT. (LBS)
			TANK SIZE	RESIN FT3	SIZE	SALT FILL	SERVICE (GPM)	DROP (PSI)	BKW (GPM)	

### Water Softeners with Fleck 2750 SXT Time Clock Valves

M4040-SE	60,000	1	12x52	2	18x40	400	15-20	15-25	4	200
M4042-SE	90,000	1	14x65	3	18x40	400	18-23	15-25	5	240
M4046-SE	120,000	1	16x65	4	18x40	400	19-25	15-25	7	320

### Water Softeners with Fleck 2750 SXT Metered Control Valves

M4040B-SE	60,000	1	12x52	2	18x40	400	15-20	15-25	4	200
M4042B-SE	90,000	1	14x65	3	18x40	400	18-23	15-25	5	240
M4046B-SE	120,000	1	16x65	4	18x40	400	19-25	15-25	7	320

### Water Softeners with Fleck 2750 NXT Metered Control Valves

M4032B-275NT	30,000	1	9x48	1	18x40	400	9-15	15-25	4	116
M4036B-275NT	45,000	1	10x54	1.5	18x40	400	10-15	15-25	4	136
M4040B-275NT	60,000	1	12x52	2	18x40	400	15-20	15-25	4	196
M4042B-275NT	90,000	1	14x65	3	18x40	400	18-23	15-25	5	240
M4046B-275NT	120,000	1	16x65	4	18x40	400	19-25	15-25	7	320

#### NOTICE

Flow rates listed above are based on pressure drop only. Selecting a system based on pressure drop alone does not guarantee that the system will provide adequately softened water. System selection should be based on resin quantity, capacity required, feed water analysis, and application requirements.

## Water Softeners with Fleck 9100 Valves

### Our Most Efficient Models

Water softeners with Fleck 9100 control valves offer twin-alternating meter initiated operation, resulting in 24/7 soft water capability.



9100 Series

### Features & Benefits

- High efficiency, no reserve capacity required
- Up to 4 CF fully assembled, ready for installation
- Capacities up to 120,000 grains per regeneration
- Digital SE version includes attached 24V transformer
- Decorative mineral tank jacket options available
- Multiple brine tank options available
- Multiple ¾" to 1¼" bypass and connection options
- Safety brine valve with air check included

### Specifications

VALVE	FLECK 9100 MECHANICAL OR DIGITAL VALVE
Electrical	120 Volt 60 Hz standard
Valve body	Xyron
Distributor	1.05" O.D.
Types	¾" meter immediate initiated
Connection	¾" MNPT Noryl® Standard
Mineral tank	Corrosion resistant FRP
Brine tank	Fully assembled polyethylene
Media	High capacity cation resin

## Twin Tank Softeners with 9100 Electromechanical Metered Control Valves

MODEL NO.	CAPACITY (MAX.)	PIPE SIZE (IN.)	MINERAL TANK		BRINE TANK		FLOW RATE & PRESSURE			SHIP WT. (LBS)
			TANK SIZE	RESIN FT3	SIZE	SALT FILL	SERVICE (GPM)	DROP (PSI)	BKW (GPM)	
M2058-91	30,000	¾	9x48	1	18x40	400	13-19	15-25	2.2	180
M2059-91	45,000	¾	10x54	1.5	18x40	400	14-21	15-25	2.4	250
M2060-91	60,000	¾	12x52	2	18x40	400	15-21	15-25	3.5	330
M2066-91	90,000	1	14x65	3	24x41	600	17-22	15-25	5.0	470
M2069-91	120,000	1	16x65	4	24x41	600	18-24	15-25	7.0	625

### NOTICE

Flow rates listed above are based on pressure drop only. Selecting a system based on pressure drop alone does not guarantee that the system will provide adequately softened water. System selection should be based on resin quantity, capacity required, feed water analysis, and application requirements.

## Water Softeners with Fleck 9000 Valves

**Ideal Softeners When Soft Water Is Required 24 / 7, Without Interruption.**

Suitable for light commercial applications ranging from 20,000 to 120,000 grains of hardness removal capacity, at flow rates to 24 GPM.

### Features & Benefits

- Top quality components
- Models for capacities to 120,000 grains
- Fleck 9000 SE control valves with "SE" electronics
- Brine tanks with grid plate for maximum saturation of brine
- Stainless steel by-pass valve is for LCTA-75 only
- Safety brine valve with air check

### Specifications

VALVE	FLECK 9000 SE
Valve body	Brass
Pipe sizes	3/4" and 1"
Types	Metered
By-pass	Additional (LCTA-75 included)
Mineral tanks	Corrosion resistant FRP. NSF.
Brine tanks	Polyethylene; fully assembled
Media	Cation resin; high capacity



9000 Series



Fleck 9000 Twin Valve

MODEL NO.	CAPACITY (MAX.)	PIPE SIZE (IN.)	MINERAL TANK		BRINE TANK		FLOW RATE & PRESSURE			SHIP WT. (LBS)
			TANK SIZE	RESIN FT3	SIZE	SALT FILL	SERVICE (GPM)	DROP (PSI)	BKW (GPM)	

### Twin Tank Softeners With 9000 Electromechanical Metered Control Valves

M2055	15,000	3/4	8x35	0.5	18x40	400	5-8	15-25	1.5	175
M2056	25,000	3/4	10x35	0.75	18x40	400	8-10	15-25	2.4	220
M2058	30,000	3/4	9x48	1	18x40	400	13-19	15-25	2.0	230
M2059	45,000	3/4	10x54	1.5	18x40	400	14-21	15-25	2.4	290
M2060	60,000	3/4	12x52	2	18x40	400	15-21	15-25	4.0	400

### Twin Tank Softeners With 9000 Digital SXT Metered Control Valves

M2058-SE	30,000	3/4	9x48	1	18x40	400	13-19	15-25	2	230
M2059-SE	45,000	3/4	10x54	1.5	18x40	400	14-21	15-25	2.4	290
M2060-SE	60,000	3/4	12x52	2	18x40	400	15-21	15-25	3.5	420
M2063-SE	75,000	3/4	13x54	2.5	18x40	400	15-21	15-25	4	460
M2066-SE	90,000	3/4	14x65	3	18x40	400	17-22	15-25	5	500
M2069-SE	120,000	3/4	16x65	4	18x40	400	17-24	15-25	7	650
M2058B-SE	30000	1	9x48	1	18x40	400	13-19	15-25	2	230
M2059B-SE	45000	1	10x54	1.5	18x40	400	14-21	15-25	2.4	290
M2060B-SE	60000	1	12x52	2	18x40	400	15-21	15-25	3.5	420
M2063B-SE	75000	1	13x54	2.5	18x40	400	15-21	15-25	4	460
M2066B-SE	90000	1	14x65	3	18x40	400	17-22	15-25	5	500
M2069B-SE	120000	1	16x65	4	18x40	400	17-24	15-25	7	650

### NOTICE

Flow rates listed above are based on pressure drop only. Selecting a system based on pressure drop alone does not guarantee that the system will provide adequately softened water. System selection should be based on resin quantity, capacity required, feed water analysis, and application requirements.

## Water Softeners with Watts 1 1/2" Valves

These water softeners are suitable for commercial applications ranging from 40,000 to 300,000 grains of hardness removal capacity at flow rates up to 68 gpm.

**Regeneration Controller** – These softeners feature the Watts Enhanced Electronic controller. It combines simplicity with flexibility in a user-friendly package that is easy to setup and operate. Fully adjustable cycle times with 6-cycle control allows for application specific settings. A coin cell lithium battery provides an 8-hour backup. A stainless steel turbine flow meter provides accurate flow measurement and allows for efficient operation.

**Control Valve** - The Watts 1 1/2" control valve operates on command from the valve controller. A hydraulically-balanced piston glides effortlessly along non-corrosive spacers and seals to precise positions. The reliable and proven DC drive performs in the toughest applications. The Lead Free brass valve body is covered with an electro-statically-applied NSF/FDA-approved epoxy coating that resists corrosion and maintains a quality appearance over time.



CWS150 Series

## Water Softeners with Watts 1 1/2" Digital Metered Control Valves

MODEL NO.	CAPACITY (MAX.)	PIPE SIZE (IN.)	MINERAL TANK		BRINE TANK		FLOW RATE & PRESSURE			SHIP WT. (LBS)
			TANK SIZE	RESIN FT3	SIZE	SALT FILL	SERVICE (GPM)	DROP (PSI)	BKW (GPM)	
M4410W	60,000	1 1/2	12x52	2	18x40	400	28-38	15-25	4	210
M4414W	90,000	1 1/2	14x65	3	18x40	400	35-46	15-25	5	240
M4418W	120,000	1 1/2	16x65	4	18x40	400	40-51	15-25	7	320
M4422W	150,000	1 1/2	18x65	5	24x41	600	44-57	15-25	11	380
M4426W	210,000	1 1/2	21x62	7	24x50	800	50-64	15-25	13	585
M4430W	300,000	1 1/2	24x72	10	30x50	1200	53-68	15-25	15	710

### NOTICE

Flow rates listed above are based on pressure drop only. Selecting a system based on pressure drop alone does not guarantee that the system will provide adequately softened water. System selection should be based on resin quantity, capacity required, feed water analysis, and application requirements.



## Water Softeners with Fleck 2850 Valves

Ideal for commercial applications with capacities to 300,000 grains.

LC-150 series softeners with Fleck 2850 brass control valves are suitable for flow rates to 55 GPM. Models with time clock and metered controls are available.

### Features & Benefits

- 1-1/2" valves for high flow rates
- Top quality components
- Models for capacities to 300,000 grains
- User friendly Fleck 2850 control valves
- Brine tanks with grid plate for maximum saturation of brine (some models)
- Safety brine valve with air check

### Specifications

VALVE	FLECK 2850 TOP MOUNT VALVE
Valve body	Brass
Pipe size	1-1/2"
Types	Time clock and metered
By-pass	None
Mineral tanks	Corrosion resistant FRP. NSF.
Brine tanks	Polyethylene; fully assembled
Media	Cation resin; high capacity



2850 Series

MODEL NO.	CAPACITY (MAX.)	PIPE SIZE (IN.)	MINERAL TANK		BRINE TANK		FLOW RATE & PRESSURE			SHIP WT. (LBS)
			TANK SIZE	RESIN FT3	SIZE	SALT FILL	SERVICE (GPM)	DROP (PSI)	BKW (GPM)	

### Water Softeners with 2850 Digital SXT Time Clock Control Valves

M4210SE	60,000	1 1/2	12x52	2	18x40	400	15-20	15-25	4	210
M4214SE	90,000	1 1/2	14x65	3	18x40	400	17-22	15-25	5	240
M4218SE	120,000	1 1/2	16x65	4	18x40	400	25-40	15-25	7	320
M4222SE	150,000	1 1/2	18x65	5	24x41	600	30-50	15-25	11	380
M4226SE	210,000	1 1/2	21x62	7	24x50	800	35-53	15-25	13	585
M4230SE	300,000	1 1/2	24x72	10	30x50	1200	40-55	15-25	15	710

### Water Softeners with 2850 Digital SXT Metered Control Valves

M4210BSE	60,000	1 1/2	12x52	2	18x40	400	15-20	15-25	4	210
M4214BSE	90,000	1 1/2	14x65	3	18x40	400	17-22	15-25	5	240
M4218BSE	120,000	1 1/2	16x65	4	18x40	400	25-40	15-25	7	320
M4222BSE	150,000	1 1/2	18x65	5	24x41	600	30-50	15-25	11	380
M4226BSE	210,000	1 1/2	21x62	7	24x50	800	35-53	15-25	13	585
M4230BSE	300,000	1 1/2	24x72	10	30x50	1200	40-55	15-25	15	710

### Water Softeners with 2850 NXT Metered Control Valves

M4210B-285NT	60,000	1 1/2	12x52	2	18x40	400	15-20	15-25	4	210
M4214B-285NT	90,000	1 1/2	14x65	3	18x40	400	17-22	15-25	5	240
M4218B-285NT	120,000	1 1/2	16x65	4	18x40	400	25-40	15-25	7	320
M4222B-285NT	150,000	1 1/2	18x65	5	24x41	600	30-50	15-25	11	380
M4226B-285NT	210,000	1 1/2	21x62	7	24x50	800	35-53	15-25	13	585
M4230B-285NT	300,000	1 1/2	24x72	10	30x50	1200	40-55	15-25	15	710

### NOTICE

Flow rates listed above are based on pressure drop only. Selecting a system based on pressure drop alone does not guarantee that the system will provide adequately softened water. System selection should be based on resin quantity, capacity required, feed water analysis, and application requirements.

## Water Softeners with Fleck 9500 Valves

### Our Most Efficient Models

Water softeners with Fleck 9500 control valves offer twin-alternating meter initiated operation, resulting in 24/7 soft water capability.

#### Features & Benefits

- Top quality components
- High efficiency, no reserve capacity required
- Digital SE version includes attached 24V transformer
- Mechanical version includes 1.5" brass meter
- SE digital version includes 1.5" plastic meter
- Capacities up to 300,000 grains per regeneration
- Decorative mineral tank jacket options available
- Multiple brine tank options available
- Safety brine valve with air check included



9500 Series

#### Specifications

VALVE	FLECK 9500 MECHANICAL OR DIGITAL VALVE
Electrical	120 Volt 60 Hz standard
Valve body	Brass
Distributor	1.9" O.D., 1.5" pipe
Types	1.5" meter immediate initiated
Connection	1.5" FNPT
Mineral tank	Corrosion resistant FRP.
Brine tank	Fully assembled polyethylene
Media	High capacity cation resin

MODEL NO.	CAPACITY (MAX.)	PIPE SIZE (IN.)	MINERAL TANK		BRINE TANK		FLOW RATE & PRESSURE			SHIP WT. (LBS)
			TANK SIZE	RESIN FT <sup>3</sup>	SIZE	SALT FILL	SERVICE (GPM)	DROP (PSI)	BKW (GPM)	

### Twin Tank Softeners with 9500 Digital SXT Metered Control Valves

M2218SE	60,000	1 1/2	12x52	2	24x41	600	15-20	15-25	3.5	270
M2220SE	90,000	1 1/2	14x65	3	24x41	600	17-22	15-25	5	550
M2222SE	120,000	1 1/2	16x65	4	24x41	600	25-40	15-25	7	720
M2224SE	150,000	1 1/2	18x65	5	24x41	600	30-50	15-25	10	900
M2228SE	210,000	1 1/2	21x62	7	24x50	800	35-53	15-25	12	1215
M2235SE	300,000	1 1/2	24x72	10	30x50	1200	40-55	15-25	15	1750

#### NOTICE

Flow rates listed above are based on pressure drop only. Selecting a system based on pressure drop alone does not guarantee that the system will provide adequately softened water. System selection should be based on resin quantity, capacity required, feed water analysis, and application requirements.

## Water Softeners with Watts 2" Valves

These water softeners are suitable for commercial applications ranging from 60,000 grains of hardness removal capacity at flow rates up to 125 gpm.

**Regeneration Controller** – These softeners feature the Watts Enhanced Electronic controller. It combines simplicity with flexibility in a user-friendly package that is easy to setup and operate. Fully adjustable cycle times with 6-cycle control allows for application specific settings. A turbine flow meter provides accurate flow measurement and allows for efficient operation. The H series controllers can be used with the auxiliary system circuit board to connect up to four units together for multiple tank applications.

**Control Valve** - The Watts 2.0" control valve operates on command from the valve controller. A hydraulically-balanced piston glides effortlessly along non-corrosive spacers and seals to precise positions. The reliable and proven DC drive performs in the toughest applications. The Lead Free brass valve body is covered with electro-statically-applied, NSF/FDA-approved epoxy coating that resists corrosion and maintains a quality appearance over time. The 2.0" H valves include a built in turbine meter for flow monitoring which reduces cost, simplifies installation, and saves space.



CWS200 Series



CWS200H Heavy Duty

MODEL NO.	CAPACITY (MAX.)	PIPE SIZE (IN.)	MINERAL TANK		BRINE TANK		FLOW RATE & PRESSURE			SHIP WT. (LBS)
			TANK SIZE	RESIN FT3	SIZE	SALT FILL	SERVICE (GPM)	DROP (PSI)	BKW (GPM)	

### Water Softeners With Watts 2" Digital Metered Control Valves

M4543W	90,000	2	14x65	3	18x40	400	39-50	15-25	5	265
M4547W	120,000	2	16x65	4	18x40	400	47-60	15-25	7	350
M4548W	150,000	2	18x65	5	24x41	600	53-69	15-25	10	400
M4552W	210,000	2	21x62	7	24x50	800	66-85	15-25	13	600
M4558W	300,000	2	24x72	10	30x50	1200	73-94	15-25	15	710
M4559W	450,000	2	30x72	15	39x48	2200	84-109	15-25	25	1160
M4560W	600,000	2	36x72	20	39x48	2200	93-119	15-25	35	1560
M4548WH	150,000	2	18x65	5	24x41	600	53-69	15-25	10	400
M4552WH	210,000	2	21x62	7	24x50	800	66-85	15-25	13	600
M4558WH	300,000	2	24x72	10	30x50	1200	73-94	15-25	15	710
M4559WH	450,000	2	30x72	15	39x48	2200	84-109	15-25	25	1160
M4560WH	600,000	2	36x72	20	39x48	2200	93-119	15-25	35	1560

#### NOTICE

Flow rates listed above are based on pressure drop only. Selecting a system based on pressure drop alone does not guarantee that the system will provide adequately softened water. System selection should be based on resin quantity, capacity required, feed water analysis, and application requirements.

## Water Softeners with Fleck 2900 Valves

Ideal for commercial applications with capacities to 600,000 grains.

LC-200 series softeners with Fleck 2900 brass control valves are suitable for flow rates to 105 GPM. Models with time clock and metered controls are available.

### Features & Benefits

- 2" valves for high flow rates
- Top quality components
- Models for capacities to 600,000 grains
- User friendly Fleck 2900 control valves
- Brine tanks with grid plate for maximum saturation of brine (some models)
- Safety brine valve with air check
- Digital Controllers are Standard



2900 Series

### Specifications

VALVE	FLECK 2900 TOP MOUNT VALVE (2")
Valve body	Brass
Types	Time clock and metered
By-pass	None
Mineral tanks	Corrosion resistant FRP. NSF.
Brine tanks	Polyethylene; fully assembled
Media	Cation resin; high capacity

MODEL NO.	CAPACITY (MAX.)	PIPE SIZE (IN.)	MINERAL TANK		BRINE TANK		FLOW RATE & PRESSURE			SHIP WT. (LBS)
			TANK SIZE	RESIN FT3	SIZE	SALT FILL	SERVICE (GPM)	DROP (PSI)	BKW (GPM)	

### Water Softeners with Fleck 2900 Time Clock Valves

M4043-29NT	90,000	2	14x65	3	18x40	400	15-30	15-25	5	350
M4047-29NT	120,000	2	16x65	4	18x40	400	20-40	15-25	7	350
M4048-29NT	150,000	2	18x65	5	24x41	600	57-65	15-25	10	400
M4052-29NT	210,000	2	21x62	7	24x50	800	60-77	15-25	13	600
M4058-29NT	300,000	2	24x72	10	30x50	1200	74-97	15-25	15	710
M4059-29NT	450,000	2	30x72	15	39x48	2200	80-100	15-25	25	1160
M4060-29NT	600,000	2	36x72	20	39x48	2200	84-105	15-25	35	1560

### Water Softeners with Fleck 2900 NXT Metered Control Valves

M4043B-29NT	90,000	2	14x65	3	18x40	400	15-30	15-25	5	350
M4047B-29NT	120,000	2	16x65	4	18x40	400	20-40	15-25	7	350
M4048B-29NT	150,000	2	18x65	5	24x41	600	57-65	15-25	10	400
M4052B-29NT	210,000	2	21x62	7	24x50	800	60-77	15-25	13	600
M4058B-29NT	300,000	2	24x72	10	30x50	1200	74-97	15-25	15	710
M4059B-29NT	450,000	2	30x72	15	39x48	2200	80-100	15-25	25	1160
M4060B-29NT	600,000	2	36x72	20	39x48	2200	84-105	15-25	35	1560

### Twin Alternating Water Softeners with Fleck 2900 NXT Metered Control Valves

M4043TA-29NT	90,000	2	14x65	3	18x40	400	15-30	15-25	5	450
M4047TA-29NT	120,000	2	16x65	4	18x40	400	20-40	15-25	7	500
M4048TA-29NT	150,000	2	18x65	5	24x41	600	57-65	15-25	10	800
M4052TA-29NT	210,000	2	21x62	7	24x50	800	60-77	15-25	13	1200
M4058TA-29NT	300,000	2	24x72	10	30x48	1200	74-97	15-25	15	1400
M4059TA-29NT	450,000	2	30x72	15	39x48	2200	80-100	15-25	25	2200
M4060TA-29NT	600,000	2	36x72	20	39x48	2200	84-105	15-25	35	3000

### NOTICE

Flow rates listed above are based on pressure drop only. Selecting a system based on pressure drop alone does not guarantee that the system will provide adequately softened water. System selection should be based on resin quantity, capacity required, feed water analysis, and application requirements.

## Heavy Duty Water Softeners with Watts 3" Valves

These water softeners are suitable for commercial applications ranging from 200,000 to 1,050,000 grains of hardness removal capacity at flow rates up to 251 gpm.

**Regeneration Controller** – These softeners feature the Watts Enhanced Electronic controller. It combines simplicity with flexibility in a user-friendly package that is easy to setup and operate. A turbine flow meter provides accurate flow measurement and allows for efficient operation. The H series controllers can be used with the auxiliary system circuit board to connect up to four units together for multiple tank applications.

**Control Valve** - The Watts Heavy Duty 3.0" control valve operates on command from the valve controller. A hydraulically-balanced piston glides effortlessly along non-corrosive spacers and seals to precise positions. The reliable and proven DC drive performs in the toughest applications. The Lead Free brass valve body is covered with an electro-statically-applied NSF/FDA-approved epoxy coating that resists corrosion and maintains a quality appearance over time.



CWS300H Heavy Duty

MODEL NO.	CAPACITY (MAX.)	PIPE SIZE (IN.)	MINERAL TANK		BRINE TANK		FLOW RATE & PRESSURE			SHIP WT. (LBS)
			TANK SIZE	RESIN FT3	SIZE	SALT FILL	SERVICE (GPM)	DROP (PSI)	BKW (GPM)	

### Water Softeners with Watts 3" Digital Metered Control Valves

M4610WH	300,000	3	24x72	10	30x50	1200	98-125	15-25	15	1070
M4612WH	450,000	3	30x72	15	39x48	2200	144-186	15-25	25	1600
M4614WH	600,000	3	36x72	20	39x60	2700	172-222	15-25	35	2015
M4616WH	900,000	3	42x72	30	42x60	3100	190-244	15-25	45	3245
M4618WH	1,200,000	3	48x72	35	50x60	4500	194-251	15-25	60	4295

#### NOTICE

Flow rates listed above are based on pressure drop only. Selecting a system based on pressure drop alone does not guarantee that the system will provide adequately softened water. System selection should be based on resin quantity, capacity required, feed water analysis, and application requirements.

## Water Softeners with Fleck 3900 Valves

High flow commercial softeners with capacities to 1,050,000 grains.

LC-300 series softeners with Fleck 3900 brass control valves are suitable for flow rates to 280 GPM. Models with time clock and metered controls are available.

### Features & Benefits

- 3" valves for high flow rates
- Top quality components
- Models for capacities to 1,050,000 grains
- 3900 controller operates on demand
- Brine tanks with grid plate for maximum saturation of brine (some models)
- Safety brine valve with air check



3900 Series

### Specifications

VALVE	FLECK 3900 TOP MOUNT VALVE
Valve body	Brass
Pipe size	3"
Types	Time clock and metered
By-pass	None
Mineral tanks	Corrosion resistant FRP. NSF.
Brine tanks	Polyethylene; fully assembled
Media	Cation resin; high capacity

MODEL NO.	CAPACITY (MAX.)	PIPE SIZE (IN.)	MINERAL TANK		BRINE TANK		FLOW RATE & PRESSURE			SHIP WT. (LBS)
			TANK SIZE	RESIN FT3	SIZE	SALT FILL	SERVICE (GPM)	DROP (PSI)	BKW (GPM)	

### Water Softeners with Fleck 3900 Time Clock Control Valves

M4110-39NT	300,000	3	24x72	10	30x50	1200	120-170	15-25	15	1070
M4112-39NT	450,000	3	30x72	15	39x48	2200	158-212	15-25	25	1600
M4114-39NT	600,000	3	36x72	20	39x60	2700	185-250	15-25	35	2015
M4116-39NT	900,000	3	42x72	30	42x60	3100	200-268	15-25	45	3245
M4118-39NT	1,050,000	3	48x72	35	50x60	4500	213-280	15-25	60	4295

### Water Softeners with Fleck 3900 NXT Metered Control Valves and Strap On Flow Sensor

M4110B-39NT	300,000	3	24x72	10	30x50	1200	120-170	15-25	15	1070
M4112B-39NT	450,000	3	30x72	15	39x48	2200	158-212	15-25	25	1600
M4114B-39NT	600,000	3	36x72	20	39x60	2700	185-250	15-25	35	2015
M4116B-39NT	900,000	3	42x72	30	42x60	3100	200-268	15-25	45	3245
M4118B-39NT	1,050,000	3	48x72	35	50x60	4500	213-280	15-25	60	4295

### Twin Alternating Water Softeners with Fleck 3900 NXT Metered Control Valves and Strap On Flow Sensor

M4110TA-39NT	300,000	3	24x72	10	30x50	1200	120-170	15-25	15	2070
M4112TA-39NT	450,000	3	30x72	15	39x48	2200	158-212	15-25	25	3000
M4114TA-39NT	600,000	3	36x72	20	39x60	2700	185-250	15-25	35	4015
M4116TA-39NT	900,000	3	42x72	30	42x60	3100	200-268	15-25	45	6245
M4118TA-39NT	1,050,000	3	48x72	35	50x60	4500	213-280	15-25	60	8295

### NOTICE

Flow rates listed above are based on pressure drop only. Selecting a system based on pressure drop alone does not guarantee that the system will provide adequately softened water. System selection should be based on resin quantity, capacity required, feed water analysis, and application requirements.

## Heavy-Duty Steel Tank Water Softeners with Fleck Valves

Heavy duty softeners for heavy duty commercial applications!

Suitable for commercial applications ranging from 300,000 to 1,200,000 grains of hardness removal capacity and flow rates to 280 GPM. Models with time clock and meters available.

### Features & Benefits

- Regeneration by time clock or meter
- Automatic brine refill by timer or controller
- Models for capacities to 1,200,000 grains
- Fleck control valves
- Steel tanks rated for 100 psi
- Exterior tanks primed for protection
- Face piping is galvanized
- Electronic controls are available
- All systems shipped with high capacity Cation resin



Steel Tank Series

### Specifications

VALVE	(SEE CHART BELOW)
Valve body	Brass
Pipe sizes	2" and 3" (see below)
Types	Time clock (meter optional)
By-pass	None
Mineral tanks	Epoxy lined steel interior
Brine tanks	Brine maker / salt storage is PE
Brine supply	Automatic brine refill
Media	Cation resin; high capacity

### Heavy-Duty Steel Tank Water Softeners with Fleck Valves

MODEL NO.	FLECK VALVE NO.	CAPACITY (MAX.)	PIPE SIZE (IN.)	MINERAL TANK		BRINE TANK		FLOW RATE & PRESSURE			SHIP WT. (LBS.)
				TANK SIZE	RESIN FT3	SIZE	SALT FILL	SERVICE (GPM)	DROP (PSI)	BKW (GPM)	
M5076-29	2900	300,000	2	20 x 60	10	30 x 50	1200	68-94	15-25	15	1930
M5078-29	2900	450,000	2	30 x 60	15	39 x 48	2200	72-102	15-25	25	2525
M5080-31	3150	600,000	2	36 x 60	20	39 x 48	2200	78-107	15-25	35	2700
M5080-39	3900	600,000	3	36 x 60	20	39 x 48	2200	185-250	15-25	35	2850
M5082-31	3150	900,000	2	42 x 60	30	42 x 60	3000	84-118	15-25	45	4650
M5082-39	3900	900,000	3	42 x 60	30	42 x 60	3000	200-268	15-25	45	4800
M5084-31	3150	1,200,000	2	48 x 60	40	50 x 60	4500	87-120	15-25	60	4950
M5084-39	3900	1,200,000	3	48 x 60	40	50 x 60	4500	213-280	15-25	60	4100

### NOTICE

Flow rates listed above are based on pressure drop only. Selecting a system based on pressure drop alone does not guarantee that the system will provide adequately softened water. System selection should be based on resin quantity, capacity required, feed water analysis, and application requirements.

ASME mineral tanks, twin, triplex, quadplex models available.

## Heavy-Duty Steel Tank Water Softeners with Fleck Valves

### Metered Models

MODEL NO.	FLECK VALVE NO.	CAPACITY (MAX.)	PIPE SIZE (IN.)	MINERAL TANK		BRINE TANK		FLOW RATE & PRESSURE			SHIP WT. (LBS.)
				TANK SIZE	RESIN FT3	SIZE	SALT FILL	SERVICE (GPM)	DROP (PSI)	BKW (GPM)	
M5076B-29	2900	300,000	2	24 x 60	10	30 x 50	1200	68-94	15-25	15	1930
M5078B-29	2900	450,000	2	30 x 60	15	39 x 48	2200	72-102	15-25	25	2525
M5080B-31	3150	600,000	2	36 x 60	20	39 x 48	2200	78-107	15-25	35	2700
M5080B-39	3900	600,000	3	36 x 60	20	39 x 48	2200	185-250	15-25	35	2850
M5082B-31	3150	900,000	2	42 x 60	30	42 x 60	3000	84-118	15-25	45	4650
M5082B-39	3900	900,000	3	42 x 60	30	42 x 60	3000	200-268	15-25	45	4800
M5084B-31	3150	1,200,000	2	48 x 60	40	50 x 60	4500	87-120	15-25	60	4950
M5084B-39	3150	1,200,000	2	48 x 60	40	50 x 60	4500	87-120	15-25	60	4950
M5076B-29NT	2900	300,000	2	20 x 60	10	30 x 50	1200	68-94	15-25	15	1930
M5078B-29NT	2900	450,000	2	30 x 60	15	39 x 48	2200	72-102	15-25	25	2525
M5080B-31NT	3150	600,000	2	36 x 60	20	39 x 48	2200	78-107	15-25	35	2700
M5080B-39NT	3900	600,000	3	36 x 60	20	39 x 48	2200	185-250	15-25	35	2850
M5082B-31NT	3150	900,000	2	42 x 60	30	42 x 60	3000	84-118	15-25	45	4650
M5082B-39NT	3900	900,000	3	42 x 60	30	42 x 60	3000	200-268	15-25	45	4800
M5084B-31NT	3150	1,200,000	2	48 x 60	40	50 x 60	4500	87-120	15-25	60	4950
M5084B-39NT	3150	1,200,000	2	48 x 60	40	50 x 60	4500	87-120	15-25	60	4950

### Twin Alternating Models

MODEL NO.	FLECK VALVE NO.	CAPACITY (MAX.)	PIPE SIZE (IN.)	MINERAL TANK		BRINE TANK		FLOW RATE & PRESSURE			SHIP WT. (LBS.)
				TANK SIZE	RESIN FT3	SIZE	SALT FILL	SERVICE (GPM)	DROP (PSI)	BKW (GPM)	
M5076TA-29	2900	300,000	2	24 x 60	10	30 x 50	1200	68-94	15-25	15	3860
M5078TA-29	2900	450,000	2	30 x 60	15	39 x 48	2200	72-102	15-25	25	5050
M5080TA-31	3150	600,000	2	36 x 60	20	39 x 48	2200	78-107	15-25	35	5400
M5080TA-39	3900	600,000	3	36 x 60	20	39 x 48	2200	185-250	15-25	35	5700
M5082TA-31	3150	900,000	2	42 x 60	30	42 x 60	3000	84-118	15-25	45	9300
M5082TA-39	3900	900,000	3	42 x 60	30	42 x 60	3000	200-268	15-25	45	9600
M5084TA-31	3150	1,200,000	2	48 x 60	40	50 x 60	4500	87-120	15-25	60	9900
M5084TA-39	3150	1,200,000	2	48 x 60	40	50 x 60	4500	87-120	15-25	60	9900
M5076TA-29NT	2900	300,000	2	20 x 60	10	30 x 50	1200	68-94	15-25	15	3860
M5078TA-29NT	2900	450,000	2	30 x 60	15	39 x 48	2200	72-102	15-25	25	5050
M5080TA-31NT	3150	600,000	2	36 x 60	20	39 x 48	2200	78-107	15-25	35	5400
M5080TA-39NT	3900	600,000	3	36 x 60	20	39 x 48	2200	185-250	15-25	35	5700
M5082TA-31NT	3150	900,000	2	42 x 60	30	42 x 60	3000	84-118	15-25	45	9300
M5082TA-39NT	3900	900,000	3	42 x 60	30	42 x 60	3000	200-268	15-25	45	9600
M5084TA-31NT	3150	1,200,000	2	48 x 60	40	50 x 60	4500	87-120	15-25	60	9900
M5084TA-39NT	3150	1,200,000	2	48 x 60	40	50 x 60	4500	87-120	15-25	60	9900

#### NOTICE

Flow rates listed above are based on pressure drop only. Selecting a system based on pressure drop alone does not guarantee that the system will provide adequately softened water. System selection should be based on resin quantity, capacity required, feed water analysis, and application requirements.



## Media Filtration Systems

Watts offers a complete line of media filtration systems for a wide variety of applications. Our Micro Z media offers superior performance, reducing particulate matter down as low as 3 micron with 2.5 times the dirt holding capacity of sand. Watts Filox media for iron, manganese, and hydrogen sulfide reduction has the highest flow rate in the market today at 6gpm.

Watts also offers other media's such as Activated Carbon, Calcite, and GreensandPlus™ to meet all your needs.

### DID YOU KNOW?

Micro Z is a single media replacement for multimedia (anthracite, sand, and garnet). It saves on shipping cost, and eliminates questions about which media goes in the tank first. It also has a higher service flow rate with a lower pressure drop and finer filtration with higher dirt holding capacity.

## Automatic Backwashing with Micro Z

### Whole House Filters For Sediment Reduction with High Efficiency Micro Z™ Filter Media

Our filtration systems for sediment use high performance Micro Z filter media to provide increased loading capability and higher service flow rates. Micro Z's unique Zeolite structure offers increased porosity to outperform conventional sand filters by reducing water consumption. Our Micro Z media offers superior performance, reducing particulate matter down as low as 3 micron with 2.5 times the dirt holding capacity of sand.

**The need to backwash is dramatically reduced!**

#### Features & Benefits

- Uses Micro Z™ for increased dirt holding capacity
- Unique structure allows for higher flow rates
- Reduces water consumption because the need to backwash is dramatically reduced
- Reliable equipment, designed for long-term service



W110 Valve

W100 Valve

### Models with Watts Valves

MODEL NO.	VALVE	PIPE SIZE (IN.)	TANK SIZE	MEDIA (CU. FT.)	PEAK SERVICE FLOW (GPM)	BACKWASH (GPM)	FLOOR SPACE (L X W X H)	SHIP WT (LBS)
<b>Residential Systems with Standard Tanks</b>								
NM09-CK10F	W100	1	9 x 48	1	5/9	5.3	16 x 10 x 55	110
NM10-CK10F	W100	1	10 x 54	1.5	7/10	7.5	16 x 11 x 62	140
NM12-CK10F	W100	1	12 x 52	2	9/15	11	17 x 13 x 60	200
NM14-CK10F	W100	1 1/4 - 1 1/2	14 x 65	3	13/21	15	18 x 15 x 74	310
NM16-CK10F	W100	1 1/4 - 1 1/2	16 x 65	4	17/28	25	20 x 17 x 74	425
NM09-W110	W110	1	9 x 48	1	9	7	16 x 10 x 55	110
NM10-W110	W110	1	10 x 54	1.5	10	7	16 x 11 x 62	140
NM12-W110	W110	1	12 x 52	2	15	12	17 x 13 x 60	200
NM14-W110	W110	1	14 x 65	3	21	15	18 x 15 x 74	310
<b>Residential Systems with Vortech Tanks</b>								
NM09-W100F	W100	1	9 x 48	1	5/9	5.3	16 x 10 x 55	110
NM10-W100F	W100	1	10 x 54	1.5	7/10	7.5	16 x 11 x 62	140
NM12-W100F	W100	1	12 x 52	2	9/15	11	17 x 13 x 60	200
NM14-W100F	W100	1 1/4 - 1 1/2	14 x 65	3	13/21	15	18 x 15 x 74	310
NM16-W100F	W100	1 1/4 - 1 1/2	16 x 65	4	17/28	25	20 x 17 x 74	425

# Automatic Backwashing Filox® and GreensandPlus™ Filters

Whole House Filters for Iron, Hydrogen Sulfide and Manganese Reduction

Iron, Manganese and Hydrogen Sulfide are common elements found in your water and can be a nuisance causing stains in sinks, bathtubs, toilets, driveways and even the side of your house. In addition Iron, Manganese and Hydrogen Sulfide release unpleasant odors and tastes to your water supply. FILOX® and GreensandPlus™ are the great solutions to these challenging water quality problems.



**Standard Mineral Tank**  
Standard tanks use gravel under bedding, which adds weight and cost. Also, re-bedding is more difficult, should riser tubes pull out of the gravel bed.



**Vortech™ Mineral Tank**  
No gravel under bedding is required, reducing weight and cost. Also, riser tubes are permanently attached, so they cannot pull out during re-bedding.

## Two Media Types

### Filox®

A non-chemical oxidizing media to reduce Iron, Manganese and Hydrogen Sulfide.

### GreensandPlus™

An enhanced version of the traditional medium to remove Iron, Manganese and Hydrogen Sulfide from water.

### Filox® System Advantages

- Highest flow rate of any Iron removal media
- No oxidizing chemicals needed for regeneration
- High efficiency with 80% Manganese dioxide for enhanced performance and capacity
- Effective from 6.5 to 9.0 pH
- System is easy to program, with 10 pre-programmed regeneration cycles to optimize water treatment

### GreensandPlus™ System Advantages

- Lower backwash requirements
- Known saturation capacity
- Higher temperatures and differential pressures than traditional Manganese Greensand
- GreensandPlus™ is also used for radium reduction
- User friendly, low maintenance electronic time clock valve
- Effective from 6.2 to 8.5 pH

### NOTICE

The use of chemicals and oxidizers, such as chlorine, potassium permanganate and oxygen may be required for both systems to provide the optimal treatment for Iron, Hydrogen Sulfide and Manganese.

## Backwashing Filox Filters

MODEL NO.	VALVE	PIPE SIZE	TANK SIZE	MEDIA (CU. FT.)	PEAK SERVICE FLOW (GPM)	BACKWASH (GPM)	FLOOR SPACE (LXWXH)	SHIP WT (LBS)
<b>Residential Systems with Standard Tanks</b>								
NF09-CK10F	W100	1	9X48	1	6	7.5	16X10X55	167
NF10-CK10F	W100	1	10X54	1.5	9	10	16X11X62	235
NF12-CK10F	W100	1	12X52	2	12	15	17X13X60	318
NF14-CK10F	W100	1 1/4 - 1 1/2	14X65	3	18	20	18X15X74	460
NF16-CK10F	W100	1 1/4 - 1 1/2	16X65	4	24	25	20X17X74	611
N2410-F	Fleck 2510	3/4	8X44	0.5	3	7	12X10X54	97
N2349-F	Fleck 2750	1	9X48	1	6	7	13X11X58	122
N2350-F	Fleck 2750	1	10X54	1.5	9	9	14X12X46	125
N2352-FA	Fleck 2750	1	12X52	2	12	15	14X14X63	303
N2353-F	Fleck 2750	1	13X54	2.5	15	15	15X15X63	342
N2415-F	Fleck 2850	1 1/2	14X65	3	18	20	16X16X58	367
NF09-W110	W110	1	9X48	1	6	7	16X10X55	167
NF10-W110	W110	1	10X54	1.5	9	10	16X11X62	235
NF12-W110	W110	1	12X52	2	12	15	17X13X60	318
NF14-W110	W110	1	14X65	3	18	20	18X15X74	460
<b>Residential Systems with Vortech Tanks</b>								
NF09-W100F	W100	1	9 X 48	1	6	7.5	16X10X55	157
NF10-W100F	W100	1	10 X 54	1.5	9	10	16X11X62	220
NF12-W100F	W100	1	12 X 52	2	12	15	17X13X60	300
NF14-W100F	W100	1 1/4 - 1 1/2	14 X 65	3	18	20	18X15X74	410
NF16-W100F	W100	1 1/4 - 1 1/2	16 X 65	4	24	25	20X17X74	515
N2349-FAIO	Fleck 2510AIO	1	9X48	1	6	8	13X11X61	148
N2350-FAIO	Fleck 2510AIO	1	10X54	1.5	9	10	14X12X67	209
N2351-FAIO	Fleck 2510AIO	1	12X52	2	12	15	14X13X65	270
N2352-FAIO	Fleck 2510AIO	1	13X54	2.5	15	15	18X15X76	337
N2353-FAIO	Fleck 2510AIO	1	14X65	3	18	20	18X16X76	411

### NOTICE

The information listed above is for residential applications only and should not be used for commercial applications.

## Automatic Backwashing Filox<sup>®</sup> and GreensandPlus<sup>™</sup> Filters (cont.)

### Backwashing GreensandPlus<sup>™</sup> Filters

MODEL NO.	VALVE	PIPE SIZE	TANK SIZE	MEDIA (CU. FT.)	PEAK SERVICE FLOW (GPM)	BACKWASH (GPM)	FLOOR SPACE (LXWXH)	SHIP WT (LBS)
<b>Residential Systems with Standard Tanks</b>								
NGP09-CK10F	W100	1	9X48	1	3	5.3	16X21X55	137
NGP10-CK10F	W100	1	10X54	1.5	4	7.5	16X22X62	190
NGP12-CK10F	W100	1	12X52	2	5	10	17X24X60	258
NGP14-CK10F	W100	1 1/4 - 1 1/2	14X65	3	6	12	18X33X74	370
NGP16-CK10F	W100	1 1/4 - 1 1/2	16X65	4	7	20	20X35X74	491
NGP09-W110	W110	1	9X48	1	3	5	16X21X55	137
NGP10-W110	W110	1	10X54	1.5	4	7	16X22X62	190
NGP12-W110	W110	1	12X52	2	5	10	17X24X60	258
NGP14-W110	W110	1	14X65	3	6	12	18X33X74	370

## Non-Backwashing Carbon Filters

These non-backwashing carbon filters are a great solution for wide variety of water related issues where backwashing is either restricted or not possible. Applications include dechlorination, taste and odor reduction, and VOC/TOC reduction. Standard pipe size offerings are 3/4" and 1" FNPT and head materials are Noryl and PVC.

### Features & Benefits

- Non Backwashing
- Simple In/Out Head for Easy Installation
- No Electricity Required
- No Drain Required
- Small Foot Print



### Non-Backwashing Tanks

MODEL NO.	VALVE	PIPE SIZE (IN)	TANK SIZE	MEDIA (CU. FT.)	PEAK SERVICE FLOW (GPM)	BACKWASH (GPM)	FLOOR SPACE (LXWXH)	SHIP WT (LBS)
<b>Residential Systems with Standard Tanks</b>								
N1041-3	None	3/4	9 x 48	1	4	None	10X10X53	85
N1042A	None	3/4	8 x 44	1	4	None	9X9X49	80
N1042A-1	None	1	8 x 44	1	4	None	9X9X49	80
N1043B-1	None	1	12 x 52	2.5*	10	None	13X13X57	125
N1043-SD	None	2	10 x 54	2	8	None	11X11X59	95

\*Note: The N1043B-1 also has 12 lbs of KDF55 installed.

## Automatic Backwashing Carbon Filters

Fully assembled backwashing filters with activated carbon and Micro Z™

### Whole House Filters For Chlorine, Taste, Odor And Sediment Reduction.

Our activated carbon filters are highly popular because they correct a wide range of water quality problems by removing chlorine, tastes, odors and sediment.

#### Benefits

- Great tasting water from every tap
- No bad tastes
- No foul odors
- User-friendly equipment
- Low maintenance due to automatic operation

#### Vortech™ Mineral Tank

Media contact time is improved with Vortech tanks by enhancing the water flow path.



W110 Valve

5600 Valve

W100 Valve

3900 Valve

### Backwashing Filters With Activated Carbon For Taste, Odor And Chlorine Reduction

MODEL NO.	VALVE	PIPE SIZE (IN)	TANK SIZE	MEDIA (CU. FT.)	PEAK SERVICE FLOW (GPM)	BACKWASH (GPM)	FLOOR SPACE	SHIP WT (LBS)
<b>Residential Systems with Standard Tanks</b>								
N2050D	Fleck F5600	3/4	9X48	1	4	4	16"x10"x55"	90
N2050	Fleck F2510	3/4	9X48	1	4	4	13"x11"x58"	90
N2051	Fleck F2510	3/4	10X54	1.5	6	5	12"x11"x65"	105
N2051-1	Fleck F2750	1	10X54	1.5	8	5	12"x11"x65"	90
N2052	Fleck F2510	3/4	12X52	2	6	7	14"x13"x65"	117
N2052-1	Fleck F2750	1	12X52	2	8	7	14"x13"x65"	105
N2056	Fleck F2750	1	14X65	3	11	10	16"x15"x77"	194
N2058	Fleck F2750	1	16X65	4	15	12	18"x17"x77"	254
NC09-CK10F	W100	1	9X48	1	4	4.2	16"x10"x55"	80
NC10-CK10F	W100	1	10X54	1.5	6	5.3	16"x11"x62"	105
NC12-CK10F	W100	1	12X52	2	8	7.5	17"x13"x60"	145
NC14-CK10F	W100	1 1/4 - 1 1/2	14X65	3	11	10	18"x15"x74"	200
NC16-CK10F	W100	1 1/4 - 1 1/2	16X65	4	14	11	20"x17"x74"	265
NC21-CK10F	W100	1 1/4 - 1 1/2	21X62	5	20	25	22"x23"x70"	365
NC09-W110	W110	1	9X48	1	4	4	16"x10"x55"	80
NC10-W110	W110	1	10X54	1.5	6	5	16"x11"x62"	105
NC12-W110	W110	1	12X52	2	8	7	17"x13"x60"	145
NC14-W110	W110	1	14X65	3	11	10	18"x15"x74"	200
NC16-W110	W110	1	16x65	4	14	12	20"x17"x74"	265
<b>Residential Systems with Vortech™ Tanks</b>								
NC09-W100F	W100	1	9X48	1	4	4.2	10"x20"x48"	80
NC10-W100F	W100	1	10X54	1.5	6	5.3	12"x20"x65"	105
NC12-W100F	W100	1	12X52	2	8	7.5	14"x20"x65"	145
NC14-W100F	W100	1 1/4 - 1 1/2	14X65	3	11	10	16"x20"x77"	200
NC16-W100F	W100	1 1/4 - 1 1/2	16X65	4	14	11	18"x20"x77"	265

**Note:** Systems with Fleck 5600 and 2510 valves include a 0.75" bypass.

## Backwashing Filters With Activated Carbon For Taste, Odor And Chlorine Reduction (cont.)

MODEL NO.	VALVE	PIPE SIZE (IN)	TANK SIZE	MEDIA (CU. FT.)	PEAK SERVICE FLOW (GPM)	BACKWASH (GPM)	FLOOR SPACE	SHIP WT (LBS)
<b>Commercial Systems with Standard Tanks</b>								
N2050-275NT	Fleck F2750 NXT	1	9X48	1	3.7	4	13"x12"x60"	90
N2051-275NT	Fleck F2750 NXT	1	10X54	1.5	5.5	5	13"x12"x65"	105
N2052-275NT	Fleck F2750 NXT	1	12X52	2	7.4	7	14"x13"x65"	117
N2056-275NT	Fleck F2750 NXT	1	14X65	3	11.1	10	16"x15"x75"	194
N2058B	Fleck 2850	1 1/2	16X65	4	15	12	18"x17"x77"	260
N2058-285NT	Fleck 2850 NXT	1 1/2	16X65	4	14.8	12	18"x17"x75"	254
N7022-2850	Fleck 2850	1 1/2	21X62	6	22	26	24"x23"x84"	410
N2059-285NT	Fleck 2850 NXT	1 1/2	21X62	7	25.9	26	24"x23"x84"	471
N7032-2850	Fleck 2850	1 1/2	24X72	10	37	30	26"x25"x92"	670
N7022	Fleck 2900	2	21X62	5	18	25	24"x23"x88"	416
N7032	Fleck 2900	2	24X72	10	37	30	26"x25"x96"	680
N2332	Fleck 3150	2	24X72	8	30	30	28"x24"x107"	735
N2332-315NT	Fleck 3150 NXT	2	24X72	10	37	30	27"x27"x95"	735
N2333	Fleck 3150	2	30X72	10	37	50	38"x30"x107"	1432
N2333-315NT	Fleck 3150 NXT	2	30X72	15	55.5	50	33"x33"x95"	1432
N2334	Fleck 3150	2	36X72	20	74	70	48"x40"x107"	3038
N4110	Fleck 3900	3	30X72	14	52	50	38"x30"x114"	1450
N4112	Fleck 3900	3	36X72	20	74	70	48"x40"x114"	1965
N4112-39NT	Fleck 3900 NXT	3	36X72	20	74	70	48"x40"x114"	1965
N4114	Fleck 3900	3	42X72	27	100	90	54"x46"x114"	2955
N4114-39NT	Fleck 3900 NXT	3	42X72	30	111	90	54"x46"x114"	3038
N4116	Fleck 3900	3	48X72	35	130	100	60"x52"x114"	3645
N4116-39NT	Fleck 3900 NXT	3	48X72	35	129.5	100	60"x52"x114"	3645
N5010	Aquamatic PDVN	2	24X72	8	30	30	36"x27"x90"	680
N5011	Aquamatic PDVN	2	30X72	15	55	50	42"x33"x90"	1025
N5012	Aquamatic PDVN	2	36X72	20	74	70	48"x40"x90"	1530
N5013	Aquamatic PDVN	2	42X72	30	111	90	57"x50"x90"	2050
N5014	Aquamatic PDVN	2	48X72	35	130	120	60"x54"x90"	3095
N5015	Aquamatic PDVN	3	63X86	64	237	210	75"x69"x98"	4091

### NOTICE

The service flow rates listed for the carbon filters are for dechlorination. Slower flow rates may be required depending on the specific contaminant and concentration of the contaminant.

**⚠ WARNING** Wet activated carbon preferentially removes oxygen from air. In closed or partially closed containers and vessels, oxygen depletion may reach hazardous levels. If workers are to enter a vessel containing carbon, appropriate procedures for potentially low-oxygen environment should be followed.

## Backwashing Filters With Calcite and Magnesium Oxide To Increase pH

MODEL NO.	VALVE	PIPE SIZE (IN)	TANK SIZE	MEDIA (CU. FT.)	PEAK SERVICE FLOW (GPM)	BACKWASH (GPM)	FLOOR SPACE	SHIP WT (LBS)
<b>Residential Systems</b>								
N2070	Fleck F2510	3/4	9x48	1	4	4	13"x11"x58"	165
N2070-56	Fleck F5600	3/4	9X48	1	4	4	16"x10"x55"	130
N2076	Fleck F2750	1	14X65	3	16	10	16"x15"x77"	392
N2078	Fleck F2750	1	16X65	4	17	12	18"x17"x77"	537

## Backwashing Filters With Micro Z™ Media With Fleck Valves

MODEL NO.	VALVE	PIPE SIZE (IN)	TANK SIZE	MEDIA (CU. FT.)	PEAK SERVICE FLOW (GPM)	BACKWASH (GPM)	FLOOR SPACE	SHIP WT (LBS)
<b>Residential Systems</b>								
N5245-09	Fleck F2750	1	9x48	1	7	7	13"x11"x58"	110
N5245-09-70	Fleck F7000	1	9x48	1	7	7	20"x10"x58"	107
N5245-10	Fleck F2750	1	10x54	1.5	8	7	12"x11"x65"	140
N5245-10-70	Fleck F7000	1	10x54	1.5	8	10	20"x11"x65"	137
N5245-12	Fleck F2750	1	12x52	2	9	10	14"x13"x65"	167
N5245-12-70	Fleck F7000	1	12x52	2	12	12	20"x13"x65"	140
N5245-13	Fleck F2750	1	13x54	2.5	14	15	18"x14"x66"	178
<b>Commercial Systems</b>								
N5245-09-275NT	Fleck F2750 NXT	1	9x48	1	6.6	7	13"x12"x60"	118
N5245-10-275NT	Fleck F2750 NXT	1	10x54	1.5	8.1	7	13"x12"x65"	147
N5245-12-275NT	Fleck F2750 NXT	1	12x52	2	11.7	10	14"x13"x65"	173
N5245-14	Fleck F2850	1 1/2	14X65	3	15	20	18"x15"x74"	258
N5245-14-285NT	Fleck F2850 NXT	1 1/2	14X65	3	16	20	15"x16"x75"	278
N5245-16	Fleck F2850	1 1/2	16X65	4	21	20	18"x17"x77"	364
N5245-16-285NT	Fleck F2850 NXT	1 1/2	16X65	4	20.8	20	18"x17"x75"	366
N5245-22	Fleck F2850	1 1/2	21X62	7	36	40	24"x23"x84"	595
N5245-21-285NT	Fleck F2850 NXT	1 1/2	21X62	7	36.1	40	24"x23"x84"	667
N5245-24-3150	Fleck F3150	2	24X72	10	47	50	28"x24"x107"	1053
N5245-24-315NT	Fleck F3150 NXT	2	24X72	10	47.1	50	27"x27"x95"	1015
N5245-30-3150	Fleck F3150	2	30X72	15	73	85	38"x30"x107"	1967
N5245-30-315NT	Fleck F3150 NXT	2	30X72	15	73.6	85	33"x33"x95"	1852
N5245-30-3900	Fleck F3900	3	30X72	15	73	85	38"x30"x114"	2007
N5245-36-3150	Fleck F3150	2	36X72	20	106	100	48"x40"x107"	2485
N5245-36-3900	Fleck F3900	3	36X72	20	106	100	48"x40"x114"	2525
N5245-36-39NT	Fleck F3900 NXT	3	36X72	20	106.1	100	48"x40"x114"	2525
N5245-36-DVN	Aquamatic PDVN	2	36X72	20	106	100	48"x40"x90"	2480
N5245-42-DVN	Aquamatic PDVN	3	42X72	30	144.3	155	54"x46"x90"	2895
N5245-48-DVN	Aquamatic PDVN	3	48X72	40	188.4	200	60"x54"x90"	3882

**Note:** Systems with the Fleck 7000 valve include a 1" By-Pass.

## FILTER MEDIA Properties and Conditions for Operation

**Note:** General reference only; conditions may vary. Ask about your application.

DESCRIPTION	LB/CF	EQUIPMENT USE
<b>Activated Carbon</b>		
Highly activated carbon. Absorbs chlorine, phenols, detergents, pesticides, etc.	28	Carbon Filters
Granular activated carbon. Absorbs larger molecular particles. Good organic trap ahead of deionizers.	28	Carbon Filters
Highly active acid washed carbon. Used in high purity applications such as pharmaceutical and medical.	27	R.O. Pretreatment Special Applications
Highly active carbon manufactured to develop catalytic functionality. Used for hydrogen sulfide and chloramine reduction. Primarily used in medical, aquatic, and bottling applications.	36	R.O. Pretreatment Special Applications
Fine mesh nut-shell activated carbon. Extremely hard, high chlorine capacity.	51	Special Filtration Products
<b>FILTER MEDIA</b>		
Crushed and graded limestone (Neutralizer™). Neutralizes water with low pH and high CO2 on sacrificial basis.	100	Neutralizer Filters
Manganese treated zeolite. Removes iron and manganese. Removes turbidity and hydrogen sulfide on special applications. Requires chemical feed pretreatment.	90	Iron Filter
Granular non-hydrous aluminum silicate for removal of suspended organic matter and turbidity (Filter-Ag)	80	Single Media Turbidity Filters
Regular birm used for iron removal when the oxygen content of the water is at least 15% of the total iron and manganese in the water.	50	Single Media Filters
Washed and graded flint gravel used as underbedding in softeners, filters and some deionizers. Iron and lime free.	100	All Units Except Mixed Bed Deionizers
Washed and graded anthracite filter media.	52	Multi-Media Depth Filters
Filter sand, specially screened.	100	Multi-Media Depth Filters
Garnet filter media, specially sized.	125	Multi-Media Depth Filters

## Automatic Backwashing Systems without Media

### NX Series Backwashing Filters - No Media

#### NX Series Backwashing Filters

Our popular backwashing filter systems are now available without media. The NX series come complete with control valve and internals. A by-pass valve is included on residential system.

- Add your "Special" media or blend that works best for your customers
- Save on Shipping
- Reduce your inventory
- Complete backwashing system just add media
- Drain line flow control washer included (sized for approximately 12 GPM per square foot) for residential systems. Drain line flow controller sold separately on commercial systems.



### NX Series Backwashing Filters without Media

MODEL NO.	VALVE	PIPE SIZE	TANK SIZE	MEDIA (CU. FT.)	GRAVEL (LBS)	BACKWASH (GPM)	FLOOR SPACE (LXWXH)	SHIP WT (LBS)
<b>Residential Systems with Standard Tanks</b>								
NX09-CK10F	W100	1	9X48	1	10	5.3	16X10X55	53
NX10-CK10F	W100	1	10x54	1.5	10	7.5	16X11X62	64
NX12-CK10F	W100	1	12X52	2	20	10	17X13X60	90
NX14-CK10F	W100	1 1/4 - 1 1/2	14X65	3	50	15	18X15X74	118
NX16-CK10F	W100	1 1/4 - 1 1/2	16X65	4	50	20	20X17X74	155
NX21-CK10F	W100	1 1/4 - 1 1/2	21X62	5	100	25	22X23X70	228
NX09-W110	W110	1	9X48	1	10	5	16X10X55	53
NX10-W110	W110	1	10X54	1.5	10	7	16X11X62	64
NX12-W110	W110	1	12X52	2	20	10	17X13X60	90
NX14-W110	W110	1	14X65	3	50	12	18X15X74	118
NX16-W110	W110	1	16x65	4	50	20	20x17x74	155

**Note:** Gravel and media amounts listed above are for reference only. Gravel and media is not included with the system.

## NX Series Backwashing Filters without Media (cont.)

MODEL NO.	VALVE	PIPE SIZE	TANK SIZE	MEDIA (CU. FT.)	GRAVEL (LBS)	BACKWASH (GPM)	FLOOR SPACE (LXWXH)	SHIP WT (LBS)
<b>Commercial Systems with FRP Tanks</b>								
NX09T2750	Fleck 2750	1	9X48	1	10	N/A	11X10X60	75
NX10T2750	Fleck 2750	1	10X54	1.5	10	N/A	12X11X66	50
NX14T2750	Fleck 2750	1	14X65	3	50	N/A	16X15X77	82
NX16T2750	Fleck 2750	1	16X65	4	50	N/A	18X17X77	89
NX18T2750	Fleck 2750	1	18X65	5	100	N/A	20X19X77	110
NX21T2750	Fleck 2750	1	21X62	7	100	N/A	23X22X77	125
NX12T2850	Fleck 2850	1 1/2	12X52	2	20	N/A	15X13X64	85
NX14T2850	Fleck 2850	1 1/2	14X65	3	50	N/A	16X15X77	90
NX16T2850	Fleck 2850	1 1/2	16X65	4	50	N/A	18X17X77	94
NX18T2850	Fleck 2850	1 1/2	18X65	5	100	N/A	19X19X77	125
NX21T2850	Fleck 2850	1 1/2	21X62	7	100	N/A	24X23X84	144
NX24T2850	Fleck 2850	1 1/2	24X72	10	200	N/A	26X25X92	203
NX12T2900	Fleck 2900	2	12X52	2	20	N/A	16X13X64	175
NX14T2900	Fleck 2900	2	14X65	3	50	N/A	17X15X77	185
NX16T2900	Fleck 2900	2	16X65	4	50	N/A	18X17X79	195
NX18T2900	Fleck 2900	2	18X65	5	100	N/A	20X19X77	210
NX21T2900	Fleck 2900	2	21X62	7	100	N/A	23X22X77	234
NX24T2900	Fleck 2900	2	24X72	10	200	N/A	25X25X88	250
NX16T3150	Fleck 3150	2	16X65	4	50	N/A	21X17X77	240
NX18T3150	Fleck 3150	2	18X65	5	100	N/A	22X19X77	250
NX21T3150	Fleck 3150	2	21X62	7	100	N/A	24X22X77	260
NX24T3150	Fleck 3150	2	24X72	10	200	N/A	28X24X107	270
NX30T3150	Fleck 3150	2	30X72	15	300	N/A	38X30X107	376
NX36T3150	Fleck 3150	2	36X72	20	500	N/A	48X40X107	428
NX42T3150	Fleck 3150	2	42X72	30	600	N/A	45X43X100	725
NX48T3150	Fleck 3150	2	48X72	35	1500	N/A	51X49X100	825
NX24TDVN	Aquamatic PDVN	2	24X72	10	200	N/A	36X27X90	564
NX30TDVN	Aquamatic PDVN	2	30X72	15	300	N/A	42X33X90	704
NX36TDVN	Aquamatic PDVN	2	36X72	20	500	N/A	48X40X90	812
NX42TDVN	Aquamatic PDVN	2	42X72	30	600	N/A	45X43X107	1300
NX48TDVN	Aquamatic PDVN	2	48X72	35	1500	N/A	60X54X90	1428
NX24T3900	Fleck 3900	3	24X72	10	200	N/A	26X25X93	335
NX30T3900	Fleck 3900	3	30X72	15	300	N/A	38X30X114	385
NX36T3900	Fleck 3900	3	36X72	20	500	N/A	48X40X114	477
NX42T3900	Fleck 3900	3	42X72	30	600	N/A	45X43X107	750
NX24TDVN3	Aquamatic PDVN	3	24X72	10	200	N/A	34X47X100	600
NX30TDVN3	Aquamatic PDVN	3	30X72	15	300	N/A	40X47X100	775
NX36TDVN3	Aquamatic PDVN	3	36X72	20	500	N/A	47X47X100	900
NX42TDVN3	Aquamatic PDVN	3	42X72	30	600	N/A	53X49X100	1525
NX48TDVN3	Aquamatic PDVN	3	48X72	35	1500	N/A	60X54X90	1634
NX63TDVN3	Aquamatic PDVN	3	63X86	50	2000	N/A	84X69X102	2125
<b>Commercial Systems with Steel Tanks</b>								
NX24T3150-STL	Fleck 3150 SM	2	24X60	10	200	N/A	39X30X84	598
NX30T3150-STL	Fleck 3150 SM	2	30X60	15	300	N/A	45X34X84	851
NX36T3150-STL	Fleck 3150 SM	2	36X60	20	500	N/A	51X38X84	1089
NX36T3900-STL	Fleck 3900 SM	3	36X60	20	500	70	51X38X84	1228
NX42T3150-STL	Fleck 3150 SM	2	42X60	30	600	N/A	57X44X84	1345
NX42T3900-STL	Fleck 3900 SM	3	42X60	30	600	N/A	57X44X84	1500

**Note:** Gravel and media amounts listed above are for reference only. Gravel and media is not included with the system.



## Drinking Water Systems

Drinking water systems provide filtration from basic to highly-advanced levels depending on the application and requirements. Basic systems can provide filtration for sediment and taste/odor reduction while advanced systems provide basic filtration plus reduce lead, cyst, and volatile organic compounds (VOCs). Our drinking water systems use proven designs in many configurations to produce high-quality, great-tasting water.

### DID YOU KNOW?

The CDC reports that Cryptosporidium and Giardia combined affects over 20,000 people annually in the US. To prevent the spread of infection by a contaminated water source it is recommended to use a filter system certified to NSF/ANSI Standard 53 for cyst reduction.

### Drinking Water System Selection Guide

					
TYPE OF FEATURE	DESCRIPTION	UNDER COUNTER QUICK-TWIST (QT)	UNDER COUNTER QUICK-CHANGE (QC)	STANDARD UNDER COUNTER SYSTEMS	COUNTER TOP SYSTEMS
Ease of Filter Change	Cartridges removed with a quarter turn	✓	✓		
Ease of Filter Change	No filter sumps, no mess, no fuss	✓	✓		
Ease of Filter Change	Water flow shuts off automatically for easy cartridge replacement	✓	✓		
Ease of Filter Change	Cartridges are color coded for easy identification		✓		
Ease of Filter Change	Performance Indicator Device(PID) Model				✓
Ease of Installation	Hardware kit for complete installation	✓	✓	✓	✓
Ease of Installation	No tank needed, frees up space	✓	✓	✓	✓
Ease of Installation	Installation is quick and easy	✓	✓	✓	✓
Ease of Installation	Easy to install, no tools required				✓
Ease of Installation	Fully assembled				✓
Options	Choice of cartridge types and sizes for residential, commercial and foodservice applications	✓	✓		
Options	Faucet options available	✓	✓	✓	
Options	UV models available			✓	
Options	Automatic shutoff flow meter to indicate cartridge replacement			✓	
Options	Ideal for private label marketing	✓	✓	✓	✓
Performance Feature	Low cost alternative to RO	✓	✓		
Performance Feature	No reject water (100% of the water is used)	✓	✓	✓	✓
Performance Feature	No pressure problems, Units work as low as 20 psi / 1.4 bar pressure	✓	✓	✓	✓
Performance Feature	Leaves essential nutrients in water	✓	✓	✓	✓
Performance Feature	Three different cartridge sizes available	✓	✓		
Performance Feature	High flow 3/8" fittings and tubes	✓			
Performance Feature	Certified by independent lab		✓		
Reliability	Cartridges have double o-rings to prevent leaks	✓	✓		
Reliability	One year limited warranty from date of purchase	✓	✓	✓	✓

## Under Counter Quick-Twist (QT) Proprietary Cartridge Drinking Water Systems

### E-Treat Drinking Water Systems

The Ideal, Low Cost Alternative To Reverse Osmosis Technology!

- No tank
- No reject water
- No pressure problems
- No sumps
- No mess
- No fuss
- Easy installation
- Low cost

#### Benefits:

- Great tasting drinking water for only pennies a gallon
- No trips to the store to buy bottled water
- Water flow shuts off when cartridges are removed



ETDWS38-T

Three stage filtration system with sediment, carbon block and hollow fiber membrane filter cartridges.

### E-Treat Drinking Water Systems

MODEL NO.	DESCRIPTION
ETDWS38-S	Single unit with bracket, head, sediment cartridge and 3/8" quick connect fittings
ETDWS38-AC	Single unit with bracket, head, activated carbon cartridge and 3/8" quick connect fittings
ETDWS38-D	Dual unit with bracket, heads, sediment & carbon cartridges, 3/8" quick connect fittings
ETDWS38-T	Triple unit with bracket, heads, sediment, carbon and hollow fiber membrane, 3/8"

### Replacement Cartridges

MODEL NO.	DESCRIPTION
ETRCS	E-Treat Melt blown sediment cartridge
ETRCAC	E-Treat carbon block cartridge
ETRCHFM	E-Treat hollow fiber membrane cartridge

## Under Counter Quick-Change (QC) Proprietary Cartridge Drinking Water Systems

### Quick-Change™ System with Ultra-Filtration Technology

Watts drinking water systems with Quick-Change™ filter elements and hollow fiber membranes come complete with sediment cartridge, carbon block cartridge, hollow fiber membrane, long reach chrome faucet, tapping valve and tubing.

#### NOTICE

System requires a minimum of 20psi inlet pressure (1.4 bar) and pressure drop is 3psi at 0.5 GPM.

#### Features & Benefits

- Quick-Change™ cartridges are removed with a single turn
- No filter sumps, no mess, no fuss
- No tank needed, frees up space
- Cartridges have double O-rings to prevent leaks
- Choice of cartridge types and sizes for residential, commercial and foodservice applications

#### Quick-Change™ Drinking Water Systems Vs. RO Systems

- Low cost alternative to RO
- No reject water (100% of the water is used)
- No pressure problems, Units work as low as 20psi / 1.4 bar pressure
- Installation is quick and easy
- Leaves essential nutrients in water
- Three different cartridge sizes available
- Cartridges are color coded for easy identification



Kits include long reach chrome faucet, Adapt-A-Valve and tubing.

#### Reduces:

##### NSF Standard 42\*

- Chlorine taste and odor (97%)
- Particulate
- Sand
- Silt
- Rust particles

##### NSF Standard 53

- Lead (95%)
- VOC's (95%)
- Herbicides
- Pesticides
- Insecticides
- Cysts



Filter units only; no faucet, Adapt-A-Valve or tubing allows dealers more flexibility to choose from a wide range of options.

### Quick-Change™ (QC) Systems

MODEL NO.	DESCRIPTION	CASE
<b>With Faucet and Installation Kit</b>		
WQCFU-AC-KIT	10" single sys. bracket, activated carbon, faucet and install kit	1
WQCFU-D-KIT	10" dual sys. bracket, sediment & carbon, faucet and install kit	1
WQCFU-T-KIT	10" triple sys., bracket, sediment, carbon, UF, faucet and install kit	1
WQCFU-T-11KIT*	10" triple sys., bracket, sediment, carbon, UF, faucet and install kit	1
<b>Without Faucet and Installation Kit</b>		
WQCFU-AC	10" single cartridge, bracket & activated carbon	1
WQCFU-S	10" single cartridge, bracket & sediment	1
WQCFU-D	10" dual sys., bracket, sediment & carbon	1
WQCFU-T	10" triple, bracket, sediment, carbon, HF membrane	1

#### Replacement Cartridges

TYPE	MICRON	MODELS		
		10"	11"	13"
Sediment (melt blown PP)	5	WQCSC10	WQCSC11	WQCSC13
Carbon	5	WQCCC10	WQCCC11	WQCCC13
Antibacterial Activated Carbon	5	WQCABC10	WQCABC11	WQCABC13
Hollow fiber membrane (UF)	0.1 - 0.3	WQCHFC10	WQCHFC11	WQCHFC13



## Standard Cartridge Drinking Water Systems

### Under Counter Standard Cartridge Systems

#### Fully Assembled Systems in “Non-Branded” Generic Packaging\*

##### Features & Benefits

- Easy to install
- Long reach, lead-free faucet
- Hardware kit for complete installation
- UV models available
- Models available with automatic shutoff flow meter to indicate cartridge replacement

\*Units are sold without cartridges unless otherwise noted.



### Models

MODEL NO.	TYPE	AUTO SHUTOFF METER	NO. PER CASE
ADWU-S	Single	No	1
ADWU-D	Dual	No	1
ADWU-DM	Dual with meter	Yes	1
ADWU-D-UV*	Dual with UV	No	1
ADWU-T	Triple	No	1
ADWU-TM	Triple with meter	Yes	1

\*ADWU-D-UV model includes UV lamp, ballast, sediment cartridge and carbon block cartridge. For other models, cartridges are not included. The recommended maximum flow rate for ADWU-D-UV system is 1 GPM.

## Counter Top Cartridge Systems

### Built-in Alarm Model with Cartridge Replacement Indicator or Conventional Model

##### Features & Benefits

- Easy to install, no tools required
- Long reach adjustable spout
- Hardware kit for complete installation
- Performance Indicator Device(PID) Model available with monitor alarm to indicate cartridge replacement
- Fully assembled
- Ideal for private label marketing



### PID Model With Audible Alarm

MODEL NO.	DESCRIPTION	CASE
HSCT-MW	White Counter Top with Chrome Spout	6

### Conventional Models Without Audible Alarm

MODEL NO.	TYPE	HOUSING	SPOUT	INLET FITTING	ELBOW	DIVERTER	CASE
ACT-C	Chrome	SS4000VWW	LRS-C-OR	C-22N	C-21-1	SDV-14S	12
ACT-P	White	SS4000VWW	LRS-P	CI010822W	CI481222W	DV800WM	12

## Top Quality Designer Faucets

Large Selection of Designer Faucets to Suit Your Taste

Why Crawl Under The Sink When You Can Install It From The Top!

### Designer Top Mount Twist Faucets

#### Features & Benefits

- Easy Installation from the top of the sink
- Reduces Installation Labor
- Easy Twist on and off faucet tops enable the end user to change faucet styles and colors without the need to disconnect the faucet from the filtration system.
- Lead Free\*
- Models with filter change monitors are available to remind customers when to change cartridges for water quality assurance
- Ceramic disc for durability
- One style works for both air gap and non-air gap installations
- Quick-Connect fittings for all tubes including air gap



Available in chrome, brushed nickel, black, white and oil rubbed bronze

*Monitor faucets remind customers when cartridge replacements are necessary to eliminate guesswork and provide top water quality assurance!*

#### How the Monitor Faucets work:

- Monitor tracks time and estimates gallons based on time when handle is in "on" position.
- Blue LED indicates filter life remaining.
- Red LED flashes after 6 months or estimated 2000 gallons indicating filter replacement required.
- Removal and reinstallation of battery will reset the monitor.

### Designer Top Mount Faucets

Twist

Non Twist



Curve



Bell



WTM



component

All WTM Faucets Are

Certified by NSF International against NSF/ANSI Standard 42 for material and structural requirements.

### Designer Faucets



Series 303



Series 133



Series 703



Series 888



Series 903



Series 905

### Dual Function Faucets



FU-GKD01-CP



FU-GKD02-CP



T277103



T277104



Faucet Finish

## Top Quality Designer Faucets

MODEL NO.	VALVE TYPE	FINISH	SIZE (IN)	CASE QTY	AIR GAP	FILTER MONITOR
<b>Top Mount Twist Faucets *NEW*</b>						
WTMTFA-CRVCM14	Ceramic Disc	Chrome	1/4	15	X	X
WTMTFA-CRVC14	Ceramic Disc	Chrome	1/4	15	X	
WTMTFA-CRVBNM14	Ceramic Disc	Brushed Nickel	1/4	15	X	X
WTMTFA-CRVBN14	Ceramic Disc	Brushed Nickel	1/4	15	X	
WTMTFA-CRVWHM14	Ceramic Disc	White	1/4	15	X	X
WTMTFA-CRVWH14	Ceramic Disc	White	1/4	15	X	
WTMTFA-CRVBKM14	Ceramic Disc	Black	1/4	15	X	X
WTMTFA-CRVBK14	Ceramic Disc	Black	1/4	15	X	
WTMTFA-CRVORM14	Ceramic Disc	Oil Rubbed Bronze	1/4	15	X	X
WTMTFA-CRVOR14	Ceramic Disc	Oil Rubbed Bronze	1/4	15	X	
WTMTFA-BELCM14	Ceramic Disc	Chrome	1/4	15	X	X
WTMTFA-BELC14	Ceramic Disc	Chrome	1/4	15	X	
WTMTFA-BELBNM14	Ceramic Disc	Brushed Nickel	1/4	15	X	X
WTMTFA-BELBN14	Ceramic Disc	Brushed Nickel	1/4	15	X	
WTMTFA-BELWHM14	Ceramic Disc	White	1/4	15	X	X
WTMTFA-BELWH14	Ceramic Disc	White	1/4	15	X	
WTMTFA-BELBKM14	Ceramic Disc	Black	1/4	15	X	X
WTMTFA-BELBK14	Ceramic Disc	Black	1/4	15	X	
WTMTFA-BELORM14	Ceramic Disc	Oil Rubbed Bronze	1/4	15	X	X
WTMTFA-BELOR14	Ceramic Disc	Oil Rubbed Bronze	1/4	15	X	
WTMTFA-CRVCM38	Ceramic Disc	Chrome	3/8	15	X	X
WTMTFA-CRVC38	Ceramic Disc	Chrome	3/8	15	X	
WTMTFA-CRVBNM38	Ceramic Disc	Brushed Nickel	3/8	15	X	X
WTMTFA-CRVBN38	Ceramic Disc	Brushed Nickel	3/8	15	X	
WTMTFA-CRVWHM38	Ceramic Disc	White	3/8	15	X	X
WTMTFA-CRVWH38	Ceramic Disc	White	3/8	15	X	
WTMTFA-CRVBKM38	Ceramic Disc	Black	3/8	15	X	X
WTMTFA-CRVBK38	Ceramic Disc	Black	3/8	15	X	
WTMTFA-CRVORM38	Ceramic Disc	Oil Rubbed Bronze	3/8	15	X	X
WTMTFA-CRVOR38	Ceramic Disc	Oil Rubbed Bronze	3/8	15	X	
WTMTFA-BELCM38	Ceramic Disc	Chrome	3/8	15	X	X
WTMTFA-BELC38	Ceramic Disc	Chrome	3/8	15	X	
WTMTFA-BELBNM38	Ceramic Disc	Brushed Nickel	3/8	15	X	X
WTMTFA-BELBN38	Ceramic Disc	Brushed Nickel	3/8	15	X	
WTMTFA-BELWHM38	Ceramic Disc	White	3/8	15	X	X
WTMTFA-BELWH38	Ceramic Disc	White	3/8	15	X	
WTMTFA-BELBKM38	Ceramic Disc	Black	3/8	15	X	X
WTMTFA-BELBK38	Ceramic Disc	Black	3/8	15	X	
WTMTFA-BELORM38	Ceramic Disc	Oil Rubbed Bronze	3/8	15	X	X
WTMTFA-BELOR38	Ceramic Disc	Oil Rubbed Bronze	3/8	15	X	
<b>Top Mount (non-Twist) Series Faucets</b>						
WTMFAG-C-M	Ceramic Disc	Chrome	3/8	15	X	X
WTMFAG-C	Ceramic Disc	Chrome	3/8	15	X	
WTMFAG-BN-M	Ceramic Disc	Brushed Nickel	3/8	15	X	X
WTMFAG-BN	Ceramic Disc	Brushed Nickel	3/8	15	X	
WTMFAG-W-M	Ceramic Disc	White	3/8	15	X	X
WTMFAG-W	Ceramic Disc	White	3/8	15	X	
WTMFAG-B-M	Ceramic Disc	Black	3/8	15	X	X
WTMFAG-ORB-M	Ceramic Disc	Oil Rubbed Bronze	3/8	15	X	X
WTMFAG-ORB	Ceramic Disc	Oil Rubbed Bronze	3/8	15	X	
<b>Series 133 Faucets</b>						
FU133CPP	Ceramic Disc	Chrome	1/4	10		
<b>Series 303 Faucets</b>						
FNP3033CP-US05	Lever Style	Chrome	1/4	50		
FNP3033NP	Lever Style	Brushed Nickel	1/4	50		
<b>Airgap Monitor</b>						
FU-AGLR.C/3	Lever Style	Brushed Nickel	1/4	50	X	
<b>Series 703 Faucets</b>						
FNCP7033CP	Ceramic Disc	Chrome	1/4	30		
FNCP7033NP	Ceramic Disc	Brushed Nickel	1/4	30		
FNCP7033OB	Ceramic Disc	Oil Rubbed Bronze	1/4	30		
<b>Series 888 Faucets</b>						
FNCP8883AB	Ceramic Disc	Antique Brass	1/4	20		
FNCP8883AW	Ceramic Disc	Antique Wine	1/4	20		
FNCP8883CP	Ceramic Disc	Chrome	1/4	20		
FNCP8883NP	Ceramic Disc	Brushed Nickel	1/4	20		
FNCP8883ST	Ceramic Disc	Satin Nickel	1/4	20		
<b>Series 903 Faucets</b>						
FNCP6034CP	Ceramic Disc	Chrome	1/4	30		
<b>Series 905 Faucet</b>						
FU-WDF-905-CP	Ceramic Disc	Chrome	1/4	30		
FNCP9053NP	Ceramic Disc	Brushed Nickel	1/4	30		
<b>Dual Function Kitchen Faucets</b>						
FU-GKD01-CP	Ceramic Disc	Chrome	1/4	8		
FU-GKD02-CP	Ceramic Disc	Chrome	1/4	8		
T277103	Ceramic Disc	Chrome	1/4	8		
T277104	Ceramic Disc	Chrome	1/4	8		

Twist Faucets



Non-Twist Faucet



Designer Faucets

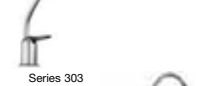

Dual Function Faucets



## Reverse Osmosis Systems

*Reverse Osmosis (RO) is a proven and dependable technology. RO systems work by forcing water through a semi-permeable membrane that separates the clean water at the molecular level from the majority of impurities. Impurities including sodium, calcium, chloride, sulfates, and heavy metals commonly measured as total dissolved solids (TDS) are typically reduced by 99% and rinsed down the drain. Watts RO systems use proven treatment methods including sediment, carbon, and membrane technology to produce highly-purified, great-tasting water.*

### DID YOU KNOW?

RO membranes are able to reject up to 99% of the dissolved solids in your water. This includes metals, salts, and minerals. RO is also able to reject up to 99.9% of cysts, bacteria, and viruses.

### RO System Selection Guide



TYPE OF FEATURE	DESCRIPTION	QUICK-CHANGE SERIES	QT-PLUS SERIES	ONE PIECE MANIFOLD SERIES	HALF-TURN SERIES	315/415/525 SERIES	PERMEATE PUMP / GTS SERIES
Ease of Filter Change	Uses industry standard cartridges			✓	✓	✓	✓
Ease of Filter Change	No need to disconnect tubing when replacing membranes	✓	✓	✓	✓*		
Ease of Filter Change	Disposable encapsulated cartridges	✓	✓				
Ease of Filter Change	Easy to remove/replace 1/4-turn filter cartridges	✓	✓				
Ease of Filter Change	Proprietary filter cartridges	✓	✓				
Ease of Filter Change	Automatic shut off when cartridges are removed	✓	✓				
Ease of Filter Change	"Swing out" feature for easy filter change out	✓					
Ease of Filter Change	Half-turn housings with Sure Seal cartridge technology				✓		
Ease of Installation	Installation kit is included	✓	✓	✓	✓	✓	✓
Ease of Installation	Inlet water fitting is adaptable to use with 3/8" or 1/2" fittings	✓	✓	✓	✓	✓	✓
Ease of Installation	Quick-Connect fittings on inlet and outlet ports	✓	✓	✓	✓	✓	✓
Options	Many faucet options available	✓	✓	✓	✓	✓	✓
Options	Advanced MCD technology booster pump or ZeroWaste kit ready	✓	✓		✓		
Options	Built-in Booster Pumps					✓	✓
Options	Tank options available (metal or plastic)	✓	✓				✓
Performance Feature	High Flow 3/8" tank to faucet tubing	✓	✓	✓	✓	✓	✓
Performance Feature	Advanced MCD technology booster pump upgrade kit available	✓	✓	✓	✓	✓	✓
Performance Feature	Permeate pump	✓					✓
Performance Feature	Permeate pump upgrade kit available	✓	✓	✓	✓	✓	✓
Performance Feature	50 GPD or greater thin film membrane	✓	✓	✓	✓	✓	✓
Reliability	Clog free brine flow control	✓	✓	✓	✓	✓	✓
Reliability	Assembled in USA	✓	✓	✓	✓	✓	✓
Reliability	Proven design - "no label" model			✓	✓		✓
Reliability	One year limited warranty from date of purchase	✓	✓	✓	✓	✓	✓

\* For Model No. F500398 only.

# Quick-Change (QC) Proprietary Cartridge Systems

The Best of the Best with Quarter-Turn Swing-out Encapsulated Cartridges

Certified by WQA

### Features & Benefits

- Swing-out feature for easy filter change out
- Automatic shut off when cartridges are removed
- Disposable encapsulated cartridges
- Easy to remove/install 1/4-turn filter cartridges
- No need to disconnect tubing when replacing membranes
- Proprietary filter cartridges
- Permeate pump uses no electricity and provides\*
  - a) More water in storage tank;
  - b) Better contaminant reduction;
  - c) Faster tank filling;
  - d) Reduces waste water by up to 67%
- Certified Systems
- Advanced MCD technology booster pump or ZeroWaste kit ready (Patented) - water saving kits section
- Inlet water supply fitting is adaptable to use with 3/8" compression or 1/2" compression fittings
- Installation kit is included
- Many faucet options available - See faucets section
- Quick-Connect fittings on inlet and outlet ports
- 50 GPD or greater thin film membrane (made in USA)
- Assembled in USA
- Clog free brine flow control
- Tank options available (metal or plastic)
- Valves are built into the heads to prevent backflow for water quality assurance
- WQA Certified to NSF/ANSI Standard 58\*\*
- All models use 3/8" tubing from the tank to the faucet

\*Quick-Change™ RO Permeate Pump Model only

\*\*Quick-Change™ RO Model only

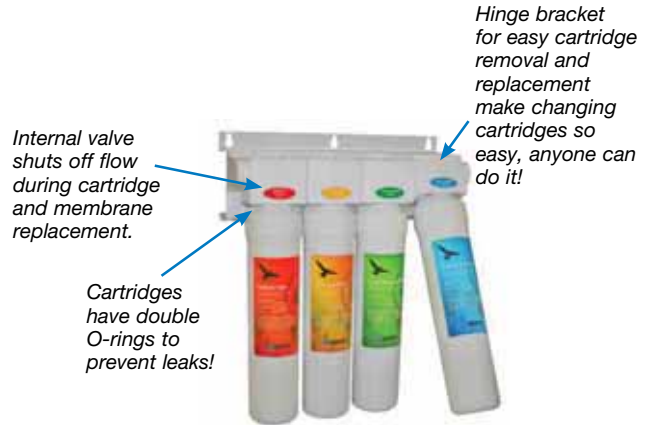

### NOTICE

Proprietary filter cartridges and membranes are installed and removed by a simple 1/4 turn.



WQA Gold Seal Certified to NSF / ANSI Standard 58



Quick-Change™ RO with Permeate Pump

## Models

MODEL NO.	STAGE	MEMBRANE (GPD)	FAUCET	FITTINGS TANK-FAUCET	TANK
WQC4R011-50PTNF	4	50	—	3/8"	RO Pro®
WQC4R011-50MTNF	4	50	—	3/8"	Metal
WQC4R013-100PT	4	100	WTM-FAG-C	3/8"	RO Pro®
WQC4R013-100MT	4	100	WTM-FAG-C	3/8"	Metal

## Permeate Pump Models

WQC4R011-50PTPP	4	50	No faucet	3/8"	RO Pro®
WQC4R013-100PTP	4	100	No faucet	3/8"	RO Pro®
WQC4R013-100MTP	4	100	No faucet	3/8"	Metal

## Proprietary Replacement Cartridges

MODEL NO.	ELEMENT	SEDIMENT	CARBON	MEMBRANE	GAC
50 GPD System	11"	WQCSC11	WQCCC11	WQCM11-50	WQCGAC11
100 GPD System	13"	WQCSC13	WQCCC13	WQCM13-100	WQCGAC13



## QT-Plus Series Quarter-Turn Proprietary Cartridge Systems

### Quarter Turn High Flow Encapsulated Cartridges

#### Features & Benefits

- Disposable encapsulated cartridges
- Automatic shut off when cartridges are removed
- Easy to remove/replace 1/4-turn filter cartridges
- No need to disconnect tubing when replacing membranes
- Proprietary filter cartridges
- High flow faucet plumbing (3/8" tubing from RO tank to faucet post filter and 3/8" tubing to faucet)
- Advanced MCD technology booster pump or ZeroWaste kit ready (Patented) - See water saving kits section
- Inlet water supply fitting is adaptable to use with 3/8" compression or 1/2" compression fittings
- Installation kit is included
- Many faucet options available - See faucets section
- Quick-Connect fittings on inlet and outlet ports
- 50 GPD or greater thin film membrane (made in USA)
- Assembled in USA
- Clog free brine flow control
- Tank options available (metal or plastic)



Watts "QT-Plus" reverse osmosis systems are highly effective because they provide four-step water treatment:

- |   |   |  |  |
|---|---|--|--|
| <p><b>Step #1<br/>PRE-FILTER</b><br/>Water is filtered with a five micron depth filter to remove particulates, sand, silt, rust particles and other solid matter.</p> | <p><b>Step #2<br/>PRE-CARBON FILTER</b><br/>Water is filtered with an activated carbon block cartridge to protect the RO membrane by removing Chlorine.</p> | <p><b>Step #3<br/>RO MEMBRANE</b><br/>Metals, salts &amp; dissolved solids are rejected by the RO membrane during this step, so only high quality water is sent to the storage tank.</p> | <p><b>Step #4<br/>POST-CARBON FILTER</b><br/>Water from the storage tank is treated with a polishing carbon filter to remove unpleasant tastes and foul odors.</p> |
|---|---|--|--|

#### Specifications

FACTORS	REQUIREMENTS
Maximum Total Dissolved Solids (TDS)	1,800 ppm
Iron, Maximum	0.2 ppm
Hardness (less than)	10 gpg
Hydrogen Sulfide	0.0 ppm
Manganese (less than)	0.05 ppm
Turbidity (less than)	1 NTU
pH	3-11
Minimum pressure	40psi (2.8 bar)
Maximum pressure	100psi (7 bar)

#### NOTICE

Booster pump required if inlet pressure is below 40psi.

#### Models

MODEL NO.	STAGE	MEMBRANE (GPD)	FAUCET	FITTINGS TANK-FAUCET	TANK
WQT4RO11-50PT	4	50	Not Included	3/8"	RO Pro®
WQT4RO11-50MT	4	50	Not Included	3/8"	Metal

#### Accessories

MODEL NO.	DESCRIPTION
ZWKIT-WATTS	ZeroWaste® Booster Pump Retro Kit, 110 V
ZWKIT-WATTS-220	ZeroWaste® Booster Pump Retro Kit, 220 V
WQTPPRK	Permeate Pump Kit

#### Proprietary Replacement Cartridges

MODEL NO.	ELEMENT	SEDIMENT	CARBON	MEMBRANE	GAC
50 GPD System	10"	WQTSC-10	WQTCBC-10	WQTCM50-10	WQTCGAC-10



Double O-rings prevent leaks. Flow shuts off automatically when cartridges are removed.



## Certified Standard Cartridge One Piece Manifold Systems

Top Quality Systems—Ideal for private label marketing

Certified by WQA

### Features & Benefits

- Uses industry standard cartridges
- High flow faucet plumbing (3/8" tubing from RO storage tank to faucet post filter and 3/8" tubing to faucet)
- Proven Manifold design - "no label" model
- Certified Systems
- Inlet water supply fitting is adaptable to use with 3/8" compression or 1/2" compression fittings
- Installation kit is included
- Many faucet options available - See faucets section
- Quick-Connect fittings on inlet and outlet ports
- 50 GPD or greater thin film membrane (made in USA)
- Assembled in USA
- Clog free brine flow control



FMRO4-MAN

Single-piece manifold design eliminates many hose connections for greater security. Comes with filter elements installed to reduce installation labor.

### Specifications FMRO4-MAN

SPECIFICATION	DATA
Membrane	50 GPD
Maximum pressure	100psi
Minimum pressure	40psi
Maximum TDS	1,800 PPM
Maximum hardness	10 GPG
Maximum Iron	0.2 PPM
Maximum Hydrogen Sulfide	0.0 PPM
Tubing (tank & faucet)	3/8"
Tubing (inlet)	1/4"

### Replacement Components (FMRO4-MAN)

COMPONENTS	MODEL
Pre-filter, sediment, 5 micron	FPMB5-978
Pre-filter, carbon, 5 micron	F109009
Membrane	F110015
Post filter	F109009
Faucet	F116023
Tank	FRO-132-WH
Fittings (inlet, outlet)	John Guest
Feed water valve	F560080
Auto shutoff valve	Built into manifold
Check valve	F134015
Flow restrictor	F122051
Wrench	F164003

### Model

MODEL NO.	STAGE	MEMBRANE (GPD)	FAUCET	FITTINGS		TANK	SHIP WT. (LBS.)	NO. PER PALLET
				INLET	TANK-FAUCET			
FMRO4-MAN	4	50	Non Air Gap	1/4" QC	3/8" QC	Metal	21	24

**Note:** Permeate pump and Booster pump kits can be used with this system.

## Standard Cartridge Half-Turn Housing Systems

Great Quality and Performance at a Competitive Price with Innovative Half-Turn Housings

### Features & Benefits

- Half-turn housings with Sure Seal cartridge technology\* (Patented)
- Uses industry standard cartridges
- Proven design - "no label" model
- Advanced MCD technology booster pump or ZeroWaste kit ready\*\* (Patented) - See water saving kits section
- Inlet water supply fitting is adaptable to use with 3/8" compression or 1/2" compression fittings
- Installation kit is included
- Many faucet options available - See faucets section
- Quick-Connect fittings on inlet and outlet ports
- 50 GPD or greater thin film membrane (made in USA)
- Assembled in USA
- Clog free brine flow control
- No need to disconnect tubing when replacing membranes\*\*

\*Component made in the USA

\*\*F500398 model only



Double O-ring and ratchet thread bowl filter sure seal technology



F500398 3 Stage RO



F500960 4 Stage RO

### Specifications

SPECIFICATION	DATA
Membrane	50 gpd
Maximum pressure	100psi
Minimum pressure	40psi
Maximum TDS	1,800 PPM
Maximum hardness	10 GPG
Maximum Iron	0.2 PPM
Maximum Hydrogen Sulfide	0.0 ppm
Tubing (tank & faucet)	3/8"
Tubing (inlet)	1/4"

### Models

MODEL NO	STAGE	MEMBRANE (GPD)	FAUCET	FITTINGS		TANK	SHIP WT. (LBS.)	NO. PER PALLET
				INLET	TANK-FAUCET			
F500398	3	50	not included	1/4" QC	3/8" QC	Metal	22	24
F500960	4	50	not included	1/4" QC	3/8" QC	Metal	25	24

### 3 Stage Replacement Components (F500398)

COMPONENTS	MODEL
Pre and Post Filter, carbon	F109009
Metal tank	FRO-132-WH
Feed water valve	F560080
HT Housing O-ring	OR-4
Valve for tank	PPSV501222W
HT Housing (sed/carbon pre-filter) *	F113080
HT Housing (membrane) *	F113102
HT Housing (carbon post-filter) *	F113083
Membrane *	F110023
MCD (Multifunction Control Device) *	F610042
Triple bracket *	F137055

\*Component made in the USA

### 4 Stage Replacement Components (F500960)

COMPONENTS	MODEL
Pre-Filter, sediment, 5 micron	FPMB5-978
Pre-Filter, carbon, 5 micron	F109009
Metal tank	FRO-132-WH
Feed water valve	F560080
HT Housing O-ring	OR-4
Valve for tank	PPSV501222W
HT Housing (sed/carbon pre-filter) *	F113080
Membrane Housing	EH2501KW
Membrane *	W-1812-50
Post-Filter (in-line)	AICRO
Auto shutoff valve	F134003

## Series 315, 415 & 525 Certified Standard Cartridge Systems

Quality, Certified Product at a Competitive Price

### Features & Benefits

- Uses industry standard cartridges
- High flow faucet plumbing (3/8" tubing between RO storage tank and faucet)
- Built-in Booster Pumps with choice of 110 or 220 volt systems (W-525P systems only)
- Certified Systems
- Inlet water supply fitting is adaptable to use with 3/8" compression or 1/2" compression fittings
- Installation kit is included
- Many faucet options available - See faucets section
- Quick-Connect fittings on inlet and outlet ports
- 50 GPD or greater thin film membrane (made in USA)
- Assembled in USA
- Clog free brine flow control
- Certified to NSF / ANSI Std. 58 for Pentavalent Arsenic, Barium, Cadmium, Chromium, Copper, Cyst, Fluoride, Lead, Radium 226/228, Selenium, Turbidity and TDS Reduction



System tested and certified by NSF International against NSF/ANSI Standard 58 for the reduction of the claims specified on the performance data sheet.



W-315



W-415



W-525P With Built-In Booster Pump

### Replacement Components

COMPONENTS	MODEL
Pre-filter, sediment, 5 micron	FPMB5-978*
Pre-filter, carbon, 5 micron	F109009
Membrane	W-1812-50
Post filter *	FI-CBA010J.38
Faucet	FU-WDF-905-CP
Tank	FRO-132-WH
Fittings (inlet, outlet)	Quick-Connect
Feed water valve	F560080
Auto shutoff valve	F134003
Check valve	WE-CU3142
Flow restrictor	F122051
Wrench	WR100

\* W-315 model only

### Specifications

SPECIFICATION	DATA
Membrane	50 GPD
Maximum pressure	100psi
Minimum pressure	40psi
Maximum TDS	1,800 PPM
Maximum hardness	10 GPG
Maximum Iron	0.2 PPM
Maximum Hydrogen Sulfide	0.0 PPM
Tubing (tank & faucet)	3/8"
Tubing (inlet)	1/4"

### Models

MODEL NO.	PUMP	VOLTS	STAGE	MEMBRANE (GPD)	FAUCET	FITTINGS		TANK	SHIP WT. (LBS.)
						INLET	TANK FAUCET		
W-315	No pump	N/A	3	50	FU-WDF-905-CP	1/4" QC	3/8" QC	Metal	25
W-315-NF	No pump	N/A	3	50	not included	1/4" QC	3/8" QC	Metal	25
W-415-NF	No pump	N/A	4	50	not included	1/4" QC	3/8" QC	Metal	26
W-525	No pump	N/A	5	50 GPD	FU-WDF-905-CP	1/4" QC	3/8" QC	Metal	30
W-525-NF	No pump	N/A	5	50 GPD	not included	1/4" QC	3/8" QC	Metal	29
W-525P	Aquatec	110	5	50 GPD	FU-WDF-905-CP	1/4" QC	3/8" QC	Metal	33
W-525P-220V	Aquatec	220	5	50 GPD	FU-WDF-905-CP	1/4" QC	3/8" QC	Metal	33

## Permeate Pump & GTS Series Standard Cartridge Systems

Quality and Performance at a Competitive Price - Ideal for Private Label Marketing

### Features & Benefits

- Uses industry standard cartridges
- Proven design - "no label" model
- High flow faucet plumbing (3/8" post filter and 3/8" tubing to faucet)
- Permeate pump uses no electricity and provides \* (Model FMRO4G-ERP)
  - a) More water in storage tank;
  - b) Better contaminant reduction;
  - c) Faster tank filling;
  - d) Reduces waste water by 67%
- Inlet water supply fitting is adaptable to use with 3/8" compression or 1/2" compression fittings
- Installation kit is included
- Many faucet options available - See faucets section
- Quick-Connect fittings on inlet and outlet ports
- 50 GPD or greater thin film membrane (made in USA)
- Assembled in USA
- Clog free brine flow control
- Tank options available (metal or plastic)



GTS450S Series



GTS550S Series



**FMRO4G-ERP\***  
Non-electric permeate pump dramatically increases water production! Permeate pump reduces back pressure on the membrane for improved performance.

### Replacement Components

COMPONENTS	MODEL
Pre-filter, sediment, 5 micron	FPMB5-978
Pre-filters, carbon, 5 micron	F109009
Membrane	W-1812-50
Membrane (MT 100)	W1812-100
Post filter	AICRO
Faucet (non air gap)	F116023
Faucet (air gap)	F116001
Metal tank	FRO-132-WH
Plastic tank	ROPRO4-W
Fittings (inlet, outlet)	Quick-Connect
Feed water valve	F560080
Auto shutoff valve	F134003
Check valve	WE-CU3142
Flow restrictor	F122051
Flow restrictor (MT 100)	F123001
Wrench	WR100

### Specifications

SPECIFICATION	DATA
Membrane	50 GPD or 100 GPD
Maximum pressure	100psi
Minimum pressure	40psi
Maximum TDS	1,800 PPM
Maximum hardness	10 GPG
Maximum Iron	0.2 PPM
Maximum Hydrogen Sulfide	0.0 PPM
Tubing (tank & faucet)	3/8"
Tubing (inlet)	1/4"

MODEL NO.	STAGE	MEMBRANE (GPD)	FAUCET	FITTINGS		TANK	SHIP WT. (LBS.)	NO. PER PALLET
				INLET	TANK-FAUCET			
<b>Model GTS450</b>								
GTS450S-NAGF-MT	4	50	Non Air Gap	1/4" QC	3/8" QC	Metal	26	24
GTS450S-NAGF-PT	4	50	Non Air Gap	1/4" QC	3/8" QC	Plastic	26	24
<b>Model GTS550</b>								
GTS550S-NAGF-MT	5	50	Non Air Gap	1/4" QC	3/8" QC	Metal	30	24
GTS550S-NAGF-PT	5	50	Non Air Gap	1/4" QC	3/8" QC	Plastic	30	24
GTS550S-AGF-MT	5	50	Air Gap	1/4" QC	3/8" QC	Metal	30	24
GTS550S-AGF-PT	5	50	Air Gap	1/4" QC	3/8" QC	Plastic	30	24
<b>Permeate Pump Model</b>								
FMRO4G-ERP	4	50	Non Air Gap	1/4" QC	3/8" QC	RO Pro®	27	24

## ZeroWaste® Water Saving Kit or Booster Pump Kit For Generic RO Systems

Designed to convert any existing generic reverse osmosis system to ZeroWaste® technology, this kit is a perfect addition for any environment! Compact design combines the pressure switch and shutoff valve into one device.

**Kit Includes:**

- Booster Pump
- Electronic Shutoff Valve
- Pressure Switch Sensor
- Transformer
- Check Valves
- Tubing
- Adapt-A-Valve™ for Hot Water Pipe Connection

Works With Any Generic RO System



ZWKIT (ZeroWaste Kit)  
F501019 (Booster Pump Kit)



W-525 Premium Series RO

## ZeroWaste® Water Saving Kit or Booster Pump Kit For RO Systems with the MCD Valve

We also offer a water saving kit, designed to convert the Watts Quick-Change, QT-Plus, and any other RO systems that have the MCD valve to ZeroWaste® technology.

**Kit Includes:**

- Booster Pump
- Pressure Switch Sensor
- Check Valves
- Transformer
- Tubing
- Adapt-A-Valve™ for Hot Water Pipe Connection

Works With Watts® Quick-Change and QT-Plus RO Systems



ZWKIT-Watts (ZeroWaste Kit)  
F501023 (Booster Pump Kit for Systems with Watts MCD Valves)



Watts® Quick-Change RO Systems



Watts® QT-Plus RO System



Watts® Half-Turn RO System

## Top Quality Designer Faucets

MODEL NO.	VALVE TYPE	FINISH	SIZE (IN)	CASE QTY	AIR GAP	FILTER MONITOR
<b>Top Mount Twist Faucets *NEW*</b>						
WTMTFA-CRVC14	Ceramic Disc	Chrome	1/4	15	X	X
WTMTFA-CRVC14	Ceramic Disc	Chrome	1/4	15	X	
WTMTFA-CRVBNM14	Ceramic Disc	Brushed Nickel	1/4	15	X	X
WTMTFA-CRVBN14	Ceramic Disc	Brushed Nickel	1/4	15	X	
WTMTFA-CRVWHM14	Ceramic Disc	White	1/4	15	X	X
WTMTFA-CRVWH14	Ceramic Disc	White	1/4	15	X	
WTMTFA-CRVBKM14	Ceramic Disc	Black	1/4	15	X	X
WTMTFA-CRVBK14	Ceramic Disc	Black	1/4	15	X	
WTMTFA-CRVORM14	Ceramic Disc	Oil Rubbed Bronze	1/4	15	X	X
WTMTFA-CRVOR14	Ceramic Disc	Oil Rubbed Bronze	1/4	15	X	
WTMTFA-BELCM14	Ceramic Disc	Chrome	1/4	15	X	X
WTMTFA-BELC14	Ceramic Disc	Chrome	1/4	15	X	
WTMTFA-BELBNM14	Ceramic Disc	Brushed Nickel	1/4	15	X	X
WTMTFA-BELBN14	Ceramic Disc	Brushed Nickel	1/4	15	X	
WTMTFA-BELWHM14	Ceramic Disc	White	1/4	15	X	X
WTMTFA-BELWH14	Ceramic Disc	White	1/4	15	X	
WTMTFA-BELBKM14	Ceramic Disc	Black	1/4	15	X	X
WTMTFA-BELBK14	Ceramic Disc	Black	1/4	15	X	
WTMTFA-BELORM14	Ceramic Disc	Oil Rubbed Bronze	1/4	15	X	X
WTMTFA-BELOR14	Ceramic Disc	Oil Rubbed Bronze	1/4	15	X	
WTMTFA-CRVCM38	Ceramic Disc	Chrome	3/8	15	X	X
WTMTFA-CRVC38	Ceramic Disc	Chrome	3/8	15	X	
WTMTFA-CRVBNM38	Ceramic Disc	Brushed Nickel	3/8	15	X	X
WTMTFA-CRVBN38	Ceramic Disc	Brushed Nickel	3/8	15	X	
WTMTFA-CRVWHM38	Ceramic Disc	White	3/8	15	X	X
WTMTFA-CRVWH38	Ceramic Disc	White	3/8	15	X	
WTMTFA-CRVBKM38	Ceramic Disc	Black	3/8	15	X	X
WTMTFA-CRVBK38	Ceramic Disc	Black	3/8	15	X	
WTMTFA-CRVORM38	Ceramic Disc	Oil Rubbed Bronze	3/8	15	X	X
WTMTFA-CRVOR38	Ceramic Disc	Oil Rubbed Bronze	3/8	15	X	
WTMTFA-BELCM38	Ceramic Disc	Chrome	3/8	15	X	X
WTMTFA-BELC38	Ceramic Disc	Chrome	3/8	15	X	
WTMTFA-BELBNM38	Ceramic Disc	Brushed Nickel	3/8	15	X	X
WTMTFA-BELBN38	Ceramic Disc	Brushed Nickel	3/8	15	X	
WTMTFA-BELWHM38	Ceramic Disc	White	3/8	15	X	X
WTMTFA-BELWH38	Ceramic Disc	White	3/8	15	X	
WTMTFA-BELBKM38	Ceramic Disc	Black	3/8	15	X	X
WTMTFA-BELBK38	Ceramic Disc	Black	3/8	15	X	
WTMTFA-BELORM38	Ceramic Disc	Oil Rubbed Bronze	3/8	15	X	X
WTMTFA-BELOR38	Ceramic Disc	Oil Rubbed Bronze	3/8	15	X	
<b>Top Mount (non-Twist) Series Faucets</b>						
WTMFAG-C-M	Ceramic Disc	Chrome	3/8	15	X	X
WTMFAG-C	Ceramic Disc	Chrome	3/8	15	X	
WTMFAG-BN-M	Ceramic Disc	Brushed Nickel	3/8	15	X	X
WTMFAG-BN	Ceramic Disc	Brushed Nickel	3/8	15	X	
WTMFAG-W-M	Ceramic Disc	White	3/8	15	X	X
WTMFAG-W	Ceramic Disc	White	3/8	15	X	
WTMFAG-B-M	Ceramic Disc	Black	3/8	15	X	X
WTMFAG-ORB-M	Ceramic Disc	Oil Rubbed Bronze	3/8	15	X	X
WTMFAG-ORB	Ceramic Disc	Oil Rubbed Bronze	3/8	15	X	
<b>Series 133 Faucets</b>						
FU133CPP	Ceramic Disc	Chrome	1/4	10		
<b>Series 303 Faucets</b>						
FNP3033CP-US05	Lever Style	Chrome	1/4	50		
FNP3033NP	Lever Style	Brushed Nickel	1/4	50		
<b>Airgap Monitor</b>						
FU-AGLR.C/3	Lever Style	Brushed Nickel	1/4	50	X	
<b>Series 703 Faucets</b>						
FNCP7033CP	Ceramic Disc	Chrome	1/4	30		
FNCP7033NP	Ceramic Disc	Brushed Nickel	1/4	30		
FNCP7033OB	Ceramic Disc	Oil Rubbed Bronze	1/4	30		
<b>Series 888 Faucets</b>						
FNCP8883AB	Ceramic Disc	Antique Brass	1/4	20		
FNCP8883AW	Ceramic Disc	Antique Wine	1/4	20		
FNCP8883CP	Ceramic Disc	Chrome	1/4	20		
FNCP8883NP	Ceramic Disc	Brushed Nickel	1/4	20		
FNCP8883ST	Ceramic Disc	Satin Nickel	1/4	20		
<b>Series 903 Faucets</b>						
FNCP6034CP	Ceramic Disc	Chrome	1/4	30		
<b>Series 905 Faucet</b>						
FU-WDF-905-CP	Ceramic Disc	Chrome	1/4	30		
FNCP9053NP	Ceramic Disc	Brushed Nickel	1/4	30		
<b>Dual Function Kitchen Faucets</b>						
FU-GKD01-CP	Ceramic Disc	Chrome	1/4	8		
FU-GKD02-CP	Ceramic Disc	Chrome	1/4	8		
T277103	Ceramic Disc	Chrome	1/4	8		
T277104	Ceramic Disc	Chrome	1/4	8		

### Twist Faucets



### Non-Twist Faucet



### Designer Faucets



### Dual Function Faucets



## Reverse Osmosis LC Series

All systems are frame mounted

### Features & Benefits

- Compact, sturdy design
- Welded powder coated frame
- Liquid filled pre-filter pressure gauge
- Integrated booster pump(s)
- Sediment & carbon pre-filtration
- Quick-Connect fittings for easy installation
- Can be used with a bladder or atmospheric tank (additional accessories required)



LC-200P-MINI



LC-200P



LC-380PP

### Models

MODEL NO.	GPD	PUMP	STAGE 1	STAGE 2	STAGE 3	STAGE 4	CARTON DIMENSIONS	SHIP WT. (LBS.)
LC-200P-MINI	200	1	FPMB5-978	FI-CT0010	W-1812-100 (2)	S7708	21 X 21 X 10	40
LC-200P	200	1	FPMB5-20	FI-CT0020/2	W-1812-100 (2)	FI-GAC020HP	36 x 21 x 10	46
LC-300P	300	1	FPMB5-20	FI-CT0020/2	W-1812-100 (3)	FI-GAC020HP	36 x 21 x 10	48
LC-380PP	380	2	FPMB5-20	FI-CT0020/2	W-1812-100 (3)	FI-GAC020HP	36 x 21 x 10	53

### Replacement Parts

MODEL NO.	DESCRIPTION	LC-200P	LC-200P-MINI	LC-300P	LC-380PP
FC-DR850W	Flow restrictor 850 ML/Min	X	X		
FC-DR1000W	Flow restrictor 1000 ML/Min			X	
FC-DR1200W	Flow restrictor 1200 ML/Min				X
PU-6200E60-38-P	Electric shutoff valve, 3/8"	X	X	X	X
PU-8010TSO/NF	Tank shutoff valve	X	X	X	X
PU-8800TGI	Booster Pump	X	X	X	2X



## Reverse Osmosis R12 Series

Compact, wall-mounted RO systems  
Four models for flow rates to 1200 US GPD.

### Standard features (package #1)

- Stainless steel frame
- Automatic inlet valve
- Pre-filter housing and cartridge, 10"
- Procon pump (brass)
- 1/2 HP motor
- Liquid filled pump pressure gauge (2-1/2")
- FRP pressure vessels
- Needle valve for concentrate line
- Needle valve for recycle line
- Check valve for product water (stainless steel)
- Product pressure switch
- Low-pressure shut-off with automatic restart

### Additional features included in package #2

- Pre-filter pressure gauges
- Product water flow meter
- Reject water flow meter

### Additional features included in package #3

- Automatic fast flush for concentrate



### Specifications

Product water & reject water connection (tubing)	3/8"
Feed water requirement (maximum)	2.4 GPM
Feed water pressure requirement (minimum)	10 PSIG
Drain requirement (maximum)	2.4 GPM
Electrical requirement	120v/60hz
Amps	8
Pump	1/2 HP

### Options

MODEL NO	DESCRIPTION
R2864	Stainless steel leg kit
R2353-SD	Product water float switch
R2288	Whole house option*

\*Includes 300 gallon tank, product water float switch and repressurization pump with built-in controls.

### Models

MODEL NO.	PACKAGE	GPD	RECOVERY (ADJUSTABLE)	MEMBRANE SIZE	NUMBER OF MEMBRANES	FEED WATER CONNECTION	TYPICAL REJECTION	DIMENSIONS L X H X D	SHIP WT. (LBS.)
R12-0150-1	1	150	15%-75%	2-1/2"x14"	1	1/2" NPT	98%	22"x32"x12"	50
R12-0150-2	2	150	15%-75%	2-1/2"x14"	1	1/2" NPT	98%	22"x32"x12"	50
R12-0150-3	3	150	15%-75%	2-1/2"x14"	1	1/2" NPT	98%	22"x32"x12"	50
R12-0250-1	1	250	15%-75%	2-1/2"x21"	1	1/2" NPT	98%	22"x32"x12"	50
R12-0250-2	2	250	15%-75%	2-1/2"x21"	1	1/2" NPT	98%	22"x32"x12"	50
R12-0250-3	3	250	15%-75%	2-1/2"x21"	1	1/2" NPT	98%	22"x32"x12"	50
R12-0600-1	1	600	15%-75%	2-1/2"x40"	1	1/2" NPT	98%	22"x52"x12"	60
R12-0600-2	2	600	15%-75%	2-1/2"x40"	1	1/2" NPT	98%	22"x52"x12"	60
R12-0600-3	3	600	15%-75%	2-1/2"x40"	1	1/2" NPT	98%	22"x52"x12"	60
R12-1200-1	1	1200	25%-75%	2-1/2"x40"	2	1/2" NPT	98%	22"x52"x12"	70
R12-1200-2	2	1200	25%-75%	2-1/2"x40"	2	1/2" NPT	98%	22"x52"x12"	70
R12-1200-3	3	1200	25%-75%	2-1/2"x40"	2	1/2" NPT	98%	22"x52"x12"	70

### NOTICE

Performance specifications are based on 77°F feed water, 3 SDI or less, TDS below 1000 and pH of 8. Please see water temperature conversion charts to determine actual production rate for each installation. Chlorine reduction and other pretreatment may be required. Membrane rejection rates are based on membrane manufacturer's specifications. Pre-filter is Flow-Pro® FPMB5-978 melt blown cartridge. Systems are designed for use with municipal and well water.

## Reverse Osmosis R13 Series

Compact, wall-mounted RO Systems  
Three models for flow rates to 1200 US GPD

### Standard features

- Powder coated steel frames
- Inlet solenoid valve
- Pre-filter
- 1/2 HP motor
- Brass pump
- Liquid filled pre-filter pressure gauge
- 2 1/2" liquid filled pump pressure gauge
- Product water & reject water flow meters
- High pressure, non-metallic membrane housings
- SS needle valves for concentrate and recycle lines
- Stainless steel product water check valve
- On / Off toggle switch
- Low-pressure shut-off with auto restart
- Feed water and product water TDS monitor

### Applications

- Whole house
- Ice makers
- Labs
- Beverages
- Coffee shops
- Restaurants

### Specifications

Feed water connection	3/4" NPTF
Product water connection	3/8" Tubing OD
Reject water connection	3/8" Tubing OD
Feed water required (max.)	2.4 GPM
Feed water pressure (min.)	10 PSI
Drain required (max.)	2.4 GPM
Electrical requirements	120 VAC 60 Hz
Amps	8
Pump (H.P.)	1/2



Model R13



Proprietary Membranes  
(for R13 systems)

### Options

PART NUMBER	DESCRIPTION
R2868	Leg Kit
R2353-SD	Product float switch
R2288	Whole house option*

\*Includes 300 gal tank, product float switch and repressurization pump with built in controls.

### Models

	R13-0250	R13-0600	R13-1200
Maximum production (gallons per day)	250	600	1200
Average membrane rejection rate	98 %	98 % 9	8 %
Recovery (adjustable)	8 - 75 %	17 -75%	34 - 75 %
Membrane size	3" x 10"	3" x 20"	3" x 20"
Number of membranes	1 (P/N R96310)	1 (P/N R96320)	2 (P/N R96320)
Pre-filter (system ships with one 5 micron cartridge)	10"	20"	20"
Dimensions, approximate (W x H x D)	26" x 26" x 9"	26" x 36" x 9"	26" x 36" x 9"
Shipping Weight, estimated (lbs.)	50	60	75

### NOTICE

Performance specifications are based on 77°F feed water, SDI < 3, TDS below 1000 ppm and pH of 8. Individual membrane productivity and rejection rates are based on manufacturer's specifications. Please see water temperature conversion charts for production factor. Chlorine reduction and other pretreatment may be required. Systems are designed for use with municipal and well water.

## Reverse Osmosis R4X40 Series

Six models for flow rates up to 6,600 US GPD

### Standard Features

- Powder coated steel frame
- Inlet solenoid valve
- 20" prefilter
- Prefilter pressure gauge
- Multistage centrifugal pump
- Low-pressure protection with microprocessor auto reset
- 2 1/2" liquid filled pump pressure gauge
- FRP pressure vessels
- Product flow meter
- Reject flow meter
- Concentrate needle valve
- Non metallic recycle needle valve
- Feed water and product water TDS monitor
- Tank level input (dry contact) **DELUXE SERIES**
- Pretreatment interlock input (dry contact) **DELUXE SERIES**

### Applications

- Whole house
  - Boiler feed water
  - Humidifiers
  - Greenhouses
  - Process Water
  - Electronics
  - Car wash spot-free
- DELUXE SERIES**

**Note: For indoor installation only. The Deluxe Series has a different controller with more input capabilities.**



Model: R4X40-1

### Specifications

	R4X40	R4X40 DELUXE
Membrane Size		4" x 40"
Average membrane rejection		98%
Feed Water Connection		3/4" NPTF
Prefilter		2.5" x 20"
Product Water Connection		5/8" tubing OD
Reject Water Connection		5/8" tubing OD
Feed Water Pressure (minimum)		10 psi
Electrical Requirement *	120 VAC 60 Hz	230 VAC 60 Hz, 1 PH

### Options

PART NUMBER	DESCRIPTION
R2353-SD	Product float switch
R2288-165	165 gal tank whole house option**
R2288	300 gal tank whole house option**
R2288-500	500 gal tank whole house option**

\*\*Includes atmospheric storage tank, product float switch, and repressure pump with built in controls. Options compatible with R4X40-1 and all DELUXE SERIES.

### Models

	R4X40-1	R4X40-1-220 DLX	R4X40-2	R4X40-2-220-DLX	R4X40-3-230	R4X40-3-220-DLX
Maximum Productivity (gallons per day)		2200		4400		6600
Recovery (user adjustable)		15 - 75 %		25 - 75%		32 - 75 %
Number Of Membranes		1		2		3
Feed Water Required (maximum)		10 gpm		12 gpm		14 gpm
Drain Required (maximum)		10 gpm		12 gpm		14 gpm
Motor Horse Power		3/4		1		1 1/2
Dimensions W x D x H (inches)		20 x 20 x 50		20 x 20 x 50		20 x 26 x 50
Shipping Weight (estimated lbs)		120		150		180
Electrical Requirement* AMPS		15		20		10
						13
		8				13

### NOTICE

Maximum production based on a feed water of 77°F, SDI < 1, 1000 ppm TDS, and pH 7. Individual membrane productivity may vary (± 15%). May be operated on other feed waters with reduced capacity. Percent Rejection is based on membrane manufacturer's specifications; overall system percent rejection may be less. \*R4X40-3-230 is available only in 230-volt single phase.

## Reverse Osmosis R14 Wall Mount Series

### Compact, wall-mounted RO systems

Three models for flow rates up to 5400 US GPD, available with brass or stainless steel fittings.

Fully assembled and ready for installation.

#### Standard features

- Stainless steel frame
- FRP side port pressure vessels
- Pre-filter housing and cartridge, 10" Full-Flow
- Multi-stage centrifugal pump
- Automatic inlet valve
- Low-pressure shut-off with automatic restart
- Tank level input
- Pretreatment interlock input
- Adjustable recycle line
- Pre-filter pressure gauges
- Pump discharge pressure gauge (liquid filled)
- Flow meter for product water
- Flow meter for reject water
- Check valve for product water
- Sample valve for product water
- On / off switch



R14-02-1WM System

#### Specifications

Feed water connection 1"	FNPT
Product water connection (1800 & 3600 GPD)	1/2" tube
Product water connection (5400 GPD)	5/8" tube
Reject water connection (all R14 Wall Mount models)	1/2" tube
Feed water pressure requirement (minimum)	10 PSIG
Drain requirement (maximum)	10 GPM
Electrical requirement	230v/60hz
Phase	1
Amps (1800 & 3600 GPD)	6
Amps (5400 GPD)	9

#### Options

PART NUMBER	DESCRIPTION
R2353-SD	Product water float switch
R2288	Whole house option*

\*Includes 300 gallon tank, product water float switch and repressurization pump with built-in controls.

#### Models

MODEL NO.	FITTINGS & VALVES	GPD	PUMP (H.P.)	RECOVERY (ADJ.)	MEMBRANE SIZE	MEMBRANES	FEED WATER REQUIRED* (GPM)	TYPICAL REJECTION	DIMENSIONS L X H X D	SHIP WT. (LBS.)
R14-01-1WM	SS	1800	1	15%-75%	4" x 40"	1	2.5	98%	49"x53"x15"	200
R14-01-BWM	Brass	1800	1	15%-75%	4" x 40"	1	2.5	98%	49"x53"x15"	200
R14-02-1WM	SS	3600	1	25%-75%	4" x 40"	2	5	98%	49"x53"x15"	250
R14-02-BWM	Brass	3600	1	25%-75%	4" x 40"	2	5	98%	49"x53"x15"	250
R14-03-1WM	SS	5400	1.5	35%-75%	4" x 40"	3	7.5	98%	49"x53"x15"	300
R14-03-BWM	Brass	5400	1.5	35%-75%	4" x 40"	3	7.5	98%	49"x53"x15"	300

\*At 50% recovery.

#### NOTICE

Performance specifications are based on 77°F feed water, 3 SDI or less, TDS below 1000 and pH of 8. Please see water temperature conversion charts to determine actual production rate for each installation. Chlorine reduction and other pretreatment may be required.

Membrane rejection rates are based on membrane manufacturer's specifications. Pre-filter is Watts WPC5FF975 synthetic pleated cartridge.

Systems are designed for use with municipal and well water.

## Reverse Osmosis R14 Series

Top quality, fully assembled RO systems

Five models for flow rates to 10,800 US GPD.

### Standard features (package #1)

- Powder coated steel frame
- FRP side-port pressure vessels
- Pre-filter housing and cartridge (20" Full-Flow)
- Vertical heavy-duty multi-stage centrifugal pump
- Automatic inlet valve
- Low-pressure shut-off with automatic restart
- Tank level input
- Pretreatment interlock input
- Adjustable recycle line
- Pre-filter pressure gauges
- Pump discharge pressure gauge (liquid filled)
- Reject pressure gauge (liquid filled)
- Flow meter for product water
- Flow meter for reject water
- Flow meter for recycle water
- Check valve for product water
- On / off switch

### Additional features included with package #2

- CI-1000 electronic controller with product water conductivity meter and alarm output
- Programmable concentrate auto flush



R14-06-1131100 System

### Specifications

Feed water connection	1" FNPT
Product water connection	3/4" FNPT
Reject water connection	3/4" FNPT
Feed water pressure requirement (min.)	10 PSIG
Drain requirement (maximum)	15 GPM
Electrical requirement	230VAC/60hz
Phase	3
Amps	15

Other voltages available, please contact us for details.

### Models

MODEL NO.	PKG.	GPD	PUMP (H.P.)	RECOVERY (ADJ.)	MEMBRANE SIZE	MEMBRANES	FEED WATER REQUIRED* (GPM)	TYPICAL REJECTION	DIMENSIONS L X H X D	SHIP WT. (LBS.)
R14-02-1111000	1	3600	5/TEFC	25%-75%	4" x 40"	2	5	98%	51"x56 <sup>5</sup> / <sub>16</sub> "x18"	400
R14-02-1131100	2	3600	5/TEFC	25%-75%	4" x 40"	2	5	98%	51"x56 <sup>5</sup> / <sub>16</sub> "x18"	400
R14-03-1111000	1	5400	5/TEFC	36%-75%	4" x 40"	3	7.5	98%	51"x56 <sup>5</sup> / <sub>16</sub> "x18"	500
R14-03-1131100	2	5400	5/TEFC	36%-75%	4" x 40"	3	7.5	98%	51"x56 <sup>5</sup> / <sub>16</sub> "x18"	500
R14-04-1111000	1	7200	5/TEFC	42%-75%	4" x 40"	4	10	98%	51"x56 <sup>5</sup> / <sub>16</sub> "x18"	600
R14-04-1131100	2	7200	5/TEFC	42%-75%	4" x 40"	4	10	98%	51"x56 <sup>5</sup> / <sub>16</sub> "x18"	600
R14-05-1111000	1	9000	5/TEFC	46%-75%	4" x 40"	5	12.5	98%	51"x56 <sup>5</sup> / <sub>16</sub> "x18"	700
R14-05-1131100	2	9000	5/TEFC	46%-75%	4" x 40"	5	12.5	98%	51"x56 <sup>5</sup> / <sub>16</sub> "x18"	700
R14-06-1111000	1	10800	5/TEFC	50%-75%	4" x 40"	6	15	98%	51"x56 <sup>5</sup> / <sub>16</sub> "x18"	800
R14-06-1131100	2	10800	5/TEFC	50%-75%	4" x 40"	6	5	98%	51"x56 <sup>5</sup> / <sub>16</sub> "x18"	800

### NOTICE

Performance specifications are based on 77°F feed water, 3 SDI or less, TDS below 1000 and pH of 8. Please see water temperature conversion charts to determine actual production rate for each installation. Chlorine reduction and other pretreatment may be required. Membrane rejection rates are based on membrane manufacturer's specifications. Pre-filter is Watts WPC5FF20 synthetic pleated cartridge. Systems are designed for use with municipal and well water.

## Reverse Osmosis R24 Series

Three models and two design options for flow rates up to 15 GPM.

### Standard features (package #1)

- Powder coated steel frame
- FRP multi-port pressure vessels
- Pre-filter housing and cartridge (20" B-B)
- Vertical multi-stage centrifugal pump
- Automatic inlet valve
- Low-pressure shut-off with auto restart
- Tank level input
- Pretreatment interlock input
- Adjustable recycle line
- Pre-filter pressure gauges
- Pump discharge pressure gauge
- Membrane feed pressure gauge
- Reject pressure gauge
- Flow meter for product water
- Flow meter for reject water
- Flow meter for recycle water
- Check valve for product water
- Sample valves for product water
- On / off switch



R24 System

### Additional features included with package #2

- CI-1000 electronic controller with product water conductivity meter and alarm output
- Programmable concentrate auto flush

### Specifications

Feed water connection	1" FNPT
Product water connection	1" FNPT
Reject water connection	3/4" FNPT
Feed water pressure requirement (min.)	10 PSIG
Drain requirement (maximum)	17, 21, 25 GPM
Electrical requirement	230VAC/60hz
Phase	3
Amps	20

Other voltages available, please contact us for details.

### Models

MODEL NO.	PACKAGE	GALLONS PER MINUTE	PUMP (H.P.)	RECOVERY (ADJ.)	MEMBRANE SIZE	MEMBRANE ARRAY	FEED WATER REQUIRED* (GPM)	TYPICAL REJECTION	DIMENSIONS	SHIP WT. (LBS.)
R24-08-1111000	1	10	7.5/TEFC	60%-75%	4" x 40"	2:1:1	17	98%	93"x68"x24"	800
R24-08-1131100	2	10	7.5/TEFC	60%-75%	4" x 40"	2:1:1	17	98%	93"x68"x24"	800
R24-10-1111000	1	12.5	7.5/TEFC	60%-75%	4" x 40"	2:2:1	21	98%	93"x68"x24"	900
R24-10-1131100	2	12.5	7.5/TEFC	60%-75%	4" x 40"	2:2:1	21	98%	93"x68"x24"	900
R24-12-1111000	1	15	7.5/TEFC	60%-75%	4" x 40"	3:2:1	25	98%	93"x68"x24"	1000
R24-12-1131100	2	15	7.5/TEFC	60%-75%	4" x 40"	3:2:1	25	98%	93"x68"x24"	1000

### NOTICE

Performance specifications are based on 77°F feed water, 3 SDI or less, TDS below 1000 and pH of 8. Please see water temperature conversion charts to determine actual production rate for each installation. Chlorine reduction and other pretreatment may be required. Membrane rejection rates are based on membrane manufacturer's specifications. Pre-filter is 20" Full-Flow plastic housing and Watts WPC5FF20 synthetic pleated cartridge. Systems are designed for use with municipal and well water

## Reverse Osmosis R44 Series

Three models and two design options for flow rates up to 30 GPM.

### Standard features (package #1)

- Powder coated steel frame
- FRP multi-port pressure vessels
- Stainless steel pre-filter and cartridges
- Vertical multi-stage centrifugal pump
- Automatic inlet valve
- Low-pressure shut-off with auto restart
- Tank level input
- Pretreatment interlock input
- Adjustable recycle line
- Pre-filter pressure gauges
- Pump discharge pressure gauge
- Membrane feed pressure gauge
- Reject pressure gauge
- Flow meter for product water
- Flow meter for reject water
- Flow meter for recycle water
- Check valve for product water
- Sample valves for product water
- On / off switch



R44 System

### Additional features included with package #2

- CI-1000 electronic controller with product water conductivity meter and alarm output
- Programmable concentrate auto flush

### Specifications

Feed water connection	2" Flange
Product water connection	1.5" Flange
Reject water connection	1" Flange
Feed water pressure requirement (min.)	10 PSIG
Drain requirement (maximum)	31, 39, 46 GPM
Electrical requirement	230VAC/60hz
Phase	3
Amps	30

Other voltages available, please contact us for details.

MODEL NO.	PACKAGE	GALLONS PER MINUTE	PUMP (H.P.)	RECOVERY (ADJ.)	MEMBRANE SIZE	MEMBRANE ARRAY	FEED WATER REQUIRED* (GPM)	TYPICAL REJECTION	DIMENSIONS	SHIP WT. (LBS.)
R44-16-1111000	1	20	10/TEFC	65%-75%	4" x 40"	2:2	31	98%	192"x26"x72"	1400
R44-16-1131100	2	20	10/TEFC	65%-75%	4" x 40"	2:2	31	98%	192"x26"x72"	1400
R44-20-1111000	1	25	10/TEFC	65%-75%	4" x 40"	3:2	39	98%	192"x26"x72"	1600
R44-20-1131100	2	25	10/TEFC	65%-75%	4" x 40"	3:2	39	98%	192"x26"x72"	1600
R44-24-1111000	1	30	10/TEFC	65%-75%	4" x 40"	4:2	46	98%	192"x26"x72"	1800
R44-24-1131100	2	30	10/TEFC	65%-75%	4" x 40"	4:2	46	98%	192"x26"x72"	1 800

### NOTICE

Performance specifications are based on 77°F feed water, 3 SDI or less, TDS below 1000 and pH of 8. Please see water temperature conversion charts to determine actual production rate for each installation. Chlorine reduction and other pretreatment may be required. Membrane rejection rates are based on membrane manufacturer's specifications. Pre-filter is Flow-Max® FM4X3 filter housing, constructed using 316 stainless steel and 2" MNPT pipe fittings and Watts WPC5-2925 synthetic pleated cartridges. Systems are designed for use with municipal and well water.

## Reverse Osmosis R48 Series

Five models for flow rates up to 120 GPM.

### Standard features

- Powder coated steel frame
- FRP multi-port pressure vessels
- Stainless steel pre-filter and cartridges
- Vertical multi-stage centrifugal pump
- Automatic inlet valve
- Low-pressure shut-off with auto restart
- Tank level input
- Pretreatment interlock input
- Adjustable recycle line
- Pre-filter pressure gauges
- Pump discharge pressure gauge
- Membrane feed pressure gauge
- Reject pressure gauge
- Flow meter for product water
- Flow meter for reject water
- Flow meter for recycle water
- Check valve for product water
- Sample valves for product water
- On / off switch



R48 System

### Additional features included

- CI-2000 electronic controller with feed and product water conductivity meter with percent rejection
- Programmable concentrate auto flush

### NOTICE

Standard electrical requirement is 460 volts 3-phase 60 hz. Other voltages available, please contact us for details.

MODEL NO.	GALLONS PER MINUTE	FEED WATER CONNECTION	PUMP (H.P.)	RECOVERY (ADJ.)	MEMBRANE SIZE	MEMBRANE ARRAY	FEED WATER REQUIRED* (GPM)	TYPICAL REJECTION	DIMENSIONS	SHIP WT. (LBS.)
R48-08-3131100	40	2" Flange	15/TEFC	65%-75%	8" x 40"	1:1	62	98%	198"x42"x72"	2500
R48-12-3131100	60	2.5" Flange	20/TEFC	65%-75%	8" x 40"	2:1	93	98%	198"x42"x72"	2800
R48-16-3131100	80	3" Flange	25/TEFC	65%-75%	8" x 40"	2:2	123	98%	198"x42"x72"	3200
R48-20-3131100	100	3" Flange	30/TEFC	65%-75%	8" x 40"	3:2	154	98%	198"x42"x72"	3500
R48-24-3231100	120	3" Flange	30/TEFC	65%-75%	8" x 40"	3:2:1	185	98%	198"x42"x80"	3800

### NOTICE

Performance specifications are based on 77°F feed water, 3 SDI or less, TDS below 1000 and pH of 8. Please see water temperature conversion charts to determine actual production rate for each installation. Chlorine reduction and other pretreatment may be required. Membrane rejection rates are based on membrane manufacturer's specifications. Pre-filter is Flow-Max® FM7x4 filter housing, constructed using 316 stainless steel and 2" MNPT pipe fittings and Flow-Max(R) FM-5-40 synthetic pleated cartridges. Systems are designed for use with municipal and well water.



## Ultraviolet (UV)

*Ultraviolet (UV) light is a water treatment disinfection technology that is highly effective in killing and inactivating many species of disease-causing micro-organisms. Ultraviolet light disinfection is effective on bacteria and chlorine-resistant protozoa like Giardia and Cryptosporidium, and, can also be effective for most viruses.*

*UV disinfection is suitable for a number of residential and commercial applications such as:*

- Agriculture: Livestock, Irrigation, Dairy
- Domestic drinking water in residential use
- Domestic drinking water in municipal use
- Food and Beverage Industry
- Breweries, Wineries
- Secondary treatment of municipal wastewater

The Watts line of UV products include ultraviolet systems, lamps, and quartz sleeves from leading brands and manufacturers including Atlantic, Flow-Max®, Trojan, and Watts.

### DID YOU KNOW?

People with immune systems that are weakened by AIDS, chemotherapy or transplant medications are more vulnerable to microbial contaminants in drinking water such as Cryptosporidium.

**UV is an effective disinfectant for chlorine-resistant protozoa like Cryptosporidium and Giardia.**

## UV Systems

### Applications

- Wells
- Homes
- Water systems
- Aquaculture
- Foodservice
- Water coolers
- RO systems

### Features & Benefits

- Disinfection with out the use of dangerous or expensive chemicals.
- Effective disinfection for chlorine resistant bacteria, virus, and protozoan cysts.
- Lamps rated for 12 month continuous service life.
- Highly polished stainless steel reactor chamber for durability.
- Audible and visual alarm standard on ballast indicating lamp failure.
- Easy lamp replacement service.
- Available in 110 v and 230v.
- 30mj/cm2 dose at specified flow rate at the end of lamp life.



### Specifications

Chamber materials	Stainless Steel
UV dose (end of life)	30 mj/cm2
Lamp life	9,000 hrs
Lamps per chamber	Single

### Water Quality Guideline

Total iron	less than 0.3 mg/l
Hydrogen sulfide	less than 0.05 mg/l
Turbidity	less than 10 mg/l
Manganese	less than 0.05 mg/l
Hardness	less than 7 grains
UV transmittance	greater than 90%

**Note:** minimum water quality guidelines are recommended to ensure proper operation and continuous disinfection.

## Watts UV Systems, Lamps, Quartz Sleeves, Ballasts

MODEL NO.	DESCRIPTION	FLOW RATE (GPM)	SIZE (IN)	REPLACEMENT LAMP	QUARTZ SLEEVE	BALLAST
WUV2-110	WATTS 2GPM SS 1/2 IN MPT 110V	2	1/2	WUVLAMP2	WUVQS2	WUVBALLAST2
WUV2-230	WATTS 2GPM SS 1/2 IN MPT 220V	2	1/2	WUVLAMP2	WUVQS2	WUVBALLAST2
WUV6-110	WATTS 6GPM SS 3/4 IN MPT 110V	6	3/4	WUVLAMP6	WUVQS6	WUVBALLAST6-12
WUV6-230	WATTS 6GPM SS 3/4 IN MPT 220V	6	3/4	WUVLAMP6	WUVQS6	WUVBALLAST6-12
WUV8-110	WATTS 8GPM SS 3/4 IN MPT 110V	8	3/4	WUVLAMP8	WUVQS8	WUVBALLAST6-12
WUV8-230	WATTS 8GPM SS 3/4 IN MPT 220V	8	3/4	WUVLAMP8	WUVQS8	WUVBALLAST6-12
WUV12-110	WATTS 12GPM SS 1 IN MPT 110V	12	1	WUVLAMP12	WUVQS12	WUVBALLAST6-12
WUV12-230	WATTS 12GPM SS 1 IN MPT 220V	12	1	WUVLAMP12	WUVQS12	WUVBALLAST6-12



## Atlantic UV Systems, Lamps, Quartz Sleeves, Ballasts

MODEL NO.	DESCRIPTION	FLOW RATE (GPM)	SIZE (IN)	REPLACEMENT LAMP	QUARTZ SLEEVE	BALLAST
<b>Atlantic Mighty Pure UV System</b>						
T1200-06	AU MIGHTY-PURE MP22 6 GPM 3/4 NPT 110V 60HZ	6	3/4	T1205-1097	T1200S-6	T1210-0137
T1200-12A	AU MIGHTY-PURE MP36C 12 GPM 1 NPT 110V 60HZ	12	1	T1205-1343	T1200S-12	T1210-0137
T1200-20	AU MIGHTY-PURE MP49 20 GPM 1 1/2 NPT 110V 60HZ	20	1-1/2	T1205-1334	T1200S-20	T1210-0137
<b>Atlantic Sanitron UV System With Bulb Wiper</b>						
T1203-06	AU SANITRON S23A 6 GPM 3/4 NPT 110V 60HZ	6	3/4	T1205-1097	T1205S-6	T1210-0137
T1203-12A	AU SANITRON S37C 12 GPM 1 NPT 110V 60HZ	12	1	T1205-1343	T1205S-12	T1210-0137
T1203-20	AU SANITRON S50 20 GPM 1 1/2 NPT 110V 60HZ	20	1-1/2	T1205-1334	T1205S-20	T1210-0137
T1203-40C	AU SANITRON S2400C 40 GPM 2 NPT 110V 60HZ	40	2	T1205-1311	T1205S-40	T1210-0201
T1203-83	AU SANITRON S5000C 83 GPM 2 NPT 110V 60HZ TWIN SYSTEM	83	2	T1205-1311	T1205S-40	T1210-0201

## Trojan UV Systems, Lamps, Quartz Sleeves

MODEL NO.	DESCRIPTION	FLOW RATE (GPM)	SIZE (IN)	REPLACEMENT LAMP	QUARTZ SLEEVE
T13650372	TROJAN UVMAX-D PLUS 3-14GPM W INTENSITY MONITOR 120V 60HZ	3-14	3/4	T13602727	T13602732
T13650378	TROJAN UVMAX-C 3-14GPM 120V 60HZ 3/4 IN NPT	3-14	3/4	T13602727	T13602732
T13650366	TROJAN UVMAX-E PLUS 7-28GPM W INTENSITY MONITOR 120V 60HZ	7-28	1	T13602728	T13602733
T13650369	TROJAN UVMAX-E 7-28GPM 120V 60HZ 1 IN NPT	7-28	1	T13602728	T13602733
T13650363	TROJAN UVMAX-F 13-47GPM 120V 60HZ 1 IN NPT	13-47	1	T13602729	T13602734

## Flow-Max UV Plus Systems, Lamps, Quartz Sleeves, Ballasts

MODEL NO.	DESCRIPTION	FLOW RATE (GPM)	SIZE (IN)	REPLACEMENT LAMP	BALLAST
HSUV-SS-1-1	UV 1 GPM UV SYS 110V	1	1/4	HSQS-11	HSEB-1F
HSUV-SS-2-1	UV 2 GPM UV SYS 110V	2	1/2	HSQS-13	HSEB-1F
HSUV-SS-5-2	UV 5 GPM UV SYS 220V	5	3/4	HSQS-18	HSEB-2F
HSUV-SS-5-1	UV 6 GPM UV SYS SIVLER BASIC 100-240V 50/60HZ	6	3/4	HSQS-18	HSEB-1F
HSUV-SS-8-1	UV 8 GPM UV SYS 110V	8	3/4	HSQS-32	HSEB-1F
HSUV-SS-12-1	UV 15 GPM UV SYS SILVER BASIC 100-240V 50/60HZ	15	1	HSQS-33	HSEB-1F

## HSFS Filter System and Components

MODEL NO.	DESCRIPTION
HSFS	HSFS FILTER SYS 0.2 MICRON CARBON 120V
HSFS-5M	HSFS FILTER SYS 5 MICRON CARBON 120V
HSFSCART-ACP	HSFS FILTER SYS CART AC CARBON PLEATED
HSFSCART-PAC	HSFS FILTER SYS CART POWDERED AC CARBON 0.2 MICRON
HSFS-COUPLING-T	HSFS COUPLING PVC 1 IN FNPT W GAUGE PORT
HSFSLAMP	HSFS FILTER SYS UV LAMP 36 IN
HSFSQUARTZ	HSFS QUARTZ SLEEVE DOME END 940 MM



## BBH150 Big Bubba® Non-Metallic Filter Housings for High Flow

*With optional activated carbon cartridge to remove Chlorine, bad tastes, foul odors and sediment.*

### Rugged Construction

Filter housings are made of rugged, glass-reinforced polypropylene so they will not chip, rust or dent. And because all wetted surfaces are non-metallic, they are ideal when chemical compatibility is an issue and for sea water applications.

### Low Cost

Filters are an economical replacement for stainless steel filtration equipment because of their non-metallic construction and today's high cost of stainless steel!

### Applications

Big Bubba® Cartridge Filters are ideal for a wide range of applications, including:

- Whole house filtration
- Commercial filtration
- Industrial filtration
- Pre-filtration for reverse osmosis equipment
- Community water systems
- Sea water applications due to their non-corrosive construction
- Replacement for bag filters more filter area
- Replacement for multiple cartridge filters for greater convenience
- Water for livestock and poultry

### Proprietary Cartridges

The replacement cartridge for the Watts whole house filter is totally proprietary, so you may enjoy the replacement cartridge business over the life of the equipment

### Conserves Water!

Watts whole house filters with our proprietary pleated activated carbon cartridge conserves water because backwashing is not required, making them 100% efficient.

### Big Bubba Non-Metallic Plastic Filter Housing & Parts

MODEL NO.	DESCRIPTION
BBH-150	JUMBO HOUSING 2 IN
BBH-150-NP	JUMBO HOUSING 2 IN NO PG OR PORTS
BB-ADAPTER	BBH ADAPTER 2 IN PVC
BB-COUPLER	BBH COUPLER BLACK
BB-COUPLER-OR	BBH O-RING FOR COUPLER
BB-DPOR	BBH DRAIN PLUG ORING
BB-DRAINPLUG	BBH DRAINPLUG BLACK
BB-ENDCAP	BBH COUPLER COVER
BB-EYEBOLT	BBH EYEBOLT
BB-LID	BBH LID W HOLE FOR PG
BB-LID-NP	BBH LID W OUT PORTS
BB-NUT	BBH NUT
BB-ORING-E	BBH O-RING FOR LID EPDM
BB-PR-ASSY	BBH PRESS RELIEF ASSY
BB-WASHER	BBH U WASHER FOR LID

### E-Z Change-Out

Cartridge replacement is easy as 1-2-3:

1. Remove swing bolts.
2. Remove lid.
3. Rotate cartridge 1/4 turn and pull-up.



### Parallel installation

Parallel installations are recommended to achieve high flow rates, by installing filters on a common manifold, feeding all filters installed in a row.

### Series installation

Series installations are recommended for applications such as surface water filtration, where cartridges having different micron ratings are used.



Model: BBH-150

## Big Bubba® Cartridge Housing

SPECIFICATIONS	DATA
Body (all wetted surfaces)	Glass reinforced PP
Cartridge end caps	Glass reinforced PP
Swing bolts	304 stainless steel
O-rings (cartridges)	EPDM (Viton optional)
O-ring (lid)	EPDM (Viton optional)
Pipe fittings	2" slip
Overall height	40"
Width (vessel OD)	12"

(p/n: for no gauge port use part # **BBH-150-NP**)

## Low Pressure Drop

Big Bubba® Cartridge Filters housings are designed to minimize pressure drop, by using 2" pipe fittings and large diameter center tubes. (See chart at right for pressure drop data using pleated cartridges.)

## Big Bubba® Cartridges

SPECIFICATIONS	DATA
Maximum flow rate	150 GPM* (36 M3/hr.)
Maximum flow (carbon)	15 GPM
Maximum flow (1 Absolute)	50 GPM
Maximum temperature	125°F (52°C) @ 80 psi
Maximum working pressure	125 psi (8.75 bar)
Burst test	300 psi
Cycle test	100,000

\* Highly dependent on micron rating, solids content and other factors. Please see pressure drop chart below.

Housing number BBH-150 has a wetted brass gauge port for the inlet pressure gauge.

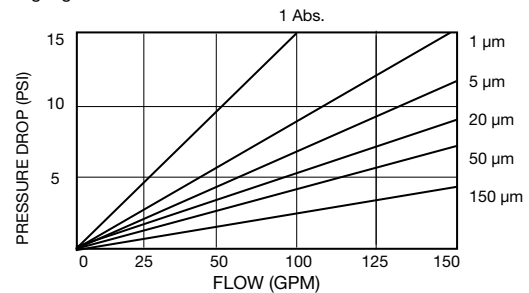

## Big Bubba® Cartridge Filter Specifications

	PLEATED	DEPTH	ACTIVATED CARBON
Media	PP	PP	Activated carbon
End caps	PP + FG	PP + FG	PP
Center tubes	PP	PP	PP
Maximum flow rate (GPM)	150	100	15
Maximum temperature	125°F (52°C)	125°F (52°C)	125°F (52°C)
Maximum ΔP (psi)	30	40	30
Chemical resistance	Excellent	Excellent	Not a factor (for water)
Length (media)	26-1/4"	26-1/4"	26-1/4"
O-rings (dual)	EPDM	EPDM	EPDM
Shipping weight (lbs.)	5	5	7
Carton dimensions	7" x 7" x 31"	7" x 7" x 31"	7" x 7" x 31"
Micron ratings	1A, 1, 5, 20, 50, 150	1, 5, 20, 50	5

Flow rates are based on each specific application, micron rating, solids content and a number of other factors. End user should consider these factors when selecting the filter housing (or number of filter housings) needed for their particular requirement.

## Pleated Cartridges

Ideal for more critical applications, offering greater efficiency, more surface area for greater throughput and reduced cost.

MODEL NO.	MEDIA TYPE	MICRON RATING	PER CASE
BBC-150-P1A	PP	1 Absolute	1
BBC-150-P1	PP	1	1
BBC-150-P5	PP	5	1
BBC-150-P20	PE	20	1
BBC-150-P50	PE	50	1
BBC-150-PM150	Mesh	150	1

5, 20, 50 and 150 micron cartridges are cleanable and reusable to reduce costs.

## Depth Cartridges

Melt blown Polypropylene cartridges are recommended when depth filtration is necessary for gelatinous substances and when chemical resistance may be a requirement.

MODEL NO.	MEDIA TYPE	MICRON RATING	PER CASE
BBC-150-D1	PP	1	1
BBC-150-D5	PP	5	1
BBC-150-D20	PP	20	1
BBC-150-D50	PP	50	1

## Activated Carbon

Ideal for whole house filtration to reduce chlorine, taste, odors and sediment.

MODEL NO.	MAX. FLOW	CAPACITY	CHLORINE REDUCTION
BBC-150-ACP	15 GPM	140,000 Gals.	90%

We build filtration systems, or they may be installed on site.

# ONE Cartridge Tank® Filtration System



## ONE Cartridge Tank® Filtration System

The ONE® Cartridge Tank® is a direct replacement for small and inefficient 2½" or 4½" housings, or expensive Stainless Steel cartridge housings, and offers extended service and life, and a more cost-effective and efficient filtration solution.

Lightweight and cost effective with multiple configuration options, from high flow commercial/industrial applications to stand-alone residential Point-of-Entry (POE) installations for city and well water applications, this is the filtration solution of the future...100% non-metallic! The Cartridge Tank® is a high performance, NSF 42 listed device and has been tested to 100 psi operating pressure with 4:1 Burst Safety Factor.

### Features & Benefits

- 100% non-metallic!
- Patented no-tools necessary snap-ring design
- Multiple filtration solutions **OR** **GR** **YE** **BL** **WH**
- Full 1¼" and 2" plumbing connection options
- Large capacity filter configurations
- Simple and easy change-out of cartridges.
- Match the filtration solution with flow rate requirements
- Extended service life, contaminant removal, and dirt holding capacity
- Low pressure drop = high flow
- Replacement option of pitcher, faucet, bottled water and/or refrigerator filters
- Reduction in frequency of replacing common 2½" or 4½" housings...Bigger is Better

### Applications

- Ideal for Residential, Foodservice, Rental Fleets, Commercial and Industrial Applications
- Make-up Water, RO Pre-filtration, Cooling Towers, Chill Water Loops, Metal Finishing
- Process Water (turbidity, particulate, colloidal suspensions)
- City water applications where water softeners are a hard sell

### Technical Schematics

#### Recommended:

Drain installed on inlet side of system, for removal of contaminants in sediment applications. Drain installed on outlet side of system, for flushing of new cartridges that have dust (i.e. Blue Series)

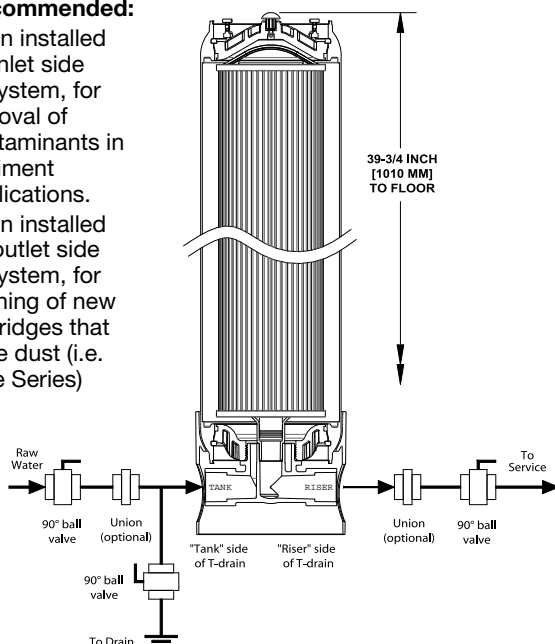

This pressure vessel is tested and certified by NSF International against NSF/ANSI Standard 61 for materials and structural integrity requirements

COMPONENT

**ONE**  
Water Filtration Simplified®



### Models and Components

Units sold fully assembled. Available Plumbing Connections:

Item #: SCT125 - 1 ¼"

Item #: SCT200 - 2"

### Color-Coded Cartridge Filtration Series

**OR** **GR** **YE** **BL** **WH**

Item #: SCT-1/4NPTLID



Top Cap option with pressure release Valve & Removal Handles

Item #: SCT-2.5LID



2.5" Threaded top/bottom Res./LC Cap threaded connection.

Item #: SCT-4.5LID



4.5" Threaded top/bottom Commercial Cap threaded connection.

Item #: SCT-RETAINRING



Snap Ring with I.D. Tag connection.

Item #: SCT-2.5DRAIN  
SCT-2.5ADAPTER



2.5" Bottom Drain Plumbing for Res./LC Filters.

Item #: SCT-4.5DRAIN  
SCT-SCT-4.5ADAPTBB



4.5" Bottom Drain Plumbing for Commercial Filters.

## Orange Filtration Series

### Dual Gradient Double Pleated Filters

The Orange Filtration Series are dual gradient double pleated filtration solutions for extended life and use, with filtration levels of 5, 10 and 20 microns. The filters are designed with a larger pre-filtration layer externally and the smaller internally, extending filtration level contamination and service life, while achieving high flow and low pressure drop.

The Orange Series also provides lower shear water velocity as the raw water passes through the filter, allowing for more contact time and interaction with the extensive surface area of the filters. This results in higher water quality and longer life of the filtration system.

Each filter comes with a unique handle designed top cap for lightweight and easy removal, a bag for proper disposal, and a double o-ring bottom connection into the Cartridge Tank® plumbing adapter for the 2½" assembly and full 1¼" PVC glue socket flow rate connections.



### Features & Benefits

- Dual Gradient Double Pleated Filters
- Double Buna-N O-ring seals
- Filter Belly Bands
- Durable Polyester filter and Polypropylene cap construction
- Extended service life, contaminant removal, and dirt holding capacity
- Low pressure drop = high flow!
- Ensures no bypass of contaminants and high chemical compatibility
- Prevent collapsing of filters under high flow or contaminant load applications
- Bacteria and chemical resistant
- Reduction in frequency of replacing common 2½" or 4 ½" housings...Bigger is Better!

### Three filter configurations:

**SCT-1005:** External 10 Micron Pleated pre-filter, with 5 Micron Pleated Internal Filter

**SCT-2010:** External 20 Micron Pleated pre-filter, with 10 Micron Pleated Internal Filter

**SCT-5020:** External 50 Micron Pleated pre-filter, with 20 Micron Pleated Internal Filter

### Applications

- Ideal for Residential, Foodservice,
- Rental Fleets, Commercial and Industrial Applications
- Make-up Water, RO Pre-filtration, Cooling Towers, Chill Water Loops, Metal Finishing
- Process Water (turbidity, particulate, colloidal suspensions)

### Better Filtration - There's No Competition

**Extended Service Life...6, 12, 18, or 24 months, versus 1-3?:** The total surface area of the dual gradient Orange Series is approximately 100 ft<sup>2</sup>, as compared to a typical single layer 2½"x20 filter, is approximately 7ft<sup>2</sup> of filter media area, and a 4 ½"x20 is approximately 16ft<sup>2</sup>. We have nearly 6.5x open area compared to standard 4.5x20 filters...100ft<sup>2</sup> vs. 16ft<sup>2</sup> and nearly 14.5x open area compared to standard 2.5x20filters...100ft<sup>2</sup> vs. 7ft<sup>2</sup>. Extended Service Life!

### Filter Performance

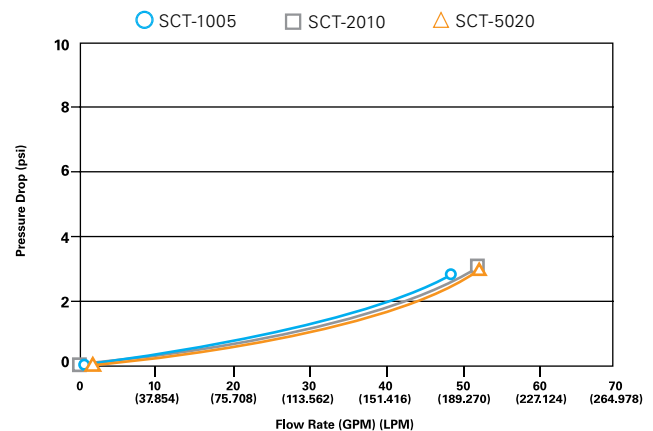

Performance claims are based on independent lab results and manufacturer's internal test data. Actual performance is dependent on influent water quality, flow rates, system design and applications. Your results may vary. Micron ratings based on 85% or greater removal of a given particle size. Flush new cartridges until water runs clear prior to use.

### NOTICE

Do not use with water that is microbiologically unsafe or of unknown quality without adequate disinfection before or after the system.

# ONE Cartridge Tank® Filtration System



## Green Filtration Series

### Dual Gradient Double Pleated Filters with NanoAI™ Media

The Green Filtration Series are electropositively charged dual gradient double pleated filtration solutions that successfully remove contaminants from 1 to 0.2 microns, featuring NanoAI™ media. The filters are designed with a larger 20 micron pre-filtration layer externally and the charged media internally, extending filtration level contamination and service life, while achieving high flow and low pressure drop.

All filters feature the use of Agion® antimicrobial technology that provides built-in protection by working 24/7 resisting the growth of microbes. Each filter comes with a unique handle designed top cap for lightweight and easy removal, a bag for proper disposal, and a double o-ring bottom connection into the Cartridge Tank® plumbing adapter for the 2½" assembly and full 1¼" PVC glue socket flow rate connections.

### Features & Benefits

- Dual Gradient Double Pleated Filters with electropositively charged NanoAI™ media
- Double Buna-N O-ring seals
- Filter Belly Bands
- PAC solution option
- Agion® antimicrobial technology
- Ensures no bypass of contaminants and high chemical compatibility
- Prevent collapsing of filters under high flow or contaminant load applications

### Two filter configurations:

**SCT-20NANOAG:** External 20 Micron Pleated pre-filter, with NanoAI™ Pleated Inner Filter w/Agion® Biostat

**SCT-20NANOPACAG:** External 20 Micron Pleated pre-filter, with NanoAI™ PAC Pleated Inner Filter w/Agion® Biostat and Carbon Block Core

### Applications

- Primary Filtration in lieu of microporous membranes
- Make Up Water (particulate, microbial control)
- Polishing Filters (carbon fines, emulsified oil removal)
- RO Prefiltration (SDI reduction)
- Process Water (turbidity, particulate, colloidal suspensions)
- Waste Water (biologicals, proteins, dyes)
- Cooling Towers, Chill Water Loops (iron removal)



is a trademark of Sciessent LLC, Wakefield, MA, USA

### Better Filtration - There's No Competition

**Known foulants for RO membranes** that are reduced by this adsorptive technology: Virus, bacteria, colloids (Iron, Manganese, Silica, etc), Cellular debris is also reduced: Lipids (hydrophobic and hydrophilic), Phospholipid, Proteins, Carbohydrates, and Glucose – mono and poly saccharides (TEP/EPS)

**Data suggests adsorptive filter media** could represent a significant improvement to membrane performance, life and overall operating cost by reducing fouling.

**Additional filtration highlights include:** Removal of Humic Acid based tannins; 3-4 log reduction, cyst removal; Endotoxin removal; Selected Heavy Metal Removal: Fe<sub>2</sub>, Fe<sub>3</sub>, Sn, Cu, Cr<sub>3</sub>, Al; Reduces Membrane fouling; Pre-, Post-, and Stand-Alone Filtration Solution

### Filter Performance

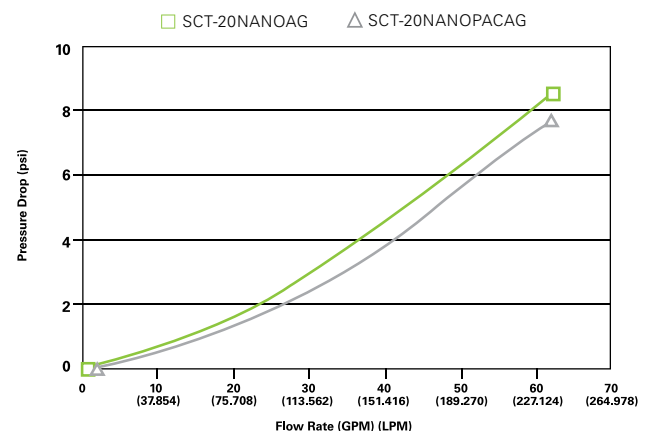

Performance claims are based on independent lab results and manufacturer's internal test data. Actual performance is dependent on influent water quality, flow rates, system design and applications. Your results may vary. Micron ratings based on 85% or greater removal of a given particle size. Estimated capacity using 2ppm free chlorine with greater than 90% reduction. Flush new cartridges until water runs clear prior to use.

### NOTICE

Do not use with water that is microbiologically unsafe or of unknown quality without adequate disinfection before or after the system.



## Yellow Filtration Series

### String Wound Filters with Meltblown Core

The Yellow Filtration Series are dual gradient double pleated filtration solutions for extended life and use, with filtration levels of 5 and 20 microns. This Series offers a combination filter composed of an outer layer of Polypropylene String with a Melt blown Polypropylene core. The precise wound pattern provides greater surface area, higher dirt-loading capacity and greater efficiency than standard wound filter cartridges. As a dual media filter, they provide a cost effective, extended-life product capable of capturing a broad range of particulates with high service flow rates greater than 30+gpm with less than 15 Delta P.

Each filter comes with a unique handle designed top cap for lightweight and easy removal, a bag for proper disposal, and a double o-ring bottom connection into the Cartridge Tank® plumbing adapter for the 2½" assembly and full 1¼" PVC glue socket flow rate connections.

### Features & Benefits

- Outer pre-filter manufactured using 100% polypropylene yarn
- Outer filter captures fine sediment, sand, silt, rust and scale particles
- Melt blown inner filter manufactured using thermally bonded polypropylene fibers
- Consistent downstream flow w/out fiber migration
- Microorganism resistant
- High purity
- Excellent chemical resistance
- High dirt holding capacity
- Graded density

### Two filter configurations:

**SCT-2005SWMB:** External 20 Micron String Wound pre-filter, with 5 Micron Meltblown Core

**SCT-5020SWMB:** External 50 Micron String Wound pre-filter, with 20 Micron Meltblown Core

### Applications

- Potable water
- Pre RO
- Electronics
- Plating solutions
- Corrosive fluids
- Concentrated acids and alkali
- Food/beverage
- Fine chemicals
- Metal finishing
- Oxidizing agents
- Gases



### Better Filtration - There's No Competition

**Extended service life:** 6, 12, 18, or 24 months versus 1-3 months, with 3x media content and 2x surface area to less efficient options!

**2x Surface area:** Wound in a precise pattern, providing greater surface area, higher dirt-loading capacity, and greater efficiency than that of a standard wound cartridge. The precise pattern offers 30-50% improved efficiency. ONE® surface area: = 566.46 sq. inches. Standard 4.5x20 = 283.23 sq. inches. = Two times the surface area.

**3x Media Content:** Both the 50x20 & 20x5 filters have a finished medium weight of 9 pounds, with a yarn content of 7.75 pounds. A standard 4.5x20 cartridge has a medium string weight of 2.5 pounds = Three times the media content.

### Filter Performance

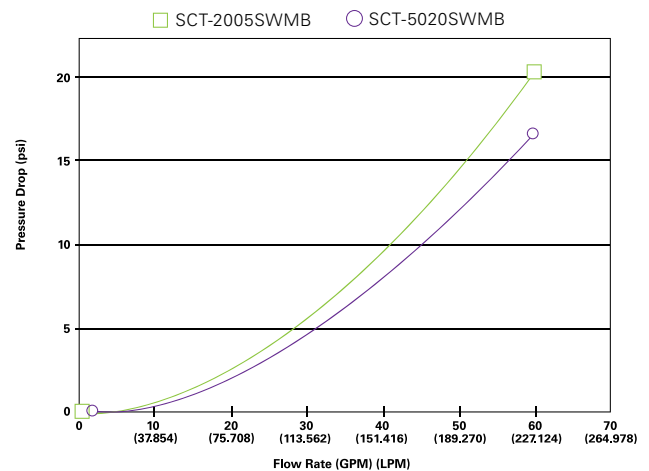

Performance claims are based on independent lab results and manufacturer's internal test data. Actual performance is dependent on influent water quality, flow rates, system design and applications. Your results may vary. Micron ratings based on 85% or greater removal of a given particle size. Flush new cartridges until water runs clear prior to use.

### NOTICE

Do not use with water that is microbiologically unsafe or of unknown quality without adequate disinfection before or after the system.

# ONE Cartridge Tank® Filtration System



## Blue Filtration Series

### High Performance Carbon Block with Chloramine Reduction

The Blue Filtration Series incorporates surface modified carbon block filter technology that is highly effective reducing bad taste, odor, and the reduction of chlorine and chloramines from potable drinking water. The filters are made using high performance coconut shell carbon, which has more micropores compared to other types of carbon.

All components and materials are made with FDA approved materials and Manufactured from NSF 61 Certified Coconut Shell carbon. Each filter comes with a unique handle designed top cap for lightweight and easy removal, a bag for proper disposal, and a double o-ring bottom connection into the Cartridge Tank® plumbing adapter for the 2½" assembly and full 1¼" PVC glue socket flow rate connections.

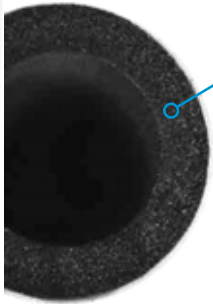

#### Features & Benefits

- High-performance carbon
- Unique binder system
- Proprietary manufacturing process
- Outer Wrap of Polypropylene
- Netting of Polyethylene
- Exceptionally low pressure drop
- High dirt holding capacity
- Excellent contaminant reductions

#### Applications

- Ideal for Residential, Food Service, Commercial and Industrial applications
- Effective at reducing unwanted bad taste and odor, along with chlorine and chloramine taste and odor from potable drinking water
- Ideal as polishing or pre-filters in applications requiring fine filtration and high capacity

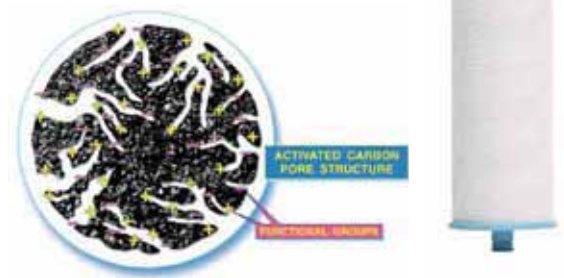

#### Three filter configurations:

**Nominal 3 micron (SCT-03CB) rated filter** to treat >250,000 gallons (946,353 Liters) of water @ 15 gpm (56.78 LPM) with greater than 90% reduction, estimated capacity using 2ppm of free chlorine. High capacity carbon block.

**Nominal 20 micron (SCT-20CB) rated filter** to treat >150,000 gallons (567,812 Liters) of water @ 7 gpm (26.50 LPM) with greater than 90% reduction, estimated capacity using 2ppm of free chlorine. High porosity/low pressure drop carbon block.

**Nominal 3 micron Chloramine (SCT-03CBAMINE) rated filter** to treat >50,000 gallons (189,271 Liters) of water @ 7 gpm (26.50 LPM) with greater than 85% reduction, estimated capacity. Chloramine reduction carbon block.

#### Filter Performance

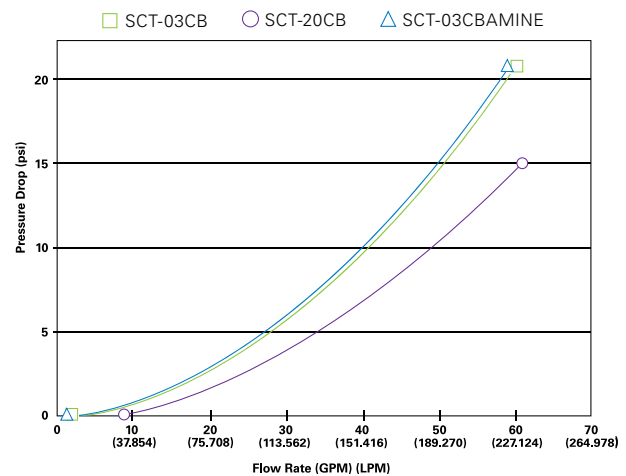

Performance claims are based on independent lab results and manufacturer's internal test data. Actual performance is dependent on influent water quality, flow rates, system design and applications. Your results may vary. Micron ratings based on 85% or greater removal of a given particle size. Estimated capacity using 2ppm free chlorine with greater than 90% reduction. Flush new cartridges until water runs clear prior to use.

#### NOTICE

Do not use with water that is microbiologically unsafe or of unknown quality without adequate disinfection before or after the system.

## White Filtration Series

### High Capacity Granular Media Bottle with Vortech Plate

The White Filtration Series is a unique and high capacity granular media bottle that allows incorporation of multiple media options and solutions to be used with the series. This filter series is a 0.5 ft<sup>3</sup> empty bottle for filling of granular filtration media. This ONE - Water Filtration Simplified™ filter series is ideal for a wide range of Residential, Food Service, Commercial, and Industrial applications, and can be used for multiple applications from Service DI, POE for city or well-water installations, Rental Programs, Exchange systems, high-purity pre- or post-filtration applications, etc...the options, configurations, and solutions are endless. Each filter comes with a unique handle designed top cap for lightweight and easy removal, and a double o-ring bottom connection into the Cartridge Tank® plumbing adapter for the 2½" assembly and full 1" PVC glue socket flow rate connections.

### Features & Benefits

- 0.5 cuft empty media bottle
- Polyethylene construction
- Vortech® distributor plate
- Locking or Removable top cap
- Double Buna-N O-ring seals
- Mid-Vortech® distributor plate option
- Extended service life and high capacity contaminant removal
- High chemical resistance
- Low pressure drop=high flow!
- Up-flow or down-flow service and full utilization of the media bed
- Ensures no bypass of contaminants and high chemical compatibility
- Separation of multi-media configurations.

### Applications

- Deal for Residential, Food/Beverage Service, Rental Fleets, Service DI Exchange, Plating solutions, Commercial and Industrial Applications
- Metal finishing, Oxidizing agents, Corrosive fluids, Electronics, Pre-RO, Process Water, Waste Water, Cooling Towers, Make-up Water, Polishing Filters, Primary Filtration
- Effective at reducing unwanted bad taste and odor, along with chlorine and chloramine taste and odor from potable drinking water

### Two filter configurations:

**SCT-MEDIA05** – Full 0.5 ft<sup>3</sup> configuration, able to be filled with any media for up-flow or down-flow service due to use of Vortech® technology.

**SCT-MEDIA05-MID** – Full 0.5 ft<sup>3</sup> configuration with Mid-Vortech® separation plate, able to be filled with any media for up-flow or down-flow service, due to use of Vortech® technology.

**Optional SCT-MEDIA05-FOAM** – Optional up-flow expansion foam pad can be added to filters used in up-flow service applications to promote consistent service flow rates and reduced pressure drop.

**Optional SCT-MEDIA05-SHIP** – Optional Box and Bag Kit solution for shipping of spent cartridges to facilities for re-generation or reuse of bottle.



### Filter Performance

#### Up Flow

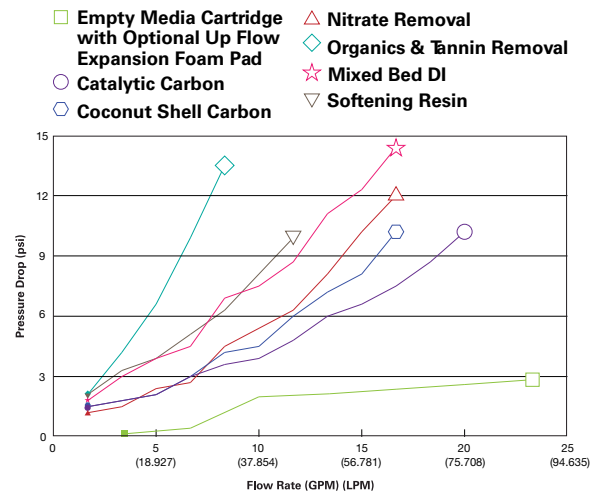

#### Down Flow

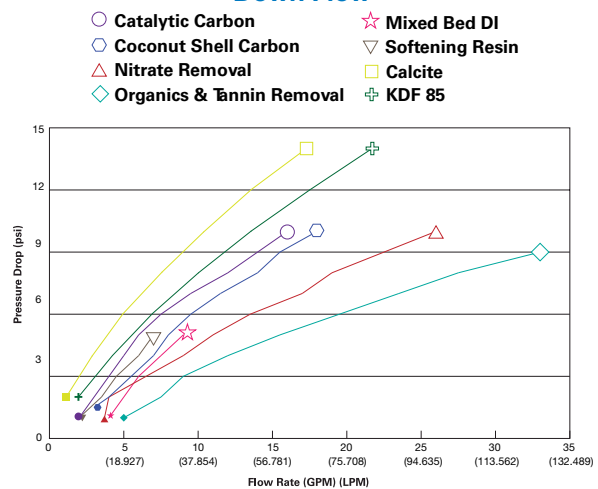

Performance claims are based on independent lab results and manufacturer's internal test data. Actual performance is dependent on influent water quality, flow rates, system design and applications. Your results may vary. Flush new cartridges until water runs clear prior to use.

### NOTICE

Do not use with water that is microbiologically unsafe or of unknown quality without adequate disinfection before or after the system.

## Flow-Max Stainless Steel Filter Housings

Check Out These Many Features And Benefits:

- 100% stainless steel for durability.
- 304 and 316 stainless steel available.
- Convenient band clamp lid closure is standard for easy cartridge replacement.
- Pipe fittings are readily accessible for easy installation.
- Adjustable top plate accepts variable length cartridges for more options.
- Two drains provided for clean and dirty fluids.
- Legs and mounting tabs are available.
- Knife edge seals are provided at both ends of all DOE cartridges for superior performance.
- Rated for temperatures to 250° F. (No plastic holding rods.)
- Pressure rating to 150 psi.
- Housings for pressures to 300psi are available.
- Optional sanitary connections.
- Models to accept DOE, 222 and cartridges with 226 end caps.
- Protective poly-coat over stainless steel standard finish.
- Electro-polishing is available.
- Standard, Premium Series and Jumbo models are in stock for immediate shipment.



### Specifications

Material	304 and 316 stainless steel are available.
Pressure rating	Housings are rated for pressures to 150 psi (10 bar).
Temperature	Filters are rated for temperatures to 250° F (121° C). Please consider cartridges to be used.
Gaskets & seals	Buna-N is standard. Viton, EDPM and Teflon are available.
Finish	Protective poly-coat over stainless is standard finish. Electro-polishing available.
Pressure drop	Initial pressure drop is <1 psi at designed flow rates for housings only.
Cartridge types	Housings are designed to accept DOE cartridges. Adapters for 222 & 226 cartridges available.

### Models



## Flow-Max Stainless Steel Filter Housings

Single cartridge models for the most “user friendly” filtration possible!



Model “170”

Model “90”

Model “40”

### Flow-Max® Commercial Quality Jumbo Cartridge Filter Housings In 316SS

MODEL NUMBER	MATERIAL	MAX. FLOW (GPM)	CARTRIDGE STYLE	NUMBER OF CARTRIDGES	PIPE SIZE	LID CLOSURE
FMJCH40	316SS	50	“40”	1	2" NPT	V-Band
FMJCH90	316SS	100	“90”	1	2" NPT	V-Band
FMJCH170	316SS	150	“170”	1	2" NPT	V-Band

**NOTICE**

Commercial quality jumbo cartridge housings are rated for pressures to 150psi (10 bar) and temperatures to 140°F with standard jumbo cartridges and 250°F using high temp cartridges. Pressure gauges included and installed on inlets and outlet.



User friendly Flow-Max jumbo cartridges are easy to install, easy to service and easy to replace!



Adjustable compression cap provides superior sealing for both ends of the jumbo cartridge.



Model FMJCH170

## Flow-Max Jumbo Cartridges

With cellulose-free synthetic and mesh media in a wide range of micron ratings.



Standard Synthetic Media



Flow-Max jumbo filter cartridge



PP Mesh Media

### Model 40

FILTER HOUSING MODEL NO.	MICRON RATING	MODEL NO. WITH SYNTHETIC MEDIA	MODEL NO. WITH MESH MEDIA	NUMBER PER CASE
40	1 Absolute	FMHC-40-1A	N. A.	1
	0.35	FMHC-40-0.35EZ	N. A.	1
	1	FMHC-40-1EZ	N. A.	1
	5	FMHC-40-5EZ	N. A.	1
	20	FMHC-40-20EZ	N. A.	1
	50	FMHC-40-50EZ	N. A.	1
	100	FMHC-40-100	N. A.	1
	150	N. A.	FMHC-40-150M	1

### Model 90

FILTER HOUSING MODEL NO.	MICRON RATING	MODEL NO. WITH SYNTHETIC MEDIA	MODEL NO. WITH MESH MEDIA	NUMBER PER CASE
90	1 Absolute	FMHC-90-1A	N. A.	1
	0.35	FMHC-90-0.35EZ	N. A.	1
	1	FMHC-90-1EZ	N. A.	1
	5	FMHC-90-5EZ	N. A.	1
	20	FMHC-90-20EZ	N. A.	1
	50	FMHC-90-50EZ	N. A.	1
	100	FMHC-90-100	N. A.	1
	150	N. A.	FMHC-90-150M	1

### Model 170

FILTER HOUSING MODEL NO.	MICRON RATING	MODEL NO. WITH SYNTHETIC MEDIA	MODEL NO. WITH MESH MEDIA	NUMBER PER CASE
170	1 Absolute	FMHC-170-1A	N. A.	1
	0.35	FMHC-170-0.35	N. A.	1
	1	FMHC-170-1EZ	N. A.	1
	5	FMHC-170-5EZ	N. A.	1
	20	FMHC-170-20EZ	N. A.	1
	50	FMHC-170-50EZ	N. A.	1
	100	FMHC-170-100EZ	N. A.	1
	150	N. A.	FMHC-170-150M	1

## Flow-Max Phenolic Cellulose Cartridges

Ideal for high temperature industrial water and oil filtration.

### Specifications

Maximum temperature	250°F (121°C)
Minimum temperature	-20°F (-29°C)
Maximum pressure	70 PSID (482 k PA)
Recommended change out	25 PSID (172 k PA)
End caps, cores, outer body	Electro plated tin
Media	Phenolic impregnated cellulose



### Standard 2-1/2" OD x 9-3/4" Length With Electro Tin Plated Outer Body

MODEL NO.	OD	LENGTH	MICRON	NO. / CASE
FMPIC-5-975	2-1/2"	9-3/4"	5	30
FMPIC-20-975	2-1/2"	9-3/4"	20	30
FMPIC-50-975	2-1/2"	9-3/4"	50	30

### Jumbo Model 40 (7-3/4" x 9-5/8")

MODEL NO.	OD	LENGTH	MICRON	NO. / CASE
FMPIC-40-5-HT	7-3/4"	9-5/8"	5	1
FMPIC-40-20-HT	7-3/4"	9-5/8"	20	1
FMPIC-40-50-HT	7-3/4"	9-5/8"	50	1

### Jumbo Model 90 (7-3/4" x 19-1/2")

MODEL NO.	OD	LENGTH	MICRON	NO. / CASE
FMPIC-90-5-HT	7-3/4"	19-1/2"	5	1
FMPIC-90-20-HT	7-3/4"	19-1/2"	20	1
FMPIC-90-50-HT	7-3/4"	19-1/2"	50	1

### Jumbo Model 170 (7-3/4" x 30-3/4")

MODEL NO.	OD	LENGTH	MICRON	NO. / CASE
FMPIC-170-5-HT	7-3/4"	30-3/4"	5	1
FMPIC-170-20-HT	7-3/4"	30-3/4"	20	1
FMPIC-170-50-HT	7-3/4"	30-3/4"	50	1

#### NOTICE

Phenolic impregnated cellulose cartridges are not to be used for potable water. Jumbo cartridges fit in Flow-Max jumbo housings only.

## Flow-Max Stainless Steel Filter Housings

Stainless steel filter housings with easy, safe and secure band-clamp lid closure.



4 &amp; 5 Round Models

12 Round

22 Round

Premium Series

### Flow-Max® Commercial Quality Multi-Cartridge Stainless Steel Filter Housings (316SS and 304SS)

MODEL NO. (316SS)	MODEL NO. (304SS)	ROUND	MAX. FLOW RATE (GPM) PLEATED	MAX. FLOW RATE (GPM) DEPTH	PIPE SIZE	DRAIN SIZE (NPT)	NO. OF STANDARD CARTRIDGES	CARTRIDGE OPTIONS (LENGTHS)
N/A	FM4X1-1-304	4	25	25	1" NPT	1/2"	4	9-3/4" - 10"
FM5X1	FM5X1-304	5	30	25	2" NPT	1/2"	5	9-3/4" - 10"
FM4X2	FM4X2-304	4	60	40	2" NPT	1/2"	4	20"
FM4X3	FM4X3-304	4	90	60	2" NPT	1/2"	4	29-1/4" or 30"
FM4X4	FM4X4-304	4	120	80	2" NPT	1/2"	4	40"
FM5X4	FM5X4-304	5	150	100	2" NPT	1/2"	5	40"

### Flow-Max® Premium Series Housings With Mounting Legs And Pressure Gauges (316SS)

MODEL NO.	ROUND	MAX. FLOW RATE (GPM) PLEATED	MAX. FLOW RATE (GPM) DEPTH	PIPE SIZE	DRAIN SIZE (NPT)	NO. OF STANDARD CARTRIDGES	CARTRIDGE OPTIONS (LENGTHS)
FMPS4X2	4	60	40	2" NPT	1/2"	4	20"
FMPS5X3	5	120	75	2" NPT	1/2"	5	29-1/4" or 30"
FMPS5X4	5	150	100	2" NPT	1/2"	5	40"
FMPS7X4	7	200	140	2" NPT	1/2"	7	40"

Flow rates shown above are for guidelines only. Actual flow rates are based on cartridge type, micron rating, solids content and a number of other factors.

## Stainless Steel Filter Housings – Tabs

MODEL NO.	DESCRIPTION
TABS	MOUNTING TABS FOR 457 ROUND



## Flow-Max In-Line Filters

Single cartridge, metal filter housings for in-line installations.

### Applications

- High temperatures
- High pressures
- Aggressive chemicals
- Water
- Oils
- Coolants
- Plating solutions
- Solvents
- Lubricants
- Hydraulic fluids

### Models

- Nickel plated brass heads with 304 stainless sumps and T-Handles for easy sump removal
- 304 stainless steel for DOE cartridges
- 316 stainless steel for 222 o-ring end caps
- Carbon steel

### Specifications

- Rated for pressures to 250 PSI (17.5 bar)
- Rated for temperatures to 250°F (121°C)
- Buna-N seals are standard. Optional seals available



### Models With Nickel Plated Brass Heads, 304 Stainless Steel Sumps and T-Handles

MODEL NO.	CARTRIDGE LENGTH	PIPE SIZE (IN.)	NO. OF CARTRIDGES	SUMP	HEAD	SHIPPING WEIGHT (LBS.)
FM10-BN-304-34T	10" *	3/4	1	304 SS	Nickel / Brass	7
FM20-BN-304-34T	20"	3/4	1	304 SS	Nickel / Brass	10

\*Accepts 10" and 9-7/8" wound or 9-3/4" cartridges with rigid end caps (pleated). Rated for pressures to 250 psi and temperatures to 250°F

### With 304 Stainless Steel Heads And 304 Sumps

MODEL NO.	CARTRIDGE LENGTH	PIPE SIZE (IN.)	NO. OF CARTRIDGES	SUMP	HEAD	SHIPPING WEIGHT (LBS.)
FM10-304-34	10" *	3/4	1	304 SS	304 SS	7
FM20-304-34	20"	3/4	1	304 SS	304 SS	10

\*Accepts 10" and 9-7/8" wound or 9-3/4" cartridges with rigid end caps (pleated). Rated for pressures to 250 psi and temperatures to 250°F

### Models With 316 Stainless Steel Construction For Cartridges With 222 O-Ring End Caps

MODEL NO.	CARTRIDGE LENGTH	PIPE SIZE (IN.)	NO. OF CARTRIDGES	SUMP	HEAD	SHIPPING WEIGHT (LBS.)
FM10-316-34-222	10"	3/4	1	316 SS	316 SS	7
FM20-316-1-222	20"	1	1	316 SS	316 SS	10

#### NOTICE

Filter housings listed directly above are rated for pressures to 250 psi and temperatures to 250°F.

### Models With Carbon Steel Sumps And Cast Iron Heads

MODEL NO.	CARTRIDGE LENGTH	PIPE SIZE	NO. OF CARTRIDGES	SUMP	HEAD	SHIPPING WEIGHT (LBS.)
FM10-CS-34	10"	3/4	1	Carbon	Cast iron	7

\*Accepts 10" and 9-7/8" wound or 9-3/4" cartridges with rigid end caps (pleated). Rated for pressures to 250 psi and temperatures to 250°F

## Flow-Max Bag Filter Housing

Bag housings with heavy-duty construction and swing-bolt lid closure.

### Features & Benefits

- Heavy-duty construction
- Swing bolt lid closure with eye nuts
- Rated for pressures to 150 PSI
- 2" NPT pipe with vent and drain
- 304 stainless steel baskets
- Adjustable legs
- Ports for pressure gauges
- Bottom outlet for easy installation
- Stainless legs on stainless models



### Bag Filter Housing Models

MODEL NO.	NO.	DESCRIPTION	HOUSING MATERIAL	ADJUSTABLE LEGS	BAG SIZE	PIPE SIZE
FMBH2-CS	#2	Swing-bolt bag filter	Carbon Steel	Carbon Steel	#2	2" NPT
FMBH2-304	#2	Swing-bolt bag filter	304SS	Stainless	#2	2" NPT

## Bag Filters

### #2 Filter Bags

MODEL NO.	NUMBER	SIZE	MATERIAL	MICRON RATING	NO./ CASE
FMPPFB2-1	#2	7" x 32"	PP	1	50
FMPPFB2-5	#2	7" x 32"	PP	5	50
FMPPFB2-10	#2	7" x 32"	PP	10	50
FMPPFB2-25	#2	7" x 32"	PP	25	50
FMPPFB2-50	#2	7" x 32"	PP	50	50
FMPPFB2-100	#2	7" x 32"	PP	100	50

Filter bags made with glazed polypropylene felt with galvanized carbon steel rings.

### #1 Felt Bags

MODEL NO.	NUMBER	SIZE	MATERIAL	MICRON RATING	NO./ CASE
FMPPFB1-1	#1	7" x 16"	PP	1	50
FMPPFB1-5	#1	7" x 16"	PP	5	50
FMPPFB1-25	#1	7" x 16"	PP	25	50
FMPPFB1-50	#1	7" x 16"	PP	50	50
FMPPFB1-100	#1	7" x 16"	PP	100	50

Filter bags made with glazed polypropylene felt with galvanized carbon steel rings.

## Resin and Media

Watts offers a variety of high-purity, premium-grade ion exchange resins and media designed for residential or commercial applications.

Our Micro Z™ granular filter media outperforms conventional multimedia materials due to its unique structure. Micro Z allows particulate to penetrate deeply into the filter bed, providing superior filtration at increased flow rates.

Our unique Catalytic granular-activated carbon concentrates reactants via adsorption, then promotes their reaction on the surface of the carbon to help remove hydrogen sulfide and chloramines.

Our unique ScaleNet media uses template assisted crystallization (TAC) technology to preemptively attract hardness minerals and convert them into harmless particles. The particles won't stick to inside of pipes and components, in turn reducing scale buildup. If you cannot find the correct resin or media in this catalog, please call us for assistance!

### ScaleNet Anti-Scale Media

ScaleNet Anti-Scale Media can be purchased in kit or bulk form. For your convenience, we offer a replacement media (RM) kit for each ScaleNet system we manufacture. The kit includes the exact, pre-measured, amount of media necessary to re-bed your existing system. Use the Replacement Media Kit chart below to select the appropriate kit for your system.



ScaleNet Media is Certified by WQA to NSF/ANSI 61.



### ScaleNet™

#### Ordering Information

MODEL NO.	DESCRIPTION	APPLICATION	UNIT OF MEASURE	CONTAINER WT. (LBS.)	PER PALLET
A8210	ScaleNet Anti-scale Media	Anti-scale	Liter	1.7	-

#### Replacement Media Kits

MODEL NO.	DESCRIPTION	RE-BEDS SYSTEM MODEL NO.	LITERS OF MEDIA	CONTAINER WT. (LBS.)	PER PALLET
M8407-COM-RM	SCALENET REBED KIT	M8407-COM	2.5	4.25	-
M8408-COM-RM	SCALENET REBED KIT	M8408-COM	3	5.1	-
M8408-RES-RM	SCALENET REBED KIT	M8408-RES	2	3.4	-
M8409-COM-RM	SCALENET REBED KIT	M8409-COM	4	6.8	-
M8409-RES-RM	SCALENET REBED KIT	M8409-RES	3	5.1	-
M8410-COM-RM	SCALENET REBED KIT	M8410-COM	5	8.5	-
M8410-RES-RM	SCALENET REBED KIT	M8410-RES	4	6.8	-
M8412-COM-RM	SCALENET REBED KIT	M8412-COM	7.5	12.75	-
M8412-RES-RM	SCALENET REBED KIT	M8412-RES	5	8.5	-
M8413-RES-RM	SCALENET REBED KIT	M8413-RES	7.5	12.75	-
M8414-COM-RM	SCALENET REBED KIT	M8414-COM	12.5	21.25	-
M8416-COM-RM	SCALENET REBED KIT	M8416-COM	19	32.3	-

## Micro Z

### Superior Filtration Media

Micro-Z™ granular filter media outperforms conventional multimedia materials due to its unique structure, allowing particulate to penetrate deeply into the filter bed to provide superior filtration at increased flow rates.

#### Features & Benefits

- Higher solids loading capability
- Superior filtration performance
- Reduced backwash frequency
- Removes finer particles
- Reduces pressure drop
- Provides higher flow rates
- Light weight
- Reduces shipping costs
- Easy to handle



A7200 is tested and certified by WQA against NSF/ANSI Standard 61.

#### Physical Properties

Color	Light green
Bulk density	55 lbs. per cu. ft.
Specific gravity	2.2 gm/cc
Mesh size	14x40
Uniform coefficient	1.9
Hardness (Mohs scale)	4

#### Conditions of Operation

Recommended bed depth	36" - 48"
Recommended freeboard	50% of bed depth
Service flow rate	12-20 GPM/sq. ft.
Backwash flow rate	12-18 GPM/sq. ft.
Backwash bed expansion	30-40 percent

#### NOTICE

Allow bed to soak overnight before initial backwash.

#### MICRO-Z vs. Conventional Filter Media

MEDIA	NOMINAL MICRON RATING	LOADING CAPACITY
Sand	20	1.0 X
Sand & Anthracite	15	1.4 X
Multimedia	12	1.6 X
Micro-Z	5	2.8 X

#### MICRO-Z Loading Information

VESSEL DIAMETER (INCHES)	MEDIA QUANTITY A7200 (CUBIC FT.)	UNDER BED A7005 (LBS.)	SERVICE FLOW RATE	BACKWASH FLOW RATE (GPM)
9	1	12	5-9	5-8
10	1.5	15	7-10	7-10
12	2	25	9-15	10-14
14	3	40	13-21	13-19
16	4	55	17-28	17-25
22	6	100	30-50	29-43
24	8	200	38-62	38-56
30	10	300	59-98	60-88
36	20	500	85-140	85-127
42	30	700	115-190	115-175
48	35	900	150-250	150-225

#### Ordering Information

MODEL NO.	DESCRIPTION	CUBIC FEET PER BAG	CONTAINER WT. (LBS.)	PACKAGE	PER PALLET
A7200	Micro-Z	1	55	Bag	40

## Activated Carbon

### Granular Activated Carbon

Activated carbon (AC) is a natural material derived from bituminous coal, lignite, wood, coconut shell etc., activated by steam and other means. Carbon is very popular due to its ability to correct many water quality problems.

#### Benefits

- Improve taste and remove odors
- Dechlorination of water
- Removes color from water
- Removal of organic substances
- Removal of synthetic organic substances
- Clear water for drinking, bathing and cooking!

#### Adsorption Influencing Factors

<b>Temperature</b>	Most effective 60°F - 80°F.
<b>pH</b>	Most organics in water are more soluble at pH lower than 7.0.
<b>Contact time</b>	Very important to achieve proper flow rates for any adsorption system to function properly.

#### Carbon Media Types

<b>Bituminous</b>	Basic coal based granular media
<b>Coconut shell</b>	Superior level of hardness; high activity level; trihalomethane removal; longer life expectancy;
<b>Acid washed</b>	Increases adsorptive capacity of carbon base and lowers the level of impurities.
<b>Catalytic</b>	Specialized carbon media to remove hydrogen sulfide gas, iron, and chloramines.



This product is UL Certified to NSF/ANSI Standard 61

#### Standard Operating Conditions

Service flow rate	2 - 6 gpm/cu.ft.
Freeboard	50% of bed depth
pH	6.5 - 7.5

#### Contaminates Adsorbed

- Chlorine
- Organic Chemicals
- Fertilizers
- TCE (Trichloroethylene)
- EDB (Ethylene dibromide)
- THM (Trihalomethanes)
- Sediment
- Chemical odor
- Pesticides
- Detergents
- Chloramines

#### NOTICE

Service flow rates are calculated at 2-6 gpm/ft<sup>3</sup> for standard taste, odor and chlorine removal application using bituminous carbon. Chloramines and TOC/VOC applications will require lower service flow rates and longer empty bed contact time or specialized carbon formulations.

#### Ordering Information

MODEL NO.	DESCRIPTION	TYPE	MESH	CUBIC FEET PER BAG	CONTAINER WT. (LBS)	PER PALLET
A9231-ALLF	Alamo Brand Low Fines Coconut Shell	Coconut	12 x 40	1	27.5	40
A9230-AL	Alamo Brand Acid Washed Coconut Shell	Coconut	12 x 40	1	27.5	40
A9030A	Acid washed, low fines	Bituminous	12 x 40	1	27.5	40
A9030-C	Calgon F-200 acid washed, low fines	Bituminous	12 x 40	1	31	40
A9231-AL	Alamo Brand Coconut Shell	Coconut	12 x 40	1	27.5	40
A9031A	Carbsorb™ 40	Bituminous	12 x 40	1	27.5	40
A9031-C	Calgon F-400 low fines	Bituminous	12 x 40	1	27.5	40
A9232-AL	Alamo Brand Coconut Shell	Coconut	8 x 30	1	27.5	40
A9231-A	Calgon coconut shell carbon media	Coconut	12 x 40	1	27.5	40

#### ⚠ WARNING

Wet activated carbon preferentially removes oxygen from air. In closed or partially closed containers and vessels, oxygen depletion may reach hazardous levels. If workers are to enter a vessel containing carbon, appropriate procedures for potentially low-oxygen environment should be followed.

## Catalytic<sup>®</sup> Granular Activated Carbon

### Hydrogen sulfide, iron and chloramines removal

Catalytic carbon is a liquid phase virgin activated carbon that has been manufactured to develop catalytic functionality. The product is unique in that it concentrates reactants via adsorption and then promotes their reaction on the surface of the pores.

#### Features & Benefits

- Catalytic activity allows for smaller more compact system sizing and lower capital requirements.
- No safety concerns with exotherms or toxicity like some impregnated medias.
- Improved trace organic capacity per unit volume.
- High hardness reduces fines and losses due to handling.
- Works with low oxidant levels and limits the need for chemicals.
- Simple and reliable equipment design that will handle spikes in concentration without metering of chemicals.
- Reduced carbon requirements, reduced operating costs.
- Enhanced carbon media performance for a greater degree of contaminant removal at reduced costs.
- Thermal reactivation is an option for recycle and reuse to minimize operating costs and eliminates disposal concerns.



Part # A8056-AL

#### Specification

Iodine number	Min. 1000 mg/g
Moisture content (as packaged)	Max. 5%
Total ash content	Max. 4%
Ball-pan hardness	Min. 98%
CTC activity	Min. 50%
Catalytic activity	Min. 20° C

#### Typical Properties

Surface area (BET)	1060 m <sup>2</sup> /g
Apparent density	490 kg/m <sup>3</sup>
Bed density, backwashed and drained	420 kg/m <sup>3</sup>
pH	10

#### Applications

- Chloramines
- Hydrogen sulfide
- Taste and odor
- VOC removal
- Iron removal
- Residential water filters
- Commercial water filters
- Bottling and soft drink industries
- Aquarium water treatment



This product is UL Certified to NSF/ANSI Standard 61

#### Design Considerations

Catalytic carbon is produced from coconut shell using a patented process for the use in liquid phase systems to promote catalytic reactions. The reactant concentration determines the effective contact time. Although it is not impregnated with metals or alkali, it displays the catalytic functionality of these materials.

#### Ordering Information

MODEL NO.	DESCRIPTION	TYPE	MESH	CUBIC FEET PER BAG	CONTAINER WT. (LBS.)	PER PALLET
A8056-AL	Alamo	Catalytic	12x40	1	27.5	40

#### WARNING

Wet activated carbon preferentially removes oxygen from air. In closed or partially closed containers and vessels, oxygen depletion may reach hazardous levels. If workers are to enter a vessel containing carbon, appropriate sampling and work procedures for potentially low oxygen spaces should be followed, including all applicable federal and state requirements.

## Resin (Alamo, Purolite, Thermax)

### Alamo Brand A4000 Resin

Alamo brand A4000 resin is a high purity, premium grade, prewashed, strong acid gel-type cation exchange resin specially designed for water softening applications. A4000 is a bead type, cross-linked, polystyrene divinylbenzene resin that offers excellent bead integrity and very low extractables.



A4000 is tested and certified by WQA against NSF/ANSI Standard 61.

### Resin Properties

Type	8% crosslink polystyrene
Form	Gel- type, light amber bead
Ionic form	Na+ (as shipped)
Functional group	Sulphonic acid
Bead size	16 x40 mesh
Effective size	0.45 ± 0.07 mm
Bulk density	53 lb/ft3
Real density	1.28 g/cm3
Bead count	>95%
Water retention	45-48%
Total capacity	>2.0meq/l
Volume change	Na+ - H+ <5%
Stability, temp.	<300°F
Stability pH	0 – 14

### Design Conditions

Bed depth	>30 in
Flow rate	2-5 gpm/ft3
Freeboard	50% of bed depth
Backwash expansion	50% of bed depth
NaCl concentration for regeneration	5-25%
NaCl flow rate for regeneration	0.25-0.5 gpm/ft3
Turbidity	<5.0 NTU
Free chlorine	<1 ppm

### Ordering Information

#### Cation

MODEL NO.	DESCRIPTION	APPLICATION	IONIC FORM	CUBIC FEET PER BAG	CONTAINER WT. (LBS.)	PER PALLET
A4000	Alamo Brand 8% crosslink	Softening	NA	1	52	40
A9009	Thermax T-42 8% crosslink	Softening	NA	1	52	40
A4005	Purolite C-100FM fine mesh	Softening	NA	1	52	40
A4004	Purolite C-100E	Softening	NA	1	52	40
A4016	Purolite C-100X10 10% crosslink	Softening	NA	1	52	40
A9000-14	Thermax T-52 10% crosslink	Softening	NA	1	52	40
A9000-25	Thermax T-42MP 8% macro	Condensate	NA	1	52	40
A4012	Purolite C-100H	DI	H+	1	52	40

#### Anion

MODEL NO.	DESCRIPTION	APPLICATION	IONIC FORM	CUBIC FEET PER BAG	CONTAINER WT. (LBS.)	PER PALLET
A4044	Purolite A-300 Type II	Alkalinity	CL	1	43	40
A4040	Purolite A-400 Type I	DI	CL	1	43	40
A4073	Purolite A-850 gel acrylic	Tannins	CL	1	43	40
A9000-35	Thermax A-72MP Type I styrene base	Tannins	CL	1	43	36
A4050	Purolite A-520E macro	Nitrates	CL	1	43	40

#### Mixed Bed

MODEL NO.	DESCRIPTION	APPLICATION	IONIC FORM	CUBIC FEET PER BAG	CONTAINER WT. (LBS.)	PER PALLET
A4140	Purolite MB3720 Semiconductor H/OH Mixed Bed	DI	H+/OH-	1	43	40
A9000-31	Thermax MB-108P 1:1 volume basis	DI	H+/OH-	1	43	36

## Iron, Hydrogen Sulfide, and Manganese Reduction

### Filox-R™ Media

Filox-R™ media is an economical Iron and Hydrogen Sulfide filtration media that out performs traditional Greensand and Birm.

#### Features & Benefits

- Superior high efficiency media for filtration and removal capabilities
- No oxidizing chemicals typically needed for regeneration (See Testing For ORP below)
- High efficiency with 80% manganese dioxide for enhanced performance and capacity.
- Effective, from 6.5 pH to 9.0 pH
- Highest flow rate of any standard iron removal media.



Certified to  
ANSI/NSF  
Std. 61

#### Operating Conditions

Active Ingredient	75-85% Manganese Dioxide
Service Flow	6 gpm/cu.ft.
Freeboard	30-50% of bed depth
Backwash rate	Backwash rate 16-30 GPM/sq.ft, depending on application specific variables, minimum recommended bed expansion is 15%
Bed depth	20 inch Minimum
pH Range	6.5 – 9.0
Screen size	12 x 40
Bulk density	114 lbs/cu.ft.
<b>Removal Capacity</b>	
Iron	10 ppm
Hydrogen Sulfide	3 ppm
Manganese	5 ppm

#### Comparative Information

PRODUCT NAME	ACTIVE INGREDIENT
Greensand	0.5% Manganese Dioxide
Filox-R™	75% - 85% Manganese Dioxide

#### Ordering Information

MODEL NO.	DESCRIPTION	CUBIC FEET PER BAG	CONTAINER WT. (LBS.)	PER PALLET
A8033	Filox-R™ media	0.5	57	38

The use of additional oxidizing agents (oxygen, chlorine, ozone, hydrogen peroxide, potassium permanganate, etc.) is recommended. Oxidizers will enhance the performance of Filox-R™. They oxidize the media, which enables Filox-R™ to perform quicker and keep cleaner. It is always a safe practice to install an oxidation method upstream (in front) of the Filox-R™ bed. Do not exceed 4 ppm free chlorine chlorine in the feed water stream or bed damage may occur.

#### Testing For ORP

Oxidation Reduction Potential (ORP) can be the most important factor to take into consideration in certain waters. Highly reducing waters may cause premature exhaustion or even destruction of the Filox-R™ bed. Precautions can be taken prior to installation that can prevent ORP problems. Use one of the screening tests and follow the instructions below if the subject water has reducing properties that will require additional oxidants.

#### Simple Test

Mix 1.75 ounces (50 grams) water with 0.75 ounces (22 grams) of potassium permanganate crystals. Then take 2 drops of the mixture and stir into a fresh 1/4 gallon (1 liter) sample of the subject water. Let the subject water stand for 15 minutes. If the pink color remains, Filox-R™ can possibly be installed without additional oxidants. If the pink color disappears, additional oxidants will be needed for Filox-R™ to function properly.

#### ORP Meter Test

##### NOTICE

Must use a calibrated ORP meter. Any reading that is above a negative 170 millivolts indicates that Filox-R™ can be used effectively, possibly without additional oxidants. Any reading falling below a negative 170 millivolts indicates that additional oxidants will be required.

See disclaimer on inside front cover

Filox Backwash Bed Expansion

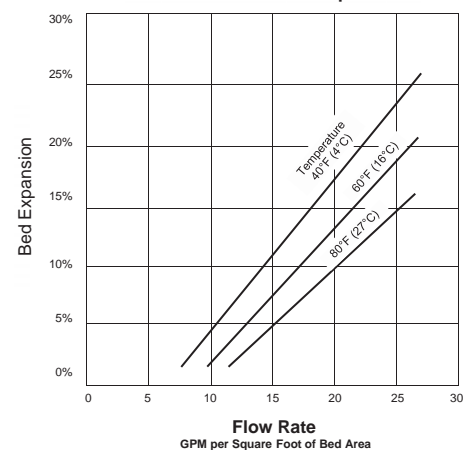

##### NOTICE

Watts recommends a small scale pilot test anytime the use of oxidizing agents are in question.



# Acid Neutralizing , Anthracite, Birm, Filter Sand, Garnet, Gravel, Greensand, KDF

## Ordering Information

### Sand

MODEL NO.	DESCRIPTION	APPLICATION	CUBIC FEET PER BAG	CONTAINER WT. (LBS.)	PER PALLET
A7002A	Filter sand 0.45-0.55 mm	Sediment turbidity	0.5	50	56
A7003A	Filter sand 0.6-0.8 mm	Sediment, turbidity	0.5	50	56
A7004A	Filter sand 0.8-1.2 mm	Sediment, turbidity	0.5	50	56

### Gravel

MODEL NO.	DESCRIPTION	APPLICATION	CUBIC FEET PER BAG	CONTAINER WT. (LBS.)	PER PALLET
A7005A	Gravel 1/8"x1/16" (#20) red marking	Sediment, bed support	0.5	50	56
A7006A	Gravel 1/4"x1/8" orange marking	Sediment, bed support	0.5	50	56
A7007A	Gravel 1/2"x1/4" black marking	Sediment, bed support	0.5	50	56

### Anthracite

MODEL NO.	DESCRIPTION	APPLICATION	CUBIC FEET PER BAG	CONTAINER WT. (LBS.)	PER PALLET
A7050	Anthracite #1 (0.6-0.8 mm) orange bags	Sediment, turbidity	1	52	50
A7051	Anthracite #1.5 (0.85-0.95 mm) blue bags	Sediment, turbidity	1	52	50
A7052	Anthracite #2 (2-4 mm) yellow bags	Sediment, turbidity	1	52	50

### Garnet

MODEL NO.	DESCRIPTION	APPLICATION	CUBIC FEET PER BAG	CONTAINER WT. (LBS.)	PER PALLET
A7084-50	Garnet #036 (0.5-0.65 mm)	Sediment, turbidity	0.37	50	80
A7085-50	Garnet #030/40 (0.32-0.39 mm)	Sediment, turbidity	0.37	50	80
A7086-50	Garnet #050 (0.24-0.33 mm)	Sediment, turbidity	0.37	50	80

### Birm

MODEL NO.	DESCRIPTION	APPLICATION	CUBIC FEET PER BAG	CONTAINER WT. (LBS.)	PER PALLET
A8006	Birm (regular)	Iron, HS reduction	1	44	40

### Greensand

MODEL NO.	DESCRIPTION	APPLICATION	CUBIC FEET PER BAG	CONTAINER WT. (LBS.)	PER PALLET
A8041-P	Greensand Plus	Iron, HS reduction	0.5	42	50

### Neutralizer

MODEL NO.	DESCRIPTION	APPLICATION	CUBIC FEET PER BAG	CONTAINER WT. (LBS.)	PER PALLET
A8012A	Flomag PWT Magnesium Oxide (similar to Corsex)	NSF Neutralizer	0.5	50	60
A8021-50	Calcite	NSF Neutralizer	0.5	50	60

### KDF

MODEL NO.	DESCRIPTION	APPLICATION	CUBIC FEET PER DRUM	CONTAINER WT. (LBS.)	PER PALLET
KDF55-DRUM	KDF-55	Chlorine reduction	0.33	57	48
KDF85-DRUM	KDF-85	Fe, Chlorine reduction	0.33	57	48

### Misc.

MODEL NO.	DESCRIPTION	APPLICATION	CUBIC FEET PER BAG	CONTAINER WT. (LBS.)	PER PALLET
A8014-FL	Filter Lite	Sediment, turbidity	2	50	40

# Cartridges

Watts offers cartridges and filters from the companies and brands of C-Max®, Flowmatic®, Doulton®, Pentair, Intelifil®, Enpress®, and Watts, among others.

## Carbon Cartridges Selection Guide

Model No.	Brands	OD (IN)	Length (IN)	Flow Rate (GPM)	Micron Rating (Nominal)	Reduction of			
						Chlorine Reduction Gallon Rating*	Cyst	VOC	Lead
<b>2-1/2 IN OD Cartridges</b>									
S7704A	Pentair	2 1/2	4 7/8	0.5	5	1,250			
WCBCS975	Watts	2 1/2	9 3/4	1	5	4,000			
S7700A	Pentair	2 1/2	9 7/8	1	5	2,500			
S7712	Pentair	2 1/2	9 7/8	1	20	7,500			
S7722A	Pentair	2 1/2	9 7/8	2	0.5	20,000	✓		
WCBCS20	Watts	2 1/2	20	2	5	8,000			
<b>2-3/4 IN OD Cartridges</b>									
GAC20NRW	Watts	2 3/4	20	2	-	5,000			
GAC10N	Watts	2 3/4	9 3/4	1	-	2,500			
GAC10S	Watts	2 3/4	9 3/4	1	-	2,500			
<b>2-3/8 IN OD Cartridges</b>									
S7604A	Pentair	2 3/8	9 3/4	5	5				
S7648	Pentair	2 3/8	20	10	5				
S7649	Pentair	2 3/8	20	10	25				
<b>2-7/8 IN OD Cartridges</b>									
MAXVOC-975	C-MAX	2 7/8	9 3/4	1	0.5	20,000	✓	✓	
MAXPB-975	C-MAX	2 7/8	9 3/4	1	0.5	20,000	✓		✓
MAXCYST-975	C-MAX	2 7/8	9 3/4	1	0.5	20,000	✓		
MAXCL-975	C-MAX	2 7/8	9 3/4	1	0.5	20,000			
MAXETW-975	C-MAX	2 7/8	9 3/4	1	5	3,000			
MAXETW-SS Candle	C-MAX	2 7/8	9 3/4	1	5	3,000			
MAXT-975	C-MAX	2 7/8	9 3/4	1	5	5,000			
S7844	Pentair	2 7/8	9 3/4	1	10	3,000			
S7708	Pentair	2 7/8	9 3/4	1	20	5,000			
MAXCL-20	C-MAX	2 7/8	20	2	0.5	45,000			
S7723XA	Pentair	2 7/8	20	2	5	12,000			
MAXETW-20	C-MAX	2 7/8	20	2	5	6,000			
S7846	Pentair	2 7/8	20	2	10	6,000			
S7732	Pentair	2 7/8	20	2	20	10,000			
MAXETW-30	C-MAX	2 7/8	30	3	5	9,000			

\* For individual chlorine claims see individual product page

## Carbon Cartridges Selection Guide — cont.

Model No.	Brands	OD (IN)	Length (IN)	Flow Rate (GPM)	Micron Rating (Nominal)	Reduction of			
						Chlorine Reduction Gallon Rating*	Cyst	VOC	Lead
<b>4-1/2 IN OD Cartridges</b>									
S7812	Pentair	4 1/2	9 3/4	2	20	12,500			
S7816	Pentair	4 1/2	9 3/4	2	25	35,000			
GAC-BB10	Watts	4 1/2	9 3/4	3	-	7,500			
WCBCCFF975	Watts	4 1/2	9 3/4	4	5	10,000			
S7814	Pentair	4 1/2	20	4	20	25,000			
S7815	Pentair	4 1/2	20	4	25	70,000			
GAC-BB20	Watts	4 1/2	20	5	-	15,000			
WCBCCFF20	Watts	4 1/2	20	8	5	20,000			
<b>4-5/8 IN OD Cartridges</b>									
S7817X	Pentair	4 5/8	9 3/4	2	5	22,000			
S7845	Pentair	4 5/8	9 3/4	2	10	15,000			
MAXCL-FF975	C-MAX	4 5/8	9 3/4	4	0.5	70,000			
MAXETW-FF975	C-MAX	4 5/8	9 3/4	4	5	11,000			
MAXPB-FF20	C-MAX	4 5/8	20	2	0.5	150,000	✓		✓
S7811XA	Pentair	4 5/8	20	4	5	40,000			
MAXCL-FF20	C-MAX	4 5/8	20	8	0.5	150,000			
MAXETW-FF20	C-MAX	4 5/8	20	8	5	20,000			
<b>Inline Encapsulated Cartridges</b>									
CL6ROT33	Watts	2	6	0.5		✓			
K2333JJ	Watts	2	6	0.75		✓			
CL10ROT33	Watts	2	10	0.5	5	✓			
K2533SS	Watts	2	10	0.5		✓			
AICRO	Watts	2	10	0.75		✓			
AICRO-JGK	Watts	2	10	0.75		✓			
GS10ROB	Watts	2	10	0.75		✓			
SCL10	Watts	2	10	0.75		✓			
GS10CAL/ROB	Watts	2	10	0.75		✓			
K2533JJ	Watts	2	10	0.75		✓			
<b>Quick-Change Encapsulated Proprietary Cartridges</b>									
WQCABC10	Watts	2 1/2	10		5	✓			
WQCCC10	Watts	2 1/2	10		5	1,500			
WQCGAC10	Watts	2 1/2	10			✓		✓	
WQCABC11	Watts	2 1/2	11		5	✓			
WQCCC11	Watts	2 1/2	11		5	2,000			
WQCGAC11	Watts	2 1/2	11			✓		✓	
WQCABC13	Watts	2 1/2	13		5	✓			
WQCCC13	Watts	2 1/2	13		5	2,500			
WQCGAC13	Watts	2 1/2	13			✓		✓	
<b>Quick-Change Hollow Fiber Membrane Cartridges</b>									
WQCHFC10	Watts	2 1/2	10	0.1					
WQCHFC11	Watts	2 1/2	11	0.1					
WQCHFC13	Watts	2 1/2	13	0.1					

\* For individual chlorine claims see individual product page

## The Watts ChloraBlock Filter

*High Performance Coconut Shell Catalytic Carbon Block*

The new Watts ChloraBlock Filter is specially designed to reduce chloramines using coconut shell catalytic carbon block.

### Innovative Features & Benefits

- Large quantity of catalytically-active Nitrogen groups for highly effective chloramine reduction
- Manufactured from advanced, high-performance media
- Unique binder system maximizes availability of catalytic sites
- 1 µm nominal filtration
- High dirt holding capacity
- No carbon fine release
- Low pressure drop
- Ideal for commercial & industrial POU and POE applications
- Greater carbon surface area
- Backed by Watts 40+ years of water quality expertise



The filter's enhanced catalytic functionality has 4 times the capacity for reducing chloramines than standard carbon blocks and 2 times the capacity for reducing chlorine over standard activated carbon.

## The Watts ChloraBlock Filter

### About Chloramine

Chloramine, an alternative to chlorine, is widely used as a residual disinfectant to maintain water safety. Chloramine is formed by mixing chlorine with ammonia, creating a more stable and less reactive compound than chlorine alone. While this stability reduces the formation of Disinfection By Products (DBPs) and provides longer-lasting disinfection, chloramine is difficult to remove using conventional filtration technology.

In addition, because chloramine is a more stable chemical, systems designed for reducing chlorine are not effective with chloramine. Effective reduction of chloramine requires catalytic carbons, or surface-modified carbons with active catalytic sites of Nitrogen groups attached to the vast surface of the activated carbon.



### Watts ChloraBlock Filter Models

MODEL NO.	TYPE	OD	LENGTH	MICRON RATING*	FLOW RATE	CHLORINE REDUCTION**	CHLORAMINE REDUCTION***	# / CASE
WCB10-CHLORA-TW	Thick wall	2 3/4"	9 3/4"	1 nominal	1 gpm	>35,000 gal @ 1 gpm	2,000 gal @ 1 gpm 3,500 gal @ 0.5 gpm	12
WCB10-CHLORA	Standard Wall	2 3/4"	9 3/4"	1 nominal	1 gpm	>25,000 gal @ 1 gpm	1,200 gal @ 1 gpm 2,000 gal @ 0.5 gpm	12
WCB20-CHLORA	Standard Wall	2 3/4"	20"	1 nominal	2 gpm	>58,000 gal @ 2 gpm	8,500 gal @ 1 gpm 4,000 gal @ 2 gpm	12
WCB10FF-CHLORA	Standard Wall	4 1/2"	9 3/4"	1 nominal	3 gpm	>100,000 gal @ 3 gpm	6,000 gal @ 2 gpm	4
WCB20FF-CHLORA	Standard Wall	4 1/2"	20"	1 nominal	7 gpm	>200,000 gal @ 4 gpm	24,000 gal @ 2 gpm 12,000 gal @ 4 gpm	4

\* Nominal micron rating for all above - 1 micron

\*\* 2ppm free chlorine > 90% reduction

\*\*\* 3ppm monochloramine > 85% reduction

### ChloraBlock Filter Applications

- Residential drinking water
- Food and Office Coffee Service
- Aquaculture: Fish, Amphibians, Reptiles
- Pharmaceutical & biotech
- Breweries & wineries
- General commercial/industrial water

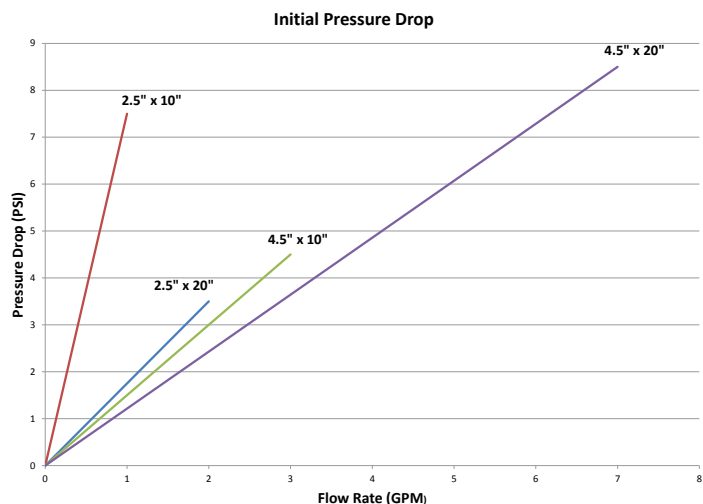

## Carbon Block Filters - C-Max

Full line of solid block activated carbon cartridges for water treatment.



Standard cartridges



Full-Flow(B-B)

Full Product Line With Color Coded End Caps To Indicate Cartridge Type



MAX-ETW



MAX-CYST



MAX-VOC



MAX-T



MAX-PB



MAX-CL

### Cartridge Selection Guide

CARTRIDGE TYPE	WALL	CARBON TYPE	MICRON	PARTICLE SIZE	VERY HIGH SEDIMENT REMOVAL	VERY HIGH CHLORINE REDUCTION	CYSTS	VOCS	LEAD
MAXETW	Thick	Coconut shell	5	Medium					
MAXCYST	Thick	Coconut shell	0.5	Fine			•		
MAXVOC	Thick	Coconut shell	0.5	Fine			•	•	
MAXT	Thick	Coconut shell	5	Medium					
MAXPB	Thick	Coconut shell	0.5	Fine			•		•
MAXCL	Thick	Coconut shell	0.5	Fine		•			



C-MAX® carbon block cartridges are tested and certified by NSF International under NSF / ANSI Standard 42 for materials only. Performance claims are supported by company test results.

**NOTICE**

C-MAX cartridges are rated for temperatures to 165°F (74°C).

## Carbon Block Filters - C-Max

Full line of solid block activated carbon cartridges for water treatment.

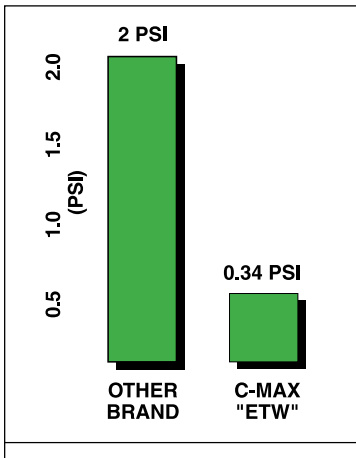

Low Pressure Drop

The chart above compares the pressure drop of MAXETW cartridges to another well known brand. This data demonstrates flow restrictions are dramatically reduced using MAXETW cartridges and not all carbon block cartridges perform the same.



### C-MAX®

**Your best choice when both price and performance are required!**

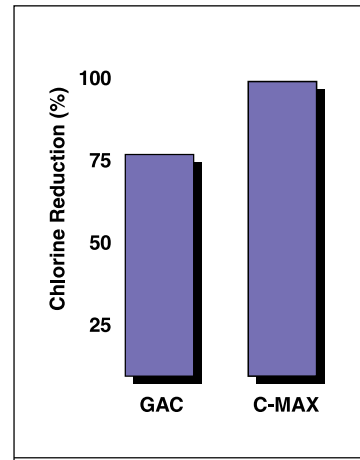

High Chlorine Reduction

Chlorine reduction with MAXETW carbon block cartridges is dramatically greater than other cartridge types, including granular activated carbon cartridges. The above data is typical for GAC and C-MAX cartridges during their usable life.

### MAX-ETW, Economical, thick wall carbon block cartridges for Chlorine taste and odor

MODEL NO.	TYPE	OD	LENGTH	MICRON RATING	CHLORINE REDUCTION	NO. / CASE
MAXETW-975	Thick Wall	2-7/8"	9-3/4"	5 nominal	3,000 gallons	12
MAXETW-20	Thick Wall	2-7/8"	20"	5 nominal	6,000 gallons	6
MAXETW-30	Thick Wall	2-7/8"	30"	5 nominal	9,000 gallons	6
MAXETW-FF975	Thick Wall	4-5/8"	9-3/4"	5 nominal	11,000 gallons	4
MAXETW-FF20	Thick Wall	4-5/8"	20"	5 nominal	20,000 gallons	6
MAXETW-SS	Candle	2-7/8"	9-3/4"	5 nominal	3,000 gallons	12

### MAX-CYST, Thick wall carbon block cartridges for fine particles, cyst reduction & extended Chlorine taste & odor reduction

MODEL NO.	TYPE	OD	LENGTH	MICRON RATING	CHLORINE REDUCTION	NO. / CASE
MAXCYST-975	Long life + cysts	2-7/8"	9-3/4"	0.5 nominal	20,000 gallons	12

## Carbon Block Filters - C-Max

Full line of solid block activated carbon cartridges for water treatment.

MAX-VOC, Coconut shell carbon block cartridges for reduction of VOC's, cysts and extended Chlorine taste and odor reduction

MODEL NO.	TYPE	OD	LENGTH	MICRON RATING	CHLORINE REDUCTION	NO. / CASE
MAXVOC-975	Water washed	2-7/8"	9-3/4"	0.5 nominal	20,000 gallons	12

MAX-T, Acid washed coconut shell carbon block cartridges for RO post treatment and improved, sweeter taste

MODEL NO.	TYPE	OD	LENGTH	MICRON RATING	CHLORINE REDUCTION	NO. / CASE
MAXT-975	Acid washed	2-7/8"	9-3/4"	5 nominal	5,000 gallons	12

MAX-PB, Coconut shell carbon block cartridges for lead and cyst reduction

MODEL NO.	TYPE	OD	LENGTH	MICRON RATING	CHLORINE REDUCTION	NO. / CASE
MAXPB-975	Lead + cysts	2-7/8"	9-3/4"	0.5 nominal	20,000 gallons	12
MAXPB-FF20	Lead + cysts	4-5/8"	20"	0.5 nominal	150,000 gallons	6

MAX-CL, Thick wall carbon block for long life and high chlorine reduction. Reduces tastes, odors, fine particles. The best choice when a "super chlorine guzzler" is needed!

MODEL NO.	TYPE	OD	LENGTH	MICRON RATING	CHLORINE REDUCTION	NO. / CASE
MAXCL-975	Thick Wall	2-7/8"	9-3/4"	0.5 nominal	20,000 gallons	12
MAXCL-20	Thick Wall	2-7/8"	20"	0.5 nominal	45,000 gallons	6
MAXCL-FF975	Thick Wall	4-5/8"	9-3/4"	0.5 nominal	70,000 gallons	4
MAXCL-FF20	Thick Wall	4-5/8"	20"	0.5 nominal	150,000 gallons	6

Premium quality and economically priced C-Max® cartridges are in stock for immediate shipment!



## Carbon Block Filters - Watts

*Thick wall carbon construction for superior performance. Low cost for economy!*

Top-of-the-line coconut shell carbon block filter cartridge for chlorine, taste, odor and sediment reduction.

- Competitively priced!
- Outperform GAC cartridges four ways:
  1. Superior chlorine reduction
  2. Lower pressure drop.
  3. Will not channel
  4. Lower cost
- 100% Coconut shell Carbon.
- Up to 99% chlorine reduction\*.
- FDA grade components & materials.

### Recommended Flow Rate

MODEL NO.	OD	LENGTH	GPM
F109009	2.5"	9-3/4"	1
F109020	2.5"	20"	2
WCBFF975	4.5"	9-3/4"	4
WCBFF20	4.5"	20"	8



Maximum operating pressure: 125 PSIG  
 Operating temperature: 50° F to 125° F  
 10° C to 52° C  
 \*Performance tested @ flow with 2ppm chlorine.

\* Tested and verified by independent laboratory testing.

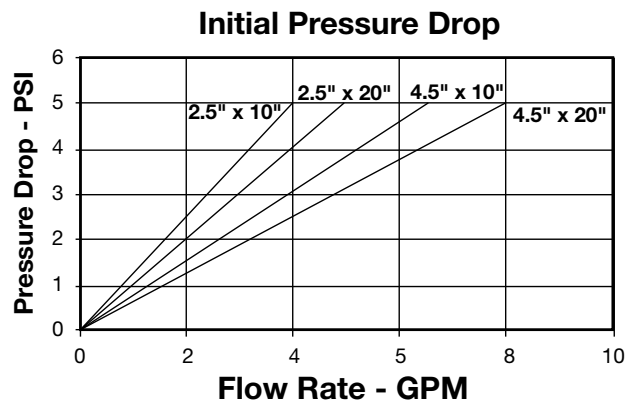

MODEL NO.	TYPE	OD	LENGTH	MICRON RATING*	CHLORINE REDUCTION*	NO. / CASE
F109009	Thick Wall	2.5"	9-3/4"	5 nominal	>4,000 Gal @ 1 gpm	25
F109020	Thick Wall	2.5"	20"	5 nominal	>8,000 Gal @ 2 gpm	25
WCBFF975	Thick Wall	4.5"	9-3/4"	5 nominal	>10,000 Gal @ 2 gpm	4
WCBFF20	Thick Wall	4.5"	20"	5 nominal	>20,000 Gal @ 4 gpm	4

## Carbon Filters – Pentair

MODEL NO.	DESCRIPTION
S7700A	AC PAPER 9 7/8 IN C1 T AND O 24 CASE NSF
S7704A	AC PAPER 4 7/8 IN C2 T AND O 24 CASE
S7722A	AC BLOCK 9 7/8 IN .5M CBC-10 12 CASE
S7712	AC GRANULAR 9 7/8 IN CC-10 COCONUT 12 CASE
S7817X	BB AC BLOCK 10 IN 5M EP-BB 4 CASE
S7723XA	AC BLOCK 20 IN 5M EP-20 EPSILON 6 CASE
S7811XA	BB AC BLOCK 20 IN 5M EP-20BB EPSILON 4 CASE
S7844	CARBON BLOCK 10 IN 10 MICRON 12 CASE
S7845	CARBON BLOCK EPM-BB 4 CASE
S7846	CARBON BLOCK EPM-20 6 CASE
S7708	AC GRANULAR 9 7/8 IN GAC-10 LIGNITE 12 CASE
S7812	BB AC GRANULAR 10 IN GAC-BB 8 CASE
S7732	AC GRANULAR 20 IN GAC-20 6 CASE
S7814	BB AC GRANULAR 20 IN GAC-BB 20 4 CASE
S7816	BB AC GRANULAR 10 IN 25M RADIAL FLOW RFC-BB 8 CASE
S7815	BB AC GRANULAR 20 IN 25M RFC-BB-20 6 CASE

## GAC Filters – Flowmatic

Water Washed Coconut Shell Granular Activated carbon Cartridges (GAC)

MODEL NO.	TYPE	O.D.	LENGTH	CAPACITY (GALS.)	NO. / CASE
GAC10N	GAC	2-3/4"	9-3/4"	2,500	24
GAC20NRW	GAC	2-3/4"	20"	5,000	24
GAC-BB10	GAC	4-1/2"	9-3/4"	7,500	8
GAC-BB20	GAC	4-1/2"	20"	15,000	4
GAC10S	GAC - Silver	2-3/4"	9-3/4"	2,500	24

## Bag Filters – Pentair

MODEL NO.	DESCRIPTION
S7241	25 BAG FILTER 10 IN BB 25M POLY 20 CASE
S7241-10	BAG FILTER 10 IN BB 10M POLY 20 CASE
S7241-5	BAG FILTER 10 IN BB 5M POLY 20 CASE
S7241-50	BAG FILTER 10 IN BB 50M POLY 20 CASE
S7242-1	BAG FILTER 20 IN BB 1M POLY 20 CASE
S7242-10	BAG FILTER 20 IN BB 10M POLY 20 CASE
S7242-100	BAG FILTER 20 IN BB 100M POLY 20 CASE
S7242-10-HE	BAG FILTER 20 IN BB HIGH EFFICIENCY 10M POLY 20 CASE
S7242-25	BAG FILTER 20 IN BB 25M POLY 20 CASE
S7242-5	BAG FILTER 20 IN BB 5M POLY 20 CASE

MODEL NO.	DESCRIPTION
S7604A	SED SPUN 9 7/8 IN 5M P5 PP
S7621-P	POLYDEPTH 9 7/8 IN 25M PD-25-934 24 CASE
S7645	BB SED SPUN 10 IN DGD DUAL GRADIENT PRE 25 POST 1MIC
S7645-20	BB SED SPUN 20 IN DGD DUAL GRADIENT PRE 25 POST1 MIC
S7646	BB SED SPUN 10 IN DGD DUAL GRADIENT PRE 50 POST 5MIC
S7646-20	BB SED SPUN 20 IN DGD DUAL GRADIENT PRE 50 POST 5MIC
S7648	SED SPUN 20.0 IN 5M PP P5-20 20 CASE
S7649	SED SPUN 20.0 IN 25M PP P25-20 20 CASE
S7686-P	POLYDEPTH 20 IN 25M PD-25-20 20 CASE
S7715-P	POLYDEPTH 9 7/8 IN 5M PD-510
S7719-P	POLYDEPTH 20 IN 5M PD-5-20 20CASE

## Inline Filters

Inline filters for reverse osmosis systems, ice makers and other water treatment needs.

### Inline Filters

For pre & post RO and ice maker filtration.

- AICRO® (our best selling in-line filter)
  - AICRO-JGK\* (With J. Guest fittings.)
- \*Coconut shell activated carbon. Rated for flow rates to 0.75. GPM and 1,500 gallons capacity



CERTIFIED  
ANSI / NSF  
STANDARD 42  
(AICRO)

### Coconut Shell GAC

MODEL NO.	O.D.	LENGTH	MEDIA	TYPE	FITTING SIZE	FITTING TYPE	NO./CASE
AICRO	2"	10"	GAC	Coconut shell	1/4"	FNPT	25
AICRO-JGK	2"	10"	GAC	Coconut shell	1/4"	Quick ct	25
K2533SS	2"	10"	GAC	Coconut shell	1/4"	JG Elbow	25
CL6ROT33	2"	6"	GAC	Acid wash coconut shell	1/4"	FNPT	25
CL10ROT33	2"	10"	GAC	Acid wash coconut shell	1/4"	FNPT	25
K2333JJ	2"	6"	GAC	Acid wash coconut shell	1/4"	J. Guest	25
K2533JJ	2"	10"	GAC	Acid wash coconut shell	1/4"	J. Guest	25
GS10ROB	2"	10"	GAC	Coconut shell	1/4"	FNPT	25

### GAC With Phosphate For Scale Reduction

MODEL NO.	O.D.	LENGTH	MEDIA	TYPE	FITTING SIZE	FITTING TYPE	NO./CASE
SCL10	2"	10"	GAC	Phosphate	1/4"	FNPT	25

### Inline Filters With GAC And Calcite To Raise TDS

MODEL NO.	O.D.	LENGTH	MEDIA	TYPE	FITTING SIZE	FITTING TYPE	NO./CASE
GS10CAL/ROB	2"	10"	GAC	With Calcite	1/4"	FNPT	25

### Inline Filters For Sediment

MODEL NO.	O.D.	LENGTH	MEDIA	TYPE	FITTING SIZE	FITTING TYPE	NO./CASE
AIPRO	2"	10"	PP SPUN	5	1/4"	FNPT	25
CL10PF5	2"	10"	PP SPUN	5	1/4"	FNPT	25
K2505JJ	2"	10"	PP SPUN	5	1/4"	J. Guest	25
K5605JJ	2-1/2"	12"	PP SPUN	5	1/4"	J. Guest	25

#### WARNING

Do not use filters listed in this section with water that is microbiologically unsafe or unknown quality without proper disinfection before or after the filter.

## Sediment Cartridges Selection Guide

Model No.	Brands	OD (IN)	Length (IN)	Micron Rating (Nominal)	Flow Rate (GPM)	Filter Style		
						Pleated	Spun - Melt Blown	String Wound
<b>2-1/2 IN OD Cartridges</b>								
FPMB1-5	FlowPro	2 1/2	5	1	1		✓	
FPMB5-5	FlowPro	2 1/2	5	5	2		✓	
FPMB20-5	FlowPro	2 1/2	5	20	3		✓	
FPMB50-5	FlowPro	2 1/2	5	50	4		✓	
FPP-0.2-975-DOE	Flow-Max HP	2 1/2	9 3/4	0.2		✓		
FPP-0.45-975-DOE	Flow-Max HP	2 1/2	9 3/4	0.45		✓		
FPP-1-975-DOE	Flow-Max HP	2 1/2	9 3/4	1		✓		
FPMBG-5-975	FlowPro	2 1/2	9 3/4	5	5		✓	
FPP-5-975-DOE	Flow-Max HP	2 1/2	9 3/4	5		✓		
FPMBG-20-975	FlowPro	2 1/2	9 3/4	20	6		✓	
FPMB1-978	FlowPro	2 1/2	9 7/8	1	3		✓	
I7516-P2600	Pentair	2 1/2	9 7/8	5	10	✓		
FPMB10-978	FlowPro	2 1/2	9 7/8	10	5		✓	
S7601A	Pentair	2 1/2	9 7/8	20	5	✓		
FPMB20-978	FlowPro	2 1/2	9 7/8	20	6		✓	
FPMB5-978	FlowPro	2 1/2	9 7/8	25	5		✓	
FPMB50-978	FlowPro	2 1/2	9 7/8	50	9		✓	
FPP-0.2-10-222	Flow-Max HP	2 1/2	10	0.2		✓		
FPP-0.2-10-222F	Flow-Max HP	2 1/2	10	0.2		✓		
FPP-1-10-222	Flow-Max HP	2 1/2	10	1		✓		
SF1-978	Watts	2 1/2	10	1				✓
FPP-5-10-222	Flow-Max HP	2 1/2	10	5		✓		
SF5-978	Watts	2 1/2	10	5				✓
MS10FS5	Watts	2 1/2	10	5				✓
SF20-978	Watts	2 1/2	10	20				✓
MS10FS20	Watts	2 1/2	10	20				✓
SF50-978	Watts	2 1/2	10	50				✓
MS10FS50	Watts	2 1/2	10	50				✓
FPP-0.2-20-DOE	Flow-Max HP	2 1/2	20	0.2		✓		
FPP-0.2-20-222	Flow-Max HP	2 1/2	20	0.2		✓		
FPP-0.2-20-222F	Flow-Max HP	2 1/2	20	0.2		✓		
FPP-0.45-20-DO	Flow-Max HP	2 1/2	20	0.45		✓		
FPMB1-20	FlowPro	2 1/2	20	1	6		✓	
FPP-1-20-DOE	Flow-Max HP	2 1/2	20	1		✓		
FPP-1-20-222	Flow-Max HP	2 1/2	20	1		✓		
SF1-20	Watts	2 1/2	20	1				✓
FPMB5-20	FlowPro	2 1/2	20	5	10		✓	
FPMBG-5-20	FlowPro	2 1/2	20	5	10		✓	
FPP-5-20-DOE	Flow-Max HP	2 1/2	20	5		✓		
FPP-5-20-222	Flow-Max HP	2 1/2	20	5		✓		
SF5-20	Watts	2 1/2	20	5				✓
MS20FS5	Watts	2 1/2	20	5				✓
FPMB20-20	FlowPro	2 1/2	20	20	12		✓	
SF20-20	Watts	2 1/2	20	20				✓
MS20FS20	Watts	2 1/2	20	20				✓
FPMB50-20	FlowPro	2 1/2	20	50	18		✓	
SF50-20	Watts	2 1/2	20	50				✓
FPMB5-2925	FlowPro	2 1/2	29 1/2	5	15		✓	
FPP-0.2-30-DOE	Flow-Max HP	2 1/2	30	0.2		✓		
FPP-0.2-30-222	Flow-Max HP	2 1/2	30	0.2		✓		
FPP-0.2-30-222F	Flow-Max HP	2 1/2	30	0.2		✓		
FPP-0.45-30-DOE	Flow-Max HP	2 1/2	30	0.45		✓		
FPMB1-30	FlowPro	2 1/2	30	1	9		✓	
FPP-1-30-DOE	Flow-Max HP	2 1/2	30	1		✓		
FPP-1-30-222	Flow-Max HP	2 1/2	30	1		✓		
SF1-30	Watts	2 1/2	30	1				✓
FPMB5-30	FlowPro	2 1/2	30	5	15		✓	
FPP-5-30-DOE	Flow-Max HP	2 1/2	30	5		✓		
FPP-5-30-222	Flow-Max HP	2 1/2	30	5		✓		
SF5-30	Watts	2 1/2	30	5				✓
MS30FS5	Watts	2 1/2	30	5				✓

## Sediment Cartridges Selection Guide cont.

Model No.	Brands	OD (IN)	Length (IN)	Micron Rating (Nominal)	Flow Rate (GPM)	Filter Style		
						Pleated	Spun - Melt Blown	String Wound
<b>2-1/2 IN OD Cartridges (cont.)</b>								
FPMB20-30	FlowPro	2 1/2	30	20	18		✓	
SF20-30	Watts	2 1/2	30	20				✓
MS30FS20	Watts	2 1/2	30	20				✓
FPMB50-30	FlowPro	2 1/2	30	50			✓	
FPP-0.2-40-222	Flow-Max HP	2 1/2	40	0.2		✓		
FPP-0.2-40-222F	Flow-Max HP	2 1/2	40	0.2		✓		
FPP-0.45-40-DOE	Flow-Max HP	2 1/2	40	0.45		✓		
FPMB1-40	FlowPro	2 1/2	40	1	12		✓	
FPP-1-40-DOE	Flow-Max HP	2 1/2	40	1		✓		
FPP-1-40-222	Flow-Max HP	2 1/2	40	1		✓		
SF1-40	Watts	2 1/2	40	1				✓
FPMB5-40	FlowPro	2 1/2	40	5	20		✓	
FPP-5-40-DOE	Flow-Max HP	2 1/2	40	5		✓		
FPP-5-40-222	Flow-Max HP	2 1/2	40	5		✓		
SF5-40	Watts	2 1/2	40	5				✓
MS40FS5	Watts	2 1/2	40	5				✓
FPMB20-40	FlowPro	2 1/2	40	20			✓	
SF20-40	Watts	2 1/2	40	20				✓
MS40FS20	Watts	2 1/2	40	20				✓
FPMB50-40	FlowPro	2 1/2	40	50			✓	
<b>2-3/4 IN OD Cartridges</b>								
FM-0.35-975	Flow-Max	2 3/4	9 3/4	0.35	3	✓		
FM-1-975	Flow-Max	2 3/4	9 3/4	1	4	✓		
FM-5-975	Flow-Max	2 3/4	9 3/4	5	7	✓		
FM-20-975	Flow-Max	2 3/4	9 3/4	20	8	✓		
FM-50-975	Flow-Max	2 3/4	9 3/4	50	10	✓		
FM-100-975	Flow-Max	2 3/4	9 3/4	100	12	✓		
FM-1A-975	Flow-Max	2 3/4	9 3/4	1A	3	✓		
WPC1-975	Watts	2 3/4	10	1	4	✓		
WPC5-975	Watts	2 3/4	10	5	7	✓		
WPC20-975	Watts	2 3/4	10	20	8	✓		
WPC50-975	Watts	2 3/4	10	50	10	✓		
FM-1-195	Flow-Max	2 3/4	19 1/2	1	8	✓		
FM-5-195	Flow-Max	2 3/4	19 1/2	5	14	✓		
FM-20-195	Flow-Max	2 3/4	19 1/2	20	16	✓		
FM-0.35-20	Flow-Max	2 3/4	20	0.35	8	✓		
FM-1-20	Flow-Max	2 3/4	20	1	8	✓		
WPC1-20	Watts	2 3/4	20	1	8	✓		
FM-5-20	Flow-Max	2 3/4	20	5	8	✓		
WPC5-20	Watts	2 3/4	20	5	14	✓		
FM-20-20	Flow-Max	2 3/4	20	20	14	✓		
WPC20-20	Watts	2 3/4	20	20	16	✓		
FM-50-20	Flow-Max	2 3/4	20	50	16	✓		
WPC50-20	Watts	2 3/4	20	50	20	✓		
FM-1A-20	Flow-Max	2 3/4	20	1A	6	✓		
FM-0.35-2925	Flow-Max	2 3/4	29 1/4	0.35	12	✓		
FM-1-2925	Flow-Max	2 3/4	29 1/4	1	12	✓		
WPC1-2925	Watts	2 3/4	29 1/4	1	12	✓		
FM-5-2925	Flow-Max	2 3/4	29 1/4	5	21	✓		
WPC5-2925	Watts	2 3/4	29 1/4	5	21	✓		
FM-20-2925	Flow-Max	2 3/4	29 1/4	20	24	✓		
WPC20-2925	Watts	2 3/4	29 1/4	20	24	✓		
FM-50-2925	Flow-Max	2 3/4	29 1/4	50	30	✓		
WPC50-2925	Watts	2 3/4	29 1/4	50	30	✓		
FM-1A-2925	Flow-Max	2 3/4	29 1/4	1A	9	✓		
FM-1-40	Flow-Max	2 3/4	40	1	16	✓		
FM-5-40	Flow-Max	2 3/4	40	5	28	✓		
WPC5-40	Watts	2 3/4	40	5	28	✓		
FM-20-40	Flow-Max	2 3/4	40	20	32	✓		
WPC20-40	Watts	2 3/4	40	20	32	✓		
FM-50-40	Flow-Max	2 3/4	40	50	40	✓		
WPC50-40	Watts	2 3/4	40	50	40	✓		

## Sediment Cartridges Selection Guide cont.

Model No.	Brands	OD (IN)	Length (IN)	Micron Rating (Nominal)	Flow Rate (GPM)	Filter Style		
						Pleated	Spun - Melt Blown	String Wound
<b>4-1/2 IN OD Cartridges</b>								
FM-BB-10-0.35	Flow-Max	4 1/2	9 3/4	0.35	9	✓		
FM-BB-20-0.35	Flow-Max	4 1/2	20	0.35	13	✓		
FM-BB-10-1	Flow-Max	4 1/2	9 3/4	1	10	✓		
FM-BB-20-1	Flow-Max	4 1/2	20	1	15	✓		
WPC1FF975	Watts	4 1/2	9 3/4	1	10	✓		
FPMB-BB1-10	FlowPro	4 1/2	9 3/4	1			✓	
FM-BB-10-5	Flow-Max	4 1/2	9 3/4	5	15	✓		
FM-BB-20-5	Flow-Max	4 1/2	20	5	25	✓		
WPC5FF975	Watts	4 1/2	9 3/4	5	15	✓		
FPMB-BB5-10	FlowPro	4 1/2	9 3/4	5			✓	
FM-BB-10-20	Flow-Max	4 1/2	9 3/4	20	15	✓		
FM-BB-20-20	Flow-Max	4 1/2	20	20	25	✓		
WPC20FF975	Watts	4 1/2	9 3/4	20	15	✓		
FPMB-BB20-10	FlowPro	4 1/2	9 3/4	20			✓	
FM-BB-10-50	Flow-Max	4 1/2	9 3/4	50	15	✓		
FM-BB-20-50	Flow-Max	4 1/2	20	50	25	✓		
WPC50FF975	Watts	4 1/2	9 3/4	50	15	✓		
FPMB-BB50-10	FlowPro	4 1/2	9 3/4	50			✓	
FM-BB-10-1A	Flow-Max	4 1/2	9 3/4	1A	8	✓		
FM-BB-20-1A	Flow-Max	4 1/2	20	1A	12	✓		
S7616A	Pentair	4 1/2	9 7/8	30	10	✓		
SF1-10-425	Watts	4 1/2	10	1				✓
S7809	Pentair	4 1/2	10	5	20	✓		
SF5-10-425	Watts	4 1/2	10	5				✓
S7805	Pentair	4 1/2	10	20	10	✓		
SF20-10-425	Watts	4 1/2	10	20				✓
S7800	Pentair	4 1/2	10	30	10	✓		
S7804A	Pentair	4 1/2	10	50	10	✓		
SF50-10-425	Watts	4 1/2	10	50				✓
WPC1FF20	Watts	4 1/2	20	1	15	✓		
FPMB-BB1-20	FlowPro	4 1/2	20	1			✓	
SF1-20-425	Watts	4 1/2	20	1				✓
S7807	Pentair	4 1/2	20	5	20	✓		
WPC5FF20	Watts	4 1/2	20	5	25	✓		
FPMB-BB5-20	FlowPro	4 1/2	20	5			✓	
SF5-20-425	Watts	4 1/2	20	5				✓
S7803	Pentair	4 1/2	20	20	10	✓		
WPC20FF20	Watts	4 1/2	20	20	25	✓		
FPMB-BB20-20	FlowPro	4 1/2	20	20			✓	
SF20-20-425	Watts	4 1/2	20	20				✓
S7807-R	Pentair	4 1/2	20	30	20	✓		
WPC50FF20	Watts	4 1/2	20	50	25	✓		
FPMB-BB50-20	FlowPro	4 1/2	20	50			✓	
SF50-20-425	Watts	4 1/2	20	50				✓
<b>Inline Encapsulated Cartridges</b>								
AIPRO	Watts	2	10		0.75		✓	
CL10PF5	Watts	2	10		0.75		✓	
K2505JJ	Watts	2	10		0.75		✓	
K5605JJ	Watts	2 1/2	12		0.75		✓	
<b>Quick-Change Encapsulated Proprietary Cartridges</b>								
WQCSC10	Watts	2 1/2	10	5				
WQCSC11	Watts	2 1/2	11	5				
WQCSC13	Watts	2 1/2	13	5				

## FlowPro® Melt Blown Cartridges

### Features & Benefits

- Low cost
- Excellent chemical resistance
- Food grade for food and beverages
- No media migration
- High dirt holding capacity
- Wide range of lengths
- Five micron ratings

### Applications

- Potable water
- Beverages
- Pre-filtration for RO
- Fine chemicals
- Electronics
- Metal finishing
- Plating solutions
- And more!

### Specifications

Material	Melt blown polypropylene
Maximum temperature	140° F / 60° C
Maximum pressure	40 PSID
Recommended change out	30 PSID
Maximum flow rate	2-8 GPM based on micron
Cartridge packaging	Shrink wrapped for purity

**Best Seller  
and  
Value Priced!**



Component certified to NSF/ANSI Standard 42

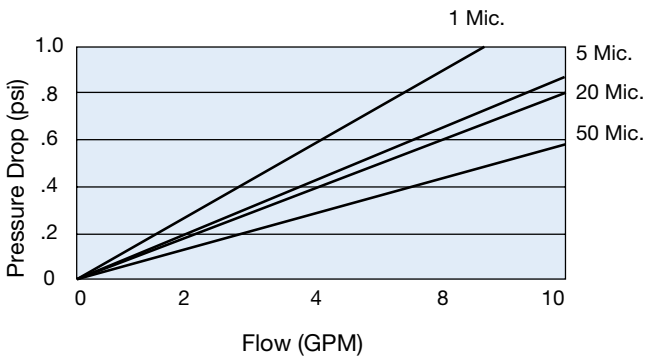

## Flow-Pro® Melt Blown Cartridges

Standard Diameter (2-1/2")

5"

MODEL	LENGTH	OD	MICRON	NO. / CASE
FPMB1-5	5"	2-1/2"	1	48
FPMB5-5	5"	2-1/2"	5	48
FPMB20-5	5"	2-1/2"	20	48
FPMB50-5	5"	2-1/2"	50	48

9-7/8"

FPMB1-978	9-7/8"	2-1/2"	1	48
FPMB5-978	9-7/8"	2-1/2"	25	48
FPMB10-978	9-7/8"	2-1/2"	10	48
FPMB20-978	9-7/8"	2-1/2"	20	48
FPMB50-978	9-7/8"	2-1/2"	50	48

20"

FPMB1-20	20"	2-1/2"	1	24
FPMB5-20	20"	2-1/2"	5	24
FPMB20-20	20"	2-1/2"	20	24
FPMB50-20	20"	2-1/2"	50	24

29-1/4"

FPMB5-2925	29-1/4"	2-1/2"	5	24
------------	---------	--------	---	----

30"

FPMB1-30	30"	2-1/2"	1	24
FPMB5-30	30"	2-1/2"	5	24
FPMB20-30	30"	2-1/2"	20	24
FPMB50-30	30"	2-1/2"	50	24

40"

FPMB1-40	40"	2-1/2"	1	24
FPMB5-40	40"	2-1/2"	5	24
FPMB20-40	40"	2-1/2"	20	24
FPMB50-40	40"	2-1/2"	50	24

### Full-Flow 9-3/4" x 4-1/2" O.D. Cartridges

MODEL NO.	LENGTH	OD	MICRON	NO. / CASE
FPMB-BB1-10	9-3/4"	4-1/2"	1	24
FPMB-BB5-10	9-3/4"	4-1/2"	5	24
FPMB-BB20-10	9-3/4"	4-1/2"	20	24
FPMB-BB50-10	9-3/4"	4-1/2"	50	24

### Full-Flow 20"x 4-1/2" O.D. Cartridges

MODEL NO.	LENGTH	OD	MICRON	NO. / CASE
FPMB-BB1-20	20"	4-1/2"	1	12
FPMB-BB5-20	20"	4-1/2"	5	12
FPMB-BB20-20	20"	4-1/2"	20	12
FPMB-BB50-20	20"	4-1/2"	50	12

### Grooved Cartridges For Increased Surface Area

MODEL NO.	LENGTH	OD	MICRON	NO. / CASE
FPMBG-5-975	9-3/4"	2-1/2"	5	48
FPMBG-20-975	9-3/4"	2-1/2"	20	48
FPMBG-1-20	20"	2-1/2"	1	24
FPMBG-5-20	20"	2-1/2"	5	24



## Pleated Filter Cartridges – Flow-Max

*Greater surface area for longer life and reduced filtration costs.*

Flow-Max filter cartridges outperform wound, spun, melt blown, resin bonded and other “depth” type filter elements because our cartridges are pleated to provide increased surface area and longer life.

Lower pressure drop is another significant advantage, using Flow-Max pleated cartridges, which allows for increased flow rates and the use of smaller filter housings to reduce capital equipment costs.

Further savings are provided because our 100% synthetic filter media is cleanable, five micron and up, to lower cartridge replacement costs.



Flow-Max filter cartridges outperform other pleated elements because our high-performance filter media is systematically produced using 100% synthetic fibers, with no binders or additives to leave a residue, foam or contaminate.

Our filter media is dramatically thicker than other products. For this reason, Flow-Max cartridges provide “depth” filtration for greater sediment removal, along with more surface area with our pleated design.

A multi-ply laminate is used with our sub and one micron absolute grades for longer life and greater solids removal. (See right.)



### Features

- Filter media is pleated for greater surface area.
- Synthetic filter media is cellulose-free.
- “Thicker” filter media has a greater capacity to capture and retain particles, compared to thin, more rigid media types, which have less void space for particle retention.
- One micron absolute and 0.35 media use a multi-ply laminate for superior performance.
- Long lengths have netting to hold pleats in place.
- All cartridge types and lengths are wrapped.
- Full product line (types, lengths & micron ratings).

### Benefits

- Low pressure drop; long life; reduced filtration costs, compared to wound and spun cartridges.
- No additives or binders, which may cause foaming.
- Increased dirt holding capacity; longer life; fewer cartridge replacements needed; and reduced filtration costs, compared to other pleated cartridge suppliers.
- Increased particle removal efficiency; longer life; and reduced cost per gallon filtered.
- Superior performance and appearance.
- Provides security at no additional cost.
- Greater selection from your single source supplier!

*Flow-Max® cartridges cost less to use . . . regardless what they cost to buy!*

## Pleated Filter Cartridges – Flow-Max

### Lower pressure drop for higher flow rates

Flow-Max® cartridges are pleated, so initial pressure drop is significantly less compared to depth cartridges, such as a wound, spun, melt blown and resin bonded. As a result, higher flow rates are possible, reducing filter housing size requirements to lower capital equipment costs.

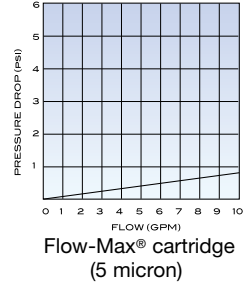
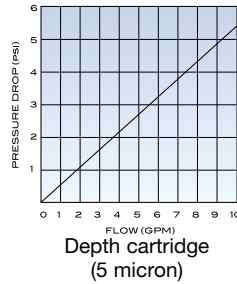

Use the pressure drop charts shown below to help determine the ideal flow rate for your particular application:

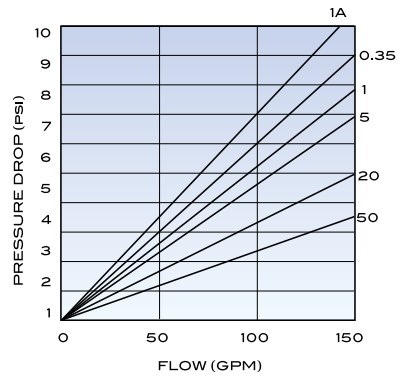
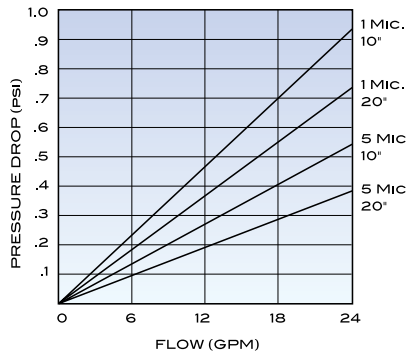
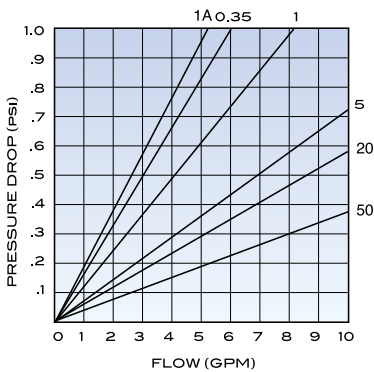

**Note:** Pressure drop data shown above include filter housing and cartridge.

### Flow rates

Maximum flow rate guidelines for Flow-Max cartridges are shown below:

### Maximum Flow Rates Per Cartridge (GPM)

MICRON RATING	STANDARD CARTRIDGE			10" FULL-FLOW	20" FULL-FLOW	JUMBO CARTRIDGE		
	9-3/4"	20"	29-1/4"			40	90	170
1 Absolute	3	6	9	8	12	20	40	80
0.35 Micron	4	8	12	9	13	25	50	100
1 Micron	4	8	12	10	15	30	60	120
5 Micron	7	14	21	15	25	50	100	150
20 Micron	8	16	24	15	25	50	100	150
50 Micron	10	20	30	15	25	50	100	150

**NOTICE**

Filter housing selection should also be considered when flow rate per cartridge is determined.



### Washable & reusable

Flow-Max® cartridges are washable and reusable, five micron and up to reduce filtration costs. For best results, direct spray into pleats to dislodge sediment. Or, let dry and brush off filter cake from surface of the media.

**All Flow-Max® cartridges are individually shrink wrapped for purity**



## Pleated Filter Cartridges – Flow-Max

Greater surface area for longer life and reduced filtration costs.

### Standard 2-3/4" OD x 9-3/4" Length

MODEL NO.	MEDIA TYPE	MICRON RATING	NUMBER PER CASE
FM-1A-975	Synthetic	1 Absolute	24
FM-0.35-975	Synthetic	0.35	24
FM-1-975	Synthetic	1	24
FM-5-975	Synthetic	5	24
FM-20-975	Synthetic	20	24
FM-50-975	Synthetic	50	24
FM-100-975	Synthetic	100	24

### Standard 2-3/4" OD x 19-1/2" Length

MODEL NO.	MEDIA TYPE	MICRON RATING	NUMBER PER CASE
FM-1-195	Synthetic	1	24
FM-5-195	Synthetic	5	24
FM-20-195	Synthetic	20	24

### Standard 2-3/4" OD x 20" Length

MODEL NO.	MEDIA TYPE	MICRON RATING	NUMBER PER CASE
FM-1A-20	Synthetic	1 Absolute	24
FM-0.35-20	Synthetic	0.35	24
FM-1-20	Synthetic	1	24
FM-5-20	Synthetic	5	24
FM-20-20	Synthetic	20	24
FM-50-20	Synthetic	50	24

### Standard 2-3/4" OD x 29-1/4" Length

MODEL NO.	MEDIA TYPE	MICRON RATING	NUMBER PER CASE
FM-1A-2925	Synthetic	1 Absolute	24
FM-0.35-2925	Synthetic	0.35	24
FM-1-2925	Synthetic	1	24
FM-5-2925	Synthetic	5	24
FM-20-2925	Synthetic	20	24
FM-50-2925	Synthetic	50	24

### Standard 2-3/4" OD x 40" Length

MODEL NO.	MEDIA TYPE	MICRON RATING	NUMBER PER CASE
FM-1-40	Synthetic	1	24
FM-5-40	Synthetic	5	24
FM-20-40	Synthetic	20	24
FM-50-40	Synthetic	50	24

### Specifications

Filter media	Synthetic (100% cellulose-free)
End caps	Plastisol (PVC)
Center tubes	Polypropylene
Temperature range	40°F - 140°F (4.4°C - 60°C)
Maximum Pressure	40 PSID
Recommended change out	20 - 30 PSID
Flow rate per 10" cartridge	3-10 GPM, depending on micron rating



## Pleated Filter Cartridges – Flow-Max

Greater surface area for longer life and reduced filtration costs.



### Highly efficient, five ply filter media

Our one micron absolute and 0.35 micron filter cartridges use a five ply filter media for greater efficiency and longer life. They are ideal for surface water filtration to reduce Cryptosporidium and Giardia cysts.

### Full-Flow 4-1/2" OD x 9-3/4" Length

MODEL NO.	LENGTH	MEDIA TYPE	MICRON RATING	NUMBER PER CASE
FM-BB-10-1A	9-3/4"	Synthetic	1 Absolute	8
FM-BB-10-0.35	9-3/4"	Synthetic	0.35	8
FM-BB-10-1	9-3/4"	Synthetic	1	8
FM-BB-10-5	9-3/4"	Synthetic	5	8
FM-BB-10-20	9-3/4"	Synthetic	20	8
FM-BB-10-50	9-3/4"	Synthetic	50	8

**Note:** Cartridges listed above fit in Full-Flow filter housings.

### Full-Flow 4-1/2" OD x 20" Length

MODEL NO.	LENGTH	MEDIA TYPE	MICRON RATING	NUMBER PER CASE
FM-BB-20-1A	20"	Synthetic	1 Absolute	4
FM-BB-20-0.35	20"	Synthetic	0.35	4
FM-BB-20-1	20"	Synthetic	1	4
FM-BB-20-5	20"	Synthetic	5	4
FM-BB-20-20	20"	Synthetic	20	4
FM-BB-20-50	20"	Synthetic	50	4

**Note:** Cartridges listed above fit in Full-Flow filter housings.

### Specifications (synthetic media for sediment)

Maximum temperature	140°F (60°C)	Center tubes	PVC
Minimum temperature	40°F (4.4°C)	End caps	Molded Urethane
Maximum pressure	40 PSID	Maximum flow rate, model 40	50 GPM (12m <sup>3</sup> HR)
Recommended change out	25-30 PSID	Maximum flow rate, model 90	100 GPM (24m <sup>3</sup> HR)
Filter media	PE & PP	Maximum flow rate, model 170	150 GPM (36m <sup>3</sup> HR)

## Pleated Filter Cartridges – Flow-Max HP Series

### High Efficiency Pleated Filter Cartridges

Flow-Max HP series filter cartridges are cost effective, disposable, filter elements for a wide range of applications. Flow-Max HP cartridges are constructed of highly efficient pleated polypropylene filter media with extended filter area to provide high flow rates, low pressure drop and increased dirt holding capacity.

#### Features

- 100% polypropylene
- Ratings from 0.2 to 50 micron
- FDA listed polypropylene components
- Removal efficiencies to 99.98%
- High surface area
- Long service life & reduced maintenance costs
- Fixed pore construction for reliability

#### Applications

- High purity water
- Traps for DI resin
- Electronics
- Pre filtration for RO
- Magnetic tape coatings
- Aqueous solutions
- Plating solutions
- Chemicals
- Cosmetics
- Inks
- Food & beverage
- Bottled water
- Edible oils
- Waste water

#### Specifications

COMPONENTS	DATA
Filter media	Polypropylene
End caps	Polypropylene
Center tubes	Polypropylene
Cage	Polypropylene
Gaskets & o-rings	EPDM, standard. (Buna-N, Viton and Silicone are optional.)
Micron ratings	0.2, 0.45, 1, 2, 5, 10, 25 & 50
Operating temperature	175° F (80° C) maximum
Collapse pressure	130 psid (8.9 bar) maximum
Change out	35 psid (2.4 bar) maximum
FDA	All materials comply with FDA 174.5, 177.1520 & 177.1630 for contact with foods & beverages

#### Dimensions

Nominal lengths	4-7/8", 9-3/4", 10", 20", 30" & 40"
Outside diameter	2.5" (6.35 cm)
Inside diameter	1.0" (2.54 cm)



#### Filter Removal Efficiency

BETA RATIO	10000	5000	100	50	10
EFFICIENCY	99.99%	99.98%	99%	98%	90%
0.2 micron	0.35	0.2	0.1	----	----
0.45	0.6	0.45	0.3	0.2	----
1 micron	1.2	1.0	0.6	0.3	0.25
2 micron	2.5	2.0	1.5	1.0	0.8
5 micron	8.0	5.0	4.0	3.0	2.0
10 micron	13.0	10.0	8.0	7.0	5.0
25 micron	32.0	25.0	19.0	15.0	13.0
50 micron	66.0	50.0	44.0	32.0	26.0

Relative performance data was developed using laboratory tests, which may be used for guidelines in cartridge selection. The single-pass test method was used with particle counters and 3 GPM flow per 10" cartridge. Results vary, and actual field tests may be necessary to determine final cartridge selection.

#### Initial pressure drop per 10" cartridge

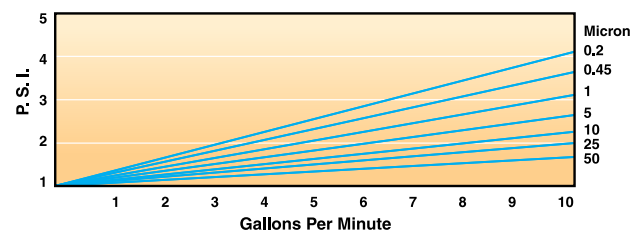

DOE



222 or 226 / Flat



222 or 226 / Fin

## Pleated Filter Cartridges – Flow-Max HP Series

MODEL NO.	MICRON	LENGTH	END CAP	NO./CASE	SHIP WEIGHT
FPP-0.2-975-DOE	0.2	9-3/4"	DOE	24	12 lbs.
FPP-0.2-20-DOE	0.2	20"	DOE	12	11 lbs.
FPP-0.2-30-DOE	0.2	30"	DOE	12	17 lbs.
FPP-0.2-40-DOE	0.2	40"	DOE	12	21 lbs.
FPP-0.2-10-222	0.2	10"	222 / flat	24	12 lbs.
FPP-0.2-20-222	0.2	20"	222 / flat	12	11 lbs.
FPP-0.2-30-222	0.2	30"	222 / flat	12	17 lbs.
FPP-0.2-40-222	0.2	40"	222 / flat	12	21 lbs.
FPP-0.2-10-222F	0.2	10"	222 / fin	24	12 lbs.
FPP-0.2-20-222F	0.2	20"	222 / fin	12	11 lbs.
FPP-0.2-30-222F	0.2	30"	222 / fin	12	17 lbs.
FPP-0.2-40-222F	0.2	40"	222 / fin	12	21 lbs.
FPP-0.45-975-DOE	0.45	9-3/4"	DOE	24	12 lbs.
FPP-0.45-20-DOE	0.45	20"	DOE	12	11 lbs.
FPP-0.45-30-DOE	0.45	30"	DOE	12	17 lbs.
FPP-0.45-40-DOE	0.45	40"	DOE	12	21 lbs.
FPP-1-975-DOE	1	9-3/4"	DOE	24	12 lbs.
FPP-1-20-DOE	1	20"	DOE	12	11 lbs.
FPP-1-30-DOE	1	30"	DOE	12	17 lbs.
FPP-1-40-DOE	1	40"	DOE	12	21 lbs.
FPP-1-10-222	1	10"	222 / flat	24	12 lbs.
FPP-1-20-222	1	20"	222 / flat	12	11 lbs.
FPP-1-30-222	1	30"	222 / flat	12	17 lbs.
FPP-1-40-222	1	40"	222 / flat	12	21 lbs.
FPP-5-975-DOE	5	9-3/4"	DOE	24	12 lbs.
FPP-5-20-DOE	5	20"	DOE	12	11 lbs.
FPP-5-30-DOE	5	30"	DOE	12	17 lbs.
FPP-5-40-DOE	5	40"	DOE	12	21 lbs.
FPP-5-10-222	5	10"	222 / flat	24	12 lbs.
FPP-5-20-222	5	20"	222 / flat	12	11 lbs.
FPP-5-30-222	5	30"	222 / flat	12	17 lbs.
FPP-5-40-222	5	40"	222 / flat	12	21 lbs.

**Note:** 2, 10, 25, and 50 micron ratings are also available by special order. (Substitute micron rating at appropriate place in product code.) Standard gaskets and o-rings are EPDM. Buna-N, Viton and Silicone are also available. (For special gaskets or o-rings, add "B" for Buna-N, "V" for Viton or "S" for Silicone at end of product code.) For 226 cartridges, substitute "226" for "222".

## Pleated Filter Cartridges – Watts

*Greater surface area, longer life, reduced filtration costs!*

Watts pleated cartridges outperform wound, spun, melt blown, resin bonded and other “depth” style filter elements because our pleated cartridges provide increased surface area, lower pressure drop and longer service life. Our 100% synthetic media is washable and cleanable, five micron and up, to reduce filtration costs.

### Features

- Filter media is pleated
- Cellulose-FREE, 100% synthetic media
- Wide range of lengths and micron ratings
- Individually wrapped for purity
- Washable and reusable, 5 micron and up
- Micron rating is embossed in the end cap
- Economical price

### Benefits

- More surface area for greater dirt holding capacity; lower initial pressure drop; higher flow rates; longer life; reduced filtration costs
- Superior performance with no additives or binders to break down which may cause foaming and filter degradation
- Full product line to satisfy your application
- Additional security at no additional charge
- Reduce filter replacement costs
- Easily identify standard OD replacements
- Reduced filter costs for higher profits



*Pleated cartridges have eight times the surface area as depth cartridges!*

**This is why Watts® pleated cartridges cost less to use,  
regardless of what they cost to buy!**

## Pleated Filter Cartridges – Watts

*Not all pleated cartridges perform the same!*



The difference is the media!

Watts, cellulose-free, 100% synthetic filter media allows the pleats to retain their form, maintaining a large amount of surface area. This allows the cartridge to handle higher solids loading and flow rates with a lower pressure drop that increases the filter efficiency and life, while reducing filter change out costs and frequency.

VS.

The cellulose blended pleats collapsed on one another, blinding off large amounts of the cartridges surface area. Premature blinding of the surface area reduces the flow capacity and efficiency while it raises the differential pressure, and contributes to a limited filter life and frequent filter change outs.

### Flow Rates

Maximum flow rate guidelines for watts cartridges are shown below:

MICRON RATING (NOMINAL)	STANDARD CARTRIDGES (2-3/4" OD)			FULL-FLOW	
	9-3/4"	20"	29-1/4"	9-3/4"	20"
1 Micron	4	8	12	10	15
5 Micron	7	14	21	15	25
20 Micron	8	16	24	15	25
50 Micron	10	20	30	15	25

### Watts Pleated Specifications

Maximum temperature	140°F (60°C)
Minimum Temperature	40°F (4.4°C)
Maximum pressure	40 psid
Recommended change out	25 psid
Filter media (1 & 5 micron)	Polypropylene
Filter media (20 & 50 micron)	Polyester
Material - center tube	Polypropylene
Material - end caps	Molded Polyurethane
ID	1-1/6"

### Washable And Reusable

Watts pleated cartridges are washable and reusable, five micron and up to reduce filtration costs. For best results, direct spray into the pleats to dislodge the sediment.





Standard cartridges (2-3/4" OD)



Full-Flow Cartridges (4-1/2" OD)

## Standard 2-3/4" OD X 9-3/4" Length

MODEL NO.	MEDIA TYPE	MICRON	MICRON IDENTIFIER	CASE / QTY
WPC1-975	Synthetic	1	Embossed	25
WPC5-975	Synthetic	5	Embossed	25
WPC20-975	Synthetic	20	Embossed	25
WPC50-975	Synthetic	50	Embossed	25

## Standard 2-3/4" OD X 20" Length

MODEL NO.	MEDIA TYPE	MICRON	MICRON IDENTIFIER	CASE / QTY
WPC1-20	Synthetic	1	Embossed	25
WPC5-20	Synthetic	5	Embossed	25
WPC20-20	Synthetic	20	Embossed	25
WPC50-20	Synthetic	50	Embossed	25

## Standard 2-3/4" OD X 29-1/4" Length

MODEL NO.	MEDIA TYPE	MICRON	MICRON IDENTIFIER	CASE / QTY
WPC1-2925	Synthetic	1	Embossed	25
WPC5-2925	Synthetic	5	Embossed	25
WPC20-2925	Synthetic	20	Embossed	25
WPC50-2925	Synthetic	50	Embossed	25

## Standard 2-3/4" OD X 40" Length

MODEL NO.	MEDIA TYPE	MICRON	MICRON IDENTIFIER	CASE / QTY
WPC5-40	Synthetic	5	Embossed	25

## Full-Flow 4-1/2" OD X 9-3/4" Length

MODEL NO.	MEDIA TYPE	MICRON	MICRON IDENTIFIER	CASE / QTY
WPC1FF975	Synthetic	1	Embossed	18
WPC5FF975	Synthetic	5	Embossed	18
WPC20FF975	Synthetic	20	Embossed	18
WPC50FF975	Synthetic	50	Embossed	18

## Full-Flow 4-1/2" OD X 20" Length

MODEL NO.	MEDIA TYPE	MICRON	MICRON IDENTIFIER	CASE / QTY
WPC1FF20	Synthetic	1	Embossed	9
WPC5FF20	Synthetic	5	Embossed	9
WPC20FF20	Synthetic	20	Embossed	9
WPC50FF20	Synthetic	50	Embossed	9

## String Wound (Standard / High temp)

*Exceptional value when depth filtration is required.*

### Features & Benefits

- Low cost
- Polypropylene media for chemical resistance
- Food grade ingredients for potable water
- No leachables to contaminate downstream
- Wide range of lengths and micron ratings
- Cartridges with stainless steel center tubes for temperature applications



MODEL NO.	LENGTH	OD	MICRON	NO. / CASE
SF1-978	9-7/8"	2-1/2"	1	25
SF5-978	9-7/8"	2-1/2"	5	25
SF10-978	9-7/8"	2-1/2"	10	25
SF20-978	9-7/8"	2-1/2"	20	25
SF30-978	9-7/8"	2-1/2"	30	30
SF50-978	9-7/8"	2-1/2"	50	25
SF1-20	20"	2-1/2"	1	25
SF5-20	20"	2-1/2"	5	25
SF10-20	20"	2-1/2"	10	15
SF20-20	20"	2-1/2"	20	25
SF50-20	20"	2-1/2"	50	15
SF1-30	30"	2-1/2"	1	15
SF5-30	30"	2-1/2"	5	25
SF20-30	30"	2-1/2"	20	15
SF1-40	40"	2-1/2"	1	10
SF5-40	40"	2-1/2"	5	25
SF20-40	40"	2-1/2"	20	10

### Full-Flow 4-1/2" OD Cartridges

MODEL NO.	LENGTH	OD	MICRON	NO. / CASE
SF1-10-425	9-3/4"	4-1/2"	1	8
SF5-10-425	9-3/4"	4-1/2"	5	8
SF10-10-425	9-3/4"	4-1/2"	10	8
SF20-10-425	9-3/4"	4-1/2"	20	8
SF50-10-425	9-3/4"	4-1/2"	50	8
SF1-20-425	20"	4-1/2"	1	4
SF5-20-425	20"	4-1/2"	5	4
SF10-20-425	20"	4-1/2"	10	4
SF20-20-425	20"	4-1/2"	20	4
SF50-20-425	20"	4-1/2"	50	4
SF100-20-425	20"	4-1/2"	100	4

## String Wound (Standard / High temp)

*Exceptional value when depth filtration is required.*

Wound Cartridges With 304 Stainless Steel Center Tubes  
For Temperatures To 200°F (93°C)

MODEL NO.	LENGTH	OD	MICRON	NO. / CASE
MS10FS5	9-7/8"	2-1/2"	5	30
MS10FS20	9-7/8"	2-1/2"	20	30
MS10FS50	9-7/8"	2-1/2"	50	30
MS20FS5	20"	2-1/2"	5	15
MS20FS20	20"	2-1/2"	20	15
MS30FS5	30"	2-1/2"	5	15
MS30FS20	30"	2-1/2"	20	15
MS40FS5	40"	2-1/2"	5	10
MS40FS20	40"	2-1/2"	20	10

## Sediment Cartridges – Pentair

MODEL NO.	DESCRIPTION
S7601A	SEDIMENT CELL PLEATED 9 7/8 IN 20M S1 PE 24 CASE
S7610A	SEDIMENT CELL PLEATED 9 7/8 IN 5M ECP-5 PE 24 CASE
S7616A	SEDIMENT PLEATED 9 7/8 IN 30M PE R30 REUSABLE WRAPPED 24 CASE
S7800	BB SEDIMENT PLEATED 10 IN 30M PE R30-BB REUSE 8 CASE
S7803	BB SEDIMENT CELL PLEATED 20.0 IN 20M PE S1-20BB 6 CASE
S7804A	BB SEDIMENT PLEATED 10 IN 50M PE R50-BB 8 CASE
S7805	BB SEDIMENT CELL PLEATED 10 IN 20M S1-BB 8 CASE
S7807	BB SEDIMENT CELL PLEATED 20.0 IN 5M ECP5-20BB 6 CASE
S7807-R	BB SEDIMENT PLEATED 20 IN 30M PE R30-20BB REUSE 6 CASE
S7809	BB SEDIMENT CELL PLEATED 10 IN 5M PE ECP5-BB 8 CASE

## Specialty Cartridges Selection Guide

Model No.	Brands	OD	Length	Micron Rating	Flow Rate (GPM)	Chlorine Reduction (Gallons)
<b>For Cryptosporidium, Giardia, Lambliia, Cyst, Bacteria Reduction</b>						
DS-1000 (Ceramic Candle)	Aqua Cera	2	10	0.5	2	-
DUC-1000 (Ultra Carbon)	Aqua Cera	2	10	0.5	0.3 - 0.5	1,500
DS-OBE (Ceramic Cartridge)	Aqua Cera	2	9 3/4	0.5	1.33	-
DUC-OBE (Ultra Carbon)	Aqua Cera	2.75	9 3/4	0.5	0.6-1	4,600
<b>For Calcium &amp; Magnesium Reduction (Softening)</b>						
IF-SM-DI010C INTELIFIL, DI COLOR IND BLUE TO AMBER, 5000 mg/l	Watts	2 1/2	10	10	1	
IF-SM-NIT010 INTELIFIL, 5000 MGL NITRATE REMOVAL	Watts	2 1/2	10	10	1	
IF-SM-SCIG010 INTELIFIL, POLYPHOSPHATE/GAC	Watts	2 1/2	10	10	1	2,000
IF-SM-WS010 INTELIFIL, SOFTENING CARTRIDGE, 19,000 mg/l	Watts	2 1/2	10	10	1	
IF-SM-AX010 ARSENIC REDUCTION	Watts	2 1/2	10	N/A	0.1	
FI-UDF010	Watts	2 1/2	10	N/A		2,500
IF-SM-DI020C INTELIFIL, DI COLOR IND BLUE TO AMBER, 11,000 mg/l	Watts	2 1/2	20	10	1	
S7864 PHOSPHATE 18 OZ PCC-218 CRYSTALS	Pentair	2 5/8	9 3/4	N/A	1.5 - 2.5	N/A
S7625 DI MB PCF1-10MB FDA, 270 mg/l	Pentair	2 2/3	9 3/4	N/A	0.25	N/A
S7858 PHOSPHATE CRYSTALS PCC-1	Pentair	2 7/8	9 5/8	N/A	5	N/A
IF-SM-DI010BC INTELIFIL, DI COLOR IND BLUE TO AMBER, 12,000 mg/l	Watts	4 1/2	10	10	1	
IF-SM-WS010B INTELIFIL, SOFTENING CARTRIDGE, 47,000 mg/l	Watts	4 1/2	10	10	1	
IF-SM-KDF85010 INTELIFIL, 1 LB KDF-85/GAC	Watts	4 1/2	10	10		10,000
IF-SM-KDF85020B INTELIFIL, 4 LB KDF85/GAC	Watts	4 1/2	20	10		40,000
<b>For Hydrocarbon (Oil, Gasoline, Diesel Fuel) Reduction</b>						
FPHRC-20	Watts	2 1/2	20	20		
FPHRC-30	Watts	2 1/2	30	20		
FPHRC-975	Watts	2 1/2	9 3/4	20		
FPHRC-BB-975	Watts	4 1/2	10	20		
FPHRC-BB-20	Watts	4 1/2	20	20		
<b>Refillable Cartridges (Fill with your choice of media)</b>						
RC-C-975-50	Watts	2.5	9 3/4			
RC-W-975-50	Watts	2.5	9 3/4			
RC-C-20-50	Watts	2.5	20			
RC-W-20-50	Watts	2.5	20			
RC-C-BB-975-50	Watts	4.5	9 3/4			
RC-W-BB-975-50	Watts	4.5	9 3/4			
RC-C-BB-20-50	Watts	4.5	20			
RC-W-BB-20-50	Watts	4.5	20			
<b>Showerhead for Chlorine, Lead, Arsenic, Bacteria, Calcium &amp; Magnesium Reduction</b>						
FMSHWR-KDF55	Watts					
FMSHWR-KDF55-PLAIN	Watts					

## Ceramic Filters

### Aqua Cera Brand Ceramic Filters

Cleanable self-sterilizing elements can be used over and over to reduce filtration costs. Capable of removing 99.9999% of suspended solids and 100% of Cryptosporidium, Giardia Lamblia cysts and bacteria. Designed to comply with the most stringent potable water standards.

- Cleanable
- Self-sterilizing
- Can be used over and over, reducing cost
- Capable of removing 99.9999% of suspended solids and 100% of Cryptosporidium, Giardia Cysts, and bacteria.



MODEL NO.	SIZE	MODEL	NO. PER CASE
DS-1000	1/4" BSP thread	Ceramic Candle	25
DUC-1000	1/4" BSP thread	Ultra Carbon	25
DS-OBE	Double open ends	Ceramic Cartridge	25
DUC-OBE	Double open ends	Ultra Carbon	16

## Specialty Cartridges – Intelifil

MODEL NO.	DESCRIPTION
FI-UDF010	UDF SERIES COC GAC 10 CARTRIDGE 2500 GAL
IF-SM-AX010	10 IN X 2 1/2 IN .1 GPM ARSENIC REDUCTION CART
IF-SM-DI010BC	IF 10 IN FULL FLOW 12K MGL DI COLOR IND BLUE TO AMBER
IF-SM-DI010C	IF 105000 MGL DI COLOR IND BLUE TO AMBER
IF-SM-DI020C	IF 20K 11K MGL DI COLOR IND BLUE TO AMBER
IF-SM-KDF85010	IF 10 IN 10000 GALLON 1 LB KDF-85 GAC CART
IF-SM-KDF85020B	IF 20 IN FULL FLOW 40000 GALLON 4 LB KDF85 GAC CART
IF-SM-NIT010	IF 10 IN 5000 MGL NITRATE REMOVAL CARTRIDGE
IF-SM-SCIG010	IF 10 IN 2000 GALLON POLYPHOSPHATE GAC CART
IF-SM-WS010	IF 10 IN 19000 MGL SOFTENING CARTRIDGE
IF-SM-WS010B	IF 10 IN FULL FLOW 47000 MGL SOFTENING CARTRIDGE

## Specialty Cartridges – Intelifil

### 9-3/4" X 2-1/2"

MODEL NO.	DESCRIPTION
IF-SM-AA010	Activated Alumina- Fluoride Reduction
IF-SM-CC010	Calcite-Increase pH
IF-SM-CG010	Catalytic GAC- Chloramine/hydrogen sulfide reduction
IF-SM-DI010	Mixed Bed DI- Dimeralization (to lower TDS)
IF-SM-DI010C	Mixed Bed DI Color Indicator- Dimeralization (to lower TDS)
IF-SM-KDF010	1 lb KDF-55/GAC Chlorine Reduction (municipal water)
IF-SM-KDF85010	1 lb KDF-85/GAC Chlorine Reduction (well water)
IF-SM-NIT010	Nitrate Removal
IF-SM-SCIO10	Polyphosphate- Scale Prevention
IF-SM-SCIG010	Polyphosphate/GAC- Scale prevention/chlorine
IF-SM-WS010	Softening- Hardness Reduction



### 20" X 2-1/2"

MODEL NO.	DESCRIPTION
IF-SM-AA020	Activated Alumina- Fluoride Reduction
IF-SM-CC020	Calcite-Increase pH
IF-SM-CG020	Catalytic GAC- Chloramine/hydrogen sulfide reduction
IF-SM-DI020	Mixed Bed DI- Dimeralization (to lower TDS)
IF-SM-DI020C	Mixed Bed DI Color Indicator- Dimeralization (to lower TDS)
IF-SM-KDF020	1 lb KDF-55/GAC Chlorine Reduction (municipal water)
IF-SM-KDF85020	1 lb KDF-85/GAC Chlorine Reduction (well water)
IF-SM-NIT020	Nitrate Removal
IF-SM-SCIO20	Polyphosphate- Scale Prevention
IF-SM-SCIG020	Polyphosphate/GAC- Scale prevention/chlorine
IF-SM-WS020	Softening- Hardness Reduction

### 9-3/4" X 4-1/2"

MODEL NO.	DESCRIPTION
IF-SM-AA010B	Activated Alumina- Fluoride Reduction
IF-SM-CC010B	Calcite-Increase pH
IF-SM-CG010B	Catalytic GAC- Chloramine/hydrogen sulfide reduction
IF-SM-DI010B	Mixed Bed DI- Dimeralization (to lower TDS)
IF-SM-DI010BC	Mixed Bed DI Color Indicator- Dimeralization (to lower TDS)
IF-SM-KDF010B	1 lb KDF-55/GAC Chlorine Reduction (municipal water)
IF-SM-KDF85010B	1 lb KDF-85/GAC Chlorine Reduction (well water)
IF-SM-NIT010B	Nitrate Removal
IF-SM-SCIO10B	Polyphosphate- Scale Prevention
IF-SM-SCIG010B	Polyphosphate/GAC- Scale prevention/chlorine
IF-SM-WS010B	Softening- Hardness Reduction

### 20" X 4-1/2"

MODEL NO.	DESCRIPTION
FI-AA020BHF	Activated Alumina- Fluoride Reduction
IF-SM-CC020B	Calcite-Increase pH
IF-SM-CG020B	Catalytic GAC- Chloramine/hydrogen sulfide reduction
IF-SM-DI020B	Mixed Bed DI- Dimeralization (to lower TDS)
IF-SM-DI020BC	Mixed Bed DI Color Indicator- Dimeralization (to lower TDS)
IF-SM-KDF020B	1 lb KDF-55/GAC Chlorine Reduction (municipal water)
IF-SM-KDF85020B	1 lb KDF-85/GAC Chlorine Reduction (well water)
IF-SM-NIT020B	Nitrate Removal
IF-SM-SCIO20B	Polyphosphate- Scale Prevention
IF-SM-SCIG020B	Polyphosphate/GAC- Scale prevention/chlorine
IF-SM-WS020B	Softening- Hardness Reduction

## Specialty Filter Cartridges - Pentair

MODEL NO.	DESCRIPTION
S7858	PHOSPHATE 9 7/8 IN CRYSTALS PCC-1 6 CASE
S7864	PHOSPHATE 9 7/8 IN X18 OZ PCC-218 CRYSTALS 6 CASE
S7625	DI MB 10 IN PCF1-10MB FDA IN NO LABEL IN 6 CASE

## Melt Blown Hydrocarbon Removal Cartridges

MODEL NO.	DESCRIPTION
FPHRC-20	2 1/2 INCH X 20 INCH HYDROCARBON REMOVAL CARTRIDGE DESIGNED FOR REMOVAL OF OIL, GASOLINE, DIESEL FUEL.
FPHRC-30	2 1/2 INCH X 30 INCH HYDROCARBON REMOVAL CARTRIDGE DESIGNED FOR REMOVAL OF OIL, GASOLINE, DIESEL FUEL.
FPHRC-975	2 1/2 INCH X 9 3/4 INCH HYDROCARBON REMOVAL CARTRIDGE DESIGNED FOR REMOVAL OF OIL, GASOLINE, DIESEL FUEL.
FPHRC-BB-20	4 1/2 INCH X 20 INCH HYDROCARBON REMOVAL CARTRIDGE DESIGNED FOR REMOVAL OF OIL, GASOLINE, DIESEL FUEL.
FPHRC-BB-975	4 1/2 INCH X 10 INCH HYDROCARBON REMOVAL CARTRIDGE DESIGNED FOR REMOVAL OF OIL, GASOLINE, DIESEL FUEL.

## Refillable Cartridges

Plastic refillable canisters for activated carbon and other filter media for water treatment.

### Refillable Canisters For Granular Media

Plastic refillable canisters for activated carbon and other granular filter media. Low cost and reusable! Made using FDA grade polypropylene. Available in white and clear.



### Refillable Canisters For Granular Filter Media

MODEL NO.	LENGTH	OD	COLOR	VOLUME (ML)	VOLUME (CU. IN.)	NO. PER CASE
RC-C-975-50	9-3/4"	2-1/2"	Clear	803	49	24
RC-W-975-50	9-3/4"	2-1/2"	White	803	49	24
RC-C-20-50	20"	2-1/2"	Clear	1,786	109	24
RC-W-20-50	20"	2-1/2"	White	1,786	109	24
RC-C-BB-975-50	9-3/4"	4-1/2"	Clear	2,130	130	8
RC-W-BB-975-50	9-3/4"	4-1/2"	White	2,130	130	8
RC-C-BB-20-50	20"	4-1/2"	Clear	4,572	279	4
RC-W-BB-20-50	20"	4-1/2"	White	4,572	279	4

### Cartridge Coupler

MODEL NO.	DESCRIPTION
CARTCPLR	2 1/2 IN CART COUPLER
CARTCPLR-BB	4 1/2 IN CART COUPLER

## Alkaline Water Filter

The innovative high-capacity, 3rd-party certified alkaline filter

### Innovative Features & Benefits

- Made in the USA
- Backed by 40+ years of water quality expertise
- Filter life up to 3,000 gallons or 18 months
- Controlled TDS release: 40ppm
- 3rd-party verification by IAPMO for the following specifications:
  - Filter life 18 to 24 months (vs. 6 months with competing filters)
  - Increases pH to levels between 8 and 9.5
  - Decreases ORP between -600 and -150
  - Mixture of 4 proprietary ceramic beads



Vertical installation recommended.

### Choosing the correct filter kit:

- 1/4" Kits fit most standard type RO systems where the Alkaline filter will be installed on a 1/4" tube between the ASO Valve and final in-line filter Tee fitting.
- 3/8" Kits are designed for most Manifold type RO systems where a 1/4" tube is not available and the Alkaline filter must be installed on a 3/8" tank tube.

Installation may vary and additional fittings may be needed in some applications.

### Ordering Information

MODEL NO.	DESCRIPTION	INCLUDES
F560105	1/4" Alkaline Water Filter Kit	Filter, tubing, fittings & mounting clips
F560106	3/8" Alkaline Water Filter Kit	Filter, tubing, fittings & mounting clips
F105377	Alkaline Replacement Water Filter	Replacement alkaline filter only

## Shower Head Filters

### Great "add on sale"

The Flowmatic® shower filter is a great "add on sale", used to reduce chlorine from shower water. The media is 100% KDF 55, to provide superior performance.

### Dial-A-Date

Flowmatic shower filters come with a unique "save-the-date" ring, which is used to remind your customers when to change cartridges, by moving the dial to the current month, plus six months.

### Features & Benefits

- Virtually eliminates chlorine from shower water.
- No chemical damage to hair!
- No dry skin!
- Uses KDF 55 media for superior performance.
- Available in an attractive retail box or plain cartons.
- Plastic components will not rust or corrode.
- Dial-A-Date ring reminds customers when to change cartridges.



### Ordering Information

MODEL NO.	DESCRIPTION	NUMBER PER CARTON
FMSHWR-KDF55	Shower filter in retail box.	1
FMSHWR-KDF55-PLAIN	Shower filter in white plain box.	1



# Tanks

*Watts offers a variety of tanks to fit your application. Our fiberglass tanks offer superior performance in both hot and cold environments and exceptional chemical and impact resistance. We also offer bright and attractive stainless steel jackets for your tank.*

## Steel Tanks

MODEL NO.	SIZE
B5151	Tank Steel 20" X 60" EP 2" TS 2" BC 2-4" x 6"
B5157	Tank Steel 24" X 60" EP 2" TS 2" BC 2-4" x 6"
B5157-3	Tank Steel 24" X 60" EP 3" TS 3" BC 2-4" x 6"
B5163	Tank Steel 30" X 60" EP 2" TS 2" BC 2-4" x 6"
B5163-3	Tank Steel 30" X 60" EP 3" TS 3" BC 2-4" x 6"
B5169	Tank Steel 36" X 60" EP 3" TS 3" BC 11" x 15" / 4" x 6"
B5175	Tank Steel 42" X 60" EP 3" TS 3" BC 11" x 15" / 4" x 6"
B5181	Tank Steel 48" X 60" EP 4" TS 4" BC 12" x 16" / 4" x 6"
B5184	Tank Steel 48" X 72" EP 4" 12" x 16" / 4" x 6"
B5187	Tank Steel 54" X 60" EP 4" 12" x 16" / 4" x 6"
B5197	Tank Steel 72" X 60" EP 4" 12" x 16" / 4" x 6"



## Fiberglass Tanks (Enpress)

ENPRESS utilizes an industry exclusive co-polymer Polypropylene formulation for its liner assembly, providing superior performance in both hot and cold temperature environments and superior chemical and impact resistance far superior than traditional polyethylene. This allows the tanks to survive harsh climate extremes and provides the highest quality product

### Features & Benefits

- Dome hole option for 10", 12" and 13" diameter
- Co-polymer Polypropylene construction
- Computer controlled cut lengths
- Special high temperature and high-pressure injection process eliminates leaks
- Superior performance in both hot and cold temperature environments
- Threaded inlet is mechanically and chemically welded to dome to prevent leaks
- 4" stainless steel threads available on 21x62, and 24x72
- 100% made in the USA



Dome holes are available.



4" stainless threads standard on 21" - 24" tanks.

## Enpress® Composite Pressure Vessels

MODEL NO.	SIZE	TOP OPENING	COLOR	CAPACITY (CU.FT.)	W/BASE
C9053	7X24	2.5"	Blue	0.45	Black
C9085-NB-TB	10x18	2.5"	Black	0.64	NA
C9014-B	10x22	2.5"	Black	0.79	NA
C9058	8x35	2.5"	Almond	0.88	Black
C9058-1	8x35	2.5"	Blue	0.88	Black
C9066	8x44	2.5"	Almond	1.14	Black
C9066B	8x44	2.5"	Blue	1.14	Black
C9084	9x48	2.5"	Almond	1.59	Black
C9084-B	9x48	2.5"	Black	1.59	Black
C9084-1	9x48	2.5"	Blue	1.59	Black
C9086-NB-DH-TB	10x24	2.5"	Black	0.88	NA
C9088-B-DH	10x35	2.5"	Black	1.38	Black
C9088-B	10x35	2.5"	Black	1.38	Black
C9088	10x35	2.5"	Almond	1.38	Black
C9090	10x44	2.5"	Almond	1.78	Black
C9090-B	10x44	2.5"	Black	1.78	Black
C9087-2-DH	10x47	2.5"	Natural	1.9	Black
C9092-DH	10x54	2.5"	Almond	2.21	Black
C9092B	10x54	2.5"	Blue	2.21	Black
C9092-B	10x54	2.5"	Black	2.21	Black
C9092	10x54	2.5"	Almond	2.21	Black
C9094-DH	12x52	2.5"	Almond	3.06	Black
C9095A	13x54	2.5"	Almond	3.74	Black
C9022	14x47	4.5"	Natural	3.65	Black
C9099-4	16x65	4"	Almond	6.91	Black

## Enpress® composite pressure vessels (cont.)

MODEL NO.	SIZE	TOP OPENING	COLOR	CAPACITY (CU.FT.)	W/BASE
C9092-DH	10x54	2.5"	Almond	2.21	Black
C9092	10x54	2.5"	Almond	2.21	Black
C9092-B	10x54	2.5"	Black	2.21	Black
C9094X	12x52	2.5"	Almond	3.06	Black
C9094X-1	12x52	2.5"	Blue	3.06	Black
C9095-DH	13x54	2.5"	Almond	3.74	Black
C9095T	13x65	2.5"	Almond	4.59	Black
C9095B	13x65	2.5"	Blue	4.59	Black
C9098	14x65	4" Poly	Almond	5.1	Black
C9099-4	16x65	4" Poly	ALM	6.55	Black
C9030	21x62	4" Stainless Steel	NAT	11.23	Black
C9031	24x72	4" Stainless Steel	NAT	15.37	Black

## Portable Exchange Tanks

MODEL NO.	SIZE	TOP OPENING	COLOR	CAPACITY (CU.FT.)	W/BASE
C9054A-DI	7x35	2.5"	Almond	0.67	Black
C9062-DI	8x40	2.5"	Natural	1.02	Black
C9090-DI	10x44	2.5"	Almond	1.78	Black
C9092-DI	10x54	2.5"	Almond	2.21	Black

## Fiberglass Tanks (Pentair)

Full Line Of Mineral Tanks,  
In Stock For Immediate Shipment

We carry a full line of Structure® tanks for a wide range of applications.

### Specifications

Construction	Fiberglass wound
Lining	ABS or polyethylene
Pressure rating	150 psi
Temperature	120°F, maximum
Opening	2-1/2" and 4" #8 Thread / 6" Flange
O-ring	EPDM or EPR*

\*Use silicone lubricants. Do not use Buna-N o-rings.



### Structural® Tanks

MODEL NO.	SIZE	TOP OPENING	COLOR	CAPACITY (CU. FT.)	BASE
C1049	6x13	2.5"	Almond	0.15	Black
C1050	6x18	2.5"	Blue	0.24	Black
C1051	6x18	2.5"	Almond	0.24	Black
C1052-1	6x35	2.5"	Almond	0.51	Black
C1062-1	8x40	2.5"	Blue	1.04	Black
C1066	8x44	2.5"	Almond	1.16	Black
C1066-B	8x44	2.5"	Blue	1.16	Black
C1084	9x48	2.5"	Almond	1.58	Black
C1084-B	9x48	2.5"	Black	1.58	Black
C1084-1	9x48	2.5"	Blue	1.58	Black
C1092	10x54	2.5"	Almond	2.19	Black
C1092-B	10x54	2.5"	Black	2.19	Black
C1094X	15x52	2.5"	Almond	2.97	Black
C1094X-1	12x52	2.5"	Blue	2.97	Black
C1095A	13x54	2.5"	Almond	3.68	Black
C1095B	13x54	4"	Almond	3.68	Black
C1095-2.5	13x54	2.5"	Blue	3.68	Black
C1098	14x65	4"	Almond	5.43	Black
C1099	16x65	4"	Almond	6.55	Black
C1030	21x62	4"	Almond	11.38	Black
C1031	24x72	4"	Natural	15.9	Black
C1036A	24x72	6"	Natural	16	Tripod Base
C1036	24x72	6"	Natural	16	STD SMC Base
C1037	30x72	6"	Natural	24	EXT Base
C1037A	30x72	6"	Natural	24	Tripod Base
C1038	36x72	6"	Natural	33.5	EXT Base
C1038A	36x72	6"	Natural	33.5	Tripod Base
C1040	48x72	6"	Natural	61.7	Tripod Base

## Rubber Bump Bands for Pentair Tanks

MODEL NO.	DESCRIPTION
C2114	Rubber Bump Band 9 Inch
C2114-10	Rubber Bump Band 10 Inch
C2115	Rubber Bump Band 14 Inch
C2116	Rubber Bump Band 8 Inch
C2118	Rubber Bump Band 12 Inch

## Stainless Steel Tank Jackets

Watts stainless steel tank jackets are manufactured using number 430 or 304 stainless steel. Number 430 bright stainless steel is typically used for interior household appliances. The composition of the metals results in a very attractive, bright finish, fabrication flexibility and lower cost. Though 430 is magnetic, it is correctly called stainless steel. Number 304 is not quite as polished as 430 but is more corrosion resistant. These jackets are designed for indoor applications and will suffer from corrosion especially if installed outside. Periodically applying a coat of paste wax will prolong aesthetic appeal.

MODEL NO.	DESCRIPTION
C3049	9X48 CHR W CAP SF HDPE
C3049-E	9X48 CHR W CAP ENPRESS HDPE
C3609-430-E	9X48 ENPRESS 430SS CRIMPED W BLACK PLASTIC CAP
C3609-E	9X48 ENPRESS 304SS CRIMPED W BLACK PLASTIC CAP
C3055-E	10X54 CHR W CAP ENPRESS HDPE
C3068B-E	10X54 BLACK W CAP ENPRESS HDPE
C3610-430-E	10X54 ENPRESS 430SS CRIMPED W BLACK PLASTIC CAP
C3610-E	10X54 ENPRESS 304SS CRIMPED W BLACK PLASTIC CAP
C3060-E	12X52 CHR W CAP ENPRESS HDPE
C3612-430-E	12X52 ENPRESS 430SS CRIMPED W BLACK PLASTIC CAP
T499120	9X48 430 OVER THE BASE WELDED STAINLESS STEEL JACKET/SPACER
T499130	10X54 430 OVER THE BASE WELDED STAINLESS STEEL JACKET/SPACER
T499170	12X52 430 OVER THE BASE WELDED STAINLESS STEEL JACKET/SPACER
T499180	13X54 430 OVER THE BASE WELDED STAINLESS STEEL JACKET/SPACER



Stainless Steel Welded Jackets



Stainless Steel Welded Jackets, Extended



Stainless Steel Crimped Jackets With Black Plastic Cap

## DI Tanks, Fittings, Hose, Drop-In Screens

### Portable DI Exchange Tanks\*

MODEL NO.	DESCRIPTION	SIZE	TOP OPENING	COLOR	CAPACITY CU.FT	WEIGHT (LBS)
C2014	XPI-25-3DS w/screen & band	9 x 42	2.5" #8	Blue	1.41	11.1
C2014-N	XPI-25-3DS w/screen & band	9 x 42	2.5" #8	Natural	1.41	11.1
C2014B	XTA-45-3-1, DS4, IS-F & band	12 x 42	4.5" #8	Natural	2.61	16.9

\*Complete exchange tank package with head/manifold (as listed) and boot. 150 psi max 120°F max

### Park Quick Disconnect Unions

MODEL NO.	DESCRIPTION	SIZE	PARK® FITTING NO
Q2005	Female union x hose barb	3/4"	UHB-75
Q2007	Male union x hose barb	3/4"	HB-75
Q2009	Male union x male NPT	3/4"	MA-75
Q2011	Female union x male NPT	3/4"	UMA-75
Q2015	Male union x hose barb	1"	HB-100
Q2016	Female union x hose barb	1"	UHB-100
Q2017	Male union x male NPT	1"	MA-100
Q2019	Female union x male NPT	1"	UMA-100
Q2010	3/4" & 1" Protective cap	1"	-
Q2012	3/4" & 1" Protective plug	1"	-
Q2014	3/4" & 1" O-ring 215 for Park QD's	1"	-

Max operating conditions: 160°F max @ 150 psi

### FDA hose for Hi-purity

MODEL NO.	DESCRIPTION	SIZE	LENGTH
Q56050	PVC grey braided	1/2"	300'
Q56075	PVC grey braided	3/4"	100'
Q56100	PVC grey braided	1"	100'
Q56150	PVC grey braided	1-1/2"	100'

### Drop-in Screens

MODEL NO.	DESCRIPTION
C2338	7" slotted PVC for 1" flo-coupling & Park Quick Disconnect
C2339	7" on brass Quick Disconnect XWPE & XPI
D4005	PVC for 3/4" Flow-coupling or 3/4" Park Quick Disconnect

## Tank Manifold Assemblies



Tank Heads, Park International Div. of Sta-Rite Industries

MODEL NO.	DESCRIPTION	PRODUCT NUMBER
XWPE Tank Manifold Assemblies, ABS 2-1/2" #8 thread w/ o-ring, 3/4" Inlet/Outlet, 1/2" riser tube, 3/4" fill-cap		
C2301	Black tank manifold	XWPE-50
C2302	Black tank manifold with inlet screen	XWPE-50-IS
C2304	Black tank manifold with inlet screen, riser tube & dist. screen	XWPE-50-IS-DS
C2311-W	White tank manifold with inlet screen	XWPE-50-IS
C2313-W	White tank manifold with inlet screen, riser tube & dist. screen	XWPE-50-IS-DS
XPI-25-2 Manifold Assemblies, ABS 2-1/2" #8 thread w/ o-ring, 3/4" Inlet/Outlet, 1/2" riser tube, No fill hole		
C2320	Black tank manifold	XPI-25-2
C2321	Black tank manifold with inlet screen	XPI-25-2-IS
C2322	Black tank manifold with riser tube & distributor screen	XPI-25-2-DS
C2323	Black tank manifold with inlet screen, riser tube & dist. screen	XPI-25-2-IS-DS
XPI-25-3 Manifold Assemblies, ABS 2-1/2" #8 thread w/ o-ring, 3/4" Inlet/Outlet, 1/2" riser tube, 3/4" fill-cap		
C2330	Black tank manifold	XPI-25-3
C2331	Black tank manifold with inlet screen	XPI-25-3-IS
C2332	Black tank manifold with riser tube & distributor screen	XPI-25-3-DS
C2333	Black tank manifold with inlet screen, riser tube & dist. screen	XPI-25-3-IS-DS
XTA-45-2 Manifold Assemblies, Glass filled Noryl® 4-1/2" #8 buttress thread w/ o-ring, 1" FPT Inlet/Outlet, 1" riser tube, No fill hole		
C2340	Black tank manifold	XTA-45-2
XTA-45-3 Manifold Assemblies, Glass filled Noryl® 4-1/2" #8 buttress thread w/ o-ring, 1" FPT Inlet/Outlet, 1" riser tube, 1-3/4" fill cap		
C2350	Black tank manifold	XTA-45-3
C2351	Black tank manifold with inlet screen	XTA-45-3-IS
C2352	Black tank manifold with inlet diffuser	XTA-45-3-ID
C2353	Black tank manifold with riser tube & distributor screen	XTA-45-3-DS4
C2354	Black tank manifold with riser tube & dbl. distributor screen	XTA-45-3-DDS4
C2355	Black tank manifold with inlet screen, riser tube & dist. screen	XTA-45-3-IS-DS4
C2356	Black tank manifold with inlet diffuser, riser tube & dist. screen	XTA-45-3-ID-DS4
C2357	Tank manifold with inlet screen, riser tube & dbl. dist. screen	XTA-45-3-IS-DDS4
XTA-45-3-1 Manifold Assemblies, Glass filled Noryl® 4-1/2" #8 buttress thread w/ o-ring, three (3) 1" FPT Inlet/Outlet, 1" riser tube, No fill plug		
C2360	Black tank manifold	XTA-45-3-1
C2361	Black tank manifold with inlet screen	XTA-45-3-1-IS
C2362	Black tank manifold with inlet diffuser	XTA-45-3-1-ID
C2365	Black tank manifold with inlet screen, riser tube & dist. screen	XTA-45-3-1-IS-DS4
C2366	Black tank manifold with inlet diffuser, riser tube & dist. screen	XTA-45-3-1-ID-DS4
C2367	Tank manifold with inlet screen, riser tube & dbl. dist. screen	XTA-45-3-1-IS-DDS4



## Bladder Tanks (Fiberglass)



### ROmate® Pressure Tanks For RO Water Storage

MODEL NO.	CAPACITY (GALS.)	DIAMETER	HEIGHT	FITTING SIZE (NPT)	COLOR	CERTIFICATION	SHIP. WT. (LBS.)
C5070	20	16"	33"	1"	Blue	NSF 58 (100 psi)	26
C5075	30	16"	44"	1"	Blue	NSF 58 (100 psi)	34
C5080	40	16"	58"	1"	blue	NSF 58 (100 psi)	43
C5085	80	24"	57"	1-1/4"	Blue	NSF 58 (100 psi)	65

**Note:** All tanks are individually boxed.

### Pressure Chart for ROmate® Pressure Tanks

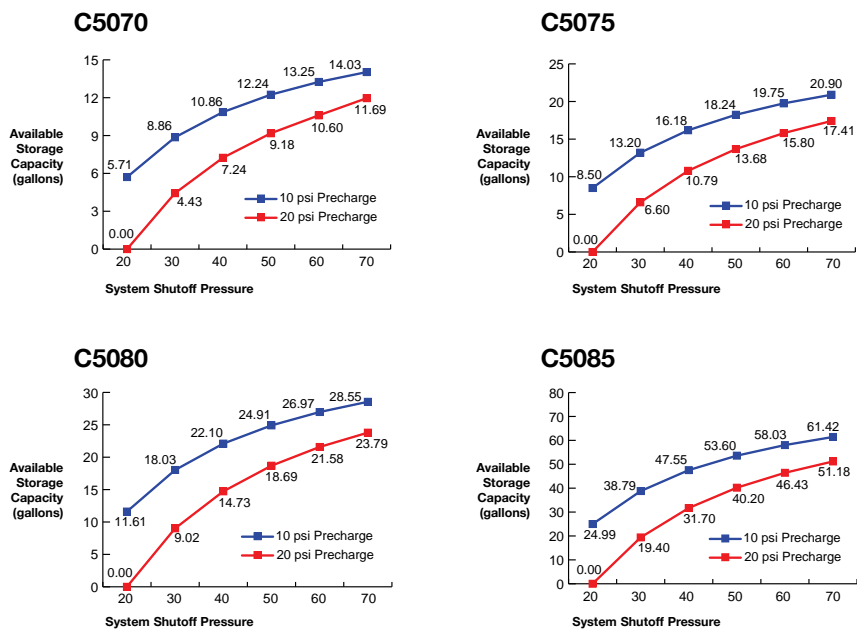

## Bladder Tanks (Steel)

MODEL NO.	*CAPACITY (GALS.)	DIAMETER	HEIGHT	FITTING SIZE (NPT)	CERTIFICATION	SHIP. WT. (LBS.)	DRAW DOWN (GALS.)		
							20/40	30/50	40/60
FWR-60	20	16"	29"	1"	ANSI/NSF 61	36	8.1	6.8	5.9
FWR-100	32	21"	28"	1.25"	ANSI/NSF 61	54	12.9	10.9	9.4
FWR-140	44	21"	36"	1.25"	ANSI/NSF 61	67	17.7	15	13
FWR-260	85	26"	45"	1.25"	ANSI/NSF 61	121	34.3	29	25.1
FWR-360	119	26"	60"	1.25"	ANSI/NSF 61	153	48	40.6	35.1

\* Capacity is total capacity not water storage capacity

## Bladder Tanks (Metal & Plastic)



Best Seller.  
Try it today!

RO PRO®  
NSF certified to 100 psi. Only 9" wide.  
(Takes less space below sink!)



PRO4000WF  
Plastic tank - NSF Certified.



FRO-132-W  
NSF Certified metal tank.

## RO Storage Tanks

MODEL NO.	CAPACITY (GALS.)	DIAMETER	HEIGHT	FITTING SIZE (NPT)	MATERIAL	COLOR	CERTIFICATION	SHIP. WT. (LBS.)
ROPRO4-W	4	9"	20"	1/4"	Plastic	White	NSF 58 (100 psi)	10
PRO4000WF	4	12"	14"	1/4"	Plastic	White	NSF 58 (50 psi)	10
FRO-132-WH	4	12"	16"	1/4"	Metal	White	NSF 58 (50 psi)	11
FRO-132-BL	4	12"	16"	1/4"	Metal	Blue	NSF 58 (100 psi)	11
FRO-1070-BL	14	15.2"	22.5"	1/4"	Metal	Blue	NSF 58 (100 psi)	24
FRO-1070-WH	14	15.2"	22.5"	1/4"	Metal	White	NSF 58 (100 psi)	24
FRO-122-WH	3.2	10"	15"	1/4"	Metal	White	NFS 58 (100psi)	6.2

## Storage Tanks Polyethylene



MODEL NO.	DESCRIPTION
C8005	65 GAL 23 IN X 43 IN 7 IN LID 2 IN DRAIN FDA
C8006	105 GAL 23 IN X 63 IN 7 IN LID 2 IN DRAIN FDA
C8009	165 GAL 31 IN X 56 IN 8 IN LID 2 IN DRAIN FDA
C8013	300 GAL 36 IN X 79 IN 16 IN LID 2 IN DRAIN FDA
C8017	500 GAL 48 IN X 72 IN 16 IN LID 2 IN DRAIN FDA

### Tank Level Float Switches

MODEL NO.	DESCRIPTION
R2350-SD	High cutoff float - closed down, open up, 115 volts, 15 amps, no plug
R2353-SD	High cutoff float - closed down, open up, 115 volts, 15 amps, piggy back plug
R2354-SD	Low cutoff float - open down, closed up, 115 volts, 15 amps, piggy back plug

## Retention Tanks Fiberglass

### Retention Tanks

MODEL NO.	CAPACITY (GAL)	TANK SIZE
C52-C2251	80	21" x 67"
C52-C2252	120	24" x 73"

# Distributors

*Watts offers a variety of distributor upper and lower baskets , hubs, and lateral components. Please contact us for assistance in locating the correct part for your application.*

## Distributor Baskets

MODEL NO.	DESCRIPTION
D2010	BASKET C1 3/4 IN MXBASKET .008 IN SLOT
D2011	BASKET C1 3/4 IN FXBASKET .008 IN SLOT
D2014	BASKET C2 3/4 IN MXBASKET .008 IN SLOT
D2015	BASKET C2 1 IN MXBASKET .008 IN SLOT
D2025	BASKET K4 3/4 IN MXBASKET
D2040	R2A BAFFLE 7 IN OR 170MM
D2043A	R2A W 2 SCREEN 1 1/2 MNPT X 1 1/4 FNPT
D2045	R2A W/3 SCREEN 2 IN NPT
D2048	R2A W/2 SCREEN 2 IN NPT
D2051	R2A GR ADAPTER 2 IN M/1 1/2 IN F X KSH

## Distributor Upper and Lower Baskets

MODEL NO.	DESCRIPTION
D5012-3	MOLDED BELL BASKET FITS 1/2", 13/16", 1.05" (ABS)
D5101	13/16" X 1.05" COUPLING ADAPTER
D5103-AMW	INLET SCREEN FOR 2.5" HEADS
D5103-P	13/16" TOP DISTRIBUTOR SCREEN
D5108	INLET SCREEN FOR 4" HEADS
D2002	1/2" MPT POLY UPPER DISTRIBUTOR
D5120-P	1.05" TOP DISTRIBUTOR SCREEN
D5120F	1.05" CAM LOCK TOP DISTRIBUTOR SCREEN
D5121	1 1/2" TOP DISTRIBUTOR SCREEN
K4512460	INLET SCREEN FOR 4.5" PVC HEADS
H6061	MPU-14 BRINE STRAINER

## Distributor Hub and Lateral Components

MODEL NO.	DESCRIPTION
D2210T	SO8 OR SK8 THRD HUB
D2225	SO6 HUB ONLY 2 IN
D2230	SK6 HUB ONLY
D2252	LATERAL W 4 SCREEN 5 3/4 IN LENGTH
D2255	LATERAL W 7 SCREEN 9 1/2 IN LENGTH
D2256	LATERAL W 8 SCREEN 10 3/4 IN LENGTH
D2257	LATERAL W 9 SCREEN 12 IN LENGTH
D2259	LATERAL W 11 SCREEN 14 1/4 IN LENGTH
D2262	LATERAL W 14 SCREEN 18 IN LENGTH
D2263	LATERAL W 15 SCREEN 19 1/2 IN LENGTH

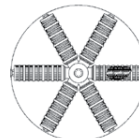

SG6

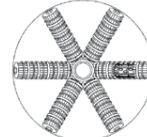

SO6



SK8

## Distributor PVC Hubs and Laterals

### PVC Hubs Tough Stuff®

MODEL NO.	PIPE SIZE	NUMBER OUTLETS	LATERAL SIZE	OUTSIDE DIAMETER
PVC HUBS - TYPE A (Angle Up)				
D5080A	1-1/2"	6	3/4"	3"
D5086A	3"	16	3/4"	4-1/2"
D5088A	4"	16	1"	5-1/2"
D5089A	6"	16	1-1/2"	8-5/8"
PVC HUBS - STRAIGHT				
D5080	1-1/2"	6	3/4"	3"
D5082	2"	8	3/4"	4"
D5086	3"	16	3/4"	4-1/2"
D5088	4"	16	1"	5-1/2"
D5089	6"	16	1-1/2"	8-5/8"
PVC HUBS - TYPE B (Angle Down)				
D5080B	1-1/2"	6	3/4"	3"
D5082B	2"	8	3/4"	4"
D5088B	4"	16	1"	5-1/2"

### PVC Laterals

MODEL NO.	DIAMETER X LENGTH	TANK SIZE
SCHEDULE 80		
D6336	3/4" x 7" Lateral	20"
D6338	3/4" x 9" Lateral	24"
D6340	3/4" x 12" Lateral	30"
D6342	3/4" x 15" Lateral	36"
D6344	3/4" x 18" Lateral	42"
D6345	3/4" x 21" Lateral	48"
D6354	1" x 7" Lateral	20"
D6016-30	1-1/2" x 30" Lateral	72"

## Distributor In Out Assemblies and Components

### PVC Machined Flanges

MODEL NO.	DESCRIPTION
Q9058	6"x4" x #8 SNA FLANGE VALVE THREAD
Q9065	6" SNA FLANGE X 2"(2) T&B



### A & M In/Out System (glass filled Noryl)

MODEL NO.	DESCRIPTION
D3020	6" #8 x 2"
D3030	6" #8 x 2-1/2" x 3"
D3040	6" flange x 2-1/2" x 3"
D3050	6" flange x 2"



### Stainless Steel Bolt Set

MODEL NO.	DESCRIPTION
D3341	Set of 12 for Structural, A&M flange
D3342	Set of 12 for Park International, A&M flange



### O-Ring

MODEL NO.	DESCRIPTION
D3346	4" on system #346 (insert)
D3362	6" on system #362 (threaded adapter)



#### NOTICE

These o-rings are sealed plastic parts. Do not over tighten (stress crack may result).

## Distributor Assembled Risers

MODEL NO.	DESCRIPTION
D5000	13/16 IN x 18 IN PVC Slotted Distributer
D5007	1 1/2 IN x 72 IN PVC Slotted Distributer
D5026	13/16 IN x 66 1/4 IN ABS Slotted Distributer
D5026-P	13/16 IN x 66 1/4 IN PVC Slotted Distributer
D5032	3/4 IN x 49 1/4 IN ABS Slotted Distributer
D5032-P	3/4 IN x 49 1/4 IN PVC Slotted Distributer
D5036	3/4 IN x 66 1/4 IN ABS Slotted Distributer
D5036-P	3/4 IN x 66 1/4 IN PVC Slotted Distributer
D5045	3/4 IN x 65 IN PVC Slotted Distributer

## Distributor SK6, SK8, S06, S08 Hub and Lateral Assemblies

For Outlet In Bottom Of Tank

### Distributor SK6 Hub and Lateral Assemblies

MODEL NO.	DESCRIPTION
D2094	SK6 2 IN 6 HUB LAT 24 IN TANK
D2095	SK6 2 IN 8 HUB LAT 30 IN TANK
D2096	SK6 2 IN 11 HUB LAT 36 IN TANK
D2097	SK6 2 IN 13 HUB LAT 42 IN TANK
D2098	SK6 2 IN 15 HUB LAT 48 IN TANK



### Distributor SK8 Hub and Lateral Assemblies

MODEL NO.	DESCRIPTION
D2108-24	SK8 3 IN W 8 LATERALS F24 IN TANK
D2108-30	SK8 3 IN W 8 LATERALS F30 IN TANK
D2108-36	SK8 3 IN W 8 LATERALS F36 IN TANK
D2108-48	SK8 3 IN W 8 LATERALS F42 IN 48 IN TANK
D2108-48-3	SK8 3 IN W 8 LATS F42 IN 48 IN T W 4 IN TOP
D2110-30	SK8 3IN W 16 LATERALS F30 IN T W 2 1/2 FPT CON
D2110-36	SK8 3IN W 16 LATERALS F36 IN T W 2 1/2 FPT CON
D2110-48	SK8 3IN W 16 LATERALS F42 IN 48 IN T W 2 1/2FPT
D2110-63	SK8 3IN W 16 LATERALS F63IN T W 2 1/2 CONN



For Outlet In Top Of Tank

### Distributor SO6 Hub and Lateral Assemblies

MODEL NO.	DESCRIPTION
D2081	SO6 2 IN 6 TM HUB LAT RING CAP 24 IN TANK
D2082	SO6 2 IN 8 TM HUB LAT RING CAP 30 IN TANK
D2083	SO6 2 IN 11 TM HUB LAT RING CAP 36 IN TANK
D2084	SO6 2 IN 13 TM HUB LAT RING CAP 42 IN TANK
D2085	SO6 2 IN 15 TM HL RING AND CAP 48 IN TANK

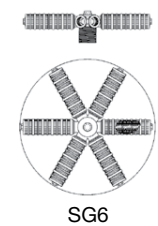

### Distributor SO8 Hub and Lateral Assemblies

MODEL NO.	DESCRIPTION
D2100	SO8 3 IN W 8 LATERALS F24 IN TANK TM
D2102	SO8 3 IN W 8 LATERALS F30 IN TANK TM
D2102D	SO8 3 IN W 16 LATERALS F30 IN TANK TM
D2104	SO8 3 IN W 8 LATERALS F36 IN TANK TM
D2104D	SO8 3 IN W 16 LATERALS F36 IN TANK TM
D2106	SO8 3 IN W 8 LATERALS F42 IN 48 IN TANK TM
D2106D	SO8 3 IN W 16 LATERALS F42 IN 48 IN TANK TM

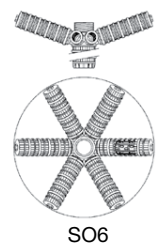

# Brine Tanks

*Watts brine tanks come fully assembled in your choice of round or square configuration in a variety of colors. We also offer a selection of brine control valves and components. Contact us today for assistance in finding the parts you need.*

## Brine Tanks

### Fully Assembled Round Brine Tanks

MODEL NO.	SIZE	COLOR	INTERNALS	MFG. TYPE
G2001-1836A	18X36	Black	474 SBV w /well & tubing	Supplied
G2001BS	18X33	Black	474 SBV w/ well, grid, tubing	Supplied
G2002AS	18X40	Almond	474 SBV w/ well, grid, tubing	Supplied
G2002BS	18X40	Black	474 SBV w/ well, grid, tubing	Supplied
G2002S	18X40	Black	474 SBV w/ well, grid, tubing	Supplied
G2003A	24X41	Blue	2300 SBV, w/ well, grid, tubing	In house (Watts)
G2003B	24X41	Black	454 Hi flo, 6" well, ¾ " w/ grid	In house (Watts)
G2007A	30X48	Black	2300 air check, well	In house (Watts)
G2028	18X40	Black	2300 w/ air check, well	In house (Watts)
G2023	10X16	Blue	2300 Safety, grid	In house (Watts)
G2028A	18X40	Blue	2300 Safety, grid	In house (Watts)
G2004A	24X50	Almond	454 Safety, grid	In house (Watts)
G2007A	30X50	Black	2300 Safety, grid	In house (Watts)
G2008C	39X48	BLACK	900 AIR CHECK	IN HOUSE (WATTS)
G2009A	30X50	BLACK	900 AIR CHECK	IN HOUSE (WATTS)

### Fully Assembled Square Brine Tanks

MODEL NO.	SIZE	TANK & COVER	COVER	INCLUDED COMPONENTS (IN ADDITION TO TANK, COVER & TUBING)	NO./CASE
G2018A-2	14x14x34	Almond	Blow molded	Overflow FTG, 2310 safety valve w/float, air check	6
G2025	14x14x34	Blue	Blow molded	Overflow FTG, 2300 safety valve w/float, air check	6
G2010BS	11X11X36	Black	Blow molded	Overflow FTG, 2310 safety valve w/float, air check	1



## Brine Tank Components

### Round Brine Tanks

MODEL NO.	SIZE	COLOR	INTERNALS	MFG. TYPE
G2001B	18X33	Black	Shell only	Blow Molded
G2001	18X33	Blue	With UVI CVR	Blow Molded
G2002	18X40	Blue	Shell only	Blow Molded
G2003	24X41	Black	Shell only	Blow Molded
G2004	24X50	Black	Shell only	Blow Molded
G2007	30X48	Black	Shell only	Rotational Molded
G2008	39X48	Black	Shell only	Rotational Molded
G2009	30X50	Black	Shell only	Blow Molded
G3010	30X60	Black	Shell only	Rotational Molded
G3015	39X60	Black	Shell only	Rotational Molded
G3020	42X60	Black	Shell only	Rotational Molded
G3025	50X60	Black	Shell only	Rotational Molded

### Square Brine Tanks

MODEL NO.	SIZE	TANK COLOR	COVER COLOR	COVER TYPE	DESCRIPTION	CASE QTY.
G2018A	14x34	Almond	Almond	Blow molded	Tank and cover only	5
G2018B	14x34	Black	Black	Blow molded	Tank and cover only	5
G2018	14x34	Blue	Blue	Blow molded	Tank and cover only	5
G2017B	13.5x44	Almond	Black	Injection molded	Tank (cabinet) and cover only	1

### Brine Tank Components

MODEL NO.	DESCRIPTION	PACK
H1016	BRINE WELL CAP 4.0"	50
H1018	BRINE OVERFLOW SET (2 PC)	50
H1024	BRINE WELL CAP 6.0"	10
H1030-14S	BRINE WELL 4.0"x14" SLOTTED 25/CASE	25
H1030-28S	BRINE WELL 4.0"x28" SLOTTED 25/CASE	25
H1030-36S	BRINE WELL 4.0"x36" SLOTTED 25/CASE	25
H1041-29	BRINE WELL 3.5"x39" ROUND SLOTTED WT&B CAPS GLI	1
H1071	BRINE WELL 6.0"x60" AWR	4
H1071-54	BRINE WELL 6.0"x54" AWR	4
H1072	BRINE GRID SET 18" TP500 W/4" HOLE	25
H1075	BRINE GRID SET 24", MINIMUM SALTING (5"LEGS)	4
H1075AS	BRINE GRID SET 24" NO LEGS	5
H3006-26	BRINE PICKUP TUBE MPU-14X26"X .25"M	1
H6001	BRINE VALVE .75"MPT TYPE A SET BRINE CHECK	5
H6010	BRINE TUBE PVC RIDGID 3/8" OD (PER FT)	50
H6061	BRINE MPU-14 STRAINER ONLY .014" OPENING	20
H6061-28	BRINE PICKUP TUBE MPU-14X28"X .375" OD TUBE	20
H7005	BRINE ASSY SBV 2300/500AC & FLOAT AWR	6
H7005-SBV	BRINE ASSY 3.5" WELL W/SBV 2300/500AC	4
H7007	BRINE ASSY SBV 2310/500AC & FLOAT AWR	4
H7007-SBV	BRINE ASSY 3.5" WELL W/SBV 2310/500AC	4
H7027-03	BRINE VALVE 464 KMN04 4OZ 3/8" F/G1015 & G1016	1
H7050	BRINE VALVE SBV 2350 W/COMM AIR CHECK 3/4", FLOAT AWR	4
H7050B	BRINE ASSY SBV 2350/900AC W/FLOAT & FIT	4
H7070	BRINE VALVE 454 KIT 3/4" W/36" FLOAT ROD	1
H7070-HF	BRINE VALVE 454 KIT HI-FLOW W/54" FLOAT ROD	4
H7070A	BRINE VALVE 454 3/4" W/48"PVC RISER ASSEMBLED AWR	4
H8000	BRINE ASSY 6" WELL W/CAP 2 PC OVERFLOW F/454 VALVE AWR	1
H8000-F	BRINE ASSY 6" WELL W/2350 VALVE COMPLETE F/1/2" TUBING AWR	1
HBPU636	BRINE PICKUP TUBE MPU-14X36"X .375" OD TUBE	100
HBPU836	BRINE AIR CHECK BPUACX36"X .375" OD TUBE	100

**Note:** Not all brine tanks and components are stocked at all locations.

## Brine Valves - Fleck® Controls

MODEL NO.	MODEL	CONNECTION	DESCRIPTION
K4560027-FFA	2300	3/8"	Brass safety brine valve only
K4102	2300	3/8"	Brass safety brine valve w/float assembly
H7005	2300	3/8"	Brass safety brine valve, 500 air check & float
H7005-SBV	2300	3/8"	Brass safety brine valve, 500 air check & float w/3.5" well, lid and overflow
K4560014	2310	3/8"	Noryl® safety brine valve
H7007	2310	3/8"	Noryl® safety brine valve w/ float assembly
H7007-SBV	2310	3/8"	Noryl® safety brine valve, 500 air check & float w/ 3.5" well, lid and overflow
K4560038	2350	1"	Brass safety brine valve only
H7050B	2350	1"	Brass safety brine valve, 900 air check & float
H8000-F	2350	1"	Brass safety brine valve, 900 air check & float w/ 6" well, lid and overflow

## Brine Control Valves

MODEL NO.	MODEL	CONNECTION	DESCRIPTION
H6000-38	A	3/8" MPT	Preset ToughStuff® brine check assembly
H6000-A	A	1/2" MPT	Preset ToughStuff® brine check assembly
H6001	A	3/4" MPT	Preset ToughStuff® brine check assembly
H7073	A	1" MPT	Preset ToughStuff® brine check assembly
H7075	A	1-1/4" MPT	Preset ToughStuff® brine check assembly
H6001-B	B	3/4" MPT	Adjustable ToughStuff® brine check assembly
H6000-C	C	1/2" MPT	Overhead refill ToughStuff® brine check assembly

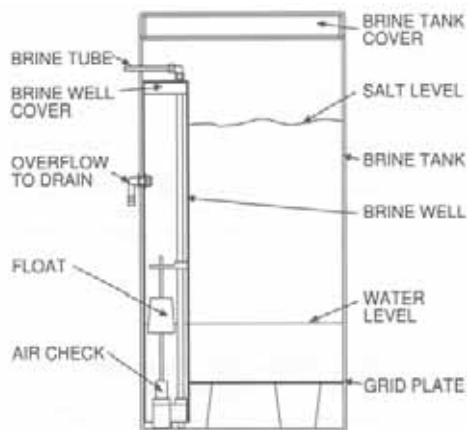

TYPICAL INSTALLATION  
TANK BRINE ASSEMBLY

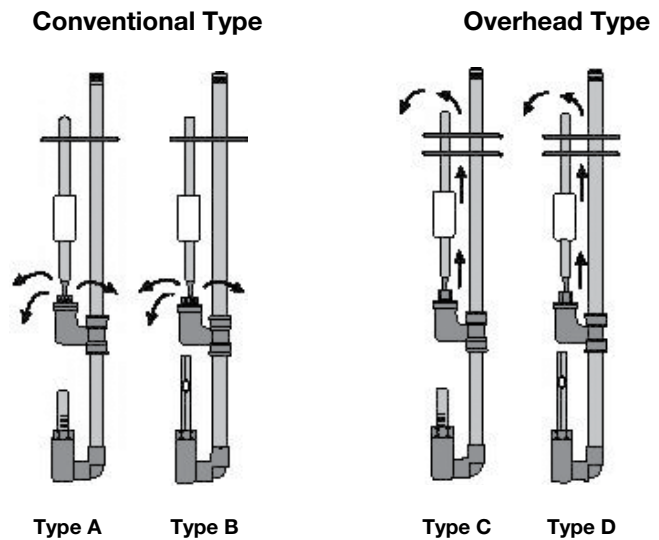

## Brine Tank Feeders Resup

Iron can foul ion exchange resin because brine itself cannot adequately remove iron a resin bead. Resup gravity drip feeders administer a small amount of liquid cleaning agents into the brine tank's brine water. This cleaning agent helps to "dig" the iron out of the resin bead with each regeneration to help maintain resin capacity. They clip over the top of the brine well and do not require electricity, so installation is a breeze.

MODEL NO.	DESCRIPTION
T7002-12	Chemical Drip Feeder 12 cc
T7002-12S	Chemical Stone for Feeder 12 cc
T7002-12W	Chemical Wick for Feeder 12 cc
T7002-30	Chemical Drip Feeder 30 cc
T7002-T-YEL	Chemical Wick for Feeder

## Fittings

Watts offers a variety of high-quality fittings for all your water treatment applications that include Sea Tech, Jaco, John Guest and Parker Fast and Tite brands

### Fittings - Sea Tech

#### Valve Angle Stops

MODEL NO.	TUBE SIZE	PER BOX
F3561-0604	3/8" MX3/8"F W/1/4"OD	50
F3561-0606	3/8" MX3/8"F W/3/8"OD	50



#### Male Connectors

MODEL NO.	TUBE SIZE	PER BOX
F3501-0806	3/8" CTS X 3/8" NPT	100
F3501-0808	3/8" CTS X 1/2" NPT	100
F3501-1008	1/2" CTS X 1/2"NPT	100
F3501-1012	1/2" CTS X 3/4"NPT	100
F3501-1412	3/4" CTS X 3/4"NPT	40
F3501-1816	1" CTS X 1" NPT	20



#### Female Connectors

MODEL NO.	TUBE SIZE	PER BOX
F3510-0808	3/8" CTS X 1/2" NPS	100
F3510-1008	1/2" CTS X 1/2" NPS	100
F3510-1012	1/2" CTS X 3/4" NPS	100
F3510-1412	3/4" CTS X 3/4"NPS	60
F3510-1816	1" CTS X 1"NPS	35



#### Reducing Stems

MODEL NO.	TUBE SIZE	PER BOX
F3514-1008	1/2" CTS STEM X 3/8"CTS	100
F3514-1410	3/4" CTS STEM X 1/2"CTS	100
F3514-1814	1" CTS STEM X 3/4"CTS	50



#### Union Connector

MODEL NO.	TUBE SIZE	PER BOX
F3515-10	1/2" CTS	90
F3515-14	3/4" CTS	40
F3515-18	1" CTS	20



#### Union Elbows

MODEL NO.	TUBE SIZE	PER BOX
F3517-08	3/8" CTS	100
F3517-10	1/2" CTS	80
F3517-14	3/4" CTS	30
F3517-18	1" CTS	20



#### Reducing Union

MODEL NO.	TUBE SIZE	PER BOX
F3516-1004	1/2" CTS X 1/4" CTS	90
F3516-1008	1/2" CTS X 3/8" CTS	90



## Fittings - Sea Tech

### Stackable Elbows

MODEL NO.	TUBE SIZE	PER BOX
F3518-08	3/8" CTS	120
F3518-10	1/2" CTS	100
F3518-14	3/4" CTS	50
F3518-18	1" CTS	25



### Male Thread Elbows

MODEL NO.	TUBE SIZE	PER BOX
F3519-1006	1/2" CTS X 3/8" NPT	100
F3519-1008	1/2" CTS X 1/2" NPT	100
F3519-1816	1" CTS X 1" NPT	25



### Female Connector Elbows

MODEL NO.	TUBE SIZE	PER BOX
F3520-0808	3/8" CTS X 3/8" NPS	80
F3520-1008	1/2" CTS X 1/2" NPS	80
F3520-1012	1/2" CTS X 3/4" NPS	60



### Union Tees

MODEL NO.	TUBE SIZE	PER BOX
F3523-08	3/8" CTS	80
F3523-10	1/2" CTS	50
F3523-14	3/4" CTS	20
F3523-18	1" CTS	15



### Reducing Tees

MODEL NO.	TUBE SIZE	PER BOX
F3524R-1004	1/2" CTS X 1/4" O.D.	50
F3524R-1814	1" CTS X 3/4" CTS	15



### Male Stem

MODEL NO.	TUBE SIZE	PER BOX
F3527-1008	1/2" CTS X 1/2" NPT	200



### Male Thread Tee

MODEL NO.	TUBE SIZE	PER BOX
F3530-1008	1/2" CTS X 1/2" MPT	60



## Fittings - Sea Tech

### Stackable Tees

MODEL NO.	TUBE SIZE	PER BOX
F3533-08	3/8" CTS	80
F3533-10	1/2" CTS	50
F3533-14	3/4" CTS	20
F3533-18	1" CTS	15



### Reducing Stackable Tees

MODEL NO.	TUBE SIZE	PER BOX
F3533R-1004	1/2" CTS x 1/4" CTS	50
F3533R-1410	3/4" CTS X 1/2" CTS	20



### Stackable Branch Tee

MODEL NO.	TUBE SIZE	PER BOX
F3534R-10	1/2" CTS	50



### Stop Valves & Reducing Stop Valves

MODEL NO.	TUBE SIZE	PER BOX
F3539-08	3/8" CTS	40
F3539-10	1/2" CTS	40
F3539-14	3/4" CTS	10
F3539-18	1" CTS	8
F3539R-1004	1/2" CTS X 1/4" O.D.	40



### Stackable Valve & Reducing Stackable Valve

MODEL NO.	TUBE SIZE	PER BOX
F3543R-1004	1/2" CTS X 1/4" OD	40
F3543-10	1/2" CTS	40



### End Stop

MODEL NO.	TUBE SIZE	PER BOX
F3545-10	1/2" CTS	100
F3545-14	3/4" CTS	90



### Collet Clip

MODEL NO.	TUBE SIZE	PER BOX
F3547-08	3/8" CTS	2500
F3547-10	1/2" CTS	2500
F3547-14	3/4" CTS	2000



## Fittings – Jaco

With molded in-tube sleeve, made from FDA grade, NSF listed Nylon.

### Jaco® Brand Male Connectors

MODEL NO.	TUBE SIZE	THREAD SIZE	COLOR	NO. CASE
F10-4-2-N-0	1/4"	1/8"	White	100
F10-4-4-N-0	1/4"	1/4"	White	100
F10-4-6-N-0	1/4"	3/8"	White	100
F10-6-4-N-0	3/8"	1/4"	White	100
F10-6-6-N-0	3/8"	3/8"	White	100
F10-6-8-N-0	3/8"	1/2"	White	100
F10-8-8-N-0	1/2"	1/2"	White	100
F10-8-8-N-PG*	1/2"	1/2"	White	100



### Jaco® Brand Union Connectors (nylon)

MODEL NO.	TUBE SIZE	THREAD SIZE	COLOR	NO. CASE
F15-4-N-0	1/4"	-	White	300
F15-6-N-0	3/8"	-	White	100



### Reducing Union Connector

MODEL NO.	TUBE SIZE	TUBE SIZE	COLOR	NO. CASE
F15-6-4-N-0	3/8"	1/4"	White	100

### Jaco® Brand Female Connectors (nylon)

MODEL NO.	TUBE SIZE	THREAD SIZE	COLOR	NO. CASE
F25-4-4-N-0	1/4"	1/4"	White	100
F25-6-6-N-0	3/8"	3/8"	White	100
F25-8-8-N-PG*	1/2"	1/2"	White	100



### Jaco® Brand Male Elbows (Nylon)

MODEL NO.	TUBE SIZE	THREAD SIZE	COLOR	NO. CASE
F40-4-2-N-0	1/4"	1/8"	White	100
F40-4-4-N-0	1/4"	1/4"	White	100
F40-4-6-N-0	1/4"	3/8"	White	100
F40-6-4-N-0	3/8"	1/4"	White	100
F40-6-6-N-0	3/8"	3/8"	White	100
F40-8-8-N-0	1/2"	1/2"	White	100



### Jaco® Brand Female Elbows (nylon)

MODEL NO.	TUBE SIZE	THREAD SIZE	COLOR	NO. CASE
F45-4-4-N-0	1/4"	1/4"	White	100
F45-6-4-N-0	3/8"	1/4"	White	100
F45-6-6-N-0	3/8"	3/8"	White	100
F45-8-8-N-0	1/2"	1/2"	White	100



\*With gripper nut to hold tubing under higher pressures.

## Fittings – Jaco

With molded in-tube sleeve, made from FDA grade, NSF listed Nylon.

### Jaco® Brand Union Elbows (nylon)

MODEL NO.	TUBE SIZE	THREAD SIZE	COLOR	NO. CASE
F50-4-N-0	1/4"	-	White	100
F50-6-N-0	3/8"	-	White	100
F50-8-N-0	1/2"	-	White	100



### Jaco® Brand Branch Tees (nylon)

MODEL NO.	TUBE SIZE	THREAD SIZE	COLOR	NO. CASE
F60-4-2-N-0	1/4"	1/8"	White	100
F60-4-4-N-0	1/4"	1/4"	White	100
F60-6-4-N-0	3/8"	1/4"	White	100



### Jaco® Brand Union Tees (nylon)

MODEL NO.	TUBE SIZE	THREAD SIZE	COLOR	NO. CASE
F70-4-N-0	1/4"	-	White	100
F70-6-N-0	3/8"	-	White	100
F70-8-N-0	1/2"	-	White	100



### Jaco® Brand Male Run Tees (Nylon)

MODEL NO.	TUBE SIZE	THREAD SIZE	COLOR	NO. CASE
F75-4-2-N-0	1/4"	1/8"	White	100
F75-4-4-N-0	1/4"	1/4"	White	100
F75-6-4-N-0	3/8"	1/4"	White	100
F75-6-6-N-0	3/8"	3/8"	White	100



### Jaco® Brand Compression Nuts (nylon)

MODEL NO.	TUBE SIZE	THREAD SIZE	COLOR	NO. CASE
N-0-4W	1/4"	-	White	100
N-0-4BLK	1/4"	-	Black	100
N-0-6W	3/8"	-	White	100



## Fittings – John Guest

Quick connect fittings to reduce labor costs and provide quality assurance.

### John Guest® Male Connectors (gray)

MODEL NO.	TUBE SIZE	THREAD SIZE	OTHER	NO./CASE
PI010821S	1/4"	1/8"	-	500
PI010822S	1/4"	1/4"	-	400
PI010823S	1/4"	3/8"	-	300
PI011222S	3/8"	1/4"	-	250
PI011223S	3/8"	3/8"	-	250
PI011224S	3/8"	1/2"	-	200
PI011623S	1/2"	3/8"	-	150
PI011624S	1/2"	1/2"	-	150



### John Guest® Union Tees (gray)

MODEL NO.	TUBE SIZE	THREAD SIZE	OTHER	NO./CASE
PI0208S	1/4"	-	-	300
PI0212S	3/8"	-	-	100
PI0216S	1/2"	-	-	50



### John Guest® Union Elbows (gray)

MODEL NO.	TUBE SIZE	THREAD SIZE	OTHER	NO./CASE
PI0308S	1/4"	-	-	400
PI0312S	3/8"	-	-	200
PI0316S	1/2"	-	-	100



### John Guest® Union Connectors (gray)

MODEL NO.	TUBE SIZE	THREAD SIZE	OTHER	NO./CASE
PI0408S	1/4"	-	-	400
PI0412S	3/8"	-	-	200
PI0416S	1/2"	-	-	100



### John Guest® Stem Adapters (gray)

MODEL NO.	THREAD SIZE	OTHER	NO./CASE
PI050821S	1/8"	1/4" stem	400
PI050822S	1/4"	1/4" stem	500
PI051222S	1/4"	3/8" stem	300
PI051624S	1/2"	1/2" stem	150



**Note:** Fittings packaged 10 per poly bag.

## Fittings – John Guest

Quick connect fittings to reduce labor costs and provide quality assurance.

### John Guest® Reducers (gray)

MODEL NO.	TUBE SIZE	OTHER	NO./CASE
PI061208S	1/4"	3/8" stem	400
PI061612S	3/8"	1/2" stem	250



### John Guest® Plugs (gray)

MODEL NO.	TUBE SIZE	OTHER	NO./CASE
PI0808S	-	1/4" stem	500
PI0812S	-	3/8" stem	400



### John Guest® Reducing Unions (gray)

MODEL NO.	TUBE SIZE	OTHER	NO./CASE
PI201008S	5/16"	1/4" tube	200
PI201208S	3/8"	1/4" tube	200
PI201210S	3/8"	5/16" tube	200
PI201612S	1/2"	3/8" tube	100



### John Guest® Reducing Elbows (gray)

MODEL NO.	TUBE SIZE	OTHER	NO./CASE
PI211008S	5/16"	1/4" tube	200
PI211208S	3/8"	1/4" tube	200
PI211612S	1/2"	3/8" tube	100



### John Guest® Plug-In Elbows (gray)

MODEL NO.	TUBE SIZE	OTHER	NO./CASE
PI220808S	1/4"	1/4" stem	500
PI221208S	1/4"	3/8" stem	300
PI221212S	3/8"	3/8" stem	200



### John Guest® Reducing Branch Tees (gray)

MODEL NO.	TUBE SIZE	OTHER	NO./CASE
PI301208S	3/8" x 2	1/4" tube	150
PI301612S	1/2" x 2	3/8" tube	50



Note: Fittings packaged 10 per poly bag.

## Fittings – John Guest

Quick connect fittings to reduce labor costs and provide quality assurance.

### John Guest® NPTF Faucet Connectors (gray)

MODEL NO.	TUBE SIZE	THREAD SIZE	OTHER	NO./CASE
CI3208U7S	1/4"	7/16"	-	250
CI3212U7S	3/8"	7/16"	-	250



### John Guest® NPTF Female Adapters (gray)

MODEL NO.	TUBE SIZE	THREAD SIZE	OTHER	NO./CASE
PI450822S	1/4"	1/4"	-	400
PI451222S	3/8"	3/8"	-	200



### John Guest® End Stops (gray)

MODEL NO.	TUBE SIZE	THREAD SIZE	OTHER	NO./CASE
PI4608S	1/4"	-	-	500
PI4612S	3/8"	-	-	500



### John Guest® NPTF Fixed Elbows (gray)

MODEL NO.	TUBE SIZE	THREAD SIZE	OTHER	NO./CASE
PI480821S	1/4"	1/8"	-	500
PI480822S	1/4"	1/4"	-	400
PI480823S	1/4"	3/8"	-	400
PI481222S	3/8"	1/4"	-	200
PI481223S	3/8"	3/8"	-	200



**Note:** Fittings packaged 10 per poly bag.

## Fittings – John Guest

Quick connect fittings to reduce labor costs and provide quality assurance.



Male Connector



Union Tee



Union Connector



Reducer



Plug-In Elbow



Fixed Elbow

### John Guest Brand Fittings (white)

MODEL NO.	DESCRIPTION	TUBE	OTHER	THREAD SIZE	NO./ CASE
CI010822W	Male Connector	1/4"	-	1/4"	400
CI011222W	Male Connector	3/8"	-	1/4"	250
CI0208W	Union Tee	1/4"	-	-	300
CI0212W	Union Tee	3/8"	-	-	100
CI0408W	Union Connector	1/4"	-	-	400
CI0412W	Union Connector	3/8"	-	-	200
CI061208W	Reducer	1/4"	3/8" stem	-	400
CI220808W	Plug-in elbow	1/4"	1/4" stem,	-	500
CI221208W	Plug-in elbow	1/4"	3/8" stem	-	300
CI221212W	Plug-in elbow	3/8"	3/8" stem	-	200
CI480821W	Fixed elbow	1/4"	-	1/8"	500
CI480822W	Fixed elbow	1/4"	-	1/4"	400
CI481222W	Fixed elbow	3/8"	-	1/4"	200

**Note:** Fittings packaged 10 per poly bag.

## John Guest Parts & Replacement O-Rings

### John Guest Misc Parts & Fittings

MODEL NO.	DESCRIPTION	NO. / CASE
PI2808S	1/4" Plastic half cart. grey body, grey collet	1000
PI2808W	1/4" Plastic half cart. white body, white collet	1000
PI2812S	3/8" Plastic half cart. grey body, grey collet	1000
CP-R08I-S	1/4" O-ring	5000
CP-R12I-S	3/8" O-ring	5000
CP-R16I-S	1/2" O-ring	3000



### Fittings- Nipples

MODEL NO.	DESCRIPTION
NP1030	NIPPLE PVC SCH 80 1 IN X 3 IN
NP1225	NIPPLE PVC SCH 80 1/2 IN X 2 1/2 IN
NP1400	NIPPLE PVC SCH 80 1/4 IN X CLOSE
NP1415	NIPPLE NYLON 1/4 IN X 1-1/2 IN WHITE
NP1425	NIPPLE PVC SCH 80 1/4 IN X 2 1/2 IN
NP3425	NIPPLE PVC SCH 80 3/4 IN X 2 1/2 IN
NP3815	NIPPLE PVC SCH 80 3/8 IN X 1 1/2 IN

### John Guest® Miscellaneous

MODEL NO.	SIZE	NO./CASE
PI491612S	1/2" x 3/8" three-way divider	50
PI2312S	3/8" Two- way divider	100
PI4712S	3/8" Cross	100
PI2808S	1/4" Plastic half cartridge	1000
PI2812S	3/8" Plastic half cartridge	1000
PIC1808R	1/4" Locking clip red	1000
PIC1812R	3/8" Locking clip red	1000



**Note:** Fittings packaged 10 per poly bag.

## Fittings - Parker Fast and Tite

### NOTICE

Descriptions are Tubing O.D. X Thread size. Material of construction is black polypropylene. Working pressure and temperature for 1/4"-1/2" is 150PSI at 150 F (66 C). For 5/8" it is 100PSI at 125 F(52 C)

MODEL NO.	DESCRIPTION
I4220	ELBOW PP 1/2 IN BARBXBARB P8EUB8 PARKER 25 BOX
I4240	TEE PP 1/2 IN BARBXBARBXBARB P8TUB8 PARKER 50 BOX
I4250	UNION PP 1/2 IN BARBXBARB P8UCB8 PKR 100 BOX
I4301	UNION 1/4 IN COMPXCOMP P4UC4
I4303	UNION 3/8 IN COMPXCOMP P6UC6
I4304	UNION 1/2 IN COMPXCOMP P8UC8
I4306	UNION 5/16 IN X1/4 IN COMPXCOMP P5UC4
I4307	UNION 3/8 IN X1/4 IN COMPXCOMP P6UC4
I4309	UNION 1/2 IN X3/8 IN COMPXCOMP P8UC6
I4310	UNION 5/8 IN X3/8 IN COMPXCOMP P10UC6
I4311	UNION 5/8 IN X1/2 IN COMPXCOMP P10UC8
I4316	MALE ADAPTER 1/4 IN X 1/8 IN COMPXM
I4317	MALE ADAPTER 1/4 IN COMPXM P4MC4
I4321	MALE ADAPTER 3/8 IN X1/4 IN COMPXM
I4322	MALE ADAPTER 3/8 IN COMPXM P6MC6
I4323	MALE ADAPTER 3/8 IN X1/2 IN COMPXM
I4324	MALE ADAPTER 3/8 IN X3/4 IN COMPXM
I4325	MALE ADAPTER 1/2 IN X 1/8 IN COMPXM
I4326	MALE ADAPTER 1/2 IN X1/4 IN COMPXM
I4327	MALE ADAPTER 1/2 IN X3/8 IN COMPXM
I4328	MALE ADAPTER 1/2 IN COMPXM P8MC8
I4329	MALE ADAPTER 1/2 IN X3/4 IN COMPXM
I4333	MALE ADAPTER 5/8 IN X1/2 IN COMPXM
I4334	MALE ADAPTER 5/8 IN X3/4 IN COMPXM
I4335	FEMALE ADAPTER 1/4 IN X 1/8 IN COMPXF
I4336	FEMALE ADAPTER 1/4 IN COMPXF P4FC4
I4337	FEMALE ADAPTER 3/8 IN X1/4 IN COMPXF
I4338	FEMALE ADAPTER 3/8 IN COMPXF P6FC6
I4339	FEMALE ADAPTER 3/8 IN X1/2 IN COMPXF
I4340	FEMALE ADAPTER 1/2 IN X3/8 IN COMPXF
I4341	FEMALE ADAPTER 1/2 IN COMPXF P8FC8
I4343	ELBOW 1/4 IN X 1/8 IN COMPXM P4ME2
I4344	ELBOW 1/4 IN COMPXM P4ME4
I4345	ELBOW 1/4 IN X3/8 IN COMPXM P4ME6
I4349	ELBOW 3/8 IN X1/4 IN COMPXM P6ME4
I4350	ELBOW 3/8 IN COMPXM P6ME6
I4351	ELBOW 3/8 IN X1/2 IN COMPXM P6ME8
I4352	ELBOW 3/8 IN X3/4 IN COMPXM P6ME12
I4353	ELBOW 1/2 IN X3/8 IN COMPXM P8ME6
I4354	ELBOW 1/2 IN COMPXM P8ME8
I4355	ELBOW 5/8 IN X1/2 IN COMPXM P10ME8



## Fittings - Parker Fast and Tite

MODEL NO.	DESCRIPTION
I4357	ELBOW 1/4 IN COMPXF P4FE4
I4359	ELBOW 3/8 IN X1/4 IN COMPXF P6FE4
I4360	ELBOW 3/8 IN COMPXF P6FE6
I4362	ELBOW 1/2 IN COMPXF P8FE8
I4362J	ELBOW NYLON 1/2 IN 45-8-8NPG JACO
I4363	ELBOW 5/8 IN X1/2 IN COMPXF P10FE8
I4364	ELBOW 1/4 IN COMPXCOMP P4EU4
I4366	ELBOW 3/8 IN COMPXCOMP P6EU6
I4367	ELBOW 1/2 IN COMPXCOMP P8EU8
I4368	ELBOW 5/8 IN COMPXCOMP P10EU10
I4370	ELBOW 3/8 IN X1/4 IN COMPXCOMP P6EU4
I4373	TEE 1/4 IN COMPXCOMPXCOMP P4TU4
I4375	TEE 3/8 IN COMPXCOMPXCOMP P6TU6
I4377	TEE 1/2 IN COMPXCOMPXCOMP P8TU8
I4379	TEE 5/8 IN COMPXCOMPXCOMP P10TU10
I4381	BRANCH TEE 1/4 IN COMPXCOMPXM P4MT4
I4384	BRANCH TEE 3/8 IN X3/8 IN X1/4 IN COMPXCOMPXM
I4387	BRANCH TEE 1/2 IN COMPXCOMPXM
I4388	BRANCH TEE 5/8 IN X5/8 IN X1/2 IN COMPXCOMPXM
I4390	RUN TEE 3/8 IN X1/4 IN X3/8 IN COMPXMCOMP
I43AGME4	TRUESEAL ELBOW 3/8 TUBE X 1/4 MPT ACETAL
I43AGTU4	TRUESEAL UNION TEE 3/8 X 1/4 TUBE ACETAL
I4402	NUT AND SPACER 1/4 IN P4NS 100 BOX
I4404	NUT AND SPACER 3/8 IN P6NS 100 BOX
I4405	NUT AND SPACER 1/2 IN P8NS
I4406	GRAB RING SS302 1/4 IN 4 GR 100 BOX
I4406-P	GRAB RING PLASTIC 1/4 IN 4 GRP 100 BOX
I4408	GRAB RING SS302 3/8 IN 6 GR 100 BOX
I4408-P	GRAB RING PLASTIC 3/8 IN 6 GRP
I4409	GRAB RING SS302 1/2 IN 8 GR 100 BOX
I4410	ORING 1/4 IN 4OR PARKER 100 BOX
I4412	ORING 3/8 IN 6OR PARKER 100 BOX
I4412-V	ORING 3/8 IN 6OR VITON
I4413	ORING 1/2 IN 8OR PARKER 100 BOX



## Tubing (Standard / Polyethylene / Vinyl)



### Watts Polyethylene Tubing

MODEL NO.	SIZE (OD)	LENGTH (FEET.)	COLOR	NO./ CASE
FMPE-14-W-500	1/4"	500	White	1
FMPE-14-B-500	1/4"	500	Black	1
FMPE-14-L-500	1/4"	500	Blue	1
FMPE-38-W-250	3/8"	250	White	1
FMPE-38-B-250	3/8"	250	Black	1
FMPE-38-L-250	3/8"	250	Blue	1

### Polyethylene Tubing

MODEL NO.	SIZE (OD)	LENGTH (FEET.)	COLOR	NO./ CASE
I8030	.375"	100'	Black Low Density	1
I8040	.50"	100'	Black High Density	1
I8045	.625"	100'	Black Low Density	1
I8050	.25"	100'	Blue High Density	1
I8055	.25"	100'	Red High Density	1
I8060	.25"	100'	Black High Density	1
I8065	.375"	100'	Blue High Density	1
I8070	.375"	100'	Black High Density	1
I8080	.50"	100'	Black Low Density	1

### White Vinyl Tubing

MODEL NO.	SIZE (OD)	LENGTH (FEET.)	COLOR	NO./ CASE
TL300	1/4"	3	White	1
TL300-5	1/4"	500	White	1
TL375-5	3/8"	500	White	1



## Tubing (Standard / Polyethylene / Vinyl)



TSNIP

### John Guest® Polyethylene Tubing

MODEL NO.	SIZE (OD)	LENGTH	COLOR	NO. / CASE
PE-08-BI-0500FN	1/4"	500 (ft)	Natural	2
PE-08-BI-0500FW	1/4"	500 (ft)	White	2
PE-08-BI-0500FE	1/4"	500 (ft)	Black	2
PE-08-BI-0500FB	1/4"	500 (ft)	Blue	2
PE-08-BI-0500FR	1/4"	500 (ft)	Red	2
PE-08-BI-0500FO	1/4"	500 (ft)	Orange	2
PE-08-BI-0500FG	1/4"	500 (ft)	Green	2
PE-08-BI-0500FY	1/4"	500 (ft)	Yellow	2
PE-08-BI-1000FN	1/4"	1000 (ft)	Natural	1
PE-08-BI-1000FW	1/4"	1000 (ft)	White	1
PE-08-BI-1000FE	1/4"	1000 (ft)	Black	1
PE-08-BI-1000FB	1/4"	1000 (ft)	Blue	1
PE-08-BI-1000FR	1/4"	1000 (ft)	Red	1
PE-10-CI-0500FB	5/16"	500 (ft)	Blue	2
PE-12-EI-0500FN	3/8"	500 (ft)	Natural	1
PE-12-EI-0500FW	3/8"	500 (ft)	White	1
PE-12-EI-0500FE	3/8"	500 (ft)	Black	1
PE-12-EI-0500FB	3/8"	500 (ft)	Blue	1
PE-12-EI-0500FR	3/8"	500 (ft)	Red	1
PE-12-EI-0500FO	3/8"	500 (ft)	Orange	1
PE-12-EI-0500FG	3/8"	500 (ft)	Green	1
PE-12-EI-0500FY	3/8"	500 (ft)	Yellow	1
PE-16-GI-0250FE	1/2"	250 (ft)	Black	1
PE-16-GI-0250FN	1/2"	250 (ft)	Natural	1
PE-16-GI-0250FB	1/2"	250 (ft)	Blue	1

## Flow Restrictors Residential RO

Inserts for Jaco® & John Guest® fittings and totally assembled fittings with flow restrictors.

### Flow Restrictors (inserts)

MODEL NO.	TO DRAIN (GPD)	COLOR	NO./CASE
<b>Insert to fit JACO 1/8" elbow</b>			
FR-50-256	50	Yellow	100
FR-70-256	70	Blue	100
FR-100-256	100	Red	100
FR-125-256	125	Green	100
FR-150-256	150	Black	100
FR-200-256	200	Brown	100

### Insert to fit John Guest 1/8" elbow

FR-50-220	50	Yellow	100
FR-70-220	70	Blue	100
FR-100-220	100	Red	100
FR-125-220	125	Green	100
FR-150-220	150	Black	100
FR-200-220	200	Brown	100

### Assembled into Jaco Fitting F40-4-2-N-O

FR-50-256JF	50	Yellow,	100
FR-70-256JF	70	Blue,	100
FR-100-256JF	100	Red,	100
FR-150-256JF	150	Black,	100
FR-200-256JF	200	Brown,	100

### Assembled into John Guest Fitting PI480821S

FR-50-220JG	50	Yellow,	100
FR-70-220JG	70	Blue,	100
FR-100-220JG	100	Red,	100
FR-125-220JG	125	Green,	100
FR-150-220JG	150	Black,	100
FR-200-220JG	200	Brown,	100



#### NOTICE

Select a flow restrictor that is rated at approximately three times the RO's production rate. Fittings are also available in white.

## Flow Restrictors Residential RO

Capillary and 1/4" Quick Connect Inline Style Flow Restrictors.

### Flow-Pur Capillary Tube Restrictor

MODEL NO.	FLOW (GPD)	FLOW (MLM)	FITTING	NO./CASE
FLOW-185	49	185	1/4" Quick conn.	50
FLOW-250	66	250	1/4" Quick conn.	50
FLOW-350	93	350	1/4" Quick conn.	50
FLOW-420	111	420	1/4" Quick conn.	50
FLOW-525	139	525	1/4" Quick conn.	50
FLOW-800	211	800	1/4" Quick conn.	50



### Flow Restrictors

MODEL NO.	DESCRIPTION	NO./CASE
FC-DR110I	Capillary Tube Flow Restrictor 110 ML/Min. Red	50
FC-DR200I	Capillary Tube Flow Restrictor 200 ML/Min. (Brown)	50
FC-DR300I	Capillary Tube Flow Restrictor 300 ML/Min. (Black)	50
FC-DR400I	Capillary Tube Flow Restrictor 400 ML/Min. (Yellow)	50
FC-DR525I	Capillary Tube Flow Restrictor 525 ML/Min. (Green)	50
FC-DR620I	Capillary Tube Flow Restrictor 620 ML/Min. (Blue)	50
FC-DR730I	Capillary Tube Flow Restrictor 730 ML/Min. (White)	50
FC-DR850I	Capillary Tube Flow Restrictor 850 ML/Min. (White)	50
FC-DR200Q/2	Flow Restrictor 200ML/Min W/Quick Connect 1/4"	10
FC-DR250Q/2	Flow Restrictor 250ML/Min W/Quick Connect 1/4"	10
FC-DR300Q/2	Flow Restrictor 300ML/Min W/Quick Connect 1/4"	10
FC-DR350Q/2	Flow Restrictor 350ML/Min W/Quick Connect 1/4"	10
FC-DR400Q/2	Flow Restrictor 420ML/Min W/Quick Connect 1/4"	10
F122031	Flow Restrictor 350ML/Min (OrangeTubing Only)	1
F122041	Flow Restrictor 400ML/Min (Yellow Tubing Only)	1



## Electrical Level Switch (Standard / Low Pressure)

### Electrical Level Switch (Standard / Low Pressure)

MODEL NO.	DESCRIPTION
F258300	Electrical Liquid Level Controller
TLC-DC	Electrical Tank Level Controller, 6800 and 8800 Pump
LPS	Electrical Low Pressure Switch
U217-2E	Electrical 30 To 50psi Pressure Switch For Repressurization Systems

## Ball Valves, Gauges, Regulators and Misc Components

Watts offers a variety of high-quality ball valves, pressure gauges and regulators, mounting clips, flow restrictors, automatic shut-off valves, tubing, and tools.

### Plastic Tubing Ball Valves



BV250B



BV9014WHC



BV250W



BV9014W



BV9014B

### Flowmatic Ball Valves

MODEL NO.	DESCRIPTION	FITTING	COLOR	SIZE	NO. / CASE
BV250W	Straight	JACO	White	1/4"	400
BV250B	Straight	JACO	Black	1/4"	400
BV9014W	Elbow	JACO	White	1/4"	500
BV9014B	Elbow	JACO	Black	1/4"	500
BV9014W-HC	Elbow	J. Guest	White	1/4"	500
BV9038W	Elbow	JACO	White	3/8"	50

### John Guest Brand Shut-Off Valve

MODEL NO.	DESCRIPTION	NO. / CASE
PPSV010822W	1/4" x 1/4" Male NPTF straight valve	200
PPSV011223W	3/8" x 3/8" Male NPTF straight valve	100
PPSV040808W	1/4" x 1/4" Straight valve	200
PPSV041212W	3/8" x 3/8" Straight valve	100
PPSV500822W	1/4" x 1/4" Female NPTF elbow valve	200
PPSV501222W	3/8" x 1/4" Female NPTF elbow valve	100
PPASV121208W	Angle stop, 3/8", 3/8", 1/4"	30
PPASV121212W	Angle stop, 3/8", 3/8", 3/8"	30



## Pressure Gauges

Full line of stainless steel pressure gauges with brass fittings.



### Side Mount Models (2-1/2" diameter)

MODEL NO.	TYPE	PSI	KG	FITTING	MATERIAL (BODY)	MATERIAL (FITTINGS)	NUMBER PER CASE
PG05L25	Glycerin Filled	0-70	0-5	1/4" MNPT	304 SS	Brass	1
PG07L25	Glycerin Filled	0-100	0-7	1/4" MNPT	304 SS	Brass	1
PG15L25	Glycerin Filled	0-200	0-15	1/4" MNPT	304 SS	Brass	1
PG20L25	Glycerin Filled	0-300	0-20	1/4" MNPT	304 SS	Brass	1

### Back Mount Models (2-1/2" diameter)

MODEL NO.	TYPE	PSI	KG	FITTING	MATERIAL (BODY)	MATERIAL (FITTINGS)	NUMBER PER CASE
PG07B25	Glycerin Filled	0-100	0-7	1/4" MNPT	304 SS	Brass	1
PG15B25	Glycerin Filled	0-200	0-15	1/4" MNPT	304 SS	Brass	1
PG20B25	Glycerin Filled	0-300	0-20	1/4" MNPT	304 SS	Brass	1

## Pressure Regulators

MODEL NO.	DESCRIPTION
P60-M1-4-25	REG 1/4 IN M5 PLASTIC 0-25 PSI 2/4 PORT LEAD FREE
FC-REG.060B	WATTS INLINE REGULATOR 0-60PSI BRASS 1/4F
P60-4	REG M1 1/4 IN PLS 0-125 PSI 2/4 PORT LF VINYL TUBING QDO
FMP60PSI	APEX PRESSURE LIMITING VALVE 60PSI
T326101	TGI-APEX FILTAMATE FMP50 PRESSURE LIMITING VALVE 1/4"
T326102	TGI-APEX PRESS.REG 85 PSI LIMITING VALVE 1/4"



## Mounting Clips (Standard / Residential RO)

Polypropylene molded clips in six styles and colors.



### Mounting Clips

MODEL NO.	SIZE	COLOR	DESCRIPTION	NO. / CASE
C-2000B	2"	Black	In-line	500
C-2000W	2"	White	In-line	500
C2500B	2-1/2"	Black	Single, membrane	300
C2500W	2-1/2"	White	Single, membrane	300
DC2000W	2" x 2"	White	Double in-line	300
DC2500B	2-1/2" x 2"	Black	Dual	300
DC2500W	2-1/2" x 2"	White	Dual	300
DC3000W	2-1/2" x 2-1/2"	White	Double	300

## Leak Protection

*International Patents Pending.*

*Don't let this happen to your customers!*

*Protect yourself from potential leaks due to high water pressure, customer issues or installation mishaps.*

Leak Protector by Watts®  
 “detects” and “protects”.

This unique Leak Protector by Watts not only detects leaks, it also shuts off flow to a drinking water system in the event a leak should occur.

### How it works!

The patented device is novel, but quite simple. When a leak occurs, the adsorbent applicator “tablet” expands to close the valve and shut off the incoming water supply. Two tablets are included with each Leak Protector, and replacement tablets are available, packaged two per pack.

Maximum operating pressure = 100 psi

Maximum ambient humidity = 70%

### **⚠ WARNING**

Keep Leak Protector Replacement Cartridges (pads) out of the reach of children.



Leak Protector



Adsorbent Applicator Pads

MODEL NO.	DESCRIPTION	QTY. PER CASE
LPSOV	1/4" Leak protector & shut off valve with two applicator tablets (1)	150
LPSOV-3/8	3/8" Leak protector & shut off valve with two applicator tablets (1)	150
LPSOV-PAD	Replacement applicator tablets (package of 2)	25

## Automatic ShutOff Valves Residential RO

*The original "dual diaphragm" design*

The original dual diaphragm design of Flowmatic's WQA validated valves provide automatic shut-off to supply line when storage tank reaches 65% of inlet pressure, to potentially save thousands of gallons of water per year. Valves are made using FDA grade, NSF certified materials in choice of models and colors.



### Flowmatic Brand Shut-Off Valves

MODEL NO.	SIZE	FITTINGS	COLOR	NO. / CASE
S2000HCB	1/4"	John Guest	Black	40
S3000W	1/4"	Jaco	White	100
S3000B	1/4"	Jaco	Black	100
S3000HCW	1/4"	John Guest	White	50
S3000HCB	1/4"	John Guest	Black	50

### Replacement Diaphragms

MODEL NO.	DESCRIPTION	NO. / CASE
DPG3000A	Upper Diaphragm (S2000, 3000)	200
DPG3000B	Lower Diaphragm (S2000, 3000)	100



## Nuts Ferrules Inserts



MODEL NO.	DESCRIPTION
SL14	TUBE SLEEVE DELRIN 1/4 IN OD TUBING
SL38	TUBE SLEEVE DELRIN 3/8 IN OD TUBING
INS14	TUBE INSERT NYLON 1/4 IN OD TUBING
INS38	TUBE INSERT NYLON 3/8 IN OD TUBING

## Feed Water Valves and Drain Saddles



MODEL NO.	DESCRIPTION
F12-38JG	DLA-12 RO DRAIN LINE ADAPTOR
SV-1	FEEDWATER VALVE 1/2 IN MNPT X 1/2 IN FNPT X 1/4 IN
SV-2	FEEDWATER VALVE 3/8 IN MNPT X 3/8 IN FNPT X 1/4 IN
SV-3	SADDLE VALVE FITS FEED PIPES 3/8 IN TO 1-1/4 IN
SV-3L	SADDLE VALVE FITS FEED PIPES 3/8 IN TO 1-1/4 IN LOW LEAD
SV-6	SADDLE VALVE FITS FEED PIPES 1/4 IN TO 3/8 IN CTS
SV-6EZ	SADDLE VALVE 1/4 IN JGQC
SV-6EZ38	SADDLE VALVE 3/8 IN JGQC
SVBV-14	PLB VALVE BALL 1/4 IN JGX1/2 IN FNPTX1/2 IN MNPT TEE
SVBV-38	PLB BALL VALVE 3/8 IN JGX1/2 IN FNPTX1/2 IN MNPT TEE
SC500B14	DRAIN SADDLE 1/4 IN JACO BLACK
SC500B38	DRAIN SADDLE 3/8 IN JACO BLACK



## Adapt-a-Valve

MODEL NO.	DESCRIPTION
F560080	ADAPT-A-VALVE KIT PLASTIC



## Installation Specialties/Tools

MODEL NO.	DESCRIPTION
I1020-10	Silicone 5.3 Oz Tube, Dow No7, 12 per Case
I1050	Teflon Tape 1/2 IN X 520 IN HD Alamo Brand
I1055	Teflon Tape 3/4 IN X 520 IN HD Alamo Brand
I1080	Leak Lock Blue Thread Sealant Per Tube USDA
BLADES	Replacement Tube Cutter Blade
TSNIP	Tube Cutter Black
TSPITool	1/4 - 3/8 Release Set Black
U1006	Funnel, 10 IN X 2-1/2 IN Hole, Blue Plastic
U1007	Funnel, 4 IN, White, Heavy Duty
U1008	Funnel, 2-1/2 IN, White, Heavy Duty

## Tank Heads

Watts offers a variety of high-quality and reliable valves & tank heads, including molded and machined tank heads, diaphragm valves, and control valves and parts.



## Tank Heads Molded/Machined/Bushings and Adaptors

### Ordering Information

#### Molded Tank Heads

MODEL NUMBER	DESCRIPTION
<b>Tank head, injection molded with o-ring</b>	
Q6041B	3/4" ABS, 890-S w/o inserts, 13/16" riser
Q5850	3/4" Poly, 3 hole, 2.5" #8 with 3/4" FNPT for riser, 13/16" riser
Q3020	1/4" Poly in/out 2.5" #8 with MPU-14 screen, 3/4" FNPT riser
Q4338E	O-ring EPDM for Q5850 & Q3020
<b>Tank head, polypropylene glass filled</b>	
QMH2587S	3/4" in/out, 13/16" riser, blue

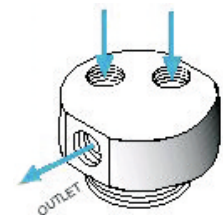
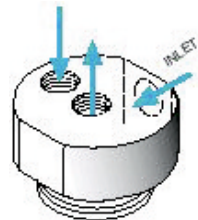
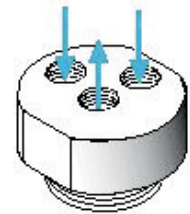
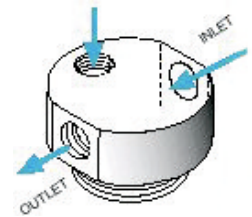

#### Machined PVC Tank Heads

MODEL NUMBER	DESCRIPTION	CENTER RISER HOLE
<b>Side ports</b>		
Q3025	2.5" x 1/4" with 3/4" fill hole & plug	3/4" NPT offset
Q8040	2.5" x 3/8"	13/16"
Q8040-.75	2.5" x 3/8" with 3/4" fill hole & plug	13/16"
Q8042	2.5" x 1/2"	13/16"
Q8042-.75	2.5" x 1/2" with 3/4" fill hole & plug	13/16"
Q8044	2.5" x 3/4"	13/16"
Q8044-.75	2.5" x 3/4" with 3/4" fill hole & plug	13/16"
Q8044-1	2.5" x 1"	1.05"
Q8044-2	2.5" x 3/4" with 3/4" fill hole & plug/inlet screen	13/16"
Q8044-DS	2.5" x 3/4" with 1/8" vent hole w/o plug	13/16"
Q8048	4" x 1"	1.05"
Q8048-1.0	4" x 1" with 1" fill hole & plug	1.05"
Q8047-1.5	4" x 1.5"	1.5"
Q8049-1.5	4" x 1.5" with 3/4" fill hole & plug	1.5" NPT offset
Q8052A	4.5" x 1" with 1" fill hole & plug	1.05"
<b>Top ports</b>		
Q8056	2.5" x 1/2"	13/16"
Q8066-1.0	4.5" x 1" with 1" fill hole & plug	1.05"
<b>Side-inlet / Top-outlet</b>		
Q8080	4.5" x 1"	1.05"

## Diaphragm Valves and Stagers



### Ordering Information

#### Aquamatic Diaphragm Control Valves\*

MODEL NO.	DESCRIPTION	SIZE	AQUAMATIC VALVE NO.	BODY	WEIGHT (LBS)
K1031	Normally Open	3/4" FNPT	421	Metal	4
K1032	Normally Open	1" FNPT	421	Metal	4
K1034	Normally Open	1-1/2" FNPT	424	Metal	7
K1035	Normally Open	2" FNPT	425	Metal	16
K1036	Normally Open	2" FNPT	426	Metal	16
K1037	Normally Open	2-1/2" FNPT	426	Metal	20
K1038	Normally Open	3" FNPT	427	Metal	31
K1039	Normally Open	3" FNPT	427	Metal	45
K1040	Normally Open	4" FLANGE	428F	Metal	75
K1131	Normally Closed	3/4" FNPT	421	Metal	4
K1132	Normally Closed	1" FNPT	421	Metal	4
K1133	Normally Closed	1-1/4" FNPT	424	Metal	12
K1134	Normally Closed	1-1/2" FNPT	424	Metal	7
K1135	Normally Closed	2" FNPT	425	Metal	16
K1138	Normally Closed	3" FNPT	427	Metal	31
K1140	Normally Closed	4" FLANGE	428	Metal	75
K1045	Normally Open w/ connector	1/2" MNPT	520	Plastic	2
K1047	Normally Open w/ connector	1" MNPT	521	Plastic	2
K1048	Normally Open w/ connector	1-1/2" MNPT	524	Plastic	3
K1050	Normally Open w/o connector	2" MNPT	524	Plastic	5
K1051	Normally Open	2" FLANGE	524F	Plastic	4
K1053	Normally Open	2-1/2" FLANGE	526F	Plastic	10
K1054	Normally Open	3" FLANGE	526F	Plastic	12
K1147	Normally Closed w/ connector	1" MNPT	521	Plastic	2
K1148	Normally Closed w/ connector	1-1/2" MNPT	524	Plastic	3
K1151	Normally Closed	2" FLANGE	524	Plastic	4
K1070	Normally Open	3"	537	Plastic	12

\*Max operating specification: 125psi @140°F. If the dome cap is set up with stager fitting the valve is normally open; if the stager fitting is on the main body & dome cap is plugged, valve is normally closed.

### Diaphragm & Seal Kits

MODEL NO.	DESCRIPTION	SIZE
K12421-RA	Diaphragm & seal kit for metal body 421 valve	3/4" & 1"
K12424-RA	Diaphragm & seal kit for metal body 424 valve	1.5"
K12425-RA	Diaphragm & seal kit for metal body 425 valve	2"
K12426-RA	Diaphragm & seal kit for metal body 426 valve	2.5"
K12427-RA	Diaphragm & seal kit for metal body 427 valve	3"
K12428-RA	Diaphragm & seal kit for metal body 428 valve	4"
K12429-RA	Diaphragm & seal kit for metal body 429 valve	6"
K12520-RA	Diaphragm & seal kit for plastic body 520 valve	1/2"
K12521-RA	Diaphragm & seal kit for plastic body 521 valve	3/4" & 1"
K12524-RA	Diaphragm & seal kit for plastic body 524 valve	1.5" & 2"
K12526-RA	Diaphragm & seal kit for plastic body 526 valve	2.5" & 3"
K12524-UA	2" Male socket adaptors for 524 valve	2"

### Aquamatic Valve Controller (Stager)

MODEL NO.	DESCRIPTION	AQUAMATIC MODEL NUMBER
K11148-NXT120	120/60 w/ homing & AMS 7D	A148-00

## PVC Eductors



### Ordering Information

#### Aquamatic PVC Eductors\*

MODEL NO.	DESCRIPTION	SIZE	COLOR
K1075-4	540-4	1/2" NPT	White
K1080-1	541-1	3/4" NPT	Red
K1080-2	541-2	3/4" NPT	White
K1080-3	541-3	3/4" NPT	Blue
K1085-1	542-1	1" NPT	Red
K1085-2	542-2	1" NPT	White
K1085-3	542-3	1" NPT	Blue
K1090-1	544-1	1-1/2" NPT	Red
K1090-2	544-2	1-1/2" NPT	White
K1090-3	544-3	1-1/2" NPT	Blue

\*Max operating temp: 140° F, operating pressure: 20 - 125 psi.



#### Eductor Sizing (model number indication chart)

TANK SIZE D" X H"	0-50 PSI	50-90 PSI	OVER 90 PSI
18 x 54	541-2	541-1	540-5
18 x 60	541-2	541-1	540-5
20 x 48	541-2	541-2	540-5
20 x 54	541-2	541-2	540-5
20 x 60	541-3	541-2	541-1
24 x 60	541-3	541-2	541-2
24 x 72	542-1	541-3	541-3
30 x 60	542-2	542-1	541-3
30 x 72	542-2	542-1	541-3
36 x 60	542-3	542-2	542-1
36 x 72	544-1	542-3	542-2
42 x 60	544-1	542-3	542-2
42 x 72	544-2	544-1	542-3
48 x 60	544-2	544-1	542-3
48 x 72	544-3	544-2	544-1
54 x 60	544-3	544-2	544-1
54 x 72	544-4	544-3	544-2
60 x 60	544-4	544-3	544-2
60 x 72	544-5	544-3	544-2
66 x 60	544-5	544-3	544-2
66 x 72	546-1	544-3	544-3
72 x 60	546-1	544-5	544-3
72 x 72	546-2	546-1	544-4

**Control Valves Autotrol 255, 263, 268**



Autotrol® 255 plastic valves

MODEL NO.	VALVE	USE	PIPE SIZE	BY-PASS	ELECTRICAL	DESCRIPTION	CASE QTY
K2000M	255/460i	Softener TC	3/4"	N/A	120/60	Valve only	8
K2000MB	255/460i	Softener TC	3/4"	3/4" PVC	120/60	Valve, bypass	8
K2000B	255/460i	Softener DEM	3/4"	N/A	120/60	Valve only, 12v trans	8
K2005	255/460i	Softener DEM	3/4"	N/A	120/60	Valve, brass piping boss, 12V trans	4
K2005B	255/460i	Softener DEM	3/4"	3/4" PVC	120/60	Valve, bypass, 12v trans	8

TC = time clock (mechanical) DEM (demand (metered))



Autrol® 263 / 268 Logix valves

MODEL NO.	VALVE	USE	PIPE SIZE	BY-PASS	ELECTRICAL	DESCRIPTION	CASE QTY
K2026876-0126	126/740	Filter	1"	N/A	120/60	Valve only	4

## Bypass Valves Autotrol

MODEL NO.	DESCRIPTION
K2101A	256 BP F255 W 3/4 IN PVC ADAPTER
K2101-ASSY	256 BP F255 WO ADAPTERS
K2101B	256 BP F255 W 1 IN PVC ADAPTER
K021265	1265 BP F/ 263, 268, and 1100

## Control Valve Parts Autotrol

MODEL NO.	DESCRIPTION
K2201F-19	BRINE CONTROL ASSY 19LBS 100N108G2
K221000811	460I AND 960 LOGIX INDOOR TRANSFORMER
K221002449	DRAIN FITTING 03/4 IN FNPT X 050 IN BARB
K22100A213-801	VALVE DISC STD AND SEVERE SERVICE F255
K221030272	INJECTOR IN D IN SIZE GREEN
K221040392	TAIL 3/4 IN CPVC PAIR
K221040393	TAIL 1 IN CPVC PAIR
K221040762	FC DISC BLANK W ORING F5-40 GPM MOQ12
K221040763	FLOW CONTROL INSERT BLANK
K221041174	VALVE DISC F263 268 269
K221235448	TRANSFORMER OUTDOOR 120 TO 12 VDC
K221236246	COVER INDOOR LOGIX DK GRAY
K221240601	COVER OUTDOOR W FRONT INSERT LOGIX UV ALM
K22155A152	VALVE DISC F155 168 730
K2228F-BB	INJECTOR IN B IN SIZE BLUE
K2228F-CC	INJECTOR IN C IN SIZE RED
K22460TC	TIMER ASSY 460TC TIMER 12V 60HZ W TRANS
K2298F-1	MOTOR 440 TIMER 120V 60HZ
K2299F-1	TRIPPER ARM 6 DAY
K2304E-1	GEAR BLACK 118 MIN-STD 420A43
K2304E-3	GEAR BLACK 420A44

# Control Valves - Fleck 5600, 2510, 4650, 7000, 2750, 9000, 9100, 9500, 2850, 2900, 3150, 3900



## Fleck® 2510 plastic valves

MODEL NO.	VALVE	USE	PIPE SIZE	BY-PASS	ELECTRICAL	DESCRIPTION	CASE QTY
K4022FM	2510	Filter, manual	3/4"	N/A	N/A	With cover, DLFC is separate	1
K4022FM-Y075	2510	Filter, manual	3/4"	N/A	N/A	Cover, 3/4" MNPT plastic yoke, DLFC	1
K4022SM	2510/1650	Softener, manual	3/4"	N/A	N/A	Cover only, DLFC is separate	1
K4022SM-Y075	2510/1650	Softener, manual	3/4"	N/A	N/A	Cover, 3/4" MNPT plastic yoke, DLFC	1
K4022FTC12-1206	2510	Filter	3/4"	N/A	120/60	Valve only, TC	1
K4022FTC-B075	2510	Filter	3/4"	3/4" plastic	120/60	With bypass, cover, DLFC	1
K4022FTC-B100	2510	Filter	3/4"	1" plastic	120/60	With bypass, cover, DLFC	1
K4022FTC-B100SS	2510	Filter	3/4"	1" stainless	120/60	With bypass, cover, DLFC	1
K4022STC-B075	2510	Softener, TC	3/4"	3/4" plastic	120/60	With bypass, cover, DLFC	1
K4022STC-B100	2510/1650	Softener, TC	3/4"	1" plastic	120/60	With bypass, cover, DLFC	1
K4022STC-B100SS	2510/1650	Softener, TC	3/4"	1" stainless	120/60	With bypass, cover, DLFC	1
K4022SMTS-1206	2510/1650	Softener, meter	3/4"	N/A	120/60	Valve only (3/4" std. range)	1
K4022SMT-B075	2510/1650	Softener, meter	3/4"	3/4" plastic	120/60	Cover, 3/4" MNPT plastic yoke, DLFC	1
K4022SMT-B100	2510/1650	Softener, meter	3/4"	1" plastic	120/60	Includes by pass and cover.	1



## Fleck® 2750 brass valves

MODEL NO.	VALVE	USE	PIPE SIZE	BY-PASS	ELECTRICAL	DESCRIPTION	CASE QTY
K4010F	2750	Filter, manual	1"	N/A	N/A	Valve only, order DLFC separately	9
K4010CF	2750	Filter	1"	N/A	120/60	Valve only, cover, DLFC separate	4
K4010CF-AMS-ENV	2750	Filter	1"	N/A	120/60	Valve only with aux micro switch*	4
K4010C	2750/1600	Softener, TC	1"	N/A	120/60	Valve only	4
K4010CM	2750/1600	Softener, meter	1"	N/A	120/60	Valve only, (3/4" meter)	1
K4010CME	2750/1600	Softener, meter	1"	N/A	120/60	Valve only, (3/4" range meter) EXT	4
K4010DE	2750/1600	Softener, meter	1"	N/A	120/60	Valve only, (1" ext range meter)	4
K4010D	2750/1600	Softener, meter	1"	N/A	120/60	Valve only, (1" meter)	4
K4010CM-SE	2750/1600	Softener, SXT	1"	N/A	120/60	SXT valve & transformer (3/4" M)*	4

M = Manual; TC = time clock; MTR = metered; A = automatic; SXT = simple electronics; NXT = networking timer; STD = standard range meter/ EXT = extended range meter; HWBP = hard water bypass piston; NHWBP = no hard water bypass piston; AMS = auxillary micro switch; ENV = enviromenta; DLFC = drain line flow control housing (order GPM button separately); PL = plastic; SS = Stainless steel; RM = remote meter; SYS = system.

## Control Valves - Fleck 5600, 2510, 4650, 7000, 2750, 9000, 9100, 9500, 2850, 2900, 3150, 3900



### Fleck® 2850 brass valves

MODEL NO.	VALVE	USE	PIPE SIZE	BY-PASS	ELECTRICAL	DESCRIPTION	CASE QTY
K4050EFC7AN	2850	Filter	1-1/2"	N/A	120/60	Valve, micro switch, NHW by-piston*	1
K4050FC	2850	Filter	1-1/2"	N/A	120/60	Valve only*	4
K4050EF-NT	2850	Filter, NXT	1-1/2"	N/A	120/60	NXT valve w/ no hard water piston*	1
K4050FNT	2850	Filter	1-1/2"	N/A	120/60	NXT valve only*	1
K4051SC	2850/1600	Softener	1-1/2"	N/A	120/60	Valve only*	1
K4051SME1	2850/1600	Softener, meter	1-1/2"	N/A	120/60	Valve only* (1" std. range)*	4
K4051SMS1	2850/1600	Softener, meter	1-1/2"	N/A	120/60	Valve only* (1" std. range)*	4
K4051ESE	2850/1650	Softener, SXT	1-1/2"	N/A	120/60	SXT valve only w/o turbine*	1
K4050-SE	2850/1650	Softener, SXT	1-1/2"	N/A	120/60	SXT valve only with turbine*	1
K4050SC	2850/1700	Softener, TC	1-1/2"	N/A	120/60	Valve only*	4
K4050SME1	2850/1710	Softener, meter	1-1/2"	N/A	120/60	Valve only* with 1" ext. range*	4



### Fleck® 2900 brass valves

MODEL NO.	VALVE	USE	PIPE SIZE	BY-PASS	ELECTRICAL	DESCRIPTION	CASE QTY
K4018F	2900	Filter	2"	N/A	120/60	Valve, C	1
K4018F-NT	2900	Filter NT	2"	N/A	120/60	Valve, C, ENV, NHWBP, w/trans	4
K4018B-E	2900/1600	Softener MTR	2"	N/A	120/60	Valve, C, 2" EXT	1
K4018B	2900/1600	Softener MTR	2"	N/A	120/60	Valve, C, 2" STD	1
K4018G	2900/1600	Softener MTR	2"	N/A	120/60	Valve, C, SYS 7, ENV, 2" RM, STD	1
K4018A	2900/1600	Softener TC	2"	N/A	120/60	Valve, C	4
K4018-NTH	2900/1650	Softener NT	2"	N/A	120/60	Valve, C, ENV, HWBP, w/trans	4
K4018-NT	2900/1650	Softener NT	2"	N/A	120/60	Valve, C, ENV, NHWBP, w/trans	1
K4017	2900/1710	Softener NT	2"	N/A	120/60	Valve, C	1
K4017CE	2900/1710	Softener MTR	2"	N/A	120/60	Valve, C, 2" EXT	4
K4017C	2900/1710	Softener MTR	2"	N/A	120/60	Valve, C, 2" STD	4
K4017DE	2900/1710	Softener MTR	2"	N/A	120/60	Valve, C, SYS 5, ENV, 2" EXT, NHWBP	4
K4017D	2900/1710	Softener MTR	2"	N/A	120/60	Valve, C, SYS 5, ENV, 2" STD, NHWBP	4
K4017G	2900/1710	Softener MTR	2"	N/A	120/60	Valve, C, SYS 7, ENV	1
K4017E	2900/1710	Softener MTR	2"	N/A	120/60	Valve, C, SYS 7, ENV, 2" RM, STD	1
K4017-NTH	2900/1710	Softener, SE	2"	N/A	120/60	Valve, C, ENV, HWBP, w/trans	1
K4017-NT	2900/1710	Softener, SE	2"	N/A	120/60	Valve, C, ENV, NHWBP, w/trans	1

M = Manual; TC = time clock; MTR = metered; A = automatic; SE = simple electronics; NT = networking timer; STD = standard range meter/ EXT = extended range meter, HWBP = hard water bypass piston; NHWBP = no hard water bypass piston; AMS = auxiliary micro switch; ENV = environmental; DLFC = drain line flow control housing (order GPM button separately); PL = plastic; SS = Stainless steel; RM = remote meter; SYS = system.



# Control Valves - Fleck 5600, 2510, 4650, 7000, 2750, 9000, 9100, 9500, 2850, 2900, 3150, 3900



## Fleck® 3150 brass valves

MODEL NO.	VALVE	USE	PIPE SIZE	BY-PASS	ELECTRICAL	DESCRIPTION	CASE QTY
K4024C	3150/1800	Softener	2"	N/A	120/60	Valve, C, SM, ENV	4
K4024CT	3150/1800	Filter	2"	N/A	120/60	Valve, C, TM, ENV	4
K4024CT-NTH	3150/1800	Filter NXT	2"	N/A	120/60	Valve, C, TM, ENV, HWBP, w/trans	1
K4024TA	3150/1800	Softener MTR	2"	N/A	120/60	Valve, C, SM, SYS 7, ENV, 2" RM, STD	4
K4024A	3150/1800	Softener MTR	2"	N/A	120/60	Valve, C, SM, ENV, 2" STD	1
K4024	3150/1800	Softener TC	2"	N/A	120/60	Valve, C, SM, ENV	1
K4024-NTH	3150/1800	Softener NXT	2"	N/A	120/60	Valve, C, SM, ENV, HWBP, w/trans	1
K4024-NT	3150/1800	Softener NXT	2"	N/A	120/60	Valve, C, SM, ENV, NHWBP, w/trans	1
K4024T	3150/1800	Softener TC	2"	N/A	120/60	Valve, C, TM, ENV	1



## Fleck® 3900 brass valves

MODEL NO.	VALVE	USE	PIPE SIZE	BY-PASS	ELECTRICAL	DESCRIPTION	CASE QTY
K4040	3900	Filter	3"	N/A	120/60	Valve, C, ENV, SF/FL TM	4
K4040SM	3900	Filter	3"	N/A	120/60	Valve, C, ENV, SM	1
K4042E	3900/1800	Softener MTR	3"	N/A	120/60	Valve, C, ENV, SF/FL TM, 3" EXT	4
K4042	3900/1800	Softener MTR	3"	N/A	120/60	Valve, C, ENV, SF/FL TM, 3" STD	4
K4041	3900/1800	Softener TC	3"	N/A	120/60	Valve, C, ENV, SF/FL TM	4
K4045E-F	3900/1800	Softener MTR	3"	N/A	120/60	Valve, C, ENV, SF/FL TM, SYS 5 EXT	4
K4045-F	3900/1800	Softener MTR	3"	N/A	120/60	Valve, C, ENV, SF/FL TM, SYS 5 STD	4
K4045	3900/1800	Softener MTR	3"	N/A	120/60	Valve, C, ENV, 6/8 TM, SYS 5 STD	4
K4043E	3900/1800	Softener MTR	3"	N/A	120/60	Valve, C, ENV, SF/FL TM, SYS 7 RM EXT	4
K4043	3900/1800	Softener MTR	3"	N/A	120/60	Valve, C, ENV, SF/FL TM, SYS 7 RM STD	4
K4041-NTH	3900/1800	Softener NXT	3"	N/A	120/60	Valve, C, ENV, SF/FL TM, HWBP, w/trans	1
K4041-NT	3900/1800	Softener NT	3"	N/A	120/60	Valve, C, ENV, SF/FL TM, NHWBP, w/trans	1
K4042SM	3900/1800	Softener MTR	3"	N/A	120/60	Valve, C, ENV, SM, 3" STD	1
K4043-SM	3900/1800	Softener MTR	3"	N/A	120/60	Valve, C, ENV, SYS 7, RM STD	1
K4041SM	3900/1800	Softener TC	3"	N/A	120/60	Valve, C, ENV, SM	1
K4041SM-NTH	3900/1800	Softener NXT	3"	N/A	120/60	Valve, C, ENV, SM, HWBP, w/trans	1
K4041SM-NT	3900/1800	Softener NXT	3"	N/A	120/60	Valve, C, ENV, SM, NHWBP, w/trans	1

## Fleck® 4650 hot water brass valves

MODEL NO.	VALVE	USE	PIPE SIZE	BY-PASS	ELECTRICAL	DESCRIPTION	CASE QTY
K4020STCH-1206	4650/1600	Softener TC	3/4"	N/A	120/60	Valve only	1
K4020S-HOT	4650/1600	Softener TC	3/4"	3/4" SS	120/60	includes cover, bypass	1

TC = time clock SS = stainless steel

M = Manual; TC = time clock; MTR = metered; A = automatic; SXT = simple electronics; NXT = networking timer; STD = standard range meter/ EXT = extended range meter; HWBP = hard water bypass piston; NHWBP = no hard water bypass piston; AMS = auxiliary micro switch; ENV = environment; DLFC = drain line flow control housing (order GPM button separately); PL = plastic; SS = Stainless steel; RM = remote meter; SYS = system.

## Control Valves - Fleck 5600, 2510, 4650, 7000, 2750, 9000, 9100, 9500, 2850, 2900, 3150, 3900



FLECK 5600 Time Clock



FLECK 5600 Metered

### Fleck® 5600 plastic valves

MODEL NO.	VALVE	USE	PIPE SIZE	BY-PASS	ELECTRICAL	DESCRIPTION	CASE QTY
K4014U	5600	Filter	3/4"	N/A	120/60	Valve only	6
K4014F	5600	Filter	3/4"	3/4" SS	120/60	Includes cover, bypass	6
K4016F	5600	Filter	3/4"	1" SS	120/60	Includes cover, bypass	6
K4014K1	5600	Filter	3/4"	N/A	120/60	Valve only for KMN04	6
K4014PB	5600	Filter	3/4"	3/4" SS	120/60	Includes cover, bypass, KMN04	6
K4014Y-09	5600/1600	Softener TC	3/4"	N/A	120/60	Valve only for 9" tank	6
K4014Y-10	5600/1600	Softener TC	3/4"	N/A	120/60	Valve only for 10" tank	6
K4014Y-12	5600/1600	Softener TC	3/4"	N/A	120/60	Valve only for 12" tank	6
K4014Y-24	5600/1600	Softener TC	3/4"	N/A	24/60	Valve only	6
K4014FL	5600/1600	Softener TC	3/4"	3/4" SS	120/60	Includes cover, bypass	6
K4016	5600/1600	Softener TC	3/4"	1" SS	120/60	Includes cover, bypass	6
K4014W-09	5600/1600	Softener MTR	3/4"	N/A	120/60	Valve only for 9" tank, STD	6
K4014W-10	5600/1600	Softener MTR	3/4"	N/A	120/60	Valve only for 10" tank, STD	6
K4014W-12	5600/1600	Softener MTR	3/4"	N/A	120/60	Valve only for 12" tank, STD	6
K4014X-24	5600/1600	Softener MTR	3/4"	N/A	24/60	Valve only	6
K4015S	5600/1600	Softener MTR	3/4"	3/4" SS	120/60	Includes cover, bypass, 3/4" STD	6
K4016A	5600/1600	Softener TC	3/4"	1" SS	120/60	Includes cover, bypass	6
K4014SE	5600/1600	Softener SXT	3/4"	N/A	120/60	Valve only, 3/4" STD, w/trans	6



### Fleck® 7000 plastic valve

MODEL NO.	VALVE	USE	PIPE SIZE	BY-PASS	ELECTRICAL	DESCRIPTION	CASE QTY
K4037FC-0246T	7000	Filter	1-1/4"	N/A	24/60	Includes transformer	1
K4037SM09-0246T	7000/1610	Softener MTR	1-1/4"	N/A	24/60	Set for 9" tank, includes trans	1
K4037SM10-0246T	7000/1610	Softener MTR	1-1/4"	N/A	24/60	Set for 10" tank, includes trans	6
K4037SM12-0246T	7000/1610	Softener MTR	1-1/4"	N/A	24/60	Set for 12" tank, includes trans	6
K4037SM12-0246T	7000/1610	Softener MTR	1-1/4"	N/A	24/60	Set for 12" tank, includes trans HF	1

HF = high flow

## Control Valves - Fleck 5600, 2510, 4650, 7000, 2750, 9000, 9100, 9500, 2850, 2900, 3150, 3900



### Fleck® 9000 twin brass valves

MODEL NO.	VALVE	USE	PIPE SIZE	BY-PASS	ELECTRICAL	DESCRIPTION	CASE QTY
K4026X	9000/1600	Softener MTR	3/4"	N/A	120/60	Valve only, STD, ICP	1
K4026XE	9000/1600	Softener MTR	3/4"	N/A	120/60	Valve only, EXT, ICP	1
K4026XSE	9000/1600	Softener SXT	3/4"	N/A	120/60	Valve only, ICP, w/trans	1
K4026	9000/1600	Softener MTR	3/4"	3/4" SS	120/60	Valve, C, BY, STD, ICP	4
K4027XX	9000/1600	Softener MTR	1"	N/A	120/60	Valve only, STD	1
K4027	9000/1600	Softener MTR	1"	N/A	120/60	Valve, C, STD	1
K4027-B	9000/1600	Softener MTR	1"	N/A	120/60	Valve, C, EXT	1



### Fleck® 9100 twin plastic valves

MODEL NO.	VALVE	USE	PIPE SIZE	BY-PASS	ELECTRICAL	DESCRIPTION	CASE QTY
K4032X	9000/1600	Softener MTR	3/4"	N/A	120/60	Electromechanical Timer	4
K4032XE	9000/1600	Softener MTR	3/4"	N/A	120/60	Electromechanical Timer	1
K4033X	9000/1600	Softener MTR	1"	N/A	120/60	Electromechanical Timer	4



### Fleck® 9500 twin brass valves

MODEL NO.	VALVE	USE	PIPE SIZE	BY-PASS	ELECTRICAL	DESCRIPTION	CASE QTY
K4028X	9500/1600	Softener MTR	1-1/2"	N/A	120/60	Valve only, 1-1/2" STD, ICP	4
K4028	9500/1600	Softener MTR	1-1/2"	N/A	120/60	Valve, C, 1-1/2" STD, ICP	4
K4028XE	9500/1600	Softener MTR	1-1/2"	N/A	120/60	Valve only, 1-1/2" EXT, ICP	4
K4028E	9500/1600	Softener MTR	1-1/2"	N/A	120/60	Valve, C, 1-1/2" EXT, ICP	4
K4028SE	9500/1600	Softener SXT	1-1/2"	N/A	120/60	Valve, T, ICP	1
K4028SE1	9500/1710	Softener SXT	1-1/2"	N/A	120/60	Valve, T, ICP	1
K4029X	9500/1710	Softener MTR	1-1/2"	N/A	120/60	Valve only, 1-1/2" STD, ICP	4
K4029	9500/1700	Softener MTR	1-1/2"	N/A	120/60	Valve, C, 1-1/2" STD, ICP	1
K4029XE	9500/1710	Softener MTR	1-1/2"	N/A	120/60	Valve only, 1-1/2" EXT, ICP	1
K4029E	9500/1710	Softener MTR	1-1/2"	N/A	120/60	Valve only, C, 1-1/2" EXT, ICP	1

## Control Valves – Fleck Meters

MODEL NO.	DESCRIPTION
K4560616	3100 METER ASSY 2 IN ELECTRONIC BRASS
K4025	3100 REMOTE METER-STD IMMED 2IN 120V 60HZ
K4025E	3100 REMOTE METER-EXT IMMED 2IN 120V 60HZ

## Control Valves - Fleck Parts

MODEL NO.	DESCRIPTION
K4102	2300 SBV W FLOAT BLUE WHITE
K4110-75	ADAPTER DLFC 3/4 IN FOR 2510 PVC
K4112	RO LOCKOUT SWITCH KIT W CAM PIN SCREWS NUTS
K4510218	MICRO SWITCH 25 2700 DR METER
K4510220	SCREW FIL HD MACH NO 4 X 1.12 FOR MICRO SWITCH
K4510302	INSULATOR LIMIT SWITCH FOR MICRO SWITCH
K4510338	PIN ROLL 3/32 X 7/8 FOR DRIVE CAM 25 2700
K4510339	NUT HEX 4-40 FOR MICRO SWITCH MOUNT
K4510760	1GPM 3LBS SALT MIN
K4510913-BL	INJECTOR NOZZLE NO 2 WHITE FOR 1600 - 12IN
K4510913-W	INJECTOR NOZZLE NO 1 WHITE FOR 1600 - 8-9-10IN
K4510913-Y	INJECTOR NOZZLE NO 2 YELLOW FOR 1600 - 14-16IN
K4510914-BL	INJECTOR THROAT NO 2 WHITE FOR 1600 - 12IN
K4510914-W	INJECTOR THROAT NO 2 WHITE FOR 1600 - 8-9-10IN
K4510914-Y	INJECTOR THROAT NO 2 YELLOW FOR 1600 - 14-16IN
K4511098	STUFFER TOOL FOR 15 25 2510 27 2750
K4511381	PIN ROLL 1/16 X 5/8
K4511726	SEAL BYPASS 3600 5600
K4511842	POWER CORD 6 FT FOR 5600
K4512085	FLOW WASHER 1.2 GPM
K4512086	FLOW WASHER 1.5 GPM
K4512087	FLOW WASHER 2GPM
K4512088	FLOW WASHER 2.4 GPM
K4512089	FLOW WASHER 3GPM
K4512090	FLOW WASHER 3.5 GPM
K4512091	FLOW WASHER 4GPM
K4512092	FLOW WASHER 5GPM
K4512094	FLOW WASHER .25 GPM
K4512095	FLOW WASHER .50 GPM
K4512097	FLOW WASHER 1GPM
K4512408	FLOW WASHER 7GPM
K4512460	DISTRIBUTOR POINT TOP BOTTOM STRAIGHT 13/16 IN WO RISER
K4512777	CAM SHUT-OFF VALVE BLACK STF 25 2700
K4512973	INJECTOR NOZZLE NO 0- NO 4 PVC KMNO4 9 IN 12 IN
K4512974	INJECTOR THROAT NO 0- NO 4 PVC KMNO4
K4513061	PULLER TOOL 1500 25 2510 27 2750
K4513509	IMPELLER SHIP IN BOXES ONLY
K4513640	FC DOLE 1 IN FXF 30GPM
K4513708	YOKE 3/4 IN SS FNPT
K4513748	SCREW FLT HD ST 6-20 X 1/2 IN FOR TOP SCREEN
K4514038	METER CAP ASSY STD RANGE FOR 5600 2500
K4514043	METER CABLE ASSY 8.25 IN FOR 5600 5000
K4514775	CAM DRIVE FOR 2900 1600
K4514801-3CY	INJECTOR NOZZLE NO 3C YELLOW FOR 1700 - 16IN
K4514801-5CW	INJECTOR NOZZLE NO 5C WHITE FOR 1700 - 30IN LOW SALT
K4514801-6R	INJECTOR NOZZLE NO 6C RED FOR 1700 - 30IN HIGH SALT

## Control Valves - Fleck Parts (cont.)

MODEL NO.	DESCRIPTION
K4514802-3Y	INJECTOR THROAT NO 3C WHITE FOR 1700 - 16IN
K4514802-5W	INJECTOR THROAT NO 5C WHITE FOR 1700 - 30IN LOW SALT
K4514802-6R	INJECTOR NOZZLE NO 6C WHITE FOR 1700 - 30IN HIGH SALT
K4515078-01	ADAPTER 1 IN COUPLING W O-RING
K4515127-05	INJECTOR THROAT NO 5 RED FOR 1800 - 30IN
K4515127-06	INJECTOR THROAT NO 5 WHITE FOR 1800 - 36IN
K4515128-05	INJECTOR NOTE NO 5 RED FOR 1800 - 30IN
K4515128-06	INJECTOR NOZZLE NO 5 WHITE FOR 1800 - 36IN
K4515131	BACKPLATE FOR 9000 9500
K4515150	METER CAP ASSY EXT RANGE PLASTIC
K4515210	ORING FOR PARK TANK TOP 2900 2930 3130 3150
K4515216	METER CABLE ASSY 15 1/4 IN FOR 2900
K4515218	METER CAP ASSY STD RANGE BRASS 1 IN 1.5 IN 2 IN
K4515237	METER CAP ASSY EXT RANGE BRASS 1 IN 1.5 IN 2 IN
K4515416	TUBE BRINE VALVE 2900 1700
K4515425	METER CABLE ASSY 13 1/4 IN FOR 9000 3/4 IN METER
K4516046	GEAR DRIVE
K4516516	STUFFER 2850 9500
K4516529	FLOW WASHER 10 GPM
K4516735	FLOW WASHER 12 GPM
K4516736	FLOW WASHER 15 GPM
K4516737	FLOW WASHER 25 GPM
K4517623	PULLER TOOL 2850 9500
K4518706	YOKE 1 IN NPT PLASTIC FOR 5000
K4518706-02	YOKE 3/4 IN MPT PLASTIC MNPT FOR 5000
K4518738	MOTOR 120V 50 60HZ 1 RPM SAIA
K4518743-1	MOTOR 120V 60HZ 1/30 RPM FOR 5600 3200 METAL PINION
K4519170	MOTOR 120V 60HZ 1/15 RPM FOR 3200
K4519480	DLFC HSG 3/4 IN X 3/4 IN FNPT FOR 8 9 10 12 15 20 25 30
K4519620	ADAPTER COUPLING ASSY 3/4 IN 90 W ORINGS CLIPS AND SC
K4519659-1	MOTOR 24V 60HZ 1/30 RPM FOR 5600 3200 METAL PINION
K4540384	MOTOR DRIVE 115V 60HZ 1500-2900
K4540387	MOTOR DRIVE 115V 60HZ 2900 LOWER
K4540569	BYPASS 7000
K4541047	PART COMMUNICATION CABLE 15 FT PHONE CORD FOR FLECK NT
K4541241-01	CONNECTOR 1 IN MPT PLASTIC SOLD EACH NEED 2 PER VLV
K4541242-01	CONNECTOR 1 IN X 1 1/4 IN SWEAT SOLD EACH NEED 2 PER VALVE
K4541243-01	CONNECTOR 1 1/4 IN X 1 1/2 SWEAT SOLD EACH NEED 2 PER VALV
K4541244-01	CONNECTOR 1 1/4 IN MPT PLASTIC SOLD EACH NEED 2 PER
K4560009	900 AIR CHECK COMMERCIAL
K4560014	2310 SAFETY BRINE VALVE
K4560020-25	BLFC ASSY .25 GPM FOR 1600 3600
K4560027-FFA	2300 SAFETY BRINE VALVE BODY
K4560028	2300 FLOAT ASSY WHT FOR ALL TEMPERATURES OF WATER
K4560029	1600 BRINE VALVE SHORT STEM NO BLFC
K4560029-100	1600 BRINE VALVE SHORT STEM W FC 1 GPM
K4560032	4650 5600 BRINE VALVE PLUNGER ASSY ONLY
K4560034	1700 BRINE VALVE 2GPM
K4560036-02	1800 BRINE VALVE ASSY STYLE NO 3
K4560037	1600 9500 BRINE VALVE
K4560038	2350 SAFETY BRINE VALVE COMMERCIAL NO FLOAT
K4560039	1700 9500 BRINE VALVE 2BLFC
K4560040SS	5600 BYPASS VALVE 3/4 IN SS
K4560041SS	5600 BYPASS VALVE 1 IN SS

## Control Valves - Fleck Parts (cont.)

MODEL NO.	DESCRIPTION
K4560049	BYPASS PLASTIC NEEDS 3/4 IN OR 1 IN YOKE
K4560049-02	BYPASS PLASTIC 1 IN W 1 IN NPT SS YOKE
K4560049-03	BYPASS PLASTIC 1 IN W 1 IN PLASTIC YOKE
K4560049-04	BYPASS PLASTIC 1 IN W 3/4 IN PLASTIC YOKE
K4560050-21	25 2750 29DRIVE ASSY STF 120V
K4560068	FLOAT ASSY FOR 2310 W 30 IN ROD
K4560080	1600 INJECTOR ASSY NO 1 Cmpl 1500 2900 60080-01, 2900 OLD STYLE
K4560084	5600 INJECTOR ASSY PL 46 5600
K4560086	5600 9000 METER ASSY 3/4 IN STD RANGE
K4560090	PISTON 1500 2500 2700 2510
K4560090-HF	PISTON 2750 2900 2700 HI BACKWASH FLOW-UPPER
K4560101-01	2750 NHWBP PISTON ASSY
K4560102	5600 PISTON ASSY STD WHITE FOR SOFTENER
K4560102-10	5600 PISTON ASSY FEEDER FILTER BLACK
K4560103	2900 PISTON ASSY STD HARDWATER BYPASS OLD STYLE
K4560104	2900 PISTON ASSY NHWBP OLD STYLE
K4560105	2850 PISTON ASSY
K4560106-00	3150 PISTON ASSY STD
K4560106-10	3150 PISTON ASSY UPFLOW HI BACKWASH 3900 UPPER
K4560107-00	3900 PISTON ASSY LOWER HARDWATER BYPASS
K4560107-10	3900 PISTON ASSY LOWER NO HARDWATER BYPASS
K4560108	9500 PISTON ASSY UPPER
K4560109	9500 PISTON ASSY LOWER
K4560113-01	3150 PISTON ASSY NHWBP
K4560114-01	2850 PISTON ASSY NHWBP
K4560121	SEAL AND SPACER KIT 2500 2750 1500 2510 2700 2900 UPPER OLD STYLE
K4560125	SEAL AND SPACER KIT 5600 9000 UPPER
K4560125-05	SEAL AND SPACER KIT 4650 HOT
K4560128	SEAL AND SPACER KIT 2900 LOWER
K4560129	SEAL AND SPACER KIT 2850
K4560131	SEAL AND SPACER KIT 3150 3900 UPPER
K4560132	SEAL AND SPACER KIT 3900 LOWER
K4560133	SEAL AND SPACER KIT 9500 LOWER
K4560134	SEAL AND SPACER KIT 9500 UPPER
K4518738	MOTOR 120V 50 60HZ 1 RPM FOR 9000 - 9500
K4560219-02	COVER ENVIRO BLACK CLEAR FOR 2750 2900 UPPER
K4560226	DESIGNER COVER BLACK BLACK 5600
K4560232-110	DESIGNER COVER BLACK 1PC FOR 15-2850 9000 9500
K4560232-112	DESIGNER COVER BLACK 1PC W LEFT WINDOW
K4560303-13	3200 7 DAY TIMER STF 120V 60HZ
K4560304-13	3200 12 DAY TIMER STF 120V 60HZ
K4560306-13	3210 DELAY TIMER STF 120V 60HZ GAL. RANGE
K4560350	9000 BRINE VALVE ASSY
K4560353-13	KIT P H 5600 TC L-BACK 120 60 WO CVR PISTON
K4560354-13	KIT P H 5600 METER L-BACK 120 60 WO CVR PISTON
K4560365	DLFC 3/4 IN NPT BRASS NO BUTTON X1/2 IN SPEC GPM 1.2-7
K4560365-2.0	DLFC 3/4 IN X1/2 IN FXF BRASS 2GPM
K4560365-2.4	DLFC 3/4 IN X1/2 IN FXF BRASS 2.4 GPM
K4560365-3.5	DLFC 3/4 IN X1/2 IN FXF BRASS 3.5 GPM
K4560365-4.0	DLFC 3/4 IN X1/2 IN FXF BRASS 4GPM
K4560365-5.0	DLFC 3/4 IN X1/2 IN FXF BRASS 5GPM
K4560365-7.0	DLFC 3/4 IN X1/2 IN FXF BRASS 7GPM
K4560366	DLFC 1 IN FNPT X 3/4 IN FOR BRASS SPEC GPM 1.2-7

## Control Valves - Fleck Parts (cont.)

MODEL NO.	DESCRIPTION
K4560366-3.5	DLFC 1 IN X 3/4 IN FXF BRASS 3.5 GPM
K4560366-5.0	DLFC 1 IN X 3/4 IN FXF BRASS 5GPM
K4560366-7.0	DLFC 1 IN X 3/4 IN FXF BRASS 7GPM
K4560376-13	9000 9500 TIMER METER 1/30 RPM 120V 60HZ
K4560381	1700 INJECTOR ASSY 1/2 IN SPEC. INJECTOR SIZE
K4560385	9000 INJ DRAIN MODULE ASSY
K4560400	9000 PISTON ASSY TOP
K4560401	9000 PISTON ASSY LOWER
K4560420	KIT P H 9500 120V 60HZ WO CVR BV PISTON
K4560421	SEAL AND SPACER KIT 9000 BOTTOM
K4560700-10.0	DLFC 3/4 IN FXF NPT 10 GPM
K4560700-12.0	DLFC 3/4 IN FXF NPT 12 GPM
K4560700-15	DLFC 3/4 IN FXF NPT 15 GPM
K4560700-25	DLFC 3/4 IN FXF NPT 25 GPM
K4560705-00	DLFC PLASTIC BLANK HSNG LESS BUTTONTF 251 27 36 50 85
K4560705-4.0	DLFC PLASTIC 4GPM FOR 251 27 36 50 85
K4560705-7.0	DLFC PLASTIC 7GPM FOR 251 27 36 50 85
K4560710-2.0	BLFC ASSY 2GPM 1 IN FXM NPT
K4560710-5.0	BLFC ASSY 5GPM 1 IN FXM NPT
K4561530	SEAL AND SPACER KIT 2900S UPPER
K4561530-01	SEAL AND SPACER KIT 2900S UPPER HOT WATER
K4561540	PISTON ASSY 2900S DOWNFLOW UPPER
K4561550	PISTON ASSY 2900S DOWNFLOW HWBP LOWER
K4561555	PISTON ASSY 2900S NHWBP LOWER
K4561560-07	METER ASSY IN-LINE 1IN BRASS ADAPT
K4561630-00	PISTON 2850S
K4561631-00	2850S NHWBP PISTON

## Control Valves - W100 Parts

MODEL NO.	DESCRIPTION
KC11H4615	WS1 ELBOW LOCKING CLIP
KC11V3003	W100 METER ASSEMBLY
KC11V3005	W100 SPACER STACK ASSEMBLY
KC11V3008-02	W100 DRAIN FTG 1 IN STRAIGHT W SILENCER
KC11V3009	W100 AUXILIARY MICROSWITCH ASSEMBLY
KC11V3010-1D	W100 INJECTOR ASY D RED 9 IN DF
KC11V3010-1F	W100 INJECTOR ASY FOR BLU 12 IN DF
KC11V3010-1H	W100 INJECTOR ASY H GRN 14 IN DF
KC11V3010-1J	W100 INJECTOR ASY J LT BLU 18 IN DF
KC11V3011	W100 PISTON DOWNFLOW
KC11V3011-01	W100 PISTON UPFLOW
KC11V3105	W100 PLUMBING CONNECTION O RING
KC11V3107-01	W100 DRIVE MOTOR
KC11V3108	W100 P C BOARD
KC11V3108TC	W100 P C BOARD TIME CLOCK
KC11V3150	W100 PLUMBING CONNECTION SPLIT RING
KC11V3158-02	W100 DRAIN ELBOW 3/4 IN MALE ASSY WO SILENCER
KC11V3162-017	W100 DLFC 1.7 GPM FOR 3/4 IN
KC11V3162-022	W100 DLFC 2.2 GPM FOR 3/4 IN
KC11V3162-027	W100 DLFC 2.7 GPM FOR 3/4 IN
KC11V3162-042	W100 DLFC 4.2 GPM FOR 3/4 IN
KC11V3162-053	W100 DLFC 5.3 GPM FOR 3/4 IN
KC11V3162-075	W100 DLFC 7.5 GPM FOR 3/4 IN
KC11V3162-100	W100 DLFC 10 GPM FOR 3/4 IN
KC11V3165-01	W100 REFILL FLOW CONTROL RETAINER ASSY
KC11V3174	W100 REGENERANT PISTON
KC11V3175EE-01	W100EE FRONT COVER ASSY BLACK
KC11V3175WC-W	W100 WEATHER COVER WHITE
KC11V3186EU	W100 TRANSFORMER 220V EUROPEAN
KC11V3190-110	W100 DLFC 11 GPM FOR 1 IN
KC11V3190-150	W100 DLFC 15 GPM FOR 1 IN
KC11V3190-200	W100 DLFC 20 GPM FOR 1 IN
KC11V3193-01	W100 EXTENDED WRENCH
KC11V3331	W100 DRAIN ELBOW 3/4 IN W DLFC RETAINER ASSY
KC11V3430	WS1.25 WS1.5 SPACER STACK ASSY
KC11V7A076B5	BACKWASH REGULATOR 5 GPM 0 3/4 IN SS
KC11V7A076B7	BACKWASH REGULATOR 7 GPM 0 3/4 IN SS
KC12PKP10TS8	W100 INSERT POLY TUBE 5/8 IN
KC12V3004	WS1 DRIVE CAP ASSY
KC12V3176	WTS WS1 INJECTOR CAP
KC12V3192	WTS W100 NUT 3/4 IN DRAIN ELBOW
KC12V3195-01	WTS WS1 REFILL PORT PLUG ASSY W O RING



# Plastic Filter Housings

*Our comprehensive selection of plastic filter housings include products from the brands and companies of Flowmatic®, Pentair, Enpress, TGI, and Watts.*

## Flowmatic - Plastic Filter Housing



### Features & Benefits

- Full product line for more types, models, pipe fittings and options than anyone in the business!
- Heavy duty construction, made using high quality FDA grade polypropylene.
- Superior chemical resistance from many aggressive chemicals.
- Buttress thread design for superior sealing and security.
- Thick side walls with heavy-duty ribs to provide greater strength.
- Cap, sump and top-seated o-rings compress to provide leak proof sealing.
- NSF Standard 42 certified (FH4200WW14, FH4200BB14, FH4200WW34).







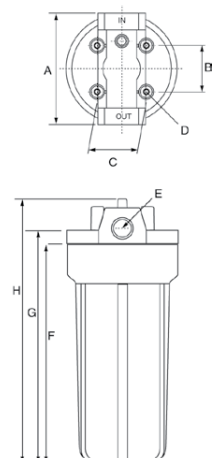

ANSI / NSF 42  
CERTIFIED  
FH4200WW14  
FH4200WW34  
FH4200BB14









MODEL NO.	SIZE	DIMENSIONS							
		A	B	C	D	E	F	G	H
500 Series	5"	4.28"	1.57"	1.18"	0.16"	X	5.7"	7.0"	7.5"
4000 Series	10"	4.72"	1.57"	1.18"	1.18"	X	10.5"	11.0"	11.8"
4200 Series	10"	4.72"	1.57"	1.18"	1.18"	X	10.5"	11.0"	11.8"
7000 Series	20"	4.72"	1.57"	1.18"	1.18"	X	20.47"	21.26"	22.8"
4500 Series	10"	5.35"	2.22"	2.28"	0.23"	X	10.43"	11.49"	12.5"
8000 Series	20"	5.35"	2.22"	2.28"	0.23"	X	20.47"	21.26"	22.8"
Full-Flow	10"	7.28"	3.03"	3.03"	0.275"	X	11.33"	11.57"	14.0"
Full-Flow	20"	7.28"	3.03"	3.03"	0.275"	X	21.25"	21.65"	24.0"

x = Depends on size of pipe fitting selected



## Housings Selection Guide

FEATURES	FLOWMATIC BRAND					
	 POU 500 Series	 POU 4200 Series	 POE 4500 Series	 POE 7000 Series	 POE 8000 Series	 POE 5000 series
<b>Port Fitting Sizes</b>						
1/4" Quick Connect						
3/8" Quick Connect						
1/4" NPT		✓				
3/8" NPT		✓		✓		
1/2" NPT		✓		✓		
3/4" NPT		✓	✓		✓	✓
1" NPT						✓
1.5" NPT						✓
Metal insert fitting						
<b>Filter Cartridge Compatibility</b>						
2.5" X 5"	✓					
2.5" X 10"		✓	✓			
2.5" X 20"				✓	✓	
4.5" X 10"						✓
4.5" X 20"						
<b>Material</b>						
<b>Chemical Resistance Rating</b>						
NSF Standard 42 certified (FH4200WW14, FH4200BB14, FH4200WW34).		✓				
Natural Polypropylene option available for high purity water		✓			✓	
O-ring material: EPDM is standard	✓	✓	✓	✓	✓	✓
<b>Temperature Rating</b>						
Temperature rated to 100°F (38°C) / Minimum temperature 40°F (4°C)		✓	✓	✓	✓	✓
Temperature rated to 125°F (52°C) / Minimum temperature 40°F (4°C)	✓	✓	✓	✓	✓	✓
Temperature rated to 200°F (93°C) / Minimum temperature 40°F (4°C)						
<b>Pressure Rating</b>						
Maximum pressure 90 psi (6.3 bar) working pressure (360 psi burst)						✓
Maximum pressure 100 psi (8.75 bar) working pressure (400 psi burst)						
Maximum pressure 125 psi (8.75 bar) working pressure (500 psi burst)	✓	✓	✓	✓	✓	
<b>Color</b>						
White Lid/White Sump	✓	✓		✓	✓	✓
Black Lid/Blue Sump		✓	✓	✓	✓	✓
White Lid/Clear Sump	✓	✓				
Black Lid/Clear Sump			✓		✓	✓
Black Lid/Black Sump		✓	✓		✓	✓
Red Lid/Red Sump			✓		✓	
Natural Polypropylene Lid/Natural Polypropylene Sump		✓			✓	
Black Lid/White Sump						
<b>Options Available</b>						
Pressure relief valve option available		✓	✓	✓	✓	✓
Concentrate port for use with membrane cartridge						
Wrench Available	WR100	WR100	WR200	WR100	WR200	WR500
<b>O-ring</b>						
EPDM o-ring	✓	✓	✓	✓	✓	✓
Viton o-ring	✓	✓	✓	✓	✓	✓
<b>Mounting screws for lid to bracket assembly</b>						
Screws to attach lids to a bracket	MS1034	MS1034	MS1410	MS1034	MS1410	MS55161
Screws to attach lids and vessel clips to a bracket	MS1010	MS1010		MS1010		
<b>Brackets</b>						
Single	FM10 FM-10AW	FM10 FM-10AW	FM20 FM-20AW	FM10 FM-10AW FM-20AW	FM20 FM-20AW	FM-25A FM-25W
Double	FM30 FM40 FM-30AW	FM30 FM40 FM-30AW	FM100SS	FM30 FM40 FM-30AW	FM100SS	FM-35AW
Triple	FM-40AW FM50 FM60 FM-50AW	FM-40AW FM50 FM60 FM-50AW		FM-40AW FM50 FM60 FM-50AW		WBKT-FF-3
Triple with pump	FM-99AW	FM-99AW		FM-99AW		
Quadruple	FM-80AW	FM-80AW		FM-80AW		

		WATTS					PENTAIR	
								
POE 10000 series	POE Valve-In-Head	POU Standard Top	POU Flat Top	POU HT series	POE Commercial	POE Full-Flow	POU/POE Standard Housing	POE Housing
				✓				
				✓				
		✓	✓	✓			✓	
		✓	✓	✓			✓	
✓	✓		✓	✓	✓	✓	✓	
✓						✓		✓
✓						✓		✓
	✓							
	✓	✓	✓	✓	✓		✓	
						✓		✓
✓						✓		✓
✓				✓				
✓	✓	✓	✓	✓	✓	✓	✓	✓
✓				✓				
	✓	✓	✓	✓	✓		✓	
✓	✓	✓	✓	✓	✓	✓	✓	
✓	✓	✓	✓	✓	✓	✓	✓	
						✓		
✓					✓	✓	✓	
WR500	WR-APC	WW-R	WW-R	FR1W	WW-C	WW-FF	FH-WWF FH-WWH S7592P FH-WWF-A2	S7594P S7595P FH-WWFB
✓	✓	WOR-R	WOR-R	FR1ORING	WOR-C	WOR-FF	FH-ORING	FH-ORING-BB
✓	✓							
MS55161	N/A N/A	MS1034 MS1010	MS1034 MS1010	MS1034 MS1010	MS1034 MS1410	GAFFSCREW	MS1034 MS1010	MS5161 N/A
FM-25A FM-25W	FM15	WBKT-RCS WBKT-RCS-SS	WBKT-RCS WBKT-RCS-SS	F137047	WBKT-RCS WBKT-RCS-SS	WBKT-FF-1	WBKT-RCS	WBKT-FF-1
FM-35AW		WBKT-RD	WBKT-RD	F137048	WBKT-CD	WBKT-FF-2	WBKT-RD	WBKT-FF-2
WBKT-FF-3		WBKT-RT	WBKT-RT	F137055	WBKT-CT	WBKT-FF-3	WBKT-RT	WBKT-FF-3

## Flowmatic - Plastic Filter Housing



Residential Series  
4200 (10") & 7000 (20")



Commercial Series  
4500 (10") & 8000 (20")



Full-Flow Series  
5000 (10") & 10000 (20")



Valve-In-Head  
Opaque & Clear



High Temp  
4500HT (10") & 8000HT (20")



Virgin Polypro  
DOE & "222"



White



Black



Blue / Black



Clear

### Specifications

Material, sumps & caps	FDA grade polypropylene.
Material, o-rings	EPDM is standard; Viton is available as a spare part.
Maximum temperature (standard)	125° F (52°C)
Maximum temperature (high temp)	200°F (93°C)
Minimum temperature	40°F (4°C)
Maximum pressure (standard)	125 psi (8.75 bar)
Maximum pressure (full flow)	90 psi (6.3 bar)
Burst test	Tested to 500 psi. (150,000 cycles from 0 to 125 psi)

## Flowmatic - Plastic Filter Housing

### 5" Clear And Opaque Housings

MODEL NO.	SIZE	PR	SUMP	CAP	PIPE SIZE	NO./ CASE	SHIPPING WT. (LBS.)	CARTON SIZE (")
FH500WW14	5"	No	White	White	1/4"	12	18	19x14x8
FH500WW12	5"	No	White	White	1/2"	12	18	19x14x8
FH500CW14	5"	No	Clear	White	1/4"	12	19	19x14x8
FH500CW12	5"	No	Clear	White	1/2"	12	19	19x14x8



### Clear Housings

MODEL NO.	SIZE	PR	SUMP	CAP	PIPE SIZE	NO./ CASE	SHIPPING WT. (LBS.)	CARTON SIZE (")
<b>10" Residential</b>								
FH4200CW14	10"	No	Clear	White	1/4"	12	31	19x14x13
FH4200CW14PR	10"	Yes	Clear	White	1/4"	12	31	19x14x13
FH4200CW38	10"	No	Clear	White	3/8"	12	31	19x14x13
FH4200CW38PR	10"	Yes	Clear	White	3/8"	12	31	19x13x14
FH4200CW12	10"	No	Clear	White	1/2"	12	31	19x14x13
FH4200CW12PR	10"	Yes	Clear	White	1/2"	12	31	19x14x13
FH4200CW34	10"	No	Clear	White	3/4"	12	31	19x14x13
FH4200CW34PR	10"	Yes	Clear	White	3/4"	12	31	19x13x14
<b>10" Commercial clear</b>								
HD4500CB34	10"	No	Clear	Black	3/4"	12	38	22x17x13
HD4500CB34PR	10"	Yes	Clear	Black	3/4"	12	38	22x17x13
<b>20" Commercial clear</b>								
FH8000CB34PR	20"	Yes	Clear	Black	3/4"	6	33	18x12x24
<b>10" Full-Flow clear</b>								
FH5000CB1PR	10"	Yes	Clear	Black	1"	4	34	16x16x14



### Valve-In-Head Housings (three function valve with flow, shut-off & by-pass)

MODEL NO.	SIZE	PR	SUMP	CAP	PIPE SIZE	NO./ CASE	SHIPPING WT. (LBS.)	CARTON SIZE (")
VIH34APC-NP-SS	10"	No	Clear	White	3/4"	12	37	20x17x14
VIH34APO	10"	No	White	White	3/4"	12	37	20x17x14

## Flowmatic - Plastic Filter Housing



Natural Polypropylene Housings (ideal for high purity water)

MODEL NO.	SIZE	PR	SUMP	CAP	PIPE SIZE	NO./ CASE	SHIPPING WT. (LBS.)	CARTON SIZE (")
FH4200NP34	10"	No	NP	NP	3/4"	12	24	19x14x13
FH8000NP34	20"	No	NP	NP	3/4"	6	29	18x12x24
FH8000NP34-222	20"	No	NP	NP	3/4"	6	29	18x12x24



All White Housings

MODEL NO.	SIZE	PR	SUMP	CAP	PIPE SIZE	NO./ CASE	SHIPPING WT. (LBS.)	CARTON SIZE (")
FH4200WW14	10"	No	White	White	1/4"	12	24	19x14x13
FH4200WW38	10"	No	White	White	3/8"	12	24	19x14x13
FH4200WW12	10"	No	White	White	1/2"	12	24	19x14x13
FH4200WW12PR	10"	Yes	White	White	1/2"	12	24	19x14x13
FH4200WW34	10"	No	White	White	3/4"	12	24	19x14x13
FH7000WW38	20"	No	White	White	3/8"	6	26	17x12x24
FH7000WW38PR	20"	Yes	White	White	3/8"	6	26	17x12x24
FH8000WW34PR	20"	Yes	White	White	3/4"	6	33	18x12x24
FH5000WW1PR	10FF	Yes	White	White	1"	4	22	16x16x14
FH5000WW15PR	10FF	Yes	White	White	1-1/2"	4	22	16x16x14
FH10000WW1PR	20FF	Yes	White	White	1"	4	35	16x16x26
FH10000WW15PR	20FF	Yes	White	White	1-1/2"	4	35	16x16x26

## Flowmatic - Plastic Filter Housing



High-Temp Housings (rated for temperatures to 200°F (93°C))

MODEL NO.	SIZE	PR	SUMP	CAP	PIPE SIZE	NO./ CASE	SHIPPING WT. (LBS.)	CARTON SIZE (")
HD4500HT34	10"	No	Red	Red	3/4"	12	50	22x17x13
FH8000HT34	20"	No	Red	Red	3/4"	12	44	18x12x24



## All Black Housings

MODEL NO.	SIZE	PR	SUMP	CAP	PIPE SIZE	NO./ CASE	SHIPPING WT. (LBS.)	CARTON SIZE (")
FH4200BB14	10"	No	Black	Black	1/4"	12	24	19x14x13
FH4200BB34	10"	No	Black	Black	3/4"	12	24	19x14x13
HD4500BB34PR	10"	Yes	Black	Black	3/4"	12	38	22x17x13
FH8000BB34PR	20"	Yes	Black	Black	3/4"	6	33	18x12x24
FH5000BB1PR	10FF	Yes	Black	Black	1"	4	22	16x16x14
FH10000BB1PR	20FF	Yes	Black	Black	1"	4	35	16x16x26

## 10" Residential Blue / Black Housings

MODEL NO.	SIZE	PR	SUMP	CAP	PIPE SIZE	NO./ CASE	SHIPPING WT. (LBS.)	CARTON SIZE (")
FH4200BL14	10"	No	Blue	Black	1/4"	12	24	19x14x13
FH4200BL14PR	10"	Yes	Blue	Black	1/4"	12	24	19x14x13
FH4200BL38	10"	No	Blue	Black	3/8"	12	24	19x14x13
FH4200BL38PR	10"	Yes	Blue	Black	3/8"	12	24	19x13x13
FH4200BL12	10"	No	Blue	Black	1/2"	12	24	19x14x13
FH4200BL12PR	10"	Yes	Blue	Black	1/2"	12	24	19x14x13
FH4200BL34	10"	No	Blue	Black	3/4"	12	24	19x14x13
FH4200BL34PR	10"	Yes	Blue	Black	3/4"	12	24	19x13x13

## Flowmatic - Plastic Filter Housing

### 20" Residential Blue / Black Housings

MODEL NO.	SIZE	PR	SUMP	CAP	PIPE SIZE	NO./ CASE	SHIPPING WT. (LBS.)	CARTON SIZE (")
FH7000BL38	20"	No	Blue	Black	3/8"	6	26	17x12x24
FH7000BL12	20"	No	Blue	Black	1/2"	6	26	17x12x24
FH7000BL12PR	20"	Yes	Blue	Black	1/2"	6	26	17x12x24



### 10" Commercial Blue / Black Housings

MODEL NO.	SIZE	PR	SUMP	CAP	PIPE SIZE	NO./ CASE	SHIPPING WT. (LBS.)	CARTON SIZE (")
HD4500BL34	10"	No	Blue	Black	3/4"	12	38	22x17x13
HD4500BL34PR	10"	Yes	Blue	Black	3/4"	12	38	22x17x13

### 20" Commercial Blue / Black Housings

MODEL NO.	SIZE	PR	SUMP	CAP	PIPE SIZE	NO./ CASE	SHIPPING WT. (LBS.)	CARTON SIZE (")
FH8000BL34	20"	No	Blue	Black	3/4"	6	33	18x12x24
FH8000BL34PR	20"	Yes	Blue	Black	3/4"	6	33	18x12x24



### 10" Full-Flow Housings

MODEL NO.	SIZE	PR	SUMP	CAP	PIPE SIZE	NO./ CASE	SHIPPING WT. (LBS.)	CARTON SIZE (")
FH5000BL34PR	10"	Yes	Blue	Black	3/4"	4	22	16x16x14
FH5000BL1	10"	No	Blue	Black	1"	4	22	16x16x14
FH5000BL1PR	10"	Yes	Blue	Black	1"	4	22	16x16x14
FH5000BB1PR	10"	Yes	Black	Black	1"	4	22	16x16x14
FH5000BL15	10"	No	Blue	Black	1-1/2"	4	22	16x16x14
FH5000BL15PR	10"	Yes	Blue	Black	1-1/2"	4	22	16x16x14
FH5000WW1PR	10"	Yes	White	White	1"	4	22	16x16x14
FH5000WW15PR	10"	Yes	White	White	1-1/2"	4	22	16x16x14
FH5000CB1PR	10"	Yes	Clear	Black	1"	4	34	16x16x14



## Flowmatic - Plastic Filter Housing



### 20" Full-Flow housings

MODEL NO.	SIZE	PR	SUMP	CAP	PIPE SIZE	NO./ CASE	SHIPPING WT. (LBS.)	CARTON SIZE (")
FH10000BL34PR	20"	Yes	Blue	Black	3/4"	4	35	16x16x26
FH10000BL1	20"	No	Blue	Black	1"	4	35	16x16x26
FH10000BL1PR	20"	Yes	Blue	Black	1"	4	35	16x16x26
FH10000BB15PR	20"	Yes	Black	Black	1-1/2"	4	35	16x16x26
FH10000BL15	20"	No	Blue	Black	1-1/2"	4	35	16x16x26
FH10000BL15PR	20"	Yes	Blue	Black	1-1/2"	4	35	16x16x26
FH10000WW1PR	20"	Yes	White	White	1"	4	35	16x16x26
FH10000WW15PR	20"	Yes	White	White	1-1/2"	4	35	16x16x26

## Flowmatic - Wrenches and O-Rings

### Wrenches

MODEL NO.	FOR HOUSING SERIES	MATERIAL	COLOR	NO. PER PACKAGE
WR100	500, 4000, 4200, 7000	Polypropylene	White	100
WR200	4500 & 8000	Polypropylene	White	100
WR500	5000 & 10000	Polypropylene	Black	90
WR-APC	VIH housing only	Polypropylene	White	100

### O-Rings

MODEL NO.	FOR HOUSING SERIES	MATERIAL	NO. PER PACKAGE
OR-1W	SS-1000	EPDM	10
OR-4	500, 4000, 4200, 7000	EPDM	10
OR-4V	500, 4000, 4200, 7000	Viton	10
OR-5	5000 & 10000	EPDM	10
OR-5V	5000 & 10000	Viton	10
OR-8	4500 & 8000	EPDM	10
OR-8V	4500 & 8000	Viton	10

## Flowmatic - Mounting Brackets and Screws



FM-10 & FM10W  
(For 500, 4200 & 7000)



FM-20  
(For 4500 & 8000)



FM25A  
(For 5000 & 10000)



FM-30  
(500, 4000, 4200, 7000)



FM-35  
(For 5000 & 10000)



FM-40  
(For 500, 4200, 7000)



FM-50  
(For 500, 4200, 7000)



FM-60  
(For 500, 4200, 7000)

### Brackets

MODEL NO.	HOUSING SERIES	NUMBER	TYPE	MATERIAL	NO. PER PKG.
FM10 (w/screws)	500, 4000, 4200, 7000	Single	Steel	Zinc plated	150
FM15	Valve-In-Head	Single	Steel	Zinc Plated	10
FM20	4500, 8000	Single	Steel	White	100
FM30	500, 4000, 4200, 7000	Double	Steel	White	30
FM40	500, 4000, 4200, 7000	Double	Steel	White	24
FM50	500, 4000, 4200, 7000	Triple	Steel	White	25
FM60	500, 4000, 4200, 7000	Triple	Steel	White	25
FM-10AW	500, 4000, 4200, 7000	Single	Aluminum	White	150
FM-20AW	4200, 4500, 8000	Single	Aluminum	White	100
FM-25A	5000, 10000	Single	Aluminum	Aluminum	25
FM-25W	5000, 10000	Single	Steel	White	10
FM-30AW	500, 4000, 4200, 7000	Double	Aluminum	White	24
FM-40AW	500, 4000, 4200, 7000	Double	Aluminum	White	24
FM-50AW	500, 4000, 4200, 7000	Triple	Aluminum	White	25
FM-60AW	500, 4000, 4200, 7000	Triple	Aluminum	White	25
FM100SS	4500, 8000	Double	Stainless	Stainless	25

### Bracket Dimensions

BRACKET	DIMENSIONS
FM10 & FM-10W	3-1/2" x 1-5/16" x 2-1/8"
FM20	4-1/2" x 2-1/4" x 3"
FM25	7" x 5-1/2" x 4-1/2"
FM30	2-1/4" x 5-3/4" x 9-1/4" x 1-1/2"
FM40	2-1/4" x 5-3/4" x 9-1/4" x 1-1/2"
FM50	2-1/4" x 5-3/4" x 14-1/8" x 1-1/2"
FM60	2-1/4" x 5-3/4" x 14-1/8" x 1-1/2"

### Mounting Screws

MODEL NO.	HOUSING SERIES	NUMBER	LENGTH	MATERIAL	NO. PER PKG.
MS1012	SS-1000	#10	1/2"	SS	100
MS1034	4000, 4200	#10	3/4"	SS	100
MS1010	4000, 4200 with clip	#10	1"	SS	100
MS1410	4500 & 8000	#14	1"	SS	100
MS0812	For mounting clip	#8	1/2"	SS	100
MS5161	5000 & 10000	5/16	1"	SS	100

## Miscellaneous - Wrenches



FH-WBFB

### Wrenches

MODEL NO.	MFG. MODEL NO.	DESCRIPTION	COLOR	NO./CASE
FH-WWF	144877	Wrench for 10" & 20" Full Circle	White	1
FH-WWH	PFW190	Wrench for 10" Half Circle	White	1
S7592P	150295	SW-2 Wrench for 3/4 "Housing	White	1
S7593P	150539	SW-1 Wrench for Slim line Housing	Black	1
FH-WWF/3	GTS-231	Wrench "Open" Imprint	White	1
S7594P	150296	SW-3 Wrench 10"BB	Black	1
S7595P	144368	SW-4 Wrench 20"BB	Grey	1
FH-WWFB	144880	Wrench for Big White 10" & 20"	White	1
FH-WWFB/3	GTS-232	Wrench for Full Flow FH/3	White	1
FH-WWFB/3B	GTS-232B	Wrench for Big Black FH/3	Black	1
F164003	-	Membrane Housing Wrench	Black	1

## Miscellaneous - O-Rings

### O-Rings

MODEL NO.	MFG. MODEL NO.	DESCRIPTION	COLOR	NO./CASE
FH-ORING	143026	O-Ring For 10" (FH-UFXX) Filter Housing	-	1
S7966-1	151122	Big Blue O-Ring Round Fits 10" & 20" BB	-	1
FH-ORING-BW	151254	Square O-Ring For Big White & Clear 10" & 20"	-	1
FH-ORING/3BB	-	Big O-Ring For FH/3 10"FF and 20"FF	-	1
FH-ORING/3/04	-	O-Ring For FH/3 Housing 1/4	-	1
FH-ORING-EG	259-130000-EP	EG Series O-Ring For FH-UF1014/EG	-	1

## Watts - Plastic Filter Housing

Residential  
(Flat top)Residential  
(Standard top)Residential  
(HT Series)Commercial  
Housing

Full-Flow

10" Full Flow  
Clear20" Full Flow  
Clear

### Features

- Highly competitive prices
- Top quality, heavy-duty construction
- Performance validated by testing facility
- Wide range of models, colors, pipe fittings
- Watts labels on shipping carton only
- No product labels on individual housings
- Full line of brackets and wrenches
- Stocked for immediate shipment

### Specifications

Materials (sumps & caps)	Polypropylene
Materials (o-ring)	EPDM
Max. temp standard housing	125°F (52°C)
Min. temp	40°F (4.4°C)
Max psi, res & com housings	125 psi (8.75 bar)
Max pressure, Full-Flow	90 psi (6.3 bar)
Cycle tests (@125 psi)	150,000 cycles
Threads	Straight

## Watts Brand Plastic Housings

### 10" Residential Housings (flat top)

MODEL NO.	SIZE	PRESSURE RELIEF	SUMP	CAP	PIPE SIZE	NO. / CASE	SHIPPING WT. (LBS.)
W10RPH14WW	10"	No	White	White	1/4"	15	30
W10RPH38WW	10"	No	White	White	3/8"	15	30
W10RPH12WW	10"	No	White	White	1/2"	15	30
W10RPH12CW	10"	No	Clear	White	1/2"	15	30

### 10" Residential Housings (standard top)

MODEL NO.	SIZE	PRESSURE RELIEF	SUMP	CAP	PIPE SIZE	NO. / CASE	SHIPPING WT. (LBS.)
W10RPH14WWSC	10"	No	White	White	1/4"	15	30
W10RPH14CWSC	10"	No	Clear	White	1/4"	15	30
W10RPH38WWSC	10"	No	White	White	3/8"	15	30

### 10" Residential Housings (HT series)

MODEL NO.	SIZE	PRESSURE RELIEF	SUMP	CAP	PIPE SIZE	NO. / CASE	SHIPPING WT. (LBS.)
F113080	10"	No	White	White	1/4" QC	20	1.2
F113081	10"	No	White	White	3/8" QC	20	1.2
F113082	10"	No	White	White	1/4" NPT	20	1.2
F113083	10"	No	White	White	1/4"QC inlet, 3/8" QC outlet and top inlet	20	1.2
F113084	10"	No	White	White	1/2" NPT	20	1.2
F113102	10"	No	White	White	1/4" QC inlet, outlet, top outlet	20	1.2
F113120	10"	No	Clear	White	1/4" QC	20	1.2
F113121	10"	No	Clear	White	3/8" QC	20	1.2
F113122	10"	No	Clear	White	1/4" NPT	20	1.2
F113123	10"	No	Clear	White	1/4"QC inlet, 3/8" QC outlet and top inlet	20	1.2
F113124	10"	No	Clear	White	1/2" NPT	20	1.2
F113125	10"	No	Clear	White	1/4" QC inlet, outlet, top outlet	20	1.2

### 10" Commercial Housings

MODEL NO.	SIZE	PRESSURE RELIEF	SUMP	CAP	PIPE SIZE	NO. / CASE	SHIPPING WT. (LBS.)
W10CPH34BLPR	10"	Yes	Blue	Black	3/4"	12	38
W10CPH12CBPR	10"	Yes	Clear	Black	1/2"	12	38
W10CPH34CBPR	10"	Yes	Clear	Black	3/4"	12	38

## Watts - Plastic Filter Housing

### 20" Commercial Housings

MODEL NO.	SIZE	PRESSURE RELIEF	SUMP	CAP	PIPE SIZE	NO. / CASE	SHIPPING WT. (LBS.)
W20CPH34BLPR	20"	Yes	Blue	Black	3/4"	12	38

### 10" Full-Flow Housings (for 9-3/4" x 4-1/2" cartridges)

MODEL NO.	SIZE	PRESSURE RELIEF	SUMP	CAP	PIPE SIZE	NO. / CASE	SHIPPING WT. (LBS.)
W10FFPH34BLPR	10"	Yes	Blue	Black	3/4"	6	33
W10FFPH1BLPR	10"	Yes	Blue	Black	1"	6	33
W10FFPH15BLPR	10"	Yes	Blue	Black	1-1/2"	6	33
W10FFPH1WLPR	10"	Yes	White	Black	1"	6	33
W10FFPH1CBPR	10"	Yes	Clear	Black	1"	6	33

### 20" Full-Flow Housings (for 20" x 4-1/2" cartridges)

MODEL NO.	SIZE	PRESSURE RELIEF	SUMP	CAP	PIPE SIZE	NO. / CASE	SHIPPING WT. (LBS.)
W20FFPH34BLPR	20"	Yes	Blue	Black	3/4"	6	52
W20FFPH1BLPR	20"	Yes	Blue	Black	1"	6	52
W20FFPH15BLPR	20"	Yes	Blue	Black	1-1/2"	6	52
W20FFPH1WLPR	20"	Yes	White	Black	1"	6	52
W20FFPH1CBPR	20"	Yes	Clear	Black	1"	6	52

## Watts - Mounting Brackets, Wrenches and O-Rings



### Heavy Duty Mounting Brackets

MODEL NUMBER	HOUSING SERIES	TYPE	MATERIAL	COLOR
WBKT-RCS	Residential & commercial housings	Single	Steel	White
WBKT-RCS-SS	Residential & commercial housings	Single	Steel	Stainless
WBKT-RD	Residential housings	Double	Steel	White
WBKT-RT	Residential housings	Triple	Steel	White
WBKT-CD	Commercial housings	Double	Steel	White
WBKT-CT	Commercial housings	Triple	Steel	White
WBKT-FF-1	Full-Flow housings	Single	Steel	White
WBKT-FF-2	Full-Flow housings	Double	Steel	White
WBKT-FF-3	Full-Flow housings	Triple	Steel	White

**Note:** Brackets for Watts housings will work with Flowmatic housings. Screws for Watts Full Flow is P/N GAFFSCREW (4/pkg).

### Wrenches For Watts Brand Plastic Housings

MODEL NUMBER	HOUSING SERIES	MATERIAL	COLOR
WW-R	Watts residential housings	Polypropylene	White
WW-C	Watts commercial housings	Polypropylene	White
WW-FF	Watts Full-Flow housings	Polypropylene	White

### O-Rings For Watts Brand Plastic Housings

MODEL NUMBER	HOUSING SERIES	MATERIAL
WOR-R	Watts residential housings	EPDM
WOR-C	Watts commercial housings	EPDM
WOR-FF	Watts Full-Flow housings	EPDM

### Screws

MODEL NUMBER	HOUSING SERIES	MATERIAL
GAFFSCREW	Full-Flow housings	Steel

## Pentair - Plastic Filter Housings



### Specifications

#### Max Temperature

Slimline and Standard 10" and 20" 125°F  
 Big Blue 10" and 20" 100°F

#### Max Pressure

Slimline and Standard 10" and 20" 125 PSI  
 Big Blue 10" 100 PSI  
 Big Blue 20" 90 PSI

### 10" Housings

MODEL NO.	PENTEK MODEL NO.	SIZE	DESCRIPTION	PIPE SIZE	NO./CTN.	SHIP WT. (LBS.)
S7521A	158114	#10	Slim line blue wo/pr	1/4"	12	26
S7521W	158125	#10	Slim line white wo/pr	1/4"	12	22
S7520	158005	#10	Slim line blue w/pr	3/8"	12	26
S7524	158007	#10	Slim line clear w/pr	3/8"	12	22
S7537	158195	#10	Slim blue w/pr	1/2"	12	26
S7537A	158196	#10	Slim blue wo/pr	1/2"	12	26
S7509	150067	#10	Blue w/pr w/mb cap	3/4"	12	38
S7510	150068	#10	Blue wo/pr w/mb cap	3/4"	12	38
S7513	150071	#10	Clear w/pr w/mb cap	3/4"	12	35
S7514	150072	#10	Clear wo/pr w/mb cap	3/4"	12	35

### 20" Housings

MODEL NO.	PENTEK MODEL NO.	SIZE	DESCRIPTION	PIPE SIZE	NO./CTN.	SHIP WT. (LBS.)
S7545	150069	#20	Blue w/pr w/mb cap	3/4"	8	38
S7546	150070	#20	Blue wo/pr w/mb cap	3/4"	8	38

### 10" Big Blue Housings

MODEL NO.	PENTEK MODEL NO.	SIZE	DESCRIPTION	PIPE SIZE	NO./CTN.	SHIP WT. (LBS.)
S7555A	150237	#10	Big Blue w/pr	1"	6	33
S7557A	150238	#10	Big Blue wo/pr	1"	6	33

### 20" Big Blue Housings

MODEL NO.	PENTEK MODEL NO.	SIZE	DESCRIPTION	PIPE SIZE	NO./CTN.	SHIP WT. (LBS.)
S7562A	150233	#20	Big Blue w/pr	1"	4	28
S7563A	150234	#20	Big Blue wo/pr	1"	4	28
S7564A	150235	#20	Big Blue w/pr	1.5"	4	30
S7565A	150236	#20	Big Blue wo/pr	1.5"	4	30

## Pentair - Mounting Brackets, Spanner Wrenches

MODEL NO.	DESCRIPTION
S7570	BRACKET KIT FOR 3/4 IN MC-1A KIT
S7577	BRACKET KIT FOR BB
S7592P	SPANNER WRENCH SW-2 PLASTIC F 3/4 IN HOUSING
S7594P	SPANNER WRENCH SW-3 PLASTIC F 10 IN BB HOUSING

## Bag Filter

MODEL NO.	DESCRIPTION
S7240-1	BAG FILTER 10 IN BB 1.0 IN IN OUT PBH 410 1 CASE
S7240-20	BAG FILTER 20 IN BB 1.5 IN IN OUT PBH 420 1 CASE
S7240-20B	BAG FILTER 20 IN BB 1.0 IN IN OUT PBH 420 1 CASE
S7240-S	STAND F S7240 SERIES

## Plastic Housings and Mounting Brackets for 1/2 Turn

MODEL NO.	DESCRIPTION
-----------	-------------

### Plastic Housing

F113080	WHITE 10 IN 1/2 TURN 1/4 IN QUICK CONNECT
F113081	WHITE 10 IN 1/2 TURN 3/8 IN QUICK CONNECT
F113082	WHITE 10 IN 1/2 TURN 1/4 IN FPT
F113083	WHI 10 IN 1/2 TURN 1/4X3/8X3/8 QC FFINAL FILTER
F113084	WHITE 10 IN 1/2 TURN 1/2 IN FPT
F113102	WHITE 10 IN 1/2 TURN FWATTS RO MEMBRANE

### Mounting Brackets

F137047	BRACKET SINGLE FOR 1/2 TURN HSGWHITE STEEL
F137048	BRACKET DOUBLE FOR 1/2 TURN HSGWHITE STEEL
F137055	BRACKET TRIPLE FOR 1/2 TURN HSG WHITE STEEL



## Feeders/Static Mixers

Watts offers a complete line of chemical feed pumps, static mixers, and solution tanks for chemical dosing applications.

### Chlorinator - Non Electric

MODEL NO.	DESCRIPTION
KF256	CHLORINATOR PVC WHITE NON ELECTRIC
T6750	CHLORINE PELLETS FOR SENTRY 5 LBS.

### Chemical Injection Miscellaneous

MODEL NO.	DESCRIPTION
T1810	CATALIZER STATIC MIXER 1- 8 GPM 1 IN
T1815	CATALIZER STATIC MIXER 20-50 GPM 1 1/2 IN
T6712	SENTRY 1 WELL PELLETT CHLORINATOR 220V 60HZ
T6750	CHLORINE PELLETS FOR SENTRY 5 LBS
T6753	SENTRY 1 OPEN AIR WBOOSTER 10 GPM

### Chemical Feed Pumps - Blue/White

MODEL NO.	DESCRIPTION
<b>Blue/White</b>	
T8028-PVDF	PUMP BW PUMP C15N101X000VCO PVDF FITTINGS
<b>Blue/White Flex Flow</b>	
T0A-1N10A6T	PUMP BW PUMP A100N PERISTALTIC STANDARD 16.0 GPD
T0A1N10C-4T	PUMP BW PUMP A100NC 4.9 GPD FIXED SPEED 115V 60HZ
T0A1N10C-6T	PUMP BW PUMP A100NC 16 GPD FIXED SPEED 115V 60HZ
T0A1N12C-4T	PUMP BW PUMP A100N 4.9 GPD FIXED SPEED 230V 60HZ



T0A1N10C-4T

## Chemical Feed Pumps and Parts - Stenner

Self-priming, peristaltic type feed pumps for chlorine and pH adjustment chemicals.

### Peristaltic Type Feed Pumps

Stenner® peristaltic feed pumps will not lose prime because they are self priming. Pumps may operate at pressures up to 100 psi, and may be mounted vertically or horizontally. Tube lubrication is not required.



### Models

MODEL NO.	TYPE	MODEL	GPD	PSI	VOLTAGE	INJECTION CHECK	TUBING (SUCTION & DISCHARGE)	SHIP WT.
T55-45MHP2	Single	45	3	100	120v/60hz	T55-UCDBINJ	1/4"	8
T55-45MHP10	Single	45	10	100	120v/60hz	T55-UCDBINJ	1/4"	8
T55-45MHP10-220	Single	45	10	100	220v/60hz	T55-UCDBINJ	1/4"	8
T55-85MHP17	Single	85	17	100	120v/60hz	T55-UCDBINJ	1/4"	8
T55-85MHP40	Single	85	40	100	120v/60hz	T55-UCDBINJ	1/4"	8

### Parts

MODEL NO.	DESCRIPTION	NUMBER PER PACKAGE
T55-UCCP201	Replacement tube #1	2
T55-UCCP202	Replacement tube #2	2
T55-UCDBINJ	Injection check valve for 1/4" tubing	1
T55-UC3ASYD	Roller assembly	1
T55-UCTHC2D	CHM FDR STENNER TUBE HOUSING	1

## Chemical Feed Pumps - Milton Roy

Flow-Pro® Chemical Feed Pumps

### Features & Benefits

- Dual output control for easy & accurate adjustment.
- Turn-down ratio (500:1) provides excellent flexibility.
- 6 - 30 GPD maximum output at 80 psi.
- Quiet operation for residential or commercial use.
- Totally enclosed construction for chemical resistance and suitability for outdoor installation.



### Standard Models

MODEL NO	GPD		GPH		LITERS PER HOUR		ML / CC PER MIN.		ELECTRICAL (W / PLUG)	AMPS	SHIP WT.
	MIN.	MAX.	MIN.	MAX.	MIN.	MAX.	MIN.	MAX.			
FP-DCP-12	0.04	12	0.002	0.5	0.006	1.9	0.11	32	120 VAC	1.4	8 lbs.
FP-DCP-30	0.06	30	0.003	1.25	0.01	4.7	0.16	79	120 VAC	1.4	8 lbs.

\*Plug not suitable for export. Maximum injection pressure is 80 psi (5.5 bar) for all models.

**Note:** Replacement repair kit #T40SP-281.

## Chemical Feed Pumps - Pulsafeeder

MODEL NO.	DESCRIPTION
T90012P	PUMP PLSTRN A PLS 12 GPD 150 PSI 120V PHC1
T90015	PUMP PULSA CT100 15 GPD 100 PSI 120V 60HZ SHC
T90024	PUMP PULSA CT100 24 GPD 100 PSI 120V 60HZ SHC
T90024-230	PUMP PULSA CT100 24 GPD 100 PSI 230V SHC
T90027	PUMP PULSA E PLS 14GPD 100PSI 120V 60HZ
T90030	PUMP PULSA CT100 30 GPD 100 PSI 120V 60HZ SHC
T90030-230	PUMP PULSA CT100 30 GPD 100 PSI 22060 SHC
T90040	PUMP PLSTRN C PLS 30 GPD 80 PSI 120V VHC1
T90054	PUMP PLSTRN C 30 GPD 80 PSI 120V VHC1



T90024

Components

## Chemical Tanks

MODEL NO.	DESCRIPTION
T4120	SOLUTION TANK 15 GAL 14 IN X 24 IN UV BLUE
T4120A	BOTTLE CAP 110M SQUEEZE CAP F 15 GAL TANK
T4121	SOLUTION TANK 15 GAL 14 IN X 24 IN NAT
T4122	SOLUTION TANK 35 GAL NAT
T4123	SOLUTION TANK 35 GAL 18 IN X 32 IN BLUE
T5102	SOLUTION TANK 50 GAL 22 IN X 40 IN
T90J40445	SOLUTION TANK 15 GAL AND STAND PULSA W LEVEL FLOAT

# Meters, Monitors, & Controllers

*Watts offers a variety of meters, monitors, controllers, cables, probes, chemicals, test kits, and accessories.*

## Flow Meters - Blue/White



### Ordering Information

MODEL NO.	DESCRIPTION	CONNECTION STYLE
R5126	BLUEWHITE F-40375LN-6 .1-1 GPM 3/8 IN	Female Inline
R5129	BLUEWHITE F-40376LN-8 .2-2 GPM 1/2 IN	Female Inline
R5132	BLUEWHITE F-40500LN-6 .5-5 GPM 3/8 IN	Female Inline
R5138	BLUEWHITE F-40500LN-8 .5-5 GPM 1/2 IN	Female Inline
R5139	BLUEWHITE F-40750LN-12 1-10 GPM 3/4 IN	Female Inline
R5140	BLUEWHITE F-40750LN-16 1-10 GPM 1 IN	Female Inline
R5141	BLUEWHITE F-41017LN-12 1-17 GPM 3/4 IN	Female Inline
R5142	BLUEWHITE F-41017LN-16 1-17 GPM 1 IN	Female Inline
R5143	BLUEWHITE F-41000LN-12 2-20 GPM 3/4 IN	Female Inline
R5144	BLUEWHITE F-41000LN-16 2-20 GPM 1 IN	Female Inline
R5149	BLUEWHITE F-44250LH-6 .025-.250 3/8 IN	Male Inline
R5153	BLUEWHITE F-44376LH-6 .2-2 GPM 3/8 IN	Male Inline
R5156	BLUEWHITE F-44500LH-8 .5-5 GPM 1/2 IN	Male Inline
R5157	BLUEWHITE F-44750LH-12 1-10 GPM 3/4 IN	Male Inline
R5175	BLUEWHITE F-44376LHE-8 .2-2 GPM 1/2 IN	Male Inline
R5177	BLUEWHITE F-44750LHE-12 1-10 GPM 3/4 IN	Male Inline
R5180	BLUEWHITE F-55375LA 0.1-1.0 GPM 3/8 IN WITH ADJ VALVE	Female Panel Mount
R5184	BLUEWHITE F-55200L 2-20GPM 1 IN MPT	Male Panel Mount
R5185	BLUEWHITE F-55500LA .5-5GPM 1/2 IN WITH ADJ VALVE	Female Panel Mount
R5241	BLUEWHITE F-45376LHN-8 .2-2 GPM 1/2 IN	Male Inline
R5243	BLUEWHITE F-45500LHN-8 .5-5 GPM 1/2 IN	Male Inline
R5300	BLUEWHITE F-550010L 1-10 GPM 1 IN	Male Panel Mount
R5319	BLUEWHITE F-44750LA-12 1-10 GPM 3/4 IN WITH ADJ VALVE	Male Panel Mount
R5369	BLUEWHITE F-43060LNS-24 6-60 GPM 1-1/2 IN	Female Inline
R5396	BLUEWHITE F-451002LHN 2-20 GPM 1 IN	Female Inline
R5397	BLUEWHITE F-451003LHN 3-30 GPM 1 IN	Female Inline
R5398	BLUEWHITE F-451004LHN 4- 40 GPM 1 IN	Female Inline
R5398-24	BLUEWHITE F-451004LHN-24 4-40 GPM 1-1/2 IN	Female Inline
R5405	BLUEWHITE F-452175LH 20-175 GPM 2 IN	Female Inline
R5407	BLUEWHITE F-44500LHE-8 .5-5 GPM 1/2 IN	Male Panel Mount
R5408	BLUEWHITE F-452060LH 6- 60 GPM 2 IN	Female Inline
R5409	BLUEWHITE F-452080LHN 10- 80 GPM 2 IN	Female Inline
R5411	BLUEWHITE F-452130LH 15-130 GPM 2 IN	Female Inline

## Flow Meters - Blue/White continued

R5416	BLUEWHITE F-55250L .025-.250 GPM 1/4 IN	Male Panel Mount
R5420	BLUEWHITE F-55376LN .2-2 GPM 3/8 IN	Male Panel Mount
R5421	BLUEWHITE F-55376LA .2-2 GPM 3/8 IN WITH ADJUSTABLE VALVE	Male Panel Mount
R5424	BLUEWHITE F-55750L 1-10 GPM 3/4 IN	Male Panel Mount
R5487	BLUEWHITE F-55375L 0.1-1.0 GPM 3/8 IN	Male Panel Mount
R5489	BLUEWHITE F-55500L 0.5-5.0 GPM 1/2 IN	Male Panel Mount
R5501	BLUEWHITE F-55750LA 1-10 GPM 3/4 IN WITH ADJ VALVE	Male Panel Mount
R54-2-136V	PART BW VITON ORING FOR F-451 SERIES	

## Analog Water Meters

MODEL NO.	DESCRIPTION
V5000	METER ABB PSM-190 1/2 IN X1/2 IN
V5004	METER ABB C700TP 5/8 IN X1/2 IN POLY W CONNECTORS
V5008	METER ABB C700TP 5/8 IN X3/4 IN POLY W CONNECTORS
V5012	METER ABB C700TP 3/4 IN X3/4 IN POLY W CONNECTORS
V5012A	METER ABB C700TP 3/4 IN X3/4 IN POLY NO CONNECTORS
V5019	METER ABB C700BP 1.0 IN BRONZE W/CONNECTORS
V5119	METER ABB CONNECTORS 1/2 IN POLY F ABB METERS PAIR
V5120	METER ABB CONNECTORS 3/4 IN POLY F ABB METERS PAIR

## DI Light Bodies and Lab Faucets - PVC

### Ordering Information

#### Light Bodies

MODEL NO.	DESCRIPTION (PIPE X LIGHT)	MATERIAL
R6000	3/8" NPT x 1/2" NPT	PVC
R6001	1/2" NPT x 1/2" NPT	PVC
R6002	3/4" NPT x 1/2" NPT	PVC
R6003	1" NPT x 1/2" NPT	PVC
R6011	3/4" NPT x 9/16" NC	PVC
R6015	1" NPT x 3/4" NPT	PVC



#### PVC Faucets

MODEL NO.	DESCRIPTION	MATERIAL
I6090	3/8" PVC Faucet with 1/2" Light Body	PVC
I6094	3/8" PVC Faucet without Light Body	PVC



## DI Lights - Resilite

### Ordering Information

#### Reslite - LED TEST LIGHT

1/2" STANDARD	1/2" W/CONTROL	9/16" STANDARD	THRESHOLD
R7031-A1	R7032-A1	-	5K
R7031-A	R7032-A	-	10K
R7031-B	R7032-B	-	20K
R7031-C	R7032-C	-	50K
R7031-D	R7032-D	-	200K
R7031-E	R7032-E	-	500K
R7031-F	R7032-F	-	1 MEG
R7031-G	R7032-G	-	2 MEG

## DI Lights & Accessories - Hylite

### Ordering Information

MODEL NO.	DESCRIPTION	SET POINT
<b>with Audible Alarm and Remote Output</b>		
R7101-2meg	HLA Series	2 megohm-cm
R7101-1meg	HLA Series	1 megohm-cm
R7101-200K	HLA Series	200 kilohm-cm
R7101-50K	HLA Series	50 kilohm-cm
R7101-25K	HLA Series	25 kilohm-cm
<b>with Silent Alarm and Remote Output</b>		
R7101-S2meg	HLS Series	2 megohm-cm
R7101-S1meg	HLS Series	1 megohm-cm
R7101-S200K	HLS Series	200 kilohm-cm
R7101-S50K	HLS Series	50 kilohm-cm
R7101-S25K	HLS Series	25 kilohm-cm

#### NOTICE

Comes with both 1/2" and 3/4" Parker Hannifin connectors. Transformer required on all models.

MODEL NO.	DESCRIPTION
R7100-T	Transformer, 110VAC/12VDC (Required On All Models)
R7101-R	Remote Alarm Module
R7100-RMR	Relay Module w/ Adj. Timer Delay
R7100-P	HL to HL Patchcord
R7100-RPC-200	HL to Remote Patchcord (200 Ft)
R7100-RPC-100	HL to Remote Patchcord (100 Ft)
R7100-RPC-50	HL to Remote Patchcord (50 Ft)

## Myron L Monitors, Probes & Accessories



### Water Quality Monitors

#### Ordering Information

MODEL NO.	DESCRIPTION
T3505-116	MYRON L 759II-116 0-200 PPM DIGITAL MONITOR ONLY
T3505-118	MYRON L 759II-118 0-500 PPM DIGITAL MONITOR CONTROLLER
T3508-109	MYRON L 757II-109 0-20 MOS ANALOG MONITOR CONTROLLER
T3508-115	MYRON L 757II-115 0-200 MOS ANALOG
T3508-117	MYRON L 757II-117 0-500 MOS ANALOG
T3508-119	MYRON L 757II-119 0-1000 MOS ANALOG
T3509-105	MYRON L 758II-105 0-5-MOS DIGITAL MONITOR CONTROLLER
T3509-107	MYRON L 758II-107 0-10 MOS DIGITAL MONITOR
T3509-107-SC	MYRON L 758II-107-SC 0-10 MOS DIGI MONT CONTR 2ND CONTROLLER
T3509-109	MYRON L 758II-109 0-20 MOS DIGITAL MONITOR CONTROLLER
T3509-109-420	MYRON L 758II-109 W 4-20 OUTPUT
T3509-114	MYRON L 758II-114 0-100 PPM DIGITAL MONITOR CONTROLLER
T3509-115	MYRON L 758II-115 0-200 MOS DIGITAL MONITOR CONTROLLER
T3509-115-4A	MYRON L 758II-115-4A0 0-200MOS W 4-20 MA INTERNAL DIGITAL
T3509-117-4A	MYRON L 758II-117-4A 0-500US W 4-20MA DIGITAL MONITOR CONTRO
T3509-117-SC	MYRON L 758II-117-SC 0-500 MOS MONT CONTR 2ND CONTRLR3
T3509-123	MYRON L 758II-123 0-5000 MOS DIGITAL MC
T3542-011	MYRON L 752II-011 0-20 MEGOHMS ANALOG MONITOR CONTROLLER
T3543-011	MYRON L 751II-011 0-20 MEGOHMS ANALOG MONTITOR ONLY
T3544-011	MYRON L 753II-011 0-20 MEGOHMS DIGITAL MONT CONTROLLER
T3545-011	MYRON L 754II-011 0-20 MEGOHMS DIGITAL MONITOR ONLY
T3544-CS11	MYRON L 20 MEGAHOM RESISTIVITY CALIBRATION MODULE

### Water Quality Probes and Accessories

MODEL NO.	DESCRIPTION
T3544-4A	MYRON L 4-20 MA ISOLATED OUTPUT MODULE
T3524	MYRON L CELL CS51LC CONDUCTIVITY CELL W 10 IN CABLE
T3525	MYRON L CELL CS51 CONDUCTIVITY CELL
T3532	MYRON L SURFACE PLATE F 750
T3556	MYRON L CELL CS10-S POLY SS W 10 FT CBL
T3556-25	MYRON L CELL CS10 CELL W 25 FT CABLE

## Water Treatment Chemicals, Cleaners and Sanitizers

MODEL NO.	DESCRIPTION
T2020	PRO-RUST OUT 1.5LB BOTTLE 12 CASE
T2021	PRO-RUST OUT 5LB ECONOMY SIZE BOTTLE 6 CASE
T2025	PRO-SOFTENER MATE 1.5LB BOTTLE 12 CASE
T2027	PRO-CITRIC ACID 1.5LB BOTTLE 12 CASE
T2027-4	PRO-BAN-T CITRIC ACID 4LB BOTTLE 6 CASE
T2033	KMNO4 5LB PRO-POT PERM 5LB BOTTLE 6 CASE HZMT
T2041	PRO-RES CARE 1QT BOTTLE 12 CASE
T2042	PRO-RES CARE 1GAL BOTTLE 4 CASE
T2049	PRO-SOFTENER MATE 4OZ RESIN CLEANER 24 CASE
T2051-RO	SANI-SYSTEM F RO .25FL OZ 24 CASE
T2051-WS	SANI-SYSTEM F SOFTENERS .5 FL OZ 24 CASE
T2061	CHM PRO EASY FEEDER STARER KIT FOR SOFTENER 2QUART WITH FEEDER
T2063	CHM SANI SYST CLEAN AND SANI KIT 5OZ
T2065	PO4-RC 104 CRYSTALS 50LB PAIL 800 OZ.
T2659-SC-1	SPECTRAGUARD SC LIQ .45GAL ANTISCALANT AND STABILIZER
T2659-SC-5	SPECTRAGUARD SC LIQ 5GAL ANTISCALANT AND STABILIZER



## Water Test Kits

MODEL NO.	DESCRIPTION
T2404	DELUXE FIELD ANALYSIS HARDNESS IRON PH CHLORINE TDS
T3001	HYDROGEN SULFIDE TEST KIT 18 TESTS
T3002	HACH 5B HARDNESS TEST KIT
T3003	IRON TEST KIT CUBE HACH 14008-00 PILLOWS
T3005	CHLORINE PH TEST KIT 752 HIGH CHLORINE
T3007	SOFT WATER SOAP TEST KIT
T3010	REAGENT FERROVER IRON PWD PILL F 5ML SAMPLE 100 PK
T3022	AQUACHECK 5 STRIP TESTS 50 STRIPS BOTTLE
T3023	SOFCHECK F TOTAL HARDNESS 50 TESTS BOTTLE 12 CS
T3030	SALOMETER 0-100 PERCENT
T3031	SDI TESTER WITH 10 FILTER DISCS
R2021	FILTER DISCS GELMAN 47MM 100 BOX ONLY
CHAMP	HI98106 HANNA PH POCKET TESTER 0.0 TO 14.0PH
WTDS-3	TDS METER 0-9990 TEMP 0-80 DEG C ATC HAND HELD WITH CASE
HI 3812	HANNA HARDNESS TEST KIT 110 STRIPS WITH CASE
HI 3831F	CHLORINE TEST KITS FREE CHLORINE 0-2.5 PPM
PH600	PH TESTER 0-14
TDS-110ELE	ELECTROLYZER WITH 4 LEGS IRON ALUM SWITCH 120 230V
TDS-999-CS91	TDS METER CS-91 AUTO TEMP COMP 0-999 PPM
TDS-999-MINI	TDS POCKET METER 1-1999 PPM 3V BATTERY INCLUDED
WP-2000	SPRITE TDS POCKET METER PROBE 0-1999 PPM WITH CASE



## PVC Flow Controllers

MODEL NO.	DESCRIPTION
V2001-0.25	PVC 1/2 IN MXM 0.25 GPM
V2001-0.50	PVC 1/2 IN MXM 1/2 GPM
V2001-1.00	PVC 1/2 IN MXM 1.0 GPM
V2001-1.40	PVC 1/2 IN MXM 1.4 GPM
V2001-1.60	PVC 1/2 IN MXM 1.6 GPM
V2001-2.00	PVC 1/2 IN MXM 2.0 GPM
V2001-2.50	PVC 1/2 IN MXM 2.5 GPM
V2001-3.00	PVC 1/2 IN MXM 3.0 GPM
V2001-3.50	PVC 1/2 IN MXM 3.5 GPM
V2001-MCH	PVC 1/2 IN MXM HSG .25-3.5 GPM SPECIFY GPM
V2002-0.50	PVC 3/4 IN MXM 1/2 GPM
V2002-1.00	PVC 3/4 IN MXM 1.0 GPM
V2002-1.60	PVC 3/4 IN MXM 1.6 GPM
V2002-2.00	PVC 3/4 IN MXM 2.0 GPM
V2002-2.50	PVC 3/4 IN MXM 2.5 GPM
V2002-3.00	PVC 3/4 IN MXM 3.0 GPM
V2002-3.50	PVC 3/4 IN MXM 3.5 GPM
V2002-B-10	PVC 3/4 IN MXM 10 GPM
V2002-B-5	PVC 3/4 IN MXM 05 GPM
V2002-B-6	PVC 3/4 IN MXM 06 GPM
V2002-B-7	PVC 3/4 IN MXM 07 GPM
V2002-B-8	PVC 3/4 IN MXM 08 GPM
V2002-B-9	PVC 3/4 IN MXM 09 GPM
V2002-B-MCH	PVC 3/4 IN MXM HSG 5-10 GPM SPECIFY GPM
V2002-B-MCH-01	PVC 3/4 IN FXF HSG 5-10 GPM SPECIFY GPM
V2002-MCH-01	PVC 3/4 IN FXF HSG .25-3.5 GPM SPECIFY GPM
V2003-10	PVC 1 IN MXM 10 GPM
V2003-5	PVC 1 IN MXM 05 GPM
V2003-7	PVC 1 IN MXM 07 GPM
V2003-8	PVC 1 IN MXM 08 GPM
V2003-9	PVC 1 IN MXM 09 GPM
V2003-A-12	PVC 1 IN MXM 12 GPM
V2003-A-15	PVC 1 IN MXM 15 GPM
V2003-A-20	PVC 1 IN MXM 20 GPM
V2003-A-MCH	PVC 1 IN MXM HSG 12,15,20 GPM SPECIFY GPM
V2003-A-MCH-02	PVC 1.0 IN FXM HSG 12-20 GPM SPECIFY GPM
V2003-C-MCH-02	PVC 1.0 IN F X M HSG .25-3.5 GPM SPECIFY GPM
V2003-MCH	PVC 1 IN MXM HSG F 5-10 GPM SPECIFY GPM
V2003-MCH-02	PVC 1.0 IN FXM HSG 5-10 GPM SPECIFY GPM

MODEL NO.	DESCRIPTION
V2004-11	PVC 1.25 IN MXM 11 GPM
V2005-A	PVC 1.50 IN MXM HSG 20-40 GPM SPECIFY GPM
V2005-A-20	PVC 1.50 IN MXM 20 GPM
V2005-A-25	PVC 1.50 IN MXM 25 GPM
V2005-A-30	PVC 1.50 IN MXM 30 GPM
V2005-A-35	PVC 1.50 IN MXM 35 GPM
V2005-A-40	PVC 1.50 IN MXM 40 GPM
V2006	PVC 2 IN MXM HSG 35-70 GPM SPECIFY GPM
V2006-35	PVC 2 IN MXM 35 GPM
V2006-40	PVC 2 IN MXM 40 GPM
V2006-45	PVC 2 IN MXM 45 GPM
V2006-50	PVC 2 IN MXM 50 GPM
V2006-55	PVC 2 IN MXM 55 GPM
V2006-60	PVC 2 IN MXM 60 GPM
V2006-70	PVC 2 IN MXM 70 GPM
V2007	PVC 2.5 IN MXM HSG 45-90 GPM SPECIFY GPM
V2007-50	PVC 2.5 IN MXM 50 GPM
V2007-70	PVC 2.5 IN MXM 70 GPM
V2007-75	PVC 2.5 IN MXM 75 GPM
V2007-90	PVC 2.5 IN MXM 90 GPM
V2008	PVC 3 IN MXM HSG 70-140 GPM SPECIFY GPM
V2008-100	PVC 3 IN MXM 100 GPM
V2008-120	PVC 3 IN MXM 120 GPM
V2008-125	PVC 3 IN MXM 125 GPM
V2008-135	PVC 3 IN MXM 135 GPM
V2008-80	PVC 3 IN MXM 80 GPM
V2008-90	PVC 3 IN MXM 90 GPM
V2009	PVC 4 IN MXM HSG 125-250 GPM SPECIFY GPM
V2009-150	PVC 4 IN MXM 150 GPM
V2009-160	PVC 4 IN MXM 160 GPM
V2009-220	PVC 4 IN MXM 220 GPM
V2032	PVC 3 IN FLANGE HSG 70-140 GPM SPECIFY GPM
V2032-100	PVC 3 IN FLANGED 100 GPM
V2032-120	PVC 3 IN FLANGED 120 GPM
V2032-80	PVC 3 IN FLANGED 80 GPM
V2033	PVC 4.00 IN FLANGE HSG 120-250 GPM SPECIFY GPM

## Waterminder Metering Valves

*Valves provide automatic shut-off, based on gallons filtered.*

These unique, patented meter valves provide automatic shut off of a potable water system for filter replacement after a pre-determined quantity of water has been filtered.

### Features

- Choice of 1,800 or 3,800 gallon capacity
- Settings in 100 gallon increments
- Accuracy within 10% of setting
- Operating pressures from 15 to 125 psi
- Burst tested to 500 psi
- Assortment of fittings
- Manufactured using NSF listed materials
- Models for gallons or liters



MODEL NO.	CAPACITY (MAX DIAL SETTING)	FITTINGS	COLOR	SIZE	NO. / CASE
WM2000B	1800 (gals.)*	Jaco	Black	1/4" MNPT	60
WM2000W	1800 (gals.)*	Jaco	White	1/4" MNPT	60
WM3000B	3800 (gals.)*	Jaco	Black	1/4" MNPT	60
WM3000W	3800 (gals.)*	Jaco	White	1/4" MNPT	60
WM3001B	15000 (ltrs.)*	Jaco	Black	1/4" MNPT	60
WM2001B	7000 (ltrs.)*	Jaco	Black	1/4" MNPT	60
WM2000HCW	1800 (gals.)*	J. Guest	White	1/4"	60
WM2000HCB	1800 (gals.)*	J. Guest	Black	1/4" quick connect	60

**Note:** \* With dial which may be adjusted in increments of 100 gallons.

## Top Quality Designer Faucets

Large Selection of Designer Faucets to Suit Your Taste

Why Crawl Under The Sink When You Can Install It From The Top!

### Designer Top Mount Twist Faucets

#### Features & Benefits

- Easy Installation from the top of the sink
- Reduces Installation Labor
- Easy Twist on and off faucet tops enable the end user to change faucet styles and colors without the need to disconnect the faucet from the filtration system.
- Lead Free\*
- Models with filter change monitors are available to remind customers when to change cartridges for water quality assurance
- Ceramic disc for durability
- One style works for both air gap and non-air gap installations
- Quick-Connect fittings for all tubes including air gap



Available in chrome, brushed nickel, black, white and oil rubbed bronze

Monitor faucets remind customers when cartridge replacements are necessary to eliminate guesswork and provide top water quality assurance!

#### How the Monitor Faucets work:

- Monitor tracks time and estimates gallons based on time when handle is in "on" position.
- Blue LED indicates filter life remaining.
- Red LED flashes after 6 months or estimated 2000 gallons indicating filter replacement required.
- Removal and reinstallation of battery will reset the monitor.

### Designer Top Mount Faucets

Twist

Non Twist



Curve



Bell



WTMT



component

All Top Mount Faucets Are

Certified by NSF International against NSF/ANSI Standard 42 for material and structural requirements.

### Designer Faucets



Series 303



Series 133



Series 703



Series 888



Series 903



Series 905

### Dual Function Faucets



FU-GKD01-CP



FU-GKD02-CP



T277103



T277104

## Top Quality Designer Faucets

MODEL NO.	VALVE TYPE	FINISH	SIZE (IN)	CASE QTY	AIR GAP	FILTER MONITOR
<b>Top Mount Twist Faucets *NEW*</b>						
WTMTFA-CRVC14	Ceramic Disc	Chrome	1/4	15	X	X
WTMTFA-CRVC14	Ceramic Disc	Chrome	1/4	15	X	
WTMTFA-CRVBNM14	Ceramic Disc	Brushed Nickel	1/4	15	X	X
WTMTFA-CRVBN14	Ceramic Disc	Brushed Nickel	1/4	15	X	
WTMTFA-CRVWHM14	Ceramic Disc	White	1/4	15	X	X
WTMTFA-CRVWH14	Ceramic Disc	White	1/4	15	X	
WTMTFA-CRVBKM14	Ceramic Disc	Black	1/4	15	X	X
WTMTFA-CRVBK14	Ceramic Disc	Black	1/4	15	X	
WTMTFA-CRVORM14	Ceramic Disc	Oil Rubbed Bronze	1/4	15	X	X
WTMTFA-CRVOR14	Ceramic Disc	Oil Rubbed Bronze	1/4	15	X	
WTMTFA-BELCM14	Ceramic Disc	Chrome	1/4	15	X	X
WTMTFA-BELC14	Ceramic Disc	Chrome	1/4	15	X	
WTMTFA-BELBNM14	Ceramic Disc	Brushed Nickel	1/4	15	X	X
WTMTFA-BELBN14	Ceramic Disc	Brushed Nickel	1/4	15	X	
WTMTFA-BELWHM14	Ceramic Disc	White	1/4	15	X	X
WTMTFA-BELWH14	Ceramic Disc	White	1/4	15	X	
WTMTFA-BELBKM14	Ceramic Disc	Black	1/4	15	X	X
WTMTFA-BELBK14	Ceramic Disc	Black	1/4	15	X	
WTMTFA-BELORM14	Ceramic Disc	Oil Rubbed Bronze	1/4	15	X	X
WTMTFA-BELOR14	Ceramic Disc	Oil Rubbed Bronze	1/4	15	X	
WTMTFA-CRVC38	Ceramic Disc	Chrome	3/8	15	X	X
WTMTFA-CRVC38	Ceramic Disc	Chrome	3/8	15	X	
WTMTFA-CRVBNM38	Ceramic Disc	Brushed Nickel	3/8	15	X	X
WTMTFA-CRVBN38	Ceramic Disc	Brushed Nickel	3/8	15	X	
WTMTFA-CRVWHM38	Ceramic Disc	White	3/8	15	X	X
WTMTFA-CRVWH38	Ceramic Disc	White	3/8	15	X	
WTMTFA-CRVBKM38	Ceramic Disc	Black	3/8	15	X	X
WTMTFA-CRVBK38	Ceramic Disc	Black	3/8	15	X	
WTMTFA-CRVORM38	Ceramic Disc	Oil Rubbed Bronze	3/8	15	X	X
WTMTFA-CRVOR38	Ceramic Disc	Oil Rubbed Bronze	3/8	15	X	
WTMTFA-BELCM38	Ceramic Disc	Chrome	3/8	15	X	X
WTMTFA-BELC38	Ceramic Disc	Chrome	3/8	15	X	
WTMTFA-BELBNM38	Ceramic Disc	Brushed Nickel	3/8	15	X	X
WTMTFA-BELBN38	Ceramic Disc	Brushed Nickel	3/8	15	X	
WTMTFA-BELWHM38	Ceramic Disc	White	3/8	15	X	X
WTMTFA-BELWH38	Ceramic Disc	White	3/8	15	X	
WTMTFA-BELBKM38	Ceramic Disc	Black	3/8	15	X	X
WTMTFA-BELBK38	Ceramic Disc	Black	3/8	15	X	
WTMTFA-BELORM38	Ceramic Disc	Oil Rubbed Bronze	3/8	15	X	X
WTMTFA-BELOR38	Ceramic Disc	Oil Rubbed Bronze	3/8	15	X	
<b>Top Mount (non-Twist) Series Faucets</b>						
WTMFAG-C-M	Ceramic Disc	Chrome	3/8	15	X	X
WTMFAG-C	Ceramic Disc	Chrome	3/8	15	X	
WTMFAG-BN-M	Ceramic Disc	Brushed Nickel	3/8	15	X	X
WTMFAG-BN	Ceramic Disc	Brushed Nickel	3/8	15	X	
WTMFAG-W-M	Ceramic Disc	White	3/8	15	X	X
WTMFAG-W	Ceramic Disc	White	3/8	15	X	
WTMFAG-B-M	Ceramic Disc	Black	3/8	15	X	X
WTMFAG-ORB-M	Ceramic Disc	Oil Rubbed Bronze	3/8	15	X	X
WTMFAG-ORB	Ceramic Disc	Oil Rubbed Bronze	3/8	15	X	
<b>Series 133 Faucets</b>						
FU133CPP	Ceramic Disc	Chrome	1/4	10		
<b>Series 303 Faucets</b>						
FNP3033CP-US05	Lever Style	Chrome	1/4	50		
FNP3033NP	Lever Style	Brushed Nickel	1/4	50		
<b>Airgap Monitor</b>						
FU-AGLR-C/3	Lever Style	Brushed Nickel	1/4	50	X	
<b>Series 703 Faucets</b>						
FNCP7033CP	Ceramic Disc	Chrome	1/4	30		
FNCP7033NP	Ceramic Disc	Brushed Nickel	1/4	30		
FNCP7033OB	Ceramic Disc	Oil Rubbed Bronze	1/4	30		
<b>Series 888 Faucets</b>						
FNCP8883AB	Ceramic Disc	Antique Brass	1/4	20		
FNCP8883AW	Ceramic Disc	Antique Wine	1/4	20		
FNCP8883CP	Ceramic Disc	Chrome	1/4	20		
FNCP8883NP	Ceramic Disc	Brushed Nickel	1/4	20		
FNCP8883ST	Ceramic Disc	Satin Nickel	1/4	20		
<b>Series 903 Faucets</b>						
FNCP6034CP	Ceramic Disc	Chrome	1/4	30		
<b>Series 905 Faucet</b>						
FU-WDF-905-CP	Ceramic Disc	Chrome	1/4	30		
FNCP9053NP	Ceramic Disc	Brushed Nickel	1/4	30		
<b>Dual Function Kitchen Faucets</b>						
FU-GKD01-CP	Ceramic Disc	Chrome	1/4	8		
FU-GKD02-CP	Ceramic Disc	Chrome	1/4	8		
T277103	Ceramic Disc	Chrome	1/4	8		
T277104	Ceramic Disc	Chrome	1/4	8		

### Twist Faucets



### Non-Twist Faucet



### Designer Faucets

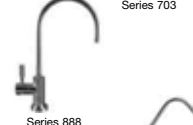

### Dual Function Faucets

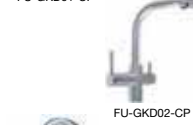



## Counter Top Accessories

MODEL NO.	DESCRIPTION	NO. PER CASE
WR100	(Housing wrench) CT-4000, APO-CTW, APC-CTW	100
OR-4	(Spare o-ring) CT-4000, APO-CTW, CT500	100
OR-4W	(Spare o-ring) SS4000 in EPDM	100
OR-1W	(Spare o-ring) SS1000 in EPDM	100

## Counter Top Spouts

MODEL NO.	DESCRIPTION	NO. PER CASE
LRS-C-OR	L.R.S chrome, double o-rings	100
LRS-P-OR	L.R.S plastic, double o-rings	100
TS-800C-OR	Std. 8" chrome, double o-ring	100
TS-800P	Std. 8" plastic, no o-ring	100
PTS-800W	Std. 8" plastic, double o-rings	100

## Diverter Valves

MODEL NO.	DESCRIPTION	NO. PER CASE
DV-14	Spring loaded, chrome, 1/4" single	200
DV-14S	Spring loaded, chrome, 1/4" single, swivel	200
SDV-14S	Manual slide, chrome, 1/4" single, swivel	200
SDV-14CQ	Manual slide, chrome, 1/4" fast connect	200
DVB-14C	Manual handle, 1/4" single, chrome	100
DVB-38-C-E	Manual handle, 3/8" single, chrome	100
DV800W	Plastic, 1/4" single, white	500
DV800WM	Plastic, 1/4" single, metal collar	500
DV803WM	1/4" double, white, metal collar	500

## Diverter Valve Adapters

MODEL NO.	DESCRIPTION	NO. PER CASE
AD1P/AD2P	Plastic, male 13/16", 15/16" X 27	500
AD1C/AD2C	Chrome, male 13/16", 15/16" X 27	500
ETA	External faucet for all diverters	100
ETA-C	External faucet, chrome / brass	100

## Counter Top Fittings

MODEL NO.	DESCRIPTION	NO. PER CASE
C-21-1	Chrome elbow for spouts w/o o-rings	100
C-22N	Chrome elbow, barbed inlet, 1/4" barb	100
EB-14W	Plastic elbow, barbed inlet, 1/4" barb	100
EB-14LW	Plastic elbow for spouts w/o o-rings	100
CI010822W	Inlet fitting for 1/4" quick connect	100
CI481222W	Elbow for spouts w/o o-rings	100

## Residential RO Membranes

Top quality membranes for residential reverse osmosis systems.



Certified to NSF/ANSI Standard 58 with the RO Data Transfer protocol.



### Watts® Residential Membranes (thin film composite)

MODEL NO.	APPLICATION	O.D.	LENGTH	CAPACITY (GPD)	NO. PER CASE
W-1812-24	Tap water	1.8"	11.75"	24	25
W-1812-36	Tap water	1.8"	11.75"	36	25
W-1812-50	Tap water	1.8"	11.75"	50	25
W-1812-75	Tap water	1.8"	11.75"	75	25
W-1812-100	Tap water	1.8"	11.75"	100	25

### Watts Membrane Specifications

DATA	W-1812-24	W-1812-36	W-1812-50	W-1812-75	W-1812-100
Membrane type	TCF	TCF	TCF	TCF	TCF
Material	Polyamide	Polyamide	Polyamide	Polyamide	Polyamide
Charge	Negative	Negative	Negative	Negative	Negative
Configuration	Spiral-wound	Spiral-wound	Spiral-wound	Spiral-wound	Spiral-wound
Salt rejection	95%	95%	95%	95%	95%
Max. operating temp.	113°F / 45°C	113°F / 45°C	113°F / 45°C	113°F / 45°C	113°F / 45°C
Max. operating pressure	125 psi	125 psi	125 psi	125 psi	125 psi
Max. turbidity (NTU)	1	1	1	1	1
Max. SDI	5	5	5	5	5
pH range	3-10	3-10	3-10	3-10	3-10
Permeate Rate	24 gpd	36 gpd	50 gpd	75 gpd	100 gpd

**Note:** Specifications based on 77°F (25°) temperature and 60 psid pressure and 500 ppm TDS



### Filmtec® By Dow® Residential Membranes (thin film)

MODEL NO.	APPLICATION	O.D.	LENGTH	CAPACITY (GPD)	NO. PER CASE
TW30-1812-24	Tap water	1.8"	11.75"	24	25
TW30-1812-36	Tap water	1.8"	11.75"	36	25
TW30-1812-50	Tap water	1.8"	11.75"	50	25
TW30-1812-75	Tap water	1.8"	11.75"	75	25
CTA-16*	Tap water	1.8"	11.25"	16	25

**Note:** \*Desalination chlorine tolerant

### Commercial RO Membranes

MODEL NO.	SIZE	DESCRIPTION	CAPACITY (GPD)
R96310	3" X 10"	Watts Brand, Thin Film, Tape Wrapped - Used on R13 Systems	250
R96320	3" X 10"	Watts Brand, Thin Film, Tape Wrapped - Used on R13 Systems	600
W-2514-TW	2.5" X 14"	Watts Brand, Thin Film, Tape Wrapped, Standard Element	200
W-2521-TW	2.5" X 21"	Watts Brand, Thin Film, Tape Wrapped, Standard Element	300
W-2540-TW	2.5" X 40"	Watts Brand, Thin Film, Tape Wrapped, Standard Element	600
W-4021-TW	4" x 21"	Watts Brand, Thin Film, Tape Wrapped, Standard Element	800
W-4040-TW	4" x 40"	Watts Brand, Thin Film, Tape Wrapped, Standard Element	1800
W-4040-LE	4" x 40"	Watts Brand, Thin Film, Tape Wrapped, Low Energy	2200
W-4040-BW	4" x 40"	Watts Brand, Thin Film, FRP Wrapped, Brackish Water	1800
TW30-4040	4" x 40"	Filmtec Brand, Thin Film, Tape Wrapped, Standard Element	1800
R9640-TM	4" x 40"	Toray Brand, Thin Film, FRP Wrapped, Brackish Water	2000

## Reverse Osmosis Membrane Housings

Top quality membrane housings for residential RO systems.

Watts membrane housings are manufactured from the highest quality NSF listed, FDA grade polypropylene.

### Features

- Standard 1/8" NPT molded threads
- Models with John Guest® fittings
- High quality finish
- Burst pressure exceeds 500 psi
- Cycle test 150 psi, 100,000 cycles
- Choice of five housing styles to meet every requirement



MH200WL/3



EH2500W



EH2501W



EH2500KW



EH2501KW

### Membrane Housings

MODEL NO.	DESCRIPTION	SIZE	COLOR	FITTINGS	NO./CASE
EH2500W	Side, Side, Side	1/8"	White	None	25
EH2501W	Side, Side, Side	1/8"	White	None	25
EH2500KW	End, Side, Side	1/8"	White	None	25
EH2501KW	End, Side, Side	1/8"	White	None	25
EH2501KHCW	End, Side, Side	1/4"	White	J.G.	25
MH-200WL/3	End, Side, Side	1/8"	White	None	24

### O-Rings

MODEL NO.	DESCRIPTION	NO./CASE
OR-2	O-ring for EH series housings	1

## Pumps and Accessories



ERP-500/ERP-1000



CDP-6800

### Permeate Pumps

MODEL NO.	MFG.	FITTING	ELECTRICAL	NOTATIONS	NO. PER CASE
ERP-500 (50GPD)	Aquatech	1/4" JG	Non-Elec.		30
ERP-1000 (100GPD)	Aquatech	1/4" JG	Non-Elec.		30

### Booster Pumps (low flow)

MODEL NO.	MFG.	FITTING	ELECTRICAL	NOTATIONS	NO. PER CASE
CDP-6800	Aquatech	1/4" JG	24 VAC	CE MARK	12
W152012	Import	1/4" JG	24 VAC		12

### Booster Pumps (high flow)

MODEL NO.	MFG.	FITTING	ELECTRICAL	NOTATIONS	NO. PER CASE
CDP-8800	Aquatech	3/8" JG	24 VAC	CE MARK	12

### Zero Waste RO Pump Kits"

MODEL NO.	MFG.	FITTING	ELECTRICAL	NOTATIONS	NO. PER CASE
ZWKIT	WATTS	1/4" JG FEED 3/8" JG PERMEATE	115V	ZERO WASTE KIT FOR GENERIC RO SYSTEMS	1
ZWKIT-220	WATTS	1/4" JG FEED 3/8" JG PERMEATE	220V	ZERO WASTE KIT FOR GENERIC RO SYSTEMS	1
ZWKIT-WATTS	WATTS	N/A	115V	ZERO WASTE KIT FOR WATTS QT/QC RO SYSTEMS	1
ZWKIT-WATTS-220	WATTS	NA	220V -220	ZERO WASTE KIT FOR WATTS QT/QT RO SYSTEMS	1

### Delivery / Transfer Pumps

MODEL NO.	MFG.	FITTING	SHUT-OFF PRESSURE (PSI)	ELECTRICAL	NOTATIONS	NO. PER CASE
F5852-7F12-J604	Aquatech	3/8" JG	70	115V	w/cord 1.4 gpm	1
F5852-IE12-J574	Aquatech	3/8" JG	70	115V	w/cord 0.6 gpm	1

### Variable Speed Pumps

MODEL NO.	MFG.	FITTING	SHUT-OFF PRESSURE (PSI)	ELECTRICAL	NOTATIONS	NO. PER CASE
F5853-GB12-V81D	Aquatech	3/8" JG	40	115V	W/CORD	1
F5853-GE12-V81D	Aquatech	3/8" JG	60	115V	W/CORD	1
F5502-IDN2-V77D	Aquatech	3/8" ports*	50	115V	W/CORD	1

**Note:** Pumps above come with power cords. \*Ports only. QJS553 (3/8" tube) or QJS554 (3/8" tube) fitting required. See accessories.

### Transformers

MODEL NO.	DESCRIPTION	PUMP	ELECTRICAL
TAS-114-19-EP1	Transformer	6800	115V 0.8 AMP
TAS-234-19EP	Transformer	6800	230V 0.8 AMP
TAS-104-19	Transformer	6800	100V 0.8 AMP
TACS-114-48	Transformer	8800, 5800	115V 2 AMP
TACS-234-48RF	Transformer	8800, 5800	230V 2 AMP
W152018	Transformer	W152012	110V
W152029	Transformer	W152012	220V

**Note:** All transformers are shipped individually.



## Pump Accessories

MODEL NO.	DESCRIPTION	PUMP	NO./CASE
PSW-240	Tank psi switch 1/4" JG	6800 & 8800	1
PSW-340	Tank psi switch 3/8" JG	6800 & 8800	1
LPS	Low pressure switch	6800 & 8800	1
TLC-DC	Tank level controller	6800 & 8800	1
F68011	Pump head	6800	1
QJS553	3/8" x 3/8" fitting	5502-IDN2-V77D	1
QJS554	1/2" x 1/2" fitting	5502-IDN2-V77D	1
PPC-1000	Clips for permeate pump	ERP-1000	1
F610041	Auto shutoff valve (MCD style)	All Zero Waste Kits	1
W152012	Booster Pump 1/4" for zero waste	All Zero Waste Kits	1
W152040	Wiring harness F149067 valve to pump	All Zero Waste Kits	1

## Procon Pumps for Reverse Osmosis Systems

*Procon pumps range from 100 to 240 Gallons per Hour*

MODEL NO.	DESCRIPTION
R2101	PROCON BRASS 3/8 IN 100GPH USE CLAMP NUMBER R2102-A
R2101-140	PROCON BRASS 3/8 IN 140GPH 225PSI RELIEF CLAMP ON
R2102-A	PROCON CLAMP COUPLING NO 1113 FOR MOUNTING PUMP TO MOTOR
R2103	PROCON BRASS 1/2 IN 240GPH BOLT ON 104E240F11XX
R2103-2	PROCON BRASS 1/2 IN 240GPH CLAMP ON 114A240F11XXX

## Reverse Osmosis Storage Tank and Pump Combinations



F252028 Pump included in whole house tank kits below



C8013 tank included in R2288 whole house tank kit below

MODEL NO.	DESCRIPTION
R2288	WHOLE HOUSE TANK 300GAL WITH FLOAT AND PUMP
R2288-165	WHOLE HOUSE TANK 165GAL WITH FLOAT AND PUMP
R2288-500	WHOLE HOUSE TANK 500GAL WITH FLOAT AND PUMP
F252028	PUMP-GRNDFS MQ3-45 115V 1HP 15GPM@35PSI

### NOTICE

Float switch is compatible with 115 volts 15 amps max.





## Watts Water Quality Dealer Branches

### **CALIFORNIA**

2352 E. WALNUT AVE  
FULLERTON CA 92831

### **SAN ANTONIO**

13700 HWY 90 WEST  
SAN ANTONIO TX 78245

### **HOUSTON**

8738 WEST PARK DR  
HOUSTON TX 77063

### **ARIZONA**

8716 W LUDLOW DR SUITE 1  
PEORIA AZ 85381

### **FLORIDA**

11611 SW 147TH CT  
DUNNELLON FL 34432

### **TAMPA**

5420 PIONEER PARK BLVD SUITE A  
TAMPA FL 33634

### **OHIO**

1869 EAST AURORA ROAD, SUITE 700  
TWINSBURG, OH, 44087

### **NEW JERSEY**

40 TWOSOME DR, SUITE 4  
MOORESTOWN NJ 08057

### **ONTARIO**

5435 NORTH SERVICE RD  
BURLINGTON ON L7L 5H7

*We have all the above full service branches in to service your requirements. All branch locations can take orders, quote prices, review inventory and check order status.*

Distributed by:



A Watts Water Technologies Company