

DULCOMETER®

Multi-parameter controller diaLog DACb

EN



Please carefully read these operating instructions before use. · Do not discard.
The operator shall be liable for any damage caused by installation or operating errors.
The latest version of the operating instructions are available on our homepage.

General non-discriminatory approach

In order to make it easier to read, this document uses the male form in grammatical structures but with an implied neutral sense. The document is always aimed equally at women, men and gender-neutral persons. We kindly ask readers for their understanding in this simplification of the text.

Supplementary information

 Please read the supplementary information in its entirety.

Information







This provides important information relating to the correct operation of the unit or is intended to make your work easier.

Warning information

Warning information includes detailed descriptions of the hazardous situation, see  *Chapter 1.1 'Labelling of Warning Information' on page 9.*

The following symbols are used to highlight instructions, links, lists, results and other elements in this document:

Tab. 1: More symbols

Symbol	Description
	Action, step by step.
	Outcome of an action.
	Links to elements or sections of these instructions or other applicable documents.
	List without set order.
<i>[Button]</i>	Display element (e.g. indicators). Operating element (e.g. button, switch).

Symbol	Description
<i>'Display/GUI'</i>	Screen elements (e.g. buttons, assignment of function keys).
CODE	Presentation of software elements and/or texts.

Table of contents

1	Safety and responsibility	9
1.1	Labelling of Warning Information.....	9
1.2	General safety information.....	10
1.3	Intended use.....	11
1.4	User qualification.....	13
2	Operating concept	15
2.1	Display and keys.....	15
2.2	Functions of the keys	19
2.3	Changes the set operating language.....	20
2.4	Acknowledge fault or warning message	21
2.5	Key Lock	21
2.6	Measured variables and measuring inputs.....	22
3	Nameplate and ID code	23
3.1	Nameplate.....	23
3.2	Identity code.....	25
3.3	A complete measuring point may comprise the following:.....	27
4	Storage and transport	28
5	Functional Description	29
6	Subsequent Extension of Functions	30
7	Functions to Backup the Controller's Setting Data	32
8	Information on fieldbus products	35
9	Assembly and installation	36
9.1	Requirements.....	36
9.2	Scope of supply.....	38
9.3	Mechanical mounting.....	38
9.3.1	Mounting on a surface.....	38
9.3.2	Control Panel Installation.....	40
9.4	Electrical installation.....	43
9.4.1	Specifications.....	43
9.4.2	Specification of the threaded connectors.....	46
9.4.3	Specification of the cables and terminals.....	47
9.4.4	Terminal diagram.....	51

9.4.5	Mounting on a surface and control panel installation.....	67
9.4.6	Switching of inductive loads.....	68
9.4.7	Connect the sensors electrically to the controller.....	70
9.5	Priming to bleeding.....	76
10	Commissioning.....	77
10.1	Switch-on behaviour during commissioning.....	77
10.2	Adjusting the backlight and contrast of the controller display.....	78
10.3	Resetting the operating language.....	78
10.4	Defining metering and control processes.....	78
10.5	Calibrating conductive conductivity, sensor parameter adjustment.....	78
11	Configuring measured variables.....	80
11.1	Information on the measured variables.....	82
11.1.1	Measured variable pH [mV].....	82
11.1.2	Temperature.....	82
11.1.3	Measured variable pH [mA].....	83
11.1.4	ORP [mV], ORP [mA].....	84
11.1.5	Chlorine, bromine, chlorine dioxide, chlorite, dissolved oxygen and ozone.....	84
11.1.6	Measured variable fluoride.....	86
11.1.7	Peracetic acid.....	86
11.1.8	Hydrogen peroxide.....	87
11.1.9	Conductivity [mA].....	87
11.1.10	Conductive [<i>conductivity</i>].....	88
11.1.11	Temperature [<i>mA</i>], (as main measured variable).....	90
11.1.12	mA general.....	90
11.1.13	Features of the two-channel version.....	90
12	Calibration.....	92
12.1	Calibrating the pH Sensor.....	93
12.1.1	Selecting the Calibration Process for pH.....	95
12.1.2	2-Point Calibration of the pH Sensor (CAL).....	96
12.1.3	pH sensor calibration (CAL) with an external sample (1-point).....	100
12.1.4	Calibration of the pH Sensor (CAL) by [<i>Data Input</i>].....	103
12.2	Calibrating the ORP Sensor.....	106
12.2.1	Selecting the calibration process for ORP.....	106
12.2.2	1-point calibration of ORP sensor (CAL).....	106
12.2.3	Calibration data for ORP sensor (CAL).....	108

Table of contents

12.3	Calibrating the Fluoride Sensor.....	109
12.3.1	Selection of the calibration process for fluoride.....	109
12.3.2	2-point fluoride sensor calibration (CAL).....	110
12.3.3	1-point fluoride sensor calibration (CAL).....	112
12.4	Calibration of Amperometric Sensors.....	114
12.4.1	Selecting the calibration process for amperometric measured variables.....	114
12.4.2	Calibrating the slope.....	115
12.4.3	Calibration of zero point.....	118
12.5	Calibrating the oxygen sensor.....	120
12.5.1	Specify the calibration interval.....	120
12.5.2	Selection of the calibration process for the measured variable O ₂	120
12.6	Measured value [mA general] calibration.....	125
12.7	Calibrating Conductivity [mA].....	125
12.8	Calibrating conductive conductivity.....	126
12.8.1	Calibrating conductive conductivity, sensor parameter adjustment.....	126
12.8.2	Calibrating conductive conductivity, cell constant.....	128
12.8.3	Calibrating conductive conductivity, temperature coefficient.....	130
12.9	Calibrating temperature.....	131
13	Setting the [Control].....	132
13.1	Control parameter [Type].....	138
13.2	Control parameter [System response].....	139
13.3	Control parameter [Setpoint].....	139
13.4	Control parameter [xp].....	140
13.5	Control parameter [Ti].....	141
13.6	Control parameter [Td].....	141
13.7	Control parameter [Add. Basic load].....	141
13.8	Control parameter [Checkout time].....	141
13.9	Control parameter [max. ctrl var.].....	141
13.10	Interference variable.....	141
13.10.1	Additive and multiplicative feed forward control.....	142
13.10.2	Multiplicative interference variable.....	144
13.11	Remote setpoint via a 0/4 ... 20 mA analogue signal.....	144
13.12	[Parameter switch] via the digital input or [Timer].....	146
14	Setting the [Limit values].....	149
14.1	Function of the limit values.....	149

14.2	Setting limit values channel 1.....	152
14.2.1	Setting [Limit 1].....	152
14.2.2	Setting [Limit 2].....	152
14.2.3	Setting [System response].....	154
15	Digital input functions that can be set.....	155
16	Setting the [Pumps].....	157
16.1	Setting [Pump 1].....	157
17	Setting the [Relays].....	160
17.1	Setting Relay 1.....	160
17.1.1	Function description [Off].....	163
17.1.2	Functional description of [Relay timer].....	163
17.1.3	Function description [Limit 1] or [Limit 2].....	163
17.1.4	Functional description of [Limit value 1/2 (control variable)].....	163
17.1.5	Function description of [Cycle].....	163
17.1.6	Functional description of [Pulse length (PWM)].....	164
18	Setting [digital inputs].....	165
18.1	Setting [Digital input 1].....	165
19	Setting the [mA outputs].....	168
19.1	Setting the [mA outputs].....	170
20	Care and maintenance.....	172
21	Function: Data logger.....	173
21.1	Activating, reading and deleting log books.....	173
21.2	Configuring log books.....	174
21.2.1	Using the [calibration log book].....	174
21.2.2	Using the [error log book].....	175
21.2.3	Using the [Data log book] (optional).....	176
22	[Diagnostics].....	179
22.1	Displaying [logbooks].....	179
22.1.1	Displaying the [Calibration Log Book].....	179
22.1.2	Reading the [Error Log Book].....	179
22.2	Displaying [simulation].....	180
22.3	Display [Device information].....	180
22.4	Error messages and warning alerts.....	181
22.4.1	Error messages.....	181

Table of contents

22.4.2	Warning messages.....	186
22.5	Help texts.....	188
23	Technical data and measuring ranges.....	189
23.1	Technical data.....	189
23.2	Measuring range/Measured value.....	192
24	Spare parts and accessories.....	194
24.1	Spare parts.....	194
24.2	Replacement of spare parts units.....	196
24.3	Replacing fan.....	199
24.4	Accessories.....	200
25	Disposal of used parts.....	201
26	Standards complied with and Declaration of Conformity.....	202
27	Index.....	203

1 Safety and responsibility

1.1 Labelling of Warning Information

Introduction

These operating instructions provide information on the technical data and functions of the product. These operating instructions provide detailed warning information and are provided as clear step-by-step instructions.

The warning information and notes are categorised according to the following scheme. A number of different symbols are used to denote different situations. The symbols shown here serve only as examples.



DANGER!

Nature and source of the danger

Consequence: Fatal or very serious injuries.

Measure to be taken to avoid this danger.

Description of hazard

- Denotes an immediate threatening danger. If the situation is disregarded, it will result in fatal or very serious injuries.



WARNING!

Nature and source of the danger

Possible consequence: Fatal or very serious injuries.

Measure to be taken to avoid this danger.

- Denotes a possibly hazardous situation. If the situation is disregarded, it could result in fatal or very serious injuries.



CAUTION!

Nature and source of the danger

Possible consequence: Slight or minor injuries. Material damage.

Measure to be taken to avoid this danger.

- Denotes a possibly hazardous situation. If the situation is disregarded, it could result in slight or minor injuries. May also be used as a warning about material damage.

NOTICE!

Nature and source of the danger

Damage to the product or its surroundings.

Measure to be taken to avoid this danger.

- Denotes a possibly damaging situation. If the situation is disregarded, the product or an object in its vicinity could be damaged.



Type of information

Hints on use and additional information.

Source of the information. Additional measures.

- *Denotes hints on use and other useful information. It does not indicate a hazardous or damaging situation.*

1.2 General safety information



WARNING!

Live parts

Possible consequence: Fatal or very serious injuries

- Measure: Ensure that the devices are de-energised before opening the housing or carrying out assembly work.
- Disconnect damaged or faulty devices from the power supply, as well as devices that have been tampered with.
- Make sure that the process that you are measuring and controlling remains safe.



WARNING!

Danger from hazardous substances!

Possible consequence: Fatal or very serious injuries.

Please ensure when handling hazardous substances that you have read the latest safety data sheets provided by the manufacture of the hazardous substance. The actions required are described in the safety data sheet. Check the safety data sheet regularly and replace, if necessary, as the hazard potential of a substance can be re-evaluated at any time based on new findings.

The system operator is responsible for ensuring that these safety data sheets are available and that they are kept up to date, as well as for producing an associated hazard assessment for the workstations affected.



WARNING!

Operating faults!

Possible consequence: fatal or very serious injuries.

- Ensure that the device is only operated by adequately qualified and technically expert personnel.
- Please also observe the operating instructions for sensors and fittings and any other units that may be fitted, such as sample water pumps ...
- The operator is responsible for ensuring that personnel are qualified.



NOTICE!

Correct sensor operation

- Correct measurement and metering is only possible if the sensor is working perfectly.
- Check and calibrate the sensor regularly.



Protection of radio reception

This equipment with communication interface is not intended to be used in residential areas and cannot guarantee appropriate protection of radio reception in these environments.

1.3 Intended use



Intended use

The device is designed to measure and regulate liquid media. The labelling of the measured variables is indicated in the controller display and is absolutely binding.

Only use the unit in accordance with the technical details and specifications provided in these operating instructions and in the operating instructions for the individual components (such as sensors, fittings, calibration devices, metering pumps, etc.).

All other uses or modifications are prohibited.



Time constant > 30 seconds

- *The controller can be used in processes, which have a time constant of > 30 seconds.*



Disturbance resistance

The device complies with disturbance resistance in accordance with EN 61326-1 and is intended for use in industrial electromagnetic environments and in residential areas.



WARNING!

Disturbance signal emission class A or B / Protection for radio reception

The device complies with the disturbance signal emission test requirements for residential areas as a Class B (Residential areas), Group 1 device.

With devices with communication interface

- B = Profibus,
- E = LAN,
- G = Profinet,

the device only complies with the limit values for a class A device (other areas with the exception residential), group 1.

This device is then not intended to be used in residential areas and cannot guarantee appropriate protection of radio reception in these environments.

1.4 User qualification



WARNING!

Danger of injury with inadequately qualified personnel

The operator of the system / equipment is responsible for ensuring that the qualifications are fulfilled.

If inadequately qualified personnel work on the unit or loiter in the hazard zone of the unit, this could result in dangers that could cause serious injuries and material damage.

- All work on the unit should therefore only be conducted by qualified personnel.
- Unqualified personnel should be kept away from the hazard zone.

The pertinent accident prevention regulations, as well as all other generally acknowledged safety regulations, must be adhered to.

Training	Definition
Instructed personnel	An instructed person is deemed to be a person who has been instructed and, if required, trained in the tasks assigned to him and possible dangers that could result from improper behaviour, as well as having been instructed in the required protective equipment and protective measures.
Trained user	A trained user is a person who fulfils the requirements made of an instructed person and who has also received additional training specific to the system from the manufacturer or another authorised distribution partner.
Trained, qualified personnel	A trained, qualified employee is deemed to be a person who is able to assess the tasks assigned to him and recognize possible hazards based on his training, knowledge and experience, as well as knowledge of pertinent regulations. A trained, qualified employee must be able to perform the tasks assigned to him independently with the assistance of drawing documentation and parts lists. The assessment of a person's technical training can also be based on several years of work in the relevant field.

Safety and responsibility

Training	Definition
Electrical technician	An electrical technician is able to complete work on electrical systems and recognise and avoid possible dangers independently based on his technical training and experience as well as knowledge of pertinent standards and regulations. An electrical technician must be able to perform the tasks assigned to him independently with the assistance of drawing documentation, parts lists, terminal and circuit diagrams. The electrical technician must be specifically trained for the working environment in which the electrical technician is employed and be conversant with the relevant standards and regulations.
Service	The Service department refers to service technicians, who have received proven training and have been authorised by the manufacturer to work on the system.

2 Operating concept

2.1 Display and keys

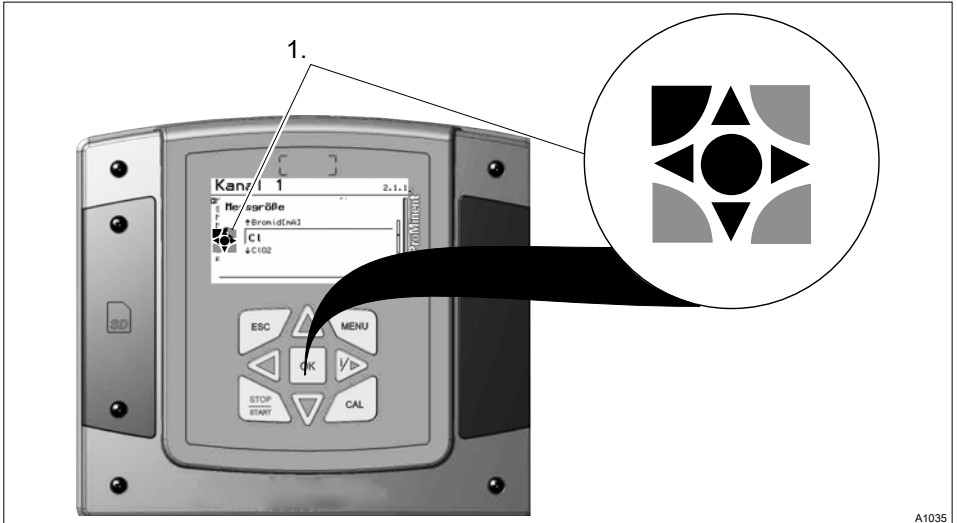

A1035

Fig. 1: Operating cross (1) / Active keys are displayed in [black] in the display; inactive keys in [grey].

The following path is shown as an example:

Continuous display → → or [Calibrate] → → or [Slope] → → .

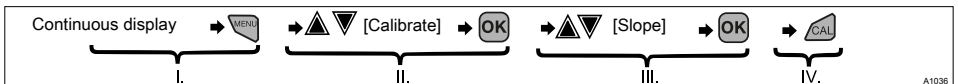

A1036

Fig. 2: A display change is made within a sequence of actions.

- I. Continuous display 1
- II. Display 2
- III. Display 3
- IV. Display 4

The function of the keys is described in the table Chapter 2.2 'Functions of the keys' on page 19.

➔ = describes as a symbol an action by the operator that leads to a new possibility for an action.

[Naming in the display] = square brackets contain the name that appears with the identical wording in the controller display.

Additional information can be obtained via the key.



Illumination of the display

In the event of an error with the status [ERROR], the backlight of the display changes from 'white' to 'red'. This makes it easier for the operator to react to an error.

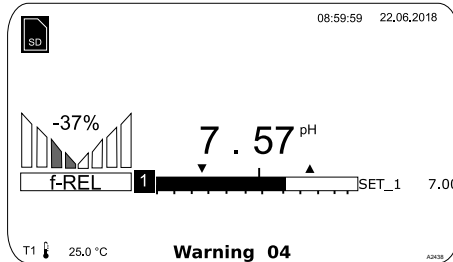

Fig. 3: Example of a continuous display when used with one measuring channel (e.g. pH).

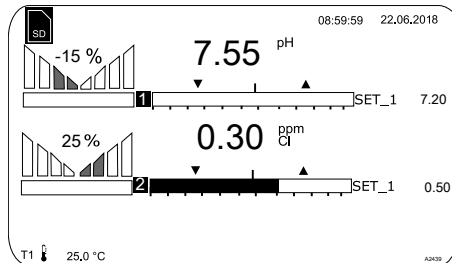

Fig. 4: Example of a continuous display when used with two measuring channels (e.g. pH/chlorine).

If you are using 3 measuring channels, select the desired measuring channel in the display using ▲ or ▼.

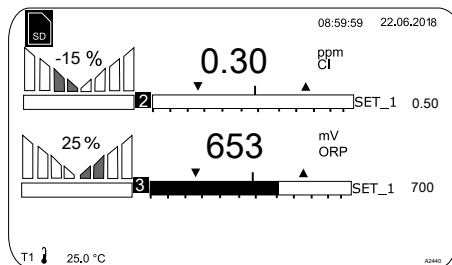

Fig. 5: Example of a continuous display when used with 3 measuring channels (e.g. pH/chlorine/ ORP).

If you are using 3 measuring channels, you can use ▲ or ▼ to display the overall view of the measuring channels as the fourth view, see .

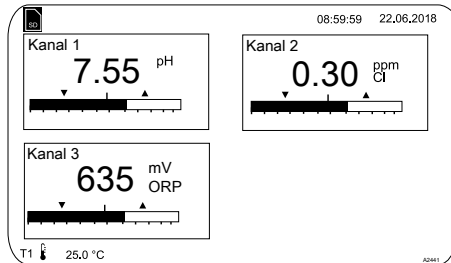

Fig. 6: Example of a continuous display when used with 3 measuring channels (e.g. pH/chlorine/ ORP) and the display of all 3 measuring channels

Parameters in the adjustable menus

Setting of the various parameters in the adjustable menus



No time-controlled menu items

The controller does not exit any menu items in a time-controlled manner, the controller remains in a menu item until this menu item is exited by the user.

1. Select the desired parameter in the display using ▲ or ▼.

⇒ There is an arrow tip in front of the selected parameter, which indicates the selected parameter.

2. Press **OK**.

⇒ You are now in the setting menu for the desired parameter.

3. You can adjust the desired value in the setting menu using the four arrow keys and then save it using **OK**.

⇒



Range error

*If you enter a value that is outside the possible setting range, the message [Range error] appears after **OK** has been pressed. Pressing **OK** or **ESC** returns you to the value to be set.*

The controller returns to the menu once **OK** has been pressed.



Cancelling the setting process

*Pressing **ESC** returns you to the menu without a value being saved.*



2.2 Functions of the keys

Tab. 2: Functions of the keys

Key	Function
	Confirmation in the setting menu: Confirms and saves the input values. Confirmation in the continuous display: Displays all information about saved errors and warnings.
	Back to the continuous display or to the start of the respective setting menu, in which you are currently located.
	Enables direct access to all of the controller's setting menus.
	Enables direct access to the controller's calibration menu from the continuous display.
	Start/Stop of the controller's control and metering function from any display.
	To increase a displayed number value and to jump upwards in the operating menu.
	Confirmation in the setting menu: Moves the cursor to the right. Confirmation in the continuous display: Displays further information about the controller input and output values.
	To decrease a displayed number value and to jump down in the operating menu.

Key	Function
	Moves the cursor to the left.

2.3 Changes the set operating language

1. Simultaneously press the keys  and 

⇒ The controller changes to the menu for setting the operating language.

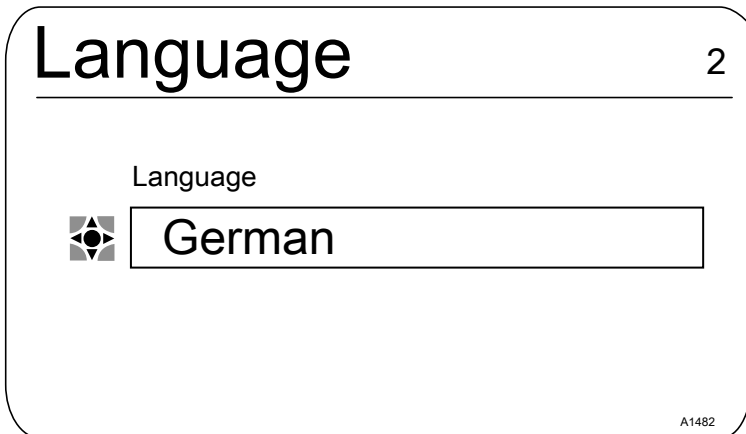





Fig. 7: Menu for setting the operating language

2. Now using keys  and  you can set the desired operating language

3. Confirm your selection by pressing the key 

⇒ The controller changes back to the continuous display and indicates the selected operating language.

2.4 Acknowledge fault or warning message

If the controller recognises an error *[Error]*, the control is stopped, the backlight switches to red lighting and the alarm relay is deactivated. You can access the next value to be set by pressing the  key. In this process, the controller indicates all errors and warnings. The pending alarm messages can be selected and, if required, acknowledged/confirmed. If you acknowledge an error, the alarm relay activates and the backlight switches back to white light. In the bottom part of the display, the error or warning message that has occurred remains displayed, such as *[Error 01]*, until the cause has been cleared.

In the event of a warning, e.g. the controller signals that a sensor has not been calibrated yet, further processing using the controller is possible with or without acknowledgement of the message.

In the event of an error message *[Error]*, *[e.g.]* the controller signals that no sensor is connected, then after acknowledgement of the message, no further processing is possible using the controller. You must now rectify the error - for this see the chapter on Diagnostics and Troubleshooting.

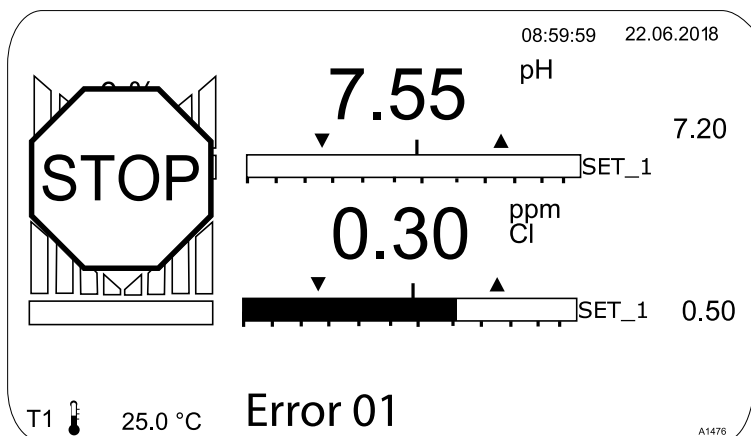





Fig. 8: Alarm message, controller stops control

2.5 Key Lock

The controller has a key lock. If the key lock is activated, the keys cannot be pressed. The key lock can be activated or deactivated by simultaneously pressing  and . An activated key lock is indicated by the  symbol.

2.6 Measured variables and measuring inputs

Measured variable	Measuring input	Modul type	
pH (mV)	mV	VA	mV/mA measuring input or mV/mV measuring input
Temperature (mV)		VV	
ORP (mV)			
pH (mA)	mA	VA	mV/mA measuring input or mA/mA measuring input
ORP (mA)		AA	
mA general			
Bromine			
Chlorine			
Chlorine dioxide			
Chlorite			
Fluoride			
Oxygen			
Ozone			
Peracetic acid			
Hydrogen peroxide			
Conductivity (mA)			
Temperature (mA)			
Conductivity (conductive)			

3 Nameplate and ID code

3.1 Nameplate

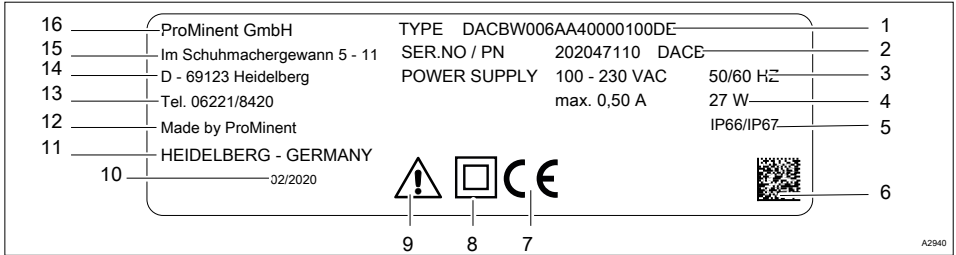

Fig. 9: Nameplate, CE

- | | | | |
|---|--|----|---|
| 1 | Device identity code | 10 | Date of production: Week/year |
| 2 | Serial number of device | 11 | Place of production: Town/country |
| 3 | Voltage and frequency of power supply | 12 | Manufacturer |
| 4 | Power consumption and output | 13 | Phone number not including country code |
| 5 | Degree of protection | 14 | Address: Town |
| 6 | 2D code | 15 | Address: Street |
| 7 | CE mark | 16 | Company name and legal form |
| 8 | Protection class II | | |
| 9 | Warning symbol: Observe the operating instructions | | |

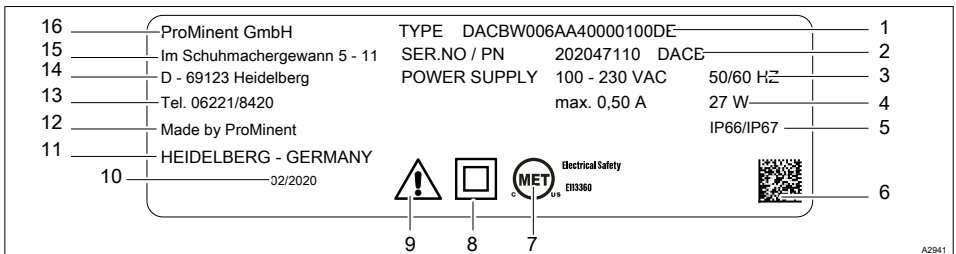

Fig. 10: Nameplate, MET

- | | | | |
|---|---------------------------------------|----|--|
| 1 | Device identity code | 9 | Warning symbol: Observe the operating instructions |
| 2 | Serial number of device | 10 | Date of production: Week/year |
| 3 | Voltage and frequency of power supply | 11 | Place of production: Town/country |
| 4 | Power consumption and output | 12 | Manufacturer |
| 5 | Degree of protection | 13 | Phone number not including country code |
| 6 | 2D code | 14 | Address: Town |
| 7 | MET symbol | 15 | Address: Street |
| 8 | Protection class II | 16 | Company name and legal form |

3.2 Identity code

Tab. 3: Device identification / Identity code

DAC: DULCOMETER®, multi-parameter controller diaLog DACb	
Mounting type	
W	Mounting on a surface
S	Control panel mounting
E	Spare parts units
Design	
00	With ProMinent logo
01	Without ProMinent logo
E0	Spare part, processor, complete
E2	Spare part, HMI, complete, with PM logo
E3	Spare part, HMI, complete, Pool design
Operating voltage	
4	24 V DC
6	100 - 230 V AC 50/60 Hz
Basic measured variables	
VA	mV/mA measuring input
AA	mA/mA measuring input
VV	mV/mV measuring input
L3	Conductive conductivity
Extended functions	
0	None
1	Hardware preparation
2	Package 2: interference variable (mA) or external remote setpoint via mA or pH compensation for chlorine (all acting on channel 1)
3	Package 3: 2nd measurement + control, additionally 2 pumps, additionally 3 control inputs, replaces the D2Ca

DAC: DULCOMETER®, multi-parameter controller diaLog DACb

4	Package 4: pH compensation for chlorine, only with basic measured variable "VA"
	Software default settings
0	No default settings
1	Batch neutralisation
2	Flow neutralisation
3	pH/ORP measurement/control (pH bidirectional, ORP monodirectional)
4	pH/Cl ₂ measurement/control (pH bidirectional, chlorine monodirectional)
5	pH/ClO ₂ measurement/control (pH bidirectional, chlorine dioxide monodirectional)
6	pH/Cl ₂ measurement/control with interference variable (pH bidirectional, chlorine monodirectional)
7	ClO ₂ /ORP measurement/control (ClO ₂ monodirectional, ORP for monitoring)
B	BOSCH
S	Default setting for swimming pool
P	Default setting for private swimming pool
	Connection of measured variables
0	All sensor inputs via terminal
1	1x mV input on SN6 socket
2	2x mV inputs on SN6 socket
3	3x mV inputs on SN6 socket
	Connection of digital sensors/actuators
0	None
	Communication interface
X	None

DAC: DULCOMETER®, multi-parameter controller diaLog DACb

	A	Modbus RTU, terminal
	B	Profibus DPV1, terminal
	E	LAN with web server, connection via M12 C-coded
	G	PROFINET® (2xM12)
		Data logger
	0	No data logger
	1	With data logger (SD card interface + SD card + card reader)
		Hardware extension
	0	None
	1	Protective RC circuit (relay)
		Approvals
	00	None
	01	CE (Standard)
	07	MET
	08	CE/MET
		Certificates
	0	none

Documentation language: The documentation is available in all the languages pre-set on the controllers. Other languages are available on request.

3.3 A complete measuring point may comprise the following:

- Transmitter/Controller DAC (see identity code)
- Bypass fitting: DGMa..., DLG III ...
- pH sensor (dependent upon the application)
- ORP sensor (dependent upon the application)
- e.g. chlorine, chlorine dioxide, chlorite, bromine, dissolved oxygen sensor
- Transformer for pH or ORP (depending on the set evaluation, pH [mA], ORP [mA])
- Sensor cable

4 Storage and transport

- **User qualifications, storage and transport:** trained personnel  *Chapter 1.4 'User qualification' on page 13*

Ambient conditions for storage and transport:

- Temperature: - 20 to + 70 °C,
- Air humidity: < 90 % relative air humidity (non-condensing).



Packaging material

Dispose of packaging material in an environmentally responsible way. All packaging components carry the corresponding recycling code .

5 Functional Description

The DULCOMETER® Multi-parameter Controller diaLog DACb is a controller platform manufactured by ProMinent. In the remainder of this document, the term 'controller' is consistently used for the DULCOMETER®. The controller has been developed for continuous measurement and control of liquid analysis parameters. For water treatment processes in environmental technology and industry. The controller is available in a version with 2 or 3 measuring channels. The controller can operate together with conventional analogue sensors and actuators. The controller is equipped to communicate with digital sensors and actuators via the CANopen sensor/actuator bus.

Typical applications:

- Potable water treatment,
- Waste water treatment,
- Industrial and process water treatment,
- Swimming pool water treatment.

Standard equipment:

- 1 measuring channel with 14 freely selectable measured variables (via mV or mA input) – depending on the identity code.
- PID controller with frequency-based metering pump control for 2 metering pumps.
- 2 analogue outputs for measured value, correction value or control variable (dependent on the optional equipment).
- 4 digital inputs for sample water fault detection, pause and parameter switch-over.
- 2 relays with limit value functions, timer and non-continuous control, 3-point step control (dependent on the optional equipment).
- Power supply 20 V DC.

- Measured variables and language selection during commissioning.
- Temperature compensation for the pH and fluoride measured variables.
- 22 operating languages.
- Saving and transfer of device parametrisation to an SD card.
- Subsequent upgrade of the software function by means of an activation key or firmware update.
- Disturbance variable processing (flow) via frequency.
- Measured value trend display via the controller display.

Optional accessories:

- Third complete measuring and control channel with 14 freely selectable measured variables (via mV or mA input).
- PC configuration software.
- Data and event logger with an SD card.
- Disturbance variable processing (flow) also via mA.
- Compensation of the influence of pH on chlorine measurement.
- 3 additional digital inputs, e.g. for level monitoring.
- PROFIBUS®-DP *.
- Modbus-RTU.
- PROFINET®.
- Visualisation via LAN/WLAN web access.

6 Subsequent Extension of Functions

- **User qualification, subsequent extension of functions:** trained user, see ↗ *Chapter 1.4 'User qualification' on page 13*

Prerequisite: The hardware for channel 3 must be available in the controller. The data logger can be enabled without the need for extension of the hardware. Missing hardware must be retrofitted in the manufacturer's factory. Channel 2 can be enabled from upgrade package 2 or upgrade package 3. The upgrade packages correspond to the upgrade packages also described in the identity code. The data logger function can always be enabled.



Validity of the activation code

An activation code is only valid and can only be used for the relevant controller with the specified serial number.























The activation code can be transmitted via email and is then read into the controller from the SD card (maximum 32 GB) or entered using the controller keypad. The enabled function is then available and need only be activated and parametrised.

The following information must be available to determine the activation code:

- The serial number of the controller in question, see operating menu under *[Diagnostics], [Device information.]*.
- the upgrade package required.

Installed	Required	Order number
Package 2	Upgrade: Package 2 to package 3.	1047874
	Upgrade: Package 2 to package 4.	1047875
Package 3	Upgrade: Package 3 to package 4.	1047876
Package 0=no data logger	Upgrade: data logger.	1047877

Manual entry of the activation code:

1.  Press .
2.  Use  and  to select *[Setup]*.
3.  Press .
4.  Use  and  to select *[Activation code]*.
5.  Press .
6.  Select *[Manual input]*.
7.  Press .
8.  Use the 4 arrow keys to enter the activation code.
9.  Press .
10.  Use  and  to select *[Double check]*.
11.  Press 
 - ⇒ The controller is now restarted.

7 Functions to Backup the Controller's Setting Data

- **User qualification, backup setting data:** trained user, see  *Chapter 1.4 'User qualification' on page 13*

The following functions are available:

























- Save unit configuration as a text file.
- Save unit configuration on an SD card.
- Upload unit configuration from SD card into DACa.

Saving the unit configuration as a text file

Maximum size of the SD card:	32 GB
------------------------------	-------















The function enables you to save the unit configuration on the SD card (maximum 32 GB) for documentation purposes and to print or document using a PC and printer. The file that is written has the name `CONFIG.TXT` and the ASCII file format. There needs to be an SD card with free memory space in the controller's reader.

Proceed as follows to save the configuration as a pure text file on the SD card:

1.  Press  key
2.  Use  and  to select *[Setup]*.
3.  Press .
4.  Use  and  to select *[Extended configuration]*.
5.  Press .
6.  Use  and  to select *[Upload or save unit configuration]*.
7.  Press .
8.  Use  and  to select *[Save unit configuration as a pure text file]*.
9.  Press 
 - ⇒ The configuration is now saved, which takes approx. 5 minutes.
10.  Then press .
11.  You can now remove the SD card and process the file, if necessary, or simply leave the file on the SD card. This file cannot be read back by the controller.

Copying unit configuration onto the SD card:

The [*Copy unit configuration file onto SD card*] function is used for documentation or backup purposes. You can use this file to distribute a recurring unit configuration to different controllers. You can save the unit configuration set on one controller as a unit configuration file on the SD card. When it is saved, the directory `CONFIG` is saved on the SD card and the file `CONFIG.BIN` is saved in this directory. This file saves all user-dependent controller setting data. Sensor calibration data is not copied as this data has to be defined separately for each measuring point. There needs to be an SD card with free memory space in the controller's reader.

1. Press .
2. Use  and  to select [*Setup*].
3. Press .
4. Use  and  to select [*Extended configuration*].
5. Press .
6. Use  and  to select [*Upload or save unit configuration*].
7. Press .
8. Use  and  to select [*Save unit configuration on the SD card*].
9. Press 
 - ⇒ The configuration is now saved, which takes approx. 3 minutes.
10. Then press .
11. You can now remove the SD card and process the file, if necessary, or simply leave the file on the SD card.



The configuration entered was accidentally overwritten

if a configuration file is stored on an SD card and another configuration file is uploaded, then the existing configuration file is renamed `CONFIG.BAK`. The new configuration file has the name `CONFIG.BIN`. If you wish to reuse `CONFIG.BAK`, then you have to delete `CONFIG.BIN` and rename `CONFIG.BAK` as `CONFIG.BIN`. You can now reuse the configuration file.

Functions to Backup the Controller's Setting Data

Uploading unit configuration file from the SD card



Different identity codes

If the identity codes of the source and destination controller differ, only the settings that both controllers have in common are carried over.

If you have copied a configuration file to an SD card using the *[Copy unit configuration file onto SD card]*, then you can use this function to upload the unit configuration file from the SD card into a DACa controller or transfer it to another DACa controller (cloning). To do this, the source and destination controller must have an identical identity code. This function saves you the work involved in manually setting up the unit configuration. Always check whether you can use the settings for your intended application.

1. ➤ There needs to be an SD card with a `CONFIG` directory and a valid `CONFIG.BIN` file in the controller's reader.
2. ➤ Press **MENU**.
3. ➤ Use **▲** and **▼** to select *[Setup]*.
4. ➤ Press **OK**.
5. ➤ Use **▲** and **▲** to select *[Extended configuration]*.
6. ➤ Press **OK**.
7. ➤ Use **▲** and **▲** to select *[Upload or save unit configuration]*.
8. ➤ Press **OK**.
9. ➤ Use **▲** and **▼** to select *[Upload unit configuration file from the SD card]*.
10. ➤ Press **OK**.
 - ⇒ The configuration now uploads, which can take around 1 minute.
11. ➤ Accept with **OK**.
 - ⇒ The controller then irrevocably accepts the configuration from the SD and deletes the configuration currently on the controller.
12. ➤ The following prompt appears: *[Are you sure?]* and when you press **OK**, the configuration is transferred.
 - ⇒ The controller then restarts, initialises itself and then starts with the new configuration.

8 Information on fieldbus products

You will find further information on our fieldbus products, including GSD files, operating instructions etc. at: www.prominent.com/fieldbus

9 Assembly and installation

9.1 Requirements

- **User qualification, mechanical installation:**
trained and qualified personnel ↪ *Chapter 1.4 'User qualification' on page 13*
- **User qualification, electrical installation:**
Electrical technician ↪ *Chapter 1.4 'User qualification' on page 13*



WARNING!

Installation site and ambient conditions

Possible consequence: fatal or very serious injuries.

Measure to be taken to avoid this danger.

- The controller meets the requirements for IP 67 degree of protection (mounting on a surface) or IP 54 (control panel-mounted (pollution degree level 2)) and (based on NEMA 4X) for leak-tightness. These standards are only met if all seals and threaded connectors are correctly fitted.
- Only carry out the (electrical) installation after (mechanical) installation.
- Ensure that there is unimpeded access for operation.
- Make sure that the fastening is secure and low-vibration.
- Avoid direct sunlight.
- Permissible ambient temperature of the controller at the installation site: -20 ... 50 °C at max. 95% relative air humidity (non-condensing).
- Take into consideration the permissible ambient temperature of the connected sensors and other components.
- The controller is only suitable for operation in closed rooms. If operating outdoors, use a suitable protective enclosure to protect the controller from the environment.



WARNING!

Installation site and ambient conditions

Possible consequence: fatal or very serious injuries.

- Install the device in a favourable position for reading and operating, preferably at eye level.



WARNING!

Mounting position

Possible consequence: fatal or very serious injuries.

- The controller is used mounted on a surface as standard.
 - Nevertheless you can fit the controller in a control panel using the optional fitting kit.
- Always install the controller so that the cable entries point downwards.
- Leave sufficient free space for the cables.

9.2 Scope of supply

Tab. 4: The following components are included as standard:

Description	Quantity
Controller DAC	1
Assembly material, complete, 2P Universal (set)	2
Operating Manual	1
General safety notes	1

9.3 Mechanical mounting

9.3.1 Mounting on a surface

Mounting materials (contained in the scope of delivery)

- 1 x surface mount
- 4 x PT screws 5 x 35 mm
- 4 x washers 5.3
- 4 x rawl plug Ø 8 mm, plastic

Mounting on a surface

Taking surface mount off housing

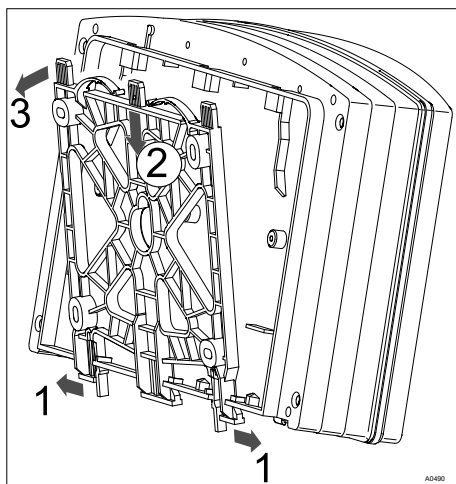

Fig. 11: Dismantling surface mount

1. ➤ Pull the two snap hooks (1) outwards.
 - ⇒ The surface mount snaps slightly downwards.
2. ➤ Push the surface mount downwards (2) from the housing and fold (3) it out.
3. ➤ Use the surface mount as a drilling template to mark the positions of four drill holes.
4. ➤ Drill the holes: Ø 8 mm, depth = 50 mm.

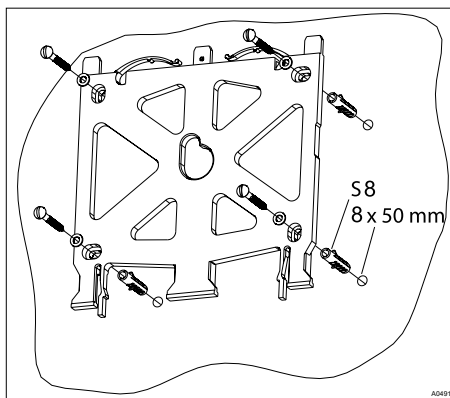

Fig. 12: Fitting surface mount

5. ➤ Screw the surface mount into position with the washers.

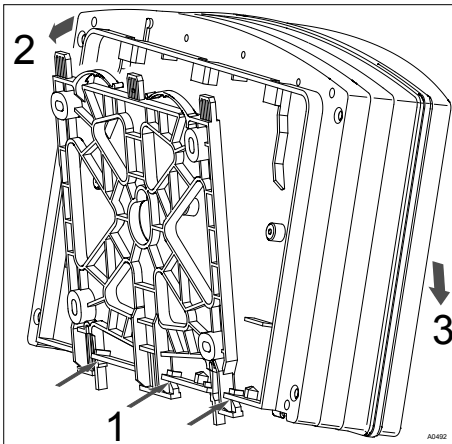



Fig. 13: Mounting surface mount

- 6.** → Hook the bottom of the housing (1) into the surface mount.
- 7.** → Lightly press the housing at the top (2) against the surface mount.
- 8.** → Then check that the housing is hooked in at the top and press down (3) until it audibly engages.

9.3.2 Control Panel Installation

**CAUTION!****Dimensional variations**

Possible consequence: material damage

- Photocopying the punched template can result in dimensional deviations
- Use the dimensions shown in Fig. 15 and mark on the control panel

**CAUTION!****Material thickness of control panel**

Possible consequence: material damage

- The material thickness of the control panel must be at least 2 mm to ensure secure fixing

The perimeter of the housing has a 4 mm wide edge that acts as a stop for the control panel, with an additional perimeter groove to accommodate a caulking strip. When mounted in the control panel, the entire front face projects about 35 mm from the control panel. Install the controller from the outside into a cut-out provided in the control panel for this purpose. Fix the device to the control panel from the inside using the fittings.

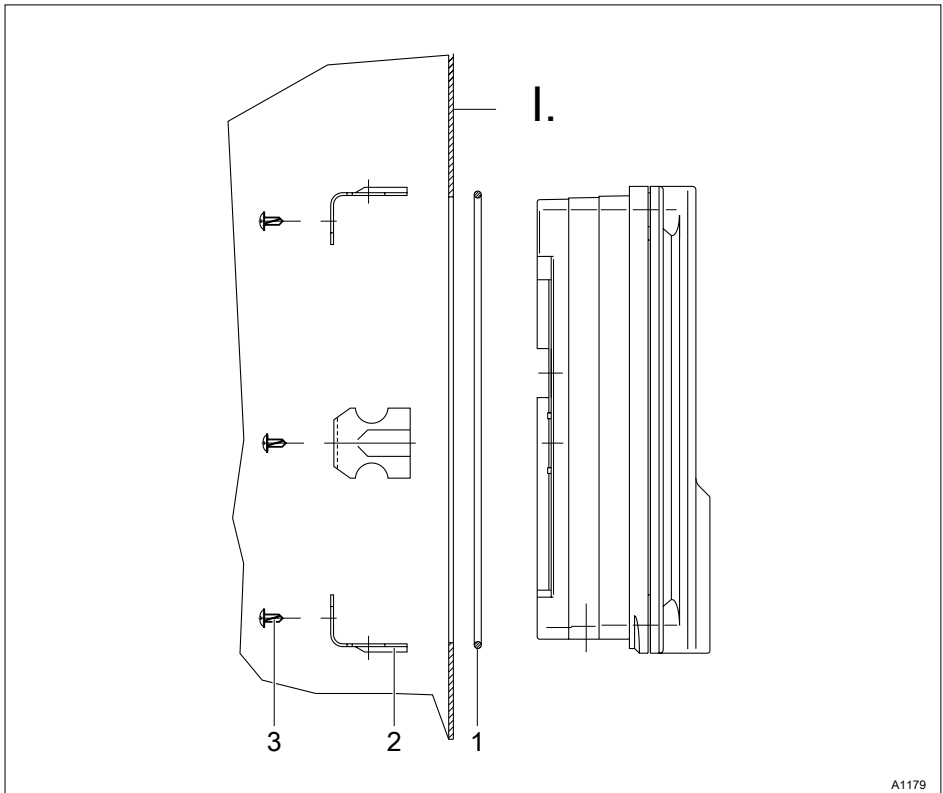

A1179

Fig. 14: Order number for the DAC control panel fitting kit (included with the scope of supply): 1041095.

- I. Control panel
 - 1. 1 x foam rubber caulking strip $\varnothing 3$
 - 2. Galvanised steel retaining brackets (6 off)
 - 3. Galvanised PT cutting screws (6 off)
- Punched template

Assembly and installation

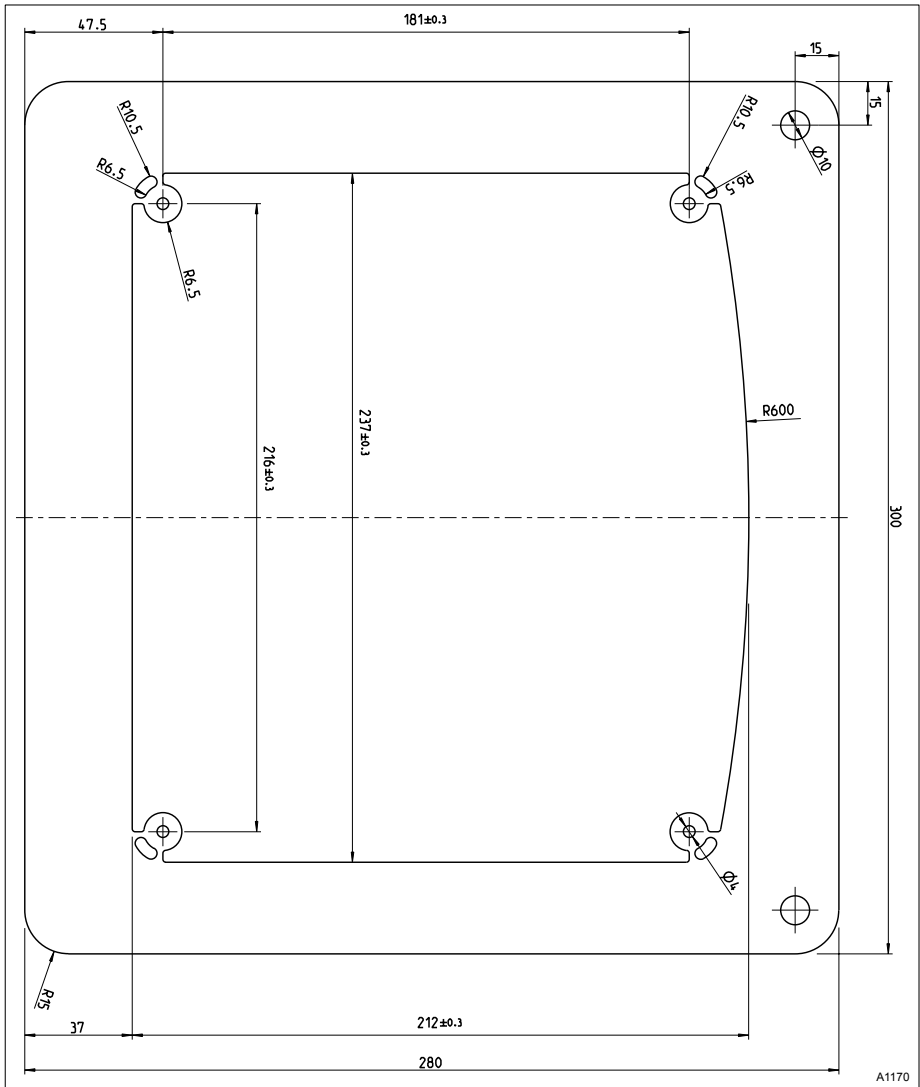

Fig. 15: The drawing is not true to scale and will not be revised as part of these operating instructions. The drawing is for information only.

1. Determine the precise position of the device on the control panel using the drilling template
2. Mark the corner points and drill (drill diameter 12 - 13 mm)
3. Using a punching tool or jigsaw, match the opening to the punched template drawing
4. Chamfer the cut edges and check whether the sealing surfaces are smooth for the caulking strip
 - ⇒ Otherwise the seal cannot be guaranteed.
5. Press the caulking strip evenly into the groove running around the device
6. Place the device into the control panel and fix in place at the rear by means of the retaining brackets and PT cutting screws
 - ⇒ The device should project approx. 35 mm from the control panel

9.4 Electrical installation

9.4.1 Specifications

- **User qualification, electrical installation:**
Electrical technician ↪ *Chapter 1.4 'User qualification' on page 13*



WARNING!

Electrical voltage at the output relays

Cause: Output relays 1 and 2 are not adequately separated from each other. This means that there is not always sufficient electrical isolation between the relays.

Possible consequence: fatal or very serious injuries.

Measure: Only ever connect one type of voltage to output relays 1 and 2. Connect either low voltage or extra-low voltage. The use of low voltage on one relay and extra-low voltage on the other is not permitted, as isolation of the relays cannot be guaranteed.



NOTICE!

Moisture at the contact points

It is essential that appropriate construction and technical measures are used to protect the connecting plugs, cables and terminals from moisture. Moisture at the contact points can adversely affect the operation of the device.



WARNING!

Galvanic isolation with the 24 V DC version.

Possible consequence: fatal or very serious injuries.

Terminals XC1 and XA3 to the mains terminal XP1 are not galvanically isolated with the 24 V DC version.

If there is a potential difference between the supply terminal XP1 and XA3 or XC1 via an external earth loop, then this can lead to a fault in the controller.

WARNING!

24 VDC version, supply line

Possible consequence: fatal or very serious injuries.

Ensure that the device is fed with protective low voltage.

Provide appropriate protection to prevent voltage surges between the plus and minus line and the earth (PE) with supply lines longer than 30 m or which exit the building.

WARNING!

Live parts!

Possible consequence: Fatal or very serious injuries

- Measure: Ensure that the open device is disconnected from the power supply before undertaking installation work on it.
- Regularly monitor the devices and de-energise damaged or defective devices, or devices that have been tampered with.
- It is the duty of the operator to install a suitable isolating device (e.g. IEC 60947-2 or IEC 60947-3) for this.
- When switching off the device, the operator must ensure that the entire process remains safe.
- The operator should fit a residual current device (RCD) or another suitable measure to protect personnel and equipment.

WARNING!

Degree of pollution 3

Possible consequence: fatal or very serious injuries.

Opening the housing (e.g. for installation or repair) is only permitted under the following conditions when using the device in pollution degree level 3 areas:

- Ambient temperature from 5 °C to 40 °C.
- Maximum relative air humidity 80 % at temperatures up to 31 °C, dropping linear to 50 %, relative air humidity at 40 °C.

WARNING!

Residual current devices (RCD)

Possible consequence: fatal or very serious injuries.

It is the duty of the operator to provide and set up an electrical isolating device and residual current devices (RCD), which need to be easily accessible.

WARNING!

Electrical isolating device

Possible consequence: fatal or very serious injuries.

The device does not include a switch. There needs to be a switch or circuit breaker fitted in the building installation. This needs to be positioned appropriately, easily accessible by the user and be labelled as an isolating device for the devices.



WARNING!

Output relay (XR1 ... XR3)

The output relays (XR1 ... XR3) have to be fitted on site with a max. 5 A fuse.

The entire device needs to be fitted on site with a max. 5 A fuse with devices with an internal protective RC circuit (module D, identity code characteristic value "1" for hardware extension).

Notes: This fuse can be provided with an appropriate isolating device, for example. This fuse means that both output relays (XR1/XR2) can each only be loaded with approx. 2 A.

The alarm relay (XR3) must be fitted separately with a max. 5 A fuse.



WARNING!

Protection of radio reception

Possible consequence: fatal or very serious injuries.

This equipment with communication interface is not intended to be used in residential areas and cannot guarantee appropriate protection of radio reception in these environments.



WARNING!

Low voltage cables

Possible consequence: fatal or very serious injuries.

The low voltage cables used must have a temperature resistance of ≥ 70 °C and may not be flammable.

Details ↪ *Tab. 31 'Technical data' on page 189*



WARNING!

Signal and control lines

Possible consequence: fatal or very serious injuries.

Signal and control lines need to be routed separately from power cables, as otherwise they could malfunction.

9.4.2 Specification of the threaded connectors

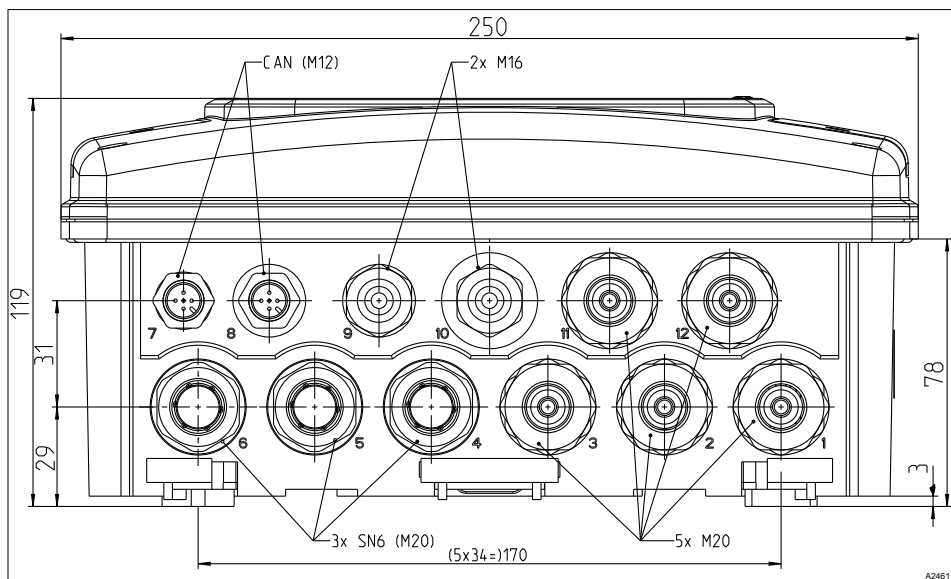

Fig. 16: All dimensions in millimetres (mm).

Threaded connector	Specification of the cable dimensions
M12	3 ... 6.5 mm
M16	4.5 ... 10 mm
M20	6 ... 12 mm

9.4.3 Specification of the cables and terminals

ESD, [electrostatic discharge]



Fig. 17: ESD-sensitive components

→

 **WARNING!**

ESD-sensitive components

Possible consequence: fatal or very serious injuries.

Adhere to the basic principles of ESD protection whenever working.

Securing single wires

The cables and lines used need to be suitable for the respective operating voltage, be made of copper and have a temperature resistance of ≥ 70 °C.

The cables need to conform to UL 2556 VW-1 or similar. The individual wires need to be mechanically fixed or secured to prevent them from loosening from the connecting terminals.

The respective permitted line cross-section can be found in the details below on the respective terminals.

9.4.3.1 Terminal type 1

Tab. 5: Connectible conductor:

Component	Value
Bared length (without cable end sleeve):	10 mm
single-wire:	min. 0.75 mm ² , max. 4 mm ² ; or min. AWG 18, max. AWG 12
fine-wired:	fine-wired: min. 0.75 mm ² , max. 2.5 mm ² ; or min. AWG 18, max. AWG 14
with cable end sleeve with collar:	with cable end sleeve with collar: min. 0.75 mm ² , max. 1.5 mm ² ; or min. AWG 18, max. AWG 16
with cable end sleeve:	with cable end sleeve: min. 0.75 mm ² , max. 2.5 mm ² ; or min. AWG 18, max. AWG 14

9.4.3.2 Terminal type 2

Tab. 6: Connectible conductor:

Component	Value
Bared length (without cable end sleeve):	10 mm
single-wire:	min. 0.2 mm ² , max. 1.5 mm ² ; or min. AWG 24, max. AWG 14
fine-wired:	min. 0.2 mm ² , max. 1.5 mm ² ; or min. AWG 24, max. AWG 14
with cable end sleeve with collar:	min. 0.25 mm ² , max. 0.75 mm ² ; or min. AWG 24, max. AWG 20
with cable end sleeve:	min. 0.25 mm ² , max. 1.5 mm ² ; or min. AWG 24, max. AWG 16

9.4.3.3 Terminal type 3 (plug-in terminal):

Tab. 7: Connectible conductor:

Component	Value
Bared length:	12 mm
single-wire:	min. 0.2 mm ² , max. 2.5 mm ² ; or min. AWG 24, max. AWG 14
fine-wired:	min. 0.2 mm ² , max. 1.5 mm ² ; or min. AWG 24, max. AWG 16
with cable end sleeve with collar:	min. 0.2 mm ² , max. 1.5 mm ² ; or min. AWG 24, max. AWG 16
with cable end sleeve:	min. 0.2 mm ² , max. 1.5 mm ² ; or min. AWG 24, max. AWG 16

9.4.3.4 Terminal type 4 (plug-in terminal):

Tab. 8: Connectible conductor:

Component	Value
Bared length (without cable end sleeve):	8 mm
single-wire:	min. 0.2 mm ² , max. 1.5 mm ² ; or min. AWG 24, max. AWG 14
fine-wired:	min. 0.2 mm ² , max. 1.5 mm ² ; or min. AWG 24, max. AWG 14
with cable end sleeve with collar:	min. 0.2 mm ² , max. 0.75 mm ² ; or min. AWG 24, max. AWG 20
with cable end sleeve:	min. 0.2 mm ² , max. 1.5 mm ² ; or min. AWG 24, max. AWG 16

9.4.3.5 Terminal type 5a (single terminal for internal conductor as a coaxial cable):

Tab. 9: Connectible conductor:

Component	Value
Terminal area (single and fine-wired):	min. 0.33 mm ² , max. 1.5 mm ² ; or min. AWG 22, max. AWG 16
Bared length:	see drawing, Fig. 31

9.4.3.6 Terminal type 5a (single terminal for external conductor as a coaxial cable):

Tab. 10: Connectible conductor:

Component	Value
Terminal area:	shielding diameter min. 1 mm, max. 5 mm
Bared length:	see drawing, Fig. 31, tighten manually.

9.4.4 Terminal diagram

9.4.4.1 Requirements

The controller is supplied with terminal diagrams showing 1:1 assignment.



Only one sensor per unit

You can connect 2 sensors to the base module and 1 sensor to the extension unit. For example, you can connect a chlorine sensor and an ORP sensor to the base module and a pH sensor or an interference variable to the extension unit.



Connection of the chlorine sensor with controllers with two channels

Note the following when connecting the sensors when measuring chlorine with pH compensation. Connect the chlorine sensor on the extension unit (Channel 2) to the terminals as per the terminal diagram.

Connect the pH sensor on the main unit (Channel 1) as follows:

- *When using a coaxial cable on the shield terminal and on the internal conductor, as per the terminal diagram.*
- *When using a transmitter pHV1 (mA) on the terminals, as per the terminal diagram.*

The pH value also needs to be temperature-compensated to ensure correct pH compensation. Therefore, connect the temperature sensor to the terminals as per the terminal diagram.

Depending on the identity code of the controller (Channel 2 = Package 4), now connect the interference variable to the mA input of the extension unit, as per the terminal diagram, if this mA input is not already occupied by the transmitter pHV1 (mA).

The interference variable influences pH and chlorine control.



pH measurement using a transmitter

If a pH measurement is connected to the controller via a transmitter DULCOMETER® DMTa or another manufacturer's pH measuring device, then assign mA-pH in the DMTa and/or in the third party manufacturer's pH measuring device as follows: [4 mA = pH 15.45] and [20 mA = pH -1.45]



Connection of the transmitter DMTa

A DMTa is connected to the controller as a 2 conductor transmitter:

- *Terminal DACx, channel 1: as per the terminal diagram*
- *Terminal DACx, channel 2: as per the terminal diagram*
- *see: ↪ Further information on page 53 and ↪ Further information on page 55*



Third party manufacturer's transmitter

Connect a third party manufacturer's transmitter as follows to the controller if the transmitter delivers an active signal:

- *Terminal DACx, channel 1: as per the terminal diagram*
- *Terminal DACx, channel 2: as per the terminal diagram*
- *see: ↪ Further information on page 53 and ↪ Further information on page 55*

9.4.4.2 Terminal layout

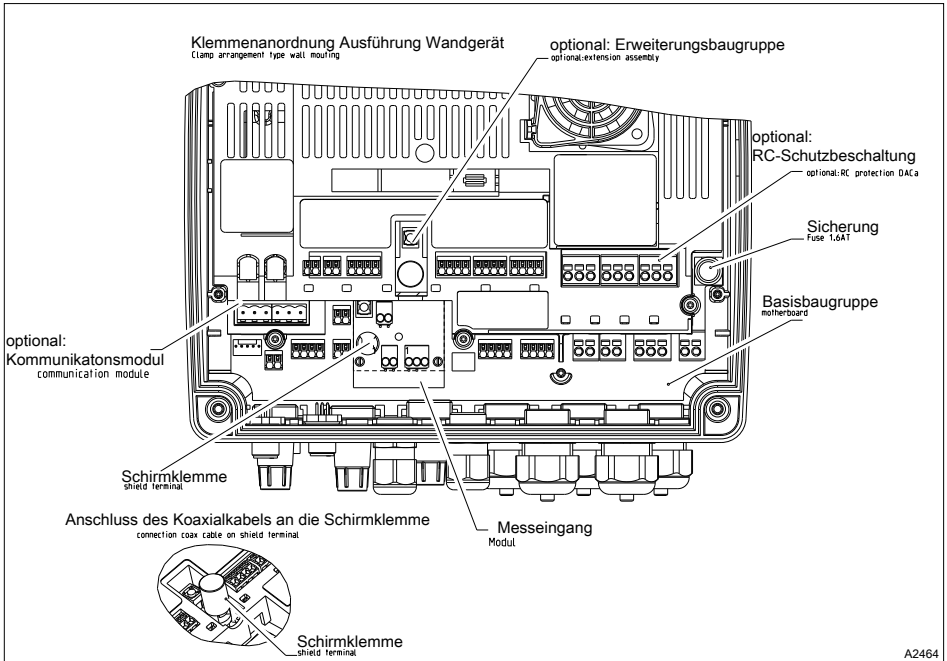

Fig. 18: Terminal layout

9.4.4.2.1 Terminal diagram for the base module (channel 1/2) with assignment options

Base module channel 1 and 2: there can only be one main measured variable, e.g. chlorine sensor connected to a unit. The dissolved oxygen sensor type DO3 cannot be connected to the extension unit but only to the base module

Assembly and installation

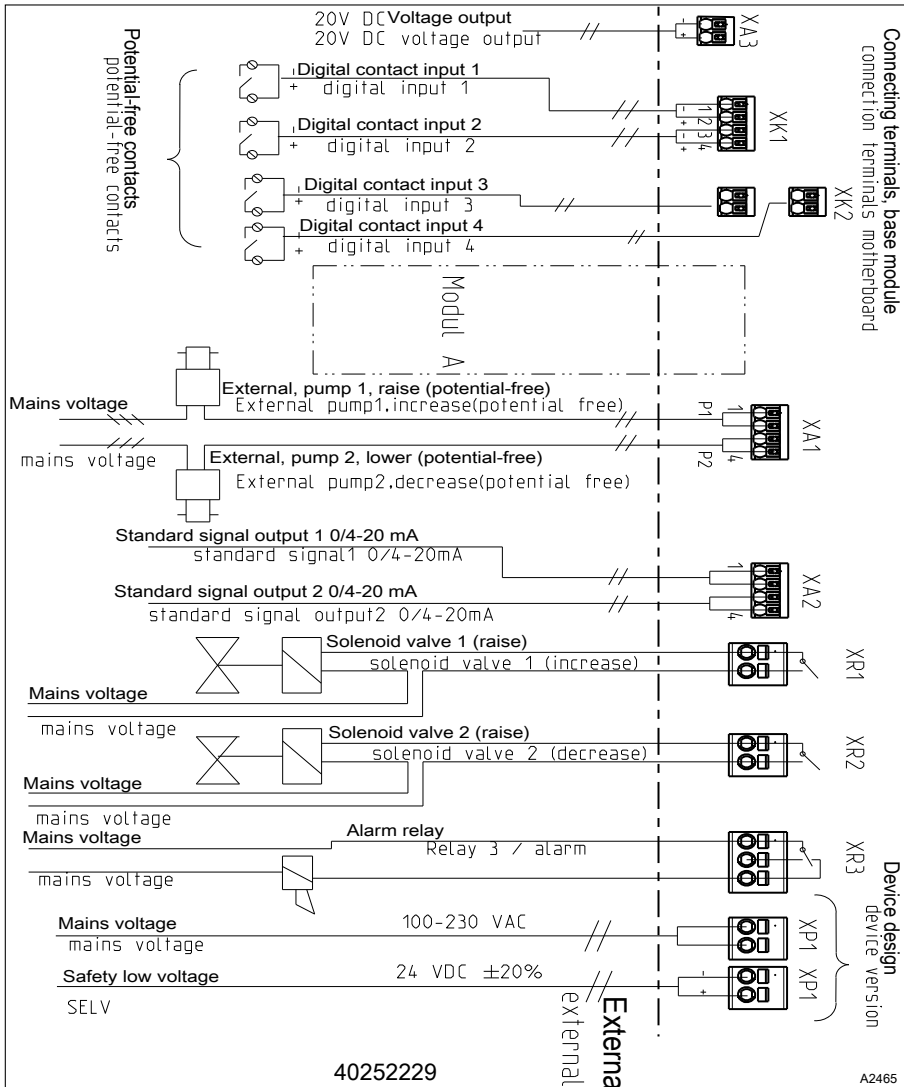

Fig. 19: Terminal diagram with assignment options.

XP1, XR1, XR2, XR3: see terminal type 1 & Chapter 9.4.3.1 'Terminal type 1' on page 48

XK1, XK2, XK3, XA1, XA2, XA3: see terminal type 2 & Chapter 9.4.3.2 'Terminal type 2' on page 48

9.4.4.2.2 Terminal diagram for the extension unit (channel 3) with assignment options

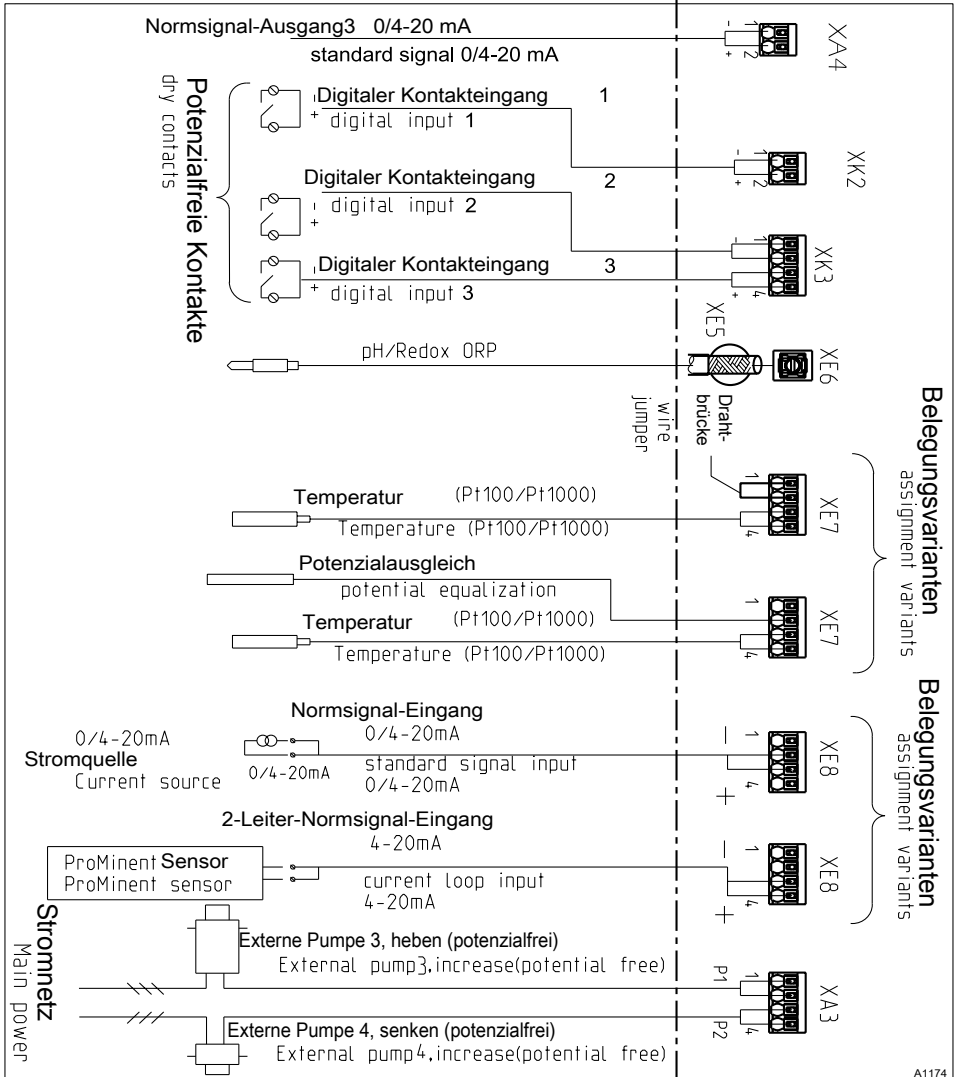

Fig. 20: Terminal diagram for the extension unit (channel 3) with assignment options (module C, optional)

Assembly and installation

Only one main measured variable, e.g. pH, may be connected to a unit. The mA signal of a magnetically inductive flow device can also be connected depending on the ID code.

XK2, XK3, XA3, XA4, XE7, XE8: see terminal type 2 ↪ *Chapter 9.4.3.2 'Terminal type 2' on page 48*

XE6: see terminal type 5a ↪ *Chapter 9.4.3.5 'Terminal type 5a (single terminal for internal conductor as a coaxial cable):' on page 50*

XE5: see terminal type 5b ↪ *Chapter 9.4.3.6 'Terminal type 5a (single terminal for external conductor as a coaxial cable):' on page 50*

9.4.4.2.3 Terminal diagram with protective RC circuit (optional)

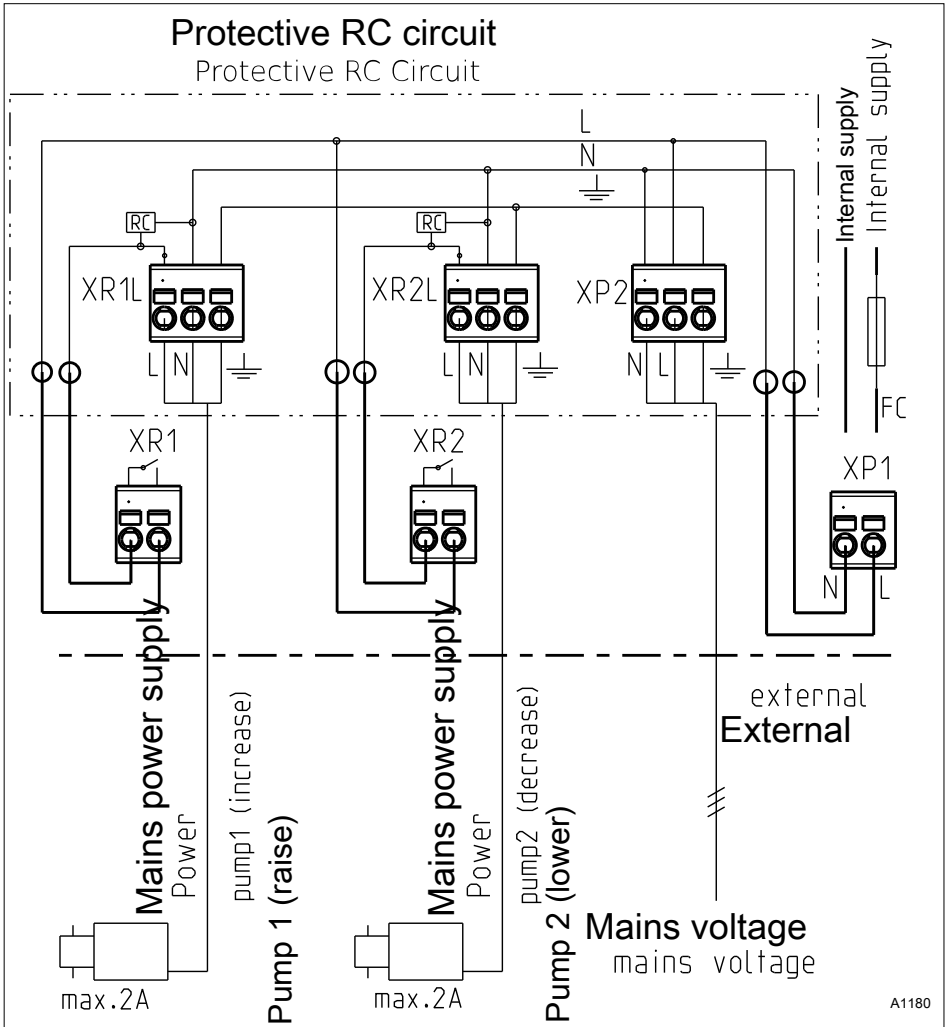

Fig. 21: Terminal diagram with protective RC circuit (module D, optional). The RC unit is only permitted in conjunction with the 230 V design.

Connectible conductor:

XP2, XR1L, XR2L: see terminal type 1 ↪ Chapter 9.4.3.1 'Terminal type 1' on page 48

9.4.4.2.4 Terminal diagram for the DAC "communication unit"

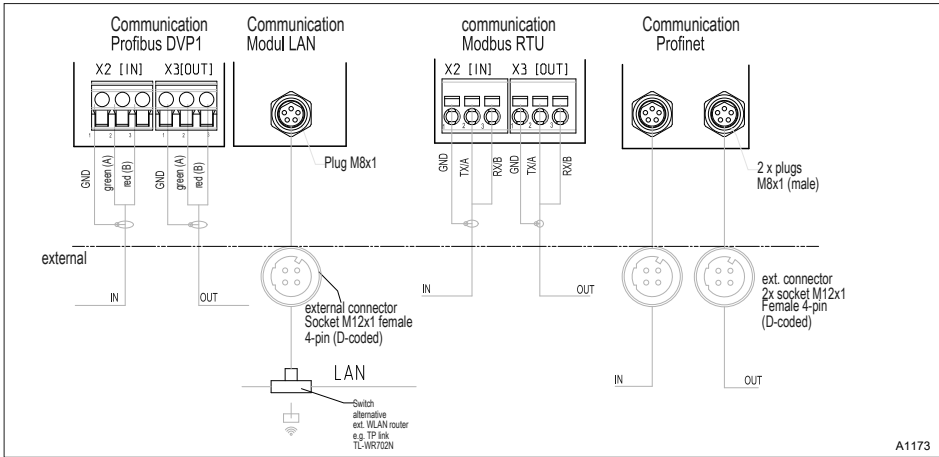

Fig. 22: Terminal diagram for the DAC communication unit (module B, optional)

Connectible conductor:

X2, X3: see terminal type 3 ↪ Chapter 9.4.3.3 'Terminal type 3 (plug-in terminal):' on page 49

9.4.4.2.5 Service interfaces

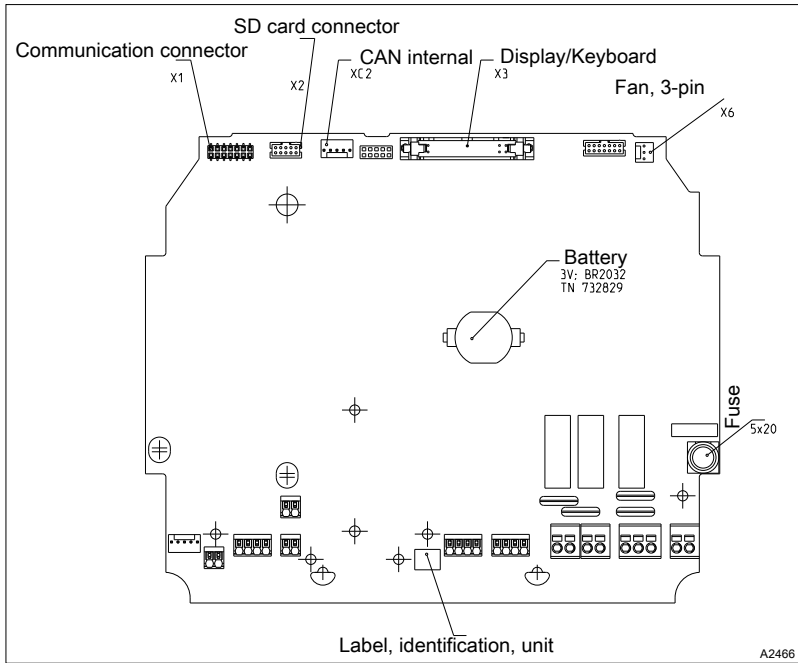

Fig. 23: Service interfaces

9.4.4.3 Module: mV temperature/mA input. Part number 734355

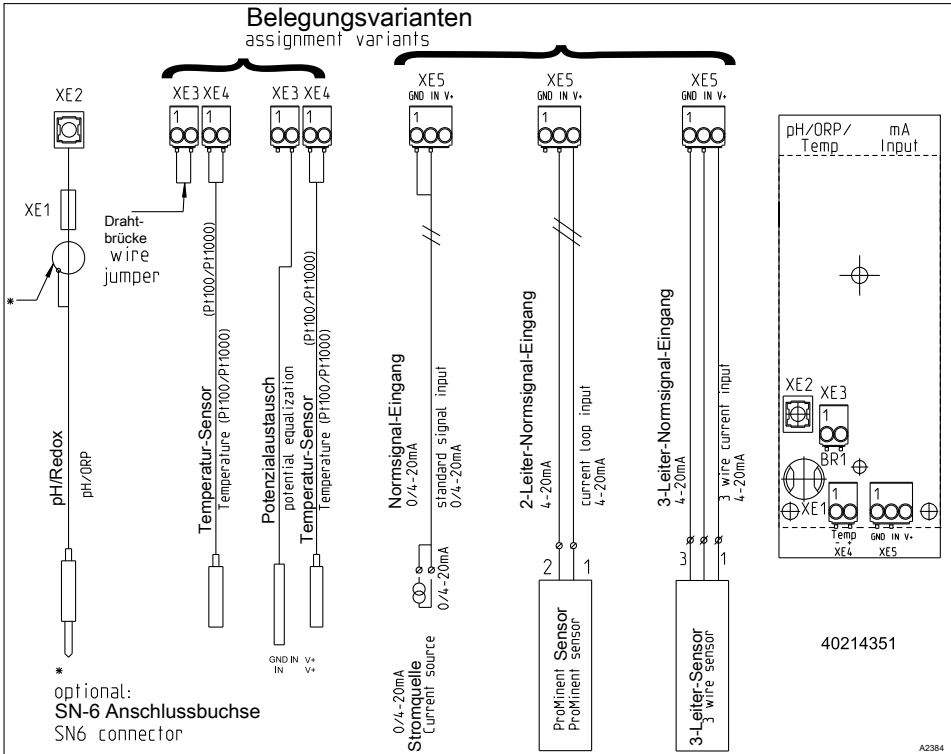

Fig. 24: Module: mV temperature/mA input. Part number 734355

A module for the direct measurement of a pH value or redox potential via a coaxial cable and a sensor signal from an mA 2-wire sensor, e.g. for chlorine, bromine or peracetic acid (PES).

mA interface:

- For use with ProMinent 2-wire transmitters and sensors with 2-wire mA interface.
- Processing of active mA signals, type of connector: current source.
- Driver voltage: 24 V DC.
- Max. current 50 mA.
- Input switches off at 70 mA.
- Protection against reverse polarity and overvoltage up to max. 30 V DC.
- Maximum cable length: 30 m, limited by the EMC specification.

2-wire control line for the connection of mA sensors to terminals XE5.2 and XE5.3

Connectible conductor:

XE3, XE4, XE5: see terminal type 4 ↪ *Chapter 9.4.3.4 'Terminal type 4 (plug-in terminal):' on page 49*

XE2: see terminal type 5a ↪ *Chapter 9.4.3.5 'Terminal type 5a (single terminal for internal conductor as a coaxial cable):' on page 50*

XE1: see terminal type 5b ↪ *Chapter 9.4.3.6 'Terminal type 5a (single terminal for external conductor as a coaxial cable):' on page 50*

Control line LiYY, 2 x 0.25 mm², Ø 4 mm, part number 725122

mV interface:

- For the direct connection of pH and ORP sensors
- Maximum cable length: 10m

Tab. 11: Sensor connection cable, coaxial, for terminal XE1/XE2

Designation	Part number
Cable combination, coaxial, Ø 5 mm 0.8 m - SN6 – pre-assembled.	1024105
Cable combination, coaxial, Ø 5 mm 2 m - SN6 – pre-assembled.	1024106
Cable combination, coaxial, Ø 5 mm 5 m - SN6 – pre-assembled.	1024107

9.4.4.4 Module: 2x mV inputs/temperature input. Part number 734131

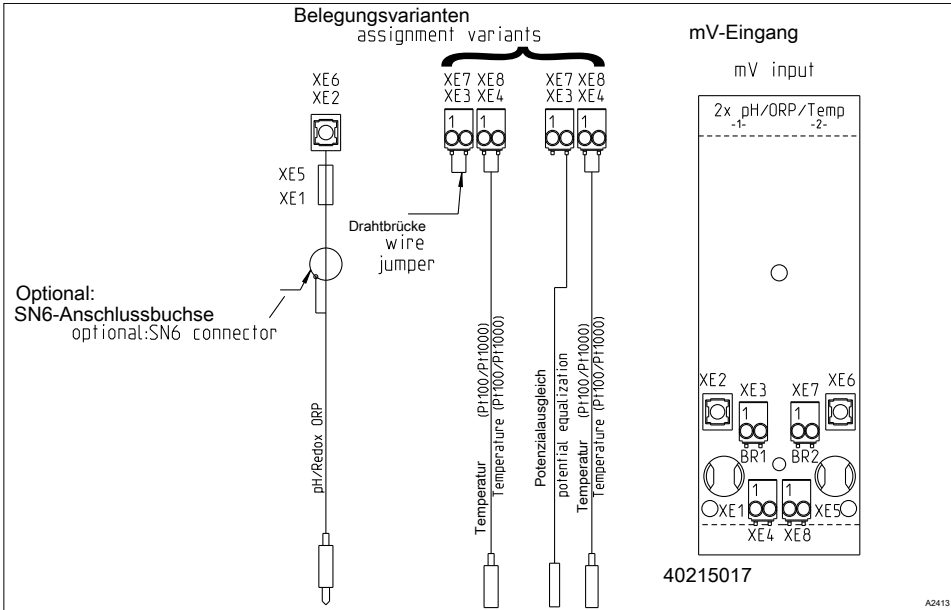

Fig. 25: Module: 2x mV inputs/temperature input. Part number 734131

Connectible conductor:

XE3, XE4, XE7, XE8: see terminal type 4 ☞ *Chapter 9.4.3.4 'Terminal type 4 (plug-in terminal):' on page 49*

XE2, XE6: see terminal type 5a ☞ *Chapter 9.4.3.5 'Terminal type 5a (single terminal for internal conductor as a coaxial cable):' on page 50*

XE1, XE5: see terminal type 5b ☞ *Chapter 9.4.3.6 'Terminal type 5a (single terminal for external conductor as a coaxial cable):' on page 50*

A module for the direct measurement of two pH values or two redox potentials or pH value and redox potential via a coaxial cable.

- For the direct connection of pH and ORP sensors.
- Maximum cable length: 10 m

Tab. 12: Sensor connection cable, coaxial, for terminal XE1/XE2 and X5/X6

Designation	Part number
Cable combination, coaxial, Ø 5 mm 0.8 m - SN6 – pre-assembled.	1024105
Cable combination, coaxial, Ø 5 mm 2 m - SN6 – pre-assembled.	1024106
Cable combination, coaxial, Ø 5 mm 5 m - SN6 – pre-assembled.	1024107

9.4.4.5 Module: 2x conductive conductivity/temperature sensors. Part number 734223

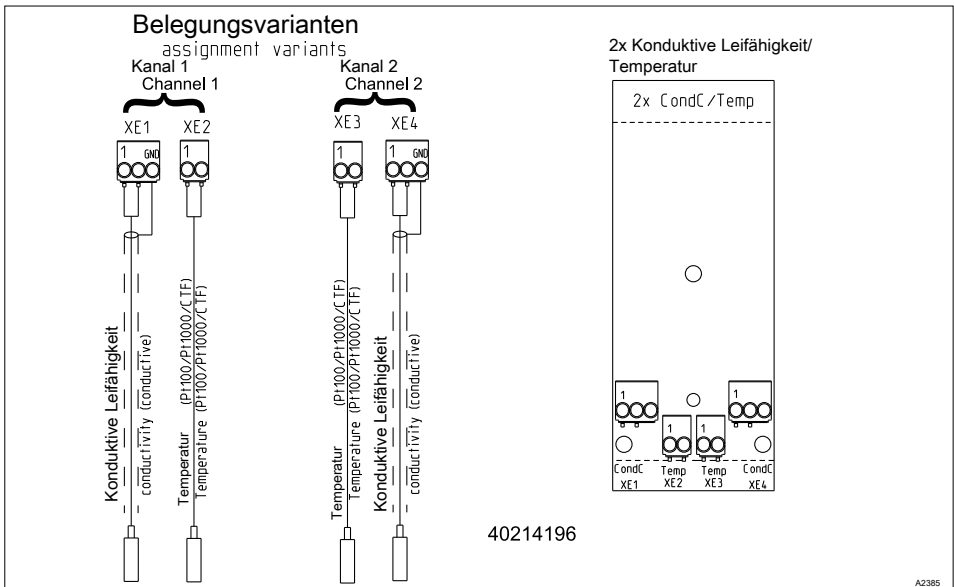

Fig. 26: Module: 2x conductive conductivity/temperature sensors. Part number 734223

A module for the direct measurement of the electrolytic conductivity based on the conductive principle. For the direct connection of 2 electrode conductivity sensors.

Connectible conductor:

XE1, XE2, XE3, XE4: see terminal type 4 ↪ Chapter 9.4.3.4 'Terminal type 4 (plug-in terminal):' on page 49

- Maximum cable length: 30 m, screened.

Assembly and installation

Electrical data

Parameter	Value
Cell constant:	0.005 1/cm ... 15 1/cm
Measuring ranges dependent on the sensor type:	
Specific conductivity:	0.001 $\mu\text{S/cm}$... 200 mS/cm
Specific electrical resistance:	5 Ωcm ... 1000 $\text{M}\Omega\text{cm}$
TOS (total dissolved solids):	0 ... 9999 ppm (mg/l)
SAL (salinity):	0.0 ... 70.0 ‰ (g/kg)
Precision:	
Specific conductivity: 1 $\mu\text{S/cm}$... 20 mS/cm :	better than 1 % of the measured value $\pm 1 \mu\text{S/cm} / \pm 1$ digit
Specific electrical resistance: 50 Ωcm ... 10 $\text{M}\Omega\text{cm}$:	better than 1 % of the measured value ± 1 digit
Specific electrical resistance: 10 $\text{M}\Omega\text{cm}$... 100 $\text{M}\Omega\text{cm}$:	better than 10 $\text{M}\Omega\text{cm}$
Correction variable: Temperature via Pt100/Pt1000, semiconductor temperature sensor	
Measuring range: (Pt100/Pt1000: Sensor cable length up to 10 m)	-20 °C ... +180 °C
Measuring range: (Pt100/Pt1000: Sensor cable length up to 50 m)	-20 °C ... +120 °C
Measuring range: (Semiconductor temperature sensor)	-20 °C ... +125 °C
Precision of the temperature measurement: better than 1% of the measured value (maximum 1 °C)	

9.4.4.6 Module: 2x mA inputs. Part number 734126

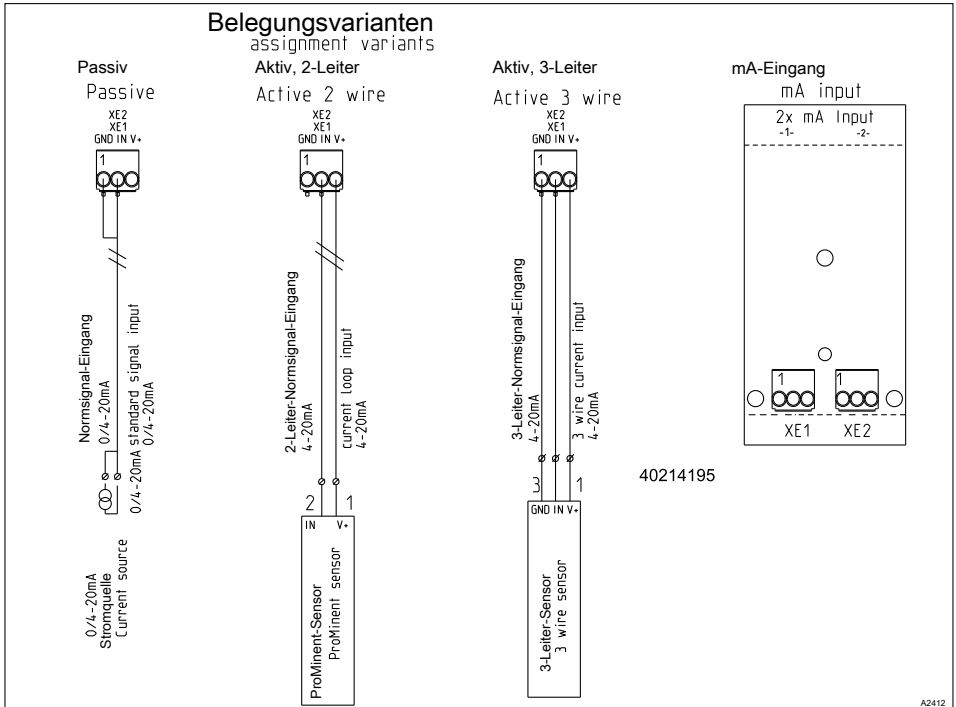

Fig. 27: Module: 2x mA inputs. Part number 734126

Connectible conductor:

XE1, XE2: see terminal type 4 [Chapter 9.4.3.4 'Terminal type 4 \(plug-in terminal\):'](#) on page 49

A module for the measurement of sensor signals from a 2-wire sensor, e.g. for chlorine, bromine or peracetic acid (PES), and pH and ORP via the pH transmitters, pHV1, part number 809126, and ORP, RHV1, part number 809127.

- For use with ProMinent 2-wire transmitters and sensors with 2-wire mA interface.
- Processing of active mA signals (type of connector: current source).
- Driver voltage: 24 V DC.
- Max. current 50 mA.
- Input switches off at 70 mA.
- Protection against reverse polarity and overvoltage up to max. 30 V DC.
- Maximum cable length: 30 m, limited by the EMC specification.

Assembly and installation

Connect sensor 1 to terminal XE1 pin 2 and pin 3 with the control cable. Connect sensor 2 to terminal XE2 pin 2 and pin 3 with the control cable.

Control cable LiYY 2 x 0.25 mm², Ø 4 mm, part number 725122.

9.4.5 Mounting on a surface and control panel installation



Seals and terminal diagram

Select suitable seals to match the cable penetrations of the controller. Close open holes with blanking plugs. Only in this way can sufficient seal integrity be ensured.

Moisture in the controller can lead to functional malfunctions.

Observe the instructions on the enclosed terminal diagrams.

Tab. 13: Kit, mounting material, part number 1045171, includes the following individual parts

Designation	Part number	Quantity
Sealing ring (M 20 x 1.5), 4xØ5	1045172	2
Sealing ring (M 20 x 1.5), 2xØ4	1045173	2
Sealing ring (M 20 x 1.5), 2xØ6	1045194	2
Sealing stopper, Ø6.5/Ø5, polyamide, black	1042417	5
Protective plug, IL4-073	140448	5
Plug, IL4-044	140412	5
SKINTOP® threaded connector (M 20 x 1.5) (5 ... 10) black	1005517	1
SKINTOP® threaded connector (M 16 x 1.5) (5 ... 10) black		
SKINTOP® threaded connector (M 12 x 1.5), (4 ... 6) black	1009734	1
Counter nut (M 12 x 1.5), 15 mm AF, brass, nickel-plated	1018314	1
Counter nut (M 16 x 1.5), 24 mm AF, brass, nickel-plated		
Counter nut (M 20 x 1.5), 30 mm AF, brass, nickel-plated	1021016	1



Ensure that the cables are not under tension.

1. Loosen the four housing screws.

2. Slightly pull the upper part of the housing to the front and insert the top part of the housing in its parked position in the lower part of the housing.

3.



Large threaded connector (M 20 x 1.5).

Medium threaded connector (M 16 x 1.5).

Small threaded connectors (M 12 x 1.5).

4. Route the cables into the controller.

5. Connect the cables as indicated on the terminal diagram.

6. Tighten the clamping nuts of the threaded connectors so that they are properly sealed.

7. Fit the upper part of the housing onto the lower part of the housing.

8. Manually tighten the housing screws.

9. Once again check that the seal is seated properly. The degree of protection IP 67 (mounting on a surface/pipe-mounted) or IP 54 (control panel-mounted) (Pollution degree 2/macro-environment) can only be ensured if mounting is correct.

9.4.6 Switching of inductive loads



If you connect an inductive load, i.e. a consumer which uses a coil (e.g. an alpha motorised pump), then you must protect your controller with a protective circuit. If in doubt, consult an electrical technician for advice.

When switching off, the connection in series of a resistor and capacitor means that the current can be dissipated in a damped oscillation.

Also when switching on, the resistor acts as a current limiter for the capacitor charging process. The RC member protective circuit is highly suitable for AC voltage supplies.

The RC member protective circuit is a simple, but nevertheless very effective, circuit. This circuit is also referred to as a snubber or Boucherot member. It is primarily used to protect switching contacts.

The magnitude of the resistance R of the RC member is determined according to the following equation:

$$R = U / I_L$$

(Where U = Voltage across the load and I_L = current through the load)

The magnitude of the capacitor is determined using the following equation:

$$C = k * I_L$$

$k = 0,1 \dots 2$ (dependent on the application).

Only use capacitors of class X2.

Units: R = Ohm; U = Volt; I_L = Ampere; C = μF



If consumers are connected which have a high starting current (e.g. plug-in, switched mains power supplies), then a means of limiting the starting current must be provided.

The switching-off process can be investigated and documented using an oscilloscope. The voltage peak at the switch contact depends on the selected RC combination.

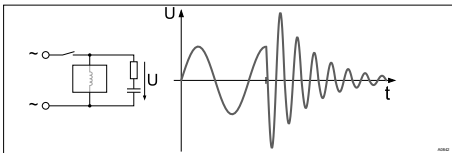

Fig. 28: Switching-off process shown on the oscillogram.

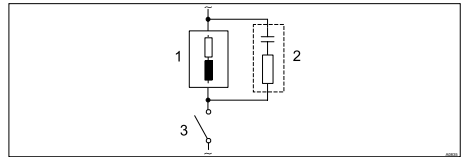

Fig. 29: RC protective circuit for the relay contacts

Typical AC current application with an inductive load:

- 1) Load (e.g. alpha motor-driven pump)
- 2) RC-protective circuit
 - Typical RC protective circuit at 230 V AC:
 - Capacitor [0.22 μF / X2]
 - Resistance [100 Ohm / 1 W] (metal oxide (pulse resistant))
- 3) Relay contact (XR1, XR2, XR3)

9.4.7 Connect the sensors electrically to the controller

User qualification, electrical installation: Electrical technician ↪ *Chapter 1.4 'User qualification' on page 13*

If possible, use only pre-assembled coaxial cables, which you can select from the product catalogue.

Coaxial cable 0.8 m, pre-assembled.

Coaxial cable 2 m-SN6, pre-assembled.

Coaxial cable 5 m-SN6, pre-assembled.

9.4.7.1 Connection of pH or ORP sensors via a coaxial cable

INFORMATION: This section relates to connection type pH/ORP via mV, with a coaxial cable directly via the electrical terminal of the controller.

! NOTICE!

Possible incorrect measurement due to poor electrical contact

Only use this type of connector if you do not wish to use pre-assembled coaxial cables. Observe the following with this type of connector:

Remove the black plastic layer from the inner coaxial cable. There is a black plastic layer on all types of cable. When doing so, ensure that individual threads of the shielding do not come into contact with the connector of the inner conductor.

INFORMATION: Depending on the design (2 or 3-channel), the controller can measure the pH or ORP value once, twice or three times.

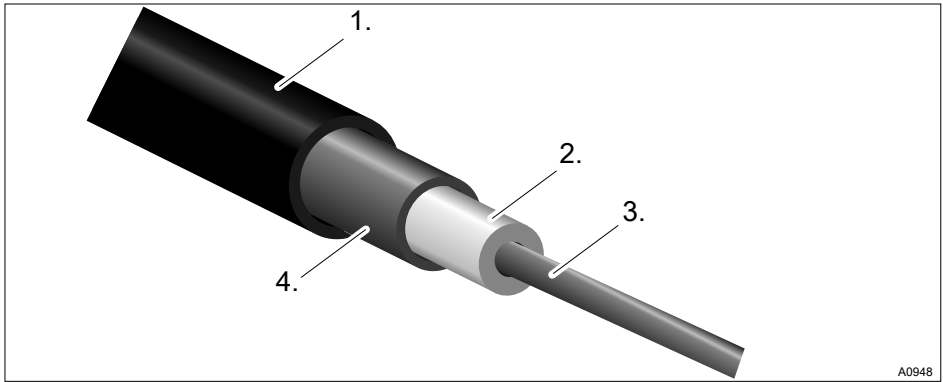

A0948

Fig. 30: Coaxial cable:

1. Protective sleeve
2. Insulation
3. Inner conductor
4. Outer conductor and shielding

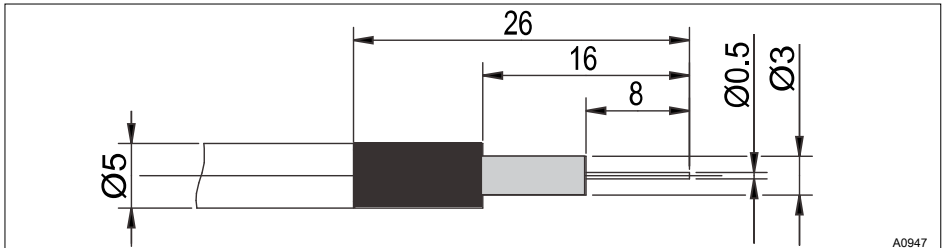

A0947

Fig. 31: Coaxial cable construction

There are two connection types:

There is a connection type without potential equalisation (unsymmetrical connection type) or a connection type with potential equalisation (symmetrical connection type).



When is potential equalisation used?

Use potential equalisation if the pH/ORP measurement is interfered with by interference potentials from the sample media. For example interference potentials may be produced by electric motors with incorrect interfer-

ence suppression or due to insufficient galvanic insulation of electrical conductors etc. The potential equalisation does not cancel this interference potential, it does however reduce its effect on the measurement. Therefore, ideally eliminate the source of the interference potential.

Switching the controller to a measurement with potential equalisation

NOTICE!

Wire jumper with connected potential equalisation

A measurement with a wire jumper and connected potential equalisation produces incorrect measured values.





Please note the following differences:

The controller is factory-preset for measurements without potential equalisation (unsymmetrical measurement).

To perform a measurement with potential equalisation (symmetrical measurement), change the setting in the [Measurement] menu accordingly.

With a symmetrical connection, remove the wire jumper and connect the potential equalisation conductor (PA) to the terminal XE3_2 (channel 1) or XE7_2 (channel 2) of the controller.

- 1.**  In the [Measurement] channel 1 or 2 menu, change the entry under [Potential equalisation] to [Yes].
- 2.**  Open the controller and remove the wire jumper.
 - on module A (measuring input): Terminal XE3_1, XE3_2 for channel 1
 - on module A (measuring input): Terminal XE7_1, XE7_2 for channel 2
 - on module C (extension unit): Terminal XE7_1, XE7_2 for channel 3

Sensor connector with potential equalisation

NOTICE!

Error sources when measuring with potential equalisation

A measurement without a wire jumper and/or unconnected potential equalisation delivers incorrect measured values.

INFORMATION: With a symmetrical connection, connect the line for potential equalisation to terminal XE3_2 (channel 1) or XE7_2 (channel 2) of the controller. Before doing so, remove the respective wire jumper at these terminals.

INFORMATION: The potential equalisation must always be in contact with the medium being measured. A special potential equalisation plug (order no. 791663) and a cable (order no. 818438) are necessary with the DGMa bypass fitting. The potential equalisation pin is always fitted with the DLG bypass fitting; only the cable (order no. 818438) is needed.

Features when calibrating with potential equalisation

When calibrating, immerse the potential equalisation in the respective buffer solution, or use the calibration receptacle which forms part of the scope of delivery of the bypass fitting. This calibration receptacle incorporates an integral potential equalisation pin to which you can connect the potential equalisation cable.

Sensor connector without potential equalisation

The sensor is connected to the controller, as shown on the terminal diagram. Do not remove the wire jumper in the controller.

9.4.7.2 Connection of amperometric sensors

Connect the sensor, as described in the sensor operating instructions, to the corresponding terminals of the controller, see  Chapter 9.4.4 'Terminal diagram' on page 51.

9.4.7.3 Connecting the conductive conductivity sensor

NOTICE!

The sensor must be dry

Do not allow the conductivity sensor to come into contact with liquid. Only allow the conductivity sensor to come into contact with liquid once the conductivity sensor has been connected, configured and calibrated. The sensor parameters (zero point) of a moist or wet conductivity sensor can no longer be properly calibrated.

If the conductivity sensor has come into contact with liquid prior to calibration, there is an option to dry the conductivity sensor. A dry conductivity sensor can be successfully recalibrated to the sensor parameters.



Shielded sensor cable

All conductivity sensors connected to the controller require a shielded sensor cable.

Connect the sensor in accordance with the wiring diagram.

Tab. 14: If you use a sensor without fixed cable or wish to extend the fixed cable, use the pre-assembled sensor cables:

Accessories	Part number
Measuring line LF 1 m:	1046024
Measuring line LF 3 m:	1046025
Measuring line LF 5 m:	1046026
Measuring line LF 10 m:	1046027

Tab. 15: If you wish to extend the fixed cable with a CTF or CCT sensor, then use the pre-assembled sensor cable:

Accessories	Part number
Measuring line 10 m:	on request



Selection of the connected sensor

All of the sensor-dependent settings are reset to the [DEFAULT] values when changing the connected sensor.

Sensor	Connector	Cell constant Cell constant (1/cm)	T-correction element	Max. temp. (°C)	Measuring range κ min (Unit)	Measuring range κ max (Unit)
LFTK1FE3m	Fixed cable 0.25 mm ² , 3 m, shielded	1.00	Pt1000	80	0.01 mS/cm	20 mS/cm
LFTK1FE5m	Fixed cable 0.25 mm ² , 5 m, shielded	1.00	Pt1000	80	0.01 mS/cm	20 mS/cm
LFTK1-DE	DIN 4-pin	1.00	Pt1000	80	0.01 mS/cm	20 mS/cm
LFTK1-1/2	DIN 4-pin	1.00	Pt1000	80	0.01 mS/cm	20 mS/cm
LF1-DE	DIN 4-pin	1.00	-	80	0.01 mS/cm	20 mS/cm
LFT1-DE	DIN 4-pin	1.00	Pt100	80	0.01 mS/cm	20 mS/cm
LFT1-1/2	DIN 4-pin	1.00	Pt100	80	0.01 mS/cm	20 mS/cm
LMP01	DIN 4-pin	0.10	Pt100	70	0.1 uS/cm	500 uS/cm
LMP01-HT	DIN 4-pin	0.10	Pt100	120	0.1 uS/cm	500 uS/cm
LMP01-TA	Fixed cable 0.34mm ² , 5 m, shielded	0.10	Pt100	70	0.1 uS/cm	500 uS/cm
LMP001	DIN 4-pin	0.01	Pt100	70	0.01 uS/cm	50 uS/cm
LMP001-HT	DIN 4-pin	0.01	Pt100	120	0.01 uS/cm	50 uS/cm
LM1	DIN 4-pin	1.00	-	70	0.1 mS/cm	20 mS/cm

Assembly and installation

Sensor	Connector	Cell constant Cell constant (1/cm)	T-correction element	Max. temp. (°C)	Measuring range κ min (Unit)	Measuring range κ max (Unit)
LM1-TA	Fixed cable 0.34 mm ² , 5 m, shielded	1.00	-	70	0.1 mS/cm	20 mS/cm
LMP1	DIN 4-pin	1.00	Pt100	70	0.1 mS/cm	20 mS/cm
LMP1-HT	DIN 4-pin	1.00	Pt100	120	0.1 mS/cm	20 mS/cm
LMP1-TA	Fixed cable 0.34 mm ² , 5 m, shielded	1.00	Pt100	70	0.1 mS/cm	20 mS/cm
CK1	DIN 4-pin	1.00	-	150	0.01 mS/cm	20 mS/cm
CKPt1	DIN 4-pin	1.00	Pt100	150	0.01 mS/cm	20 mS/cm

9.5 Priming to bleeding



The pump is working at 100% performance

Note any installation work in your surroundings, as feed chemical can uncontrollably escape into the environment in the event of open pipes etc.

Fig. 32: [Prime with <OK>] e.g. to bleed a pump

If you select the function [Prime with <OK>] when the pumps are connected and operable, the pumps continue to operate at 100% power for as long as you press and hold down the key.

You can use this function, for example, to transport the feed chemical to the pump, thereby bleeding the metering line.

Pump 1

5.1.1

- ▣ Function Decrease value
- Max. stroke rate 180
- Assignment Channel 1

A1098

10 Commissioning

- **User qualification:** trained user, ↗ *Chapter 1.4 'User qualification' on page 13*



WARNING!

Sensor run in periods

This can result in hazardous incorrect metering.

Consider the run in period of the sensor when commissioning:

- There must be sufficient feed chemical in the sample water for your application (e.g. 0.5 ppm chlorine).
- Correct measuring and metering is only possible if the sensor is working perfectly.
- It is imperative that you adhere to the run in periods of the sensor.
- Calculate the run in period when planning commissioning.
- It may take a whole working day to run-in the sensor.
- Refer to the sensor's operating instructions.

After mechanical and electrical installation, the controller must be integrated into the measuring point.

10.1 Switch-on behaviour during commissioning

Switching On - First Steps



Installation and function control

- Check that all the connections have been made correctly
- Ensure that the supply voltage matches the voltage indicated on the nameplate

- Switch the supply voltage on
- The controller displays a menu in which you can set the language with which you wish to operate the controller
- Wait for the controller's module scan

Module scan

Base module	<input checked="" type="checkbox"/>
Softw. version: 01.00.00.00	
Expansion module	<input checked="" type="checkbox"/>
Softw. version: 01.00.00.00	
continue with <OK>	
Auto continue in 10 s	

Fig. 33: Module scan

- ⇒ The controller indicates the controller modules installed and identified.
- Press **OK**
 - ⇒ The controller now changes to its continuous display. From the continuous display, you can access all the controller's functions using

10.2 Adjusting the backlight and contrast of the controller display



Continuous display →  →  [Setup] → 
[Device setup] →  or  [Device configuration]
→  [Backlight]

Under this menu item you can set the brightness and contrast of your controller display to match the ambient conditions at your installation location.

10.3 Resetting the operating language



Resetting the operating language

In the event that a foreign and hence incomprehensible operating language has been set, the controller can be reset to the basic setting. This is implemented by the simultaneous pressing of the  and  keys.

If you no longer know whereabouts you are in the operator menu, you must press the  key as often as necessary until the continuous display becomes visible again.

10.4 Defining metering and control processes

Set the controller once you have integrated it into the control circuit. Setting the controller adapts it to your process.

Define the following parameters to set up a controller:

- What type of a process is planned?
- Which measured variables are there?
- Is there an in-line, batch or circulation process planned?

- Should the controller operate as a one-way or two-way control?
- Which control variables are there?
- What control parameters are necessary?
- What should the controller do in [HOLD]?
- How should the actuators be controlled?
- How should the mA-outputs be set?

10.5 Calibrating conductive conductivity, sensor parameter adjustment



NOTICE!

The sensor must be dry

Do not allow the conductivity sensor to come into contact with liquid. Only allow the conductivity sensor to come into contact with liquid once the conductivity sensor has been connected, configured and calibrated. The sensor parameters (zero point) of a moist or wet conductivity sensor can no longer be properly calibrated.

If the conductivity sensor has come into contact with liquid prior to calibration, there is an option to dry the conductivity sensor. A dry conductivity sensor can be successfully recalibrated to the sensor parameters.

If *[Sensor not dry]* continues to be displayed despite the conductivity sensor having been dried, then you will have to wait some time until the controller has detected the sensor as dry.

Once you have selected the sensor type, the prompt automatically appears asking whether the sensor parameters (zero point) have to be determined. You can initiate this prompt manually as follows:

Continuous display → Menu → ▲ or ▼
[Measurement] → **OK** → ▲ or ▼
[Measuring channel X Conductivity] **OK** → ▲ or ▼
▼ *[Sensor parameter adjustment]* → **OK**.

1. ➤ Use the arrow keys to select *[Automatically determine sensor parameters]*.
2. ➤ Continue with **OK**.
 - ⇒ You will see the display showing *[Sensor dry]* and *[Automatically determine sensor parameters]*.
3. ➤ Continue with **OK**.
 - ⇒ You will see the display with the message *[Sensor parameters are automatically determined]*.

The sensor parameters are automatically carried over.

11 Configuring measured variables

- **User qualification:** trained user ↪ Chapter 1.4 'User qualification' on page 13

Continuous display → → [Measurement] → [Measurement] → or [Meas. channel 1]
 → or [Measured variable]



Measuring channel settings

This descriptions of [Channel 1] apply correspondingly to the settings in all other measuring channels. The procedure for entering the settings for the channel in question is identical, however the parameters to be set may differ. Your attention is drawn to the differences, which are also described.

Channel 1

<input checked="" type="checkbox"/> Measured variable	Chlorine
Sensor type	CLE3/CLE3.1
Measuring range	0... 2.0 ppm
Temperature	Manual
Process temperature	10.0 °C
pH compensation	Off

Fig. 34: Setting measured variables, using the example of [Channel 1] and [Chlorine].

Tab. 16: The following measured variables can be set at the controller:

Measured variable	Meaning	Unit
[None]	The controller does not carry out any measurement.	
[pH [mV]]	pH sensor with mV signal	[pH]
[pH [mA]]	pH sensor with mA signal	[pH]
[ORP [mV]]	ORP sensor with mV signal	[mV]
[ORP [mA]]	ORP sensor with mA signal	[mV]

Configuring measured variables

Measured variable	Meaning	Unit
<i>[mA general]</i>		<ul style="list-style-type: none"> ■ <i>[Freely selectable]</i> ■ <i>[%]</i> ■ <i>[mA]</i> ■ <i>[m]</i> ■ <i>[bar]</i> ■ <i>[psi]</i> ■ <i>[m³/h]</i> ■ <i>[gal/h]</i> ■ <i>[ppm]</i> ■ <i>[%RH]</i> ■ <i>[NTU]</i>
<i>[Bromine]</i>	Bromine	<i>[ppm]</i>
<i>[Chlorine]</i>	Chlorine	<i>[ppm]</i>
<i>[Chlorine dioxide]</i>	Chlorine dioxide	<i>[ppm]</i>
<i>[Chlorite]</i>	Chlorite	<i>[ppm]</i>
<i>[Fluoride [mA]]</i>	Fluoride	<i>[ppm]</i>
<i>[Oxygen]</i>	Oxygen	<i>[ppm]</i>
<i>[Ozone]</i>	Ozone	<i>[ppm]</i>
<i>[Peracetic acid]</i>	Peracetic acid	<i>[ppm]</i>
<i>[Hydrogen per.]</i>	Hydrogen peroxide with a sensor type <i>[PER]</i>	<i>[ppm]</i>
<i>[Cond. [mA]]</i>	Conductivity sensor with mA signal	<i>[μS]</i>
<i>[Conductivity]</i>	Conductive conductivity	<i>[μS]</i>
<i>[Temp. [mA]]</i>	Temperature sensor with mA signal	<i>[°C]</i> or <i>[°F]</i>
<i>[Temp.[Pt100x]]</i>	Temperature with a sensor type Pt 100 or Pt 1000	<i>[°C]</i> or <i>[°F]</i>



If you carry out the pH value measurement using potential equalisation, then you must adopt this approach when selecting the measured variable as a parameter.

11.1 Information on the measured variables



Available measured variables

All measured variables are available and can be used in the controller.

11.1.1 Measured variable pH [mV]

The measured variable pH [mV]

The pH sensor of the measured variable pH [mV] is connected using a coaxial cable via which the mV signal is transmitted to the controller. This measurement can be used if the cable is less than 10 metres in length.

Decimal places

The function shows the pH value in the display with one or two decimal places. An adaptation of the display to one decimal place makes sense if a change in the 1/100 value is unimportant or if the value is unsteady.

Factory setting: 2 decimal places

Glass break detection

[ON] / *[OFF]*: Switches glass break detection of the pH sensor *[ON]* or *[OFF]*. The factory setting is *[OFF]*. If the controller has the setting *[ON]*, it displays an error message if an error is detected.

The function *[Glass break detection]* increases the safety of the measuring point.

Cable break detection

[ON] / *[OFF]*: Switches cable break detection of the coaxial cable *[ON]* or *[OFF]*. The factory setting is *[OFF]*. If the controller has the setting *[ON]*, it displays an alarm message if an error is detected.

The function *[Cable break detection]* increases the safety of the measuring point.

11.1.2 Temperature

Temperature

With amperometric measured variables, the temperature influence on the measurement is automatically compensated in the sensor. A separate temperature measurement is only used, if necessary, to display and issue the temperature values via an mA-output. Separate temperature compensation is only needed with a chlorine dioxide sensor type CDP.

Temperature compensation

This function is used for compensation of the temperature influence on the measurement. This is only necessary with pH and fluoride measurement and when chlorine dioxide is measured using a CDP sensor.

Temperature: [Off] / [Manual] / [Automatic]

- *[Off]* switches the process temperature setting off
- *[Manual]* enables the process temperature to be manually specified, which makes sense with constant temperatures
- *[Automatic]* uses a measured process temperature. Automatic measurement of the temperature using the temperature sensor, e.g. Pt1000. With pH, temperature compensation can be switched *[ON]* or *[OFF]* in the menu.

11.1.3 Measured variable pH [mA]

Measured variable pH [mA]:

If the measured variable '*pH [mA]*', i.e. pH measurement using a mA signal, is selected, then the possibility of sensor monitoring for cable or glass breaks is no longer available.

For a pH measurement using a mA signal, either a DMTa or a pH-V1 measuring transducer is connected to the pH sensor. A 2-conductor connection cable is used between the DMTa-/pH-V1 measuring transducer and the controller. The connection cable supplies the DMTa-/pH-V1 measuring transducer and routes the measured value as a 4 ... 20 mA signal to the controller.

When using the DMTa measuring transducer or the measuring transducer of another supplier, the measuring range allocation must be set to the following values:

- 4 mA = 15.45 pH
- 20 mA = -1.45 pH

With a pH-V1 measuring transducer, the setting of the measuring range allocation is automatically specified.

Temperature compensation

This function is used to compensate for the temperature influence on the measurement. The process temperature is set in the DMTa measuring transducer when using a DMTa measuring transducer

Temperature: [Off] / [Manual] / [Automatic]

- *[Off]* switches the process temperature setting off
- *[Manual]* permits manual process temperature setting
- *[Automatic]* uses a measured process temperature

Configuring measured variables

11.1.4 ORP [mV], ORP [mA]

Measured variables ORP [mV], ORP [mA]

If the measured variable 'ORP [mV]' or 'ORP [mA]' is selected, measurement of the process temperature is only possible for information or recording purposes.

For the measured variable 'ORP [mV]', the measuring range is fixed in the range -1500 mV ... + 1500 mV.

For the measured variable 'ORP [mA]', the measuring range is dependent on the RH-V1 measuring transducer and is 0 ... +1000 mV.

11.1.5 Chlorine, bromine, chlorine dioxide, chlorite, dissolved oxygen and ozone

Measured variable chlorine, bromine, chlorine dioxide, chlorite, dissolved oxygen and ozone:

The measured variables chlorine, bromine, chlorine dioxide, chlorite, dissolved oxygen and ozone are always measured using a mA signal because the measuring transducer is located in the sensor.

The temperature compensation takes place automatically inside the sensor (exception: CDP, chlorine dioxide sensor). For further information see the operating instructions of the sensor used.

Measurement of chlorine with pH compensation

Chlorine used in water disinfection comes in various forms, e.g. as liquid sodium-calcium hypochlorite, as dissolved calcium hypochlorite or as chlorine gas. All of these forms can be measured using DULCOTEST chlorine sensors. After the addition of chlorine to water, the chlorine splits into two fractions depending on the pH value:

- 1. Into hypochlorous acid (HOCl) a strongly oxidising, efficient, anti-bacterial agent that destroys most organisms very quickly.
- 2. Into the hypochlorite anion (OCl⁻) – with a weak anti-bacterial effect that takes a long time to kill off organisms.

The sensors for measuring free chlorine selectively measure the very effective hypochlorous acid (HOCl), but not the hypochlorite anion. If the pH value changes during the process, then the ratio of the two chlorine fractions changes and hence the sensitivity (slope) of the chlorine sensor. If the pH value increases, the measured HOCl concentration decreases. If there is an integrated control, then the control tries to compensate for this. If the pH value now decreases, the result can be a considerable overdosing of chlorine, even though no extra dosing has taken place. Use of a pH compensated chlorine measurement can prevent this.

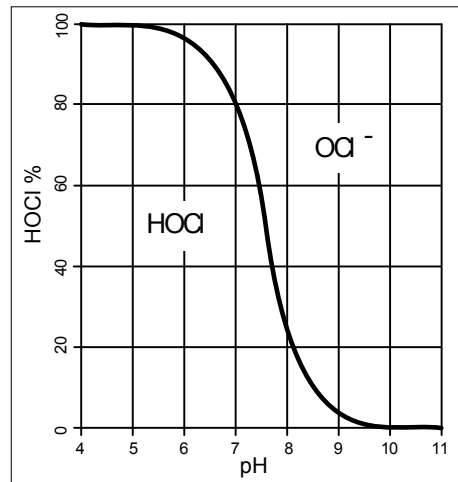

Fig. 35: HOCl/OCl equilibrium

As the graph shows, for pH values of > 8.5, less than 10% of the HOCl is contained in the water and hence the disinfecting power is lower. The chlorine value shown after compensation is a calculated chlorine value. The calculated chlorine value does not change the effective disinfection effect in the water.

Nevertheless, the aforementioned overdosing is avoided. The recognised reference method DPD 1 (for free chlorine) is used as a comparison method to calibrate the amperometric sensors. The reference method is pH-independent (or buffers the pH value to 6.5) and therefore determines the free chlorine nearly completely as 100% HOCl. The pH influence on the chlorine value measured by the sensor can be compensated by the controller so that the concentration value measured by the amperometric chlorine measuring system corresponds to this free chlorine value. The controller can carry out this compensation automatically either using an integrated pH measurement or manually relative to a fixed pH value. We recommend the automatic version. Here it is also essential to measure the sample water temperature, as it has a significant influence on the pH measurement. If this influence were not to be compensated, then the pH value would not be measured accurately and then the chlorine value would be incorrectly compensated.

No calibration is possible at high pH values without pH compensation, because the difference between the measurement with the chlorine sensor and the comparison DPD 1 reference method is too great.

The working range of the pH compensation: pH 4.00 ... 8.50, Temperature: 5 ... 45 °C

Measurement of dissolved oxygen: You need to enter the following correction variables in the event of exacting requirements relating to measuring accuracy (see specification of sensor types): Air pressure, Higher than NNI, Salinity or Conductivity. The temperature correction variable is already corrected in the

sensor with sensor types DO1, DO2 and DO3. If you switch the temperature to "OFF" for these sensor types, then you need to update the values of the correction variable at least prior to each calibration.



Calibration of the chlorine sensor with active pH compensation

It is mandatory that you always calibrate the pH sensor first and only then the chlorine sensor. Whenever the pH sensor is calibrated in future, the chlorine sensor always needs to be calibrated afterwards. Otherwise the chlorine measurement will be incorrect.

Sensor type:

First select the sensor type. The sensor type is given on the sensor nameplate. This sensor selection is necessary and activates the sensor-specific data in the controller.

Measuring range of the sensors

Select the measuring range. The measuring range is given on the sensor nameplate. An incorrect measuring range leads to an incorrect measurement.

Temperature

The temperature measurement is used only for information and recording purposes, but not for temperature compensation. Temperature compensation is performed in the sensor. If the measured variable [*Chlorine dioxide*] and the [*CDP*] type of sensor have been selected, then a separate temperature measurement is needed for temperature compensation.

11.1.6 Measured variable fluoride

Fluoride Measured Variable

When measuring fluoride as the measured variable, the sensor signal is converted into a 4 - 20 mA signal by a FPV1 or FP100V1 measuring transducer, depending on the measuring range. The measuring transducer is connected to the controller's mA input. The REFP-SE reference sensor is connected to the measuring transducer using a coaxial cable with an SN 6 plug.

FPV1 measuring transducer: Measuring range 0.05 ... 10 mg/l.

FP100V1 measuring transducer: Measuring range 0.5 ... 100 mg/l.

Measuring range of the measuring transducer

Select the measuring range. The measuring range is printed on the nameplate of the measuring transducer. An incorrect measuring range will lead to an incorrect measurement.

Temperature compensation

This function is used for compensation of the temperature influence on the measurement. This is only necessary with pH and fluoride measurement and when chlorine dioxide is measured using a CDP sensor.

Temperature: [Off] / [Manual] / [Automatic]

- *[Off]* switches the process temperature setting off
- *[Manual]* enables the process temperature to be manually specified, which makes sense with constant temperatures
- *[Automatic]* uses a measured process temperature. Automatic measurement of the temperature using the temperature sensor, e.g. Pt1000. With pH, temperature compensation can be switched *[ON]* or *[OFF]* in the menu.

11.1.7 Peracetic acid

Peracetic acid measured variable

Peracetic acid as a measured variable is measured via one of the two mA sensor inputs. Temperature compensation is performed in the sensor. An additionally connected temperature sensor is only used for display and data recording with a data logger and can be issued on a mA-output via field bus or web server.

Measuring range of the sensors

Select the measuring range. The measuring range is given on the sensor nameplate. An incorrect measuring range leads to an incorrect measurement.

Temperature

The temperature measurement is used only for information or recording purposes, but not for temperature compensation. Temperature compensation is carried out in the sensor.

11.1.8 Hydrogen peroxide

Hydrogen peroxide as a measured variable [mA]

Hydrogen peroxide as a measured variable is measured via one of the two mA sensor inputs. Temperature compensation is performed in the sensor. An additionally connected temperature sensor is only used for display and data recording with a data logger and can be issued on a mA-output via field bus or web server.

Measuring range of the sensors

Select the measuring range. The measuring range is given on the sensor nameplate. An incorrect measuring range leads to an incorrect measurement.

Temperature

The temperature measurement is used only for information or recording purposes, but not for temperature compensation. Temperature compensation is carried out in the sensor.

11.1.9 Conductivity [mA]

Measured variable conductivity [mA]

When measuring conductivity [mA], use of a measuring transducer is a prerequisite, e.g. a measuring transducer DMTa conductivity. A conductivity sensor cannot be directly connected to the controller.

Measuring range:

- Select the measuring range corresponding to the measuring range of the measuring transducer used. An incorrect measuring range leads to an incorrect measurement.

Temperature:

- The temperature measurement is used only for information or recording purposes, but not however for temperature compensation. Temperature compensation is carried out in the measuring transducer.

11.1.10 Conductive [*conductivity*]

Temperature compensation and reference temperature

NOTICE!

The sensor must be dry

Do not allow the conductivity sensor to come into contact with liquid. Only allow the conductivity sensor to come into contact with liquid once the conductivity sensor has been connected, configured and calibrated. The sensor parameters (zero point) of a moist or wet conductivity sensor can no longer be properly calibrated.

If the conductivity sensor has come into contact with liquid prior to calibration, there is an option to dry the conductivity sensor. A dry conductivity sensor can be successfully recalibrated to the sensor parameters.

Set the temperature compensation and reference temperature for correct display of the conductive conductivity and resistance.

Non-adjustable values are specified by the controller for the display of [*TDS*] and [*SAL*].

Tab. 17: Temperature compensation and reference temperature

Variable	Description	Type of temperature compensation	Area	Reference temperature (°C)
Specific conductivity / Electrical resistance	off	none		
	lin	linear, 0 ... 9.99%/K	- 20 °C...150 °C	15 °C ... 30 °C adjustable
	nLF	non-linear for natural water (DIN EN 27888)	0 °C...35 °C	20 °C or 25 °C selectable
		extended nLF function	35 °C ... 120 °C	20 °C or 25 °C selectable
TDS	---	linear	0 °C...40 °C	25 °C, fixed
SAL	---	non-linear according to PSS-78	0 °C...35 °C	15 °C, fixed according to PSS-78

The conductive conductivity measured at the fluid temperature is converted to the reference temperature [TREF].



Changing the reference temperature

The temperature coefficient must be recalibrated if the reference temperature is changed.

Adjustable process for temperature compensation

- [off]
 - *Temperature compensation is switched off. It is measured based on the set reference temperature.*
- [lin]
 - *Linear temperature compensation via the temperature range permitted for the sensors. The reference temperature can be set between 15 °C ... 30 °C.*
- [nLF]
 - *Non-linear temperature compensation according to DIN EN 27888 for natural water, between 0 °C ... 35 °C. The reference temperature can be switched, 20 °C / 25 °C.*

Configuring measured variables

Measured variable: TDS value

Symbol displayed in the controller's display:
[TDS] (total dissolved solids)

Unit of measurement: ppm (mg/l)

Physical variable: Total of all inorganic and organic substances dissolved in a solvent

Display range: 0 ... 9999 ppm

Temperature range: 0 ... 35 °C

[TLIMIT ↑]: ≤ 40 °C

Setting the TDS value displayed: You can set a multiplicative factor [TDS] in the menu, with which the TDS value displayed can be changed:

Displayed TDS value [ppm] = K (25 °C) [uS/cm]
* TDS factor

Setting range of TDS factor: 0.400 ... 1.000
(Default: 0.640)

Temperature compensation is always linear on the TDS display with a reference temperature of 25 °C.

Measured variable: Salinity (SAL)

Symbol displayed in the controller's display:
[SAL] units: ‰ (g/kg)

Physical variable: Mass of salts in one kg of water given in PSU (practical salinity units).

The salinity is derived from the conductivity measured, with a specified non-linear temperature compensation and a reference conductivity (KCL).

Display range: 0 ... 70.0 ‰

Temperature range: 0 ... 35 °C

[TLIMIT ↑]: ≤ 35 °C

The salinity [SAL] is calculated based on the [Practical Salinity Scale 1978 (PSS-78)]

11.1.11 Temperature [mA], (as main measured variable)

Measured variable temperature [mA], (as main measured variable):

For the measured variable 'Temperature [mA]' use of a DMTa temperature measuring transducer or a Pt100V1 measuring transducer is prerequisite. The measuring range is: 0 ... 100 °C. A temperature sensor cannot be connected directly to the controller.

11.1.12 mA general

Measured variable [mA general]

With the [mA general] measured variable, various preselected measured variable can be selected and/or one measured variable can also be freely edited with its unit of measure. The temperature measurement cannot be used for compensation purposes, because the influence of the temperature measurement on the measured value is not known. In principle, the settings are performed in the same way as with the other measured variable. A standardised calibrated signal is expected by the controller from each connected device

11.1.13 Features of the two-channel version

Two channel version

If a second measuring channel is available (dependent on the identity code, channel 2), then this second measuring channel can be configured according to the descriptions of the first measuring channel.

Two channel version with two identical measured variables

If the measured variables of measuring channel 1 and measuring channel 2 are chosen identically, then the menu item

[Differential meas] appears in the *[Measurement]* menu. The *[Differential meas]* function is switched off "ex works". The function *[Differential meas]* can be activated and the calculation *[K1-K2]* executed. The result of the calculation is displayed in the main display 2 by pressing the ▼ key or ▲ key. By pressing the ▼ or ▲ key again you jump back to the main display 1. The limit value criteria for the *[Differential meas]* can be set in the menu *[Limit values]*.

12 Calibration

- **User qualification:** instructed user,  Chapter 1.4 'User qualification' on page 13



Measuring channel settings

This descriptions of [Channel 1] apply correspondingly to the settings in all other measuring channels. The procedure for entering the settings for the channel in question is identical, however the parameters to be set may differ. Your attention is drawn to the differences, which are also described.







Display tolerances

Display tolerances between the sensor and/or measuring device and controller must be calibrated with sensors and/or with output signals from measuring devices that do not require calibration or where calibration is performed in the sensor/measuring device. The relevant information for this is contained in the respective operating instructions for the sensor or measuring device.





Cancelling the calibration process with ESC

ESC can be used to cancel an ongoing calibration process at any stage. The controller then continues to operate with the last calibration result detected as valid.

Continuous display  Menu  or  [Calibration]  .

or

Continuous display  .

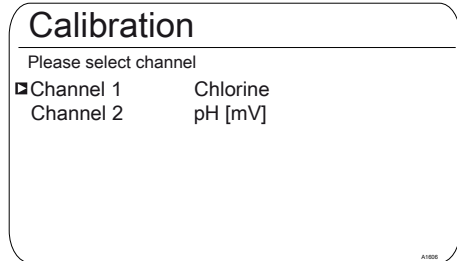

Fig. 36: Please select the channel.

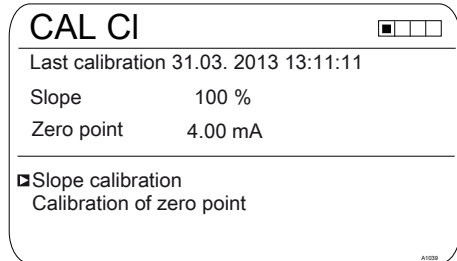

Fig. 37: [Calibration] display with the example of [Chlorine].



Calibration of the measuring channels

The calibration processes are identical for all measuring channels. However, it is necessary to calibrate each measuring channel separately.

12.1 Calibrating the pH Sensor

To ensure a high level of measuring accuracy, adjust the pH sensor at set time intervals. This calibration interval seriously depends on the application of the pH sensor and on the required measurement accuracy and reproducibility. The calibration interval can vary between daily and every few months.

Tab. 18: Valid calibration values

Evaluation	Zero point	Slope
Good	-30 mV ... +30 mV	-55 mV/pH ... -62 mV/pH
Acceptable	-60 mV ... -30 mV	- 40 mV/pH ... -55 mV/pH
	+30 mV ... +60 mV	-62 mV/pH ... - 65 mV/pH



If you measure the pH with potential equalisation, set the [Potential equalisation] procedure as a parameter when selecting the measured variable as a parameter.



Calibrate the pH-sensor for the function: pH compensation for chlorine measurement

It is mandatory that the pH measurement is always calibrated first and then the chlorine measurement. All other calibration of the pH measurement must always be followed by calibration of the chlorine measurement. Otherwise the chlorine measurement will be inaccurate.

Selecting the calibration process

Select the calibration process prior to initial calibration. This selection is saved until you select a new process.

- 2-point calibration: This is the recommended calibration process because it evaluates the sensor characteristic data: asymmetric potential, slope and response speed. 2 buffer solutions are needed for 2-point calibration, e.g. pH 7 and pH 4 if subsequent measurement is to be performed in an acidic medium or pH 7 and pH 10, if subsequent measurement is to be performed in an alkaline medium. The buffer gap should be at least 2 pH units.
- Samples (1-point) calibration: There are two options here. Samples (1-point) calibration is only recommended with reservations. From time to time check the sensor with 2-point calibration.
 - The pH sensor remains in the sample medium and you should calibrate a sample of the medium to be measured against an external comparison measurement. Perform the comparison measurement using an electrochemical method. Deviations of up to ± 0.5 pH units can occur using the phenol red method (photometer).
 - Calibration solely using a pH 7 buffer. This only calibrates the zero point. The sensor is not checked for an acceptable slope.
- Data input: With this calibration method, using a comparison measuring device, determine in advance the characteristic data of the pH sensor (asymmetry and slope) at standard temperature and enter this data into the controller. The comparative calibration should not have been done more than a week before, as the pH sensor's characteristic data changes if it is stored for longer.

Buffer temperature dependencies



Buffer temperature

At temperatures that differ by 25°C in the process, adjust the pH of the buffer solution by entering the reference values printed on the buffer solution bottle into the controller prior to calibration.



Buffer temperature dependencies

An incorrectly entered buffer temperature can lead to incorrect calibration.

Each buffer has different temperature dependencies. You have various choices in terms of compensating for these temperature dependencies, so that the controller can correctly process the buffer temperature.

- *Buffer temperature [Manual]: Ensure that the buffer temperature is identical for both buffers. Enter the buffer temperature in the [CAL Setup] menu item in the controller.*
- *Buffer temperature [Automatic]: Then immerse the temperature sensor connected to the controller together with the pH sensor into the buffer. Wait for a sufficiently long period of time until the pH and temperature sensor have recorded the buffer temperature.*
- *Buffer temperature [Off]: this setting is not recommended. Please use another setting.*

The sensor stability information displayed during calibration, *[acceptable]*, *[good]* and *[very good]*, indicates to what extent the sensor signal fluctuates during calibration. At the start of calibration, the waiting time for stabilisation of the measured value is 30 seconds; during this waiting time, *[Please wait!]* flashes in the display. You cannot continue with calibration during this waiting time.

If the pH sensor is cold, e.g. $< 10\text{ }^{\circ}\text{C}$, then the pH sensor responds slowly and you have to wait a few minutes until the sensor signal has stabilised.

The controller has no waiting time limit. You will see the actual [sensor voltage] in mV and can identify high fluctuations and assign influences to them, such as the movement of the sensor cable.

Calibration is impossible if the sensor signal is very unsteady and the sensor signal is disrupted by external influences, or if the sensor cable has a cable break or the coaxial cable is damp. Rectify any fault or cable break.

You can only continue with calibration once the signal bar has reached the *[acceptable]* range and remains there or moves towards *[good]* or *[very good]*. Changes to the signal within the ranges *[acceptable]*, *[good]* and *[very good]* are permitted.

The signal fluctuation width within the ranges is specified as follows:

- first 30 seconds wait time, then evaluation of the sensor signal
 - Acceptable: 0.5 mV/30s
 - Good: 0.3 mV/30s
 - Very good: 0.1mV/30s

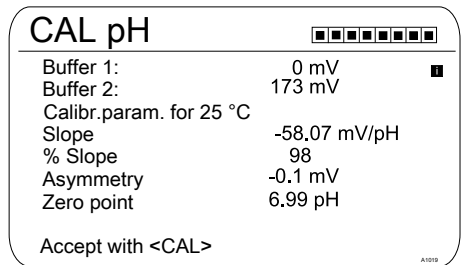

Fig. 38: Display of the calibration result

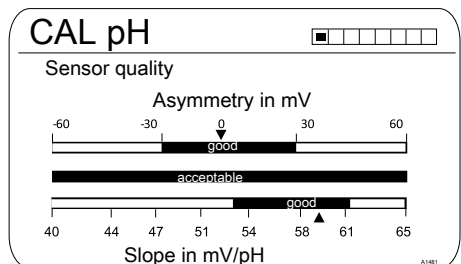



Fig. 39: Displayed after the \blacktriangleright key has been pressed

12.1.1 Selecting the Calibration Process for pH

To calibrate the controller there are three available calibration processes:

- 2-point
- Sample (1-point)
- Data input

Selecting the calibration process

1. ➔ Continuous display ➔ 
⇒ The Calibration menu is displayed, you may need to select [Channel 1] or [Channel 2], depending on the measuring channel on which the pH measurement is performed.

2. ➔ Press 

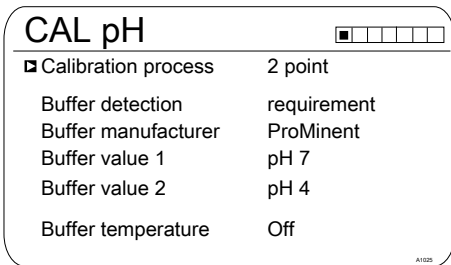



The screenshot shows a menu titled "CAL pH" with a progress indicator (a bar with 6 segments, the first is filled). Below the title is a list of settings:

▣ Calibration process	2 point
Buffer detection	requirement
Buffer manufacturer	ProMinent
Buffer value 1	pH 7
Buffer value 2	pH 4
Buffer temperature	Off

A1122

Fig. 40: Selecting the calibration process

3. ➔ Use the arrow keys to select the required menu item and press 
⇒ The input window appears and you can make the necessary settings for your process
4. ➔ Use the arrow keys to select the calibration process and press 
5. ➔ Continue with 
⇒ You can now start your chosen calibration process.

12.1.2 2-Point Calibration of the pH Sensor (CAL)



Correct sensor operation

- Correct measuring and metering is only possible if the sensor is working perfectly.
- Refer to the sensor's operating instructions.
- 2-point calibration is strongly recommended and is preferable to other methods.
- The sensor needs to be removed and refitted in the in-line probe housing for calibration. Refer to the operating instructions for your in-line probe housing.

i **Defining buffer detection**

There are 2 buffer detection options with 2-point calibration.

[Presetting]: select 2 buffers from the 4 possible buffer sets. During calibration, adhere to the selected order e.g. Buffer value 1: pH 7 and Buffer value 2: pH 4:

- ProMinent® (pH 4; 7; 9; 10). (default setting)
- NBS/DIN 19266 (pH 1; 4; 7; ; 9).
- DIN 19267 (pH 1;4; 7; 9; 13).
- Merck + Riedel® (pH 2; 4; 7; 9; 12).

The buffer sets differ in their pH values and temperature dependencies set in the controller. The pH values at the different temperatures are also printed on the buffer containers.

[Manual]: enter the buffer value with the associated temperature into the controller.

- The pH values of the buffer solution, at temperatures other than 25°C, are printed in a table on the label of the buffer bottle.

Select the available buffer.

CAL pH		■ □ □ □ □ □ □ □
<input checked="" type="checkbox"/> Calibration process	2 point	
Buffer detection	Manual	
Buffer manufacturer	ProMinent	
Buffer value 1	pH 7	
Buffer value 2	pH 4	
Buffer temperature	Manual	
Buffer temperature	25.0 °C	

Fig. 41: Example: Display in [CAL-Setup]

i **Used buffer**

Dispose of the used buffer solution. For more information: refer to the material safety data sheet for the buffer solution.

i **Valid calibration values**

Valid calibration:

- Zero point -60mV... +60 mV
- Slope 55 mV/pH...62 mV/pH

Two test containers with a buffer solution are required for calibration. The pH values of the buffer solutions must be at least 2 pH values apart. Thoroughly rinse the sensor with water when changing the buffer solution.

Continuous display ➔

CAL pH			■ □ □ □ □ □ □ □
Last calibration	06/04/2013	14:26:07	
Slope	56.64mV/pH		
Zero point	7,00 pH		
<input checked="" type="checkbox"/> CAL setup			■
Calibration process	2 point		
continue with <CAL>			

Fig. 42: pH sensor calibration (CAL)

1. ➔ Continue with .
2. ➔ Rinse the sensor thoroughly with water and dry with a cloth (pat dry, don't rub).
3. ➔ Immerse the sensor in test container 1 which contains the buffer solution (e.g. pH 7). Gently move the sensor.
4. ➔ Continue with .



Do not move the sensor cable during calibration as this can lead to signal variations.

⇒ Calibration is running .
[Please wait!] flashes.

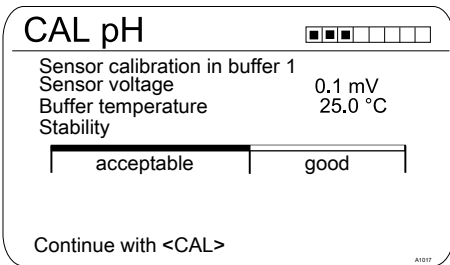

Fig. 43: Display of the sensor stability achieved

5. ➤ The range [acceptable / good / very good] is displayed.
 - ⇒ The black part of the horizontal bar indicates the determined range.
6. ➤ As soon as the black bar appears, the display changes from [Please wait!] to continue with .



The black bar does not need to be at [very good].

7. ➤ [Buffer detection] e.g. [Manual]: Press and, using the four arrow keys, set the buffer value for buffer 1 to the value of the buffer you are using. Press to confirm input of the value.
8. ➤ Remove the sensor from the buffer solution, rinse thoroughly in water and then dry with a cloth (pat dry, don't rub!)
9. ➤ Continue with .
10. ➤ Immerse the sensor in test container 2 which contains the buffer solution (e.g. pH 4). Gently move the sensor.
11. ➤ Continue with .



Do not move the sensor cable during calibration as this can lead to signal variations.

⇒ Calibration is running .
[Please wait!] flashes.

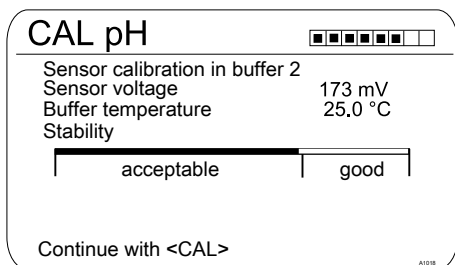

Fig. 44: Display of the sensor stability achieved

- 12. ▶ The range [acceptable / good / very good] is displayed.
 - ⇒ The black part of the horizontal bar indicates the determined range.
- 13. ▶ As soon as the black bar appears, the display changes from [Please wait!] to continue with .

The black bar does not need to be at [very good].

- 14. ▶ [Puffer detection] [Manual]: Press and, using the four arrow keys, set the buffer value for buffer 2 to the value of the buffer you are using. Press to confirm input of the value.
- 15. ▶ Continue with .

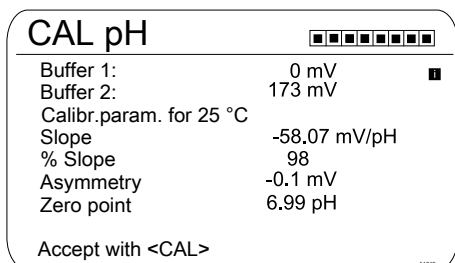

Fig. 45: Display of the calibration result

16. ▶

Incorrect calibration

An error message appears if the result of the calibration lies outside the specified tolerance limits. In this case the current calibration is not carried over.

Check the prerequisites for calibration and eliminate the error. Then repeat calibration.

Cleaning and care of pH and ORP sensors

Please note the separate instructions supplied with the pH and ORP sensors for cleaning and care of pH and ORP sensors.

After cleaning, the sensor must be conditioned in 3-molar potassium chloride solution for 60 minutes before it can be reused for calibration.

Carry over the result of the calibration into the controller memory by pressing .

- ⇒ The controller shows the continuous display again and operates with the results of the calibration.

12.1.3 pH sensor calibration (CAL) with an external sample (1-point)



Measuring and control behaviour of the controller during calibration

During calibration the actuating outputs are deactivated. Exception: a basic load or a manual control variable has been set. This remains active. The measured value output [standard signal output mA] is frozen, corresponding to its settings in the mA output menu.

When calibration/testing has been completed successfully, all of the error checks relating to the measured value are restarted. The controller saves all the determined data for zero point and slope upon a successful calibration.



NOTICE!

Poor sensor operation and fluctuating pH values during the process

The calibration method with an external sample has a number of disadvantages compared with the buffer solution calibration method. If the pH value fluctuates significantly during the process, then the pH value may change by a variable amount in the period between sampling, sample measurement and entry of the pH value into the controller. This could mean that the pH value entered into the controller does not correspond to the actual pH value in the process. Consequently the result is a linear displacement of the pH value across the entire measuring range.

If the pH sensor no longer reacts to changes in the pH value and only gives out a constant uniform mV signal, this cannot be detected using the calibration method with an external sample. With the calibration method with two buffers (e.g. pH 7 and pH 4), this becomes apparent if the pH sensor does not detect any changes in the pH value.

The calibration method with an external sample should only be used with installations where there is poor access to the pH sensor and the identical or very uniform pH values are used in the process. In addition the pH sensor should be regularly serviced or replaced.



Correct sensor operation

- Correct measuring, control and metering is only possible if the sensor is working perfectly
- Refer to the sensor's operating instructions

Tab. 19: Valid calibration values

Evaluation	Zero point	Slope
Very good	-30 mV ... +30 mV	56 mV/pH ... 60 mV/pH
Good	-45 mV ... +45 mV	56 mV/pH ... 61 mV/pH
Acceptable	-60 mV ... +60 mV	55 mV/pH ... 62 mV/pH

Continuous display ➔

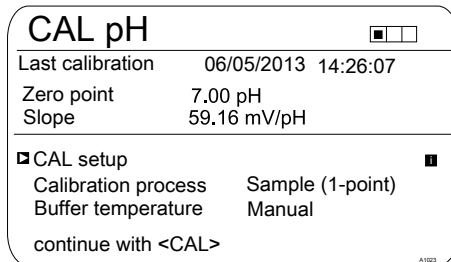

Fig. 46: pH sensor calibration (CAL)

1. ➔ Continue with
2. ➔ Take a water sample at the in-line probe housing and, using a suitable method (measuring strips, hand measuring instrument), measure the pH value of the sample

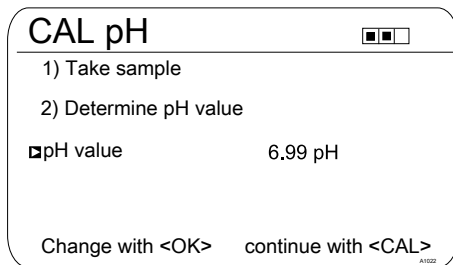

Fig. 47: Instructions for determining the pH value using the [Sample] method

3. ➔ Press **OK**
4. ➔ Use the arrow keys to enter the pH value you have determined in the controller
5. ➔ Press **OK**
6. ➔ Accept the pH value by pressing **CAL**
 - ⇒ All the values of the calibration result are shown in the display.



Incorrect calibration

An error message appears if the result of the calibration lies outside the specified tolerance limits. In this case, the current calibration is not applied.

Check the prerequisites for calibration and clear the error. Then repeat calibration.

7. ➔ Transfer the result of the calibration into the controller memory by pressing **CAL**
 - ⇒ The controller displays the continuous display again and operates with the results of the calibration.

12.1.4 Calibration of the pH Sensor (CAL) by [Data Input]



Data input

With the [Data input] calibration method, the known data of the sensor is entered in the controller. Calibration by data input is only as accurate and reliable as the method with which the data was determined.

The sensor data must have been determined recently. The more up-to-date the sensor data, the more reliable is this calibration method.



Correct sensor operation

- *Correct measuring and metering is only possible if the sensor is working perfectly.*
- *Refer to the sensor's operating instructions.*



Measuring and control behaviour of the controller during calibration

During calibration the actuating outputs are deactivated. Exception: a basic load or a manual control variable has been set. This remains active. The measured value output [standard signal output mA] is frozen, corresponding to its settings in the mA output menu.



When calibration/testing has been completed successfully, all of the error checks relating to the measured value are restarted. The controller saves all the determined data for zero point and slope upon a successful calibration.



Incorrect calibration

An error message appears if the result of the calibration lies outside the specified tolerance limits. In this case the current calibration is not carried over.

Check the prerequisites for calibration and eliminate the error. Then repeat calibration.

5.  Carry over the result of the calibration into the controller memory by pressing .
- ⇒ The controller shows the continuous display again and operates with the results of the calibration.

12.2 Calibrating the ORP Sensor

12.2.1 Selecting the calibration process for ORP

Selecting the calibration process

There are two calibration processes available for calibrating the controller:

- 1-point (with buffer solution)
- Data input

1. ➔ Continuous display ➔ 

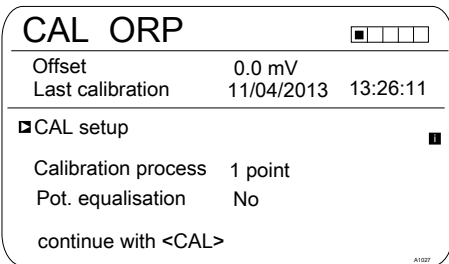



Fig. 50: [ORP] calibration menu

⇒ The calibration menu is displayed.

2. ➔ Use  to select the Setup menu or start calibration by pressing 

Selecting the calibration process

3. ➔ [CAL Setup]: Press 

⇒ The menu for selecting the calibration process appears.

4. ➔ Using the arrow keys select the required menu item [Calibration process] and press 

⇒ The input window appears.

5. ➔ Use the arrow keys to select the calibration process and press 

6. ➔ Continue with 

⇒ You can now start your chosen calibration process.

12.2.2 1-point calibration of ORP sensor (CAL)

Correct sensor operation

- Correct measuring and metering is only possible if the sensor is working perfectly
- Refer to the sensor's operating instructions
- Remove the sensor from the in-line probe housing and re-fit it for calibration. To do this, refer to the operating instructions for your in-line probe housing

ORP sensor calibration

The ORP sensor cannot be calibrated. Only an [OFFSET] deviation of magnitude ± 40 mV can be set and thus compensated. If the ORP sensor deviates by more than ± 40 mV from the reference value, then it must be checked in accordance with the requirements of the sensor operating instructions.

i **Measuring and control behaviour of the controller during calibration**

During calibration the actuating outputs are deactivated. Exception: a basic load or a manual control variable has been set. This remains active. The measured value output [standard signal output mA] is frozen, corresponding to its settings in the mA output menu.

When calibration/testing has been completed successfully, all of the error checks relating to the measured value are restarted. The controller saves all the determined data for zero point and slope upon a successful calibration.

i **Buffer used**

Dispose of the used buffer solution. For more information: refer to the buffer solution safety data sheet.

You need one test container with a buffer solution for calibration.

Continuous display ➔ 

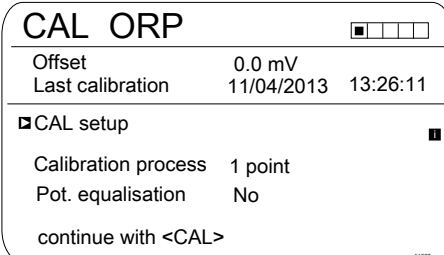

CAL ORP ■ □ □ □ □

Offset	0.0 mV	
Last calibration	11/04/2013	13:26:11

■ CAL setup ■

Calibration process	1 point
Pot. equalisation	No

continue with <CAL>

A1027

Fig. 51: 1-point calibration of ORP sensor (CAL)

1. ➔ Continue with 

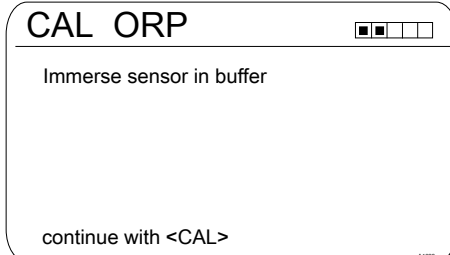

CAL ORP ■ □ □ □ □

Immerse sensor in buffer

continue with <CAL>

A1028

Fig. 52: 1-point calibration of ORP sensor (CAL)

2. ➔ Carry out the instructions and then press 

⇒ Calibration is running .
[Please wait!] flashes.

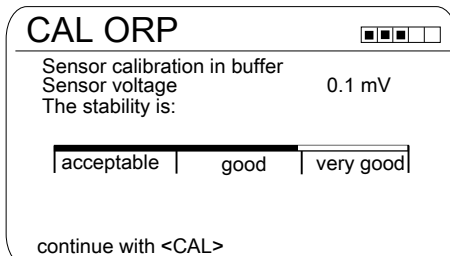

CAL ORP ■ □ ■ □ □

Sensor calibration in buffer
Sensor voltage 0.1 mV
The stability is:

| acceptable | good | very good |

continue with <CAL>

A1029

Fig. 53: Display of the sensor stability achieved

3. ➔ The [acceptable / good / very good] range is displayed

⇒ The black part of the horizontal bar indicates the range detected.

4. ➔ Continue with 

CAL ORP	
Buffer value	165 mV
Offset	0.0 mV

Accept with <CAL>

Fig. 54: Adjusting the buffer value

5. Press **OK** and use the four arrow keys to adjust the mV value of the buffer you are using
6. Press **OK**
7. Transfer the result of the calibration into the controller memory by pressing **CAL**
 - ⇒ The controller operates with the calibration results.

12.2.3 Calibration data for ORP sensor (CAL)



Correct sensor operation

- Correct measuring and metering is only possible if the sensor is working perfectly
- Refer to the sensor's operating instructions
- Remove the sensor from the in-line probe housing and re-fit it for calibration. To do this, refer to the operating instructions for your in-line probe housing



ORP sensor calibration

The ORP sensor cannot be calibrated. Only an "OFFSET" deviation of magnitude ± 40 mV can be set and thus compensated. If the ORP sensor deviates by more than ± 40 mV from the reference value, then it must be checked in accordance with the requirements of the sensor operating instructions.



Measuring and control behaviour of the controller during calibration

During calibration the actuating outputs are deactivated. Exception: a basic load or a manual control variable has been set. This remains active. The measured value output [standard signal output mA] is frozen, corresponding to its settings in the mA output menu.

When calibration/testing has been completed successfully, all of the error checks relating to the measured value are restarted. The controller saves all the determined data for zero point and slope upon a successful calibration.

Continuous display → 

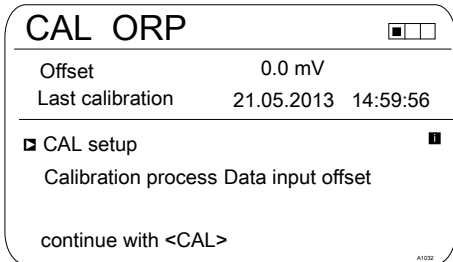

Fig. 55: Data input, ORP sensor calibration (CAL)

1. → Continue with 

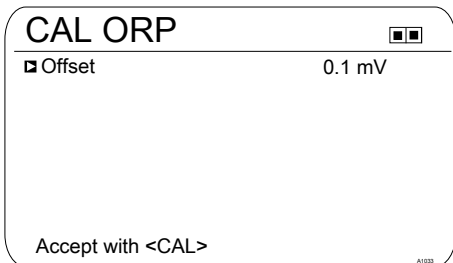



Fig. 56: Adjusting the [Offset]

2. → Press **OK** and use the four arrow keys to adjust the mV value of the buffer you are using
3. → Press **OK**
4. → Transfer the result of the calibration into the controller memory by pressing 
 - ⇒ The controller operates with the calibration results.

12.3 Calibrating the Fluoride Sensor

12.3.1 Selection of the calibration process for fluoride

To calibrate the controller there are two available calibration processes:

- 1 point
- 2 point

Calibration process selection

1. → Continuous display → 

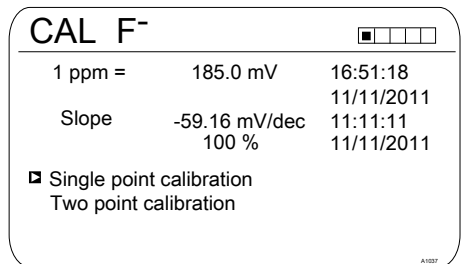

Fig. 57: Calibration menu [Fluoride]

- ⇒ The calibration menu is displayed.
2. → Using the arrow keys select the desired menu item. Press the **OK** key
 - ⇒ You can now start the selected calibration process.

12.3.2 2-point fluoride sensor calibration (CAL)



Correct sensor operation

- *Correct measuring and metering is only possible if the sensor is working perfectly*
- *Observe the sensor operating instructions*
- *The carrying out of a 2-point calibration is strongly recommended and is to be preferred to other methods*
- *For calibration the sensor must be removed and refitted in the in-line probe housing. To do this, observe the operating instructions of your in-line probe housing*



Used calibration solution

Dispose of the used calibration solution. For more information: see calibration solution safety data sheet.

Two test containers with a calibration solution are required for calibration. The fluoride content of the calibrating solutions should be at least 0.5 ppm F⁻ apart from each other. The sensor should be rinsed thoroughly with fluoride-free water when changing the calibrating solution.

Material required for calibration of fluoride sensors:



- Two test containers with calibrating solution



Measuring and control behaviour of the controller during calibration

During calibration the actuating outputs are deactivated. Exception: a basic load or a manual control variable has been set. This remains active. The measured value output [standard signal output mA] is frozen, corresponding to its settings in the mA output menu.

When calibration/testing has been completed successfully, all of the error checks relating to the measured value are restarted. The controller saves all the determined data for zero point and slope upon a successful calibration.

1. ➔ Press the  key in the continuous display.
2. ➔ Using the arrow keys select *[Two point calibration]*
3. ➔ Then press 

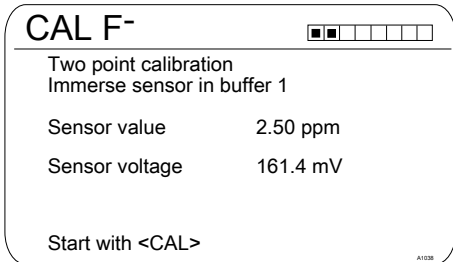



Fig. 58: Fluoride sensor calibration (CAL)

4. ➔ Immerse the sensor in test container 1 with calibration solution. When doing so gently move the sensor
5. ➔ Then press 
 - ⇒ *[Calib. in progress]* 

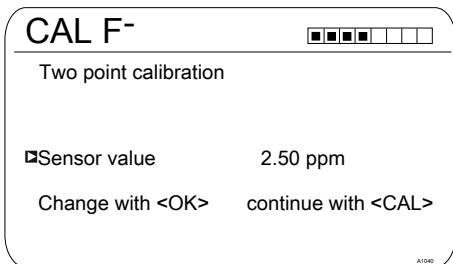





Fig. 59: Fluoride sensor calibration (CAL)

6. ➔ Then press  to change the ppm value or press  to continue with the calibration
7. ➔ Then press 

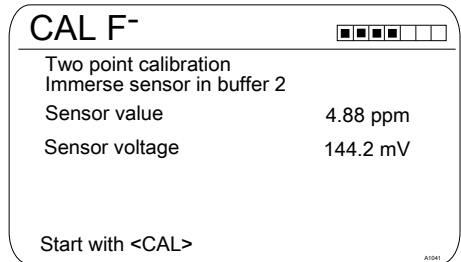







Fig. 60: Fluoride sensor calibration (CAL)

8. ➔ Immerse the sensor in test container 2 with calibration solution. When doing so gently move the sensor
9. ➔ Then press 
 - ⇒ *[Calib. in progress]* 
10. ➔ Then press  to adjust the ppm value or press  to continue with the calibration
11. ➔ Then press 
12. ➔ Import the result of the calibration into the controller memory by pressing the  key
 - ⇒ The controller displays the continuous display again and operates with the results of the calibration.



Incorrect calibration

Should the result of the calibration lie outside the specified tolerance limits, an error message appears. In this case the current calibration will not be applied.

Check the prerequisites for the calibration and clear the error. Then repeat the calibration



Measuring and control behaviour of the controller during calibration

During calibration the actuating outputs are deactivated. Exception: a basic load or a manual control variable has been set. This remains active. The measured value output [standard signal output mA] is frozen, corresponding to its settings in the mA output menu.

When calibration/testing has been completed successfully, all of the error checks relating to the measured value are restarted. The controller saves all the determined data for zero point and slope upon a successful calibration.

12.3.3 1-point fluoride sensor calibration (CAL)



Correct sensor operation

- *Correct measuring and metering is only possible if the sensor is working perfectly*
- *Observe the sensor operating instructions*
- *The carrying out of a 2-point calibration is strongly recommended and is to be preferred to other methods*
- *For calibration the sensor must be removed and refitted in the in-line probe housing. To do this, observe the operating instructions of your in-line probe housing*





Used calibration solution

Dispose of the used calibration solution. For more information: see calibration solution safety data sheet.

One test container with calibration solution are required for calibration.

Material required for calibration of fluoride sensors:

- One test container with calibration solution

1. ➔ Press the  key in the continuous display.
2. ➔ Using the arrow keys select *[Single point calibration]*
3. ➔ Then press 

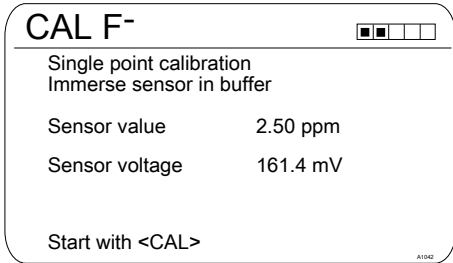



Fig. 61: Fluoride sensor calibration (CAL)

4. ➔ Immerse the sensor in test container 1 with calibration solution. When doing so gently move the sensor
5. ➔ Then press 
 - ⇒ *[Calib. in progress]* 

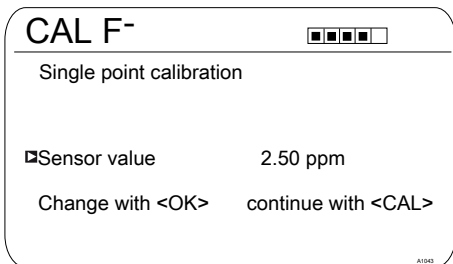





Fig. 62: Fluoride sensor calibration (CAL)

6. ➔ Then press  to change the ppm value or press  to continue with the calibration
7. ➔ Then press 
8. ➔ Import the result of the calibration into the controller memory by pressing the  key
 - ⇒ The controller displays the continuous display again and operates with the results of the calibration.



Incorrect calibration

Should the result of the calibration lie outside the specified tolerance limits, an error message appears. In this case the current calibration will not be applied.

Check the prerequisites for the calibration and clear the error. Then repeat the calibration

12.4 Calibration of Amperometric Sensors



Calibration of Amperometric Sensors

The calibration procedure for amperometric sensors is the same for all amperometric measured variables.

The procedure for calibrating amperometric measured variables is described throughout based on the measured variable chlorine [Cl]. All other measured variables require the same procedure as the measured variable chlorine [Cl].

The following measured variables can be calibrated using the procedure described here:

- Chlorine
- Chlorine dioxide
- Bromine
- Chlorite
- Ozone
- Peracetic acid (PES)
- H_2O_2



Combined calibration of pH and chlorine

It is mandatory that the pH measurement is always calibrated first and then the chlorine measurement. All other calibration of the pH measurement must always be followed by calibration of the chlorine measurement. Otherwise the chlorine measurement will be inaccurate.



Free chlorine or total available chlorine

Calibration of the zero point is not necessary.

Slope: Possible calibration in the range: 20% ... 300%.

A slope below 70% indicates a blockage of the diaphragm. Refer to the operating instructions for your sensor.

A slope of over 150% with sensors CLE3/CLE1 indicates surface-active components (surfactants) in the sample water. Replacing the diaphragm only delivers short-term improvement. It is important to prevent the occurrence of surfactants in the water. If surfactants cannot be avoided, then use an appropriate sensor, for example sensor type CBR.

12.4.1 Selecting the calibration process for amperometric measured variables

There are two calibration processes available for calibrating the controller:

- Calibrating the slope
- Calibrating the zero point

Selecting the calibration process

1. ➔ Continuous display ➔ 

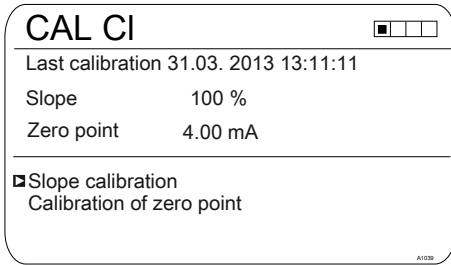



Fig. 63: [Chlorine] calibration menu

⇒ The calibration menu is displayed.

2. ➔ Use the arrow keys to select the chosen menu item. Press 

⇒ You can now start your chosen calibration process.

12.4.2 Calibrating the slope

 **CAUTION!**

Correct sensor operation / Run-in period

Damage to the product or its surroundings

- Correct measuring and metering is only possible if the sensor is working perfectly
- Please read the operating manual for the sensor
- Please also read the operating manuals for the fittings and other components used
- It is imperative that the run in periods of the sensors are adhered to
- The run in periods should be allowed for when planning commissioning
- It may take an entire working day to run in the sensor



Measuring and control behaviour of the controller during calibration

During calibration the actuating outputs are deactivated. Exception: a basic load or a manual control variable has been set. This remains active. The measured value output [standard signal output mA] is frozen, corresponding to its settings in the mA output menu.

When calibration/testing has been completed successfully, all of the error checks relating to the measured value are restarted. The controller saves all the determined data for zero point and slope upon a successful calibration.

The measured value frozen at the start of calibration is suggested as a reference value. The reference value can be set using the arrow keys. Calibration is only possible if the reference value is $\geq 2\%$ of the measuring range of the sensor.



NOTICE!

Prerequisites for correct calibration of the sensor slope

- The reference method needed is used, depending on the feed chemical used (e.g. DPD 1 for free chlorine).
- The run-in period for the sensor has been complied with; refer to the operating instructions for the sensor.
- There is permitted and constant flow at the in-line probe housing
- There is temperature balance between the sensor and the sample water
- There is a constant pH value in the permitted range

Material required for calibration of amperometric sensors:

- A reference method suitable for the measured variable in question

Remove sample water directly at the measuring point and determine the content of the feed chemical in the sample water in [ppm] using an appropriate reference method (e.g. DPD, titration etc.). Enter this value into the controller as follows:

1. ➔ Press **CAL** in the continuous display.
2. ➔ Use the arrow keys to select [Slope calibration]
3. ➔ Continue with **OK**

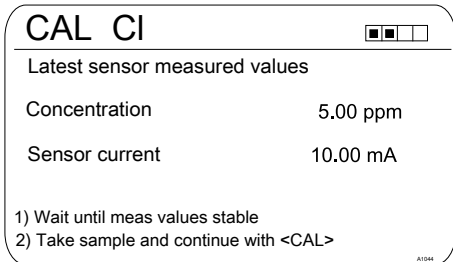

Fig. 64: Reference value calibration shows the actual sensor values

4. ➔ Continue with **CAL**

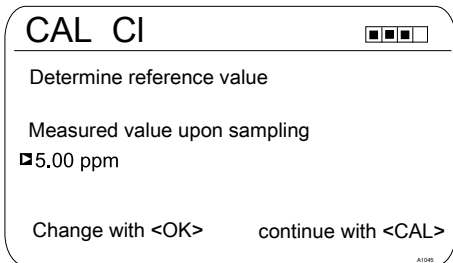

Fig. 65: Reference value calibration, the sensor value is frozen here; now take the sample and measure using DPD, for example

5. ➔ Then press **OK** to adjust the ppm value or press **CAL** to continue with the calibration

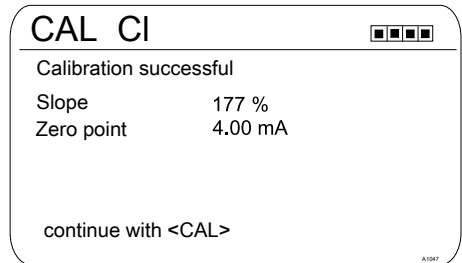

Fig. 66: Calibrating the reference value

6. ➔ Transfer the result of the calibration into the controller memory by pressing **CAL**
 - ⇒ The controller displays the continuous display again and operates with the results of the calibration.



Incorrect calibration

An error message appears if the result of the calibration lies outside the specified tolerance limits. In this case, the current calibration is not applied.

Check the prerequisites for calibration and clear the error. Then repeat calibration



Permitted calibration range

The permitted calibration range is 20 ... 300% of the sensor's rated value.

Example of a shallow slope: Blocking of the sensor membrane leads to a low slope (low slope = low sensor sensitivity)

Example of a steep slope: Surfactants make the sensor membrane more permeable, leading to a steeper slope (steep slope = high sensor sensitivity)



CAUTION!

Correct sensor operation / Run-in period

Damage to the product or its surroundings

- Correct measuring and metering is only possible if the sensor is working perfectly
- Please read the operating manual for the sensor
- Please also read the operating manuals for the fittings and other components used
- It is imperative that the run in periods of the sensors are adhered to
- The run in periods should be allowed for when planning commissioning
- It may take a whole working day to run-in the sensor

12.4.3 Calibration of zero point



Necessity for calibrating the zero point

Calibration of the zero point is not generally necessary. A calibration of the zero point is only necessary if the sensor is operated at the lower limit of the measuring range or if the 0.5 ppm sensor version is used.



Measuring and control behaviour of the controller during calibration



During calibration the actuating outputs are deactivated. Exception: a basic load or a manual control variable has been set. This remains active. The measured value output [standard signal output mA] is frozen, corresponding to its settings in the mA output menu.

When calibration/testing has been completed successfully, all of the error checks relating to the measured value are restarted. The controller saves all the determined data for zero point and slope upon a successful calibration.

! NOTICE!

Prerequisites for a correct calibration of the sensor zero point

- The run in period for the sensor has been adhered to
- There is permitted and constant flow at the in-line probe housing
- There is temperature balance between the sensor and the sample water
- There is a constant pH value in the permitted range

1. ➔ Press the  key in the continuous display.
2. ➔ Using the arrow keys select the [Zero point]
3. ➔ Then press 

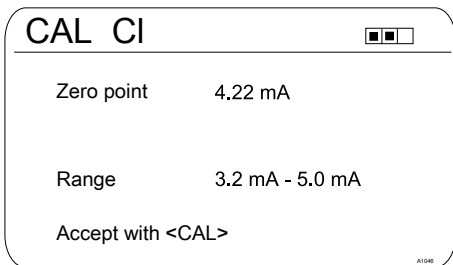



Fig. 67: Calibration of zero point

4. ➔ Then press 

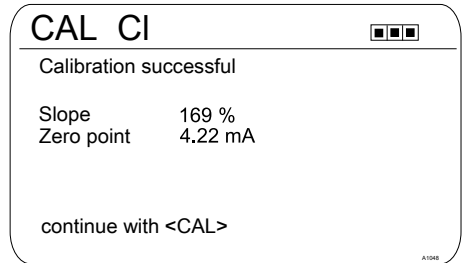



Fig. 68: Calibration of zero point

5. ➔ Import the result of the calibration into the controller memory by pressing the  key
 - ⇒ The controller displays the continuous display again and operates with the results of the calibration.



Incorrect calibration

Should the result of the calibration lie outside the specified tolerance limits, an error message appears. In this case the current calibration will not be applied.

Check the prerequisites for the calibration and clear the error. Then repeat the calibration

12.5 Calibrating the oxygen sensor

12.5.1 Specify the calibration interval

The calibration interval depends strongly on:

- the application
- the installation location of the sensor

If you wish to calibrate a sensor for a special application and/or a special installation location, then you can determine the calibration intervals using the following method. Check the sensor, e.g. one month after its commissioning:

1. Take the sensor out of the medium
 2. Clean the outside of the sensor with a damp cloth
 3. Then gently dry the sensor diaphragm, e.g. using a paper towel
 4. After 20 minutes, measure the oxygen saturation index in the air
 5. Protect the sensor against external influences, such as sunlight and wind
- ⇒ Now decide depending on the result:

Calibrate the sensor if the measured value is not $102 \pm 2\%SAT$.

If the value is within the target range, then you can extend the calibration interval. Repeat this process monthly and determine from the results the optimum calibration interval for your application.

 **Sensor manufacturer's calibration specifications**

When determining the calibration interval, consider the sensor operating instructions as they may specify additional and/or deviating calibration intervals.

12.5.2 Selection of the calibration process for the measured variable O₂

Different calibration modes are offered depending on the sensor type.

12.5.2.1 Calibration of the slope in air

1. ➤ Press the CAL key in the continuous display.
2. ➤ Use OK to select the measuring channel.
 - ⇒ The display appears as follows:

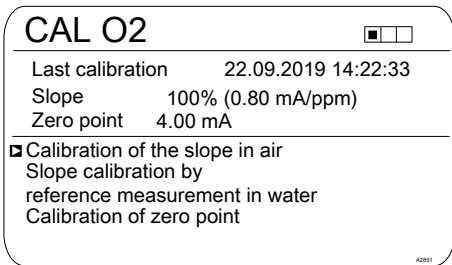

Fig. 69: Calibration of the slope in air

3. ➤ Use OK to select the calibration process: Calibration of the slope in air.
 - ⇒ The display appears as follows:

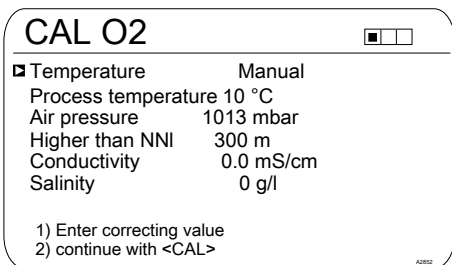

Fig. 70: Correction variable values

4. ➤ Enter the current values for the correction variables: Use OK to select the correction variable. Use the arrow keys to enter the values.
5. ➤ Use CAL to continue.
 - ⇒ The display appears as follows:

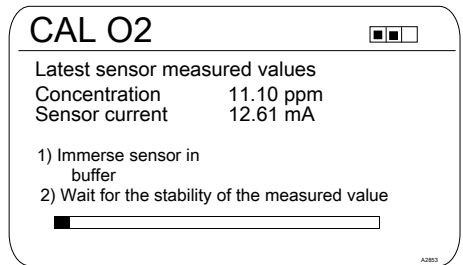

Fig. 71: Keeping the sensor in air saturated with water vapour

6. ➤ Keep the sensor in air saturated with water vapour.
7. ➤ Wait for the stability of the measured values.
8. ➤ The display appears as follows if calibration is successful:

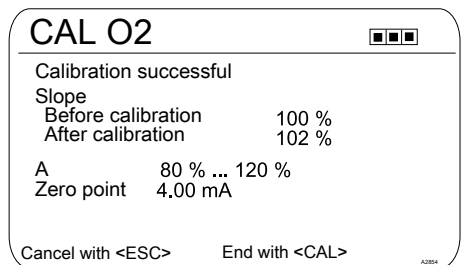

Fig. 72: Successful calibration

9. ➤ ■ Use CAL to confirm.
 - Press ESC to cancel.

10. ➔ The display appears as follows if calibration is unsuccessful:

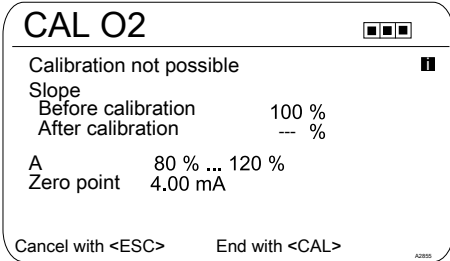

Fig. 73: Unsuccessful calibration

11. ➔ ■ Use CAL to end.
 ■ Press ESC to cancel.
12. ➔ Check the sensor and installation once again and repeat the calibration procedure.

12.5.2.2 Calibrating the slope using a reference measurement in water

1. ➔ Press the CAL key in the continuous display.
2. ➔ Use OK to select the measuring channel.
 ⇒ The display appears as follows:

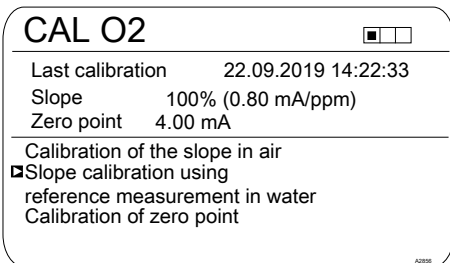

Fig. 74: Calibrating the slope using a reference measurement in water

3. ➔ Use OK to select the calibration process: Calibrate the slope using a reference measurement in water.
 ⇒ The display appears as follows:

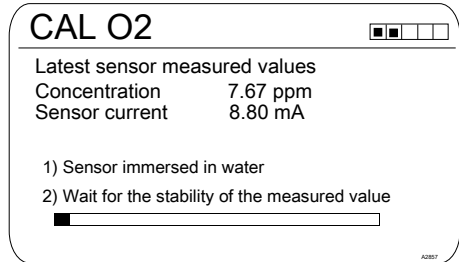

Fig. 75: Latest sensor measured values

4. ➔ Install the sensor in water.
5. ➔ Wait for the stability of the measured values.
 ⇒ The display appears as follows:

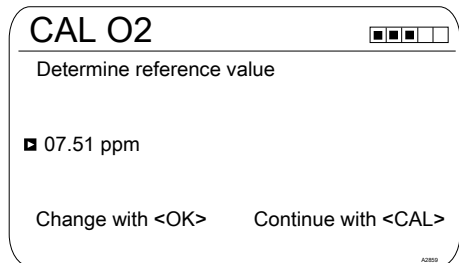

Fig. 76: Reference value

6. ➔ Use OK and the arrow keys to enter the reference value
 ⇒ The display appears as follows:

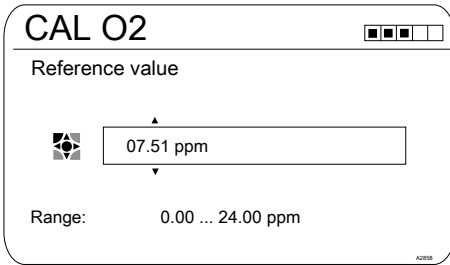

Fig. 77: Reference value

7. ➤ Continue with CAL.
8. ➤ The display appears as follows if calibration is successful:

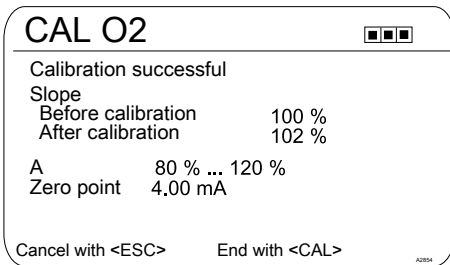

Fig. 78: Successful calibration

9. ➤
 - Use CAL to confirm
 - Press ESC to cancel
10. ➤ The display appears as follows if calibration is unsuccessful:

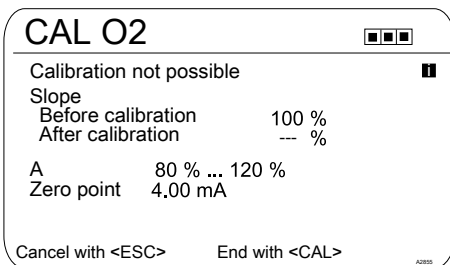

Fig. 79: Unsuccessful calibration

11. ➤
 - Use CAL to end
 - Press ESC to cancel
12. ➤ Check the sensor and installation once again and repeat the calibration procedure.

12.5.2.3 Calibration of the zero point

Calibration of the zero point is only needed for precise measurements at the lower end of the measuring range (< 5% of the measuring range).

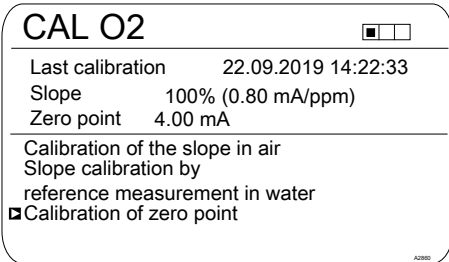

Fig. 80: Introduction: Calibration of the zero point

1. Use OK to select the calibration process: Calibration of the zero point.
⇒ The display appears as follows:

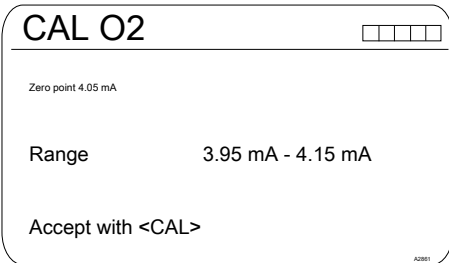

Fig. 81: Zero point

2. Position the sensor in an oxygen-free environment e.g. in water with a slight excess of sodium hydrogen sulfite and wait until the signal is stable
3. Use CAL to accept
4. The display appears as follows if calibration is successful:

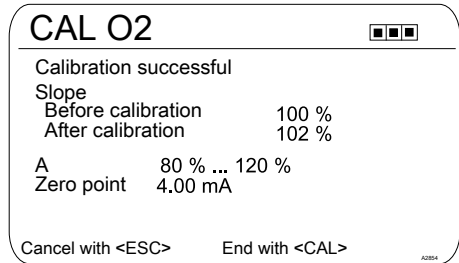

Fig. 82: Successful calibration

5. Use CAL to confirm
Press ESC to cancel
6. The display appears as follows if calibration is unsuccessful:

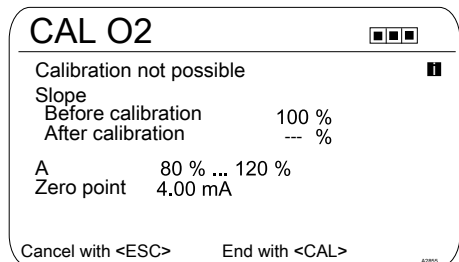

Fig. 83: Unsuccessful calibration

7. Use CAL to end
Press ESC to cancel
8. Check the sensor and installation once again and repeat the calibration procedure.

12.6 Measured value [mA general] calibration

Measured value [mA general] calibration

The measured value [mA general] cannot be calibrated, this menu item is shown 'greyed out' and has no purpose.















12.7 Calibrating Conductivity [mA]

Measuring and control behaviour of the controller during calibration

During calibration the actuating outputs are deactivated. Exception: a basic load or a manual control variable has been set. This remains active. The measured value output [standard signal output mA] is frozen, corresponding to its settings in the mA output menu.

When calibration/testing has been completed successfully, all of the error checks relating to the measured value are restarted. The controller saves all the determined data for zero point and slope upon a successful calibration.

You may need a manual measuring instrument for the conductivity measured variable. This manual instrument should measure and display sufficiently accurately to guarantee successful calibration.

1.  Press  in the continuous display.
2.  Use the arrow keys to select [Slope calibration].
3.  Continue with .
4.  Follow the instructions in the controller display and perform calibration.
5.  Continue with .
6.  Then press  to adjust the $\mu\text{S}/\text{cm}$ value or press  to continue with calibration.
7.  Carry over the result of the calibration into the controller memory by pressing .
 -  The controller shows the continuous display again and operates with the results of the calibration.

Incorrect calibration

An error message appears if the result of the calibration lies outside the specified tolerance limits. In this case, the current calibration is not carried over.

Check the prerequisites for calibration and eliminate the error. Then repeat calibration.

12.8 Calibrating conductive conductivity



Measuring and control behaviour of the controller during calibration

During calibration the actuating outputs are deactivated. Exception: a basic load or a manual control variable has been set. This remains active. The measured value output [standard signal output mA] is frozen, corresponding to its settings in the mA output menu.

When calibration/testing has been completed successfully, all of the error checks relating to the measured value are restarted. The controller saves all the determined data for zero point and slope upon a successful calibration.

12.8.1 Calibrating conductive conductivity, sensor parameter adjustment



NOTICE!

The sensor must be dry

Do not allow the conductivity sensor to come into contact with liquid. Only allow the conductivity sensor to come into contact with liquid once the conductivity sensor has been connected, configured and calibrated. The sensor parameters (zero point) of a moist or wet conductivity sensor can no longer be properly calibrated.

If the conductivity sensor has come into contact with liquid prior to calibration, there is an option to dry the conductivity sensor. A dry conductivity sensor can be successfully recalibrated to the sensor parameters.

If *[Sensor not dry]* continues to be displayed despite the conductivity sensor having been dried, then you will have to wait some time until the controller has detected the sensor as dry.

Once you have selected the sensor type, the prompt automatically appears asking whether the sensor parameters (zero point) have to be determined. You can initiate this prompt manually as follows:

Continuous display → Menu → ▲ or ▼
[Measurement] → OK → ▲ or ▼
[Measuring channel X Conductivity] → OK → ▲ or ▼
 ▼ *[Sensor parameter adjustment]* → OK.

1. ➤ Use the arrow keys to select *[Automatically determine sensor parameters]*.
2. ➤ Continue with OK.
 - ⇒ You will see the display showing *[Sensor dry]* and *[Automatically determine sensor parameters]*.
3. ➤ Continue with OK.
 - ⇒ You will see the display with the message *[Sensor parameters are automatically determined]*.

The sensor parameters are automatically carried over.

12.8.2 Calibrating conductive conductivity, cell constant

Prerequisite for calibration. The conductivity sensor is connected. The conductivity sensor is in a conductivity calibration solution, the conductivity of which is known.

Material	Order number
Conductivity calibration solution, 1413 $\mu\text{S}/\text{cm}$, 250 ml.	1027655
Conductivity calibration solution, 1413 $\mu\text{S}/\text{cm}$, 1000 ml.	1027656
Conductivity calibration solution, 12.88 mS/cm , 250 ml.	1027657
Conductivity calibration solution, 12.88 mS/cm , 1000 ml.	1027658

All parameters for the conductivity sensor are correctly entered in the *[Measurement]* menu item.

1. Press in the continuous display.
2. Use the arrow keys to select the channel which should be calibrated.
3. Then press
 - ⇒ You will see the display with the menu for selection of *[Cell constant]* or *[Temp. coefficient]*.

Calibration of the cell constant

4. Use the arrow keys to select *[Cell constant]*.
5. Continue with
 - ⇒ You will see the current data for the *[Cell constant]*. Enter the temperature coefficient of the calibration solution here.
6. Continue with calibration with .
7. Continue with .
8. Enter the known conductance of your conductivity calibration solution.
9. Accept with .
10. Continue with .
11. Apply the result of the calibration into the controller memory by pressing or cancel the process with ESC.
 - ⇒ The controller shows the calibration menu again and operates with the results of the calibration.

***Incorrect calibration***



Cell constant, valid range: 0.005 ... 15 1/cm

An error message appears if the result of the calibration lies outside the specified tolerance limits. In this case, the current calibration is not carried over.



Check the prerequisites for calibration and eliminate the error. Then repeat calibration.

12.8.3 Calibrating conductive conductivity, temperature coefficient

Prerequisite for calibration. The conductivity sensor is connected. The conductivity sensor is in a suitable liquid, e.g. a sample from the bypass fitting.

1. Press  in the continuous display.
2. Use the arrow keys to select the channel which should be calibrated.
3. Then press 
 - ⇒ You will see the display with the menu for selection of *[Cell constant]* or *[Temp. coefficient]*.

Check the *[Temp. coefficient]*

4. Use the arrow keys to select *[Temp. coefficient]*.
5. Continue with 
 - ⇒ You will see the current data for the *[Temp. coefficient]*.
6. Continue with 
 - ⇒ The sensor signal stability will be displayed – the temperature values relate to the temperature difference of the medium:
 - low (< 10 °C is too low),
 - good (> 10 °C is good),
 - very good (> 15 °C is very good).

 is displayed if the bar graph is in the "good" area.
7. Warm up the conductivity calibration solution by at least 10 °C but better by 15 °C while the conductivity sensor is in the conductivity calibration solution.
 - ⇒ The *[Sensor signal stability]* bar moves now to the right.

If *[low]* is displayed, then repeat the process at a temperature of 1 ... 2 °C higher. If *[low]* continues to be displayed, then the sensor is faulty. With *[good]* and *[very good]*, continue with .

8. Apply the result of the calibration by pressing 
 - ⇒ The controller shows the calibration menu again and operates with the results of the calibration.



Incorrect calibration

An error message appears if the result of the calibration lies outside the specified tolerance limits. In this case, the current calibration is not carried over.

Check the prerequisites for calibration and eliminate the error. Then repeat calibration.

12.9 Calibrating temperature



Measuring and control behaviour of the controller during calibration

During calibration the actuating outputs are deactivated. Exception: a basic load or a manual control variable has been set. This remains active. The measured value output [standard signal output mA] is frozen, corresponding to its settings in the mA output menu.

When calibration/testing has been completed successfully, all of the error checks relating to the measured value are restarted. The controller saves all the determined data for zero point and slope upon a successful calibration.

You may need a manual measuring instrument for the temperature measured variable. This manual instrument should measure and display sufficiently accurately to guarantee successful calibration.

1. ➤ Press in the continuous display.
2. ➤ Then press .
3. ➤ Follow the instructions in the controller display and perform calibration
4. ➤ Then press .
5. ➤ Then press to adjust the value or press to continue with calibration
6. ➤ Import the result of the calibration into the controller memory by pressing
 - ⇒ The controller shows the continuous display again and operates with the results of the calibration.



Incorrect calibration

An error message appears if the result of the calibration lies outside the specified tolerance limits. In this case the current calibration is not carried over.

Check the prerequisites for calibration and eliminate the error. Then repeat calibration.

13 Setting the [Control]

- **User qualification:** trained user,  Chapter 1.4 'User qualification' on page 13

Continuous display →  →  or  [Control] →  [Control]



Measuring channel settings

This descriptions of [Channel 1] apply correspondingly to the settings in all other measuring channels. The procedure for entering the settings for the channel in question is identical, however the parameters to be set may differ. Your attention is drawn to the differences, which are also described.



NOTICE!





Possible data loss

If you change the measured variable in the [Measurement] menu, see  Chapter 11 'Configuring measured variables' on page 80, all settings in the [Measurement] and [Control] menus are reset to their factory settings (default values). You then have to re-enter the settings in the [Measurement] and [Control] menus. The operator is responsible for the correct set-up of the controller.



Prerequisites for set-up of the [Control]:

The following settings are necessary for the [Control] set-up: Enter the settings if you have not yet done so.

- Specify the measured variable and all the necessary settings in the [Measurement] menu, see  Chapter 11 'Configuring measured variables' on page 80
- Specify all the actuators planned for the control task: You can find specifications for the relevant electrical connections and settings in the following menus
 - [Pumps], see  Chapter 16 'Setting the [Pumps]' on page 157.
 - [Relays], see  Chapter 17 'Setting the [Relays]' on page 160.
 - [mA outputs], see  Chapter 19 'Setting the [mA outputs]' on page 168.

Actuators (control elements) can include, for example, metering pumps, solenoid valves, motorised valves etc.

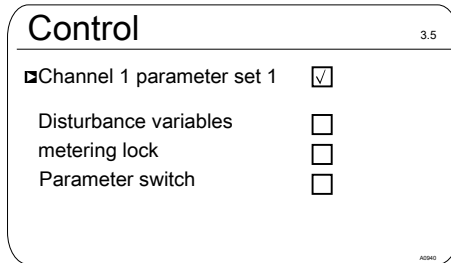

Fig. 84: Continuous display → → or [Control] → [Control]

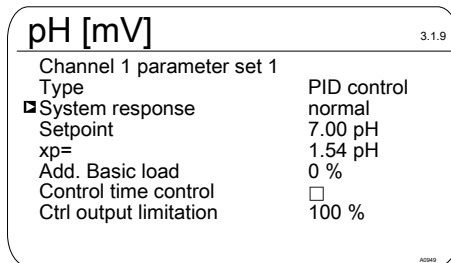

Fig. 85: for the example of pH [mV]: Continuous display → → or [Control] → [Control] → or [Channel 1 parameter set 1] → [Channel 1 parameter set 1]

Parameter level 1	Function	Parameter
[Channel 1 parameter set 1]	[Type]	none
		P-control
		PID control
	[System response]	normal
		manual
		with neutral zone
	[Setpoint]	The adjustable range of the setpoint is specified by the device.
	xp=	The adjustable range of the xp-value is specified by the device.

Setting the *[Control]*

Parameter level 1	Function	Parameter	
	Ti=	The adjustable range of the Ti-value is specified by the device.	
	Td=	The adjustable range of the Td-value is specified by the device.	
	<i>[Add. basic load]</i>	The adjustable range of the additive basic load is specified by the device.	
	<i>[Control checkout time]</i>	Checkout time ↑ (upper)	
		Checkout time ↓ (lower)	
		Control variable threshold	
<i>[Control variable limit]</i>	The adjustable range of the maximum control variable is specified by the device.		
<i>[Interference variables]</i>	Interference variable input	Off	
		On	
<i>[Setpoint]</i>	Channel 1, 2 or 3	Off	
		On	
<i>[Parameter switch-over]</i>	<i>[Event control]</i>	Off	
		On	
	<i>[Time control]</i>	Timer 1 ... 10: Off	
		Timer 1 ... 10: On	

Each controller can be configured as a monodirectional or bidirectional controller. Two parameter sets are available for each controller. The 2nd parameter set is activated if the digital input 2 is set as the *[Control. Parameter switch-over]*. In this case *[Parameter set 2]* can be configured in the menu.

When connecting the actuator, ensure that the actuator which raises the measured value is connected to the corresponding output *[Raise measured value]*, and the actuator which lowers the measured value is connected to the output *[Lower measured value]*, see ↗ *Chapter 9.4 'Electrical installation' on page 43*.

Example: A medium with an actual value of pH 3 should have its pH raised to the setpoint pH 7 using a sodium hydroxide solution (pH >14). Therefore connect the actuator to the control output *[Raise measured value]*.

Effective direction of the [control], bidirectional or monodirectional

You can vary the [control] based on various characteristics.

Function: A bidirectional [control] operates in two possible directions (raise AND lower measured value).

Application: Acidic or alkaline waste water is produced alternately in a neutralisation process in an industrial waste water system. Before the water can be fed into the sewage system, the pH value must be set, for example, to a value between pH 6.8 and 7.5. A bidirectional controller with two metering pumps for metering acid and alkali is used for this purpose. The pH value can be both lowered or raised to come within the necessary setpoint range.

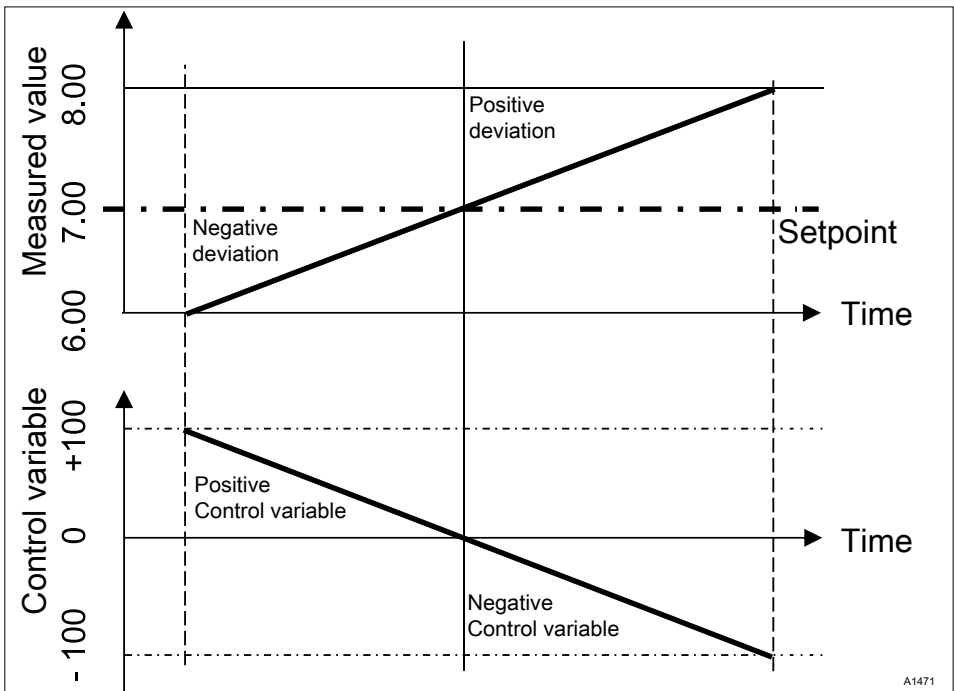
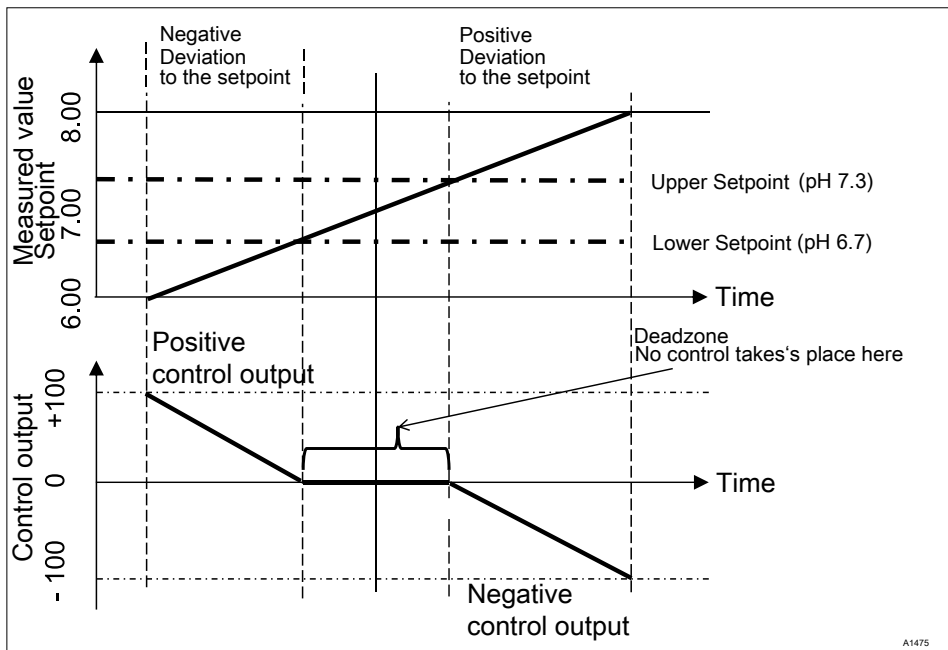

Fig. 86: Control type PID bidirectional. Control characteristic without neutral zone



A1475

Fig. 87: Control type PID bidirectional, with neutral zone

Function: A monidirectional [control] operates in only one of two possible directions (raise OR lower measured value).

Application: This affects, for example, a disinfection process, in which chlorine is added to water. The incoming water has a chlorine concentration of 0 ppm and is to be adjusted to 0.5 ppm by the addition of sodium-calcium hypochlorite. The addition of sodium-calcium hypochlorite raises the measured value.

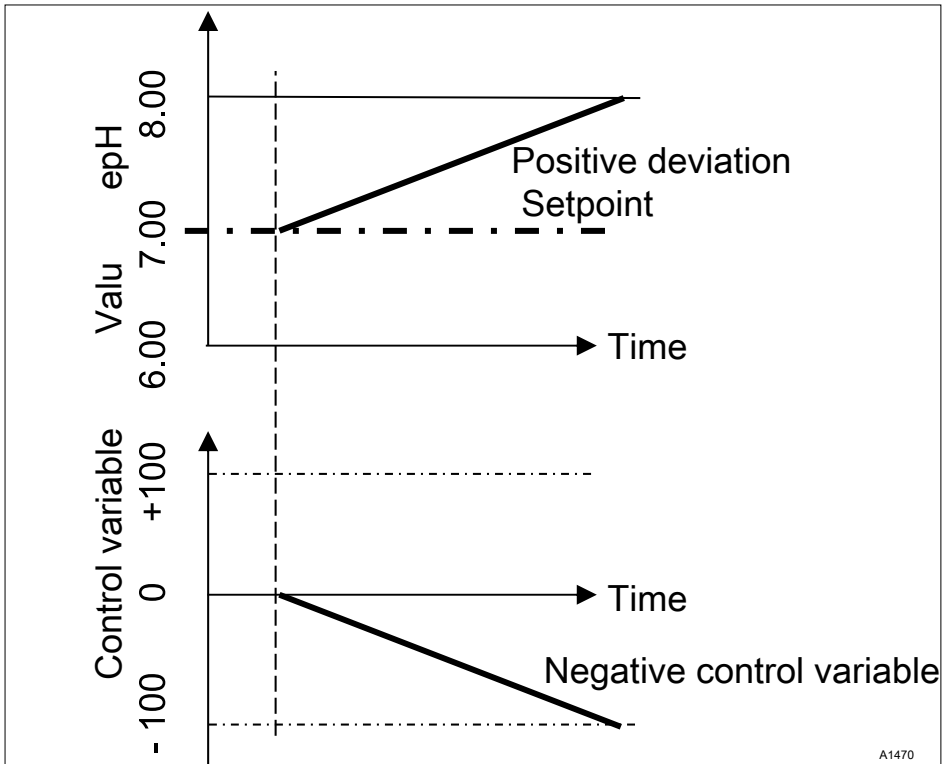

Fig. 88: Control type PID monidirectional, pH-lowering direction

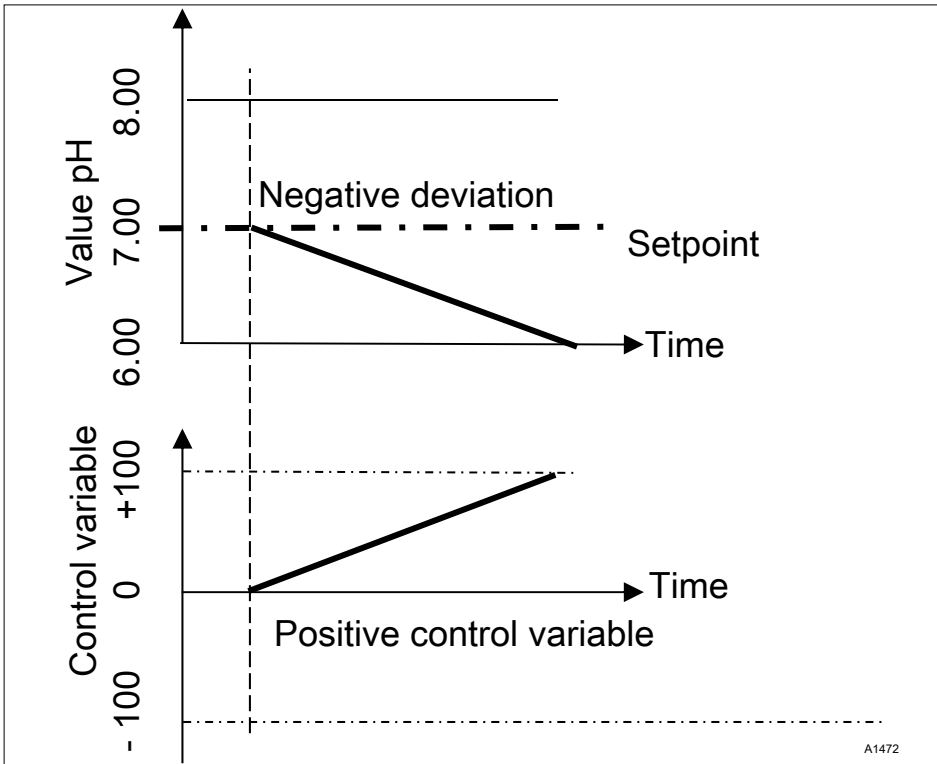

Fig. 89: Control type PID monodirectional, pH-raising direction

Adjustable parameters in the [Control] menu

Make the following selection in the Control menu:

13.1 Control parameter [Type]

You set the controller type under the menu option [Type]. You can set the [Type] as [1-way] or [2-way].

P, PI, PID controllers are continuous controllers. The control variables can take any value in the control range from -100 % ... +100 %.

P controller:

This controller type is used with an integrating control path (e.g. [Batch Neutralisation]). If the control deviation becomes small then the control (actuation) of the actuator becomes smaller (proportional relationship). If the setpoint is nearly reached, then the control output is nearly 0 %. However the setpoint is never exactly reached. Consequently a permanent control deviation results. When stabilizing large changes, excess oscillations may occur.

PI controller:

This controller type is used with a non-integrating control path (e.g. flow neutralisations). Here excess fluctuation must be avoided. No permanent control deviation must occur. The setpoint must always be adhered to. A constant addition of metering chemicals is required. It is not a malfunction when the controller does not stop metering when the setpoint is reached.

PID controller:

This controller type has the properties of a PI controller. Due to the differentiating control part [D], it also offers a certain level of foresight and can react to forthcoming changes. It is used when measurement spikes occur in the measurement curve and these must be quickly regulated out.

13.2 Control parameter [System response]

You can set the system response of the controller under the menu option [System response].

Standard

The controller reacts with its P, PI or PID system response as described in ↗ Chapter 13.1 'Control parameter [Type]' on page 138.

[Standard] is the selection for [1-way] controlled processes.

[Dead zone]

The [Dead zone] is defined by an upper and lower setpoint. The [dead zone] only operates with a [2-way] [control], if an actuator is available for each direction.

The [dead zone] should have the effect of preventing the control path from starting to oscillate. If the measured value lies within both the setpoints, then no control of the actuators takes place. In this case even a PI/PID controller does not activate its actuators. The [dead zone] is used with a [2-way] neutralisation.

13.3 Control parameter [Setpoint]

The setpoint specifies the target value for control. The controller attempts to maintain the deviation between the setpoint and the actual value (measured value) as close to '0' as possible.

13.4 Control parameter [xp]

The xp value is the controller amplification factor. The xp value relates to the measuring range end of a controller and is entered as an absolute value. For pH for example $xp=1.5$.

For measured variables such as chlorine, the sensor measuring range is selected. The sensor measuring range corresponds to the measuring range end.

For pH, the measuring range end is 15.45. Here the default xp value is 1.54 (corresponds to ± 1.54 pH). The xp value states that for a deviation of ± 1.54 from the setpoint, the control variable equals $\pm 100\%$. The smaller the xp value, the more 'forcefully' the control reacts, however the control also moves slightly into the over-control range.

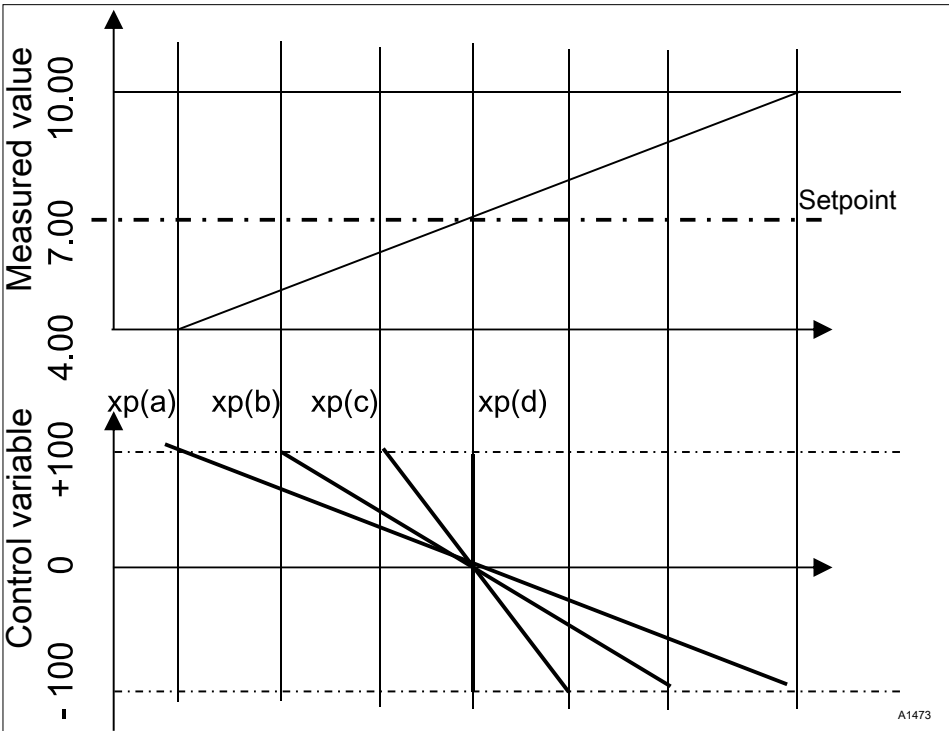

Fig. 90: The smaller the xp value, the more "forcefully" the control reacts.

13.5 Control parameter [Ti]

The time $[Ti]$ is the integral time of the I-controller (integral controller) in seconds. The time $[Ti]$ defines the time integration of the control deviation from the control variable. The smaller the time $[Ti]$, the greater the effect on the control variable. An infinitely long time $[Ti]$ results in a pure proportional control.

13.6 Control parameter [Td]

The time $[Td]$ is the differentiation time of the D-controller (differential controller) in seconds. The D-controller reacts to the rate of change of the measured value.

13.7 Control parameter [Add. Basic load]

[Add. Basic load] is the additive basic load. The additive basic load should balance out a continuous requirement for feed chemical in order to maintain the setpoint.

The additive basic load can be set in the range -100 % ... +100 %.

The additive basic load is added to the control variable determined by the controller and is effective in both control directions. E.g., if the control variable calculated by the controller equals

→ $y = -10\%$ and the add. basic load equals +3 %, then the resulting control variable = $Y = -10\% + (+3\%) = -7\%$

→ $y = 10\%$ and the add. basic load equals +3 %, then the resulting control variable = $Y = 10\% + (+3\%) = 13\%$

→ $y = 0\%$ and the add. basic load equals +3%, then the resulting control variable = $Y = 0\% + (+3\%) = 3\%$

13.8 Control parameter [Checkout time]

The *[checkout time]* should prevent overdosing as a result of a malfunction.

During the *[checkout time]* the control variable is compared with an adjustable *[threshold]* (= control variable threshold). Depending on the control direction, you can set different values for the *[checkout times]* *[Checkout time □ up]* for increasing and *[Checkout time □ down]* for reducing.

The thresholds depend on the concentration of the metered feed chemical. If the threshold is exceeded, time recording starts *[(checkout time)]*.

If during the *[checkout time]* the variable again falls below the threshold, then the time is again reset to '0' s.

If the control variable remains exceeded for longer than is permitted by the *[checkout time]*, then control stops immediately. This function (Control stop) resets automatically once the threshold is again undershot.

13.9 Control parameter [max. ctrl var.]

The *[max. ctrl var.]* specifies the maximum control variable to be output. This makes sense if an actuator is over-dimensioned and must not be opened to 100 %.

13.10 Interference variable

Steady control of flow processes using a feed forward control.

13.10.1 Additive and multiplicative feed forward control

Alongside information relating to the actual measured variable, e.g. the chlorine concentration, the interference variable is a further source of information for the controller that makes it easier for the controller to provide stable control during flow processes. During flow processes, both the above parameters change frequently within wide ranges. If one parameter variable is not known, then it is impossible to achieve stable control of the other parameter variable. If processing of an interference variable is enabled, then the processing of the interference variable is signalled on the controller's continuous display under *[NAME OF INTERFERENCE VARIABLE]* and *[UNIT]* with the letter *[Q]*. Depending on the configuration, an interference variable can be effective for one or both measuring channels

The signal source of the interference variable can be supplied to the controller via an analogue signal or a pulse frequency from a flow meter.

The following options are available in the basic version of the controller with measured variables VA and AA:

- Pulse frequency interference variable,
- mA interference variable,
- pH compensation for chlorine.

If both channels of the VA or AA module are used for measured variables, then you will need equipment package 4 to process the interference variable as an analogue signal.

A pulse frequency signal can be connected to digital input 2 and an analogue signal, depending on the identity code, to mA input 2 or 3.

With equipment package 4, the multiplicative interference variable can act on channel 1 and channel 2.

An additive interference variable can only act on channel 1 or 2.

e.g. Identity code: ...VA0

- mV input, channel 1: pH measurement
- mA input, channel 2: chlorine measurement
- Correction functions included:
 - pH compensation for chlorine
 - Temperature for pH

e.g. Identity code: ...VA0

- mV input, channel 1: pH measurement
- mA input, channel 2: mA interference variable
- Correction functions included:
 - Flow interference variable for channel 1
 - Temperature for pH

e.g. Identity code: ...AA0

- mA input, channel 1: chlorine measurement
- mA input, channel 2: mA interference variable
- Correction functions included:
 - Flow interference variable for channel 1

e.g. Identity code: ...VA4

- mV input, channel 1: pH measurement
- mA input, channel 2: chlorine measurement
- mA input, channel 3: mA interference variable
- Correction functions included:
 - pH compensation for chlorine
 - Additive interference variable for channel 2
 - Temperature for pH

Applicational example of additive interference variable

If the addition of a chemical is largely dependent on the flow (proportional dependency), then the addition of an additive interference variable proportional to the interference variable (flow), adds a proportion of the control variable to the control variable of the setpoint controller (setpoint control, that is the comparison, setpoint: actual value). It is also possible to completely switch off control of the setpoint and only provide flow-proportional metering. The measurement of the main measured value can be used together with the limit values as a monitoring function.

Applicational example:

You are to chlorinate potable water. The required setpoint is 0.3 mg/l (ppm) chlorine. The volumetric flow of the drinking water is measured with a flow meter. The measuring signal of the flow meter is routed to the controller via a 4 ... 20 mA signal. A chlorine sensor CLE3 continuously measures the chlorine. The volumetric flow changes within a wide flow range from 0 ... 250 m³/h. The chlorine concentration of 0.3 mg/l is achieved using the proportionality between the water flow and the added volume of chlorine. This requires the correct design of the metering pump according to the chlorine concentration. If the chlorine requirement were now to increase, caused by a higher flow or greater depletion (higher temperature, more germs), then an additional positive fraction of the setpoint control would be added to the flow-proportional control variable. If, by contrast, too much chlorine is metered, caused by a too high proportionality, then a negative control variable would be issued and added to the flow-proportional control variable, and the resulting control variable would fall.

Set the following in the menu of the control:

[Menu], [Control], [Interference variable], [On], [Signal source] = [mA input 2]

[Effect]: [additive]

[Assignment]: [0...20mA] or [4...20 mA]

[Nominal value]: enter the maximum expected analogue current here, e.g. 18 mA



13.10.2 Multiplicative interference variable

The multiplicative interference variable can influence the control variable of the setpoint controller over the entire control range proportionally to the interference variable. This corresponds to a proportionality factor of 0.00 = 0 % and 1.00 = 100 %, including all intermediate values.

Tab. 21: Interference variable

Parameter	Default setting	Possible values	Minimum value	Maximum value	Remark
Function	Off	On / Off			Switches the interference variable function on or off
Signal source	Frequency DI 2	Frequency DI 2 / mA input 2			Specifies the signal source from which the interference signal originates
Effect	additive	Additive / multiplicative			Specifies the effect of the interference variable
Nominal value	10 Hz	1...500 Hz	1 Hz	500 Hz	Specifies the maximum frequency of the contact water meter at maximum flow

13.11 Remote setpoint via a 0/4 ... 20 mA analogue signal

Continuous display →  → ▲ or ▼ [Control] →  [Control] → ▲ or ▼ [Remote setpoint (mA)] →  [Remote setpoint]



Availability of the remote setpoint

The menu [Remote setpoint (mA)] is only available with the 1-channel control of the controller.

The function [Remote setpoint] makes it possible for you to change the setpoint within a to be specified range for all measured variables of the controller channel 1 using an external 0/4 ... 20 mA analogue signal. The analogue signal can originate as an active signal from a PLC Programmable Logic Controller or also be specified using a 1 kOhm precision potentiometer.

Remote setpoint		3.3.1
Function	On	
Signal source	mA output 1	
▣ Range	4 ... 20 mA	
4mA =	1.00 ppm	
20 mA	1.00 ppm	
Assignment	Channel 1	

Fig. 91: Remote setpoint via a 0/4 ... 20 mA analogue signal

Description	Factory setting	Setting options
Function	Off	On/Off
Signal source	Fixed, mA input 2	
Area	4...20 mA	0...20mA/4...20mA
4 mA	Dependent on the measured variable and measuring range	Dependent on the measured variable and measuring range
20 mA	Dependent on the measured variable and measuring range	Dependent on the measured variable and measuring range
Assignment	Fixed, channel 1	

Applicational example:

In a process control system, several different pH setpoints must be reached in steps and then maintained. The system is controlled using a PLC Programmable Logic Controller. The PLC Programmable Logic Controller indicates the required standard signals to the controller via an analogue mA output. The controller automatically regulates based on the setpoint. The controller can report the current pH value to the PLC Programmable Logic Controller via an analogue mA output.



Electrical connection

The 0/4 ... 20 mA analogue signal specifies the setpoint and is connected to terminals XE8 3 (-) and 4 (+) of the extension unit.

13.12 [Parameter switch] via the digital input or [Timer]

Continuous display →  → ▲ or ▼ [Control] →  [Control] → ▲ or ▼ [Parameter switch] →  [Parameter switch]

An [Event controlled] or [Time controlled] [Parameter switch] allows you to activate an external potential-free switching signal for each alternative parameter set for all of the measured variables of channel 1 and channel 2 of the controller. Alternatively you can activate this switchover in a time dependent manner using 10 [Timers]. The existing active signal is valid, either [Time controlled] or [Event controlled].

If [Parameter switch] is activated, then menu 3.1 also includes the parameterisation option for the respective parameter set 2. The selection option within the parameter set is identical to parameter set 1. If parameter set 2 is not active, then parameter set 1 is automatically activated.

Application example:

In a process control system, two different pH setpoints with different control parameters must be reached and maintained. The system is controlled using a PLC. The PLC indicates the required event signal to the controller via a digital output. The controller then switches from [Channel 1 parameter set 2] to [Channel 2 parameter set 2] and then maintains the relevant setpoint automatically. [Parameter set 2] must always be activated from 22:00 to 05:00 Monday to Friday irrespective of the PLC setting. This is a combination of [Event controlled] and [Time controlled] operation.



Electrical connection

The external release signal can be processed from digital input 2 (terminal XK1_3 and 4) or digital input 5 (terminal XK3_3 and 4).

Event controlled

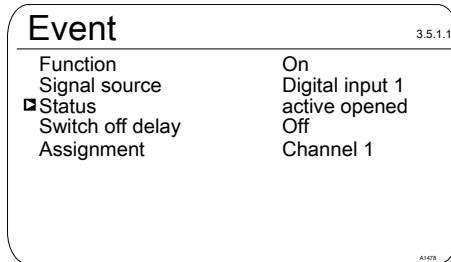

Fig. 92: Event controlled

Description	Factory setting	Adjustment Options
Function	Off	On/Off
Signal source	Digital input 2	Digital input 2, digital input 5
Status	Active opened	Active opened, Active closed
Switch off delay	Off	0=Off...1800s
Assignment	Channel 1	Dependent on device configuration, channel 1, channel 2, channel 1+2

Time controlled



For use of a [Timer] function, a [Timer] 1 ... 10 must be switched on. The On time and Off time must be specified within the [Timer]. If the off time (e.g. 11:00) is before the on time (e.g. 12:00), then the [Timer] is activated over two days.

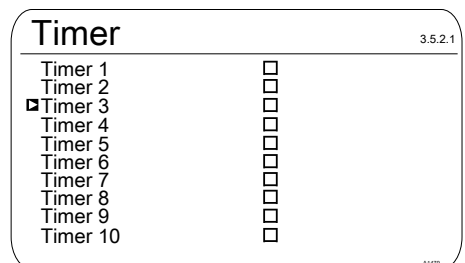

Fig. 93: [Timer control] = [Timer]

Timer 1		3.5.2.1.1
Function	On	
On time	03:00	
<input checked="" type="checkbox"/> Off time	03:01	
Monday	<input type="checkbox"/>	
Tuesday	<input type="checkbox"/>	
Wednesday	<input type="checkbox"/>	
Thursday	<input type="checkbox"/>	
Friday	<input type="checkbox"/>	
Saturday	<input type="checkbox"/>	
Sunday	<input type="checkbox"/>	

A1102

Fig. 94: Example: Timer 1

14 Setting the *[Limit values]*

- **User qualification:** trained user, see  Chapter 1.4 'User qualification' on page 13

Continuous display →  →  or  *[Limit values]* →  *[Limit values]*



Measuring channel settings

This descriptions of [Channel 1] apply correspondingly to the settings in all other measuring channels. The procedure for entering the settings for the channel in question is identical, however the parameters to be set may differ. Your attention is drawn to the differences, which are also described.

Limit values

4.1

▶ Limit value channel 1

A1011

*Fig. 95: Setting the *[Limit values]**

14.1 Function of the limit values

The limit values are not related to the control setpoint.

The limit values are continuously compared with the measured value.

Setting the *[Limit values]*

The limit values are values that can be set within the measuring range of a measured variable. For each measuring channel a Limit *[1]* can be set for exceeding, i.e. the measured value is greater than the limit value and a Limit *[2]* can be set for undershooting, i.e. the measured value is less than the limit value. As the controller only has two limit value relays, there is an option of selecting a limit value 'range'. An upper and lower limit are set as a limit value 'range'. If the measured value is above or below the 'range', then a limit value transgression exists.

If the limit is exceeded for longer than the *[Control time lim. val. (Δt_{on})]*, then an error message is triggered that has to be acknowledged and the alarm relay is deactivated. If the *[controller]* is also set to *[OFF]* then the control process stops.

[Lower lim] means that the limit criterion has been transgressed by undershooting of the lower limit.

[High limit] means that the limit criterion has been transgressed by exceeding of the upper limit.

The controller has the option of defining *[Hysteresis limit values]*.

[Hysteresis] works towards rectifying the limit transgression, i.e. if the *[Limit 1 upper]* of, for example, pH 7.5 has been exceeded by a set hysteresis limit of, for example, pH 0.20, then the criterion for limit transgression is redundant when the value drops below the lower limit of pH 7.3. The hysteresis behaviour for undershooting a *[Low limit]* functions in a similar way (here the hysteresis value is added to the limit value). In this way it is possible to forego an external relay in self-retaining mode.

If the limit is exceeded for longer than the *[Delay period limit values (Δt_{on})]*, then an acknowledgeable fault message is triggered and the alarm relay is deactivated. If the *[controller]* is also set to *[OFF]* then the control process stops.

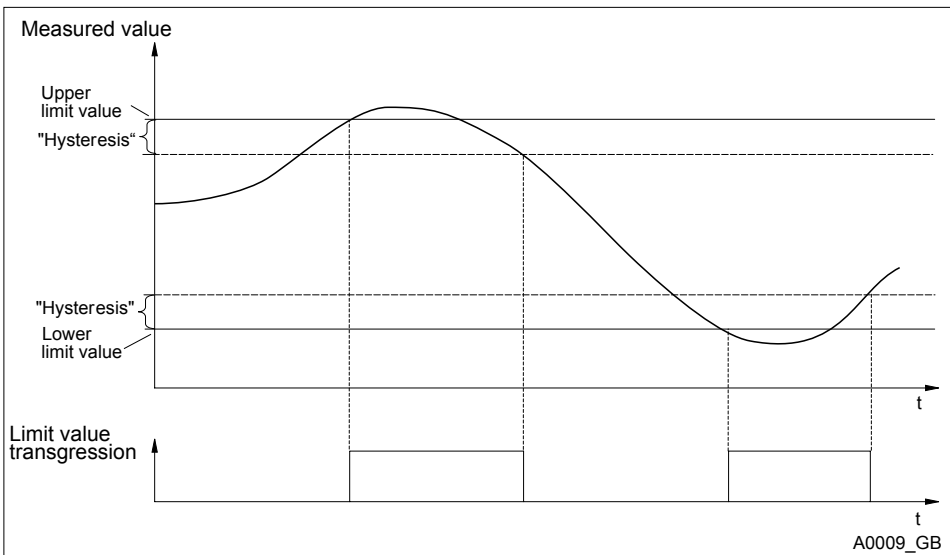

Fig. 96: Hysteresis

If the relays are defined as limit value relays, when a limit value transgression occurs they also switch to the alarm relay.

Different switch on-delays (Δt On) and Switch off delays (Δt Off) can be set for the limit value relays for *[Limit 1]* and *[Limit 2]*. They prevent the limit value relay from switching back and forward if the limit value is only exceeded for a short time (damping function).

If there are no limit value relays, the limit values can nevertheless be entered. The controller displays the reactions described when a limit value transgression occurs

Limit value relay used as an actuator

If the relays are defined as actuators, then they react like control outputs. Example: In the event of Pause being activated, or in the event of an alarm, an activated limit value relay is deactivated.

Existing limit value error with alarm

You can manually reset an existing limit value error with alarm, for instance to enable a controlled restart of a system to ensure that the limit value situation can be left.

If an alarm is pending, you can call up the *[System alerts]* menu from the continuous display by pressing **OK**. Select the alarm in question and use **OK** to reset. Resetting the alarm cancels the limit value error/alarm. Checking of the limit value criterion restarts in line with the delay periods set. Metering is started if necessary.

14.2 Setting limit values channel 1

Continuous display → → or [Limit values] → [Limit values] → or [Limit value channel 1] → [Limit value channel 1]

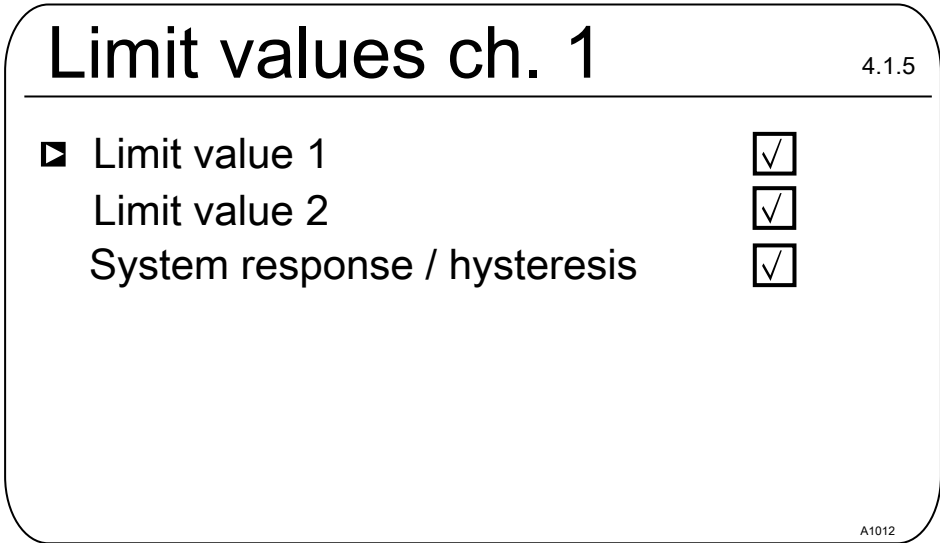

Fig. 97: Setting limit values channel 1

14.2.1 Setting [Limit 1]

Continuous display → → or [Limit values] → [Limit values] → or [Limit value channel 1] → [Limit ch. 1] → or [Limit ch. 1] → [Limit 1]

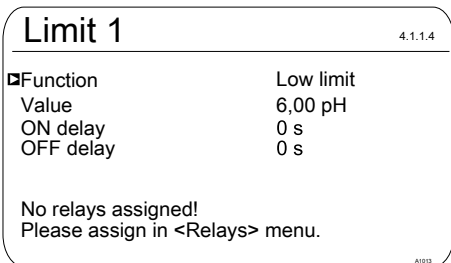

Fig. 98: Setting Limit 1

14.2.2 Setting [Limit 2]

Continuous display → → or [Limit values] → [Limit values] → or [Limit value channel 1] → [Limit value channel 1] → or [Limit 2] → [Limit 2]

Limit 2

4.1.3.1

<input checked="" type="checkbox"/> Function	High limit
Value	9.00 pH
ON delay	0 s
OFF delay	0 s

No relays assigned!
Please assign in <Relays> menu.

A1166

Fig. 99: Setting [Limit 2]

14.2.3 Setting [System response]

Continuous display → → or [Limit values] → [Limit values] → or [Limit value channel 1] → [Limit value channel 1] → or [System response] → [System response]

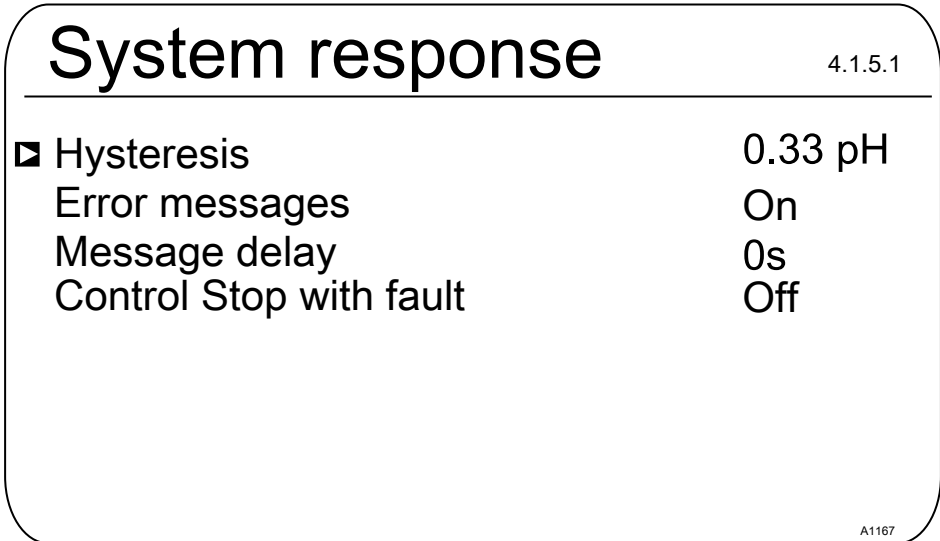

Fig. 100: Setting [System response]

You can select which control channel is stopped with a limit value transgression in the [Limit values] → [System behaviour] → [Hysteresis] menu.

The selection options are [Control stop]:

- Off
- Channel 1
- Channel 2

Example 1: If the pH value of channel 1 is so high that chlorine metering in channel 2 could become dangerous, then the metering of channel 2 is stopped when the pH value of channel 1 is too high and an alarm is triggered.

Example 2: The ORP value of channel 2 does not match the chlorine dioxide concentration of channel 2 and vice versa. Metering of chlorine dioxide can stop in these cases.

15 Digital input functions that can be set

Digital input	Off	Error sample water	Pause	Pause Hold	Level in storage tank 1	Level in storage tank 2	Level in storage tank 3
1 Base, module A	X	X	X	X			
2 Base, module A	X	X	X	X			
3 Base, module A	X	X	X	X	X		
4 Base, module A	X	X	X	X		X	
5 Extension, module C	X	X	X	X	X		
6 Extension, module C	X	X	X	X		X	
7 Extension, module C	X	X	X	X			X

Description of the functions:

Measuring channels 1 and 2 are located on the base module (module A). Channel 3 is optional and is located on the extension unit (module C)

The digital inputs 1, 2, 3 and 4 are located on the base module (module A).

The digital inputs 5, 6 and 7 are on the optional extension unit (module C).

Sample water error:

If a sample water error is pending, then metering of the selected channels is stopped immediately. An alarm is emitted, the display lights up red, an alarm relay is activated and the alarm relay drops out. Once the sample water error has been rectified, then the error status is reset, and the controllers restart according to the switch off delay set.

Pause:

When the Pause input is set, then metering stops immediately and all control outputs are set to 0 %. When the Pause input has been reset, then the controllers restart according to the switch off delay set. The last current I-factor has been saved and the I-factor is added to the P-factor currently calculated.

Pause Hold:

When the Pause Hold input is set, then the control outputs are frozen in the status prior to "Pause Hold". When the Pause Hold input has been reset, then the controller restarts according to the switch off delay set. The last current I-factor has been saved and the I-factor is added to the P-factor currently calculated.

Level of storage tank 1 ... 3

If a float switch input is set, then metering of the selected channels is stopped immediately. An alarm is emitted, the display lights up red, an alarm relay is activated and the alarm relay drops out.

'active open' / 'active closed' state:

'active open' means that the function to be controlled is activated when the input is open or not actuated. This status represents a safe status, a status that also occurs in the event of a line rupture.

'active closed' means that the function to be controlled is activated when the input is closed or actuated. This status represents a potentially unsafe status, a status that does not remain in the event of a line rupture.

Switch off delay 0 ... 1800 s:

Means that when activation is removed, the function is delayed by the time set.

Assignment of channel 1, channel 2, channel 3, channel 1+2, channel 1+3, channel 2+3, channel 1+2+3:

the function can either be applied only on 1 channel, on 2 channels or on all 3 channels.

16 Setting the [Pumps]

- **User qualification:** trained user, see *Chapter 1.4 'User qualification' on page 13*

Continuous display →  →  or  [Pumps] →  [Pumps]



Measuring channel settings

This descriptions of [Channel 1] apply correspondingly to the settings in all other measuring channels. The procedure for entering the settings for the channel in question is identical, however the parameters to be set may differ. Your attention is drawn to the differences, which are also described.

Pumps

5.2

- Pump 1 channel 1
- Pump 2 channel 1 ■
- Pump 3 channel 2
- Pump 4 channel 2

A1104

Fig. 101: Setting the [Pumps]



Setting [Pump 1] or [Pump 2]

Only the process for [Pump 1] is described. The set-up process for [Pump 2], [Pump 3] or [Pump 4] is the same as for [Pump 1].

16.1 Setting [Pump 1]



CAUTION!

Refer to the operating manual for the pump

Possibility of damaging the pump.
Faults in the process.

- Set the pump to [External Contact] operating status
- Observe the maximum stroke rate for the pump
- Switch off any stored stroke settings in the pump control
- The maximum stroke rate for the pump can be found in the pump operating manual
 - Setting a stroke rate on the controller, which is higher than the pump's actual possible maximum stroke rate, can lead to hazardous operating statuses



Maximum pump frequency

The pumps are activated according to the control variable up to the pump's respective maximum stroke rate.

Setting the [Pumps]

Continuous display →  →  or  [Pumps] →
 [Pumps] →  or  [Pump 1 channel 1] →

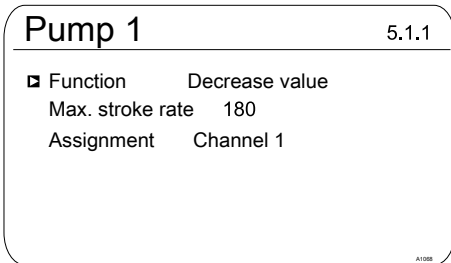





Fig. 102: Setting [Pump 1]

- Use the  or  keys to select the menu and confirm with 
- ⇒ The relevant setting menu appears.

Parameter	Settable function
<i>[Function]</i>	Set the pump to: <ul style="list-style-type: none">■ <i>[Increase value]</i>■ <i>[Decrease value]</i>■ <i>[Off]</i>
<i>[Max. stroke rate]</i>	The maximum stroke rate can be set freely between 0 ... 500 /min. The factory setting is 180/min
<i>[Assignment]</i>	Assign the pump to the relevant measuring channel: <ul style="list-style-type: none">■ Channel 1: Pump 1 and pump 2■ Channel 2: Pump 3 and pump 4

17 Setting the [Relays]

- **User qualification:** trained user, see  Chapter 1.4 'User qualification' on page 13

Continuous display →  →  or  [Relay] →  [Relay]



Measuring channel settings

This descriptions of [Channel 1] apply correspondingly to the settings in all other measuring channels. The procedure for entering the settings for the channel in question is identical, however the parameters to be set may differ. Your attention is drawn to the differences, which are also described.

Relay

6.1

<input checked="" type="checkbox"/> Relay 1	<input checked="" type="checkbox"/>	Limit value 1
Relay 2	<input type="checkbox"/>	Off
Alarm relay	<input type="checkbox"/>	Off
Relay timer	<input type="checkbox"/>	Off

A1069

Fig. 103: Setting the [relays]



Setting [Relay 1], [Relay 2], [Alarm relay] or [Relay timer]

Only the process for setting [Relay 1] is described. The setting process for [Relay 2], the [Relay timer] or the [Alarm relay] is the same as when setting [Relay 1].



17.1 Setting Relay 1

Continuous display →  →  or  [Relays] →
 [Relays] →  or  [Relay 1] → 

Relay 1		6.1.1
<input type="checkbox"/> Function	Limit 1	
Assignment	Channel 1	

A1070

Fig. 104: Setting Relay 1

- ➔ Use the  or  key to select the respective menu and confirm with 
- ⇒ The relevant setting menu appears.

Setting the [Relays]

Tab. 22: Settable parameters of Relay 1 and Relay 2

Parameter	Settable function	Relay state
[Function]	Set relay as: <ul style="list-style-type: none"> ■ [Off] ■ [Limit value 1] ■ [Limit value 2] ■ [Limit value 1 <Control variable>] ■ [Limit value 2 <Control variable>] ■ [Cycle] ■ [Pulse length (PWM)] 	Active closed (default). Active opened.
[Assignment]	Assign the relay to the relevant measuring channel: <ul style="list-style-type: none"> ■ [Channel 1] ■ [Channel 2] ■ [Channel 3] ■ [Channel 1+2] ■ [Channel 1+2+difference] 	Active closed (default). Active opened.

Tab. 23: Settable alarm relay parameters

Parameter	Settable function
[Function]	Set relay as: <ul style="list-style-type: none"> ■ [Off] ■ [Alarm] ■ [Limit value 1] ■ [Limit value 2] ■ [Limit value 1+2] ■ [Pause]



Changeable scope of the menus

The number of adjustable parameters may differ depending on the type and scope of the [Function] selected. The controller provides you with the possible adjustable parameters. Use the ▲ or ▼ key to select them and confirm with [OK]. The possible adjustment ranges are specified by the controller.

Relay 1

6.1.1

Function	Control variable
Function	Increase value
Cycle time	10s
Min. time	1s
Assignment	Channel 1

A1071

Fig. 105: Possible adjustable parameters with [Function] include, for example, [Control variable]

17.1.1 Function description [Off]

If the setting is [Off], the relay does not accept any functions or allow any actions.

17.1.2 Functional description of [Relay timer]

The [Relay timer] is a real-time timer based on relay 1 and 2. The [Relay timer] lets you perform recurring weekday and time-dependent metering processes. Timer 1 is for relay 1 / Timer 2 is for relay 2.

17.1.3 Function description [Limit 1] or [Limit 2]

[Relay 1] and/or [Relay 2] can be operated as limit value relays. The limit values can be set in the menu ⚙ Chapter 14 'Setting the [Limit values]' on page 149.



Limit value relay used as an actuator

Extended functions

- The limit value relays can also be defined in such a way that they react like an actuator. If, for example, a limit value relay is activated, then it is deactivated if the pause contact is closed and for a subsequent delay period t_d (if $t_d > 0$ min is set).

17.1.4 Functional description of [Limit value 1/2 (control variable)]

With the [Limit value 1/2 (control variable)] setting, the limit value relay reacts to faults and to Pause like an actuator

17.1.5 Functional description of [Cycle]

With the [Cycle] setting, the assigned relays are activated cyclically independently of the time. The Cycle timer can, for example, be used with shock metering, if the timing of the metering does not matter. Use what is known as the [Relay timer] if it is important to perform metering at a specific time.

CAUTION!

The [Cycle] is reset when there is no supply voltage

Possible consequence: slight or minor injuries. Material damage.

- Configure the power supply so that it cannot be interrupted
- With critical processes, practically address the possible failure of the timer when designing your application

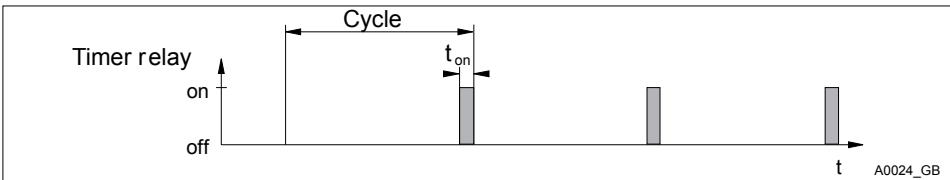

Fig. 106: Timer relay

At the end of the (Timer) cycle time, the controller closes the assigned timer relay for a period of [t on]. [Pause] interrupts the timer. If the clock is visible in the LCD display, then the OK key can be used to reset the [Cycle] to the beginning of the cycle. The % figure in the LCD display indicates the remaining runtime.

17.1.6 Functional description of [Pulse length (PWM)]

If the output relays are configured as [Pulse length (PWM)], then these output relays emit the pulse length determined by the controller, to control an actuator (e.g. motor-driven metering pump, solenoid valve).

18 Setting [digital inputs]

- **User qualification:** trained user, see Chapter 1.4 'User qualification' on page 13

Continuous display → → or [Digital inputs] → [Digital Inputs]



Measuring channel settings

This descriptions of [Channel 1] apply correspondingly to the settings in all other measuring channels. The procedure for entering the settings for the channel in question is identical, however the parameters to be set may differ. Your attention is drawn to the differences, which are also described.

Digital Inputs

7.1

- | | | |
|--|-----------------|------------------------------|
| | Digital input 1 | <input type="checkbox"/> Off |
| | Digital input 2 | <input type="checkbox"/> Off |
| | Digital input 3 | <input type="checkbox"/> Off |
| | Digital input 4 | <input type="checkbox"/> Off |
| | Digital input 5 | <input type="checkbox"/> Off |



A0987

Fig. 107: Setting digital inputs [Dig. inputs]

The inputs 5 ... 7 are optional and thus not available with every device.

18.1 Setting [Digital input 1]

Continuous display → → or [Digital inputs] → [Digital Inputs] → or [Digital input 1] →

Digital input 1		7.1.1
Function	Pause	
Status	Active opened	
Switch off delay	10 s	
Alarm	On	
Assignment	Channel 1	

Fig. 108: Setting [Digital input 1]

Tab. 24: Pause

Parameter	Adjustment range
Function	Pause / Off / Pause Hold
Status	Active open / Active closed
Switch off delay	0 ... 1800 s
Alarm	On/Off
Assignment	Channel 1, channel 2, channel 1+2

Setting [Digital input 2]

Tab. 25: Sample water fault

Parameter	Adjustment range
Function	Off / Sample water fault
Status	Active open / Active closed
Switch off delay	0 ... 1800 s
Assignment	Channel 1, channel 2, channel 1+2

Setting [Digital input 3]
Tab. 26: Level of storage tank 1

Parameter	Adjustment range
Function	Off / Pause Hold / Pause / Level of storage tank 1
Status	Active open / Active closed
Switch off delay	0 ... 1800 s
Assignment	Channel 1, channel 2

Setting [Digital input 4]
Tab. 27: Level of storage tank 2

Parameter	Adjustment range
Function	Off / Sample water fault / Level of storage tank 2
Status	Active open / Active closed
Switch off delay	0 ... 1800 s
Assignment	Channel 1, channel 2, channel 1+2

Setting [Digital input 5]
Tab. 28: Level of storage tank 3

Parameter	Adjustment range
Function	Off / Level of storage tank 3
Status	Active open / Active closed
Switch off delay	0 ... 1800 s
Assignment	Channel 1, channel 2, channel 1+2

19 Setting the [mA outputs]

- **User qualification:** trained user, ↗ Chapter 1.4 'User qualification' on page 13

Continuous display →  →  or  [mA outputs] →  [mA outputs]



Settings for [Channel 2] and [Channel 3]

The 2-channel version of the controller has 2 mA outputs and the 3-channel version has 3 mA outputs. The descriptions of [Channel 1] correspondingly apply to the setting of [Channel 2] and [Channel 3]. The procedure for setting the respective mA output channels is identical, however the parameters to be set may differ. Your attention is drawn to the differences, which are also described.



CAUTION!

Destruction of the monitors

Only connect passive monitors to the mA outputs. For example, if the mA outputs are connected to a PLC, then a 4-wire connection type must be selected on the PLC. The 2-wire connection type can result in incorrect operation and, possibly, the destruction of the monitors.

In its basic version, the controller has 2 active mA outputs, meaning that the mA outputs actively supply an output current, without an external supply voltage being provided. The mA outputs are galvanically isolated.

Reaction on [Pause Hold]: [Pause Hold] determines the system response of the mA outputs if [Pause Hold] is active.

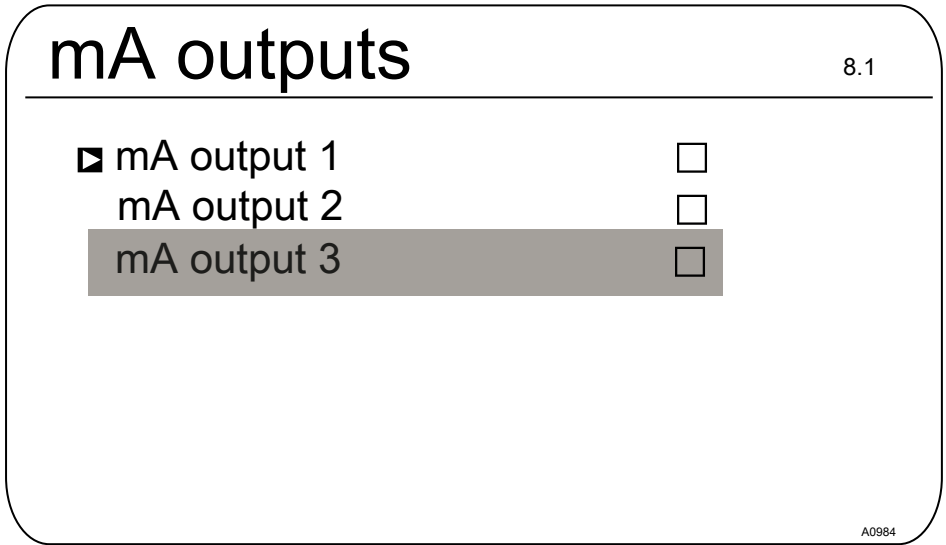

Fig. 109: Setting the [mA outputs].



Optional mA outputs

The menu items for the optional mA outputs have the same setting options as the [mA output 1] menu item. A separate description is not provided.

19.1 Setting the [mA outputs]

Continuous display → → ▲ or ▼ [mA outputs] → [mA outputs] → ▲ or ▼ [mA output 1] [Function] Set function

mA-output 1	
Function	Measured value
Assignment	Channel 1
Output range	0 ... 20 mA
Current on error	23 mA
0 mA	-1,45 pH
20 mA	15,45 pH
Damping	high
HOLD reaction	HOLD

Fig. 110: Setting [mA output 1]

[Function]	Adjustable value	Explanation
[Function]	[Off]	The mA output has no function
	[Measured value]	
	[Control variable]	
	[Correction value]	Temperature

The mA output is held at the valid mA output value upstream of [Pause Hold].

The following adjustable parameters are available when selecting the [Measured value], [Control variable] and [Correction value] functions:

[Function]	Adjustable value	Adjustable ranges or counter values
[Measured value]	[Output range]	0 ... 20 mA
[Control variable]		Assignment to the required measuring range start and end value.
[Correction value]		4 ... 20 mA
		Assignment to the required measuring range start and end value.

<i>[Function]</i>	Adjustable value	Adjustable ranges or counter values
	<i>[Error current]</i>	<i>[Off]</i> 23 mA
	<i>[0 mA]</i>	- 100% ... + 100%
	<i>[20 mA]</i>	- 100% ... + 100%
	<i>[Filtering]</i>	<i>[high]</i> <i>[average]</i> <i>[weak]</i>
	<i>[Response with Pause Hold]</i>	<i>[None]</i> The mA output changes with the measured value <i>[Fixed]</i> The mA output is set to a fixed mA output value, which is always issued at <i>[Pause Hold]</i> <i>[Hold]</i>

20 Care and maintenance

- **User qualification:** instructed user
↳ *Chapter 1.4 'User qualification'*
on page 13

The device does not require regular care and maintenance. If necessary, you can wipe down the surface of the device with a damp micro-fibre cloth.

21 Function: Data logger



Data backup / limited service life

There is a possibility of loss of data with all types of data storage. Data loss can be caused by damage to hardware, software, or unauthorised access etc. The operator of the device is responsible for backing up data recorded by the data logger. This should be done in accordance with the national and international requirements, regulations and standards applicable to the operator of the device. Define and document this data backup in a backup or recovery plan.

The manufacturer of the device is not responsible for backup or recovery of data.

SD cards only have a limited service life. This service life is based, for example, on the general ageing of the SD card and depends on the memory technology (flash memory) of the fundamentally limited number of write processes. Bear this in mind with your data backup strategy and ensure that you regularly replace your SD card.

21.1 Activating, reading and deleting log books

The controller supports the following log books as standard:

- Calibration log book
- Error log book



Access flap to the SD card slot

Always keep the access flap to the SD card slot closed during operation. If the access flap is open, extraneous matter, like dust and moisture, can enter and cause damage to the controller.

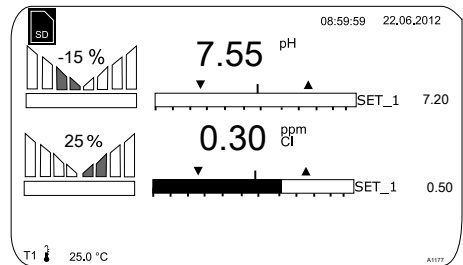

Fig. 111: Display showing symbol for the presence of an SD card (top right)

The data log book (optional)

The data log book is an optional feature. This option is currently supplied as an industrial 512 MB SD card. The SD card provided has a recording capacity of around 20 years based on a recording interval of 10 seconds. SD cards with a capacity of up to 32 GB can be used. They can therefore record approximately 1280 years.

If the SD card is inserted into the controller, this is displayed on the display in the top left corner by the [SD] symbol. If the SD card is 80% full, then this level also appears on the screen as [80% full]. If the SD card is full, then the data is stored in the controller's internal memory. If this internal memory is full, then the oldest data is overwritten.

21.2 Configuring log books

- **User qualification:** instructed user, see [↪ Chapter 1.4 'User qualification'](#) on page 13

Continuous display \Rightarrow  \Rightarrow  or 
[Diagnostics] \Rightarrow  [Diagnostics]

It is possible to look through log books, perform a simulation of outputs or view device information in this menu.

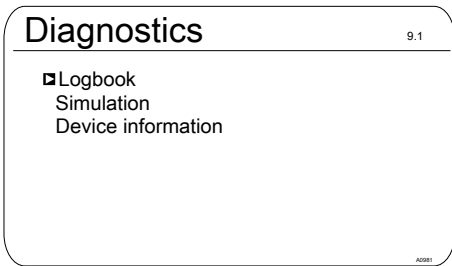





Fig. 112: [Diagnostics] > [Log books]

The calibration log book stores all calibrations of measured variables with a time stamp.

1. \Rightarrow Press  in the continuous display
2. \Rightarrow Use the arrow keys to select [Diagnostics]
3. \Rightarrow Press 
4. \Rightarrow Use the arrow keys to select [Log books]
5. \Rightarrow Press 
6. \Rightarrow Use the arrow keys to select [Calibration log book]
7. \Rightarrow Press 

21.2.1 Using the [calibration log book]

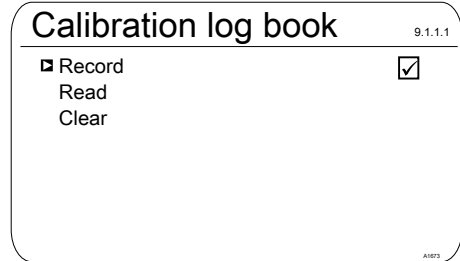





Fig. 113: Using the [calibration log book]

1. \Rightarrow Use the arrow keys to move the cursor to [Record]
2. \Rightarrow Press 
 - \Rightarrow The activation symbol (tick) appears in the selection boxes. Now all calibrations performed are recorded.

Reading calibrations

3. \Rightarrow Use the arrow keys to move the cursor to [Read]
4. \Rightarrow Press 
 - \Rightarrow This automatically removes the activation symbol. If you wish to record further calibrations after [Reading], then it is necessary to reactivate the [Calibration log book]. The tick reappears.

Deleting the [calibration log book]

5. \Rightarrow Use the arrow keys to move the cursor to [Delete]
6. \Rightarrow Press 
 - \Rightarrow This will irrevocably delete the calibration log book file on the SD card.

Calibration log book

▣ Entry	17/17
Channel 1	Chlorine
Slope	5.99 mA/ppm
Zero point	4.00 mA
31.02.2014	12:42:11

Fig. 114: Reading the [calibration log book]

Use the arrow keys to browse through the entries in the calibration log book. Press **ESC** to return to the continuous display.

21.2.2 Using the [error log book]

Error log book

9.1.2.1

▣ Record	<input checked="" type="checkbox"/>
Read	
Clear	

Fig. 115: Using the [error log book]

1. Use the arrow keys to select *[Error log book]*
2. Press **OK**
3. Use the arrow keys to move the cursor to *[Record]*
4. Press **OK**
 - ⇒ The activation symbol (tick) appears in the selection boxes. Now all warnings and error messages are recorded.

Reading messages

5. Use the arrow keys to move the cursor to *[Read]*
6. Press **OK**
 - ⇒ This automatically removes the activation symbol. If you wish to record further errors after *[Reading]*, then it is necessary to reactivate the *[Error log book]*. The tick re-appears.

Deleting the [error log book]

7. Use the arrow keys to move the cursor to *[Delete]*
8. Press **OK**
 - ⇒ This will irrevocably delete the error log book file on the SD card.

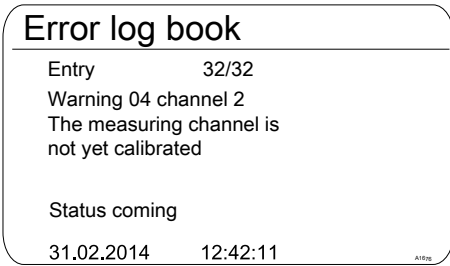

Fig. 116: Reading the [Error log book]

Use the arrow keys to browse through the entries in the error log book. Press to return to the continuous display.

21.2.3 Using the [Data log book] (optional)

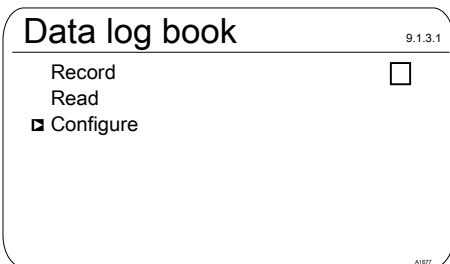
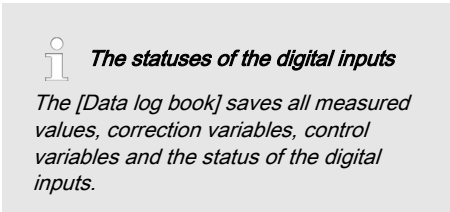

Fig. 117: Configuring the [Data log book]

First configure the [Data log book] before you activate it. You can select which data is to be recorded. All data is selected by default. You can specify at what interval the data is to be saved. For example, if one file is to be created each per day, from 00.00 to 24.00. Then the file

name is = YYYYMMDD.CSV. You can also record an endless file and give it a random name. Data is always saved in CSV format. CSV stands for **C**omma-**s**eparated **v**alues. This format can be, for example, read and edited with MS Excel.

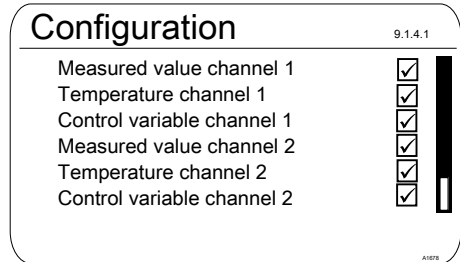

Fig. 118: [Configuration] of the data log book

[Configuration] of the data log book

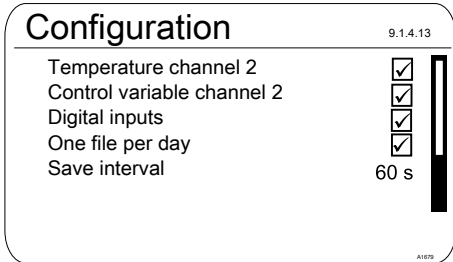

Fig. 119: [One file per day] checked

If you uncheck [One file per day], then a new input option appears: [File name].

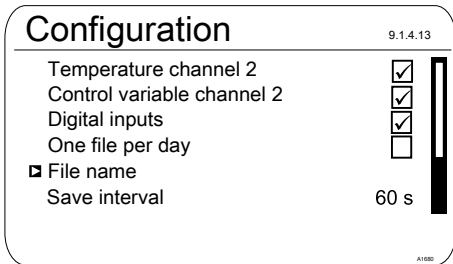

Fig. 120: [One file per day] unchecked

1. ➔ If you wish to specify a file name, then place the cursor on [File name] and press **OK**
 - ⇒ [New] appears.
2. ➔ Place the cursor on [New] and press **OK**
 - ⇒ You can now enter a random name with a maximum of 8 digits name as well as the proposed [DATALOG0.CSV] and/or set from 0 to 1 ... n.



The maximum file size is 2 GB

The maximum file size is 2 GB. The SD card needs to be the same size.

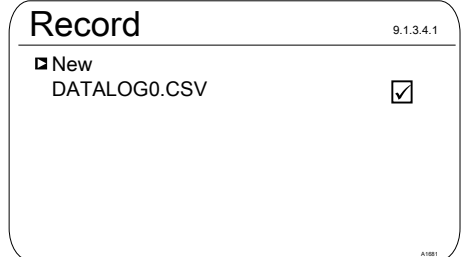

Fig. 121: Check the file to write it to an existing file, here [DATALOG0.CSV]

3. ➔ If you wish to attached measured data to an existing file, then check this file and the data will be written to this file

If the SD card is removed, then data can be recorded for a maximum of 24 hours in the controller's internal memory with a storage interval of 10 seconds. Around six times as long with an interval of 60 seconds. When the SD card is re-inserted into the controller, then the data from

Function: Data logger

the internal memory is backed up to the SD card. This can take up to 20 minutes if 24 hours of data has been recorded. The green LED on the SD card reader flashes red/orange during this time.

22 [Diagnostics]

- **User qualification:** instructed user
 ↳ Chapter 1.4 'User qualification'
 on page 13

Continuous display →  → ▲ or ▼
 [Diagnostics] →  [Diagnostics]

It is possible to view logbooks, perform a simulation of outputs or view device information in this menu.

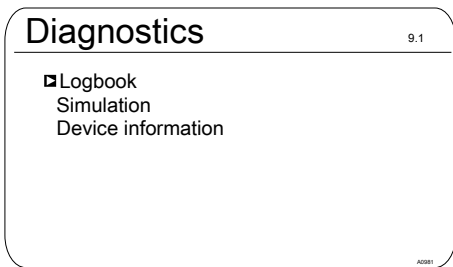

Fig. 122: Diagnostics

22.1 Displaying [logbooks]

Continuous display →  → ▲ or ▼
 [Diagnostics] →  [Diagnostics] → ▲ or ▼
 [Calibration log book] →  [Calibration log book]

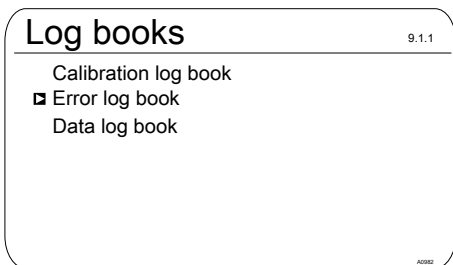

Fig. 123: Displaying [Log books]

22.1.1 Displaying the [Calibration Log Book]

The data on the sensor calibrations successfully completed are stored in the internal [Calibration log book]. Up to 30 calibrations can be stored. Thereafter the oldest entry is overwritten with the most recent entry.

The following data is stored:

- Name of the measuring channel
- Measured variable
- Time of calibration
- Zero point
- Slope

Deleting entries in the [Calibration log book]

You can also delete entries in the Calibration log book. Deleting the entries does not affect the calibrations stored in the controller.

22.1.2 Reading the [Error Log Book]

The error message data is stored in the [Error log book]. Up to 30 error messages can be stored. Thereafter the oldest entry is overwritten with the most recent entry.

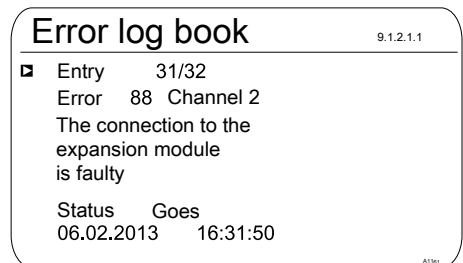

Fig. 124: [Error log book]

Deleting entries in the [Error log book]

You can also delete entries in the Error log book. Deleting the entries does not affect the errors stored in the controller.

22.2 Displaying [simulation]

Continuous display → → or
[Diagnostics] → [Diagnostics] → or
[Simulation] [Simulation]



WARNING!

Uncontrolled response

Cause: A controller operates uncontrolled in [Simulation] mode under full load and thus so do the connected actuators.

Possible consequence: Fatal or very serious injuries

Measure: Never leave a controller and its installed functional modules unattended if the simulation function is active.

The [Simulation] menu item enables you to activate all outputs for test purposes during commissioning. A simulated output remains activated until you quite the [Simulation] menu item. It is also possible to prime a peristaltic pump, for example, with [Simulation] mode. A

Simulation		9.2.1
<input checked="" type="checkbox"/> Relay 1	Off	
Relay 2	Off	
Alarm relay	On	
Pump 1	Off	
Pump 2	Off	
Pump 3	Off	
Pump 4	On	
mA output 1	Off	
mA output 1	Off	

Fig. 125: Displaying simulation

22.3 Display [Device information]

Continuous display → → or
[Diagnostics] → [Diagnostics] → or
[Device information] [Device information]

Device info		9.3.3
Identity code	DACb006VA4000X00000DE	
Snrn:	15082008	
Softw. version:	02.00.00.23	
Module rev.	0100	
Expansion module		
Softw. version:	01.02.01.01	
Operating temperature	35,5 °C	A1154



Fig. 126: Device information

22.4 Error messages and warning alerts

22.4.1 Error messages

Tab. 29: Error messages

Error	Error message text	Cause	Remedy
01	The mV input voltage is too low.	Coaxial cable connection disconnected.	Check that the coaxial cable connection is fitted correctly and re-connect. Check the coaxial cable connection for corrosion and moisture and replace with a new cable, if necessary.
		pH/ORP sensor is faulty	Replace the sensor.
02	The mV input voltage is too high.	The connected signal does not come from a pH sensor. A disturbance signal is picked up.	Check the origin of the sensor signal. Check the raw signal by pressing  . The sensor raw value is shown here in mV. If the value with pH is greater than ± 500 mV, or with ORP is greater than ± 1500 mV, then these are wrong sensor values. Check once again the cabling and origin of the sensor signal. Ensure that the measuring lines are not laid parallel to power cables.
03	The temperature is too low.	Incorrect sensor connected.	Check the type of sensor connected. Only Pt 100 and Pt 1000 sensors work.
04	The temperature is too high.	No sensor or incorrect sensor connected.	Check the sensor connection
			Check the type of sensor connected. Only Pt 100 and Pt 1000 sensors work.
05	A calibration error is pending.	With amperometric analysis (e.g. chlorine): The calculated reference value deviates too much from the real value or the sensor value.	With amperometric analysis (e.g. chlorine): Check the correctness of the reference method, e.g. DPD1.
		With pH and ORP: the buffers used differ from the nominal value, are outdated or watered down.	With pH and ORP: replace the buffer with new buffer.

Error	Error message text	Cause	Remedy
06	No sensor detected, please check the connection.	Measuring cable connection disconnected.	Check the correct connection of the measuring cable connection.
		No sensor is connected.	Connect the sensor correctly.
		Cable faulty or not connected.	
		Sensor is suspended in the air.	Install the sensor correctly in the bypass fitting.
07	Check the mechanical state of the sensor. Glass breakage is possible.	Diaphragm glass broken.	Replace sensor. Check the reason for the broken glass e.g. solids, too high a flow velocity.
08	The checkout time was transgressed.	In the <i>[Control]</i> menu, the set control variable has exceeded the threshold for a longer time than the checkout time control variable.	The control section needs a longer time to regulate itself than the selected checkout time.
			The control section needs a greater control variable threshold to regulate itself than the selected one.
			The metering chemical is empty or has a too low/high a concentration.
			The metering line is disconnected or the point of injection blocked.
09	The mA input current is too high.	The current is greater than the maximum permitted current of 23 mA.	Check the origin of the current.
			Check the raw value in mA in the Information menu by pressing  . If the value is >23 mA, then it is not a correct sensor signal. Replace the sensor with a new sensor.
10	The mA input current is too low.	The power circuit is disconnected.	Check the 2-wire connection between the sensor/transmitter and controller and check the raw value in mA by pressing  . If the value is 0 mA, then the connection is disconnected.

Error	Error message text	Cause	Remedy
11	A limit value error still exists after the delay time has elapsed.	The measured value lies above the limit value for a period longer than the set delay time.	Check whether the choice of the limit value matches the application and adjust the limit value if necessary.
			Check whether the choice of the delay period matches the application and adjust the delay time if necessary.
			Check the design of the actuator. Is the actuator selected too large?
			Check the concentration of the metering chemical – is the concentration too high?
			Check the control parameters. Does the control tend to over/undershoot?
12	There is a sample water fault e.g. no flow.	The sample water limit contact of the in-line probe housing e.g. DGMa was triggered by the float dropping.	Check the routing of the sample water line.
			Check the sample water discharge point. Is it blocked?
			Check if a sample water filter is fitted and clean it if necessary.
13	The controller is in 'Pause' status.	The Pause input (digital input) was activated externally.	Check whether the Pause signal received matches the system's expected operating mode.
			Check whether the 'NO/NC' actuating direction matches the choice in the controller.
14	The controller is in 'Pause (Hold)' status.	The Pause input (digital input) was activated externally.	<p>Check whether the Pause signal received matches the system's expected operating mode.</p> <p>Check whether the 'NO/NC' actuating direction matches the choice in the controller.</p>

Error	Error message text	Cause	Remedy
15	The mA input supply is overloaded.	<p>The sensor input of Channel 1 or 2 is used in 2-wire connection mode, e.g. together with chlorine sensor CLE3.</p> <p>The polarity was not noted or there is a short circuit between the two poles.</p>	<p>Check the polarity against the terminal diagram.</p> <p>Make sure that the two wires do not touch (shorten the bared length, use insulated end sleeves, use heat-shrink tubing).</p>
16	The mA input is overloaded.	The sensor input of Channel 1 or 2 is used in 2-wire connection mode, but the signal is an active signal carrying voltage.	Use a multimeter to check the measuring signal. If it is an active / driven signal (voltage is measurable), then the type of connection has to be selected for active signals; refer to the terminal diagram in the operating instructions. This type of connection is not shown on the enclosed terminal assignment diagram.
17	The level in the storage tank 1 is too low.	The chemical in storage tank 1 is used up.	Top up the corresponding chemical.
18	The level in the storage tank 2 is too low.	The chemical in storage tank 2 is used up.	Top up the corresponding chemical.
19	The level in the storage tank 3 is too low.	The chemical in storage tank 3 is used up.	Top up the corresponding chemical.
21	The conductivity is too low.	This liquid cannot be measured with this sensor.	Use a suitable sensor, if necessary.
22	The conductivity is too high	This liquid cannot be measured with this sensor.	Use a suitable sensor, if necessary.

Error	Error message text	Cause	Remedy
34	The correction variable is faulty.	One or more correction variables have been incorrectly entered and/or the correction variable has been incorrectly recorded.	Check the correction variable and all connected components.
85	The external power supply is faulty.	The external power supply has been incorrectly designed or is faulty.	Return the external power supply to its correct working order.
86	The communication is faulty.		
87	The connection to the communication module is faulty.	The connection elements have been incorrectly installed or are faulty.	Return the controller to the factory for inspection.
88	The connection to the extension unit is faulty.	The connection cable has slipped out of the socket.	Check the connection cable and tighten.
		Connection problems between the main and extension unit.	Return the controller to the factory for inspection.
99	A system error exists.	System components have failed.	Return the controller to the manufacturer for inspection.

22.4.2 Warning messages

Tab. 30: Warning messages

#	Warning message text	Cause	Remedy
01	The limit value was undershot	The measured value is below the limit value	Check whether the choice of the limit value matches the application and adjust if necessary.
			Check the design of the actuator: has too small an actuator been selected?
			Check the concentration of the feed chemical: is the concentration too low?
			Check the control parameters: does the control tend to over/undershoot?
02	The limit value was exceeded	The measured value is above the limit value	Check whether the choice of the limit value matches the application and adjust if necessary.
			Check the design of the actuator: has too large an actuator been selected?
			Check the concentration of the metering chemical – is the concentration too high?
			Check the control parameters: does the control tend to over/undershoot?
03	The wash timer has timed out. Maintenance is necessary	<p>The wash timer activates a relay.</p> <p>The sensor is cleaned with cleaning fluid.</p> <p>A visual check may be necessary as outline in your maintenance schedule</p>	Clean and check the sensor.
04	The measuring channel is not yet calibrated	The sensor connected to a measuring channel has not yet been calibrated	Calibrate the sensor.
05	Not yet calibrated.	The system has not yet been calibrated.	Calibrate the system e.g. the sensor.

#	Warning message text	Cause	Remedy
71	The battery needs to be replaced	The battery has a service life of about 10 years, but this can be reduced by environmental factors	Replace the battery or inform Service. Battery BR 2032, Part no. 732829.
72	Check the time	The time has changed when replacing the battery	Reset the time.
73	The fan has a fault	The internal fan is no longer rotating	Please check to see whether an object has become trapped in the impeller otherwise return the controller to the manufacturer for inspection.
85	A fault in the external power supply.	The external power supply has been incorrectly designed or is faulty.	Return the external power supply to its correct working order.
87	The connection to the communication module is faulty.	The connection elements have been incorrectly installed or are faulty.	Check the connection, repair it or replace faulty components.
89	System warning 1	A system error exists	Return the controller to the manufacturer for inspection.

22.5 Help texts

Content of the help texts	Cause	Remedy
The DPD value is too small, DPD value > MRS + 2 %	If the calculated reference value (e.g. DPD1) for calibrating a sensor is less than 2 % of the measuring range, then calibration is not possible.	Increase the concentration of the chemical to be measured in the process/sample water and determine the reference value again (e.g. DPD1) after the run-in period.
The slope is too shallow, < 20 % of the MR	The sensor can no longer detect the chemicals to be measured	Replace the membrane cap and replace the electrolyte for new material
The slope is too steep, > 300 % of the MR	The sensor has been permanently affected by for example surface-active substances (surfactants).	Make sure that none of these substances are present in the water. Replace the membrane cap and replace the electrolyte for new material
The zero point is too low, < 3.2 mA	The sensor delivers a measured signal that is less than 3.2 mA. This value is outside of the specification.	Check the raw value in mA in the Information menu, by pressing  in the main display. If the value is < 3.2 mA, then this is not the correct sensor signal. Check the cabling and replace the sensor with a new sensor.
The zero point is too high, > 5 mA	You would like to calibrate the zero point but the sensor is still detecting the chemical to be measured	Rinse the sensor with water containing no chemicals that are to be measured before zero point calibration. The water with which the zero point is determined should also not contain traces of this chemical. Use mineral water without carbon dioxide for this purpose.
An unknown calibration error		
In the residual period parameter set 1 is used	If parameter set 2 is not active, then parameter set 1 is activated	Check the control signals/lines that switch the parameter set or check the timer settings.

23 Technical data and measuring ranges

23.1 Technical data

Tab. 31: Technical data

Designation	Technical data
pH resolution:	0.01
ORP voltage:	1 mV
Temperature:	0.1 °C
Amperometric analysis (chlorine etc.):	0.001/0.01 ppm, 0.01 vol.%, 0.1 vol.%
Precision:	0.3 % based on the full-scale reading
pH/ORP measuring input:	Input resistance > 0.5 x 10 ¹² Ω
Correction variable:	Temperature via Pt 100/Pt 1000
Temperature correction range:	0 ... 100 °C
pH correction range for chlorine:	6.5... 8.5
Interference variable:	Flow via mA or frequency
Control characteristic:	P/PID control
Control:	2 bidirectional controllers or 1 bidirectional controller and 1 monodirectional controller
mA output signal:	2 x 0/4 ... 20 mA galvanically isolated, max. load 450 Ω, range and assignment (measured, correction, control variable) can be set
Control output:	2 x 2 pulse frequency outputs for the control of metering pumps
	2 relays (limit value, 3-point step or pulse length control)
	2 x 0/4 ... 20 mA
20 V output (XA3)	Output voltage approx. 20 V, max. 200 mA (power-restricted). Terminal XA3 is not galvanically isolated from the mains terminal XP1 with the 24 V DC version. Only connect galvanically isolated devices to the 24 V supply. If a voltage of less than approx. 22 V is fed at XP1, then the voltage at XA3 is also lower.

Technical data and measuring ranges

Designation	Technical data
Alarm relay:	250 V ~3 A, 750 VA, type of contact: changeover contact. No inductive loads: use an additional protective RC circuit (optional) with inductive loads. Fusing (by others) of the output relay (XR1 ... XR3) with 5 A.
Limit value relay:	250 V ~3 A, 750 VA, type of contact: changeover contact. No inductive loads: use an additional protective RC circuit (optional) with inductive loads. Fusing (by others) of the output relay (XR1 ... XR3) with 5A.
Electrical connection:	100 ... 230 V, 50/60 Hz, 27 W 24 V DC \pm 20 %, 25 W
Overvoltage category:	II
Degree of pollution (IEC 61010-1):	Installation on a surface: 3 Control panel installation: 2
Maximum operating height:	maximum 2000 metres above sea level (m.a.s.l.)
Ambient conditions:	Use indoors or with protective enclosure Maximum 95 % relative air humidity (non-condensing)
Ambient temperature:	Ambient temperature - 20 ... +50°C
Low voltage cables:	Copper low voltage cables are needed with a temperature resistance of ≥ 70 °C., min. AWG 18 or min. 0.75 mm ² at the ambient temperatures. Isolated wires, cables and other electrical conductors are needed, which need to be flame-resistant. It is assumed that wires with rated data in accordance with UL 2556 VW-1 or similar normative regulations meet this requirement.
Degree of protection:	Installation on a surface: IP66/IP67 Control cabinet installation: IP 54 based on NEMA 4X Indoor
Material:	Housing PC with flame proofing configuration

Designation	Technical data
Dimensions:	250 x 220 x 122 mm (WxHxD)
Weight:	net 2.1 kg

The technical data on the module: 2x conductive conductivity/temperature sensors, part number 734223, see [Chapter 9.4.4.5 'Module: 2x conductive conductivity/temperature sensors. Part number 734223'](#) on page 63

23.2 Measuring range/Measured value

Tab. 32: Measuring range/Measured value

Parameter	Measuring range/Measured value
Measuring range connector type mV:	pH: 0.00 ... 14.00
	ORP voltage: -1500 ... +1500 mV
Connector type mA (amperometric measured variables, measuring ranges according to the sensors):	Chlorine
	Chlorine dioxide
	Chlorite
	Bromine
	Ozone
	Hydrogen peroxide (PER sensor)
	Hydrogen peroxide (PEROX sensor with transducer)
	Peracetic acid
	Dissolved oxygen
Connector type mA (potentiometric measured variables, measuring ranges according to the transmitters):	pH
	ORP voltage
	Fluoride
Conductivity (measuring ranges according to the transmitters):	via transmitter 0/4 ... 20 mA
Temperature:	via Pt 100/Pt 1000, measuring range 0 ... 150 °C
Conductive conductivity:	
Specific conductivity:	0.001 µS/cm ... 200 mS/cm

Technical data and measuring ranges

Parameter	Measuring range/Measured value
Specific electrical resistance:	5 Ω cm ... 1000 M Ω cm
TOS (total dissolved solids):	0 ... 9999 ppm (mg/l)
SAL (salinity):	0.0 ... 70.0 ‰ (g/kg)

24 Spare parts and accessories

24.1 Spare parts

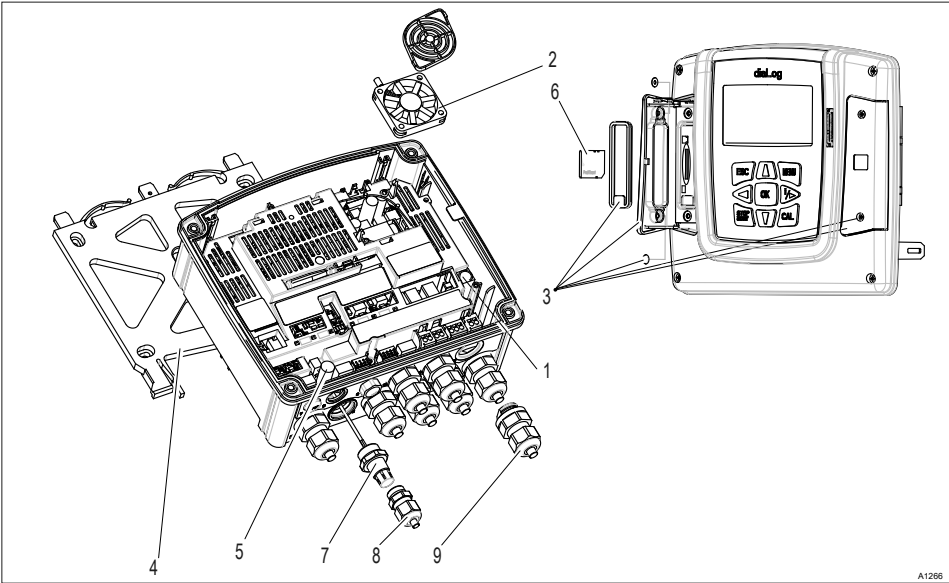

Fig. 127: Spare parts

Pos.	Spare parts	Order number	Installed by ⚡ Chapter 1.4 'User qualification' on page 13
1	with 230 V device: Micro-fuse 5x20 T 1.6 A	732411	Electrical technician
1	with 24 V device: Micro-fuse 5x20 T 3.15 A	732414	Electrical technician
2	Fan housing with speed signal, 5 V DC, 50x50x10 mm	733328	Electrical technician

Pos.	Spare parts	Order number	Installed by <i>& Chapter 1.4 'User qualification' on page 13</i>
3	Interface cover, spare parts package <ul style="list-style-type: none"> ■ Cover, left ■ Cover, right ■ Fastenings, complete 	1044187	Trained, qualified personnel
4	Bracket for mounting on a surface	1039767	Trained, qualified personnel
5	Guard terminal, top part	733389	Trained, qualified personnel
6	SD card, industrial quality	732483	Instructed personnel
7	SN6 socket	1036885	Electrical technician
8	Cable threaded connector, M16x1.5	1005874	Electrical technician
9	Cable threaded connector, M20x1.5	1005517	Electrical technician
10	Counter nut, M20x1.5	1021016	Electrical technician

The spare parts units are ordered as identity code features and replaced and configured as described.

24.2 Replacement of spare parts units

Replacement of the upper part of the housing with display

- **User qualification, replacement of the upper part of the housing with display:** Electrical technician ↪ Chapter 1.4 'User qualification' on page 13



Fig. 128: ESD-sensitive components

Adhere to the basic principles of ESD protection whenever working.

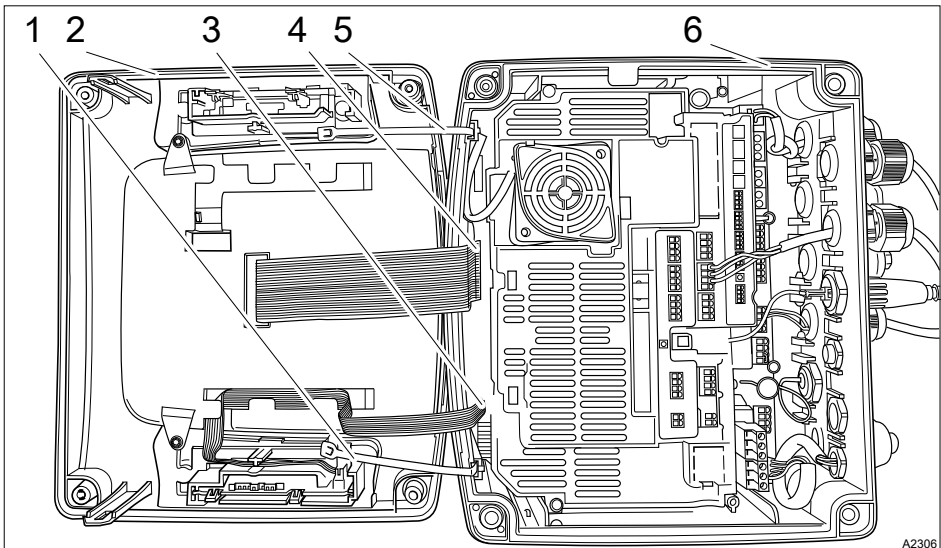











Fig. 129: Replacement of spare parts units

1. Strain relief
2. Upper part of the housing
3. Plug, small
4. Plug, large
5. Strain relief
6. Lower part of the housing





1.  Disconnect the controller from the mains power supply.
2.  Loosen 4 screws on the upper part of the housing (2) and remove the upper part of the housing.
3.  Place or suspend the upper part of the housing near the controller.
4.  If fitted: loosen the strain relief (1 and 5).
5.  Remove the plugs (3 and 4), using pointed pliers if necessary.
 - ⇒ You can now replace the old upper part of the housing with the new upper part of the housing.
6.  Replace the plugs (3 and 4), using pointed pliers if necessary.
7.  If fitted: fit the strain relief (1 and 5).
8.  Place the upper part of the housing back on the controller and secure the 4 screws of the upper part of the housing.
9.  Connect the controller to the mains power supply.
 - ⇒ Check all functions of the controller.

Replacing the lower part of the housing



Back up all parameters

Where possible, back up all the controller's set parameters on the SD card before replacing the lower part of the housing (6). You can then use this data backup when the unit is recommissioned to upload all the old parameters to the new controller.

1.  Disconnect the controller from the mains power supply.
2.  Loosen 4 screws on the upper part of the housing (2) and remove the upper part of the housing.
3.  Place or suspend the upper part of the housing near the controller.
4.  If fitted: loosen the strain relief (1 and 5).

Spare parts and accessories

5. ➤ Remove the plugs (3 and 4), using pointed pliers if necessary.
 - ⇒ Place the upper part of the housing to one side.
6. ➤ Note or mark the assignment of the cables to the terminals.
7. ➤ Loosen all the cable connectors used.
8. ➤ Loosen and remove all the cable connectors fitted.
9. ➤ Loosen the lower part of the housing (6) from the fixing and replace the lower part of the housing with the spare part.
10. ➤ Guide cables back through the threaded connectors.
11. ➤ Connect cables to the designated terminals.
12. ➤ Replace the plugs (3 and 4), using pointed pliers if necessary.
13. ➤ If fitted: fit the strain relief (1 and 5).
14. ➤ Place the upper part of the housing back on the controller and secure the 4 screws of the upper part of the housing.
15. ➤ Connect the controller to the mains power supply.
 - ⇒ Perform complete commissioning, as described in the operating instructions for the controller.

24.3 Replacing fan

- **User qualification, replacing fan:** Electrical technician ↪ *Chapter 1.4 'User qualification' on page 13*

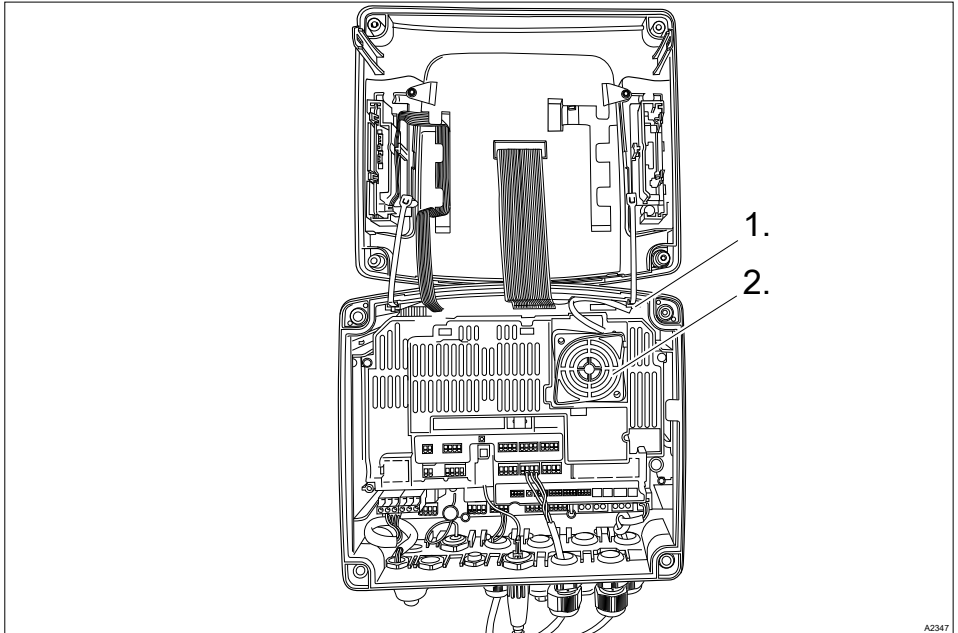

Fig. 130: Replacing fan, part no. 733328

1. ➤ Open housing of controller.
2. ➤ Using an appropriate tool, such as pointed pliers (e.g. DIN EN 60900; VDE 0682-201), loosen the electrical plug-in connector (1).
3. ➤ Remove the fan (2).
4. ➤ Insert the new fan (2). The ProMInent lettering faces you.
 - ⇒ Make sure that the two fixing hooks slot in properly.
5. ➤ Use an appropriate tool to connect the plug-in connector (1).
 - ⇒ The fan must now rotate.
6. ➤ Close housing of controller.

24.4 Accessories

- **User qualification, accessories:** Electrical technician ↪ *Chapter 1.4 'User qualification' on page 13*

Accessories	Order number
Cable combination coaxial 0.8 m, pre-assembled	1024105
Cable combination coaxial 2 m-SN6 - pre-assembled	1024106
Cable combination coaxial 5 m-SN6 - pre-assembled	1024107
SN6-socket, retrofit	1036885
Installation kit - DAC - control panel mounting	1041095

25 Disposal of used parts

- **User qualification:** instructed user, see *Chapter 1.4 'User qualification' on page 13*

! NOTICE!

Regulations governing the disposal of used parts

- Note the national regulations and legal standards that currently apply in your country

The manufacturer will take back decontaminated used devices providing they are covered by adequate postage.

Decontaminate the device before returning it for repair. To do so, remove all traces of hazardous substances. Refer to the Material Safety Data Sheet for your feed chemical.

A current Declaration of Decontamination is available to download on the ProMinent website.

Sign indicating EU collection system



In accordance with the European Directive 2012/19/EU on waste electrical and electronic equipment, this device features the symbol showing a waste bin with a line through it. The device must not be disposed of along with domestic waste. To return the device, use the return and collection systems available and observe the local legal requirements.

26 Standards complied with and Declaration of Conformity

The Declaration of Conformity for the controller is available to download on our homepage.

EN 61010-1 Safety requirements for electrical equipment for measurement, control and laboratory use – Part 1: General requirements

EN 61326-1 Electrical equipment for measuring, control and laboratory use – EMC requirements (for class A and B devices)

DIN EN 50581 - Technical documentation for the assessment of electrical and electronic products with regard to the restriction of hazardous substances

EN 60529 - Degrees of protection provided by enclosures (IP code)

With devices with MET certification

UL 61010-1:2012-05 and Revision 2016-04-29 including Amd 1:Nov 2018

CAN/CSA C22.2 No. 61010-1-12/AMD 1:2018

27 Index

1, 2, 3 ...

[Relay timer]	163
32 GB	30

A

Above sea level (ASL)	189
Accessibility	37
Accessories	200
Action, step by step	2
Activation code	30
Actuating outputs	119
Actuator	151
Additive and multiplicative feed forward control	142
Air humidity, relative	189
Alarm relay	189
Ambient conditions	28
Ambient conditions:	189
Applicational example of additive interference variable	143
Assembled sensor cables	74

B

Backlight	78
Bleeding	76
Brightness	78
Bus system	35

C

Calibrating the "Conductive conductivity" measured variable	126
Calibrating the "Conductivity" measured variable	125
Calibrating the "Temperature" measured variable	131

Calibrating the zero point	116
Calibration	92
Calibration log book	173
Calibration of amperometric measured variables	114
Care	172
Caulking strip	42
Chlorine calibration	114
Configuration of the data log book	177
Configuring the log books	174
Connection of the chlorine sensor with controllers with two channels	51
Connection of the transmitter DMTa	52
Contrast	78
Control outputs	116
Control panel installation	40
Copying unit configuration onto the SD card	33
Correct measurement and metering is only possible if the sensor is working perfectly.	11
CSV format	176
Cycle	163

D

Danger from incorrect display	11
Data backup	173
Data input	103
Data log book	173
Data logger	173
Declaration of Conformity	202
degree of contamination	68
Degree of pollution (IEC 61010-1)	189
Degree of protection IP 54 (Pollution degree 2/macro-environment)	68
Degree of protection IP 67	68
Delay period of the limit values	150

Index

Destruction of the monitors 168

Device identification 25

E

Error log book 173

ESD 47

ESD-sensitive components 47

F

Faults, signal and control lines 45

Fieldbus 35

Foam rubber 42

Function of the keys 15

G

General non-discriminatory approach 2

I

Identity code 25

Incorrect measured values. 11

Industrial and process water treatment 29

Information on a fieldbus 35

K

Key Lock 21

L

Language settings 20

Limit exceeded 150

Limit value 1/2 (control variable) 163

Limit value relay 151, 189

Limit values 149

Links to elements or sections of these instructions or other applicable documents 2

Loosen from the connecting terminals 47

Low voltage cables, temperature resistance 45

M

Maintenance 172

Manual entry of the activation code 31

Material thickness 40

Maximum operating height 189

Micro-fibre cloth, moist 172

More symbols 2

Multiplicative interference variable 144

N

Nameplate 23

Non-discriminatory approach 2

O

Only one sensor per unit 51

Operating concept 15

Operating height 189

Operating language 20, 78

Overvoltage category 189

P

Packaging material 28

pH calibration 93

pH measurement using a transmitter 51

Poor sensor operation and fluctuating pH values during the process 101

Potable water treatment 29

Projection of device 43

Protection against voltage surges 44

Protection of radio reception 45

Protective enclosure 189

Punched template 40

Q

Question: Are there disadvantages with pH calibration with an external sample? 101

Question: How can I bleed the hydraulic installation?	76	Question: What should I consider when connecting passive monitors?	168
Question: How can I reset the operating language?	78	Question: What sort of applications are there?	29
Question: How can I set or change the operating language?	20	Question: What spare parts are available?	194
Question: How do I adjust the display brightness?	78	Question: What type of buffer solutions do I need for a fluoride calibration?	111, 113
Question: How do I adjust the display contrast?	78	Question: What type of buffer solutions do I need for pH calibration?	97
Question: How do I connect a transmitter?	52	Question: What type of equipment does the controller have as standard?	29
Question: How does the controller operate?	15	Question: Where can I find the Declaration of Conformity?	202
Question: How does the key lock work?	21	Question: Where do I find the [Simulation] function?	180
Question: How thick should the control panel be to accommodate the controller?	40	Question: Which calibration process can you use to calibrate amperometric measured variables?	115
Question: In which file format is the data log book data?	176	Question: Which calibration process can you use to calibrate the DO measured variable?	121
Question: What accessories are available for the controller?	200	Question: Which calibration process can you use to calibrate the fluoride value?	109
Question: What ambient conditions are permissible?	28	Question: Which calibration process can you use to calibrate the ORP value?	106
Question: What are the effects of a multiplicative interference variable?	144	Question: Which calibration process can you use to calibrate the pH value?	96
Question: What causes an additive and multiplicative feed forward control?	142	Question: Which components are included as standard?	38
Question: What does the relay function [Cycle] do?	164	Question: Which conductivity sensor can I connect to the controller?	74
Question: What does the relay function [Limit 1] or [Limit 2] action?	163	Question: Which standards are complied with?	202
Question: What does the relay function [Limit value 1/2 (control variable)] do?	163	Question: Which values render pH calibration valid?	97
Question: What does the relay function [Off] do?	163		
Question: What does the relay function [Pulse length (PWM)] do?	164	R	
Question: What does the relay function [Relay timer] do?	163	Recycling	28
Question: What optional accessories are available for the controller?	29	Reducing inserts	67

Index

Remove and refit the fluoride sensor in the in-line probe housing	110, 112
Remove and refit the pH sensor in the in-line probe housing	96
Residential areas	45
Run in periods	116, 118

S

Saving the unit configuration as a text file	32
SD cards	173
Securing single wires	47
Selection of the connected sensor	75
Sensor connector	74
Sensor function	116, 118
Service life of the SD card	173
Setting the mA outputs	168
Signal and control lines	45
Simulation	180
Spare parts units	196
Standard signal outputs	116, 119
Standards complied with	202
Strain relief	67
Swimming pool water treatment	29

T

Temperature resistance, low voltage cables	45
Terminal diagrams showing 1:1 assignment	51
Test container 1 with buffer solution	97

Test container 1 with fluoride calibration solution	110, 112
Test container 2 with buffer solution	97
Test container 2 with fluoride calibration solution	110
The maximum file size is 2 GB	177
Third party manufacturer's transmitter	52
Threaded connector, large (M 20 x 1.5)	67
Threaded connector, medium (M 16 x 1.5)	67
Threaded connector, small (M 12 x 1.5)	67
Timer relay	164

U

Upgrade package	30
Uploading unit configuration file from the SD card	34
Use indoors	189
User qualification	13

V

Validity of the activation code	30
Voltage surges	44

W

Warning information	9
Waste water treatment	29

Z

Zero point calibration	118
----------------------------------	-----



ProMinent GmbH
Im Schuhmachergewann 5 - 11
69123 Heidelberg, Germany
Telephone: +49 6221 842-0
Fax: +49 6221 842-419
Email: info@prominent.com
Internet: www.prominent.com

983369, 6, en_GB