

# 250 A 1 000 V

*U MAXI*

## DECONTACTOR™ DS2



IP66  
IP67



70-95 mm<sup>2</sup> <sup>(1)</sup>  
70-120 mm<sup>2</sup> <sup>(2)</sup>



METAL



IK10



-40 °C  
+60 °C



AC-22  
AC-23



60309-1  
60309-4  
60947-3



6 AUX. <sup>(3)</sup>



EMC

<sup>(1)</sup> Flexible wiring (min.-max.).  
<sup>(2)</sup> Stranded wiring (min.-max.).  
<sup>(3)</sup> Flexible wiring : 2,5 mm<sup>2</sup>.

### LOAD-BREAK CAPABILITY OF THE DECONTACTOR™

Comply with IEC/EN 60309-1 and IEC/EN 60309-4 standards	(250 A/500 V) or (200 A/690 V)
Load-break capability according to IEC/EN 60947-3/AC-22	(250 A/400 V) or (125 A/690 V)
Load-break capability according to IEC/EN 60947-3/AC-23	160 A/440 V
Short-circuit current I <sub>cc</sub>	10 kA



Other configurations on request.



Each inlet should be connected to a wall box, a sleeve, a handle or a spacer to ensure correct operation of the closing mechanism.

**SOCKET-OUTLET**  
female  
**DS2**



**INLET** male  
**DS2**

















380-440 V AC	3P+E	3924013	3928013
220-250 V AC 380-440 V AC	3P+N+E	3924017	3928017
660-690 V AC	3P+E	3924193	3928193
380-400 V AC 660-690 V AC	3P+N+E	3924197	3928197
1 000 V AC**	3P+E	3924223	3928223
Auxiliaries 5 A/400 V AC	+ 2 contacts	Ref. + 972	Ref. + 972
Auxiliaries 5 A/400 V AC	+ 4 contacts*	Ref. + 174	Ref. + 174
Auxiliaries 5 A/400 V AC	+ 6 contacts*	Ref. + 976	Ref. + 976



► Other currents, voltages, frequencies and contact configurations are available (see page 14).

\* These versions cannot be ordered with neutral.







\*\* Switch rating up to 150 A.

OPTIONS	Section de câblage	Reference
<b>LOCKING PIN FOR 2 PADLOCKS Ø 4 TO 8 mm (PADLOCKS NOT SUPPLIED)</b>		
		Socket-outlet ref. +843
<b>SAFETY HASP FOR UP TO 6 PADLOCKS</b>		
		399A541
<b>ALLEN-SCREW LOCKING LATCH</b>		
Direct latch locking, no padlocking option.		Ref. socket + 22
<b>INLET CAP IP66/IP67</b>		
		392A426
<b>IP40 SELF RETURNING LID (MANUAL CLOSING)</b>		
		Socket-outlet ref.+R
<b>ELECTROMAGNETIC COMPATIBILITY (EMC) ● NEW</b>		
	Please order a metal threaded accessory herewith, together with a EMC cable gland to be found on page 318.	
<b>CABLE AMPLIFIER LUGS</b>		
	Flexible 120 mm <sup>2</sup> Stranded 150 mm <sup>2</sup>	392A277150
	Flexible 150 mm <sup>2</sup> Stranded 185 mm <sup>2</sup>	392A277185
<b>INCOMPATIBILITY ●</b>		
	Those products marked with a red dot are incompatible with for use with amplifier ends.	
<b>SPACERS (BETWEEN THE WALL BOX OR PANEL)</b>		
	Depth 68 mm	5K7M0-68
	Depth 115 mm	5K7M0-115
<b>PADLOCKING/ELECTRO-MECHANICAL INTERLOCKING</b>		
	Socket-outlet reference+MIL. Check out the details on page 312	

SLEEVE	∠x°	Reference
<b>METAL SLEEVE ●</b>		
	0° (Straight)	596M0
	60°	596M6
	60°	597M6

BOXES	∠x°	Input	Reference
<b>METAL BOX (+ EARTHING WIRE) + METAL SLEEVE + CORNET ●●</b>			
	60°	M50	596E6M50
	60°	M63	596E6M63
	60°	M75	596E6M75
<b>METAL BOX (+ EARTHING WIRE) + METAL SLEEVE + CORNET ●</b>			
	60°	M63	597E6M63
	60°	M75	597E6M75

Cable glands are not delivered with the boxes.

HANDLE	Input/ Cable outer Ø	Reference
<b>ELASTOMER HANDLE WITH GLAND</b>		
	25-35 mm	556P0D35
	35-45 mm	556P0D45
	45-49 mm	556P0D49
<b>POLY HANDLE + POLY CABLE GLAND</b>		
	35-48 mm	516P063P
<b>POLY HANDLE (WITHOUT CABLE GLAND)</b>		
	M63	516P0M63
	M75	516P0M75
<b>METAL HANDLE WITH INTEGRATED CABLE CLAMP</b>		
	40-50 mm	5K6P0D50
	51-60 mm	5K6P0D60
	61-70 mm	5K6P0D70
	71-80 mm	5K6P0D80
	81-90 mm	5K6P0D90
<b>METAL HANDLE METRIC THREAD ENTRY (WITHOUT CABLE GLAND) ●●</b>		
	M50	596P0M50
	M63	596P0M63
	M75	596P0M75
<b>METAL HANDLE METRIC THREAD ENTRY (WITHOUT CABLE GLAND) ●</b>		
	M40	5K6P0M40L
	M50	5K6P0M50L
	M63	5K6P0M63L
	M75	5K6P0M75L
<b>METAL HANDLE METRIC THREAD ENTRY (WITHOUT CABLE GLAND) - LARGE SIZE ●</b>		
	M63	796P0M63
	M75	796P0M75

# DRAWINGS AND DIMENSIONS

PLUG ON SOCKET-OUTLET

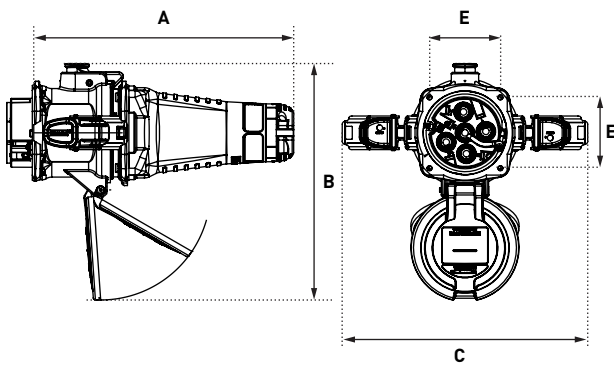

A	B	C	E
362	327	340	98

COUPLER

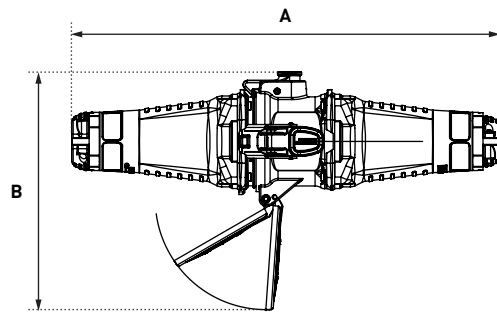

A	B
590	327

PLUG ON 60° WALL BOX MOUNTED SOCKET OUTLET

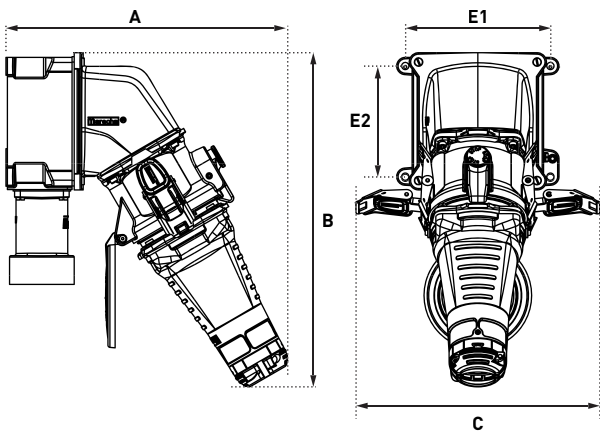

A	B	C	E1	E2
392	465	340	202	154

PLUG ON 60° INCLINED SOCKET OUTLET

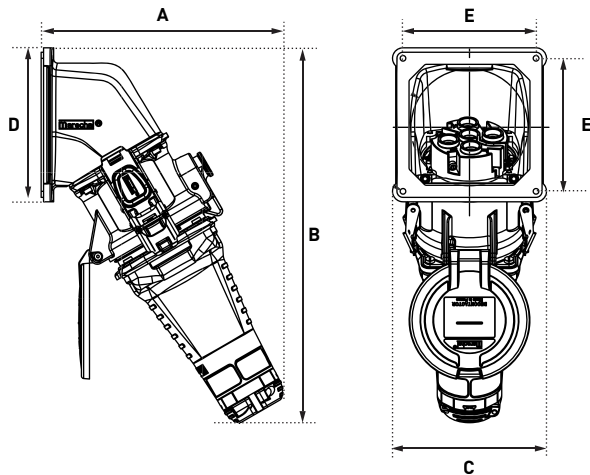

A	B	C	D	E
300	465	191	191	165

