

# Knürr® IT Special Catalog

Knürr IT Special Catalog

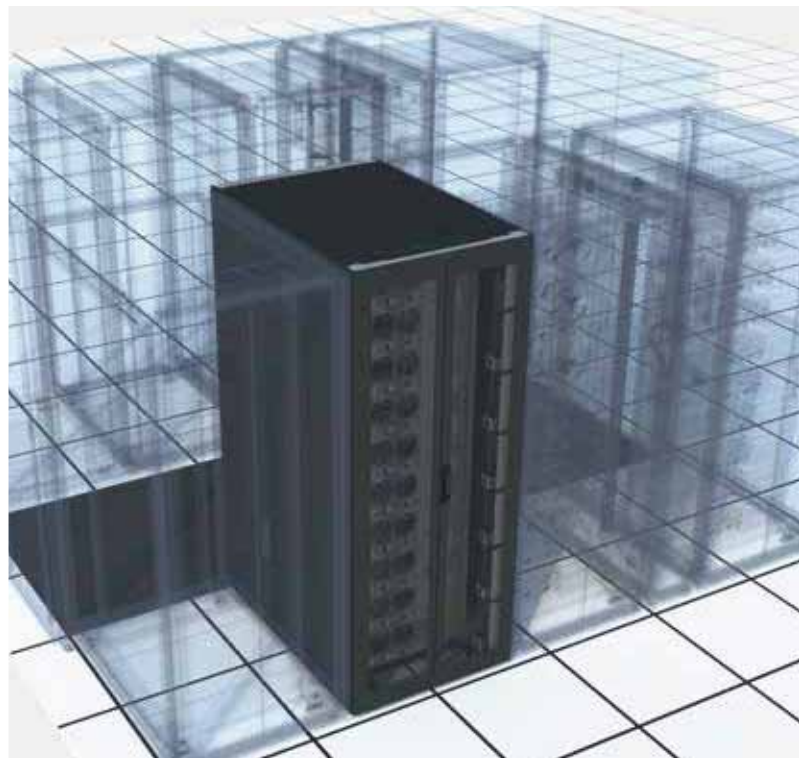

Status 03/2015

  
**EMERSON**  
Network Power

A division of the Emerson Group, **Emerson Network Power**, is a global company that combines technology and design to offer their customers innovative and effective solutions.

Emerson Network Power protects and optimizes infrastructures for data centers, communication networks, the health sector and industrial systems.

With its comprehensive technology base and global know-how, Emerson Network Power supports a broad range of company-level solutions that constitute one of the most important requirements for today's business.



No company, irrespective of its size, can afford a failure of its critical business systems or time losses incurred when IT infrastructures have to be restored following a downtime.

Leave the work to us: we are experts for all types of systems, from the supply network to the chip, and can deliver tailored solutions for both very large and small data centers.

High-level standardization ensuring that the installation won't cost you any extra. Our solutions are user-friendly: You needn't be an expert to find the best option for your company. Furthermore, we offer comprehensive support so that you have full protection while you go about your business.



Emerson Network Power endorses the European Code of Conduct for Energy Efficiency in Data Center.

# Table of Contents

<b>Mechanics – Racks</b>	Page 4	Knürr DCM®
	Page 26	Knürr Miracel® Server Rack
	Page 39	Knürr Miracel® Network Rack
<b>Accessories</b>	Page 62	Knürr @lock systems
	Page 69	Knürr Cable Management
	Page 92	Knürr System Accessories
	Page 112	Knürr Fan Units
<b>Mechanics – Enclosure</b>	Page 126	Knürr Smaract®
	Page 142	Knürr DoubleProRack®
	Page 151	Knürr ConAct®
<b>SmartAisle™ – Containment</b>	Page 156	SmartAisle™ – Containment
	Page 174	SwitchTubes™
<b>Cooling HDCS</b>	Page 181	Cooling HDCS
	Page 182	Knürr® DCL
	Page 188	Knürr® DCD
	Page 193	Knürr CoolTherm®
<b>Power Distribution Rack</b>	Page 199	Knürr PowerTrans2®
<b>Rack PDUs</b>	Page 203	Emerson Network Power Rack PDUs
	Page 205	MPX™
	Page 216	MPH2™
	Page 226	DI-STRIP®
<b>Monitoring</b>	Page 250	Knürr RMS Compact II®
	Page 256	Inline Metering System
<b>Emerson Network Power</b>	Page 262	Glossary
	Page 263	Centers of Expertise
	Page 264	Data Center Infrastructure for Large Applications

# Knürr DCM® – Rack System

Market-leading Data Center Technologies for your Company

**Integrated solutions.**  
**Integrated benefits.**  
**Integrated energy efficiency.**

- **Reliability:**  
Proven business-critical technologies that minimize failure sources and guarantee the greatest possible reliability for your IT systems.
- **Everything from one source:**  
One central provider for the provision, configuration, installation and support of your products and technologies.
- **Integration:**  
From the rack through to the entire room – our products and services form one integrated holistic system.
- **Technical support:**  
Where required, on-site and factory-site support is provided by application specialists. Emerson Network Power has the largest team of customer service specialists in the world.
- **Flexible configuration options:**  
Our products and technologies deliver flexibility, adaptability and cost-effective solutions.
- **Energy efficiency:**  
We offer our customers "Green IT" solutions that set standards on the ITC market – a data-center infrastructure that stays abreast current and future requirements and facilitates management and automation of physical infrastructure.

**Knürr provides comprehensive products and services for all requirements – from compact racks and computer rooms, right through to global data centers.**

Based on a variety of data centers' specific requirements, Emerson Network Power has developed a customized, ready-made solution: rack systems with integrated thermal management, power supply cooling and monitoring. We also provide optional services such as on-site expertise and support, thereby ensuring that you can easily order, configure, manage and implement your Knürr solution.



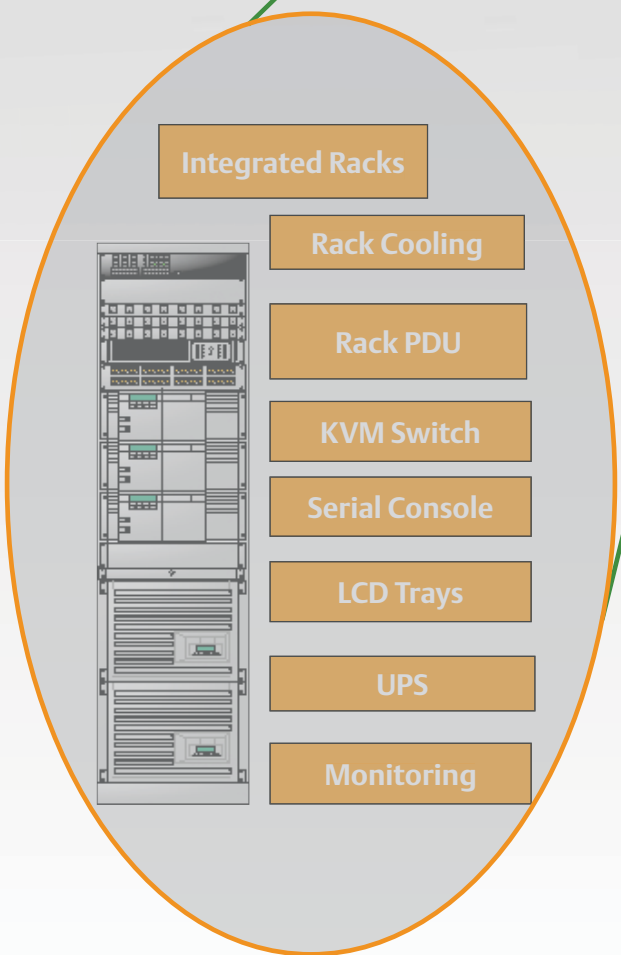
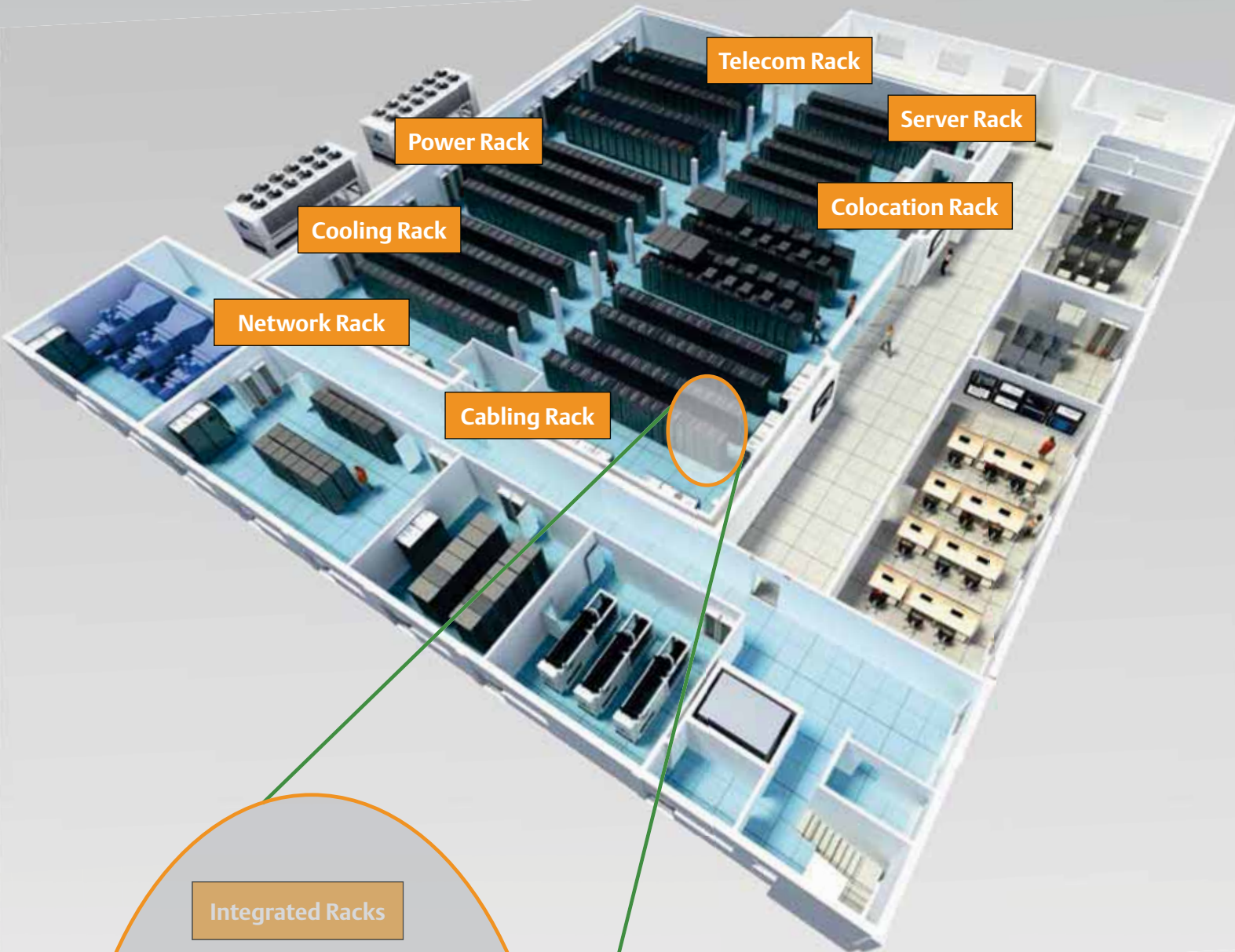

# Knürr DCM® – Rack System

## Overview



### Knürr DCM® and DCM® Colocation

- **Light aluminum frame, can be disassembled**
  - Easy, low weight transport.
  - Low stress on DC raised floors.
- **42 U / 47 U**
  - e.g. 42 U with 2000 mm external height including caster mounting.
- **Static load rating**
  - 15000 N with stationary version.
  - 10000 N with caster mounting.
- **Simple internal cabling**
- **Comfort and safety**
  - Easy to move even when rack is fully equipped.
- **T-slot system**
  - Freely selectable arrangement of accessories.



### Knürr Miracel® Server Rack

- **Aluminum construction, threaded connection system**
  - High flexibility and stability with low weight; simple assembly and disassembly.
- **41 U / 46 U**
  - e.g. 41 U with 2000 mm external height or 41 U with 2100 mm and mobile plinth.
- **Static load rating**
  - 5000 N with stationary version.
  - 3000 N with mobile plinth.
- **Special server extrusions**
  - Guaranteed easy mounting of 19" servers from all manufacturers.
- **Optional tilt restraint**
  - Ensures safety of service personnel. Also available integrated into the plinth.
- **Flexible ventilation components**
  - Always the right ventilation solution with the corresponding accessory components, e.g. via perforated floor panels, top covers and doors (perforation: 83%).



### Knürr Miracel® Network Rack

- **Aluminum construction, Threaded connection system**
  - High flexibility and stability with low weight; simple assembly and disassembly.
- **Static load rating**
  - 5000 N with stationary version.
  - 3000 N with mobile plinth.
- **T-slot system**
  - Freely selectable arrangement of accessories. Easy mounting of all non-standard components – variable in 19" and 25 mm increments.
- **Cable management**
  - Guaranteed orderly and space-saving cable management.
  - Easily adjustable to installation site: Cable management can be selected from an extensive range of accessory components.



# Knürr DCM®

## The Modular Rack Platform for a Future-proof Data Center

- Modular building box: quick, cost-effective and sustainable.
- Maximum space for power-supply and cabling components allowing them to be placed alongside the panels.
- Structural stability with low weight provided by light aluminum structure that can be disassembled.
- More variability with stepless, adjustable-depth air containment with vertical extrusions.

### Everything in the data center begins with the Knürr DCM®!

The Knürr DCM® is the modular building block for all "in row" applications of Emerson Network Power's products. This means that linked racks in a rack suite work in perfect unison as server racks, power racks, or storage racks.

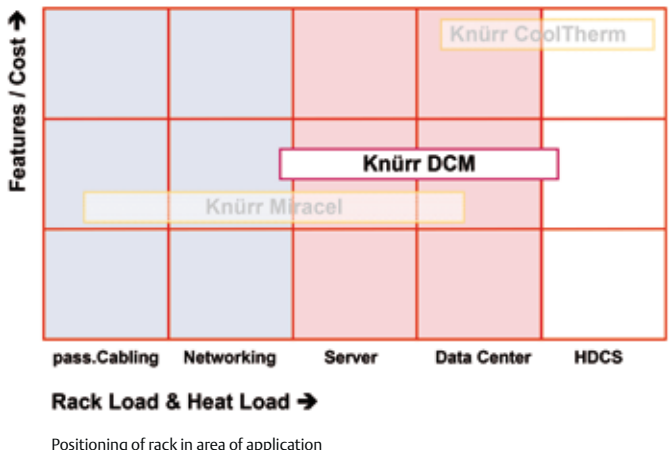
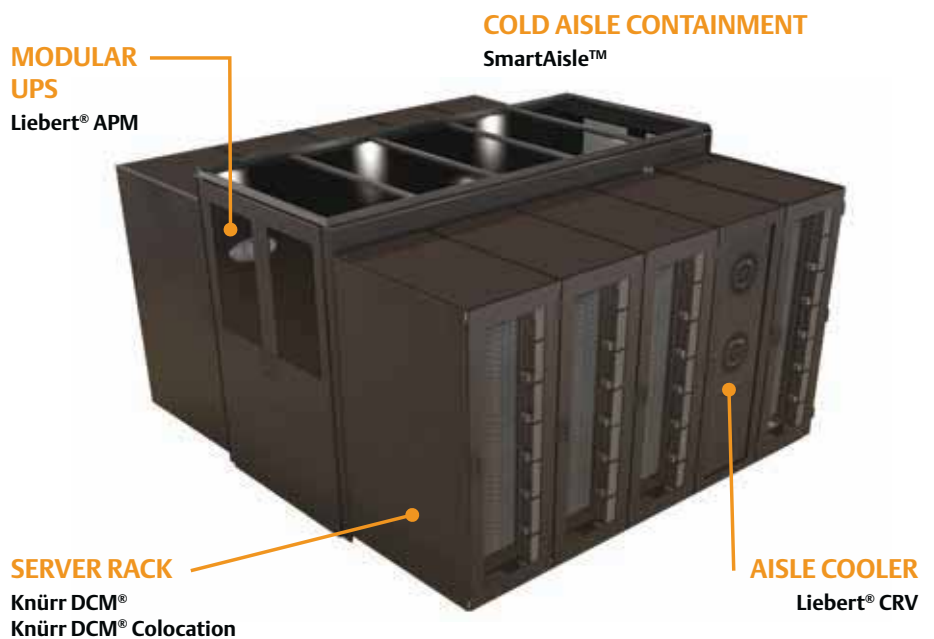





# Knürr DCM®

Application-optimized Server-Rack Solution –  
The Keystone for your IT Solutions



The right rack size  
for every application

- **Knürr Data Center Module**  
The Knürr DCM® is Emerson Network Power's globally available rack for world-wide, standardized data center planning.
- **Global standard**  
The 2000 mm height and 1100 mm depth rack version is the global platform for rack suites at Emerson Network Power. Cooling racks, power racks and server racks based on the Knürr DCM platform guarantee easy integration into the rack suite.
- **Metric measurements**  
for global use.
- **Stable and secure**  
Knürr DCM seismic-tested version available up on request. Static load of up to 1500 kg. Flexible use as a server or active network rack.





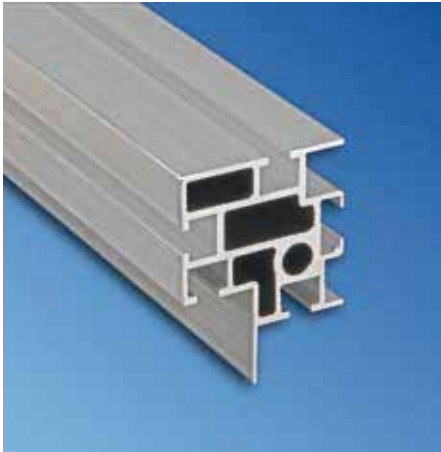

1. DCM20059



3. DCM20030

## Knürr DCM® Features

- **High-load cabinet**  
Static load of 1500 kg featuring a new design, more stable profiles and new high-load corner joints. (1)
- **Screw design**  
Since the rack can easily be dismantled, even to the most restricted areas are accessible. (2)
- **Light aluminum frame**  
Lower weight allows for easier, lighter transportation. (3)
- **Convenient**  
Tool-free door assembly. (4)
- **Low, heavy-duty casters**  
Even fully equipped rack can be moved safely and conveniently. (5)
- **Integrated tilt restraint**  
Quick and easy installation and disassembly.
- **Cable management**  
Guaranteed orderly and space-saving cable management. Adaptable to site installation requirements: cable management can be selected from an extensive range of accessory components. (6)
- **Largest possible perforation**  
For improved airflow. (7)
- **Maximum space**  
PDUs and cable management can also be housed in the space between the 19" level and the side panel. (8)
- **Adjustable-depth air separation**  
Cold/warm air is sealed alongside the panels, permitting adjustment of the depth. The standard air-containment accessory (with 1 U slot) can be used to increase the usable space of your server rack up to 6 U. (8)



2. DCM20008



4. DCM20006



5. DCM20028



6. DCM20027

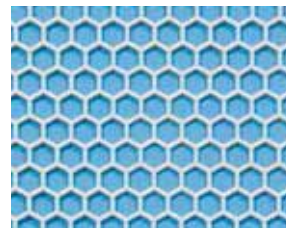

7. MIR20265



8. DCM20000

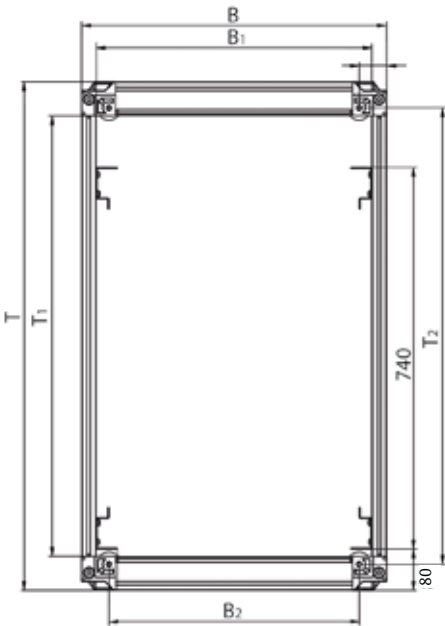

DCM20066

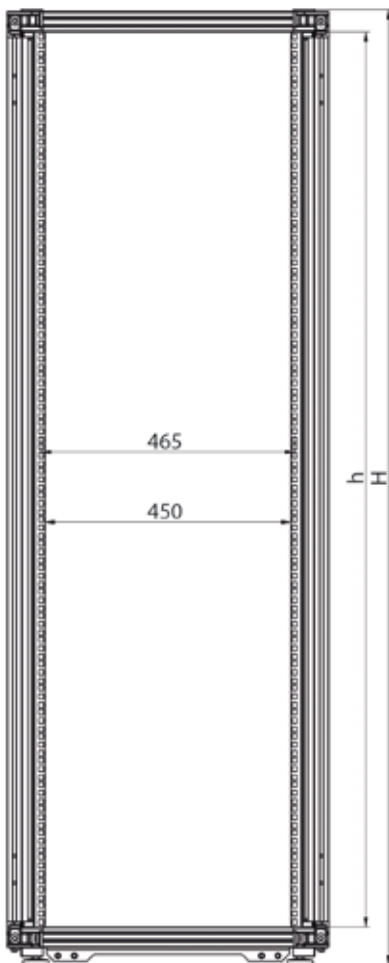

## Knürr DCM® Technical data

- Material**
  - Extruded aluminum.
  - Corner piece, die-cast aluminum.
  - Covers, steel sheet, zinc-passivated.
  - Steel sheet doors.
- Installation dimensions compliant with IEC 60297-1 and IEC 60297-2**
  - Height: 42 U / 47 U (1 U) = 44.45 mm).
  - Width: 482.6 mm (19" construction).
- Available space**
  - Jumping space, 80 mm.
  - 130° door opening angle in the rack suite and 180° as individual rack.
- Configurations**
  - Stationary on leveling feet.
  - Mobile with caster mounting and leveling feet.
- Finish/Color**
  - Basic rack, polished.
  - Visible surface of covers RAL 7021 dark-grey.
- Static load rating**
  - 15000 N (stationary model).
  - 10000 N (mobile model).
- Tests depending on design**
  - IP test compliant with IEC 60529.
  - Earthing and protective conductor test compliant with DIN EN 60950.

Further standards and tests may be provided upon on request.
- Rack suites**

To create a rack suite with "n" racks, the following is required:

  - n-1 racks without side panels and 1 rack with side panels.
  - In a rack suite, per connection you one set of rack connectors.

Nom. dimension	W	W1	W2	D	D1	D2
W 600 / D 1000	591	535	485	986	856	885
W 600 / D 1100	591	535	485	1086	956	985
W 600 / D 1200	591	535	485	1186	1056	1085
W 800 / D 1000	791	735	685	986	856	885
W 800 / D 1100	791	735	685	1086	956	985
W 800 / D 1200	791	735	685	1186	1056	1085

Nom. height	H	h
H 2000	1996	1872.60
H 2200	2218	2094.85

Knürr DCM®  
Configurator

- Up to 15000 different assembly options



**Knürr DCM® – configured by you**

Impressive number of variations: There are now up to 15000 options for a configuration with the 'Configurable Article Number' (which replaces the old order numbers).

A system building box that significantly simplifies your combinations.

This 'Configurable Article Number' reproduces all requested properties via multiple choice (see chart below), without requiring detailed rack descriptions.

Definite identification is also possible with a repeat order or upgrade.

The 'Configurable Article Number' makes a significant contribution to simplifying the selection and ordering process.

To simplify order handling, kindly use the enclosed form. Fill out as required and send directly by fax to the Knürr product experts at Customer Engineering.

A corresponding offer based on the enquiry will be submitted without delay.

**Module**  
Knürr DCM®

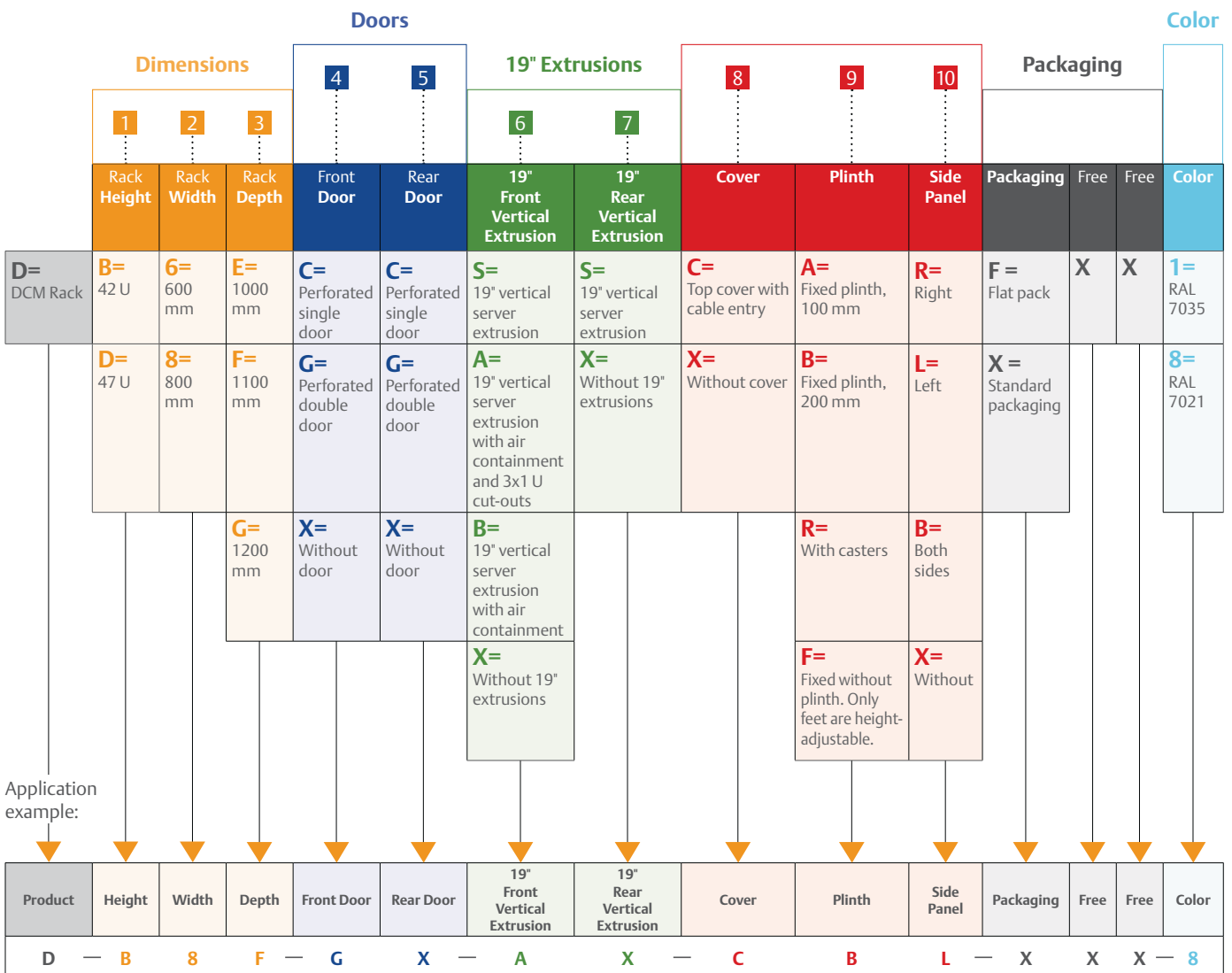

Example product number



DCM20003 stationary DCM20022 mobile

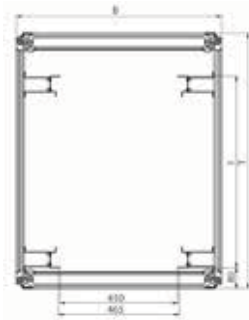

DCM20063 Average width 800 mm, stationary



DCM20062 Average width 600 mm, stationary

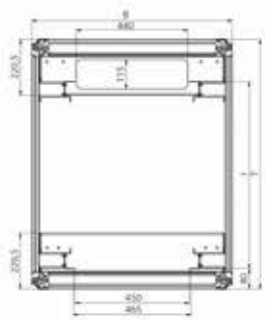

DCM20065 Average width 800 mm, mobile

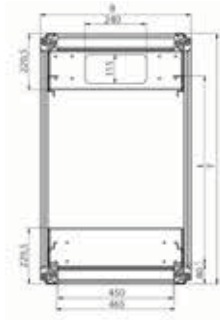

DCM20064 Average width 600 mm, mobile

### DCM® 19" Heavy Duty Server Rack Width 600 and 800, Stationary and Mobile

- Perforated front door.
  - Perforated rear double door.
  - Special 19" server extrusions for mounting all off-the-shelf 19" servers.
  - Components compliant with IEC 297-3.
  - Cable entry via top and bottom cover.
  - Cable entry on the top cover can be completely removed at the rear allowing installing and removal of top cover after cabling.
  - Mobile design includes heavy-duty casters with ample floor clearance.
- **Color**
    - Visible surfaces and covers coated with RAL 7021, dark-grey.
  - **Standard inclusion**
    - 1 x basic rack.
    - 4 x 19" server extrusions, steel sheet inclusive U marking.
    - 2 x side panels with quick connectors.
    - 1 x top cover with cable entry (three-piece sliding plates can also be opened completely).
    - 1 x front door, single, perforated, with handle and mounting for cylinder lock.
    - 1 x rear door, double, perforated, steel sheet, with handle and mounting for cylinder lock.
    - 4 x leveling feet.
    - 1 x complete earthing test (VDE 0100).
    - Mobile design: additionally 2 caster mountings with heavy-duty casters and integrated cable entry.
  - **Jumpering space**
    - Front 80 mm.
  - **Load rating**
    - 15000 N static.
    - 10000 N mobile in data center with load.
  - **Protection rating**
    - IP 20.
  - **Tests**
    - Earth compliant with DIN EN 60950.
    - Mobile design: Earthing compliant with VDE 0100 T 540.
    - IP test compliant with DIN 40 050 / IEC 529.
  - **Airflow circulation**
    - Perforation: 83 %.
  - **Material / Finish**
    - Basic rack, extruded aluminum, polished.
    - Corner piece, die-cast aluminum, polished.
    - Doors, steel sheet, powder-coated texture.
    - Covers, zinc-passivated steel sheet, powder-coated texture.
    - 19" extrusions, 2.5 mm zinc-passivated steel sheet.
  - **Delivery**
    - Mounted.
  - **Note**
    - Order mounting adapters for 19" server extrusion for mounting Knürr accessories are also available (see page 21).

W	H	D	U	d	Model	Order No.	UP
600	2000	1200	42	740	Stationary with side panels	DB6GCGSSCFBXXX8	1 unit
600	2200	1200	47	740	Stationary with side panels	DD6GCGSSCFBXXX8	1 unit
800	2000	1200	42	740	Stationary with side panels	DB8GCGSSCFBXXX8	1 unit
800	2200	1200	47	740	Stationary with side panels	DD8GCGSSCFBXXX8	1 unit
600	2000	1200	42	740	Stationary, no side panels	DB6GCGSSCFXXX8	1 unit
600	2200	1200	47	740	Stationary, no side panels	DD6GCGSSCFXXX8	1 unit
800	2000	1200	42	740	Stationary, no side panels	DB8GCGSSCFXXX8	1 unit
800	2200	1200	47	740	Stationary, no side panels	DD8GCGSSCFXXX8	1 unit
600	2000	1200	42	740	Mobile with side panels	DB6GCGSSCRBXXX8	1 unit
800	2200	1200	47	740	Mobile with side panels	DD8GCGSSCRBXXX8	1 unit
600	2000	1200	42	740	Mobile, no side panels	DB6GCGSSCRXXX8	1 unit
800	2200	1200	47	740	Mobile, no side panels	DD8GCGSSCRXXX8	1 unit

Dimensions in mm:				Conversion:	
W = Width	L = Length	U = Standard rack unit	kg = Weight	1 mm = 0.03937 inch	
H = Height	h = Installation height	(1 U = 44.45 mm)		1 kg = 2.2046 pounds	
D = Depth	d = Insertion depth	UP = Packaging unit			



**DCM® Colocation Rack**  
**Width 800 mm**



DCM20085



DCM20086



DCM20087



DCM20088

- Perforated front doors with one-point lock.
- Perforated rear doors with one-point lock.
- Special 19" server extrusions for mounting all off-the-shelf 19" servers.
- Components compliant with IEC 297-3.
- Standard cable entry with fixed cable duct on the right.
- Optional cable entry left and right via cover and shelf by reconfiguration of the cable ducts.
- Secure partitioning of the individual bays using securely mounted partition shelves.
- With lateral air containment at the front left and right, each with 1 U opening for mounting different components.
- Doors with handle and mounting for cylinder lock.
- Adjustment of the 19" extrusions in 50 mm increments.

■ **Jumpering space**

- Front 80 mm.

■ **Load rating**

- 25 kg per rack unit (stationary).
- e. g.: 15 U x 25 kg = 375 kg load for one bay.

■ **Protection rating**

- IP 20.

■ **Tests**

- Earthing compliant with VDE 0100 T 450.
- IP test compliant with DIN 40 050 / IEC 529.

■ **Airflow circulation**

- Perforation: 83%.

■ **Material / Finish**

- Basic rack, extruded aluminum, polished.
- Corner piece, die-cast aluminum, polished.
- Doors, steel sheet, powder-coated texture.
- Partitioning walls, zinc-passivated steel sheet.
- 19" extrusions, 2.0 mm zinc-passivated steel sheet.
- Shelf supports, zinc-passivated.

■ **Color**

- Visible cover surface
- Final digit of Order No. .1: RAL 7035 light-grey.
- Final digit of Order No. .8: RAL 7021 dark-grey.

■ **Standard inclusion**

- x 1 basic rack.
- 4 x 19" server extrusions with regular perforations, steel sheet with rack unit marking for each bay.
- 1 x top cover, including cable-inlet covers on the left and right sides.
- 1 x shelf, including cable-inlet cover on the right; open on the left for cable duct = cable entry.
- 2 x partitioning shelves for 3-way colocation.
- 1 x partitioning shelf for 2-way colocation.
- 3 x perforated front and rear doors for 3-way colocation.
- 2 x perforated front and rear doors for 2-way colocation.
- Air containment at the front with covered 1 U cut-out.

■ **Delivery**

- Mounted.

■ **Note**

- Also order mounting adapters for 19" server extrusion for mounting Knürr accessories (see page 21).
- Side partitioning walls must be ordered separately (see page 25).
- Cylinder locks must be ordered separately.

W	H	D	U	d	Model	Order No.	UP
800	2000	1100	13	740	3-way colocation without side panels	<b>01.143.000.X-001</b>	1 unit
800	2000	1200	13	740	3-way colocation without side panels	<b>01.143.000.X-002</b>	1 unit
800	2200	1100	15	740	3-way colocation without side panels	<b>01.143.000.X-003</b>	1 unit
800	2200	1200	15	740	3-way colocation without side panels	<b>01.143.000.X-004</b>	1 unit
800	2000	1100	20	740	2-way colocation without side panels	<b>01.143.001.X-001</b>	1 unit
800	2000	1200	20	740	2-way colocation without side panels	<b>01.143.001.X-002</b>	1 unit
800	2200	1100	23	740	2-way colocation without side panels	<b>01.143.001.X-003</b>	1 unit
800	2200	1200	23	740	2-way colocation without side panels	<b>01.143.001.X-004</b>	1 unit
800	2000	1100	13	740	3-way colocation with side panels	<b>01.143.002.X-001</b>	1 unit
800	2000	1200	13	740	3-way colocation with side panels	<b>01.143.002.X-002</b>	1 unit
800	2200	1100	15	740	3-way colocation with side panels	<b>01.143.002.X-003</b>	1 unit
800	2200	1200	15	740	3-way colocation with side panels	<b>01.143.002.X-004</b>	1 unit
800	2000	1100	20	740	2-way colocation with side panels	<b>01.143.003.X-001</b>	1 unit
800	2000	1200	20	740	2-way colocation with side panels	<b>01.143.003.X-002</b>	1 unit
800	2200	1100	23	740	2-way colocation with side panels	<b>01.143.003.X-003</b>	1 unit
800	2200	1200	23	740	2-way colocation with side panels	<b>01.143.003.X-004</b>	1 unit



DCM20097

**DCM® Steel Sheet Door, with Perforation, Single**

- **Material**  
– Steel sheet 1.0 mm.
- **Finish / Color**  
– Powder-coated texture, RAL 7021, dark-grey.
- **Standard inclusion**  
– 1 x door (single).  
– 1 x Mounting kit.
- **Delivery**  
– Preassembled.
- **Volume flow**  
– Large surface perforation (83 % free surface) enables optimum airflow through the rack.

W	H	D	Model	Order No.	UP
600	2000			<b>01.147.803.8</b>	1 unit
600	2200			<b>01.147.806.8</b>	1 unit
800	2000			<b>01.147.805.8</b>	1 unit
800	2200			<b>01.147.808.8</b>	1 unit



DCM20127

**DCM® Steel Sheet Door without Perforation, Single**

- **Material**  
– Steel sheet 1.0 mm.
- **Finish / Color**  
– Powder-coated texture, RAL 7021, dark-grey.
- **Protection rating**  
Installation in the DCM® rack (depending on the other rack components) enables a maximum protection class of IP 20.
- **Standard inclusion**  
– 1 x single steel sheet door.  
– 1 x Mounting kit.
- **Delivery**  
– Preassembled.

W	H	D	Model	Order No.	UP
600	2000			<b>01.147.534.8</b>	1 unit
600	2200			<b>01.147.537.8</b>	1 unit
800	2000			<b>01.147.536.8</b>	1 unit
800	2200			<b>01.147.539.8</b>	1 unit



DCM20096

**DCM® Steel Sheet Door with Perforation, Double**

- **Material**  
– Steel sheet 1.0 mm.
- **Finish / Color**  
– Powder-coated texture, RAL 7021, dark-grey.
- **Standard inclusion**  
– 1 x double door.  
– 1 x Mounting kit.
- **Delivery**  
– Preassembled.
- **Volume flow**  
– Large surface perforation (83 % free surface) enables optimum airflow through the rack.

W	H	D	Model	Order No.	UP
600	2000			<b>01.147.921.8</b>	1 unit
600	2200			<b>01.147.922.8</b>	1 unit
800	2000			<b>01.147.929.8</b>	1 unit
800	2200			<b>01.147.930.8</b>	1 unit



DCM20129

**DCM® Steel Sheet Door without Perforation, Double**

- **Material**  
– Steel sheet 1.0 mm.
- **Finish / Color**  
– Powder-coated texture, RAL 7021, dark-grey.
- **Protection rating**  
Installation in the DCM® rack (depending on the other rack components) enables a maximum protection class of IP 20.
- **Standard inclusion**  
– 1 x double steel sheet door.  
– 1 x Mounting kit.
- **Delivery**  
– Preassembled.

W	H	D	Model	Order No.	UP
600	2000			<b>01.147.570.8-002</b>	1 unit
600	2200			<b>01.147.570.8-003</b>	1 unit
800	2000			<b>01.147.570.8-010</b>	1 unit
800	2200			<b>01.147.570.8-011</b>	1 unit

Dimensions in mm:				Conversion:	
W = Width	L = Length	U = Standard rack unit	kg = Weight	1 mm = 0.03937 inch	
H = Height	h = Installation height	(1 U = 44.45 mm)		1 kg = 2.2046 pounds	
D = Depth	d = Insertion depth	UP = Packaging unit			



DCM20128

### DCM® Single Glass Door

- **Material**
  - Steel sheet 1.0 mm.
  - Single safety-glass panel, 4.0 mm clear glass.
- **Finish / Color**
  - Powder-coated texture, RAL 7021, dark-grey.
- **Protection rating**

Installation in the DCM® rack (depending on the other rack components) enables a maximum protection class of IP 20.
- **Standard inclusion**
  - 1 x single glass door.
  - 1 x Mounting kit.
- **Delivery**
  - Preassembled.

W	H	D	Model	Order No.	UP
600	2000			<b>01.147.540.8</b>	1 unit
600	2200			<b>01.147.543.8</b>	1 unit
800	2000			<b>01.147.542.8</b>	1 unit
800	2200			<b>01.147.545.8</b>	1 unit



DCM20130

### DCM® Double Glass Door

- **Material**
  - Steel sheet 1.0 mm
  - Single safety-glass panel, 4.0 mm clear glass.
- **Finish / Color**
  - Powder-coated texture, RAL 7021, dark-grey.
- **Protection rating**

Installation in the DCM® rack (depending on the other rack components) enables a maximum protection class of IP 20.
- **Standard inclusion**
  - 1 x double glass door.
  - 1 x Mounting kit.
- **Delivery**
  - Preassembled.

W	H	D	Model	Order No.	UP
600	2000			<b>01.147.571.8-002</b>	1 unit
600	2200			<b>01.147.571.8-003</b>	1 unit
800	2000			<b>01.147.571.8-010</b>	1 unit
800	2200			<b>01.147.571.8-011</b>	1 unit

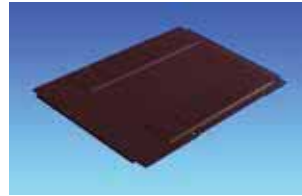

DCM20079

### DCM® Cover with Lateral Cable Entry

- With lateral cable entry on both sides (sliding plates).
- For orderly cable management inside the rack.
- **Material**
  - Steel sheet 1.5 mm.
- **Finish / Color**
  - Powder-coated texture, RAL 7021, dark-grey.
- **Standard inclusion**
  - 1 x top cover with lateral cable entry.
  - 1 x Mounting kit.
- **Delivery**
  - In sets.

W	H	D	Model	Order No.	UP
600		1000		<b>01.147.572.8</b>	1 unit
600		1100		<b>01.147.573.8</b>	1 unit
600		1200		<b>01.147.574.8</b>	1 unit
800		1000		<b>01.147.577.8</b>	1 unit
800		1100		<b>01.147.578.8</b>	1 unit
800		1200		<b>01.147.579.8</b>	1 unit

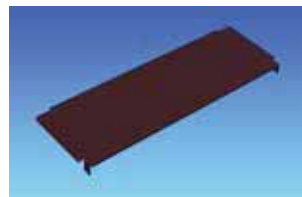

DCM20081

### DCM® Short Cover

- For covering the front area of the top; the rest remains open.
- Facilitates unobstructed cable entry in the rack.
- **Material**
  - Steel sheet 1.5 mm.
- **Finish / Color**
  - Powder-coated texture, RAL 7021, dark-grey.
- **Standard inclusion**
  - 1 x short cover.
  - 1 x Mounting kit.
- **Delivery**
  - In sets.

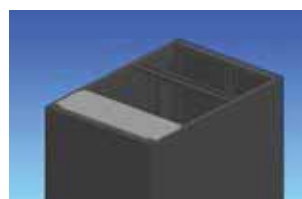

DCM20080

B <sub>Rack</sub>	L	Model	Order No.	UP
600	250		<b>01.147.268.8</b>	1 unit
800	250		<b>01.147.269.8</b>	1 unit



## DCM® Side Panel

– Side panel module for Knürr DCM® 19" heavy duty server rack

- **Material**  
– Steel sheet 1.0 mm.
- **Finish / Color**  
– Powder-coated texture, RAL 7021, dark-grey.
- **Standard inclusion**  
– 1 x side panel.  
– 1 x Mounting kit.
- **Delivery**  
– In sets.

DCM20069

W	H	D	Model	Order No.	UP
	2000	1000		<b>01.147.876.8</b>	1 unit
	2000	1100		<b>01.147.877.8</b>	1 unit
	2000	1200		<b>01.147.878.8</b>	1 unit
	2200	1000		<b>01.147.880.8</b>	1 unit
	2200	1100		<b>01.147.881.8</b>	1 unit
	2200	1200		<b>01.147.882.8</b>	1 unit



## DCM® Heavy Duty Plinth Fixed, Height 100 mm

– Fixed.  
– Cable entry possible from all sides.  
– Cover plate front and rear with vent slots and installation option for filter mat.

- **Load rating**  
– 10000 N static.
- **Material**  
– Steel sheet.
- **Finish**  
– Powder-coated texture, RAL 7021.
- **Standard inclusion**  
– 4 x plinth corners with leveling.  
– 2 x plinth cover plates with slots.  
– 2 x plinth cover plates closed on the side.  
– 1 x Mounting kit.
- **Delivery**  
– In sets.

DCM20037

W	H	D	Model	Order No.	UP
600	100	1000		<b>01.147.738.8</b>	1 unit
600	100	1100		<b>01.147.739.8</b>	1 unit
600	100	1200		<b>01.147.740.8</b>	1 unit
800	100	1000		<b>01.147.746.8</b>	1 unit
800	100	1100		<b>01.147.747.8</b>	1 unit
800	100	1200		<b>01.147.748.8</b>	1 unit



DCM20037b

## DCM® Heavy Duty Plinth Fixed, Height 200 mm

– Fixed incl. leveling option.  
– Cable entry possible from all sides.  
– Cover plate front and rear with vent slots and installation option for filter mat.

- **Load rating**  
– 10000 N static.
- **Material**  
– Steel sheet.
- **Finish**  
– Powder-coated texture, RAL 7021.
- **Standard inclusion**  
– 4 x plinth corners, incl. leveling feet.  
– 8 x cover plates.  
– 1 x Mounting kit.
- **Delivery**  
– In sets.

W	H	D	Model	Order No.	UP
600	200	1000		<b>01.147.788.8</b>	1 unit
600	200	1100		<b>01.147.789.8</b>	1 unit
600	200	1200		<b>01.147.790.8</b>	1 unit
800	200	1000		<b>01.147.796.8</b>	1 unit
800	200	1100		<b>01.147.797.8</b>	1 unit
800	200	1200		<b>01.147.798.8</b>	1 unit

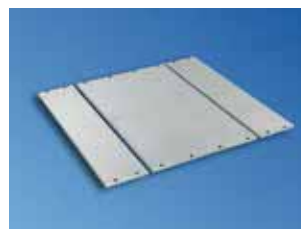

DCM20032

## DCM® Floor Panel 3-piece

– For covering the rack underside.  
– For flexible cable entry at the front and rear  
– For racks with caster mounting.

- **Material / Finish**  
– Steel sheet, 1.5 mm, zinc passivated.
- **Standard inclusion**  
– 3 x floor panels.  
– 2 x mounting brackets.  
– 1 x Mounting kit.
- **Delivery**  
– In sets.

W	H	D	Model	Order No.	UP
600		1000	without cable entry	<b>01.147.834.0</b>	1 unit
600		1100	without cable entry	<b>01.147.835.0</b>	1 unit
600		1200	without cable entry	<b>01.147.840.0</b>	1 unit
800		1000	without cable entry	<b>01.147.838.0</b>	1 unit
800		1100	without cable entry	<b>01.147.839.0</b>	1 unit
800		1200	without cable entry	<b>01.147.844.0</b>	1 unit

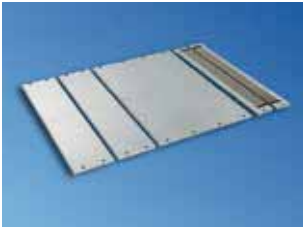

DCM20035

**DCM® Floor Panel for Cable Entry with Sponge-rubber Seal**

- For covering the rack underside.
- With rubber seal for flexible cable entry at the front or rear.
- For racks without caster mounting.

■ **Material / Finish**

- Steel sheet, 1.5 mm, zinc passivated.
- Sponge rubber, 50 mm x 50 mm.

■ **Standard inclusion**

- 1 x cable entry.
- 2 x floor panels.
- 2 x mounting brackets.
- 1 x Mounting kit.

■ **Delivery**

- In sets.

W	H	D	Model	Order No.	UP
600	1000		With cable entry	<b>01.147.846.0</b>	1 unit
600	1100		With cable entry	<b>01.147.847.0</b>	1 unit
600	1200		With cable entry	<b>01.147.852.0</b>	1 unit

800	1000		With cable entry	<b>01.147.850.0</b>	1 unit
800	1100		With cable entry	<b>01.147.851.0</b>	1 unit
800	1200		With cable entry	<b>01.147.856.0</b>	1 unit

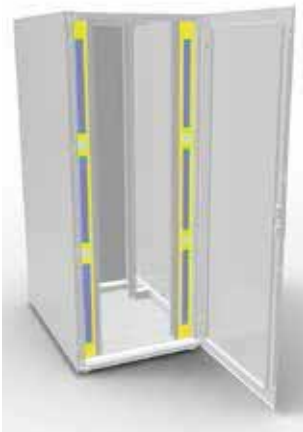

LUF20351

**DCM® Air Containment Unit with 3 x 1 U Cover Plates, Vertical**

- Quick and easy retrofitting of cold/warm area separation unit in rack.
- Side cover plates with 2 cut-outs each for cable routing.
- 3 x 1 U cut-outs, covered with cover plates.
- Screwed to the side of the 19" extrusions.
- Foam seals off the side panels or the same level in the linked rack enabling stepless depth adjustment.

■ **Material**

- Steel sheet.

■ **Cross brace finish / color**

- Powder-coated texture, RAL 7021 dark-grey.

■ **Standard inclusion**

- 2 x side cover plates.
- 1 x cover plate, bottom.
- 1 x foam element, top.
- 1 x Mounting kit.

■ **Delivery**

- In sets.

W	H	D	Model	Order No.	UP
800	2000	20	3 x 1 U cover plate, for racks with caster mounting	<b>01.147.904.8</b>	1 set
800	2000	20	3 x 1 U cover plate, for racks without caster mounting	<b>01.147.907.8</b>	1 set

800	2200	20	3 x 1 U cover plate, for racks with caster mounting	<b>01.147.905.8</b>	1 set
800	2200	20	3 x 1 U cover plate, for racks without caster mounting	<b>01.147.908.8</b>	1 set



LUF20350

**DCM® Air Containment Unit Closed**

- Quick and easy retrofitting of cold/warm area separation unit in rack.
- Side cover plates, closed.
- Screwed on the side on the 19" extrusions.
- Foam seals off the side panels or the same level in the linked rack enabling stepless depth adjustment.

■ **Material**

- Steel sheet.

■ **Cross brace finish / color**

- Powder-coated texture, RAL 7021 dark-grey.

■ **Standard inclusion**

- 2 x side cover plates (only B800).
- 2 x vertical foam elements.
- 1 x cover plate, bottom.
- 1 x foam element, top.
- 1 x Mounting kit.

■ **Delivery**

- In sets.

W	H	D	Model	Order No.	UP
600	2000	20	No cut-outs, for racks with caster mounting	<b>01.147.898.8</b>	1 set
600	2000	20	No cut-outs, for racks without caster mounting	<b>01.147.901.8</b>	1 set
600	2200	20	No cut-outs, for racks with caster mounting	<b>01.147.899.8</b>	1 set
600	2200	20	No cut-outs, for racks without caster mounting	<b>01.147.902.8</b>	1 set

800	2000	20	No cut-outs, for racks with caster mounting	<b>01.147.889.8</b>	1 set
800	2000	20	No cut-outs, for racks without caster mounting	<b>01.147.895.8</b>	1 set
800	2200	20	No cut-outs, for racks with caster mounting	<b>01.147.890.8</b>	1 set
800	2200	20	No cut-outs, for racks without caster mounting	<b>01.147.896.8</b>	1 set



DCM20052

**DCM® Mounting Adapter for 19" Server Extrusion**

- For mounting standard Knürr components (storage shelves, drawers, chassis rails, keyboard tray, etc.) in 19" installation space.

■ **Material**

- Steel sheet, zinc-passivated 2.5 mm.

■ **Standard inclusion**

- 4 x adapters.

W	H	D	U	h	d	kg	Model	Order No.	UP
44	44	44	1					<b>01.147.640.9</b>	1 set

**Dimensions in mm:**

W = Width L = Length U = Standard rack unit kg = Weight  
 H = Height h = Installation height (1 U = 44.45 mm)  
 D = Depth d = Insertion depth UP = Packaging unit

**Conversion:**

1 mm = 0.03937 inch  
 1 kg = 2.2046 pounds



DCM20077

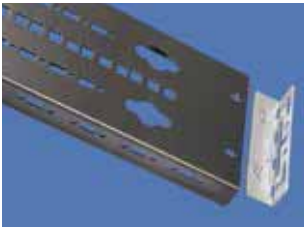

DCM20076

## DCM® PDU Bracket

- For orderly cable management in the rack.
- For hanging in trade-standard PDUs without tools.
- Especially suited to Knürr and Liebert PDUs.

■ **Material / Finish**  
- Steel sheet, 1.5 mm, zinc passivated, powder-coated.

■ **Color**  
- RAL 7021, dark-grey.

■ **Standard inclusion**  
- 1 x PDU bracket.  
- 1 x Mounting kit.

■ **Delivery**  
- In sets.

W	H <sub>Rack</sub>	D	U	Model	Order No.	UP
125	2000	25	42		<b>01.147.816.8</b>	1 unit
125	2200	25	47		<b>01.147.817.8</b>	1 unit



DCM20105

## DCM® Partitioning Wall for Retrofitting

- For air containment between two fixed adjacent racks.
- The partition wall is fitted between two racks and can be inserted from one side of the linking racks, and guided along the upper rear-enclosure extrusion of one of the linked racks.
- After the partition wall has been inserted, fasteners are bent or welded on one side of the wall and screwed into the vertical T-slot to secure the structure. The rack connectors included in the supply are used on the opposite side.

■ **Material**  
- Steel sheet 1.0 mm.

■ **Finish / Color**  
- Powder-coated texture, RAL 7021, dark-grey.

■ **Standard inclusion**  
- 1 x partitioning wall for retrofitting.  
- 1 x set of rack connectors.  
- 1 x Mounting kit.

■ **Delivery**  
- In sets.



DCM20106

W	H	D	Model	Order No.	UP
2000	1000			<b>01.147.644.8</b>	1 unit
2000	1200			<b>01.147.646.8</b>	1 unit
2200	1000			<b>01.147.647.8</b>	1 unit
2200	1200			<b>01.147.649.8</b>	1 unit



DCM20103

## DCM® Partitioning Wall Mounted, Fixed

- For air containment between two fixed adjacent racks.
- The partition wall is mounted only on one rack. It must be mounted before the other racks are installed.
- The partition wall is slotted in at the top of the rear extrusion and mounted to the basic rack with quick connectors. The rack connectors are then fitted to the top and bottom of the frame extrusions from the inside.
- Plastic cover extrusions are provided to seal the gap between two racks. These can be clipped into place at the front and back of the gap.

■ **Material**  
- Steel sheet 1.0 mm.

■ **Finish / Color**  
- Powder-coated texture, RAL 7021, dark-grey.

■ **Standard inclusion**  
- 1 x fixed partition wall.  
- 1 x set of rack connectors.  
- 2 x cover extrusions.  
- 1 x Mounting kit.

■ **Delivery**  
- In sets.



DCM20104

W	H	D	Model	Order No.	UP
2000	1000			<b>01.147.690.8</b>	1 unit
2000	1200			<b>01.147.692.8</b>	1 unit
2200	1000			<b>01.147.693.8</b>	1 unit
2200	1200			<b>01.147.695.8</b>	1 unit

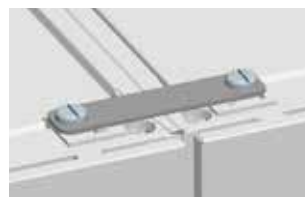

DCM20082

## DCM® Rack Connector Installed on Top

- For mechanical, stable joining of rack and enclosure suites.
- Can be installed on the racks from the top directly into the die-cast corner piece.
- Easy access for installation from the outside.

■ **Material / Finish**  
- Steel sheet, 3 mm, zinc passivated.

■ **Standard inclusion**  
- 2 x rack connectors for connecting 2 racks / frames).  
- 4 x knurled screws M12.

■ **Delivery**  
- In sets.



DCM20083

W	H	D	Model	Order No.	UP
			30x140	<b>01.147.642.7</b>	1 set

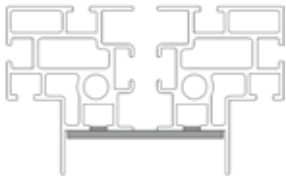

### Rack Connector External Mounting

- For secure connection of several racks.
- Front and rear external mounting.

**Material**

- Steel sheet, 1 mm, electroplated zinc.

**Standard inclusion**

- 6 x mounting straps.  
- 1 x Mounting kit.

DCM20125



DCM20123x

W	H	D	U	h	d	kg	Model	Order No.	UP
								<b>01.127.114.9</b>	1 set



### Rack Connector Internal Mounting

- For mechanical, stable joining of rack and enclosure suites.

**Material / Finish**

- Steel sheet, 2 mm, zinc passivated.

**Installation positions**

1. On the horizontal extrusion (bottom and top; front and rear).
2. Vertically on the vertical extrusion (front and rear; top and bottom).

**Standard inclusion**

- 8 x mounting brackets (for connecting 2 racks / frames)  
- 1 x Mounting kit.

**Delivery**

- In sets.

**Note**

Only use on racks without partition walls.

MIR00100

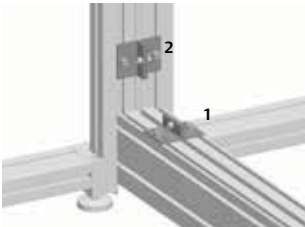

DCM20084

W	H	D	U	h	d	kg	Model	Order No.	UP
								<b>01.130.935.7</b>	1 set

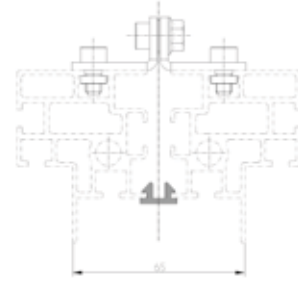

### Cover Extrusion for Rack Suites, IP20

**Material**

- PVC extruder cover, black.

**Standard inclusion**

- 2 x vertical lengths.  
- 2 x depth lengths.

DCM20126

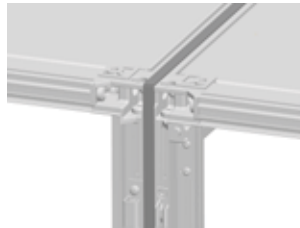

DCM20124

W	H	D	U	h	d	kg	Model	Order No.	UP
2000	1000	42						<b>01.127.760.9</b>	1 set
2200	1000	47						<b>01.127.761.9</b>	1 set
2000	1200	42						<b>01.127.762.9</b>	1 set
2200	1200	47						<b>01.127.763.9</b>	1 set



### Tilt Restraint for DCM®

- Quick and easy mounting and removal.
- Can be integrated in the Knürr DCM® rack.
- Use only as required.

**Standard inclusion**

- 2 x anti-tilt restrainers.

**Delivery**

- In sets.

DCM20026

W	H	D	U	Model	Order No.	UP
					<b>01.147.641.9</b>	2 unit

**Dimensions in mm:**

W = Width    L = Length    U = Standard rack unit    kg = Weight  
H = Height    h = Installation height (1 U = 44.45 mm)  
D = Depth    d = Insertion depth    UP = Packaging unit

**Conversion:**

1 mm = 0.03937 inch  
1 kg = 2.2046 pounds



DCM20090

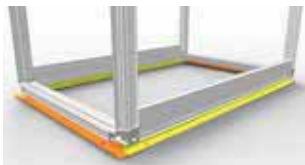

DCM20091

## Mounting Bracket fixed

- Fixed.
- Sits flush (airtight).
- Even load distribution on base.
- Also suitable for Miracel® racks.

### ■ Load rating

- 15000 N static.

### ■ Material

- Steel sheet 3.0 mm.

### ■ Finish

- Powder-coated texture, RAL 7021.

### ■ Standard inclusion

- 2 x mounting brackets for the depth.
- 2 x mounting brackets for the width.
- 1 x Mounting kit.

### ■ Delivery

- In sets.

W	H	D	Model	Order No.	UP
600	27	600		<b>01.147.509.8</b>	1 unit
600	27	700		<b>01.147.510.8</b>	1 unit
600	27	800		<b>01.147.511.8</b>	1 unit
600	27	900		<b>01.147.512.8</b>	1 unit
600	27	1000		<b>01.147.513.8</b>	1 unit
600	27	1100		<b>01.147.514.8</b>	1 unit
600	27	1200		<b>01.147.515.8</b>	1 unit
700	27	600		<b>01.147.517.8</b>	1 unit
700	27	700		<b>01.147.518.8</b>	1 unit
700	27	800		<b>01.147.519.8</b>	1 unit
700	27	900		<b>01.147.520.8</b>	1 unit
700	27	1000		<b>01.147.521.8</b>	1 unit
700	27	1100		<b>01.147.522.8</b>	1 unit
700	27	1200		<b>01.147.523.8</b>	1 unit
800	27	600		<b>01.147.525.8</b>	1 unit
800	27	700		<b>01.147.526.8</b>	1 unit
800	27	800		<b>01.147.527.8</b>	1 unit
800	27	900		<b>01.147.528.8</b>	1 unit
800	27	1000		<b>01.147.529.8</b>	1 unit
800	27	1100		<b>01.147.530.8</b>	1 unit
800	27	1200		<b>01.147.531.8</b>	1 unit



DCM20107

## DCM® Seismic Kit

- Retrofitting set for DCM® racks.
- Installed on site.
- Rack with installed seismic kit tested in accordance with Telcordia GR63 Zone 4.
- Maximum total load for seismic application: 500 kg per rack.

### ■ Material / Finish

- Steel sheet, powder-coated.

### ■ Color

- RAL 7021, dark-grey.

### ■ Standard inclusion

- 2 x seismic frames.
- Support for rear EIA-compliant level.
- 1 x Mounting kit.

### ■ Delivery

- In sets.

W	H	D	Model	Order No.	UP
600	2000		DCM® USA	<b>01.147.909.8</b>	1 set
600	2000		DCM® Standard	<b>01.147.912.8</b>	1 set





DCM20110

### Partitioning Wall for Retrofitting

- To secure the partitions between the individual bays against unauthorized access.
- Each bay can be closed off separately after initial installation.
- The partitioning wall is inserted above and below on mounting strips provided for this purpose.
- The partitioning wall is screwed into place at the front and covered by the door.

- **Material**
  - Steel sheet 1.0 mm.
- **Finish / Color**
  - Zinc-passivated steel sheet.
- **Standard inclusion**
  - 1 x partitioning wall for retrofitting.
  - 1 x Mounting kit.

- **Delivery**
  - In sets.

- **Note**

Partitioning wall can be installed from every position (top, middle, bottom, left and right).



DCM20109

W	H	D	Model	Order No.	UP
2000	1100		For 3-way colocation	<b>01.143.100.X-001</b>	1 unit
2000	1200		For 3-way colocation	<b>01.143.100.X-002</b>	1 unit
2200	1100		For 3-way colocation	<b>01.143.100.X-003</b>	1 unit
2200	1200		For 3-way colocation	<b>01.143.100.X-004</b>	1 unit
2000	1100		For 2-way colocation	<b>01.143.100.X-005</b>	1 unit
2000	1200		For 2-way colocation	<b>01.143.100.X-006</b>	1 unit
2200	1100		For 2-way colocation	<b>01.143.100.X-007</b>	1 unit
2200	1200		For 2-way colocation	<b>01.143.100.X-008</b>	1 unit



DCM20099

### Cable Duct for Retrofitting

- Secure cabling for data and power-supply lines.
- Subsequent installation in 2- or 3-way colocation.
- Cable duct can be rebuilt at any time.

- **Material**
  - Steel sheet 1.0 mm.
- **Finish / Color**
  - Zinc-passivated steel sheet.
- **Standard inclusion**
  - 1 x cable duct for retrofitting.
  - 1 x Covers.
  - 1 x Mounting kit.

- **Delivery**
  - In sets.



DCM20100

W	H	D	Model	Order No.	UP
2000			Short, for 3-way colocation	<b>01.143.101.X-001</b>	1 unit
2000			Long, for 3-way colocation	<b>01.143.101.X-002</b>	1 unit
2200			Short, for 3-way colocation	<b>01.143.101.X-003</b>	1 unit
2200			Long, for 3-way colocation	<b>01.143.101.X-004</b>	1 unit
2000			For 2-way colocation	<b>01.143.101.X-005</b>	1 unit
2200			For 2-way colocation	<b>01.143.101.X-006</b>	1 unit

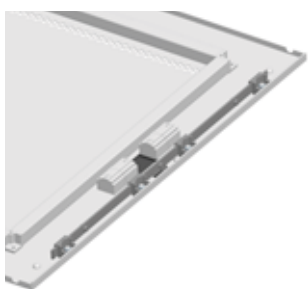

DCM20111

### 3-point Locking Upgrade Kit

- Upgrade kit for conversion to 3-point locking.
- Additional security.
- Can be upgraded at any time.
- Suitable for heights of 2000 and 2200 mm.

- **Standard inclusion**
  - 1 x Rod for locking unit.
  - 1 x Rod guide.

- **Delivery**
  - In sets.

W	H	D	Model	Order No.	UP
2000, 2200			for 3-way colocation	<b>01.143.102.X-001</b>	1 unit
2000, 2200			for 2-way colocation	<b>01.143.102.X-002</b>	1 unit

Dimensions in mm:				Conversion:
W = Width	L = Length	U = Standard rack unit	kg = Weight	1 mm = 0.03937 inch
H = Height	h = Installation height (1 U = 44.45 mm)			1 kg = 2.2046 pounds
D = Depth	d = Insertion depth	UP = Packaging unit		

# Knürr Miracel® Server Rack

Versatile, Distinctive, Integrative

## Features

- **ALUMINUM CONSTRUCTION**  
Proven technology based on aluminum extrusions provides high flexibility and stability at a low weight, thereby significantly simplifying handling and installation.
- **T-SLOT SYSTEM**  
Freely selectable arrangement of accessories. Easy mounting of all non-standard components – variable in 19" and 25 mm increments.
- **SCREW DESIGN**  
The cabinet is easy to dismantle which guarantees ease of access even in restricted areas.
- **CAN BE EXTENDED AT ANY TIME**  
System can be extended easily while maintaining the IP protection rating (IP20).
- **FLEXIBLE VENTILATION COMPONENTS**  
Always the right ventilation solution with the corresponding accessories, such as perforated doors, (perforation: 83%).
- **CABLE MANAGEMENT**  
guarantees optimized cable routing. Cable management can be selected from an extensive range of accessory components.
- **ALUMINUM SERVER EXTRUSIONS COMPLIANT WITH IEC 60297**  
Extrusions for quick installation of all commercially available servers as well as network- and telecom components.

**Knürr Miracel®**, the name that stands for renown, innovative 19" racks, delivers a rack system that significantly enhances energy efficiency.

The main feature of Miracel is the unsurpassed aluminum extrusion with T-slot. It is easy to assemble and offers an extensive range of accessory options.

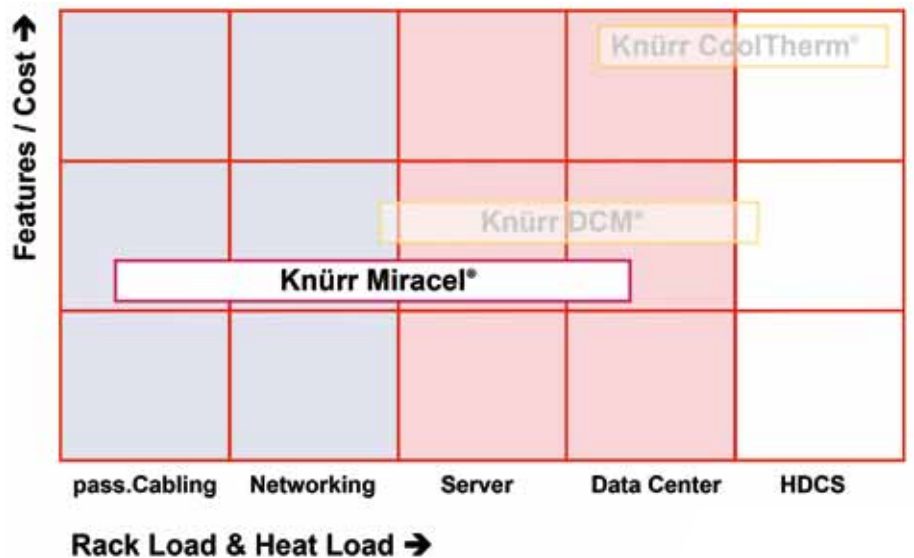





1. MIR20265



2. MIR20054

## Knürr Miracel® Server Rack Features

- A variety of concepts and designs for front-to-rear airflow. 83% perforation guarantees optimum airflow. (1)
- Optional tilt restraint ensures safety of service personnel. Also available integrated into the plinth. (2)
- Different cable-management variants permit adaptation to set-up conditions. (3)
- Special server extrusions guarantee easy mounting of 19" servers supplied by all manufacturers. (4)



1. MIR00407

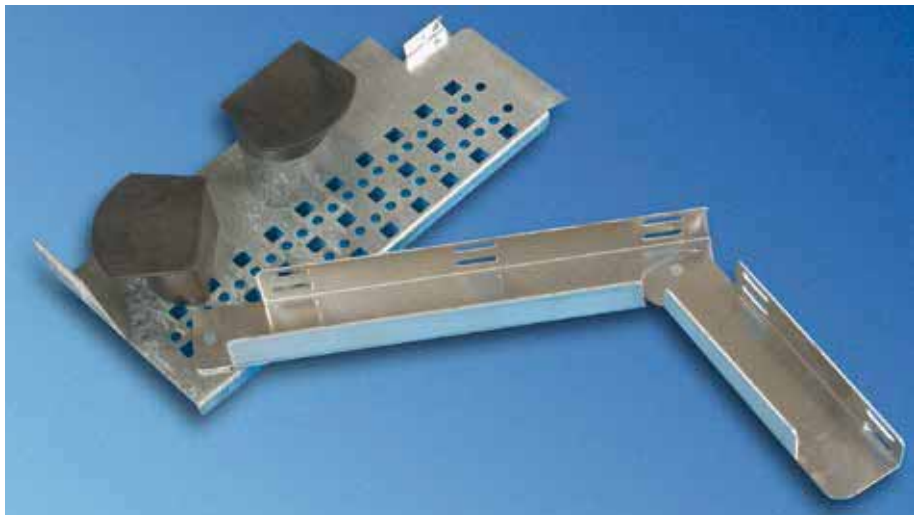

3. MIR20058



2. MIR20053



4. MIR20082

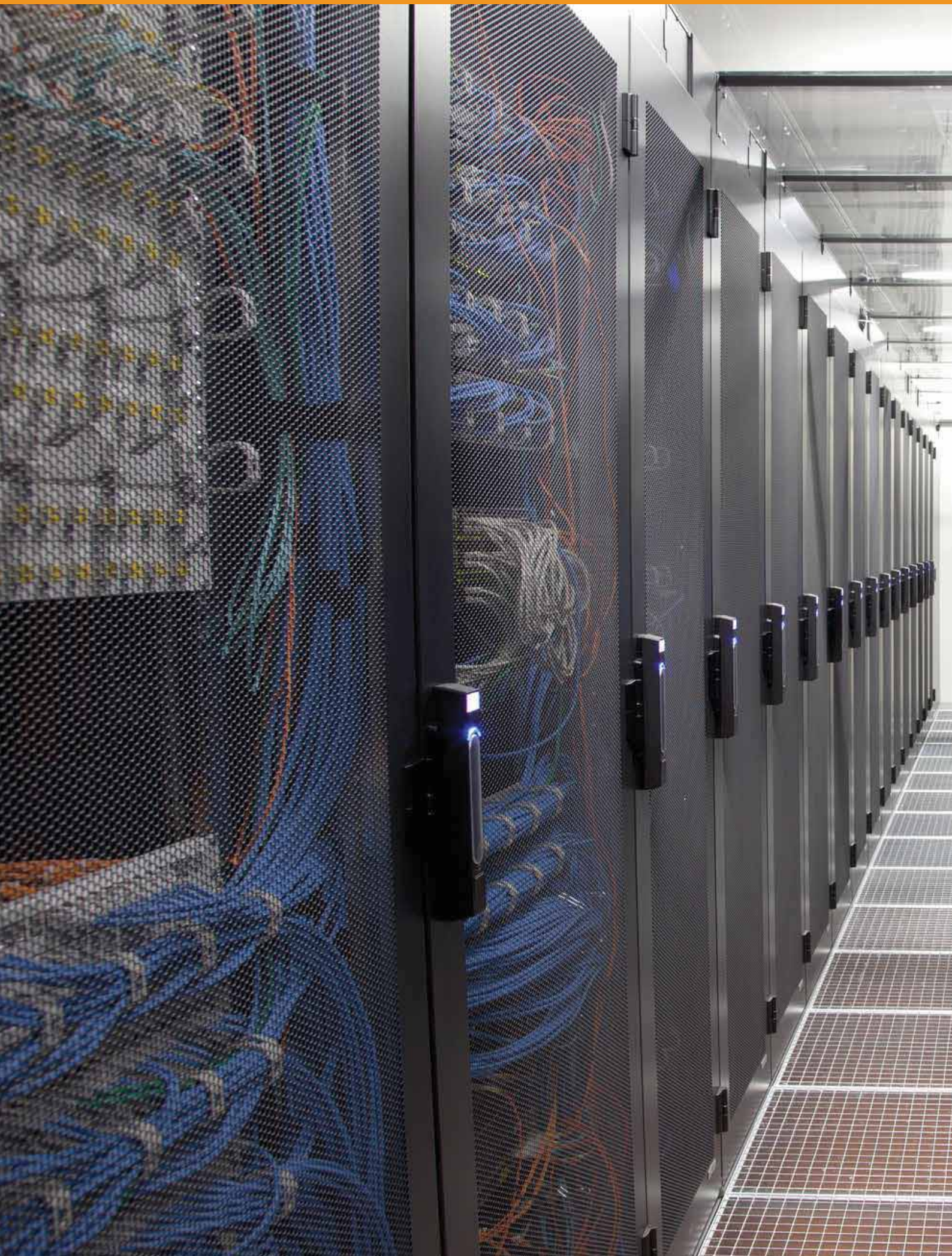

## Knürr Miracel® Technical data

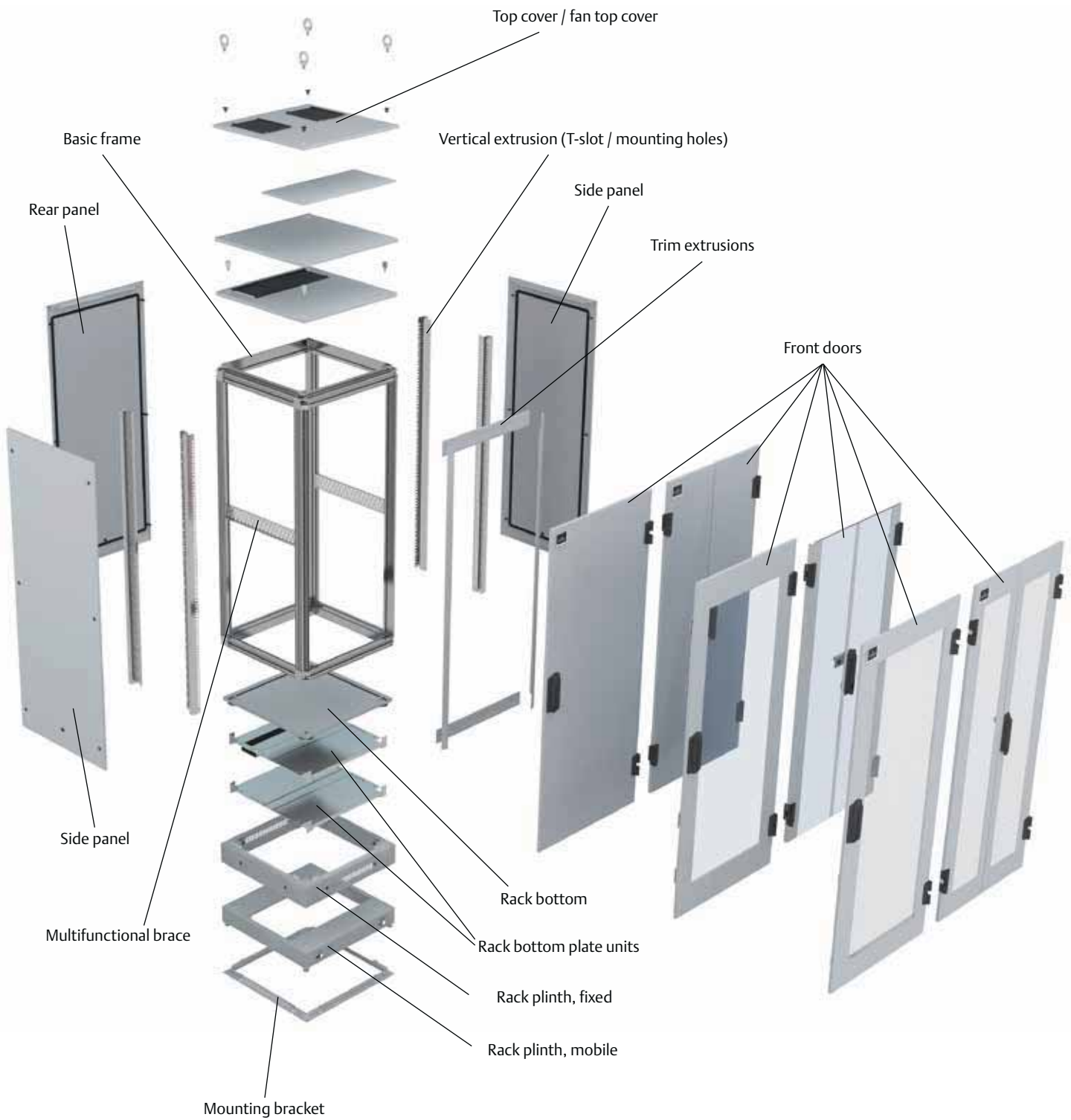

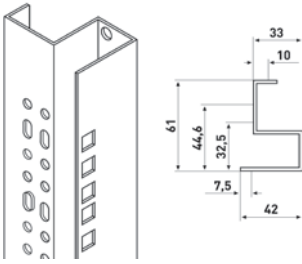

MIR00309 Vertical extrusion with mounting holes  
Steel for 19" racks

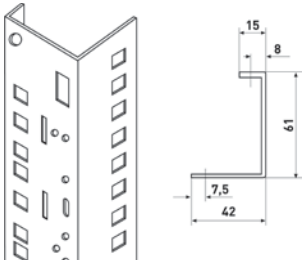

MIR20041 19" server extrusion

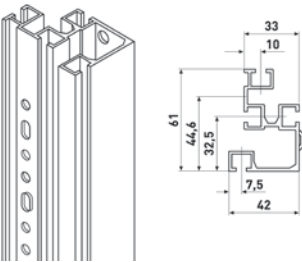

MIR00307 Vertical extrusion with T-slot  
Aluminum for 19" construction

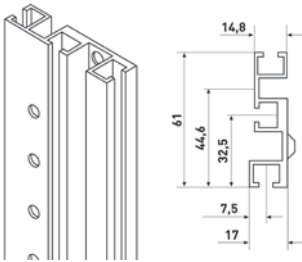

MIR00308 Vertical extrusion with T-slot  
Aluminum for metric construction, 20 module

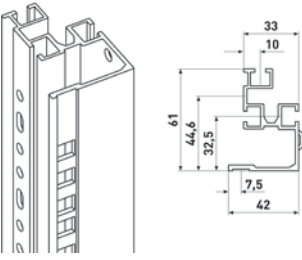

MIR20271 Vertical extrusion with mounting holes  
Aluminum for 19" racks

- **Material**
  - Extruded aluminum
  - Corner piece, die-cast aluminum
  - Covers, sheet steel, zinc-passivated
  - Doors: sheet steel or with single safety-glass panel, 4 mm or 6 mm (double doors).

■ **Installation dimensions IEC 297-3 and IEC 917 compliant**

- Height: 23 U / 37 U / 41 U / 46 U (1 U = 44.45 mm)  
66 module / 74 module / 82 module (1 module = 25 mm).
- Width: 482.6 mm (19" construction)  
535 mm (20" module construction).

■ **Available space**

- 82% of the basic surface can be used as space for installation and cable routing.
- Jumping space in front, 123 mm or 73 mm.
- 180° door opening angle.

■ **Configurations**

- Stationary, on leveling feet.
- Stationary with plinth.
- Mobile with plinth and snib.

■ **Finish / Color**

- Basic rack, polished.
- Optional: door trim, black, RAL 9011.
- Visible surface of covers powder-coated, light-grey RAL 7035 or dark-grey RAL7021.

■ **Static load rating**

- 5000 N with stationary version.
- 3000 N with mobile plinth.

■ **Heat transfer**

- Dissipation:
  - Closed cover: up to 500 W.
  - Vent lid: up to 700 W.

■ **Tests depending on design**

- Vibration test compliant with MIL-STD 810 E.
- IP test compliant with IEC 529.
- UL test 1244.
- NEMA 12 standard.
- EMC shielding attenuation compliant with MIL-STD 285 (10 MHz - 30 MHz) and VG 95 373 Part 15 (30 MHz - 1GHz).
- Vibration and shock test compliant with ETS 300 019.
- Seismic test, Bellcore (NEBS) TR-NWT 000063 Zone 4.
- Earthing, VDE 0 100 T 540.

Further standards and tests up on request.

■ **Rack suites**

- To create a rack suite with 'n' racks, the following is required: n-1 racks without side panels and one rack with side panels.  
In a rack suite you require one set of rack connectors per connection.

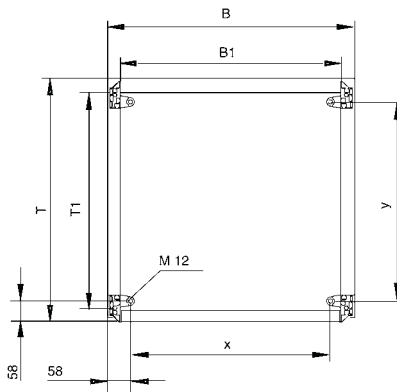

W [mm]	W1 [mm]	X [mm]
600	535	485
700	635	585
800	735	685
900	835	785

D [mm]	D1 [mm]	Y [mm]
600	530	485
800	730	685
900	830	785
1000	930	885
1200	1130	1085

MIR00332

## Knürr Miracel® Configurator

- Up to 415,000 different assembly options





## Knürr Miracel® – configured by you

Impressive number of variations: there are now up to 415,000 options for a configuration with the 'Configurable Article Number' (which replaces the old order numbers).

A system building box that significantly simplifies your combinations.

This 'Configurable Article Number' reproduces all requested properties via multiple choice (see chart below), without requiring detailed rack descriptions.

Clear identification is also possible with a repeat order or upgrade.

The 'Configurable Article Number' makes a significant contribution to simplifying the selection and ordering process.

To simplify order handling, kindly use the enclosed form. Fill out as required and send directly by fax to the Knürr product experts at Customer Engineering.

A corresponding offer will be submitted based on the request.

### Module Knürr Miracel®

	Dimensions			Doors		19" Extrusions		Cover			Packaging			Color
	1 Rack height	2 Rack width	3 Rack depth	4 Door front	5 Door rear	6 19" vertical extrusion, front	7 19" vertical extrusion, rear	8 Cover	9 Plinth	10 Side panel	Packaging	Free	Free	Color
M= Miracel Modular Rack	A= 41 U	6= 600 mm	C= 800 mm	A= Single glass door	A= Single glass door	S= 19" Server vertical extrusion	S= 19" Server vertical extrusion	C= Cover with cable entry and prepared for upgrade with CoolBlast fan unit	A= Fixed plinth, 100 mm	R= Right	F= Flat pack	X	X	1= RAL 7035
		8= 800 mm	E= 1,000 mm	B= Sheet steel single door	B= Sheet steel single door	H= 19" vertical-extrusion with holes	H= 19" vertical-extrusion with holes	D= Cover with cable entry (raised with spacers, 30 mm) and prepared for retrofitting CoolBlast fan unit	D= Mobile plinth	L= Left	X= Standard packaging			8= RAL 7021
			G= 1,200 mm	C= Perforated single door	C= Perforated single door	T= 19" vertical extrusion with T-Slot	T= 19" vertical extrusion with T-Slot	T= Cover closed	F= No plinth. Height can only be varied with adjustable feet.	B= Both sides				
				E= Double glass door	E= Double glass door	X= Without 19" extrusions	X= Without 19" extrusions	S= Cover closed (raised with spacers, 30 mm)		X= Without				
				F= Sheet steel double door	F= Sheet steel double door			X= Without cover						
				G= Perforated double door	G= Perforated double door									
				R= With rear panel	R= With rear panel									
				X= Without door	X= Without door									
Application example:														
Product	Height	Width	Depth	Front door	Rear door	19" vertical extrusion, front	19" vertical extrusion, rear	Cover	Plinth	Side panel	Packaging	Free	Free	Color
M	A	8	E	G	X	T	X	C	A	L	X	X	X	8

Example product number



MIR20318

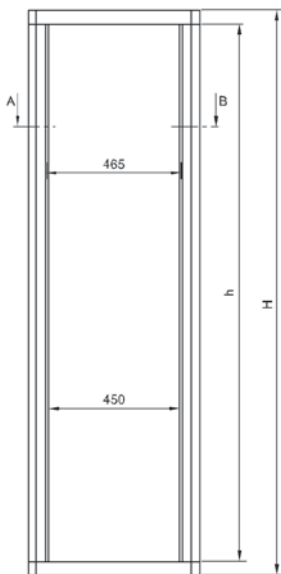

MIR20131

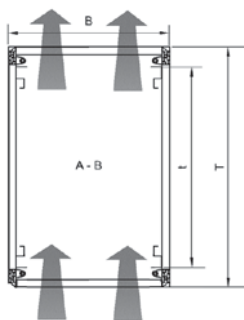

MIR20131

## Knürr Miracel® 19" ASP Rack / 19" server rack Widths 600 mm and 800 mm, front door with perforations

- Basic version without plinth; can be ordered if required.
  - With special 19" server extrusions for mounting trade-standard servers.
  - With a perforated doors on the front and rear for optimal airflow.
- **Jumpering space**
    - Front 85.5 mm.
  - **Load rating**
    - 5000 N static.
  - **Protection rating**
    - IP 20.
  - **Airflow circulation**
    - Perforation 83 %.
  - **Tests**
    - Earthing compliant with VDE 0100 T 540.
    - Vibration test compliant with MIL-STD 810 E.
    - IP test compliant with DIN 40 050 / IEC 529.
  - **Material / Finish**
    - Basic rack, extruded aluminum, polished.
    - Corner piece, die-cast aluminum.
    - Multifunctional braces and 19" angular extrusions, sheet steel, zinc-passivated.
    - Visible surface of the cover powder-coated texture.
- **Color**
    - Final digit of order number 1: x=1 Visible surface of covers RAL 7035 light-grey.
    - Final digit of order number 8: Visible surfaces of the covers RAL 7021 dark-grey.
  - **Standard inclusion**
    - 1 x basic rack.
    - 4 x 19" server sheet-steel mounting hole extrusions.
    - 2 x perforated doors (perforation: 83%).
    - 2 x side panels.
    - 1 x cover, closed.
    - 1 x complete earthing set.
    - 1 x complete locking set.
  - **Delivery**
    - Mounted.
  - **Note**
    - Order mounting adapter for 19" server extrusion for Knürr accessories is also available (see page 57).

W	H	D	U	h	d	kg	Model	Order No.	UP
600	2000	900	41	1852	740	87		01.127.933.X	1 unit
600	2000	1000	41	1852	740	91		01.127.935.X	1 unit
600	2200	1000	46	2052	740	97		01.127.936.X	1 unit
600	2000	1200	41	1852	740	100		01.128.310.X	1 unit
600	2200	1200	46	2052	740	110		01.128.311.X	1 unit
600	2000	900	41	1852	740	74	without side panels	01.127.980.X	1 unit
600	2000	1000	41	1852	740	78	without side panels	01.127.982.X	1 unit
600	2200	1000	46	2052	740	82	without side panels	01.127.983.X	1 unit
800	2000	1000	41	1852	740	99		01.128.314.X	1 unit
800	2200	1000	46	2052	740	108		01.128.315.X	1 unit
800	2000	1200	41	1852	740	108		01.128.316.X	1 unit
800	2200	1200	46	2052	740	116		01.128.317.X	1 unit
800	2000	1000	41	1852	740	86	without side panels	01.128.330.X	1 unit
800	2200	1000	46	2052	740	93	without side panels	01.127.331.X	1 unit
800	2000	1200	41	1852	740	93	without side panels	01.128.332.X	1 unit
800	2200	1200	46	2052	740	99	without side panels	01.127.333.X	1 unit



MIR20319

## Knürr Miracel® 19" Server Rack Width 700, doors with perforation

- 1 front door with extensive perforation for air intake.
- Prepared for lateral cable management with asymmetric layout of the extrusions.
- On the front installation space, on the left or the right side, 3 x 2 U additional 19" installation frame.

■ **Jumpering space**  
- Front 85.5 mm.

■ **Protection rating**  
- IP 20.

■ **Airflow circulation**  
- Perforation 83%.

■ **Material / Finish**  
- Basic rack, extruded aluminum, polished.  
- Corner piece, die-cast aluminum, polished.  
- Covers, zinc-passivated sheet steel, powder-coated texture.  
- Doors, sheet steel, powder-coated texture.  
- Multifunctional braces and 19" extrusions, sheet steel, zinc-passivated.

■ **Color**  
- Final digit of order number 1:  
Visible surface of covers  
RAL 7035 light-grey.  
- Final digit of order number 8:  
Visible surfaces of the covers  
RAL 7021 dark-grey.

■ **Standard inclusion**  
- 1 basic rack.  
- 4 19" sheet-steel server extrusions.  
- 1 panel, side with 3 x 2 U vertical installation space.  
- 2 side panels.  
- 1 cover, closed.  
- 1 front door with extensive perforation.  
- 1 rear door with extensive perforation.  
- 1 mobile plinth with rear cable entry and leveling feet.  
- 1 complete earthing set.  
- 1 complete locking set.

■ **Delivery**  
- Mounted.

■ **Note**  
Order mounting adapter for 19" server extrusion for Knürr accessories is also available (see page 57).

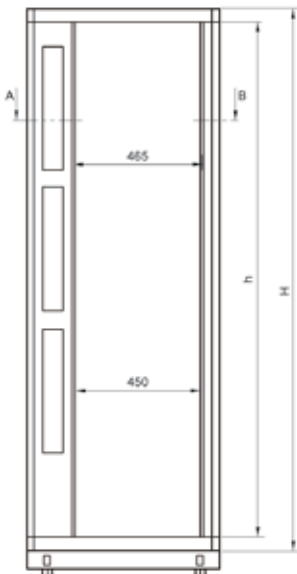

MIR20279

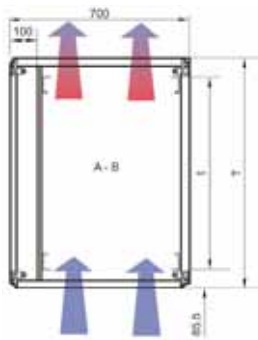

MIR20279

W	H	D	U	h	d	kg	Model	Order No.	UP
700	2100	1000	41	1852	740	104		<b>01.127.962.X</b>	1 unit
700	2300	1000	46	2052	740	111		<b>01.127.963.X</b>	1 unit

Dimensions in mm:				Conversion:
W = Width	h = Installation height	U = Standard rack unit	kg = Weight	1 mm = 0.03937 inch
H = Height	d = Insertion depth	(1 U = 44.45 mm)		1 kg = 2.2046 pounds
D = Depth	L = Length	UP = Packaging unit		



LUF20381

## Miracel® air containment for 19" rack, fixed depth

- For separating cold and warm areas in the rack.
- Prevention of hot-spots (air recirculation).
- Quick and easy rack upgrading.
- Ample 19" installation space: Side cover plates with additional 2 x 1 U each in the 19" vertical area.
- Side cover plates with 3 cut-outs each for cable routing (covered with rubber sleeve as standard).

■ **Material**  
- Sheet steel.

■ **Finish**  
Final digit of order number 1: powder-coated, RAL 7035 light-grey.  
Final digit of order number 8: powder-coated, RAL 7021 dark-grey.

■ **Standard inclusion**  
- 2 side cover plates (cut-outs covered).  
- 2 cover plates, top / bottom.  
- Mounting kit.

■ **Delivery**  
- In sets.

■ **Note**  
Use only with server extrusions.



LUF20234

W	H	D	U	JD	For rack type	Order No.	UP
600	2000	41	85.5	Miracel	<b>03.028.036.X</b>	1 set	
700	2000	41	85.5	Miracel – asymmetric only	<b>03.028.037.X</b>	1 set	
800	2000	41	85.5	Miracel	<b>03.028.038.X</b>	1 set	
600	2200	46	85.5	Miracel	<b>03.028.056.X</b>	1 set	
700	2200	46	85.5	Miracel – asymmetric only	<b>03.028.057.X</b>	1 set	
800	2200	46	85.5	Miracel	<b>03.028.058.X</b>	1 set	
600	2000	41	123	Miracel	<b>03.028.031.X</b>	1 set	
700	2000	41	123	Miracel – asymmetric only	<b>03.028.032.X</b>	1 set	
800	2000	41	123	Miracel	<b>03.028.033.X</b>	1 set	
600	2200	46	123	Miracel	<b>03.028.051.X</b>	1 set	
700	2200	46	123	Miracel – asymmetric only	<b>03.028.052.X</b>	1 set	
800	2200	46	123	Miracel	<b>03.028.053.X</b>	1 set	

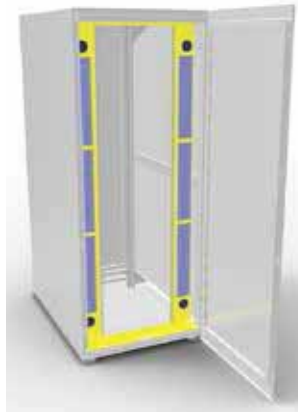

LUF20382

## Miracel® air containment for 19" rack for cross cabling

- For separating cold and warm areas in the rack.
- Prevention of hot-spots (air recirculation).
- Suitable for applications with cross cabling from rack to rack (e.g. switches).
- Ample 19" installation space: side cover plates with additional 3 x 2 U each in the 19" vertical area (can be used for components, cable entry and cable routing).
- Side cover plates with 2 round cut-outs each for cable routing (covered with rubber sleeve).
- Generous recess depth for large cable volumes (depth of 200 is recommended for switch applications).

■ **Material**  
- Cover plates: sheet steel.  
- High-density: PUR foam (UL94 HF-1).

■ **Finish**  
Final digit of order number 1: powder-coated, RAL 7035 light-grey  
Final digit of order number 8: powder-coated, RAL 7021 dark-grey.

■ **Standard inclusion**  
- 2 side cover plates (cut-outs covered).  
- 2 cover plates, top / bottom.  
- High-density foam.  
- Mounting kit.

■ **Delivery**  
- In sets.

■ **Note**  
Use only with server extrusions.

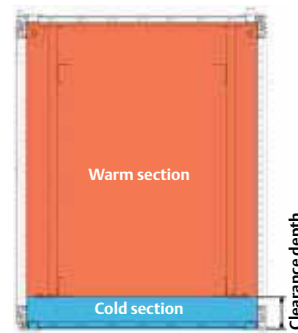

LUF20343

W	H	D	U	JD	For rack type	Order No.	UP
800	2000	41	123			<b>03.028.082.X</b>	1 set
800	2000	41	200			<b>03.028.084.X</b>	1 set
800	2200	46	123			<b>03.028.086.X</b>	1 set
800	2200	46	200			<b>03.028.088.X</b>	1 set

Dimensions in mm:				Conversion:	
W = Width	h = Installation height	U = Standard rack unit	kg = Weight	1 mm = 0.03937 inch	
H = Height	d = Insertion depth	(1 U = 44.45 mm)		1 kg = 2.2046 pounds	
D = Depth	L = Length	UP = Packaging unit			



MIR20050



MIR20053



MIR20260

MIR20261

## Knürr Miracel® plinth

Mobile and fixed, with tilt restraint; height 100 mm

- **Type**
  - Type 1: mobile.
  - Type 2: fixed.
- **Cable entry**
  - Possible at the rear.
- **Load rating**
  - 5000 N static.
- **Material**
  - Sheet steel 2 mm.
- **Finish / Color**
  - Powder-coated texture, RAL 7035 light-grey.
- **Standard inclusion Type 1:**
  - 1 x plinth frame.
  - 2 x fixed casters with snib.
  - 2 x swivel casters.
  - 4 x leveling feet.
  - 1 x tilt restrainer.
  - 1x Mounting kit.
- **Standard inclusion Type 2:**
  - 1 x plinth frame.
  - 4 x leveling feet.
  - 1 x tilt restrainer.
  - 1 x Mounting kit.
- **Delivery**
  - In sets.



MIR20051

## Tilt restraint for Miracel® racks Quick assembly system

- For fixing on the front vertical posts of all types of Miracel® racks.
- Quick and easy mounting and removal without tools.
- Use only as required.
- **Standard inclusion**
  - 2 tilt restrainers.
- **Delivery**
  - In sets.

W	H	D	U	h	d	kg	Model	Order No.	UP
								<b>01.127.310.9</b>	2 units



MIR20095

## Combination lock

- Mechanical solution for a top-quality locking system.
- Access either via a three-digit code that can be individually set on the handle or via a master key for access to the rack independent of the code setting.
- Suitable for Miracel rack single doors with swing handle.
- Subsequent retrofitting also possible without mechanical alteration.

W	H	D	U	h	d	kg	Model	Order No.	UP
600	100	900					Type 1, mobile:	<b>01.127.260.X</b>	1 unit
800	100	900					Type 1, mobile:	<b>01.127.262.X</b>	1 unit
600	100	1000					Type 1, mobile:	<b>01.127.263.X</b>	1 unit
700	100	1000					Type 1, mobile:	<b>01.127.264.X</b>	1 unit
800	100	1000					Type 1, mobile:	<b>01.127.265.X</b>	1 unit
600	100	1200					Type 1, mobile:	<b>01.127.266.X</b>	1 unit
800	100	1200					Type 1, mobile	<b>01.127.268.X</b>	1 unit

600	100	900					Type 2, fixed	<b>01.127.270.X</b>	1 unit
700	100	900					Type 2, fixed	<b>01.127.271.X</b>	1 unit
800	100	900					Type 2, fixed	<b>01.127.272.X</b>	1 unit
600	100	1000					Type 2, fixed	<b>01.127.273.X</b>	1 unit
700	100	1000					Type 2, fixed	<b>01.127.274.X</b>	1 unit
800	100	1000					Type 2, fixed	<b>01.127.275.X</b>	1 unit
600	100	1200					Type 2, fixed	<b>01.127.276.X</b>	1 unit
800	100	1200					Type 2, fixed	<b>01.127.278.X</b>	1 unit



MIR20106

## Support bracket

- For B 700 server rack with BN 01.132.043.1 and 01.132.044.1.
- For mounting slot-ins on the 19" level with 4 fixing points.

W	H	D	U	h	d	kg	Model	Order No.	UP
			2					<b>01.132.053.9</b>	1 unit
			3					<b>01.132.054.9</b>	1 unit

Model	Order No.	UP
Single doors DCM® / Miracel®	<b>01.137.013.9</b>	1 unit



MIR20460

## Door locking set

- **Standard inclusion**
  - 1 lock set.
  - 2 keys (half-cylinder).

W	H	D	U	h	d	kg	Model	Order No.	UP
								<b>05.041.299.9</b>	1 set



MIR00069

## Complete locking set

- **Standard inclusion**
  - 2 cylinders with 2 keys each.
  - 2 lockable fasteners for side panel with 2 keys each.

W	H	D	U	h	d	kg	Model	Order No.	UP
								<b>01.130.940.9</b>	1 set



MIR20092



MIR20273



MIR20274

## Knürr Miracel® Extension kit, 100 mm

- For rack depth extensions even at a later stage.
- Can be used in combination with doors (cannot be used for rear panel).
- Further cabling space, for airflow etc. easily added.

### Material

- Sheet steel.

### Finish / Color

- Powder-coated texture, RAL 7035.

### Standard inclusion

- 2 x vertical cover plates.
- 1 x horizontal cover plate, top.
- 1 x Extension adapter.
- 1 x Mounting kit.

### Delivery

- In sets.

### Note

Please also order lock bracket set if using double doors:  
Order no. 01.127.649.9

W	H	D	U	h	d	kg	Model	Order No.	UP
600	1200		23					01.127.550.1	1 set
600	1800		37					01.127.553.1	1 set
600	2000		41					01.127.554.1	1 set
600	2200		46					01.127.555.1	1 set
700	1800		37					01.127.559.1	1 set
700	2000		41					01.127.560.1	1 set
700	2200		46					01.127.561.1	1 set
800	1200		23					01.127.562.1	1 set
800	1800		37					01.127.565.1	1 set
800	2000		41					01.127.566.1	1 set
800	2200		46					01.127.567.1	1 set

#### Dimensions in mm:

W = Width    h = Installation height    U = Standard rack unit    kg = Weight  
 H = Height    d = Insertion depth    (1 U = 44,45 mm)  
 D = Depth    L = Length    UP = Packaging unit

#### Conversion:

1 mm = 0.03937 inch  
 1 kg = 2.2046 pounds



## Knürr Miracel® Network Rack Features

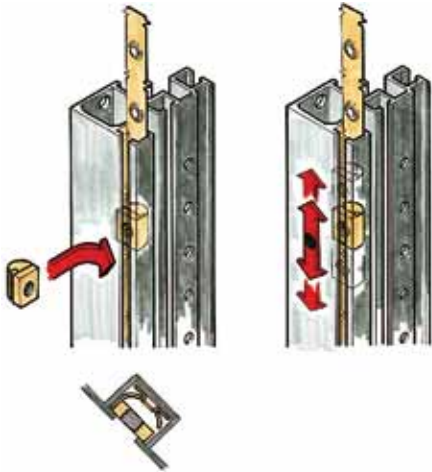

1. MIR00139

- Versatile rack system with many features.
- **Modular construction**  
Easy mounting, including all non-standard components – variable and integrated 19" or 25 mm increments. (1)
- **Advanced Technology**  
Future-proof and flexible with integrated 19" and metric technology. (2)
- **Expandable at all times**  
System can be expanded easily while maintaining the IP protection rating. (3)

- **Cable management**  
Guaranteed orderly and space-saving cable management. Adaptable to installation-site requirements: cable management can be selected from an extensive range of accessory components. (4)
- **Flexible ventilation components**  
The correct ventilation solution is achieved by an appropriate selection of accessory components enabling the airflow to be specially adapted to the built-in components – for example, through perforated bottom plates, top covers and doors. (5)

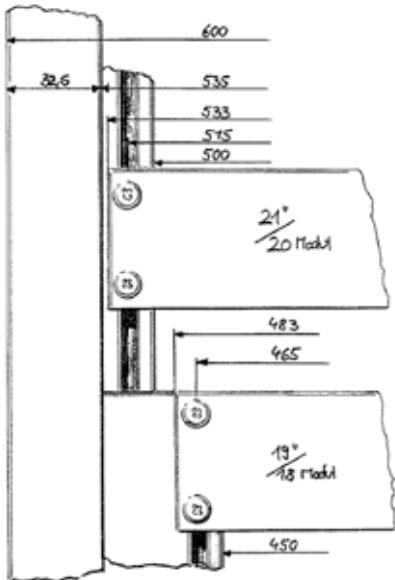

2. MIR20466



4. MEC20084

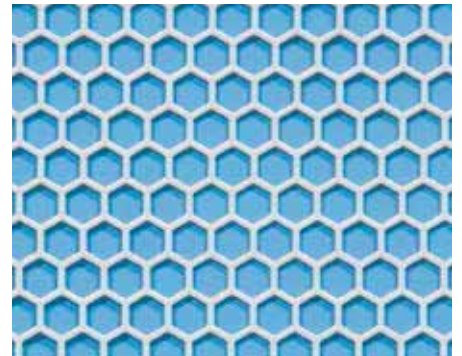

5. MIR20265



3. TEC00028



4. MIR00143



5. LUF20124





MIR20301

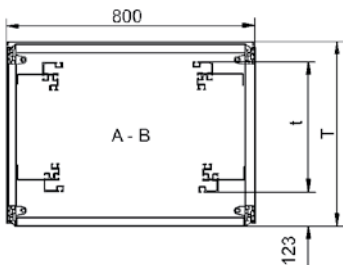

MIR20050

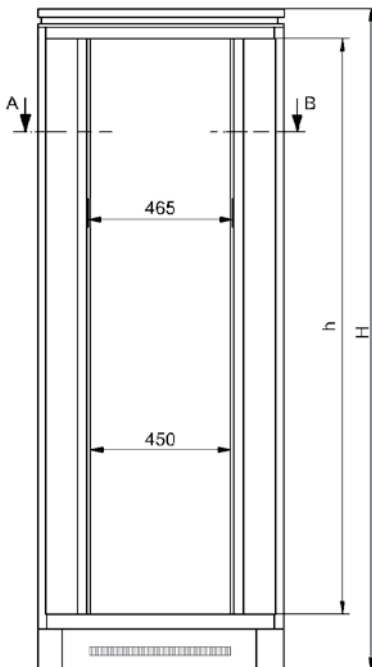

MIR20050

## Knürr Miracel® 19" distribution rack, NS 25 Width 800, front glass door, T-slot extrusions

- With fixed 19" component on the front and rear for IEC 297-3-compliant components.
  - Installation of slot-in runners and 19" shelves available.
  - Flexible assembly of the built-in units with T-slot.
  - Cable entry via plinth and top cover.
  - Cable entry on the top cover can be completely removed at the rear allowing for installation and removal of top cover after cabling.
  - Dissipated heat discharge via raised fan top cover.
  - Top cover prepared for retrofitting CoolBlast® fan units facilitating flexible adjustments in accordance with customer requirements.
  - Door opening angle, 180°.
- **Color**
    - Final digit of order number 1: Visible surface of covers RAL 7035 light-grey.
    - Final digit of order number 8: Visible surfaces of the covers RAL 7021 dark-grey.
  - **Standard inclusion**
    - 1 x basic rack.
    - 4 x aluminum vertical extrusions with T-slot and increment slide for M5 spring nut.
    - 2 x multifunctional braces for cable clamping and universal mounting options.
    - 2 x side panels with quick connectors.
    - 1 x raised fan top cover with cable entry (three-piece sliding plates, can also be opened completely), prepared for retrofitting CoolBlast® fan units.
    - 1 x front door, single, single safety-glass panel with handle and mounting for cylinder lock.
    - 1 x rear door, single, sheet steel, with handle and mounting for cylinder lock.
    - 1 x plinth for cable management on the side and rear with leveling feet (0 - 25 mm).
    - 2 x plinth cover plates for front and rear with vent slots and mounting for filter mat.
    - 2 x plinth cover plates, closed.
    - 1 x complete earthing set (VDE 0100).
  - **Jumpering space**
    - Front 123 mm.
  - **Load rating**
    - 5000 N static.
  - **Protection rating**
    - IP 40.
  - **Tests**
    - Earthing compliant with VDE 0100 T 540.
    - Vibration test compliant with MIL-STD 810 E.
    - IP test compliant with DIN 40 050 / IEC 529.
  - **Material / Finish**
    - Basic rack, extruded aluminum, polished.
    - Corner piece, die-cast aluminum, polished.
    - Doors, sheet steel, powder-coated texture.
    - Covers, zinc-passivated sheet steel, powder-coated texture.
    - Glass infill front door, single safety-glass panel, 4 mm.
    - Multifunctional braces, sheet steel, zinc-passivated.
  - **Delivery**
    - Mounted.

W	H	D	U	h	d	kg	Model	Order No.	UP
800	2120	800	41	1852	565	120	with side panels	<b>01.136.050.X</b>	1 unit
800	2320	800	46	2052	565	130	with side panels	<b>01.136.051.X</b>	1 unit
800	2120	900	41	1852	665	124	with side panels	<b>01.136.056.X</b>	1 unit
800	2320	900	46	2052	665	134	with side panels	<b>01.136.057.X</b>	1 unit
800	2120	1000	41	1852	740	140	with side panels	<b>01.127.970.X</b>	1 unit
800	2320	1000	46	1852	740	140	with side panels	<b>01.127.971.X</b>	1 unit
800	2120	800	41	1852	565	109	without side panels	<b>01.136.250.X</b>	1 unit
800	2120	900	41	1852	665	118	without side panels	<b>01.136.256.X</b>	1 unit
800	2120	1000	41	1852	740	128	without side panels	<b>01.127.975.X</b>	1 unit



MIR20301

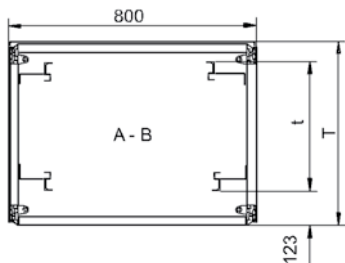

MIR00223

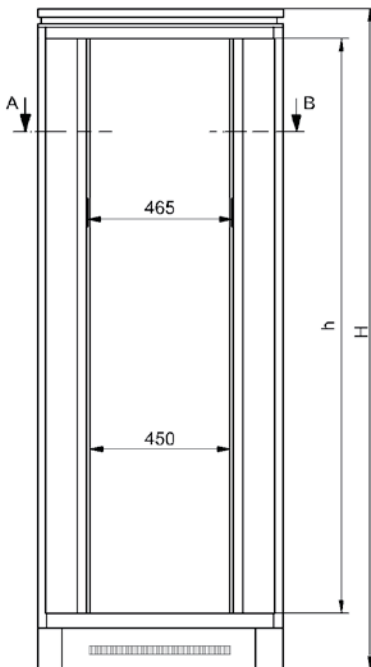

MIR20050

## Knürr Miracel® 19" distribution rack, NS 25 Width 800, front glass door, 19" mounting hole extrusions

- With fixed 19" component on the front and rear for IEC 297-3-compliant components.
- Installation of slot-in runners and 19" shelves available.
- Cable entry via plinth and top cover.
- Cable entry on the top cover can be completely removed at the rear allowing for installation and removal of top cover after cabling.
- Dissipated heat discharge via raised fan top cover.
- Top cover prepared for retrofitting CoolBlast® fan units facilitating flexible adjustments in accordance with customer requirements.
- Door opening angle, 180°.

### ■ Jumping space

- Front 123 mm.

### ■ Load rating

- 5000 N static.

### ■ Protection rating

- IP 40.

### ■ Tests

- Earthing compliant with VDE 0100 T 540.
- Vibration test compliant with MIL-STD 810 E.
- IP test compliant with DIN 40 050 / IEC 529.

### ■ Material / Finish

- Basic rack, extruded aluminum, polished.
- Corner piece, die-cast aluminum, polished.
- Doors, sheet steel, powder-coated texture.
- Covers, zinc-passivated sheet steel, powder-coated texture.
- Glass infill front door, single safety-glass panel, 4 mm.
- Multifunctional braces, sheet steel, zinc-passivated.

### ■ Color

- Final digit of order number 1:  
Visible surface of covers  
RAL 7035 light-grey.
- Final digit of order number 8:  
Visible surfaces of the covers  
RAL 7021 dark-grey.

### ■ Standard inclusion

- 1 x basic rack.
- 4 x 19" vertical extrusions, sheet steel with mounting holes.
- 2 x multifunctional braces for cable clamping and universal mounting options.
- 2 x side panels with quick connectors.
- 1 x raised fan top cover with cable entry (three-piece sliding plates can also be opened completely), prepared for retrofitting CoolBlast® fan units.
- 1 x front door, single, single safety-glass panel with handle and mounting for cylinder lock.
- 1 x rear door, single, sheet steel, with handle and mounting for cylinder lock.
- 1 x plinth for cable management on the side and rear with leveling feet (0 - 25 mm).
- 2 x plinth cover plates for front and rear, with vent slots and fixture for filter mat.
- 2 x plinth cover plates, closed.
- 1 x complete earthing set (VDE 0100).

### ■ Delivery

- Mounted.

W	H	D	U	h	d	kg	Model	Order No.	UP
800	2120	800	41	1852	565	120	with side panels	<b>01.133.041.X</b>	1 unit
800	2320	800	46	2052	565	130	with side panels	<b>01.133.042.X</b>	1 unit
800	2120	900	41	1852	665	124	with side panels	<b>01.133.043.X</b>	1 unit
800	2320	900	46	2052	665	134	with side panels	<b>01.133.044.X</b>	1 unit
800	2120	1000	41	1852	740	140	with side panels	<b>01.133.045.X</b>	1 unit
800	2120	800	41	1852	565	109	without side panels	<b>01.133.047.X</b>	1 unit
800	2120	900	41	1852	665	118	without side panels	<b>01.133.048.X</b>	1 unit
800	2120	1000	41	1852	740	128	without side panels	<b>01.133.049.X</b>	1 unit

#### Dimensions in mm:

W = Width    h = Installation height    U = Standard rack unit  
 H = Height    d = Insertion depth (1 U = 44.45 mm)  
 D = Depth    L = Length    UP = Packaging unit

#### Conversion:

1 mm = 0.03937 inch  
 1 kg = 2.2046 pounds



MIR20302

Color: dark gray or light gray

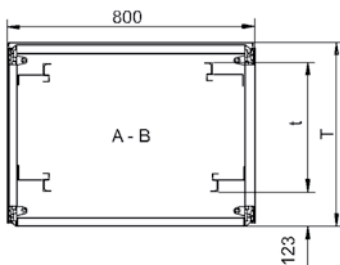

MIR20223

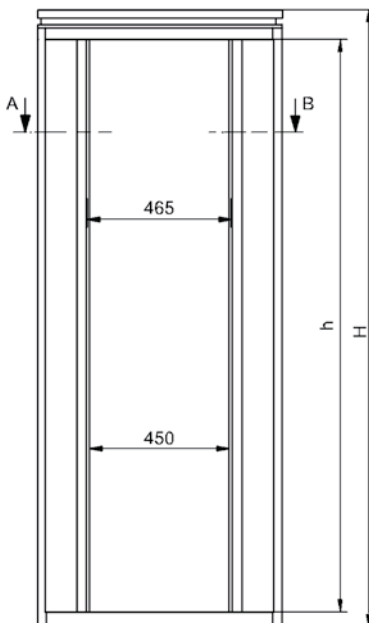

MIR20223

**Knürr Miracel® 19" distribution rack, NS 26**  
**Width 800, front glass door, mounting hole extrusions**

- With fixed 19" component on the front and rear for IEC 297-3-compliant components.
  - Installation of slot-in runners and 19" shelves available.
  - Top cover equipped for retrofitting CoolBlast® fan units facilitating flexible adjustments in accordance with customer requirements.
  - Door opening angle, 180°
- **Jumpering space**
    - Front 123 mm.
  - **Load rating**
    - 5000 N static.
  - **Protection rating**
    - IP 40.
  - **Tests**
    - Earthing compliant with VDE 0100 T 540.
    - IP test compliant with DIN 40 050 / IEC 529.
  - **Material / Finish**
    - Basic rack, extruded aluminum, polished.
    - Corner piece, die-cast aluminum, polished.
    - Covers, zinc-passivated sheet steel, powder-coated texture.
    - Doors, sheet steel, powder-coated texture, glass infill, front door, single safety-glass panel, 4 mm.
    - Multifunctional braces and 19" extrusions, sheet steel, zinc-passivated.
  - **Color**
    - Final digit of order number 1: Visible surface of covers RAL 7035 light-grey.
    - Final digit of order number 8: Visible surfaces of the covers RAL 7021 dark-grey.
  - **Standard inclusion**
    - 1 x basic rack.
    - 4 x 19" vertical extrusions, sheet steel with mounting holes.
    - 2 x multifunctional braces for cable clamping and universal mounting options.
    - 2 x side panels with quick connectors.
    - 1 x raised fan top cover with cable entry (three-piece sliding plates can also be opened completely), prepared for retrofitting CoolBlast® fan units.
    - 1 x front door, single, single safety-glass panel with handle and mounting for cylinder lock.
    - 1 x rear door, single, sheet steel, with handle and mounting for cylinder lock.
    - 1 x complete earthing set (VDE 0100).
    - 4 x leveling feet.
  - **Delivery**
    - Mounted.
  - **Note**
    - Not available with double doors.
    - Not available with bottom plates.

W	H	D	U	h	d	kg	Model	Order No.	UP
800	2000	800	42	1900	565	116	with side panels	<b>01.136.280.X</b>	1 unit
800	2200	800	47	2100	565	126	with side panels	<b>01.136.281.X</b>	1 unit
800	2000	900	42	1900	665	120	with side panels	<b>01.136.286.X</b>	1 unit
800	2200	900	47	2100	665	120	with side panels	<b>01.136.287.X</b>	1 unit
800	2000	800	42	1900	565	105	without side panels	<b>01.136.306.X</b>	1 unit
800	2000	900	42	1900	665	116	without side panels	<b>01.136.312.X</b>	1 unit



MIR20303

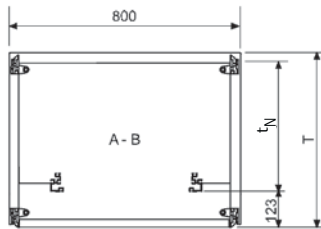

MIR00607

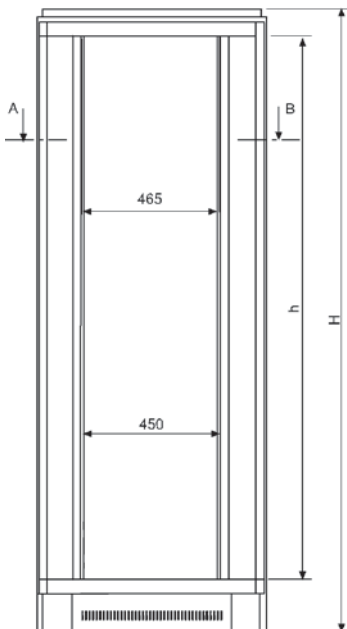

MIR00607

## Knürr Miracel® 19" distribution rack, NS 19.8 Width 800, front glass door

- With fixed 19" component on the front for IEC 297-3-compliant components.
- Flexible assembly of the built-in units with T-slot.
- Cable entry via plinth and top cover.
- Cable entry on the top cover can be completely removed at the rear allowing for installation and removal of top cover after cabling.
- Dissipated heat discharge via raised fan top cover.
- Top cover prepared for retrofitting CoolBlast® fan units facilitating flexible adjustments in accordance with customer requirements.
- Door opening angle, 180°.

### ■ Jumping space

- Front 123 mm.

### ■ Load rating

- 5000 N static.

### ■ Protection rating

- IP 40.

### ■ Tests

- Earthing compliant with VDE 0100 T 540.
- Vibration test compliant with MIL-STD 810 E.
- IP test compliant with DIN 40 050 / IEC 529.

### ■ Material / Finish

- Basic rack, extruded aluminum, polished.
- Corner piece, die-cast aluminum, polished.
- Covers, zinc-passivated sheet steel, powder-coated texture.
- Doors, sheet steel, powder-coated texture, glass infill, front door, single safety-glass panel.
- Multifunctional braces, sheet steel, zinc-passivated.

### ■ Color

- Visible surface of the covers, RAL 7035 light-grey.

### ■ Standard inclusion

- 1 x basic rack.
- 2 x 19" aluminum vertical extrusions with T-slot and increment slide for M5 spring nut.
- 2 x multifunctional braces for cable clamping and universal mounting options.
- 1 x raised fan top cover with cable entry (three-piece sliding plates can also be opened completely), prepared for retrofitting CoolBlast® fan units.
- 1 x front door, single or double, single safety-glass panel with handle and mounting for cylinder lock.
- 1 x rear door, single or double, sheet steel, with handle and mounting for cylinder lock.
- 2 x side panels with quick connectors (according to model).
- 1 x plinth for cable management on the side and rear with leveling feet (0 - 25 mm).
- 2 x side plinth cover plates, closed (according to model).
- 2 x plinth cover plates for front and rear, with vent slots and mounting for filter mat.
- 1 x complete earthing set (VDE 0100).

### ■ Delivery

- Mounted.

W	H	D	U	h	d <sub>0</sub>	kg	Model	Order No.	UP
800	1320	600	23	1052	435	78	glass door, side panel	01.135.001.1	1 unit
800	1920	600	37	1652	435	103	glass door, side panel	01.135.003.1	1 unit
800	2120	600	41	1852	435	112	glass door, side panel	01.135.004.1	1 unit
800	1320	800	23	1052	635	80	glass door, side panel	01.135.019.1	1 unit
800	1920	800	37	1652	635	111	glass door, side panel	01.135.021.1	1 unit
800	2120	800	41	1852	635	120	glass door, side panel	01.135.022.1	1 unit
800	1320	800	23	1052	635	80	double glass door, side panel	01.135.037.1	1 unit
800	1920	800	37	1652	635	111	double glass door, side panel	01.135.039.1	1 unit
800	2120	800	41	1852	635	120	double glass door, side panel	01.135.040.1	1 unit
800	2320	800	46	2052	635	121	double glass door, side panel	01.135.041.1	1 unit

#### Dimensions in mm:

W = Width    h = Installation height    U = Standard rack unit  
 H = Height    d = Insertion depth (1 U = 44.45 mm)  
 D = Depth    L = Length    UP = Packaging unit

#### Conversion:

1 mm = 0.03937 inch  
 1 kg = 2.2046 pounds



MIR20304

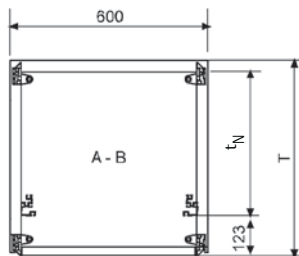

MIR00056

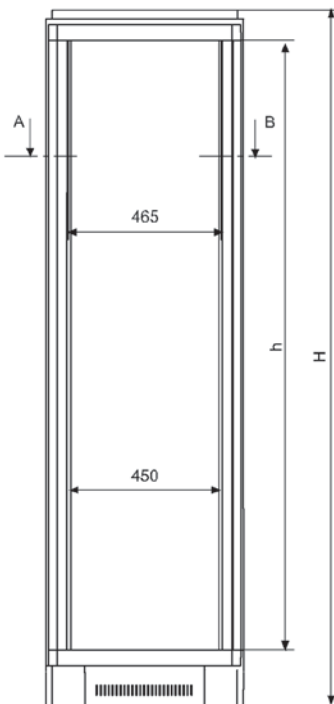

MIR00031

## Knürr Miracel® 19" distribution rack, NS 19.6 Width 600, with front glass door

- With fixed 19" component on the front for IEC 297-3-compliant components.
  - Flexible assembly of the built-in units with T-slot.
  - Cable entry via plinth and top cover.
  - Cable entry on the top cover can be completely removed at the rear allowing for installation and removal of top cover after cabling.
  - Dissipated heat discharge via raised fan top cover.
  - Top cover prepared for retrofitting CoolBlast® fan units facilitating flexible adjustments in accordance with customer requirements.
  - Door opening angle, 180°.
- **Jumpering space**
    - Front 123 mm.
  - **Load rating**
    - 5000 N static.
  - **Protection rating**
    - IP 40.
  - **Tests**
    - Earthing compliant with VDE 0100 T 540.
    - Vibration test compliant with MIL-STD 810 E.
    - IP test compliant with DIN 40 050 / IEC 529.
  - **Material / Finish**
    - Basic rack, extruded aluminum, polished.
    - Corner piece, die-cast aluminum, polished.
    - Covers, zinc-passivated sheet steel, powder-coated texture.
    - Doors, sheet steel, powder-coated texture, glass infill, front door, single safety-glass panel, 4 mm.
    - Multifunctional braces, sheet steel, zinc-passivated.
- **Color**
    - Visible surface of the covers, RAL 7035 light-grey.
  - **Standard inclusion**
    - 1 x basic rack.
    - 2 x 19" aluminum vertical extrusions with T-slot and increment slide for M5 spring nut.
    - 2 x multifunctional braces for cable clamping and universal mounting options.
    - 1 x raised fan top cover with cable entry (three-piece sliding plates can also be opened completely), prepared for retrofitting CoolBlast® fan units.
    - 1 x front door, single, single safety-glass panel with handle and mounting for cylinder lock.
    - 1 x rear door, single, sheet steel, with handle and mounting for cylinder lock.
    - 2 x side panels with quick connectors.
    - 1 x plinth for cable management on the side and rear with leveling feet (0 - 25 mm).
    - 2 x side plinth cover plates, closed.
    - 2 x plinth cover plates for front and rear, with vent slots and mounting for filter mat.
    - 1 x complete earthing set (VDE 0100).
  - **Delivery**
    - Mounted.

W	H	D	U	h	i <sub>0</sub>	kg	Model	Order No.	UP
600	1320	600	23	1052	435	72	with side panel	01.135.109.1	1 unit
600	1920	600	37	1652	435	95	with side panel	01.135.111.1	1 unit
600	2120	600	41	1852	435	103	with side panel	01.135.112.1	1 unit
600	2320	600	46	2052	435	112	with side panel	01.135.113.1	1 unit
600	1320	800	23	1052	635	74	with side panel	01.135.127.1	1 unit
600	1920	800	37	1652	635	102	with side panel	01.135.129.1	1 unit
600	2120	800	41	1852	635	110	with side panel	01.135.130.1	1 unit
600	2320	800	46	2052	635	119	with side panel	01.135.131.1	1 unit



MIR20307

## Miracel® 19" lab rack, NO 19 With 2 x 19" T-slot extrusions (basis for rack widths 600 / 700 / 800)

- With fixed 19" component on the front for IEC 297-3-compliant components.
  - Flexible assembly of the built-in units with T-slot.
- **Jumpering space**
    - Front 123 mm.
  - **Load rating**
    - 5000 N static.
  - **Tests**
    - Earthing compliant with VDE 0100 T 540.
    - Vibration test compliant with MIL-STD 810 E.
  - **Material / Finish**
    - Basic rack, extruded aluminum, polished.
    - Corner piece, die-cast aluminum.
    - Multifunctional braces, sheet steel, zinc-passivated.
  - **Standard inclusion**
    - 1 x basic rack.
    - 2 x 19" aluminum vertical extrusions with T-slot and increment slide for M5 spring nut.
    - 2 x multifunctional braces for cable clamping and universal mounting options.
    - 4 x leveling feet (0 - 25 mm).
  - **Delivery**
    - Mounted.

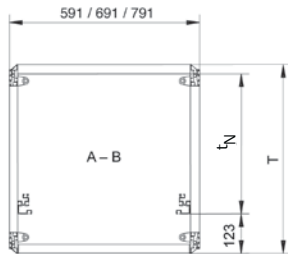

MIR00043a

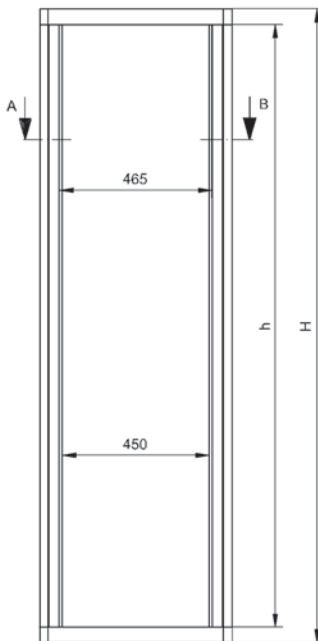

MIR20002

W	H	D	U	h	i <sub>b</sub>	kg	Model	Order No.	UP
600	1200	600	23	1052	435	14		01.135.793.3	1 unit
600	1800	600	37	1652	435	16		01.135.795.3	1 unit
600	2000	600	41	1852	435	17		01.135.796.3	1 unit
600	2200	600	46	2052	435	18		01.135.797.3	1 unit
600	1200	800	23	1052	635	16		01.135.817.3	1 unit
600	1800	800	37	1652	635	18		01.135.819.3	1 unit
600	2000	800	41	1852	635	19		01.135.820.3	1 unit
600	2200	800	46	2052	635	20		01.135.821.3	1 unit
600	1200	900	37	1652	735	19		01.135.842.0	1 unit
600	2000	900	41	1852	735	20		01.135.843.0	1 unit
600	2200	900	46	2052	735	21		01.135.844.0	1 unit
600	1800	1000	37	1652	835	20		01.133.600.0	1 unit
600	2000	1000	41	1852	835	21		01.133.610.0	1 unit
600	2200	1000	46	2052	835	22		01.133.620.0	1 unit
600	1800	1200	37	1652	1035	22		01.133.605.0	1 unit
600	2000	1200	41	1852	1035	23		01.133.615.0	1 unit
600	2200	1200	46	2052	1035	24		01.133.625.0	1 unit
700	1200	600	23	1052	435	15		01.135.799.3	1 unit
700	1800	600	37	1652	435	17		01.135.801.3	1 unit
700	2000	600	41	1852	435	18		01.135.802.3	1 unit
700	2200	600	46	2052	435	19		01.135.803.3	1 unit
700	1200	800	23	1052	635	17		01.135.823.3	1 unit
700	1800	800	37	1652	635	19		01.135.825.3	1 unit
700	2000	800	41	1852	635	20		01.135.826.3	1 unit
700	2200	800	46	2052	635	21		01.135.827.3	1 unit
700	1800	900	37	1652	735	19		01.133.630.0	1 unit
700	2000	900	41	1852	735	20		01.133.645.0	1 unit
700	2200	900	46	2052	735	22		01.133.660.0	1 unit
700	1800	1000	37	1652	835	21		01.133.635.0	1 unit
700	2000	1000	41	1852	835	22		01.133.650.0	1 unit
700	2200	1000	46	2052	835	23		01.133.665.0	1 unit
700	1800	1200	37	1652	1035	23		01.133.640.0	1 unit
700	2000	1200	41	1852	1035	24		01.133.655.0	1 unit
700	2200	1200	46	2052	1035	25		01.133.670.0	1 unit

Continued on next page!

W	H	D	U	h	i <sub>b</sub>	kg	Model	Order No.	UP
800	1200	600	23	1052	435	16		<b>01.135.805.3</b>	1 unit
800	1800	600	37	1652	435	18		<b>01.135.807.3</b>	1 unit
800	2000	600	41	1852	435	19		<b>01.135.808.3</b>	1 unit
800	2200	600	46	2052	435	20		<b>01.135.809.3</b>	1 unit
800	1200	800	23	1052	635	18		<b>01.135.829.3</b>	1 unit
800	1800	800	37	1652	635	20		<b>01.135.831.3</b>	1 unit
800	2000	800	41	1852	635	21		<b>01.135.832.3</b>	1 unit
800	2200	800	46	2052	635	22		<b>01.135.833.3</b>	1 unit
800	1800	900	37	1652	735	21		<b>01.135.847.0</b>	1 unit
800	2000	900	41	1852	735	22		<b>01.135.848.0</b>	1 unit
800	2200	900	46	2052	735	23		<b>01.135.849.0</b>	1 unit
800	1800	1000	37	1652	835	20		<b>01.133.675.0</b>	1 unit
800	2000	1000	41	1852	835	22		<b>01.133.685.0</b>	1 unit
800	2200	1000	46	2052	835	24		<b>01.133.695.0</b>	1 unit
800	1800	1200	37	1652	1035	22		<b>01.133.680.0</b>	1 unit
800	2000	1200	41	1852	1035	24		<b>01.133.690.0</b>	1 unit
800	2200	1200	46	2052	1035	26		<b>01.133.700.0</b>	1 unit

**Dimensions in mm:**

W = Width    h = Installation height    U = Standard rack unit  
H = Height    i<sub>b</sub> = Inside depth    (1 U = 44.45 mm)  
D = Depth    L = Length    UP = Packaging unit

**Conversion:**

1 mm = 0.03937 inch  
1 kg = 2.2046 pounds



MIR20309

## Knürr Miracel® Without front door, width 600 mm

- With fixed 19" component on the front and rear.
- Installation of chassis runners and 19" shelves available.
- For IEC 297-3-compliant components.
- For installing 19" components on the front and rear.
- For installing equipment with a max. width of 450 mm.
- Installation accessories.

### ■ Jumpering space

- Front 73 mm.

### ■ Load rating

- 5000 N static.

### ■ Tests

- Earthing compliant with VDE 0100 T 540.
- Vibration test compliant with MIL-STD 810 E.

### ■ Material / Finish

- Basic rack, extruded aluminum.
- Corner piece, die-cast aluminum.
- Covers and trim extrusions, zinc-passivated sheet steel, powder-coated texture.
- Multifunctional braces and 19" extrusions, sheet steel, zinc-passivated.

### ■ Color

- Basic rack, polished.
- Visible surface of the covers, RAL 7035 light-grey.
- Trim extrusions: RAL 5008 grey-blue.

### ■ Standard inclusion

- 1 x basic rack.
- 4 x 19" sheet steel angular extrusions with mounting holes.
- 2 x multifunctional braces for cable clamping and universal mounting options.
- 1 x cover, closed.
- 1 x rear panel with quick connectors.
- 2 x side panels with quick connectors.
- 2 x horizontal trim extrusions, front.
- 2 x vertical trim extrusions, front.
- 4 x leveling feet (0 - 25 mm).

### ■ Delivery

- Mounted.

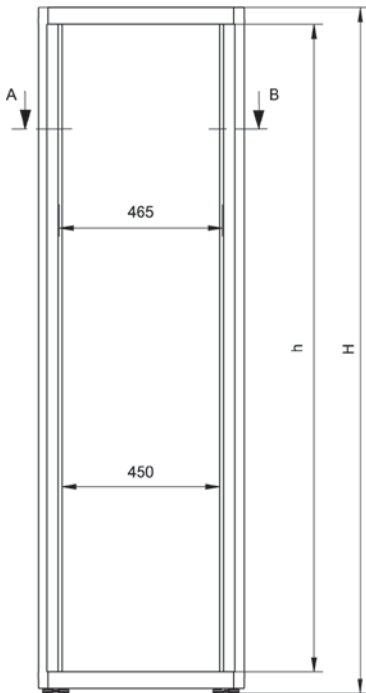

MIR00540

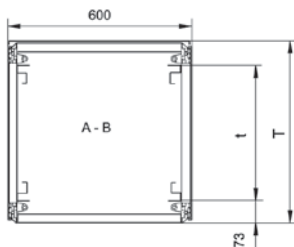

MIR00540

W	H	D	U	h	d	kg	Model	Order No.	UP
600	1200	600	23	1052	440	42		01.131.068.1	1 unit
600	1800	600	37	1652	440	57		01.131.071.1	1 unit
600	2000	600	41	1852	440	62		01.131.072.1	1 unit
600	2200	600	46	2052	440	66		01.131.073.1	1 unit
600	1200	800	23	1052	640	48		01.131.074.1	1 unit
600	1800	800	37	1652	640	63		01.131.077.1	1 unit
600	2000	800	41	1852	640	69		01.131.078.1	1 unit
600	2200	800	46	2052	640	75		01.131.079.1	1 unit

#### Dimensions in mm:

W = Width h = Installation height U = Standard rack unit  
 H = Height d = Insertion depth (1 U = 44.45 mm)  
 D = Depth L = Length UP = Packaging unit

#### Conversion:

1 mm = 0.03937 inch  
 1 kg = 2.2046 pounds





MIR20336

## Knürr Miracel® IP 55 With single glass door, width 600 mm

- With fixed 19" component on the front and rear.
- For IEC 297-3-compliant components.
- Door opening angle, 180°.
- For installing 19" components on the front and rear.
- For installation equipment with a max. width of 450 mm.
- Installation accessories.

### ■ Jumping space

- Front 73 mm.

### ■ Load rating

- 5000 N static.

### ■ Protection rating

- IP 55.

### ■ Tests

- Earthing compliant with VDE 0100 T 540.
- Vibration test compliant with MIL-STD 810 E.
- IP test compliant with DIN 40 050 / IEC 529.

### ■ Material / Finish

- Basic rack, extruded aluminum, polished.
- Corner piece, die-cast aluminum, polished.
- Covers, zinc-passivated sheet steel, powder-coated texture.
- Doors, sheet steel, powder-coated texture, glass infill, front door, single safety-glass panel, 4 mm.
- Multifunctional braces and 19" extrusions, sheet steel, zinc-passivated.

### ■ Color

- Visible surface of the covers, RAL 7035 light-grey.

### ■ Standard inclusion

- 1 x basic rack.
- 4 x 19" sheet steel angular extrusions with mounting holes.
- 2 x multifunctional braces for cable clamping and universal mounting options.
- 1 x top cover, closed, IP 55.
- 1 x front door, single, single safety-glass panel, with handle and mounting for cylinder lock, IP55.
- 1 x rear panel with quick connectors, IP 55.
- 2 x side panels with quick connectors, IP 55.
- 1 x floor, closed, IP 55.
- 4 x leveling feet (0 - 25 mm).

### ■ Delivery

- Mounted.

### ■ Note on rack suites

To create a rack suite with "n" racks, the following is required:

- (n-1) racks without side panels.
- 1 rack with side panels.

In a rack suite, per connection you will require a set of BN 01.130.935.7 suite connectors.

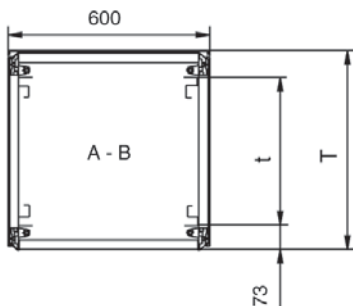
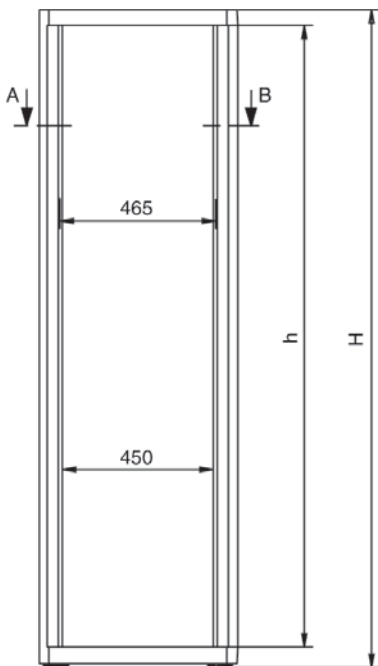

MIR00301

W	H	D	U	h	d	kg	Model	Order No.	UP
600	1800	600	37	1652	440	75		<b>01.132.271.1</b>	1 unit
600	2000	600	41	1852	440	80		<b>01.132.272.1</b>	1 unit
600	1800	800	37	1652	640	83		<b>01.132.277.1</b>	1 unit
600	2000	800	41	1852	640	90		<b>01.132.278.1</b>	1 unit



MIR20310

## Miracel® sheet-steel door with perforation, single

- **Material**
  - Sheet steel 1.0 mm.
- **Finish / Color**
  - Final digit of order number 1: Powder-coated texture, RAL 7035, light-grey.
  - Final digit of order number 8: Powder-coated texture, RAL 7021 dark-grey.
- **Standard inclusion**
  - 1 x door.
  - 1 x Mounting kit.
- **Volume flow**
  - Large surface perforation (83% free surface) enables optimum airflow through out the rack.

W	H	D	U	h	d	kg	Model	Order No.	UP
600	1200						compl. door	<b>01.147.400.X</b>	1 unit
700	1200						compl. door	<b>01.147.401.X</b>	1 unit
800	1200						compl. door	<b>01.147.402.X</b>	1 unit
600	1800						compl. door	<b>01.147.412.X</b>	1 unit
700	1800						compl. door	<b>01.147.413.X</b>	1 unit
800	1800						compl. door	<b>01.147.414.X</b>	1 unit
600	2000						compl. door	<b>01.147.416.X</b>	1 unit
700	2000						compl. door	<b>01.147.417.X</b>	1 unit
800	2000						compl. door	<b>01.147.418.X</b>	1 unit
600	2200						compl. door	<b>01.147.420.X</b>	1 unit
700	2200						compl. door	<b>01.147.421.X</b>	1 unit
800	2200						compl. door	<b>01.147.422.X</b>	1 unit



MIR20460

## Door locking set

- **Standard inclusion**
  - 1 x lock set.
  - 2 x keys (half-cylinder).

W	H	D	U	h	d	kg	Model	Order No.	UP
								<b>05.041.299.9</b>	1 set



– MIR20461

## Spare key for door

- **Standard inclusion**
  - 1 x key.

W	H	D	U	h	d	kg	Model	Order No.	UP
								<b>00.078.467.9</b>	1 unit



MIR20277

## Miracel® sheet-steel door with perforation, double

- **Material**
  - Sheet steel 1.0 mm.
- **Finish / Color**
  - Final digit of order number 1: Powder-coated texture, RAL 7035, light-grey.
  - Final digit of order number 8: Powder-coated texture, RAL 7021 dark-grey.
- **Standard inclusion**
  - 1 x door.
  - 1 x Mounting kit.
- **Volume flow**
  - Large surface perforation (83% free surface) enables optimum airflow through out the rack.

W	H	D	U	h	d	kg	Model	Order No.	UP
600	2000						double door	<b>01.128.260.X</b>	1 unit
700	2000						double door	<b>01.128.261.X</b>	1 unit
800	2000						double door	<b>01.128.262.X</b>	1 unit
600	2200						double door	<b>01.128.263.X</b>	1 unit
700	2200						double door	<b>01.128.264.X</b>	1 unit
800	2200						double door	<b>01.128.265.X</b>	1 unit



MIR20445

## Miracel® spare handle swing handle, black

- **Material**
  - PA 6 UL 94 V-1.
- **Color**
  - Black.
- **Standard inclusion**
  - 1 x handle.

W	H	D	U	h	d	kg	Model	Order No.	UP
								<b>01.137.017.9</b>	1 unit



MIR00069

## Complete locking set

- **Standard inclusion**
  - 2 x cylinders with 2 keys each.
  - 2 x lockable fasteners for side panel with 2 keys each.

W	H	D	U	h	d	kg	Model	Order No.	UP
								<b>01.130.940.9</b>	1 set



MIR20313

## Knürr Miracel® sheet-steel door single and double

- **Material**
  - Sheet steel 1.0 mm.
- **Finish / Color**
  - Order no. 1: Powder-coated texture, RAL 7035 light-grey.
  - Order no. 8: Powder-coated texture, RAL 7021 dark-grey.
- **Protection rating**
  - Installation of IP 40 double doors in the Miracel rack (depending on other rack components), achieves a maximum protection rating of IP 55.
- **Standard inclusion**
  - 1 x sheet-steel door.
  - 1 x Mounting kit.
- **Delivery**
  - Preassembled.



MIR20314



MIR20311

- **Material**
  - Sheet steel 1.0 mm.
  - Single safety-glass panel, 4.0 mm clear glass.
  - Double door 6.0 mm.

- **Finish / Color**
  - Order no. 1: Powder-coated texture, RAL 7035 light-grey.
  - Order no. 8: Powder-coated texture, RAL 7021 dark-grey.



MIR20312

- **Protection rating**
  - Installation of IP 20 double doors in the Miracel® rack (depending on other rack components), achieves a maximum protection rating of IP 55.

- **Standard inclusion**
  - 1 x glass door.
  - 1 x Mounting kit.

- **Delivery**
  - Preassembled.

W	H	D	U	Model	Order No.	UP
600	1200	23	compl. door		<b>01.147.440.X</b>	1 unit
700	1200	23	compl. door		<b>01.147.441.X</b>	1 unit
800	1200	23	compl. door		<b>01.147.442.X</b>	1 unit
600	1800	37	compl. door		<b>01.147.452.X</b>	1 unit
700	1800	37	compl. door		<b>01.147.453.X</b>	1 unit
800	1800	37	compl. door		<b>01.147.454.X</b>	1 unit
600	2000	41	compl. door		<b>01.147.456.X</b>	1 unit
700	2000	41	compl. door		<b>01.147.457.X</b>	1 unit
800	2000	41	compl. door		<b>01.147.458.X</b>	1 unit
600	2200	46	compl. door		<b>01.147.460.X</b>	1 unit
700	2200	46	compl. door		<b>01.147.461.X</b>	1 unit
800	2200	46	compl. door		<b>01.147.462.X</b>	1 unit

600	1200	23	double door, steel		<b>01.131.820.1</b>	1 unit
700	1200	23	double door, steel		<b>01.131.821.1</b>	1 unit
800	1200	23	double door, steel		<b>01.131.822.1</b>	1 unit
600	1800	37	double door, steel		<b>01.131.835.1</b>	1 unit
700	1800	37	double door, steel		<b>01.131.836.1</b>	1 unit
800	1800	37	double door, steel		<b>01.131.837.1</b>	1 unit
600	2000	41	double door, steel		<b>01.131.840.1</b>	1 unit
700	2000	41	double door, steel		<b>01.131.841.1</b>	1 unit
800	2000	41	double door, steel		<b>01.131.842.1</b>	1 unit
600	2200	46	double door, steel		<b>01.131.845.1</b>	1 unit
700	2200	46	double door, steel		<b>01.131.846.1</b>	1 unit
800	2200	46	double door, steel		<b>01.131.847.1</b>	1 unit

W	H	D	U	Model	Order No.	UP
600	1200	23	compl. door		<b>01.147.480.X</b>	1 unit
700	1200	23	compl. door		<b>01.147.481.X</b>	1 unit
800	1200	23	compl. door		<b>01.147.482.X</b>	1 unit
600	1800	37	compl. door		<b>01.147.492.X</b>	1 unit
700	1800	37	compl. door		<b>01.147.493.X</b>	1 unit
800	1800	37	compl. door		<b>01.147.494.X</b>	1 unit
600	2000	41	compl. door		<b>01.147.496.X</b>	1 unit
700	2000	41	compl. door		<b>01.147.497.X</b>	1 unit
800	2000	41	compl. door		<b>01.147.498.X</b>	1 unit
600	2200	46	compl. door		<b>01.147.500.X</b>	1 unit
700	2200	46	compl. door		<b>01.147.501.X</b>	1 unit
800	2200	46	compl. door		<b>01.147.502.X</b>	1 unit

600	1200	23	double door, glass		<b>01.131.850.1</b>	1 unit
700	1200	23	double door, glass		<b>01.131.851.1</b>	1 unit
800	1200	23	double door, glass		<b>01.131.852.1</b>	1 unit
600	1800	37	double door, glass		<b>01.131.862.1</b>	1 unit
700	1800	37	double door, glass		<b>01.131.863.1</b>	1 unit
800	1800	37	double door, glass		<b>01.131.864.1</b>	1 unit
600	2000	41	double door, glass		<b>01.131.866.1</b>	1 unit
700	2000	41	double door, glass		<b>01.131.867.1</b>	1 unit
800	2000	41	double door, glass		<b>01.131.868.1</b>	1 unit
600	2200	46	double door, glass		<b>01.131.870.1</b>	1 unit
700	2200	46	double door, glass		<b>01.131.871.1</b>	1 unit
800	2200	46	double door, glass		<b>01.131.872.1</b>	1 unit

### Dimensions in mm:

W = Width    h = Installation height    U = Standard rack unit    kg = Weight  
 H = Height    d = Insertion depth (1 U = 44.45 mm)  
 D = Depth    L = Length    UP = Packaging unit

### Conversion:

1 mm = 0.03937 inch  
 1 kg = 2.2046 pounds



MIR00070

## Miracel® top cover Closed, IP55

- Can be optionally used as top cover or bottom cover (combination with stationary plinth is not possible with us as bottom cover).

### Protection rating

- Installation in the Miracel rack (depending on other rack components), achieves a maximum protection rating of IP 55.

### Finish

- Powder-coated texture, RAL 7035.

### Standard inclusion

- 1 x cover, closed.
- 1 x Mounting kit.

### Delivery

- In sets.

W	H	D	U	h	d	kg	Model	Order No.	UP
600		600						<b>01.130.690.1</b>	1 unit
600		800						<b>01.130.691.1</b>	1 unit
600		900						<b>01.130.692.1</b>	1 unit
600		1000						<b>01.127.700.1</b>	1 unit
600		1200						<b>01.133.760.1</b>	1 unit
700		600						<b>01.130.694.1</b>	1 unit
700		800						<b>01.130.695.1</b>	1 unit
700		900						<b>01.130.696.1</b>	1 unit
700		1000						<b>01.127.701.1</b>	1 unit
700		1200						<b>01.133.761.1</b>	1 unit
800		600						<b>01.130.691.1</b>	1 unit
800		800						<b>01.130.699.1</b>	1 unit
800		900						<b>01.130.700.1</b>	1 unit
800		1000						<b>01.127.702.1</b>	1 unit
800		1200						<b>01.133.762.1</b>	1 unit



MIR20093

## Miracel® brush strip

- Brush strip for all covers with cable entry.
- For dust-protected and flexible cable entry.
- Can be used instead of mounting the sliding covers in the top cover.

### Standard inclusion

- 2 x brush strips.

### Delivery

- In sets.

W	H	D	U	h	d	kg	Model	Order No.	UP	
								For rack width 700 / 800	<b>01.130.999.9</b>	2 units
								For rack width 600	<b>01.130.998.9</b>	2 units

### Dimensions in mm:

W = Width	h = Installation height	U = Standard rack unit	kg = Weight	Conversion:
H = Height	d = Insertion depth	(1 U = 44.45 mm)		1 mm = 0.03937 inch
D = Depth	L = Length	UP = Packaging unit		1 kg = 2.2046 pounds



MIR20439

## Miracel® top cover with lateral cable entry

- With lateral cable entry on both sides (sliding plates).
- For orderly cable management in the rack.

### Material

- Sheet steel 1.5 mm.

### Finish / Color

- Final digit of order number 1: Powder-coated texture, RAL 7035, light-grey.
- Final digit of order number 8: Powder-coated texture, RAL 7021 dark-grey.

### Standard inclusion

- 1 x top cover with lateral cable entry.
- 1 x Mounting kit.

### Delivery

- In sets.

W	H	D	For rack type	Order No.	UP
600		1000	Miracel®	<b>01.130.630.X-003</b>	1 unit
600		1100	Miracel®	<b>01.130.630.X-004</b>	1 unit
600		1200	Miracel®	<b>01.130.630.X-005</b>	1 unit
800		1000	Miracel®	<b>01.130.630.X-008</b>	1 unit
800		1100	Miracel®	<b>01.130.630.X-009</b>	1 unit
800		1200	Miracel®	<b>01.130.630.X-010</b>	1 unit



MIR20441

## Miracel® top cover short

- For covering the front area of the top; the rest remains open.
- Facilitates unobstructed cable entry in the rack.

### Material

- Sheet steel 1.5 mm.

### Finish / Color

- Final digit of order number 1: Powder-coated texture, RAL 7035, light-grey.
- Final digit of order number 8: Powder-coated texture, RAL 7021 dark-grey.

### Standard inclusion

- 1 x cover, short.
- 1 x Mounting kit.

### Delivery

- In sets.

B <sub>Rack</sub>	L	D	For rack type	Order No.	UP
600	250		Miracel®	<b>01.130.628.X</b>	1 unit
800	250		Miracel®	<b>01.130.629.X</b>	1 unit



MIR00064

## Miracel® side panel

- **Protection rating**
  - Installation with in the Miracel rack (depending on other rack components) achieves a maximum protection rating of IP 55.
- **Material**
  - Sheet steel 1.0 mm.
- **Finish / Color**
  - Order no. 1: Powder-coated texture, RAL 7035 light-grey.
  - Order no. 8: Powder-coated texture, RAL 7021 dark-grey.
- **Standard inclusion**
  - 1 x side panel.
  - 1 x Mounting kit.
- **Delivery**
  - In sets.

W	H	D	U	h	d	kg	Model	Order No.	UP
1200	600	23						<b>01.130.643.X</b>	1 unit
1200	800	23						<b>01.130.649.X</b>	1 unit
1200	900	23						<b>01.130.655.X</b>	1 unit
1800	600	37						<b>01.130.646.X</b>	1 unit
1800	800	37						<b>01.130.652.X</b>	1 unit
2000	600	41						<b>01.130.647.X</b>	1 unit
2000	800	41						<b>01.130.653.X</b>	1 unit
2000	900	41						<b>01.130.659.X</b>	1 unit
2000	1000	41						<b>01.127.739.X</b>	1 unit
2000	1200	41						<b>01.128.874.X</b>	1 unit
2200	600	46						<b>01.130.648.X</b>	1 unit
2200	800	46						<b>01.130.654.X</b>	1 unit
2200	900	46						<b>01.130.660.X</b>	1 unit
2200	1000	46						<b>01.127.740.X</b>	1 unit
2200	1200	46						<b>01.128.875.X</b>	1 unit



MIR00064

## Miracel® rear panel

- **Protection rating**
  - Installation with in the Miracel rack (depending on other rack components) achieves a maximum protection rating of IP 55.
- **Material**
  - Sheet steel 1.0 mm.
- **Finish / Color**
  - Order no. 1: Powder-coated texture, RAL 7035 light-grey.
  - Order no. 8: Powder-coated texture, RAL 7021 dark-grey.
- **Standard inclusion**
  - 1 x rear panel.
  - 1 x Mounting kit.
- **Delivery**
  - In sets.

W	H	D	U	h	d	kg	Model	Order No.	UP
600	1200	23						<b>01.130.662.X</b>	1 unit
600	1800	37						<b>01.130.665.X</b>	1 unit
600	2000	41						<b>01.130.666.X</b>	1 unit
600	2200	46						<b>01.130.667.X</b>	1 unit
700	1200	23						<b>01.130.668.X</b>	1 unit
700	1800	37						<b>01.130.671.X</b>	1 unit
700	2000	41						<b>01.130.672.X</b>	1 unit
700	2200	46						<b>01.130.673.X</b>	1 unit
800	1200	23						<b>01.130.674.X</b>	1 unit
800	1800	37						<b>01.130.677.X</b>	1 unit
800	2000	41						<b>01.130.678.X</b>	1 unit
800	2200	46						<b>01.130.679.X</b>	1 unit



MIR20331

## Knürr Miracel® quick connectors For side and rear panels

- Covers can be secured quickly by rotating the locks 90°.
- Easy to turn with wide flat-head screwdriver.
- **Material / Color**
  - Final digit of order number 1: Polyamide PA66, RAL 7035, light-grey.
  - Final digit of order number 9: Polyamide PA66, RAL 9011, dark-grey.
- **Delivery**
  - Sets of 50 units.

Model	Order No.	UP
for side panel RAL 7035	<b>01.133.900.1</b>	1 set
for side panel RAL 9011	<b>01.133.900.9</b>	1 set
for rear panel RAL 7035	<b>01.133.910.1</b>	1 set
for rear panel RAL 9011	<b>01.133.910.9</b>	1 set

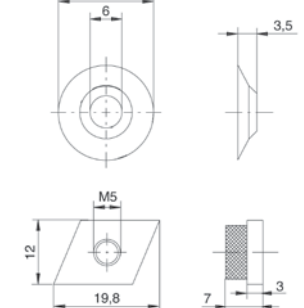

MIR00318

## Miracel® assembly kit Side panel threaded connection

- Used to screw on the side walls instead of quick connectors.
- Renders rack more sturdy.
- **Material**
  - Countersunk washers and mounting nuts, stainless steel.
- **Standard inclusion (for 2 side panels)**
  - 16 x countersunk washers.
  - 16 x mounting nuts, M5.
  - 16 x countersunk screws, M5 x 12.
- **Delivery**
  - In sets.

W	H	D	U	h	d	kg	Model	Order No.	UP
								<b>01.130.937.9</b>	1 set



MIR00068

## Miracel® locking set for side or rear panel

- For installation in the side or rear panel. For protection against unauthorized access.
- Can be retrofitted.

- **Standard inclusion**
  - 1 x lockable fastener.
  - 2 x keys.
- **Delivery**
  - In sets.

W	H	D	U	h	d	kg	Model	Order No.	UP
								<b>01.130.938.9</b>	1 set



MIR00076

## Miracel® plinth Fixed, height 200 mm

- Stationary included leveling options.
- Cable entry possible from all sides.
- Cover plate front and rear with vent slots and installation option for filter mat.

- **Load rating**
  - 3000 N static.
- **Material**
  - Sheet steel.
- **Finish**
  - Powder-coated texture, RAL 7035.
- **Standard inclusion**
  - 4 x plinth corners, incl. leveling feet.
  - 8 x cover plates.
  - 1 x Mounting kit.
- **Delivery**
  - In sets.

W	H	D	U	h	d	kg	Model	Order No.	UP
600	200	600						<b>01.130.958.1</b>	1 unit
600	200	800						<b>01.130.959.1</b>	1 unit
600	200	900						<b>01.130.960.1</b>	1 unit
600	200	1000						<b>01.130.961.1</b>	1 unit
600	200	1200						<b>01.130.963.1</b>	1 unit

800	200	600						<b>01.130.970.1</b>	1 unit
800	200	800						<b>01.130.971.1</b>	1 unit
800	200	900						<b>01.130.972.1</b>	1 unit
800	200	1000						<b>01.130.973.1</b>	1 unit
800	200	1200						<b>01.130.975.1</b>	1 unit

Dimensions in mm:						Conversion:	
W = Width	h = Installation height	U = Standard rack unit	kg = Weight	1 mm = 0.03937 inch			
H = Height	d = Insertion depth	(1 U = 44.45 mm)	1 kg = 2.2046 pounds				
D = Depth	L = Length	UP = Packaging unit					



MIR00414

## Miracel® plinth Fixed, height 100 mm

- Stationary.
- Cable entry possible from all sides.
- Cover plate front and rear with vent slots and installation option for filter mat.

- **Load rating**
  - 5000 N static.
- **Material**
  - Sheet steel.
- **Finish**
  - Powder-coated texture, RAL 7035.
- **Standard inclusion**
  - 4 x plinth corners with leveling.
  - 2 x plinth cover plates with slots.
  - 2 x plinth cover plates closed on the side.
  - 1 x Mounting kit.
- **Delivery**
  - In sets.

W	H	D	U	h	d	kg	Model	Order No.	UP
600	100	600						<b>01.130.538.1</b>	1 unit
600	100	800						<b>01.130.539.1</b>	1 unit
600	100	900						<b>01.130.540.1</b>	1 unit
600	100	1000						<b>01.127.650.1</b>	1 unit
600	100	1200						<b>01.133.710.1</b>	1 unit
700	100	600						<b>01.130.544.1</b>	1 unit
700	100	800						<b>01.130.545.1</b>	1 unit
700	100	900						<b>01.130.546.1</b>	1 unit
700	100	1000						<b>01.127.651.1</b>	1 unit
700	100	1200						<b>01.133.711.1</b>	1 unit
800	100	600						<b>01.130.550.1</b>	1 unit
800	100	800						<b>01.130.551.1</b>	1 unit
800	100	900						<b>01.130.552.1</b>	1 unit
800	100	1000						<b>01.127.652.1</b>	1 unit
800	100	1200						<b>01.133.712.1</b>	1 unit



MIR00521

## Miracel® plinth trim with brush strip

- For cable entry on the side, front and rear.
- **Finish**
  - Powder-coated texture, RAL 7035.
- **Standard inclusion**
  - 1 x plinth cover plate with brush strip.
  - 1 x Mounting kit.
- **Delivery**
  - In sets.

W	H	D	U	h	d	kg	Model	Order No.	UP
600		600						<b>01.130.744.1</b>	1 unit
800		800						<b>01.130.745.1</b>	1 unit



## Miracel® filter mat

for plinth cover plate for installation in plinth cover plate at the front and rear

- **Standard inclusion**
  - 2 x filter mats.
- **Delivery**
  - In sets.

W	H	D	U	h	d	kg	Model	Order No.	UP
600								<b>01.130.530.9</b>	2 units
700								<b>01.130.531.9</b>	2 units
800								<b>01.130.532.9</b>	2 units



MIR00077

## Miracel® plinth Mobile, height 100 mm

- Cable entry possible at the rear.
- With leveling feet for fixed model.

- **Load rating**
  - 3000 N static.
- **Material**
  - Sheet steel 2 mm.
- **Finish**
  - Powder-coated texture, RAL 7035.
- **Standard inclusion**
  - 1 x plinth frame.
  - 2 x fixed casters with snib.
  - 2 x swivel casters.
  - 4 x leveling feet.
  - 1 x Mounting kit.
- **Delivery**
  - In sets.

W	H	D	U	h	d	kg	Model	Order No.	UP
600	100	600						<b>01.130.561.1</b>	1 unit
600	100	800						<b>01.130.562.1</b>	1 unit
600	100	900						<b>01.130.563.1</b>	1 unit
600	100	1000						<b>01.127.250.1</b>	1 unit
600	100	1200						<b>01.133.715.1</b>	1 unit
700	100	600						<b>01.130.565.1</b>	1 unit
700	100	800						<b>01.130.566.1</b>	1 unit
700	100	1000						<b>01.127.253.1</b>	1 unit
700	100	1200						<b>01.133.716.1</b>	1 unit
800	100	600						<b>01.130.569.1</b>	1 unit
800	100	800						<b>01.130.570.1</b>	1 unit
800	100	900						<b>01.130.571.1</b>	1 unit
800	100	1000						<b>01.127.254.1</b>	1 unit
800	100	1200						<b>01.133.717.1</b>	1 unit



## Side plinth, cover plate closed

- Suitable for plinth height of 100 mm.
- Cover plates, closed.
- **Material**
  - Sheet steel.
- **Finish**
  - Powder-coated texture, RAL 7035.
- **Standard inclusion**
  - 1 x plinth cover plate.
  - 1 x Mounting kit.
- **Delivery**
  - In sets.

W	H	D	U	h	d	kg	Model	Order No.	UP
	100	600						<b>01.139.697.1</b>	1 unit
	100	800						<b>01.139.698.1</b>	1 unit
	100	900						<b>01.139.699.1</b>	1 unit
	100	1000						<b>01.139.699.1-001</b>	1 unit
	100	1200						<b>01.139.699.1-003</b>	1 unit



MIR00355

## Miracel® bottom plate

For flexible cable entry with rubber seal, IP 40

- For covering the rack underside.
- With rubber seal for flexible cable entry at the front or rear.
- **Material / Finish**
  - Sheet steel, 1.5 mm, electroplated zinc.
  - Sponge rubber, 50 mm x 50 mm.
- **Standard inclusion**
  - 1 x cable entry.
  - 2 x bottom plates.
  - 2 x mounting brackets.
  - 1 x Mounting kit.
- **Delivery**
  - In sets.

W	H	D	U	h	d	kg	Model	Order No.	UP
600		600						<b>01.130.732.0</b>	1 unit
600		800						<b>01.130.733.0</b>	1 unit
600		900						<b>01.130.734.0</b>	1 unit
600		1000						<b>01.127.670.0</b>	1 unit
600		1200						<b>01.133.740.0</b>	1 unit
700		600						<b>01.130.735.0</b>	1 unit
700		800						<b>01.130.736.0</b>	1 unit
700		900						<b>01.127.671.0</b>	1 unit
700		1000						<b>01.127.672.0</b>	1 unit
700		1200						<b>01.133.741.0</b>	1 unit
800		600						<b>01.130.738.0</b>	1 unit
800		800						<b>01.130.739.0</b>	1 unit
800		900						<b>01.130.740.0</b>	1 unit
800		1000						<b>01.127.673.0</b>	1 unit
800		1200						<b>01.133.742.0</b>	1 unit



MIR00357

## Miracel® bottom plate 3-piece

- For covering the rack underside.
- For flexible cable entry front and rear.
- **Material / Finish**
  - Sheet steel, 1.5 mm, zinc passivated.
- **Standard inclusion**
  - 3 x bottom plates.
  - 2 x mounting brackets.
  - 1 x Mounting kit.
- **Delivery**
  - In sets.

W	H	D	U	h	d	kg	Model	Order No.	UP
600		600						<b>01.130.750.0</b>	1 unit
600		800						<b>01.130.751.0</b>	1 unit
600		900						<b>01.130.752.0</b>	1 unit
600		1000						<b>01.127.660.0</b>	1 unit
600		1200						<b>01.133.730.0</b>	1 unit
700		600						<b>01.130.753.0</b>	1 unit
700		800						<b>01.130.754.0</b>	1 unit
700		900						<b>01.130.755.0</b>	1 unit
700		1000						<b>01.127.662.0</b>	1 unit
700		1200						<b>01.133.731.0</b>	1 unit
800		600						<b>01.130.756.0</b>	1 unit
800		800						<b>01.130.757.0</b>	1 unit
800		900						<b>01.130.758.0</b>	1 unit
800		1000						<b>01.127.663.0</b>	1 unit
800		1200						<b>01.133.732.0</b>	1 unit



MIR20462

## Bottom plate, perforated

- For vented racks.
- Replacement for segmented bottom plates.
- **Material / Finish**
  - Sheet steel, 1.5 mm, electroplated zinc.
- **Standard inclusion**
  - 1 x bottom plate.
- **Delivery**
  - In sets.

W	H	D	U	h	d	kg	Model	Order No.	UP
600								<b>01.139.628.0</b>	1 unit
700								<b>01.139.629.0</b>	1 unit
800								<b>01.139.630.0</b>	1 unit

### Dimensions in mm:

W = Width	h = Installation height	U = Standard rack unit	kg = Weight	1 mm = 0.03937 inch
H = Height	d = Insertion depth	(1 U = 44.45 mm)	1 kg = 2.2046 pounds	
D = Depth	L = Length	UP = Packaging unit		

### Conversion:



MIR20088

## Miracel® casters

- Can be mounted on the threaded eyelet of the basic rack.
- Caster diameter, 75 mm.
- Threaded bolt, M12.
- Load capacity per caster: 100 kg
- **Standard inclusion**
  - 4 x swivel casters.
- **Delivery**
  - In sets.

W	H	D	U	h	d	kg	Model	Order No.	UP
109.5								<b>05.031.057.9</b>	4 units

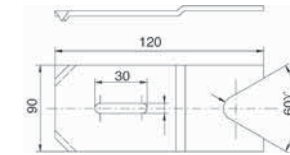

MIR00319

## Assembly kit for securing bottom plate

- **Material**
  - Sheet steel 3.0 mm.
- **Finish**
  - Galvanized.
- **Standard inclusion**
  - 4 x clamping plates.

W	H	D	U	h	d	kg	Model	Order No.	UP
								<b>01.130.934.7</b>	4 units



ELM00103a

## Front cover plate (pivots)

- For covering the side clearance space at the front of the 800-width Miracel racks.
- Easy to open for cable management.
- **Material / Finish**
  - Sheet steel, 1.0 mm, powder-coated texture.
- **Color**
  - Final digit of order number 1: RAL 7035 light-grey.
  - Final digit of order number 8: RAL 7021 dark-grey.
- **Standard inclusion**
  - 2 x front cover plates.
  - 1 x Mounting kit.
- **Delivery**
  - In sets.

W	H	D	U	h	d	kg	Model	Order No.	UP
1003		23					For rack width 800	<b>01.113.044.X</b>	2 units
1803		41					For rack width 800	<b>01.113.048.X</b>	2 units
2002		46					For rack width 800	<b>01.113.049.X</b>	2 units



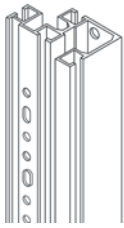

MIR00307

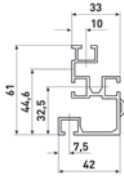

## Miracel® 19" vertical extrusion aluminum with T-slot and increment slide

- For front and rear installation with in the rack.
- Spring nut, variable and adjustable, in U increments (19").
- Please order suitable assembly kit for rack widths 700 / 800.
- Screws and spring nuts for W 600.

- **Material**  
- Extruded aluminum, polished.
- **Standard inclusion**  
- 2 x vertical extrusions with increment slide.

W	H	D	U	h	d	kg	Model	Order No.	UP
	1200		23		1100			<b>01.130.828.0</b>	2 units
	1800		37		1700			<b>01.130.834.0</b>	2 units
	2000		41		1900			<b>01.130.835.0</b>	2 units
	2200		46		2100			<b>01.130.836.0</b>	2 units

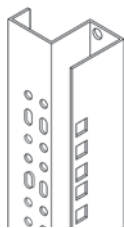

MIR00309

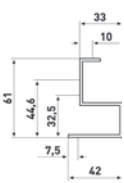

## Miracel® 19" vertical extrusion, steel with mounting holes

- For front and rear installation with in the rack.
- Caged nut mountable in U increments (19").
- Please order suitable assembly kit for rack widths 700 / 800.
- Screws and spring nuts for W 600.

- **Material**  
- Sheet steel, 1.5 mm, zinc passivated.
- **Standard inclusion**  
- 2 x vertical extrusions with mounting holes.

W	H	D	U	h	d	kg	Model	Order No.	UP
	1200		23		1100			<b>01.130.803.0</b>	2 units
	1800		37		1700			<b>01.130.809.0</b>	2 units
	2000		41		1900			<b>01.130.810.0</b>	2 units
	2200		46		2100			<b>01.130.811.0</b>	2 units

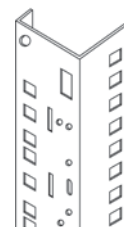

MIR20041

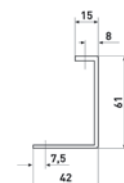

## Miracel® 19" server extrusion, steel with mounting holes

- For mounting trade-standard 19" servers.
- Please order suitable assembly kit for rack widths 700 / 800.
- Please order mounting adapter for Knürr standard components.

- **Material**  
- Sheet steel, 2 mm, zinc passivated.
- **Standard inclusion**  
- 4 x 19" server extrusions.

W	H	D	U	h	d	kg	Model	Order No.	UP
	2000		41					<b>01.127.214.0</b>	4 units
	2200		46					<b>01.127.215.0</b>	4 units

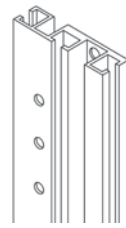

MIR00308

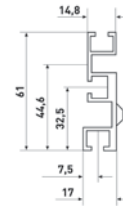

Type

## Miracel® vertical extrusion, ETSI 20 module / 21"

- For metric racks, 20 module 21".
- Spring nut, variable and adjustable in standard increments.
- Please order suitable assembly kit for rack widths 700 / 800.
- Screws and spring nuts for W 600.

- **Material**  
- Type 1: Extruded aluminum, polished.  
- Type 2: Sheet steel, 1.5 mm, zinc-passivated.

- **Standard inclusion**  
- 2 x vertical extrusions.



MIR00311

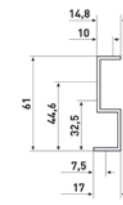

Type 2

W	H	D	Module	h	d	kg	Model	Order No.	UP
	1800		66		1700		alu. T-slot	<b>01.130.847.0</b>	2 units
	2000		74		1900		alu. T-slot	<b>01.130.848.0</b>	2 units
	2200		82		2100		alu. T-slot	<b>01.130.849.0</b>	2 units

	1800		66		1700		steel mount. holes	<b>01.130.822.0</b>	2 units
	2000		74		1900		steel mount. holes	<b>01.130.823.0</b>	2 units
	2200		82		2100		steel mount. holes	<b>01.130.824.0</b>	2 units



LUF20337

## Miracel® U tape measure

- For sticking on Miracel® 19" extrusions.
- Enables fast component positioning at the correct U position.
- Standard length, 48 U; shorten as required.

- **Standard inclusion**  
- 1 x tape measure.

W	H	D	U	h	d	kg	Model	Order No.	UP
			48					<b>01.128.400.9</b>	1 unit



MIR20044

## Miracel® mounting adapters for 19" server extrusion

- For mounting standard Knürr components (storage shelves, drawers, chassis rails, keyboard tray, etc.) in 19" installation space.

- **Material**  
- Zinc-passivated sheet steel.

- **Standard inclusion**  
- 4 x adapters.

W	H	D	U	h	d	kg	Model	Order No.	UP
			1					<b>01.127.119.9</b>	4 units



MIR00510

## Miracel® assembly kits for extrusions

- **Standard inclusion**
  - 4 x node brackets (full-length).
  - 2 x node brackets (short).
  - 2 x Z brackets (short).
  - 1 x Mounting kit.

W	H	D	U	h	d	kg	Model	Order No.	UP
700							short	<b>01.131.219.7</b>	1 set
800							short	<b>01.131.221.7</b>	1 set
700							full-length	<b>01.131.220.7</b>	1 set
800							full-length	<b>01.131.222.7</b>	1 set

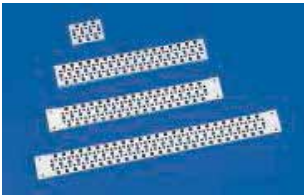

MIR00089

## Multifunctional brace

- For routing cables with cable ties.
- For universal mounting option.
- Holes for mounting caged nuts.
- Distance between two multifunctional braces can be selected using T-slot.
- Installation on the extrusions of the rack frame or on the 19" extrusions, diagonal and lateral.

- **Installation positions**
  - 1 toward rear of basic frame.
  - 2 across width of basic frame.
  - 3 across width of 19" extrusions.
  - 4 toward rear of 19" extrusions.

- **Material**
  - Sheet steel 1.5 mm.

- **Finish**
  - Zinc-passivated.

- **Standard inclusion**
  - 4 x multifunctional braces.

- **Delivery**
  - In sets.

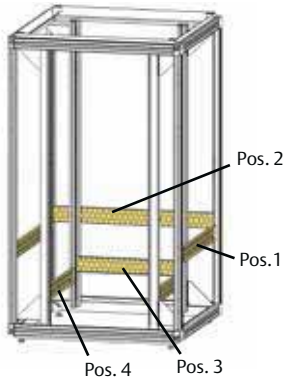

MIR88003

W <sub>Rack</sub>	D <sub>Rack</sub>	d	Installation position	For rack type	Order No.	UP
600		1		Miracel	<b>05.040.160.9</b>	4 units
800		1		Miracel	<b>05.040.161.9</b>	4 units
900		1		Miracel	<b>05.040.162.9</b>	4 units
1000		1		Miracel	<b>05.040.163.9</b>	4 units
1100		1		Miracel	<b>05.040.164.9</b>	4 units
1200		1		Miracel	<b>05.040.165.9</b>	4 units
600		2		Miracel/Smaract	<b>05.040.173.9</b>	4 units
800		2		Miracel	<b>05.040.174.9</b>	4 units
		3		Miracel/Smaract/DPR	<b>05.040.175.9</b>	4 units
600	365	4		Miracel/Smaract	<b>05.040.168.9</b>	4 units
800	565	4		Miracel/Smaract	<b>05.040.169.9</b>	4 units
600	440	4		Miracel/Smaract	<b>05.040.170.9</b>	4 units
800	640	4		Miracel/Smaract	<b>05.040.171.9</b>	4 units
900	740	4		Miracel/Smaract	<b>05.040.172.9</b>	4 units
1000	740	4		Miracel/Smaract	<b>05.040.172.9</b>	4 units

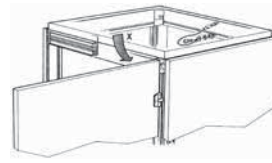

MIR00216

## Earthing set / door Side panel / rear panel

- For safe earthing of doors and panels.

- **Standard inclusion**
  - 1 x earthing connection.
  - 1 x Mounting kit.

- **Delivery**
  - In sets.

W	H	D	Model	Order No.	UP
			for single steel / glass doors	<b>01.130.624.9</b>	1 set
			for side and rear panel	<b>01.133.745.9</b>	1 set
			for steel double doors	<b>01.139.540.9</b>	1 set
			for glass doors or perforated double doors	<b>01.139.541.9</b>	1 set

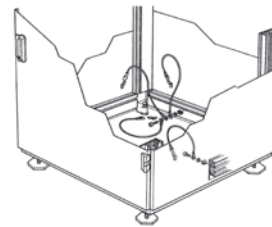

MIR00217

## Rack earthing set

- For safe earthing of rack.
- Standardized protective conductor connection.

- **Standards**
  - IEC 950.
  - VDE 0100.

- **Standard inclusion**
  - 5 x earthing connections.
  - 1 x Mounting kit.

- **Delivery**
  - In sets.

W	H	D	Model	Order No.	UP
				<b>01.130.529.9</b>	1 set

Dimensions in mm:				Conversion:
W = Width	h = Installation height	U = Standard rack unit	kg = Weight	1 mm = 0.03937 inch
H = Height	d = Insertion depth	(1 U = 44.45 mm)		1 kg = 2.2046 pounds
D = Depth	L = Length	UP = Packaging unit		



MIR20452

## Miracel® partition wall can be retrofitted

- For air containment between two fixed adjacent racks.
- The partition wall is fitted between two racks and can be inserted from one side of the linking racks; guided along the upper rear-enclosure extrusion of one of the linked racks.
- After the partition wall has been inserted, fasteners are bent or welded on one side of the wall and screwed into the vertical T-slot to secure the structure. The rack connectors included in the supply are used on the opposite side.



MIR20453

- **Material**
  - Sheet steel 1.0 mm.
- **Finish / Color**
  - Powder-coated texture, RAL 7035 light-grey.
- **Standard inclusion**
  - 1 x partitioning wall for retrofitting.
  - 1 x set of rack connectors.
  - 1 x Mounting kit.
- **Delivery**
  - In sets.

W	H	D	Model	Order No.	UP
2000	1000			01.133.835.1	1 unit
2000	1200			01.133.837.1	1 unit
2200	1000			01.133.838.1	1 unit
2200	1200			01.133.840.1	1 unit



MIR00100

## Rack connector Internal mounting

- For mechanical, stable joining of rack and enclosure suites.

- **Material / Finish**
  - Sheet steel, 2 mm, zinc passivated.
- **Installation positions**
  - 1. On the horizontal extrusion (bottom and top; front and rear).
  - 2. Vertically on the vertical extrusion (front and rear; top and bottom).
- **Standard inclusion**
  - 8 x mounting brackets (for connecting 2 racks / frames).
  - 1x Mounting kit.
- **Delivery**
  - In sets.
- **Note**
  - Only use on racks without partition walls.

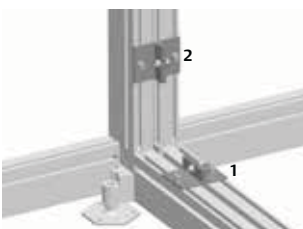

MIR20442

W	H	D	U	h	d	kg	Model	Order No.	UP
								01.130.935.7	1 set



MIR20450

## Miracel® partition wall mounted, fixed

- For air containment between two fixed adjacent racks.
- The partition wall is mounted on only one rack. It must be mounted before the other racks are installed.
- The partition wall is slotted in at the top of the rear extrusion and mounted to the basic rack with quick connectors. The rack connectors are then fitted to the top and bottom of the frame extrusions from the inside.
- Plastic cover extrusions are provided to seal the gap between two racks. These can be clipped into place at the front and back of the gap.



- **Material**
  - Sheet steel 1.0 mm.
- **Finish / Color**
  - Powder-coated texture, RAL 7035 light-grey.
- **Standard inclusion**
  - 1 x fixed partition wall.
  - 1 x set of rack connectors.
  - 2 x cover extrusions.
  - 1 x Mounting kit.
- **Delivery**
  - In sets.

W	H	D	Model	Order No.	UP
2000	1000			01.133.860.1	1 unit
2000	1200			01.133.862.1	1 unit
2200	1000			01.133.863.1	1 unit
2200	1200			01.133.865.1	1 unit

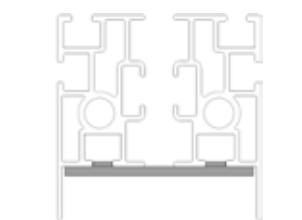

MIR20465

## Miracel® rack connector External mounting

- For secure connection of several racks.
- Front and rear external mounting.
- **Material**
  - Sheet steel, 1 mm, electroplated zinc.
- **Standard inclusion**
  - 6 x mounting straps.
  - 1 x Mounting kit.



MIR20463

W	H	D	U	h	d	kg	Model	Order No.	UP
								01.127.114.9	1 set

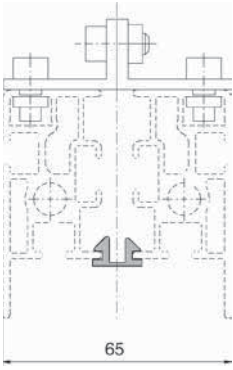

## Miracel® cover extrusion for rack suites, IP 20

- **Material**  
– PVC extruder cover, black.
- **Standard inclusion**  
– 2 x vertical lengths.  
– 2 x depth lengths.

MIR00320

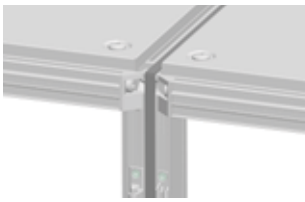

MIR20443

W	H	D	U	h	d	kg	Model	Order No.	UP
1200	600	23						<b>01.131.270.9</b>	1 set
1800	600	37						<b>01.131.273.9</b>	1 set
2000	600	41						<b>01.131.274.9</b>	1 set
2200	600	46						<b>01.131.275.9</b>	1 set
1200	800	23						<b>01.131.276.9</b>	1 set
1800	800	37						<b>01.131.279.9</b>	1 set
2000	800	41						<b>01.131.280.9</b>	1 set
2200	800	46						<b>01.131.281.9</b>	1 set
1200	900	23						<b>01.131.282.9</b>	1 set
1800	900	37						<b>01.131.285.9</b>	1 set
2000	900	41						<b>01.131.286.9</b>	1 set
2200	900	46						<b>01.131.287.9</b>	1 set
2000	1000	41						<b>01.127.760.9</b>	1 set
2200	1000	46						<b>01.127.761.9</b>	1 set
2000	1200	41						<b>01.127.762.9</b>	1 set
2200	1200	46						<b>01.127.763.9</b>	1 set



MIR20447

## Miracel® Cover screws

- **Material**  
– Plastic.
- **Delivery**  
– Sets of 4 units.

W	H	D	U	h	d	kg	Model	Order No.	UP
								<b>01.139.903.9</b>	4 units

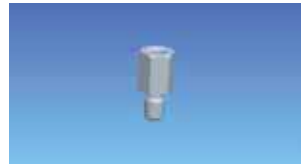

MIR20464

## Miracel® Spacer bolt

- M12 bolts.
- **Standard inclusion**  
– 1 x spacer bolt.

W	H	D	U	h	d	kg	Model	Order No.	UP
								<b>00.077.162.7</b>	1 unit



MEC00074

## Miracel® Crane eyes

- For hanging on crane hooks.
- The crane eyes are screwed into the threads provided on the basic frame.

- **Load rating**  
– Max. 6,800 N.
- **Material**  
– Tool steel, forged.
- **Standard inclusion**  
– 4 x ring bolts.  
– 4 x washers.
- **Delivery**  
– In sets.

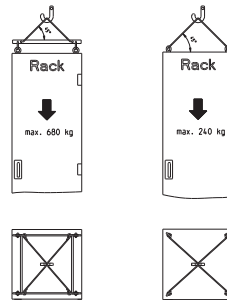

MEC20194

W	H	D	U	h	d	kg	Model	Order No.	UP
								<b>01.131.745.9</b>	1 set

Dimensions in mm:				Conversion:	
W = Width	h = Installation height	U = Standard rack unit	kg = Weight	1 mm = 0.03937 inch	
H = Height	d = Insertion depth	(1 U = 44.45 mm)		1 kg = 2.2046 pounds	
D = Depth	L = Length	UP = Packaging unit			



DCM20090

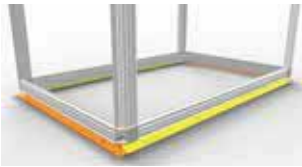

MIR20449

### Mounting bracket Fixed

- Sits flush ("airtight").
- Even load distribution on base.
- Also compatible with DCM racks.

■ **Load rating**

- 15,000 N static.

■ **Material**

- Sheet steel 3.0 mm.

■ **Finish**

- Order no. 1:  
Powder-coated texture,  
RAL 7035 light-grey.
- Order no. 8:  
Powder-coated texture,  
RAL 7021 dark-grey.

■ **Standard inclusion**

- 2 x mounting brackets for the depth.
- 2 x mounting brackets for the width.
- 1x Mounting kit.

■ **Delivery**

- In sets.

W	H	D	Model	Order No.	UP
600	27	600		<b>01.147.509.X</b>	1 unit
600	27	700		<b>01.147.510.X</b>	1 unit
600	27	800		<b>01.147.511.X</b>	1 unit
600	27	900		<b>01.147.512.X</b>	1 unit
600	27	1000		<b>01.147.513.X</b>	1 unit
600	27	1100		<b>01.147.514.X</b>	1 unit
600	27	1200		<b>01.147.515.X</b>	1 unit
700	27	600		<b>01.147.517.X</b>	1 unit
700	27	700		<b>01.147.518.X</b>	1 unit
700	27	800		<b>01.147.519.X</b>	1 unit
700	27	900		<b>01.147.520.X</b>	1 unit
700	27	1000		<b>01.147.521.X</b>	1 unit
700	27	1100		<b>01.147.522.X</b>	1 unit
700	27	1200		<b>01.147.523.X</b>	1 unit
800	27	600		<b>01.147.525.X</b>	1 unit
800	27	700		<b>01.147.526.X</b>	1 unit
800	27	800		<b>01.147.527.X</b>	1 unit
800	27	900		<b>01.147.528.X</b>	1 unit
800	27	1000		<b>01.147.529.X</b>	1 unit
800	27	1100		<b>01.147.530.X</b>	1 unit
800	27	1200		<b>01.147.531.X</b>	1 unit

## @Lock – solutions for racks

### Access control for data centers and technical rooms

**Data centers are broken into on a regular basis. In many cases, the intention is simply to steal high-quality IT equipment. However, breaking in may only be a pretense for stealing data and/or putting in place a man-in-the-middle infrastructure.**

On 28 February 2011 for example, an important data center belonging to a global telecommunications service provider was paralyzed by intruders. Only a few weeks previously, a DC service provider working on behalf of a major health care company became the victim of an attempted break-in, which resulted in the entire security concept undergoing a TÜV audit. Generally speaking, attacks of this kind go undetected. Data centers are security areas and therefore need to be secured through various measures. An important part of this is controlling access to and in the data center.

Controlling access to the data center is usually achieved through a combination of organizational measures, e.g., gates and turnstiles, besides a building access control system.

Working with various partners, Emerson Network Power has developed system concepts which not only improve physical security through access controls within the data center but also simplify operative processes, making them less susceptible to errors. These concepts are known as "@Lock".



@lock solution with MLR handles in a co-location datacenter



## Option 1: Transponder card system @Lock "transponder card system" concept

This system concept can be applied throughout – from the DC and cold aisle doors to the individual cabinets. In addition to the card readers and handles, the extensive "Administration Suite" management software is a key part of the system.

Thanks to its modular design and open infrastructure architecture, the new Administration Suite can be expanded as required and can also be implemented for third party providers.

- Encrypted data communication between the hardware, server and client.
- Runs on Windows 2000, Windows XP, Windows Vista, Windows Server 2003, Windows Server 2008, Citrix.
- Allows administration of various users with different types of authorization.
- Client/server capability.
- Web client-capable, SNMP alarming.
- Record changes made to the system by users.
- Straightforward user guidance in spite of extensive tools.
- Wide range of alarm messages.
- Automatic alarm notification via e-mail.
- Centralized locking plans and access management.
- Freely selectable four-eyes-principle.
- Support for the most common transponder types.
- Central management of various systems.
- Records all actions in "Log Events".
- Free replacement of the lock system if the authorizing medium is lost.
- Real-time visualization of the swing handle stations.
- Configuration of special days with different locking regimes.
- Allocation of time profiles for access.
- Able to export "Log Events".
- Multilingual software.

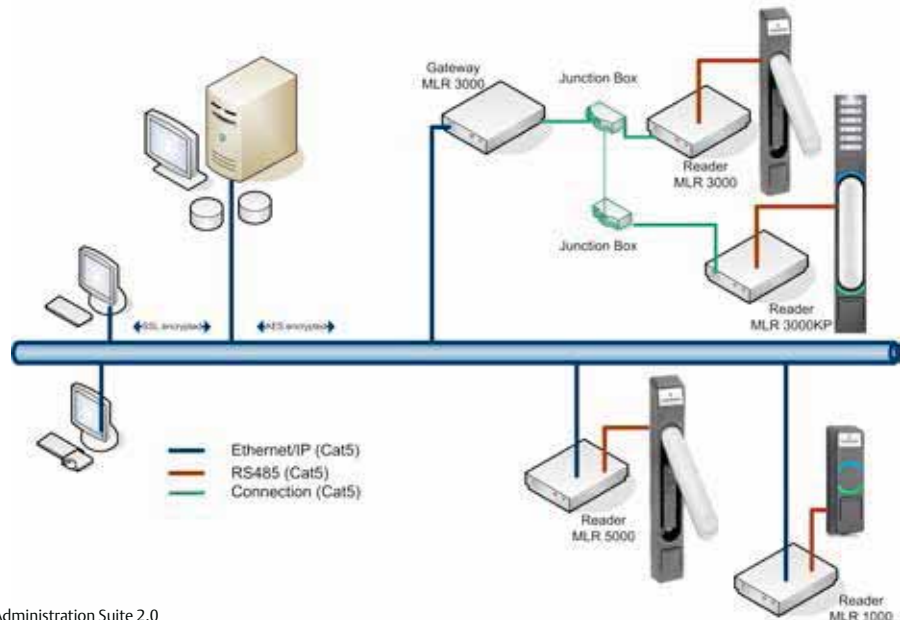
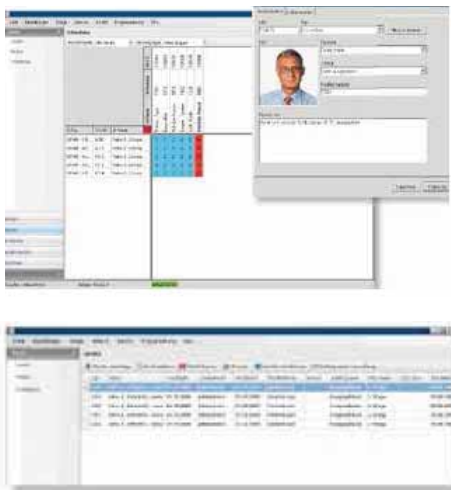

Administration Suite 2.0  
Order number: 01.180.049.9



**MLR 3000 and MLR 5000 handles are suitable for linking server or network cabinets to the transponder card system. The E-LINE, by Dirak mechatronic swing handles and the Administration Suite software, provide a convenient, reliable way of monitoring access to your data or server cabinet. With the Administration Suite software, security officers can conveniently monitor and manage access directly from a PC.**

The integrated LEDs display alarm messages and types of authorization on the handle itself. As a result, technicians on site are given the same information that the Administration Suite software sends to the headquarters. LEDs at the top and bottom of the handle offer permanently high luminosity with low power consumption. As a result, the lock status can be determined quickly, even from a distance of several meters.

The top LED can indicate various statuses, such as that the handle is ready to be opened or locked. The bottom LED displays whether the handle is within or outside the temperature range for the cabinet selected by the customer. As a result, irregularities may be identified quickly, leaving enough time for appropriate action to be taken.

The information display integrated into the handle is backlit and allows customer-specific information, such as the cabinet row, cabinet number etc., to be added for extra clarity.

**Handles are also available with integrated Keypad (MLR5000KP). They can be used with either keycard, keypad or both (two-factor authentication).**



**@LockMLR3000**

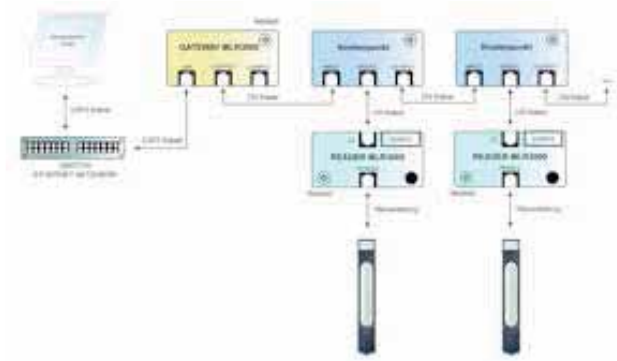

**@LockMLR5000**

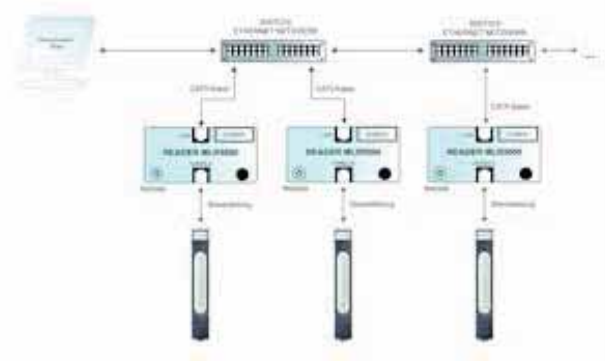

**Technical data – @Lock MLR3000/5000**

Handle electronics	
Two-part hardware design	Swing handle and reader unit
Visualization	Multicolored status LED
Reader	For 125 kHz transponders (HID 26 bit system), alternatively 13.56 MHz (MIFARE)
Reader	
Housing	Reader unit in plastic housing can be fixed with screws or self-adhesive pad
Power supply	12 V ± 10 % (DC) via low voltage socket
Standby current (system ready)	40 mA (DC)
Max. current consumption (with connector tightening)	440 mA (DC)
RS232 interface for MLR3000	RS232 cable (RXD, TXD, GND, Reader present, PC present), 38,400 baud
Current increase for MLR5000 via Ethernet interface	125 mA (DC)
TCP/IP interface	Ethernet, 10/100 Autosense, up to 100 Mbaud
Connecting cable (reader - handle electronics)	8-pole, 350 cm, UL stranded wire AWG 26, one side with gated RJ45 plug, one side with crimped JST ZH connector ZHR-8
Relay output (via screw clamps)	2.5 mm <sup>2</sup> , can be screwed in from plug side, relay contact: 12 V, 3 A, 60 W, 120
Door contact input (via screw clamps)	2.5 mm <sup>2</sup> , can be screwed in from plug side, terminals 1 and 2
RS485 interface	RS485 cable to the E-LINE by DIRAK Gateway, (+/A, -/B), 38,400 baud
Memory capacity for transponder cards	2000 + 1 master transponder
Memory capacity for events	500 (ring memory)
Memory capacity for time profiles	30
Integrated real-time clock	With buffering of up to 60 min at 25 °C
Temperature range	-20°C – +70°C

Type	Model	Order No.	UP
@LockMLR3000	for Miracel and DCM front door	<b>01.180.225.9</b>	1 unit
@LockMLR3000	for twin door (e.g. DCM rear door)	<b>01.180.227.9</b>	1 unit
@LockMLR5000	for Miracel and DCM front door	<b>01.180.228.9</b>	1 unit
@LockMLR5000	for twin door (e.g. DCM rear door)	<b>01.180.229.9</b>	1 unit
@LockMLR5000KP	for Miracel and DCM front door	<b>01.180.240.9</b>	1 unit
@LockMLR5000KP	for twin door (e.g. DCM rear door)	<b>01.180.241.9</b>	1 unit

Accessories	Order No.	UP
Door contact	<b>06.108.115.9</b>	1 unit
HID transponder card	<b>01.180.040.9</b>	1 unit
Desktop reader for the initial reading of transponder cards	<b>01.180.040.9</b>	1 unit
MLR3000 Gateway	<b>01.180.111.9</b>	1 unit
Plug-in power supply (Europe)	<b>01.180.035.9</b>	1 unit

Other plug-in power supplies on request

## Technical data – MLU3000/5000



**MLU card readers can be used to connect a room door with existing electromechanical locking or motorized cold aisle door (Coolfex):**

- Three-part hardware design MLU3000 set comprising: external MLU reader, network reader unit and MLU1000 lock.
- Visualization on MLU reader: 2 x multicolored status LEDs and 1 x backlit information display.
- Antenna for 125 kHz transponders (HID 26 bit system).
- **Optional MLU1000 lock**
  - Die-cast zinc (GDZn), color: matt chrome.
  - 4 m control cable.
  - Power supply 24 V DC +/- 10% 100 mA.
  - Proximity sensor status contact.
  - Wall/sheeting thickness independent.
  - Electronic opening by interrupting the power supply.
- **MLU3000/MLU5000 network reader**
  - Housing reader unit in plastic housing can be fixed with screws or a self-adhesive pad.
  - Nominal input voltage 12/24/48 V ± 10 % (DC) depending on the electronic lock connected.
  - Standby current (system ready) 40 mA (DC).
  - Max. current consumption RJ12 (LOCK) 1.5 A (DC).
  - Max. current consumption via relay clamp 3.0 A (DC), clamps 10-11.
  - RS232 interface RS 232 cable (RXD, TXD, GND, Reader present, PC present), 38,400 baud.
  - Connecting cable (reader - external MLU antenna) 8-pole, 350 cm, UL stranded wire AWG 26, one side with gated RJ45 plug, one side with crimped JST ZH connector ZHR-8.
  - Relay output (via screw clamps) 2.5 mm, can be screwed on from plug side, relay contact: 12 V, 3 A, 60 W, 120 VA, terminals 3 - 5.
  - Door contact input (via screw clamps) 2.5 mm<sup>2</sup> can be screwed from plug side, terminals 1 and 2.
  - RS485 - RS485 interface - cable to the E-LINE by DIRAK Gateway, (+/A, -/B), 38,400 baud (MLU3000).
  - TCP/IP Ethernet interface, 10/100 Autosense, up to 100 MBit/s (MLU5000).
  - Power off when open/closed: depending on the electronic lock connected, this is configured in the Administration Suite Config Tool.
  - Memory capacity for transponder cards 2000: + 1 master transponder.
  - Memory capacity for events: 500 (ring memory).
  - Memory capacity for time profiles: 30.
  - Integrated real-time clock with buffering of up to 60 min at 25 °C.
  - Temperature range -20°C – +70°C.

**Option 2: BlueID**  
@Lock "Blue ID" system concept

@Lock BlueID is an innovative data center locking system which is highly flexible and user-friendly. Instead of a set of keys or transponder cards, "virtual" keys, kept on mobile communication devices (smartphones, tablets etc.), are used. These virtual keys are transferred to a mobile device via SMS. No online access is necessary to use the keys.

The locking system comprises MLR1000 handles, a BlueID control system, a power supply, vouchers for generating keys (100 daily tickets, 10 yearly tickets, 10 reload tickets) and installation materials. Additional ticket packages or two additional MLR1000 handles per BlueID box can be ordered separately.

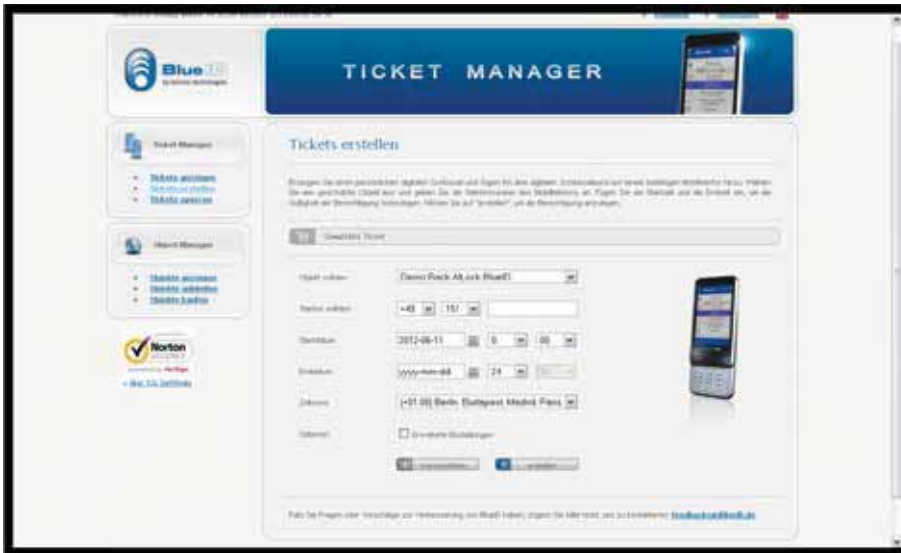

**Technical data – BlueID control system**

- Dimensions: 157 x 86 x 58 mm (WxHxD) plus antenna and plug.
- Weight: 0.24 kg.
- Temperature range – storage: -40°C to +85°C.
- Temperature range – operation: -20°C to +70°C.
- Supply voltage: 7-32 V DC; max: 400 mA.
- Power consumption: 2 W.
- Relay switching voltage (max.): 250 V AC.
- Relay switching current (max.): 5 A.
- Contact clamps (potential-free): 4 x 2.
- Optocoupler inputs (potential-free): 4 x 2.
- Connection: Bluetooth 2.0 EDR.
- Connection: Ethernet (RJ45).
- Connection: WLAN/WiFi (optional, with BlueID WLAN/WiFi upgrade accessory, Art. No. 4260200780775).

- Internal antenna connection: RP-SMA (right hand thread).
- Bluetooth range: up to 5 m / up to 50 m / up to 150 m.
- Security specification: allocation of access authorization and command execution.
- RSA/AES-encrypted up to 4,096 bit.
- Security specification: connection to trust center infrastructure in ISO/IEC 27001:2005-certified data center.
- Security specification: FIPS 140-2-certified cryptography modules; security specification: certificate-based ticket issuing (SHA).
- Security specification: public key infrastructure (PKI).
- Protection class: IP20.
- Certification: CE.

Type	Order No.	UP
Knürr bundle. @LockBlueID for Knürr DCM	<b>01.180.320.0</b>	1 unit
Package of 100 daily tickets	<b>01.180.321.0</b>	1 unit
Package of 10 yearly tickets	<b>01.180.322.0</b>	1 unit
Package of 10 reload tickets	<b>01.180.323.0</b>	1 unit

## Option 3: Potential-free contacts @Lock "potential-free contacts" system concept

Swing handles from the @Lock MLR1000 range are suitable for connecting electromechanical swing handles to existing building management systems or local identification systems, in addition to complementing @LockBlueID or rack monitoring systems.

The handle can be opened as soon as its potential-free contacts are activated or a voltage of 12-24 V DC is supplied. Following activation, the MLR1000 switches to ready-to-open status.

During this period, the user can open the MLR1000 by pressing a button. The LED at the top of the handle offers permanently high luminosity with a low power consumption. As a result, the lock status can be determined quickly, even from a distance of several meters.

The information display integrated into the handle is backlit and allows customer-specific information such as the cabinet row, cabinet number etc., to be added for further clarity.

### Technical data – @LockMLR1000

Handle electronics	
Two-part hardware design	MLR1000 and MLR1000 Box
Visualization	Status LED
MLR1000 Box	
Housing	Interface unit, plastic housing can be fixed with screws or self-adhesive pad
Power supply	12 V DC ± 10 % via screw clamps
Standby current (system ready)	40 mA (DC)
Max. current consumption (with connector tightening)	410 mA (DC)
Operating mode	100 % ED
Relay control	12V DC
Operating time	Max. 3 seconds
Contact output	250 V AC, 2 A
Installation position	Vertical
Connection type	Screw clamps, 2.5mm <sup>2</sup>
Connecting cable (reader - handle electronics)	8-pole, 350 cm, UL stranded wire AWG 26, one side with gated RJ45 plug, one side with crimped JST ZH connector ZHR-8
Temperature range	-20°C – +70°C

	@Lock MLR5000	@Lock MLR3000	@Lock MLR1000	@Lock BlueID
Software necessary	Admin Suite	Admin Suite	Custom	Web browser, Mobile phone app
E-Line Administration Suite Software	Yes	Yes	No	No
External emergency power supply connector	Yes	Yes	Yes	No
Identification	Transponder card	Transponder card	Dependent on customer's equipment and software	BlueID
IP support	Yes	Gateway	No	Optional
Log files	Yes (in combination w. Administration Suite)	Yes (in combination w. Administration Suite)	Dependent on customer's equipment and software	Optional
User profiles	Yes (in combination w. Administration Suite)	Yes (in combination w. Administration Suite)	Dependent on customer's equipment and software	No
Four-eyes-principle	Yes (in combination w. Administration Suite)	Yes (in combination w. Administration Suite)	Dependent on customer's equipment and software	Yes
Off-line mode	No	No	No	Yes
Technology partner	Eline by Dirak	Eline by Dirak	Eline by Dirak	BlueID by Baimos Technologies

Type	Model	Order No.	UP
@LockMLR1000	for Miracel and DCM front door	01.180.224.9	1 unit
@LockMLR1000	for twin doors (e.g. DCM rear door)	01.180.226.9	1 unit

# Knürr Cable Management

## Features

- Allows for prescribed cable radii.
- Components are easy to secure and use.
- Components feature addition functions.
- Extensive use of reusable Velcro strips precludes cable strain.
- No blockage of airflow within the rack.

**Obstacle-free cable management has been a longstanding feature in Knürr racks. While access is an important issue, the high density of cables and their varying structural connections play a significant role. This is where Knürr cable management comes in.**

The rack platform used in data centers or in network environments has been meticulously planned by Knürr, taking into account not only how active and passive components are arranged, but also ensuring that cabling is managed simply and efficiently.

Knürr cable management delivers products and solutions for server racks, active networks, passive network racks and special racks.

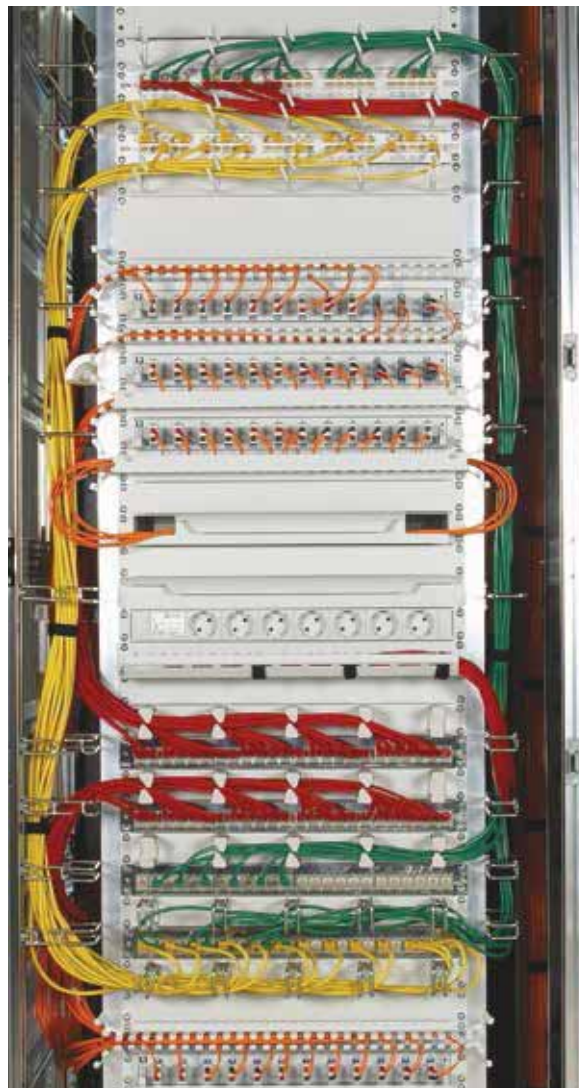



MEC20064



MEC20074



MEC20084

## Knürr Cable Management Proper Usage

Laying cables involves ensuring that mechanical stresses are completely avoided.

### ■ Bending load

The bending radii may never fall below the values provided by the cable manufacturer in the respective data sheets. Where excessive bending occurs, the cables' electrical properties are impaired, and transmission bandwidths and ranges are adversely affected. If manufacturer specifications are not available, then the following rule of thumb applies: loose cabling should be at least 15 times the external cable diameter and fixed cabling at least 10 times the external cable diameter.

### ■ Buckling load

Extreme bending loads can cause the cable to break.

### ■ Tensile load

This is determined solely by the copper cross-section of the conductor, as all other materials are too soft. The cable may not be exposed to stress exceeding 50 N/mm<sup>2</sup> (Cu cross-section) as this causes the conductors to stretch which reduces the cross-section. If higher "pulling" forces are required, cables with additional strain-reduction elements must be used.

### ■ Compressive stress

Compressive stress is caused by loads bearing down from above, fixed clamping or sharp cable kinking and must always be avoided, as otherwise the "loose" cable structure changes and electrical transmission properties are impaired.

### ■ Torque strains (twisting)

Cables must never be subjected to torque strains, as they cause cable elements to shift and change their position relative to each other, thereby impairing transmission properties.

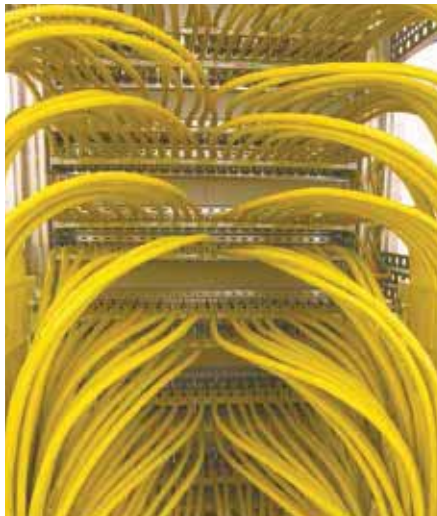

MEC20086

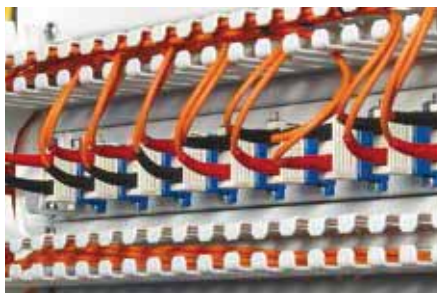

MEC20058



LIG00021



1. MEC20082

## Knürr Cable Management Proper Usage

- Various components for fiberglass and copper cables – especially fastening options such as Velcro and cable bundling using different colored strips – guarantee transparent cable management, providing an optimal starting point for both intelligent network expansion and ideal service convenience. (1)
- Special attention has been paid to ensuring that all cable management components can be fastened with Velcro strips which eliminate cable strain and can be reused at any time. Velcro cable ties also aid the installation technician as they are easily manageable, using pinch-free cable bundling. (2)
- Excess cable is stored separately from the patch fields while remaining easily accessible. Copper cable excess can be stored separately from fiberglass excess within the Knürr rack systems: the copper cables are stored on the side while the more sensitive fiberglass cables are stored in a drawer at the front. (3)
- A closer look at the individual products reveals their outstanding versatility. The cable-routing multifunctional brace, for example, not only provides the option of routing cables both horizontally and vertically using Velcro or cable ties, but additionally allows numerous components to be mounted with screws and caged nuts. These caged nuts can also be shifted in a slot with room for play, so that every mounting dimension is accommodated. (4)
- The prescribed radii are maintained with radius guides. These components prevent a reduction of the transmission bandwidths and ranges, as well as a cable break. (5)



2. MEC20070



3. MEC20099



3. MEC20079



4. MEC20077



4. MEC20091



5. MEC20071

# Knürr Cable Management

## Overhead Cabling

### Features

- Modular, extremely flexible.
- Robust construction.
- Includes integrated radius for cable entry into rack.
- New cover panel with lateral cable entry.
- Selection of cable troughs and mesh cable trays.
- Suitable for DCM® and Miracel®.
- Includes SmartAisle™ enclosure. Various combinations possible.

### Emerson Network Power's Overhead Cabling Solution

The Knürr overhead cable management system is a complete, modular system which offers a variety of cable-tray installment options. The components are very flexible and can be installed on site or modified with ease, to accommodate cable-management requirements that differ from rack to rack. This extremely sturdy and robust system can withstand high stress levels and is suitable for any application. Combined with other items from the Knürr cable-management product range, it provides a comprehensive solution that delivers proper cable bend radii.

### Example of Overhead Configuration

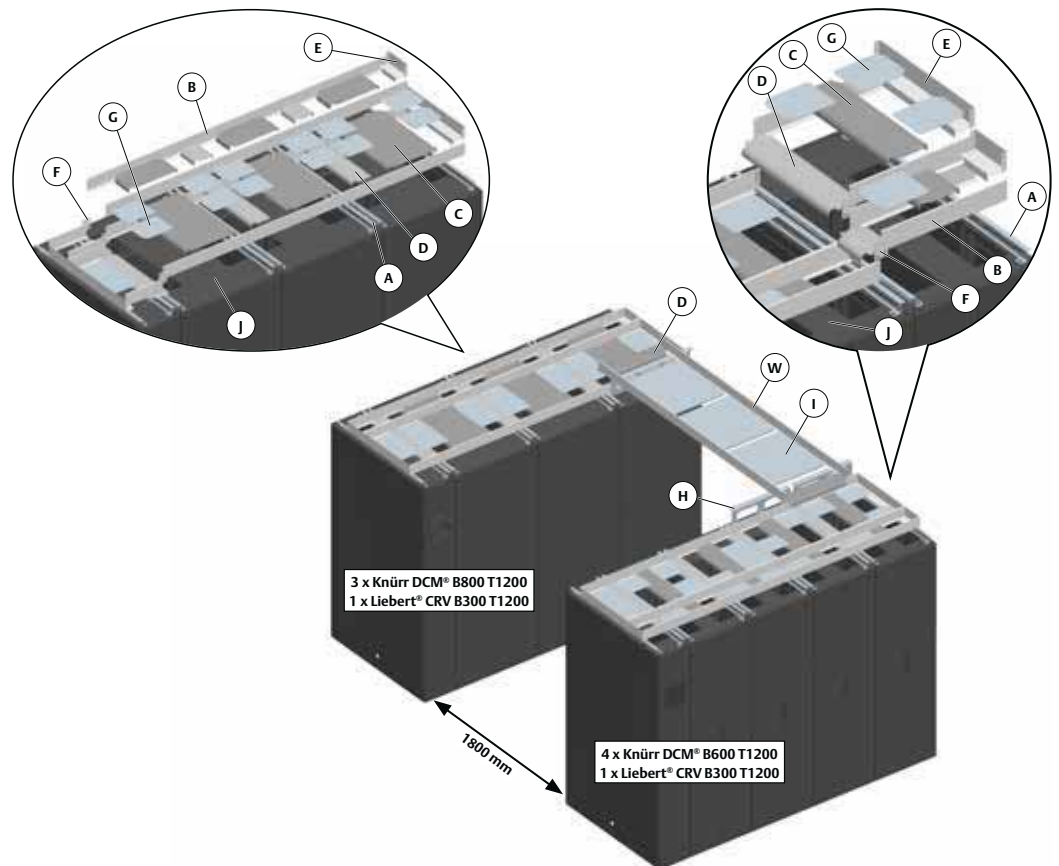

### Legend

- (A)** Support bracket
- (W)** Mounting bracket
- (C)** Center panel insert
- (D)** Transitional cover
- (E)** End panel insert
- (F)** Connecting panel insert
- (G)** Cover plate
- (H)** Support bracket cross-cabing
- (I)** Cover cross-cabing
- (J)** New cover panel with lateral cable entry



## Configuration Assistant

Sample Order	Name	Item	
<b>- Left rack suite</b>	Knürr DCM® B800 T1200	3	01.147.722.8
	New cover panel with lateral cable entry <b>(J)</b>	3	01.147.579.8
	Liebert® CRV B300 T1200	1	CR0302XXX-XXXXXX
	Support bracket <b>(A)</b>	4	05.045.005.X
	Mounting bracket <b>(B)</b>	2	05.045.011.X
		2	05.045.015.X
	Center panel insert <b>(C)</b>	3	05.045.023.X
		3	05.045.024.X
	Transitional cover <b>(D)</b>	3	05.045.031.X
		3	05.045.032.X
	End panel insert <b>(E)</b>	1	05.045.041.X
		1	05.045.042.X
	Connecting panel insert <b>(F)</b>	1	05.045.045.X
	Cover plate <b>(G)</b>	2	05.045.047.X
<b>- Right rack suite</b>	Knürr DCM® B800 T1200	4	01.147.714.8
	New cover panel with lateral cable entry <b>(J)</b>	4	01.147.574.8
	Liebert® CRV B300 T1200	1	CR0302XXX-XXXXXX
	Support bracket <b>(A)</b>	4	05.045.005.X
	Mounting bracket <b>(B)</b>	2	05.045.011.X
		8	05.045.012.X
	Center panel insert <b>(C)</b>	4	05.045.021.X
		4	05.045.022.X
	Transitional cover <b>(D)</b>	4	05.045.031.X
		4	05.045.032.X
	End panel insert <b>(E)</b>	1	05.045.041.X
		1	05.045.042.X
	Connecting panel insert <b>(F)</b>	2	05.045.045.X
	Cover plate <b>(G)</b>	2	05.045.047.X
<b>- Cross-cabling</b>	Support bracket <b>(H)</b>	1	05.045.052.X
		1	05.045.053.X
	Mounting bracket <b>(B)</b>	1	05.045.015.X
	Transitional cover <b>(D)</b>	2	05.045.032.X
	Cover <b>(I)</b>	1	05.045.057.X

Required Data for Overhead Cabling	Example
– Width of racks in the rack suite (300, 600 or 800 mm)	Rack width (W) = 800 mm
– Depth of racks in the rack suite (1000 to 1200 mm)	Rack depth (D) = 1200 mm
– Number of racks in one rack suite	
– Aisle width (Standard dimensions 1200, 1500 and 1800 mm ± 50 mm) – for cross-cabling	Aisle width (AW) = 1800 mm
– Color light-grey RAL 7035 or dark-grey RAL 7021)	Dark-grey RAL 7021

## Prerequisites for Overhead Cabling

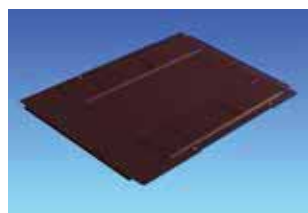
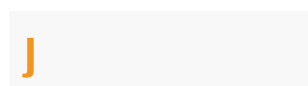

DCM20079

### DCM® cover panel with lateral cable entry

- With lateral cable entry on both sides (sliding plates).
- For orderly cable management with in the rack.
- Optional brush strips.
- **Material**
  - Sheet steel, 1.5 mm.
- **Finish / Color**
  - Powder-coated texture, RAL 7021, dark-grey.
- **Standard inclusion**
  - 1 x cover panel with lateral cable entry.
  - 1 x Mounting kit.
- **Delivery**
  - In sets.

W <sub>Rack</sub>	H	D <sub>Rack</sub>	For rack type	Order No.	UP
600		1000	DCM®	<b>01.147.572.8</b>	1 unit
600		1100	DCM®	<b>01.147.573.8</b>	1 unit
600		1200	DCM®	<b>01.147.574.8</b>	1 unit
800		1000	DCM®	<b>01.147.577.8</b>	1 unit
800		1100	DCM®	<b>01.147.578.8</b>	1 unit
800		1200	DCM®	<b>01.147.579.8</b>	1 unit

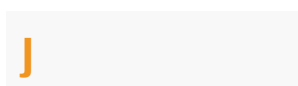

MIR20439

### Miracel® cover panel with lateral cable entry

- With lateral cable entry on both sides (sliding plates).
- For orderly cable management with in the rack.
- Optional brush strips.
- **Material**
  - Sheet steel, 1.5 mm.
- **Finish / Color**
  - Final digit of order number .1: powder-coated, RAL 7035 light-grey.
  - Final digit of order number .8: powder-coated, RAL 7021 dark-grey.
- **Standard inclusion**
  - 1 x cover panel with lateral cable entry.
  - 1 x Mounting kit.
- **Delivery**
  - In sets.

W <sub>Rack</sub>	H	D <sub>Rack</sub>	For rack type	Order No.	UP
600		1000	Miracel®	<b>01.130.630.X-003</b>	1 unit
600		1100	Miracel®	<b>01.130.630.X-004</b>	1 unit
600		1200	Miracel®	<b>01.130.630.X-005</b>	1 unit
800		1000	Miracel®	<b>01.130.630.X-008</b>	1 unit
800		1100	Miracel®	<b>01.130.630.X-009</b>	1 unit
800		1200	Miracel®	<b>01.130.630.X-010</b>	1 unit

Dimensions in mm:			Conversion:	
W = Width	L = Length	U = Standard rack unit	kg = Weight	1 mm = 0.03937 inch
H = Height	R = Bending radius	(1 U = 44.45 mm)		1 kg = 2.2046 pounds
D = Depth		UP = Packaging unit		

## K

### DCM® cover panel short

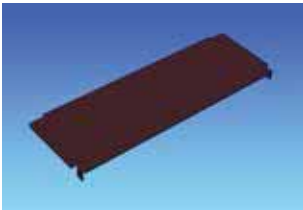

DCM20081

- For covering the front overhead area; the rest remains open.
- Facilitates unobstructed cable entry inside the rack.

■ **Material**  
- Sheet steel, 1.5 mm.

■ **Finish / Color**  
- Powder-coated texture, RAL 7021, dark-grey.

■ **Standard inclusion**  
- 1 x cover panel, short.  
- 1 x Mounting kit.

■ **Delivery**  
- In sets.

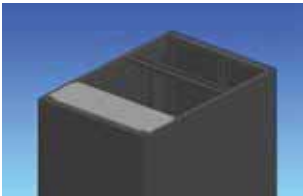

DCM20080

W <sub>Rack</sub>	L	D	For rack type	Order No.	UP
600	250		DCM®	<b>01.147.268.8</b>	1 unit
800	250		DCM®	<b>01.147.269.8</b>	1 unit

## K

### Miracel® cover panel short



MIR20441

- For covering the front overhead area; the rest remains open.
- Facilitates unobstructed cable entry inside the rack.

■ **Material**  
- Sheet steel, 1.5 mm.

■ **Finish / Color**  
- Final digit of order number .1:  
powder-coated, RAL 7035 light-grey.  
- Final digit of order number .8:  
powder-coated, RAL 7021 dark-grey.

■ **Standard inclusion**  
- 1 x cover panel, short.  
- 1 x Mounting kit.

■ **Delivery**  
- In sets.



MIR20440

W <sub>Rack</sub>	L	D	For rack type	Order No.	UP
600	250		Miracel®	<b>01.130.628.X</b>	1 unit
800	250		Miracel®	<b>01.130.629.X</b>	1 unit

## A

### Support bracket



MEC20200

- Secures corner piece at the top of the rack.
- Quick and easy mounting.
- Suitable for both Miracel and DCM racks.
- Includes screw for securing the mounting brackets, transitional cover and end panel inserts.

■ **Material**  
- Sheet steel 2.0 mm.

■ **Finish**  
- Final digit of order number .1:  
powder-coated, RAL 7035 light-grey.  
- Final digit of order number .8:  
powder-coated, RAL 7021 dark-grey.

■ **Standard inclusion**  
- 2 x support brackets.  
- 1 x Mounting kit.

■ **Delivery**  
- In sets.

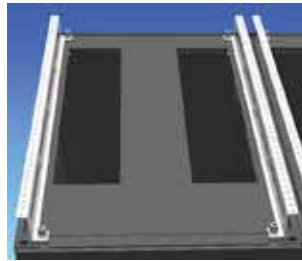

MEC20201

W / L	H	D <sub>Rack</sub>	For rack type	Order No.	UP
44	900		Miracel®/DCM®	<b>05.045.002.X</b>	1 set
44	1100		Miracel®/DCM®	<b>05.045.004.X</b>	1 set
44	1200		Miracel®/DCM®	<b>05.045.005.X</b>	1 set

## B

### Mounting brackets



MEC20202

- Secured on support bracket.
- Quick and easy mounting.
- Separate cable trays.

■ **Material**  
- Sheet steel 1.0 mm.

■ **Finish**  
- Final digit of order number .1:  
powder-coated, RAL 7035 light-grey.  
- Final digit of order number .8:  
powder-coated, RAL 7021 dark-grey.

■ **Standard inclusion**  
- 2 x mounting brackets.  
- 1 x Mounting kit.

■ **Delivery**  
- In sets.

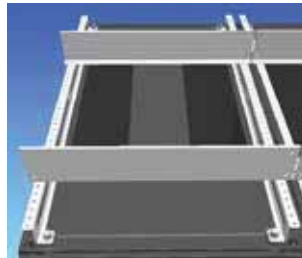

MEC20203

W / L	H	D	For rack type	Order No.	UP
300	90		Miracel®/DCM®	<b>05.045.011.X</b>	1 set
600	90		Miracel®/DCM®	<b>05.045.012.X</b>	1 set
800	90		Miracel®/DCM®	<b>05.045.013.X</b>	1 set
2400	90		Miracel®/DCM®	<b>05.045.015.X</b>	1 set
3000	90		Miracel®/DCM®	<b>05.045.016.X</b>	1 set

## C

### Center panel insert

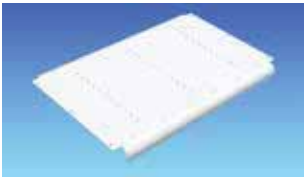

MEC20205

- Secured on mounting bracket.
- Quick and easy mounting.
- With 25 mm radius for bending the cables.

■ **Material**  
- Sheet steel, 1.5 mm.

■ **Finish**  
- Final digit of order number .1:  
powder-coated, RAL 7035 light-grey.  
- Final digit of order number .8:  
powder-coated, RAL 7021 dark-grey.

■ **Standard inclusion**  
- 1 x center panel insert.  
- 1 x Mounting kit.

■ **Delivery**  
- In sets.

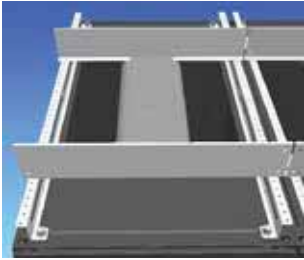

MEC20204

W / L	W <sub>Rack</sub>	D	R	For rack type	Order No.	UP
200	600		25	Miracel®/DCM®	<b>05.045.021.X</b>	1 set
600	600		25	Miracel®/DCM®	<b>05.045.022.X</b>	1 set
200	800		25	Miracel®/DCM®	<b>05.045.023.X</b>	1 set
600	800		25	Miracel®/DCM®	<b>05.045.024.X</b>	1 set

## E

### End panel insert

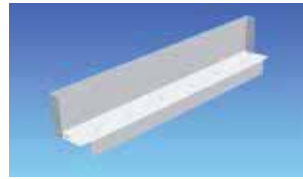

MEC20207

- Secured on support bracket.
- Quick and easy mounting.
- Completes cable trays.

■ **Material**  
- Sheet steel 1.0 mm.

■ **Finish**  
- Final digit of order number .1:  
powder-coated, RAL 7035 light-grey.  
- Final digit of order number .8:  
powder-coated, RAL 7021 dark-grey.

■ **Standard inclusion**  
- 2 x end panel inserts.  
- 1 x Mounting kit.

■ **Delivery**  
- In sets.

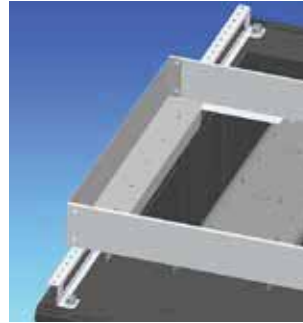

MEC20214

W / L	H	D	For rack type	Order No.	UP
200			Miracel®/DCM®	<b>05.045.041.X</b>	1 set
600			Miracel®/DCM®	<b>05.045.042.X</b>	1 set

## D

### Transitional cover from rack to rack

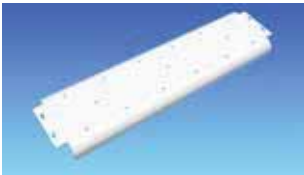

MEC20206

- Secured on support bracket.
- Quick and easy mounting.
- With 25 mm radius for bending the cables.

■ **Material**  
- Sheet steel, 1.5 mm.

■ **Finish**  
- Final digit of order number .1:  
powder-coated, RAL 7035 light-grey.  
- Final digit of order number .8:  
powder-coated, RAL 7021 dark-grey.

■ **Standard inclusion**  
- 1 x transitional cover.  
- 1 x Mounting kit.

■ **Delivery**  
- In sets.

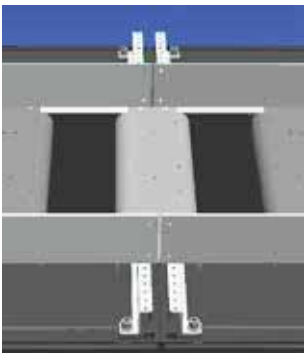

MEC20212

W / L	H	D	R	For rack type	Order No.	UP
200			25	Miracel®/DCM®	<b>05.045.031.X</b>	1 set
600			25	Miracel®/DCM®	<b>05.045.032.X</b>	1 set

## F

### Connecting panel insert



MEC20208

- For joining mounting brackets.
- Quick and easy mounting.

■ **Material**  
- Sheet steel, 1.5 mm.

■ **Finish**  
- Final digit of order number .1:  
powder-coated, RAL 7035 light-grey.  
- Final digit of order number .8:  
powder-coated, RAL 7021 dark-grey.

■ **Standard inclusion**  
- 10 x connecting panel inserts.  
- 1 x Mounting kit.

■ **Delivery**  
- In sets.



MEC20213

W	H	D	For rack type	Order No.	UP
64	86		Miracel®/DCM®	<b>05.045.045.X</b>	1 set

## G

### Cover plate

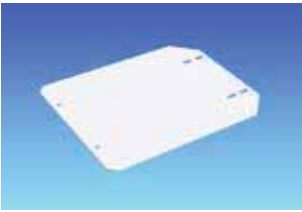

MEC20209

- For covering the space between the center panel inserts and transitional covers.
- Quick and easy mounting.

■ **Material**  
- Sheet steel 1.0 mm.

■ **Finish**  
- Final digit of order number .1:  
powder-coated, RAL 7035 light-grey.  
- Final digit of order number .8:  
powder-coated, RAL 7021 dark-grey.

■ **Standard inclusion**  
- 10 x cover plates.  
- 1 x Mounting kit.

■ **Delivery**  
- In sets.

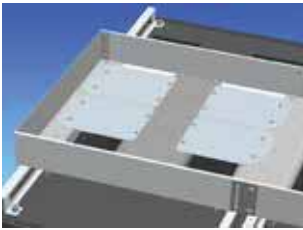

MEC20215

L	W	D	For rack type	Order No.	UP
229	183		Miracel®/DCM®	<b>05.045.047.X</b>	1 set

## Option

### Mesh cable tray



MEC20218

- Secured on support bracket.
- Quick and easy mounting.

■ **Material**  
- Round steel, d = 4.5 mm.

■ **Finish**  
- Zinc-passivated.

■ **Standard inclusion**  
- 1 x mesh cable tray.  
- 1 x Mounting kit.

■ **Delivery**  
- In sets.

B	L	H	For rack type	Order No.	UP
200	3000	54	Miracel®/DCM®	<b>05.045.061.9</b>	1 set
600	3000	54	Miracel®/DCM®	<b>05.045.062.9</b>	1 set

## H

### Support bracket Cross-cabling

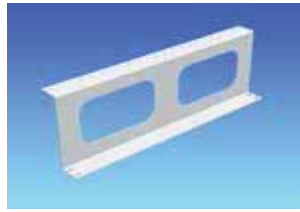

MEC20210

- For cable management at the top between rack suites.
- Quick and easy mounting.
- Includes screw for securing the mounting brackets, transitional covers and cover plates.

■ **Material**  
- Sheet steel 2.0 mm.

■ **Finish**  
- Final digit of order number .1:  
powder-coated, RAL 7035 light-grey.  
- Final digit of order number .8:  
powder-coated, RAL 7021 dark-grey.

■ **Standard inclusion**  
- 2 x support brackets, cross-cabling.  
- 1 x Mounting kit.

■ **Delivery**  
- In sets.

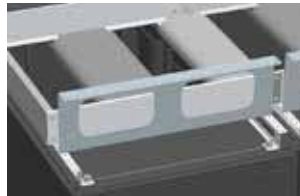

MEC20216

W / L	H	W <sub>Rack</sub>	For rack type	Order No.	UP
166	600		Miracel®/DCM®	<b>05.045.052.X</b>	1 set
166	800		Miracel®/DCM®	<b>05.045.053.X</b>	1 set

## I

### Cross-cabling Cover

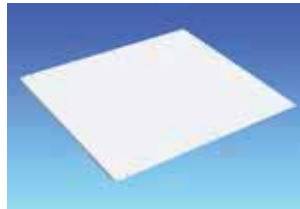

MEC20211

- Provides support for cables and covers the space between the rack suites.
- Secured on mounting bracket.
- Quick and easy mounting.

■ **Material**  
- Sheet steel 1.0 mm.

■ **Finish**  
- Final digit of order number .1:  
powder-coated, RAL 7035 light-grey.  
- Final digit of order number .8:  
powder-coated, RAL 7021 dark-grey.

■ **Standard inclusion**  
- 5 x cover plates.  
- 1 x Mounting kit.

■ **Delivery**  
- In sets.

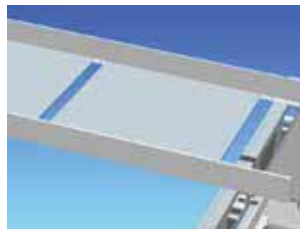

MEC20217

L	W	H	For rack type	Order No.	UP
200	200		Miracel®/DCM®	<b>05.045.055.X</b>	1 set
200	600		Miracel®/DCM®	<b>05.045.056.X</b>	1 set
600	600		Miracel®/DCM®	<b>05.045.057.X</b>	1 set

#### Dimensions in mm:

W = Width L = Length U = Standard rack unit kg = Weight  
H = Height R = Bending radius (1 U = 44.45 mm)  
D = Depth UP = Packaging unit

#### Conversion:

1 mm = 0.03937 inch  
1 kg = 2.2046 pounds

## Knürr cable manager

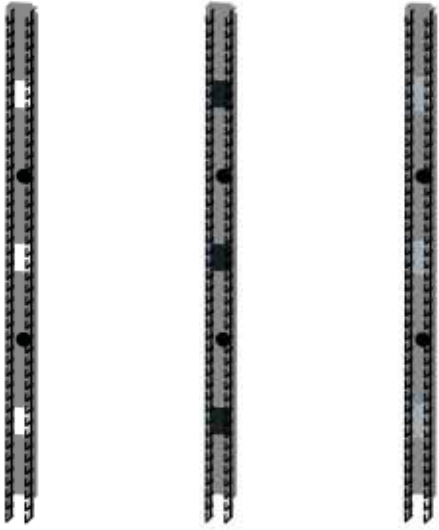

Type 1

Type 2

Type 3

### ■ Features

- Organized cabling of jumper cables.
- Suitable for 19" Knürr, DCM® and Miracel® racks.
- Also available optionally as cold/warm partitioning.
- Cutouts for cabling from front to back.
- Lightweight plastic construction of the cable fingers ensures durability and simple installation (clip-on).
- Distance between fingers provides sufficient space for all patch cords.
- Rounded edges on the fingers protect cables against damage.

## Cable manager models

- **Type 1:** Standard (open cutouts).
- **Type 2:** Version with brush strips in cutouts for cable routing towards the rear.
- **Type 3:** Version with sheet-steel cover plates in cutouts as part of the cold/warm partitioning.

## Technical data and required recess depths

### Knürr DCM®

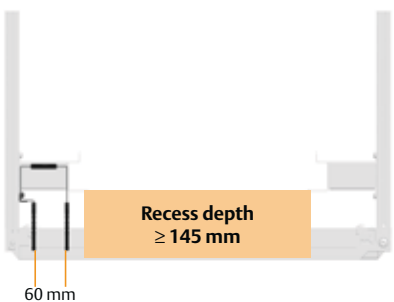
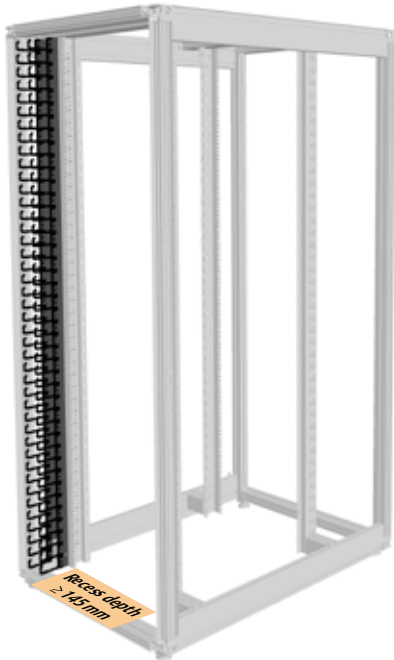

### Knürr DCM®

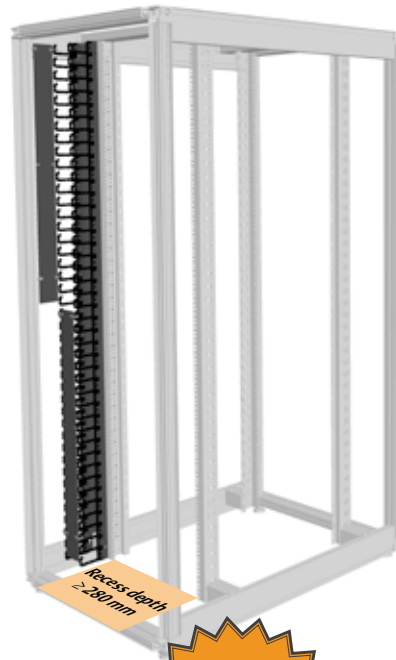

### Knürr Miracel®

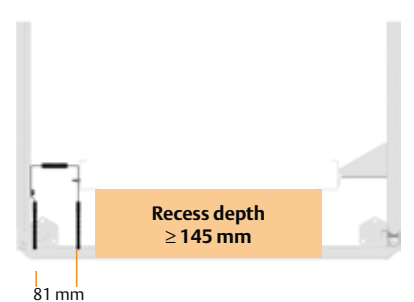

## DCM® cable manager, vertical



DCM20118



DCM20119

### Description

- **Left and right models (2 cable managers) included in the delivery.**
- Ideal for organizing cabling of jumper cables (copper and fiber optic cables).
- Retrofitting is possible.
- Prepared for full cold/warm partitioning.
- Cable fingers can be easily installed (clipped on).
- Cabling towards the rear through rubber bushings or cutouts.
- **Can be used for recess depths from 145 mm.**

### Material / Finish

- Cable duct: Sheet steel, 2.0 mm.  
Final digit of order number .1: powder-coated, RAL 7035 light-grey.  
Final digit of order number .8: powder-coated, RAL 7021 dark-grey.
- Cable fingers: Polyamide (UL 94 V-0), black.

### Standard inclusion

- 1 x cable duct, left.
- 1 x cable duct, right.
- 4 x rows with cable fingers.
- 4 x rubber bushings.
- 1 x Mounting kit.

### Delivery

- In pairs (cable fingers unassembled).

W <sub>Rack</sub>	H <sub>Rack</sub>	D	U	Recess depth	Cutout size	Order No.	UP
800	2000	42		Starting from 145 mm	66 x 100 mm	<b>05.045.102.X</b>	1 pair
800	2200	47		Starting from 145 mm	66 x 100 mm	<b>05.045.103.X</b>	1 pair

## DCM® cover panel for vertical cable manager



DCM20120



DCM20121

- **For only 1 cable manager, i. e., 2 kits required for B800 rack.**
- Covers the vertical cable manager.
- Tool-less fastening – clips onto cable finger.
- Can be swiveled on both sides and removed completely.

### Material / Finish

- Cover: sheet steel, 2.0 mm.  
Final digit of order number .1: powder-coated, RAL 7035 light-grey.  
Final digit of order number .8: powder-coated, RAL 7021 dark-grey.
- Clip: polyamide (UL 94 V-0), black.

### Standard inclusion

- 2 x covers.
- 8 x clips.

### Delivery

- In sets (clips pre-assembled).

W	H	D	U	Model	Order No.	UP
55	927	42			<b>05.045.112.X</b>	1 set
55	1038	47			<b>05.045.113.X</b>	1 set



DCM20117

## DCM® kit for air partitioning for vertical cable manager

- **Suitable for DCM racks.**
- Separates the cold and hot areas within the rack.
- Prevents hot-spots (air recirculation).

### Material / Finish

- Bottom plate, cover plate: sheet steel, 1.0 mm.  
Final digit of order number .1: powder-coated, RAL 7035 light-grey.  
Final digit of order number .8: powder-coated, RAL 7021 dark-grey.
- High-density foam: PUR foam (UL94 HF-1).

### Standard inclusion

- 1 x bottom plate.
- 6 x covers for cable routing.
- 1 x Foam element, side.
- 1 x Foam element, top.
- 1 x Mounting kit.

### Delivery

- In sets.

W <sub>Rack</sub>	H	D	U	Order No.	UP
800			42 and 47	<b>05.045.132.X</b>	1 set

## Miracel® cable manager, vertical

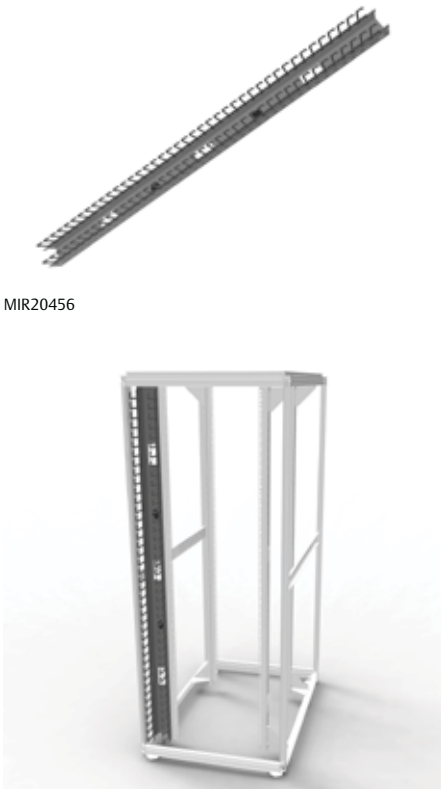

MIR20456

MIR20457

### Description

- Compatible with B800 and B700 racks, asymmetrical.
- **1 item suitable for left and right models (i.e., 2 items needed for B800 racks).**
- Ideal for orderly cabling of jumper cables (copper and fiber optic cables).
- **Retrofitting is not possible.**
- Prepared for full cold/warm partitioning.
- Cable fingers can be easily installed (clipped on).
- Cabling towards the rear through rubber bushings or cutouts.
- **Can be used for recess depths from 145 mm.**

### Material / Finish

- Cable duct: Sheet steel, 2.0 mm
- Final digit of order number .1: powder-coated, RAL 7035 light-grey.
- Final digit of order number .8: powder-coated, RAL 7021 dark-grey.
- Cable fingers: Polyamide (UL 94 V-0), black.

### Standard inclusion

- 1 x cable duct.
- 2 x rows with cable fingers.
- 2 x rubber bushings.
- 1 x Mounting kit.

### Delivery

- Single items (cable fingers unassembled).

W <sub>Rack</sub>	H <sub>Rack</sub>	D	U	Recess depth	Cutout size	Order No.	UP
800	2000	41		Starting from 145 mm	66 x 100 mm	<b>05.045.107.X</b>	1 unit
800	2200	46		Starting from 145 mm	66 x 100 mm	<b>05.045.108.X</b>	1 unit

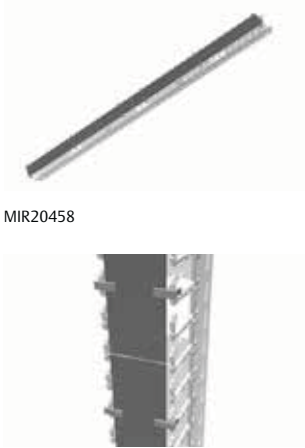

MIR20458

MIR20459

## Miracel® cover for vertical cable manager

- **For only 1 cable manager, i. e., 2 kits required for B800 rack.**
- For covering the vertical cable manager.
- Tool-less fastening – clips onto cable finger.
- Can be swiveled on both sides and removed completely.

### Material / Finish

- Cover: Sheet steel, 2.0 mm
- Final digit of order number .1: powder-coated, RAL 7035 light-grey.
- Final digit of order number .8: powder-coated, RAL 7021 dark-grey.
- Clip: polyamide (UL 94 V-0), black.

### Standard inclusion

- 2 x covers.
- 12 x clips.

### Delivery

- In sets (clips pre-assembled).

W	H	D	U	Model	Order No.	UP
76	905	41			<b>05.045.117.X</b>	1 set
76	1015	46			<b>05.045.118.X</b>	1 set



MIR20455

## Miracel® kit for air partitioning for vertical cable manager

- **Suitable for Miracel racks.**
- Separates the cold and hot areas in the rack.
- Prevents hot-spots (air recirculation).
- **Can only be used for recess depths of 200 mm.**

### Material / Finish

- Bottom plate, covers: Sheet steel, 1.0 mm.
- Final digit of order number .1: powder-coated, RAL 7035 light-grey.
- Final digit of order number .8: powder-coated, RAL 7021 dark-grey.
- High-density foam: PUR foam (UL94 HF-1).

### Standard inclusion

- 1 x bottom plate.
- 1 x cover, top.
- 6 x covers for cable routing.
- 1 x Foam element, side.
- 1 x Mounting kit.

### Delivery

- In sets.

W <sub>Rack</sub>	H	D	U	Order No.	UP
800		41		<b>05.045.133.X</b>	1 set
800		46		<b>05.045.134.X</b>	1 set



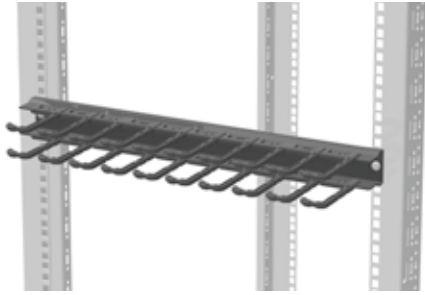

DCM20112

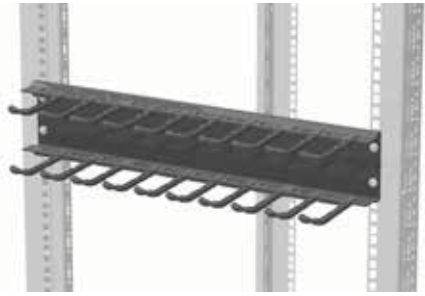

DCM20114

## 19" cable manager, horizontal

### Description

- 1 U and 2 U models.
- For organized cabling of jumper cables (copper and fiber optic cables).
- Front-mounting on 19" extrusions.
- Cable fingers can be easily installed (clipped on).
- **Can be used for recess depths from 145 mm.**

### Standard inclusion

- 1 x cable duct.
- 2 x rows with cable fingers.
- 1 x Mounting kit.

### Delivery

- In sets (cable fingers unassembled).

### Material / Finish

- Cable duct: sheet steel, 2.0 mm.
- Final digit of order number .1: powder-coated, RAL 7035 light-grey.
- Final digit of order number .8: powder-coated, RAL 7021 dark-grey.
- Cable fingers: polyamide (UL 94 V-0), black.

W	H	D	U	Recess depth	Order No.	UP
483			1	Starting from 145 mm	<b>05.045.120.X</b>	1 unit
483			2	Starting from 145 mm	<b>05.045.122.X</b>	1 unit

## Cover for 19" horizontal cable manager

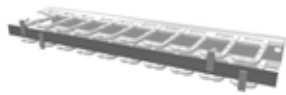

DCM20113

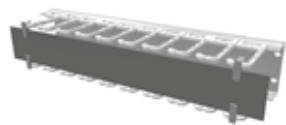

DCM20115

- Covers the horizontal cable managers.
- Tool-less fastening - clips onto cable finger.
- Can be swiveled on both sides and removed completely.

### Material / Finish

- Cover: sheet steel, 2.0 mm.
- Final digit of order number .1: powder-coated, RAL 7035 light-grey.
- Final digit of order number .8: powder-coated, RAL 7021 dark-grey.
- Clip: polyamide (UL 94 V-0), black.

### Standard inclusion

- 1 x cover.
- 4 x clips.

### Delivery

- In sets (clips pre-assembled).

W	H	D	U	Order No.	UP
483	20		1	<b>05.045.121.X</b>	1 set
483	65		2	<b>05.045.123.X</b>	1 set



MIR20093

## Set of brush strips for vertical cable manager

- Upgrade kit for vertical cable manager for routing cables toward the rear.
- Inserted in openings in cable duct (1 pair of brushes per opening).

### Standard inclusion

- 3 x pairs of brushes (length: 99 mm).

### Delivery

- In sets.



DCM20122

L	H	D	U	for cutouts	Order No.	UP
99				66 x 100 mm	<b>05.045.130.9</b>	1 set

### Dimensions in mm:

W = Width    h = Installation height    U = Standard rack unit  
 H = Height    d = Insertion depth    (1 U = 44.45 mm)

kg = Weight

### Conversion:

1 mm = 0.03937 inch  
 1 kg = 2.2046 pounds

D = Depth    L = Length    UP = Packaging unit



DCM20116

## DCM® kit for cascading; vertical cable manager

- Separates individual cable groups.
- Tool-less fastening – clips onto cable finger.
- Protects the cables and can be used for labeling.

- **Material / Finish**
  - Cascade: sheet steel, 2.0 mm. Powder-coated texture, RAL 7021 dark-grey.
  - Clip: polyamide (UL 94 V-0), black.

- **Standard inclusion**
  - 10 x cascades.
  - 20 x clips.

- **Delivery**
  - In sets (clips pre-assembled).

W	H	D	U	Order No.	UP
55	10			<b>05.045.136.8</b>	1 set

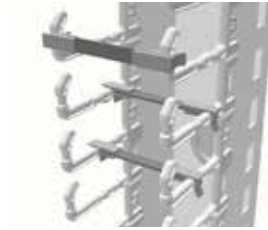

MIR20454

## Miracel® kit for cascading; vertical cable manager

- For separating individual cable groups.
- Tool-less fastening – clips onto cable finger.
- Protects the cables and can be used for labeling.

- **Material / Finish**
  - Cascade: sheet steel, 2.0 mm. Powder-coated texture, RAL 7021 dark-grey.
  - Clip: polyamide (UL 94 V-0), black.

- **Standard inclusion**
  - 10 x cascades.
  - 20 x clips.

- **Delivery**
  - In sets (clips pre-assembled).

W	H	D	U	Order No.	UP
76	10			<b>05.045.137.8</b>	1 set



MEC00110

Type 1

## 19" cable routing board 1 U

- For orderly cable routing.
- Enables safe and secure cable routing of copper and fiberglass cables.

- **Material / Finish**
  - Type 1: Front plate, sheet steel, 1.5 mm, powder coated.
  - Type 2: Front plate, sheet steel, 1.0 mm, powder coated.

- **Color**
  - Final digit of order number .1: RAL 7035, light grey.
  - Final digit of order number .8: RAL 7021 dark-grey.

- **External dimensions**
  - Cable routing:
    - Type 1: 55 x 22 mm, plastic.
    - Type 2: 95 x 32 mm, steel.

- **Standard inclusion**
  - 1 x 19" front plate.
  - 5 x cable routers.

- **Delivery**
  - Pre-assembled.

- **Note**
  - Please also order mounting material for front plates.



MEC20014

Type 2

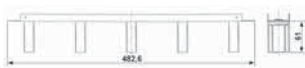

MEC20103

Type 1



MEC20104

Type 2

W	H	D	U	Jumpering space	Model	Order No.	UP
483			1	from 80 mm	Type 1	<b>05.040.111.X</b>	1 unit
483			1	from 123 mm	Type 2	<b>01.117.144.X</b>	1 unit



MEC20041

## 19" cable routing board, flexible, 1 U

- For orderly cable routing.
- Enables safe and secure cable routing of copper and fiberglass cables.

- **Material / Finish**
  - Front plate, sheet steel, 1.5 mm, powder coated.
  - Cable routing bracket, round steel, d = 5 mm, zinc-passivated.

- **Color**
  - Final digit of order number .1: RAL 7035, light grey.
  - Final digit of order number .8: RAL 7021 dark-grey.

- **External dimensions**
  - Cable routers (a x b):
    - 1 U: 82 x 43 mm.
    - 2 U: 102 x 82 mm.

- **Standard inclusion**
  - 1 x front plate.
  - 5 x cable routing boards.

- **Delivery**
  - Pre-assembled.

- **Note**
  - Please also order mounting material for front plates.

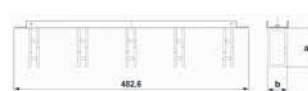

MEC20102



MEC20076

W	H	D	U	Jumpering space	Model	Order No.	UP
483			1	from 100 mm	Type 1	<b>05.040.100.X</b>	1 unit
483			2	from 120 mm	Type 2	<b>05.040.101.X</b>	1 unit

### Dimensions in mm:

W = Width	h = Installation height	U = Standard rack unit	kg = Weight	Conversion:
H = Height	d = Insertion depth	(1 U = 44.45 mm)		1 mm = 0.03937 inch
D = Depth	L = Length	UP = Packaging unit		1 kg = 2.2046 pounds



MEC20081

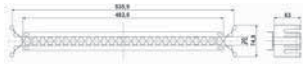

MEC20105



MEC20058

## Fiber optic cable routing panel 1 U

- For orderly cable routing.
- Enables safe and secure cable routing of fiber optic cables.
- Optionally with cover plates to protect the cables and can be used for labeling.

### Material / Finish

- Sheet steel, 1.5 mm, powder-coated texture.

### Color

- Final digit of order number .1: RAL 7035, light grey.
- Final digit of order number .8: RAL 7021 dark-grey.

### Standard inclusion

- 1 x 19" cable routing board.

### Delivery

- Single items.

### Note

Please also order mounting material for front plates and cover.  
Not suitable for rack widths of 600 mm and 700 mm (asymmetrical).

W	H	D	U	Model	Order No.	UP
483			1	Cable routing board	<b>05.040.050.1</b>	1 unit
				Accessories: cover	<b>05.040.051.1</b>	1 unit
483			1	Cable routing board	<b>05.040.050.8</b>	1 unit
				Accessories: cover	<b>05.040.051.8</b>	1 unit



MEC20049



MEC20063

## 19" cable trough

- For organized cable management at the 19" front plate.
- Mounting possible on front plates.
- Cables can be fastened with Velcro.

### Material / Finish

- Sheet steel, 1.5 mm, powder-coated texture.

### Color

- Final digit of order number .1: RAL 7035, light grey.
- Final digit of order number .8: RAL 7021 dark-grey.

### Standard inclusion

- 1 x cable trough.

### Delivery

- Single items.

### Note

Please also order mounting material for front plates and Velcro rolls.

W	H	D	U	Model	Order No.	UP
483		100	1		<b>05.040.055.1</b>	1 unit
483		100	1		<b>05.040.058.8</b>	1 unit



MEC20224



MEC20067

## Cable trough

- For orderly cable management in the Miracel and DCM racks.
- Cables secured with Velcro strips or cable ties.
- 9 mm slit width for securing various parts to caged nuts.

### Material / Finish

- Sheet steel, 1.5 mm, zinc passivated, powder-coated.

### Color

- .1; RAL 7035 light grey.
- .8; RAL 7021, dark-grey.

### Standard inclusion

- 1 x cable trough.
- 1 x Mounting kit.

### Delivery

- In sets.

### Note

If required, please also order Velcro rolls.

W	H	w	Model	Order No.	UP
	2000	100	For Miracel and DCM racks	<b>05.040.251.X</b>	1 set
	2200	100	For Miracel and DCM racks	<b>05.040.252.X</b>	1 set
	2000	150	For Miracel and DCM racks	<b>05.040.254.X</b>	1 set
	2200	150	For Miracel and DCM racks	<b>05.040.255.X</b>	1 set
	2000	200	For Miracel and DCM racks	<b>05.040.257.X</b>	1 set
	2200	200	For Miracel and DCM racks	<b>05.040.258.X</b>	1 set



DCM20077

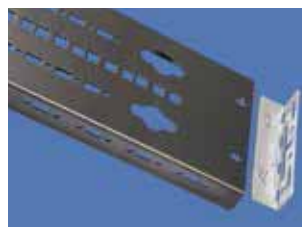

DCM20076

## DCM® PDU bracket

- For organized cable management in the rack.
- Tool-less mounted trade-standard PDUs.
- Especially suited to Knürr and Liebert PDUs.

### Material / Finish

- Sheet steel, 1.5 mm, zinc passivated, powder-coated.

### Color

- RAL 7021, dark-grey.

### Standard inclusion

- 1 x PDU bracket.
- 1 x Mounting kit.

### Delivery

- In sets.

W	H <sub>Rack</sub>	D	U	Model	Order No.	UP
125	2000	25	42		<b>01.147.816.8</b>	1 set
125	2200	25	47		<b>01.147.817.8</b>	1 set

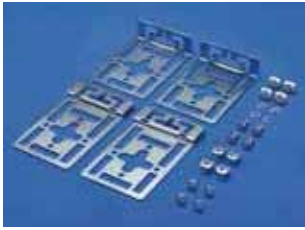

MEC20222

Type 1



MEC20223

Type 2

## PDU mounting kit

- For securing various rack PDUs.
- Suitable for Miracel and DCM racks.
- For installing 1 or 2 PDUs.
- Installation options are described in the "Installation instructions for PDUs" manual.

### Material / Finish

- Sheet steel, 2 mm, zinc passivated.

### Standard inclusion

- 2 x L mounting brackets.
- 2 x angular mounting brackets.
- 1 x Mounting kit.

### Delivery

- In sets.

W	H	D	d	Model	For rack type	Order No.	UP
				Type 1: short	DCM/Miracel	<b>01.147.813.9</b>	1 set
				Type 2: long	DCM/Miracel	<b>01.147.814.9</b>	1 set

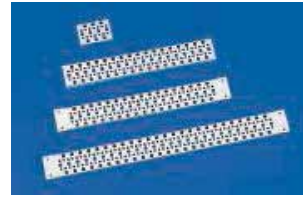

MIR00089

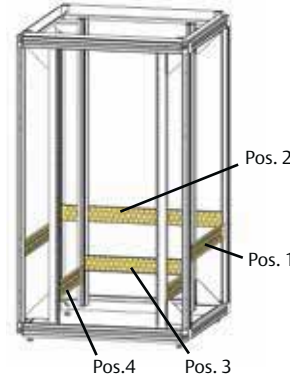

MIR88003

## Multifunctional brace

- For cable management with cable ties.
- Provides universal securing options.
- Holes for mounting caged nuts.
- Distance between two multifunctional braces can be variably selected using T-slot.
- Installation on the extrusions of the rack frame or on the 19" extrusions, diagonal and lateral.

### Installation positions

- 1 toward rear of basic frame.
- 2 across width of basic frame.
- 3 across width of 19" extrusions.
- 4 toward rear of 19" extrusions.

### Material

- Sheet steel, 1.5 mm.

### Finish

- Zinc-passivated.

### Standard inclusion

- 4 x multifunctional braces.

### Delivery

- In sets.

W <sub>Rack</sub>	D <sub>Rack</sub>	d	Installation position	For rack type	Order No.	UP
600		1		Miracel	<b>05.040.160.9</b>	4 units
800		1		Miracel	<b>05.040.161.9</b>	4 units
900		1		Miracel	<b>05.040.162.9</b>	4 units
1000		1		Miracel	<b>05.040.163.9</b>	4 units
1100		1		Miracel	<b>05.040.164.9</b>	4 units
1200		1		Miracel	<b>05.040.165.9</b>	4 units
600		2		Miracel/Smaract	<b>05.040.173.9</b>	4 units
800		2		Miracel	<b>05.040.174.9</b>	4 units
		3		Miracel/Smaract/DPR	<b>05.040.175.9</b>	4 units
600	365	4		Miracel/Smaract	<b>05.040.168.9</b>	4 units
800	565	4		Miracel/Smaract	<b>05.040.169.9</b>	4 units
900	740	4		Miracel/Smaract	<b>05.040.172.9</b>	4 units
1000	740	4		Miracel/Smaract	<b>05.040.172.9</b>	4 units

### Dimensions in mm:

W = Width h = Installation height U = Standard rack unit  
 H = Height d = Insertion depth (1 U = 44.45 mm)  
 D = Depth L = Length UP = Packaging unit

### Conversion:

1 mm = 0.03937 inch  
 1 kg = 2.2046 pounds



MEC20091

## 1 cable routing brace

- Fitted to the Miracel/Smaract basic frame and the 19" extrusion.
- Cables fastened using Velcro and cable ties.
- For organized cable management with in the rack.
- Two-sided installation.
- Provides universal mounting using caged nuts (all dimensions can be accommodated; caged nuts are flexible).

■ **Material**  
- Sheet steel, 1.5 mm.

■ **Finish**  
- Zinc-passivated.

■ **Standard inclusion**  
- 4 x cable routing braces.  
- 1 x Mounting kit.

■ **Delivery**  
- Single items.

■ **Note**  
If required, please also order Velcro rolls.



MEC20078

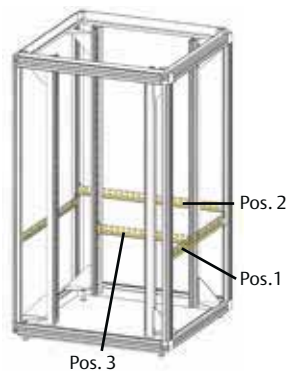

MIR88001

W <sub>Rack</sub>	H <sub>Rack</sub>	D <sub>Rack</sub>	L	Model	For rack type	Order No.	UP
600		455	Pos. 1	Miracel		<b>05.040.200.9</b>	4 units
800		655	Pos. 1	Miracel		<b>05.040.201.9</b>	4 units
900		755	Pos. 1	Miracel		<b>05.040.202.9</b>	4 units
1000		855	Pos. 1	Miracel		<b>05.040.203.9</b>	4 units
1200			Pos. 1	Miracel		<b>05.040.205.9</b>	4 units
600		534	Pos. 2	Miracel/Smaract		<b>05.040.213.9</b>	4 units
800		734	Pos. 2	Miracel		<b>05.040.214.9</b>	4 units
		468	Pos. 3	Miracel/Smaract/DPR		<b>05.040.215.9</b>	4 units

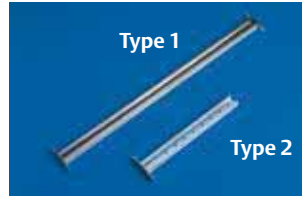

MEC00113

## C extrusion rail

- Cables secured with U-clamps or cable clamping bars.
- Space-saving installation between the extrusions on the basic rack.
- Two-sided installation.

■ **Material**  
- Sheet steel, 1.5 mm, zinc-passivated.

■ **Finish**  
- Zinc-passivated.

■ **Standard inclusion**  
- 4 x extrusion rails.  
- 1 x Mounting kit.

■ **Delivery**  
- In sets.

■ **Note**  
Please also order U-clamps, cable clamping bars or threaded plates.

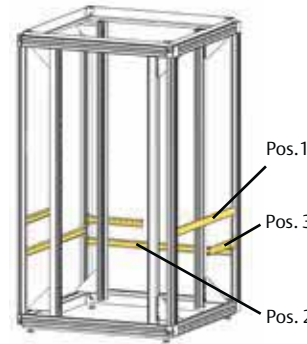

MIR88004

W <sub>Rack</sub>	D <sub>Rack</sub>	W <sub>Rack</sub>	Installation position	For rack type	Order No.	UP
	600		1	Miracel	<b>05.040.180.9</b>	4 units
	800		1	Miracel	<b>05.040.181.9</b>	4 units
	900		1	Miracel	<b>05.040.182.9</b>	4 units
	1000		1	Miracel	<b>05.040.183.9</b>	4 units
	1200		1	Miracel	<b>05.040.185.9</b>	4 units
			3	Miracel/Smaract	<b>05.040.195.9</b>	4 units
	800	2		Miracel/Smaract	<b>05.040.194.9</b>	4 units
	600	2		Miracel/Smaract	<b>05.040.193.9</b>	4 units



MIR00096

## C extrusion rail

- Cables secured with U-clamps or cable clamping bars.
- Cable clamping close to entry point (type 1).
- Suitable for use with cover panel including cable entry.

■ **Material / Finish**  
- Sheet steel, 1.5 mm, zinc passivated.

■ **Standard inclusion**  
- 1 x C extrusion rail.  
- 1 x Mounting kit.

■ **Delivery**  
- In sets.

■ **Note**  
Please also order U-clamps, cable clamping bars or threaded plates.

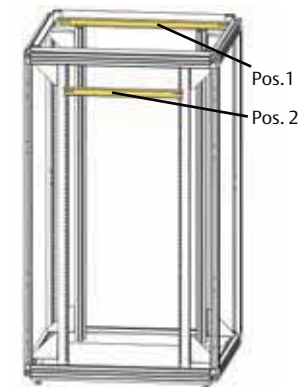

MIR88002

W	H	D	L	Model	Order No.	UP
600			482.5	Pos. 1 Miracel/Smaract	<b>05.040.080.0</b>	1 unit
800			682.5	Pos. 1 Miracel	<b>05.040.082.0</b>	1 unit
19"			508	Pos. 2 Miracel/Smaract/Doubleprorack	<b>01.110.719.9</b>	1 unit



MEC00114

## Cable clamping bar

- Clips onto the C extrusion rail.
- **Material**  
- Polyamide, black.
- **Standard inclusion**  
- 1 set of 10 cable clamping bars.
- **Delivery**  
- In sets.

W	H	D	U	d	L	Model	Order No.	UP
							<b>01.130.869.9</b>	10 units



MIR00096

## U clamp

- Reduces cabling strain and permits individual routing of cables and lines.
- Clamping range, 8–64 mm.
- **Material**  
- Steel / plastic.
- **Standard inclusion**  
- 25 x U clamps.  
- 25 x clamping saddles.

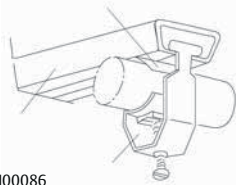

ELM00086

- **Delivery**  
- In sets.

W	H	D	U	d	L	Clamping range	Order No.	UP
						8 - 12 mm	<b>05.040.150.9</b>	1 unit
						12 - 16 mm	<b>05.040.151.9</b>	1 unit
						16 - 22 mm	<b>05.040.152.9</b>	1 unit
						22 - 28 mm	<b>05.040.154.9</b>	1 unit
						34 - 40 mm	<b>05.040.155.9</b>	1 unit
						46 - 52 mm	<b>05.040.157.9</b>	1 unit
						58 - 64 mm	<b>05.040.159.9</b>	1 unit



MEC20051

## M5 threaded plate

- Used with C extrusion rails.
- **Material / Finish**  
- Flat rolled steel, 4.0 mm, zinc passivated.
- **Standard inclusion**  
- 20 x threaded plates.
- **Delivery**  
- In sets.



MEC20069

W	H	D	L	Order No.	UP
				<b>05.040.077.9</b>	1 set



MEC20136

Type 1



MEC20120

Type 1

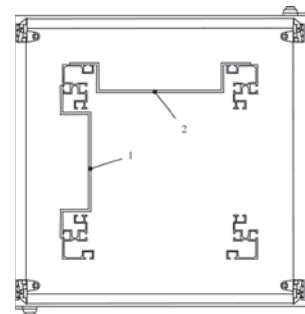

MIR00094

W/d	U	w1	w2	X	Type	Model	Order No.	UP
19"	1	482	442.6	81.5	1	Pos. 2 Miracel/Smaract	<b>05.040.018.1</b>	1 unit

## Assembly crossbar

- Cable management with Velcro strips.
- Universal mounting option for installation accessories, socket strips, telecommunication installation units, mounting panels, etc.
- For side and cross installation.
- **Material / Finish**  
- Sheet steel 1.5 mm, powder-coated texture, RAL 7035, light-grey.
- **Standard inclusion**  
- 1 x assembly crossbar.
- **Delivery**  
- Single items.
- **Note**  
Please also order the appropriate mounting material.



MEC20042

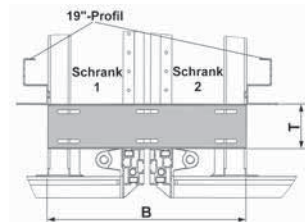

MEC20119

## Cable trough between the racks

- For orderly cable routing between linked racks, adjacent racks.
- Velcro strips can be used for fastening.
- **Material / Finish**  
- Sheet steel, 1.5 mm.  
- Powder-coated texture, RAL 7035 light-grey.
- **Standard inclusion**  
- 1 x cable trough.  
- 1 x Mounting kit.
- **Delivery**  
- In sets.
- **Note**  
Please also order Velcro rolls.

W	H	D	U	Model	Order No.	UP
265		60			<b>05.040.058.1</b>	1 unit



MEC20047

## FOC 19" excess cable drawer, 1 U

- For storing excess fiber optic cable.
- Pull-out.
- Cables can be fastened with Velcro.

### Material / Finish

- Sheet steel, 1.5 mm.
- Powder-coated texture, RAL 7035 light-grey.

### Standard inclusion

- 1 x unit.
- 1 x drawer.

### Delivery

- In sets.

### Note

Please also order mounting material for front plates and Velcro rolls.



MEC20099

W	H	D	Model	Order No.	UP
483	44	350		05.040.047.1	1 set



MEC20044

## Excess fiber optic cable storage

- For orderly cable routing of Fiber optic cables in Miracel rack (from B 800 mm).
- For storing excess cable.

### Material / Finish

- Base plate: powder-coated texture, RAL 7035 light-grey.
- Cable routing head: polyamide, black.

### Standard inclusion

- 1 x base plate.
- 1 x cable routing head.
- 1 x Mounting kit.

### Delivery

- In sets.



MEC20146

W	H	D	U	Model	Order No.	UP
			2		05.040.041.1	1 set



MEC20038

## Universal cable routing bracket

- Used for extrusion distance (from front) 123 mm and 73 mm.
- For organized cable management.
- Open version, no threading.
- Mounting on the external side of the 19" extrusion.
- Any installation position selectable.

### Material

- Round steel, d = 6 mm.

### Finish

- Zinc-passivated.

### Standard inclusion

- 4 x cable routing brackets.
- 1 x Mounting kit.

### Delivery

- In sets.



MEC20072

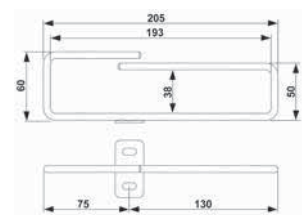

MEC20106

W <sub>Rack</sub>	For rack type	Order No.	UP
from 800	Miracel	05.040.220.9	4 Stk



MEC20039

## Square cable routing bracket

- For orderly cable management.
- Open version, no threading.
- Mounted on the external side of the 19" extrusion.
- Any installation position selectable.
- For high cable density.

### Material

- Round steel, d = 6 mm.

### Finish

- Zinc-passivated.

### Standard inclusion

- 4 x square cable routing brackets.
- 1 x Mounting kit.

### Delivery

- In sets.

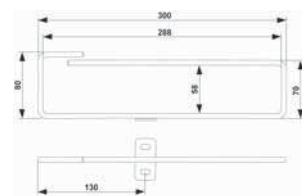

MEC20107

Type 1

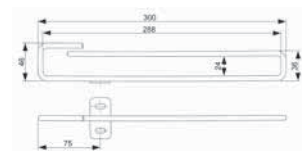

MEC20116

Type 2

W <sub>Rack</sub>	Type	For rack type	Order No.	UP
from 800	Type 1	Miracel	05.040.221.9	4 units
from 700	Type 2	Miracel	05.040.222.9	4 units
600	Type 2	Smaract	05.040.222.9	4 units

### Dimensions in mm:

W = Width	h = Installation height	U = Standard rack unit	kg = Weight	Conversion:
H = Height	d = Insertion depth	(1 U = 44.45 mm)		1 mm = 0.03937 inch
D = Depth	L = Length	UP = Packaging unit		1 kg = 2.2046 pounds

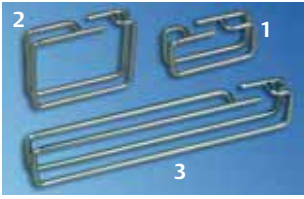

MEC20035

## Cable routing bracket, flexible

- Enables flexible and organized cable routing.
- Can be easily installed in various positions within the rack.
- Open version, no threading.



MEC20065

- **Material**
  - Round steel, d = 5 mm.
- **Finish**
  - Zinc-passivated.
- **Standard inclusion**
  - 10 x cable routing brackets.
  - 1 x Mounting kit.
- **Delivery**
  - In sets.

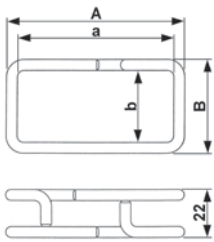

MEC20108

A	a	W	w	Model	Order No.	UP
82	72	43	33	Fig. 1	05.040.231.9	10 units
222	212	30	20	Fig. 3	05.040.232.9	10 units
102	92	82	72	Fig. 2	05.040.233.9	10 units



ELM00117

## Square cable routing bracket

- For organized cable management.
- Open version, no threading.
- Mounted on the external lateral T-slot of the 19" extrusion.
- Any installation position selectable.

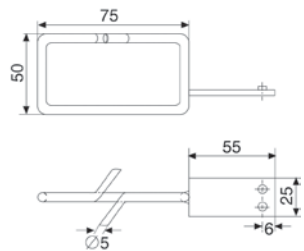

ELM00106

- **Material**
  - Round steel, d = 5 mm.
- **Finish**
  - Zinc-passivated.
- **Standard inclusion**
  - 4 x cable routing brackets.
  - 1 x Mounting kit.
- **Delivery**
  - In sets.

For rack type	Order No.	UP
DoubleProRack	05.040.226.9	4 units



MIR00564

## Cable routing bracket

- For organized cable management.
- Open version, no threading.
- **Material / Finish**
  - Round steel, d = 5 mm.
- **Finish**
  - Zinc-passivated.
- **Standard inclusion**
  - 4 x cable routing brackets.
  - 1 x Mounting kit.
- **Delivery**
  - In sets.

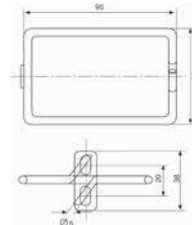

MEC00122

Model	Order No.	UP
95 x 60	05.040.225.9	4 units



ELM00028

## Section support bracket

- Ideal for vertical routing and reducing cabling strain.
- Open version, no threading.
- Mounted on the external lateral T-slot of the 19" extrusion.
- Any installation position selectable.
- From rack width 600 mm.
- **Material / Finish**
  - Round steel, d = 5 mm, zinc-passivated.
- **Standard inclusion**
  - 2 x section support brackets.
- **Delivery**
  - In sets.
- **Note**
  - Please also order the appropriate mounting material.

Z56-1/FH

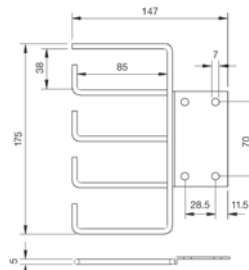

ELM00029

W	H	D	U	d	L	Model	Order No.	UP
							01.117.033.7	2 units

Dimensions in mm:				Conversion:	
W = Width	h = Installation height	U = Standard rack unit	kg = Weight	1 mm = 0.03937 inch	
H = Height	d = Insertion depth	(1 U = 44.45 mm)		1 kg = 2.2046 pounds	
D = Depth	L = Length	UP = Packaging unit			





MIR00183

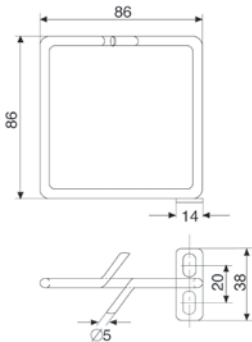

ELM00057

W <sub>Rack</sub>	Model	Order No.	UP
from 800	86 x 86	05.040.224.9	4 units

## Cable routing bracket, square

- For organized cable management.
- Open version, no threading.
- Mounted on the external lateral T-slot of the 19" extrusion.
- Any installation position selectable.
- From rack width 800 mm.

- **Finish**
  - Zinc-passivated, Zn 10c, white.
- **Standard inclusion**
  - 4 x vertical cable routing brackets.
  - 1 x Mounting kit.
- **Delivery**
  - In sets.



MEC20185



MEC20186

## Quick-Strip ties for T-slot Tool-less mounting

- Quick tool-less securing.
- For bundling cables.
- Can be unfastened and reused.
- For organized cable management.
- Can be fitted into T-slots in any position.

- **Material**
  - Polyethylene and nylon.
  - F.R.T., UL-94 HB.

- **Color**
  - Black.

- **Standard inclusion**
  - 10 x Quick-Strip Velcro ties.

- **Delivery**
  - In sets.

W	H	D	U	d	L	For rack type	Order No.	UP
						DCM, Miracel	00.218.506.0	1 set



ELM20008



ELM20007

## Cable routing ring

- For organized cable management.
- Open version, no threading.
- Secured on the T-slots of the vertical extrusions.
- Any installation position selectable.

- **Material / Finish**
  - PA 6, GF 15, black, UL-94-HB.

- **Standard inclusion**
  - 5 x cable routing rings.
  - 1 x Mounting kit.

- **Delivery**
  - In sets.

W	H	D	U	d	L	Model	Order No.	UP
						54 x 118 mm	01.312.207.9	5 units



MEC20187



MEC20188

## Quick-Clamp plastic cable routing bracket for T-slot mounting without tools

- Quick tool-less securing.
- For organized cable management.
- Open version, no threading.
- Secures T-slots in any position.

- **Material**
  - Nylon.
  - F.R.T., UL-94 HB.

- **Color**
  - Black.

- **Standard inclusion**
  - 10 x plastic cable routing brackets.

- **Delivery**
  - In sets.

W	H	D	U	d	L	For rack type	Order No.	UP
						DCM, Miracel	00.218.505.0	1 set

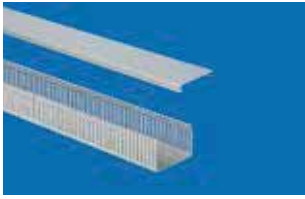

ELM00004

## Cable duct

- Ideal for organized and covered cable management of jumper cables.

■ **Material**  
- Hard PVC.

■ **Finish**  
- Stone-grey RAL 7030.

■ **Standard inclusion**  
- 1 x cable duct with cover.  
- 1 x Mounting kit.

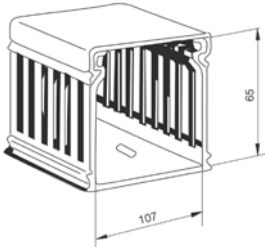

ELM00052

W	H	D	U	d	L	Model	Order No.	UP
					2000		<b>01.117.098.3</b>	1 unit



LIG00068

## Fiber optic cable router

- For safe and organized cable management of fiber optic cables.
- With step-index extrusion of the slots to reduce cabling strain on the fiber optic cables.
- Mounted on the external side of the 19" extrusion.

■ **Material**  
- PA UL (94-VO).

■ **Standard inclusion**  
- 1 x pair of fiber optic cable routers.  
- 1 x Mounting kit.

■ **Delivery**  
- In sets.



LIG00021

W	H	D	U	d	L	Model	Order No.	UP
							<b>01.117.099.1</b>	1 pair



MEC20158

## Cable routing ring

- For organized cable management.
- Dimensions:  
Exterior 61 mm x 42.5 mm.  
Interior 52 mm x 23 mm.

■ **Material / Finish**  
- Cable support: PPO, similar to RAL 7035 light-grey.  
- Soft rubber extrusion: EPDM, similar to RAL 7021 dark-grey.

■ **Standard inclusion**  
- 10 x cable routers.

■ **Delivery**  
- In sets.

■ **Note**  
Please also order the appropriate mounting material.

W	H	D	Model	Order No.	UP
			Screw-on	<b>05.040.113.9</b>	10 units
			For 9,5 x 9,5 mm cutout. Plug-in	<b>05.040.112.9</b>	10 units



MEC20048

## Velcro rolls (by the meter)

- For strain-free fastening and bundling of Cu and fiber optic cables.
- Velcro rolls can be cut to any required length.

■ **Material / Color**  
- Black: One-Wrap fastener.  
- F.R.T., UL 94-V2.  
- Blue: One-Wrap fastener.

■ **Standard inclusion**  
- 1 meter or 25 meter Velcro rolls.

■ **Delivery**  
Sold by the meter.



MEC20147

W	H	D	L	Model	Order No.	UP
16			1000	Black	<b>05.040.060.9</b>	1 meter
16			1000	Blue	<b>05.040.061.9</b>	1 meter
16			25000	Black	<b>05.040.065.9</b>	25 meters
16			25000	Blue	<b>05.040.066.9</b>	25 meters

Dimensions in mm:				Conversion:	
W = Width	h = Installation height	U = Standard rack unit	kg = Weight	1 mm = 0.03937 inch	
H = Height	d = Insertion depth	1 U = 44.45 mm		1 kg = 2.2046 pounds	
D = Depth	L = Length	UP = Packaging unit			



MEC20025

## Velcro strip with plastic eyelet

- For mounting non-standard components.
- For bundling cables.

■ **Material / Color**  
- Polypropylene / Polyamide, black.

■ **Standard inclusion**  
- 20 x Velcro strips.

■ **Delivery**  
- In sets.

W	H	D	L	Model	Order No.	UP
16			300		01.240.550.9	1 set



ELM00049

## Cable band clip

- For organized cable management.
- For securing harnesses and cables with large cross sections.
- Quick and easy mounting.
- Clips into T-slots in any position.
- Includes releasable clip.



ELM00050

■ **Material**  
- PA 6.6, black, UL 94-V0.

■ **Standard inclusion**  
- 20 units.

■ **Delivery**  
- In sets.

W	H	D	U	d	L	Model	Order No.	UP
							01.240.548.9	20 units

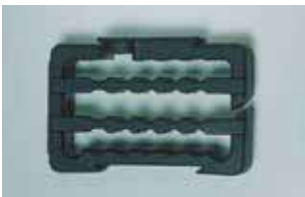

MEC20048

## Cable clamping frame

- For organized cable management.
- Open version, no threading.
- Cross-section for cable routing, variable with removable routing ribs.
- Can be expanded by adding on further cable clamping frames.
- Mounting options: lengthwise or across the width.

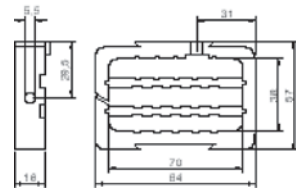

MEC20147

■ **Material**  
- Polypropylene, black.

■ **Standard inclusion**  
- 1 x cable clamping frame.  
- 1 x Mounting kit.

■ **Delivery**  
- In sets.

W	H	D	U	d	L	Model	Order No.	UP
							01.113.153.9	1 unit



MEC20154

## Cable cantilever

- Easy mounting in rack /on the shelf; easy connection/disconnection from shelf or rack with a spring clip.
- Guarantees defined and kink-free cable management.
- Minimum space requirement at the back of shelves: 40 mm.

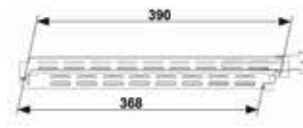

MEC88005

■ **Material / Finish**  
- Sheet steel, 1.5 mm, zinc passivated.

■ **Standard inclusion**  
- 1 x cable cantilever.  
- 1 x Mounting kit.

■ **Delivery**  
- In sets.

W	H	D	U	d	W x L	Type	Order No.	UP
						2-piece	05.040.096.0	1 unit



TEL00034

## Cable support bar

- For 19" racks and enclosures.
- Reduces the cable load on slot-in.
- Orders cabling.
- Prevents cable-slack.

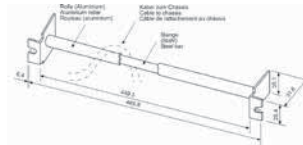

TEL00051

■ **Material**  
- Sheet steel, 1.5 mm.

■ **Standard inclusion**  
- 1 x cable support bar.

W	H	D	U	d	L	Model	Order No.	UP
							05.043.327.9	1 unit

# Knürr System Accessories

### Features

#### BLANKING PANELS

- Design identical to racks
- Tool-less, threaded version available.
- Varying sizes for quick mounting and efficient cooling.

#### CHASSIS RAILS

- Various designs catering to different requirements.
- Height positioning for different corpus heights of the subracks possible (not defined according to 19" standard).

#### DRAWERS AND SHELVES

- Various designs catering to different loads.
- Shelves with tool-less mounting available.

**Mechanical accessories are fundamental to effective and economical use of server- and network racks.**

Blanking panels are an essential feature in operating an energy-efficient data center, as they ensure that cold and warm air in the rack are separated.

When there are no mounting adapters for IT components, chassis rails and shelves are required.

Drawers are used to store manuals, spare parts and tools needed on site.







MEC20179

## QuickFix 19" blanking panel Tool-less assembly

- For covering free 19" spaces (cold-hot separation).
- Quick and easy tool-less assembly (one click) and disassembly (quarter turn).
- Suitable for 9.5 x 9.5 square holes.



MEC20180

- **Material**
  - Sheet steel, 1.0 mm.
- **Finish**
  - Final digit of order number .1: powder-coated texture, RAL 7035, light-grey.
  - Final digit of order number .8: powder-coated texture, RAL 7021 dark-grey.



MEC20178

- **Standard inclusion**
  - X (see Order Number for quantity) QuickFix 19" blanking panel.
  - Mounting kit.
- **Delivery**
  - In sets (see Order Number for quantity); fixing clips pre-assembled.

W	H	D	U	d	L	For rack type	Order No.	UP
482.6	43.6	1					01.103.301.X	6 units
482.6	88.1	2					01.103.302.X	3 units
482.6	132.5	3					01.103.303.X	2 units
482.6	265.9	6					01.103.306.X	1 unit
482.6	399.2	9					01.103.309.X	2 units
482.6	932.6	21					01.103.321.X	1 unit



CUD00021

## 19" blanking panel, cable port, threaded connection

- For organized cable management inside the rack.
- With edge protector.

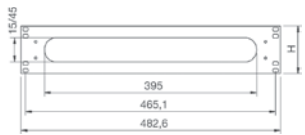

CUD00023

- **Material**
  - Sheet steel, 1.0 mm.
- **Finish**
  - Final digit of order number .1: powder-coated texture, RAL 7035, light grey.
  - Final digit of order number .8: powder-coated texture, RAL 7021 dark-grey.



CUD00022

- **Standard inclusion**
  - 6 x QuickFix 19" blanking panel cable ports.
- **Delivery**
  - In sets.
- **Note**
  - Please also order mounting kit for front panel.

W	H	D	U	For rack type	Order No.	UP
483	44	1			01.103.231.X	6 units
483	88	2			01.103.232.X	3 units



MEC20181

## 19" QuickFix blanking panel, tool-less assembly

- For orderly cable management inside the rack.
- Quick and easy tool-less assembly (one click) and disassembly (quarter turn).
- Suitable for 9.5 x 9.5 square holes.



MEC20178

- **Material**
  - Sheet steel, 1.0 mm.
- **Finish**
  - Final digit of order number .1: powder-coated texture, RAL 7035, light-grey.
  - Final digit of order number .8: powder-coated texture, RAL 7021 dark-grey.



MEC20229

- **Standard inclusion**
  - 6 x QuickFix 19" blanking panel cable ports.
  - 1 x Mounting kit.
- **Delivery**
  - In sets (clips pre-assembled).

W	H	D	U	d	L	For rack type	Order No.	UP
482.6	43.6	1					01.103.331.X	6 units

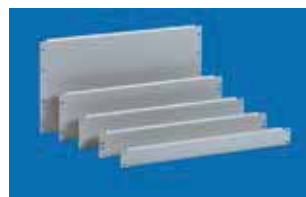

CUD00005

## 19" blanking plate Screw-on

- For covering free 19" spaces (cold-hot separation).



CUD00004

- **Material**
  - Sheet steel, 1.0 mm.
- **Finish**
  - Final digit of order number .1: powder-coated texture, RAL 7035, light-grey.
  - Final digit of order number .8: powder-coated texture, RAL 7021 dark-grey.

- **Standard inclusion**
  - X (see Order Number for quantity) QuickFix 19" blanking panel.

- **Delivery**
  - In sets (see ON for quantity).

- **Note**
  - Please also order front panel mounting material.

W	H	D	U	d	L	For rack type	Order No.	UP
482.6	43.6	1					01.103.201.X	6 units
482.6	88.1	2					01.103.202.X	3 units
482.6	132.5	3					01.103.203.X	2 units
482.6	265.9	6					01.103.206.X	1 unit
482.6	399.2	9					01.103.209.X	2 units

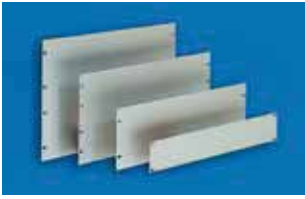

FR000005

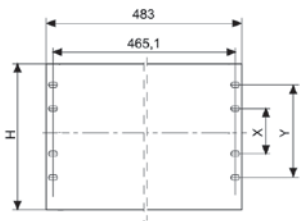
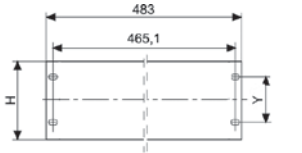

MEC20109

## 19" front plate Aluminum 3 mm

- **Material / Finish**
  - Final digit of order number .0:  
AlMg3 - F23 polished with lamination sheet.
  - Final digit of order number .1:  
AlMg3 - F23, powder-coated, RAL 7035, light-grey.
  - Final digit of order number .6:  
AlMg3 - F23 EB (anodize-enabled), anodized E6/EV1.
  - Final digit of order number .8:  
AlMg3 - F23, powder-coated, RAL 7021, dark-grey.
- **Standard inclusion**
  - 1 x 19" front plate.
- **Delivery**
  - Single items.
- **Note**
  - Please also order the appropriate mounting kit for the front plates.

H	X	Y	U	Model	Order No.	UP
43.6		31.7	1	Polished	<b>02.008.021.0</b>	1 unit
88.1		76.2	2	Polished	<b>02.008.022.0</b>	1 unit
132.5		57.1	3	Polished	<b>02.008.023.0</b>	1 unit
177.0		101.6	4	Polished	<b>02.008.024.0</b>	1 unit
221.4		146.0	5	Polished	<b>02.008.025.0</b>	1 unit
265.9	76.2	190.4	6	Polished	<b>02.008.026.0</b>	1 unit
43.6		31.7	1	Powder-coated, RAL 7035	<b>02.008.021.1</b>	1 unit
88.1		76.2	2	Powder-coated, RAL 7035	<b>02.008.022.1</b>	1 unit
132.5		57.1	3	Powder-coated, RAL 7035	<b>02.008.023.1</b>	1 unit
177.0		101.6	4	Powder-coated, RAL 7035	<b>02.008.024.1</b>	1 unit
221.4		146.0	5	Powder-coated, RAL 7035	<b>02.008.025.1</b>	1 unit
265.9	76.2	190.4	6	Powder-coated, RAL 7035	<b>02.008.026.1</b>	1 unit
43.6		31.7	1	Powder-coated, RAL 7021	<b>02.008.021.8</b>	1 unit
88.1		76.2	2	Powder-coated, RAL 7021	<b>02.008.022.8</b>	1 unit
132.5		57.1	3	Powder-coated, RAL 7021	<b>02.008.023.8</b>	1 unit
43.6		31.7	1	Anodized	<b>02.008.071.6</b>	1 unit
88.1		76.2	2	Anodized	<b>02.008.072.6</b>	1 unit
132.5		57.1	3	Anodized	<b>02.008.073.6</b>	1 unit
177.0		101.6	4	Anodized	<b>02.008.074.6</b>	1 unit
221.4		146.0	5	Anodized	<b>02.008.075.6</b>	1 unit
265.9	76.2	190.4	6	Anodized	<b>02.008.076.6</b>	1 unit



LUF88006

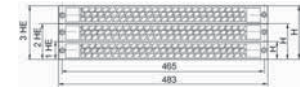

LUF00093

## 19" vented front cover plate

- Provides additional ventilation for 19" racks and 19" plinths compliant with IEC 297.
- **Material / Color**
  - Final digit of order number .1:  
ABS (UL 94 V0), light-grey RAL 7035.
  - Final digit of order number .9:  
ABS (UL 94 V0), black RAL 9011.
- **Standard inclusion**
  - 1 x vented front cover plate.
  - 2 x connectors.
- **Delivery**
  - In sets.
- **Note**
  - Please also order the appropriate mounting kit for the front plates.

W	H	D	U	Model	Order No.	UP
483	43.6		1		<b>02.008.111.1</b>	1 unit
483	43.6		1		<b>02.008.111.9</b>	1 unit



MEC20144



MEC20149

## Cover-plate filter for 19" vented front cover plate

- Used with 19" vented front cover plate.
- **Material / Color**
  - Non-woven and screen cloth.
- **Standard inclusion**
  - 1 x cover-plate filter.
  - 1 x Mounting kit.
- **Delivery**
  - In sets.

W	H	D	U	Model	Order No.	UP
			1		<b>02.008.131.9</b>	1 unit

Dimensions in mm:				Conversion:	
W = Width	h = Installation height	U = Standard rack unit	kg = Weight	1 mm = 0.03937 inch	
H = Height	d = Insert depth	(1 U = 44.45 mm)		1 kg = 2.2046 pounds	
D = Depth	L = Length	UP = Packaging unit			



LUF00217

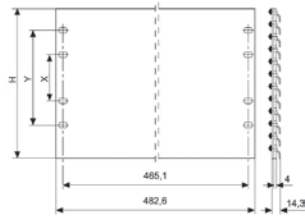

MEC20110

## 19" ventilation front panel

- Provides additional ventilation for 19" racks and 19" plinths compliant with IEC 297.

■ **Material**  
- Aluminum.

■ **Finish**  
- Final digit of order number .1: powder-coated, RAL 7035 light-grey.  
- Final digit of order number .6: colorless anodized E 6 / EV 1.

■ **Standard inclusion**  
- 1 x ventilation front plate.

■ **Delivery**  
- Single items.

■ **Note**  
Please also order the appropriate mounting kit for the front plates.

H	X	Y	U	Model	Order No.	UP
43.6		31.7	1	Powder-coated, RAL 7035	<b>02.008.101.1</b>	1 unit
43.6		31.7	1	Anodized	<b>02.008.101.6</b>	1 unit
132.5		57.1	3	Powder-coated, RAL 7035	<b>02.008.103.1</b>	1 unit
132.5		57.1	3	Anodized	<b>02.008.103.6</b>	1 unit



FRO00007

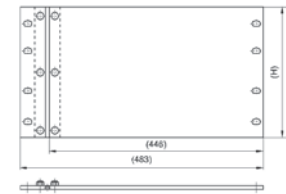

FRO00006

## 19" front plate hinged

- With 19" adapter and hinge.

■ **Material**  
- Aluminum, 3 mm.

■ **Finish**  
- Anodized.

■ **Standard inclusion**  
- 1 x front plate, hinged.  
- 1 x 19" adapter.  
- 1 x hinge.

■ **Delivery**  
- In sets.

■ **Note**  
Please also order the appropriate mounting kit for the front plates.

W	H	D	U	Model	Order No.	UP
			3	Anodized	<b>01.110.780.6</b>	1 unit
			6	Anodized	<b>01.110.781.6</b>	1 unit

**Dimensions in mm:**

W = Width    h = Installation height    U = Standard rack unit    kg = Weight  
H = Height    d = Insertion depth    (1 U = 44.45 mm)

D = Depth    L = Length    UP = Packaging unit

**Conversion:**

1 mm = 0.03937 inch  
1 kg = 2.2046 pounds



MEC20162



MEC20167



MEC20167

## Chassis runner

Can be hooked on and screwed on

- For installation in 19" rack and 19" enclosure.
- Can be hooked on for quick and easy mounting.
- Can also be attached with screws to accommodate heavier loads.
- Can be screwed from inside (used in rack suites).
- Adjustable height to suit various main-section heights.

■ **Material / Finish**  
- Sheet steel, 2.0 mm.  
- Zinc-passivated, blue chrome-plated.

■ **Load rating**  
- 1000 N max. with even load distribution.

■ **Standard inclusion**  
- 2 x chassis runners.  
- 1 x Mounting kit.

■ **Delivery**  
- In pairs.

■ **Note**  
When selecting the chassis runner, please take into account the depth "d" of the rack or enclosure. Four 19" extrusions are required for mounting.

W	H	D <sub>Rack</sub>	U	d	L	For rack type	Order No.	UP
	600		365	336		Miracel/Smaract	<b>01.103.051.0</b>	1 pair
	600		440	411		Miracel/Smaract	<b>01.103.052.0</b>	1 pair
	800		565	536		Miracel/Smaract	<b>01.103.053.0</b>	1 pair
	800		640	611		Miracel/Smaract	<b>01.103.054.0</b>	1 pair
	900		665	636		Miracel/Smaract	<b>01.103.055.0</b>	1 pair
	from 900		740	711		Miracel/Smaract/CoolTherm	<b>01.103.056.0</b>	1 pair





MEC20189

## Aluminum chassis runner

- Can be screwed on.
- For installation in 19" rack and 19" enclosure.
- Can be screwed from inside (used in rack suites).
- Height can be adjusted to suit various main-section heights.

- **Material / Finish**
  - Extruded aluminum, polished.
- **Load rating**
  - 700 N max. with even load distribution.
- **Standard inclusion**
  - 2 x chassis runners.
  - 1 x Mounting kit.
- **Delivery**
  - In pairs.
- **Note**

When selecting the chassis runner, please take into account the depth "d" of the rack or enclosure. Four 19" extrusions are required for mounting.

W <sub>Rack</sub>	H <sub>Rack</sub>	D <sub>Rack</sub>	U	d	L	For rack type	Order No.	UP
		600	365	336		Miracel/Smaract	<b>01.103.101.0</b>	1 pair
		600	440	411		Miracel/Smaract	<b>01.103.102.0</b>	1 pair
		800	565	536		Miracel/Smaract	<b>01.103.103.0</b>	1 pair
		800	640	611		Miracel/Smaract	<b>01.103.104.0</b>	1 pair
		800	665	636		Miracel/Smaract	<b>01.103.105.0</b>	1 pair
		from 900	740	711		Miracel/Smaract/ CoolTherm	<b>01.103.106.0</b>	1 pair
		500	285	254		ConAct	<b>01.103.111.0</b>	1 pair
		600	385	354		ConAct	<b>01.103.112.0</b>	1 pair
		600	435	403		DoubleProRack with door	<b>01.103.118.0</b>	1 pair
		800	635	603		DoubleProRack with door	<b>01.103.119.0</b>	1 pair
		500	460	428		DoubleProRack, no door	<b>01.103.122.0</b>	1 pair
		600	560	528		DoubleProRack, no door	<b>01.103.123.0</b>	1 pair
		700	660	628		DoubleProRack, no door	<b>01.103.124.0</b>	1 pair

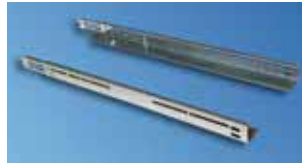

MEC20163



MEC20166

## Chassis runner, adjustable depth

- For installation in 19" rack and 19" enclosure.
- Adjustable depth.
- Can be screwed from inside (used in rack suites).
- Height can be adjusted to suit various main-section heights.

- **Material / Finish**
  - Sheet steel, 1.25 mm.
  - Zinc-passivated, blue chrome-plated.
- **Load rating**
  - 200 N max. with even load distribution.
- **Standard inclusion**
  - 2 x basic rails.
  - 2 x extension rails.
  - 1 x Mounting kit.
- **Delivery**
  - In pairs.
- **Note**

When selecting the chassis runner, please take into account the depth "d" of the rack or enclosure. Four 19" extrusions are required for mounting.

W	H	D	U	d	For rack type	Order No.	UP
		600		365-440	Miracel/Smaract	<b>01.103.091.0</b>	1 pair
		800-1200		565-740	Miracel/Smaract	<b>01.103.092.0</b>	1 pair
		900-1200		740	CoolTherm	<b>01.103.092.0</b>	1 pair
		600		385	ConAct	<b>01.103.091.0</b>	1 pair
		500-600		435-460	DoubleProRack	<b>01.103.091.0</b>	1 pair
		600-800		560-660	DoubleProRack	<b>01.103.092.0</b>	1 pair

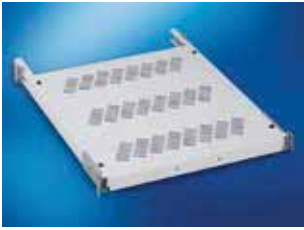

MEC00451

## 19" shelf Fixed

- Integrated mounting holes; front and rear for handle or hinged cable routing.
- Perforated to optimize air supply.

### Material / Finish

- Sheet steel 1.0 mm, electroplated zinc, powder-coated texture.

### Color

- Final digit of order number .1: RAL 7035, light grey.
- Final digit of order number .8: RAL 7021 dark-grey.

### Load rating

- 500 N static per item.

### Standard inclusion

- 2 x mounting rails, incl. mounting bracket.
- 1 x shelf board.
- 1 x extension board (from L = 600).
- 1 x Mounting kit.

### Delivery

- In sets.

### Note

Please order requisite mounting adapter when used for DCM or Miracel/Smaract server extrusion.

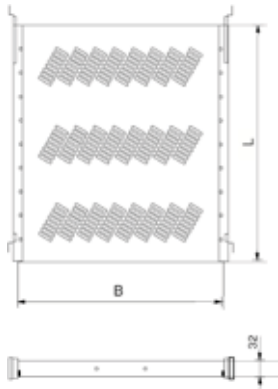

MEC20018

W	H	D	d	WxL	For rack type	Order No.	UP
	365			430 x 300	DCM / Miracel /Smaract	<b>01.102.001.1</b>	1 unit
	440			430 x 300	DCM / Miracel /Smaract	<b>01.102.002.1</b>	1 unit
	565			430 x 500	DCM / Miracel /Smaract	<b>01.102.003.X</b>	1 unit
	640			430 x 600	DCM / Miracel /Smaract	<b>01.102.004.X</b>	1 unit
	740			430 x 600	DCM / Miracel /Smaract	<b>01.102.005.X</b>	1 unit
	435, 460			430 x 300	DoubleProRack	<b>01.102.002.1</b>	1 unit
	560			430 x 500	DoubleProRack	<b>01.102.003.1</b>	1 unit
	635, 660			430 x 600	DoubleProRack	<b>01.102.004.1</b>	1 unit
	285			430 x 200	ConAct	<b>01.102.000.1</b>	1 unit
	385			430 x 300	ConAct	<b>01.102.001.1</b>	1 unit

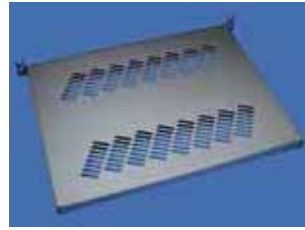

MEC20221

## 19" QuickFix shelf tool-less assembly

- Quick and easy tool-less mounting. Mounted on 19" cutouts.
- Quick and easy tool-less fitting (one click and removal (quarter turn).
- Suitable for all racks and enclosures with 19" mounting hole extrusions (9.0 x 9.0 square holes).
- Adjustable depth to accommodate variable recess depths and special dimensions.
- Perforated to optimize air supply.

### Material

- Sheet steel, 1.0 mm.

### Finish

- Final digit of order number .1: powder-coated texture, RAL 7035, light-grey.
- Final digit of order number .8: powder-coated texture, RAL 7021 dark-grey.

### Load rating

- 700 N static with even load distribution.

### Standard inclusion

- 1 x 19" QuickFix shelf.
- 1 x Mounting kit.

### Delivery

- In sets.

### Note

Cannot be used for 19" t-slot extrusions.

W	H	D	U	d	w x l	Order No.	UP
				365-500	430 x 300	<b>01.102.071.X</b>	1 unit
				565-740	430 x 500	<b>01.102.072.X</b>	1 unit

#### Dimensions in mm:

W = Width h = Installation height U = Standard rack unit  
 H = Height d = Insertion depth (1 U = 44.45 mm)  
 D = Depth L = Length UP = Packaging unit

#### Conversion:

1 mm = 0.03937 inch  
 1 kg = 2.2046 pounds

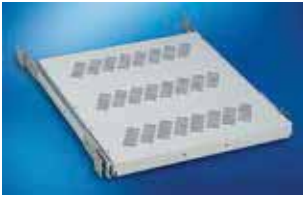

MEC00452

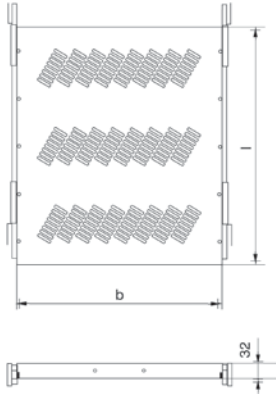

MEC20019

## 19" shelf partially retractable

- Integrated mounting holes, front and rear for handle or hinged cable routing.
- Perforated to optimize air supply.
- Locks in retracted position (friction lock); easy conversion to form lock with stop spring.
- Quick separator for tool-less removal and decoupling of shelf board.

### Material / Finish

- Sheet steel 1.0 mm, electroplated zinc, powder-coated texture.

### Color

- Final digit of order number .1: RAL 7035, light grey.
- Final digit of order number .8: RAL 7021 dark-grey.

### Load rating

- 500 N static per item.

### Standard inclusion

- 1 x pair of telescopic slides.
- 1 x shelf board.
- 1 x extension board (from L = 600).
- 1 x Mounting kit.

### Delivery

- In sets.

### Note

Order requisite mounting adapter when used for DCM or Miracel/Smaract server extrusion.

d	WxL	For rack type	Order No.	UP
365-560	430 x 360		<b>01.102.042.X-001</b>	1 unit
565-750	430 x 560		<b>01.102.043.X-001</b>	1 unit

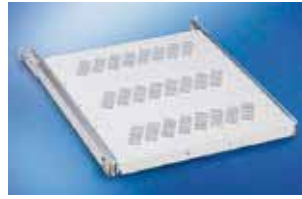

MEC00462

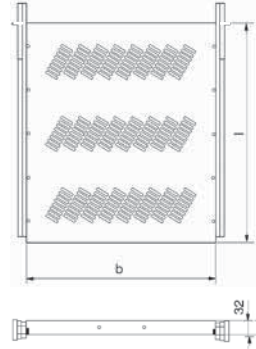

MEC20020

## 19" shelf fully retractable

- Integrated mounting holes, front and rear for handle or hinged cable routing.
- Perforated to optimize air supply.
- Locks in retracted position (friction lock); easy conversion with stop spring.
- Quick separator for tool-less removal and decoupling of shelf.

### Material / Finish

- Sheet steel 1.0 mm, electroplated zinc, powder-coated texture.

### Color

- RAL 7035 light-grey.

### Load rating

- 500 N static per item.

### Standard inclusion

- 1 x pair of telescopic slides.
- 1 x shelf board.
- 1 x extension board (from L = 600).
- 1 x Mounting kit.

### Delivery

- In sets.

### Note

Please order requisite mounting adapter when used for DCM or Miracel/Smaract server extrusion.

d	WxL	For rack type	Order No.	UP
365-560	430 x 360		<b>01.102.040.X-001</b>	1 unit
565-750	430 x 560		<b>01.102.041.X-001</b>	1 unit

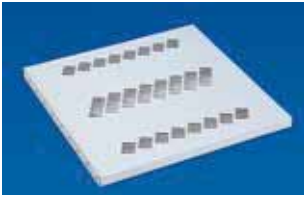

MEC00120

## 19" heavy-duty shelf fixed

- Perforated utility space.
- Installed as base plate for server or battery.

- **Material / Finish**
  - Sheet steel 1.5 mm, electroplated zinc, powder-coated texture.

- **Color**
  - Final digit of order number .1: RAL 7035, light grey.
  - Final digit of order number .8: RAL 7021 dark-grey.

- **Load rating**
  - 1000 N static for CW installation.
  - 1500 N static for 19" installation.

- **Standard inclusion**
  - 1 x shelf, fixed, threaded connection.
  - 2 x mounting braces.
  - 1 x Mounting kit.

- **Delivery**
  - In sets.

- **Note**
  - Please order requisite mounting adapter when used for DCM or Miracel/Smaract server extrusion.

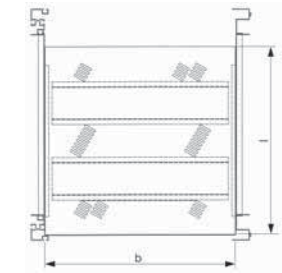

MEC20117

W	H	D	d	WxL	For rack type	Order No.	UP
			565	467 x 460	DCM / Miracel / Smaract	<b>01.131.473.X</b>	1 unit
			640	467 x 460	DCM / Miracel / Smaract	<b>01.131.475.X</b>	1 unit
			665	467 x 460	DCM / Miracel / Smaract	<b>01.131.476.X</b>	1 unit
			740	467 x 560	DCM / Miracel / Smaract	<b>01.131.474.X</b>	1 unit

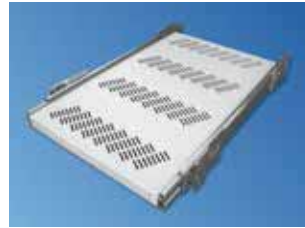

MEC20022

## 19" heavy-duty shelf fully retractable

- Perforated to optimize air supply.
- Locks in pushed-in and fully retracted position.
- Easy mounting with patented quick-mounting system.
- Installed as base plate for server or battery.

- **Material / Finish**
  - Sheet steel, 1.5 mm, powder-coated texture.

- **Color**
  - Final digit of order number .1: RAL 7035, light grey.
  - Final digit of order number .8: RAL 7021 dark-grey.

- **Load rating**
  - 1200 N static.

- **Standard inclusion**
  - 1 x pair of telescopic slides.
  - 1 x shelf board.
  - 1 x Mounting kit.

- **Delivery**
  - In sets.

- **Note**
  - Please order requisite mounting adapter when used for DCM or Miracel/Smaract server extrusion.

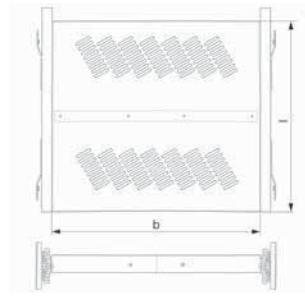

MEC20113

W	H	D	d	WxL	For rack type	Order No.	UP
			565, 640	412 x 460	DCM / Miracel / Smaract	<b>01.102.031.X</b>	1 unit
			665, 740	412 x 660	DCM / Miracel / Smaract	<b>01.102.032.X</b>	1 unit



MEC20154

## Cable cantilever

- Can be tilted outward from the rear, facilitating easy access to the rear (only 3 piece).
- For easy mounting in side the rack/on the shelf; shelf or rack easily attached or decoupled with spring clip.
- Guarantees defined and kink-free cable management.
- Minimum space requirement at the back of shelves: 40 mm.

- **Material / Finish**
  - Sheet steel, 1.5 mm, zinc passivated.

- **Standard inclusion**
  - 1 x cable cantilever.
  - 1 x Mounting kit.

- **Delivery**
  - In sets.

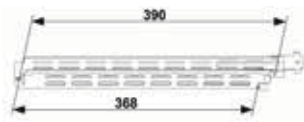

MEC88005

W	H	D	U	d	w x l	Type	Order No.	UP
						2-piece	<b>05.040.096.0</b>	1 unit



MEC20138

## Handle

- Suitable for traditional and heavy-duty shelves.
- With M5 internal thread.

- **Material**
  - Die-cast aluminum consoles.
  - Extruded aluminum handles.
  - Cap made of ABS UL 94 HB.

- **Finish**
  - Handle, powder-coated, grey-blue, RAL 5008/ Cap, light-grey, RAL 7035.

- **Standard inclusion**
  - 2 x handles.

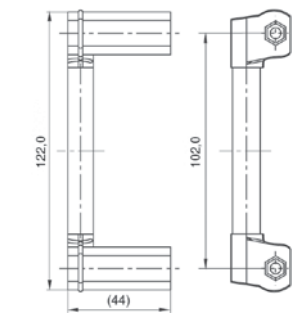

MEC20111

W	H	D	U	d	w x l	For rack type	Order No.	UP
							<b>00.050.503.1</b>	1 set



MIR00373

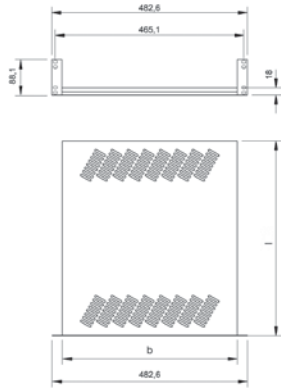

MIR00375

W	H	D	w x l	For rack type	Order No.	UP
482.6	88.1		442 x 280		01.113.736.1	1 unit
482.6	88.1		442 x 380		01.113.737.1	1 unit

## 19" shelf, 2 U Fixed

- Installed in racks with fixed 19" components, front.
- Quick and easy mounting on 19" extrusions.
- Also for swing frame in the 19" rack and 19" enclosure.

- **Finish / Color**
  - Powder-coated texture, RAL 7035.
  - Light-grey.
- **Material**
  - Sheet steel, 1.5 mm.
- **Load rating**
  - 200 N static.
- **Standard inclusion**
  - 1 x shelf, fixed.
  - 1 x Mounting kit.
- **Delivery**
  - In sets.



SCH00058

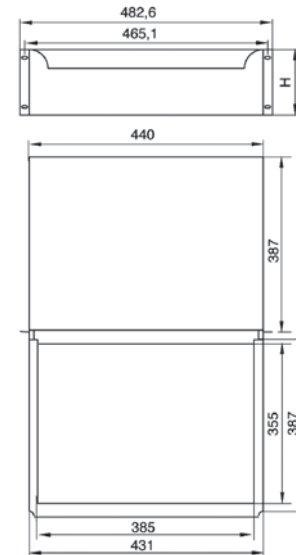

SCH00054

W	H	D	U	For rack type	Order No.	UP
482.6	43.6	600-1000	1	Miracel/Smaract/ DoubleProRack/ConAct	01.113.926.1	1 unit
482.6	88.1	600-1000	2	Miracel/Smaract/ DoubleProRack/ConAct	01.113.927.1	1 unit
482.6	132.5	600-1000	3	Miracel/Smaract/ DoubleProRack/ConAct	01.113.928.1	1 unit

## 19" drawer Installed on the front

- Installed on front 19" extrusions.
- For storing service documents.
- Quick and easy mounting.

- **Material / Finish**
  - Drawer, sheet steel 1.0 mm, powder-coated texture; telescopic slides, Sendzimir zinc-coated.
- **Color**
  - Final digit of order number .1: RAL 7035, light grey.
  - Final digit of order number .8: RAL 7021 dark-grey.
- **Load rating**
  - 150 N static.
- **Standard inclusion**
  - 1 x 19" drawer with lock, including key.
  - 1 x pair of telescopic slides.
  - 1 x Mounting kit.
- **Delivery**
  - Pre-assembled.



MIR00102

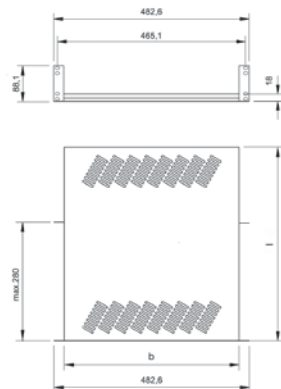

MIR00103

W	H	D	w x l	For rack type	Order No.	UP
482.6	88.1		442 x 280		01.113.409.1	1 unit
482.6	88.1		442 x 380		01.113.410.1	1 unit
482.6	88.1		442 x 480		01.113.411.1	1 unit

## 19" shelf, 2 U Adjustable

- Installed in racks with adjustable 19" components, front.
- Quick and easy mounting on 19" extrusions.
- Also for swing frame in the 19" rack and 19" enclosure.
- Depth can be adjusted in increments of 25 mm.

- **Material / Finish**
  - Sheet steel, 1.5 mm, powder-coated texture.
- **Color**
  - RAL 7035, light-grey.
- **Load rating**
  - 200 N static.
- **Delivery**
  - In sets.

Dimensions in mm:				Conversion:	
W = Width	h = Installation height	U = Standard rack unit	kg = Weight	1 mm = 0.03937 inch	
H = Height	d = Insertion depth	(1 U = 44.45 mm)		1 kg = 2.2046 pounds	
D = Depth	L = Length	UP = Packaging unit			



SCH00057

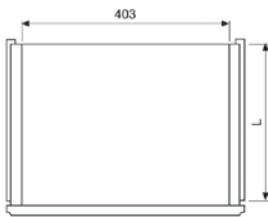
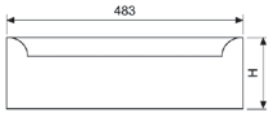

SCH00053

## 19" drawer with lock Mounted on 19" components front and rear

- Installed in racks with fixed 19" components on the front and rear.
- Fully retractable.
- With lock.

### Material / Finish

- Drawer, sheet steel 1.0 mm, powder-coated texture; telescopic slides, cold rolled steel, Sendzimir zinc-coated.

### Color

- Drawer RAL 7035 light-grey.

### Load rating

- 1 U - 200 N static.
- 2 U - 400 N static.
- 3 U - 400 N static.
- 4 U - 400 N static.

### Standard inclusion

- 1 x 19" drawer with lock, including key.
- 1 x pair of telescopic slides.
- 1 x Mounting kit.

### Delivery

- Pre-assembled.

W	H	U	d	WxL	For rack type	Order No.	UP
1	365, 440, 565	412 x 460	DCM / Miracel / Smaract	<b>02.045.151.1</b>	1 unit		
2	440, 565	412 x 660	DCM / Miracel / Smaract	<b>02.045.152.1</b>	1 unit		
3	440, 565	412 x 460	DCM / Miracel / Smaract	<b>02.045.153.1</b>	1 unit		
4	440, 565	412 x 660	DCM / Miracel / Smaract	<b>02.045.154.1</b>	1 unit		
1	640, 665, 740	412 x 460	DCM / Miracel / Smaract	<b>02.045.161.1</b>	1 unit		
2	665, 740	412 x 660	DCM / Miracel / Smaract	<b>02.045.162.1</b>	1 unit		
3	665, 740	412 x 460	DCM / Miracel / Smaract	<b>02.045.163.1</b>	1 unit		
4	665, 740	412 x 660	DCM / Miracel / Smaract	<b>02.045.164.1</b>	1 unit		
1	435, 460, 560	412 x 460	DoubleProRack	<b>02.045.151.1</b>	1 unit		
2	435, 460, 560	412 x 660	DoubleProRack	<b>02.045.152.1</b>	1 unit		
3	435, 460, 560	412 x 460	DoubleProRack	<b>02.045.153.1</b>	1 unit		
4	435, 460, 560	412 x 660	DoubleProRack	<b>02.045.154.1</b>	1 unit		
1	635, 660	412 x 460	DoubleProRack	<b>02.045.161.1</b>	1 unit		
2	635, 660	412 x 660	DoubleProRack	<b>02.045.162.1</b>	1 unit		
3	635, 660	412 x 460	DoubleProRack	<b>02.045.163.1</b>	1 unit		
4	635, 660	412 x 660	DoubleProRack	<b>02.045.164.1</b>	1 unit		



SCH00062

## Writing board for 19" drawer with lock

- For drawer depth 400 mm and 600 mm.

### Material / Finish

- Sheet steel, 1.0 mm, powder-coated texture.

### Color

- RAL 7035, light-grey.

### Standard inclusion

- 1 x writing board.
- 1 x Mounting kit.

### Delivery

- In sets.

W	H	D	U	d	L	For rack type	Order No.	UP
					400		<b>02.045.202.9</b>	1 unit
					600		<b>02.045.203.9</b>	1 unit

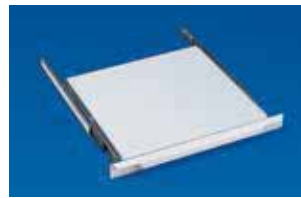

MEC00118

## 19" shelf, 1 U Pull-out

- With handle.
- Can also be used as writing board.

### Material / Finish

- Shelf, sheet steel, 1.0 mm.
- Telescopic slide, cold-rolled steel.

### Finish / Color

- Powder-coated texture.
- RAL 7035, light-grey.

### Load rating

- 200 N static.

### Standard inclusion

- 1 x shelf.
- 1 x pair of telescopic slides.
- 1 x Mounting kit.

### Delivery

- Pre-assembled.

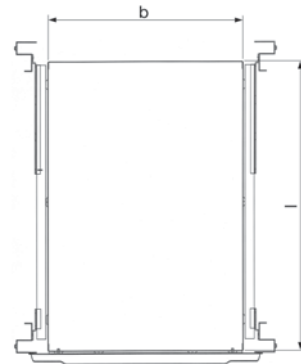

MEC20118

d	WxL	For rack type	Order No.	UP
365-560	430 x 360		<b>01.102.045.X-001</b>	1 unit
565-750	430 x 560		<b>01.102.046.X-001</b>	1 unit

### Dimensions in mm:

W = Width h = Installation height U = Standard rack unit  
 H = Height d = Insertion depth (1 U = 44.45 mm)  
 D = Depth L = Length UP = Packaging unit

### Conversion:

1 mm = 0.03937 inch  
 1 kg = 2.2046 pounds

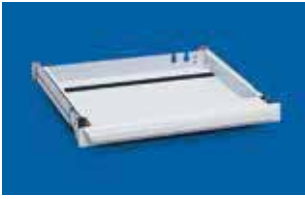

SCH00059

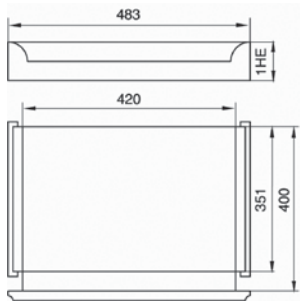

SCH00055

## 19" keyboard drawer, 1 U for 19" keyboard

- With hand support.
- With cable strain relief.
- No telescopic slides locks.

### Material

- Main unit, sheet steel, 1.0 mm.
- Front panel, sheet steel, 1.0 mm.

### Finish / Color

- Powder-coated texture, RAL 7035 light-grey.

### Standard inclusion

- 1 x 19" keyboard drawer, 1 U.
- 1 x pair of telescopic slides.
- 1 x Velcro for securing the keyboard.
- 1 x Mounting kit.

### Delivery

- Pre-assembled.

W	H	D	U	d	For rack type	Order No.	UP
1	440, 565, 640, 665, 740				DCM / Miracel / Smaract	<b>02.011.101.1</b>	1 unit
1	435, 635				DoubleProRack	<b>02.011.101.1</b>	1 unit



VHP00155

## 19" compact keyboard

IBM-compatible keyboard with trackball

- Suitable for keyboard drawer 01.136.378.1.
- Flat keyboard with 84 keys and integrated trackball.

### Electrical data

- Power supply +5 V/DCmax. 18 mA.
- Mains cable (1.6 m) with taps for two 6-pin mini DIN plugs (PS/2).
- For Windows 98/ME/NT/2000/XP.

### Dimensions

- Length x width x height: 370 x 138.5 x 20 mm.

W	H	S	U	A1	A2	P <sub>max</sub>	Model	Order No.	UP
							German	<b>06.002.048.3</b>	1 unit



MEC20027

## Document holder

- Self-adhesive; for higher loads use 6 mm holes.
- For DIN A4 documents.

### Material

- High-impact PS.

### Color

- Grey.

### Standard inclusion

- 1 x document holder.

W	L	D	Order No.	UP
264	236	30	<b>05.016.045.0</b>	1 unit

## The right mounting set for every rack type

DCM	Miracel T-slot	Miracel Mount. holes	Miracel Server	Miracel Swing frame	Smaract T-slot	Smaract Mount. holes	Smaract Server	Double ProRack T-slot	Double ProRack Mount. holes	ConAct	Name	Order No.	UP
	●				●						T-Slot mounting set, M5, wide	05.041.320.9	1 set
		●				●					Mounting set Mount. holes M5/BI 1.5	05.041.321.9	1 set
●			●	●			●				Mounting set Mount. holes M5/BI 2.5	05.041.325.9	1 set
								●			Mounting set dpr T-slot, M5 narrow	05.041.323.9	1 set
									●		Mounting set dpr mount. holes M5	05.041.322.9	1 set
										●	Mounting Set, ConAct M5	05.041.324.9	1 set

## The right mounting set for front panel mounting Model: Z-form screw

DCM	Miracel T-slot	Miracel Mount. holes	Miracel Server	Miracel Swing frame	Smaract T-slot	Smaract Mount. holes	Smaract Server	Double ProRack T-slot	Double ProRack Mount. holes	ConAct	Name	Order No.	UP
	●				●						FP mounting set, T-slot M5, wide	05.041.335.9	1 set
		●				●				●	FP mounting set Mount. holes M5/BI 1.5	05.041.336.9	1 set
●			●	●			●			●	FP mounting set Mount. holes M5/BI 2.5	05.041.337.9	1 set
								●			FP mounting set, T-slot M5, narrow	05.041.338.9	1 set

## The right mounting set for front panel mounting Model: countersunk screw + rosette

DCM	Miracel T-slot	Miracel Mount. holes	Miracel Server	Miracel Swing frame	Smaract T-slot	Smaract Mount. holes	Smaract Server	Double ProRack T-slot	Double ProRack Mount. holes	ConAct	Name	Order No.	UP
	●				●						FP mounting set, T-slot M5, wide	05.041.340.9	1 set
		●				●				●	FP mounting set Mount. holes M5/BI 1.5	05.041.341.9	1 set
●			●	●			●			●	FP mounting set Mount. holes M5/BI 2.5	05.041.342.9	1 set
								●			FP mounting set, T-slot M5, narrow	05.041.343.9	1 set



## The right accessories for every rack type

DCM	Miracel T-slot	Miracel Mount. holes	Miracel Server	Miracel Swing frame	Smaract T-slot	Smaract Mount. holes	Smaract Server	Double ProRack T-slot	Double ProRack Mount. holes	ConAct	Name	Order No.	UP
	●				●						Spring nut, M5 wide	01.350.431.9	1 set
								●			Spring nut, M5 narrow	05.041.503.9	1 set
	●				●						Spring nut M6	01.350.405.9	1 set
		●				●				●	Cage nut M5/BI 1.5	05.041.513.7	1 set
●			●	●			●		●		Cage nut M5/BI 2.5	05.041.518.7	1 set
	●				●			●			Oval-head screws, Z-form, M5 x 10	05.041.330.9	1 set
●		●	●	●		●	●		●	●	Oval-head screws, Z-form, M5 x 16	05.041.331.9	1 set
	●				●			●			Countersunk screw M5 x 12 + rosette	05.041.203.9	1 set
●		●	●	●		●	●		●	●	Countersunk screw M5 x 16 + rosette	05.041.290.9	1 set



MIR00114

## Mounting tool for cage nuts

- Allows easy clipping of cage nuts on extrusions.

- **Material**
  - Spring steel.

- **Standard inclusion**
  - 1 x mounting tool.

W	H	D	U	d	L	Model	Order No.	UP
							01.130.985.9	1 unit



MEC20125

## T-Slot mounting set, M5, wide for Miracel® / Smaract®

- For securing 19" front panels and 19" components.

- **Standard inclusion**
  - 100 x spring nuts, M5 wide.
  - 100 x oval-head screws, Z-form, M5 x 10.
  - 20 x cage nuts M5 /plate, 1.5 mm.
  - 20 x cylinder screws, M5 x 8.

- **Delivery**
  - In sets.

W	H	D	U	d	L	Model	Order No.	UP
							05.041.320.9	1 set



MEC20126

## Mounting set, M5 / plate, 1.5 mm for Miracel® / Smaract®

- For securing 19" front panels and 19" components.

- **Standard inclusion**
  - 100 x cage nuts M5 /plate, 1.5 mm.
  - 100 x oval-head screws, Z-form, M5 x 16.
  - 20 x spring nuts, M5 wide.
  - 20 x cylinder screws, M5 x 8.

- **Delivery**
  - In sets.

W	H	D	U	d	L	Model	Order No.	UP
							05.041.321.9	1 set



MEC20126

## Mounting set; mounting holes server extrusion M5 / plate, 2.5 mm for Miracel® /DCM®/Smaract®

- For securing 19" front panels and 19" components.

- **Standard inclusion**
  - 100 x cage nuts M5 /plate, 2.5 mm.
  - 100 x oval-head screws, Z-form, M5 x 16.
  - 20 x spring nuts, M5 wide.
  - 20 x cylinder screws, M5 x 8.

- **Delivery**
  - In sets.

W	H	D	U	d	L	Model	Order No.	UP
							05.041.325.9	1 set



MEC20127

## T-slot mounting set, M5, narrow for DoubleProRack®

- For securing 19" front panels and 19" components.

- **Standard inclusion**
  - 100 x spring nuts, M5 narrow.
  - 20 x oval-head screws, Z-form, M5 x 10.
  - 50 x cylinder screws, M5 x 10.
  - 30 x oval-head screws, Z-form, M5 x 8.

- **Delivery**
  - In sets.

W	H	D	U	d	L	Model	Order No.	UP
							05.041.323.9	1 set



MEC20126

## Mounting set; mounting holes M5 for DoubleProRack®

- For securing 19" front panels and 19" components.

- **Standard inclusion**
  - 100 x cage nuts M5 /plate, 2.5 mm.
  - 50 x oval-head screws, Z-form, M5 x 16.
  - 40 x spring nuts, M5 narrow.
  - 40 x cylinder screws, M5 x 10.

- **Delivery**
  - In sets.

W	H	D	U	d	L	Model	Order No.	UP
							05.041.322.9	1 set

Dimensions in mm:				Conversion:	
W = Width	h = Installation height	U = Standard rack unit	kg = Weight	1 mm = 0.03937 inch	
H = Height	d = Insertion depth	(1 U = 44.45 mm)		1 kg = 2.2046 pounds	
D = Depth	L = Length	UP = Packaging unit			



MEC20096

### Mounting holes, mounting set, M5 for ConAct®

- For securing 19" front panels and 19" components.

#### ■ Standard inclusion

- 50 x cage nuts M5 /plate, 1.5 mm.
- 50 x oval-head screws, Z-form, M5 x 16.
- 50 x cylinder screws, M5 x 8.
- 25 x locking nuts, M5.

#### ■ Delivery

- In sets.

W	H	D	U	d	L	Model	Order No.	UP
							<b>05.041.324.9</b>	1 set



MEC20129

### Front panel mounting set, T-slot, M5 wide for Miracel® / Smaract®

- For securing 19" front panels and 19" components.

#### ■ Standard inclusion

- Type 1:
  - 50 x spring nuts, M5 wide.
  - 50 x oval-head screws, Z-form, M5 x 10.
- Type 2:
  - 50 x spring nuts, M5 wide.
  - 50 x countersunk screws, M5 x 12.
  - 50 x rosettes.

#### ■ Delivery

- In sets.

W	H	D	U	d	L	Model	Order No.	UP
						Type 1: Z-form screw	<b>05.041.335.9</b>	1 set
						Type 2: screw + rosette	<b>05.041.340.9</b>	1 set



MEC20098

### Front panel mounting set for Miracel®/Smaract®/ConAct®

- For securing 19" front panels and 19" components.
- Mounting holes.

#### ■ Standard inclusion

- Type 1:
  - 50 x cage nuts M5 /plate, 1.5 mm.
  - 50 x oval-head screws, Z-form, M5 x 16.
- Type 2:
  - 50 x cage nuts M5 /plate, 1.5 mm.
  - 50 x countersunk screws, M5 x 16.
  - 50 x rosettes.

#### ■ Delivery

- In sets.

W	H	D	U	d	L	Model	Order No.	UP
						Type 1: Z-form screw	<b>05.041.336.9</b>	1 set
						Type 2: screw + rosette	<b>05.041.341.9</b>	1 set



MEC20098

### Front panel mounting set; mounting holes, M5/plate, 2.5 mm for Miracel®/DCM®/Smaract®/DoubleProRack®

- For securing 19" front panels and 19" components.

#### ■ Standard inclusion

- Type 1:
  - 50 x cage nuts M5 /plate, 2.5 mm.
  - 50 x oval-head screws, Z-form, M5 x 16.
- Type 2:
  - 50 x cage nuts M5 /plate, 2.5 mm.
  - 50 x countersunk screws, M5 x 16.
  - 50 x rosettes.

#### ■ Delivery

- In sets.



MEC20097

W	H	D	U	d	L	Model	Order No.	UP
						Type 1: Z-form screw	<b>05.041.337.9</b>	1 set
						Type 2: Screw + rosette	<b>05.041.342.9</b>	1 set



MEC20129

### Front panel mounting set, T-slot for DoubleProRack®

- For securing 19" front panels and 19" components.

#### ■ Standard inclusion

- Type 1:
  - 50 x spring nuts, M5 narrow.
  - 50 x oval-head screws, Z-form, M5 x 10.
- Type 2:
  - 50 x spring nuts, M5 narrow.
  - 50 x countersunk screws, M5 x 12.
  - 50 x rosettes.

#### ■ Delivery

- In sets.



MEC20130

W	H	D	U	d	L	Model	Order No.	UP
						Type 1: Z-form screw	<b>05.041.338.9</b>	1 set
						Type 2: screw + rosette	<b>05.041.343.9</b>	1 set



MEC00060

## Spring nut

- To clip on T-slot where required.
  - Type 1: M5 wide for Miracel / Smaract. T-slot size: 10 x 13 mm.
  - Type 2: M5 narrow for DoubleProRack. T-slot size: 8 x 13 mm.
  - Type 3: M6 for Miracel / Smaract. T-slot size: 10 x 13 mm.
- **Standard inclusion**
    - 50 x spring nuts.
  - **Delivery**
    - In sets.

W	H	D	U	d	L	Model	Order No.	UP
						Type 1: M5 wide	<b>01.350.431.9</b>	1 set
						Type 2: M5 narrow	<b>05.041.503.9</b>	1 set
						Type 3: M6	<b>01.350.405.9</b>	1 set



MEC20139

## Cage nut

- For clipping into extrusions with mounting holes.
  - Type 1: Plate, 1.5 mm for Miracel / Smaract / ConAct / SoHo.
  - Type 2: Plate, 2.5 mm for Miracel Server / Smaract Server / DoubleProRack mounting holes.
- **Standard inclusion**
    - 50 x cage nuts.
  - **Delivery**
    - In sets.

W	H	D	U	d	L	Model	Order No.	UP
						M5: Type 1: Plate, 1.5 mm	<b>05.041.513.7</b>	1 set
						M5: Type 2: Plate, 2.5 mm	<b>05.041.518.7</b>	1 set
						M6: Type 1: Plate, 1.5 mm	<b>05.041.514.7</b>	1 set
						M6: Type 2: Plate, 2.5 mm	<b>05.041.519.7</b>	1 set

### Dimensions in mm:

W = Width h = Installation height U = Standard rack unit  
 H = Height d = Insertion depth (1 U = 44.45 mm)  
 D = Depth L = Length UP = Packaging unit

### Conversion:

1 mm = 0.03937 inch  
 1 kg = 2.2046 pounds



MEC20140

## Oval-head screw

- IEC DIN 967.
- **Standard inclusion**
  - 50 x oval-head screws, Z-form.
- **Delivery**
  - In sets.

W	H	D	U	d	L	Model	Order No.	UP
						M5 x 10	<b>05.041.330.9</b>	1 set
						M5 x 16	<b>05.041.331.9</b>	1 set
						M6 x 10	<b>05.041.332.9</b>	1 set
						M6 x 16	<b>05.041.333.9</b>	1 set



MEC20141

## Countersunk screw + rosette

- IEC DIN EN ISO 7047
- **Standard inclusion**
  - 50 x countersunk screws.
  - 50 x rosettes.
- **Delivery**
  - In sets.

W	H	D	U	d	L	Model	Order No.	UP
						M5 x 12	<b>05.041.203.9</b>	1 set
						M5 x 16	<b>05.041.290.9</b>	1 set



MEC80020

## Oval-head screw self-guiding

- DIN 7500.
- Suitable for system accessories fixed on the inside of the 19" extrusions.
- Suitable for 19" steel and 19" aluminum extrusions.
- Easy screwing.
- **Standard inclusion**
  - 50 x oval-head screws, M6x10.
- **Delivery**
  - In sets.

W	H	D	U	d	L	Model	Order No.	UP
						M6 x 10	<b>05.041.334.9</b>	1 set



MEC20227

## Oval-head screw With Phillips head

– IEC DIN EN ISO 7045.

- **Standard inclusion**
  - 1 x set of 50 units.



MEC20228

W	H	D	U	d	L	Model	Order No.	UP
					8	M 5 no washer	<b>05.041.611.8</b>	1 set
					12	M 4 no washer	<b>05.041.609.8</b>	1 set
					12	M 5 with washer	<b>05.041.613.8</b>	1 set
					16	M 5 with washer	<b>05.041.614.8</b>	1 set
					16	M 6 with washer	<b>05.041.616.8</b>	1 set



MEC20226

## Cylinder screw With hexagon head

– IEC ISO 4762 (modified).

- **Standard inclusion**
  - 1 x set of 50 units.

W	H	D	U	d	L	Model	Order No.	UP
					8	M 5	<b>05.041.574.8</b>	1 set
					8	M 5 microencapsulated	<b>05.041.575.9</b>	1 set



MEC20225

## Tensiloc nut

- **Material**
  - Steel nickel-plated.

- **Standard inclusion**
  - 1 x set of 50 units.

W	H	D	U	d	L	Model	Order No.	UP
						M 5	<b>05.041.533.8</b>	1 set



HEI00234

## Cable entry rail

– Alternative to cable entry: use brush strips when distributor box is installed in open frames.

- **Material / Finish**
  - Zinc-passivated sheet steel.

- **Standard inclusion**
  - 1 x cable routing panel.
  - 11 x bushing sockets.
  - 1 x Mounting kit.

W	H	D	Model	Order No.	UP
				<b>03.013.386.1</b>	1 unit



ELM00058

## Luminestra Rack lighting

- Only for rack type Miracel W 700, W 800.
- Mounted on the basic frame above the vertical extrusions.
- With 13 watt fluorescent tube.
- With on/off rocker switch.
- With 2 m power supply cable and EURO plug.
- Complete with mounting material.
- Only with 123 mm front clearance space.

- **Color**
  - White.

- **Standard inclusion**
  - 1 x Luminestra rack lamp.
  - 2 x mounting brackets.
  - 1 x Mounting kit.

W	H	D	U	h	d	w	Model	Order No.	UP
70	20	555						<b>01.131.227.9</b>	1 unit



ELM00135

## Compact rack lamp

- **Features**
  - Magnetic mounting.
  - Energy-saving lamp.
  - Protective contact socket.
  - ON/OFF switch.
  - Power supply lead 3 m.
  - Cover panel.

- **Compliance**
  - VDE ICE.

- **Protection rating**
  - IP20.

- **Technical data**
  - Operating voltage 230 V / 50-60 Hz.
  - Lighting: compact fluorescent tube with integrated starter.
  - Power consumption: 11 W  $\hat{=}$  75 W bulb.
  - Light intensity: 900 Lm.
  - Interference suppression compliant with VDE 0712, IEC 82.
  - Socket: 230 VAC / 16A.
  - Connections: 3-pole screw clamp, 2.5 mm<sup>2</sup> with strain relief.

W	H	D	U	h	d	w	Model	Order No.	UP
65	65	365						<b>01.131.465.9</b>	1 unit



HEI00379

## Distribution box

- For mounting trade-standard installation technology DIN rail components, such as fuses, clamps, relays, etc.
- When installed, the mounting level can be pulled out at the front and locked in position, significantly simplifying the wiring of the individual components. Not available for "fixed installation" model. Up on request: Delivered assembled and wired. Further versions and models up on request.
- Installation space for up to 22 pieces of equipment with 18 mm width each.
- Mounting of the TS35 DIN rail on several levels with simple plug-in connection. Not available for "fixed installation" model.
- "Snap-in" mounting of DIN rail components.
- Easy access to the protective grounding and neutral conductor rails from the front.
- Various positioning options available for N and PE rails. Not available for "fixed installation" model.
- Cable entry at the rear via double brush strip (optionally via bushing sockets).
- Cable strain relief on the inside and therefore accessible from the front.
- Labeling strips on the front, above and below the installation space.
- Installation options available for power distribution with 230 V AC, but also in the low-voltage range (e.g. 48 V DC).
- 19" slot-in, 3 U, depth 150 mm.

### Material / Finish

- Panels powder-coated texture, RAL 7035 light-grey.
- Main unit, sheet steel, zinc-passivated.

### Standard inclusion

- 1 x distribution box.
- Including N and PE rails, cable entry, cable strain relief, empty panel covers and grounding set.

### Delivery

- Fully assembled.

W	H	D	U	19"	Model	Order No.	UP
482.6	134	150	3	•	Pull-out	<b>03.013.385.1</b>	1 unit
482.6	134	150	3	•	Fixed	<b>03.013.470.1</b>	1 unit



HEI20282



ELM00137

## Door contact switch

- On/off switch, 4 A, 230 V ~.
- Activated by opening and closing door.
- **Standard inclusion**
  - 1 x door contact switch (not wired).
  - 1 x mounting bracket.
  - 1 x Mounting kit.

W	H	S	U	h	d	w	Model	Order No.	UP
								<b>01.110.722.9</b>	1 unit



ELM00033

## Cable junction box

- For 230 V electrical installation on-site.
- As fixed-location exchange point.
- Quick and easy mounting.
- **Standard inclusion**
  - 1 x cable junction box.

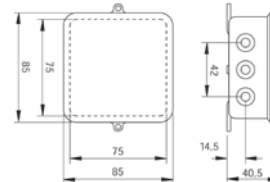

ELM00034

W	H	D	U	h	d	w	Model	Order No.	UP
								<b>00.078.720.9</b>	1 unit



ELM00128

## Modular terminal box

- For 230V electrical installation on-site.
- With series terminal, 8 x 42.
- Pg 11/16 entry.
- IP 54.

### Material

- High-impact, fire-resistant polystyrene.

### Standard inclusion

- 1 x modular terminal box.
- 4 pg compression glands, pg11.

W	H	S	U	h	d	w	Model	Order No.	UP
								<b>01.117.521.9</b>	1 unit



ELM00114

## 1 equipotential bonding bar

- For central grounding of all protective conductors.
- With sealable cover.
- Connection options:
  - 1 x round conductor 8 – 10 mm Ø
  - 1 x flat conductor up to 30 mm wide or round conductor 8 – 10 mm Ø.
- 7 x single or multi-wire conductors up to 16 mm<sup>2</sup> or fine-wire conductors up to 10 mm<sup>2</sup>.

- **Material**
  - Base plate and cover plate, high-impact plastic.
  - Brass nickel-plated contact strip.

- **Standard inclusion**
  - 1 x equipotential bonding bar.

W	H	S	U	h	d	w	Model	Order No.	UP
								<b>01.117.524.3</b>	1 unit



ELM00068

## Grounding bar

- For safe grounding or potential equalization of equipments and components.

- **Material**
  - Electrolyte copper 9 x 9.

- **Standard inclusion**
  - 1 x grounding bar.
  - 2 x brackets.
  - 1 x Mounting kit.

W	H	S	U	h	d	w	Model	Order No.	UP
			24				For DoubleProRack	<b>01.240.546.9</b>	1 unit
			21				For DoubleProRack	<b>01.240.545.9</b>	1 unit
			18				For DoubleProRack	<b>01.240.544.9</b>	1 unit
			15				For DoubleProRack	<b>01.240.543.9</b>	1 unit
			45				For Miracel	<b>01.110.709.9</b>	1 unit
			41				For Miracel	<b>01.110.708.9</b>	1 unit
			12				For Miracel	<b>01.110.703.9</b>	1 unit



DOP20016

## Contact clamp

- Enables safe connection of equipment and components to grounding bar.
- For cables up to 25 mm<sup>2</sup>.

- **Standard inclusion**
  - 20 x contact clamps.

W	H	S	U	h	d	w	Model	Order No.	UP
								<b>01.110.715.9</b>	20 units

Dimensions in mm:				Conversion:
W = Width	h = Installation height	U = Standard rack unit	kg = Weight	1 mm = 0.03937 inch
H = Height	d = Insertion depth	(1 U = 44.45 mm)		1 kg = 2.2046 pounds
D = Depth	L = Length	UP = Packaging unit		

# Knürr Fan Units

### Features

#### CoolBlast®

- Modular construction for varying heat loads; different designs available.
- Top-mounting fan and 19-fan unit available.
- Special protection grid keeps pressure losses to a minimum and reduces noise levels.
- Energy-efficient speed-controlled design also available.

#### Silent top-mounting fan

- Minimal noise level for use in office environment.
- Provides forced rack cooling.

#### Filter fan

- Protection class IP54.
- Filter can be replaced quickly and easily.
- Can be used to draw or push air.

**The ever-increasing power losses of electronic modules make for high demands on effective cooling. Large air-flow volumes ensure secured heat dissipation. The packing density of the electronic equipment in racks and enclosures is also increasing.**

The sharp rise in the price of electricity has resulted in energy efficiency gaining importance and environmental concerns increasingly become a prominent decision-making factor. Consequently, the use of speed-controlled fan units is rising. The additional costs generally prove to be a worthwhile investment.









LUF20203



LUF20205



LUF20124

## Knürr CoolBlast® Fan Unit for Cover Panel Installation Unregulated and thermostat-controlled

- Provides powerful rack cooling.
- Suitable for retrofitting in cover panel of Miracel® rack.
- DC versions and 115 VAC versions upon request (see Knürr CoolBlast® fan inserts).
- Thermostat-controlled model: Fan function (ON/OFF) thermostat-controlled; setting range from 0° to + 60° C.

### Material

- Enclosure: sheet steel, high-grade steel grid.

### Finish

- Zinc-passivated.

### Technical data for single fan

- See page 126.

### Compliance

- CE marking compliant with Low Voltage Directive 73/23/EEC; EMC directive 89/366/EEC.

### Standard inclusion

- 1 x CoolBlast fan unit.
- 1 x mains cable, 3 m with safety plug (230 VAC).
- 1 x Mounting kit.
- 1 x Operating instructions.

### Delivery

- Assembled, wired and tested.

### Note

- Please also order corresponding mains cable (see page 133).

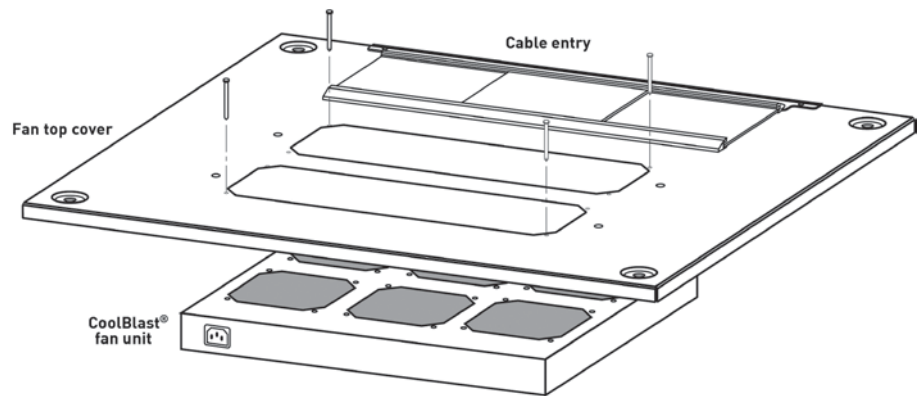

LUF20175

Name	Model	Electrical connection	P(W)	V' (m³/h)	ΔP(Pa)	p(dB(A))	Order No.	UP
CoolBlastT 230V 2-piece		207...253 VAC; 50/60 Hz	30	330	74	43.4	<b>03.027.300.1</b>	1 unit
CoolBlastT 230V 3-piece		207...253 VAC; 50/60 Hz	45	495	74	45.2	<b>03.027.301.1</b>	1 unit
CoolBlastT 230V 6-piece		207...253 VAC; 50/60 Hz	90	990	74	48.8	<b>03.027.302.1</b>	1 unit
CoolBlastT 230V 2-piece	Thermostat	207...253 VAC; 50/60 Hz	30	330	74	43.4	<b>03.027.310.1</b>	1 unit
CoolBlastT 230V 3-piece	Thermostat	207...253 VAC; 50/60 Hz	45	495	74	45.2	<b>03.027.311.1</b>	1 unit
CoolBlastT 230V 6-piece	Thermostat	207...253 VAC; 50/60 Hz	90	990	74	48.8	<b>03.027.312.1</b>	1 unit



LUF20160



LUF20161



LUF20124

## Knürr CoolBlast® Fan Unit for Cover Panel Installation speed-controlled

- Provides powerful rack cooling.
- Suitable for retrofitting in top cover of Miracel rack.
- DC version upon request (see CoolBlast fan inserts).
- Settable reference temperature (20° to 55° C).
- Speed control, 30 to 100%, if sensor fails, 100% rotation.
- Individual fan monitoring.
- Potential-free common alarm output for excess temperature and fan failure.
- Visual status display for O.K., excess temperature and fan failure.
- Acoustic warning inclusive reset button.

### Material

- Enclosure: sheet steel, high-grade steel grid.

### Finish

- Zinc-passivated front cover plate, powder-coated, smooth in RAL 7035 light-grey.

### Technical data for single fan

- See page 126.

### Compliance

- CE marking compliant with Low Voltage Directive 73/23/EEC; EMC directive 89/366/EEC.

### Standard inclusion

- 1 x CoolBlast fan unit.
- 1 x sensor cable, 2 m (plug-in).
- 1 x signal cable, 2 m (plug-in).
- 1 x mains cable, 3 m with safety plug (230 VAC).
- 1 x Mounting kit.
- 1 x Operating instructions.

### Delivery

- Assembled, wired and tested.

### Note

- Please also order specific mains cable (see page 133).

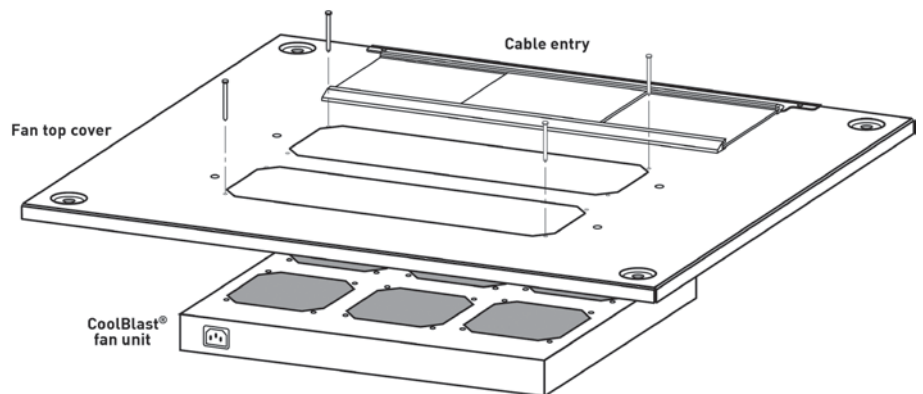

LUF20175

Name	Model	Electrical connection	P(W)	V' (m³/h)	ΔP(Pa)	p(dB(A))	Order No.	UP
CoolBlastT 230V 3-piece	Regulated SP	100...253 VAC; 50/60 Hz	25	553	68	49.6	<b>03.027.321.1</b>	1 unit
CoolBlastT 230V 6-piece	Regulated SP	100...253 VAC; 50/60 Hz	48	1106	68	53.3	<b>03.027.322.1</b>	1 unit
CoolBlastT 230V 3-piece	Regulated HP	100...253 VAC; 50/60 Hz	32	711	173	55.8	<b>03.027.324.1</b>	1 unit
CoolBlastT 230V 6-piece	Regulated HP	100...253 VAC; 50/60 Hz	62	1422	173	59.1	<b>03.027.325.1</b>	1 unit

### Dimensions in mm:

W = Width    h = Installation height    U = Standard rack unit    kg = Weight

H = Height    d = Usable depth    (1 U = 44.45 mm)

D = Depth    L = Length    UP = Packaging unit

SP = Standard Performance    V' = Air-flow volume (m³/h)

HP = High Performance    ΔV' = Air-flow volume loss (%)

UP = Ultra High Performance    ΔP = Pressure increase (Pa)

n = Number of fans    I<sub>nom</sub> = Nominal current (A)

W = Power consumption    I<sub>max</sub> = Residual current (A)

V = Voltage    p = Sound pressure (dB(A))

(400V = 3-phase)    distance from the rack 1 m (600 mm x 600 mm; raised cover)

### Conversion:

1 mm = 0.03937 inch

1 kg = 2.2046 pounds

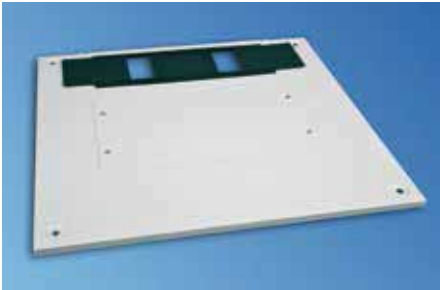

LUF20163



LUF20169

## Fan Top Cover for Knürr CoolBlast®

- Used with CoolBlast fan unit.
- Suitable for installation in Miracel.
- With cable routing (sliding plate).
- Two-part cover to facilitate retrofitting and servicing.

### Material

- Sheet steel.

### Finish / Color

- Final digit of order number .1:  
Powder-coated texture, RAL 7035, light-grey (e. g. X=1; 01.149.031.X=01.149.031.1=light-grey).
- Final digit of order number .8:  
Powder-coated texture, RAL 7021 dark-grey (e. g. X=8; 01.149.031.X=01.149.031.8=dark-grey).

### Standard inclusion

- 1 x cover panel with cover strip and cable entry.
- 2 x covers.

### Delivery

- Pre-assembled.

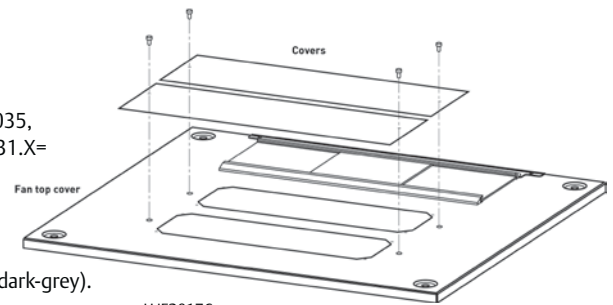

LUF20176

W	H	D	Model	Order No.	UP
600		600	For 2 or 3-piece	<b>01.149.031.X</b>	1 unit
700		600	For 2 or 3-piece	<b>01.149.041.X</b>	1 unit
800		600	For 2 or 3-piece	<b>01.149.051.X</b>	1 unit
600		800	For 2, 3 or 6-piece	<b>01.149.033.X</b>	1 unit
700		800	For 2, 3 or 6-piece	<b>01.149.043.X</b>	1 unit
800		800	For 2, 3 or 6-piece	<b>01.149.053.X</b>	1 unit
600		900	For 2, 3 or 6-piece	<b>01.149.034.X</b>	1 unit
700		900	For 2, 3 or 6-piece	<b>01.149.044.X</b>	1 unit
800		900	For 2, 3 or 6-piece	<b>01.149.054.X</b>	1 unit
600		1000	For 2, 3 or 6-piece	<b>01.149.035.X</b>	1 unit
700		1000	For 2, 3 or 6-piece	<b>01.149.045.X</b>	1 unit
800		1000	For 2, 3 or 6-piece	<b>01.149.055.X</b>	1 unit
600		1200	For 2, 3 or 6-piece	<b>01.149.037.X</b>	1 unit
800		1200	For 2, 3 or 6-piece	<b>01.149.057.X</b>	1 unit



LUF20121

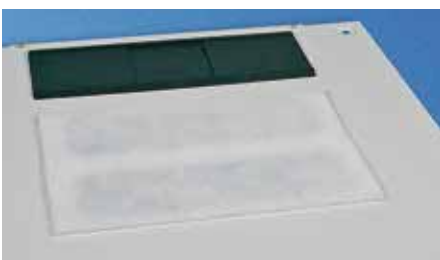

LUF20168

## CoolBlast® Dust/Particle Protection Solution 1: Filter Mat

- Used with CoolBlast® fan top cover.
- Simple filter cover preventing the ingress of dust when the fan stops (regulated or thermostat-controlled version available).
- For all top-cover sizes; filter and adhesive tape can be cut to the required length.

### Material

- Filedon (filter class G2).

### Standard inclusion

- 1 x filter.
- 1 x Adhesive tape.

### Delivery

- In sets.

W	H	D	kg	Model	Order No.	UP
				For 2, 3 and 6-piece fan unit	<b>01.149.101.9</b>	1 set

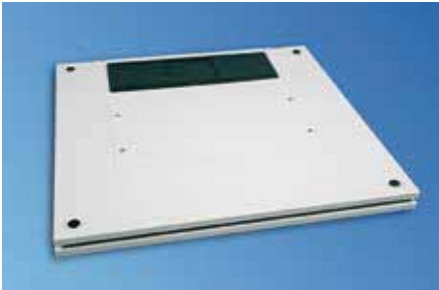

LUF20174



LUF20172

## Knürr CoolBlast® Dust/Particle Protection Solution 2: Vent Cover

- Used with CoolBlast fan top cover.
- Closed cover panel with cable entry for protection against foreign particles and dust.
- Mounting on the spacer bolts on the standard cover.

- **Material**
  - Sheet steel.

- **Finish / Color**
  - Final digit of order number 1: powder-coated, RAL 7035 light-grey.
  - Final digit of order number .8: powder-coated, RAL 7021 dark-grey.

- **Standard inclusion**
  - 1 x cover panel with cable entry.

- **Delivery**
  - In sets.

W	H	D	Model	Order No.	UP
600		600	with cable entry	01.149.031.X	1 unit
700		600	with cable entry	01.149.041.X	1 unit
800		600	with cable entry	01.149.051.X	1 unit
600		800	with cable entry	01.149.033.X	1 unit
700		800	with cable entry	01.149.043.X	1 unit
800		800	with cable entry	01.149.053.X	1 unit
600		900	with cable entry	01.149.034.X	1 unit
700		900	with cable entry	01.149.044.X	1 unit
800		900	with cable entry	01.149.054.X	1 unit
600		1000	with cable entry	01.149.035.X	1 unit
700		1000	with cable entry	01.149.045.X	1 unit
800		1000	with cable entry	01.149.055.X	1 unit
600		1200	with cable entry	01.149.037.X	1 unit
800		1200	with cable entry	01.149.057.X	1 unit
600		600	closed	01.130.690.X	1 unit
700		600	closed	01.130.694.X	1 unit
800		600	closed	01.130.691.X	1 unit
600		800	closed	01.130.691.X	1 unit
700		800	closed	01.130.695.X	1 unit
800		800	closed	01.130.699.X	1 unit
600		900	closed	01.130.692.X	1 unit
700		900	closed	01.130.696.X	1 unit
800		900	closed	01.130.700.X	1 unit
600		1000	closed	01.127.700.X	1 unit
700		1000	closed	01.127.701.X	1 unit
800		1000	closed	01.127.702.X	1 unit

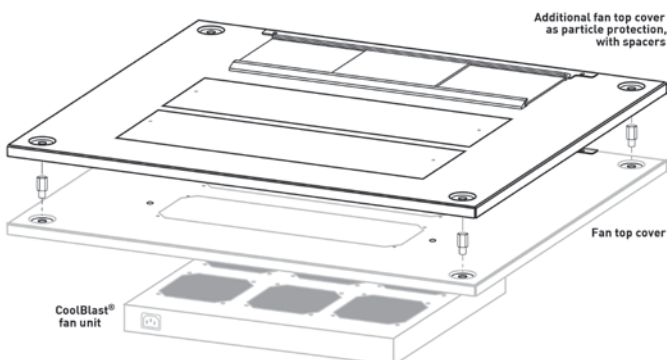

LUF20177

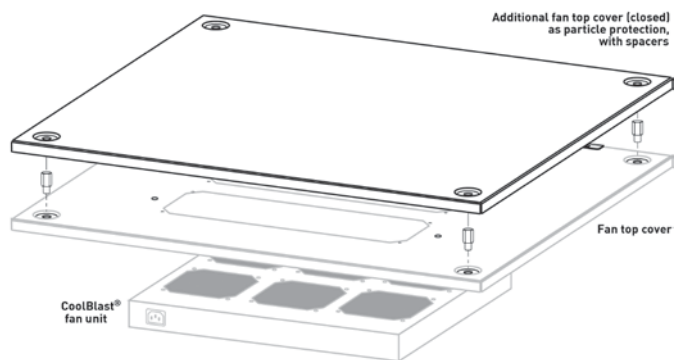

LUF20178



LUF20125

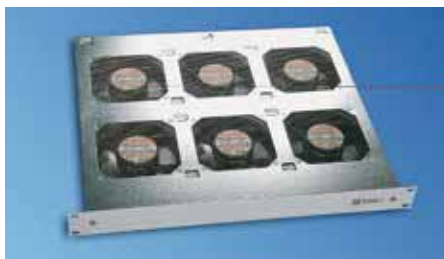

LUF20139

## 19" Knürr CoolBlast® Fan Unit Unregulated and thermostat-controlled

- Fan unit for vertical ventilation of modules in 19" racks.
  - Chassis rails are recommended for mounting. Chassis rails are required with 6-piece CoolBlast.
  - Thermostat-controlled model: Fan function (ON/OFF) thermostat-controlled; setting range from 0° to + 60° C.
- **Material**
    - Sheet steel, high-grade steel grid.
  - **Finish / Color**
    - Enclosure zinc-passivated.
    - Front cover plate, powder-coated, smooth in RAL 7035 light-grey.
- **Delivery**
    - Assembled, wired and tested.
  - **Compliance**
    - CE marking compliant with Low Voltage Directive 73/23/EEC; EMC directive 89/366/EEC.
  - **Standard inclusion**
    - 1 x CoolBlast fan unit, packed with operating instructions.
    - 1 x connection cable, 2 m; Euro power plugs and sockets.
  - **Note**
    - Please also order specific mains cable (see page 133).

Name	W	H	D	kg	n	Electrical connection	P(W)	V' (m³/h)	ΔP(Pa)	p(dB(A))	Order No.	UP
CoolBlast 230V 3-piece	440	43.6	230	3	3	207 ... 253VAC; 50/60Hz	45	495	74	45.2	<b>03.027.001.1</b>	
CoolBlast 230V 6-piece	440	43.6	390	6	6	207 ... 253VAC; 50/60Hz	90	990	74	48.8	<b>03.027.002.1</b>	
CoolBlast 115V 3-piece	440	43.6	230	3	3	103.5 ... 126.5VAC; 50/60Hz	44	576	88	47.3	<b>03.027.004.1</b>	
CoolBlast 115V 6-piece	440	43.6	390	6	6	103.5 ... 126.5VAC; 50/60Hz	88	1152	88	50.8	<b>03.027.005.1</b>	
CoolBlast 230V 3-piece, thermostat	440	43.6	230	3	3	207 ... 253VAC; 50/60Hz	45	495	74	45.2	<b>03.027.011.1</b>	
CoolBlast 230V 6-piece, thermostat	440	43.6	390	6	6	207 ... 253VAC; 50/60Hz	90	990	74	48.8	<b>03.027.012.1</b>	
CoolBlast 115V 3-piece, thermostat	440	43.6	230	3	3	103.5 ... 126.5VAC; 50/60Hz	44	576	88	47.3	<b>03.027.014.1</b>	
CoolBlast 115V 6-piece, thermostat	440	43.6	390	6	6	103.5 ... 126.5VAC; 50/60Hz	88	1152	88	50.8	<b>03.027.015.1</b>	

## Technical data for Axial Single Fan

	Knürr CoolBlast®	Knürr CoolBlast®	Knürr CoolBlast®	Knürr CoolBlast®	Knürr CoolBlast®
Item number	01.914.070.9	01.914.075.9	01.914.050.9	01.914.051.9	01.914.051.9-2
Dim: L x W x H	119 x 119 x 38	119 x 119 x 38	119 x 119 x 38	119 x 119 x 38	119 x 119 x 38
Max. volume flow, free blowing:	184.2 m³/h	237 m³/h	192 m³/h	165 m³/h	120 m³/h
Voltage	24 VDC	24 VDC	115 VAC	230 VAC	230 VAC
Frequency			50 Hz	50 Hz	50 Hz
Power consumption	7.4 W	11 W	14.5 W	15 W	7.5 W
Noise, free blowing	43 dB(A)	59 dB(A)	41 dB(A)	38 dB(A)	32 dB(A)
Bearing system	Ball bearing	Ball bearing	Ball bearing	Ball bearing	Ball bearing
Nominal speed	2950 min-1	4400 min-1	2900 min-1	2600 min-1	2100 min-1
Permitted ambient temp.	-10 °C to + 70 °C	-30 °C to + 55 °C	-40 °C to + 60 °C	-40 °C to + 60 °C	-40 °C to + 70 °C
Service life, L10 at 40°C	75,000 h	70,000 h	43,500 h	43,500 h	43,500 h
Compliance	CE, VDE	CE, VDE	CE, VDE	CE, VDE	CE, VDE
<b>Use in fan unit:</b>	03.027.021.1 03.027.022.1 03.027.051.1 03.027.052.1 03.027.321.1 03.027.322.1	03.027.024.1 03.027.025.1 03.027.054.1 03.027.055.1 03.027.324.1 03.027.325.1	03.027.004.1 03.027.005.1 03.027.014.1 03.027.015.1	03.027.001.1 03.027.002.1 03.027.011.1 03.027.012.1 03.027.300.1 03.027.301.1 03.027.302.1 03.027.310.1 03.027.311.1 03.027.312.1 02.111.180.9 05.010.306.1 01.113.430.0 01.113.431.0 01.243.428.1 03.028.110.8	02.111.181.9 05.010.307.1



LUF20128



LUF20140



LUF20054

## 19" Knürr CoolBlast® Fan Unit Speed-controlled

- Fan unit for vertical ventilation of modules in 19" racks.
- Reference temperature can be set (20°C to 55°C).
- Speed control, 30 to 100%; if sensor fails, 100% rotation.
- Individual fan monitoring.
- Potential-free alarm output for excess temperature alarm and fan failure.
- Visual status display for O.K., excess temperature and fan failure.
- Acoustic alarm can be switched off with switch.
- Chassis rails are recommended for mounting. Chassis rails are required with 6-piece CoolBlast.

- **Material**
  - Sheet steel, high-grade steel grid.
- **Finish / Color**
  - Enclosure zinc-passivated.
  - Front cover plate, powder-coated, smooth in RAL 7035 light-grey.

- **Compliance**
  - CE marking compliant with Low Voltage Directive 73/23/EEC; EMC directive 89/366/EEC.
- **Standard inclusion**
  - 1 x CoolBlast fan unit, packed with operating instructions.
  - 1 x sensor cable, 2 m (plug-in).
  - 1 x signal cable, 2 m (plug-in).

Only with DC devices:  
- 1 x connection cable, 2 m with connector plug and free ends.

Only with AC devices:  
- 1 x connection cable, 2 m; Euro power plugs and sockets.

- **Delivery**
  - Assembled, wired and tested.

- **Note**

Further project-specific characteristics can be realized in line with standards.

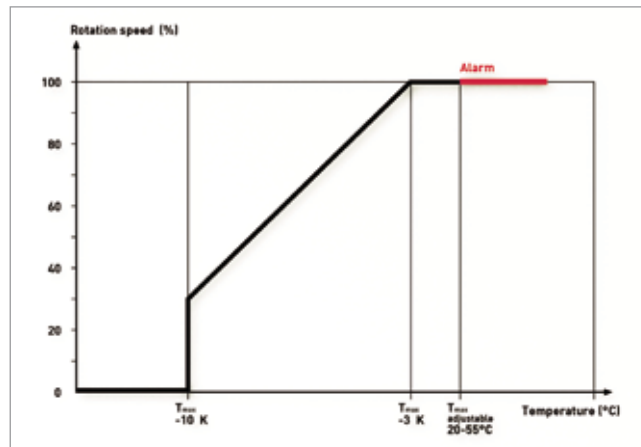

LUF20179

Name	W	H	D	kg	n	Electrical connection	P(W)	V' (m³/h)	ΔP(Pa)	p(dB(A))	Order No.	UP
CoolBlast 115/230V, 3-piece, controlled SP	440	43.6	230	3.2	3	100 to 253VAC; 50/60Hz	25	553	68	49.6	03.027.021.1	
CoolBlast 115/230V, 6-piece, controlled SP	440	43.6	390	6.2	6	100 to 253VAC; 50/60Hz	48	1106	68	53.3	03.027.022.1	
CoolBlast 115/230V, 3-piece, controlled HP	440	43.6	230	3.2	3	100 to 253VAC; 50/60Hz	32	711	173	55.8	03.027.024.1	
CoolBlast 115/230V, 6-piece, controlled HP	440	43.6	390	6.2	6	100 to 253VAC; 50/60Hz	62	1422	173	59.1	03.027.025.1	
CoolBlast 24/48V, 3-piece, controlled SP	440	43.6	230	3.1	3	20 to 60VDC	25	553	68	49.6	03.027.051.1	
CoolBlast 24/48V, 6-piece, controlled SP	440	43.6	390	6.1	6	20 to 60VDC	48	1106	68	53.3	03.027.052.1	
CoolBlast 24/48V, 3-piece, controlled HP	440	43.6	230	3.1	3	20 to 60VDC	32	711	173	55.8	03.027.054.1	
CoolBlast 24/48V, 6-piece, controlled HP	440	43.6	390	6.1	6	20 to 60VDC	62	1422	173	59.1	03.027.055.1	

## Knürr CoolBlast® Air-flow Routing via Front Intake Main features

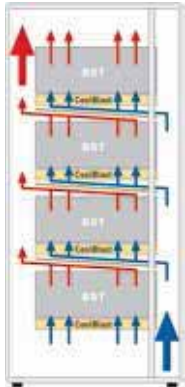

LUF20156

The "front-intake unit" for the Knürr CoolBlast fan delivers targeted cooling for module supports arranged on top of each other (heat sources).



LUF20131

### Knürr CoolBlast® – Air-flow Routing via Front Intake, 1 U

- For Knürr CoolBlast slot-in unit 3- and 6 piece for front intake.
- Used as cooling baffle.
- Can be supplemented with front plate and filter mat.



LUF20142

- **Material**
  - Sheet steel.
- **Finish / Color**
  - Powder-coated texture, RAL 7035.
  - Light-grey.
- **Standard inclusion**
  - 1 x air-flow guide.
- **Delivery**
  - Single items.

W	H	D	Model	Order No.	UP
43.6	230		For 3-piece	<b>03.027.094.1</b>	1 unit
43.6	390		For 6-piece	<b>03.027.095.1</b>	1 unit



LUF00205

### 19" Filter Unit, 1 U

- Suitable for use with CoolBlast slot-in unit.
- Adjusted to the respective recess depth.
- **Material**
  - Enclosure: sheet steel.
  - Front cover plate: ABS (UL94 V-0).
  - Handle: extruded aluminum.
  - Filter: Viledon P 15/150.
- **Filter class**
  - G2.
- **Finish / Color**
  - Enclosure: powder-coated texture, RAL 9011 dark-grey.
  - Front cover plate: RAL 7035, light-grey.
  - Handle: powder-coated texture, RAL 5008 grey-blue.
- **Standard inclusion**
  - 1 x filter insert.
  - 1 x filter.
- **Delivery**
  - Single items.

W	H	D	kg	W	n	Model	Order No.	UP
43.6	282	2.0					<b>03.025.250.1</b>	1 unit
43.6	660	4.0					<b>03.025.253.1</b>	1 unit



LUF20136

### Knürr CoolBlast® Front Plate for Air-flow Routing via Front Intake, 1 U

- For use with air-flow guide for front intake.
- Can be retrofitted.
- **Material**
  - Sheet steel.
- **Finish / Color**
  - Powder-coated, RAL 7035.
  - Light-grey, smooth.
- **Standard inclusion**
  - 1 x front plate.
- **Delivery**
  - Single items.

W	H	D	Model	Order No.	UP
43.6				<b>03.027.097.1</b>	1 unit

Dimensions in mm:				Conversion:	
W = Width	h = Installation height	U = Standard rack unit	kg = Weight	1 mm = 0.03937 inch	
H = Height	d = Usable depth	(1 U = 44.45 mm)		1 kg = 2.2046 pounds	
D = Depth	L = Length	UP = Packaging unit			
SP = Standard Performance	V' = Air-flow volume (m³/h)				
HP = High Performance	ΔV' = Air-flow volume loss (%)				
UP = Ultra High Performance	ΔP = Pressure increase (Pa)				
n = Number of fans	I <sub>nom</sub> = Nominal current (A)				
W = Power consumption	I <sub>max</sub> = Residual current (A)				
V = Voltage (400V = 3-phase)	p = Sound pressure (dB(A) distance from the rack 1 m (600 mm x 600 mm; raised cover)				





LUF20135

## Knürr CoolBlast® Filter for Front Intake

- For use with air-flow routing via front intake.
- Can be retrofitted; filter can also be replaced during operation.

■ **Filter class**  
- G2.

■ **Material**  
Viledon K15/150.

■ **Standard inclusion**  
- 1 x filter.

■ **Delivery**  
- Single items.

W	H	D	Model	Order No.	UP
400		160	For 3-piece	<b>03.027.098.1</b>	1 unit
400		320	For 6-piece	<b>03.027.099.1</b>	1 unit



LUF00280

## Replacement Filter

- For 19" filter insert.

■ **Material**  
- Filter: Viledon P 15/150.

■ **Filter class**  
- G2.

■ **Standard inclusion**  
- 1 x filter.

■ **Delivery**  
- Single items.

W	H	D	kg	W	n	Model	Order No.	UP
							<b>03.025.246.9</b>	1 unit
							<b>03.025.249.9</b>	1 unit



LUF20194

## Silent Top-mounting Fan

- Used for applications with silent environment (e. g. offices).
- Suitable for installation in Miracel.
- High volume flow with low noise generation (e.g. for office applications).

■ **Material / Finish**  
- Sheet steel.

■ **Technical data for single fan**  
- Max. volume flow (free blowing): -1500 m³/h.  
- Voltage / frequency: 230 V / 50 Hz.  
- Power consumption: 117 W.  
- Noise level: 40 dB(A).  
- Temperature range: -25 to 40°C.

■ **Finish / Color**  
- Final digit of order number 1:  
powder-coated, RAL 7035 light-grey.  
- Final digit of order number .8:  
powder-coated, RAL 7021 dark-grey.

■ **Standard inclusion**  
- 1 x top-mounting fan.  
- 1 x mains cable, 3 m with safety plug (230 VAC).  
- 1 x Mounting kit.

■ **Delivery**  
- In sets.

■ **Note**  
Please also order suitable cover panel.



LUF20195

W	H	D	For rack type	Order No.	UP
449	237	490	Miracel	<b>03.028.111.X</b>	1 unit

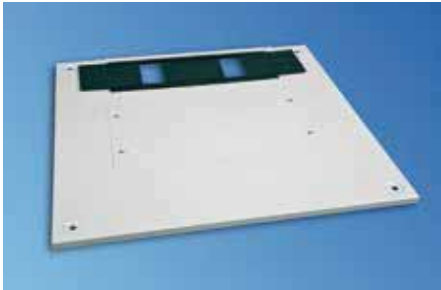

LUF20163



LUF20195

## Fan Top Cover for Silent, Top-mounting Fan

- Used with silent-fan top cover.
- Suitable for installation in Miracel.
- With cable routing (sliding plate).
- Two-part cover to facilitate retrofitting and servicing.

- **Material / Finish**
  - Sheet steel.

- **Finish / Color**
  - Final digit of order number 1: powder-coated, RAL 7035 light-grey.
  - Final digit of order number .8: powder-coated, RAL 7021 dark-grey.

- **Standard inclusion**
  - 1 x cover panel with cover strip and cable entry.
  - 1 x Mounting kit.

- **Delivery**
  - In sets.

W	H	D	For rack type	Order No.	UP
600		600	Miracel	01.149.201.x	1 unit
700		600	Miracel	01.149.202.x	1 unit
800		600	Miracel	01.149.203.x	1 unit
600		800	Miracel	01.149.206.x	1 unit
700		800	Miracel	01.149.207.x	1 unit
800		800	Miracel	01.149.208.x	1 unit
600		900	Miracel	01.149.211.x	1 unit
700		900	Miracel	01.149.212.x	1 unit
800		900	Miracel	01.149.213.x	1 unit
600		1000	Miracel	01.149.216.x	1 unit
700		1000	Miracel	01.149.217.x	1 unit
800		1000	Miracel	01.149.218.x	1 unit
600		1200	Miracel	01.149.221.x	1 unit
700		1200	Miracel	01.149.222.x	1 unit
800		1200	Miracel	01.149.223.x	1 unit



LUF20180

## Knürr CoolBlast® Fan Installation Kit with Thermostat

- For flexible positioned ventilation of racks.
- Miracel / Tecoras Indoor.
- Installed in the top cover area.
- No loss of 19" installation space.
- Retrofitting also possible.
- With 2 fans (160 m<sup>3</sup>/h per fan).

- **Material / Finish**
  - Sheet steel, 1.5 mm, zinc passivated.

- **Compliance**
  - CE marking compliant with Low Voltage Directive 73/23/EEC; EMC directive 89/336/EEC.

- **Technical data for thermostat**
  - Setting range: + 0°C to + 60°C.
  - Power supply: 240 V / 50 Hz.
  - Mains current: 16 A.

- **Standard inclusion**
  - 1 x mounting panel for fans.
  - 2 x fans.
  - 1 x connection cable, 2.0 m with safety plug.
  - Type 1: with thermostat.
  - Type 2: without thermostat.
  - 1 x Mounting kit.

- **Delivery**
  - Assembled, wired and tested.

W	H	D	For rack type	Order No.	UP
534			Miracel / B 600 / with thermostat	01.113.430.0	1 unit
734			Miracel / B 800 / with thermostat	01.113.431.0	1 unit



LUF20057



LUF20058

## Filter Fan

- For specific use where hot spots occur.
- Also suitable for retrofitting, quick and easy.
- The filter mats provide high-level filtration, are easily exchanged and can be cleaned.
- These maintenance-free fans feature a long service life and low noise levels.
- Air-flow routing: blows into the rack (pre-set).
- Can be used to draw in or move air out.

- **Material**
  - Heat-resistant ABS plastic, UL 94 V-0.
- **Color**
  - RAL 7035 light-grey.
- **Compliance**
  - CE marking.
- **Protection rating**
  - IP 54.

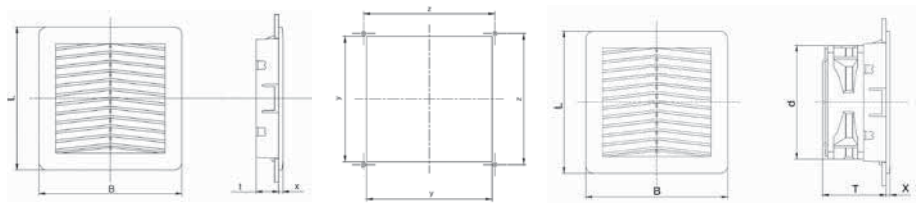

LUF80011

LUF800040

LUF80012

LxW	D/l/x	y/z	kg	Max. AF	El. conn.	L	G	N	Service life/40°	Model	Order No.	UP
150 x 150	71/120/5	125/131	0.812	57 m³/h	230V / 50/60Hz	20 W	43 dB(A)	2650/min	40,000 h	Filter fan	<b>03.026.501.1</b>	1 unit
204 x 204	90/120/5.7	177/185	1	90 m³/h	230V / 50/60Hz	20 W	43 dB(A)	2650/min	40,000 h	Filter fan	<b>03.026.502.1</b>	1 unit
250 x 250	113/172/6	223/230	1.690	240m³/h	230V / 50/60Hz	29 W	50 dB(A)	2800/min	40,000 h	Filter fan	<b>03.026.503.1</b>	1 unit
325 x 325	125/208/7	291/302	3.620	520m³/h	230V / 50/60Hz	67 W	63 dB(A)	2770/min	50,000 h	Filter fan	<b>03.026.504.1</b>	1 unit
150 x 150	24/5	125/131	0.140							Exit filter	<b>03.026.511.1</b>	1 unit
204 x 204	20.5/5.7	177/185	0.275							Exit filter	<b>03.026.512.1</b>	1 unit
250 x 250	25/6	233/230	0.440							Exit filter	<b>03.026.513.1</b>	1 unit
325 x 325	26/7	291/302	0.780							Exit filter	<b>03.026.514.1</b>	1 unit
150 x 150										Replacement filter mat	<b>03.026.521.9</b>	6 unit
204 x 204										Replacement filter mat	<b>03.026.522.9</b>	6 unit
250 x 250										Replacement filter mat	<b>03.026.523.9</b>	6 unit
325 x 325										Replacement filter mat	<b>03.026.524.9</b>	6 unit

Dimensions in mm:				Conversion:
W = Width	h = Installation height	U = Standard rack unit	kg = Weight	1 mm = 0.03937 inch
H = Height	d = Usable depth	(1 U = 44.45 mm)		1 kg = 2.2046 pounds
D = Depth	L = Length	UP = Packaging unit		
SP = Standard Performance	V' = Air-flow volume (m³/h)			
HP = High Performance	ΔV' = Air-flow volume loss (%)			
UP = Ultra High Performance	ΔP = Pressure increase (Pa)			
n = Number of fans	I nom = Nominal current (A)			
W = Power consumption	I max = Residual current (A)			
V = Voltage (400V = 3-phase)	p = Sound pressure (dB(A) distance from the rack 1 m (600 mm x 600 mm; raised cover)			



LUF00237a

## Temperature Module

- For monitoring the inside temperature of the rack.
- Temperature display (+ 10°C to + 70°C).
- Alarm temperature set via potentiometer at the front.
- Visual alarm display (LED red).
- Alarm signaling via potential-free switching contact (1 changeover contact 250 VAC / 8 A).
- Power supply 230 V / 50 Hz.

### Material

- Plastic.

### Compliance

- CE marking compliant with Low Voltage Directive 73/23/EEC; EMC directive 89/336/EEC.

### Standard inclusion

- 1 x Temperature module.
- 1 x Temperature sensor (3 m).

### Delivery

- Assembled, wired and tested.

W	H	D	LxW	kg	W	n	Model	Order No.	UP
								01.117.525.1	1 unit



LUF00256

## 19" Front Plate 1 U for Temperature Module

- For temperature module installation.

### Material / Finish

- Sheet steel, 1.5 mm, powder-coated texture.

### Color

- RAL 7035 light-grey.

### Standard inclusion

- 1 x 19" front plate.

W	H	D	LxW	kg	W	n	Model	Order No.	UP
								01.117.526.1	1 unit



LUF00255

## Bracket for Temperature Module

- For non-standard temperature module installation, e.g., on the side of the 19" extrusion.

### Material / Finish

- Aluminum, 2 mm, polished.

### Standard inclusion

- 1 x bracket.
- 1 x Mounting kit.

### Delivery

- In sets.

W	H	D	LxW	kg	W	n	Model	Order No.	UP
								01.117.527.0	1 unit



LUF20000

## Thermostat

- For monitoring the inside temperature of the rack with respect to slot-in units and heating fans.
- Setting range: + 10°C to + 60°C.
- Switching temperature difference (hysteresis) 2 K.
- Contact type: 1 changeover contact.
- Sensor: thermo-bimetal.
- Contact rating: 230 VAC/10 A (heating), 5 A (cooling).
- Interference suppression: compliant with DIN 55014.

### Material

- Plastic.

### Protection rating

- IP 30.

### Compliance

- CE marking compliant with Low Voltage Directive 73/23/EEC; EMC directive 89/336/EEC.

### Dimensions

- 74 x 74 x 23 mm.

### Standard inclusion

- 1 x thermostat.
- 1 x mounting bracket.
- 1 x Mounting kit.

W	H	D	LxW	kg	W	n	Model	Order No.	UP
								01.113.384.3	1 unit



DOS00076

## Euro Mains Cable

For DIN 49 440 and French/Belgian standard

- Mains plug CEE/VII - Euro socket IEC 320.
- Cable: H05VV-F 3G 1 mm<sup>2</sup>.

- **Mains voltage**  
- 250 VAC.
- **Nominal current**  
- 10 A.

L	S	n	F1	F2	19"	safe	Model	Order No.	UP
2000								<b>04.000.054.9</b>	1 unit
5000								<b>04.000.050.9</b>	1 unit



DOS00077

## Euro Mains Cable for Swiss Standard

- Mains plug: Type 12 - Euro socket IEC 320.
- Cable: H05VV-F 3G 1 mm<sup>2</sup>.

- **Mains voltage**  
- 250 VAC.
- **Nominal current**  
- 10 A.

L	S	n	F1	F2	19"	safe	Model	Order No.	UP
2000								<b>04.000.055.9</b>	1 unit



DOS00519

## Euro Plug Connection Cable

- Mains plug: IEC 320 - Euro socket IEC 320.
- Cable: H05VV-F 3G 1 mm<sup>2</sup>.

- **Mains voltage**  
- 250 VAC.
- **Nominal current**  
- 10 A.

L	S	n	F1	F2	19"	safe	Model	Order No.	UP
900								<b>04.000.051.9</b>	1 unit



DOS00078

## Euro Mains Cable for British Standard

- Mains plug: Type BS 1363 - IEC320 Euro socket.
- Cable: H05VV-F 3G 1 mm<sup>2</sup>.

- **Mains voltage**  
- 250 VAC.
- **Nominal current**  
- 10 A.

L	S	n	F1	F2	19"	safe	Model	Order No.	UP
2000								<b>04.000.056.9</b>	1 unit

### Dimensions in mm:

W = Width    h = Installation height    U = Standard rack unit    kg = Weight  
 H = Height    d = Usable depth    (1 U = 44.45 mm)  
 D = Depth    L = Length    UP = Packaging unit

### Conversion:

1 mm = 0.03937 inch  
 1 kg = 2.2046 pounds

SP = Standard Performance    V' = Air-flow volume (m<sup>3</sup>/h)  
 HP = High Performance    ΔV' = Air-flow volume loss (%)  
 UP = Ultra High Performance    ΔP = Pressure increase (Pa)  
 n = Number of fans    I<sub>nom</sub> = Nominal current (A)  
 W = Power consumption    I<sub>max</sub> = Residual current (A)  
 V = Voltage    p = Sound pressure (dB(A))  
 (400V = 3-phase)    distance from the rack 1 m (600 mm x 600 mm; raised cover)

# Knürr Smaract®

## CompactRack

### Features

- Ample space for components and cabling provided in an efficient, compact design.
- The innovative frame concept with triangular extrusions ensures low weight while maintaining high stability.
- Modular, stackable construction.
- Easy access from all sides for installation and maintenance – hinged doors and side panels can be quickly removed.
- Secured access: The side panels can only be removed once the front or rear door has been opened.
- The patented mounting hole rails in the 19" extrusion ensure that all components can be positioned quickly and easily.
- Doors and side panels have an 180° opening angle.
- Available as server compact rack: Perforation of front and rear doors > 80 %.
- Available as EMC and IP version (also IP-EMC combination).

**The Smaract® CompactRack is an innovative and practical 19" enclosure with extremely low space requirements that is highly flexible and efficient. At the same time, it facilitates integration and modular expansion, delivering a wide range of impressive detailed solutions.**

Knürr Smaract is an ideal, compact 19" platform available in various models that meet IP and EMC requirements.





## Knürr Smaract® Main features

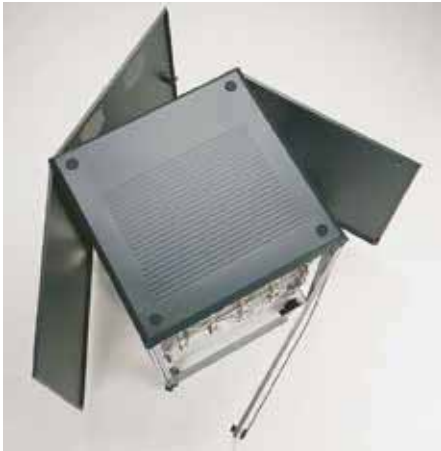

1. SMA20006



4. SMA20126

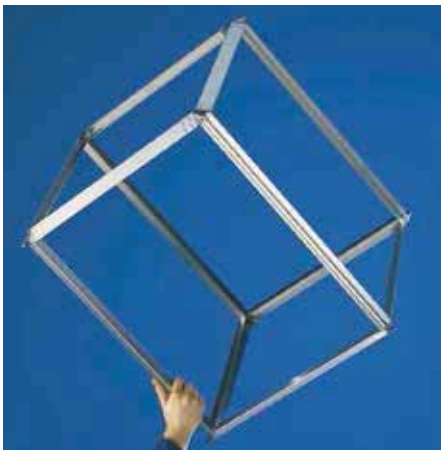

2. SMA20005



5. SMA20046



3. SMA20004



6. SMA20017

- **Access**  
 Access from all sides is a time-saving factor, e. g. for integration of components and for maintenance. (1)
- **Intelligent construction**  
 Innovative frame concept delivers low weight while providing high stability with new triangular extrusions. (2)
- **Modular concept: simple expansion with stackability**  
 Provides adequate space on the side for cabling; cable entry on rear door. (3)
- **Cable management**  
 Well prepared to have and easy and self-explanatory cabling. (4)
- **EMC and IP version**  
 The compact rack can be upgraded to IP or EMC standard at all times. (Also in combined IP/EMC version). (5)
- **Forward-thinking Solutions**  
 Flexibility due to integration of 19" technology.  
 6 heights to choose from; 9 U to 24 U. (6)





SMA20067

**Knürr Smaract® 19" Rack Compliant with IEC 297**  
**Technical data**

- **19" components compliant with IEC 297-3**
  - Height: 9 U / 24 U  
1 U = 44,45 mm.
  - Width: 482.6 mm (19").
  - Depths: 600, 800, 900 and 1000 mm.
- **Versions**
  - IP 20.
  - IP 54.
  - EMC.
- **Available space**
  - 82 % of the basic surface can be used as space for installation and cable routing.
- **Configuration**
  - Fixed, on leveling feet.
  - Mobile, on casters with snib.
- **Tests Dependent on design**
  - Safety compliant with EN 50298 and EN 60950.
  - Protective conductor/grounding compliant with DIN VDE 0701-1.
  - Vibration test compliant with MIL-STD 810 E.
  - Vibration and shock test compliant with DIN EN 300019-2-2.
  - IP test compliant with DIN EN 60529.
  - EMC shielding attenuation compliant with IEEE-STD-299 and VG 95 373 part 15 (30 MHz - 1 GHz).
  - Plastic components as per UL94 V-0.

**Applications**



SMA20166



SMA20109



SMA20122



SMA20181



SMA20009



SMA20024

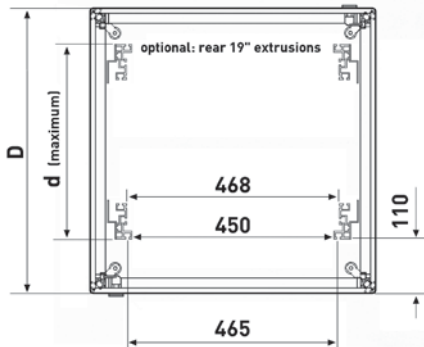
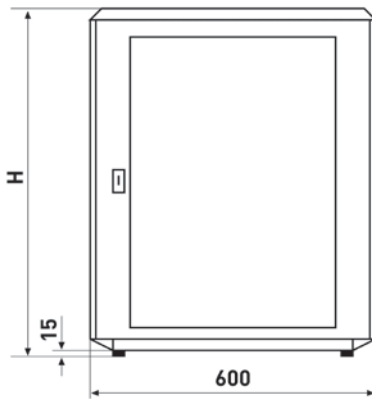

SMA20026

## Knürr Smaract® 19" Compact Rack with Glass Door

- For components compliant with IEC 297-3.
- Access from all sides with removable covers.
- Flexible assembly of the components using T-slot (optional with mounting holes).
- Cable entry via rear panel (optional via top cover/bottom cover).
- Heat loss discharge via own convection or with fan unit on the rear panel (accessory).
- Door opening angle, 180°.
- Front door with safety glass, lockable.

### ■ Jumpering space

- Front 110 mm.

### ■ Load rating

- 2000 N static.

### ■ Protection rating

- IP 20.

### ■ Material / Finish

- Basic rack, extruded aluminum, polished.
- Corner piece, die-cast aluminum, polished.
- Covers, sheet steel, powder-coated texture.
- Glass infill front door, single safety glass panel.

### ■ Color

- RAL 7035, light-grey.

### ■ Standard inclusion

- 1 x basic rack.
- 2 x side panels, closed; hinged on both sides.
- 1 x top cover, closed.
- 1 x glass front door, lockable.
- 1 x rear door with cable entry, lockable, prepared for ventilation unit.
- 2 x 19" aluminum vertical extrusions, front, with T-slot and increment slide for spring nut M5 or 19" sheet steel vertical extrusion, front (see table).
- 1 x grounding set.
- 4 x leveling feet.

### ■ Delivery

- Mounted.

### ■ Note

If required, please also order 19" extrusions (see pages 141) for rear 19" level.

W	H	D	U	h	D (max.)	kg	Model	Order No.	UP
600	478	600	9	450	16	With 19" T-slot extru.	<b>02.110.007.1</b>	1 unit	
600	612	600	12	450	20	With 19" T-slot extru.	<b>02.110.012.1</b>	1 unit	
600	745	600	15	450	24	With 19" T-slot extru.	<b>02.110.017.1</b>	1 unit	
600	879	600	18	450	28	With 19" T-slot extru.	<b>02.110.022.1</b>	1 unit	
600	1012	600	21	450	32	With 19" T-slot extru.	<b>02.110.027.1</b>	1 unit	
600	1143	600	24	450	36	With 19" T-slot extru.	<b>02.110.032.1</b>	1 unit	

600	478	800	9	650	19	With 19" T-slot extru.	<b>02.110.009.1</b>	1 unit
600	612	800	12	650	23	With 19" T-slot extru.	<b>02.110.014.1</b>	1 unit
600	745	800	15	650	27	With 19" T-slot extru.	<b>02.110.019.1</b>	1 unit
600	879	800	18	650	31	With 19" T-slot extru.	<b>02.110.024.1</b>	1 unit
600	1012	800	21	650	35	With 19" T-slot extru.	<b>02.110.029.1</b>	1 unit
600	1145	800	24	650	39	With 19" T-slot extru.	<b>02.110.034.1</b>	1 unit

600	478	600	9	450	16	With 19" mount. hole extru.	<b>02.110.057.1</b>	1 unit
600	612	600	12	450	20	With 19" mount. hole extru.	<b>02.110.062.1</b>	1 unit
600	745	600	15	450	24	With 19" mount. hole extru.	<b>02.110.067.1</b>	1 unit
600	879	600	18	450	28	With 19" mount. hole extru.	<b>02.110.072.1</b>	1 unit
600	1012	600	21	450	32	With 19" mount. hole extru.	<b>02.110.077.1</b>	1 unit
600	1145	600	24	450	36	With 19" mount. hole extru.	<b>02.110.082.1</b>	1 unit

600	478	800	9	650	19	With 19" mount. hole extru.	<b>02.110.059.1</b>	1 unit
600	612	800	12	650	23	With 19" mount. hole extru.	<b>02.110.064.1</b>	1 unit
600	745	800	15	650	27	With 19" mount. hole extru.	<b>02.110.069.1</b>	1 unit
600	879	800	18	650	31	With 19" mount. hole extru.	<b>02.110.074.1</b>	1 unit
600	1012	800	21	650	35	With 19" mount. hole extru.	<b>02.110.079.1</b>	1 unit
600	1145	800	24	650	39	With 19" mount. hole extru.	<b>02.110.084.1</b>	1 unit



SMA20067

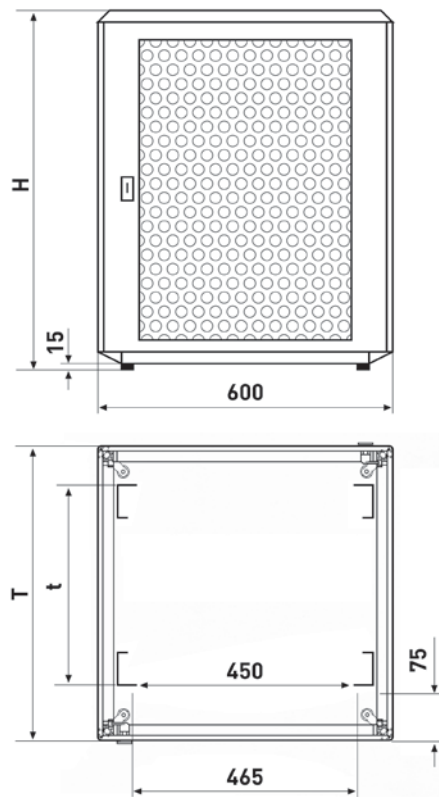

SMA20060

## Knürr Smaract® 19" Server-Compact Rack with Perforated Door

- For components compliant with IEC 297-3.
- Access from all sides, removable covers.
- With special 19" server extrusions for mounting trade-standard servers.
- With perforated doors on the front and rear (hexagonal holes with large flow cross-section) for optimal airflow.
- Door opening angle, 180°.

### ■ Jumping space

- Front 75 mm.

### ■ Flow cross-section

- 1150 cm<sup>2</sup> with 9 U.
- 1950 cm<sup>2</sup> with 15 U.
- 2700 cm<sup>2</sup> with 21 U.
- 3100 cm<sup>2</sup> with 24 U.

### ■ Material / Finish

- Basic rack, extruded aluminum, polished.
- Corner piece, die-cast aluminum, polished.
- Covers, sheet steel, powder-coated texture.

### ■ Color

- Final digit of order number .1: RAL 7035, light-grey.
- Final digit of order number .8: RAL 7021 dark-grey.

### ■ Standard inclusion

- 1 x basic rack.
- 2 x side panels, closed, hinged on both sides.
- 1 x top cover, closed.
- 1 x front door with perforation, lockable.
- 1 x front door with perforation, lockable.
- 4 x 19" server sheet-steel with mounting hole extrusions.
- 1 x grounding set.
- 4 x leveling feet.

### ■ Note

Order mounting adapters for 19" server extrusion for applying Knürr accessories. Set with 4 adapters referenz number 01.127.119.9.

W	H	D	U	h	d	kg	Model	Order No.	UP
600	478	900	9		740	21	Door without extrusion	<b>02.110.010.1</b>	1 unit
600	478	900	9		740	21	Door without extrusion	<b>02.110.010.8</b>	1 unit
600	745	900	15		740	29	Door with extrusion	<b>02.110.020.1</b>	1 unit
600	745	900	15		740	29	Door with extrusion	<b>02.110.020.8</b>	1 unit
600	1012	900	21		740	37	Door with extrusion	<b>02.110.030.1</b>	1 unit
600	1012	900	21		740	37	Door with extrusion	<b>02.110.030.8</b>	1 unit
600	1145	900	24		740	41	Door with extrusion	<b>02.110.035.1</b>	1 unit
600	1145	900	24		740	41	Door with extrusion	<b>02.110.035.8</b>	1 unit
600	1145	1000	24		740	43	Door with extrusion	<b>02.110.040.1</b>	1 unit
600	1145	1000	24		740	43	Door with extrusion	<b>02.110.040.8</b>	1 unit

#### Dimensions in mm:

W =Width	h =Installation height	U =Standard rack unit	kg =Weight
H =Height	d =Usable depth	(1 U = 44.45 mm)	
D =Depth	L =Length	UP =Packaging unit	

#### Conversion:

1 mm =0.03937 inch
1 kg =2.2046 pounds



SMA20194

## Knürr Smaract® Glass Door, with Swing Handle

- Can be used as front and rear door.
- With swing handle for mounting a profile half-cylinder lock.
- **Material**
  - Covers, sheet steel, powder-coated texture.
  - Glass infill, single safety glass panel.
- **Finish**
  - Powder-coated texture, RAL 7035 light-grey.
- **Standard inclusion**
  - 1 x glass door with swing handle.
  - 1 x Mounting kit.
- **Delivery**
  - In sets.

W	H	D	U	d (max.)	kg	Model	Order No.	UP
600	478		9			Glass door	02.111.086.1	1 unit
600	612		12			Glass door	02.111.087.1	1 unit
600	745		15			Glass door	02.111.088.1	1 unit
600	879		18			Glass door	02.111.089.1	1 unit
600	1012		21			Glass door	02.111.090.1	1 unit
600	1143		24			Glass door	02.111.091.1	1 unit



SMA20193

## Knürr Smaract® Door, perforated with Swing Handle

- Can be used as front and rear door.
- With swing handle for mounting a profile half-cylinder lock.
- Hexagonal holes with large flow cross-section.
- **Material**
  - Covers, sheet steel, powder-coated texture.
- **Finish**
  - Final digit of order number .1: powder-coated texture, RAL 7035, light-grey.
  - Final digit of order number .8: powder-coated texture, RAL 7021 dark-grey.
- **Standard inclusion**
  - 1 x perforated door with swing handle.
  - 1 x Mounting kit.
- **Delivery**
  - In sets.

W	H	D	U	d (max.)	kg	Model	Order No.	UP
600	478		9			Perforated door	02.111.096.1	1 unit
600	612		12			Perforated door	02.111.097.1	1 unit
600	745		15			Perforated door	02.111.098.1	1 unit
600	879		18			Perforated door	02.111.099.1	1 unit
600	1012		21			Perforated door	02.111.100.1	1 unit
600	1143		24			Perforated door	02.111.101.1	1 unit

Dimensions in mm:				Conversion:	
W = Width	h = Installation height	U = Standard rack unit	kg = Weight	1 mm = 0.03937 inch	
H = Height	d = Usable depth	1 U = 44.45 mm		1 kg = 2.2046 pounds	
D = Depth	L = Length	UP = Packaging unit			



SMA20195

### Knürr Smaract® Ventilation Unit

- Easily added onto a rear panel.
- With two axial fans.
- With thermostat.
- Available in two different performance classes.

- **Technical data for single fan**
  - Type 1:
    - max. volume flow (free blowing): 162 m³/h.
    - Noise emission (free blowing): 37 dB(A).
  - Type 2 (quiet):
    - max. volume flow (free blowing): 120 m³/h.
    - Noise emission (free blowing): 32 dB(A).

- **Technical data for thermostat**
  - Setting range: 0 to 60 °C.
  - Mains supply: 240 V / 50 Hz.
  - Nominal current: 16 A.

- **Material / Finish**
  - Zinc-passivated sheet steel.

- **Standard inclusion**
  - 1 x fan unit wired ready for connection, with thermostat.
  - 1 x Mounting kit.

- **Delivery**
  - Pre-assembled.



SMA20180

W	H	D	U	h	d	kg	Model	Order No.	UP
							Type 1	02.111.180.9	1 unit
							Type 2 (quiet)	02.111.181.9	1 unit



SMA20103

### Knürr Smaract® 19" Aluminum Extrusion with T-slot

- For front and rear installation.

- **Material / Finish**
  - 19" extrusions: extruded aluminum polished.
  - Mounting bracket: Sheet steel, zinc-passivated.

- **Standard inclusion**
  - 2 x 19" extrusions with T-slot incl. increment slides.
  - 4 x mounting brackets.
  - 1 x Mounting kit.

- **Delivery**
  - In sets.

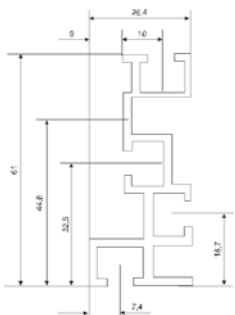

SMA20105

W	H	D	U	d	kg	Model	Order No.	UP
			9				02.111.146.9	1 unit
			12				02.111.147.9	1 unit
			15				02.111.148.9	1 unit
			18				02.111.149.9	1 unit
			21				02.111.150.9	1 unit
			24				02.111.151.9	1 unit



SMA20104

### Knürr Smaract® 19" Steel Extrusion with Mounting Holes

- For front and rear installation.

- **Material / Finish**
  - 19" extrusions: sheet steel, zinc-passivated.
  - Mounting bracket: sheet steel, 1.5 mm, zinc-passivated.

- **Standard inclusion**
  - 2 x 19" extrusions with mounting holes.
  - 4 x mounting brackets.
  - 1 x Mounting kit.

- **Delivery**
  - In sets.

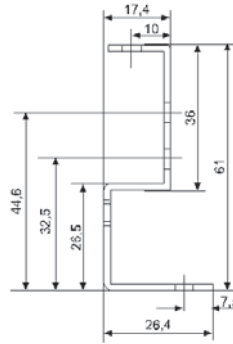

SMA20106

W	H	D	U	d	kg	Model	Order No.	UP
			9				02.111.156.9	1 unit
			12				02.111.157.9	1 unit
			15				02.111.158.9	1 unit
			18				02.111.159.9	1 unit
			21				02.111.160.9	1 unit
			24				02.111.161.9	1 unit



MIR20046

### Knürr Smaract® 19" Sheet Steel Server Extrusion

- For front and rear installation.

- **Material / Finish**
  - Sheet steel, zinc-passivated 2.5 mm.

- **Standard inclusion**
  - 2 x 19" extrusions with mounting holes.
  - 1 x Mounting kit.

- **Standard inclusion**
  - In sets.

- **Note**
  - Please also order mounting adapter: 01.127.119.9 (complete with 4 adapters).

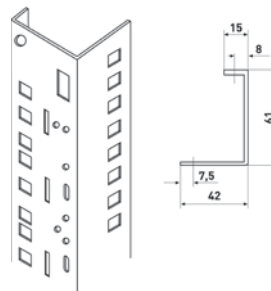

MIR20041

W	H	D	U	d	kg	Model	Order No.	UP
			9				02.111.136.9	1 unit
			12				02.111.137.9	1 unit
			15				02.111.138.9	1 unit
			18				02.111.139.9	1 unit
			21				02.111.140.9	1 unit
			24				02.111.141.9	1 unit



MIR20044

## Mounting Adapters for 19" Server Extrusion

- For mounting standard Knürr components (storage shelves, drawers, chassis rails, keyboard tray, etc.) in 19" installation space.

- **Material**  
- Zinc-passivated sheet steel.
- **Standard inclusion**  
- 4 x adapters.

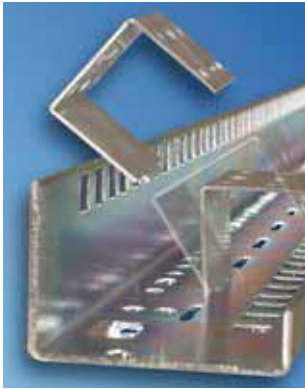

MIR20082

W	H	D	U	d	kg	Model	Order No.	UP
			1				01.127.119.9	1 unit



SMA20172

## Knürr Smaract® Depth Brace

- For additional strengthening of the enclosure.
- For routing cables with cable ties and as universal mounting option.
- With holes for mounting cage nuts.
- Variable positioning with T-slot.
- Installation on the frame extrusions.

- **Material / Finish**  
- Sheet steel, zinc-passivated 1.5 mm.

- **Standard inclusion**  
- 1 x depth brace.  
- 1 x Mounting kit.

- **Delivery**  
- In sets.

- **Note**  
Not compatible with 19" server extrusions.

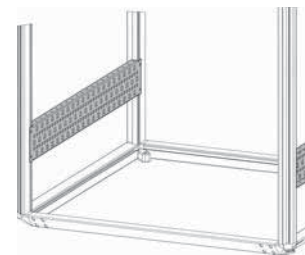

SMA20173

W	H	D	U	d	kg	Model	Order No.	UP
		600					02.111.002.0	1 unit
		800					02.111.004.0	1 unit
		900					02.111.005.0	1 unit



SMA20031

## Mounting Adapters for 19" Server Extrusion

- Can be used as front and rear door.

- **Material / Finish**  
- Sheet steel, powder-coated texture.

- **Standard inclusion**  
- 1 x rear door, closed.  
- 1 x Mounting kit.

- **Delivery**  
- In sets.

- **Color**  
- RAL 7035, light-grey.

W	H	D	U	d	kg	Model	Order No.	UP
			9				02.111.076.1	1 unit
			12				02.111.077.1	1 unit
			15				02.111.078.1	1 unit
			18				02.111.079.1	1 unit
			21				02.111.080.1	1 unit
			24				02.111.081.1	1 unit

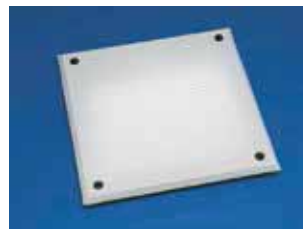

SMA20028

## Knürr Smaract® Top Cover/Bottom Cover closed

- **Material / Finish**  
- Sheet steel, powder-coated texture.

- **Color**  
- Final digit of order number .1:  
RAL 7035, light-grey.  
- Final digit of order number .8:  
RAL 7021 dark-grey.

- **Standard inclusion**  
- 1 x bottom cover, closed.  
- 1 x Mounting kit.

- **Delivery**  
- In sets.

- **Note**  
The bottom cover complete with the fixed plinth.

W	H	D	U	d	kg	Model	Order No.	UP
600		600					02.111.052.1	1 unit
600		800					02.111.054.1	1 unit
600		900					02.111.055.1	1 unit
600		900					02.111.055.8	1 unit
600		1000					02.111.056.1	1 unit
600		1000					02.111.056.8	1 unit



SMA20168

## Knürr Smaract® Top Bottom Cover with Cable Entry

- With integrated cable clamping.
- With brush strip for cable entry.

■ **Material / Finish**  
- Sheet steel, powder-coated texture.

■ **Color**  
- Final digit of order number .1:  
RAL 7035, light-grey.  
- Final digit of order number .8:  
RAL 7021 dark-grey.

■ **Standard inclusion**  
- 1 x bottom cover with cable routing.  
- 1 x brush strip.  
- 1 x Mounting kit.

■ **Delivery**  
- In sets.

W	H	D	U	d	kg	Model	Order No.	UP
600		600					02.111.042.1	1 unit
600		800					02.111.044.1	1 unit
600		900					02.111.045.1	1 unit
600		900					02.111.045.8	1 unit
600		1000					02.111.046.1	1 unit
600		1000					02.111.046.8	1 unit

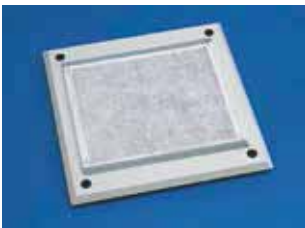

SMA20029

## Knürr Smaract® Bottom Cover, perforated with Filter Mat

- For cooling with air convection.

■ **Material / Finish**  
- Bottom cover: sheet steel, powder-coated texture.  
- Filter mat: Filedon

■ **Color**  
- RAL 7035, light-grey.

■ **Standard inclusion**  
- 1 x perforated bottom cover with filter mat.  
- 1 x Mounting kit.

■ **Delivery**  
- In sets.

W	H	D	U	d	kg	Model	Order No.	UP
600		600					02.111.062.1	1 unit
600		800					02.111.064.1	1 unit
600		900					02.111.065.1	1 unit



SMA20058

## Knürr Smaract® Replacement Filter Mat for perforated Bottom Cover

- Used with perforated bottom cover.

■ **Material / Finish**  
- Filedon.

■ **Standard inclusion**  
- 5 x replacement filter mats.

■ **Delivery**  
- In sets.

W	H	D	U	d	kg	Model	Order No.	UP
						for D600	02.111.068.9	5 units
						For D800	02.111.069.9	5 units
						for T900	02.111.069.9	5 units



SMA20177

## Knürr Smaract® Plinth

- Fixed.
- Cable entry possible from all sides.
- Panels front and rear with vent slots and installation option for filter mat.

■ **Material / Finish**  
- Sheet steel, powder-coated texture.

■ **Color**  
- Final digit of order number .1:  
RAL 7035, light-grey.  
- Final digit of order number .8:  
RAL 7021 dark-grey.

■ **Standard inclusion**  
- 4 x plinth corners.  
- 2 x cover plates, closed.  
- 2 x cover plates with vent slots.  
- 1 x Mounting kit.

■ **Delivery**  
- In sets.

W	H	D	U	d	kg	Model	Order No.	UP
600	100	600					02.111.201.1	1 set
600	100	800					02.111.203.1	1 set
600	100	900					02.111.204.1	1 set
600	100	900					02.111.204.8	1 set

### Dimensions in mm:

W = Width    h = Installation height    U = Standard rack unit  
H = Height    d = Usable depth                    1 U = 44.45 mm  
D = Depth    L = Length                    UP = Packaging unit

### Conversion:

kg = Weight    1 mm = 0.03937 inch  
1 kg = 2.2046 pounds



SMA20098

## Knürr Smaract® Plinth Cover Plate with Cable Entry

- Used with plinth.
- **Material / Finish**
  - Sheet steel, powder-coated texture.
- **Standard inclusion**
  - 1 x cover panel with cable entry.
  - 1 x brush strip.
  - 1 x Mounting kit.
- **Color**
  - Final digit of order number .1: RAL 7035, light-grey.
  - Final digit of order number .8: RAL 7021 dark-grey.
- **Delivery**
  - In sets.

W	H	D	U	d	kg	Model	Order No.	UP
600	100						02.111.206.1	1 unit
600	100						02.111.206.8	1 unit



SMA20034

## Knürr Smaract® Twin Caster

- Height 50 mm.
- **Color**
  - RAL 9011, graphite black.
- **Load rating**
  - 400 N per caster.
  - 1200 N max. static total load per rack.
- **Standard inclusion**
  - 2 x twin casters.
  - 2 x fixed casters.
- **Standards**
  - Casters compliant with DIN 12530.
  - Load compliant with DIN 12527.
- **Delivery**
  - In sets.

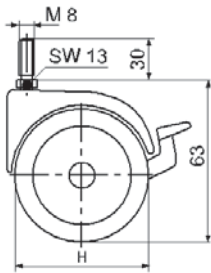

DOP00233

W	H	D	U	d	kg	Model	Order No.	UP
							02.111.175.9	4 units



SMA20035

## Knürr Smaract® Stacking Set

- Fixed connection for stacking compact racks.
- **Material / Finish**
  - Steel, cold rolled, zinc-passivated.
- **Standard inclusion**
  - 4 x stacking elements.
  - 1 x Mounting kit.
- **Delivery**
  - In sets.

W	H	D	U	d	kg	Model	Order No.	UP
							02.111.171.9	4 unit



MEC00074

## Knürr Smaract® Eyebolt Set

- Mounted/fixed on crane hooks.
- Load rating, 1900 N static per ring screw.
- **Material / Finish**
  - Tool steel, forged.
- **Standard inclusion**
  - 4 x crane eyes.
- **Delivery**
  - In sets.

W	H	D	U	d	kg	Model	Order No.	UP
							01.243.440.9	4 units

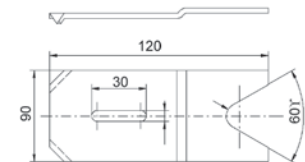

MIR00319

## Assembly kit for Securing Bottom Plate

- **Material / Finish**
  - Sheet steel, 3.0 mm.
- **Finish**
  - Galvanized.
- **Standard inclusion**
  - 4 x clamping plates.

W	H	D	U	d	kg	Model	Order No.	UP
							01.130.934.7	1 unit



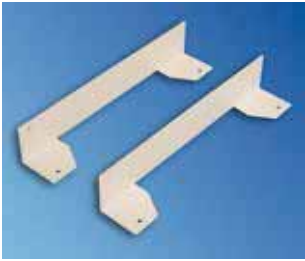

SMA20094

### Knürr Smaract® Wall Mounting Bracket

- **Material / Finish**  
– Sheet steel, powder-coated texture.
- **Color**  
– RAL 7035, light-grey.
- **Standard inclusion**  
– 2 x wall mounting brackets.  
– 1 x Drill hole template.  
– 1 x Mounting kit.
- **Load rating**  
– 500 N.
- **Delivery**  
– In sets.



SMA20085

W	H	D	U	d	kg	Model	Order No.	UP
600							<b>02.111.220.9</b>	1 set



ELM00068

### Grounding Bar

- For safe grounding or potential equalization of equipments and components.
- **Material**  
– Electrolyte copper 9 x 9.
- **Standard inclusion**  
– 1 x grounding bar.  
– 2 x brackets.  
– 1 x Mounting kit.

W	H	S	U	h	d	w	Model	Order No.	UP
			12					<b>01.110.703.9</b>	1 unit
			15					<b>01.240.543.9</b>	1 unit
			18					<b>01.240.544.9</b>	1 unit
			21					<b>01.240.545.9</b>	1 unit
			24					<b>01.240.546.9</b>	1 unit



DOP20016

### Contact Clamp

- Enables safe connection of equipment and components to grounding bar.
- For cables up to 25 mm<sup>2</sup>.
- **Standard inclusion**  
– 20 x contact clamps.

W	H	S	U	h	d	w	Model	Order No.	UP
								<b>01.110.715.9</b>	20 units

Dimensions in mm:						Conversion:	
W = Width	h = Installation height	U = Standard rack unit	kg = Weight	1 mm = 0.03937 inch			
H = Height	d = Usable depth	1 U = 44.45 mm		1 kg = 2.2046 pounds			
D = Depth	L = Length	UP = Packaging unit					



SMA20035

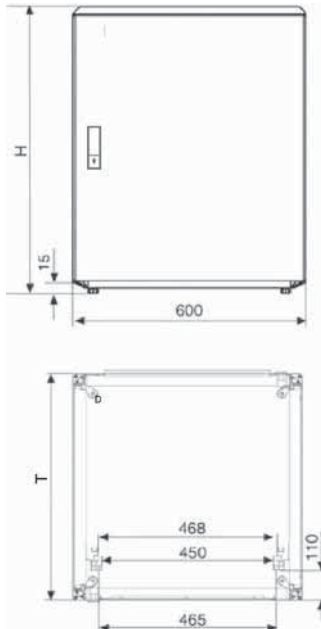

SMA20059

## Knürr Smaract® 19" Compact Rack

- For components compliant with IEC 297-3.
- Removable covers.

### Load rating

- 2000 N static.

### Material

- Basic frame: extruded aluminum.
- Panels: sheet steel.
- EMC spring: stainless steel.

### Finish

- Basic frame: polished.
- Panels: powder-coated texture.

### Color

- RAL 7035, light-grey.

### Standard inclusion

- 1 x basic rack.
- 2 x side panels, EMC, closed, top on both sides.
- 1 x top cover, EMC, closed.
- 1 x bottom cover, EMC, closed.
- 1 x front door, EMC, closed, lockable.
- 1 x rear panel, EMC, closed, screwed.
- 2 x 19" front aluminum vertical extrusions with T-slot incl. increment slide.
- 1 x grounding set.
- 4 x leveling feet.

### Delivery

- Mounted.

W	H	D	U	h	d (max.)	kg	Model	Order No.	UP
600	612	600	12			28		<b>02.110.312.1</b>	1 unit
600	879	600	18			36		<b>02.110.322.1</b>	1 unit
600	1146	600	24			44		<b>02.110.332.1</b>	1 unit
600	612	800	12			32		<b>02.110.314.1</b>	1 unit
600	879	800	18			40		<b>02.110.324.1</b>	1 unit
600	1146	800	24			48		<b>02.110.334.1</b>	1 unit

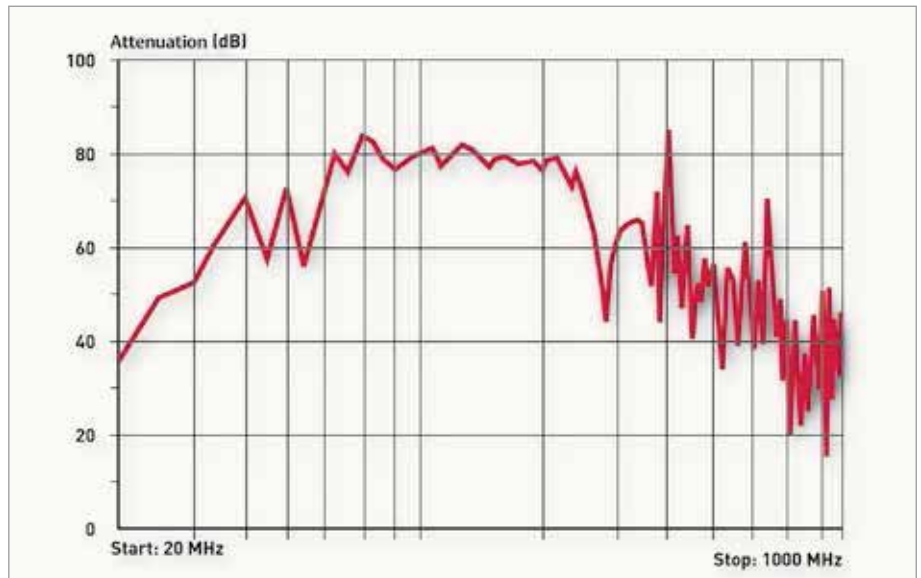

- EMC measurements performed by pkm Electronic GmbH, Frontenhausen.
- Tests were carried out in compliance with the following standard: VG 95373 Part 15.
- Tested rack: width 600, depth 600, height 1150, closed version.



SMA20148

**Knürr Smaract®**  
Connection Plate, EMC, closed

- EMC shielding.
- Screwed.
- **Material**
  - Panel: sheet steel.
  - EMC spring: stainless steel.



SMA20137

- **Finish**
  - Powder-coated texture.
- **Color**
  - RAL 7035, light-grey.
- **Standard inclusion**
  - 1 x connection plate.
  - 2 x brackets.
  - 1 x Mounting kit.
- **Delivery**
  - In sets.

W	H	D	U	h	d	kg	Model	Order No.	UP
600	131.3		3					02.111.351.1	1 set



SMA20145

**Knürr Smaract®**  
Connection Plate, EMC, with Cable Entry

- EMC shielding.
- Screwed.
- **Material**
  - Panel: sheet steel.
  - EMC spring: stainless steel.
  - EMC seal extrusion: with high-grade steel grid; rubber.



SMA20137

- **Finish**
  - Powder-coated texture.
- **Color**
  - RAL 7035, light-grey.
- **Standard inclusion**
  - 1 x connection plate with cable entry.
  - 2 x brackets.
  - 1 x Mounting kit.
- **Delivery**
  - In sets.

W	H	D	U	h	d	kg	Model	Order No.	UP
600	131.3		3					02.111.361.1	1 set

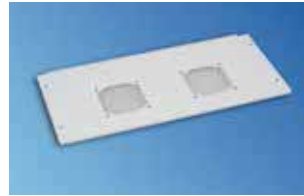

SMA20150

**Knürr Smaract®**  
Connection Plate, EMC, for Fan Unit

- EMC shielding.
- Screwed.
- **Material**
  - Panel: sheet steel.
  - EMC spring: stainless steel.



SMA20135

- **Finish**
  - Powder-coated texture.
- **Color**
  - RAL 7035, light-grey.
- **Standard inclusion**
  - 1 x connection plate for fan unit.
  - 2 x brackets.
  - 1 x Mounting kit.
- **Delivery**
  - In sets.
- **Note**
  - Suitable fan unit: 02.111.180.9.

W	H	D	U	h	d	kg	Model	Order No.	UP
600	264.6		6					02.111.372.1	1 set



SMA20152

**Knürr Smaract®**  
Rear Plate, EMC, closed

- EMC shielding.
- Screwed.
- **Material**
  - Panel: sheet steel.
  - EMC spring: stainless steel.



SMA20137

- **Finish**
  - Powder-coated texture.
- **Color**
  - RAL 7035, light-grey.
- **Standard inclusion**
  - 1 x connection plate.
  - 2 x brackets.
  - 1 x Mounting kit.
- **Delivery**
  - In sets.

W	H	D	U	h	d	kg	Model	Order No.	UP
600	422.9		9					02.111.353.1	1 set
600	556.3		12					02.111.354.1	1 set
600	689.6		15					02.111.355.1	1 set

**Dimensions in mm:**

W = Width    h = Installation height    U = Standard rack unit    kg = Weight  
 H = Height    d = Usable depth (1 U = 44.45 mm)  
 D = Depth    L = Length    UP = Packaging unit

**Conversion:**

1 mm = 0.03937 inch  
 1 kg = 2.2046 pounds



SMA20062

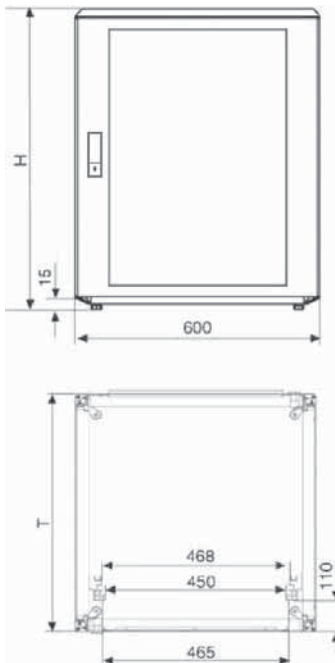

SMA20108

## Knürr Smaract® 19" Compact Rack with Glass Door

- For components compliant with IEC 297-3.
- Removable covers.
- **Load rating**
  - 2000 N static.
- **Protection rating**
  - IP 54.
- **Material**
  - Basic frame: extruded aluminum.
  - Panels: sheet steel.
  - Foam seal: polyurethane.
- **Finish**
  - Basic frame: polished.
  - Panels: powder-coated texture.
- **Color**
  - RAL 7035, light-grey.
- **Standard inclusion**
  - 1 x basic frame.
  - 2 x side panels, IP 54, closed, stop on both sides.
  - 1 x top cover, IP 54, closed.
  - 1 x bottom cover, IP 54, closed.
  - 1 x glass front door IP 54, lockable.
  - 1 x rear panel, IP 54, closed, screwed.
  - 2 x 19" aluminum vertical extrusions, front, with T-slot incl. increment slide.
  - 1 x grounding set.
  - 4 x leveling feet.
- **Delivery**
  - Mounted.

W	H	D	U	h	d (max.)	kg	Model	Order No.	UP
600	612	600	12			28		02.110.212.1	1 unit
600	879	600	18			36		02.110.222.1	1 unit
600	1146	600	24			44		02.110.232.1	1 unit
600	612	800	12			32		02.110.214.1	1 unit
600	879	800	18			40		02.110.224.1	1 unit
600	1146	800	24			48		02.110.234.1	1 unit



SMA20148

**Knürr Smaract®  
Connection Plate**

- Protection rating, IP 54
- Screwed.
- Material**
  - Panel: sheet steel.
  - Foam seal: polyurethane.



SMA20138

- Finish**
  - Powder-coated texture.
- Color**
  - RAL 7035, light-grey.
- Standard inclusion**
  - 1 x connection plate.
  - 2 x brackets.
  - 1 x Mounting kit.
- Delivery**
  - In sets.

W	H	D	U	h	d	kg	Model	Order No.	UP
600	131.3		3					<b>02.111.301.1</b>	1 set



SMA20139

**Knürr Smaract®  
Connection Plate, with Cable Entry**

- Possible sealing: IP 54.
- Screwed.
- Material**
  - Panel: sheet steel.
  - Foam seal: polyurethane.
  - Seal extrusion:
    - Type 1: sponge-rubber seal.
    - Type 2: polymeric reinforced with metal.



SMA20169

- Finish**
  - Powder-coated texture.
- Color**
  - RAL 7035, light-grey.
- Standard inclusion**
  - 1 x connection plate with cable entry.
  - 2 x brackets.
  - 1 x Mounting kit.
- Delivery**
  - In sets.

W	H	D	U	h	d	kg	Model	Order No.	UP
600	131.3		3				Type 1	<b>02.111.311.1</b>	1 set
600	131.3		3				Type 2	<b>02.111.312.1</b>	1 set



SMA20143

**Knürr Smaract®  
Connection Plate, for Fan Unit**

- Protection rating, IP 54.
- Screwed.
- Material**
  - Panels: sheet steel.
  - Foam seal: polyurethane.
  - Exit filter: plastic, UL94 V-0.



SMA20136

- Finish**
  - Powder-coated texture.
- Color**
  - RAL 7035, light-grey.
- Standard inclusion**
  - 1 x connection plate for fan insert.
  - 2 x brackets.
  - 1 x Mounting kit.
- Delivery**
  - In sets.
- Note**
  - Suitable fan unit: 02.111.180.9.

W	H	D	U	h	d	kg	Model	Order No.	UP
600	264.6		6					<b>02.111.322.1</b>	1 set

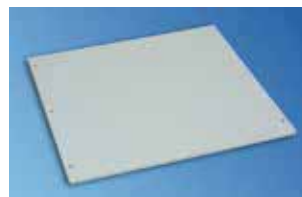

SMA20141

**Knürr Smaract®  
Rear Panel, closed**

- Protection rating, IP 54.
- Screwed.
- Material**
  - Panels: sheet steel.
  - Foam seal: polyurethane.



SMA20138

- Finish**
  - Powder-coated texture.
- Color**
  - RAL 7035, light-grey.
- Standard inclusion**
  - 1 x connection plate for fan insert.
  - 2 x brackets.
  - 1 x Mounting kit.
- Delivery**
  - In sets.

W	H	D	U	h	d	kg	Model	Order No.	UP
600	156.3		3					<b>02.111.308.1</b>	1 set
600	289.6		6					<b>02.111.302.1</b>	1 set
600	422.9		9					<b>02.111.303.1</b>	1 set
600	556.3		12					<b>02.111.304.1</b>	1 set
600	689.6		15					<b>02.111.305.1</b>	1 set
600	823		18					<b>02.111.306.1</b>	1 set
600	956.3		21					<b>02.111.307.1</b>	1 set

Dimensions in mm:						Conversion:	
W = Width	h = Installation height	U = Standard rack unit	kg = Weight	1 mm = 0.03937 inch			
H = Height	d = Usable depth	(1 U = 44.45 mm)		1 kg = 2.2046 pounds			
D = Depth	L = Length	UP = Packaging unit					

# Knürr DoubleProRack®

## Stand-Alone Enclosure

### Features

- Complete 19" enclosure range from the 3 U desktop enclosure to the 24 U compact rack.
- Innovative design.
- Removable front glass door.
- Integrated carrying handle permits easy manageability, particularly with the desktop enclosure.
- Open front end makes for easy accessibility.

**DoubleProRack is the choice of rack if an innovative design is requested for electronic and networking applications.**



*Knürr DoubleProRack®*



## Knürr DoubleProRack® 19" Enclosure Compliant with IEC 297-3 Technical data

- Die-cast aluminum frame construction connected with depth and vertical extrusions made of aluminum.
- **External dimensions**
  - Widths:
    - 554.4 mm
    - 754.4 (network enclosure).
  - Depths
    - 500, 600, 700 or 800 mm.
  - Heights: 3 U to 24 U.
- **Installation space compliant with IEC 297-3.**
  - Height 3 – 24 HE
  - (1 U = 44.45 mm).
  - Width 19".
- **Tests**
  - Vibration test compliant with MIL-STD 810 E.
  - NEMA 12 test.

### Applications



DOP20019



DOP00225



DOP20037



DOP20028





DOP00256

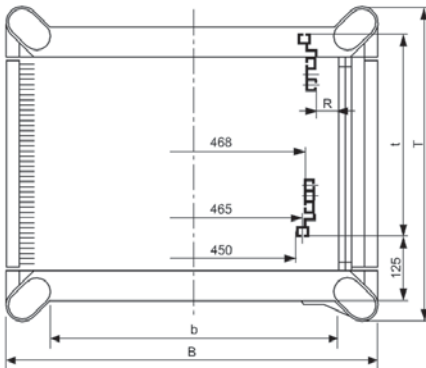
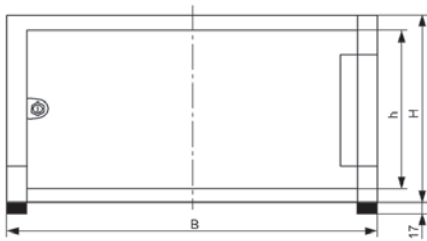

DOP00230

## Knürr DoubleProRack® 19" Stand-alone Enclosure

### Description

- For components compliant with IEC 297-3.
- Side covers and rear panel may be removed.
- Flexible assembly of components using T-slot (also available with mounting holes).
- Cable entry via rear panel.
- Heat loss discharge via convection on the rear panel (optional with fan unit).

### Jumpering space

- Front 125 mm.

### Load rating

- 1500 N static.

### Protection rating

- IP 20.

### Material / Finish

- Covers, sheet steel, powder-coated texture.
- Die-cast aluminum frame.
- Aluminum extrusions.
- Front door glass infill, single safety glass panel.

### Color

- Panels RAL 7035 light-grey.
- Frame and extrusions, RAL 5008, grey-blue.

### Standard inclusion

- 1 x frame rack incl. side covers.
- 1 x full glass door.
- 1 x rear panel with cable entry, 3 parts.
- 1 x panel, above, with vent slots.
- 1 x panel, below, with vent slots.
- 1 x 19" component set (4 vertical extrusions with T-slot).
- 1 x grounding set with M8 grounding bolt.

### Delivery

- Mounted.

W	H	D	U	h	d (max.)	kg	Model	Order No.	UP
554.4	311	600	6	265	435		With full glass door	<b>01.246.641.1</b>	1 unit
554.4	444	600	9	399	435		With full glass door	<b>01.246.642.1</b>	1 unit
554.4	577	600	12	532	435		With full glass door	<b>01.246.643.1</b>	1 unit
554.4	711	600	15	666	435		With full glass door	<b>01.246.644.1</b>	1 unit
554.4	844	600	18	799	435		With full glass door	<b>01.246.645.1</b>	1 unit
554.4	978	600	21	932	435		With full glass door	<b>01.246.646.1</b>	1 unit
554.4	1111	600	24	1066	435		With full glass door	<b>01.246.647.1</b>	1 unit
554.4	577	800	12	532	635		With full glass door	<b>01.246.843.1</b>	1 unit
554.4	711	800	15	666	635		With full glass door	<b>01.246.844.1</b>	1 unit
554.4	844	800	18	799	635		With full glass door	<b>01.246.845.1</b>	1 unit
554.4	978	800	21	932	635		With full glass door	<b>01.246.846.1</b>	1 unit
554.4	1111	800	24	1066	635		With full glass door	<b>01.246.847.1</b>	1 unit

#### Dimensions in mm:

W = Width	h = Installation height	U = Standard rack unit	kg = Weight
H = Height	d = Usable depth	1 U = 44.45 mm	
D = Depth	L = Length	UP = Packaging unit	

#### Conversion:

1 mm = 0.03937 inch
1 kg = 2.2046 pounds



DOP00253

## Knürr DoubleProRack® 19" Enclosure without Front Door

- Description**
  - For components compliant with IEC 297-3.
  - Side covers and rear panel may be removed.
  - Heat loss discharge via convection on the rear panel (optional with fan unit).
- Load rating**
  - 1500 N static.
- Protection rating**
  - IP 20.
- Material / Finish**
  - Covers, sheet steel, powder-coated texture.
  - Die-cast aluminum frame.
  - Aluminum extrusions.
- Color**
  - Panels RAL 7035 light-grey.
  - Frame and extrusions, RAL 5008, grey-blue.
- Standard inclusion**
  - 1 x frame rack incl. side covers.
  - 1 x panel, above, with vent slots.
  - 1 x panel, below, with vent slots.
  - 1 x rear panel (from 12 U enclosure height incl. 3 U vented front cover plate).
  - 2 x 19" extrusions, front, with mounting holes.
  - 2 x 19" extrusions at the rear, T-slot.
- Delivery**
  - Mounted.

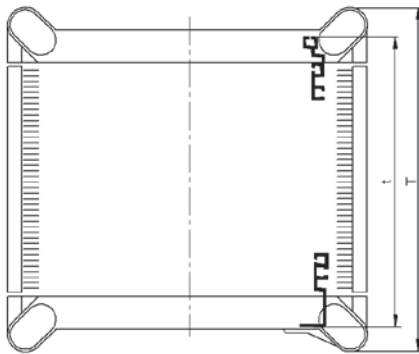
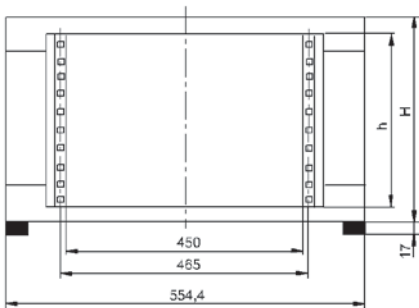

DOP00052

W	H	D	U	h	d (max.)	kg	Model	Order No.	UP
554.4	178	500	3	132	460	10.0	Without door	01.243.503.1	1 unit
554.4	311	500	6	265	460	12.5	Without door	01.243.506.1	1 unit
554.4	444	500	9	399	460	15.0	Without door	01.243.509.1	1 unit
554.4	577	500	12	532	460	17.0	Without door	01.243.512.1	1 unit
554.4	711	500	15	666	460	19.5	Without door	01.243.515.1	1 unit
554.4	844	500	18	799	460	22.0	Without door	01.243.518.1	1 unit
554.4	311	600	6	265	560	14.0	Without door	01.243.606.1	1 unit
554.4	444	600	9	399	560	16.5	Without door	01.243.609.1	1 unit
554.4	577	600	12	532	560	19.0	Without door	01.243.612.1	1 unit
554.4	711	600	15	666	560	22.0	Without door	01.243.615.1	1 unit
554.4	844	600	18	799	560	24.5	Without door	01.243.618.1	1 unit
554.4	978	600	21	932	560	27.0	Without door	01.243.621.1	1 unit
554.4	1111	600	24	1066	560	29.5	Without door	01.243.624.1	1 unit
554.4	577	700	12	532	660	21.5	Without door	01.243.712.1	1 unit
554.4	711	700	15	666	660	24.0	Without door	01.243.715.1	1 unit
554.4	844	700	18	799	660	27.0	Without door	01.243.718.1	1 unit
554.4	978	700	21	932	660	29.5	Without door	01.243.721.1	1 unit
554.4	1111	700	24	1066	660	32.5	Without door	01.243.724.1	1 unit

Dimensions in mm:				Conversion:	
W = Width	h = Installation height	U = Standard rack unit	kg = Weight	1 mm = 0.03937 inch	
H = Height	d = Usable depth	(1 U = 44.45 mm)		1 kg = 2.2046 pounds	
D = Depth	L = Length	UP = Packaging unit			



DOP20004

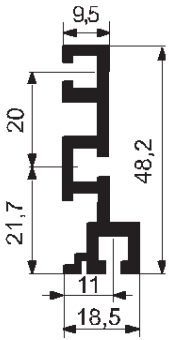

DOP00313

W	H	D	U	h	d	kg	Model	Order No.	UP
			6					01.240.440.9	1 set
			9					01.240.443.9	1 set
			12					01.240.445.9	1 set
			15					01.240.446.9	1 set
			18					01.240.447.9	1 set
			21					01.240.448.9	1 set
			24					01.240.449.9	1 set

## Knürr DoubleProRack® 19" Component, Front with T-slot

- Can also be used as second mounting level.

- **Material**  
- Aluminum extrusions.
- **Finish**  
- Polished.
- **Standard inclusion**  
- 2 x 19" extrusions at the front, T-slot.  
- 1 x Mounting kit.
- **Delivery**  
- In sets.



DOP20035

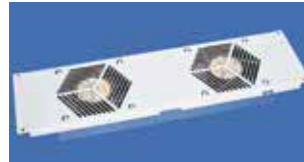

DOP20036

## Knürr DoubleProRack® Fan Rear Panel 3 U

- With axial fans.
- With thermostat.

- **Technical data for single fan**  
- Max. volume flow (free blowing): 162 m³/h.  
- Noise emission (free blowing): 37 dB(A).

- **Technical data for thermostat**  
- Setting range: 0 to 60°C.  
- Mains supply: 240 V / 50 Hz.  
- Nominal current: 16 A.

- **Standard inclusion**  
- 1 x fan rear panel, wired.  
- 1 x Mounting kit.

- **Finish / Color**  
- Powder-coated texture,  
RAL 7035 light-grey.

- **Delivery**  
- Mounted.

- **Note**  
Cannot be used in the enclosure's lowest U.

W	H	D	U	h	d	kg	Model	Order No.	UP
554.4	132.5		3				With thermostat	01.243.428.1	1 unit



DOP20005

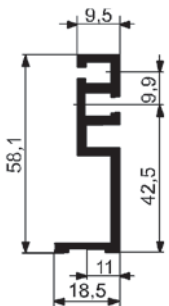

DOP00055

W	H	D	U	h	d	kg	Model	Order No.	UP
			6					01.240.490.9	1 set
			9					01.240.493.9	1 set
			12					01.240.495.9	1 set
			15					01.240.496.9	1 set
			18					01.240.497.9	1 set
			21					01.240.498.9	1 set
			24					01.240.499.9	1 set

## Knürr DoubleProRack® 19" Component, Front with Mounting Holes

- Can also be used as second mounting level.

- **Material**  
- Extruded aluminum extrusions.
- **Finish**  
- Polished.
- **Standard inclusion**  
- 2 x 19" extrusions at the front, mounting holes.
- **Delivery**  
- In sets.



DOP00275

## Knürr DoubleProRack® Rear Panel, closed

- For DoubleProRack width 554.4 mm.

- **Material / Finish**  
- Sheet steel, 0.8 mm, powder-coated texture.

- **Color**  
- RAL 7035, light-grey.

- **Standard inclusion**  
- 1 x rear panel, closed.  
- 1 x Mounting kit.

- **Delivery**  
- In sets.

W	H	D	U	h	d	kg	Model	Order No.	UP
554.4			3					01.240.451.1	1 unit
554.4			6					01.240.454.1	1 unit
554.4			9					01.240.457.1	1 unit
554.4			12					01.240.459.1	1 unit
554.4			15					01.240.460.1	1 unit
554.4			18					01.240.461.1	1 unit
554.4			21					01.240.462.1	1 unit



DOP00278

## Knürr DoubleProRack® Multi-functional Handle

- **Material / Finish**  
– Die-cast powder-coated texture.
- **Color**  
– RAL 5008, grey-blue.
- **Standard inclusion**  
– 2 x handles.  
– 1 x Mounting kit.
- **Delivery**  
– In sets.

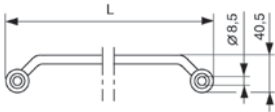

DOP00231

W	H	D	U	Model	Order No.	UP
			500		01.240.641.1	1 unit
			600		01.240.642.1	1 unit
			700		01.240.643.1	1 unit
			800		01.240.644.1	1 unit



DOP00270

## Knürr DoubleProRack® Connection Panel with Cable Routing

- To cover rear panel in combination with the corresponding rear panel shortened by 3 U.
- **Material / Finish**  
– Sheet steel, 0.8 mm, powder-coated texture.
- **Color**  
– RAL 7035, light-grey.
- **Standard inclusion**  
– 1 x connection plate with cable routing.  
– 1 x Mounting kit.
- **Delivery**  
– In sets.

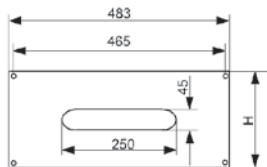

DOP00287

W	H	D	U	h	d	kg	Model	Order No.	UP
554.4	132.5		3					01.243.435.1	1 unit



DOP00274

## Knürr DoubleProRack® Connection Panel with Brush Strip

- To cover rear panel along with the corresponding rear panel shortened by 3 U.
- For DoubleProRack width 554.4 mm.
- With brush strip for cable routing and strain relief.
- **Finish / Color**  
– Powder-coated texture, RAL 7035 light-grey.
- **Standard inclusion**  
– 1 x connection plate.  
– 1 x Mounting kit.
- **Delivery**  
– In sets.

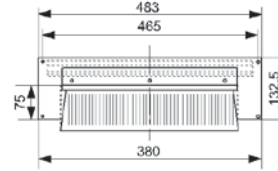

DOP00288

W	H	D	U	h	d	kg	Model	Order No.	UP
554.4	132.5		3					01.243.438.1	1 unit



MEC20122

## Knürr DoubleProRack® Grounding Set for Enclosures

- For grounding top bottom cover.
- With central grounding bolt.
- **Standard inclusion**  
– 2 x grounding connections, length 250 mm.  
– 4 x spring nuts, M5.  
– 2 x washers.  
– 4 x cylinder screws, M5 x 10.  
– 1 x grounding bolt.
- **Delivery**  
– In sets.



DOP20025

W	H	D	U	h	d	kg	Model	Order No.	UP
								01.243.400.9	1 set

Dimensions in mm:				Conversion:	
W = Width	h = Installation height	U = Standard rack unit	kg = Weight	1 mm = 0.03937 inch	
H = Height	d = Usable depth	1 U = 44.45 mm		1 kg = 2.2046 pounds	
D = Depth	L = Length	UP = Packaging unit			



MEC20035

## Knürr DoubleProRack®

– For grounding doors and/or cover plates.

### Standard inclusion

- 5 x grounding connections, length 250 mm.
- 1 x grounding connection, 250 mm, two-sided AMP plug.
- 5 x spring nuts, M5.
- 5 x cylinder screws, M5 x 10 with tooth-lock washer.
- 5 x washers.

### Delivery

- In sets.

W	H	D	U	h	d	kg	Model	Order No.	UP
								01.245.400.9	1 set



ELM00068

## Grounding Bar

– For safe grounding or potential equalization of equipment and components.

### Material

- Electrolyte copper 9 x 9.

### Standard inclusion

- 1 x grounding bar.
- 2 x brackets.
- 1 x Mounting kit.

W	H	S	U	h	d	kg	Model	Order No.	UP
			12					01.110.703.9	1 unit
			15					01.240.543.9	1 unit
			18					01.240.544.9	1 unit
			21					01.240.545.9	1 unit
			24					01.240.546.9	1 unit



DOP20016

## Contact Clamp

– Enables safe connection of equipment and components to grounding bar.  
– For cables up to 25 mm.

### Standard inclusion

- 120 x contact clamps.

W	H	S	U	h	d	kg	Model	Order No.	UP
								01.110.715.9	20 units



DOP00282

## Knürr DoubleProRack® Mounting Bracket

– For mounting socket strips and cable duct.

### Material / Finish

- Zinc-passivated sheet steel.

### Standard inclusion

- 2 x mounting brackets.
- 1 x Mounting kit.

### Delivery

- In sets.

W	H	D	U	h	d	kg	Model	Order No.	UP
								01.240.533.9	1 set



DOP00283

## Knürr DoubleProRack® Rack Connector

– For mechanical, stable joining of enclosure suites.

### Material / Finish

- Zinc-passivated sheet steel.

### Standard inclusion

- 4 x rack connectors.
- 1 x Mounting kit.

### Delivery

- In sets.

W	H	D	U	h	d	kg	Model	Order No.	UP
								01.240.525.7	1 set



DOP00311

## Knürr DoubleProRack® Bottom-cover Fastening Unit

– Used with leveling feet.

### Material / Finish

- Sheet steel, black, zinc passivated.

### Standard inclusion

- 4 x bottom-cover fastening units.
- 1 x Screws and dowels.

### Delivery

- In sets.

W	H	D	U	h	d	kg	Model	Order No.	UP
								01.243.441.3	1 set

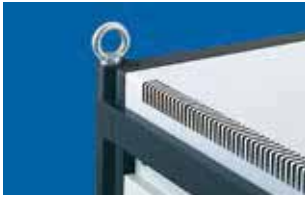

DOP00281

## Knürr DoubleProRack® Eyebolt Set

- Mounted/fixed on crane hooks.
- Load rating, 1900 N static per ring screw.

■ **Material**

- Tool steel, forged.

■ **Standard inclusion**

- 4 x eyebolts, M 8.

■ **Delivery**

- In sets.

W	H	D	U	h	d	kg	Model	Order No.	UP
								01.243.440.9	1 set



DOP00267

## Knürr DoubleProRack® Twin Caster 50 mm

- For mobile installation of the DoubleProRack stand-alone enclosure with fixed casters.

■ **Material / Finish**

- Polyamide, RAL 9011 black.

■ **Load rating**

- 400 N per caster.
- 1200 N max. static total load per rack.

■ **Standard inclusion**

- 2 x twin casters.
- 2 x fixed casters.
- 4 x lock washers.

■ **Delivery**

- In sets.

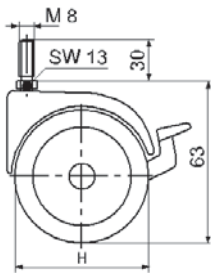

DOP00233

W	H	D	U	h	d	kg	Model	Order No.	UP
50								01.240.527.9	1 set
75								01.240.528.9	1 set

Dimensions in mm:				Conversion:
W = Width	h = Installation height	U = Standard rack unit	kg = Weight	1 mm = 0.03937 inch
H = Height	d = Usable depth	1 U = 44.45 mm		1 kg = 2.2046 pounds
D = Depth	L = Length	UP = Packaging unit		

# Knürr ConAct®

## Network wall-mounted housing

### Features

- Economical: savings of up to 50% on transport volume and storage space.
- Practical: "one-person" installation as housing is delivered in parts.
- Convenient for laying cables as it can be accessed from all sides; generous lateral clearance space.
- Individual configuration: various modification options available (color, design etc.).

**The ConAct® network wall-mounted housing is notable due to its simple and quick "one-person" installation.**

The ConAct® wall-mounted housing offers ideal conditions for network distribution. It is delivered in flat-pack sets.

Installing the ConAct network housing involves: Unpacking – and then network installation can begin within minutes.





A. ACT00024



B. ACT00031



C. ACT00030



D. ACT00033



E. ACT00034



F. ACT00033

## ■ Economical

- Savings of up to 50% of transport volume with flat-pack packaging (see figure A).
- Easily transported and installed thanks to space-saving packaging.
- Small packaging allows for maximized storage space.

## ■ "One-person" installation

- No unnecessary dismantling of housing as it is delivered in parts.
- Rear panel mounted using drill-hole template.
- Easy assembly:
  - Keyhole punching on the rear panel (see figure B).
  - Push-in technology for mounting rails and covers.
  - Symmetrical housing configuration.

## ■ Cabling made easy

- Access from all sides guarantees convenient mounting of the components.
- Open construction design permits easy cable management.
- Organized cable management with spacious lateral clearance area and cable clamping rails (see figures C+D).

## ■ Accessories

- Easy integration of accessories; e.g. socket strips with screw-on points on the vertical extrusion or on the rear panel (see figure E).
- Accessories available for orderly cable management; e.g. cable routing board or cable-routing bracket (see figure F).
- Comprehensive standard range of accessories available; e.g. shelves, drawers, socket strips, etc.

## ■ Maintenance-friendly

- Easy access for servicing is guaranteed when removing the side panels.
- Housing can be locked with security lock.
- Door opening angle: 180°.



ACT00017



ACT00024

1. Unpack



ACT00004

2. Mount rear panel



ACT00005

3. Mount supports and vertical extrusions



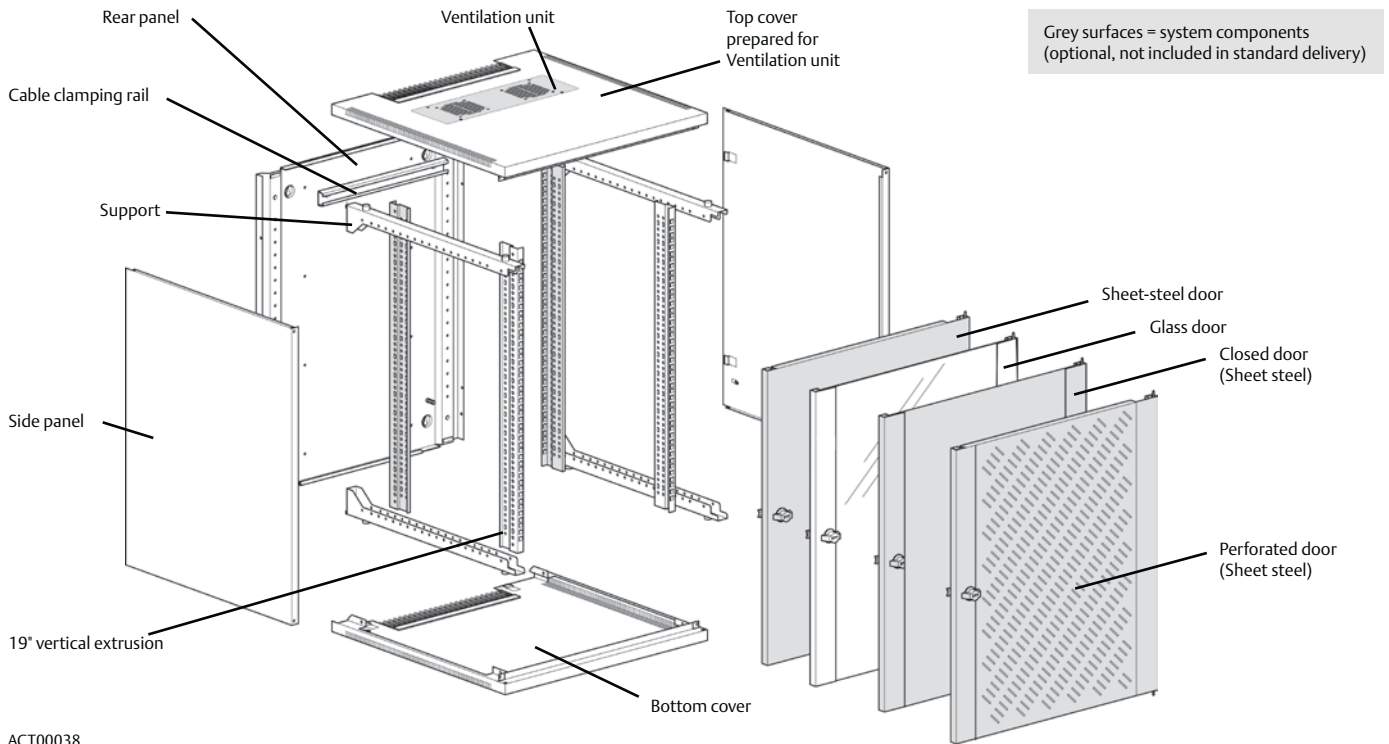

### Knürr ConAct® Technical data

■ **19" installation dimensions as per IEC 297-3**

- Heights: 6 U / 9 HE / 12 U / 15 U / 18 U / 21 U / 24 U (1 U = 44.45 mm).
- Widths: 482.6 mm (19").

■ **External dimensions**

- Heights: 352 mm / 486 mm / 619 mm / 752 mm / 886 mm / 1019 mm / 1152 mm.
- Widths: 600 mm.
- Depths: 400 mm / 500 mm / 600 mm.

■ **Standards**

- Grounding VDE 0100 T 540, EN 60950, EN 60529.

■ **Configurations**

- Wall mounting.



4. Install cables and components

ACT00006



5. Fit covers into place

ACT00007



6. Installation is now complete.

ACT00008



ACT20053

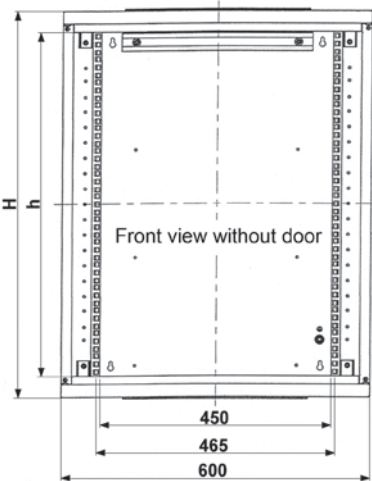
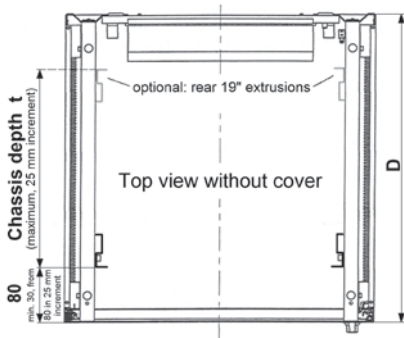

ACT20041

## Knürr ConAct® Standard 19" Wall-mounted Housing

### Description

- For components compliant with IEC 297-3.
- Accessible from all sides; covers can be removed quickly.
- Cable routing via brush strip on top and bottom covers.
- Ventilation unit, optional (can easily be retrofitted).
- Front door with safety glass, lockable.

### Jumpering space

- 80 mm (minimum 32, > 80 in 25 mm increments).

### Load rating

- 500 N static.

### Protection rating

- IP 20.

### Material / Finish

- Rear panel and basic frame, sheet steel, zinc-passivated.
- Removable covers, powder-coated sheet steel.
- Front door, single safety glass panel, textured.
- 19" vertical extrusions, zinc-passivated sheet steel.

### Color

- RAL 7035, light-grey.

### Standard inclusion

- 1 x rear panel.
- 4 x mounting rails.
- 2 x 19" sheet-steel vertical extrusions.
- 1 x top cover, prepared for ventilation unit.
- 1 x bottom cover, closed.
- 2 x side panels.
- 1 x glass door.
- 1 x cable clamping rail.
- 1 x Mounting kit.

### Delivery

- In parts.

W	H	D	U	h	d (max.)	kg	Model	Order No.	UP
600	352	400	6	270	235	16	With glass door	05.010.000.1	1 unit
600	486	400	9	404	235	19	With glass door	05.010.001.1	1 unit
600	619	400	12	537	235	22	With glass door	05.010.002.1	1 unit
600	752	400	15	670	235	25	With glass door	05.010.003.1	1 unit
600	886	400	18	804	235	28	With glass door	05.010.004.1	1 unit
600	1019	400	21	937	235	31	With glass door	05.010.005.1	1 unit
600	1152	400	24	1070	235	34	With glass door	05.010.006.1	1 unit
600	352	500	6	270	335	18	With glass door	05.010.007.1	1 unit
600	486	500	9	404	335	21	With glass door	05.010.008.1	1 unit
600	619	500	12	537	335	24	With glass door	05.010.009.1	1 unit
600	752	500	15	670	335	28	With glass door	05.010.010.1	1 unit
600	886	500	18	804	335	31	With glass door	05.010.011.1	1 unit
600	1019	500	21	937	335	34	With glass door	05.010.012.1	1 unit
600	1152	500	24	1070	335	37	With glass door	05.010.013.1	1 unit
600	352	600	6	270	435	20	With glass door	05.010.014.1	1 unit
600	486	600	9	404	435	23	With glass door	05.010.015.1	1 unit
600	619	600	12	537	435	27	With glass door	05.010.016.1	1 unit
600	752	600	15	670	435	30	With glass door	05.010.017.1	1 unit
600	886	600	18	804	435	34	With glass door	05.010.018.1	1 unit
600	1019	600	21	937	435	37	With glass door	05.010.019.1	1 unit
600	1152	600	24	1070	435	41	With glass door	05.010.020.1	1 unit

#### Dimensions in mm:

W = Width	h = Installation height	U = Standard rack unit	kg = Weight
H = Height	d = Usable depth	1 U = 44.45 mm	
D = Depth	L = Length	UP = Packaging unit	

#### Conversion:

1 mm = 0.03937 inch
1 kg = 2.2046 pounds



ACT00029

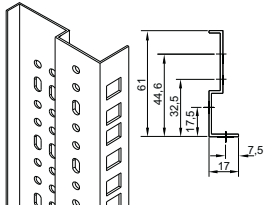

ACT00035

### Knürr ConAct® 19" Vertical Extrusion

- Install in front and/or rear of housing.
- **Material / Finish**  
- Sheet steel, 1.5 mm, zinc passivated.
- **Standard inclusion**  
- 2 x vertical extrusions.  
- 1 x Mounting kit.

W	H	D	U	h	d	kg	Model	Order No.	UP
			6					<b>05.010.321.9</b>	1 set
			9					<b>05.010.322.9</b>	1 set
			12					<b>05.010.323.9</b>	1 set
			15					<b>05.010.324.9</b>	1 set
			18					<b>05.010.325.9</b>	1 set
			21					<b>05.010.326.9</b>	1 set
			24					<b>05.010.327.9</b>	1 set



ACT20058

### Knürr ConAct® Ventilation Unit with Thermostat

- Easy retrofitting of ventilation unit in top cover.
- With two axial fans.
- With thermostat.
- Available in two performance classes.

- **Material / Finish**  
- Zinc-passivated sheet steel.
- **Technical data for single fan**  
Type 1:  
- Volume flow (free blowing): 162 m³/h per fan.  
- Noise emission (free blowing): 37 dB(A).  
Type 2 (quiet):  
- Volume flow (free blowing): 120 m³/h per fan.  
- Noise emission (free blowing): 32 dB(A).

ACT20056



ACT20059

- **Technical data for thermostat**  
- Setting range: 0 to 60°C.  
- Mains supply: 240 V / 50 Hz.  
- Nominal current: 16 A.
- **Color**  
- RAL 7035, light-grey.
- **Standard inclusion**  
- 1 x ventilation unit ready for connection.  
- 1 x Wired with thermostat.
- **Delivery**  
- Assembled, wired and tested.

W	H	D	U	h	d	kg	Model	Order No.	UP
							Type 1	<b>05.010.306.1</b>	1 set
							Type 2 (quiet)	<b>05.010.307.1</b>	1 set



ACT20027

### Knürr ConAct® Sheet Steel Door

- Alternative to glass door.
- **Material / Finish**  
- Sheet steel, powder-coated texture.
- **Color**  
- RAL 7035, light-grey.
- **Standard inclusion**  
- 1 x steel door.  
- 1 x Mounting kit.
- **Delivery**  
- In sets.
- **Note**  
If required, we also deliver our ConAct wall-mounted housing with a sheet-steel door. Please contact us at your leisure.



ACT20054

W	H	D	U	h	d	kg	Model	Order No.	UP
			6					<b>05.010.421.1</b>	1 unit
			9					<b>05.010.422.1</b>	1 unit
			12					<b>05.010.423.1</b>	1 unit
			15					<b>05.010.424.1</b>	1 unit
			18					<b>05.010.425.1</b>	1 unit
			21					<b>05.010.426.1</b>	1 unit
			24					<b>05.010.427.1</b>	1 unit



ACT00026

### Knürr ConAct® Grounding Set

- For grounding all covers on housing frame.
- **Standard inclusion**  
- 5 x grounding conductors, 6 mm².  
- 1 x Mounting kit.

W	H	D	U	h	d	kg	Model	Order No.	UP
								<b>05.010.330.9</b>	1 set



MIR00641

### Knürr ConAct® Cable Clamping Rail

- Cables secured with U-clamps, clamping bars or hammer-head threaded plate.
- For mounting on rear panel.
- **Material / Finish**  
- Zinc-passivated sheet steel.
- **Standard inclusion**  
- 1 x cable clamping rail.  
- 1 x Mounting kit.
- **Delivery**  
- In sets.



ACT00006\_A

W	H	D	U	h	d	kg	Model	Order No.	UP
								<b>05.010.340.9</b>	1 set

# SmartAisle™

## The Comprehensive Solution for Data Centers

### Features

- Outstanding fail-safe design.
- Ideal temperature for IT equipment; no hot spots.
- Minimal energy consumption.
- Easy to plan a new data center.

### Comprehensive Solution

- Racks.
- Rack PDUs.
- Power distribution.
- UPS.
- iCOM-controlled cooling.
- Containment.
- Cable management.
- Rack and aisle monitoring.
- Data center infrastructure.
- DCIM Management.
- Commissioning and maintenance.
- Other services.

All have interfaces at a top-level infrastructure management system (Trellis™), which facilitates holistic monitoring, management and automation of the physical infrastructure.

**The most important trend in IT is the increasing independence of applications from the IT infrastructure. Virtualization and cloud computing are the current buzzwords. Hardware is based on energy-efficient IT components and the dynamic control of these components to meet the applications' current requirements.**

Emerson Network Power's SmartAisle™ is the SmartAisle™ solution encompasses the space, power supply and cooling for servers, storage and the network in the data center. Data centers are highly individual and are constantly subject to change. The physical infrastructure can be adapted to meet any conceivable need by selecting comprehensive portfolio components that harmonize with one another.

The SmartAisle™ solution is future-proof and delivers outstanding availability and efficiency.

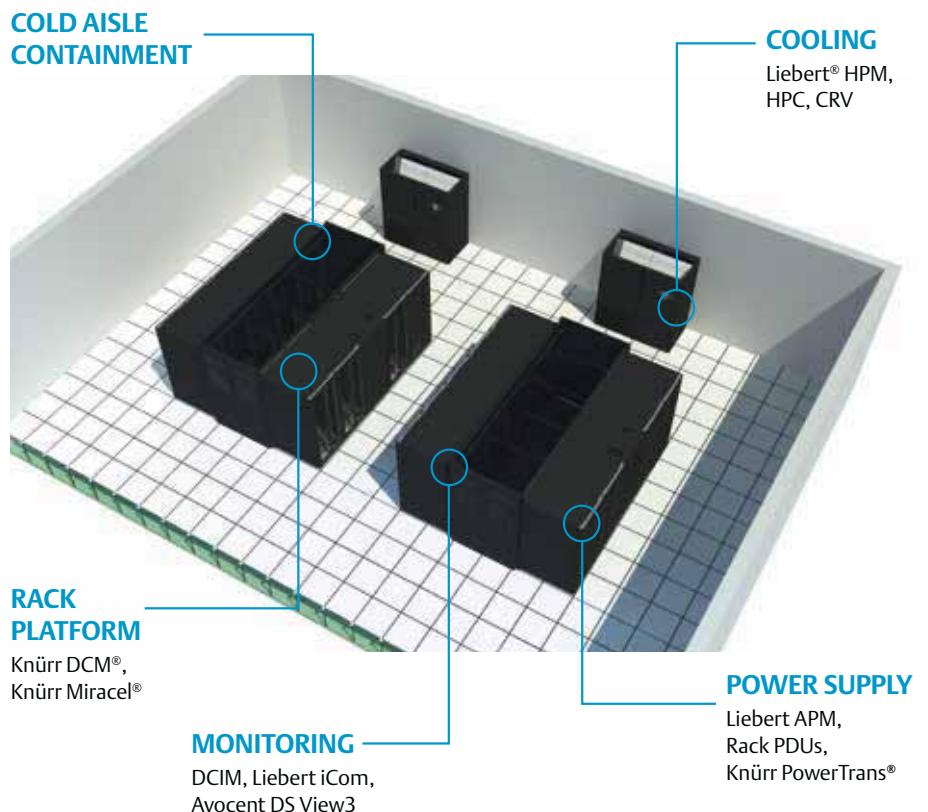

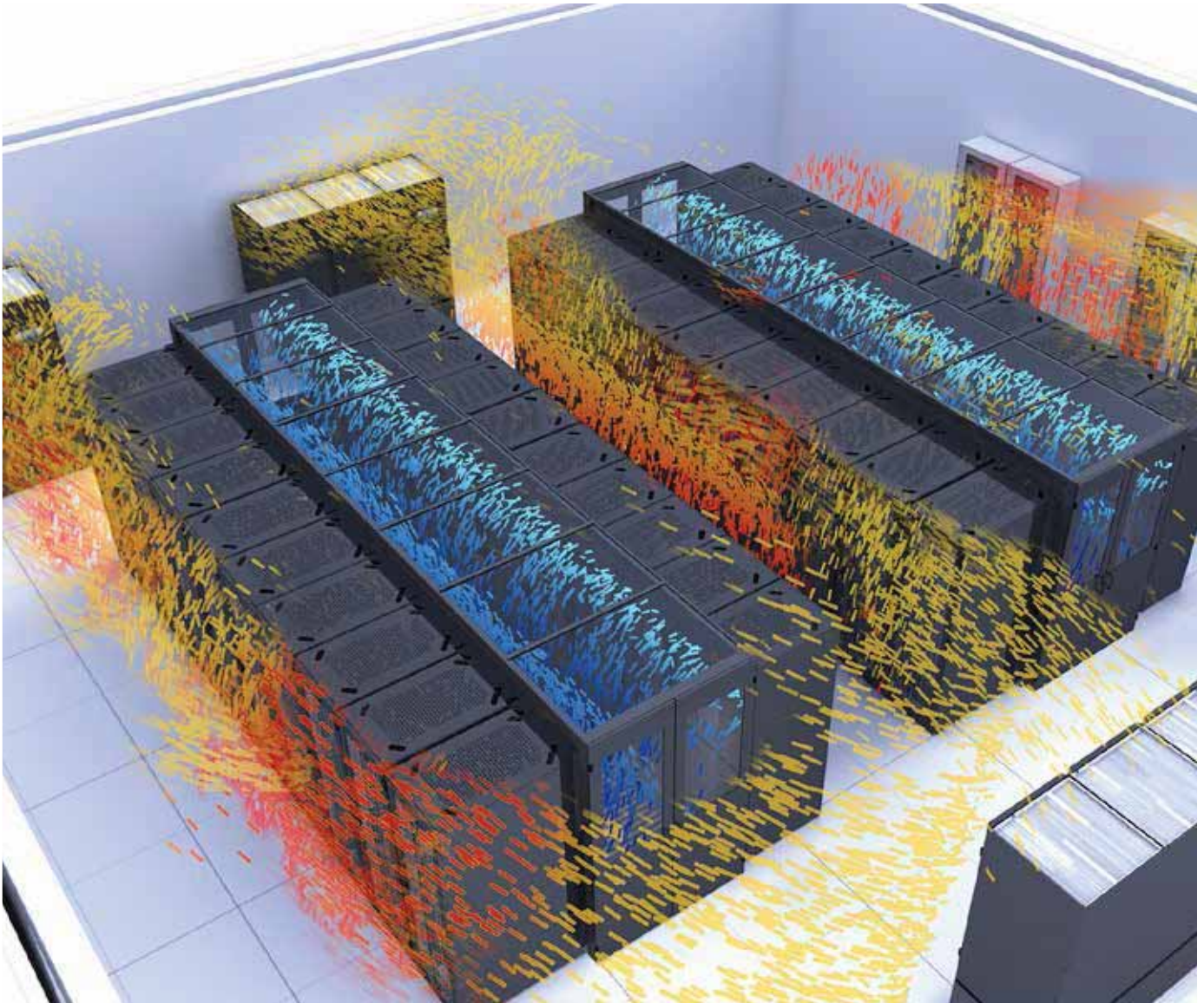

SmartAisle™ containment – consistent separation of warm and cold air is the cornerstone of an energy-efficient data center.

# SmartAisle™

The Comprehensive Solution Concept for Data Centers

## Emerson Network Power Control System



**Due to rising power costs and increased environmental awareness, the main objective for most operators is to maximize the energy efficiency of their data centers.**

Many have already implemented basic separation of cold air from warm air with blanking panels, bushings for cable entry, cold aisle containment, etc. Air-cooling units are key to energy-efficient data centers and further optimization is achieved by adjusting the fans' speed. The operator reduces electricity costs significantly by choosing the right type of control system, which in turn increases availability. In the event of one recirculated air cooling device malfunctioning, temperature control

is maintained by increasing the speed of the remaining devices. The two most common control principles are pressure control and control via the cold aisle temperature.

With the SmartAisle™ control principle, the cold aisle temperature, i.e. the temperature of the air supply to the servers is used to control the fans in the room's climate control equipment (see diagram). This control principle is patented.

## The SmartAisle™ Control-System Principle

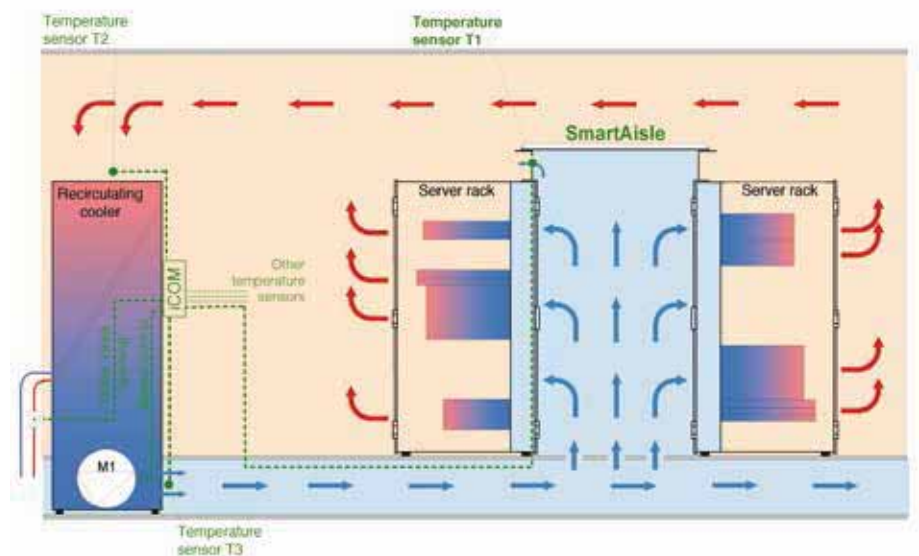



# SmartAisle™

The Comprehensive Solution Concept for Data Centers

## Overview of SmartAisle™ Containment



**STANDARD**

**Standard program:**

- Aisle width 1200 / 1500 and 1800 mm.
- Rack height 2000 and 2200 mm.

**Features:**

- Ideal for new data centers and for retrofitting homogeneous rack aisles.
- Industrial prefabrication makes for a highly economic solution.
- Quick and easy on-site installation.



**CUSTOMIZED**

**Features:**

- Precision fit to racks and rows.
- Suitable for retrofitting heterogeneous data centers.
- Compatible with standard SmartAisle™.



**FREE-STANDING**

**Features:**

- Flexible adjustment to racks with non-standard dimensions.
- For racks and applications that are exchanged at intervals.
- Compatible with standard SmartAisle™.



**SWITCH TUBES**

**Features:**

- No hot spots.
- Suitable airflow routing.
- Utilized in energy-efficient data centers.



# Standard SmartAisle™ Containment

## Emerson Network Power Containment Solution

### Standard program

- Aisle width: 1200 / 1500 and 1800 mm.
- Rack height: 2000 and 2200 mm.

### Features

- Ideal for new data centers and for retrofitting homogeneous rack aisles.
- Industrial prefabrication makes for a highly economic solution.
- Quick and easy on-site installation.
- The containment can be used for Emerson racks as well as for the most common racks in the market.
- The racks do not need to be installed in pairs.
- The top panels are transparent so that the available room lighting can be used.

**The standard SmartAisle™ product range consists of flexible, adaptable and user-friendly components.**

The individual components equalize the tolerances of the racks, which are not usually installed with millimeter precision. The system is compatible with most commercially available racks.

The standard top covers have been prepared for the patented SmartAisle™ control system.

Different door systems are available, including hinged and sliding doors. Hinged or swing doors offer advantages in terms of safety and emergency exits, while sliding doors take up less space.



## Standard SmartAisle™ Containment

### ■ Configuration assistant

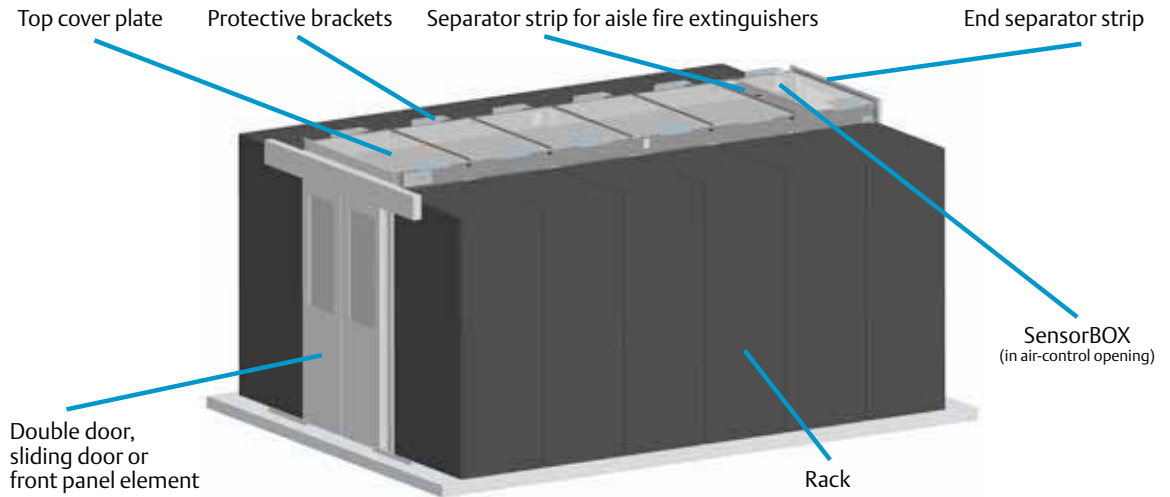

CAC20000

Required data per cold aisle	Example
- Aisle width (standard dimensions 1200, 1500 and 1800 mm ± 50 mm)	Aisle width (AW) = 1200 mm
- Rack height (standard dimensions 2000 and 2200 mm)	Rack height (H) = 2000 mm
- Aisle length	Aisle length (L) = 4800 mm
- Rack type	Knürr DCM® B800
- Color (light-grey RAL 7035 or dark-grey RAL 7021)	Dark-grey RAL 7021

Options	Example	Item	
- Front door component (sliding door, double door, front panel)	Sliding door	<b>03.029.026.8</b>	1 unit
- Front door c closer (mechanical, electric)	Electric door closer	<b>03.029.046.8</b>	1 unit
- Rear door component (sliding door, double door, front panel)	Double door	<b>03.029.021.8</b>	1 unit
- Rear door closer (mechanical, electric)	Mechanical door closer		(integrated in double door)
- Top cover plate	Top cover plate L2400	<b>03.029.129.8</b>	2 sets
- End separator strip	End separator strip GB 1200	<b>03.029.010.8</b>	1 pair
- SensorBOX	Yes	<b>03.029.132.8</b>	2 units
- Protective brackets	Yes	<b>03.029.041.8</b>	6 sets
- DCM® adjustment shim	Yes	<b>03.029.137.8</b>	3 sets
- Filler panel	No		
- Height trims	No		
- Sealing set	Yes	<b>03.029.040.9</b>	2 sets
- Raised-floor air barrier for cable entry	Yes (per rack)	<b>03.029.211.9</b>	22 units
- Open mesh flooring plate	Yes	<b>03.029.090.8</b>	28 units

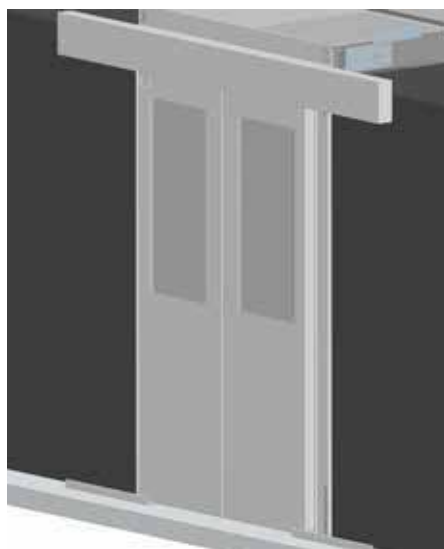

CAC20001

## SmartAisle™ Sliding-door Prepared for Automatic Door Closers

- Description**
  - Used in cold aisle containment for aisle widths: 1200 / 1500 / 1800 mm (± 50 mm).
  - Quick and easy mounting.
  - Suitable for Miracel® and DCM® racks and most other brands.
- Clear door opening**
  - Width: at least 950 mm.
  - Height: 2080 mm.
- Material**
  - Door components: sheet steel.
  - Observation window: single safety-glass panel.
  - Brush strips: polyamide (UL94 HF-1).
- Finish**
  - Final digit of order number .1: powder-coated, RAL 7035 light-grey (e. g. X=1; 03.029.026.X=03.29026.1=light-grey).
  - Final digit of order number .8: powder-coated, RAL 7021 dark-grey (e. g. X=8; 03.029.026.X=03.29026.8=dark-grey).
- Standard inclusion**
  - 1 x frame.
  - 2 x doors.
  - 2 x floor guides.
  - 1 x Covers.
  - 1 x Sealing material.
  - 1 x Mounting kit.
- Delivery**
  - In sets.
- Note**

Please order the requisite closers (electric or mechanical).

W / L	H	D	OW	For rack type	Order No.	UP
	2000		1200		<b>03.029.026.X</b>	1 set
	2200		1200		<b>03.029.027.X</b>	1 set
	2000		1500		<b>03.029.061.X</b>	1 set
	2200		1500		<b>03.029.062.X</b>	1 set
	2000		1800		<b>03.029.066.X</b>	1 set
	2200		1800		<b>03.029.067.X</b>	1 set



CAC20004



CAC20005

## Electric Sliding-door Closer

- Description**
  - Compatible with SmartAisle™ sliding door.
  - Increases energy efficiency as doors closes automatically.
  - Opens with "push & go".
  - Closes with "push & go" or automatically (0 to 30 seconds).
  - Opener/closer contact for control (e.g. fire alarm system).
- Material**
  - Sheet steel.
- Finish**
  - Final digit of order number .1: powder-coated, RAL 7035 light-grey.
  - Final digit of order number .8: powder-coated, RAL 7021 dark-grey.
- Standard inclusion**
  - 1 x electric drive.
  - 1 x cover.
  - 1 x Mounting brackets.
  - 1 x Mounting kit.
- Technical data**
  - Power supply: 230 V / 50 - 60 Hz.
  - Opening speed: 0.4 m/s.
  - Closing speed: 0.2 m/s.
  - Automatic closing time, adjustable: 0 to 30 s.
  - Force: 30 N.
- Delivery**
  - Single items.

W / L	H	D	OW	For rack type	Order No.	UP
					<b>03.029.046.X</b>	1 set

Dimensions in mm:				Conversion:	
W = Width	L = Length	U = Standard rack unit	kg = Weight	1 mm = 0.03937 inch	
H = Height	OW = Aisle width	(1 U = 44.45 mm)		1 kg = 2.2046 pounds	
D = Depth		UP = Packaging unit			



CAC20006



CAC20007

## Mechanical Sliding-door Closer

■ **Description**

- Suitable for SmartAisle™ sliding door.
- Increases energy efficiency as doors open and close automatically.
- Stop function when open.

■ **Material**

- Sheet steel.

■ **Finish**

- Final digit of order number .1: powder-coated, RAL 7035 light-grey (e. g. X=1; 03.029.026.X=03.29026.1=light-grey).
- Final digit of order number .8: powder-coated, RAL 7021 dark-grey (e. g. X=8; 03.029.026.X=03.29026.8=dark-grey).

■ **Standard inclusion**

- 2 x sets of gas pressure springs.
- 1 x cover.
- 1 x Mounting brackets.
- 1 x Mounting kit.

■ **Technical data**

- Force: 20 N.

■ **Delivery**

- Single items.

W / L	H	D	OW	For rack type	Order No.	UP
					03.029.047.X	1 set

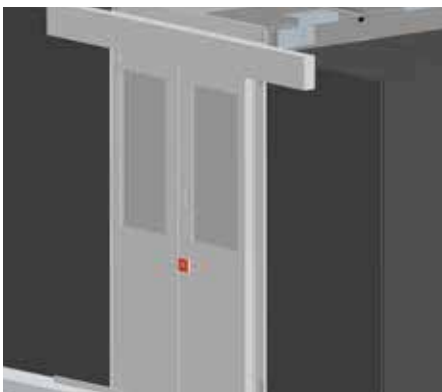

CAC20002

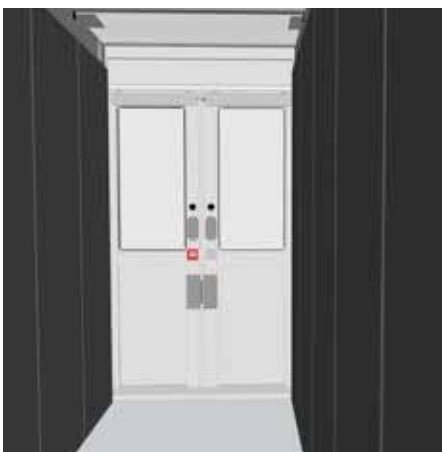

CAC20003

## SmartAisle™ Sliding-door with Access Check

■ **Description**

- Used in cold aisle containment for aisle widths: 1200 / 1500 / 1800 mm (± 50 mm).
- Quick and easy mounting.
- Suitable for Miracel® and DCM® racks and most other brands.
- Magnets ensure safe closing; in the event of a power failure, the door can easily be opened manually.
- Standard access check with keypad (other systems also available).
- Inside switch for routine exit.
- VdS-compliant emergency switch inside; height of switch < 1 meter.
- VdS-compliant emergency switch outside for rescue purposes.
- Door contact switch for monitoring "door open" - "door closed".

■ **Clear door opening**

- Width: at least 950 mm.
- Height: 2080 mm.

■ **Material**

- Door components: sheet steel.
- Observation window: single safety-glass panel.
- Brush strips: polyamide (UL94 HF-1).

■ **Finish**

- Final digit of order number .1: powder-coated, RAL 7035 light-grey.
- Final digit of order number .8: powder-coated, RAL 7021 dark-grey.

■ **Standard inclusion**

- 1 x frame.
- 2 x doors.
- 2 x floor guides.
- 1 x rack monitoring system.
- 1 x Electrical closing system.
- 1 x Covers.
- 1 x Sealing material.
- 1 x Mounting kit.

■ **Delivery**

- In sets.

W / L	H	D	OW	For rack type	Order No.	UP
	2000		1200		03.029.029.X	1 set
	2200		1200		03.029.029.X	1 set

Dimensions in mm:				Conversion:	
W = Width	L = Length	U = Standard rack unit	kg = Weight	1 mm = 0.03937 inch	
H = Height	OW = Aisle width	(1 U = 44.45 mm)		1 kg = 2.2046 pounds	
D = Depth		UP = Packaging unit			



CAC20008

### SmartAisle™ Double Door with Automatic Door Closer

- **Description**
  - Used in cold aisle containment for aisle widths: 1200 / 1500 / 1800 mm (± 50 mm).
  - Quick and easy mounting.
  - Suitable for Miracel® and DCM® racks and most other brands.
  - Integrated automatic/mechanical door closer (opening angle 180°, stop angle approx. 120°; door closes automatically from approx. 100°).
- **Clear door opening**
  - Width: 1200 mm.
  - Height: 2100 mm (for rack height 2000 mm); 2300 (for rack height 2200).
- **Material**
  - Door frame: aluminum.
  - Door components: sheet steel.
  - Observation window: single safety-glass panel.
  - Brush strips: polyamide (UL94 HF-1).
- **Finish**
  - Final digit of order number .1: powder-coated, RAL 7035 light-grey.
  - Final digit of order number .8: powder-coated, RAL 7021 dark-grey.
- **Standard inclusion**
  - 1 x door frame.
  - 2 x doors.
  - 3 x design covers.
  - 2 x door closers.
  - 1 x Mounting kit.
- **Delivery**
  - In sets.

W / L	H	D	OW	For rack type	Order No.	UP
	2000		1200		03.028.021.X	1 set
	2200		1200		03.028.022.X	1 set
	2000		1500		03.028.041.X	1 set
	2200		1500		03.028.042.X	1 set
	2000		1800		03.028.046.X	1 set
	2200		1800		03.028.047.X	1 set

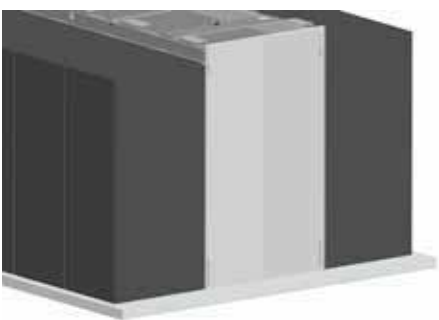

CAC20009

### SmartAisle™ Front Panel

- **Description**
  - Used in cold aisle containment for aisle widths: 1200 / 1500 / 1800 mm (± 50 mm).
  - Alternative to cold aisle door.
  - Quick and easy mounting.
  - Suitable for Miracel® and DCM® racks and most other makes.
- **Material**
  - Sheet steel.
- **Finish**
  - Final digit of order number .1: powder-coated, RAL 7035 light-grey.
  - Final digit of order number .8: powder-coated, RAL 7021 dark-grey.
- **Standard inclusion**
  - 1 x bracing bracket.
  - 2 to 4 panels.
  - 1 x Mounting kit.
- **Delivery**
  - In sets.

W / L	H	D	OW	For rack type	Order No.	UP
	2000		1200		03.029.031.X	1 set
	2200		1200		03.029.032.X	1 set
	2000		1500		03.029.034.X	1 set
	2200		1500		03.029.035.X	1 set
	2000		1800		03.029.037.X	1 set
	2200		1800		03.029.038.X	1 set

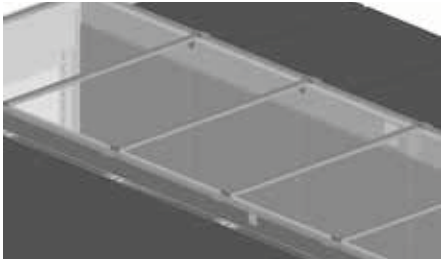

CAC20010

## SmartAisle™ Top Cover Plate

### ■ Description

- Used in cold aisle containment for aisle widths: 1200 / 1500 / 1800 mm (± 50 mm).
- Quick and easy mounting.
- Suitable for Miracel® and DCM® racks and most other brands.
- With rubber sleeves for cable routing.
- Top cover plate with low fire load and smoke generation (optionally with compound safety glass).
- Top cover plate(s) can be removed quickly and easily.
- Equipped with SensorBOX for energy-efficient operation of the recirculated air cooling devices and for preventing hot spots.

### ■ Clear aisle height

- Rack height 2000 mm: 2150 mm.
- Rack height 2200 mm: 2350 mm.

### ■ Material

- Angular extrusion, cross brace: sheet steel.
- Top cover plate: polycarbonate, UL94 V-0/DIN 4102 B1.

### ■ Finish

- Final digit of order number .1: powder-coated, RAL 7035 light-grey.
- Final digit of order number .8: powder-coated, RAL 7021 dark-grey.

### ■ Standard inclusion

- 2 x angular extrusions with air regulation opening.
- 1 x separator strip for W 300/600/800, 3 x separator strips for L 2400.
- 1 x top cover plate for W 300/600/800, 3 x top cover plates for L 2400.
- 2 x angular extrusion plates.
- 1 x Mounting kit.

### ■ Delivery

- In sets.

### ■ Important Note

When using Knürr DCM® racks, please also order corresponding adjustment plates.

### ■ Note

Please also order correct number of Sensor-BOXes for the recirculated air cooling devices' control system.

W / L	H	D	OW	For rack type	Order No.	UP
300			1200		03.029.120.X	1 set
600			1200		03.029.123.X	1 set
800			1200		03.029.126.X	1 set
2400			1200		03.029.129.X	1 set
300			1500		03.029.121.X	1 set
600			1500		03.029.124.X	1 set
800			1500		03.029.127.X	1 set
2400			1500		03.029.130.X	1 set
300			1800		03.029.122.X	1 set
600			1800		03.029.125.X	1 set
800			1800		03.029.128.X	1 set
2400			1800		03.029.131.X	1 set



CAC20011

## SmartAisle™ End Separator Strip

### Description

- Used in cold aisle containment for aisle widths: 1200 / 1500 / 1800 mm (± 50 mm).
- Quick and easy mounting.
- For connecting the door component or front panel.

### Material

- Sheet steel.

### Finish

- Final digit of order number .1: powder-coated, RAL 7035 light-grey.
- Final digit of order number .8: powder-coated, RAL 7021 dark-grey.

### Standard inclusion

- 2 x end separator strips.
- 1 x Mounting kit.

### Delivery

- Single items.

W / L	H	D	OW	For rack type	Order No.	UP
			1200		<b>03.029.010.X</b>	1 pair
			1500		<b>03.029.011.X</b>	1 pair
			1800		<b>03.029.012.X</b>	1 pair

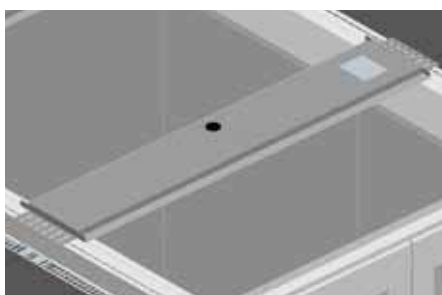

CAC20012

## SmartAisle™ Separator Strip for Aisle Fire Extinguisher for SmartAisle™ Top Cover Plate

### Description

- For gas extinguisher in cold aisle.
- Rubber sleeve for covering piping, and/or the nozzles in the cold aisle.
- Screw fitting for securing the piping to the cold-aisle containment.
- Equipped with SensorBOX for energy-efficient operation of the recirculated air cooling devices as well as to prevent hot spots.

### Material

- Sheet steel.

### Finish

- Final digit of order number .1: powder-coated, RAL 7035 light-grey.
- Final digit of order number .8: powder-coated, RAL 7021 dark-grey.

### Standard inclusion

- 1 x separator strip for aisle fire extinguisher.
- 1 x Mounting kit.

### Delivery

- In sets.

W / L	H	D	OW	For rack type	Order No.	UP
200			1200		<b>03.029.115.X</b>	1 set
200			1500		<b>03.029.116.X</b>	1 set
200			1800		<b>03.029.117.X</b>	1 set

#### Dimensions in mm:

W = Width	L = Length	U = Standard rack unit	kg = Weight
H = Height	OW = Aisle width	(1 U = 44.45 mm)	
D = Depth		UP = Packaging unit	

#### Conversion:

1 mm = 0.03937 inch
1 kg = 2.2046 pounds



CAC20013



CAC20014

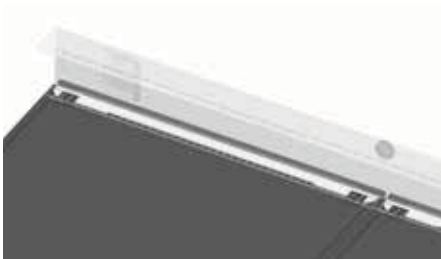

CAC20015

### SmartAisle™ DCM® Adjustment Shim used with Knürr DCM® Racks

- **Description**
  - Spacer between DCM® rack and cold aisle containment.
- **Material**
  - Sheet steel.
- **Finish**
  - Final digit of order number .1: powder-coated, RAL 7035 light-grey.
  - Final digit of order number .8: powder-coated, RAL 7021 dark-grey.
- **Standard inclusion**
  - 1 x adjustment shim.
- **Delivery**
  - In sets.

W / L	H	D	OW	For rack type	Order No.	UP
300				DCM®	03.029.134.X	1 set
600				DCM®	03.029.135.X	1 set
800				DCM®	03.029.137.X	1 set
1000				DCM®	03.029.139.X	1 set



CAC20016

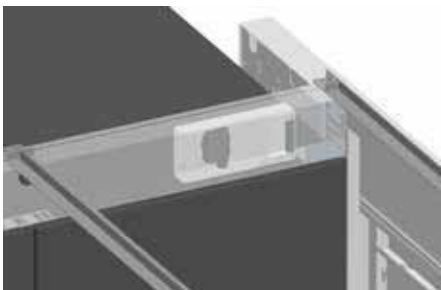

CAC20017

### SmartAisle™ SensorBOX for SmartAisle™ Top Cover Plates

- **Description**
  - Suitable for air regulation opening of the top cover plates.
  - As per patented control-system principle designed for energy-efficient operation of the cooling system.
  - Prepared for Liebert® temperature sensor.
  - Compatible with a variety of sensors.
- **Material**
  - Sheet steel.
- **Finish**
  - Final digit of order number .1: powder-coated, RAL 7035 light-grey.
  - Final digit of order number .8: powder-coated, RAL 7021 dark-grey.
- **Standard inclusion**
  - 1 x SensorBOX.
  - 1 x Mounting kit.
- **Delivery**
  - In sets.

W / L	H	D	OW	For rack type	Order No.	UP
					03.029.132.X	1 set





CAC20018

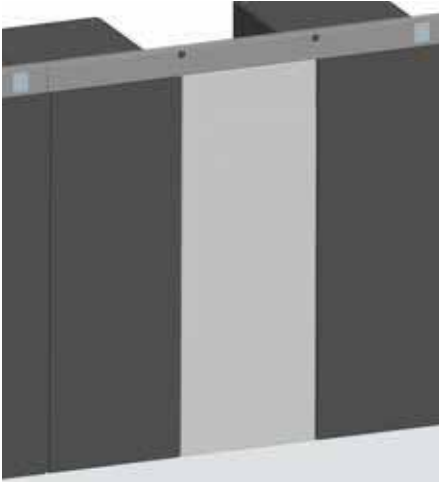

CAC20019

## SmartAisle™ Filler Panel

### Description

- For sealing off the compartments without racks in the suite.
- Quick and easy mounting.
- Variable height; can be used for total rack heights of 1990 to 2220 mm.
- Several filler panels can be set up in a row.

### Material

- Sheet steel.

### Finish

- Final digit of order number .1:  
powder-coated, RAL 7035 light-grey.
- Final digit of order number .8:  
powder-coated, RAL 7021 dark-grey.

### Standard inclusion

- 1 x filler panel (two parts).
- 1 x Mounting kit.

### Delivery

- In sets.

W / L	H	D	For rack type	Order No.	UP
300	2000 / 2200			<b>03.029.055.X</b>	1 set
600	2000 / 2200			<b>03.029.056.X</b>	1 set
800	2000 / 2200			<b>03.029.058.X</b>	1 set

#### Dimensions in mm:

W = Width    L = Length    U = Standard rack unit    kg = Weight  
 H = Height    OW = Aisle width    (1 U = 44.45 mm)

UP = Packaging unit

#### Conversion:

1 mm = 0.03937 inch  
 1 kg = 2.2046 pounds



DCM20057



LUF20328

### SmartAisle™ Height Trim

- For adjusting the separation of the cold and hot areas in smaller racks.

■ **Material**

- Sheet steel.

■ **Finish**

- Final digit of order number .1: powder-coated, RAL 7035 light-grey.
- Final digit of order number .8: powder-coated, RAL 7021 dark-grey.

■ **Standard inclusion**

- 1 x height trim.
- 1 x Mounting kit.

■ **Delivery**

- In sets.

■ **Note**

Where there are several adjacent height panels, please request the corresponding angular extrusion plates.

W	H	D	OW	For rack type	Order No.	UP
300	221			DCM®	<b>03.029.140.X</b>	1 set
600	221			DCM®	<b>03.029.141.X</b>	1 set
600	200			Miracel®	<b>03.029.051.X</b>	1 set
800	221			DCM®	<b>03.029.143.X</b>	1 set
800	200			Miracel®	<b>03.029.052.X</b>	1 set
1000	221			DCM®	<b>03.029.145.X</b>	1 set

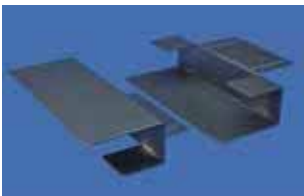

DCM20131



LUF20383

### SmartAisle™ Protective Brackets for Top Cover Plate

- Prevents Plexiglas panels from lifting up when there is excess pressure.
- Enables safe pressure equalization in the event of a malfunction or while a fire is being extinguished.

■ **Material**

- Sheet steel.

■ **Finish**

- Final digit of order number .1: powder-coated, RAL 7035 light-grey.
- Final digit of order number .8: powder-coated, RAL 7021 dark-grey.

■ **Standard inclusion**

- 1 x pair of protective brackets.
- 1 x Mounting kit.

■ **Delivery**

- In sets.

W	H	D	OW	For rack type	Order No.	UP
					<b>03.029.041.X</b>	1 set

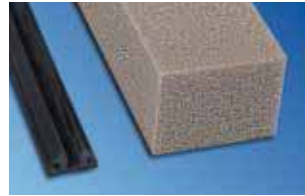

LUF20336

### SmartAisle™ Sealing Set for 4.8 meter Aisle Length

- Suitable for installation in Miracel® rack.
- For sealing the leveling area between the floor and the rack.
- For sealing Miracel® rack suites without side panels.

■ **Material / Color**

- Foam element: PUR ether UL94 HF-1, black.
- Cover extrusion: PVC extruder extrusion, black.

■ **Standard inclusion**

- 10 meters of foam 40 x 25 mm.
- 31 meters cover extrusion.

■ **Delivery**

- In sets.

W	H	D	OW	For rack type	Order No.	UP
4800				Miracel®	<b>03.029.040.9</b>	1 set

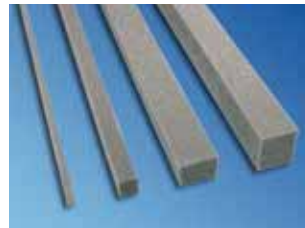

DCM20047

### SmartAisle™ Sealing Set for 4.8 meter Aisle Length

- Suitable for sealing gaps (e. g. in the leveling area between floor and rack, between racks, etc.).

■ **Material / Color**

- PUR ether (UL94 HF-1), black.

■ **Standard inclusion**

- 5 x 2 meters of foam.

■ **Delivery**

- In sets.

W	H	D	OW	Size	Order No.	UP
				40 x 40 (adhesive surface) mm	<b>03.029.042.9</b>	1 set
				20 x 20 (adhesive surface) mm	<b>03.029.043.9</b>	1 set
				5 x 10 (adhesive surface) mm	<b>03.029.044.9</b>	1 set
				25 x 40 (adhesive surface) mm	<b>03.029.045.9</b>	1 set

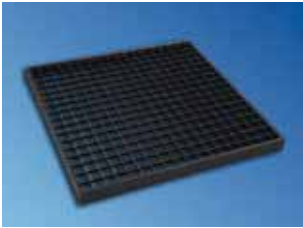

LUF20331

**SmartAisle™ Open Mesh Flooring Plate for Raised Floors**

- Used in raised floors.
- Can be used with high heat loads and high cooling-air requirements per rack.
- For energy-efficient operation of the recirculated air cooling devices.
- Stiffener distance 33 x 16 mm.

**Material**

- Steel, zinc-passivated.

**Finish**

- Final digit of order number .1: powder-coated, RAL 7035 light-grey.
- Final digit of order number .8: powder-coated, RAL 7021 dark-grey.

**Standards**

- Produced as per RAL-GZ 638.
- Load capacity as per DIN EN 12825
- On supports: class 1A, deflection under instantaneous working load (2 kN) and 2C (3kN); measured at the center of plate.
- On supports and control-room profiles: deflection under instantaneous working load 2A (3kN).

**Standard inclusion**

- 1 x open mesh flooring plate for raised floor.

**Technical data**

- Size 598 x 598 x 40 mm (W x L x H).
- Free cross-section: 88 %.
- Max. surface load 50,000 N/m<sup>2</sup> with even distribution;
- Max. point load (on surface 200 x 200 mm) 4,500 N.

**Delivery**

- Single items.

**Note**

- Suitable for raised floors with 40 mm panel heights.

W	H	D	OW	For rack type	Order No.	UP
					<b>03.029.090.X</b>	1 unit

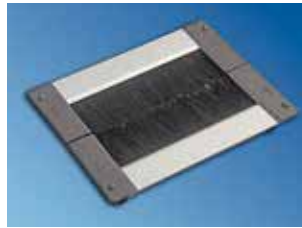

LUF20334

**SmartAisle™ Raised Floor Air Barrier for Cable Entry**

- For cable entry from the raised floor.
- Lowered into raised floor, or can be mounted on top.
- Two-row tight brushes for pressure-resistant cold-hot separation.
- For new cutouts and as add-on to existing cutouts.
- Two-piece – easy extend and retrofit option.
- The length can easily be shortened on-site (metal saw).
- Also suitable for cabling on the rack wall (U-shape, two pieces).
- Slot-in – and additional threaded connection.

**Dimensions**

- **03.028.211.9:**
  - External dimension (270 mm x 220 mm).
  - Usable cable entry (200 mm x 126 mm).
  - Raised floor cutout (240 mm x 180 mm).
- **03.028.212.9:**
  - External dimension (600 mm x 220 mm).
  - Usable cable entry (530 mm x 126 mm).
  - Raised floor cutout (570 mm x 180 mm).

**Standard inclusion**

- 1 x pair of raised floor air barriers.
- 1 x Mounting kit.

**Delivery**

- In sets.

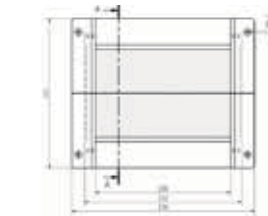

LUF20301

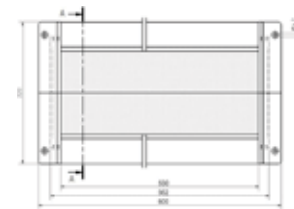

LUF20302

W	H	D	U	d (max.)	kg	for type	Order No.	UP
270	220					Length, 270 mm	<b>03.028.211.9</b>	1 set
600	220					Length, 600 mm	<b>03.028.212.9</b>	1 set

Dimensions in mm:				Conversion:	
W = Width	L = Length	U = Standard rack unit	kg = Weight	1 mm = 0.03937 inch	
H = Height	OW = Aisle width	(1 U = 44.45 mm)		1 kg = 2.2046 pounds	
D = Depth		UP = Packaging unit			

# Customized SmartAisle™ Containment

Customized – Retrofitting Solution from Emerson Network Power

## Features

- Precision fit on racks and rack rows.
- Suitable for retrofitting heterogeneous data centers.
- Combined with standard SmartAisle™.

**Data center structures are often the result of ongoing changes and modifications spanning a number of years.**

The racks have different dimensions and they are not always positioned in a line. Knürr offers this solution based on a profile construction that can be made on site to correspond to the precise dimensions of a given data center.

With the customized solution, the dimensions are measured on site and the profiles and panels for the containment are cut and assembled to meet precise requirements. The panels are normally cut outside the data center in a designated area.

If possible, the customized elements are combined with standard components. As a rule, standard sliding or hinged doors are used. The standard top cover plate is generally used, thus, customized elements are only used to fill the gaps between the racks.



# Free-Standing SmartAisle™ Containment

## Free-Standing – Emerson Network Power's Special Solution

### Features

- Can be flexibly adjusted to racks with non-standard dimensions.
- For racks and applications that are exchanged at intervals.
- Combined with standard SmartAisle™.

### Free-Standing System

In many data centers, so-called "free-standing systems" are installed in addition to the server racks. These often non-standard racks are regularly exchanged at defined intervals (usually one to three years).

Free-standing systems may include storage cabinets, cluster applications (e.g. IBM, SUN) or server racks (e.g. IBM, HP, SUN, etc.). There are a number of reasons for delivering a complete package including the racks. For storage applications, one of the main reasons is product liability. Cluster applications are usually leased and with server applications, the reasons are often marketing-related.

The challenge facing the SmartAisle™ for free-standing systems is to construct a flexible cold aisle containment, allowing a modular and fast exchange of these free-standing systems.

The free-standing cold aisle containment solution is based on standard SmartAisle™ products and used in combination with these. The panels for the free-standing solution can be customized in both dimensions (height and width) according to the rack dimensions.



# SmartAisle™ Containment Switch Tubes

## Switch Tubes – Switch Cooling from Emerson Network Power

### Switches have special requirements.

#### ■ Cooling/ventilation

- Mostly lateral air flow (from right to left, from left to right, from left and right toward the rear, including many other directions)  
→ switches draw in warm air.
- Power requirements for cooling are often high (up to over 10 kW per switch).

#### ■ Max. permitted input air temperature

- Max. permitted input air temperature is approx. 37° to 40°C.  
→ Probably higher inlet temperatures in efficient cold/warm separation environment.
- High energy consumption for cooling.

#### ■ Cabling

- Large cable volumes.
- Fan units free from cabling; repair work can be performed during operation.
- Air flow should have be free of cables.

#### ■ Mechanics

- Various heights (1 U to approx. 24 U).
- Various depths, where air can be drawn in from different areas.

Emerson Network Power offers a large range of switch tubes for the most common switch types.

#### ■ Features

- No hot spots.
- Suitable airflow routing.
- Utilized in energy-efficient data center.

### Cooling switches

For cooling purposes, servers draw in cold air from the front and blow heated air out at the rear. By contrast, switches mainly draw the cold air in from the side and blow air out either laterally or at the rear. Since cooling problems arise in racks equipped with consistent hot/cold separation, Special airflow systems are required for switch applications to ensure reliability and energy efficiency.

The SmartAisle™ switch tube is a flexible and safe add-on to the complete SmartAisle program. Various standard products are available for the respective switch types.

### Switch Tubes – controlled switch cooling

**Servers are usually cooled from the front to the rear, in line with modern and energy-efficient data center requirements. However, cooling direction for switches most often occurs from the side. In this application, the switches draw the cooling air out of the warm area.**

The SwitchTube provides air for the switch from the cold aisle, where heated air is directed into the warm aisle.



Air flow in switch rack for switches equipped with lateral cooling.

## SmartAisle™ 19" SwitchTube



LUF20360

03.029.217.X



LUF20379

03.029.217.X

### Description

- For cooling a core switch from the cold aisle.
- Can be used with or without a raised floor.
- Provides energy-efficient cooling for laterally cooled switches.
- Cooling air drawn in from cold aisle (ideally with containment).
- Suitable for both Knürr Miracel® and DCM® racks; width of rack 800 mm.
- Space requirement: 3 or 6 U of the 19" installation space.
- Suitable for a number of switch heights.
- Installation height of switches in rack can be adjusted.
- Note: cold/warm separation in rack is required.

### Material

- Tube: sheet steel.
- High-density foam: PUR ether foam (UL94 HF-1).

### Finish

- Final digit of order number .1: powder-coated, RAL 7035 light-grey.
- Final digit of order number .8: powder-coated, RAL 7021 dark-grey.

### Standard inclusion

- 2 x air intake units (for 12 – 21 U models)
- 1 x air intake unit (for 7 – 12 U / 4 – 6 U models).
- 1 x adjustable depth lateral air duct.
- 1 x High-density foam.
- 1 x Mounting kit.

### Delivery

- In sets.

### Important Note

Suitable for cooling max. 5 kW thermal load (at  $\Delta T = 13 K$ ) per switch tube.

### Important Note

With many switches, part of the front air-intake perforation is covered (as these are generally located near the front, directly behind the front 19" extrusion).

### Important Note

May not be suitable for switches with different cooling directions.

### Note

Retrofitting may not be applied due to cables and other accessories.

$W_{\text{Rack}}$	H	D	Application	For rack type	Order No.	UP
800			Core switch 12 - 21 U	Miracel®, DCM®	03.029.217.X	1 set
800			Core switch 12 - 21 U	Miracel®, DCM®	03.029.218.X	1 set
800			Core switch 7 - 12 U	Miracel®, DCM®	03.029.213.X	1 set
800			Core switch 7 - 12 U	Miracel®, DCM®	03.029.215.X	1 set
800			Core switch 4 - 6 U	Miracel®, DCM®	03.029.214.X	1 set



LUF20358

03.029.213.X



LUF20377

03.029.215.X



LUF20359

03.029.214.X



LUF20375

03.029.213.X



LUF20378

03.029.215.X



LUF20376

03.029.214.X

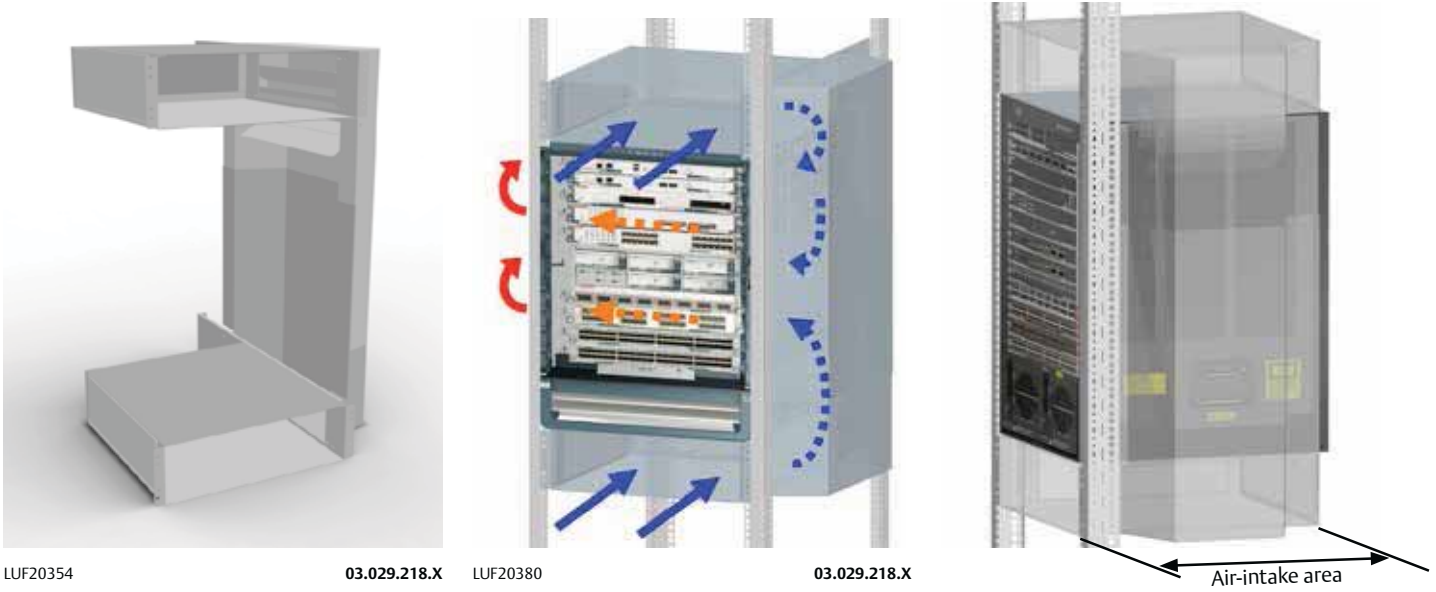

LUF20354

03.029.218.X

LUF20380

03.029.218.X

Air-intake area

Item number	Switch height [U]	Max. cooling	Max. air-intake area depth in mm (Distance to 19" level)	Compatible with
03.029.217.X	12-21	approx. 7 kW ( $\Delta T = 13$ K) per switch tube	460	CISCO Catalyst 6506(-E), 6509(-E), 6513, MDS 9509 Director
03.029.218.X	12-21	approx. 7 kW ( $\Delta T = 13$ K) per switch tube	600	Cisco Nexus 7009
03.029.213.X	7-12	approx. 3 kW ( $\Delta T = 13$ K) per switch tube	320	CISCO Catalyst 4503(-E), 4506(-E), 4507R(-E), 4510R(-E)
03.029.215.X	7-12	approx. 3 kW ( $\Delta T = 13$ K) per switch tube	600	Cisco Nexus 7004
03.029.214.X	4-6	approx. 3 kW ( $\Delta T = 13$ K) per switch tube	550	CISCO Catalyst 6503(-E), 6504(-E)

**Dimensions in mm:**

W = Width L = Length U = Standard rack unit kg = Weight  
 H = Height OW = Aisle width (1 U = 44.45 mm)  
 D = Depth UP = Packaging unit

**Conversion:**

1 mm = 0.03937 inch  
 1 kg = 2.2046 pounds



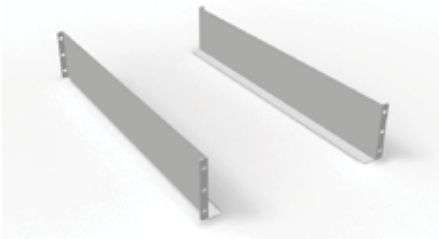

LUF20364



LUF20365



LUF20366

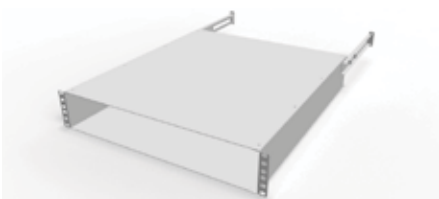

LUF20372

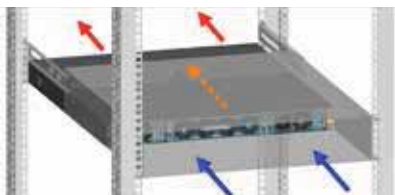

LUF20373



LUF20374

## Chassis Runner Tube T740

### Description

- For supporting switches during installation in rack.
- Supports weight of switches during installation and fitting in rack.
- Can be used with SmartAisle™ 19" switch tubes 12 - 21 U.
- Suitable for insertion depth of 740 mm.
- Suitable for all 19" extrusions.
- Suitable for CISCO Catalyst 6506(-E), MDS 9509 Director.

### Material / Finish

- Sheet steel, 2.0 mm, zinc passivated.

### Standard inclusion

- 2 x chassis runners.
- 1 x Mounting kit.

### Delivery

- In pairs.

W	U	D <sub>Rack</sub>	For insertion depth	Order No.	UP
130	3	from 900	740	03.029.230.7	1 pair

## SmartAisle™ SwitchTube 1 U Back-to-front for 1 U Switch Height

### Description

- For 1 U switches with back-to-front cooling.
- Extractable – can be used for different switch depths.
- Suitable for various insertion depths.
- Compatible with both Miracel® and DCM® racks.
- Suitable for Enterasys SSA 180.

### Standard inclusion

- 1 x air intake unit.
- 2 x rear support brackets.
- 1 x High-density foam.
- 1 x Edge protector.
- 1 x Mounting kit.

### Delivery

- In sets.

### Note

Retrofitting may not be applied due to cables and other accessories.

### Material

- Tube: sheet steel.
- High-density foam: PUR ether foam (UL94 HF-1).

### Finish

- Final digit of order number .1: powder-coated, RAL 7035 light-grey.
- Final digit of order number .8: powder-coated, RAL 7021 dark-grey.

W	H	U	For insertion depth	Model	Order No.	UP
450	87.5	2	600-740		03.029.212.X	1 unit

## SmartAisle™ 19" SwitchTube for Switch Heights 1 U / 2 U / 3 U

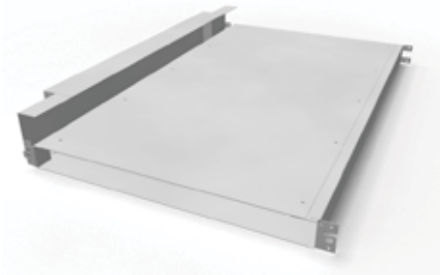

LUF20356

03.029.210.X



LUF20368

03.029.210.X

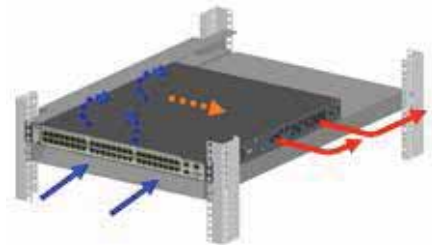

LUF20369

03.029.210.X

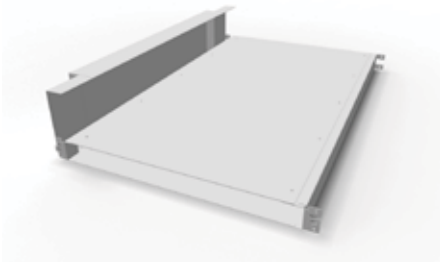

LUF20357

03.029.211.X



LUF20370

03.029.211.X



LUF20371

03.029.211.X

### Description

- For 1 U, 2 U or 3 U switches with lateral cooling.
- Can be used in racks with front-to-back cooling.
- Extractable – can be used for different switch depths.
- Front or rear installation possible.
- Suitable for different cooling directions (from left to right, from right to left or from right and left toward the rear).
- Suitable for insertion depth of 740 mm.
- Compatible with both Miracel® and DCM® server extrusions.
- Suitable for rack widths of 600, 700, 800 and 1000.
- Suitable for CISCO Catalyst 3750, Juniper EX3200, Juniper EX4200.

### Material

- Tube: sheet steel.
- High-density foam: PUR ether foam (UL94 HF-1).

### Finish

- Final digit of order number .1: powder-coated, RAL 7035 light-grey.
- Final digit of order number .8: powder-coated, RAL 7021 dark-grey.

### Standard inclusion

- 1 x air intake unit.
- 2 x lateral air ducts.
- 1 x side cover.
- 1 x High-density foam.
- 1 x Mounting kit.

### Delivery

- In sets.

### Note

Retrofitting may not be applied due to cables and other accessories.

W	H	U	For insertion depth	Model	Order No.	UP
440	88.1	2	740	for 1 U switch	03.029.210.X	1 unit
440	132.5	3	740	for 2 U switch	03.029.211.X	1 unit
440	177	4	740	for 3 U switch	03.029.208.X	1 unit

## SmartAisle™ SwitchRack for Cisco Nexus 7018

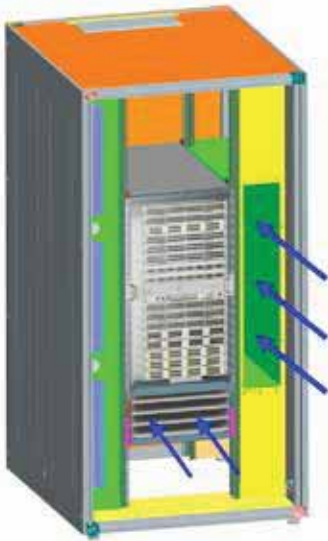

LUF20362

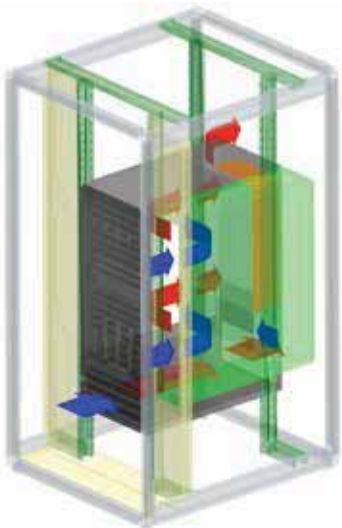

LUF20363

### Description

- For installing a CISCO Nexus 7018 at a height of 7 U to 31 U.
- Based on DCM® rack.
- Rack width 1000 mm as per CISCO requirements for adequate cooling air.
- Prevents hot-spots (air recirculation).
- 200 mm clearance space for orderly cabling.
- Includes cold/warm plates for reliable and energy-efficient operation.
- Cold air drawn in from cold aisle.

### Material / Finish

- Basic rack, extruded aluminum, polished.
- Corner piece, die-cast aluminum, polished.
- Doors, sheet steel, powder-coated texture.
- Covers, zinc-passivated sheet steel, powder-coated texture.
- PUR ether foam (UL94 HF-1).

### Color

- Final digit of order number .1: visible surface of covers RAL 7035 light-grey.
- Final digit of order number .8: visible surfaces of the covers RAL 7021 dark-grey.

### Standard inclusion

- 1 x basic frame.
- 4 x 19" server extrusions, sheet steel incl. U marking.
- 2 x side panels with quick connectors.
- 1 x top cover with cable entry (three-piece sliding plates can also be opened completely).
- 1 x front door, single, perforated, with handle and mounting for cylinder lock.
- 1 x rear door, double, perforated, sheet steel, with handle and mounting for cylinder lock.
- 1 x complete air separation unit (left plate with 3 x 2 U 19" cutouts, right plate with air duct).
- 4 x leveling feet.
- 1 x complete grounding set (VDE 0100).

### Delivery

- Mounted.

### Note

Also order mounting adapter for 19" server extrusion to mount Knürr accessories (01.147.640.9).

W	H	D	U	Recess depth	Insertion depth	Model	Order No.	UP
1000	2000	1200	42	200	740	DCM®	03.029.222.X	1 unit

#### Dimensions in mm:

W = Width	L = Length	U = Standard rack unit	kg = Weight
H = Height	OW = Aisle width	(1 U = 44.45 mm)	
D = Depth		UP = Packaging unit	

#### Conversion:

1 mm = 0.03937 inch
1 kg = 2.2046 pounds

## SmartAisle™ Raised Floor SwitchTube



LUF20355



LUF20367

### Description

- For cooling a core switch from the raised floor.
- Provides energy-efficient cooling for laterally cooled switches.
- Cold air drawn in from raised floor.
- Compatible with Knürr Miracel® rack: width 800 mm (NOT for DCM® rack).
- Suitable for different switch heights.
- Installation height of switches in rack can be adjusted; tool-less blanking plates for covering areas outside of switches.
- Air-duct area: 420 cm<sup>2</sup>.
- Size of cutouts in raised floor (min./max.): 355/410 x 127/162 mm.
- Note: Cold/warm separation in rack is required.
- Note: for max. switch air-intake depth from 460 mm (distance to 19" level).
- **SUITABLE FOR CISCO CATALYST 6509(-E), CATALYST 6513, CATALYST 6506(-E), MDS 9509 DIRECTOR, HP PROCURVE 8212.**

### Material

- Tube: sheet steel.
- High-density foam: PUR ether foam (UL94 HF-1).

### Finish

- Final digit of order number .1: powder-coated, RAL 7035 light-grey.
- Final digit of order number .8: powder-coated, RAL 7021 dark-grey.

### Standard inclusion

- 1 x air duct with blanking plates (1 U, 3 U).
- 1 x bottom plate.
- 1 x Sealing material.
- 1 x Mounting kit.

### Delivery

- In sets.

### Important Note

- Suitable for cooling max. 5 kW thermal load (at  $\Delta T = 13$  K) per switch tube.
- The tube covers part of the front air-intake perforation with many switch types (as these are generally located near the front, directly behind the front 19" extrusion).
- May not be suitable for switches with different cooling directions.
- The uppermost 3 U in the rack cannot be used for cooling.

### Note

- Retrofitting may not be applied due to cables and other accessories.

W	H	D	Item	For rack type	Order No.	UP
800	2000		Tube	Miracel®	<b>03.029.200.X</b>	1 set
800	2200		Tube	Miracel®	<b>03.029.202.X</b>	1 set

#### Dimensions in mm:

W = Width	L = Length	U = Standard rack unit	kg = Weight
H = Height	OW = Aisle width	(1 U = 44.45 mm)	
D = Depth	UP = Packaging unit		

#### Conversion:

1 mm = 0.03937 inch
1 kg = 2.2046 pounds

# Emerson Network Power

## Cooling solutions

All issues and arguments to date can be summarized under three main criteria for assessing data center infrastructure.

### 1. Availability

The key issue for all data centers is availability. Maximum computing power, rapid access or lowest costs, are of little use if availability is jeopardized by uncertainties, failures or even lengthy downtimes.

Data center services users, whether it be in-house or a customer that outsources its computing power, will only remunerate the finest computing technology (including cloud computing) if they can rely one hundred percent on the availability of the data they need.

With Emerson Network Power data center infrastructure, you are always in a position to achieve the degree of availability that matches your scope of work.

### 2. Efficiency

A customer who can rely on the availability will still be dissatisfied if this availability is achieved at the expense of efficiency. Efficiency must be seen as a multi-purpose term. Efficiency covers:

The functionality of technical processes, e.g. expressed in the efficiency of the cooling or power supply.

Cost effectiveness in terms of both investment and running costs. When we talk about investment, it is not just the pure equipment investment that matters;

other important factors are:

- Building costs.
- Consequential costs for recirculation facilities
- Consequential costs for power supply
- Efficiency of the cooling and power supply facilities
- Consumption values and costs for operating equipment
- Monitoring, service and repair costs

Timely efficiency in relation to processing speed and the period from data provision to data output.

### 3. Adaptability

Availability and efficiency are only sufficient if planning, project management and implementation is short term rather than sustainable.

Future-proofing and adaptability for Emerson Network Power are also crucial factors in the development and delivery of data center infrastructure.

Future-proofing renders data center infrastructure operational even:

- there is demand for increased computing capacity
- the heat loads caused by new server types – or changes to the proportions of different server types – are increased or redistributed
- current flow and speed, volume flow or the pressure ratios are changed.

Products from Emerson Network Power are future-proof and provide an appropriate and efficient response.

Adaptability delivers highly efficient results even during planning and project management and is, naturally, also part of future-proofing.

# Knürr® DCL

## Modular Rack Cooling up to 60 kW

**Rack cooling enables you to expand server performance without interfering with existing room cooling. Knürr offers 3 basic solutions:**

### Adaptability

- Two "room neutral" architectures for medium to high power density
- Can be retrofitted easily on site.
- Various combinations from up to four server racks.

### Availability

- N +1 fan redundancy.
- Multi-level "fail-safe" controller.
- Comprehensive alarm and monitoring functions.
- Automatic emergency door opening

### Efficiency

- Minimizes power consumption with controlled EC fans.
- Long freecooling periods due to large dimensioned heat exchanger.



Knürr DCL with DCM rack





Simple fan replacement



Knürr DCM® server rack for cooling with Knürr® DCL, Liebert®; integrated power distribution modules and cable management.



Embedded controller



Knürr® DCL fans



Switchover between a 2 and 3-way valve



Detail of the DCL data center

## Knürr® DCL Benefits

### ■ Availability

An essential requirement for data center operators is to ensure uninterrupted availability. Knürr guarantees this by means of:

- Embedded controller hardware guaranteeing autonomous continued operation of the control system in the event of a component failure.
- Access control and data security guaranteed by means of HTTPS and SNMP V3.
- Alarm management can be integrated into DCIM (Data Center Infrastructure Management).

### ■ Efficiency

Given current competition, no data center operator can leave the costs issue to chance. Anyone who only thinks about the upfront costs or wants to cut costs at the expense of reliability will be in for unpleasant surprises later on.

- Greater power density in the data center results in better use of space and reduced building costs.
- High cold-water supply temperature increases the proportion of free cooling during cold-water generation and improves the energy efficiency rating (EER) of the chiller.
- Low air-side pressure loss reduces the power consumption of the fans.

### ■ Adaptability

The modular DCL design accommodates frequently changing requirements:

- Two room-neutral cooling architectures for medium- to high-power density.
- Simple retrofitting on site.
- A number of combinations with up to 4 server racks to choose from.



## Knürr® DCL Configurations

- DCL-L facilitates efficient rack cooling from 1 to 4 server racks

### Knürr® DCL – L

- Air flow completely contained in rack or suite.
- No thermal load or air flow in the room for greatly reduced noise levels.
- Comprehensive separation of IT equipment and IT room; precisely controlled cooling air temperature.
- No special room requirements; raised floor not necessary.



Knürr® DCL-L with one-sided connection to Knürr DCM®



\*Flow diagram

### Knürr® DCL – H

- Hybrid configuration: air flow in containment within rack and room.
- Cooling devices and racks are open at the front and closed at the rear.
- No thermal load in room; warm air contained within racks.
- Cold air distribution throughout the room; cold air reserve available in the event of cooling failure.
- A better alternative to hot aisle containment.
- Raised floor not required.



Knürr® DCL-H with one-sided connection to Knürr DCM®



\*Flow diagram

### Knürr® DCL – R

- Aisle cooling device for SmartAisle cold aisle containment.
- Alternative to Liebert CRV030/034, if control system is the same as that used for DCL-L or DCL-H.
- Switching to Knürr DCL-L or DCL-H can be done simply by changing the doors.



Knürr® DCL-R with one-sided connection to Knürr DCM®

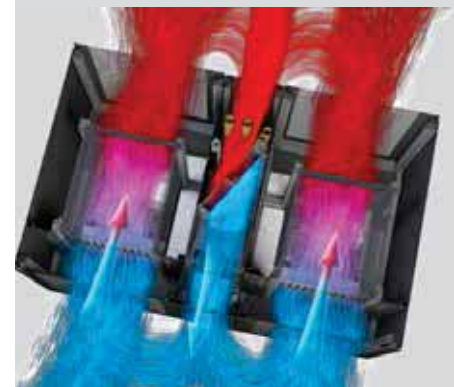

\*Flow diagram

\* Diagrams show horizontal cross-section from above.

## Knürr® DCL Basic Specifications

Cooling power levels/specification		Knürr® DCL 30 kW	Knürr® DCL 34 kW
Product name Knürr® DCL for rack cooling		Knürr® DCL30L	Knürr® DCL34L
Product name Knürr® DCL for hybrid solution		Knürr® DCL30H	Knürr® DCL34H
Product name Knürr® DCL for aisle cooling		Knürr® DCL30R	Knürr® DCL34R
Nominal cooling power*		30 kW	34 kW
Volume flow rate of air		5000 m³/h	6000 m³/h
Volume flow rate of water		4.5 m³/h	5.0 m³/h
Max. water pressure		10 bar (145 PSI)	10 bar (145 PSI)
Number of fans		5	6
Max. power consumption of fans		5 x 170 W	6 x 170 W
Dimensions	Height	2000 mm	2200 mm
	Width	300 mm	
	Depth	DCL-L	1.200 mm - 1.300 mm
		DCL-H	1.100 mm - 1.300 mm
DCL-R	1.000 mm - 1.300 mm		

\* when cooled at a water temperature of 16/22 °C and air inlet temperature of 43 °C



Knürr® DCL with Knürr® DCM

## Knürr® DCL Order number

Model number – Part 1/2										Detail of model											Part 2/2			
1	2	3	4	5	6	7	8	9	10	11	12	13	14	15	16	17	18	19	20	21	22	23	24	25
D	C	L	3	0	L																			
D	C	L	3	4	H																			
D	C	L	3	0	R																			

<b>1. – 3.</b>	<b>DCL (Modular Rack Cooling for Data Centers)</b> DCL – Knürr® DCL
<b>4. – 5.</b>	<b>Nominal Cooling Capacity</b> 30 – 30 kW (height 2000 mm / 42 U) 34 – 34 kW (height 2200 mm / 47 U)
<b>6.</b>	<b>Application</b> L – Cooling with closed cold-air circulation (without side panels) H – Hybrid cooling (open in the front; closed at the rear - without side panels) R – Cooling with perforated doors (with side panels)
<b>7.</b>	<b>Depth</b> 1 – 1000 mm (only for DCL-R version) R – 1100 mm (not for DCL-L version) 2 – 1200 mm H – 1300 mm
<b>8.</b>	<b>Rollers and Ramp for Transport</b> 0 – No rollers (2 devices on one pallet) D – Transport rollers (one device on one pallet with ramp)
<b>9.</b>	<b>Power Connection</b> 2 – 230 V AC 1-phase 50/60 Hz CE 4 – 230 V AC 1-phase 50/60 Hz CE with A/B switching 2 – 230 V AC 1-phase 50/60 Hz 2-pole CE B – 230 V AC 1-phase 50/60 Hz 2-pole CE with A/B switching P – 208 / 230 V AC 2-pole 50/60 Hz CSA S – 208 / 230 V AC 2-pole 50/6 Hz CSA with A/B switching
<b>10.</b>	<b>Water Connection and Heat Exchanger Redundancy</b> Z – Water connection, bottom Y – Water connection, top 9 – Water connection, top and bottom V – Redundant water connection, bottom (external valve)
<b>11.</b>	<b>Filter (only for DCL-R)</b> N – No filter A – MERV 1 (not possible for 1000 mm depth) C – MERV 1, filter monitoring (not possible for 1000 mm depth)
<b>12.</b>	<b>Screen Display</b> 0 – Without Y – 145 cm display (5.7"); touchscreen
<b>13.</b>	<b>Preparation for Automatic Door Opening</b> 0 – Not prepared 1 – Prepared for one rack with automatic door opener 2 – Prepared for two racks with automatic door opener 3 – Prepared for three racks with automatic door opener 4 – Prepared for four racks with automatic door opener
<b>14.</b>	<b>Cooling Water Monitoring / Condensate Pump</b> 0 – Without T – Temperature sensor inlet flow / return flow 4 – Heat meter 5 – Condensate pump 6 – Temperature sensor inlet flow / return flow + condensate pump 7 – Heat meter + condensate pump
<b>15.</b>	<b>Environmental Monitoring</b> 0 – Without S – Smoke detection H – Humidity monitoring B – Smoke detection and humidity monitoring
<b>16.</b>	<b>Color</b> 1 – RAL 7021, (dark-grey) G – RAL 7035, (light-grey) 2 – No standard color
<b>17. – 18.</b>	<b>Free (for Future Use)</b>
<b>19.</b>	<b>Communication Interface</b> 0 – Standard / always available (HTTPS, SSH, MODBUS TCP, SNMP - to V3) D – Digital input / output (8/4) M – Modbus RTU B – Bacnet V – 4 digital input / output + Modbus RTU W – 4 digital input / output + Bacnet
<b>20.</b>	<b>Server Rack Monitoring (Accessory Kit)</b> 0 – Without 1 – Door contacts 1 rack 2 – Door contacts 2 racks A – Door contacts 3 racks B – Door contacts 4 racks 3 – 2 x temperature sensors 1 rack 4 – 2 x 2 temperature sensors 2 racks C – 3 x 2 temperature sensors 3 racks D – 4 x 2 temperature sensors 4 racks 7 – Door contacts + temperature sensors 1 rack 8 – Door contacts + temperature sensors 2 racks E – Door contacts + temperature sensors 3 racks F – Door contacts + temperature sensors 4 racks
<b>21.</b>	<b>Packaging</b> P = Land freight – short distance (pallet, shrink film, cardboard protection) S = Sea freight (air freight) – large distance (wooden crate)
<b>22.</b>	<b>Special Note</b> A = No special customer request to be confirmed by contractor; standard device X = Includes special customer request to be confirmed by contractor
<b>23. – 25.</b>	<b>Manufacturer's Configuration Number</b>

# Knürr® DCD

## Cooling Door for Maximum Energy Efficiency

**ENP DCD is an air-water heat exchanger that is integrated in the rear door of a server rack. The heat exchanger is designed to absorb heat loads of up to 35 kW from server racks.**

- Compact solution for new and existing data centers.
- Highest possible energy efficiency with shortage of fans.
- Supports cold-room concept.
- Permanent water circulation piping can be routed through water-carrying hinges.



Opened Knürr® DCD





Special water-bearing hinge



Water-connection fitting for the top



Condensation-water discharge fittings



Condensate pan

## Knürr® DCD Benefits

### ■ Availability

- No additional fans are required for cooling; fan failure is no longer an issue.
- System is highly reliable.
- Fewer sources of failure.
- No additional fans needed; thus no heat is wasted.
- Guaranteed 35 kW cooling.
- Minimal air pressure drop for cooling air.
- Conduit and collector for condensate water in the event of the temperature dropping below dew point. Condensate water is discharged via a flexible 5/8" hose attached to a male coupling.

### ■ Efficiency

- Optimal space utilization through ultra compact design and hence very low room costs.
- Lowest possible pressure loss in water cooling circulation: only 54 kPa minimizes energy consumption of pumps.
- Minimal pressure loss in cooling air flow through optimized heat exchanger structure and linear air paths without bends: no energy costs incurred by additional fan for cooling unit.

### ■ Adaptability

- Standard heights for 2000 and 2200 mm (42 / 47U).
- Standard widths 600, 700 and 800 mm.
- Top or bottom cold-water connection (field can be adjusted).
- Using a special adapter frame, the Knürr® DCD cooling door is compatible with server racks from other manufacturers.

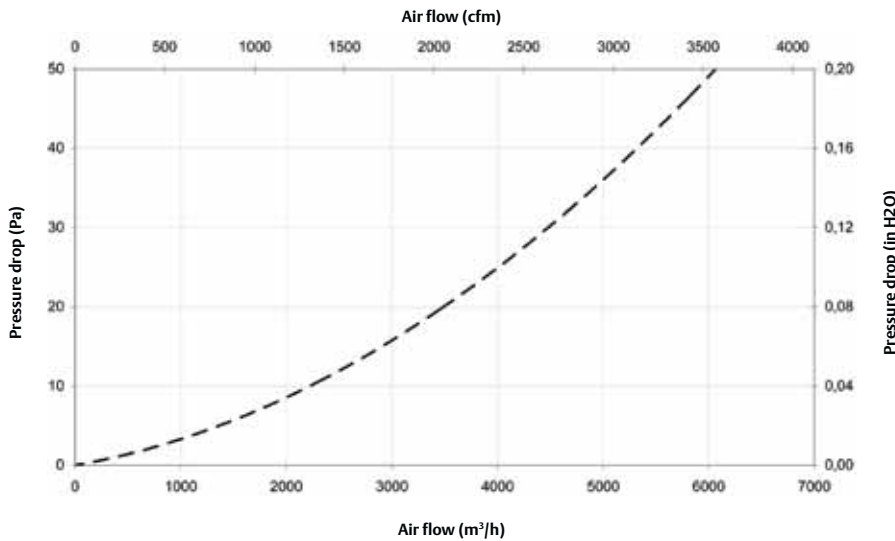

35Pa can be handled in servers with typical fans

PUE = 2

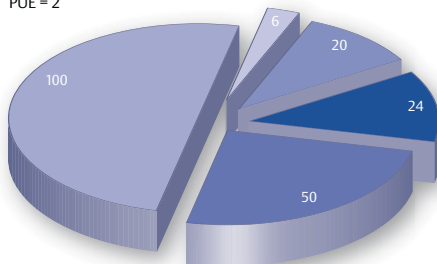

PUE = 1.2

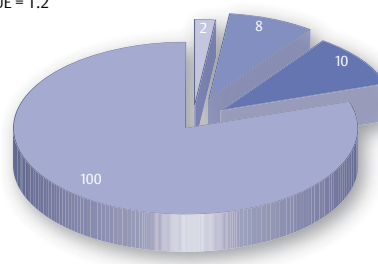

- Lighting
- Electrical losses
- Air circulation
- Cooling
- IT equipment

## Knürr® DCL Configurations



Knürr® DCD open without trim



Server rack cooling components with Knürr® DCD cooling door



Server rack air flow with Knürr DCL (cross-section)

## Knürr® DCD/DCM Basic Specifications

### Cooling-air side

Housing material	Sheet steel (powder-coated)
Operating ambient temperature	10 °C ÷ 35 °C (50 °F - 95 °F) (other temperatures available upon on request)
Max. absolute humidity on site	8 g/kg
Air outlet temperature (as per ASHARE)	18 °C ÷ 27 °C (64.4 °F - 80.6 °F)
Air temperature difference - OFF	15 K ÷ 20 K

### Cold-water side

Cooling power	35 kW
Cold water inlet temperature	12 °C ÷ 18 °C (53.6 °F - 64.4 °F) (other temperatures available upon on request)
Cold water outlet temperature	18 °C ÷ 24 °C (64.4 °F - 75.2 °F) (other temperatures available upon on request)
Max. operating pressure	10 bar (145 psi)
Pipe connection IN / OUT	1 "IG (on frame) (DIN ISO 228-1)

## Knürr® DCD Configuration number

Model number – Part 1/2										Detail of model										Part 2/2				
1	2	3	4	5	6	7	8	9	10	11	12	13	14	15	16	17	18	19	20	21	22	23	24	25
D	C	D	3	5	A	6	3	3	0	0	0	0	0	0	1	0	0	0	0	S	X	0	0	1

<b>1. – 3.</b>	<b>Product Description</b> DCD = ENP DCD	<b>10.</b>	<b>Options</b> 0 = No options (currently not available)
<b>4. – 5.</b>	<b>Nominal Cooling Capacity</b> 35 = 35 kW	<b>11. – 15.</b>	<b>Not in Use</b> 0 = No options (currently not available)
<b>6.</b>	<b>Rack Height</b> A = 2000 mm (78 – 6/8") B = 2100 mm (82 – 5/8") C = 2200 mm (86 – 5/8") M = Modification (only SFA)	<b>16.</b>	<b>Color</b> 1 = RAL 7035 (light-grey) G = RAL 7021, (dark-grey) 2 = Non-standard color (SFA)
<b>7.</b>	<b>Rack Width</b> 6 = 600 mm (23 – 5/8") 7 = 700 mm (27 – 4/8") 8 = 800 mm (31 – 4/8") M = Modification (only SFA)	<b>17. – 20.</b>	<b>Not in Use</b> 0 = No options (currently not available)
<b>8.</b>	<b>Rack Depth</b> E = 1000 mm (39 – 3/8") F = 1100 mm (43 – 3/8") G = 1200 mm (47 – 2/8") 3 = 3rd party rack adapter 0 = No rack M = Modification (only SFA)	<b>21.</b>	<b>Packaging</b> P = Land freight – short distance (pallet, shrink film, cardboard protection) S = Sea freight (air freight) – large distance (wooden crate)
<b>9.</b>	<b>Cold-water Connection –Position of Hinge</b> 1 = top – left 2 = top – right 3 = bottom – left 4 = bottom – right	<b>22.</b>	<b>SFA – Special Features</b> X = SFAs included A = No SFAs
		<b>23. – 25.</b>	<b>Order ID</b>



# Knürr CoolTherm®

## Water-Cooled Server Rack

### Features

- Compact solution for new construction using a minimal space of up to 35 kW.
- Energy-efficient EC radial fans which deliver the chilled air required for a wide variety of server types.
- Newly developed V-shaped air/water heat exchanger.
- Broad spectrum of environmental monitoring functions.
- Supports cold-room concept.

With this solution launched in 2002, Knürr was the first to facilitate efficient cooling of server racks, helping servers work optimally even at high temperatures. Thanks to the features listed below, hundreds of Knürr CoolTherm® units have been providing reliable server cooling in data centers of well-known customers for over 10 years.



Knürr CoolTherm® 35 kW



V-shaped heat exchanger, 35 kW

### Knürr CoolTherm® Benefits

#### ■ Availability

- Autonomous server rack; independent of ambient conditions.
- n+1 fan redundancy.
- Internal environmental monitoring (humidity and smoke detection) and fire extinguisher.
- Alarm management system and RMS (Rack Monitoring System) provide all the necessary information.
- 2 or 3-way cold-water valve configuration and redundant cooling water supply available.

#### ■ Efficiency

- Maximum packing density for high-performance servers, saving up to 80% space in the data center.
- Reduced room and building requirements (climate control, raised floor, room height).

- Maximum density delivers optimal usage of space.
- Control valve allows pump output to be adjusted to the current cold water requirement.

#### ■ Adaptability

- 3 sizes ranging from 1800 to 2400 mm for optimum customization of specified room heights.
- Depths of 1200 and 1300 mm guarantee optimum use of space for a wide variety of server types.
- Width of 800 mm ensures sufficient space for power distribution and cable routing without blocking the air passages.
- Intelligent power distribution systems; unique cable management.

## Knürr CoolTherm® Configurations



## Knürr CoolTherm® Application example

- **Industry**
  - Scientific computing.
- **Requirement**
  - High power density in minimum space.
  - High cold-water inlet temperatures achieved by cooling via an absorption cooling device powered by district heating systems and an adiabatic cooling tower.
- **Solution**
  - Scalable number of Knürr CoolTherm® server racks.
  - Power supply from the busbars at the top.
  - Cold water connection from below.
  - Heat exchanger among the servers.



Knürr CoolTherm® air flow



Knürr CoolTherm® 35 kW

## Knürr CoolTherm® Basic Specifications

Effective cooling capacity (kW)	Water content (l)	Water flow rate m³/h	Pressure loss (bar)	Nominal cooling water temperature difference (K)
12	5.9	1.79	0.41	6
17	7.9	2.55	0.62	6
25	9.9	3.72	0.58	6
35	9.9	3.72	0.58	8.1

## Knürr CoolTherm® Order Number

Cooling capacity (kW)	Width (mm)	Height (mm)	Depth (mm)	Useable height (U)	Useable depth (mm)	Order name (W)	Order No.
12 kW	700	1800	1200	29	740	CoolTherm 12 kW	08.006.001.x
		2000		33			08.006.002.x
		2200		38			08.006.003.x
	1800	1300	29	840	CoolTherm 12 kW	08.006.006.x	
			2000			33	08.006.007.x
			2200			38	08.006.008.x
17 kW	800	2000	1200	35	740	CoolTherm 17 kW	08.006.012.x
		2200		40			08.006.013.x
		2400		44			08.006.014.x
	2000	1300	35	840	CoolTherm 17 kW	08.006.022.x	
			2200			40	08.006.023.x
			2400			45	08.006.024.x
25 kW	800	2200	1200	37	740	CoolTherm 25 kW	08.006.033.x
		2400		42			08.006.034.x
	2200	1300	37	840	CoolTherm 25 kW	08.006.043.x	
			2400			42	08.006.044.x



## Rack Cooling Accessories

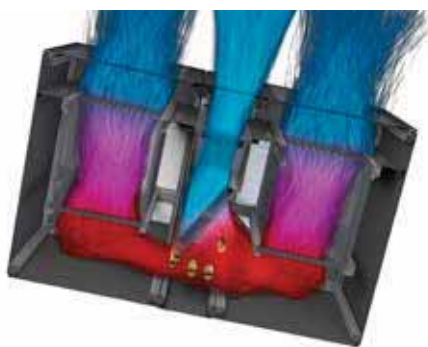
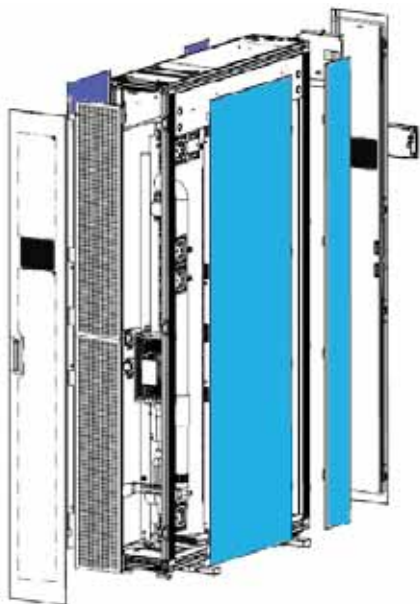

An add-on kit should be ordered to secure the adjacent racks in a straight line; to ensure an airtight seal and guarantee the separation of the warm and cold air sides. The same connection set is used for sealing DCM / DCM and DCL / DCM combinations. The kit contains: metal connection brackets (4), horizontal foam sealing strips and vertical plastic extrusion sealing tape.

### Knürr® DCL Partition Panels

■ **Application**

– Used for changing air flow rate.

■ **Material**

– Sheet steel, 1.0 mm.

■ **Color**

– Powder coated texture, RAL 7021, dark-grey.

H [mm]	D [mm]	Description	Order No.
2000	1000-1100	Internal side panel front, right H2000 D1000 - 1100 dark-grey	<b>080130708</b>
2000	1200-1300	Internal side panel front, right H2000 D1200 - 1300 dark-grey	<b>080130718</b>
2200	1000-1100	Internal side panel front, right H2200 D1000 - 1100 dark-grey	<b>080130808</b>
2200	1200-1300	Internal side panel front, right H2200 D1200 - 1300 dark-grey	<b>080130818</b>
2000	1000-1100	Internal side panel front, left H2000 D1000 - 1100 dark-grey	<b>080130728</b>
2000	1200-1300	Internal side panel front, left H2000 D1200 - 1300 dark-grey	<b>080130738</b>
2200	1000-1100	Internal side panel front, left H2200 D1000 - 1100 dark-grey	<b>080130828</b>
2200	1200-1300	Internal side panel front, left H2200 D1200 - 1300 dark-grey	<b>080130838</b>
2000	1000	Internal side panel rear, right H2000 D1000 dark-grey	<b>080130748</b>
2000	1100-1200	Internal side panel rear, right H2000 D1100 - 1200 dark-grey	<b>080130758</b>
2000	1300	Internal side panel rear, right H2000 D1300 dark-grey	<b>080130768</b>
2200	1000	Internal side panel rear, right H2200 D1000 dark-grey	<b>080130848</b>
2200	1100-1200	Internal side panel rear, right H2200 D1100 - 1200 dark-grey	<b>080130858</b>
2200	1300	Internal side panel rear, right H2200 D1300 dark-grey	<b>080130868</b>
2000	1000	Internal side panel rear, left H2000 D1000 dark-grey	<b>080130778</b>
2000	1100-1200	Internal side panel rear, left H2000 D1100 - 1200 dark-grey	<b>080130788</b>
2000	1300	Internal side panel rear, left H2000 D1300 dark-grey	<b>080130798</b>
2200	1000	Internal side panel rear, left H2200 D1000 dark-grey	<b>080130878</b>
2200	1100-1200	Internal side panel rear, left H2200 D1100 - 1200 dark-grey	<b>080130888</b>
2200	1300	Internal side panel rear, left H2200 D1300 dark-grey	<b>080130898</b>

### Knürr® DCL / DCM Add-on Kit

■ **Application**

– Connects and seals the DCL and DCM racks.

■ **Material**

– Metal plate, plastic extrusion strips, foam strips.

■ **Consists of**

– Connection plates, vertical sealing strips, horizontal sealing strip.

Description	Order No.
Add-on kit DCL / DCM	<b>080134530</b>

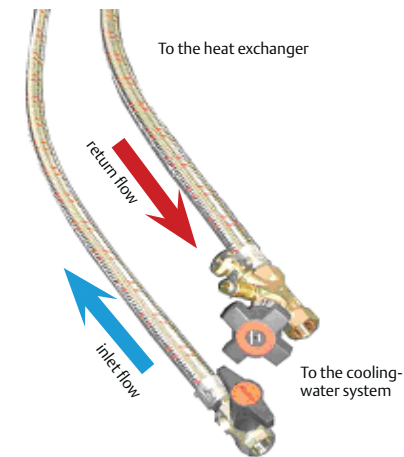

Draining and purging valve with nipple for measurement device connection (3/4", female) (for measuring water flow rate)

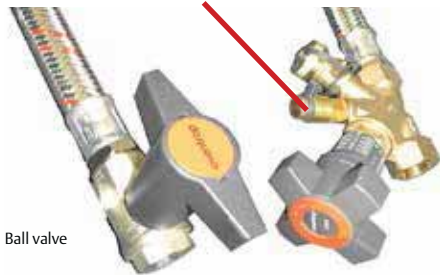

Ball valve

Shut-off and control valves (to set the volumetric flow rate)

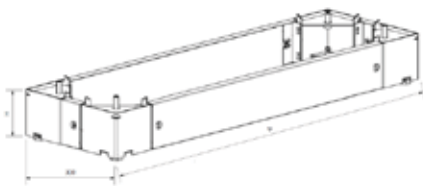

## Knürr® Chilled Water Connecting Kit

- **Application**
  - Simple connection to water circulation, simple start-up.
- **Consists of**
  - Two flexible armored tubes, stainless steel plated, water-resistant and frost-resistant EPDM. Nickel-plated pipe connections.
- **Temperature range**
  - 0 – 110° C.
- **Operating pressure**
  - Max. 10 bar.
- **Inner diameter**
  - 31 mm.
- **Connections**
  - Threaded connection, 1 1/4" (or 1"), flat sealing.
- **Length**
  - 1500 mm.
- **Ball valve connections**
  - 1 1/4" (or 1").

Shut-off and control valves with 3/4" draining and purging connection and a nipple for measuring pressure and temperature. Connections: 1 1/4" (or 1").

Description	Order No.
Cold-water connection kit 5/4" (for DCL)	080090910
Cold-water connection kit 1" (for CoolTherm and DCD)	080090660

## Knürr® DCL Plinth

- **Application**
  - For installing lower cold-water connection without a raised floor.
- **Material**
  - Sheet steel, 1.0 mm.
- **Color**
  - Powder-coated, RAL 7021 - dark-grey, RAL 7035 - light-grey.

H [mm]	D [mm]	Description	Order No.
100	1000	Plinth H100 D1000 dark-grey	011479838
100	1100	Plinth H100 D1100 dark-grey	011479848
100	1200	Plinth H100 D1200 dark-grey	011479858
100	1300	Plinth H100 D1300 dark-grey	011479868
100	1000	Plinth H100 D1000 light-grey	011479831
100	1100	Plinth H100 D1100 light-grey	011479841
100	1200	Plinth H100 D1200 light-grey	011479851
100	1300	Plinth H100 D1300 light-grey	011479861
200	1000	Plinth H200 D1000 dark-grey	011479788
200	1100	Plinth H200 D1100 dark-grey	011479798
200	1200	Plinth H200 D1200 dark-grey	011479808
200	1300	Plinth H200 D1300 dark-grey	011479818
200	1000	Plinth H200 D1000 light-grey	011479781
200	1100	Plinth H200 D1100 light-grey	011479791
200	1200	Plinth H200 D1200 light-grey	011479801
200	1300	Plinth H200 D1300 light-grey	011479811

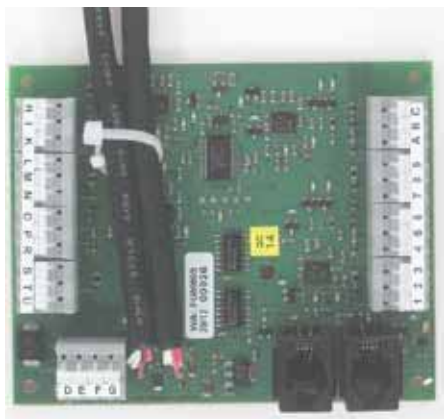

Sensor module

## Knürr® Additional Temperature Sensor Kit

### ■ Application

- For installing the remote temperature measuring point (e. g. in SmartAisle containment).

### ■ Consists of

- Sensor module, temperature sensor with cable and plug.

Description	Order No.
Temperature sensor	400006856
Analog sensor module	400006853



Temperature sensor with cable and plug

# Knürr PowerTrans2®

## Power Distribution Rack

### Features

- The Knürr PowerTrans2 has a modular design with a versatile plug-in units that can be used as required.
- **Plug and Play:**  
Only the main feed must be installed by a qualified electrician.
- The plug-in units can be inserted during operation; there are no downtimes.
- **Elementary model:**  
Power distribution unit without metering.
- **Metered version:**  
Power distribution unit offers extensive metering functions with a high level of accuracy (up to  $\pm 1\%$ ).
- **Highest power density:**  
up to max. 346 kVA.

**The Knürr PowerTrans2 forms the interface between the low-voltage power supply and rack PDUs as well as further components for supplying servers and other IT devices.**

Rack basics: connecting the Knürr DCM rack and the existing PowerTrans2 19" plug-in units simply involves slotting the elements into a free slot and securing them. The rack is then immediately connected to the power supply. The power is distributed via the individual slot-in units, avoiding installation within the building.



PowerTrans2: 19" slot-in



#### Input Power

- Max. 250 A per phase.
- 1 ph. or 3 ph. feed.
- Max. 2 feeds per rack.



#### Modularity

- Output distributors can be installed as modules during running operation.



#### Output Distributor

- 230/400V – 32A via IEC 60309 socket.
- 230/400V – 16A via GST 18 socket.
- 230V – 32A via IEC 60309 socket.
- 230V – 16A via GST18 socket.



#### Monitoring

- Input level.

# Knürr PowerTrans2®

Power distribution unit between

Liebert® APM™ UPS system and MPX rack PDUs

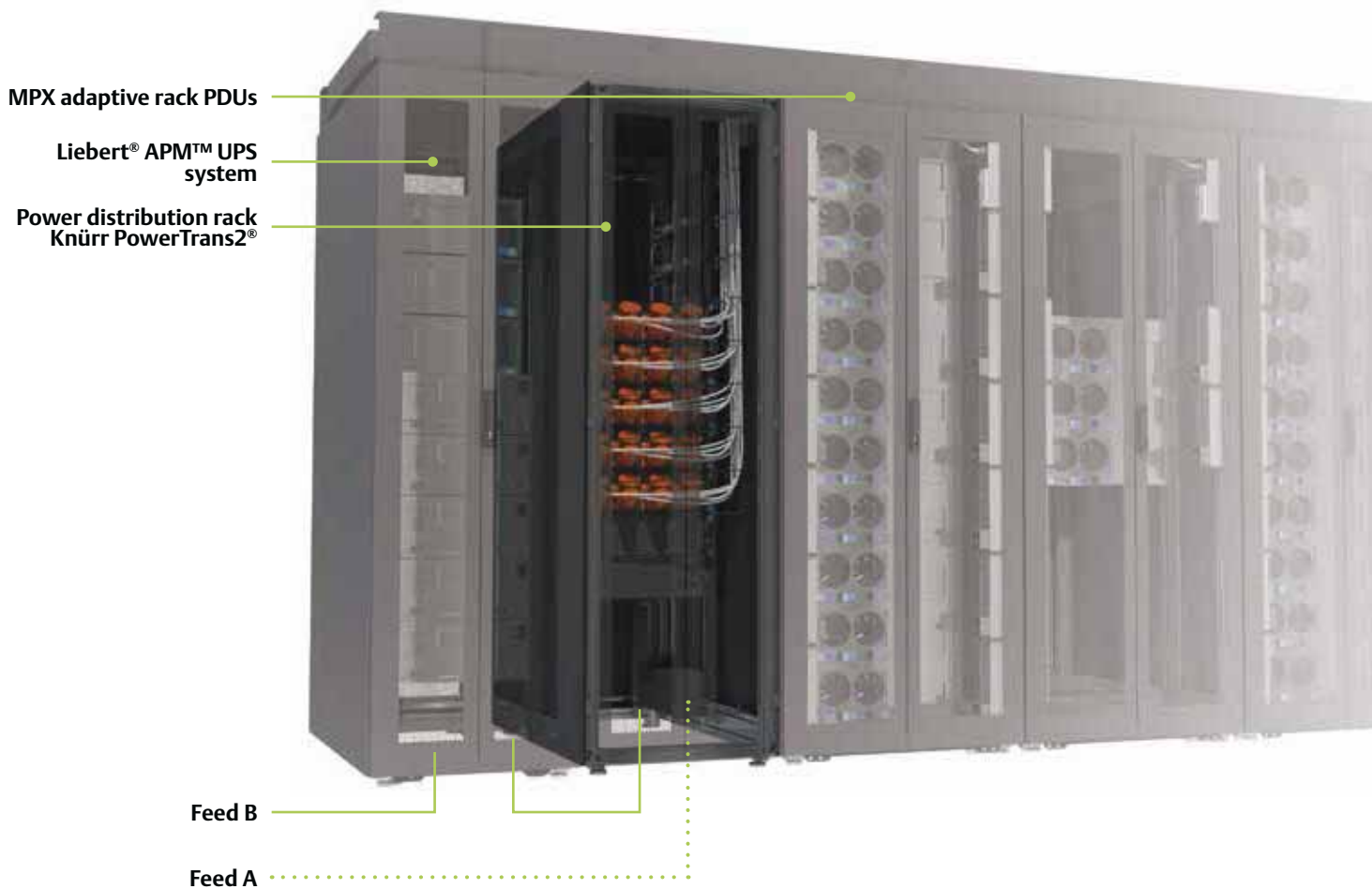

## Benefits

- Two feeds (A + B) available for each rack.
- Optimum power distribution from the Liebert® APM™ UPS system to the MPX rack PDUs.
- Each phase input from the Knürr PowerTrans2® is monitored and evaluated.
- The PowerTrans2 Basic can be populated with a maximum of 10 plug-in units, while the metered version can be populated with a maximum of 8 plug-in units.
- Minimal footprint due to a rack width of 600 mm.





Knürr PowerTrans2

## Knürr PowerTrans2® 19" Power Distribution Rack

### ■ Elementary and Monitored type

- Feed of 2 separate 3-phase 400V mains, L1, L2, L3, N, PE.
- Each with a 250 A circuit breaker in the input.
- Distribution to the individual plugs via busbars and contact-safe plug-in connections.
- Up to 8 (Monitored) / 9 (Elementary) slot-in units where A feed and B feed are possible.

### ■ Monitored type

- Provides the following phase-input data: voltage, current, effective power, consumption and frequency.
- Power alarm functions for the individual phases and their operating status are also supported.

### ■ Technical data Interfaces

- RJ-45 LAN port (10/100 MBit) – for connecting to local network (LAN) via an Ethernet cable.
- Serial interface: RS485.
- Remote management: Onboard Web Interface, SNMPv1,2,3, SSH and Syslog can be integrated into Nform & Trellis as well as Nagios or other management software programs.

### ■ Material / Finish

- Basic rack, extruded aluminum, polished.
- Corner piece, die-cast aluminum, polished.
- Perforated front door.
- Rear door, double, closed.
- Covers, zinc-passivated sheet steel, powder-coated texture.

### ■ Color

- RAL 7021 dark-gray.

### ■ Standard inclusion

- 1 x rack with covers, front door, rear door.
- 1 x set of safe-contact busbars, for A feed and B feed.
- 2 x circuit breakers, max. 250 A.
- 18 x (Monitored type) / 20 x (Elementary type) power supply plugs for the slot-in units wired on the busbars.
- 1 x 19" PowerTrans2 metering slot-in unit (Monitored type).
- 2 x 19" T-slot extrusions.
- 20 x chassis runners.
- 1 x complete earthing set.
- 1 x complete locking set.

W	H	D	U	h	d	kg	Model	Cable entry	Order No.	UP
600	2000	1000	42				Elementary	Below	03.014.600.8.004	1
600	2000	1100	42				Elementary	Below	03.014.600.8.005	1
600	2000	1200	42				Elementary	Below	03.014.600.8.006	1
600	2200	1000	47				Elementary	Below	03.014.600.8.010	1
600	2200	1100	47				Elementary	Below	03.014.600.8.011	1
600	2200	1200	47				Elementary	Below	03.014.600.8.012	1
600	2000	1000	42				Monitored	Below	03.014.601.8.004	1
600	2000	1100	42				Monitored	Below	03.014.601.8.005	1
600	2000	1200	42				Monitored	Below	03.014.601.8.006	1
600	2200	1000	47				Monitored	Below	03.014.601.8.010	1
600	2200	1100	47				Monitored	Below	03.014.601.8.011	1
600	2200	1200	47				Monitored	Below	03.014.601.8.012	1
600	2000	1000	42				Elementary	Above	03.014.602.8.004	1
600	2000	1100	42				Elementary	Above	03.014.602.8.005	1
600	2000	1200	42				Elementary	Above	03.014.602.8.006	1
600	2200	1000	47				Elementary	Above	03.014.602.8.010	1
600	2200	1100	47				Elementary	Above	03.014.602.8.011	1
600	2200	1200	47				Elementary	Above	03.014.602.8.012	1
600	2000	1000	42				Monitored	Above	03.014.603.8.004	1
600	2000	1100	42				Monitored	Above	03.014.603.8.005	1
600	2000	1200	42				Monitored	Above	03.014.603.8.006	1
600	2200	1000	47				Monitored	Above	03.014.603.8.010	1
600	2200	1100	47				Monitored	Above	03.014.603.8.011	1
600	2200	1200	47				Monitored	Above	03.014.603.8.012	1



PowerTrans2

## Knürr PowerTrans2® 19" Slot-in Power Distributor

- Power distributor slot-in for PowerTrans2 rack.
- Also functions without PowerTrans2 rack if used with a suitable connection cable.
- 19" slot-in housing.
- Width 19".
- Height: 3 U.
- Depth: 480 mm.
- Color: RAL 7021 dark-gray.
- 2 separate 3-phase inputs with max. 63 A phase current (feed A + feed B).
- Outputs are shown in the table below.
- Backups: 1-pole (for single-phase) or 3-pole (for 3-phase). 2-pole or 4-pole backups available upon request.

Inputs	Outputs		Order No.
Phase tap per feed	Feed A	Feed B	
L1-N, L2-N, L3-N	6 x 230Vac 16 A GST 18i3	6 x 230Vac 16 A GST 18i3	<b>03.014.011.8.002</b>
L1-N, L2-N	2 x 230Vac 32 A IEC60309 1ph/N/PE 6h	2 x 230Vac 32 A IEC60309 1ph/N/PE 6h	<b>03.014.011.8.005</b>
L2-N, L3-N	2 x 230Vac 32 A IEC60309 1ph/N/PE 6h	2 x 230Vac 32 A IEC60309 1ph/N/PE 6h	<b>03.014.011.8.006</b>
L3-N, L1-N	2 x 230Vac 32 A IEC60309 1ph/N/PE 6h	2 x 230Vac 32 A IEC60309 1ph/N/PE 6h	<b>03.014.011.8.007</b>
L1-N, L2-N, L3-N	3 x 230/400Vac 3 x 16 A GST18i5	3 x 230/400Vac 3 x 16 A GST18i5	<b>03.014.012.8.002</b>
L1-N, L2-N, L3-N	2 x 230/400Vac 3 x 32 A IEC60309 3ph/N/PE 6h	2 x 230/400Vac 3 x 32 A IEC60309 3ph/N/PE 6h	<b>03.014.012.8.003</b>

## Knürr PowerTrans2® Connection Cable

- Connection cable between 19" power distributor slot-in and rack PDUs

Length	Input connector	Output socket	Order No.
5000	230Vac 16 A GST 18i3	230Vac 16 A IEC60320 C19	<b>03.014.013.9.001</b>
5000	230Vac 16 A GST 18i3	230Vac 16 A IEC60309 1ph/N/PE 6h	<b>03.014.013.9.003</b>
5000	230/400Vac 3 x 16 A GST 18i5	230/400Vac 3 x 16 A IEC60309 3ph/N/PE 6h	<b>03.014.014.9.001</b>
5000	230Vac 32 A IEC60309 1ph/N/PE 6h	230Vac 32 A IEC60309 1ph/N/PE 6h	<b>On request</b>
5000	230/400Vac 3 x 32 A IEC60309 3ph/N/PE 6h	230/400Vac 3 x 32 A IEC60309 3ph/N/PE 6h	<b>03.014.014.9.003</b>
10000	230Vac 16 A GST 18i3	230Vac 16 A IEC60320 C19	<b>03.014.013.9.002</b>
10000	230Vac 16 A GST 18i3	230Vac 16 A IEC60309 1ph/N/PE 6h	<b>03.014.013.9.004</b>
10000	230/400Vac 3 x 16 A GST 18i5	230/400Vac 3 x 16 A IEC60309 3ph/N/PE 6h	<b>03.014.014.9.002</b>
10000	230Vac 32 A IEC60309 1ph/N/PE 6h	230Vac 32 A IEC60309 1ph/N/PE 6h	<b>On request</b>
10000	230/400Vac 3 x 32 A IEC60309 3ph/N/PE 6h	230/400Vac 3 x 32 A IEC60309 3ph/N/PE 6h	<b>03.014.014.9.004</b>

## This is how you can benefit from Emerson Network Power Rack PDUs

### Featuring High Availability

**Emerson Network Power rack PDUs are especially designed to provide maximum power densities and high temperature stability commonly required in modern data center racks.** The system was developed to optimize basic availability of the power supply, minimizing downtimes as PDUs can be expanded easily. Additionally, Emerson Network Power offers requisite support enabling you to fulfill your service-level agreements.

- High temperature stability
- Modular hot-swap-enabled communications card
- Hydraulic-magnetic circuit breaker
- MPX™ rack PDU featuring an adaptive, modular system design
- Bistable / normally closed relay

### Optimized Energy and Capacity Management

**Thanks to highly accurate and comprehensive energy metering of the entire system up to the connection level. The superior visibility delivered by the MPX and MPH2™ rack PDUs for monitoring the energy consumption of your IT equipment enables you to scale your energy-consumption infrastructure and avoid unnecessary costs.** These rack PDUs feature the lowest energy consumption in their class.

- Essential electrical parameters metered with an accuracy of  $\pm 1\%$
- Lowest PDU power consumption of all switched rack PDUs in the industry
- Reports are compiled using a variety of Emerson Network Power DCIM solutions

### Simplified Integration into Management Tools

**MPX and MPH2 rack PDUs offer a simplified approach to implementation and change management that translates to real cost savings and operational advantages.** These rack PDUs support all conventional management, authentication and encryption standards and protocols, allowing for integration into industry-leading Kernel-based Virtual Machine (KVM) systems, serial consoles and Emerson Network Power infrastructure management systems. Furthermore, MPX and MPH2 integrate the rack PDU monitoring and environment information at rack level in the superordinate data-center management software provided by Emerson Network Power or a third party.

- Up to four PDUs with one IP address within one Rack PDU Array™
- Integrated into KVM, serial consoles and infrastructure management appliances; integrated in Emerson Network Power software stack
- IPv6 support
- Remote authentication protocol support (LDAP, Active Directory, Radius, Kerberos, TACACS+) and encryption

### Simpler Physical and Electrical Installation

**Emerson Network Power rack PDUs are easy to install and use in trade-standard racks.** The rack PDUs can be delivered pre-installed in purchased Emerson Network Power racks, saving time and money. Many important global power networks commonly used in data centers or remote locations are available – an Emerson Network Power expert can help you choose the right rack PDU to meet your needs.

- Special tool-less Knürr DCM rack fixture
- Can be pre-installed in Emerson Network Power rack solutions.
- Available in standard voltage / current strength combinations

# Emerson Network Power Rack PDUs

## Emerson Network Power Rack PDUs Europe

### Product Series Overview

Overview: Emerson Network Power Rack PDUs Europe										
	MPX - Adaptive Rack PDU			MPH2 - Managed Rack PDU				DI-STRIP Basic Rack PDU		
Features	MPX-R	MPX-B	MPX-E	MPH2-R	MPH2-M	MPH2-C	MPH2-B	DI-STRIP RM	DI-STRIP M	DI-STRIP E
Modular	■	■	■							
Local display	■	■	■*	■	■	■	■	■	■	
Remote interface	■	■	■*	■	■	■	■	■		
Metering per phase	■	■	■*	■	■	■	■	■	■	
Metering per group	■	■		■	■	■	■			
Metering per output	■			■	■					
Switch per output	■			■		■				
Metering parameter	A, V, W, kWh, VA, Hz, power factor crest factor	A, V, W, kWh, VA, Hz, power factor	A, V, W, kWh, Hz	A, V, W, kWh, VA, Hz, power factor crest factor	A, V, W, kWh, VA, Hz, power factor crest factor	A, V, W, kWh, VA, Hz, power factor	A, V, W, kWh, VA, Hz, power factor	A	A	
Input power	1ph + 3ph max 63A	1ph + 3ph max 63A	1ph + 3ph max 63A	1ph + 3ph max 32A	1ph + 3ph max 32A	1ph + 3ph max 32A	1ph + 3ph max 32A	1ph + 3ph max 32A	1ph + 3ph max 32A	1ph + 3ph max 32A
Outputs	IEC C13&C19 Schuko	IEC C13&C19 Schuko	IEC C13&C19 Schuko Switzerland GST18	IEC C13&C19	IEC C13&C19	IEC C13&C19	IEC C13&C19	IEC C13&C19 Schuko Switzerland France	IEC C13&C19 Schuko Switzerland France	IEC C13&C19 Schuko Switzerland France
Sensor connections	■	■	■*	■	■	■	■			

MPX and MPH2 accessories are similar, simplifying installation.

\* Only with MPX-PEM monitored

# MPX™ – Adaptive Rack PDU

## Respond to change and maximize profits

No-one can make definite predictions about the power-supply demands the future will bring. But one thing is certain: the versatile, adaptive MPX rack PDUs equip you with the wherewithal to face all eventualities. They enable you to react quickly to changes in rack equipment and provide dynamic capacities, offering:

- Modular hot-swap-enabled output power
- Modular hot-swap-enabled communication
- Modular input power.

### Benefits of MPX

- **Adaptive** capacity, distribution, monitoring, control and administration of critical equipment.
- **Flexibility** in reacting to constant changes – modules can be regrouped to accommodate altered requirements.
- **Only purchase what you really need** and utilize existing investments.
- **Reliable communication.**

### Flexible, configurable input and output distribution

The scalable design of the MPX rack PDU allows on-site configuration that meets the current requirements of the IT equipment. It is the perfect solution for coping with the ever increasing demands of expanding data centers. You can set up your IT equipment at another location or add new components to extend your environment. All you need to do in this case is simply reconfigure the power supply and the power distribution.

### Equipped to face the demands of today and tomorrow

The MPX rack PDU supports a variety of configurations for single-phase and three-phase power inputs enabling changes while retaining the distribution infrastructure.

### Developed for critical environments

- **Critical rack operating temperature** – of up to 60° C suitable for high temperatures inside racks.
- **Accurate voltage and current metering** with tolerances of  $\pm 1\%$  offer a comprehensive overview.
- **Energy and power metered** with outstanding precision all the way through to output level.
- **Extensive alert function; including notification before failure occurs.**
- **Monitoring of environment conditions** including alerts and alarms.
- **Notification** upon failure or if individual components are removed.

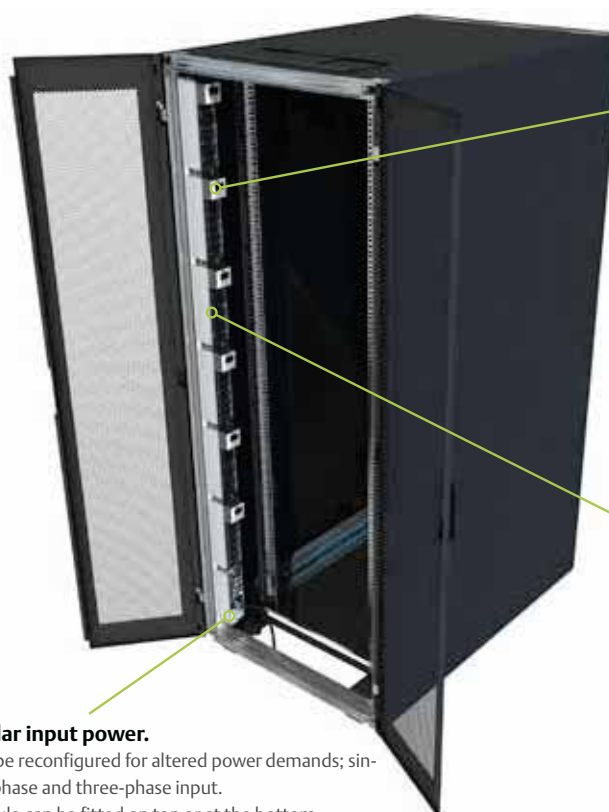

#### Hot-swap-enabled output module

Simple implementation for quick start-up of IT equipment.

#### Outputs and modules

Outputs can be controlled and measured remotely thereby increasing flexibility and on-site security.

#### Modular input power.

- Can be reconfigured for altered power demands; single-phase and three-phase input.
- Module can be fitted on top or at the bottom.

# MPX™

## Benefits of the modular MPX rack PDU

### INPUT POWER

- Configurable: 20 to 60 A (USA); 16 to 63 A (EU).
- Single-phase and three-phase.
- Cable routing possible from above and below.

### OUTPUT DISTRIBUTOR

- Scalable, combination-compatible and can be replaced during operation
- Single-phase NEMA 5-20R, IEC-C13, IEC-C19, Schuko, Switzerland, GST18.
- Load balance.

### MODULARITY

- Input modules.
- Output modules.
- External display.
- External sensors.
- RPC2 communication card.

### MONITORING

- Three levels: Input level, module level, output level.
- Temperature and humidity.
- Door contacts and floating break input contacts.

### REMOTE CONTROLLED SOCKETS

- Socket level.

### Featuring High Availability

- Heat resistant up to 60° C ensuring reliable operation in the warm aisle.
- Modular hot-swap-enabled output module, controller card and sensors; can be exchanged or updated during operation.
- Special switch relay (normally closed); connected servers have an uninterrupted power supply even in the event of failure.
- Redundant power supply for control electronics.
- Fixed databus on the busbar.
- Complete data tapping on the Power Entry Module (PEM) (without any additional external monitoring devices).
- Proactive alert by additional metering of the neutral conductor and crest factor (assessment of network quality facilitating early detection of power-supply unit failures).

### Maximum Flexibility and Scalability

- All modules configured in line with requirements (patented quick-mount fitting for safe installation).
- One busbar for different networks and power levels – input module can be freely selected. All other components are "hot-swap-enabled" when running operation.
- Mobile display for reading all MPX data on the rack.
- Optical slot-space display (easy server slot-space identification at the push of a button).

### Highest Possible Power Levels in all Areas

- Power feed of max. 3 x 63 A; optimal for Blade server applications.
- Only one IP address for up to 4 rails with 24 modules.
- Plug and Play for numerous sensors.
- Extensive monitoring with a metering accuracy of  $\pm 1\%$  right through to output level.
- Module and sensor autodetect function with operating software.
- Minimal power loss for MPX systems.

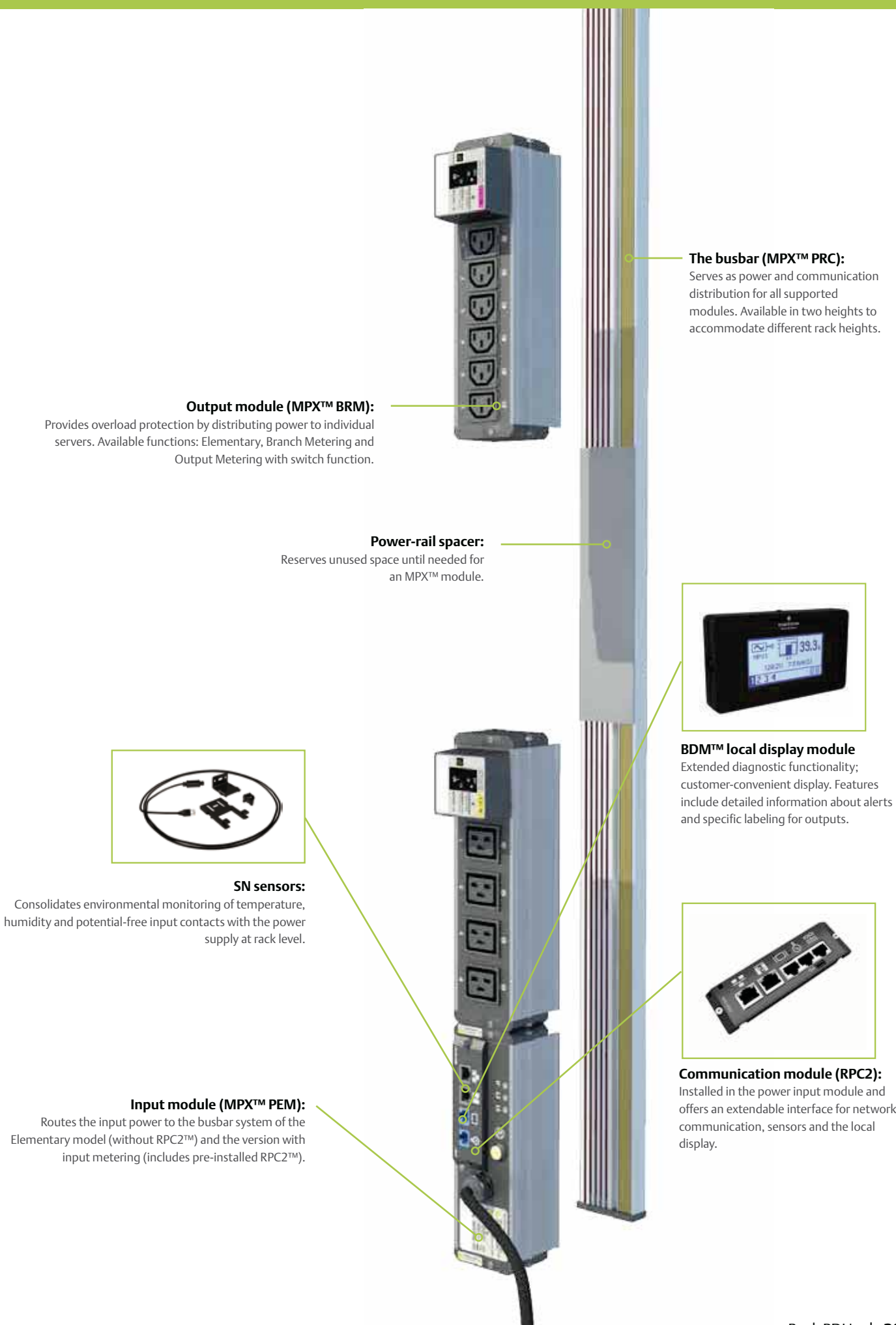

**The busbar (MPX™ PRC):**  
Serves as power and communication distribution for all supported modules. Available in two heights to accommodate different rack heights.

**Output module (MPX™ BRM):**  
Provides overload protection by distributing power to individual servers. Available functions: Elementary, Branch Metering and Output Metering with switch function.

**Power-rail spacer:**  
Reserves unused space until needed for an MPX™ module.



**BDM™ local display module**  
Extended diagnostic functionality; customer-convenient display. Features include detailed information about alerts and specific labeling for outputs.

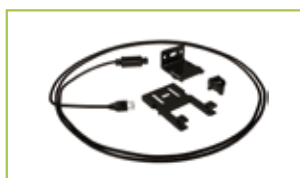

**SN sensors:**  
Consolidates environmental monitoring of temperature, humidity and potential-free input contacts with the power supply at rack level.



**Communication module (RPC2):**  
Installed in the power input module and offers an extendable interface for network communication, sensors and the local display.

**Input module (MPX™ PEM):**  
Routes the input power to the busbar system of the Elementary model (without RPC2™) and the version with input metering (includes pre-installed RPC2™).

# MPX™

## Four equipment models for different requirements

The MPX modular rack PDU consists of various components. The basic element is a busbar, which is responsible for the power and communication distribution to the individual modules. The input power is routed via the MPX Power Entry Module (MPX PEM) to the MPX system. Different output modules (MPX Branch Receptacle Modules, MPX BRM) are available depending on requirements. Four different variants can be set up depending on the component population of the busbars:

### 1. MPX Elementary

Modular basic power distribution without metering and control function. An upgrade to another equipment model is quick and easy.

### 2. MPX Elementary Phase Monitored

Modular power distribution with metering on input. An upgrade to a superordinate line is possible by populating with appropriate output modules.

### 3. Branch-Monitored MPX

Modular power distribution with metering on input and each output module.

An upgrade or downgrade to another line is possible if installed with appropriate output modules.

### 4. Receptacle Managed MPX

Modular power distribution with input, metering, each output module and each output. Individual outputs can also be switched on and off remotely. A downgrade to another line is possible if installed with the appropriate output modules.

A combination of the "Elementary Phase Monitored", "Branch-Monitored" and "Receptacle Managed" lines on a shared busbar is also possible and is one of the exceptional features of the MPX. Interfaces for the network communication, sensors and/or local display are provided by the Rack PDU Card (RPC) in the MPX PEM. The RPC Card enables connection to an optional RPC Basic Display Module (RPC BDM) to display local status and alerts.

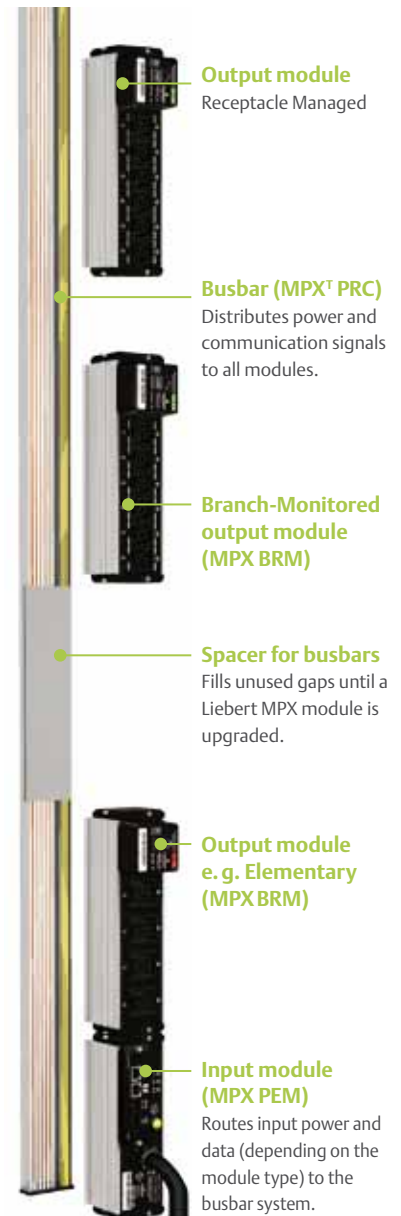



# MPX™ – Configuration models in Europe

			Four equipment models			
		Order number	MPX™ Elementary	MPX™ Elementary Phase-Monitored	MPX™ Branch-Monitored	MPX™ Receptacle Managed
Busbar	Length 1035	MPXPRC-V1035XXX	■	■	■	■
	Length 1880	MPXPRC-V1880XXX	■	■	■	■
Input Modules	1ph 32A fixed*	MPXPEM-EHAEXQ30	■			
		MPXPEM-EHABXQ30		■	■	■
	3ph 16A fixed	MPXPEM-EHAEXT30	■			
		MPXPEM-EHABXT30		■	■	■
	3ph 32A fixed	MPXPEM-EHAEXR30	■			
		MPXPEM-EHABXR30		■	■	■
	3ph 63A fixed	MPXPEM-EHBEXZ30	■			
		MPXPEM-EHBBXZ30		■	■	■
Elementary Output Modules	IEC-C13 L1	MPXBRM-EEBC7N1N	■	■		
	IEC-C13 L2	MPXBRM-EEBC7N2N	■	■		
	IEC-C13 L3	MPXBRM-EEBC7N3N	■	■		
	IEC-C19 L1	MPXBRM-EEBC4O1N	■	■		
	IEC-C19 L2	MPXBRM-EEBC4O2N	■	■		
	IEC-C19 L3	MPXBRM-EEBC4O3N	■	■		
	Schuko L1	MPXBRM-EEBC3P1N	■	■		
	Schuko L2	MPXBRM-EEBC3P2N	■	■		
	Schuko L3	MPXBRM-EEBC3P3N	■	■		
	Switzerland T23	MPXBRM-EEBC4S1N	■	■		
	Switzerland T23	MPXBRM-EEBC4S2N	■	■		
	Switzerland T23	MPXBRM-EEBC4S3N	■	■		
	GST18	MPXBRM-EEBC9U1N	■	■		
	GST18	MPXBRM-EEBC9U2N	■	■		
	GST18	MPXBRM-EEBC9U3N	■	■		
Branch-Monitored Output Modules	IEC-C13 L1	MPXBRM-EBBC6N1N			■	
	IEC-C13 L2	MPXBRM-EBBC6N2N			■	
	IEC-C13 L3	MPXBRM-EBBC6N3N			■	
	IEC-C19 L1	MPXBRM-EBBC4O1N			■	
	IEC-C19 L2	MPXBRM-EBBC4O2N			■	
	IEC-C19 L3	MPXBRM-EBBC4O3N			■	
	Schuko L1	MPXBRM-EBBC3P1N			■	
	Schuko L2	MPXBRM-EBBC3P2N			■	
	Schuko L3	MPXBRM-EBBC3P3N			■	
Receptacle Managed Output Modules	IEC-C13 L1	MPXBRM-ERBC6N1N				■
	IEC-C13 L2	MPXBRM-ERBC6N2N				■
	IEC-C13 L3	MPXBRM-ERBC6N3N				■
	IEC-C19 L1	MPXBRM-ERBC4O1N				■
	IEC-C19 L2	MPXBRM-ERBC4O2N				■
	IEC-C19 L3	MPXBRM-ERBC4O3N				■
	Schuko L1	MPXBRM-ERBC3P1N				■
	Schuko L2	MPXBRM-ERBC3P2N				■
	Schuko L3	MPXBRM-ERBC3P3N				■
Sensors	1xTemp.	SN-Z01		■	■	■
	3xTemp.	SN-Z02		■	■	■
	3xT. + 1xHum	SN-Z03		■	■	■
	1xTemp. Mod.	SN-T		■	■	■
	Temp/Hum Mod.	SN-TH		■	■	■
	2xDoor Mod.	SN-2D		■	■	■
	3xInput Mod.	SN-3C		■	■	■
External Display	RPCBDM-1000		■	■	■	

Upgrade possible

Different combinations available

\*Note: One-phase input modules can only be populated with L1 modules.

## Simple integration into DCIM systems

The MPH2™ and MPX™ rack PDUs can be administrated locally and remotely. Thanks to the metering of all electrical parameters right up to output, phase, bank or rack PDU levels, as well as the integration of environment sensors, these rack PDUs are key when recording power consumption and environment information at rack level. Since they support all important industry standards and protocols for administration, authentication and encryption, these products can easily be integrated into any existing network or system architecture.

### Flexible local and remote management

The integrated MPH2 standard display provides readings of all important rack-related information. The optional BDM local display is available for MPH2 or MPX and can easily be mounted to where it can best be read.

Remote communication at rack PDU level is delivered by the modular hot-swap-enabled RPC2™ card, which is maintenance – friendly and provides seamless extendability. RPC2 features:

- **Supports up to four PDUs within one PDU Rack Array™:** Minimizes number of IP addresses.
- **Supports up to ten environment sensors:** Consolidates power and environment monitoring at rack level.
- **Supports Web UI, CLI, SSH and Telnet:** Windows, Linux and network administrators can use their preferred communication to the rack PDU.
- **Supports all standard remote authentication and encryption protocols:** Simple integration into existing security infrastructure.
- **Supports SNMP v1, v2 and v3:** For secure communication across network management systems.
- **Supports IPv4 and IPv6:** Future-proof IP support for rack PDUs.
- **Data protocols:** All data is automatically stored making trouble shooting easy without involving external management software.

Remote monitoring interface featuring:

- Snapshot of all electrical parameters on output, group, phase and entire levels.
- Snapshot of environment-sensor metering values and status.
- Threshold value configuration, alert and notification.
- Control of individual outputs and groups.
- Status information and configuration of all outputs.
- Network management settings.

The **Avocent Rack Power Manager** which includes access and control functions, enables central administration of all rack PDUs in the data center, simplifying administration and monitoring of your PDUs.

The **Rack Power Manager** is equipped with state-of-the-art monitoring capabilities that enable intelligent server grouping across disparate racks. It also enables custom reporting, scheduled regular reports and the ability to set real-time threshold alerts to give you the highest quality information on your data center’s power infrastructure so as to truly leverage the investment in PDUs.

- **Measure and Track Power Costs –** The Rack Power Manager calculates and compares cost across multiple levels (rack, row, data centers or companies) to track cost over a period of time and also measure the impact of any consolidation or expansion projects.
- **Review Historical Capacity and Consumption Reports –** Plan for future expansion or new facilities more accurately based on real historical data.
- **Protect Against Downtime –** Help get a total reading on power usage for the data center and set a maximum threshold of power usage. Set alerts to know when the threshold is reached or exceeded and allow time to make changes.
- **Precision planning –** Help IT identify what electrical infrastructure to build into a new location or disaster recovery site. The design can be based on real historical data rather than maximum values or estimates.

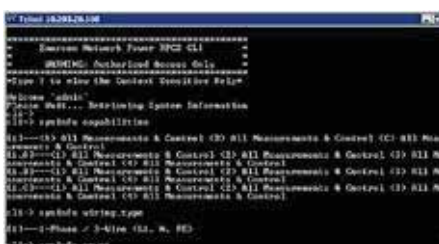

Command-line interface



User interface



Avocent® Rack Power Manager

## Optimal Utilization of Your Rack PDU Investment

The MPX™ and MPH2™ rack PDUs can be integrated in industry-leading KVM systems, serial consoles and Emerson Network Power infrastructure management systems. Furthermore, the rack PDU monitoring and environment information can be integrated into comprehensive data-center management software provided by Emerson Network Power or a third party. The information provided by this intelligent rack PDU offers Emerson Network Power's customers a comprehensive, user-friendly power distribution and administrative solution.

Integration into the **Avocent® Advanced Console Server**, **MergePoint™ Unity KVM Switches** and **Universal Management Gateway-Appliances** offers the following benefits:

- Rack PDUs are integrated into the out-of-band-management solution.
- Rack PDUs are included in a consolidated access and control solution.
- The number of IP addresses required for rack PDU administration are minimized.

By consolidating all data-center management functionality into a single interface, **Avocent DSView™ 4** management software delivers the complete data-center control necessary for the 24/7 data center.

The software enables secure, out-of-band, centralized management of all connected IT and network devices in complex and geographically dispersed data centers.

When used in conjunction with KVM appliances, serial console appliances, service processor gateways and PDUs, the hardware and software combine to allow IT administrators to remotely access, monitor and control target devices on multiple platforms at numerous locations—anywhere, anytime.

Used in combination with rack PDUs, DSView4 management software ensures:

- that PDUs are part of a consolidated access and control solution.
- simple assignment of IT equipment to PDU outputs they are connected to.
- that PDUs are part of a consolidated authentication, authorization and audit solution.

Integration into **Liebert® Nform™** and **Liebert SiteScan®** delivers:

- Inclusion of rack PDUs in a consolidated monitoring solution for data centers at infrastructure level.
- Real-time monitoring and control of almost every component of the critical support equipment.
- Date analysis and trend reports.
- Event management.

The **Trellis™** platform is a trailblazing DCIM innovation from Emerson Network Power. It minimizes IT risks while increasing operating efficiency, overcoming challenges and preparing you for the future.

For both expansion and consolidation, as well as planning IT measures, constant monitoring, tracking and an overview of real-time infrastructure metered values and data are necessary for precision planning and making informed decisions. The Trellis platform provides all relevant information when you need it enabling data center administration without having to use several tools.

With real-time visualization, power-supply monitoring and mobile access offered by the Trellis™ platform you can:

- Reduce inefficiencies without interrupting running processes.
- Postpone investments and increase your operating margin.
- Improve the Service Level Agreement with comprehensive transparency across the entire infrastructure.
- Reduce operating costs without compromising availability and adaptability.
- Manage remote resources more effectively.
- Increase overall efficiency by gaining a better insight into the data center.

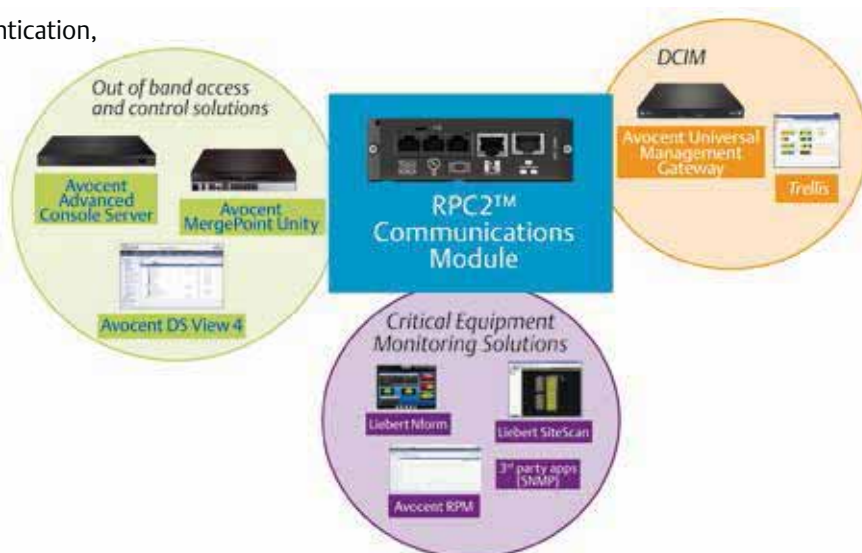



DOS20153

## MPX™ – Input Module/Power Supply

### Elementary and Monitored type

- The MPX PEM is fixed on the MPX PRC and provides the connection to the power supply.
- Fixed-connection cable; 3 m long.
- With IEC60309 plug, 1Ph/N/PE 6h blue, 3Ph/N/PE 6h red.

### Monitored type

- The MPX PEM provides connection to the databus for data communication.
- Integrated RPC2 communication card enables remote monitoring and maintenance of the MPX modules.
- Provides the following phase-input data: voltage, current, effective power, consumption and frequency.
- Power alarm functions for individual phases and their operating status are also supported.
- Further important features: Three displays inform the user on the current status of each individual input. An acoustic alarm is activated at certain overload conditions.
- The communication card centralizes the MPXs local and remote administration.
- Serves as the connection point for versatile support options and devices, such as the display module (RPC BDM), various sensors and connection to other MPX™ or MPH2™ systems, for example.
- Has RJ-45 ports for all connections (except USB port) and does not require any special cabling.

### ■ Technical Data Interfaces:

- RJ-45 LAN port (10/100 MBit) – for local network (LAN) connection via an Ethernet cable.
- Expansion / administration port for local configuration using a computer / laptop, for creating a link-up of several PDUs (MPX or MPH).
- Serial interface RS232.

- Display port for connecting the RPC BDM (display module).
- External sensor port for connecting optional sensors.
- Remote management: Onboard Web interface, CLI, SNMPv1,2,3, SSH, Telnet Syslog, compatible with Avocent ACS, UMG & MPU, SiteScan, DSView, Rack Power Manager, Nform & Trellis as well as Nagios or other management software programs.
- Authentication: local, remote: Active Directory, LDAP, TACACS, Radius, Kerberos.
- Encryption: MD5, AES, DES.

### ■ Material / Finish

- Enclosure: aluminum.
- Cover: sheet steel.
- Power contacts: silver-plated.
- Databus contacts: gold-plated (only Monitored type)

### ■ Dimensions

- Width: 75 mm.
- Height: 65 mm.
- Feed cable: 3 m.

### ■ Color

- Enclosure: aluminum/RAL7021 dark-gray

### ■ Certification

- CE label in accordance with Low Voltage Directive 2006/95/EC.
- EMC Directive 2004/108/EC.
- BV BG.

### ■ Standard inclusion

- 1 x MPX PEM power input module.
- Including connection cable.
- Including RPC2 communication card (only Monitored type).

L	W	H	U	Feed	Load rating	Type	Order No.	UP
220	75	65		Fixed	230 VAC, max. 32 A	Elementary	MPXPPEM-EHAEXQ30	1 unit
220	75	65		Fixed	230/400 VAC, max. 16 A	Elementary	MPXPPEM-EHAEXT30	1 unit
220	75	65		Fixed	230/400 VAC, max. 32 A	Elementary	MPXPPEM-EHAEXR30	1 unit
266	75	65		Fixed	230/400 VAC, max. 63 A	Elementary	MPXPPEM-EHBEXZ30	1 unit
220	75	65		Fixed	230 VAC, max. 32 A	Monitored	MPXPPEM-EHABXQ30	1 unit
220	75	65		Fixed	230/400 VAC, max. 16 A	Monitored	MPXPPEM-EHABXT30	1 unit
220	75	65		Fixed	230/400 VAC, max. 32 A	Monitored	MPXPPEM-EHABXR30	1 unit
266	75	65		Fixed	230/400 VAC, max. 63 A	Monitored	MPXPPEM-EHBBXZ30	1 unit

#### Dimensions in mm:

W = Width	n = Number of sockets	U = Standard rack unit	Conversion:
H = Height	F1 = Standard side panel	1 U = 44.45 mm	1 mm = 0.03937 inch
L = Length	F2 = Design side panel	UP = Packaging unit	1 kg = 2.2046 pounds
S = Switch	19" = ideal for 19" components	Safe = child-proof	

Replace .x with the number of the color combination you require: .1 = RAL 7035, .6 = RAL 7035/RAL 2003



DOS20153

## MPX™ BRM – Output Module

- The MPX BRM enables the distribution to the individual consumers.
  - Each module taps a color-coded phase.
  - All modules are protected against overload with a 20 A circuit breaker.
  - Modules can be exchanged during operation thereby facilitating user-specific installation without having to shut down the MPX.
  - Up to 3 BRM output modules can be installed on a 1,035 mm PRC busbar; up to 6 BRM output modules can be installed on a 1,880 mm PRC busbar.
- **Dimensions**
    - Width: 75 mm.
    - Height: 65 mm.
  - **Color**
    - Enclosure: aluminum/RAL7021 dark-gray
  - **Certification**
    - CE label in accordance with Low Voltage Directive 2006/95/EC.
    - EMC Directive 2004/108/EC.
    - BV BG.
  - **Standard inclusion**
    - 1 x MPX PEM power output module.
    - 1 x instruction manual.
- **Material / Finish**
    - Enclosure: aluminum.
    - Cover: sheet steel.
    - Power contacts: silver-plated.
    - Databus contacts: gold-plated (only type B and R).

### Type E – Elementary

- Module for power distribution via respective outputs.

### Type B – Branch-Monitored

- Module for power distribution via respective outputs with metering function on module level.
- The MPX BRMs have LED ID indicator which identifies every module with a number.
- Modules are administered in the software.
- Provides the following metered readings: voltage, current, power, apparent power, kWh and power factor.
- Power alarm functions and operating status are supported.

### Type R – Receptacle Managed:

- Module for power distribution via respective outputs with metering function on module level and output level.
- The MPX BRMs have LED ID indicator which identifies every module with a number.
- Modules are administered in the software.
- Provides the following metered readings: voltage, current, power, apparent power, kWh, frequency, power factor and crest factor.
- Power alarm functions and operating status are supported.
- Individual outputs can be switched on and off remotely.

L	n	Outputs	Load rating per output	Phase tap	Type	Order No.	UP
266	7	IEC320 C 13	10 A	L1	E	MPXBRM-EEBC7N1N	1 unit
266	7	IEC320 C 13	10 A	L2	E	MPXBRM-EEBC7N2N	1 unit
266	7	IEC320 C 13	10 A	L3	E	MPXBRM-EEBC7N3N	1 unit
266	4	IEC320 C 19	16 A	L1	E	MPXBRM-EEBC4O1N	1 unit
266	4	IEC320 C 19	16 A	L2	E	MPXBRM-EEBC4O2N	1 unit
266	4	IEC320 C 19	16 A	L3	E	MPXBRM-EEBC4O3N	1 unit
266	3	Schuko CEE 7/4	16 A	L1	E	MPXBRM-EEBC3P1N	1 unit
266	3	Schuko CEE 7/4	16 A	L2	E	MPXBRM-EEBC3P2N	1 unit
266	3	Schuko CEE 7/4	16 A	L3	E	MPXBRM-EEBC3P3N	1 unit
266	4	Switzerland T23	16 A	L1	E	MPXBRM-EEBC4S1N	1 unit
266	4	Switzerland T23	16 A	L2	E	MPXBRM-EEBC4S2N	1 unit
266	4	Switzerland T23	16 A	L3	E	MPXBRM-EEBC4S3N	1 unit
266	9	GST18 3-pole	16 A	L1	E	MPXBRM-EEBC9U1N	1 unit
266	9	GST18 3-pole	16 A	L2	E	MPXBRM-EEBC9U2N	1 unit
266	9	GST18 3-pole	16 A	L3	E	MPXBRM-EEBC9U3N	1 unit
266	6	IEC320 C 13	10 A	L1	B	MPXBRM-EBBC6N1N	1 unit
266	6	IEC320 C 13	10 A	L2	B	MPXBRM-EBBC6N2N	1 unit
266	6	IEC320 C 13	10 A	L3	B	MPXBRM-EBBC6N3N	1 unit
266	4	IEC320 C 19	16 A	L1	B	MPXBRM-EBBC4O1N	1 unit
266	4	IEC320 C 19	16 A	L2	B	MPXBRM-EBBC4O2N	1 unit
266	4	IEC320 C 19	16 A	L3	B	MPXBRM-EBBC4O3N	1 unit
266	3	Schuko CEE 7/4	16 A	L1	B	MPXBRM-EBBC3P1N	1 unit
266	3	Schuko CEE 7/4	16 A	L2	B	MPXBRM-EBBC3P2N	1 unit
266	3	Schuko CEE 7/4	16 A	L3	B	MPXBRM-EBBC3P3N	1 unit
266	6	IEC320 C 13	10 A	L1	R	MPXBRM-ERBC6N1N	1 unit
266	6	IEC320 C 13	10 A	L2	R	MPXBRM-ERBC6N2N	1 unit
266	6	IEC320 C 13	10 A	L3	R	MPXBRM-ERBC6N3N	1 unit
266	4	IEC320 C 19	16 A	L1	R	MPXBRM-ERBC4O1N	1 unit
266	4	IEC320 C 19	16 A	L2	R	MPXBRM-ERBC4O2N	1 unit
266	4	IEC320 C 19	16 A	L3	R	MPXBRM-ERBC4O3N	1 unit
266	3	Schuko CEE 7/4	16 A	L1	R	MPXBRM-ERBC3P1N	1 unit
266	3	Schuko CEE 7/4	16 A	L2	R	MPXBRM-ERBC3P2N	1 unit
266	3	Schuko CEE 7/4	16 A	L3	R	MPXBRM-ERBC3P3N	1 unit



DOS20153

## MPX™ PRC – Power Distribution Unit / Communication Bus

- The MPX PRC is the basic element of the MPX power distribution unit.
- Power and data transfer buses are integrated across the entire length of the MP PRC.
- The MPX BRMs (output modules) and the MPX PEM (power input module) are fixed on the MPX PRC and, depending on the type, facilitate the modules' power feed, output, monitoring and management.

■ **Material / Finish**

- Busbar housing: aluminum.
- Busbars: copper.
- Databus: gold-plated.

■ **Dimensions**

- Width: 68 mm.
- Height: 24 mm.

■ **Color**

- Enclosure: aluminum.

■ **Approvals**

- CE label in accordance with Low Voltage Directive 2006/95/EC.
- EMC Directive 2004/108/EC.
- BV BG.

■ **Load rating**

- Max. current: 3 x 63 A.
- Nominal voltage (L-N / L-L): 230 / 400 VAC.

■ **Standard inclusion**

- 1 x MPX PRC - power distribution unit / communication bus.
- 1 x mounting kit.

L	W	H	U	Model	Order No.	UP
1035	68	24	23	1 PEM (220 mm) + 3 BRM	<b>MPXPRC-V1035XXX</b>	1 unit
1880	68	24	42	1 PEM (220/266 mm) + 6 BRM	<b>MPXPRC-V1880XXX</b>	1 unit



DOS20153

## MPX™/MPH™/MPH2™/IMS™ – Sensors

- These sensors are designed for tool-less installation in a Knürr Miracle / DCM rack, and is also compatible with all other rack types.
- "Fixed" type sensors are attached to a cable.
- "Modular" type sensors can be connected to the delivered cable.
- Plugged into the RPC-1000 or RPC2 communication card.
- Several sensors can be connected in rows.
- Automatically displayed in the MPX/MPH/MPH2/IMS software.
- Temperature measurement range: 5 – 60° C.
- Accuracy: ± 0.5° C.
- Humidity measurement range: 10 – 95 %.
- Accuracy: ± 3.5 %.

■ **Note**

Sensors are not required for operating the MPX or MPH, MPH2, IMS. However, a communication card is needed.

■ **Standard inclusion**

- 1 x sensor with connection cable.
- 1 x instruction manual.

Cable length	Type	Model	Order No.	UP
3660	Fixed	Temperature sensor, single	<b>SN-Z01</b>	1 unit
5180	Fixed	Temperature sensor, triple	<b>SN-Z02</b>	1 unit
5180	Fixed	Temperature sensor, triple + humidity sensor, single	<b>SN-Z03</b>	1 unit
2000	Modular	Temperature sensor, single	<b>SN-T</b>	1 unit
2000	Modular	Temperature sensor, single + humidity sensor, single	<b>SN-TH</b>	1 unit
2000	Modular	2 x door contact - input module*	<b>SN-2D</b>	1 unit
2000	Modular	3 x digital input	<b>SN-3C</b>	1 unit

\* Suitable door contact switch: Order no.: 06.108.115.9



DOS20153

### RPC BDM - 1000 Display Module

- Provides the local display of the monitored data for all connected MPX/MPH/MPH2/IMS systems.
- Operated with a navigation switch.
- Connected via a cable with the RPC, enabling the user to place the displays where they can be easily read in the given local space conditions.
- An individual display can be used for up to four MPX/MPH/MPH2/IMS PDUs, which are all connected in a PDU array.

- **Note**  
The display module is not required when operating the MPX or MPH, MPH2, IMS. However, a communication card is needed.
- **Standard inclusion**
  - 1 x RPCBDM-1000 display module.
  - 1 x connection cable 2 m.
  - 1 x mounting kit.

L	W	H	U	Model	Order No.	UP
					<b>RPCBDM-1000</b>	1 unit



xxx

### BRM Power-Distribution Cable-Holder Clip Set

- Cable clips provide strain relief for the feed lines of the network equipment.
- Cable clips are suitable for most IEC-C13 socket plugs with a raised edge. (Must be checked for suitability).
- Cable clips are sold in sets of 18 units.

- **Delivery**
  - In sets.
- **Note**
  - Optimal function only with cable connector 04.000.051.9.
  - Can only be used with MPXBDM-EBBC6NxN and MPXBDM-ERBC6NxN (x = 1, 2, 3).

- **Standard inclusion**
  - 1 x cable holder set (18 units).



xxx

L	W	H	U	Model	Order No.	UP
					<b>03.910.216.9</b>	1 unit



DOS20493

### SafetySleeve™ Cable Protection IEC C19

- SafetySleeves protect the feed lines of the network equipment.
- They can be used on all C19 cables and fit onto all PDUs.

- **Material / Finish**
  - PVC, black.

L	W	H	U	Model	Order No.	UP
				C20 plug in C19 socket	<b>03.910.212.9 001</b>	20 unit



DOS20494

### SafetySleeve™ Cable Protection IEC C13

- SafetySleeves protect the feed lines of the network equipment.
- They can be used on all C13 cables and fit onto all PDUs.

- **Material / Finish**
  - PVC, black.

L	W	H	U	Model	Order No.	UP
				C14 plug in C13 socket	<b>03.910.213.9 001</b>	50 unit

# MPH2™ – Managed Rack PDU

## Monitoring and Control

The newly developed MPH2™ Managed Rack PDU is a power supply system with monitoring and control functions. The MPH2™ offers outstanding features such as easy rack-integration and management architecture as well as optimum availability and energy efficiency.

Four MPH2™ versions are available:

- With input metering, output metering and output switching.
- With input metering and output metering.
- With input metering and output switching.
- With input metering.

### Benefits of MPH2™

- **Monitors several parameters** with defined thresholds and alarm tools.
- **Monitors and controls individual outputs** and/or load and appliance groups.
- **A variety of measurements** allow you to predict failing conditions before they occur and proactively manage connected equipment for maximum uptime.
- **Energy and power metering** maximize the data center power and cooling infrastructure.
- **Lowest power consumption** of all switched-rack PDUs lowers power costs and thermal load.
- **Up to four rack MPH2™ PDUs** can be connected in a Rack PDU Array™ thereby consolidating user-specific IP connections and equipment monitoring.

### Developed for critical environments

- **Industry-leading operating temperature** of up to 60° C suitable for high temperatures inside racks.
- **Bistable relays ensure basic power supply** even when shortfalls occur elsewhere.
- **Accurate voltage and current metering up to outlet level** with ±1 % tolerances deliver reliable results.
- **Extensive alarm functions including notification** when an overload occurs in individual groups.
- **Monitoring of environment conditions (temperature, humidity and input contacts)** with alerts and alarms.
- **Notification** upon failure or if loads are removed in individual racks.



### MPH2™ savings for a typical data center

	Typical rack PDU with 24 outputs	MPH2™
Power consumption of PDU (in Watt)	20	5
Annual energy consumption of PDU (kWh)	176	44
Total proportion of the data center's energy consumption (kWh)*	333	83
<b>Energy saving</b>	<b>75%</b>	

Compared with a Switched Rack-PDU model for a typical data center with a 1.9 PUE.

\* according to Energy Logic calculations

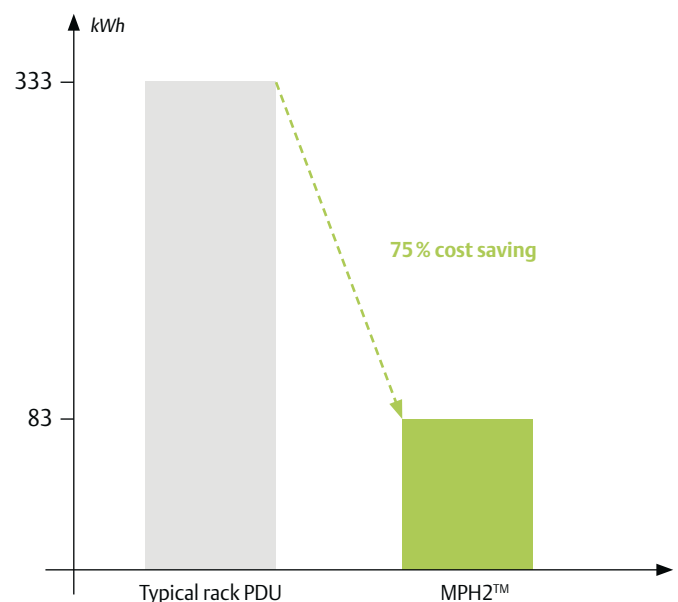



**INPUT POWER**

- 16 to 32 A (EU).
- Single-phase and three-phase.

**OUTPUT DISTRIBUTOR**

- IEC C13 and IEC C19.
- Combination systems.

**MODULARITY**

- Communication card.
- External display.
- External sensors.

**MONITORING**

- Three various levels: Input level, group level, output level
- Temperature and humidity.
- Door contacts and potential-free input contacts.

**REMOTE CONTROLLED SOCKETS**

- Socket level.

# MPH2™

## Benefits

### Highest availability levels

- Modular communications card; can be replaced during operation. This simplifies maintenance and increases the level of availability.
- Bistable relays in switchable designs; the server's power supply is ensured even during outages.
- Software-controlled overload protection – affected outputs are switched off before the advance fuse is activated.
- Additional metering of the neutral conductor and of the crest factor; possible faults that cause switch-off are detected in advance.

### Leading technology in many areas

- Operating temperatures of up to 60 °C allow secure operation in the warm aisle.
- Metering accuracy of  $\pm 1\%$  ensures reliable measurement results.
- Power losses of approx. 5 W, even in switchable models, reducing electricity costs and minimizing the thermal load.

### Industry-leading management properties

- An integrated local display and an optional external display facilitates flexible local management.
- Onboard web interface and CLI/SSH interface; suitable for both Windows and Linux administration.
- A variety of authentication options and encrypted protocols ensure integration into Enterprise Security architectures.
- SNMPv3 and IPv6 support so that current requirements, particularly from the public sector, can be satisfied.

### Simple integration into ENP solutions

- Can be delivered pre-installed in Knürr racks to save time and costs during installation in the data center.
- Serial integration into Avocent UMG, ACS and MPU guarantees redundant management access to the MPH2.
- Integration into ENP software solutions; the MPH2 is an integral part of a comprehensive DCIM solution with monitoring and control functions.



**Special tool-less Knürr DCM rack fixture:**

Lowers installation costs and extra space in rack for cables and other components.



**Connection cable with locking mechanism**

Prevents IT cables from being accidentally disconnected.



**SN sensors:**

Consolidates environmental monitoring of temperature, humidity and potential-free input contacts with the power supply at rack level.



**Flexible network cable input:**

Simplifies installation in the rack PDU.



**Cable and fixed wiring options:**

Flexible power distribution; input-cable can be connected locally.



**Communications module (RPC2™):**

Offers extendable interfaces for network communication, sensors and local display.



**BDM™ local display module**

Extended diagnostic functionality; user-friendly display. Features include detailed information about alerts and specific labeling for outputs.



**Integrated display:**

Provides easy access to important information on the rack.



**Ultra-flat circuit breakers:**

Compact construction; minimizes space requirements in the rack.

## Simple Integration into DCIM Systems

The MPH2™ and MPX™ rack PDUs can be administrated locally and remotely. Thanks to the metering of all electrical parameters right up to output, phase, bank or rack PDU levels and the integration of environment sensors, these rack PDUs are key to recording power consumption and environment information at rack level. Since they support all important industry standards and protocols for administration, authentication and encryption, these products can easily be integrated into any existing network or system architecture.

### Flexible local and remote management

The integrated MPH2 standard display provides readings of all the important rack-related information. The optional BDM local display is available for MPH2 or MPX and can easily be mounted where necessary.

Remote communication at rack PDU level is delivered by the modular hot-swap-enabled RPC2™ card, which is user-friendly and provides seamless extendability. RPC2 features:

- **Support for up to four PDUs within one PDU Rack Array™:** Minimizes number of IP addresses.
- **Supports up to ten environment sensors:** Consolidates power and environment monitoring on rack level.
- **Supports Web UI, CLI, SSH and Telnet:** Windows, Linux and network administrators can use their preferred communication to the rack PDU.
- **Supports all standard remote authentication and encryption protocols:** Simple integration into existing security infrastructure.
- **Supports SNMP v1, v2 and v3:** For secure communication across network management systems.
- **Supports IPv4 and IPv6:** Future-proof IP support for rack PDUs.
- **Data protocols:** All data is automatically stored making trouble shooting easy without involving external management software.

Remote monitoring interface featuring:

- Snapshot of all electrical parameters on output, group, phase and entire levels.
- Snapshot of environment-sensor metering values and status.
- Threshold value configuration, alert and notification.
- Control of individual outputs and groups.
- Status information and configuration of all outputs.
- Network management settings.

The Avocent Rack Power Manager, which includes access and control functions, enables central administration of all the rack PDUs in the data center simplifying the administration and monitoring of your PDUs.

The Rack Power Manager is equipped with state-of-the-art monitoring capabilities that enable intelligent server grouping across disparate racks. It also enables custom reporting, scheduled regular reports and the ability to set real-time threshold alerts to give you the highest quality information on your data center's power infrastructure and so you can truly leverage the investment in PDUs.

- **Measure and Track Power Costs –** The Rack Power Manager calculates and compares cost across multiple levels (rack, row, data centers or companies) to track cost over a period of time and also to measure the impact of any consolidation or expansion projects.
- **Review Historical Capacity and Consumption Reports –** Plan for future expansion or new facilities more accurately based on real historical data rather than manufacturer's data or estimates which result in overbuilding and lead to inefficiencies.
- **Protect Against Downtime –** Help get a total reading on power usage for the data center and set a maximum threshold of power usage. Set alerts to know when the threshold is reached or exceeded and allow time to make changes before there are actual problems.
- **Precision planning –** Help IT know what electrical infrastructure to build into a new location or disaster recovery site. The design can be based on actual historical data rather than maximum values or estimates which result in overbuilding and lead to hard-to-correct inefficiencies.

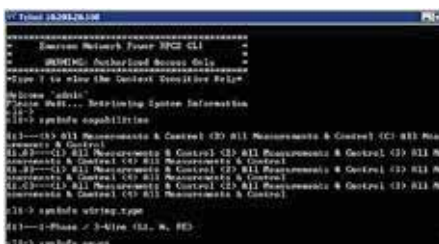

Command-line interface



User interface



Avocent® Rack Power Manager

## Optimal Utilization of Your Rack PDU Investment

The MPX™ and MPH2™ rack PDUs can be integrated in industry-leading KVM systems, serial consoles and Emerson Network Power infrastructure management systems. Furthermore, the rack PDU monitoring and environment information can be integrated into comprehensive data-center management software provided by Emerson or a third party. The information provided by this intelligent, easy-to-use rack PDU offers Emerson Network Power's customers a comprehensive, user-friendly power distribution and administration solution.

Integration into the **Avocent® Advanced Console Server**, **MergePoint™ Unity KVM Switches** and **Universal Management Gateway-Appliances** offer the following benefits:

- Rack PDUs are integrated into the out-of-band-management solution.
- Rack PDUs are included in a consolidated access and control solution.
- The number of IP addresses required for rack PDU administration are minimized.

By consolidating all data-center management functionality into a single interface, **Avocent DSView™ 4** management software delivers the complete data-center control necessary for the data center.

The software enables secure, out-of-band, centralized management of all connected IT and network devices in complex and geographically dispersed data centers.

When used in conjunction with KVM appliances, serial console appliances, service processor gateways and PDUs, hardware and software combine to allow IT administrators to remotely access, monitor and control target devices on multiple platforms at numerous locations—anywhere, anytime.

Used in combination with rack PDUs, DSView4 management software ensures:

- That PDUs are part of a consolidated access and control solution.
- Simple assignment of IT equipment to the PDU outputs they are connected to.
- That PDUs are part of a consolidated authentication, authorization and audit solution.

Integration into **Liebert® Nform™** and **Liebert SiteScan®** delivers:

- Inclusion of rack PDUs in a consolidated monitoring solution for data centers at infrastructure level.
- Real-time monitoring and control of almost every component of the critical support equipment.
- Data analysis and trend reports.
- Event management.

The **Trellis™** platform is a trailblazing DCIM innovation from Emerson Network Power. It minimizes IT risks while increasing operating efficiency solving existing problems and preparing you for the future.

For both expansion and consolidation, as well as planning IT measures, constant monitoring, tracking and an overview of real-time infrastructure, metered values and data are necessary for precision planning and making informed decisions. The Trellis platform provides all the relevant information providing data center administration without having to resort to several tools.

With the time visualization, power-supply monitoring and mobile access offered by the Trellis platform, you can:

- Reduce inefficiencies without interrupting running processes.
- Postpone investments and increase the operating margin.
- Improve the Service Level Agreement with comprehensive transparency across the entire infrastructure.
- Reduce operating costs without compromising availability and adaptability.
- Manage remote resources more effectively.
- Increase overall efficiency by gaining better insight into the data center.

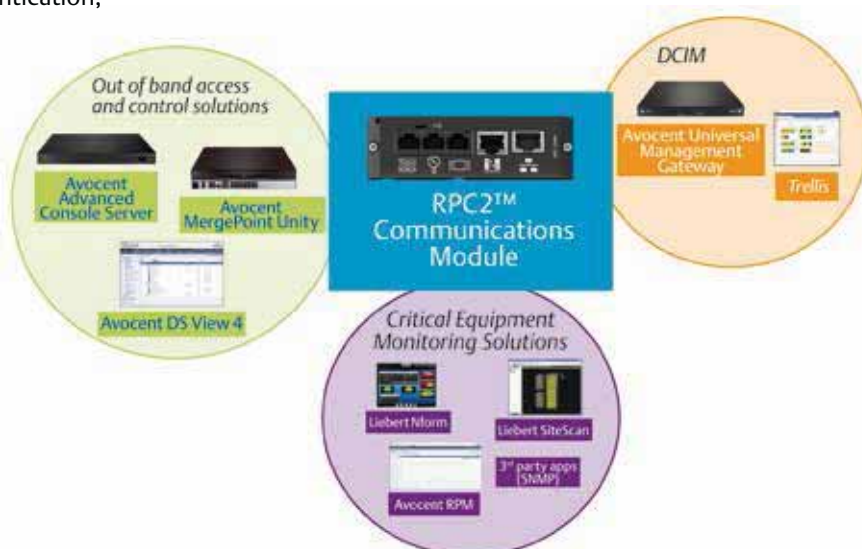

## MPH2™

- The MPH2 is a power distribution unit for IT racks which provides metering of electrical values. Depending on the model, individual outputs can also be remote-controlled.
- The integrated RPC2k communications card allows you to connect up to 4 MPH2 / MPX™ units as well as monitor and maintain all connected units remotely. Up to 10 sensors (temperature, air humidity, door contacts as well as potential-free input contacts) can be connected.
- The MPH2™ unit has an integrated display. In addition, the optional external RPCBDM-1000 display module can easily be connected and mounted on the rack.
- Special cables with locking mechanisms can be connected to the outputs.
- Depending on the model, the connecting cable for the MPH2 is attached to the housing (cable length 3 m), also permitting a connecting cable can be connected on site (model with connection unit).

- Remote management: Onboard Web Interface, CLI, SNMPv1,2,3, SSH, Telnet, integratable into Avocent ACS, UMG & MPU, DSView, Rack Power Manager, Nform & Trellis as well as Nagios or other management software programs.
- Authentication: local, remote: active directory, LDAP, TACACS, Radius, Kerberos. Encryption: MD5, AES, DES.
- Measurement parameters: Current (A), voltage (V), real power (W), apparent power (VA), consumption (kWh), power factor, frequency and crest factor (only tapes M and R). Accuracy: ±1 % (V, A).

### ■ MPH2™ models

- **MPH2™ B** – Metering per phase and per group (only models with >16 A input power).
- **MPH2™ C** – Metering per phase and per group (only models with >16 A input power). Each output can also be individually switched remotely.
- **MPH2™ M** – Metering per phase and per group (only models with >16 A input power) and per output.
- **MPH2™ R** – Metering per phase and per group (only models with >16 A input power) and per output. Each output can also be individually switched remotely.

### ■ Material / finish / color

- Closed housing, aluminum profile, finely textured powder-coated top (RAL 7021), Vampamid 6 0024 V0 (UL94) recyclable plastic parts, finely textured and colored (RAL 9005).

### ■ Mechanical dimensions

- Width x depth x length (mm): 56 x 50 x (see table).

### ■ Certification

- CE label in accordance with Low Voltage Directive 2006/95/EC.
- EMC Directive 2004/108/EC.
- BV BG.

### ■ Standard inclusion

- MPH2™ rack PDU.
- Standard mounting bracket.
- Safety instructions.
- Quickstart guide.

## MPH2™ Types for Europe

### MPH2™ B – input metering

### MPH2™ C – input metering and output switching

### MPH2™ M – input metering and output metering

### MPH2™ R – input metering, output metering and output switching

Type	Input Values		Input Connector	Outputs		Length (mm)	Order Number
	Voltage	Current		C13	C19		
B	230V	16A	C20 inlet	17	2	916.5	MPHB3241
B	230V	16A	C20 inlet	21		916.5	MPHB3141
B	230V	16A	C20 inlet	30	6	1736.5	MPHB1241
B	230V	16A	IEC 60309 16A 1P+N+G	17	2	916.5	MPHB3242
B	230V	16A	IEC 60309 16A 1P+N+G	21		916.5	MPHB3142
B	230V	16A	IEC 60309 16A 1P+N+G	30	6	1736.5	MPHB1242
B	230V	32A	IEC 60309 32A 1P+N+G	30	6	1736.5	MPHB1243
B	230V	32A	Connection unit	30	6	1736.5	MPHB1260
B	230/400V	3 x 16A	IEC 60309 16A 3P+N+G	30	6	1736.5	MPHB1244
B	230/400V	3 x 32A	IEC 60309 32A 3P+N+G	42		1826.5	MPHB1545
B	230/400V	3 x 32A	IEC 60309 32A 3P+N+G	18	12	1826.5	MPHB1345
B	230/400V	3 x 32A	IEC 60309 32A 3P+N+G	30	6	1826.5	MPHB1245
B	230/400V	3 x 32A	Connection unit	42		1826.5	MPHB1562
B	230/400V	3 x 32A	Connection unit	18	12	1826.5	MPHB1362
B	230/400V	3 x 32A	Connection unit	30	6	1826.5	MPHB1262
C	230V	16A	C20 inlet	8		916.5	MPHC3341
C	230V	16A	C20 inlet	16		1004	MPHC3141
C	230V	16A	C20 inlet	18	6	1736.5	MPHC1141
C	230V	16A	C20 inlet	24		1736.5	MPHC1241
C	230V	16A	IEC 60309 16A 1P+N+G	18	6	1736.5	MPHC1142
C	230V	16A	IEC 60309 16A 1P+N+G	24		1736.5	MPHC1242
C	230V	16A	IEC 60309 16A 1P+N+G	16		1004	MPHC3142
C	230V	32A	IEC 60309 32A 1P+N+G	18	6	1736.5	MPHC1143

Type	Input Values		Input Connector	Outputs		Length (mm)	Order Number
	Voltage	Current		C13	C19		
C	230V	32 A	IEC 60309 32 A 1P+N+G	24		1736.5	MPHC1243
C	230V	32 A	Connection unit	18	6	1736.5	MPHC1160
C	230V	32 A	Connection unit	24		1736.5	MPHC1260
C	230/400V	3 x 16 A	IEC 60309 16 A 3P+N+G	18	6	1736.5	MPHC1144
C	230/400V	3 x 16 A	IEC 60309 16 A 3P+N+G	24		1736.5	MPHC1244
C	230/400V	3 x 16 A	Connection unit	18	6	1736.5	MPHC1161
C	230/400V	3 x 16 A	Connection unit	24		1736.5	MPHC1261
C	230/400V	3 x 32 A	IEC 60309 32 A 3P+N+G	18	6	1736.5	MPHC1145
C	230/400V	3 x 32 A	IEC 60309 32 A 3P+N+G	24		1736.5	MPHC1245
C	230/400V	3 x 32 A	IEC 60309 32 A 3P+N+G	6	12	1736.5	MPHC1345
C	230/400V	3 x 32 A	Connection unit	18	6	1736.5	MPHC1162
C	230/400V	3 x 32 A	Connection unit	24		1736.5	MPHC1262
C	230/400V	3 x 32 A	Connection unit	6	12	1736.5	MPHC1362
M	230V	16 A	C20 inlet	8		916.5	MPHM3341
M	230V	16 A	IEC 60309 16 A 1P+N+G	8		916.5	MPHM3342
M	230V	16 A	C20 inlet	16		1004	MPHM3141
M	230V	16 A	C20 inlet	18	6	1736.5	MPHM1141
M	230V	16 A	C20 inlet	24		1736.5	MPHM1241
M	230V	16 A	IEC 60309 16 A 1P+N+G	18	6	1736.5	MPHM1142
M	230V	16 A	IEC 60309 16 A 1P+N+G	24		1736.5	MPHM1242
M	230V	16 A	IEC 60309 16 A 1P+N+G	16		1004	MPHM3142
M	230V	32 A	IEC 60309 32 A 1P+N+G	18	6	1736.5	MPHM1143
M	230V	32 A	IEC 60309 32 A 1P+N+G	24		1736.5	MPHM1243
M	230V	32 A	Connection unit	18	6	1736.5	MPHM1160
M	230V	32 A	Connection unit	24		1736.5	MPHM1260
M	230/400V	3 x 16 A	IEC 60309 16 A 3P+N+G	18	6	1736.5	MPHM1144
M	230/400V	3 x 16 A	IEC 60309 16 A 3P+N+G	24		1736.5	MPHM1244
M	230/400V	3 x 16 A	Connection unit	18	6	1736.5	MPHM1161
M	230/400V	3 x 16 A	Connection unit	24		1736.5	MPHM1261
M	230/400V	3 x 32 A	IEC 60309 32 A 3P+N+G	18	6	1736.5	MPHM1145
M	230/400V	3 x 32 A	IEC 60309 32 A 3P+N+G	24		1736.5	MPHM1245
M	230/400V	3 x 32 A	IEC 60309 32 A 3P+N+G	6	12	1736.5	MPHM1345
M	230/400V	3 x 32 A	Connection unit	18	6	1736.5	MPHM1162
M	230/400V	3 x 32 A	Connection unit	24		1736.5	MPHM1262
M	230/400V	3 x 32 A	Connection unit	6	12	1736.5	MPHM1362
R	230V	16 A	C20 inlet	8		916.5	MPHR3341
R	230V	16 A	IEC 60309 16 A 1P+N+G	8		916.5	MPHR3342
R	230V	16 A	C20 inlet	16		1004	MPHR3141
R	230V	16 A	C20 inlet	18	6	1736.5	MPHR1141
R	230V	16 A	C20 inlet	24		1736.5	MPHR1241
R	230V	16 A	IEC 60309 16 A 1P+N+G	18	6	1736.5	MPHR1142
R	230V	16 A	IEC 60309 16 A 1P+N+G	24		1736.5	MPHR1242
R	230V	16 A	IEC 60309 16 A 1P+N+G	16		1004	MPHR3142
R	230V	32 A	IEC 60309 32 A 1P+N+G	18	6	1736.5	MPHR1143
R	230V	32 A	IEC 60309 32 A 1P+N+G	24		1736.5	MPHR1243
R	230V	32 A	Connection unit	18	6	1736.5	MPHR1160
R	230V	32 A	Connection unit	24		1736.5	MPHR1260
R	230/400V	3 x 16 A	IEC 60309 16 A 3P+N+G	18	6	1736.5	MPHR1144
R	230/400V	3 x 16 A	IEC 60309 16 A 3P+N+G	24		1736.5	MPHR1244
R	230/400V	3 x 16 A	Connection unit	18	6	1736.5	MPHR1161
R	230/400V	3 x 16 A	Connection unit	24		1736.5	MPHR1261
R	230/400V	3 x 32 A	IEC 60309 32 A 3P+N+G	18	6	1736.5	MPHR1145
R	230/400V	3 x 32 A	IEC 60309 32 A 3P+N+G	24		1736.5	MPHR1245
R	230/400V	3 x 32 A	IEC 60309 32 A 3P+N+G	6	12	1736.5	MPHR1345
R	230/400V	3 x 32 A	Connection unit	18	6	1736.5	MPHR1162
R	230/400V	3 x 32 A	Connection unit	24		1736.5	MPHR1262
R	230/400V	3 x 32 A	Connection unit	6	12	1736.5	MPHR1362



DOS20153

### MPX™/MPH™/MPH2™/IMS™ – Sensors

- These sensors are designed for tool-less installation in a Knürr Miracle / DCM rack, but is also compatible with all other rack types.
- "Fixed" type sensors are attached to a cable.
- "Modular" type sensors can be connected to the delivered cable.
- Plugged into the RPC-1000 or RPC2 communication card.
- Several sensors can be connected in rows.
- Automatically displayed in the MPX/MPH/MPH2/IMS software.
- Temperature measurement range: 5 – 55° C.
- Accuracy: ± 0.5° C.
- Humidity measurement range: 10 – 95 %.
- Accuracy: ± 3.5 %.

- **Note**  
The sensors are not required for operating the MPX or MPH, MPH2, IMS. However, a communication card is needed.
- **Standard inclusion**
  - 1 x sensor with connection cable.
  - 1 x instruction manual.

Cable length	Type	Model	Order No.	UP
3660	Fixed	Temperature sensor, single	<b>SN-Z01</b>	1 unit
5180	Fixed	Temperature sensor, triple	<b>SN-Z02</b>	1 unit
5180	Fixed	Temperature sensor, triple + humidity sensor, single	<b>SN-Z03</b>	1 unit
2000	Modular	Temperature sensor, single	<b>SN-T</b>	1 unit
2000	Modular	Temperature sensor, single + humidity sensor, single	<b>SN-TH</b>	1 unit
2000	Modular	2 x door contact - input module*	<b>SN-2D</b>	1 unit
2000	Modular	3 x digital input	<b>SN-3C</b>	1 unit

\* Suitable door contact switch: Order no.: 06.108.115.9



DOS20153

### Liebert RPC BDM - 1000 Display Module

- Provides the local display of the monitored data for all connected MPX/MPH/MPH2/IMS systems.
- Operated with a navigation switch.
- Connected via a cable with the RPC, enabling the user to place the displays where needed in the given local space conditions.
- An individual display can be used for up to four MPX/MPH/MPH2/IMS PDUs, which are all connected in a PDU array.

- **Note**  
The display module is not required for operating the MPX or MPH, MPH2, IMS. However, a communication card is needed.
- **Standard inclusion**
  - 1 x RPCBDM-1000 display module.
  - 1 x connection cable 2 m.
  - 1 x mounting kit.

L	W	H	U	Model	Order No.	UP
					<b>RPCBDM-1000</b>	1 unit





DOS20495



DOS20496



DOS20497



DOS20498



DOS20499



DOS20500

## SafetyLock™ Connection Cable IEC C13 EU

- Connection cables have integrated protection against accidental disconnection.
- For straight locking from C14 to C13.
- Locking cables are sold in sets of 9 units.

### ■ Technical data

- Standard: IEC 60320.
- Load rating: 250 Vac/10 A.
- Operating temperature: -25° C ~ +70° C.
- Extraction force with locking function: up to 120 N.
- Electric power cable: H05VV-F 3G 1.0 mm².
- Flame retardance: Plug: UL 94V-2 or better; cable: UL VW-1, IEC60332-1. Cat F2.

### ■ Certification

- ENEC.
- VDE.
- CB scheme.
- RoHS compliant.

### ■ Color

- Black/white.
- Other colors available upon request.

### ■ Standard inclusion

- 9 x locking cables.

### ■ Delivery

- In sets.

L	Model	Order No.	UP
0.5 m	Black	03.951.450.0,001	9 unit
1.0 m	Black	03.951.450.0,002	9 unit
1.5 m	Black	03.951.450.0,003	9 unit
0.5 m	White	03.951.451.0,001	9 unit
1.0 m	White	03.951.451.0,002	9 unit
1.5 m	White	03.951.451.0,003	9 unit

## SafetyLock™ Connection Cable IEC C19 EU

- Connection cables have integrated protection against accidental disconnection.
- For straight locking from C20 to C19.
- Locking cables are sold in sets of 6 units.

### ■ Technical data

- Standard: IEC 60320.
- Load rating: 250 Vac/16 A.
- Operating temperature: -25° C ~ +70° C.
- Extraction force with locking function: up to 120 N.
- Electric power cable: H05VV-F 3G 1.5 mm².
- Flame retardance: Plug: UL 94V-2 or better; cable: UL VW-1, IEC60332-1. Cat F2.

### ■ Approvals

- ENEC.
- VDE.
- CB scheme.
- RoHS compliant.

### ■ Color

- Black/white.
- Other colors available upon request.

### ■ Standard inclusion

- 6 x locking cables.

### ■ Delivery

- In sets.

L	Model	Order No.	UP
0.5 m	Black	03.951.455.0,001	6 unit
1.0 m	Black	03.951.455.0,002	6 unit
1.5 m	Black	03.951.455.0,003	6 unit
0.5 m	White	03.951.456.0,001	6 unit
1.0 m	White	03.951.456.0,002	6 unit
1.5 m	White	03.951.456.0,003	6 unit

## DI-STRIP® – Basic Rack-PDU

*Robust PDUs with useful equipment features*

### Features

- Closed sheet-steel extrusions and ideal integration into Knürr rack systems deliver high stability and torsional strength.
- Best possible conductivity: Full-length brass busbar provided with many models.
- Double spring contacts for reliable and low contact resistance.

**Emerson Network Power's Basic Rack PDUs are the solution for every data center looking for robust, economical and flexible rack concepts.**

The DI-STRIP product family meets a broad range of data center power distribution requirements for IT and other applications.

Specially configured for the growing number of electronic components in network switching racks or server racks. Available with different accessories, such as circuit breakers, overvoltage protection, mains filter, master-slave function, emergency stop switch, fault-current circuit-breaker, local and remote power metering.

**INPUT POWER**

- Single-phase or three-phase.
- Up to 22 kVA.
- Simple input supply.

**OUTPUT DISTRIBUTOR**

- NEMA 5-20R single-phase, IEC C13 and C19, combination systems.
- Schuko, France, Switzerland.

**MODULARITY**

- More connectivity with expansion unit for Basic Rack PDU GST18.

**FORM FACTOR**

- Vertical mounting (0 U).
- Rack installation.
- Workstation mounting.

**LOCAL MONITORING**

- Fixed display.

**REMOTE MONITORING**

- Secure Web and SNMP interfaces with Liebert Nform.

**OVERLOAD PROTECTION**

- Circuit breakers/fuses per branching cable/output as required.

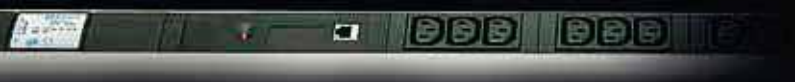
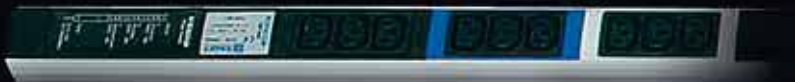

## Benefits

- Optimal phase distribution across the entire rack with color-coded identification of the individual phases.
- Up to 48 different plug options per PDU: shortens the cable distance between the PDU and the consumer.
- One of the most compact PDUs on the market: measures only 44.4 x 45.5 mm, which saves space even on a 600 mm-wide rack.
- Simple and quick installation on the rack extrusion: reduces installation and wiring costs.



**Highest possible security and availability with:**

- Closed sheet-steel extrusions that deliver high stability and torsional flexibility.
- Extensive certification compliant with the international Standard.
- Double spring contacts for reliable and low contact resistance.
- Unbalanced load monitoring prevents feed-cable overload of 3-phase feed (only DI-STRIP versions M and RM).
- Optimal load monitoring for server installation (only DI-STRIP versions M and RM).
- Individual output-backup with DI-STRIP BladePower and Pizza Power.

**Maximum flexibility attained due to:**

- Internationally compatible configurations and options.
- Power cable lengths of 2.5 m or 4 m for more spatial flexibility.
- Rotating current indicator in 90° steps (only M and RM DI-STRIP versions).
- Tool-less installation, which means quick and easy extension in the rack (only with DI-STRIP HighPower).

**Extremely low operating costs:**

- Installation in the rack is rapid and easy requiring minimal space and reduced installation time.
- Automatic background-light reduction reduces the rack PDU power loss (only with M and RM DI-STRIP versions).
- Especially flat housing extrusion, providing full accessibility to the 19" level on 600 mm wide server racks.

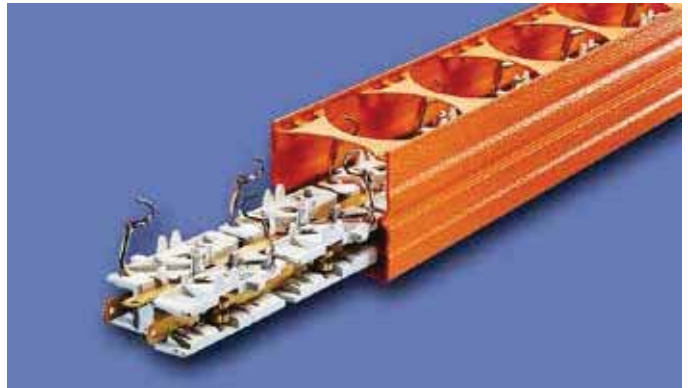

Reliable power distribution at full power delivered by full-length brass busbars.

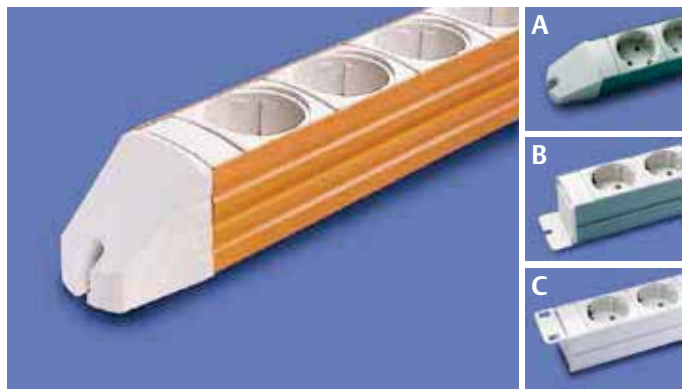

Can be fitted to a rack or workstation.



Highly compact construction; minimizes space requirements in the rack.

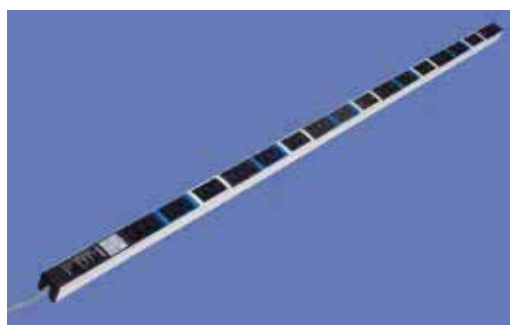

Color-coded phase allocation (L1, L2, L3).

## DI-STRIP®

## European Equipment Models

DI-STRIP models	Functions	Input power	Outputs	Technical description
Euro socket system IEC 320	Basic power distribution	1 x 16 A 3.68 kVA	IEC60320 C13 & C19	Page 253
TriplePower	Basic power distribution	3 x 16 A 11 kVA	IEC60320 C13 & C19 & Schuko	Page 253
PizzaPower	Basic power distribution	1 x 32 A, 3 x 32 A 7.36 kVA, 22 kVA	IEC60320 C13 & C19 & Schuko	Page 254
BladePower	Basic power distribution	1 x 32 A, 3 x 32 A 7.36 kVA, 22 kVA	IEC60320 C13 & C19	Page 254
HighPower	Basic power distribution	1 x 32 A, 3 x 32 A 7.36 kVA, 22 kVA	IEC60320 C13 & C19	Page 255
Classic	Basic power distribution/extra large distance between the sockets	1 x 16 A 3.68 kVA	Schuko, France, Switzerland	Page 255
Compact	Basic power distribution	1 x 16 A 3.68 kVA	Schuko, France, Switzerland	Page 256
Protector FI	Fault-current circuit-breaker FI	1 x 16 A 3.68 kVA	Schuko, France, Switzerland	Page 256
Protector LS	Circuit breaker (LS) FI	1 x 16 A 3.68 kVA	Schuko, France, Switzerland	Page 257
Protector FI/LS	Combination FI + LS	1 x 16 A 3.68 kVA	Schuko, France, Switzerland	Page 257
Protector Emergency Stop	Emergency stop switch	1 x 16 A 3.68 kVA	Schuko, France, Switzerland	Page 258
Protector Emergency Stop FI/LS	Combination emergency stop + FI + LS	1 x 16 A 3.68 kVA	Schuko, France, Switzerland	Page 258
Power Cleaner	Mains filter	1 x 16 A 3.68 kVA	Schuko, France	Page 259
Safety Basic	Overvoltage protection	1 x 16 A 3.68 kVA	Schuko, France, Switzerland	Page 259
Safety Standard	Mains filter + overvoltage protection	1 x 16 A 3.68 kVA	Schuko, France, Switzerland	Page 260
Master Slave	Master Slave	1 x 16 A 3.68 kVA	Schuko, France	Page 261
Combi	Combination Master Slave + overvoltage protection + mains filter	1 x 16 A 3.68 kVA	Schuko, France	Page 261
M (metered)	Phase current metered reading, local	1 x 16 A, 1 x 32 A, 3 x 16 A 3.32 A to 22 kVA	IEC60320 C13 & C19 & Schuko	Page 262
RM (remote metered)	Phase current metered reading local + remote	1 x 16 A, 1 x 32 A, 3 x 16 A 3.32 A to 22 kVA	IEC60320 C13 & C19 & Schuko	Page 262



DOS20062



DOS00458



DOS00460



DOS20102

## DI-STRIP® Euro Socket System, IEC 320

- Optionally with illuminated switch; 2-pole switching.
  - 19" installation option.
  - Euro socket combinations of IEC 320 C13 and C19 sockets.
  - Feed cable: H05VV-F 3G 1.5/2.5 mm<sup>2</sup>.
  - Feed cable: 2.5 m / 5 m.
- **Material / Finish**
    - Housing: closed sheet steel extrusion, zinc-passivated, powder-coated texture.
    - Plastic parts: Vampamid 6 0024 VO (UL94), recyclable.
  - **Dimensions**
    - Height: 45.5 mm.
    - Width of housing: 44.4 mm (= 1 U).
- **Approvals/certificates**
    - CE label in accordance with Low Voltage Directive 2006/95/EC.
    - EMC Directive 2004/108/EC.
    - BV BG.
    - CB scheme.
    - CSA (only models with IEC60320 input).
  - **Color**
    - Enclosure: RAL 7035, light-gray.
    - Plastic parts: RAL 7021 dark-gray.
  - **Standard inclusion**
    - 1 x socket strip.
    - 2 x mounting brackets.

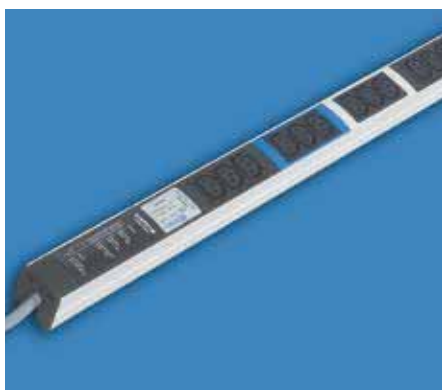

DOS20126

## DI-STRIP® TriplePower® Euro Socket System

- Feed cable: H05VV-F 5 G 2.5 mm<sup>2</sup>.
  - Feed cable: 2.5 m (optional with IEC60309 plug, 3Ph/N/PE 6h).
  - Easy mounting on the rack extrusion.
  - Standard feed 3 x 16 A.
  - Ideal for implementing redundancy (e.g. 96 A with redundant feed).
  - Color-coded phase allocation.
  - Optimum distribution across the entire rack height (23 U and 41 U).
  - Alternative to 3-phase GST18 system.
- **Material/ Finish**
    - Housing: closed sheet steel extrusion, zinc-passivated, powder-coated texture.
    - Plastic parts: Vampamid 6 0024 VO (UL94), recyclable.
  - **Dimensions**
    - Height: 45.5 mm.
    - Width of housing: 44.4 mm (= 1 U).
- **Approvals/certificates**
    - CE label in accordance with Low Voltage Directive 2006/95/EC.
    - EMC Directive 2004/108/EC.
    - BV BG.
    - CB scheme.
    - IEC 320.
  - **Color**
    - Enclosure: RAL 7035, light-gray.
    - Plastic parts: RAL 7021 dark-gray.
  - **Load rating**
    - 100-240/173-415 Vac.
    - Input: 3 x 16 A.
    - Output: 10 A (C13).
    - Output: 16 A (C19 / Schuko).
  - **Standard inclusion**
    - 1 x socket strip.
    - 2 x mounting brackets.

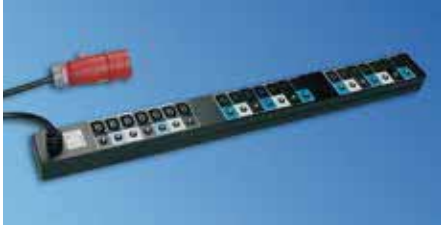

DOS20158



DOS20159



DOS20153



DOS20155

## Knürr DI-STRIP® PizzaPower®

- Individually fused thermal circuit breaker that can be reset in accordance with IEC60934.
- Feed cable: H05VV-F 5 G 4 mm<sup>2</sup>.
- Feed cable: 4 m.

### Material / Finish

- Enclosure: sheet steel, zinc passivated, powder-coated.

### Dimensions

- Height: approx. 60 mm.
- Width of housing: 84 mm.
- Height with cable: approx. 176 mm.

### Color

- Enclosure: RAL 9005, black.

### Certification

- CE label in accordance with Low Voltage Directive 2006/95/EC.
- EMC Directive 2004/108/EC.
- BV BG (only without plug).

### Load rating

- 100-240 / 173-415 Vac.
- Input: 1 x 32 A or 3 x 32 A.
- Output: 10 A (C13).
- Output: 16 A (C19).

### Standard inclusion

- 1 x socket strip (PDU).
- 2 x mounting brackets.
- 1 x 19" mounting bracket (additionally with 19" installation option).
- 1 x instruction manual.

## Knürr DI-STRIP® BladePower®

- IEC 320 sockets (10 A and 16 A).
- Individually fused via thermal circuit breaker that can be reset in accordance with IEC 60934.
- Feed cable: H05VV-F 5 G 4 mm<sup>2</sup>.
- Feed cable: 4 m.
- With IEC60309 plug, 1Ph/N/PE 6h blue, 3Ph/N/PE 6h red.

### Material / Finish

- Housing: sheet steel, zinc passivated, powder-coated.

### Dimensions

- Height: approx. 60 mm.
- Width of housing: 84 mm.

### Color

- Enclosure: RAL 9005, black.

### Approvals

- CE label in accordance with Low Voltage Directive 2006/95/EC.
- EMC Directive 2004/108/EC.
- BV GS.
- CSA NRTL/C (only without plug).

### Load rating

- 100-240 / 173-415 Vac.
- Input: 1 x 32 A or 3 x 32 A.
- Output: 10 A / 16 A.

### Standard inclusion

- 1 x socket strip (PDU).
- 2 x mounting brackets.
- 1 x 19" mounting bracket (additionally with 19" installation option).
- 1 x instruction manual.





DOS20153

## Knürr DI-STRIP® HighPower

- Flat design provides easy access to the 19" level, even with 600 mm-wide racks.
- Individual backup for outputs (10 A groups).
- Outputs divided into groups with max. 20 A per group.
- Modular expansion in the rack with tool-less PDU installation.

Additional functions for HighPower RM type (remote metering).

- Large LCD display with ample overview.
- Displays real energy reading of alternating current input.
- LCD display rotation in 90° steps.
- Display contrast can be adjusted.
- Signals indicate load changes.
- Automatic reduction of background light.
- Technical description of data interface (see DI-STRIP RM).

### Material / Finish

- Enclosure: sheet steel, zinc passivated, powder-coated.

### Dimensions

- Width: 134 mm.
- Height: 47 mm.
- Feed cable: 3 m.

### Color

- Housing: RAL 9005 black.

### Certification

- CE label in accordance with Low Voltage Directive 2006/95/EC.
- EMC Directive 2004/108/EC.

### Standard inclusion

- 1 x socket strip (PDU).
- 1 x 1 integrated remote ampere meter (only HighPower RM).
- 2 x mounting brackets.
- 1 x instruction manual.



DOS00403

## Knürr DI-STRIP® Classic

- Optionally with illuminated switch; 2-pole switching.
- Socket rotation: 45°.
- Feed cable: H05VV-F 3G 1.5 mm<sup>2</sup>.
- Optionally with Euro plug, IEC320 for UPS application.

### Material / Finish

- Housing: closed sheet steel extrusion, zinc-passivated, powder-coated texture.
- Plastic parts: Vampamid 6 0024 VO (UL94).
- Internal conductor: full-length busbars, brass.

### Dimensions

- Distance between sockets: 100 mm.
- Height: 45.5 mm.
- Width of housing: 44.4 mm (= 1 U).
- Feed cable: 2.5 m.

### Approvals/certificates

- CE label in accordance with Low Voltage Directive 2006/95/EC.
- EMC Directive 2004/108/EC.
- BV BG.
- CB scheme.
- VDE GS.

### Color

- RAL 7035, light-gray.

### Load rating

- 100-240 Vac/16 A (output Schuko and UTE).
- 100-240 Vac/10A (outputs Switzerland).

### Standard inclusion

- 1 x socket strip.
- 2 x mounting brackets.



DOS00401

with switch.

## Knürr DI-STRIP® Compact

- Optionally with illuminated switch; 2-pole switching.
  - 19" installation option (for length 483 mm).
  - 2 versions: standard side panel or design side panel.
  - Socket rotation: 45°.
  - Feed cable: H05VV-F 3G 1.5 mm<sup>2</sup>.
  - Molded right angle plug.
  - Optionally with Euro plug, IEC320 for UPS applications.
- **Material / Finish**
    - Housing: closed sheet steel extrusion, zinc-passivated, powder-coated texture.
    - Plastic parts: Vampamid 6 0024 VO (UL94), recyclable.
    - Internal conductor: full-length busbars, brass.
- **Dimensions**
    - Distance between sockets: 50 mm.
    - Height: 45.5 mm.
    - Width of housing: 44.4 mm (= 1 U).
    - Feed cable: 2.5 m.

- **Approvals/certificates**
  - CE label in accordance with Low Voltage Directive 2006/95/EC.
  - EMC Directive 2004/108/EC.
  - BV BG.
  - CB scheme.
  - VDE GS.

- **Color combination**
  - Final digit of order number .1: RAL 7035, light-gray.
  - Final digit of order number .6: housing RAL 2003 pastel orange.
  - Plastic parts: RAL 7035, light-gray.

- **Load rating**
  - 100-240 Vac/16 A (output Schuko and UTE).
  - 100-240 Vac/10 A (outputs Switzerland).

- **Standard inclusion**
  - 1 x socket strip.
  - 2 x mounting brackets.



DOS20065

with FI circuit breaker

## Knürr DI-STRIP® Protector FI

- **Protector FI**
  - Fault-current circuit breaker for user protection.
  - Protection against indirect contact by disconnection of the circuit when inadmissibly high contact voltage occurs through bodily contact with electrical equipment.
  - Additional protection against direct contact.
  - Residual operating current I<sub>g</sub> = 10 mA for alternating and pulsating direct fault currents.
  - 19" installation option (for length 483 mm).
  - Socket rotation: 45°.
  - Feed cable: H05VV-F 3G 1.5 mm<sup>2</sup>.
  - Molded right angle plug.
- **Material/ Finish**
  - Housing: closed sheet steel extrusion, zinc-passivated, powder-coated texture.
  - Plastic parts: Vampamid 6 0024 VO (UL94), recyclable.
  - Internal conductor: full-length busbars, brass.

- **Dimensions**
  - Distance between sockets: 50 mm.
  - Height: 78 mm.
  - Width of housing: 44.4 mm (= 1 U).
  - Feed cable: 2.5 m.

- **Approvals/certificates**
  - CE label in accordance with Low Voltage Directive 2006/95/EC.
  - EMC Directive 2004/108/EC.
  - BV BG.
  - CB scheme.

- **Color combination**
  - Final digit of order number .1: RAL 7035, light-gray.
  - Plastic parts: RAL 7035, light gray.

- **Load rating**
  - 100-240 Vac/16 A.

- **Standard inclusion**
  - 1 x socket strip.
  - 2 x mounting brackets.



DOS00692

with circuit breaker.

## Knürr DI-STRIP® Protector LS

### ■ Protector LS

- Circuit breaker for overload and short circuit.
- Protects cables and lines by switching off rapidly in the event of a short circuit and defined delayed switch-off when overloads occur.
- Circuit breaker: 16 A.
- Trip characteristics: type B, 2-pole.
- 19° installation option (for length 483 mm).
- Socket rotation: 45°.
- Feed cable: H05VV-F 3G 1.5 mm<sup>2</sup>.
- Molded right angle plug.

### ■ Material/ Finish

- Housing: closed sheet steel extrusion, zinc-passivated, powder-coated texture.
- Plastic parts: Vampamid 6 0024 VO (UL94), recyclable.
- Internal conductor: full-length busbars, brass.

### ■ Dimensions

- Distance between sockets: 50 mm.
- Height: 78 mm.
- Width of housing: 44.4 mm (= 1 U).
- Feed cable: 2.5 m.

### ■ Approvals/certificates

- CE label in accordance with Low Voltage Directive 2006/95/EC.
- EMC Directive 2004/108/EC.
- BV BG.
- CB scheme.
- VDE GS.

### ■ Color combination

- Final digit of order number .1:
- RAL 7035, light-gray.
- Plastic parts: RAL 7035, light gray.

### ■ Load rating

- 100–240 Vac/16 A.

### ■ Standard inclusion

- 1 x socket strip.
- 2 x mounting brackets.



DOS00693

## Knürr DI-STRIP® Protector FI / LS

### ■ Protector FI / LS

- Fault current switch and circuit breaker.
- Provides a combination of user, overload and short circuit protection.
- Residual operating current  $I_g = 30$  mA for alternating and pulsating direct fault currents.
- Circuit breaker 16 A (Schuko and France) / 10A (Switzerland).
- Trip characteristics, type B, 2-pole.
- 19° installation option (for length 483 mm).
- Socket rotation: 45°.
- Feed cable: H05VV-F 3G 1.5 mm<sup>2</sup>.
- Molded right angle plug.

### ■ Material / Finish

- Housing: closed sheet steel extrusion, zinc-passivated, powder-coated texture.
- Plastic parts: Vampamid 6 0024 VO (UL94), recyclable.
- Internal conductor: full-length busbars, brass.

### ■ Dimensions

- Distance between sockets: 50 mm.
- Height: 78 mm.
- Width of housing: 44.4 mm (= 1 U).
- Feed cable: 2.5 m.

### ■ Approvals/certificates

- CE label in accordance with Low Voltage Directive 2006/95/EC.
- EMC Directive 2004/108/EC.
- BV BG.
- CB scheme.

### ■ Color combination

- Final digit of order number .1:
- RAL 7035, light-gray.
- Plastic parts: RAL 7035, light-gray.

### ■ Load rating

- 100–240 Vac/16 A (Schuko and France).
- 100–240 Vac/10 A (Switzerland).

### ■ Standard inclusion

- 1 x socket strip.
- 2 x mounting brackets.



DOS20059

## Knürr DI-STRIP® Protector Emergency Stop

- With 2-pole emergency stop switch for user protection.
  - For manually disconnecting consumers in an emergency.
  - Phase and neutral conductors are separated safely.
  - Switch must be intentionally unlocked to restart.
  - 19" installation option (for length 483 mm).
  - Socket rotation: 45°.
  - Feed cable: H05VV-F 3G 1.5 mm<sup>2</sup>.
  - Molded right angle plug.
- **Material / Finish**
    - Housing: closed sheet steel extrusion, zinc-passivated, powder-coated texture.
    - Plastic parts: Vampamid 6 0024 VO (UL94), recyclable.
    - Internal conductor: full-length busbars, brass.
- **Dimensions**
    - Distance between sockets: Classic: 100 mm, Compact: 50 mm.
    - Height: 101 mm.
    - Width of housing: 44.4 mm (= 1 U).
    - Feed cable: 2.5 m.

- **Approvals/certificates**
  - CE label in accordance with Low Voltage Directive 2006/95/EC.
  - EMC Directive 2004/108/EC.
  - BV BG.
  - CB scheme.
- **Color combinations**
  - Final digit of order number .1: RAL 7035, light gray.
  - Plastic parts: RAL 7035, light gray.
- **Load rating**
  - 100–240 Vac/16 A.
- **Standard inclusion**
  - 1 x socket strip.
  - 2 x mounting brackets.



DOS00456

## Knürr DI-STRIP® Protector Emergency Stop FI /LS

- With 2-pole emergency stop switch for user protection.
  - For protecting operating personnel.
  - For manually disconnecting consumers in an emergency.
  - Phase and neutral conductors are separated safely.
  - Switch must be intentionally unlocked to restart.
  - Socket rotation: 45°.
  - Feed cable: H05VV-F 3G 1.5 mm<sup>2</sup>.
  - Molded right angle plug.
- **Material/ Finish**
    - Housing: closed sheet steel extrusion, zinc-passivated, powder-coated texture.
    - plastic parts: Vampamid 6 0024 VO (UL94), recyclable.
    - Internal conductor: full-length busbars, brass.
- **Dimensions**
    - Distance between sockets: Compact: 50 mm.
    - Height: 101 mm.
    - Width of housing: 44.4 mm (= 1 U)
    - Feed cable: 2.5 m.

- **Approvals/certificates**
  - CE label in accordance with Low Voltage Directive 2006/95/EC.
  - EMC Directive 2004/108/EC.
  - BV BG.
  - CB scheme.
- **Color combinations**
  - Final digit of order number .1: RAL 7035, light-gray.
  - Plastic parts: RAL 7035, light-gray.
- **Additionally:**
  - With 2-pole fault-current switch and circuit breaker
  - Provides a combination of user, overload and short circuit protection.
- **Load rating**
  - 100–240 Vac/16 A.
- **Standard inclusion**
  - 1 x socket strip.
  - 2 x mounting brackets.



DOS20061

## Knürr DI-STRIP® Power Cleaner

- High-frequency glitches generally occur in switching processes ranging from 100 kHz to 5 MHz. This high-frequency rate overloads the mains frequency and affects adjacent electronic equipment. The mains filter attenuates this high-frequency rate.
  - The attenuation behavior is harmonized with the typical interference spectrum.
  - The mains filter works in both directions: where glitches from the equipment to the socket strip are also filtered from the mains.
  - 19" installation option (for length 483 mm).
  - Socket rotation: 45°.
  - Feed cable: H05VV-F 3G 1.5 mm<sup>2</sup>.
  - Molded right angle plug.
- **Material / Finish**
    - Housing: closed sheet steel extrusion, zinc-passivated, powder-coated texture.
    - Plastic parts: Vampamid 6 0024 VO (UL94), recyclable.
    - Internal conductor: full-length busbars, brass.
- **Dimensions**
    - Distance between sockets: 50 mm.
    - Height: 45.5 mm.
    - Width of housing: 44.4 mm (= 1 U).
    - Feed cable: 2.5 m.
- **Approvals/certificates**
    - CE label in accordance with Low Voltage Directive 2006/95/EC.
    - EMC Directive 2004/108/EC.
    - BV BG.
    - CB scheme.
  - **Color combination**
    - Final digit of order number .1: RAL 7035, light-gray.
    - Final digit of order number .6: housing RAL 2003 pastel orange.
    - Plastic parts: RAL 7035, light-gray.
  - **Technical data**
    - Nominal voltage: max. 250 Vac, 50 Hz.
    - Nominal current, max. 16 A.
    - Filter compliant with VDE 0565-3 (EN 60939-1).
  - **Standard inclusion**
    - 1 x socket strip.
    - 2 x mounting brackets.
    - 2 x 19" mounting brackets (additionally with 19" installation option).



DOS20068

with overvoltage protection

## Knürr DI-STRIP® Safety Basic

- For protection against transient overvoltage from the mains, which, for example, are caused by switching machines on and off.
  - When critical overvoltages occur, the connection to the mains is cut off.
  - Once the protective conductor has been triggered, the green function display light is not illuminated. Thus, the socket strip can no longer be used.\*
  - Basic equipment protection is classified as class 3 (category D).
  - For optimal protection, class 1 and 2 (categories B and C) protective equipment must be installed in the building.
  - 19" installation option (for length 483 mm).
  - Socket rotation: 45°.
  - Feed cable: H05VV-F 3G 1.5 mm<sup>2</sup>.
  - Molded right angle plug.
- **Material / Finish**
    - Housing: closed sheet steel extrusion, zinc-passivated, powder-coated texture.
    - plastic parts: Vampamid 6 0024 VO (UL94), recyclable.
    - Internal conductor: full-length busbars, brass.
- **Dimensions**
    - Distance between sockets: 50 mm.
    - Height: 45.5 mm.
    - Width of housing: 44.4 mm (= 1 U).
- **Approvals/certificates**
    - CE label in accordance with Low Voltage Directive 2006/95/EC.
    - EMC Directive 2004/108/EC.
    - BV BG.
    - CB scheme.
  - **Color combination**
    - Final digit of order number .1: RAL 7035, light-gray.
    - Final digit of order number .6: housing RAL 2003 pastel orange.
    - Plastic parts: RAL 7035, light-gray.
  - **Technical data**
    - Appliance class: Type 3 as per DIN EN 61643-11.
    - Requirement class: category D as per VDE 0675-6.
    - Mains voltage: 230 VAC.
    - Nominal current, max. 16 A.
    - Discharge surge current (8/20 µs): 10 kA.
    - Reaction time: < 25 ns.
    - Safety level (at 100 A varistor peak current): L with respect to N: < 800 V, L / N with respect to PE: < 1500 V.
  - **Standard inclusion**
    - 1 x socket strip.
    - 2 x mounting brackets.

\* Send the socket strip to the manufacturer for the protective conductor to be replaced!



DOS20069

## Knürr DI-STRIP® Safety Standard

- Standard safety models consist of a combined overvoltage protection/mains filter element.
  - Protects against transient overvoltages from the mains, which, for example, are caused by switching machines on and off.
  - When critical overvoltages occur, connection to the mains is cut off.
  - Once the protective conductor has been triggered, the green function display light is not illuminated. The socket strip can thus no longer be used.\*
  - Basic equipment protection is classified as class 3 (category D).
  - For optimal protection, class 1 and 2 (categories B and C) protective equipment must be installed in the building.
  - High-frequency glitches are generally caused by switching processes in an operation from 100 kHz to 5MHz.
  - This high-frequency rate overloads the mains frequency and affects adjacent electronic equipment. The mains filter attenuates this high-frequency rate.
  - The attenuation behavior is harmonized with the typical interference spectrum.
  - 19" installation option (for length 483 mm).
  - Socket rotation: 45°.
  - Feed cable: H05VV-F 3G 1.5 mm<sup>2</sup>.
  - Molded right angle plug.
- **Material/ Finish**
    - Housing: closed sheet steel extrusion, zinc-passivated, powder-coated texture.
    - Plastic parts: Vampamid 6 0024 VO (UL94), recyclable.
    - Internal conductor: full-length busbars, brass.
- **Dimensions**
    - Distance between sockets: 50 mm.
    - Height: 45.5 mm.
    - Width of housing: 44.4 mm (= 1 U).
    - Feed cable: 2.5 m.
- **Approvals/certificates**
    - CE label in accordance with Low Voltage Directive 2006/95/EC.
    - EMC Directive 2004/108/EC.
    - BV BG.
    - CB scheme.
- **Color combination**
    - Final digit of order number .1: RAL 7035, light-gray.
    - Final digit of order number .6: housing RAL 2003 pastel orange.
    - Plastic parts: RAL 7035, light-gray.
- **Technical data**
    - Mains voltage: 230 VAC.
    - Nominal current: max. 16 A / 10 A.
    - Discharge surge current (8/20 μs): 10 kA.
    - Reaction time: < 25 ns.
    - Safety level (at 100 A varistor peak current): L with respect to N: < 800 V, L / N with respect to PE: < 1500 V.
    - Overvoltage protection
    - Appliance class: Class 3 – as per DIN EN 61643-11.
    - Requirement class: Category D as per VDE 0675-6.
    - Mains filter: as per VDE 0565 (EN 60939).
- **Standard inclusion**
    - 1 x socket strip.
    - 2 x mounting brackets.

\* Send the socket strip to the manufacturer for the safety arrester to be replaced!



DOS20070

## Knürr DI-STRIP® Master-Slave

- Slave plugs will switch on if master switches on.
- Note:
  - The master consumer's power intake must always exceed the switch-on threshold. When switching off the master consumer, the power intake must fall below the switch-off threshold.
  - 19" installation option (for length 483 mm).
  - Socket rotation: 45°.
  - Feed cable: H05VV-F 3G 1.5 mm<sup>2</sup>.
  - Molded right angle plug.
- **Material / Finish**
  - Housing: closed sheet steel extrusion, zinc-passivated, powder-coated texture.
  - Plastic parts: Vampamid 6 0024 VO (UL94), recyclable.
  - Internal conductor: full-length busbars, brass.
- **Dimensions**
  - Distance between sockets: 50 mm.
  - Height: 45.5 mm.
  - Width of housing: 44.4 mm (= 1 U).
  - Feed cable: 2.5 m.
- **Approvals/certificates**
  - CE label in accordance with Low Voltage Directive 2006/95/EC.
  - EMC Directive 2004/108/EC.
  - BV BG.
  - CB scheme.
  - VDE GS.
- **Color combination**
  - Final digit of order number .1:
  - RAL 7035, light-gray.
  - Plastic parts: RAL 7035, light-gray.
- **Load rating**
  - Max. 250 Vac/16 A.
- **Technical data**
  - Switching-threshold setting range
  - On: 20 - 200 mA (approx. 55 mA on delivery).
  - Off: 16 - 160 mA (approx. 44 mA on delivery).
  - Switching delay: 550 ms, ± 20 %.
  - Electronic module: 2-pole switching.
- **Standard inclusion**
  - 1 x socket strip.
  - 2 x mounting brackets.



DOS00325

with master-slave overvoltage protection and mains filter.

## Knürr DI-STRIP® Combi

- Master-slave with overvoltage protection and mains filter.
- Automatic consumer switching.
- Combines Master-Slave (page 261) and Safety Standard (page 260) functions.
- Socket rotation: 45°.
- Feed cable: H05VV-F 3G 1.5 mm<sup>2</sup>.
- Molded right angle plug.
- **Material / Finish**
  - Housing: closed sheet steel extrusion, zinc-passivated, powder-coated texture.
  - Plastic parts: Vampamid 6 0024 VO (UL94), recyclable.
  - Internal conductor: full-length busbars, brass.
- **Dimensions**
  - Distance between sockets: 50 mm.
  - Height: 45.5 mm.
  - Width of housing: 44.4 mm (= 1 U).
  - Feed cable: 2.5 m.
- **Approvals/certificates**
  - CE label in accordance with Low Voltage Directive 2006/95/EC.
  - EMC Directive 2004/108/EC.
  - BV BG.
  - CB scheme.
- **Color combination**
  - Final digit of order number .1:
  - RAL 7035, light-gray.
  - Plastic parts: RAL 7035, light-gray.
- **Technical data**
  - With overvoltage protection and mains filter.
  - Mains voltage: max. 250 Vac.
  - Nominal current: 16 A.
  - Requirement class: D (protection as per VDE 0675).
  - Surge current resistance (8/20 µs wave): Max. 10 kA.
  - Protection level (1.5/50 µs wave): < 1500 V (L + N against PE).
  - Master-slave function:
    - Switching-threshold setting range
      - On: 20 - 200 mA (approx. 55 mA on delivery).
      - Off: 16 - 160 mA (approx. 44 mA on delivery).
    - Switching delay: 550 ms ± 20 %.
    - Electronic module: 2-pole switching.
- **Standard inclusion**
  - 1 x socket strip.
  - 2 x mounting brackets.



DOS80002

## Knürr DI-STRIP® M

- Large LCD display for clear view.
- Effective metering of alternating current displayed per phase (single-phase or 3-phase, depending on model).
- LCD display rotation in 90° steps.
- Display contrast can be adjusted.
- Unbalanced-load warning display with 3-phase model.
- Signals indicate load changes.
- Automatic reduction of background light.
- Feed cable: 4 m H05VV-F 5 G 4 mm<sup>2</sup> (PizzaPower M).
- Feed cable: 2.5 m H05VV-F 5 G 2.5 mm<sup>2</sup> (TriplePower M).
- Feed cable: 2.5 m H05VV-F 3G 1.5 mm<sup>2</sup> (DI-STRIP Compact M, DI-STRIP IEC320 M).

### Material/ Finish

- PizzaPower® model; Housing: sheet steel, zinc-passivated, powder-coated.
- Other models; Housing: closed sheet steel extrusion, zinc-passivated, powder-coated texture.
- Plastic parts: Vampamid 6 0024 VO (UL94), recyclable.

### Approvals/certificates

- CE label in accordance with Low Voltage Directive 2006/95/EC.
- EMC Directive 2004/108/EC. EN61326-1, EN61000-3-2, EN61000-3-3.
- FCC Class B.
- CB scheme (TriplePower M, DI-STRIP compact M, IEC320M, ampere meter GST18i).

### Color

- PizzaPower M model; Housing: RAL 9005 black.
- Other models; Housing: RAL 7035 light-gray.
- Plastic parts: RAL 7021 dark-gray.

### Standard inclusion

- 1 x socket strip with ampere meter.
- 2 x mounting brackets.
- 2 x 19" mounting brackets (with 19" installation option).

### Note

- Other models (e.g C 19 outputs) available on request.



DOS80002

## Knürr DI-STRIP® RM

- Displays real RMS value for the alternating current per phase.
- LCD display rotation in 90° steps.
- Display bright/dark switchover.
- Warning display for unbalanced load.
- Signals indicate load changes.
- Automatic darkening of background light for energy saving.

### Data interface:

- The plug strip can be integrated into the network via an RJ45 plug.
- Access is possible without special software via a remote browser.
- Three variable limit values and a warning for unbalanced loads can be specified.
- The module enables access for up to 5 users or administrators; access is password-protected.
- The software displays the name and location of the PDU; this information can be entered by an administrator.
- The user can specify a static IP address or access using DHCP.
- Firmware updates can be made via a web browser.
- Supported protocols: HTTP, SNMP (Traps, SET, GET), Syslog.

### Material / Finish

- PizzaPower model; Housing: sheet steel, zinc-passivated, powder-coated.
- Other models; Housing: closed sheet steel extrusion, zinc-passivated, powder-coated texture.
- Plastic parts: Vampamid 6 0024 VO (UL94), recyclable.

### Dimensions

- Width: 84 mm (PizzaPower), 44.4 mm (others).
- Height: 60 mm (PizzaPower), 44.4 mm (others).

### Color

- PizzaPower model; Housing: RAL 9005 black.
- Other models; Housing: RAL 7035 light-gray.
- Plastic parts: RAL 7021 dark-gray.

### Approvals

- CE label in accordance with Low Voltage Directive 2006/95/EC.
- EMC Directive 2004/108/EC.
- BV BG.

### Standard inclusion

- 1 x socket strip (PDU) with remote ampere meter.
- 1 x mounting bracket.
- 1 x instruction manual.



DI-STRIP Model	Input Values		Input Connector	Outputs					L	S	F1	F2	19"	Safe	Order No.
	Voltage	Current		C13	C19	Schuko	UTE	Type 13							
<b>Euro plug IEC320 system</b> (technical description on page 231)															
With feed cable	230V	16 A	Schuko CEE7/7	6					333		■				03.600.006.1
	230V	16 A	Schuko CEE7/7	9					483	■	■		■		03.602.009.1
	230V	10 A	IEC60320 C13	12					483		■		■		03.600.312.1
	230V	16 A	IEC60320 C19	15	3				783		■				03.600.418.1
	230V	16 A	IEC60309 1ph/N/PE 6h	15	3				783		■				03.600.518.1
Euro input in plug panel	230V	10 A	IEC60320 C14 inlet	6					383		■				03.622.006.1
	230V	10 A	IEC60320 C14 inlet	9					483		■		■		03.622.009.1
	230V	10 A	IEC60320 C14 inlet	6					433	■	■				03.624.006.1
Euro input on side panel	230V	10 A	IEC60320 C14 inlet	6					333		■				03.622.706.1
	230V	10 A	IEC60320 C14 inlet	9					433		■				03.622.709.1
	230V	10 A	IEC60320 C14 inlet	6					383	■	■				03.624.706.1
230V	10 A	IEC60320 C14 inlet	9					483	■	■				03.624.709.1	
With overload protection 10 A	230V	10 A	Schuko CEE7/7	10					483	■	■		■		03.632.010.1
GST18 input in side panel	230V	16 A	GST18	6					383		■				03.600.206.1
<b>TriplePower</b> (technical description on page 231)															
	230/400V	3 x 16 A	none	24					1033		■				03.600.024.1
	230/400V	3 x 16 A	none	48					1833		■				03.600.048.1
	230/400V	3 x 16 A	IEC60309 3ph/N/PE 6h	24					1033		■				03.600.824.1
	230/400V	3 x 16 A	IEC60309 3ph/N/PE 6h	48					1833		■				03.600.848.1
	230/400V	3 x 16 A	IEC60309 3ph/N/PE 6h	18	6				1133		■				03.600.524.1
	230/400V	3 x 16 A	IEC60309 3ph/N/PE 6h	36	6				1733		■				03.600.542.1
	230/400V	3 x 16 A	IEC60309 3ph/N/PE 6h		6				483		■		■		03.600.506.1
	230/400V	3 x 16 A	IEC60309 3ph/N/PE 6h			12			833		■				03.300.812.1
	230/400V	3 x 16 A	IEC60309 3ph/N/PE 6h	18	3				833		■				03.600.521.1
	230/400V	3 x 16 A	IEC60309 3ph/N/PE 6h	18		3			833		■				03.300.521.1
	230/400V	3 x 16 A	IEC60309 3ph/N/PE 6h	21					833		■				03.600.821.1
	230/400V	3 x 16 A	IEC60309 3ph/N/PE 6h	45					1733		■				03.600.845.1
	230/400V	3 x 16 A	IEC60309 3ph/N/PE 6h	36		6			1733		■				03.300.542.1
<b>PizzaPower</b> (technical description on page 232)															
	230V	32 A	IEC60309 1ph/N/PE 6h	7					400		■		■		03.631.007.1
	230V	32 A	none	7					400		■		■		03.631.807.1
	230V	32 A	IEC60309 1ph/N/PE 6h	12	4				720		■				03.631.124.1
	230V	32 A	IEC60309 1ph/N/PE 6h	24					960		■				03.631.240.1
	230V	32 A	IEC60309 1ph/N/PE 6h	21	4				1017		■				03.631.214.1
	230/400V	3 x 32 A	IEC60309 3ph/N/PE 6h	21					933		■				03.631.021.1
	230/400V	3 x 32 A	none	21					933		■				03.631.821.1
	230/400V	3 x 32 A	IEC60309 3ph/N/PE 6h		6				408		■				03.631.006.1
	230/400V	3 x 32 A	IEC60309 3ph/N/PE 6h	9	12				939		■				03.631.912.1
	230/400V	3 x 32 A	IEC60309 3ph/N/PE 6h	36					1362		■				03.631.360.1
	230/400V	3 x 32 A	IEC60309 3ph/N/PE 6h	18	6				1002		■				03.631.186.1
<b>BladePower</b> (technical description on page 232)															
	230V	32 A	IEC60309 1ph/N/PE 6h	2	3				375		■		■		03.630.005.1
	230/400V	3 x 32 A	IEC60309 3ph/N/PE 6h	6	9				740		■				03.630.015.1
	230V	32 A	none	2	3				375		■		■		03.630.805.1
	230/400V	3 x 32 A	none	6	9				740		■				03.630.815.1
<b>HighPower</b> (technical description on page 233)															
	230V	32 A	IEC60309 1ph/N/PE 6h	20	4				540						03.632.100.8
	230/400V	3 x 32 A	IEC60309 3ph/N/PE 6h	6	12				850						03.632.102.8
	230/400V	3 x 32 A	IEC60309 3ph/N/PE 6h	18	6				850						03.632.103.8
With RM metering module	230V	32 A	IEC60309 1ph/N/PE 6h	20	4				540						03.632.200.8
	230/400V	3 x 32 A	IEC60309 3ph/N/PE 6h	6	12				850						03.632.202.8
	230/400V	3 x 32 A	IEC60309 3ph/N/PE 6h	18	6				850						03.632.203.8

DI-STRIP Model	Input Values		Input Connector	Outputs					L	S	F1	F2	19"	Safe	Order No.
	Voltage	Current		C13	C19	Schuko	UTE	Type 13							
<b>Classic</b> (technical description on page 233)															
	230V	16 A	Schuko CEE7/7			17			1783		■				03.300.067.X
	230V	16 A	Schuko CEE7/7			13			1383		■				03.300.063.X
	230V	16 A	Schuko CEE7/7			9			983		■				03.300.059.X
	230V	16 A	Schuko CEE7/7			5			583		■				03.300.055.X
	230V	16 A	Schuko CEE7/7			16			1733	■	■				03.302.066.X
	230V	16 A	Schuko CEE7/7			12			1333	■	■				03.302.062.X
	230V	16 A	Schuko CEE7/7			8			933	■	■				03.302.058.X
	230V	16 A	Schuko CEE7/7			4			533	■	■				03.302.054.X
	230V	16 A	Schuko CEE7/7				17		1783		■			■	03.400.067.X
	230V	16 A	Schuko CEE7/7				13		1383		■			■	03.400.063.X
	230V	16 A	Schuko CEE7/7				9		983		■			■	03.400.059.X
	230V	16 A	Schuko CEE7/7				5		583		■			■	03.400.055.X
	230V	16 A	Schuko CEE7/7				16		1733	■	■			■	03.402.066.X
	230V	16 A	Schuko CEE7/7				12		1333	■	■			■	03.402.062.X
	230V	16 A	Schuko CEE7/7				8		933	■	■			■	03.402.058.X
	230V	16 A	Schuko CEE7/7				4		533	■	■			■	03.402.054.X
	230V	10 A	SEV 1011 T12					17	1783		■				03.700.067.X
	230V	10 A	SEV 1011 T12					13	1383		■				03.700.063.X
	230V	10 A	SEV 1011 T12					9	983		■				03.700.059.X
	230V	10 A	SEV 1011 T12					5	583		■				03.700.055.X
	230V	10 A	SEV 1011 T12					16	1733	■	■				03.702.066.X
	230V	10 A	SEV 1011 T12					12	1333	■	■				03.702.062.X
	230V	10 A	SEV 1011 T12					8	933	■	■				03.702.058.X
	230V	10 A	SEV 1011 T12					4	533	■	■				03.702.054.X
<b>Compact</b> (technical description on page 234)															
	230V	16 A	Schuko CEE7/7			15			883		■				03.300.015.X
	230V	16 A	Schuko CEE7/7			11			732			■			03.300.111.X
	230V	16 A	Schuko CEE7/7			11			683		■				03.300.011.X
	230V	16 A	Schuko CEE7/7			7			532			■		■	03.301.107.X
	230V	16 A	Schuko CEE7/7			7			532			■			03.300.107.X
	230V	16 A	Schuko CEE7/7			7			483		■		■		03.300.007.X
	230V	16 A	Schuko CEE7/7			8			483		■		■		03.300.008.1
	230V	16 A	Schuko CEE7/7			4			382			■		■	03.301.104.X
	230V	16 A	Schuko CEE7/7			4			382			■			03.300.104.X
	230V	16 A	Schuko CEE7/7			4			333		■				03.300.004.X
	230V	16 A	Schuko CEE7/7			14			883	■	■				03.302.014.X
	230V	16 A	Schuko CEE7/7			10			732	■		■			03.302.110.X
	230V	16 A	Schuko CEE7/7			10			683	■	■				03.302.010.X
	230V	16 A	Schuko CEE7/7			6			532	■		■		■	03.303.106.X
	230V	16 A	Schuko CEE7/7			6			532	■		■			03.302.106.X
	230V	16 A	Schuko CEE7/7			6			483	■	■		■		03.302.006.X
	230V	16 A	Schuko CEE7/7			7			483	■	■		■		03.302.007.1
	230V	16 A	Schuko CEE7/7			3			382	■		■		■	03.303.103.X
	230V	16 A	Schuko CEE7/7			3			382	■		■			03.302.103.X
	230V	16 A	Schuko CEE7/7			3			333	■	■				03.302.003.X
UPS application	230V	10 A	IEC60320 C14			8			483		■		■		03.300.308.1
	230V	16 A	IEC60320 C20			8			483		■		■		03.300.408.1
	230V	16 A	GST18			6			583	■	■				03.302.206.1
	230V	16 A	GST18			3			433	■	■				03.302.203.1
	230V	16 A	GST18			7			533		■				03.300.207.1
	230V	16 A	GST18			4			383		■				03.300.204.1
	230V	16 A	Schuko CEE7/7				15		883		■			■	03.400.015.X
	230V	16 A	Schuko CEE7/7				11		732			■		■	03.400.111.X
	230V	16 A	Schuko CEE7/7				11		683		■			■	03.400.011.X
	230V	16 A	Schuko CEE7/7				7		532			■		■	03.400.107.X

DI-STRIP Model	Input Values		Input Connector	Outputs					L	S	F1	F2	19"	Safe	Order No.
	Voltage	Current		C13	C19	Schuko	UTE	Type 13							
<b>Compact</b> (technical description on page 234)															
	230V	16 A	Schuko CEE7/7				7		483						03.400.007.X
	230V	16 A	Schuko CEE7/7				4		382						03.400.104.X
	230V	16 A	Schuko CEE7/7				4		333						03.400.004.X
	230V	16 A	Schuko CEE7/7				14		883						03.402.014.X
	230V	16 A	Schuko CEE7/7				10		732						03.402.110.X
	230V	16 A	Schuko CEE7/7				10		683						03.402.010.X
	230V	16 A	Schuko CEE7/7				6		532						03.402.106.X
	230V	16 A	Schuko CEE7/7				6		483						03.402.006.X
	230V	16 A	Schuko CEE7/7				3		382						03.402.103.X
	230V	16 A	Schuko CEE7/7				3		333						03.402.003.X
	230V	16 A	GST18				6		583						03.402.206.1
	230V	16 A	GST18				3		433						03.402.203.1
	230V	16 A	GST18				7		533						03.400.207.1
	230V	16 A	GST18				4		383						03.400.204.1
	230V	10 A	SEV 1011 T12					15	883						03.700.015.X
	230V	10 A	SEV 1011 T12					11	732						03.700.111.X
	230V	10 A	SEV 1011 T12					11	683						03.700.011.X
	230V	10 A	SEV 1011 T12					7	532						03.700.107.X
	230V	10 A	SEV 1011 T12					7	483						03.700.007.X
	230V	10 A	SEV 1011 T12					4	382						03.700.104.X
	230V	10 A	SEV 1011 T12					4	333						03.700.004.X
	230V	10 A	SEV 1011 T12					10	732						03.702.110.X
	230V	10 A	SEV 1011 T12					10	683						03.702.010.X
	230V	10 A	SEV 1011 T12					6	532						03.702.106.X
	230V	10 A	SEV 1011 T12					6	483						03.702.006.X
	230V	10 A	SEV 1011 T12					3	382						03.702.103.X
	230V	10 A	SEV 1011 T12					3	333						03.702.003.X
<b>Protector FI</b> (technical description on page 234)															
	230V	16 A	Schuko CEE7/7				13		883						03.304.013.1
	230V	16 A	Schuko CEE7/7				9		683						03.304.009.1
	230V	16 A	Schuko CEE7/7				5		483						03.304.005.1
	230V	16 A	Schuko CEE7/7				13		883						03.404.013.1
	230V	16 A	Schuko CEE7/7				9		683						03.404.009.1
	230V	16 A	Schuko CEE7/7				5		483						03.404.005.1
<b>Protector LS</b> (technical description on page 235)															
	230V	16 A	Schuko CEE7/7				13		883						03.308.013.1
	230V	16 A	Schuko CEE7/7				9		683						03.308.009.1
	230V	16 A	Schuko CEE7/7				5		483						03.308.005.1
	230V	16 A	Schuko CEE7/7				13		883						03.408.013.1
	230V	16 A	Schuko CEE7/7				9		683						03.408.009.1
	230V	16 A	Schuko CEE7/7				5		483						03.408.005.1
<b>Protector FI/LS</b> (technical description on page 235)															
	230V	16 A	Schuko CEE7/7				13		883						03.310.013.1
	230V	16 A	Schuko CEE7/7				9		683						03.310.009.1
	230V	16 A	Schuko CEE7/7				5		483						03.310.005.1
	230V	16 A	Schuko CEE7/7				13		883						03.410.013.1
	230V	16 A	Schuko CEE7/7				9		683						03.410.009.1
	230V	16 A	Schuko CEE7/7				5		483						03.410.005.1
	230V	10 A	SEV 1011 T12					9	683						03.710.009.1
	230V	10 A	SEV 1011 T12					5	483						03.710.005.1
<b>Protector emergency stop switch</b> (technical description on page 236)															
	230V	16 A	Schuko CEE7/7				10		683						03.326.010.1
	230V	16 A	Schuko CEE7/7				6		483						03.326.006.1
Compact	230V	16 A	Schuko CEE7/7				10		683						03.426.010.1
	230V	16 A	Schuko CEE7/7				6		483						03.426.006.1

DI-STRIP Model	Input Values		Input Connector	Outputs					L	S	F1	F2	19"	Safe	Order No.
	Voltage	Current		C13	C19	Schuko	UTE	Type 13							
<b>Protector emergency stop switch</b> (technical description on page 236)															
Classic	230V	16 A	Schuko CEE7/7			12			1333		■				03.326.062.1
	230V	16 A	Schuko CEE7/7			8			933		■				03.326.058.1
	230V	16 A	Schuko CEE7/7				12		1333		■			■	03.426.062.1
	230V	16 A	Schuko CEE7/7				8		933		■			■	03.426.058.1
<b>Protector emergency stop switch FI/LS</b> (technical description on page 236)															
	230V	16 A	Schuko CEE7/7			8			683		■				03.328.008.1
	230V	16 A	Schuko CEE7/7				8		683		■			■	03.428.008.1
<b>Power Cleaner</b> (technical description on page 237)															
	230V	16 A	Schuko CEE7/7			13			883		■				03.312.013.X
	230V	16 A	Schuko CEE7/7			9			683		■				03.312.009.X
	230V	16 A	Schuko CEE7/7			5			483		■		■		03.312.005.X
	230V	16 A	GST18	6					483		■		■		03.612.206.1
	230V	16 A	Schuko CEE7/7				13		883		■			■	03.412.013.X
	230V	16 A	Schuko CEE7/7				9		683		■			■	03.412.009.X
	230V	16 A	Schuko CEE7/7				5		483		■		■	■	03.412.005.X
<b>Safety Basic</b> (technical description on page 237)															
	230V	16 A	Schuko CEE7/7			10			732				■		03.316.110.1
	230V	16 A	Schuko CEE7/7			10			683		■				03.316.010.X
	230V	16 A	Schuko CEE7/7			6			532				■	■	03.317.106.1
	230V	16 A	Schuko CEE7/7			6			532				■		03.316.106.1
	230V	16 A	Schuko CEE7/7			6			483		■		■		03.316.006.X
	230V	16 A	Schuko CEE7/7			4			432				■	■	03.317.104.1
	230V	16 A	Schuko CEE7/7			4			432				■		03.316.104.1
	230V	16 A	Schuko CEE7/7			4			383		■				03.316.004.1
	230V	16 A	GST18			4			433		■				03.316.204.1
	230V	16 A	GST18	6					483		■		■		03.616.206.1
	230V	16 A	Schuko CEE7/7				10		732				■	■	03.416.110.1
	230V	16 A	Schuko CEE7/7				10		683		■			■	03.416.010.1
	230V	16 A	Schuko CEE7/7			6			532				■	■	03.416.106.1
	230V	16 A	Schuko CEE7/7			6			483		■		■	■	03.416.006.1
	230V	16 A	Schuko CEE7/7			4			432				■	■	03.416.104.1
	230V	16 A	Schuko CEE7/7			4			383		■			■	03.416.004.1
	230V	16 A	GST18			4			433		■			■	03.416.204.1
<b>Safety Standard</b> (technical description on page 238)															
	230V	16 A	Schuko CEE7/7			13			883	■	■				03.318.013.X
	230V	16 A	Schuko CEE7/7			9			732	■				■	03.319.109.X
	230V	16 A	Schuko CEE7/7			9			732	■			■		03.318.109.X
	230V	16 A	Schuko CEE7/7			9			683	■	■				03.318.009.X
	230V	16 A	Schuko CEE7/7			5			532	■			■		03.319.105.X
	230V	16 A	Schuko CEE7/7			5			532	■			■		03.318.105.X
	230V	16 A	Schuko CEE7/7			5			483	■	■		■		03.318.005.X
	230V	16 A	GST18			5			583		■				03.318.205.1
	230V	16 A	GST18	6					483		■		■		03.618.206.1
	230V	16 A	Schuko CEE7/7				13		883	■	■			■	03.418.013.X
	230V	16 A	Schuko CEE7/7				9		732	■				■	03.418.109.X
	230V	16 A	Schuko CEE7/7				9		683	■	■			■	03.418.009.X
	230V	16 A	Schuko CEE7/7			5			532	■			■	■	03.418.105.X
	230V	16 A	Schuko CEE7/7			5			483	■	■		■	■	03.418.005.X
	230V	16 A	GST18			5			583		■			■	03.418.205.1
	230V	10 A	SEV 1011 T12					9	683	■	■				03.718.009.X
	230V	10 A	SEV 1011 T12					5	483	■	■		■		03.718.005.X

DI-STRIP Model	Input Values		Input Connector	Outputs					L	S	F1	F2	19"	Safe	Order No.
	Voltage	Current		C13	C19	Schuko	UTE	Type 13							
<b>Master-Slave</b> (technical description on page 239)															
	230V	16 A	Schuko CEE7/7			9			683		■				03.314.009.1
	230V	16 A	Schuko CEE7/7			5			483		■	■			03.314.005.1
	230V	16 A	GST18			5			533		■				03.314.205.1
	230V	16 A	Schuko CEE7/7				9		683		■		■		03.414.009.1
	230V	16 A	Schuko CEE7/7			5			483		■	■	■		03.414.005.1
	230V	16 A	GST18			5			533		■		■		03.414.205.1
<b>Combi</b> (technical description on page 239)															
	230V	16 A	Schuko CEE7/7			9			782			■			03.320.109.1
	230V	16 A	Schuko CEE7/7			9			733		■				03.320.009.1
	230V	16 A	Schuko CEE7/7			5			582			■	■		03.321.105.1
	230V	16 A	Schuko CEE7/7			5			582			■			03.320.105.1
	230V	16 A	Schuko CEE7/7			5			533		■				03.320.005.1
	230V	16 A	Schuko CEE7/7				9		782			■	■		03.420.109.1
	230V	16 A	Schuko CEE7/7				9		733		■		■		03.420.009.1
	230V	16 A	Schuko CEE7/7			5			582			■	■		03.420.105.1
	230V	16 A	Schuko CEE7/7			5			533		■		■		03.420.005.1
<b>M</b> (technical description on page 240)															
	230V	32 A	IEC60309 1ph/N/PE 6h	7					483		■	■			03.636.007.1
	230/400V	3 x 32 A	IEC60309 3ph/N/PE 6h	21					933		■				03.636.021.1
	230/400V	3 x 16 A	IEC60309 3ph/N/PE 6h	21					1033		■				03.606.821.1
	230/400V	3 x 16 A	IEC60309 3ph/N/PE 6h	45					1833		■				03.606.845.1
	230/400V	3 x 16 A	IEC60309 3ph/N/PE 6h	18	6				1133		■				03.606.824.1
	230/400V	3 x 16 A	IEC60309 3ph/N/PE 6h	36	6				1733		■				03.606.842.1
	230V	16 A	Schuko CEE7/7			6			483		■	■			03.306.006.1
	230V	16 A	Schuko CEE7/7	9					483		■	■			03.606.009.1
	230V	16 A	GST18						233		■				03.606.200.1
<b>RM</b> (technical description on page 240)															
	230V	16 A	Schuko CEE7/7			8			733		■				03.307.008.1
	230V	16 A	Schuko CEE7/7			17			1183		■				03.307.017.1
	230V	16 A	Schuko CEE7/7	9					633		■				03.607.009.1
	230V	16 A	Schuko CEE7/7	18					933		■				03.607.018.1
	230/400V	3 x 16 A	IEC60309 3ph/N/PE 6h	24					1133		■				03.607.825.1
	230/400V	3 x 16 A	IEC60309 3ph/N/PE 6h	45					1833		■				03.607.845.1
	230/400V	3 x 16 A	IEC60309 3ph/N/PE 6h	18	6				1233		■				03.607.824.1
	230/400V	3 x 16 A	IEC60309 3ph/N/PE 6h	36	6				1833		■				03.607.842.1
	230V	32 A	IEC60309 1ph/N/PE 6h	24					1111		■				03.637.023.1
	230V	32 A	IEC60309 1ph/N/PE 6h	12	4				871		■				03.637.016.1
	230V	32 A	IEC60309 1ph/N/PE 6h	21	4				1168		■				03.637.025.1
	230/400V	3 x 32 A	IEC60309 3ph/N/PE 6h		6				563		■				03.637.006.1
	230/400V	3 x 32 A	IEC60309 3ph/N/PE 6h	6	12				995		■				03.637.018.1
	230/400V	3 x 32 A	IEC60309 3ph/N/PE 6h	21					1022		■				03.637.021.1
	230/400V	3 x 32 A	IEC60309 3ph/N/PE 6h	18	6				1157		■				03.637.024.1
	230/400V	3 x 32 A	IEC60309 3ph/N/PE 6h	36	6				1751		■				03.637.042.1

**Outputs:**

C13 = IEC60320 C13

C19 = IEC60320 C19

Schuko = Protective contact plug DIN 49440

UTE = France Standard CEE 7-V

Type 13 = Switzerland, type 13

L = Length in mm

S = Switch

F1 = Standard side pane (for rack mounting)

F2 = Design side panel (for installing at workstation)

19" = Suitable for 19" installation

safe = Child-proof



1. DOS20147

### 3-Phase in Rack with GST18 Features



2. DOS20132



3. DOS20142

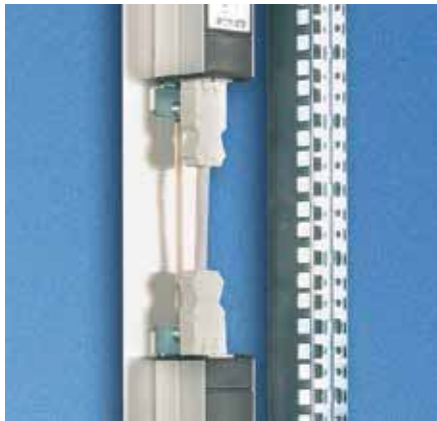

4. DOS20135

- **Requirement**  
Constant energy increase requirements in the rack caused by high packing densities (e.g. 1 U Pizza servers, blade servers, etc.) (1)
- **Solution**  
3-phase distributor with GST18 plug system, e.g. 96 A with redundant feed. (2)
- **Benefits (3, 4)**
  - Modularity.
  - Plug-in capability (no wiring required).
  - Can be expanded.
  - Cascadable.
  - Easy implementation of redundancies/UPS-secured circuits.
  - Combination of DIN Schuko / IEC320 Euro systems.
  - Any installation position can be selected.
  - Good alternative to 3-phase DI-STRIP Triple Power.



DOS20104

### Power Supply Cable, 3-Phase Accessories for GST 18 Plug System

- GST 18 socket for connecting GST18i5 distributor block with 3 phases.
- 5-pole (L1, L2, L3, N, PE) 250/400 V ~.
- Cable: H05VV-F 5G 2.5 mm<sup>2</sup>.

- **Color**  
– Black.

L	S	n	F1	F2	19"	Safe	Model	Order No.	UP
2000								04.000.048.0	1 unit



DOS20103

### GST18i5 Distributor Block, 3-Phase

- For individual connection at the customer.
- Modular plug-in connection.
- 3-phase distribution on various socket strips.
- Including mounting panel.

- **Color**  
– Black.

L	S	n	F1	F2	19"	Safe	Model	Order No.	UP
								04.000.038.9	1 unit



DOS00467

### Power Supply Cable, Single Phase Accessories for GST 18 Plug System

- Mains plug CEE/VII: GST18 socket (Wieland).
- Cable: H05VV-F3G 1.5 mm<sup>2</sup>.

- **Color**  
- White.

L	S	n	F1	F2	19"	Safe	Model	Order No.	UP
2000								<b>04.000.040.0</b>	1 unit
5000								<b>04.000.041.0</b>	1 unit



DOS00469

### Connection Cable Accessories for GST 18 Plug System

- GST 18 plug.
- GST 18 socket.
- Cable: H05VV-F3G 1.5 mm<sup>2</sup>.

- **Color**  
- For color coding circuits (e.g. UPS).

L	S	n	F1	F2	19"	Safe	Model	Order No.	UP
200							White	<b>04.000.042.0</b>	1 unit
200							Black	<b>04.000.042.9</b>	1 unit
500							White	<b>04.000.037.0</b>	1 unit
500							Black	<b>04.000.037.9</b>	1 unit
1000							White	<b>04.000.044.0</b>	1 unit
1000							Black	<b>04.000.044.9</b>	1 unit
5000							White	<b>04.000.045.0</b>	1 unit



DOS20105

### GST18 Socket

- With threaded connection for cross-section 1.5 – 2.5 mm<sup>2</sup> with cable strain relief.
- For individual connection.

- **Color**  
- White.

L	S	n	F1	F2	19"	Safe	Model	Order No.	UP
								<b>04.000.046.0</b>	1 unit

DOS00471



DOS00470

### GST18 Plug

- With threaded connection for cross-section 1.5 – 2.5 mm<sup>2</sup> with cable strain relief.
- For individual, further cabling.

- **Color**  
- White.

L	S	n	F1	F2	19"	Safe	Model	Order No.	UP
								<b>04.000.047.0</b>	1 unit



DOS00076

### Mains Cable for Euro Socket Strip For DIN 49 440 and French/Belgian Standard

- Mains plug CEE/VII: Euro socket IEC 320.
- Cable: H05VV-F 3G 1 mm<sup>2</sup>.
- **Mains voltage**  
- 250 VAC.
- **Nominal current**  
- 10 A.

L	S	n	F1	F2	19"	Safe	Model	Order No.	UP
2000								<b>04.000.054.9</b>	1 unit
6000								<b>04.000.053.9</b>	1 unit



DOS00077

### Mains Cable for Euro Socket Strip For Swiss Standard

- Mains plug: Type 12 - Euro socket IEC 320.
- Cable: H05VV-F 3G 1 mm<sup>2</sup>.
- **Mains voltage**  
- 250 VAC.
- **Nominal current**  
- 10 A.

L	S	n	F1	F2	19"	Safe	Model	Order No.	UP
2000								<b>04.000.055.9</b>	1 unit



DOS00078

### Mains Cable for Euro Socket Strip For British Standard

- Mains plug: Type BS 1363 - IEC320 Euro socket.
- Cable: H05VV-F 3G 1 mm<sup>2</sup>.
- **Mains voltage**  
- 250 VAC.
- **Nominal current**  
- 10 A.

L	S	n	F1	F2	19"	Safe	Model	Order No.	UP
2000								<b>04.000.056.9</b>	1 unit



DOS00519

### Euro Connection Cable

- Mains plug: IEC 320.
- Euro socket IEC 320.
- Cable: H05VV-F 3G 1 mm<sup>2</sup>.
- USA: SJT AWG18 with USA approval.
- **Mains voltage**  
- 250 VAC.
- **Nominal current**  
- 10 A.

L	S	n	F1	F2	19"	Safe	Model	Order No.	UP
900							EU	<b>04.000.051.9</b>	1 unit
900							USA	<b>04.000.052.9</b>	1 unit

Dimensions in mm:			Conversion:	
L = Length	n = Number of sockets	U = Standard rack unit	1 mm = 0.03937 inch	
S = Switch	F1 = Standard side panel	UP = Packaging unit	1 kg = 2.2046 pounds	
	F2 = Design side panel	Safe = child-proof		
	19" = ideal for 19" components			

Replace .x with the number of your color combination: .1 = RAL 7035, .6 = RAL 7035/RAL 2003





DOS20493

### SafetySleeve™ Cable Protection IEC C19

- SafetySleeves protect the feed lines of the network equipment.
- Compatible with all C19 cables and fit onto all PDUs.

- **Material / Finish**
- PVC, black.

L	W	H	U	Model	Order No.	UP
				C20 plug in C19 socket	<b>03.910.212.9 001</b>	20 unit



DOS20494

### SafetySleeve™ Cable Protection IEC C13

- SafetySleeves protect the feed lines of the network equipment.
- Compatible with all C13 cables and fit onto all PDUs.

- **Material / Finish**
- PVC, black.

L	W	H	U	Model	Order No.	UP
				C14 plug in C13 socket	<b>03.910.213.9 001</b>	50 unit

# Knürr RMS Compact II®

## Constant Reliability with Remote Monitoring

### The advantages of Knürr's modern rack monitoring system:

- Guarantees fault-free operation.
- Early disturbance detection.
- Incident logging.
- Automatic monitoring simplifies maintenance.
- Activates countermeasures in the event of a malfunction.
- Central status control of: filters, paper, toner, meter readings, inspection intervals, and much more.
- Up to 12 sensors can be connected in any arrangement.

### System Reliability and Availability

System and network management requirements mean the systems' ambient conditions must be monitored. Compliance with the required ambient parameters is extremely important for successful/continuous operation of high-grade components.

### Management Software

Inadmissible fluctuations in temperature or humidity often cause hardware defects. Constant automatic monitoring of these parameters is therefore a basic requirement for safeguarding operability. All the relevant data can be recorded and forwarded directly to a higher-level management system, e.g. Nagios Liebert Nform™ with the Knürr RMS Compact II®.

### Alarm Consolidation and Control

Simply recording data does not suffice to ward off damages. When faults occur, short response times are aided by the monitoring system triggering actions automatically (e.g. activating additional fans).

### Fast Response

When defined incidents occur, the RMS Compact II can immediately send a message as an "SNMP trap" to the management system or directly as an e-mail to a technician or an SMS gateway.







RMS20013



RMS20015



RMS20047



RMS20048

## Knürr RMS Compact II®

### Description

- **Compact construction** - Zero unit solution (for mounting outside the 19" installation area).
- 19" installation with adapter bracket.
- Safe clamping of all connected cables with integrated cable clamping bracket.
- Cost-effective orderly installation with Plug & Play concept.
- Convenient cabling with RJ45 sensor connections.
- TCP/IP connection via Ethernet (10/100 Base T).
- Configuration via SNMP and Web-Browser.
- Web access is password-protected and optionally encrypted (https).
- 3 different user levels.
- Freely programmable filter system (Boolean logic) for implementing all alarm conditions.
- Compatible with standard network-management and infrastructure-management systems such as Liebert NFORM or Open-Source.
- Sensors for monitoring all relevant environmental influences (optional).
- Internal power supply for sensor equipment (no additional power supply necessary).
- Alarms via LEDs, relay, network management or e-mail (SMTP).
- Support from Modbus/TCP.
- System time balancing with NTP servers.

### Technical data

- 12 universally usable sensor inputs for temperature and humidity sensors, digital (on/off) or analog sensors (0...10V).
- 3 digital outputs (2 x relay, max. 3 A at 230 VAC, 1 x 750 mA at 48 VDC).
- Power supply: 100 - 240 VAC.
- Operating voltage: 12 VDC.

### Compliance

- CE marking compliant with Low Voltage Directive 73/23/EEC; EMC directive 89/336/EEC.

### Color

- RAL 7021, dark-grey.

### Standard inclusion

- 1 x Knürr RMS Compact II.
- 1 x power supply unit.
- 2 x 19" mounting brackets.
- 1 x support bracket for power supply unit.
- 1 x CD ROM (with manual, MIB file)

### Delivery

- In sets.

W	H	D	Model	Order No.	UP
350	42	170	RMS Compact II®	06.108.200.8	1 set



LUF20069

## ECO Temperature Sensor

- **Quick and easy installation**
  - Insensitive to disturbances.
  - No additional power supply required.
  - The sensor must be recalibrated.
- **Technical data**
  - Temperature measurement range: 0...60°C.
  - Accuracy: ± 5 %.
- **Standard inclusion**
  - 1 x sensor.
  - 1 x mounting kit.

W	H	D	U	h	d	kg	Model	Order No.	UP
							ECO	06.108.220.9	1 unit

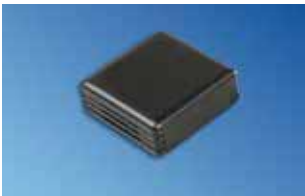

RMS20019

(similar to picture)  
RMS compact-specific

## Humidity Sensor

- **Avoids dew**
  - Insensitive to disturbances.
  - Additional power supply required.
  - The sensor does not have to be recalibrated.
- **Technical data**
  - Air measurement range 30 – 90 %.
  - Accuracy: ± 5 %.
- **Standard inclusion**
  - 1 x sensor with RJ45 port.
  - 1 x mounting kit.

Order No.	UP
06.108.212.9	1 unit



RMS20031

## Water Sensor

- **Conductive water spot sensor**
  - Detects presence of water.
- **Technical data**
  - Operating voltage: max. 24 VDC.
- **Standard inclusion**
  - 1 x sensor with 2 m connection cable.
  - 1 x mounting bracket.

W	H	D	U	h	d	kg	Model	Order No.	UP
								06.108.217.9	1 unit



RMS20006

## Door Contact Sensor

- **No additional magnet required**
  - Magnet bridge sensor works on all magnetic conductive materials (no special mating part required).
  - Can also be used for monitoring side panels and roof.
  - Standard cable length, 4 m.
- **Technical data**
  - Temperature range: -20° C to +70° C.
  - Switching voltage, max. 200 VDC.
  - Switching current, max. 500 mA.
- **Standard inclusion**
  - 1 x sensor with 4 m connection cable.
  - 1 x mounting kit.

W	H	D	Model	Order No.	UP
				06.108.215.9	1 unit



RMS20032

## Air Speed Sensor

- **Fan and filter monitoring**
  - No additional power supply.
  - Automatic detection as analog sensor.
  - Does not have to be recalibrated.
  - Offset and alarm parameters can be set in RMS.
- **Technical data**
  - Measurement range: 0 to 1 m/s.
  - Non-linear measurement, Value table:

< 0 m/s	< 1 V
0 m/s	1 V
1 m/s	1.7 V
2 m/s	2.9 V
3 m/s	4.1 V
4 m/s	5 V (6 V max.).
- **Standard inclusion**
  - 1 x sensor with 4 m connection cable.
  - 1 x mounting kit.

W	H	D	U	h	d	kg	Model	Order No.	UP
20	39	9						06.108.218.9	1 unit

### Dimensions in mm:

W = Width    h = Installation height    U = Standard rack unit  
 H = Height    d = Usable depth (1 U = 44.45 mm)  
 D = Depth    L = Length    UP = Packaging unit

### Conversion:

1 mm = 0.03937 inch  
 1 kg = 2.2046 pounds



RMS20005

## Smoke Detector

- **Sends signal to IT Department**
  - Optical smoke detector with VdS approval.
  - For early fire detection with smoke emission.
  - Power supply provided via RMS compact.
  - Standard cable length, 4 m.
- **Technical data**
  - Operates between -20°C and +75°C.
- **Standard inclusion**
  - 1 x sensor with 4 m connection cable.
  - 1 x mounting kit.

W	H	D	Model	Order No.	UP
Ø 90	75			<b>06.108.211.9</b>	1 unit

## Vibration Sensor

- **Protection against vandalism**
  - Detects vibrations.
  - Theft prevention.
  - Reset possible via Viewer software.
- **Standard inclusion**
  - 1 x sensor with 4 m connection cable.

W	H	D	U	h	d	kg	Model	Order No.	UP
								<b>06.108.213.9</b>	1 unit

## Passive Infrared Movement Sensor

- **Security**
  - Room monitoring with state-of-the-art technology.
- **Technical data**
  - VdS approval: Classes A + B.
  - Range of volumetric lens: 2 – 16 m.
  - Long lens range: 29 – 50 m.
  - Curtain lens range: 17 – 30 m.
  - Manipulation monitoring.
  - Digital fault evaluation.
  - Corner or wall mounting.
- **Standard inclusion**
  - 1 x sensor with 4 m connection cable.
  - 1 x mounting kit.

W	H	D	U	h	d	kg	Model	Order No.	UP
								<b>06.108.214.9</b>	1 unit

Dimensions in mm:						Conversion:	
W = Width	h = Installation height	U = Standard rack unit	kg = Weight	1 mm = 0.03937 inch			
H = Height	d = Usable depth	(1 U = 44.45 mm)		1 kg = 2.2046 pounds			
D = Depth	L = Length	UP = Packaging unit					

## Sensor Cable

- **Plug & Play for own sensors** (Third party and/or any existing analogue/digital sensor)
  - The 4 m long cable is used for connecting further analog/digital sensors or alarm outputs to the sensor input of the Knürr RMS compact II.
  - One end of the cable has an RJ45 connection while other end is open.
  - The RMS automatically recognizes a sensor that is connected to this cable as an analog sensor.
  - A sensor can be supplied with 12 V voltage using the cable.
- **Technical data**
  - Length: 4 m.
- **Standard inclusion**
  - 1 x cable.
  - 1 x layout overview.
- **Delivery**
  - In sets.

Model	L	Order No.	UP
Analog sensor cable	4000	<b>06.108.225.9</b>	1 unit
Digital sensor cable	4000	<b>06.108.224.9</b>	1 unit

## Sensor Extension Cable

- **Flexible positioning of sensors**
  - The cable is used for extending RMS compact II sensors.
  - It consists of a cable with a connected RJ45 plug and an RJ45 connector.
- **Technical data**
  - Length: 3 m and 10 m.
- **Standard inclusion**
  - 1 x cable.
- **Delivery**
  - In sets.

Model	L	Order No.	UP
Sensor extension cable	3000	<b>06.108.223.1</b>	1 unit
Sensor extension cable	10000	<b>06.108.223.5</b>	1 unit

## Power over Ethernet (PoE) Update Set

- **Save on cabling**
  - Saves on costly power supply installations (e.g. WLAN access points) or enables centralized UPSs for decentralized equipment (e.g. IP phones).
  - Using the PoE update set, the RMS can therefore support installations with the corresponding UPS concepts and/or non-standard IDF room.
- **Dimensions**
  - Length: 81 mm.
  - Width: 52 mm.
  - Height: 28 mm.
- **Approvals**
  - EMI: FCC Part 15 Class B, CE Class B.
  - Safety: UL, TUV.
- **Standard inclusion**
  - 1 x PoE adapter.
  - 1 x mounting bracket for easy attachment to the RMS (similar to the classic power supply unit mounting bracket).
- **Delivery**
  - In sets.

Model	Order No.	UP
PoE update set	<b>06.108.230.8</b>	1 unit



RMS20032

## Carbon Monoxide Alarm Sensor

### ■ Detects smoke-free gases and triggers an alarm

- Used for detecting carbon monoxide emitted by burning fire-retardant cables.
- Sends signals carbon monoxide to the RMS and triggers an alarm.
- Standard cable length, 4 m.
- The RMS automatically recognizes this sensor as a digital sensor.

### ■ Technical data

- Operating voltage: 12 VDC (± 20 %).
- Power consumption: approx. 190 mA (idle) approx. 280 mA (alarm).
- Sensitivity: 100 ppm CO.
- Ambient temperature: -15° C to 40° C.
- Piezo alarm: approx. 85 dB(A) at 3 m away.
- Protection rating: IP 20.
- Switching output 12 V DC: Max. 170 mA.
- Relay output: Changeover contact, max. 5 A 230 V DC, max. 5 A 30 V DC.
- Reset: automatic when the gas concentration falls below sensitivity level.

### ■ Dimensions

- Length: 140 mm.
- Width: 125 mm.
- Height: 40 mm.

### ■ Color

- White.

### ■ Standard inclusion

- 1 x sensor.
- 1 x sensor connection cable.
- 1 x Mounting kit.
- 1 x Instructions.

### ■ Delivery

- In sets.

Model	Order No.	UP
Carbon monoxide alarm sensor	06.108.211.8	1 unit

## Liebert Nform™

*Increases Reliability and Energy Efficiency*



**Liebert Nform™ helps meet these requirements:**

### Overview of data center status

- Liebert Nform is data-center monitoring software especially for Liebert infrastructure systems with a trend analysis function, alarm management and result notifications.



### What does Nform offer?

- Liebert Nform provides a uniform monitoring interface with an overview of the operative status of a large number of devices, such as:
  - PDUs: Liebert MPX®, Liebert MPH®, Knürr DI-STRIP® RM.
- Uninterrupted power supplies.
- Water-cooled racks, such as:
  - Knürr CoolLoop®, Knürr CoolTherm®.
- Thermal management equipment.
- Environmental monitoring systems, such as:
  - Knürr RMS Compact II®.

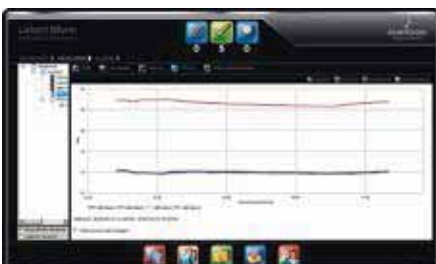

## Inline Metering System (IMS)

### Optimum Upgrade Solution for Existing Installations

#### Emerson Network Power Inline Metering System (IMS) benefits:

- Existing rack PDUs can be retrofitted for optimal savings.
- Almost all consumers can be integrated into the monitoring system, since numerous plug systems are provided (1 ph – 3 ph, max. 63 A per phase).
- Flexible installation inside or outside the rack (e.g. on shelf).

Monitoring is already part of the everyday routine in most data centers when it comes to system availability. Consequently, new systems are equipped with socket strips or **PDUs with integrated monitoring** (Managed PDUs or Adaptive PDUs). Yet, what can be done about existing systems containing socket strips or PDUs that do not provide measuring functions?

**Emerson Network Power's solution for this is called IMS** (Inline Metering System). These modules allow existing racks with installed basic power distributors to be upgraded accordingly. As almost all server racks are supplied with an A and B-feed, **retrofitting is possible without have to interrupt operation**. The IMS modules can also be installed inside or outside the rack; e.g., on the shelf to save space. The Inline Metering Systems (IMS) are divided into **three different product groups with different features**.

#### IMS model series overview

##### MPX IMS

##### Features

- The rack PDU software interface is familiar; communication card is the same as the ones for MPX/MPH.
- Highest possible reliability and availability with an operating temperature of max. 55°C.
- Comprehensive measurement functions (electricity, current, power and energy) with a high measurement accuracy of up to  $\pm 1\%$ .
- N-conductor overload with 3-phase systems can be prevented as the N-conductor current is monitored.
- Easy connection to the network of up to 4 Liebert MPX IMS / MPH / MPX with only one IP address.
- External sensors and a display can also be connected.



##### Modular IMS

##### Features

- Extensive measurement functions (electricity, current, effective power, apparent power, reactive power, energy and power factor), with high measurement accuracy of up to 0.17% (referring to the end value of specified measurement range).
- Very high input currents can be measured (up to 999 A per phase via external transducer).
- The modular setup allows the solution to be customized (e.g. up to 4 in-feeds per module with different input plugs or even fixed feed).
- Up to 75 modules can be controlled via one IP address.
- Storage in external databases possible without additional software.







## INPUT POWER

- Single-phase or three-phase
- 16 A up to max. 63 A



## OUTPUT DISTRIBUTOR

- Single-phase or three-phase
- 16 A up to max. 63 A



## MODULARITY

- External displays or external sensors (depending on the type of communication card).



## MONITORING

- Input level



## LOCAL MONITORING

- Display for user (MPX™ IMS).



## REMOTE MONITORING

- Secure web and SNMP interfaces



## RACK PDU ARRAY™

- One IP address; up to 4 rack PDUs (MPX IMS)
- MPX, MPH™ and IMS in the same private network



# Inline Metering System

## Emerson Network Power IMS – product series

Features	MPX™ IMS	Knürr Modular IMS
Measurement module	■	■
Modular		■
Display	External	
Remote interface	■	■
Measuring at input level	■	■
Measurement modules per IP address	4	75
Max. measurement points per IP address	4	300
Visualization at PDU level	■	■
Visualization at rack level	■	■
Visualization at room level	Only with additional software: Nform or Avocent DSView	■
Measurement parameters	A, V, W, kWh	A, V, W, VA, Var, kWh, cosphi
Phase asymmetry analysis	■	■
External sensor connection options	■	■
Input power	1 ph + 3 ph, max 32 A	1 ph + 3 ph, max. 63 A (max. 4 feeds ), max. 3 ph 999 A (via external transducer)
Connection option	IEC 60309	IEC 60309, GST18, fixed connection
Protocols	HTTP, HTTPS, SNMP, Telnet	HTTP, HTTPS, SNMP v3,
Storage in external database	Only with additional software: Nform or Avocent DSView	Oracle, MySQL, MSSQL

Order number		
1 ph. 16 A	MPXIMS-EHBAXS30	On request
1 ph. 32 A	MPXIMS-EHBAXQ30	On request
3 ph. 16 A	MPXIMS-EHBAXT30	On request
3 ph. 32 A	MPXIMS-EHBAXR30	On request
Control unit	Not required	On request

Easy Upgrade from Basic Power Distributor to Measurement-enabled Power Distributor

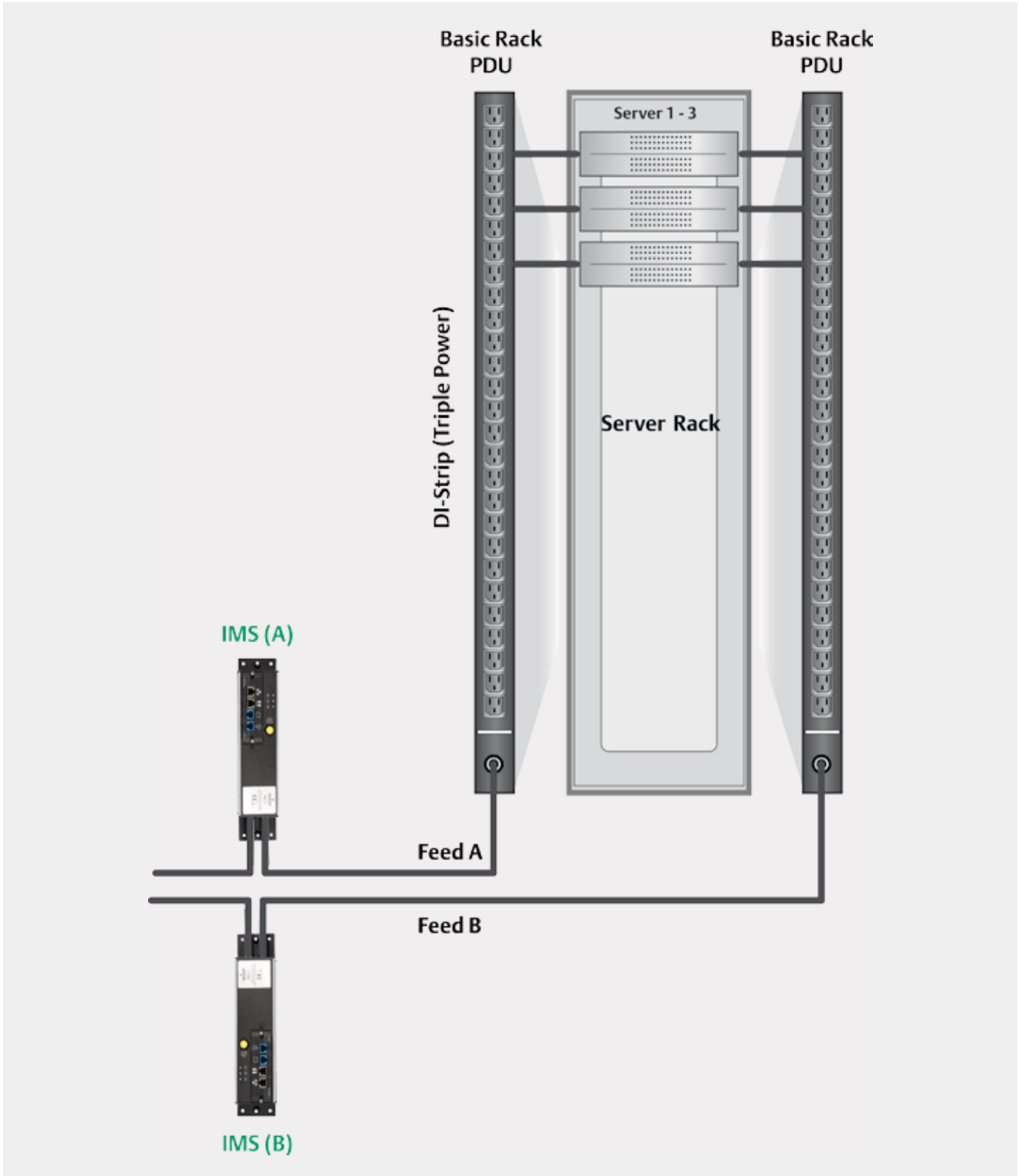



IMS\_8141

## Liebert MPX™ IMS

- Existing rack PDUs do not have to be replaced as the modules can be retrofitted.
- Almost all consumers can be integrated into the monitoring system, since numerous plug systems are provided (1 ph – 3 ph, max. 32 A per phase).
- Flexible installation inside or outside the rack (e.g. on shelf).
- Liebert Rack PDU software interface is familiar; communication card is the same as the one for Liebert MPX/MPH.
- Highest possible reliability and availability with an operating temperature of max. 55°C.
- Comprehensive measurement functions (electricity, current, power and energy), with high measurement accuracy of up to  $\pm 1\%$ .
- N-conductor overload with 3-phase systems can be prevented since the N-conductor current is monitored.
- Easy connection to the network of up to 4 Liebert MPX IMS / MPH / MPX with only 1 IP address.
- External sensors and a display can also be connected.

### ■ Technical data

#### Interfaces:

- RJ-45 LAN port (10/100 MBit) for connecting to local area network (LAN) via an Ethernet cable.
- Expansion / administration port for local configuration using a computer / laptop, for setting up a link-up of several PDUs (Liebert MPX™ or MPH™).
- Serial interface RS232.
- Display port for connecting the RPC BDM (display module).
- External sensor port for connecting optional sensors.
- Remote management: Onboard web interface, CLI, SNMPv1, 2, 3, SSH, Telnet, integratable into Avocent ACS, UMG & MPU, DSView, Rack Power Manager, Nform & Trellis as well as Nagios or other management software programs.
- Authentication: local, remote; active directory, LDAP, TACACS, Radius, Kerberos.
- Encryption: MD5, AES, DES.

### Supported technologies:

- Web support provided by Liebert MPX control and management. Authorized users can view status information via their network.
- SNMP support provided by Liebert MPX SNMP management.
- Easy integration into Liebert Nform, Avocent DSVIEW3 and Nagios.

### ■ Material / Finish

- Enclosure: aluminum.
- Cover: sheet steel.

### ■ Dimensions

- Height: 81 mm.
- Width: 75 mm.
- Length: 266 mm.
- Input cable length: 3 m.
- Output cable length: 0.5 m.

### ■ Certification

- CE label in accordance with Low Voltage Directive 2006/95/EC.
- EMC Directive 2004/108/EC.
- BV GS.

### ■ Color

- Enclosure: aluminum/RAL 7021 dark-gray.

### ■ Standard inclusion

- 1 x MPXIMS-Module/power supply.

### ■ Delivery

- In sets.

Model	L	Input values	Input connector	Output socket	Order No.	UP
Liebert MPX™ IMS 1 x 16 A	266	230 Vac, 16 A	IEC60309 1ph/N/PE 6h	IEC60309 1ph/N/PE 6h	<b>MPXIMS-EHBAXS30</b>	1 unit
Liebert MPX™ IMS 1 x 32 A	266	230 Vac, 32A	IEC60309 1ph/N/PE 6h	IEC60309 1ph/N/PE 6h	<b>MPXIMS-EHBAXQ30</b>	1 unit
Liebert MPX™ IMS 3 x 16 A	266	230/400 VAC, 16 A	IEC60309 1ph/N/PE 6h	IEC60309 1ph/N/PE 6h	<b>MPXIMS-EHBAXT30</b>	1 unit
Liebert MPX™ IMS 3 x 32 A	266	230/400 VAC, 32 A	IEC60309 1ph/N/PE 6h	IEC60309 1ph/N/PE 6h	<b>MPXIMS-EHBAXR30</b>	1 unit



IMS\_Module

## Knürr Modular IMS

- Existing rack PDUs modules can be retrofitted.
  - Almost all consumers can be integrated into the monitoring system, since numerous plug systems are provided (1 ph – 3 ph, max. 63 A per phase).
  - Flexible installation inside or outside the rack (e.g. in shelf).
  - Extensive measurement functions (electricity, current, effective power, apparent power, reactive power, energy and power factor), with high measurement accuracy of up to 0.17 % (referring to the end value of the specific measurement range).
  - Very high input currents can be measured (up to 999 A per phase via external transducer).
  - The modular setup means the solution can be customized (e.g. up to 4 in-feeds per module with different input plugs or even fixed feed).
  - Up to 75 modules can be controlled via one IP address.
  - Storage in external databases possible without additional software.
- **Technical data**
    - The measurement modules can only be operated with a control unit.
    - No more than 75 measurement modules can be connected to a single control unit.
    - 2 x RJ 45 LAN Port 10/100MBit for local network connection (on the control unit).
    - Visualization of all connected measurement modules via WEB.
    - Status information visible via WEB.
    - Protocols: HTTP, HTTPS, SNMPv3.
    - Storage in external data base possible (Oracle, MySQL, MSSQL).
    - Integration into building systems also possible via potential-free contacts.
    - Temperature sensors can be connected.
  - **Dimensions**
    - Length/depth (control unit): 600 mm.
    - Length/depth (module): 400 mm.
    - Width: 483 mm (19").
    - Height: 88.8 mm (2 U).
    - Power supply cable: length, 2 m.
    - Output: socket fixed on device.
  - **Approvals/certificates**
    - CE label in accordance with Low Voltage Directive 2006/95/EC.
    - EMC Directive 2004/108/EC.
    - FFC.
    - GS Certificate.
    - CB scheme.
  - **Color**
    - RAL 7021, dark-gray.
  - **Standard inclusion**
    - 1 x Measurement modules, control unit.
  - **Delivery**
    - In sets.

Model	L	Input values	Input connector	Output socket	Order No.	UP
Knürr Modular IMS 1x16 A		2 x 230 VAC, 16 A	2 x IEC60309 1ph/N/PE 6h	2 x IEC60309 1ph/N/PE 6h	<b>On request</b>	1 unit
Knürr Modular IMS 1 x 32 A		2 x 230 VAC, 32 A	2 x IEC60309 1ph/N/PE 6h	2 x IEC60309 1ph/N/PE 6h	<b>On request</b>	1 unit
Knürr Modular IMS 3 x 16 A		2 x 230/400 VAC; 16 A	2 x IEC60309 1ph/N/PE 6h	2 x IEC60309 1ph/N/PE 6h	<b>On request</b>	1 unit
Knürr Modular IMS 3 x 32 A		2 x 230/400 VAC; 32 A	2 x IEC60309 1ph/N/PE 6h	2 x IEC60309 1ph/N/PE 6h	<b>On request</b>	1 unit
Knürr Modular control unit					<b>On request</b>	1 unit

## Glossary

### Adaptive Architecture

#### Liebert Adaptive Architecture™

The Liebert Adaptive Architecture product and technology family distinguishes itself by delivering an ideal balance between minimal TCO and optimal availability.

#### Open Architecture/

#### Closed Architecture

**Open architecture** utilizes cooling coils and the room's air volume as thermal storage to guarantee continuity in the event of power failures.

**Closed architecture** means that the rack is entirely closed off. The cooling coils are inside the enclosure. Other provisions must be made to bridge power failures.

#### Redundancy

Measure of a system's failure tolerance and the extent to which maintenance work can be performed on a product in operation without function loss.

- Systems without redundancy can fail as soon as one single component fails; or cannot be operated during maintenance work.
- Redundancy is achieved with the parallel setup of the same components, of which at least one of these is not required for the system to achieve 100 % functionality. Such a setup means that even the failure of important components or planned maintenance work will not impair the product's continuous operation. Redundancy concepts can therefore deliver very high system availability levels.
- The highest level of redundancy is attained with the installation of two independent systems whose incoming and outgoing lines are also separated. Preventive maintenance work or component faults do not impair the system's performance because the second system can take over the entire desired functionality at any time.

### Industry Terms and Phrases

#### Availability

Availability is achieved through proven technology or a system that minimizes malfunction risks and downtimes of your IT system.

#### Flexibility

"Flexible" products and systems that can be reconfigured or extended to meet the requirements of new technologies, provide even more protection, or meet the requirements of corporate growth or business changes.

#### Total Cost Of Ownership

All operating costs (TCO) of a solution, including purchase, future changes and maintenance.

### Power Supply

#### Power supply; three-phase (EMEA)

A three-phase power circuit has three conductors, an earth connection, and in most cases, a neutral conductor. Typical voltages for such power circuits are 380 V, 400 V and 415 V.

#### Power supply; single-phase (EMEA)

Single-phase power circuits have two cables and an earth connection. Typical voltages are 220 V, 230 V and 240 V.

#### Power density

More power. More heat generation. Less space. Since the performance of processors is constantly growing but the amount of space available is decreasing, power density rises (from less than 50 to more than 300 watt per m<sup>2</sup>). This generates far more heat, resulting in hot spots that can occur in your data center.

#### UPS types:

##### Online and Line Interactive

An online UPS is used to back up critical applications and guarantee a continuous, uninterrupted power supply. Frequency and wave form are also regulated. A line-interactive UPS prevents voltage peaks and inadmissible power-supply parameters. This energy-efficient technology regulates the power supply and the battery backup system which is especially ideal for installations that rarely suffer power failures, but frequently suffer supply fluctuations.

#### Battery capacity

The percentage power capacity of your batteries, depending on their age, usage period, environment, ambient temperature and maintenance status. A normal VRLA battery can achieve 80 % and has to be replaced after 3-5 years.

#### Battery runtime

The time (in minutes) in which your batteries provide power supply and protect your information in the event of a power or system failure.

#### kW

Standard measurement unit for electrical power. 1 kW is 1,000 W or power consumption of 1,000 joules per second. (1 joule is the required energy it takes to heat 1 kg of water by 1°C.)

### Cooling

#### Back cooling

Absorbs the heat generated by air-cooled condensers and dry coolers for all ambient temperatures or heights. Hot air or hot water is drawn off; water is cooled and recirculated.

#### Precision cooling

The precise controlling and regulation of temperatures, moisture or air filtering.

#### Hot Aisle / Cold Aisle

A highly efficient method of improving performance with existing raised floor systems with high-density rack-based installations. The racks and frames are set up to create "hot" and "cold aisles". Perforated bottom covers from which the raised floor's cool air flows are only placed in the cold aisles.

#### Sensible heat

"Sensible" or "tangible" heat can be directly sensed or measured. Sensible heat changes a material's temperature. Essentially, it provides information on temperature, comparable to that of a weather forecast. Sensible heat is measured with a thermometer. Servers, for example, emit solely sensible heat.

#### Latent heat

"Latent heat" is the heat energy that goes into a material's state change. During a thermally managed cooling process, latent heat is diverted into the air by vapor condensation when the air is cooled below dew point (dehumidification). Latent heat discharge does not have any effect on the temperature you feel.

#### Total heat

Total heat is composed of the heat content of the air (sensible heat) and the water-vapor mixture (latent heat). It is crucial for the thermal device's nominal power.

#### BTU

BTU is a heat energy unit. It is the amount of heat required to raise the temperature of 1 British pound of water by 1 degree Fahrenheit (at sea level). One ton of cooling power is equal to 12,000 BTU/hour.

#### Ton

A ton, in relation to cooling systems, is the amount of heat required to melt 1 ton of ice in 24 hours. A ton is equal to 12,000 BTU/hour or 3,025,900 calories/hour.



## ■ AC Power

Sustaining critical operations that simply can't go down. We deliver a full range of uninterruptible power systems plus STS devices, providing everything from individual products to integrated power protection solutions that keep network closets, computer rooms and data centers up and running.

## ■ DC Power

Supporting voice and communication networks through reliable and efficient DC power. The extensive DC power portfolio includes a wide range of -48 V and 400 V DC systems; from sub-racks to large stand-alone systems. Improved reliability, increased energy efficiency and load balancing is enabled through the Intelligent Load Management functionality (patent pending).

## ■ Infrastructure Management & Monitoring

Managing and monitoring critical environments at multiple sites around the clock. We make it easy in today's ROI-driven business environment, with comprehensive infrastructure management and monitoring systems for both IT and facilities. Solutions and services that provide continuous oversight of data centers, computer rooms and network closets, as well as wireless, wireline and enterprise telecom applications.

## ■ Power Switching & Controls

Safeguarding facilities from operational disruption due to electrical power interruption. We provide ASCO® power-transfer switches, generator paralleling switchgear/power control systems, and touch screen SCADA for monitoring and control of the utility service and on-site backup power generators; all helping to ensure continuity of supply to essential and mission-critical communications, data-processing, life-safety, and other critical loads. Backed by the largest manufacturers, direct field based project management and service technicians in the industry.

## ■ Thermal Management

Managing the heat transferred from the data center to the external environment, while assuring the right temperature and airflow for each server. The Thermal Management range of Liebert® solutions answers to all different customer needs and applications, adopting state-of-the-art technologies to achieve the highest efficiency while minimizing energy costs.

## ■ Racks & Integrated Solutions

Optimizing technology and performance needs for indoor IT applications. We deliver standard and customized integrated cabinet solutions that meet unique and specific needs, from Knürr® and Liebert® rack solutions for computer rooms of all sizes to integrated racks with self-contained cooling, UPS and cable management in a solid, lockable cabinet.

## ■ Surge Protection

Defending power, voice and data moving through a network against grid irregularities and dangerous electrical disturbances. Depending on the application, we offer Liebert® and PowerSure™ AC Power Protection, Islatrol™ Active Tracking Filters and Edco™ data/signal surge protective devices; all of which provide power protection to reduce downtime, saving crucial man-hours and extending equipment life.

## ■ Service and Solutions

Delivering assessment, testing and reliability programs backed by the largest global services organization in the industry. We offer engineering, installation, startup services, project management and training together with entire life-cycle management including preventive and predictive maintenance, remote diagnostics, on-site operations management, and energy consumption monitoring.

## Centers of Expertise

When you partner with Emerson Network Power for your business continuity needs across your enterprise, you benefit from more than products to support and protect your technology infrastructure.

Developing such a wide range of technologies gives us in-depth industry knowledge and a “big-picture” understanding of how all systems must work together within any critical environment. We deliver this knowledge through Emerson Network Power's Centers of Expertise: distinct areas of world-class products and services that help you determine what you need and where, depending on your application.

All so that you can keep your business moving forward for your customers.

# Emerson Network Power

## Data Center Infrastructure for Large Applications

**SmartAisle™**

- Aisle containment.
- Provides highest energy efficiency.
- Control compatible with Thermal Management units.

**Knürr® Power Distribution Rack**

Central connection unit for power supplies in individual server racks.

- Interface between the low voltage feed and PDU.
- Individual plug-in units.
- Up to 346 kVA/Rack.

**Knürr® CoolTherm 4-35 KW**

Energy efficient server cabinet technology.

- Significant Total Cost of Ownership (TCO) reduction.
- Autonomous server rack; independent from environmental conditions.
- Up to 30% improved cooling system energy efficiency.

**Knürr® DCL**

- Modular cooling device up to 34 kW.
- Designed for rack and row cooling.
- Fail-safe controller design.

**Knürr® DCD**

Passive chilled water heat exchanger.

- Cooling capacity up to 35 kW.
- "Room-neutral" design.
- Usable for third party racks.

**Knürr Mirace!/Knürr® DCM**

Global rack platform for data centers, networks and telecommunications.

- Lightweight aluminum frame.
- T-slot system.
- Simple cable management.
- Holds up to 1,500 kg.
- Also available with @lock (electronic locking solutions).

**Rack PDU**

Rack-based power distribution units.

- Supports strip-level metering, outlet-level switching and outlet-level metering/switching for remote power management and control.
- Horizontal and vertical models designed for a variety of rack configurations in branch and remote offices.

- 1** AC Power
- 2** Infrastructure Management & Monitoring
- 3** Power Switching & Controls
- 4** Thermal Management
- 5** Racks & Integrated Solutions
- 6** Surge Protection
- 7** DC Power



A photograph showing three business professionals (two men and one woman) sitting around a conference table in a meeting room. They are looking at documents and a laptop. The man on the left is wearing glasses and a white shirt with a blue tie. The woman in the middle is wearing a red sweater over a white collared shirt. The man on the right is wearing a white shirt and a red tie. The background is a blurred office setting.

## Emerson Network Power – For greater Energy Efficiency in your IT Environment

Really reliable availability of business-critical networks requires a network infrastructure installation you can fully depend on, administration and continuous support.

This in turn depends on the power supply and cooling infrastructure supporting these systems and is based on the following key components:

- **Business-critical power supply**
- **Business-critical cooling**
- **Rack and enclosure systems**
- **Monitoring and management**
- **Proactive maintenance**

Emerson Network Power has developed new power-supply-, cooling-, rack- and enclosure systems, as well as monitoring solutions which further support uninterrupted availability – and offer real added value that goes well beyond the sum of the individual solutions.

With our solutions we provide unsurpassed adaptability, individualization and the ability to integrate into the most diverse products and services.

We acquire extensive knowledge of the challenges you face and are in a position to meet your requirements.

Our exceptionally reliable and comprehensive solutions are tailored to your requirements – thereby providing the benefit of optimized strategic and operational efficiency enhanced reliability, higher flexibility and lower overall operating costs.

Drawing on the combined use of our knowledge, our experience and our resources, we deliver a demand-driven solution from a single source.

The result: an infrastructure that stays abreast of current and future requirements.



## Ensuring high availability of mission-critical data and applications.

### Information on Emerson Network Power

Emerson Network Power, an Emerson company (NYSE:EMR), provides software, hardware and services for maximizing availability, capacity and efficiency for computer centers, healthcare systems and industrial plants.

Industry leader for intelligent infrastructure technologies, Emerson Network Power offers innovative management solutions for computer-center infrastructures which bridge the gap between IT and Facility Management while ensuring efficiency and unrestricted availability for all capacity requirements. A closely-knit global network of service technicians guarantees the high level of availability of all Emerson Network Power technologies.

Visit [www.EmersonNetworkPower.eu](http://www.EmersonNetworkPower.eu) to obtain further information on the products and services offered by Emerson Network Power.

### Sites

#### Emerson Network Power

Global Headquarters  
1050 Dearborn Drive  
P.O. Box 29186  
Columbus, OH 43229, USA  
T +1 614 8880246

#### Emerson Network Power Europe Middle East And Africa

Mariakirchener Straße 38  
94424 Arnstorf  
Germany  
T +49 8723 27 0  
F +49 8723 27 154  
[knuerr@emerson.com](mailto:knuerr@emerson.com)

#### Emerson Network Power United Kingdom

George Curl Way  
Southampton  
SO18 2RY, UK  
T +44 (0)23 8061 0311  
F +44(0)23 8061 0852  
[UK.Enquiries@Emerson.com](mailto:UK.Enquiries@Emerson.com)

Although all appropriate care was taken to ensure that the information in this brochure is correct and complete, Emerson does not accept responsibility for its contents and rejects any claims for liability for damages occurring as a result of use of the printed information, nor does it accept responsibility for errors or omissions. Technical data may change without prior notice.

1101.150.110

MKA4CATOUKIT

[EmersonNetworkPower.eu](http://EmersonNetworkPower.eu)

Follow us on:



Emerson, Consider it Solved, LIFE, Trellis, Emerson Network Power and the Emerson Network Power logo are registered trademarks or service marks of Emerson Electric Co. or of one of its affiliated companies. ©2014 Emerson Electric Co. All rights reserved.

EMERSON. CONSIDER IT SOLVED.™