

Mitutoyo 14" OPTICAL COMPARATOR

- 14" protractor screen.
- Fine ground glass with cross-hair lines
- Vernier reading resolution: 2'.
- Twin fiber optic illuminator.
- Magnifications - 10X (standard).
- Illumination contour-24V, 150W (512305) halogen lamp, telecentric illumination.
- Inverted image.



MODEL No.
172-810PG
Reg. \$6220.00

\$5495.00

Equipped with
"KA" Counter
Linear Scales,
10X Lens,

MODEL No.
172-810PA
Reg. \$7859.00

\$6695.00

Equipped with
"QM" Data 200,
Linear Scales,
10X Lens,

QM-DATA 200

Measurement function-point, line, radius, circle, angle (vertex point), distance min./max. dist. between features, form information, data cloud, rotary axis, incremental/absolute, intersections, constructions, create, preset, forward/backward annotation, feature stamp, geometric tolerancing, measure.

Model	Description	List	Sale
172-810PA	PH-A14 with QM-Data 200	\$7859.00	\$6695.00
172-810PG	PH-A14 with KA Counter	6220.00	5495.00
332-151	Optpeye with Attachment	1599.00	1185.00
64AAA129B	Heavy Duty Steel Stand	690.00	595.00

*For Complete Accessories, Visit www.penntoolco.com



DIGITAL LEVEL, PROTRACTOR INCLINATOR ~ PRO360 & PRO3600

The PRO360 & PRO3600 Digital Protractor from Smarttool Technologies is a revolutionary measuring tool that provides an immediate, digital reading of all angles in a 360° range. The unit utilizes a patented, liquid-filled sensor combined with a precision measurement circuitry to provide unparalleled accuracy and stability.



MADE IN
USA

Shown with
Magnetic Base
Attachment

Female to PC
or Interface Unit

Foot Switch

V-Groove
On Bottom

To Digital Protractor



PRO3600 Data Logger System Software

- Records data from Pro 3600 Digital level onto a computer with Windows XP® as operating system.
- Recording can be triggered with footswitch PRO-361
- After data is collected, the "Export" key will send it to an existing program for future analysis.

Model	Description	List	Sale
PRO360	PRO360 0.1° Resolution	\$275.00	\$199.95
PRO3600	PRO3600 0.01° Resolution	425.00	299.95
PRO361	Foot Switch w/ SPC Cable for PRO3600	175.00	139.00
PRO029	Data Logger System Software for PRO3600	75.00	69.95
KS5571	Magnetic Base Attachment	85.00	69.95
LEV-CERT	Certification to N.I.S.T.	70.00	55.00



DYNAMO POWER FEEDS

For Bridgeport Type Milling Machines
And other popular Series 1 Knee Mills



- Variable speed control Feed rate: 0.4 to 37.4; 140 torque.
- Electro-mechanical clutch for superior cutting at slow speeds.
- Helical gear for quiet, dependable operation.
- Jog switch and rapid traverse button.
- Special safety features include: Fluid protective lip. on/off circuit breaker.
- Warranty 1 year, 115v single phase.

MODEL No.
D-1000X
Reg. \$430.00

\$369.95

Model	Description	List Price	Sale Price
D-1000X	"X" Axis Feed	\$430.00	\$369.95
D-1000Y	"Y" Axis Feed	530.00	419.95
D-1000Z	"Z" Axis Feed	550.00	449.95



TESA-HITE MAGNA 400/700

Made to withstand severe workshop conditions

- Dynamic probing of the workpiece with a constant measuring force.
- Easiness, high reliability when checking bores or shafts using TESA's unique device for automatic detection of the culmination point-patented.
- Acoustic signal to acknowledge value capture, also conveniently programmable.
- TESA's magnetic system guaranteeing correct operating even in harsh workshop conditions-patented.
- Large LC display, also with symbols for the measuring functions.
- Zero setting anywhere within the measuring range.
- PRESET function for entering any given value.
- Metric/inch conversion. • RS-232 data output.
- SCS calibration certificate provided with each height gauge.

Equipped With:

- 1 Standard probe insert holder.
- 1 Standard probe insert with a 5mm dia. tungsten carbide ball tip.
- 1 Master piece for establishing the probe constant nominal dimension to 6.350mm/0.250"

0-16"/22"
MODEL No.
00730047
Reg. \$3645.00



0-28"/34"
MODEL No.
00730059
Reg. \$4650.00

\$3195.00

\$3995.00

Specifications:

Accuracy: 8µm/0.0003"
Repeatability:00015" (flat surface)
..... .00020" (inside bores)
Resolution: 0.001/0.005/0.01mm
..... .0001/0.0002/.001"



SAVE
37%

Mitutoyo 0-1" MICROMETER



- Satin Chrome Finish.
- Ratchet Stop. • Locknut.
- Carbide Tipped Anvils.
- Supplied Fitted Case.
- .0001" Graduation.

MODEL No.
103-260-99
List \$81.10

\$59.95

Precise LARGE LCD ELECTRONIC CALIPERS 3 KEY ~ AUTO-OFF

- Automatic power on/off or manual on/off.
- Three-key Model: Inch/MM, On/Off & Zero.
- Switchable inch/metric, with resolution to .0005"/.01mm on high contrast LCD display.
- 4-way measurements: Outside, Inside, Depth & Step.
- Floating zero.
- Body is hardened stainless steel.
- Standard SR 44, 1.55V battery included.
- With fitted case.



0-6"/0-150mm
MODEL No.
PYT-202

\$18.95

Model	Range	Accuracy	Price
PYT-201	0-4"/0-100mm	±0.001"/0.02mm	\$18.95
PYT-202	0-6"/0-150mm	±0.001"/0.02mm	18.95
PYT-203	0-8"/0-200mm	±0.001"/0.02mm	29.95
PYT-204	0-12"/0-300mm	±0.0015"/0.4mm	49.95

Mitutoyo HIGH-ACCURACY SUB-MICRON ELECTRONIC MICROMETER

.000005"/0.0001mm RESOLUTION ~ THE WORLD'S FIRST

- New submicron micrometer technology that is ideal for highly accurate handheld measurements.
- Measurements are made to an accuracy of +/-0.5 micron with the reliable ABS technology. Achieved with the newly designed rotary sensor, rigid frame, contact pressure mechanism, and precision thread spindle.
- Same reliable ABSOLUTE TECHNOLOGY as the conventional model, but with unparalleled accuracy.



ABSOLUTE Introducing The NEW MODEL No. 293-130 Reg. \$1590.00 **\$1495.00**

Removable heat shield minimizes the error caused by thermal expansion of the frame when performing handheld measurements

Specifications:

Range 0-1"/0-25mm
Resolution .000005"/.00002"
0.0001mm/0.0005mm (switchable)
Accuracy +/- .00002"
Contacts Ø 3.2mm
Measuring Force 7 to 9N
Mass 400g
Battery Type Lithium CR2032
Battery Life 2 years



Fowler INDI-X Blue ELECTRONIC INDICATOR

- Direct Inch/Metric conversion
- Auto off feature.
- 2-1/4" dial face.
- Flatback and Lugback supplied
- Stem Diameter is 3/8"
- Resolution .0005"/.01mm
- Tolerance indicators.
- Absolute/incremental reading.
- Floating zero.
- Carbide tipped point.



INCH • METRIC • FRACTION

Carbide Tipped Point!



Model	Description	List	Sale
54-520-255	.5"/12.5mm Indi-X Blue Electronic Indicator	\$89.00	\$49.95
54-520-250	1"/25mm Indi-X Blue Electronic indicator	94.00	57.95
54-520-260	1"/25mm/64ths Indi-X Blue Inch/metric Fraction Electronic Indicator	98.00	59.95
54-520-774	Quick Lifting Hook Stem Attachment		15.00

Precise AGD 1" TRAVEL DIAL INDICATOR AND MAGNETIC BACK

Dial Indicator:

- 1" Travel .001" Graduations
- Stainless steel parts.
- Rotatable bezel with clamps.
- Lug back with 1/4" hole.
- Interchangeable hardened contact points.
- Conforms to AGD standards.

Magnetic Back:

- Permanent, powerful magnet.
- Direct mount of dial indicators AGD.



SET No. MBD-800 **\$18.95**

Fowler BORE GAGE SETTING MASTER KIT

Fowler's new Bore gage Setting Master Kit is used for accurately setting any bore gage up to 6" in diameter to an accuracy of .0001"

Each Set Includes: Setting Device

- Base anvil: 2.750" x .80"
- Adjustable anvil: 2.375" x .375" (two each)
- Internal capacity: 6"
- Depth capacity: 1"
- Centralizer capacity width: 2.625"
- Quick-release holder for fast adjustment.

Economy Gage Block Set

- 36 Piece
- Tolerances to .00005"
- Certificate of Calibration to N.I.S.T.



SET No. 53-646-000 List \$275.00

\$199.95

With High Quality Wooden Case

Mitutoyo QuantuMike

Rapid Measurement

- By using a coarser thread which feeds the spindle by 2mm per revolution of the thimble instead of the standard 0.5mm
- This increase in thread lead has been made possible thanks to new high precision thread-cutting and test techniques.
- Trials show that a reduction in positioning times of 60% and measuring times of 35% can be obtained, compared with a conventional micrometer.

Function Locks help Prevent Error

- QuantuMike is equipped with a function lock feature to prevent the origin point being moved by mistake during measurement.
- Measurements are made to an accuracy of ±1µm/.00005" throughout the range.

Repeatable Measurement

- The patented ratchet thimble mechanism help ensure repeatable results by transmitting microvibrations along the spindle to contact face to provide a constant measuring force and encourage good contact with the workpiece.
- The ratchet works from the thimble as well as the speeder so it always easy to use - even when making measurements one-handed.

IP65

MODEL No. 293-185 Reg. \$220.00

\$179.95



Model	Range	Resolution	Remarks	List	Sale
293-185	0-1"/0-25mm	.00005"/0.001mm	Without SPC Output	\$220.00	\$179.95
293-186	1-2"/25-50mm	.00005"/0.001mm	Without SPC Output	225.00	215.00
293-187	2-3"/50-70mm	.00005"/0.001mm	Without SPC Output	302.00	255.00
293-188	3-4"/75-100mm	.00005"/0.001mm	Without SPC Output	363.00	305.00
293-180	0-1"/0-25mm	.00005"/0.001mm	With SPC Output	256.00	239.95
293-181	1-2"/25-50mm	.00005"/0.001mm	With SPC Output	293.00	269.95
293-182	2-3"/25-50mm	.00005"/0.001mm	With SPC Output	349.00	310.00
293-183	3-4"/75-100mm	.00005"/0.001mm	With SPC Output	379.00	335.00
05CZA662			40" IP65 SPC Connecting Cable		\$81.75
05CZA663			80" IP65 SPC Connecting Cable		90.15

Mitutoyo NEW-TECHNOLOGY DRO'S For Both Mill & Lathe Functions

Dual Axis Counter

- Bolt hole circle calculation.
- Diameter display and tool off sets (parameter mode).
- Memory compensation value.
- Selecting coordinates 0 to 10.
- Zero approach machining.
- Pitch approach machining.
- 1/2 calculation.
- MM/Inch.

IP67

AT-715 Magnetic Scales

- Fully submersible in coolant (coolant never effects scale position reading).
- Shock resistant.
- ± .00038 accuracy over 36 inches (nearly as accurate as glass scales.
- True Absolute (No battery backup) means position information is never lost even after power interruption.

Mill Package 12" x 30" Travel MODEL No. 64PKA058 Reg. \$1490.00 **\$1195.00**

Complete



Mill Package 12" x 36" Travel MODEL No. 64PKA059 Reg. \$1490.00 **\$1195.00**

Complete



See Page 67 for additional sizes

Fowler XTRA-VALUE ELECTRON™ INTERNAL AND EXTERNAL CALIPER GAGES

- Robust housing.
- Large LCD display.
- Reading: .01"/.1mm/1/64ths
- Accuracy: .01"/.1mm/1.64ths
- Battery: CR2032
- Spring loaded with locking nut.

Buy Both SAVE MORE SET No. 54-554-000 **\$64.95**



Model	Description	Range	List	Sale
54-554-630	Outside Caliper Gage	0-6"/150mm	\$45.00	\$34.95
54-554-730	Inside Caliper Gage	.5-6"/150mm	45.00	34.95

Mitutoyo USB INPUT DIRECT

Our USB Input Tool Direct has been streamlined into a range of dedicated models for each type of measuring instrument

- Data collection can start immediately after connecting the measuring instrument to a computer.
- Because the input tool is automatically recognized as an HID keyboard device (a standard Windows driver) just by connecting it to a USB port, no special software is required.

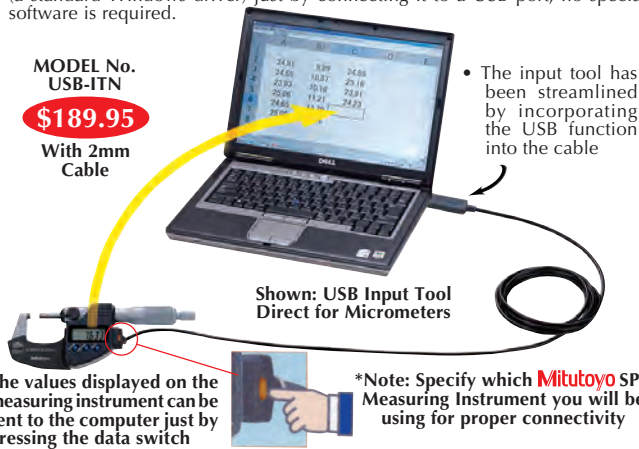

Although measurement data can be simply loaded directly into an Excel spreadsheet by connecting the instrument and input tool to a computer, using the optional **USB-ITPAK** software enables time-saving operations and procedures that significantly improve reliability and efficiency.

Measurement data collection software: USB-ITPAK® No. 06ADV386 \$295.00
This setup and data collection software is used to input data from one or more measuring instruments (connected by way of **USB-ITN**) to any Excel sheet. (This software package cannot be used with **IT-012U**.)

USB-ITPAK



USB Dongle



Software use requires USB Dongle

- Excel input settings: The input destination (a workbook, sheet, or cell), cell-fill direction (right or down), cell-fill interval, and other settings can be specified.
- Measurement method selection: Any of the following three methods can be selected: Sequential measurement, batch measurement, or individual measurement. (For details, see the measurement examples.)
- Data input control: Data can be requested, canceled, or skipped by using mouse buttons, function keys, or foot switch.
- Character string input by the USB foot switch adapter, USB-FSW: Any previously specified character string can be input using the foot switch. Examples: pass or fail
- Number of units that can be connected (total number for both USB-ITN and USB-FSW): Up to 20 units can be connected for Windows Vista or Windows 7, and up to 100 units can be connected for Windows 2000 or Windows XP. However, the above numbers might be less depending on the system configuration.
- Data importation time: About 0.2 to 0.3 seconds per unit. However, this value differs depending on the connected measuring instruments and measurement environment.
- Driver software: The VCP (virtual COM port) drivers for USB-ITN and USB-FSW are individually recognized using a built-in COM number.
- Patent pending (Japan)

Mitutoyo MEASURELINK® 7 REALTIME SPC SOFTWARE

An Integrated Solution for Quality Data Management

MeasurLink 7 Real-Time Standard Edition is designed for customers who want to acquire and analyze data in real-time and check variable and attribute inspection to maximize production and minimize defects.

It has views to allow the user to create Parts, Characteristics with nominal and tolerance and Traceability lists.

The data collection interface provides real-time graphics for Run charts, Control charts, Histograms and Statistics.

Standard views include Datasheet (observations and charts), Classic View (chart windows), and the 2D view (part images with callouts that include charts and statistical data). Full reporting template functionality is also provided. Supported data sources include keyboard, RS232C and USB devices.

MeasurLink 7 Real-Time Professional Edition enables customers to connect and acquire data from Mitutoyo Coordinate Measuring Machines, Vision and Form Measuring Systems via native integration (DDE). ASCII and QMD (xml-based) file imports are also supported. In addition to all of the features supported by MeasurLink 7 Real-Time Standard Edition, this application also supports data filters. Full reporting functionality with templates is also provided. Supported data sources include keyboard, RS232C and USB devices, native Mitutoyo integration (DDE), ASCII and QMD (xml-based) file imports.

MeasurLink 7 Real-Time Professional 3D Edition is designed for customers who wish to collect data using the Hoops 3D graphics view. Hoops 3D files can be exported from most CAD systems and provides the operator with a real view of the part. Camera angle and position can be saved for each characteristic providing for an intuitive prompted guided sequencing for the inspector. Supported data sources include keyboard, RS232C and USB devices, native Mitutoyo integration (DDE), ASCII and QMD (xml-based) file imports.



Database Management System (DBMS) Requirements
MeasurLink 7 ships with a copy of Microsoft® SQL Server Express Edition 2008 R2, this can be for a standalone or a workgroup installation. MeasurLink 7 also supports the following Microsoft SQL Server Versions:

- Microsoft SQL Server 2008 Standard Edition
- Microsoft SQL Server 2008 Enterprise Edition
- Microsoft SQL Server 2005 Workgroup Edition
- Microsoft SQL Server 2005 Standard Edition

Model	Description	List	Sale
6AAB117	MeasurLink V7.0 Real-Time Standard Edition	\$1195.00	\$1095.00
6AAB178	MeasurLink V7.0 Real-Time Professional Edition	1795.00	1695.00
6AAB179	MeasurLink V7.0 Real-Time Professional 3D Edition	1995.00	1795.00

Mitutoyo MULTIPLEXERS - DIGIMATIC/RS-232 INTERFACE UNITS

- A measurement data transfer device, multiplexer MIG-2B and MIG-4A converts digimatic output measurement data to RS-232C and outputs it to an external device such as PC.
- Up to eight/four measuring instruments with the digimatic output feature can be connected.
- Units can be daisy-chained to meet any size needs.
- MIG-4A includes toggle switch for each input.

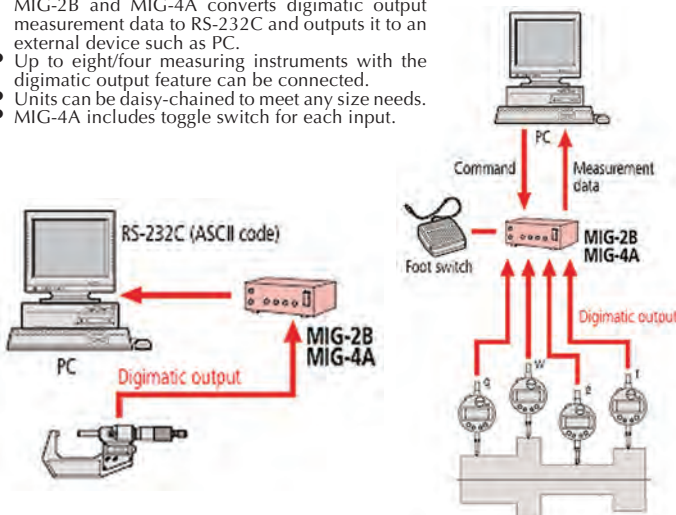

MIG-4A



982-548-10A Front



982-548-10A Back

MIG-2B



982-547-10A Front



982-547-10A Back

Model No.	MIG-2B	MIG-4A
Order No.	982-547-10A	982-548-10A
Gage Capacity	8	4
Dimensions(mm) WxHxD	146 x 150 x 45	146 x 150 x 70
Mass (g)	540	710
Price	\$1325.00	\$1695.00

TRIGA-BORE™ 3-POINT GAGING SYSTEM

- True-Bore heads have a large measuring range and are supplied with fixed anvils eliminating operator error. 24 heads cover 0.236" - 7.87" (6-200mm range)
- Unique System design requires only two handles to accommodate the entire range of 24 heads
- Extensions available for increased gaging depths
- Repeatability: .0001" / 0.002mm
- High degree of accuracy can be achieved without need for special skills
- Made in England.

Shown With
Pistol Handle
Gage head and
Electronic
Indicator



Flexbar Lever
Style Bore gage
Handles can
be used with
entire range of
True-Bore 3-Point
Bore gage heads.
Ideal for use in
vertical gaging
applications and
light access
situations.

Master Setting Rings					
Model	Size	Price	Model	Size	Price
21162	.2912"	\$ 82.00	21455	3.7500"	\$315.00
21164	.3437"	82.00	21456	4.1250"	340.00
21167	.4375"	93.00	21457	4.5625"	345.00
21172	.5625"	95.00	21458	4.9062"	460.00
21177	.7187"	95.00	21459	5.3125"	470.00
21185	.9062"	100.00	21460	5.7187"	540.00
21205	1.4062"	138.00	21461	6.1093"	540.00
21450	1.7500"	175.00	21462	6.5000"	745.00
21451	2.1875"	205.00	21463	6.9062"	745.00
21452	2.5625"	205.00	21464	7.2912"	770.00
21453	2.9375"	240.00	21465	7.6875"	770.00
21454	3.3437"	260.00			

Triga-Bore Handles Only

Model No.	Range of Gage Head	Handle Type	Price Each
20308	.236"-.630"	Pistol	\$315.00
20309	.630"-7.874"	Pistol	315.00
20310	.236"-.630"	Lever	\$335.00
20311	.630"-7.874"	Lever	335.00

Triga-Bore Gage Heads

Model	Range	Price	Model	Range	Price
20312	.236"-.315"	\$387.00	20324	3.150"-3.543"	\$452.00
20313	.315"-.394"	387.00	20325	3.543"-3.937"	522.00
20314	.394"-.511"	315.00	20326	3.937"-4.330"	580.00
20315	.511"-.630"	315.00	20327	4.330"-4.724"	605.00
20316	.630"-.787"	315.00	20328	4.724"-5.118"	625.00
20317	.787"-1.023"	315.00	20329	5.118"-5.512"	650.00
20318	1.023"-1.260"	315.00	20330	5.512"-5.906"	670.00
20319	1.260"-1.575"	338.00	20331	5.906"-6.299"	685.00
20320	1.575"-1.968"	365.00	20332	6.299"-6.693"	703.00
20321	1.968"-2.362"	385.00	20333	6.693"-7.087"	775.00
20322	2.362"-2.756"	415.00	20334	7.087"-7.480"	780.00
20323	2.756"-3.150"	483.00	20335	7.480"-7.874"	825.00

Digimatic Electronic Indicator

Model	Range	Graduation	Price
543-472B	1.00/25mm	.00005"/.0001"/0.001mm/0.01mm	\$495.00

Complete Triga-Bore Sets with Digimatic Inch/Metric Indicator

Model No.	Measuring Range	Contents of Sets	Set Price
20442	.236"-.630"	Triga-Bore Pistol Grip, 4 Heads, 2 Rings	\$2695.00
20443	.630"-1.575"	Triga-Bore Pistol Grip, 4 Heads, 2 Rings	2595.00
20444	1.575"-2.362"	Triga-Bore Pistol Grip, 2 Heads, 1 Ring	1995.00
20445	2.362"-3.150"	Triga-Bore Pistol Grip, 2 Heads, 1 Ring	2125.00
20446	3.150"-3.937"	Triga-Bore Pistol Grip, 2 Heads, 1 Ring	2225.00

Fowler X-TENDED RANGE PIN GAGE SETS

Minus and Plus Tolerances

Ideal for checking hole size, location, gage slots, distance between holes, go/no-go gaging and setting other gages and micrometers.

- Class ZZ
- Black oxide finish offers extra protection against corrosion and rust, promoting longer life, also highlights wear trends that enables calibration to be performed more effectively.
- 240 pieces
- Set includes 2 handles and our X-Guide all purpose teflon lubricant
- Certificate of accuracy traceable to N.I.S.T. and registered ISO 9001



Two Ranges
In One Set!
.011"-.060" & .061"-.250"

Model No.	Description	Accuracy	List	Sale
53-880-823	Plus Pin Gage Set	+0.0002"-0.0000"	\$240.00	\$199.95
53-880-833	Minus Pin Gage Set	+0.0000"-0.0002"	240.00	199.95

Fowler CALIPER, MICROMETER & SNAP GAGE CHECKING SET

Fowler's setting master is quick, easy and extremely accurate. It comes with a certificate of calibration and a fitted aluminum case. Save time and money by calibrating your own measuring tools quickly and easily.

Set Includes:

- Calibration certification traceable to N.I.S.T. standards and provides the individual deviation of each block.
- Stand height: 12.5"
- 9 Pc. Grade AS-0 gage block set (sizes: .625", .100", .125", .200", .250", .300", .500", 1.000" & 2.000")
- Optical flat (flatness: .000004"; Parallelism: .00002")
- 4.0mm ball end T-handle hex wrench.

MODEL No.
53-813-001
List \$305.00
\$265.00



Fowler 2 POINT ELECTRONIC BORE GAGE SYSTEM

.037" - .250" With Setting Rings

- The new Fowler-Bowers MicroGage 2-point bore gaging system has been designed specifically for the measurement of small bores between 1.0 - 6.0mm.
- Featuring a completely new digital readout and extremely compact overall dimensions, the MicroGage is truly a pocket-sized instrument.
- The clear LCD display is easily set using only two buttons and results are shown with switchable 0.01/0.001/0.0005mm resolution.
- Digital readout and measuring head together are about the same size and format as a ballpoint pen which represents a big advantage for those needing to measure small precision parts and who need to have their gage with them all the time.
- Data transfer is via Proximity-RS232 or Proximity-USB output, the measuring heads are equipped with spherical hard-chromed contact points and are set in appropriate setting rings.



Model	Range	Price
54-551-001	.037"-.061"/0.95mm-1.55mm	\$2995.00
54-551-002	.060"-.096"/1.50mm-2.45mm	1995.00
54-551-003	.089"-1.67"/1.67mm-4.25mm	2795.00
54-551-004	.144"-2.50"/3.65mm-6.35mm	2195.00
54-551-010	.037"-.096" 2 Piece Set	\$3595.00
54-551-011	.060"-1.67" 2 Piece Set	3495.00
54-551-012	.089"-2.50" 2 Piece Set	3575.00

VALTRA STANDARD TOOLING BALLS



A	B	C	Slip Fit	Press Fit	Price
±.0002"					
0.2500	0.1250	9/16	826705	826706	\$15.20
0.3750	0.1875	3/4	826710	826711	16.20
0.5000	0.2500	15/16	826715	826716	17.30
0.5000	0.2500	1-1/2	826720	826721	18.00
0.5000	0.3125	1-1/2	826725	826726	18.00
0.5000	0.3750	1-1/2	826730	826731	18.00

VALTRA SHOULDER TOOLING BALLS

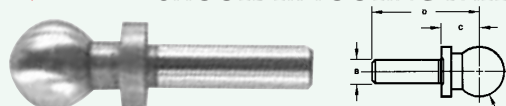

A	B	C	D	Slip Fit	Press Fit	Price
±.0002"		±.0002				
0.2500	0.1250	0.200	3/4	826805	826806	\$17.10
6mm	3mm	6mm	12mm	-	826808	24.80
±.010mm	±.000/-0.010mm	±.0005mm				
0.3750	0.1875	0.300	3/4	826810	826811	17.85
0.5000	0.2500	0.400	15/16	826815	826816	18.55
0.5000	0.2500	0.500	1-3/8	826820	826821	20.25
0.5000	0.3125	0.500	1-1/2	826825	826826	21.30
0.7500	0.3750	0.500	1-1/4	826830	826831	25.65

Slip-fit shank tolerance is plus 0.0000, minus 0.0004. Press-fit shank tolerance is plus 0.0003, minus 0.0000. Ball and shank are concentric with 0.0002 T.I.R.



Mitutoyo DIGIMATIC ELECTRONIC CALIPERS Mitutoyo

With Exclusive Absolute AOS Encoder Technology

- New electromagnetic inductive (AOS) sensor - Improved resistance to environmental conditions such as dirt, oil and water that can cause false readings.
- ABS sensor - Eliminates the necessity of setting the reference when tool is powered on.
- Zero-setting of the display is also possible at any slider position for easy comparison measurements (incremental mode).
- Large .295" high LCD digits (.365" high LCD digits for 12" model) allow measurement results to be viewed at a glance.
- A scale contamination detection function is implemented to detect contamination of surface and display the error message (ErrC) on the LCD. The correct value is only displayed if the contamination is removed.
- Increased battery life - 3.5 years under normal operation.



ABSOLUTE AOS DIGIMATIC

MODEL No. 500-196
REG. LIST \$156.00

NOW

\$114.95

0-6"/0-150mm

With-out SPC output .0005 Resolution

Model	Range	List	Sale
500-195	0-4"/0-100mm	\$144.00	\$114.95
500-196	0-6"/0-150mm	156.00	114.95
500-197	0-8"/0-200mm	224.00	189.95
500-193	0-12"/0-300mm	439.00	369.95

Replacement battery No. 541980 \$4.50

With SPC output .0005 Resolution

Model	Range	List	Sale
500-170	0-4"/0-100mm	\$172.00	\$149.95
500-171	0-6"/0-150mm	183.00	159.95
500-172	0-8"/0-200mm	241.00	212.00
500-173	0-12"/0-300mm	512.00	450.00
500-505	0-18"/0-450mm	799.00	699.50
500-506	0-24"/0-600mm	878.00	772.50
500-507	0-40"/0-1000mm	1700.00	1495.00

With SPC output .0005" Resolution

Model	Range	List	Sale
550-341	0-12"/0-300mm	\$ 744.00	\$ 655.00
550-223	0-18"/0-450mm	933.00	820.00
550-225	0-24"/0-600mm	1040.00	915.00
550-227	0-40"/0-1000mm	2030.00	1785.00

SPC Connecting Cable No. 959149 (1 Meter) \$45.00
No. 959150 (2 Meters) \$50.00

A New Generation in Dial Calipers

Mitutoyo WORLD FAMOUS DIAL CALIPERS Mitutoyo

These dial calipers have been re-designed with a new dial movement to give an ultra smooth feel and provide extra shock protection for the gear train. In addition, a TiN coating has been applied to the beam wear surfaces on the 6" and 8" calipers to increase tool life.

- Satin chrome finished scale surface is marked with clear engraved graduations in inches.
- Accuracy ±.001" per 6".
- Adjuster makes zero point re-adjustment easy. Includes carrying case.



0-6" Range Reg. List \$108.00
MODEL No. 505-717 **\$79.95**



Model No.	Range	Range Rev.	Dial Face	List Price	Sale Price
505-716	0-4"	.200"	White	\$ 92.85	\$ 74.00
505-674	0-4"	.100"	White	100.00	79.50
505-717	0-6"	.200"	Tin White	\$108.00	\$ 79.95
505-675	0-6"	.100"	Tin White	118.00	89.95
505-675-56	0-6"	.100"	Tin Black	118.00	89.95
505-675-66	0-6"	.100"	Black with Ratchet Roller	118.00	89.95
505-675-51	0-6"	.100"	Tin Blue	118.00	89.95
505-675-52	0-6"	.100"	Tin Purple	118.00	89.95
505-675-53	0-6"	.100"	Tin Green	118.00	89.95
505-675-54	0-6"	.100"	Tin Red	118.00	89.95
505-675-55	0-6"	.100"	Tin Orange	118.00	89.95
505-718	0-6"	.200"	O.D. Carbide Jaws, White	151.00	128.00
505-708	0-6"	.100"	O.D. Carbide Jaws, White	180.00	153.00
505-712	0-6"	.100"	O.D. & I.D. Carbide Jaws, White	202.00	171.50
505-719	0-8"	.200"	Tin White	\$161.00	\$128.00
505-676	0-8"	.100"	Tin White	173.00	135.00
505-720	0-12"	.200"	White	\$255.00	\$215.00
505-677	0-12"	.100"	White	274.00	232.50

Brown & Sharpe MICROMETERS & SETS

Providing Measuring Consistency For 150 Years

The original and still the best! Silky-smooth, precise operation and functional design combine to continue the tradition of the Brown & Sharpe micrometer as the basic tool of choice for quality-minded individuals. Carbide measuring faces, convertible "friction" to "feel" thimble sleeves, easy-reading satin chrome finish and spindle locks are standard on all the micrometers listed below.

Convertibility allows B&S mics. to be used either as solid thimble tools or w/ automatic friction action, which stops the spindle advance when a predetermined amount of pressure is exerted against the part by spindle contact.

Graduations are crisp, easy reading with satin-chrome background. All thimble parts are completely interchangeable to simplify maintenance. Accuracy meets Federal and DIN Specifications.



Model No. 599-1-31
Reg List \$189.00

\$149.95



0-3" Sets
Mahogany Case And Standards Included

Model No. 599-181-901
Reg List \$697.00

\$550.00

INDIVIDUAL MICROMETERS

Model	Range	Grad.	Line Type	Price
599-1-31*	0-1"	.0001"	Slant Line	\$149.95
599-1-32*	0-1"	.0001"	Straight Line	149.95
599-2-31	1-2"	.0001"	Slant Line	189.95
599-2-32	1-2"	.0001"	Straight Line	189.95
599-3-31	2-3"	.0001"	Slant Line	199.50
599-3-32	2-3"	.0001"	Straight Line	199.50
599-1-9999	0-1"		Mahogany Case	16.50
599-20-9998	1-2"		Mahogany Case	37.50
599-30-9996	2-3"		Mahogany Case	52.00

* With Wood Case

MICROMETER SETS 0-3" WITH STANDARDS & CASE

599-181-901	0-3"	.0001"	Slant Line	\$550.00
599-181-9011	0-3"	.0001"	Straight Line	550.00

Slant Line w/wood Case



Slant Line

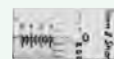

Straight Line

Brown & Sharpe UNIVERSAL DIAL CALIPERS

The Finest Dial Caliper Available

For quality of construction and operation, you can't beat Dial-cal. Compare Dial Cal's features with other tools and see why it's the worlds universal dial caliper.

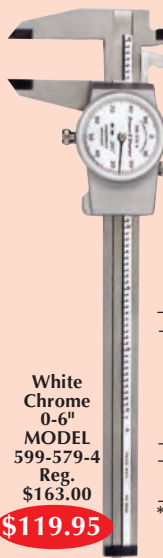

White Chrome 0-6" MODEL 599-579-4 Reg. \$163.00

\$119.95

- **Reliable** Dial Cal's slide is covered to seal out dirt and grease.
- **Versatile** Dial Cal measures four ways: Inside, outside, depth and step.
- **Accurate** Slide lock enables measurements to be taken in hard-to-reach locations and locked until they can be easily read.
- **Convenient** Zero can be quickly and easily reset.
- **Quick-Reading** One revolution per beam grad.
- **Tough** Dial Cal's shock-proof (patented) antibacklash system protects its gear mechanism.
- **Precise** Silky-smooth operation through its entire range for precise measurement.
- **Durable** Rugged stainless steel construction and satin chrome finish

Model	Range	Grad.	Dial face	Price
599-579-4	0-6"	.001"	White Chrome	\$119.95
599-579-5	0-6"	.001"	Black Satin	119.95
599-579-8*	0-8"	.001"	White Chrome	245.00
599-579-85*	0-8"	.001"	Black Satin	245.00
599-579-121*	0-12"	.001"	White Chrome	289.95
599-579-125*	0-12"	.001"	Black Satin	289.95
579-25	T-Bar depth base attachment-3" wide			\$ 19.95
599-578-9999	Fitted Mahogany Case For 6" Dial-Cal And T-Bar			19.95

*Supplied With Wooden Case

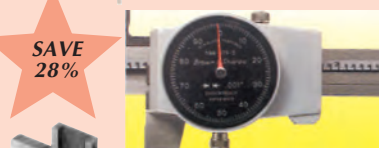

MODEL No. 579-25

\$19.95

T-Bar Depth Base Attachment

Four Precision Measuring Functions

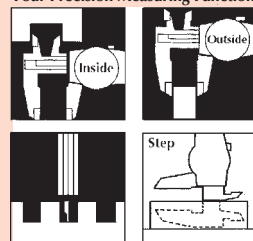

Mitutoyo SUPER SOLAR CALIPER IP 67

- Absolute Encoder Technology.
- IP-67 coolant proof rating.
- Works in low lighting conditions above 60 luxes.
- No battery needed.
- Super capacitor power back-up.

- 0.0005"/0.01mm resolution.
- Certificate of inspection provided.

World's Only  Solar Caliper

ABSOLUTE
Absolute System Patented by Mitutoyo

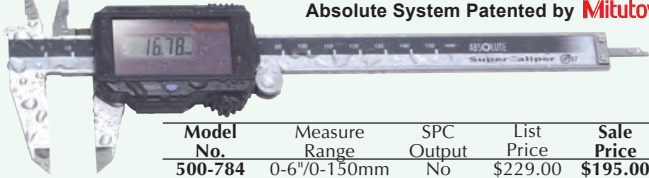

Model No.	Measure Range	SPC Output	List Price	Sale Price
500-784	0-6"/0-150mm	No	\$229.00	\$195.00
500-785	0-8"/0-200mm	No	299.00	265.00
500-786	0-6"/0-150mm	Yes	260.00	230.00
500-787	0-8"/0-200mm	Yes	322.00	285.00
05CZA624	SPC Cable (IP67) 40"			\$ 84.00
05CZA625	SPC Cable (IP67) 80"			86.00

0-6" DIAL-CAL® SET

With Signature Mahogany Case & Depth Base Attachment

- Rugged construction - High accuracy - Patented shockproof design
- Stainless steel construction - Adjustable Zero Set - 1.25" Diameter Rotating dial with lock - Anti-backlash, shockproof design



SET No.
599-579-50
Reg. \$225.00

\$144.95

SAVE 40%

Model No.	Range Inch	Grad. Inch	Per Rev.	Dial Face	Set Price
599-579-40	0-6"	.001"	.100"	White	\$144.95
599-579-50	0-6"	.001"	.100"	Black	144.95

Sylvac ULTRA-CAL ELECTRONIC CALIPER

- Maximum Error: .001"/.02mm
- 4-way measurement, inside, outside, depth and step
- Resolution: .0005"/.01mm
- Repeatability: .0005"/.01mm
- Range: 6"/150mm
- Direct inch/metric conversion
- Temperature range 5 to 40C° working; -20 to 60C° in storage
- Hardened stainless steel construction
- Direct RS-232 output
- Features Absolute/Relative Measuring Modes
- Hold function
- Includes molded case



MODEL No.
54-100-067
Reg. \$189.00

\$125.00



Model	Description	Accuracy	List	Sale
54-100-067	0-6"/150mm Ultra-Cal V Electronic Caliper	±.001"/.02mm	\$189.00	\$125.00
54-100-068	0-8"/200mm Ultra-Cal V Electronic Caliper	±.0015"/.03mm	463.50	395.00
54-100-069	0-12"/300mm Ultra-Cal V Electronic Caliper	±.0015"/.03mm	659.00	495.00
54-115-526	Proximity USB-Cable	-	-	\$125.00
54-115-350	CR2032 Battery	-	-	5.50

Precise COOLANT, WATER & OIL RESISTANT TO IP54 ELECTRONIC CALIPERS

Water, oil and fluid resistant to **IP54**

- Water resistant to IP54 specifications.
- Stainless steel frame.
- Can be exposed to water, oil and fluid.
- Zero setting at any position.
- Direct inch/metric conversion.
- Accuracy: .001"/.02mm
- Resolution: .0005"/.01mm
- Absolute and incremental measurement mode and data output.
- Large and easy to read LCD display.
- 4-way measurement.
- Includes molded case.



MODEL No.
IPC-006
Reg. \$49.95

\$39.95

Water, oil and fluid resistant to **IP54**

Model	Range	Resolution	Reg.	Sale
IPC-006	0-6"/0-150mm	.0005"/.01mm	\$49.95	\$39.95
IPC-008	0-8"/0-200mm	.0005"/.01mm	64.95	54.95
IPC-012	0-12"/0-300mm	.0005"/.01mm	89.95	75.00



ELECTRONIC CALIPER Inch, Metric and Fractions

- New, 6" Electronic caliper, 3-way push button displays .0005", .01mm or 64ths resolution.
- Floating zero, locking nut, battery and fitted case included
- Metal Body.

MODEL No.
8000-P3
Reg. \$ 49.95

\$24.95



Model	Description	List	Sale
8000-P3	6" Electronic Caliper	\$49.95	\$24.95
8000-P4	12" Electronic Caliper	79.95	59.95

SNAP-CAL

Snap-Caliper is ideal for measuring a wide range of materials from metal, plastic and glass to small wires, fibers and paper.

- Range: 0-1.25"/31.5mm.
- Resolution: .0005"/.01mm
- Spring-loaded.
- Wide faced flat jaw for easy positioning.
- Dimensions of fixed jaw: .470" x .900"
- Accuracy: .001"/.02mm
- Hardened stainless steel construction
- Direct inch/metric conversion.
- Measuring speed of 60"/second.
- Large, high contrast LCD display.
- Hanging loop included for attachment to belt or chain.



MODEL No.
54-550-000-1
Reg. \$134.00

\$89.95

PREMIUM BRAND SHOCKPROOF DIAL CALIPERS With ThumbRoll

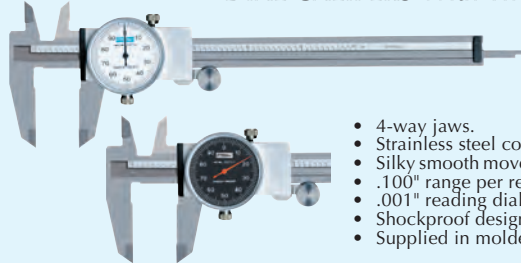

- 4-way jaws.
- Stainless steel construction.
- Silky smooth movement throughout
- .100" range per revolution.
- .001" reading dial face.
- Shockproof design.
- Supplied in molded case.

Model No.	Range	Dial Face	Reg. Price	Sale Price
52-008-706	0-6"	White	\$59.95	\$44.95
52-008-707	0-6"	Black	59.95	44.95
52-008-708	0-8"	White	75.00	59.95
52-008-712	0-12"	White	99.50	79.95

LONG RANGE DIAL CALIPERS

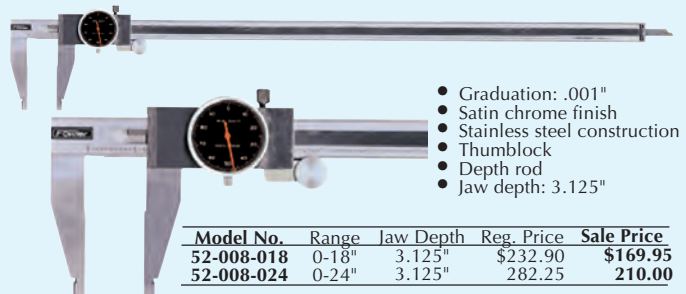

- Graduation: .001"
- Satin chrome finish
- Stainless steel construction
- Thumblock
- Depth rod
- Jaw depth: 3.125"

Model No.	Range	Jaw Depth	Reg. Price	Sale Price
52-008-018	0-18"	3.125"	\$232.90	\$169.95
52-008-024	0-24"	3.125"	282.25	210.00

Precise DIAL CALIPERS

- Widely spaced, microfing graduations.
- Diameter of dial face 1-1/2".
- Adjustable bezel with locking device.
- Satin chrome finish.
- 4-way measurements, inside outside, depth and step.
- Accuracy .001" in 6 inches.
- Covered rack keeps gear teeth clean.
- Stainless, hardened steel beam and jaws with lapped measuring faces.
- Complete in fitted case.

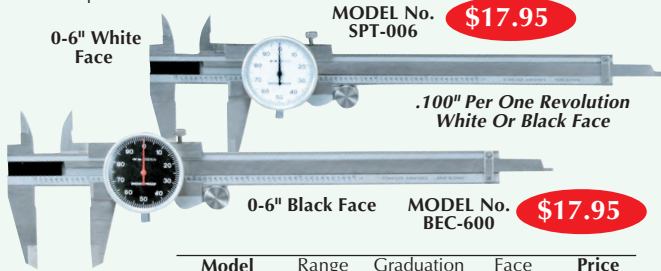

MODEL No. **\$17.95**
SPT-006

.100" Per One Revolution
White Or Black Face

0-6" Black Face MODEL No. **\$17.95**
BEC-600

Model No.	Range Inch	Graduation	Face Color	Price Each
SPT-004	0-4"	.001"	White	\$ 15.95
BEC-400	0-4"	.001"	Black	15.95
SPT-006	0-6"	.001"	White	17.95
BEC-600	0-6"	.001"	Black	17.95
SPT-008	0-8"	.001"	White	29.95
BEC-800	0-8"	.001"	Black	29.95
SPT-012	0-12"	.001"	White	49.95
BEC-120	0-12"	.001"	Black	49.95
*HDD-012	0-12"	.001"	White	\$ 59.95
*SPT-018	0-18"	.001"	White	99.95
*SPT-024	0-24"	.001"	White	129.50

*Heavy Duty Type



Mitutoyo ABSOLUTE COOLANT PROOF ELECTRONIC CALIPERS



The world's first IP67 digital caliper sealed against fluids and contaminants! Coolant proof, Dust Proof & Chip Proof. It also includes Mitutoyo's patented absolute encoder technology. The "Set'N Forget" origin set-up feature.

- Auto power on/off.
- Convenient thumb roller.
- Data output function (output models only).
- Three years battery life under normal use.
- Resolution: .0005"/0.01mm (inch/metric) 0.01mm (metric).
- Accuracy: ±.001"/0.02mm (6" and 8"), ±.0015"/0.03mm (12")



Special SPC cable with IP67 protection level



0-6"/0-15mm MODEL No. **\$175.00**
500-752
Reg. \$204.00

Model	Range	Output	List	Sale
500-752	0-6"/0-150mm	No	\$204.00	\$175.00
500-762	0-6"/0-150mm	Yes	242.00	215.00
500-753	0-8"/0-200mm	No	273.00	235.00
500-763	0-8"/0-200mm	Yes	313.00	275.00
500-754	0-12"/0-300mm	No	472.00	395.00
500-764	0-12"/0-300mm	Yes	524.00	470.00
With Carbide Tipped Jaws OD & ID				
500-735	0-6"/0-150mm	No	\$350.00	\$299.50
500-737	0-6"/0-150mm	Yes	447.00	415.00
500-734	0-8"/0-200mm	No	430.00	365.00
500-738	0-8"/0-200mm	Yes	454.00	410.00
05CZA624	IP67 SPC Connecting Cable 1mm			\$84.00
05CZA625	IP67 SPC Connecting Cable 2mm			\$86.00

Precise HEAVY DUTY LARGE VERNIER CALIPER

LC-018 and LC-024 Features:

- Direct read either I.D. or O.D., no additional calculation for measurements necessary.
- Engraved scales, not etched.
- Satin chrome finish. Wooden case included.
- LG-012, 016, 040, 060, 080 and 120
- These modes have .001" graduations on the bottom scale and 1/50mm on the top scale.



0-18" MODEL No. **\$69.95**
LC-018

0-24" MODEL No. **\$79.95**
LC-024

0-40" MODEL No. **\$225.00**
LC-040

Model No.	Range Inch/metric	Graduations Bottom/Top	Jaw Depth	Price Each
LC-012	0-12"/0-300mm	1/1000"/1/50mm	3.5"	\$ 39.95
LC-018	0-18"	1/1000"/1/1000"	4.0"	69.95
LC-024	0-24"	1/1000"/1/1000"	4.0"	\$ 79.95
LC-040	0-40"	1/1000"/1/50mm	5.5"	225.00
LC-060	0-60"	1/1000"/1/50mm	6.0"	395.00
LC-080	0-80"	1/1000"/1/50mm	7.8"	850.00
LC-100-1	0-100"	1/1000"/0.02mm	9.84"	2495.00
LC-120	0-120"	1/1000"/1/50mm	9.84"	3495.00

Precise GROOVE-MASTER®

Quick & Accurate! Measure Internal And External Diameters Of Retaining Ring Grooves, O-Ring Grooves & Undercuts

- Machined from steel and hard chrome plated.
- Fits all 6" Calipers with a maximum jaw thickness of .140".
- Measure internal grooves from .200" up to the capacity of the caliper.



3 Pc. Set #1,2,3 w/ 0-6" Digital Caliper SET No. GMS-001 **\$134.95**

Model	Description	Sale
29500	3 piece set, size 1, 2 & 3	\$119.95
29505	5 piece set, 1 each of all sizes	225.00

Individual Sizes & Specifications

Model No.	Size	Min. Bore	Flange Width	Max. Depth	Groove Depth	Price Each
29510	#1	.200"	.015"	.400"	.050"	\$45.00
29511	#2	.300"	.015"	.625"	.070"	45.00
29512	#3	.600"	.025"	1.000"	.200"	45.00
29513	#4	.725"	.040"	1.250"	.255"	50.00
29514	#5	External	.024"	3.000"	.375"	60.00

Precise LONG RANGE HEAVY DUTY ELECTRONIC CALIPER - WITH FINE ADJUSTMENT

- Resolution: .0005" (.01mm).
- Direct inch/metric conversion.
- Large, high contrast LCD display.
- Non glare satin reading surface.
- Absolute/incremental measurement.
- Fast tracking speed of 60" per second.
- Price includes deluxe fitted wooden case.
- 12" Model No. 303-539 has knife jaws on top scale.



12" MODEL No. **\$109.95**
303-539

24" MODEL No. **\$199.95**
303-545

18", 24", 40" 60" & 80" (TYPE SHOWN)

Model No.	Range Inch/Metric	Resolution Inch/metric	Jaw Length	Sale Price
303-539	12"/300mm	.0005"/.01mm	2.95"	\$109.95
303-511	18"/450mm	.0005"/.01mm	3.25"	159.95
303-545	24"/600mm	.0005"/.01mm	3.94"	199.95
303-547	40"/100mm	.0005"/.01mm	4.93"	450.00
303-548	60"/1500mm	.0005"/.01mm	6"	795.00
303-549	80"/2000mm	.0005"/.01mm	8"	1395.00



ELECTRONIC TOOL SET

- Kit includes: 6" Electronic Caliper 0.0005"/0.001mm resolution. Floating zero thumb, extra large display roll battery included.
- 1" Travel Electronic indicator 0.001"/0.01mm resolution with floating zero, lug back and battery.
- Fine adjustment Magnetic Base 100lb hold, on-off switch, two adjustable holding clamps.

Includes Fitted Case

3 Pc. SET No. 8000-53 Reg. \$89.95 **\$59.95**



brown & sharpe
DURA-CAL



IP67 ELECTRONIC CALIPER

- Encapsulation of the main components prevents dust, particles of metal and spraying liquids from entering the caliper.
- New electronic measuring system protected for liquids and immune to magnetic fields.
- Specifications consistent with DIN 862.
- Large 1/4" LC display for easy reading.
- Auto shut-off after two hours.
- Instant inch/metric conversion.
- Power supply: one 3V lithium battery, type CR 2032.
- Battery life approx. 1.5 years.

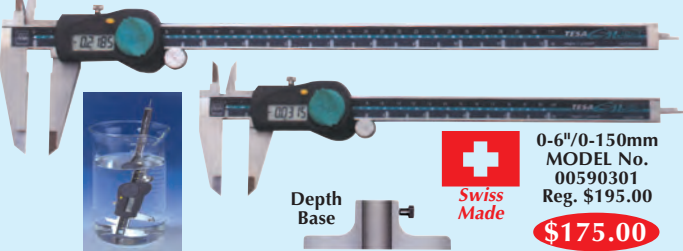

0-6"/0-150mm
MODEL No.
00590301
Reg. \$195.00
\$175.00

Model	Range	Graduation	RS-232	List	Sale
00590301*	0-6"/0-150mm	.0005"/0.01mm	No	\$195.00	\$175.00
00530301	0-6"/0-150mm	.0005"/0.01mm	No	211.00	185.00
00530302	0-8"/0-200mm	.0005"/0.01mm	No	327.00	295.00
00530311	0-6"/0-50mm	.0005"/0.01mm	Yes	\$264.00	\$235.00
579-25	Depth measuring foot for calipers having a 6in/150mm measuring span			\$ 47.00	\$ 19.95
19-61000	3V lithium Battery CR2032			6.20	5.95
47-61046	RS-232 opto-coupled cable, 6.5 ft/2m long (9 pin)				95.00

* Without Thumb Wheel



IP54 ELECTRONIC CALIPERS

- Water resistant to IP54 specifications.
- Patented ceramic capacitive sensor.
- Stainless steel frame.
- Direct Inch/Metric conversion.
- Accuracy: .001"/.02mm
- Resolution: .0005"/.01mm
- Large easy to read LCD display.
- 4-way measurement.
- Includes molded case.



Dust,
Water &
Oil
Resistant

Model No.	Range	Reg. Price	Sale Price
54-100-777	0-6"/150mm	\$123.00	\$ 89.95
54-100-712	0-12"/0-300mm	179.00	139.95



EURO-CAL IV

- Water Resistant to IP54.
- Reads in Inch, Metric & Fractions.
- Unique Full Size Decimal Characters*

- Reads in inch, metric and fractions.
- Resolution: .0005"/.01mm (fractions in 1/64th increments.)
- Direct inch/metric/fraction conversion
- Absolute incremental measurement.
- Water resistant to IP54 standards.
- Stainless steel frame.
- 4-way measuring.
- RS232 output.
- Includes molded plastic case.



MODEL No.
54-100-330-1
Reg. \$111.95
\$69.95

Model No.	Description	List	Price
54-100-330	6"/150mm Euro-Cal IV Electronic Caliper	\$111.95	\$69.95
54-100-331	8"/200mm Euro-Cal IV Electronic Caliper	132.50	99.50
54-100-332	12"/300mm Euro-Cal IV Electronic Caliper	170.00	125.00
54-100-350	Replacement Battery	-	5.50

* On our competitor's fractional calipers the characters following the decimal point are not full size



X-TRA-RANGE ELECTRONIC CALIPERS

- RS232C direct output.
- Hold feature.
- Preset mode now includes offset for inside jaws.
- All sizes feature fine adjustment screw
- Resolution: .0005"/.01mm
- Inch/metric conversion.
- Includes wooden case.



Model	Range	Jaw Depth	List	Sale
54-100-312	0-12"/300mm	3.5"	\$193.75	\$169.95
54-100-024	0-24"/600mm	4"	282.25	239.95
54-100-042	0-40"/1000mm	6"	1170.35	649.95

brown & sharpe

TWIN-CAL IP67

- Highest protection against liquids and dust IP67, also with TLC (TESA Link Connector) connected
- Biggest LCD with 11mm digits
- More than 12000 hours autonomy
- ABS measuring mode
- Built-in RS232 output connection
- Wireless and cable connectivity concept with TWIN & LINK features
- Soft touch feature for smooth measurements
- Stainless steel plate cover with PVD deposit for optimal protection
- Instant in/mm conversion
- Auto shut-off after 2 hours
- Battery CR2032
- ISO 13385-1



No. 599-25
T-Bar Depth
Gage Attachment

All With RS-232 Output

Model	Range	Resolution	Depth Rod	List	Sale
00590302	0-6"/0-150mm	.0005"/0.01mm	Round	\$195.00	\$175.00
00590303	0-6"/0-150mm	.0005"/0.01mm	Flat	195.00	175.00
00590304	0-8"/0-200mm	.0005"/0.01mm	Flat	245.00	210.00
00590305	0-12"/0-300mm	.0005"/0.01mm	Flat	360.00	315.00
599-25	T-Bar Depth Gage Attachment 3" Wide				\$19.95

Precise CAL-X-TENDER

Converts Your 6" Caliper Into A Large Measuring Device

- Cal-X-Tender readily attaches to your caliper (two set screws and 2 clamp screws). In no way detrimental to your caliper which may be quickly removed or left assembled as a permanent measuring device.
- A six inch calibration rod is supplied so that exact calibration is assured.



Model No.	Description	Regular Price	Sale Price
CXT-626	0-26" Cal-X-Tender	\$165.00	\$149.95
CXT-636	0-36" Cal-X-Tender	210.00	189.95
CXT-651	0-51" Cal-X-Tender	295.00	249.95
CXT-671	0-71" Cal-X-Tender	325.00	279.95
CXT-691	0-91" Cal-X-Tender	475.00	395.00

For Added Versatility - Optional Accessories

- CXT-001 1" projection pins (pair) **\$34.00**
- CXT-002 1-1/2" projection pins (pair) **\$36.00**
- CXT-003 Layout kit w/carbide scribe Pt. **\$50.00**
- CXT-004 Center line gage pins **\$50.00**
- CXT-005 Complete Kit of all of the above **\$150.00**



ULTRA-LITE DIGITAL CALIPERS

Lightweight Aluminum Alloy Frame

- Titanium jaws (O.D.)
- 12" to 120" sizes.
- Patented inductive measuring system.
- Resolution: .0005"
- Inch/Metric conversion.
- Min/Max and preset functions.



Model No.	Range Inch/Metric	Max. Perm Error	Repeatability	Price Each
00590061	12"/300mm	30µm	20µm	\$1295.00
00590062	24"/630mm	40µm	20µm	1650.00
00590063	40"/1025mm	60µm	20µm	1850.00
00590064	60"/1525mm	150µm	20µm	3250.00
00590065	80"/2040mm	250µm	30µm	4100.00
00590066	100"/2545mm	350µm	30µm	5450.00
00590067	120"/3045mm	450µm	30µm	6100.00

Fowler XTRA-VALUE CAL

ELECTRONIC DIGITAL CALIPER

- Stainless steel frame.
- Large easy-to-read display.
- Resolution: .0005"
- Direct inch/metric conversion.
- Absolute/incremental measurement.
- 4 way measuring.
- Comes with storage case.



Also Available with a Super Large Display with Hold Feature!



Model	Range	Display Type	List	Sale
54-101-150-2	6"/150mm	Regular Display	\$45.00	\$32.50
54-101-600-1	6"/150mm	Super large Display with hold feature	56.00	38.50
54-101-200-1	8"/200mm	NEW Regular Display	67.20	57.50
54-101-800-1	8"/200mm	NEW Super large Display with hold feature	84.00	70.00
54-101-300-1	12"/300mm	Regular Display	90.00	87.50
54-101-900-1	12"/300mm	NEW Super large Display with hold feature	110.00	82.50
54-100-350	Replacement Battery		\$5.50	

Fowler SYLVAC FLUID RESISTANT 0-6"/0-150MM ELECTRONIC CALIPER

- Inductive measuring system.
- 4-way measurement.
- Hardened stainless steel construction.
- Repeatability/Resolution: .0005"/.01mm.
- Auto-off option.
- Range: 6"/150mm.
- SPC output.
- Direct inch/metric conversion.
- Includes storage case.



MODEL No. 54-100-444
Reg. \$178.00

\$119.95



Model	Range	List	Sale
54-100-444	0-6"/150mm	\$178.00	\$119.95
54-100-448	0-8"/200mm	459.00	389.95
54-100-412	0-12"/300mm	649.00	479.95
54-115-525	Opto USB Cable		\$145.00
54-100-350	CR2032 Battery		5.50

Good Brown & Sharpe SHOP-CAL



Stainless Steel Body

- Absolute Measuring System.
- Range: 0-6"/0-150mm.
- Specifications consistent with DIN 862
- Absolute and differential measuring system.
- A large, 1/4" LC display for easy readings
- Auto shut-off
- Instant inch/metric conversion.
- Power supply: 3V lithium battery, type CR 2032
- Battery life: approx. 1.5 years



Features Absolute Measuring System

MODEL No. 00590091
Reg. \$149.00

\$114.95
0-6"/0-150mm
.0005"/0.01mm
Resolution

SAVE 25%

Good Brown & Sharpe SHOP-CAL TRIO PACK

The Brown & Sharpe Shop-Cal provides easy-to-read accurate measurements of day to day operations. Stainless Steel for durable, reliable and accurate measurements.



SET No. 590090
List \$447.00

\$329.95

- Absolute and differential measuring system.
- A large, 1/4" LC display for easy readings.
- Auto shut-off
- Instant Inch/metric conversion
- Power supply: 3V lithium-battery, type CR 2032
- Battery life: approx. 1.5 years.
- 0-6"/0-150mm Range .0005"/0.01mm Resolution

Mitutoyo MyCAL LITE

DIGITAL CALIPER-ALL STEEL CONSTRUCTION

- Large LCD digits ensure error free reading in either inch or mm mode.
- Additionally, the zero point can be set anywhere to allow quick comparison measurements.

0-6"/0-150mm Range
.001/0.1mm Graduation

MODEL No. 700-113
Reg. \$113.00

\$95.00

With Shop-Hard Fitted Case

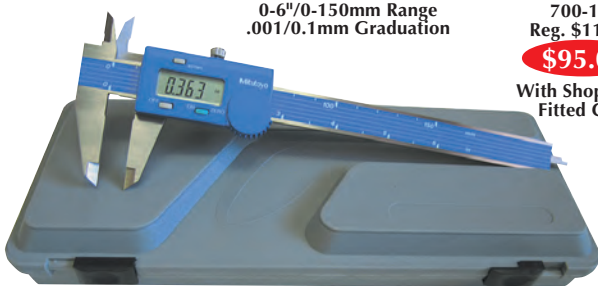

FLEXBAR

ULTRALIGHT HIGH PRECISION ELECTRONIC VERNIER CALIPERS

Lightweight & Balanced for Highly Accurate Readings

- Flexbar's new series of precision lightweight calipers are constructed from light alloys, stainless steel and carbon fiber beam providing both stability and balance for highly accurate measurements.
- Features special cylindrical measuring tips on top jaws.
- .0005"/.01mm resolution.
- Jaw depth 4.00"
- IP54 Protection.
- Swiss Sylvac Electronics with RS232 output.



Model	Range	List	Sale
19430	20"/500mm	\$1850.00	\$1750.00
19431	24"/600mm	1975.00	1850.00
19432	32"/800mm	2200.00	1950.00
19433	40"/1000mm	2300.00	2100.00

GENERAL ULTRATECH TOOL SYSTEM CARBON FIBRE DIGITAL/FRACTIONAL CALIPERS

3 MODE DISPLAY

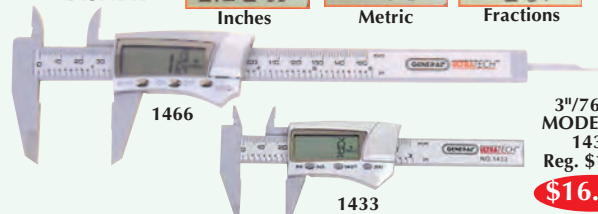
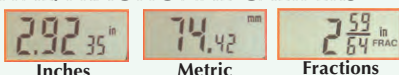

3"/76mm
MODEL No. 1433
Reg. \$19.95

\$16.95

Model No.	Range Inch/Metric	Resolution & Repeatability	Sale Price
1433*	0-3"/0-76mm	0.0005"/0.01mm, 1/64"	\$16.95
1466	0-6"/0-150mm	0.0005"/0.01mm, 1/64"	24.95

*3" Model clips into your pocket

GENERAL ULTRATECH TOOL SYSTEM

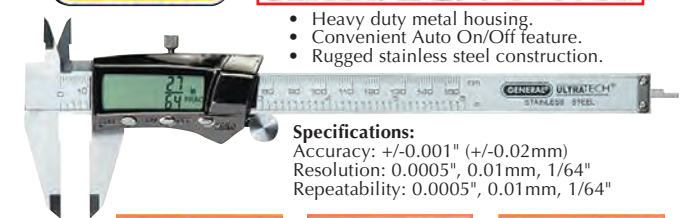

Specifications:
Accuracy: +/-0.001" (+/-0.02mm)
Resolution: 0.0005", 0.01mm, 1/64"
Repeatability: 0.0005", 0.01mm, 1/64"

Model	Description	List	Sale
UT-147	6"/153mm FRACTION+ Digital Fractional Caliper	\$49.00	\$39.95
UT-1478	8"/203mm FRACTION+ Digital Fractional Caliper	65.00	49.95
UT-14712	12"/305mm FRACTION+ Digital Fractional Caliper	110.00	79.95

Mitutoyo DIGIMATIC CARBIDE BLADE CALIPER

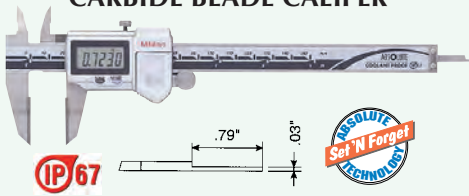

Model No.	Range Inch/Metric	Resolution Inch/Metric	Sale Price
573-734	0-6"/0-150mm	.0005"/0.01mm	\$515.00

NECK TYPE DIGIMATIC CALIPER

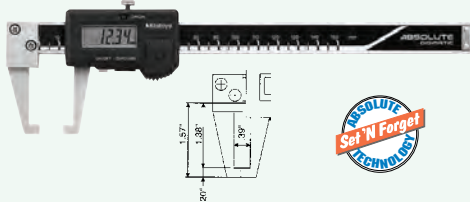

Model No.	Range Inch/Metric	Resolution Inch/Metric	Sale Price
573-751	0-6"/0-150mm	.0005"/0.01mm	\$595.00

POINT TYPE DIGIMATIC CALIPER

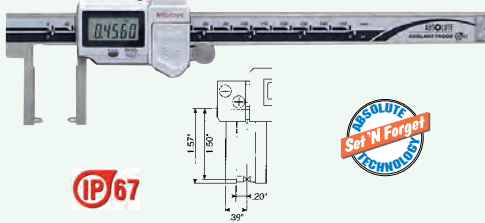

Model No.	Range Inch/Metric	Resolution Inch/Metric	Sale Price
573-752	0-6"/0-150mm	.0005"/0.01mm	\$720.00

TUBE THICKNESS DIGIMATIC CALIPER

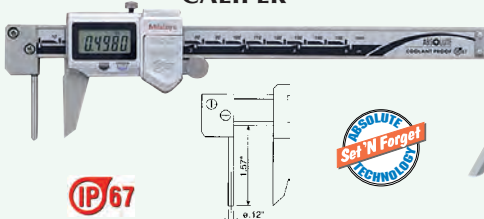

Model No.	Range Inch/Metric	Resolution Inch/Metric	Sale Price
573-761	0-6"/0-150mm	.0005"/0.01mm	\$580.00

SNAP DIGIMATIC CALIPER

Spring-loaded mechanism to allow quick and efficient GO/±NG inspection.



- 1) Push the whole sliding unit against your masterpiece. (Gage block used here lock with clamp)
- 2) Use zero-set function to zero the Digimatic display.
- 3) Open and close jaws with snap lever to check workpieces allows .079" (2mm) retraction.

Model No.	Range Inch/Metric	Resolution Inch/Metric	Sale Price
573-281	0-4"/0-100mm	.0005"/0.01mm	\$380.00
573-282	0-6"/0-150mm	.0005"/0.01mm	440.00

Mitutoyo DIGIMATIC LONG JAW DIGIMATIC CALIPERS

- The sharp jaw edges provide easy access to portions that ordinary calipers cannot measure.
- The Digimatic caliper provides digital readout to .0005"/0.01mm for error-free reading.



Model No.	Range Inch/Metric	Jaw Depth	Sale Price
551-311	0-8"/0-200mm	2.4"	\$ 520.00
551-341	0-12"/0-300mm	3.6"	745.00
551-224	0-20/0-500mm	5.90"	1095.00
551-226	0-30/0-750mm	5.90"	1775.00
551-227	0-40"/0-1000mm	5.90"	1850.00

LONG JAW VERNIER CALIPERS

- With a fine-adjustment carriage to fine-feed the slider
- Long jaws for measuring hard-to-reach portions.
- The jaws have round measuring faces for accurate ID measurement. • No depth measuring bar.



Model No.	Range Inch	Grad.	Jaw Depth	Sale Price
534-117	0-12"	.001"	3.55"	\$ 450.00
534-118	8-20"	.001"	7.87"	775.00
534-119	8-30"	.001"	7.87"	995.00
534-120	8-40"	.001"	7.87"	1395.00

INSIDE KNIFE-EDGE TYPE



Model No.	Range	Resolution	Jaw Depth	Sale Price
573-742	8"/200mm	.0005"/0.01mm	2.76"	\$795.00

OFFSET JAW DIGIMATIC CALIPER

- Main scale jaw can slide up and down to facilitate measurement of stepped sections.
- The Digimatic Calipers provide digital readout to .0005"/0.01mm for error-free reading. These models also incorporate Mitutoyo's exclusive Absolute reading scale.
- All models feature a depth rod.



Model No.	Range	Resolution	Jaw Depth	Sale Price
573-701	0-6"/0-150mm	.0005"/0.01mm	3.61"	\$395.00
573-702	0-8"/0-200mm	.0005"/0.01mm	3.61"	475.00
573-704	0-12"/0-300mm	.0005"/0.01mm	5.4"	625.00

Mitutoyo OFFSET CENTERLINE DIGIMATIC CALIPERS

- Specially designed for center to center distance measurements on the same and offset planes.
- Can also measure from edge to center.
- Hole diameter should be in the range of 1.5mm - 10mm (.06"-.4")
- With SPC data output. (Series 573).
- Supplied in fitted plastic case.



Model No.	Range	Resolution	Sale Price
573-705	.4-6"/10-150mm	.0005"/0.01mm	\$499.50
573-706	.4-8"/10-200mm	.0005"/0.01mm	575.00
573-708	.4-12"/10-300mm	.0005"/0.01mm	695.00

Precise LEFT HANDED ELECTRONIC CALIPER

- Special made model for left-handed people.
- Extra large LCD dimension: 1.5"L x 0.55"W.
- Three-key model: Inch/MM, On/Off and Zero.
- Digits display height: 0.4".
- Resolution: .0005"/.01mm.
- Made of stainless steel and hardened.
- 4-way measurement: Outside, Inside, Depth and step. • Battery: One button SR44, 1.55V.



MODEL No.	MODEL No.	MODEL No.
0-6"/150mm	0-12"/0-300mm	303-1502
		410-212

\$29.95 **\$69.95**

Precise LEFT HANDED DIAL CALIPER

- Stainless steel fully hardened frame.
- Shock proof, reading 1/1000".
- With thumbroll and lock screw.
- Measuring faces hardened, ground and lapped.
- 4-way measurement: inside, outside, depth and step.
- Single revolution dial graduated 0-100 with .100" per revolution.
- Covered rack-closed plastic cover.
- Each piece fitted in a plastic



MODEL No.	Price	Range
MCD-611	\$29.95	0-6"

Precise HEAVY DUTY DIAL CALIPER WITH CROSS JAWS

- One revolution per each 0.100".
- Heavy duty made stainless steel hardened and precision ground.
- 4 way measurement with out side knife jaws.
- With fitted wooden case.



Model	Range	Price
410-248	0-8"	\$ 74.95
410-242	0-12"	115.00

Mitutoyo CARBON FIBER DIGIMATIC CALIPERS

- Lightweight Digimatic Calipers that employ CFRP (Carbon Fiber Reinforced Plastics) in the beam and jaws.
- Highly durable and easy to handle.
- The range of applications can be expanded by using the optional attachments.
- Preset function for setting a desired starting point.
- Direct readout of ID measurements from the LCD (offset value can be set easily by pressing the Offset key).
- With SPC data output.
- Special model available with ceramic jaws which are suitable for measuring abrasive and magnetic products.
- Supplied in fitted wooden case.



Centerline Attachments

ID Point Attachments

Model No.	Range Inch/Metric	Resolution Inch/Metric	Jaw Depth	Price Each
552-160	12"/300mm	.0005"/0.01mm	7.9"	\$1265.00
552-312	18"/450mm	.0005"/0.01mm	4.0"	830.00
552-165*	18"/450mm	.0005"/0.01mm	4.0"	1250.00
552-313	24"/600mm	.0005"/0.01mm	4.0"	925.00
552-166*	24"/600mm	.0005"/0.01mm	4.0"	1325.00
552-161	24"/600mm	.0005"/0.01mm	7.9"	1340.00
552-314	40"/1000mm	.0005"/0.01mm	6.0"	1650.00
552-315	60"/1500mm	.0005"/0.01mm	6.0"	1975.00
552-316	80"/2000mm	.0005"/0.01mm	6.0"	2995.00

* With Ceramic Jaws

Optional Accessories

Model	Description	Price	Model	Description	Price
914055	Centerline Attachments (mm)*	\$212.00	914045	Attachment clamps (for models over 600mm/24" Range)	\$166.00
914056	Centerline Attachments (inch)*	217.00	905338	SPC Cable (Straight, 1m/40")	35.50
914057	Pointed ID Measuring Attachments (mm)*	241.00	905409	SPC Cable (Straight, 2m/80")	42.00
914058	Pointed ID Measuring Attachments (inch)*	241.00	905689	SPC Cable (L-type, 1m/40")	32.30
914053	Attachment clamps (for models up to 600mm/24" Range)	158.00	905690	SPC Cable (L-type, 2m/80")	38.95

* Attachment clamps are required and not available for long jaw type.

Fowler GEAR TOOTH CALIPER



The Gear Tooth Caliper is used for the testing of gear teeth. The vertical scale measures the depth of gear teeth from the top to the pitch line, and the horizontal scale measures the thickness of teeth in the pitch line.

The Gear Tooth Caliper provides an LCD readout, true inch/metric conversion, floating zero and complete portability.

- Tooth thickness range (horizontal scale) is 0-1.56" (39.6mm).
- Chordal thickness range (vertical scale) is 0-1.44" (36.7mm).
- Resolution: .0005" (.01mm)
- Includes a fitted case and batteries.

Digital Type
MODEL No. 54-955-201
\$295.00

Non Digital Vernier Type
.0001" Grad.
MODEL No. MCG-000
\$79.95

Fowler XTRA-VALUE DEPTH GAGE AND POLY-CAL® KIT

Poly-Cal

- Range 6"/150mm.
- Polycarbonate Frame.
- Resolution .0005"/.01mm (fractions by 1/64" increments.)
- Absolute/Incremental measurement.

Xtra-Value Depth Gage:

- Spring-loaded with a hold measurement button for ease-of-use.
- Super large display.
- Range: 0-6"/150mm.
- Resolution .0005"/.01mm (fractions in 1/64" increments.)
- Resolution .0005"/.01mm (fractions by 1/64" increments.)

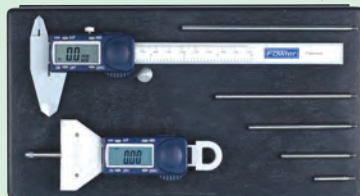

MODEL No. 54-004-255
Reg. \$90.00
\$79.95

Supplied in Shop Hardened Case

Fowler XTRA-VALUE CALIPER AND CENTERLINE ACCESSORY SET

Xtra Value Electronic Caliper:

- Range: 6"/150mm
- Resolution: .0005"/.01mm
- Accuracy: .001"/.02mm
- Absolute/incremental measurement
- True Inch/Metric conversion
- 4-way measuring.

Accessory Set

- 6 sets of interchangeable anvils
- Allows measurement of hard to reach places including undercuts, grooves, webs and shoulders.
- Corrosion resistant black oxide plating.
- Includes fitted wooden case.

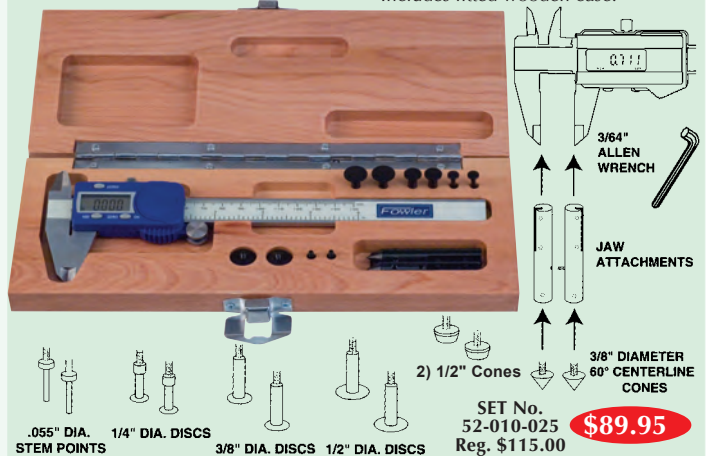

.055" DIA. STEM POINTS

1/4" DIA. DISCS

3/8" DIA. DISCS

1/2" DIA. DISCS

2) 1/2" Cones

3/8" DIAMETER 60° CENTERLINE CONES

SET No. 52-010-025
Reg. \$115.00
\$89.95



ELECTRONIC DEPTH CALIPER

- Stainless steel.
- Direct metric/inch conversion.
- Resolution .0005"/0.01mm
- Large LC display.
- Steel Pin Tip series has spring loaded travel and additional 1/64" fraction resolution.
- Supplied in a Fitted case with Inspection report.



Double Hook

Single Hook

Steel Pin

Resolution: .0005"/0.01mm

Model No.	Measuring Range	Base Size	Tip Type	List Price	Sale Price
00534105	0-6"/150mm	4"	Single Hook	\$ 73.00	\$ 53.95
00534106	0-8"/200mm	4"	Single Hook	80.00	59.95
00534107	0-12"/300mm	6"	Single Hook	126.00	93.99
00534108	0-20"/500mm	6"	Single Hook	188.00	140.95
00534109	0-6"/150mm	4"	Double Hook	\$ 98.00	\$ 72.95
00534110	0-8"/200mm	4"	Double Hook	106.00	78.95
00534111	0-12"/300mm	6"	Double Hook	150.00	111.95
00534112	0-20"/500mm	6"	Double Hook	192.00	143.95
00534113	0-6"/150mm	4"	Steel Pin	\$ 73.00	\$ 53.95
00534114	0-8"/200mm	4"	Steel Pin	80.00	59.95
00534115	0-12"/300mm	6"	Steel Pin	126.00	93.95
00534116	0-20"/500mm	6"	Steel Pin	188.00	140.95

Mitutoyo BENCH COMPARATOR

- 25mm/1" stroke micrometer head (Graduation: 0.001mm/.0001") is provided.
- Retractable anvil with dial indicator for high accuracy inspection of mass-produced parts.
- Anvil pressure is variable.
- Adjustable workpiece stage height.
- Dial Indicator is shockproof.
- ø8mm (or 3/8") probe of Mitutoyo Mu-Checker can be attached for higher precision measurement if required.

Dimensions

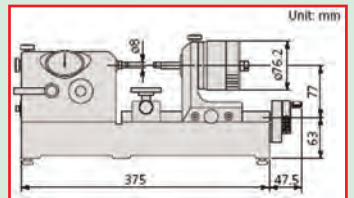

Model No.	Range Overall	Micrometer Range & Grad.	Dial Graduation	List Price	Price Each
162-102	0-4"	0-1" x .0001"	.0001"	\$6090.00	\$5450.00
162-101	0-100mm	0-25mm x 0.001mm	0.001mm	6090.00	5450.00

Fowler Rotocal® ELECTRONIC ROTOR GAGE With Flat & Conical Anvil

- Range: 5.5"/140mm
- Reads in inch, metric and fractions.
- Direct inch/metric/fraction conversion.
- Resolution: .0005"/.01mm (Fractions in 1/64" increments)
- Water resistant to IP54 standards.
- Conical anvil for groove measurement.
- 3.5" jaw depth for larger rotors.
- Includes molded case.



Model	Description	List	Sale
74-150-006	Rotary Gage with 3-1/2" Jaw Depth	\$ 95.00	\$69.95
74-150-002	Rotary Gage with 6" Jaw Depth	125.00	79.95
74-100-350	Replacement Battery	-	3.95

Fowler Rotocal® ELECTRONIC ROTOR GAGE With Twin Conical Anvils

- Range: 5.5"/140mm
- Reads in inch, metric and fractions.
- Direct inch/metric/fraction conversion.
- Resolution: .0005"/.01mm (Fractions in 1/64" increments)
- Water resistant to IP54 standards.
- Conical anvils measure scored surfaces
- 3.5" jaw depth for larger rotors.
- Includes molded case.



MODEL No.
74-150-004
Reg. List \$95.00
\$69.95

Fowler ELECTRONIC BRAKE DRUM GAGE

- 4" to 20"/100 to 500mm capacity.
- Inch/Metric/Fraction conversion.
- 4" drum preset.
- Zero Set.
- Hold function.
- Preset depth at 1" and 1.5".
- Resolution: 0.0005"/0.01mm (Fractions in 1/64" increments)
- Protected to IP54 specifications.
- Beam has vernier scale to double check reading.
- Thumb lock.
- Direct RS-232 output.
- Can be used to check some disc measurements.
- Includes wooden case.



MODEL No.
74-150-020

Reg. List
\$285.00
\$195.00

CENTERLINE PLUS ACCESSORY KIT

- Exclusive 4-48 threaded holes in accessory jaws allow the use of any AGD Standard Point w/4-48 threads - virtually unlimited uses.
- Measure places impossible to reach with regular caliper - undercuts, grooves, webs, etc.
- Exclusive interchangeable centerline cones.
- Cold rolled steel, case hardened with black oxide plating for long life & corrosion protection.
- Permanent alignment pin assures easy alignment.
- Includes hex key and all hardware for attaching jaws to calipers.
- Comes complete in a fitted mahogany case.



SET No.
CPA-367
Reg List \$110.00
\$79.95

Fits all
6" Dial, Digital,
& Vernier calipers

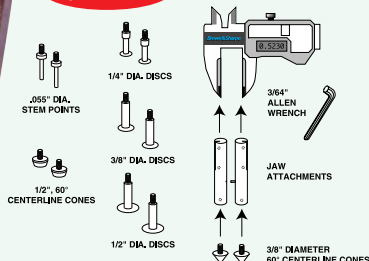

Fowler ELECTRONIC GROOVE & RECESS GAGE

- Direct RS-232 output.
- External measurement 0-12" depending on accessories.
- Internal measurement 1-13/16" - 13-1/2" depending on accessories.
- Resolution: .0005"/.01mm
- Accuracy: ±0015"/.04mm
- Sylvac capacitive measuring system.
- Measures rotors and brake drums.
- Two preset memories.
- Inch/metric conversion.
- Interchangeable anvils for inside/outside measurement.
- Includes flat and point style contacts & battery.
- Uses 4-48 thread contact points.



MODEL No.
74-150-012
Reg. List
\$525.00
\$395.00

Fowler DRUM AND ROTARY MEASURING KIT WITH XTRA-VALUE CAL ELECTRONIC CALIPER

- Drum and Rotor Kit Features:
- Measures disc brakes and up to 12"/300mm or 16"/400mm on brake drums.
- When measuring brake drums only, add 8" to measurement- allows for long cone & jaw widths.
- Includes set of clamps; 4 sets of set screws; 1 Allen wrench; 1 set of 3-3/4" contact points; 1 set of 3/4" cone contact points & 1 set of 3/4" flat contact points in plastic tube.
- 16"/400mm Set includes 1 pair of 2" extensions.



Model	Description	List	Sale
74-101-777	12"/300mm Drum and Rotor with XTRA-VALUE CAL	\$ 95.00	\$75.00
74-101-888	16"/400mm Drum and Rotor with XTRA-VALUE CAL	110.00	89.50
72-010-777	12"/300mm Drum Kit only	65.00	39.50
72-010-888	16"/400mm Drum Kit only	75.00	45.00

Precise ELECTRONIC DIGITAL DEPTH GAGE

- SPC Output.
- .0005"/.01mm resolution
- Inch/metric conversion.
- Zero set.
- On/Off.



Model	Range	Base	Sale
303-752	0-6" x 0-150mm	4"	\$ 45.00
303-753	0-8" x 0-200mm	4"	49.50
303-755	0-12" x 0-300mm	4"	59.50
303-756	0-20" x 0-500mm	4.7"	115.00

Precise ELECTRONIC DEPTH GAGE

- Sliding LCD unit features push-button control.
- Stainless steel linear scale.
- Inch/Metric conversion.
- Accuracy: .001"/.02mm
- 0-6"/0-150mm Range, 4" Base.
- With Fitted case.
- With Hook.



MODEL No.
4500-0006
\$49.95

Mitutoyo DIGIMATIC MICROMETERS ~ COOLANT PROOF

- Extra large LCD readout.
- Accuracy $\pm .00005"$.
- TUV certified.
- Two measuring modes - ABS (absolute) and INC (incremental) for measuring (with SPC output Model).

- Functions available: Origin setting, Inch/mm selection, Zero-setting, Data hold (with SPC Models), Error alarm, Auto-sleep, Data output (where noted).
- Carbide-tipped measuring faces.



Ratchet Stop
MODEL No.
293-340
Reg. \$173.00

\$129.95



Standard Friction
Thimble
MODEL No.
293-348
Reg. \$173.00

\$129.95



New Ratchet-Friction
Thimble
(Internal "clicking"
ratchet mechanism)
MODEL No.
293-344
Reg. \$173.00

\$129.95



Special SPC
Cable with IP65
Protection Level

IP65

**SAVE
25%**

Without SPC Output

Model	Range	Resolution	Remarks	List	Sale
293-340*	0-1" 0-25.4mm	.00005" 0.001mm	Without SPC output Ratchet Stop	\$173.00	\$129.95
293-348*	0-1" 0-25.4mm	.00005" 0.001mm	Without SPC output Friction Thimble	173.00	129.95
293-349*	0-1" 0-25.4mm	.00005" 0.001mm	Without SPC output Ratchet Friction Thimble	173.00	129.95
293-344*	0-1" 0-25.4mm	.00005" 0.001mm	Without SPC output Ratchet Friction Thimble	173.00	129.95
293-341*	1-2" 25.4-50.8mm	.00005" 0.001mm	Without SPC output Ratchet Stop and Standard	236.00	199.95
293-345*	1-2" 25.4-50.8mm	.00005" 0.001mm	Without SPC output Ratchet Friction Thimble & Standard	236.00	199.95
293-342	2-3" 50.8-76.2mm	.00005" 0.001mm	Without SPC output Ratchet Stop and Standard	294.00	245.00
293-346	2-3" 50.8-76.2mm	.00005" 0.001mm	Without SPC output Ratchet Friction Thimble & Standard	309.00	262.00
293-343	3-4" 76.2-101.6mm	.00005" 0.001mm	Without SPC output Ratchet Stop and Standard	352.00	299.00
293-347	3-4" 76.2-101.6mm	.00005" 0.001mm	Without SPC output Ratchet Friction Thimble & Standard	333.00	283.00
293-350	4-5" 101.6-127.0mm	.00005" 0.001mm	Without SPC output and Standard Ratchet Stop	451.00	385.00

With SPC Output

293-330*	0-1" 0-25.4mm	.00005" 0.001mm	With SPC output Ratchet Stop	\$233.00	\$220.00
293-335*	0-1" 0-25.4mm	.00005" 0.001mm	With SPC output Friction Thimble	233.00	220.00
293-334*	0-1" 0-25.4mm	.00005" 0.001mm	With SPC output Ratchet Friction Thimble	249.00	235.00
293-331*	1-2" 25.4-50.8mm	.00005" 0.001mm	With SPC output & Standard Ratchet Stop	275.00	260.00
293-336*	1-2" 25.4-50.8mm	.00005" 0.001mm	With SPC output & Standard Friction Thimble	275.00	260.00
293-332	2-3" 50.8-76.2mm	.00005" 0.001mm	With SPC output & Standard Ratchet Stop	339.00	320.00
293-333	3-4" 76.2-101.6mm	.00005" 0.001mm	With SPC output & Standard Ratchet Stop	365.00	345.00
05CZA662	1mm SPC Connecting Cable IP-65				\$75.00
05CZA663	2mm SPC Connecting Cable IP-65				\$82.00

*Certificate of Inspection Provided. Sizes Available up to 20" (Inquire)
Sets With Standards, Ratchet Stop And Case

293-960	0-3"/0-75mm Without SPC Output	\$853.00	\$ 725.00
293-961	0-4"/0-100mm With SPC Output	1190.00	1065.00

Mitutoyo SLIMLIGHT 0-1"/0-25.4MM DIGITAL MICROMETER

- Inch/Metric key.
- The world's lightest digital micrometer .47 lbs. (215g) in wt.
- Made slim for easy access to the stepped feature.
- Easily measures 0 through 1"/25.4mm with resolution to .00005"/0.001mm.
- Measuring faces carbide tipped.
- Includes a zero-set key easy origin setting.
- Measurement readout with large characters on the LCD screen.
- The display stays on for the entire battery life (1.2 years).
- Battery: SR44



Friction
Thimble

MODEL No.
293-831 Reg. List
\$135.00
W/Ratchet Stop

\$114.95

Your
Choice

MODEL No.
293-832
Reg. List
\$135.00
W/Friction
Thimble



Fowler E-Z READ STANDARD DIGITAL MICROMETER



0-1"
MODEL No.
52-222-201
Reg. \$55.00

\$39.95

- Accuracy: .00016" for 1 & 2" sizes
- Carbide tipped measuring faces.
- Insulated steel frame.
- Meets or exceeds Federal accuracy specs.
- Includes shop-hardened case.

Model	Range	Graduation	List	Sale
52-222-201	0-1"	.0001"	\$55.00	\$39.95
52-222-202	1 - 2" w/Standard	.0001"	65.00	52.50
52-222-203	2 - 3" w/Standard	.0001"	70.00	57.50
52-222-204	3 - 4" w/Standard	.0001"	80.00	62.50
52-222-333	0-3" set w/Standards	.0001"	195.00	165.00

Mitutoyo DATA COLLECTION AND PROCESSOR

- Mitutoyo's new processor is so compact, but with this powerful little device you can print data from your Digimatic caliper, micrometer and more using the Data Output function, and it can even calculate statistics.



Shown with Optional:
No. 293-330
0-1" Digimatic IP-65
Micrometer **\$220.00**
No. 05CZA662
Connecting Cable (1mm) **\$75.00**
No. 156-101
Micrometer Stand **\$99.95**

Data Collection
and Processor
MODEL No. 264-504
Reg. \$494.00

\$465.00

Mitutoyo INPUT TOOL FOR USB For All Mitutoyo SPC Tools

- Any of Mitutoyo's SPC output tools can be sent to a commercial spreadsheet.
- Power is supplied from the PC automatically.
- Data can be sent by Data Button on Input Tool or instrument or by optional footswitch (937199T)
- No special software for PC input is necessary. The user can use his own software for data collection.



Note: SPC Connecting Cable
for Digimatic Tools are required

Optional:
Foot Switch
No. 937199T
\$75.00

MODEL No.
264-012-10
\$179.95

Mitutoyo SPECIAL APPLICATION DIGIMATIC MICROMETERS

Inch/Metric Instant Conversion

Inch/Metric Conversion



Disk
MODEL
323-
IP65

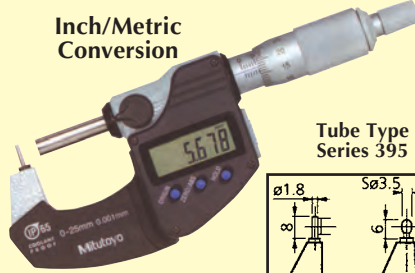

Tube Type
Series 395

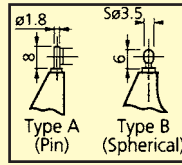

Point
MODEL
342-
IP65



Spherical Type
Series 395

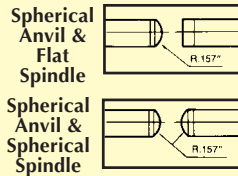

Blade
MODEL
422-
IP54



Inside Caliper

Carbide
Pins



V-Anvil
MODEL
314-
IP65



Series 331

Spline Type

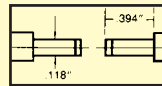

Mic. Head
MODEL
350-
IP65



Uni-Mike
Series 317
IP65

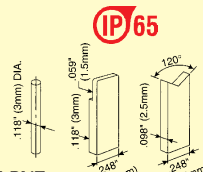

WITH SPC OUT-PUT
LCD READOUT .00005"/0.001MM

WITH SPC OUT-PUT
LCD READOUT .00005"/0.001MM

Model	Range	Type	Price
323-350	0-1"	Disc .315"	\$425.00
323-351	1-2"	Disc .315"	475.00
323-352	2-3"	Disc .315"	535.00
323-353	3-4"	Disc .315"	570.00
342-351	0-1"	15° Point	\$390.00
342-352	1-2"	15° Point	435.00
342-353	2-3"	15° Point	455.00
342-354	3-4"	15° Point	475.00
342-361	0-1"	30° Point	380.00
342-362	1-2"	30° Point	430.00
342-363	2-3"	30° Point	445.00
342-364	3-4"	30° Point	485.00
422-330	0-1"	Blade .030" Thick	\$665.00
422-331	1-2"	Blade .030" Thick	710.00
422-332	2-3"	Blade .030" Thick	750.00
422-333	3-4"	Blade .030" Thick	780.00
314-351	.05"-6"	V-Anvil	\$575.00
314-352	.4"-1"	V-Anvil IP-54	620.00
314-353	1"-1.6"	V-Anvil	645.00
350-351	0-1"	Mic. head w/o clamp nut	\$255.00
350-352	0-1"	Mic head with clamp nut	260.00
937387	1 Meter	SPC Output Cable	\$ 45.00
965013	2 Meter	SPC Output Cable	52.00

Model	Range	Type	Price
395-362	0-1"/0-25mm	Spherical B	\$384.00
395-261	0-25mm x 0.001mm	Pin A	384.00
395-351	0-1"/0-25mm	Spherical Anvil & Flat Spindle	\$335.00
395-352	1-2"/25-50mm	Spherical Anvil & Flat Spindle	360.00
395-353	2-3/50-75mm	Spherical Anvil & Flat Spindle	410.00
395-354	3-4"/75-100mm	Spherical Anvil & Flat Spindle	439.00
395-371	0-1"/0-25mm	Spherical Anvil & Spherical Spindle	\$345.00
395-372	1-2"/25-50mm	Spherical Anvil & Spherical Spindle	370.00
395-373	2-3/50-75mm	Spherical Anvil & Spherical Spindle	420.00
395-374	3-4"/75-100mm	Spherical Anvil & Spherical Spindle	445.00
345-350	2-1.2"/5-30mm	Inside Caliper	\$470.00
345-351	1-2"/25-50mm	Inside Caliper	495.00
331-351	0-1"/0-25mm	Spline ø .118"	\$395.00
331-352	1-2"/25-50mm	Spline ø .118"	445.00
331-353	2-3/50-75mm	Spline ø .118"	485.00
331-354	3-4"/75-100mm	Spline ø .118"	560.00
331-361	0-1"/0-25mm	Spline ø .079"	395.00
331-362	1-2"/25-50mm	Spline ø .079"	445.00
331-363	2-3/50-75mm	Spline ø .079"	465.00
331-364	3-4"/75-100mm	Spline ø .079"	490.00
317-351	0-1"/0-25mm	w/Flat & Rod Anvil	\$450.00
317-352	1-2"/25-50mm	w/Flat & Rod Anvil	455.00
201218		V-Anvil (Only)	13.50
937387	1 Meter	SPC Output Cable	\$ 45.00
965013	2 Meter	SPC Output Cable	52.00

Mitutoyo ADJUSTABLE LOW FORCE DIGIMATIC MICROMETERS

- Constant and low measuring force mechanism in the thimble.
- Adjustable measuring force (0.5-2.5N or 2-10N) accommodates various kind of work materials.
- The measurement-value hold function automatically retains the data at a specified measuring force, ensuring accuracy.
- Non-rotating spindle and new ratchet friction thimble.
- Speedy spindle feed by 10mm/rev and .4"/rev for inch/metric model.
- With absolute linear scale.
- With SPC data output.
- Supplied in fitted plastic case.



Resolution .00005"/0.001mm

Model	Range	Measuring Force	Price
227-211	0-.6"/0-15mm	0.5N to 2.5N	\$750.00
227-212	0-.6"/0-15mm	2N to 2.5N	750.00
227-213	.6" to 1.2"/15-30mm	0.5N to 2.5N	\$790.00
227-214	.6" to 1.2"/15-30mm	2N to 10N	790.00

Precise INDICATING MICROMETER AND STAND COMBINATION SET



Micrometer Stand:
• Compact, folding micrometer stand with a unique locking mechanism that positions the micrometer for perfect use and viewing.

0-1"
.00005" Grad.
Indicating Mic and Stand
SET No.
PIM-100
\$189.95

Model	Range	Graduation	Price
303-230	0-1"	.00005"	\$179.95
303-231	1-2"	.00005"	195.00

Precise DIAL INDICATOR PIN CHUCK For Quick & Easy Hole and Slot Depth Measuring

- Use your own gage pins.
- Contact points.
- Standard 4-48 thread.
- Eliminate making custom points.
- To measure small hole depths.
- Instantly eliminate more than 100 indicator point diameters.



MODEL No.
DPC-100
\$14.95
Each

Enlarged View



(Pack of 2)
SET No.
DPC-1001
\$24.95



EZ-READ SPECIAL APPLICATION DIGITAL MICROMETERS



DISC TYPE
Series "250"



LARGE ANVIL TYPE
Series "621"



BALL TYPE
Single Ball
Ball Anvil/Ball Spindle
Series "244"

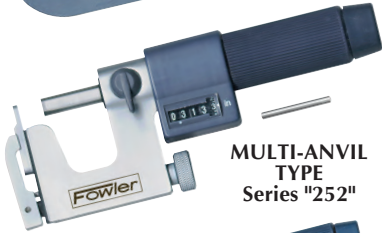

MULTI-ANVIL TYPE
Series "252"



V-ANIL TYPE
Series "211"



POINT TYPE
15° And 60°
Series "226"

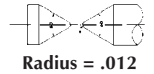

Radius = .012



SPLINE TYPE
Series "218"



THREAD TYPE
Series "219"

Non Rotating Spindle



BLADE TYPE
Series "246"



TUBE TYPE
Series "611"



MULTI-ANVIL TYPE
Series "212"



INSIDE Series "275"



7 Pair of Anvils

- Features**
- Anvils and spindles hardened, ground & micro-lapped.
 - Accuracy: .0002".
 - Friction thimble.
 - Revolutionary patented design.
 - Meet or exceeds Federal accuracy specifications.
 - Includes fitted case.
 - Heat insulated frames
 - All EZ read micrometers are available in metric (Inquire)

.0001" GRADUATION

Model	Range	Type	Price
52-250-012	0-1"	Disc .788	\$79.95
52-250-022	1-2"	Disc .788	89.95
52-250-023	2-3"	Disc .788	99.95
52-250-024	3-4"	Disc .788	145.00
52-252-211	0-1"	Multi Anvil	\$119.50
52-252-212	1-2"	Multi Anvil	135.00
52-218-721	0-1"	Spline (Pin)	\$75.00
52-218-722	1-2"	Spline (Pin)	85.00
52-611-011	0-1"	Tube	\$62.95
52-611-012	1-2"	Tube	69.95

.0001" GRADUATION

Model	Range	Type	Price
52-621-001	0-1"	Large Anvil	\$159.95
52-621-002	1-2"	Large Anvil	189.95
52-211-141	.04-.6"	V-Anvil	\$155.00
52-211-142	.2-.8"	V-Anvil	165.00
52-211-143	.8-1.4"	V-Anvil	170.00
52-211-151	-.2-1"	Flat Anvil	160.00
52-219-091	0-1"	64-5 Pitch	\$145.00
52-219-092	1-2"	44-3.5 Pitch	155.00
52-212-351	0-1"	Multi	\$199.95
52-212-352	1-2"	Multi	210.00

.0001" GRADUATION

Model	Range	Type	Price
52-244-601	0-1"	Single Ball Anvil	\$ 54.95
52-244-602	1-2"	Single Ball Anvil	59.95
52-244-621	0-1"	Ball on both Anvil	55.00
52-244-622	1-2"	Ball on both Anvil	59.95
52-226-661	0-1"	15° Point	\$ 75.00
52-226-662	1-2"	15° Point	79.95
52-226-641	0-1"	60° Point	79.95
52-246-121	0-1"	Blade .030°	\$125.00
52-246-122	1-2"	Blade .030°	135.00
52-246-123	2-3"	Blade .030°	145.00
52-246-124	3-4"	Blade .030°	159.00
52-275-401	.2-1.2"	Inside	\$ 79.95
52-275-402	1-2"	Inside	85.00
52-275-403	2-3"	Inside	89.00
52-275-404	3-4"	Inside	95.00



DEEP-THROAT MICROMETERS

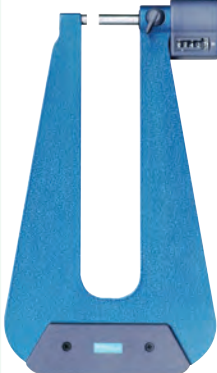

.0001" GRADUATION

Used For Measuring Sheets of Metal or Plastic Where Depths of 2-12" are Needed

- Features**
- Spindle, thread and measuring face hardened and ground.
 - Carbide tipped measuring face.
 - Accuracy to .0003".
 - Diameter of measuring face: .256".
 - Meets or exceeds Federal accuracy specifications.
 - Includes fitted wood case.

Model	Range	Throat	Type	Price
52-617-606	0-1"	6"	Digital	\$89.95
52-617-612	0-1"	12"	Digital	115.00
52-517-611	0-1"	6"	Non-Digital	\$99.95
52-517-612	0-1"	12"	Non-Digital	145.00



EZ-READ INTERCHANGEABLE ANVIL MICROMETERS

Each micrometer is equipped w/a series of easily interchangeable anvils to fulfill the ranges listed. Standards are included to accurately adjust the required range.

- Adjusting collar fitted on each anvil to set overall dimensions.
- Spindle and thread hardened and ground.
- Supplied with six anvils.
- Sizes over 1"/25mm include a measuring standard.
- Meets or exceeds Federal accuracy specifications.

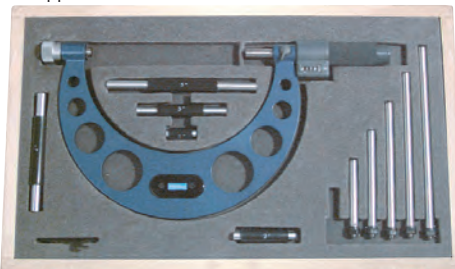

Model	Range	Graduation	Type	Price
52-401-206	0-6"	.0001"	Digital	\$155.00
52-401-207	6"-12"	.0001"	Digital	185.00



EZ-READ GEAR ROOT DIAMETER MICROMETER

Perfect for quick comparisons of thread accuracy, measurement of small flutes or recess, grooved wires, keyways and other hard-to-reach areas.

- Wide measuring range.
- Adjustable anvil.
- Graduation: .001".
- Spindle and thread precision ground.
- Carbide tipped anvil & spindle.
- Includes standards and a fitted case.



Model	Range	Accuracy	Price
52-214-081	.2"-4"	.0002"	\$135.00
52-214-082	4"-8"	.0003"	155.00
52-214-083	8"-12"	.0004"	195.00



SPECIAL APPLICATION ELECTRONIC MICROMETERS



- Large LCD Display.
- Absolute & Incremental modes.

- Automatic switch off.
- Resolution: .00005"/.001mm

- Direct RS232 output.
- Includes shop hardened case.

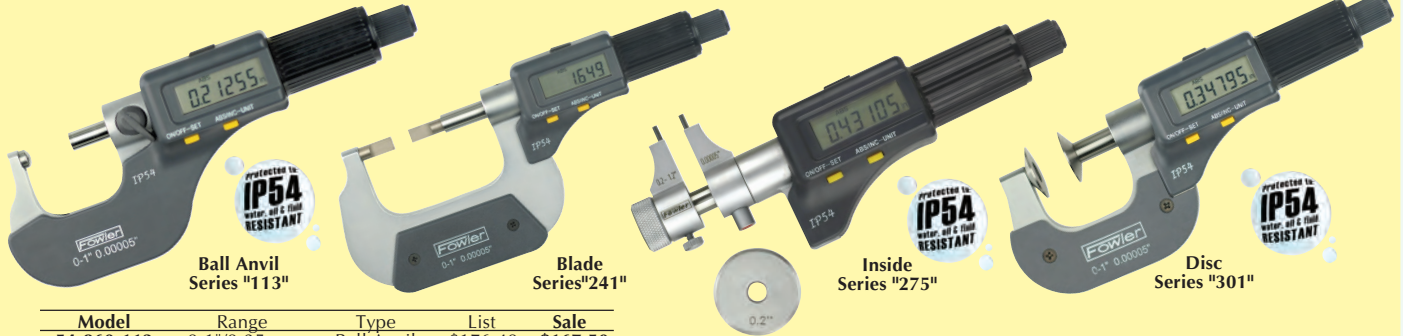

Model	Range	Type	List	Sale
54-860-113	0-1"/0-25mm	Ball Anvil	\$176.40	\$167.50
54-860-114	1-2"/25-50mm	Ball Anvil	188.00	175.00
54-860-211	0-1"/0-25mm	Ball & Spindle	176.40	167.50
54-860-212	1-2"/25-50mm	Ball & Spindle	188.00	175.00
54-860-241	0-1"/0-25mm	Blade	\$232.90	\$221.50
54-860-242	1-2"/25-50mm	Blade	253.00	240.00
54-860-243	2-3"/50-75mm	Blade	265.00	250.00
54-860-244	3-4"/75-100mm	Blade	277.00	263.00

Model	Range	Type	List	Sale
54-860-275	.2-1.2"/0-25mm	Inside	\$215.00	\$205.00
54-860-276	1-2"/25-50mm	Inside	230.00	218.50
54-860-301	0-1"/0-25mm	Disc	\$229.95	\$218.50
54-860-302	1-2"/25-50mm	Disc	246.95	234.50



MICROMETERS AND SETS 0-1" With Decimal Equivalents

- Series No. 52-229-**
- .0001" reading.
 - Carbide measuring faces.
 - Ratchet thimble and locking nut.
 - Microfine graduations.
 - Sizes over 1" include standard.
 - Meets or exceeds Federal specifications.
 - Complete in case.

- Model No. 54-235-001-1**
- Back decimal equivalents on satin chrome finished forged steel frame.
 - Graduations: .0001".
 - Ratchet thimble and locking nut.
 - Complete in case.



0-3" SET
MODEL No. 52-229-213
Reg. \$141.10 **\$95.00**

0-4" SET
MODEL No. 52-229-214
Reg. \$217.30 **\$119.95**

Model	Range	Reg.	Sale
52-229-201	0-1"	\$39.15	\$22.50
52-229-202	1-2"	45.85	29.31
52-229-203	2-3"	56.55	35.00
52-229-204	3-4"	64.90	39.50
52-229-205	4-5"	80.10	47.00
52-229-206	5-6"	94.10	58.00



MODEL No. 54-235-001-1
Reg. \$52.65
\$29.95

Starrett ELECTRONIC MICROMETERS With IP67 Protection

- IP67 level protection against coolant, water, dirt and dust.
- Balanced, tapered frame.
- Starrett no-glare satin chrome finish on thimble and sleeve.
- Hard and stable one piece spindle.
- Large, easy-to-read LCD readout.
- Micro-lapped carbide measuring faces.
- Automatic OFF after 20 minutes of nonuse.
- Inch/millimeter conversion.
- Measurement HOLD button.
- Zero tool at any position-retain and return to true zero
- Resolution: .00005" (0.001mm)
- Accuracies: Inch: ±.0001", Metric: ±.002mm

0-1"/0-25mm



Ratchet Thimble

Friction Thimble

Model	Range	Thimble	List	Sale
796XFL-1	0-1"	Friction	\$169.00	\$160.00
796XFL-2	1-2"	Friction	232.00	220.00
796XFL-3	2-3"	Friction	303.00	287.00
796XFL-4	3-4"	Friction	327.00	310.00
796XRL-1	0-1"	Ratchet	\$169.00	\$160.00
796XRL-2	1-2"	Ratchet	232.00	220.00
796XRL-3	2-3"	Ratchet	303.00	287.00
796XRL-4	3-4"	Ratchet	327.00	310.00



ELECTRONIC MICROMETERS

- Large, easy to read LCD display.
- Automatic switch off.
- Resolution: .0005"/.001mm
- Accuracy: .00016" 0-1"
- Direct RS232 output.
- Sizes over 1"/25mm are supplied with standards.
- Insulated frames.
- Electronics are protected by tough, ABS housing.
- Friction thimble.
- Includes fitted case.



IP-40 Series with Standard

Model	Range	IP-40	List	Sale
54-870-001	0-1"/25mm	Yes	\$85.00	\$59.50
54-870-002	1-2"/25-50mm w/standard	Yes	110.00	75.00
54-870-003	2-3"/50-75mm w/standard	Yes	125.00	89.95
54-850-004	3-4"/75-100mm w/standard	Yes	\$175.00	\$145.00
54-850-005	4-5"/100-125mm w/standard	Yes	190.00	163.50
54-850-006	5-6"/125-150mm w/standard	Yes	225.00	183.50
54-870-103	0-3"/0-75mm Set w/standards & case	Yes	\$275.00	\$183.95
54-850-104	0-4"/0-100mm Set w/standards & case	Yes	-	475.00
54-850-106	0-6"/0-150mm Set w/standards & case	Yes	-	824.30

IP-54 Series

Model	Range	IP-54	List	Sale
54-860-001	0-1"/25mm	Yes	\$106.40	\$79.20
54-860-002	1-2"/25-50mm w/standard	Yes	123.20	89.20
54-860-003	2-3"/50-75mm w/standard	Yes	134.40	99.80
54-860-004	3-4"/75-100mm w/standard	Yes	195.00	155.00
54-860-005	4-5"/100-125mm w/standard	Yes	225.00	174.50
54-860-006	5-6"/125-150mm w/standard	Yes	250.00	195.00
54-860-007	6-7"/150-175mm w/standard	Yes	265.00	215.00
54-860-008	7-8"/175-200mm w/standard	Yes	280.00	230.00
54-860-009	8-9"/200-225mm w/standard	Yes	295.00	244.00
54-860-010	9-10"/225-250mm w/standard	Yes	310.00	262.00
54-860-011	10-11"/250-275mm w/standard	Yes	350.00	290.00
54-860-012	11-12"/275-300mm w/standard	Yes	365.00	302.00
54-860-103	0-3"/0-75mm Set w/standards & case	Yes	\$370.00	\$259.70
54-860-104	0-4"/0-100mm Set w/standards & case	Yes	-	550.00
54-860-106	0-6"/0-150mm Set w/standards & case	Yes	-	875.00
54-860-112	0-12"/0-300mm Set w/standards & case	Yes	-	2450.00
54-115-779	Computer Connect Kit			\$115.00
54-902-110	Replacement Battery Type			6.00

Precise MIC-CALIPER ELECTRONIC DIGITAL THICKNESS GAGE

- Specifically designed to easily measure outside dimensions up to 1" including tube diameters, as well as accurately measure wall thickness up to .08" simply by raising the oval tip rod.
- Spring loaded plunger guarantees repeatable pressure against the measured surface for more accurate reading.
- Long lasting corrosion free aluminum body
- Measuring tip diameter is 5mm.
- 3 button operation: On/Off.
- Floating zero for easy direct reading of relative measurements.
- Inch/Metric conversion.
- Resolution: .0005" x 0.01MM
- Auto shut-off will turn off the gage after 5 minutes of idle time.
- Fitted in a plastic box with 2 SR44 batteries.



Specifications:

Range 0-1/0-25mm
Wall Thick Range . . . 0-.08"/0-2mm
Resolution 0005"/0.01mm

MODEL No. MQR-ON
Reg. \$78.50

\$59.95

Precise SPECIAL APPLICATION ELECTRONIC MICROMETERS AND GAGES

Quality Electronic Digital Readout Provides Error-Free Readings To .00005"/.001mm

ELECTRONIC OUTSIDE MICROMETERS

- Extra large high contrast LCD display.
- Spindle lock.
- Carbide-tipped measuring faces.
- Graduation: .00005"/.001mm
- 3-key model: Inch/Metric On/Off & Zero
- Ratchet stop for a constant measuring force.



Accuracy:
.0001"/.002mm

Model No.	Range Inch/Metric	Sale Price
303-245	0-1"/0-25mm	\$ 44.95
303-246	1-2"/25-50mm	79.95
303-247	2-3"/50-75mm	95.00
303-248	3-4"/75-100mm	105.00

ELECTRONIC 30° POINT MICROMETERS

Similar Features as Above

- For measurement of small grooves, keyways & other hard to reach measurements.
- 30 degree points. • Points are carbide tipped.
- Resolution: .00005"/.001mm.
- Includes fitted case.



Resolution:
.00005"/.001mm

30° Points

Model No.	Range Inch/Metric	Sale Price
EPT-001	0-1"/0-25mm	\$119.95
EPT-002	1-2"/25-50mm	129.95

DELUXE MICROMETER STAND

- Adjustable to any position.
- Modern styled cast iron stand.
- Lacquer coating. • Adjustable clamp.



MODEL No.
MS-445

\$24.95

Less Micrometer

Precise ELECTRONIC DIGITAL TEST INDICATOR

- Manual power on/off. • Zero setting at any position.
- Inch/Metric system conversion at any position.
- Large LCD display on 2" diameter face.
- Jeweled movement. • Supplied with carbide contact point, 2 mounting stems and fitted case.



Set No.
DTI-001

\$149.95

Resolution
.0005"/.01mm
Range
±0.02"/±0.5mm

ELECTRONIC MULTI-ANVIL

- Unique, vise-like special frame holds 2 interchangeable anvils.
- Supplied with both a flat and rod anvil (rod anvil O.D. is .118).
- Measures hard to reach locations such as from a hole or slot to an edge, small tube wall thickness, shoulder to an edge, etc.
- Carbide tipped spindle face.
- Similar electronic features as other models.
- Resolution: .00005"/.001mm. • Includes fitted case.



Resolution:
.00005"/.001mm

Model No.	Range Inch/Metric	Sale Price
EAN-001	0-1"/0-25mm	\$129.95
EAN-002	1-2"/25-50mm	145.00

ELECTRONIC BLADE MICROMETER

- For measurement of keyways, groove diameters of shafts, and other hard to reach dimensions.
- Similar features as Electronic Micrometer.
- Non-rotating spindle. • Includes fitted case.
- Carbide tipped measuring faces.



Resolution:
.00005"/.001mm

Model No.	Range Inch/Metric	Sale Price
EBM-001	0-1"/0-25mm	\$145.00
EBM-002	1-2"/25-50mm	155.00
EBM-003	2-3"/50-75mm	165.00

ELECTRONIC DEEP THROAT MICROMETERS 6" THROAT DEPTH

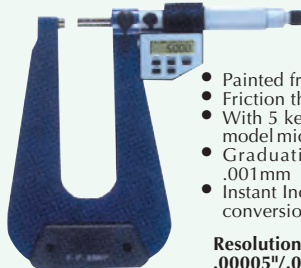

- Painted frame.
- Friction thimble.
- With 5 keys Deluxe model micrometer head.
- Graduation .00005"/.001mm
- Instant Inch/Metric conversion.

Resolution:
.00005"/.001mm

Model No.	Range Inch/Metric	Throat Depth	Sale Price
EDT-001	0-1"/0-25mm	6"	\$185.00
EDT-002	1-2"/25-50mm	6"	200.00

Precise DIGITAL ELECTRONIC AGD INDICATOR

- Large LCD display.
- Instant Inch/Metric conversion.
- On/Off and zero setting button.
- Resolution .0005"/0.01mm.
- 3/8" mounting stem and rear lug mount back plate



FREE!
22 Piece Point Kit
Included



.500"/12.7mm
MODEL No.
PDA-002

\$49.95

Model	Range	Resolution	Price
PDA-002	.500"/12.7mm	.0005"/0.01mm	\$49.95
PDA-003	1.00"/25mm	.0005"/0.01mm	59.95
PDA-004	2.00"/50mm	.0005"/0.01mm	119.95

ELECTRONIC DISC MICROMETER

- For measurement of narrow grooves, slots and recesses. Useful for measurements of parts with ribs, lands, fins, cutting edges on form tools & more.
- Similar Features as Electronic Outside Micrometers.
- Measuring disc is hardened, ground and microlapped.
- Includes fitted wooden case.



Resolution:
.00005"/.001mm

Model No.	Range Inch/Metric	Sale Price
EDA-001	0-1"/0-25mm	\$129.95
EDA-002	1-2"/25-50mm	145.00

ELECTRONIC INSIDE MICROMETERS

- Measuring faces are hardened, precision ground and microlap finished.
- Caliper type jaws are made of high-grade tool steel; satin chrome finished.
- Locking clamp, friction stop. • Preset function.
- Resolution: .00005"/.001mm. • Includes fitted case.



Resolution:
.00005"/.001mm

Model No.	Range Inch/Metric	Sale Price
EIM-001	.2-1.2"/5-30mm	\$129.95
EIM-002	1-2"/25-50mm	145.00

ELECTRONIC SPLINE MICROMETER

A micrometer with the anvil and spindle reduce to .79"(2mm) diameter x 5mm length.

Features:

- .79" (2mm) diameter anvil and spindle.
- Satin chrome thimble. • .00005" readings - inch.
- .001mm readings - metric. • Spindle lock.
- Friction thimble. • Preset function.
- Includes fitted case.



Resolution:
.00005"/.001mm

Model No.	Range Inch/Metric	Sale Price
ESM-002	1-2"/25-50mm	\$145.00
ESM-003	2-3"/50-75mm	165.00

ELECTRONIC BALL END MICROMETERS

- Chrome plated frame.
- Friction thimble and locking lever.
- With 5 keys Deluxe model micrometer head.
- Graduation .00005"/.001mm



Resolution:
.00005"/.001mm

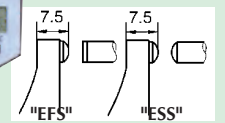

Flat Spindle	Spherical Spindle	Range Inch/Metric	Sale Price
EFS-001	ESS-001	0-1"/0-25mm	\$119.95
EFS-002	ESS-002	1-2"/25-50mm	129.95
EFS-003	ESS-003	2-3"/50-75mm	139.95

Mitutoyo DIGITAL POCKET QUICK MINI MICROMETER

- Quick-Mini - precision in the palm of your hand! Keep it in your pocket. Its a handy, personal measuring tool.
- Ideal for determining the thickness of a variety of items and materials.
- Its the size of a business card, but with the power and precision of Mitutoyo inside.



0-.5"
MODEL No.
700-118
Reg. List \$115.00
\$99.95

Order No.	700-118
Measuring Range	.5" (12mm)
Resolution	.0005" (.01mm)
Instrumental Error	±.001" (±0.02mm)
Repeatability	.0005" (0.01mm)
Battery (Life)	SR44 #541980 (2 years under normal use)
Max. Response Speed	1,600 mm/s
Alarm	Battery voltage low, overspeed

Precise V-ANVIL MICROMETERS

3 Flute And 5 Flute

- Measures the outside diameter of cutting heads (such as taps, reamers, end mills) with an odd number of flutes.
- Carbide-tipped spindle.



Resolution
.00005"/.001mm

Mechanical

.0001" Graduation

Model No.	Range Inch/Metric	Type Mech or Elec	No. of Flutes	Sale Price
VAM-001	.2"-.8"/5-20mm	Mech 60°	3	\$119.95
VAM-002	.8"-1.4"/20-35mm	Mech 60°	3	129.95
VAM-003	1.4"-2.0"/35-50mm	Mech 60°	3	135.00
VAM-004	.2"-1"/5-25mm	Mech 108°	5	145.00
VAM-005	.2"-.8"/5-20mm	Elec 60°	3	\$159.95
VAM-006	.8"-1.4"/20-35mm	Elec 60°	3	175.00
VAM-007	1.4"-2"/35-50mm	Elec 60°	3	210.00



SCHERR-TUMICO INSIDE MICROMETERS

- Silver mist chrome finish head.
- Hardened and radius ground contacts for more accurate measurements.
- Black lines numbers for easy reading.
- Includes fitted wood case



Rod Type

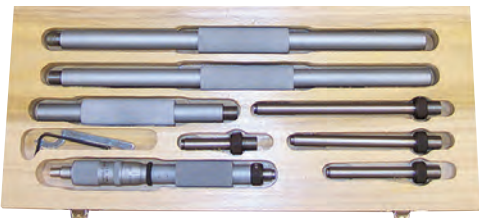

Tubular Type

MADE IN USA



Rod Type
Micrometer Head

Model	Range	Rod Type	Price
10-0065	1-1/2"-6-1/2"		\$195.00
10-0085	1-1/2"-8-1/2"		210.00
10-0090	1-1/2"-12"		250.00

Model	Range	Tubular Type	Price
10-0440	4"-40"		\$435.00
10-0626	6"-26"		535.00
10-0636	6"-36"		650.00
10-1636	16"-36"		685.00
10-2646	26"-46"		790.00
10-3656	36"-56"		895.00
10-3676	36"-76"		1250.00
10-3886	36"-86"		1365.00
10-3696	36"-96"		1750.00

Also available in Metric (Inquire)

Mitutoyo QUICKMIKE Fast Response-Non Rotating Spindle

- Quick non-rotating 1.2"(30mm) stroke spindle. The spindle advances .4" (10mm) per thimble rotation.
- Large LCD readout (H-.3"/7.5mm).
- Absolute encoder technology sensor, set the origin only once! The absolute linear tracks the origin throughout the life of battery, meaning no more zero setting or over speed errors.
- Available with SPC data output.
- IP-54 protection, resist water splash and shop floor contaminant for safe operation in harsh machine shop environments.
- Resolution .00005"/.001mm



Standard Type

Blade Type

Disc Type

Standard Type			
Model No.	Measuring Range	List Price	Sale Price
293-676	0-1.2"/0-30mm	\$562.00	\$495.00
293-677	1-2.2"/25-55mm	614.00	550.00
293-678	2-3.2"/50-80mm	668.00	595.00
293-679	3-4.2"/75-105mm	728.00	650.00
Blade Type			
422-421	0-1.2"/0-30mm	\$960.00	\$860.00
422-422	1-2.2"/25-55mm	1030.00	925.00
Disc Type			
369-421	0-1.2"/0-30mm	\$775.00	\$695.00
369-422	1-2.2"/25-55mm	954.00	858.00



SCHERR-TUMICO BLADE MICROMETER .0001" GRADUATION

- Exclusive "Feathertouch" tubular steel frame.
- Reading to .0001".
- Carbide spindle & anvil available (Inquire).
- No-rotating spindle.
- .017" thick blades.
- Durable black wrinkle finish frame.
- Spindle hardened to Rc 62-64 with lead error held to .00005".
- Lock nut.
- Silver mist chrome finish head.
- Black lines and numbers for easy reading.
- 0-1" model includes plastic case.
- Fitted wood case available.



Size from
6-7" Thru 11-12"
Also available
(Inquire)

Model	Range	Graduation	Price	Wood Case
07-0010	0-1"	.0001"	\$350.00	\$25.00
07-0020	1-2"	.0001"	360.00	27.00
07-0030	2-3"	.0001"	380.00	29.00
07-0040	3-4"	.0001"	390.00	30.00
07-0050	4-5"	.0001"	395.00	32.00
07-0060	5-6"	.0001"	420.00	42.00

Also available Sizes 6-7" to 11-12" and Metric (Inquire)



SCHERR-TUMICO INTERCHANGEABLE ANVIL MICROMETERS

- Exclusive "Feathertouch" tubular steel frame.
- Reading to .001" or .01mm available.
- Hardened steel measuring faces.
- Lock nut and ratchet stop standard.
- Durable black wrinkle finish frame.
- Spindle hardened to Rc 62-64 with lead error held to .00005".
- Silver mist chrome finish head.
- Black lines and numbers for easy reading.
- Checking standards with handles.
- Includes fitted wood case.



MADE IN USA

Model	Range	Graduation	Price
05-0004	0-4"	.001"	\$ 360.00
05-0007	0-6"	.001"	375.00
05-0051	6-12"	.001"	785.00
05-0016	12-16"	.001"	675.00
05-0052	12-18"	.001"	1195.00
05-0020	16-20"	.001"	850.00
05-0053	18-24"	.001"	\$1295.00
05-0024	20-24"	.001"	975.00
05-0054	24-30"	.001"	1350.00
05-0055	30-36"	.001"	1450.00
05-0056	36-42"	.001"	1795.00
05-0057	42-48"	.001"	1995.00
05-0058	48-54"	.001"	\$2250.00
05-0059	54-60"	.001"	2650.00

Also available
60" to 106"
and Metric

IBS Brown & Sharpe MICROMASTER DIGITAL MICROMETERS

A sleek, ergonomic design and plenty of impressive features, including the new "capa μ system" give the Micromaster Digital Micrometer a comfortable advantage in both form and function.

- Large, easy-to-read 1/4" digital display.
- Preset absolute and differential modes.
- Battery life: 1 to 2 years normal usage.
- Automatic shut-off after 10 minutes.
- Meets or exceeds applicable Federal and DIN standards.
- Shop-hardened, fitted case.



Swiss Quality



MODEL No. 599-100
Reg. \$310.00
\$263.50

Model No.	Range Inch/Metric	Water Resistant	RS-232 Output	List Price	Sale Price
599-100	0-1.2"/0-30mm .00016"	N	N	\$310.00	\$263.50
599-125	0-1.2"/0-30mm .00016"	Y	N	325.00	275.00
599-125RS	0-1.2"/0-30mm .00016"	Y	Y	353.00	300.00
599-126	1-2.2"/25-50mm .0002"	Y	N	403.00	342.50
599-126RS	1-2.2"/25-50mm .0002"	Y	Y	420.00	357.00
599-127	2-3"/50-75mm .0002"	Y	N	446.00	379.00
599-127RS	2-3"/50-75mm .0002"	Y	Y	451.00	383.50
599-128	3-4"/75-100mm .0002"	Y	N	476.00	405.50
599-128RS	3-4"/75-100mm .0002"	Y	Y	482.00	409.50
19-61000	Lithium Battery-3V, CR2030				\$ 7.25
47-61046	RS-232 Interface Cable 9 Pin				120.00

Precise INDICATING MICROMETER AND STAND COMBINATION SET

Indicating Micrometer:

- Jeweled bearings, hardened pinion and gear.
- Hardened and ground spindle and anvil, .255" diameter.
- Push button actuated retractable anvil, .040" travel.
- Carbide measuring faces.
- Indicator range ±.003", reading .0001"
- Micrometer reading .001"
- Satin chromed frame with plastic heatshield.
- Furnished in wooden case.

Micrometer Stand:

- Compact, folding micrometer stand with a unique locking mechanism that positions the micrometer for perfect use and viewing.

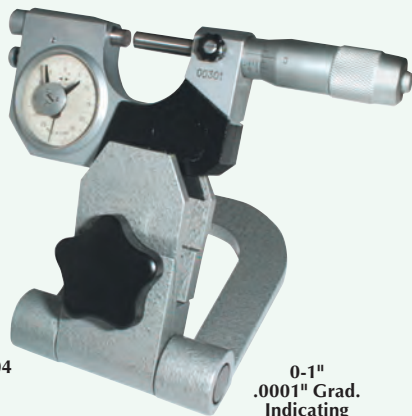

Micrometer Stand
MODEL No. 303-304
\$16.95

Model	Range	Graduation	Price
303-201	0-1"	.0001"	\$139.95
51-551	0-1"	.00005"	254.95

0-1"
.0001" Grad.
Indicating
Mic and Stand
SET No.
PIM-100
\$149.95

Precise TOOL SET WITH 8-DRAWER WOOD CHEST

- Perfect starter set for machinist, tool and die makers, apprentices, mechanics and the serious home workshop.
- Contains a fine felt lined 10-Drawer Gerstner Oak tool chest with either electronic or mechanical tool selection.



Mechanical
Tool Set
MODEL No.
ETS-100
Reg. \$459.95

\$379.95

Contains:

- 1) 0-1" micrometer .0001" grad.
- 1) 0-6" dial caliper
- 1) 0-1" AGD dial indicator .001" grad. & fine adj. mag. base

Plus with each set

- 1) 10-drawer Gerstner wood tool chest with lockable drawers

- 1) 4-piece 12" "Combination square set"



- 1) Telesight binocular magnifier 2-1/4X

- 1) 29th edition machinery handbook

Gerstner Oak Tool Chest also sold separately
No. GI-532 - \$299.95

Electronic
Tool Set
MODEL No.
ETS-200
Reg. \$550.00
\$445.00

Contains:

- 1) 0-1"/0-25mm electronic micrometer
- 1) 0-6"/0-150mm electronic caliper
- 1) 0-1"/0-25mm electronic dial indicator & fine adj. mag. base



ETALON OUTSIDE MICROMETERS

Swiss Made

- Friction stop, highly rigid frame.
- Built for accuracy under the most rugged conditions.
- Insulating grips.
- Fitted case included.
- Reads to .0001"
- Satin chrome finish on thimble & barrel.



Swiss Quality



0-1"
MODEL No. 260-B1
Reg. \$246.00
\$209.95

SAVE
15%

Model	Range	Reading	List	Sale
260-B1	0-1"	.0001"	\$246.00	\$209.95
260-B2	1-2"	.0001"	346.00	305.00
260-B3	2-3"	.0001"	380.00	339.50
260-B4	3-4"	.0001"	415.00	373.50

Larger sizes up to 10" available, Inquire



ETALON DIAL INDICATING MICROMETERS

Swiss Made

Swiss Quality

- Easy to read, wide spaced, graduations are permanently deep-etched with acid on large diameter thimble.
- Can be set and locked for continuous accurate gaging. Retractable anvil for quick part insertion and removal.
- Easily adjustable dial with individual adjustment of tolerance hands, color coded for plus or minus sides.
- Jeweled, shockproof movement. Carbide measuring faces.
- Hardened one-piece stainless steel screw.
- Micrometer graduations .0001". Dial graduations in .0001" or .00005"



0-1"/.00005" Grad.
MODEL No.
225B-B1
Reg. \$1256.00
\$1095.00
W/FREE Mic Stand

Model	Range	Dial Grad.	List	Sale
225B-B1	0-1"	.00005"	\$1256.00	\$1095.00
225B-B2	1-2"	.00005"	1301.00	1150.00

Shown With
FREE Mic Stand

Precise DIGITAL MICROMETERS

- Hammertone blue bed enamel frame heat insulated frame on 0-1" size only.
- Micro-fine graduations on satin chrome.
- Ratchet-stop thimble.
- Positive locking nut on spindle.
- Anvil and spindle hardened and precision ground, with micro lap finish and carbide tipped measuring faces. The spindle thread is hardened, ground and lapped.
- Quick, easy zero adjustment on sleeve.

MODEL PDM-001
Reg. \$44.95

\$24.95

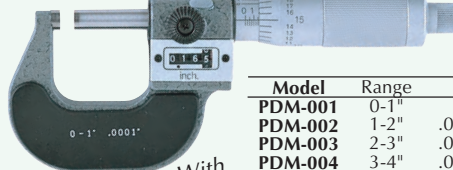

With
Fitted
Case

Model	Range	Graduation	Price
PDM-001	0-1"	.0001"	\$ 24.95
PDM-002	1-2"	.0001" w/standard	29.95
PDM-003	2-3"	.0001" w/standard	36.95
PDM-004	3-4"	.0001" w/standard	45.00
PDM-030	0-3" Set	.0001" w/standards	\$ 79.95
PDM-005	0-4" Set	.0001" w/standards	125.00
PDM-006	0-6" Set	.0001" w/standards	189.95

Precise MEASURING TOOL KIT

Here's Our Most Popular and Cost Efficient Set

- 0-1" Micrometer, .0001" Graduations
- Carbide tipped faces and ratchet thimble.
- 6" 4R grad stainless steel rule
- 0-6" Dial caliper.
- 0-6" Range, .001" Graduations
- .100" per one revolution.
- Satin chrome.
- Fitted foam case.



SET No.
ETK-003

\$46.95

With Case

Precise ULTRA PRECISE INDICATING MICROMETER

- Indicator Range: +/- 0.0015"
- Direct GO/NO GO reading for mass-produced parts.
- Carbide tipped measuring faces.
- Constant measuring force 5-10N.
- With fitted metal case.

.00005"
Resolution

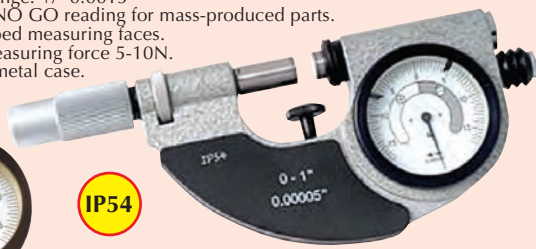
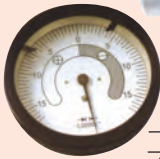

Model	Range	Resolution	Price
4200-0242	0-1"	.00005"	\$295.00
4200-0243	1"-2"	.00005"	325.00

Precise INDICATING MICROMETER European Design ~ .0005" Resolution

- Anvil retracts 0.078" with button for insertion of item to be measured.
- carbide tipped measuring surfaces.
- Graduations: .00005"
- Accuracy: .00012"/mic/.00005" ind.
- Faces parallel to .000025"
- Range of indicator ±.0025" by .00005"
- Satin chrome sleeve and thimble.
- Jeweled bearings.



MODEL No.
303-2301

\$199.95

Model	Range	Graduation	Price
303-2301	0-1"	.00005"	\$199.95
303-2303	1"-2"	.00005"	249.95

Mitutoyo INDICATING MICROMETER

- Retractable anvil with indicator for three wire measurements of pitch diameter of precision screws and parallelism measurements.
- With a standard bar except for 0-1" model.
- IP protection level: 54
- Supplied in fitted plastic case.

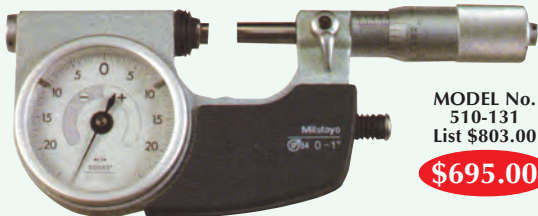

MODEL No.
510-131
List \$803.00

\$695.00

Model No.	Range Inch	Graduation Inch	Indicating Range	List Price	Sale Price
510-131*	0-1"	.00005"	±.0023"	\$803.00	\$695.00
510-151	0-1"	.00005"	±.0023"	803.00	695.00
510-152	1-2"	.00005"	±.0023"	865.00	725.00
510-133	2-3"	.00005"	±.0023"	964.00	850.00
510-134	3-4"	.00005"	±.0023"	1050.00	925.00

*Retractable Anvil Button on the Right Side

Mitutoyo SNAP METERS

- Various types of indicators, LVDT's and Linear Gages can be selected according to the measurement applications.
- Supplied in fitted plastic case.
- Use Electronic, Dial AGD Indicators or Linear Gages with 3/8" Stem Diameter.

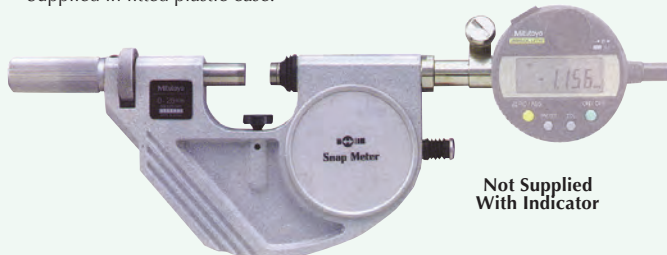

Not Supplied
With Indicator

Model No.	Range Inch	Anvil Movement	List Price	Sale Price
523-151	0-1"	.078"	\$425.00	\$359.95
523-152	1-2"	.078"	475.00	425.00
523-153	2-3"	.078"	636.00	565.00
523-154	3-4"	.078"	753.00	650.00

Fowler Rotocal® EXTENDED RANGE DISC BRAKE MICROMETERS DIGITAL TYPE

- Fast easy to read digit counter.
- Range: 0.3"-1.7"/10-45mm.
- Digital counter reads .001"/0.01mm sleeve reads .0001"/0.01mm.
- Ratchet thimble.
- carbide tipped measuring faces.
- Includes case and measuring standard.

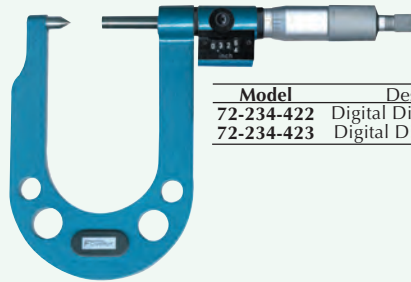

Model	Description	Price
72-234-422	Digital Disc Mic. English	\$89.95
72-234-423	Digital Disc Mic. Metric	95.00

Rotocal® ELECTRONIC DISC BRAKE MICROMETER

- Range: 0.3"-1.7"/7-44mm
- Resolution: .00005"/.001mm
- IP54: Water, oil resistant.
- Jaw depth: 3.5"
- Friction thimble.
- Carbide tipped measuring faces.
- Auto-shutoff.
- ABS/INC measurement.
- Preset recall.
- Direct Inch/Metric conversion.
- Direct RS-232 output.
- Includes case and measuring standard.



Model	Description	Price
74-860-434	Electronic Disc Brake Mic.	\$195.00
74-902-110	357 Replacement Battery	6.00

Mahr FEDERAL Universal ~ Single Axis

Linear 100 is a universal, user-friendly length measuring instrument for rapid, precise internal and external measurements up to 4" (100mm), directly in the manufacturing environment. The unit's simple design makes it possible to carry out measurements in no time at all and adapt quickly to new measurement tasks.

- The **Linear 100** is very flexible when it comes to external measurements, with a direct measuring range of up to 2" (50mm) and an application range of up to 4" (100mm). For internal measurements, the application range is 0.59" to 4" (15mm to 100mm), with additional option of 0.24" to 4" (6mm to 100mm)
- It is possible to switch from internal to external measurements at any time without having to recalibrate. The instrument can be used to measure lengths and diameters. This allows multifaceted measuring tasks to be solved, for example on the dimension over two balls on outer gears.



Resolution per measuring channel can be independently set
0.0001mm; 0.001mm; 0.01mm
0.00001inch; 0.0001 inch;
0.001 inch
0.001" decimal; ° min, sec

MODEL No.
5357301

\$13,995.00

- Consists of:
 - **Linear 100** universal measuring instrument, height adjustable 70 X 70mm object table with electronic display (MarCheck) and connection cable.
 - Measuring anvils for internal measurements from 15mm to 100mm and external measurements from 0mm to 100mm.
 - Measuring anvils for external measurements have a diameter of 6.5mm



Mitutoyo PRECISION MICROMETERS AND SETS

- Carbide faces.
- Positive locking clamp.
- Friction thimble or ratchet stop for exact and accurate repetitive readings
- Clear graduations on satin-chrome finish.
- Complete with fitted carrying case and inspection standards.

Series "101" Has Full Chrome Finished Steel Hardened Frames



No. 101-113

No. 103-260-99
List \$85.55

\$59.95



Series "103" Has Hammerstone Blue Baked Enamel Finished Frames

Model	Range	Resolution	Thimble	List Price	Sale Price
103-260-99	0-1"	.0001"	Ratchet	\$ 85.55	\$ 59.95
103-135	0-1"	.0001"	Friction	116.00	98.50
101-117	0-1"	.0001"	Friction	130.00	110.50
101-113	0-1"	.0001"	Ratchet	158.00	134.00
103-136	1-2"	.0001"	Friction	\$136.00	\$115.50
103-262	1-2"	.0001"	Ratchet	135.00	114.75
101-114	1-2"	.0001"	Ratchet	158.00	134.00
101-118	1-2"	.0001"	Friction	158.00	134.00
103-217	2-3"	.0001"	Ratchet	\$150.00	\$127.50
101-119	2-3"	.0001"	Ratchet	173.00	119.00
103-218	3-4"	.0001"	Ratchet	\$173.00	\$147.00
101-120	3-4"	.0001"	Ratchet	190.00	161.50
103-219	4-5"	.0001"	Ratchet	187.00	158.95
103-220	5-6"	.0001"	Ratchet	208.00	176.80
103-221	6-7"	.0001"	Ratchet	\$235.00	\$199.75
103-222	7-8"	.0001"	Ratchet	248.00	210.50
103-223	8-9"	.0001"	Ratchet	275.00	233.75
103-224	9-10"	.0001"	Ratchet	285.00	242.00
103-225	10-11"	.0001"	Ratchet	299.00	254.00
103-226	11-12"	.0001"	Ratchet	311.00	264.00

Sizes up to 40" Available (Inquire)

Mitutoyo MICROMETER SETS

All Sets Are Supplied In Fine Finished Wood Cases

Features:

- Carbide measuring tips, ratchet stop or friction thimble and lock nut.
- Chrome finished measuring heads with baked enamel.
- Supplied with fitted case.
- Checking standards are supplied with Set No.'s 103-922, 103-931, 103-907, 103-908 and 103-909

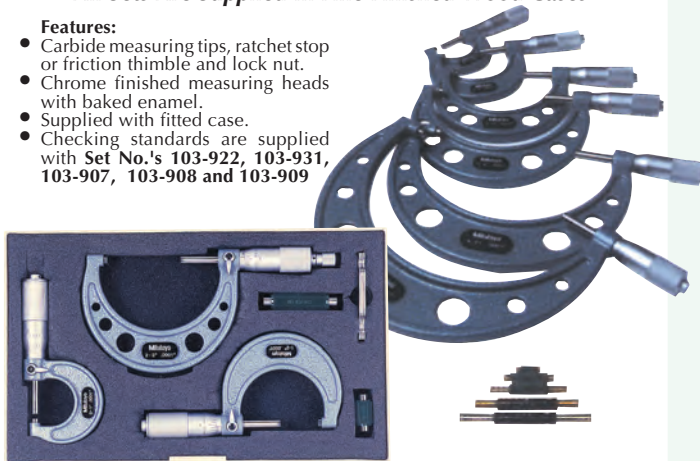

Model	Range	Resolution	Thimble	List Price	Sale Price
103-922	0-3"	.0001"	Ratchet	\$420.00	\$355.00
103-931	0-4"	.0001"	Ratchet	519.00	440.00
103-907	0-6"	.0001"	Ratchet	855.00	725.00
103-909	6-12"	.0001"	Ratchet	1710.00	1450.00
103-908	0-12"	.0001"	Ratchet	2360.00	1995.00

VALUE-LINE OUTSIDE MICROMETER

- Satin-chrome thimble.
- .0001" graduations.
- Straight-line graduations.
- Black enamel frame.
- Spindle lock.
- Fixed/friction thimble.
- Tungsten carbide tipped faces.
- Meet Federal Specifications



0-1"
MODEL No.
599-1-44 **\$99.50**
Reg. List \$124.00



Model	Range	Grad.	List	Sale
599-1-44	0-1"	.0001"	\$124.00	\$99.50
599-2-44	1-2"	.0001"	128.00	108.50
599-3-44	2-3"	.0001"	135.00	114.75
599-4-44	3-4"	.0001"	137.00	116.00
599-5-44	4-5"	.0001"	153.00	129.50
599-6-44	5-6"	.0001"	157.00	133.00

Micrometer Set With Standards & Wood Case

599-181-923-1	0-3"	.0001"	\$506.00	\$399.95
599-181-924-1	0-4"	.0001"	683.00	545.00
599-182-926-1	0-6"	.0001"	1188.00	950.00
599-183-908*	6-12"	.0001"	1968.00	1550.00
599-184-907*	0-12"	.0001"	2972.00	2375.00

*Standard are sold Separately. Please Inquire



TESA CLASSICMASTER® 0-1" - .0001" GRADUATION



- Top quality - Swiss Precision Micrometer.
- Durable enamel frame.
- Supplied in a plastic case.
- Friction drive guarantees constant measuring force.
- Tungsten carbide measuring face, .256" (6.5mm).



0-1"
MODEL No.
599-1-50
Reg. \$129.50
\$99.95

Precise SUPER PRECISION MICROMETERS

SPECIAL FEATURES:

- .001" reading plus .0001" vernier.
- Swiss-style design, balance and quality. • Flatness= .00003".
- Ratchet thimble assures you of consistent reading at all times.
- Barrel, thimble and frame are satin chrome, microfine graduations allow easy readings.
- Measuring faces are carbide-tipped.
- Insulated frame isolates heat from operators hand.
- Parallelism= .00005" for the 0-1" measuring range.
- The one-piece design is extremely well-balanced and lightweight (0-1" sizes weighs only 7-3/4 oz.).
- Positive lever locking clamp ensures reliable measurement at all times.
- Includes standards for sizes 2" and over. • Accuracy= .0001" for 0-1".
- 256" diameter spindle.
- Anvil and spindle are hardened and precision ground.
- Price includes fitted case.
- Meets or exceeds U.S. Federal specifications for accuracy.



0-1" Range
.0001" Grad.
No. 26-081
\$14.95

Specs meet or Exceed
Federal Standard.
Swiss Style Design,
Balance and Quality

INDIVIDUAL MICROMETERS

Model	Range	Graduation	Price
26-081	0-1"	.0001"	\$14.95
26-082	1-2"	.0001"	16.95
26-083	2-3"	.0001"	18.95
26-084	3-4"	.0001"	20.95
26-085	4-5"	.0001"	24.95
26-086	5-6"	.0001"	29.95
26-087	6-7"	.0001"	\$35.00
26-088	7-8"	.0001"	46.00
26-089	8-9"	.0001"	49.00
26-090	9-10"	.0001"	55.00
26-091	10-11"	.0001"	60.00
26-092	11-12"	.0001"	68.00

MICROMETER SETS

26-097	0-3"	.0001"	\$32.95
26-093	0-3"	.0001"	44.50
26-098	0-4"	.0001"	69.95
26-094	0-6"	.0001"	115.00
26-095	6-12"	.0001"	275.00
26-096	0-12"	.0001"	375.00



0-3" Set
.0001" Grad.
w/standards
& wood case
MODEL No.
26-093
\$44.50

0-6" Set
.0001" Grad.
w/standards
& wood case
MODEL No.
26-094
\$115.00

Mitutoyo RATCHET THIMBLE MICROMETERS

- Improved repeatability for both "expert" and novice users.
- Constant force device allows easy one hand operation.
- Clearly audible ratchet.
- Full wrap heat insulation cover.
- Certificate of Inspection provided.
- Speeder for quick thimble rotation.
- Carbide measuring faces.



New Style Ratchet Thimble with a new mechanism

SET No. 102-908

Model	Range	Graduation	Accuracy	List	Sale
102-717	0-1"	.0001"	±0.0001"	\$150.00	\$127.50
102-718	1-2"	.0001"	±0.0001"	197.00	167.25
102-908	Set of the above with 2 each, Red, Yellow, Blue Speeder Sleeves			\$242.00	\$205.50

Mitutoyo AND Precise INTERCHANGEABLE ANVIL MICROMETERS

- Furnished anvils are quickly interchanged and are etched with length.
- Adjustable stopper on the anvil permits calibration of overall dimension and the anvil is micro-lapped, but not carbide-tipped.
- The spindle diameter is .250" and .315"
- The spindles are carbide-tipped and micro-lapped for lasting accuracy.

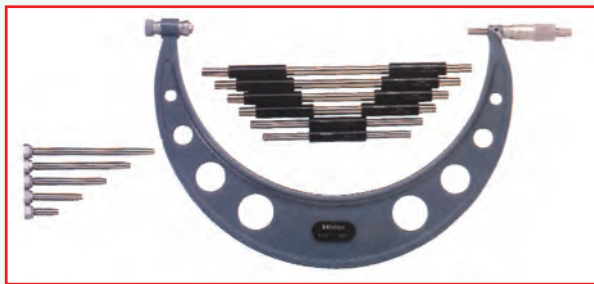

.001" Graduation

Mitutoyo SIX ANVILS			Mitutoyo 4 ANVILS		Precise (China) 4 ANVILS	
Range	Model	Price	Model	Price	Model	Price
0-6"	104-137	\$319.50	-	-	IAM-422	\$115.00
6-12"	104-138	575.00	-	-	IAM-423	155.00
12-16"	-	-	104-152	\$585.00	IAM-424	165.00
12-18"	104-201	795.00	-	-	-	-
16-20"	-	-	104-153	720.00	IAM-425	185.00
18-24"	104-202	925.00	-	-	-	-
20-24"	-	-	104-154	855.00	IAM-426	215.00
24-28"	-	-	104-155	1035.00	IAM-427	265.00
24-30"	104-203	1095.00	-	-	-	-
28-32"	-	-	104-156	1085.00	IAM-428	285.00
30-36"	104-204	1195.00	-	-	-	-
32-36"	-	-	104-157	1185.00	IAM-429	345.00
36-40"	-	-	104-158	1295.00	IAM-410	415.00
36-42"	104-205	1295.00	-	-	-	-

Mitutoyo & Precise DIGITAL ELECTRONIC INTERCHANGEABLE ANVIL MICROMETERS

- Friction thimble.
- Deluxe micrometer head with 5 keys.
- Painted frame.
- Automatic zero-setting
- Instant inch/metric conversion.
- RS-232 SPC Output.

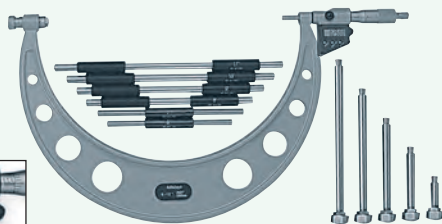

Mitutoyo

Precise			Mitutoyo	
Model	Range	Sale	Model	Sale
IAM-050	0-6"	\$159.95	340-351	\$642.50
IAM-052	6-12"	225.00	340-352	790.00
IAM-054	12-16"	235.00	340-720	990.00
IAM-056	16-20"	325.00	340-721	1125.00
			340-722	1250.00
			340-723	1295.00

SPi GROOVE MICROMETER

- Measures grooves, recesses and shoulders located inside the bore.
- Discs are hardened and lapped.
- Measure from an edge to a land or form shoulder to groove.
- Satin chrome finish.



.001" Graduation

Model No.	Outside Range	Inside Range	Measure Diameter	Reach	Sale Price
13-533-5	0-1"	.055-1.050"	.250"	1.40"	\$199.50
13-534-3	0-1"	.055-1.050"	.500"	3.38"	203.30
13-535-0	1-2"	1.050-2.050"	.500"	3.38"	223.65
13-536-8	2-3"	2.050-3.050"	.500"	3.38"	266.00
13-537-6	3-4"	3.050-4.050"	.500"	3.38"	290.15

Mitutoyo CAN SEAM MICROMETER

- Measures the width, height and depth of can seams.
- Three types of micrometers are available for: steel cans, aluminum cans and sprayer cans
- Supplied in fitted carton.



Model	Range	Graduation	Type	List	Sale
303-223	0-.2"	.001"	For Most Cans	\$ 65.00	\$ 49.95
147-104	0-.5"	.001"	For Steel Cans	216.00	183.50
147-106	0-.5"	.001"	For Aluminum Cans	216.00	183.50
147-201	0-.5"	.001"	For Spray Cans	166.00	141.00

Metric Available at The Same Price (Inquire)

WIRE MICROMETER

- Designed for measuring the diameter of wire or small ball.
- Carbide face.
- Satin chrome finish.
- Friction thimble.



Model	Range	Clearance	Reg.	Sale
303-2227	0-.400"	T255F	\$75.00	\$49.95

Precise SPECIALTY MICROMETERS MICROMETER HEADS

- Microlapped oil spindle
- Ratchet stop.
- Quick and easy adjustment.
- Precision ground threads.
- Meeting or exceeding federal specification.
- Carbide face.

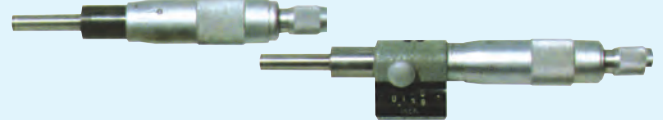

Model	Range	Graduation	Type	Reg.	Sale
303-2639	0-1"	.0001"	Standard	\$22.00	\$17.95
303-2641	0-1"	.0001"	Digital	35.00	27.50

HUB MICROMETER

- Shallow specially designed frame to clear through 3/4" diameter hole (1" Model)
- Measuring hub thickness and shoulders inside bore.
- Carbide faces



Model	Range	Graduation	Reg.	Sale
303-2224	0-1"	.0001"	\$70.00	\$54.50
303-2225	1-2"	.0001"	80.00	65.00
303-2226	2-3"	.0001"	90.00	73.00

CALIPER TYPE MICROMETER

- Measures hard-to-reach places.
- The measuring anvils are approximately 3/4" above the micrometer and carbide faced for long-lasting accuracy.

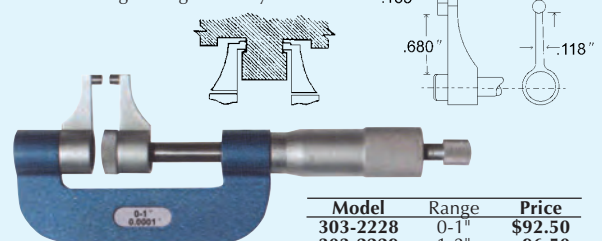

Model	Range	Price
303-2228	0-1"	\$92.50
303-2229	1-2"	96.50

Fowler RAPID-MIC IP67 ELECTRONIC MICROMETER

- Rapid-movement, non-rotating spindle means faster opening and closing.
- IP67: Water, oil, coolant and fluid proof.
- Smart inductive sensor.
- Range: 0-1.2"/0-30mm
- Resolution: .00005"/.001mm
- Accuracy: .00012"/.003mm
- Adjustable measuring force: 5N/10N
- Spring loaded thimble ensures repeatability.
- S-connect proximity connector USB/RS-232/Wireless.
- 2-Year battery.



Model	Description	List	Sale
54-815-030	Rapid-Mic IP67 Electronic Micrometer	\$546.00	\$495.00
54-115-526	Proximity Cable		125.00
54-100-350	CR2032 Battery		5.50

Fowler DIGITAL MICROMETER

- Protected to IP54 specifications.
- Range: 0-1"/0-25mm.
- Rugged steel design.
- Large LCD display.
- Absolute and incremental modes.
- Automatic switch off.
- Resolution: .00005"/.001mm.
- Direct RS232 output.
- Carbide measuring faces.



Model	Range	List	Sale
54-815-001-2	0-1"/0-25mm	\$150.00	\$134.50
54-815-002-2	1-2"/25-50mm	160.00	149.50
54-815-003-2	2-3"/50-75mm	175.00	155.00

Fowler INDI-X INDICATING MICROMETER

- Fully insulated frame, and satin chrome finish.
- Wider Micro-Fine graduations.
- Carbide anvil & spindle.
- Retracting button conveniently located to operators hand.
- 0-1" Range, Head graduated in .001"
- Indicator graduated in .0001"
- Indicated accuracy of .00015"
- Diameter of spindle: .256"
- Includes case.



MODEL No.
52-245-106
Reg. \$315.00
\$279.95

Precise MICROMETER CALIBRATION SET

- 9 Pc. rectangular sets including two optical flats.
- Assists in meeting both Federal specification GGG-C-105c and ISO 9000 requirements.
- Contains one block of each of the following sizes: .0625, .100, .125, .200, .250, .300, .500, 1.000 & 2.000"
- TWO OPTICAL FLATS that vary in size by .0125" which allows checking anvil faces at half rotations of spindle for measuring flatness.
- Supplied with fitted wooden case and certification to NIST on each block.
- Grade 2 blocks within +8, -4.



SET No.
53-670-002
Reg. \$255.00
\$219.95

ST SCHEER TUMICO CHROME FULL FINISH MICROMETERS

This quality American made precision measuring instrument meets or exceeds government specifications GGG-C 105c for accuracy.

- Lock nut and ratchet stop standard.
- Carbide spindle & anvil faces standard.
- Drop forged steel frame designed for easy access into narrow spaces.
- Spindle hardened to Rc 62-64 with lead error held to .00005"
- Silver mist chrome finish frame and head.
- Black lines & numbers for easy reading.
- Supplied with plastic case.



Model	Range	Graduation	Faces	List	Sale
0901-14	0-1"	.0001"	Carbide	\$136.50	\$122.50
0902-14	1-2"	.0001"	Carbide	165.00	148.50

SCHEER TUMICO DEEP THROAT MICROMETERS

- Exclusive "Feathertouch" tubular steel frame on 3" & 6" models.
- 3/16" radius ground anvil.
- Spindle hardened to Rc. 62-64 with lead error held to within .00005"
- Lock nut and ratchet stop standard.
- Silver mist chrome finish head.
- Durable black wrinkle finish frame.
- Black lines & numbers for easy reading.
- Includes fitted wood case.



.001" Grad.				.001" Grad.			
Model	Range	Depth	Price	Model	Range	Depth	Price
08-2103	0-1"	3"	\$210.00	08-2203	1-2"	3"	\$350.00
08-2106	0-1"	6"	220.00	08-2206	1-2"	6"	410.00
08-2109	0-1"	9"	475.00	08-2209	1-2"	9"	665.00
08-2112	0-1"	12"	595.00	08-2212	1-2"	12"	790.00

CORREX TENSION/COMPRESSION GAGES

- The ideal instrument to measure, calibrate and standardize the pressure or power to actuate fine mechanisms and spring tensions of: Micro Switches and Relays, Electric Contacts, Business Machines, Communication Instruments, Precision Instruments & Gages, Controls with Adjustable Friction Torque, Automotive Parts etc. • Furnished in protective case.
- Measurements can be made in clockwise or counterclockwise directions.

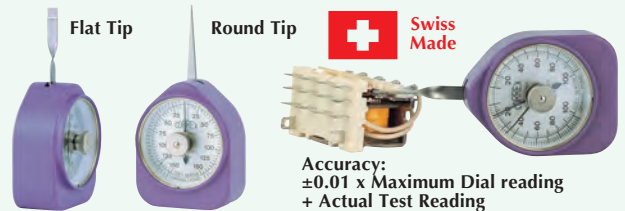

Accuracy:
±0.01 x Maximum Dial reading
+ Actual Test Reading

Feeler Length 1-1/4", Dial Diameter 1-1/2"

Model No.	Price Each	Model No.	Price Each	Grad. Grams	Range in Grams
31-001-1	\$246.70	31-016-9	\$246.70	1/10	.3-3
31-002-9	246.70	31-017-7	246.70	1/5	.6-6
31-003-7	258.45	31-018-5	258.45	1/2	2-15
31-004-5	258.45	31-019-3	258.45	1	3-30
31-005-2	258.45	31-020-1	258.45	1	5-50
31-006-0	258.45	31-021-9	258.45	2	10-100
31-007-8	260.80	31-022-7	260.80	5	15-150
31-008-6	260.80	31-023-5	260.80	5	25-250

ST INDUSTRIES, INC. SCREW THREAD MICROMETERS

SCHERR - TUMICO

- Screw Thread Micrometer spindle and anvil are designed to permit measurement of screw threads on pitch diameter. Meets or exceeds new J Series Thread Form and United States Standard or revised American Standard GGG-C-105c for accuracy
- Decimal equivalents stamped on frame
 - Checking standards available
 - Spindle hardened to Rc 62-64 with lead error held to .00005"
 - Silver mist chrome finish head & frame
 - Reading to .001"
 - Black lines & numbers for easy reading
 - Fitted wood case available
 - Supplied with plastic case
 - Lock nut and ratchet stop



MADE IN USA

0-1" Range x .001" Graduation			1-2" Range x .001" Graduation		
Model No.	Thread Range	Price Each	Model No.	Thread Range	Price Each
08-8053	8-13	\$225.00	08-8062	8-13	\$260.00
08-8054	14-20	225.00	08-8063	14-20	260.00
08-8055	22-30	225.00	08-8064	22-30	260.00
08-8056	32-40	225.00	08-8065	32-40	260.00
Thread Checking Standards					
01-8974	1" Standard	\$ 75.00	01-8284	2" Standard	\$ 79.00

Precise TUBING MICROMETER

- Dimensions between a hole and an edge of other shaped pieces can be measured with these micrometers
- Measures wall thickness of parts with cylindrical walls
- High contrast, clear LCD display on electronic model
- Direct RS232 output on electronic model
- Minimum Hole Size (dial): 0.19"



No. 4200-0350
0-1" Electronic (Shown)

Electronic				
Model	Range	Anvil Diameter	Graduation	Price
4200-0350	0-1"/0-25mm	.19"	.00005"/.001mm	\$149.95
Fowler Digital (Not Shown)				
52-011-011	0-1"	.19"	.0001"	\$64.95
52-011-012	1-2"	.19"	.0001"	75.00
Precise Mechanical (Not Shown)				
303-2351	0-1"	.19"	.0001"	\$39.95
303-2352	1-2"	.19"	.0001"	45.00

Precise SOLID FRAME MICROMETERS AND SETS

- Solid Mitutoyo style metal C-shape frame for all sizes.
- Graduation: 0.0001"
- Hardened and precision ground anvil spindle thread with microlap finish on ends.
- Carbide tipped faces.
- Positive locking clamp with ratchet stop.
- Meets or exceeds federal specifications.
- Supplied with fitted case and standards.



0-1" MODEL No. 4200-150 Reg. \$29.50
\$19.95

.0001" Grad. with Standards & Case

Model	Size	Price	Model	Size	Price
4200-150	0-1"	\$19.95	4200-157	6-7"	\$49.50
4200-152	1-2"	22.50	4200-158	7-8"	59.50
4200-153	2-3"	27.95	4200-159	8-9"	63.50
4200-154	3-4"	31.50	4200-160	9-10"	72.00
4200-155	4-5"	33.50	4200-161	10-11"	78.50
4200-156	5-6"	39.95	4200-162	11-12"	95.00
Micrometer Sets with Standards & Case					
4200-165	0-3"	.0001" Graduations			\$ 68.95
4200-164	0-4"	.0001" Graduations			99.95
4200-166	0-6"	.0001" Graduations			179.95
4200-167	6-12"	.0001" Graduations			350.00

ST INDUSTRIES, INC. TRI-FLUTE MICROMETERS

SCHERR - TUMICO

- Meets or exceeds government specification GGG-C-105c for accuracy.
- Reading to .0001" Carbide Faces.
- Spindle hardened to Rc 62 with lead error held to within .00005"
- Silver mist chrome finish head.
- Black lines & numbers for easy reading.
- Durable black wrinkle finish frame.
- Fitted wood case.

MADE IN USA

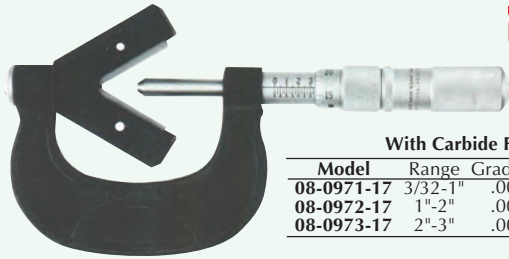

With Carbide Faces

Model	Range	Graduation	Price
08-0971-17	3/32-1"	.0001"	\$475.00
08-0972-17	1"-2"	.0001"	565.00
08-0973-17	2"-3"	.0001"	950.00

Precise HIGH PRECISION DIGITAL MICROMETER

Reads To .0001" Graduation on Digital Dial

- Digital dial read to .0001" graduation.
- Micro fine reading on spindle.
- Friction thimble stop and lock nut.
- Anvil and spindle hardened and precision ground, with micro lap finish and carbide tipped measuring faces. The spindle thread is hardened, ground and lapped.



0-1" Range MODEL No. PDM-001S Reg. \$59.95

\$49.95

With Fitted Case

Fowler ELECTRONIC MICROMETER HEAD

0-1"/0-25mm

- Protected to IP54 specifications
- True inch/metric conversion.
- Resolution: .00005"/.001mm
- Large LCD display.
- Friction thimble.
- Direct RS232 output.



0-1"/0-25mm MODEL No. 54-220-777 Reg. \$110.00

\$89.95

XTRA-VALUE

Mitutoyo LARGE OUTSIDE MICROMETERS

- Wide measuring range with extension anvil collars.
- 2" spindle stroke.
- With Ratchet Stop for constant force.
- Supplied with zero-setting standards bar for each range.
- Square and round pipes are combined for light weight and rigid frame (for models over 40" range).
- Workpiece stopper (for models over 40" range).
- Supplied in a fitted wooden case.



Extension Anvil Collar

Model No.	Range Inch	Extension Collar	List Price	Sale Price
105-428	40"-44"	2"	\$2750.00	\$2335.00
105-429	44"-48"	2"	2950.00	2500.00
105-430	48"-52"	2"	3170.00	2690.00
105-431	52"-56"	2"	3470.00	2945.00
105-432	56"-60"	2"	3780.00	3200.00
105-433	60"-64"	2"	4170.00	3540.00
105-434	64"-68"	2"	4540.00	3850.00
105-435	68"-72"	2"	4840.00	4100.00
105-436	72"-76"	2"	5020.00	4250.00
105-437	76"-80"	2"	5370.00	4550.00

Mitutoyo POINT MICROMETERS

- Pointed spindle and anvil for measuring the web thickness of drills, small grooves, keyways, and other hard to reach dimensions.
- 15 degree and 30 degree measuring points are available.
- The measuring points have approximately .012 radius.
- With Ratchet stop for constant force.



Model No.	Range Inch/Metric	Resolution Inch/Metric	Point Degrees	List Price	Sale Price
342-351	0-1"/0-25mm	.0005"/.001mm	15°	\$451.00	\$425.00
342-361	0-1"/0-25mm	.0005"/.001mm	30°	440.00	415.00
342-352	1"-2"/25-50mm	.0005"/.001mm	15°	\$502.00	\$475.00
342-362	1"-2"/25-50mm	.0005"/.001mm	30°	492.00	465.00
342-353	2"-3"/50-76mm	.0005"/.001mm	15°	\$524.00	\$495.00
342-363	2"-3"/50-76mm	.0005"/.001mm	30°	514.00	475.00
342-354	3"-4"/76-101mm	.0005"/.001mm	15°	\$547.00	\$515.00
342-364	3"-4"/76-101mm	.0005"/.001mm	30°	557.00	525.00

Mechanical Point Micrometers					
Model No.	Range	Resolution	Point Degrees	List Price	Sale Price
112-189	0-1"	.001"	15°	\$278.00	\$245.00
112-177*	0-1"	.001"	15°	219.00	195.00
112-237	0-1"	.001"	30°	224.00	195.00
112-225*	0-1"	.001"	30°	166.00	145.00
112-190	1"-2"	.001"	15°	\$299.00	\$265.00
112-178*	1"-2"	.001"	15°	262.00	230.00
112-238	1"-2"	.001"	30°	233.00	205.00
112-226*	1"-2"	.001"	30°	192.00	170.00
112-191	2"-3"	.001"	15°	\$246.00	\$215.00

*The Points do not have Carbide Steel Tips

Mitutoyo CRIMP HEIGHT MICROMETERS

Point Spindle and Blade Anvil

- IP54/65 water/dust protection.
- Measures the height of crimp contacts.
- With ratchet Stop for constant force.
- With SPC output.
- Accuracy: $\pm .00015"$, Mass (270g)
- Supplied in fitted plastic case.



Model	Range	Resolution	List Price	Sale Price
342-371	0-0.8"/0-20mm	.00005"/0.001mm	\$459.00	\$429.98

Mitutoyo NEW SURFTEST SJ-310 SURFACE ROUGHNESS TESTER

- Large 5.7" color LCD with touch screen improves operability and achieves high visibility.
- Conforms to the roughness standards JIS-B0601-2001, JIS-B0601-1994, JIS-B0601-1982, VDA, ISO-1997 and ANSI.
- Statistic measurements up to 3 parameters of 300 samples can be performed showing average, standard deviation, max, min, pass rate and histogram.
- Up to ten measurement conditions along with stored data can be displayed and printed out by the built-in thermal printer. It can also store up to 10 measurement conditions with the built-in memory.
- The SJ-310 supports a micro-SD card (optional) for storage of up to 10,000 measurement values, 500 measuring conditions, 1000 measuring data, 500 image (BMP) data, 500 statistic data or auto save up to the last 10 sets of measurement data.



Model No.	Detector w/unit	Drive Type	List Price	Sale Price
178-571-01	0.75mN	Standard	\$4070.00	\$3795.00
178-571-02*	4mN	Standard	4070.00	3795.00
178-573-01	0.75mN	R-Type	4870.00	4595.00
178-573-02	4mN	R-Type	4870.00	4595.00
178-575-01	0.75mN	S-Type	6870.00	6400.00
178-575-02	4mN	S-Type	6870.00	6400.00

* Standard Stock Item

Mitutoyo DISK MICROMETERS

- Diameter of measuring disk: .787"/20mm
- With ratchet stop for constant force.
- With a standard bar except for 0-1"/0-25mm model.
- With SPC output (Series 323)
- Supplied in fitted plastic case.



Rotating Spindle Type

Model	Range	Resolution	List Price	Sale Price
323-350	0-1"/0-25mm	.00005"/0.001mm	\$487.00	\$455.00
323-351	1"-2"/25-50mm	.00005"/0.001mm	546.00	505.00
323-352	2"-3"/50-76mm	.00005"/0.001mm	617.00	575.00
323-353	3"-4"/76-101mm	.00005"/0.001mm	653.00	595.00
123-125	0-1"	.001"	\$238.00	\$199.98
123-126	1"-2"	.001"	262.00	235.00
123-127	2"-3"	.001"	278.00	250.00
123-128	3"-4"	.001"	303.00	270.00

Non-Rotating Spindle Type

369-350	0-1"/0-25mm	.00005"/0.001mm	\$708.00	\$660.00
369-351	1"-2"/25-50mm	.00005"/0.001mm	754.00	715.00
369-352	2"-3"/50-76mm	.00005"/0.001mm	793.00	750.00
369-353	3"-4"/76-101mm	.00005"/0.001mm	832.00	780.00
169-203	0-1"	.001"	\$352.00	\$315.00
169-204	1"-2"	.001"	397.00	350.00
169-206	2"-3"	.001"	412.00	370.00
169-208	3"-4"	.001"	424.00	380.00

Mitutoyo UNI-MIKE

INTERCHANGEABLE ANVILS

- Measures tubing thickness, shoulder edge distance, rivet head height, etc. with interchangeable anvils (flat anvil, rod anvil) V-anvil (optional)
- With special Disk Anvils, the Uni-Mike is used as a height micrometer. The disks have a lapped, mirror surface.
- Supplied in fitted plastic case.

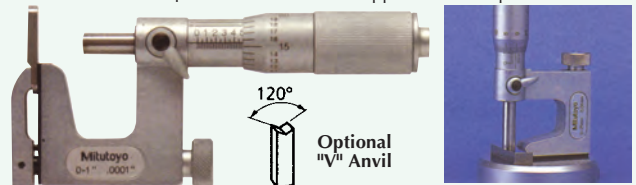

Model	Range	Graduation	List Price	Sale Price
117-107	0-1"	.0001"	\$203.00	\$169.95
117-108	1"-2"	.0001"	238.00	202.00
201218	Optional "V" Anvil		\$ 15.15	\$ 14.25
950758	Height Gage Disc for 1"		87.25	80.00

- The total measurement and sectional measurement results can be displayed as well as the evaluation curve, BAC/ADC curve. The display unit supports all three types of Standard, S-Drive and R-Drive units.
- USB, Digimatic SPC output, RS-232C and External Software connectivity is supported.
- Security is managed via a password lock to restrict function changes and unnecessary settings that could cause operation errors.
- 16 languages can be selected and are switchable.

Standard Detector

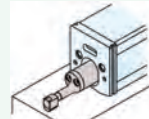

No. 178-296	0.75mN	\$435.00
No. 178-390	4mN	\$435.00

Gear-Tooth Detector



No. 178-388	0.75mN	\$1275.00
No. 178-398	4mN	\$1275.00

Small Hole Detector



No. 178-383	0.75mN	\$725.00
No. 178-392	4mN	\$650.00

Deep Groove Detector

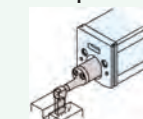

No. 178-385	0.75mN	\$695.00
No. 178-394	4mN	\$695.00

Extra Small Hole Detector

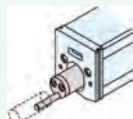

No. 178-384	0.75mN	\$740.00
No. 178-393	4mN	\$650.00

Detail Specifications For:
Detector, MiCat Software & Accessories
Visit Our Website

www.penntoolco.com

Mitutoyo LASER SCAN MICROMETER BENCH TOP

Features:
 Visible semiconductor laser.
 Wavelengths: 670nm
 Scanning speed: 8900"/s (226m/s)
 Fluorescent display 16-digit+11-digit, guidance LEDs
 Segment designation: 1 to 7 (1 to 3 for transparent)
 10 program storage (Prog. 0 to Prog. 9)
 255 edge designations can be detected
 Multi-limit GO/+NG tolerance judgment (up to 7 intervals)
 Dual-Axis LED display
 offset setting and mastering

Features:
 Reference value setting
 Automatic workpiece detection
 Dual-gage calibration
 Inch/mm conversion
 Abnormal data elimination
 Dual data measurement
 Statistical processing
 Workpiece position display
 Foot-switch connector

.02"-2.36" Range
 MODEL No.
 544-116-1A
 Reg. \$8720.00

\$7,995.00



Measuring Range: .02-2.36" (0.5-60mm)
 Measuring Area: .02 x 2.36" (5 x 60mm) (*1)
 Scanning rate: 1600/sec.
 Reading (Selectable) .000002-.005" (0.05-100µm)
 Repeatability (±0.6µm) (±2σ measuring rate: 0.32s)
 Accuracy: Linearity (*2) ±.0001" (±2.5µm)
 The optical axis direction ±.0001" (±2.5µm)
 The scanning direction ±(.00008+L/10000)" [L: inch] (*3) ±(2.0+L/100µm [L:mm] (*3)

Mitutoyo DIGIMATIC MICROMETER HEAD

- The display can be rotated up to 330° for easy reading in any position.



Model	Range	Accuracy	List	Sale
164-164	0-2"/0.50mm	±.00015"	\$897.00	\$795.00



Resolution .0005"/0.01mm

Model	Range	Spindle Face	IP65	Price
350-351-10	0-1"/0-25.4mm	Flat (carbide tip)	-	\$272.50
350-352-10	0-1"/0-25.4mm	Flat (carbide tip)	-	294.00
350-353-10	0-1"/0-25.4mm	Spherical (SR4)	-	283.50
350-354-10	0-1"/0-25.4mm	Spherical (SR4)	-	305.00
350-381-10	0-1"/0-25.4mm	Flat (carbide tip)	IP65	\$285.00
350-382-10	0-1"/0-25.4mm	Flat (carbide tip)	IP65	285.00
350-383-10	0-1"/0-25.4mm	Spherical (SR4)	IP65	285.00
350-384-10	0-1"/0-25.4mm	Spherical (SR4)	IP65	305.00
350-361-10*	0-1"/0-25.4mm	Flat	IP65	279.50

* with non-rotating device and 18mm stem bushing.
 05CZA662 SPC cable with data switch (1m/40°) \$
 05CZA663 SPC cable with data switch (2m/80°) \$

Mitutoyo LASER SCAN MICROMETERS 3,200 Scans Per Second

Mitutoyo's LSM-500S Series Laser Micrometers have the highest scanning speed in the world. A speed of 3,200 scans/sec makes in line measurements more accurate and repeatable. It's memory function has been increased to allow storage of up to 100 programs and includes a built in program to measure odd fluted drills and endmills.



Model	Range	Repeatability	Linearity	List	Sale
544-532*	.0002"- .08"/0.005~2mm	±0.03µm	±0.3µm	\$6,920.00	\$6,645.00
544-534*	.002"- .4"/0.05~10mm	±0.04µm	±0.5µm	5,900.00	5,595.00
544-536*	.012"- 1.18"/0.3~30mm	±0.11µm	±1.0µm	6,660.00	6,300.00
544-538*	.04"- 2.36"/1~60mm	±0.36µm	±3µm	8,000.00	7,500.00
544-540*	.04"- 4.72"/1~120mm	±0.85µm	±6µm	14,000.00	12,995.00
544-496A**	.004"- 1.0"/0.1~25mm	±0.05µm	±0.5µm	11,900.00	11,250.00
544-072A*	LSM-6200 Display Unit is required			\$3,415.00	\$2,995.00
544-072A**	LSM-6200 Unit is included				

PREISSER INTERNAL GROOVE BENCH GAGE

- High precision measuring probe slideways with constant measuring pressure.
- Adjustment of height using gage blocks and diameter using setting ring gages.
- Measuring table (Ground & Lapped): 4.33" x 2.87".
- System uses interchangeable measuring probes (purchase separately per application requirements).
- Mounting hole diameter: 8mm/h7.

MODEL No. 14820

\$1595.00

Shown with
 No. 18318 DIGI-MET®
 Electronic Indicator
 Add..\$450.00
 Less Measuring Probes



Model	Description	Price
14820	Preisser internal groove bench gage Less indicator and measuring probes	\$1595.00
18318	Digi-Met electronic indicator 0-1"/0-25mm range .00005"/0.001mm resolution Certificate of calibration traceable to N.I.S.T.	\$450.00

Measuring Probes (Pair) \$159.00

Model No.	Groove Height	Groove Width	Groove Recess Dia.	Inner Dia. Range
14821	0-.315"/8mm	.029"/.74mm	+2mm	.157-1.1"/4-28mm
14822	0-.394"/10mm	.039"/.1mm	+4mm	.256-1.18"/6.5-30mm
14823	0-.709"/18mm	.047"/1.2mm	+2mm	.511-1.5"/13-38mm
14824	0-.984"/25mm	.047"/1.2mm	+4mm	.807-2.0"/20.5-51mm

Mahr FEDERAL O.D. CALIPER GAGE

- The most widely used gages for checking medium tolerance dimensions on patterns, castings, forgings, dies, sheet metal.
- Generous clearance on jaws reaches over non-measured part protrusions for easy access to areas where thickness must meet critical dimensional specs.
- Retraction lever is conveniently located for one-hand operation.
- Continuous reading dials with revolution counters normally provided.
- Cylindrical radius steel contact tips normally furnished.



Model Inch	Model Metric	Capacity Inch/Metric	Gage Depth	Graduation Inch/Metric	Price Each
49P-17	49P-17M	0-2"/0-50mm	4"/100mm	.001"/0.02mm	\$795.00
49P-19	49P-19M	0-2"/0-50mm	8"/200mm	.001"/0.02mm	850.00

DIGITAL ELECTRONIC CALIPER, MICROMETER AND ADG INDICATOR SET

Precise DIGITAL ELECTRONIC SPC CALIPER 6", 8" & 12"

- Features:
- XTRA large LCD easy read display.
- Direct Inch/Metric conversion.
- On/Off and zero set buttons.
- Thumb roll for easy, smooth motion.

- Body is made of stainless steel and hardened.
- Measures 4-ways, inside, outside, step and depth.
- Supplied with 1.5V battery and fitted case.
- S P C output port.

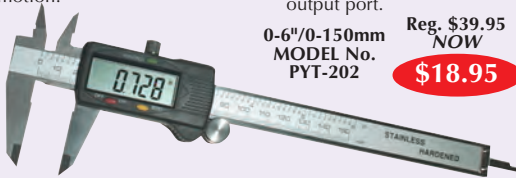

0-6"/0-150mm
MODEL No. PYT-202
Reg. \$39.95
NOW \$18.95

Model	Range	Resolution	Reg.	Sale
PYT-202	0-6"/0-150mm	.0005"/0.1mm	\$39.95	\$18.95
PYT-203	0-8"/0-200mm	.0005"/0.1mm	69.95	29.95
PYT-204	0-12"/0-300mm	.0005"/0.1mm	99.95	49.95



SAVE MORE
2 PIECE SET
SET No. DCM-100

0-6" Digital Caliper
+ 0-1" Digital Mic

\$74.95

Precise ELECTRONIC DIGITAL MICROMETER

- Functions: Abs/Inc, In/mm, On/Off, origin data set
- Chrome-plated frame, carbide measuring face.
- Resolution: 0.00005"/0.001mm.
- Range: 0-1"/0-25mm.



MODEL No. EDM-001-1
\$59.95

MODEL No. PDA-002
\$49.95
Range .500"/12.7mm
.0005" Resolution



SAVE MORE
3 PIECE SET
SET No. CMI-100

0-6" Digital Caliper
0-1" Digital Mic
0-5" Electronic Indicator

\$119.95

Precise SPECIAL APPLICATION MICROMETERS Precise

MULTI-ANVIL TYPE

The Uni-Mike has a vise-like special frame, which is designed to hold interchangeable anvils.

- Two interchangeable anvils - Flat Anvil and Rod Anvil are furnished.
- Measures hard-to-reach locations, such as from a hole or slot to an edge, small tube wall thickness, shoulder to an edge, etc.
- Carbide tipped spindle face.

0-1" Range
.0001" Grad.



MODEL No. MAM-107
Imported
\$79.95

Mitutoyo
MODEL No. 117-107
Reg. \$203.00
\$169.95

DISC-TYPE MICROMETERS

- Measuring discs are hardened, ground and micro-lapped for greater accuracy.
- Disc flatness: .0004".
- Extra-large disc, 787" in diameter, with .030" edge thickness to enter narrow recess.
- Supplied with fitted carrying.



0-1"
Disc Mic
MODEL No. DCM-001
\$64.95

Mitutoyo
MODEL No. 123-125
Reg. \$238.00
\$199.95

Model	Range	Grad.	Sale
DCM-001	0-1"	.0001"	\$49.95
DCM-002	1-2"	.0001"	59.95
DCM-003	2-3"	.0001"	65.00
DCM-004	3-4"	.0001"	85.00

POINT-MICROMETERS

For measurement of small grooves, keyways of small grooves, keyways and other hard-to-reach dimensions. The measuring points have approximately .012" radius.



0-1"
MODEL No. PTM-001
\$49.95

Model	Range	Grad.	Sale
PTM-001	0-1"	.001"	\$49.95
PTM-002	1-2"	.001"	59.95
PTM-003	2-3"	.001"	65.00

BLADE MICROMETER

- Spindle and anvil are hardened, ground and lapped.
- Non-rotating spindle.
- Parts where graduations appear are of hard chrome plate, no-glare satin finish.
- Includes fitted case.



MODEL No. BLM-001
\$79.95

0-1"
Mitutoyo
MODEL No. 122-125
Reg. \$294.00
\$249.95

Model	Range	Grad.	Sale Price
BLM-001	0-1"	.0001"	\$79.95
BLM-002	1-2"	.0001"	84.95
Mitutoyo			
122-125	0-1"	.0001"	\$249.95
122-126	1-2"	.0001"	259.95



MARCAL UNIVERSAL CALIPER KIT

- The 16 EWW can also be used as a standard caliper (4 types of measurement)
- When used in conjunction with standard accessories; it is possible to measure recesses, grooves, etc.
- In conjunction with the additional accessories; threads, bores, serrations, etc. can be measured.

REFERENCE

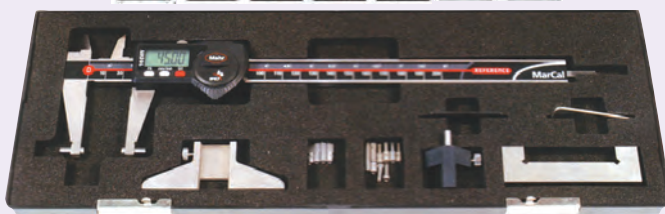

Model	Range/Resolution	List	Sale
4118807	8"/200mm .0005"/0.01mm	\$567.00	\$525.00
4102520	Battery 3V, Type CR2032		12.50
4102357	Data Connection Cable USB (2m)		136.00
4102410	Data Connection Cable Opto RS232C w/SUB-D jack 9-pin		80.00
4102411	Data Connection Cable Digimatic (2m) Flat Plug 10-pin		84.50

Precise LEATHER HOLSTER

For 6" Calipers & 0-1" Micrometers

- Any on-the-go machinist or quality Control Inspector will certainly agree that the difficulties incurred in keeping expensive micrometers and calipers both easily accessible and well protected when in use is a major concern.
- Given the ever increasing replacement costs of top-quality inspection caliper measuring tools, the investment with the protection they warrant is certainly a worthwhile investment that will be instantly recognized.

MICROMETER & DIAL CALIPER
Holster without Dial Caliper & Micrometer
MODEL No. MCH-100
\$19.95

Holster with 0-6" Dial Caliper & 0-1" Micrometer
MODEL No. MCH-101
\$49.95



0-1"
MICROMETER ONLY
Holster without Micrometer
MODEL No. MCH-200
\$14.95

Holster with 0-1" Micrometer
MODEL No. MCH-201
\$24.95

Dial Caliper Supplied Is No. SPT-006
Micrometer Supplied Is No. 26-081

Mahr
FEDERAL

DIGITAL ELECTRONIC CALIPERS WITH THUMB ROLL

- Housing and operating buttons are made from Ultradur which has an excellent chemical resistance.
- Lapped guide ways allows smooth and even movement.
- With Flat Depth Rod.
- Excellent protection against Water, Oil and Dust. **IP-67**
- Reference-lock-function secures zero position and prevents operating error.
- Housing and operating buttons are made the chemical resistant material Ultradur.

REFERENCE



Model	Range	Graduation	List	Sale
4103061*	6" x 150mm	.0005"/0.01mm	\$179.00	\$159.95
4103067**	6" x 150mm	.0005"/0.01mm	228.00	205.00
4103069**	8" x 200mm	.0005"/0.01mm	289.00	255.00
4103071**	12" x 300mm	.0005"/0.01mm	420.00	375.00

Note: *Equipped with Data-Lock, DIN862 & IP67, ** Has Everything

Mahr
FEDERAL

DIGITAL ELECTRONIC CALIPERS

Only MarCal have **lapped guide way surfaces**, these guarantee an even and sensitive run of the slide. Additionally, the service life of the caliper increases compared to a ground guide way due to the greater contact area on the guideway surface.

- On/Off, Reset (Set display to zero), mm/inch, Reference-Lock/Unlock, Auto-On/Off.
- MarConnect data output, choose alternatively: USB, OPTP RS232C or Digimatic.
- Immediate measurement due to the **Reference system**.
- Life of the battery up to **3 years**.
- High contrast Liquid Crystal Display with 8.5mm high digits.
- Beam and crossbeam are made of hardened stainless steel.

REFERENCE



Model	Range	Graduation	Depth Rod	List	Sale
4103002**	6"/150mm	.0005"/0.01mm	Round	\$155.00	\$139.50
4103003**	6"/150mm	.0005"/0.01mm	Flat	155.00	139.50
4103004**	8"/200mm	.0005"/0.01mm	Flat	210.00	189.00
4103005**	12"/300mm	.0005"/0.01mm	-	330.00	247.50
4103060***	6"/150mm	.0005"/0.01mm	Round	\$179.00	\$159.95
4103062***	6"/150mm	.0005"/0.01mm	Flat	179.00	159.95
4103064****	6"/150mm	.0005"/0.01mm	Round	225.00	202.50
4103066****	6"/150mm	.0005"/0.01mm	Flat	225.00	202.50
4103069****	8"/200mm	.0005"/0.01mm	Flat	276.00	245.00

Plus MahrConnect & Wireless Transmission, *Plus IP67, **** Has Everything

Mahr
FEDERAL

DIGITAL MICROMETERS REFERENCE SYSTEM



- Zero setting, ABS (switching between relative and absolute measurement) inch/mm.
- Preset (enter a numerical value).
- Data (Data transmission via connection cable).
- Capacitive measuring system, life of battery: approx. 2 years.
- Data output: Opto RS232C or alternatively Digimatic.
- High contrast LCD with 7.5mm high digits.
- Lacquered steel frame, heat insulated.
- Spindle and anvil are carbide tipped.
- Spindle is made of stainless steel, hardened throughout and ground.
- Ratchet is integrated in the thimble.



0-1"/0-25mm Reg. \$295.00
MODEL No. 4151721 **\$255.00**

Error Limit 2µm - Spindle Thread 0.635mm

Model	Range	Resolution	SPC Output	List	Sale
4151721	0-1"/0-25mm	.00005"/0.001mm	No	\$287.00	\$255.00
4151705	0-1"/0-25mm	.00005"/0.001mm	Yes	335.00	295.00
4151706	1-2"/25-50mm	.00005"/0.001mm	Yes	361.00	225.00
4151707	2-3"/50-75mm	.00005"/0.001mm	Yes	593.00	530.00
4151708	3-4"/75-100mm	.00005"/0.001mm	Yes	603.00	540.00
4102357	Data Connecting Cable USB (2mm)	-	-	-	\$125.00
4102410	Data Connecting Cable Opto RS232	-	-	-	75.00

LONG RANGE STYLE

Mahr
FEDERAL

REFERENCE



Model	Range	Graduation	List	Sale
4112705	12"/300mm	.0005"/0.01mm	\$ 650.00	\$ 595.00
4112713	20"/500mm	.0005"/0.01mm	1190.00	1095.00
4112715	30"/750mm	.0005"/0.01mm	1650.00	1495.00
4112717	40"/1000mm	.0005"/0.01mm	2100.00	1850.00

AVENGER

TITANIUM NITRIDE COATED 6" DIAL CALIPER

- Superior wear and corrosion resistance with smooth movement.
- 6" precision caliper with .001" graduations, .100 per revolution.
- Titanium nitride coating provides superior wear and corrosion resistance.
- Caliper is manufactured to close tolerances for excellent repeatability and accuracy.
- Swiss design metal casing.
- Smooth movement.
- Measures inside, outside, depth and step measurements.
- Covered rack.
- Depth bar.
- Jaw faces and head are ground after coating to provide the closest accuracy.
- Shock proof design.

With Plastic Fitted Case MODEL No. CDT-600 **\$38.95**

As Shown With Solid Mahogany Case MODEL No. CDT-600-1 **\$52.95**



Precise DUAL DIAL CALIPERS INCH/METRIC COMBINATION

- Range: 0-6" and 0-150mm.
- 0-8" and 0-200mm.
- 0-12" and 0-300mm.
- .100" per revolution.
- Accuracy ±.001" in six inches.
- Hardened stainless steel, satin chrome finish.
- Measuring faces hardened, ground and lapped.
- Comes with fitted case.



0-6"/0-150MM MODEL No. INC-006 REG. \$37.50 **\$29.95**

Model	Description	Reg.	Sale
INC-006	0-6"/0-150mm Dual Cal	\$37.50	\$29.95
INC-008	0-8"/0-200mm Dual Cal	52.50	39.95
INC-012	0-12"/0-300mm Dual Cal	77.50	54.95

Mahr
FEDERAL

MICROMETERS, OUTSIDE DISC And BLADE TYPE

- Chromium plated steel frame.
- Spindle and anvil made of hardened steel with carbide tipped measuring faces.
- Rapid drive with integrated ratchet.
- Span of error is .00016" and the pitch of spindle threads .025
- Operating and scale parts with satin chromium finish.
- Locking device.
- Heat insulators.
- Includes: case, setting standard (starting with measuring range 1-2") operating instructions.



0-1" MODEL No. 134-900 Reg. \$81.00 **\$64.95**

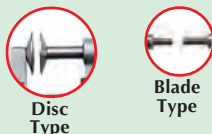

Disc Type

Blade Type

Model No.	Range Inch	Reading Inch	Type	Reg. Price	Sale Price
134-900	0-1"	.0001"	Outside	\$ 81.00	\$ 69.95
134-901	1-2"	.0001"	Outside	125.00	110.00
134-902	2-3"	.0001"	Outside	125.00	110.00
134-903	3-4"	.0001"	Outside	138.00	118.00
134-904	4-5"	.0001"	Outside	174.00	149.00
134-905	5-6"	.0001"	Outside	192.00	164.00
134-950	0-1"	.0001"	Disc	\$303.00	\$270.00
134-930	0-1"	.0001"	Blade	262.00	235.00
134-931	1-2"	.0001"	Blade	273.00	245.00



STANDARD GAGE BY HEXAGON METROLOGY ELECTRONIC CALIPERS

- Stainless steel beam and slider.
- Thumbwheel for rapid setting.
- Direct metric/inch conversion.
- Resolution .0005"/0.01mm
- Large LC display.
- Supplied in a Fitted case.

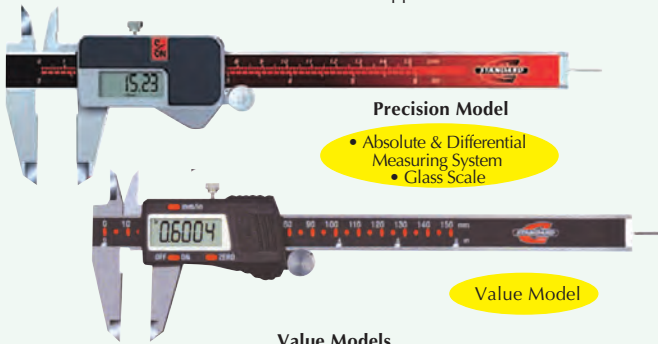

Precision Model

- Absolute & Differential Measuring System
- Glass Scale

Value Model

Value Models

Model No.	Range Inch/Metric	Resolution Inch/Metric	Accuracy Inch/Metric	List Price	Sale Price
00534020	0-6"/0-150mm	.0005"/.01mm	.001"/.02mm	\$ 66.00	\$ 45.95
00534021	0-8"/0-200mm	.0005"/.01mm	.0015"/.04mm	73.00	50.95
00534022	0-12"/0-300mm	.0005"/.01mm	.0015"/.04mm	118.00	81.95
Precision Models with Inspection Report					
00534003	0-6"/0-150mm	.0005"/.01mm	.001"/.02mm	\$118.00	\$ 81.95
00534004	0-8"/0-200mm	.0005"/.01mm	.0015"/.04mm	156.00	108.95
00534005	0-12"/0-300mm	.0005"/.01mm	.0015"/.04mm	194.00	134.95
00564001	Depth Measuring Base 3" for 6" Models Only			\$24.00	\$ 17.95



STANDARD GAGE BY HEXAGON METROLOGY ELECTRONIC DEPTH CALIPER

- Stainless steel.
- Direct metric/inch conversion.
- Resolution 0,01 mm / .0005 in.
- Large LC display.
- Supplied in a suited case with inspection report.

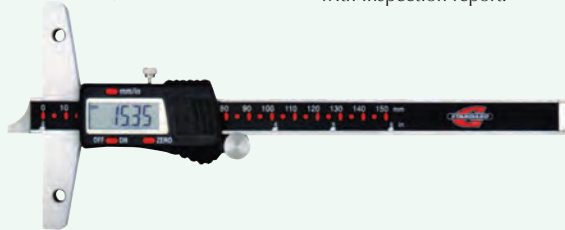

Model No.	Range Inch/Metric	Reading Graduation	Base Length	List Price	Sale Price
00534101	0-6"/0-150mm	0005"/0.01mm	4"	\$ 58.00	\$ 39.95
00534102	0-8"/0-200mm	0005"/0.01mm	4"	62.00	43.95
00534103	0-12"/0-300mm	0005"/0.01mm	6"	103.00	71.95
00534104	0-20"/0-500mm	0005"/0.01mm	6"	167.00	126.95

Removable Bridge Extension

00564002	Optional Bridge, size 7.2"	\$ 32.00	\$ 22.95
00564003	Optional Bridge, size 10.4"	45.00	32.95
00564004	Optional Bridge, size 12.8"	55.00	38.95



STANDARD GAGE BY HEXAGON METROLOGY ELECTRONIC MICROMETERS

- Protection level IP54
- Absolute measurement
- Carbide-tipped measuring faces with .25" dia.
- Digital resolution to .0001"
- Sizes over 1" include a setting standard
- Ratchet friction thimble and locking nut
- Inch/Metric conversion
- Origin data set
- Battery included
- Auto power off
- Delivered in a plastic case with inspection report



IP54

Model	Range	Accuracy	List	Sale
00134021	0-1"/0-25mm	.00016"	\$133.00	\$ 95.95
00134022	1-2"/25-50mm	.00016"	164.00	116.95
00134023	2-3"/50-75mm	.00020"	180.00	126.00
00134024	3-4"/75-100mm	.00020"	199.00	137.00
Electronic Micrometer Sets				
00134045	0-3"/0-75mm	3 Piece Set	\$471.00	\$338.95
00134046	0-4"/0-100mm	4 Piece Set	671.00	476.95



STANDARD GAGE BY HEXAGON METROLOGY DIGITAL MICROMETERS

- High resolution mechanical digit counter for quick and error-free reading.
- Carbide-tipped measuring faces with .25" dia.
- Counter resolution to .0001"
- Micrometer head resolution to .0001"
- Sizes over 1" include a setting standard
- Ratchet friction thimble and locking nut
- Delivered in a plastic case with inspection report



.001" Counter Resolution

Model	Range	Accuracy	List	Sale
00124024	0-1"	.00016"	\$ 85.00	\$ 55.95
00124025	1"-2"	.00016"	87.00	59.95
00124026	2"-3"	.00020"	99.00	65.95
00124027	3"-4"	.00020"	109.00	71.95
Digital Micrometer Sets				
00124028	0-3"	3 Piece Set	\$268.00	\$176.95
00124029	0-4"	4 Piece Set	377.00	248.95



STANDARD GAGE BY HEXAGON METROLOGY CHROME FRAME MICROMETERS

- Black decimal equivalents on satin chrome finished forged steel frame
- Carbide-tipped measuring faces with a .25" dia.
- Graduations to .0001"
- Sizes over 1" include a setting standard
- Ratchet friction thimble and locking nut
- Delivered in a plastic case with inspection report

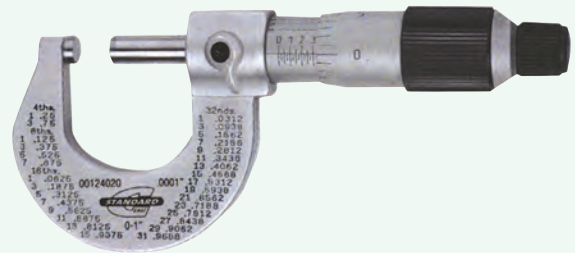

.0001" Graduation

Model	Range	Accuracy	List	Sale
00124020	0-1"	0.0001"	\$55.00	\$40.95
00124021	1-2"	0.0001"	65.00	48.95
00124022	2-3"	0.0001"	77.00	56.95



STANDARD GAGE BY HEXAGON METROLOGY VERNIER DEPTH MICROMETERS

- High accuracy interchangeable depth rods (.176" dia.) adjusted in increments of 1"
- No need for resetting when changing rods
- Hardened base surface, ground and lapped
- Resolution to .001"
- Ratchet friction thimble and locking nut
- Delivered in a plastic case with inspection report



Model	Range	Base	Rods	List	Sale
00224001	0-4"	2.5"	4	\$ 96.00	\$70.95
00224002	0-6"	2.5"	4	115.00	84.95
00224003	0-4"	4"	6	106.00	74.95
00224004	0-6"	4"	6	124.00	91.95



STANDARD GAGE BY HEXAGON METROLOGY DIAL TEST INDICATORS

- Small and large dial diameters
- Resolution to 0.001, 0.0001 or 0.0005"
- Carbide contact point
- Supplied in a case made of industrial plastic with inspection report



Model No.	Graduation	Dial Range	Dial Diameter	Dial Color	Sale Each
01824001	0.001"	0.03"	1.26"	White	\$65.00
01824002	0.001"	0.03"	1.26"	Black	65.00
01824003	0.0005"	0.03"	1.26"	White	74.00
01824004	0.0005"	0.03"	1.26"	Black	74.00
01824005	0.0005"	0.03"	1.54"	White	74.00
01824006	0.0005"	0.03"	1.54"	Black	74.00
01824011	0.0001"	0.008"	1.26"	White	\$85.00
01824012	0.0001"	0.008"	1.26"	Black	85.00
01824013	0.0001"	0.008"	1.54"	White	85.00
01824014	0.0001"	0.008"	1.54"	Black	85.00



STANDARD GAGE BY HEXAGON METROLOGY ELECTRONIC INDICATORS 0.0005"/0.01mm Graduations

- 8mm diameter shank
- LCD display, 10.5mm digit height
- PRESET function
- Metric/Inch conversion
- ON/OFF function

- ABS/DIFF modes
- CR2032 battery type
- Supplied in a case made of industrial plastic with inspection report



No. 01434001

No. 01434002

No. 01434003

Model No.	Measuring Range	Graduation	List Price	Sale Price
01434001	0.5"/12.5mm	0.0005"	\$106.00	\$ 67.95
01434002	0.8"/0.250mm	0.0005"	142.00	78.95
01434003	0.5"/12.5mm	0.00005"	144.00	101.95
01434004	1.0"/25mm	0.00005"	174.00	120.95



STANDARD GAGE BY HEXAGON METROLOGY VALUE MICROMETERS

- Carbide-tipped measuring faces with .25" dia.
- Graduations to .0001"
- Sizes over 1" include a setting standard
- Ratchet friction thimble and locking nut
- Delivered in a plastic case with inspection report



Model	Range	Graduation	List	Sale
00124010	0-1"	.0001"	\$36.00	\$24.95
00124011	1-2"	.0001"	42.00	29.95
00124012	2-3"	.0001"	47.00	30.95
00124013	3-4"	.0001"	52.00	34.95
00124014	4-5"	.0001"	56.00	38.95
00124015	5-6"	.0001"	64.00	43.95
00124016	6-7"	.0001"	75.00	51.95
00124017	7-8"	.0001"	85.00	57.95
Value Micrometer Sets				
00124040	0-3"	.0001"	\$120.00	\$ 81.95
00124041	0-4"	.0001"	165.00	113.93



STANDARD GAGE BY HEXAGON METROLOGY DIAL INDICATORS AGD2

- Travel to 1"
- Continous reading 0-.100"
- AGD2 -2-1/4" dial diameter
- Revolution counter
- Carbide points
- Tolerance markers
- Measurement report included
- Supplied in durable plastic case



No. 01424011

No. 01424010

No. 01424012

Model	Range	Graduation	Travel	Dial Face	Sale
01424010	1.00"	.001"	.100"	White	\$27.95
01424011	1.00"	.001"	.100"	Black	27.95
01424012	.500"	.0005"	.100"	White Shockproof	38.95



STANDARD GAGE BY HEXAGON METROLOGY CALIPER AND MICROMETER SETS



Micrometer and Caliper Set

- 0-1" Chrome Frame Micrometer: .0001" Reading
- Shockproof 0-6" Black Face Dial Caliper with Thumbwheel
- Depth Measuring base for Dial Caliper .2" Steel Ball diameter. Used for measuring tube thickness

MODEL No. 00524102
List \$150.00 **\$112.95**



Electronic Toolset

- 0-1" IP54 Digital Micrometer
- 0-6" Digital Caliper with Precision Glass Scale
- Caliper Resolution: .00005"
- Absolute Measuring System
- Includes Depth Base Attachment for Digital Caliper
- Fitted Plastic Case

MODEL No. 00524105
List \$229.00 **\$161.95**



STANDARD GAGE BY HEXAGON METROLOGY SHOCKPROOF DIAL CALIPERS

- 4-way measuring: outside, inside, depth and step
- Stainless steel construction
- Silky smooth movement throughout the entire range
- .100" reading dial face
- Inspection report included
- Supplied in a shop-hardened case

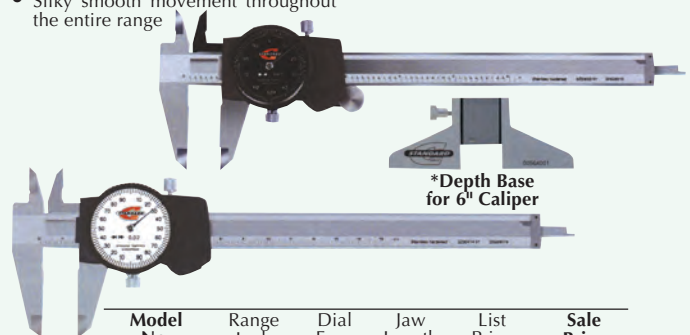

*Depth Base for 6" Caliper

Model No.	Range Inch	Dial Face	Jaw Length	List Price	Sale Price
00524010	0-6"	Black	1.6"	\$ 73.00	\$49.95
00524011	0-6"	White	1.6"	73.00	49.95
00524012	0-8"	White	2"	90.00	65.95
00524013	0-12"	White	2.5"	121.00	91.95
00564001*	3" Wide Depth Base Attachment				\$17.95

*For 6" Dial Caliper Only

Precise ELECTRONIC INSPECTION 2 Pc. TOOL KIT

- | | |
|--|--|
| <p>0-1"/0.25mm Electronic Micrometer</p> <ul style="list-style-type: none"> • Extra large high contrast LCD display. • Spindle lock. • Carbide-tipped measuring faces. • Graduation: .00005"/.001mm • 3-key model: Inch/Metric On/Off & Zero • Ratchet stop for a constant measuring force. | <p>0-6"/0-150mm Electronic Caliper</p> <ul style="list-style-type: none"> • Auto power On/Off or manual On/Off. • 3-key model: Inch/Metric On/Off & Zero. • Body is hardened stainless steel. • Switchable Inch/metric, with resolution of .0005"/.01mm on high contrast LCD display. • 4-way measurements: outside, inside, depth & step. |
|--|--|



KIT No. ETK-950 **\$89.95**

brown & sharpe WORLD CLASS ELECTRONIC TOOL KIT

- Equipped with a new, patented electronic measuring system which provides absolute and differential modes.
 - Fitted molded case.
 - Automatic shut-off extends battery life to 2 years (2000 hours per year) with one lithium battery.
 - Display Digits enlarged to 1/4" high for easier reading.
 - Meets or exceeds applicable Federal and DIN standards.
- Features of the Brown & Sharpe Digit-Cal Caliper: No. 00590090**
- Frame constructed from hardened and ground stainless steel.
 - Measures outside, inside, depth and steps.
 - Range: 0-6"/0-150mm • Resolution: .0005"/0.01mm
- Features of the Micromaster mm2000 Micrometer:**
- Tungsten carbide anvil and spindle measuring face.
 - Spindle lock.
 - Webbed thimble with slip friction drive.
 - Range: 0-1.2"/0-30mm. • Resolution: .00005"/1µm

SET No. 599-5712
List \$465.00

\$385.00



With Special Designed Fitted Case As Shown

Precise INTERCHANGEABLE ANVIL THREAD MICROMETER

- 60° V-anvils, hardened and ground.
- Adjustable anvil for zero setting.
- Ratchet stop.

MODEL No. TMI-001
64-7 TPI
0-1" Range
Reg. List \$119.90
NOW

\$89.95

Complete Set

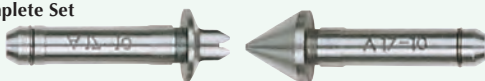

Model No.	Range Inch	Threads Per Inch	List Price	Sale Price
TMI-001	0-1"	64-5	\$119.90	\$89.95
TMI-002	1"-2"	44-3.5	132.90	110.00
TMI-003	2"-3"	24-3.5	137.90	125.00
TMI-004	3"-4"	24-3.5	149.90	135.00
TMI-005	4"-5"	13-3.5	169.90	150.00
TMI-006	5"-6"	13-3.5	192.09	170.00

Mitutoyo DIGIMATIC ELECTRONIC MICROMETER-&-CALIPER KIT



This new tool set gives you Mitutoyo's latest and most advanced 1" Digimatic Micrometer (293-831) and 6" Digimatic Caliper (500-196) in a handsome solid mahogany fitted carrying case. These state of the art instruments provide the most accurate and efficient means to measure small and medium sized parts by hand.

- New Features**
- 1) 2 Year Battery life
 - 2) Larger LCD display
 - 3) New built-in "hold" button



MODEL No. 950-940
REG. LIST \$302.00
SPECIAL

\$239.95

with solid mahogany case (Shown)

MODEL No. DEK-940
REG. LIST \$282.00
SPECIAL

\$219.95

without mahogany case

brown & sharpe WORLD CLASS MICROMETER & SHOP-CAL DIGITAL CALIPER TOOL KIT



Set Contains:
Electronic Caliper
0-6"/0-150mm B&S/Tesa
.0005"/0.1mm Resolution

SET No. 599-085
Reg. List \$325.00

\$239.95

0-1" Classic Master Micrometer .0001" Grad.
Carbide Face, Friction Thimble,
6" B&S Chrome 4R Graduation
Scale & Shop Hard Fitted Case

Precise EVERYTHING UNIVERSAL ANVIL ELECTRONIC MICROMETER

The new Everything Universal Anvil Micrometer accepts 7 pairs of individual anvils making it possible to gage a variety of dimensions unachievable with a single micrometer.



0-1" Range
SET No. UAV-001
\$179.95

1-2" Range
SET No. UAV-002
\$189.95

- Resolution 0.00005" (0.001mm)
- Non-rotating spindle
- Direct inch metric conversion
- ABS/INC measuring mode
- Tolerance and preset function
- Comes complete with 7 anvil sets
- Satin chrome finish
- Includes fitted wood case

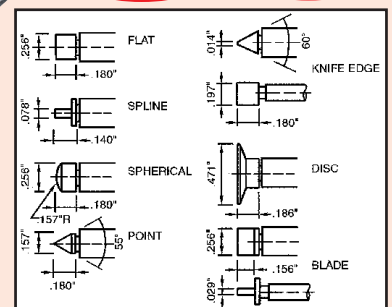



TOOLMAKERS UNIVERSAL MEASURING SET

- 6" Dial Caliper 52-008-007
- 0-1" Micrometer 52-229-201
- 6" Flexible rule 52-300-006
- All contained in a fitted, shop-hardened case.



SET No.
52-095-007
Reg. \$138.60

\$89.95



BASIC DEPTH GAGE AND POLY-CAL® KIT

- Poly-Cal:**
- Range 6"/150mm
 - Polycarbonate Frame.
 - Resolution: .0005"/.01mm, fractions by 1/64 increments.

- Xtra-Value Depth Gage:**
- Spring loaded with a hold measurement button for ease-of-use.
 - Super large display.
 - Travel: 0-1"/25mm
 - Application range: 0-22"/550mm
 - Resolution: .0005"/.01mm, fractions by 1/64 increments.
 - Supplied in shop-hardened case.

INCH • METRIC • FRACTION

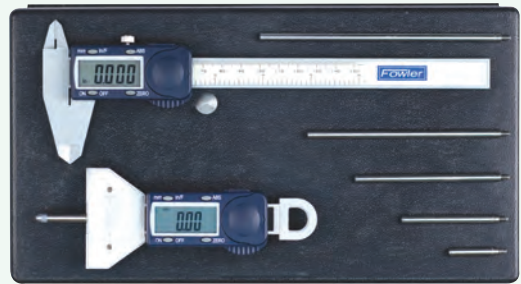

SET No.
54-004-255
Reg. \$90.00

\$79.95



ELECTRONIC CALIPER & EZ READ MIC MEASURING SET

- 6" Electronic Caliper 54-100-000-1
- EZ Read Digit Counter Micrometer 52-222-201, Accuracy: .0001", Friction Thimble.
- All contained in a fitted, shop-hardened case.



SET No.
54-004-201
Reg. \$154.00

\$138.50



BLACKFACE MEASURING SET

- Blackface indicator 52-562-778.
- 0-1" Outside Micrometer 52-229-201.
- 6" shockproof Dial Caliper with thumbroll 52-008-707
- All contained in a fitted, shop-hardened case.



ELECTRONIC CALIPER & ELECTRONIC MIC SET

- 6"/150mm Electronic Caliper 54-100-000-1
- 0-1"/25mm Electronic Micrometer 54-870-001
- Complete with shop-hardened case.



SET No.
54-004-850
Reg. \$189.00

\$169.95



POCKET ELECTRONIC LEVEL/INCLINATOR

- Aluminum base with built-in magnet.
- Display of angle in degrees and in %
- Hold function - Precision: ±0.2°
- 2 x CR2032 batteries.

Specifications:
Measuring Range 4 x 90°
Reading 0.1°
Length 4"



MODEL No.
00534010
List \$46.00

\$33.95



CHROME FLEX MAG SET

With **INDI-X Blue** Electronic Indicator or **AGD Black Face Indicator**

Indi-X Blue Indicator features:

- Direct Inch/Metric Conversion
- 1"/25mm travel
- Auto Off feature
- 2-1/4" dial face
- Lugback and 3/8" stem mountings
- Resolution .0005"/.01mm
- Tolerance indicators
- Absolute/incremental reading
- Floating zero
- Carbide tipped point



Flex Arm Mag Base features:

- Corrosion resistant chrome plated flex arm
- 85 lb. pull magnet
- Holds rigidly in almost any position.
- V- base for mounting on rounded surfaces.

Magnetic Indicator Back features:

- Use for positioning the indicator on most metal surfaces.
- Protective coating



Included Magnetic Indicator Back for mounting to most metal surfaces!

- AGD Indicator features:**
- AGD Group 2
 - Dial diameter: 2-1/4"
 - Travel: 1"
 - Reading: .001"
 - Continuous reading: .100"
 - Carbide tipped point

Model	Description	List	Sale
54-585-100	Chrome Flex Mag and Indi-X Blue Electronic Indicator Set	\$231.00	\$195.00
52-585-500	Chrome Flex Mag and AGD Black Face Indicator Set	150.00	129.95

Mitutoyo ABSOLUTE ID-S TYPE DIGIMATIC ELECTRONIC INDICATORS WITH NEW ABSOLUTE LINEAR ENCODER

MODEL NO. 543-683 **\$159.95**
Reg. List \$173.00

- After the initial ZERO setting with the origin switch, zero-setting is no longer necessary over the entire battery life.
- It indicates the absolute position of the spindle from the reference at power-on, ready to start measurement.
- Measurement error due to spindle over-speed is eliminated with the ABSOLUTE encoder.
- Large LCD (8.5mm character height) and simple key operation.



RESOLUTION .0005"/0.01MM

Model	Range	Mounting	Price
543-683	.5"/12.7mm	Lug Back	\$159.95
543-683B	.5"/12.7mm	Flat Back	159.95
905338	SPC Connecting Cable (1m)		\$35.00
905409	SPC Connecting Cable (2m)		42.00

ABSOLUTE™
Absolute System Patented by MITUTOYO

Mitutoyo DIGIMATIC INDICATOR .0001"/.00005"/0.001mm High Resolution - Low Price

- Functions: Origin-Set, power on/off, ± Counting directions, Inch/mm conversion (inch/mm model only), SPC data output.
- Battery: SR44 (1 pc.) (938882).
- Battery life: Approx. 20,000 hours in continuous use.
- Quantizing error: ±1 count.
- Alarm: Low battery voltage, scale contamination.

- Plus New Features:**
- The ability to attach the lifting lever to both the right and left side to improve the spindle lifting operation.
 - Larger buttons for easier operation.
 - Larger display with 9mm character height.

ABSOLUTE™
Set 'N Forget TECHNOLOGY



MODEL No. 543-793
Reg. List \$266.00
\$249.95

ABSOLUTE™
Absolute System Patented by MITUTOYO

Range .5"/12.7mm

Model No. Back/w lug	Model No. Flat back	Resolution Inch/Metric	Measuring Force	Price Each
543-793	543-793B	.0001"/0.001mm	1.5N or less	\$249.95
543-792	543-792B	.00005"/0.001mm	1.5N or less	249.95
543-796	543-796B	.00005"/0.001mm	2.5N or less	249.95

SPC Output Cable; #905338 (40") \$35.00 #905409 (80") \$42.00

Mitutoyo DIGIMATIC INDICATOR ID-C For Inside & Bore Gage Measurement

- The minimum value holding function provides the easy detection of hole diameter.
- An analog bar indicator is integrated to enhance the intuition in reading.
- GO/±NG judgement is performed by setting the upper/lower tolerances.
- Up to three sets of master value and upper/lower tolerance value can be memorized.
- Employing the ABSOLUTE linear encoder, the Signal ID-C always displays the spindle "Absolute Position" from the origin at power-on.

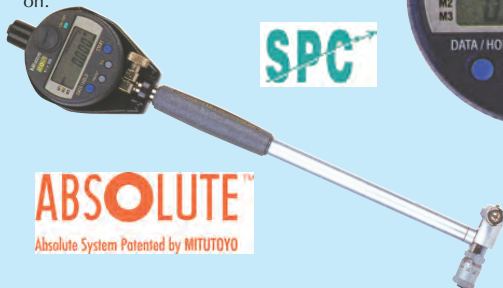

SPC

ABSOLUTE™
Absolute System Patented by MITUTOYO

Model	Range	Resolution	List	Sale
543-266B	.5"/12.7mm	.00005"/0.001mm	\$489.00	\$459.95
543-267B	.5"/12.7mm	.0001"/0.001mm	489.00	459.95

SPC output order Connecting Cable 905338 (1m) \$35.00 or 905409 (2m) \$42.00

Mitutoyo DIGIMATIC INDICATORS CALCULATION TYPE IDC Quick Measurements without Converting

- Using the Ax + B + Cx⁻¹ formula lets you measure difficult to measure features. Simply input constants for A, B and C, measure your part, and the indicator does the rest.
- Applications include OD, ID, Radius of Curvature, Groove Width, Hole Diameter, Countersink, Depth and Diameter.

Resolution: .00001"/0.0002mm (12 Selectable Stepped Resolutions)
Stem Diameter: 3/8"
Accuracy: .00012" (0.0003mm) or less (Quantization error is not included).

ABSOLUTE™
Set 'N Forget TECHNOLOGY

Ax + B + Cx⁻¹



SPC

All Are Supplied With Flat Back

Model	Range	Accuracy	List	Sale
543-287B	0-.5"/0-12mm	.00012"	\$409.00	\$375.00
543-482B	0-1"/0-25mm	.00012"	447.00	415.00
543-487B	0-2"/0-50mm	.00024"	574.00	535.00
101306	Lug Back Plate on Center			\$10.00

SPC output order Connecting Cable 905338 (1m) \$35.00 or 905409 (2m) \$42.00

Mitutoyo DIGIMATIC INDICATORS SIGNAL IDC



SPC

MODEL No. 543-283
Reg. \$553.00
\$515.00

- The Signal IDC indicator's Green/Red LED and Go/±NG output show operators whether a part is good or bad at a glance. No more reading each indicator to see if a part meets spec.
- Designed for PLCs and gage fixtures requiring a GO/±NG signal.
- The Signal IDC's wiring harness can be quickly disconnected from the indicator for quick indicator replacement if the indicator is damaged.
- In addition to GO/±NG judgements, the Signal IDC has lines for "Preset Value Recall" and Reset for "Max, Min or TIR" mode.
- IP-54 Dust/Waterproof protection.

ABSOLUTE™
Absolute System Patented by MITUTOYO

Accuracy: .00012"/0.003mm ±1 count

Model	Range	Back	Resolution	Price
543-283	.500/12mm	Lug	.0001"/.001mm	\$515.00
543-283B	.500/12mm	Flat	.0001"/.001mm	515.00
543-282	.500/12mm	Lug	.00005"/.001mm	\$515.00
543-282B	.500/12mm	Flat	.00005"/.001mm	515.00

SPC output order Connecting Cable 905338 (1m) \$35.00 or 905409 (2m) \$42.00

Mitutoyo DIGIMATIC ID-H INDICATOR High Accuracy and High Functional Type

- Take advantage of it's high accuracy backed up by 0.5µm/.00002" resolution, remote control functionality via a hand held controller (or an RS-232C interface) and easy runout measurements with the well established analog bar display.
- With RS-232 input/output.
- GO/±NG judgment is performed by setting the upper and lower tolerances. If a judgment result is out of tolerance, the display backlighting changes from green to red, so tolerance judgment can be at a glance.
- The max, min, or runout value can be displayed during measurement.

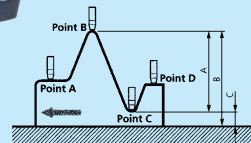

Difference/Runout measurement Example: Indicator travel from points A to D
Difference (or Total Runout) is displayed as A.
Dimensions B (maximum value) and C (minimum value) can be recalled from memory with a simple key sequence.

Model	Range	Resolution	Accuracy	List	Sale
543-562A	1.2"/30mm	.00002"/0.0005mm or .00005"/0.001mm	.00006"/0.0015mm	\$861.00	\$795.00
543-564A	2.4"/60mm	.00002"/0.0005mm or .00005"/0.001mm	.0001"/0.0025mm	1020.00	955.00
21EZA009	Optional Infra-Red Remote				78.00

Mitutoyo IDC DIGIMATIC INDICATORS

- Absolute Encoder ensures all settings and readings maintained for the life of the battery (even when the power is turned off).
- Preset, Zero-Set, Inch/Metric, +/- direction and Go/±NG functions.
- Face rotates 330° for use at various angles.
- Stem diameter.
- Immune to overspeed error.
- SPC output provided.
- Average battery life 7,000 hours using SR-44 battery.

New!

- ✓ Now with Calculation function $F(x)=Ax$
- ✓ Models available with selectable resolutions: .00005"/.0001"/.0005"/0.001mm/0.01mm Resolution



Model	Range	Back Type	List	Sale
.0005"/0.01mm Resolution				
543-402B	.500"/12.5mm	Flat	\$302.00	\$269.95
543-406B*	.500"/12.5mm	Flat	485.00	435.00
543-476B	1.00"/25mm	Flat	443.00	395.00
543-496B	2.00"/50mm	Flat	582.00	525.00
.00005"/.0001"/0.001mm/0.01mm Resolution				
543-392B	.500"/12.5mm	Flat	\$414.00	\$375.00
543-396B	.500"/12.5mm	Flat	647.00	575.00
543-472B	1.00"/25mm	Flat	554.00	495.00
543-492B	2.00"/50mm	Flat	696.00	625.00
101306	Lug Back Mount			\$10.00

* Low Force Pressure
SPC Output Cable #905338(1mm) \$35.00 or #905409(2mm) \$42.00

Precise AGD DIAL INDICATORS

- Stainless steel parts.
- Rotatable bezel with clamps.
- Lug back with 1/4" hole.
- Interchangeable hardened contact point.
- Conforms to AGD standards



1-1/4" Dial Face \$14.95
1" Travel \$13.95
Inch/metric \$39.95
2" Travel \$32.95

Model No.	Travel Range	Graduation	Dial Diameter	Sale Price
DCI-100**	.250"	.001"	1-1/4"	\$14.95
DCI-025	.250"	.001"	2-1/4"	14.95
DCI-050	.500"	.001"	2-1/4"	14.95
DCI-001	1.000"	.001"	2-1/4"	13.95
DCI-010*	1.000"	.001"	2-1/4"	14.95
DCI-005	1.000"	.0005"	2-1/4"	17.95
DCI-020	1.000"	.0001"	2-1/4"	59.95
DCI-002	2.000"	.001"	2-1/4"	32.95
DCI-006*	2.000"	.001"	2-1/4"	33.95
DCI-030	2.000"	.0001"	2-1/4"	110.00
DCI-009	3.000"	.001"	3-1/8"	165.00
DCI-004	20mm	.01mm	2-1/4"	\$17.95

Dual Dial Inch/Metric

DCI-008	1"/25mm	.001"/0.01mm	2-1/4"	\$39.95
---------	---------	--------------	--------	---------

* Black face, Orange Needle, ** Supplied with Flat Back

Mitutoyo IDF ABSOLUTE DIGIMATIC INDICATOR

- The new multi-function IDF Absolute Digimatic Indicator from Mitutoyo's leading-edge Absolute Encoder Technology address various digital indicator measurement requirements.
- Absolute encoder never forgets its absolute origin throughout the entire service life unless otherwise preset for a different setup or the main is disconnected.
- The large backlit LCD has several features including greatly improved visibility, green/red backlit screen for easy GO/NG judgement, the analog bar indicator for easy process monitoring such as zero/tolerance zone approaching. Maximum/minimum value hold, runout measurement and data output functions.



Model	Range	Resolution
543-552A	1"/25mm	.00005", .0005" .0001", 0.01mm
543-558A	2"/50.8mm	0.001mm, 0.01mm .00005", .0005" .0001", .001" 0.001mm, 0.01mm

SPC Outout Cable 40" #936937 \$40.00 or #965014 \$50.00

Precise IDF DIGIMATIC INDICATORS

Analog & Digital Display

- Range 0-0.5"/12.7mm
- Coolant, water & oil resistant to IP54 specifications
- Optional SPC output cable available.
- Six (6) analog resolutions and automatic switch-over.
- Absolute and incremental measurement conversion.
- High contrast LCD display 1.65 x 1.1"
- Zero set and TOL features.
- 2.4" diameter bezel.
- Dual measuring references.
- With rubber boot & analog scale.
- Dial rotates ±170° for easy reading.
- Lug back and 3/8" stem diameter
- On/Off button.



Model	Range	Resolution	Accuracy	Price
303-309	0.5"/12.7mm	.0002"/.005mm	.0008"	\$119.95
303-310-2	0.5"/12.7mm	.00005"/.001mm	.0004"	139.95
303-311-1	0.5"/12.7mm	.00005"/.001mm	.0002"	195.00
303-312-1		SPC Output Cable		54.95

Fowler TRAVEL INDICATOR COMBO

- Indicator:
 - Range: 0—1"
 - Continuous reading: 0—100
 - Revolution counter hand
- Meets AGD specifications
- Graduation: .001"
- Microfine graduations



Combo includes: 0—1" Indicator, Mag Base with fine adjustment
Set No. FVF-300 with White Face Ind.
Set No. FVF-301 with Black Face Ind.
\$38.95

- Mag Base:
 - Fine adjustment
 - Accepts all AGD indicators & mount test indicators with 1/4" shank.
 - V-base for use on rounded surfaces.

Indicator Only

Description	Model No.	Regular Price	Sale Price
White Face Indicator	52-520-110	\$65.00	\$29.95
Black Face Indicator	52-520-109	\$65.00	\$29.95

Precise BACK PLUNGER DIAL INDICATOR

- Easy to read.
- Conforms to AGD standards.
- Dial face diameter: 1-3/8".
- Made of stainless steel.
- Rotatable bezel.



Range: 0-0.020"
Reading: 0-100
Graduation: .001"
MODEL No. 400-015
\$42.95

Range: 0-5mm
Reading: 0-100
Graduation: 0.01mm
MODEL No. 303-310-1
\$42.95



MAXUM® II DIGITAL COMPARATOR FEDERAL 0.00001", 0.00002" Selectable Range

Standard Features

- Inch/Metric-operator selectable with switchable resolution.
- Normal/Reverse Sensing.
- Preset capabilities to view actual size.
- "Absolute" Transducer - no overspeed errors or constant re-zeroing. Transducer always remembers its location, even if power is off.
- High resolution digital readout and analog bar graph-digital display shows deviation from zero or actual dimension size (Preset).

- Lightweight, contamination resistant, ruggedly built to withstand hard use-gasket case, crystal and stem assemblies resist fluid contamination.
- Calibratable - if ever needed-values remembered even after battery change.
- Marconnect data output: USB, OPTO RS232C, Digimatic.
- Auto-power down - provides extremely low battery consumption.
- Unilateral Tolerances, Go/NoGo display feature.

Advanced Features

- Dynamic mode operation:
 - Max, Min, TIR
- Two point difference measurement-Provides comparison of two readings or measuring locations. Calculate the distance between 2 measured values.
- Multiplier factor for ratio measurements.
- Hold function-holds reading on display until ready to resume measuring.
- Data output with serial number identification capability.
- Data output with selectable continuous output or single request of readings



Stem Diameter
.375" or 8mm
(Specify)

No. 2034101
2034103
2034201
2034203



No. 2034252
2034212

Model No.	Range Inch	Resolution Selectable	Features	Stem Length	Sale Price
2034101	±0.040"	(0.00001", 0.00002")	Standard	0.46"	\$345.00
2034103	±0.040"		Standard	1.50"	345.00
2034201	±0.040"	(0.00005", 0.00001")	Advanced	0.46"	430.00
2034203	±0.040"		Advanced	1.50"	430.00
2034252	±.050"	(0.0002", 0.0005", 0.001")	Advanced	0.63"	430.00
2034212	±1.00"		Advanced	0.63"	495.00

SPi STANDARD DIAL INDICATORS

- Accuracy meets or exceeds Federal Specifications.
- Easy reading graduations.
- Thread size: #4-48, metric 2.5mm
- Stem diameter 3/8", metric 8mm.
- Adjustment bezel for convenient zero setting with clamp screw.
- Lug back supplied except where noted.



1" Range
.001" Grad.
MODEL NO.
20-703-5
Reg. \$65.00
\$50.35

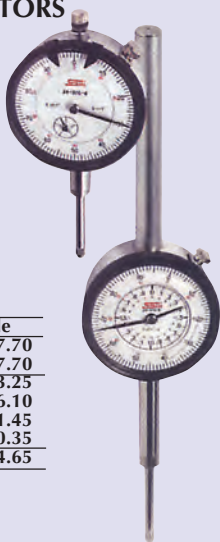

Model	Range	Dial Reading	Graduation	Sale
14-653-0*	0.250"	0-50-0	0.001"	\$67.70
14-654-8*	0.250"	1-100	0.001"	67.70
20-701-9	0.200"	0-100 & 0-50-0	0.0001"	\$103.25
20-704-3	0.500"	0-50 & 0-25-0	0.0005"	56.10
20-700-1	0.500"	0-100 & 0-50-0	0.001"	51.45
20-703-5	1.000"	0-100 & 0-50-0	0.001"	50.35
20-361-2	Steel Ball Contact Point			\$4.65

* AGD Group 1 • Flat Back Only

Precise DIAL INDICATOR DEPTH BASE

- Fits any standard AGD dial indicator with 3/8" diameter stem.
- Made of hardened and ground steel for flatness.
- Black oxide finish.



Model	Base Length	Price
9228	2-1/2"	\$23.95
9229	4"	27.95

Mitutoyo SOLAR ELECTRONIC ABS DIGIMATIC INDICATOR

- Measurement tool with a solar power source. Ready for use from 40 lux illumination.
- Two large function buttons improve operability.
- Mitutoyo's unique ABS (Absolute) sensor automatically restores the last origin position when the indicator is turned on. This allows quick-start operation, which is especially useful in multipoint measurement.
- A super capacitor maintains a reserve of approx. 3.5 hours under low light conditions.
- Origin-set +/- direction and inch/mm.
- Resolution: .0005"/0.01mm or .00005"/0.001mm
- Measuring Range: .5"/12.7mm
- Stem diameter: 3/8" or 8mm available.
- SPC output provided.
- Character Height: 9mm



Lifting Lever



Lifting Knob



Lifting Cable

3/8" Stem Diameter - 1.5N or Less Measuring Force

Model No.	Range Inch/Metric	Resolution Inch/metric	List Price	Sale Price
543-502	.5"/12.7mm	.00005"/0.001mm	\$296.00	\$269.95
543-502B	.5"/12.7mm	.00005"/0.001mm	296.00	269.95
543-507	.5"/12.7mm	.0005"/0.01mm	190.00	169.95
543-507B	.5"/12.7mm	.0005"/0.01mm	190.00	169.95
21EZA199		Lifting Lever		\$ 5.00
21EZA150		Lifting Knob		21.00
540774		Lifting Cable		30.00
905338		SPC Connecting Cable 40"		35.50
905409		SPC Connecting Cable 80"		42.00

* No.'s 543-502 and 543-507 have Lug Backs.
No.'s 543-502B and 543-507B have Flat Back



DIGICO 205 DIGITAL ELECTRONIC INDICATOR

The only electronic indicator that fully conforms with DIN requirements

- Dimensions according to DIN 878
- ABSOLUTE measuring mode.
- Combined analog/digital display.
- Mechanical tolerance markers.
- OPTO-RS data output.
- Auto-reverse and lockable keypad.
- Inspection report included.
- Swiss made.



Model No.	Range In/mm	Resolution In/mm	Measuring Force (N)	List Price	Sale Price
39676	.5"/12.5mm	0005"/0.01mm	<2.0	\$265.00	\$235.00

Mitutoyo UNIVERSAL DIAL TEST INDICATOR

- Universal application to all directions. (Not only the direction of the measuring point, but also the direction of measurement itself can be adjusted 360 degrees without moving the indicator).

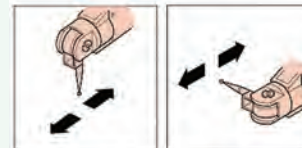

Full Set



SET No.
513-304GT
List \$438.00
\$369.95

Model	Graduation	Range	Reading	Accuracy
513-304GT	.0005"	.03"	0-15-0	.0005"

Mitutoyo IDC ABSOLUTE ENCODER WITH PEAK HOLD DIGIMATIC INDICATORS

- Peak hold: Displays the max. or min. value during measurement.
- Runout (TIR): Displays a runout (max. value-min. value) during measurement.
- It is possible to set the tolerance for TIR, Max, Min value.
- Absolute Encoder ensures the measurement origin is maintained for the life of the battery.
- Resistant to overspeed error.

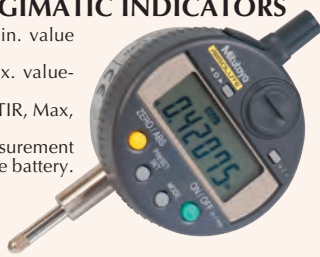

Accuracy .00012"/0.003mm

Model	Range	Resolution	List	Sale
543-262	0-.5"/0-12.7mm	.00005"/0.001mm	\$489.00	\$459.95
543-262B*	0-.5"/0-12.7mm	.00005"/0.001mm	489.00	459.95
543-263	0-.5"/0-12.7mm	.0001"/0.001mm	489.00	459.95
543-263B*	0-.5"/0-12.7mm	.0001"/0.001mm	489.00	459.95

*Supplied with Flat Back

SPC Output Cable 40" #905338 \$35.00 or 80" #905409 \$42.00



Mitutoyo IDU DIGIMATIC INDICATORS With Absolute Encoder

- Compact and economical design.
- Provided with a data output port for connection with the SPC system.
- Operating temperature: 0°C-40°C.
- Membrane sealed face helps keep out contaminants.
- 0-1"/0-25.4mm measuring range.
- .0008" accuracy (20°C).

MODEL No. 575-123
Reg. \$190.00

\$175.00



Absolute System Patented by MITUTOYO

SPC Output Cables

No. 905338 4" SPC Cable \$39.00

No. 905409 80" SPC Cable 45.00

No. 540774 Spindle Lifting Lever Cable 45.00
.4"/10mm Stroke



Mitutoyo LOW MEASURING FORCE IDC DIGIMATIC INDICATORS

- The low measuring force indicators are specially designed for elastic workpieces such as plastic parts, foam, etc.
- SPC Output.
- Stem diameter is 3/8".
- Steel ball contact point with #4-48UNF thread.

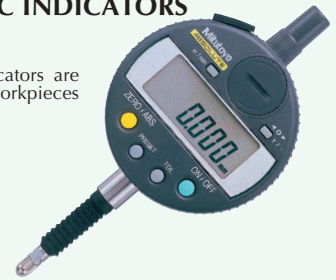

Model	Range	Resolution	Accuracy	List	Sale
543-396	0-.5"/0-12.7mm	.00005"/0.001mm	.00012"	\$647.00	\$595.00
543-396-1*	0-.5"/0-12.7mm	.00005"/0.001mm	.00012"	647.00	595.00
543-406	0-.5"/0-12.7mm	.00005"/0.01mm	.0008"	485.00	445.00
543-406-1*	0-.5"/0-12.7mm	.00005"/0.01mm	.0008"	485.00	445.00

*Supplied with Flat Back

SPC Output Cable 40" #905338 \$35.00 or 80" #905409 \$42.00

ELECTRONIC INDICATOR



0-1"/0-25mm Range
.0005"/.01mm Resolution

- Direct Inch/Metric conversion.
- 2-1/2" dial face.
- Lug back with 3/8" stem diameter.
- Resolution .0005"/.01mm
- Tolerance indicators.
- Min/max measurement.
- Floating zero.
- Carbide-tipped point
- Includes 2 extra points for small hole applications: one .078" dia. x 1" long and one needle point x 1" long.



MODEL No. 54-520-025
Reg. \$188.00

\$165.00

Carbide-tipped point



Mitutoyo DIAL TEST INDICATOR KIT

Dial Test Indicator

- Graduation .0005"
- Range .03"
- Dial reading 0-15-0
- Jeweled bearing, Anti-magnetic.
- ø3/8" stem

Mini Magnetic Stand

- ø3/8" ø5/32" applicable holding stem.
- With dovetail groove.
- 150N magnetic force



KIT No. 513-907
Reg. \$210.00

\$185.00

Also Available In Metric At Same Price

Mitutoyo DIAL TEST INDICATOR With TI Ruby Stylus

- Wear characteristic improved by 50%.
- Non-magnetic and non-conductive material, enable us to use in EDM operation.

Specification:

Graduation: .0005"
Measuring Range: .03"
Accuracy: ±.0005"
Measuring force: .07165 or less
Contact Point diameter: .79"
Stem diameter: ø3/8"



MODEL No. 513-472
Reg. \$141.00

\$125.00

.79" Ruby Contact Point



TIN COATED .0005" DIAL TEST INDICATOR

- Titanium nitride coated frame gives the dovetail positioning guideways additional wear resistance. The contact point is also Titanium nitride coated.
- Precise gear driven design with jeweled movement.
- .0005 graduations, .030 per revolution.
- Dovetail guideways on the top and back.
- Adjustable bezel. • Auto reversing.
- Comes standard with 1 each 5/32" and 3/8" dovetail extensions.
- Supplied in fitted plastic case.



SET No. TCI-005

\$43.95



CERTIFIED AGD 1" TRAVEL DIAL INDICATOR & POINT KIT

Indicator features:

- 1" travel.
- AGD group 2.
- Certificate of calibration.
- Solid brass housing.
- 2-1/4" dial diameter.
- Reading: .001"
- Continuous reading 0-100
- Carbide contact point.

6 Piece Point Set Features:

- Complete set of six points.
- Complete with threaded base.

Black Face
MODEL No. 52-520-065
Reg. \$65.00

\$49.95

With Certification and Point Kit



CDI CHICAGO DIAL ELECTRONIC INDICATORS LOGIC™ ALG

CHICAGO

- Numeric & Analog Display
- Analog Visual Display
- Incremental Measuring mode
- SPC Cables USB, MTI, RS232
- Measuring System in English or Metric
- Travel Reverse
- Auto Off
- Floating Zero
- Rotating Bezel
- Internal and External Serial Numbers

- T.I.R. Measuring with Low & High Storage Recall
- Power with Batteries
- Additional Power Options Through AC Jack or Data Output
- Programmable Lock Combination
- User Tolerance Settings (high and low)
- Up to 4 User Changeable Resolutions
- Inch/Metric display conversion
- Large LCD Display
- Maximum Reading Hold
- Display / Freeze Reading Hold
- Minimum Reading Hold
- Absolute/Preset Measuring Mode
- Extra large Number Display

Logic™ IQ Additional Features:

- 3 Programmable Presets & 3 Programmable Ratios
- Absolute/Preset Measuring Mode

Model	Range	Resolution	Price	Model	Range	Resolution	Price
IQ	Travel	Operator Changeable	Each	ALG	Travel	Operator Changeable	Each
Q2500	.250	.0001"/.002mm	\$ 375.00	A2500	.250	.0001"/.002mm	\$ 375.00
Q3500	.250	.00005"/.001mm	385.00	A3500	.250	.00005"/.001mm	385.00
Q4600	.600	.0005"/.01mm	375.00	A4600	.600	.0005"/.01mm	375.00
Q2600	.600	.0001"/.002mm	385.00	A2600	.600	.0001"/.002mm	385.00
Q3600	.600	.00005"/.001mm	425.00	A3600	.600	.00005"/.001mm	425.00
Q4110	1.0	.0005"/.01mm	385.00	A4110	1.0	.0005"/.01mm	385.00
Q2110	1.0	.0001"/.002mm	395.00	A2110	1.0	.0001"/.002mm	395.00
Q3110	1.0	.00005"/.001mm	445.00	A3110	1.0	.00005"/.001mm	445.00
Q1720	2.0	.001"/.02mm	675.00	A1720	2.0	.001"/.02mm	675.00
Q4720	2.0	.0005"/.01mm	685.00	A4720	2.0	.0005"/.01mm	685.00
Q2720	2.0	.0001"/.002mm	695.00	A2720	2.0	.0001"/.002mm	695.00
Q1820	4.0	.001"/.02mm	995.00	A1820	4.0	.001"/.02mm	995.00
Q4820	4.0	.0005"/.01mm	1035.00	A4820	4.0	.0005"/.01mm	1035.00
Q2820	4.0	.0001"/.002mm	1075.00	A2820	4.0	.0001"/.002mm	1075.00

* Note: Certificate of Calibration Traceable to NIST Add \$25.00 and Specify with order



Fowler INDI-MAX ELECTRONIC INDICATORS

- Direct Inch/Metric Conversion
- IP54 Coolant & fluid resistant
- Auto Off feature
- 2-1/4" dial face
- 3/8" stem- 4-48 thread
- Resolution .00005"/.001mm
- Accuracy: .00016"/.004mm (to 1")
- Tolerance indicators
- Absolute/incremental reading
- Lugback on 1/2" model
- Floating zero
- Carbide tipped point



Model	Description	List	Sale
54-520-305	.5"/12.5mm Indi-Max Electronic Indicator with point set	\$329.00	\$269.95
54-520-310	1"/25mm Indi-Max Electronic Indicator with point set	369.00	299.95
54-520-320	2"/50mm Indi-X Blue Electronic Indicator with point set	479.00	410.00
54-100-350	CR2032 Battery		5.50
54-520-399	Absolute data cable*		139.00

* Works with 06ADV380C MIT cable

Fowler SYLVAC MARK VI ELECTRONIC INDICATORS

- Robust construction.
- Water and coolant resistant to IP67
- Direct Inch/Metric conversion.
- Large easy-to-read LCD display with tolerance indicators.
- 10,000 hour battery life.
- Wide range of functions (MIN/MAX/ DELTA, TOL, Factor, Preset, Auto Off, etc.)
- Bezel rotates 270° for easy reading.
- Includes shop-hardened case.



Model	Description	Resolution	List	Sale
54-530-124	0-.500"/12.5mm Electronic Indicator	0.0005"/0.01mm	\$425.00	\$360.00
54-530-134	0-.500"/12.5mm Electronic Indicator	0.00005"/0.001mm	550.00	450.00
54-530-144	0-1"/25mm Electronic Indicator	0.0005"/0.01mm	495.00	395.00
54-530-154	0-1"/25mm Electronic Indicator	0.00005"/0.001mm	650.00	490.00

Mahr FEDERAL REFERENCE DIGITAL INDICATORS

The new Digital Indicators are equipped with the innovative Reference-System. The Zero position only has to be set one time: once it is set, the zero remains stored for all further measurements. Therefore, when the indicator is switched ON or the measuring spindle is moved the indicator is immediately ready for measurement; thus the need to reset as with a conventional indicator is now obsolete.

FEATURES:

- ON/OFF Reset (Set display to zero mm/ inch)
- Reversal of counting direction PRESET (for entering a numerical value).
- DATA (data transmission with a data connection cable)
- LOCK-function: Individual buttons can be locked. Auto-OFF (selectable)
- Immediate measurement due to the Reference System.
- Max. measuring speed 1.5m/sec (60"/sec)
- MarConnect Data output: choose either USB, OPTO RS232C, Digimatic.
- High contrast LCD display with 12mm high digits.
- Operation temperature 10-40°C
- Class of protection IP52 according to IEC 60529



MODEL No. 4336010P
List \$204.00

\$185.00

Model No.	Measuring Range	Resolution Inch/Metric	List Price	Promo Price
4336010P	.5"/12.5mm	0.0005"/0.01mm	\$204.00	\$185.00
4336020P	.5"/12.5mm	0.0001"/0.005mm	277.00	255.00
4336030P	.5"/12.5mm	0.00005"/0.001mm	337.00	319.50

ULTRA SERIES QUILL CLAMP HOLDER



MODEL No. 4409-0010

\$19.95

Indicator not included

- Manufactured and inspected at world class factory that produces highest quality European brands.
- Fits Bridgeport type milling machines.
- Fits milling machines with 1-7/8" diameter quills.
- Clamps directly onto machine quill.
- Will not disturb working tool in the machine.

Starrett ELECTRONIC INDICATORS

The **Starrett2900 Series** is available in a choice of configurations to meet a range of requirements. Innovative True Absolute Sensor Technology minimizes the chance of data loss for exceptional reliability. Built with **IP67** protection and renowned Starrett quality.



- Intuitive design and layout - easy to learn and use.
- Positive, tactile - feel button activation.
- Long battery life.
- CE compliant.
- Data output on all models.
- Compatible with Starrett 25 indicator backs.

Accuracy +/- .00012" (0.003mm)

Model	Range	Resolution	List	Sale
2900-1	.5" (12mm)	.00005" (0.001mm)	\$304.00	\$288.00
2900-2	.5" (12mm)	.0001" (0.001mm)	275.00	260.00
2900-4	.5" (12mm)	.0005"/.0001"/.00005" (0.01/0.001mm)	390.00	370.00
2900-6	.5" (12mm)	.0005"/.0001"/.00005" (0.01/0.001mm)	461.00	437.00

Starrett ELECTRONIC INDICATORS

The **Starrett 3600 Series** has simple, powerful, easy-to-use functions. Versions are available for inch/metric and metric only.

- Long battery life.
- Plastic storage case with clear cover.
- Large, easy-to-read LCD.
- Zero setting at any position.
- Reverse travel (control indicates direction)
- Dust cap.



Accuracy +/- .00012" (0.003mm)

Model	Range	Resolution	List	Sale
3600-5	.5" (12.7mm)	.0005" (0.01mm)	\$158.00	\$142.00
3600M-5	12.7mm	0.01mm	158.00	142.00

ULTRA TRAVEL AGD DIAL INDICATORS

- Manufactured and inspected at world class factory that produces highest quality European brands.
- 6 jewel movement.
- Contact point interchangeable with thread 4-48
- Stem: 3/8" diameter.
- Reading range pointers installed in the bezel.
- Complete with a fitted durable Case.
- Long form of Calibration Certificate included.



Model No.	Range Inch	Graduation Inch	Reading	Dial Diameter	Sale Price
4409-1105	0-.25"	.001"	0-100-0	1-1/2"	\$42.00
4409-1101	0-1.00"	.001"	0-100-0	2-1/4"	49.00
4409-1109	0-1.00"	.0005"	0-100-0	2-1/4"	49.00

ULTRA TRAVEL AGD DIAL INDICATORS

- Manufactured and inspected at world class factory that produces highest quality European brands.
- Shock-Proof.
- Contact point interchangeable with thread M2.5.
- Stem: 8mm diameter.
- Reading range pointers installed in the bezel.
- Complete with a fitted durable Case.
- Long form of Calibration Certificate included.



Model No.	Range Metric	Graduation Metric	Reading	Dial Diameter	Sale Price
4409-1110	0-5mm	.01mm	0-100-0	40mm	\$42.00
4409-1111	0-10mm	.01mm	0-100-0	60mm	49.00

Starrett ELECTRONIC INDICATORS

The **Starrett 2700 Series** is one of the most versatile of the electronic indicators. All indicators feature a glass scale design with an unsurpassed accuracy of \pm two resolutions when measuring from a known standard. All have rugged, sealed enclosures as well.

- Plus or minus travel direction.
- Zero the tool at any position of the spindle.
- Rotating bezel.
- Auto Off after 10 minutes of non-use.
- Three power sources - operate by battery, A/C adapter or through data port.
- Output jack allows data transmission.



Model	Range	Resolution	List	Sale
F2730AD	1" (25mm)	.001"/.0005"/.0001"/.00005" (0.02/0.01/0.002/0.001mm)	\$ 490.00	\$440.00
F2740AD	2" (50mm)	.001"/.0005"/.0001"/.00005" (0.02/0.01/0.002mm)	740.00	665.00
F2750AD	4" (100mm)	.001"/.0005"/.0001"/.00005" (0.02/0.01/0.002mm)	1120.00	995.00
F2730IQ	1" (25mm)	.001"/.0005"/.0001"/.00005" (0.02/0.01/0.002/0.001mm)	490.00	440.00
F2740IQ	2" (50mm)	.001"/.0005"/.0001"/.00005" (0.02/0.01/0.002mm)	740.00	665.00
F2750IQ	4" (100mm)	.001"/.0005"/.0001"/.00005" (0.02/0.01/0.002mm)	1120.00	995.00
2700SCKB	Smartcable w/USB 2.0 for 2700 Series Micrometer		199.00	185.00

Precise MAGNETIC BASE With Direct Mount Backs

- Permanent powerful magnet.
- Size 2-1/4" diameter 9/16" thickness.
- Direct mount of dial indicators A.G.D. groups 1 and 2.
- Indicators not included in prices.



MODEL No. MBD-829
\$9.95

Group (2)
.001 Grad.
1 Travel Indicator
W/mag. Base
SET No.
MBD-800
\$18.95

Magnetic Base Only

Model No.	A.G.D. Group	Will Fit Indicators	Price Each
MBD-829	(2) 2" Diameter Dial	Japan & China	\$9.95

Mahr FEDERAL
MarCator® DIGITAL INDICATORS
Analog And Digital Display

Functions:
ON/OFF
RESET (set digital and analog displays to zero)
-0- (set the analog display to zero)
 Preset (enter any numerical values)
Data (data transmission) mm/inch switchable. Reversal of counting direction (switch value in digital display)

Tolerance function:
 clearly visual tolerance excess due to the change of color in the background lit display.

Max-Min memory, ideal for searching the reversal point.
Max-Min memory, ideal for testing flatness and concentricity.
TOL (enter tolerance limit values).
Lock: operating functions can be blocked via PC-software.

IP54

Analog Display Resolution

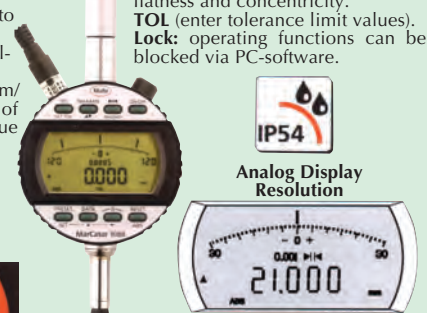

Readings (switchable) mm/inch Display Range mm/inch

0.0001/.00005"	±0.030/±.0015"
0.002/.00001"	±0.060/±.0030"
0.005/.00005"	±0.150/±.0150"
0.01/.0001"	±0.30/±.0150"

Sylvac "S" STYLE ONE INDICATORS
ELECTRONIC IP-67

- Range: 0-1/2"/12.5mm
- Removable lifting
- Direct inch/metric conversion
- High contrast LCD display
- Lift lever and lubback included
- Range: 0-1"/25mm
- Removable lifting
- Direct inch/metric conversion
- High contrast LCD display
- Lift lever and lubback included

Sylvac **Fowler SPC** **5-YEAR WARRANTY**



Model	Range	Resolution	Accuracy	List	Sale
54-530-124	0-1/2"	.0005"/0.1mm	.0005"/.01mm	\$385.00	\$345.00
54-530-134	0-1/2"	.00005"/0.01mm	.0003"/.007mm	495.00	445.00
54-530-144	0-1"	.0005"/0.1mm	.0005"/.01mm	\$440.00	\$385.00
54-530-154	0-1"	.00005"/0.01mm	.00035"/.008mm	540.00	475.00
54-530-164	0-2"	.0005"/0.1mm	.0005"/.01mm	\$715.00	\$635.00
54-530-174	0-2"	.00005"/0.01mm	.00035"/.008mm	790.00	698.00

Fowler COAX-2D
2 DIMENSIONAL COAXIAL INDICATOR SET

Features:

- Indicator assembly with 1.6" (42.5mm) diameter dial.
- Graduations and revolution counter .0005" (.01mm).
- 3 internal and external feelers.
- Center point feeler.
- Restraining arm.
- Complete in a fitted case.

Specifications:

- Length: 6-7/8" (175mm).
- Shank: 3/8" diameter x 7/8" (10mm x 20mm) long.
- Feeler ball: 1/8" (3mm) diameter.
- Dial readings: 0-40 (10-50mm).
- Measuring range: .250" (6mm) axis offset.
- Locating accuracy to with .0002" (1.005mm) of true center.
- Capacity depends on feelers installed, but overall range is 5/32"-12" (4-300mm) internal diameter; 0-12" (0-300mm) external diameter.



Model	Description	List	Sale
52-710-025	2D Coaxial Set-Inch	\$225.00	\$159.95
52-710-030	2D Coaxial Set-Metric	225.00	159.95

Mitutoyo ID-N (NARROW) ID-B (BACK-PLUNGER) DIGIMATIC INDICATORS

- Space saving design for gang measuring.
- Absolute Encoder ensures all setting and readings maintained for the life of the battery (even when the power is turned off).
- IP-66 level of protection.
- Small 1.38" (35mm) width is an ideal advantage for multiple gauge applications.
- Multi direction measurements are possible by the reversible LCD display.
- Measurement fixtures for various applications can be constructed with the combination of ID-N and ID-B indicators.
- For SPC, order cable 21EAA194 40" (1m) or 21EAA190 80" (2m)

ID-N Narrow **ABSOLUTE**



Model	Range	Resolution	List	Sale
543-571	.5"/12.7mm	.0005"/0.01mm	\$352.00	\$330.00
543-576	.5"/12.7mm	.00005"/0.001mm	488.00	435.00
ID-B Back Plunger				
543-581	.2"/12.7mm	.0005"/0.01mm	\$388.00	\$345.00
543-586	.2"/5.08mm	.00005"/0.001mm	525.00	470.00

No. 21EAA194 SPC Cable 40" \$37.00
 21EAA190 SPC Cable 80" \$50.00

Mitutoyo DIAL GAGE TESTER

- The UDT-2 Dial Gage Tester consists of a specially designed 0-1"/0-25mm micrometer head, with a large disc, and rigid holding fixtures. Gage tester to calibrate measuring accuracy of dial indicators, dial test indicators and dial bore gage.
- Clamping stem diameter- 170-102-10: 6mm and 8mm 170-101-10: .25" and .375"
- With optional stand (12AAK824), inspection of Dial Bore Gages becomes possible to perform.



Model	Description	Price
170-101-10	DGT .0001" Grad., ±.0001" Accuracy	\$1995.00
170-102-10	DGT 0.001mm Grad., ±1µm Accuracy	1995.00
12AAK824	Stand for Bore Gage Testing	195.00

SPi ELECTRONIC INDICATORS
0.00005"/0.001mm Resolution

- Inch/Metric conversion.
- SPC output.
- Large 1/2" clear crisp readings on LCD display.
- Auto On/Off power.
- Zero setting function.
- Stem diameter: 3/8"
- #4-48 thread.
- Certificate of calibration traceable to NIST.
- Furnished in fitted case.

SPi Certified Right Out of the Box!



Model	Range	Resolution	List	Sale
14-794-2	0-0.500"/0-12.50mm	0.0005"/0.01mm	\$120.00	\$ 84.29
14-795-9	0-0.500"/0-12.50mm	0.00005"/0.001mm	130.00	109.49
14-796-7	0-1.000"/0-25mm	0.0005"/0.01mm	\$125.00	\$ 91.97
14-797-5	0-1.000"/0-25mm	0.00005"/0.001mm	135.00	106.56
07-310-6	Replacement Battery			\$2.00

HAIMER

Quality Wins.

UNIVERSAL 3D SENSOR/TASTER Locate Your Workpiece Edge in X, Y, and Z Easy as 1,2,3

The Universal 3D Sensor is a very precise and versatile edge-finding, measuring instrument for milling and EDM machines (insulated probe) The 3D Sensor is clamped into a tool holder and inserted into a milling spindle. Once clamped into the machine spindle, the run-out (T.I.R.) is fully adjustable to zero. Then, you are able to find exact positioning of the spindle axis on the edges of the workpiece. This allows for zeros to be set and the length to be measured quickly and easily. You may approach in any direction (X-, Y-, Z axis-hence the name "3D Sensor"). When the dial gage shows zero, the spindle axis is exactly on the workpiece edge. **Only the HAIMER 3D-Sensor** allows for the edge to be found on the first attempt. No calculating of the probe's ball diameter is necessary - just Zero it out!

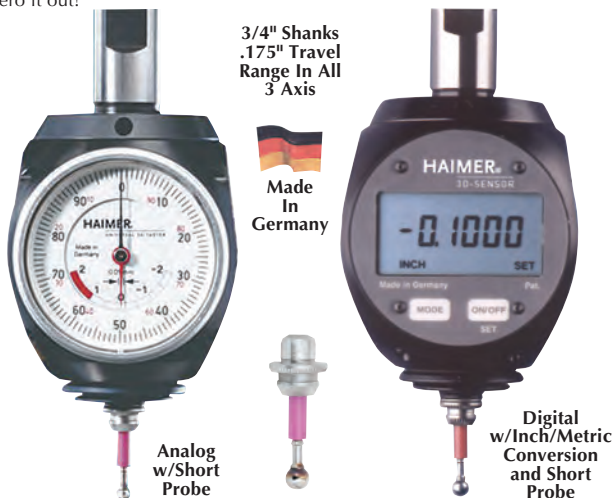

3/4" Shanks
.175" Travel
Range In All
3 Axis



Analog
w/Short
Probe

Digital
w/Inch/Metric
Conversion
and Short
Probe

Model	Type	Graduation	Accuracy	Price
80360	Analog	.0005"	.0004"	\$429.95
80360M	Analog	0.01mm	0.01mm	429.95
80460	Digital	.00005"	.0002"	795.00
80362	Short Probe 1" Length x 0.02" Tip			\$44.95
80363	Long Probe 2.6" Length x 0.04" Tip			74.95

HAIMER. ANALOG METRIC ZERO MASTER

Quality Wins.

- Zero Master**- The precise and versatile measuring instrument for milling and EDM machines (insulated Probe)
- It is clamped into the milling spindle or the electrode head and makes possible an exact positioning of the spindle axis on the edges of the workpiece or jig set and the length to be measured quickly and easily. You may measure in any direction (X-, Y-, Z axis). Once clamped in the machine spindle the runout (T.I.R.) is fully adjustable to zero.
- Easy Handling.** The dial gauge indicates the distance between spindle axis and workpiece edge. As soon as the gauge shows zero, the spindle axis is exactly on the workpiece edge on the first attempt. This eliminates calculating or problems with positive or negative signs.
- The extended overrun** distance in connection with the proven preset breaking point of the probe give additional security.



10mm
Shank



Model	Graduation	Accuracy	Repeatability	Price
80960	0.01mm	0.01mm	0.01mm	\$475.00
80362	Short Probe 1" Length x 0.02" Tip			\$44.95
80363	Long Probe 2.6" Length x 0.04" Tip			74.95

HAIMER. NEW GENERATION 3-D SENSOR/TASTER

Quality Wins.

The 3-D Sensor NG is a further development of our worldwide accepted and proven Universal 3-D Sensor. Its distinguishing features are improved mechanics and a new and compact design.



Made
In
Germany



Analog
w/Short
Probe

Advantages:

- Compact and easy to grip casing, no restriction to working area.
- Precise display of spindle position with large 1/100mm dial gauge (2hands)
- Ultmost precision of 0,01mm (when using original Haimer probe tips)
- Marked overrun distance (Safety distance).

Functions:

- Aligning machine spindles to work piece edges and reference edges (x-,y-,z axis)
- Set zeros.
- Center borings and shafts.
- Measuring lengths and depths.
- Checking straightness and levelness of surfaces.
- Aligning work pieces and vices.
- Quick, without calculations, no mistakes with algebraic signs.

Specifications:	Metric
Shank	12mm
Graduations	0.01mm
Centering Accuracy	0.01mm

Model	Description	Price
8036NG	New Generation 3-D Sensor Metric	\$429.95
8036200	Short Probe 25mm x 4mm Tip	\$44.95
8036300	Long Probe 65mm x 8mm Tip	74.95

HAIMER. CENTRO 3-D SENSOR

Quality Wins.

Provides quick and precise location of the centers of bores and shafts

Dial Gauge always in sight

The probe tip slides at low spindle speed along the surface of the workpiece. Its movement is transferred to the pointers of the dial gauge. The housing of the Centro does not rotate with the spindle and thus the dial gauge always stays within sight of the operator.

Centro finds the axis you wanted, for sure. The pointers deflect as long as the spindle and the wanted axis do not coincide. Now the position of the spindle can be corrected until the pointers come to a standstill. The wanted axis is found.

Further advantages:

- Checking face run of surface to spindle.
- Concentricity errors of spindle and chuck will be compensated->> Adjustment not necessary.
- The unusual big sized dial gauge eliminates every single imprecision.
- Replaceable probe.

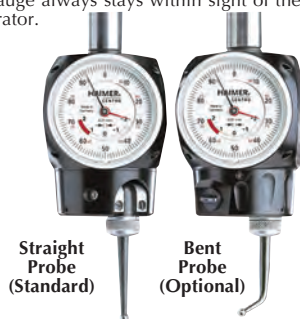

Straight
Probe
(Standard)

Bent
Probe
(Optional)

Specifications:

Straight probe Tip 5mm
Shank Size 16mm
Centering Accuracy 0,003mm
Max. Rotation Speed 150 1/min
Measuring range interior diameter
Drill hole 3-125mm
Measuring range exterior diameter
(Shaft, with probe tip bent) .. 0-125mm

Model	Description	Price
80300-1	Center 3-D Sensor w/Straight Probe 5mm	\$549.95
80301	Straight Probe with 5mm Ball Tip	49.50
80302	Bent Probe with 5mm Ball tip	65.00
80303	Straight Probe with 2mm Ball Tip	55.00



Mahr FEDERAL 3D DIGITAL TOUCH PROBE ALIGNMENT & POSITIONER

Features:

- High accuracy and linearity-suitable for measuring work pieces and measurement over the entire working range is possible.
- Can be controlled independently of a machine tool.
- Mechanical Model**
- Easy to read display.
- Shock proof and Water proof, ideal for use on a machine with a tool changer.
- Determine and correct the position of a work piece and for measurement of:
 - lengths
 - Depths.
- Large working range in all axis (X, Y, Z) prevents damage to the stylus by contacting errors.
- Compact metal housing and long probe arm
- Progressive analog display (bar graph) for dynamic path information.
- Digital display for accurate reading.



Model
4304305



With
4mm
Styli

Model	Resolution	Repeatability	List	Sale
4304305	.0001"	±.0001"	\$1100.00	\$1025.00
4304330	4mm	Ball Styli x 44.8mm		\$ 33.00
4304331	3mm	Ball Styli x 32.6mm		37.00
4304332	6mm	Ball Styli x 71.1mm		47.00

Interapid DIAL TEST INDICATORS

Double Your Range With One Indicator



Interapid, international acclaimed as the finest test indicators, are made in Switzerland to traditional precision and perfection.

- Inclined dial for easier reading.
- Exceptional sensitivity and responsiveness.
- Very light measuring pressure.
- Ball bearing contact point pivot and jewelled mechanism.
- Automatic reversing contact point, swivelling through 210°, vertical models 190°.
- Revolution counter.
- One piece, solid case for maximum rigidity.
- Universal swivel stem 5/32" diameter and two dovetails (vertical models one dovetail) for convenient mounting.
- Includes .080" carbide contact point, metric models 2mm, chrome plated.
- Complete with contact point wrench in fitted case.



Horizontal Style
.0005" Grad.
MODEL No. 312B-1
Reg. List \$273.00

\$239.50



Vertical Style

Horizontal Style

Model No.	Graduation	Capacity	Point Length	Dial Dia.	List Price	Price Each
312B-20	.001"	.060"	1 1/16"	1"	\$276.00	\$245.00
312B-1	.0005"	.060"	1 1/16"	1-1/2"	273.00	239.50
312B-2	.0005"	.060"	1 1/16"	1"	271.00	242.50
312B-3	.0001"	.016"	1 1/16"	1-1/2"	336.00	299.50
312B-4	.0001"	.016"	1 1/16"	1"	339.00	305.00
312B-15	.0005"	.060"	2-3/4"	1-1/2"	375.00	335.00

Vertical Style

312B-20V	.001"	.060"	1 1/16"	1"	\$276.00	\$245.00
312B-1V	.0005"	.060"	1 1/16"	1-1/2"	290.00	259.50
312B-2V	.0005"	.060"	1 1/16"	1"	290.00	259.50
312B-3V	.0001"	.016"	1 1/16"	1-1/2"	365.00	328.50
312B-15V	.0005"	.060"	2-3/4"	1-1/2"	385.00	345.00

Interapid ACCESSORY ATTACHMENTS

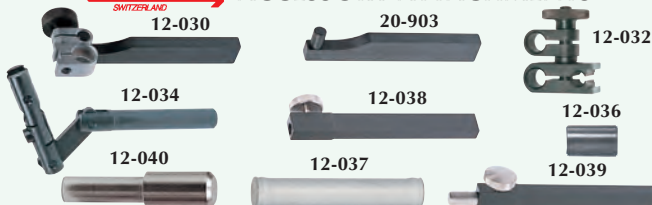

Model	Reference	Description	Price
12-030	A1/310	Height gage bar w/clamp	\$54.00
20-903	A11/310	Rectangular bar 1/2" x 1/4"	25.00
12-032	A12/310	Universal Clamp	33.00
12-033		Axial support with 8mm diameter stem	60.00
12-034	A2/310B	Axial support with 3/8" diameter stem	33.00
12-035		Reduction sleeve 8mm to 4mm	16.00
12-036		Reduction sleeve 3/8" to 5/32"	16.50
12-037		Case for contact points	6.75
12-038		Holding bar with pin	53.00
12-039		Holding bar	39.50
12-040		Holding pin	13.00

Interapid EXTRA CARBIDE CONTACT POINTS

Carbide Tip Contact Points

Model No.	Point Diameter	Length of Point	Price Each
INP-015	.015"	.697"	\$16.95
INP-031	.031"	.687"	14.95
INP-062	.062"	.697"	14.95
INP-080	.080"	.687"	14.95
INP-093	.093"	.697"	14.95
INP-010	.120"	.687"	14.95
INP-011	.080"	1.45"	\$16.95
INP-015-1	.015"	1.45"	16.95
INP-031-1	.031"	1.45"	16.95
INP-019	.015"	1.750"	\$16.95
INP-020	.031"	1.750"	15.95
INP-021	.060"	1.750"	15.95
INP-022	.080"	1.750"	15.95
INP-023	.120"	1.750"	15.95
INP-012	.031"	2.75"	\$16.95
INP-013	.062"	2.75"	16.95
INP-014	.080"	2.75"	16.95
INP-016	.100"	2.75"	18.95
INP-017	.031" Bent	.6875"	\$18.95
INP-018	.060" Bent	.6875"	18.95

Bent

Brown & Sharpe BesTest® INDICATORS



Automatic Reverse



1-1/2" Dial Diameter Models
599-7031-5
599-7033-5
599-7035-5



1" Dial Diameter Models
599-7029-5
599-7030-5
599-7031-5
599-7032-5
599-7033-5
599-7034-5
\$149.95



Long Point Diameter Models
599-7034-5
599-7035-5

Free With Purchase

2 Brown and Sharpe carbide contact points*
Send proof of purchase to:
Brown & Sharpe Mfg. Co.
P.M.I. Division
Free Contact Program
200 Frenchtown Road
N. Kingston, RI 02852

Constant Clockwise Rotation Indicator pointer always rotates clockwise (whether measuring over or under) to eliminate plus or minus confusion.

Anti-Magnetic and Corrosion Resistant Safe for use around magnetic chucks. Chrome plated to resist corrosion.

Swivelling Point Contact point can be set over 210° arc to measure hard-to-reach areas.

Carbide Tip furnished as standard on all BesTest Indicators.

Universal Mounting Dovetails top, front and back for required mounting and rigid set up.

Monobloc (precision watch) Body Design All pinions are mounted in jeweled bearings in an isolated assembly completely separate from outer body to maintain highest accuracies.

Automatic Reversal Measuring is bi-directional with double lever system. No switch to interfere with movement. Measures inside, outside, over and under.

Model No.	Smallest Division	Marking	Dial Dia.	Point Length	Special Price
599-7029-5	.001"	0-15-0	1"	1/2"	\$155.00
599-7030-5	.0005"	0-15-0	1"	1/2"	149.95
599-7031-5	.0005"	0-15-0	1-1/2"	1/2"	179.95
599-7032-5	.0001"	0-4-0	1"	1/2"	215.00
599-7033-5	.00005"	0-4-0	1-1/2"	1/2"	227.50
599-7034-5	.0005"	0-10-0	1"	1-7/16"	199.50
599-7035-5	.0005"	0-10-0	1-1/2"	1-7/16"	215.00

Each BesTest® Indicator comes with (1) carbide tip contact point; (1) 1/2" long x .080" dia. extension with dovetail; (1) contact point wrench; (1) durable molded case; and a Certificate of accuracy and traceability

CARBIDE TIPPED CONTACT POINTS

Model	Tip Diameter x Length	Price
CTC-001	.015" x 1/2"	\$16.95
CTC-002	.040" x 1/2"	14.95
CTC-003	.062" x 1/2"	14.95
CTC-004	.080" x 1/2"	14.95
CTC-005	.120" x 1/2"	14.95
CTC-005	.015" x 1-7/16"	14.95
CTC-006	.015" x 1-7/16"	14.95
CTC-007	.015" x 1-7/16"	14.95
CTC-008	.015" x 1-7/16"	14.95

Fowler TEST-BEST INDICATORS AUTO-REVERSE

- Bi-directional constant clockwise rotation.
- Automatic reversal.
- Three dovetail mountings.

- 0.080" contact point diameter.
- Jewelled movement.
- Two dovetail extensions.
- Molded case.



Model No.	Face Color	Graduation	Range Reading	Dial Diameter	Point Length	Sale Price
52-562-775	White	.001"	0-15-0	1"	1/2"	\$59.95
52-562-778	Black	.0005"	0-15-0	1"	1/2"	59.95
52-562-775	White	.0005"	0-15-0	1"	1/2"	59.95
52-562-776	White	.0005"	0-15-0	1-1/2"	1/2"	64.95
52-562-780	Black	.0005"	0-15-0	1-1/2"	1/2"	64.95
52-563-770	White	.0001"	0-4-0	1"	1/2"	\$84.95
52-563-771	Black	.0001"	0-4-0	1"	1/2"	84.95
52-563-777	White	.0001"	0-4-0	1-1/2"	1/2"	89.95
52-563-772	Black	.0001"	0-4-0	1-1/2"	1/2"	89.95
52-562-781	White	.0005"	0-10-0	1"	1-7/16"	\$84.95
52-562-782	Black	.0005"	0-10-0	1"	1-7/16"	84.95
52-562-783	White	.0005"	0-10-0	1-1/2"	1-7/16"	84.95
52-562-784	Black	.0005"	0-10-0	1-1/2"	1-7/16"	84.95
52-563-677	White	.01mm	0-40-0	1-1/4"	1/2"	\$69.95
52-560-060	White/Inch/Metric	.0005"	0-10-10/0-.25-0	1-1/2"	1/2"	82.95

Fowler XTRA CARBIDE CONTACT POINTS

Model No.	Point Diameter	Length of point	Price Each
FVF-001	.015"	1/2"	\$14.95
FVF-002	.031"	1/2"	12.95
FVF-003	.060"	1/2"	12.95
FVF-004	.080"	1/2"	12.95
FVF-005	.120"	1/2"	12.95
FVF-006	.015"	1-7/16"	16.95
FVF-007	.031"	1-7/16"	14.95
FVF-008	.080"	1-7/16"	14.95
FVF-009	.120"	1-7/16"	14.95

Mitutoyo "QUICK-SET" TEST INDICATOR SETS WITH DOVETAIL MOUNT Mitutoyo

- With dovetail mount.
- Anti-magnetic*.
- Jeweled bearing.
- No-clutch structure.
- Water and dust resistant.
- Glare-free crystal with scratch-resistant coating.
- Metric dial faces in yellow.
- Measuring force 0.3N or less.



Horizontal Model No. 513-402 Reg. \$127.00 **\$107.95**

Inch Basic Sets							
Model	Type	Range	Grad.	Reading	List	Sale	Description
513-402	Horizontal	.03"	.0005"	0-15-0	\$127.00	\$107.95	Basic Sets
513-403	Horizontal	.008"	.0001"	0-4-0	165.00	139.95	Includes: one .078" Dia. carbide
513-452	Vertical	.03"	.0005"	0-15-0	165.00	139.95	point installed,
513-412	Long Point	.03"	.0005"	0-15-0	181.00	153.50	one stem 3/8" dia.
513-282	Parallel	.03"	.0005"	0-15-0	176.00	149.50	(8mm dia. for metric indicators)
513-406	Combitec	.03"	.0005"	0-15-0	148.00	125.50	
		.7mm	.01mm	35-0-35			

Inch Complete Sets							
Model	Type	Range	Grad.	Reading	List	Sale	Description
513-402T	Horizontal	.03"	.0005"	0-15-0	\$150.00	\$127.50	Plus: clamp with dovetail, holding bar and .039" and .118" steel ball
513-403T	Horizontal	.008"	.0001"	0-4-0	193.00	164.00	contact point.
513-452T	Vertical	.03"	.0005"	0-15-0	181.00	153.50	Supplied with fitted plastic case
513-412T	Long Point	.03"	.0005"	0-15-0	210.00	178.50	
513-282T	Parallel	.03"	.0005"	0-15-0	190.00	161.50	
513-406T	Combitec	.03"	.0005"	0-15-0	165.00	140.00	
		.7mm	.01mm	35-0-35			

Metric Complete Sets							
Model	Type	Range	Grad.	Reading	List	Sale	Description
513-404T	Horizontal	0.8mm	.01mm	0-40-0	\$151.00	\$124.00	
513-405T	Horizontal	0.2mm	.002mm	0-100-0	186.00	153.50	
513-414T	Horizontal	0.5mm	.01mm	0-25-0	200.00	164.50	
513-454T	Vertical	0.8mm	.01mm	0-40-0	181.00	149.50	
513-455T	Horizontal	0.2mm	.002mm	0-100-0	217.00	179.00	

Extra Contact Points - .455" Length - Steel Ball Diameter: .031", .040", .080", .120" \$7.95 ea
 Carbide Ball Diameter: .031", .040", .080", .120" \$13.95 ea. .015" x 1.198" \$14.95 ea.
 1.198" Length - Carbide: .031", .040", .080", .120" \$14.95 ea. .015" x 1.198" \$15.95 ea.
 (Specify: Steel or Carbide and Size)

brock brown & sharpe AGD DIAL INDICATORS

Now available in easy-to-read satin black "Jet Console" face with high visibility orange hand or standard white face with black hand

- Rack teeth are ground to ensure accuracy, responsiveness and reliability that you can count on.



Group #0" 1-1/8" Dial Diameter

Group #1" 1-11/16" Dial Diameter

Group #2" 2-1/4" Dial Diameter

- Supplied with central lug back which can be rotated 90° for vertical or horizontal use.
- Racks and bottom bearings are made from stainless steel.

MODEL No. MB216 .001" Grad. 1" Travel Reg. \$121.00 **\$95.00**

Special Offer
 MB216 Brock Brown & Sharpe Black Face 1" Travel AGD Indicator On-Off Heavy-Duty Magnetic Base Plus 22 Piece Point Kit A \$135.00 Value SET No. MB216-1 **\$109.95**

Model	Reading	Travel	Graduations	Dial Color	Group	Price
MW71	.001"	.050"	0-20-0	White	"0"	\$239.00
MB71	.001"	.050"	0-20-0	Jet Black	"0"	239.00
MW73	.0001"	.050"	0-5-0	White	"0"	288.00
MB73	.0001"	.050"	0-5-0	Jet Black	"0"	288.00
MW181	.001"	.250"	0-50-0	White	"1"	\$140.00
MB181	.001"	.250"	0-50-0	Black	"1"	140.00
MW183	.0005"	.250"	0-25-0	White	"1"	147.50
MB183	.0005"	.250"	0-25-0	Black	"1"	147.50
MW193	.0001"	.050"	0-5-0	White	"1"	195.00
MB193	.0001"	.050"	0-5-0	Black	"1"	195.00

Model	Reading	Travel	Graduations	Dial Color	Group	Price
MW210	.001"	.500"	0-50-0	White	"2"	\$129.50
MB210	.001"	.500"	0-50-0	Black	"2"	129.50
MW214	.0005"	.500"	0-20-0	White	"2"	132.00
MB214	.0005"	.500"	0-20-0	Black	"2"	132.00
MW216	.001"	1"	0-100	White	"2"	95.00
MB216	.001"	1"	0-100	Black	"2"	95.00
MW217	.0005"	1"	0-50-0	White	"2"	110.00
MB217	.0005"	1"	0-50-0	Black	"2"	110.00
MW240	.0001"	.200"	0-5-0	White	"2"	175.00
MB240	.0001"	.200"	0-5-0	Black	"2"	175.00

Mahr DIAL INDICATORS, JEWELLED BEARING, SHOCK PROOF, AGD TYPE, GROUP 1, 2, AND 3

Mahr FEDERAL

- One-piece, forged bronze case for strength and durability.
- Nickel-plated case interior and movement plates means no flaking to interfere with performance.
- Unit construction, removable movement saves repair/cleaning time and maintenance costs.
- Hardened gears and stainless steel racks provide lasting protection against indicator failure due to shock and wear.
- Jeweled bearings resist friction, add to longer indicator life.
- Skeletonized, hobbled gears for more sensitive response, superior indicator accuracy with minimal hysteresis error.
- Special steel alloy, balanced dial hand affords no-shift, precise reading.
- Controlled rack and pinion mesh eliminates slope for precise response and reading.
- Smooth adjusting bezels for easy setup.
- Positive pressure pull back spring less maintenance.
- Compliance with ANSI/AGD specifications.



Mahr FEDERAL

AGD Group	Dial Face
1	1.688"
2	2.250"
3	2.750"

- Large, easy-to-read dial.
- Constant measuring force.
- Self contained, shockproof movement.
- Box design housing.
- Jeweled bearings, precision ground gears and pinions.
- Includes 9.5mm/.375 bushing for mounting to US standard stands.
- Built-in fine adjustment and revolution counter



Mahr FEDERAL

Model	Ranges	Resolution	Dial	Group	Price
121-1	.025"	.0001"	0-5-0	1	\$185.00
B3Q	.050"	.0005"	0-10-0	1	185.00
B81	.250"	.001"	0-50-0	1	154.00
221-1	.025"	.0001"	0-5-0	2	195.00
C5M	.075"	.0005"	0-15-0	2	180.00
C71	.125"	.0005"	0-25-0	2	180.00
2016005	.250"	.001"	0-100	2	99.00
2016004	.500"	.001"	0-100	2	103.00
2016002	1.000"	.001"	0-100	2	113.00
D81S	1.000"	.001"	0-100	3	190.00

Model	Range	Resolution	Accuracy	Price
433-590	±.0010"	.00002"	±.00002"	\$450.00
433-490	±.0020"	.00005"	±.00005"	205.00
433-290	±.010"	.0005"	±.0005"	194.00
433-390	±.005"	.0001"	±.0001"	194.00

Mahr FEDERAL

Mitutoyo TRUETEST INDICATOR SETS

20° Tilt Face ~ Long Range ~ 1.57" Dial Face

The most direct gear train design ever applied to Test Indicators means - higher levels of sensitivity, reliability, repeatability and accuracy throughout tool life.

- Smooth spindle movement for increase measuring accuracy.
- 20° tilted dial face for easy reading.
- Anti-magnetic characteristics.
- With rev counter.
- Jeweled movement.



Model	Graduation	Range	Reading	List	Sale
513-442T	.0005"	.060"	0-15-0	\$194.00	\$169.95
513-446T	.0005"	.060"	0-15-0	259.00	229.95
513-443T	.0001"	.016"	0-4-0	245.00	219.95
513-452T	.0005"	.030"	0-15-0	181.00	159.95

Fowler MULTIMODE ELECTRONIC TEST INDICATOR

QuadraTest

- True Inch/Metric conversion.
- Water, oil & coolant resistant.
- 1-1/2" diameter dial face rotates a full 360°.
- Bar graph and numeric digital display.
- .080" contact ball diameter.
- Meets or exceeds Din/ISO standards.
- Maximum error on .00005" scale at full range: .0004".
- .080" contact ball diameter



Model	Resolution	Point	List	Sale
54-562-777	0-40-0 .0005"	1/2"	\$229.00	\$209.00
	0-40-0 .0005"			
54-562-888	0-1-0 0.01mm	1-7/16"	339.00	\$315.00
	0-1-0 0.0001mm			
54-115-350	Power USB Cable			\$195.00

Mahr DIGITAL TEST INDICATOR MarTest®

FEDERAL

- ON/OFF, RESET (Set display to zero) mm/inch.
- MAX/MIN memory, MAX-Min ideal for testing concentricity and flatness.
- Inductive measuring system, battery lifespan ca. 2 years.
- Combined analog and digital display.
- Operating and display unit (bezel) can be rotated through 360°.
- Satin chrome finished housing with 3 dovetail guideways.
- Bearings are jewelled.
- Automatic matching to sensing direction.
- Anti-magnetic.
- Double lever supported in ball bearings, overload protection provided by slip clutch.
- Supplied with: Plastic case, spanner to change the styluses, contact point ø2mm, mounting shaft.

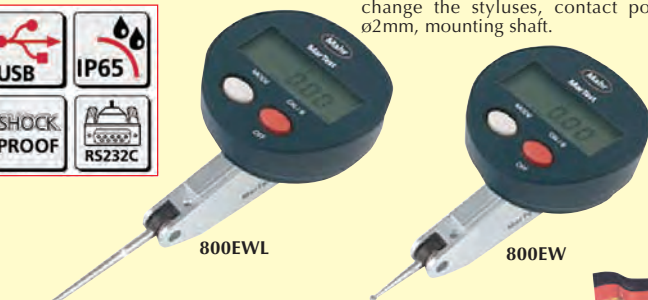

Model No.	Resolution Switchable	Range mm	Styli Length	Price Each
800EWL	0.001"/.00005"	+/-0.25mm	41.24mm	\$495.00
800EW	0.01"/.0005"	+/-0.4mm	14.5mm	450.00



compac/Alina DIAL TEST INDICATORS

Essential for the workshop, but also in the inspection room and laboratory - Ideal for comparative measurement on a surface plate - Detect form and position errors - Measure axial and radial runouts, especially.

- Features:
- Reversible action contact point without lever.
 - Clockwise hand rotation even in reverse.
 - Standard contact point with tungsten carbide ball.
 - Easy point replacement, without adjustment.
 - Made in Switzerland.
 - Main pivot on oversized self-adjusting angular contact bearings.
 - Dovetails are machined directly on the indicator.
 - Automatic clutch reversal.
 - Body and dial ring dull chrome plated.
 - Easy to read dial face rotates 360°.
 - Unaffected by magnetic fields used in ordinary mechanics.
 - Fitted in high impact plastic case.



Inspection Report With Declaration Of Conformity

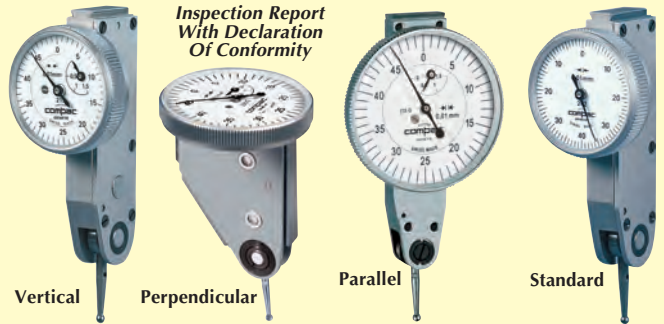

Vertical Series Wide Range

Model No.	Graduation	Total Range	Travel Per Revolution	Dial Face	Point Length	Price Set
214A	.0005"	.060"	.020"	1.065"	.72"	\$195.00
214GA	.0005"	.060"	.020"	1.575"	.72"	215.00
213LA	.0005"	.120"	.020"	1.063"	1.44"	285.00
213GLA	.0005"	.120"	.040"	1.575"	1.44"	350.00
215A	.0001"	.024"	.004"	1.063"	.72"	245.00
215GA	.0001"	.024"	.004"	1.575"	.72"	265.00

Perpendicular Series ~ Wide Range

Model No.	Graduation	Total Range	Travel Per Revolution	Dial Face	Point Length	Price Set
224A	.0005"	.060"	.020"	1.065"	.72"	\$235.00
224GA	.0005"	.060"	.020"	1.575"	.72"	265.00
223GLA	.0005"	.120"	.040"	1.575"	1.44"	355.00
225GA	.0001"	.024"	.004"	1.575"	.72"	315.00

Vertical Series ~ Standard Range

Model No.	Graduation	Total Range	Travel Per Revolution	Dial Face	Point Length	Price Set
244A	.0005"	.030"	.020"	1.065"	.675"	\$145.00
245A	.0001"	.008"	.080"	1.063"	.720"	165.00
245GA	.0001"	.008"	.080"	1.575"	.720"	175.00

Supplied with .080" Carbide Contact Point, 2 Dovetail Stems in Fitted Case and Inspection Report With Declaration Of Conformity

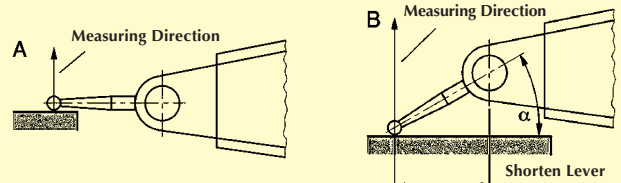

compac/Alina CARBIDE TIP CONTACT POINTS

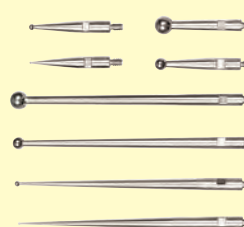

Model	Point	Length	Price
CCP-100	.015"	.72"	\$14.95
CCP-110	.031"	.72"	12.95
CCP-200	.040"	.72"	12.95
CCP-210	.062"	.72"	12.95
CCP-300	.080"	.72"	12.95
CCP-310	.120"	.72"	13.95
CCP-400	.015"	1.44"	16.95
CCP-410	.031"	1.44"	12.95
CCP-500	.062"	1.44"	12.95
CCP-510	.080"	1.44"	12.95
CCP-600	.120"	1.44"	16.95

Fowler SYLVAC VERTICAL MINI-RESISTANT ELECTRONIC INDICATOR

- Water and coolant resistant according to IP65.
- Data output RS-232 combined with power supply.
- Range: .200"/5mm
- 8mm mounting stem
- Dovetail
- Error Max: .0002"/.005mm



Model	Description	Resolution	List	Sale
54-520-414	Vertical Mini-Resistant Indicator	.0005"/.01mm	\$413.00	\$375.00
54-520-454	Vertical Mini-Resistant Indicator	.00005"/.001mm	468.00	425.00

Precise DIAL TEST INDICATORS

Jeweled Bearing - Auto Reverse

- Auto reversing .098" contact points supplied.
- 180° swing on point and shaft.
- Fully jeweled movements.
- Clear, crisp graduations.
- Universal positioning capability.
- Top quality clutch mechanism.
- Top quality satin chrome finish.
- Large dial faces.
- Dovetails top, back and front.



SET No.
PDT-703

\$29.95

White Face

Vertical Style

Optional Attachments

Universal Clamp
SET No. UCG-001 **\$10.95**

Height Gage Attachment

HORIZONTAL STYLE

Model No.	Graduation	Range Inch	Dial Range	Dial Face	Set Price
PDT-703	.0005"	.030"	0-15-0	White	\$29.95
PDT-704	.0005"	.030"	0-15-0	Black	29.95
PDT-705	.0001"	.080"	0-4-0	White	39.95

VERTICAL STYLE

Model No.	Graduation	Range	Dial Range	Dial Face	Set Price
TVI-030	.0005"	.030"	0-15-0	White	\$44.95
TVI-040	.0001"	.080"	0-4-0	White	59.95

* Extra Carbide Contact Points available @ \$7.95 ea. .015"Dia., .032", .040", .080", .120" all 1/2" Long

Mitutoyo DIAL TEST INDICATOR POCKET TYPE

- Jeweled bearings assure higher sensitivity and accuracy.
- Reversible measuring direction.
- Two holding bars are supplied. (Full sets only).
- Fully adjustable bezel/dial face.
- Contact point is adjustable within 220°.
- Bezel is sealed with an O-ring to keep out water/oil.
- Full set consists of Indicator, Swivel Clamp, 2 Holding bars, Contact Carbide Points, .079", .039" Dia., and .118", 2 holding stems.



Model	Grad.	Range	Reading	Point Length	List	Sale
513-518T	.001"	.04"	0-20-0	26mm	\$135.00	\$114.75
513-528T	.001"	.04"	0-20-0	18.7mm	141.00	119.75
513-512T	.0005"	.02"	0-10-0	37.4mm	178.00	150.00
513-504T	.0001"	.01"	0-5-0	18.7mm	172.00	146.00

GEM DIAL TEST INDICATOR SETS JEWELLED MOVEMENT



Basic Set

Complete Set also Includes These Attachments & 2 Extra Contact Points

MADE IN USA

Model No.	Graduation	Dial Range	Dial Diameter	Set Type	Set Price
222-B	.001"	.030"	15/16"	Basic	\$105.00
225-C	.001"	.030"	15/16"	Complete	155.00
334-30	.0005"	.030"	1-3/8"	Basic	119.95
335-30	.0005"	.030"	1-3/8"	Complete	159.00

Fowler XTEST TWICE THE RANGE FOR LESS .060" RANGE TEST INDICATORS

- Dial reading: 0-15-0.
- Jewelled movement.
- Revolution counter.
- Easy-to-read tilted dial.
- Automatic reversal.
- 210° swivel arc.
- 3 Tungsten carbide contact points .040", .080", .120"
- Furnished in molded case.

Set includes:

- X-Test dial test indicator
- Axial support.
- Height gage bar with clamp.
- Universal holder.
- 2 dovetail stems.
- Contact point case.
- 3 Tungsten carbide contact points .040", .080", .120"
- Complete in "Shop hardened" case.



.0005" Indicator
1-1/2" Dial
No. 52-562-001
Reg. \$128.00

\$115.00

With 2 Dovetail Stems

2 Xtra Contact Points w/Purchase

Model No.	Grad.	Dial Dia.	Price
52-562-001	.0005"	1.5"	\$115.00
52-562-002	.0005"	1.16"	115.00
52-562-003	.001"	1.16"	115.00
52-562-007	.01mm	25mm	\$115.00
52-562-008	.01mm	38mm	115.00

Complete Set

Model No.	Grad.	Dial Dia.	Price
52-562-100	.0005"	1.5"	\$149.95
52-562-110	.0005"	1.16"	149.95

Fowler XTEST XTRA MAG COMBO A Versatile Test Indicator, Universal and Mag Base Combo!

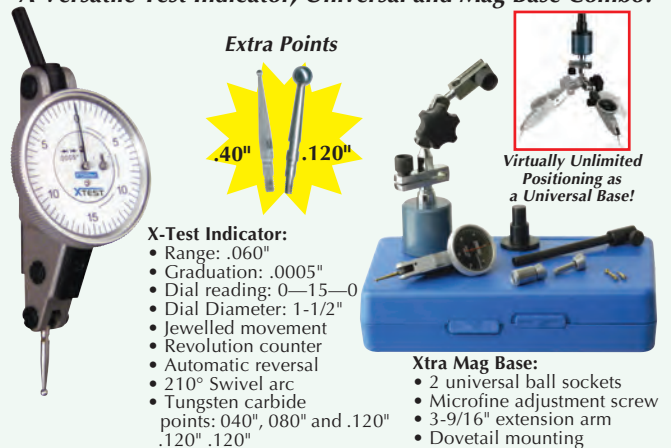

Extra Points

.40" .120"

Virtually Unlimited Positioning as a Universal Base!

X-Test Indicator:

- Range: .060"
- Graduation: .0005"
- Dial reading: 0—15—0
- Dial Diameter: 1-1/2"
- Jewelled movement
- Revolution counter
- Automatic reversal
- 210° Swivel arc
- Tungsten carbide points: .040", .080" and .120"
- .120" .120"

Xtra Mag Base:

- 2 universal ball sockets
- Microfine adjustment screw
- 3-9/16" extension arm
- Dovetail mounting

All Complete in a Shop Hardened Case

Model No.	Description	List Price	Sale Price
52-585-105	Xtra Mag only	\$ 64.00	\$ 49.50
52-562-105	Xtra Mag with Xtest Indicator	155.00	129.95

Fowler XTEST VERTICAL INDICATORS .060" Range ~ Twice The Range

- Range: .060"
- Dial reading: 0-15-0
- Jeweled movement
- Revolution counter
- Easy to read tilted dial
- Easy to read tilted dial
- Automatic reversal
- 210° swivel arc
- 5/32" stem
- Tungsten carbide point: .080"

2 Xtra Contact Points .040" & .120" w/Purchase

Model	Description	Grad.	Dial Dia.	List	Sale
52-562-004	Vertical X-test Indicator	.0005"	1-1/2"	\$145.00	\$129.95
52-562-005	Vertical X-test Indicator	.0005"	1"	145.00	129.95
52-562-006	Vertical X-test Indicator	.001"	1"	145.00	129.95



DIAL TEST INDICATOR SET Jeweled Bearing - Auto Reverse



- Graduations: .0005"
- 0-15-0 Reading.
- Range .030"
- Jeweled movement.
- Bi-directional constant clockwise rotation.
- Automatic reversal.
- 3 dovetail mountings.
- 2 dovetail extensions.
- Includes molded case.

SET No.
52-562-778
Reg. \$117.00

\$59.95

Includes 2 FREE
contact points!
(.040" & .120")
&
Universal
Indicator
Holder with
Swivel



Precise MEASURING TOOL KIT

0-6" DIAL CALIPER
.001" Grad, 0 to 100, per
revolution, Covered rack,
Chrome stainless steel

0-1" MICROMETER
.0001" Graduation, Carbide
faces, Ratchet & lock nut,
Chrome finish

DIAL TEST INDICATOR
Automatic reversing,
Jeweled, .005" Graduation,
.030" range, Reading 0-15-0,
and 2 mounting stems

**1" TRAVEL AGD DIAL
INDICATOR**
.001" grad., 0-100 reading

**MAGNETIC BASE WITH
FINE ADJUSTMENT**
100 Lbs. pull magnet,
On-Off switch,
Base size 2-3/8" x 1-3/4",
Overall height 9"

MODEL
PMT-006
Reg. \$129.00

\$89.95



QUILL CLAMP INDICATOR HOLDER

- Manufactured and inspected at world class factory that produces highest quality European brands.
- Fits Bridgeport type milling machines.
- Fits milling machines with 1-7/8" diameter quills.
- Clamps directly onto machine quill.
- Will not disturb working tool in the machine.



Quill Clamp
Only
MODEL No.
4409-0010

\$19.95

With .0005"
Grad. Dial Test
Indicator Set
& Quill Clamp
MODEL No.
4409-0011

\$46.95

Mitutoyo A.D.G. DIAL INDICATORS



1-1/2"
Dial
Face



2-1/4"
Dial
Face



Model	Graduation	Range	Dial Dia.	List	Sale
1410F	.001"	.25"	1-1/2"	\$105.00	\$ 89.00
1506S	.0005"	.125"	1-1/2"	97.50	82.50
2414	.001"	.50"	2-1/4"	\$107.00	\$89.50
2416S	.001"	1.00"	2-1/4"	116.00	89.95
2424-10	.001"	2.00"	2-1/4"	215.00	175.00
4887S-19	.001"	3.00"	3-5/8"	332.00	280.00
2803-10	.0001"	.025"	2-1/4"	156.00	130.00
2804-10	.0001"	.05"	2-1/4"	161.00	135.00
2109-10	.001mm	1mm	2-1/4"	\$196.00	\$165.00

UNIVERSAL INDICATOR HOLDERS

- Suitable for all popular indicators with 5/32" shank or dovetail.
- Does not disturb the working tool.
- Mounts with single pressure screw directly on machine quill, bypassing the working tool.

Imported
For Bridgeport Mill
"J" Head
MODEL No. IND-871

\$14.95

Length from clamp bracket
to indicator 4-1/2"
Clamp Diameter 1-7/8"



INDICOL MADE IN USA

Model No.	Clamp Diameter	Length from Clamp Bracket to Indicator	List Price	Sale Price
IND-138*	1-3/8"	4-1/2"	\$108.00	\$ 95.00
IND-178†	1-7/8"	4-1/2"	75.00	59.50
IND-200	2"	4-1/2"	99.00	89.50
IND-225	2-1/4"	5"	124.00	115.00
IND-250	2-1/2"	5-3/4"	140.00	129.50
IND-275	2-3/4"	5-3/4"	150.00	135.00
IND-300	3"	5-3/4"	165.00	150.00

* For Bridgeport Mill "M" Head. † For Bridgeport Mill "J" "2J" Type

INDICOL UNIVERSAL INDICATOR HOLDERS

- The "Adjustol" allows extremely fine adjustment of your indicator by means of a patented differential screw.
- The "Adjustol" can be used with your Indicol to achieve precise, time saving adjustment.
- The "C" spring design makes for zero backlash and extreme accuracy.

MODEL No.
IND-150
\$26.95

MODEL No.
IND-100
\$24.95

Fits Your
Existing
Indicols

Fits No's
IND-225
Thru
IND-300

Fits No's
IND-138
IND-178

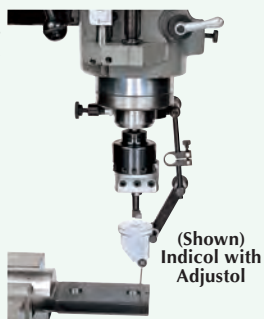

(Shown)
Indicol with
Adjustol

Precise LONG RANGE DIAL TEST INDICATOR Swiss Style ~ .060 Range ~ Imported

- Dial reading: 0-15-0.
- Jewelled movement.
- Revolution counter.
- Easy-to-read tilted dial.
- Automatic reversal.
- 210° swivel arc.
- 3 Tungsten carbide contact points .040", .080", .120"
- Furnished in molded case.

- Set includes:
- Dial test indicator
 - Axial support.
 - Universal holder.
 - 2 dovetail stems.
 - 3 Tungsten carbide contact points .040", .080", .120"
 - Complete in "Molded" case.



.0005" Grad.
1-1/2" Dial Dia.
Model No.
400-106
\$89.95

Complete Set
Model No.
400-014
\$115.00



Starrett Global Series ELECTRONIC CALIPERS

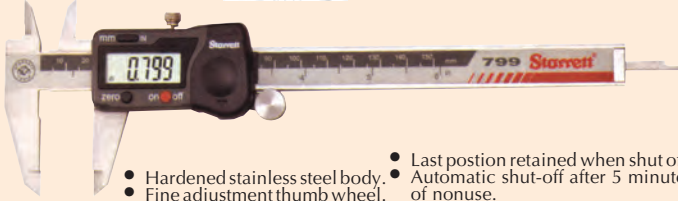

- Hardened stainless steel body.
- Fine adjustment thumb wheel.
- Zero at any position.
- Inch/millimeter conversion.
- Last position retained when shut off.
- Automatic shut-off after 5 minutes of nonuse.
- Linear accuracy meets DIN862.
- Integrated depth rod.

Model	Range	Resolution	List Price	Sale Price
799A-6150	0-6"/0-150mm	.0005"/0.01mm	\$151.00	\$135.50
799A-8200	0-8"/0-200mm	.0005"/0.01mm	214.00	192.50
799A-1230	0-12"/0-300mm	.0005"/0.01mm	519.00	285.00
799A-2460	0-24"/0-300mm	.0005"/0.01mm	720.00	645.00
799A-4010	0-40"/0-1000mm	.0005"/0.01mm	1445.00	1295.00

Starrett DIAL CALIPERS

- Graduation: .001"
- Revolution: .100"
- Thumb operated fine adjustment.
- Positive, spring-loaded double pinion anti-backlash control.
- Knife edge contacts.
- Supplied with fitted case.
- Made in China to the specifications and tolerances of the L.S. Starrett Company.



MODEL No. 1202-6
Reg. List \$101.00
\$89.95



Model	Range	Graduation	List	Sale
1202-6	0-6"	.001"	\$101.00	\$89.95
1202-8	0-8"	.001"	143.00	129.95
1202-12	0-12"	.001"	208.00	185.00
1202-6F	0-6"	1/64" +.01"	101.00	89.95

Starrett LAST WORD DIAL TEST INDICATORS

- For precise indicating in machining, layout and inspection.
- Jeweled lever for extra smooth indicator action.
- Swiveling tubular body.
- Hard chrome-plated ratchet contact point.
- Shaded dial for jig-borer use.
- Reversible action.



MODEL 711-GPSZ
Includes universal friction holder and universal shank

Complete With All Attachments
MODEL No. 711-GCSZ
Reg. List \$243.00

\$225.00

MODEL No. 711-FSAZ
Reg. List \$177.00

\$165.00

MODEL 711-HS
Indicators furnished with shaded dials as shown. Shaded area is colored yellow

MODEL 711-HSAZ
Includes universal shank

Indicator .001" Grad. .030" Range with Case

Model	Description	List	Sale
711-FSAZ	With Uni. shank long/short arm, body clamp	\$177.00	\$165.00
711-FSBZ	With Gooseneck shank	175.00	165.00
711-FSZ	With body clamp	164.00	155.00
711-GCSZ	Complete with all attachments	243.00	225.00
711-GPSZ	With Uni. shank, Uni. friction holder	172.00	163.00

Indicator .0005" Grad. .030" Range with Case

711-HSAZ	With Uni. shank long/short arm, body clamp	\$180.00	\$170.00
711-HSZ	With body clamp	169.00	160.00
711-LCSZ	Complete with all attachments	248.00	235.00
711-LPSZ	With Uni. shank, Uni. friction holder	177.00	165.00

Metric Available: 0.01mm Grad. 0.7mm Range

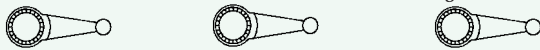

Starrett EXTRA CONTACT POINTS Starrett

Model No.	Ball Dia.	Ball Material	Price Each	Model No.	Ball Dia.	Ball Material	Price Each
SCP-100	.015"	Carbide	\$16.95	SCP-500	.031"	Steel	\$5.95
SCP-200	.031"	Carbide	14.50	SCP-600	.060"	Steel	5.95
SCP-300	.060"	Carbide	14.50	SCP-700	.120"	Steel	5.95
SCP-400	.120"	Carbide	14.50				

Starrett MULTI-ANVIL MICROMETER

- Interchangeable anvils are rigidly held in the vise type frame and quickly interchanged by a single lock screw adjustment.
- Two hardened anvils furnished-round anvil approx. .120" diameter and flat anvil approx. .125" and .060" thick.
- Rigid one piece frame of drop forged steel.
- Can be used as a height gage by removing the vise jaw.
- Quick reading figures-every thousandth numbered on inch tools.
- Extremely hard and stable one piece spindle.
- Tool is accurate to ±.0002" or ± 0.004mm



MODEL No. 220XFL-1
Reg. List \$258.00

\$240.00

0-1" Capacity, friction & Carbide Spindle, Locknut

Fitted Case No. 22022-1
\$11.50

Optional: V-Anvil No. 13017
\$22.00

Starrett ANGLED HEAD DIAL TEST INDICATORS

- Angled head for better reading position.
- Precision gear driven design with smooth, jeweled movement.
- Three dovetail positioning mounts work with existing test indicator accessories.
- Contact point reverses automatically, always maintaining clockwise hand rotation.
- Large 1-3/8" dial diameter.
- Long carbide contacts 13/16" furnished standard on all indicators.



Angled Head for easy reading

Easy Read 1-3/8" Dial Faces

.0005" GRADUATIONS

Model No.	Grad.	Range	Dial Color	Description	List Price	Sale Price
709ACZ	.0005"	.030"	White	With Attachments	\$284.00	\$269.50
R709ACZ	.0005"	.030"	Red	With Attachments	284.00	269.50
B709ACZ	.0005"	.030"	Black	With Attachments	284.00	269.50
709BCZ	.0005"	.060"	White		\$353.00	\$335.00

.0001" GRADUATIONS

708AZ	.0001"	.010"	White	Without Attachments	\$274.00	\$260.00
708BZ	.0001"	.020"	White	With Attachments	329.00	310.00
708ACZ	.0001"	.010"	White	With Attachments	\$345.00	\$325.00
708BCZ	.0001"	.020"	White	With Attachments	403.00	375.00

Attachments include-Dovetail body clamp, Tool post holder, Swivel post snug with dovetail indicator clamp, Snug and rod unit.

Starrett Extra Contact Points

Carbide Ball .015" \$16.95
.031", .080", .120 \$14.95
Steel Ball .031", .080", .120" . . . \$5.95

Starrett MICROMETERS AND SETS

.0001" GRAD., CARBIDE FACES, RATCHET & LOCK NUT

- Starrett satin chrome finish - no glare - resists rust.
- Advanced sleeve design with staggered lines and distinct figures for precise and easy readability.
- Balanced frame and thimble design insure easy handling.
- Ring-type knurled lock nut for quick and sure locking.
- The combination ratchet and speeder for uniform pressure and quicker adjustment.
- Rigid one-piece steel frame ribbed for extra strength-sizes through 6".
- Extremely hard and stable one-piece spindle (the heart of our accuracy).



Model	Range	List Price	Sale Price
T436XRL-1	0-1"	\$129.00	\$119.95
*T436XFL-1	0-1"	129.00	119.95
T436XRL-2	1-2"	157.00	145.00
T436XRL-3	2-3"	195.00	185.00
T436XRL-4	3-4"	212.00	195.50
T436XRL-5	4-5"	230.00	215.00
T436XRL-6	5-6"	250.00	235.00
ST436-3	0-3" Set	\$559.00	\$499.95
ST436-6	0-6" Set	1361.00	1195.00

*T436XFL-1 has friction thimble

Sets Include Standards and Case

Precise SHALLOW TEST GAGE

Ideal for accurate measurement of shallow bores, outside diameters, slots and more.

- Made of hardened tool steel, black-ox finish.
- Works with most brands of horizontal, vertical or side-mounted test indicators. Indicator not included.
- Lightweight, handy and highly sensitive.
- Good visibility to measuring area.
- Easy set up with fine adjustment using gage blocks, ring gage or qualified part.
- Indicator contact point stopper ensures smooth entry to measuring area.
- Includes a hardened tool steel contact pin, two Allen wrenches and storage. (Less Indicator)

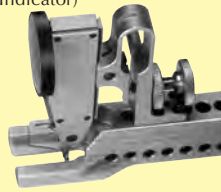
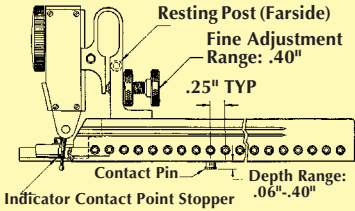

Model No.	Range Internal	Range External	Depth Range	Price Each
S-520	.55"-5.20"	.24"-4.92"	.05"-40"	\$195.00
S-720	.55"-7.20"	.24"-6.92"	.05"-40"	225.00
S-120-1	2.00"-12.1"	1.95"-12.05"	.05"-40"	350.00
S-100	10" Extension For #S-120-1			\$ 85.00
S-200-1	20" Extension For #S-120-1			120.00
CB-187	Carbide Ball Contact Stem			21.00

MADE IN USA

Fowler XTRA-SURF

Surface Gage with built-in Switchable Magnetic Base

- Set includes 3-1/8" x 2-1/16" permanent magnetic base with on/off switch, fine adjustment on base and a 5/16" x 9" upright.
- .0005" test indicator with .040", .080" & .120" contact points.
- Form fitted shop-hardened case for easy accessibility and storage.

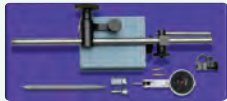

All in a Shop-Hardened Case!

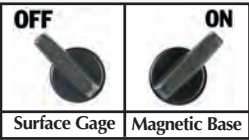

SET No.
52-155-747
Reg. \$185.00

\$119.95

Complete With Indicator Set

- Swivel clamp to mount indicator.
- Two dovetail stems: 5/32" & 3/8".
- 4" hardened universal scribe

XTRA-SURF
Mag. Surface Gage Only
No. 52-155-743

\$89.95

Less Indicator

Fowler HEIGHT TRANSFER & SQUARENESS GAGE

- Used for a variety of surface plate applications.
- Large fine adjustment knob for precise control.
- Swivel clamp anchors swivel and indicator for added accuracy.
- Rear surface of the gage has a reference surface to square against a master for checking squareness.
- Includes a 6" x 4" long post, indicator rod and clamp.

MODEL No.
53-620-010
Reg. \$249.95

\$199.95

Less Indicator & Standard



Fowler TRANSFER STAND

- Overall height 12".
- Revolutionary design.
- Large range fine adjustment.
- Holds test indicators or dial gages with dovetail holders & special adaptors.
- Large capacity positioning range.
- Can be locked in any position.
- Base 3" wide x 3.54" long.
- Large hand wheel provides fine adjustment.
- Stainless steel construction.
- Packed in deluxe wood case.
- Weight 4.8 lbs.



MODEL No.
52-620-717
Reg. \$110.00

\$89.95

Less Indicators

Mahr FEDERAL

DIAL TEST INDICATOR SETS

New Water Resistant Models

- Shockproof
- Anti magnetic
- Movement bearing are jeweled with 8 precious stones
- Automatic matching to sensing direction, thus ensuring error-free reading
- Doubles lever supported in ball bearing, overload protection provided by slip clutch
- Dial face is sealed with an O-ring
- Satin-chrome finished housing
- Contact point with Tungsten Carbide ball

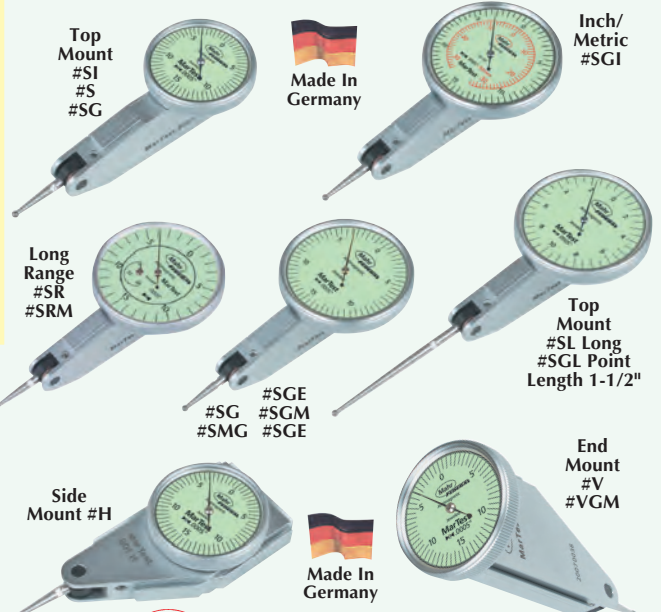

Mahr FEDERAL DIAL TEST INDICATOR SETS

Model No.	Graduation	Range (+) (-)	Dial Diameter	Point Length	List Price	Sale Price
801-SI	.001"	±.015"	1.1"	.514"	\$154.00	\$138.50
801-S	.0005"	±.015"	1.1"	.514"	154.00	138.50
801-SG	.0005"	±.015"	1.5"	.514"	174.00	156.50
801-SGI	.0005" 0.01mm	±.015" ±0.3mm	1.5"	.514"	\$149.00	\$134.00
801-SL	.0005"	±.010"	1.1"	1.620"	\$183.00	\$164.50
801-SGL	.0005"	±.010"	1.5"	1.620"	208.00	187.00
801-SM	.0001"	±.004"	1.1"	.514"	\$189.00	\$170.00
801-SGM	.0001"	±.004"	1.5"	.514"	215.00	193.50
801-SGE	.00005"	±.004"	1.5"	.378"	188.00	169.00
801-SR	.0005"	±.030"	1.5"	.514"	\$216.00	\$194.50
801-SRM	.0001"	±.008"	1.5"	.514"	229.00	206.50
End Mount (Perpendicular)						
801-V	.0005"	±.015"	1.1"	.514"	\$199.00	\$179.00
801-VGM	.0001"	±.004"	1.5"	.514"	215.00	193.50
Side Mount						
801-H	.0005"	±.015"	1.1"	.514"	\$146.00	\$131.00

*Sets Include: Indicator, .080" Carbide Point and fitted case. Metric Models are also available, inquire.

Mahr FEDERAL

EXTRA CARBIDE CONTACT POINTS

Model No.	Point Diameter	Length of Point	Price Each
FCP-001	.015"	.514"	\$11.95
FCP-002	.031"	.514"	10.95
FCP-003	.040"	.514"	10.95
FCP-004	.060"	.514"	10.95
FCP-005	.080"	.514"	10.95
FCP-006	.120"	.514"	12.95
FCP-007	.015"	1.620"	\$15.95
FCP-008	.031"	1.620"	12.95
FCP-009	.040"	1.620"	12.95
FCP-010	.080"	1.620"	12.95
FCP-011	.120"	1.620"	15.95

Mahr FEDERAL

HOLDERS AND ATTACHMENTS

Mounting Shaft w/Dovetail

No. 800-250-1
1/4" x 1" \$18.00
*No. 800-325
3/8" x 1" \$18.00

Universal Holder Swivel w/Dovetail

1/4" x 3"
No. 599-7054 . . . \$24.95

*Height Gage Holder
No. 800-H2 \$25.00
1/4" x 1/2" x 4"

BUY BOTH
No. 800-HK
\$60.00

Universal Body Clamp

5/32" Hole and 3/8" Hole }
No. 800-K \$42.00

Fowler X-PROOF

WATER RESISTANCE ADG DIAL INDICATOR & MAGNETIC BASE



SET No. 52-585-155
Reg. \$77.85

\$59.95

- X-Proof Indicator**
- Travel: 1"
 - Reading: .001"
 - Continuous reading: 0-100
 - Tolerance markers
 - AGD Group 2, 2-1/4" dia.
 - Lugback and carbide point
 - Robust, shockproof design
 - Rubber bellows on stem
 - O-ring seal on safety cap
 - O-ring protection for bezel and rotating dial
 - Sealed back plate
- Magnetic base**
- Fine adjustment
 - Base dimensions: 2" x 2-11/32" x 1-1/3/16"
 - Also mounts test indicators with 1/4" post
 - 85 lb. pull
 - On/Off lever release magnet
 - V-base for placing on round surfaces



Mitutoyo CALIBRATION TESTER

The Calibration Tester is specially designed to calibrate measuring accuracy of short range dial indicators, dial test indicators and other electronic comparison gage heads.

- Universal bracket accepts any dial indicator, dial test indicator, lever head of Mu-Checker without any additional accessory.
- Clamping capacity: ϕ 4mm - ϕ 10mm / .157" - .394" diameter
- Dual color indexed directional graduations to facilitate measurements.



Calibrating Test Indicator

Model	Range	Graduation	Accuracy	Price
521-104	0-.05"	.0001"	\pm .00001"	\$4850.00
521-106	0-2"	.0001"	\pm .00003"	5295.00
521-103	0-1mm	0.00002mm	\pm 0.2 μ m	\$4850.00
521-105	0-5mm	0.00002mm	\pm 0.8 μ m	5295.00

BACK PLUNGER DIAL INDICATORS



BAKER

Universal Features:

- Universal Test Set is simple, reliable, easy to use and eliminates checking problems.
- Set includes G clamp, tool post base and vertical rod, swinging arm, ball anvil, 1/2" anvil, thumb clamp and 11/32" standard anvil. Back plunger indicator is fully jeweled.

Deluxe Features:

- Economy Test Set is dependable, easy to use & overcomes problems in the workshop.
- Set includes G clamp, tool post base, vertical rod, extension rod, 3/16" standard anvil, 5/16" anvil, thumb clamp and swing arm attachment. Back plunger indicator is jeweled bearing.



Universal Complete Back Plunger Sets 1-1/2" Dial Diameter

Model	Type	Graduation	Range	Dial Reading	Price
P135-K	Universal	.001"	.200"	0-100"	\$79.95
P135-KA	Universal	.001"	.200"	0-50-0	79.95
P135-KM	Universal	.02mm	5.0mm	0-2.5mm	79.95

Universal Back Plunger Indicators Only

P951	Universal	.001"	.200"	0-100"	\$49.95
P961	Universal	.001"	.200"	0-50-0	49.95
P971	Universal	.02mm	5.0mm	0-2.5mm	49.95

BAKER Deluxe Back Plunger Complete Set

U51-PTS	Deluxe	.001"	.100"	0-50-0	\$109.95
U52-PTS	Deluxe	.001"	.100"	0-100"	109.95

BAKER Deluxe Back Plunger Indicators Only

A51-PTS*	Deluxe	.001"	.100"	0-50-0	\$55.00
A52-PTS*	Deluxe	.001"	.100"	0-100"	55.00

*Note: Shank Size is 1/4" x 4"

Fowler X-LOCK

LOCKING ARM MAGBASE & INDICATOR SET

Locking-Arm Mag Base Features:

- Accepts all AGD dial indicators and test indicators.
- Length of arm 6"
- Push button magnetic base.
- The central locking mechanism allows for easy set up of gages.

AGD Indicator Features:

- 1" travel.
- Continuous reading 0-100.
- AGD group 2, 2-1/4" dial diameter.
- Revolution counter.
- Tolerance markers.
- Lug back mount.
- Carbide point.



SET No. 52-588-030
List \$90.00

\$67.50

Includes Shop-Hard Case



FLEXBAR

DIAL INDICATOR TESTER

Provides A Quick & Highly Accurate Method For Calibrating Dial Indicators, Test (Lever Style) Indicators and Dial Bore Gages. Can be used with Flexbar Digital Electronic Indicator. For Readout or Digital Probe Style Readout Systems.

- Precise and sensitive micrometer drum with non rotating anvil provides the required fine drive to the reference master on one side and on the other side the gauge under calibration.
- Robust in construction with vertical stand for easy operation and clear visibility.
- Design based on Abbe's principle, that is the measuring axis and the evaluation axis are in the same line.
- Direct comparative measurement gives the required accuracy.
- Can be placed horizontally to accommodate the Lever Type Dials & Dial Bore gauges for calibration.
- Can be used in two different combinations with:
 - Digital Dial Gauge with .00005"/0.01mm resolution for calibration of .005"/0.01mm least count dial gauges.
 - Digital Display Unit and Probe with 0.0001mm resolution for 0.0001 and 0.002mm (or inch equivalents) least count dial gauges.
- Inch Resolution dial gauges can also be checked.
- Can be interfaced with computer by RS232 Port and Software for recording and evaluation.
- The DG Cal Software provides calibration results
- Accessories such as clamp, magnifying lens and holders are provided.



MODEL No. 19350

\$3695.00

DG Cal Software

- Direct Data acquisition to computer.
- Window based and user friendly software.
- Graphical presentation of Dial indicator errors in forward and backward directions.
- Software is capable of maintaining Gauge history.



MODEL No. 19351 **\$950.00**

Mitutoyo BACK PLUNGER TYPE DIAL INDICATORS

- Back plunger type dial gauges are suitable for mounting onto leveling machine tool tables or inspection jigs, and for use in small spaces where graduations of standard dial gauges are difficult to see.
- Model No. 1960 which uses Mitutoyo's proprietary shock-proofing mechanism, has excellent durability and shock resistance.



No. 1961 1-1/4" Dial Series 1 Diameter

Shown with Optional Holding Bar



No. 1960



Shock Proof

Inch Series 1 Stem 3/8" Diameter, 4-48 UNF Thread

Model No.	Graduation	Range	Range Per Revolution	Dial Reading	List Price	Sale Price
1961	.001"	.04"	.05**	20-0-20	\$151.00	\$134.95
1166-1	.001"	.2"	.05"	0-50	139.00	124.95
1167-1	.001"	.2"	.05"	0-25-0	139.00	124.95
1168-1	.001"	.2"	.05"	50-0	139.00	124.95

Metric Series 1 Stem 8mm Diameter, M2 x 5.0 045 Thread

1960	0.01mm	1mm	1.27mm	50-0-50	\$146.00	\$129.95
1160	0.01mm	5mm	1mm	0-100	139.00	124.95
1162-1	0.01mm	5mm	1mm	100-0	139.00	124.95

124625	Holding Bar	.25" x 3.19"	\$3.25	136567	Holding Bar	6mm x 81mm	\$3.25
21AAA167	Holding Bar	.25" x 1.65"	4.25	136568	Holding Bar	8mm x 81mm	3.25

* Full Stroke

Precise A.G.D. INDICATOR AND ON-OFF MAGNETIC BASE WITH FINE ADJUSTMENT

MIGHTY MAG
MADE IN USA

4-1/2" x 1" x 1-1/2"
6 Mounting locations
SET No. MMD-100

\$24.95

Set With
.001" Grad.
1" Travel
Indicator &
Mighty Mag Base



Mighty Mag (Only)
MODEL No.
MM-279

\$12.95



Set With
.001" Grad.
1" Travel
Indicator
& Mag Base
SET No. SMD-51

\$23.95

Mag Base
Only
MODEL No.
MBF-002

\$12.95

Precise TRAVEL INDICATOR & MAGNETIC BASE

- Graduation .001"
- Standard American gage design.
- Dial graduation 0-100.
- Stainless steel parts.
- Rotatable bezel with clamp.
- Lugback with 1/4" hole.



Mag. Base
Only
MODEL No.
MBF-002

\$12.95

SPECIAL COMBO PACKAGE!

1" INDICATOR WITH
FINE ADJUSTMENT
ON-OFF MAGNETIC
BASE PLUS 22 PC.
INDICATOR POINT KIT
\$49.00 VALUE

MODEL No. DCI-003

\$23.95



Model	Travel	Diameter	Grad.	Sale
DCI-025	.250"	2-1/4"	.001"	\$12.95
DCI-050	.500"	2-1/4"	.001"	12.95
DCI-001	1.000"	2-1/4"	.001"	12.95
DCI-002	2.000"	2-1/4"	.001"	26.95

1" Travel
Indicator
MODEL No.
DCI-001

\$12.95

Precise COMPARATOR STAND

- Accepts all A.G.D. type dial indicators with 3/8" or 5/16" diameter stem.
- Has fine adjustment for accurate positioning.
- Cast iron base and anvil base is precision ground.
- The post is 8" high and the base is 4" wide by 6" long.



Shown With
Square Flat
Anvil

Your Choice
Of Round or
Square Anvil

\$99.95



Shown With
Round Serrated
Anvil

Model No.	Anvil Size	Anvil Type	Price Complete
CSF-003	2-3/8"	Round Serrated	\$99.95
CSF-004	2-3/8"	Round Flat	99.95
CSF-005	2-3/8"	Square Serrated	99.95
CSF-006	2-3/8"	Square Flat	99.95

Precise GRANITE COMPARATOR STANDS WITH FINE ADJUSTMENT

It's a Black Granite Surface Plate!
It's a Dial Comparator Stand!

- Granite Stand.
- Microscrew fingertip control.
- .00005 granite flatness.
- 10" height column.
- Accepts all AGD indicators.

Granite Stand
Model No. CSG-006
6" X 6" X 2"
less indicator

\$24.95

6" x 6" x 2"
Granite Stand
With 1" Travel
.001" Grad. Indicator
Set No. CSG-012

\$32.95

Model	Granite Size	Column	Price
CSG-006	6" x 6" x 2"	10"	\$24.95
CSG-008	6" x 8" x 2"	10"	39.95
CSG-009	9" x 12" x 3"	10"	59.95

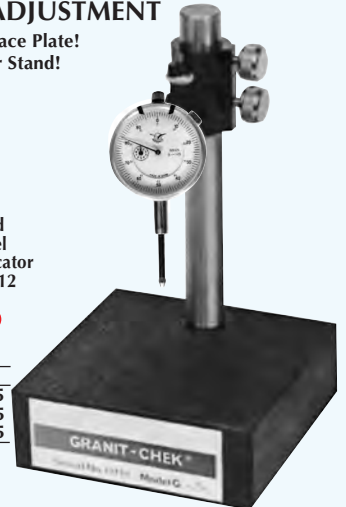

Starrett SURFACE GAGES

- Ground and polished contact faces.
- Four gage pins for linear work.
- V-groove for cylindrical work.
- Spindle adjusts to any angle, above or below the base.

MADE IN USA



No. 56B

Hardened &
Ground Base

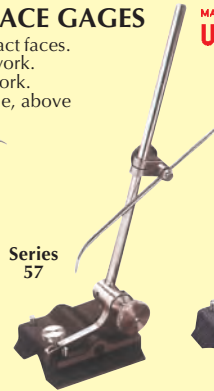

Series 57

Cast Iron
& Ground Base



Series 257

Hardened &
Ground Base

Model No.	Spindle Length	Base Size	List Price	Sale Price
56B	4" & 7"	2" x 1-1/2"	\$253.00	\$225.00
57B	9" & 12"	3" x 2-9/16"	196.00	175.00
57D	12" & 18"	3-3/4" x 3-3/8"	237.00	213.00
257B	9" & 12"	2-7/8" x 2-3/8"	218.00	195.00
257D	12" & 18"	3-1/2" x 3-3/16"	275.00	245.00

Starrett UNIVERSAL SNUGS



MODEL No. 57S
Include: Spindle hole
diameters 5/16" & 3/8"
and gripping hole dia.
9/64", 5/32", 3/16", & 1/4"

\$55.00



MODEL No. 58S
Include: Spindle hole
diameters 1/4", 5/16" &
3/8" & gripping hole
dia. from 3/32" to 1/4"

\$30.50

MURKENS® INDICATOR BASE FOR SURFACE PLATE WORK

Transfers Dimensions - Checks Squareness

The patented front-spring design greatly increases indicator repeatability and decreases time spent on irritating readjustments.

- Built-in ground rear bar for easily and accurately checking squareness.
- Large fine-adjustment knob for fast, smooth moves.



STAND ONLY
MODEL No.
MPT-610

\$249.95

With
No. MPT-610
Stand and
not brown & sharpe

.0005" Graduation
Best Test Indicator

SET No.
MPT-611

\$339.95



Model No.	Base Size	Working Height	Weight lbs.	Price Each
MPT-008	1-1/2" x 2-3/8"	8"	3/4 lbs.	\$145.00
MPT-610	2-1/2" x 3-3/4"	14-1/2"	2-1/2 lbs.	249.95
MPT-024	2-1/2" x 3-3/4"	24"	8-1/2 lbs.	369.95

Fowler PRECISION DIAL GAGE STAND

- 10" in overall height with a precision serrated anvil.
- Quick positioning and adjustment.
- Zero settings with knob for fine adjustment.
- Fine adjustment of 5/32"
- Total height of column 8"
- Dial gage stand holds indicators with stems of 3/8" and 8mm.
- Round working surface of 2" serrated anvil.
- Diameter of column .980"
- 2" serrated anvil.

MODEL No.
52-580-011
Reg. \$150.00

\$99.95



Fowler ECONOMY DIAL GAGE STAND

- Accepts all lug-back indicators.
- Positive lock screw.
- Column is 5/8" from back edge of working surface.
- Column diameter: 1"
- Fine adjustment: 3/8"
- Capacity of 6-1/2" from working surface.
- Bracket with 1/4" bolt for dial indicator is 2-1/4" from center of column.
- Fine adjustment knob for zero setting.
- Rapid preliminary positioning adjustment is featured.
- Ground steel post mounted at right angles to the base.
- Ground working surface 5-1/2" x 4-1/4"

MODEL No.
52-580-020
Reg. \$110.00

\$75.50



Fowler DELUXE DIAL GAGE STAND

- Measuring Range: 5"/125mm
- Quick positioning and adjustment.
- Zero settings with knob for fine adjustment.
- Fine adjustment of 5/32"
- Holds indicators with stems of 3/8" and 8mm
- Diameter of column is 1"
- Working surface of 3-1/2" x 3-1/2"
- Base Height: 1.5"
- Base Width: 4"
- Base Length: 6"
- Overall Height: 8.5"

MODEL No.
52580015-1

\$139.95

With AGD Indicator
1" Travel, .001" Grad.



Mitutoyo PRECISION GRANITE STANDS

- By mounting precision measuring instruments such as Digimatic Indicators, Mu-Checker Cartridge Heads, and Linear gages onto the stands, it is possible to satisfy all manner of measuring assignment.
- The rigid granite base is free from burrs, pileups, rust, and deterioration over time.

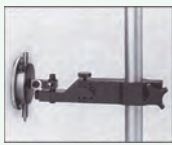

Model No.	Base Size	Column Height	Throat Clearance	Weight lbs.	Price Each
517-890	6" x 8" x 2"	6"	4.375"	18	\$745.00
517-891	6" x 8" x 2"	8"	4.375"	19	860.00
517-892	6" x 8" x 2"	12"	4.375"	20	860.00
517-893	6" x 8" x 2"	18"	4.375"	21	870.00
517-895	8" x 12" x 2"	6"	5.8"	29	885.00
517-896	8" x 12" x 2"	8"	5.8"	30	895.00
517-897	8" x 12" x 2"	12"	5.8"	31	920.00
517-898	8" x 12" x 2"	18"	5.8"	32	925.00
517-899	8" x 12" x 2"	24"	5.8"	35	975.00

FLEXBAR LARGE HEAVY DUTY COMPARATOR STAND

A vertical pillar boom arm which is mounted asymmetrically to allow the dial gauge to be positioned over virtually all points on the base.

- Measuring base: Hardened & precision ground special tool steel with square grids.
- Size: 8" x 8"/200mm x 200mm
- Vertical range:
Model No. 19290: 6.5"/190mm
Model No. 19291: 12"/300mm
- Throat Depth: 7.5"/190mm
- Pillar Diameter: 1.2"/31mm
- Dial Gage Holder: 3/8" dia. with 8mm bushing adapter
- Net Weight: 22.75Kgs.

6.5" Range
MODEL No.
19290

\$365.00

12" Range
MODEL No.
19291

\$385.00

Less Indicator



Fowler DELUXE DIAL GAGE STAND

No. 52-580-015

- Quick positioning and adjustment.
- Zero settings with knob for fine adjustment.
- Fine Adjustment of 5/32"
- Holds indicators with stems of 3/8" and 8mm
- Diameter of column is 1"
- Working surface of 3-1/2" x 3-1/2"

No. 52-580-015
With Flat Surface
3-1/2" x 3-1/2"



No. 52-580-010

- Quick positioning and adjustment.
- Zero settings with knob for fine adjustment.
- Fine Adjustment of 5/32"
- Holds indicators with stems of 3/8" and 8mm
- Round working surface of 2-1/4"
- Diameter of column is 1"

No. 52-580-010
With 2-1/4"
Round Surface



Model No.	Base Height	Base Width	Base Length	Overall Height	Price Each
52-580-015	1.5"	4"	6"	8.5"	\$125.00
52-580-010	2"	4"	6"	10"	210.00

FLEXBAR C-FRAME DIAL GAGE STAND WITH HEIGHT ADJUSTABLE ANVIL

- Accommodates 3/8" dia. stems and 8mm stems with supplied bushing adapter.
- Measuring Base: Hardened & Precision ground special tool steel
- Size: 2.36"/60mm dia.
- Vertical Range: 1.18"/30mm
- Throat Depth: 1.75"/45mm
- Net Weight: 2.5 kgs.

MODEL No.
19278

\$75.00

Less Indicator



Mitutoyo GRANITE COMPARATOR STAND

- The rigid granite base is free from burrs and pileups due to its fine grain composition and less viscosiveness compared with casting iron: the flatness is always accurate and the workpiece is free from damage.
- Easy maintenance due to the non-rusting base.
- The base is made of black granite that stays free of burrs and pileups due to its fine-grain composition.



Model No.	Base Size	Column Travel	Remarks	Price Each
215-151-10	6" x 8" x 2"	6"	w/fine adjustment 1mm	\$ 865.00
215-153-10	8" x 10" x 3"	6.2"	w/fine adjustment 1mm	995.00
215-156-10	12" x 10" x 3"	11"	w/fine adjustment over the entire travel	1125.00

Fowler ECONOMY DIAL GAGE STANDS

- Accepts all dial indicators with 3/8" stems
- Column 5/8" from back edge of working surface.
- Column diameter: 1". • Fine adjustment: 3/8"
- Positive lock screw.
- Capacity of 6-1/2" from working surface.
- Bracket with 1/4" bolt for dial indicator is 2-1/4" from center of column.
- Microfine adjustment knob for zero setting.
- Microscrew finger tip control.
- Ground steel post mounted at right angles to the base.

MODEL No.
52-580-016
Reg. \$125.00

\$99.95

Reducing Bushing
from 3/8" to 8mm
(for Metric Indicators)
No. Z2106 \$6.00



Fowler HIGH PRECISION DIAL GAGE STAND WITH 2 ANVILS

- Quick positioning and adjustment.
- Zero settings with knob for fine adjustment
- Fine adjustment of 5/32"
- Total height of column 14"
- Can hold indicators with stems of 3/8" and 8mm.
- Diameter of column .980"
- Supplied with two 2-3/8" diameter anvils, flat and serrated.

MODEL No.
52-580-014
Reg. \$165.00

\$149.95



Fowler DIAL GAGE STAND

- State of the art ceramics provide durability and micro flatness.
- Serrated working surface provides a stable and accurate reference base.
- Polished chrome column and rack and pinion adjustment for fine measurements.
- Accepts all electronic and standard dial gage and electronic probes 3/8" or 8mm mounting.



Model No.	Work Area	Overall Height	Surface Plate	Price Each
54-618-576	3-1/4" x 3-1/4"	9.5"	Ceramic	\$695.00
54-618-578	4" x 4"	13"	Ceramic	550.00

Mitutoyo TRANSFER STAND

The Transfer Stands are designed for comparison measurements of height using a dial indicator or Digimatic Indicator.

Features:

- Vertical travel of the gage holder 13-1/2", 15-1/2" Post Height, 30mm Post diameter.
- Fine Adjustment of 1mm available for zero-setting of the indicator.
- Optional interchangeable anvils. Domed anvil (101463) and Flat anvil (101461) are optional.

MODEL No.
519-109-10
Reg. \$631.00

\$555.00

With Serrated Anvil



Domed Anvil



Flat Anvil



3/8" Stem Hole

Optional Accessories:

- No. 101461 Hardened steel flat anvil (flatness: 1µm) . . \$36.00
- No. 101463 Hardened steel domed anvil 42.00
- No. 390070 Dovetail attachment used with test indicators 35.50

FLEXBAR FLEXIBLE ARMS ON WEIGHTED AND VACUUM BASES

- Instant Positioning - Instant Locking
- UNIVERSAL HOLDER/POSITIONERS FOR ALL AGD INDICATORS AND ELECTRONIC SENSORS (Lug Backs Too!)
- Cable and swaged fittings are stainless aircraft and Mil Spec Grade.
- Locked by Tensioning of Cable, incredible rigidity is achieved by this design. (No Movement once locked).
- The heavy duty FLEXBAR is completely flexible; lets you reach over, under, around, instantly and surely. Elimination of the large assortment of rods, swivels, clamps and other hardware necessary to reach and measure in obstructed areas. Cuts set-up time as much as 75% to 90%. FLEXBAR sets and locks with a simple twist of the lever.



Shown With Weighted base

Shown With Vacuum Base

MADE IN USA

Model No.	Base Type	Flexbar Length	Lock Type	Price Each
18030-WB	Weighted	19"	Camlock	\$ 74.95
18046-WB	Weighted	13"	Knoblock	85.00
18031-VB	Vacuum	19"	Camlock	139.95
18046-VB	Vacuum	13"	Knoblock	159.95

VIS GAGE BLOCK ACCESSORIES AND SETS For Rectangular Gage Blocks

14 Piece Set*



- Base Block **
Gage Block mounting surface
Lapped flat and parallel
with base size
4" x 2.75" x 1.375



Holders
*2.250"**, - 4.000"***
*6.000"**, - 10.000"***

27 Piece Set**

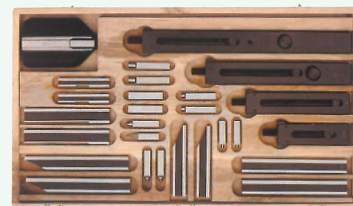

- Scriber Point **
For scribing lines



- Center Point **
For locating centers



- Points **
For checking graduations



Cylindrical Jaws (Pair)

For inside and outside measurements and setting of instruments accuracy

Radius size
*.100" **
*.200" **
*.250" **
*.500" **
-.750" **

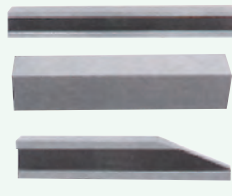

- Flat Jaws (Pair)**
2 sides lapped and accurately flat, parallel and to size. .750" height, 6" long.

Jaws with reference lines (Pair)**
For spacing blocks within limits .0625"

Jaws with beveled ends (Pair)
*.750" height, 4" long **
*.750" height, 6" long **

Note: All Items may be purchased separately. Inquire or visit our website www.penntoolco.com



GRANITE GAGE STANDS

- USA Components.
- Imported Granite.
- Grade A Surface Accuracy = +/- 0.0001"
- 6" x 6" Stand comes in Lug Mount or Stem Mount



Model No.	Granite Size	Rod Diameter	Rod Height	Indicator Mount	Price Each
STA-662	6" x 6" x 2"	1"	8"	Lug Mount	\$125.00
STA-662-SM	6" x 6" x 2"	1"	8"	3/8 Stem	125.00
STA-8122	8" x 12" x 2"	1.25"	12"	3/8 Stem	150.00
STA-12184	12" x 18" x 4"	1.25"	12"	3/8 Stem	225.00

* Indicator Not Included

Precise UNIVERSAL HYDRAULIC MAGNETIC BASE

- Absolute sealed hydraulic system.
- Knob turning creates tension and high pressure on the joints to hold the rods absolutely rigid.
- Multi-nimble joint for instant fix at any desired position.
- Fine adjustment.
- Fits dovetail and 3/8" stem indicators.
- Super power pull 130 lbs.
- Base dimension: 2"(Width) x 2-1/2"(Depth).

Fine Adjustment



MODEL No. 401-003
Reg. \$60.00
\$49.95

Precise VACUUM BASE INDICATOR HOLDER

- Ideal for granite plates and other non-magnetic smooth surface.
- A powerful 3" diameter suction disk.
- On/Off lever.
- Accepts both standard test and AGD indicators.
- Fine adjustment.

MODEL No. 401-051-1
Reg. \$45.00
\$34.95



Precise FLEXIBLE SHAFT WITH INDICATOR AND VISE GRIP WRENCH

- Accepts Electronic and AGD indicators.
- Flex arm, total length 12"
- Locking pliers, length 7.1", adjustable jaw opening from 0-1"
- Packed in blow mold case.



Model No. 4401-0522 (Shown)

Model	Description	Price
4401-0520	Flexible Shaft and Vise Grip Wrench	\$34.95
4401-0521	Same as above with 1" Travel, .001" Grad. AGD Dial Indicator	43.95
4401-0522	Same as above with 1" Travel, .0005" Electronic Indicator	89.95

ManyForm MAGNETIC BASE

Will Fit Many Shapes - Any Contour

- Powerful permanent magnet always stays on.
- Cam lock mechanism easily loosens segments for contour adjustments. No more hassles using an extra fixture to set indicators.
- Rigid, one-piece construction.
- Unlimited versatility; can be used with coolant systems, lamps, etc.

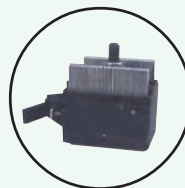

Magnetic Base With .001" Grad. 1" Travel Dial Indicator
SET No. 401-501
\$39.95

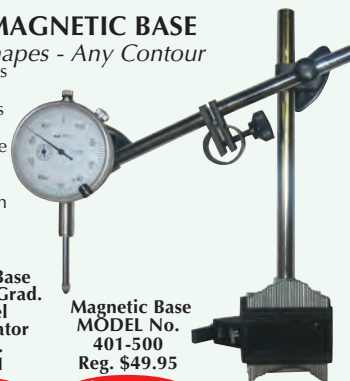

Magnetic Base MODEL No. 401-500
Reg. \$49.95
\$29.95
w/o Indicator

SPI PRECISION SURFACE GAGE

- Base hardened.
- Bottom grooved for cylindrical
- Front end recessed for depressing spindle below screw in rocker for extra fine adjustment.
- Knurled thumb screw in rocker for extra fine adjustment.
- Includes scriber.

Universal Surface Gage

- Includes clamp attachment (with 5/32" and 15/64" holes) for holding indicators, scribers, etc.
- With 9" and 12" spindles.
- Base dimensions: length 3-1/8", width 2-3/8", height 1-1/8".

MODEL No. SPI-675
Reg. \$82.95

\$69.95



Precise FLEXIBLE MAGNETIC BASE

- Adjustable cable tension.
- Overall length 13".
- Permanent magnet with On/Off switch.
- Accepts all AGD dial indicators with stems 1/4 & 5/32" diameter.
- Stem flexes 360°.
- Cam lever operates cable and locks arm instantly in any position.

Flexible Mag. Base & 1" Travel AGD Dial Indicator
.001" Graduations
SET No. 401-007
\$34.95



Flexible MODEL No. 401-002
Reg. \$48.00
\$24.95

Mitutoyo MICROMETER STANDS

These stands are designed to allow benchtop use with hand micrometers or other gages



No. 156-105



No. 156-106



No. 156-101



No. 156-102

Model No.	Micrometer Range	Stand Type	Price Each
156-105	1" & 2"	Fixed Angle	\$ 65.00
156-101	Up to 4"	Adjustable Angle	95.00
156-106	1" & 2"	Platform & Fixed Angle	245.00
156-102	5" to 12"	Vertical Type	495.00
156-103	12" to 40"	Vertical Type	995.00

Precise UNIVERSAL MAG BASE

- 3-D rigid steel arm movement.
- Unique central locking mechanism.
- Fine adjustable.
- On/Off switch.
- Super power pull 130 lbs.
- Base dimension:
1-7/8"W x 2-1/4"H x 2-7/8"D
- 12" maximum reach.
- Accepts all A.G.D. dial indicators and test indicators.



Mag Base
MODEL No.
401-005
Reg. \$49.95

\$39.95

Mag Base
With Indicator
.0005" Grad.
MODEL No.
401-000

\$64.95

Precise MINI UNIVERSAL MAG BASE

Pro-Quality Series

- 3-D rigid steel arm movement.
- Unique central locking mechanism.
- Accepts all A.G.D. dial indicators and test indicators.
- On/off magnet power switch.
- Maximum reach: 7.5".
- Base dimension:
1.2" (width) x 1.5" (depth).

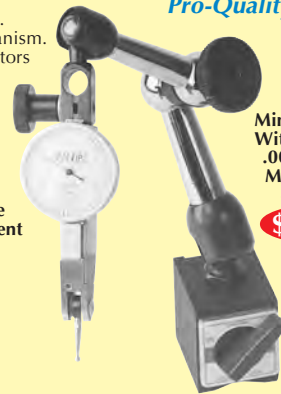

Mini Mag Base
With Indicator
.0005" Grad.
MODEL No.
401-009

\$59.95

Mini Mag Base
MODEL No.
401-008

\$32.95

Mini Mag Base
w/Fine Adjustment
MODEL No.
401-081

\$36.95

FLEXBAR FLEXBAR® DUAL AXIS MAGNETIC BASE

The new Flexbar® Dual Axis flexible arm offers complete range of movement for precise positioning of AGD dial travel and test indicators.

- Flexbar arms are made in the USA, cable and fittings are stainless aircraft and Mil Spec. grade.
- Unique arm can position around and into places where normal straight arms cannot.
- Red cam lever instantly locks the arm in a rigid position.
- Dual axis fine adjustment allows for sensitive and accurate positioning of gages.
- Can hold AGD dial indicators with 3/8" stems, 8mm bushing adaptor included.



FLEXBAR

USA
MODEL No.
AMB-300

\$99.95

Precise

China
MODEL No.
FMB-338

\$49.95

AVENGER MAGNETIC BASES 180 lbs. of Pulling Power

- 180 pounds of pulling power.
- Back rails and bottom surfaces are surface ground square and parallel to within .001".
- Base can be mounted vertically as well as horizontally.
- V bottom base allows mounting on cylindrical surfaces.
- Front handle assembly parts are made from nickel plated zinc die castings.
- On/Off switch.



(Shown)
MODEL
AMB-2
Fine
Adjustment

MODEL
AMB-1T
Standard
Adjustment

Chrome Plated Arms

Dimensions:
Base 3-1/2" L x 2"W x 2.1H
Arms:
Main Column 7" x .475"
Clamping Rod 7" x .390"

Model	Description	Price
AMB-1	With standard arms	\$39.95
AMB-2	With fine adj. arms	45.95
Titanium Plated Arms		
AMB-1T	With standard arms	\$45.95
AMB-2T	With fine adj. arms	49.95

MYFORM MAGNETIC BASES

*Will Fit Any Shape,
Any Contour!*



No. AMB-100

No. AMB-102

No. AMB-103

- Powerful permanent magnet always stays on.
- Cam lock mechanism easily loosens segments for contour adjustments. No more hassles using an extra fixture to set indicators.
- Rigid, one-piece construction.
- Unlimited versatility; can be used with coolant systems, lamps, etc.
- Available with standard, fine adjustment or flexible arms and clamps.
- Rotary On/Off knob included: on Model No's AMB-104, AMB-105, AMB-106 & AMB-107

Model	Description	Price
AMB-100	Magnetic base only	\$ 44.95
AMB-101	Magnetic base with standard arms & clamps	49.95
AMB-102	Magnetic base with fine adjust arms & clamps	52.50
AMB-103	Magnetic base with flexible arm	139.95
AMB-104	On/Off magnetic base only	\$ 79.95
AMB-105	On/Off magnetic base with standard arms & clamps	85.00
AMB-106	On/Off magnetic base with fine adjust arms & clamps	85.00
AMB-107	On/Off magnetic base with flexible arm	169.95

NOGA MAGNETIC BASES

- Unique 5 axis, 3-dimensional holder.
- Unique patented 360° fine adjustment at the base.
- Central locking mechanism with NOGA designed spring-loaded bearing.
- Lower arm= 2.204" Upper arm= 2.007"



Permanent
Mag Base
MODEL No.
NF-1033

\$89.95

On/Off
Mag Base
MODEL No.
NF-1024-1

\$99.50

NOGA MAGNETIC ON/OFF BASES

- 3-D arm movement.
- Unique central locking mechanism.
- Rigid steel arms
- Compatible with NOGA magnets.
- With NEW Fine Adjustment, holds 6mm, 8mm, 3/8" and Dovetail Indicators



Heavy Duty
176 lbs. Pull Force
Upper Arm= 4-1/2"
Lower Arm= 5-1/8"
MODEL No.
MG-61003
Reg. \$ 160.00

\$129.95

With NEW
Fine adjustment
Metal Body
Holds 6mm, 8mm
3/8" and Dovetail

Big Boy
285lbs. Pull Force
Upper Arm= 9-1/2"
Lower Arm= 12-7/8"
MODEL No.
MA-61003
Reg. \$195.00

\$189.95



ERICK MAGNA HOLDER

- Here is a rugged holder for Indicators for use as lathe stops, etc.
- Assures fast accurate work in facing, boring, turning, etc.
- Widely used on machines where graduations are hard to read.

- Lug back Indicators (not furnished) are mounted directly on unit with bolt and nut provided to give powerful compact unit.
- Base has powerful lifetime guaranteed magnetic grip which assures you of accurate work.

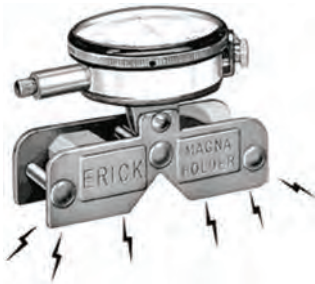

MODEL No. EMH-300

\$29.95

Less Indicator

Base Size 3-1/2" x 1/8" x 1"



ERICK MAGNA HOLDER

Magnetic Indicator Holder for Every Type of Dial Indicator

- Large 1/4" lug back type Indicators mount in specially designed extension links which provide great flexibility.
- To accommodate small test Indicators mount the 6" long, 1/4" diameter stainless steel attachment in a 360° swivel block.
- Unit has precision lateral adjustment controlled by large thumb screw located at rear of unit with 1/2" travel-highly important for "zeroing in" Indicator.
- All components of this unit are chrome, aluminum, stainless steel and black oxide.
- Base has powerful magnetic pull with magnetic release.



90 lbs. Pull Neo Mag Base MODEL No. 350-N

\$69.95

50 lbs. Pull Alnico Mag Base MODEL No. 350-A

\$54.95



ERICK MAGNA HOLDER

Designed for use with Small Test Indicators

- Unit has fine precision adjustment similar to surface gauge controlled by thumb screw allowing the most minute adjustment of Indicator without touching work or Indicator.
- Base has powerful magnetic grip and will adhere firmly to round or flat surfaces with magnetic release.
- 1/4" stainless steel non-magnetic holding rod is 6" long, set in hardened ball socket setting which allows universal positioning of indicator.
- Base finish is hammered blue. All other parts are plated or are of stainless steel.



50 lbs. Pull MODEL No. 200-BS

\$46.95

90 lbs. Pull MODEL No. 200-BN

\$54.95

Good brown & sharpe BesTest INDICATOR W/FREE MAGNETIC BASE

- Easy-to-read "jet console" face w/high visibility orange hand.
- Constant clockwise rotation.
- Automatic reversal.
- Swiveling point.
- Carbide tip point.
- Universal mounting.
- Monoblock (Precision Watch) body design.
- Anti-magnetic and corrosion resistant.



.0005" Grad. .030" Range 0-15-0 1" Dial Face

BesTest Indicator set comes complete with one carbide tip contact point, .080" diameter; one 1/2" long x .250" diameter extension with dovetail; one contact point wrench; one durable molded case and certificate of accuracy; traceability and magnetic base.

SET No. 599-7030-P Reg. List \$175.00

\$149.95

Mag Base 130 lbs. pull With Fine Adjustment



Z-HEIGHT HEAVY DUTY COMPARATOR STAND

Precision Rack and Pinion Vertical Column for Mounting and Positioning both Plunger and Lever Type Dial Gages

- Measuring base: Hardened & Precision Ground special tool steel with serrations.
- Base size: 5" x 5" (125mm x 125mm)
- Dial Gage Holder: 3/8" dia. with 8mm bushing adapter.
- Vertical Range: 5.1" (130mm)
- Throat Depth: 4.7" (120mm)
- Net weight: 12kgs.

MODEL No. 19284

\$339.95

Less Indicator



SPECIAL APPLICATION COMPARATOR STAND

Useful for checking Radial & Axial Run Out on Cylindrical Shafts



- Measuring Base: Precision ground, stable cast iron bed.
- Size: 16"/400mm long
- Tee slot adjustment of centers.
- Flatness of bed: .0005"/.010mm
- Axiality of centers: .0005"/.010mm
- Maximum distance between centers: 8.65"/220mm
- Center height: 4"/100mm
- Dial indicator not included
- Net weight: 22kgs

MODEL No. 19285

\$550.00

Less Indicator



3D ARTICULATING ARMS WITH MAGNETIC OR VACUUM BASES

- Cleverly designed central tightening system. Three joints can be fixed and moved in five different directions with a single touch. The Purely mechanical and infinitely adjustable central tightening system with the quick lock offers the greatest possible ease of operation.
- Secure, stable bases. A safe stable base provides the essential foundation for precise measurements. The articulated arms can be mounted as desired, on a strong magnet, vacuum or a granite sliding base.



No. 18416



No. 14840-1



No. 18415

Model No.	Arm Radius of Movement	Magnetic Base Size	Approximate Holding Power	Price Each
14840-1	5.15"/130mm	34 x 30 x 35mm	67 lbs.	\$215.00
14845-1	8"/200mm	60 x 50 x 55mm	168 lbs.	235.00
14848	8"/200mm	Vacuum 88mm	-	265.00
18416	11"/280mm	60 x 50 x 55mm	168 lbs.	310.00
18415	11"/280mm	Vacuum 88mm	-	355.00
14828	11"/280mm	75 x 50 x 55mm	202 lbs.	375.00



INDICATOR AND MAGNETIC BASE



Dial Test Indicator: Series No. 312B-1 .0005" Graduation 0-15-0 Dial .060" Range 1-1/2" Dial Face

- Magnetic Base
- Fine adjustment.
- 5/32" scriber opening.
- 2-3/8" x 1-3/4" base.
- 9" height.
- 100 lbs. magnet pull, On/Off switch.
- Quality import.



Buy Both SET No. 312B-150 Reg. \$295.00

\$224.95



GEM MAGNETIC BASE With Push Button On-Off

- The model 500FA has a 3/8" center post 7-1/2" long, mounted on a rigidly-locking ball joint, plus a fine adjustment on the center post.
- It includes a base measuring 1-7/8" x 1-7/8" x 1-5/8" with three ground surfaces for sure gripping in any direction, plus a V-slot for round surfaces and an on-off push button release.
- The 1/4" cross bar is 7" long, and has an adapter for AGD (lug-back) indicators.

MODEL No.
500FA



\$81.50

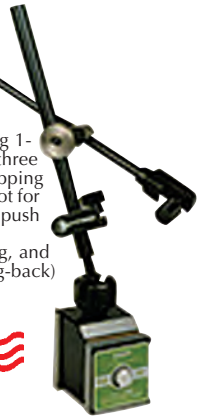

GEM MAGNETIC BASE

- This model includes a powerful permanent magnet base measuring 1-3/16" diameter. x 1-3/8" high.
- Fine adjustment movement for indicator applications.
- Ball swivel, locks at 90° at any position in 360°.
- The 5/16" diameter center post is 5" high. The cross bar is 1/4" x 5".

MODEL No.
555FA



\$43.50



GEM MAGNETIC BASE

- 55 lbs. min. holding power.
- Fine adjustment movement for indicator applications.
- Ball swivel, locks at 90° at any position in 360° no tools required.
- Mounts on flat, round and irregular surfaces.
- Release lever for easy removal.
- Non-magnetic feature on holding rod.
- Sturdy, six point riveted construction.
- Specifications: Length 3-1/2", Width 1-1/8", Height 1"

MODEL No.
G-5000

\$48.50



GEM MAGNETIC BASE

- 35 lbs. min. holding power.
- Fine adjustment movement for indicator applications.
- Ball swivel, locks at 90° at any position in 360° no tools required.
- Mounts on flat, round and irregular surfaces.
- Release lever for easy removal.
- Non-magnetic feature on holding rod.
- Sturdy, six point riveted construction.
- Specifications: Length 1-3/4", Width 1-1/8", Height 1"

MODEL No.
G-2500

\$32.95



AGD INDICATOR STEM BUSHINGS

- Accepts 8mm stem, converts to 3/8" diameter stem. Straight bushing, no head, .600" length. Brass, Nickel Plated.

MODEL No.
Z2106

\$6.95 Ea.



- Accepts 8mm Indicator Stem - converts to 3/8" diameter stem.
- Split one side for entire length. 5/8" head OD x .065" thick. 9/16" overall length.



MODEL No.
Z2105

\$9.95 Ea.

Precise MINI INDICATOR MAG. BASE -One Knob Lock

- Max. Reach: 10"
- On/Off switch.
- Hold stems: 3/8" & 8mm
- With dovetail clamp.
- Base dimensions: 1-1/8"W x 1-3/8"H x 1-3/8"D

MODEL No.
4401-0005

\$22.95



Precise EASY RELEASE MAGNETIC BASE

- Single universal rod, has 3 diameters to allow mounting popular indicators without changing rods.
- Full 360° swivel.
- Strong magnetic pull with easy release switch.

MODEL No.
4401-0802

\$34.50



Precise MAGNETIC INDICATOR HOLDER



- 80 lbs. magnetic pull.
- Overall height: 5"
- Fine adjustment.
- Holds most of dial and test indicators.
- Stem holds: 3/8", 5/16", 1/4" diameter.

MODEL No.
4401-0004

\$12.95

Precise GRANITE STAND WITH UNIVERSAL ARM

- 12x8x2" granite plate.
- 3-D rigid steel arm movement.
- Unique central locking mechanism.
- Dovetail groove for clamping test indicator.
- Indicator stem hole 8mm.
- Overall Reach: 15"
- Weight: 24 lbs.

MODEL No.
4401-0120

\$125.00



Precise UNIVERSAL ARM FOR INDICATORS

- Rigid universal steel arm
- Fine adjustment.
- Indicator stem hole: 8mm
- Arm length: 11"
- Unique central locking mechanism.
- Dovetail groove for clamping test indicator.
- Rod side dimension (dia.x L): 8mm x 40mm

MODEL No.
4401-0115

\$28.95



Precise MINI UNIVERSAL ARM FOR INDICATORS

- Rigid universal steel arm
- Fine adjustment.
- Indicator stem hole: 8mm
- Arm length: 6"
- Unique central locking mechanism.
- Dovetail groove for clamping test indicator.
- Rod side dimension (dia.x L): 8mm x 40mm

MODEL No.
4401-0117

\$24.95



Precise STRONG LOCK UNIVERSAL MAGNETIC BASE

- Solid arm & joint mechanism.
- Unique central locking mechanism.
- 3-D steel arm movement.
- Fine adjustment.
- On/Off switch.
- Super power pull 220 lbs.
- Base Dimension: 2" x 2" x 3" (Depth)

MODEL No.
4401-0528

\$79.50



Precise ROUND UNIVERSAL MAGNETIC BASE

- 3-D rigid steel arm movement.
- Unique central locking mechanism.
- Power pull 90 lbs.
- Base diameter: 1.6"

MODEL No.
4401-0525

\$69.95



Precise HYDRAULIC MAGNETIC BASE

- Absolute sealed hydraulic system.
- Knob turning creates tension and high pressure on the joints to hold the rods absolutely rigid.
- Multi-nimble joint for instant fix at any desired position.
- Fine adjustment.
- Fits dovetail and 3/8" stem indicators.
- Super power pull 130 lbs.
- Base Dimensions: 2"W x 2-1/2"D

MODEL No.
4401-0003

\$49.95



Precise MAGNETIC BASE WITH DOVETAIL CLAMP

- Dovetail groove for clamping a test indicator.
- Indicator stem hole on top 8mm diameter.
- Fine adjustment.
- On/Off switch.
- Base Dimension: 2x2x2-1/4" (Depth)
- Main stem: 7" long
- Branch stem: 8" long
- Power pull: 130 lbs.

MODEL No.
4401-0530

\$17.95



Precise FLEXIBLE INDICATOR HOLDER

- Ideal for very light work areas.
- Flexible arm with fine adjustment.
- 5" high post.
- 25 lbs. power pull magnetic base.

MODEL No.
4401-0801

\$19.95

Indicator not included



NOGA ARTICULATING ON-OFF 5-AXIS MAGNETIC BASES

Due to its stability and ease of use, NOGA articulated holder has become the industry most wanted.

- New fine adjustment on top with universal swivel clamp.
- Holds 6mm, 8mm, 3/8", dovetail and back lug.
- Five axis holder.
- Powerful on/off magnetic base.
- Central locking mechanism with NOGA designed spring loaded bearing.
- Instant fixation in any position.
- Fast and easy to set up gauges into required position.
- Black finished arms.

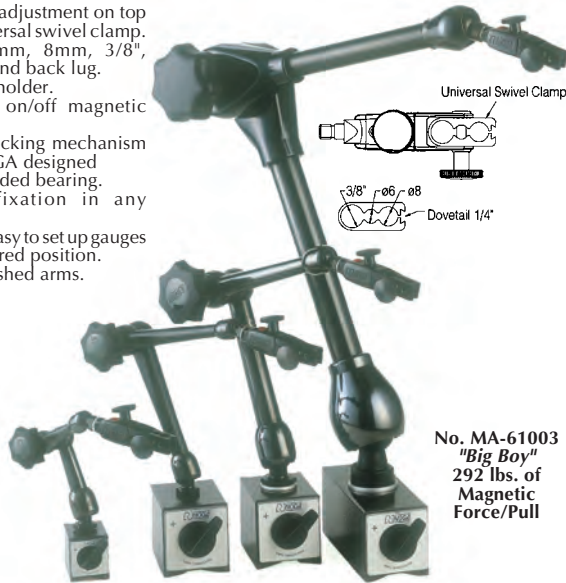

No. MA-61003
"Big Boy"
292 lbs. of
Magnetic
Force/Pull

Model No.	Bottom Arm	Top Arm	Magnetic Force/Pull	Weight Pounds	Price Each
NF-61003	2-3/8"	2"	72 lbs.	1.1 lbs.	\$ 79.95
DG-61003	4-3/8"	4"	180 lbs.	3 lbs.	99.95
MG-61003	5-1/4"	4-1/2"	180 lbs.	4.2 lbs.	129.95
MA-61003	12-7/8"	9-5/8"	292 lbs.	11.2 lbs.	195.00



Model No.	Mag Base Dimensions
NF-61003	1-3/16"W x 1-9/16"L x 1-7/16"H
DG-61003	2"W x 2-3/8"L x 2-3/16"H
MG-61003	2"W x 3"L x 2-3/16"H
MA-61003	2"W x 4-3/4"L x 2-3/16"H

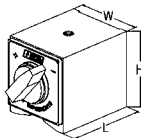

CONTACT POINT RING GAGE SETS

A top quality contact assortment for the professionally equipped dial indicator, includes the following contacts, secured in a machined ring suitable for workbench or flat storage.



10 Piece Set with Ring

Set No.	Consists of 1) Each	Price Each
Z9013	3/8" CNC Qualified Roller Bearing 1/2" CNC Qualified Roller Bearing 3mm Ruby Tip x 1/2" long Flat Steel Point 7/32 diameter x 1/4" long Flat Steel Point 7/32 diameter x 1/2" long Flat Steel Point 7/32 diameter x 3/4" long Flat Steel Point 7/32 diameter x 1-1/4" long Flat Contact 1/4" wide Flat Contact 1/2" wide .060 Steel Ball Tip, 5/16" long	\$89.95



14 Piece Set with Ring

Z9414	3/8" Ground Flat Bottom Contact, 3/8" length 1/2" Ground Flat Bottom Contact, 3/8" length 1/2" Button Contact, Steel Black Oxide 3/8" Button Contact, Steel Black Oxide 1/2" Lth 90 Degree Cone Point Contact, Steel Black Oxide 1/16" Ball Contact, 1/4" length, Steel Black Oxide 5/8" Lth Tapered Contact, Steel Black Oxide Button Contact, 13/64" Dia. x 5/32" Lth, Steel Black Oxide Shock Absorbing Contact Point 9/32" Lth Cone Point, Steel Hard Black Oxide 1" Lth Polished Radius Point, Steel Hard Black Oxide 3/4" Lth Polished Radius Point, Steel Black Oxide 1/2" Lth Polished Radius Point, Steel Black Oxide 1/4" Lth Polished Radius Point, Steel Black Oxide	\$79.95
-------	---	---------

NOGA MAGNETIC INDICATOR BASES

With Unique Fine Adjustment at Base

- Single direction fine adjustment at base.
- Powerful on/off magnetic base.
- Universal swivel clamp for all dial and test indicators.
- Holds 6mm, 8mm, 3/8", dovetail and back lug.
- Strong arm lock by using 3 points clamp.
- Easy to set up gauges into required position.
- Black finished arms.



Model No.	Main Post	Arm Post	Magnetic Force/Pull	Weight Pounds	Price Each
PH3100	4-3/4"	4-3/8"	72 lbs.	1.1 lbs.	\$33.50
PH2040	8"	7-5/32"	180 lbs.	3-3/4 lbs.	41.50
PH4016	10-1/4"	8-7/8"	225 lbs.	5-1/2 lbs.	69.95



MINI MAGNETIC BASE

- 5 axis holder.
- Patented 360° fine adjustment base.

- Holds indicator with stem and dovetail.
- Central locking mechanism with NOGA designed spring loaded bearing.

Model No. NF-1033

- Permanent magnet.
- Magnet dimensions - 2-3/8" x 1-1/4" x 5/8"
- Magnet Force - 68 lbs.

Model No. NF-1024-1

- On/Off switch.
- Magnet dimensions - 1-3/16" x 2-5/16" x 1-7/16"
- Magnet Force - 72 lbs.



MODEL No.
NF-1033
\$89.95

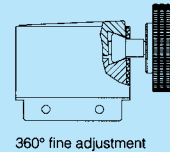

360° fine adjustment



MODEL No.
NF-1024-1
\$99.50



FLEX INDICATOR HOLDER

- Used for centering of workpieces.
- Holds indicator with stem or dovetail.
- Central locking mechanism with spring loaded bearing.
- Bottom arm - 56mm.
- Top arm - 51mm.
- Centering rod ø 8mm x 40 mm.
- Black finished arms.
- Weight: 0.345 Kg. NF1018 3/8"



MODEL No.
NF-1018-1
\$49.95

Precise GRANITE COMPARATOR STAND

Extended Arm & Fine Adjustment

- Comparator stand has a black granite base 8" x 12" x 2".
- It's 3/4" x 9-7/8" upright Base post provides maximum rigidity for the entire indicator assembly.
- Accepts both AGD and Test Indicators.

MODEL No.
202-651-1

\$62.95

With 1" Travel
.001 Grad. AGD
Dial Indicator



MODEL No.
202-651

\$52.95

Stand Only
Less Indicator

Precise THREAD TRIANGLES

- Thread Triangles quickly measure pitch diameter of all 60 degree threads from 4 to 80 pitch, standard and special.
- Instantly classifies thread as 2, 2a, 3a.
- No complicated formulas to figure! For any standard thread refer directly to chart. For special threads just add 2 numbers.
- Convenient Neo-Prene holders, fit any make micrometer spindle.
- Thread Triangles nest well into the "V" of the thread instead of making just point contact.
- Micrometer rests on two parallel flat surfaces for better feel.

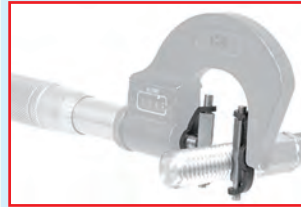

SET No.
TT-60

\$32.95

Less Micrometer

MADE IN
USA



Fowler XTRA-SET INDICATOR HOLDING KIT

A Practical Test Indicator and Accessory Set for Most of Your Indicator Setup Needs

Set Includes:

- Zero-Set Indicator holding tool.
- Test Indicator 52-562-778 includes points and dovetails.
- Axial support post.
- Bar and dovetail clamp.
- Universal holder with swivel.
- All enclosed in a shop-hardened case.



MODEL No.
52-585-250
Reg. \$195.00

\$159.95

Test Indicator Includes:

- Range: .030"
- Reading: 0-15-0
- Jewelled movement
- Graduation: .0005"
- Auto-reversing
- .080" diameter point

Fowler 2" To 6" RIGHT ANGLE DIAL BORE GAGE

For Measuring Difficult-to-Reach Bores in Tight or Inconveniently located Spaces on Machine Applications

Set Includes:

- Easy-to-read.
- Economical.
- Range: 2" to 6".
- Graduation: .0005".
- Chrome plated handle.
- Insulated grip.
- Includes extension holder and fitted wooden case.

MODEL No.
52-646-250
Reg. \$225.00

\$175.00

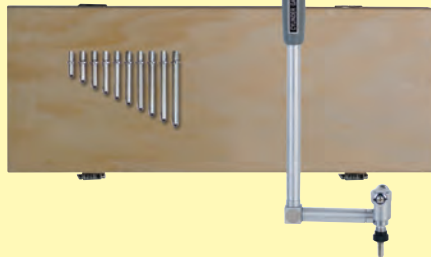

Fowler Xtra-Value CAL & DEPTH ATTACHMENT COMBO

Xtra-Value Cal:

- Accuracy: .001"/.02mm.
- Range: 6"/150mm.
- Stainless steel frame.
- Large easy-to-read display.
- Resolution: .0005"/.01mm.
- Direct inch/metric conversion.
- Absolute/incremental measurement.
- 4 way measuring.

MODEL No.
52-008-715
Reg. \$55.00

\$39.95

Depth Attachment:

- Attaches quickly
- Positive locking screw
- Precision-ground contact surface



Fowler ARTICULATING MAG BASE & INDICATOR COMBO

Articulating Mag Base

- Adjust in almost unlimited ways.
- Fine adjust • 85 lb. pull.
- V-slot on base for mounting on rounded surfaces.

AGD Indicator

- 1" travel.
- Continuous reading: 0-100.
- Reading: .001".
- AGD group 2, 2-1/4" dial dia.
- Revolution counter.
- Tolerance.
- Lug back mount.
- Carbide point.

MODEL No.
52-585-150
Reg. \$129.95

\$69.95

Set Includes
Shop-hardened case



Precise SCREW THREAD MICROMETER KITS

- Direct reading of pitch diameter in threads 7-11, 12-18, 20-28, 30-44, 48-64, 20-28, 30-44, 48-64 TPI with interchangeable anvil and spindle pairs.
- Ratchet stop.
- Fitted case.
- Micro fine slant line graduations.
- Anvils and spindles made of tool steel, hardened and ground.
- Kit includes: micrometer and 5 pairs of anvils & spindles.



Model	Range	Graduation	Reg.	Sale
420-226	0-1"	.0001"	\$75.00	\$59.95
420-227	1"-2"	.0001"	82.00	65.00
420-228	2"-3"	.0001"	95.00	75.00

THREAD CHEK™ THREAD WIRE ATTACHMENT SYSTEM

- Fits all MIC's with .245 to .312 anvils.
- No more lost thread wires in the chip pans.
- Specifically designed for rapid and accurate measurement.
- Each part fits 2 sizes of wires.

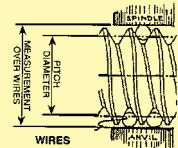

Instructions:

1. Select the proper size wires.
2. Match the wire size with the proper P.D. Check™.
3. Slip two wires in the holder.
4. Now place the holder on the MIC's anvil.
5. Hold the micrometer in one hand and the third wire in the other.
6. Check the threads.



SET No.
16707

\$32.95

Set of 5 Color Coated Holders:
.018"-.022" (Purple) .024"-.032" (Blue) .040"-.045" (Yellow) .055"-.063" (Green) .072"-.081" (Red)
Plus 48 Wires, 16 Different Sizes 60°

MICROMETER ANVIL ATTACHMENTS

7 DIFFERENT SHAPES

- Fits all micrometers with spindle diameters of .235", .250", .256" and .270"
- Each anvil attachment is held with its own reinforced neoprene boot.
- Measures hard to reach places and odd workpieces. (shoulders, webs, angles, slots, grooves, etc.)
- Ball attachment .200" diameter chrome alloy steel.
- Attractive plastic case.
- Supplied with simple to use instructions.
- All parts hardened and ground. Finest quality. Made in U.S.A.

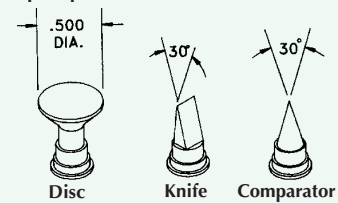
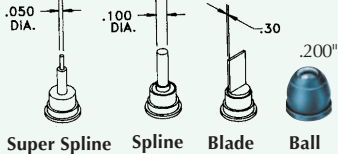

Model	Description	Price
MAA-001	.500" Dia. Disc	\$11.95
MAA-002	.100" Spline	11.95
MAA-003	.050" Spline	11.95
MAA-004	.200" Ball	3.00
MAA-005	.303" Blade	11.95
MAA-006	.020" x 30° Knife	11.95
MAA-007	.030" x 30° Point	11.95
MAA-700	Kit contains one each of above	\$39.95

Mitutoyo CENTER MASTER HEIGHT GAGE ATTACHMENT

- Locates the hole center as its head is inserted in a hole.
- The distance between two hole centers can be measured with this attachment.
- Largest measurable hole diameter is approximately 1-1/2"
- The stem dimension is 1/4" x 1/2".
- Chrome plated body and triangle, movable hole center.



MODEL No. 900581
List \$155.00

\$139.50

INDICATOR PIN VISE

- Allows any A.G.D. dial indicator to hold any diameter probe, needle, etc. 0 to .040" capacity.
- Uses standard 4-48 thread for easy mounting to indicator spindle.

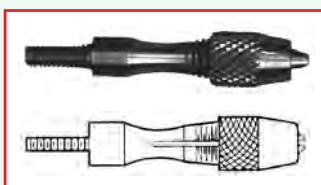

Has 4-48 Thread

MODEL No. 18560

\$24.95

SPI KAFER MULTI MAG BASE

- For quick set-ups on machines.
- 2-1/4" permanent magnet surface includes 120°V" holder with 1/4" depth.
- Swivel mount adjustable horizontally and vertically with 360° rotation.
- 2-3/4" L x 1-3/8" W x 2-3/8" H
- D.O.T. regulated. Shipped via ground freight only. No UPS consignee or collect shipments.



MODEL 20-756-3
\$135.25

Less Indicator



Made In Germany

MIGHTY-MAG

- 45 lbs. of holding power.
- Zinc die-cast housing.
- Size: 4-1/2" x 1" x 1-1/4"
- 5 locations for mounting accessories:
 - 3 positions 1/4-20 for lug mounts.
 - 1 tapped hole 10-32.
 - 1 reamed hole 3/8"



USA
Mighty-Mag
MODEL No. MM-279
\$12.95

China
Mighty-Mag
MODEL No. IMM-972
\$4.95

Precise MAGNETIC BASE PUSH BUTTON ON-OFF

- Easy on-off push button.
- Four ground surfaces to grip including V-slot for round surfaces.
- 3/8" x 9" center post with 1/4" x 7" cross and indicator clamp.



Mag. Base Only
MODEL No. PMB-670
\$19.95

Mag. Base and .0005" Grad. Indicator
SET No. COM-001
\$44.95

"TOM THUMB" FLEXIBLE INDICATOR HOLDER

With Fine Adjust. Mag. Base
Flexible locks simply by turning a knob. The universal flexible arm becomes extremely rigid in the exact location which you position it. Can support 4lb. load when tightened fully.

- Magnet (cylindrical) 1-3/8" dia. x 1-1/8" high, 25 lbs. pull.
- 5" bottom of base to top of post.
- Post diameter 5/16".
- Diameter of joined column 5/16".
- Total height base to top: adjustable from 8" to 12".
- Fine adjuster located at base for remote control.
- Top clamp: clamps anything up to 1/4" and swivels 360°.

MODEL Less TTF-009 Indicator

\$63.50



"TOM THUMB" FLEXIBLE CABLE ARM 6" OR 9"

- Accommodates mounting rods up to 1/4" diameter.
- Turn 1-1/4" diameter circle and locks securely to let you reach "impossible" areas.
- Mounting clamp fits 5/16" posts.

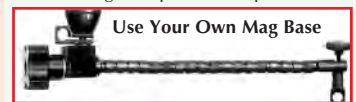

Model	Description	Price
TTF-050	6 Inches	\$42.00
TTF-052	9 Inches	48.00

NOGAFLEX HOLDER

- Most useful for centering holes on milling machines.
- Test indicator holder arm with 8mm diameter x 40mm long stem.



MODEL No. FH-1018
Reg. \$56.95 **\$49.95**

INDICATOR CLAMP

Fits All Indicators

- Clamps all standard dovetails.
- Clamps all dia. from 1/8" to 1/4"



MODEL ICL-008
\$9.95

MinIndicol UNIVERSAL INDICATOR HOLDER

- A simplified version of the popular Indicol.
- Two holders in one! Its parts allow it to be assembled also as a cylinder holder.
- Three point adjustment.
- Reach from 0 to 12" diameter.



MODEL MUH-400
\$59.95
MADE IN USA

DOUBLE-JOINTED INDICATOR HOLDER

- 3-link rod 3/8" diameter, precision made, heat treated and black oxidized.
- The joints are precision pivots with adjustable friction.
- Provides dovetail grip as well as firm holding of 5/32" stem indicators
- Upper link has 1/4-28 tapped hole to receive the supplied 2-1/4" extension for extra deep and extra wide reach.
- With Double Jointed Holder the test indicator can be moved out of the way without losing the centerline of the set-up.



MADE IN USA
MODEL DJH-100
\$89.50

INDICATOR HOLDERS For Dovetail & 5/32" Stem CYLINDER HOLDER



Model	Shank	Price
CHH-001	1/4"	\$33.50
CHH-002	3/16"	33.50

RECTANGULAR HOLDER

1/4" x 1/2" Shank for Dovetail & 5/32" Stem



MODEL RHH-003 **\$39.95** MADE IN USA

HALF ROUND COMBINATION HOLDER

1/4" Shank, for Dovetail & 5/32" Stem



MADE IN USA
2 Point Adjustment
MODEL HRC-004 **\$43.50**

ZERO-IT TEST INDICATOR SETUP ATTACHMENT

- Set up workpieces and check the alignment of the centers of round material in relation to the cutting head.
- Manufactured with 1/4, 3/8 and 1/2" spindle post, and has an effective measuring range of 3/8 to 10".
- Speeds setup operations tremendously.
- Quick adjustments and fine adjustment controls.

Zero-Set
MODEL No.
ZRO-879

\$36.95

Less Indicator

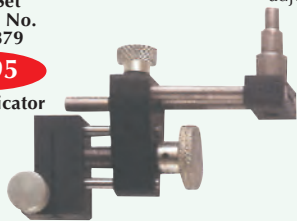

SAVE MORE!

Buy Both

SET No.
ZRO-881

\$59.95

ZERO-IT UNIVERSAL ATTACHMENT

- Allows placement of any test indicator equipped with dovetails or 1/4" posts in a multitude of positions.
- Angles up to 90° on either side and bends both forward and backward.
- Allows an infinite range of measurements over an extensive area.
- Attaches to our Zero-Set and ready for use in seconds.

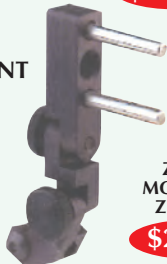

Zero-IT
MODEL No.
ZRO-880

\$29.95



MONORAIL INDICATOR HOLDER

- For use in Milling Machines or Holders. Reach is 3-1/2". Mounting is secure and rock solid. 5/32" hole in shaft also accepts Dovetail Holder with 5/32" Stem.
- An excellent device for set ups and measurements.

Specifications:

- Aluminum Body.
- 3-1/2" Reach.
- Accepts 5/32" Dovetail stems.
- Locking shaft for secure mounting.



Monorail
Ind. Hold
Without
Indicator
MODEL No.
MI4-861

\$59.95

Set With Swiss Style
No. 400-106
Indicator
.0005" Grad.
And Monorail
SET No.
562-001

\$109.95



NOVA DUAL TENSION INDICATOR SWIVEL

- Swivel tension and Clamping Mechanism adjust independently.
- Smooth swivel action using high strength engineered polymer bearings.
- Fits standard dovetail style test indicators.
- Compact size: 3/8 diameter by 1.400 long.
- Black oxide finish for corrosion resistance.
- Hardened stem and dovetail pin.



Dual Tension
Independently
Adjusting: Swivel
Tension Clamping
Mechanism

Swivel With
5/32" Stem
MODEL No.
NOV-532

Swivel With
7/32" Stem
MODEL No.
NOV-732

Swivel With 3/8" Stem
MODEL No. NOV-380

Your Choice

\$19.95

With .0005" Grad.
Brown Sharpe
Indicator
Set No.
599-7030-N

\$139.95

Shown w/Brown & Sharpe
599-7030-5 Indicator
.0005" Graduation

UNIVERSAL INDICATOR HOLDERS "FROGS LEGS"



Dovetail Holder
No. MDI-886

Single Jointed
No. FLH-006

Double Jointed
No. FLH-007

Axial Support No. AXS-610

Model	Description	Price
MDI-886	1/4" x 3" Dovetail Swivel Holder	\$12.50
FLH-006	1/4" Shank x 3" Single-Jointed	29.95
FLH-007	3/8" Shank x 4-1/2" Double -Jointed	36.95
AXS-610	3/8" Body Diameter, 5-1/4" Reach, 6-1/2" Sweep	29.95

Precise MINORMAG MAGNETIC BASE DIAL TEST INDICATOR WITH BODY CLAMP

COMPLETE SET
Mag. Base Dial Indicator
W/Body Clamp

SET No.
MIN-100

\$39.95

MinorMag Mag. Base

- Powerful permanent magnet 1" diameter.
- Total height is 5" with 3" of reach
- With fine adjustment and dovetail indicator body clamp.

BASE No. MMB-100
Reg. List \$15.95

\$11.95

Dial Test Indicator with body clamp:

- Jeweled bearing, auto reverse.

Specifications: Reading: 0-15-0
Range: .030" Dial face: 1-1/4"
Graduation: .0005" Contact: .098"



brock brown & sharpe BESTEST INDICATOR & MAGNETIC BASE

INCLUDED IN SET:

- BESTEST INDICATOR: #599-7030-5
- .0005" graduations - .030" range - reads 0-15-0
- Anti-magnetic and corrosion resistant
- Includes one carbide tip contact point: (.08" diameter by 1/2" long)
- MAGNETIC BASE: #MM-101
- Two universal ball sockets adjusts to any angle position
- Fine adjustment
- Dovetail clamp
- Base 1-3/16" diameter, 1 high
- Extension rod 1/4" diameter by 3-1/2" long

SAVE
35%

Magnetic
Base Only
MODEL No.
MM-101
Reg. \$28.95

\$16.95

brock brown & sharpe
BestTest Indicator
With Magnetic Base
SET No.

599-7030-M
Total List
\$183.95

\$159.95



Sweep-it UNIVERSAL INDICATOR RIGID ATTACHMENT

- The only universal indicator extension with ability to adjust to your needs easily and accurately.
- Constant tension for quick adjustments.
- Eliminates indicator sage in both vertical and horizontal applications.
- Sweep-it will accept all dovetail and 5/32" shanked indicators. 3/8" mounting shank.
- Movement range from 10 deg's past center to 100 deg's from center.
- Constructed from lightweight anodized aluminum and electropolished stainless steel.

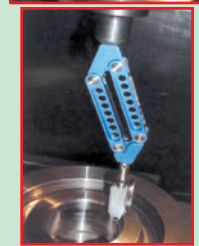

0-8" Range
MODEL No.
SWP-080

\$49.50

0-12" Range
MODEL No.
SWP-012

\$54.50



ADJUSTABLE SWIVEL CLAMPS



- Any combination of 17 standard size holding diameters: Heavy-duty: from 3/8" x 3/8" to 1" x 1" diameter. Medium-duty: from 5/32" x 1/4" to 1/2" x 3/8" diameter.
- Specials: Larger sizes and decimal sizes in specified materials.
- Available in stainless steel for sanitary and corrosion resistant applications. Special sizes available.



Models
"SH"



Models
"S"



Models
"T"

Model	Size	Price
SH-09	3/8" x 3/8"	\$31.95
SH-10	3/8" x 1/2"	31.95
SH-11	1/2" x 1/2"	30.95
SH-12	1/2" x 5/8"	33.95
SH-13	5/8" x 5/8"	34.00
SH-14	5/8" x 3/4"	37.00
SH-15	3/4" x 3/4"	52.50
SH-16	3/4" x 1"	70.00
SH-17	1" x 1"	75.00

Model	Model	Size	Price
S-01	ST-01	5/32" x 5/16"	\$13.95
S-02	ST-02	1/4" x 5/16"	13.95
S-03	ST-03	1/4" x 3/8"	13.95
S-04	ST-04	1/4" x 1/4"	13.95
S-05	ST-05	5/16" x 5/16"	13.95
S-06	ST-06	5/16" x 3/8"	13.95
S-07	ST-07	3/8" x 3/8"	18.95
S-08	ST-08	3/8" x 1/2"	19.95

ADAPT - A - TIP

CONVERTS YOUR TEST INDICATOR TIP FOR USE ON YOUR DIAL INDICATOR

- A unique & handy conversion point allows the use of your Test Indicator Tips on your drop style dial indicator.
- Use for extended reach applications, measuring small grooves & pockets or other hard to reach places.
- Fits any standard 4-48 threaded AGD Dial indicator.



Model No.	Fits Brand	Internal Thread	Price Each
6995	Brown & Sharpe	M1.4 x .35	\$11.95
6996	Interapid, Girod Fowler, Compac Peacock, etc.	M1.7 x .35	11.95

AGD METRIC/ENGLISH CONVERSION POINT

- Allows all standard AGD 4-48 thread points and contacts to be used on metric indicators.
- Converts 4-48 points to metric M2.5 x 0.45 thread found on most metric dial indicators.
- Conversion point is 1/2" long, with 3-48 internal threads and M2.5 x 0-45 external thread.

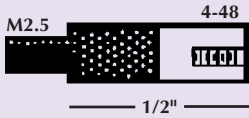

MODEL No. 9344 **\$6.75**



AGD EXTENSION POINT KIT 3 PIECE SET

- Includes 1", 2", and 3" indicator extension points.
- Has 4-48 internal and external threads.
- Made In U.S.A.

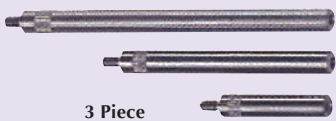

3 Piece Kit MODEL No. 9350 **\$9.95**



INDIVIDUAL EXTENSION POINTS



Model	Length	Price
9391	0.500"	\$3.95
9392	0.750"	3.95
9393	1.000"	3.95
9393	1.250"	5.50
9343	1.500"	5.95
9394	1.750"	6.50
9340	2.000"	4.50
9351	2.500"	4.75
9341	3.000"	5.25
9352	4.000"	6.75
9353	6.000"	7.95

AGD SPECIAL CONTACTS

- Popular specialized contacts for dial indicators.
- Has 4-48 threads to fit all AGD groups 1, 2, 3, 4 indicators.

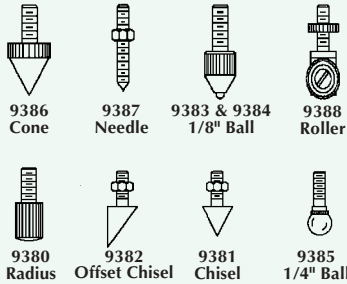

Model	Description	Price
9380	Radius Contact	\$ 4.50
9381	Chisel Contact	14.95
9382	Offset Chisel	14.95
9383	1/8" Steel Ball	3.95
9384	1/8" Carbide Ball	10.95
9385	1/4" Steel Ball	14.00
9386	5/16" Cone Point	7.95
9387	1/16" Needle Stud	7.95
9388	3/8" Roller Anvil	21.50
*9389	3/8" Roller Bearing	35.00
*9390	1/2" Roller Bearing	39.00

*CNC Qualified Series allow the changing of the roller bearing, for unlimited life

AGD FLAT CONTACTS

Hardened Steel with Black Oxide plating AGD 4-48 threads.

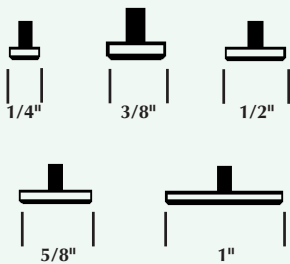

Model	Diameter	Thickness	Price
9365	1/4"	.112"	\$4.00
9366	3/8"	.093"	4.25
9367	1/2"	.100"	4.50
9368	5/8"	.100"	4.75
9370	3/4"	.100"	5.00
9369	1"	.125"	8.00
9371	1-1/2"	.125"	12.50

AGD BUTTON CONTACTS

Hardened Steel with Black Oxide plating AGD 4-48 threads.

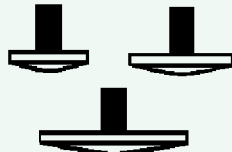

Model	Diameter	Thickness	Price
9355	3/8"	.090"	\$3.50
9356	1/2"	.156"	3.95
9357	3/4"	.156"	4.50

AGD TAPERED CONTACTS

Hardened Steel with Black Oxide plating AGD 4-48 threads.

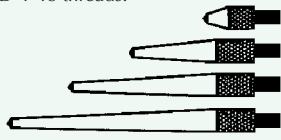

Model	Diameter	Price
9375	13/32"	\$2.95
9376	1"	3.15
9377	1-1/2"	3.45
9378	2"	4.50

AGD CARBIDE & RUBY CONTACT TIPS

- Available from stock with Grade 25 Tungsten Carbide, or Grade 25 Ruby Ball Tips.
- Both tungsten carbide and ruby have extremely hard and smooth measuring surfaces.
- Fits all AGD standard groups 1, 2, 3, 4, indicators.



TUNGSTEN CARBIDE TIPS

Model No.	Tip Length	Ball Size	Thread Size	Price Each
6960	1/4"	3mm	4-48	\$12.00
6961	1/4"	3mm	M2-5	12.00
6962	1/2"	3mm	4-48	12.50
6964	3/4"	3mm	4-48	13.00
6966	1/4"	4mm	4-48	12.50
6967	1/4"	4mm	M2.5	12.50
6968	1/2"	4mm	4-48	13.00
6970	3/4"	4mm	4-48	13.50

RUBY TIPS

6972	1/4"	3mm	4-48	\$13.50
6973	1/4"	3mm	M2-5	13.50
6974	1/2"	3mm	4-48	14.50
6976	3/4"	3mm	4-48	15.00
6978	1/4"	4mm	4-48	15.00
6979	1/4"	4mm	M2.5	15.00
6980	1/2"	4mm	4-48	15.50
6983	3/4"	4mm	4-48	16.00

CONTACT POINT RING

- A top quality assortment for the professionally equipped dial indicator.
- Secured in a machined ring suitable for workbench or flat.



SET No. Z9013 **\$79.95**

Kit Contains:

- 1) Each No. 9389, 9390, 6974, 9211, 9313, 9315, 9318, 9365, 9367, 9396

CHROME STEEL CONTACT POINTS
6 ASSORTED SHAPES
4-48 THREAD SIZE

SET No. CPK-001 **\$12.95**



Convex .394", Flat .323" & .394", Taper .984", Convex .220", Flat .220"

AGD STANDARD BALL TIP

- Replacement point for all standard AGD 4-48 dial indicators. 5/16" long tip has a steel ball tip.
- Cold rolled steel with black oxide protective plating.



MODEL No. 9396 **\$3.50**

GAGE BALL TIPS INDICATOR POINTS

- Grade 25 (accurate to 25 millionths) chrome alloy steel gage balls, mounted on stems with 4-48 threads.
- These gage ball tips attach directly to dial indicators, or use the attachments to attach them to calipers.

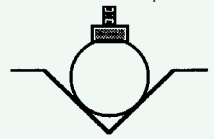

Model No.	Ball Size	Price Each
6931	0.0310	\$ 9.95
6932	0.0460	9.95
6933	0.0625	9.95
6934	0.0780	9.95
6935	0.0938	8.50
6936	0.1250	8.50
6937	0.1562	9.25
6938	0.1875	9.25
6939	0.2188	8.75
6940-1	0.2500	8.75
6941	0.2812	10.50
6942	0.3125	10.50
6943	0.3438	11.50
6944	0.3750	11.50
6945	0.4060	11.75
6946	0.4370	12.50
6947	0.4680	12.95
6948	0.5000	13.75
6950	0.5310	14.25
6951	0.5625	15.00
6952	0.5937	15.95
6953	0.6250	16.25
6954	0.6560	16.75
6955	0.6870	17.50
6956	0.7180	18.25
6957	0.7500	18.25
7100	0.7812	19.00
7101	0.8125	20.00
7102	0.8750	21.75
7103	0.9375	22.50
7104	1.0000	23.50
7105	1.0625	24.50
7106	1.1250	25.50
7107	1.1875	26.00
7108	1.2500	28.00

Note: These tips are designed for use as an indicator point and are not to be used for sizing and gaging applications where side pressure is present.

GAGE BALL MOUNTING CALIPER ATTACHMENT

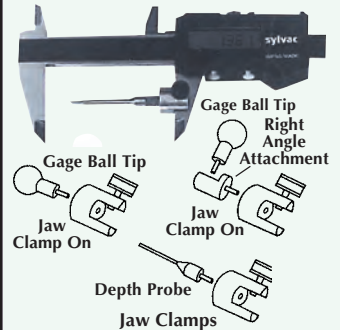

Model	Description	Price
6958	For 6" Calipers (.133 max. jaw width)	\$22.50
6959	For 12" Calipers (.186 max. jaw width)	29.50
6983	For 18" Calipers (.245 max. jaw width)	24.50
Depth Probes		
Model	Description	Price
6989	1/2" overall length .049 diameter	\$19.95
6990	3/4" overall length .049 diameter	20.50
6985	1" overall length .062 diameter	22.00
6986	1-1/2" overall length .062 diameter	23.50
6987	2" overall length .062 diameter	24.00

Precise DOVETAIL CLAMPS

- Rigid steel construction.
- Dovetail groove for clamping test indicators.
- Bores for indicators' stem.



Model No.	Stem Bore	Clamp Hole	Price Each
4401-0465	4 & 8mm	6mm	\$8.95
4401-0466	6 & 8mm	6mm	8.95
4401-0467	4 & 6mm	4mm	8.95
4401-0468	5/32 & 3/8"	1/4"	8.95
4401-0469	1/4 & 3/8"	1/4"	8.95
4401-0470	5/32 & 1/4"	5/32"	8.95

Precise SWIVEL HEAD CLAMP & HEIGHT GAGE BAR KIT

- Rigid steel construction.
- Dovetail groove for clamping test indicators.
- Bore for indicators' stem.



Model	Bore	Bar	Price
4401-0450	5/32 & 1/4"	1/2" x 1/4" x 3"	\$12.95
4401-0453	5/32 & 3/8"	1/2" x 1/4" x 3"	12.95
4401-0456	1/4" & 3/8"	1/2" x 1/4" x 3"	12.95
4401-0421	3/8" & 7/32"	3/8" x 3/8" x 4"	13.95
4401-0420	6 & 8mm	9 x 9 x 100mm	13.95

Precise STEM INDICATOR POINTS

Designed for user modifications. These single and double stem indicator points can be shaped for your special application. The reduced diameter stem can be angled and positioned for hard to reach areas.

- AGD Standard 4-48 Threads.
- Low Carbon Steel, Soft.
- Black Oxide Plated.



Model No.	Stem Type	Stem Dia.	Overall Length	Price Each
Z9333	Bent	1/6"	1-1/4"	\$4.50
Z9334	Double	.062" & .016"	.697" & .118"	4.75
Z9336	Double	.062" & .016"	.960" & .100"	4.95
Z9337	Double	.062" & .016"	.960" & .235"	5.25
Z9338	Single	.062"	1.354"	4.50
52-525-112	Single	.062"	.937"	4.75

Precise DRAW BARS

- Shaft length 18-1/2"
- Thread & Length 7/16"-20 x 1-3/4"
- Spacer length 1/4"
- For milling machines using R8 tooling.
- For Bridgeports & copies.
- Draw Bars are manufactured from two parts - the shaft and the hex.



Model	Overall Length	Price
Z9005	22-3/4"	\$19.95
Z9004	20-1/4"	\$17.95

KLINGEN SWING MOUNTS

- Klingen Swing with magnetic mounting.
- Klingen Swing with 3/8"-16 female Threaded Mount



MODEL No. Z0077

\$48.00

MODEL No. Z0076

\$35.00

KLINGEN WITH KNUCKLE 6" x 8" Chipshield and Magnetic Base



MODEL No. Z0075

\$69.95

Klingen Magnetic Mount with 4" Extension and 6" x 8" Lexan Shield

MODEL No. Z0075E

\$79.95

BUILD YOUR OWN KLINGEN



Extender Bar 3/8" Dia. x 4-1/4" L
MODEL No. Z0060
\$5.95

Knuckle .655" Dia. x 1-5/16" L
MODEL No. Z0058
\$3.95

Long Knuckle .655" Dia. x 4-1/4" L
MODEL No. Z0059
\$6.00

Swivel Clamp 3/8" MODEL No. Z7012
\$17.95

Axial Support with Internal Tap Connection
MODEL No. Z9610-T
\$30.00

Solid Clamping Bar 3/8" Dia. x 5-3/4" L
MODEL No. Z0062
\$7.00

HEIGHT GAGE PROBE KIT

- This Height Gage Attachment lets you use any M2 threaded CMM Probe in your height Gage.
- Holder comes with (3) Ruby Ball CMM probes - 2MM Ruby Ball x 20MM Length (Z3100)
- Packed in Fitted Wood Case.



MODEL No. Z9609

\$79.95

HEIGHT GAGE UNIVERSAL CLAMP KIT

- A universal clamp set that adjusts from 1.075" down to .575".
- This means that 99.9% of all attachments can be used with any height gage, whether it's Chinese, Swiss or German.
- Every shop with a height gage needs one of these sets.



MODEL No. Z9607

\$99.95

QUILL FREE

- Stops the Quill Lock handle from falling and putting drag on the Quill.
- Provides positive lock engagement and eliminates all drag.

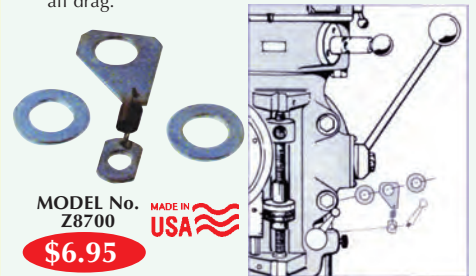

MODEL No. Z8700

\$6.95

"Z" AXIS MOUNTING KIT FOR MILLING MACHINES

- Holds all common Digital Calipers for mounting on the Z axis of most Milling machines.
- Simple installation with minor machining.
- Full instructions and all mounting hardware included.
- After the initial installation, the Caliper can be mounted and taken off quickly and easily.



MODEL No. Z9040

\$29.95

CMM RUBY STYLI



M2 Thread Ruby Styli

Model No.	Ball Size	Length Inch	Renishaw Equivalent	Price Each
Z3000	1mm	10	-	\$21.50
Z3001	1.5mm	10	PS24R	22.50
Z3090	2mm	10	PS8R	22.50
Z3290	3mm	10	PS1R	23.50
Z3500	6mm	10	PS14R	38.50
Z3600	8mm	12	PS15R	79.50
Z3010	1mm	20	PS23R	30.00
Z3011	1.5mm	20	-	28.00
Z3100	2mm	20	PS2R	28.00
Z3300	3mm	20	PS16R	30.00
Z3400	4mm	20	PS17R	32.00
Z3405	5mm	20	-	36.00
Z3407	1.5mm	40	-	47.00
Z3410	3mm	40	-	49.00

M3 Thread Ruby Styli

Model No.	Ball Size	Length Inch	Renishaw Equivalent	Price Each
Z3000M3	1mm	10	-	\$ 33.00
Z3500M3	6mm	10	-	60.00
Z3600M3	8mm	12	-	125.00
Z3010M3	1mm	20	PS1-9R	40.00
Z3100M3	2mm	20	PS1-10R	39.00
Z3300M3	3mm	20	PS1-11R	39.00
Z3400M3	4mm	20	PS1-12R	39.00
Z3405M3	5mm	20	PS1-13R	58.00

M4 Thread Ruby Styli

Model No.	Ball Size	Length Inch	Renishaw Equivalent	Price Each
Z3000M4	1mm	10	-	\$ 34.00
Z3500M4	6mm	10	-	65.00
Z3600M4	8mm	12	-	135.00
Z3010M4	1mm	20	PS2-3R	19.00
Z3100M4	2mm	20	PS2-4R	40.00
Z3300M4	3mm	20	PS2-5R	43.00
Z3400M4	4mm	20	PS2-6R	65.00
Z3405M4	5mm	20	-	67.00

Cylinder Styli

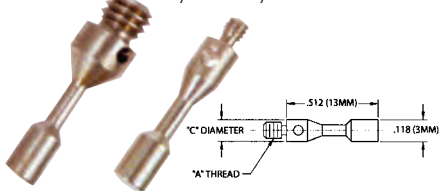

Model No.	Thread Size	Cylinder Diameter	Styli Length	"C" Base Dia.	Price Each
Z3999	M2 x .4	3M	13mm	3M	\$18.00
Z3999M3	M3 x .5	3M	13mm	3M	19.00
Z3999M4	M4 x .7	3M	13mm	4.75M	19.00

CMM 11 PIECE RUBY STYLI KIT



Kit Contains 1 of Each:

- Z3000 1mm Ruby CMM Tracer Tip
- Z3010 1mm Ruby Ball CMM Tracer Tip
- Z3090 2mm Ruby Ball CMM Tracer Tip
- Z3100 2mm Ruby Ball CMM Tracer Tip
- Z3290 3mm Ruby Ball CMM Tracer Tip
- Z3300 3mm Ruby Ball CMM Tracer Tip
- Z3820 CMM Extension - 20mm LTH M2 X .4
- Z3840 CMM Extension - 40mm LTH M2 X .4
- Z3860 8mm CMM Probe Swivel M2 X .4
- Z3864 CMM X-Head 6.5 X 6.5mm X 3mm THK.
- Z2999 Styli Wrench .050 OD Tip X 1-13/16 OAL S/S

No. 54-772-000 \$250.00

**THREADED EXTENSIONS
STAINLESS STEEL**



M2 Thread Extensions

Model No.	Length	Diameter	Renishaw Equivalent	Price Each
Z3805	5mm	3mm	-	\$18.00
Z3810	10mm	3mm	SE4	18.00
Z3820	20mm	3mm	SE5	19.00
Z3830	30mm	3mm	SE6	20.00
Z3835	35mm	3mm	-	15.00
Z3840	40mm	3mm	SE18	21.00
Z3849	60mm	3mm	-	23.00

M3 Thread Extensions

Model No.	Length	Diameter	Renishaw Equivalent	Price Each
Z3810M3	10mm	4mm	SE8	\$10.95
Z3820M3	20mm	4mm	SE2	11.50
Z3830M3	30mm	4mm	-	18.00
Z3835M3	35mm	4mm	-	19.00
Z3840M3	40mm	4mm	-	19.95
Z3849M3	60mm	4mm	-	21.00

M4 Thread Extensions

Model No.	Length	Diameter	Renishaw Equivalent	Price Each
Z3810M4	10mm	6.3mm	-	\$10.95
Z3820M4	20mm	6.3mm	-	10.95
Z3830M4	30mm	6.3mm	-	18.50
Z3835M4	35mm	6.3mm	-	18.95
Z3840M4	40mm	6.3mm	-	20.00
Z3849M4	60mm	6.3mm	-	38.00

ADAPTER TIPS - STAINLESS STEEL

- Converts your probe head to a different thread size, allowing multiple uses of CMM styli or accessories.

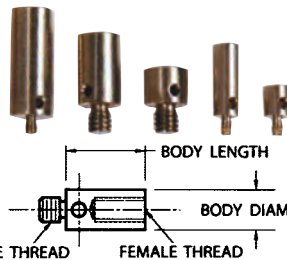

Model No.	Male to Female Thread	Body Diameter	Body Length	Price Each
Z3850	M3 x.5 to M2 x.4	4mm	5mm	\$18.00
Z3851	M2 x.4 to M3 x.5	4mm	10mm	19.00
Z3852	M4 x.7 to M2 x.4	6.3mm	5mm	21.00
Z3853	M2 x.4 to M4 x.7	6.3mm	15mm	23.00
Z3854	M4 x.7 to M3 x.5	6.3mm	10mm	24.00

**CMM STYLI UNIVERSAL WRENCH
Fits All Styli**

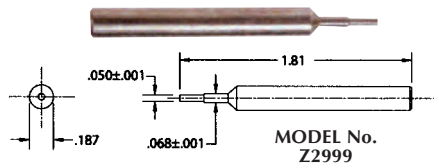

\$12.95

**Special Orders
Available -
Small Quantities
to Large Volume**

CMM CROSSHEADS

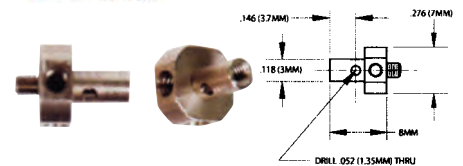

Model No. Z3865 \$

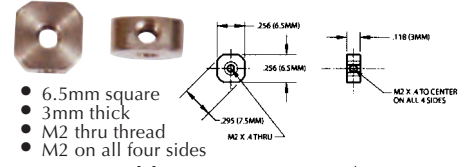

- 6.5mm square
- 3mm thick
- M2 thru thread
- M2 on all four sides

Model No. Z3864 \$

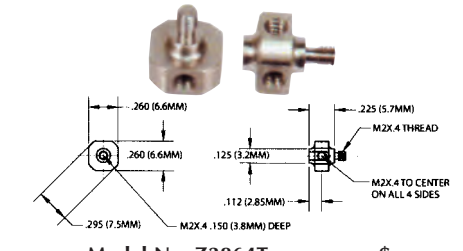

Model No. Z3864T \$

CMM STYLI KNUCKLES

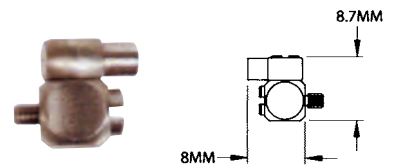

Model No. Z3860 \$75.00

CMM STAR STYLI

6 Piece Set

- (1) Z3864T Cmm Crosshead
- (1) Z3005 2mm x 17.2mm Ruby Ball Probe
- (4) Z3002 2mm x 6.6mm Ruby Ball probe

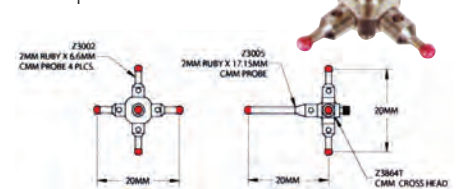

Model No. Z3862 \$125.00

6 Piece Set

- (1) Z3864T Cmm Crosshead
- (1) Z3005 2mm x 17.2mm Ruby Ball Probe
- (4) Z3003 2mm x 11.6mm Ruby Ball probe

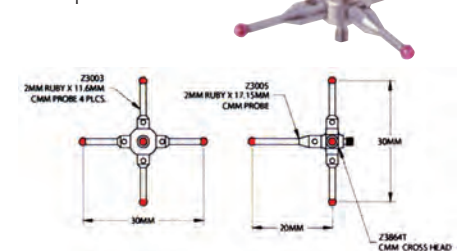

Model No. Z3863 \$139.50

SPi HOLMIKE BORE GAGES

- These point internal micrometer for precise direct measurement of bore diameters.
- Hole-Mike and Setting Ring accuracy within $\pm .0001''$.
- Self aligning and self-centering.
- Carbide measuring anvils.
- Ratchet stop provides uniform measuring pressure and assures highest reading accuracy.
- Suitable to measure to within $.050''$ of bottom of blind holes.
- Feelers taper toward the back for positive reading on the front edge.



Measuring				Depth Extension				Setting Ring			
Model	Range	Reading	Depth	Price	Model	Size	Price	Model	Size	Price	
10-701-1	.150-.175"	.0001"	.78"	\$264.65	10-708-6	.175"	\$96.35				
10-702-9	.175-.225"	.0001"	.78"	264.65	10-709-4	.225"	96.35				
10-703-7	.175-.275"	.0001"	.78"	264.65							
10-700-3	SET .150-.275"	Incl.	Setting Rings and Spanners in Wooden Case	\$829.05							
10-711-0	.275-.350"	.0001"	2.00"	\$264.65	10-717-7	4"	\$82.00	10-718-5	.350"	\$76.35	
10-712-8	.350-.425"	.0001"	2.00"	264.65	10-719-3	.500"	76.35				
10-713-6	.425-.500"	.0001"	2.00"	264.65							
10-710-2	SET .275-.500"	Incl.	Setting Rings and Spanners in Wooden Case	\$829.05							
10-721-9	.500-.650"	.0002"	2.36"	\$264.65	10-727-6	6"	\$82.60	10-728-4	.650"	\$76.85	
10-722-7	.650-.800"	.0002"	2.36"	264.65							
10-720-1	SET .500-.800"	Incl.	Setting Rings and Spanners in Wooden Case	\$513.50							
10-731-8	.800-1.000"	.0002"	3.15"	\$264.65	10-737-5	6"	\$82.60	10-738-3	1.000"	\$86.05	
10-732-6	1.000-1.200"	.0002"	3.15"	264.65	10-739-1	1.400"	103.25				
10-733-4	1.200-1.400"	.0002"	3.15"	264.65							
10-734-2	1.400-1.600"	.0002"	3.15"	264.65							
10-730-0	SET .800-1.600"	Incl.	Setting Rings and Spanners in Wooden Case	\$1051.85							
10-741-7	1.600-2.000"	.0002"	3.54"	\$331.40	10-748-2	2.000"	\$142.25				
10-742-5	2.000-2.400"	.0002"	3.54"	331.40	10-749-0	2.800"	147.95				
10-743-3	2.400-2.800"	.0002"	3.54"	331.40	10-747-4	6"	\$82.60	10-750-8	3.600"	160.60	
10-744-1	2.800-3.200"	.0002"	3.54"	331.40							
10-745-8	3.200-3.600"	.0002"	3.54"	331.40							
10-746-6	3.600-4.000"	.0002"	3.54"	331.40							
10-740-9	SET 1.600-4.000"	Incl.	Setting Rings and Spanners in Wooden Case	\$2025.00							
10-751-6	4.000-5.000"	.0002"	5.51"	\$657.10	10-753-2	5.000"	\$463.70				
10-752-4	5.000-6.000"	.0002"	5.51"	645.80							
10-754-0	6.000-7.000"	.0002"	5.51"	645.80	10-756-5	7.000"	551.95				
10-755-7	7.000-8.000"	.0002"	5.51"	645.80							
10-757-3	8.000-9.000"	.0002"	5.51"	829.05	10-759-9	9.000"	588.15				
10-758-1	9.000-10.000"	.0002"	5.51"	829.05							
10-760-7	10.000-11.000"	.0002"	5.51"	829.05	10-762-3	11.000"	653.75				
10-761-5	11.000-12.000"	.0002"	5.51"	829.05							

brock brown & sharpe INTERMIKES .275" to 8.00"

- Unique cone-generated movement eliminates common wear problems.
- 120° spaced contact point ensure correct entering and alignment.
- Fixed measuring ranges avoid recalibration between uses.
- Ratchet setting for consistent repeatability and accuracy.



Sets with Ring Gages, Extensions & case

Model No.	Range Inch	No. of Pieces	Sale Price
599-282	.275"-1.500"	3	\$1550.00
599-283	.500"-1.800"	3	1695.00
599-284	.800"-1.600"	4	2495.00
599-285	1.600"-4.000"	6	5295.00
599-286	4.000"-8.000"	4	6295.00



Model	Range	Sale	Model	Range	Sale
599-281-3	.275"-.350"	\$520.00	599-281-28	2.400"-2.800"	\$720.00
599-281-4	.350"-.425"	522.00	599-281-32	2.800"-3.200"	740.00
599-281-5	.425"-.500"	525.00	599-281-36	3.200"-3.600"	750.00
599-281-6	.500"-.600"	535.00	599-281-40	3.600"-4.000"	765.00
599-281-7	.600"-.700"	539.00	00882701	4.000"-5.000"	1195.00
599-281-8	.700"-.800"	550.00	00882702	5.000"-6.000"	1230.00
599-281-10	.800"-1.000"	590.00	00882703	6.000"-7.000"	1265.00
599-281-12	1.00"-1.200"	595.00	00882704	7.000"-8.000"	1295.00
599-281-14	1.200"-1.400"	600.00	00883201	8.000"-9.000"	1695.00
599-281-16	1.400"-1.600"	603.00	00883202	9.000"-10.000"	1750.00
599-281-20	1.600"-2.000"	695.00	00883203	10.000"-11.000"	1795.00
599-281-24	2.000"-2.400"	705.00	00883204	11.000"-12.000"	1865.00

Precise HOLEMIKES

- Self-centering 3-point for accurate measurement of internal diameters.
- Highly durable because of carbide tipped contact points.
- Measurement can be taken closer to the bottom of the blind bore, and can be taken into a deep hole with an extension.
- Includes setting ring.

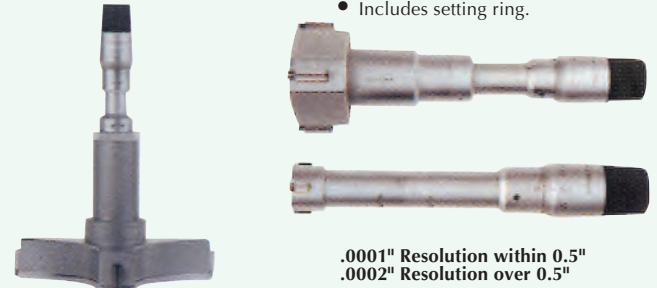

Model No.	Range Inch	Setting Ring Diameter	Sale Price
PHM-011	.5-.65"	.00016"	\$195.00
PHM-012	.65-.8"	.00016"	195.00
PHM-013	.8-1"	.00016"	225.00
PHM-014	1-1.2"	.00016"	245.00
PHM-015	1.2-1.6"	.00016"	265.00
PHM-016	1.6-2"	.0002"	\$295.00
PHM-017	2-2.5"	.0002"	325.00
PHM-018	2.5-3"	.0002"	355.00

.0001" Resolution within 0.5"
.0002" Resolution over 0.5"

Model	Range	Price
PHM-019	.5-.8"	\$349.95
PHM-020	.8-2"	995.00



BOWERS XT HOLEMIKES EXTENDED TRAVEL

- Graduations 0.00025" (0.0025MM).
- 3-pt contact with tungsten carbide measuring anvils above .5" (12.5mm).
- Blind bore measuring above .5" (12.5mm).
- Ratchet stop for consistent measuring.
- Non-removable anvils.
- Extensions available for deep measuring.
- Heads with special anvils available for threads, splines, slots, etc.
- Setting rings included in all sets.
- Includes UKAS certificates for all Holemikes and setting rings.
- Every gage is individually serialized.
- Special anvils available



Model	Range	Meas. Depth	Ring	List	Sale
52-255-310	.250"-.312"	2.28"	.312"	\$675.00	\$549.95
52-255-311	.312"-.375"	2.28"	.312"	625.00	499.50
52-255-312	.375"-.500"	2.28"	.5"	625.00	499.50
52-255-313	.500"-.625"	2.44"	.5"	625.00	499.50
52-255-314	.625"-.750"	2.44"	.75"	641.00	549.00
52-255-315	.750"-1"	2.60"	.75"	704.00	598.80
52-255-316	1"-1.375"	2.60"	1.375"	1003.00	859.70
52-255-317	1.375"-2"	3.15"	1.375"	1027.00	869.50
52-255-318	2"-2.625"	3.15"	2.625"	1225.00	998.80
52-255-319	2.625"-3.250"	3.15"	2.625"	1236.00	998.70
52-255-320	3.250"-4"	3.94"	3.25"	1542.00	1319.60

Bower XT Hole Mike Set

Model	Range	Includes	List	Sale
52-255-562	.250"-.375"	2 heads, 2 handles, 1 ring	\$1499.00	\$1275.00
52-255-665	.375"-.750"	3 heads, 3 handles, 2 rings	1707.00	1450.00
52-255-775	.750"-2"	3 heads, 3 handles, 2 rings	2682.00	2250.00
52-255-885	2"-4"	3 heads, 3 handles, 2 rings	3636.00	3150.00

Mitutoyo GROOVE MICROMETERS

- Flanged spindle for measuring width, depth, and location of grooves inside/outside bores, and tubes.
- Non-rotating spindle type has two-directional ratchet stop. (Measuring force: 0.7-1.2N)
- Provided with two types of graduations for inside and outside measurements.

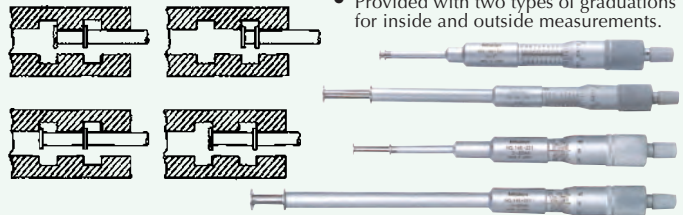

Rotating Spindle Type .001 Graduation

Model No.	Range Outside	Range Inside	Flange Diameter	Mass (g)	Sale Price
146-131	0-1"	.055"-1.05"	ø.25"	135	\$205.00
146-132	0-1"	.055"-1.05"	ø.5"	185	275.00
146-133	1"-2"	1.05"-2.05"	ø.5"	175	295.00
146-134	2"-3"	2.05"-3.05"	ø.5"	165	320.00
146-135	3"-4"	3.05"-4.05"	ø.5"	160	340.00

Non Rotating Spindle Type .001 Graduation

Model No.	Range Outside	Range Inside	Flange Diameter	Mass (g)	Sale Price
146-231	0-1"	.055"-1.05"	ø.25"	135	\$305.00
146-232	0-1"	.055"-1.05"	ø.5"	185	370.00
146-233	1"-2"	1.05"-2.05"	ø.5"	175	395.00
146-234	2"-3"	2.05"-3.05"	ø.5"	165	399.00
146-235	3"-4"	3.05"-4.05"	ø.5"	160	440.00

Precise ELECTRONIC DIGITAL 3-POINT BORE GAGES AND SETS

- LCD readout .00005"/0.001mm.
- Carbide tipped contact points.
- Two measurement modes ABS (absolute) and INC (increments).
- Functions include: Zero-setting preset, data output.
- Power: silver oxide cell (SR-44)

Water, oil and fluid resistant **IP54**



Setting Ring & Extension Included



Resolution: .00005"/.001mm

Model	Range	Sale	Model	Range	Sale
303-310	.275"-.350"	\$345.00	303-317	1.20"-1.60"	\$385.00
303-311	.350"-.425"	345.00	303-318	1.60"-2.00"	395.00
303-312	.425"-.500"	345.00	303-319	2.00"-2.50"	435.00
303-313	.500"-.650"	340.00	303-320	2.50"-3.00"	435.00
303-314	.650"-.800"	340.00	303-321	3.00"-3.50"	470.00
303-315	.800"-1.00"	340.00	303-322	3.50"-4.00"	515.00
303-316	1.00"-1.20"	340.00	303-336	4.00"-5.00"	850.00
			303-337	5.00"-6.00"	1030.00



Sets

Model	Range	Extension	Sale
303-330	.275"-.500"	4"	\$ 850.00
303-331	.500"-.800"	6"	595.00
303-332	.800"-2.00"	6"	1275.00
303-333	2.00"-4.00"	6"	1550.00
303-338	4.00"-10.0"	4"	2750.00

Mitutoyo DIGIMATIC DEPTH GAGES

- IP67 Waterproof rating.
- Digimatic SPC output.
- Stainless steel construction.
- ABS scale, no need to zero.
- Three year battery life.
- Inch/Metric. • Offset.
- Integral end hook, won't work loose.
- Base and measuring faces are hardened and micro-lapped.
- Auto power On/Off.
- Convenient mounting holes in the base.
- Battery life 3 years under normal use.
- Optional wider extension base available.

IP67

ABSOLUTE
Absolute System Patented by MITUTOYO

SPC



Resolution: .00005"/0.01mm

No. 571-263

No. 571-264

Hook Style

Model	Range	Price
571-264*	6"/150mm	\$470.00
571-265*	8"/200mm	515.00

*IP67 Coolant Proof

Optional Accessories

Extension Bases:		
No. 900367	7" Base	\$39.00
No. 900368	10" Base	57.00
No. 900369	12" Base	66.00
SPC Cables:		
No. 05CZA624	40"	\$84.00
No. 05CZA625	80"	86.00

Point Style

Model	Range	Price
571-211	6"/150mm	\$365.00
571-261*	6"/150mm	455.00
571-212	8"/200mm	395.00
571-262*	8"/200mm	505.00
571-213	12"/300mm	455.00
571-263*	12"/300mm	525.00
571-214	18"/450mm	745.00
571-215	24"/600mm	810.00
571-216	30"/750mm	875.00
571-217	40"/1000mm	1025.00

*IP67 Coolant Proof

FLEXBAR

DIGI-CIRCLE MULTI FUNCTION GAGE High Precision Double Sliding Gage Accepts a range of Interchangeable Accessories For Measuring:

- Inside/Outside Dimensions • Center Distances
- Grooves • Offset Dimensions • Diameters and More

- Heavy-duty hardened stainless steel and light weight carbon fiber beam.
- Mobile double sliding jaws allows balanced weight for taking small measurements.
- Swiss Sylvac electronics, .0005"/.01mm reading, RS232C output.
- Pre-set functions for zeroing setting at any position.



Shown with No. 19402 Conical Measuring Attachments for direct measurement of hole center distances

Model No.	Overall Length	Graduation Inch/Metric	Price Each
19400	24"/600mm	.0005"/.01mm	\$1795.00
19401	40"/1000mm	.0005"/.01mm	2895.00

Interchangeable Measuring Accessories For Digi-Circle

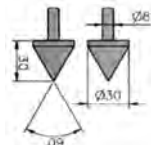

No. 19402
Conical shaped jaw blades for direct measurement of hole center distances (self-centering).

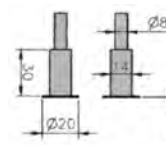

No. 19403
Disc jaw blades for stable measurement of grooves and slots

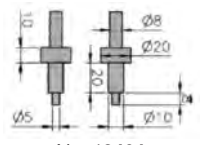

No. 19404
Cylindrical jaw blades for measuring hole and wall center distances. 5, 10 and 20mm diameters can be used as shown by always using an anti-pivot support

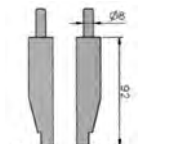

No. 19405
"Femo" model long jaw blades for measuring inside and outside walls and holes

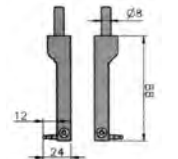

No. 19406
UL Accessory
By inserting this accessory in the special slots on the "circle" gauge, it is possible to measure inside & outside diameters and grooves.

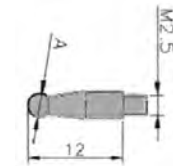

*3mm Ball Attachment For No. 19406 UL Accessory

Model No.	Price Pair	Model No.	Price Pair	Model No.	Price Each
19402	\$350.00	19404	\$350.00	*19386	\$75.00
19403	350.00	19405	300.00		
		19406	575.00		

*Other Available Ball Diameter

1.5, 2, 2.5, 3.5, 4, 4.5, 5, 5.5 and .6mm @\$75.00 Each

Precise GEARTOOTH CALIPER



- Allows teeth measurement without removing the gear from the machine.
- Two adjustable verniers provide simultaneous measurement of the chordal addendum and the chordal thickness.
- The vertical scale will measure chordal addendum from 0-1.0"
- The horizontal scale will measure tooth chordal thickness from 0-1.6"
- Carbon steel frame satin chrome finish.
- With plastic box.
- .001" Grad.

MODEL No. MCG-000
Reg. \$110.00

\$89.95

Fowler INTERNAL/EXTERNAL CALIPERS GAGES

- Easy to hold
- RS232 output
- Rugged housing
- Large, LCD display
- Resolution: .0005"/.01mm
- Accuracy: $\pm .0008"/\pm .02$ mm
- Direct inch/metric conversion
- Absolute/incremental measurements.

External

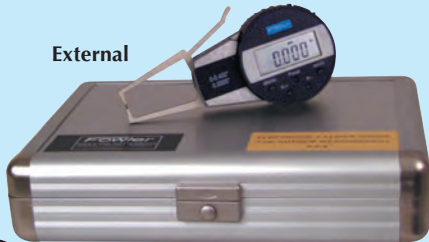

Internal

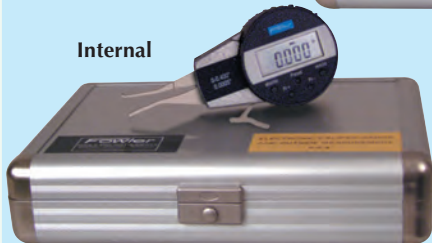

Internal Caliper Gages			External Caliper Gages		
Model	Range	Sale	Model	Range	Sale
54-554-611	.200"-.590/5-15mm	\$139.95	54-554-711	0-.400"/0-10mm	\$139.95
54-554-622	.200"-1.1"/5-25mm	149.95	54-554-722	0-.790"/0-20mm	149.95
54-554-623	.400"-1.2"/10-30mm	159.95	54-554-723	.400"-1.2"/10-30mm	159.95
54-554-624	.790"-1.6"/20-40mm	159.95	54-554-724	.790"-1.6"/20-40mm	159.95
54-554-625	1.2"-2"/30-50mm	159.95	54-554-725	1.2"-2"/30-50mm	159.95

Mitutoyo INSIDE MICROMETERS

- Each interchangeable rod is marked with its measuring range.
- Both micrometer head and furnished rods are satin-chrome finished throughout.
- Positive-locking clamp attached on No. 141-102 no lock on the larger sizes.
- Spherical and hardened contact points for extra long tool life. Overall accuracy is .0004" up to 12" (300mm), .001 thereafter to 40".
- Supplied in fitted carrying case.



Mitutoyo
2" to 12"
MODEL No.
141-233
Reg. List
\$229.00
\$189.95

Made In
China
2" to 12"
MODEL No.
303-2218
\$89.95

Model No.	Range Inch	Mic Travel	No. of Rods	List Price	Sale Price
141-102	1"-2"	.250"	2	\$190.00	\$165.00
141-208	2"-8"	.500"	6	190.00	165.00
141-233	2"-12"	.500"	10	229.00	189.95
141-121	8"-20"	1.00"	3	365.00	325.00
141-122	8"-40"	1.00"	8	543.00	485.00

Precise HOLE GAGE

Instantly Measures Small Hole Diameters

- Instantly gives you a diameter reading in less than two seconds. Merely insert the precision ground, hardened tool steel Gaging Plunger into the hole, press the base of the gage firmly against the part and read the dial directly in .001" or .02mm diameter increments on the dial face.
- No setting Master (Standard) or look-up chart required.
- To check the setting, press the base of the gage against any flat ground surface and adjust the dial to read the "Set To" number stamped on the back.
- These models cover a range capacity from .010"(25mm) to 1.030"(26.20mm)
- All gages furnished with foam lined storage case and complete operating instructions.

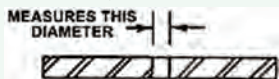

MADE IN
USA

Model	Capacity	Price	Model	Capacity	Price
HC-680	.010"-.040"	\$215.00	HC-686	.530"-.630"	\$545.00
HC-681	.030"-.130"	220.00	HC-687	.630"-.730"	575.00
HC-682	.130"-.230"	225.00	HC-688	.730"-.830"	595.00
HC-683	.230"-.330"	230.00	HC-689	.830"-.930"	625.00
HC-684	.330"-.430"	360.00	HC-690	.930"-1.030"	725.00
HC-685	.430"-.530"	435.00			

Note: .0001" Graduations Add \$125.00
For metric Graduations Add \$150.00 to Price

N.C.K. INTERNAL DIAL CALIPER GAGES

- For checking internal bores, recess diameter, etc.
- Each instrument has a movement of 1"
- Can be set with a micrometer or a ring gage.
- Bezel rotates for zero setting.
- Button for opening/closing arms.
- Arms automatically open/close when button is released.
- Includes fitted case.

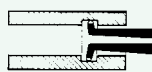

Internal Application



Made in Japan

✓ Unique Bezel and Clamp Screw Stopper

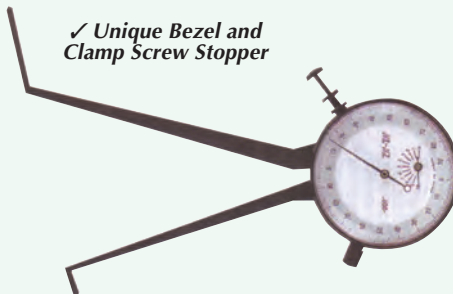

Model No.	Range Inch	Graduation Inch	Arm Length	Price Each
IDG-001	.375"-1.375"	.001"	3-1/4"	\$119.95
IDG-002	.75"-1.75"	.001"	3-1/4"	139.95
IDG-003	1.125"-2.125"	.001"	3-1/4"	145.00
IDG-004	1.5"-2.5"	.001"	3-1/4"	150.00
IDG-005	1.875"-2.875"	.001"	3-1/4"	160.00
IDG-006	2.250"-3.25"	.001"	3-1/4"	210.00
IDG-007	2.875"-3.875"	.001"	3-1/4"	215.00
IDG-008	3.25"-4.25"	.001"	3-1/4"	225.00



GROOVE CHECKING COMPARATOR

Internal Grooves From 3/8" To 6"

- Serrated hinge joints keeps tips parallel on wide measurements.
- Set comes complete with both short and long groove tips for hole checking, centering arms, spare screws, special socket wrench and screw driver, all in sturdy case.
- All tips are chrome plated, smallest set enters 1/4" (6mm) hole when retracted

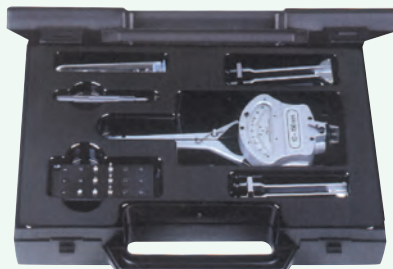

.0005" Grade
SET No.
IRA-2A
Reg. \$2550.00

\$2395.00

Optional:

Model	Description	Price
IRA-136	Contact points for blind holes: Height 5/64" (Set of 3)	\$154.00
IRA-135	Contact points for blind holes: Height 3/16" (Set of 3)	\$157.00

Precise CHAMFER GAGE

Instantly Measures Top Diameter of Tapered Holes

- Measure the top (major) diameter of a chamfer, countersink, center drill, or tapered hole.
- Press the spring loaded, conically ground, precision 3-blade Gaging Plunger into the chamfer or countersink and instantly read the dial in .001" or .01mm/.022mm diameter increments.
- The Chamfer Gage is a direct reading gage. No setting, Master (Standard) or look-up chart is required.
- Available in two angular ranges: 0°-90°, 90°-127°

MADE IN
USA

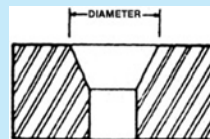

Guaranteed Accuracy:
within $\pm .001$ " in 0°-90° models
within $\pm .002$ " in 90°-127° models

0-90° Angle			90°-127° Angle		
Model	Capacity	Price	Model	Capacity	Price
CC-009	0-3/8"	\$275.00	CC-012	0-3/8"	\$295.00
CC-509	0-1/2"	245.00	CC-512	0-1/2"	265.00
CC-660	0-1"	240.00	CC-662	0-1"	260.00
CC-661	1"-2"	325.00	CC-663	1"-2"	355.00
CC-309	2"-3"	495.00	CC-312	2"-3"	525.00
CC-409	3"-4"	765.00	CC-412	3"-4"	765.00

Note: .0001" Graduations Add \$100.00
For metric Graduations Add \$50.00. Sizes Available up to 8"

SPi ELECTRONIC INTERNAL/EXTERNAL CALIPER GAGES

- Easily held compact design.
- Large LCD display with 0.0005" resolution.
- Accuracy: $\pm 0.0008"$
- Absolute and incremental reading.
- Furnished in fitted case.



Internal
Ball diameter: 0.06"
Groove width: .200"x .187" Deep

External
Groove width: 0.04"

Model	Range	Price	Model	Range	Price
13-661-4	0.4000-1.200"	\$216.40	14-289-3	0.0000-0.800"	\$209.15
13-662-2	0.8000-1.600"	216.40	14-290-1	0.4000-1.200"	209.15
13-663-0	1.2000-2.000"	216.40	14-291-9	0.8000-1.600"	209.15
			14-292-7	1.2000-2.000"	209.15

Mitutoyo CALIPER MICROMETER

- With ratchet Stop for constant force.
- With SPC output (Series 343).
- With a standard bar except 0-25mm and 0-1" model.
- Supplied in fitted plastic case.



No. 143-121

No. 343-350

Mechanical Type

Model	Range	Graduation	List	Sale
143-121	0-1"	.001"	\$416.00	\$365.00
143-122	1-2"	.001"	438.00	385.00
143-123	2-3"	.001"	456.00	395.00

Digital Type

Model	Range	Graduation	List	Sale
343-350	0-1"	.0005"/0.001mm	\$718.00	\$680.00
343-351	1-2"	.0005"/0.001mm	782.00	735.00
343-352	2-3"	.0005"/0.001mm	828.00	785.00
343-353	3-4"	.0005"/0.001mm	871.00	825.00

Mitutoyo LIMIT MICROMETER

- Can be used as a GO/±NG gage by setting the upper and lower limits.
- Provided with a standard bar for 25mm-50mm model.
- Supplied in fitted plastic case.

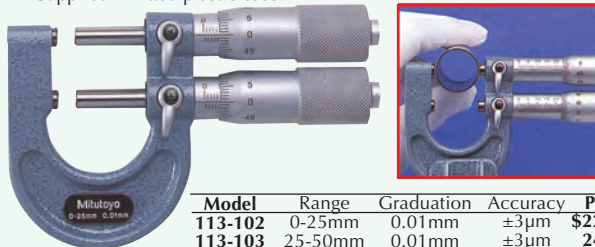

Model	Range	Graduation	Accuracy	Price
113-102	0-25mm	0.01mm	$\pm 3\mu$ m	\$225.00
113-103	25-50mm	0.01mm	$\pm 3\mu$ m	245.00

The Vyndicator WIRELESS TEST INDICATOR

- The Industries first wireless test indicator that provides a remote readout of stylus movement.
- Featuring a bright OLED display with traveling stylus position bar, the VYNDICATOR'S ample range and accuracy speeds set up and alignment in difficult to read locations.
- The 30 foot transmission range accommodates most all remote reading requirements.
- With Zigbee compliant transmission protocol, multiple units may be used in the same area. Seven stylus lengths provide ranges up to .325 inch. The VYNDICATOR uses standard industry mounting Dovetails.



MODEL No. VWT-001

\$375.00

Specifications:

- 30 foot range
- .0001 inch resolution
- Accuracy $\pm .0002$ inch with (.780 inch stylus)
- .170 inch range (.780 inch stylus)
- .300 inch range (1.40 inch stylus)

Zigbee compliant transmission protocol

- Features:**
- Wireless remote reading.
 - Metric and Inch modes.
 - Choice of 7 stylus lengths
 - Bright OLED display.
 - Standard industry mounting VEES
 - Use multiple units in the same area.
 - Uses common batteries.
 - Automatic shutoff when not in use.
 - Moving bar shows stylus position.
 - Reversible stylus.
 - Battery minute usage counter.

Precise TUBULAR TYPE

LONG RANGE INSIDE MICROMETER SETS

- By combining of extension rods provide a wide measuring range can be accomplished.
- Supplied with a standard caliper gage for zero setting.
- Carbide measuring faces.
- Laser engraved graduations.
- Positive locking clamp.
- Micrometer head has 1.0" travel and .001" graduations, rod diameter .61"



Model No.	Range Inch	Extension Rods (.610" Diameter)	Sale Price
TIM-260	2" - 6"	1", 2"	\$ 75.00
TIM-210	2" - 10"	2", 3", 4"	89.95
TIM-212	2" - 12"	2, 3, 4", 6"	99.95
TIM-420	2" - 24"	1", 2", 4", 8"	124.95
TIM-436	2" - 40"	1", 2", 4", 8", 16"	385.00
TIM-452	2" - 60"	1", 2", 4", 8", 16" (2 Pcs.)	745.00

Precise OR Mitutoyo INSIDE MICROMETER

- Satin chrome finish on barrel and thimble.
- Measuring faces are fully hardened, precision ground and microlap finished to assure exceptionally accurate measuring.
- Spindle threads are hardened & ground.
- Microfine graduations .001" a satin chrome finish permit easy reading.
- Ratchet stop thimble assures exact and repetitive readings.
- Easy zero adjustment on the sleeve.
- Price includes a spanner wrench and a fitted case.

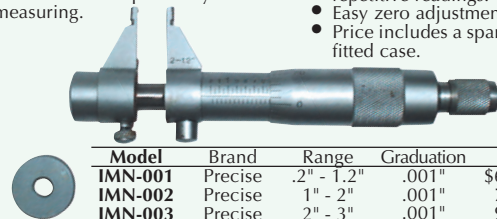

Model	Brand	Range	Graduation	List	Sale
IMN-001	Precise	.2" - 1.2"	.001"	\$65.00	\$49.95
IMN-002	Precise	1" - 2"	.001"	75.00	59.95
IMN-003	Precise	2" - 3"	.001"	95.00	79.95
IMN-004	Precise	3" - 4"	.001"	115.00	99.95
145-193	Mitutoyo	.2" - 1.2"	.001"	\$238.00	\$205.00
145-194	Mitutoyo	1" - 2"	.001"	255.00	220.00

Fowler X-TRA-RANGE INSIDE MICROMETER

- Range: .2-2.2"
- Satin chrome finish on barrel and thimble.
- Microfine graduations (.001" or .01mm) on a satin chrome finish permit easy reading.
- Accuracy: $\pm .0002"$ (.005mm)
- Ratchet stop thimble.
- Easy zero adjustment on the sleeve.
- Meets or exceeds Federal accuracy specs.
- Includes a setting ring.
- Includes a spanner wrench and a fitted case.



MODEL No. 52-275-005
Reg. \$165.00

\$145.00

Mitutoyo HOLETEST - THREE POINT INTERNAL MICROMETERS

DIGIMATIC HOLETEST MICRO TEST BORE MATIC TEST



See The Complete Mitutoyo HoleTest Series ~ .08" To 12" Range ~ Specifications And Discount Pricing On www.penntoolco.com or Call

Precise ELECTRONIC DIAL BORE GAGE SETS

- Resolution: .00005"/.002mm
- Zero reset allows absolute or comparative measurements.
- True inch/metric conversion.
- ABS/INC measurements.
- Extra large LCD, 360° rotation.
- Dual display: digital & electric scale



2" to 6" Range
.00005" Resolution
MODEL No.
303-743

\$189.95

.00005"/.002mm Resolution

Model No.	Range Inch/Metric	Probe Depth	No. of Anvils	Set Price
303-740	0.4-0.7"/10-18mm	4"	9	\$189.95
303-741	0.7-1.5"/18-35mm	6"	9	189.95
303-742	1.4-2.4"/35-50mm	6"	4	189.95
303-743	2-6"/50-160mm	6"	12	189.95
303-744	6-10"/160-250mm	10"	5	195.00
303-745	1.4-6"/35-150mm	6"	15	220.00

INDICAL "O" RING INTERNAL GROOVE GAGE

- Indical is a simple holder to which any type indicator can be attached for checking bores, O ring and snap ring grooves, thread reliefs, undercuts, etc.
- For indicator without dovetail special adapters are required, specify make and model.
- I.D. range .600"- 6" - (.200"-.600" with optional off-set points 06-003-8)

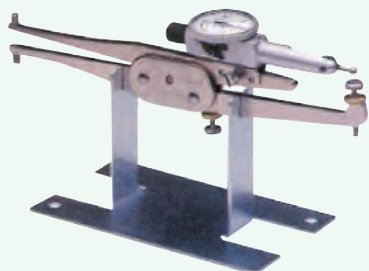

The Complete Set
W/ Stand, Extension
All Points and .0005"
Dial Indicator
MODEL No.
IDC-015

\$179.95

Groove Gage
W/ Extensions & Points
MODEL No.
IDC-010

\$135.00

Less Indicator
& 06-003-8 Offset Points

Optional:
Offset Points
No. IDC-200

\$16.50

Stand Only
No. IDC-105

\$16.50

FLEXBAR DEEP THROAT MICROMETER - ELECTRONIC DIGITAL

This Rugged, yet lightweight micrometer provides quick and easy measurements for ranges up to 2.400" and will accommodate depths up to 3.3". Ideal for shop requirements.

- Fast sliding scale for quick measurements.
 - Easy to read large digital display.
 - Easy to hold - ergonomic finger tip.
 - Cast aluminum frame - rugged lightweight.
 - Includes heavy duty molded plastic case.
- Specifications:**
Measurements range . . . 0-2.400" (61mm)
Maximum measuring depth 3.3"
Resolution0005"/.01mm
Accuracy001"/.02mm
Inch/Metric conversion
Zero setting
On/Off buttons

Model No.
15785

\$189.95

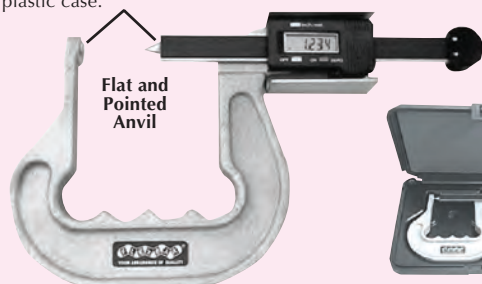

Flat and Pointed Anvil

BLAKE CO-AXIAL INDICATOR SETS

- Designed for centering a work piece of fixture.
- Operates at any angle.
- Use vertical or horizontal.
- Use internal or external.
- While spindle rotates, the centering indicator always faces the operator.



MADE IN USA

- Includes:
- Restraining Rod.
 - 4" Straight feeler.
 - 4" Curved feeler

Specifications:

Length 6-7/8"
Shank 3/8" diameter x 7/8" long
Weight 9-1/2oz. net
Feeler ball 1/8" diameter
Measuring range 250 axis offset
Capacity internal: 5/32 to 4-1/4 diameter
external: zero to 4-1/4 diameter
Speed it is recommended that operating speed not exceed 800 rpm approximately
Locating accuracy to within 0.0002"
Graduation of true center 0.0005"

Metric
MODEL No.
COA-850M
Reg. \$349.00

\$310.00

MADE IN USA

Accessories:

20-869-4	Carbide feeler I.D. range 4-1/4" dia.	\$26.75	20-874-4	Assembly, center point feeler	\$30.75
20-870-2	Carbide feeler O.D. range 4-1/4" dia	28.75	20-896-7	Feeler I.D. range 6" dia.	19.50
20-871-0	Feeler I.D. range 8" dia.	20.75	20-897-5	Feeler O.D. range 6" dia.	23.75
20-872-8	Feeler I.D. range 12" dia.	24.75	20-898-3	Feeler O.D. range 8" dia.	24.75
20-873-6	Feeler O.D. range 12" dia.	29.75	20-899-1	Feeler I.D. range 10" dia.	22.75
			20-900-7	Feeler O.D. range 10" dia.	27.75

* Metric Model Available Model No. COA-850M . . . \$269.95

Precise 2 DIMENSIONAL COAXIAL INDICATOR SET

The 2D Coaxial Set for accurate component centering and positioning in most machining applications. The 2D Coaxial indicator can be used at any angle and the dial remains stationary.

Features:

- Indicator assembly with 1.6" diameter dial.
- Graduations and revolution counter .0005"
- 3 internal and external feelers.
- Center point feeler.
- Restraining arm.
- Complete in a fitted case.

Specifications:

- Length: 6-7/8"
- Shank: 3/8" dia. x 7/8" long.
- Feeler ball: 1/8" diameter.
- Dial readings: 0-40
- Measuring range: .250" axis offset.
- Speed- recommended not to exceed approx. 800 RPM.
- Locating accuracy to within .0002" of true center.
- Capacity depends on feelers installed, but overall range is 5/32-12" internal diameter; 0-12" external diameter.



SET No.
DXI-001
Reg. \$125.00

\$89.95

Metric
SET No.
400-0121

\$125.00

BACK PLUNGER

UNIVERSAL DIAL INDICATOR

MADE IN USA

- Designed for making comparative tests where precision counts.
- All sets are complete with:
- Jeweled bearing indicator with 1-1/2" diameter bezel and rear mounted plunger.
- Indicator holding rod (two sections).
- Two extra contacts (1/16" diameter and 5/16" diameter).
- Hole attachment for checking bores (.125" range).
- Indicator C-clamp mounting, or magnetic base.
- Universal rod connector and tool post holder.



With
Clamp
And
Rods



With
Magnetic
Base
And
Rods

Sets With C-Clamp

Set No.	Range	Graduation	Reading	Price
6400	.200"	.001"	0-100	\$79.95
6401	.200"	.001"	0-50-0	79.95
6402	5.00mm	.02mm	0-2.0	79.95

Sets With Magnetic Base

6405	.200"	.001"	0-100	\$75.00
6406	.200"	.001"	0-50-0	75.00
6407	5.00mm	.02mm	0-2.0	95.00

Fowler XTENDER-E ELECTRONIC DIAL BORE GAGE

1.4" To 6" Most Popular Range

Bore Gage Feature:

- Range: 1.4"-6"/35mm-150mm
- Carbide anvils.
- Easily adjustable.
- Self-centering.
- Includes extension holder.
- Shop hardened case.
- BS/INC measurements.

Indicator features;

- Dual reading inch/metric electronic indicator.
- Bar graph and numeric digital display.
- Resolution: .00005"/.001mm.
- preset with recall.
- Min/Max/Tir.

SET No.
54-646-401
Reg. \$301.90

Sale

\$259.95

Includes FREE
Instructional CD



"Two Gages in One" - Inch & Metric

Mitutoyo DIAL BORE GAGE SETS

- Interchangeable anvils and necessary accessories to perform close tolerance I.D. measurements.
- Carbide ball contact point for durability.
- Optional extension rods can be attached.
- A Digimatic Indicator can be attached in place of the dial gage.
- Accuracy: .0002"/5µm.



2"-6"
MODEL No. 511-743
Reg. \$384.00

\$299.95

With .0005" Graduation Dial Indicator

Set No.	Range	Probe Depth	No. of Anvils	Spacers	List Price	Sale Price
511-213	.24-.4"	2"	9	1	\$591.00	\$515.00
511-207	.4-.74"	2"	9	1	617.00	540.00
511-741	.7-1.4"	5"	9	2	347.00	299.95
511-742	1.4-2.5"	6"	6	4	347.00	299.95
511-743	2.0-6.0"	6"	11	4	\$384.00	\$335.00
511-744	4.0-6.5"	6"	13	4	509.00	445.00
511-745	6.5-10"	10"	6	7	577.00	505.00
511-746	10-16"	10"	5	7	701.00	615.00
511-931	.7-6"	4" & 6"	26	10	951.00	835.00

With .0001" Graduation Dial Indicator

Set No.	Range	Probe Depth	No. of Anvils	Spacers	List Price	Sale Price
511-212	.24-.4"	2"	9	-	\$614.00	\$540.00
511-206	.4-.74"	2"	9	1	639.00	560.00
511-751	.7-1.4"	5"	8	3	401.00	350.00
511-752	1.4-2.5"	6"	6	4	391.00	344.00
511-753	2.0-6.0"	6"	11	4	\$427.00	\$362.95
511-932	.7-6.0"	4" & 6"	25	11	\$1000.00	\$875.00
511-754	4.0-6.5"	6"	13	4	519.00	455.00
511-755	6.5-10.0"	10"	5	6	636.00	559.00
511-756	10.0-16.0"	10"	6	6	657.00	575.00

Fowler TWIN BEAM HEIGHT GAGES

DIAL TYPE

- Separate digit counters register both upward & downward travel.
- Zero setting setting can be obtained throughout the gage's range.
- Coarse readings in .100" graduations; fine readings taken on indicator are .001"
- Dual chrome plated beams.
- Carbide-tipped scribe.
- base is hardened, ground and lapped for maximum flatness.

ELECTRONIC

- Patented linear scale measuring system.
- Large LCD.
- Direct inch/metric conversion.
- Resolution: .001"/.01mm.
- Hold function.
- ABS/INC function allows measurements of the true size or comparison measurements of parts to master.

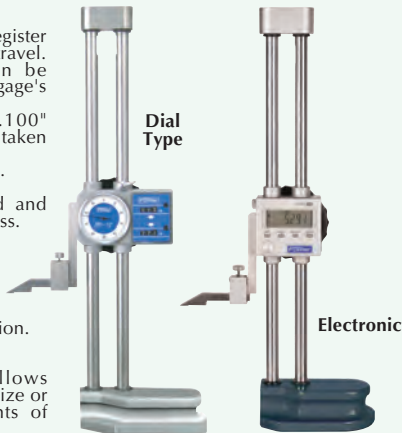

Model	Type	Range	List	Sale
52-174-212	Dial	0-12"	\$334.90	\$199.95
52-174-224	Dial	0-24"	682.10	395.00
54-174-212	Electronic	12"/300mm	\$464.75	\$329.95
54-174-224	Electronic	24"/600mm	935.15	595.00

Fowler XTENDER DIAL BORE GAGE SETS

The industries most popular bore gage ranges!

- Carbide Anvils
- Easy-to-read
- Economical
- Graduation: .0005"
- Insulated grip
- Chrome plated handle.
- Includes extension holder and fitted case.

With Carbide Anvils

2"-6"
SET No.
52-646-300
Reg. \$115.00

\$99.95



Model	Range	Graduation	List	Sale
52-646-100	.7"-1.5"	.0005"	\$115.00	\$99.95
52-646-300	2"-6"	.0005"	115.00	99.95
52-646-400	1.4"-6"	.0005"	179.00	119.95
52-646-600	4"-12"	.0005"	285.00	195.00

Precise DIAL BORE GAGES

.0005" or .0001" GRADUATIONS- SELF CENTERING

- Reference chart in each set, indicating ring & rod sizes to select specific range.
- All Dial Bore Gages are supplied w/AGD group 2 Dial Indicators & fitted case.
- Self centering.

2"-6"
MODEL No. BG-005

\$79.95



Range Capacity	Probe Depth	No. of Anvil	.0005" Grade	.0005" Price	.0001" Grade	.0001" Price
.25"-0.4"	2"	8	BG-001	\$79.95	BG-111	\$195.95
0.4"-0.7"	4"	10	BG-002	74.95	BG-112	195.00
0.7"-1.5"	6"	8	BG-003	74.95	BG-108	149.95
1.4"-2.4"	6"	6	BG-004	74.95	BG-109	159.95
2.0"-6.0"	6"	11	BG-005	79.95	BG-110	179.95
6.0"-10.0"	10"	9	BG-006	99.95	BG-113	199.95
10.0"-16.0"	16"	13	BG-007	119.95	-	-

Precise ELECTRONIC HEIGHT GAGES 12" & 20"

- Large, clear LCD display eliminates errors.
- Non-contact measuring system; oil and chip proof.
- Can be zeroed out at any height.
- Battery included
- .0005"/.01mm resolution.
- Carbide tipped scribe.
- Locking mechanism.

0-20"/0-500mm
MODEL No. EHG-020
Reg. \$285.00

\$199.50

0-12"/0-300mm
MODEL No. EHG-012
Reg. \$210.00

\$129.95



Precise ELECTRONIC HEIGHT GAGE TWIN COLUMN

- Double column structure ensures high measuring accuracy.
- Easy-to-use design. SPC output.
- Display LCD, 5 digits and a minus sign (-).
- Functions include: Zero-setting, Data hold, Presetting, Inch/mm conversion.
- Carbide-tipped scribe.
- Uses 2 standard SR-44 batteries supplied with each unit.



0-12"/0-300mm
MODEL No. DEG-012

\$199.95

Model	Resolution	Accuracy	Price
DEG-012	.001"/.01mm	±.001"	\$199.95
DEG-018	.001"/.01mm	±.002"	295.00
DEG-024	.001"/.01mm	±.002"	350.00

SPI INTERTEST CALIPER GAGES

- Used for measuring bores, internal grooves and recesses.
- Jeweled movement, dust, splash and shockproof.
- Carbide measuring contacts.

- Dampened movement with steel string transmission for higher precision.
- Mechanical gages are IP65 rated. Electronic gages are IP67 rated.
- Electronic models use 1.5V AAA battery (included).

IP65



15-508-5



15-515-0

IP67

Mechanical

Model No.	Range Inch	Graduation	Accuracy	Meas. Depth	Groove Max. Depth	Groove Min. Width	Contact Points	Price Each
15-508-5	0.10"-0.5"	0.0002"	0.0008"	0.47"	0.027"	0.024"	Chisel/Chisel	\$631.25
15-509-3	0.20"-0.6"	0.0002"	0.0008"	1.37"	0.090"	0.032"	Ball/Ball	631.25
15-510-1	0.40"-1.2"	0.0005"	0.0015"	3.30"	0.190"	0.060"	Ball/Ball	631.25
15-511-9	0.80"-1.6"	0.0005"	0.0015"	3.30"	0.260"	0.060"	Ball/Ball	631.25
15-512-7	1.20"-2.0"	0.0005"	0.0015"	3.30"	0.260"	0.060"	Ball/Ball	631.25
15-513-5	1.60"-2.4"	0.0005"	0.0015"	3.30"	0.310"	0.060"	Ball/Ball	631.25
15-514-3	2.00"-2.8"	0.0005"	0.0015"	3.30"	0.310"	0.060"	Ball/Ball	631.25
15-515-0	2.40"-3.2"	0.0005"	0.0015"	3.30"	0.310"	0.060"	Ball/Ball	631.25

Electronic for Inch/Metric (Not Shown)

Model No.	Range Inch/Metric	Resolution Inch/Metric	Meas. Depth Inch/Metric	Groove Max. Depth Inch/Metric	Groove Min. Depth Inch/Metric	Contact Points	Price Each
15-490-6	0.10-0.49/25-12.5	0.0002/0.005	0.47/12	0.027/0.7	0.023/0.5	Chisel/Chisel	\$652.45
15-491-4	0.20-0.59/5.0-15.0	0.0002/0.005	1.37/35	0.090/2.3	0.032/0.8	Ball/Ball	652.45
15-492-2	0.39-1.18/10.0-30.0	0.0005/0.01	3.30/85	0.190/5.2	0.060/1.2	Ball/Ball	652.45
15-493-0	0.79-1.58/20.0-40.0	0.0005/0.01	3.30/85	0.260/7.0	0.060/1.2	Ball/Ball	652.45
15-494-8	1.18-1.97/30.0-50.0	0.0005/0.01	3.30/85	0.260/7.0	0.060/1.2	Ball/Ball	652.45
15-495-5	1.58-2.36/40.0-60.0	0.0005/0.01	3.30/85	0.310/8.3	0.060/1.2	Ball/Ball	652.45
15-496-3	1.97-2.75/50.0-70.0	0.0005/0.01	3.30/85	0.310/8.3	0.060/1.2	Ball/Ball	652.45
15-497-1	2.36-3.15/60.0-80.0	0.0005/0.01	3.30/85	0.310/8.3	0.060/1.2	Ball/Ball	652.45
15-498-9	2.75-3.54/70.0-90.0	0.0005/0.01	3.30/85	0.310/8.3	0.060/1.2	Ball/Ball	652.45

SPI ODITEST CALIPER GAGES

- Used for measuring external grooves, recess diameters and thickness.
- Certain Oditest gages are used for measuring the wall thickness of small pipes and tubes.
- Jeweled movement, dust, splash and shockproof.
- Carbide measuring contacts.

- Dampened movement with steel string transmission for higher precision.
- Mechanical gages are IP65 rated. Electronic gages are IP67 rated.
- Electronic models use 1.5V AAA battery (included).

IP67



15-500-2

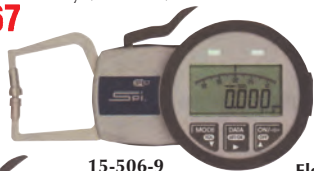

15-506-9

IP65



15-526-7

Mechanical

Model No.	Range	Graduation	Accuracy	Meas. Depth	Groove Max. Depth	Groove Min. Depth	Contact Points	Price Each
15-523-4	0-0.4"	0.0002"	0.0008"	1.37"	0.75"	0.16"	Ball/Ball	\$631.25
15-524-2	0-0.8"	0.0005"	0.0015"	3.20"	0.97"	0.16"	Ball/Ball	631.25
15-525-9	0-0.8"	0.0005"	0.0015"	3.20"	0.97"	0.15"	Chisel/Chisel	631.25
20-580-7*	0-2.0"	0.001"	0.002"	6.80"	1.25"	0.18"	Ball/Ball	737.60

*Not IP65 Rated

Mechanical for Pipes & Tubes

Model No.	Meas. Range	Graduation	Accuracy	Min. Pipe I.D.	Max. Pipe I.D.	Contact Points	Price Each
15-526-7	0-0.4"	0.0002"	0.0008"	0.12"	1.37"	Ball/Ball	\$631.25
15-527-5	0-0.4"	0.0002"	0.0008"	0.12"	1.37"	Chisel/Ball	631.25
20-586-4*	0-2.0"	0.001"	0.002"	0.47"	6.70"	Ball/Ball	737.60

Electronic for Inch/Metric

Model No.	Range Inch/Metric	Grad. Inch/Metric	Meas. Depth Inch/Metric	Groove Max. Depth Inch/Metric	Groove Min. Width Inch/Metric	Contact Points	Price Each
15-500-2	0-0.39/0-10	0.0002/0.005	1.37/35	0.75/18.6	0.16/4.0	Ball/Ball	\$652.45
15-506-9	0-0.39/0-10	0.0002/0.005	1.37/35	0.58/14.8	0.24/6.0	Flat/Flat	652.45
15-501-0	0-0.78/0-20	0.0005/0.01	3.20/85	0.97/24.6	0.16/4.0	Ball/Ball	652.45
15-502-8	0-0.78/0-20	0.0005/0.01	3.20/85	0.97/24.6	0.15/3.8	Chisel/Chisel	652.45

NEW LONG RANGE Mitutoyo DRO LATHE PACKAGES & SCALES

The AT715 Scales use a New Electromagnetic Induction Detection method for improved reliability and contamination protection. True Absolute Scale Technology means your original part datum point is never lost, even after power down.

The New IP67 Coolant Proof Rating means increased production by putting the coolant where it's needed, without having to worry about scale damage. The new IP67 Coolant Proof rating means less downtime for maintenance.

AT715 SCALES IP67 - OIL SUBMERSIBLE & COOLANT PROOF

IP67

IP67 Protection Level: Level 6: Dust Tight
No ingress of dust.



Mitutoyo KA Counter

KA Counter Features:

- Preset.
- Inch/mm
- 1/2 Calculation.
- 10 Tool off sets.
- Diameter Display.
- Zero Approach Machining.
- Pitch Approach Machining.
- Bolt Hole Circle Calculation.
- Detection reference (with AT100 series scales).
- Touch Signal Probe Set and Hold (with AT100 series scales)
- Standard Resolution .0005"/.0002"/.0001"/.00005" 0.005mm/0.002mm/0.001mm
- Build your own package.
- No. 174-173 KA Counter and choose Individual Scales



ABSOLUTE™
Absolute System Patented by MITUTOYO



MODEL No. 174-173A **\$495.00**
List Price \$587.00 Dual Axis

New Mitutoyo Lathe Packages

Individual Scales			
Model No.	Range	List	Sale
539-801	4"/100mm	\$296.00	\$250.00
539-802	6"/150mm	296.00	250.00
539-803	8"/200mm	299.00	254.00
539-804	10"/250mm	299.00	254.00
539-805	12"/300mm	299.00	254.00
539-806	14"/350mm	302.00	256.00
539-807	16"/400mm	306.00	260.00
539-808	18"/450mm	312.00	265.00
539-809	20"/500mm	315.00	268.00
539-811	24"/600mm	321.00	273.00
539-813	28"/700mm	327.00	278.00
539-814	30"/750mm	332.00	282.00
539-815	32"/800mm	334.00	284.00
539-816	36"/900mm	365.00	310.00
539-817	40"/1000mm	379.00	322.00

Individual Scales			
Model No.	Range	List	Sale
539-818	44"/1100mm	\$430.00	\$365.00
539-819	48"/1200mm	482.00	410.00
539-820	52"/1300mm	553.00	455.00
539-821	56"/1400mm	585.00	497.00
539-822	60"/1500mm	649.00	552.00
539-823	64"/1600mm	727.00	618.00
539-824	68"/1700mm	803.00	705.00
539-825	72"/1800mm	880.00	748.00
539-860	80"/2000mm	1340.00	1139.00
539-861	88"/2200mm	1430.00	1220.00
539-862	96"/2400mm	1720.00	1462.00
539-863	100"/2500mm	1760.00	1496.00
539-864	104"/2600mm	1800.00	1530.00
539-865	112"/2800mm	1920.00	1632.00
539-866	120"/3000mm	2140.00	1819.00

Model No.	Size	List	Sale
174-173PL8	72" x 12"	\$1980.00	\$1680.00
174-173PL15	80 x 6"	2380.00	2020.00
174-173PL20	80 x 8"	2390.00	2030.00
174-173PL22	80 x 10"	2390.00	2030.00
174-173PL30	80 x 12"	2390.00	2030.00
174-173PL36	80 x 14"	2390.00	2030.00
174-173PL39	80 x 16"	2390.00	2030.00
174-173PL9	88 x 12"	2390.00	2030.00
174-173PL23	100" x 10"	2490.00	2115.00
174-173PL10	100" x 12"	2490.00	2115.00
174-173PL37	100" x 14"	2490.00	2115.00
174-173PL40	100" x 16"	2490.00	2115.00
174-173PL24	120" x 10"	2860.00	2430.00
174-173PL11	120" x 12"	2860.00	2430.00
174-173PL12	120" x 14"	2860.00	2430.00
174-173PL41	120" x 16"	2860.00	2430.00

Level 7: Protected against the effects of temporary immersion in water. Ingress of water in quantities causing harmful effects shall not be possible when the enclosure is temporarily immersed 1 meter in water under standardized conditions of pressure and time (30 min.)

Mitutoyo DIAL THICKNESS GAGES

Features:

- Reading direct 0-100 (with revolutions counter) with clear black graduations for .001" minimum reading.
- Reading direct 0-10" with clear black graduations.
- Hammerstone-green baked-enamel finished frame.
- Diameter of upper anvil is .394", except 7312.
- Complete with fitted carrying case.



Model	Range	Throat	Graduation	Price
7300-1	.4"	1"	.001"	\$115.00
7304-1	1.0"	1-1/8"	.001"	135.00
7322-1	1.0"	4-3/4"	.001"	159.50
7312-1	.4"	1-3/16"	.001"	140.00
7326-1	.05"	1"	.0001"	190.00

Available in Metric, Inquire

Mitutoyo DIGIMATIC THICKNESS GAGES

Features:

- Provides snap-action movement with the clear LCD readout of Mitutoyo's popular IDS indicator.
- Instant inch/metric conversion and zero-setting at any point.
- Control buttons are membrane sealed to keep out contaminants.



INCH/
METRIC

Specifications:

Range 0-.4"
Throat0005"
Graduation . . . less than 1.6N



Model No.	Range	Resolution	Type	Throat Depth	Sale Price
547-526	0-.47"/0-12mm	.0001"/0.001mm	ø .4" Flat	1.18"	\$345.00
547-500	0-.47"/0-12mm	.0005"/0.01mm	ø .4" Flat	1.18"	260.00
547-520	0-.47"/0-12mm	.0005"/0.01mm	ø .4" Flat	4.72"	280.00
547-400	0-.47"/0-12mm	.000005"/0.001mm	ø 6.3 Flat	.75"	765.00
547-512	0-.47"/0-12mm	.0005"/0.01mm	Reverse Anvil	1.18"	265.00
547-516	0-.47"/0-12mm	.0005"/0.01mm	Blade Anvil	1.18"	280.00
547-561	0-.47"/0-12mm	.0005"/0.01mm	Pipe Measuring	.826"	260.00

With Ceramic Spindle Anvils

547-300	0-.47"/0-10mm	.0005"/0.01mm	ø 10 Flat	1.18"	\$415.00
547-320	0-.47"/0-10mm	.0005"/0.01mm	ø 10 Flat	4.8"	425.00

Mitutoyo INTERCHANGABLE ANVIL DIGIMATIC DIAL THICKNESS GAGE

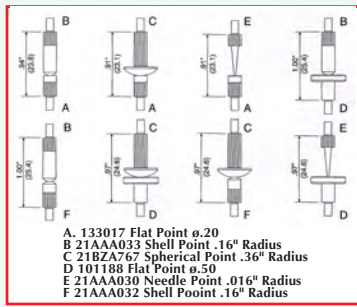

Model	Range	Resolution	Indicator	Price
547-528	0-.47"/0-12mm	.0005"/0.01mm	Digimatic	\$310.00
7328S	0-.4"	.001"	Dial Type	175.00

Fowler XTRA-VALUE DIGITAL THICKNESS GAGE

- Range: 0-1"/25mm
- Robust housing
- Large LCD display
- Reading: .001/.01mm/1/64ths
- Accuracy: .004"
- Includes: 1/8" ball contact, taper point, and a long-stem point.
- Battery: CR2032
- Three interchangeable points
- Battery life: approximately 1 year



MODEL No.
54-554-830
Reg. \$59.95

INCH • METRIC • FRACTION

\$49.95

Precise POCKET THICKNESS GAGES



- Fraction~Metric conversion chart on rear of gage.
- Spindle made of hardened stainless steel.
- Measuring faces are ground, lapped and hardened for accuracy.
- Dimensions: 2.12H x 2.5L x 0.535" T.
- Revolution counter.
- Throat capacity .500"

Throat Depth .500"

Model	Range	Graduation	Reading	Price
PTG-521	0-0.5"	.0005"	0-100	\$49.95



POCKET THICKNESS GAGES

- Model 22P-11 model with continuous reading dial and revolution counter for absolute measurement of thin materials, plastic films and small parts.
- XLI model with Maxum® II XL digital indicator can be right/left hand operated or front mounted and used with a BA-26 Stand for bench applications.
- Switchable Resolutions: 0.00001" / 0.0002mm
- Graduation: 0.0001"



No. 22P-15



No. XLI-22P-20

Model No.	Capacity Inch/Metric	Throat Depth	Graduation Inch/Metric	List Price	Sale Price
22P-11	0-10"	1.13"	.0001"	\$509.00	\$475.00
22P-15	0-.50"	2"	.001"	539.00	510.00
22P-20	0-1"	2"	.001"	539.00	510.00
XLI-22P-20	0-1"/25mm	2"	.00005"/.001mm	850.00	795.00

Precise COUNTERSINK GAGES

Instantly Measure Countersink Diameters

The **COUNTERSINK GAGE** is a precision instrument designed specifically to measure the top (major) countersink diameter. Merely press the spring loaded, exact angle Gaging Plunger into the countersink and read the dial directly in .002" or .05mm diameter increments on the dial face.

- 84 Models (42 English/42 Metric) provide a diameter range from .020" (.50mm) to 1.180" (30.00mm). for 30°, 60°, 82°, 90°, 100°, 110°, and 120° countersink angles.
- Special angles such as 15°, 78°, 127°, 130°, 160° or ANY other angle from 0° to 180° can be furnished upon request.
- Full-round, conically ground, exact (dedicated) angle Gaging Plunger instantly alerts operator of incorrect countersink angle
- "Peak Hold" mechanism, standard on all Models, allows for one-hand operation.
- Every gage furnished with a functionally calibrated Setting Ring and a foam lined Storage Case with complete Operating Instructions.
- Optional NIST Letter Certification also available.

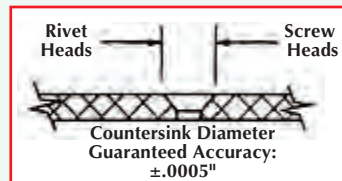

Specify C'SINK Angle When Ordering

Model No.	C'SINK Angle	Capacity Inch	Price Each
CG-001	30°, 60°, 82°	.020"-1.70"	\$395.00
CG-002	90°, 100°, 110°, 120°	.160"-.360"	375.00
CG-003	30°, 60°, 82°	.360"-.560"	395.00
CG-004	30°, 60°, 82°	.560"-.780"	420.00
CG-005	30°, 60°, 82°	.780"-.980"	465.00
CG-006	30°, 60°, 82°	.980"-1.180"	495.00

Note: For Exact metric equivalent, add M to Model No. and \$50.00 to Inch Price

Fowler ELECTRONIC DEPTH MICROMETER

- Range: 6"/150mm.
- 4" base: hardened tool steel, precision ground and microlapped.
- Protected to IP54 standards.
- Resolution: .00005"/.001mm.
- Direct RS232 output.
- Automatic switch off.
- Large LCD display.



SET No.
54-225-456
Reg. \$199.90

\$175.00

Water, oil and fluid
resistant
to **IP54**

Mitutoyo DEPTH MICROMETERS

- Ratchet stop for consistent and repetitive measurements.
- .157" diameter interchangeable rods, with lapped measuring end, are calibrated and tested. Rod length is adjustable to compensate for wear on measuring tip. Two wrenches are also included.
- Satin-chrome finish throughout.
- Crisp clear graduations on thimble.
- Accuracy $\pm .0003"$.
- Complete with fitted carrying case.

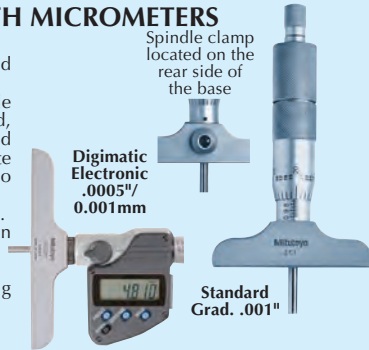

Spindle clamp
located on the
rear side of
the base

Digimatic
Electronic
.0005"/
0.001mm

Standard
Grad. .001"

Model No.	Range Inch	Base Length	Type	List Price	Sale Price
129-127	0-4"	2-1/2"	Standard	\$182.00	\$159.95
129-128	0-6"	2-1/2"	Standard	220.00	195.00
129-149	0-12"	2-1/2"	Standard	388.00	345.00
129-131	0-4"	4"	Standard	\$202.00	\$175.00
129-132	0-6"	4"	Standard	236.00	210.00
129-150	0-12"	4"	Standard	406.00	350.00
329-350	0-6"	4"	Digimatic	576.00	540.00
329-351	0-12"	4"	Digimatic	708.00	665.00

Starrett DEPTH MICROMETER SETS

- All heads used in our depth micrometers are accurate to $\pm .0001"$.
- All base and rods are hardened, ground and lapped for permanent accuracy.
- All reading surfaces have a satin chrome finish that resists rust and provides a no-glare background for the sharp lines and figures.

Round Blade
2-1/2" Base 0-3" Range
MODEL No.
440Z-3RL
Reg. \$240.00

\$215.00

Round Rotating
Series #440
1/8" Rod Dia.
Series #445
5/32" Rod Dia.



With
Fitted
Case

Flat Non
Rotating Rod
.045" x 1/8" Wide
Series #449

Flat Blade
2-1/2" Base
0-3" Range
MODEL No.
449A-3R
Reg. \$279.00

\$249.50

Non-Rotating Flat Blade

Model	Base	Range	Price
440Z-3RL	2-1/2"	0-3"	\$215.00
440Z-6RL	2-1/2"	0-6"	265.00
445A-3RL	3"	0-3"	225.00
445A-6RL	3"	0-6"	285.00
445B-3RL	4"	0-3"	245.00
445B-6RL	4"	0-6"	285.00
445B-9RL	4"	0-9"	350.00

Model	Base	Range	Price
449A-3R	2-1/2"	0-3"	\$249.50
449A-6R	2-1/2"	0-6"	320.00
449B-3R	4"	0-3"	275.00
449B-6R	4"	0-6"	335.00

Save Big On All
Starrett Tools

*6" Base, range 3", 6", 9" Available
Also Metric Please Inquire

Precise DIGITAL ELECTRONIC DEPTH CALIPER GAGE

- Slide, beam & cross beam made of hardened stainless steel.
- High contrast 7.5mm LCD display.
- Marconnect provides RS232 and digimatic data output.
- Includes case and operating instructions.

Model No.
303-752
0-6"/0-150mm
Reg. \$59.95

\$49.95

Model	Range	Base	Price
303-752	0-6"/0-150mm	4"	\$49.95
303-753	0-8"/0-200mm	4"	59.95
303-755	0-12"/0-300mm	4"	69.95
303-756	0-20"/0-500mm	4"	135.00

Fowler DEPTH MICROMETERS



Mechanical

- Satin chrome finish.
- Base surface hardened, ground & lapped.
- Locking clamp.
- Rod diameter: .176"
- Ratchet thimble.

Digital
Counter

Mechanical- Includes Shop Hardened Case

Model	Range	Base	Graduation	List	Sale
52-225-110	0-4"	2.5"	.001"	\$112.60	\$94.50
52-225-112	0-6"	2.5"	.001"	138.80	115.00
52-225-114	0-4"	4"	.001"	112.60	99.50
52-225-116	0-6"	4"	.001"	138.60	119.95

Digital Counter- Includes Shop Hardened Case

52-225-176	0-6"	2.5"	.001"	\$141.00	\$139.95
52-225-226	0-6"	4"	.001"	153.00	149.95

Precise DEPTH MICROMETERS

- 0-6" Range Depth Micrometer includes 6 rods with spherical faces.
- Hardened 4" x 3/4" base.
- Spindle lock.
- Micrometer reading .001".
- Satin chrome finish throughout.
- Furnished in wooden case.



2-1/2" Base
0-4" Range
MODEL No.
711-204

\$49.95

Model No.	Base Size	Range Inch	No. of Rods	Price Set
711-204	2-1/2"	0-4"	4	\$49.95
711-206	2-1/2"	0-6"	6	59.95
711-404	4"	0-4"	4	52.95
711-406	4"	0-6"	6	66.95



SCHIER-TUMICO DEPTH MICROMETERS



Rods are easily inserted and held by knurled rod cap. Adjusting nuts on end of rod compensates for wear. Ends of rods are hardened, precision ground and lapped. All depth micrometers meet or exceed government specification GGG-C-105c for accuracy.

- Reading to .001"
- Spindle hardened to Rc 62-64
- Silver mist chrome head and base.
- Lock nut and ratchet stop standard.
- Base micro lapped and hardened.
- Bases hardened to Rc 62.
- Furnished in fitted mahogany case.



0-6" Range
2-1/2" Base
MODEL No.
0216-04
Reg. \$240.00

\$199.95



Model	Range	Base	Rods	List	Sale
0213-04	0-3"	2-1/2"	3	\$204.00	\$185.00
0216-04	0-6"	2-1/2"	6	240.00	219.50
0243-04	0-3"	4"	3	228.00	199.50
0246-04	0-6"	4"	6	266.00	235.00
0256-04	0-6"	5"	6	275.00	248.00
0510-04	0-10"	5"	10	340.00	310.00

Mitutoyo DIGIMATIC DEPTH GAGE

- Large LCD for error-free reading in inch or mm.
- Zero-set at any point for comparison measurements.
- Operates on one SR-44 battery cell (#541980) which will provide approximately 2 years of use.
- Tire tread depth gage.

Range: 0-1" 0-25mm
Led Res .001" - 0.1mm
Accuracy $\pm .008" \pm 0.2mm$

Precise
MODEL No.
303-513
\$16.95



Mitutoyo
MODEL No.
700-105
Reg. \$73.35

\$65.00

SPi GROOVE DEPTH RODS

Quick & Accurate Check Of groove Location,
Width Of Groove Of Grooves & Shoulders.
Internal Or External Checking

- Rods have precision lapped end-flanges and satin chrome plated clamping devices.
- Ideal to measure depth and width of grooves and recesses.
- Rods attach easily to your depth micrometer and can be locked in any position within it's range.
- Flanges are precision lapped to .025" thickness.

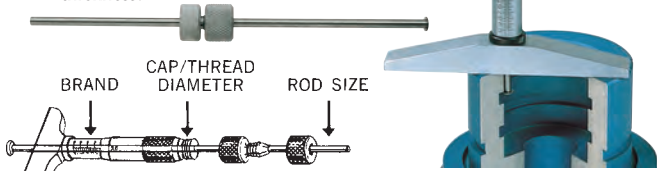

Brand No.	Brand	Rod Size	Cap Thread Diameter
25	440 Starrett	1/8"	.286"
50	440 Starrett	1/8"	.243"
100	445 Starrett	5/32"	.281"
250	Brown & Sharpe	1/8"	.434"
550	Scherr/Craftsman	1/8"	.281"
650B	Mitutoyo	5/32"	.512"
100D	Starrett	5/32"	.346"
650BD	Mitutoyo Digital	5/32"	.512"
599	Brown & Sharpe	1/8"	.275"

Brand No.	0-3" Range Order No.	0-6" Range Order No.	0-9" Range Order No.	0-12" Range Order No.
25	GDR-950	GDR-958	GDR-966	GDR-974
50	GDR-951	GDR-959	GDR-967	GDR-975
100	GDR-952	GDR-960	GDR-968	GDR-976
250	GDR-953	GDR-961	GDR-969	GDR-977
550	GDR-954	GDR-962	GDR-970	GDR-978
650B	GDR-955	GDR-963	GDR-971	GDR-979
100D	GDR-935	GDR-937	GDR-939	GDR-941
650BD	GDR-936	GDR-938	GDR-940	GDR-942
599	GDR-943	GDR-944	GDR-957	GDR-965
Price	\$65.00	\$80.00	\$85.00	\$95.00

Slot and Point Checking Rods

- The slot and point checking rod is ideal for checking points of drilled holes, depth of concave, radii, depth of narrow slots, etc. This rod is also to be used with the clamping device as shown with the groove checking rod.

Brand No.	0-3" Range Order No.	0-6" Range Order No.
25	30-982-3	30-990-6
50	30-983-1	30-991-4
100	30-984-9	30-992-2
250	30-985-6	30-993-0
550	30-986-4	30-994-8
650B	30-987-2	30-995-5
100D	30-981-5	30-997-1
650BD	30-989-8	30-999-7
599	30-948-4	30-949-2
Price Each	\$24.50	\$29.25

0-6" BROWN & SHARPE DEPTH MICROMETER SETS

Features:

- 1/8" measuring rods. • Friction thimble for "Uniform measurement".
- Ring lock. • Hardened precision base
- "Glare free" satin chrome finish. • Supplied in a fitted mahogany case.



0-6" Range
2.5 Base
Reg. List
\$286.00
MODEL No.
603-126

\$239.95

Range	No. of Rods	Base Length	Set No.	Reg. Price	Sale Price
0-3"	3	2.5	603-123	\$246.00	\$209.00
0-3"	3	4	603-143	251.00	213.00
0-6"	6	2.5	603-126	286.00	239.95
0-6"	6	4	603-146	289.00	245.00
0-12"	6	4	603-148	481.00	395.00

Fowler X-DEPTH DIGITAL DEPTH GAGE

- Bottom surface of the base is hardened, ground and lapped.
- Hold feature.
- 4" base.
- Includes fitted case.



0-22"
Inch/Metric
.00005" Resolution

SET No.
54-125-777
Reg. List
\$229.95

\$199.95

Fowler X-DEPTH 22 DIAL DEPTH GAGE

- Range 0-22"
- Carbide contact point Includes 2 extra points for small hole applications; one 0.078" diameter x 1" long and one needle point x 1" long
- 0-1" travel indicator
- .001" graduations
- Rods connect together for full 22" capacity
- Satin chrome finish
- Base size: 4"
- Complete in shop hardened case



SET No.
52-125-006-1
Reg. \$170.00

\$99.95

Precise V-ANGLE DIAL DEPTH GAGE BASE

Ideal for checking cylindrical parts ranging from 10mm/.394" to 100mm/3.94" This "Keyway" base will accept any dial or digital gage with a .375 stem, or 8mm stem using supplied reducer bushing.

- Made of tempered stainless steel with ground base.
- Other surfaces are rust-proof treated
- Thickness: .630"

Specifications:

Width:
Outside 2.6"
Inside 2.2"
Angle 120°
Height 1.24"

MADE IN USA

MODEL No.
16839

\$110.00

Base Only



MODEL No.
16839-1

\$159.95

With .0001" Indicator
#24-302-2

ELECTRONIC DEPTH MICROMETER

- Interchangeable stainless rods, .160" dia. with flat ends. • Inch/metric conversion.
- Satin chrome base, hardened with micro lapped finish. • Automatic zero-setting.
- Min/Max values. • Hold function. • SPC output.
- Includes fitted wooden case.

2-1/2" Base
0-6"/0-150mm
Range
MODEL No.
EDG-001

\$119.95

4" Base
0-6"/0-150mm
Range
MODEL No.
EDG-002

\$149.95

Resolution:
.00005"/.001mm



Mitutoyo DIGIMATIC HEIGHT GAGE Multi Function Type

- Highly versatile multi-function type.
- Rigid construction ensures repeatable measurement.
- Coarse/fine feed switching.
- With SPC data output.
- Bi-directional touch-signal probe is optional for 670 series. It can quickly and accurately measure steps, inside width, and outside width.
- Supplied with carbide tipped scriber

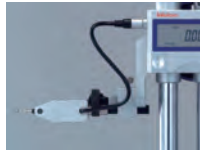

SPC Connecting Cable No. 905338 (40") \$39.00
No. 905409 (80") 45.00

Model	Range	Resolution	Accuracy	List Price	Sale Price
Standard Style with Output					
192-630	0-12"/0-300mm	.0005"/0.01mm	±.001"	\$1500.00	\$1335.00
192-631	0-18"/0-450mm or	±.002"	±.002"	2060.00	1850.00
192-632	0-24"/0-600mm	.0002"/0.005mm	±.002"	2620.00	2450.00
Heavy Duty with Output And Touch Probe Port					
192-670	0-12"/0-300mm	.0005"/0.01mm	±.001"	\$1730.00	\$1625.00
192-671	0-18"/0-450mm or	±.0015"	±.0015"	2220.00	1995.00
192-672	0-24"/0-600mm	.0002"/0.005mm	±.0015"	2850.00	2695.00
Touch Probe for Output Style Ht. Gage					
192-008	Bi-Directional Touch Probe			\$809.00	\$750.00

Mitutoyo QM-HEIGHT GAGE

The Worlds First GO/±NG judgment using a backlit red and green LCD display.

- Extreme accuracy, increased functionality and ease of use.
- The QM-Height delivers outstanding accuracy of ±(2.8+5L/1000)µm to satisfy your most critical measurement needs.
- It measures max/min and displacement from the surface plate or as an incremental measurement. It also measures ID and OD.
- Selectable resolutions: .00005", .0001", .0002", 0.001mm, 0.005mm
- Easy to use reference icon keys
- A variety of optional probes available
- RS-232 and Digimatic output
- Elevation wheel with coarse and fine feed selection

0-14"/0-35mm
MODEL No.
518-221
Reg. \$2930.00

\$2695.00

0-24"/0-600mm
MODEL No.
518-223
Reg. \$3800.00

\$3395.00



Mitutoyo ABSOLUTE DIGIMATIC HEIGHT GAGE Absolute Encoder Built-in Height Gage

Now you can have the ease and speed of digital, at about the price of a vernier height gage. And with Mitutoyo's new design, you get extra rigidity.

Built-in ABS (Absolute) Encoder

- This encoder eliminates the necessity of setting the reference point at every power on.
- It has improved reliability because no over-speed error will occur.

Specifications:
Resolution .0005"/0.01mm
Repeatability .0005"/0.01mm
Response speed No limit
Function On/Off, Origin, Zero/ABS, In/mm, Data/Hold.

MODEL No.
570-312
12"/300mm
List \$612.00

\$549.95

Model No.	Measuring Range	Resolution	List Price	Sale Price
570-312	12"/300mm	.0005"/0.01mm	\$612.00	\$549.95
570-313	18"/450mm	.0005"/0.01mm	859.00	765.00
570-314	24"/600mm	.0005"/0.01mm	1100.00	985.00
905338	40" SPC Connecting Cable			\$39.00
905409	80" SPC Connecting Cable			45.00



Mitutoyo LINEAR HEIGHT GAGE LH600D

High Performance
2D Measuring

- Excellent accuracy of (1.1+0.6L/600)µm with 0.1µm/0.5µm resolution/repeatability.
- Perpendicularity (frontal) of 5µm and straightness of 4µm are guaranteed.
- Pneumatic full/semi-floating system allows adjustment of air-cushion height.
- Basic statistical functions are provided and, additionally, RS-232/USB data output provides the option of evaluating measurement data externally with SPC software on a PC.
- One-key operation for running a semi-automatic measurement.
- Data entry from Digimatic tool.
- Language of display: English/German/French/Spanish/Italian/Japanese



SPC Results

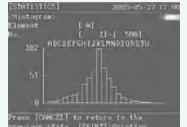

Histogram

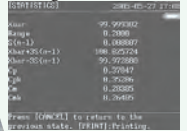

Perpendicularity/Measurement

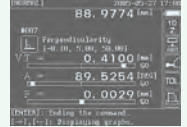

Model No.	Measuring Range	Resolution	Switchable	List Price	Sale Price
518-351A	0-38"/0-972mm	.00001"/.00001"/.0001"/.001"		\$8270.00	\$7395.00
		0.0001mm/0.001mm/0.01mm/0.1mm			
12AAA807	RS-232 Connecting Cable			\$52.95	\$50.00

Special Accessory Package Available (Inquire)

Mitutoyo HEIGHT MASTERS Mitutoyo

Features:

- Models with staggered arrangement of block stack have two measuring faces on the same level, one facing up and the other down (except for 515-310)
- Each Height Master is supplied with a gage block for zero-setting.
- Supplied in fitted wooden case.



MODEL's
515-310
515-311

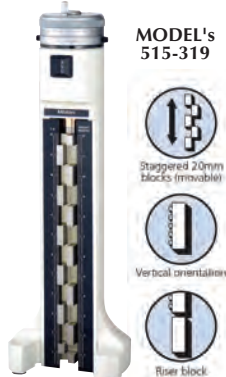

MODEL's
515-319

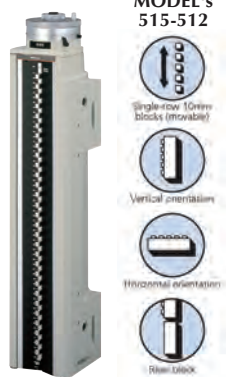

MODEL's
515-512



Mitutoyo RISER BLOCKS

- These riser blocks are specially designed for standard/Digimatic height masters.



Model No.	Range	Block Step	Graduation	Block Pitch Accuracy	Parallelism of Block	Micrometer Head Accuracy	List Price	Sale Price
515-310	.2"-12.2"	.5" (Straight)	.0001"	±.00005"	.00004"	±.00005"	\$3,390.00	\$2,995.00
515-311	.2"-12.2"	1" (Staggered)	.00001"	±.00005"	.00004"	±.00005"	3,810.00	3,425.00
515-319	.5"-12"	1" (Staggered)	.0001"	±.0001"	.00005"	±.0001"	\$4,270.00	\$3,825.00
515-512	.2"-18.2"	.5" (Straight)	.00001"	±.00005"	.00006"	±.00004"	\$5,970.00	\$5,650.00
515-510	.2"-24.2"	.5" (Straight)	.00001"	±.0001"	.00006"	±.00004"	8,200.00	7,750.00
515-513	.2"-40.2"	.5" (Straight)	.00001"	±.0015"	.0008"	±.00006"	13,400.00	12,500.00

Model	Height	Accuracy	Price
515-113	6"	±0.6µm	\$ 735.00
515-114	12"	±1.0µm	1050.00
515-115	24"	±2.0µm	1495.00

Precise HEIGHT GAGES

Features:

- Beam and measuring slide of hardened stainless steel.
- Extra-long vernier scale.
- Measuring faces and guideways precision ground and micro-lapped for accuracy.
- Scale satin chrome finished with micro-fine engraved graduations.
- Vernier reads English and metric to .001"-1/20mm.
- Adjustable sliding scale allows measuring to start from an even figure eliminating error & therefore giving fast, accurate readings.
- Dial test indicator with holder can replace scriber.

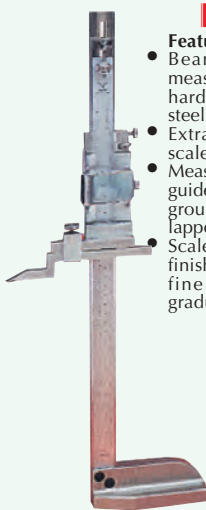

.001" Graduation

Model	Size	Type	Price
VHG-080	8"	Vernier	\$44.95
VHG-12	12"	Vernier	69.95
VHG-18	18"	Vernier	99.00
VHG-24	24"	Vernier	118.50
DCH-060	6"	Dial	\$59.95
DCH-080	8"	Dial	69.95
DCH-120	12"	Dial	79.95

Precise DIGITAL/DIAL HEIGHT GAGE

- Digit/Dial Height Gages combine a large dial indicator with a dual digital counter for easy, error free reading.
- Double digital counter for convenient up and down readings in .100" increments.
- Two independent floating zero adjustment buttons.
- 2-3/16" diameter dial with wide spread .001" graduation, .100" per revolution.
- Heavy base with hardened, ground and lapped bottom surface.
- Carbide tipped off-set scriber to cover entire range from bottom surface.

.001" GRADUATION

Model	Range	Price
DCH-012	0-12"	\$129.95
DCH-018	0-18"	199.95
DCH-024	0-24"	229.95

MODEL No.
DCH-012
0-12"

\$129.95



Fowler Z-HEIGHT-ELECTRONIC HEIGHT GAGE

- Direct Inch/metric conversion.
- Accuracy:
0-6" Model: ±.001"
0-12" Model: ±.0015"
0-18" Model: ±.002"
0-24" Model: ±.002"
- Resolution .0005" (.01mm)
- Large, high contrast LCD display.
- Hold feature.
- ABS/INC measurement.
- Floating zero.
- Positive lock
- Includes molded case.
- Carbide scriber.

Model	Range	List	Sale
54-175-006*	0-6"/150mm	\$196.00	\$139.95
54-175-012	0-12"/300mm	466.00	329.95
54-175-018	0-18"/450mm	545.00	389.95
54-175-024	0-24"/600mm	615.00	459.95

*Without Handwheel



Mitutoyo DIGIMATIC HEIGHT GAGES

- The Mitutoyo Heightmatic is a new high precision digital height gage designed for applications needing extremely accurate measurements.
- The bi-directional touch signal probe is adopted for improved efficiency and reliability of measurement.
- 0.001mm/.0001" resolution.
- ±0.004mm/±.0002" accuracy.
- Versatile digital functions include: Zero-setting, presetting, ABS/INC measurement mode switching, GO/NG judgement, Data hold, Count direction switching, inch/mm conversion, Data output.
- Supplied with the bi-directional touch signal probe. The stylus tip ball diameter is automatically compensated for measurement.
- Fine feed wheel for the slider is provided on the base for easy operation.
- Provided with a data output port for connection with the SPC system.

Model No.	Measuring Range	List Price	Sale Price
574-212	0-12"/0-300mm	\$4790.00	\$4295.00
574-211-1	0-18"/0-450mm	5310.00	4750.00
574-210	0-24"/0-600mm	5920.00	5295.00
905691	SPC Cable (40")		\$37.00
905692	SPC Cable (80")		45.00



TESA-HITE ELECTRONIC HEIGHT GAGE MAGNA 400 AND 600

- 16" (400mm) and 28" (700mm) measuring range.
- Electronics completely protected against liquids or dust penetration.
- Automatic diameter measurement using TESA's patented system which determines the culmination point.
- Parallelism and perpendicularity measurements.
- TESA opto-electronic measuring system (patented).
- Compatible with TESA Micro-Hite accessories, including measuring inserts and holder.
- SCS calibration certificate delivered with each instrument.

TESA-HITE Plus M (Motorized)

- Built-in air bearing
- New ergonomically designed control panel with built-in printer.
- Easy-to-use, intuitive power control.
- Geometric functions for 1D or 2D measurements.
- Automatic programming and generation of the measurement cycles.
- Statistical data processing.
- Opto-electronic TESA measuring system. Patented.

TESA-HITE MAGANA 400+700 (Less Printer)

Model	Range	Resolution	List	Sale
00730047	16"/415mm	.0001"/.0002"/.001"	\$3645.00	\$3295.00
00730059	28"/715mm	0.001/0.005/0.01mm	4650.00	4195.00

TESA-HITE Plus M (Motorized) with Built-in Printer

00730057	16"/415mm	.0001"/.0002"/.001"	\$8690.00	\$8295.00
00730058	28"/715mm	0.001/0.005/0.01mm	9745.00	9295.00



Starrett TOOL & INSTRUMENT OIL 4 fl. oz.

Ideal in the shop for maximum protection and lubrication of measuring tools, precision instruments and light machinery; to guard highly finished tools, parts, machine surfaces against rust.



MODEL No.
1620
\$6.95
Model No.
1620-10
(Box of 10)
\$65.00

Trimos ALTA HEIGHT GAGE

Unlike some of our competitor's height gages that require expensive accessories, the Alta comes fully equipped to handle diameter, center line and center to center line measurements.



No Expensive Accessories Required!

Specifications:
Measuring range: 24"/600mm
Application range: 32"/835mm
Max. Resolution: .00005"/.0001mm
Accuracy: .0004"/10 µm
Squareness deviation (in measuring direction)
.0008"/20 µm
Repeatability (2s): .00015"/4 µm
Max. displacement spd: 1.5 m/s
Measuring force: 1N
Data output: RS232

MODEL No.
54-191-024
List \$7095.00
\$5495.00



Mitutoyo ABSOLUTE DIGIMATIC HEIGHT GAGE WITH ABSOLUTE LINEAR ENCODER

- Built in **ABSOLUTE** linear encoder. This encoder eliminates the necessity of setting the reference point at every power-on. It has improved reliability because no over-speed error will occur.
- Fine adjustment carriage to feed the slider finely.
- Carbide-tipped scriber is provided.
- With SPC data output.

Function:
Origin setting, ABS/INC switching, Presetting, +/- Switching, Data hold, Data output, inch/metric conversion (on inch/metric models only)
Alarm:
Low voltage, Counting value composition error



Model	Range	Resolution	List	Sale
570-244	0-8"/0-200mm	.0005"/0.01mm	\$ 620.00	\$ 575.00
570-248	0-40"/0-1000mm	.0005"/0.01mm	3700.00	3450.00
905338	SPC Cable, 40"/1m		\$45.00	\$39.00
905409	SPC Cable, 80"/2m		\$2.00	\$45.00

Mahr FEDERAL I.D./O.D. GAGING SYSTEM

- The 36B I.D./O.D. gage is offered with both the "T" plate and "V" plate in the same package. Along with the system will be a 1087B Digital Indicator with latching ability (Min/Max) to save time with both the setup and the measuring process.
- When using the 1087B on the 36B gage you simply zero and look for your high and low on the master using the analog scale and re-zero. Place the workpiece on the gage and press the blue start button and the indicator latches on the high or low depending if you're measuring I.D.'s or O.D.'s, and you're good to go.



Model	Description	Price
EDI-36B-10	Mahr Gage System with T-Plate	\$2495.00
EDI-36B-9	Mahr Gage System with V-Plate	2495.00
2061657	Mahr Gage System with V&T Plates	2995.00

Precise ELECTRONIC HEIGHT GAGE

- Large display screen
- Preset memorizing function
- Hardened and ground stainless steel frame
- Cast iron base
- True inch/metric conversion.

0-12"/0-300mm
MODEL No. 430-012
\$185.00

0-20"/0-500mm
MODEL No. 430-020
\$265.00

0-24"/0-600mm
MODEL No. 430-124
\$299.00



Fowler SYLVAC H_GAGE ONE 24" ELECTRONIC HEIGHT GAGE

Scale Not Affected by Oil, Dust, Chips, Shock etc.

Fowler-Sylvac's NEW H_Gage One Electronic Height Gage features a 0-24"/600mm range, true inch-metric conversion and a patented and proven electronic scale that is not affected by oil, dust, chips or shock.

- Range: 0-24"/600mm
- Direct RS-232 output
- The sylvac measuring system is exceptionally fast (60" per second traverse) and is the most reliable and maintenance free system ever created for measurement.
- True inch/metric conversion
- Resolution: .0005"/.01mm
- Repeatability: .0004"/10µm
- Base size: 5.6" wide x 6.8" length



MODEL No. 54-212-024
Reg. \$1725.00
\$1350.00



Fowler Z-600 1D MOTORIZED HEIGHT GAGE

- Motorized movement
- Easy-to-use icon driven display
- Ergonomic design
- Built-in pump provides air cushion to reduce wear and fatigue
- Multiple references at any point
- USB output

Measurement Features:

- Heights, depths
- I.D./O.D. Measurements
- Centerline measurements
- Groove and Ledge measurement
- Squareness measurement capability
- Parallelism measurement
- Preset at any point
- 1D Measurement
- Inch/metric conversion

How does the New Z-600 measure up to the competition? ✓ Check it out

Specifications:

Measuring Range	✓ 24"
Application Range	✓ 36"
Motorized Movement	✓ Yes
Resolution	0.00005"
Max Error/Full Range	±0.0002"
Repeatability	0.0001"
Battery Life	✓ 16 Hours
Squareness Measurement	Yes
Warranty	✓ 36 Months
Air Cushion	Yes
Multiple Reference Points	Yes
Zero Setting at any Point	Yes
USB Output	✓ Yes
Measuring Force	✓ 1.2 N ± 0.2
Max Measurement Speed	✓ 24"/sec
Sweep Probe for High/Low	Yes
Diameter Readings	Yes
Probe and Master Block	Included
Weight	53 lbs.

MODEL No. 54-180-600
List \$4895.00
\$3995.00

Includes 3 Year Extended Warranty



Sylvac Hi-CAL ELECTRONIC HEIGHT GAGE

Operator Friendly

- All functions for height, reference, min, max, delta and diameter/centerline are easily accessed by the operator on a simple control pad.

New Innovations

- Motorized carriage displacement is controlled by a pair of pressure sensitive switches. The harder the operator presses, the faster the carriage moves.

Accurate and Repeatable

- The patented speed and measuring force setting allow excellent repeatability by removing operator "feel"



Model No.	54-931-150	54-931-300
Range:	0-6"/150mm	0-12"/300mm
Resolution:	0.00005"/(0.001mm/1µm)	
Measuring Pressure:	Adjustable Approx. 0.2-0.3 Newtons	
Accuracy (STD):	Accuracy: 2.5[µm] + (L/175) [mm]	
Repeatability:	2 µm (.000080")	
Output Type:	RS-232C and USB (Wi-Fi available)	
Display:	Bright LCD with Easy-to-Use controls.	
Included Probe:	Standard 3mm ball probe & setting gage	
Operational Temperature:	+10° to +40° C	
Power Supply	Rechargeable Battery Pack (>40 hours)	
List	\$4695.00	\$5395.00
Sale	\$3995.00	\$4795.00



Precise IPD GAGING SYSTEM

A Versatile Measurement System for Internal Pitch Diameters, as Well as Internal Bores, Grooves, Recesses and Internal Gears

Features:

- Major breakthrough in utilizing computer software with a measuring instrument.
- With this new concept, accurate measurements of internal threads and compensation calculations for ball diameter variations or lead angles are made extremely simple.
- The software diskettes supplied with the IPD Gage can be used in any IBM compatible PC to obtain all data required for accurate inspection of any specific internal thread without the necessity of a master gage.
- Easy to set IPD Gage with micrometer or gage blocks, etc.
- Universal, can be used as a general purpose internal gage for measuring bores, grooves and pitch diameters of screw threads and internal gears, etc.

Features:

- Indicator alone, with the included adapter, extensions and contact points, make it possible to measure internal threads and bores from 1-1/2" to 18".
- Rigid construction plus special high precision pivot bearing assure repeatability of .0002" or less.
- Balanced body design for easy and convenient handling.
- Adjustable contact pressure.
- Carbide ball contact points are optional, not included.
- System includes internal gage, 1" travel indicator, indicator-adapter, 8 extensions (1/4", 3/8", 1/2", 3/4", 1", 2", 3", and 4" long), measuring tip organizer, 2 standard contact points 1/4" long, Allen wrench, fitted case plus software cassette for internal pitch diameter threads and instruction manual.

Software Diskette

The IPD software complies with ANSI standard; fully compensates for the effects of lead angle.

User Friendly

On screen explanation, no commands to remember. Error free data entry, will detect invalid input data.

Universal

Supports UN series and metric threads as well as threads with user defined thread angle and number of starts for Acme, Whitworth and multiple start threads.

- Software calculates the correct diameter for any chosen ball contact point within the specific range per table below.
- Diameter setting with micrometer or gage blocks, no master thread setting ring required.

MADE IN USA



Specifications:

Measuring Range:
 Bores93" to 8"
 Nominal size threads . . 1-1/8" to 8"
 Extended range with included
 Indicator adapter 7-1/2" to 18"
 Gage arm travel625"
 Max. reach in 1-1/4" dia. bore: 4.8"
 1" travel indicator graduation: .0005"



Optional Carbide Ball Contact Points. 1/4" Length A.G.D. #4-48 Thread. Sold in Pairs

Model	Description	Price
IPD-001	IPD Gage and Software	\$895.00
IPD-002	Metric Indicator for IPD Gage	140.00
IPD-003	4 Pairs carbide point contact points package #1 1/32, 3/64, 1/16, 3/32" diameter covering UN Series threads from 24 to pitch	125.00
IPD-004	7 Pairs carbide ball contact points package #2 1/32, 3/64, 1/16, 5/64, 3/32, 7/64, 1/8" diameter and multiple starts	225.00

Model No.	Ball Dia. Tolerance ±.0001"	UN Series Threads Per Inch	ACME Threads Per Inch	Metric Threads Pitch (mm)	Price Pair
IPD-005	.03125" (1/32)	24 - 14		1.25 - 1.75	\$28.00
IPD-006	.046875" (3/64)	16 - 8		1.75 - 3	28.00
IPD-007	.0625" (1/16")	11 - 6		2.5 - 4	28.00
IPD-008	.07813" (5/64)	9 - 5		3 - 5	31.00
IPD-009	.09375" (3/32")	6 - 4		4 - 6	31.00
IPD-010	.10939" (7/64)	6 - 3.5	5	4 - 7	31.00
IPD-011	.125" (1/8)	5 - 3	4	5 - 8	35.00
IPD-012	.1875" (3/16)	3.5 - 2	3	7 - 13	35.00
IPD-013	.250" (1/4)	3 - 1.5	2	8 - 17	35.00

Precise HEIGHT GAGE CENTERING CONE SET Measures Center To Center Distance Using Most Height Gages

- A very useful accessory for any manual or electronic Height Gage.
- 3 Part set consists of: Height gage attachment and centering cone holder, 2) cones for 1/16" to 1-1/16" ID holes.

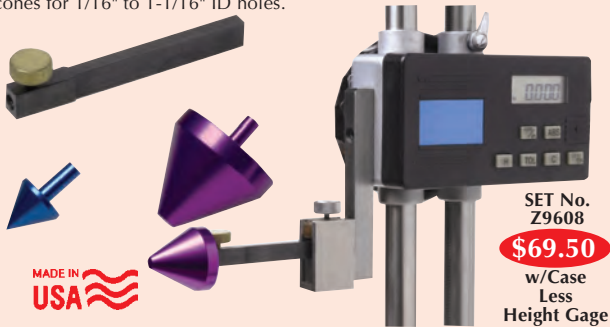

SET No. Z9608

\$69.50

w/Case
Less
Height Gage

Precise CALIPER ACCESSORY KIT

Measures Slots, Grooves, Shoulders, Holes, Pockets, ID and OD

- Set screws firmly hold square jaw attachment to any 4, 6 or 8" caliper.
- Threaded holes are located in front, both sides and on the bottom of the jaw attachments.
- Locate any of the points in a wide variety of positions on the jaws, depending on your specific measuring application.
- Steel, black oxide plated.

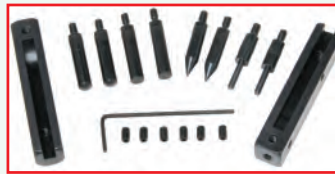

SET No. Z9020

\$49.95

Less Caliper

Contains:

- Universal bodies 3/8" sq. x 2" long. Slot for jaws is .147" wide.
- Flat points 3/16" dia. x .810 Lth.
- Cone points 3/16" dia. x .810 Lth
- Stem points 3/16" body dia. .084 stem dia. x .820 Lth
- Ball Points 3/16" dia. x .810 Lth

Fowler XTRA-VALUE

0-6" DEPTH GAGE Inch/Metric/Fraction

- Spring-loaded and hold measurement button for ease-of-use.
- Super-large display.
- Range: 0-6"/150mm.
- Resolution: .0005"/.01mm, fractions in 1/64" increments.
- Supplied in vinyl holster.



MODEL No. 54-225-555
Reg. \$60.00

\$39.95

CENTERLINE CALIPER GAGE For Vernier, Dial And Electronic Calipers

- Pairs of conical probes are specially designed for dial and vernier calipers to quickly measure centerline distances.
- The 60° conical probe snugly fits into the holes and takes guesswork away from center distance measurements.

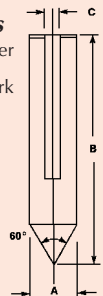
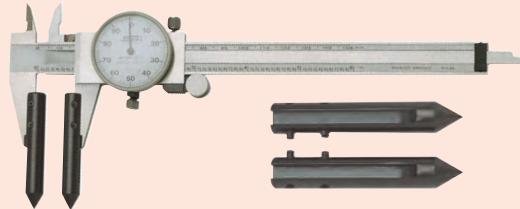

Model No.	Fits Calipers	Contact Width "A" (IN.)	Oal "B" (IN.)	Width "C" (IN.)	Price Set
12-439-4	4", 6" & 8"	0.375	2.187	0.141	\$22.95
12-440-4	12"	0.500	2.750	0.183	44.95

Mitutoyo U-WAVE WIRELESS SYSTEM ~ UP TO 60' TRANSMISSION RANGE

- The U-Wave system enables easy wireless data communication from a measuring tool to a PC using the digimatic protocol. Measurement efficiency is improved by eliminating long and cumbersome data cables. The user-friendly interface allows data to be loaded into any software product that accepts keyboard input, such as Excel or Notepad.

How to "Spec" a U-Wave System:

- One U-Wave-R required per system (will support up to 100 U-Wave-T).
- One U-Wave-T required per tool: Order No.01AZD730D.
- Required IP67 connecting cable (6' length). Please specify measuring tool number you are using or call us for proper cable connection

U-WAVE-R loads data received from U-WAVE-T onto a PC software package via a USB port

U-WAVE-T units transmit data from measuring tools to U-WAVE-R

Measurement data can be entered into a software package

U-WAVE-R

U-WAVE-T

U-WAVE-T

Special Introductory Pricing

U-WAVE "R"

Features:

- Supports up to 100 U-Wave-T.
- Comes complete with U-WavePak set-up/data input software.
- U-WavePak, standard w/U-Wave-R features a keyboard interface function. This allows measurement data to be easily entered into an Excel, Notepad or other formats that accepts numeric value input via a keyboard.
- Supplied with USB connecting cable.
- Measurlink V6.1 real-time Plus also supports the U-Wave system.



MODEL No.
02AZD810D
Reg. List
\$487.00
Sale

\$429.95

U-WAVE "T"

Features:

- Is IP67 rated.
- IP67 cables available for your Mitutoyo waterproof tools.
- Battery life approx. 400,000 data transmissions.
- Up to 60 feet transmission range Actual range depends on the local radio transmission characteristics.



MODEL No.
02AZD730D
Reg. List
\$215.00
Introductory
Price

\$189.95



No. UWC-001 IP67 Cables **\$89.95**
Fits All Mitutoyo Micrometers,
Calipers, Indicators And Other
Tools with Output Capability

Mahr
FEDERAL

DIGIMAR® ELECTRONIC HEIGHT GAGE New Quick Mode-The Revolutionary Way To Simplify Measurement

The new height measuring instrument Digimar 817 CLM with the innovative Quick Mode. Highly accurate rapid measurements, a wide range of measuring and evaluation possibilities and excellent operator comfort.

2D-Measuring Functions

The most important 2D measuring functions can be executed with the touch of a single key, e.g.: perpendicularity measurements, the calculation of an angle or pitch circle.

40 Measuring programs

You can quickly create customized measuring programs with the "easy-to-use" learn program, which simplifies and reduces inspection times.



- Large back-lit display.
- Self-explanatory guided operation with icons



Comfort to operate all
Measurement functions with
the function keys due to the
clearly defined symbols

Quick Mode

Easy to operate due to the "Quick Mode", an innovative solution from Mahr (patent pending)



Move the measuring carriage by hand in the direction of the object to be measured



The motor starts, the measurement procedure will be performed automatically

Measuring Range	Inch/metric	14"/350mm	24"/600mm	40"/1000mm
Application Range	Inch/mm	20.47"/5200mm	30.61"/30.31mm	46.06"/1170mm
Resolution	inches	0.001"/0.0005"/0.0001"/0.00005"		
Measuring error*	µm	(1,8+L/600), L in mm		
Repeatability*	µm	0,5mm(plane)1(bore)		
Perpendicularity error	µm	Frontal 5	Frontal 6	Frontal 10
Measuring force	N	1,0±0,2N		
3-point air cushion, height	µm	ca.9		
Weight	lbs.	55.5	66.14	77.16

MODEL No. 2D Panel	4429010	4429011	4429012
Reg. Price	\$9,020.00	\$9,900.00	\$16,150.00
Sale Price	\$8,550.00	\$9,350.00	\$15,300.00

Precise I.D.-O.D. O-RING GROOVE GAGE

- Simple, economical I.D.-O.D. O-ring Groove Gage used in combination with standard Test Indicators.
- Easy to set-up in a wide range 0-6" or 6-12" with Gage Block, Micrometers or Setting Masters.
- Highly accurate method to inspect short step counterbores, keyways and O-ring grooves. • Light weight, black anodized aluminum.

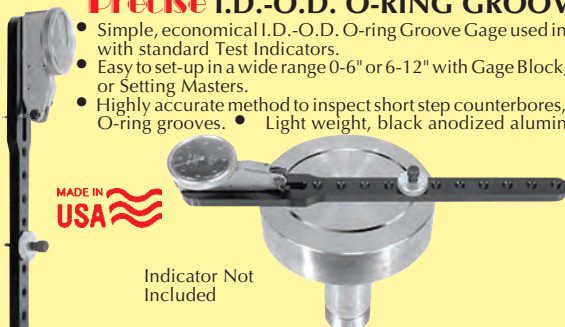

Model	Range	List Price	Price
ORG-481	0-6"	\$43.00	\$39.95
ORG-482	6"-12"	47.00	44.95

Fowler

ELECTRONIC DIVIDER 8"/200mm



- Range: 0-8"/200mm
- Robust housing
- Large LCD display
- Reading: .01"/.1mm/1/64ths
- Accuracy: .001"
- Satin chrome finish
- Alloy jaws
- Includes metal scribe and graphite attachments.

MODEL No.
54-554-930
Reg. \$75.00

\$59.95

INCH • METRIC • FRACTION

Mitutoyo VISION MEASURING SYSTEMS

Non Contact - High Accuracy - Real Affordability

- The most affordable Quick Scope model.
- 0.1µm resolution and 6" z-axis range.
- Magnification can be adjusted by changing objectives.
- Excellent observation/measurement for a single workpiece.
- The quick release system in the stage allows instant switching between coarse and fine movement.
- An optional fiber-optic ring light is available.
- Graphic and Navigation functions allow for quick maneuvering around the workpiece.
- Part programs are easily created in the Windows® based QSPAK software.

MODEL No.
359-710-1A
List \$19,600.00

\$16,995.00

Complete



System Includes:

- QSPAK Software.
- Dell PC System w/19" flat panel monitor and color printer.
- 1X Objective Lens.

Note:
For additional Models and Accessories
visit our website: www.penntoolco.com

MASTAG HEIGHT MASTER TRANSFER GAGE

The Height Master is a Micro-Adjustable, self contained, precision inspection gage designed to inspect multiple part locations quickly and accurately

- Locates heights, holes, grooves, etc. Quickly, easily, and accurately.
- Multiple T-slot channels provide room for many different height combinations.
- Inspects complex parts in a precise, timely manner.
- Works great for presetting tool lengths.
- Simple adjustability of the block height makes it ideal to use even on single dimension parts and short run jobs.
- Comes in three convenient heights 12" and 18" to satisfy many part sizes.
- Removable numbered buttons make each block distinctive from the other.



0-6"
MODEL No.
HMT-006

\$195.00

0-12"
MODEL No.
HMT-012

\$250.00

0-18"
MODEL No.
HMT-018

\$295.00

Note: Height Gage & Indicator Not Included

Fowler MEGELLAN VISION SYSTEM

Made in the USA and offering both live-graphical-part and live-image views, Fowler's Magellan Vision System is available in two measuring ranges featuring Multi-Point Video Edge Detection for fast and accurate non contact measurements.

Magellan Vision System features:

- Bench Top Granite Machine Base.
- Precision Mono-Rail Bearing Measuring Stage
- Quick Release X and Y Axis Controls
- Programmable 6.5 to 1 Motorized Zoom
- Thru-Lens Laser Spot Part Finder
- 1.2 Megapixel Digital Camera
- Programmable LED illumination
- Multi-touch Win7 Panel PC

Video Work Shop Measuring Software

- Multi-Touch User interface
- Multi-Point Video Edge Detection
- Video Edge Focus Meter
- Part Programming
- DXF import with Video Overlay
- Feature Data Export, Excel/SPC
- Live Image Capture
- Live Graphical Part View
- Lamp and Zoom Controls
- User Programmable Memories

MADE IN
USA



Technical Specifications:

- Measuring Range: 8" x 6" x 6"
- Resolution: .001mm
- XY Accuracy: E2= (3+L/100)µm
- Max stage lead: 40lbs
- Illumination: Profile LED Telecentric; Surface LED 48 Ring Light
- Objective: 6.5 to 1 Motorized Zoom
- Weight: 150 lb
- Power: 110-240 VAC, 50-60Hz 70w

Model No.	Measuring Range	List Price	Sale Price
54-900-200	8" x 6" x 6"	\$19,850.00	\$18,750.00
54-900-300	12" x 8" x 6"	23,475.00	21,395.00

SHORE DUROMETER

- Use to determine rubber (plastic) hardness.
- Tire hardness tester.
- Reading 0-100
- Supplied with pouch.

MODEL No.
4400-4000

\$49.95



Mitutoyo HARDNESS TESTERS HR SERIES Mitutoyo

Order No. 963-220-10A
Model No. HR-210MR

- Rockwell.
- Motorized test force control.
- Test force selection manual by weight

Order No. 963-231-10A
Model No. HR-320MS

- Rockwell/Rockwell Superficial
- Motorized test force control.
- Test force selection manual by weight

Order No. 963-240-10A
Model No. HR-430MR

- Rockwell.
- Motorized test force control.
- Dial a weight test force selection.
- Auto brake/start

Order No. 963-241-10A
Model No. HR-430MS

- Rockwell/Rockwell Superficial
- Motorized test force control.
- Dial a weight test force selection.
- Auto brake/start

- Mitutoyo is proud to introduce the new 963 Series of hardness testers.
- Four new feature packed yet economical Rockwell and Rockwell Superficial Hardness Testers cover a large range of testing applications.
- These testers meet the current international requirements such as ASTM E18 and are designed for years of accurate results.



Model Order No.	HR-210MR 963-220-10A	HR-320MS 963-231-10A	HR-430MR 963-240-10A	HR-430MS 963-241-10A
Rockwell	○	○	○	○
Rockwell Superficial		○		
Light Force Brinell	Optional	Optional	Optional	Optional
Display Unit	Analog	Digital: Hardness Value, Scale display, Timer setting, Conversion, GO/NG judgment, Offset setting		
Data Output	RS-232C SPC (Digimatic)			
Dial a Weight			○	○
Loading Drive Unit	Motorized	Motorized	Motorized	Motorized
Automatic Brake/Start			○	○
List	\$5950.00	\$8530.00	\$8780.00	\$9780.00
Price	\$4990.00	\$6990.00	\$7990.00	\$8990.00

Note: For Complete Details, Visit our website:
www.penntoolco.com

Mitutoyo 14" OPTICAL COMPARATOR

- 14" protractor screen.
- Fine ground glass with cross-hair lines
- Vernier reading resolution: .2'.
- Twin fiber optic illuminator.
- Magnifications - 10X (standard).
- Illumination contour-24V, 150W (512305) halogen lamp, telecentric illumination.
- Inverted image.



QM-DATA 200

Measurement function-point, line, radius, circle, angle (vertex point), distance min./max. dist. between features, form information, data cloud, rotary axis, incremental/absolute, intersections, constructions, create, preset, forward/backward annotation, feature stamp, geometric tolerancing, measure.

MODEL No.
172-810PG
Reg. \$6220.00

\$5495.00

Equipped with
"KA" Counter
Linear Scales,
10X Lens,

MODEL No.
172-810PA
Reg. \$7859.00

\$6695.00

Equipped with
"QM" Data 200,
Linear Scales,
10X Lens,

Model	Description	List	Sale
172-810PA	PH-A14 with QM-Data 200	\$7859.00	\$6695.00
172-810PG	PH-A14 with KA Counter	6220.00	5495.00
332-151	Optoeye with Attachment	1599.00	1495.00
64AAA129B	Heavy Duty Steel Stand	690.00	635.00

*For Complete Accessories, Visit www.penntoolco.com

Mitutoyo PROFILE PROJECTOR 12.4"

- A series of midsize profile projectors featuring bright, 12.40" (315mm) diameter screens and easy-to-operate XY measurement tables.
- Easy-to-read digital counters are located near the projection screen, thereby minimizing strain associated with excessive movement. A digital angle display eliminates the need to perform complex calculations.
- A floating table makes measuring quicker and easier.

MODEL No.
302-713A **\$9,950.00**
Reg. \$10,500.00

Optional

Order No.	Description	Price
264-141A	QM-Data 200	\$1750.00
332-151	Optoeye 200	1495.00
64PMI167	Stand for PJ-A3000	635.00
12AAA807	RS-232C cable	48.50
12AAE671	Attachment board (A)	35.00



QM-Data
200
264-141A
(Optional)

Model	302-711A	302-712A	302-713A
Table Size	15" x 10"	11" x 6"	10" x 10"
Range	8" x 4"	8" x 4"	4" x 4"
Resolution Workpiece	.001"	.00005"	.0001"
Height	3.64"	4.07"	3.58"
Price	\$12,250.00	\$10,995.00	\$9,950.00

Fowler 12" BENCH TOP OPTICAL COMPARATOR W/10X LENS, PROFILE & SURFACE ILLUMINATION Plus Special Accessory Package

- Featuring the basics for comparative/ absolute measurements.
- 1 quadrant protractor screen graduated to 10X, 20X & 40X.
- 2 each, AGD Group 2, 0—1"/25mm electronic digital indicators with .0005"/.01mm resolution.
- 10X lens is included with the unit and other lenses are available.
- T-slot stage with a travel of 6" horizontally and 2-1/2" vertically make the unit universal for many different types of set-ups.

Includes:
T-Slot V-Blocks and T-Slot Centers
Shown Below A \$200.00 Value



MODEL No.
53-900-000
Reg. List
\$2450.00

\$1995.00

W/Accessory
Package
A \$200.00 Value

Mitutoyo 14" OPTICAL COMPARATOR ERECT IMAGE

- Heavy-duty, bench-top model with horizontal optical system.
- Erect image on day-bright screen.
- 14" (356mm) diameter protractor screen with crosshair line for easy alignment.
- Floating-type workstage incorporates linear scales for fast, accurate measurement.
- Suitable for thread pitch measurements, free from blurred or distorted images when the workpiece is angled.

Main Unit
MODEL No.
172-848PG
Reg. \$12,500.00

\$11,500.00

Optional:
Surface Illuminator
Fiber Optic Illuminator

For Further
Information
Call Us
1-800-526-4956



Model	Description	Price
172-848PG	PH-3515F with QM-Data 200	\$11,500.00
172-848PL	PH-3515F with QM-Data 200, Optoeye w/attachment	12,700.00

Suburban MASTER-VIEW™ 14" OPTICAL COMPARATOR

- Surface illumination through duplex fiber optics.
- Digital LCD scales on X and Z axes provide readings to .0005".
- SPC output from scales that is compatible with most SPC systems.
- High capacity 4" x 8" travel stage with 4.5 x 19" work surface.
- Ball way construction handles loads to 100 lbs.
- Heavy-duty monorail type welded steel frame.
- 3-position rotary switch selects profile, surface, or combination surface and profile illumination modes.
- Single long-life tungsten-halogen illumination light source.
- 10x lens system.
- Rotary frosted glass screen with 90° crosslines and 360° protractor rim.
- Vernier readings to 5 min. of arc.
- Overlay chart clips.

Optional Accessories:

Model	Description	Price
MV-1401	Cabinet base	\$965.00
MV-1402	Stage Centers	680.00
MV-1403	Rotary Base Vise	795.00
MV-1404	V-Block	295.00
MV-1405	X & Z-axis remote LED display	945.00
MV-1406	Lens 20x	970.00
MV-1407	Lens 50x	1080.00
MV-1408	Comb. Grid/Radius Chart 10x	95.00
MV-1409	Radius Chart 10x	95.00
MV-1410	Grid Chart 10x	95.00
MV-1411	Screw Thread Chart 10x	95.00
MV-1412	Radius/Angle Chart 10x	95.00
MV-1414	MV14 Bulb	29.00
MV-14CV	Poly-Coated Zippered Fitted Cover	250.00

Overlay charts available. Call us with your magnification requirements

Suburban

14" Comparator
MODEL No. MV-1400
Reg. \$4837.00

\$4595.00

Wt. 245 lbs.

With

Digimatic

Scale

8" and 4"

.005"/0.01mm

Graduation

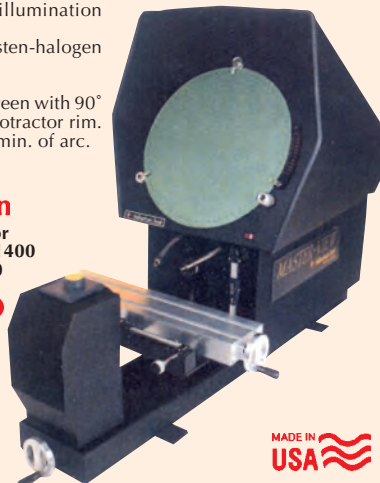

MADE IN
USA

Suburban

14" Comparator
with FAGOR NV20
.0002" X, Y
Axis Scales
Digital Readout
MODEL No.
MV-1400-P
Reg. \$6145.00

\$5795.00

Suburban

14" Comparator
with Quadra-Chek
2000 Series DRO
.0001" x, y axis
Glass scales
MODEL No.
MV-1410-I
Reg. \$8497.00

\$7995.00

Wt. 265 lbs.



Mitutoyo TOOLMAKER'S MICROSCOPE

- The eyepiece section of the optical tube incorporates a vernier. Angle measurement is performed easily by turning the protractor to align the cross-hair reticle with the workpiece image.
- Complete selection of inter-changeable reticles available.
- Both the transmitted and reflected illumination intensity can be adjusted to obtain the optimal illumination intensity for the workpiece.

Fluorescent Ring Light No. 176-152 \$155.00



- No. 152-391 "X"
- No. 152-392 "Y"
- Mechanical Micrometer Heads For X or Y Axis**
- Bidirectional graduation for versatile measurement.
- Provided w/non-rotating spindle tip.
- Floating thimble allows zero setting at any spindle position.
- 1" range .0001" graduation. (Also available in metric.)

MODEL No. 176-400
Shown with Digimatic Mic Heads 2" Range .00005" Grad. Inch/Metric 9.4" x 6" Table
Reg. List \$6995.00
\$6250.00

Model No.	Table Size	Table Travel	Micrometer Heads "X" "Y"	Total Magnification	Complete Sale Price
176-100	6" x 6"	2" x 2"	2) Mechanical	30X	\$3675.00
176-200	6" x 6"	2" x 2"	2) Digimatic	30X	4695.00
176-300	9.4" x 6"	4" x 2"	2) Mechanical	30X	5250.00
176-400	9.4" x 6"	4" x 2"	2) Digimatic	30X	6250.00
64PM1189	TM-500 Digital Camera 2.0 Megaplex-USB				\$1125.00

Precise TOOLMAKER MEASURING MICROSCOPE

Features:

- Heavy-duty base and column for greater stability.
- Precision 2" x 2" travel microstage (includes 2 each 0-1" travel .0001" resolution micrometer heads) and 2 each 1" grade B gage blocks.
- 90° broken crosshair reticle.
- Surface illumination.
- Individual variable intensity control featured for both surface illuminator and the substage lamps.
- Ball bearing guide rails ensure true linear travel in X & Y axis.
- Easy-to-use eyepiece protractor is graduated in 1° units with the vernier scale. The angle can be measured to within 6 minutes.



MODEL No. TMM-202
A \$3000.00 Value
\$1695.00

Quality Import

Fowler XTRA RANGE MICROSCOPE

- 10X eyepieces with adjustable centers and rubber eyecups.
- 2X objective lens.
- Top swiveling light source - 12 volt lamp, 110V supply.
- Positive rack and pinion focusing.
- Articulated 12" long extension arm.
- Heavy base plate insures stability and houses transformer which measures 5'x 8'x 2.5".
- Overall base and column height of 12".



MODEL No. STX-720
Reg. \$347.00
\$315.00

Precise DELUXE STEREO MICROSCOPE 10X & 30X

Features:

- Choose low or high magnification simply by turning objective turret.
- Viewing head has advanced 45° inclined design and is post-mounted to permit 360° rotation or adjustment up/down to accommodate larger specimens.
- Paired widefield eyepiece are 45° inclined, with diopter adjustment. Interpupillary adjustment from 50mm to 75mm.
- Paired objectives are parfocalled, parcentered, achromatic.
- Magnification changed by rotating objective turret to positive click stops.
- High-intensity, 12V 10 watt built-in illumination with base-mounted on/off switch, 3-wire cord.
- Rack and pinion focusing with slip clutch and tension adjustment.
- 90mm reversible and frosted stage plates.
- Locked-on stage clips.
- Rugged cast metal frame, gray enamel finish.
- Fitted styrofoam box with vinyl dust cover.

MODEL No. STM-330
\$249.95

Quality Import



Optional: 15X Wide Field Eye Piece No. EPX-150 \$60.00
No. RTB-330 Top replacement bulb \$10.00 cover.

Specifications:

Objectives 1X & 3X Magnification 10X & 30X
Eyepiece WF10X Height 11"

Precise DELUXE STEREO ZOOM MICROSCOPE 6.5-40X

Features:

- 10X super widefield eyepieces are 45° inclined with diopter adjustments.
- Interpupillary adjustment form 55 to 75mm.
- Viewing head rotates 360°.
- 7:1 range stepless magnification gives 6.5X-45X continuous imification.
- 3-mode high-intensity illumination system.
- 4-way light switch: top, bottom, top/bottom and off.
- Low-voltage transformer base with built-in 6V/15W halogen and 5W fluorescent.
- Rotating knob for incident (top) for variable intensity control on halogen illumination.
- Rack and pinion focusing.
- Large 6-3/4W x 9-3/4"D base with 95mm frosted glass plate.
- Dust cover included.



Optional: 15X Wide Field Eye Piece
15X Widefield Eyepiece paired \$60.00
20X Widefield Eyepiece paired \$75.00

Replacement (Top) Bulb 6V/15W \$10.00
Replacement Fluorescent Bottom Lamp \$10.00

6.5-45X
MODEL No. SZ-131
\$545.00

Precise STEREO MICROSCOPE UNIVERSAL STAND

- A massive, rugged stand with 18" chrome vertical and horizontal extension with chrome finish.
- 10" square metal base made of steel.
- Rack and pinion focus adjustment.
- Rack and pinion side-to-side adjustment.
- Locking collar to prevent slipping.

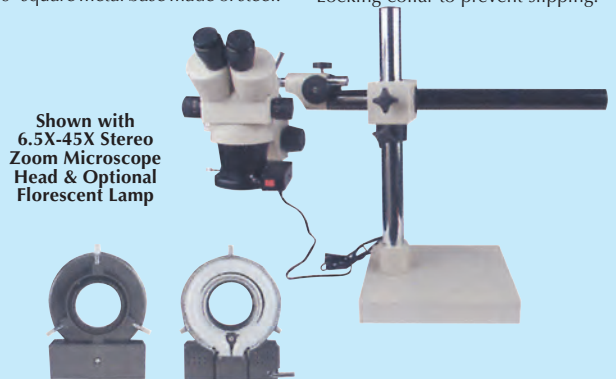

Shown with 6.5X-45X Stereo Zoom Microscope Head & Optional Fluorescent Lamp

Model	Description	Wt.	Price
SZM-150	Universal stand with 2166 1620 zoom head	51 lbs.	\$695.00
SZ-151	optional fluorescent lamp	-	85.00

Mahr FEDERAL **MahrSurf PS1 PORTABLE SURFACE ROUGHNESS TESTER**

- MahrSurf PS1 base unit.
- Drive unit.
- 1 Standard pick-up, conforms to standards.
- Integrated batter.
- Roughness standard integrated into casing.
- Height adjustment.
- Pick-up protection.
- Charger/adapter.
- Operating instructions.
- Carrying case with shoulder strap and belt attachment.
- USB cable.



MODEL No. PS-100 **\$2395.00**
Reg. \$2640.00



The scope of delivery for the MahrSurf PS1 includes a simple mount for height adjustment. This enables measurements to be performed on e.g. cones.



Perfect upside down measurement with the MahrSurf PS1. All you have to do is position the part and start measurement. This enables small workpieces to be measured without additional mounts. **Additional Probes are available call or visit our website: www.penntoolco.com**

The MahrSurf PS1 is the perfect entry-level measuring instrument for a wide range of standards-compliant roughness measurements.



Unit of measurement	Metric, Inch
Parameters (24, with tolerance limits)	Ra, Rq, Rz corr. to TV (JIS), Rmax, Rp, Rp, (ASME) Rpm, (ASME), Rpk, Rk, Rvk, Mr1, Mr2, A1, A2, Vo Rt, R3z RPC, Rmr corr. to tp (JIS ASME), Rsm, R, Ar, Rx
Languages	14 including 3 Asian languages
Measuring Range*	350µm, 180µm, 90µm, (0.014", 0.007", 0.004")
Profile Resolution*	32nm, 16nm, 8nm, (1.3µin, 0.6µin, 0.3µin)
Cutoff IC**	0.25mm, 0.8mm, 2.5mm auto. (0.010", 0.030", 0.100")
Traversing Length Lt**	1,75mm, 5.6mm, 17.5mm auto. (0.069", 0.22", 0.69")
Traversing Length (MOTIF)	1mm, 2mm, 4mm, 8mm, 12mm, 16mm, (0.04", 0.08", 0.16", 0.32", 0.48", 0.64")
Short Cutoff**	Selectable
Evaluation Length in**	1.25mm, 4.0mm, 12.5mm (0.050", 0.15", 0.50")
Sampling Lengths	Number n selectable: 1 to 5
Memory Capacity	max. 15 profiles, max. 20,000 results
Dimensions	5.51" x 1.97" x 2.76"
Weight	0.88 lbs.
Battery	Li-ion Battery
Interfaces	USB, MaeConnect (RS232)
Long-range power supply	100 to 264V

Mahr FEDERAL

POCKET SURF® PORTABLE SURFACE ROUGHNESS GAGE

The Pocket sized completely portable, economically priced tool for performing traceable surface roughness measurements

Features:

- Pocket sized, compact and solidly built.
- Operates in four probe positions: 0°, 90°, 180°, and 270°.
- Easily interchangeable probes.
- Measures four, switch-selectable Parameters:
Ra - Average roughness
Ry - Maximum roughness depth
Rmax - Max. roughness depth (DIN).
Rz - Mean roughness depth (DIN) also called Rtm.
- Built in digital output.
- Supplied with General purpose probe. For most surface roughness applications. Has a 90° conical diamond stylus.



MADE IN USA

Optional Probes & Printer

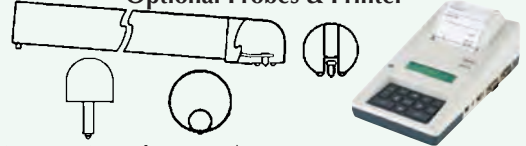

- No. EGH-1019 General Purpose \$495.00**
With a 90° conical diamond stylus, 10µm/.0004" radius. For most surface roughness applications.
- No. EGH-1026 General Purpose \$495.00**
With a 90° conical diamond stylus, 5µm/.0002" radius. For most surface roughness applications.
- No. EGH-1020 Traverse Chisel Probe \$650.00**
For gaging sharp edges or small O.D.'s where probe is aligned with (in 180° or closed position) to axis of traverse. 90° sapphire chisel, 10µm/.0004" radius
- No. EGH-1020-2 Parallel Chisel Probe \$650.00**
For gaging sharp edges or small O.D.'s where probe is perpendicular (in 90° or 270° position) to axis of traverse. 90° sapphire chisel, 10µm/.0004" radius. Also used with EAS-2421 Vee fixture for O.D.'s smaller than 6.35mm/.25"
- No. EGH-1021 Small Bore Probe \$675.00**
With a 90° conical diamond stylus, 10µm/.0004" radius, For gaging small bores (3.2mm/.125" minimum I.D.) up to a depth of 19mm/.75"
- No. EGH-1027 Small Bore Probe \$675.00**
With a 90° conical diamond stylus, 5µm/.0002" radius
- No. EGH-1028 Groove Bottom Probe \$675.00**
For measuring the bottom of grooves, recesses and small holes to depths of 6.35mm/.25" Also used for short lands and shoulders. With a 90° conical diamond stylus, 10µm/.0004" radius. **NOTE:** Small Bore and Groove Bottom Probes can only be used in 180° position with the Pocket Surf unit supported in a height stand or other fixture.
- No. 4102040 Statistics Printer \$650.00**
- No. 4102046 Connecting Cable \$ 95.00**

MODEL No. 1500-311 Reg. List \$2295.00 **\$2095.00** U.S.A.

Model No.	Description	Sale Price Per Set
1500-311	Pocket Surf with .0004" Radius Probe	\$2095.00
1500-321	Pocket Surf with .0002" Radius Probe	\$2095.00

Mahr FEDERAL **Height Stand**

A compact, convenient fixture with a bracket to hold the pocket Surf gage. Designed for making measurements on a granite surface plate or on any suitable, flat working surface to a maximum height of about 4.375"/111mm



No. EAS-2496 \$375.00

Vee Adapter Kit
Attaches to bottom of Pocket Surf unit, permitting convenient hand-held measurements of hard-to-reach cylindrical surfaces, such as crankshaft journals without having to fix the workpiece. Suitable for parts with diameters from 5.0mm/.19" to 125mm/5"



No. EAS-2739 \$340.00

Bore Adapter
For timesaving hand-held measurement of bores without having to fix the workpiece. Accommodates all inside diameters from 25mm/1" to 150mm/6"; depths from 25mm/1" to 60mm/2.4"



No. EAS-2839 \$315.00

Mounting Bracket for Height Gages
For mounting the Pocket Surf to most standard height gages. The bracket includes a rectangular bar that is 0.45" x 0.25" to fit the holder of the height gage. A swivel feature is included to permit the Pocket Surf to be set anywhere within a 360° rotation.



No. EAS-3048 \$125.00

Mahr FEDERAL **Swivel Fixture for Height Stand**

Exclusive Swivel Fixture that will allow you to mount the Pocket Surf horizontally or vertically enhancing the capabilities of both the Pocket Surf and your height gage or height stand



No. EAS-3048 \$125.00

Portable Vee Fixture

For measuring small parts with outside diameters from 3.1mm/.125" to 25mm/1" for lengths of 25mm/1" minimum - includes PS-145 setting pin.



No. EAS-2421 \$105.00



MARSURF M300 SURFACE ROUGHNESS TESTER WITH BLUETOOTH TECHNOLOGY

Cable Free Connection Between Evaluation Unit and Drive Unit

The operation of this instrument is based on the well-proven catalog of functions which enables instrument settings such as measuring conditions, language and record contents to be selected very easily, thus offering a maximum of comfort and flexibility.

The MarSurf M300 not only meets requirements for determination and documentation of selected parameters, but also makes most of the parameters and characteristic curves stipulated in DIN/ISO/JIS available for the evaluation of the profile assessed.

Moreover, the MarSurf M300 offers an integrated memory for up to 40,000 results or 30 profiles, as well as the functions of tolerance monitoring, vertical scale selection and the setting of unsymmetric intersection lines for peak count calculation.



Evaluation Unit

Drive Unit

Complete Kit
MODEL No.
6910401
Reg. \$4995.00

\$4,795.00

Consists of:
Evaluation unit, Drive unit with Integrated Roughness Standard, Standard probe, Height Attachment, Calibration Certificate, Foam Fitted Carrying Case



Brilliant, illuminated color display. A large color display to read the parameters and the profiles so that you can read the correct results in a poorly lit atmosphere



The data stored in the MarSurf M300 can e.g. be printed out in any format. The measuring data can be displayed in different forms: Profile and results, Results, Profile + MRK+ Results, Statistics, and much more.



During installation, a MarSurf M300 directory is automatically created. The results and profiles saved in the M300 can simply be moved to that directory or any directory of your choice using "Drag & Drop" and are therefore secured



Also Measures Upside Down

Mitutoyo SURFTEST SJ-210 Portable Surface Roughness Tester

The new SurfTest® SJ-210 portable surface roughness tester combines high accuracy and measurement speed with numerous innovative features creating a new class leader in surface inspection.

- 2.4" color LCD display includes backlighting and over-size fonts.
- Display direction can be changed to be read vertically or horizontally right and left handed.
- Self-timed measurement supported.
- Color tolerance judgments, evaluation curves and all data can be displayed in one of 16 languages.
- Security management supports password protected function locks.
- The detector/drive unit can be detached from the display unit for effortless measurement of awkwardly oriented workpieces.



MODEL No.
178-561-02A
List \$2370.00

\$2195.00

With Standard Detector Probe



Mitutoyo SURFTEST SJ-301 With Built-In printer

- Graphic display of measured profile.
- Easy to operate touch panel.
- Built-in printer.
- JIS/DIN/ISO/ANSI compatible 36 evaluation parameters and 3 analysis graphs.
- Rechargeable battery.
- 350µm wide measuring range detector.
- Statistical processing function included.
- Compatible with PC base Surfpak-SJ software.
- Auto-sleep function for power conservation.



Model No.
178-571-02
REG. \$4070.00

\$3850.00

With Standard Detector

Detector Probes for SurfTest SJ-210 and SJ-301

Model	Description	List Price	Sale Price
178-390	Standard Detector	\$456.00	\$433.00
178-391	Detector for Soft Materials	456.00	433.00
178-392	Small Hole Detector (Min. 4.5mm Dia.)	697.00	662.00
178-393	Extra Small Hole Detector (Min. 2.8mm Dia.)	697.00	662.00
178-394	Deep Groove Detector	697.00	662.00
178-395	Low Force Detector	444.00	422.00

Fowler XPRO PORTABLE ROUGHNESS TESTER

- Small compact size.
- 2 Selectable parameters: Ra and Rz.
- Large LCD display.



- Meets ISO and DIN standards.
- N.I.S.T. traceable specimen
- Uses 9 volt battery (approx.) 3000 measurements).
- Includes fitted case.

Specifications:
Overall Dimension: Approx. 5.5"x 3"x 1"
Measuring Range:
Ra - 1µ" to 250µ"/0.01µm to 6.35µm
Rz* - 8µ" to 999µ"/0.2µm to 25.0µm
Display Resolution: 1µ"/.01µm
Max Stylus Force: 1500mfg/15.0mN
*per DIN 4768. Note that the .0002"/5µm stylus radius must be used to measure these parameters

MODEL No.
54-410-500
Reg. \$1695.00

\$1495.00

Complete

Model No.	Description	List	Sale
54-410-500	X-Pro Portable Roughness Tester .0004" Probe	\$1695.00	\$1495.00
54-410-600	X-Pro Portable Roughness Tester .0002" Probe	1695.00	1495.00

X-Pro Portable Roughness Tester Probes and Accessories

Model No.	Description	Resolution	Price
54-400-896	Stand with Swivel Attachment	-	\$395.00
54-400-319	General Purpose Probe	.0004"	545.00
54-400-326	General Purpose Probe	.0002"	545.00
54-420-321	Small Bore Probe	.0004"	715.00
54-420-327	Small Bore Probe	.0002"	715.00
54-420-301	Traverse Chisel Probe	.0004"	715.00
54-420-302	Parallel Chisel Probe	.0004"	715.00
54-420-328	Groove Bottom Probe	.0004"	715.00
54-420-120	AC Adapter Kit	-	60.00

Fowler ELECTRONIC SNAP GAGE

Special Features:

- Ranges available: 0-8"/0-200mm
- Adjustable anvil through 1"/25mm range
- Adjustable gaging pressure
- Lightweight, metallurgically stabilized aluminum frame.
- .66 inch square tungsten carbide anvils
- Within the 1/2" central square surface, anvils are parallel within .00015" on sizes up to 4"/100mm
- .0002" on sizes 4"/100mm to 8"/200mm

Indicator Features:

- Dual reading Inch/metric Electronic Indicator
- Resolution: .00005"/.001mm
- Preset with recall
- ABS/INC Measurement
- Min/Max/TIR

Model No.	Range Inch/Metric	Price Each
54-666-371	0-1"/0-25mm	\$775.00
54-666-372	1-2"/22-51mm	815.00
54-666-373	2-3"/51-76mm	825.00
54-666-374	3-4"/76-102mm	825.00
54-666-375	4-5"/102-127mm	890.00
54-666-376	5-6"/127-152mm	995.00
54-666-377	6-7"/152-178mm	1035.00
54-666-378	7-8"/178-203mm	1095.00

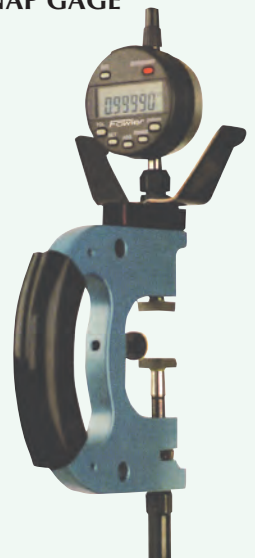

ROCKWELL TYPE HARDNESS TESTER

- Rockwell system of hardness testing.
- Furnished complete with linkage dashpot and dial indicator, diamond penetrator, 1/16" steel ball penetrator, 10 replacement balls, 2 hardness test blocks (1 "C" scale and 1 "B" scale).
- 3 weights for major loads of 60 kgs, 100 kgs and 150 kgs for standard scales, 15 kgs, 30 kgs, 45 kgs for superficial type.
- Large master anvil, large V-block anvil, flat anvil with 1/4" projection in center.
- Furnished complete with hardness conversion table and accessory case.



**Rockwell Type
Model No.
MTR-100**

\$3,695.00

**Superficial Type
Model No.
MTR-101**

\$2,995.00

Testing height 8-1/2"
Depth from center of column . . . 5-1/2"
Overall height 26"
Length 19-1/4"
Width 9-7/16"
Weight 150 lbs.



Precise ROCKWELL TYPE HARDNESS TESTER WITH AUTOMATIC WEIGHT SELECTION

Hardness tester has the features required for the precise measurements of hardness. It is very effective on all metals and alloys. Whether your material is flat, or round, soft or hard, regular in shape this tester can do it all. The durable frame & fine craftsmanship combine to present to you, the operator, a first class piece of equipment.



Specifications:
Maximum load 150kg
Load range 10, 100, 150kg
Initial range load 10kg
Max. test height 1.69"
Throat depth 5-1/4"
Max. depth of spindle below base . . . 2"
Base size 7" x 18"
Machine height 24-1/2"
Approx. net weight 150lbs

Standard Accessories:

- 5-3/4" testing table
- 2-1/16" testing table
- 2-3/16" testing table with "V" groove
- 120° diamond penetrator
- 1/16" steel ball penetrator
- 1 Rockwell A test block
- 2 Rockwell B test blocks
- 3 Rockwell C test blocks
- 2 screwdrivers
- Instruction manual
- Dust resistant plastic cover

**MODEL No.
900-3R
Reg. \$1195.00**

\$995.00

Mitutoyo ROCKWELL AND SUPERFICIAL HARDNESS TESTER

- Closed-loop control of testing forces.
- Primary and final forces (loads) are applied with unparalleled accuracy and repeatability.
- Extended indenter arm reaches inside diameters and hard to reach surfaces at eye level, allowing the operator to easily see where the indenter addresses small or hard to reach parts.
- Auto setting of preliminary test force and application of total test force.
- Indenter escape function allows automatic removal of preliminary test force at end of the test cycle.
- Touch screen operation with backlit LCD graphic display.
- Hardness scale is set automatically via the touch screen.
- Cylindrical and spherical surface compensation.
- Auto conversion to all hardness scales or tensile strength.



*With
Real-Time
Electronic
Test Force
Control*

**MODEL No.
810-202-03A
Reg. List \$14,600.00**

\$13,500.00

Preliminary Test Force 29.42N (3kgf), 98.07N (10kgf)
Test Force Rockwell 588.4N (60kgf), 980.7N (100kgf), 1471N 9150kgf
Rockwell Superficial 147.1N (15gf), 294.2N (30kgf), 441.3N (45kgf)

Ames PORTABLE ROCKWELL HARDNESS TESTERS

Every genuine Ames Hardness Tester is individually calibrated to the Rockwell scales before leaving the plant. The signed certificate with each unit reflects a painstaking process involving from 70 to 100 separate readings.

MADE IN USA



There are two basic types of hardness testing: Standard and Superficial. Each requires a slightly different instrument construction.

Ames standard testers read directly in these fifteen Rockwell scales:
A, B, C, D, E, F, G, H, K, L, M, P, R, S, and V.

Superficial models are for testing case-hardened stocks, thin stock and soft materials in the Rockwell N and T scales.

Model	Opening	Depth	Type	Price
APT-001	1"	1"	Rockwell	\$2350.00
APT-003	1"	1"	Superficial	2475.00
APT-004	1"	4"	Rockwell	2795.00
APT-005	1"	4"	Superficial	2825.00
APT-006	2"	2"	Rockwell	\$2585.00
APT-008	2"	2"	Superficial	2640.00
APT-009	4"	2"	Rockwell	\$2795.00
APT-010	4"	2"	Superficial	2900.00
APT-011	4"	4"	Rockwell	3150.00
APT-012	8"	4"	Rockwell	4500.00
APT-031	Tube Tester		15T scale only	2475.00

Standard Equipment

- 1 diamond penetrator.
- 1-1/16" ball penetrator.
- 1 flat anvil, 1 V anvil
- Extensions in appropriate sizes.
- High-impact carrying case.
- 3 test blocks, 2 hard steel, 1 brass. (additional anvils for some models)

Fowler ROCKWELL HARDNESS TESTERS

Digital Features (Shown)

- Automatic loading and unloading, automatic holding of test force and an easy-to-read LCD.
- Large backlit display with load progress bar.
- Standards: EN-ISO 6508 and ASTM-E18.
- Resolution: .5 of a Rockwell unit.
- Test loads: 10 jgf preload/60, 100, 150 kgf load.
- Rockwell scales: A, B, C, D, E, F, G, H, K, L, M, P, R, S, V, (Direct display of HRC, B, A, F)
- Testing space: Vertical=6.7"/170mm, Horizontal=6.5"/165mm (from centerline)

Analog Features

- Standards: EN-ISO 6508 and ASTM-E18.
- Resolution: .5 of a Rockwell unit.
- Test loads: 10 jgf preload/60, 100, 150 kgf load.
- Rockwell scales: A, B, C, F
- Testing space: Vertical=6.7"/170mm, Horizontal=6.5"/165mm (from centerline)

Accessories Included:

- Diamond Rockwell indenter.
- Rockwell ball indenter 1/16"
- ±60HRC Hardness test block
- ±25HRC Hardness test block
- ±85HRB Hardness test block
- Flat anvil 60mm ø
- V-anvil 400 ø
- Adjustable feet



**Analog
Readout**



Model	Description	List	Sale
53-770-600	Analog Hardness Tester	\$2194.50	\$1995.00
54-770-650	Digital Hardness Tester	4985.00	4695.00

Fowler PORTABLE DUROMETERS

Fowler's Portable Durometers Are Just Right For Testing The hardness of Flexible Materials Such as Rubber And Plastics. These Gages Conform to Shore Scales

- Manufactured in accordance with DIN, ASTM, ISO and JIS specifications.
- Includes reference test block, operating instructions and fitted case.
- Optional bench stand available.

Applications:

35° blunt taper Durometers are suitable for testing soft and natural rubber products, neoprene, polyesters, soft P.V.C., leather, thiokol, nitril rubbers, wax felt and more. Sharp 30° point Durometers are ideal for testing hard rubber, hard synthetic materials, e.g. acrylics, glass, polystyrol, thermoplastics, printing rolls, vinyl sheets, cellulose acetates, densified wood, etc.



Model	Penetrator	Shore Scale	Grad.	List	Sale
53-762-101	Blunt Taper 35°	A	1 Shore	\$274.50	\$225.00
53-762-102	Blunt Taper 30°	D	1 Shore	280.50	235.00

phase II DIGITAL ROCKWELL/SUPERFICIAL HARDNESS TESTER

Test Rockwell and Superficial Rockwell Hardness in 1 Unit

- Loaded with features such as ultra precise measurements, wide measuring range, automatic main test force loading/unloading, digitally displayed results, automatic printing, RS232 & USB output, etc.
- The indenter design is ideal for testing inside diameters and recesses. Inside diameters as small as 1-1/2-inches can be tested with the standard indenter.
- 30 rockwell hardness scales, HRA, HRB, HRC, HRD, HRE, HRF, HRG, HRH, HRK, HRL, HRM, HRP, HRR, HRS, HRV, HR15N, HR30N, HR45N, HR15T, HR30T, HR45T, HR15W, HR30W, HR45W, HR15X, HR30X, HR45X, HR15Y, HR30Y and HR45Y.
- Auxiliary functions:** Capable of upper and lower limit settings; data statistics, the computing for average value, standard deviation, maximum and minimum; scale conversion (the testing results can be converted into the values of HB, HV, HLD, HK and b (strength); curved surface correction will automatically correct the measuring results for cylindrical surface and spherical surface.
- Digital Motorized Hardness Tester.**



5 Year
Warranty
Lifetime
Tech Support

MODEL No.
900-385
Reg. \$9995.00

\$9650.00

Equipped With:

- Diamond Conical Indenter
- 1/16" Carbide Ball Indenter
- 1- HRC Test Blocks
- 1- HRB Test Block
- 1- HRA Test Block
- 1- HR30N Test Block
- 1- HR30T Test Block
- Test Table 5.87" (150mm)
- Flat Anvil 2.5" (63mm)
- Std. V- Anvil
- Accessory Case
- Dust Cover

phase II DIGITAL ROCKWELL HARDNESS TESTER

This digital Rockwell hardness tester with fully automated load/unload procedures affords highly sensitive and accurate readings. Micro computer controlled with USB output to built-in mini printer or PC. The hardness tester offers programmable scale conversions, dwell times, statistical capabilities and test counter. Capable of testing in all of the regular Rockwell® scales.

- Automatic conversions to: HRN, HRT, HB, HV, HLD and b
- Easily obtain Average, Min/Max, S, R
- Menu selectable system
- Upper/Lower Limit Settings
- Memory of 500 test results
- Curved Surface Auto Correction
- Preload: 98.1N (10gf)
- Total test force: 588.4N(60kgf), 980.7N(100kgf), 1471N(150kgf)
- Scales: HRA, HRB, HRC, HRE, HRF, HRG, HRH, HRK, HRL, HRM, HRP, HRR, HRS, HRV
- Conversions: the 900-365 digital Rockwell hardness tester can convert the measured Rockwell hardness value to other scales or even tensile strength.
- Digital Motorized Hardness Tester.**

MODEL No.
900-365
Reg. \$6995.00

\$6750.00

5 Year
Warranty
Lifetime
Tech Support



Equipped With:

- C-scale Diamond Indenter
- 1/16" Ball Indenter
- 2- HRC test Blocks
- 1- HRB Test Block
- Built-in Mini Printer
- Test Table 5.87" (150mm)
- Flat Anvil 2.5" (63mm)
- Std. Vee Anvil
- Accessory Case
- Dust Cover

phase II ROCKWELL TYPE HARDNESS TESTERS

- This hardness tester comprises the very best in "state of the art" design coupled with dynamic precision only found at Phase II.
- The hardness tester is easy to operate yet engineered to obtain highly sensitive and accurate readings.
- A perfect, rugged performer suited for almost any environment including heat treat facilities, tool rooms, workshop, laboratories and inspection labs.
- Conforms to ASTM E-18**
- Lifetime technical support is included on all Phase II Hardness Testers.



5 Year
Warranty
Lifetime
Tech Support



242 Lbs.

Model No.	Scale Test	Test Force Control	Dimensions Inch	Reg. Price	Sale Price
900-331	"C"-Scale	Hydraulic	30" x 8-1/2" x 20"	\$2495.00	\$2150.00
900-345	"N" & "T" (Superficial)	Motorized	28" x 9" x 20"	2995.00	2895.00

Equip with Diamond Indenter 1/16" Ball Indenter, 3- HRC Test Blocks, Test Block, Test table 5.87", Flat Anvil 2.5", Spot Anvil .38, Standard Vee Anvil, H/D Accessory Case

phase II ROCKWELL/SUPERFICIAL ROCKWELL TWIN HARDNESS TESTER

Test Rockwell and Superficial Rockwell Hardness in 1 Unit

Tests both Rockwell hardness and Superficial Rockwell hardness in one unit, with state of the art design and dynamic precision. The Twin Rockwell/Superficial Rockwell hardness tester is ruggedly engineered to obtain highly sensitive and accurate readings. Conforming to ASTM E-18 Rockwell hardness standards, this hardness tester will offer unmatched repeatability in all Rockwell hardness scales.

- Direct analog dial reading.
- Advanced design, easy to operate.
- Engineered to obtain highly sensitive and accurate readings.
- Conforms to ASTM E-18.
- Hardness scales: HRA, B, C, D, E, F, G, H, K, L, M (superficial) HR15N, HR15T, HR30T, HR45N, HR45T

MODEL No.
900-375
Reg. \$4495.00

\$4250.00

5 Year
Warranty
Lifetime
Tech Support



Equipped With:

- Diamond Conical Indenter
- 1/16" Ball Indenter
- 2- HRC Test Blocks
- 1- HRB Test Block
- 1- HR15N Test Block
- 1- HR30N Test Block
- 1- HR45T Test Block
- Test Table 5.87" (150mm)
- Flat Anvil 2.5" (63mm)
- Std. Vee Anvil
- Accessory Case
- Dust Cover

phase II HARDNESS TESTERS ACCESSORIES

Model	Description	Price
330-9440	120° Diamond Indenter	\$135.00
330-9441	1/16" Carbide Steel Indenter	89.00
330-120	1/2" Carbide Ball Indenter	130.00
330-140	1/4" Carbide Ball Indenter	130.00
330-180	1/8" Carbide Ball Indenter	89.00

Other Available Test Blocks

- Full range of Rockwell Scale Test Blocks
- Full range of Brinell Test Blocks
- Most Micro hardness test Blocks including Vickers and Knoop

Model	Description	Price
330-9405	Small Round Anvil	\$59.95
330-9411	Large Round Anvil	69.95
330-9407	V-anvil	65.00

Model	Description	Price
330-943	A-scale test block	\$19.95
330-944	B-scale test block	19.95
330-945	C-scale (low range) test block	19.95
330-9416	C-scale (mid range) test block	19.95
330-947	C-scale (hi range) test block	19.95

Model	Description	Price
340-901	HR15N superficial test block	\$29.95
340-902	HR30N superficial test block	29.95
340-903	HR45N superficial test block	29.95
340-904	HR45N superficial test block	29.95
340-905	HR30N superficial test block	29.95
340-906	HR15N superficial test block	29.95

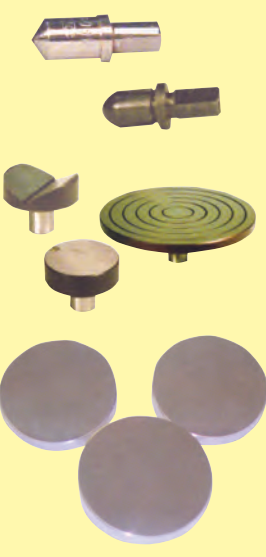

phase II DIGITAL MOTORIZED BRINELL HARDNESS TESTER

- Load Cell driven system provides precise control of test force application
- Measuring Range: 8-650HBW
- The test load is applied via a closed-loop control unit with load cell, a DC motor and an electronic measurement and control unit.
- The absence of mechanical weights not only eliminates friction problems but also makes the equipment less sensitive to misalignments caused by vibrations.
- Test load selection by keyboard and LCD screen.
- The Brinell hardness Tester features a fully automatic test cycle, load application, holding, unloading, is performed fully automatically.
- Selectable dwell times by screen. The indenter, load, and other test information are shown clearly on the large LCD screen.
- The directions for 0.102F/D² ratios selecting according to the materials and hardness range can be showing on the screen.
- Equipped with a 20X optical microscope to measure the diameter of Brinell indentation.



MODEL No.
900-355
Reg. \$6495.00

\$6295.00

5 Year
Warranty
Lifetime
Tech Support

phase II ULTRASONIC HARDNESS TESTER

Non Destructive Hardness Testing!

Designed to test specific material reading chosen scale, the new Phase II miniature ultrasonic hardness testers are capable of measuring surface hardness of metals with flat, thin, round or large surfaces. Accurate measurements of steels and aluminum are easily attained with these compact instruments.

Specifications:

- Easy To Read Menu Operation
- Large LCD Display w/ Back Light USB Interface
- Automatic Mean Value
- Data Archive Capacity

Standard Accessories:

- Base Instrument
- Calibrated Test Blocks
- Custom Carry Case
- Battery Charger
- Operation Manual

5 Year
Warranty
Lifetime
Tech Support

NIST
TRACEABLE



Model No.	Scale Type	Pressure Force	Measure Range	Price Each
MET-HRC15	Rockwell C	10N (1.5kgf)	20-70 HRC	\$3795.00
MET-HRC50	Rockwell C	50N (5kgf)	20-70 HRC	3795.00
MET-HB50	Brinell	50N (5kgf)	75-650 HB	3795.00
MET-HV15	Vickers	10N (1.5kgf)	75-1000 HV	3795.00

phase II DIGITAL SUPERFICIAL/ROCKWELL MOTORIZED HARDNESS TESTER

With Built-In Mini Printer

- Fully automated load/unload procedures affords highly sensitive and accurate readings.
- Micro computer controlled with USB output to built-in mini printer or PC.
- Offers programmable scale conversions, dwell times, statistical capabilities and test counter.
- Capable of testing in all of the Superficial Rockwell scales.
- Automatic conversions to HRC, HRB, HB, HV, HLD and Ob.
- Easily obtain Average, Min/Max, S, R, Menu selectable system.
- Upper/Lower Limit Settings.
- Memory of 500 test results.
- Curved Surface Auto correction.

Specifications:

- Minor load 3Kgf
- Major load 15Kgf, 30Kgf, 45Kgf
- Test Force App. Dead weight
- Test Force Control Motorized
- Results Display Hi Def LCD Digital
- Vertical Capacity 7.87"
- Throat Depth 6.50"
- Height 28.34"
- Width 7.87"
- Depth 21.60"
- Shipping Weight 220 lbs.

Equipped With:

- N-Scale Diamond Indentor
- 1/16" Steel Ball Indentor
- 2-HRN Test Blocks
- 3-HRT Test Blocks
- Test Table 5.87" (150mm)
- Flat Anvil 2.5" (63mm)
- Std. "V" Anvil
- Accessory Case
- Dust Cover

NIST
TRACEABLE

5 Year
Warranty
Lifetime
Tech Support

MODEL No.
900-348
Reg. \$6995.00

\$6750.00



Mitutoyo HARDMATIC DUROMETERS SHORE "A"

Digital/Dial Durometers are suitable for testing the nature of the following materials - natural rubber, neoprene, polyesters, P.V.C., leather, nitrile rubber, wax, vinyl, cellulose, acetates, glass polystyrene, etc.

- Designed in accordance with ASTM D 2240, ISO868, ISO 7619, DIN 53 505, JIS K 7215 specifications.
- Units are available in both Shore A and Shore D scales and will test a wide variety of applications.
- The Digital Durometer is provided with data hold function, permitting the operator to make an error-free reading on the LCD screen.
- The Dial Durometer is provided with a peak retaining hand for error-free reading.

Specifications:

- Indenter . . . Blunt Taper Tip Dia.0.79mm
- Tip Angle 35°±0.25°
- Resolution Digital 0.5
- Dial 1
- Range 10-90



Model	Description	List	Sale
811-335	Shore "A" Dial Durometer	\$ 584.00	\$ 554.00
811-336	Shore "A" Digital Durometer	1250.00	1185.00
64AAA964	Calibration Test Blocks, Shore "A"	183.00	173.50

*For Additional Models and Specifications. Visit our website:
www.penntoolco.com

phase II TALL FRAME ROCKWELL HARDNESS TESTER

The 900-332 Rockwell hardness tester is perfectly designed for that large part application. It is easy to operate and engineered to take highly sensitive and accurate readings. Perfect for the shop floor, labs, heat treat facilities and tool rooms.

- 15-3/4" Test height for extremely large parts.
- Direct analog dial reading.
- Advanced design, easy to operate.
- Engineered to obtain highly sensitive and accurate readings

Specifications:

- Minor load 10Kgf
- Major load 60Kgf, 100Kgf, 150Kgf
- Test Force App. Dead weight
- Test Force Control Hydraulic Dashpot System
- Results Display Analog Dial Gage
- Vertical Capacity 15-3/4"
- Throat Depth 5.5"
- Height 33.0"
- Width 18.0"
- Depth 70.0"
- Shipping Weight 200 lbs.

MODEL No.
900-332
Reg. \$4295.00

\$3995.00

5 Year
Warranty
Lifetime
Tech Support

NIST
TRACEABLE



phase II MICRO VICKERS HARDNESS TESTER

- 10x objective and a 40x objective and a 10x microscope for measurement.
- Displays measuring method, testing force value, indentation length, hardness value, dwell time of the testing force, as well as the number of measurement on the LCD screen.
- Automatic calculations after value entered on keypad shown on the display.
- Threaded interface that can be linked to the digital camera and CCD pickup camera.
- Adopted cold light source with life approx. 10000 hours. The user also can select halogen lamp as light source according to their requirement.
- The CCD Automatic Image Measuring Device can be equipped on present tester according to user's requirement.
- The LCD Video Measuring Device can be equipped on the present tester according to user's requirement.
- Knoop hardness values can be obtained by installing a Knoop indenter.

Specifications:

- Testing Range: 1HV-2967HV
- Test Force: 0.098N(10g), 0.246V(25g), 0.49V(50g), 0.98N(100g), 1.96N(200g), 4.9N(500g), 9.8N(1000g/1kg)
- Max. Height of the specimen: 70mm
- Max. Distance from the Indenter Center to the Instrument Panel: 95mm
- Len/indenters with: With Hand Turret
- Carriage Control: Automatic (Load/Dwell/Unload)
- Amplification of the microscope: 100x/400x
- Dwell Time of the Test Force: (5-60)S
- Min. Graduation Value of the testing Drum Wheel: 0.25µm
- Dimension of the XY Table: 25x25mm
- Light source/Power Supply: 110/220
- Weight/Gross Weight: 41.5kg/net Weight: 35kg
- Package Dimensions: 425 x 245 x 490mm

MODEL No.
900-390
Reg. \$7995.00

\$7595.00

5 Year
Warranty
Lifetime
Tech Support

NIST
TRACEABLE



RUGOSURF 20

Portable Surface Finish Instrument

Easy-to-use surface roughness gage with a wide choice of accessories for measuring workpieces of many shapes and forms.

MODEL No.
06930013
List \$3647.00

\$3450.00



Technical Data:

Measured Parameters:	Ra-Rq(RMS) -RT -Rz -Rc -Rsm -Rmr -Rmax -R _{Pc} -PPc
Calculated as per ISO 4287-1:	Pt - R - Rx - AR. Calculated as per ISO 12085 (CNOMO)
Measuring Spans:	0-0.015in/0-400µm
Resolution:	0.01µin/0.001µm
Cut-offs:	c=0.25-0.8 - 2.5mm. Choice between 1 to 5 cut-offs for the relevant measurement
Filter:	GAUSSIAN according to ISO 11562
Cut-off length lc:	Number of cut-offs x c (0.5 to 12.5mm)
Total length lt:	Number of cut-offs + 1 x c (0.75 to 15.0mm)
Inductive probe:	5 µm, 90°
Measuring Force:	0.75 mN (ISO 3274)
Calibration Function:	Using reference specimen Ra=2.7 µm
RS232 Data Output:	For data transmission to Rugosoft 10 software

phase II PORTABLE DIGITAL HARDNESS TESTER

- State of the art, digital tester is designed to test the hardness of large hard metal parts. Loaded with useful functions only found on high priced models.
- Fast test speeds coupled with memory and output, this unit is a hand's down winner whether you are in the field or in the QC shop.

Operation:

- Load the impact body.
- Place the impact body on your test piece.
- Push the button to begin testing and obtain reading.

Functions:

- Easy to use keypad operation.
- Auto identification of Impact Device.
- Large LCD display with back light.
- USB output.
- Automatic conversions to: Brinell, Rockwell B&C, Vicker and Shore.
- Automatic mean value as well as Min & Max Values.
- Battery indicator.
- Memory capacity (100 groups).

- The PHT-1800 can perform tests that easily convert to the most popular hardness scales, including Rockwell, Brinell, Vickers, Shore, etc.

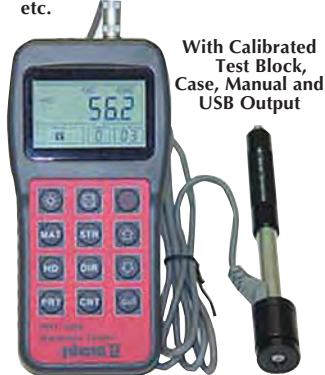

MODEL No. PHT-1800
Reg. \$1395.00

phase II MINI PORTABLE HARDNESS TESTER

The PHT-3500 can perform tests that easily convert to the most popular hardness scales, including Rockwell, Brinell, Vickers, Shore, etc.

- State of the art digital tester is designed to test the hardness of large metal part. Loaded with useful functions and a built-in mini-printer.
- The PHT-3500 is clearly the industry leader for fast accurate hardness testing with advanced thermal printing capabilities.

Functions:

- Easy to use keypad operation.
- Auto identification of Impact Device
- Large LCD display with back light.
- USB Output.
- Automatic conversions to: Brinell, Rockwell, B&C, Vicker and Shore.
- Automatic mean value as well as Min & Max. values.
- Upper/Lower limit setting w/ alarm.
- Battery indicator.
- Memory capacity (500 groups).

Specifications:

- Measuring range: 200-960 HL.
- Minimum Thickness: <0.5" (Steel)



MODEL No. PHT-3500
Reg \$1895.00
\$1795.00

Specifications:

- Accuracy: +/-0.5% (referred to L=800)
- Repeatability accuracy: +/-4L units L=Leeb
- Materials: steel & cast steel, alloy tool steel, stainless steel, grey cast iron.
- Spheroidal iron, cast aluminum, brass, bronze, wrought copper alloy

phase II ULTRASONIC HARDNESS TESTER

- "Ultrasonic UCI" technology, which enables the hardness testing of very thin and small workpieces, which otherwise could not be tested accurately using a portable device.
- Non-destructive in it's function, these hardness testers allow for the testing of highly sensitive or finished parts that previously could not be tested in an operational setting.
- The no-destructive (ndt) feature of these hardness testers allow the operator accurately test parts without causing physical or structural damage that would normally lead to disposal or refinish of operators part.



Test Device	U1 (UCI)	D1 (Dynamic)
Length	160mm	140mm
Diameter	25mm	25mm
Indentation Depth	30µm	300µm
Pressure Force	14.7N	11Nm
Transducer Test Life (Approx)	1mm	12mm
Min. Radius for Test	5mm	10mm
Mx. Roughness of Surface	Ra 2.5µm	Ra 3.2µm
Max. Archive	100 Tests	100 Tests
Time of Test	4 Sec.	2 Sec.

Standard Accessories

- Base instrument
- 10N (1kgf) hand-held probe
- Dynamic "D" Leeb Impact Device
- Calibrated HRC test blocks
- 2pc. HRC Test Blocks
- USB Output cable
- Custom carry case
- Battery charger
- Operation manual

Scales	Measurement Range
Rockwell C	20-67 HRC
Rockwell B	59-99 HRB
Brinell	75-650 HB
Vickers	75-1000 HV
Leeb	200-900 HL
HRA	2088 HRA
HRN	20-91 HRN
HRT	12-82 HRT
HSD	23-102 HSD

Model	Description	List	Price
MET-U1A	Ultrasonic Hardness Tester for polished finish	\$5,595.00	\$5,095.00
MET-U1A-5	Ultrasonic Hardness Tester for machined finish	5,595.00	5,095.00
MET-1000	Precision Test Stand		395.00

phase II DIGITAL SHORE DUROMETERS

- These testers are crafted and engineered to perform at the highest level of accuracy.
- An ergonomic and attractive design combined with lightweight assists in taking precise hardness measurements.



RS-232 Output

Conforms To ASTM-D2240 ISO 7619 DIN 53505



Specifications:

- Measurement range: 0-100HSA
- Deviation: <1% H
- Repeatability: 20-90HSA <±1H
- Resolution: 0.1H
- Peak value lock in: Yes
- Statistics: Mean, Min, Max, No. of measurements and deviation
- Power supply: 4 x AAA

Model	Description	Price
PHT-950	Digital Shore A Durometer	\$375.00
PHT-975	Digital Shore D Durometer	375.00
PHT-950-25	Shore A master test block kit (7Pc. set)	115.00
PHT-975-25	Shore D master set (3Pcs. in case)	280.00

Monarch INSTRUMENTS LASER TACHOMETER CONTACT/NON-CONTACT

- PLT200 is a 32 function Tachometer/Ratemeter, Totalizer/Counter and timer (stopwatch), which is programmable in both Imperial and Metric rates.
- Two phono plug connectors for our optional Remote Contact Assembly (RCA) or remote sensors.

- The PLT200 also has a TTL compatible pulse output to trigger devices like vibration data collectors or stroboscopes.
- The KIT is supplied complete with a remote Contact Assembly including concave and convex tips and a cm linear speed wheel all in a latching carrying case.



KIT No. PLT-200K

Specifications:

- Display . . . 5 digits, 45 alphanumeric LCD
- Range(s) . . . *Optical: 5 to 200,00 RPM **Contact: 0.5 to 20,00 RPM
- Totalizer . . . 1-999-990 (events or length)
- Accuracy . . . *Optical: ±0.01% of reading **Contact: ±0.05% of reading (RPM)
- Timer 99.59.9 Min, Sec, tenths
- Res.: 0.001 to 10 RPM-range dependent
- Operating distance . . . 2" to 25' (5cm to 7.62m), ±70° from perpendicular
- Memory maximum, minimum & last
- Power: (2) "AA" 1.5 VDC batteries (30 hrs)

Model	Description	Price
6125-010	Pocket Laser Tachometer/Timer/Totalizer with N.I.S.T. traceable certificate of calibration and 12" of reflective tape	\$199.50
6125-011	Pocket laser Tachometer 200 kit includes Tach, RCA carrying case, N.I.S.T & 5' roll of T-5 reflective tape	285.00

phase II ULTRASONIC THICKNESS GAUGE

- This handheld unit has precise touch and read capabilities yet is economically priced.
- The UTG-1500 is designed to measure the thickness of metallic and non-metallic materials such as aluminum, titanium, plastics, ceramics, glass and any other good ultrasonic wave conductor as long as it has parallel top and bottom surfaces.
- The UTG-1500 will accurately display readings in either inch or millimeter after a simple calibration to a known thickness or sound velocity.

MODEL No.
UTG-1500
\$565.00



Complete with
Certificate of
Calibration,
Couplant Gel, AA
Batteries, Operation
Manual and Custom
Carry Case

Specifications:

Display type	3-digit LCD
Resolution	0.001"/0.01mm
Measuring Range	0.04" to 8.0"
Sound velocity range:	3280-32805 ft/s (1000-9999m/s)
Operating temperature	32-122 degrees F
Frequency	5MHz
Update range	4Hz
Memory	N/A
Output	N/A
Printing	N/A
Power supply	AA alkaline batteries (4pc supplied)
Battery life	Approx. 250 hour/set
Power consumption	Working current is less than 3V
Dimensions	4.9" x 2.6" x 0.9" (161 x 69 x 32mm)
Weight	0.7Lbs (300g)

phase II COATING THICKNESS GAUGES

The PHASE II PTG-3500 series of gages can perform two different methods of calculating thickness measurement by utilizing the characteristics of both eddy current and magnetic induction. Testing performance is both non-destructive and extremely accurate.

The PTG-3500 utilizes an integrated probe that can automatically detect a ferrous or non-ferrous substrate and comes with 2 substrate samples (steel, aluminum), 4 calibrated thickness samples, carry case, batteries and operation manual.

The PTG-3500 comes complete with 1 pc external auto-detect ferrous/non-ferrous probe, 2 substrate samples (steel, aluminum), 4 calibrated thickness specimens, carry case, batteries and operation manual.

Model No.
PTG-3550

\$479.95



(Shown)

Model No.
PTG-3500
\$479.95

(Not Shown)

Specifications:

Measuring range:	0-2000mm max. or 0-80mils
Resolution:	0.1mm/0.01 mils (0-99mm) or 1mm (ver 100mm)
Guaranteed tolerance:	
After one-point calibration:	±1-3% or 2mm (whichever is greater)
Display:	4 digits (digit height + 10mm/0.4")
Minimum measuring area:	0.2" x 0.2" (5mm x 5mm)
Minimum radius of curvature:	Convex: 0.12" (3mm) Concave: 1.2" (30mm)

Minimum substrate thickness:

Ferrous	20 mils (0.5mm)
Non-ferrous:	2 mils (50mm)
Calibration:	Zero calibration/Foil calibration
*Max. surface temp. of test object:	302°F (contact time max is 2 sec.)
Power source:	4-AAA batteries
Dimensions:	161 x 69 x 32mm
Weight:	9oz. (260g)

phase II COATING THICKNESS GAGE WITH FLIP DISPLAY

Simplicity in Coating Thickness Measurement

- The coating thickness gauge can perform two different methods of calculating thickness measurement by utilizing the characteristics of both eddy current and magnetic induction.
- This sleek integrated coating thickness gauge is capable of measuring coatings on Fe and NFe metallic substrates and has a push button FLIP screen for easy reading while testing upside down.
- With this state of the art thickness gauge, you can easily detect the thickness of nonmagnetic coating on a magnetic substrate (ferrous) or an insulating coating on a non-magnetic conductive substrate (non-ferrous) utilizing either an integrated probe or our version that comes with 1 auto-detect external probe.
- The PTG-4500 utilizes an integrated probe that can automatically detect a Ferrous or Non-Ferrous substrate and comes with 2 substrate samples (steel aluminum), 2-calibrated thickness samples, carry case, battery and operations.

Measuring Range:
0-1000µm (0-40 mils)

Accuracy:
+/-2 µm +3%H (H=actual value)
+/-0.1mils +3%H (H=actual value)

Display:
3-Digits
Min Measuring Area:
0.2" x 0.2" (5mm x 5mm)
Min Substrate Thickness:
Fe: 20mils(0.5mm)
NFe: 2 mils (50mm)

MODEL No.
PTG-4500

\$475.00

5 Year
Warranty
Lifetime
Tech Support



phase II ULTRASONIC THICKNESS GAGE

With Thru Coating Capabilities

- State of the art, digital tester is capable of reading wall thickness thru coatings and point without affecting the measurement and is packed with the most popular features including basic measurement, Scanning Capabilities, Adjustable Sound Velocity, extended memory and RS 232 output capabilities.
- This dynamic sonic gauge is designed to measure the thickness of metallic and non-metallic materials such as steel, aluminum, titanium, plastics ceramic, glass and any other good ultrasonic wave conductor as long as it has parallel top and bottom surfaces.



MODEL No.
UTG-2600

\$1195.00

w/Certification
of Calibration

Specifications:

Display type:	4-digit LCD w/back light
Min. display range:	0.003 (if>3.93", 0.0003"(if<3.93")
Measuring range:	Standard mode: 0.03-8.0" in steel Thru coating mode: 0.118"-.905" 3.0-23mm w/standard probe
Accuracy:	±1% x H + 0.0007" (H=displayed value)
Sound velocity range:	3280-32805ft/s (1000-9999m/s)
Operating temperature:	32-122°

Frequency:	4MHz
Update range:	4Hz
Memory:	500 test values
Output:	RS 232
Power supply:	3V AA Alkaline batt. (2pc)
Battery life:	Approx. 100 Hours. (w/backlight off)
Power consumption:	Working current is less than 3V
Dimensions:	5.86" x 2.87" x 1.25" (149x 73 32mm)
Weight:	5.6 oz. (160g)



phase II DIGITAL VIBRATION TESTER

The multi-functional vibration meter will measure velocity, acceleration, displacement and RPM. Full frequency ranges are utilized for broad detection abilities.

- Quick accurate analysis for checking balance and alignment of a rotating object.
- Large LCD display.
- RS232 output.
- Inch/Metric conversion with the push of a button.
- Statistics: Mean, Max, Min No. of measurements and Standard deviation.
- Max hold function.
- Regulated output (AC output 2.0V peak full scale).



Frequency range: 10Hz-1KHz
Frequency range: 10Hz-10KHz
Frequency range: 10Hz-1KHz
Frequency range: 10Hz-500KHz

Specifications:

Acceleration:	Peak value: 0.1-200 m/s or 0.3-656 ft/m/s
Velocity (RMS):	RMS: 0.1-400 (mm/s) or 0.004-16.0 inch/s
Displacement:	Peak to Peak 0.001 - 2.0(mm) or 0.04-80mil
RPM (revolution)	5-100,000 r/min
Frequency	0.1-10KHz
Accuracy	<5%
Operating Temperature	0-45°C
Power	4-AAA batteries
Dimensions	161 x 69 x 32mm
Weight	300g

MODEL No.
DVM-1000

\$595.00

Includes
1 Powerful Magnet
1-Accelerator
1-Stinger Probe (cone)
1-Stinger Probe (ball)
1-Operation Manual
Carry Case

phase II DIGITAL VIBRATION TESTER

The multi-functional vibration meter will measure Velocity, Acceleration, Displacement, and RPM. Full frequency ranges are utilized for broad detection abilities.

- Quick accurate analysis for checking balance and alignment of a rotating object.
- Large LCD display
- Statistics: Mean, Max, MIN, No. of Measurements and Std deviation
- Inch/Metric Conversion with the push of a button
- Max Hold Function
- Regulated Output(AC output 2.0v peak full scale

Specifications:

Acceleration Peak Value: 0.1-200m/s
or 0.3-656 ft/m/s
Velocity(RMS) RMS:0.1-400(mm/s)
or 0.004-16.0inch/s
Displacement Peak to Peak 0.001-2.0(mm)
or 0.04-80mil
RPM(revolution) 5-100,00 r/min
Frequency 0.1-10KHz
Accuracy <5%
Operating Temp 0-45°C
Power 4-AAA Batteries
Dimensions 161 x 69 x 32mm
Weight 300g

Frequency Range: 10Hz-1KHz
Frequency Range: 10Hz-10KHz
Frequency Range: 10Hz-1KHz
Frequency Range: 10Hz-500Hz



MODEL No. DVM-1000
Reg. \$595.00

\$569.50

phase II DIGITAL FORCE GAGE

Automatic peak/hold functions tolerance limit functions and average calculations of memorized data, show off some basic abilities. All digital force gauges can read in three resolution modes, lbf, kgf, and newtons. Each force gauge is supplied in kit form containing 5 measuring attachments and plastic carrying case. Force Gauges can be hand-held or mounted to an optional force gauge stand.

- Designed for tension/compression measurements
- Min/Max Setting with Go/No Go Light Feature
- Peak value controls • Heavy-Duty Construction
- Auto weight conversion • Extreme Accuracy to +/- 0.5%
- Versatile range of gages are supplied in complete test kit form containing full set of accessories and carry case.
- Can be hand-held or mounted to optional test stand

Model No.	Capacity	Resolution	Price
DFG-0100	2 N	0.001N	\$475.00
	7.19 oz.	0.001 oz.	
	203.94 g	0.0001 kg	
DFG-0200	5 N	0.001N	475.00
	17.99 oz.	0.001 oz.	
	509.85 g	0.0001 kg	
DFG-0300	10 N	0.005N	475.00
	2.25 lb.	0.0005 lb.	
	1 oz.	0.005 oz.	
DFG-0400	50 N	0.01N	475.00
	11.24 lb.	0.001 lb.	
	5.10 kg	0.001 kg	
DFG-0500	100 N	0.05N	475.00
	22.48 lb.	0.005 lb.	
	10.19 kg	0.005 kg	
DFG-0600	500 N	0.1N	475.00
	112.40 lb.	0.01 lb.	
	50.99 kg	0.01 kg	
DFG-0700	1000 N	0.5N	475.00
	224.80 lb.	0.05 lb.	
	101.97 kg	0.005 kg	



phase II GEAR TEETH HARDNESS TESTER

- This dedicated unit is designed to test gear teeth and other difficult to access applications.
- The 1840 is loaded with the same features found on the base 1800 version which includes memory, USB output and software for downloading to your PC.
- The 1840 hardness tester is capable of measuring the surface hardness of a broad variety of metals on flat and round surfaces.
- This instrument comes complete with a dedicated DL impact device, calibrated test block and rugged carry case.

Designed to test large hard parts:
Example: tool steel should be close to
1" thick of solid material



MODEL No. PHT-1840
Reg. \$2095.00

\$1995.00

phase II GEAR TEETH HARDNESS TESTER

- This dedicated unit is designed to test gear teeth and other difficult to access applications.
- The 1740 is an economically priced hardness tester that is loaded with the same features found on the base 1700 version.
- The 1740 hardness tester is capable of measuring the surface hardness of a broad variety of metals on flat and round surfaces.
- This instrument comes complete with a dedicated DL impact device, calibrated test block and rugged carry case.

Designed to test large hard parts:
Example: tool steel should be close to
1" thick of solid material



MODEL No. PHT-1740
Reg. \$1895.00

\$1795.00

phase II NEW DIGITAL DUROMETERS

Shore A scale is for testing the following materials:

Rubber: Soft vulcanized (ie tyre), natural nitrile

Elastomeric materials (rubber & rubber like): GR-S, GR-1, neopene, thiokol, flexible polyacrylic esters neoprene, thiokol, flexible polyacrylic esters.

Other: Wax, felt, leather etc. (materials that normally yield under fingernail pressure, such as the heel on your shoe).

"A" Scale
MODEL No. PHT-960
Reg. \$199.00

\$189.95



Specifications:

- Auto Hold feature
- Accurate and repetitive deviation = 20-90HSA
- HSA < +/- 1 grade
- Uses 1-SR44 Button Cell Battery
- Custom rugged carry case

Shore D scale is for testing the following materials:

Rubber: Hard
Plastics: Harder grades such as rigid thermoplastics, plexiglass, thermoploystrene, vinyl, sheet, cellulose acetate, thermosetting Laminates (ie fornica)

Other: Paper filled calendar rolls, calendar bowls, etc. (materials that would not normally indent under fingernail pressure, such as a pocket comb or bowling ball).

"D" Scale
MODEL No. PHT-980
Reg. \$199.00

\$189.95



phase II FORCE GAUGES With Direct Scale Readout

- The Phase II force gauges include a direct dual scale reading in both lbf and kgf, eliminating the need for two separate gauges in the shop. Force gauges can be hand-held or mounted to an optional force gauge test stand
- All force gauges come as a complete kit, containing 5 measuring attachments and plastic carrying case. Numerous models are available to cover a complete range of force capacities.



Model	Capacity	Resolution	Price
AFG-100	1 lb./0.90kg	0.01	\$195.00
AFG-200	5 lb./2.26kg	0.025	195.00
AFG-300	10 lb./4.53kg	0.05	195.00
AFG-400	20 lb./9.07kg	0.1	195.00
AFG-500	50 lb./22.67kg	0.25	195.00
AFG-600	100 lb./45.36kg	0.5	195.00
AFG-700	Optional Stand		\$190.00
9.25"L x 5.98"W x 15.75"H			

GENERAL**MOISTURE METER**

- Detects moisture in soft construction materials such as gypsum or plaster and wood.
- Illuminated LCD with bar graph display.
- Measured value can be read quickly from the large clear dual scale.
- Protective cap with self-test function.
- Auto power off.
- Low battery display.
- Range/Accuracy: Wood: 0-44%/±2% other materials: 32° to 104°F (0° to 40°C) RH: <85%.

MODEL No.
MM80G
Reg. \$69.96

\$59.95

Includes:
9V Battery &
Instruction Manual

GENERAL**ALL-IN-ONE DELUXE MOISTURE METER WITH PIN TYPE AND NON-INVASIVE ROLLER PROBES**

- Digital LCD display with luminescent back-light.
- Stores up to 99 readings, Max/Min average values recalled.
- Interchangeable extension probes.
- Measuring range: 5.5 to 99.9% H2O% WME.
- Resolution: 0.1%
- Accuracy: (at 25°C) ±1% Wood Scale.
- Display: Digital dual LCD display, with multi-function indicator.
- Sampling Rate: 0.3 seconds.
- Wood Group Scales: Select from 8 wood species groups.
- Data Memory: 99 readings.
- Signal Output: Analog DC0-1V (10mV/1%), load >500V.
- Calibration: Built-in calibration adjustment.

MODEL No.
MM7022
Reg. \$499.95

\$425.00

With Pin and Roller Probes

**GENERAL****HIGH ACCURACY TEMPERATURE HUMIDITY & IAQ MONITOR WITH OUTPUT RELAY**

- IAQ monitoring and ventilation
- Digital wall mountable / desktop type.
- Visible and audible CO2 warning alarm.
- NDIR (Non-Dispersive Infrared) Waveguide Technology with ABC (Automatic Background Calibration)
- TWA (8 Hour Weighted Average).
- STEL (15 Minute Weighted Average).
- Alarm output for ventilation control.
- PC connect via RS232 interface.
- Triple display of CO2 level, temperature and humidity.

- CO2 range: 0-5000ppm
- CO2 accuracy: ±30 ppm or ±5% reading.
- Temp. accuracy: 14° to 140°F (-10° to 60°C).
- Temp. accuracy: ±0.9°F / ±0.6°C.
- RH range: 0% to 85%.
- RH accuracy: ±3% (10 to 90%) ±5% (others).
- Dew point temp.: -100° to 140°F (-73.4° to 60°C).
- Wet bulb temp.: 8° to 140°F (-13.3° to 60°C).

Model No.
CDM77232
List \$399.95

\$349.50

**GENERAL****BRIGHT RED JUMBO DISPLAY DATA LOGGING LED TEMPERATURE/HUMIDITY**

- Complete environmental monitor and alarm.
- Wall-mounted, LED type easy reading.
- Alarm set for Hi and low limit-Temperature and Humidity.
- Data logging capacity 30,000 records.
- LED displays real time data.
- USB interface.

- Temperature Range: -4° to 140°F (-20° to 60°C).
- Temp. accuracy: ±1.8°F (1.0°C), 23° to 104°F / -5.0° to 40.0°C; ±3.6°F (2.0°C) (other).
- Temp. resolution: 0.1°F (0.1°C).
- Temp. update rate: times/second.
- Temp. sensor type: Diode.
- RH range: 5% to 95%.
- RH accuracy: ±2.0%RH (at 25°C, 35% to 80%RH. ±2.5% (at 25°C, 10% to 35%RH, 80% to 90%RH) other ±5.0%RH (at 25°C), <10%RH, >90%RH).
- Relative humidity resolution: 0.1RH.
- Relative humidity response time: below 4 seconds.
- LED display: 8.4"(W) x 4.73"(H) (214 x 120mm).
- Power supply: AC to DC adapter (9V/1A).
- Battery backup: 1 "9V" battery enables continued measuring during power disruptions.
- Size: 10.2"(L) x 7"(W) x 1.9"(D).
- Weight: 35.3oz (1000g).



Model No.
LRTH185DL
List \$899.00

\$795.00

GENERAL**HIGH ACCURACY DATA LOGGING THERMO-HYGROMETER**

1% RH Accuracy and Large Red LED Display Makes it Ideal For Process Control, Labs and Other Critical Areas

- Dual LCD Display.
- Displays both temperature and RH.
- Measures both °F/°C.
- Real time data.
- Data hold function.
- Data hold function.
- Alarm function
- Dew-Point and Wet-Bulb temp.
- USB PC interface.

Model No.
DTH18DL
List \$1299.00

\$1175.00

Includes:

- Instruction manual
- 1 "9V" battery
- Mini USB 4P (Male) to USB A type cable
- CD software.

**SPECIFICATIONS:**

- Temperature -4° to 140°F (-20° to 60°C) ±1.8°F (0.5°C) (32° to 104°F / 0° to 40°C) ±3.6°F (2°C) (other).
- Humidity: 5 to 95%, 1% RH (15 to 80%RH) 2.5% (other)
- Temperature sensor: Diode.
- Humidity sensor: Capacitor sensor.
- Sampling: 1 times/second
- Power source: 1 "9V" battery or AC to DC adapter (9V/300mA).
- Resolution: 0.1% RH 0.1°F, 0.1°C.
- Size: 5.1" (L) x 2.2" (W) x 1.5" (D) (130 x 56 38mm).
- Weight: 8.8oz (250g).

phase II ULTRASONIC THICKNESS GAGE

- State of the art, digital ultrasonic thickness gage is packed with features typically found on high end models only. This multi-functional ultrasonic thickness gage offers everything from basic measurement, Scanning Capabilities, Adjustable Sound Velocity, extended memory and USB output capabilities.
- This dynamic ultrasonic thickness gage is designed to measure the thickness of metallic and non-metallic materials such as steel, aluminum, titanium, plastics, ceramics, glass and any other good ultrasonic wave conductor as long as it has parallel top and bottom surfaces.
- The UTG-2800 ultrasonic thickness gage will accurately display readings in either inch or millimeter after a simple calibration to a known thickness or sound velocity.

MODEL No.
UTG-2800
\$750.00

Complete with
Certificate of Calibration,
Operation Manual and
Carry Case

Specifications:

Display Type
Minimum Display Unit
Measuring Range
Accuracy
Sound Velocity Range
Upper/Lower Limit Preset Alarm
Operating Temperature
Frequency
Update Range
Memory
Output
Mini-Printer
Power Supply
Battery Life
Power Consumption
Dimensions
Weight

4-digit LCD w/Back Light
0.001"/0.01 mm (selectable)
0.02-12.0" in steel w/standard probe
+/- (0.5% thickness + .001")
3280-32805 ft/s (1000-9999m/s)
Yes
32-122 degrees F
5MHz
4Hz
20 Groups (100 files/group)
USB
Optional
3v AA alkaline batteries (2pc)
Approx. 100 hours (w/backlight off)
Working current is less than 3v
5.90" x 2.91" x 1.30" (150 x 74 x 33mm)
8.6oz. (245g)



CHECKLINE® DIGITAL TACHOMETER

Contact ~ Non-Contact Measuring

- Measure speeds from as low as 1.00 RPM up to 99,999 RPM.
- Non-Contact or Contact operation for RPM, Surface Speed & Length.
- Accuracy of 0.02% with a resolution of 0.01 RPM.
- Easily converts from non-contact to contact operation with a rugged slide-in adapter.
- Non-contact sensing from up to 14" with visible red light source.
- User selected units of measure
 - * Rotational speed:
 - * Surface speed: Feet per minute, meters per minute, inches per minute.
 - * Length: Feet, meters, inches.
 - Built-in memory stores maximum, minimum and last reading for recall to the display.
 - Uses only two AA batteries (included)



Contact RPM

Linear Speed & Length

Non-Contact RPM

5 Year WARRANTY

On-Target Indicator

Contact Indicator

Units of Measure

Memory Indicators

Kit includes the Tachometer, slide-in contact adapter, 6" Universal surface speed wheel, Cone tip adapter, Reflective tape, 2 AA batteries, Operating Instruction manual, Accuracy Certificate, In a foam-fitted, hard plastic Carrying case.

KIT No. CDT-2000HD
\$279.95

CHECKLINE STROBOSCOPE

- Internal NiMH battery provides one hour of continuous operation, regardless of flash rate.
- Bright (800 Lux) flash intensity with life of 100 million flashes.
- Resolution of ± 1 RPM over the entire range with highly accurate speed control & drift-free operation.
- Accepts input from sensor for external flash triggering.
- Fits in pocket or can be worn on optional belt holster small and light for portable, one-hand use.
- CE-certified. • **Free NIST certification.**



KIT No. PK-200

\$589.95



Flash range 30-12,500 FPM
Flash brightness 800 Lux
Accuracy $\pm 0.01\%$ over entire range
Resolution \pm FPM over entire range
Display 5-digit LCD
Display update 0.5 seconds
Flash energy 150 mj maximum
Flash tube longevity ... 100 million flashes

Kit Includes:
Stoboscope, battery charger, external triggering jack, NIST-traceable calibration certificate and instruction manual, all supplied in a hard shell carrying

Supco INSULATION TESTER ELECTRONIC MEGOHMMETER

This reliable, battery-operated instrument features LED indicators and will accurately measure insulation values up to 1000 megohms at 500 VAC and also indicate the condition of insulation on the zone scale.

- Avoid Motor Burn-Out**
- Test and measure the resistance of the motor winding insulation.
 - Diagnose heat-damaged and deteriorating insulation.
 - Hand held and economical.
 - Full range scale up to 1000 Megohms.
 - Zone scale to indicate condition of insulation.
 - Battery operated.
 - Impact resistant.
 - Operating manual furnished.
 - Vinyl carrying case furnished.

MODEL M500

\$149.95

With Zippered Case



EXTECH INSTRUMENTS

POCKETTACH™ MINI TACHOMETERS

Contact

- Noncontact**
- Integral light beam with a measurement range of up to 6" (300mm).
 - Large easy-to-read LCD display.
 - Hold button freezes displayed readings.
 - Ergonomically designed and pocket sized housing with protective finger guard.
 - Complete with 9V battery and reflective tape.
- Contact**
- Surface wheel measures linear surface speed in ft/min, and yd/min.
 - Contact wheel measures RPM & linear speed.
 - Large easy-to-read display.
 - Hold button freezes displayed readings.
 - Ergonomically designed and pocket sized housing with protective finger guard.
 - Complete with 9V battery and wheels for surface speed and RPM.



Specifications:

RPM 10,000 to 99,999
RPM resolution 0.001 RPM
Accuracy $\pm 0.1\%$

Model	Type	Price
461700	Non Contact	\$145.00
461750	Contact	145.00
461936	Spare 23" roll reflective tape (10 Pack)	42.00

Specifications:

RPM 10 to 20,000
Ft/min 3 to 6560
M/min 1 to 1999.9
Yd/min 1 to 5,000
RPM resolution 0.001 RPM
Accuracy $\pm 1.55\%$



Monarch VIBRATION METER And TRENDING SOFTWARE

- Examiner 1000 overall vibration meter and electronic stethoscope is the ideal tool for cost-effective predictive maintenance.
- This meter is simple to operate with only one button and volume adjustment.
- Troubleshoot bearing and lubrication with the digital LCD and stethoscope features to enhance machinery reliability.
- Compare your vibration results by using the ISO 10816 severity chart right on the meter. N.I.S.T. traceable calibration is available.

OnTime Trending Software is a simple-to-use, graphical program designed for condition-based maintenance through the routine trending of vibration and process information. Trending is the best method to judge the dynamic operating conditions of your machinery. OnTime helps you to manage all key machinery operating conditions.

Trend:

- Overall vibration readings
- Temperature
- Speed
- Process measurements of any type.

Examiner Kit With Software



Examiner 1000

Model	Description	Price
6400-010	Examiner 1000 System Overall vibration Meter, electronic stethoscope and OnTime GP Software. Includes: vibration meter, batteries, accelerometer integrated cable, mag. base, stinger probe, stereoheadphones, field carrying case, owners manual & machinery data worksheet	\$1750.00
6400-011	Examiner 1000 Same as 6400-010 except without OnTime software	1150.00

GENERAL**INFRARED THERMOMETER**

- Rugged and ergonomic design for general purposes.
- Ultra low power consumption in shutdown mode.
- Extended long time measuring reliability.
- Switch On/Off laser sighting.
- Backlit LCD display.
- °F or °C selectable.



**8:1
Spot Ratio
MODEL No.
IRT-206**
\$49.95

Specifications:

Distance to spot ratio: 8:1
Range: -4° to 604°F (0° to 320°C)
Emissivity: Fixed at 0.95
Resolution: 0.5°F / 0.5°C
Operating temperature:
32° to 122°F, 10 to 90%RH
Includes: 1" "9V" battery

GENERAL**HIGH-PERFORMANCE ULTRA WIDE INFRARED THERMOMETER**

**30:1
Spot Ratio
MODEL No.
IRT-670**
\$239.95

- Switchable On/Off laser sighting.
- °F/°C switchable.
- High/Low audible alarm.
- Backlit LCD display.
- Min/Max/Avg.
- Auto measuring.
- Extended, long time measuring reliability.
- 10 point memory.
- Temperature data storage.
- Low battery indication.
- Ultra-low power consumption in shutdown mode.
- Electronic trigger lock.
- Ergonomic design.

Specifications:

Distance to spot ratio: 30:1
Range: -25° to 1400°F (-32° to 760°C)
Emissivity: Adjustable 0.1 to 1.0
Accuracy (@ ambient temperature of 77°F/25°C): ±5°F (±3°C) within -25.6° to -4°F (-32° to -20°C)
+3°F (±2°C) within -4° to 212°F (-20° to 100°C)
±2% within 212° to 1400°F (100° to 760°C)

GENERAL**INFRARED THERMOMETER W/K-PORT AND AUTO ADJ. EMISSIVITY**

- Switchable On/Off laser sighting.
- °F/°C switchable.
- High LCD display.
- Backlit LCD display.
- Max/Min/Avg
- Auto measuring.
- Low battery indication.
- Extended, long time measuring reliability.
- Ultra-low power consumption in shutdown mode.
- Electronic trigger lock.
- Ergonomic design
- CIS: Temperature sensitivity color LCD display alert.
- E-smart: Automatic emissivity adjustment for accurate measurement.



**12:1
Spot Ratio
MODEL No.
IRT-642**
\$119.95

Specifications:

Distance to spot ratio: 12:1
Range: -25° to 999°F (32° to 535°C)
Emissivity: Adjustable 0.1 to 1.0
Accuracy (@ ambient temperature of 77°F/25°C): ±5°F (-3°C) within -25° to -4°F (-32° to -20°C)
+3°F (±2°C) within -4° to 212°F (-20° to 100°C)
±2% within 212° to 999°F (100° to 535°C)

GENERAL**THERMOSEEKER™****8:1 Energy Audit IR Thermometer/Scanner with Star Burst Laser Targeting**

- The device allows its user to automatically acquire a reference temperature and determine, with its tri-colored light system and audible alarm, whether subsequent readings are above or below the set-point value.
- With its STAR BURST laser targeting system, the IRTC50 enables the user to approximate the size of the measured spot, resulting in a quick and accurate temperature measurement without the uncertainty of a traditional IR thermometer.



**MODEL No.
IRT-C50**
\$54.95

GENERAL**HEATSEEKER™****Standard Unit Provides High Temperature Readings at a Low Cost**

- With its durable, ergonomic grip and backlit LCD display, the IRT207 is suitable for any application.
- The IRT207 measures temperatures from -4°F to 604°F (-20° to 317°C), with an accuracy of +/-2% and an 8:1 distance to spot ratio.
- Other features include switchable on/off laser targeting and ultra-low battery consumption in shutdown mode.



**MODEL No.
IRT207**
\$37.95

GENERAL**12:1 WIDE RANGE INFRARED THERMOMETER WITH STAR BURST LASER TARGETING****Perfect for HVAC, Automotive and Industrial Use**

- Backlit LCD display, over-range indication, auto measuring capability, and temperature data storage.
- The IRT 657 measures temperatures from -40-degrees to 1076-degrees F (-40-degrees to 580-degrees C) with an accuracy of +/- 2-percent and a 12:1 spot ratio.
- Also included are a soft carrying pouch and a certificate of traceable calibration.
- Its Star Burst laser targeting system enables the user to approximate the size of the measured spot, resulting in a quick and accurate temperature measurement.



**MODEL No.
IRT657**
\$54.95

GENERAL**PIN/PINLESS DEEP SENSING MOISTURE METER WITH SPHERICAL SENSOR & REMOTE PROBE**
Distinct advantages over other moisture meters on the market

- Two different modes (pin mode uses replaceable pins at the end of a 46 in. cable; pinless mode uses an integral spherical sensor) enable users to measure moisture in corners, hard-to-reach areas, narrow spaces and uneven surfaces.
- The spherical sensor measures the average moisture level up to a depth of 4 in., and its small contact area provides superb repeatability.
- The auto-calibrating meter works in any position, can accommodate a wide viewing angle and, with its strong RF sensor, can detect moisture where other meters fail (e.g., masonry).



**MODEL No.
MMD950**
\$179.95

GENERAL**PINLESS LCD MOISTURE METER****Non-invasive unit for analyzing wood and other construction materials**

- Enables moisture measurement of a variety of materials without having to pierce the material's surface.
- The unit has a range of 0.0 to 99.9% WME for wood, and 0.0 to 56.5% WME for building materials, and measures up to a depth of 3/4in.
- It sports a Jumbo LCD display with intuitive on-screen icons for low/medium/high moisture content, and wood/concrete mode.



**MODEL No.
MMD5NP**
\$82.95

GENERAL**4-IN-1 PIN/PAD RH MOISTURE METER****Versatile unit features two modes of measurement as well as ambient temperature and humidity**

- This unit features both pin-type and flat surface (dual pad) sensors.
- It features two displays; one for moisture content and one for ambient temperature and humidity.
- The MMD800 provides a moisture level range of 5-percent to 50-percent in wood and 1.5-percent to 33-percent in building materials, and offers an audible indication of moisture level and storage of moisture level readings.



**MODEL No.
MMH800**
\$89.95

ACU-RITE DIGITAL READOUT MILL PACKAGES . . . Lathe & Grinder Packages Also Available, Inquire

ACU-RITE is a world-leading manufacturer of readout systems and precision linear encoders. ACU-RITE is committed to continuous improvement and has consistently met or exceeded the industry standard for accuracy. All ACU-RITE readout and encoder products are covered by a 3 year hassle-free warranty. All ACU-RITE products are manufactured in the USA and designed to meet UL/CSA/CE specifications. Mounting hardware included.



200S Features:

- Downloadable software upgrades.
- Feed rate display.
- Bolt hole routines with graphics.
- Approaching near-zero warning.
- Tool offsets.
- Sealed 3D rubber keypad.
- Data preset.
- Center find.
- Battery backup.
- Self diagnostics
- Metal die-cast chassis.
- 5.7" monochrome LCD.
- Error compensation.
- Absolute/Incremental.
- Inch/Metric conversion.
- Position-Trac™ Automatic zero recall.

300S Standard Features:

- Full color 5.7" LCD.
- 2, 3, or 4 axes.
- Fully programmable.
- All 200S features.

Available in 2, 3, 4, Axes!

200S/300S 2-AXIS LCD MILL PACKAGES

Includes:

- 2-axis 200S/300S LCD readout.
- Readout mounting arm.
- (2) 5µm (.0002") SENC 150 precision linear encoders with 13 foot armor cable.
- X and Y axis linear encoder universal bracket kit.



Table Size	Description & Travel	200S		300S	
		Model	Price	Model	Price
9" x 36"	12" x 24" Milling Package	21212-24	\$1695.00	21312-24	\$1995.00
9" x 42"	13" x 32" Milling Package	21213-32	1695.00	21313-32	1995.00
9" x 49"	13" x 35" Milling Package	21213-35	1695.00	21313-35	1995.00
10" x 42"	16" x 32" Milling Package	21216-32	1695.00	21316-32	1995.00
10" x 50"	16" x 35" Milling Package	21216-35	\$1695.00	21316-35	\$1995.00
10" x 54"	16" x 36" Milling Package	21216-36	1695.00	21316-36	1995.00



Model 300S Shown

200S/300S 3-AXIS LCD MILL PACKAGES

Includes:

- 3-axis 200S/300S LCD readout.
- Readout mounting arm.
- (3) 5µm (.0002") SENC 150 precision linear encoders with 13 foot armor cable.
- X and Y, Z or W axis linear encoder universal bracket kit.



Table Size	Description & Travel	200S		300S	
		Model	Price	Model	Price
With Quill Scale (Z) Axis (Specify Travel) 4", 6", 14", 16", & 18"					
8" x 36"	12" x 24" Milling Package	3121224Q	\$2225.00	3131224Q	\$2550.00
9" x 42"	13" x 32" Milling Package	3121332Q	2225.00	3131332Q	2550.00
9" x 49"	13" x 35" Milling Package	3121335Q	2275.00	3131335Q	2595.00
10" x 50"	16" x 35" Milling Package	3121635Q	2285.00	3131635Q	2595.00
10" x 54"	16" x 36" Milling Package	3121636Q	2285.00	3131636Q	2595.00
With Knee Scale (Y) Axis (Specify Travel) 4", 6", 14", 16", & 18"					
8" x 36"	12" x 24" Milling Package	3121224K	\$2275.00	3131224K	\$2595.00
9" x 42"	13" x 32" Milling Package	3121332K	2275.00	3131332K	2595.00
9" x 49"	13" x 35" Milling Package	3121335K	2325.00	3131335K	2650.00
10" x 50"	16" x 35" Milling Package	3121635K	2350.00	3131635K	2650.00
10" x 54"	16" x 36" Milling Package	3121636K	2350.00	3131636K	2675.00



Model 200S Shown

Note: All linear encoder travels listed above are actual travels. Please confirm machine axis travels before ordering. Additional bracket kits are available for special order. Call for details.

ACU-RITE VUE READOUT MILL PACKAGE SYSTEMS

Standard Features:

- Absolute/Incremental.
- Error Compensation.
- Bolt hole routines.
- Inch/Metric conversion.
- Multiple Display Resolution.
- Sealed 3D membrane keypad.
- Data Preset.
- Self diagnostics.
- Metal die-cast chassis.
- Mounting hardware included.

VUE 2-AXIS, 3-AXIS LCD MILL/DRILL AND MILLING PACKAGES

Includes:

- 2-axis or 3-axis VUE readout.
- Readout mounting arm.
- (2) 5µm (.0002") ENC 125 precision linear encoders with 13 foot braided cable.
- X and Y axis front mount linear encoder universal bracket kit. (included in system price)
- Z-axis is included for 3-axis package



Table Size	Description & Travel	Model	Price
-	VUE 8" x 18" Mill/Drill Packages	21V-0818	\$1295.00
9" x 32"	VUE 10" x 20" Mill/Drill Packages	21V-1020	1295.00
9" x 42"	VUE 13" x 32" Milling Packages	21V-1332	1395.00
9" x 49"	VUE 13" x 35" Milling Packages	21V-1336	1395.00
10" x 50"	VUE 16" x 35" Milling Packages	21V-1635	1395.00
10" x 54"	VUE 16" x 36" Milling Packages	21V-1636	1395.00
* With Quill or Knee Scale Mill Packages (Specify Travel) 4", 6", 14", 16" & 18"			
9" x 42"	VUE 13" x 32" x * Milling Packages	31V-1332	\$1895.00
9" x 49"	VUE 13" x 35" x * Milling Packages	31V-1335	1895.00
16" x 50"	VUE 16" x 35" x * Milling Packages	31V-1635	1895.00
16" x 54"	VUE 16" x 36" x * Milling Packages	31V-1636	1895.00

Note: All linear encoder travels listed above are actual travels. Please confirm machine axis travels before ordering. Additional bracket kits are available for special order. Call for details.

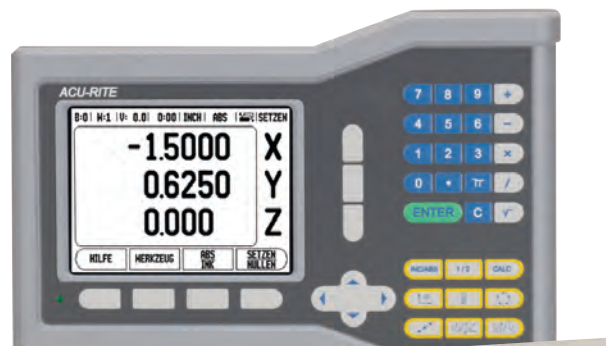

UNIQUINO DIGITAL READOUT MILLING AND LATHE PACKAGES

2-Axis and 3-Axis DRO's

- Zero setting.
- Half calculating, locating workpiece center.
- Inch/metric conversion and INC/ABS conversion.
- Diameter/radius selection. Simple & smooth "R" function.
- Divide/ht perimeter of circle # (Bolt Circle Drilling).
- Hole drilling along an oblique line.
- Save 200 Work piece zero points.
- Angular surface processing.
- Progressive processing of rectangular inner chamber.
- To reach objective values stop.
- Cone measure.
- Number percolate.
- Takes 16 bits & 32 bits CPU technology.
- 200 cutlery memory.
- One year warranty on parts.
- Power failure memory.
- KA-300 series small size encoder.

- All mounting hardware.
- 2-Axis OR 3-Axis Digital Readout (DRO) counter.
- Linear Glass Scales.
- Mounting arm for DRO
- Operating Manual

2-Axis
Milling Package
Reg. \$895.00

\$549.95



2-Axis X&Y Milling Package			
Model	Machine Travel	Table Size	Price
UNI-913	8" x 18"	Mill/Drill	\$549.95
UNI-917	10" x 20"	Mill/Drill	549.95
UNI-932	8" x 24"	9" x 32"	549.95
UNI-936	12" x 24"	9" x 36"	549.95
UNI-942	12" x 32"	9" x 42"	549.95
UNI-949	12" x 36"	9" x 49"	549.95
UNI-142	16" x 32"	10" x 42"	549.95
UNI-154	16" x 38"	10" x 54"	549.95

3-Axis On Knee, X, Y, Z Milling Package			
Model	Machine Travel	Table Size	Price
UNI-374	8" x 24" 18"	9" x 32"	\$750.00
UNI-375	10" x 24" x 14"	8" x 36"	750.00
UNI-376	12" x 34" x 16"	9" x 42"	750.00
UNI-377	12" x 34" x 16"	9" x 49"	750.00
UNI-378	16" x 36" x 18"	10" x 54"	750.00

3-Axis On Quill X, Y, Z Milling Package			
Model	Machine Travel	Table Size	Price
UNI-974	8" x 24" x 6"	9" x 32"	\$795.00
UNI-970	10" x 24" x 6"	9" x 36"	795.00
UNI-971	13" x 32" x 6"	9" x 42"	795.00
UNI-972	14" x 30" x 6"	9" x 49"	795.00
UNI-973	16" x 40" x 6"	10" x 54"	795.00

2-Axis X, Y Lathe Package					
Model	Travel	Price	Model	Travel	Price
UNI-636	6" x 36"	\$595.00	UNI-108	10" x 80"	\$1340.00
UNI-660	6" x 60"	795.00	UNI-101	10" x 100"	1725.00
UNI-830	8" x 30"	595.00	UNI-923	12" x 60"	795.00
UNI-836	8" x 36"	595.00	UNI-127	12" x 72"	925.00
UNI-920	8" x 40"	595.00	UNI-128	12" x 80"	1340.00
UNI-860	8" x 60"	795.00	UNI-121	12" x 100"	1725.00
UNI-880	8" x 80"	1340.00	UNI-122	12" x 118"	1995.00
UNI-872	8" x 72"	925.00	UNI-141	14" x 100"	1725.00
UNI-921	10" x 40"	595.00	UNI-161	16" x 118"	1995.00
UNI-922	10" x 60"	795.00	UNI-201	20" x 118"	1995.00
UNI-107	10" x 72"	925.00			

Many Other Sizes Available (Inquire)

NEWALL DIGITAL READOUT DP700 PACKAGES FOR MILLS, LATHES AND GEOMETRIC FUNCTIONS

- Metal die-cast case.
- Cap-sense keypad.
- 5.7" QVGA blue STN with CCFL backlight.
- 2, 3 or 4 axes with optional rotary axis.
- Half function
- Absolute/incremental readings.
- Switchable resolutions.
- Home reference.
- Feed rate display.
- Multiple program storage.
- Data preset/reset.
- Tool path graphics in real time.
- Probe co-ordinate readings.
- Programmable memory with graphical presentation.
- Insert/delete sub data.
- Teach mode with graphics.
- Zero approach warning.
- Sleep/data hold.
- Navigation keys.
- Zoom.
- Intuitive help
- Job timer.
- Touch probe option.
- Calculator with trig functions.
- Tap drill library.
- Linear error compensation.
- Segmented error compensation.
- Vibration keystroke entry.
- USB-B program storage.



Syherosyn Encoder Features:

- IP67 rating (fully submersible), completely sealed.
- Withstands dust, dirt, oil and other environmental conditions.
- No mechanical wear characteristics.
- Requires no cleaning or maintenance.
- No more broken or scratched glass.
- Vibration and shock resistant.

Resolution:
0.0005"/0.0002"
0.01mm/0.0005mm



IP-67
Rating



DP700 Features Include:

- Feed Rate Display
- Bolt Hole Circle Routine
- Line Hole Routine
- Arc Contouring • Taper Calculations
- Programmable Memory/Teach
- Polar Coordinates • Tool Offsets
- Axis Vectoring/Summing
- Linear and Segmented Error Comp.
- RS232 Output • Undo
- Languages: English, French, German, Spanish, Italian, Turkish, Czech, Russian, Portuguese, Danish

CMM Inspection:

- O.D. calculations with center find.
- I.D. calculations with center find.
- Skew. • Step. • Length
- Datum find • Incline
- Angle

Milling Machine Packages

Model	Axis	Axis Travel	List	Price
DP702-1	2 Axis	12" x 24"	\$1681.00	\$1350.00
DP703-2	3 Axis w/Quill	12" x 24" x 6"	2290.00	1850.00
DP703-3	2 Axis	12" x 30"	1681.00	1350.00
DP703-4	3 Axis w/Quill	12" x 30" x 6"	2290.00	1850.00
DP703-5	2 Axis	12" x 36"	1681.00	1350.00
DP703-6	3 Axis w/Quill	12" x 36" x 6"	2290.00	1850.00
DP703-7	2 Axis	16" x 30"	1681.00	1350.00
DP703-8	3 Axis w/Quill	16" x 30" x 6"	2290.00	1850.00
DP703-9	2 Axis	16" x 36"	1681.00	1350.00
DP703-10	3 Axis w/Quill	16" x 36" x 6"	2290.00	1850.00
DP703-11	2 Axis	16" x 40"	1681.00	1350.00
DP703-12	3 Axis w/Quill	16" x 40" x 6"	2290.00	1850.00

Lathe Packages

Model	Axis	Axis Travel	List	Price
DP708	8" x 40"	Travel 2 Axis	\$2234.00	\$1895.00
DP710	10" x 40"	Travel 2 Axis	2234.00	1895.00
DP716	12" x 60"	Travel 2 Axis	2649.00	2295.00
DP712	12" x 80"	Travel 2 Axis	3223.00	2750.00

Many Other Sizes Available up to 520" (Inquire)

Precise DIGITAL READOUT SCALES

- It can be mounted on almost any surface.
- With SPC output.
- Resolution .0005"/0.01mm.
- Accuracy: ±.001/±0.03mm.
- LCD unit displays "E-05" for movement error.
- It offers the user precise linear measurement capabilities.
- One SR44 1.5V battery is supplied.
- Note: sliding unit can be moved as fast as 40" per second.

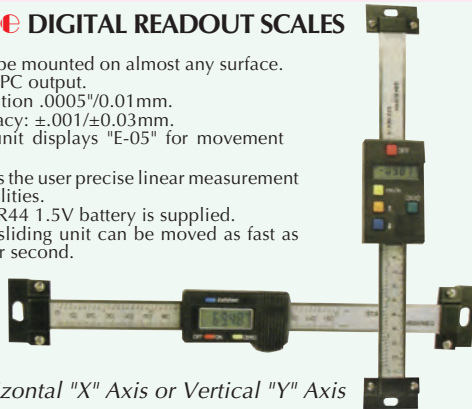

Horizontal "X" Axis or Vertical "Y" Axis

Model No.	Range	Price Each	Model No.	Range	Price Each
303-933	6"/150mm	\$ 44.95	303-934	6"/150mm	\$ 54.95
303-935	8"/200mm	56.95	303-936	8"/150mm	75.00
303-937	12"/300mm	79.95	303-938	12"/150mm	95.00
303-939	18"/450mm	125.00	303-9310	18"/150mm	145.00
303-931	24"/600mm	175.00	303-932	24"/150mm	185.00
303-941	32"/800mm	255.00	303-940	32"/150mm	255.00
303-9317	40"/1000mm	335.00	303-9313	40"/150mm	335.00

Mitutoyo ABSOLUTE COOLANT PROOF DIGIMATIC SCALE UNITS



- Newly employed detection method (electromagnetic induction method) enables use in adverse environments with water and cutting oil.
- Specially designed output cables are developed to maintain the water resistant structure.
- No over speed error since it employs absolute scale which reads the absolute value.
- Once an absolute zero (origin) point is set, the Digimatic Scale Unit shows its absolute distance from the point whenever turned on rather than 0.00".

IP 66



Model	Range	Resolution	List	Sale
572-613	0-4"/0-100mm	.005"/0.01mm	\$284.90	\$245.00
572-614	0-6"/0-150mm	.005"/0.01mm	309.00	275.00
572-615	0-8"/0-200mm	.005"/0.01mm	416.00	360.00
05CZA624	40"/1mm SPC Connecting Cable			\$ 84.00
05CZA625	80"/1mm SPC Connecting Cable			86.00

SONY DIGITAL READOUT PACKAGES

By combining both Mill and Lathe features, the LH70 offers flexibility for multiple applications in a single DRO display

DRO Features:

- Function-specific keys for ease of use.
- Simple, intuitive function operation.
- Function LEDs guide you through each operation.
- Productivity enhancing features include:
 - Bolt Hole Circle
 - Line Hole Calculator
 - Tool Offset
 - Arc Contouring
 - Programmable Memory Positions
 - Linear Error Compensation
 - Power Saving "Sleep Mode"

Magnescales:

- Flexible Reader Head mounting provides wider installation tolerances and less installation time.
- Excellent resistance to workshop conditions(IP64).
- Classic Sony Magnescale benefits: No cleaning or maintenance, and no scratched or broken glass.
- No machined surface or backer bar required.
- Reader Head Status brackets slide and rotate to accommodate a wide range of installation configurations.
- Removable cable for easy replacement.

Meeting the challenge of Simplicity



Milling Machine Packages- Dual Axis

Model No.	Travel "Y" x "X"	List Price	Sale Price
LH70-1230	12" x 30"	\$1385.00	\$1175.00
LH70-1236	12" x 36"	1385.00	1175.00
LH70-1240	12" x 40"	1495.00	1270.00
LH70-1836	18" x 36"	1385.00	1175.00
LH70-1840	18" x 40"	1495.00	1270.00

Lathe Packages-Dual Axis

Model No.	Travel "Y" x "X"	List Price	Sale Price
LH70-626	6" x 26"	\$1660.00	\$1400.00
LH70-636	6" x 36"	1750.00	1485.00
LH70-640	6" x 40"	1830.00	1550.00
LH70-648	6" x 48"	1990.00	1690.00
LH70-1036	10" x 36"	\$1750.00	\$1485.00
LH70-1040	10" x 40"	1850.00	1570.00
LH70-1054	10" x 54"	2110.00	1790.00
LH70-1062	10" x 62"	2200.00	1870.00
LH70-1448	14" x 48"	\$2020.00	\$1700.00
LH70-1462	14" x 62"	2110.00	1875.00
LH70-1480	14" x 80"	2620.00	2225.00
LH70-1648	16" x 48"	\$2040.00	\$1725.00
LH70-1662	16" x 62"	2230.00	1895.00
LH70-1680	16" x 80"	2660.00	2260.00
LH70-2060	20" x 62"	\$2270.00	\$1925.00
LH70-2080	20" x 80"	2700.00	2295.00

All Packages Include: Dual Axis Display, 2 S300 Linear Scales with 3 meter cable, Brackets for Readerhead installation, Counter Arm and Tray.

DRO QUILL KITS FOR "Z" AXIS TRAVEL

- Easy to use LCD with resolution of .0005"/0.01mm.
- Push button controls for inch/mm, Zero-set and On/Off.
- Powered by a single SR-44 battery which lasts about 1 year with normal use.
- SPC output for data transmission to data processors or LED remote display box.
- Easy installation fits most vertical mills.



0-6" Travel
Precise
SET No.
303-9319
Reg. \$146.00
\$99.95

0-6"

0-5" Travel
Mitutoyo
SET No.
053906
Reg. \$306.00
\$275.00

Complete

Quill Kit mounted on a vertical mill

Mitutoyo NEW-TECHNOLOGY DRO'S

For Both Mill & Lathe Functions

Dual Axis Counter

- Bolt hole circle calculation.
- Diameter display and tool off sets (parameter mode).
- Preset.
- Memory compensation value.
- Selecting coordinates 0 to 10.
- Zero approach machining.
- Pitch approach machining.
- 1/2 calculation.
- MM/Inch.

AT-715 Magnetic Scales

- Fully submersible in coolant (coolant never effects scale position reading).
- Shock resistant.
- ± .00038 accuracy over 36 inches (nearly as accurate as glass scales).
- True Absolute (No battery backup) means position information is never lost even after power interruption.

IP67



Mill Package
12" x 36"
Travel
MODEL No.
64PKA059
Reg. \$1490.00
\$1195.00
Complete

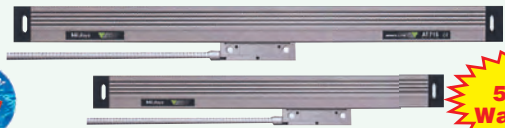

New
5 Year
Warranty

* Lathe Packages

Package Model No.	Scale Range	Package Price
64PKA038	6" x 40"	Reg. \$1630.00
64PKA039	8" x 40"	\$1295.00
64PKA042	10" x 40"	
64PKA045	10" x 60"	Reg. \$ 1980.00
64PKA050	12" x 60"	\$1495.00
64PKA056	14" x 60"	

Mill Packages

Package Model No.	Scale Range	Package Price
64PKA058	12" x 30"	\$1195.00
64PKA059	12" x 36"	1195.00
64PKA061	14" x 40"	1195.00
64PKA062	16" x 36"	1195.00
64PKA063	16" x 40"	1195.00

Standard Resolution: .0005"/.0002"/.0001"/.00005" W/Mounting Brackets
Other Sizes Available .0010"/.0005"/.0004"/.0002"/.0001" And Display Tray
Many other scale ranges available that are not listed. (Inquire)



HIGH RESOLUTION TFT COLOR SCREEN

Innova 40i True Vision DRO's
For Milling Machines

- Solid Graphics with sectional views.
- Conversational graphic help screens.
- Pocket, Bolt-hole, Linear & Matrix Cycles (Milling).
- 3D turning simulation, Taper calculation, Axis coupling (Turning).
- "Distance to go" bar for easy positioning.
- Customizable for Milling, Boring, Turning, Grinding etc.
- 50 work offsets (Milling), Multiple Tool offsets (16 or 20 sets).
- Built-in calculator with auto recall.
- Software travel limits for safety.
- Part centering, Part alignment, Angle calculation in the plane.
- USB port for easy communication and software updates.

The Clearest Choice from any Point of View!



2 Axis Pro Kit Packages

Model No.	Scale Range	Price	Model No.	Scale Range	Price
PRO-MC20	8" x 14"	\$1295.00	PRO-MC07	14" x 32"	\$1375.00
PRO-MC21	8" x 20"	1295.00	PRO-MC08	14" x 36"	1375.00
PRO-MC22	8" x 24"	1295.00	PRO-MC09	16" x 30"	1375.00
PRO-MC23	10" x 20"	1325.00	PRO-MC03	16" x 32"	1375.00
PRO-MC24	10" x 24"	1325.00	PRO-MC05	16" x 36"	1395.00
PRO-MC25	12" x 24"	1350.00	PRO-MC10	16" x 40"	1395.00
PRO-MC01	12" x 30"	1375.00	PRO-MC11	18" x 36"	1395.00
PRO-MC02	12" x 36"	1375.00	PRO-MC04	18" x 40"	1395.00
PRO-MC06	14" x 30"	1375.00	-	-	-

Complete Kits With Mounting Brackets, Display Arm & Cable

Features:

- Preset/Reset
- DISPLAY OFF mode
- Absolute & Incremental
- INCH/MM
- Calculator
- TFT Color Monitor
- High Clarity View from angle
- Multiple bolt hole patterns
- Solid graphics
- 3D simulation
- "Distance to Go"
- Feedback alarm
- Software travel with safety alarm
- Feedback signal monitoring
- Auto-detection & Parameter setup
- Rotary axis management
- UL approval
- Specifications:
 - Resolution: 0.0002"/0.0005"
 - Color LCD display
 - Armored cables
 - Scale accuracy: 10 microns
 - Roller bearing technology

Precise RECTANGULAR GAGE BLOCK SETS

- Each block is steel and hardened to 65RC, stress relieved, lapped to accurate size, parallelism & flatness, then carefully inspected and marked for size designed to meet close tolerance.
- Each set includes standard sizes found in more expensive sets. Each block conforms to the rigid standards of the National Bureau Of Standards and includes an **Overall Accuracy Certificate**.

81 Piece Set
Grade "B" ±.000050"
SET No. 100-810

\$79.95

81 Piece Set Grade "B"
SET No. 100-811

\$99.95

With Certificate
traceable to N.I.S.T.



Steel Rectangular

Set No.	No. of Blocks	Grade Accuracy	Type	Sale Price
SS-36B	36	Grade B±50 Millionths	Steel	\$59.95
SS-36AB	36	Grade 3+ 8-4 Millionths	Steel	99.95
SS-36A	36	Grade 2+ 4-2 Millionths	Steel	155.00
100-810	81	Grade B±50 Millionths	Steel	\$79.95
100-811	81	Grade B±50 Millionths with N.I.S.T. Certificate	Steel	99.95
SGB-813	81	Grade 3+ 8-4 Millionths	Steel	169.95
CGB-300	81	Grade 3+ 8-4 Millionths with N.I.S.T. Certificate	Steel	289.50
SCB-812	81	Grade 2+ 4-2 Millionths	Steel	275.00
CGB-200	81	Grade 2+ 4-2 Millionths with N.I.S.T. Certificate	Steel	375.00
MGB-870	87	Grade 3 Metric 0.5 thru 100mm	Steel	\$149.95
MGB-872	87	Grade 2 Metric 0.5 thru 100mm	Steel	175.00
Carbide Rectangular				
303-506	81	Grade B±50 Millionths	Carbide	\$495.00
CGB-813	81	Grade 3+ 8-4 Millionths	Carbide	695.00
303-502	81	Grade 2+ 4-2 Millionths	Carbide	1195.00
Ceramic Rectangular				
700-363	36	Grade 3+ 8-4 Millionths	Ceramic	\$595.00
700-362	36	Grade 2+ 4-2 Millionths	Ceramic	795.00
700-813	81	Grade 3+ 8-4 Millionths	Ceramic	1495.00
700-812	81	Grade 2+ 4-2 Millionths	Ceramic	1995.00

Precise 8 PIECE LONG GAGE BLOCK SETS

- 8 Pieces 5", 6", 7", 8", 10", 12", 16", 20"
- Meets Federal Specifications GGG-G-15C Tolerances on length for inch gage blocks.
- Each set is supplied with a calibration certificate.
- 303-532 with mfg certificate. Additional traceable to N.I.S.T. available, please inquire.
- 303-530 & 531 with N.I.S.T. certificate traceable.

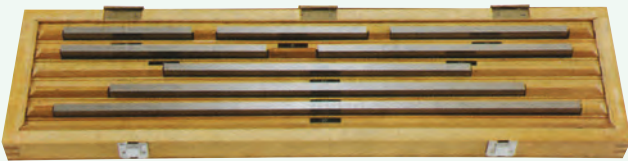

Set No.	No. of Blocks	Grade Accuracy	Type Rectangular	Sale Price
303-532	8	B± 50 Millionths	Steel	\$675.00
303-531*	8	3+ 8-4 Millionths	Steel	850.00
303-530*	8	2+ 4-2 Millionths	Steel	1350.00

Grade "B" Individual Long Gage Blocks

Model	Length	Price	Model	Length	Price
303-341	5"	\$ 65.00	303-345	10"	\$150.00
303-342	6"	95.00	303-346	12"	175.00
303-343	7"	110.00	303-347	16"	210.00
303-344	8"	125.00	303-348	20"	235.00

Precise GAGE BLOCK HOLDER For Rectangular Blocks

- Made with gage block accuracy.
- Base block's mounting surface lapped flat and parallel with base.

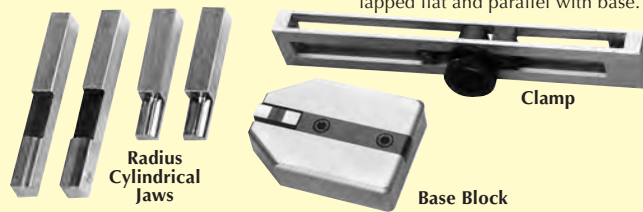

Model	Description	Price
101-601	Base Block (4" x 2.750" x 1/7")	\$135.00
101-606	Clamp 4" Capacity	39.95
101-607	Clamp 8" Capacity	59.95
101-610	Radius (0.0787") Cylindrical Jaws (pair)	\$95.00
101-611	Radius (0.200") Cylindrical Jaws (pair)	75.00
101-612	Radius (0.750") Cylindrical Jaws (pair)	65.00

Precise STEEL PIN GAGE SETS

- Ends are ground, not cut off.
- Centerless lapped w/10 micro finish or better.
- .0002" accuracy in tolerance.
- Heat treated to 60/63RC. Uniform 2" length.
- Avail. in plus & minus tolerances.
- Size is etched on each member.
- With fitted cases.

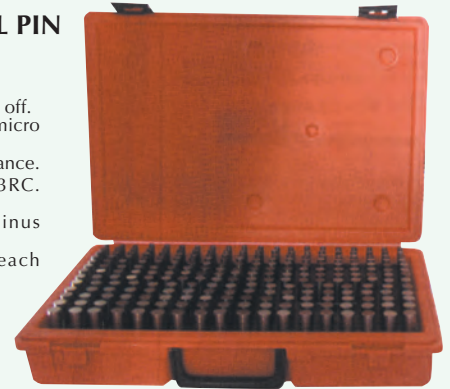

Model	Size	Tolerance	Members	Sale
HDT-001	.011"-.060"	Minus	50	\$ 29.95
HDT-012	.011"-.060"	Plus	50	29.95
HDT-111	.061"-.250"	Minus	190	49.95
HDT-122	.061"-.250"	Plus	190	49.95
HDT-211	.251"-.500"	Minus	250	89.95
HDT-222	.251"-.500"	Plus	250	89.95
HDT-311	.501"-.625"	Minus	125	89.95
HDT-322	.501"-.625"	Plus	125	89.95
HDT-411	.626"-.750"	Minus	125	99.95
HDT-422	.626"-.750"	Plus	125	99.95
HDT-511	.751"-.832"	Minus	81	110.00
HDT-522	.751"-.832"	Plus	81	110.00
HDT-611	.833"-.916"	Minus	84	129.95
HDT-622	.833"-.916"	Plus	84	129.95
HDT-711	.917"-1.000"	Minus	84	145.00
HDT-722	.917"-1.000"	Plus	84	145.00
HDT-723	.061"-.750"	Minus	690	325.00

Metric Series minus .005mm plus .000mm tolerance

Model	Size	Tolerance	Members	Price
MPG-000	.22-1.50mm	Minus	65	\$ 34.95
MPG-002	1.72-12.70mm	Minus	250	115.00
MPG-003	12.72-15.30mm	Minus	130	135.00
MPG-004	15.32-17.80mm	Minus	125	140.00
MPG-005	17.82-20.36mm	Minus	128	175.00
MPG-006	20.38-22.04mm	Minus	84	195.00
MPG-007	22.06-23.72mm	Minus	84	210.00
MPG-008	23.74-25.40mm	Minus	84	195.00

Save More

"COMBO SET SPECIAL"
Range .011" to .500"
3 Sets
(490 Members)
Tolerance; minus .0002"
Plus .0000"
SET No.COM-490

\$149.95

ALL 8 SETS
Range .011" to 1.00"
(989 Members)
Tolerance; minus .0002"
Plus .0000"
SET No.COM-989

\$665.00

Precise PIN GAGE HANDLE

- Machined from solid aluminum.
- Go and NoGo are marked clearly.
- Capacity 1/32" - 1/2" diameter.
- Pin gage not included.



U.S.A.
Aluminum
MODEL No.
GH-270

\$14.95

Model	Description	Price
GH-270	Pin Gage Handle Aluminum	\$14.95
GH-271	Pin Gage Handle Green	19.95
GG-272	Pin Gage Handle Purple	19.95
GH-273	Pin Gage Handle Red	19.95
GH-274	Pin Gage Handle Yellow	19.95

Import
Aluminum
MODEL No.
410-020

\$7.95

Mitutoyo GAGE BLOCK SETS

Inspection Grade AS-1

The lapping technique is one of Mitutoyo's specialties. our advanced lapping technique, developed for more than a half century, enables us to achieve the best flatness and surface roughness needed for gage blocks and realize a great wringing force.

CERA Blocks
CERA blocks, made of ceramic materials with superior surface quality, that were developed by Mitutoyo's ultra precision machining techniques solve all problems that the steel gage block had.

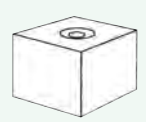
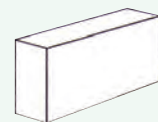
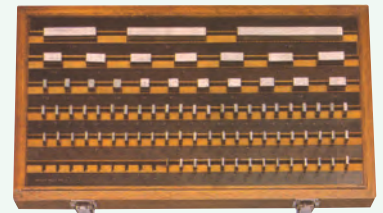

Inspection Certificate Traceable To N.I.S.T.

Model No.	No. of Blocks	Shape Material	Size In Set	List Price	Sale Price
516-903	81 Pc.	Rect/Steel	.1001"to 4"	\$1620.00	\$1375.00
516-303	81 Pc.	Rect/Cera	.1001"to 4"	3330.00	2795.00
516-403	81 Pc.	Square/Steel	.1001"to 4"	2390.00	1995.00
516-203	81 Pc.	Square/Cera	.1001"to 4"	3790.00	3200.00



MEYER STEEL PIN GAGE SETS

*New Class "Z" .0001" Deviation
Roundness .00005" - Surface Finish 8 Micro*

- Boxes and gages both marked.
- Material: 52100 Bearing Steel
- Size laser etched on each piece (M-0 pins not etched).
- No sharp edges.
- All members 2" long.

Finish:

- Each gage is inspected and has a 8 micro finish or better.
- Heat treated to a hardness of 60-62 Rockwell C.
- All English gages with .0001" limit.
- Centerless lapped.
- Individual gages available in both Inch and Metric.



All Sets Furnished with Certificate of Accuracy Traceable To N.I.S.T.

.0001" Deviation Minus or Plus

Model No.	Range Inch	No. of Members	List Price	Sale Price	Individual Members
M-0	.011-.060	50	\$ 82.00	\$ 73.50	\$3.95
M-05	.0115-.0605	50	82.00	73.50	3.95
M-1	.061-.250	190	184.00	165.00	3.95
M-15	.0615-.2505	190	184.00	165.00	3.95
C-10	.011-.250	240	252.00	225.00	3.95
C-105	.0115-.2505	240	252.00	225.00	3.95
M-2	.251-.500	250	273.00	245.00	3.95
M-25	.2515-.5005	250	273.00	245.00	3.95
M-3	.501-.625	125	320.00	285.00	6.50
M-35	.5015-.6255	125	320.00	285.00	6.50
M-4	.626-.750	125	355.00	319.50	7.50
M-45	.6265-.7505	125	355.00	319.50	7.50
M-5	.715-.832	82	602.00	555.00	12.75
M-55	.7155-.8325	82	602.00	555.00	12.75
M-6	.833-.916	84	702.00	625.00	13.75
M-7	.917-1.000	84	736.00	660.00	13.75
M-75	.9175-1.0005	84	736.00	660.00	13.75

* Specify Minus or Plus .0001" Deviation Tolerance



LIBRARY SERIES - STEEL PIN GAGES



All Set Furnished with Certificate of Accuracy Traceable To N.I.S.T.



NEW LOCKING FEATURE



.0001" Deviation Minus or Plus

Model No.	Size Range	No. of Members	Weight lbs.	List Price	Sale Price
L-S	.011"-.625"	615	87	\$ 973.00	\$ 875.00
L-C	.011"-.750"	740	120	1490.00	1265.00
L-1	.061"-.750"	690	122	1345.00	1200.00
L-2	.061"-.5005"	880	98	1142.00	1025.00
L-2C	.011"-.5005"	980	100	1269.00	1140.00
L-3**	.061"-1.000"	940	250	3430.00	3085.00
L-4**	.011"-1.000"	990	260	3494.00	3140.00
L-5	.751"-1.000"	250	140	2244.00	2015.00

**Consists of 2 Seven Drawer Cabinets

Metric .0025mm Tolerance Limits

Model	Size Range	No. of Members	Weight lbs.	List Price	Sale Price
L-10MM	1.52-17.80mm	815	130	\$1877.00	\$1685.00
L-11MM	1.53-17.81mm	815	130	1877.00	1685.00
L-20MM	17.82-25.40mm	380	178	2970.00	2670.00
L-21MM	17.83-25.41mm	380	178	2970.00	2670.00
L-30MM	1.52-25.40mm	1195	310	4848.00	4350.00
L-31MM	1.53-25.41mm	1195	310	4848.00	4350.00

Upgrade Existing Sets

Model	Description	Weight lbs.	List Price	Sale Price
L-E	Four drawer cabinet empty	36 lbs.	\$ 337.00	\$300.00
L-IN	Four cabinet with four inserts of your choice	47 lbs.	414.00	370.00

* Specify Minus or Plus .0001" Deviation Tolerance



MEYER GAGE .0001" CLASS X GAGE PIN SETS

- Each set contains 25 pieces of Class X tolerance (.00004") gage pins.
- Choice of two tolerances Plus (+.00004") or Minus (-.00004").
- Sets consists of a center nominal size, and 12 gages larger in .0001" steps and 12 gages smaller in .0001" steps.
- Each gage is inspected and has a 2 micro-finish or better.
- Heat treated and through hardened to 60-62 Rockwell C.
- All pin gages over .060" or 1.51mm are laser marked with size direction of tolerance and serial number for traceability.



Set No.	Nominal Size Range	Price
MG1-250	.0110 to .0609 or .28mm to 1.54mm	\$283.00
MG2-250	.0610 to .2509 or 1.55mm to 6.37mm	141.00
MG3-250	.2510 to .5009 or 6.38mm to 12.72mm	163.00
MG4-250	.5010 to .7499 or 12.73mm to 19.04mm	224.00
MG5-250	.7500 to .8129 or 19.05mm to 20.64mm	315.00

To order simply select your nominal size from any .0001" English or .01mm Metric increment and direction of tolerance. Then refer to the above to find the set price

SPi PIN GAGE HANDLES

Comfortable, ergonomically designed



Range Capacity	Model	Price
.011-.060"	13-137-5	\$12.20
.061-.250"	13-138-3	15.30
.251-.500"	13-139-1	18.05
.501-.625"	13-140-9	19.25
.625-.750"	13-141-7	19.25
.751-.832"	13-142-5	20.45
.833-.916"	13-143-3	20.45
.917-1.000"	13-144-1	22.90



METRIC GAGE SETS

.0025 MM Class Z



Just look at this selection of Metric gage pin sets. If we don't make it you probably don't need it! These sets have all the features of our English set, but provide the finer increments in size that you just can't get by converting English to Metric.



All Set Furnished with Certificate of Accuracy Traceable To N.I.S.T.



.0025MM Tolerance Limits

Model No.	Gage Size	No. of Members	List Price	Sale Price	Individual Members
M-0MM	.22-1.50	65	\$106.00	\$ 95.00	\$4.75
M-01MM	.23-1.51	65	106.00	95.00	4.75
M-1MM	1.52-7.70	310	375.00	335.00	3.95
M-11MM	1.53-7.71	310	375.00	335.00	3.95
M-2MM	7.72-12.70	250	403.50	363.00	3.95
M-21MM	7.73-12.71	250	403.50	363.00	3.95
M-3MM	12.72-15.30	130	447.00	363.00	5.25
M-31MM	12.73-15.31	130	447.00	363.00	5.25
M-4MM	15.32-17.80	125	474.00	400.00	6.50
M-41MM	15.33-17.81	125	474.00	400.00	6.50
M-5MM	17.82-20.36	128	563.00	505.00	7.95
M-51MM	17.83-20.37	128	563.00	505.00	7.95
M-6MM	20.38-22.04	84	674.00	605.00	9.50
M-61MM	20.39-22.05	84	674.00	605.00	9.50
M-7MM	22.06-23.72	84	779.00	700.00	10.50
M-71MM	22.07-23.73	84	779.00	700.00	10.50
M-8MM	23.74-25.40	84	800.00	720.00	12.00
M81MM	23.75-25.41	84	800.00	720.00	12.00

Specify Minus or Plus .0025MM Tolerance when Ordering (I.E. M-1MM plus)

MEYER BLACK OXIDE PIN GAGE SETS



- Black OX surface treatment.
- Class ZZ .0003" tolerance.
- Box and gages clearly marked.
- No sharp edges.
- Certificate of conformance to ANSI N89.1.5-1998.
- All gages 2" long.
- Centerless ground.
- 10 micro-inch finish.
- Heat treated to 60-62 Rockwell C.
- Each gage with .0002" limit.
- Roundness geometry .0001" limit.



BLACK OX



Shows Wear

Set No.	Description	Pieces	List	Sale
B-0M	.011"-.060" (Minus)	50	\$ 60.00	\$ 49.95
B-0P	.011"-.060" (Plus)	50	60.00	49.95
B-10M	.011"-.250" (Minus)	240	190.00	169.95
B-10P-1	.011"-.250" (Plus)	240	190.00	169.95
B-1M	.061"-.250" (Minus)	190	134.00	119.95
B-1P	.061"-.250" (Plus)	190	134.00	119.95
B-2M	.251"-.500" (Minus)	250	200.00	175.00
B-2P	.251"-.500" (Plus)	250	200.00	175.00

Replacement Pins All Sizes (Specify Size) \$3.35 Each

mhc PRECISION STEEL PIN GAGE SETS CLASS "ZZ" -0.0002"+.0"



- Inspection Certificate with every set
- All pin gages are manufactured to a 0.0002" tolerance
- Color coded, fully adjustable Go/No-Go gage handle furnished with each set
- Sets are supplied in rugged, high impact protective cases with each space marked for the appropriate gage
- Offered in 0.001" increments
- Each pin is centerless lapped and is clearly etched with the stated size except .011" - .060" sets.
- All gages are 2 inches long and hardened to RC 60/65
- All sharp corners are broken

.011" Thru .500"
490 Sizes
SET No.
616-500
Reg. \$295.00

\$259.95



Range Inch	Gages In Set	-0.00002" +.0"	+0.00002" -.0"	Set Price
.011"-.060"	50	616-8201	616-8200	\$ 45.00
.061"-.250"	190	616-8211	616-8210	85.00
.251"-.500"	250	616-8221	616-8220	165.00
.501"-.625"	125	616-8231	616-8230	175.00
.626"-.750"	125	616-8241	616-8240	185.00
.751"-.832"	82	616-8251	616-8250	195.00
.833"-.916"	84	616-8261	616-8260	225.00
.917"-1.000"	84	616-8271	616-8270	250.00

Note: Individual Sizes are also available

Precise TELESCOPING GAGE SETS

- Double action (self-centering for quick checking of inside measurements).
- Rigid handle with self centering feature.
- Uniform contact pressures.
- Contact point ends are hardened tool steel and precision ground on a radius of the smallest hole the gage will enter.

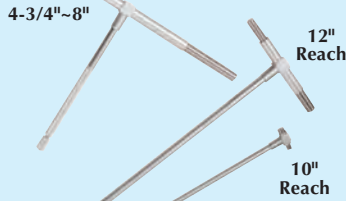

Standard Set 5" Long
5/16"-6" 6 Pc. Set
MODEL No. TGI-060

\$19.95

10" Long Reach
5/16"-1-1/4" 3 Pc. Set
MODEL No. 420-260

\$24.95

8" Wide, 6" Long
4-3/4"-8" Range
MODEL No. TGT-080

\$14.95

12" Long Reach
1-1/4"-6" 3 Pc. Set
MODEL No. 420-262

\$29.95



PRECISION CHROME STEEL RULES

- Finest quality steel available.
- Fully hardened and tempered.
- Precise etching, black filled.
- Satin chrome finish.

4R: 8ths, 16ths, 32nds, 64th.
5R: 32nds, 64th, 10th, 100th.
16R: 32nds, 64th, 50th, 100th.
E/M: 32nds, 64th, 1/2mm, 1mm



Flexible Chrome Finished Rules

Model	Size	Grad.	Thickness	Sale
FR-351	6"	4R	.015" x 1/2"	\$ 8.50
FR-356	6"	5R	.015" x 1/2"	8.50
FR-361	6"	16R	.015" x 1/2"	8.50
FR-370	6"/150mm	E/M	1/2" x .015"	8.50
FR-352	12"	4R	.015" x 1/2"	\$17.95
FR-357	12"	5R	.015" x 1/2"	17.95
FR-362	12"	16R	.015" x 1/2"	17.95
FR-371	12"/150mm	E/M	1/2" x .015"	17.95



Rigid Chrome Finish Rules

Model	Size	Grad.	Thickness	Sale
RR-331	6"	4R	.040" x 3/4"	\$ 9.50
RR-331E*	6"	4R	.040" x 3/4"	10.50
RR-336	6"	5R	.040" x 3/4"	9.50
RR-341	6"	16R	.040" x 3/4"	9.50
RR-349	6"/150mm	E/M	3/4" x .040"	9.50
RR-332	12"	4R	.040" x 1"	\$18.95
RR-337	12"	5R	.040" x 1"	18.95
RR-342	12"	16R	.040" x 1"	18.95
RR-350	12"/150mm	E/M	3/4" x .040"	18.95

*RR-331E has 1/8ths & 1/16ths End Graduations On Front and Back



MEYER GAGE SETS "X" TOLERANCE 0.00004" LIMITS 100% INSPECTED FOR ACCURACY

- Offers the same "features" as our Class Z pin gages but with .00004" tolerance limit and .00002" roundness limit.
- The pins are perfect for critical inspection needs or when you want to maximize your GO/NOGO tolerance limits.
- They're also a great way to calibrate measuring equipment, micrometers, and calipers.

All Gages and sets are traceable to N.I.S.T.



Features:

- Centerless lapped
- Each gage is inspected and has a 2 microfinish or better
- Heat treated to a hardness of 60-62 Rockwell C
- Size and serial number laser etched on each piece (MOX not etched)
- Material: 52100 Bearing Steel.
- No sharp edges.
- All members 2" long.

Specify minus .00004" or plus .00004" tolerance when ordering

Model No.	Range Inch	No. of Members	List Price	Sale Price
M0X	.011"-.060"	50	\$ 445.00	\$ 395.00
M05X	.0115"-.0605"	50	445.00	395.00
M1X	.061"-.250"	190	1170.00	1050.00
M15X	.0615"-.2505"	190	1170.00	1050.00
C10X	.011"-.250"	240	1548.00	1390.00
C105X	.0115"-.2505"	240	1548.00	1390.00
M2X	.251"-.500"	250	1548.00	1390.00
M25X	.2515"-.5005"	250	1548.00	1390.00
M3X	.501"-.625"	125	1315.00	1180.00
M35X	.5015"-.6255"	125	1315.00	1180.00
M4X	.626"-.750"	125	1393.00	1250.00
M45X	.6265"-.7505"	125	1393.00	1250.00
M5X	.751"-.832"	82	1171.00	1050.00
M55X	.7515"-.8325"	82	1171.00	1050.00
M6X	.833"-.916"	84	1232.00	1105.00
M65X	.8335"-.9165"	84	1232.00	1105.00
M7X	.917"-.1.000"	84	1414.00	1270.00
M75X	.9175"-.1.0005"	84	1414.00	1270.00

Individual sizes available. Please Inquire

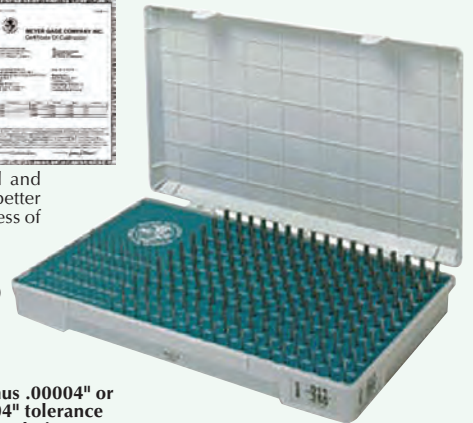

Precise LIBRARY SERIES STEEL PIN GAGE SETS

- Ends are ground, not cut off.
- Centerless lapped with 10 micro finish or better.
- .0002" accuracy in tolerance.
- Available in Minus tolerance.
- Heat treated to 60/63RC.
- Uniform 2" length.
- Size is etched on each member.
- With lockable drawers.
- Class "ZZ"



Model	Range	Members	Tolerance	Price
410-008*	.061"- .500"	440	Minus .0002"	\$285.00
303-453M	.061"- .750"	690	Minus .0002"	595.00
LPG-104	.061"-1.00"	940	Minus .0002"	1295.00

* No. 410-008 Supplied in wood 2 Drawer Case



VERMONT GAGE 8-DRAWER WOOD MOBILE PIN GAGE LIBRARY

Make quick and accurate measurements with Vermont Gage pin gages. Measure hole sizes. Calculate distances between holes. Gage slot widths. Check locations. Use for Go/No-Go gaging. Size in micrometers and snap gages.

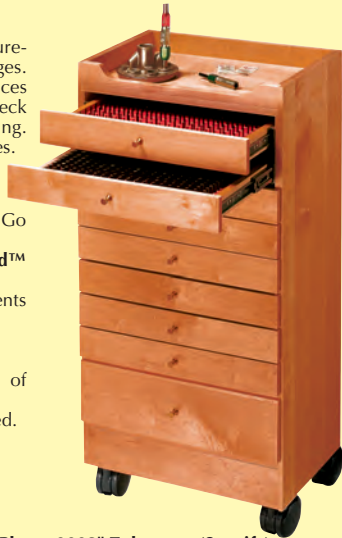

- Class ZZ .0002" tolerance for Go (Plus) or NoGo (Minus).
- Available in **Steel** or **Black Guard™**
- **NIST traceable.** • 2" long.
- .0005" sizes. • .001" set increments
- Tool steel; 60/62 Rc.
- 10 micron finish or better.
- Within .0001" round.
- Marked with size & direction of tolerance on gages over .060"
- **Certificate of Accuracy** included.



.001" Increments Minus or Plus ± .0002" Tolerance (Specify)

Range Inch	Members In Set	Set No.	Steel Set	Set No.	Black Guard
.0060"-1.000"	995	SPG-001	\$2995.00	GPG-001	\$3195.00
.0065"-1.005"	995	SPG-002	2995.00	GPG-002	3195.00

Precise SQUARE GAGE BLOCK SETS

- For those who need a value-priced set.
- All blocks are manufactured to the same high standards as our premium sets.
- Each set is provided in a fitted wood case.
- Each set is supplied with a certificate guaranteeing that each block is manufactured to meet or exceed Federal Spec GGG-G-15C, and is within the gage B tolerance (±.000050). This certificate does not show the individual deviation of each blocks.



Grade "B" Shop Accuracy
±.000050" approx.
Grade "3" (A & B) Accuracy
+.000080"- .000040"
Grade "2" Inspection Accuracy
+.000040"- .000020"



Square Steel

Model No.	No. of Blocks	Grade Accuracy	Included In All Sets	Sale Price
SBS-81B	81	"B"	1 Block .050"	\$495.00
SBS-813	81	"3"	10 Blocks .101 thru .149 in .0001" steps	995.00
SBS-812	81	"2"	49 Blocks .101 thru .149 in .001" steps 17 Blocks .150 thru .950 in .05" steps 4 Blocks 1.0 thru 4.0 in 1" steps	1195.00
Square Zirconia Ceramic				
684-813	81	"3"	9 Blocks .1001" thru .1009" step of .0001" 49 Blocks .101" thru .149" step of .001" 19 Blocks .050" thru .950" step of .050" 4 Blocks 1.000" thru 4.000" step of 1.000"	\$1995.00

Precise 115 PIECE PRECISION STEEL PIN GAGE SETS 1/16" To 1/2", A Thru Z and #1 To 60

- Made for checking most of popular drill sizes.
- Sizes marked on each pin for easy identification.
- Fill hardened to 60-62 RC.
- Finish to 10 micron or better.
- OAL: 2" • Class: ZZ • Tolerance: .0002"

Set Includes:

- 26 Pc-A to Z letter size.
- 60 Pc-No. 1-60 wire gauge size.
- 29 Pc-1/16-1/2" by 64ths fraction size



MODEL No.
4101-1020
Reg. \$150.00

\$129.95

Fowler 9" ELECTRONIC LEVEL

Fowler's 9" Laser Level provides instant 4 x 90° digital inclination display. With embedded magnets on its measuring surface, a beamsplitter projects a 90° laser cross hair for leveling at-a-distance. It also includes a 1/4-20mount for tripod use.

- Standard 9volt battery (250 hours life)
- Dimensions: 9"L x 1"W x 2-1/4"H
- Includes two-way level and plumb vials.
- Reversible reading for inverted use.
- Measuring range: 4 x 90°
- Resolution: .05°
- Accuracy: ±.2°
- Repeatability: ±.05



MODEL No.
54-440-60
List \$85.00

\$65.00

Less
Sine-Bar

Suburban 14" OPTICAL COMPARATOR MASTerview™ WITH ERECT IMAGE

Suburban's own MV-14-DRO2 3-axis digital readout with:

- Part view to show the relationship between all part features.
- 5.7" LCD screen.
- Direct measurement of circles, arcs, angles, points, lines, distance, perpendicularity, parallelism and slots.
- Part programming.
- Auto-enter, looping and auto-finish.
- 360° digital protractor.
- Multiple languages.
- Output to PC or printer.
- Inch/Metric conversion.
- Skew capability.
- 1 micron glass scales.
- Display reads to 0.0001"

- Two long-life tungsten-halogen light sources.
- Extra bright surface illumination through duplex fiber optics.
- Individual switches select profile, surface or combination surface and profile illumination modes.
- High capacity 4" x 8" travel stage with 4-1/2" x 19" work surface.
- Ball way construction handles loads to 100 lbs.
- Heavy duty monorail type, welded steel frame.
- Rotary frosted glass screen with 90° crosslines and 360° protractor markings.
- Verier readings to 5 arc minutes.
- 10 power lens system (20 & 50 X optional)
- **Edge detection is standard.**
- Screen mounted overlay chart clips.
- Weighs 235 lbs.
- Measures 46-1/2" long x 22-1/2" wide x 35-1/2" high.

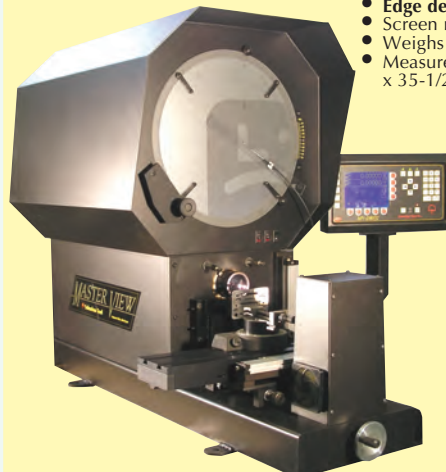

MODEL No.
MV-140SE
Reg. \$10,500.00

\$9750.00

Same as above
with Medtronics
Quadra-Chek
Digital Readout
MODEL No.
MV-140QRE
Reg. \$12,995.00

\$12,250.00



3 - WIRE THREAD MEASURING SYSTEM

The traditional three-wire method is the effective or pitch diameter of an externally in the past, holding and cor-against a thread while simulta-ment had been an extremely Check's-3 Wire thread measur-and precise way for determining parts and thread plug gages. precision made to predetermine wires are held in a predeter-ure clips. The holders rotate freely device so as to engage the lead angle



most accurate method of measuring external screw thread. Unfortu-rectly positioning three wires neously taking an accurate mea-cumbersometask. Now, thread ing system provides a simple the pitch diameter for threaded Thread measuring holders are thread pitches. Thread measur-ined position by light pres-on the spindle of the measuring of a thread.

Base Assembly No. 1001B . . . \$210.00

- Vertically adjustable platform for supporting and positioning threads between anvils of micrometer.
- Knurled screw knob for locking platform in position.
- Exclusive "U" track for maintaining wire holders in the ideal position for engaging the lead angle of a thread.
- Locking clamp for accurately securing micrometer in place.

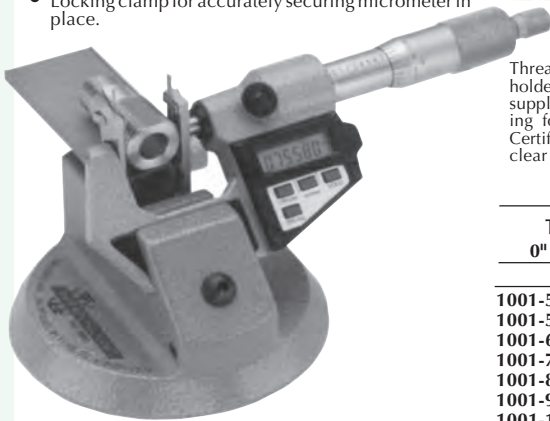

Thread Check's holders and wires are supplied in special packaging for protection and visibility. Certification is in the bottom of the clear case for convenient access.

ACME HOLDERS & WIRES

Thread Check		Threads Per Inch	Wire Diameter	Price
0" to 1"	1" to 2"			
Part Numbers				
1001-5A	1101-5A	5	.10329	\$200.00
1001-5.5A	1101-5.5A	5.5	.09390	180.00
1001-6A	1101-6A	6	.08608	180.00
1001-7A	1101-7A	7	.07378	180.00
1001-8A	1101-8A	8	.06456	180.00
1001-9A	1101-9A	9	.05738	180.00
1001-10A	1101-10A	10	.05164	180.00
1001-11A	1101-11A	11	.04695	180.00
1001-12A	1101-12A	12	.04304	180.00
1001-14A	1101-14A	14	.03689	180.00
1001-16A	1101-16A	16	.03228	180.00
1001-18A	1101-18A	18	.02869	180.00
1001-520A	1101-520A	20	.02582	180.00

LIBRARIES IN WOODEN CASES

1001FL5A-20A	1101FL5A-20A	Full Library	\$2170.00
--------------	--------------	--------------	-----------

Precise THREAD PLUG GAGES AND RING GAGE SETS SHOP QUALITY

- Gages are made in ".X" tolerance.
- Classes are 2B and 2A most commonly used for general applications including bolts, nuts, screws and similar fastener.



Plug Gage GO-NOGO with handle Class 2B			Ring Gage GO-NOGO Class 2A	
Set No.	Size & Thread	Set Price	Set No.	Set Price
410-208	4-40UNC	\$42.00	410-308	\$67.00
410-210	5-40UNC	42.00	410-310	67.00
410-212-1	6-32UNC	45.00	410-312	65.00
410-214	8-32UNC	45.00	410-314	65.00
410-216	10-24UNC	45.00	410-316	65.00
410-217	10-32UNF	45.00	410-317	65.00
410-221	1/4-20UNC	42.00	410-321	63.00
410-222	1/4-28UNC	42.00	410-322	63.00
410-224	5/16-18UNC	42.00	410-324	63.00
410-225	5/16-24UNF	42.00	410-325	63.00
410-227	3/8-16UNC	45.00	410-327	64.00
410-228	3/8-24UNF	45.00	410-328	64.00
410-230	7/16-14UNC	45.00	410-330	64.00
410-231	7/16-20UNF	45.00	410-331	64.00
410-233	1/2-13UNC	49.00	410-333	72.00
410-234	1/2-20UNF	49.00	410-334	72.00



TAPPED HOLE LOCATION GAGES & SETS

- Hardened and precision ground.
- Shaft diameter .250" + .0002" x 3/8" long, 6.35mm + 0.005mm x 3/8" long.
- All diameters concentric within .0002" T.I.R.
- Right hand thread.

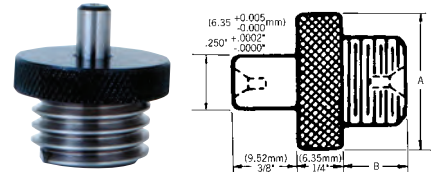

Model	Thread	A	B	Price
10309	*10-32	5/16"	.250	\$102.00
10310	*1/4-28	3/8"	.250	102.00
10311	*5/16-24	1/2"	.250	102.00
10312	*3/8-24	1/2"	.250	102.00
10313	*7/16-20	7/8"	.250	102.00
10314	*1/2-20	7/8"	.250	102.00
10315	*5/8-18	7/8"	.250	102.00

Set No. 10316 Contains 2 Each (Sizes Above 14 Pieces) \$1395.00

Model	Thread	A	B	Price
10317	**2-56	5/16"	.250	\$125.00
10318	**4-40	5/16"	.250	110.00
10319	**5-40	5/16"	.250	110.00
10320	**6-32	5/16"	.250	110.00
10321	**6-40	5/16"	.250	110.00
10322	**8-32	5/16"	.250	110.00
10301	*10-24	5/16"	.250	110.00
10302	*1/4-20	3/8"	.250	92.00
10303	*5/16-18	1/2"	.250	92.00
10304	*3/8-16	1/2"	.250	92.00
10305	*7/16-14	7/8"	.250	92.00
10306	*1/2-13	7/8"	.250	92.00
10307	*5/8-11	7/8"	.250	92.00
10330	3/4-10	1"	.250	125.00

Set No. 10323 Contains 2 Each (Sizes Above 12 Pieces) \$1295.00

Set No. 10308 Contains 2 Each (Sizes Above 14 Pieces) \$1250.00

Model	Thread	A mm	B mm	Price
11101	1.6 x .35	7.95	6.35	\$120.00
11103-1	2.0 x .40	7.95	6.35	120.00
11105-1	2.5 x .45	7.95	6.35	120.00
11107	3.0 x .50	7.95	6.35	110.00
11109	4.0 x .70	7.95	6.35	110.00
11111-2	5.0 x .80	9.53	6.35	110.00
11113-1	6.0 x 1.00	9.53	6.35	110.00
11121-1	8.0 x 1.25	12.7	6.35	110.00
11123-1	10 x 1.50	12.7	6.35	120.00
11125-1	12 x 1.75	22.23	6.35	120.00
11127-1	16 x 2.0	22.23	6.35	120.00
11129-1	20 x 2.50	25.4	6.35	120.00

Visit Us On The Web
www.penntoolco.com

STANDARD HOLDERS & WIRES

Thread Check		Threads Per Inch	Wire Diameter	Price
0" to 1"	1" to 2"			
Part Numbers				
1001-120	1101-120	120	.00481	\$200.00
1001-100	1101-100	100	.00577	200.00
1001-95	1101-95	95	.00577	200.00
1001-90	1101-90	90	.00601	200.00
1001-80	1101-80	80	.00722	200.00
1001-72	1101-72	72	.00802	200.00
1001-64	1101-64	64	.00902	190.00
1001-56	1101-56	56	.01031	190.00
1001-50	1101-50	50	.01155	190.00
1001-48	1101-48	48	.01203	155.00
1001-44	1101-44	44	.01312	155.00
1001-40	1101-40	40	.01443	155.00
1001-36	1101-36	36	.01604	155.00
1001-32	1101-32	32	.01804	155.00
1001-30	1101-30	30	.01925	155.00
1001-28	1101-28	28	.02062	155.00
1001-27	1101-27	27	.02138	155.00
1001-26	1101-26	26	.02221	155.00
1001-24	1101-24	24	.02406	155.00
1001-22	1101-22	22	.02624	155.00
1001-20	1101-20	20	.02887	155.00
1001-18	1101-18	18	.03208	155.00
1001-16	1101-16	16	.03608	155.00
1001-14	1101-14	14	.04124	155.00
1001-13	1101-13	13	.04441	155.00
1001-12	1101-12	12	.04811	155.00
1001-11.5	1101-11.5	11.5	.05020	155.00
1001-11	1101-11	11	.05249	155.00
1001-100	1101-100	10	.05774	155.00
1001-9	1101-9	9	.06415	156.00
1001-8	1101-8	8	.07217	155.00
1001-7.5	1101-7.5	7.5	.07698	155.00
1001-7	1101-7	7	.08248	155.00
1001-6	1101-6	6	.09623	155.00
1001-5.5	1101-5.5	5.5	.10497	190.00
1001-5	1101-5	5	.11547	190.00

LIBRARIES IN WOODEN CASES

1001PL6-36	1101PL6-36	Partial Library*	\$2900.00
1001FL5-80	1101FL5-80	Full Library*	4545.00

* 7.5 and 22 TPI not included

Precise BLACK GRANITE SURFACE PLATES

- The hardness and stability allow accuracies within millionths of an inch. Along with the high accuracies, granite is rust-proof, non-magnetic, abrasive resistant, non-wedging, wrap-resistant and easily cleaned. The granite used for surface plates has an excellent distribution of hard quartz which provides a smooth, long-wearing working surface.
- Granite surface plates meet or exceed Federal Specifications GGG-P463. Final inspection and calibration of every surface plate is accomplished by use of the Auto-Collimeter

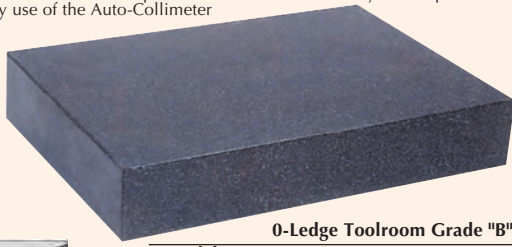

0-Ledge Toolroom Grade "B"

Model	Size	Accuracy	Weight	Sale
PSP-912	9" x 12" x 2"	.0001"	30 lbs.	\$ 26.95
PSP-121	12" x 12" x 2"	.0001"	45 lbs.	39.95
PSP-128	12" x 18" x 3"	.0001"	75 lbs.	49.95
PSP-182	18" x 24" x 3"	.00015"	140 lbs.	98.00
PSP-236	24" x 36" x 4"	.0002"	430 lbs.	245.00
PSP-348	36" x 48" x 4"	.0004"	800 lbs.	625.00
PSP-472	48" x 72" x 8"	.0007"	2280 lbs.	1995.00
PSP-469	48" x 96" x 8"	.0015"	3990 lbs.	3995.00

2-Ledge Inspection Grade "A"

Model	Size	Accuracy	Weight	Sale
PSP-219	9" x 12" x 3"	.00005"	26 lbs.	\$ 32.95
PSP-821	12" x 18" x 3"	.00005"	70 lbs.	55.00
PSP-281	18" x 24" x 3"	.000075"	135 lbs.	125.00
PSP-632	24" x 36" x 4"	.0001"	365 lbs.	295.00
PSP-843	36" x 48" x 6"	.0002"	1140 lbs.	650.00
PSP-482	48" x 72" x 8"	.0006"	3010 lbs.	2295.00
PSP-489	48" x 96" x 10"	.0008"	5160 lbs.	4650.00

Laboratory Grade "AA" 2-Ledge

Model	Size	Accuracy	Weight	Sale
PSP-131	12" x 18" x 3"	.000025"	70 lbs.	\$ 89.95
PSP-132	18" x 24" x 3"	.000032"	190 lbs.	195.00
PSP-133	24" x 36" x 4"	.000042"	475 lbs.	420.00
PSP-134	36" x 48" x 6"	.000075"	1140 lbs.	795.00

Heavy Duty Steel Stands W/Leveling Screw

Model	To Fit Plate Size	W/Leveling Screws
STC-001*	18" x 24"	\$125.00
STC-002*	24" x 36"	185.00
STC-003*	36" x 48"	365.00
STC-005*	48" x 72"	685.00
STC-006*	48" x 96"	825.00

Heavy Duty Steel Stand w/Rollers

Model	Size	Weight	Price
STC-100*	18" x 24"	115 lbs.	\$275.00
STC-200*	24" x 36"	130 lbs.	375.00
STC-300*	36" x 48"	190 lbs.	595.00

* Note: Specify when ordering for "O" - Ledge or 2-Ledge Granite Plate

Buy The Set And Save More

24" x 36" Grade "B" Surface Plate Plus Stand W/Leveling Screws
MODEL No. PSP-500

\$395.00

Repeatability Grade "B" Toolroom ± 100 Millionths

Grade "A" Inspection ± 50 Millionths Inspection

Precise GRANITE ANGLE PLATES

Grade "A" ± .00005" Per 6"

- Furnished with two finished faces or four finished faces.
- Finished square and flat to Master Grade Tolerance: .00005"/6". Grade A.
- When four faces are finished, they are the 2"L" faces and the back and bottom of the Angle Plate. Two face models have only the back and bottom finished.

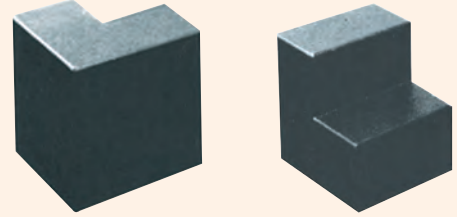

Size Inch	2 Face		4 Face	
	Model	Price	Model	Price
4" x 4" x 4"	303-920-1	\$ 95.00	303-924	\$135.00
6" x 6" x 6"	303-921	135.00	303-925	195.00
6" x 9" x 12"	303-922	255.00	303-926	295.00

Precise GRANITE V-BLOCKS

- Supplied in matched pairs, cylindrical pieces are supported or held during testing.
- 90° V centered and parallel to the bottom, two sides and square to the ends.
- Master Grade Tolerance: .0001"/6".



Price Per Matching Pairs

Model	Size	Weight	Price (Pr.)
303-927	3" x 3" x 3"	2.7 lbs.	\$295.00
303-928	4" x 4" x 4"	6.8 lbs.	435.00
303-929	6" x 6" x 6"	12.2 lbs.	595.00

Precise GRANITE PARALLELS

- Precision ground can be equipped in matched pairs with two faces or faces parallel.
- Grade A. .000050" Per 6".

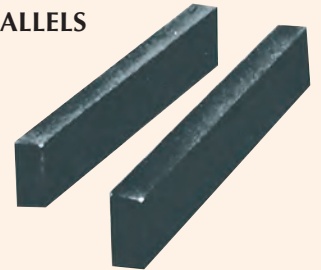

Size L x W x H	2 Face		4 Face	
	Model	Price Per Pair	Model	Price Per Pair
6" x 3/4" x 1"	303-918	\$ 85.00	303-912	\$115.00
12" x 1" x 2"	303-919	160.00	303-913	220.00
18" x 1-1/2" x 3"	303-910	220.00	303-914	295.00
24" x 2" x 4"	303-991	295.00	303-915	395.00

Precise GRANITE STRAIGHT EDGES

- Precision lapped. Straight edges are ground on one narrow surface as standard.
- Two narrow surface as required have been ground in a straight and parallel.
- Grade A. ±.000050" Per 12".

Model No.	Size L x W x H	Wt.	Price Each
303-171	24" x 2" x 4"	15	\$265.00
303-172	36" x 2" x 6"	30	420.00
303-173	48" x 2" x 8"	60	550.00
303-174	60" x 3" x 10"	90	725.00
303-175	72" x 3" x 12"	270	825.00



Precise PRECISION GRANITE SQUARES

- For inspecting squareness.
- Squareness: ± .0001"
- Round hold for less weight and easy handling.
- Includes calibration sheet.



Model	Dimensions	Weight	Sale
303-916	10"H x 6"W x 1" Thick	6 lbs.	\$135.00
303-917	15"H x 10"W x 1-1/2" Thick	19 lbs.	235.00
303-918-1	24"H x 15"W x 3" Thick	92 lbs.	595.00



RED GRANITE SURFACE PLATES



- Red Granite has a higher quartz crystal content (approximately 28%) than all other types of granite, providing the best surface hardness and wear resistance. Can outlast black granite plates as much as 5 to 1.
- Meets or exceeds 50 lb. per square foot load bearing specifications.
- Available in toolroom grade (B) tolerances.

Model	Size	Flatness	Weight	Price
RGP-912	9" x 12" x 1"	.0002"	13 lbs.	\$ 38.95
RGP-128	12" x 18" x 3"	.0002"	50 lbs.	63.95
RGP-184	18" x 24" x 3"	.00026"	150 lbs.	159.95
RGP-246	24" x 36" x 4"	.00034"	400 lbs.	325.00

Precise GRANITE PLATE CLEANER

- An exclusive formulation that is extremely effective for the cleaning and care of Granite Surface Plates.
- It is also easy to ship via UPS or Common Carriers.
- MSDS sheets are shipped with each order.
- Leaves no residue on the granite.



Model	Sizes	Weight	Price
Z9412	Pint	1-1/4 lbs.	\$ 3.95
Z9406	Pint, Spray Pump	1-1/4 lbs.	4.95
Z9407	Quart	2-1/2 lbs.	6.50
Z9408	1/2 Gallon	5 lbs.	9.50
Z9409	1 Gallon	9-1/4 lbs.	12.95
Z9410	5 Gallon	45 lbs.	45.00

S&W **THREAD CHECKER** **S&W** **MADE IN USA**

The Thread Checker™ is an accurate and easy-to-use thread verifier for both nuts and bolts. Conveniently assembled onto a wire loop, it is especially well suited for distinguishing between similar inch and metric threads.

- Each size has a nut and bolt checker on the same gauge
- Thread sizes are permanently stamped onto each gauge
- Inch gauges are clear zinc plated, metric gauges are black oxide
- Wire cable with loop for convenient hanging



The Original Thread Checker™

Set No. SWTC-S21 \$29.95
6-32, 6-40, 8-32, 10-24, 10-32, -20, -28, 5/16-18, 5/16-24, 3/8-16, 3/8-24, 7/16-14, 7/16-20, -13, -20, 5/8-11, 5/8-18, -10, -16, 1-8, 1-12

Set No. SWTC-M21 \$29.95
M3x0.5, M4x0.7, M5x0.8, M6x1.0, M7x1.0, M8x1.0, M8x1.25, M10x1.0, M10x1.25, M10x1.5, M12x1.25, M12x1.5, M12x1.75, M14x1.5, M14x2.0, M16x1.5, M16x2.0, M20x1.5, M20x2.5, M24x2.0, M24x3.0

Set No. SWTC-26 \$29.95
6-32, 8-32, 10-24, 10-32, -20, -28, 5/16-18, 5/16-24, 3/8-16, 3/8-24, 7/16-14, 7/16-20, -13, -20; M4x0.7, M5x0.8, M6x1.0, M7x1.0, M8x1.0, M8x1.25, M10x1.0, M10x1.25, M10x1.5, M12x1.25, M12x1.5, M12x1.75

United States Patent #7877882

Stop-Loc® LATHE STOP & MILLING VISE TOOL
The Only Adjustable Front Collet/Chuck Stop In The World

- No more fixed length shop-made front collet stops.
- For CNC or manual lathes whether manually pulling a bar through a collet/chuck or using a bar puller (first pull for each bar)
- Gauge lengths up to 5-1/2" long.
- Can be used on all stock shapes up to 3" round, square, hex, etc.
- Self-centering, unobstructed viewing, and contrasting colors for user confidence by feeling/seeing that the dimension is being controlled.
- Change dull drills (up to 3/4" diameter) in your turret.
- Mill both sides of your stock without a stop in the way.
- Its also a ruler for visual reference.



The Original MODEL No. OSL-550 **\$13.95**

Deluxe MODEL No. DSL-550 **\$17.95**

Quick and Easy - Just stop, lock, remove and you're ready to machine!

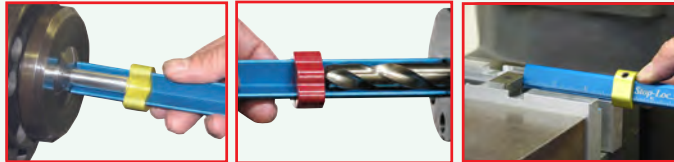

Versatile - Can Be Used On All Stock Shapes

Custom Drill Stop - Change Dull Drills In Your Turret

Mill Both Sides Of Your Stock Without A stop In Your Way

SPG SERVICE PRECISION GRINDING TDR/SRD DRILL SHARPENER

- Quick web thinning.
- Rugged construction.
- Optional tap & reamer resharpener using the 5C collet holder & indexing finger, utilizing your 5C collets.
- Diamond wheels are available for carbide drills, taps or reamers.
- Precise results, drill point concentricity is .001" lip to lip.
- Solid cast iron mountings for totally enclosed Baldor motor.
- Hardened and ground slide rails.
- Cast iron, aluminum and steel construction.



MODEL No. 82-R **\$1295.00**

S&W **THREAD CHECKER WALL MOUNTABLE**

- Bolt thread checker in both standard and metric sizes
- Nut thread checker in both standard and metric sizes
- Bolt length checker in both standard and metric sizes
- Screw size checker in both standard and metric sizes
- Mounted On Heavy-duty 1/2 Inch Sintra® and more

Model No. SWTC-WM1 \$54.95
6-32, 8-32, 10-24, 10-32, -20, -28, 5/16-18, 5/16-24, 3/8-16, 3/8-24, 7/16-14, 7/16-20, -13, -20; 9/16-12, 9/16-18; M4x0.7, M5x0.8, M6x1.0, M7x1.0, M8x1.0, M8x1.25, M10x1.0, M10x1.25, M10x1.5, M12x1.25, M12x1.5, M12x1.75

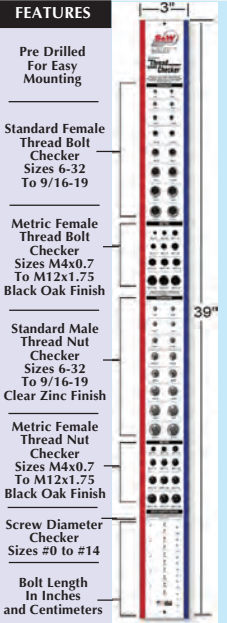

FEATURES
Pre Drilled For Easy Mounting
Standard Female Thread Bolt Checker Sizes 6-32 To 9/16-19
Metric Female Thread Bolt Checker Sizes M4x0.7 To M12x1.75 Black Oak Finish
Standard Male Thread Nut Checker Sizes 6-32 To 9/16-19 Clear Zinc Finish
Metric Female Thread Nut Checker Sizes M4x0.7 To M12x1.75 Black Oak Finish
Screw Diameter Checker Sizes #0 to #14
Bolt Length In Inches and Centimeters

SCREW CHART THE ULTIMATE ENGINEERING SCREW CHART

- Great Innovations' Screw Chart includes technical information from many of the quick references that are commonly found in the work areas of designers, engineers, and machinists.
- Material: Heavy Duty Plastic
- All of this information is compiled for both English (Imperial) and Metric systems in a single screw chart.
- Screw Chart Overall Size: 8.75 X 11 X .06 inches (222 X 280 X 1.5 mm)

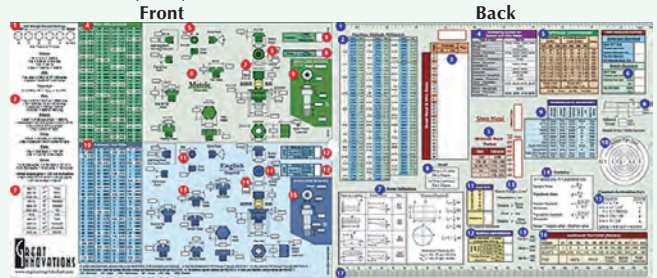

For Detail Specifications and Demo Video, Visit our website @ www.penntoolco.com

Model	Description	Price
ENG-CHART1	Ultimate Screw Chart (Quantity 1 to 11, Price Each)	\$28.95
ENG-CHART2	Ultimate Screw Chart (Quantity 12 to 25, Price Each)	26.95
ENG-CHART3	Ultimate Screw Chart (Quantity 26 or more, Price Each)	24.95



Table can be set at any angle

- Sharpens standard drills 1/16" - 13/16" & center drills #1 to #8.
- Quick change options for left-hand drills, taps/reamers and point splitting.
- Carbide drills need an optional diamond wheel.

Model	Description	Price
PBOP-R	Point Splitting Option	\$280.00
TPOP-R	Tap/Reamer Option	425.00
LHOP-R	Left Hand Drill Option	109.00
1760-P	Aluminum Oxide-90 grit for high speed steel & cobalt, 1-3/8" OD, 3/8"-16 thread	17.00
1790-P	Aluminum Oxide-fast cut 60 grit for high speed steel & cobalt, 1-3/8" OD, 3/8"-16 thread	17.00
1750-P	Silicone carbide-120 grit for carbide, 1-3/8" OD, 3/8"-16 thread	25.00
1770-P	Diamond-180 grit for carbide, 1-3/8" OD, 3/8"-16 thread	185.00
7370-P	Aluminum Oxide-120 grit for high speed steel & cobalt, 3/4" OD, 1-3/8" OD, 3/8"-16 thread (replacement for PBOP-R)	20.00
1580-P	Standard replacement drill chuck for drills 1/16"-13/16"	195.00
1582-P	Counter bored chuck for taper shank drills 1/16"-13/16"	250.00
8670-P	Diamond dresser (replacement for PBOP-R)	45.00

Specifications:
Angle Range 85° to 160°
Relief Angles 0° to 20°
Dimensions 16" x 10" x 8"
Weight 50 lbs.
Motor 110V
Right hand Drill Capacity 1/16"-13/16"
Left Hand Drill Capacity 1/16"-1/2"
Point Splitting Capacity 1/8"-1/2"
Point Splitting Capacity 1/8"-1/2"
Tap Capacity #10 - 3/4"
Reamer Capacity 1/8" - 3/4"



MICROMETER SET MASTERS

- Use as a toolcrib master, calibration master, quality control standard to check lead and parallelism of your micrometers.
- Stainless steel to reduce wear and prevent rust.
- Hardened, stabilized, ground and lapped to $\pm .0001"$.



0-1"
MODEL No.
MSM-010

\$350.00

ISO
9001
CERTIFIED

Model	Description	Price
MSM-010	0-1" .100"-1.00" by .100" increments	\$350.00
MSM-161	1"-6" by 1" increments	595.00
MSM-165	1/2"-6" by 1/2" increments	895.00
MSM-112	1"-12" by 1" increments	1895.00

Also Available in Metric at the same price as English

Long Form Certificate of Conformance to "NIST"
No. MSM-010C for #MSM-010 Add \$73.00
No. MSM-161C for #MSM-161 add \$73.00
No. MSM-165C for #MSM-165 add \$145.00
No. MSM-112C for #MSM-112 add \$195.00

Mikemaster® SURVEILLANCE KITS

For 1" Micrometers For 1", 2" & 3" Micrometers

- Designed and packaged for the shop using a majority of 1" micrometers.
- Has nine different sized steps, each one accurate to $\pm .0001"$.
- Steps will explore out-of-parallel anvils in 45° increments and determine any other wear in the micrometer.
- Long form certificate to N.I.S.T. Add: \$75.00 for #DMG-800, \$185.00 for #DMG-900.



0-1"
MODEL
MSK-100

\$275.00

With Metal
Foam Case



1", 2", 3"
MODEL
MSK-200

\$775.00

With Metal
Foam Case

- Metric available at the same price.
 - Long Form Certification to N.I.S.T.
- No. MSK-100C for #MSK-100 add \$75.00, No. MSK-200C for #MSK-200 add \$150.00



QUICK CHECK MASTERS FOR CMMs

All Quickcheck's are made of 440c stainless steel hardened to 62 Rockwell C scale, stress relieved and triple stabilized, ground and lapped flat and parallel.

Run Quickcheck once a week to assure your CMM is operating properly between the yearly manufacturer calibrations.

Check diameter, linear length and squareness X to Y axis then X to Z axis. Measure the 45° length for a volumetric check.

Quickcheck is your mechanical assurance that your CMM is within the specified tolerance of the manufacturer.



ISO
9001
CERTIFIED

Specifications:	8"	16"
Hole diameter	1.0000	2.0000
☿ to ☿ Holes 2 legs	8.0000	16.0000
Hypotenuse ☿ to ☿	11.3137	22.6274
Diameter roundness within	.000010	.000020
Length measurement uncertainty	.000020	.000040
Angle, less than:	1 sec.	1 sec.
Flat & parallel within	.000050	.0002

8" MODEL No.
MCH-008

\$3995.00

16" MODEL No.
MCH-016

\$8995.00



DEPTH MICROMETER MASTERS AND Z AXIS CHECK MASTERS

Depth Master

- Depth Micrometer masters are used to calibrate and set Depth Micrometers.
- The master is superior to gage block calibration because they do not require block stacks and therefore it is much faster to inspect the linear range of the tool.
- The new model offers a more rigid and stable tool than the traditional "step" master.



#DM-1E $\pm .0001"$
#ADM-E $\pm .0002"$

Model	Range & Steps	Price
DM-1E	.50"-5.50" x 1" Steps	\$ 850.00
ADM-E	6.50"-11.50" x 1" Steps	2495.00

Long Form Certificate of Conformance to N.I.S.T.
No. DM-1EC for # DM-1E add \$73.00
No. ADM-EC for # ADM-E add \$180.00

Z Axis Check Masters

- Z axis check masters is used to calibrate and set the z axis on optical measuring machines.
- The master is superior to gage block calibration because they do not require block stacks and therefore it is much faster to inspect linear range of the machine.
- Engraved to the nearest .000010"

Lapped Base
with Mirror Finish

Ground Base
for less reflection

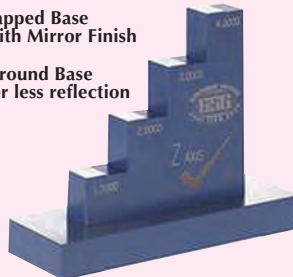

Model	Finish	Price
LX-001	Lapped Base	\$675.00
LX-002	Ground Base	595.00



VERNIER CALIPER MASTERS SURVEILLANCE MASTER

- Used for checking outside jaws, inside jaws and parallelism of jaws.
- Black-oxide to prevent rust.
- Lapped gaging faces are accurate within $\pm .0002"$ or $\pm .005$ mm from the normal size.



1" to 6"

MODEL No.
VCS-100

\$395.00

1" to 12"
MODEL No.
MSK-700

\$1395.00

ISO
9001
CERTIFIED

Specifications:

1" to 6" range in 1" increments for outside & outside jaw calibration.
1" to 12" range in 1" (24 settings) for outside & inside jaw calibration.

Long Form Certificate of conformance to "NIST"

No. VCS-100C for #VCS-100 add \$80.00

No. MSK-700C for #MSK-700 add \$195.00

Depthmaster® DEPTH MICROMETER CHECKER

- Convenient tool crib surveillance for quick & easy inspection of depth gages when they are checked out.
- Model DMG-800 has six step depth for checking the accuracy of dial depth gages and depth micrometers and proper seating of rods.
- Range .500" to 5.500" in 1" increments.
- Model DMG-900 is for checking depth gages longer than the conventional 6" size, can be done accurately and quickly.
- Range .500" to 11.500" in 1" increments. The .500" to 5.500" steps accurate to $\pm .0002"$. Steps 6.500" to 11.500" are accurate to $\pm .0003"$.



Model	Description	Price
DMG-800	Depthmaster .500"-5.500"	\$ 875.00
DMG-900	Depthmaster .500"-11.500"	2300.00

Long Form Certification to N.I.S.T.
No. DMG-800C for #DMG-800 add \$80.00
No. DMG-900C for #DMG-900 add \$190.00

FLEXPBAR CALIPER & HEIGHT GAGE CHECKER

A Calibration Master for in-house calibration of Vernier, Dial and Digital Calipers and Height Gages. Includes Certificate of Calibration Traceable to N.I.S.T.

- Hardened and ground, permanently wrung, high grade gage blocks are stacked in the rigid housing.
- All gage blocks are sub-zero treated for dimensional stability.
- Selected sizes of measuring slips provides for calibration of small scale as well as vernier scales of the instrument.



Calibration of Height Gage using vertical position

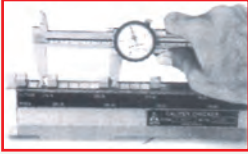

Checking the accuracy of Dial Calipers by external jaw



Checking the accuracy of Calipers by internal jaw

- Accuracy: $\pm 5\mu\text{m}$ ($\pm 0.0002''$)
- Available in Two Checking Ranges: Lengths to check up to 12" and up to 24"

Model	Description	Price
15930	12" Range, Caliper/Height Gage Checker	\$1750.00
15931	24" Range, Caliper/Height Gage Checker	2495.00

FLEXPBAR MICROMETER CHECK

A Calibration Master for in-house Calibration of External Micrometers. Hardened, Ground and Lapped High Grade Gage Blocks are fitted in a rigid housing which make external measurements very easy. Includes Certificate of Calibration Traceable to N.I.S.T.

Micrometer Check Set with 10 Gage Blocks
Grade 1 Accuracy.

- Checking Range up to 1"

MODEL No. **\$695.00**
15935

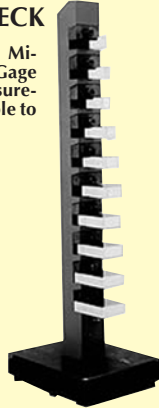

MIKEMASTERS

- Has 12 steps.
- Chrome finished to prevent rust and corrosion.
- Made of hardened, stabilized steel ground and lapped for long life and consistent accuracy.
- Includes heavy-gage polyethylene.



Metric Sizes Available At No Extra Cost

Model	Range	Increments	Price
MSK-300	1" to 6"	1" Steps	\$ 550.00
MSK-400	1" to 6"	1/2" Steps	895.00
MSK-500	1" to 12"	1" Steps	1595.00

*Long Form Certification: Add: \$90.00 for Model No. MSK-300
\$160.00 for Model No. MSK-400 \$200.00 for Model No. MSK-500



GEOMETRIC CHEK MASTER

- Master is supplied with complete certification for roundness, parallelism, perpendicularity and concentricity.

MODEL No. **\$1350.00**
GC-100 Re-Calibration **\$150.00**



NEMI TOOL SETTER

- The NEMI Tool Setter allows you to measure tools off-line.
- You can measure tools in seconds and be ready for the next job while the machine is still in production.
- No starting and stopping of your CNC machine, the machinist pre-sets tools at their work bench.
- The NEMI Tool Setter allows you to find the distance from the gage line of the holder to the tip of the cutting tool. This number becomes the tool offset number that gets entered into your CNC machine.

Specifications:

Capacity: 0-12" Optional: 16" post available
Dimensions: . . . 19.5" Tall x 7.5" Long x 6.0" Wide
Weight: 14 pounds
Resolution: 0.0005"
Repeatability: $\pm 0.0004''$

Aluminum pocket is standard. Optional: Hardened and Ground steel pockets available.

Your Choice of Taper Pocket:
30, 40, 50 or HSK Tool Pocket (Specify Taper)
Optional: Hardened Taper Pocket Add **\$295.00**
16" Tool Setter Post Add **\$300.00**



MODEL No. 727-40

\$1195.00

MADE IN USA

Precise H/V TOOL SETTING FIXTURE

- Quick and easy way to set tool holders horizontal or vertical.

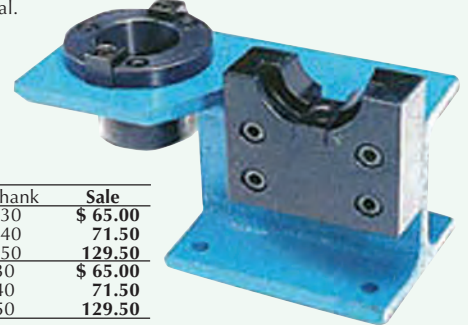

Model	Tool Shank	Sale
3900-4083	CAT30	\$ 65.00
3900-4084	CAT40	71.50
3900-4085	CAT50	129.50
202-2630	BT30	\$ 65.00
202-2632	BT40	71.50
202-2634	BT50	129.50

Precise MICRO CHECKING SET 12 PIECES With Optical Flats

- For checking various spindle positions of entire micrometer range.
- Meet or exceeds U.S. Federal Specification GGG-G-15C and ISO 9000 requirements.
- Gauge blocks include: .105, .210, .315, .420, .500, .605, .710, .815, .920 & 1.000"
- Optical flats for checking micrometer flatness are .500 & .5125"
- Manufacturer's calibration certificate included.
- Complete with fitted case.



Grade AS-0 +4/-2 millionths
MODEL No. 4101-0032
\$195.00

Precise MICRO CHECKING SET 10 PIECES With Optical Flat

- Meet or exceeds U.S. Federal Specification GGG-G-15C and ISO 9000 requirements.
- Gauge blocks include: 0.625, .100, .125, .200, .250, .300, .500, 1.000 & 2.000"
- Optical flats for checking micrometer flatness.
- Manufacturer's calibration certificate included.
- Complete with fitted case.



Grade AS-0 +4/-2 millionths
MODEL No. 4101-0031
\$195.00



PRECISION REFERENCE STANDARD AND STYLUS CHECK

Shows actual patch mean values certified by the National Institute of Standards and Technology (NIST) Calibrate your surface analyzing equipment to peak efficiency



- The Precision Reference Standard provides an economical calibration tool which permits the technician to calibrate surface analyzing equipment to its peak efficiency.
- It is the only calibration block on the market to show the actual patch mean values of low and high microinch surfaces and certified N.I.S.T.

Has actual mean patch values. Each duplicate of master plate tested and certified by N.I.S.T. Conforms to ANSI-B 46.1-1985

PATCH MEAN VALUE		
Area	18.10	119.5
No.	microinches	microinches
1	16.20	119.40
2	16.20	119.40
3	15.66	118.10
4	16.00	119.63
5	16.26	119.50

MODEL No. 16037

Complete with Metric Conversion Chart plus signed Certificate of Traceability to NIST. Made of pure electroformed nickel. Provided with protective case



\$165.00



MICRO COMPARATOR

The Original Made in U.S.A.

Composite Set of 22 Specimens
5 Machine Finishes - Most Useful Values
Made of solid Electroformed Nickel - Premium Quality

Model No.	(in microinches)
Lapped	2, 4, 8
Ground	8, 16, 32, 63
Blanchard Ground	16, 32
Shape Turned	32, 63, 125, 250, 500
Profiled	63, 125, 250, 500
Milled	63, 125, 250, 500



Model No.	Description	Price
16038	(microinches) Made of Solid Electroformed Nickel. All Complete w/Case & Instructions	\$69.95
16038-M	(micrometers) Made of Solid Electroformed Nickel. All Complete w/Case & Instructions	65.00
S-22	Same as above. (Made in China)	49.95

Precise SURFACE ROUGHNESS GAGES

- Pocket size gage has 22 precision surfaces for specifying and controlling surface finishes.
- Includes lapped, ground, turned and milled specimens.
- Range: 2 to 500 micro-inches.
- Dimensions: 5" x 2"
- Leather case included.



MODEL No. S-22 **\$49.95**

FLEXBAR COMPOSITE SET OF ROUGHNESS STANDARDS

Now available with individual serialized calibration report traceable to N.I.S.T.

- Made of solid electroformed nickel. A truly international set with markings in AA (microinches) and Metric Ra (micrometers)
- 30 specimens 7/8" x 3/8" of electroformed solid nickel.
- Each type of surface finish, such as flat lapping, reaming, grinding, horizontal milling, vertical milling, and turning, is truly and consistently reproduced so as to give the operator or designer a realistic idea of the feel, appearance, and texture of the machined components.
- A set of instructions is included with each set.
- By means of this set, or one of our individual (larger) standards specimen scale sets, quick and easy comparisons can be made.



3 Specimens Flat Lapping	2, 4 and 8µ" AA
3 Specimens Reaming	16, 32 and 63µ" AA
6 Specimens Grinding	2, 4, 8, 16, 32 and 63µ" AA
6 Specimens Horizontal Milling	16, 32, 63, 125, 250 and 500µ" AA
6 Specimens Vertical Milling	16, 32, 63, 125, 250 and 500µ" AA
6 Specimens Turning	16, 32, 63, 125, 250 and 500µ" AA

Model	Description	Price
16008-2	Composite Set- Surface Roughness Standards (Includes Certificate of Conformance)	\$105.00
16008-CAL	Composite Set- Surface Roughness Standards complete with Long Form Calibration report Traceable to N.I.S.T.	255.00



CAST AND TURN COMPARATORS

9 Specimens

- 9 specimens provided. Cast surface values for Die Casting, Investment, Shell, Centrifugal, Permanent Mold Ferrous and Non-Ferrous, Sand and Green Sand from 20 to 900 microinches.

Model	Description	Price
16039	Complete with Instructions, Engineering Data and Case	\$75.00
16039-M (metric)	0.51 to 22.86 micrometers	69.50

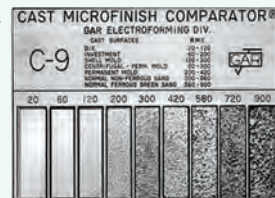

GRIND AND TURN COMPARATORS

4 Models - Inch & Metric Made of Solid Nickel

- Furnished in attractive Vinyl case with Instructions.
- Each model has 10 specimens: 5 each internal diameter (concave) and 5 each Outside Diameter (convex)



Model No. 16041 (in microinches) **\$75.00**
Cylindrical Turning Comparator
10 Specimens-(Shows I.D. and O.D.)

5 each I.D. (concave) 16, 32, 63, 125 & 250 Ra
5 each O.D. (convex) 16, 32, 63, 125 & 250 Ra

Model No. 16041-M (in micrometers) **\$75.00**
Metric Cylindrical Turning Comparator
10 Specimens-(Shows I.D. and O.D.)

5 each I.D. (concave) 0.4, 0.81, 1.6, 3.18, 6.35
5 each O.D. (convex) 0.4, 0.81, 1.6, 3.18, 6.35

Model No. 16042 (in microinches) **\$69.50**
Cylindrical Turning Comparator
10 Specimens-(Shows I.D. and O.D.)

5 each I.D. (concave) 4, 8, 16, 32 & 63 Ra
5 each O.D. (convex) 4, 8, 16, 32 & 63 Ra

Model No. 16042-M (in micrometers) **\$69.50**
Metric Cylindrical Turning Comparator
10 Specimens-(Shows I.D. and O.D.)

5 each I.D. (concave) 0.1, 0.2, 0.4, 0.81, 1.6
5 each O.D. (convex) 0.1, 0.2, 0.4, 0.81, 1.6



PAK KIT ~ MICROFINISH COMPRESSOR SCALE KIT

- The Gar Pak enables the user to have the full range of surface finish scales available at all times in a convenient protective case.
- The scales are furnished in an attractive pocket-sized vinyl case.

Contains:

- S-22 standard machine finishes.
- G-6 grit blast finishes.
- SH-6 shot blast finishes.
- E-9 electrical discharge machine finishes.

MODEL No. G-400

\$190.00



SURFACE FINISH COMPARATORS

- ACCURATE - Exact Reproductions. Range: 16 to 500 Microinch Finish.
- CONVENIENT - Pocket size (3-1/2" x 5"), Weight: 1 oz.
- Has a handy "hang up hole".
- VERSATILE - Specimens include Mill, End Mill, Grinding, Shape Turning and Flame Cut.

Machining Method	Microinches (AA or Ra)
Grinding	16, 32, 63, 125 and 250
End Milling	63, 125, 250 and 500
Milling	63, 125, 250 and 500
Shape Turning	63, 125, 250 and 500
Flame Cutting	500

Model	Description	Price
16007	Made of tough, scratch resistant ABS Unbreakable Plastic, Black Color. Complete with Plastic Wallet.	\$ 8.95
16045	Durable Nickel-Chrome Metal Finish Complete with Plastic Wallet.	18.95



SPI PRO-TRONIC DIGITAL LEVEL, PROTRACTOR, INCLINOMETER



- Measures full 360°, 0° to 90° in each quadrant, with standard counter-clockwise rotation.
- Reset plus Superset self calibration modes.
- Large clear LCD display instantly shows level, true vertical and any angle between.
- Uses standard 9V Alkaline batteries. Batteries included.
- Hold button freeze for convenient out of sight measurements, a V-groove on the top plate for accurate registration on curved or cylindrical surfaces and tapped #6-32 holes in base plate for special mountings.



PRO-3600 Data Logger System Software

- Records data from Pro 3600 Digital level onto a computer with Windows XP® as operating system.
- Recording can be triggered with footswitch PRO-041
- After data is collected, the "Export" key will send it to an existing program for future analysis.

Model	Description	List	Sale
PRO-046	PRO-360 0.1° resolution with pouch	\$255.70	\$215.00
PRO-040	PRO-3600 0.01° resolution SPC output & case	397.85	\$35.00
PRO-041	SPC cable & foot switch for PRO-3600 Level	-	139.00
KS-5571	Magnetic Base Attachment	-	69.50
PRO-029	Data Logger Software for PRO 3600	-	\$ 69.95
LEV-CERT	Certification to N.I.S.T.	-	55.00

Mitutoyo DIGITAL PROTRACTOR LEVEL PRO 360 & PRO 3600



These Digital Protractors present inclination values on an easy-to-read liquid crystal display. The measurements are generated by an electric gravity sensor and processed by the latest low power electronic circuit technology.

- Simple calibration requiring no special fixtures.
- Display remains upright to view at all angles.
- 950-318 has SPC output.
- V-groove on bottom of base.
- Full 360° range (90° x 4)
- Machined aluminum frame.
- Alternate reference (zero)
- Reading hold



PRO360
950-317
Reg. \$263.00

\$219.95

Model	Description	Range	Res.	List	Sale
950-317	Pro 360	360° (90° x 4)	0.1°	\$263.00	\$219.95
950-318	Pro 3600	360° (90° x 4)	0.01°	434.00	369.00
64PPP794	Magnetic Base Attachment			\$ 85.00	\$ 69.50
PRO-029	Data Logger Software for PRO-3600				69.95
50AAA985A	RS-232 Cable with foot switch			190.00	165.00
LEV-CERT	Certification to N.I.S.T.				\$55.00

Precise DIGITAL PROTRACTOR LEVEL

The Digital Protractor present inclination values on an easy-to read liquid crystal display. The measurements are generated by an electronic gravity sensor and processed by the latest low-power electronic circuit technology.

- Full 360° range (90° x 4).
- Machined aluminum frame.
- Alternate reference (zero).
- Reading hold.
- Simple calibration requiring no special fixtures.
- Display remains upright to view at all angles.



Specifications:

Range 360° (90° x 4)
Resolution 0.1°
Accuracy . . ±0.1° Level ±10°
 Plumb ±10°
Dimensions:
L x W x H: 6" x 1-3/8" x 2-7/16"
Weight 6.5 oz

MODEL No.
901-010-1

Reg. \$149.00

With Pouch

\$79.95

With Magnetic Base

MODEL No.
901-010-2

\$99.95

"MIRACLE POINT" MAGNETIC BASE PROTRACTOR

- An extremely accurate protractor with extremely sensitive, sealed mercury balanced needle.
- Protractor is permanently attached as an integral part of a powerful Magnetic V Base containing lifetime Alnico magnets.
- V base is precision ground.
- Gives immediate readings of angles for full 360 degree radius.



Specifications:

Height: 5-1/4" Width: 5"
Depth: 1" Weight: 16 oz.
Packaged one per carton 23 oz.

MODEL No.

MPP-900

\$289.95

Complete With:

Certificate of
Conformance as Note
Under FED-STD-638
N.I.S.T. #821/25017

Optional:
No. MPI-100
Replacement
Center Punch
\$32.95

No. MPP-901
Metal Fitted
Case
\$44.95

No. 900-22 Replacement Lens,
Lens Guard, Steel Ring, Glue
and Instructions **\$32.95**

No. 900-20
Lens Only
\$21.95

"MIRACLE POINT" LARGE SPAN MAGNETIC BASE PROTRACTOR & CENTER LOCATOR

- An extremely accurate protractor with extremely sensitive, sealed mercury balanced needle.
- Gives immediate readings of angles for full 360 degree radius.
- Protractor is permanently attached as an integral part of a powerful Magnetic V Base containing lifetime Alnico magnets.
- V base is precision ground.

With V-Base
MODEL No.
MPP-200

\$579.95

With Plastic Case
Accuracy: +/- .5°
Up to 27" Dia.

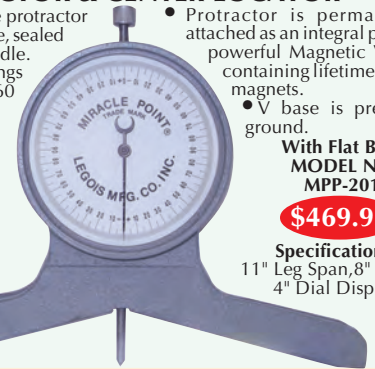

With Flat Base
MODEL No.
MPP-201

\$469.95

Specifications:
11" Leg Span, 8" Height
4" Dial Display

VIS MASTER PRECISION LEVELS

- The V-groove allows for leveling cylindrical surfaces.
- Two graduated vials allow for lateral and horizontal settings.
- Flatness for 12" level 0.0002".
- The main level vial is graduated to 10 second accuracy (1 division equals .0005" per foot).
- The body of the level is of cast iron and the base is hand scraped for extreme accuracy.
- Plastic knobs on the frame to insulate the instrument from the heat of the hand.

12" Level
MODEL No.
422-012

\$239.95



PRECISION FRAME SPIRIT LEVELS

Frame Spirit Level Features:

- This level comes 2" "V" and 2 flat bases.
- Bubble tube is interchangeable.
- Sensitivity range: .0005"/10".
- Protective insulating handle.
- Wooden case.

Magnetic Spirit Level Features:

- This level checks horizontal and vertical surfaces.
- Perfect adhesion to vertical surfaces.
- Magnetic inserts are inside vertical leg.
- Both legs have "V" grooves and a flat face.
- Bubble tube is interchangeable.
- Supplied with insulating handle and wooden case.

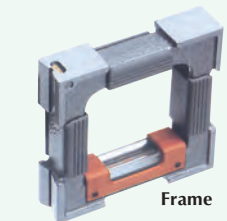

Frame



Magnetic

Model No.	Dimensions	Size	List	Sale
Frame Square Type				
53-31201	4" x 1-5/8" x 4"	4"	\$1218.00	\$1150.00
53-31204	6" x 1-5/8" x 6"	6"	1395.00	1325.00
53-31208	8" x 1-5/8" x 8"	8"	1504.00	1425.00
53-31210	10" x 1-5/8" x 10"	10"	1812.00	1720.00
Magnetic Type				
53-31002	6" x 1-9/16" x 6"	6"	\$1664.00	\$1575.00

Precise DIGITAL ANGLE GAGE 0-360° With Magnetic Base

- The Digital Angle Gage is an innovative tool that provides digital reading between ± 0-180°.
- Extra large LCD is convenient to read.
- Compact and lightweight it is easily ready to use.
- Magnetic base has powerful disk magnets



Specifications:
 Resolution: 0.1 degree
 Repeatability: ±0.1 degree
 Angle Range: ±0-180°
 Waterproof: IP54
 Power: 3V Lithium Battery
 Dimensions: 2" x 2" x 1.3"

MODEL No. **\$39.95**
DAG-360
Reg. \$69.95 With Soft Case
 & Instructions

Fowler MINI-MAG PROTRACTOR



The mini-MAG protractor provides instant 360° inclination display of any angle with the additional unique feature of embedded magnets on both sides and the bottom which make it ideal for a variety of measurements

- **Embedded magnets with 35lb pull.**
- Measuring range: 360° (4 x 90°)
- Display inverts
- Resolution: .05°
- Accuracy: ± .2°
- Repeatability: ± .05°
- Uses Standard 9V battery (250 hrs.)
- Hold feature



MODEL No.
54-422-450-1
Reg. \$99.95

Dimensions: L: 2.375" x W: 1.375"
 x H: 2.375"

\$64.95

XTRA-VALUE DIGI-LEVEL

The Xtra Value Digi-Level provides instant 360° digital inclination display of any angle, aluminum housing, with large LCD, reading hold, absolute 0° at sea level and supplied in vinyl pouch.

- Measuring Range: 360° (4 x 90°)
- Resolution: .05°
- Accuracy: ± .02° maximum error.
- Repeatability: ± .1°
- Dimension: 4"L x 1"W x 3"H
- Voltage: Standard 9V battery.
- Battery life: up to 250 hours.
- Operating Temp: -5°C to 50°C (23°F to 122°F)
- Storage Temp: -20°C to 65°C (-4°F to 176°F)
- Weight: 1.1 lbs.



MODEL No.
54-422-444
Reg. \$120.00
\$99.95

WYLER



CLINOTRONIC PLUS ELECTRONIC LEVEL

- Range of ±45°, capacity of 0-360° using all four bases.
- Programmable base length.
- Display: use any units common to inclination measurements.
- Desired units to be selected by push button.
- Automatic setting of zero by push button command.
- Absolute or relative measuring mode selectable by push button.
- Low battery indication.
- No loss of calibration data by power failure.
- Includes case.
- Built-in calibration program.
- Uses standard 1.5V AA batteries.
- Seal-tec technology for excellent performance even in difficult environmental conditions.
- Interface connection RS485 is integrated. Special RS-232 adaptor cables are available.

MODEL No. **+**
54-635-601
List \$1895.00 **Swiss Made**

\$1795.00

RS-232 Cable with Adapter
No. 54-635-432
\$425.00



WYLER



DIGITAL CLINO 2000

- Highest possible precision over large measuring range of ±45° with integrated temperature compensation.
- Effortless zero adjustment by using the integrated software and a reversal measurement.
- Easy to calibrate due to implemented software guidance and calibration aids included.



MODEL No.
54-825-200
List \$4750.00

\$4495.00



Swiss Made

WYLER



MAGNETIC PRECISION & SPIRIT LEVELS

- The Wyler Magnetic Precision Spirit level has two prismatic measuring bases for checking horizontal and vertical cylinders and surfaces.
- Sensitivity .0002" per 10"
- Insulated handle.
- Magnets to ensure complete adherence to vertical surfaces of parts and vertical arbors or shafts.
- Vial unit is set into a steel tube in stress free location.
- Includes wooden case.
- Simple adjustment system.
- Stability of twist to ±.5°
- Fully in compliance with DIN standards.



MODEL No.
53-422-048
List \$2485.00

\$2295.00

Precise PRECISION FRAME SPIRIT LEVELS

- This level comes with frame level and master level.
- .0002" Graduations.
- With fitted case.



6" x 6"
MODEL No.
4901-0077

\$99.95

8" x 8"
MODEL No.
4901-0078

\$109.95

12" x 12"
MODEL No.
4901-0007

\$189.95

Precise MASTER PRECISION LEVELS

- **Graduation: 0.0005" per 10".**
- For accuracy checking the work of machinists and toolmakers setting up machinery and other work that requires extreme leveling accuracy.
- Ground and graduated main vial of 10 second accuracy.



4"
MODEL No.
4901-0084

\$79.95

8"
MODEL No.
4901-0081

\$89.95

12"
MODEL No.
4901-0008

\$145.00

WYLER

Fowler

CROSS SPIRIT LEVELS

52-422-078

- The Cross Spirit Level is used for leveling machines & other apparatus
- Overall length: 3.15"; 2.64" width; .667" thickness
- Center to center distance of holes is 1.378"
- Sensitivity is .002"/10", 20 seconds (.1mm/m)
- Level is screw-on type.



- The Cross Spirit Level is used for leveling machines & other apparatus
- Overall length: 6"; 6" width; 1.18" thickness
- Center to center distance of holes is 2.36"
- Sensitivity is .0002"/10", 4 seconds (.02mm/m)
- Level is screw-on type.

Model	Description	Price
52-422-078	Cross Spirit Level 3" (80mm)	\$ 625.00
52-422-079	Cross Spirit Level 6" (150mm)	1375.00

WYLER

Fowler

SCREW-ON SPIRIT LEVELS

- Screw-on Spirit levels are used for leveling machines, apparatus and other technical purposes.
- Overall length: 2.36" (60mm)
- Thickness: .55" (14mm)
- Width: .47" (12mm)
- Hole diameter: .135" (3.5mm)
- Center to center distance: 1.97" (50mm)



MODEL No. 54-422-066

\$450.00



WYLER

Fowler

PRECISION SPIRIT LEVELS

- Protective wooden handle with large plastic window prevents damage to the vial from dirt and rough handling.
- Fully in compliance with DIN standards.
- Magnetic inserts available upon request.
- To ensure constant high precision, the main vial is mounted under stress free conditions within a steel tube.
- In addition to the normal viewing from above, the large window enables the vial to be observed from both sides. This advantage is obvious when the operator is working in confined, close, remote areas and unable to move about during his inspections.
- Includes wooden case.



Model	Level Sensitivity	Dimensions	Price
53-422-525	.0005"/10" (.05mm/m) 10 sec.	7-7/8" x 1-11/16" x 1-5/8"	\$
53-422-555	.0005"/10" (.05mm/m) 10 sec.	11-13/16" x 2" x 2"	

WYLER

Fowler

CIRCULAR SPIRIT LEVELS

- Circular Spirit levels are used for leveling machines and other types of apparatus.
- Mounting diameter of No. 52-422-074 is .984" (25mm). The screw hole diameter on this model is .98" (2.5mm)
- Mounting diameter on No. 52-422-072 is 1.968" (50mm). The screw hole diameter is .135" (3.5mm)



Model	Base	Sensitivity	Price
52-422-072	2.360"	20-30 min. of arc	\$265.00
52-422-073	.787"	20-30 min. of arc	85.00
52-422-074	1.181"	20-30 min. of arc	105.00



WYLER

Fowler

SPIRIT LEVELS

Precision Frame Spirit levels

Levels are used for adjusting and checking horizontal and vertical surfaces and shafts. Sensitivity .0005" per 10". The level features two prismatic sides and also come equipped with insulating handles.



- Ultra high quality.
- Hand scraped by Swiss craftsmen.
- A clear view of the main vial can be observed not only from above, but also from both sides. This full view allows position of the bubble to be read easily.

Model No.	Inch	Metric	Sensitivity Angular	Overall Dimensions	Price
53-422-057	.0005"/10"	.05mm/m	10 Sec.	6" x 1-3/8" x 6"	\$1350.00
53-422-058	.0005"/10"	.05mm/m	10 Sec.	4" x 1-3/8" x 4"	1335.00
53-422-059	.0005"/10"	.05mm/m	10 Sec.	7-7/8" x 1-9/16" x 7-7/8"	1850.00

WYLER

Fowler

PRECISION SPIRIT LEVELS

Features: 53-422-063

- Shaft Spirit Level constructed with side viewing slots and a prismatic base.
- Base length is 7-7/8" x 1-13/16" x 1-3/8"
- Includes wooden case.



Features: 53-422-061

- The Inspection Spirit level features a prismatic base.
- Length of base is 7-7/8" x 1-3/4" x 3-1/6"
- Includes wooden case.



Features: 53-422-068

- The adjustable Micrometer Spirit level is used to measure flatness of surfaces, inclination, tapers or concentricities.
- Prismatic measuring base is hardened and ground and the level includes an insulated handle.
- Base measures 5-7/8" x 1-3/4" x 3-1/6"

- Micrometer has a hundred division lines with engraving of figures from 0-100.
- By depressing center knob, the micrometer can be turned easily and positioned to zero.
- Angle of level is fine adjusted using the micrometer knob.
- Includes wooden case.



Model	Description	Sensitivity	Price
53-422-061	Inspection Spirit level	.0005" per 10"	\$1695.00
53-422-063	Shaft Spirit Level	.001" per 10" (.1mm per m), 20 seconds	875.00
53-422-068	Adjustable Micrometer Spirit Level	.00025" per 12"	4250.00

WYLER

Fowler

BlueCLINO HIGH PRECISION LEVEL

- Large and very well readable color display: Various color profiles can be chosen, Various display methods like bar graphs or spirit levels can be chosen, All current units can be indicated.
- High Precision over the whole measuring range of $\pm 1^\circ$ with integrated temperature compensation.
- The internal software, together with a reversal measurement allows, a simple zero setting.
- Rugged housing, rust protected and hand-scraped prismatic bases made out of cast iron.
- Built-in cross vial for easy alignment of the vertical axis in order to avoid "twist errors".
- The instrument is compatible with the whole range of digital sensors of WYLER.
- Powered with common 1.5V batteries, rechargeable batteries or with mains adapter.
- Fulfills the strict CE requirements (immunity against electromagnetic smog).
- The instrument can be adjusted to the local gravitation
- Limits of error: Under $0.5^\circ = 1\%$ of measured value, Over: $0.5^\circ = 0.1 \times (2x \text{ measured value}) - 0.5^\circ$



Specifications:

Measuring Range: ± 1 degree
 Limits of error at $-45^\circ, 0^\circ, +45^\circ$ right: after quick calibration, using the calibration aids/gain: Limits of error as above in range of $+45^\circ$, but <30 Arcsec
 Wireless Option: Bluetooth@ISM Band/ 2,4000-2,4835 GHz
 Dimension Housing + net Weight: Cast Iron, rust-protected: 150 x 150 x 40mm 3450kg

MODEL No. 54-825-400

\$11,995.00

No. 54-896-200 USB Cable \$280.00



Precise DIGITAL LAYOUT PROTRACTOR

- Easy to measure all kinds of angle and draw lines. Best tool for power hand saw to cut the wood at all angles.
- Conversion between absolute measurement and relative measurement.
- Display always reads upright, no matter which way it is turned.
- Easy calibration and Zero setting.
- Analogue quadrant showing for easy reading.
- High accuracy level bubble for measuring horizontal level easily.
- Lock the moving blade at any angle.



Put the moving blade in the same surface of the fixing blade



MODEL No.
DLP-100
Reg. \$59.95

\$39.95

Specifications:

Blade Length 10.16" Work Temperature ... +5° C- +45° C
Resolution 0.05° Work Humidity <85%RH
Accuracy 0.1° Waterproof IP54
Measuring Range 360° Power 3VCR2032Lithiumbattery



T-BEVEL-STAINLESS STEEL

- High accuracy T-Bevel features both straight slots and offset slots in the blade and straight slots in the stock. This combination allows for the widest possible variety of adjustments.
- Align the T-Bevel with the angle you want to duplicate then tighten the knurled locking nut. Stainless steel.

MODEL No.
5150-006

\$22.95

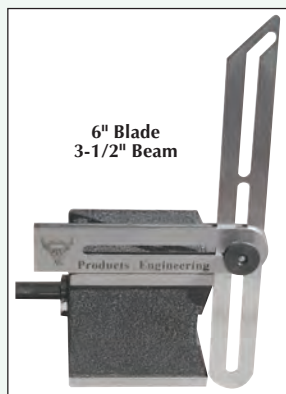

6" Blade
3-1/2" Beam

Precise UNIVERSAL BEVEL PROTRACTORS

With 6" and 12" Blades

- Dial face and vernier finished in satin chrome for easy reading and fine adjustment.
- 6" and 12" blade slides full length, fastened by a knurled thumb lock which can be set at any point. Blades beveled 45° on one side; 60° on other.
- Protractor dial graduated over 360° in 0 to 90° sectors and rotates around the full circle. Readings to 5 min. of arc with vernier.
- Price includes fitted case.

Dial Type
MODEL No.
UDP-100

\$59.95



Vernier Type
MODEL No.
BP-301

\$49.95



ELECTRONIC UNIVERSAL PROTRACTOR WITH 6" & 12" BLADES

- Hardened stainless steel
- Range selection: 1x360°, 2x180°, 4x90°
- Dual reading LCD display arc minutes/decimal degrees
- Preset function
- 6" and 12" blades and acute angle attachment included
- Fine adjustment
- RS-232 output
- Measuring range: 0-360°
- Resolution: 30"
- Accuracy: ±5°



Model No.	Description	Reg. Price	Sale Price
52-440-750	Electronic Universal Protractor	\$249.95	\$199.95

Precise DIGITAL ANGLE PROTRACTOR

- 10" blades and body are made of precision cast aluminum.
- Resolution 0.1° repeatability ± 0.1°, measuring range 0-180°.
- Large digital display with on/off, ABS/Zero and hold buttons.
- Powered by lithium 2000 hour battery.
- Waterproof protected IP-54

MODEL No.
DAP-180

\$79.95

With Metal Case

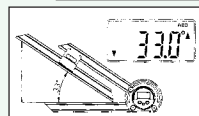
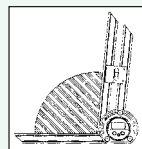
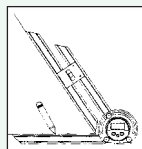
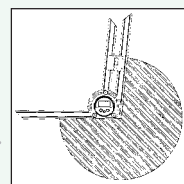
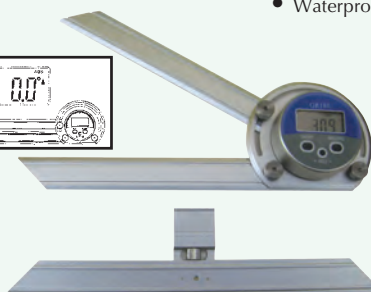

GENERAL PRO-ANGLE DIGITAL PROTRACTOR

- 6" (150mm) stainless steel protractor arm with knurled locking nut.
- Large, easy-to-read display.
- Absolute and relative measurements.
- Accuracy: 0.1°.
- Resolution: 0.05°.
- Range: 0.00° to 180.00°.
- Display can be inverted for easy reading.
- Hold function to freeze measurement.
- Includes: 1 "CR2023" (1.55V) battery.



MODEL No.
1702
List \$33.95

\$26.95



TORPEDO LEVELS

- True Blue are accurate to within 0.00050" per inch in all 10 level and plumb working position.
- Heavy-duty aluminum frame with top read window.
- Strong-holding magnetic edge.

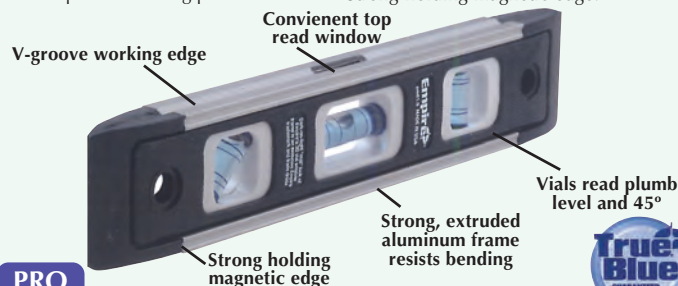

PRO
LIFETIME
WARRANTY

Model	Description	Price
EM-8810	10" level with rare earth magnet edge	\$24.95
EM-519	9" level with strip magnets edge	9.95



Precise DIGITAL/LASER LEVEL

- The Digital Laser Level combined with laser technology is the most advanced and ease to use instrument today.
- It can display both degree and slope. The Digital Laser Level can measure all angles in either a 360° range or four 90° quadrants.
- The Digital Laser Level also includes a backlight so the unit can be used day or night.
- Not only can this instrument measure with a surface at level or at right angles, it can measure the angles of all slopes rise and fall.



MODEL No.
DLL-024
Reg. \$75.00

\$49.95

Specifications

- Length: 24"
- Range: 4 90° (0~360°)
- Resolution: 0.1"
- Accuracy: 0° and 90° <0.1° other angle <0.2°
- Working temperature: +5°C~+40°C
- Working humidity: <85%RH
- Power: AAA 3V (1.5v x 2)

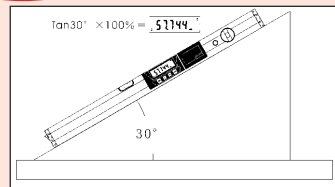

GENERAL

DIGITAL SLIDING T-BEVEL GAUGE

First & only on the market; enables storage & transfer of digital angle measurements

- The new Model 828 (Patent Pending) offers pioneering technology that takes the guesswork out of angle duplication and eliminates the problems associated with analog readings and manual measurement transfer.
- It is ideal for measuring, storing and transferring inside and outside angles when building cabinetry, furniture and picture frames; installing tile and more.
- This highly accurate tool offers easy-to-read measurements via a large LCD display and integrates an 8" stainless steel blade with a steel locking knob.
- Practical function buttons make it ultra-convenient for setting and transferring measurements instantly.



MODEL No. 828
\$29.95

GENERAL

DIGITAL ANGLE FINDERS

Design provides ultimate accuracy & efficiency, reverse angle function & lock angle feature

- These new angle finders combine the ruggedness of analog rulers (standard and metric) together with the digital technology needed for complete accuracy when measuring inside, outside and reverse angles.
- One button activates the reverse angle function, a hold button digitally saves the measurement and the large ergonomic locking knob saves the angle manually.
- A big LCD readout makes measurements extremely easy to read while an innovative center 'check' notch enables exact ruler placement marking.

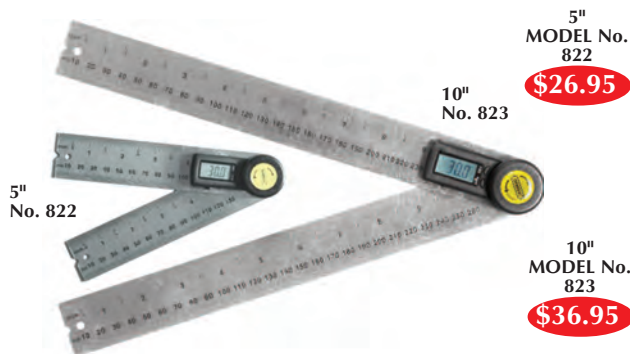

5" MODEL No. 822
\$26.95

10" MODEL No. 823
\$36.95

Starrett MACHINIST'S IMPROVED LEVELS

Features:

- Levels have ground and graduated main vials.
- All sizes have a cross test vial except 4".
- The cross test level allows simultaneous leveling in 2 directions.
- Sizes 6-18" main level have 80-90 second graduations.
- Involute groove running through the base, ideal for round pipes or shafting.

Series 98

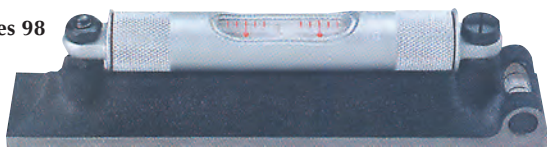

Model No.	Size	Description	List	Sale
98-4	4"	Without cross test vial	\$ 104.00	\$ 98.50
98-6	6"	With cross test vial	122.00	115.00
98-8	8"	With cross test vial	150.00	142.00
98-12	12"	Single plumb vial and cross test vial	211.00	199.50
98Z-12*	12"	Single plumb vial and cross vial w/case	286.00	268.50
98-18	18"	Double plumb vial and cross test vial	\$341.00	\$320.00
98Z-18*	18"	Double plumb vial and cross test vial w/case	435.00	410.00

*Finished wood case.

Fowler

DIGI-PRO ELECTRONIC PROTRACTOR

The Digi-Pro electronic protractor includes embedded magnets for unique measurement areas. On/Off, Zero, Hold and Reverse feature to invert the display for easier reading in certain situations.

- Embedded 25 lbs. pull magnets.
- Full, 360° measuring range.
- Accuracy: .2°±
- Repeatability: .05°±
- Resolution: .05°
- Invertible display feature
- Voltage: Standard 3V lithium battery.



MODEL No. 54-440-775
Reg. \$89.95
\$69.95



Use the Digi-Pro to make fast and Accurate Angular measurements.

Model	Description	List	Sale
54-440-740	4" Digi-Pro Electronic Protractor	\$75.00	\$55.95
54-440-775	12" Digi-Pro Electronic Protractor	89.95	69.95

PROTRACTORS MAGNETIC BASE

Model No. 361

- New, multi purpose tool function as level, protractor, square & pitch gage.
- Measures angles in full 360 range.
- Accurately transfers angles and measures pitch angles.
- Instantly adjustable.

Model No. 361-1

- Magnetic base and back.
- Easy reading dial with adjustable angle pointer.
- Built-in angle pitch calculator on back.
- Less level.

With Level MODEL No. 361

\$8.95



MODEL No. 361-1

\$11.95



PIVOT SQUARE

- Locking mechanism - sets the square on specific pitches or angles for repetitive accurate marking.
- Three UV resistant level vials use as protractor for determining roof pitches and angles, grade indicating, mitre cuts, leveling and plumbing components.
- T-base or fence - use to square lumber, mark plumb cuts, seat cuts, and rafter tails and use as a saw guide.
- Dual graduations - allows user to measure angle in both degrees and roof pitch.
- Includes clear, well illustrated manual - written in precise language. This manual takes the mystery out of roof framing and other common construction applications.
- Includes case - protects tool, has pockets for manual marking pencil, and attaches to tool belt.



MODEL No. 03060

\$59.95

Reg. \$83.95 11"W x 13"H x 2.5"D



GOLDEN RULES TIN COATED



- Long-lasting, hard wearing, non-glare finish = RC80 HARDNESS!
- Scratch resistant, microfine graduations with excellent clarity & contrast.
- 30% harder than standard chrome rulers.



Graduation Type:
4R Grad: 8ths, 16ths, 32nds & 64ths
5R Grad: 32nds, 64ths, 10ths & 100ths
In/Metric: 32nds, 64ths, 1/2mm & 1mm

Titanium coated for exceptional wear & visibility!



Model No.	Size	Type	Reading	Price	Sale
401-006	6"	Flex	4R	\$25.00	\$18.95
401-012	12"	Flex	4R	45.00	33.50
501-006	6"	Flex	5R	25.00	18.95
501-012	12"	Flex	5R	45.00	33.50
402-006	6"	Rigid	4R	25.00	18.95
402-012	12"	Rigid	4R	45.00	33.50
502-006	6"	Rigid	5R	25.00	18.95
502-012	12"	Rigid	5R	45.00	33.50
261-006	6"/150mm	Flex	in/metric	25.00	15.95
261-012	12"/300mm	Flex	in/metric	45.00	33.50
262-006	6"/150mm	Rigid	in/metric	25.00	15.95
262-012	12"/300mm	Rigid	in/metric	45.00	33.50



CERTIFIED/CALIBRATED RULES

NIST Traceable Meets ISO Requirements

Features:

- Rules are hardened and tempered.
- Precisely etched for high accuracy.
- Inspected to:
- Each rule etched with serial number and certificate of inspection, good for 5 years.



ML-STD-45662A 4R: 8ths, 16ths, 32nds, 64th.
ISO10012-1 5R: 32nds, 64th, 10th, 100th.
ANSI/NCSL Z640-1 E/M: 32nds & 64ths, mm & .5mm
NIST#821/260733-98 (Also available)

Certified Rigid Rules

Certified Flexible Rules

Model	Description	Sale	Model	Description	Sale
402-006CT	6" 4R Rigid Rule	\$ 25.95	401-006CT	6" 4R Flex Rule	\$ 25.95
402-012CT	12" 4R Rigid Rule	39.95	401-012CT	12" 4R Flex Rule	39.95
402-018CT	18" 4R Rigid Rule	57.50	401-018CT	18" 4R Flex Rule	57.50
402-024CT	24" 4R Rigid Rule	72.00	401-024CT	24" 4R Flex Rule	72.00
402-036CT	36" 4R Rigid Rule	140.00	401-036CT	36" 4R Flex Rule	140.00
402-048CT	48" 4R Rigid Rule	195.00	401-048CT	48" 4R Flex Rule	195.00
502-006CT	6" 5R Rigid Rule	\$ 25.95	501-006CT	6" 5R Flex Rule	\$ 25.95
502-012CT	12" 5R Rigid Rule	39.95	501-012CT	12" 5R Flex Rule	39.95
502-018CT	18" 5R Rigid Rule	57.50	501-018CT	18" 5R Flex Rule	57.50
502-024CT	24" 5R Rigid Rule	72.00	501-024CT	24" 5R Flex Rule	72.00
502-036CT	36" 5R Rigid Rule	140.00	501-036CT	36" 5R Flex Rule	140.00
502-048CT	48" 5R Rigid Rule	195.00	501-048CT	48" 5R Flex Rule	195.00



POCKET STEEL RULES 6"

- Made in U.S.A. Stainless steel, tempered.
- Micro-fine graduations.
- Round end rule with pocket clip.



Graduations:

PE/D: 32nds, 64ths, decimal equivalent chart on opposite side
PEM/M: 64ths and mm, metric equivalent chart on opposite side
PE: 32nds and 64ths on opposite face

Model	Type	Grad.	Price
PS-722	Flex	PE/D	\$2.95
PS-723	Flex	PEM/M	2.95
PS-724*	Flex	PE/D	4.95
PS-725*	Flex	PEM/M	4.95

* Hard Chrome Plated

Narrow Pocket Rule W/Clip

Model	Type	Grad.	Price
PS-735	Rigid	PE	\$5.95



ADJUSTABLE HOOK RULES

- Made in U.S.A. Accuracy meets Federal Specifications
- Tool steel, hardened and tempered. Thickness .040"
- Micro fine graduations.
- Hard chrome finish, no glare.
- Furnished with adjustable hook.

4R: 8ths, 16th, 32nds, 64ths
16R: 32nds, 16ths, 50th & 100ths
PE: 32nds & 64ths on opposite sides

Model	Size	Grad.	Width	Price
HR-190	6"	4R	3/4"	\$17.95
HR-191	12"	4R	1"	24.95
HR-192	18"	4R	1-1/8"	38.95
HR-193	24"	4R	1-1/8"	49.95
HR-195	6"	16R	3/4"	\$17.95
HR-196	12"	16R	1"	24.95
HR-197	18"	16R	1-1/8"	38.95
HR-198	24"	16R	1-1/8"	49.95
HR-215	*6"	PE	7/32"	\$16.50
HR-216	*12"	PE	7/32"	23.50



STEEL CHROME RULES



- Finest quality steel available.
- Fully hardened and tempered.
- Precise etching, black filled.
- Satin chrome finish.

4R: 8ths, 16ths, 32nds, 64th.
5R: 32nds, 64th, 10th, 100th.
16R: 32nds, 64th, 50th, 100th.

Satin Chrome Finish

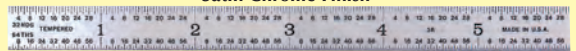

** EZ Read Rigid Rules Black Satin Chrome Finish



Flexible Satin Chrome Finish

Model	Size	Grad.	Thickness	Reg.	Sale
FR-351	6"	4R	.015" x 1/2"	\$10.00	\$ 8.50
FR-352	12"	4R	.015" x 1/2"	32.75	17.95
FR-353	18"	4R	.020" x 3/4"	30.00	23.95
FR-354	24"	4R	.020" x 3/4"	42.50	35.95
FR-355	36"	4R	.020" x 3/4"	95.00	75.95
FR-048	48"	4R	.020" x 3/4"	175.00	140.00
FR-356	6"	5R	.015" x 1/2"	\$10.00	\$ 8.50
FR-357	12"	5R	.015" x 1/2"	32.75	17.95
FR-358	18"	5R	.020" x 3/4"	30.00	23.95
FR-359	24"	5R	.020" x 3/4"	42.50	35.95
FR-022	36"	5R	.020" x 3/4"	95.00	75.95
FR-036	48"	5R	.020" x 3/4"	175.00	140.00
FR-361	6"	16R	.015" x 1/2"	\$10.00	\$ 8.50
FR-362	12"	16R	.015" x 1/2"	32.75	17.95
FR-363	18"	16R	.020" x 3/4"	30.00	23.95
FR-364	24"	16R	.020" x 3/4"	42.50	35.95
FR-024	36"	16R	.020" x 3/4"	95.00	75.95
FR-030	48"	16R	.020" x 3/4"	175.00	140.00
FR-406**	6"	4R	.020" x 1/2"	\$ 9.95	\$ 6.95
FR-412**	12"	4R	.020" x 1/2"	18.75	14.50
FR-506**	6"	5R	.020" x 1/2"	9.95	6.95
FR-512**	12"	5R	.020" x 1/2"	18.75	14.50
FR-606**	6"	16R	.020" x 1/2"	9.95	6.95
FR-612**	12"	16R	.020" x 1/2"	18.75	14.50

Rigid Satin Chrome Finish

Model	Size	Grad.	Thickness	Reg.	Sale
RR-331	6"	4R	.040" x 3/4"	\$12.50	\$ 9.50
RR-331E	*6"	4R	.040" x 3/4"	14.00	10.50
RR-332	12"	4R	.040" x 1"	24.00	18.95
RR-333	18"	4R	.040" x 1-1/8"	30.00	25.95
RR-334	24"	4R	.040" x 1-1/8"	48.00	39.50
RR-355	36"	4R	.040" x 1-1/4"	102.00	82.00
RR-048	48"	4R	.040" x 1-1/4"	175.00	145.00
RR-336	6"	5R	.040" x 3/4"	\$12.50	\$ 9.50
RR-337	12"	5R	.040" x 1"	24.00	18.95
RR-338	18"	5R	.040" x 1-1/8"	30.00	25.95
RR-339	24"	5R	.040" x 1-1/8"	48.00	39.50
RR-036	36"	5R	.040" x 1-1/4"	102.00	82.00
RR-480	48"	5R	.040" x 1-1/4"	175.00	145.00
RR-341	6"	16R	.040" x 3/4"	\$12.50	\$ 9.50
RR-342	12"	16R	.040" x 1"	24.00	18.95
RR-343	18"	16R	.040" x 1-1/8"	30.00	25.95
RR-344	24"	16R	.040" x 1-1/8"	48.00	39.50
RR-034	36"	16R	.040" x 1-1/4"	102.00	82.00
RR-042	48"	16R	.040" x 1-1/4"	175.00	145.00

** EZ Read Rigid Rules Black Satin Chrome Finish

RR-406**	6"	4R	.035" x 3/4"	\$ 7.95	\$ 6.95
RR-412**	12"	4R	.035" x 1"	15.95	12.95
RR-506**	6"	5R	.035" x 3/4"	7.95	6.95
RR-512**	12"	5R	.035" x 1"	15.95	12.95
RR-606**	6"	16R	.035" x 3/4"	7.95	6.95
RR-612**	12"	16R	.035" x 1"	15.95	12.95

Size up to 120" Available. Also Inch/Metric and all Metric



PROTRACTOR & DEPTH GAGES

- Graduated from 0 to 180° in opposite directions.
- 6" x 1/4" depth gage rule is graduated in 32nds and 64ths.
- Spring tension nut locks rule for making both depth and angle measurements.



Model No.	Description	List Price	Sale Price
P19	Stainless Steel	\$20.50	\$16.98



COMBINATION SQUARE SETS

- All blades are fully hardened and tempered.
- Durable, easy-to-read satin chrome finished blades.
- High contrast, micro fine blade graduations.
- Square/mitre head features level vial and hardened scribe tool.
- Heads supplied with a hammertone powder coat finish.
- Double indexed protractor is graduated 180° in both directions.
- Meets Fed. Specs. Type VI Class A.

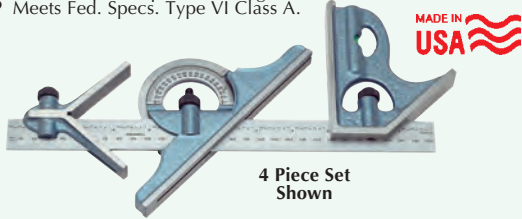

4 Piece Set Shown

MADE IN USA

Square Head & Machinist Blade					
2 Piece Sets		Cast Heads		Hardened Heads	
Set No.	Blade Length	Blade Grad.	Sale Price	Set No.	Sale Price
2CS-64	6"	4R	\$47.95	2HS-64	\$57.50
2CS-66	6"	16R	49.95	2HS-66	60.00
2CS-124	12"	4R	59.95	2HS-124	72.00
2CS-126	12"	16R	61.95	2HS-126	74.00
2CS-123	12"/300mm	E/M	61.95	2HS-123	74.00
2CS-184	18"	4R	79.95	2HS-184	95.00
2CS-186	18"	16R	81.95	2HS-186	97.00
2CS-244	24"	4R	95.00	2HS-244	118.00
2CS-246	24"	16R	99.00	2HS-246	122.00
Square Head, Center Head & Machinist Blade					
3 Piece Sets		Cast Heads		Hardened Heads	
3CS-64	6"	4R	\$69.50	3HS-64	\$79.95
3CS-124	12"	4R	75.50	3HS-124	89.95
3CS-184	18"	4R	105.00	3HS-184	125.00
3CS-244	24"	4R	115.00	3HS-244	143.00
Square Head, Center Head, Rev. Protractor & Machinist Blade					
4 Piece Sets		Cast Heads		Hardened Heads	
4CS-124	12"	4R	\$119.95	4HS-124	\$139.95
4CS-126	12"	16R	121.95	4HS-126	141.95
4CS-123	12"/300mm	E/M	121.95	4HS-123	141.95
4CS-184	18"	4R	135.00	4HS-184	159.95
4CS-186	18"	16R	137.00	4HS-186	161.95
4CS-244	24"	4R	155.00	4HS-244	185.00
4CS-246	24"	16R	157.00	4HS-246	188.00

Precise COMBINATION SQUARE SET & GROUND HARDENED HEADS

- Reversible protractor heads.
- Square head has level and scribe point.
- Finished in baked enamel.
- Double-indexed protractor is graduated 180° in both directions.
- Micro-fine blade graduation.
- Easy to read satin chrome finished blades.
- Square head and center heads are hardened.

4 Pc. Set
Model No.
CSS-012

\$39.95

4R: 8ths, 16ths,
32nds, 64ths,
16R: 32nds,
64ths, 50ths,
100ths

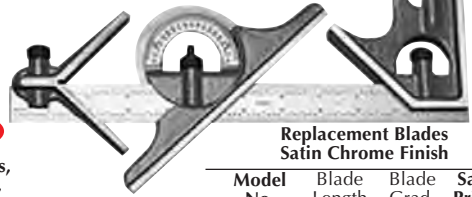

Replacement Blades
Satin Chrome Finish

Model No.	Blade Length	Blade Grad.	Sale Price
303-608-1	12"	4R	\$12.95
303-609	12"	16R	14.95
303-602	24"	4R	26.95
303-610	24"	16R	28.95

Precise 6" COMBINATION SQUARES

- Square head has level and scribe point.
- Finished in baked enamel.
- Square heads and center heads are hardened.
- Double-indexed protractor is graduated 180° in both directions.
- Micro-fine blade graduation.
- Easy to read satin chrome finished blades.

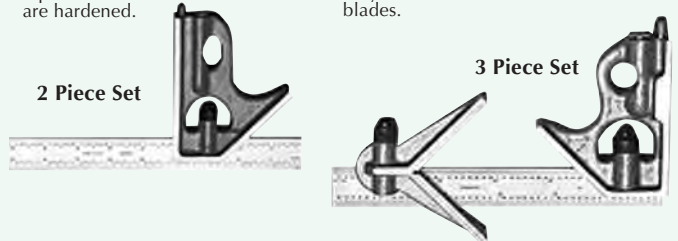

2 Piece Set

3 Piece Set

Model No.	Blade Length	Blade Grad.	Piece In Set	Sale Price
CSS-062	6"	4R	2	\$24.95
CSS-063	6"	4R	3	29.95

COMBINATION SQUARE SET COMPONENTS

Build Your Own Set

MADE IN USA

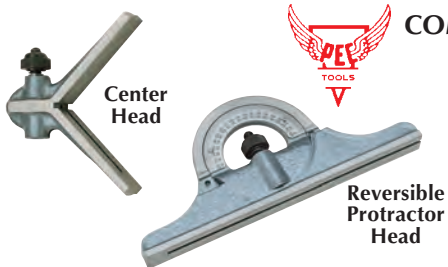

Center Head

Reversible Protractor Head

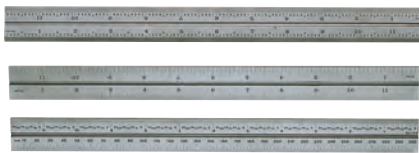

Blades



Square Head

Individual Blades

- Hardened, satin chrome finish.
- Made in USA.

Individual Heads

- For cast iron and hardened square sets.
- Made in the USA.

Combination Square Blades

Model	Size	Grad.	Thickness	Width	Sale
CB-816	4"	4R	5/64"	3/4"	\$19.95
CB-820	6"	(8th, 16ths, 32nds, 64ths)	5/64"	3/4"	22.50
CB-822	12"		3/32"	1"	35.50
CB-824	18"		3/32"	1"	49.50
CB-826	24"		3/32"	1"	63.00
CB-818	4"	16R	5/64"	3/4"	\$21.95
CB-821	6"	32nds, 64ths	5/64"	3/4"	24.95
CB-823	12"	50ths, 100ths	3/32"	1"	37.50
CB-825	18"		3/32"	1"	49.50
CB-827	24"		3/32"	1"	63.00
CB-831	6"/150mm	English/Metric	5/64"	3/4"	\$21.50
CB-832	12"/300mm	32nds & 0.5mm	3/32"	1"	37.50
CB-833	18"/450mm	64ths & 1mm	3/32"	1"	49.50
CB-834	24"/600mm		3/32"	1"	63.00

Cast Heads			
Model	Description	Reg. List	Sale
SQ-800	6" Square Head	\$33.00	\$23.95
SQ-801	12" Square Head	36.00	28.50
CH-802	6" Center Head	27.00	19.98
CH-803	12" Center Head	29.50	21.50
PH-814	12" Rev. Protractor Head	62.00	47.50
Hardened Heads			
SQ-812	6" Square Head	\$42.00	\$29.95
SQ-813	12" Square Head	46.95	35.50
CH-804	6" Center Head	42.50	29.50
CH-805	12" Center Head	47.50	33.95
Replacement Lock Nut Screw Assembly			
LSA-100	Screws for 6" Heads		\$ 4.25
LSA-101	Screws for 12", 18" & 24" Heads		4.50

Starrett DOUBLE SQUARE 2-1/2"

Designed for tool and diemakers, these fine precision double steel squares have adjustable blades, ideal for tight fits. A knurled clamping nut accurately locks the blades in any position.

- Beveled blade is 45° on one end and 30° on the other.
- 2-1/4" Narrow blade has 32nds and 64ths graduations. It is 5/32" wide over a length of approximately 1-5/8" and cut away at one end to a width of 3/32"



MODEL No.
14D

\$135.00



DOUBLE SQUARE

- Precision-ground satin chrome blade hardened and tempered.
- Can be used as a parallel or as a double square.
- Supplied in box.
- 4R graduations: 8ths, 16ths, 32nds and 64ths.
- 16R graduations: 32nds, 64ths, 50ths & 100ths.
- E/M graduations: 32nds, 64ths, .5mm and 1mm.

Model	Size	Grad.	Sale
DS-534	4"	4R	\$29.95
DS-535	4"	16R	29.95
DS-536	6"	4R	29.95
DS-537	6"	16R	29.95
DS-540	4"/100mm	In/mm	27.95
DS-541	6"/150mm	In/mm	31.95

MADE IN USA



Precise DIE MAKERS SQUARE SET



- Die makers Square set is ideal for the toolmaker working on precise miniature layouts.
- Sets consist of: 3 hardened beveled edged squares 3/4", 1-1/4" and 2-3/8". 1-1/2" triangular straight edge with a removable handle.
- Beam is grooved at inner corner for clearance of burr and dirt.
- Includes fitted case.

SET No. **\$69.95**
424-000

Fowler

SQUARE SETS



- Made of the finest carbon tool steel these economy squares have true right angles both inside and outside.
- Beams and blades ground and lapped for straightness and parallelism
- hardened blade
- Beam grooved at inner corner for clearance of burrs and dirt.
- Complete in a shop hardened molded case.

Blade Size	Beam Size
2"	1.5"
3"	2.5"
4"	3"
6"	4"
9"	6"
12"	8"

Model	Set Includes	Reg. Price	Sale Price
52-432-444	3 Squares: 2", 4" & 6"	\$ 65.00	\$44.95
52-432-246	4 Squares: 2", 3", 4" & 6"	75.00	59.95
52-432-469	4 Squares: 4", 6", 9" & 12"	145.00	99.95



PI-TAPE DIAMETER MEASURING Quick-Accurate

- Standard tape manufactured with a 1/4" wide Verier Gage, a 1/2" wide Main Body and a 1/4" wide Gage Member.
- The standard thickness is .010" (0.25mm) for tapes with a starting point of 2" (50mm) or larger.
- Smaller sizes have a thickness of either .006" (0.15mm) or .007" (0.18mm) depending on the material type.
- Calibration report traceable to N.I.S.T. is furnished with each new tape at no additional charge.
- I.D. tapes are available in most sizes (additional \$10.00 Per Tape) Please specify inside Diameter when ordering.
- Metric sizes also available



Diameter range	1095 Spring Steel No.	Price	716 Stainless Steel No.	Price
.500"-2" O.D.	PIT-001	\$123.00	PIT-001S	\$158.00
.75"-7" O.D.	PIT-002	93.00	PIT-002S	158.00
2"-12" O.D.	PIT-003	93.00	PIT-003S	144.00
2"-24" O.D.	PIT-004	145.00	PIT-004S	208.00
12"-24" O.D.	PIT-005	96.50	PIT-005S	149.00
12"-36" O.D.	PIT-006	154.00	PIT-006S	222.00
24"-36" O.D.	PIT-007	109.00	PIT-007S	164.00
24"-48" O.D.	PIT-008	162.00	PIT-008S	246.00
36"-48" O.D.	PIT-009	117.00	PIT-009S	173.00
48"-60" O.D.	PIT-010	131.00	PIT-010S	193.00
60"-72" O.D.	PIT-011	145.00	PIT-011S	215.00
72"-84" O.D.	PIT-012	155.00	PIT-012S	235.00
84"-96" O.D.	PIT-013	171.00	PIT-013S	255.00
96"-108" O.D.	PIT-014	181.00	PIT-014S	267.00
108"-120" O.D.	PIT-015	198.00	PIT-015S	286.00
120"-132" O.D.	PIT-016	204.00	PIT-016S	297.00
132"-144" O.D.	PIT-017	214.00	PIT-017S	308.00

SPi MAGNETIC BASE PROTRACTOR

Machined V-Base and leg ends have strong magnetic pull making it easy to secure to the work piece

- Used for tool rooms and machine shops to find center of round stock and to make angular adjustments.
- 2-3/8" dial face has machine-divided graduations to 1 degree in four 90° quadrants.
- Maximum V-opening 3-3/16"
- Overall length of legs: 4-13/16"
- Accuracy: ±1/2 degree.



MODEL No. MBP-244
\$159.95



Precise SOLID SQUARES

- Made from high-quality tool steel.
- True right angles inside and outside.
- Beams and blades are precision ground.
- Blade is hardened.
- Length of blade is measured from inner edge of beam to end of blade.

3 Pc SET
MODEL No. S-346

\$29.95

4 Pc SET
MODEL No. S-469

\$69.95

Includes: 3", 4", 6" Includes: 4", 6", 9", 12"

Model	Blade	Beam	Tolerance	Price
S-2	2"	1-1/2"	.001"	\$ 7.95
S-3	3"	2-1/2"	.001"	8.95
S-4	4"	3"	.001"	9.95
S-6	6"	4"	.0015"	13.95
S-9	9"	6"	.002"	19.95
S-12	12"	8"	.0025"	24.50
S-18	18"	10"	.003"	49.50
S-24	24"	12"	.003"	85.00

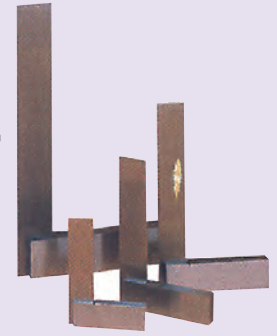

Precise BEVELED EDGE STEEL SQUARES Precision Grade Glass "H"

- Beams and blades are ground and hardened to min 55 HRC and are accurately lapped for straightness and parallelism.
- Blades are beveled on both edges of each side.

Blade Inch	Beam Inch	Model No.	Price Each
2-1/2"	1-1/2"	BES-02	\$ 9.95
3-1/2"	2"	BES-03	12.95
4"	2-3/4"	BES-04	15.95
5"	3"	BES-05	17.50
6"	4"	BES-06	19.95
8"	5"	BES-08	25.00



Good brown & sharpe WORKSHOP SQUARE SET

Complete in a "Shop-Hardened" protective molded case

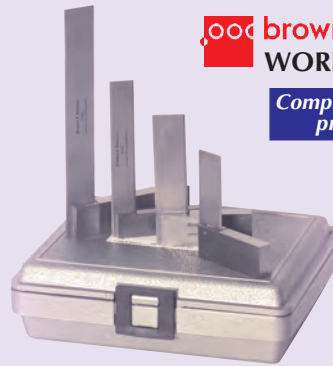

- Features:
- Hardened and ground steel blades.
- Square within .0006".
- Machined notch at inner corner burrs.
- Select three or four piece set.

MADE IN USA

Model No.	Description	Reg. List	Sale Price
540-246	3 Pcs. set (2", 4", 6")	\$ 85.00	\$69.95
540-2346	4 Pcs. set (2", 3", 4", 6")	106.00	87.50

Blade Size	Beam Size
2"	1-1/2"
3"	2-1/2"
4"	3"
6"	4"

Precise CENTER FINDER SQUARE

- 90° V and beveled edge.
- Made from ground tool steel.
- Hardened and tempered blade.
- Useful square for rapid location of round bar or disc.

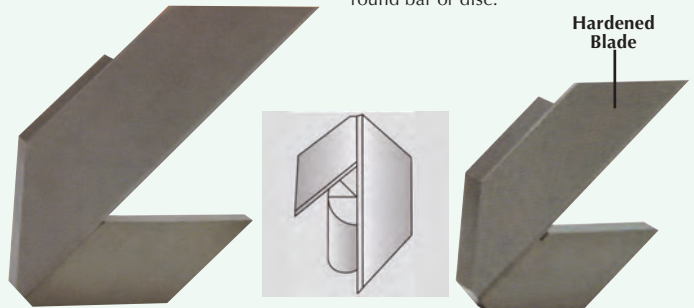

Model	Description	Price
ACS-2256	1-1/2" Center Finder Square	\$12.95
ACS-2257	3" Center Finder Square	22.75
ACS-2258	1-1/2" & 3" Center Finder Square Set	32.95



DEPTH AND ANGLE GAGE

Features:

- Made of hardened steel.
- Protractor graduations include 30, 45 and 60° angles.
- Base surface measures 2-1/2" x 1/8" thick with deeply etched, quick-reading markings.
- 6" non-graduated 3/32" steel rod included for measuring holes too narrow for use with the rule.
- Graduation: 32nds and 64ths, .05mm and 1mm.

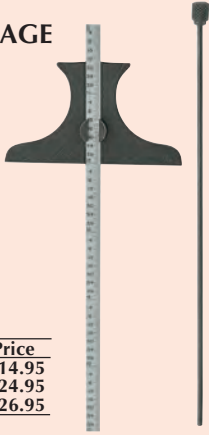

Model	Description	Price
444	6" Scale without round depth rod	\$14.95
704-006	6" Scale with round depth rod	24.95
4012	12" Scale with round depth rod	26.95



DRILL POINT GAGES

- 6" rigid rule is calibrated in 8ths, 16ths, 32nds and 64ths.
- End clip is adjustable and removable.
- For properly grinding 59° drill points and for measuring drill lips.
- Made of stainless steel with no glare hard chrome finish.



MODEL No. DPG-328

\$32.95

Starrett
MODEL No. 22C

\$57.95



STEEL PROTRACTORS

- Made of ground stainless steel for optimum accuracy.
- Permanently etched graduations from 0 to 180° in opposite directions.
- 3-3/8" x 2" head.
- 6" adjustable protractor arm locks into desired position with knurled thumb nut.



Model	Description	Price
P17	Square head stainless steel	\$23.95
P18	Round head stainless steel	23.95
CF-17	Square head chrome steel	\$26.95
PCP-184*	Round head chrome steel	26.95

*PCP-184 is made by SPI



BOLT SIZER AND THREAD PITCH GAGE

Quickly Identifies the Correct Bolt Needed to get the job done right

- High Grade stainless steel, so it's rust free.
- Tension wheels are ribbed, for a non-slip grip.
- Finger notches are easy to use, for a better grip.
- Predrilled to put on your tool belt.
- Rounded edges to prevent injury.
- Bolt sizer blades are marked with bolt diameter and wrench size.

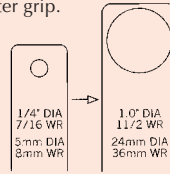

Model	Bolt Sizer Blades	Price
TBS-100	1/4", 5/16", 3/8", 7/16", 1/2", 9/16", 5/8", 3/4", 7/8", 1"	\$22.95
TBS-200	5mm, 6mm, 8mm, 9mm, 10mm, 11mm, 12mm, 14mm, 16mm, 20mm, 24mm	22.95

SPI CNC TOOL SETTING GAGE

- Designed for use on CNC slant bed machines.
- Accurately sets turning, boring and facing tools on the centerline of the workpiece.
- No. 13-718-2 includes easy to read Laser Etched protractor.
- Adjustable to any slant angle (360°)
- Can also be used for setting grinding wheels and for many applications involving horizontal and vertical milling machines.



Model No. 98-274-4
List \$25.90

\$15.92

Model No. 13-718-2
List \$42.00

\$32.24



DRILL AND ROD GAGES



Features:

- Made of heavy gauge, hardened steel for long wear.
- Hole sizes meet Federal Specifications.
- Front face shows gage size and decimal equivalents.



Model	Description	Price
DG-12	Letter size drills A to Z	\$17.50
DG-14	Fractional size drills 1/16" to 1/2" x 64ths	19.50
DG-15	Number size drills 1 to 60	19.50
DG-35	Metric size drills 1.0 to 5.9mm x 0.5mm	19.50
DG-36	Metric size 1.5mm to 12.5mm x 0.5mm	19.50
DG-13	3" x 1" Number size drills 61 to 80	15.95



QUICK CHECK SCREW GAGE

- Durable engineering plastic.
- Quick way to identify machine screws, bolts, wood screws, standard size rivets and common cotter pin sizes up to 5/16" (8mm).
- 3" scale to check screw lengths.
- Checker gives required drill size for corresponding tap size and proper drill size for like hole.
- Threaded holes indicate threads per inch while unthreaded indicate size by number and fractions of an inch.

MODEL No. 714

\$10.95

SIZE	1	2	3	4	5	6	7	8	9	10	11	12	13	14	15	16	17	18	19	20	21	22	23	24	25	26	27	28	29	30	31	32	33	34	35	36	37	38	39	40	41	42	43	44	45	46	47	48	49	50	51	52	53	54	55	56	57	58	59	60
DRILLS → 48	1	2	3	4	5	6	7	8	9	10	11	12	13	14	15	16	17	18	19	20	21	22	23	24	25	26	27	28	29	30	31	32	33	34	35	36	37	38	39	40	41	42	43	44	45	46	47	48	49	50	51	52	53	54	55	56	57	58	59	60
DRILLS → 43	1	2	3	4	5	6	7	8	9	10	11	12	13	14	15	16	17	18	19	20	21	22	23	24	25	26	27	28	29	30	31	32	33	34	35	36	37	38	39	40	41	42	43	44	45	46	47	48	49	50	51	52	53	54	55	56	57	58	59	60
DRILLS → 38	1	2	3	4	5	6	7	8	9	10	11	12	13	14	15	16	17	18	19	20	21	22	23	24	25	26	27	28	29	30	31	32	33	34	35	36	37	38	39	40	41	42	43	44	45	46	47	48	49	50	51	52	53	54	55	56	57	58	59	60
DRILLS → 33	1	2	3	4	5	6	7	8	9	10	11	12	13	14	15	16	17	18	19	20	21	22	23	24	25	26	27	28	29	30	31	32	33	34	35	36	37	38	39	40	41	42	43	44	45	46	47	48	49	50	51	52	53	54	55	56	57	58	59	60
DRILLS → 28	1	2	3	4	5	6	7	8	9	10	11	12	13	14	15	16	17	18	19	20	21	22	23	24	25	26	27	28	29	30	31	32	33	34	35	36	37	38	39	40	41	42	43	44	45	46	47	48	49	50	51	52	53	54	55	56	57	58	59	60
DRILLS → 23	1	2	3	4	5	6	7	8	9	10	11	12	13	14	15	16	17	18	19	20	21	22	23	24	25	26	27	28	29	30	31	32	33	34	35	36	37	38	39	40	41	42	43	44	45	46	47	48	49	50	51	52	53	54	55	56	57	58	59	60
DRILLS → 18	1	2	3	4	5	6	7	8	9	10	11	12	13	14	15	16	17	18	19	20	21	22	23	24	25	26	27	28	29	30	31	32	33	34	35	36	37	38	39	40	41	42	43	44	45	46	47	48	49	50	51	52	53	54	55	56	57	58	59	60
DRILLS → 13	1	2	3	4	5	6	7	8	9	10	11	12	13	14	15	16	17	18	19	20	21	22	23	24	25	26	27	28	29	30	31	32	33	34	35	36	37	38	39	40	41	42	43	44	45	46	47	48	49	50	51	52	53	54	55	56	57	58	59	60
DRILLS → 8	1	2	3	4	5	6	7	8	9	10	11	12	13	14	15	16	17	18	19	20	21	22	23	24	25	26	27	28	29	30	31	32	33	34	35	36	37	38	39	40	41	42	43	44	45	46	47	48	49	50	51	52	53	54	55	56	57	58	59	60
DRILLS → 3	1	2	3	4	5	6	7	8	9	10	11	12	13	14	15	16	17	18	19	20	21	22	23	24	25	26	27	28	29	30	31	32	33	34	35	36	37	38	39	40	41	42	43	44	45	46	47	48	49	50	51	52	53	54	55	56	57	58	59	60

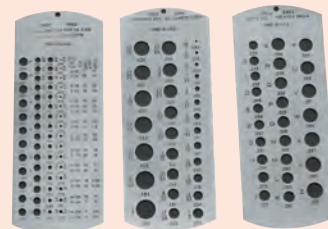

Precise

3 Pc. DRILL GAGE SET

- Made of heavy gauge and ground carbon steel.
- Hole sizes and decimal equivalents permanently etched.
- For drill A-Z, 1-60, 1/16-1/2 by 64ths.

SET No. DGS-958 \$13.95

Precise TAPER HOLE GAGE

- Handy gage for measuring cylindrical bores, bearing work and gaging slots.
- Made from polished stainless steel.
- Clearly etched graduations for inch on one side and mm on the other one.

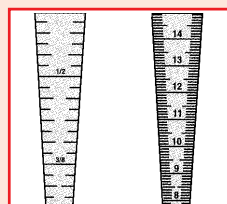

LC = 1/64" LC = 0.1mm

MODEL No. MGB-359

\$9.95



Precise RADIUS GAGE & ANGLE GAGE SETS

Radius Gage Set

- Satin chrome finish
- Stainless steel

Ideal for checking convex and concave radii. 1/64" to 17/64" x 64ths & 9/32" to 1/2" x 32nds with holder. Each gage has 5 gaging surfaces face for convex and concave radii.

25 Piece Set

MODEL RGS-300
Reg. \$29.95

\$19.95



Angle Gage Set

- 5° Thru 90° angle
- 18 piece set
- Stainless steel

Eight gaging surfaces per gage. Precision finished edges for accurate checking. Each gage checks primary, 1/2 primary & complimentary angles.

Buy Both
25 Pc. Radius
gage Set
18 Pc. Angle
Gage Set
Combo No.
L300AX

\$36.95



SET No. L300AG **\$19.95**

Precise FILLET OR RADIUS GAGES

Series 178

- Each gage has leaves for measuring both concave and convex radii, with each leaf stamped with the radius size.
- Made of high quality steel.
- Any one of the leaves can be securely locked in position by a locking device.



178

Series 272, 279

- An external and internal radius on each leaf permits both concave and convex surfaces to be measured.
- The leaves are specially shaped for use in any position at any angle to measure fillets and radii in corners or against shoulders.
- Each leaf is stamped with the radius size.



272

Model No.	No. of Leaves	Range (Concave & Convex)	Reg. List	Sale Price
178A	30	1/32" - 1/4" by 64ths	\$18.00	\$13.95
178B	32	17/64" - 1/2" by 64ths	24.00	16.95
272A	16	1/32" - 17/64" by 64ths	\$18.00	\$10.95
272B	16	9/32" - 33/64" by 64ths	24.00	14.95
272MA	18	.75mm to 5mm by 0.25mm	18.00	15.95
272MB	16	5.5mm to 13mm by 0.5mm	24.00	19.95
279	20	.020 to .400" decimal		\$59.95

Precise RADIUS GAGE SETS

- Made of rust proof steel, satin chrome finish.
- Each gage is marked with its radius size.
- Each gage has 5 measuring surfaces for convex and concave radii.
- All sets furnished in vinyl case.

25 Piece Set
1/64" thru 1/2"
MODEL No.
RGS-300

\$19.95

With Holder
& Vinyl Case

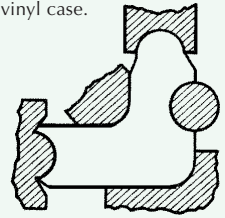

Model	Description	Price
RGS-300	25 Piece Set with holder consisting of 1/64" to 17/64" by 64ths and 9/32" to 1/2" by 32nds in vinyl case	\$19.95
RGS-301	8 Piece Set with holder consisting of 9/16" to 1" by 16ths in vinyl case	\$39.95
RGS-302	8 Pieces 1-1/16" to 1-1/2" by 16ths	\$75.00
RGS-304	26 Pieces .010 thru .500"	\$29.95
RGS-305	10 Pieces .550 thru 1" by .050"	\$59.95
RGS-306	26 Piece metric Set with holder 0.5 to 13mm in increments of 0.5mm	\$22.95

Precise GAGES

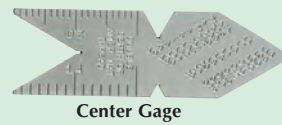

Center Gage

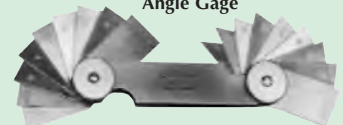

Angle Gage



Involute Gear Tooth Gage



Acme Thread Gage

Model	Description	Price
CF-001	Center Gage 60° American, Chrome Finished & US Standards	\$ 7.95
S-466	Angel Gage 18 sizes 1-45°, 1 thru 10° 20°, 14°, 14-1/2°, 15°, 25°, 30°, 35°, 45°	24.95
DP-14	Involute Gear Tooth Gage, 13 leaves 6 thru 80	\$39.95
DP-7	7 leaves 2 thru 5	29.95
S-17	Acme Thread gage 14-1/2° (29° included angle)	\$19.95

Precise SCREW PITCH GAGES

- Blades are of narrow leaf design for inside as well as outside screw threads.
- Blade sets are contained in a sturdy steel protective case with a locking device at each end
- Each blade is clearly marked with the proper thread size.



Group 2

Group 3

Group 1

Model No.	Range T.P.I.	No. of Blades	Group	Sale Price
SPG-181	4-42	30	2	\$ 7.95
SPG-189	4-84	51	3	11.95
SPG-329	4-80	28	2	9.95
SPG-330	9-80	22	2	9.95
SPG-332	.5-7mm	17	2	\$ 9.95
SPG-333	.25-2.5mm	28	2	10.95
SPG-331	4-56/5-6mm	28	2	\$ 10.95
SPG-323	4-42/4-7mm	51	2	11.95
29-730	1-12N Acme 29°	16	1	\$17.95
SPG-396	4-84 (Made in USA)	51	3	\$32.95

Precise THICKNESS GAGES

- Blades are made of the finest feeler gage stock, hardened and tempered.
- Lock-nut on gages securely holds one or more blades in desired position for taking measurements.
- Blades can easily be removed or replaced.
- Each blade is clearly marked with its thickness.
- Sturdy steel case protects blades safely and securely.

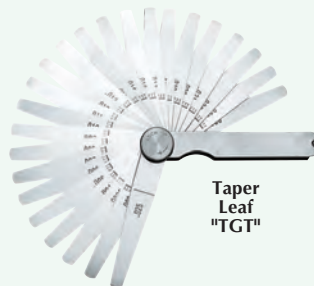

Taper Leaf "TGT"



Straight Leaf "TGS"

Model	Blades	Range	Price
TGS-51	26 Straight	.0015-.002-.0025-.003-.004-.005-.006-.007-.008	\$16.95
TGS-52	26 Tapered	.009-.010-.011-.012-.013-.014-.015-.016-.017 .018-.019-.020-.021-.022-.023-.024-.025	16.95

GENERAL

MULTI-USE RULE AND GAGE

MODEL No.
16ME

\$10.95

Each

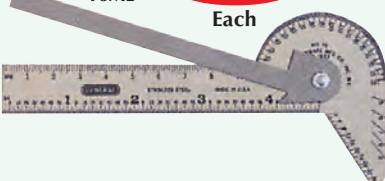

- Made of stainless steel.
- 4" rule graduation in 64ths and millimeters.
- Used as a drill point gage, a square, bevel protractor and center finder, has a tap and drill table.
- Vinyl pocket case included.

S&W **THREAD CHECKER** **S&W** **MADE IN USA**

The Thread Checker™ is an accurate and easy-to-use thread verifier for both nuts and bolts. Conveniently assembled onto a wire loop, it is especially well suited for distinguishing between similar inch and metric threads.

- Each size has a nut and bolt checker on the same gauge
- Thread sizes are permanently stamped onto each gauge
- Inch gauges are clear zinc plated, metric gauges are black oxide
- Wire cable with loop for convenient hanging



United States Patent #7877882

The Original Thread Checker™

Set No. SWTC-S21 \$29.95
6-32, 6-40, 8-32, 10-24, 10-32, -20, -28, 5/16-18, 5/16-24, 3/8-16, 3/8-24, 7/16-14, 7/16-20, -13, -20, 5/8-11, 5/8-18, -10, -16, 1-8, 1-12

Set No. SWTC-M21 \$29.95
M3x0.5, M4x0.7, M5x0.8, M6x1.0, M7x1.0, M8x1.0, M8x1.25, M10x1.0, M10x1.25, M10x1.5, M12x1.25, M12x1.5, M12x1.75, M14x1.5, M14x2.0, M16x1.5, M16x2.0, M20x1.5, M20x2.5, M24x2.0, M24x3.0

Set No. SWTC-26 \$29.95
6-32, 8-32, 10-24, 10-32, -20, -28, 5/16-18, 5/16-24, 3/8-16, 3/8-24, 7/16-14, 7/16-20, -13, -20; M4x0.7, M5x0.8, M6x1.0, M7x1.0, M8x1.0, M8x1.25, M10x1.0, M10x1.25, M10x1.5, M12x1.25, M12x1.5, M12x1.75

Stop-Loc® LATHE STOP & MILLING VISE TOOL
The Only Adjustable Front Collet/Chuck Stop In The World

- No more fixed length shop-made front collet stops.
- For CNC or manual lathes whether manually pulling a bar through a collet/chuck or using a bar puller (first pull for each bar)
- Gauge lengths up to 5-1/2" long.
- Can be used on all stock shapes up to 3" round, square, hex, etc.
- Self-centering, unobstructed viewing, and contrasting colors for user confidence by feeling/seeing that the dimension is being controlled.
- Change dull drills (up to 3/4" diameter) in your turret.
- Mill both sides of your stock without a stop in the way.
- Its also a ruler for visual reference.



The Original MODEL No. OSL-550 **\$13.95**

Deluxe MODEL No. DSL-550 **\$17.95**

Quick and Easy - Just stop, lock, remove and you're ready to machine!

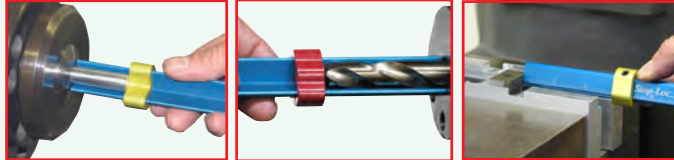

Versatile - Can Be Used On All Stock Shapes

Custom Drill Stop - Change Dull Drills In Your Turret

Mill Both Sides Of Your Stock Without A stop In Your Way

SPG SERVICE PRECISION GRINDING TDR/SRD DRILL SHARPENER

- Quick web thinning.
- Rugged construction.
- Optional tap & reamer resharpener using the 5C collet holder & indexing finger, utilizing your 5C collets.
- Diamond wheels are available for carbide drills, taps or reamers.
- Precise results, drill point concentricity is .001" lip to lip.
- Solid cast iron mountings for totally enclosed Baldor motor.
- Hardened and ground slide rails.
- Cast iron, aluminum and steel construction.



MODEL No. 82-R **\$1295.00**

S&W **THREAD CHECKER WALL MOUNTABLE**

- Bolt thread checker in both standard and metric sizes
- Nut thread checker in both standard and metric sizes
- Bolt length checker in both standard and metric sizes
- Screw size checker in both standard and metric sizes
- Mounted On Heavy-duty 1/2 Inch Sintra® and more

Model No. SWTC-WM1 \$54.95
6-32, 8-32, 10-24, 10-32, -20, -28, 5/16-18, 5/16-24, 3/8-16, 3/8-24, 7/16-14, 7/16-20, -13, -20; 9/16-12, 9/16-18; M4x0.7, M5x0.8, M6x1.0, M7x1.0, M8x1.0, M8x1.25, M10x1.0, M10x1.25, M10x1.5, M12x1.25, M12x1.5, M12x1.75

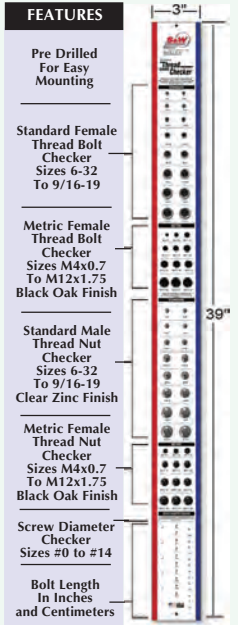

SCREW CHART THE ULTIMATE ENGINEERING SCREW CHART

- Great Innovations' Screw Chart includes technical information from many of the quick references that are commonly found in the work areas of designers, engineers, and machinists.
- Material: Heavy Duty Plastic
- All of this information is compiled for both English (Imperial) and Metric systems in a single screw chart.
- Screw Chart Overall Size: 8.75 X 11 X .06 inches (222 X 280 X 1.5 mm)

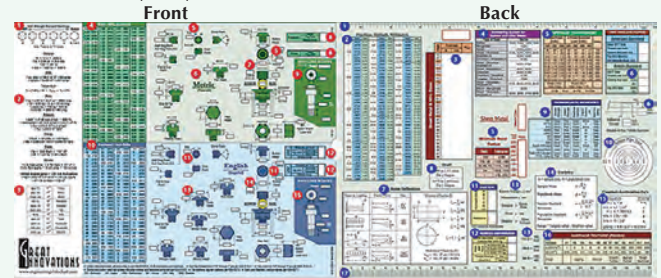

For Detail Specifications and Demo Video, Visit our website @ www.penntoolco.com

Model	Description	Price
ENG-CHART1	Ultimate Screw Chart (Quantity 1 to 11, Price Each)	\$28.95
ENG-CHART2	Ultimate Screw Chart (Quantity 12 to 25, Price Each)	26.95
ENG-CHART3	Ultimate Screw Chart (Quantity 26 or more, Price Each)	24.95



Table can be set at any angle

- Sharpens standard drills 1/16" - 13/16" & center drills #1 to #8.
- Quick change options for left-hand drills, taps/reamers and point splitting.
- Carbide drills need an optional diamond wheel.

Model	Description	Price
PBOP-R	Point Splitting Option	\$280.00
TPOP-R	Tap/Reamer Option	425.00
LHOP-R	Left Hand Drill Option	109.00
1760-P	Aluminum Oxide-90 grit for high speed steel & cobalt, 1-3/8" OD, 3/8"-16 thread	17.00
1790-P	Aluminum Oxide-fast cut 60 grit for high speed steel & cobalt, 1-3/8" OD, 3/8"-16 thread	17.00
1750-P	Silicone carbide-120 grit for carbide, 1-3/8" OD, 3/8"-16 thread	25.00
1770-P	Diamond-180 grit for carbide, 1-3/8" OD, 3/8"-16 thread	185.00
7370-P	Aluminum Oxide-120 grit for high speed steel & cobalt, 3/4" OD, 1-3/8" OD, 3/8"-16 thread (replacement for PBOP-R)	20.00
1580-P	Standard replacement drill chuck for drills 1/16"-13/16"	195.00
1582-P	Counter bored chuck for taper shank drills 1/16"-13/16"	250.00
8670-P	Diamond dresser (replacement for PBOP-R)	45.00

Specifications:
 Right hand Drill Capacity . . . 1/16"-13/16"
 Angle Range 85° to 160° Left Hand Drill Capacity 1/16"-1/2"
 Relief Angles 0° to 20° Point Splitting Capacity 1/8"-1/2"
 Dimensions 16" x 10" x 8" Point Splitting Capacity 1/8"-1/2"
 Weight 50 lbs. Tap Capacity #10 - 3/4"
 Motor 110V Reamer Capacity 1/8" - 3/4"



CAM•LOCK TAP & TOOL WRENCH

The Patented 3-Piece Design gives this one tool a range from 1/8" to 1/2" which normally requires 2 standard tap wrenches

- The heart of the tool is the Cam-Lock double-sided collet, one end holds 1/8-1/4 tools the other holds 1/4-1/2 tools.
- Choose the correct collet size and insert it into the Cam-Lock wrench body.
- With the collet in place, screw the knurled collet head onto the wrench body.
- With the Cam-Lock handle parallel to the wrench body (as shown) insert your Tap or Drill and finger tighten only.
- Turn the Cam-Lock wrench from parallel to a perpendicular position, cam action locks cam, collet & tool all firmly in place.
- To change tools, just turn the handle to the parallel position & insert new tool. Fast-no wrench-won't loosen-hassle free.

MODEL No. CLT-005

\$29.95



Etch-O-Matic

ELECTRIC METAL MARKING SYSTEM

- Etch-O-Matic can be as deep as .003" of an inch in less than 30 seconds or mark the hardest tool steel and carbides almost instantly.
- It marks any flat or round metal surface down to 1/16" diameter and any metal thickness from thin foil up the largest castings easily.



STARTER KIT
10 Volt - 2 Amps
Kit No. EOM-100

\$89.95

SUPER KIT
15 Volt - 10 Amps
Heavy Duty
Kit No. EOM-200

\$199.95

*Additional Supplies and Refills Available

Contains: Etch-O-Matic marker with standard head marking size 7/8" x 1-3/4", electrical cord, ground plate, 2 oz. Electrolyte solution in plastic bottle, 10 special stencils, neutralizer, deep etching adapter clip and complete instructions.

It can make fast A.C. marks, then change instantly to deep etch marking down to .003" deep. It can make large marks 2"x 4" or larger for trademarks or etch hard-to-mark coating like black oxide quickly.

Contains: 1 - 15-volt, 10-amp. marker unit with external transformer; adapter clip for deep etch marking; ground plate; 8-oz. general purpose electrolyte; 8-oz. neutralizer; extra pads; 100 pack special stencils; complete instructions and packed in study plastic carrying case.

Precise XTREME LED FLASHLIGHTS

- New technology designed LED lights provides an extra long battery life up to 600 hours continuous use.
- Last 50 times longer than regular flashlights.
- Provides brighter and stronger natural light.
- Switch rated for 10,000 on/off.
- All climate and corrosion resistance METAL barrel.
- Use regular cell battery (not included)



Mini



XTREME



Fishman's

Model No.	Type Style	No. of LED Bulbs	Overall Length	Battery Type	Price Each
806-003	Mini	5	3.3"	1-AAA	\$ 6.50
806-004	Fishman's	15	4"	3-AAA	18.50
806-001	XTREME	6	8.5"	3-AA	21.95



V-TAP GUIDES

- Automatically squares up the tap with the surface.
- A V-groove along the bottom of the V-TapGuide allows for perpendicular alignment with all tap sizes on round parts or corners.
- Portable, pocket size.
- Natural steel finish non-plated.
- Made from special nickel alloyed steel that is heat treated.
- The bottom surface is ground to assure stability & accurate perpendicular alignment on flat surfaces.
- Supplied with a handy plastic storage case.
- Guide holes are sized for ANSI standard ground taps.

MADE IN USA



Model	Description	List	Sale
VTG-001	NC & NF Sizes from 0-80 thru 5/8" (Except #12 & 9/16")	\$29.95	\$24.95
VTG-002	Metric Sizes: 1.6mm, 2mm, 2.5mm, 3mm, 3.5mm, 4mm, 5mm, 6mm, 8mm, 10mm, 12mm, 14mm & 16mm	29.95	24.95



ELECTRO - SPARK ENGRAVER

- Writes with ease on all metals, aluminum, brass, steel, hardened steel, carbide etc.
- Safe continuous use, no danger of shock.
- The spark produced between the electrode engraving point and the workpiece leaves a clean oxide marking in the engraved areas.
- Permanent marking - can be removed by grinding only.
- The electric pen is connected to a single phase transformer, specifically constructed for the purpose.
- Made in Switzerland.
- Optional settings provide smooth writing from fine to very heavy.
- Ideal for clean marking on metal parts, dies, cutting tools, measuring tools.
- Furnished complete with a 3 ea. 3/64" x 1" electrodes.



3 Setting Type (Shown)

Model	Description	Price
97-474-1	25 Watt, 3 Setting Kit	\$409.05
97-475-8	50 Watt, 6 Setting Kit	502.95
97-476-6	3/64" x 1" Electrode	9.90
97-477-4	1/32" x 1" Electrode	10.10
97-478-2	1/16" x 1" Electrode	11.45



UNIVERSAL MAGNETIC BASE MINI LED FLASHLIGHT

- 14 LED Ultra-bright flashlight.
- Powerful, low-profile magnetic base.
- Slim, articulating flex bar allows easy and accurate positioning.
- Quick release mounting bracket clamp.
- Batteries included.

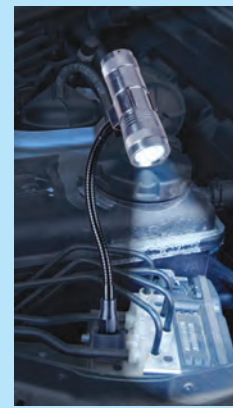

Model	Description	List	Sale
8401-0440	Mini Flexlight with 1" Magnetic Base	\$37.50	\$25.95
52-630-455	Mini Flexlight with 2" Magnetic Base	39.50	26.50

✓ FLEXBAR ✓ MICROINCH COMPARATOR PLATES

Surface Roughness (Texture) Comparison Standards Made of Solid Electroformed Nickel

- The LARGEST VARIETY OF STANDARDS available for assessing and specifying, by Symbol, the DEGREE OF ROUGHNESS of machined parts - including every machining method known.
- **EVERY OBTAINABLE VALUE**
- Each value size is 16mm x 25mm (or 5/8" x 1").
- Overall dimensions of each plate 25mm x 128mm (or 2-1/16" x 5").
- Light in weight - can be carried in pocket. Supplied in Plastic Wallet.
- Markings: Graduated in American values- AA (microinches) as well as I.S.O. standards such as Metric Equivalents Ra (µ)



Your Choice **\$87.50** Each **MADE IN USA**

Model No.	Machining Method	No. of Specimens	Range Ra µm	Range AA µ"	N Numbers
16009	Surface Grinding	8	.025-3.2	1,2,4,8,16,32,63,125	1-8
16010-2	Cylindrical Grinding	8	.025-3.2	1,2,4,8,16,32,63,125	1-8
16011	Face Turning	8	0.4-50	16,32,63,125,250,500,1000,2000	5-12
16012	Cylindrical Turning	8	0.4-50	16,32,63,125,250,500,1000,2000	5-12
16013	End Milling	8	0.4-50	16,32,63,125,250,500,1000,2000	5-12
16014	Reaming & Drilling	8	0.4-12.5	16,32,63,125 Reaming 63,125,250,500 Drilling	5-10
16015	Horizontal Milling	8	0.4-50	16,32,63,125,250,500,1000,2000	5-12
16016	Planing or Shaping	8	0.8-100	32,63,125,250,500,1000,2000	6-13
16017	E.D.M.	8	0.4-50	16,32,63,125,250,500,1000,2000	5-12
16019	Cylindrical Lapping	8	.025-0.2	1,2,4,8 Cyl. Lap .025-0.2 Superfin.	1-4
16021	Grit Blasting	8	3.2-18	128,320,520,720	5-10
	Shot Blasting		3.2-25	128,420,720,1000	
16022	Hand Filing	5	0.4-6.3	16,32,63,125,250	5-9
16023	Casting	7	0.8-50	32,63,125,250,500,1000,2000	6-12
16026	Polishing	5	.0125-0.20	0.5,1,2,4,8	0-4
16044	Belt Sanding	6	0.10-3.2	4,8,16,32,63,125	3-8

Each set is supplied in rugged vinyl case which contains a durable instruction card with valuable information in easily understood language. This enables the user to obtain best results when assessing roughness or finish by sight and touch. All 15 plates conform to S.A.E. and Mil specs.

Note: Also available with Long Form Calibration report for additional charge.

SE TOOLS PNEUMATIC SCRIBER

- Lightweight & easy to Operate.
- Quick-chuck allows easy replacement of stylus & use of optional bits.
- 4-1/2" aluminum motor assembly with adjustable throttle.
- 8 ft. rubber/cloth braided air hose with 1/4" NPT fitting.
- Air requirements: 90 PSI
- Deluxe carrying case & instructions included.
- Write on a soft metal, steel up to RC-64
- De-burr, trim & remove broken fasteners with optional bit kit.



Chisel Kit for Air Marking Pen
 1) 1/4" Flat Chisel
 1) Round Nose Chisel
 2) O-Rings
 1) Anvil No. PAS-7425
\$69.95

Stylus Chuck Replacement Scriber Tips
 No. PAS-7177
\$19.95(5 Pack)

Pneumatic Scriber
 MODEL No. PAS-361
\$399.95



PAS-7425

PAS-7177



COLLET PROTECTIVE & ORGANIZING SYSTEM

- Don't take a chance with steel stamped trays that can damage accurate locating surfaces.
- Protect your expensive investments with high impact plastic.
- Sliding see thru plastic cover.
- Up to 40 ER, 76 5C and 52 R8 collets per tray - holds a full set plus special and metric sizes.
- Angled seat location to secure collet.

MADE IN USA

5C & R8 Collet



"ER" Collet

30 & 40 Taper

Model No.	Collet Size	Tray Capacity	Price Each
ERT-114	ER-11	40	\$36.95
ERT-164	ER-16	40	36.95
ERT-204	ER-20	40	37.95
ERT-254	ER-25	40	37.95
ERT-324	ER-32	40	39.95
ERT-402	ER-40	28	39.95

Model No.	Collet Size	Tray Capacity	Price Each
30CNC	30CNC	10	\$36.95
40CNC	40CNC	10	36.95
5C76	5C	76	36.95
R852	R8	52	36.95

MOGATOR TOOLS PORTABLE V-DRILL GUIDES **MADE IN USA**

- It's like a portable drill press for precision alignments.
- Prevents drill from drifting off center on round materials.
- Portable, pocket sized.
- Automatically squares up the drill with the surface.
- V-groove design allows for perpendicular alignment on tubing, pipes, round stock and corners.
- V-groove along the bottom of the V-Drill guide allows for perpendicular alignment with all drill sizes on round parts or corners.
- Made from special nickel alloyed steel that is heat treated for durability like drill bushings.
- No drill bushing required.
- Natural steel finish, non-plated.
- Round stock hole alignment marks on one side.



Inch

MODEL No. STD100 **\$24.95**

- Accepts (17) drill sizes: 1/8", 9/64", 5/32", 11/64", 3/16", 13/64", 7/32", 15/64", 1/4", 17/64", 9/32", 19/64", 5/16", 21/64", 11/32", 23/64" & 3/8"

MODEL No. STD200 **\$24.95**

- Accepts (9) drill sizes: 3/8", 25/64", 13/32", 27/64", 7/16", 29/64", 15/32", 31/64" & 1/2"

Metric

MODEL No. MDG1000 **\$24.95**

- Accepts (17) drill sizes: 3mm, 3.3mm, 3.5mm, 4mm, 4.2mm, 4.5mm, 5mm, 5.5mm, 6mm, 6.5mm, 6.8mm, 7mm, 7.5mm, 8mm, 8.5mm, 9mm & 9.5mm

PEE DEE THREAD MEASURING WIRES

- 48 wires - 16 different sizes.
- Measures all threads from 3 - 48 threads per inch.
- Measures all metric threads from .5mm to .6 mm.
- Also measures ACME threads.
- Laminated chart included.
- Furnished in fitted vinyl case.
- Made in USA.



PEE DEE U.S.A.

MODEL No. 100-370 **\$26.95**

Precise Import

MODEL No. 100-371 **\$14.95**

SPi QUILL RETURN

- Eliminates the problem of quill lock drag.
- Maintains lever in lock position without rubber bands or other devices.
- Easily attaches to locking lever.



Model No. 98-217-3

\$13.50

Precise CALIPER DEPTH BASE

- Precision hardened and ground for flatness.
- For 4", 6", 8" and 12" dial and vernier calipers.



MADE IN USA



Model No.	Fits Calipers	Slot Size	Base Length	Price Each
12-426	4", 6" and 8"	0.700"	3"	\$31.95
12-427	4", 6" and 8"	0.700"	4"	38.95
12-428	12"	0.865"	5"	46.95

Starrett TAP WRENCHES

- Tap wrenches are strong and well proportioned.
- They are nicely finished and the gripping surfaces are properly tempered. They will firmly hold square or round shanks.
- The plunger, operated by the knurled sleeve, will back off the instant that pressure is removed by the sleeve.



No. 174

MADE IN USA

Series 91

Model No.	Tap Capacity	Shank Size	Body Length	List Price	Sale Price
174	0-#14	1/4" Dia.	3-5/8"	\$30.00	\$27.00
91A	1/16"-1/4"	5/32" - 5/32"	6"	46.50	41.85
91B	3/16"-1/2"	5/32" - 9/32"	9"	68.00	61.50
91C	1/4"-5/8"	5/32" - 3/8"	12"	110.00	99.00
91D	5/16"-3/4"	13/64" - 7/16"	16"	146.00	131.50

Precise MACHINE TAP GUIDE

- Provides sensitive feel for hand tapping small holes on milling machines, drilling presses and lathes.
- Starts every hole straight and prevents tap breakage.
- 0 to No. 12 tap capacity.
- Shank diameter 3/8"

MODEL No. MTG-364 **\$19.95**



Precise TAP WRENCH EXTENSION

- Eliminates need for expensive hard to get extension taps.
- All steel construction with knurled grip chuck.
- Attractive finish.

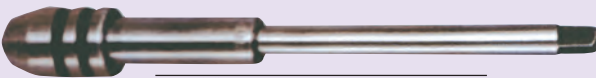

Model	Range	Length	Price
TE-506	#0-12"	7"	\$ 9.95
TE-507	#12-1/2"	11"	11.95

TAP EX CAM-LOCKING TAP WRENCH

Quick Release Cam~Fast & Tight Change Taps Fast

- 3 times the range of most tap wrenches!
- Fits wide range of tap sizes: 1/8" to 1/2" (M3 to M12)
- Patented Revolutionary Cam-Lock System
- Quick-action clamping for easy replacement.
- Taps will never release during use.
- Heavy-duty design for reliability and long life.
- Handles extreme torque.
- Can be used as a hand drill for sizes: 1/16" to 5/16"



MODEL No. 52-492-350 **\$29.95**

MADE IN USA



BROKEN TAP REMOVAL DRILLS

Features:

- Removes even the most stubborn broken taps.
- Revolutionary carbide grade and advanced drill point geometry.
- Works on spiral flute, straight flute and forming taps.

MADE IN USA



7 Pc. Set No. OMR-007 **\$129.95**

Includes: #4-1/2", Pin vise & 2 picks

Individual Sizes

Model	Diameter	Removes Sizes	Price
OMR-001	5/64"	#4, #5, #6, M3, M3.5	\$26.95
OMR-002	1/8"	38, #10, #12, M4, M5	29.95
OMR-003	3/16"	1/4", 5/16", M6, M7	38.95
OMR-004	1/4"	5/16", 3/8", 7/16", 1/2", M8, M10, M12	46.95

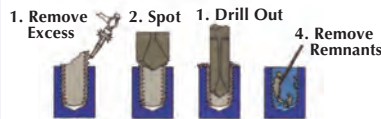

GENERAL PRECISION TAP WRENCHES

Plain Type

- Self centering hardened tool steel jaws and knurled chuck sleeve.
- No. 163 has rigid T-handle.
- Nos. 164 & 166 have sliding T-handle for fitting into tight spaces with greater leverage.

Reversible Ratchet Type

- Ratchet can be set for right or left hand operation or locked for non ratchet use.
- Self centering hardened tool steel jaws and knurled chuck sleeve provide positive grip on taps, reamers and small tools.

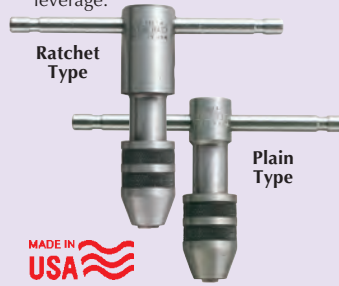

MADE IN USA

PLAIN TYPE

Model	Tap Capacity	Length	Price
GTW-163	0 - #8	2-1/4"	\$10.50
GTW-164	0 - 1/4"	2-3/4"	11.70
GTW-166	0 - 1/2"	3-3/4"	13.95

REVERSIBLE RATCHET TYPE

GTW-160	0 - #8	2-3/4"	\$29.50
GTW-161	0 - 1/4"	3-1/2"	29.95
GTW-162	0 - 1/2"	4-1/4"	37.50

*Replacement jaws available. Specify tool number.

Precise T-HANDLE TAP WRENCHES

- High quality Tap Wrenches for hand tapping, drilling and reaming.
- Jaws are hardened and tempered.
- Jaws are replaceable and self equalizing.
- Shiny ground finish.
- Knurled chuck sleeve.
- Available in plain type as well as Ratchet type.

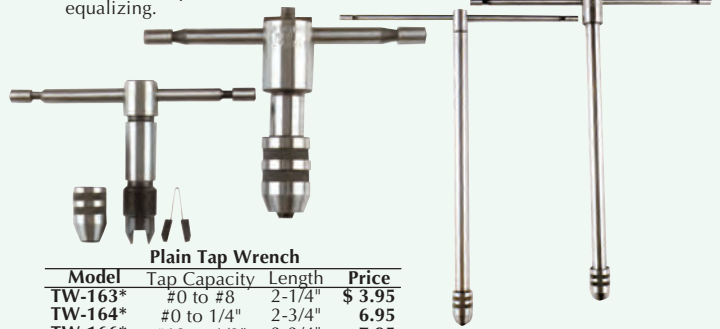

Plain Tap Wrench

Model	Tap Capacity	Length	Price
TW-163*	#0 to #8	2-1/4"	\$ 3.95
TW-164*	#0 to 1/4"	2-3/4"	6.95
TW-166*	#12 to 1/2"	3-3/4"	7.95
TW-166L	#12 to 1/2"	13"	15.95

Ratchet Tap Wrenches

TW-160R*	#0 to #8	2-3/4"	\$ 6.95
TW-161R*	#0 to 1/4"	3-1/2"	8.95
TW-162R*	#12 to 1/2"	4-1/4"	9.95
TW-164L	#12 to 1/2"	13-1/2"	18.95

Replacement Jaws available; Specify Tool No.

3 Piece * Plain Tap Wrench Set No. PTW-600 **\$14.95**

3 Piece * Ratchet Tap Wrench Set No. RTW-601 **\$22.95**

Precise PRECISION TAP WRENCH WITH GUIDE

- Place guide in chuck.
- Tap into work guided.
- Lathe or drill press.
- Heat-treated jaws.
- Standard tap wrench.
- Insert wrench in guide.
- Measures tread depth.
- Heat-treated adjust nut.
- Sliding handle.
- Heavy-duty, Made in USA.



MADE IN USA

Model No.	Tap Capacity	Price Each
PTW-140	0 to 1/4"	\$19.95
PTW-120	1/4" to 1/2"	27.95
PTW-340	1/2" to 3/4"	59.95
PTW-100	3/4" to 1"	79.95

Precise ADJUSTABLE TAP & REAMER WRENCHES

- Knurled steel handles, one end with cross hole.
- Jaws surface-hardened .020" deep.
- Hammertone baked enamel finish.
- 4 Piece set includes: Sizes 0, 4, 5 and 6

4 Piece Set MODEL No. ATW-034 **\$26.50**



Model No.	Size	Tap Capacity	Pipe Tap Range	O.A.L.	Price Each
ATW-00	0	0-1/4"	-	5"	\$ 4.55
ATW-15	4	1/8"-3/8"	-	7"	5.60
ATW-02	5	3/16"-1/2"	1/8"-1/4"	11-1/2"	8.00
ATW-03	6	1/4"-3/4"	1/8"-3/8"	15-3/8"	11.45
ATW-04	7	1/4"-1-1/8"	1/8"-3/4"	20"	17.20
ATW-06	7-1/2	3/4"-1-1/2"	1/4"-1"	40"	57.45
ATW-08	8	1"-2-1/2"	1/2"-1-1/4"	54"	91.95

Precise 4" AND 8" LONG DRIVE PIN PUNCH

- Made of tool steel.
- Punch section centerless ground.
- Handles black oxide for rust prevention.
- Knurled body for better grip.
- Hardened both ends, Rc 45 to 52.
- 8" length, drive pin section 3-1/2" long.
- Set supplied in fitted pouch with clear size markings.

**8" Long
5 Piece Set**
1/8", 3/16", 1/4"
5/16", 3/8"
5/16" & 3/8"
SET No. DPP-8
\$8.95



4" Long 8 Piece Set
1/16", 3/32", 1/8"
5/32", 3/16", 7/32"
1/4" & 5/16"
SET No. DPP-4
\$9.95



Precise BENCH BLOCK & DRIVE PIN PUNCH

- V-groove across the face accommodates round and odd shaped stock.
- Hardened and ground knurled body for a firm grip.
- Block diameter 3" x 1-1/2" H. Holes are 1/8" to 5/8"

Bench Block No. BB-101
\$16.95



Buy Both
SET No. BBD-184
Reg. \$33.90
\$29.95

- Very handy pin punch set in a plastic pouch.
- Consists of eight popular sizes in 4" long (1/16" to 5/16") and five popular sizes in 8" long (1/8" to 3/8") drive pin punches.

13-Piece Pin Punch Set No. DPP-84
\$17.95



GENERAL PRECISION PUNCH SETS



Drive Pin Punches
4" Length 8 Piece Set
1/16" thru 5/16" by 16ths

- Tool steel punches are uniformly heat treated and centerless ground to withstand the hardest use.
- 4" long with knurled bodies.
- Ends are ground square for accurate pin driving.
- Federal Specs - GGG-P-831E

Extra Long Punches
8" Length 5 Piece Set
1/8", 3/16", 1/4", 5/16", 3/8"

- Made of tool steel, hardened and centerless ground.
- Knurled body is 4-1/2" long and the drive pin section 3-1/2" long.
- For use on work not accessible with shorter punches.



No. SPC-75



No. SPC-76

Model	Description	Price
SPC-75	4" Set Plastic Case	\$29.95
SPC-76	8" Long Set Plastic Case	27.95

Precise TRANSFER PUNCH SETS

Precision/Matched

- For toolmakers, machinists and tool cribs.
- Made of the finest tool steel Blade oxide finish.
- Carefully heat treated - tempered.
- Diameters .0025" undersize to facilitate use.

28 Piece Set
3/32" - 17/32"
SET No.
STP-16
\$10.95

Imported



Model	Description	Price
STP-16	28 punches - 4-7/8" long, 3/32" to 1/2" by 1/64", plus 17/32"	\$10.95
TPS-100	33 punches - 1/2" to 1" by 1/64th 4-7/8" long	45.00
TPS-160	60 punches - 4-7/8" long, wire gage sizes #1 thru #60	10.95
TPS-026	26 punches - 4-7/8" long, letters A to Z	12.95
TPS-113	25 punches - 1.0mm thru 13.0 by .5mm	18.95
TPS-114	All of the above 5 Sets	\$84.95

Precise TRU-CENTER EXPANDING TRANSFER PUNCH SET

Made In Japan

- Compact set of 3 takes the place of numerous individual solid punches.
- Each punch expands within its range to pick up to true center of holes from 1/4" to 1 1/16" diameter.
- By turning the knurled head, the punch body expands to the perfect fit in the bottom of the hole.
- A light hammer stroke on the top of the center pin provides the desired "Tru-Center" mark.



SET No.
TCE-750

\$129.95



GENERAL AND Precise 5 PIECE CENTER PUNCH SETS - ROUND SHANK

- Points are ground to size for maximum strength and penetration.
- Knurled body.
- Stamped with size for quick identification.
- Set contains on each of the five sizes, AA-D, packed in a vinyl case.
- Conforms to government specifications GGG-P-831E.

GENERAL
SET No.
SPC-74
Reg. \$20.80
\$16.50

Precise
Imported
SET No.
CP-05
\$7.95



Individual Sizes
Available Upon Request



ON-MARK OPTICAL CENTER PUNCH

MADE IN USA



Place the acrylic lens in the holder to easily and accurately site in the area on the workpiece to be punched. Replace the lens with the center punch and quickly and accurately mark the workpiece.

- Efficient and precision punching of hole centers
- Magnified center dot and circle for accurate punching
- Used for marking, punching, stoking and riveting
- 9x acrylic lens



Model No.	Reg. Price	Sale Price
52-500-075	\$84.50	\$79.95

SPi METAL ETCHING PEN

- Indispensable anyplace where metals, hardened as well as thin walled, have to be marked or identified.
- Strong effect on heavy metals, stainless steel, iron, copper, brass, nickel, tin, lead.
- Leaves distinctive, smudge proof, black markings.
- No electrical flux is necessary. A special acid solution flows like ink in a felt-tip pen and a permanent etch is produced on the metal.
- Ideal for toolroom use and marking in the machine shop.
- Apply on clean surface. After application wipe dry with oily cloth.



97-470-9
Reg. \$23.90

\$17.90

Precise 4 PIECE DIVIDER/CALIPER SET

- All dividers and calipers are made of high grade polished steel.
- Legs are well finished and balanced.
- Spring is hardened and tempered.
- Solid nut and washer permits fast and positive adjustment.
- Heat treated points to give accurate measurement.



SET No.
010-600
Reg. \$26.00
\$18.95

Consists of:
1) 6" Divider
1) 6" Inside Caliper
1) 6" Outside Caliper
1) 6" Hemaphrodite Caliper

PRYOR MARKING PUNCH SETS

- Made of Sheffield tool steel, hardened to Rc 59-61.
- Compact - easily storable font box.
- Each set supplied with type holder and tweezers.
- Sets supplied with positive locking, durable type holder and spacers.



A	A	B	B	C	C	D	D	E	E
E	E	F	F	G	G	H	H	I	I
I	I	J	J	K	K	L	L	M	M
M	M	N	N	O	O	P	P	Q	Q
Q	Q	R	R	S	S	T	T	U	U
U	U	V	V	W	W	X	X	Y	Y
Y	Y	Z	Z	1	1	1	1	1	1
1	1	2	2	2	2	3	3	3	3
3	3	4	4	4	4	5	5	5	5
5	5	6	6	6	6	7	7	7	7
7	7	8	8	8	8	9	9	9	9
9	9	0	0	0	0	0	0	0	0

Detailed composition of the standard 112 piece font set

DIVIDERS AND CALIPERS INSIDE AND OUTSIDE

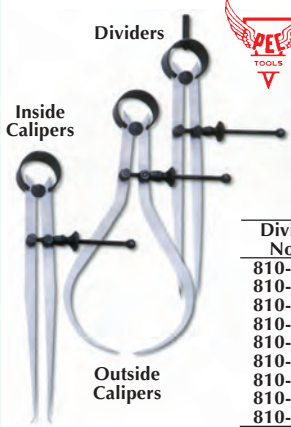

- All dividers and calipers are made of high grade polished steel.
- Legs are well finished and balanced.
- Spring is hardened and tempered.
- Solid nut and washer permits fast and positive adjustment.
- Heat treated points to give accurate measurement.

Divider No.'s	Inside No.'s	Outside No.'s	Size Inch	Sale Price
810-003	820-003	830-003	3"	\$ 4.95
810-004	820-004	830-004	4"	5.95
810-006	820-006	830-006	6"	6.50
810-008	820-008	830-008	8"	7.95
810-010	820-010	830-010	10"	10.95
810-012	820-012	830-012	12"	12.95
810-018	820-018	830-018	18"	19.95
810-024	820-024	830-024	24"	35.00
810-036	820-036	830-036	36"	55.00

Set No.	Description and Sizes	Characters Per Holder	Set List	Set Sale
TIF-H15	112 Pc. type set - letters & numbers with type holder & tweezers - 1/16"	18	\$ 569.00	\$475.00
TIF-H25	112 Pc. type set - letters & numbers with type holder & tweezers - 3/32"	18	581.00	475.00
TIF-H30	112 Pc. type set - letters & numbers with type holder & tweezers - 1/8"	8	581.00	495.00
TIF-H05	106 Pc. type set - letters & numbers with type holder & tweezers - 3/16"	8	681.00	495.00
TIF-H06	106 Pc. type set - letters & numbers with type holder & tweezers - 1/4"	6	1133.00	795.00
TIF-H10	106 Pc. type set - letters & numbers with type holder & tweezers - 3/8"	6	1415.00	995.00

TRANSFER SCREWS AND SETS

To use, insert screws into holes to be transferred and tighten with a wrench. Next, invert the screw and apply onto the new material and strike a sharp blow. The drill center will penetrate the new material to a depth of .010 to .015". Screws are case-hardened steel and have a uniform shoulder height regardless of diameter.



MADE IN USA

Quickly & Accurately Duplicate Blind-Screw & Stud Holes of Various Sizes



Model	Description	Sale Price
TSS-900	#0 NC Set (10-24, 10-32, 1/4-20)	\$24.00
TSS-902	#0 NF Set (10-24, 10-32, 1/4-28)	24.00
TSS-904	#1 NC Set (1/4-20, 5/16-18, 3/8-16)	26.00
TSS-906	#1 NF Set (1/4-28, 5/16-24, 3/8-24)	26.00
TSS-908	#2 NC Set (5/16-18, 3/8-16, 1/2-13)	28.50
TSS-910	#2 NF Set (5/16-24, 3/8-24, 1/2-20)	28.50
TSS-912	#3 NC Set (3/8-16, 1/2-13, 5/8-11)	32.50
TSS-914	#3 NF Set (3/8-24, 1/2-20, 5/8-18)	32.50
TSS-916	#4 NC Set (1/2-13, 5/8-11, 3/4-10)	35.00
TSS-918	#4 NF Set (1/2-20, 5/8-18, 3/4-16)	35.00

SPi MAGNETIC EDGE FINDERS

- Conveniently attached itself to workpiece with built-in permanent magnet
- Made in U.S.A.
- Precision ground, allows workpiece to be indicated with in accuracy of ±.0001".
- If hole or slot is indicated to centerline of spindle, the edge of workpiece will automatically be on centerline.
- Two models to choose from—slotted model to pick up single edges and Double Edge model with centering hole to pick up tangent of 2 edges.

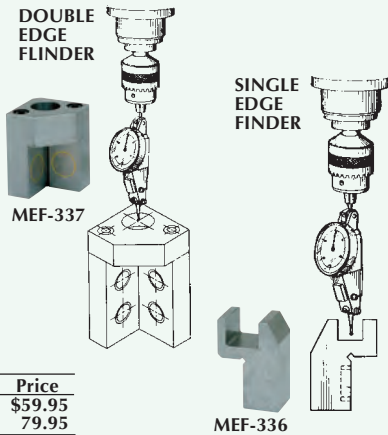

Model	Description	Price
MEF-336	Single Edge Finder	\$59.95
MEF-337	Double Edge Finder	79.95

GENERAL WIGGLER/CENTER FINDER SET

- The snap-in ball and socket wiggler is essential for precise setups in machine shops.
- Locates spindle centers and working points on drill presses, milling and other machines.
- Four interchangeable point attachments snap into adjustable spring tension clutch holder.
- Set includes snap-in holder, needle point, disk point, ball shaft and indicator shaft packed in vinyl case.



GENERAL MADE IN USA

MODEL No. S389-4
\$24.95

Precise Import MODEL No. WCF-4
\$12.95

ERGO-FOLD™ KEY SETS *Feel The Difference!*

Ergo-Fold Key Sets feature a composite grip handle shaped for superior ergonomics. A soft cushion-grip insert provides comfort and slip resistance. A hard shell provides maximum strength. As strong as steel, they are guaranteed forever.

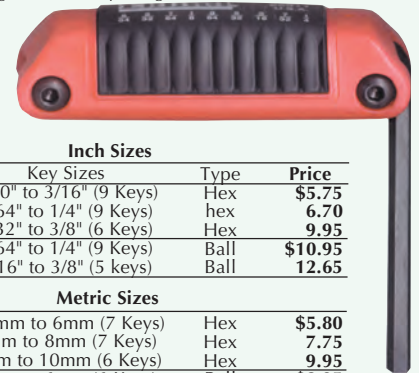

Inch Sizes			
Model	Key Sizes	Type	Price
25912	.050" to 3/16" (9 Keys)	Hex	\$5.75
25911	5/64" to 1/4" (9 Keys)	hex	6.70
25611	5/32" to 3/8" (6 Keys)	Hex	9.95
25919	5/64" to 1/4" (9 Keys)	Ball	\$10.95
25519	3/16" to 3/8" (5 Keys)	Ball	12.65
Metric Sizes			
25171	1.5mm to 6mm (7 Keys)	Hex	\$5.80
25172	2mm to 8mm (7 Keys)	Hex	7.75
25161	3mm to 10mm (6 Keys)	Hex	9.95
25169	2mm to 6mm (6 Keys)	Ball	\$8.95
25159	4mm to 10mm (5 Keys)	Ball	12.60
Torx Sizes			
25582	T6 to T25 (8 Keys)	Torx	\$12.60
25581	T8 to T40 (8 Keys)	Torx	12.60
25024	Combination Pack Inch, Metric & Torx 3 Sets 1 Each #25911 #25171 #25581		\$24.95

MAGLITE LED TECHNOLOGY FLASHLIGHTS 3 WATTS

The Maglite® flashlight, renowned for its quality, durability, and reliability, is now available with the MAG-LED™ Technology

- A powerful projecting beam that focuses simply by rotating the head.
- **Balanced Optics™**, combining a highly refined reflector with a quality LED, for a brilliant adjustable beam.
- Batteries Included with all models

New MAG-LED™ Technology make the Maglite® LED flashlight a technologically advanced lighting instrument.

- Intelligent Energy Source Management (patent pending) balancing high brightness with extended battery life.
- Interchangeable Light Sourcing. Use either the installed LED module or the Krypton lamp (stored in the tailcap)



No. SP2201
2AA Cell Cell Flashlights



No. ST2D016
2D Cell Flashlight



No. ST3D016
3D Cell Flashlight



No. ST4D016
4D Cell Flashlight



MAGLITE LED UPGRADE MODULE 3 WATTS For Your Existing Maglite™

- **Balanced Optics™**, combining a highly refined reflector with a quality LED, for a brilliant adjustable beam.
- The Kits are cell number/size specific i.e. 2 Cell, 3 Cell, 4 Cell and must be matched to a 2, 3, or 4 Cell Maglite® flashlight. Unlike "LED retrofits"



Step 2 Step 3



- Step 1** Unscrew the Maglite™ flashlight head assembly.
- Step 2** Unscrew the retaining collar and remove lamp.
- Step 3** Insert LED Module and replace retaining collar and head assembly

Model	SH32DC	SH33DC	SH34DC
LED Module	2D	3D	4D
Sale Price	\$17.50	\$17.75	\$17.95

Model	SP2201	ST2D016	ST3D016	ST4D016
Overall Length	6.6"	10"	12-11/32"	14-23/32"
Barrel Diameter	.709"	1-9/16"	1-9/16"	1-9/16"
Head Diameter	1"	2-1/4"	2-1/4"	2-1/4"
Weight w/ Battery	4.15 oz.	23 oz.	30 oz.	36 oz.
Color	Black	Black	Black	Black
Batteries	2AA	2D	3D	4D
Sale Price	\$28.95	\$34.95	\$36.95	\$37.95



HOLLOW PUNCH TOOL KITS

- These hollow punches may be paired and interchanged to give you an endless combination of size possibilities.
- The unique patented design of the locking system allows you to rapidly change the cutting tools & lock them in place giving a precise cut time after time.
- These punches are used for cutting out washers and sealing rings & can be used on multitude of different materials including foam, cardboard, leather, rubber, fiber, plastic, gasket material & lead.



High quality precision made tool

Unique patented locking system enables easy changing of dual cutting heads



Interchangeable dual heads allow for precise cuts from between 1/8" to 2"

Model	Description	List	Sale
66000	16 Pc. 1/8" to 1-3/16" Kit	\$245.00	\$195.00
66002	27 Pc. 1/8" to 2" Kit	487.00	375.00
66008	11 Pc. 1/8" to 3/4" Kit	152.00	120.00
66012	10 Pc. 1/8" to 3/8" Kit	110.00	85.00
66016	36 Pc. 1/8" to 2-3/8" Kit	949.00	750.00
66010	11 Pc. Metric 3mm to 20mm Kit	\$152.00	\$120.00
66004	16 Pc. Metric 3mm to 30mm Kit	245.00	195.00
66006	31 Pc. Metric 2mm to 50mm Kit	533.00	425.00

Note: Individual Sizes Available (Inquire)



TRANSFER SCREW SETS

A Faster, more precise way to transfer the exact location of open and blind threaded holes to mating parts

- Transfer screw sets are complete, self-contained tools. The hollow handle is both a wrench and storage holder for six screws.
- More accurate than transfer punches which must be made undersize to clear the hole, creating the possibility of misalignment.
- Can be used in open or blind threaded holes, where transfer punches can only be used in open holes.

Sets Consists of Six Screws Nested in a Combination Wrench Holder



Model No.	Size	Pitch (Specify)	Price Per Set	Model No.	Size	Pitch (Specify)	Price Per Set
TRS-04	#4	40 or 48	\$13.95	TRS-18	3/8"	16 or 24	\$14.50
TRS-05	#5	40 or 48	13.95	TRS-20	7/16"	14 or 20	14.50
TRS-06	#6	32 or 40	13.75	TRS-22	1/2"	13 or 20	14.50
TRS-08	#8	32 or 36	13.75	TRS-24	9/16"	12 or 18	14.50
TRS-10	#10	24 or 32	13.95	TRS-26	5/8"	11 or 18	14.95
TRS-12	#12	24 or 28	13.95	TRS-28	3/4"	10 or 16	14.95
TRS-14	1/4"	20 or 28	13.95	TRS-29	7/8"	9 or 14	16.50
TRS-16	5/16"	18 or 24	14.50	TRS-30	1"	8 or 14	16.95

* Also available in metric thread sizes (inquire)



SCRIBERS



No's 88-CM 88



No. 84

No.'s 81-1 83-1

No. 380A

No. 80



Model	Description	Price
88-CM	Carbide Point with Magnetic Pick-up	\$6.95
88	Carbide Point without Magnetic Pick-up	5.95
88-P	Extra Carbide Point	2.95
84	Needle Point Scriber	4.50
84-P	Extra Needle Points (1 Dozen)	4.50
81-1	Pocket Scriber 3/8" body	5.50
83-1	Pocket Scriber 1/4" body	4.50
380A	3-Piece Set 12" long	4.95
80	2-Piece Fixed Set 8-1/2" OAL	3.95



AUTOMATIC CENTER PUNCHES

ONE HAND OPERATION - ADJUSTABLE STROKE



No. PAC-87

No. BBP-77

No.'s ASP-78 ASP-79



Model	Description	Price
PAC-87	Aluminum Body Pencil Slim Design	\$13.95
BBP-77	Aluminum Body 5/8" x 5" Ball Bearing	16.95
ASP-78	Steel Body 5/8" x 6" Heavy Duty	32.50
ASP-79	Steel Body 1/2" x 5" Heavy Duty	23.50

Replacement Points available for all models

Precise TELESCOPING GAGE SETS

- Double action (self-centering for quick checking of inside measurements.
- Rigid handle with self centering feature.
- Uniform contact pressures.
- Contact point ends are hardened tool steel and precision ground on a radius of the smallest hole the gage will enter.



• Self Centering

Range:
5/16"-1/2"
1/2"-3/4"
3/4"-1-1/4"
1-1/4"-1-1/8"
2-1/8"-3-1/2"
3-1/2"-6"

Precise
Tin Coated
SET No.
4200-066

\$29.95

• Satin Chrome

MADE IN
USA

SET No.
TGA-006

\$79.95

Precise
Imported
SET No.

TGI-060

\$19.95

Precise V-BLOCK & CLAMP SETS

- Made of chrome steel, hardened and ground to matched accuracy of .0002".
- Models VB-015 and VB-020 are designed so that clamps do not protrude over the sides; tool can thus be used on its sides. • Matched and numbered in pairs.
- 90° V ground central, parallel and square with ends.
- All sides ground square and parallel to each other.

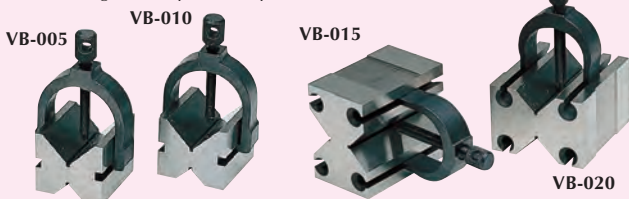

Model No.	Dimensions H x W x L	V-Capacity Inch	Set Price
VB-005	1-1/4" x 1-1/4" x 1-5/8"	1"	\$16.95
VB-010	1-5/8" x 1-3/4" x 2-3/4"	1-1/2"	41.95
VB-015	1-3/4" x 2-1/2" x 2-3/4"	1-1/2"	59.95
VB-020	2-3/4" x 3-1/2" x 4-7/8"	2-1/8"	119.95

Precise SURFACE GAGES

- Spindle arm and scribes are adjustable and lock into position at any angle for laying out & scribing lines.
- Hardened & ground steel base has V-groove for scribing cylindrical work.
- Recessed front allows spindle to be depressed below base line depth gaging.
- With scribe point and two spindles.



Model No.	Base Size	Spindle Included	Price Each
SG-100	2-1/8" x 1-9/16"	4" & 7"	\$16.95
SG-101	3-1/2" x 2-1/2"	9" & 12"	24.95
SG-102	4" x 3-3/8"	12" & 18"	39.95

#SG-100
\$16.95

#SG-102
\$39.95

#SG-101
\$24.95

Wood brown & sharpe ULTRA PRECISION WAVY PARALLEL SET

High quality steel, hardened, stress relieved and precision ground. Shims can be compressed which enables thin parts to hold

Features:

- Nine pairs 4-1/4" long, in the following height: 1/2" 5/8", 3/4", 7/8", 1", 1-1/8", 1-3/8" and 1-1/2".
- Parallel within ±.0002" and pairs matched within ±.0002".
- Includes fitted wooden case.

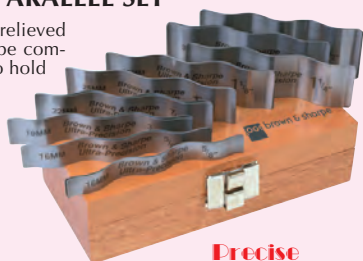

Wood brown & sharpe

MODEL No.
599-921-25
Reg. List \$173.00

\$139.95

Precise
Imported
MODEL No.
PWP-430

\$36.95

Precise ADJUSTABLE PARALLELS

- Consists of two Precision Ground pieces which slide smoothly on each other.
- Can be quickly inserted into openings and expanded to exact size, then measured with a micrometer.
- Locked into position by set screws.



6 Piece Set
No. AP-06
Reg. \$49.95

\$34.95

SAVE
30%



Precise 1-2-3 BLOCK SET INSPECTION TYPE - NO HOLES

- Made of first grade tool steel, stabilized and hardened 52 to 58 RC.
- Flatness and parallelism .0001".
- To size, -.000 +.0002".
- Blocks measure 1" x 2" x 3".



MODEL No.
NBS-123-1

\$19.95

With
Fine
Wood
Case

SAVE
50%

SET No.
NBS-123
REG. LIST
\$44.95

\$14.95

Per Pair



Precise SMALL HOLE GAGE SETS

- Full radius measuring faces with flat bottom, ideal for measuring shallow holes, slots, grooves.
- Size adjustment by knurled knob.
- Final size is obtained by measuring over the contact points with a micrometer.
- Gaging surface is fully hardened.
- Satin chrome finish.
- Extra long for gaging deep holes and slots.
- Set is furnished in fitted case.



Full
Ball
Type

Model No.	Type Radius	Measurement Range	Price Set
SHG-040	Half Ball	.125"-.500"	\$19.95
SHG-050	Full Ball	.125"-.500"	19.95

Wood brown & sharpe TELESCOPE GAGE AND ADJUSTABLE PARALLEL SETS



With Case
Order No. 599-591-20
6-Piece Telescoping
Gage SET 5/16" to 6"
Satin Chrome Finish

Reg. List
\$157.00

\$129.95



Order No. 599-673-20
6-Piece Adjustable
Parallel Set 3/8" To
2-1/4" With Case

Reg. List
\$176.00

\$139.95

Precise EDGE FINDERS

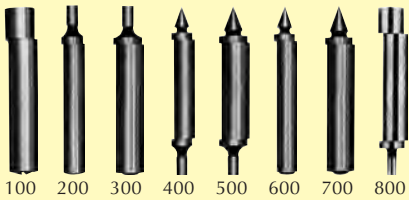

- IMPORT**
- Edge finders accurately locate working edges, shoulders, grooves, center and scribed lines.
 - Hardened and centerless ground to precision tolerances

SAVE MORE
3 piece set:
3/8" body includes
PEF-200, 400 & 600
Set No. PEF-003

\$18.95

5 piece set: 1/2" body
includes IEA# PEF-100,
300, 500, 700 and 800
Set No. PEF-005

\$29.95

Model	End	Tip Size	Body Size	Price
PEF-100	Single	.500"	1/2"	\$6.95
PEF-200	Single	.200"	3/8"	6.95
PEF-300	Single	.200"	1/2"	6.95
PEF-400	Double	.200" & Point	3/8"	7.95
PEF-500	Double	.200" & Point	1/2"	7.95
PEF-600	Single	Point	3/8"	6.95
PEF-700	Single	Point	3/8"	6.95
PEF-800	Double	.200" & .500"	1/2"	6.95

Precise ELECTRONIC EDGE FINDER

- Quick, precise Edge Finder lights up instantly when stylus .200" diameter x 5/8" length reaches the work edge.
- Made in U.S.A.
- Exact reading off any electrically conductive metal with clean surface.
- Furnished complete with 1-1/2" volt AAA alkaline battery and Sylvania #224 bulbs in protective case.
- 1/2" diameter shank, 3/4" length.



MODEL No.
EEF-315
Reg. List
\$29.95

\$24.95



Precise ELECTRONIC LOCATION GAGES

Edge Finder

- Designed of one-piece construction which gives strength and accuracy.
- Made of high quality tool steel hardened to 60 RC
- Dimensions: 3/4" Diameter x 3-1/2" O.A.L. x .400" Ball Probe.
- Precision ground on all surfaces.
- Four high visible lights.
- Easily replace lamp and battery.
- Repeatability T.I.R. within .0002"-0.006mm



MODEL No.
ELG-311
\$129.95



MODEL No.
302-1279
Imported
\$49.95

Preset Gage

- Designed of one-piece construction which gives strength and accuracy.
- Made of high quality tool steel hardened to 60 RC.
- Precision ground on all surfaces.
- Four high visible lights.
- Easily replace lamp and battery.
- Repeatability T.I.R. within .0002"-0.006mm
- Place electronic "Height Preset Gage" on table under machine spindle
- Make contact between tool in machine spindle and top gage. When contact is made, the lamp will illuminate.

MODEL No.
ELG-312
\$129.95

Dimensions:
2" Wide - 2" High
3 1/8" Head Diameter

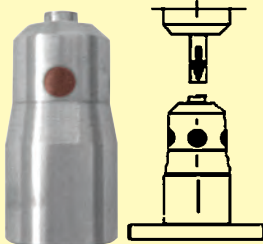

3-D Electronic Sensor

- A new concept for fast and accurate "zero" finding and starting point for all three axes X, Y, Z.
- Made of high quality tool steel hardened to RC60, precision ground on all surface.
- Dimensions: 3/4" Diameter x 3.66" O.A.L. x .400" Probe
- Operate in vertical or horizontal position.
- Over travel safety zone in all three axes: x, y, z-.200 inch or 5mm.
- Repeatability ±.0005 inch or ± 0.015mm



MODEL No.
TAC-313
\$169.95



Brown & Sharpe / FISHER

EDGE FINDERS & AUDIBLE EDGE FINDERS

Audible Edge Finders help assure accuracy by releasing an audible click when the tip jumps. This allows the operator to listen as well as watch the tool.

- Available in five sizes: 1/4", 3/8", 1/2", 3/4" & 10mm.
- Hardened and ground on all working surfaces.



Standard Edge And Center Finders

Model	Description	Price
EF-250	1/4" x .200 tip single end	\$12.95
EF-001	3/8" x .200 tip single end	11.95
EF-002	1/2" x .200 tip single end	11.95
EF-003	3/8" x point center finder	11.95
EF-004	1/2" x point center finder	11.95
EF-005	3/8" x .200 x point combination	14.95
EF-006	1/2" x .200 x point combination	15.95
EF-011	10mm/.375" shank x 10mm tip	\$13.95
EF-012	10mm shank x 10mm tip	13.95
EF-007	1/2" x .500 tip single end	\$11.95
EF-750	3/4" x .750 tip single end	12.95

Audible Edge And Center Finders

AA-250	1/4" x .200 tip single end	\$14.95
AA-100	3/8" x .200 tip single end	12.95
AA-200	1/2" x .200 tip single end	13.95
AB-500	1/2" x .500 tip single end	13.95
AA-750	3/4" x .750 tip single end	19.95
AG-300	10mm/.375" shank x 10mm tip	16.95
AG-400	10mm shank x 10mm tip	15.50



ELECTRONIC EDGE FINDER WITH 6 LIGHTS

- Made in the USA.
- Read off any electronically conductive metal.
- Repeatability: .0002"
- Edge finder lights instantly when stylus touches work edge.
- Furnished complete with bulb and AAA alkaline battery.

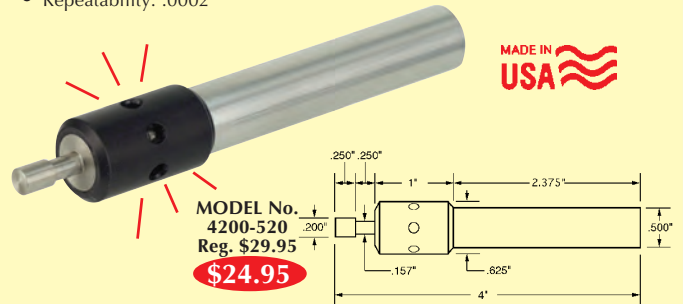

MODEL No.
4200-520
Reg. \$29.95
\$24.95



ELECTRONIC EDGE FINDER

- Six equally-spaced light ports provide visibility at any angle.
- Edge finder lights instantly when stylus touches work edge.
- Repeatability: .0002"
- Works on any conductive metal.
- Battery 12 volt.
- Along with light indicator, No. 54-575-650 emits an audible "Beep" at contact.



Model	Stylus	Shank	Audible	List	Sale
54-575-600	.200"	1/2"	No	\$28.00	\$22.50
54-575-625	.200"	1/2"	No	98.75	74.95
54-575-650	.400"	3/4"	Yes	98.75	79.95

Starrett RADIUS GAGE SET AND SCREW PITCH GAGE

- Made of satin stainless steel rust and satin resistant.
- Each gage is clearly marked with its radius.
- All gages have precision finished radii with extra smooth, accurate edges.

Set No. S167CHZ
1/64" Thru 1/2"
W/Holder
And Case
Reg. List
\$172.00

\$162.50



51 Leaves
4 to 84 T.B.I.
Plus 11-1/2 & 27
Pipe Thread
Set No.
472-1
Reg. List
\$74.00

\$69.50



Starrett ADJUSTABLE PARALLEL SET

3/8" To 2-1/4" 6 Piece

- Their adjustable feature makes it possible to adjust them to exact size by micrometer measurement and also permits use in place of several solid-type parallels.
- Parallels slide smoothly and can be easily adjusted. The smaller sizes A, B and C, are locked by one screw while the larger sizes, D, E and F, have two lock screws. All parallels are 9/32" thick.



SET No.
S154LZ
Reg. List
\$249.00

\$234.50



Starrett SMALL HOLE GAGE SET

Full-Ball or Half-Ball Contact .125"-.500"

- Hardened-ball measuring surface with two-point contact.
- Radius on each gage is less than the minimum diameter to be measured, which provides the two-point contact necessary for maximum accuracy.
- Smooth, sensitive adjustment for better feel, giving more accurate measurements.

Full-Ball
SET No.
S829EZ
Reg. \$158.00

\$146.00

Half-Ball
SET No.
S830FZ
Reg. \$210.00

\$189.00



Starrett SOLID TYPE INSIDE MICROMETERS .001" GRADUATION

- Measuring rods are solid and assembled on one side of the micrometer head.
- Rods are insulated.
- Each rod marked with length.
- Hardened and ground anvils on rods, adjustable for length. Head anvils is hardened and ground.
- Quick-reading figures, every thousandth numbered on inch reading tool.



2"-12"
RANGE
SET No.
124BZ
Reg. List
\$300.00

\$285.00



Starrett SQUARE SHANK 7PC. CENTER PUNCH SET

- These center punches have a square knurled grip and will not roll when laid down.
- They are hardened and properly tempered.
- The tips are accurately centered and ground at the proper angle to give maximum service



SET No.
S264WB
Reg. List
\$74.00

\$66.50

Lengths From
3" to 5"

Starrett DRIVE PIN PUNCH

Starrett No. 565 Drive Pin Punches are well proportioned, hardened properly tempered, nicely finished and have a knurled finger grip. Each punch has the size stamped on the head.



Set of 8 Punches 4" Length
1 Each: 1/16" Thru 5/16" by 32nds

Plastic Case
SET No.
S565WB
\$56.00

\$50.50

Vinyl Case
SET No.
S565PC
\$52.00

\$46.95

Starrett T-HANDLE TAP WRENCHES

- The body is centered, enabling the worker to use it on a lathe centers or an upright drilling machine.
- The jaws conform to the tool being held making it rigid and less apt to loosen.
- All wrenches have a sliding handle which is frictionally held.

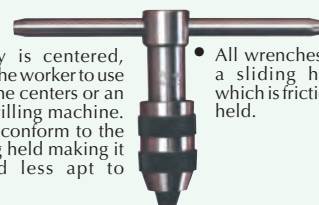

Model No.	Tap Size	Body Length	List Price	Sale Price
93A	1/16-3/16"	2"	\$33.50	\$29.95
93B	7/32-7/16"	2-1/2"	35.50	33.50
93C	1/4-1/2"	3-1/2"	46.00	43.50
93D	1/16-3/16"	6"	49.50	44.50
93E	7/32-7/16"	10"	65.00	61.50
93F	1/4-1/2"	13"	71.00	67.25

Shopmath Software

- Simple and immediate solutions to complex shop math.
- Use your own computer system. Minimum requirements: any Windows® operating system. Minimum 1.5MB hard drive space.
- Units changeable from inch-millimeter and degree. Decimal-degree, minutes seconds.

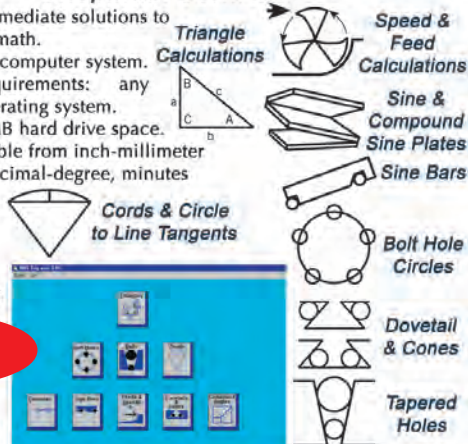

Model No.
SSW-1000
Reg. \$129.95

\$109.95

Mitutoyo COMBINATION SQUARE SETS

Hardened Heads and Blades Chrome Finished

- All blades are fully hardened and tempered.
- Durable, easy-to-read satin chrome finished blades.
- High contrast, micro-fine blade graduations.
- Square/miter head features level vial and hardened scribe tool.
- Heads supplied with a hammertone powder-coat finish.
- Double indexed protractor is graduated 180° in both directions.
- Meets Fed. Specs. Type VI Class A.

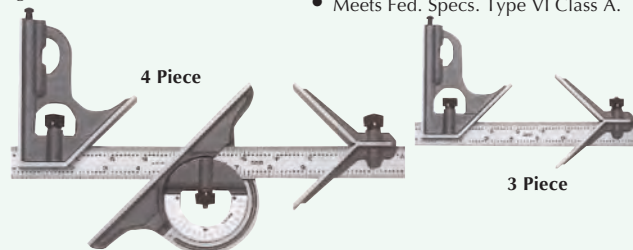

Model No.	Blade Length	Blade Graduation	No. of Pieces	List Price	Sale Price
180-903	12"	1/2", 1/16", 1/32", 1/64"	3	\$143.00	\$111.95
180-904	12"	32", 64", 50", 100"	3	147.00	124.95
180-905	12"	1/2", 1/16", 1/32", 1/64"	4	\$225.00	\$189.95
180-906	12"	32", 64", 50", 100"	4	228.00	193.50

Starrett MASTER PRECISION SQUARES 1-1/2" TO 36"

- The finest precision-checking squares, not graduated. Squareness accuracy to .0001" every 6".
- The beams and blades are hardened, ground, and lapped to insure parallelism and straightness.
- The beam is grooved at the inner corner for clearance of burr or dirt.

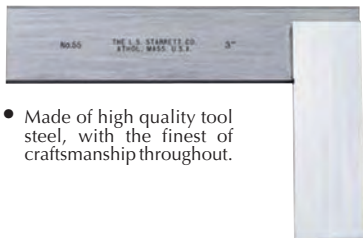

- Made of high quality tool steel, with the finest of craftsmanship throughout.

Square Size Blade X Beam	Straight Blade#	Price Each	Beveled Blade#	Price Each
1-1/2"x 1-1/2"	20-1-1/2	\$171.50	55-1-1/2	\$190.00
3"x 2-3/8"	20-3	180.00	55-3-1	205.00
4-1/2"x 3-1/2"	20-4-1/2	220.00	55-4-1/2	255.00
6"x 4-15/16"	20-6	290.00	55-6	295.00
12"x 7"	20-12	645.00		
24"x 12-15/16"	20-24	1500.00		
36"x 20"	20-36	3750.00		

*Length of blade from the inner edge of the beam to the end of the blade. Wood cases available (Inquire)

Starrett V-BLOCKS & CLAMP

- Can be used on it's base, on the end or on either side.
- The clamp is smaller than outside width of the block, but has an adjustable side screw to support the block and prevent tilting.
- The V at the stepped end is at right angles to the base and is handy for holding shouldered studs, pins, etc.
- A clearance hole for drilling or removing dowel pins is provided in the block.
- The block has four 3/8-16 tapped holes, two in the base and one on each side for attachment to an angle iron.



MODEL No.
567
\$299.95

1-15/16" V
Capacity

Starrett HOLD DOWNS

- The contact edges are tapered to hold the work securely and to force it downward to the bed of the machine or against any parallel surface.
- They are especially useful for holding small work or thin materials without distortion.
- They are made of tool steel, hardened and ground.



Hold-Downs side view - tapered edges hold the work securely

Model	Length	Width	Price
54A (Pair)	4"	27/32"	\$82.50

Starrett V-BLOCKS & CLAMP

- The V-blocks of this set are of case hardened steel for wear resistance and may be used singly or in pairs.
- This set includes a steel rod that passes through each block, firmly held by friction positioning.
- This keeps the blocks in alignment and adds convenience for holding work with shoulders because the shoulders can rest between the blocks.
- Two grooves on each side of the blocks will hold the clamp for small or large work.
- The clamp is a steel forging, able to hold work up to 1-1/4" (32mm) in diameter.



SET No.
271C
\$96.50

1-1/4" V Capacity

Starrett V-BLOCKS & CLAMPS

- V-Blocks are precision ground to extreme accuracy.
- The V's are central, parallel and square with the ends and sides.
- The blocks are made of steel, hardened and ground and numbered in series so that the vees in each set are always in alignment.
- The blocks have a 1/4-20 tapped hole through the sides so that they may be attached to an angle iron.
- Each block is 1-1/4" square and 1-5/8" (40mm) long.

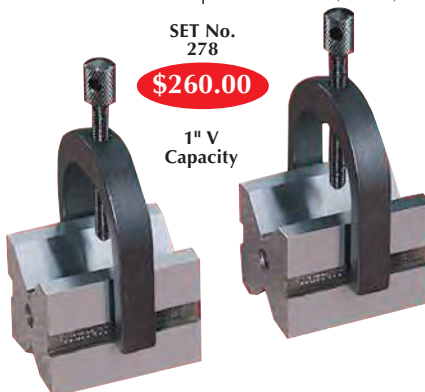

SET No.
278
\$260.00

1" V
Capacity

Starrett V-BLOCK & CLAMP SET 2" Round & 1-7/16" Square Capacity

- Hardened steel, precision ground parallel and square.
- V-grooves are ground central and parallel to the sides and base.
- Clamps have screw holes at 45° and 90° to hold either square or round work.
- Stepped groove construction permits high or low clamp mounting for small or large work.
- Clamps do not project over the width of the block, permitting it to be used on the base, ends or sides.
- 3/8-16 tapped holes permit mounting blocks on faceplates or angle irons.
- Each block is 2-1/2" long x 3" wide x 2" high (63 x 75 x 50mm).



SET No.
568C
\$439.95

Starrett TAPER GAGE

- This gage is specially designed for rapid, accurate checking of inside diameters of tubing.
- Also very useful for general gaging of slot widths, hole sizes, setting calipers, etc.
- This gage has thin, tapered leaves graduated to measure inside diameters or widths from 1/16" to 1-1/16" in 64ths of an inch. They are made of nicely finished spring-tempered steel, approximately 1" wide by 5-1/4" long.

Starrett
MODEL No. 267
\$115.00

SPI
MODEL No.
14-183-8
\$82.25



Starrett TAPER GAGES

- These gages are for determining hole sizes in dies and all kinds of other work.
- They read in thousandths of an inch or 0.02mm.
- Made of tempered steel with a locking device for fixing any leaf in position for use.

SPI
.100"-.500"
MODEL No.
14-184-6
\$87.95

SPI
2-12mm
MODEL No.
14-185-3
\$87.95

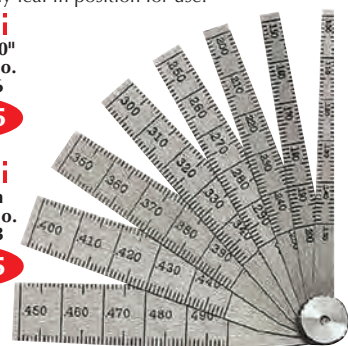

Starrett .001" Graduations

Model	Range	Length	Leaves	Price
269A	.100-.500"	2-1/2"	8	\$126.00
269B	.500-1"	2-3/4"	10	148.00
0.02mm Graduations				
269MA	2-12mm	64mm	10	\$126.00
269MB	12-25mm	70mm	13	148.00

Starrett TAPER GAGE .010-.150"/0.3-4mm

- The gage is made of quality tool steel 7/16" wide by 6-1/4" long and is accurately tapered throughout its entire length for quick and convenient measuring of slot widths, etc.
- One side is graduated from .010" to .150" in thousandths of an inch and the reverse side from 0.3mm to 4mm in one twentieth of a mm (0.05mm)



Starrett
MODEL No. 270
\$105.00

SPI
MODEL No.
14-179-6
\$81.45

Starrett TOOLMAKERS STEEL CLAMP/VISE SET

- Each is furnished with two take-up blocks that slip on the end of the screw.
- The blocks are held to allow a slight swivel action that conforms the angle of the block to the shape of the work being held.
- There is a hole in the base of the Clamp/Vise so that they may be fastened to a bench. Clamp/Vise are made of case-hardened steel & are smoothly finished.



Match Pair
SET No. 160
\$154.50

2"
Capacity

TITAN CENTERING MICROSCOPES

- The most minute spindle run-out can be compensated for both the X & Y & Z Series Centering Microscopes the X Series uses the popular (3) master centering screw method where the reticle floats between the centering screws just below eyepiece of the microscope.
- The Y & Z Series Centering Microscope have a "Prismatic" centering device where only two screws are needed for especially simple and fast centering to compensate for spindle run-out. The Prismatic setting on the Y & Z Series has the advantage of not changing the settings of one axis while you are adjusting the other axis, as both settings are entirely independent of each other. Both methods can be quickly mastered. Special instructions come with the units. It is an easy matter to adjust the microscope for perfect centering every time.

Specifications:

- SHANK: 3" long, 1/2" diameter, hardened and ground.
- EYETUBE: 3 1/2" long at 45° angle to the center of the body.
- IMAGE: Optically correct. Right side up not inverted.
- EYEPIECE: Color coated and achromatic Kelnher type.

Model No.	Magnification	Field of View	Working Distance	Price Each
X-100	20X	.270"	.27"	\$895.00
X-200	50X	.105"	.2086"	895.00
X-TSVA	Video Adapter			485.00
WCS-001	Wood Case for Either Model			68.00
Y-100	20X	.382"	2.598"	\$1450.00
Y-200	50X	.158"	1.078"	1450.00
Y-300	100X	.080"	0.255"	1550.00
Y-400	200X	.038"	0.060"	1550.00
Y-TSVA	Video Adapter for "Y" & "Z"			595.00
Z-100	10X	.760"	6.250"	\$1425.00
Y-20	20X Eyepiece for "Z" Series			295.00

Illuminator & Transformer For All Models No. CMI-CMT \$295.00



Precise 10X POCKET OPTICAL COMPARATOR SET

- Widely used by machinists, toolmaker, and inspectors for checking angles, diameters, radii, thread pitches, hole sizes, etc.
- The scales are photo etched into glass reticle for easy reading.
- Reticle screw-in mounting are interchangeable.
- 9 piece/set includes: 1 pc. Comparator and 8 pc. Reticle.
- Lens diameter: 21mm 1" diameters reticles 1#-13# can be used.
- Body height 2".



Precise 45X CENTERING SCOPE

- Enable operator to locate work for drilling, boring, etc., on vertical milling machines, jig bores or drill presses.
- Edges, lines or punch marks on work piece can be quickly located or centered relative to the axis of the machine, locate lines.
- To use, simply place instrument in machine, locate lines on work to match crosshair lines in viewing aperture.
- Knurled sleeve on lower end of scope is turned to compensate for misalignment.
- The work layout intersection is now in the exact center of the spindle axis, ready for cutting tool.
- True position accuracy $\pm .0001"$.
- Crosshair reticle for use as reference of X and Y axis.
- Eyepiece angle 60°.
- Field of view 1/8". Working distance 1" from lens.



Precise EYE LOUPES

- For toolmakers, jewelers, instrument assemblers, etc.
- Lenses made of polished optical glass
- Lens diameter: 1"



WYLER Fowler BlueSYSTEM FOR SURFACE PLATE FLATNESS TESTING

The Fowler/Wyler Surface Plate Kit is a full-featured and economical kit designed specifically for testing surface plate flatness quickly and accurately.

- Includes 2 Wyler levels
- Wyler Bluemeter Basic
- Wyler Levelsoft software
- Meter to level cables
- USB computer cable

Accessories:

Wyler Infra-Red Zapper allows for remote measurement taking to avoid inaccuracies caused by vibration and other contact-induced aberrations.

120 Volt Power Supply for convenient non-battery power.



Levelsoft PRO Software is a well known, user-friendly measuring and calibration software for checking flatness geometry measurement (Measuring - and setting plates, geometry of machine tools etc.). It is available for use with the MINILEVEL NT, LEVELTRONIC NT, NivelSWISS and BlueSYSTEM series of WYLER instruments.

By using **Levelsoft PRO** the instruments may be used in a number of combinations and configurations (e.g. differential measurement with two instruments), for measurement of straightness of lines, the measurement of guide ways with twist or the flatness of large and small surfaces.

Model	Description	Price
54-895-250	Wyler Surface Plate Kit with BlueMeter Basic and Software	\$28,500.00
54-895-010	120 Volt Power Supply	
54-895-999	Infra-Red Zapper	
54-895-779-1	Levelsoft PRO Software	

WYLER Fowler CLINOMETER

Simple to operate. For the initial setting, i.e., to the nearest degree, depress the spring loaded micrometer drum to disengage the drive to the main scale. Coarse setting is then made by rotating the spirit level by hand. Re-engage drive and rotate micrometer drum to obtain one final setting.

- Although smaller and more compact than most Clinometers, it still provides the same accuracy.
- Overall height 4.562"; base length 6"; base width 1.375". Weight is 3 lbs. 9 oz.
- Main circle: 1 division = 1 degree. Micrometer: 1 division = 1 minute. Accuracy: 1-1/2 minutes.
- Base hardened, ground flat with a longitudinal prismatic vee which allows it to be easily placed on flat & cylindrical surfaces.
- Includes fitted wood case.
- Circular scale, observed through viewing window, is marked 0-180-0 at one degree intervals and figured every 10 degrees.
- A spirit level vial, is attached to the adjusting collar.
- Scale is subdivided by means of an external micrometer graduated in minutes with a sensitivity of 1 division = 1 min., .0003"/10" (.3mm/m). Easy estimation to 30 seconds can be achieved. Drum graduated in minutes; figured every 5 minutes.

MODEL No. 53-635-500

\$3295.00



FLEXBAR VIDEO-BORESCOPE

Reach Inaccessible Areas Quickly and Easily!

- High resolution full color image.
- 9mm diameter fits most small access applications.
- Adjustable LED lighting.
- Detachable, wireless monitor 2.4: LCD for remote viewing.
- Standard one meter (39") lengths with option extension cable.
- Runs on 4 AA batteries.



MODEL No.
13290

\$295.00

With Fitted Case

Optional:
3 Foot Extension Cable*
No. 13291 **\$20.50**

* When using extension, must have entrance diameter of .710"



ILLUMINATED 10X JEWELER LOUPES

- Built-in band of six LED lights.
- Emits a cool bright light.
- Direct illumination eliminates shadows.
- Leather storage case included.
- Ultraviolet light.
- Essential for identifying fluorescent shades.



Model	Description	Price
29-610	10X Illuminated Loupe	\$29.95
29-615	10X Illuminated Loupe with Ultraviolet Lighting	39.95

CncGcoder HD® Eliminate Costly "DNC" Systems by Transferring "G" Code From CNC Control to PC via PDA

- You can use the CncGcoder® HD to make quick program edits right in front of your CNC. The built-in CNC style keyboard makes it easy to change speeds, feeds, or even program numbers on the shop floor. You can make your changes and send the new program to the cnc in seconds. (only files less than 30,000 characters can be edited in the CncGcoder)
- The unit is liquid, dust and shock resistant. It will withstand a splash of oil or a few chips. It will even tolerate the occasional dents and dings common in any shop.
- Never have difficulty finding the right program again. File management has been simplified. The G-Code programs can be saved with descriptive names as PC formatted files. These files can be organized into any number of folders or directories.
- The unit also has an integrated SD slot for limitless memory capabilities. Use an SD memory card to store and organize all of your G-Code programs, or use different cards for different machines.
- The CncGcoder HD is equipped with a large capacity rechargeable battery for hours of continuous use between charges.
- Never need to worry about available memory on your CNC again. Store your G-Code programs on your PC and then use your CncGcoder HD to transfer the programs to your CNC when needed. (up to 1 MB per transfer is supported)
- By displaying the program on the unit's screen, you can be sure it is correct the first time. No time is wasted running to and from the computer to check what is being transferred. You can walk up to the machine and start communications.



No. 003 (Shown)

Model	Description	Price
GNC-003	HDX Super CncGcoder with NEW Extreme Duty Durable Cable and Enhanced USB Port	\$1095.00
GNC-002	Extreme Duty Durable Cable with USB Port for older HD model upgrade	180.00

Bausch & Lomb

ILLUMINATED CODDINGTON MAGNIFIER

Features:

- Solves the problem of adequate illumination for high-power magnification.
- Designed to allow the viewed area to be flood with light through the lens itself.
- Operated by 2 AAA batteries (not included).



MODEL No.
81-34-34
Reg. \$40.90

\$29.95

Specifications:

Focal distance 1"
Power 10X

TITAN CENTERING MICROSCOPES

- Titan Centering Microscopes have an upright image, optically correct from left to right so that the operator sees the workpiece with the microscope the same as without it, mistakes due to transposing or converting are eliminated.
- The X & Y & Z Series Centering Microscopes all come with hardened and ground 1/2" x 3" diameter shanks so that they are adaptable to all machines through the use of collets. It is suggested if it will be used continuously in one machine that it be fitted with its own collets.

- The most minute spindle run-out can be compensated for both the X & Y & Z Series Centering Microscopes and the X Series uses the popular (3) master centering screw method where the reticle floats between the centering screws just below eyepiece of the microscope. The Y & Z Series have a "Prismatic" centering device where only two screws are needed for especially simple and fast centering to compensate for spindle run out. The prismatic setting on the Y & Z Series has the advantage of not changing the settings of one axis while you are adjusting the other axis, as both settings are entirely independent of each other. Both methods can be quickly mastered. Special instructions come with the units. It is an easy matter to adjust the microscope for perfect centering every time.

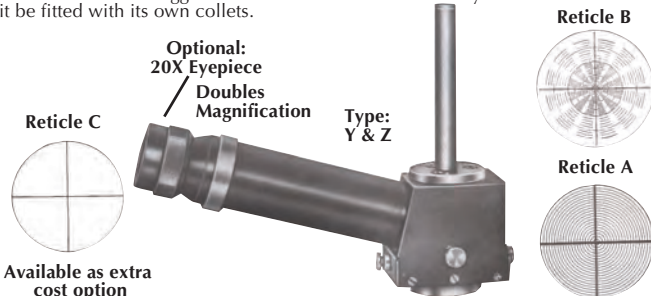

Available in inch or metric (can be ordered as standard in Model Y-1, Y-II and Y-III in inch. Only has to be ordered as extra for Models Z-1 and Y-IV)

Shipped with Reticle "A" unless Reticle "B" is specified. Only available in inch Divisions

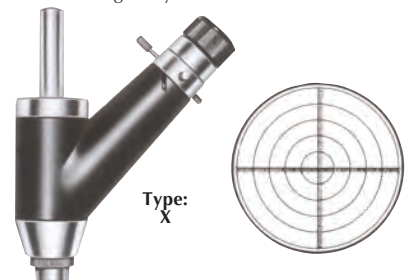

Optional for all Models

Model	Description	Price
OEX-002	20X Eye Piece	\$295.00
WCS-001	Fitted wood Case for all models	\$ 75.00

Model No.	Magnification	Field of View	Working Distance	Type	Price Each
XCS-004	20X	.270"	2.086"	X-1	\$ 895.00
XCS-005	50X	.105"	.8267"	X-2	895.00
YCS-007	20X	.382"	2.60"	Y-1	\$1450.00
YCS-008	50X	.158"	1.078"	Y-2	1450.00
YCS-009	100X	.080"	.255"	Y-3	1550.00
YCS-010	200X	.038"	.060"	Y-4	1550.00
ZCS-006	10X	.760"	6.25"	Z-1	1425.00

PEAK POCKET OPTICAL COMPARATORS PEAK

7X Pocket Comparator 1" Diameter Lens

- Pocket-size measuring and inspection comparator.
- 7x magnification, Kellner type, achromatic lens, (3 elements, 2 group) for sharp, undistorted images.
- Highly accurate measurements are obtained with sharp photo etched reticles as shown.
- Body height 2-5/16".



Complete With
#5 Reticle
SET No. X7-1

\$69.00

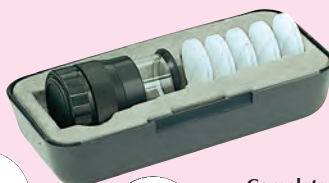

Complete
With
5 Reticles,
Illuminator
and Case
SET No. X-7-5

\$146.00

- Provides excellent illumination for precision work



MODEL No.
IL-143

\$14.50

Requires 2C
Batteries, Not
Included



#13

#13 Reticle .0005" Scale
No. 40-093-7 \$17.00

Optional:
#13 Reticle .0005" Scale
No. 40-093-7 \$17.00

Bausch & Lomb METAL FRAME EYEGLASS LOUPES

- Made with precision optical glass.
- Ideal for any detail work.
- Available in single or double lens configurations.
- Side shield adapter kit provided for use with safety eyewear.
- High quality case provided to protect your investment.

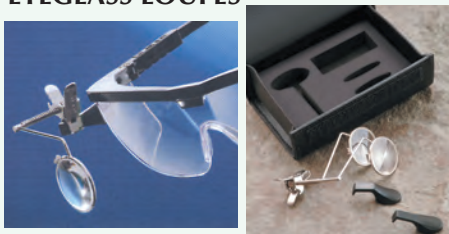

Model No.	Power "X"	Focal Distance	Lens Size	Reg. List	Sale Price
81-41-17	3X	3.3"	24mm	\$44.00	\$28.95
81-41-27	4X	2.5"	24mm	44.00	28.95
81-41-37	5X	2"	24mm	44.00	28.95
81-41-47	7X	1.5"	24mm	44.00	28.95
Double Lens					
81-41-78	4X & 7X	2.5" & 1.5"	24mm(2)	\$60.00	\$36.95
81-41-79	3X & 5X	3.3" & 2"	24mm(2)	60.00	36.95

Bausch & Lomb INSPECTION EYE LOUPES

- Lenses are made of optical glass.
- Rests comfortably in the eye socket.
- Powers range from 4x to 10x.



Model No.	Power "X"	Focal Distance	Lens Size	Reg. List	Special Price
81-41-70	10x	1"	1"	\$18.90	\$12.95
81-41-71	7x	1.5"	1"	16.90	11.95
81-41-72	5x	2"	1"	16.90	11.95
81-41-73	4x	2.5"	1"	16.90	11.95

New Headband (soft spandex material) eye loupe holder
Model 81-41-14 \$5.95 each

Bausch & Lomb VISOR MAGNIFIER

Bausch & Lomb quality optics
Contemporary molded frame
Comfortable & washable padding

- Ergo feel headband for hours of comfort. Easily removed for cleaning.
- Precision Bausch & Lomb optics.

Scratch proof coated/hardened lens
Multiple magnifications
2 Year warranty

- Acrylic lenses specially coated and hardened for heavy duty applications.
- Three lenses with focal lengths of 6", 8" and 12".



With All 3
Interchangeable
Lenses
MODEL No.
81-42-000
\$49.95

Replacement Lens

Model	Description	Price
81-43-06	2.75x Lens, 6" Focal Length	\$9.95
81-43-08	2.5x Lens, 8" Focal Length	9.95
81-43-12	2.0x Lens, 12" Focal Length	9.95

Bausch & Lomb CODDINGTON AND HASTINGS TRIPLET

CODDINGTON:

Correction in these magnifiers is achieved through the use of a single thick lens with a central groove diaphragm. This provides a sharp crisp image.

HASTINGS TRIPLET:

Three separate lenses, bonded together to form a compound lens, provide sharp, very distinct magnified images with no color distortion even under 14 and 20 power magnification.

CODDINGTON

Model No.	Focal Distance	Power X	Lens Diameter	Price Each
81-61-31	1"/2.5cm	10x	19.75mm	\$22.95
81-61-35	3/4"/1.9cm	14x	15.75mm	23.95
81-61-41	1/2"/1.3cm	20x	12.45mm	29.95

HASTINGS TRIPLET

81-61-68	1-1/2"/3.8cm	7x	19.8mm	\$36.95
81-61-71	1"/2.5cm	10x	15.8mm	38.95
81-61-75	3/4"/1.9cm	14x	12.5mm	41.50
81-61-81	1/2"/1.3cm	20x	8.25mm	41.50



MARK II MAGNI-FOCUSER

A VISION-AID FOR CLOSE-UP, HANDS FREE WORK

- No center post for unobstructed field of vision.
- High-impact, non corrosive ABS plastic front lens unit flips up when not needed.
- Adjustable, contoured padded vinyl headband for perfect fit.
- Can be worn over glasses.
- Lightweight. • Washable.
- Comfortable.



MADE IN
USA

Auxiliary Lens
2.25x
MODEL No.
MFM-105
Reg. List \$25.50
\$19.95

Power Without Aux. Lens	Working Distance	Regular Model	Sale Price	With Auxiliary Lens	Sale Price
1.75x	14"	MFM-103	\$19.95	MAM-113	\$24.95
2.25x	8"	MFM-105	19.95	MAM-115	24.95
2.75x	6"	MFM-107	19.95	MAM-117	29.95
3.50x	4"	MFM-110	24.95	-	-
2.75x	Auxiliary Lens AUX-275 (Fits all Models)	-	-	-	\$ 6.50

Opti-SIGHT® VISORS Lightweight - Bends To Fit Your Head

- Precision optical grade acrylic
- Visor can be worn over prescription or safety glasses.
- Three different interchangeable lens plates are included.
- 11 design shields out unwanted glare.
- High strength plastic will not break.



Slate Blue

MADE IN
USA

Opti-Sight with 3 Lens Plates

Model	Lens Included	List	Sale
OSC-178	1-3/4 Times #3	\$35.50	\$27.95
	2 Times #4		
	2-1/2 Times #5		

Precise DELUXE SHOP MICROSCOPES

- Wide field eyepiece with direct reading reticle (no calibration required). Eyepiece turns to permit sharp focus of reticle scale.
- Penlight illuminator in swivel mount. Requires 2 AAA batteries.
- Jack and pinion focusing with dual focusing knobs.
- Cast aluminum structure.
- Height: 9".

40X Power
MODEL No.
892-036

\$119.50

80X Power
MODEL No.
892-037

\$125.00

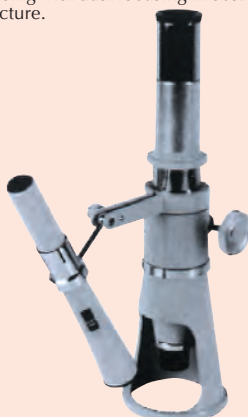

Precise INDUSTRIAL GRADE FLUORESCENT MAGNIFIER

- Fluorescent light illuminating.
- Rectangular lens 7" x 5.2".
- 3 diopter lens provides 1.75x magnification.
- Swing arm with 32" reach.
- Max. 2-1/2" adjustable bench clamp.
- Power On/Off switch.
- Power supply: 115V, 9W (H-shape fluorescent bulb included).



MODEL No.
841-047

\$99.95

HASTINGS TRIPLET MAGNIFIERS

- Triplet lens system.
- Case color: Black.



Model	Power	Lens Diameter	Price
490-045	10X	21mm	\$24.95
490-046	15X	21mm	24.95

Precise TUBULAR MICROSCOPE

- 30X measuring microscope with an adjustable eyepiece.
- The reticle has 90° crosslines and .001" divisions with major numerical markings at .01" intervals.
- The microscope is 6-1/2" long and has a 1" diameter eyepiece with the microscope body being .500" diameter.

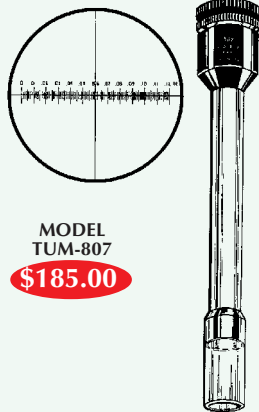

MODEL
TUM-807

\$185.00

SPi LIGHT LOUPE

- Crystal-clear lens 10X, shielded by hard plastic holder.
- Built-in light for clear vision in dark.
- Battery case is made of rust proof brass.
- Require 2 C batteries (not included).



MODEL No.
40-158-0

\$29.99

PEAK ZOOM COMPARATOR

- Continuous zooming magnification from 8X to 16X with click stops at 8X, 10X, 12X, 14X and 16X.
- Field of view .788" to .394" diameter.
- Size 2.56" x 1.77" diameter.
- Diopter adjustment ring +2.5D to -5D.
- Reticle with .005"/0.1mm graduation included.
- 1-3/8" diameter reticles listed with 10X comparators also fit this instrument.



MODEL No.
ZOM-138
Reg. \$296.00

\$295.00

PEAK MINI COMPARATOR

7X Power 1" Diameter Reticle

- Doublet type achromatic lens.
- Sharp resolving power - photo etched clear reticle.
- Smooth multiple-threads for sharp focusing.
- Body height 27/32".
- 1" diameter reticles #001 to #013 can be used.



MODEL No.
PMC-144

\$89.00

With #005
Reticle

PEAK RETICLES

1" Diameter For 7X Comparators

- Reticles are easily interchanged by a screw-in mount. Use them to measure radii, diameters, angles, pitch and thickness.

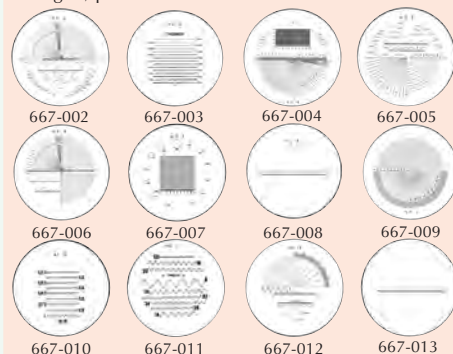

Reticles #2 Thru #13 (Specify #) **\$9.95 Each**
PEAK HIGH POWER 15X POCKET COMPARATOR 1" DIA. LENS

- Unique four lens system for high precision viewing with 15X magnification.
- Precision ground glass reticle 1" diameter with very sharp .005" scale graduation.
- Handy ring for accurate focal adjustments.
- Furnished in fitted etui.

MODEL
X-15-1

\$175.00

With
Reticle

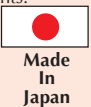

PEAK POCKET MICROSCOPE

- High quality magnifier for microscopic inspection.
- Convenient pocket clip.



Model	Description	Price
PMC-198	25X Pocket Microscope	\$71.85
PMC-199	50X Pocket Microscope	99.95

PEAK 10X DELUXE POCKET OPTICAL COMPARATOR

- Deluxe type measuring and inspection comparator
- Wide visual field - 1-3/8"
- Photo etched large reticles.
- 10X magnification achromatic lens, precision ground sharp, undistorted images.
- Handy ring for accurate focal adjustments.

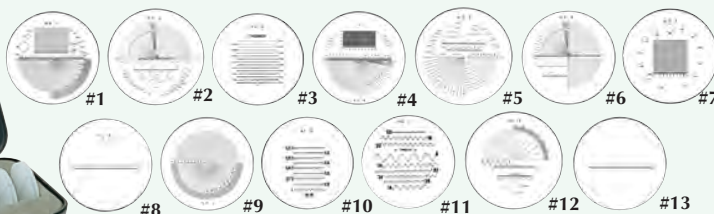

Model	Description	Price
40-145	10X Deluxe Comparator with #5 reticle, 1-3/8" dia. in velvet fitted case	\$105.00
40-146	10X Deluxe Comparator with #1, #5, #7, #8 and #12 reticle, 1-3/8" dia. in fitted case	165.00
40-148	Illuminator (requires 2-C batteries, not included)	14.50
All 1-3/8" Reticles #1 to #13 (Specify #)		\$15.75

GENERAL

**VIDEO INSPECTION SYSTEM
Compact Video Camera Scopes**

- **DCS-200** 2.4" (70mm) Color LCD screen for crystal clear image.
- **DCS-300** 3.5" (88.9mm) Color LCD screen for superb clarity and viewing effect.
- 0.47"(12mm) diameter camera-tipped probe is flexible and strong with built-in adjustable LED lighting and is slim enough to perform automotive engine check up.
- Flexible probe retains configured shape to suit different inspection needs.
- Probe length: **Standard:** 39.4" **Optional:** up to 32.8ft.
- View findings instantaneously.
- Mirror, magnet and pick-up hook.



Specifications:
Resolution: 320 x 234 Pixels
Field of Depth: .98" to 11.8"
Field of View: 60°
Light Source: Two adjustable LED's
Power Source: 1 9V battery

Model	Description	Price
DCS-200-1	2.4" Screen Video System	\$135.00
DCS-300-1	3.5" Screen Video System	175.00

GENERAL

WIRELESS VIDEO INSPECTION SYSTEM

- 3.5" TFT-LCD Wireless Color Monitor, can be detached from the unit for remote viewing up to 32.8ft. away.
- 39.4" Flexible Waterproof (IP67) Obedient Probe retains configured shape. **Standard Length:** 39.4" **Optional Length:** up to 18 ft.
- 0.67" diameter Camera-tipped Probe has built-in adjustable LED lighting.
- Records in Still Photo (JPEG) and Video (AVI), to view it live.
- Records up to 3 Hours continuously.
- NTSC or PAL compatible.
- Choices of 10 Menu languages: English, Chinese, German, French, Spanish, Dutch, Portuguese, Italian, Japanese and Russian.
- **Includes:** MicroSD Memory Card, Extension Tools:(Mirror, Magnet, Pick-up Hook), Video Interconnect Cable, USB Cable, Magnetic Base Stand, AC Adaptor, 4 "AA" Batteries, Blow Mold Case, Instruction manual.



MODEL No.
DCS-400
\$270.00

Camera Specifications:
Transmission Range: 32.8 ft.
Transmission Frequency: 2468MHz
Resolution: 712 x 486 Pixels (NTSC)
704 x 576 Pixels (PAL)
Field of Depth: 5.9" to 9.8"
Field of View: 50°
Camera-Tipped Probe Diameter: 0.66"
Probe Length: Standard 39.4"
Optional up to 18 ft.
Dimensions: 7.3" x 5.7" x 1.6"
Weight: 18.7oz.

Monitor Specifications:
Display: 3.5" Color TFT LCD Screen
Resolution: 320 x 240 Pixels
Video Output Level: 0.9 to 1.3V@75V
Video/Image Resolution:
960 x 240 (AVI format)
640 x 480 (JPEG format)
CE/FCC Approvals: Yes
Power Source: 4 "AA" Batteries
Dimensions: 3.9"x2.7"x1"
Weight: 4.9oz.
Warranty: 1 Year

STREAMLIGHT STYLUS REACH PEN LIGHT

- The slim, compact, lightweight Stylus Reach penlight allows you to see almost anywhere. Thanks to its flexible cable, nothing is out of sight.
- Includes flexible cable extension cable that allows for total reach.
- High intensity LED lasts 100,000 hrs. White LED (4.3 lumens) extended; runs on 3 AAAA batteries.

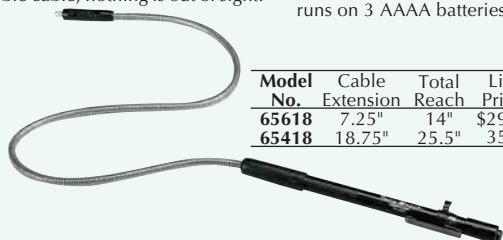

Model No.	Cable Extension	Total Reach	List Price	Sale Price
65618	7.25"	14"	\$29.95	\$23.95
65418	18.75"	25.5"	35.95	29.95

OptiVISOR® OPTICAL MAGNIFIER

- **Lightweight lenses** & tough materials are designed to last a lifetime.
- Dial adjustment headband conforms to comfortably fit all head sizes.
- Optical prismatic lenses from precision ground and highly polished models.
- Genuine leather padded comfort band with orthopedic felt for extra comfort.



OptiVISOR®
Shown With
Optional
Visilight
Illuminator
#LTX-006



ALL MODELS
Reg. \$42.50
\$32.95

Model	Focal	Magnification
LX-300	14 Inch	1-3/4X Power
LX-400	10 Inch	2X Power
LX-500	8 Inch	2-1/2X Power
LX-700	6 Inch	2-3/4X Power

ALX-100	Monocular attachable lens, adds 2-1/12 power to all models	\$ 6.95
LTX-006	Visor mounting Xenon laserbeam illuminates viewing area	\$26.95

OptiVISOR® BINOCULAR MAGNIFIERS WITH OPTICAL GLASS LENS

- **Optical Glass** Prismatic Lenses-Ground and polished to precision optical standards-beveled edged and mounted in interchangeable plastic frame.
- Adjustable pivots allow the visor to be tilted out of the way when not needed.
- Adjustable headband-conforms to fit all head sizes.



MODEL No.
LP-100
\$10.95

OptiLoupe®
An attachable lens that adds the additional power of an Eye Loupe to the Optivisor. 2-1/2X

Model	Power	Focal Length
DA-200	1-1/2X	20"
DA-300-1	1-3/4X	14"
DA-400	2X	10"
DA-500	2-1/2X	8"
DA-700	2-3/4X	6"
DA-100	3-1/2X	4"

Your Choice
Reg. List \$60.65
NOW \$42.95

FLEXBAR EXHAUST FUME REMOVAL PRODUCTS

Our newest exhaust fan combines both fume removal from the work area and a carbon activated filter. Flux fumes are also noxious fumes, headaches, nausea and eye irritation. This unit may be positioned easily from either side to keep your work area fume free and uncluttered.

*ESD construction, filters included.
Mounted on our 43" long Ultraflex arms for dependability, strength and easy movement.
Black hard coat finish.*



- Features:**
- 5" - 100 CFM fan UL/CSA
 - 10" - 550 CFM fan UL/CSA
 - Protective steel guards
 - Activated carbon filters (replaceable #12829)
 - Fully adjustable Ultraflex arms 43"
 - 10 year mechanical warranty
 - ESD construction
 - Black finish
- Mechanical Features:**
- 43" Ultraflex arms
 - 1/2" square x .042" thick ultraflex arms
 - Easy movement, excellent holding power
 - Steel & aluminum construction
 - Universal fit in bases

- Electrical Specs:**
- 120 volt
 - 230 volt optional
 - 3 wire grounded cord
 - UL/CSA fan

Model No.	Fan CFM	Mounting Clamp On	Screw On	Price Each
12822	Yes	-	Yes	\$299.50
12823	Yes	-	Yes	299.50
12826	-	Yes	Yes	375.00
12828	-	Yes	Yes	375.00

No. 12829, ESD Construction Filters \$36.00

QUASAR LED LIGHTING SYSTEM Fits All OptiVISOR® Binocular Magnifiers

- The L.E.D.'s are specifically chosen to give you the best possible L.E.D. lighting solution.
- Similar to a "Pure White" light bulb, the L.E.D.'s are bright white with blue hue to them which is ideal for most inspection purposes.
- The extreme brightness coupled by the extensive battery life is simply mind boggling
- The entire lightning system is also light weight.

LED Light System
MODEL No.
QSL-6010

\$24.95

Light System With LX-500
OptiVISOR® & LP-100
Optiloupe (As Shown)
SET No.
QSL-500

\$49.95

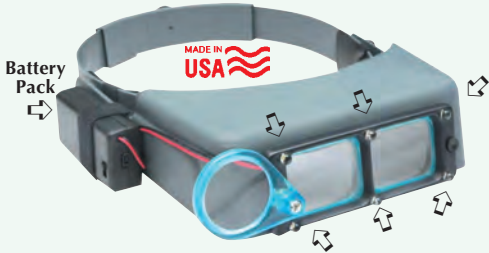

Model	Description	Price
QSL-300	Light system with 1-3/4"X Optivisor 14" F.L.	\$49.95
QSL-400	Light system with 2X Optivisor 10" F.L.	49.95
QSL-500	Light system with 2-1/2X Optivisor 8" F.L.	49.95
QSL-700	Light system with 2-3/4X Optivisor 6" F.L.	49.95
QSL-100	Light system with 3-1/2X Optivisor 4" F.L.	59.95
QSL-6010	Light system (Fits your existing Optivisor)	\$24.95

CARICA DELUXE PICK-UP AND RETRIEVAL TOOLS

- Exceptionally strong rare earth magnet. Energy collar increases magnetic strength 35% and reduces side pull 99.9%.
- Durable, Patented Stainless Steel Telescoping Shaft, retracted to: 7" fully extended: 34" graduated bevel edge.
- Mirror and magnifier are made from shatter resistant acrylic and are replaceable. Patented swivel ball provides ultra quick mirror positioning, swivels 180°, rotates 360°.
- Protective cover included for mirror.
- Solvent resistant PVC cushion grip. • Made in USA.

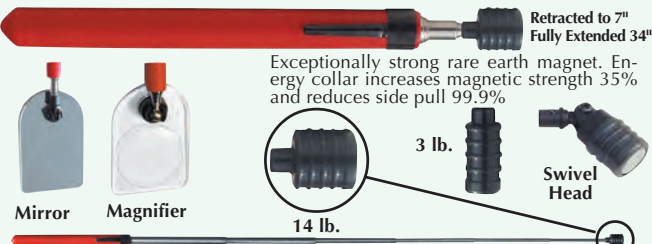

5 Piece Tool Kit



3 & 14 lb. capacity rare earth magnet with energy collar. Replaceable shatter-resistant acrylic mirror and magnifier.

Model	Description	Sale
MG-01	14 lb. Magnetic Pick-up Tool	\$15.95
MG-02	14 lb. Swivel Head Magnetic Pick-up Tool	19.95
MG-03	3 lb. Magnetic Pick-up Tool	13.95
MR-01	2-1/2" Inspection Mirror	14.95
MR-02	1-3/4" Inspection Mirror	7.50
TF-01	Magnifier	11.95

Model	Description	Sale
TK-6000	5 Piece Tool Kit	\$42.95
TK-2020	Teluminator Pick-up Kit	99.95

Teluminator Pick Up Kit



High intensity focusing krypton inspection light encased in a durable housing, one hand operation. Includes two AA batteries. Stainless steel telescoping shaft with brass quick change coupler. Telescopes from 7" to 32". Three shatter resistant acrylic inspection mirrors & one magnifier. Two magnets (3 & 14 lb.) with energy collar. Aluminum case.

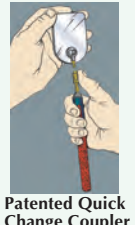

Patented Quick Change Coupler

Precise DELUXE MICROSCOPE 20X

- Focus of the eyepiece is highly corrected for chromatic aberration.
- Includes a pen light powered by AAA batteries and a bracket.
- Reticle supplied as standard equipment has 2 crosshair lines .005" & 0.1mm.
- Reticle can be rotated within the axis of the instrument and focused for individual eyesight.
- Microscope tubes supplied with a screw type adjustment vertical movement.

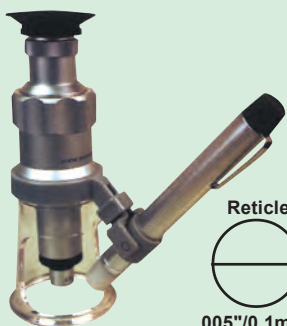

MODEL No.
902-035
Reg. \$125.00

\$95.00

Reticle
0.005"/0.1mm
Graduations

STEELMAN® BEND-A-LIGHT®

- High intensity flexible light bends and holds position.
- Provides bright light in tight places.
- Protective cover can be used for extension.
- Durable handle with brass shafts.
- Batteries and bulbs are included.



Model No.	Flex Length	OAL Length	Probe Diameter	Price Each	Extra Bulb	Bulb Price
10150A	9.5"	15-3/4"	5/32"	\$24.95	12100-1	\$6.95
10250A	9.5"	15-3/4"	3/32"	29.95	12120	8.95
106102	6"	11-1/2"	5/32"	19.95	12100-1	6.95
15150A	15-3/4"	24"	5/32"	39.95	12110	8.95
96285	15-3/4"	24"	1/8"	29.95	96402	9.95

*Bulb Description and Life. No. 12100-1 Standard 4 hrs., No. 12120 Grain of Wheat 50 hrs., No. 12110 Krypton 20 hrs., No. 96402 LED 50,000 Hrs.

INTRA-FLEX LIGHTS:

Will enter opening as small as .156" diameter. Light intensity 350 lumens. Plug-in stepdown transformer for standard outlet. 4' cord with on/off switch. Complete with three 3' thin probe cord. Complete with three 3 volt 1/2 amp bulbs.

INTRA-LIGHTS:

Will enter openings as small as .234" diameter. Light intensity 350 lumens. Plug-in stepdown transformer for standard outlet. 4' cord with on/off switch. 3' flexible, thin, probe cord. Complete with three 3 volt 1/2 amp bulbs.

NEEDLE LIGHT:

Will enter opening as small as .110" diameter. Light intensity 200 lumens. Plug-in stepdown transformer for standard outlet. 4' cord with on/off switch. 3' flexible, thin probe cord. Complete with three 3 volts 1/2 amp bulbs.

Intra PROBE LIGHTS



Model	Size	Type	Price
FL-12	12"	Flex	\$124.50
FL-24	24"	Flex	149.50
IL-12	12"	Intra	\$124.50
IL-24	24"	Intra	149.50
ILB	Extra Bulb		\$ 6.95

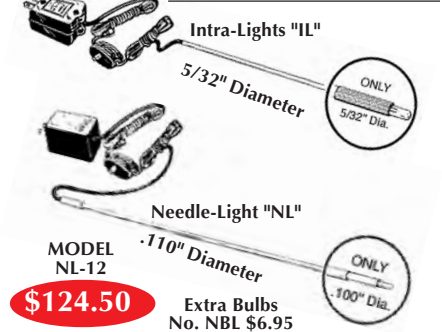

MODEL NL-12
\$124.50

Extra Bulbs
No. NBL \$6.95



TELESCOPING MAG PICK-UP TOOL WITH LITE

- This pick-up tool telescopes from 7-1/2" to 32". Features a form fit easy grip handle, smooth movements, powerful magnetic tip and strong LED light for finding lost tools in dark corners.



MODEL No.
9000-035 **\$7.95**

CATSPAW® TELESCOPING LED FLASHLIGHT AND MAGNETIC PICK-UP TOOL

- LED Flashlight with magnetic end has 5 lbs. of pulling power.
- Extends from 7-1/2" to 22-3/8" for reach.



MODEL No.
45044
Reg. \$27.30

\$19.95

VANTAGE CODDINGTON MAGNIFIERS

- Swing out double lens systems in chrome plated brass case.
- Vinyl carrying case.



Model No.	Lens Power	Lens Diameter	Sale Price
V-400	15X & 20X	15 & 20mm	\$19.95
V-309-15	10X	15mm	9.95
V-309-23	10X	23mm	15.95

VANTAGE ACHROMATIC MAGNIFIERS

- Coated lens system voids color aberrations



Model No.	Lens Power	Lens Diameter	Sale Price
V-394-15	15X	15mm	\$29.95
V-394-20	20X	20mm	33.95

GENERAL OBLONG ILLUMINATED MAGNIFIER

- Lens measures 2" x 4" for distortion-free magnification of large areas.
- Reversible light reflector adapts for right or left hand use.
- 2.5 power shatterproof lens, with 5 power bifocal insert.
- Replaceable bulb and 2 AA batteries are included.



MODEL No.
565
\$29.95

GENERAL STAINLESS STEEL TWEEZER WITH MAGNIFIER



MODEL No.
425
\$5.50

5x Power
1.102 Focal
Length

Precise BORESCOPE

- The Borescope is used by placing the mirror into any location that requires inspection. The sight tube is placed against the eye and held with one hand, and the handle is held with the other hand. This permits the handle to be adjusted on the sight tube by sliding or twisting it, which changes the position of the mirror's view. Adjustments to the alignment of the mirror so that it can be seen through the sight tube are made by twisting the battery pack while holding the handle and/or by slightly bending the tips shaft.
- The sight tube provides a direct view of the mirror without distraction from unwanted light.
- The lighted mirror shaft can then be sent to accommodate the viewing environment.

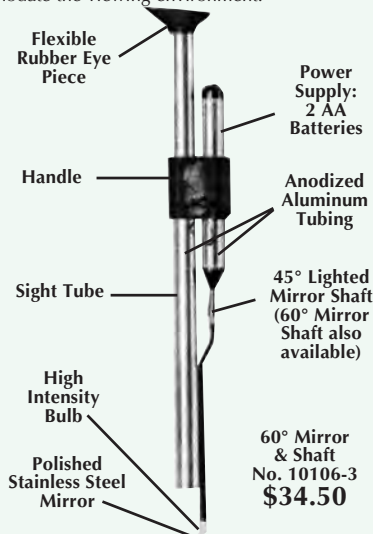

MODEL NO.
10100-1
\$129.95

Extra Bulb
No. 12120-1
\$8.95

GENERAL FOLDING POCKET MAGNIFIERS

- Fine quality magnifiers for laboratory technicians, engineers, mechanics and inspectors.
- Case and lens rims are made of black molded plastic.
- Available in single lens and double lens models.

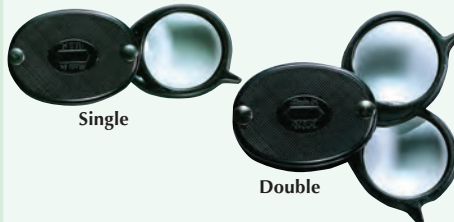

Model	Type	Power	Focal	Price
533	Single	4X	1"	\$ 8.95
536-1	Double	4X, 8X	1"	11.95
537-1	Double	3X, 6X	1-1/4"	12.95

GENERAL 4X POCKET ILLUMINATED MAGNIFIER

- Handy 4 power magnifier has plastic body and lens.
- Comes with 2 AAA batteries and No. 222 bulb.



MODEL No.
553
\$8.95

GENERAL ILLUMINATED 4" MAGNIFIER

- 4" diameter with 3 power lens covers large areas of print.
- 5 power bifocal lens insert gives even greater magnification.
- Bulb gives wide circle of illumination.
- Plastic body & optical plastic lens.



MODEL No.
554
\$24.95

Fowler POCKET SCOPE and MICRO-LITE

Pocket Scope Features:

- Fixed focus, no moving parts-never loses focus.
- Accurate readings without adjusting.
- Compact in size, under 5".
- Provides on-the-job viewing.
- Special bevelled opening gathers and focuses light.

Micro-Lite Features

- Invaluable for inspection and measurement of hard-to-see and reach places.



20x Scope
W/Micro-Lite
MODEL No.
52-662-020-1

\$39.95

Model No.	Power "X"	Field of View	Reticle Supplied	Sale Price
MMM-101	10X	.265"	.005"	\$24.95
MMM-103	10X	.265"	Cross-Hair	24.95
MMM-104	10X	.265"	Protractor	24.95
52-662-020	20X	.190"	.002"	\$27.95
MMM-204	20X	.190"	Protractor	19.95
52-662-040	40X	.082"	.001"	\$27.95
MMM-402	40X	2.1mm	1mm	19.95
MMM-403	40X	.082"	Cross-Hair	19.95
MMM-404	40X	.082"	Protractor	19.95
52-662-045	Micro-lite/AAA Batteries Not Included			\$19.95

Note: *MMM Models Limited Supply

OPTICAID CLIP-ON MAGNIFIER

- Ophthalmic quality magnifying loupe and a hard coated scratch resistant acrylic lens.
- Swings out of the line of vision when not in use.



Model No.	Power "X"	Working Distance	Price Each
CIB-713	1.75X	14"	\$21.95
CIB-714	2.00X	10"	21.95
CIB-717	2.25X	8"	21.95
CIB-710	3.50X	4"	24.95

VANTAGE FLASHLIGHT ILLUMINATED MAGNIFIERS

- Chrome plated battery handle.
- Double magnifiers lens system.



Model No.	Lens Power	Lens Diameter	Price Each
IFM-050	3.5X	3"	\$19.95
IFM-010	5X	2"	26.95
IFM-015	10X	1-1/4"	24.95

Note, Batteries not included

Bausch & Lomb

ILLUMINATED LENSCOPE

The Lenscope Magnifier is a new hand-held precision examination & measuring tool from Bausch & Lomb. Four interchangeable photo-metallic glass measuring scales are available to measure fractional inches, centimeters, angles and radii.

Features:

- Your choice of two interchangeable Hastings triplet lenses, Bausch & Lomb's finest 7X or 10X.
- An ergonomic plastic body that fits easily in a pocket.
- A clear, distortion free image.
- Two angled illumination lamps 45 or 90 from the viewing angle (two AA batteries not included).
- Hinged top storage case.

ROUND MAGNIFIERS

Bausch & Lomb has improved the traditional round large area magnifiers by use of a scientifically designed aspheric lens. Aspheric lenses assure edge to edge clarity. In addition, a special higher power Inset lens provides extra magnification. The durable single piece design features a stabilizing edge for two hand positioning. The Ergo Touch grip is molded to fit your hand for hours of comfortable use.



Model No.	Description	Power	Lens Diameter	Inset Power	Price Each
81-33-03	3" round	2X	87.7mm	4X	\$14.95
81-33-04	4" round	2X	107.4mm	6X	19.95
81-33-05	5" round	2X	133.0mm	4X	26.95

RECTANGULAR MAGNIFIERS

- The Rectangle Magnifier is an efficiently shaped large magnifier which provides the viewing area of a 4" round magnifier. It features a stabilizing edge for two handed positioning. All of rectangular magnifiers feature an aspheric lens for edge-to-edge clarity.
- The Folding illuminating Magnifier has a built-in light powered by two AAA batteries (included). Its unique handle swings open for use and folds shut for storage in a protective case.

Bausch & Lomb



Folding Illumination

STORAGE CASE

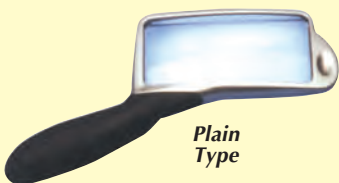

Plain Type

Model	Size	Power	Type	Price
81-33-76	2" x 4"	2X	Plain	\$14.95
81-90-13	2" x 4"	2X	Folding Illumination	23.50

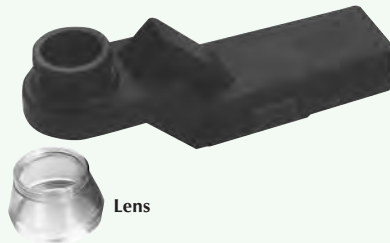

Lens

Model No.	Lens Power	Focal Distance	Lens Diameter	Price Each
81-34-43*	7X Set	5/32"	13/16"	\$49.95
81-34-42*	10X Set	7/64"	5/8"	49.95
81-34-45	7X Lens	5/32"	13/16"	\$31.95
81-34-44	10X Lens	7/64"	5/8"	31.95

* Sets are supplied with lens

FOLDING POCKET MAGNIFIERS

- The folding Pocket Magnifiers are available in a wide range of powers from 3X to 20X.
- By combining lenses, three powers are available with the two-lens model, seven different powers with the three-lens model.
- A swing-away case of durable plastic serves both as a handle and as a protective case

Bausch & Lomb



Model No.	Power "X"	Lens Size	Focal Distance	Price Each
81-23-54	4X	1.4" (1 lens)	2.5"	\$14.95
81-23-64	4X, 5X, 9X	.9" (2 lens)	2.5"-1.1"	21.95
81-23-65	5X, 7X, 12X	.8" (2 lens)	2.0"-0.8"	21.95
81-23-67	5X to 20X	.6"- .8" (3 lens)	2.0"- .05"	24.50

PACKETTE MAGNIFIERS

- Slightly larger than a pack of matches. The plastic covers snap open, click shut.
- The 5X is an aspheric lens and provides greater magnification.



Bausch & Lomb

Model No.	Power "X"	Focal Distance	Lens Diameter	Price Each
81-31-33	5X	2"/5.1cm	36.0mm	\$8.95

COMPACT LIGHTED MAGNIFIER

- Illuminated Magnification in a convenient size perfect for pocket, briefcase and glove box. Take it anywhere. Stores in its own protective case. Push buttons first to Release the large 2 inch lens. Again, to light the lamp.
- Ideal for reading in low-light conditions, or where convenience is important. Batteries included (2 AAA).



Bausch & Lomb

Model No.	Power	Diopters	Lens Diameter	Price
81-90-08	2X	8D	50.8 x 50.8mm	\$9.75

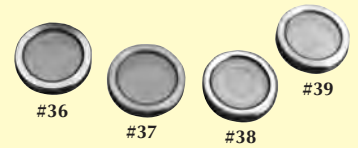

Model	MEASURING SCALES	Price
81-34-36	General purpose scale for measuring radii from 1/8" to 5/8" in 1/32nd increments. Angles in single degrees to 90°. 10mm scale in 0.1mm increments. 1/2" scale in .005" increments. Line widths of .001", .002" and .003"	\$29.95
81-34-37	Inch scale, 3/4" in 0.005" intervals	29.95
81-34-38	mm scale, 20mm in 0.1mm inter.	29.95
81-34-39	Protractor scale, 360° in single °	29.95

ILLUMINATING STAND MAGNIFIER

- Both the lens and light are adjustable.
- When the lens is parallel to the work surface anything laid beneath it is I focus.
- 2X power lens with 6X inset. Aspheric design for edge-to-edge clarity.
- The lens is 2" x 4" and the lamp is a 7 watt GE 7C7 (or equal) 115-volt. The stand is chromium plated steel.

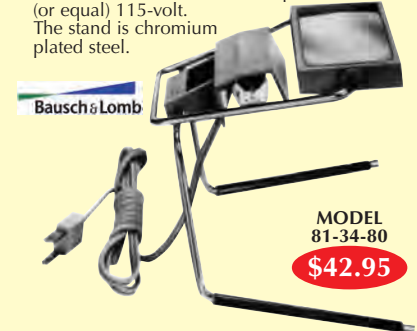

Bausch & Lomb

MODEL 81-34-80

\$42.95

LINEN TESTER MAGNIFIER

- Linen Tester offers a strong 5X double acrylic lens and a fold-out stand with an inch (in 32ns) and a 20mm (in 1.0mm) scale in the base
- It's supplied with a rigid plastic case for optimum lens protection.

Bausch & Lomb

ASPHERIC 5X MAGNIFIER

- An excellent high-power magnifier, the 2" 5X aspheric glass lens assures optimum edge-to-edge clarity.

MODEL 81-31-22

\$26.95



SHEET STYLE & PAGE MAGNIFIERS

Specifically designed Fresnel lenses are molded into acrylic, not stamped, to provide optimum image quality. Different style available to satisfy a variety of needs from small wallet size for convenience to full page magnification.



Model No.	Lens Size	Power	Price
81-90-01	1" x 4"	2.5X	\$1.50
81-90-02	2" x 3"	3X	1.50
81-90-07	8.25" x 10.75"	2X	6.25

GENERAL[®] PROTAP WRENCH SETS

- Self-centering, hardened steel jaws and knurled chuck sleeve.
- For holding taps, reamers, screw extractors, hand turned tools and drill bits.
- The No. 715P Plastic Reference Table is the essential reference table for tool makers, machinists and mechanics.
- The front has machine screw size tap drill chart for recommended 75% depth thread.
- The back has decimal equivalents table in 64ths from 1/64" to 63/64".
- Packaged in a sturdy, fitted foam lined plastic case designed specifically for this set.

Reversible Ratcheting Set
1) 0 to 1/4"
1) #12 to 1/2"
1) Reference Table
MODEL No. 165
Reg. \$85.50
\$69.50



Plain Tap Wrench Set
1) 0 to 1/4"
1) #12 to 1/2"
1) Reference Table
MODEL No. 167
Reg. \$34.75
\$27.50

GENERAL[®] LED LIGHTED TWEEZER

*Working Inside Those dark, Confined Space
On The Job Got A Lot Easier*

- Push On/Off
- Powerful LED light.
- Heat treated steel.
- Non-Slip comfort grips.
- Corrosion resistant non-glare black finish.
- 6.25" long includes 3 LR-141 batteries.

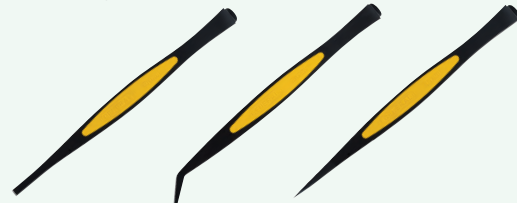

Model	Description	List	Sale
70403	Serrated blunt tip lighted tweezers	\$10.95	\$8.95
70408	Serrated bent tip lighted tweezers	10.95	8.95
70401-1	Smooth pointed tip tip lighted tweezers	10.95	8.95
70402-1	(2 Pc. Set) 70401-1, 70408	19.96	16.95
70400-1	(3 Pc. Set) 70401-1, 70403, 70408	29.96	25.50

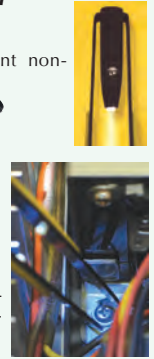

MAGNA-LITE[®] ILLUMINATED MAGNIFIERS

- Illuminating magnifier with 1-1/4" square, lightweight acrylic lens.
- Battery operated light beam illuminates the magnified area to provide perfect lighting.
- Overall length 4-3/4".
- Furnished complete with 2 replaceable AAA batteries and type 222 bulb.



Model	Description	Price
1002-1	Mag-Lite 100 5X	\$11.95
1502	Mag-Lite 150 3X	13.95
3002	Mag-Lite 300 10X	19.95
1004-TW	Mag-Lite 100 5X with Tweezer	29.95

MAGNA-LITE[®] ILLUMINATED MAGNIFIER 200 2X

- Larger version of battery operated magnifier.
- 3-1/4" dia. optical quality acrylic 2X lens.
- Overall length 9".
- Furnished complete with 4 replaceable AA batteries and GE PR17 bulb.

MODEL No. 2001

\$25.95



GENERAL[®] DELUXE TECHNICIAN KIT

- Includes:**
- Manual range digital multimeter - 5 functions, 18 ranges.
 - 4-1/4" diagonal cutting pliers.
 - 4-1/2" linesmen pliers.
 - 6-in 1 screwdriver.
 - Steel rule.
 - Complete in case.

Specifications:

DC voltage . . . 0-200mV/2/20/200/600 Vdc (±1%)
AC voltage 0-200/600 Vac (±2.5%)
DC current 0-2m/20m/200A/10Adc (±1.5%)
Resistance 0-200/2k/200k/2M/20 (±1.5%)
Diode test and continuity buzzer.

MODEL No. ETK-300
List \$75.00

\$59.95



Precise QUILL STOP TRAVEL GUARD

- Adjustable lightweight protection.
- Non-breakable clear Lexan Shield
- Non-magnetic.
- Won't damage Quillstop Screw.
- Follows the cutter
- Mounts easily, Economical.

MODEL No. QST-610

\$18.95

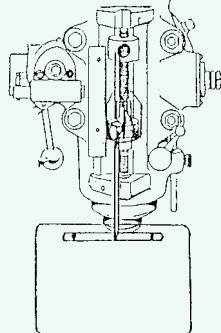

GENERAL[®] INSPECTION MIRRORS

- Easy wing nut adjusting ball & socket links.
- No tools needed.
- Bevel edge, polished mirrors.
- Chrome plated frames & adjusting arms



Model	Description	Price
555	1-1/4" dia., 8-1/2" long with pocket clip	\$5.95
557	2-1/4" dia., adjustable 9" to 15" long overall	7.95
558	1" x 2" oval with pocket clip, 9" long overall	6.95
560	2" x 3-1/2" oblong, adjustable 10-1/2" to 16-1/2" long overall	8.95

Precise CONDUCT-A-LITE ~ DEEP HOLE LIGHT

- Self-contained light for easier viewing of hard to reach areas.
- Ideal for inspection tools, dies, machined parts, castings, checking deep surfaces etc. • Chrome plated and distortion free.
- Batteries not included. • Furnished in plastic case.



KIT "A" 5-PIECE
MODEL No. DHL-100

\$26.95

Includes: Battery housing for use of 2AA pen-light batteries- instant on-off switch- 6" straight lucite conductor- 4" curved lucite conductor- Clip-on 1" dia. mirror.

KIT "B" 7-PIECE
MODEL No. DHL-200

\$45.95

Includes: Battery housing for use of 2 AA pen-light batteries- instant On-off switch- 2-1/4" & 6" straight lucite conductors- 4" curved lucite conductor- 6" magnetic pick-up- 1/2" dia. & 1" dia. Clip-on mirrors.

BEHR SPECTACLE LOUPES

Designed To Fit Wire and Plastic Frames

- Behr Loupes are made of the finest material and precision ground glass lens for true magnification without distortion.
- A Semi-soft brass base frame material allows individual movement for personal adjustment. Durable nickel plated cover protects for a lifetime.



Single Loupe

Double Loupe
Combination

MADE IN USA

Model No.	Magnification	Focal Length	Lens Diameter	Sale Price
55-15	7X	1-1/2"	24mm	
55-20	5X	2"	24mm	\$34.95
55-25	4X	2-1/2"	24mm	Each
55-30	3.3X	3"	24mm	
Double Lens				
55-41	4X-10X	2-1/2"-1"	24-15mm	
55-45	4X-5X	2-1/2"-2"	24-15mm	\$49.95
55-47	4X-7X	2-1/2"-1-1/2"	24-15mm	Each
55-35	3X-5X	3-1/2"-2"	24-15mm	

phase II RIGID BORESCOPE

- This Phase II Fiber-optic Borescope is engineered with a portable, rugged design which enables users to view critical components in high resolution through access holes as small as .160" (4mm).
- Borescope utilizes a high intensity tungsten halogen light source operated by 2 AA batteries.
- Built-in light source affords user extreme versatility anywhere in the shop.
- Supplied with custom fitted case.

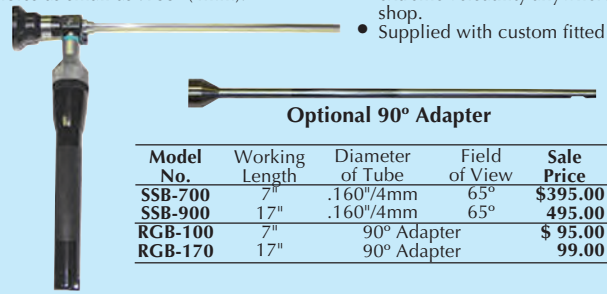

Optional 90° Adapter

Model No.	Working Length	Diameter of Tube	Field of View	Sale Price
SSB-700	7"	.160"/4mm	65°	\$395.00
SSB-900	17"	.160"/4mm	65°	495.00
RGB-100	7"	90° Adapter		\$ 95.00
RGB-170	17"	90° Adapter		99.00

SPi CENTERING SCOPES

- Adopts to any machine spindle with maximum accessibility to the operator.
- 45X magnification for optical position accuracy of .0001".
- Single dash line reticle for easy observation of the work reference line.
- Unique compensation of spindle runout by adjustment screw.
- Straight shank 1/2" diameter eye piece angle 60°.
- Filed of view .100" diameter focal length 5/8".
- Optional Edge Block to locate the edge of any workpiece to the spindle axis and V-block gage for precision centering of a V-block to the spindle for cross axis boring.

CENTER SCOPE
MODEL No.
40-120-8

\$476.80



OPTIONAL:
No. 40-121-6
Edge Block
\$81.05

No. 40-122-4
V-Block Gage
\$64.40

Precise INSPECTION EYE LOUPE

- Double power (2 lenses) 2-1/2" focal length by 5X power when combined (both lens) 1" focal length by 12X power.
- Ideal for toolmakers and machinists.
- Rests comfortably in eye socket.

MODEL No.
IEL-480
Reg. \$12.95

\$6.95

Made In Japan



GENERAL WIRELESS DATA LOGGING VIDEO BORESCOPE

- Operate the instrument anywhere without the cable. An image can be sent to a larger screen up to 98' (30m) away.
- Three different application modes (on console, on large screen and projected) allow wide application.
- There is no need for an external light, power or screen. With the palm sized console you can inspect many applications.
- No special software required.
- Bright TFT display (thin film transfer) display.
- The wireless DCS1800 includes hands free, one-handed and two-handed modes. You can choose the appropriate mode to meet your needs in different working applications.
- Console and probe can be set up for hands free operation.
- Record still images or MPEG 4 compatible streaming video at the touch of a button.
- High quality metal lens sleeve can withstand high temperatures and provides protection of the lens module.

Includes:

Waterproof blow mold case
3.3 ft. (1M) semi rigid probe
2 GB SD ram memory card
A/C adapter charger
Video cables
LCD cleaning cloth
Instruction manual



3.5" Screen

MODEL No.
DCS1800
List \$1299.00

\$1165.00

With:
Camera Probe
5.5mm(0.23") Diam.
x 1m (3.28 ft.) Long

MODEL No.
DCS1800ART
List \$2499.00

\$2245.00

With: Articulating
Camera Probe
6mm(0.24") Diam.
x 1m(3.28 ft.) Long

SPECIFICATIONS:

Diameter of Insert Tube: 0.2" (5.5mm)
Resolution: 325 (H), 250 (V)
Housing: Steel
Light Source: White LED
Length: 3.3ft (1m)
Dimensions: 5.5" x 1.4" x 1.3"
Weight: 7.8oz
Wireless Transceiver Frequency: 2.4GHz - 4 channels (2414MHz 2432MHz 2450MHz 2468MHz)
Battery: Rechargeable Li-Polymer battery 3.7V
Brightness Control: Variable
Audio: Integrated microphone
System Dimensions: 5.8" x 4.1" x 2.8"
System Weight: 11.8ozs
Power: Battery - rechargeable Lipolymer battery 3.7V
Power supply-AC 100-240V 50-60Hz
Power consumption-DC5.5 1.8A
Display: 3.5 TFT LCD QVGA

Recording Medium: 1G SD Card (up to 2G)
Video Out Format: NTSC & PAL
Interface: AV out
Wireless Receiver Frequency: 2.4GHz - 4 channels (2414MHz 2432MHz 2450MHz 2468MHz)
Compression Format: Compliant with MPEG4
Still Image Storage Format: jpeg (640 x 480)
Frame Rate: ~30 fps
Exposure: Automatic
White Balance: Fixed
S/N Ratio: 42db or more
Languages: English, German, French, Portuguese
Operating Environment: -4° to 140°F (-20° to 60°C)
Storage Environment: -4° to 140°F (-20° to 60°C)
Recharge Environment: 32° to 104°F (0° to 40°C)

Optional Probes" 5.5mm Diameter

Model	Description	Price
P1618-1SR	3.3 ft. (1m) Obedient, Dia. 5.5mm	\$1090.00
P1618-2SR	6.6 ft. (2m) Obedient, Dia. 5.5mm	1100.00
P1618-3SR	9.8 ft. (3m) Obedient, Dia. 5.5mm	1150.00
P1618-1SM	3.3 ft. (1m) Soft Metal, Dia. 5.5mm	1000.00
P1618-3SM	9.8 ft. (3m) Soft Metal, Dia. 5.5mm	1200.00
P1618-5SM	16.4 ft. (5m) Soft Metal, Dia. 5.5mm	1100.00
P1618-10SM	32.8 ft. (10m) Soft Metal, Dia. 5.5mm	1400.00
P1618-30SM	98.4 ft. (30m) Soft Metal, Dia. 5.5mm	2200.00
P18ART-1SM	3.3 ft. (3m) ArticulatingSoft Metal Probe, Dia. 5.5mm	2695.00

GENERAL

Speed-Chuck™

TELESCOPING INSPECTION SETS

- Stainless Steel Speed Chuck and telescoping wand combination provides quick and limitless inspection and retrieval solutions.
- Economically designed handle with contoured head for greater control and comfort.
- Handle telescopes from 6-3/8" to 26".
- Spring loaded Speed Chuck allows blade changes instantly.
- All attachments are fastened to a stainless steel Speed Chuck adapter with a double ball joint, adjusts to any angle.
- Precision Locking System firmly holds blades in place.

Available Attachments:

- Neodymium magnets: 2 lb., 5 lb. and 10 lb. smooth surface pull capacities.
- Mirrors & magnifiers: 1-1/2" diameter.
- 2" x 3" rectangular mirror.
- 2-3/8" dia. 3X power magnifying mirror.
- 2-1/2" dia. 3X power magnifier.
- Alligator clip. • Mini-Lite.
- All sets are securely and safely protected within a fitted zippered case.

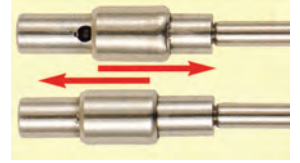

3-PIECE TELESCOPING SPEED CHUCK™ INSPECTION SET

- Set includes:
 - 1-1/2" round plastic mirror
 - Mini-Lite
 - Batteries included
 - Precision engineered 750 Series Versa-Grip™ handle for maximum performance
- 26" stainless steel telescoping wand with Speed-Chuck™ handle
- 2 lb. magnetic pick-up

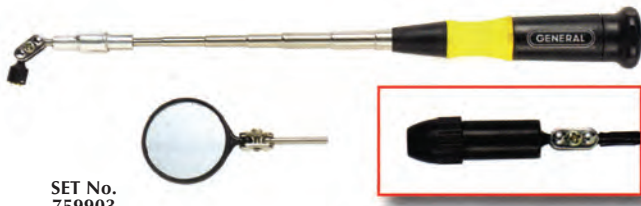

SET No. 759903

\$29.95

In Zippered Case

5-PIECE TELESCOPING SPEED CHUCK™ INSPECTION SET

- Set includes:
 - 3x power magnifier, alligator clip
 - Mini-Lite. Batteries included
 - Precision engineered 750 Series Versa-Grip™ handle for maximum performance
- 26" stainless steel telescoping wand with Speed-Chuck™ assembly
- 5 lb. magnetic pick-up
- 2" x 3" rectangular plastic mirror

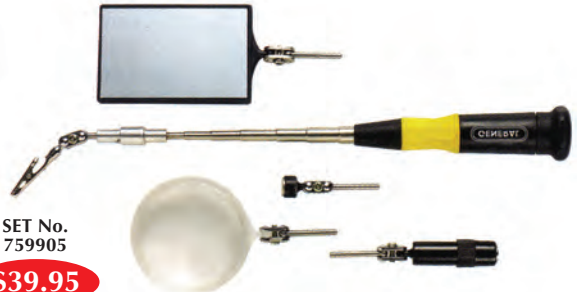

SET No. 759905

\$39.95

In Zippered Case

9-PIECE TELESCOPING SPEED CHUCK™ INSPECTION SET

- Set includes:
 - 26" stainless steel telescoping wand with Speed-Chuck™ assembly
 - 2 lb., 5 lb. and 10 lb. magnetic pick-ups
 - 1-1/2" round mirror
 - 2" x 3" rectangular mirror
 - 2-1/2" round glass magnifying mirror
 - 3x power magnifier, alligator clip
 - Mini-Lite
 - Batteries included
 - Precision engineered 750 Series Versa-Grip™ handle for maximum performance



SET No. 759909

\$59.95

In Zippered Case

METAL INSPECTION "FLAME" TELESCOPING MIRROR

- Includes plastic protective sheath.
- Heavy-duty construction.



Model	Size	Overall Length	Price
5561	1-1/4" x 2" Oval	9-3/4" to 26"	\$10.35
5562	2" x 3-3/4" Rectangular	10-3/4" to 26"	12.25
5563	3" x 3/4" Rectangular	9-3/4" to 26"	12.95

XTRA LONG TELESCOPING INSPECTION MIRROR

- Handle has black cushion grip.
- Non-slip grip.
- Mirror size: 2" diameter.
- 36" telescoping.



MODEL No. 559

\$10.25

GENERAL

USB VIDEO INSPECTION SYSTEM

Budget Scope Provides Ideal Inspection Solution for DIY Work

- General's most compact video inspection system.
- The SEEKER 050 plugs into any Windows PC and comes with a 12mm (0.47 in.), 1m (3.28 ft.) long, flexible-obedient, camera-tipped probe with adjustable LED lighting.
- The SEEKER 050 doesn't need a battery since it is powered through the computer's USB 2.0 port.



MODEL No. DCS050

\$49.95

GENERAL

USB WIRELESS VIDEO INSPECTION SYSTEM

Compact Scope Offers Video Capture Technology at a Highly Affordable Price

- The slim SEEKER 100 offers wireless functionality between the unit and a Windows PC using the included RCV100 Wireless USB Video Receiver.
- The RCV100 plugs into any Windows USB port and works in concert with the grip and included software to view, manage, and record video and images, and to stream video over the Internet via a VoIP application such as Skype™.



MODEL No. DCS100

\$185.00



ROLLING INSPECTION MIRRORS 7" x 14" Mirror

- Large 7"x14" glass mirror increases inspection area
- Durable nylon base
- Two fixed rubber casters for ease of operation
- 44" to 67" infinitely adjustable handle adapts to inspectors requirements
- Steel clip for D-cell flashlight. Inspector can add a flashlight for low light operation
- Comfort vinyl grip



MODEL No.
3714

\$159.95

With Fixed Caster

No. 3715 With Swivel Casters **\$165.00**



ELITE MAGNETIC PICK-UP TOOL WITH EXTENSION HANDLE

- Elite line magnets are surrounded by powder-coated steel virtually eliminating annoying side pull issues.
- Elite line magnets offer extra-long 6-1/2" to 33" telescoping handle for those hard to get to jobs.
- Elite line tools feature soft, two-tone, durable, chemical and fuel resistant vinyl grips that outperform standard grips.



No. 925
Has 180°
Ball Joint

Model No.	Magnetic Pull	Full Range	Price Each
923	5 lbs.	7-1/4" ~ 33-1/2"	\$11.95
924	14 lbs.	7-1/4" ~ 33-3/4"	13.95
925	14 lbs.	7" ~ 34-1/4"	16.95



READ-RIGHT MIRROR

- Single pull extension hex rod handle
- Solid stainless steel mirror - won't break like glass!
- Vinyl grips
- Reads hidden serial numbers, dial indicators & part numbers sequentially unlike standard mirrors that read reverse sequence



MODEL No.
390X1

\$17.50



SMALL READ-RIGHT EXTENSION MIRROR

- 180 degree single ball & socket hinge
- 6-1/2" to 33" stainless steel telescoping handle
- Soft vinyl grip
- 7" collapsed, 35-3/4" extended overall length



MODEL No.
390X2

\$13.95



TILTING FLIP MIRROR

- Mirror angle friction lock
- Zinc-coated assembly with return spring



Model No.	Mirror Size	Overall Length	Price Each
311SI	1" x 1-1/2"	11"	\$17.50
317SI	1-11/16" x 2-1/2"	16"	19.50
319SI	2-5/16" x 3-3/8"	17"	20.50



SUPER MAGNETIC PICK-UP 30 lbs. PULL

- 30 lb magnet with powder-coated steelhead that reduces side pull
- 15-1/2" to 27-1/2" telescoping zinc-plated steel handle
- Soft vinyl grip
- 16-1/2" collapsed, 28-1/2" extended overall length



MODEL No.
990SM

\$39.95



iBOREScope WIFI ENABLED REALTIME VIDEO CAPTURE

Ideal for making high-quality video inspections of hard-to-reach or hard-to-see areas or equipment. By running a free app from the iTunes App Store, any iPhone or iPad can display real-time video and store still images captured by the iBorescope probe. The transfers are wireless, via an ad hoc WiFi hot spot (without Internet access) generated by iBorescope.

- Generates ad hoc WiFi network (without Internet access) for transmitting probe video to app enabled iPhone or iPad
- Long (35 in./900mm), thin (0.39 in./9.8mm diameter) flexible-obedient probe captures VGA (640 x 480 pixel) resolution video
- Ideal camera depth of field of 1/2 in. to 12 in. (12.7 to 305mm)
- Longer and thinner probes for specific applications coming soon
- App's SNAP SHOT soft button captures still .jpg images of live video stream and saves files to Photos folder on iPhone/iPad. Photos can be viewed immediately, shared immediately by text, or shared later via e-mail or Skype.
- Non-replaceable Li-ion battery charges through included USB cable (compatible with iPhone/iPad Power Adapter and all computers). Full charge is good for 3 hours of operation.
- Thumb wheel on pistol grip controls camera lighting
- Adjustable video attributes (brightness, contrast, hue, saturation)
- Video Out jack and cable and Low Battery indicator
- Includes three useful probe tip accessories (45° mirror, pickup hook, magnetic pickup)
- 1-year limited warranty

MODEL No.
DC1S1
\$285.00

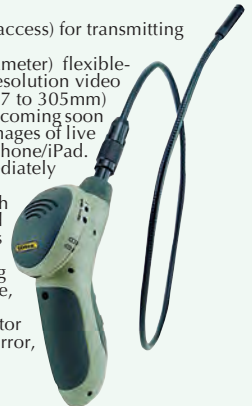

Specifications:

Compatible with	iPad, iPad 2, iPad 3, iPhone 3GS, iPhone 4, iPhone 4S running iOS 4.1 or later	Camera Depth of Field	in. to 12 in. (12.7 to 305mm)
Security	WiFi (WEP) password	Probe Length	35 in. (900mm)
Video Resolution	640 x 480 pixels (VGA)	Probe Minimum Bending Radius	1.77 in. (45mm)
Frame Rate	30 frames per second (fps)	Dust & Water Resistance Rating	IP67 (Probe & Camera Head only)
Streaming Video Format	MPEG4	Operating Voltage	3.7V internal from 5V input
WiFi Range	60 ft. (18m), max (unobstructed)	Current Consumption	600 mA, max @ 5VDC
Camera Lighting	2 white LEDs	Operating Temperature	32° to 104°F (0° to 40°C)
Camera Head Diameter	0.39 in. (9.8mm)	Power Supply	Rechargeable Li-ion battery with 5V/1A output
		Life of Full Battery Charge	3 hours, typical

GENERAL ULTRATECH™

GLASS LENS MAGNIFIERS

- Polished optical glass lens with a metal frame.
- Versa-Grip™ Handle with a non-slip cushion grip.
- Round lens is distortion free.
- A powerful magnifier for working in confined or obstructed spaces.



Model No.	Diameter Inch	Focal Length X Power	Price Each
700540	2"	6" x 1.6X	\$ 7.45
750541	2-1/2"	6" x 1.6X	9.25
750542-1	3"	6" x 1.6X	11.25
750543	3-1/2"	8" x 1.25X	12.95
750544-1	4"	8" x 1.25X	14.95
750545	4-1/2"	8" x 1.25X	16.95

GENERAL ULTRATECH™ LED

LIGHTED INSPECTION MIRRORS

- New LED inspection mirrors get into tight places and its diffused LED bulbs spread light evenly over the viewing area.
- Fully polished glass mirror is shatter resistant.
- 2" CF2032" batteries included.
- 360° swivel double ball joint.



No. 80560



No. 80557

Model	Size	Overall Length	Price
80560-1	2" x 3"	12-1/4" extends to 33"	\$15.95
80557	1.85 Dia.	11-1/2" extends to 34-1/4"	15.95

GENERAL ULTRATECH™

TELESCOPING MINI-LIGHT WITH MAGNETIC PICK-UP

- A powerful permanent magnetic pick-up tool.
- Telescopes from 7-3/4" - 28-3/4"
- LED light bulb has a life of 100,000 hours of continuous use.
- Four Alkaline "LR41" batteries with a battery life of 48 continuous hours.



No. 759582

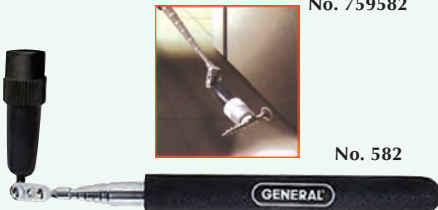

No. 582

Model No.	Magnetic Pull	Price Each
759582	2 lbs.	\$19.95
582	10 lbs.	16.95

GENERAL "LITE-IT" CLIP-ON MINI LIGHT

- Light is fastened to a rugged high-impact ABS plastic Alligator clip with a double ball joint that adjusts to any angle.
- LED light bulb has a life of 100,000 hours of continuous use.
- Four Alkaline "LR41" batteries with a battery life of 48 continuous hours.



MODEL No. 580 **\$10.95**

GENERAL LUMILENS™

LIGHTED MAGNIFIER WITH STAND

- Push On/Off powerful LED light.
- Contoured handle for handheld use.
- Integrated stand for hands free use.
- Shatter resistant lens.
- 3-1/2" Lens diameter (89mm)
- 3X Magnification (6X Inset lens)
- Power source: 2 "AA" batteries (included)
- Includes protective pouch.



MODEL No. 800543

\$17.95



GENERAL 12 PIECE SWISS PATTERN NEEDLE FILE SET

- Set includes 12 different files. All measure 5-1/2" (138mm) long with 1/8" (3mm) diameter shanks
- Files are constructed of high quality Chromium Alloy Steel
- All files are 2-1/2" long, #2 Single Cut Swiss Pattern
- Knurled handle file can be used without hand assembly
- Precision locking screw chuck holds files securely in place
- Precision engineered 700 Series Versa-Grip™ handle for maximum performance

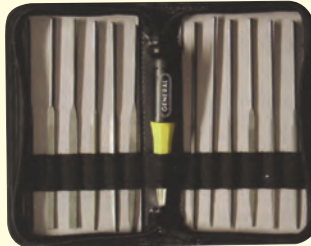

SET No. 707475

\$21.95

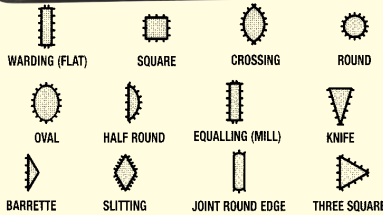

GENERAL 12 PIECE STAINLESS STEEL POSITIONING & SPRING HOOK SET

- Heavy-duty locking screw chuck holds blades securely in place
- Each blade is 5" long; OAL 7-1/2" - 8-1/2" with handle
- Set Contains: • Twist Chuck Multi-Purpose Handle • 5" Extension blade • Straight • 35° Bend • 90° Bend • 180° Loop, Double Bend • 180° Hook Probes
- Offset Pull Hook • 135° Pull Hook • Pull/Push Hook
- Adjusting Pull/Push Hook • Placement Guide/Lifter
- Precision engineered 700 Series Versa-Grip™ handle for maximum performance

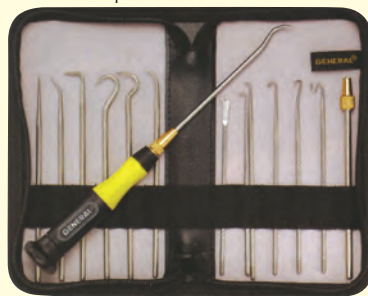

SET No. 707865 **\$24.95** With Zippered Case

GENERAL 4 PIECE INTERCHANGEABLE STAINLESS STEEL PROBE SET

- Set Includes:
- Four heat treated stainless steel point configurations:
- Straight • 180° Hook • 35° Bend • 90° Bend
- Precision locking screw chuck holds blades securely in place
- Each blade is 5" long; OAL 8-1/2" with handle
- Precision engineered 700 Series Versa-Grip™ handle for maximum performance

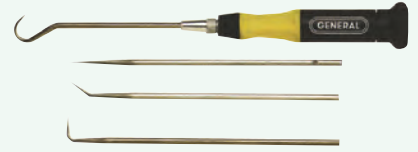

SET No. 707862 **\$11.95** In Case

GENERAL 5 PIECE STAINLESS STEEL POSITIONING & SPRING HOOK SET

- Heavy-duty locking screw chuck holds blades securely in place
- Each blade is approximately 5" long; OAL 7-1/2" - 8-1/2" with handle
- Set Contains: • Twist Chuck Multi-Purpose Handle • Offset Pull Hook • 135° Pull Hook • Pull/Push Hook
- Adjusting Pull/Push Hook • Placement Guide/Lifter
- Holster included for convenient storage
- Precision engineered 700 Series Versa-Grip™ handle for maximum performance



SET No. 707863 **\$14.50** With Holster

Precise STEEL STAMP SETS

36 PIECES A THRU Z, 1 TO 9, PERIOD

- Manufactured from alloy steel which gives durability and extended life.
 - Hardness at the stamping end is maintained at HRC 50-55.
- Sets Include:
- 36 pieces: A thru Z, period, 1 thru 8 (the 6 is used as 9).



Model No.	Impression Size	Sale Price
505-150	1/8"	\$10.95
505-151	3/16"	12.95
505-152	1/4"	18.95

GENERAL MAGNETIC PICK-UP AND SWEEPER

- An ideal tool for retrieving iron, steel and all ferrous material.
- Powerful, permanent magnet for a no-stoop pick-up.
- Vinyl-coated magnet for long-life and durability.
- Plastic handle for greater control and comfort.



No. 397 No. 354

Model	Description	Price
397	37" Pick-up Sweeper	\$19.95
354	39" Long x 24" Wide Sweeper	69.95



ILLUMINATING MAGNIFIERS

- Improve your quality control and reduce operator eye fatigue with this 5 inch illuminated magnifier.
- The scratch resistant polycarbonate housing holds the distortion free glass lens and a 22 watt circline fluorescent bulb that provides 360° of shadow free light.
- Spring balanced arm glides into position at the touch of a finger and stays put to deliver light where it's needed most.
- 3 year warranty. UL listed. Made in USA. Available color Black.



Model No.	Magnification	Focal Length	Arm Reach	Base Type	Sale Price
7121	1.75X	13"	45"	Clamp-On	\$124.95
7122	2.25X	8"	45"	Clamp-On	145.95
7125	1.75X	13"	30"	Weighted	159.95
7126	2.25X	8"	30"	Weighted	174.95

Accessories:

- Table Mount No. TM-1 \$18.00,
- 3 Diopter X1-14" add-on lens No. MAG-3 \$20.00
- 4 Diopter X4" add-on lens No. MAG-4 \$38.00,
- 8 Diopter X3" add-on lens No. MAG-8 \$46.00
- 10 Diopter X1-1/4" add-on lens No. MAG-10 \$27.00



MACHINIST CALCTM PRO

Advanced Machining Math and Reference Tool

Fast, precise solutions for your every day machining calculations built into a rugged and cost-effective handheld calculator

- It is the first dedicated handheld machining math and reference tool to provide a complete assortment of essential machine shop solutions
- Reduce wear and tear on costly cutting tools.
- Convenient data look up for drill and thread sizes.
- Built-in formula calculations.

Calculations

Dedicated Keys quickly and easily solve:

- Speeds and Feeds
- Right triangle math.
- Bolt Pattern hole layouts.
- Trigonometric solutions.
- 3-Wire measurements.

Charts

Built-in Advanced Drill and Thread Size Tables save you time and steps.

- Compliant with ANSI/ASME B1.1-2003 and ANSI/ASME B1.13M-2005

Conversions

Work in and convert between U.S. and Metric units, including:

- Decimal Inches/Mills
- Feet-Inch-Fractions
- m, mm, cm
- Area, Volume and Weight

MODEL No. 4087

Reg. \$79.95 **\$69.95**

Includes: Shock resistant Armadillo Gear case, protects your calculator from moisture and dust.



MACHINIST CALCTM PRO FOR WINDOWS[®]

- You can have all the power of the Machinist Calc Pro on your PC.
- Use it as a handy pop up program without leaving your estimating, scheduling, Excel or other machining software applications. Print your results to a file or take them to your operator, providing precise instruction.
- More complete Thread data than the Machinist's Handbook, including step saving Thread and Drill Size chart look ups, speeds and feeds, right triangle solutions, bolt patterns and much more.

Charts

- Built-in advanced drill and thread size tables save you time and steps
- Compliant with ANSI/ASME B1.1-2003 and B1.13M-2005

Conversions

- Work in and convert between U.S. and metric units, including: decimal inches/mils, feet-inch-fractions, m, mm, cm, area, volume and weight



Model No. 4084

\$39.95



STEELMAN[®] INSPECTION MIRROR FLEXIBLE SHAFT WITH LIGHT

- 90° adjustable mirror.
- Thumb wheel controls mirror angle.
- Light floods work area.
- 4-power mirror (Model #05100A comes with only a 1-Power mirror.
- 2 AA alkaline batteries included.

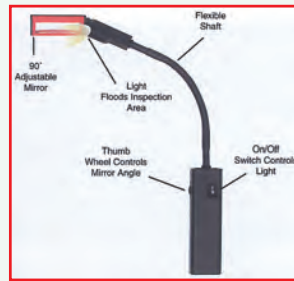

Model	Description	Sale
05180	18" Flexible Shaft	\$27.95
05240	24" Flexible Shaft	29.95
05420	42" Flexible Shaft	35.95

Precise FLUORESCENT LAMP & MAGNIFIER 36" REACH

- 13" focal length, 110V, 5" lens.
- 3 diopter lens provides 1.75 x magnification.
- 22 watt circline fluorescent tube offers shadowless, cool illumination. Bulb included.
- Clamp-on base. 38" reach, 4-3/4" diameter.



MODEL No. 854-0502
Reg. \$93.50

\$59.95

White



HALOGEN TASK LIGHTS

- 25" reach gooseneck.
- Compact 3" x 3" shade with protective glass lens for lamp.
- Model 7304-2 comes with zinc cast adjustable clamp.
- Model 7305 comes with powerful magnetic base with 90 pounds of pull strength.

MODEL No. 7304-2
Reg. \$109.00

\$89.95



Color: Black

Model	Description	Price
7305	Magnetic Base Task Lamp	\$89.95
7304-2	Clamp-On Task Lamp	89.95
1361	Halogen MR-16 Bulb	14.00

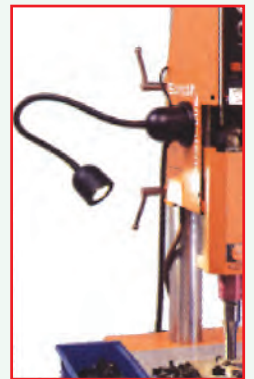

COLORFUL WORK LAMPS 6" SHADE 8" x 15" ARM

Features:

- Articulated arm construction makes it adjustable to wide work area.
- Compact, light in weight and economically priced, this range of work lamps are suitable for a variety of applications.
- Accepts all voltage. (Used voltage same as bulb voltage, no need of transformer).
- Dustproof luminair head



Model No.	Shade Color	Price Each
CWL-002	Red	\$32.95
CWL-004	Green	32.95
CWL-005	Purple	32.95

Clamp Mount #HMS-005 \$7.50 & Angle Clamp #HMS-006 \$6.25

Precise LED FLASHLIGHT WITH MAGNETIC BASE

- Flexible shaft with universal movement.
- Max. reach: 8".
- Magnetic Base: 1-1/2" diameter, 25 lbs power pull.
- **LED** flash light requires 3xAAA battery.



MODEL No.
8401-0440

\$21.95



SNAP-LOC SYSTEMS OPTI-VIEW

Magnification At a Glance For Convenient Inspection, Assembly Or Quality Control

Features:

- Magnification power of 2X.
- Stays in position. Arm flexes easily to desired position and stays there.
- Opti-View can be easily moved into use or out of the way.



Model	Description	Price
8550-283	(A) 3" round magnifier, Magnetic Base	\$40.95
8450-155	1/2" I.D. hose segment Black plastic-approx. 12"	\$9.50

Precise MAGNETIC BASE ON-OFF LAMP

- Powerful magnet base with On/Off switch.
- Guaranteed power pull 130 lbs.
- Flexible arm for any position adjustment.
- 60 VA power rating.
- Power supply: 115V/60Hz/1 phase.
- Use regular screw-on bulb (not included).
- Base dimensions.



MODEL No.
401-004

\$26.95



OPTI-SHIELDS

- 360 degree adjustability.
- Durable, clear polycarbonate shield.
- Magnetic base holds firmly in position.
- Adjustable length.
- Variety of replacement shield sizes.



Model	Description	Price
8550-226	6" x 6" Opti-Shield	\$37.50
8550-420	9" x 9" Opti-Shield	39.50
8550-255	12" x 12" Opti-Shield	45.00
8550-256	6" x 6" Replacement Shield	\$12.50
8550-421	9" x 9" Replacement Shield	16.00
8550-259	12" x 12" Replacement Shield	19.00

TELESIGHT BINOCULAR MAGNIFIER

- Optical quality acrylic prismatic lenses.
- Scratch resistant coating.
- Flip up flip down movement.
- May be worn with or without glasses.
- Adjustable soft headband for maximum comfort.
- Our products are made in the USA.



MODEL No.
BMH-500
2-1/4X

\$16.95

Supplied With **FREE**
Auxiliary Swing Up
Lens Adds 5-1/2X

Model No.	Power X	Focal Range	Sale Price
BMH-300	1-3/4X	14"	\$16.95
BMH-500	2-1/4X	8"	16.95
BMH-700	2-3/4X	6"	18.95



TASK LIGHTS Cool Shade ~ Flexible Arms



- 100 watt equivalent capacity with Compact Fluorescent Energy Star Rated bulb included for bright task lighting.
- Cool-to-the-touch double 4-1/2" wall shade.
- Innovative finned aluminum heat sink keeps toggle switch cool for long switch life.
- Heavy-duty vinyl covered flexarm for long lasting performance.
- 6 ft. grounded cord, SJTO oil-resistant jacket.
- Color: gloss black.



C-Clamp
Mount
2" Grip

Magnetic
Base Has
100 lbs. Pull
3" Diameter

Quick
Coupler
Base

Direct
Mount Base
Supplied with
complete mounting
hardware kit

Model	Description	Price
MTL-180C	Task Light 18" Arm, C-Clamp Base	\$59.95
MTL-240C	Task Light 24" Arm, C-Clamp Base	65.00
MTL-180M	Task Light 18" Arm, Mag. Base	59.95
MTL-240M	Task Light 24" Arm, Mag. Base	65.00
95040	Task Light 18" Arm, Quick Coupler Base	59.95
95041	Task Light 24" Arm, Quick Coupler Base	65.00
95049	Task Light 18" Arm, Direct Mount Base	59.95
95050	Task Light 24" Arm, Direct Mount Base	65.00



55 WATT HALOGEN WATERPROOF HEAD MACHINIST LAMP

- Wide, 5-1/2" lens surface that offers a wide, powerful beam of white work surface illumination.
- 5 adjustable joints offer superior flexibility for better task light positioning.
- Sealed against coolant, debris and metal shaving fragments.
- Concealed 12 volt transformer protects against high voltage peaks, prevents damage to light fixture and extends bulb life.
- 6 foot heavy-duty grounded cord.
- 120V/50 watt Halogen bulb.
- Upper arm length - 17"/lower arm length - 16".
- 4" base - lamp swivels 180° on top of base.



MODEL
7240

List Price
\$159.95

\$139.95

Color:
Metallic Grey

Precise 20" FLEXIBLE SHAFT HALOGEN LAMP WITH MAGNETIC BASE

- Adjustable 20" flexible shaft.
- Powerful magnet base with On/Off switch.
- Can be bolted on the table.
- Power supply: 110V/60 HZ/1 Phase 35W.
- one halogen bulb included.



MODEL No.
8401-0415
Reg. \$65.00

\$49.50



HIGH INTENSITY COOL LED MACHINE LIGHTING

- Fully sealed against the impingement of water, synthetic, and petroleum based fluids, Flexbar's new LED series Lights meets the stringent IP65 waterproof standards. Due to the rugged design, these fixtures are suitable for applications where extreme vibration shall be encountered. Our LED's provide 50,000+ hours of trouble free service.
- Two Arm Styles are available in Standard 4.5W LED (270 total Lumens) and Deluxe 9W LED (540 total Lumens) Models.

Common Specifications:

- 120V-277V AC, 50/60HZ (24V Available upon Request)
- 6 ft., 3 Prong Molded Cord
- "No Heat" Spot Light
- Direct Mount Pivoting Head
- Built-In Electronic Transformer
- Approvals: CE, IP65
- Mounting Options: See Below-



High Intensity Output		
Model	Description	Price
19365	6-LED Machine Light, Direct Pivot Mount	\$545.00
19366	6-LED Machine Light, 32" Articulating Arm	575.00
19367	Edge Clamp Mount for High Output Models	35.00
19368	Wall Mount Bracket for High Output Models	25.00

Standard Intensity Output Series		
Model	Description	Price
19360	3-LED Machine Light, Direct Pivot Mount	\$320.00
19361	3-LED Machine Light, 23" Articulating Arm	340.00
19362	Magnetic Base Assembly for Standard Output Models	36.00
19363	Table Edge Clamp Mount for Standard Output Models (Not Shown)	32.00
19364	Wall Mount Bracket for Standard Output Models	23.00

FLEXBAR LED FLEXI-LAMP

Advanced Technology 15-LED Lamp Providing Up To 1000 Hours Continuous Use. Light Runs On 3 AAA Batteries

- High Intensity, Cordless, Heavy-Duty Aluminum Light Is Mounted On Our Original Flexbar-Instant Positioning - Instant Locking Arm.
- 5 MODELS AVAILABLE WITH A CHOICE OF MOUNTING OPTIONS: Shown Model No. 19370 Flexi-Lamp on On/Off Magnetic Base.
- Flexi-Lamp with additional mounting options:

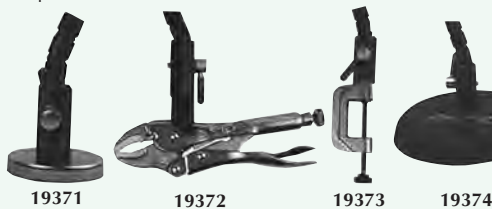
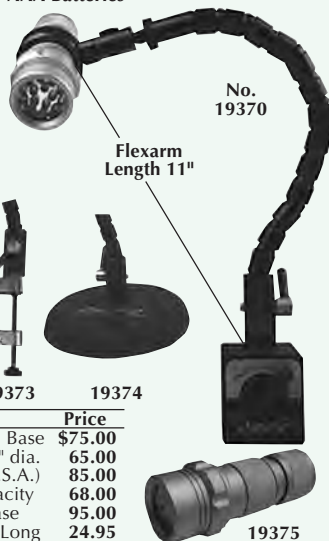

Model	Description	Price
19370	Lamp on V-Bottom On/Off Mag. Base	\$75.00
19371	Lamp on Disc Mag. Base, 3-1/8" dia.	65.00
19372	Lamp on No. 7CR Vise Grip (U.S.A.)	85.00
19373	Lamp on C-Clamp, 1-3/8" Capacity	68.00
19374	Lamp on 6" dia. Weighted Base	95.00
19375	15-LED High Intensity Light, 4" Long	24.95

electrix LED TASK LIGHTS

- Retains 100% of lumen output through its 40,000 hour life
- Annual energy cost is reduced by 80% when it replaces a 20 watt Halogen lamp; Ruggedly built
- Epoxy coated durable all metal construction
- Brilliant white light delivered exactly where needed
- Safe 12V transformer integrated in base
- 25" flexible Steel Gooseneck Reach
- Cooltouch shade measures 3" x 3"
- Three year warranty



Model	Description	List	Sale
7904	LED Task Light with Clamp	\$209.00	\$175.00
7905	LED Task Light with Mag. base	209.00	175.00
3557	LED Replacement Bulb		45.00

Precise 20" LED WORK LIGHTS MAGNETIC BASE - FLEXIBLE SHAFT

- Cold light with low energy consumption.
- Optics projection design.
- Shockproof and super long life time up to 50,000 hours.
- Waterproof IP67
- Magnetic base.
- Power supply: 120V 1 watt

MODEL No.
8401-0423
\$114.95



Precise 22" LED WORK LIGHTS BOLT ON TYPE - FLEXIBLE SHAFT

- LED lights provide an excellent solution for heat intensive environment.
- Lasts 50 times longer than regular flashlights.
- 30 LED bulbs provides brighter and stronger natural light.
- Power supply: 110V AC/single phase.

MODEL No.
8401-0443
\$49.95



Precise 25" LED WORK LIGHT ON-OFF MAGNETIC BASE - FLEXIBLE SHAFT

- Magnetic Base: 2-1/2x2" with On/Off switch, 150 lbs. power pull.
- LED lights provide an excellent solution for heat intensive environment.
- Lasts 50 times longer than regular flashlights.
- 30 LED bulbs provides brighter and stronger natural light.
- Power supply: 110V AC/ single phase.

MODEL No.
8401-0445
\$69.95



Precise CNC MACHINE STOP WARNING LIGHTS

- Mainly used for CNC machines and other applications.
- Shows the working status.
- 3 bolt holes for mounting.
- Power supply: 120V 1Phase.

Red/Green/Blue
MODEL No.
8401-0434
\$69.50

Red/Green
MODEL No.
8401-0433
\$59.50



GENERAL

THERMAL IMAGING CAMERAS ~ GTi10 "PREDATOR"

GENERAL

Ideal for revealing hidden heat-driven processes and problems. Applications include equipment operations and preventive maintenance, MRO power generation and distribution, building energy audits, food production, water damage restoration, firefighting and navigation.



- 160 x 120 (19,200) pixel focal plane array IR detector
- Temperature sensitivity of $\pm 0.14^{\circ}\text{F}$ (0.8 $^{\circ}\text{C}$) or better
- 4 in. (100mm) minimum focal distance allows close-up work
- Included 2 GB MicroSD card stores images for later uploading to PC
- USB 2.0 and Video Out jacks
- Bright 3.5 in. diagonal flip-up color LCD
- Manually or automatically adjustable image level and span (brightness and contrast)
- Variable emissivity
- Tripod mount (optional adaptor)
- Water, dust and oil-resistant to IP54 standard
- Shock and vibration-resistant
- Powered by rechargeable Li-ion battery 3 Year Warranty
- Up to 5 hours of operation using 2 batteries AC adaptor and car charger

Includes:

- Camera
- 2 Rechargeable Li-ion Batteries
- AC Adaptor
- Compact Battery Charger
- 2GB MiniSD Memory Card
- SD Card Reader
- Video Cable with BNC Plug
- USB 2.0 Cable
- Bluetooth Headset with Charger (GTi30 only)
- Lens Cap; Analysis & Reporting Software on CD
- Calibration Certificate
- Hand & Neck Straps
- Custom Hard Case
- User's Manual
- 3 Year Limited Warranty

Model No.	GTi10	GTi20	GTi30	GTi50
Picture-In-Picture Mode (Visual + Thermal Image Fusion) Analysis Tools	No 2 Movable spots, isothermal Analysis	Yes 4 Movable spots, isothermal Analysis	Yes 9 Movable spots, isothermal Analysis Profile Analysis, 5 Area Analysis Yes (Via USB)	Yes 9 Movable spots, isothermal Analysis Profile Analysis, 5 Area Analysis Yes (Via USB)
Thermal Video Streaming	No	No	Yes	Yes
LED Flashlight	No	Yes	Yes	Yes
Voice Annotation	No	No	Yes (Via Bluetooth)	Yes (Via Bluetooth)
Temperature Alarms	No	Yes	Yes	Yes
Refresh Rate	30 frames per second (fps)	30 frames per second (fps)	30 frames per second (fps)	30 frames per second (fps)
Visual Image Display Resolution	N/A	620 x 480 pixels	620 x 480 pixels	620 x 480 pixels
Visual File Format	No	CCD/JPG	CCD/JPG	CCD/JPG
Laser Pointer	Yes	Yes	Yes	Yes
Field of View	20° x 15°	20° x 15°	20° x 15°	24° x 18°
Spatial Resolution	2.2 mrad	2.2 mrad	2.2 mrad	1.3 mrad
Temperature measurement Range	-4° to 572°F(-20° to 300°C), upgradeable to 2732°F (1500°C)	-4° to 572°F(-20° to 300°C), upgradeable to 2732°F (1500°C)	-4° to 572°F(-20° to 300°C), upgradeable to 2732°F (1500°C)	-4° to 572°F(-20° to 300°C), upgradeable to 2732°F (1500°C)
IR Detector Spectral Range	8 to 14µ	8 to 14µ	8 to 14µ	8 to 14µ
Focusing	Manual	Manual	Manual	Manual
Minimum Focal Distance	4 in. (100mm)	4 in. (100mm)	4 in. (100mm)	4 in. (100mm)
Optional Telephoto and Wide Angle Lenses	Yes (6.4°, 9° and 38° Field of view available)	Yes (6.4°, 9° and 38° Field of view available)	Yes (6.4°, 9° and 38° Field of view available)	Yes (6.4°, 9° and 38° Field of view available)
Video Output Formats	NTSC, PAL	NTSC, PAL	NTSC, PAL	NTSC, PAL
Image Storage medium, Capacity	2GB MiniSD memory card (included)	2GB MiniSD memory card (included)	2GB MiniSD memory card (included)	2GB MiniSD memory card (included)
Price	\$1895.00	\$2375.00	\$3595.00	\$5195.00

VOscope PICTURE AND VIDEO STORAGE DEVICE

VOscope's new user friendly picture and video storage device allows you to directly download and save from our popular VS 10mm Videostik series inspection scope. An excellent way to document and provide important and supportive info to your customers.

- Cell phone size for easy carry.
- Auto on with one touch recording.
- Both JPEG picture and AVI video recording.
- Eliminates the need to have a computer nearby.
- 2 Gig storage for 100's of pics or up to 2 hrs. video.
- USB and RCA cords supplied.
- AAA batteries included.



MODEL No. 45004-PS
\$149.95

MADE IN USA

VOscope BORE INSPECTION SCOPES

Features of "VO" Series

- 7400 Pixels for clear and detailed image.
- Dual white LEDs at tip for superior illumination.
- Waterproof shaft, petroleum and chemical resistant material.
- Stay-lok shaft.
- Bending radius down to 3 inches.
- Poly pro storage case.
- Thru-threads for precise focusing.
- Water and abrasive shafts.
- Viewing from infinity down to 0.4 inches.
- 3 Year warranty.

Features of "VT" Series

- 7400 Pixels for clear and detailed image.
- White LED flashlight with 3 watts of penetrating power for optimized viewing.
- Poly pro storage case.
- Thru-threads for precise focusing.
- Fuel and chemical resistant shafts.
- Water and abrasive shafts.
- Bending radius down to 3 inches.
- Viewing from infinity down to 0.4 inches.
- 3 Year warranty.

MADE IN USA



VO Kits Include: Scope, Batteries, Mirror, Magnet, and Storage Case



Model	Description	List	Sale
VO2410	24", 10mm, Dual White LEDs at tip	\$358.00	\$295.00
VO3610	36", 10mm, Dual White LEDs at tip	430.00	325.00
VO4810	48", 10mm, Dual White LEDs at tip	568.00	395.00
VT246	24", 4.3mm, LED Flashlight (white)	395.00	295.00
VT366	36", 5.8mm, LED Flashlight (white)	484.00	395.00

VOscope ARTICULATING VIDEO SCOPE

Visual Optics new video based inspection scope, the VS36-8WA, gives you the latest in remote video technology

- High resolution auto focus color camera
- 2.5" full color viewing monitor
- 7.8mm shaft diameter
- Sealed, Fluidproof, Flexible shaft
- 36" Standard Shaft Lengths
- High output LED illumination with Dimming Control
- 3 hrs operation on 4 AA batteries included
- Poly pro storage case
- LED internal light source in handle
- 1 year warranty

MODEL No. VS36-8WA
\$449.95



- State of the art video inspection tool.
- High resolution remote color camera.
- 2.5" full color viewing monitor.
- Waterproof, flexible Stay-lok shaft.
- High output LED illumination.
- 5 hours operation on 4 AA batteries (included)
- Mirror and magnet accessories included.
- 10mm shaft diameter.
- Poly Pro storage case.
- Video output to your favorite recording device.
- 1 Year warranty.



MODEL No. VS-3610
Reg. \$350.00

\$250.00

36", 10mm Shaft

MADE IN USA

Model	Description	List	Sale
VS-2460	24" Video Scope w/6mm Shaft dia.	\$250.00	\$195.00
VS-3660	36" Video Scope w/6mm Shaft dia.	350.00	250.00
VS-3610	36" Video Scope w/10mm Shaft dia.	350.00	250.00
VS-7210	72" Video Scope w/10mm Shaft dia.	385.00	295.00



WIRELESS V-SNAKE™ WITH DELUXE COLOR MONITOR

- Provides high resolution remote color video inspection.
- Allows the user to view, record and download inspection video.
- Video can be saved on SD memory card downloaded to PC or viewed on a TV.
- Wireless camera provides maximum inspection flexibility.
- Rechargeable lithium battery in monitor and camera.



MODEL No.
70930
\$595.00

Wireless Deluxe Color Monitor

- 2.5" full color viewing monitor.
- Rechargeable internal lithium battery.
- 4 channel wireless selection.
- Universal charging adapter.
- Hanging hook and fold out monitor stand.
- Protective monitor cover.
- 2GB SD memory card (included) for additional video storage.
- USB cable for computer download.
- AV output cable.
- Brightness and color controls.
- Supports MP3, JPEG, MPEG4 formats.
- FCC and CE certifications.
- UL approved.

Wireless Inspection Camera

- High resolution auto focus color camera.
- 30'/10 meter wireless inspection range.
- 4 channel wireless selection on camera wand.
- Flexible 28"/700mm camera wand.
- 10mm camera with internal LED lighting and dimmer control on camera wand.
- Rechargeable internal lithium battery.
- 90 degree mirror attachment.
- Magnetic pickup attachment.

VOscope SOUND STIK

- The SoundStik is designed to listen to a non audible unique range of Ultra Sounds which are extremely useful in the Automotive Industrial and Service Trades.
- Ultrasound technology allows smart, cost effective preventative maintenance and quick findings of potential or existing problems in major areas.

MODEL No.
SS-1000

\$250.00

Kit Contains:

- SoundStik receiver
- SoniPod transmitter
- Contact rod
- Extension tube
- High Fidelity earbuds
- Carry bag.

Specifications:

Dimensions:
Width 2-1/2"
Depth 1"
Length 5-1/4"
Weight 1 lb.
Battery Life Approx. 15 hrs.
Power requirement ... Standard 9 volt
Power consumption ... 30mA, typical
Frequency Response 40kHz Centered
Housing Chemical and oil resistant
Circuitry Solid State
Headphone High Fidelity Microbuds
Headphone Connector 3.5m phone plug
Operating temp. Range 10 to +60 degrees Celsius



DONEGAN FLEX-A-MAG



- Light weight 4" optical grade Acrylic Lens is mounted on a 12" flexible arm for convenient use.
- Leaves hands free for work under powerful 4" diopter lens.
- Makes small jobs go faster and easier.



MODEL No.
204-D **\$29.95**

GENERAL

HIGH PERFORMANCE VIDEO BORESCOPE

Advanced unit offers super-slim probe, straight on or right angle viewing

- This high-performance camerascope offers the ability to switch on the fly and view either straight ahead or at a 90° angle from the direction of the probe.
- The right angle feature also allows 360° rotational viewing, offering a panoramic view of the area being inspected. Its super slim, 4.9mm probe includes two separate cameras, each with its own built-in light source, and allows inspection through very small openings.
- The DCS 1100 features a 2.4 in. LCD screen with a resolution of 320x240 pixels.
- **Optional probes** for this unit include ultra-slim 3.9mm probes, 5.5mm soft-metal, flexible-obedient probes and 6mm articulating probes (of various lengths). **Please Inquire**

MODEL No.
DCS1100

\$750.00



EZRED DOUBLE BARREL LIGHT

Cordless ~ Rechargeable

- Rechargeable double head LED work light with laser pointer.
- Two light heads each with 19 LED's (top head with one laser pointer LED) for a total of 37 clear LED's and one laser.
- Three position switch for LED's: top head on, bothheads on, off.
- Separate laser pointer on/off switch.
- Water resistant.
- 50% wider span of illuminated area than any other conventional LED work light.
- 228 Lumen Light Output. or 114 per head.
- Up to 10 hour cordless use between charging.
- Laser= Max. output: <5mW wavelength: 630-650nm, Class:IIIa
- Extremely durable shatter resistant ABS housing.



MODEL No.
DBXL5000

\$69.95

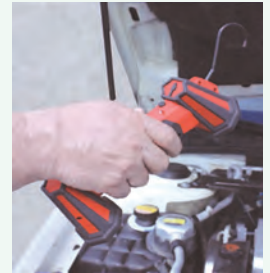

EZRED TWIN BEAM LED SPOTLIGHT WITH LASER

- Unique pocket LED flash light with laser pointer.
- Twin LED's powered with 3 AAA batteries (included) including a laser pointer in the front under the twin beams.
- Pocket clip.
- 12 Lumen Light Output.
- Up to 5 hour on time.

MODEL No.
PCL2

\$15.95



DONEGAN FOLDING POCKET OPTICAL MAGNIFIERS

- Magni-pak magnifiers are available in a range of powers extending from 3X to 9X.
- The lenses in the double lens magnifiers can be used alone or in combination to produce the desired magnification.
- The swing away case is designed to be used as a handle when the magnifier is in use and a protective case when not in use.



Model	Description	Price
P-937	Double Lens 3X, 4X or 7X	\$9.95
P-949	Double Lens 4X, 5X or 9X	9.95
P-903	Single Lens 3X	8.95
P-904	Single Lens 4X	8.95
P-905	Single Lens 5X	8.95

CARSON zPiX™ DIGITAL ZOOM MICROSCOPE

- The zPiX™ is a powerful Zoom Digital Microscope that displays the Magnified image right on your computer screen.
- The impressive 34x-168x (based on 14" screen) Zoom Magnification allows you to see details of ordinary objects you never knew existed!
- Capture an image to keep using the built-in 1.3 megapixel resolution Digital Camera.
- You can even capture close-focus video!
- The MM-740 Zoom Digital Microscope is compatible with the following: Mac OS X 10.4 or later, PC with Windows 2000 SP4, Windows XP, Windows Vista and Windows 7. A USB 2.0 port is required.



MODEL No.
MM-740
\$90.00

Specifications:

Magnification: 34-168x on 14" screen (up to 265x on 22" screen)
Weight: 8.8 oz.
Dimensions: 4.125" x 1.75" x 1.6875"
Accessories: Specimen base, 3 blank slides, 1 prepared slide, forceps, eyedropper, USB cable, CD ROM software

CARSON MAGNIFLASH™ 7X MAGNIFIER WITH LED LIGHT

- The MagniFlash™ Magnifier is part of the new PRO Series.
- It is a aspheric lens, LED lighted Magnifier and Flashlight combination.
- The MagniFlash™ comes with a neck strap and case.
- It is lightweight and compact to take with you anywhere.



Model No.	Magnification	Lens Size	Price Each
CP-24	7x	1.5"	\$34.95
CP-32	9x	1.5"	39.95
CP-40	10x	1.5"	44.95

CARSON zPiX™ ACCESSORY KIT

- The zPiX™ Accessory Kit is the perfect companion for your zPiX™ Digital Microscope or for any standard Microscope.
- Includes three prepared slides containing insects to view under your microscope and 10 blank slides to find your own specimens to examine.
- The zPiX™ Accessory Kit also includes slide covers, tweezers and a storage case.



MODEL No.
MM-01
\$5.50

CARSON DESKBRITE™ ILLUMINATED LED DESK MAGNIFIER

- The DeskBrite™ Plus from the PRO Series is a 1.8x power, LED lighted, adjustable arm desk magnifier.
- It boasts 48 super bright LED lights. Plug into a standard outlet using the included AC/DC adapter.
- Attach the DeskBrite™ Plus to your desk or table using the included C-Clamp. Ideal for hobbies & crafts...



Specifications:
Magnification: 1.8x
Lens Size: 130mm (5")
Weight: 5.17 lbs.
Dimensions: 31" x 9" x 22" at 90°

MODEL No.
CP-70
\$179.95

CARSON SOLDERMAG™ SOLDERING STATION AND MAGNIFIER

- The CP-50 SolderMag™ PRO Series is a Solder Station Magnifier. It is a 1.75x power hands free Magnifier with a 4.5x spot lens. It has a built-in soldering iron holder and solder spool dispenser.
- The SolderMag™ boasts 16 super bright LED's.
- Plug into a standard outlet using the included AC/DC adapter or 4 AA batteries (not included).



MODEL No.
CP-50
\$132.00

Specifications:

Magnification: 1.75x / 4.5x spot lens
Lens Size: 95mm (3.75")
Weight: 1.2 lbs.
Dimensions: 8.75" x 6.75" x 18.5"
Batteries: AC/DC Adapter or 4 AA batteries

CARSON BOAMAG™ MULTI-FUNCTION

- It can be used as a Hands Free or freestanding Magnifier.
- Simply wrap the Magnifier around your machine for easy viewing.
- Or use the 20-inch coil to make a freestanding Magnifier and keep it on your desk for everyday uses.
- The BoaMag™ can be wrapped around just about anything.
- One side of the BoaMag™ has a light and 2.5x lens with 5x spot lens Magnifier while the other end can just be used as a flashlight.
- You can power the BoaMag™ using 3 AAA batteries or the included AC adapter.



MODEL No.
SM-22
\$29.95

Specifications:
Magnification: 2.5x / 5x
Lens Size: 90mm (3.5")
Weight: 12.5 oz.
Dimensions: 31.75" x 3.75" x 1"

CARSON MAGNIVISOR™ DELUXE WITH LED LIGHT SOURCE

- The CP-60 MagniVisor™ Deluxe PRO Series is a Hands Free, head-worn Magnifier with 4 different lenses; 1x, 1.5x, 2x and 2.5x.
- It comes with an adjustable headband. The removable LED lamp can be used as a free standing light source.
- The MagniVisor™ Deluxe is the perfect Low Vision Aid.



MODEL No.
CP-60
\$46.00

Specifications:

Magnification: 1x / 1.5, 2x, 2.5x
Lens Size: 4"
Weight: 5.8 oz.
Dimensions: 9.75" x 7.5" x 3.5"
Batteries: 3 AAA (not included)

CARSON SUREGRIP™ HAND HELD MAGNIFIER

- The SureGrip™ is a Handheld Magnifier with an ergonomically designed soft-grip handle for the ultimate in comfort.
- Its crystal-clear all-glass lens gives you a sharp distortion-free view, and a high-power spot lens allows you to see even the finest details with ease.
- The SureGrip™ Magnifier comes with a soft-padded zipper pouch to protect both lenses.



Model No.	Magnification	Lens Size	Dimensions	Price Each
SG-10	2x/10x	3.5"	8.75" x 3.75"	\$ 9.95
SG-12	2x/10x	4.3"	9.5" x 4.375"	11.95
SG-14	2x/10x	5"	10.125" x 5.25"	13.50

CARSON DESKBRITE™ MAGNIFIER
DESK LAMP 2X

- The DeskBrite™ is a 2x LED Magnifier Desk Lamp with a 5x power spot lens.
- The Desk Lamp features two super-bright LED lights, while it's large 4" crystal-clear acrylic lens provides a large viewing area.
- The LED Magnifier Desk Lamp also has a flexible neck that allows you to position the Magnifier where you need it.
- The Magnifier Desk Lamp plugs into any standard outlet or can be powered by using 3 AA batteries (not included).

MODEL No.
LM-20
\$34.95



Specifications:
Magnification: 2x / 5x
Lens Size: 4.3"
Weight: 1.2 lbs.
Dimensions: 7" x 5.75" x 20.5"

electrix 3-D DIOPTER MAGNIFIER &
HALOGEN INSPECTION LIGHT

- Magnifier and halogen light are mounted on independent industrial grade flexible steel goosenecks.
- 5" diameter 3-diopter (1.75X) precision ground, distortion free glass lens.
- Powerful, 50W halogen lamp (included) provides bright, clear illumination.
- Heavily weighted zinc cast base integrates safe, low voltage transformer.



- Supplied with 9 ft. 3-conductor cord.
- Color black.

MODEL No.
7310A **\$124.95**

CARSON MAGNIFLEX™ FLEXIBLE
ARM LED MAGNIFIER

- The MagniFlex™ is a lighted, fully-adjustable, flexible arm Hands Free Magnifier that attaches to your tabletop for convenient Hands Free use.
- Its large 2x power lens gives you a sharp, distortion-free view, and 3.5x power spot lens allows you to see even the finest details with ease.
- Three super bright LED lights allow for use in low-light conditions.



MODEL No.
CL-65 **\$39.95**

Specifications:
Magnification: 2x / 3.5x
Lens Size: 110mm (4.3")
Weight: 18 oz.
Dimensions: 24" x 4" x 2"
Accessories: C-clamp and 4.5V DC adapter
Batteries: 3AAA (not included)

CARSON MAGNILAMP™ MAGNIFIER

- The MagniLamp™ is a Handheld or fully adjustable stand Magnifier with built-in light that lets you see all the details.
- Its large acrylic 2x power main lens and 3.5x power spot lens provide sharp, crystal-clear images.

MODEL No.
GN-55 **\$13.95**

Specifications:
Magnification: 2x / 3.5x
Lens Size: 110mm (4.3")
Weight: 7 oz.
Dimensions: 7" x 6" x 5.5"
Accessories: Base Stand
Batteries: 2AA (not included)



CARSON ATTACH-A-MAG

- The AM-16 Attach-A-Mag™ is a Hands Free, clip-on 2x power rimless Magnifier. Included with the Attach-A-Mag™ Magnifier is an interchangeable magnetic base.
- The AM-20 LED Attach-A-Mag™ is a Hands Free, fully adjustable, LED lighted Magnifier with a clamp-on base that attaches to most tabletops.
- Its large 2x power acrylic lens provides sharp, crystal-clear images.



MODEL No.
AM-16 **\$11.95**

MODEL No.
AM-20 **\$17.50**
Shown

CARSON ezRead™

Transforms Your TV Screen Into A Visual Aid

- The ezRead™ transforms your television into a visual aid!
- Simply place the ezRead™ directly on top of your reading material to display the Magnified image in full color right on your television screen.
- Connects to your television in seconds using the supplied 10' video cable.
- Internal LED illumination ensures that the image on screen is bright and easy to read.
- The size of your television monitor determines the actual Magnification of the item.
- Operates with 3AAA batteries (not included) and supplied 10' A/C power adapter and is UL listed.

MODEL No.
DR-200 **\$99.95**



Specifications:
Weight: 6.1 oz.
Dimensions: 4.75" x 4" x 2.75"
Batteries: 3AAA (not included)

CARSON FREEHAND™
LED MAGNIFIER

- The FreeHand™ can be used as a Hand Held Magnifier or folded for convenient Hands Free use.
- The FreeHand™ Magnifier features a 2.5x power lens with a built-in 5x spot lens for viewing the finest details.
- A built-in LED light allows for use even in low light conditions.

MODEL No.
FH-25 **\$12.95**



Specifications:
Magnification: 2.5x / 5x
Lens Size: 90mm (3.5")
Weight: 4 oz.
Dimensions: 8" x 3" x 1"
Batteries: 2AA (not included)

CARSON MAGNILOUPE™ &
HEADBAND

- The MagniLoupe™ are powerful eye Loupes.
- These Magnififiers boast a soft rubber cushion that provides comfort during use.
- The MagniLoupe Headband is an adjustable soft rubber strap that provides comfort during extended use.



Model	Magnification	Price
ML-44	4.5x	\$3.95
ML-66	7x	3.95
ML-88	8x	3.95
ML-30	Loupe Headband	\$4.95

CARSON WAVE™ STAND 4X
MAGNIFIERS

- The Wave™ are 4x power Stand Loupe Magnifiers.
- The Wave™ has a stylish and sleek design, which makes it the perfect addition to any desk.
- The Magnifiers are ideal for use as a Jeweler Loupe, Photographer Loupe and Printers Loupe.



No. WX55BL Aqua No. WX55PL Fuschia No. WX55SI Silver

Model	Magnification	Dimensions	Price
WV-55BL	4x	5" x 2.125" x 2.25"	\$8.95
WV-55PI	4x	5" x 2.125" x 2.25"	8.95
WV-55SI	4x	5" x 2.125" x 2.25"	8.95

CARSON OcuLens™ EYEGLASS
MAGNIFIER

- The OcuLens™ is a convenient, Hands Free Magnifier that attaches with ease to most eyeglass frames.
- Once attached, the interchangeable 5x and 8x lenses can be used to examine objects very close up without needing to hold the Magnifier.
- Simply flip down and move the fully adjustable lens to get the best view possible when in use.
- When no longer needed, simply flip up the Magnifier and it will be out of the way.



MODEL No.
OL-57 **\$8.95**

Specifications:
Magnification: 5x / 8x Weight: 1 oz.
Lens Size: 1", 1.2" Accessories: Soft Pouch

CARSON CLIP & FLIP EYEGLASS
MAGNIFIER LENSES

- The Clip & Flip™ are a flip-up, Magnifying Lenses that turns any pair of regular glasses into "flip-down" Hands Free Magnifiers.
- Included with the Magnifying Lenses is a pouch.



Model No.	Magnification	Dimensions Overall	Price Each
CF-10	1.5x (2.25 Diopt)	5" x 2-1/2" x 1"	\$7.95
OD-12	1.75x (3.00 Diopt)	4-7/8" x 2-3/8" x 0.5"	7.95
OD-14	2x (4.00 Diopt)	4-7/8" x 2-1/4" x 5/8"	7.95

CARSON HANDHELD™
RECTANGULAR MAGNIFIER

- The HandHeld™ Magnifier is a compact, easy to use 2x power Magnifier
- Its crystal clear acrylic lens gives you a sharp distortion-free view. The HandHeld™ Magnifier has a 6.5x power bifocal lens, which allows you to see even the finest details with ease. and the lens measures 3.3" x 2" at 3.2oz.



MODEL No.
JS-18 **\$7.50**

CARSON LINENTEST™ WITH LED ILLUMINATION

- The Lighted LinenTest™ Magnifier is a compact, fold-out LinenTest Magnifier featuring a 11.5x power 15mm lens.
- Dual lens design ensures a clear, distortion-free view. Super bright LED light illuminates your subject.
- Make fine focus adjustments by twisting the focus wheel.
- Contains markings in both inches and centimeters for easy measuring of small parts

MODEL No.
LT-10
\$14.95



Specifications:

Magnification: 11.5x
Lens Size: 15mm (.5")
Weight: 0.5 oz.
Accessories: Hard Plastic case
Dimensions: 1-1/2" x 1-1/2" x 3/4"
Batteries: 3#392 button cell batteries (included)

CARSON METAL LINENTEST™

- The Metal LinenTest™ Magnifier is a compact, fold-out LinenTest Magnifier featuring a glass lens.
- The metal frame design is sturdy and durable.
- Contains markings in both inches and centimeters for easy measuring of small parts.
- This Magnifier is portable and folds flat for storing when not in use.
- The Magnifier Includes a soft pouch to protect from damage when not in use.



Model No.	Magnification	Lens Size	Weight Ounce	Price Each
LT-80	5x	1.2"	3.3 oz.	\$10.95
LT-60	6.5x	1"	1.5 oz.	9.95

CARSON TRIVIEW™ 3 LENS FOLDING MAGNIFIER

- The TriView™ Magnifier is a compact, portable folding loupe Magnifier with power ranging from 3x-9x and 5-15x power magnification.
- Each lens contains 3x or 5x power magnification.
- Combine two lenses together to make 6x or 10x power magnification, or three to make 9x 05 15x power.
- The TriView™ Magnifier is lightweight, portable and comes in it's own protective case.



Model No.	Magnification	Lens Size	Weight Ounce	Price Each
TV-36	3x, 6x, 9x	1.2"	1.28 oz.	\$7.95
TV-15	5x, 10x, 15x	1.2"	1.28 oz.	8.95

CARSON LED MAGNIFOLD™ RECTANGULAR HANDHELD MAGNIFIER

- The LED Lighted MagniFold™ represents the latest in Handheld Magnifier design.
- Its rectangular lens is shaped for the way you naturally view things, and a collapsible handle locks into any of six different positions for the most comfortable alignment.
- Fold the handle flush for easy storage.
- The Magnifier has built-in LED illumination.

MODEL No.
MJ-50
\$16.95



Specifications:

Magnification: 2x
Weight: 4.45 oz.
Dimensions: 5" x 3" x 1"

Batteries: 3#392 button cell batteries (included)

CARSON POCKET MAGNIFIER WITH LED ILLUMINATION



- The Pocket Magnifier™ is a multi-power LED lighted Magnifier.
- This HandHeld Pocket Magnifier™ has three magnifying powers: 6x, 5x and 2.5x.
- It features a crystal-clear acrylic lens. It is an ideal low vision aide.
- The Pocket Magnifier™ is also perfect for reading fine print and is so compact that it can easily fit in a pocket or purse.

MODEL No.
PM-33
\$10.95

Specifications:
Magnification: 6x / 5x / 2.5x
Weight: 1.4 oz.
Dimensions: 4.25" x 2.375" x .375"
Batteries: 2#CR2032 (included)

CARSON SCOUT™ COMPACT BINOCULARS

- The Scout™ is a Compact Binocular that provides superior optical quality while maintaining a compact, portable size.
- It has a center focus knob with an independent right diopter adjustment for maximum focusing flexibility.



Model No.	Magnification	Lens Size	Field of View	Dimensions	Price Each
JD-718	7x	18mm	489'@1000 yds.	3"x2.75"x1.5"	\$34.50
JD-822	8x	22mm	393'@1000 yds.	4"x3-3/8"x1-1/4"	44.00
JD-025	10x	25mm	342'@1000 yds.	4"x4"x2"	49.50

CARSON COMPACT ZOOM BINOCULARS

- The Compact Zoom Binocular allows you to view a magnification and then zoom-in for pinpoint accuracy without ever losing sight of you object.
- It has high performance prisms and fully multi-coated lenses that provide exceptionally sharp, high-contrast images.
- Lens are fully coated.
- Supplied with pouch, neck strap and lens cloth.



Model No.	Magnification	Lens Size	Field of View	Dimensions	Price Each
CZ-021	10-30x	21mm	173/84ft.	3-3/4"x4-1/8"x1-5/8"	\$59.95
MZ-517	5-15x	17mm	315/183 ft.	3-3/4"x4-1/4"x1-1/4"	65.00

CARSON MOSSY OAK COMOUFLAGE BINOCULAR

- The 10x25mm Binocular with Mossy Oak® Treestand® camouflage.
- They feature fully coated optics to ensure a crisp, bright image.
- It is lightweight and portable enough to bring with you anywhere.



Model No.	Magnification	Lens Size	Field of View	Dimensions	Price Each
MO-025	10x	25mm	320'@1000 yds.	4"x4"x1-3/4"	\$69.95

CARSON RAVEN™ BINOCULAR WATERPROOF AND FOG PROOF

- The Raven Binocular is an 8x26mm roof prism Compact Binocular with a contemporary open-hinge design.
- These Compact Binoculars boast high quality BAK-4 prisms and fully multi-coated optics to ensure a crisp, bright image.
- The durable, waterproof and fogproof design makes it perfect for outdoor use in all conditions.
- Comes complete with a soft pouch, neck strap and lens cloth.



Model No.	Magnification	Lens Size	Field of View	Dimensions	Price Each
RV-826	8x	26mm	330'@1000 yds.	4.5"x4.25"x1.5"	\$59.95

CARSON HAWKEYE™ GOLF MONOCULAR SPOTTER

- The HawkEye™ can help with club selection as you approach the green.
- Its fully-coated lenses reduce glare and increase brightness.
- Distance scales in both yards and meters accurately determine how far it is to the pin.
- The HawkEye™ has an adjustable eyepiece focus for ease of use.
- It is compact and ultra-lightweight.

MODEL No.
GS-718
\$24.95



Specifications:

Magnification: 7x
Lens Size: 18mm
Lens Coating: Fully Coated
Eye Relief: 8mm
Field of View: 378 ft. at 1000 yards
Weight: 1.9 oz.
Dimensions: 3.5" x 1" x 1"
Accessories: Soft pouch, carrying strap and lens cloth

CARSON BACKCOUNTRY™ ZOOM SPOTTING SCOPE

- The BackCountry™ is a 15-40x power Zoom Spotting Scope that collapses to a very portable 9 inches in length when not in use.
- This Scope features a unique twisting body design allowing for both 45 degree and straight observation use.
- The BackCountry™ Spotting Scope features a large 50mm objective lens and multi-coated optics, which provide crisp, bright images.

MODEL No.
SS-550
\$175.00



Specifications:

Magnification: 15-40x
Lens Size: 50mm
Prism Type: BK-7
Lens Coating: Multi Coated
Eye Relief: 14-11mm
Field of View: 141-72 ft. at 1000 yards
Weight: 23.5 oz.
Dimensions: 7.5" x 4" x 3.5"
Accessories: Zoom eyepiece, tripod and pouch

CARSON SKYSEEKER™ TELESCOPE

- The SkySeeker™ Telescope has precision 60mm Optics and a 40x-100x power range for high-quality imaging.
- Its 5x24mm finder Scope makes it a snap to "zero-in" on your subject.
- The SkySeeker™ Telescope comes with a deluxe aluminum Tripod.

MODEL No.
JC-1000
\$95.00



Specifications:

Magnification: 40-100x
Aperture: 60mm
Focal Length: 800mm
Finderscope: 5x24mm
Weight: 3.05 lbs.
Dimensions: 33.75" x 46.25" x 31.825"
Accessories: Case, H8 and H20 eyepieces
5x24mm finderscope and an adjustable aluminum tripod

CARSON SKYRUNNER™ WIDE ANGLE TELESCOPE

- The SkyRunner™ Short-Tube Wide-Angle Telescope is a lightweight, refractor type Telescope that is rugged, compact and easy to use.
- It has a 70mm objective lens with a 350mm focal length.
- The SkyRunner™ is equipped with two removable Kellner Eyepieces (6mm/25mm) and a 2x power Barlow Lens.
- The finder scope is 8x21mm and a folding tabletop Tripod is supplied.

MODEL No.
SV-350
\$175.00



Specifications:

Magnification: 14-116.6x
Aperture: 70mm
Focal Length: 350mm
Finderscope: 8x21mm
Weight: 3.05 lbs.
Dimensions: 15.375" x 13" x 19"
Accessories: Case, 2x barlow lens, two kellner eyepieces and table-top tripod

CARSON AIM™ REFRACTOR TYPE TELESCOPE

- The Aim™ refractor type Telescope is rugged and easy to operate, making it perfect for the beginning observer.
- Features a focal length of 350mm, a power range of 20x-80x and an adjustable tabletop Tripod for steady viewing.

MODEL No.
MTEL-50
\$65.00



Specifications:

Magnification: 20-80x
Aperture: 50mm
Focal Length: 350mm
Finderscope: None
Weight: 1.3 lbs.
Dimensions: 12.75" x 13.25" x 12.25"
Accessories: Case, 2x barlow lens, three kellner eyepieces and table-top tripod

CARSON RED PLANET 100 NEWTONIAN TELESCOPE

- The Red Planet Series RP-100 is a Newtonian Reflector telescope.
- It's large 76mm diameter reflecting mirror captures plenty of light for crisp, bright images and startling detail.
- The RP-100 features a high-quality, heavy duty aluminum tripod and a U-Mount with slow motion controls for easy tracking of specific stars, planets and constellations.
- It features a 10x30mm finder scope and two high quality eyepieces for the best viewing results.
- The RP-100 includes both an H20mm and an H8mm erecting eyepiece. These erecting eyepieces keep the viewing image right-side up which is perfect for both terrestrial and astronomical viewing.

MODEL No.
RP-100
\$139.95



Specifications:

Magnification: 35x-87.5x
Aperture: 76mm (2.99")
Focal Length: 700mm (27.56")
Finderscope: 10x30mm (Erecting)
Weight: 8 lbs.
Dimensions: 25.5" x 5" x 5" (Tube Size)
Accessories: H20mm and H8mm (Erecting) eyepieces and an adjustable aluminum Tripod

CARSON RED PLANET 200 REFRACTOR TELESCOPE

- The Red Planet Series RP-200 is a Refractor telescope. It features superior, fully coated optics and a high quality, heavy-duty aluminum tripod.
- The RP-200 features a Horizon mount with slow motion cables for smooth, easy tracking of celestial objects.
- It features an 8x21mm finder scope, two high quality eyepieces and a 45 degree corner lens for the best viewing results.
- The RP-200 comes with a K20mm and K9mm eyepiece.
- The corner lens can be used to flip the viewing image right-side up making this telescope perfect for both terrestrial and astronomical viewing.

MODEL No.
RP-200
\$195.00



Specifications:

Magnification: 25x-56x
Aperture: 80mm (3.15")
Focal Length: 500mm (19.69")
Finderscope: 8x21mm (Erecting)
Weight: 8 lbs.
Dimensions: 18.5" x 4.5" x 4.5" (Tube Size)
Accessories: K20mm and K9mm (Erecting) eyepieces 90° corner lens and an adjustable aluminum Tripod

CARSON AURA™ NIGHTVISION DIGITAL MONOCULAR 200

- Say goodbye to night vision devices with image intensifier tubes that burnout over time.
- The Mini Aura™ is a completely digital night vision monocular that won't burn out.
- The image seen will no longer be green but a crisp black and white view.
- The intensity can be easily adjusted with a simple push of a button.
- It boasts a 19-degree angle of view and you can see up to 82 feet in total darkness.
- It can be used in ambient light or total darkness.

MODEL No.
NV-200
\$129.95



Specifications:

Weight: 3.4 oz.
Dimensions: 2.6" x 2.2" x 2.2"
Accessories: Carry Pouch and Wristband
Batteries: 3 AAA (Not included)

CARSON RED PLANET 300 NEWTONIAN TELESCOPE

- The Red Planet Series RP-300 is a Newtonian Reflector telescope.
- It's large 114mm diameter reflecting mirror captures plenty of light for crisp, bright images and startling detail.
- Features a high-quality, heavy duty aluminum tripod and a sturdy equatorial mount to counteract shaking and movements.
- It features setting circles which allow you to dial in coordinates similar to "latitude and longitude" to find specific stars and constellations.
- It features a 6x30mm finder scope and two high quality eyepieces for the best viewing results.
- It comes with a K20mm and K9mm eyepiece.

MODEL No.
RP-300
\$245.00



Specifications:

Magnification: 45x-100x
Aperture: 114mm (4.49")
Focal Length: 900mm (35.43")
Finderscope: 6x30mm
Weight: 17.2 lbs.
Dimensions: 34.25" x 5.75" x 5.75" (Tube Size)
Accessories: H20mm and K9mm eyepieces and an adjustable aluminum Tripod

CARSON RED PLANET 400 REFRACTOR TELESCOPE

- It features superior, fully coated optics and a high quality, heavy-duty aluminum tripod with an equatorial mount to counteract shaking and movements.
- It features setting circles which allow you to dial in coordinates similar to "latitude and longitude" to find specific stars, planets and constellations.
- It features a 6x30mm finder scope and two high quality eyepieces for the best viewing results.
- The RP-400 comes with a PL20mm and PL10mm eyepiece.

MODEL No.
RP-400
\$295.00



Specifications:

Magnification: 50x-100x
Aperture: 90mm (3.54")
Weight: 21.8 lbs
Finderscope: 6x30mm
Focal Length: 1000mm (39.37")
Weight: 21.8 lbs.
Dimensions: 38.5" x 4.5" x 4.5" (Tube Size)
Accessories: PL20mm and PL10mm eyepieces, 90° corner lens and an adjustable aluminum Tripod

CARSON AURA™ NIGHTVISION Portable, Digital Monocular 100

- The Aura™ Night Vision Monocular uses digital technology to provide a bright, clear and sharp image.
- No more blurry green images using old intensifier tubes!
- The Aura™ Optics operate on 4 AA batteries (not included), and includes a soft pouch and wrist strap.

MODEL No.
NV-100
\$199.95



Specifications:

Magnification: 2x / 3x
Lens Size: 12mm
Weight: 10.5 oz.
Dimensions: 6.25" x 3.75" x 2.25"
Accessories: Soft Pouch and Wrist Strap
Batteries: 4 AA (Not included)

CARSON Innovation In Quality Optics **MicroMax™ 60-100X ZOOM POCKET MICROSCOPE**



- The MicroMax™ is a powerful 60-100x power Magnification Pocket Microscope with an extremely lightweight and portable design.
- This Pocket Microscope features a built-in light that provides a bright, clear image and a rubberized eyepiece for comfortable viewing.
- The MicroMax™ fits easily in your Pocket so you can bring it with you anywhere.

MODEL No
MM-100

\$13.95

Specifications:
Magnification: 60-100x
Weight: 1.28 oz.
Dimensions: 3.5" x 2" x .75"
Batteries: 3 AAA (not included)

CARSON Innovation In Quality Optics **MICROMAX PLUS™**

The MM-250 MicroMax Plus™ from Carson Optical will turn your iPhone 4/4S into a Digital Microscope!

- It is a powerful 60-100x power Magnification Pocket Microscope with an iPhone 4/4S Adapter. Taking close up images and video is easy using the iPhone 4/4S.
- Set up is easy, simply attach the Adapter case and MicroMax LED Pocket Microscope to your iPhone 4/4S.
- Open the camera setting in your iPhone 4/4S and start viewing.
- The built-in LED light provides a bright, clear image. You can zoom in using the focus knob on the MicroMax LED or digitally using the zoom function on your iPhone 4/4S



MODEL No
MM-250

\$23.50

CARSON Innovation In Quality Optics **MicroMax™ LED 60-100X POCKET MICROSCOPE**



- The MicroMax Plus™ is a powerful 60-100x power Magnification Pocket Microscope with an extremely lightweight and portable design.
- This Pocket Microscope features a built-in LED light that provides a bright, clear image and a rubberized eyepiece for comfortable viewing.
- The MicroMax LED™ fits easily in your Pocket so you can bring it with you anywhere.

MODEL No
MM-200

\$13.95

Specifications:
Magnification: 60-100x zoom
Weight: 1.1 oz.
Dimensions: 3.25" x 1.25" x .75"
Batteries: 3SG3 Button Cell
Batteries (included)

CARSON Innovation In Quality Optics **X SCOPE™**

- The X-Scope™ is a 7-function, multi-use optical Pocket tool.
- The X-Scope™ contains a 30x Microscope, 8x Telescope, 9x fold-out Magnifier, LED flashlight, signal whistle, directional compass and digital clock.
- It is compact, lightweight and easy to use. This multi-use Pocket tool will provide hours of entertainment and fun.

MODEL No
CP-11

\$12.70

Specifications:
Magnification: 8x / 9x / 30x
Weight: 1.9 oz.
Dimensions: 1.625" x 1.75" x 4.75"
Batteries: 2 AAA Not included



CARSON Innovation In Quality Optics **MAGNISCOPE™**

- The MagniScope™ is the most unusual and useful magnifying instruments ever offered.
- Two components combine to create three different optical devices... an 8x20mm Monocular, 3x power stand Magnifier, and when threaded together, a precision 30x portable Microscope.

MODEL No
MA-30

\$72.95

Specifications:
Magnification: 3x / 8x / 30x
Weight: 4 oz.
Dimensions: 7" x 2" x 2"
Batteries: Not included



CARSON Innovation In Quality Optics **zOrb 35X**

- The zOrb is a Digital Microscope with an integrated camera that displays the magnified image right on your computer screen.
- The impressive 35x Magnification (14" monitor) allows you to see details of ordinary objects you never knew existed!
- The built-in internal illuminator ensures a clear and bright image.
- Capture an image to keep using the built-in 640 x 480 resolution digital camera. You can even capture close-focus video with the zOrb!

Specifications:
Magnification: 35x
Weight: 3.6 oz.
Dimensions: 2.9" x 1.9"
Accessories: USB cable, CD ROM software



MODEL No
MM-480B

\$70.00

Other Colors are
Safari Green and
Lava Orange
Add "G" or "O"

CARSON Innovation In Quality Optics **MICROBITE™ ZOOM MICROSCOPE 20X-40X**

- The MicroBrite™ is a 20x-40x Zoom Pocket Microscope.
- Super-bright LED light illuminates your viewing subject to ensure a clear, bright image.
- View your object at 20x magnification or zoom in to an impressive 40x magnification to see even the finest details.
- Simply place the MicroBrite™ Zoom Pocket Microscope directly on any subject to see a magnified view or use the included base to view specimen slides.
- The MicroBrite™ is so compact and portable you can bring it with you anywhere.
- The Microscope comes complete with Pocket Microscope, 2 slides and base stand.

Specifications:
Magnification: 20-40x
Weight: 2 oz.
Dimensions: 3.875" x 2.125" x 1.25"
Batteries: 3 LR-44 Button Cell Batteries (included)

MODEL No
MM-24

\$11.40



CARSON Innovation In Quality Optics **zPIX™ DIGITAL ZOOM MICROSCOPE**

- The zPix™ is a powerful Zoom Digital Microscope that displays the Magnified image right on your computer screen.
- The impressive 26x-130x (based on 14" screen) Zoom Magnification allows you to see details of ordinary objects you never knew existed!
- Capture an image to keep using the built-in 640 x 480 resolution Digital Camera.
- You can even capture close-focus video!
- The MM-640 Zoom Digital Microscope is compatible with the following: Mac OSX 10.4 or later, Windows 98 SE, Windows 2000, Windows ME, Windows XP, Windows Vista. A USB 2.0 port is required.

Specifications:
Magnification: 26-130x on 14" screen (up to 190x on 22" screen)
Weight: 7 oz.
Dimensions: 4.125" x 1.75" x 1.6875"
Accessories: Specimen base, 3 blank slides, 1 prepared slide, forceps, eyedropper, USB cable, CD ROM software



MODEL No
MM-640

\$80.00

STREAMLIGHT HEADLAMPS AND COAST™ PURE BEAM OPTIC HEADLAMP

Septor LED Headlamp With Strap

- Seven ultra bright white LEDs
- Features three levels of lighting and up to 120 hours of continuous run time
- Includes both elastic and rubber head straps
- 90-degree tilt mechanism reduces neck strain
- Includes three AAA batteries

MODEL No. 61052 **\$39.95**



Waterproof White LED, Black Body, Elastic Strap, 2AAA

- Impact resistant ABS case
- Unbreakable polycarbonate lens
- 1 super high flux LED, 100,000 hour life
- Run time: low beam (25%) up to 24 hours, high beam (100%) up to 6 hours at regulated intensity
- 1-1/4" wide by 2-1/4" deep

MODEL No. 61400 **\$18.50**



Trident-Super-Bright LED/Incandescent Combo Headlamp

- LED/Incandescent combo headlamp
- Contains 3 white LEDs and a xenon bulb within same the reflector
- Features three levels of lighting and up to 120 hours of continuous run time.
- Includes both elastic and rubber head straps

MODEL No. 61050 **\$29.95**



COAST™ Pure Beam LED

- COAST Pure Beam Focusing Optic
- 196 lumens; 109 meter beam distance
- 3xAAA batteries – 5.75 hour run time
- Includes helmet clips for hard had use

MODEL No. 19723

\$51.50



Ullman ROTATING MAGNETIC LED WORKLIGHTS

- Sturdy Aluminum Red Housing.
- Rotates 360°
- Strong Magnetic Base attaches to any Ferrous metal
- Rotating Head pivots to direct light to any needed angle



No. RT-2LT
No. RT-48LT
Includes (3)
AAA Batteries



No. RT-LTCH
Includes 110 Volt
Charger

Model	Description	Price
RT-2LT	Worklight w/24 LED Lights w/(3) AAA batteries	\$24.95
RT-48LT	Worklight w/48 LED Lights w/(3) AAA batteries	39.95
RT-LTCH	Worklight w/24 LED Lights w/110 Volt Charger	49.95

STEELMAN. TWIN TUBE LED WORK LIGHT

- 36 bright white LEDs with max 220 lumens of output
- Run time with use of one tube (18 LEDs) is approximately 8 hours before recharge is necessary, with two tubes (36 LEDs) approximately 4 hours
- LED tubes open up 180 degrees and rotate 360 degrees
- Includes fold-away hook above LED tube and magnetic base with built-in hang hook
- Rechargeable with 2200 mAh Li-ion Battery (3.7V 2200MA 18650)
- Includes AC wall charger (110-220V) & 12 Volt DC car charger
- Dimensions: 15L x 2.75W (body) x 3W (base) x 2.5Thk (without tube open). Width at widest point - 18.5



MODEL No. 98639
Reg. \$85.00

\$59.95



STEELMAN. HYBRID LIGHT

- 53 bright white LEDs rated up to 120 lumens
- 1 watt bright white LED flashlight head rated up to 130 lumens
- 3.6V - 2500mAh rechargeable Ni-MH battery
- Tough anodized aluminum handle and cap design
- Impact resistant tube lens
- Magnetic base
- UL AC wall adapter



MODEL No. 95864
Reg. \$110.00 **\$79.95**

SHAVIV USA by VARGUIS GOLDEN FLEX SCRAPER SETS

With Aluminum Telescoping Handle and TiN Coated Blades

- Featuring a durable Aluminum Handle and 5 different pairs of TiN coated Multipurpose blades in each set, Shaviv Golden Flex Sets provide superior value in terms of wear resistance, surface finish and tool life.

Golden Flex Set "B"

- Consists of:
- Standard Deburring
 - Aluminum Handle
 - Blade Holder B
 - 5 Different Pairs of TiN Coated Multi-purpose B Blades: B10Px2, B11Px2, B12Px2, B20Px2, B30Px2

MODEL No. 155-00258 **\$34.95**
Reg. \$59.65

Golden Flex Set "E"

- Consists of:
- Heavy Duty Deburring
 - Aluminum Handle
 - Blade Holder E
 - 5 Different Pairs of TiN Coated Multi-purpose E Blades: E100Px2, E110Px2, E111Px2, E200Px2, E300Px2

MODEL No. 155-00259 **\$39.95**
Reg. \$66.70



SHAVIV USA by VARGUIS DEBURRING PACKAGES

For Extra Close Work
Each Bonus Pack includes 10 blades and FREE Mango II B/E handle. Available with HSS or Cobalt B10 or E100 blades.

For Long Reach Work
Each Bonus Pack includes 10 blades + holder, and FREE Mango II handle. Available with HSS or Cobalt B10 or E100 blades.

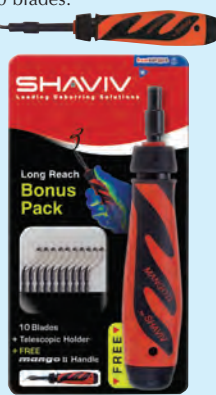

Model No.	Reach Type	Blades Included	B10 Blade		E100 Heavy Duty	
			List Price	Sale Price	List Price	Sale Price
29249	Close	(10) B10HSS	\$18.95	\$10.95		
29250	Close	(10) E100HSS	25.50	14.95		
29255	Close	(10) B10Cobalt	20.00	11.95		
29251	Close	(10) E100Cobalt	27.00	16.50		
29252	Long	(10) B10HSS	\$27.90	\$15.95		
29253	Long	(10) E100HSS	34.00	19.95		
29256	Long	(10) B10Cobalt	29.00	11.50		
29254	Long	(10) E100Cobalt	36.50	21.95		

SHAVIV USA DEBURRING TOOLS
WITH ERGONOMIC **mango II**
LONG REACH HANDLES

mango II SET B THE WORKHORSE

- Popular set for holes, slots & edges. B Holder supports all B blades which can be inserted axially or perpendicular to the holder.



mango II SET C THE SCRAPER

- Features triangular blade with 3 cutting edges for high quality finishing & scraping. The telescoping blade holder lets you get to difficult-to-reach areas. Includes key for safely removing blades.



mango II SET D SHEET CLEANER

- Perfect for sheet metal up to 0.12" thick (3mm).
- Blade deburrs both sides of sheet in one pass.
- Blade also functions as a surface cleaner.



mango II SET E HEAVY DEBURRING

- Rugged deburring set for heavy-duty deburring of holes, slots and edges.



mango II SET M STANDARD "B" & HEAVY DUTY "E" BLADES

- Deburr holes, slots & edges. Holder M supports both B and E blades.



mango II SET BURR-BI HEAVY DUTY SHEET CLEANER WITH PROTECTIVE HAND GUARD

For heavy duty deburring of materials with single or double straight edges up to 0.56" (14mm) thick. Holder can take two R10, R20 or R30 blades for arc shape finishes on workpieces up to 0.63" (16mm) thick. Hand guard attached for worker safety.



mango II SET K SURFACE SCRAPER

- The original industrial surface scraper. Pulling/pushing action makes it perfect for smoothing metal and plastic surfaces as well as scraping paint and varnishes.



mango II SET FR RATCHET BURR FOR ID

- Features FR ratchet holder, ideal for rotational chamfering, even when workspace is limited. Inside diameter (ID) up to 0.79" (20mm)



mango II SET F COUNTERSINK

- Powerful tool, excellent for chamfering and countersinking. Use for hole-edge applications with



mango II SET BURR-EX RATCHET BURR FOR OD

- Features FR ratchet holder, ideal for rotational chamfering, even when workspace is limited. For: Outer Diameter (OD) chamfering up to 1" (26mm)



mango II SET G SLOT EDGE CLEANER

- Ideal for deburring and cleaning edges of internal & external keyways and slots up to 0.6" (15mm) wide. Blade features 8 cutting edges.



SHAVIV USA HANDYCHUCK PIN VISE

- Holds small files, drills, reamers, taps, mold polishing stones, wires, countersinks, etc.
- Grips objects with 1mm (0.04") to 8mm (0.32") diameter.
- Can be used with C50 & C60 scrapers.



SHAVIV USA CERA-BURR CERAMIC BLADE TOOL

- High quality ceramic blade affixed on strong lightweight handle.
- Excellent for deflashing plastics and deburring soft metals.
- The ideal tool to remove unwanted mold gate trim on plastic work pieces.



SHAVIV USA TOOL & DIE MAKERS KIT

Professional, miniature deburring & scraping tools for providing a quality finish to dies & molds. Packaged in an attractive leather case.

MODEL No. 29079
\$59.95



Contains Blades:
UF1-Flat Diamond coated file.
US1-Triangular scraper.
US2-Flat scraper.
US3-Round scraper.
US4-Hooked corner scraper.
UB38-Miniature rotational deburring tool for min. hole diameter 0.08"(2mm)

SHAVIV USA SCRAPER-BURRS KIT

- All 3 Scrape-Burrs in one kit! Plus FREE Glo-Burr handle with B10 blade.

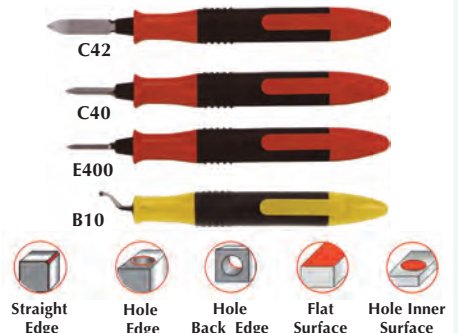

Model	Blade	Description	Price
29012	B10	HSS. Deburrs materials with spiral chips	\$.95
29013	B10C	Solid carbide, B10 geometry	5.95
29014	B10D	Diamond-coated, B10 geometry	8.95
29210	B10S	Long lasting, cobalt-enriched B10 geometry	1.95
29108	B11	Extra thin HSS Deburrs holes with min. diameter 0.08"	1.25
29122-1	B11P	PVD TiN coated for high resistance to wear. B11 geometry	2.25
29016	B12	Short nosed, HSS	1.15
29019	B20	HSS. Rotates clockwise & counterclockwise	\$.95
29020-1	B20C	Solid carbide. Rotates clockwise & counterclockwise	5.95
29021	B21	PVD TiN coated for high resistance to wear. Rotates clockwise & counterclockwise	1.95
29023	B30	Simultaneously deburrs the inside & outside of holes	\$1.50
29024	B30P	PVD TiN coated for high resistance to wear. B30 geometry	2.50
29025	B32	Rotates clockwise & counterclockwise. B30 geometry	1.50
29027	B60	HSS. Removes burrs from back edges of holes up to	\$1.95
29028	B70	Carbide tipped. Deburrs sheet metal up to 0.14" thick	5.95
29000-1		Extra Holder for all "B" Blades	4.95
29138		Extra Holder for all "B" & "E" Blades	5.95
29029	C40	Small, 0.16" triangular HSS scraper for precision work	\$5.95
29030	C42	Standard size, 0.31" triangular HSS scraper	9.50
29117	C50	Double sized, 0.30" (7.8mm) triangular scraper	18.00
29118	C60	Double sized, 0.19" (4.8mm) triangular scraper	20.00
29001		Extra Holder for all "C" Blades	4.95
29031	D80C	Solid carbide, 6 cutting edges. Scrapes surfaces & deburrs sheet metal up to 0.35" thick	\$5.95
29032	D82C	Heavy duty. Double-edged carbide blade. Deburrs sheet metal up to 0.24" Thick	9.50
29033	D85	Tough HSS with chipbreaker & 6 cutting edges. Deburrs sheet metal up to 0.24" Thick	11.00
29002		Extra Holder for all "D80, D82" Blades	4.95
29003		Extra Holder for all "D85" Blades	4.95
29034	E100	Heavy duty HSS. Deburrs materials with spiral chips	\$1.25
29035	E100C	Wear resistant carbide. E100 geometry	5.95
29036	E100D	Diamond-coated. E100 geometry	10.50
29037	E100P	E100 for left handed users	2.25
29211	E100S	PVD TiN coated for high resistance to wear E100 geometry	1.25
29040	E200	HSS for materials with powdery chips. Rotates clockwise & counterclockwise	\$1.20
29099	E200P	PVD TiN coated for high resistance to wear E200 geometry	2.50
29041	E200C	Wear resistant carbide. E200 geometry	\$5.95
29042	E300	HSS for materials with powdery chips. Simultaneously deburrs the inside & outside of holes up to 0.24 thick.	1.60
29227	E300P	PVD TiN coated for high resistance to wear E300 geometry	2.50
29043	E320	HSS for materials w/powdery chips. Simultaneously deburrs the inside & outside of holes up to 0.24 thick. Rotates clockwise & counterclockwise	9.60
29044	E350	HSS for materials with powdery chips. Rotates clockwise & counterclockwise	1.25
29045	E600	HSS. Removes burrs from back edges of holes up to 0.78" thick	\$2.50
29046	E601	Extra-long HSS. Removes burrs from back edges of holes up to 1.57" thick	3.00
29004		Extra Holder for all "E" Blades	4.95
29049	F12	Countersink for hole-edges with up to 0.47" diameter.	\$11.50
29050	F20	Countersink for hole-edges with up to 0.78" diameter.	15.50
29051	F30	Countersink for hole-edges with up to 1.18" diameter.	25.00
29147	F26X	Excellent for external chamfering of pipes, tubes & other items with up to 1.02" diameter	19.95
29005		Extra Holder for all "F" Blades	4.95
29052	G10	HSS. deburrs slots up to 0.6" wide	\$4.25
29053	G20	HSS. 4 cutting corners. For slots up to 0.4" wide	4.25
29115	G30C	Solid carbide, 3 cutting corners. cleans corners & removes radii after machining for smooth flush mating of adjoining faces	8.95
29103	G40C	Carbide, 4 cutting corners. For slots up to 0.4" wide	4.25
29007		Extra Holder for all "G10 thru G40" blades	4.95
29141	R10	Double-sided, round HSS blade "A" side deburrs materials w/ spiral chips	\$4.25
29142	R20	Double-edged, round HSS blade for massive deburring tasks on materials with spiral chips	5.50
29143	R30	Produces arc-shaped finish on materials up to 0.63" thick. 0.63" thick. Use a single R30 for one straight edge, or two blades at once to deburr both edges simultaneously	7.95
29093		Stainless Steel Handguard to protect your hand Attaches to blade holder	\$9.95

SHAVIV USA HEAVY DUTY PIPE CLEANER

- Perfect tool to deburr tubing on both inner and outer edges.
- Excellent for plumbers, installers and electricians.
- Use for aluminum, copper and brass tubing.
- Tubing range: 1/4" to 1-5/8" (6mm-41mm)



MODEL No. 90082
\$17.95



ROUT-A-BURR SLOT EDGE CLEANER

- The original set for heavy-duty deburring of holes and edges.
- Features a built-in, non-telescopic steel blade, which holds blades close to the handle.

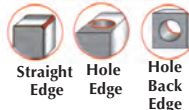

MODEL No. 29078
\$9.95



ROUT-A-BURR "THE WORKHORSE"

- Popular set for holes, slots & edges.
- B holder supports all B blades which can be inserted axially or perpendicular to the holder



MODEL No. 29065
\$10.95



ROUT-A-BURR With ALUMINUM HANDLE

- Popular set for holes, slots & edges.
- B holder supports all B blades which can be inserted axially or perpendicular to the holder

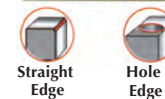

MODEL No. 29066
\$13.95



HANDY CHUCK AND SCRAPER

- Delivers pin vise versatility for finishing & scraping applications.
- Also used for gripping miniature files, drills, reamers, taps, wires, countersinks and other small objects - 0.04"-0.32" (1-8mm) in diameter.



MODEL No. 29116
\$39.95

SHAVIV USA DEBURRING SETS

For Aviation/Aerospace/Medical

- Customized for applications required by the aerospace industries, excellent for electronic and medical applications.
- Designed to deburr curves and small holes as small as 1/16" (1.5mm)
- Blades are TiN (Titanium Nitride) coated.
- TiN coated blades provide up to 5 times the life of standard non-coated blades.



Model	Description	Price
90110	Mango II with Extension Blade Holder "B" & 5 #B11P Blades	\$13.95
90111	Mango II with Extension Blade Holder "B" & 5 #E11P Blades	15.95

NOGA LIZA BURR REVERSABLE AND TELESCOPING DEBURRING TOOL KIT

For All "B" Standard & "E" Heavy Duty Blades

Includes: Uni-handle, SN-holder, B-10 & B-20 blades. Double sides Blade holder to utilize both light duty "B" series Blades and heavy duty "E" series Blades. Telescopes from 20-110mm with "B" blades. 20-94mm with "E" blades.



KIT No. LB-1900
Reg. \$24.50

\$17.95

With Blades
6-#B-10, 5-#E-100
1-#B-20

NOGA SOFT GRIP BLADE HOLDER For STANDARD "B" AND HEAVY DUTY "E" BLADES

Non Telescoping



Soft Grip
Handle Only
w/o Blades
No. SG-3000

\$4.95

Ø 3.2mm
Ø 2.6mm



3-Pc.
KIT No.
SG-1000
Reg. \$12.95

\$6.95

3-Piece Kit
Contains:
Soft Grip handle
Cobalt Blades
#10 & #100
For Stainless Steel

21 Pc.
KIT No.
SG-2001

\$24.95

21-Piece Kit
Contains:
Soft Grip handle
Cobalt Blades
10-#10 & 10-#100
For Stainless Steel

NOGA BURR NON TELESCOPING

- Capable of holding all blades.
- Quick change of blade by pressing safety button.
- Handle made of lightweight, wear resistant acetal.
- Blades rotate inside glass reinforced plastic.
- Handle has lifetime guarantee.
- Blades are stored inside the handle.



Workhorse Handle
No. NB-1000
Holds all "B" Blades

\$3.95



3-Piece Set
No. NB-3000
1) NB Handle
& 1 each Blades #B-10
#B-20 & #B-30

\$6.95

5-Piece Set
No. NB-5000

\$8.95

1) NB Handle
1 Each Blade
#B-10, #B-20, #E-100,
#E-200, #E-300

NOGA BURR EDGE-OFF

- This tool consists of E-100-1 Blades mounted into a plastic handle with pocket clip, and will accept replacement "E" type replacement blades.



MODEL No.
EO-2000

\$3.95

"E" HEAVY DUTY BLADES: FOR NOGA & SHAVIV

E-100-1 \$1.25	The basic Blade used for steel and aluminum	E-300 \$1.60	Removes external and internal burrs simultaneously from holes drilled into tubing and sheet metal
E-100P \$2.95	"P" TIN COATED	E-350 \$1.25	Especially handy for straight edges, keyways, etc.
E-100C \$5.95	Solid carbide blade similar to E-100 for extra hard applications	E-600 \$2.50	Heavy duty H.S.S. internal blade. Facilitates deburring in the most inaccessible locations
E-100D \$10.50	Heavy duty blade, impregnated with diamond grit. Used to break corners in hardened steel, carbide, glass etc.	E-601 \$3.00	A longer version of E-600
E-200 \$1.20	Used for brass & cast iron. Can rotate clockwise and counter-clockwise.	E-200C \$5.95	Solid carbide blade similar to E-200 for extra hard applications

SHAVIV USA DEBURRING KIT

- Excellent all-around deburring kit for your workshop.
- You get all the tools you need for 1000+ applications.

Contains:

- Classic Handle "A" No. 29005
- Holders - B, C, D, E & F
- Blades - B10, B20, B30, B50, B70, C40, C42, D80C, E100, E200, E300, E350, E600 & F20.

KIT No.
29199

List \$163.00

\$99.95



Straight Edge



Hole Edge



Hole Back Edge



Cross-Hole Both Edges



Flat Surface



Sheets

SHAVIV USA DEBURRING STARTER KIT

- The all-in-one deburring kit for your workshop. Includes an ergonomic Mango II handle with the three most popular types of blades and holders for different deburring applications.

Contains:

- Mango II Handle
- Holders - B, C & E
- Blades - B10, B20, B30, B50, B60, C40, E100 & E300

KIT No.
90085

List \$99.50

\$59.95



Straight Edge



Hole Edge



Hole Back Edge



Cross-Hole Both Edges



Flat Surface



Hole Inner Surface

"B" Series Blades: Fits NOGA & SHAVIV Deburring Holders

B-10	H.S.S. blade excellent for materials with spiral chips such as aluminium, plastic, steel, etc.	\$.95
B-10L	Left hand version of B-10	1.95
B-10P	PVD Titanium Nitride coated B10 for high wear conditions	2.28
B-10PL	Left hand version of blade B10P	2.95
B-10C	Solid carbide B10 for hardened steels	5.95
B-20	H.S.S. blade ideal for brass, cast iron and other materials with a powdery chip	.95
B-20P	PVD titanium nitride coated B20 for high wear conditions	2.25
B-20C	Solid carbide B20 for hardened steels (from HRC38)	5.95
B-30	Hooked blade simultaneously removes external and internal burrs from holes drilled into steel and plastics	1.50
B-50	Carbide tipped scriber. Can be reground	3.50
B-60	H.S.S. blade can reach inside a wall up to 20mm (9.8") thick to remove internal	1.95
B-70	Carbide tipped deburring blade for sheet metal up to (0.12") thickness. Handguard 3G recommended.	4.95
M-100	Blade Holder. Two applications in one holder Takes all "B" or "E" series blades.	6.95
C-001	"C" Scraper blade holder	4.95
C-40	H.S.S. standard triangular scraper. (0.16") Excellent for delicate precision work	5.95
C-42	H.S.S. standard triangular scraper (0.31")	9.50



DRAFTING INSTRUMENTS

- Solid brass legs with durable satin chrome finish.
- Legs are jointed for increased range.
- Supplied in custom fitted case, complete with spare lead.
- Spare points available by special order for compass-divider conversion.



212-TC
Standard



306-TC
Fine Adjust



408-TC
Speed Bow

Model	Diameter	Description	Price
211-TC	1/16"-14"	Compass Only	\$12.95
212-TC	1/16"-14"	Compass with Pen Adapter	16.95
213-TC	1/16"-14"	Compass with Pen Adapter and Lengthening Arm	18.95
306-TC	1/16"-12"	Compass Only	\$16.95
307-TC	1/16"-12"	Compass with Pen Adapter	18.95
308-TC	1/16"-24"	Compass with Pen Adapter and Lengthening Arm	23.95
406-TC	1/16"-12"	Compass Only	\$18.95
407-TC	1/16"-12"	Compass with Pen Adapter	21.50
408-TC	1/16"-24"	Compass with Pen Adapter and Lengthening Arm	26.00



10 PIECE DRAFTING INSTRUMENT SET

- Set includes 4-3/4" and 5-3/4" spring blade adjustment ruling pens.
- 6" pivot compass with pen, pencil and lengthening bar.
- 3-3/4" bow pencil, 4" bow divider, 6" friction divider.
- Screwdriver, lead holder and spare leads and spare parts holder.
- Solid brass legs with durable satin chrome finish.
- Supplied in custom fitted case.

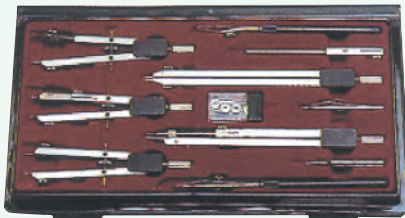

SET No. 4360-TC **\$49.95**



FRICTION DIVIDER

- Solid brass legs with durable satin chrome finish.
- Straight leg type with helical tooth gears for constant load without jamming.

Model	Size	Price
40006-1	6"	\$5.95
40007-1	7"	6.95



T-SQUARES

- 2-1/2" wide blade made of wood and plastic.
- Transparent edges with fixed head.
- Manufactured in accordance with CID A-A-843C.



30" MODEL No. 5272 **\$23.50**

GENERAL ULTRA RULE STAINLESS STEEL RULES

Ultra Rule precision marking rule looks like an ordinary ruler. Look closer and you will see micro-fine marking holes and slots at every scale position to instantly locate a sharp pencil point or scriber exactly where you want it. you can effortlessly place your mark precisely on target with zero uncertainty and no eye strain.

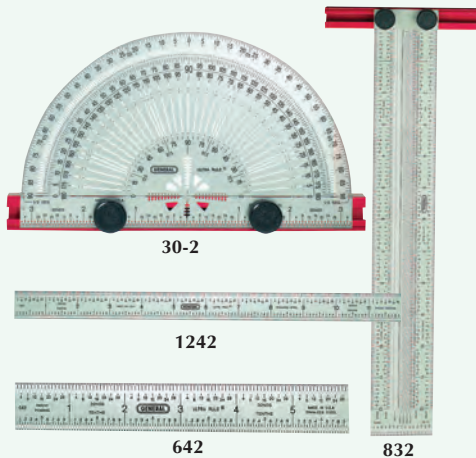

Model	Description	Graduations	Width	Price
30-2	6" Flex Protractor	Degrees, 1/2 degrees, 32nds	3-7/8"	\$35.00
832	12" Flex T-Rule	16ths, 32nds, 64ths	2"	35.00
1241	12" Flex Marking Rule	32nds, mm's	7/8"	16.50
1242	12" Flex Marking Rule	32nds, 10ths	7/8"	16.50

GENERAL WIRE GAGE

- American Standard wire gage 0 to 36 used for gaging non-ferrous wire & metals such as copper, brass and aluminum.
- Satin finished, heavy gage hardened and tempered steel.
- Decimal equivalents of each size are stamped on reverse side.
- 3-1/4" diameter, 3/32" thick.



MODEL No. 20
Reg. \$26.00
\$19.95

GENERAL SHEET METAL GAGE

- For gaging uncoated sheet metal, plate iron and steel.
- gage numbers are U.S. Standard 0 to 36.
- decimal equivalents of each size are stamped on reverse side.
- satin finished, heavy agage steel is hardened and tempered.
- 3-1/4" diameter, 3/32" thick



MODEL No. 21
Reg. \$25.00
\$19.50



PROTRACTORS

- Molded in tinted polystyrene.
- Graduated in 0-90° quadrants and 0-360° in 1/2° increments.
- Features beveled edges and cut-out centers.
- Manufactured in accordance with CID-A-A-52300.

Model	Size	Description	Price
3547	4"	Semi-Circular	\$1.25
3548	6"	Semi-Circular	2.00
3544	8"	Circular	2.50

GENERAL CONTOUR GAGE

- Contour gage can duplicate any shape.
- The stainless steel pins on the gage slide to conform to irregular surfaces.
- This tool can be used for pattern and mold making, duplicating parts and transferring prototype contours.
- Inch graduation on body.
- Component parts are enamel painted and brass plated.



Model	Size	Price
837	6" x 3-1/2"	\$ 8.95
833-1	10" x 3-1/2"	17.95



Precise HAND TALLY



MODEL No. HT-005
Reg. \$13.50
\$7.95

- **Hand Tally**
- Compact, versatile for inventory control, traffic flow, census and production counting.
- Chrome plated with thumb lever, reset knob, finger ring.

GENERAL PLASTIC PROTRACTOR

- Use this protractor/angle finder to measure and mark the degrees of an angle on outside, inside and sloped angles.
- Fine black graduations from 0° to 80° in opposite directions.
- Brass lock nut.



MODEL No. 29
\$5.95

Precise RATCHET COUNTER



MODEL No. MC-576
\$8.95

- **Machine Counter**
- Count to 99,999 on upstroke and have a lever on the right-hand side for actuation, adjusts to any position.
- Rotary reset knob. Base has four holes for mounting.

1-3/16" Thick
1-1/2" Wide
2-3/4" Long

SWISS DEAD BLOW MADE Nylon Hammers

- These dead blow nylon hammers features a hollow hammer head filled with thousands of tiny steel balls.
- The inertia of the pieces provides a bounce-free, 100% impact.
- Mar-resistant, comfortable to use.
- Easily replaceable nylon head inserts.



Hickory Handle Model

Rubber Grip Model

Heavy Duty Rubber Grip Models

Order	Face	Length	Weight	Price
98-500-2	1-3/16"	10"	1.25 lbs.	\$38.05
98-501-0	1-3/8"	10"	1.5 lbs.	40.75
98-502-8	1-3/4"	10"	2.1 lbs.	48.95
98-503-2	2"	10"	2.4 lbs.	62.45

Hickory Handle Models

98-510-1	3/4"	11"	.5 lbs.	\$33.35
98-511-9	1"	11"	.75 lbs.	34.60
98-512-7	1-3/16"	11-3/4"	1.1 lbs.	36.65
98-513-5	1-3/8"	11-3/4"	1.5 lbs.	40.75
98-514-3	1-9/16"	12-1/4"	1.75 lbs.	44.90
98-515-0	2"	12-1/4"	2.4 lbs.	55.65

Replacement Tips Available. Please Inquire

Replacement Nylon Inserts

Face Dia.	Order No.	Price Each
3/4"	98-540-8	\$ 3.95
1"	98-541-6	4.85
1-3/16"	98-542-4	5.85
1-3/8"	98-544-0	7.55
1-9/16"	98-545-7	8.18
1-3/4"	98-546-5	8.88
2"	98-547-3	11.25

COOK 100% POLYURETHANE ONE PIECE DEAD BLOW HAMMERS

- One piece construction.
- No exposed metal on handles or heads.
- No mark, no spark, complete protection and safety for machinery, product and worker.
- Trucothane™ is custom formulated to set a new standard for soft face performance and durability. Eliminates mushrooming, splitting, absorption of liquids, contamination and chip pickup in faces.
- Outlasts rawhide, brass, lead, nylon and other plastic type heads by 10-20 times.
- Exclusive textured, nonslip, comfort contoured handle and safety flanged butt provide sure grip and reduce worker fatigue.

Steel canister and rod are welded together for greater strength and safety

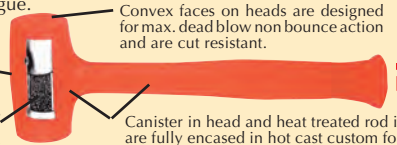

Convex faces on heads are designed for max. dead blow non bounce action and are cut resistant.

Shotfired canister provides dead blow action in head for impact, max. power & striking force.

Canister in head and heat treated rod in handle are fully encased in hot cast custom formulated Trucothane™ polyurethane

MADE IN USA

Standard Heads

Model No.	Weight Oz.	Face Diameter	Head Length	Overall Length	Reg. List	Sale Price
DBH-900	13	1-1/4"	3-1/8"	10-1/8"	\$28.70	\$22.95
DBH-901	21	1-3/4"	3-3/4"	11-1/4"	36.10	27.95
DBH-902	26	2"	4-1/8"	12-3/4"	41.95	28.95
DBH-903	45	2-1/4"	4-5/8"	14-3/8"	59.00	44.95
DBH-904	53	2-3/4"	5-3/8"	15-1/4"	81.75	69.95

Slim Heads

DBH-905	8	7/8"	2-7/8"	9-3/8"	\$26.75	\$22.95
DBH-906	18	1-1/4"	4-3/16"	10-5/8"	33.70	25.50
DBH-907	22	1-1/2"	4-1/4"	12-1/8"	36.40	28.95
DBH-908	26	1-3/4"	5-3/16"	12-3/4"	44.90	34.95

COOK HAMMER COMPANY INC.

NON-SPARKING HAMMERS BRASS & COPPER HIGH VISIBILITY YELLOW GRIP

- Non-sparking.
- Will not mark finished iron or steel surfaces.
- Premium grade A hickory handles.

MADE IN USA

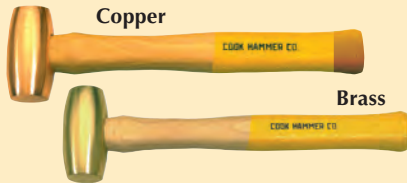

Copper

Brass

Approx. Weight	Face Diameter	Handle Length	Brass		Copper	
			Model No.	Price	Model No.	Price
1/2 lb.	1"	12"	BHC-701	\$ 19.95	CHC-801	\$ 29.95
1 lb.	1-1/8"	12"	BHC-702	24.75	CHC-802	29.95
1-1/2 lbs.	1-3/8"	13"	BHC-703	27.50	CHC-803	32.95
2 lbs.	1-3/8"	13"	BHC-704	30.50	CHC-804	34.95
3 lbs.	1-1/2"	14"	BHC-705	43.00	CHC-805	44.95
4 lbs.	1-5/8"	16"	BHC-706	55.00	CHC-806	55.00
5 lbs.	1-3/4"	16"	BHC-707	60.00	CHC-807	60.00
6 lbs.	2"	16"	BHC-708	67.00	CHC-808	67.00
10 lbs.	2"	26"	BHC-709	110.00	CHC-809	110.00

COOK HAMMER COMPANY INC.

NON MARRING LEAD HAMMERS

- Lead alloy provides the softest blow.
- Steel handles with ergonomic shur-grips.
- Excellent deadblow hammer.
- Hi-viz fluorescent orange.



Model No.	Approx. Weight	Face Diameter	Handle Length	Reg. List	Sale Price
NLH-113	1 lb.	3/4"	9"	\$22.00	\$18.95
NLH-114	2 lbs.	1-3/16"	9"	26.00	23.75
NLH-115	3 lbs.	1-5/8"	9-1/2"	29.50	27.50
NLH-116	4 lbs.	1-9/16"	9-1/2"	33.00	28.95
NLH-117	5 lbs.	1-5/8"	9-1/2"	35.00	32.50
NLH-118	6 lbs.	1-3/4"	9-1/2"	38.50	32.50
NLH-123	11 lbs.	2"	26"	62.00	52.50

SOCK-IT-OUT STRIPPED HEAD REMOVER SETS

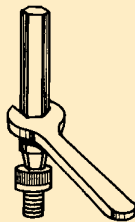
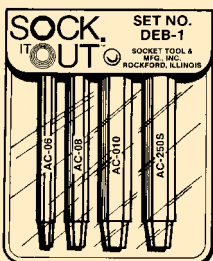

- Saves time, no more drilling out stripped Head Cap Screws-removed in seconds.
- Simply drive Socket-It-Out into Head Cap Screw with hammer until firmly wedged, grab it at bottom with wrench and turn.
- Furnished in vinyl case.

Model No.	Removes Head Cap Screws	Price Set
DEB-1	#6, #8, #10, & 1/4"	\$32.50
DEB-2	1/4, 5/16, 3/8, 7/16 & 1/2"	42.50
DEB-3	5/8" and 3/4"	32.50
DEB-4	7/8" and 1.0"	34.95

Precise POLYURETHANE DEAD BLOW HAMMERS

Features:

- Shot-loaded interior produces more driving force.
- Non-marring, non-sparking.
- Tough, durable polypropylene casing.
- Resistant to industrial chemicals.



16 oz.
No. CH-001
\$8.95

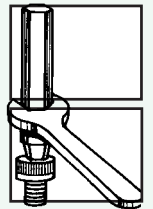

Model No.	Head Weight	Head Diameter	Handle Length	Price Each
CH-001	1 lb.	1-3/4"	11"	\$ 8.95
CH-002	1-1/2 lbs.	1-7/8"	12"	11.95
CH-200-1	2 lbs.	2-1/8"	12"	13.95
CH-003	2-1/2 lbs.	2-1/4"	12"	15.95
CH-300	3 lbs.	2-1/4"	12"	17.95
CH-400	4 lbs.	2-11/16"	12"	19.95

VAUGHAN BALL PEIN HAMMERS

Hickory Handle

- Polished face, bevel and pein.
- Other surface rust-resistant black paint.
- Compression wedged hickory handle.

Fiberglass Handle

- Striking head, cheeks and pein highly polished.
- Exclusive hollow core fiberglass handle provides better balance, absorbs shock more effectively than solid fiberglass.
- Steel wedged and epoxy sealed assembly neoprene grip.



Hickory Handles

Model No.	Head Wt. Oz.	O.A.L.	Price
150-20	2	10-1/4"	\$11.95
151-20	4	10-1/4"	11.95
153-20	8	12"	13.50
154-20	12	12-3/4"	13.95
155-20	16	13-3/4"	14.95
156-20	20	15"	14.95
157-20	24	15-1/4"	16.50
158-20	32	15-3/4"	17.50
159-20	40	16"	19.50
160-20	48	16"	23.95

Fiberglass Handles

Model No.	Head Wt. Oz.	O.A.L.	Price
161-10	8	12-1/2"	\$19.95
162-10	12	13"	19.95
163-10	16	13"	21.95
164-10	24	14-1/2"	23.50
165-10	32	14-3/4"	24.95



DEAD BLOW HAMMERS WITH POLYURETHANE PRESS FIT TIPS

- Preserves sensitive surfaces and edges.
- Increases striking power.
- Avoids hand fatigue.
- Steel head for incredible strength.
- Faces polyurethane, shatterproof, wear resistant, extremely durable.

Made In Germany



All Steel Body With Ergo Cushion Grips

Face Diameter	Head Length	Overall Length	Weight Oz.	Model No.	Steel Price
1"	4"	11.3"	18.3	80225	\$31.25
1.2"	4.5"	11.4"	20.9	80230	31.25
1.4"	4.6"	11.8"	24.9	80235	33.15
1.6"	4.9"	12.0"	29.9	80240	37.25
1.8"	5.1"	12.2"	37.3	80245	41.50
2.0"	5.1"	14.4"	49.4	80250	49.85
2.3"	6"	14.7"	71.6	80260	66.95
2.8"	6"	15.1"	97	80270	82.00

All Steel Head With Hickory Handles

Face Diameter	Head Length	Overall Length	Weight Oz.	Model No.	Hickory Price
1"	4"	12.5"	18.3	80025	\$27.15
1.2"	4.5"	13.7"	20.9	80030	27.15
1.4"	4.6"	13.9"	24.9	80035	27.15
1.6"	4.9"	14.7"	29.9	80040	31.30
1.8"	5.1"	14.9"	37.3	80045	36.45
2.0"	5.1"	15.1"	49.4	80050	41.30
2.3"	6"	16.5"	71.6	80060	58.75
2.8"	6"	16.9"	97	80070	70.50

Replacement Tips Medium/Hard

Face Diameter	Model No.	Price Each	Face Diameter	Model No.	Price Each
1"	80200	\$4.50	1.8"	80208	\$ 7.00
1.2"	80202	4.70	2.0"	80210	8.00
1.4"	80204	5.50	2.3"	80213	11.00
1.6"	80206	6.25	2.8"	80216	13.50



SLEDGE HAMMERS

- Unbreakable Handle Technology and steel core design prevents breaking during overstrikes.
- Hi-Vis Green easily identifiable on jobsite and Flat Head to stand upright for easy reach.
- Safety plate locks head firmly to handle eliminating head dislodging.
- Non-slip grip textured handle and Lanyard Hole to safely secure sledge to your wrist.
- Anti-Vibe neck ergonomically designed to prevent injury from repeated jobsite use.
- **Soft Face Head** designed to mushroom when striking hard base materials.



Sledge Hammer

Model	Description	Price
20212-1	2-1/2 lb. Head, 12"	\$ 38.95
20412	4 lb. Head, 12"	42.95
20424	4 lb. Head, 24"	63.95
20624	6 lb. Head, 24"	59.95
20630	6 lb. Head, 30"	65.00
20636	6 lb. Head, 36"	68.00
20816-1	8 lb. Head, 16"	74.95
20830-1	8 lb. Head, 30"	75.00
21016	10 lb. Head, 16"	89.95
21024	10 lb. Head, 24"	83.50
21030-1	10 lb. Head, 30"	86.00
21036	10 lb. Head, 36"	94.50
21230	12 lb. Head, 30"	99.50
21236	12 lb. Head, 36"	105.00
21424	14 lb. Head, 24"	121.95
21430	14 lb. Head, 30"	108.00
21436	14 lb. Head, 36"	115.00
22024-1	20 lb. Head, 24"	169.95
22030-2	20 lb. Head, 30"	174.95
22036-1	20 lb. Head, 36"	145.00

Soft Face Sledge

Model	Description	Price
40212	2-1/2 lb. Head, 12"	\$ 34.95
40416	4 lb. Head, 16"	46.95
40624	6 lb. Head, 24"	62.00
40636	6 lb. Head, 36"	68.50
40824	8 lb. Head, 24"	70.00
41036	10 lb. Head, 36"	94.50
41236	12 lb. Head, 36"	105.00
41436	14 lb. Head, 36"	115.00

Cross Pein

Model	Description	Price
30216	2 lb. Head, 16"	\$ 44.95
30316	3 lb. Head, 36"	49.95
32414	24 oz. Head, 14"	37.50
33214-1	32 oz. Head, 14"	42.00
34014	40 oz. Head, 14"	48.00

Ball Pein

Model	Description	Price
32414-1	24 oz. Head, 14"	\$ 34.95
33214-2	32 oz. Head, 14"	40.95
34014-1	40 oz. Head, 14"	46.95



DEAD BLOW HAMMERS

The Original American Made Dead Blow Hammers

- One Piece Urethane Construction.
- No Exposed Metal on Handles or Heads.
- No Mark, No Spark, Completely Formulated to Set a New Standard for Soft Face Performance and Durability. Eliminates Mushrooming, Splitting, Absorption of Liquids, Contamination and Chip Pick-up in Faces.
- Outlasts Rawhide, Rubber, Brass, Lead, Nylon and Other Plastic Type Heads by 10-20 Times.
- Exclusive textured, nonslip, comfort contoured handle & safety flanged butt provide sure grip and reduces worker fatigue.
- Hot cast urethane is 4 times more cut resistant than injection molded and nylon materials.



Standard Soft Face Series "TSS"



Model No.	Weight lbs.	Head Diameter x Length	Overall Length	Head Type	Price Each
TSS-000	0.8	1-1/4" x 3-1/8"	10-1/8"	Standard	\$19.95
TSS-001	1.31	1-3/4" x 3-3/4"	11-1/4"	Standard	23.95
TSS-002	1.625	2" x 4-1/8"	12-3/4"	Standard	26.95
TSS-003	2.81	2-1/4" x 4-5/8"	14-5/8"	Standard	36.95
TSS-004	3.31	2-3/4" x 5-3/8"	15-1/4"	Standard	49.95
TST-000	.5	7/8" x 2-7/8"	9-3/8"	Slimline	\$18.95
TST-001	1.112	1-1/4" x 4-3/16"	10-5/8"	Slimline	21.95
TST-002	1.375	1-1/2" x 4-1/4"	12-1/8"	Slimline	24.95
TST-003	1.625	1-3/4" x 5-3/16"	12-3/4"	Slimline	28.95
TST-004	2.0	1-3/4" x 8-1/2"	12-3/4"	Slimline	35.95
TBP-016	1.625	1" x 4-3/16"	12-3/4"	Ball Pein	\$39.95
TBP-024	2.25	1-1/4" x 4-1/2"	13"	Ball Pein	47.95
TBP-032	2.937	1-3/4" x 4-13/16"	13-5/8"	Ball Pein	57.95
TBP-040	3.12	1-3/4" x 4-13/16"	14-13/16"	Ball Pein	65.00
TSH-007	5.5	2-3/4" x 7"	20"	Sledge	\$74.95
TSH-010	9	2-3/4" x 7"	30"	Sledge	105.00
TSH-012	10.5	3-1/4" x 8"	30"	Sledge	145.00
TSH-014	12	3-1/4" x 8"	36"	Sledge	165.00
TBM-001	1.5	2-5/16" x 5"	13"	Bossing	\$42.95
TBM-002	2.3	2" x 6.875"	12"	Bossing	47.95
TBM-003	3	2-11/16" x 8"	14"	Bossing	57.95



B.A.S.H. SPLITTING MAULS UNBREAKABLE TECHNOLOGY

1. **Unbreakable Technology:** Steel core design prevents breaking during overstrikes
2. **Safety Plate:** Locks head firmly to handle eliminating dislodging
3. **No-Slip Grip:** Textured handle for secure grip while striking
4. **Anti-Vibe Neck:** Ergonomically designed to prevent injury from repeated job site use



Model No.	Head Size	Handle Size	List Price	Sale Price
50630	6 lbs.	30"	\$126.00	\$ 79.95
50636	6 lbs.	36"	132.00	84.95
50830	8 lbs.	30"	146.00	94.95
50836	8 lbs.	36"	156.00	99.95



BRASS SLEDGE HAMMERS

- Non-sparking for use near combustible materials and non-marring to reduce work damage.



Model No.	Head Size	Handle Size	List Price	Sale Price
90212	2-1/2 lbs.	12"	\$130.00	\$ 87.00
90412	4 lbs.	12"	170.00	150.00
90416	4 lbs.	16"	190.00	120.00
90616	6 lbs.	16"	250.00	165.00



SPLIT HEAD HAMMERS WITH RAWHIDE HEADS

Split-Head Mallets

The split-head hammer does the work of live different hammers because the face can be easily changed. Five face types are available: Rawhide, copper, urethane, nylon and Gar-Dur plastic.



Supplied With Rawhide Heads



Model No.	Face Diameter	Head Length	Size	Sale Price
31001	1-1/4"	3-7/8"	1	\$38.50
31002	1-1/2"	4-1/2"	2	42.50
31003	1-3/4"	4-3/4"	3	49.00
31004	2"	5-3/8"	4	55.00
31005-1	2-3/4"	5-3/4"	5	87.00

Replacement Faces

Face Diameter	Rawhide (Soft-face provides a smooth non-marring impact)		Nylon (Med.) Hard-face used for working w/more malleable items	
	Model No.	Price Pair	Model No.	Price Pair
1-1/4"	21001-1	\$ 9.50	22001	\$ 9.50
1-1/2"	21002-1	11.50	22002	11.50
1-3/4"	21003-1	16.00	22003	13.75
2"	21004-1	19.25	22004	17.00
2-3/4"	21005-1	37.50	22005	31.00

Face Diameter	Urethane (soft) Soft-face used for striking irregular surfaces w/more rebound		Gar-DUR (Hard) Heavy-duty face for work in solvent or wet areas	
	Model No.	Price Pair	Model No.	Price Pair
1-1/4"	23001	\$ 9.25	24001	\$ 8.95
1-1/2"	23002	9.90	24002	9.95
1-3/4"	23003	10.50	24003	10.95
2"	23004	11.50	24004	13.50
2-3/4"	23005	17.00	24005	18.00



RAWHIDE MALLET

Raw Mallets

Garland's all-rawhide mallets are made of tough, long-wearing, water buffalo rawhide. They're ideal for use on broad-faced striking surfaces in a broad range of applications.

Weighted Rawhide Mallets

Weighted rawhide mallets are designed for the extra strength needed on tougher jobs. The added weight the user a heavy, balanced blow without scratching the work surface.



Rawhide Mallets

Model No.	Face Diameter	Head Length	Weight Oz.	Sale Price
GRM-000	1"	2"	2	\$11.95
GRM-001	1-1/4"	2-1/2"	4	14.95
GRM-002	1-1/2"	3"	6	16.95
GRM-003	1-3/4"	3-3/8"	9	20.50
GRM-004	2"	3-1/2"	11	24.75
GRM-005	2-3/4"	4-1/4"	22	43.50
GRM-006	2-3/4"	4-3/4"	24	49.50

Weighted Rawhide Mallets

GRM-007	1-1/4"	2-1/2"	8	\$21.50
GRM-008	1-1/2"	3"	12	22.00
GRM-009	1-3/4"	3-3/8"	16	27.00
GRM-010	2"	3-1/2"	20	31.50
GRM-011	2-3/4"	4-1/4"	40	55.00

NO-MAR PRESS-ON TIP HAMMERS

- Toughest urethane tips.
- Non rusting head, precision balanced, machined steel.
- Replaceable press-on tips also available.
- Select hickory handles.



Model No.	Head Dia.	Head Length	Handle Length	Weight Oz.	Sale Price
NMH-620	5/8"	2-1/4"	8"	3-3/4	\$19.50
NHM-621	3/4"	2-1/2"	10"	4-1/2	21.50
NHM-622	7/8"	3"	11"	5-1/2	22.25
NHM-623	1"	3-1/4"	11"	8	24.00
NHM-624	1-1/4"	3-1/4"	1"	12	25.95
NHM-625	1-3/8"	4-1/8"	13"	16	33.75
NHM-626	1-1/2"	4"	13"	20	44.50
NHM-627	2"	4"	13"	32	52.00

Replacement Tips

Model	Dia.	Price	Model	Dia.	Price
RPL-630	5/8"	\$5.25	RPL-634	1-1/4"	\$ 9.05
RPL-631	3/4"	5.85	RPL-635	1-3/8"	11.60
RPL-632	7/8"	6.15	RPL-636	1-1/2"	13.15
RPL-633	1"	7.60	RPL-637	2"	17.35

THE FRUGG DUAL PURPOSE Hammer-Steel or Brass

- Precision machined head provides excellent balance.
- Hard face and soft face in one hammer.
- Durable urethane replaceable tip.
- Brass head version is a nonsparking safety hammer.
- Steel head is heat-treated.
- High quality.



Model	Weight	Head	Price
FDP-740	16 oz.	Steel	\$34.95
FDP-741	12 oz.	Steel	32.95
FDP-742	16 oz.	Brass	39.95
FDP-743	12 oz.	Brass	37.95



POWER DRIVE DEAD BLOW HAMMERS

- Shot-loaded interior for no bounce.
- Solid fiberglass handles.
- Produces 40% more force than conventional hammers.
- Solid Nuplaglas fiberglass handle for lifetime durability.
- Resistant to chemicals.
- Nonmarring.
- Cush-N-Grip for extra nonslip comfort, chemical-resistant and weatherproof (available on 8 oz. model).



"CS" Series Cush-N-Grip

Super Grip "SG" Series



Model	Face	Head	Handle	Sale
SF-8CS	1"	8 oz.	9-1/2"	\$24.95
SF-1CS	1.6"	1 lb.	11"	26.95
SF-2CS	2"	2 lbs.	12"	33.50
SF-3CS	2-1/2"	3 lbs.	12"	41.00
SF-4CS	3"	4 lbs.	13"	55.00
SF-TSG	1.6"	1 lb.	11"	\$26.95
SF-2SG	2"	2 lbs.	12"	34.50
SF-3SG	2-1/2"	3 lbs.	12"	45.00
SF-4SG	3"	4 lbs.	13"	59.50

Starrett TOOLMAKERS

HAMMER WITH MAGNIFYING LENS

- Faster, easier and more accurate spotting and punching of centerlines and intersections.
- A magnifying lens built into the head of the hammer eliminates the usual fumbling and looking away involved when a separate glass and hammer are used.



4 Oz.

MODEL No. 815
Reg. \$82.00

\$74.95



CLAMP MFG. NO-MAR SCREW-ON TIP HAMMERS

- Hammer holders with zinc or aluminum heads are available.
- Replaceable screw-on tips. (See section below).
- Order with fiberglass handle with synthetic grip or select hickory wood handle.
- Meets all government specifications.



Hammers Include Green and Red Tips



Model No.	Head Diameter	Head Length	Handle Length	Sale Price
NMH-641	1"	3-1/2"	11"	\$24.95
NMH-651	1-1/2"	4-1/2"	12"	28.95
NMH-661	2"	5"	13"	38.95

Extra Interchangeable Tips

Model No.	Head Diameter	Color Type	Price Each
EHT-645	1"	Green (Tough)	\$4.55
EHT-646	1"	Red (Medium)	4.55
EHT-647	1"	Brown (Soft)	4.55
EHT-648	1"	Cream (Med. Hard)	5.25
EHT-649	1"	Black (Hard)	5.25
EHT-655	1-1/2"	Green (Tough)	\$5.65
EHT-656	1-1/2"	Red (Medium)	5.65
EHT-657	1-1/2"	Brown (Soft)	5.65
EHT-658	1-1/2"	Cream (Med. Hard)	7.90
EHT-659	1-1/2"	Black (Hard)	7.90
EHT-665	2"	Green (Tough)	\$8.20
EHT-666	2"	Red (Medium)	8.20
EHT-667	2"	Brown (Soft)	8.20
EHT-668	2"	Cream (Med. Hard)	12.10
EHT-669*	2"	Black (Hard)	11.90

*Nylon

STANLEY TINNERS RIVETING HAMMER

- Polished heads with Rim Tempered face.
- Selected clear laquered hickory handles.



Model No.	Weight Oz.	O.A. Length	Sale Price
54-462	12	13"	\$29.95
54-463	16	14"	32.50

ABBOTT PURE ALUMINUM HAMMERS

- The Abbott Pure aluminum Hammer replaces old-fashioned lead hammers. Made of certified pure aluminum, the Abbott soft hammer is non-contaminating on exotic high temperature metals. One-piece poured construction guarantees safety. No "flying off the handle". Non-sparking. May be placed on any machine or part without marring or contaminating.
- The hammers are non-sparking, non-marring and have excellent vibration dampening characteristics that allow the handle to absorb impact forces instead of your hand.



MADE IN USA

Model	Weight	Length	Alloy	Price
PAH-000	1.4 lbs.	12"	A100 Aluminum	\$18.95
PAH-001	1.8 lbs.	12"	A100 Aluminum	19.95
PAH-002	3.3 lbs.	13"	A100 Aluminum	34.50
PAH-005	9.1 lbs.	22"	713 Tenzaloy	105.00
PAH-010	16.3 lbs.	29"	713 Tenzaloy	149.50

SHOPAID INCORPORATED

SHIM PUNCH SETS

1/8" to 3/4" and 3.5mm to 19.5mm

- The Shim Punch Set provides accurate replacement parts for a variety of uses in seconds for only pennies.
- By simply inserting stock into the punch set and driving the correct size punch through your stock, you can punch holes in nine different sizes from 1/8" to 3/4" diameter in standard and 3.5 to 19.5 in metric.

The Capabilities Include Punching • Tempered Stainless Steel • Shim Stock • Cork • C.R.S. • Rubber Gasket Material • Material .002" to .025" thick



1/8" to 3/4"
SET No.
40PS-9

\$99.95

MADE IN USA

Precise WHITNEY TYPE METAL HOLE PUNCH

- Easy, smooth operation.
- Sizes: 3/32", 1/8", 5/32", 3/16", 7/32" 1/4", and 9/32".
- Complete set with 7 die/punch sets. Punches and dies are hardened to C50-52.
- Punches up to 16 gage steel



SET No.
PHP-268

\$39.95

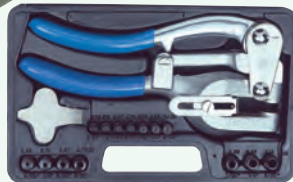

Precise COLLAPSIBLE DOCUMENT STAND

- Collapsible Document Stand
- Holds blueprints, drawings and other papers firmly and neatly.
- Attaches to any toolbox, work bench or desk.
- Equipped with 100 lbs. of magnetic holding power with just four small magnets.
- Made of sturdy, corrosion resistant plated steel.



MODEL NO.
CDS-950
REG. LIST
\$39.95

\$19.95

SAVE
50%



Precise BALL PEIN HAMMER SET & RUBBER Mallet SET

5 Piece Ball Pein Set

- Drop forged head, fiberglass handle and rubber grip.
- Sizes: 8 oz., 12 oz., 24 oz., 16 oz. and 32 oz.



5 PIECE SET
Fiberglass Handle
With Rubber Grip
8oz., 12oz., 16oz.,
24oz., 32oz.

SET No.
BHP-274-1

\$39.95

Rubber Mallet Set

- 4 piece set includes: 32 oz.-203/4" face, 24 oz.-2-1/2" face, 16 oz.-2-3/8", 8 oz.-2" face.
- Solid non-vibrating fiberglass handle with rubber grip.



4 PIECE SET
Rubber Mallet Set
SET No.
RMS-059

\$14.95

GRIP

22-Pc. MECHANIC HI-VIS SCREWDRIVER SET.

- Heavy duty mechanics handle for sure grip.
- Chrome Vanadium steel blades.

Set Includes:

- 9 slotted and 5 Phillips screwdrivers.
- 5 Torx drivers.
- Scratch awl.
- Slotted screw driver with screw holder.
- Tack puller



MODEL No.
SS-262

\$14.95

GATCO SHARPENERS

KNIFE SHARPENING SYSTEM

Innovation . . . Precision . . . 100% Guaranteed

- These sharpeners utilize a specially engineered clamp to hold the knife and provide you with six distinct and precise angles for sharpening (11, 15, 19, 22, 25 and 29 degrees).
- The knife clamp and angle guide used in conjunction with our superior abrasive grains combine to provide the most effective of sharpening instruments.

- Guaranteed to produce superior razor-like edges on all your sporting, kitchen and utility cutlery.
- Used in conjunction with our serrated knife blade hone, it will be your most versatile sharpening tool.



3-Stone
System
MODEL No.
10003
Reg. \$39.95

\$32.95

No. 10005
Illustrated

5-Hone
system
includes
serration

MODEL No.
10005
Reg. \$59.95

\$41.95



GATCO SHARPENERS

DIAMOND POCKET HONES

- Durable - Diamond is the hardest material in existence.
- Fast - Diamonds are the fastest cutting abrasive in the world.

- Ease of use - Simple design and fast cutting crystals sharpen quickly.

- Versatile - Gatco diamond technology solves the most difficult industrial, commercial and D-I-Y sharpening, deburring and stock removal challenges.

- Clean - can be used dry for increased neatness.

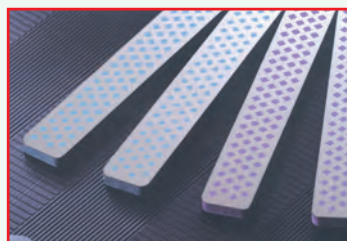

Model	Grit	Price
16006	Course mesh	\$18.95
16007-1	Medium mesh	Each
16008-1	Fine mesh	

GENERAL

CIRCLE CUTTERS

- These tools have been a General Hardware customer favorite for more than 30 years.
- Adjusts from 1" to 6" diameter circles.
- Replaceable 3/16" high speed steel bit and replaceable 1/4" pilot drill.
- Square shank circle cutter No. 5A conforms to government specifications GGG-C748b.

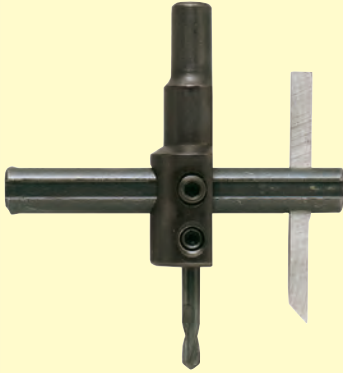

Model	Range	Shank	Price
004	7/8"-4"	Round & Square	\$13.95
005B	1"-6"	3/8" Round	19.95

HEAVY DUTY CIRCLE CUTTER

- General's industrial quality cutter is most preferred by professional craftsmen.
- 1/2" round shank for drill press use.
- Replaceable 1/4" high speed steel tool bit and replaceable 1/4" pilot drill.

MODEL 055

\$28.95



Capacity 1-3/4"-8"

WHEEL & CIRCLE CUTTER

- General's wheel and circle cutter is the only one that cuts the exact diameter you need anywhere from 1" to 6".
- Produces precision circles and holes in sheet metal, brass, copper, aluminum, plastic, wood and composition materials.
- Change from circle to wheel cutting by simply reversing the double ended blade.
- Sturdy round shank for use in any drill press or drill stand with 3/8" chuck. Maximum safe speed is 250 RPM.

MODEL 006

\$29.95



GENERAL

WASHER & GASKET CUTTER

- This tool cuts washers and gaskets in leather, rubber, cork, graphite, fiber, copper and other soft materials.
- Combination round and square shank permits use with bit brace or hand drill.
- Made of steel with graduated beam to adjust to diameters from 1/2" to 6-1/2".
- Replaceable tool steel cutter blades no. 11B and center pilot pin.
- Two independently adjustable cutter blades cut inside and outside diameters simultaneously. MODEL 011

Capacity 1/2" to 6-1/2"

\$26.95



PRECISION ADJUSTABLE TRAMMELS

- Draw large circles and measure sizable distances with the accuracy of a divider.
- Fine adjustable screw sets points accurately.
- Points are removable and may be replaced with the pencil holder which is securely fastened to the beam provided.
- Die cast bodies with hardened and ground 3" needlepoint legs.
- Clamp opening for beam is 3/8" x 3/4".



MODEL 520-1

\$36.95

PRECISION TRAMMEL SET

Will accurately transfer measurements, scribe arcs, and lay out circles too large for conventional compasses.

- Will fit any scale 1/2" to 1-1/8" wide.
- Two scriber points and two pencil points included.
- Up to four points can be stored in body.
- Free-wheeling thimble for greater precision.
- Aluminum knurled body.
- Steel collet holds replacement leads, scribes and crayons.
- Points reverse into body for safety.

SET NO. 524

\$19.95

Less Ruler



GENERAL

LIGHTED SCREWDRIVER SET

- Rotating cap: facets fits palm, recess fits finger tips.
- Push On /Push Off powerful LED light.
- Non-slip cushion grip.
- Oxide blades are rust and corrosion resistant.
- Hard rubber bit organizer.

Set Includes:

- 1 Multi-blade handle
- 3 Reversible blades
- Slotted: 3/32", 1/8"
- Phillips: #000, #00
- Torx: T5, T6
- 3 "LR44" batteries



MODEL No. 1700

List \$12.95

\$10.95



UNIVERSAL TRANSFER PUNCH 3/16" THRU 3/4"

- Will transfer an amazing total of 67 different hole sizes in the 3/16" - 3/4" range of the tool.
- Now you can transfer all fraction, number, letter-threaded, drilled reamed-hole sizes, assuring perfect alignment.
- Made of steel 1" diameter, knurled for positive finger grip, sliding punch 3/16" diameter, 3" long.
- All working parts are properly hardened for long life.
- Easy to use, self-centering locating sleeve enables quick and accurate transfer of any hole.

MODEL UTP-011

\$6.95



CENTER PUNCH WITH MAGNIFIER

- Made of special steel, hardened and black anodized
- 4" length.
- Displaceable 1/2" diameter magnifier, 3X magnification.

MODEL CPM-262

\$6.95



GENERAL

JEWELER'S SCREWDRIVERS

- For jewelers, instrument makers, sub miniature parts assemblers, and model makers.
- Nickel plated screwdriver bodies with swivel heads.

SIX PIECE SET

- Nickel plated blade sizes: .100", .080", .070", .055", .040", .025".
- Screw chucks have identification rings showing blade size.
- Overall length 3-7/8".



MODEL SPC-600

With Plastic Case

\$22.95

FIVE PIECE SCREWDRIVER SET

- One nickel plated body with screw chuck and five interchangeable blades.
- Four polished tempered steel straight blades and one crosspoint blade.

MODEL S-605

\$7.95



SWIVEL VACUUM VISE

- This popular vise grips firmly to glass, metal, formica, fiberglass, or any smooth, non porous surface with quick lever action.
- Universal ball joint swivels 360 to any position and tilts 90 to an y angle.
- V-grooved replaceable hardened steel jaws are 3" wide and open to 2-5/8".
- Furnished with slide on rubber jaws for fragile work.

MODEL 1850

\$59.95



Model	Base	Height	Price
1850	6-1/4"	6-1/4"	\$59.95
Replacement Parts			
1857	Steel Jaws		\$4.50
1858	Rubber Pad		4.75

DUMONT SWISS TWEEZER Non-Magnetic ~ Anti-Acid ~ Stainless Steel

- Handles are covered by an insulating, non skid, wear and shock resistant material in specially chosen aesthetically pleasing color.
- Manufactured to highest quality and precision.



Swiss Made

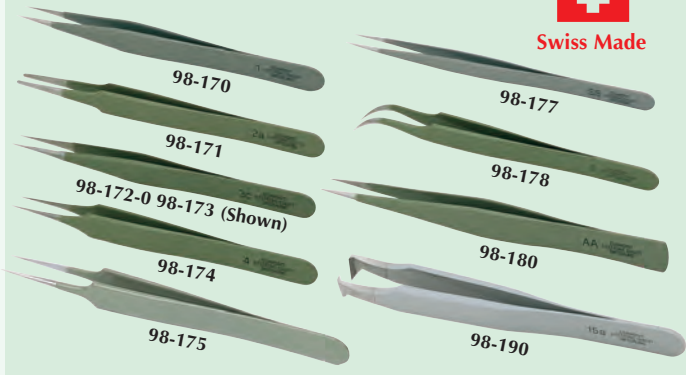

Model	Style	Length	Usage	Price
98-170	1	4-3/4"	For general use, assembly sorting, etc. Sharp, Strong and plain points	\$27.50
98-171	2a	4-3/4"	For wafer handling. Strong assembly tool. Flat but round-off points	19.50
98-172	3	4-3/4"	For smaller parts and components. Fine point to increase sensitivity	23.00
98-173	3C	4-1/4"	Shorter version of style 3	23.50
98-174	4	4-1/4"	For microscopic size parts. Extra fine, needle-like, honed points	25.50
98-175	5	4-1/4"	For use on very delicate parts. Finest of all tweezers	26.00
98-177	SS	5-1/2"	Ideal assembly tool for hard to reach places. Fine sharp points, slim & long	18.50
98-178	7	4-1/2"	To reach spots where straight tweezers cannot be used. Fine sharp points	25.50
98-180	AA	5"	Boley Style - ideal for assembly, strong and very precise	17.50
Cutting Tweezer • Carbon Steel				
98-190	15A	4-1/2"	Cuts copper & soft wire of .20" dia. Flush cut, oblique head	\$95.00

ABRASIVE ROTATING SANDING STICK 7 Grits - Color Coded

- Developed for technicians, machinist, hobbyist or anyone who needs to finish those detailed or hard-to-reach surfaces.
- Made of a high impact chemical resistant material. Its unique design allows the user to rotate the abrasive belt 360 degrees for its complete and economical use.

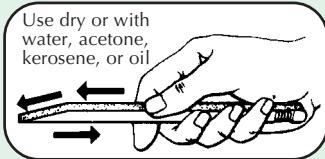

COMPLETE WITH ONE BELT 1/4" WIDE x 6" LENGTH				ABRASIVE BELTS 1/4" WIDE x 6" LENGTH			
Model	Grit	Color	Price	Model	Grit	Price	
ARS-200	80		\$2.95	ARB-100	40	\$.75	
ARS-001	120	Red	2.95	ARB-200-1	80	.75	
ARS-002	240	Blue	2.95	ARB-017	120	.75	
ARS-003	320	Green	2.95	ARB-018	240	.75	
ARS-004	400	Yellow	2.95	ARB-019	320	.75	
ARS-005	600	Black	2.95	ARB-020	400	.75	
ARS-006	Set of All 6		\$16.50	ARB-021	600	.75	
1/2" WIDE x 8" LENGTH				ABRASIVE BELTS 1/2" WIDE x 8" LENGTH			
ARS-007	120	Red	\$3.65	ARB-022	120	\$1.15	
ARS-008	240	Blue	3.65	ARB-023	240	1.15	
ARS-009	320	Green	3.65	ARB-024	320	1.15	
ARS-010	400	Yellow	3.25	ARB-025	400	1.15	
ARS-011	Set of All 4		\$12.95				
3/4" WIDE x 10" LENGTH				ABRASIVE BELTS 3/4" WIDE x 10" LENGTH			
ARS-012	120	Red	\$4.50	ARB-026	120	\$1.30	
ARS-013	240	Blue	4.50	ARB-027	240	1.30	
ARS-014	320	Green	4.50	ARB-028	320	1.30	
ARS-015	400	Yellow	4.50	ARB-029	400	1.30	
ARS-016	Set of All 4		\$14.75				

Spring tension on belt allows easy rotation, removal & replacement.

GENERAL ULTRATECH TOOL SYSTEM SETS

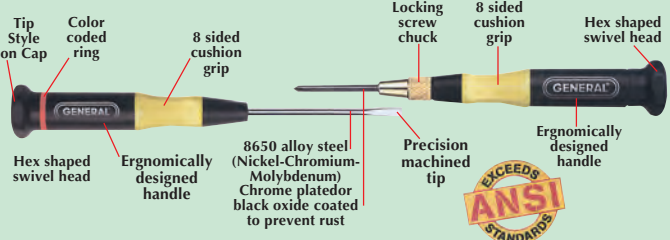

18-Pc. PRECISION ULTRATECH SCREWDRIVER SET

Slotted 3/64", 1/16", 5/64", 3/32"

Phillips #000, #00

Torx T6, T7, T8, T9

Hex .050", 1/16", 5/64"

Nut-Drivers 3/32", 1/8", 5/32"

Awl/Scriber

SET No. 63518B

\$34.00

GENERAL 7-Pc. SCREWDRIVER SET

1/16 3/32 1/8 #00 #0 #1 T6

SET No. 67123

\$24.00

5-Pc. TORX SCREWDRIVER SET

T6 T7 T8 T9 T10

SET No. 711

\$24.00

GENERAL 8-Pc. TORX SCREWDRIVER SET

T6 T7 T8 T9 T10 T15 T20

SET No. 67308

\$26.50

GENERAL 8-Pc. NUT DRIVER SET

5/64", 3/32", 1/8", 5/32", 3/16", 7/32", 1/4"

SET No. 67508

\$32.50

GENERAL 8-Pc. BALL HEX DRIVER SET

.050", 3/32", 9/64", 1/16", 7/64", 5/32", 5/64", 1/8"

SET No. 56748

\$22.00

GENERAL 5-IN-ONE MULTI-BIT PRECISION

T6" 1/16" 5/64" 3/32" #00

SET No. 735

\$10.25

GENERAL 5-Pc ESD SCREWDRIVER SET

3/32" 1/8" #00 #0 #1

Electro-Static Dissipating Screwdrivers, safely take static electricity away from the work place.

SET No. 713

\$34.50

GENERAL

3-PIECE PROBE

For probing, cleaning, picking, or marking small work surfaces.

- Three heat treated, high carbon steel point configurations: 45 degree, double bend, and hook bend.
- Extra long aluminum knurled body.
- Hex head prevents rolling.
- Overall length 6-1/2".



MODEL 862

\$8.75

ADJUSTABLE TOOL/FILE HANDLE

- For holding files, reamers, hacksaw blades and other tang handles tools.
- Exclusive steel parallel clamping jaws grip the entire length of the inserted tang to prevent slipping.
- Large, quick adjusting knurled knob ensures positive locking.
- Rustproof handle with steel parts.
- Conforms to government specifications NN-H0085.



MODEL No. 890

\$6.50

TRIANGULAR SCRAPER

- Hardened and tempered triple edge blade is secured in wood handle with steel ferrule.
- Hollow ground cutting edges stay sharp longer & resharpen easily.

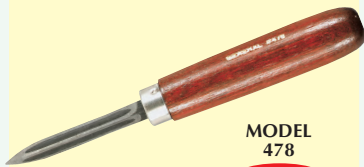

MODEL 478

\$9.95

BULLS EYE LEVEL

- A circular, all directional level made of unbreakable acrylic plastic.
- For leveling machines, hi-fi equipment, pool and game tables, electric appliances and many other items which must be level to give their best performance.



MODEL No. 847

\$4.95

GENERAL

SIX PIECE CARVING SET

- Blades are made of high grade tool steel hand forged for long lasting sharpness.
- Blades are hardened and ground.
- Each tool measures 6-1/4" and has a straight style hardwood handle.
- In vinyl case, with honing stone.



MODEL No. 1290

\$56.95

Blade Shape

- Bent large gouge, 5/16"
- Straight small gouge, 5/32"
- Straight square chisel, 5/16"
- Bent V parting tool, 5/16"
- Straight skew chisel, 5/16"
- Bent square chisel, 5/16"

FIVE PIECE CARVING SET

- Five different blade shapes.
- Blades are made of hand forged tool steel and ground and hardened for lasting sharpness.
- Half round palm style handles are made of hardwood.
- In vinyl case, with honing stone.
- Overall length 5".



MODEL No. 1293

\$49.95

Blade Shape

- Bent large gouge, 5/16"
- Straight small gouge, 5/32"
- Bent V parting tool, 5/32"
- Straight skew chisel, 5/16"
- Bent square chisel, 5/16"

SPRING CLAMPS

- For firmly holding together parts when gluing or fastening.
- Made of zinc plated steel with heavy duty tension spring.



Model No.	O.A. Length	Spring Capacity	Price Each
892-A	4"	1"	\$1.55
892-C	9"	3"	4.95

TWEezer MAGNIFIER

- A useful tool for detailed projects.
- It is equipped with a 5 power lens, stainless steel tweezers and a double hinged adjustable arm.
- The handle and frame are made of durable plastic.



MODEL No. 425

\$6.45

GENERAL

PRECISION TWEEZERS

For electronic, computer instrument, radio and other small or subminiature assembly, servicing and repairs.



Precision Boley Style
Nickel Plated Steel

Model	Style	Length	Price
401-AA	AA-Strong bevel points	5"	\$6.95
401-MM	MM-Very fine points	5"	6.95

Swiss Dumont Style
Stainless Steel

Model	Style	Length	Price
423-3	3-Very fine points	4-5/8"	\$10.95
423-3C	3C-Very fine points	4-1/8"	10.95

TWEezer SETS SIX PIECE

- Consists of six nickel plated steel tweezers for home and industrial use.
- One each of Nos. 401XX, 403, 412, 414, 415, 417.
- In clear vinyl pouch.



MODEL No. C421

\$34.95

Precise MAGNETIC BASE COOLANT HOSE ASSEMBLY

- 110 Lbs. magnetic pull.
- Two 1/4" diameter flexible coolant hoses. Either one can be shut off.
- On/Off switchable magnetic base.

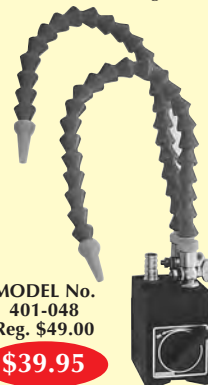

MODEL No. 401-048

Reg. \$49.00

\$39.95

GENERAL

UTILITY TWEEZERS

Utility nickel plated steel tweezers for mechanics, craftspeople and hobbyists.



414

415

416

Model	Style	Length	Price
414	Blunt serrated (self closing)	6-1/2"	\$6.50
415	Curved	6-1/2"	7.50
416	Spade	4-1/2"	3.25

GENERAL

INDUSTRIAL TWEEZERS

Nickel plated tweezers for toolmakers, repairmen, electronic assemblers and other professionals.

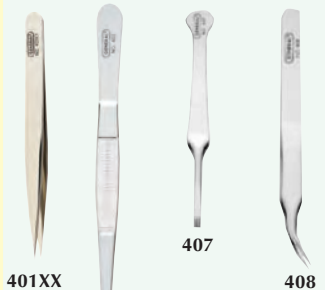

401XX

407

408

403



410

411

412

413

Model	Style	Length	Price
401XX	Strong sharp	4-1/2"	\$6.95
403	Blunt serrated	6"	5.95
407	Blunt (soldering)	4"	3.95
408	Sharp bent	4-1/4"	5.95
410	Narrow sharp	4-1/4"	4.95
411	Sharp (self-closing)	4-3/4"	4.95
412	Blunt (side lock)	6-1/2"	6.25
413	Sharp	4-1/2"	4.50

PRO GAUGE MAGNETIC PAINT THICKNESS GAUGE

- ProGauge II is a magnetic coating thickness gauge that measures the thickness of nonferrous coating on steel with a range of 1 to 15 mils or B model 0-35 microns.
- The most popular paint gauge in history.
- Know when panels are repainted; know when paint is too thick or thin.
- Easy to use: just place on paint, read scale as gauge is pulled off the paint.
- Includes heavy duty case and instruction book complete with information on automotive paint thickness and factory specifications.



1 to 15 Mil
MODEL No.
2438

\$59.95

0 to 350
Microns
MODEL No.
2438B

\$63.95

PRO PREPPEN

Adjustment Sanding Pen

- Save time and money by replacing folded sandpaper with PrePen.
- Scuff, sand degloss, clean. Faster, easier and saves money.
- Won't scratch glass or chrome.
- Reach where sandpaper can't.
- Also great for removing rust from paint chips or tight spots.
- Cleans electrical connectors too.
- Comes with extra long-lasting refill cartridge inside handle.



Single
Pre-Pen
MODEL 3437

\$6.95
Each

DRIVE SOCKETS - TWO SIZES FITS ALL

Socket Instantly Adjusts To Grip Hex Nuts, Screw Eyes, Hooks, Lag Screws Bolt heads, Stripped Nuts and Fasteners

2 Size Fits standard 1/4" - 1-1/4", Metric 7-32mm, Nuts & Bolts

- Gator Grip does the work of many tools...replaces both metric and standard sockets and wrenches, replaces pliers, locking pliers and adjustable wrenches.
- Unique design...54 steel rods automatically adjust to grip hex nuts, wing nuts, square nut, cup hooks, eye screw, lag screws, even removes broken and rusted nuts.



3/8" Drive
Socket Fits Any
1/4"-3/4",
7-19mm Nut or
Eye Bolt Head
ORDER No.
ETC-120

\$12.95

1/2" Drive
Socket Fits Any
7/16"-1-1/4",
11-32mm Nut or
Bolt Head
ORDER No.
ETC-125

\$29.95

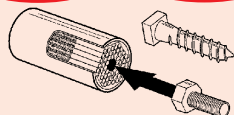

FLEXBAR OR Precise SELF-ALIGNING 0 TO 1/2" HANDTAPPER & REAMER GUIDE

- Accurate, economical, time saving.
- Aligner automatically squares up the tap or reamer with the surface.
- Holds tap and reamer true, preventing breakage.
- Hardened jaws. When changing jaws, housing slots serve as wrench for closing sleeve.
- 3/8" diameter x 1/2" stem for chucking alignment.
- Center drill on stem for floating center.
- Slip-fit T-wrench made of steel, finish ground all over.
- Base of guide has two 120° Vees, which also accepts round parts.



MADE IN
USA

MODEL No.
HT-365

\$49.95

IMPORT
Precise
MODEL No.
100-365

\$19.95



GENERAL ALL AMERICAN TOOL KIT

- General's best-selling tools in a handy pocket sized kit.
 - Pocket flap is imprinted with full color American Flag.
 - Made in U.S.A.
- Includes:
- 1) 6" Flex scale with depth & pocket clip.
 - 1) 383X, telescoping magnetic pickup.
 - 1) 7, automatic center punch.
 - 1) 88 scriber.
 - Vinyl, snap-close pocket protector.

SET No.
S008
Reg. \$30.50

\$24.95



Precise 5 Pc. APPRENTICE MEASUREMENT SET

- Consists of 1 each:
- 6" outside caliper
 - 6" spring divider
 - 6" inside caliper
 - 6" inch/mm pocket rule
 - 5" Vernier caliper

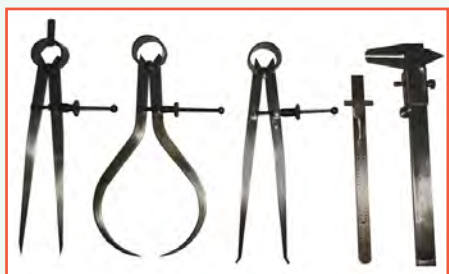

MODEL No.
AMS-001

\$12.95



VERSA-HOOK™ MAGNETIC HOOK HOLDER PLUS AGD DIAL INDICATOR ADAPTER

- Powerful 2-1/4" magnet with 5/16" hook holds tools, air hose, utility lights and much more.

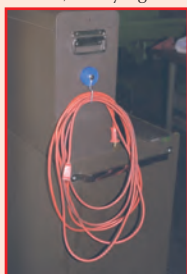

SET No.
VEH-203

\$12.95

Sopko Style GRINDING WHEEL ADAPTER

- Hardened and ground.
- Heat treated nuts.
- 1" diameter at large end of taper.
- For 1-1/4" I.D. wheels.



Model	Wheel Width	Thread	List	Sale
2420-0320	1-4 - 3/4"	1-1/4" - 16(LH)	\$48.00	\$39.95

Tatung-Okuma GRINDING MACHINE WHEEL ADAPTER

- Hardened and ground.
- Heat treated nuts.
- For 1-1/4" I.D. wheels.
- Wheel width capacity: 1/4 to 3/4"
- 1" diameter at large end of taper hole 1-1/4"-16 thread.
- Adapter O.D.: 3"
- Heat treated and precision ground.
- Balance adjustable.



Model	Wheel Width	Thread	List	Sale
2420-0350	1-4 - 3/4"	LH	\$68.00	\$49.95

GENERAL

TUBING CUTTERS

- General's full range of cutters makes the job easier to do for the professional plumber as well as the do-it-yourselfer.
- Each of our cutters produces clean, precision cuts on copper, aluminum, and thin wall tubing.
- Sizes range from 1/8" to 1-1/2" capacity.
- One size replaceable wheel fits all cutters.

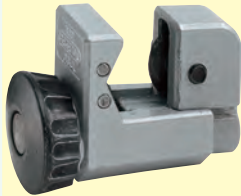

MODEL No. 123R
\$9.95
1/8" to 5/8" Capacity

STANDARD CUTTERS

- Anti friction flare groove rollers allow you to cut tubing close to the flared ends, thus avoiding tubing replacements in existing installations.
- Hardened steel reamer slides and locks in place.
- Reamer retracts for safety when not in use.
- Replaceable hardened alloy steel cutting wheel.

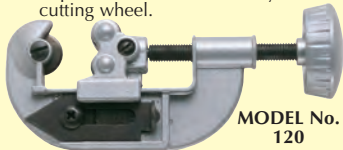

MODEL No. 120
\$10.95
1/8" to 1-1/8" Capacity

ENCLOSED FEED CUTTER

- Feed is enclosed to keep tool size consistent for work in confined spaces.
- Enclosed threads seal out dirt.
- Flare groove rollers.
- Hardened steel retractable reamer with built-in gas bottle wrench.
- Replaceable alloy steel cutter wheel plus extra cutter stored in large feed knob.



MODEL No. 128
\$21.50
1/8" to 1-1/8" Capacity

HEAVY DUTY CUTTER

- Designed for heavy duty and industrial application.
- Twin hardened flare groove rollers.
- Double retractable tool steel reamer.
- Replaceable hardened alloy steel cutting wheel.



MODEL 125
\$17.95
1/4" to 1-1/2" Capacity

REPLACEMENT WHEELS

- Hardened alloy steel wheel fits all General tubing cutters.

MODEL No. RW121
\$3.95
Each



GENERAL

STANDARD FLARING TOOL

- Screw yoke slips quickly over bars without removing heavy duty wing nuts.
- Quick opening plated bars for easy insertion and removal of tubing.
- Screw yoke has free wheeling cone for faster, smoother flaring.
- Sliding T-handle provides maximum leverage.



MODEL No. 155
\$32.50

Capacity:
3/16", 1/4", 5/16",
3/8", 7/16", 1/2", 5/8"

TUBING BENDERS

- These tools eliminate crimping and collapsing of copper and other thin wall tubing.
- Set consists of one each tube size: 1/4", 5/16", 3/8", 7/16", 1/2" and 5/8" by 11" long.

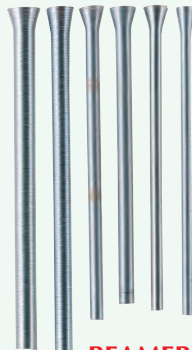

MODEL No. S106
\$9.95
Complete Set of 6

REAMERS

- Made of hardened and tempered tool steel with precision ground cutting edges.



T-HANDLE TYPE MODEL 130
\$16.95
1/8" To 1/2"

SCREW DRIVER HANDLE MODEL 131
\$11.95
1/8" To 3/8"

ROUND SHANK REAMERS

- General's best selling heavy duty reamer used by mechanics and plumbers.
- Forged high carbon heat treated tool steel.
- 1/2" round shank for use in drill presses or large capacity power.



Model	Capacity	Price
136-RS	1/4" to 1-1/2"	\$38.95
137-RS	3/8" to 2"	45.00

GENERAL

RATCHET OFFSET SCREWDRIVER

- For reaching hard to get at screws, especially where leverage is required.
- Blades are made of machined ground and hardened tool steel.
- Ratchet adjusts for forward or reverse position.

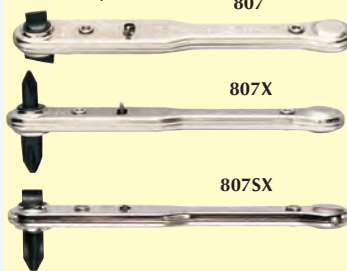

Model	Description	Price
807	1/4" and 3/8" straight blade	\$6.95
807X	No.1 and No. 2 Crosspoint blades	9.95
807SX	1/4" straight and No.2 Crosspoint blades	8.95

Precise MACHINIST'S JACK

- Base is made of a heavy cast steel with adjustable screw and tilting swivel head; lock nut for permanent positioning.
- Lifting capacity approx. 1,000 lbs.
- 1" adjustment.
- 3" high when closed, and 4" high when fully extended.



MODEL NE60-193
\$4.95

ADJUSTABLE PIN VISE

- Use for electronic assemble, tool making, model making & hobbies.
- Holds small drills, burs, wires, files, reamers and other small tools.
- 3 jaw hardened steel keyless chuck, sturdy plastic handle.



MODEL 93
Capacity 0-1/4"
\$11.95

DOUBLE PIN VISE

- Each end has a double end collet which may be reversed to desired size.
- Nickel plated body is made of tubing to permit use of long wire or rods.
- Measures 3-3/4" overall with 5/16" body diameter.



MODEL 90
Capacity 0-.125"
\$12.95

SWIVEL HEAD PIN VISE

- Two double end reversible collets are made of hardened tool steel.
- Has large free wheeling swivel head.



MODEL 92
Capacity 0-.125"
\$9.95

GENERAL

PRECISION RAZOR KNIVES

- A complete line of precision knives for industrial users, craftspeople and hobbyists.
- A board selection of surgically sharp replacement and accessory blades is available.

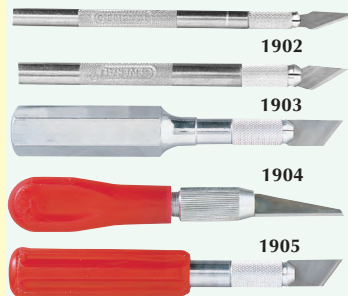

Model	Handle	Weight	Price
1901	Aluminum	Light Duty	\$2.95
1902	Aluminum	Med. Duty	3.50
1903	Aluminum	Heavy Duty	5.50
1904	Wooden	Heavy Duty	6.50
1905	Plastic Handle		\$3.80

PRECISION KNIFE CHEST

No. 1915

- Consists of one each Nos. 1901, 1902 and 1903 knives and 10 assorted blades in a fitted wooden chest.



MODEL No. 1915
\$24.95

PRECISION KNIFE & BLADE SET - 22 PIECE

- A complete set for precision cutting.
- Includes 2 Versa-Grip handles - 700 and 750 series.
- o 5 of #11 Sharp Angle o 3 of #22 Long Radius
- o 5 of #16 Short Angle o 2 of #26 Extended Radius
- o 3 of #17B 1/4" Chisel o 2 of #28 Reverse Curve



Reg. \$21.80
SET No. 75622 **\$18.50**

KNIFE BLADES



Model No.	Replacement For	Pack Qty.	Pack Price
1920	1901	5	\$2.75
1921	1901	5	2.75
1922	1902,1903,1905	5	3.75
1923	1902,1903,1905	5	2.95
1924	1902,1903,1905	5	2.95
1925	1904	2	3.50
1926	1904	2	3.50
1927	1904	2	3.50

GENERAL E•Z RATCHET TUBING CUTTER

- Ratcheting action rotates the cutter around the tube allowing a standard size cutter to be used in close quarter applications
- Wide hardened flared grooved rollers allow true cuts to flared end tubing to avoid tube replacement in existing installations.
- Cuts copper, aluminum, brass, thin wall tubing and stainless steel.



GENERAL E•Z RATCHET II TUBE AND PIPE CUTTER

- Cuts without rotating tool completely around tube or pipe.
- Exclusive "One-hand" operation. Ratchets in 5° increments while cutting 360° around tube.
- Large cutting diameter 1/8" to 1-1/8".
- Cuts copper, brass, aluminum, stainless steel, PVC and thin wall conduit.



GENERAL RATCHET OFFSET DRIVER SETS

- The Ratchet Offset Screwdriver is used for reaching concealed or obstructed screws, and is helpful in situations where leverage is required
- The Ratchet drive handle reverses instantly for clockwise and counter-clockwise rotation
- Permits short radius movements where turning space is limited
- 72 tooth ultra-fine ratchet requires only 5° turning radius
- The Chrome Vanadium Steel ratcheting handle is ergonomically designed which allows for greater control, comfort and torque
- Hardened tempered alloy steel bits included
- 1/4" magnetic bit-holder can be used in power tools
- Accepts industry standard insert bits



Model	Description	Price
80075	9 Pc. Set: One reversible ratchet handle, 1/4" & 3/16" Slotted bits	\$19.95
80078	No. 1 & No. 2 Phillips bits, T15 & T20 Torx, 1/8" & 5/32" Hex 18 Pc. Set: One reversible ratchet handle, 1-2-3/8" extension shaft, 1-1/4" square drive adapter, 1 each No. 1 & No. 2 Phillips bits, 1 each 3/16" & 1/4" slotted bits, 1 each T15 & T20 Star bits, 1 each S1 & S2 Square Drive bits, 1 each 1/8" & 5/32" Hex bits, 6 Socket sizes: 3/8", 11/32", 5/16", 9/32", 1/4", 7/32", All Sockets are for use with the 1/4" Square Drive adapter	\$32.95

GENERAL ONE HAND PVC/HOSE CUTTER

- For cutting PVC, PE, PEX, ABS pipe.
- Professional quality, all-metal construction for greater durability.
- Ratcheting action for easy cutting.
- High carbon steel blade provides longer sharpness and clean cuts.
- Handle locks for safety.



GENERAL HOSE & TUBING CUTTER

- Cuts flexible rubber, PVC, ABS & Polyethylene tubing.
- Long handles provide added leverage for easy cuts.
- Curved holder supports hose for square cuts.
- Replaceable steel blade.
- Capacities: rubber hose 2", Polyethylene and ABS pipe 1", PVC pipe 1".



Chapman MIDGET RATCHET SETS

- The Chapman twenty tooth ratchet is made of stainless steel and a strength that far exceeds the torque standards set by Military Specifications.
- Its short (18 degree) working arc is unbeatable for working in close quarters.
- Reverse the action by turning the ratchet over.
- Chapman adapters are constructed of fully hardened tool steel.
- Adapters have special "Spinner Tops" and can hold and start very small Allen type fasteners.



16 Piece Set
MODEL No. 1316
\$20.50

Set No.	Contents in Set	Price
1313	Midget Ratchet plus 12 HEX adapters .050", 1/16", 5/64", 3/32", 7/64", 1/8", 9/64", 5/32", 3/16", 7/32", 1/4", 5/16"	\$17.00
1316	Midget Ratchet Plus 16 Pcs. 10 HEX adapters .050", 1/16", 5/64", 3/32", 1/8", 5/32", 3/16", 7/32", 1/4", 5/16" 2 Slotted Head Adapters 1/4", 3/8" 2 Phillips Head Adapters #1, #2 1 Square Drive Socket Adapter 1/4"	\$20.50
1316X	Same as above with added 9/64" HEX adapter less 1/4" Square Drive Socket adapter	\$20.50
2307	Midget Ratchet plus 7 metric HEX adapters 1.5mm, 2.0mm, 2.5mm, 3.0mm, 4.0mm, 5.0mm, 6.0mm	\$12.00

GENERAL PLIER FLARING TOOL

- All-steel construction.
- Freewheeling cone self centers accurately over tubing.
- Quick release allows insertion and removal of tubing easily.
- Quick release plier action handles hold tubing securely while flaring



MODEL No. 152
\$36.50 5/8", 1/2", 7/16", 5/16", 1/4", 3/16"

GENERAL PRO INTERNAL PIPE WRENCH & SETS

- For the removal of broken threaded ends of pipe, pipe plugs and fitting.
- Hex body can be used with a wrench.
- Pipe sizes are marked on each wrench.
- Heat treated alloy steel, plated to prevent rust.
- Size stamped on body.
- Conforms to government spec. GGG-W643b.

Model	Size	Length	Price
139A	3/8"	3-3/4"	\$ 5.50
139B	1/2"	3-3/4"	6.00
139C	3/4"	3-3/4"	7.00
139D	1"	3-3/4"	9.50
139-ST	Set of 3 internal pipe wrenches (139A, 139B, 139C)		\$17.95
139-4	Set of 4 internal pipe wrenches (139A, 139B, 139C, 139D)		29.50

GENERAL ACCU-DRILL GUIDE

- Attaches to all 3/8" and 1/2" power drills.
- Cross slide lock for accurate shaping and carving.
- 3/8" capacity drill chuck with key.
- Positive stop for accurate drill depth control.
- Dual locking knob and handle holds precise angle setting.
- Folds flat for tool box storage.
- Easy-to-read protractor scale has 5° graduations (0°-45° left or right).
- V-guides automatically center round stock for drilling.
- Self centering channel for edge drilling.



GENERAL CIRCLE CUTTER

- These tools have been a General Hardware customer favorite for more than 30 years.
- Adjusts from 1-1/4" to 4" diameter circles.



- To tackle even the toughest jobs, each Ball Driver tool is made from Protanium high torque steel.
- Manage the most difficult angles. Loosen or tighten screws at up to 25° angle.



BALL DRIVER HEX DRIVER SETS

Comfort Grip

MADE IN USA

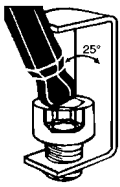

WITH "L" WRENCH STYLE

Model	Sizes	Sale
BLX-12	12 Sizes .050"-5/16"	\$ 8.95
BLX-13*	13 Sizes .050"-3/8"	10.95
BLX-8	8 Sizes .050"-5/32"	4.95
BLX-9*	9 Sizes 1.5 - 10mm	7.95
BLX-15	15 Sizes 1.27 - 10mm	13.95
11346	6 Piece Torx T-6 thru T-15	14.95
11332	* Piece Torx T-9 thru T-40	23.95
COMBINATION INCH/METRIC SET		
20199	1# BLX-13 & 1# BLX-9	\$16.95



T-HANDLE
Cushion Grip

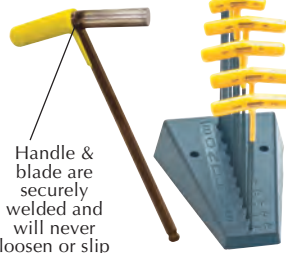

Handle & blade are securely welded and will never loosen or slip



WITH COMFORT GRIP HANDLE

Model	Sizes	Price
BSX-13	13 Sizes .050"-3/8"	\$29.95
BSX-9	9 Sizes 1.5-10mm	24.95
WITH "T" HANDLE CUSHION GRIP		
BXT-600	6 Sizes 5/32"-3/8"	\$19.95
BXT-100	10 Sizes 3/32"-3/8"	29.95
BXT-500	5 Sizes 4mm-10mm	19.95
BXT-700	7 Sizes 2.5mm-10mm	24.95



PROHOLD SOCKET BITS

- Bits snap into any standard six point socket. Quick, easy bit replacement. No need for special tools to remove bit. Bits can be purchased with or without sockets. Available in Hex, Star and Ball end tips.
- High torque steel. Sharper corners for extra grab up to 20% more torque. Tighter screws, longer wear.



MADE IN USA

Ball Sets

Model	Sizes	Length	Description	Price
43445	1/8, 5/32, 3/16, 7/32, 1/4, 5/16, 3/8"	2"	Sockets & Bits	\$49.95
31445	1/8, 5/32, 3/16, 7/32, 1/4, 5/16, 3/8"	2"	Bits Only	26.95
43845	1/8, 5/32, 3/16, 7/32, 1/4, 5/16, 3/8"	6"	Sockets & Bits	59.95
31645	1/8, 5/32, 3/16, 7/32, 1/4, 5/16, 3/8"	6"	Bits Only	29.95
43487	3, 4, 5, 6, 7, 8, 9, 10mm	2"	Sockets & Bits	\$59.95
31487	3, 4, 5, 6, 7, 8, 9, 10mm	2"	Bits Only	29.95
43887	3, 4, 5, 6, 7, 8, 9, 10mm	6"	Sockets & Bits	69.95
31687	3, 4, 5, 6, 7, 8, 9, 10mm	6"	Bits Only	37.95

Hex Sets

43229	5/32, 3/16, 7/32, 1/4, 5/16, 3/8, 1/2, 9/16, 5/8"	2"	Sockets & Bits	\$69.95
33229	5/32, 3/16, 7/32, 1/4, 5/16, 3/8, 1/2, 9/16, 5/8"	2"	Bits Only	33.95
43645	5/16, 3/8, 1/2, 9/16, 5/8"	6"	Sockets & Bits	62.95
33645	5/16, 3/8, 1/2, 9/16, 5/8"	6"	Bits Only	31.95
43298	4, 5, 6, 7, 8, 10, 12, 14, 17mm	2"	Sockets & Bits	\$69.95
33298	4, 5, 6, 7, 8, 10, 12, 14, 17mm	2"	Bits Only	35.95
43646	4, 5, 6, 7, 8, 10mm	6"	Sockets & Bits	51.95
33646	4, 5, 6, 7, 8, 10mm	6"	Bits Only	25.95

Star Sets

44038	T10; T15; T20; T25; T27; T30; T40; T45; T50; T55	2"	Sockets & Bits	\$65.00
32038	T10; T15; T20; T25; T27; T30; T40; T45; T50; T55	2"	Bits Only	34.00
44037-1	T8; T10; T15; T20; T25; T27; T30; T40; T45; T50; T55; T60	2"	Sockets & Bits	85.00
32037	T8; T10; T15; T20; T25; T27; T30; T40; T45; T50; T55; T60	2"	Bits Only	26.00
44699	T8; T9; T10; T15; T20; T25; T27; T30; T40	6"	Sockets & Bits	58.00
34099	T8; T9; T10; T15; T20; T25; T27; T30; T40	6"	Bits Only	32.00
44632	T8; T10; T15; T20; T25; T27; T30; T40	6"	Sockets & Bits	52.00
34032	T8; T10; T15; T20; T25; T27; T30; T40	6"	Bits Only	28.00

*Individual sizes available. Inquire



DRILL-OUT® POWER SCREW AND BOLT EXTRACTOR

- The Drill-out® is available in 8 sizes. Engineered with a Winslow self-centering tip, each tool is specially designed to drill into rough surfaces that are caused when bolts break.
- The Drill-out® tip not only gives you complete control-it allows you to obtain a perfectly centered hole without the tip walking or wandering.
- The Drill-out®'s tip is its left hand cutting edge. This feature helps to loosen and sometimes even turn the bolt out during drilling.



SAVE 40%

7 Piece Set
No. P701S
Reg. \$99.95

\$59.95



Set No.	Sizes Contained in Sets	Regular Price	Sale Price
A401C	*1/4", *5/16", *3/8" & *1/2"	\$69.95	\$44.95
P450S	*#5, *#6, *#8 & 1/4"	59.95	34.95
P701S	*Each of the above (7Pcs.)	99.95	59.95



DAMAGED SCREW REMOVER

When a Screwdriver Can't Remove The Screw Use X-Out

MADE IN USA

Place the tip of the X-Out onto the center of the damaged fastener. Apply firm pressure in the direction of the damaged screw or fastener. Power the drill to the lowest level possible. Maintain a firm pressure towards the screw or fastener. The screw will begin to turn out.



SET Of 3 Removers
#8 Thru #14
MODEL No. 2019
Reg. \$29.95

\$22.95

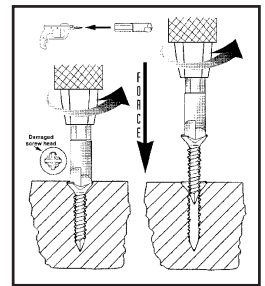

COMBINATION NUMBER & LETTER SETS (36Pc)

- All of our steel stamps are made with carbon tool steel. We use a special heat treatment so they won't shatter under stress.
- Young Bros. Gruv-Grip steel letter and figure stamps are furnished in gothic-style characters, level on the face and square with the shank, with crowned hammer ends.
- Each stamp has the exclusive, dual purpose thumb groove for a sure grip. Finding the thumb side is easy, even in low light.

WARRANTY

Young Bros. Stamp Works Inc. warrants to replace, at no charge, defective steel stamps which, upon our examination, have failed due to faulty materials or workmanship.



Set No.	Size Inch	Size of Square	Steel Length	List Price	Sale Price
01361	1/16"	1/4"	2-3/8"	\$76.30	\$49.60
02361	3/32"	1/4"	2-3/8"	76.30	49.60
03361	1/8"	1/4"	2-3/8"	76.30	49.60
05361	3/16"	5/16"	2-7/16"	96.15	62.50
06361	1/4"	3/8"	2-5/8"	113.60	73.85

SAVE 35%

MADE IN USA



proanium High Torque Steel
 20% Stronger
 Protanium™ Steel
 B650 or Chrome Vanadium
 Carbon Steel Independent lab test available upon request

PROHOLD TOOLS



Angle Entry to 25%

- Holds screws tight First Time - Every Time.
- Allow for maximum torque without distortion of ProHold button.
- Non-magnetic technology.
- Lifetime warranty Available on all sizes.
- Inch: .050-3/8"
- Metric: 1.27-10mm

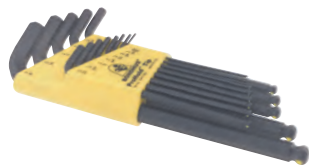

ProHold Balldriver L-Wrench Sets

9 Piece Metric Set - 1.5-10mm
 Set No. 74999 Reg. \$20.70 **\$12.95**
 13 Piece Inch Set - .0500-3/8"
 Set No. 74937 Reg. \$25.50 **\$14.95**



ProHold Balldriver T-Handle Sets

6 Piece Inch Set - 5/32-3/8"
 Set No. 75146 Reg. \$39.65 **\$22.95**
 5 Piece Metric Set - 4-10mm
 Set No. 75148 Reg. \$33.92 **\$18.95**



ProHold Balldriver Screw Sets

8 Piece Inch Set - .050-5/32"
 Set No. 74632 Reg. \$23.69 **\$14.95**
 6 Piece Metric Set - 1.5-5mm
 Set No. 74686 Reg. \$20.13 **\$11.95**



THE ORIGINAL GOLDGUARD 14K PLATED HEX WRENCH SETS



SAVE 46%

- 20% more torque.
- Tighter screws.
- Longer wear.
- Sharper corners for extra grab.
- Features
- 14K gold plated for corrosion resistance and identification.
- Precision milled Balldriver tip.



Model	Description	List	Sale
37937	13 Pc. Set .050"-3/8"	\$20.45	\$12.95
38099	9 Pc. Set 1.5mm-10mm	16.60	11.95
20899	22 Piece Double Pack Inch/Metric	35.00	21.95



STUBBY™ BALL DRIVERS

- Tight Fit? Get a Stubby™!
- "Shorter" Short Arm L-wrench.

- Smaller inside radius.
- Precision cut tip.



TIGHT FIT?

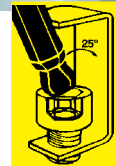

GET A Stubby™



ProGuard™ Dry Surface Technology

- Prevents rust .5 times better than other leading brands.
- Protects your tools.

Set No.	Description	Reg.	Sale
16537	13 Pc. Set (.050 - 3/8")	\$20.25	\$12.95
16538	10 Pc. Set (1/16" - 1/4")	12.65	8.95
16592	7 Pc. Set (1.5 - 6mm)	10.00	6.95
16599	9 Pc. Set (1.5 - 10mm)	16.45	9.95
20599	9 Pc. mm Set & 13 Pc. Inch set		\$19.95

CHAPMAN MIDGET RATCHET SETS

Adaptable to five different head styles. Designed to function in confined areas, Chapman Tools are a must for anyone who works with small to medium sizes screws, bolts and nuts. Ratchet needs only 18 degree working arc to operate. Adapters have fast, spinner tops for quick finger tightening of threads.



SET No. 7331
 27 Pc. Standard/Metric
\$37.00

Includes:

1-Ratchet, Handle, Extension, 12 Hex adapters; .050", 5/64", 7/64", 7/32", 5/16", 2-Slotted adapters; 1/4", 3/8", 2-Phillips adapters; No. 1, No. 2, 1-1/4" Square drive adapter. Plus Metric; 1.5mm, 2.0mm, 2.5mm, 3.0mm, 4.0mm, 5.0mm, 6.0mm.

Includes:

1-Ratchet, Handle, Extension, 12 Hex adapters; .050", 5/64", 7/64", 7/32", 5/16", 2-Slotted adapters; 1/4", 3/8", 2-Phillips adapters; No. 1, No. 2, 1-1/4" Square drive adapter.

SET No. 4320
 20 Pc. Standard
\$32.00

CHAPMAN TORX® MIDGET RATCHET SETS

- This high quality, miniature ratchet is the heart of each Chapman kit.
- The Chapman twenty tooth ratchet is made of steel and has a strength which far exceeds the torque standards sets by Military specifications.



TORX PLUS SET

27 Pcs.
 SET No. 6810

\$44.75

27 Piece Set Contains:

- 7) Torx sizes: T-6, T-8, T-10, T-15, T-20, T-25 & T-30
- 11) Allen hex-type adapters
- 30 Slotted head adapters
- 1) 1/4" square drive adapter
- 1) Screwdriver handle
- 1) Yellow blow molded polyethylene case
- 2) Phillips adapters 1) Phillips adapters
- 1) Ratchet 1) Extensions 3) Screwdriver

8 Pcs.
 SET No. 1068

\$18.00

8 Piece Set Contains:

- 7) Torx sizes: T-6, T-8, T-10, T-15, T-20, T-25 & T-30
- 1) Ratchet 1) Soft vinyl case



THE ORIGINAL TORX® WINGDRIVER FLAGDRIVER SETS



20% Stronger Than Competition



LIFETIME WARRANTY



Wing Driver Sets

Model	Type	Sizes	OAL	List	Sale
34745	Torx	(7) T6 to T20	3"	\$25.05	\$15.95
33945	Torx Plus	(7) T6 to T20	3-1/2"	28.95	16.95

Flag Driver Sets

34445	Torx	(7) T6 to T20	3"	\$24.00	\$14.95
35045	Torx Plus	(7) T6 to T20	3-1/2"	27.80	16.95

Torx® is a registered Trademark of Camcar/Textron

Eklind CLASSIC HEX KEYS

Keys are top quality 8650 chrome nickel alloy steel, drawn to a tolerance of +.000-.001, with square-cut, and sharp hex corners for precise fit to hex sockets. Precision hardened and tempered for extra torque.

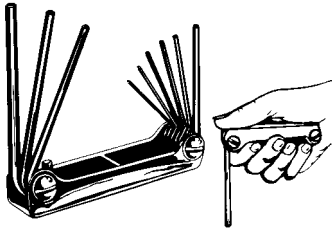

Model No.	Description Sizes	Blade length	Price Each
81	.050, 1/16, 5/64, 3/32, 7/64, 1/8, 9/64, 5/32"	1-3/4"	\$4.85
91-S	.050, 1/16, 5/64, 3/32, 7/64, 1/8, 9/64, 5/32, 3/16"	2-7/8"	5.50
91	5/64, 3/32, 7/64, 1/8, 9/64, 5/32, 3/16, 7/32, 1/4"	3-7/8"	7.50
51	3/16, 7/32, 1/4, 5/16, 3/8"	3-3/8"	9.75
812	3/32, 7/64, 1/8, 9/64, 5/32, 3/16, 7/32, 1/4"	3-1/2"	9.75

Metric			
17-M	1.5, 2, 2.5, 3, 4, 5, 6mm	1-3/4"	\$ 5.95
15-M	4, 5, 6, 8, 10mm	3-1/2"	10.50

TORX KEY SETS

- A basic tool for an increasing number of maintenance and repair applications.
- Late model automobiles-tail lights, headlights, turn signals, luggage racks, interior and exterior trim.
- Smaller sizes T6-T20 with small handle for carbide inserts in boring bars, lathe tools and milling cutters.

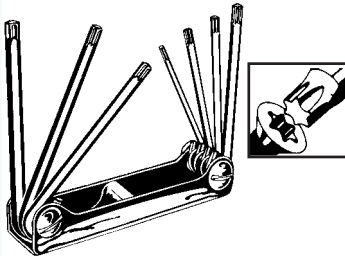

Model No.	Description Sizes	Handle length	Price Each
22571	T-10, T-15, T-20	4-1/4"	\$11.95
22572	T-25, T-30, T-40	2-3/4"	
	T-6, T-7, T-8, T-9	3"	11.95
	T-10, T-15, T-20	2-7/8"	

Eklind COMBINATION SCREWDRIVER SETS

No. 22461 Fold-up Screwdriver Set includes T15 TORX for replacement of headlights, tail lights, turn signals, exterior trim and instrument panels, plus No. 1 Phillips, 1/4", 3/16" and 1/8" flat blades and 3/16" point scratch awl.

No. 22451 Fold-up Screwdriver Set includes No. 1 Phillips, 1/4", 3/16" and 1/8" flat blades and 3/16" point scratch awl.

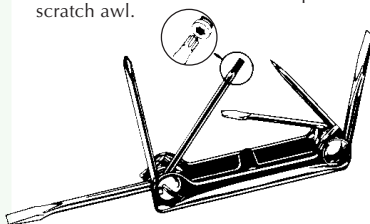

Model No.	Description	Handle length	Price Each
22461	6 Blades in 1	3-5/8"	\$8.50
22451	5 Blades in 1	3-5/8"	7.70

Eklind LONG REACH "T" HANDLE HEX KEY BENCH SETS

Keys are high-quality 8650 chrome nickel alloy steel, precision drawn for closest tolerance to insure fit into screw sockets. Hardened and tempered by Eklind's exclusive special martempering process for maximum strength.

Continuous 1-piece integrat loop handles are correctly proportioned.



Model No.	Arm Length	Key Sizes	Price Set
30160	6"	3/32, 7/64, 1/8, 9/64, 5/32"	\$32.95
30190	9"	3/16, 7/32, 1/4, 5/16, 3/8"	37.00
36168	6"	2, 2.2, 2.5, 3, 4, 5, 6, 8, 10mm	\$32.00
36198	9"	2, 2.2, 2.5, 3, 4, 5, 6, 8, 10mm	34.50

Eklind CUSHION GRIP "T" HANDLE HEX KEY SETS

Vinyl Coated-Reduces Hand Fatigue

- One piece loop handle for extra strength. No assemblies to break down.
- 6 & 9 inch blades provide long reach to save time disassembling.
- Precision drawn 8650 chrome nickel alloy steel. The same high quality Eklind has supplied to industry for over 40 years.



Model	Description	Price
50160	6" Arm Length, 10 Keys 3/32" to 3/8" with stand	\$41.50
50190	9" Arm Length, 10 Keys 3/16" to 3/8" with stand	44.00
56168	150mm Arm Length Keys 2mm to 10mm with stand	37.50
56198	230mm Arm Length Keys 2mm to 10mm	40.95
SERVICE KITS WITH POUCH		
53610	6" Arm Length, 10 Keys 3/32" to 3/8"	\$37.50
53910	9" Arm Length, 10 Keys 3/32" to 3/8"	40.95
55168	150mm Arm Length Keys 2mm to 10mm	37.50

Eklind COMBINATION INCH/METRIC LONG ARM HEX • L KEY SET

- 22 Pc. Inch & Metric Long Arm Hex • L Key Set designed with the Professional user in mind.
- The Long Arm Hex • L Keys provide Extra Reach for those hard Extra Leverage for real stubborn fasteners.
- The compact holders firmly retains each key so you always know where they are...and of course all keys are made using only the finest, hardened and tempered 8650 alloy steel.



MODEL No. 10222 Contains: 13 Pc. Long Arm: .050"-3/8" 9 Pc. Long Arm Metric 1.5mm-10mm

Eklind HEX • L KEYS

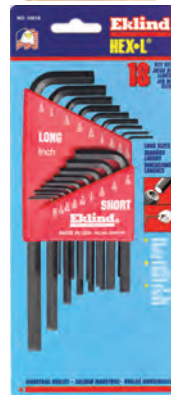

"COMBO" LONG & SHORT ARM SET .050" to 5/16" 18-PIECES

MODEL No. 10018 \$8.75

INCH SETS

Model	Description	Price
10107	7-Piece, Short Arm 5/64" to 1/4"	\$ 3.50
10111	11-Piece, Short Arm .050" to 1/4"	5.50
10113	13-Piece, Short Arm .050" to 3/8"	8.25
10207	7-Piece, Long Arm 5/64" to 1/4"	\$ 5.50
10211	11-Piece, Long Arm .050" to 1/4"	7.70
10213	13-Piece, Long Arm .050" to 3/8"	11.95

METRIC SETS

10507M	7-Piece, Short Arm 1.5mm to 6mm	\$ 5.95
10509M	9-Piece, Short Arm 1.5mm to 10mm	9.50
10607M	7-Piece, Long Arm 1.5mm to 6mm	7.50
10609M	9-Piece, Long Arm 1.5mm to 10mm	11.95

DRIFT KEY

- Made of special steel.
- Hardened and anodized.



Model	For Morse Taper	Price
DRP-446	1 MT	\$3.95
DRP-447	2 MT	4.75
DRP-448	3 MT	5.25
DRP-449	4 MT	7.75

Eklind

L•HEX KEYS WITH METAL CASE

- Eklind L•Keys are produced from 8650 Chrome Nickel Alloy Steel.
- Heat treated for maximum strength and finished to resist rust.
- Eklind's superior quality provides maximum torque and prevents rounding out of the key or hex socket.



STANDARD LENGTH

Set	Description	Price
10115-1	15 Pc. .028-3/8"	\$21.50
10118	18 Pc. .028-5/8"	38.50
10512	12 Pc. .7mm-10mm	21.50
10515	15 Pc. .7mm-17mm	38.95

LONG LENGTH

10214-1	14 Pc. .050-1/2"	\$21.95
10217	17 Pc. .035-5/8"	47.95
10294-1	14 Pc. .035-3/8"	29.95
10610-2	10 Pc. 1.5mm-12.0mm	20.95
10611-2	.9mm-10mm	30.50
10614	14 Pc. .9mm-17mm	51.00

Eklind

L•HEX KEYS WITH VINYL POUCHES



Set	Description	Price
69113	13 Pc. .050 thru 3/8"	\$13.75
69215	15 Pc. .028 thru 3/8"	14.95
87170	20 Pc. .028 thru 3/4"	52.50
69205	7 Pc. 2mm thru 8mm	5.95
69511	11 Pc. 1.5mm thru 10mm	18.50
LONG LENGTH		
69213	12 Pc. .050 thru 3/8"	\$16.95
69209-1	9 Pc. 5/64" thru 3/8"	9.50
69611	11 Pc. 1.5mm thru 10mm	21.95

GRIP MEASURING POWER TAPES

Self locking tape allows one handed operation. Push button release with comfortable and contoured rubber grip. Magnetic tip keeps tape in place for exact measurements. Large inch measurements with 1/8" increments.

MODEL No. 77195

\$5.95

With Magnetic Tip



Model	Blade Length	Price
77195	25' x 1"	\$5.95
77114	33' x 1-1/4"	7.95

GENERAL THE QUAD SAW/DRIVER

14 PIECE SAW/DRIVER SET

The QUAD Saw/Driver set offers a 4 in 1 cutting and driving system; a jab saw, key hole saw, power driver, and speed driver. The 2 position quick change locking handle offers both power and speed. A convenient holster holds all 14 pieces.

- A 4 in 1 cutting and driving system
- (1) Jab saw with straight handle and special Sheetrock reciprocal blade
- (2) Keyhole saw in the pistol grip position.
- (3) Power driver in the pistol grip position
- (4) Speed driver, screw or nut driver with straight handle
- The keyless Quick-Change locking chuck accepts both Quick-Change bits and industry standard reciprocating saw blades.

14-PIECE SET INCLUDES:

- 3 saw blades; drywall, Metal/PVC, wood,
- 7 insert bits
- 1 hex to square adaptor
- 1 quick change handle
- 1 holster with belt-clip
- 1 bit extender
- Swivel locking chuck holds all reciprocating blades and speedshank power bits
- Comfortable handle easily locks in the straight or pistol grip position

SET No. 86014-1 **\$19.95**

With Holster

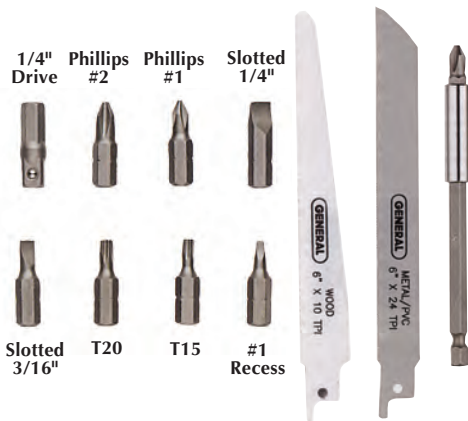

GENERAL CORDLESS PRECISION ENGRAVER

Diamond Tip Bit, Tri-Lobe Ergonomic Grip

- Precision cordless engraving anywhere by anyone - from professional technicians and mechanics to homeowners and DIY ers.
- Users can protect all types of valuables with identifying markings and even perform delicate personalization of items.
- The engravers powerful 20,000 RPM motor is powered by just two AAA batteries and enables engraving in glass, metal ceramic and plastic.
- An aluminum body offers superior durability and the one-of-a-kind tri-lobe ergonomic grip provides the ultimate in comfort and ease-of-use.



MODEL No. 505

\$19.95

GENERAL LIGHTED SCREWDRIVER SET

- Rotating cap: facets fits palm, recess fits finger tips.
- Push On /Push Off powerful LED light.
- Non-slip cushion grip.
- Oxide blades are rust and corrosion resistant.
- Hard rubber bit organizer.

Set Includes:

- 1 Multi-blade handle
- 3 Reversible blades
- Slotted: 3/32", 1/8"
- Phillips: #000, #00
- Torx: T5, T6
- 3 "LR44" batteries



MODEL No. 1700
List \$12.96

\$10.95



GENERAL HOLLOW STEEL PUNCHES

- For punching holes in leather, rubber, canvas, cardboard, plastic and other materials.
- Made of forged steel with side clearance hole for easy removal of punched material.



Model	Size	Price
1280A	3/32"	\$ 5.95
1280B	1/8"	4.95
1280C	5/32"	4.95
1280D	3/16"	4.95
1280E	7/32"	5.20
1280F	1/4"	5.50
1280G	9/32"	5.50
1280H	5/16"	5.95
1280I	11/32"	6.95
1280J	3/8"	7.50
1280K	13/32"	7.75
1280L	7/16"	8.25
1280M	1/2"	8.95
1280N	9/16"	9.95
1280-O	5/8"	9.95
1280P	3/4"	12.50
1280ST	Set of 6 sizes	\$34.95
	3/16", 1/4", 5/16", 3/8"	
	7/16", 1/2" in roll up pouch	

GENERAL ARCH PUNCHES

- For punching holes in leather, rubber, gasket material and soft metals.
- Inside taper for clearance.
- Heat treated forged steel.



Model	Size	Price
1271A	1/4"	\$ 8.95
1271B	5/16"	8.95
1271C	3/8"	8.95
1271D	7/16"	8.95
1271E	1/2"	10.50
1271F	9/16"	10.50
1271G	5/8"	12.50
1271H	11/16"	14.50
1271I	3/4"	14.50
1271J	13/16"	16.50
1271K	7/8"	16.50
1271L	15/16"	17.50
1271M	1"	18.50
1271N	1-1/8"	20.00
1271O	1-1/4"	25.00
1271P	1-3/8"	31.50
1271Q	1-1/2"	33.50
1271ST	Set of 7 sizes 1 each:	\$79.95
	1/4", 3/8", 1/2", 5/8", 3/4"	
	7/8" & 1" in roll up pouch	
AP-005	Set of 5 sizes 1 each:	\$179.95
	1-1/16", 1-1/4", 1-3/8",	
	1-5/8", 1-3/4"	



MIRROR & MAGNETIC PICKUP

Ball joint swivel on mirror holds firm at any angle. Handy set specially designed for auto mechanics for those hard to see areas. Powerful magnet picks up 2 lbs. and telescopes from 7" to 21-1/2". Mirror telescopes from 11" to 16-1/2"



SET No. 53021

\$4.95



8 PIECE SCREW EXTRACTOR

Remove broken screws with ease. Multi-fluted extractors are made from high carbon steel. Includes blow mold storage case. Sizes - #1, #2, #3, #4, #5, #6, #7, #8.



SET No. 53100-1

\$9.95

Spindle Square

.....ALL STEEL

- Fully assembled with two AGD2 or AGD dial indicators, .001", .0005", or .01mm graduations.
- Self Calibrating** – no other tools, shims, blocks etc. required to calibrate
- Large 2-1/4" or 1-1/4" diameter dial indicators for easy reading; .250 or .125" total range.
- Patented.
- 4" between contact points
- Ground surface, **Solid Steel Construction of body**
- Size is about 6 3/4 wide and 5 1/2 from top of shank to end of contact points
- Accuracy to .001 inch
- Weight is about 4 lbs. for shipping, with custom case



Model No.	Graduation	Total Range	Distance Centers	Dial Diameter	Price Each
NSS-001	.001"	.250"	4"	2-1/4"	\$159.95
NSS-002	.0005"	.125"	4"	2-1/4"	175.00
NSS-003	.0005"	.125"	3"	1-1/4"	175.00
NSS-004	.01mm	2.5mm	101.6mm	2-1/4"	175.00

EDGE CNC LATHE GAGE

- The CNC Lathe Gage by Edge Technology is used to set lathe tools on the spindle axis for optimum cutting conditions.
- To use this gage first adjust it to match the angle of your slant bed lathe and install the 1/4" shaft in a collet or chuck.
- Then set one of the contact faces of the gage on the cutting edge of the tool.
- Next adjust the tool until the bubble is centered in the level.
- This procedure ensures the cutter is accurately placed on a plane that intersects the rotational axis of the spindle. (Note: it is necessary for the lathe to be leveled for the CNC Lathe gage to work properly)
- Set turning, boring, and facing tools on spindle axis for optimum cutting conditions
- Precision glass vial level with 30"/2mm sensitivity

- Cutter contact faces designed to work with tools that have cutting edges facing up as well as facing down
- Angular adjustability of +/- 60° to match any lathe slant bed angle
- Hands free design
- Ground steel shaft supported by dual ball bearings.
- Durable anodized finish with easy-to-read engraved marks
- Made from high strength aluminum



MODEL No. 13-000

\$44.95

MADE IN USA

SPi QUILL RETURN

- Eliminates the problem of quill lock drag.
- Maintains lever in lock position without rubber bands or other devices.
- Easily attaches to locking lever.

Model No. 98-217-3

\$13.50



INDUSTRIAL PRESS CNC CONTROL SETUP FOR MILLING AND TURNING

No other book covers CNC control setup in such practical detail. This unique reference from the author of the best-selling CNC Programming Handbook features nearly all of the activities a typical CNC operator performs on a daily basis. Starting with overall descriptions and in-depth explanations of various features, it goes much further and is sure to be a valuable resource for anyone involved in CNC

Features:

- Describes working with all types of offsets for milling and turning applications, interpretation of part programs, applying trial cuts, making program changes, and much more.
- Places emphasis on troubleshooting many common problems that occur in CNC operations.
- Presents suggested methods of correction, along with methods of prevention.

No. 3350-3
Reg. \$59.95

\$44.95

For Additional details
Visit our website:
www.penntoolco.com



EDGE PRO TOUCH OFF GAGE

- The Pro Touch Off Gage allows you to standardize the way tool offsets are measured in your shop.
- To use this gage just lower the tool down onto the contact face until the indicator reads zero, at that point you can be confident that the tool tip is exactly 4 inches from the surface the Pro Touch Off Gage is sitting on.
- Large 2.2 in easy to read indicator face.
- Large 1 in diameter contact face allows all flutes of the tool to make contact
- Contact face is lightly spring loaded to protect against overrun.
- Body made from red anodized 6061-T6 aluminum
- Offset height 4.000 in
- Gage repeatability 0.0002 in
- Easy calibration using 1-2-3 blocks.



MODEL No. 04-000
Reg. \$99.95

\$84.95

Replacement Contact Face No. 04-001 \$5.00

MADE IN USA



EDGE TAP AND REAMER LEVELS

- The Tap Handle Level by Edge Technology is specifically designed to eliminate tap breakage.
- The most common cause of tap breakage is starting the tap into the hole at an angle. The large bulls-eye-level in this unit allows the angle of the tap to be monitored as it is started into the hole.
- The unit is easily installed on any flat top tap handle and the magnetic recess of the unit will secure it in place.

Specifications:

- Magnetic recess ensures unit stays in position
- Made from high strength aluminum
- Durable red anodize finish

Set of 2 levels
1) Small .550" Diameter
1) Large .875" Diameter

MODEL No. 15-000

\$22.95

Less Tap Wrenches

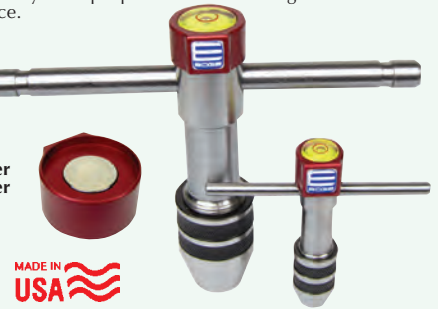

MADE IN USA

EDGE MILL CADDY

With the Mill Caddy from Edge Technology you can now hang your vise handle, dead blow hammer and air line from the front of the mill table. The Mill Caddy puts your most frequently used tools at your finger tips yet out of the way allowing for a less cluttered work area.

- Designed to mount using T-slot on table front. (mounting hardware included)
- Made from high strength aluminum.
- Durable red anodized finish.
- Vise handle slot width (0.750 in)
- Hammer slot width (1.125 in)

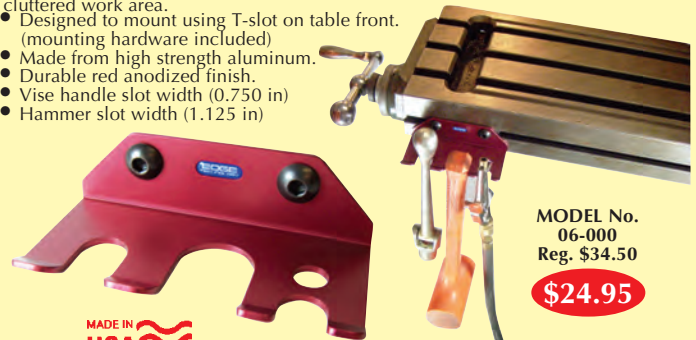

MODEL No. 06-000
Reg. \$34.50

\$24.95

MADE IN USA

Precise PRO/CALC MATERIAL DIRECTORY SPINDLE SPEED ~ CHIP LOAD & FEED RATE CALCULATOR

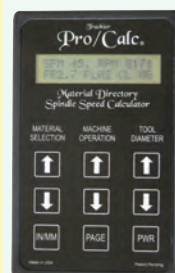

Eliminate the hassle of calculating proper RMP's for optimum tool life!

MODEL No. PRO-100
REG. \$74.95
\$59.95

Simply Select

- Material to be machined.
- Operation to be performed.
- Tool diameter to be used.
- Number of cutter tips.

The recommended RPM and FEED RATE are AUTOMATICALLY DISPLAYED

Also contains tap sizes in English & metric, coarse & fine and surface foot & surface meter calculation.

EDGE MINI PRO TRAM

The Mini Pro Tram by Edge Technology has all the same great features of the full size Pro Tram but in a smaller package. The unit is perfectly sized for bench-top and mini-mill machines.

- Square the head of a milling machine and milling vises quickly and easily
- Simply lower unit to table and adjust the head until both indicators read the same
- Can be used with a sine bar or sine plate to adjust the head to precise angles
- Calibration procedure accounts for any error introduced by worn collets
- Guaranteed to be equal to or better than any other tramping method or spindle squaring device available.
- Indicator graduation 0.001" & repeatability of 0.0002"
- Includes calibration gage and padded case

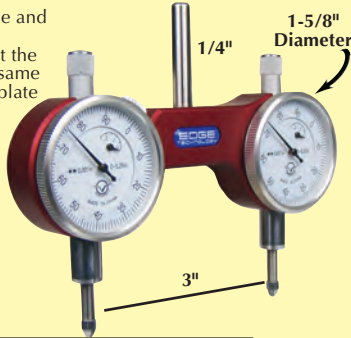

Model No.	Graduation Inch	Shank Size	List Price	Sale Price
11-000	0.001"	1/4"	\$124.95	\$99.95
12-000	0.001"	1/8"	124.95	99.95

EDGE SPEEDY LATHE GAGE

- Lathe Gage will allow you to set the height of your tools for optimum cutting conditions.
- The Speedy Lathe Gage is CNC machined to exacting tolerances from 6061-T6 aluminum.
- Simply set the gage on the cutter and adjust the tool height until the bubble is centered in the level. This ensures the cutter is accurately placed at the same height as the rotational axis of the spindle.



MODEL No. 08-000
Reg. \$24.95
\$19.95



EDGE PRO VISE WORK STOP

- Its super low profile design stays completely below the top surface of the vise which means that you do not need to worry about it interfering with the cutting tool paths.
- It is an ideal datum surface to locate your parts.
- The Pro Stop is extremely versatile allowing you to quickly position the hardened steel contact rod in any location you need it.

MODEL No. 03-000
Reg. \$79.95
\$59.95



Designed to Mount on Anglock Type Vises

Model No.	To Fit Vise Size	Price Each
03-000	6"	\$59.95
19-000	5"	59.95
21-000	4"	59.95

EDGE PRO MILL STOP TABLE MOUNT

- Specifically designed to increase accuracy and minimize setup time by ensuring the stop rod stays square to the work piece at all times.
- This is made possible by constraining the moveable components of the unit to linear motion.
- The lever arm can also be rotated out of the way for cutter clearance and accurately relocated for repeat setup.
- Versatile design allows the 1/4" hardened stop rod to be quickly and accurately positioned
- Lever arm can be rotated out of the way for cutter clearance and accurately relocated for repeat setup
- Non-marring 1/4"-20 nylon tip set screw used to secure stop rod mount without damage to lever arm
- Base is keyed with table T-slot to keep unit square to work piece. T-nut included

Model No.	To Fit Table Slot	Price Each
16-000	5/8" Slot	\$59.95
17-000	9/16" Slot	59.95



EDGE PRO TRAM SYSTEM

- Tramping is the process of squaring the head of your mill to the table. Most machinists know that if your mill is not tramped properly surface finishes will be poor and parts will not be flat or square.
- The **patent pending** Pro Tram by Edge Technology solves all of these problems allowing you to tram your mill quickly and accurately.
- To use the Pro Tram simply lower the unit down onto the table and adjust the head until both indicators read the same number. Repeat this process for the opposite axis and you are done.
- The Pro Tram is also sized perfectly to fit the bed of a 6 inch vise allowing you to tram the head to the vise instead of the table.
- 6" between centers of indicators.



MODEL No. 01-000
Reg. \$124.95
\$114.95

With Calibration Gage & Padded Case



Model No.	Graduation Inch	Shank Size	Sale Price
01-000	0.001"	1/2"	\$114.95
10-000	0.001"	3/8"	114.95
09-000	0.0005"	1/2"	134.95

EDGE PRO LATHE GAGE

The Pro Lathe Gage will allow you to set the height of your tools for optimum cutting conditions. With this "Hands Free" design you simply set the gage on the cutter and adjust the tool height until the bubble is centered in the level. This ensures the cutter is accurately placed at the same height as the rotational axis of the spindle

- Precision ball bearing and ground bearing rod (included) are utilized to ensure an accurate reading every time.
- Typically installed in a collet or 3-jaw chuck on the spindle side of the lathe but it can also be installed in a drill chuck on the end of the tail stock end of the lathe
- Pro Lathe Gage will fit any Lathe.
- Recessed design allows boring bars to be easily set.
- Made from 6061-T6 aluminum with red hard anodize.

MODEL No. 02-000
Reg. \$39.50
\$29.95



EDGE PRO VISE STOP DOUBLE SIDE

- Low profile design stays below the top surface of vise jaws for cutter clearance
- Versatile design allows the 1/4" hardened stop rod to be quickly and accurately positioned
- Allows two work pieces to be located for increased productivity
- Lever arm can be rotated out of the way for cutter clearance and accurately relocated for repeat setup
- Locate long stock with the included stop rod collar
- Body made from red anodized 6061-T6 aluminum



Model No.	To Fit Vise Width	Price Each
18-000	6"	\$89.95
20-000	5"	89.95
22-000	4"	89.95

EDGE VISE JAW STOP

- It features a micro stop rod that is positioned below the top surface of the vise jaws for cutter clearance.
- The stop rod is also adjustable side-to-side to allow space between the unit and the work piece for even more cutter clearance.

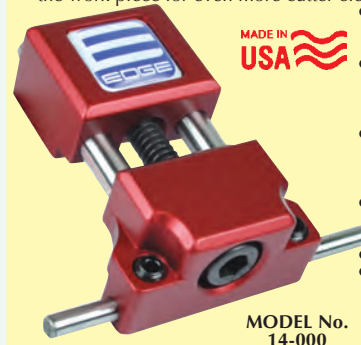

MODEL No. 14-000
\$24.95

- Fits all milling machine vises with 1/2" - 7/8" thick jaws and 1/8" minimum protrusion
- 1-1/8" wide body with 2 hardened steel guide pins and large #10 clamp screw are used to secure the unit to the vise jaw
- 1/8" x 2" hardened stop pin is used to accurately locate work pieces. The stop pin is also adjustable side-to-side to allow for cutter clearance
- The stop pin is positioned completely below the top surface of vise jaw to allow for cutter clearance
- Body made from anodized aluminum
- 8-32 non-marring flat point set screws are used to secure stop rod

Precise 1-2-3 BLOCK SETS

- Heat treated above 48 Rockwell "C".
- Cross drifting design for extra strength for minimum weight.
- Five 3/8" - 16 tapped holes are provided for clamping operations.
- .0001" to .0003" over allowance for nominal tapping squareness of all sides are within .0001" per inch.

SET No. TBS-123

\$14.95

Without Case



Model	Size	Holes	Price
TBS-123	1" x 2" x 3"	23	\$14.95
TBS-113	1" x 2" x 3"	11	15.50
NBS-123	1" x 2" x 3"	0	16.95
NBS-113	1" x 2" x 3"	1	16.95
*TBS-123T	1" x 2" x 3"	23	19.95
TBS-234	2" x 3" x 4" (5)5/8"-11		65.00
TBS-246	2" x 4" x 6" (5)5/8"-11		99.50
TBS-468	4" x 6" x 8" (5)5/8"-11		295.00

* TIN Coat



With Fine Fitted Wood Case
SET No. TBS-123C

\$21.95

brown & sharpe UNIVERSAL 1-2-3 BLOCK SET

- Hardened steel, precision all six sides to $\pm .0001$ " squareness per inch.
- To size within $\pm .0002$ ".
- The 5/16-18 tapped holes are arranged for screw mounting and conversion into angle plates and various other inspection or production set-ups.



brown & sharpe

MODEL No. 599-750-50
Reg. \$103.00

\$89.95

Precise Import
MODEL No. UBS-123

\$29.95

brown & sharpe UNIVERSAL 1-2-3 BLOCK SET

Within $\pm .0001$ " Squareness

- Each block is ground and case hardened on all six surfaces.
- Surface finish 6 to 16 microinches.
- Squareness on all sides to $\pm .0001$ ".
- 23 holes: 5 tapped 3/8-16, 18 untapped thru holes.
- Over sized to allow for normal tapping .0001" - .0003".
- Case hardened to 50-60 HRC.

brown & sharpe

MODEL No. 599-750-10
Reg. \$83.00

\$69.95



Each set consists of a pair of 1 x 2 x 3 inch blocks, five 3/8-16 stainless steel socket head cap screws and a hex key wrench. Supplied in custom molded case

Precise Import
SET No. PBG-123

\$29.95

Precise ULTRA-PRECISION V-BLOCKS AND CLAMP SET

Hardened And Ground

- One reversible swing-away clamp is provided with each V-block.
- This versatile clamp, plus the unique offset hole pattern in the top of the V-block, offers a large variety of the clamping possibilities.
- The side slots allow easy clamping to almost any surface.
- All V-blocks are parallel, square and centered within .0002".



Model No.	Dimensions L x W x H	Capacity Max.	Set Price
VBS-001	1-3/8" x 1-3/8" x 1-3/16"	19/32"	\$32.95
VBS-02	2-3/8" x 2-3/8" x 2"	1-3/16"	49.95
VBS-03	4-1/8" x 4-1/8" x 3-1/16"	2-9/16"	99.50
VBS-04	3" x 4" x 3"	2-1/4"	125.00

Precise TOOL MAKERS SET

SET INCLUDES:

- Precision Screwless Vise.** Hardened and ground. $\pm .0002$ " tolerance, 3" wide x 7-1/2" long. No. RTV-370
- Toolmaker V-Block.** $\pm .0003$ " tolerance, 2v's hold large & small work, 3-5/8" long, 1-7/8" sq. No. VB-745
- 1-2-3 Blocks, Matched Pair.** Hardened & ground on all 6 sides, 5 tapped holes, 18 untapped, .0001" squareness per inch, 1" x 2" x 3" per block. No. TBS-123
- Angle Plate Set.** Hardened steel HRC 55, ± 20 seconds, precision ground. No. SAB-500

Reg. Sale \$167.95
Complete Set No. PTS-400

\$139.95

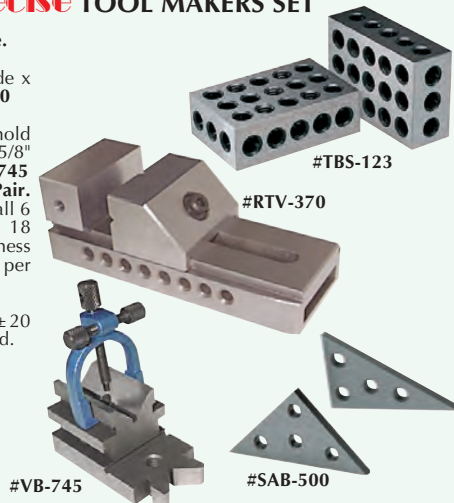

#TBS-123

#RTV-370

#VB-745

#SAB-500

AVENGER TIN COATED PRECISION V-BLOCKS SETS

- Made from 1 pc of solid steel, hardened and ground to close tolerances.
- Clamps to almost any work surface.
- Reversible swing away clamps provided with each block.
- Tin coated for wear and corrosion resistance.

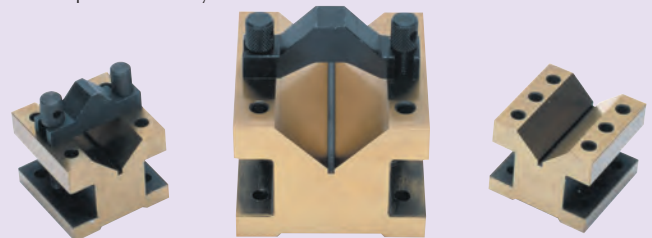

Model	Size	Capacity	Price
TVB-200	2-3/8" x 2-3/8" x 2"	13/64" x 1-3/16"	\$69.95
TVB-300	4-1/8" x 4-1/8" x 3-1/16"	9/32" x 2-9/16"	95.00

Precise COMPOUND ANGLE PLATE

PAP-460 compound angle plate is a multi-use angle plate. It is especially useful for squaring operations. Several small ground vees allows the holding of small round parts.

- Square and parallel with-in .0002".
- Clamp and screws included.
- Made from steel hardened to.
- Solid, single piece construction provides stable and reliable positioning for compound use.

MODEL No. PAP-460

\$134.95

Dimensions: 6" x 4" x 1" 11 Lbs.

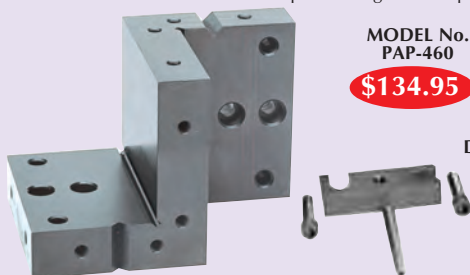

Precise STEPPED ANGLE PLATE

- Manufactured from a single piece of hardened tool steel.
- A convenient step of 1-1/4" down from the top and a 1/2" seat allows for use with smaller work pieces.
- Precision ground finishing.
- Square and parallel within .0002"
- Tapped holes allow for fastening to fixtures and clamping workpiece to the angle plate.



Model No.	Dimensions	Thread of tapped holes	Reg. Price	Sale Price
SAP-100	3" x 3" x 3" x 1-1/2"	(20) 1/4"-20	\$67.35	\$59.95
SAP-200	4" x 4" x 4" x 1-1/4"	(20) 5/16"-18	86.55	89.95

Brown & Sharpe ULTRA WEE-VEE BLOCK SET

- Capacity of Ultra Wee-Vee - .030" to 9/32".
- Capacity of V-block .500" to 2.500".
- V-block specifications: 1-5/8" wide x 1-3/4" high x 2-3/4" tall. 1-1/2" capacity.
- Furnished with bridges to straddle long work pieces, allowing top hold-downscrew of V-block clamp to be used.
- Hardened and high precision ground Wee Blocks, squareness and parallelism within .0002"
- Set contains 2 Ultra Wee-Vee blocks, one clamp, size A .030" - 5/32" capacity, and size B .050" - 9/32" capacity, Bridge A and B plus 5 upper prisms, 1/8", 5/32" and 3/16" capacity.

Capacity from
.030" to 2.500"
Complete in a
Shop Hardened
Molded Case

Capable of holding parts
as small as a paper clip!

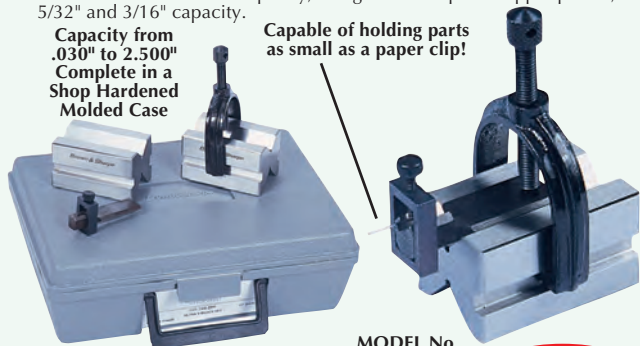

Extra V-Block Clamp
No. 99-749-101 \$24.95

MODEL No.
599-749-100 **\$196.50**
Reg. List \$224.00

Precise ANGLE BLOCK SETS

- Simple, quick angle setups.
- Eliminates calculations, avoids errors.
- Lightly magnetized for better holding.
- Manufactured of steel, hardened, stabilized and ground.
- Sizes: 3" long x 1/4" thick.
- Accuracy: + .0001" per inch.
- Oil-hardened steel, precision ground.



Model	Description	Sale
AB-160	10 Piece Set 1°, 2°, 3°, 4°, 5°, 10°, 20°, 25°, 30°	\$34.95
ABA-012	12 Piece Set, same as above Plus 1/4° and 1/2°	49.95
599-921-18	Brown & Sharpe 12 Piece Set	\$225.00
53-666-000	Fowler 12 Piece Set	69.95

Precise ALUMINUM CAST MAGNETIC V-BLOCK SETS

- Holds cylindrical workpieces for grinding.
- 90° Vee blocks.
- Precision ground flat, square and parallel to 0.0005".
- Switch On/Off.

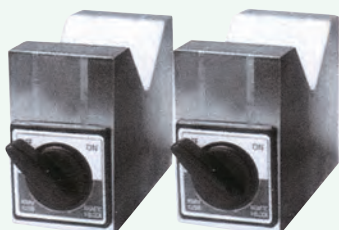

Supplied In
Matched Pair

Model No.	Dimensions Height x Width x Depth	Max. Hold Diameter	Power Pull Each lbs.	Price Paid
3402-0890	2" x 1-1/2" x 2-3/4"	1.90"	33	\$119.95
3402-0900	3" x 2" x 4"	3.15"	44	165.00
3402-0902	4" x 2" x 6"	3.90"	50	275.10

Precise MAGNETIC V-BLOCKS WITH SWITCH

- Precision ground finished working surfaces.
- Ideal for scribing, grinding, measuring and machining round or irregular shape items.
- On/Off switch.
- Two-centered 90° Vees.



Model No.	Dimensions Height x Width x Depth	Power Pull lbs.	Price Each
3402-0990	3-3/4" x 2-3/4" x 3"	130	\$79.95
3402-0901	3-3/4" x 2-3/4" x 4"	250	84.95
3402-0992	3-3/4" x 2-3/4" x 5"	275	119.95
3402-0993	3-3/4" x 3" x 6"	320	195.00

Precise V-BLOCK SETS

DOUBLE "V" TYPE

- Hardened and Ground within .0003".
- Unique Style w/2 "V"s, holds large & small work.
- 4 Tapped Holes 3/8-16 for additional clamping.
- Forged clamp w/ adjustable side screw for support.

Capacity: 1-5/16" Diameter
Dimensions: 1-7/8" sq. x 3-5/8" Long

MODEL No. **\$49.95**
VB-745



SAVE
MORE

BUY BOTH SETS
SET No. SVB-700
\$109.95

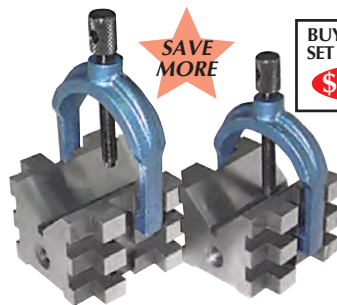

MODEL No. **\$69.95**
VB-750
(Pair)

STEPPED "V" TYPE

- Hardened and Ground within .0003".
- Made of two Matched Blocks & two Clamps.
- Step Groove Construction permits clamping use on its sides.
- Work Capacity of "V"s' 2" diameter.

Dimensions Per Block
2-1/2" Long x 2-3/4" W x 2" H

Precise ANGLE BLOCK SET

17 PIECE IN FITTED CASE

- A new design which gives you quick set-ups in grinding various angles from 1/4° - 45°.
- Accuracy in seconds!
- Accuracy .0003".
- Can be used for set-ups in milling small parts.
- Just load in vise and rest work piece on any angle you choose.
- Made from hardened steel.
- Eliminate time it takes to dress wheels.
- Furnished in custom fitted case.

SET No.
ABS-170 **\$89.95**
Reg List \$150.00

Sizes In Set:
1°, 2°, 3°, 4°, 5°,
10°, 15°, 20°, 25°,
30°, 35°, 40°, 45°
Plus 2 Rise Blocks



Precise VEE BLOCKS SET

- Made of high quality fine grained cast iron, stress relieved.
- Ideal for holding round and irregular shape parts in drilling, machining, inspection etc.
- Accurately machined with 90° Vee in center.
- Machined square and parallel to base within .001"

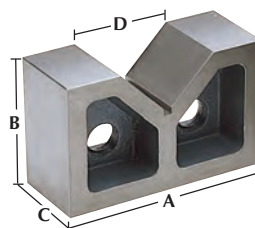

Model No.	Dimensions A	B	C	D	Weight lbs.	Price Per Pair
CAV-2	2"	1-1/4"	1"	1"	1-1/2	\$13.95
CAV-3	3"	2-3/8"	1-3/4"	1-1/4"	2.5	19.50
CAV-4	4"	2-5/8"	2"	1-5/8"	5	24.50
CAV-5	5"	3-1/8"	2-5/8"	2"	9	37.50
CAV-6	6"	3-1/2"	3-3/4"	2-3/8"	13	46.95
CAV-7	7"	4-1/2"	3-3/4"	3"	26	79.95
CAV-8	8"	4-1/2"	4-1/2"	4"	46	110.00
CAV-10	10"	6-1/2"	5"	6"	76	185.00
CAV-12	12"	8"	7"	6-1/2"	135	349.95

PRECISION INSPECTION GAGE BALL SETS

- Meets all grade 24 AFBMA standards.
- Chrome alloy steel, hardened to 63RC.
- Surface finish to 1.5 micro-inches.
- Within .0001"/0.0025mm of actual size.
- Spherical accuracy within .000025"/0.0006mm.
- Inches-includes: 26 pairs in English sizes 1/8" to 1"
- Metric-includes: 25 pairs in Metric sizes 1mm to 25mm in 1mm increments.

Good brown & sharpe

Inch set
MODEL No.
599-766
Reg. \$99.00

\$83.95



SPI
Inch Set
MODEL No.
10-193-1
Reg. \$75.00

\$64.00

SPI
Metric Set
MODEL No.
10-194-9
Reg. \$89.95

\$64.00

AVENGER TIN COATED 1-2-3 BLOCKS

- Titanium nitride coated surface provides extra wear and corrosion resistance.
- Precision ground & heat treated to 55-62 rc.
- Parallel to .0003 on all sides; up to .0003 over allowance for nominal lapping.
- Has 23 holes - 5 holes tapped 3/8-16, 18 drilled through.
- Sold in pairs.



SET No.
TBS-321

\$19.95

Good brown & sharpe TOOLMAKERS VISE AND CLAMP

- Handy for use in drilling, fitting and laying out work surface plates.
- Tongue on large jaw slides in groove in base and is held in place by a strap that prevents jaw from lifting. 1-15/16" capacity. Furnished with two steel jaws as shown.

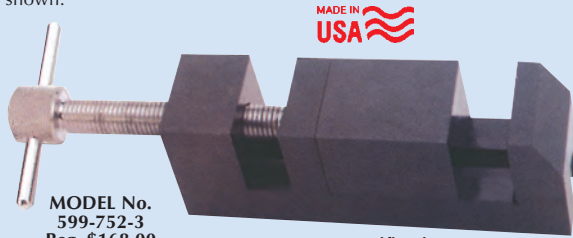

MODEL No.
599-752-3
Reg. \$168.00

\$149.95

MADE IN USA

Specifications

Vise Capacity	Jaw Depth	Jaw Width	Vise Length
1-15/16"	3/4"	7/8"	3-1/4"

TECO BALL BEARING PARALLELS

- Designed to ease heavy loads especially on band saw work.
- Eliminates bell mouth holes on reaming operations.
- Ball bearings are 3/8" thick & plates are 1/4" thick.

MADE IN USA



Model	Length	Width	No. of Balls	Price
5020-1	6"	2-1/2"	18	\$19.95
5020-1	12"	2-1/2"	36	34.95
5020-3	18"	2-1/2"	54	56.50

Fowler CERTIFIED SPACE-BLOX 36 PIECE SET

- Tolerances to .00005".
- Certificate of inspection included.
- Inspected according to meet NIST Federal Specification ASME B89 1.9 - 2002 tolerances. on length for inch gage blocks.
- 36 blocks.
- Ground hardened and tapped.
- 4 connection screws included.
- Includes shop hardened fitted case.



SET No.
53-680-050
Reg. \$175.00

\$129.95

AVENGER TIN COATED PARALLEL SET 1/8" THICK - 10 PAIR

- 10 pairs 1/8" thick with heights of 1/2, 5/8, 3/4, 7/8, 1", 1-1/8, 1-1/4, 1-3/8, 1-1/2 and 1-5/8. All parallels are 6" in length.
- Made from high grade alloy steel and stress relieved against distortion. Titanium nitride coated for extra wear and corrosion resistance.
- Precision ground and hardened to 55-62 rc.
- Parallel to .0003; within .001 on overall size.
- Great for layout work, various uses as standards and set ups.
- Comes in fitted plastic case.



SET No.
TCP-810

\$59.95

phase II+ CAM GRIP WORK HOLDING KIT

Cam action clamping for tables with a 5/8" T-slot.



MODEL No.
CGK-001
Reg. \$89.00

\$59.95

Kit Includes: 4 ea. 5/8" T-slot
6 ea. Cam action fixture clamps,
2 Hex keys & Fitted plastic case.

Fowler X-BLOX 4 PIECE SET

V-Block Set

- 2 each @:
- Dimensions: 1-1/2"L x 1-1/4"W x 1-1/4"H.
 - Work capacity: Approximately 1"
 - 2 clamps.
- 2 each @:
- Dimensions: 2"L x 1-1/2"W x 1-1/2"H
 - Work capacity" 1-1/2"
 - 2 clamps.

- All feature:
- Surfaces are square and parallel within .0005".
 - V-grooves are square and parallel with all surfaces within .0005".
 - Corresponding dimensions for each pair are alike within .0005".
 - All enclosed in shop-hardened case.



SET No.
52-475-500
Reg. \$103.00

\$69.95

Precise WAVY PARALLEL SET 9 PAIRS IN WOOD CASE

- Thin and fragile workpieces can be secured without damage by utilizing the spring pressure of these parallels.
- Can readily be used as elastic shims.
- Made of high-quality spring steel, hardened stress-relieved and precision ground.
- Guaranteed to size in height and parallelism $\pm .0002$ "
- Range: 1/2 to 1-1/2" in 1/8" height increment.
- Economical and easy to use.

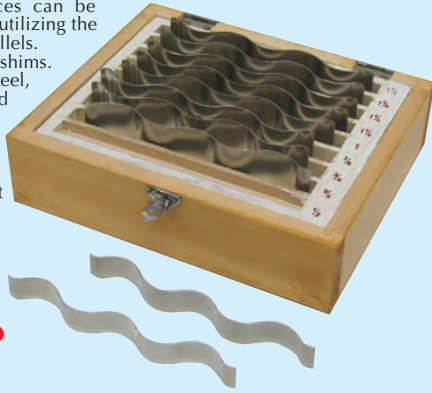

SET No.
PWP-430

\$39.95

Precise 1/2" PARALLEL SET 8 MATCHED PAIRS

- High quality alloy steel, hardened and ground to better than 16 Micro-Finish.
- Two holes in each parallel for easier handling and greater versatility for set-ups.



SET No.
SPU-128

\$69.95

SIZE IN SET :

1/2" x 7/8", 1/2" x 1"
1/2" x 1 1/8", 1/2" x 1 1/4"
1/2" x 1 3/8", 1/2" x 1 1/2"
1/2" x 1 5/8" and 1/2" x 1 3/4"

Precise 6" LONG STEEL PARALLEL SETS

- Made of high grade alloy steel, hardened and ground, holes in each parallel to make them lighter and for easy set-ups. • Paired .0003" in Height.



ALL LENGTHS ARE 6"

Set No.	Size Thickness	Pair Per Set	Size Height	Set Price
SPU-410	3/16"	4	1", 1-1/4", 1-1/2", 1-3/4"	\$39.95
SPU-415	1/2"	4	1", 1-1/4", 1-1/2", 1-3/4"	42.95
SPU-312	3/16" & 1/2"	4	1", 1-1/4", 1-1/2", 1-3/4"	39.95
CLS-017	1/4"	9	3/4", 7/8", 1", 1-1/8", 1-1/4", 1-3/8", 1-1/2", 1-5/8", 1-3/4"	59.95

Precise PRO SERIES T-SLOT CLAMPING KIT

- Special made downward force for holding thin or small workpiece.
- Used for milling, drilling and EDM with 5/8" T-slot table.
- Kit includes: 4 Pc. of T-slot, clamping pieces and bolts.
- Quick and easy setting with hex key wrench.
- Made of tool steel hardened.
- T-slot length: 1.77"
- T-slot Height: 1.145"
- With fitted wooden case.



4 Piece Kit
MODEL No.
3900-0316

\$84.95

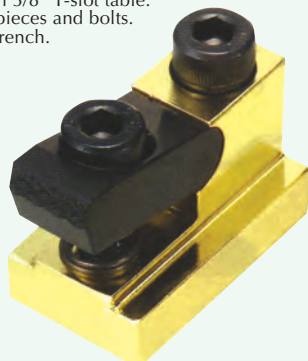

Precise ULTRA THIN PARALLEL SET 1/32" THICKNESS - 20 PAIRS

- Set of 20 pairs of parallels, 1/2" to 1-11/16" high in increments of 1/16th.
- 6" long, 1/32" thick, 50 Rc hardness.
- Accuracy: Height $\pm .001$ " parallelism $\pm .0001$ ".
- In Fitted case.

SET No.
UTH-120

\$44.95

Tin Coated
SET No.
UTH-120T

\$69.95



Precise 1/8" THIN PARALLELS

- 1/8" Thick Parallel Set. • In Fitted Case.
- 10 Piece set, 6" long. Sizes: 1/2", 5/8", 3/4", 7/8", 1", 1-1/8", 1-1/4", 1-3/8", 1-1/2" & 1-5/8".
- High grade alloy steel, hardened and ground from 1/8" stock. 2 or 5 holes in each parallel.
- Accuracy $\pm .0002$ " parallelism in height - .001" to size in height.

SET No.
TPS-081

\$39.95

Tin Coated
SET No.
TPS-081T

\$69.95



Precise SOLID ANGLE PLATES

- Precisely ground angles for convenient setups in tooling, production and inspection.
- Hardened and ground steel.
- 4-11/32" holes for easy mounting.
- Supplied in fitted case.

Includes:
Solid angle plate
3" x 3" x 5/16" with angles
45 x 90° and 2" x 3-3/8" x 5/16"
with angles 30° x 60°

2 Piece Set
MODEL No.
SAB-500

\$16.95



Precise PLANER GAGE

- Features:
- Hardened and ground, forged steel.
 - Built-in precision level.
 - Ground, flat on V ways assure accuracy, eliminating side play.
 - Both sides are ground square with the working edges.
 - Base is 5-1/4" long x 3/4" wide.
 - Includes 3" extension & wood case.



MODEL No.
PSG-100

\$64.95

Precise HOLD-DOWN CLAMPS

- Allows quick set up on mill tables
- The body of the clamp is formed by forging and qualified, a brass spacer is mounted on the end to prevent the work-piece from damage
- Instant height adjustment.
- Supplied in pairs.



Model No.	T-Slot x Stud Size	Length	Clamping Range	Load Limit	Price Pair
202-4838	1/2" x 3/8"-16	3"	Up to 2"	13,000 lbs.	\$24.95
202-4810	5/8" x 1/2"-13	4"	Up to 2-1/2"	16,000 lbs.	28.95
202-4811	3/4" x 5/8"-11	5"	Up to 4"	18,000 lbs.	32.95
202-4812	7/8" x 3/4"-10	6"	Up to 5"	24,000 lbs.	45.95

Suburban TOOL PRECISION VISES

- Solid, one piece body.
- Square & parallel w/i 0.0002" and 0.0003".
- Made from steel hardened to Rc 58-62.

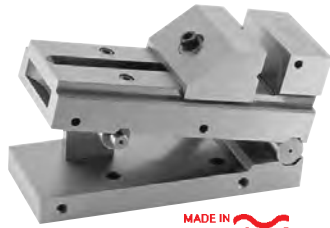

MADE IN USA



- Moveable jaw pulls into base at 45 to 60 degree to insure maximum holding power and hold down force, eliminating tilting and lifting.

- NC models have bi-directional 11/16" keyways ground in bottom.

Precision Vises

Model	Dimensions	Cap.	Price	Sale
V-225**	5-5/8" x 2" x 2"	3-1/4"	\$367.00	\$ 325.00
V-225-S0	5-5/8" x 2" x 2"	3-1/4"	424.00	380.00
V-237**	7-1/2" x 3" x 2-5/8"	4-3/4"	470.00	420.00
V-237-S1	7-1/2" x 3" x 2-5/8"	4-3/4"	526.00	470.00
V-237-J	7-1/2" x 3" x 2-5/8"	5"	527.00	474.00
V-411**	11" x 4" x 3"	7"	818.00	735.00
V-411-S2	11" x 4" x 3"	7"	867.00	775.00

Precision N/C Vises & Matched Pairs

V-411-NC**	11" x 4" x 3"	7-1/2"	\$977.00	\$ 875.00
V-411-NC-M**	11" x 4" x 3"	7-1/2"	2159.00	1940.00
V-612-NC**	12" x 6" x 3-7/16"	8-1/2"	1385.00	1245.00
V-612-NC-M**	12" x 6" x 3-7/16"	8-1/2"	3084.00	2775.00

Precision Sine Vises

SV-337**	7-1/2" x 3" x 3-5/8"	4-3/4"	\$ 769.00	\$ 690.00
SV-337-S1	7-1/2" x 3" x 3-5/8"	4-3/4"	803.00	745.00
SV-411**	11" x 4" x 4-5/8"	7"	1257.00	1130.00
SV-411-S2	11" x 4" x 4-5/8"	7"	1302.00	1170.00

**Not SineSet Compatible M=matched Pair

* V-237-J has Vees on top of the Jaw and 1/8" x 1/8" steps at the top inside face of the Jaw

Precise TOOLMAKERS VISES

- Hardened and precision ground on all surfaces
- The vise can be used on its sides, top, bottom and the ends.
- Simple operation just move the jaw to the desired location and fix with the adjustable bar.
- Locking and clamping mechanism also closes on a ratchet in the base of the vise.
- Squareness and parallelism are within ±.0002"

- 1" MINI INSERT VISE
- May be loaded off-station then inserted in prepositioned grinding vise for matching without disturbing set-up.
- Ideal for transferring small pieces from one machine to another without losing location relationship.
- Used in larger vises also.
- ±.0001" Parallelism & squareness.

7" x 3" MODEL RTV-370 \$69.95



1" x 2" MODEL MIV-100 \$34.95

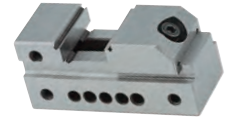

Model No.	Jaw Width	Jaw Opening	Jaw Depth	Vise Length	Vise Weight	Sale Price
MIV-100	1"	13/16"	3/8"	2"	6 oz.	\$ 34.95
202-1120	2"	2-1/2"	1"	5-3/8"	5 lbs.	59.95
202-1121	2-1/2"	3-3/8"	1-1/4"	6-3/4"	8 lbs.	64.95
RTV-370	3"	3-3/4"	1-3/8"	7-1/4"	10 lbs.	69.95
202-1212	3"	5"	1-5/16"	7-1/2"	12 lbs.	79.95
202-1122	3-1/2"	4-7/8"	1-1/2"	9-1/8"	18 lbs.	95.00
202-1123	4"	4-7/8"	1-3/4"	9-5/16"	23 lbs.	145.00
202-1125	5"	6"	2"	11"	34 lbs.	189.50
202-1214	6"	8"	1-11/16"	12"	40 lbs.	265.00

Precise STEP-SINE GAGE

- Unique, patented Gage for quick and simple set-ups of 5" Sine Bars and 5" Sine Plates.
- Saves considerable time in setting most commonly used angles.
- Made of hardened steel 58-62R.

- Clearly marked steps for angles of 5°, 10°, 15°, 20°, 30° and 45°.
- Eliminates stacking errors.
- Precision ground to ±.0002" in size and ± 15 seconds on the angles.



MODEL No. SSG-378 \$59.95



Application for Step Sine Shown

Suburban SINE SET™ SYSTEM

Features:

- A complete sine system through uniquely designed precision tools with "memory" holes.
- All tools can be bolted on, parallel and perpendicular to the hinges, in a multitude of different ways, without clamps and with little or no indicating.
- Tools can be used individually or in the sine system
- Made of quality steel, hardened to Rc 58-62.

Standard Pole Features:

- Produces deep flux lines for holding thick parts.
- Ceramic magnets will not lose power.
- Sealed against dirt and liquids.

Fine Pole Features:

- 1/8" poles and 1/8" separators produce shallow flux lines for holding small and thin parts.
- Chucks use ceramic magnets for superior holding power that never fades.
- Sealed against dirt and liquids.
- Side rail, back rail and two clamps included.

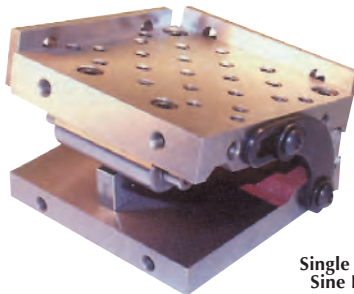

6" x 6" x 3-1/8" Single Angle Sine Plate MODEL No. SP-66-S1 Reg. \$682.00

\$595.00

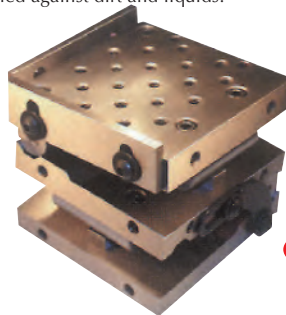

6" x 6" x 5-3/4" Compound Sine Plate MODEL No. SPC-66-S1 Reg. \$1468.00

\$1295.00



6" x 6" x 5-3/4" Magnetic Chuck Standard Pole Compound Sine Plate MODEL No. MSPC-66-F1 Reg. \$2356.00

\$2095.00

Larger sizes Available. Call For More Information

Single Angle Sine Plate With Standard Pole Magnetic Chuck

Single Angle Sine Plate With Fine Pole Magnetic Chuck

Size & Sine System	Center Distance of Rolls	Model No.	Wt. (lbs.)	Sale Price	Size	Model No.	Wt. (lbs.)	Sale Price	Size	Model No.	Wt. (lbs.)	Sale Price
4 x 4 x 2" S0	3.000 ± .0002"	SP-44-S0	9	\$ 418.00	-	-	-	-	4 x 4 x 4-5/8"	MSP-44-F0	21	\$1065.00
6 x 6 x 3-1/8" S1	5.000 ± .0002"	SP-66-S1	18	595.00	6 x 6 x 4-5/8"	MSP-66-S1	39	\$1395.00	6 x 6 x 4-5/8"	MSP-66-F1	43	1395.00
6 x 12 x 2-5/8" S2	5.000 ± .0002"	SP-612-S2	47	1230.00	6 x 12 x 5-1/4"	MSP-612-S2	89	2115.00	6 x 12 x 5-1/4"	MSP-612-F2	87	2315.00
12 x 6 x 2-5/8" S2	10.000 ± .0002"	SP-126-S2	45	1215.00	12 x 6 x 5-1/4"	MSP-126-S2	87	2150.00	12 x 6 x 5-1/4"	MSP-126-F2	92	2300.00
6 x 18 x 3-3/8" S2	5.000 ± .0002"	SP-618-S2	90	3500.00	6 x 18 x 6"	MSP-618-S2	155	4780.00	6 x 18 x 6"	MSP-618-F2	160	4950.00
18 x 6 x 3-3/8" S2	15.000 ± .0003"	SP-186-S2	84	3500.00	18 x 6 x 6"	MSP-186-S2	149	4785.00	18 x 6 x 6"	MSP-186-F2	160	4950.00
8 x 12 x 2-5/8" S2	5.000 ± .0003"	SP-812-S2	62	1595.00	8 x 12 x 5-1/4"	MSP-812-S2	120	2745.00	8 x 12 x 5-1/4"	MSP-812-F2	125	2900.00
12 x 12 x 2-5/8" S2	10.000 ± .0002"	SP-1212-S2	90	2775.00	12 x 12 x 5-1/4"	MSP-1212-S2	190	4620.00	12 x 12 x 5-1/4"	MSP-1212-F2	196	6500.00
				Compound Sine Plate With Standard Pole Magnetic Chuck				Compound Sine Plate With Fine Pole Magnetic Chuck				
Size & Sine System	Center Distance of Rolls	Model No.	Wt. (lbs.)	Sale Price	Size	Model No.	Wt. (lbs.)	Sale Price	Size	Model No.	Wt. (lbs.)	Sale Price
4 x 4 x 3-1/8" S0	3.000 within .0002"	SPC-44-S0	13	\$ 790.00	-	-	-	-	4 x 4 x 5-3/4"	MSPC-44-FS0	25	\$1425.00
6 x 6 x 3-1/8" S1	5.000 within .0002"	SPC-66-S1	27	1295.00	6 x 6 x 5-3/4"	MSPC-66-S1	48	\$2095.00	6 x 6 x 5-3/8"	MSPC-66-FS1	52	2195.00
6 x 12 x 4-3/16" S2	5.000 & 10.000 within .0002"	SPC-612-S2	71	2170.00	6 x 12 x 6-13/16"	MSPC-612-S2	113	3100.00	12 x 6 x 7"	MSPC-612-FS2	118	3250.00
8 x 12 x 4-3/16" S2	5.000 & 10.000 within .0002"	SPC-812-S2	93	2995.00	8 x 12 x 6-13/16"	MSPC-812-S2	151	4235.00	8 x 12 x 6-13/16"	MSPC-812-FS2	156	4350.00

Precise TOOLMAKERS INSPECTION VISE

Precision Ground 0.0004"

- Made of steel hardened to 55HRC. grooved jaw for holding round work pieces
- The base and front jaw are one piece, all steel construction.
- All surfaces are hardened and ground square and parallel to an accuracy of 0.0004"
- Hardened and ground dovetail slides eliminate "lift" and insure consistent accuracy

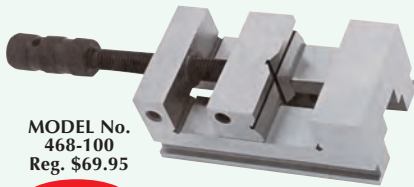

MODEL No.
468-100
Reg. \$69.95

\$49.95

Model No.	Jaw Width	Jaw Opening	Jaw Depth	Body Length	Sale Price
468-100	2-1/2"	3-3/8"	1-1/4"	7-1/4"	\$ 49.95
468-112	3"	4"	1-3/8"	8-1/16"	95.00
202-112	3-1/2"	4-3/4"	1-9/16"	10"	110.00
202-113	4"	4-3/4"	1-3/4"	10-1/4"	129.00

Precise SINE VISES

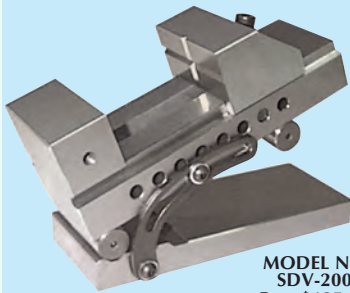

- High precision, solid one-piece steel vise mounted to precision hinged bottom plate.
- Body, jaws and bottom are hardened to 58-62 Rc.
- Moveable jaw is pulled into base between 45 and 60 degrees, insuring maximum holding power and hold-down force, eliminating tilting and lifting.
- One locking strap included.
- Center distance of rolls within .0002".

MODEL No.
SDV-200
Reg. \$125.00

\$89.95

Model No.	Dimensions L x W x H	Jaw Capacity	Distance of Rolls	Sale Price
SDV-200	5-3/8" x 2" x 3-1/8"	2-5/8"	4"	\$ 89.95
SDV-300	7-1/2" x 3" x 3-5/8"	4-3/4"	5"	124.95
SDV-700	11" x 4" x 4-5/8"	7"	10"	295.00
SDV-800	12" x 6" x 5-1/8"	8"	10"	645.00



GOLD TOOLMAKER TIN COATED RAPID VISE

- Precision ground square and parallel to within .00025.
- Made from high grade alloy steel, case hardened.
- Ideal for precision grinding, inspection and in EDM uses.
- All surface are titanium nitride coated for additional wear and corrosion resistance.
- Holes and locking set-screw provide adjustable positions.
- One piece body construction. Vees in sliding jaw square & parallel $\pm .0005"$

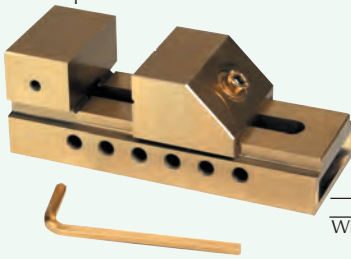

2" Jaw Vise
MODEL No.
MTC-200-1

\$74.95

3" Jaw Vise
MODEL No.
MTC-300-1

\$89.95

Dimensions:	MTC-200-1	MTC-300-1
Width X Height of	1.96" x .984"	2.87" x 1.37"
Jaw x OAL	x 5.51"	x 7.48"
Jaw Opening	2.55"	3.93"

Precise MINI PRECISION TILT & SWIVEL VISE

- Complete with jig plates, which are removable for grinding and milling.
- Swivel angle attachment may be removed for use as a plain vise.
- This is an ideal vise for jig boring, jig grinding, precision grinding, as well as milling and drilling operations.
- Tolerance $\pm 0.0005"$, graduations are furnished on both the tilt and swivel.



MODEL No.
MPV-275
Reg. \$229.95

\$199.95

Specifications:

Jaw Width	2-3/4"
Max. Opening	5/8"
Jaw Depth	25/32"
Total Height	3-5/8"

Precise TOOL MAKERS SET

SET INCLUDES:

- **Precision Screwless Vise.** Hardened and ground. $\pm .0002"$ tolerance, 3" wide x 7-1/2" long. No. RTV-370
- **Toolmaker V-Block.** $\pm .0003"$ tolerance, 2v's hold large & small work, 3-5/8" long. 1-7/8" sq. No. VB-745
- **1-2-3 Blocks, Matched Pair.** Hardened & ground on all 6 sides, 5 tapped holes, 18 untapped, .0001" squariness per inch, 1" x 2" x 3" per block. No.TBS-123
- **Angle Plate Set.** Hardened steel HRC 55, ± 20 seconds, precision ground. No. SAB-500

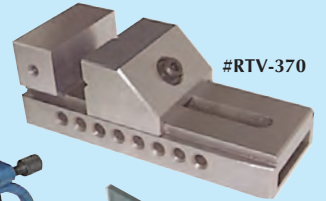

Reg. Sale
\$167.95
Complete Set
No. PTS-400

\$129.95

Precise UNIVERSAL PRECISION VISE

- This fixture is composed of two parts: a precision vise and a swivel angle plate base.
- Vise is capable of revolving 360° horizontally with a 3' graduation engraved and $\pm 45^\circ$ vertical with a 3' graduation engraved.
- L-wrench included for locking vise horizontal at any position.
- Vertical angle can be adjusted with fine adjustment knob.
- Hardened and precision ground provide a tolerance of 0.00004" Parallelism and Squareism.
- Unique universal movement for precision grinding, machining, boring and various applications.

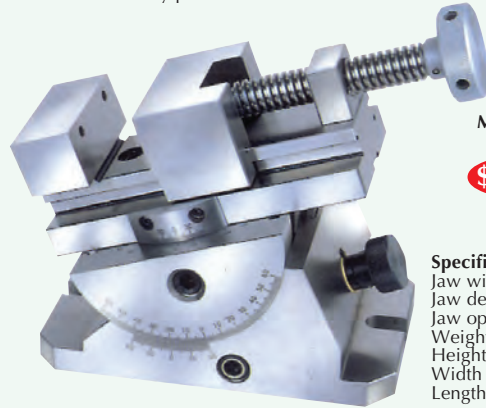

MODEL No.
900-026

\$749.95

Specifications:

Jaw width	2-3/4"
Jaw depth	1.18"
Jaw opening	3.15"
Weight	31 lbs.
Height	5.40"
Width	4.33"
Length	6.30"

brown & sharpe SINE BAR SET

Eliminate constant table to calculate angles and have blocks to set angles...Simply choose the angle setting blocks required for the desired angle. Quick and simple set-up for use in for grinding, milling drilling and inspection applications.

Complete Set Includes:

- One 5" sine bar, 1" square, hardened and precision ground.
- Sine bar is parallel top to bottom of rods within .0002"
- 18 Risers with a range of 1/2° to 15° resulting angle, including two risers providing "Taper-per-foot" of 1/4° and 1/2°.
- Exact constant within .0001".
- Shop hardened fitted molded case.

brown & sharpe
SET No.
598-291-60
Reg. \$220.00

\$195.00

Imported
Version
SET No.
SBS-500

\$69.95



MAGNETIC CYLINDER SQUARES

- Designed to easily check squareness, parallelism, concentricity and runout on workpieces.
- Base is perpendicular to shaft within 0.00005" over the length of the square.
- Magnetic base eliminates clamping distortion and speeds setup.
- Manufactured from steel selected and normalized to insure stability and uniformity.

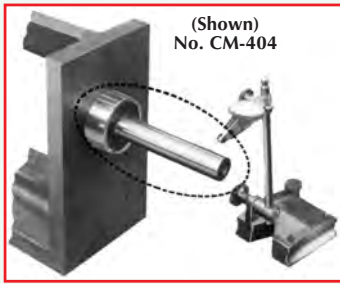

(Shown)
No. CM-404



(Shown)
MODEL No.
PMC-006

A permanent magnet holds the cylinder square to the machined surface when the knurled aluminum knob is turned to the ON position. Turn the knob OFF for easy removal, without marking or moving the part.



Model	Length	Base	Shaft	Weight	Price
CM-404	4-1/2"	1-1/2"	1/2"	4 lbs.	\$325.00
CM-406	6"	3"	1"	7 lbs.	375.00
PMC-006	5-1/2"	2"	2"	8 lbs.	\$299.95

Precise AND **lock brown & sharpe** SINE BARS



No. VSB-500



(A) **Thin Sine Bar No. TBS-300 \$11.95**
Precision Hardened & Ground. 3" Thin bar will fit in bottom of vise and accurately set work piece to desired angle. Can be used for accurately setting swivel vise or angle vise; to set work piece at an angle to T-slot of milling table, back rail of magnetic chuck, and to set milling machine head or down feed on shapes. Multiply 3 x the sine of angle to determine height of gage blocks to set under radius. Two 1/4" holes are provided for mounting purpose.

(B) **Value-Line 5" Sine Bar** is a must for all machinist tool boxes for quickly measuring the desired angles in machine setups.

- Hardened and precision ground. • Body size 1".
- 5" distance between centers of rolls within .0003"
- Top parallel to bottom of rolls within .0002"
- Supplied with back plate.

(C) Precision Sine Bars

- Both sine bar and rolls are hardened and ground for extreme accuracy.
- Flatness of working surface .0004" per 4" of length.
- Parallelism of working surface to roll bottom lines .0001"
- Center to center distance between center of rolls is accurate within .00007"
- There is a flange on the end for resting work.

(B) 5" Sine Bars

Model	Dimensions	Sine	Price
SB-25	1" x 3-5/8" x 1"	2-1/2"	\$19.95
SB-50	1" x 5-1/2" x 1"	5"	24.95
lock brown & sharpe 599-291-500	1" x 5-3/4" x 1"	5"	\$55.00
VSB-500	1-1/4" x 5-3/4" x 1"	5"	\$150.00

With V-Groove & Clamp

(C) Precision Sine Bars

Model	Size	Sine	Price
SB-010	1" x 5"	5"	\$ 59.95
SB-015	1-1/4" x 10"	10"	124.95
SB-020	2" x 5"	2"	79.95

SPi 2-1/2" MAGNETIC MINI SINE BAR

- Hardened and ground steel. 2-1/2" length x 1-1/2" width.

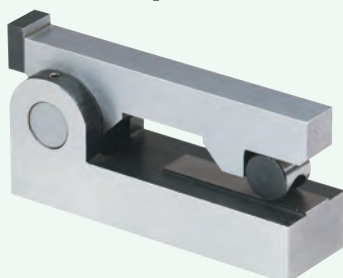

MODEL No.
MSB-250

\$189.95

SQUAROL

- Indicator mountings pivoting grip can receive the standard 60° indicators dovetail or clamp the 5/32" diameter stems.
- Fine adjustment feature is to adjust the contact of the indicator tip in order to bring the dial hand into a desirable reading position.
- Set "O" reading with master square and compare squareness with your work.
- The hardened and ground base provides two pockets, one upper and one lower to mount the inserted reference ring.



MODEL No. SQL-700
Reg. \$238.00

\$210.00



Less Indicator and Cylinder

Precise MICRO TANGENT ANGLE BAR AND ANGLE BLOCK SET

- Made of hardened steel, precision ground.
- Accuracy ±.0001" per inch.
- Interlocking slots.
- Size angle blocks: 35" x 3".
- Fast, easy angular set-up.
- Dial your angle direct in degrees and minutes.
- Add one or two angle block gauges for angles over 5°.
- Secure assembly by dropping 1/8" dowel or square key into slot provided.

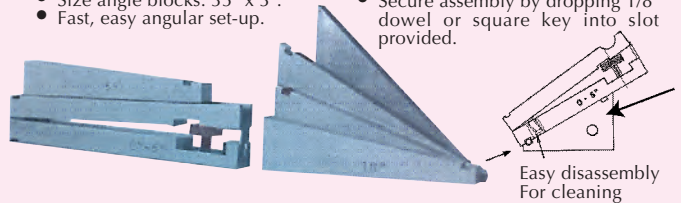

Easy disassembly For cleaning

Precise
SET No.
MTB-500

\$49.95

Set Contains:
Includes one adjustable bar with 5 angle gage blocks (5°, 10°, 20°, 30° & 45°)



Precise ANGLE BLOCK SET - 10 PIECE

- Simple, quick angle set ups.
- Made of tool steel-hardened, stabilized and ground.
- Accuracy: + .0001 per inch.
- Fitted case.
- Block size 3" length x 1/4" thick.
- 10 Pieces, 1°, 2°, 3°, 4°, 5°, 10°, 20°, 25°, 30°

SET No.
AB-140
Reg. \$49.95

\$29.95

With Wood Case



Optional:
No. 30-142: 1/4° Angle Block \$4.50
No. 30-143: 1/2° Angle Block \$4.50

Precise SINE BAR 2" With Permanent Magnetic Base

- Designed for any machine on angular testing.
- Magnetic base with permanent power pull.
- Hardened and precision ground HRC 56-68°.

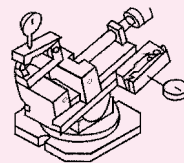

Specifications:

Base Magnetic Power 8lbs.
Parallelism within 0.0001"
Squareness within 0.0002"
Distance between Roll Centers 2"
Rolls Accuracy +0.00008"
Overall Length 3"

MODEL No.
800-541

\$199.95

FLEXBAR

BALL BEARING V-BLOCKS

- Accuracy of balls .000025" sphericity on small and medium sets, .0005" on large sets.
- Balls finished to .2 micro-inch.
- Balls hardened to Rc. 62.
- Overall accuracy of matched pairs ±5 microns.
- Cast iron base and housing are heat-stabilized and seasoned.
- Inspect components from 2 angles by turning spacer block 90°.
- Sold in pairs and test balls.
- **Clamps are not included.**



MADE IN USA

Model No.	Description	Inspection Capacity	Diameter of Ball	Load Capacity	Price Per Pair
16097	Small Pair	3/64-2-1/2"	1/2"	220 lbs.	\$225.00
16098	Medium Pair	3/32-5"	15/16"	1100 lbs.	315.00
16099	Large Pair	3/16-15"	1-1/2"	2000 lbs.	495.00

No. 16123 Pair clamps for # 16097 \$52.00 Pr.
 No. 16124 Pair clamps for # 16098 \$75.00 Pr.
 No. 16125 Pair clamps for # 16099 \$128.00 Pr.

Precise MACHINIST SET-UP KIT

- 1-2-3 Block Set**
 - Tolerance: .001" (squareness per inch).
 - Dimensions: 1" x 2" x 3".
 - Hardened to 58-60 Rockwell C.
 - Matched accuracy within .0002" per inch.
 - Includes fitted case.
- Jack Stand Set**
 - Up to 1000 lbs.
 - Range: 2.25" to 3.375".
 - Jack base diameter: 1.25"
 - 1" and 2" extension bases.
 - Extension may be combined.
 - Includes shop-hardened.
- Angle Block Set**
 - Precision ground.
 - Accuracy; ±30 seconds.
 - All blocks 3" long and .250" thick.
 - Each set includes 1° thru 5° blocks in 1° increments and 5° thru 30° blocks in 5° increments as well as 1/4" and 1/2" blocks.
 - Includes fitted case.
- Spacer Blocks**
 - 3/4" diameter, 1/4"-28 ID thread.
 - Ground hardened and tapped.
 - 4 connecting screws included.
 - Accuracy: ±.0001"



Complete SET
 No. PSK-100
 Reg. \$175.00
\$129.95

Precise PRECISION CYLINDER SQUARE

- Used for checking squares, height gages, and many instruments.
- Easy to access from any angle around it.
- Hardened and both ends are lapped.
- Absolute 90° angle.



Model	Size	Squareness	Weight	Price
CS-006	6" x 3"	±0.00010"	13 lbs.	\$115.00
CS-012	12" x 4"	±0.00015"	45 lbs.	175.00

Precise ECONOMY ANGLE & PARALLEL SETS

4-Pair Parallel Set
 SET No. CLS-001
\$15.95
 Includes:
 4 pairs of parallels: 1/2, 5/8, 3/4 & 7/8" 3 long x 5/32" thick

6-Piece Angle Set
 SET No. TAS-001
\$15.95
 Includes:
 1/2° thru 5° in half degree increments 3-1/2" long x 5/32" thick
 Two 1/4" holes drilled in each

5-Piece Angle Set
 SET No. TAS-002
\$15.95
 Includes:
 6° thru 10° in full increments 3-1/2" long x 5/32" thick
 Two 1/4" holes drilled in each

FLEXBAR

MICRO-RISE

- Hardened and ground anvils support up to 1000 lbs.
- Wide angle "V" accepts 3/16" to 5" diameters.
- Top flats ground parallel to base. Can hold wide, flat parts. Narrow flats may be held on parallel across top.
- Vibration lock, (position lock), prevents creeping.
- Insures solid support without deflection.
- 1/2" total rise of "V", .050 per revolution. Dial graduated in increments of .001"
- Available in metric screw and dial.



Specifications:
 Base: 1-3/4" x 4" V Section: 13/16" wide
 Height closed: 3" Height open: 3-1/2"
 V-angle: 120°



X-Tra Large

Model	Description	Price
16505	Standard 2 Pc. Set without clamps	\$395.00
16507	Standard 2 Pc. Set with clamps	495.00
16513	X-tra large 5" x 10" Capacity 2 Pc. Set w/o clamps	\$1095.00

Precise SPACE BLOCK SET

- Ideally used wherever accurate spacing is required, such as setting sine plates, sine bars, etc.
- Each block clearly marked for size. 3/4" O.D., M6 x 1 thread.
- 36 space block with 4 connecting screws complete in fitted case.
- Hardened, lapped to ±.001".



SET No. SB-036
 Reg. \$79.95
\$59.95



.050	.090	.500	1.000*	.105	.110	.150
.060	.100	.600	.101	.106	.120	.160
.0625	.200	.700	.102	.107	.125	.170
.070	.300	.800	.103	.108	.130	.180
.080	.400	.900	.104	.109	.140	.190

*Each Included

Harig SUPER WEE BLOCKS

- A unique and universal holding tool for small, miniature or intricate parts, used in conjunction with larger V-blocks.
- Capacity .030" to 9/32".
- Ideal holding fixture for grinding/indexing punches and pins, drilling, milling EDM, inspection on optical comparators.
- Furnished with bridges to straddle long workpieces, allowing top hold-down screw of V-block fixture to be utilized.
- Hardened and high precision ground Wee Blocks, squareness and parallelism within .0002".
- Set in attractive fitted case includes 2 Super Wee Blocks size A .030" - 5/32" cap and size B .050"-9/32" cap, Bridge A and B, plus 5 upper prisms, 1/8", 5/32" and 3/16" cap, U.S. made.

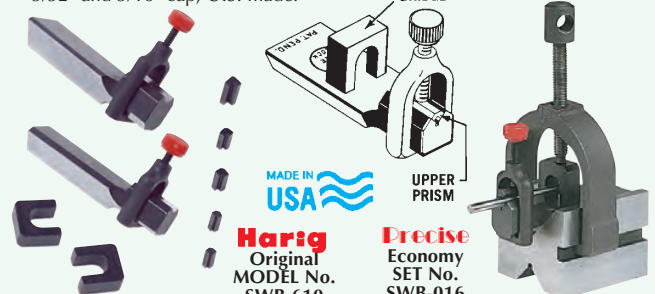

MADE IN USA

Harig
 Original MODEL No. SWB-610

\$119.95

Precise
 Economy SET No. SWB-016

\$79.95

Precise MAGNETIC V-BLOCKS AND PARALLELS

- Integrally aluminum cast into one solid piece. • V-blocks hold in any direction on the magnetic chuck. • Ground all over.

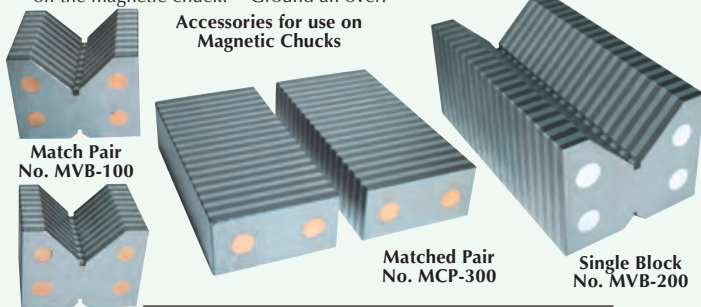

Accessories for use on Magnetic Chucks

Match Pair No. MVB-100

Matched Pair No. MCP-300

Single Block No. MVB-200

Model	V-Block Description	Price
MVB-100	Small set 1-7/8" x 2-3/8" x 2" large V cap. 2" round, small V 1/2" round matched pair	\$34.95
MVB-200	Large V-block 1-7/8" x 2-3/8" x 4-3/8", Large V cap. 2" round, Small V 1/2" round single V-block	\$36.95
MVB-202	Matched Pair same as above size	\$69.95
Model	Chuck Parallels	Price
MCP-300	Aluminum cast, 1" x 2" x 4" ground all over	\$34.95
MCS-400 Combo Set	Small set V-block Model MVB-100 & Model MCP-300 magnetic chuck parallels	\$62.95

Brown & Sharpe JACK SCREW UTILITY SET

Complete In A Shop-Hardened, Protective Molded Case



Use the Jacks Crew Utility Set when you are setting up machinery and in other machine shop applications. Perfect for levelling work on planer beds and upright drills.

- 1-1/4" diameter jack (at base).
- 2-1/4" to 3-3/8" range.
- Easily lifts 1,000 lbs.
- Two extension bases: 2" and 1" high respectively.
- Use extensions singly or together.
- When used together, a height of 6-3/8" may be obtained with the jack.

SET No. 599-680

\$32.50

Fowler MACHINIST SCREW JACK SET

- Set consists of 2 machinists jacks supplied in a shop-hardened case.
- Individual jacks consists of a heavy, steel cast base with adjustable steel screw and tilting swivel head, with a lock nut for permanent positioning.
- 1-1/2" jack base for added stability.
- Range: Min: 3" Max: 4" • Minimum capacity: 1000 lbs.



SET No. 52-104-025

\$13.95

FISHER MICRO MAGNETIC CHUCK PARALLELS & UNIVERSAL V-BLOCKS

Integrally Cast Into One Solid Piece

- These fine V-Blocks are now made Universal (Holds in any direction on the Magnetic Chuck).
- Ground all over and in serial numbered in pairs.
- Forget the direction of your plates. Place it on any direction and grind your piece in either V.
- Steel used in all the V-Blocks and Parallels is selected for the highest magnetic transfer and low retention of magnetic flux.

#MVB-002

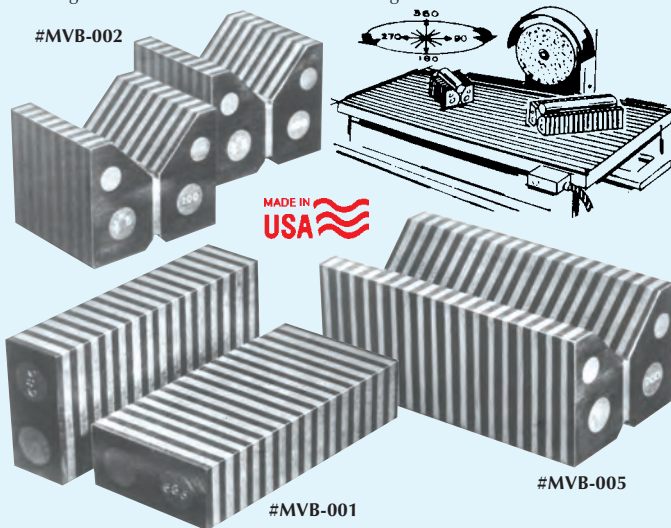

MADE IN USA

#MVB-001

#MVB-005

Model	Description	Price
MVB-001	Magnetic Parallel (Pair) 1" x 2" x 4" #1	\$ 95.00
MVB-002	Pair Magnetic V-Blocks 1-7/8" x 2-3/8" x 2" Capacity #4	130.00
MVB-005	One Long V-Block 1-7/8" x 2-3/8" x 4"	130.00
MVB-005M	One Matched Pair of long V-Blocks	235.00
MVB-014	Combo Set of #1 & #4 in one chest	215.00

Fowler JACK STAND SET

- Up to 1000 lbs.
- Range: 2.25" to 3.375"
- Jack base diameter: 1.25"
- 1" and 2" extension bases.
- Extension may be combined.

MODEL No. 52-104-000

\$24.95



Fowler MAX-JACK HEAVY DUTY SCREW JACK

- Simplify set-up applications on all machine and inspection operations.
- Adjustable from 4.5" to 8".
- Quick-acting height adjustment.
- Fine adjust ring for easy leveling.
- Height locking ring.
- Lifting capacity 2000 lbs. (approx.)

Adjustable from 4.5" to 8"



Model No.	Description	List Price	Sale Price
52-104-050	Max-Jack screw jack	\$125.00	\$ 99.95
52-104-055	Pair of Max-Jack screw jacks (2 each)	245.00	195.00

Precise "LITTLE GIANT" STYLE JACK SCREW SETS

- Versatile set which includes jack, extension bases and attachments.
- Used for leveling work on planer beds, upright drills and setting up machinery.
- Ability to lift 1000 lbs.
- Jack body alone has a range of 2-1/4" to 3-3/8".



Model	Lift Range	Set	List	Sale
3900-0260	1-1/2" to 2-1/4"	6	\$25.00	\$19.95
3900-0266	2-1/4" to 3-3/8"	6	34.00	26.95

KANETEC MAGNETIC V-BLOCK

Useful as a holder for precision work in measuring, boring and marking off.

- On-off switch makes it easy to attach and remove the block easy.
- Two pieces, finished to same dimension and precision and are furnished together as a pair.



Made In Japan

Model No.	Dimensions L x H x W	"V" Diameter	Price Pair
KMV-50	2.76" x 1.97" x 1.57"	1.42"	\$445.00
KMV-80	3.94" x 3.15" x 1.97"	2.36"	595.00
KMV-125	5.91" x 3.94" x 1.97"	3.54"	825.00

KANETEC MAGNETIC V-HOLDER

Usable for marking off round bar, measuring, grinding & boring the works of different shape, tapping & other similar operations.

- Magnetic force works on the upper, base and V-shaped faces
- Magnetic force is easily changed over by lever operation.
- Water-proof construction.



Made In Japan

Model	Width x Height x Length	V-Dia.	Price
KVA-100	2.4" x 2.9" x 3.1"	1-1/2"	\$189.95
KVA-200	2.4" x 2.9" x 4.9"	1-1/2"	250.00
KVA-300	2.4" x 2.9" x 7.1"	1-1/2"	525.00

KANETEC MAGNETIC MINI-CHUCKS

- Permanent, powerful magnet.
- On and Off switch.
- Available in rectangular or round shapes.
- D.O.T. Regulated. Shipped via ground freight only.

Made In Japan

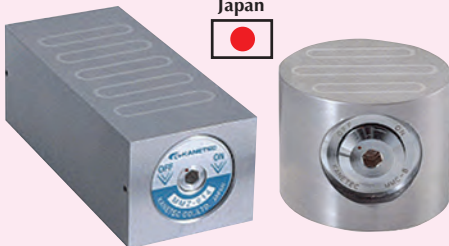

RECTANGULAR TYPE

Model No.	Dimensions L x W x H	Weight lbs.	Price Each
MMZ-412	4.5" x 1.6" x 1.6"	2	\$545.00
MMZ-614	5.3" x 2.0" x 2.0"	4.5	695.00

ROUND TYPE

Model No.	Dimensions	Price Each
MMC-5	2" Diameter x 2"H	\$345.00
MMC-8	3-5/32" Diameter x 3-5/32" H	550.00

MAGNETIC QUICK CLAMP

- Designed to enable fast and accurate holding of ferrous metals for welding and assembly jobs.
- The Quick Clamp will hold sheet and tube at angles of 180°, 90°, 75°, 60°, 45°, & 30°.
- The three body holes enable this new magnetic tool to be built into jigs or hung up when not in use.

Dim:
Base: 3-12/16"
Height: 2-1/2"
Length: 4"

MODEL No.
MQC-001
\$10.95

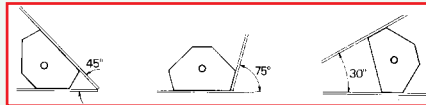

POWER POT MAGNETS

- Extremely powerful holding strength.
- Provided with push-off screw to remove work from magnetic hold.



Model No.	Dimensions Dia. x Height	Magnetic Pull	Price Each
PPM-650	1-3/4" x 1-3/4"	50 lbs.	\$24.95
PPM-651	2-1/8" x 2-1/8"	70 lbs.	33.95
PPM-652	2-3/4" x 2-5/8"	150 lbs.	45.00

MAGNETIC WELDING LINK

- Ideal for holding steel parts for welding, brazing, etc.
- Wing nut adjustment, no clamp needed.
- Two heavy mag block 2-3/8" long x 1-1/8" square linked together for easy adjustment.

MODEL No.
MWL-002
\$19.95



MAGNETIC ADAPTER PLATE

Top & Bottom Surface Magnet

- The magnetic section on one side is separated so as to adapt itself to the surface of the instrument, tool or part to be held.
- The opposite side attracts itself to any metal surface on any machine.
- Converts your surface gage into a magnetic unit and also be used as a grinding chuck for small grinding operations.
- Top & bottom parallel within .001".
- 3-1/2" long x 2-1/2" wide x 7/8" high.

MODEL No.
MAP-280
\$24.95



KANETEC MAGNETIC SQUARE BLOCK

With 1 Vee

- Permanent, powerful magnet.
- Ideal for holding round or irregular shapes.
- Top surface with V magnetized.
- Oil and waterproof.
- Double side On/Off lever switch.



Made In Japan

Open "KYB"

Model No.	Dimensions W x L x H	Weight lbs.	Price Each
KYB-8	3.1" x 3.1" x 3.1"	13	\$ 570.00
KYB-13	4.9" x 4.9" x 4.9"	38	1050.00
KYB-18	7.1" x 7.1" x 7.1"	60	1425.00

With 2 Offset Vee's

- Permanent, powerful magnet.
- Ideal for holding round or irregular shapes.
- All surfaces and vees are precision ground.
- 3 faces, top and both sides are magnetized.
- Oil and waterproof.
- Double side On/Off lever switch.



Solid "KYA"

Made In Japan

Model No.	Dimensions W x L x H	Weight lbs.	Price Each
KYA-8	3.1" x 3.1" x 3.1"	7	\$ 935.00
KYA-13	4.9" x 4.9" x 4.9"	51	1695.00
KYA-18	7.1" x 7.1" x 7.1"	75	2750.00

Suburban MAGNETIC TOOLMAKER'S CHUCKS

Precision Ground

- Top, bottom and end magnetize simultaneously.
- All models precision ground flat, square and parallel to an overall accuracy of .0005".
- Bottom surface relieved .125" to minimize loss of magnetism.
- Model MTC-300 has 3/16" x 1/16" fine pole construction for holding small or thin parts and removable side and end rails.

MADE IN USA

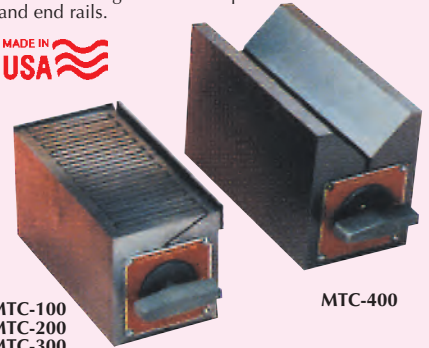

Model	Width	Height	Length	Price
MTC-100	2"	2"	5"	\$350.00
MTC-200	2-3/4"	2-1/2"	5-1/2"	395.00
MTC-300	2-3/4"	3"	5-1/2"	450.00
MVB-400	2-3/4"	3-5/8"	5-1/2"	450.00
MVB-500	Matched Pair of MVB-400			995.00

POSITIONING MAGNETIC CUBE

- The 1" cube has four magnetic surfaces.
- The cube can be positioned from any side.
- It can hold two objects parallel, plus round pieces in 90° V.
- It can be rotated to be used on all sides on the work table and simultaneously holding two objects parallel or a round inspection piece in the 90° V.

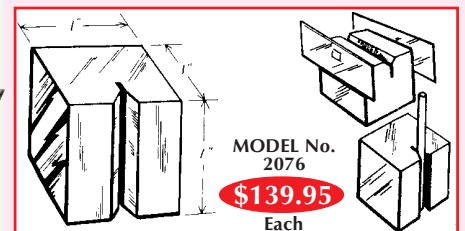

MODEL No.
2076
\$139.95
Each



**MAGNET PARALLELS
PRECISION GROUND**

- Ground on all four sides.
- Adjacent sides square with each other within .004.
- Provides positive grip for small, thin or irregular work which can not be held directly on a magnetic chuck. Greater gripping for thin work than if held directly on a magnetic chuck.
- Non-magnetic in itself but design to transmit the maximum holding power of a magnetic chuck. Provides positive grip on the work
- Constructed of fused lamination in precise alignment. No pins. May be machined to fit any job.
- Highest permeability & low residual magnetism.
- Alternate laminations. of 1/16" iron x 1/16" brass.

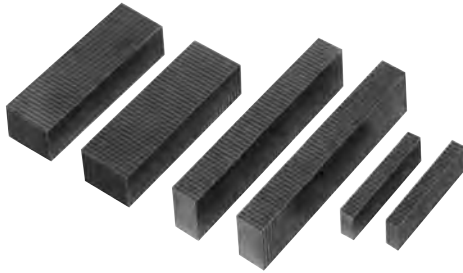

**MAGNETIC V-BLOCKS
PRECISION GROUND
CAN BE USED AS PARALLELS
AND ANGLE PLATES**

- Non-magnetic in itself but designed to transmit the maximum holding power of a magnetic chuck. Provides positive grip on the work.
- Constructed of fused laminations in precision alignment. No pins. May be machined to fit any job.
- Highest permeability and low residual magnetism.
- Made with alternate laminations of 1/16" iron x 1/16" brass.

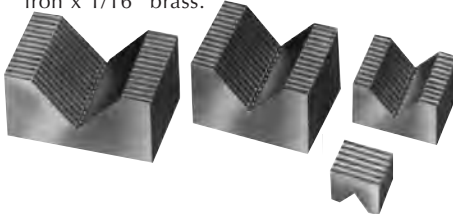

1/16" Iron 1/16" Brass	Dimensions L x W x H	Price Each	Price Per Pair
MV-1-16	1-1/2" x 1-5/8" x 1"	\$145.00	\$280.00
MV-2-16	2-1/2" x 3" x 1-5/8"	285.00	545.00
MV-3-16	3-3/8" x 4-1/4" x 2-1/2"	545.00	1045.00
MV-4-16	3-3/8" x 5-1/4" x 2-1/2"	665.00	1265.00

SPECIFY - "P" for Pair After Number

SPECIFICATIONS

90°V is held central with the sides & parallel with the bottom within .0005. All working surfaces square with each other within .0004. Furnished in pairs matched to .0001 T.I.R.

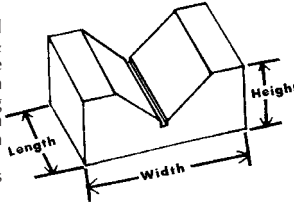

PARALLEL & V-BLOCK SET

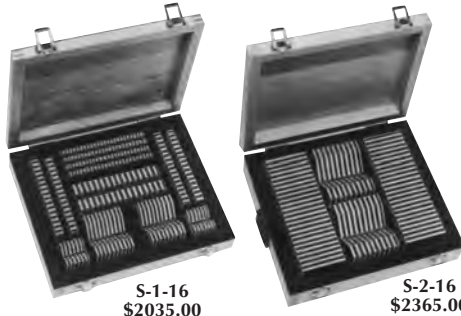

SET No.	PRICE PER SET	SET No.	PRICE PER SET
S-1-16	\$2035.00	S-2-16	\$2365.00
EACH SET CONSISTS OF THE FOLLOWING		EACH SET CONSISTS OF THE FOLLOWING	
Pair	PARALLELS	Pair	PARALLELS
2	1/4 x 1/2 x 6	1	2 x 3-1/4 x 9
1	1/2 x 1 x 6	Pair	V-BLOCKS
1	1/2 x 1-1/4 x 6	1	3-3/8" L x 4-1/4" W x 2-1/2" H - 3" Dia. Work Holding Cap
1	3/4 x 1-1/2" x 6		

Pair	V-BLOCKS	Work Hldg. Cpty.
1	1-1/2Lx1-5/8Wx1H	1" Dia.
1	2-1/2Lx3Wx1-5/8H	2" Dia.

SET No.	PRICE PER SET
S-3-16	\$2965.00
EACH SET CONSISTS OF THE FOLLOWING	
Pair	PARALLELS
1	1 x 2 x 12
1	1-1/2 x 3 x 12
Pair	V-BLOCKS
1	3-3/8" L x 5-1/4" W x 2-1/2" H - 4" Dia. Work Holding Cap

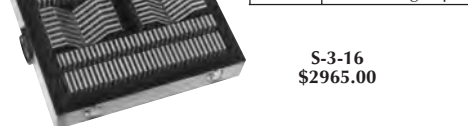

1/16 Iron 1/16 Brass	Dimensions W x H x L	Price Each	Price Per Pair
P-26-16	1" x 2" x 6"	\$235.00	\$460.00
P-28-16	1" x 2" x 8"	310.00	600.00
P-36-16	1" x 3" x 6"	360.00	715.00
P-38-16	1" x 3" x 8"	385.00	755.00
P-61-16	1/4" x 1/2" x 6"	110.00	210.00
P-62-16	1/2" x 1" x 6"	140.00	255.00
P-63-16	1/2" x 1-1/4" x 6"	150.00	292.00
P-64-16	3/4" x 1-1/2" x 6"	160.00	320.00
P-41-16	1" x 2" x 4"	185.00	330.00
P-44-16	1" x 4" x 4"	277.00	540.00
P-46-16	1" x 4" x 6"	405.00	790.00
P-48-16	1" x 4" x 8"	515.00	990.00
P-121-16	1" x 2" x 12"	345.00	665.00
P-122-16	1-1/2" x 3" x 12"	745.00	1395.00
P-91-16	2" x 3-1/4" x 9"	635.00	1235.00

SPECIFY - "P" for Pair After Number

Length	Total Parallelism & Straightness Over Entire Length	Total Size Tolerance Between a Pair
6"	.0002	.0002
9"	.0002	.0002
12"	.0003	.0003

**MAGNET AUXILIARY
PLATES AND BLOCKS**

- Models map-116 and map-1612 increase the magnetic holding power of your chuck for thin and small irregular work.
- Alternate laminations. of 1/16" iron x 1/16" brass.
- Feature high permeability and low residual magnetism. Precision ground.
- Laminations are precision aligned. Are constructed by fusing the laminations. No pins are used.
- Models MBM-1,2,3,4, & 5 are milled finished so they may be machined into special shapes and sizes.

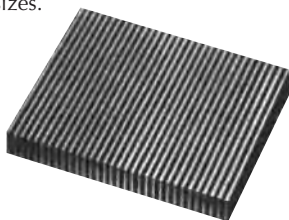

Model No.	Size L x W x H	Price Each
MAP-116	6" x 4" x 1/2"	\$ 365.00
MAP-1612	12" x 12" x 1"	1285.00
MBM-1	6" x 4-5/8" x 3-1/4"	715.00
MBM-2	6" x 12" x 2"	1045.00
MBM-3	9" x 3-1/4" x 2"	655.00
MBM-4	12" x 12" x 3-1/4"	2640.00
MBM-5	15" x 12" x 3-1/4"	3740.00
MBM-6	18" x 12" x 3-1/4"	5150.00

**MAGNETIC ADJUSTABLE
V-BLOCK**

- Unique, first Magnetic Adjustable V-Block of its kind.
- Made of alternating material of high permeability-low residual magnetism and non-magnetic brass strips.
- Exclusive method of holding laminations without pins or rivets, laminations are guaranteed not to shift.
- For maximum holding power, laminations of V, base & laminated V match perfectly.
- Vernier is graduated to 5 minutes.
- Angular setting by sectional gear and gear pinion with knurled knob for easy turning. Extension rod for hairline setting.
- Vernier plate and sectional gear pinned to V and keyed to base to eliminate any shifting.
- V groove is precision ground to an included angle of 90° parallel to the base and side of the bottom block to .00005 over its entire length.

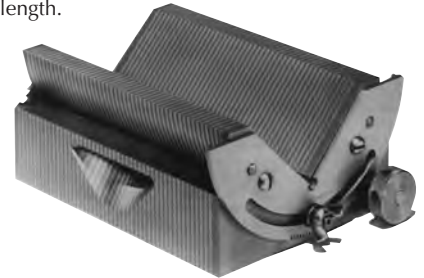

Laminated V insert for flat work with unit (as shown in photo). Handy knobs at each end to facilitate insertion and removal, automatically line up laminations for better magnetic performance.

Model	Size	Price
MAV-64	6" x 4-1/2" x 2-1/2"	\$2525.00
MAV-64-1	Wood Case	95.00

PRECISION MAGNETIC BLOCK

- The V-block has three magnetic surfaces consisting of a 90° V-angle 1-5/8" across the top, bottom surface and end.
- V-block has a .0035" accuracy for squareness, parallelism and frames.
- It is 2" wide, 2.75" high and 4" long.
- The unit has it's own self-contained magnet with approximately 220 lbs. of pull.

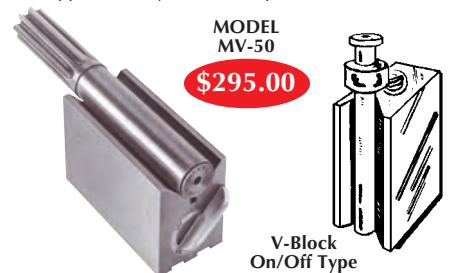

**Precise MAGNETIC V-BLOCKS
WITH ON-OFF SWITCH**

- Precision ground finished working surfaces.
- Ideal for scribing, grinding, measuring and machining round or irregular shape items.
- On/Off switch.
- Two centered 90° Vees.



Model No.	Dimensions H x W x D	Power Pull	Price Each
3402-0990	3-3/4" x 2-3/4" x 3"	130 lbs.	\$ 79.95
3402-0901	3-3/4" x 2-3/4" x 4"	250 lbs.	85.00
3402-0992	3-3/4" x 2-3/4" x 5"	275 lbs.	119.95
3402-0993	3-3/4" x 3" x 6"	320 lbs.	185.00

Precise FINE POLE MAGNETIC CHUCKS

- General purpose applications.
- Sealed against dirt and liquid.
- Removable handle.
- A size for every application.
- Handles move easily to turn chuck on or off.
- High holding power: Max. 140 lbs./sq.in.
- Steel pole spacing: 1/16"
- Brass pole spacing: 1/32"
- Fine pole division for more uniform magnetic holding of small parts.

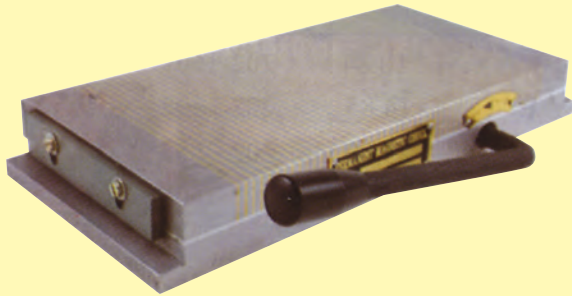

Model No.	Magnetic Surface Area	Table Height	Weight lbs.	Sale Price
202-2452	4" x 7"	1.60"	19 lbs.	\$ 255.00
202-2453	5" x 10"	1.60"	35 lbs.	295.00
202-2401	6" x 12"	2"	40 lbs.	335.00
202-2402	6" x 18"	2"	70 lbs.	450.00
202-2454	8" x 18"	1.97"	130 lbs.	625.00
202-2408	8" x 24"	1.97"	170 lbs.	1195.00
202-2409	12" x 24"	1.97"	210 lbs.	1495.00

Precise FINE POLE CIRCULAR MAGNETIC CHUCKS

- For holding magnetic workpieces on grinders and lathes with rotating spindles.
- Solid top and bottom plates to retain accuracy.
- Bottom surface with tapped holes with counterbores for convenient mounting.
- High holding power: Max. lbs./sq. in.
- Fine pole division for more uniform magnetic holding of small parts.
- Pole spacing: Steel 1/16" and Brass 1/32"

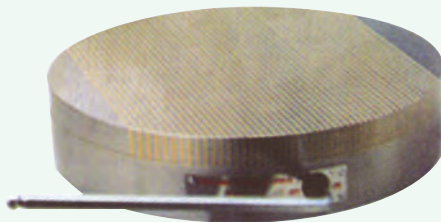

Model No.	Chuck Diameter	Holding Area	Height Inch	Weight lbs.	Sale Price
202-2404	6-1/4"	4-7/8"	2-15/16"	18 lbs.	\$ 395.00
202-2405	8"	6-11/16"	3-1/8"	29 lbs.	525.00
202-2406	12"	10-11/16"	3-21/64"	65 lbs.	1275.00

Precise MAGNETIC CHUCKS

Powerful Yet Economical

- Low height for greater clearance.
- Solid top & bottom plates assure retained accuracy.
- Positive on/off control and removable handle.
- Individually magnetized poles assure uniform holding power over the entire surface.
- Ideal for use on surface grinders, mill and other metal removing machines.



Rectangular

Circular				Rectangular			
Model	Dia.	Height	Price	Model	Size	Height	Price
RNC-500	5"	2-5/8"	\$195.00	PMC-470	4" x 7"	2"	\$169.95
RNC-600	6"	2-5/8"	225.00	PMC-510	5" x 10"	2"	225.00
RNC-900	9"	2-5/8"	375.00	PMC-612	6" x 12"	2-1/8"	295.00
RNC-12	12"	2-5/8"	450.00	PMC-618	6" x 18"	2-1/8"	395.00
				PMC-818	8" x 18"	2-3/8"	550.00
				PMC-824	8" x 24"	2-3/8"	695.00

Suburban RECTANGULAR MAGNETIC CHUCKS

Standard Pole Features:

- 1/4" poles and 1/8" separators produce a deep flux.
- Ceramic magnets will not lose power.
- Removable handle.
- Sealed against dirt and liquids.
- Ideal height for work clearance.

Fine Pole Features:

- 1/8" poles and 1/8" separators produce shallow flux lines for holding small and thin parts.
- Chucks use ceramic magnets for superior holding power that never fades.
- Sealed against dirt and liquids.
- Side rail, back rail and two clamps included.



MC-66
Parallel Chuck
shown on
AP-664-S1
Angle Plate

Dimensions W x L x H	Standard Pole		Fine Pole	
	Model	Price	Model	Price
3" x 6" x 2-5/8"	-	-	MC-36-FP*	\$ 490.00
4" x 7-1/2" x 2-5/8"	MCB-47	\$ 495.00	MCB-47-FP	540.00
5" x 10-1/2" x 2-5/8"	MCB-510	670.00	MCB-510-FP	775.00
6" x 6" x 2-5/8"	MC-66*	795.00	MC-66-FP*	895.00
6" x 12-1/2" x 2-5/8"	MCB-612	895.00	MCB-612-FP	1025.00
6" x 14-1/2" x 2-5/8"	MCB-614	1005.00	MCB-614-FP	1135.00
6" x 18-1/2" x 2-5/8"	MCB-618	1195.00	MCB-618-FP	1370.00
8" x 12-1/2" x 2-3/4"	MCB-812	1125.00	MCB-812-FP	1285.00
8" x 15-1/2" x 2-3/4"	MCB-815	1350.00	MCB-815-FP	1545.00
8" x 18-1/2" x 2-3/4"	MCB-818	1650.00	MCB-818-FP	1830.00
8" x 24-1/2" x 2-3/4"	MCB-824	2200.00	MCB-824-FP	2480.00
10" x 15-1/2" x 2-3/4"	MCB-1015	2135.00	MCB-1015-FP	2335.00
10" x 18-1/2" x 2-3/4"	MCB-1018	2565.00	MCB-1018-FP	2745.00
10" x 24-1/2" x 2-3/4"	MCB-1024	3600.00	MCB-1024-FP	3790.00
12" x 12-1/2" x 2-3/4"	MCB-1212	1725.00	MCB-1212-FP	1930.00
12" x 18-1/2" x 2-3/4"	MCB-1218	3275.00	MCB-1218-FP	3480.00
12" x 24-1/2" x 2-3/4"	MCB-1224	4050.00	MCB-1224-FP	4490.00

PARALLEL GRIPS

For Holding Non Magnetic Parts on Magnetic Chucks

- Ideal for holding very thin, small and awkward parts with little surface contact area.
- Non-magnetic parts are clamped between the two serrated edges of the Parallel Grips and positively held against the face of the magnetic chucks.
- Each grip features a preloaded spring steel strip.
- The serrated spring action of each Grip is positioned at a specific angle to secure maximum hold down.
- The vertical pull-down force of the Magnetic chuck will also exert a horizontal force against the non-magnetic workpiece from each Parallel Grip and therefore hold the workpiece firmly in position.

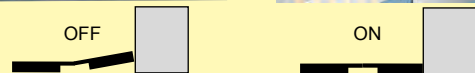

Model	Size	Price Pair
CP-5010	6" x 40mm x .040" Thick	\$495.00
CP-5015	6" x 43mm x .060" Thick	475.00
CP-5030	6" x 43mm x .160" Thick	450.00
CP-5040	10" x 52mm x .160" Thick	750.00
CP-5050	20" x 52mm x .160" Thick	1195.00

Precise 1/8" x 3" LONG PARALLEL SET

- Made from fine quality tool steel stress relieved against distortion, precision ground and hardened.
- Complete with fitted durable plastic case.
- 2 holes in each parallel.
- Tolerance: parallel to 0.0003 on 2 sides, top and bottom.
- Within 0.001" allowance



MODEL No.
3900-3012
\$38.95

Dimensions: 10 Pair

- 1/8" x 1/2" x 3"
- 1/8" x 5/8" x 3"
- 1/8" x 3/4" x 3"
- 1/8" x 7/8" x 3"
- 1/8" x 1" x 3"
- 1/8" x 1-1/8" x 3"
- 1/8" x 1-1/4" x 3"
- 1/8" x 1-3/8" x 3"
- 1/8" x 1-1/2" x 3"
- 1/8" x 1-5/8" x 3"

Suburban MAGNUM PERMANENT MAGNETIC CHUCKS

- Dual magnets provide 120% more power than our standard chuck and positive shut-off for easy work piece removal.
- Ceramic magnets are used because they never lose their holding power.
- Submersible design for use in EDM or other fluids.
- Magnetic free chucks are sealed and lubricated.
- Rigid work surface provided by laminated and brazed top plate.
- Maximum holding of both small & large pole spacing.
- Clamps included. • Full 24 month warranty.

MADE IN USA

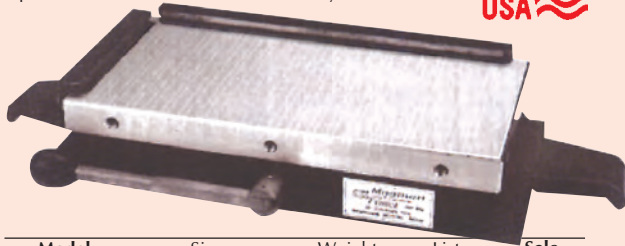

Model No.	Size L x W x H	Weight lbs.	List Price	Sale Price
DMB-44	4" x 4" x 2-3/8"	10	\$1043.00	\$ 935.00
DMB-48	8" x 4" x 2-3/8"	20	1102.00	990.00
DMB-510	10" x 5" x 2-3/4"	28	1275.00	1145.00
DMB-512	12" x 5" x 2-3/4"	35	1468.00	1320.00
DMB-66	6-1/2" x 6-1/2" x 2-3/4"	25	1226.00	1100.00
DMB-610	10" x 6" x 2-3/4"	35	1312.00	1180.00
DMB-612	12" x 6" x 2-3/4"	44	1440.00	1295.00
DMB-618	18" x 6" x 2-3/4"	66	1896.00	1695.00
DMB-818	18" x 8" x 2-3/4"	87	2769.00	2490.00
DMB-820	20" x 8" x 2-3/4"	102	3143.00	2825.00
DMB-824	24" x 8" x 2-3/4"	116	3231.00	2895.00

Suburban ROUND MAGNETIC CHUCKS

The sides of magnetic chucks are diamagnetic, they create no magnetic field, and therefore will not attract ferrous particles. The surface plates of the chucks are almost without pitch permitting you to use them for jobs (small or thin parts) that previously couldn't be handled by the ordinary type magnetic chuck. Handle release is positive.



Fine Pole pattern for tiny and thin pieces only

MADE IN USA



Standard Pole

Model	Diameter	Height	Weight lbs.	List	Sale
RMC-5	5-1/2"	2-13/16"	15	\$ 571.00	\$ 510.00
RMC-6	6-1/4"	2-15/16"	17	880.00	790.00
RMC-9	9-1/4"	2-15/16"	36	1556.00	1395.00
RMC-12	12-1/4"	2-15/16"	60	2251.00	1995.00
RMC-15	15-1/4"	3-3/4"	120	4391.00	3950.00
RMC-16	16"	2-15/16"	96	4505.00	4050.00
RMC-20	20"	4-1/8"	205	7377.00	6625.00

Fine Pole					
Model	Diameter	Height	Weight lbs.	List	Sale
RMC-6FP	6-1/4"	2-15/16"	18	\$1104.00	\$ 990.00
RMC-8FP	7-3/4"	2-15/16"	26	1433.00	1285.00
RMC-10FP	10"	2-15/16"	43	1927.00	1730.00
RMC-12FP	12-1/4"	2-15/16"	62	2699.00	2395.00

WALKER

CERAMAX MAGNETIC CHUCKS AND LBP ELECTRO MAGNETIC CHUCKS

WALKER

Fine-Division Permanent

This patented design offers maximum holding power, ease of installation and operation. It is extremely versatile. In addition to general toolroom grinding, it is suitable for many milling applications.



MADE IN USA

Solid Construction Top Plate -

Protects permanent magnetic pack from penetration of coolant provides stronger more rigid work surface

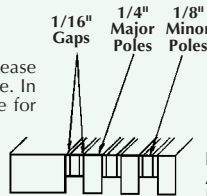

Full Magnetic Surface To All Edges - Powerful holding over entire chuck surface

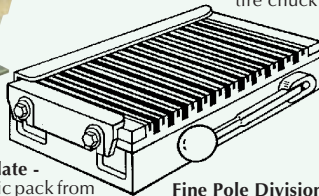

Fine Pole Divisions - For more uniform magnetic holding

Ceramax Magnetic Chucks - Precision Grade

Model	Size	Height	Weight	Price
CMC-440	4" x 4"	2-3/8"	10	\$ 1525.00
CMC-480	4" x 8"	2-3/8"	20	2015.00
CMC-510	5" x 10"	2-5/8"	29	2140.00
CMC-512	5" x 12"	2-5/8"	36	2255.00
CMC-612	6" x 12"	2-3/4"	45	2310.00
CMC-614	6" x 14"	2-3/4"	53	2375.00
CMC-618	6" x 18"	2-3/4"	67	2575.00
CMC-818	8" x 18"	2-3/4"	90	3220.00
CMC-824	8" x 24"	2-3/4"	120	4210.00
CMC-1015	10" x 15"	2-3/4"	94	3905.00
CMC-108	10" x 18"	2-3/4"	105	3980.00
CMC-104	10" x 24"	3-5/8"	140	6650.00
CMC-124	12" x 24"	3-5/8"	200	7025.00

MADE IN USA

Fine-Division LBP

The LBP is an extremely versatile electric chuck. Its variable holding power permits easy flat grinding (without shimming) of workpieces which do not have one true flat surface. The magnetic surface pattern allows for simple and inexpensive tolling designs to hold intricately shaped workpieces.



Suitable For EDM Applications

Fine Pole Division (1/8") - For more uniform magnetic holding of small parts

Lowest Height of Any Electro Magnetic Chuck

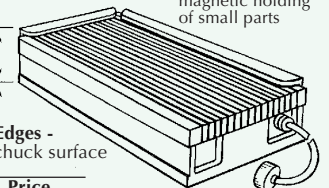

Full Magnetic Surface To All Edges - Powerful holding over entire chuck surface

Electro Magnetic Chucks

Model	Size	Watts	Height	Weight	Price
LPB-480	4" x 8"	26	2-7/8"	22	\$ 970.00
LPB-410	4" x 10"	32	2-7/8"	28	1150.00
LPB-510	5" x 10"	35	2-7/8"	35	1595.00
LPB-512	5" x 12"	42	2-7/8"	43	1595.00
LPB-612	6" x 12"	50	2-7/8"	46	1070.00
LPB-618	6" x 18"	85	2-7/8"	70	1695.00
LPB-818	8" x 18"	100	2-7/8"	100	2030.00
LPB-1015	10" x 15"	90	2-7/8"	130	2980.00
LPB-824	8" x 24"	150	2-7/8"	130	3005.00
LPB-108	10" x 18"	105	2-7/8"	160	3145.00
LPB-104	10" x 24"	150	2-7/8"	215	4115.00
LPB-128	12" x 18"	156	3-1/8"	140	4080.00
LPB-124	12" x 24"	141	3-1/8"	185	4485.00
LPB-132	16" x 32"	281	3-5/8"	312	10,795.00

Solid Construction Top Plate - Protects coil from penetration of coolant; provides stronger, more stable work surface

WALKER

AUTOMATIC RELEASE CONTROLS

Touch-pad control allows easy selection of full, residual, variable and release positions.

- Automatic release cycle assured workpiece release, freeing machine operator from manual operation.

SMART-B SERIES

Full, Variable and Residual Holding
Designed to be used with any chuck Input 115 VAC, output 0-110 VDC

Model No.	Wattage Capacity	Net Wt. (lbs.)	Price Each
SMART-1B	150	13	\$ 965.00
SMART-3B	300	16	1235.00
SMART-5B	500	18	1315.00



WALKER

MANUAL RELEASE CONTROLS

SCV SERIES VARIABLE HOLDING

Provides a direct current supply input 155 VAC, output 0-110 VDC

Model	Wattage	Price
SCV-15	150	\$450.00



Precise SINE-PLATES ECONOMICAL PRICING

- Made of quality steel, hardened to 55-62 RC.
- Tapped holes in top plate.
- Two hardened and ground side rails and one locking strap included.
- 0-60° capacity.
- Squareness and parallelism within .0002"
- Center distance of rolls within .0002"

MODEL No.
SP-660
SPECIAL

\$175.00

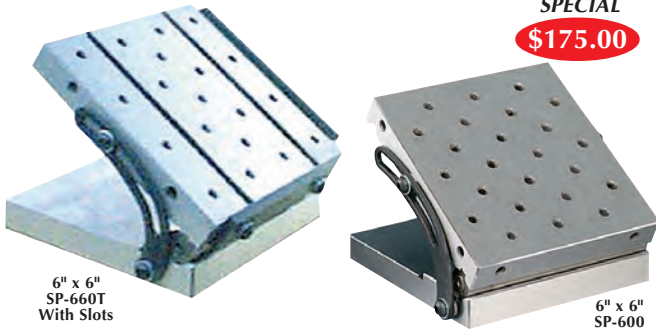

6" x 6"
SP-660T
With Slots

6" x 6"
SP-600

Model No.	Width Inch	Length Inch	Height Inch	Dist. Rolls	Weight lbs.	Sale Price
SP-350	3-1/4"	6"	1-7/8"	5"	9	\$139.95
SP-400	4"	4"	2"	3"	9	145.00
SP-470	4"	7"	3"	5"	17	165.00
SP-660	6"	6"	2"	5"	18	175.00
SP-660T	6"	6"	2.5"	5"	22	295.00
SP-1200	6"	12"	2-5/8"	5"	45	395.00
SP-1206	12"	6"	2-5/8"	10"	47	385.00
SP-1212	12"	12"	2-5/8"	10"	90	675.00

Precise COMPOUND SINE-PLATES

- Made of quality steel, hardened to 55-62 RC.
- Minute angle step 0.200 built into the front gage block roll - eliminates steps in the base plate.
- Center of distance of rolls with 0.0001"
- 0-60° capacity.
- Tapped holes 1/4"-20 in top.
- Two end rails and one locking strap included.



MODEL No.
SPC-006
Reg. \$795.00

\$595.00

Model No.	Width Inch	Length Inch	Height Inch	Dist. Rolls	Weight lbs.	Price Each
SPC-047	4"	7"	4"	5"	24	\$550.00
SPC-006	6"	6"	3-1/8"	5"	26	595.00

Precise ALUMINUM CAST MAGNETIC V-BLOCK PAIRS

- Holds cylindrical workpieces for grinding.
- 90° Vee v-blocks.
- Precision ground flat, square and parallel to 0.0005"
- Switch On/Off.



Supplied In
Matched Pairs

Model No.	Dimensions H x W x D	Max. "V" Hold Diameter	Power Pull	Price Pair
3402-0890	2" x 1-1/2" x 2-3/4"	1.90"	33 lbs.	\$119.95
3402-0900	3" x 2" x 4"	3.15"	44 lbs.	165.00
3402-0902	4" x 2" x 6"	3.90"	50 lbs.	265.00

Precise ANGLE PLATE HARDENED AND GROUND

- Solid, one piece angle plates are made from hardened steel.
- PAP-443NH are square and parallel within .0001". All other models are held to .0002".
- PAP-443NH has no holes. All others are furnished with tapped holes.

Quality
Import

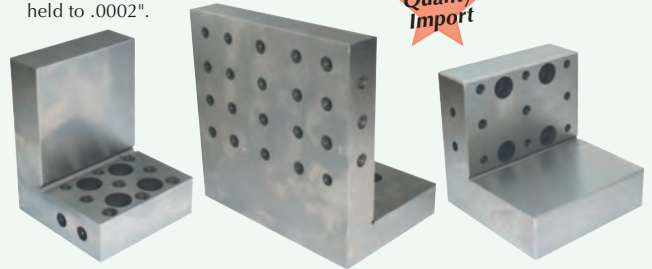

No. PAP-334

No. PAP-664

No. PAP-444

Model No.	Dimensions	Tapped Holes	Wt.	Price Each
PAP-334	4" x 3" x 3" x 1"	(13) 1/4-20	6	\$44.95
PAP-443NH	4" x 4" x 3" x 1-1/8"	solid, no holes	9	49.95
PAP-444NH	4" x 4" x 4" x 1-1/4"	solid, no holes	12	59.95
PAP-444	4" x 4" x 4" x 1-1/4"	(13) 1/4-20	10	56.95
PAP-446	6" x 4" x 4" x 1-1/4"	(14) 3/8-16	14	69.95
PAP-664	6" x 6" x 4" x 1-1/4"	(33) 1/4-20	20	99.95

Precise MAGNETIC SINE PLATES Single and Compound Angles

- Rigid angles lock strap capacity 0~60° (Accuracy 5' / per 15°).
- Hardened side and back rolls included.
- Made of high grade steel hardened to 55~62 RC and ground.
- Removable On/Off handle included.

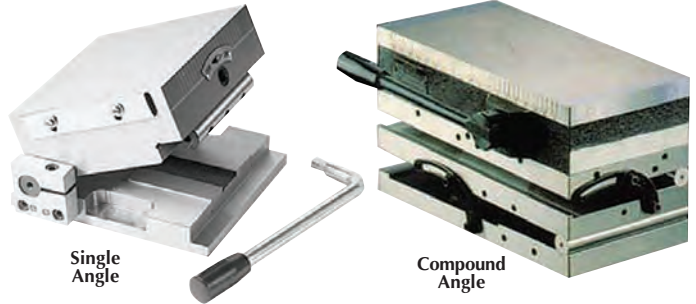

Model No.	Size L x W x H	Center Dist. of Rolls	Pole Spacing	Angle Type	Weight lbs.	Price Each
MSP-475	4" x 7" x 4"	3"	Standard	Single	25	\$ 645.00
MSP-665	6" x 6" x 4"	5"	Standard	Single	27	695.00
3402-0810	6" x 6" x 4"	100mm	Fine	Single	35	875.00
MSP-6125	6" x 12" x 4"	5"	Standard	Single	70	1050.00
MSPC-665	6" x 6" x 6"	5"	Standard	Compound	60	\$1050.00
MSPC-6125	6" x 12" x 6"	5" & 10"	Standard	Compound	90	1650.00

Precise TILTING TABLE & ADJ. ANGLE PLATES

- This study built table has machined T-slots and is rigidly constructed throughout.
- Has two screws to lock setting.
- Heavy casting.
- Graduated in degrees for setting purpose.
- Heavy casting and rugged construction.
- Graduation in degrees and 90° range.
- 2 screws lock setting.
- Saves setup time.
- Machined 1/2" "T" slots on "TTP" Series

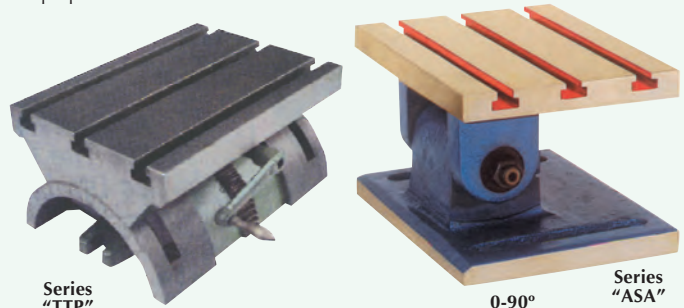

Series
"TTP"

0-90°

Series
"ASA"

1/2" T-Slots 0-45° Both Sides				Model	Size	Height	Weight	Price
Model	Size	Height	Weight	Price	ASA-001	6" x 5"	4-1/2"	22 lbs. \$ 69.95
TTP-001	5" x 7"	3-3/4"	20 lbs.	\$ 79.95	ASA-002	8" x 6"	5"	26 lbs. 120.00
TTP-002	7" x 10"	5"	50 lbs.	135.00	ASA-003	10" x 8"	6-1/2"	62 lbs. 145.00
TTP-003	10" x 15"	6-1/2"	120 lbs.	275.00	ASA-004	12" x 10"	8"	110 lbs. 225.00
					ASA-005	15" x 12"	9"	170 lbs. 295.00

Suburban SOLID ANGLE PLATES

- Ground finish - square and parallel within 0.0005" per on the two working faces only.
- Made of high quality grained cast iron, stress relieved.
- Extra thick and ribbed construction.
- Machined finish - square and parallel within 0.002" per 6".

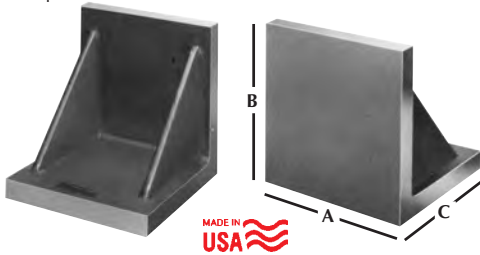

MACHINE FINISH

Model No.	Dimensions A x B x C	Wall Thickness	Sale Price
PAW-02M	2" x 2" x 2"	1/2"	\$ 33.00
PAW-03M	3" x 3" x 3"	1/2"	36.00
PAW-04M	4" x 4" x 4"	5/8"	58.00
PAW-05M	5" x 5" x 5"	11/16"	85.00
PAW-06M	6" x 6" x 6"	3/4"	120.00
PAW-08M	8" x 8" x 8"	7/8"	210.00
PAW-10M	10" x 10" x 10"	1"	465.00
PAW-12M	12" x 12" x 12"	1-1/8"	495.00

GROUND FINISH

Model No.	Dimensions A x B x C	Wall Thickness	Sale Price
PAW-02G	2" x 2" x 2"	1/2"	\$ 68.00
PAW-03G	3" x 3" x 3"	1/2"	75.00
PAW-04G	4" x 4" x 4"	5/8"	105.00
PAW-05G	5" x 5" x 5"	11/16"	160.00
PAW-06G	6" x 6" x 6"	3/4"	245.00
PAW-08G	8" x 8" x 8"	7/8"	365.00
PAW-10G	10" x 10" x 10"	1"	715.00
PAW-12G	12" x 12" x 12"	1-1/8"	950.00

Suburban SLOTTED ANGLE PLATES

- Open end type - 4 easy and all ends machined square and parallel within 0.002" per 6".
- Made of high quality cast iron, stress relieved.
- Webbed type - 2 faces and all ends machined square and parallel within 0.002 per 6".
- Clamping slots for easy mounting of workpiece.

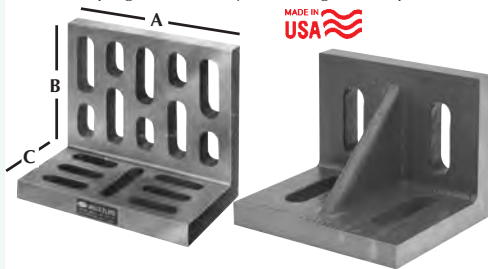

OPEN END ANGLE PLATES

Model No.	Dimensions A x B x C	Wall Thickness	Sale Price
SAO-005	4-1/2" x 3-1/2" x 3"	1/2"	\$ 81.00
SAO-006	6" x 5" x 4-1/2"	11/16"	115.00
SAO-007	7" x 5-1/2" x 4-1/2"	11/16"	135.00
SAO-008	8" x 6" x 5"	3/4"	160.00
SAO-009	9" x 7" x 6"	3/4"	190.00
SAO-010	10" x 8" x 6"	7/8"	245.00
SAO-012	12" x 9" x 8"	1"	325.00

WEBBED ANGLE PLATES

Model No.	Dimensions A x B x C	Wall Thickness	Sale Price
SOW-302	3-1/2" x 3" x 2-1/2"	1/2"	\$ 60.00
SOW-303	4-1/2" x 3-1/2" x 3"	11/16"	63.00
SOW-504	6" x 5" x 4-1/2"	11/16"	82.00
SOW-705	7" x 5-1/2" x 4-1/2"	3/4"	115.00
SOW-605	8" x 6" x 5"	3/4"	137.00
SOW-706	9" x 7" x 6"	7/8"	170.00
SOW-806	10" x 8" x 6"	1"	195.00
SOW-908	12" x 9" x 8"	1"	325.00

Note: Also available ground finished \pm 0.002" square & parallel 0.0005" per 6"

Suburban BOX PARALLELS

- Machined finish - Size \pm 0.015". Square and parallel within 0.002" per 6".
- Made of high quality fine grained cast iron, stress relieved.
- All faces and ends finished square and parallel.

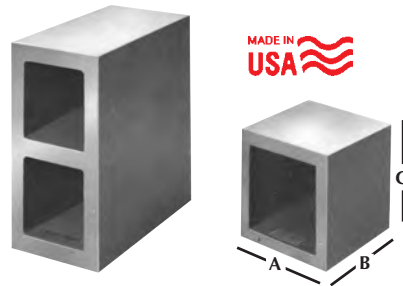

Model No.	Dimensions A x B x C	Wall Thickness	Sale Price
BXB-444	4" x 4" x 4"	5/8"	\$170.00
BXB-446	4" x 4" x 6"	3/4"	195.00
BXB-466	4" x 6" x 6"	3/4"	295.00
BXB-510	5" x 10" x 10"	3/4"	595.00
BXB-666	6" x 6" x 6"	3/4"	295.00
BXB-668	6" x 6" x 8"	3/4"	355.00
BXB-612	6" x 12" x 12"	3/4"	715.00
BXB-888	8" x 8" x 8"	5/8"	605.00

Note: Also available ground finished \pm 0.002" square & parallel 0.0005" per 6"

Suburban UNIVERSAL ANGLE IRONS

- Machined finish - square and parallel within 0.002" per 6".
- Made of high quality fine grained cast iron, stress relieved.
- All faces and ends finished square and parallel.
- Ground finish - Square within 0.0005" per 6". Parallel within 0.00025" per 6".

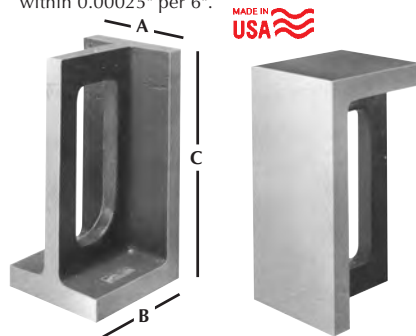

MACHINE FINISH

Model No.	Dimensions A x B x C	Wall Thickness	Sale Price
URA-345	3-3/4" x 4" x 5"	3/4"	\$ 81.00
URA-446	4" x 4" x 6"	7/8"	105.00
URA-441	4-1/2" x 5" x 6"	7/8"	115.00
URA-456	4" x 5" x 8"	1"	155.00
URA-507	5-1/2" x 7" x 10"	1-1/8"	220.00
URA-510	5-1/2" x 8" x 10"	1-1/8"	235.00
URA-581	5" x 8" x 12"	1-1/4"	250.00
URA-668	6" x 6" x 8"	7/8"	215.00
URA-891	8" x 9" x 16"	1-3/8"	435.00
URA-811	8" x 10" x 12"	1-1/4"	385.00

GROUND FINISH

Model No.	Dimensions A x B x C	Wall Thickness	Sale Price
URA-543	3-3/4" x 4" x 5"	3/4"	\$215.00
URA-644	4" x 4" x 6"	7/8"	245.00
URA-144	4-1/2" x 5" x 6"	7/8"	265.00
URA-458	4" x 5" x 8"	1"	295.00
URA-705	5-1/2" x 7" x 10"	1-1/8"	425.00
URA-015	5-1/2" x 8" x 10"	1-1/8"	440.00
URA-185	5" x 8" x 12"	1-1/4"	465.00
URA-866	6" x 6" x 8"	7/8"	435.00
URA-198	8" x 9" x 16"	1-3/8"	825.00
URA-118	8" x 10" x 12"	1-1/4"	625.00

ood brown & sharpe MAGNETIC BLOCK

Fine-pole top plate is specially designed for holding small work. Working surface and base of block are ground parallel. Back end is square with the working surface. One side and one end stop plate are furnished.



MODEL No. 745-255
Reg. \$1075.00

\$950.00

Dimensions
2-7/8"H x 5-1/4"L
x 2-7/16"W

ood brown & sharpe MAGNETIC V-BLOCK

Holds work in contact with the V faces. Block is accurately ground and faces of V-groove are hardened. Removable stop plate furnished for back end of block. "V" takes round stock to 1-3/4" diameter. Sides and bottom are parallel to vee to .001" and vee is central within .001".



MODEL No. 599-750-4
Reg. \$1312.00

\$1195.00

Dimensions
2-7/16"H x 5-1/4"L
x 2-7/16"W

ood brown & sharpe MAGNETIC BLOCK

Working surface and base are ground parallel. Back end is square with working surface. Removable stop plates are furnished for back end and one for use on either side.



MODEL No. 599-760
Reg. \$940.00

\$875.00

Dimensions
2-7/16"H x 5-1/4"L
x 2-7/16"W

Suburban MAGNA-SQUARE

- A versatile tool for layout, inspection & squaring operations on a surface grinder.
- Combine the advantages of a universal right angle iron & a present magnetic chuck.
- Magnetic face is energized by turning a recessed control bar.
- Can be placed on any side for workholding.
- Heavy support rib provides structural strength and a carrying case.
- Made from class 40 cast iron, stress relieved and annealed.
- All faces and ends of the Magna-Square are ground flat, square and parallel within 0.0003".



Overall size:
4-3/4" x 4-1/4" x 6-1/2"
Magnetic surfaces:
4" x 6-5/8"

MODEL No. MAI-644
Reg. 1799.00

\$1595.00

Precise SOLID ANGLE PLATES

- Made of high quality fine grained cast iron, stress relieved.
- Faces and all ends square and parallel.
- Precision ground finished square & parallel within .0005" per 6 inches.

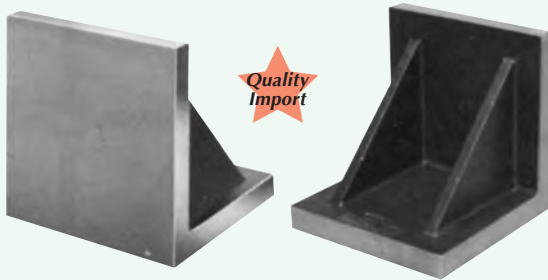

Model Size	Square Size (inch)	No. of Ribs	Approx. Weight	Precision Ground
AP-002	2 x 2 x 2	1	3 lbs.	\$11.95
AP-003-1	3 x 3 x 3	1	3 lbs.	15.50
AP-004	4 x 4 x 4	1	6 lbs.	23.50
AP-005-1	5 x 5 x 5	2	12 lbs.	33.50
AP-006	6 x 6 x 6	2	16 lbs.	39.50
AP-008	8 x 8 x 8	2	32 lbs.	78.00
AP-010	10 x 10 x 10	2	65 lbs.	135.00
AP-012	12 x 12 x 12	2	100 lbs.	199.00

Precise SLOTTED ANGLE PLATES

- Webbed-End type 2 faces and all ends machined square and parallel within .002" per 6 inches.
- Open-End type 4 faces and all ends machined square and parallel within .002" per 6 inches.

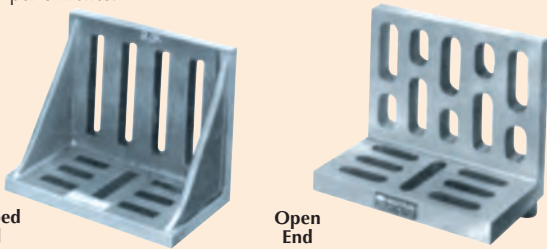

Dimensions W x H x D	Webbed Model	Webbed Price	Open-End Model	Open-End Price
3" x 2-1/2" x 2"	WA-1	\$16.95	-	-
3-1/2" x 3" x 2-1/2"	WA-2	17.95	OA-10	\$17.95
4-1/2" x 3-1/2" x 3"	WA-3	19.95	OA-11	24.95
6" x 5" x 4-1/2"	WA-4	36.95	OA-12	32.95
7" x 5-1/2" x 4-1/2"	WA-5	41.95	OA-13	38.95
8" x 6" x 5"	WA-6	44.95	OA-14	49.95
9" x 7" x 6"	WA-7	59.95	OA-15	65.00
10" x 8" x 6"	WA-8	85.00	OA-16	89.50
12" x 9" x 8"	WA-9	99.50	OA-17	125.00

Precise UNIVERSAL RIGHT ANGLE IRONS

- Made of high quality fine cast iron, stress relieved.
- Size tolerance $\pm 0.015"$.
- Ground finish, square within .0005" per 6 inches parallel within .0005" per 6 inches.
- All faces and ends finished square and parallel.

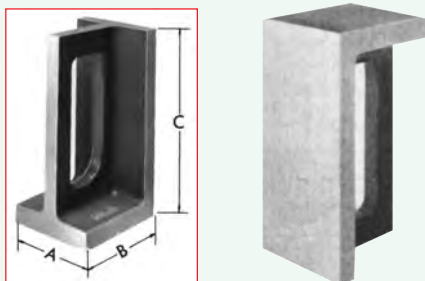

Dimensions A x B x C	Weight lbs.	Ground Model	Ground Price
3-3/4" x 4" x 5"	10 lbs.	UR-21P	\$ 32.95
4" x 4" x 6"	13 lbs.	UR-22P	44.95
4" x 5" x 6"	16 lbs.	UR-23P	52.00
4-1/2" x 5" x 8"	22 lbs.	UR-24P	60.00
5" x 8" x 12"	40 lbs.	UR-25P	125.00
5-1/2" x 8" x 10"	42 lbs.	UR-27P	120.00
6" x 6" x 8"	34 lbs.	UR-28P	90.00
8" x 10" x 12"	82 lbs.	UR-29P	185.00
8" x 9" x 16"	95 lbs.	UR-10P	195.00
10" x 12" x 16"	130 lbs.	UR-16P	395.00
12" x 12" x 24"	218 lbs.	UR-12M*	750.00

*Machine Finished Square & Parallel within .0005" per 6"

Precise 0-60° PRECISION ANGLE BLOCKS



- Features:**
- 0-60° adjustable angle by locking the hex screw on the bottom.
 - Squareness .0002".
 - Angle accuracy $\pm 10'$.
 - RC 50-55.

Most Popular Size
4" x 1-3/4" x 1-3/16"
MODEL No. ASU-004

\$59.95

Model	Length	Height	Width	Price
ASU-003	3"	1-1/4"	1"	\$49.95
ASU-004	4"	1-3/4"	1-3/16"	59.95
ASU-005	4"	1-3/4"	1-3/4"	69.95

Brown & Sharpe ULTRA PRECISION ADJUSTABLE ANGLE BLOCK

Precision ground angle block is ideal for drilling, milling, grinding and setup task.

- Features:**
- 3-3/4" wide by 1-3/4" thick by 2" high.
 - Approximately 1-3/4" work capacity.
 - Angle accuracy $\pm 10'$, squareness within .0002".
 - Hardened to 50-55 Rc.
 - Includes fitted wooden case.

MODEL No. 599-750-25
Reg. List \$189.00

\$165.00



Precise GIANT ANGLE PLATES

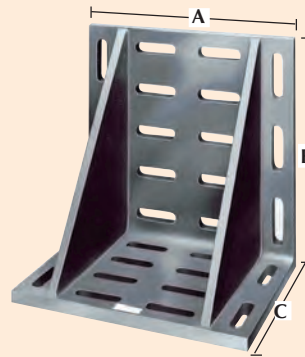

- Made of high grade seasoned semi-steel casting.
- Best suited for setting up jigs, planning machines, radial drilling machines.
- Slots arranged for maximum clamping versatility.

Quality Import

Model No.	Dimensions A x B x C	Weight lbs.	Price Each
G111	16" x 12" x 9"	72	\$269.50
G112	20" x 16" x 12"	145	495.00
G113	24" x 24" x 18"	343	1095.00
G114	36" x 24" x 24"	594	2395.00

Precise "VANGLE" V-ANGLE PLATE

- The V-Angle is manufactured from a high grade cast iron that is fully stress relieved to give stability throughout its working life.
- The V-Angle has many more clamping positions than an ordinary angle plate.
- Its design allows almost any shape to be clamped securely, and all types of clamps to be used.

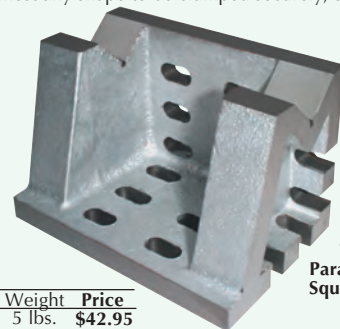

"Vangle" V-Angle Plate
Parallelism $\pm .00025"$
Squareness $\pm .00025"$
MODEL No. APV-335

\$42.95

Model	Size	Weight	Price
APV-335	3" x 3" x 5"	5 lbs.	\$42.95
APV-446	4" x 4" x 6"	9 lbs.	65.00
APV-557	5" x 5" x 7"	15 lbs.	79.95
APV-666	6" x 6" x 8"	25 lbs.	125.00

Suburban "SINE SET" SYSTEM ANGLE PLATES

- Suburban's precision angle plates are of solid, one piece construction.
- Made of steel, hardened to Rc 58-62 and ground flat square and parallel within .0002"
- Tapped holes on all models.
- The AP-664-S1 model is a SineMate 90 degree conversion plate. It's hole pattern duplicates that of the 6" x 6" Sineset sine plates, allowing the S-1 Sinemate accessories to be bolted on.

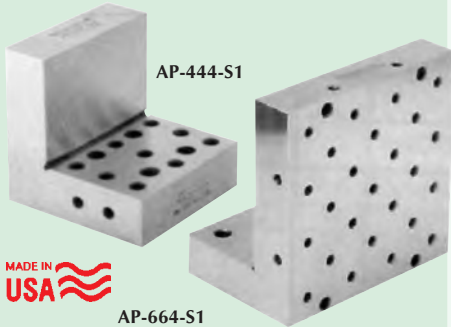

Model No.	Dimensions Inch	Tapped Holes	Wt. lbs.	Sale Price
AP-334-S0	4 x 3 x 3 x 1"	(13)1/4-20	6	184.50
AP-444-S1	4 x 4 x 4 x 1-1/4"	(13)1/4-20	10	280.00
AP-446-S2	6 x 4 x 4 x 1-1/4"	(14)3/8-16	13	345.50
AP-664-S1	4 x 6 x 6 x 1-1/4"	(33)1/4-20	20	520.00

- Suburban's AP-333 is a small stepped angle plate. This very useful tool fits easily in your toolbox.



- **Cap-46 compound angle plate** is a multi-use angle plate. It is especially useful for squaring operations. Several small ground vees allow the holding of small round parts.
- The **C-36-1 cube** is slotted on all four sides for extra clamping possibilities. Top and all four sides have tapped holes.

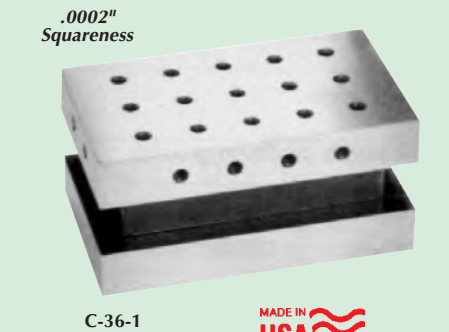

Model No.	Dimensions Inch	Tapped Holes	Wt. lbs.	Sale Price
AP-333	3 x 3 x 3 x 1 x 1/2"	(24)1/4-20	5	\$265.00
CAP-46	6 x 4 x 4 x 1"	(16)1/4-20	11	625.00
C-36-1	6 x 3-1/2 x 3"	(27)1/4-20	15	315.00

Suburban MILL-MASTER

- Specifically designed for use on milling machines.
- Mounts directly to table with std. T-bolts and nuts.
- Solid cast iron construction.
- Standard 5/8" T-slots in top plate for easy mounting of clamps or vises.
- 10" sine center distance held within .001"
- Edge rail for quick locating of workpiece.
- Can be used as standard angle plate in closed.



MODEL No.
SPBM-10
Reg. List
\$3011.00

\$2695.00

Suburban PLANER GAGE

- Body and slide are hardened and ground alloy steel castings
- Wide body for stable operation.
- Beveled construction eliminates side play and provides accurate alignment and parallelism.
- Multiple tapped holes in the slide allow for attachment of extension nib or other accessories.
- 3" extension nib and fitted wooden case included.

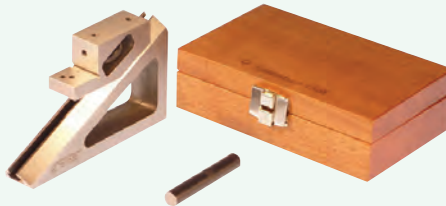

Specifications:

Length	6-3/16"
Width	1-1/8"
Height	3-1/2"
Range	7/16"-10"
Weight	6 lbs.

MODEL No.
PG-613
Reg. \$360.00

\$325.00

Suburban V-BLOCKS

- All V-blocks are parallel, square and central within .0002".
- Each block comes with one clamp and blocks are available in matched pairs.
- All models are made of hardened steel.
- Sizes other than those listed are available by special order.



90° Degree V-Blocks

Model No.	Dimensions	Cap. lbs.	Wt. lbs.	Price Each	*Price Pair
VB-222	2-1/2" x 2-1/2" x 2"	1-3/8"	3	\$145.00	\$340.00
VB-334	3" x 4" x 3"	2-1/4"	9	199.00	460.00
VB-466	6" x 6" x 4"	4-3/8"	33	525.00	1225.00
VB-666	6" x 6" x 6"	4-3/8"	50	770.00	1850.00

60° Degree V-Blocks					
Model No.	Dimensions	Cap. lbs.	Wt. lbs.	Price Each	*Price Pair
VB-602	2-1/2" x 2-1/2" x 3"	1-3/8"	3	\$250.00	\$690.00
VB-604	3" x 4" x 3"	2-1/4"	8	365.00	935.00

* Add "M" to Model Number for Matched Pair

Suburban STRAIGHT EDGES

- They provide an extremely accurate reference line & may be used for checking surfaces for straightness.
- Graduated & non-graduated models are available.
- Furnished in both precision ground & finely finished tool steel & micro-polished stainless steel.
- Stainless steel models have a hang-up hole.
- Straight edges in sizes 36" & longer are marked with arrows at two suspension points. They should be supported at these two points to minimize the deflection caused by their length & weight.



BEVELED EDGE TOOL STEEL NON-GRAD.

Model	Length	Width	Thickness	Price
BSE-001	12"	1-13/32"	11/64"	\$ 45.00
BSE-002	24"	1-13/32"	11/64"	110.00
BSE-003	36"	2-13/32"	7/32"	150.00
BSE-004	48"	2-13/32"	7/32"	245.00
BSE-005	72"	3-5/32"	9/32"	360.00
BSE-006	96"	3-1/4"	5/16"	565.00

BEVELED EDGE TOOL STEEL 1/32"nd GRAD.

BSE-008	24"	1-13/32"	11/64"	\$175.00
BSE-009	36"	2-13/32"	7/32"	295.00
BSE-010	48"	2-13/32"	7/32"	380.00

BEVELED EDGE STAINLESS STEEL NON-GRAD.

BSE-011	12"	1-1/2"	3/16"	\$169.00
BSE-012	24"	2"	3/16"	185.00
BSE-013	36"	2"	1/4"	270.00
BSE-014	48"	2-1/2"	1/4"	395.00
BSE-015	60"	3"	1/4"	545.00
BSE-016	72"	3"	1/4"	645.00
BSE-017	96"	3-1/4"	5/16"	975.00

Suburban ANGLE PLATES T-SLOTTED WEB SERIES

- Extra heavy 2-1/2" wall thickness provides stability during milling operations.
- Standard 5/8" T-slots on a 6" grid pattern are provided on both faces.
- One piece, class 40 cast iron material that has been stress relieved.
- An accurate vertical base for mounting vises, subplates, parts or fixtures.
- Faces and edges machined flat, square and parallel within .001" per 12".

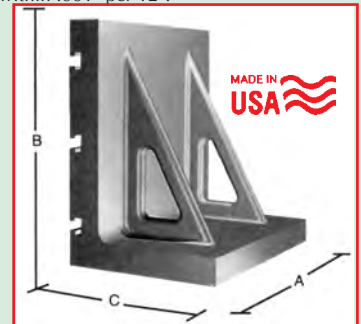

Model No.	Size A	Size B	Size C	Wall Thickness	Wt. lbs.	Price Each
TAP-1218	18"	18"	12"	2-1/2"	450	\$3490.00
TAP-1224	24"	24"	12"	2-1/2"	700	3985.00

GIANT SLOTTED WEBBED SERIES

- High quality fine grained cast iron, stress relieved.
- Extra thickness and heavy ribbed construction design for milling and drilling.
- Machined finished- square and parallel within .002" per 6"

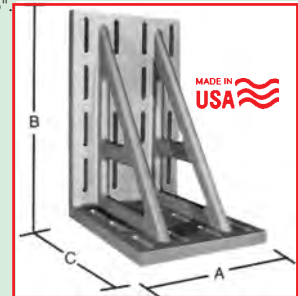

Model No.	Size A	Size B	Size C	Wall Thickness	Wt. lbs.	Price Each
GAW-1612	16"	12"	9"	1-1/8"	112	\$ 520.00
GAW-2016	20"	16"	12"	1-1/8"	200	750.00
GAW-1224	12"	24"	18"	1-1/2"	300	1895.00
GAW-1830	18"	30"	24"	1-3/4"	700	3685.00

* Ground Finish also available - Inquire



BUSCH PRECISION CAST IRON SURFACE PLATES

- Sturdy, modern design, trimmed of excess weight for handling ease.
- Made from quality close-grained castings specially heat-treated for stress relief, stability and wear resistance.
- Precision ground finish in tenth accuracies.
- Can be easily drilled and tapped for special gages and fixtures.
- Comply with all federal specifications.



#BCP-1054
24" x 48"
Ground Finish
Surface Plate
on Stationary
Stand



Heavy Duty Steel Stands

Custom designed and fabricated to provide the proper support essential to maintain the precision tolerances. Leveling screws in each leg. Stands can be furnished with heavy-duty casters. Orders should specify the exact working height desired - from floor to the top of the surface plate.

Model	Dimensions	TT#	Accuracy	Weight lbs.	Price
BGP-1013	12" x 18" x 4"	5/8"	.00025"	82	\$ 1545.00
BGP-1014	12" x 24" x 5"	3/4"	.00025"	126	1750.00
BGP-1030	18" x 18" x 5"	3/4"	.00025"	140	2670.00
BGP-1031	18" x 24" x 6"	3/4"	.00025"	180	2770.00
BGP-1050	24" x 24" x 7"	3/4"	.0005"	345	4615.00
BGP-1052	24" x 36" x 7"	1"	.0005"	525	6975.00
BGP-1054	24" x 48" x 7"	1"	.0005"	640	7990.00
BGP-1061	30" x 36" x 7"	1-1/4"	.0005"	655	9550.00
BGP-1071	36" x 48" x 8"	1-1/2"	.0005"	1250	11090.00
BGP-1072	36" x 60" x 9"	1-1/2"	.0005"	1500	19370.00
BGP-1080	48" x 48" x 10"	1-1/2"	.0005"	1450	18910.00



FLEXBAR SNAP GAGE



MODEL CS
Type "C"

(2 Square Buttons and Anvil)



MODEL AR
Type "A"

(2 Round Buttons Top and Bottom)

Model	Frame #	Range	Price	Model	Frame #	Range	Price
11-1001	1	0-1/4"	\$ 62.00	11-2001	1	0-1/2"	\$ 56.00
11-1002	2	1/4"-1/2"	62.00	11-2002	2	1/2"-1"	56.00
11-1003	2X	1/2"-3/4"	64.00	11-2003	3	1"-1-1/2"	64.00
11-1004	3	3/4"-1"	64.00	11-2004	4	1-1/2"-2"	68.00
11-1005	3X	1-1/4"	70.00	11-2005	5	2"-2-1/2"	70.00
11-1006	4	1-1/4"-1-1/2"	70.00	11-2006	6	2-1/2"-3"	109.00
11-1007	4X	1-1/2"-1-3/4"	74.00	11-2007	7	3"-3-3/4"	111.00
11-1008	5	1-3/4"-2"	74.00	11-2008	8	3-3/4"-4-1/2"	118.00
11-1009	5X	2"-2-1/4"	82.00	11-2009	9	4-1/2"-5-1/4"	120.00
11-1010	6	2-1/4"-2-1/2"	82.00	11-2010	10	5-1/4"-6"	120.00
11-1011	6X	2-1/2"-2-3/4"	86.00				
11-1012	7	2-3/4"-3-1/16"	86.00				
11-1013	7X	3-1/16"-3-7/16"	91.00				
11-1014	8	3-7/16"-3-13/16"	91.00				
11-1015	8X	3-13/16"-4-3/16"	93.00				
11-1016	9	4-3/16"-4-9/16"	98.00				
11-1017	9X	4-9/16"-4-15/16"	109.00				
11-1018	10	4-15/16"-5-5/16"	135.00				
11-1019	10X	5-5/16"-5-11/16"	135.00				
11-1020	11	5-11/16"-6-1/8"	163.00				
11-1021	11X	6-1/8"-6-5/8"	189.00				
11-1022	12	6-5/8"-7-1/8"	198.00				
11-1023	12X	7-1/8"-7-5/8"	215.00				



Stand
MODEL No.
16361

Stand will accept all Flexbar snap gage sizes.
MODEL No. 16361
\$158.00
(Snap Gage not included)

Options:
Setting and Sealing:
Add \$45.00*
* Includes N.I.S.T.
Certification

Tolerance Table	
Size Range-In	Gage Tolerances
0-6	+0 -.00015
6-12	+0 -.00025



BUSCH PRECISION PARALLEL STRAIGHT EDGES

Cast Iron

- Strong I-beam design, cored and ribbed for rigidity and lightness.
- Quality, close-grained castings, specially treated for stability.
- Precision accuracies in tenths.
- Precision ground surface finishes of 16 RMS or better.

Aluminum

- At less than half the weight of cast iron, these aluminum straight edges combine light weight convenience with wear qualities.
- For storage and transport, specially fitted, cushioned cases are available at additional cost.



Cast Iron Straight Edge

Model No.	Dimensions W x H x L	Accuracy		Approx. Wt. lbs.	Price Each
		Parallel	Straight		
BSB-6102	1" x 2" x 24"	.0002"	.0002"	8	\$ 690.00
BSB-6103	1.5" x 3" x 36"	.0002"	.0002"	23	790.00
BSB-6104	1.5" x 3" x 48"	.0002"	.0002"	31	1130.00
BSB-6105	2" x 4" x 60"	.0002"	.0002"	47	1880.00
BSB-6106	2" x 4" x 72"	.0002"	.0002"	54	2330.00

Aluminum Straight Edge

BSA-6103	1.5" x 3" x 36"	.0002"	.0003"	18	\$ 1990.00
BSA-6104	1.5" x 3" x 48"	.0002"	.0004"	20	2730.00
BSA-6105	2" x 4" x 60"	.0002"	.0005"	28	2945.00
BSA-6108	2" x 4" x 96"	.0004"	.0008"	56	4990.00
BSA-6110	3" x 6" x 120"	.0004"	.0010"	66	6830.00
BSA-6112	3" x 8" x 144"	.0004"	.0012"	100	10280.00
BSA-6114	3" x 8" x 168"	.0004"	.0014"	175	12435.00
BSA-6116	3" x 8" x 192"	.0004"	.0016"	235	13070.00



BUSCH PRECISION GIANT ANGLE PLATE

T-Slotted

- 1" T-bolt slots on 6" centers providing great flexibility in holding heavy parts in a vertical plane.

#3972 is precision ground on the vertical face and is square to base within .0002" in 12". The large 96" angle has a planer finish with an accuracy of .0002" in 12". Both angles are furnished complete with two heavy-duty swivel hoist rings for controlled handling.

Slotted Angle

Made of specially quality treated close-grained castings, these angles are ground on sides and ends square with the faces precision ground square to .0002" in 8".



Slotted



T-Slotted

Model	Size	Wt.	Price	Model	Size	Wt.	Price
BGS-3854	12"x14"x30"	300	\$4175.00	BGT-3972	14"x36"x72"	3300	\$26,860.00
BGS-3872	18"x18"x36"	490	4975.00	BGT-3996	36"x48"x96"	6800	29,830.00
BGS-3874	18"x24"x36"	800	5590.00				
BGS-3886	30"x18"x36"	960	6755.00				



Precise KEYWAY BROACH SETS- High Speed Steel

- The sets are furnished in fine quality wooden boxes and include Keyway broaches, slotted bushings and necessary shims.
- American standard sets.

SET "10"
ORDER No.
868-510
A \$268.00
Value
\$149.95



Order No.	Set No.	Keyway Combinations	Collard Bushings	Sale Price
868-500	00	1/16, 3/32, 1/8A	1/4, 5/16, 3/16, 1/2	\$109.95
868-510	10	1/8, 3/16B	1/2, 5/8, 3/4, 7/8 1, 1-1/8, 1-1/4 1-3/8, 1-1/2	\$149.95
868-511	10-10A	1/8, 3/16B 1/4, 3/8C	1/2, 9/16, 5/8, 11/16, 3/4 3/16, 7/8, 15/16, 1, 1-1/16 1-1/8, 1-3/16, 1-1/4 1-5/16, 1-3/8, 1-7/16 1-1/2, 1-9/16	\$249.95
868-520	20	1/8, 3/16B 1/4, 3/8C	1/2, 9/16, 11/16, 3/4 13/16, 7/8, 15/16, 1 1-1/16, 1-1/8, 1-3/16 1-1/4, 1-5/16, 1-3/8 1-7/16, 1-1/2, 1-9/16	\$329.95
869-570	70	4mm, 5mmB 6mm, 8mmC	12, 14, 15, 16, 18, 19, 20 22, 24, 25, 26, 28, 30mm	\$395.00

Note: Individual Components Available, Broaches, Bushings and Shims both Inch and Metric (Inquire)

SPI MILLING & VISE STOPS

Multi-Functional - Reduces errors and Saves Time

Work stops

- 5-Axis adjustment moves the stop your job requires 1/4" stop rod can be modified, replaced or extended with longer piece of bar stock.
- Locking lever can be positioned 360° to avoid interference.
- T-nuts fit 5/8" table studs.

Standard



Deluxe



5-Axis Milling Stop

- Hardened spring work stop clamp for vises with protrusion of 1/16"
- For narrow jaws, less than 1/2" (70-945-1) and less than (70-949-3), the spring has been removed.
- Two ground pins for positive location.
- Hard anodized aluminum body.

Model	Description	Sale
95-111-1	5-Axis Milling Stop	\$157.65
70-945-1	Standard Stop 3/8"-3/4" range	22.60
70-949-3	Standard Stop 1/2"-7/8" range	22.60
70-950-1	Deluxe Stop f/3/4" thick jaws	30.80
70-951-9	Deluxe Stop f/7/8" thick jaws	30.80

Mitutoyo BENCH CENTERS HORIZONTAL & VERTICAL

Shown with Vertical Mounting Attachment

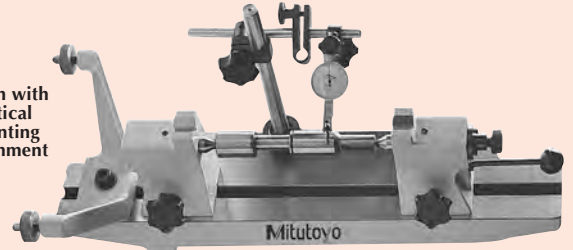

Parallelism of Centers .0002"

Model No.	Center To Center	Diam. of Workpiece	Flatness of Surface	Weight lbs.	Sale Price
967-101	13.7"	7"	.0003"	88	\$1895.00
967-203	5.9"	3.8"	.0004"	15.4	675.00
967-201	11.8"	5.8"	.0006"	28.6	1195.00
967-204	17.7"	7.8"	.0007"	132	1850.00
967-202	23.6"	9.8"	.0008"	154	2795.00

Vertical Mounting Attachment

069303	For Mounting No. 976-101	\$95.00
069304	For Mounting No. 967-203	85.00

Fowler MIRAGE TOOL SETTER

Mirage Tool Set Is An Easy And Affordable Way To Set Z Depths Quickly And Accurately

- Can be operated directly off table or from machine vise.
- Aluminum contact face eliminates carbide chipping on cutting tools.
- Repeatability: .0002".
- Block dimensions: 1" x 2" x 3".
- Batteries included.



MODEL No. 54-575-750
Reg. Price \$110.00

\$89.95



ZERO-SET CNC INSTRUMENT SETTER

- Mechanical zero-setting instrument for CNC Machine centers.
- Fast and sure establishing of "0" reference point with built-in indicator.
- No averaging of several spindle approaches is required, as is the case with most electronic point finders.
- Positive alignment of zero position with easy reading precision indicator.
- Spring loaded setting face to safeguard against damage from overrun.
- Positioning accuracy & repeatability .0004".



Model	Graduation	Body	Price
401-050	.0005"	1.45"Sq x 2"H	\$ 89.95
401-051	.0005"	1.45"Sq x 3-1/2"H	105.00

Precise ZERO-SETTER

- Precise Zero Setting for CNC Machine centers.
- Direct establishment of "0" point.
- Positive alignment of zero position with .0005" graduation Precision Indicator (.001" supplied with imported model)
- The spring loaded setting face assures against overrun and damage.
- USA brand body 1.45" diameter x 1" height.

MADE IN USA
.0005"
Graduation
MODEL No. ZER-340
Reg. \$380.00

\$275.00

With Fitted Case



Precise Z-AXIS PRESETTER AND OPTICAL HEIGHT PRESETTER

Z-Axis Pre-Setter



MODEL No. 441-053

\$195.00

Optical Pre-Setter W/Mag Base



MODEL No. 441-052

\$189.95

- Low spring force to avoid breaking of small size end mills and drills.
- 2" height.
- Accuracy: .0004".
- Built-in dial indicator.

- Magnetic base.
- 50mm height.
- Red lamp illuminates when touched by ferrous material.

Suburban MINI-MASTER™ SPIN INDEX FIXTURE

- 3" height is ideal for small machine setups.
- Hardened steel base plate is ground square and parallel with spindle axis within 0.0002".
- 72 position index plate allows an index every 5 degrees.
- Spindle can be secured by stop button for easy tightening of collets.
- Spindle runs in two sealed preloaded bearings.
- Uses standard ER-25 spring collets.
- Fitted wooden case included.

WITH ER-25 Collets:
1/8", 1/4", 3/8"
1/2" & 5/8"

ORDER No. MM25R
Reg. \$819.00

\$735.00

MADE IN USA



KI KALAMAZOO UNIVERSAL INDEXER

- Takes a 4" universal chuck - 3 or 6 jaw or 5C collets.
- Head can be angled from minus 0° to 100° +.
- Indexes quickly, easily - spindle locks in positive position.
- Numerous combinations by changing ground indexing spacer.
- Can be dismantled in seconds for easy cleaning.
- With 24 space ringless chuck.

MODEL No.
UI-5C
Reg. \$659.00

\$624.95

Less Chuck
Wt. 241 lbs.

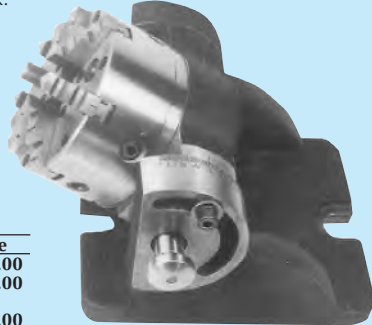

Optional:

Model	Description	Price
AT-100	Tailstock	\$195.00
1034	4" Universal 3 Jaw Chuck	525.00
AS	Stub Arbor 1" 10	125.00
Index Rings		
AR-0	Blank	\$ 25.00
AR-36	36 Spaces	45.00
AR-20	20 Spaces	45.00

Precise 5-C COLLET INDEX FIXTURE

For Use In Vertical Position or with
Angle Plate For Horizontal Position

- Precision steel spindle, hardened and ground, 5C taper.
- Top ground parallel with bottom, back edge parallel with spindle nose.
- Spindle can be locked in any position without index pin engaged.
- Numerous index combinations by easy changing of index ring.
- Chucks can be used with Stub Arbor (1" 10 thread).
- 3-1/4" from base to center line.

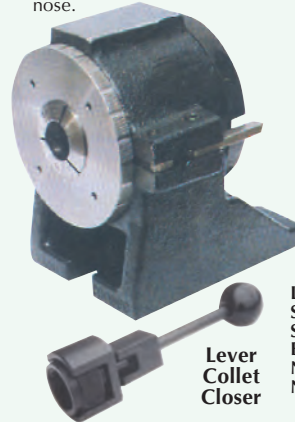

Lever
Collet
Closer

Precise
5-C Fixture
W/24" Index Ring
MODEL No.
CIF-001

\$99.95



5-C Fixture
W/24" Index Ring
MODEL No.
5C-001

\$345.00

Optional		
LC-001	Lever collet closer	\$85.00
SA-110	Stub arbor (1"-10 thread)	125.00
ST-100-1	Standard tailstock	195.00
BR-001	Blank index ring	25.00
NI-200	20 notch index ring	45.00
NT-360	36 notch index ring	45.00
	5-C collets (all sizes) 1/16" to 1-1/8" by 64ths	5.95

Precise HEAVY DUTY BENCH CENTERS

For Accurate Concentricity Inspection

- Quick release centers. • M.T.2 centers are hardened and ground.
- Indicator holder included. • Hand scraped ways, adjustable gibs.
- Head stock can be adjusted lengthwise and locked securely in any position by special lever type handle.

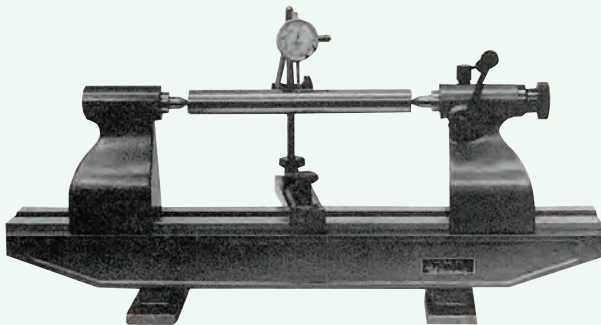

Model	Accuracy	OAL	Center to Center	Max. Swing	Price
4401-0023	0.00015" run-out	36"	19"	10.5"	\$749.95
4401-0024	0.00015" run-out	40"	23.5"	10.5"	950.00
4401-0025	0.00018" run-out	56"	39"	17.0"	995.00

Precise 5-C COLLET SPIN INDEX FIXTURE

Features:

- Accepts 5C collets up to 1-1/8" capacity.
- Multi-purpose accessory.
- Index plate has precise (10°) 36-hold circle.
- Vernier setting to 1°.
- 2-1/16" spindle travel for flute grinding.

Economy Made
in China
Model No. 10-500-1

\$44.95

phase II
The Source of Quality
Closer Tolerance
Model No. 225-204

\$79.95

Specifications:

- Dividing spindle concentricity0004"
- Cylindrical center bore (per 1") concentricity0012"
- Spindle center line parallelism to base0008"

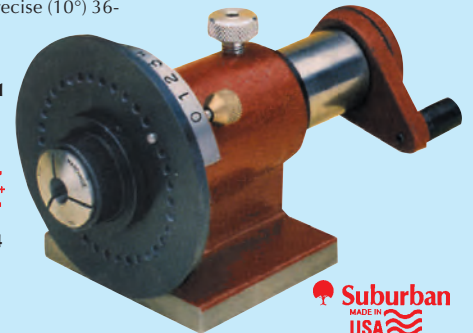

Suburban
MADE IN
USA
Model No. MI-500
Reg. List
\$750.00
\$650.00
T.I.R. .0005"
Guaranteed

Harig 5-C SPIN-INDEXER - MANUAL & MOTORIZED Harig

- Large preloaded ball bearing.
- 1/15 HP variable speed motor 110 VAC.
- Study and dimensionally stable cast iron housing.
- On/Off switch built into speed control.
- 2 holes in the base of fixture for a diamond dresser.
- 4-90° indexes standard, 24-15° indexes optional.

Grinding Fixture Specifications:

Base size 4-1/2" x 6"
Height 6-3/8"
Weight 23 lbs.
Spindle
Taper standard 5C
Speed range 40-550 rpm

Accuracies

Spindle0001"
Spindle parallelism to base0002" in 6"
Spindle squareness to ends of housing0002"
Indexing ±30 sec. of arc



MC-002 Permanent
Magnetic Chuck
4-3/4" Diameter
x 2-3/4" Thick
With Adapter



Shown With
Front mount
Motor



Supplied With
Rear Mounted
Motor Bracket

Shown With
Model AACC-007
Automatic Air 5C
Collet Closure

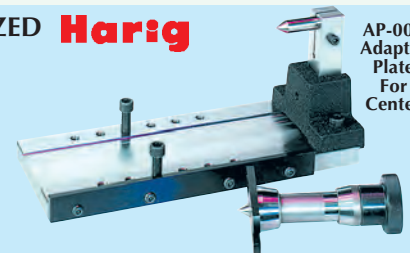

AP-003
Adapter Plate
For
Center

Model	Description	Price
GFV-100	Spin-Indexer, 24 divisions, Manual	\$1050.00
GFV-245	Spin-Indexer, 24 divisions, Motorized	1495.00
Optional Attachments		
SP-001	Sine Plate, 4-1/2" x 6"	\$ 850.00
MC-002	Magnetic Chuck, 5" diameter with adapter shank	1050.00
AP-003	Adapter Plate Assembly 12" long with (2) centers	875.00
FP-004	Face Plate, 5" diameter with adapter plate	180.00
135-100	Steady Rest with Magnetic Base	125.00
CC-006	Collet Closer, manual	90.00
AACC-007	Automatic Air Collet Closer, Push button, spring set	780.00
TJC-008	3-Jaw Chuck with reversible jaws with adapter shank	995.00

Precise ER COLLET PUNCH FORMER

- Clamps workpiece quickly and steadily when processing.
- Clamping diameter: .0787-.787"
- Utilized with ER32 spring collet.

MODEL No.
380-688

\$695.00



Includes: 7 Pc. ER-32 Collet
1/8", 1/4", 5/16", 3/8", 1/2", 5/8", 3/4"

Precise PUNCH FORMER AND RADIUS DRESSER

Applications for grinding wheel and forming punch. Use for inside and outside radius. Radius dresser standard with both models.

- Max. diameter workpiece: 1-1/4"
- V-Block: 1-3/16"
- V-Block adjusting system: rack & pinion.
- Center height: 3-1/2"
- Graduation: 360°
- Indexing divisions: 24 every 15°± 10 seconds.
- Roundness: within 0.0001" in 4"
- Squareness: within 0.0002" in 4"
- Tangential travel: 25-32"

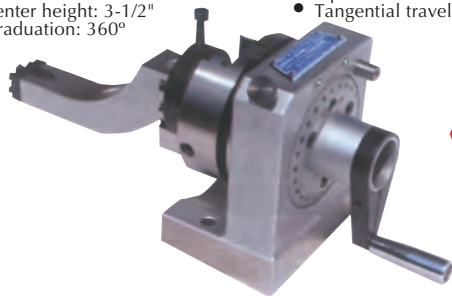

MODEL No.
202-320

\$795.00

W/Radius
Dresser Arm
and Diamond

Harig LECTRIC - CENTERS

Harig's original cylindrical grinding fixture used for precision grinding between centers. Dead center design permits "tenths" accuracies to be easily obtained. Quickly converts a surface grinder to cylindrical grinding applications for grinding punches, pins, reamers, cutters, shanks and shafts. Hold the piece part in the Lectric-Centers to grind angles, grooves, races, and slots accurately and efficiently. Also can be used for critical inspection. Motorized head and two-speed pulley for fast Stock removal.

MODEL No.
025-100
Reg. \$2190.00

\$1995.00

With 11" Base Plate
& carrying Case

MADE IN
USA



Features:

- Hardened & ground tool steel base allows grinding between centers up to 7".
- Grind and check parts within 0.00005 TIR.
- Fan cooled motor and 2 speed pulley for efficient operation.
- Interchangeable hardened tool steel centers are male on one end, female on the other.
- Tail stock taper adjustment allows extremely accurate settings to be obtained.
- Head stock center is on lever controlled sliding ram and has adjusting screw for spring tension.
- Head stock & tail stock are both adjustable.
- Base plate & tail stock with addition of rail can be used with other Harig fixtures.
- Built in diamond holder for quick dressing of grinding wheels.

Specifications:

Center Height 3.000"
Swing 6"
Motor 115V, 60C
Speeds 180 & 360 RPM
Weight 20lbs.

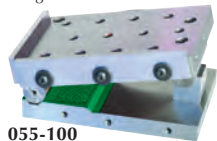

055-100



105-100

Accessories

Model	Description	Price
15-30	18" Base Plate	\$950.00
91005	Diamond Nib	25.00
25-40	Carbide Head Stock	245.00
25-41	Carbide Tail Stock	200.00
055-100	Sine-Plate 4" x 6"	795.00
105-100	Sine-Chuck 6" x 6"	1550.00

KI KALAMAZOO INDUSTRIES 5C COLLET FIXTURES

Collet does not move up or down and retains positive relationship to base.

KI Made In
USA

MODEL No.
10C-100

\$285.00

Weight 18 lbs.

Precise
MODEL No.
3430

\$69.95

Weight 115.5 lbs.

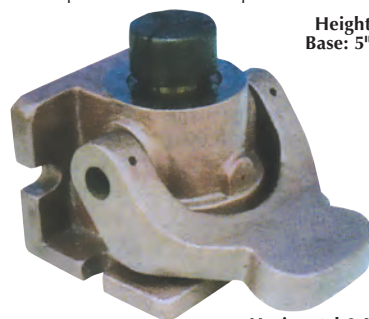

Height: 3-3/4"
Base: 5" x 3-5/8"

Horizontal & Vertical
Hardened & Ground

Precise 5C HORIZONTAL & VERTICAL COLLET VISE

- Uses any standard 5C collet for a capacity up to 1-1/8" round. Hex and square collets are also available. Small movement of lever opens or closes collet.
- Can be used in either horizontal or vertical position.

MODEL No.
900-0016

\$59.95

Height: 4-1/2"
Base: 4-1/4" x 4"



Precise 5C VERTICAL COLLET VISE

- Uses any standard 5C collet for a capacity up to 1-1/8" round. Hex and square collets are also available. Small movement of lever opens or closes collet.
- Mounted on plate for use in either vertical or horizontal position.

MODEL No.
2035

\$39.95

Height: 3-1/2"
Base: 2-1/8" x 7-3/4"

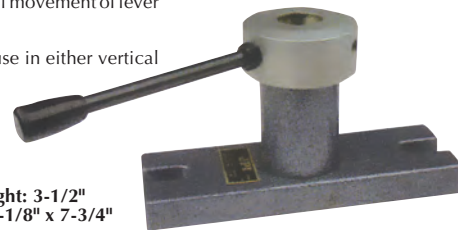

EAGLE ROCK 5C HORIZONTAL & VERTICAL COLLET FIXTURE

Features:

- Collet does not move up or down.
- Retains positive relation to base.
- Can be adjusted or changed without disturbing setup.
- With Cam-Lock and a positive release.

Can be used in either horizontal or vertical position.

Made in
USA

EAGLE ROCK

MODEL No.
A1-210-5C

\$195.00

Made in
China

Precise

MODEL No.
10-505-1

\$59.95



Height: 3-3/4"
Base: 5" x 3-5/8"

Precise 5C HEX & SQUARE COLLET BLOCK CHUCKS

- For standard 5C collets.
- For fast setups on lathes, milling machines, surface grinders and drill presses.
- Made of tool steel, hardened and ground square and parallel within .0005".
- Collet rings only supplied in 3 piece set.



Model	Description	Price
CBS-2*	Square, for 5C Collets	\$27.50
CBS-3*	Hex, for 5C Collets	27.50
CBS-4	Quick-Acting, Lever Collet Closer	16.50

3 Piece Set
SET No.
CBS-1
\$46.95

*Collet Rings Not Included

Suburban PUNCH MASTER PM-V2 INDEX FIXTURE

- 48 position index plate for hard index every 7-1/2°
- Built-in sine bar for setting angles between hard index locations.
- Ball & race design with 36 balls under preload for minimum deflection.
- Bearings sealed to protect against grit & moisture.
- Extra large 1-5/8" v-block capacity.
- Square & parallel within 0.0002"
- Maximum spindle runout ±0.000050"
- Fitted wooden case included.

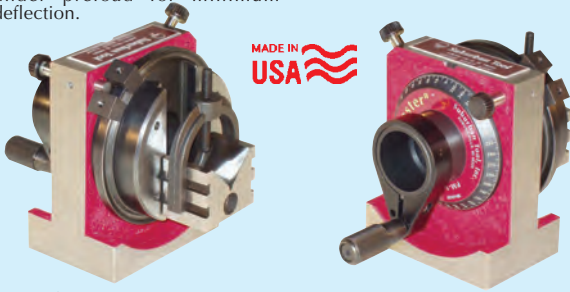

MADE IN USA

Specifications:

Center height 3"
Thru Hole 1-1/4"
Weight 12 lbs.
Overall Length 7"
Height 5-7/16"
Width 4-1/2"

MODEL No.
PM-V2
Reg. \$2056.00

\$1850.00

With Wood Case

Suburban MASTER GRIND TWINDEX: Combines 5C Collets And V-blocks In One Fixture

Sinset
Compatible

- 72 position index plate for hard index every 5 degrees.
- Built in sine bar setting angles between hard index locations.
- Two heavy duty 4" diameter tapered roller bearing in spindle.
- Horizontal or vertical V-block mounting.
- Extra large 1-5/8" V-block capacity.
- Square and parallel within .0002".
- Spindle runout .00005".
- Fitted wooden case included.

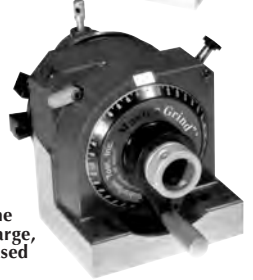
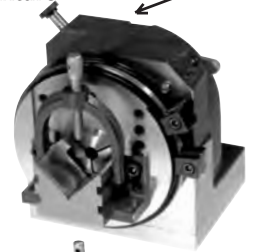

Center Height 3"
Through Hole 1-1/4"
Base: 4" x 5"
Weight: 22 lbs.

MODEL No.
MG-5CV-S1
Reg. List
\$2404.00

\$2150.00

OPTIONAL ACCESSORIES:
No. MG5-MD Motor Drive Kit \$635.00
No. MG5-BTS Base and Tailstock \$655.00

Note: Factory fitting of the MG-5CV-S1 to the MG5-BTS is required. This is included at no charge, even when the Baseplate & Tailstock is purchased separately from the index Fixture

Harig GRIND-ALL NO.1 FIXTURE

- The fixture is built for high precision work within ±.0001"...radii generated with sliding V-block..multi-sides produced w/24 division index.
- Constructed of hardened tool steel and with critical internal parts protected from grinding dust, the Grind-all is built for long lasting, accurate performance.

2" V-Block
Capacity
Grind-All No. 2
MODEL No.
020-100
Reg. \$3950.00

\$3750.00

With Case

1-1/4" V-Block
Capacity
Grind-All No. 1
MODEL No.
010-100
Reg. \$2395.00

\$2250.00

With Case

- Universal holding tool for small, miniature or intricate parts, used in conjunction with larger V-blocks.
- Ideal holding fixture for grinding/indexing punches and pins-drilling-milling-EDM-inspection optical comparators.
- Capacity .030" to 9/32"

Specifications: Index Div 24°
V-block Cap . . . 1-1/4" ± 10 Sec Grad. . . 360°
Center Ht. 3.000" Net Weight 12lbs

Many other Attachments available.
Visit our web site @ www.penntoolco.com

MADE IN USA

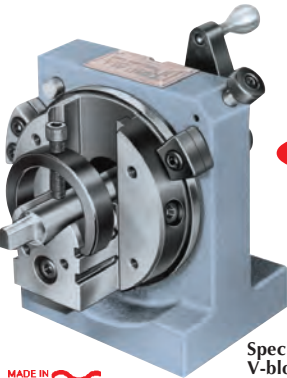

Harig ULTRA GRIND With V-Block & 5C Collet Capacity

- Large 2" capacity v-block within 0.0001".
- 4.000" center height & 6-7/8" diameter face-plate.
- 24 division indexing to +/- 10 seconds
- Optional rotary table mechanism provides geared rotation in the horizontal position.



MODEL No.
215-100
Reg. \$2990.00

\$2895.00

MADE IN USA



Model	Description	Price
215-100	Ultra Grind Fixture	\$2895.00
210-70	Motor Attachment	450.00
015-100	Base Plate & Tailstock (11" with rail)	950.00

Many other Attachments available.
Visit our web site @ www.penntoolco.com

Harig UNI-DEX COLLET INDEX FIXTURE

- Hardened and ground tool steel with solid one piece construction
- Preloaded ball and race design provides highest accuracy
- 5C collet holder ground in assembly to under 0.00005 runout
- 360 degree graduated dial for convenience
- 24 division index plate with precision index pin locks in every 15 degrees to +/- 10 seconds
- 2 adjustable stops work with stop pin to set accurate angles between index locations
- Locking screw locks spindle at any position between indexes
- Includes carrying case for protective dust-free storage.

Optional:
No. 120-50 \$190.00
5" Face Plate with Adapter Shank
No. 120-60 \$1025.00
3 Jaw Chuck 3-3/8" opening w/
Adapter Shank
No. 120-70 \$1050.00
4-3/8" Magnetic Chuck w/Adapter
shank

Specifications:
Center Height 3.000"
Square & Parallel 0.0001"
Weight 11 lbs.

MODEL No.
070-100

\$1950.00

With Case

Many other Attachments available.
Visit our web site @ www.penntoolco.com

MADE IN USA

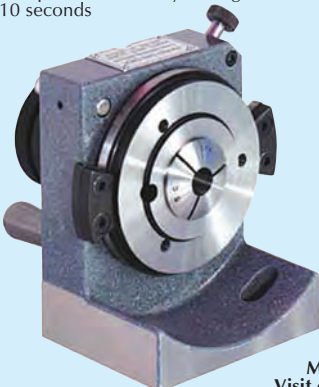

Harig DUO-FORM DUAL PURPOSE RADIUS-TANGENT WHEEL DRESSER & PUNCH GRINDER

- Unique tangent "throw" allows Duo-Form to swing 9/16" to either side of center and makes radius to tangent wheel dressing easy and efficient.
- Straight angles and radii can be ground without removing punch from v-block.
- Timesaving fixture acts like two units in one, for grinding punches and EDM electrodes, precision radius-tangent dressing, indexing and inspecting.
- Hardened and ground tool steel with solid one piece construction
- Preloaded ball and race design provides highest accuracy
- V-Block adjusting screw allows for quick movement of v-block to +/- 0.0002 without tapping



Optional:
No. 10-52 \$150.00
Radius Dresser Arm for dressing
wheels up to 10" diameter
No. 91002 \$75.00
O.D. Diamond Nib (#7)
No. 91003 \$78.00
I.D. Diamond Nib (.020)

Specifications:
Center Height 3.000"
V-Block Capacity 1-1/4"
Graduations 360°
Square & Parallel 0.0002"
Weight 17 lbs.

MODEL No.
060-100
Reg. \$4590.00

\$4350.00

With Case

MADE IN USA

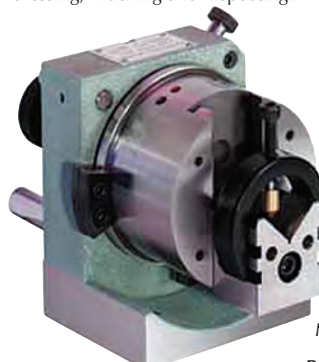

phase II 4" PRECISION ROTARY TABLE

- Precision indexing table is designed exclusively for the miniature, desktop machine tool market.
- Ultra-smooth 10" (second) vernier reading.
- 1:72 gear ratio.
- Great for the entire mini-manufacturing industry, including jewelers, gear makers, home hobbyists, etc.
- Weighs 2 lbs.
- Two year warranty!

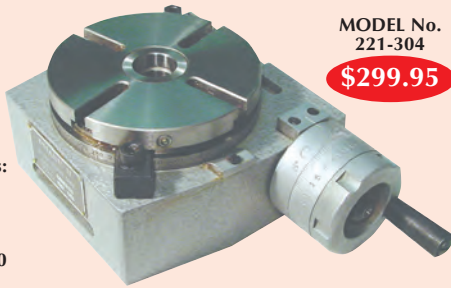

MODEL No.
221-304

\$299.95

Optional Accessories:
No. 3900-2406
Tailstock \$95.00

No. 3900-2400
Dividing plates \$55.00

Precise 4" TILTING INDEX SPACER

- Perfect for small precision detail work on benchtop machines, full size mills, drill, engraving machines, jig bores, etc.
- Micro dial for easy movement of chuck.
- 360° graduated ring.
- Thru backlash adjustment.
- Titrting 0-90° via graduated ring and positive lock lever.

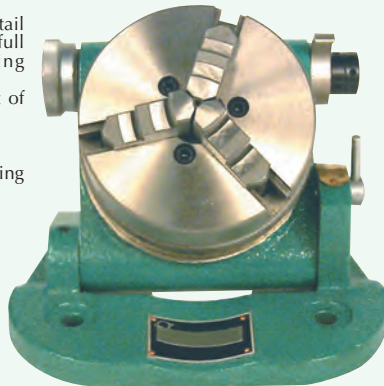

MODEL No.
225-001-1

\$349.95

phase II 17 x 10" PRECISION CROSS SLIDE TABLE

- 6" overall height.
- 5/8" T-slots.
- 500 lbs. Max. load on center.
- 0.001" graduated dials with backlash adjustment.
- ±4.5: cross travel from center.
- ±3" axial travel from center.



MODEL No.
PCS-1710

\$1195.00

Weight. 225 lbs.

360° Heavy-Duty Swivel Base!



BUSCH LAPPING PLATES

MADE IN USA

- The finest in precision lapping equipment.
- Grooves are .078"W x .100"D on .531" centers.

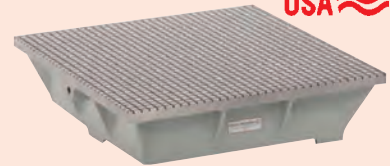

Model	Size W x L x H	Accuracy	Weight lbs.	Price
1200-2	3" x 5" x 1"	.00020"	5	\$ 675.00
1205	8" x 12" x 2.5"	.00020"	25	990.00
1210	12" x 12" x 4"	.00025"	60	1220.00
1213	12" x 18" x 4"	.00025"	85	2330.00
1222	14" x 18" x 5"	.00025"	120	4245.00
1227	16" x 22" x 4"	.00025"	135	4070.00
1230	18" x 18" x 5"	.00025"	140	4070.00
1231	18" x 24" x 6"	.00025"	180	4220.00
1250-2	24" x 24" x 7"	.00050"	345	4360.00
1252-1	24" x 36" x 7"	.00050"	525	4645.00
1270	36" x 36" x 8"	.00050"	900	7670.00

PRECISION COMPOUND SLIDING TABLE TABLE SWIVELS 360°

- Designed for light precision machining operations in all positions.
- Hand wheel calibration 0.001" and 0.002" for micro dialing on small and big holes.
- Surface table swivels 360°.



MODEL	CT-660	CT-880	CT-812
Table Size	6" x 6"	8" x 8"	8" x 12"
Height	4"	4"	4-3/4"
Travel X-Y	5" x 5"	5" x 5"	8" x 8"
Tee Slot	1/2"	1/2"	1/2"
Weight	44 lbs.	55 lbs.	93 lbs.
Sale Price	\$99.95	\$129.95	\$179.95

Precise COMPOUND MILL & DRILL TABLE

- The heavy-duty slide makes this table perfect for milling, drilling & microscope viewing.
- Locking screws allow table to lock in place.

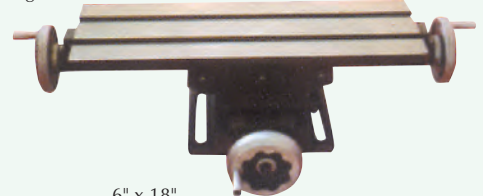

Specifications:

Table 6" x 18"
Travel:
Longitudinal 13"
Cross 6"
Height 5"
Base 10-1/2" x 8"
U-slot for bolts up to 5/8"
T-slot size 5/8"
Weight 56lbs.

MODEL No.
CMD-618

\$139.50

Precise COMPOUND SLIDE-MILLING & DRILLING TABLE

A heavy, rugged slide used in all kinds of positioning, milling, drilling, microscope viewing and staging, adjustable bases for heavy loads, small jig boring, precision cut-off.

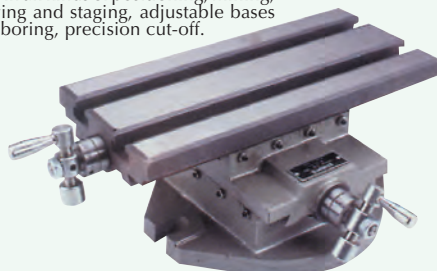

MODEL No.
CST-800
Reg. List \$129.95
NOW

\$124.95

Specifications:

Table 5-1/2"x12" T-slots on 2-1/2" centers
Height 4-1/2"
Travel 8" longitudinal, 5" transverse
Base 8"x9" oval with U-slots for up to 5/8" bolt on 7-3/4" to 8-1/2" bolt circle
T-slots 2-1/2" on center

Precise CROSS SLIDE DRILL PRESS MILL/DRILL TABLE

- A small low silhouette table for light duty work.
- The table fastens readily to the drill press table by means of a central base bolt.
- With adjustable gibs.

MODEL No.
MDT-500

\$124.95

Dimensions:

Table: 7" x 7" Rotatable 360°, locks by two set screws and internal locking shoes.
Base: 4-5/8" dia. with 1-1/8" long base bolt for mounting.
Height: 4-9/16"
Travel: 4" in each axis
Weight: 17.2 lbs.



EAGLE ROCK® 5C AIR COLLET FIXTURE

- Designed especially for high production applications.
- Their light weight and compact size permits the use of several units on indexing tables for custom applications or used individually for fast chucking of parts on milling machines and drill presses.
- Air operation is double acting for "Power" opening and closing of the collet. The collet is locked into position for positive depth location of work.
- These units operate efficiently and effectively on air pressure up to 150 PSI with upward clamping pressure exceeding 7.5 times line pressure.
- All bearings and moving parts are hardened and precision ground for accuracy and long life.



No. A1-212-5C

MADE IN USA



No. A1-212-5CK

Model	Description	Price
A1-212-5C	5C Air Collet Fixture	\$229.50
A1-212-5CK	5C Air Collet Fixture Kit	369.50

EAGLE ROCK® VISE JAW SWIVEL BLOCKS

- For improved holding of round or odd shaped parts in your milling vices.
- Block and ball pad swivel to accommodate irregular shapes for improved holding pressure.
- Body and swivel are solid steel construction for durability and long life.

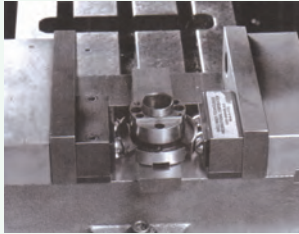
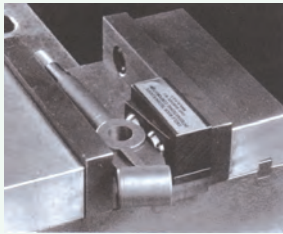

Model No.	Dimensions Width x Depth x Height	Swivel Angle	Price Each
A1-26-2500	2-1/2" x 1-5/16" x 1-1/2"	13°	\$ 89.95
A1-26-4500	4-1/2" x 1-5/16" x 1-1/2"	7°	110.00
A1-26-5500	5-1/2" x 1-13/16" x 1-1/2"	6°	135.00
A1-26-6500	6-1/2" x 1-13/16" x 1-1/2"	5°	150.00

Precise MOTORIZED PUNCH GRINDER

- High accuracy cylindrical grinding work possible just by putting this economical unit on surface grinder.
- No center alignment necessary, just put work on rollers.
- Portable with single hand, thus easily set on grinders.
- With rollers motor driven, attention can be concentrated on table/wheel feeds.
- Work also can be formed in radius or taper.

MODEL No.
PGM-001

\$1195.00



Specifications:
Unit Size WxLxH lever excluded:
 6-7/8" x 10-3/16" x 2-9/16"
Mounting Surface RL x FB:
 6-7/8" x 3-9/16"
Capacity of Head:
 1-3/4" Max.
Roller Speed:
 60 Hz.
Roller Driving Motor:
 110V/single phase/25W
Accuracy/roundness/concentricity:
 0.00008"

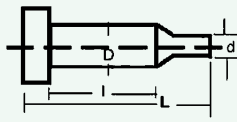

D..... 1/16" - 1.5"
 d..... 0.02 - 1"
 L..... Max 10-1/4"
 (Double roller.... 10-1/4")
 l..... 7/8"

Examples

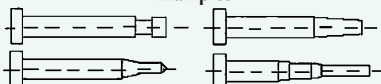

Precise STAINLESS STEEL EDM PRECISION VISES

- Made of stainless steel to resist erosion.
- One piece body construction.
- Hardness: HRC-55
- Parallelism and squareness within 0.0002".
- Precision ground and hardened throughout.
- Hardened and precision ground.
- Made of stainless steel specially for EDM, grinding and other application which is sensitive to rust.

No. 3900-2001

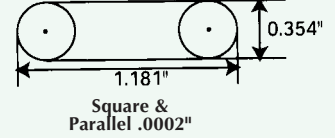

Model No.	Jaw Width	Jaw Opening	Jaw Depth	Length Height	Price Each
202-1050	1.24"	4"	1.18"	6.7" x 3.54"	\$425.00
202-1051	1.26"	6"	1.38"	8.9" x 3.94"	575.00
202-1052	1.40"	8"	1.57"	8.43" x 3.94"	685.00
390-2001	3"	4"	1.58"	7-5/8" x 2-1/2"	\$465.00

Precise RAPID KNOTCH POSITION SCREWLESS TOOLMAKERS VISE

- Oil hardened.
- Precision ground.
- Rapid positioning notches.
- .00025" square and parallel.



Model No.	Jaw Width	Jaw Opening	Jaw Depth	Overall Length	Price Each
3900-0020	1"	1"	3/8"	2-5/8"	\$38.50
3900-0022	2"	3"	1-1/4"	6"	54.00
3900-0024	3"	4"	1-5/8"	7-5/8"	95.00

Precise SOFT TOUCH SPEED HANDLE

The Soft Touch Handle works just like the handle you are using now, except that it will not clamp as tight on parts. Excellent for all types of plastic and thin-walled parts, as well as parts requiring critical surface finishes. Fits most 6" vises.

- Made of Aircraft Grade 606-1-T65 aluminum. Gold hard anodized for wear protection



MODEL No.
STS-100

\$34.95



Precise WHEEL BALANCE STAND

- The wheel type balancing stand is made to last with endurance.
- This stand can be used for wheel up to 16" in diameter.
- For balancing, straightening and wheel alignment.
- No levelling centering or set-up needed.
- Hardened & ground discs freely rotate on ball bearings.

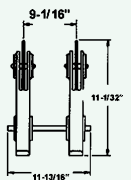
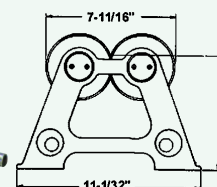

MODEL No.
WBS-002

\$395.00

Unit is adaptable to various length arbor (balancing arbor not included)

Precise GRINDING DRIVING CARRIERS

- Suitable for grinding of shafts.
- Easy attach and detach.
- Precision Steel Castings

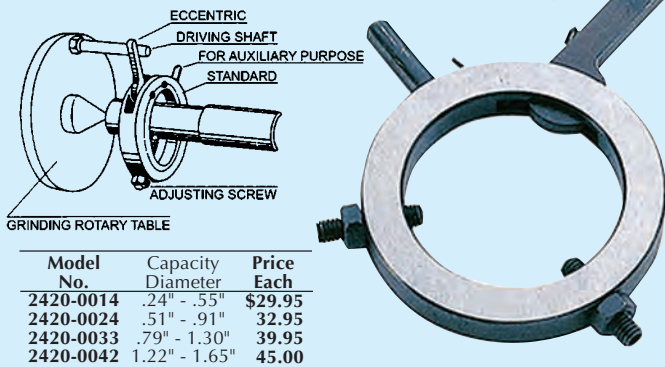

Model No.	Capacity Diameter	Price Each
2420-0014	.24" - .55"	\$29.95
2420-0024	.51" - .91"	32.95
2420-0033	.79" - 1.30"	39.95
2420-0042	1.22" - 1.65"	45.00

FLEXBAR ANTI-CHATTER GRINDING FIXTURE

- Dampens vibration substantially.
- Prevents wheel breakage.
- Hence saves \$\$ on Diamond Wheels.
- Gives you better microinch finish and better workpiece geometry

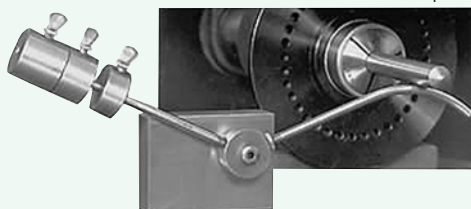

It is designed and built with a perfect combination of weights and counterbalances. Weights are easily positioned by the operator (because different shapes and types of material require different balance attitudes). Arm, which is over 4" long, can be lowered (out of the way) when measuring work. Lever and weight mechanisms are perfectly tuned and mounted on a heavy steel base. Fits all types of Grinding Machines- for wheels of diamond, silicon carbide, etc.

MODEL No. **\$110.00** Base Dimensions: 14260 2-1/2"W x 2"H x 3/4"D

VALTRA INC. CAM ACTION CLAMP

- The Cam Action Clamp is a low profile quick action clamp.
- Jaw pivots forward and downward at the same time when the handle is turned.
- Clamp locks positively at any position within its 180° turn allowing it to hold parts that vary slightly in dimension.
- The Cam Action Clamp with the extended base allows position adjustment on machine tables.

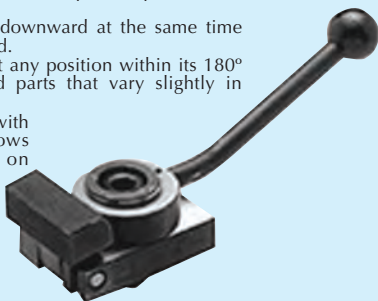

Model	Base	Stud	Dimensions	Price
850290	Standard	5/16-18"	1.25"W x 1"H x 1.75"L	\$ 79.95
850295	Extended	5/16-18"	1.25"W x 1"H x 3.13"L	89.95
850300	Standard	1/2-13"	1.88"W x 1.5"H x 2.75"L	99.95
850305	Extended	1/2-13"	1.88"W x 1.5"H x 1.75"L	105.00

Precise UNI-VISE GRINDING FIXTURE

- For use on a grinder or milling machine.
- Adjust the 4 screw nuts to set the required angle for precision grinding on solid carbide end mills, drills, tool bits as well as engraving cutters of various shapes, angles and diameters.
- It can also clamp workpiece for machining on various angles.
- Parallelism of the cutter carrier to the bottom: 0.001
- Base dimension: 6.3" x 7.1"
- Weight: 18 lbs.



MODEL No. 202-2615 **\$159.95**



KURT 3-IN-ONE SYSTEM JAW PLATE SETS



- Ideal for quick setup of common angle cuts.
- Pins sets included are: 4 ea. 6mmx22mm 3 ea. 6mmx40mm 7 ea. 6mmx58mm 3 ea. 6mmx76mm
- Preset patterns in jaws provide these 7 popular angles: 5°, 10°, 15°, 20°, 25°, 30°, 45°.
- Pinsets Dimensional Tolerance: ±0.0007" (0.018mm)
- Tolerance between holes 0.0004" (0.01mm)
- Doubles as a conventional workstop, Triples as a parallel. Does the work of 3 products.
- KSJ6 6" x 1.735" x 0.725" ±0.000787" (±0.02mm)
- KSJ8 8" x 2.20" x 1.075" ±0.000787" (±0.02mm)



6" SET No. KSJ6 **\$289.95**

8" SET No. KSJ8 **\$529.95**



KWIK TILT SINE BLOCK TABLE

It Only Takes a Few Minutes to Set Up, Not Hours!

- Use a 6" Angle-Lock or Accu-Lock type vise you already have on the machine, no need to clear and clean the machine table or remove existing work, no need to tilt the spindle.
- Precise machined and ground surfaces. Working area is 5.0-4.8" x 10.0-9.8". It comes Angularity +30 seconds from the jaw plane.
- Hard anodized 6061-t6 Aluminum
- Set of four (4) .5000" Pins for the Correspondent Holes.



From zero degrees to any angle in a minute!

Model	Description	Price
KWT-001	Kwik Tilt Sine Block Table	\$650.00
KWT-002	Extra Set of 10 Kwik Pin Gages for increments of 1, 2, 3, 4 and 5 degrees	30.00

NOTE: For other angles use Gage Blocks that shall be calculated using a sine table for a hypotenuse of 5.0000". Gage blocks shall not exceed 0.500"

TRIGO MICRO-DROP® DISPENSER

- Solenoid versions allow these units to be interfaced with CNC controls or other signaling devices. The pressurized delivery system provides instant on/off performance when used with the solenoid control.

FEATURES:

- Simple easy-to-use controls. No confusing timer to set.
- The anti-siphon valves permit the nozzle to be mounted in any position.
- Relative liquid scale allows repeatable set-ups and saves time in adjusting flow rates for different applications.
- Independent controls allow for maximum flexibility in adjusting liquid and air flow for each nozzle.
- Typical applications use 1 oz. of lubricant in an 8-hour shift.
- High energy nozzle design eliminates fogging for cleaner environment and greater chip clearing power, allowing faster speed and feeds.
- Positive pressure design gives instant fluid delivery for faster cycle times.



For Manual Machines

Model	Description	List	Sale
30801	MD-1200 w/1 Line, Micro-Dispenser	\$573.50	\$525.00
30802	MD-1200 w/2 Lines, Micro-Dispenser	689.50	635.00
With Solenoid For CNC Machines			
30805	MD-1200 w/1 Line, w/Solenoid	\$649.50	\$585.00
30806	MD-1200 w/2 Lines, w/Solenoid	805.50	750.00

WILTON SELF CENTERING VISE

With Sivel Base

Features:

- Automatically adjusts workpiece to it's center.
- Made from close grained cast iron.
- Opposite threads for quick, accurate centering.
- Swivel base provides positive locking mechanism that adjusts through 360°.

Specifications:

Jaw Width 4"
Jaw Depth 1-1/2"
Jaw Opening 4"
Weight 32 lbs.



MODEL No.
11713

\$395.00

PALMGREN UTILITY VISE

Features:

- Sturdy and compact 3-1/2" vise with an overall height of only 2-9/16".
- Base includes three bolt lugs for versatility in mounting.
- Steel adjusting screw has a coarse-pitch trapezoidal thread for fast action.
- Movable jaw is grooved vertically and horizontally.



MODEL No.
12351
Reg. \$195.00

\$149.95

Specifications:

Jaw Width 3-1/2"
Jaw Depth 1-1/2"
Jaw Opening 4"
Overall height 2-1/2"
Weight 32 lbs.

PALMGREN CROSS-SLIDE VISE

Features:

- For quick and precise X and Y axis positioning.
- Locking levers on both the X and Y axis for securing the vise into position.
- Ball crank handles aid in rapid movement.
- Three bolt lugs on each side of the base to match most table configurations.
- 30303** and **30601-1** have knurled jaw faces.
- 30801** has smooth jaw faces.

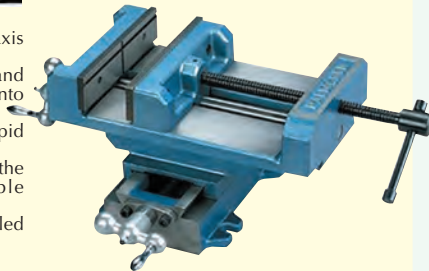

Model No.	Jaw Width	Jaw Depth	Jaw Opening	Height	Base Dimensions	Net Weight	Reg. Price	Sale Price
30303	3"	1-1/4"	2-7/8"	4-1/2"	8-1/4" x 6"	18 lbs.	\$112.85	\$95.00
30601	6"	1-7/8"	6"	6-1/2"	11" x 6-3/4"	65 lbs.	218.00	185.00
30801-1	8"	1-7/8"	7-1/8"	7-1/8"	12-1/4" x 7-5/8"	82 lbs.	293.00	249.00

PALMGREN QUICK VISES

Features:

- Precision-ground guide bar for smooth, rapid movement.
- Locking-clamp mechanism for tight, accurate holding.
- 3" model features a side-actuated clamping mechanism and 1/2" slots for mounting.
- 4" and 6" models have a top-actuated clamp and 1/2" lugs on each side.
- Replaceable jaws are ground flat.
- 6" model has a smooth, stepped jaw.

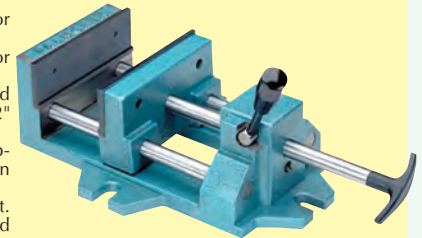

Model No.	Jaw Width	Jaw Depth	Jaw Opening	Height	Base Dimensions	Net Wt.	Reg. Price	Sale Price
12321	3"	1-1/16"	3"	2-3/4"	7-1/8"x5-3/8"	9 lbs.	\$55.95	\$39.95
12421	4"	1-3/8"	4"	3-9/16"	11-3/16"x5-3/4"	19 lbs.	149.90	129.95
12621	6"	1-5/8"	6"	4-5/16"	14-5/8"x9-3/16"	34 lbs.	198.50	145.00
12821	8"	1-5/8"	8"	4-1/2"	18-1/2"x11-5/8"	59 lbs.	275.50	189.50

PALMGREN CROSS-SLIDE ROTARY VISE

Features:

- Accurately position work on the X and Y axes, as well as 360° base rotation.
- Do hundreds of jobs that were never before possible using a standard drill press.
- May be used to position or to actively feed under the machine spindle.
- Tops are ground to 0.001" total indicator reading.
- Heavy handles permit smooth movement & do not extend below the base, eliminating interference with the machine table.
- Cross slide travel is 4" on 8" and 10" tables, 8" on 15" tables.
- Rotary dials are direct 1 minute reading on 15" models.

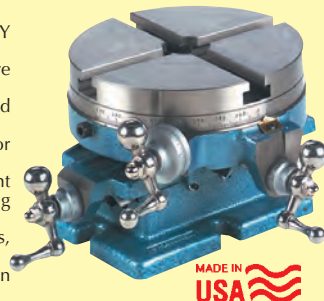

MADE IN USA

Model No.	Table Dia.	Overall Height	Base Ratio	Gear Ratio	Table T-Slots	Net Weight	Reg. Price	Sale Price
32803	8"	5-1/2"	5/8"	40:-1	5/8"	40 lbs.	\$988.00	\$750.00
34102	10"	5-5/8"	5/8"	40:-1	5/8"	52 lbs.	1176.00	895.00

PALMGREN SLIDE CROSS-SLIDE TABLES

Features:

- Precision ground tops to 0.001" total indicator reading.
- Graduated dials with thumbscrew for easy "0" setting.
- Solid steel ball crank handles do not extend below base.
- #36101**, **#37121** and **#47163** features single axis movement.
- #37123** and **#47163** have both X and Y axis movement.
- #37124** has angular inclination from 0-90° via two side plates secured with four bolts.
- #36101**, **#37121**, **#37123** and **#37124** have a single longitudinal T-slot with three transverse 7/16" T-slots and four 1/2" bolt lugs, one on each side.

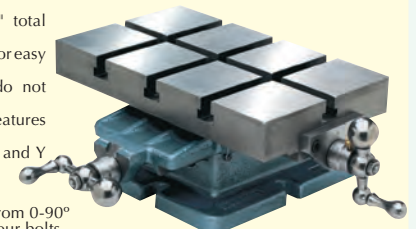

Model No.	Table Size	Height	Base Size	Table Travel	Net Wt.	Reg. Price	Sale Price
36101-1	10" x 6"	3-1/2"	6-3/8" x 7-5/8"	6"	34 lbs.	\$502.00	\$375.00
37121	12" x 6"	3-1/2"	6-3/8" x 7-5/8"	8"	39 lbs.	542.00	395.00
37123	12" x 6"	4-3/8"	7-5/8" x 6-3/8"	8" x 4"	44 lbs.	725.00	565.00
37124	12" x 6"	4-5/8"	9" x 5"	6" x 4"	48 lbs.	902.00	750.00

PALMGREN ROTARY TILTING CROSS-SLIDE TABLES

MADE IN USA

Features:

- Adds complete versatility to your drill press, milling matching, surface grinder or layout table.
- Table tops are precision ground flat to within 0.001" center bore is 1-5/8" in diameter and T-slots are 5/8" x 1".
- Angle is held by four screws in 2 heavy duty side plates.
- Bolt lugs base keyways are 5/8".



Model No.	Table Dia.	Height at 0°	Base (X x Y)	Table Travel	Net Weight	Reg. Price	Sale Price
32804	8"	5"	9" x 5"	4" x 4"	45 lbs.	\$1126.00	\$895.00
34103	10"	5-3/4"	9" x 5"	4" x 4"	54 lbs.	1329.00	995.00

PALMGREN COMPOUND MILLING TABLES

Specifications:

Table size 18-5/8" x 6"
Height 5-3/16"
Base size 12" x 7-7/8"
Travel 12" x 8"
Weight 63 lbs.

Features:

- Dual axis (lateral and cross) positioning via three wheel-style handles.
- Handles at each end of the 18-5/8" tables surface make it possible to use the table from either side.
- Solid, cast iron construction.
- Slides have adjustable gibs to maintain accuracy.
- Two 9/16" T-slots, 2-3/8" center-to-center.
- Rotary dials graduated in .02mm increments: each full rotation gives approximately .0008" movement.

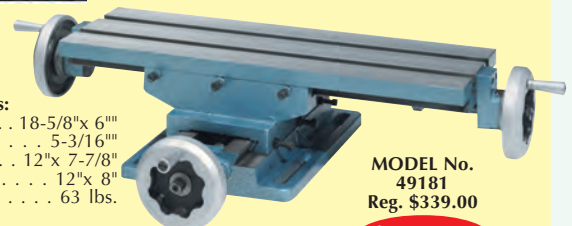

MODEL No.
49181
Reg. \$339.00

\$275.00



INDEXING SPACER WITH 6" OR 8" 3-JAW UNIVERSAL CHUCK

- The simple index is basically a heavy-duty base on which is mounted a hardened and ground precision turntable.
- It can be used in either a horizontal and vertical position.
- Using one of the masking plates provided the index can carry out many dividing functions. Indexing of 2,3,4,6,8,12 and 24 divisions can be rapidly and simply carried out.



Made In Taiwan
6" Diameter Chuck
MODEL No. 10-600-6

\$525.00

8" Diameter Chuck
MODEL No. 10-800-8

\$725.00

Optional Tailstock for both Model #s
30-002-3

\$145.00



SUPER INDEXING SPACER 6" OR 8" 3-JAW CHUCK

- This index combines the advantages of simple index with those of a worm-gear index. When mounted on a milling, boring or other machine tool it can carry out single-purpose indexing and indirect indexing using the worm-drive mechanism.
- Disengaging the worm drive the 24-notch master plate permits 2,3,4,6,8,12 and 24 dividing in the same manner as the simple index.
- When the chuck is removed the unit can be used as a horizontal and vertical type rotary table. The operating handle to rotary table gear reduction ratio is 1:90.

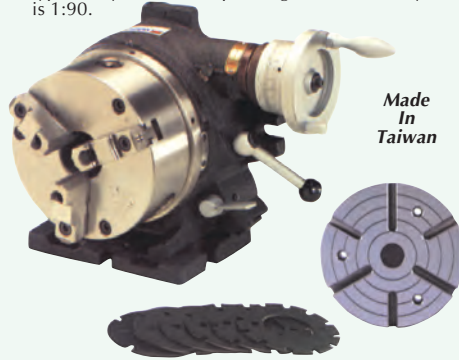

Made In Taiwan
6" Diameter Chuck
MODEL No. 20-600-6

\$795.00

8" Diameter Chuck
MODEL No. 20-800-8

\$995.00

Optional Tailstock for both Model #s
30-002-3

\$145.00

phase II TILTING ROTARY TABLE

Precision 10 second vernier reading and inclinable reading in minutes provide the needed accuracy for most inspection applications. Completely sealed gears and heavy duty construction assure trouble-free usage. 90:1 gear ratio on both 10" and 12" tables.

- Two year warranty.
- Extra deep coolant channel.
- Low profile.
- Dual positive action locks.
- Satin chrome dials.
- Gear ratio 90:1.
- Ten second vernier reading.
- Gear drive immersed in oil.
- Accuracy: 45 seconds.

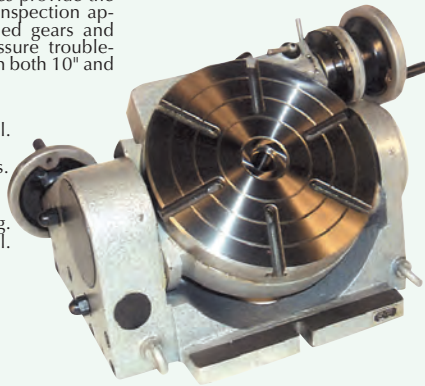

Specifications:

Model No.	222-410	222-412
Diameter	9.81"	12.6"
Table Height	8.07"	10.04"
Center Height	5.51"	6.89"
Centering Hole	1.2"	1.6"
Center Taper	MT-3	MT-4
Weight lbs.	172	293
Price	\$1195.00	\$1495.00

Optional:

No. 240-001	10" ADJ Tailstock	\$125.00
No. 240-002	12" ADJ Tailstock	\$155.00
No. 241-101	Dividing Plates	\$125.00

Precise SEMI-UNIVERSAL AND UNIVERSAL TYPE DIVIDING HEADS

- Hardened and ground spindle is rigidly held in a tapered seat by draw-in nut.
- The worm is hardened and ground and the interlocking with the worm gear is easily adjustable and can be disengaged for direct indexing.
- All models have threaded spindle nose & 24-hole dividing plate with easy conversion to fast direct indexing on numbers 2,3,4,6,8, 12 and 24.
- The swivel head can be locked at any angle from 10° below horizontal to 90° vertical-precision fitting to base assures smooth rotation.
- Semi-universal dividing head set includes head, adjustable tailstock, 3 dividing plates, center and drilling assemble and threaded backplate for mounting 3 or 4 jaw chuck.

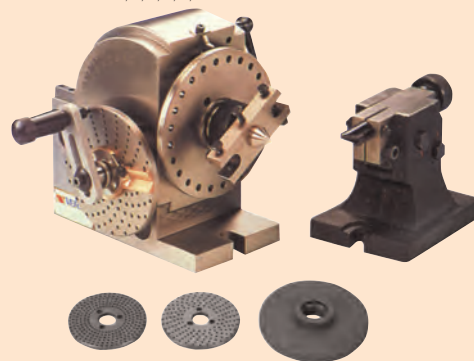

Semi-Universal
7-7/8" Swing
Model No. 20-700-2

\$449.95

Semi-Universal
10-3/8" Swing
Model No. 20-900-2

\$549.95

Universal
10-1/2" Swing
Model No. 20-100-2

\$995.00

Precise 5C COLLET INDEX FIXTURE HORIZONTAL/VERTICAL

- Rapid opening and closing is performed with a leverage ration of 100 to 1
- Convenient ratchet mounted on front of spindle provides rapid indexing.
- Index plate has 24 index locations (15° increments).

Threaded Spindle is Hardened & Ground
2-1/4" - 8 TPI

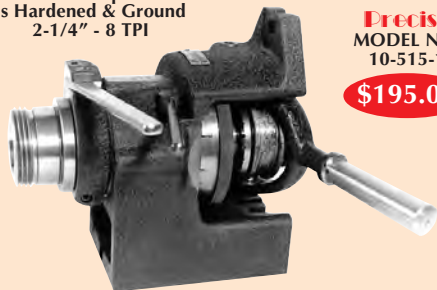

Precise
MODEL NO.
10-515-1

\$195.00

phase II
With Patented
Single Lever
Action
MODEL No.
225-205

\$295.00

SPECIFICATIONS

Dividing Spindle Concentricity 0002"
Cylindrical center bore (part 1) concentricity0008"
Spindle center line parallelism 0008"
Base to face squareness0008"
Center slot to dividing spindle concentricity0008"
Lateral offset of central slot to dividing spindle0008"

Accepts all
5C collets



VERTEX ECONOMICAL RAPID INDEX HORIZONTAL & VERTICAL

- Simple & rapid operation.
- Table scale 1°, for angular indexing.
- Horizontal/vertical & 2 direction.
- Suitable for milling & drilling machine use.
- Dividual number 24-notch (15° Each).
- Table bore 30mm.
- 3-jaw self centering chucks supplied.



Model No.	Chuck Diameter	Height Horizontal	Height Vertical	Weight lbs.	Price Each
VSI-400	4"	5.40"	5.85"	25	\$395.00
30-603-3		Optional Adjustable Tailstock			145.00



VERTEX UNIVERSAL TILTING ROTARY TABLES 4" & 8"

- Tilting range 0-90 degrees from horizontal to vertical position, it is height rigidity.
- Minimum set-up time has two screws to lock setting. Low profile body for bigger capacity.
- Worm is hardened and ground. The ratio is 90:1 The worktable is graduated a full 360° so that the handle moves the table through 4". Micro collar is graduated in steps of 2' min.
- For arc or index cutting at milling machine, grinding machine or drill machine.
- The tailstock & dividing plates are optional.



Model No.	Table Dia.	Horizontal Height	Hole Taper	Weight lbs.	Price Each
UVT-100	4"	4.68"	2 MT	30	\$525.00
UVT-200	8"	6.97"	3 MT	110	725.00

Optional Accessories

Model	Description	Price
30-601-6	Complete set of dividing plates	\$125.00
30-603-3	Adjustable Tailstock	145.00



VERTEX HORIZONTAL/VERTICAL LOW PROFILE ROTARY TABLES

- 10 seconds vernier reading.
- Made of high density meehanite with ground surface areas.
- Hardened and ground worm gear.
- Accuracy within 40 seconds.
- Adjustable dial on hand wheel.
- Vernier plate permits direct reading within 5 seconds.
- Gear ratio 90:1.



SPECIAL NOW
8" Rotary Table
20-008-2
Reg. List \$545.00
\$449.95

Model	Size	Approx. Wt.	Price
20-004-2	4"	20 lbs.	\$299.95
20-006-2	6"	44 lbs.	325.00
20-008-2	8"	66 lbs.	449.95
20-010-2	10"	117 lbs.	595.00
20-012-2	12"	183 lbs.	750.00
20-014-2	14"	242 lbs.	850.00

Optional Accessories

Model	Description	Price
30-601-6	Complete set of dividing plates (Specify rotary table size)	\$125.00
30-602-3	Adjustable Tail Stock (Specify rotary table size)	145.00

Precise HORIZONTAL/VERTICAL ROTARY TABLE SET With Face Mounting Plate & 3-Jaw Chuck

Rotary Table:

- 10 second vernier reading.
- Gear ratio 90:1
- One rotation of handle equals 4° on collar.
- 4" Table: utilizes profile locks for added workspace.
- Gear ratio: 4" Table is 72:1; 6-16" table is 90:1

- Supplied with 3-Jaw universal chuck.

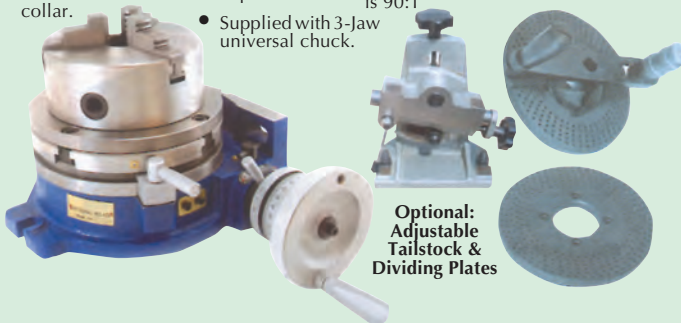

Optional:
Adjustable
Tailstock &
Dividing Plates

Model	Description	Price
HVR-004	4" H/V Rotary Table w/3" 3-Jaw Chuck & 4" Plate	\$450.00
HVR-006	6" H/V Rotary Table w/4" 3-Jaw Chuck & 6" Plate	495.00
HVR-008	8" H/V Rotary Table w/6" 3-Jaw Chuck & 8" Plate	685.00
HVR-010	10" H/V Rotary Table w/8" 3-Jaw Chuck & 10" Plate	850.00
HVR-012	12" H/V Rotary Table w/10" 3-Jaw Chuck & 12" Plate	1295.00
202-2006	Adjustable Tailstock for 6", 8", 10" Rotary Table	\$129.95
202-2005	Adjustable Tailstock for 12" Rotary Table	139.95
202-2007	Dividing Plate for 6", 8", 10" & 12" Rotary Table	114.95

Precise HEAVY-DUTY MILLING MACHINE VISE Big 8" Jaw Capacity

- Cast parts are made from highest grade ductile iron.
- The vise body with flame hardened bed provides solid work support.
- Screws are hardened and ground, then totally enclosed for years of productivity.
- Hardened spherical segment eliminates movable jaw tilt.
- Vises have a roller bearing thrust collar, which reduces friction and significantly increases holding power.
- Swivel base is graduated to 180° in 1° increments.
- 4-position of jaw plates allows extra capacity in outside position.
- Precision ground surfaces provided on top and bottom of vise bed and swivel base, also tops of both jaws.

MODEL No.
ELV-6X

\$229.95

With Swivel Base

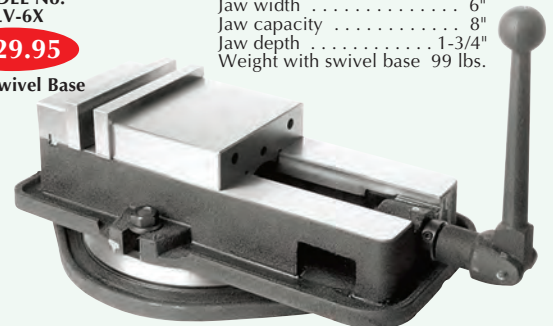

Dimensions:

Jaw width 6"
Jaw capacity 8"
Jaw depth 1-3/4"
Weight with swivel base 99 lbs.

- Flat bed parallel ±.0001" per inch.
- Greater precision clamping with deflection less than .0015".



VERTEX UNIVERSAL 3-WAY PRECISION ANGLE MILLING VISE

- Jaw plates are manufactured with tool steel and the screw is made of carbon tool steel.
- Body of Meehanite steel.
- Precise angular settings in all planes can be read from the mounted scale.
- Upper angle setting base is inclinable from the horizontal position to the vertical position. The lower angle setting inclines 45° in either right or left directions.
- Critical parts are carefully finished and ground.
- Swivel base is graduated in 1° increments (360°).



Model No.	Jaw Width	Jaw Opening	Jaw Height	Base Diameter	Weight lbs.	Price Each
VW-300	3-1/8"	3-1/2"	1-3/16"	7" x 9-1/4"	32	\$395.00
VW-400	4-1/8"	4-1/8"	1-9/16"	8-3/4" x 11-3/8"	82	495.00
VW-500	5-1/8"	5-3/4"	2-1/16"	9-7/8" x 12-7/8"	96	595.00

MASTAC 3" LEVER LOCK VISE

- Size-Small footprint allows more parts each machining cycle.
- Versatility-Hold various part configurations (square, round, irregular castings)
- Durability-Proven reliability in harsh environments.
- Repeatability-Repeatability within .0005"
- Customizing-Machine the jaws to the configuration you need.
- Flexible-Equipped with replaceable soft jaws or optional one piece solid jaw.
- Finish-Corrosion resistant black oxide finish.
- Accessories available- Replacement jaws, larger jaws, etc.
- Price-A fraction of the cost of competitive work holding systems.

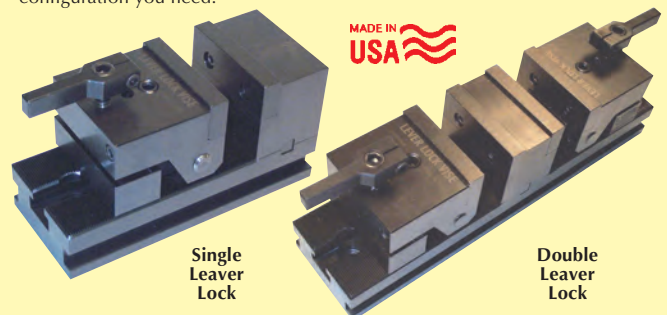

MADE IN USA

Model	Opening	Dimensions	Weight	Price
SLV-431	2.25"	3"W x 3-5/8"H x 7-1/4"L	17 lbs.	\$250.00
DLV-431	2.25"	3"W x 3-5/8"H x 12-1/2"L	27 lbs.	420.00



KURT ANGLOCK® MACHINE VISES

The Industry Standard

MADE IN USA

- All Kurt vises have a friction reducing, needle bearing, thrust collar on the screw. The needle bearing increases jaw clamping pressure.
- Anglock® design assures the movable jaw does not lift. Hardened vise bed. Hardened jaw plates. Semi-hard steel screw. 80,000 PSI ductile iron construction.
- Clamping force: D40(4000 lb.), D100 (20,000 lb.).

Each pound of force in this direction...

Induces 1/2 pound of force in this direction



MODEL No. D-688
Reg. List \$595.00
\$549.95

6" Plain Base
(Less Swivel Base)



Spherical segment (Hardened) produces "all directional" alignment. Jaw can't lift.

Model No.	Jaw Width	Jaw Opening	Base Type	Approx. Weight	List Price	Sale Price
D-40	4"	4"	Plain	32 lbs.	\$661.00	\$539.50
D-40S	4"	4"	Swivel	48 lbs.	1060.00	975.00
D-688	6"	8.8"	Plain	80 lbs.	595.00	549.95
D-688S	6"	8.8"	Swivel	106 lbs.	1095.00	935.00
HDM690	6"	9"	Plain	80 lbs.	750.00	679.50
D-810	8"	10"	Plain	158 lbs.	\$1695.00	\$1550.00
D-810S	8"	10"	Swivel	238 lbs.	2155.00	1995.00

Precise PARALLEL SEPARATOR

- Spring loaded Parallel Separator holds parallels securely in place.
- Eliminates the frustrating, repetitive and time consuming job of repositioning parallels.

Fits 4", 5" & 6" Milling Vise
No. KPS-6000
Reg. \$53.90

For 8" Vise
No. KPS-9000
Reg. \$77.00

\$38.95

\$49.95

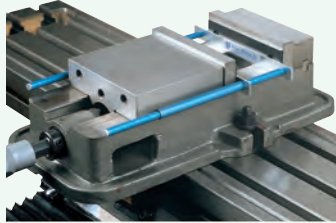

ACCU-TORQUE HANDLE

- Vises can be completely opened in a few seconds.
- Saves time and increases production.
- Clears machine dial and bed.
- Assumes more precise feel of clamping pressure.

Model	Fits	Price
QT-4	9/16" Hex, 4" Vise	\$24.95
QT-5	5/8" Hex, 5" Vise	24.95
QT-6	3/4" Hex, 6" Vise	24.95
QT-8	7/8" Hex, 8" Vise	49.95



FLEXBAR MILLING VISE GUARD

Quick and easy vise mount Lexan® shield helps to protect machine operators from hot chips and coolant spray at the spindle of your machine

- Easy to use- the Viseguard fits over the end of most standard vises.
- Flexible- when access to the workpiece is needed, the shield flips down easily (using heavy-duty hinge).
- Shatter resistant-made of high strength polycarbonate.
- Deflects chips- chips are deflected down and away from the machine operator.
- See-through- allows the operator to view the workpiece while the machining is being performed.
- Easy mounting-clamps in place with the twist of a knob.
- Clamps on in seconds.

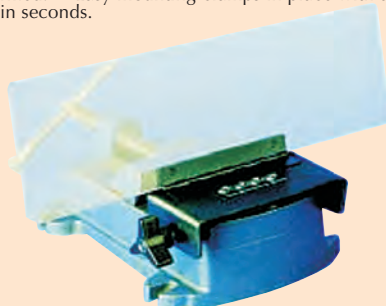

Model	Description	Price
13147	For use on standard 6" vise systems	\$49.50
13148	For use on standard 6" vise systems	54.00



KURT "HDL" ANGLOCK® MODULAR VISE

4" And 6" Wide Models

The HDL Anglock Vises are high density long vises with two clamping stations. They provide repeatable clamping to 0.001 inch and combine density with heavy duty features. Designed on a rugged 80,000 PSI ductile iron body with steel components, both models provide strength, rigidity and long term accuracy while absorbing machining vibrations.

- Two clamping stations - repeatable clamping to 0.001".
- Full 4" opening in each station with standard hard jaw system.
- Maximizes the number of parts in the work envelope. Adjustable pre-load features allows you to open or close the vise (manual version).
- Fast easy conversion between manual and hydraulic models.
- Holding block features the ability to clamp same or dissimilar sized parts and provides preloaded ability in the front or back jaw.

"HDL" Shown with Aluminum Jaw Kit



"HDL" Shown with Hard Jaw Kit

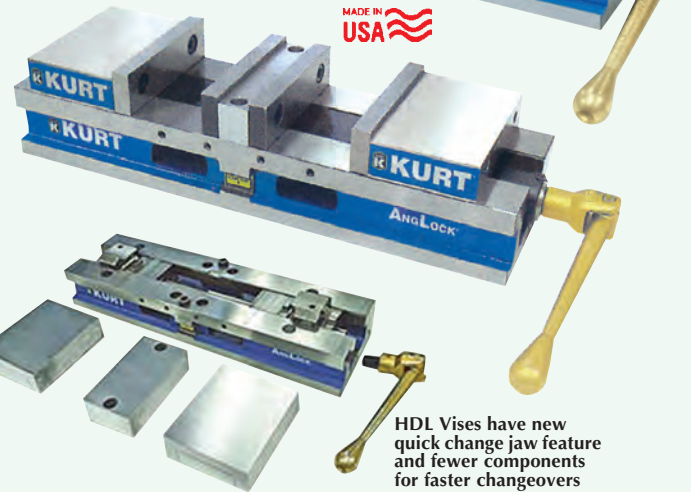

MADE IN USA

HDL Vises have new quick change jaw feature and fewer components for faster changeovers

Model	Description	Jaw Opening	Wt.	List	Sale
HDL-M4J	HDL Anglock vise with hard jaw kit	4" 3"	44 lbs.	\$1399.00	\$1350.00
HDL-M4A	HDL Anglock vise with 1.4" (H) aluminum jaw kit	4" 3"	40 lbs.	1197.00	1150.00
HDL-M4C	HDL Anglock vise with cast iron jaw kit	4" 3"	41 lbs.	1249.00	1200.00
HDL-M4	HDL Anglock vise without jaws (body only)	-	34 lbs.	1039.00	1000.00
HDL-M6J	HDL Anglock vise with hard jaw kit	6" 4"	97 lbs.	\$1841.00	\$1785.00
HDL-M6A	HDL Anglock vise with 1.73" (H) aluminum jaw kit	6" 4"	83 lbs.	1363.00	1320.00
HDL-M6C	HDL Anglock vise with 1.73" (H) cast iron jaw kit	6" 4"	110 lbs.	1745.00	1675.00
HDL-M6	HDL Anglock vise without jaws (body only)	-	71 lbs.	1490.00	1425.00

Model	Description	Width	Height	Price
HDL-100	Aluminum jaw kit	4"	1.4"	\$150.00
HDL-200	Aluminum jaw kit	4"	1.9"	175.00
HDL-300	Cast ductile iron	4"	1.4"	199.00
HDL-400	Hard steel jaw kit	4"	-	450.00
HDL-001	Aluminum jaw kit	6"	1.73"	\$200.00
HDL-002	Aluminum jaw kit	6"	2.40"	240.00
HDL-003	Cast ductile iron	6"	1.73"	250.00
HDL-004	Cast ductile iron	6"	2.40"	300.00
HDL-005-1	Hard steel jaw kit	6"	1.73"	475.00



SPi QUICKIE VISE HANDLE

- Speeds up opening and closing of machine vises.
- Provides faster and more efficient production.
- Fits all vises with 3/4" hex.
- Short turning radius for clamping of more delicate parts.
- Machined anodized aluminum.
- Use permanently on CNC vises and with any standard handle.



Model	Description	Price
76-424-1	Single position Quick Handle	\$15.55
76-425-8	Double position Quick Handle	29.25

PARLEC TE-Co PRECISION MILLING VISES

6" x 9" Opening & 8" x 11" Opening

Featuring the largest opening in its class and a more robust main screw that can handle higher torque loads and transmit higher clamping pressure. The angled slide and locking jaw design prevents lifting of the moveable jaw.

- Powder coated paint resists flaking and peeling.
- 80,000 PSI ductile iron body with increased nickel content for improved corrosion resistance.
- Hardened vise bed and jaw plated.
- Sealed and lubricated needle roller thrust bearing for maximum life and minimum torque.
- PWS-8110 has up to 12,000 lbs. of clamping force.
- PWS-6900 has up to 8,200 lbs of clamping force
- Repeatability within .001"
- Outside rails of body are machined within 0.0005" square to jaw.
- Bed height matched to size +/-0.0005"
- Footprint and distance from the keyway to stationary jaw meets industry standard.

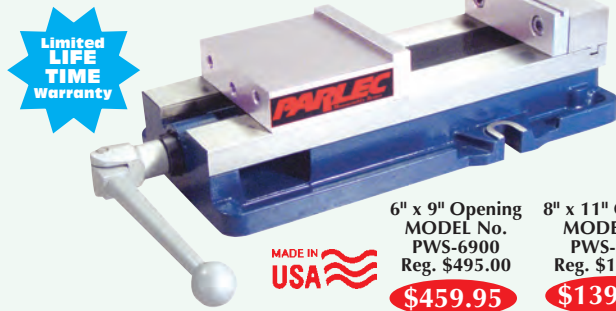

MADE IN USA

6" x 9" Opening
MODEL No.
PWS-6900
Reg. \$495.00
\$459.95

8" x 11" Opening
MODEL No.
PWS-8110
Reg. \$1465.00
\$1395.00

Limited LIFE TIME Warranty



KURT ULTIMATE 6" TOOL ROOM VISE D-688 WITH BIG 8.8" OPENING

With Groove Lock Jaw & Work Stop

- Outside rail edges of body are machined. This new edge allows you to indicate alignment during set-up.
- Vise nut does not extend beyond the end of the vise body.
- GrooveLock jaw and workstop standard.
- Patented "O" ring pull down feature standard.
- Approximately a 20% increase in clamping force over D675 vise.
- Patented Anglock design.
- 80,000 PSI ductile iron construction.
- Bed height matched to size, 2.875" within ±.0005".
- Long life guaranteed, 10 year warranty.

MADE IN USA



MODEL No.
D-688
Reg. List \$595.00
\$549.95

Ship Wt. 78 lbs.
KURT LIFETIME WARRANTY
IRONCLAD



Machined edge of D688 vise allows precision alignment of vise when used on Angle Plate with sine bar for locating.

Optional Swivel Base
MODEL No.
D-60-4
\$425.00



VERSA LOCK THE MODULAR VISE FOR VERSATILE WORKHOLDING

MADE IN USA

Now get .0005" repeatable clamping accuracy and up to 12,600 lbs. clamping force from the worlds most versatile vise. Your modular, 6 inch Kurt Versalock Vise converts in to 12 different vises at any time your changing production workholding requirements. Each is pre-engineered to do the exact workholding job intended. Look what one Versa-lock vise become using simple field conversion kits.



6" Aluminum Soft Jaws
a \$29.50 Value
No. VJ-601
\$19.95

MODEL No.
3600V
Reg. List \$794.00
NOW
\$765.00

KURT LIFETIME WARRANTY
IRONCLAD

Standard vise, reverse vise, short vise, short reverse vise, alt vise, reverse vise, short air vise, short reverse air vise, hydraulic vise, reversal hyd. vise, short hyd. vise, short reverse hyd. vise.



KURT 6" MILLING VISE WITH 9" OPENING

- Pull type body design reduces stress in the body resulting in more accurate clamping.
- Quick change movable jaw. The HD platform movable jaw allows for quick change and carvability to hold that odd shaped part.
- Adaptable to hydraulic.
- A full 9 inch opening between jaws.
- Less deflection of stationary jaw. Wider more stable stationary jaw equals less deflection.
- Uses sine keys for adjustment.
- Swivel base available.
- Stationary jaw bolts down from top. No need to remove from table to disassemble vise. Bolting the stationary from the top reduces the stress in the body and will stay flatter after assembly.
- Narrower body width allows more vises in the same work envelope.
- Taller body design equals less deflection under clamping loads.
- Bolts and locates directly on standard grid plates: 40mm, 50mm or 2 inch.
- GrooveLock® jaw and workstop included.

KURT LIFETIME WARRANTY
IRONCLAD
MADE IN USA



MODEL No.
HDM690
Reg. \$750.00
\$679.50

Each pound of force in this direction...
Induces 1.2 pound of force in this direction



ReLOCK® DOUBLE STATION VISES

- Compact modular design allows a multitude of mounting configurations.
- Exclusive auto offset mechanism allows non-simultaneous workpiece clamping and unclamping.
- Exclusive SnapLock knuckle allows SnapLock soft and carrier jaws to be attached and removed in seconds.
- Chip shields completely wrap around the SnapLock knuckles, keeping chips out. Can be removed easily for maintenance.

Features:

- ✓ Body manufactured from 80,000 PSI ductile cast iron.
- ✓ Ways flame hardened to 40 R/C maximum and ground to accuracies of ±.0005"

Vise with Hard Jaws

- ✓ Outside carrier jaws manufactured from high quality aluminum material.

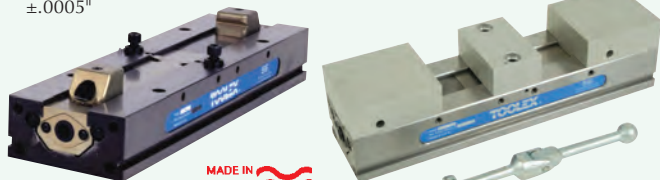

Vise Carrier

MADE IN USA

Vise Carrier with 3 Piece Jaw Set

Vise Carrier with Soft Machinable 3 Piece Jaw Set

Model No.	Vise Width	Vise Length	Carrier Height	Clamping Pressure	List Price	Sale Price
RWS-400SJ	4"	16.000"	2.500"	6,000 lbs.	\$1198.00	\$1095.00
RWS-600SJ	6"	20.500"	3.250"	12,000 lbs.	1517.00	1390.00
RWS-800SJ	8"	28.500"	4.000"	16,000 lbs.	4253.00	3975.00

Vise Carrier with 2 Carrier & 3 Piece Hard Jaws

RWS-400HS	4"	16.000"	2.500"	6,000 lbs.	\$1525.00	\$1375.00
RWS-600HS	6"	20.500"	3.250"	12,000 lbs.	1759.00	1590.00
RWS-800HS	8"	28.500"	4.000"	16,000 lbs.	4995.00	4875.00



KURT VISE KEYS

- Hardened vise keys are used to align your Kurt vise to your milling machine table.
- Step keys are used when the keyway in the vise is different than that of the machine T-slot.
- Standard keys are used when they are the same width

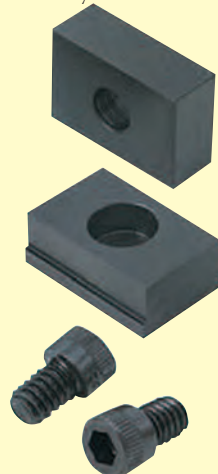

Hardened Standard Keys (Pair)

Model	Key Size	Vise	Price (Pr.)
D-30-50	1/2 x 1/2"	4"	\$36.00
D-50-50	11/16 x 11/16"	6"	30.00
D-80-5	13/16 x 13/16"	8" & 10"	35.00

Hardened Step Keys (Pair)

Model	Key Size	Vise	Price (Pr.)
D-30-30A	1/2 x 5/8"	4"	\$34.00
D-50-33A	11/16 x 5/8"	6"	30.00
D-50-33B	11/16 x 13/16"	6"	30.00
D-50-33C	11/16 x 3/4"	6"	30.00
D-50-33D	11/16 x 9/16"	6"	30.00
D-50-33E	11/16 x 1/2"	6"	30.00
D-80-33A	13/16 x 7/8"	8" & 10"	34.00
D-80-33B	13/16 x 11/16"	8" & 10"	34.00
D-80-33C	13/16 x 3/4"	8" & 10"	34.00
D-80-33D	13/16 x 5/8"	8" & 10"	34.00

CHICK QWIK-LOK™ SYSTEM AND JAWS

- QwikChange jaw interface for fast, accurate setups.
- Stainless steel slide assembly.
- High strength, aircraft grade aluminum for reliable hold with less weight.
- Completely sealed system for maximum chip control.
- Versatility of wide range of jaw options.
- Prices include standard aluminum jaws.



CHICK SYSTEM 5

Jaws & Accessories
Go to:
www.pennoolco.com

Qwik-Lok™ System with Aluminum Jaw Set

Model No.	Width	Dimensions Length	Height	Price Complete
081-1205AL*	2"/50mm	10"/250mm	3"/75mm	\$ 765.00
5QL1040-AL*	4"/100mm	16"/400mm	3.8"/95mm	1210.00
5QL1040-CI*	4"/100mm	16"/400mm	3.8"/95mm	1210.00
5QL1550-AL*	6"/150mm	20"/500mm	4.8"/120mm	1550.00
5QL1550-CI*	6"/150mm	20"/500mm	4.8"/120mm	1550.00

*"AL" Denotes Aluminum Base and "CI" has Cast Iron Base

CHICK MULTI-LOK™ HORIZONTAL SYSTEM

- Chick offers a broad range of horizontal workholding. Multi-Loks are available for all major machining centers in four sided, six sided, and speciality styles.



4 Sided Multi-Lok System



6 Sided Multi-Lok System

4 Side Multi-Lok™ System with Aluminum Jaw Sets

Model No.	Width	Dimensions Height	Swing Diameter	Price Each Less Base Plate
082-4201	8.4"/210mm	10.12"/253mm	8.64"/216mm	\$3720.00
5ML-1040-4	9.6"/240mm	16.2"/405mm	10.4"/260mm	4845.00
5ML-1550-4	12"/300mm	20.28"/507mm	13.36"/334mm	6970.00

6 Side Multi-Lok™ System with Aluminum Jaw Sets

Model No.	Width	Dimensions Height	Swing Diameter	Price Each Less Base Plate
082-201	9.2"/230mm	10.12"/253mm	9.4"/235mm	\$5680.00
5ML-1040-6	12"/300mm	16.2"/405mm	12.64"/316mm	8125.00
5ML-1550-6	16.4"/410mm	20.28"/507mm	17.44"/436mm	11,490.00

CHICK SYSTEM 5 ALUMINUM JAW SETS

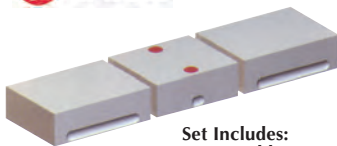

Set Includes:
(2) Movable Jaws
(1) Fixed Center Jaw

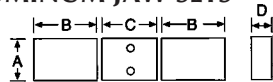

Holding Capacity and Machinable Area

Dual Station Standard Height

Set No.	Dimensions mm				To Fit System	Set Price
	A	B	C	D		
080-2500DS	49	75	36	25	2"	\$ 85.00
1040-1040S	99	105	70	40	4"	124.00
1550-1570H	148	135	100	50	6"	225.00

Dual Station High Height

1040-1055D	99	105	70	55	4"	\$175.00
1550-1570D	148	135	100	70	6"	325.00

*Wide and Oversize Jaw Sets Available

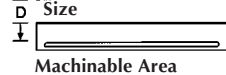
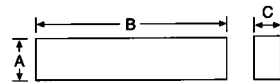

Machinable Area

Face Plates Standard Height

Set No.	Dimensions mm				To Fit System	Price Each
	A	B	C	D		
080-2625FP	49	248	25	14	2"	\$ 96.00
1040-1040F	99	398	40	26	4"	168.00
1550-1550F	148	498	50	32	6"	315.00

Face Plates High Height

1040-1055F	99	398	55	41	4"	\$200.00
1550-1570F	148	498	70	52	6"	405.00

*Wide and Oversize Jaw Sets Available

CHICK SYSTEM 5 ALUMINUM JAW SETS

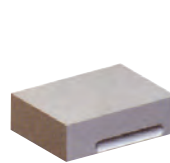

Set Includes:
(1) Movable Jaw
(1) Fixed Single Station Jaw

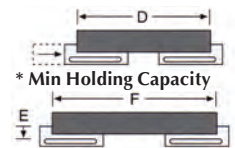
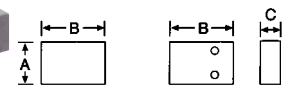

* Min Holding Capacity

* Max Holding Capacity and Machinable Area

Single Station Standard Height

Set No.	Dimensions mm						To Fit System	Set Price
	A	B	C	D	E	F		
080-2580SS	49	75	25	91	14	235	2"	\$ 74.00
1040-104SS	99	130	40	138	26	380	4"	114.00
1550-155SS	148	160	50	153	32	480	6"	204.00

Single Station High Height

1040-105SH	99	130	55	138	41	380	4"	\$122.00
1550-157SH	148	160	70	153	52	480	6"	240.00

*Wide and Oversize Jaw Sets Available



TABLE GUARD & TOTE Two Products In One

- This tray easily fits around vises and swivel bases.
- Outside rib (A) is molded to fit vise contour.
- Cut on the line arc (B) to fit swivel base contour.
- Holes can be drilled (C) in slots to accommodate fluid drainage.
- Benefits:
 - Keep your tools in easy reach.
 - Stops chips from falling into "T" slots
 - Step saver easy way to carry your tools.
 - Specially grooved to fit right into table's "T" slots.
 - Heavy duty plastic - won't dent, chip, or peel.

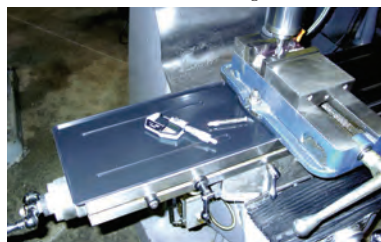

SET of 2 Trays
MODEL No.
8706-001

\$21.95



9-1/4" Wide x 17-1/4" Long

Precise UNIVERSAL VISE JAW WITH WORK STOP

- Multi-function V-shape jaw can hold workpiece at horizontal and vertical position.
- Made of high grade tool steel hardened and ground.
- Squareness and parallelism: 0.0002"
- Will fit vise jaw with 4 to 4-1/4" width.
- Two set screws for attached to vise and one long set screw used as work stop.
- Jaw width: 5.70"
- Jaw height: 1.94"
- Jaw thickness: 0.86"



MODEL No.
3900-2164

\$95.00



ULTRA PRECISION CLAMPING MILLING VISES

- For all of your CNC Milling Machine needs whether heavy milling, boring, tapping, drilling, or grinding.
- TMX vises deliver the same proven accuracy every time, improving on industry standards.
- TMX Vises are ultra precision in flatness, parallelism and verticality.

Features:

- 10 Year warranty.
- Body made from high quality ductile Iron hardened to 45RC.
- Sealed bearing system increases the life of the vise.
- Close tolerance bed heights for excellent accuracy.
- Anti-lift mechanism keeps the work piece from lifting.
- Chip cover for lead screw protection.

10 Year Warranty



No. 3-220-006
Reg. \$467.00

\$325.00

Model No.	Jaw Width	Jaw Opening	Weight lbs.	Reg. Price	Sale Price
3-220-006	6"	7-1/2"	79	\$ 467.00	\$325.00
3-220-0068	6"	9"	80	539.00	390.00
3-220-0081	8"	10"	150	1055.00	795.00

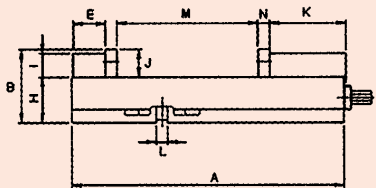
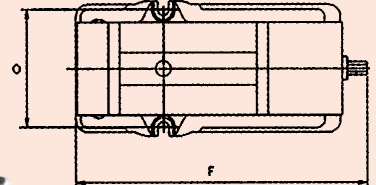

Part Number	A	B	C	D	E	F	G	H (Bed height)	I	J	K	L	M	N	O	Max Clamping Force
3-220-006	17.008	4.627	9.252	5.984	2.047	19.094	3.875	2.875" +/- 0.0005"	1.496	1.752	4.843	0.688	7.559	0.709	7.64	8,200 lbs
3-220-0068	17.205	4.627	8.750	5.984	2.047	18.937	3.875	2.875" +/- 0.0005"	1.496	1.752	4.843	0.688	8.898	0.709	7.64	9,840 lbs
3-220-0081	21.850	5.515	11.614	7.992	2.283	23.031	4.724	3.310" +/- 0.0005"	1.969	2.205	6.181	0.813	10.433	0.953	10.00	11,600 lbs

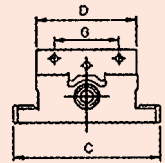

CARVLOCK HEAVY DUTY VISE

- Quick change machinable jaw now makes maximum density workholding possible.
- Compact size.
- Enclosed vise body keeps chips and contaminants out, making clean-up fast and easy.
- Provides rugged strength, rigidity and long-term accuracy while absorbing machining vibration.
- Overall length: 13.75"
- Overall width: 6"
- Clamping power: up to 7800 lbs. of force.
- Accuracy: repeatable clamping to 0.0005".
- 60,000 PSI ductile iron body.
- Made in USA.



Carvlock Vise w/Aluminum Jaws



Fixture Plate

Model	Description	List	Sale
HDM6AL	Carvlock Vise w/Aluminum Jaw Kit 6"	\$1567.00	\$1495.00
HDM6	Carvlock Manual Base Assembly (Jaws sold separately)	1208.00	1150.00
HDM6C	Carvlock Vise w/Cast Jaw Kit 6"	1381.00	1325.00
HDM6AL2.5	Carvlock Manual Vise w/2.5 Jaw Kit 6"	1392.00	1350.00
HD6AL	Carvlock Aluminum Jaw Kit 6"W x 1.73"H	\$239.00	\$230.00
HD6AL2.5	Carvlock Aluminum Jaw Kit 6"W x 2.40"H	348.00	337.00
HD6C	Carvlock Cast Iron Jaw Kit 6"W x 1.73"H	278.00	269.00
HD6ALFP	Carvlock Fixture Plate	298.00	289.00



MODULAR MILLING VISES

Maintains Accuracy Under The Most Severe Operating Conditions

- High accuracy
- Unlimited clamping range
- High quality alloy steel
- High clamping pressure
- No length of height limitations
- No jaw lift
- Low profile
- All vises are matched
- Mechanical and hydraulic blocking devices

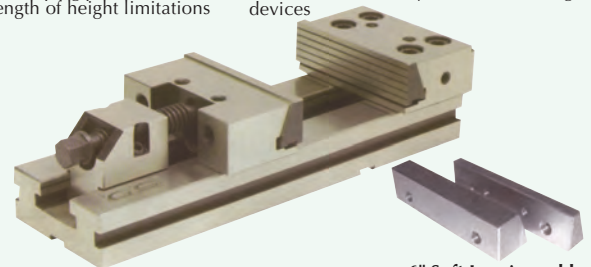

6" Soft Jaw Assembly

Model No.	Jaw Width	Jaw Opening	Jaw Height	Base Length	Weight Each	Price Each
382-005	4"	4"	1.2"	10.8"	15 lbs.	\$ 495.00
382-015	6"	8"	2"	16.8"	56 lbs.	695.00
382-060	6"	12"	3.2"	28.7"	231 lbs.	2250.00
382-040	8"	12"	2.6"	26.8"	152 lbs.	1295.00
382-895	6" Soft Jaw Assembly					\$ 225.00

THE PLANK™ MOVES YOUR MILLING VISE SAFELY AND EASILY!

Supports the weight of heavy vises, rotary tables, fixtures and work pieces, allowing the machine operator to safely load and unload heavy items onto the table of the machine!

- Eliminate the need for the machine operator to lift heavy objects.
- Minimizes injury or strain to operators.
- Securely attaches to machine tool tables in seconds.
- Made from 356 T6 Aluminum.



For 5/8" Table Slots
MODEL No.
PLK-625

\$89.50



ANGLOCK VISE WORK STOPS

- Versatile, quick, mounting work stops.
- Permits fast accurate position on repetitive work.
- Teams up with your Anglock precision vises for real production.

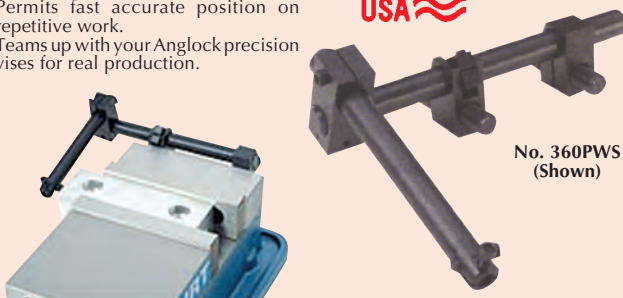

No. 360PWS (Shown)

Model	Description	Price
D30-45	To Fit 4" Vise	\$105.00
360PWS	To Fit 6" Vise	95.00
D80WS	To Fit 8" Vise	129.95
Precise Imported Version		
3900-2123	To Fit 5" & 6" Anglock type vises	\$19.95



LOCATOR MASTER JAW SET WITH BUILT-IN WORKSTOP PIN

- Can be used with most 6" single-station vises
- Workstop pins are labeled, and easily push in and out to accurately locate your part
- No guess repeatability
- Easy to install - just bolt master jaws to your existing vise
- Helps save time and money!

MODEL No.
TL-6000

\$175.00



CHICK CNC ONE LOK SINGLE STATION VISE

- The One-Lok CNC Vise is the first of it's kind. It is not a knee mill vise adapted for use on a CNC machine.
- The One-Lok has been designed specially for CNC.
- As a single station CNC vise, it is ideally suited for job shops, tool & die shops, prototype work, or other small batch (1-20) CNC milling applications.
- For CNC Vise Specifications, accessories and Softjaws, visit our website: www.pennnutool.com

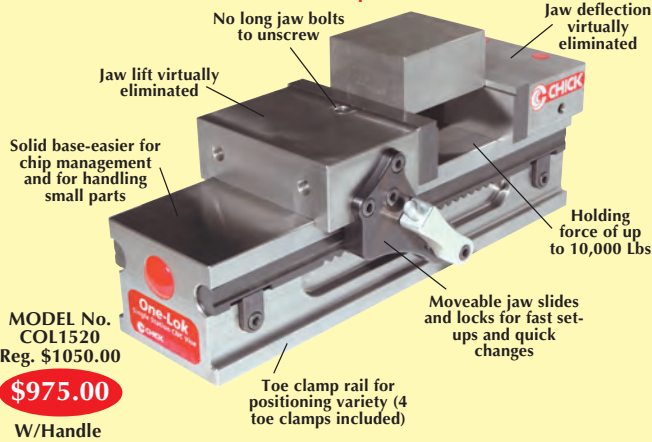

MODEL No. COL1520
Reg. \$1050.00

\$975.00

W/Handle

Precise SUPER~LOCK VISE FOR NC/CNC MACHINES

- Lock down type.
- Ideal for all types of milling, grinding, drilling, and tapping applications in multiple vise set-ups.
- Flatness of all side to .001" guaranteed.
- Mounting in 3 modes: upright, left and right side.
- Both sides parallel to each other to .0005" per 4".
- Up to 3000 N clamping force.

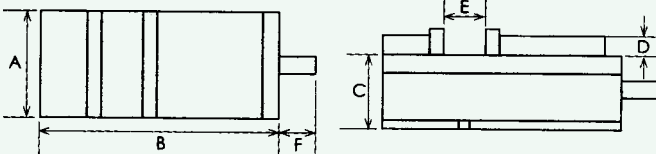
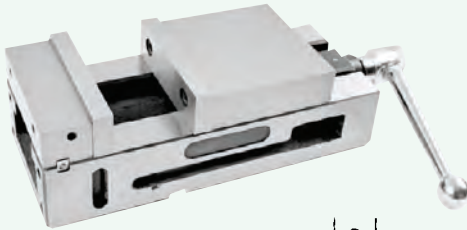

Model No.	Jaw (A) Width	Dimensions B C D E F H	Price Each
CNC-400	4"	11.2"B, 2.48"C, 1.13"D, 4.2"E, 1.63"F, 4.25"H	\$190.00
CNC-600	6"	15.1"B, 3.19"C, 1.50"D, 5-1/2"E, 3.50"F, 5.62"H	\$225.00

Bock WORKHOLDING TWIN VISES

- Double sided aluminum soft jaws suitable for milling.
- Hard jaws and hardened jaw plates available.
- Rapid jaw changes in a few seconds.
- Large single-station conversion plate available.
- Straight base design with flat clamping edge.

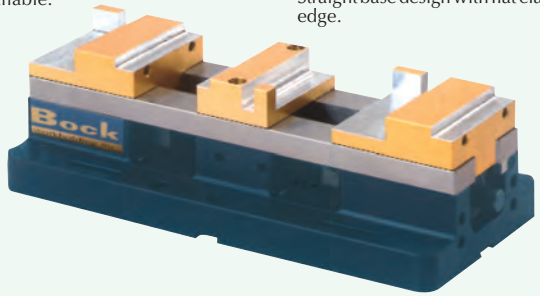

Model No.	Description	Weight	List Price	Sale Price
TV4-100S	4" Twin Vise W/soft Jaws	25 lbs.	\$1099.00	\$ 995.00
TV6-150S	6" Twin Vise W/soft Jaws	30 lbs.	1499.00	1375.00
SJS-100	4" Soft Jaw Set (3 Pc. Jaws)	7 lbs.	149.00	142.50
SJS-150	6" Soft Jaw Set (3 Pc. Jaws)	13 lbs.	239.00	227.00
HJS-4	4" Hard Jaw Carrier Set (3 Pc. Set)	6 lbs.	\$219.00	\$205.00
HJS-6	6" Hard Jaw Carrier Set (3 Pc. Set)	12 lbs.	319.00	300.00

Bock locator plates available for repeat set ups - call for more information

Precise TWIN-LOCK SELF CENTERING PRECISION CNC MILLING VISE

- Precision clamping force per jaw set.
- Precision ground on all sides, can be mounted vertically or horizontally.
- Bed hardened to RC 45 or higher to resist wear.
- Reversible hardened jaw plates for standard or, stepped part holding.
- Reduces the tool changes per job by 50%.
- Uses the same machine space as conventional vises limited to half the part holding capacity.
- Top mounted center block can be removed easily for larger parts application.



4" Vise
MODEL No. CNC-420

\$275.00

6" Vise
MODEL No. CNC-620

\$369.95

6" 3/4" Vise Dimensions:

A=6.27/3.94", B=20.8/15.7", C=3.15/2.40", D=1.61/1.22", E=4/3", F=3.5/2.5", G=2/1.47", J=3.95/2.44", K=1.23/0.75", L=1.01/0.86"

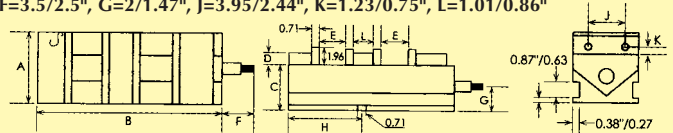

Magnum MACHINING VISE ALUMINUM BODY MILLING VISE

- 7" full length opening.
- Machined steel handle.
- Hardened jaws.
- Interlocking body.
- Closer tolerances.
- Anodized aluminum body.
- 6" jaw width.
- Bed height of each vise is 2.875" within +/- .0005".
- Heat treated steel components.
- Machined surfaces are square and parallel within .001"
- Non-lifting movable jaw design.
- Semi-hard nickel plated steel screw.
- Needle bearing facilitates greater clamping pressure and ease of use.
- 51 lbs. shipping weight.

Reduce Heavy lifting with our light weight but "Magnum" rugged aluminum vise.



MODEL No. MMV-600A
Reg. \$760.00

\$595.00

6" Jaw
7" Opening

MADE IN USA

With LIFETIME Warranty

Magnum MACHINING VISE MILLING VISES 5", 6" & 8"

- Attractive black & silver vein powder coating is much more durable than ordinary paint.
- Stress-relieved 80,000 psi ductile iron vise body. Vise bed is flame-hardened.
- All machined surfaces are square and parallel within .001"/.025mm.
- Supplied with a removable chip shield.
- Non lifting movable jaw design.
- Semi-hard nickel plated steel screw.
- Needle bearing facilitates greater clamping pressures.

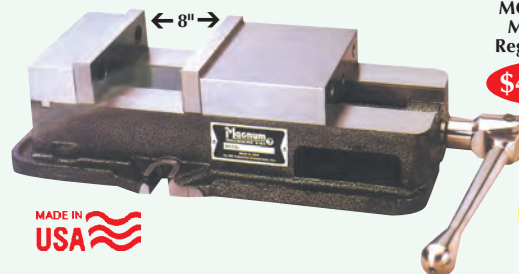

6" x 8" Capacity
MODEL No. MMV-600
Reg. \$515.00

\$449.95

With LIFETIME Warranty

Model No.	Jaw Width	Vise Bed Capacity	Bed Height	Shipping Weight	Price Each
MMV-600	6"	8"	2.875"±.0005"	80 lbs.	\$449.95
MMV-500	5"	5"	2.500"±.0005"	53 lbs.	495.00
MMV-800	8"	9.95"	3.312"±.0005"	170 lbs.	995.00

Jergens 5-AXIS QUICK CHANGE FIXTURING SYSTEM

No Limits On Your 5-Axis Machine or Your Productivity

- Getting your spindle and cutting tool close to the workpiece without running into obstructions is a challenge on a 5-axis machine. Jaws and other vise components, and even the machine table itself, can restrict your access and prevent you from machining multi-sided parts. Your only choice is stopping the machine and repositioning your part.
- Jergens unique modular system features a variety of riser sizes and styles to get your part off the table and allow unrestricted access. But what about applications which also require aggressive metal removal? This system was built with rigidity in mind, from uniquely designed pull studs to 5-axis vises and dovetail clamps. This added rigidity helps maintain accuracy, even in your most aggressive roughing and finishing operations.

Feature Focus: The Drop&Lock™ Pallet Changer

This simple element is the key to the entire 5-Axis Quick Change System. While it serves the same function as a fixture plate, it doesn't have to be locked down with 4 set screws. Instead, you simply install pull studs into the bottom of your fixture or vise and literally drop it into the pallet changer. In less than two quick turns of a hex wrench, you can switch out your workpiece without re-indicating.

Drop it, Lock it, and go!



MADE IN USA

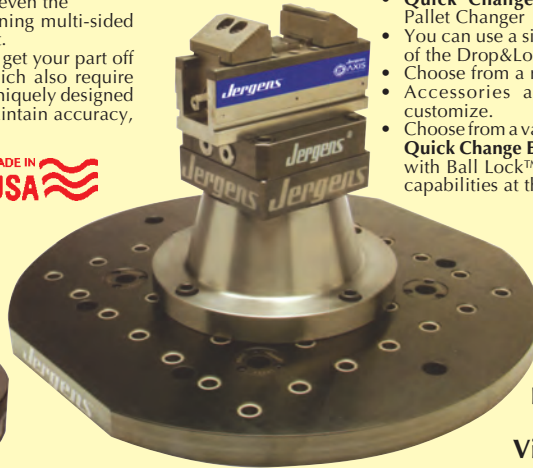

- 5-Axis Vise or Dovetail Clamp.
- **Quick Change Element!** Drop&Lock™ Pallet Changer
- You can use a simple adapter plate instead of the Drop&Lock™ Pallet Changer.
- Choose from a range of risers.
- Accessories and hardware help you customize.
- Choose from a variety of standard subplates. **Quick Change Element!** can be configured with Ball Lock™ or QLS for quick change capabilities at the subplate level.



MODEL No. JER-500

For Specifications and Pricing Visit Our Website www.penntoolco.com

WILTON SUPER PRECISION 4" SELF CENTERING MILLING VISE

- Allows for accurate centering of jobs automatically.
- Special design allows accurate setting up of jobs with only a single machine setting.
- Vise bodies are constructed of close grained, high tensile, seasoned alloy castings.
- Swivel base provided with positive locking and adjustable through 360°.
- Hardness of jaws 55±3HRC
- Automatically adjusts work piece to center.



MODEL No. 11713
List \$690.00
\$549.95

Specifications:
Jaw Width 4"
Jaw Opening 4"
Jaw Depth 1-1/2"
Weight 32 lbs.

Precise SELF-CENTERING 4" MILLING VISE

- Both jaws on this precision vise move in equal and opposite directions so parts of varying size remain centered as long as the vise remains centered to the milling machine spindle.
- Precision ground dovetailed ways and an adjustable gib provide ultra smooth operation.
- The jaws measure 4" wide by 1-1/2" high and maximum capacity is also 4".
- The crank handle measures 4" long and slides on and off when needed.
- Overall size is 10" long x 8-1/2" high. Ideal for milling structural tubing of different diameters.



MODEL No. D4064
\$199.95

Specifications:
Jaw Width 4"
Jaw Opening 4"
Jaw Height 4"
Overall Dimensions:
10"L x 8-1/2"H



VERTICAL 2-1/2" VISE BRACKET TO MOUNT WITH YOUR 6" VISE SIDEWINDER™ VISE FOR 2nd OPERATION WORKHOLDING

The Kurt SideWinder is a vise that mounts vertically to the back of any Kurt 6" vise with an integral bracket. The bracket will include a stabilization leg that will mount to the table on the movable end of the vise and a workstop to position the height of the part.

Purpose: For doing 2nd op work holding the part vertically rather than horizontally.

Advantage:

- Saves set up time for 2nd op vertical work
- Machining can be done on both vises in the same setup
- Vise is at an elevated position which is more conducive to longer reach machining
- Has a stabilizer foot for vibration control
- Can be mounted to any Kurt industry standard 6" vise
- Has a round nut which controls deflection to a greater degree
- Does not interfere with the host vise
- Pull type vise
- AngLock design

MODEL No. SDW25
\$675.00



Vise Features:

- Jaw width: 2.500"
- Jaw height: 1.063"
- Max. opening: 2.500"
- Max. clamping force: 2450 lbs.

Bracket Features:

- Adjustment range of workstop: 0"-4.313"
- Hex size: 0.375"
- Overall bracket width: 14.000"
- Bracket height: 7.6"/8.4"
- Hex length: 0.453"
- Weight: 19 lbs.



SBM MACHINABLE SOFT JAWS

- Fits Kurt Anglock™ and similar precision machine vises
- Perfect for easy and quick set-ups, reducing down time
- Customize jaws for drill or mill features
- Reusable, saving you time and money!
- Price is for set of 2 jaws

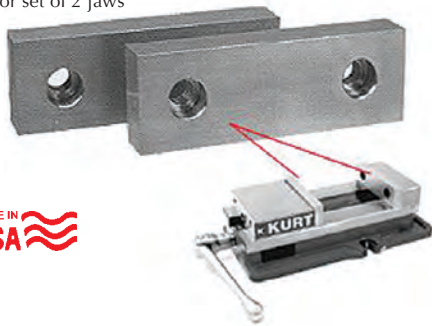

Price
Per Pair

MADE IN
USA

Aluminum

Model	Jaw Dimensions	Price
VJ-401	4"L x 1-3/4"H x 3/4"W	\$14.95
VJ-601	6"L x 2"H x 3/4"W	19.95
VJ-801	8"L x 2-1/2"H x 1"W	29.95

HARDENED AND GROUND STEP JAWS



Price
Per Pair

Model	Step Dimensions	Price
SJ-401	4"L x .157"D x .138"W	\$ 69.95
SJ-501	5"L x .157"D x .138"W	65.00
SJ-602	6"L x .197"D x .177"W	85.00
SJ-801	8"L x .236"D x .216"W	125.00

QUICK CHANGE ALUMINUM JAWS



Price
Per Pair

Model	Jaw Dimensions	Screw Thread	Price
QVJ-417	4"L x 3/4"W x 1-3/4"H	3/8"	\$18.95
QVJ-420	4"L x 1"W x 2"H	3/8"	21.95
QVJ-620	6"L x 3/4"W x 2"H	1/2"	22.95
QVJ-621	6"L x 1"W x 2"H	1/2"	24.95
QVJ-622	6"L x 1-1/4"W x 2"H	1/2"	28.95
QVJ-625	6"L x 1-1/2"W x 2"H	1/2"	35.00
QVJ-626	6"L x 2"W x 2"H	1/2"	40.00
QVJ-821	8"L x 1"W x 2-1/2"H	5/8"	35.00
QVJ-822	8"L x 1-1/4"W x 2-1/2"H	5/8"	45.00

MOUNTING SCREWS FOR QUICK CHANGE JAWS

Model No.	Vise Size	Screw Thread	Price Per 4 Package
SNL-416	4"	3/8"	\$ 7.95
SNL-613	6"	1/2"	9.95
SNL-811	8"	5/8"	21.95



Precise MAGNETIC SOFT VISE JAWS

- Fits any milling or bench vise
- Magnetized for mounting



Model No.
T-10100

\$24.95

Per Set

FLEXBAR MAGNETIC "SOFT JAW" VISE LINERS

- One jaw has Vee groove in Horizontal Plane.
- Second jaw has 2 Vee's in Vertical plane. Plus 1 Vee, 45 degrees.
- Accepts all shapes
- 5 inches (one size) fits all vises.
- Made of nylon.
- Overlap configuration for easy positioning assuring parallel set up.
- Magnetic on one side, can be cut to size or left with an overlap.



MODEL No.
14001

\$16.95

FLEXBAR MAGNETIC VISE JAWS Aluminum & Brass - Sold In Pairs

- Soft jaws with magnetic inserts for easy mounting and holding on your vises
- Protect your work piece against scratching and nicking
- Grooves ensure tight holding of different shapes of work piece



Aluminum		
Model	Jaw Width	Price
13560	4"	\$19.95
13561	5"	21.95
13562	6"	23.95

Brass		
Model	Jaw Width	Price
13563	4"	\$43.95
13564	5"	54.95
13565	6"	65.00

FLEXBAR UNIVERSAL VISE JAW WITH WORK STOP

- Multi-function V-shape jaw can hold workpiece at horizontal and vertical position
- Made of high grade tool steel hardened and precision ground
- Squareness and Parallelism: 0.0002"
- Will fit vise jaw with 6 to 6 1/2" width
- Two set screws for attached to vise and one long set screw used as work stop
- Jaw Width: 7.50"
- Jaw Height: 2.10"
- Jaw Thickness: 1.57"



MODEL No.
13566

\$129.95

ROYAL "MAGIC/GRIP" VISE LINERS

- Provide sure gripping without damaging finished parts.
- Easily adaptable to all vises.
- "Magic / Grip" has a memory - takes up to 14,000 psi pressure and still returns to original shape after use.
- Easily bendable by hand.
- Can be used as a vibration isolator.
- Can be used when hammering sheet metal to protect the surface especially painted metal.
- Holds odd-shaped parts without damaging them.



Model	Size	Price
26010	12" x 4"	\$50.00
26011	6" x 4"	32.00

WILTON 3-AXIS SUPER PRECISION MILLING VISES

- Perfect vise for 3-axis jobs in milling, drilling, grinding, shaping and jig boring.
- Vise bodies are constructed of close grained, high tensile, seasoned alloy castings.
- Ergonomically designed all steel handle with spring loaded ball attachment.
- Durable polychromatic finish.
- 360 degree swivel base.
- 45 degree tilting on either side.
- 90 degree vertical indexing.



2 Year Warranty

Model No.	Jaw Width	Jaw Opening	Jaw Depth	Weight lbs.	List Price	Sale Price
11700-1	2"	2"	1"	9	\$480.00	\$345.00
11701	3"	3"	1-5/16"	24	880.00	595.00
11702	4"	4"	1-1/2"	46	1120.00	795.00
11803	5"	5"	1-3/4"	83	1320.00	850.00
11804-1	6"	6"	1-3/4"	119	1600.00	1095.00

WILTON 2-AXIS SUPER PRECISION MILLING VISES

- Perfect vise for applications where the workpiece requires machining on an angle.
- Vise bodies are constructed of close grained, high tensile, seasoned alloy castings.
- All ground surfaces made to close tolerances.
- Ergonomically designed all steel handle with spring loaded ball attachment.
- 360 degree swivel base.
- 90 degree vertical and 180 horizontal indexing.
- 90 degree tilting.



2 Year Warranty

Model No.	Jaw Width	Jaw Opening	Jaw Depth	Weight lbs.	List Price	Sale Price
11703	2"	2"	1-5/16"	9	\$360.00	\$275.00
11704	3"	3"	1-5/16"	24	580.00	395.00
11705	4"	4"	1-9/16"	46	720.00	495.00
11706	5"	5"	2"	63	1040.00	795.00
11707	6"	6"	2"	92	1300.00	850.00

WILTON TOOLMAKER VISES

- Made from specially selected alloy steel.
- Every part is precision ground and parallel within 0.0002"
- Rapid positioning notches.
- Positive downward clamping force
- Vees in sliding jaws hold work pieces securely and accurately.
- Hardness 50 to 55 HRC.
- Minute angle step of 0.2" built into the vise ease using standard gauge blocks.

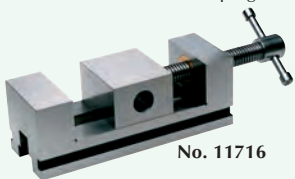

No. 11716

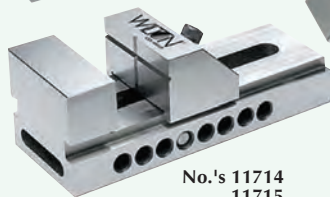

No.'s 11714
11715



No. 11717

Model No.	Jaw Width	Jaw Opening	Jaw Depth	Length Inch	Weight lbs.	Price Each
11716-1	2-3/4"	3"	1-9/16"	7-3/32"	11	\$495.00
11714	2"	3-1/8"	1"	5-1/2"	8	250.00
11715	3"	3-3/4"	1-3/8"	7"	11	345.00
11717*	2-3/4"	3-3/4"	1-3/8"	7-1/2"	17	\$595.00

*Sine Vise Center Distance, No. 11717 6"

CARDINAL -SPEED VISE- QUICK ACTION DESIGN

- Quick-action design-for speed.
- Screw and nut hardened steel-for long life.
- Heavy semi-steel castings-for strength.
- Heavy steel base plate-for rigidity.
- Standardized holes in jaws-for attaching interchangeable jaw plates and fixtures.
- Supplied with combination Jaw Plates (1 smooth, 1 grooved)



Model No.	Jaw Width	Jaw Depth	Jaw* Opening	Overall Height	Overall Length	Weight lbs.	Price
554-3BV	3"	1-1/2"	3"	2-9/16"	9"	8	\$199.50
554-4BV	4"	1-1/2"	4"	2-7/8"	11-1/2"	15	285.00
554-5BV	4"	1-1/2"	6"	3"	13"	18	295.00
554-6BV	6"	2"	6"	3-11/16"	15"	35	375.00
554-7BV	6"	2"	8"	3-7/8"	17"	44	475.00
554-8BV	8"	3"	10"	5-1/2"	21-3/4"	103	995.00

*Jaw Opening without Jaw Plates. Replacement parts available

WILTON SUPER PRECISION DRILL PRESS VISE

- Combines a smooth moveable jaw plate with a cross-patterned 90° v-groove stationary jaw.
- Body made from special cast iron.



Model No.	Jaw Width	Jaw Depth	Jaw Opening	Weight	List Price	Sale Price
2296-6030	3-3/16"	1"	3-1/2"	13 lbs.	\$220.00	\$169.95
2296-6032	4"	1-1/4"	4"	20 lbs.	300.00	225.00

Jergens HEAVY DUTY ANGLE TIGHT MILLING VISE

Anchored by its rugged cast iron base, Jergens Heavy Duty Machine Vise creates rock-solid workholding power, while also delivering exacting workholding precision and exceptional application versatility.

- Single station
- Cast iron base
- Available in 8.00" or 9.85" opening
- Reversible jaws for large I.D. capacity.
- Low profile design
- Soft jaws that are interchangeable with common industry styles

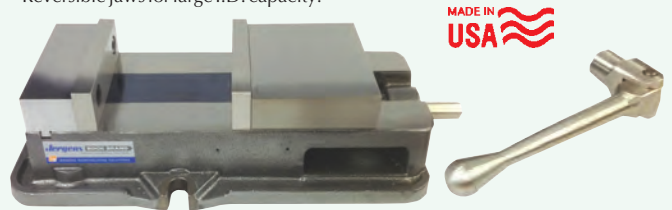

Model No.	Jaw Width	Jaw Opening	Overall Length	Weight lbs.	List Price	Sale Price
80075-1	6"	8"	16.75"	80	\$ 525.00	\$ 475.00
80082	8"	9.85"	21.625"	158	1250.00	1095.00

Precise HEAVY DUTY MULTIPURPOSE ROTATING VISES

- Full 360° rotational jaws.
- Machine-cut parallel jaws.
- Larger, stronger pipe jaws.
- Unique "V" jaws provide 4 point holding power.



Head Swivels 360°

Model No.	Width	Open	Throat Depth	Pipe Jaws Max. Open	"V" Jaw Max. Open	Anvil Size	Weight	Sale Price
850-RT-5	5"	4"	3-1/2"	3"	4"	2-1/2" x 3-1/2"	46 lbs.	\$ 69.95
850-RT-6	6"	5-1/4"	3-1/2"	6-1/4"	7-1/4"	3" x 4"	97 lbs.	175.00

Precise DRILL PRESS VISES

FLAT VISE

- High tensile iron casting.
- Accurate machining and assembling.
- Jaw plates-one grooved and one plain.
- Four sides and one end machined.

P-250

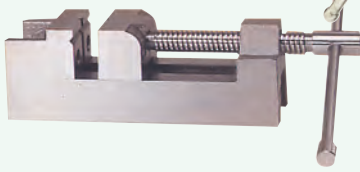

ANGLE VISE

- Full 90 degrees adjustment, horizontal to vertical.
- One grooved and one plain jaw plates.
- Two bolt lugs on the base for setting on machine table.

P-250A
P-350A

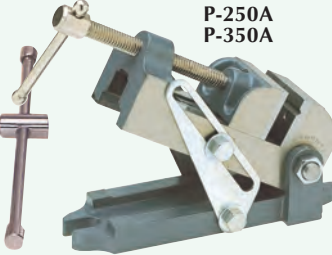

Model No.	Jaw Width	Jaw Depth	Jaw Open	Overall Length	Price Each
P-150	1-1/2"	15/16"	1-1/2"	4-1/8"	\$12.95
P-250	2-1/2"	1-1/2"	2-9/16"	7-1/4"	17.95
P-130	3"	1-3/4"	3"	9-1/4"	32.95
P-400	4"	1-3/4"	4-1/8"	11-1/8"	39.95
P-250A	2-1/2"	1-1/2"	2-1/2"	9"	24.95
P-350A	3"	1-3/4"	3"	12"	34.94

Precise 2-WAY CROSS SLIDE MACHINE VISE

- Suitable for clamping soft materials such as aluminum, copper etc.
- Secures firmly on drill press table and moves similar to vertical mill.
- Accurate positioning in two directions (crossed).
- Each dial is graduated in .001" increments for precise adjustments and easily adjusts to 0.
- Ball crank handles are solid and balanced.
- Feed screws have precision cut acme threads.
- Malleable cast body.
- Heat treated steel jaws.

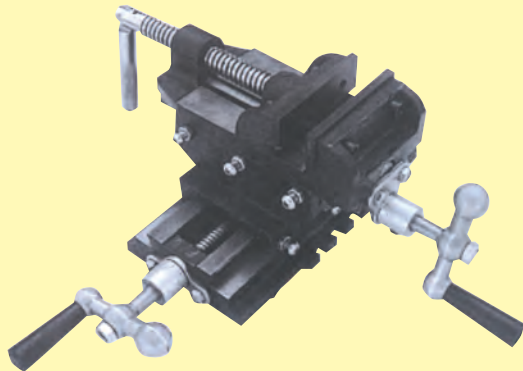

Model No.	Jaw Width	Jaw Depth	Cross Travel	Jaw Opening	Longitudinal Travel	Wt. lbs.	Sale Price
GSS-103	3"	1-1/8"	3"	2-3/4"	5"	16	\$58.50
GSS-104	4"	1-7/16"	4"	3-3/4"	6"	24	99.50
GSS-105	5"	1-9/16"	5"	4-3/4"	7"	32	115.00
GSS-106	6"	1-11/16"	6"	5-3/4"	8"	39	175.00



ROPER WHITNEY PUNCH KITS

- The No. 5 Jr. punch has a standard 1-3/4" throat depth, while the No. XX has a deep throat configuration to punch up to 3-1/4" from the edge.
- The No. XX may be used to punch light channels with 1" minimum inside dimension and 1-3/8" maximum flange.



Optional:
Bench Mount Bases



For No. XX
\$49.00



For No. 5JR
\$35.00

Model No.	Throat Depth	Length O.A.L.	Opening w/punch	Kit Price
RWP-5JR	1-3/4"	8-1/4"	7/16"	\$95.00
RWP-XX	3-1/4"	10-1/4"	2-1/8"	250.00

* Includes tool, and one 3/32", 1/8", 5/32", 7/32", 1/4", and round punch and die and plastic box.

** Includes tool and one 5/32", 7/32", 9/32", 11/32", 13/32", 15/32", and 17/32", round punch and die and plastic box.

heinrich GRIPMASTER VISES

- Recessed parallel soft steel jaw inserts level work, can be removed to accommodate jig and fixture components.
- Hollow base for clear through drilling.
- Hardened and ground bars and locking mechanism.

- A simple push or pull on the center bar knob sets the jaw in position. An easy press on the locking lever cams jaw ahead 3/32", exerting holding pressure, adjustable from 400 to 1100 lb.

MADE IN USA



Model No.	Jaw Width	Jaw Opening	Vise Height	Vise Price	V-Block Price
3-SV	3"	3"	2-2/4"	\$145.00	\$38.00
4-GM*	4"	4-11/16"	3-1/4"	210.00	45.00
6-SV	6"	6-3/16"	3-3/4"	275.00	60.00
8-SV	8"	8"	4-7/16"	385.00	75.00
Three Sided Vise - Ground Right Angles					
3-TS	3"	3"	2-3/4"	\$148.00	\$38.00
4-TS	4"	4-11/16"	3-1/4"	195.00	46.00

*4-GM, Extensions on one side of body casting precision ground square with jaw inserts for machining from top or one side without resetting work.

Precise QUICK ACTING DRILL PRESS VISES

- Center bar of high carbon steel and locking mechanism are hardened and ground.
- Set screw adjusts clamping pressure and feed of the sliding jaw, when lever is in operation.



Recessed jaw plates level workpiece

Model No.	Jaw Width	Jaw Depth	Jaw Opening	Wt. lbs.	List Price	Sale Price
QGV-03	3"	1-1/4"	3"	10 lbs.	\$79.50	\$59.95
QGV-03A*	3"	1-1/4"	3"	10 lbs.	91.50	69.95
QGV-04	4"	1-5/16"	4-11/16"	19 lbs.	97.50	77.50
QGV-04A*	4"	1-5/16"	4-3/4"	17 lbs.	115.00	85.00
QGV-06	6"	1-13/16"	6-3/16"	32 lbs.	155.00	124.00
QGV-08	8"	2"	8-3/8"	51 lbs.	200.00	159.00

* Ground at right angle to the jaw facing for mounting from top and both sides without resetting the workpiece.

Precise VISE FOR HOLDING SHAFTS AND ROUNDWORK

This vise is used for clamping round workpieces with diameters from .394" to 6.30". For use on a milling machine or drill press.

- 4" wide hardened steel replaceable jaws.
- Capacity 3/8" to 2-1/2" round parts.
- Work rests on V-block made of hardened and ground tool steel.
- Adjustable sliding rod to set work in proper position.
- Vise ends are ground so that it can be used vertically or horizontally.



MODEL No. RSV-400 **\$219.95**

Model No.	Width of Jaw	Shaft Capacity	Weight lbs.	Sale Price
RSV-400	4"	25/64" to 2-1/2"	54	\$219.95

heinrich AUTOMATIC SELF-CENTERING PRODUCTION VISE



- Automatically centers parts with varying outside dimensions.
- Each two opposing jaws is actuated directly by cylinders on both ends of the vise.
- Jaws are connected by a concealed gear and rack so that they move together equally on both sides of center, within an accuracy of $\pm .001"$

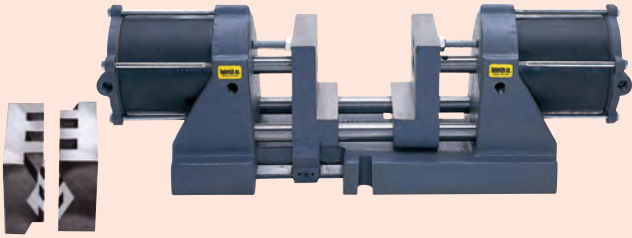

Model No.	Jaw Width	Jaw (Ea.) Travel	Jaw Opening Min/Max.	Power Factor	Weight Gross	Price Each
DA-2200	4"	1-1/8"/2-1/4"	1 3/4-1/4"	15X	43	\$ 965.00
DA-6600	6"	3 3/6"	2-3/4"/8-3/4"	19X	158	2250.00
DA-8800	8"	5-1/4"/10-1/2"	3-1/2"/14"	33X	390	3595.00

Interlocking Horizontal V-Jaws

2219	1/4" Minimum	1-3/4" Maximum (Round)	\$140.00 Pr.
6619	1" Minimum	5" Maximum (Round)	400.00 Pr.
8819	2" Minimum	9" Maximum (Round)	925.00 Pr.

heinrich AIR VISES-SINGLE ACTING CYLINDERS

- Diaphragm type, spring return air cylinder. Holding power, 15X air pressure (Example: 1500 lbs. at 100 psi.) maximum operating pressure, 120 lbs. psi.
- Amount of pressure may be controlled to suit the operation by use of an air regulator maximum travel after setting.
- Ratched operated, triple-lead thread adjusting screw quickly positions jaw at any point within the jaw opening, locked securely by set screw.
- Operates with No. 34-12CI three way foot treadle or No. 34-18 three way hand valve. Two No. 34-14 hoses required to operate with hand or foot valves.

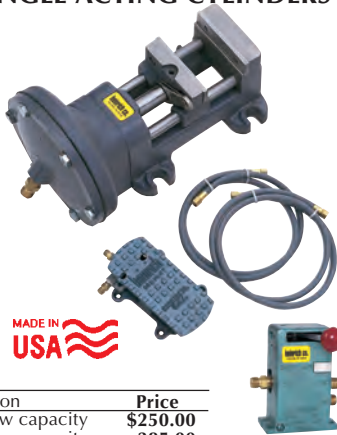

Model	Description	Price
33-A	Air Vise 3-1/8" jaw capacity	\$250.00
44-A	Air Vise 4-5/8" jaw capacity	385.00
34-12CI	3 way hand valve	\$ 65.00
34-18	Foot treadle valve	105.00
34-14	5' air hose (2 hoses required)	12.00
34-AV	3 way air valve	21.00
37-XV	Quick exhaust valve	35.00
3-VB	3" V-block jaw attachment	38.00
4-VB	4" V-block jaw attachment	46.00

heinrich BAND SAW VISE

Keeps Hands Clear Of Saw

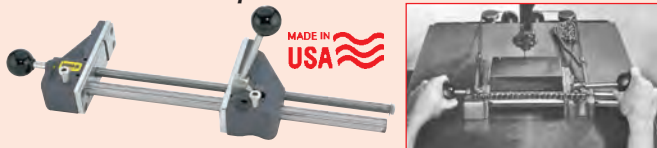

Model	Capacity	Weight	Price
12-WH	12-3/4"	12 lbs.	\$219.95

heinrich SAFETY DRILL PRESS VISE

Quick-Acting Open to 12-3/4"

- Sets instantly by sliding movable jaw into position. Press on lever advances jaw, locking workpiece securely.
- Built-in recessed parallel jaw inserts hold work square.
- Vertical V-Groove in jaw provides positive grip on rounds.

MODEL No. 13WH



\$235.00



Mounts on drill press table, eliminating danger of unit spinning or breaking loose from table. Swings off table when not in use.

heinrich CAMLOCK VISE

- Horizontal movement of the locking lever clamps or releases the part, providing one-hand operation.
- Maximum travel, after setting-5/16"
- Recessed parallel jaw inserts level work, can be removed to accommodate jig and fixture components.
- Hollow base for clear through drilling. Hardened and ground bars and eccentric parts.



Model No.	Jaw Width	Jaw Opening	Jaw Depth	Weight lbs.	Price Each
4-CL	4"	4"	13/16"	23	\$295.00
4-VB	V-block for vise				46.00

heinrich GRIP-MASTER FIXTURE LOCKS

- Quick acting clamps simplify jig and fixture design, speed production. Long travel provides plenty of chip clearance, easy loading and unloading. Gets into hard to reach places. Bar soft 1" on one end for adapting to fixture.
- Screwless design for rapid positioning and locking.
- The locking lever moves the jaw ahead 3/32" exerting a holding force adjustable from 400 to 1200 lbs.



Model No.	Dimensions L x W x H	Length of Holding Bar*	Price Each
2-FL	3-5/16" x 3-3/16" x 2-7/8"	9"	\$ 82.50
2-PA**	3-5/16" x 3-3/16" x 2-7/8"	.493 Dia.	100.00
9-FL	4-1/4" x 3-11/16" x 3-15/16"	10"	\$104.00
9-PA**	4-1/4" x 3-11/16" x 3-15/16"	.742 Dia.	125.00

* Special bars available in 12, 14, 16, 18 and 24 inch lengths.

** PA (Pumping Action) Operator is able to "pump" jaw forward, thereby "taking up" on compressible materials.

heinrich PRODUCTION AIR VISE

- The vise is adjusted to the desired opening in the same manner as an ordinary bench vise.
- Double acting, piston type, air cylinder provides 1" travel and holding power 33 times air line pressure.
- 4-1/2" Jaw Width opens to 6 inches. A locking lever controls rotation of vise on swivel base.
- Hardened and ground bars maintain perfect jaw alignment.
- Serrated, hardened jaw faces are replaceable.



MODEL No. PAV-400

\$1345.00

with 4-way Foot Treadle & 3 Air Hose

heinrich AIR COLLET FIXTURE

- Uses standard 5-C type collets up to 1-1/8".
- Can also be used with step chuck collets and expanding chucks for internal gripping.
- Double acting, piston type air cylinder develops holding power 18 times air line pressure.
- Has 1-7/64" hole completely through unit for bar feeds or dropping finished parts.
- Operates with No. 45-12CI four-way foot treadle or No. 45-18 four-way hand valve and three No. 34-14 air hoses.



Model	Description	Price
1-AC	Complete with 45-12C four-way foot treadle & three No. 34-14 air hoses	\$575.00
1-AC-A	Air Collet (Fixture only)	450.00
45-18	Four-way hand valve	140.00
34-14	Air hose (2 required)	12.00



EARTH-CHAIN MAGNETIC VISES

Machine All 5-Sides

It's easy to perform complex **5-sided machining** using the **MagVISE**. You can even machine on 5 sides while holding a large number of workpieces using an array of **MagVISE** blocks. The machinable soft jaws permit workpiece nesting for improved accuracy over other workholding systems. Also, you can machine right through the part without affecting the workholding.

- Powerful magnetic workholding
- FASTEST - load and unload
- Reduce set-up times
- Machine 5-sides easily
- Machinable soft jaws
- Modular system grows with you
- No workpiece distortion
- Better accuracy and repeatability
- Use on pallet or machine bed
- Maintenance free
- Stop plates are included to help align small parts and machine them more accurately
- **Hardened to HRC 55** - 18 hardened points keep top and bottom surfaces parallel.

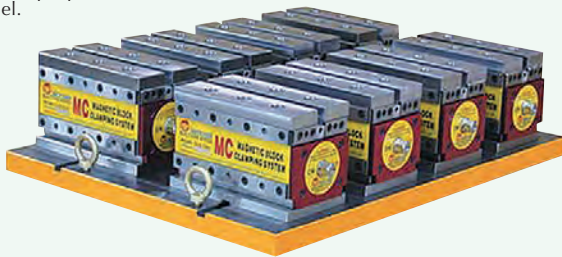

Model No.	Size L x W x H	Min. Workpiece Thickness	Max. Force	Price Each
ECB-050CN	5" x 3" x 3"	0.4"	1,100 lbs.	\$1065.00
ECB-075CN	6.8" x 3" x 3"	0.4"	1,650 lbs.	1255.00
ECB-120CN	7.3" x 4.2" x 4.2"	0.6"	2,640 lbs.	1795.00
ECB-210CN	9.2" x 5.2" x 5.3"	0.8"	4,620 lbs.	2600.00

Additional machinable Soft jaws are in stock if needed

Precise UNIVERSAL VISE 3-AXIS

- Specially designed for surface, universal tool and cutter grinding.
- Bed and swivel base ground. • Jaws hardened to standard.
- Two swiveling movements graduated through 180°.
- Capable of swiveling through 360°.
- Any compound angle scale cable set.
- Once locked at any angle it is impossible to shift



Model No.	Jaw Width	Jaw Depth	Jaw Opening	Vise Height	Price Each
M-150	6"	1-5/8"	4-1/2"	8-3/4"	\$249.95



SWIVEL VACUUM VISE

- This popular vise grips firmly to glass, metal, Formica, fiberglass or any smooth nonporous surface with quick lever action.
- Universal ball joint swivels 360° to any position and tilts 90° to any angle.
- V-grooved replaceable hardened steel jaws are 3" wide and open to 2-5/8"
- Furnished with slide on rubber jaws for fragile work.
- Folds for storage.

MODEL No. SVV-300
Reg. \$54.95

\$42.95



Precise SUPER LOCK MILLING VISES

With Swivel Base

- Eliminates tilt. • Coolant trough.
- Enclosed lead screw.
- Removable hinged handle for fast locking.
- Provides better clamping pressure.
- Eliminates hammering.

6" Vise
MODEL No. **\$159.95**
1-300-6
With Swivel Base



1 lb. of force horizontally, 1/2 lb. of force vertically pushes jaw downward.

Model No.	Jaw Width	Max. Opening	Vise Height	Body Length	Jaw Height	Weight lbs.	Sale Price
1-300-3	3"	3"	3"	10-3/4"	1"	35	\$99.50
1-300-4	4"	4"	3-1/2"	12-9/16"	1-1/4"	46	110.00
1-300-5	5"	5"	3-7/8"	14-9/16"	1-1/2"	105	132.50
1-300-6	6"	6-1/4"	4-3/8"	16-3/4"	1-3/4"	110	159.95
ELV-6X	6"	8"	4-3/8"	19"	1-3/4"	132	229.95
1-300-8	8"	8-1/2"	5-5/16"	21-3/4"	2"	225	225.00

Precise 2 PIECE MILLING TABLE VISE

- Body made of high quality casting. • Hardened and ground jaw plates.
- Designed to handle extra long workpiece, utilizing full length of machine bed. • Work locates directly on bed for extra rigidity. • Quarter turn of detachable handle clamps work firm enough for heaviest cuts.



Model No.	Jaw Width	Jaw Depth	Key Slot Width	Clamp Travel	Price Each
TMV-6	6"	3"	11/16"	3/8"	\$124.95
TMV-8	8"	3-1/4"	13/16"	5/8"	159.95

Precise 2 WAY TILT & SWIVEL ANGLE VISE

- Vise body made of high tensile closed grain cast iron.
- Steel jaw plates are ground and hardened to 50-60 HRC.
- Base can be swiveled through 360° and vise tilted through 90°.
- Vise can be locked positively at various compound angles.
- Two oil holes provided on vise body. • Ideal vise for milling, grinding, shaping, drilling and jig boring.



Model No.	Jaw Width	Jaw Depth	Jaw Opening	Weight lbs.	Price Each
2AV-4	4"	1-3/4"	4"	44	\$165.00
2AV-6	6"	2-1/8"	6"	89	290.00

Precise 3-WAY UNIVERSAL TILT & SWIVEL ANGLE VISE

- Vise body made of high tensile closed grain cast iron.
- Steel jaw plates are ground and hardened to 50-60 HRC.
- Tilting range 90° vertical to horizontal and 45° from center to each side.
- Vise top surface is ground accurately to facilitate use of magnetic tool holders and other accessories. • Swivel range 360° around base.

MODEL No. OT-100

\$349.95

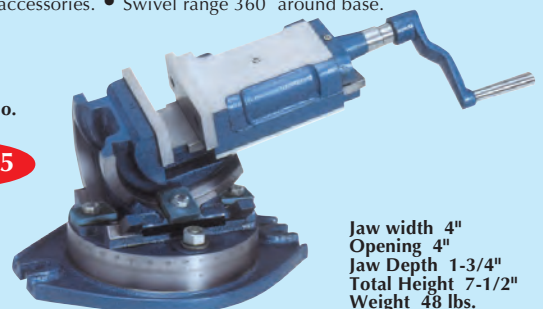

Jaw width 4"
Opening 4"
Jaw Depth 1-3/4"
Total Height 7-1/2"
Weight 48 lbs.



The patented "split ball" allows the vise head to move effortlessly through three planes: it tilts, turns and rotates to position the vise head anywhere you want it

MINI VISE
All Angle 2-875" Opening



MODEL No. PV-201
Reg. \$29.95

\$26.95

PANA VISE COMPONENTS
Build Your Own System



With Nylon Jaws No. PV-503 (Shown)

Model	Description	Price
PV-303	Vertical mount Vise 2.5" Jaw width	\$27.95
PV-304	Horizontal mount with steel jaws Vise 2.25" Jaw width	36.00

Replacement Jaws (Pair)		
Model	Description	Price
PV-343	Nylon jaws 6/6	\$ 2.75
PV-344	Nylon jaws w/groove	3.60
PV-352	Teflon jaws	11.50
PV-353	Plated steel	10.50
PV-354	Brass jaws	11.50



PARTS TRAY BASE
Neatly Organizes your Small parts and Tools
8-1/2" Diameter



MODEL No. PV-312 **\$21.50**



MODEL No. PV-301
Reg. \$54.95 **\$49.50**

VACUUM BASE MINI VISE



2-875" Opening

MODEL No. PV-209
Reg. \$34.95

\$29.50

PANA VISE BASES



No. PV-300

No. PV-380

Model	Description	Price
PV-300	Standard base 3-3/4" Ht.	\$27.00
PV-305	Low profile 2-1/2" Ht.	27.00
PV-380	Vacuum base	45.00

MAGNETIC BASE MOUNT
All Angle 2-875" Opening

For Vise Base PV-300 and PV-305



MODEL No. PV-335
Reg. \$25.00 **\$21.25**

FIXTURE HEAD 4.375" Dia.



MODEL No. PV-337 **\$21.50**

VACUUM BASE



MODEL No. PV-381
Reg. \$74.95 **\$67.50**

MULTI-PURPOSE WORK CENTER



MODEL No. PV-350
Reg. \$99.95 **\$89.95**

PANA PRESS

- Reversible ram is 0.75"x 0.75" and 5.875" long and applies up to 1/4 ton of pressure.
- One end of the ram is reamed 0.251" (6.4mm) for adding tooling.
- Base footprint is 3.7" and includes four 0.25" holes for bolting to a work surface. • Height 7". Weight: 5.4 lbs.



MODEL No. PV-502
Reg. \$176.00

\$150.00

Flat Ribbon Cutters



Replacement Cutters

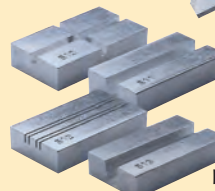

Base Plates



MODEL No. PV-324
Reg. \$99.95

\$78.00

RAPID ASSEMBLY CIRCUIT BOARD HOLDER



MODEL No. PV-333
Reg. \$97.95 **\$79.95**

IDC ASSEMBLY PRESS RETROFIT KIT

- Converts PanaPress
- Retrofit Kit includes IDC base (for holding IDC Base Plates), ram adapter (for applying even pressure across a connector), cable guide, mounting screws and Allen wrench.
- Smoothly and securely terminates up to 64-pin conductor cable.
- More effective than hand crimpers (completely eliminates the "scissors" effect).



Kit No. PV-506
Reg. \$60.00

\$49.95

Less Press

Model	Description	Price
PV-507	Flat ribbon cable	\$65.00
PV-530	Replacement cutter	12.95

Base Plates		
Model	Description	Price
PV-510	Female socket transition connectors	\$29.95
PV-511	Card edge connectors	29.95
PV-512	DIP plugs	29.95
PV-513	D-Sub connectors	29.95



Adjustable Positive Stop
MODEL No. PV-570

\$7.95

Fits Over Top Of Ram



3-WAY UNIGRIP PRECISION DRILL PRESS VISE

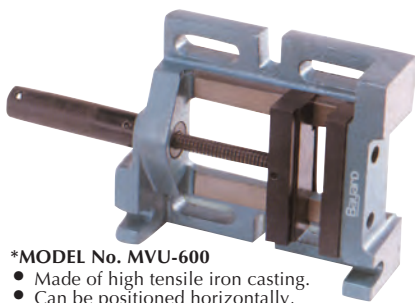

***MODEL No. MVU-600**

- Made of high tensile iron casting.
- Can be positioned horizontally, vertically and longitudinally.
- Heavy duty construction.

Model No.	Jaw Width	Jaw Depth	Jaw Open	Body Length	Weight lbs.	Price Each
*MVU-600	3-7/8"	1-1/8"	3-1/2"	7-1/2"	11	\$39.95
MVU-521	3-1/4"	1-1/4"	2-7/8"	6-7/8"	7.5	\$29.95
MVU-522	3-7/8"	1-1/2"	3-7/8"	7-3/4"	9.4	\$34.95

UNIGRIP PRECISION DRILL PRESS VISE

- MODEL No.'s MVU-521 MVU-522
- Made of high tensile iron casting.
- Used for precision jobs.
- Slots for easy clamping to the tables.
- Heavy duty construction.

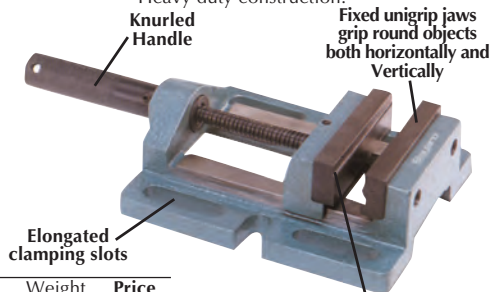

Seat in jaws helps to clamp flat workpieces



ULTRA-PRECISE 3-WAY UNIVERSAL TILT TABLE



4" x 5" (2) T-Slot

MODEL No. MAP-388

\$149.95

Height - 4-3/4"
Weight - 12 lbs.



2" MODULAR 3-WAY MACHINE VISE



MODEL No. MMV-697

\$149.95

Height - 5-3/8"
Weight - 10.5 lbs.

Precise DRILL PRESS VISES

- Four slots for easy clamping to tables.
- Body and slide made of selected cast iron.
- Guiding groove controls the parallel movement and rigidity of moveable jaw.
- Replaceable steel jaws.
- Handle adjusts to any angle.



Model No.	Jaw Width	Jaw Height	Jaw Opening	Weight lbs.	Price Each
39000177	3"	3/4"	3-1/8"	5	\$17.95
39000174	4"	1"	4-3/8"	7	22.50
39000175	5"	1"	5"	9	35.00
39000176	6"	1"	5-7/8"	11	45.00

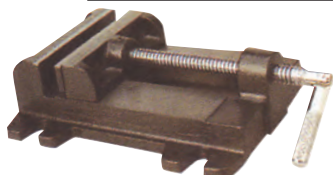

- Plain jaws of special steel.
- High-tensile iron casting.
- Cold rolled screw thread.
- Four bolt lugs for rigid mounting to machine table

Model No.	Jaw Width	Jaw Height	Jaw Opening	Weight lbs.	Price Each
22965703	3"	1-1/8"	3"	7	\$18.95
22965704	4"	1-3/8"	4"	7	24.95
22965705	5"	1-1/2"	5"	15	39.95
22965706	6"	1-1/2"	6"	17	49.95

Precise Wilton Style MECHANIC'S VISE WITH SWIVEL BASE

- Swivel base rotates 360° and has double lockdowns ensuring maximum stability.
- Powder coat paint resists scratches and provides a tough durable finish.
- Replaceable hardened steel top.
- large anvil work surface.
- Steel pipe jaws.

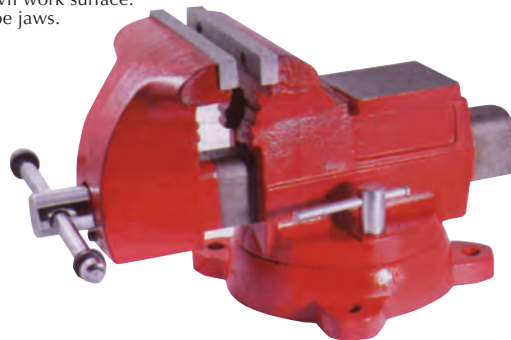

Model No.	Jaw Width	Jaw Opening	Throat Depth	Pipe Capacity	G.W. lbs.	Sale Price
3900-2514	4-1/2"	4"	2-5/8"	1/8-2"	16	\$ 69.95
3900-2515	5-1/2"	5"	3-7/16"	1/8-2-1/2"	35	95.00
3900-2516	6-1/2"	5-1/2"	3-11/16"	1/8-2-1/2"	44	119.95
3900-2518	8"	7-1/2"	4-1/2"	1/8-3"	80	215.00

STRONGHAND 4-IN-1 CLAMPING SYSTEM

POWER Tools of Clamping

The Most Versatile Sliding Arm Clamps in the market



Spring Loaded Stop
(UF, UG, UM)
Allows removal and reversal of the clamp arm for spreading.
-UD models, remove keyring
-UP models, remove screw

The 4-IN-1 Clamp Kit comes complete with the V-Pad and Extender Block accessories



Tapped Hole
For attaching accessories such as a V-Pad or Extender Block



Standard Sliding Arm Clamps are 10x faster than a C-Clamp!



Pipe V-Pad Add the exclusive V-Pad to create a Pipe Clamp!



Spreader Reverse the clamp arm and create a Spreader Clamp

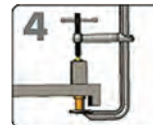

Step-Over Add the Extender Block to create a Step-Over Clamp

All Strong Hand Tools™ Utility Clamps are made of high quality heat treated steel and nickel/chrome plated for strength and durability

Model No.	Capacity Inch	Throat Depth	Clamping Pressure	Rail Size	Price Each
UD45-C3	4-1/2"	3-1/4"	500 lbs.	5/8" x 5/16"	\$ 15.95
UD65-C3	6-1/2"	3-1/4"	500 lbs.	5/8" x 5/16"	16.95
UF65-C3	6-1/2"	4-3/4"	1000 lbs.	7/8" x 7/16"	29.95
UG85-C3	8-1/2"	4-3/4"	1200 lbs.	1" x 15/32"	35.00
UG125-C3	12-1/2"	4-3/4"	1200 lbs.	1" x 15/32"	44.50
UG1257-C3	12-1/2"	7"	800 lbs.	1" x 15/32"	45.50
UM85P-C3	8-1/2"	5-1/2"	2400 lbs.	1-3/16" x 9/16"	55.00
UM105P-C3	10-1/2"	5-1/2"	2400 lbs.	1-3/16" x 9/16"	63.00
UM125-C3	12-1/2"	5-1/2"	2400 lbs.	1-3/16" x 9/16"	74.50
UM165-C3	16-1/2"	5-1/2"	2400 lbs.	1-3/16" x 9/16"	82.00
UM205-C3	20-1/2"	5-1/2"	2400 lbs.	1-3/16" x 9/16"	95.00
UP205-C3	20-1/2"	7"	4800 lbs.	1-9/16" x 3/4"	150.00



DRILL PRESS CLAMP

- This Drill Press Clamp adjusts quickly and easily to lock your workpiece in any position.
- The Clamping pad pivots to conform to any workpiece, ensuring uniform pressure.



Model	Description	Price
W1301	DP Clamp 6" Long and 1-1/2" Capacity	\$13.95
D2192	DP Clamp 10" Long and 3" Capacity	16.50
D2493	DP Clamp 12" Long and 5" Capacity	18.95

WILTON COMBINATION PIPE AND BENCH VISES

- Self-centering pipe jaws-hardened steel jaws hold up to 6" pipe safely, securely.
- Hardened steel jaw inserts-machine serrated, replaceable jaws assure a positive hold.
- 60,000 PSI tensile ductile iron body parts for mass and strength.
- Large anvil.
- Enclosed construction keeps lubrication in contaminants out.
- Locking swivel base with double lockdowns for non-slip hold in any position.
- Alloy steel slide bar added strength and keyed for a precision fit.
- Precision thrust bearing creates greater clamping pressure and increased longevity.



With Pipe Jaw & Swivel Base

Model No.	Jaw Width	Jaw Opening	Weight lbs.	List Price	Sale Price
10200-3	3-1/2"	5"	52	\$ 920.00	\$ 695.00
10225	4-1/2"	6"	78	1320.00	950.00
10250	5"	7"	113	1720.00	1250.00
10275	6"	9"	205	2520.00	1850.00

WILTON TRADESMAN VISES

- Wider jaws provide greater clamping surface.
- Fully enclosed spindle and nut increases the life of the vise.
- Made from 60,000 PSI tensile ductile iron.
- Large anvil work surface.
- Precision tuned side-bar.
- 360° swivel base with double lockdowns.



With Pipe Jaw & Swivel Base

Model No.	Jaw Width	Jaw Opening	Weight lbs.	List Price	Sale Price
1745	4-1/2"	4"	42	\$ 630.00	\$ 475.00
1755	5"	5"	53	760.00	575.00
1765	6-1/2"	6-1/2"	73	850.00	595.00
1780A	8"	7"	109	1270.00	950.00

WILTON MECHANICS BENCH VISES

- Heavy duty 30,000 PSI castings for long life and added strength.
- Large anvil work surface.
- Swivel base rotates 360° and has double lockdowns ensuring maximum stability.
- Powder coat paint resists scratches and provides a tough durable.
- Replaceable hardened steel top and pipe jaws.



With Pipe Jaw & Swivel Base

Model No.	Jaw Width	Jaw Opening	Weight lbs.	List Price	Sale Price
744	4"	4-1/2"	37	\$ 240.00	\$ 175.00
745	5"	5-1/4"	50	340.00	259.00
746-1	6"	5-3/4"	64	440.00	339.00
748	8"	8-1/4"	89	630.00	489.00

WILTON HIGH VISIBILITY SAFETY VISES

- Safety color conforms to OSHA standard for physical hazards; regulation #1910.144.
- Powder coat paint resists scratches and provides a tough durable finish.



With Pipe Jaw and Swivel Base

Model No.	Jaw Width	Jaw Opening	Jaw Depth	Weight lbs.	List Price	Sale Price
1550-3	5"	5-1/4"	3-3/4"	52	\$350.00	\$269.00
1560	6"	5-3/4"	4-1/8"	64	460.00	325.00

WILTON SUPER-JUNIOR VISES

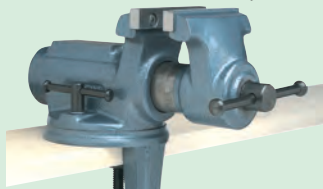

- Available in two styles: clamp-on and swivel base.
- Top jaws are grooved and replaceable.

Camp-On Base

Model No.	Jaw Width	Jaw Opening	Throat Depth	List Price	Sale Price
CBV-65	2-1/2"	2-1/8"	2"	\$150.00	\$115.00
CBV-100	4"	2-1/4"	2"	190.00	145.00

Swivel Base Model

SEV-65	2-1/2"	2-1/8"	2"	\$130.00	\$ 95.00
SEV-100	4"	2-1/4"	2"	150.00	115.00

WILTON COPPER JAW CAPS

- Permanent or temporary work-holding.
- Designed to avoid marring the surface of materials.
- 100% copper jaw caps have polished faces and pliable copper extensions for a sure-grip fit.



Made To Fit Any Type Vise

Model No.	Jaw Width	List Price	Sale Price
404-30	3"	\$ 42.00	\$ 35.00
404-31	3-1/2"	48.00	39.00
404-40	4"	50.00	42.00
404-41	4-1/2"	55.00	44.00
404-50	5"	64.45	57.00
404-51	5-1/2"	73.34	62.00
404-60	6"	101.13	80.00
404-61	6-1/2"	106.68	90.00
404-80	8"	144.47	125.00

Precise PIN CHUCK SET



For holding small rods, wire, drills, taps and other small tools.

SET No. PCS-160 **\$14.95**

Includes: 0-1/32", 1/32-1/16", & 1/16-3/32" Collets.

WILTON/HARGROVE FORGED HI-VIS C-CLAMPS



Model No.	Capacity Opening	Throat Depth	Spindle Diameter	Sale Price
402-CS	0-2-1/8"	2-1/4"	9/16"	\$14.95
404-CS	0-4-1/4"	3-1/4"	3/4"	27.00
406-CS	0-6"	4-1/8"	3/4"	39.00
408-CS	0-8"	5"	3/4"	49.00
410-CS	2"-10"	6"	7/8"	69.00
412-CS	2"-12"	6-5/16"	7/8"	115.00

WILTON 400 SERIES C-CLAMPS ~ DROP FORGED

Industry's Top Choice for maintenance, Production and Repair Operations

- Drop-forged steel frame, regular-duty with extra deep-throat.
- Black-oxide coated spindles and Perma-Pad resist corrosion and are replaceable.
- Innovation frame geometry for maximum strength.



Model No.	Capacity Opening	Throat Depth	Spindle Diameter	Sale Price
402-20	0-2-1/8"	2-1/4"	9/16"	\$14.95
403-30	0-3"	2-1/2"	9/16"	19.95
404-40A	0-4-1/4"	3-1/4"	3/4"	27.00
406-60	0-6-1/16"	4-1/8"	3/4"	39.00
408-80	0-8-1/4"	5"	3/4"	49.00
410-10	2-10-1/8"	6"	3/4"	69.00
412-12	2-12-1/4"	6-5/16"	7/8"	115.00

WILTON-GRIP HANDLES

- Soft rubber handle press fits over T-handle to provide comfortable grip.
- Press on middle or on the end of T-handle for greater torque.
- Clamps close up to 50% faster when used with Wilton-Grip handles.

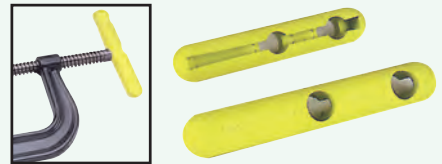

Model No.	Fits Model	Pieces Per Pack	Pack Price
63180	402, 403	4-Pack	\$16.50
63181	404	4-Pack	16.50

PIN AND HAND VISE

Designed for holding small drills in a drilling machine. Three interchangeable collets.

Import MODEL No. 100-600 **\$18.95**

GENERAL

MODEL No. S-94

\$39.95 MADE IN USA





3-JAW UNIVERSAL SELF CENTERING SCROLL CHUCKS

- TMX chucks come with American Standard two piece tong and groove jaws.
- Plain back and Direct mount.
- Semi-steel body
- Chuck body is made of high quality cast iron. All guideways and bearing surfaces are precisely machined.
- Scroll plate is drop forged of fine Alloy steel, and carefully case hardened, thread flanks are ground on both sides.
- The jaw's teeth and guideways are hardened and fully ground on both sides.
- Pinions are hardened and ground.

TMX chucks are provided with:
 1 set of hard master jaws.
 1 set of hard top reversible jaws.
 1 self ejecting chuck wrench.
 1 set of mounting bolts.
 2 hex keys.
 Eye bolts provided with 12-1/2" and 15-3/4" chucks

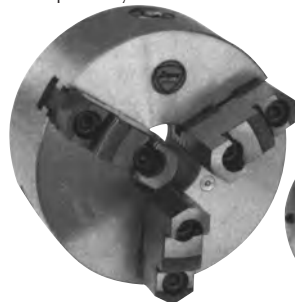

Plain Back Type

Model No.	Chuck Diameter	Hole Diameter	Back Type	Weight lbs.	List Price	Sale Price
3-800-0600	6-1/4"	1.7717	Plain	19.4	\$314.00	\$265.00
3-800-0800	8"	2.5591	Plain	34	391.00	330.00
3-800-1000	10"	3.1496	Plain	57	574.82	485.00
3-800-1200	12-1/2"	4.0945	Plain	104	1001.00	850.00
3-800-1600	15-3/4"	5.3543	Plain	157	1435.00	1195.00

D-1 Camlock Back Type

Model No.	Chuck Diameter	Hole Diameter	Back Type	Weight lbs.	List Price	Sale Price
3-803-0634	6-1/4"	1.7717	D1-4	20	\$375.00	\$315.00
3-803-0834	8"	2.1654	D1-4	42	470.00	395.00
3-803-0836	8"	2.1654	D1-6	42	470.00	395.00
3-803-1036	10"	3.1496	D1-6	71	690.00	585.00
3-803-1038	10"	3.1496	D1-8	71	690.00	585.00
3-803-1236	12-1/2"	3.9370	D1-6	112	1195.00	895.00
3-803-1238	12-1/2"	3.9370	D1-8	112	1195.00	895.00
3-803-1638	15-3/4"	5.3543	D1-8	223	1715.00	1450.00
3-803-1639	15-3/4"	5.3543	D1-11	223	1715.00	1450.00

A-1 and A-2 Direct Mount Back Type

Model No.	Chuck Diameter	Hole Diameter	Back Type	Weight lbs.	List Price	Sale Price
3-801-0816	8"	2.1654	A1-6	42	\$470.00	\$395.00
3-801-1016	10"	2.1654	A1-6	71	690.00	585.00
3-801-1216	12-1/2"	3.9370	A2-8	121	1195.00	995.00
3-801-1218	12-1/2"	3.1496	A1-8	121	1195.00	995.00
3-801-1619	15-3/4"	4.9213	A1-11	203	1715.00	1450.00



4-JAW INDEPENDENT SEMI-STEEL LATHE CHUCKS

- Chucks are provided with hard solid reversible jaws.
- Jaws are made of high quality steel and are hardened.



Equipped with:
 1 Set of hard solid reversible jaws.
 1 Self-ejecting wrench.
 1 Set of mounting bolts.
 1 Hex key for mounting bolts.
 Eye bolts provided with 12-1/2" to 20" chucks

Model No.	Chuck Diameter	Hole Diameter	Weight lbs.	List Price	Sale Price
3-850-0600	6-1/4"	1.7717	17	\$159.00	\$135.00
3-850-0800	8"	2.2047	32	180.30	150.00
3-850-1000	10"	2.9528	51	244.00	205.00
3-850-1200	12-1/2"	3.7402	88	375.00	315.00
3-850-1600	15-3/4"	4.9213	121	470.00	395.00
3-850-2000	20"	6.2992	225	810.00	685.00



SEMI-MACHINED BACK PLATES For Independent Chucks



"Threaded" Back Plates



"A" Taper

Model No.	For Chuck Diameter	Thread Back	Price Each	Model No.	For Chuck Diameter	Taper Size	Price Each
3-871-052	6" to 8"	1-1/2"-8	\$51.50	3-873-085	10"	A-5	\$84.50
3-871-062	8"	1-1/2"-8	57.00	3-873-086	10" to 12-1/2"	A-6	84.50
3-871-063	6-1/4"	2-1/4"-8	57.00	3-873-106	15-3/4"	A-6	125.00
3-871-083	10"	2-1/4"-8	66.00	3-873-108	15-3/4"	A-8	135.00
				3-873-126	20"	A-6	170.00
				3-873-128	20" to 25"	A-8	180.00



SET-TRU SCROLL CHUCKS 3-Jaw - 0.0006" T.I.R. Fine Adjustment

- Fine adjustment.
- 3 pinion design.
- Available with semi-steel body.
- 4 micro adjustment screws provide .0004" T.I.R. repeatability.
- Two piece top and master jaws are American Standard tongue and groove.
- Scrolls are forged and fully hardened with thread flanks ground on both sides, then precisely balanced for longer life and higher accuracy.
- Jaw teeth and guides on both sides are fully hardened and ground. Hardened and ground bushings are pressed into the pinion seats. Pinions in 3 pinion models are hardened and ground.
- Steel mounting plates are interchangeable with Toolmex SET-TRU chucks of the same size so that one chuck can be used on different spindles.
- The life of your Toolmex chuck can be extended significantly through proper maintenance and must be cleaned on a regular basis.

Each Chuck is provided with:

- 1 Set of hard master jaws
- 1 Set of Hard Top Reversible Jaws
- 1 Self-ejecting chuck wrench
- 1 Set of mounting bolts
- 1 Set of fine adjustment screws
- 2 Hex keys

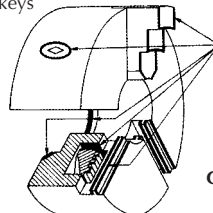

Hardened and Ground Surfaces



Model	Diameter	Thru Hole	Weight	List	Sale
3-866-060Z	6-1/4"	1.7717	21 lbs.	\$ 499.00	\$ 425.00
3-866-080Z	8"	2.1654	35 lbs.	575.00	485.00
3-866-100Z	10"	3.1496	59 lbs.	820.00	695.00
3-866-120Z	12-1/2"	4.0945	105 lbs.	1291.00	1095.00
3-866-160Z	15-3/4"	5.3543	201 lbs.	1899.00	1595.00



BACK PLATES Fully machined to Fit SET-TRU Chucks



"D" Taper



"A" Taper

Model No.	For Chuck Diameter	Taper Size	Price Each	Model No.	For Chuck Diameter	Taper Size	Price Each
3-875-063	6-1/4"	D1-3	\$125.00	3-874-065	6-1/4"	A-5	\$110.00
3-875-064	6-1/4"	D1-4	125.00	3-874-085	8"	A-5	120.00
3-875-084	8"	D1-4	155.00	3-874-086	8"	A-6	140.00
3-875-085	8"	D1-5	165.00	3-874-105	10"	A-5	175.00
3-875-086	8"	D1-6	155.00	3-874-106	10"	A-6	175.00
3-875-106	10"	D1-6	195.00	3-874-126	12-1/2"	A-6	235.00
3-875-108	10"	D1-8	215.00	3-874-128	12-1/2"	A-8	250.00
3-875-126	12-1/4"	D1-6	240.00				
3-875-128	12-1/4"	D1-8	345.00				



INTEGRAL SHANK KEYLESS DRILL CHUCKS

- Extremely accurate.
- 3 times better clamping compared to keyed chucks.
- Taper ground to AT3 standards or better.
- Nickel plated for longevity.
- All ground internal parts.
- Wrench included for extra tightening power.



Model No.	Capacity Inch	Taper Size	List Price	Sale Price
3-183-1403	5/16"	CAT40	\$175.50	\$140.00
3-183-2433	1/2"	CAT40	215.00	179.00
3-183-2435	5/8"	CAT40	232.00	190.00
3-183-1503	1/2"	CAT50	\$290.00	\$240.00
3-183-1504	5/8"	CAT50	427.50	350.00



BISON CHUCK GREASE



1/2 lbs.
 MODEL No.
 7-799-025
\$35.00

BTC POWER SET CHUCKS

Simply The Best In Value And Performance

Supplied with Spindle Mounting Plate, Semi Finished Draw Nut, Draw Nut Wrench, Soft Top Jaws and Jaw T-Nuts.

- Direct Replacement Chuck for most Japanese power chucks.
- Interchangeable top tooling 1.5mm x 60 degree serrations.
- Full 1 year warranty parts and labor. • Easy retrofit.
- Hardened jaw ways, master jaws and internal parts.
- Large thru-holes, plus quick change cover plate for closed center applications.
- Chuck accuracy plus/minus .0005" repeatability.
- High speed.



Model No.	Size Inch	Mount	Thru Hole	Draw Tube	Max. Jaw Force	Price Each
B106A5	6"	A-5	45mm	M55	12,540	\$1395.00
B108A5	8"	A-5	52mm	M60	18,920	1675.00
B108A6	8"	A-6	52mm	M60	18,920	1675.00
B110A6	10"	A-6	75mm	M85	24,420	2375.00
B110A8	10"	A-8	75mm	M85	24,420	2375.00
B112A6	12"	A-6	91mm	M90	31,680	2550.00
B112A8	12"	A-8	91mm	M100	31,680	2550.00
B115A8	15"	A-8	100mm	M110	31,680	4795.00

BTC UNIVERSAL PLAIN BACK 3-JAW SCROLL CHUCKS WITH TWO PIECE HARD REVERSE JAWS



Also Available With Back Plate Mounts "D", "L", "A" & Threaded Inquire For Best Prices

Body - universal three jaw scroll lathe chucks with two piece hard reversible jaws. Semi-steel body. Scroll and jaws hardened and ground.
Jaws - teeth and guides are hardened and fully ground on both sides.
Pinions - hardened and ground.
Bushings - hardened and ground, pressed into the pinion seats.

With Chuck Wrench & Mounting Screws

Model No.	Chuck Diameter	Thru Hole	Approx. Weight	Sale Price
5033	*3"	.629"	3.1 lbs.	\$195.00
5043-1	*4"	.787"	5.3 lbs.	220.00
3053R	5"	1.25"	10 lbs.	255.00
3063R	6"	1.65"	19 lbs.	320.00
3083R	8"	2.16"	34 lbs.	395.00
3103R	10"	2.99"	57 lbs.	475.00
3123R	12"	4.05"	91 lbs.	595.00
3153R	15"	5.35"	188 lbs.	1050.00
3203R	20"	7.48"	320 lbs.	2195.00
3253R	25"	9.92"	551 lbs.	4000.00
3323R	32"	-	750 lbs.	12950.00

*Model No. 5033 and 5043 have two sets of hard solid jaws

BTC ZERO-SET PRECISION .0005 T.I.R. FINE ADJUSTMENT LATHE CHUCKS CAST STEEL BODY

- 6-Jaw grips firmly with less total pressure, less distortion. Ideal for thin wall and second operation work. Eliminates the need for collets.
- Outstanding accuracy, versatility and long life make our "ZERO-SET" self-centering chucks invaluable in the workshop and indispensable in the toolroom.
- Scroll and jaws hardened and ground. Scroll balanced. Three hardened and ground pinions.
- Special fine adjustment screws are used to set up the chuck on it's mounting plate to get precision within .0005" total indicator reading on duplicate parts.

3-Jaw Chuck American standard two-piece tongue and groove jaws

Model No.	1053R	1063R	1183R	1103R	1123R	1153R
Chuck Size	5"	6"	8"	10"	12"	15"
Thru Hole	1.299"	1.520"	2.257"	2.810"	3.257"	4.250"
R.P.M. Max.	3500	3400	2700	2700	2200	1800
Weight lbs.	15	19	50	70	116	200
Sale Price	\$419.95	\$485.00	\$565.00	\$795.00	\$980.00	\$1845.00

*Solid jaws

6-Jaw Chuck American standard two-piece tongue and groove jaws

Model No.	1066R	1086R	1106R	1126R	1156R
Chuck Size	6"	8"	10"	12"	15"
Thru Hole	1.520"	2.257"	2.810"	3.257"	4.250"
R.P.M. Max.	2500	2200	1900	1500	1300
Weight lbs.	22	53	72	146	240
Sale Price	\$595.00	\$795.00	\$1095.00	\$1350.00	\$2695.00



8" 3-Jaw MODEL No. 1183R

\$565.00

Back Plates Available Style "A", "D", "L" "Threaded", Hardening And "Rotary Table" (Inquire)

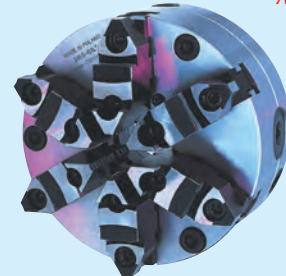

8" 6-Jaw MODEL No. 1086R

\$795.00

BTC ULTRA SHORT 3-JAW SCROLL CHUCK ~ SOLID JAWS

- These chucks are operated manually or by a lever.
- They have a high centricity as well as a wide clamping range.
- Knurled clamping ring.



Supplied With Chuck:
One set of reversible solid hard jaws,
Lever and mounting screws

Model No.	Chuck Diameter	Chuck Thickness	Thru Hole	Back Type	Weight lbs.	Price Each
0023	2.5"	0.984"	0.551"	Flat	2.5	\$175.00
0033	3.5"	1.181"	0.630"	Flat	4.5	220.00
0043	4.5"	1.47"	0.866"	Flat	4.5	295.00
0023T	2.5"	0.984"	0.551"	M 14 x 1	2.5	175.00
0033T	3.5"	1.181"	0.630"	M 16 x 1	3.5	220.00
0043T	4.5"	1.47"	0.866"	M 24 x 1.5	4.5	295.00

BTC TWO JAW SELF CENTERING SCROLL CHUCK WITH TOP REVERSIBLE JAWS ~ FLAT BACK

American Standard two-piece tongue & groove jaws. Semi-steel body. Scroll and jaws hardened ground. Top reversible jaws.



Model No.	Chuck Diameter	Thru Hole	Chuck Thickness	Weight lbs.	Price Each
2062R	6"	1.575"	2.559"	22	\$295.00
2082R	8"	2.559"	2.953"	35	340.00
2102R	10"	3.150"	3.150"	51	420.00
2122R	12"	3.937"	3.858"	99	650.00
2152R	15"	5.315"	3.858"	155	1150.00

20" and 25" 2-Jaw Chuck Available (Inquire)



BISON LATHE CHUCKS



Body – Universal three-jaw scroll lathe chucks with two-piece hard reversible jaws. Semi-steel body. Scroll and jaws hardened and ground.

6" 6-Jaw Lathe Chuck
MODEL NO. 800-060-1
Reg. List \$550.00
\$475.00

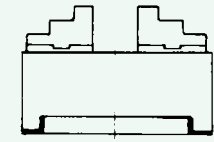

3-Jaw Lathe Chuck Self Centering Plain Recess Back

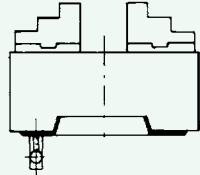

3-Jaw Lathe Chuck Self Centering "D-1" Camlock Mount

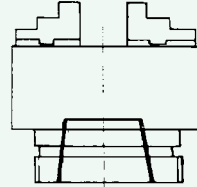

3-Jaw Lathe Chuck Self Centering "L" Long Taper

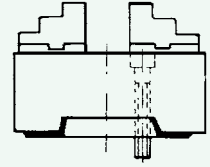

3-Jaw Lathe Chuck Self Centering "A" Short Taper

Three-Jaw Self-Centering Scroll Chucks
2 Piece Jaws

Scroll Plate – drop-forged of fine alloy steel, carefully case hardened. Thread flanks ground on both sides.

Four-Jaw Independent Lathe Chucks

Jaws – teeth and guides are hardened and fully ground on both sides.
Pinions – hardened & grd.
Bushings – hardened and ground, pressed into the pinion seats.



Universal Two-Three And Four-Jaw Self Centering Lathe Chucks

Model No.	Chuck Dia.	Center Hole	Price Each
810-030	*3"	.629"	\$345.00
810-040	*4"	.787"	405.00
800-050	5"	1.259"	450.00
800-060-1	6"	1.653"	475.00
800-080	8"	2.165"	570.00
800-100	10"	2.992"	825.00
800-120	12"	4.055"	1195.00
800-160	16"	5.354"	1995.00
800-200	20"	7.480"	5300.00
800-250	25"	9.921"	8250.00
7-800-3200	32"	10.5"	14,450.00
7-800-4000	40"	16.30"	24,450.00

*Model No. 810-030 and 810-040 have two sets of tailstock jaws

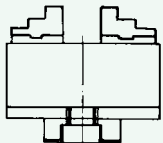

3-Jaw Lathe Chuck Self Centering Threaded Back Mount

Model No.	Chuck Dia.	Center Hole	Price Each
805-0451	*4"	1"-10	\$550.00
805-0452	*4"	1-1/2"-8	550.00
805-0551	5"	1"-10	650.00
805-0552	5"	1-1/2"-8	650.00
805-0652	6"	1-1/2"-8	695.00
805-0653	6"	2-1/4"-8	695.00
805-0852	8"	1-1/2"-8	825.00
805-0853	8"	2-1/4"-8	825.00
805-0854	8"	2-3/8"-6	825.00
805-1053	10"	2-1/4"-8	1100.00

*Model No. 805-0451 and 805-0452 have two sets of hard solid jaws

Model No.	Chuck Dia.	Spindle "D"	Price Each
803-0534	5"	D1-3	\$665.00
803-0633	6"	D1-3	765.00
803-0634	6"	D1-4	765.00
803-0833	8"	D1-3	895.00
803-0834	8"	D1-4	895.00
803-0835	8"	D1-5	895.00
803-0836	8"	D1-6	895.00
803-1035	10"	D1-5	1225.00
803-1036	10"	D1-6	1225.00
803-1038	10"	D1-8	1225.00
803-1236	12"	D1-6	1895.00
803-1238	12"	D1-8	1895.00
803-1239	12"	D1-11	1895.00
803-1636	16"	D1-6	3400.00
803-1638	16"	D1-8	3400.00
803-1639	16"	D1-11	3400.00
803-2038	20"	D1-8	6995.00
803-2039	20"	D1-11	6995.00
803-2539	25"	D1-11	8995.00

Two-Jaw Scroll Chucks Self Centering



Plain Recess Back

Soft Top Jaws

Model No.	Chuck Dia.	Center Hole	Price Each
830-0600	6"	1.653"	\$525.00
830-0800	8"	2.165"	570.00
830-1000	10"	2.992"	665.00
830-1200	12"	4.055"	1025.00
830-1600	16"	5.354"	1900.00

Model No.	Chuck Dia.	Spindle Taper	Price Each
804-0641	6"	L00	\$725.00
804-0642	6"	L0	725.00
804-0841	8"	L00	850.00
804-0842	8"	L0	850.00
804-0843	8"	L1	850.00
804-1042	10"	L0	1195.00
804-1043	10"	L1	1195.00
804-1044	10"	L2	1195.00
804-1242	12"	L0	1695.00
804-1243	12"	L1	1695.00
804-1244	12"	L2	1695.00
804-1643	16"	L1	2795.00
804-1644	16"	L2	2795.00



Rotating Three Jaw Morse Taper Chucks – Self Centering

- These chucks are used in tailstocks for jobs where centers cannot be used (example: machining of tube).
- Hardened and ground M/T spindle.

With Two Sets of Hardened Solid Jaws Inside & Outside Series 860 (Shown)



With 2 Piece Reversible Top Jaws (Series 865)

Model No.	Chuck Diameter	Morse Taper	Jaw Type	Weight lbs.	List Price	Sale Price
860-0300	3"	2MT	Solid Jaw	8 lbs.	\$ 645.00	\$ 575.00
860-0400	4"	3MT	Solid Jaw	13.5 lbs.	730.00	650.00
860-0500	5"	4MT	Solid Jaw	25 lbs.	850.00	750.00
860-0600	6"	5MT	Solid Jaw	34 lbs.	1210.00	1085.00
865-0500	5"	4MT	2 Piece Rev.	25 lbs.	\$ 987.00	\$ 885.00

BISON "SET-TRU" STEEL BODY SCROLL CHUCKS BISON



3-Jaw & 6-Jaw With Fine Adjustment



- A unique micro-adjustment feature enables concentricity to be adjusted to 0.0002" of full indicator movement.
- "Set Tru" chucks can be used at many machining operations for which ordinary scroll chucks are unsuitable and at all the operations for which ordinary chucks are normally used.

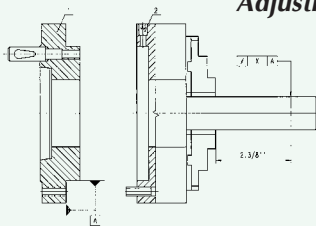

1. Adapters – Tapers "A" or "D"
2. Micro adjustment screws

3-Jaw With Fine Adjustment						
Model No.	Chuck Size	Hole Size	Max. RPM	Weight lbs.	Price Each	
866-040	4"	.787"	4200	10	\$745.00	
866-050	5"	1.37"	3800	11.24	745.00	
866-060	6"	1.65"	3500	20.5	785.00	
866-080	8"	2.16"	3000	34.5	975.00	
866-100	10"	2.99"	2500	59	1250.00	
866-120	12"	4.05"	2000	105	1795.00	
866-160	16"	5.35"	-	201	3100.00	

6-Jaw With Fine Adjustment						
Model No.	Chuck Size	Hole Size	Max. RPM	Weight lbs.	Price Each	
868-060	6"	1.65"	3500	25.2	\$1150.00	
868-080	8"	2.16"	3000	41.5	1475.00	
868-100	10"	2.99"	2500	78.8	1795.00	
868-120	12"	4.05"	2000	128	2595.00	
868-160	16"	5.35"	-	250	4650.00	

Adapters (Back Plates)

For 3 & 6 Jaw "Set-Tru" Chuck					
Model	Size	Price	Model	Size	Price
875-063	6" D1-3	\$33500	874-065	6" A1-5	\$212.00
875-064	6" D1-4	335.00	874-085	8" A1-5	228.00
875-065	6" D1-5	350.00	874-086	8" A1-6	235.00
875-083	8" D1-3	365.00	874-105	10" A1-5	280.00
875-084	8" D1-4	365.00	874-106	10" A1-6	280.00
875-085	8" D1-5	369.00	874-108	10" A1-8	285.00
875-086	8" D1-6	375.00	874-126	12" A1-6	435.00
875-105	10" D1-5	515.00	874-128	12" A1-8	435.00
875-106	10" D1-6	535.00	874-062	16" A1-6	675.00
875-108	10" D1-8	550.00	874-063	16" A1-8	675.00
875-126	12" D1-6	735.00	874-082	20" A1-8	1025.00
875-128	12" D1-8	740.00	874-084	20" A1-15	1040.00
875-129	12" D1-11	740.00			



BISON LATHE CHUCKS

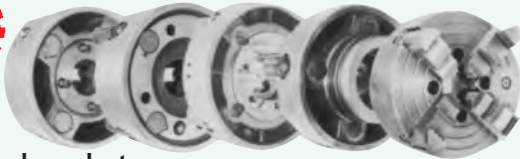

4-Jaw Independent Lathe Chucks



Plain Back

Model No.	Chuck Dia.	Price Each
850-0300	3-1/2"	\$475.00
850-0500	5"	795.00
850-0600	6"	835.00
850-0800	8"	550.00
850-1000	10"	630.00
850-1200	12"	875.00
850-1600	16"	1195.00
850-2000	20"	1895.00
850-2500	25"	2550.00
850-3200	32"	4900.00

4-Jaw Independent Lathe Chucks

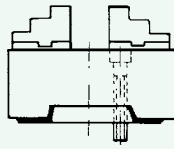

"A" Short Taper

Model No.	Chuck Dia.	Spindle Taper	Price Each
851-0815	8"	A1-5	\$620.00
851-0816	8"	A1-6	620.00
851-1025	10"	A2-5	740.00
851-1016	10"	A1-6	740.00
851-1226	12"	A2-6	925.00
851-1218	12"	A1-8	925.00
851-1626	16"	A2-6	1380.00
851-1628	16"	A2-8	1380.00
851-1619	16"	A1-11	1380.00
851-2019	20"	A1-11	2200.00
851-2519	25"	A1-11	2880.00
851-3219	32"	A1-11	5500.00

4-Jaw Independent Lathe Chucks

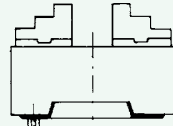

"D-1" Camlock

Model No.	Chuck Dia.	Spindle Taper	Price Each
853-0833	8"	D1-3	\$620.00
853-0834	8"	D1-4	625.00
853-0835	8"	D1-5	615.00
853-1034	10"	D1-4	638.00
853-1035	10"	D1-5	745.00
853-1036	10"	D1-6	760.00
853-1236	12"	D1-6	970.00
853-1238	12"	D1-8	995.00
853-1636	16"	D1-6	1295.00
853-1638	16"	D1-8	1295.00
853-1639	16"	D1-11	1295.00
853-2038	20"	D1-8	1850.00
853-2039	20"	D1-11	2125.00
853-2539	25"	D1-11	2200.00

4-Jaw Independent Lathe Chucks

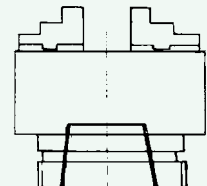

"L" Long Taper

Model No.	Chuck Dia.	Spindle Taper	Price Each
854-0841	8"	L00	\$785.00
854-0842	8"	L0	785.00
854-1041	10"	L00	895.00
854-1042	10"	L0	895.00
854-1043	10"	L1	895.00
854-1242	12"	L0	1165.00
854-1243	12"	L1	1165.00
854-1244	12"	L2	1165.00
854-1643	16"	L1	1750.00
854-1644	16"	L2	1750.00
854-2044	20"	L2	2295.00



TOOLMEX CORPORATION POWER CHUCKS

Advanced Technological Processes

- High quality alloy steel body allows for higher speed.
- Sharply increased dynamic gripping force greatly improves work efficiency and safety.
- Interchangeable top tooling with 1.5mm x 60° jaw serration pitch.
- Compact and lightweight, allowing for improved efficiency.
- Direct mounting to fit ASA B5.9 Type A spindles.
- High accuracy and endurance due to improved lubrication system.
- Heat treated alloy steel for greater durability.



3-Jaw Plain Back Large Thru-Hole

Model No.	Chuck Diameter	Thru Hole	Max. RPM Speed	Weight lbs.	List Price	Sale Price
3-780-0500	5"	1.2992"	7000	14.8	\$ 982.00	\$ 795.00
3-780-0600	6"	1.8110"	6000	27.6	1372.00	1125.00
3-780-0800	8"	2.0472"	5000	49.2	1686.00	1390.00
3-770-0800	8"	2.5984"	5000	50.7	1892.00	1550.00
3-780-1000	10"	3.0315"	4200	76.1	2118.00	1585.00
3-770-1000	10"	3.2283"	4200	70.5	2402.00	1740.00
3-780-1200	12"	3.5827"	3300	121.6	3255.00	2680.00
3-780-1500	15"	4.6457"	2500	264.6	4513.00	3725.00
3-780-1800	18"	4.6457"	2000	361.6	7467.00	5995.00
3-780-2100	21"	5.5118"	1700	518.1	10389.00	8550.00
3-780-2400	24"	6.4961"	1400	645.9	12987.00	9950.00

3-Jaw A2 Direct Mount Large Thru-Hole

Model No.	Chuck Size	Thru Hole	Max. RPM Speed	Weight lbs.	List Price	Sale Price
3-781-0650	6"-A2-5	1.8110"	6000	30.2	\$ 1568.00	\$ 1295.00
3-781-0860	8"-A2-6	2.0472"	5000	52.0	1913.00	1575.00
3-771-0860	8"-A2-6	2.5984"	5000	52.0	2040.00	1680.00
3-781-1080	10"-A2-8	3.0315"	4200	88.2	2395.00	1975.00
3-771-1080	10"-A2-8	3.2283"	4200	88.2	2550.00	2075.00
3-781-1280	12"-A2-8	3.5827"	3300	141.1	3383.00	2775.00
3-781-1511	15"-A2-11	4.6457"	2500	280.0	5296.00	4300.00
3-781-1811	18"-A2-11	4.6457"	2000	392.4	8448.00	6950.00
3-781-2115	21"-A2-15	5.5118"	1700	542.3	12198.00	9950.00
3-781-2415	24"-A2-15	6.4961"	1400	670.2	14613.00	11950.00



CHUCK SAFETY WRENCHES

- A spring loaded or self ejecting chuck wrench can be used on lathes or other machines equipped with manually adjusted chucks.
- The spring loaded sleeve ejects the wrench from the chuck after each use.
- This wrench is engineered and designed to provide proper loads for self-removal of the wrench weight.



Adjusting the chuck using a spring-loaded chuck wrench

MADE IN USA



Square Hexagon Type

3/4" Enlargement Lengths All Models

Model No.	Nominal Size	Actual Size	Bar Diameter	Overall Diameter	Price Each
KMC-011	9/32" SQ	.271"	3/4"	1.050"	\$129.95
KMC-001-1	5/16" SQ	.303"	3/4"	1.050"	129.95
KMC-002	3/8" SQ	.365"	3/4"	1.050"	129.95
KMC-003	7/16" SQ	.427"	3/4"	1.050"	129.95
KMC-004	1/2" SQ	.490"	3/4"	1.050"	129.95
KMC-005	9/16" SQ	.552"	15/16"	1.315"	129.95
KMC-006	5/8" SQ	.615"	15/16"	1.315"	129.95
KMC-007	11/16" SQ	.678"	15/16"	1.315"	129.95
KMC-008	3/4" SQ	.740"	15/16"	1.315"	129.95
KMC-500	1/2" HEX	.490"	3/4"	1.050"	129.95
KMC-501	5/8" HEX	.615"	3/4"	1.050"	129.95
KMC-502	3/4" HEX	.740"	15/16"	1.315"	129.95



SOFT TOP JAWS - SERRATED 1.5mm x 60



Set No.	To Fit Chuck	List Price	Set of 3 Price	Set No.	To Fit Chuck	List Price	Set of 3 Price
3-788-306	6"	\$113.40	\$ 89.95	3-788-312	12"	\$223.50	\$178.50
3-788-308	8"	134.50	105.00	3-788-315	13"	447.00	355.00
3-788-310	10"	167.65	135.00	3-788-321	21 & 24"	655.00	524.00

Precise 3 JAW PLAIN BACK CHUCKS



Features:

- Semi-Steel body.
- Self-centering 0.003" T.I.R.
- Requires chuck plate.

Includes:

- 2 Piece hardened reversible jaws.
- 3-jaw lathe chucks & accessories.
- Chuck key and mounting screws.

Model No.	Chuck Diameter	Thru Hole	Weight lbs.	Sale Price
559-110*	3"	0.63	6	\$ 79.95
559-111*	4"	0.87	8	89.95
559-112	5"	1.77	18	99.95
559-113	6"	1.570	20	139.95
559-114	8"	2.550	35	195.00
559-115	10"	3.150	55	269.95
559-116	12"	3.930	109	450.00
559-117**	16"	5.320	152	675.00
559-118**	20"	8.27	280	1395.00

* 1 Piece Solid Jaws ** Truck Shipment

Precise 3 JAW DIRECT MOUNTING D-1 SERIES CHUCKS

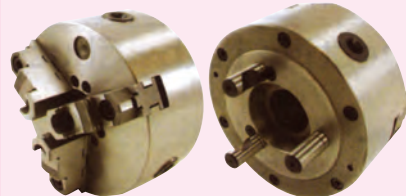

Features:

- Semi-Steel.
- Self-centering.
- Standard scroll.
- Chuck Key.
- 2 Piece reversible jaws.

Model No.	Chuck Diameter	Spindle	Thru Hole	Weight lbs.	Sale Price
559-101	6"	D1-4	1.570	31	\$215.00
559-102	8"	D1-4	1.960	46	279.95
559-104	8"	D1-6	1.960	46	279.95
559-106	10"	D1-6	2.750	82	375.00
559-107	10"	D1-8	3.140	92	375.00
559-108D	12"	D1-6	3.930	110	525.00
559-108	12"	D1-8	3.930	110	575.00
559-109D*	15"	D1-8	5.110	150	895.00
559-109*	15"	D1-11	5.110	150	895.00

* Truck Shipment

Precise LATHE CHUCK ADAPTERS

D-Mount Chuck Converters for Phase II 3 Jaw Plain Back Chucks



Applications:

- For adapting flat back chucks to D1 taper spindle.
- Also available Back-plates, Threaded, Rough casting, "L" and "A" type. Call for Price.

Model	Description	Taper	Dia.	Sale
556-216	D1-4 6" Lathe Chuck Adapter	D1-4	6"	\$ 79.50
556-218	D1-4 8" Lathe Chuck Adapter	D1-4	8"	95.00
556-238	D1-6 8" Lathe Chuck Adapter	D1-6	8"	95.00
556-240	D1-6 10" Lathe Chuck Adapter	D1-6	10"	120.00
556-250	D1-8 10" Lathe Chuck Adapter	D1-8	10"	125.00
556-242	D1-6 12" Lathe Chuck Adapter	D1-6	12"	175.00
556-252	D1-8 12" Lathe Chuck Adapter	D1-8	12"	175.00
556-273	D1-8 15" Lathe Chuck Adapter	D1-8	15"	310.00
556-274	D1-11 15" Lathe Chuck ADP	D1-11	15"	365.00
556-280	D1-11 20" Lathe Chuck ADP	D1-11	20"	390.00

Precise 4-JAW PLAIN BACK INDEPENDENT CHUCKS



Features:

- Cast iron body.
- 1 set solid reversible jaws.
- Heat treated operating screws.
- Requires chuck plate.

Includes:

- One set mounting screws.
- One chuck wrench.

Model No.	Chuck Dia.	Approx Bolt Hole Circle	Approx Recess	Thru Hole	Body Thick	Jaw Height	Approx Weight	Sale Price
557-006	6"	5-23/32"	5-1/8"	1-1/2"	2-9/16"	1-3/16"	23 lbs.	\$ 99.95
557-008	8"	4-9/64"	4-15/16"	1-15/16"	3"	1-3/8"	38 lbs.	115.00
557-010	10"	4-3/4"	3-15/16"	2-1/2"	3-1/4"	1-3/8"	56 lbs.	150.00
557-012	12"	6-1/2"	5-1/2"	3-3/4"	3-3/4"	1-3/4"	95 lbs.	215.00
557-016	16"	8-5/16"	7-1/8"	3-1/2"	3-3/4"	2"	165 lbs.	295.00
557-020	20"	9-1/4"	7-1/8"	6-1/4"	4-1/8"	2-1/8"	225 lbs.	445.00

Precise ACCU-SET LATHE CHUCKS AND BACK PLATES

With Fine Adjustment For "0" Set

- 3-Jaw & 6-Jaw self centering chucks.
- .0005" T.I.R. repeatability.
- Hardened and ground scroll and jaws.
- Four adjustable screws.
- Three hardened and ground pinions.
- Two-piece hardened reversible jaws.



3-Jaw Accu-Set Chucks

Model No.	Chuck Dia.	Thru Hole	Sale Price
560-006	6"	1.535"	\$395.00
560-008	8"	2.260"	465.00
560-010-1	10"	2.835"	575.00
560-012	12"	3.268"	950.00

6 Jaw Accu-Set Chucks

Model No.	Chuck Dia.	Thru Hole	Sale Price
560-026	6"	1.535"	\$495.00
560-028	8"	2.260"	595.00
560-030-1	10"	2.835"	925.00
560-032	12"	3.268"	1195.00

D1 Back Plates

Model No.	Size Mount	Sale Price
560-040	6" D1-4	\$ 99.50
560-048	8" D1-4	120.00
560-049	8" D1-6	120.00
560-050	10" D1-6	135.00
560-051	10" D1-8	135.00
560-052	12" D1-6	165.00
560-053	12" D1-8	165.00

Precise DRILL CHUCKS

All parts are made of high grade alloy steel and heat treated, resulting in strong durability



0-1/2"
MODEL No.
202-503
Reg. \$19.95

\$14.95

With Key

Model No.	Chuck Capacity	Back Taper	Sale Price
202-501-1	0-1/4"	1 JT	\$ 7.95
202-502-1	0-3/8"	2 JT	9.95
202-503-1	0-1/2"	33 JT	14.95
202-504-1	0-1/2"	6 JT	14.95
202-505-1	1/8"-5/8"	3 JT	19.95
202-506-1	3/16"-3/4"	3 JT	29.95

Drill Chuck Arbor Available: Morse Taper, Straight, R-8

RÖHM BALL BEARING DRILL CHUCK

- Use this ball bearing chuck on heavy, close tolerance jobs for extra tightening power.
- Hardened body and smooth jaw movement.



Made In Germany

With Key

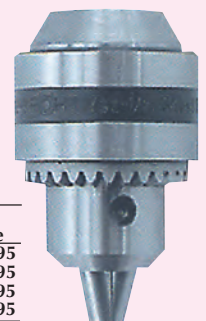

Model No.	Chuck Capacity	Taper Mount	Reg. Price	Sale Price
21500	1/32"-1/2"	3 JT	\$ 90.00	\$ 79.95
21501	1/32"-5/8"	3 JT	100.00	89.95
21502	3/16"-3/4"	4 JT	182.00	159.95
21503	3/16"-1-1/32"	5 JT	243.00	199.95

Mounting Arbors: R-8, Taper & Straight shank (Specify)

AJAX INDUSTRIES SERRATED CHUCK JAWS

Japanese Chucks

- Features:**
- 1.5mm (.0591) pitch x 60° serration.
 - For Kitagawa, Howa, Nikko, Matsumoto and Seiki chucks.

SAVE 15%

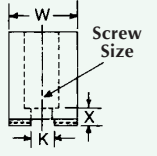
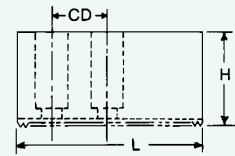
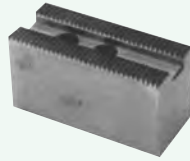

Chuck Size	L	H			Critical Dimensions			Standard Height			Standard Ht. Pointed			Extra High			Extra High Pointed		
		Std.	High	W	K	CD	Screw Size	Model	Reg.	Price	Model	Reg.	Sale	Model	Reg.	Price	Model	Reg.	Price
4"	2.00"	1.00"	2.00"	0.75"	.315"	.591"	M6	02810005	\$20.30	\$17.25	02810025	\$24.00	\$20.40	02810045	\$24.70	\$21.00	02810065	\$26.00	\$22.10
4" & 5"	2.00"	1.00"	2.00"	1.00"	.394"	.551"	M8	02810006	20.30	17.25	02810026	24.00	20.40	02810046	24.70	21.00	02810066	26.00	22.10
5"	2.25"	1.50"	3.00"	1.00"	.394"	.713"	M8	02810007	18.15	15.43	02810027	21.50	18.28	02810047	24.50	20.83	02810067	24.90	21.17
5"	2.50"	1.50"	3.00"	1.00"	.394"	.750"	M8	02810008	18.15	15.43	02810028	21.50	18.28	02810048	24.50	20.83	02810068	24.90	21.17
6"	2.75"	2.00"	3.00"	1.25"	.433"	.984"	5/16"	02810009	15.50	13.18	02810029	18.75	15.94	02810049	20.00	17.00	02810069	22.50	19.13
6"	2.75"	2.00"	3.00"	1.25"	.473"	.787"	M10	02810010	17.50	14.88	02810030	20.75	17.64	02810050	20.90	17.77	02810070	22.50	19.13
8"	4.00"	2.00"	4.00"	1.50"	.551"	.984"	M12	02810011	21.90	18.62	02810031	25.95	22.05	02810051	28.00	23.80	02810071	28.50	24.23
8"	3.75"	2.00"	4.00"	1.50"	.630"	.984"	M12	02810012	25.50	21.68	02810032	29.70	25.25	02810052	35.00	29.75	02810072	35.50	30.18
10"	4.75"	2.00"	4.00"	1.50"	.630"	1.181"	M12	02810013	24.00	20.40	02810033	24.75	21.04	02810053	28.00	23.80	02810073	28.50	24.23
10"	4.75"	2.00"	4.00"	1.75"	.630"	1.181"	M12	02810014	24.25	20.70	02810034	26.00	22.10	02810054	28.50	24.23	02810074	28.50	24.23
10"	4.75"	2.00"	4.00"	1.50"	.630"	1.260"	1/2"	02810015	24.25	20.70	02810035	26.00	22.10	02810055	28.50	24.23	02810075	28.50	24.23
12"	5.09"	2.00"	4.00"	2.00"	.710"	1.181"	M14	02810016	24.00	20.40	02810036	27.30	23.20	02810056	30.90	26.27	02810076	31.00	26.35
12"	5.50"	2.50"	4.00"	2.00"	.827"	1.181"	M16	02810017	37.00	31.45	02810037	41.00	34.85	02810057	48.00	40.80	02810077	45.00	38.25
12"	4.75"	2.00"	4.00"	1.50"	.710"	1.81"	5/8"	02810018	24.00	20.40	02810038	27.00	22.95	02810058	29.00	24.65	02810078	29.00	24.65
12"	5.50"	2.50"	4.00"	2.00"	.710"	1.81"	5/8"	02810019	26.00	22.10	02810039	30.00	25.50	02810059	34.00	28.90	02810079	34.50	29.33
12"	5.75"	2.50"	4.00"	2.00"	.788"	1.375"	1/2"	02810020	27.00	22.95	02810040	31.50	26.78	02810060	36.00	30.60	02810080	34.90	29.67
12"	5.50"	2.50"	4.00"	2.00"	.827"	1.378"	M12	02810021	33.00	28.05	02810041	36.50	31.03	02810061	42.00	35.70	02810081	41.50	35.28
15"	5.75"	3.00"	4.00"	2.50"	.866"	2.360"	M20	02810022	57.00	48.45	02810042	61.00	51.85	02810062	57.00	48.45	02810082	60.00	51.00
15"	6.12"	3.00"	4.00"	2.50"	.866"	1.690"	M20	02810023	57.00	48.45	02810043	61.00	51.85	02810063	57.00	48.45	02810083	60.00	51.00
15"	6.12"	3.00"	4.00"	2.50"	1.005"	1.690"	0M2	02810024	57.00	48.45	02810044	61.00	51.85	02810064	57.00	48.45	02810084	60.00	51.00

AJAX INDUSTRIES T-NUTS AND JAW NUTS

- Features:**
- Material: 4140 heat treated to RC28-32.
 - For Kitagawa, Howa, Nikko, Matsumoto and Seiki chucks.

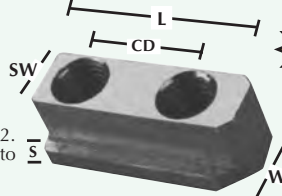

SAVE 15%

AJAX INDUSTRIES SERRATED REVERSIBLE HARD JAWS

- Features:**
- Material: 4140 heat treated to RC 28-32.
 - For Kitagawa, Howa, Nikko, Matsumoto and Seiki chucks.

SAVE 15%

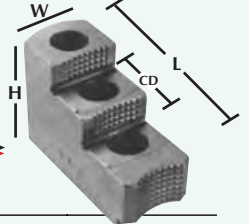

Chuck Size	L	H	W	Critical Dimensions			Screw Size	Model No.	Reg.	Price
				SW	S	CD				
6"	1.417"	.728"	.689"	.472"	.295"	.787"	10MM	02810113	\$27.50	\$23.38
8"	1.842"	.807"	.807"	.551"	.335"	.984"	12MM	02810114	30.25	25.72
10"	1.981"	.846"	.886"	.630"	.335"	1.181"	12MM	02810115	31.50	26.78
12"	2.185"	1.318"	1.040"	.708"	.531"	1.181"	12MM	02810116	36.00	30.60
12"	2.186"	1.09"	1.160"	.825"	.453"	1.181"	16MM	02810117	36.00	30.60
15"	3.149"	1.79"	1.318"	.864"	.649"	1.690"	20MM	02810118	48.50	41.23
15"	3.149"	1.55"	1.375"	1.003"	.758"	1.690"	20MM	02810119	48.50	41.23

Chuck Size	L	H	W	Critical Dimensions			Screw Size	Model No.	Reg.	Price
				K	CD	0MM				
6"	2.846"	2.00"	1.25"	.473"	.787"	10MM	02810120	\$128.00	\$108.80	
8"	3.802"	2.50"	1.50"	.551"	.984"	12MM	02810121	145.00	123.25	
10"	4.352"	2.50"	1.75"	.630"	1.181"	12MM	02810122	160.00	136.00	
12"	5.024"	2.75"	2.00"	.710"	1.181"	14MM	02810123	170.00	161.50	
12"	5.024"	2.75"	2.00"	.827"	1.181"	16MM	02810124	190.00	161.50	
15"	5.712"	3.00"	2.50"	.866"	1.690"	20MM	02810125	370.00	314.50	
15"	5.712"	3.00"	2.50"	1.005"	1.690"	20MM	02810126	370.00	314.50	

AJAX INDUSTRIES TONGUE & GROOVE CHUCK JAWS

Centrally Located

- Features:**
- American standard master.
 - For Bergman, Bison, Buck, Cushman, Nobel, Pratt Burner America, Rohm, Sca, S-P Warner and Sawsey and Yuasa.

SAVE 15%

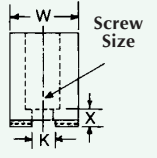
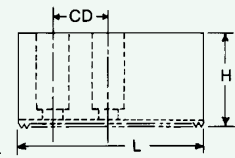
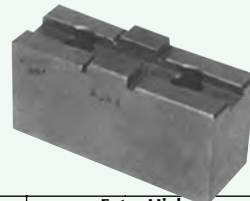

Chuck Size	L	H		W	Critical Dimensions			Screw Size	Standard Height			Extra High		
		Std.	High		K	T	CD		Model	Reg.	Price	Price	Reg.	Sale
5"	2.1875"	1.375"	3.375"	.75"	.3125"	.4375"	1.25"	5/16"	02810127	\$16.00	\$13.60	02810134	\$27.00	\$22.95
6"	2.8125"	1.375"	3.375"	1.00"	.3125"	.50"	1.50"	3/8"	02810128	17.30	14.70	02810135	29.00	24.65
8"	3.3125"	1.875"	3.375"	1.25"	.3125"	.50"	1.750"	3/8"	02810129	18.20	15.47	02810136	31.00	26.35
10"	3.9125"	1.875"	3.375"	1.50"	.50"	.75"	2.125"	1/2"	02810130	21.70	18.45	02810137	33.00	28.05
12"	4.50"	1.125"	3.875"	1.75"	.50"	.75"	2.50"	1/2"	02810131	23.00	19.55	02810138	35.00	29.75
15"	5.1875"	2.250"	3.750"	1.75"	.50"	.75"	3.0"	5/8"	02810132	34.00	28.90	02810139	62.00	52.70
18" Up	5.1875"	2.750"	4.750"	2.25"	.50"	.75"	3.0"	3/4"	02810133	47.00	39.95	02810140	83.00	70.55

AJAX INDUSTRIES TONGUE & GROOVE HARD JAWS

Serrated Reversible

- Features:**
- Material: CD 1018.
 - Case hardened to 56-58 Rockwell C.
 - American standard master, Bergman, Buck, Cushman, Pratt burner, Bison, Rohm, SCA, S-P, Warner A& Swasey and Yuasa chucks

SAVE 15%

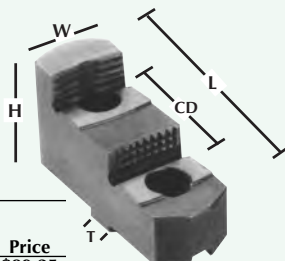

AJAX INDUSTRIES BORING RING

Hardened and Ground

- Features:**
- Save set-up time.
 - Easy to use: just insert bolt in hole of soft jaw, close the chuck and bore.



Chuck Size	L	H	W	Critical Dimensions			Screw Size	Model	Reg.	Price
				K	T	CD				
6"	3.25"	1.50"	1.00"	.3125"	.50"	1.50"	3/8"	02810153	\$105.00	\$89.25
8"	3.56"	1.87"	1.25"	.3115"	.50"	1.75"	3/8"	02810154	115.00	97.75
10"	3.79"	2.37"	1.75"	.50"	.75"	2.125"	1/2"	02810155	121.00	102.85
12"	4.36"	2.37"	1.75"	.50"	.75"	2.50"	1/2"	02810156	150.00	127.50
15"	5.50"	2.50"	2.50"	.50"	.75"	3.00"	5/8"	02810157	160.00	136.00

Chuck Dia.	Bolt Size	Model	Reg.	Price
6"	M10-1.60	02810182	\$196.00	\$166.60
8"	M12-1.75	02810183	238.00	202.30
10"	M12-1.75	02810184	253.00	215.05
12"	M14-2.00	02810185	313.00	266.05
15"	M20-2.50	02810186	450.00	382.50

LLAMBRICHUSA INDUSTRIAL DRILL CHUCKS

Formerly The Manufacturer for **Jacobs**

Ball Bearing

- Equipped with ball bearings to reduce friction in the tightening mechanism and provide a better grip on the drill shaft. • Chuck Key Included.
- All pieces are hardened and ground.
- The one-piece gear ring and sleeve eliminate the possibility of the teeth breakage.

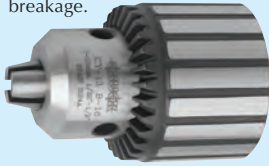

Ball Bearing

Plain Bearing

- The one piece gear ring and sleeve eliminates the possibility of teeth breakage. • Chuck key Included.



Plain Bearing



Stainless Steel

Plain Bearing

Model	Size	Taper	Price
L4070	1/64"-5/16"	2JT	\$ 84.50
L4071	1/32"-3/8"	2JT	89.50
L4062	1/32"-1/2"	6JT	129.00
L4072	1/32"-1/2"	3JT	129.00
L4073	1/32"-5/8"	3JT	145.00
L4074	1/32"-3/4"	4JT	220.00
L4075	3/16"-1"	5JT	295.00
Stainless Steel			
L4026	1/64"-1"	3/8"-24"	\$165.00

Model	Size	Taper	Price
L4030	1/64"-1/4"	1JT	\$ 44.00
L4031*	1/64"-3/8"	2JT	66.00
L4032	1/64"-3/8"	1JT	69.00
L4011	1/64"-1/2"	2JT	61.00
L4017*	1/64"-1/2"	6JT	80.00
L4018	1/64"-1/2"	33JT	64.00
L4013*	1/64"-5/8"	3JT	98.00
L4012*	1/64"-3/4"	3JT	119.00

* Extra Heavy Duty

LLAMBRICHUSA CERTIFIED PRECISION KEYLESS DRILL CHUCK

Formerly The Manufacturer for **Jacobs**

- All drill chucks are 100% inspected to ensure not to exceed a maximum total integrated run-out of 0.0016".
- The self-tightening feature automatically increases clamping force proportional to increased torque to prevent tool shank slippage.
- All components of the JKP drill chuck series that are exposed to wear have been hardened to maintain accuracy and extend the tool and chuck life.
- The JKT drill chuck series offers the addition of milled wrench flats to be used in applications where more tool clamping force is necessary. Clamping forces can be increased up to 3 times with light wrench tightening versus the standard hand tightening.



JKP Series



Extra-Torque JKT Series



Supplied with wrench for additional clamping force

JKP Number	JKT Number	Capacity Range	Taper Mount	JKP Price	JKT Price
JKP-30J0	-	0-1/8"	0JT	\$250.00	-
JKP-30J1	-	0-1/8"	1JT	250.00	-
JKP-65J1	JKT-65J1	0-1/4"	1JT	170.00	\$199.00
JKP-80J2	-	0-5/16"	2JT	185.00	-
JKP-100J2	JKT-100J2	0-3/8"	2JT	175.00	205.00
JKP-100J33	JKT-100J33	0-3/8"	33JT	170.00	205.00
JKP-130J2	JKT-130J2	1/32"-1/2"	2JT	\$180.00	\$215.00
JKP-130J33	JKT-130J33	1/32"-1/2"	33JT	180.00	215.00
JKP-130J6	JKT-130J6	1/32"-1/2"	6JT	180.00	215.00
JKP-160J33	-	1/8"-5/8"	33JT	199.00	-
JKP-160J6	JKT-160J6	1/8"-5/8"	6JT	199.00	250.00

Shanks Available in Stock: CAT, BT, Morse, Straight, R-8 (Specify when orderings) Spare parts available interchangeable with Jacobs

Precise MICRO DRILL ADAPTER

- Super sensitive adapter system makes small hole drilling easy and prevents drill breakage. • 3/4" travel of depth control.
- Light spring tension retracts the drill to starting position.
- Hardened and precision ground shank 1/2" dia. 2" long.
- Permits quicker setup and sensitive drilling on big machines as well.

Drill Adapter With **Jacobs** 0-5/32nds Key Type Chuck

MODEL No. DF-240
\$139.95



Keyless Type
DF-400
DF-15J
DF-30J

Model No.	Capacity Inch	Drill Chuck With Adapter	Sale Price
DF-240	0-5/32"	Jacobs-Key Type	\$139.95
DF-15J	0-1/16"	Albrecht-Keyless	299.95
DF-30J	0-1/8"	Albrecht-Keyless	299.95
DF-500	-	Adapter only (3/4" Travel)	69.95

LLAMBRICHUSA SUPER PRECISION DRILL CHUCKS WITH INTEGRATED SHANKS

Hexagonal Key Lock System Maximum Run-Out 0.0012"



CERTIFIED
CERTIFICATE OF INSPECTION
ACCURACY

Available with Coolant-Thru Capabilities!

Model	Capacity	Shank	Type	List	Sale Price
HX13-R8	1/32"-1/2"	R8	Non-Coolant	\$625.00	\$435.00
HX16-R8	1/8"-5/8"	R8	Non-Coolant	698.00	495.00
HX13-40R	1/32"-1/2"	CAT40	Non-Coolant	700.00	495.00
HX13-40R	1/32"-1/2"	CAT40	Coolant-Thru	845.00	595.00
HX16-40R	1/8"-5/8"	CAT40	Non-Coolant	735.00	525.00
HX16-40R	1/8"-5/8"	CAT40	Coolant-Thru	875.00	625.00

LLAMBRICHUSA HIGH TORQUE HIGH PRECISION KEYLESS DRILL CHUCKS

With Integral Shanks - Certified

- The integrated shank design makes it impossible for the arbor and drill chuck to become separated. This provides a unit of greater rigidity and precision. The compact design reduces the overall total runout to a minimum.
- The Self-Tightening feature automatically increases clamping force proportional to increased torque to prevent tool shank slippage. This is standard for right-hand rotation applications, left hand rotation is available upon request.
- The JK-SOLID series is furnished with milled wrench flats to be used in applications where more tool clamping force is necessary. Clamping forces can be increased up to 3 times with light wrench tightening versus the standard hand tightening.
- 100% of JK-SOLID drill chucks are individually controlled to ensure not to exceed a maximum total integrated run-out of 0.0016"



Supplied with wrench for additional clamping force

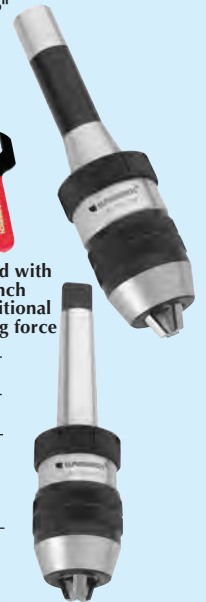

Model No.	Capacity Inch	Shank Size	Price Each
JK-082	0-5/16"	MT2	\$225.00
JK-102	0-3/8"	MT2	225.00
JK-132	1/32"-1/2"	MT2	\$220.00
JK-133	1/32"-1/2"	MT3	225.00
JK-134	1/32"-1/2"	MT4	240.50
JK-135	1/32"-1/2"	5/8"	220.00
JK-138	1/32"-1/2"	R8	242.00
JK-162	1/8"-5/8"	MT2	\$250.00
JK-163	1/8"-5/8"	MT3	255.00
JK-164	1/8"-5/8"	MT4	265.00
JK-168	1/8"-5/8"	R8	275.00



WAHLSTROM FULLY AUTOMATIC DRILL CHUCKS

It is no longer necessary to stop the spindle. One drill press with a Wahlstrom Automatic Drill Chuck does the work of several. You can spot drill, drill and ream in one setup. No keys, collets or wrenches are used.

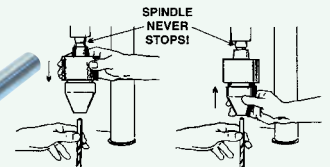

- Grip sleeve. Pull down. Jaws open automatically; drill is released
- Insert new drill. Push down. Jaws tapered part up. Drill is locked in place.

Model	Shank Type	Price
93-MT1	#1 Morse Taper	\$210.00
93-MT2	#2 Morse Taper	215.00
93-JF2	#2 Female J.T.	210.00
93-JF33	#33 Female J.T.	210.00
93-500	1/2" Straight	240.00
93-R8	R-8 Shank	295.00

Important Note: Wahlstrom automatic drill chucks are for manually operated drill presses and milling machines only. Not for automated drill press.

Model	Shank Type	Price
94-MT1	#1 Morse Taper	\$239.00
94-MT2	#2 Morse Taper	263.00
94-MT3	#3 Morse Taper	268.00
94-JF2	#2 Female J.T.	249.00
94-JF33	#33 Female J.T.	249.00
94-500	1/2" Straight	259.00
94-750	3/4" Straight	259.00
94-R8	R-8 Shank	315.00

ALBRECHT CLASSIC KEYLESS CHUCKS

The Albrecht chuck is widely used today on high accuracy drill presses, jig bores, milling machines and production drilling equipment. The ultimate in drill chuck accuracy.

Made In Germany



Chuck No.	Chuck Capacity	Back Taper	Weight	List Price	Sale Price
15-J0	0-1/16"	0JT	.1 lb.	\$295.00	\$239.95
30-J0	0-1/8"	0JT	.2 lb.	245.00	189.95
30-J1	0-1/8"	1JT	.2 lb.	245.00	189.95
65-J1	0-1/4"	1JT	.7 lb.	265.00	210.00
80-J2	0-5/16"	2JT	1.0 lb.	270.00	245.00
100-J33	0-3/8"	33JT	1.4 lbs.	285.00	239.95
100-J2	0-3/8"	2JT	1.4 lbs.	290.00	239.95
130-J33	1/32-1/2"	33JT	2.1 lbs.	325.00	265.00
130-J2	1/32-1/2"	2JT	2.1 lbs.	325.00	265.00
130-J6	1/32-1/2"	6JT	2.1 lbs.	325.00	265.00
160-J6	1/8-5/8"	6JT	2.8 lbs.	325.00	299.95

*Arbors are Available for all chucks. Specify your requirements Thru-Hole, Diamond coated jaws, Stainless steel & thread mounts available

Precise KEYLESS DRILL CHUCKS Economy - Taper Mount

- Self-tightening design.
- No chuck key required.
- Hardened tool steel to insure accuracy and extended chuck life.
- Can be used on a wide variety of machinery.
- Solid steel body.

ACCURACY:
.0048"



Taper Mount
Specify Arbor
When Ordering
(Taper, Straight, R-8)

Model	Range	Taper	List	Sale
202-500	0-1/4"	1 JT	\$39.95	\$26.95
202-501	0-3/8"	2 JT	42.95	29.95
202-502	0-3/8"	33 JT	42.95	29.95
202-503	1/32"-1/2"	33 JT	48.95	32.95
202-504	1/32"-1/2"	2 JT	48.95	32.95
202-505	1/32"-1/2"	6 JT	48.95	32.95
202-506	1/8"-5/8"	6 JT	52.95	36.95
202-507	3/16"-3/4"	3 JT	59.95	45.00

Precise KEYLESS ULTRA PRECISION CHUCKS

CNC
Quality



- Super heavy duty ultra precision drill chucks.
- Normal gripping power when hand tightened. Double the torque when used with optional spanner wrench.
- Especially suitable for CNC machining centers; will not loosen up with instant spindle stop and reverse.

ACCURACY
.0024"

*Optional
Spanner
Wrench
No. SPA-001
\$6.50



Model	Range	Taper	Sale
DCK-382	0-3/8"	2JT	\$52.95
DCK-383	0-3/8"	33JT	52.95
DCK-386	0-3/8"	6JT	56.95
DCK-122	1/32"-1/2"	2JT	59.95
DCK-123	1/32"-1/2"	33JT	59.95
DCK-126	1/32"-1/2"	6JT	59.95
DCK-586	1/8"-5/8"	6JT	68.95
DCK-343	3/16"-3/4"	3JT	79.95

Note: R-8, Straight and Morse Taper Arbors to fit taper are available (Specify) *Not available for 5/16" & 3/4" chucks.

JACOBS PLAIN BEARING & BALL BEARING DRILL CHUCKS

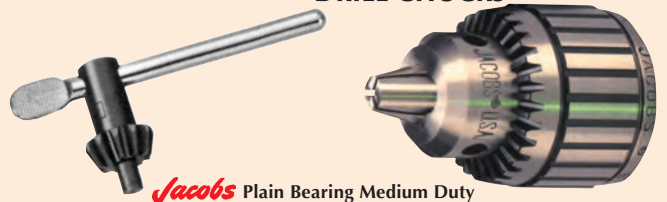

JACOBS Plain Bearing Medium Duty

Model No.	Capacity	Tapered Mount	Uses Key No.	List Price	Sale Price
0-A	0-5/32"	0 JT	K0	\$ 85.00	\$ 76.50
1A	0-1/4"	1 JT	K1	69.00	62.00
2A	0-3/8"	2 JT	K2	95.00	85.50
33	5/64-1/2"	33 JT	K32	106.00	95.50
33-26A	5/64-1/2"	5/8 Str.	K32	134.00	120.50
34-33C*	0-1/2"	33 JT	K3C	105.00	94.50
33KD**	5/64-1/2"	33 JT	K32	117.00	105.00

JACOBS Plain Bearing Heavy Duty

Model No.	Capacity	Tapered Mount	Uses Key No.	List Price	Sale Price
31-01	0-3/8"	1 JT	K7	\$105.00	\$ 94.50
31-02	0-5/16"	2 Short JT	K30	110.00	99.00
34-02	0-1/2"	2 JT	K3	99.00	89.00
34-33	0-1/2"	33 JT	K3	112.00	100.50
34-06	0-1/2"	6 JT	K3	129.00	116.00
3A	1/8-5/8"	3 JT	K3	154.50	139.00
36	3/16-3/4"	3 JT	K4	194.00	174.50
36KD**	3/16-13/16"	3 JT	K4	190.00	171.00
36PD***	3/16-13/16"	3 JT	K4	190.00	171.00

- * Equipped with a threaded locking collar which has a 1-1/16-20 thread
- ** Equipped with a positive driving slot
- *** Equipped with a pin-type positive drive

JACOBS Ball Bearing Super Chucks

Model No.	Capacity	Short Mount	Uses Key No.	List Price	Sale Price
8-1/2N	0-1/4"	2 JT	K30	\$127.00	\$114.25
11N	0-3/8"	2 JT	K32	141.00	126.90
14N	0-1/2"	3 JT	K3	197.00	177.00
16N	1/8-5/8"	3 JT	K4	226.00	203.00
18N	1/8-3/4"	4 JT	K4	340.00	306.00
20N	3/8-1"	5 JT	K5	457.00	410.00



BALL BEARING KEYLESS CHUCKS WITH INTEGRAL CAT AND BT FLANGE

- CAT & BT shanks are produced according to AT3 specifications.
- Made of alloy forged steel for long, durable service life.
- Keyless operations.
- Integral shank design is more compact than a combined drill chuck and arbor. It gives greater accuracy and rigidity.
- Self-tightening (clockwise rotation only).



Max. T.I.R. 0.0015"

Model No.	Capacity Inch	Taper No.	Drawbar Thread	Price Each
187-433	1/32"-1/2"	CAT40	5/8"-11"	\$210.00
187-435	1/8"-5/8"	CAT40	5/8"-11"	225.00
187-563	1/32"-1/2"	CAT50	1"-8"	253.00
187-565	1/8"-5/8"	CAT50	1"-8"	265.00
174-433	1/32"-1/2"	BT40	M16 x 2	\$185.00
174-435	1/8"-5/8"	BT40	M16 x 2	202.00
174-563	1/32"-1/2"	BT50	M24 x 2	230.00
174-565	1/8"-5/8"	BT50	M24 x 3	245.00

Precise CLASSIC PLUS KEYLESS CHUCK WITH INTEGRAL R-8 SHANK

- Features:
 - Integral shank design is more compact than a combined drill chuck and arbor.
 - Often less expensive than a separate chuck and arbor.
 - Keyless operation.
 - Self-tightening.
 - Balanced.

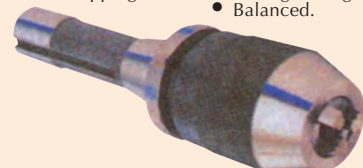

Model No.	Capacity Inch	Max. RPM	Weight lbs.	Shank Type	Sale Price
202-5017	1/32"-1/2"	7000	2.6	R-8	\$69.95
202-5018	1/8"-5/8"	4000	4.2	R-8	79.95

LLAMBRICHUSA MICRO DRILL ADAPTERS

Chucks & Adapters - Ideal for micro hole drilling.
Very accurate and sensitive for precise drilling.

- Precision $\pm .0016"$ (.04 mm)
- Very accurate and sensitive for precise drilling
- Longer tool life and less occurrence of catastrophic tool failure.
- To be used in mills, lathes, drill presses, jigbores and Swiss machines.
- Eliminates the need of secondary operations to drill small holes
- Spindle speeds up to 50,000 RPM (SP-1.5)
- All micro drill chucks available upon request with thru hole for EDM machines
- Micro Drill Chucks and Adapters can be supplied separately, or as part of a KIT

Simple to Use:

- Feed with gentle finger pressure.
- Free turning knurled ring
- Spring return upon release.
- $3/4"$ total travel
- Standard $1/2"$ straight shank or #1 Morse taper to go directly into the spindle of your machine or it can be held with a rotary toolholder or drill chuck



Model No.	Chuck Size	Chuck Type	Shank Size	Kit Price
L04689B	.008-1/16"	Keyless	1/2"	\$375.00
L04690B	.008-1/16"	Keyless	1MT	395.00
L04691B	1/64"-1/8"	Keyless	1/2"	370.00
L04692B	1/64"-1/8"	Keyless	1MT	375.00
L04693B	1/64"-5/32"	Key Type	1/2"	170.00
L04694B	1/64"-5/32"	Key Type	1MT	185.00
L40687B	1 Morse Taper Drill Feed Only			\$145.00
L40688B	1/2" Straight Shank Feed Only			135.00

LLAMBRICHUSA HYBRID DRILL CHUCKS

The Hybrid - This unique, patent pending, innovative design drill chuck has the features and benefits of both the keyed and keyless drill chucks

- Another solution offered first by the worlds leader of drill chucks from Barcelona Spain, Llambrich.
- Specially developed for the USA market, with the most demanding features and benefits of both the keyed and keyless chucks.
- Self-tightening feature automatically increases gripping force in proportion to the increase of torque to prevent tool slippage.
- The Hybrid is furnished with a key to allow additional gripping torque that also permits clockwise and counterclockwise rotation of the tool.
- The tool better resists loosening on high speed machines that have instant spindle stop. $.0016"$ repeatability on taper mounted chucks.



Model	Capacity	Taper	List	Sale
L40674B	1/32"-3/8"	J2	\$435.00	\$279.95
L40675B	1/32"-3/8"	J33	439.00	282.00
L40668B	1/32"-1/2"	J6	441.00	285.00
L40676B	1/32"-1/2"	J2	440.00	285.00
L40677B	1/32"-1/2"	J33	440.00	285.00
L40678B	1/8"-5/8"	J6	475.00	305.00

LLAMBRICHUSA INOX STAINLESS STEEL SURGICAL DRILL CHUCKS

- Manufactured from stainless steel to withstand chemical corrosion.
- Identified with special laser markings to hold up to the autoclave process.
- FGE Keyless chucks have milled instead of knurled grip areas to ensure non slip hand tightening free of sharp edges. Excellent choice for use when operating with rubber gloves.
- All FGE and GE drill chuck models are bead blasted with glass balls and have passivation by an electropolishing technique. This adds additional protection against all types of corrosion, eliminates undesirable residual contaminants, and improves of the finish of the surface profile.
- For the insertion of nails, screws, pins and other medical fasteners all chucks come with a through hole.

The Hybrid

A unique drill chuck developed by Llambrich combining features & benefits of both Keyed and Keyless chucks. Patented. Self tightening feature automatically increases gripping force in proportion to the increased torque to prevent tool slippage.



Model	Range	Type	Mount	Wt. Gr.	Price
SP-03R	.012"-.125"	Keyless	3/8"-24	110	\$463.00
SP-07J	.012"-.291"	Keyless	1 JT	200	463.00
SP-07R	.012"-.291"	Keyless	3/8"-24	200	463.00
CSS-04J	.020"-.156"	Key Type	0 JT	48	\$144.00
CSS-04R	.020"-.156"	Key Type	5/16"-24	50	142.50
CSS-06J	.020"-.291"	Key Type	1 JT	110	142.50
CSS-06R	.020"-.291"	Key Type	3/8"-24	110	142.50
CSS-06RG	.020"-.291"	Key Type	5/16"-24	110	185.00
SPH-03R	.012"-.125"	Hybrid	3/8"-24	140	\$460.00
SPH-07R	.012"-.291"	Hybrid	3/8"-24	220	460.00
SPH-07J	.012"-.291"	Hybrid	1 JT	220	460.00



5C COLLET CHUCK For Mounting With Adapter Plate

Designed for use with 5C collets. It can be used for turning, facing boring grinding and milling operations on center lathes and grinding machines. The simple key-operated scroll provides a uniform distortion-free clamping of workpieces and low collet exchange times.

SPECIFICATIONS:

Chuck size 5"
Collet capacity 1/16"-1/8"
Weight 13 Lbs.
Max. RPM 6,000

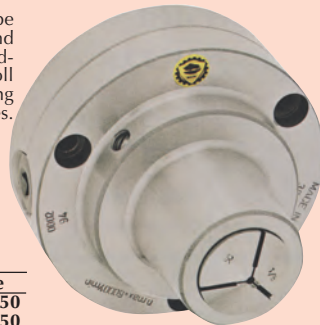

MODEL No. 862-0501
Reg. \$495.00 **\$395.00**

Adapter For 5C Collet Chuck

Model	Spindle	List	Price
877-001	A-6	\$230.00	\$195.50
877-002	A-8	230.00	195.50
878-053	D1-3	235.00	199.50
878-054	D1-4	235.00	199.50
878-005	D1-5	235.00	199.50
878-056	D1-6	235.00	199.50

Precise PRECISION CHUCK WITH 5C - R8 OR MT ADAPTER

- 3-Jaw chuck
- Self centering 0.003" TIR
- It has a set of inside jaws and a set of outside
- Independent jaw are adjustable.
- 1 set reversible jaws allow for internal and external usage.

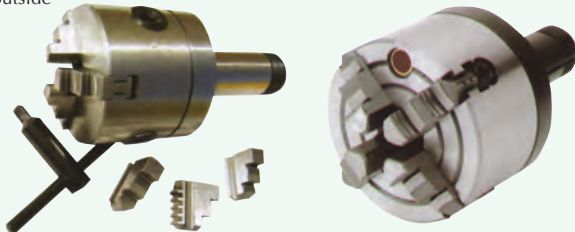

Model No.	Size & Type	Shank Type	Clamping Range	Price Each
202-414	3"-3 Jaw	5C	0.179-3.15"	\$110.00
202-415	4"-4 Jaw	5C	0.179-3.15"	139.95
202-446	3"-4 Jaw	5C	0.179-3.15"	125.00
202-447	4"-4 Jaw	5C	0.236-3.94"	135.00
202-445	3"-3 Jaw	R8	0.079-2.48"	145.00
202-417	3"-3 Jaw	2MT	0.179-3.15"	140.00
202-416	4"-3 Jaw	R8	0.079-3.15"	150.00
202-402	2"-3 Jaw	1MT	-	89.95
202-403	2"-3 Jaw	2MT	-	89.95

Precise JAW BORING RINGS For Boring Soft & Round Jaws

- Suitable for CNC lathe.
- Ideal for machining soft jaws.
- Attaches to front of jaws without tools, compensating for "jaw lift".
- Applies equal pressure on all jaws.
- Since no discs or bungs are used to clamp jaws, through boring of jaws is possible.

How to Install:

- 1 Place the jaw boring ring over chuck and locate the bring ring pins in the counterbore of your chuck jaws.
 - 2 Turn the jaw boring ring until snug.
 - 3 Activate your jaws.
- The jaw boring ring will apply equal pressure on all jaws, allowing for a consistent bore.

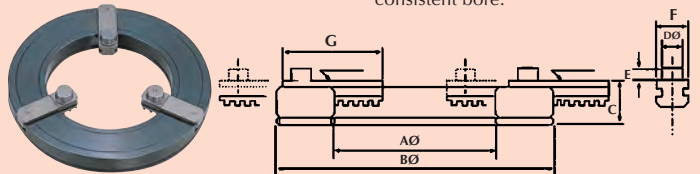

Model No.	Chuck Size	A	B	C	D (dia.)-E	F-G	Jaw Stroke (ea.)	Max. Speed RPM	Sale Price
3900-4666	5,6,8"	3.94	6.7	1.02	.512-.28	.748-2.4	7.4	800	\$390.00
3900-4668	6,8,10"	4.92	7.9	1.02	.642-.32	.748-2.4	7.4	700	420.00
3900-4669	8,10,12"	6.30	9.8	1.22	.720-.32	.945-3.2	8.5	600	495.00

Precise PRECISION DRILL CHUCK ARBORS



Morse Taper Jacobs Taper

Taper Shank	Jacobs Taper	Model No.	Price
0 MT	0 JT	DCA-029	\$ 5.50
0 MT	1 JT	DCA-030	5.50
0 MT	2 JT	DCA-701	5.50
0 MT	3 JT	DCA-077	5.50
0 MT	33 JT	DCA-078	5.50
1 MT	0 JT	DCA-031	\$ 4.95
1 MT	1 JT	DCA-032	4.95
1 MT	2 JT	DCA-033	4.95
1 MT	3 JT	DCA-034	4.95
1 MT	33 JT	DCA-035	4.95
2 MT	0 JT	DCA-036	\$ 5.95
2 MT	1 JT	DCA-037	5.95
2 MT	2 JT	DCA-038	5.95
2 MT	3 JT	DCA-039	5.95
2 MT	4 JT	DCA-040	5.95
2 MT	5 JT	DCA-041	5.95
2 MT	6 JT	DCA-042	5.95
2 MT	33 JT	DCA-043	5.95
3 MT	1 JT	DCA-044	\$ 6.95
3 MT	2 JT	DCA-045	6.95
3 MT	3 JT	DCA-050	6.95
3 MT	4 JT	DCA-051	6.95
3 MT	5 JT	DCA-052	6.95
3 MT	6 JT	DCA-053	6.95
3 MT	33 JT	DCA-054	6.95
4 MT	2 JT	DCA-055	\$ 8.95
4 MT	3 JT	DCA-056	8.95
4 MT	4 JT	DCA-057	8.95
4 MT	5 JT	DCA-058	8.95
4 MT	33 JT	DCA-059	8.95
5 MT	2 JT	DCA-060	\$11.95
5 MT	3 JT	DCA-061	11.95
5 MT	4 JT	DCA-062	11.95
5 MT	5 JT	DCA-063	11.95
5 MT	6 JT	DCA-064	11.95
5 MT	33 JT	DCA-070	11.95

DRIFT KNOCKOUT KEYS

- Fully drop-forged, tools are used to knock taper shank drills, reamers, etc., out of Morse taper sleeves.

4 Pc. SET
MODEL No. DRP-450

\$19.50

1 Each
1,2,3,4 MT



Model	For Morse Taper	Price
DRP-446	1 MT	\$3.95
DRP-447	2 MT	4.75
DRP-448	3 MT	5.25
DRP-449	4 MT	7.75



BISON CAT 40 & 50 V-FLANGE DRILL CHUCK ARBORS

- Jacob's Taper T.I.R. < 0.002".
- Retention knobs are sold separately.

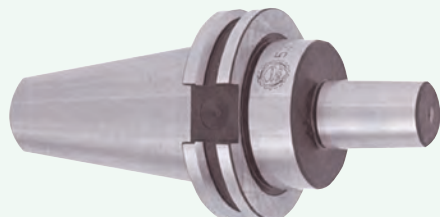

Model No.	CAT Taper	Jacobs Taper	Gage Length	Price Each
181-402		2		
181-403		3		
181-404	40	4	1-1/2"	\$69.95
181-406		6		Each
181-433		33		
181-503		3		
181-504		4		
181-505	50	5	1-1/2"	\$119.95
181-506		6		Each
181-533		33		

Note: BT40 & 50 Also available



Straight Shank Jacobs Taper

Shank	Jacobs Taper	Model No.	Price
3/8"	0 JT	DCA-001	\$9.95
3/8"	1 JT	DCA-002	9.95
3/8"	2 JT	DCA-003	9.95
1/2"	0 JT	DCA-004	\$4.95
1/2"	1 JT	DCA-005	4.95
1/2"	2 JT	DCA-006	4.95
1/2"	3 JT	DCA-007	4.95
1/2"	4 JT	DCA-008	4.95
1/2"	6 JT	DCA-009	4.95
1/2"	33 JT	DCA-010	4.95
5/8"	1 JT	DCA-013	\$5.95
5/8"	2 JT	DCA-014	5.95
5/8"	3 JT	DCA-015	5.95
5/8"	4 JT	DCA-016	5.95
5/8"	6 JT	DCA-017	5.95
5/8"	33 JT	DCA-018	5.95
3/4"	2 JT	DCA-019	\$6.95
3/4"	3 JT	DCA-020	6.95
3/4"	4 JT	DCA-021	6.95
3/4"	6 JT	DCA-022	6.95
3/4"	33 JT	DCA-023	6.95
1"	2 JT	DCA-024	\$7.95
1"	3 JT	DCA-025	7.95
1"	4 JT	DCA-026	7.95
1"	6 JT	DCA-027	7.95
1"	33 JT	DCA-028	7.95

SEMI-AUTOMATIC SAFETY DRIFT KEY

- Semi-automatic, for extra power and safety.
- Makes ejection of tapered tools from your machine spindles quick and easy.
- Avoids damage to spindle, adapters, tools and workpieces.
- Assures safety against hand injuries, etc.
- Made of special, hardened and anodized.

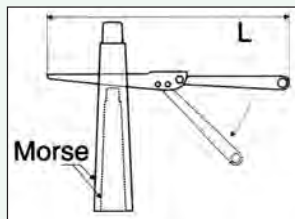
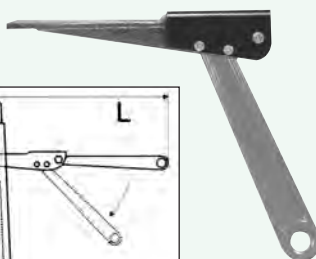

Model No.	For Morse Taper	"L" Length	Price Each
SDP-450	1, 2, 3 MT	12-1/2"	\$89.95
SDP-451	4, 5, 6 MT	15"	99.95

Precise NMTB TO JACOBS TAPER DRILL CHUCK ADAPTERS



Model No.	NMTB Tape	Jacobs Taper	Price Each
202-721	30	1JT	\$38.95
202-722	30	2JT	38.95
202-723	30	2JT	38.95
202-724	30	6JT	38.95
202-725	30	33JT	38.95
201-733	40	33JT	\$39.95
201-720	40	3JT	39.95
201-728	40	2JT	39.95
201-729	40	6JT	39.95
202-564	50	2MT	\$54.95
202-565	50	3MT	54.95
202-566	50	4MT	54.95



R-8 Shank Jacobs Taper

Shank	Jacobs Taper	Model No.	Price
R-8	1 JT	DCA-071	\$19.95
R-8	2 JT	DCA-072	19.95
R-8	3 JT	DCA-073	19.95
R-8	4 JT	DCA-076	19.95
R-8	6 JT	DCA-074	19.95
R-8	33 JT	DCA-075	19.95

THREADED ARBORS



Taper Shank			
Model	Shank	Thread Mount	Price
202-5730	2 MT	3/8-24	\$14.95
202-5731	2 MT	1/2-20	14.95
202-5732	2 MT	5/8-16	14.95
R8 & Straight Shank			
DCA-2512	3/4"	7/8-20	\$26.00
DCA-2518	R-8	7/8-20	52.00

JACOBS WEDGE SETS To Separate Arbors From Chucks



Model No.	Description	For JT#	Set Price
13266	#1 Wedge Set	1JT	\$6.95
13267	#2 Wedge Set	2JT	6.95
13268	#3 Wedge Set	3JT	6.95
13269	#6 Wedge Set	6JT	6.95

*Removal of Jacobs tapers No. 4 and No. 5 requires stackings of No. 3 and No.6 wedge sets

CHUCK KEYS



Fits Jacobs Chuck No.s	Jacobs No.	Price Each	Model No.	Price Each
0A, 0B	K0	\$4.50	SEK-100	\$6.95
1A, 1B	K1	3.25	-	-
2A, 2B	K2	4.45	SEK-102	8.95
3A, 3B, 34, 14N	K3	5.25	SEK-103	8.95
633C, 633D	K3C	6.25	-	-
7, 7-1A, 7B	K7	\$3.90	-	-
30, 30B, 31B	K30	4.30	SEK-106	\$ 8.95
33, 32BA, 11N	K32	4.50	SEK-107	8.95
36, 16N, 10N	K4	8.75	SEK-109	25.00
20N	K5	19.00	SEK-110	35.00

Precise MASTER CHUCK KEYS

- These tools allow you to open over 200 different chucks.
- With these two sizes you can open almost any 1/4" to 3/4" drill chuck.
- The squared center of the keys opens acetylene tanks.



Carbon Steel		
Model	Description	Price
ST-130	For 1/4"-1/2" light duty	\$16.95
ST-120	For chucks 3/8"-3/4" heavy duty	19.95
Stainless Steel		
ST-130A	For 1/4"-1/2" light duty	\$18.95
ST-120A	For chucks 3/8"-3/4" heavy duty	21.95



HEAVY DUTY AIR CHUCKS

The Redmer Air Chuck is a heavy holding fixture that has many uses in second operation work, such as drilling, milling, threading, tapping, deburring, etc. It is also an ideal fixture for use in assembly work.



Air Chuck

This compact model with 1/2" capacity was designed especially for small work applications where limited amount of space is available

Model	Collet	Price
RE-000	#00	\$230.00
RE-03C	3C	230.00

Also available for 3AT collets

NC Air Chuck

Dual chamber piston provides powerful holding of parts to 1-1/16". Designed for mounting vertically or horizontally. Narrow profile allows for side-by-side stacking to fully utilize table space. Ideal for CNC Machining Centers and shuttle tables.

Model	Collet	Price
RE-11C	11C	\$595.00
RE-05C	5C	595.00

Also available for the following collets: B&S#00, #10, #11, #11C, #21, 3C, 3AT

#2S Air Chuck

A real heavy-duty workhorse for the most demanding applications. For parts up to 2" diameter.

Model	Collet	Price
RE-22D	#22D	\$545.00
RE-RC5	RC5	545.00

Also available for the following collets: B&S#22, 22C, 16C

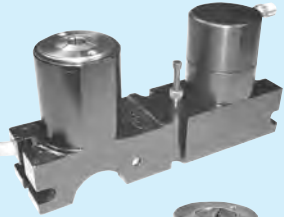

EASY CHANGE R-8 Quick-Change Tool System

- The Royal Quick-Change Tool System provides a fast method for changing tools on a Bridgeport-style mill once the R8 body is installed in the machine spindle, tools can be changed in seconds.
- One hand operation simply depress the brass locking button and rotate collar to the locked-open position. When a new tool is inserted, it depresses a spring-loaded pin, snapping the collar back into the locked-closed position.
- Very accurate total system runout is less than 0.0005" TIR.
- Short overhang (1-1/8" and two positive-drive keys enable many common milling & drilling operation to be easily performed.
- Please note that this tool is designed for light/medium-duty application where the ability to change tools quickly outweighs the need for extreme rigidity. We do not recommend using this system for heavy milling or high-production applications.



Unit Only
Protrudes
1-1/8"
Beyond
Spindle



1. Loading the Quick-change body into a standard R8 spindle



2. Loading drill chuck holder & drill into body



3. Removing drill chuck holder with one hand



4. Inserting endmill holder & endmill for next operation

Model	Description	Price
24100	R8 Quick Change Body Holder	\$665.00
24200	1/8" End Mill Tool Holder	205.00
24205	3/16" End Mill Tool Holder	205.00
24210	1/4" End Mill Tool Holder	205.00
24215	3/8" End Mill Tool Holder	205.00
24220	1/2" End Mill Tool Holder	205.00
24225**	5/8" End Mill Tool Holder	205.00
24230**	3/4" End Mill Tool Holder	215.00
24235**	1" End Mill Tool Holder	240.00

**For light milling only. For heavy use solid endmill holder

24285	Drill Chuck Holder J2	\$170.00
24290	Drill Chuck Holder J3	170.00
24295	Drill Chuck Holder J6	170.00
24300	Drill Chuck Holder J33	170.00
24250	1/2" Holder Shell Mill Holder	\$265.00
24255	3/4" Holder Shell Mill Holder	295.00
24260	200DA Collet Chuck Tool Holder	\$295.00
24265	180DA Collet Chuck Tool Holder	310.00
24266	ER-16 Collet Chuck Tool Holder	295.00
24268	ER-32 Collet Chuck Tool Holder	325.00



KNURLMASTER KNURLING TOOLS

Internal Hand Knurling Tool

An excellent hand tool for the machine shop as well as the maintenance department. The standard tool has a 1-1/4" to 5" capacity. The deluxe tool includes adapters to reduce the minimum capacity to 5/8". Tools and adapter sets include one set of medium pitch, straight pattern knurls.



Knurlmaster Hand Knurling Tool

1/8" to 1" capacity. For straight and diamond pattern knurling excellent for "on the spot" repairing of shafts. Available in standard and deluxe kits.

- Knurl size 1/2"x 1/4"x 3/16" hole.



Model	Description	Price
K1-207-10	Standard Kit	\$149.50
K1-207-20	Deluxe Kit	269.50
K1-237-00	Hand Knurler	294.50

Model	Description	Price
K1-229-00	Standard Internal Knurler	\$139.50
K1-229-10	Deluxe Internal Knurler	215.00
K1-229-20	Adapter Blocks (only)	78.50

Deluxe Kit: 6 sets of knurls, diamond & straight, fine medium & coarse
Standard kit contains: 1 set of knurls straight, medium T.P.I.



WAHLSTORM FLOAT-LOCK VISES BANDSAW VISE

For hard-to-hold pieces, vertical cutting, automatic chain feed operation, irregular shapes & compound angle cutting. Each Band Saw Vise comes complete with one set of deluxe jaw blocks that feature Horizontal and Vertical "V" grooves that align and grip rounds securely. Parallel grooves align work for flat stock.

MODEL
MW-894

\$179.95



10" Capacity
O.A.L. 24"



DRILL PRESS VISES

- Float-Lock Vise features a quick-acting ratchet adjustment for faster setups & use.
- The thumb ring release the ratchet to move the ratchet jaw along the vise shaft.
- Vise turns on three sides, which permits drilling many holes without removing work.
- Each drill press vise comes complete with a table mounting clamp and one set of deluxe jaw blocks.

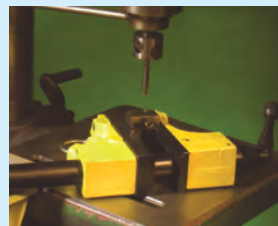

M1-89-9

Corner Mounting Attachment. Quickly attaches the vise to any drill press table. Eliminates the need to drill a mounting hole in the vise to be easily moved between multiple drill presses.

Model	Description	Price
MW-891	9" capacity safety vise	\$195.00
MW-892	12" capacity safety vise	205.00
*MW-898	8" capacity safety vise	165.00
M1-89-9	Corner Mount Attachment	\$ 45.00

*Has Screw Adjustment



KOOL MAGNETIC FLUID DISPENSER

- Magnetic base can be mounted in seconds on flat or round surfaces.
- Separate air and fluid control.
- Stainless steel armored siphon hose.
- Nozzle connected via Loc-Line flexible hose.
- Simple, inexpensive and ruggedness pays for itself on first day.

1 Hose
Fluid Dispenser
MODEL No.
NOG-001

\$99.95

2 Hose
Fluid Dispenser
MODEL No.
NOG-002

\$124.95

19" Replacement
Hose
MODEL No.
NOG-003

\$29.95

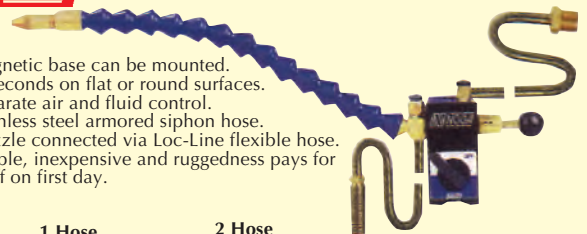

Precise SELF REVERSING TYPE TAPPING HEADS

With Two
FREE
Rubber Flex
Collets
A \$60.00
Value

- Chatter-free clutch has positive engagement which allows for a smoother more accurate tapping operation and more rapid reversal.
- Guaranteed depth control to $\pm 0.004"$
- Radial float is self-centering to compensate for hole center misalignment to 0.005".
- Unique Double Spring mechanism produces Automatic Feed and Cushion Drive. There are two springs for the feed and two springs for the reversal. Each set gives you double smoothness for Ultra accurate tapping applications.
- Pre-set torque control permits easy operation of tap brake torque control.
- Supplied with 2 collets.



MODEL No.
354-002
List \$245.00

\$199.95

Model No.	Capacity In Steel	Max. Speed RPM's	Gear Ratio	Body Diameter	Overall Length	Arbor Mount	Uses Collets	List Price	Sale Price
354-002	0-1/4"	1500	1:1.6	2.215"	5.118"	6 Jacobs	J-116, 117	\$265.00	\$199.95
354-012	8-1/2"	1000	1:1.75	2.950"	6.140"	6 Jacobs	J-421, 422	350.00	295.00
354-022	(1/8"-1/4"NPT) 5/16"-3/4" (1/8"-1/4"NPT)	600	1:1.7	3.580"	8.030"	20mm Thread	J-441, 445	425.00	325.00



Arbor For Tapping Heads

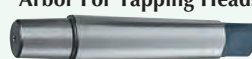

Arbor No.	Shank Size	Jacobs Size	Price Each
DCA-009	1/2"	6 JT	\$ 4.95
DCA-017	5/8"	6 JT	5.95
DCA-022	3/4"	6 JT	6.95
DCA-027	1"	6 JT	7.95

Arbor No.	Shank Size	Jacobs Size	Price Each
DCA-042	2 MT	6 JT	\$ 5.95
DCA-053	3 MT	6 JT	6.95
DCA-082	4 MT	6 JT	8.95
DCA-074	R-8	6 JT	19.95

Arbor No.	Shank Size	Thread Size	Price Each
DCA-080	3 MT	20mm	\$15.75
DCA-081	4 MT	20mm	15.75
DCA-079	R-8	20mm	35.50

TAPMATIC TAPPING HEADS/SELF REVERSING

- Self-feed assures quality threads. The tap acts as own lead screw.
- Preselective torque control eliminates tap breakage. Presets rotational force required to drive any tap in any material.
- Cushioned drive eliminates cross-threading. No chatter in neutral.
- Cushioned reverse has smooth transition from forward to reverse.
- Positive depth control allows you to control thread depth precisely.
- **Prices are less Rubber Flex Collets.**



Model No.	Capacity In Steel	RPM Max. Speed	*Taper Mount	List Price	Sale Price
30X	#0 - 1/4"	2000 RPM	#6JT #33JT	\$ 719.00	\$ 635.00
50X	#6 - 1/2"	1500 RPM	#6JT #33JT	\$941.00	\$ 825.00
70X	#10 - 5/8"	1200 RPM	#3JT	\$1263.00	\$1095.00
90X	1/2" - 1-1/8" 3/4" NP	600 RPM	#4JT	1567.00	1375.00

*Specify: Choice of Taper Mount And Mounting Arbor

RUBBER FLEX COLLETS FOR TAPPING HEADS

Collets outperform conventional split-steel collets in gripping power, accuracy and durability



Model No.	Tap Capacity	Tapping Head	Price Each
J-116	#0- #8	30X	\$36.95
J-117	#10- 1/4"	30X	36.95
J-421	#0- 1/4"	50X	34.50
J-422	1/4" - 1/2"	50X	34.50
J-440	5/16" - 5/8"	70X	36.95
J-441	#10 - 1/2"	70X	36.95
J-461	1/2" - 3/4"	90X	99.50
J-462	7/8" - 1-1/8"	90X	99.50



E-Z HAND TAPPER

- Assures straight perpendicular tapped holes up to 3/4" diameter.
- Complete with tap guide, precision ground work table, tap spindle wrench, and 9 steel tap adapters# 8, #10, 1/4", 5/16", 3/8", 7/16", 1/2", 5/8" & 3/4".

Specifications:

Table size 13 x 8"
Height 14"
Clearance height 7"
Depth of throat 7-1/2"
Approx. weight 35 lbs.



USA
Brand
MODEL No.
8200-002
\$299.95

Import
MODEL No.
390-249
\$159.95

Complete with tap guide, precision ground work table, tap spindle wrench, and 9 steel tap adapters# 8, #10, 1/4", 5/16", 3/8", 7/16", 1/2", 5/8" & 3/4".

TapWizard #0 THRU 1/2" ARTICULATING ARM TAPPER

- Air-driven reversible motor (c/w Quick change tap chuck).
- 5 Bilz type torque limiting tap holders (up to 1/2") plus 3/8" drill chuck with holder. • Universal tapping head (vertical & horizontal).
- Air regulator, lubricator & water trap. • Heavy duty articulate construction.

MODEL No.
TWT-025

\$2495.00

Complete
W/5 Tapping
Chucks, Holders

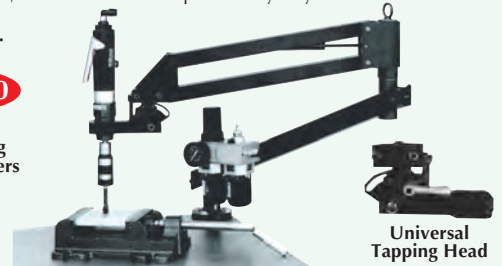

Universal
Tapping Head

*All tapping machines are sold with a 90-day warranty on the air motor. Customers have a 30 day return privilege. (Satisfaction Guaranteed)

Model No.	Tap Capacity	Speed RPM	Working Radius	Price
TWT-025	Up to 1/4"	1200	3"-39"	\$2495.00
TWT-516	Up to 5/16"	700	3"-39"	2495.00
TWT-500	Up to 1/2"	400	3"-39"	2495.00

Precise UNIVERSAL HAND TAPPER #6 TO 5/8" CAPACITY

- Complete with offset handle, precision spindle, and adapter rack.
- Includes 9 tap adapters: Nos. 6, 8, 10, 1/4", 5/16", 3/8", 7/16", 1/2", 5/8".
- Spindle balance allows for highly sensitive tap feel.
- Sliding jaw prevents crimping.

SET No.
265-110

\$149.95

Specifications:

Table size 6-1/2"x12-1/2"
Clearance height 7-7/8"
Spindle diameter 1"
Depth of throat 7-1/2"
Weight 50 lbs.



Precise MINI E-Z HAND TAPPER

- Assures straight perpendicular tapped holes up to #10 diameter.
- Complete with tap guide, precision ground work table, tap spindle wrench, and 7 steel tap adapters: #0-5/16"

Specifications:

Table size 8-1/2 x 6"
Height 9"
Clearance height 3-3/4"
Depth of throat 4-1/2"
Approx. weight 12 lbs.

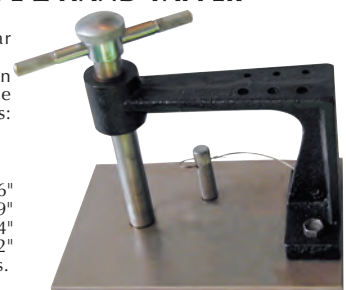

MODEL No.
390-252

\$69.95

Complete with tap guide, precision ground work table, tap spindle wrench, and 7 steel tap adapters: #0-5/16"

Precise BORING HEADS

- Rugged construction and maximum bearing surface between the sliding gib and the body provides the optimum in precision.
- Superior rigidity for chatter-free boring & precise hole-size accuracy.
- 2 Vertical and 1 cross hole extra large bring range.
- Overall length held to a minimum.
- Bar holder moves freely and smoothly. When locked in place it holds firmly against tool-cutting pressures.
- Micrometer leadscrew provides .001" direct reading accuracy.
- Easy hole diameter adjustment
- Threaded back for convenient shank interchangeability.



Rugged Construction



All Sets Include R-8 Shank & carbide Tipped Boring Bar Set

2" Dia. Head Set No. BHS-200

\$79.95

3" Dia. Head Set No. BHS-300

\$109.95

4" Dia. Head Set No. BHS-400

\$169.95

(Boring Heads Only)

Model No.	Head Dia.	Hole Size	Offset Travel	Overall Length	Price Each
PBH-02	2"	1/2"	5/8"	2-7/16"	\$ 59.95
PBH-03	3"	3/4"	1"	3-5/32"	74.95
PBH-04	4"	1"	1-5/8"	4-1/2"	139.95

Arbors For Above (1-1/2"-18 Thread)

SHR-810	R-8 Shank	\$19.95
SHS-500	1/2" Shank	11.95
SHS-340	3/4" Shank	14.95
SHS-100	1" Shank	19.95

Carbide Tipped Boring Bar Sets

A-375	3/8" Shank (9 Pcs)	\$14.95
B-500	1/2" Shank (9 Pcs)	18.95
C-750	3/4" Shank (12 Pcs)	34.95
E-100	1" Shank (6 Pcs)	65.00

PRO-SERIES BORING HEAD SETS

- Wide bearing surface provides super accuracy.
- Rugged design allows excellent rigidity for chatter-free boring.
- Head features a threaded back for multiple shanks exchangeable.
- Set complete with Boring head, Boring Shank, Boring bars, Adapters and L-Shape Hex wrenches.
- Dial on head with 0.0005" graduation for accurate hole sizing.
- Fitted durable carry case included.



3 Year Warranty

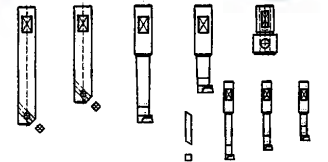

Model No.	Head Diameter	Shank Adapter	Hole Size	Offset Range	No. of Bars/Adapters	Set Price
3800-5935	2"	R8	1/2"	5/8"	2/1	\$265.00
3800-5940	3"	R8	3/4"	3/4"	5/3	375.00
3800-5942	3"	NT/NMTB40	3/4"	3/4"	5/3	395.00

heinrich ADJUSTABLE CROSS HOLE DRILL JIG

MADE IN USA

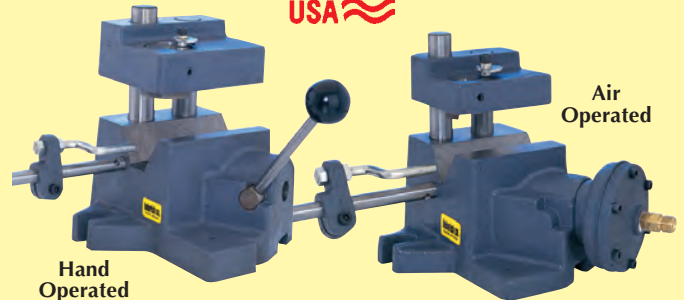

Capacity	Hand Operated	Hand Price	Air Operated	Air Price
1/8" to 3/4"	305	\$295.00	AR-305* AR-305A	\$425.00 325.00
3/4" to 1-1/2"	605	\$370.00	AR-605* AR-605A	\$475.00 375.00
1-1/2" to 2-1/2"	905	\$695.00	AR-905* AR-905A	\$850.00 710.00

*AR-Air-operated furnished with No. 32-12CI three-way foot treadle, valve and two 34-14 air hose

PRECISION BORING HEADS With Integrated Shanks

- Direct reading .001 micrometer.
- Precision hardened steel.
- Boring capacity up to 4".

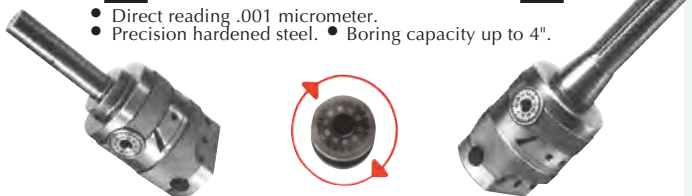

Model No.	Head Diameter	Shank Size	Hole Diameter	Offset Travel	Price Each
BH-34A	2"	3/4"	3/8"	3/4"	\$114.00
BH-34B	2-1/2"	3/4"	1/2"	3/4"	137.00
BH-34C	2-1/2"	3/4"	5/8"	3/4"	148.00
BH-1D	3"	1"	3/4"	1-1/4"	170.00
BHR-8A	2"	R-8	3/8"	3/4"	170.00
BHR-8B	2-1/2"	R-8	1/2"	3/4"	180.00
BHR-8C	2-1/2"	R-8	5/8"	3/4"	200.00
BHR-8D	3"	R-8	3/4"	1-1/4"	225.00

Precise PUNCH GRINDER

- Full 360° grinding of punches and other round workpieces.
- Clamps workpiece rigidly in position.
- Built-in backstop prevents workpiece from sliding horizontally.
- Punch capacity up to 1" diameter.
- Locking mechanism also allows grinding of flats. All ball bearing construction.
- Parallelism of workpiece at less than 1' overhang, 0.0002".
- Green hammertone finish.
- Runout of rollers within .0002".
- Furnished complete with heavy duty vinyl coated wood case.

MODEL No. PPG-037

\$369.95



SPIN ROLL PRECISION FIXTURE FOR I.D. OR O.D. MADE IN USA

Intermeshing Contact Rolls Center, linear Position, Rotate & Release Workpieces In Seconds

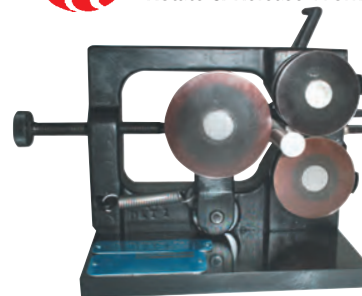

Simply mount this compact, portable, lightweight workholder on a suitable machine, insert the workpiece between the three intermeshing contact rolls and against the adjustable end stop. Tighten the clamping knob (no additional clamping, fitting or adjusting is necessary). Turn the hand crank (on the shaft of one contact roll). All rolls revolve and rotate the piece on its own circumference, achieving precise concentricity while maintaining linear position. Workpieces remove easily, Spin Roll assures exact duplication on multiple runs.

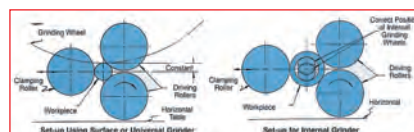

Model No.	Accommodates Body Dia.	Finished Length	Speed	Weight lbs.	Price Each
525-M	1/64" to 1-1/4"	5/8" to 5"	Manual	91 lbs.	\$ 849.95
530-M	1-1/4" to 3"	5/8" to 5"	Manual	22 lbs.	2495.00

narex UNIVERSAL BORING AND FACING HEAD SETS

Basic Machining Operations shown for the VHU type Universal Boring Heads

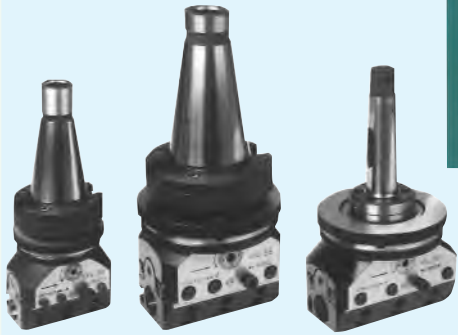

- 1 Boring of holes
- 2 Spotlacing of small end large diameter and faces
- 3 Recessing inside holes
- 4 Reccessing on surfaces of parts
- 5 Free recessing
- 6 External diameter machining
- 7 Boring of tapered holes
- 8 External machining of taper
- 9 Facing of rear end faces
- 10 Thread cutting



COMPLETE SETS CONSISTS OF:
 Boring head, 2 boring bars, 2 boring bar holders, reinforcing rings, 4 carbide tool bits, HSS tool bits, reducing sleeves and fitted case. Less Shanks.



Complete Sets less Arbor

Model No.	VHU-36	VHU-56	VHU-80	VHU-125
Price (Less Arbor)	\$2795.00	\$3595.00	\$3795.00	\$4995.00
Operating Accuracy	±.0002"	±.0002"	±.0002"	±.0002"
Boring and facing range from 0 up to	9"	13"	16"	24"
Max. adjustability of slide	1.375"	2.125"	3.125"	4.875"
Max. diameter of slide	2.750"	4.250"	6.250"	9.750"
Various automatic slide-feeds per revolution	.0016"	.004"	.004"	.004"
	.0032"	.006"	.006"	.006"
	.0048"	.008"	.008"	.008"
	.0005"	.0005"	.0005"	.0005"
1 graduation of sensitive adjustments ins. on dia.				
1 Revolution of sensitive adjustment	.016"	.016"	.016"	.016"
Quick return per revolution	.030"	.120"	.120"	.160"
Diameter of tool post holes in slide	5/8"	1"	5/8"	1-1/4"
Height of head without shank	3.125"	4.350"	4.350"	5.000"
Width of head	2.875"	4.500"	5.500"	8.725"
Weight of head without shank	4 lbs.	12 lbs.	16 lbs.	31 lbs.

Arbors for Above

Model Type	Type	Price	Price	Price	Price
10-2-	2MT	\$240.00	-	-	-
10-3-	3MT	250.00	-	-	-
10-4-	4MT	290.00	\$325.00	\$325.00	-
10-5-	5MT	-	-	375.00	\$375.00
10-6-	6MT	-	-	450.00	450.00
10-30-	ISA30	\$225.00	-	-	-
10-40-	ISA40	240.00	\$275.00	\$275.00	\$275.00
10-50-	ISA50	-	325.00	325.00	325.00
10-R8-	8-8	195.00	210.00	-	-
10-75-	3/4"SS	120.00	-	-	-
10-100-	1"SS	150.00	-	-	-
10-CAT40-	CAT40	\$325.00	\$350.00	\$350.00	\$365.00
10-CAT50-	CAT50	-	385.00	385.00	385.00
10-BT40-	BT40	325.00	365.00	365.00	365.00
10-BT50-	BT50	-	380.00	380.00	380.00

When ordering Arbors, specify Boring Head number after Model No. (Example 10-R8-VHU-36)

Atlas SUPER THIN UNIVERSAL 4-JAW SQUARE CHUCKS

- Universal scroll chuck design
- End-surface clamping design enables fast efficient mounting of several chucks to a worktable
- Super thin design allows greater Z-axis machining
- Elongated slots allows fast and easy positioning on worktable, simply use standard T-bolts, versus mounting connecting plates required by conventional chucks
- Milled key-slots on the base plate allows accurate quick changing of the chucks
- Ideal for pallet applications, Standard Mills, Vertical Machining Centers, Angle Plates, Tombstones, and Grinding Machines.
- American standard, hard top and master jaws
- One year warranty



Model No.	Chuck Size	Hole Size	Weight lbs.	Sale Price
MCA6	6"	1.57"	31	\$995.00
MCA8	8"	2.17"	46	1375.00
MCA10	10"	2.76"	70	1795.00
MCA12	12"	3.94"	124	2350.00

PBA AIR POWERED FRONT MOUNT 5C COLLET CHUCKS No Draw-Tube or Air Feed Tubes Required

- No hydraulic system required.
- No draw tube or air feed tubes restricting spindle bore.
- No rear cylinders and cylinder adapters.
- Easily convert any lathe or grinder into a production machine.
- Ideal for rotary table applications.
- Change form collet chuck to standard chuck quick and easy.
- High speed 5000 RPM.
- High accuracy less than .001" TIR.
- Repeats on duplicate parts plus minus .00015".
- Dead length design.
- Lever or foot pedal actuated.
- Low maintenance with mist lubrication system.
- High resistance to coolant and chip penetration.
- Available in A, D, L, 4 degrees, threaded and straight recess mounting.

Specifications:
 Screw hole dia. 9mm (0.35") x 4
 Collet type 5C collets
 Max. RPM 5000
 Sleeve stroke 4mm (0.16")
 Air pressure: 3-8kg/cm₂ (42-114 psi)
 Through hole dia. 26mm (1.06")
 Chuck weight 10kg (22 lbs)
 Grip force 10,500 lbs @ 100 psi

Choice of Mount:
 Type: DI-3, DI-4, D1-5
 D1-6, DI-8, A4, A5, A6, A8
 2-1/4"-8, 4° taper
 2-3/16"-10, 2-3/8-6



MODEL No. ATL-206

\$2995.00

W/Mount (Specify)
 Also Available for 16C collets and B42 collet (Inquire)

- Plus:**
- 2 filter bars
 - 2 air hoses
 - 1 fixing bracket for hoses
 - 1 FC collet wrench
 - 1 hex key
 - Mounting bolts
 - User manual

Atlas LOW PROFILE - SUPER THIN 3-JAW UNIVERSAL CHUCKS

- Three operating pinions positioned at a 45 degree angle for easier operation.
- Sizes available 6, 8, 10 and 12 inch diameter.
- Easy Installation with flange type mounting.
- One Year Warranty
- Accurate-.001" repeatability on duplicate parts using the nominated pinion.
- Ideal for Drill Presses, Standard Mills, Vertical Machining Centers, Angle Plates, Tombstones, and Grinding Machines.
- American standard hard top and master jaws



Weight:
 No. NBK6 27 lbs.
 No. NBK8 42 lbs.
 No. NBK10 64 lbs.
 No. NBK12 103 lbs.

Model No.	Chuck Diameter	Flange Diameter	*Total Height	Center Hole	Price Each
NBK6	6.69"	8.67"	2.43"	1.76"	\$925.00
NBK8	8.27"	10.63"	2.56"	2.36"	1375.00
NBK10	10.04"	12.40"	2.87"	3.15"	1650.00
NBK12	12.00"	14.55"	3.16"	4.13"	1995.00

*Total Height Does Not Include Jaw Height



AIR POWERED 5C STATIONARY DEAD LENGTH COLLET CHUCK

- Use for parallels, tombstones, machining centers, standard mills and drills.

MODEL No. 225-5C
 Reg. \$625.00

\$575.00

MADE IN USA

Accessories

Model	Description	Price
LEV-100	Lever control, Filter, Lubricator, Regulator, Lines & Fittings	\$290.00
FOT-200	Foot control, Filter, Lubricator, Regulator, Lines & Fittings	590.00





BISON 5C PRECISION ROUND COLLETS

0.00005" Concentricity Guaranteed

Made In Italy



5C Round Hole

5C Hex Hole



Bison 5C Round (#5CR- Specify Size)

Model	Type Range & Increment	Price
5CR-(Size)	Round 3/64"	\$19.50
5CR-(Size)	Round 1/16", 5/64", 3/32" and 7/64"	12.95
5CR-(Size)	Round 1-5/64", 1-3/32", 1-7/64" and 1-1/8"	21.95
5CR-(Size)	Round 3/64" thru 7/64" by 64ths	19.95
5CR-(Size)	Round 1/8" thru 1-1/16" by 64ths	11.95
5CRM-(Size)	Round Metric 3mm thru 26mm by 1mm	11.95

Bison 5C Round Collet Sets

510-008	1/8" thru 1" by 8ths 8 Pcs.	\$85.00
510-015	1/8" thru 1" by 16ths 15 Pcs.	155.00
510-029	1/8" thru 1" by 32nds 29 Pcs.	295.00
510-065	1/8" thru 1-1/16" by 64ths 60 Pcs.	635.00

Precise 5C Hex & Square Hole

5CH-(Size)	Hex 1/8" thru 7/8" by 16ths	\$17.95
5CS-(Size)	Square 1/8" thru 3/4" by 1/16ths	17.95

Precise 5C Hex & Square Hole Collet Sets

5CR-130	13 Pc. Hex Collet 1/8" thru 7/8" by 1/16ths	\$210.00
5CS-110	11 Pc. Square Collet set 1/8" thru 3/4" by 1/16ths	161.50

Precise 5C & R8 EMERGENCY COLLETS

Especially well suited for holding soft or delicate workpieces without marring surfaces.



Model No.	Pilot Hole	Material & Type	Price Each
5CES	1/16"	Steel 5C	\$11.95
R8ES	1/16"	Steel R8	24.95
5CEB	1/16"	Brass 5C	24.95
5CEN	-	Nylon 5C	16.95

Precise 5C CLUTCH COLLETS



- One piece construction
- Easily machined.
- Precision ground body
- Spring tempered to allow easy workpiece loading and removal.
- Fits all 5C closers and fixtures.
- Can be rebored for additional jobs.

Model No.	Head Diameter	Pilot Hole	Price Each
5C2	2"	1/4"	\$22.95
5C3	3"	5/16"	28.95
5C4	4"	5/16"	42.95
5C5	5"	5/16"	49.95
5C6	6"	5/16"	59.95

Precise 5C FIXTURE MOUNTS

- A lathe tool for use in place of faceplate fixtures.
- Quick mounting and dismounting.
- Repeat accuracy.
- Soft head for easy machining.
- Heat treated tool steel shank.
- Precision ground all over.
- Black oxide finish.

Model No.	Head Dia.	Head Length	Price Each
FM-470	2"	1"	\$19.95
FM-472	2"	3"	22.95
FM-473	3"	1"	\$24.95
FM-475	3"	3"	34.95
FM-476	4"	1"	39.95
FM-478	4"	3"	45.95
FM-479	5"	1"	48.95
FM-480	6"	1"	52.95



Precise 5C ADJUSTABLE COLLET STOP

- Hardened.
- Fully threaded.
- For chucking parts to a depth from face of collets.

3/8" - 16 Thread
MODEL No. ACS **\$6.95**



Precise 5C UNIVERSAL COLLET STOP

- Converts standard 1" capacity lathe collets into solid stop or spring ejector stop collets without alteration of the standard collets.
- Fits directly into collet.
- Shining black finish.

MODEL No. MCS-386 **\$12.95**



BISON R8 PRECISION COLLETS

0.00004" Concentricity Guaranteed

Made In Italy



Bison Specify Size to Model #R8-(Size)

Model	Range & Increments	Price
R8C-(Size)	1/16" and 3/32nds	\$19.95
R8C-(Size)	1/8" thru 3/4" by 32nds	11.95
R8C-(Size)	25/32", 13/16", 27/32", 7/8" and 1"	19.95
R8CM-(Size)	Metric 2mm thru 20mm	11.95

Bison R8 Collet Sets

810-060	1/8" thru 3/4" by 8ths 6 Pcs.	\$ 63.95
810-011	1/8" thru 3/4" by 16ths 11 Pcs.	116.95
810-021	1/8" thru 3/4" by 32nds 20 Pcs.	219.00
810-027	1/16" thru 7/8" by 32nds 27 Pcs.	575.00

R8 COLLET ROTATING HOLDER

- Holds your eleven most used R8 collets conveniently in a revolving tray.



MODEL No. 90-360
\$24.95
Less Collets

R8 HOLDER WITH COVER

- Easy to mount on the side of your machine with two 1/4" screws.
- Holds 12 R8 collets.
- Closed cover protects collets from chips at all times.
- Collets not included.



MODEL No. CR-R8 **\$14.95**
Less Collets

R8 COLLET TOOL TRAY

- This convenient tray will cut down setup and tool changing time.
- Every operator works more efficiently when tools are neatly organized.
- Easy to install, only a few minutes are required to drill and tap 1/4" holes in the base casting 1" below the degree ring.



MODEL No. CTT-008
\$16.95

Precise 5C & R8 COLLET RACKS

- Made of durable heavy aluminum.
- Double plate construction.
- Selects collets instantly and retains collets firmly.
- Can be set on machine or bench or mounted on wall.



Holds 72 5C Collets
MODEL No. 150-072

Dimensions:
12-1/2" High
15-1/2" Wide
8" Deep

\$29.95

Holds 48 R8 Collets
MODEL No. 150-048

\$22.95

5C Rack

- Holds up to 30 collets.
- Baked enamel paint finish.
- Hangs on wall or machine, or sets on a shelf or workbench.
- Collets not included.

MODEL No. CR-5C **\$12.95**

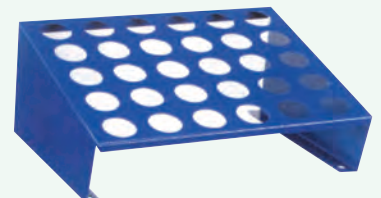

Precise 5-C COLLETS & SETS

HARDENED & GROUND THROUGHOUT

- Precision: .0006" TIR



Rack not included with Sets
 Outside Thread 1.245 x 20 R.H.
 Inside Thread 1.047 x 24 R.H.

Series	Description	Price
005-*	3/64" thru 1-1/8" by 64ths *Note: To order specify series & size I.E. .005-1/2"	\$5.95 Each
SETS WITH COLLET RACK		
005-008	1/8" thru 1" by 8ths, 8 Pcs.	\$42.95
005-015	1/8" thru 1" by 16ths, 15 Pcs.	79.95
005-029	1/8" thru 1" by 32nds, 29 Pcs.	159.95
005-065	1/8" thru 1" by 64ths, 65 Pcs.	349.95

\$5.95

Each
 From 3/64" Thru
 1-1/8" By 64ths

Precise R-8 COLLETS & SETS

HARDENED & GROUND THROUGHOUT

- Precision: .0006" TIR



7/16-20
 Draw Bar
 Thread

Rack not included with Sets

Series	Description	Price
008-*	1/16" thru 7/8" by 32ndths *Note: To order specify series & size I.E. .008-3/4"	\$5.95 Each
008-100	1" R-8 Collet	5.95
SETS WITH COLLET RACK		
008-060	1/8" thru 3/4" by 8ths, 6 Pcs.	\$32.95
008-011	1/8" thru 3/4" by 16ths, 11 Pcs.	59.95
008-021	1/8" thru 3/4" by 32nds, 21 Pcs.	112.50
008-022	1/8" thru 7/8" by 32nds, 25 Pcs.	133.95

\$5.95

Each
 1/32" Thru 7/8"
 By 32nds



TIN COATED 5-C COLLETS TIR .0005" GUARANTEED

- A special high precision collet with a guaranteed TIR of .0005"
- Tin coated for wear and corrosion resistance.
- Available in 1/16" increments from 1/16" - 1".

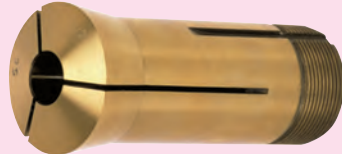

Model	Size	Price
TCC-001-1	1/16"	\$8.95
TCC-002-1	1/8"	8.95
TCC-003	3/16"	8.95
TCC-004	1/4"	8.95
TCC-005	5/16"	8.95
TCC-006	3/8"	8.95
TCC-007	7/16"	8.95
TCC-008	1/2"	8.95

SAVE MORE!
 Complete Set
 16 Pcs
 1/16" thru 1"
 by 1/16ths
 SET No.
 TCC-017
\$129.95

Model	Size	Price
TCC-009	9/16"	\$8.95
TCC-010	5/8"	8.95
TCC-011	11/16"	8.95
TCC-012	3/4"	8.95
TCC-013	13/16"	8.95
TCC-014	7/8"	8.95
TCC-015	15/16"	8.95
TCC-016	1"	8.95

Precise R-8 TOOLING ROTATING COLLET CADDY

- Fits Bridgeport type mills. • Holds 16 R-8 collets. • Easy installation. Includes rotating rack, steel mounting bracket and bolt assembly.



Empty
 Collet
 Caddy
 MODEL No.
 RCC-001
\$24.95

With 11 Pc.
 R-8 Collets
 1/8" - 3/4" by 16ths
 MODEL No.
 RCC-002
\$79.95

KI KALAMAZOO 5C COLLET CHUCK

- For short runs using a 5C collet, chuck this collet holder and you're ready to go!
- Lock and release at the front Heavy-Duty all steel, hardened and ground.
- Drilled and tapped holes at rear of collet chuck for mounting to a plate.



MADE IN
 USA

5C Collet Chuck
 MODEL No.
 ICC-001
\$389.95

Shown On Optional
 Fixture Plate
 No. ICC-002 **\$95.00**

Precise PUNCH FORMER - ER32 COLLETS

- Clamping diameter: .0787~.787"
- Clamps workpiece quickly and steadily when processing without checking the center.
- Utilized with ER32 spring collet.

MODEL No.
 VPS-320
 Reg. \$795.00

\$620.00

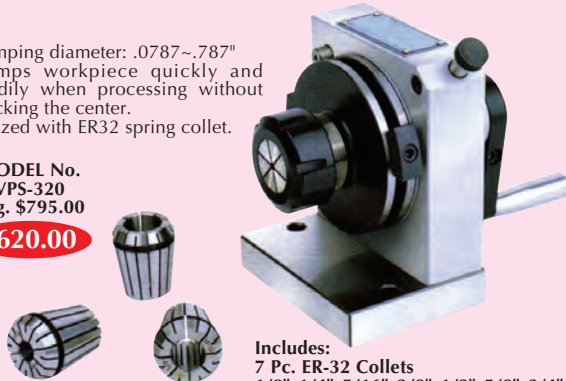

Includes:
 7 Pc. ER-32 Collets
 1/8", 1/4", 5/16", 3/8", 1/2", 5/8", 3/4"



STRAIGHT SHANK SHELL MILL ARBOR

- Fully hardened and ground.
- Solid one piece shank head and plug.



Model	Shank	Bore	Price
SMA-100	1/2"	1/2"	\$78.00
SMA-200	1/2"	3/4"	78.00
SMA-300	3/4"	3/4"	78.00
SMA-400	3/4"	1"	87.00
SMA-500	3/4"	1-1/4"	87.00
SMA-600	1"	1"	87.00

Precise FLY CUTTERS

- Counterbalanced to get smoother finishes. • Made of hardened steel.
- Machines up to 6" wide surface with standard tool bit.
- Shiny black finish. • Sets supplied on wooden stand.

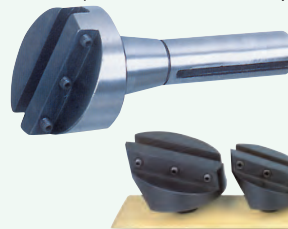

R-8 Shank, uses 5/16" tool bits
 MODEL No.
 FC-R8
\$19.95

Consists of 5 pcs with 1/2" Shank suitable for 3/16", 1/4", 5/16", 3/8" tool bits and 1 Pc with 5/8" Shank suitable for 1/2" tool bits.

SET No.
 FCH-397
\$29.95

Precise EXPANDING 5C COLLET SET

- Highly effective expansion up to .006".
- Soft head for easy mounting.
- Heat Treated tool steel 5-C collet shank, precision ground all over.
- One Piece construction.
- Head width 1".
- Kit includes collets No. 1 to No. 4" fitted stand, range 1/44" - 1-15/16".



SET NO. EX-5C

\$79.95

Replacement Collets

Model	Range	Price
EX1	Collet No. 1 .250-.468" range	\$29.95
EX2	Collet No. 2 .437-.800" range	29.95
EX3	Collet No. 3 .750-1.437" range	29.95
EX4	Collet No. 4 .750-1.937" range	29.95

HAND-E-EXPANDING ARBORS

- Chuck arbor in machine to be used.
- Tighten expanding screw so that arbor expands .005".
- Loosen expanding screw.
- Machine arbor to length and size required.
- Position part on arbor and tighten expanding screw.
- All Arbors are also sold separately. Inquire.



8-Piece Set
1/4" to 1-1/4" By 1/8ths
SET No. 9125

\$49.95



3-Piece Set
1-1/2", 1-3/4", 2"
SET No. 9121

\$129.95

SPEED STOP EXPANDING COLLET STOPS

- Ingenious design expanding collet stop.
- The patented Delrin sleeve expands tightly inside the collet, forming a solid grip which eliminates push-back.
- Fits all standard 5C collets with threaded I.D.
- Lightweight aluminum construction eliminates possible vibrations.
- 3/8" diameter stop bar is adjustable with a set-screw.
- Optional precision machined spring ejector rod with 3 steel tips 1/4", 3/8" and 1/2" diameter.
- Made in USA.



Model	Description	Price
5CS-100	5-C Collet Stop	\$32.95
3JC-200	3-J Collet Stop	54.95
SCS-100	#10 Collet Stop	29.95
SCS-200	#11 Collet Stop	34.95
SCS-300	#16C Collet Stop	49.95
SCS-400	#21 Collet Stop	35.95
SCS-500	#22 Collet Stop	38.95
EJR-100	Spring Ejector Rod to fit Collets 5-C, #11, #21 and #22 only	\$34.95



Precise 5C COLLET WRENCH

- Simplifies insertion and removal of collet on the spindle noses of CNC turning machines.
- Steel head with comfort handle.

MODEL No.
900-016

\$18.95



EAGLE ROCK® 5C EXPANDING MACHINABLE INTERNAL COLLETS

The most effective and accurate means of internal chucking short runs to mass production. Once Seated in spindle and machined to size, these collets can hold concentricity well within .0005".
Machinable to any configuration within their stock and minimum diameters.



5C Extended Collets

Made for holding delicate or long and narrow parts or where there is a machine clearance problem. Machinable to any dimension within their range, only the front (1" long) expands.



Note:
Dimensions "A" Min. Machinable Diameter is .750"

Model No.	Length	Diameter Maximum	Diameter Minimum	Price Each
20801	1"	1/2"	.250"	\$ 42.50
20830	2"	1/2"	.250"	92.00
20831	3"	1/2"	.250"	115.00
20834	1"	3/4"	.250"	42.50
20802	1"	1"	.437"	42.50
20832	2"	1"	.437"	92.00
20833	3"	1"	.437"	115.00
20803	1"	1-1/2"	.750"	42.50
20804	1-1/2"	1-1/2"	.750"	70.00
20805	2"	1-1/2"	.750"	75.00
20806	2-1/2"	1-1/2"	.750"	95.00
20807	3"	1-1/2"	.750"	105.00
20808	1"	2"	.750"	75.00
20809	1-1/2"	2"	.750"	80.00
20810	2"	2"	.750"	95.00
20811	2-1/2"	2"	.750"	105.00
20812	3"	2"	.750"	120.00
20813	1"	2-1/2"	.750"	85.00
20814	1-1/2"	2-1/2"	.750"	95.00
20815	2"	2-1/2"	.750"	105.00
20816	2-1/2"	2-1/2"	.750"	120.00
20817	3"	2-1/2"	.750"	130.00
20818	1"	3"	.750"	105.00
20819	1-1/2"	3"	.750"	115.00
20820	2"	3"	.750"	120.00
20821	2-1/2"	3"	.750"	130.00
20822	3"	3"	.750"	150.00
20823	1"	4"	.750"	115.00
20824	1-1/2"	4"	.750"	125.00
20825	2"	4"	.750"	140.00
20826	2-1/2"	4"	.750"	150.00
20827	3"	4"	.750"	160.00
20828	2"	5"	.750"	200.00
20829	2"	6"	.750"	225.00

5C EXTERNAL OVERSIZE COLLET - STEEL OR ALUMINUM

Exchangeable On Adapter

- May be machined for irregular shapes.
- May be used in any application where a 5C collet can be used.
- Adapter broached for 3/8" Allen wrench, large end, to facilitate head removal.

Steel or Aluminum

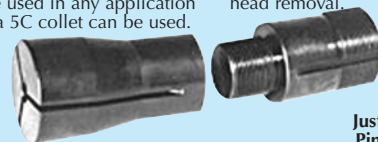

MODEL
03-142
5C Adapter

Just Insert Furnished Pin, Draw-in Collet, and Bore or Mill to Size.

Model No.	Collet Diameter	Collet Thickness	Collet Price
03-134	1-1/2"	7/8"	\$24.95
03-135	2"	3/4"	29.50
03-136	2"	1-1/4"	33.00
03-137	2-1/2"	1"	33.00
03-138	2-1/2"	1-1/2"	35.50
03-139	3"	1"	35.50
03-140	3"	1-5/8"	39.90
03-141	4"	1"	44.50
03-142	5C Adapter		\$20.50

Note: If Aluminum Collet is Desired Add "A" to Model Number Otherwise Steel Will Be Shipped.

THE PERFECT CUT FLUSH MILLING ARBORS



- Side milling cutter for face milling horizontally or vertically.
- Cutter cuts its full diameter of flat surface.
- Complete with all spacers, bushings and keys.
- For typical milling operations.
- Includes flush arbor.



Model No.	Taper Size	Max. Cutter Width	Cutter Hole Size	Price Each
25304006	R8	3/4"	1 & 1-1/4"	\$295.00
25304007	3/4" SS	3/4"	1 & 1-1/4"	325.00
25304008	1" SS	3/4"	1 & 1-1/4"	325.00
25304009	1-1/4" SS	3/4"	1 & 1-1/4"	325.00
25304010	2" SS	1-1/4"	1-1/2"	450.00
25304002	40 NMTB	3/4"	1 & 1-1/4"	\$395.00
25304003	50 NMTB	3/4"	1"	450.00
25304005	50 NMTB	1"	1-1/4"	550.00
25304004	50 NMTB	1-1/4"	1-1/2"	595.00



Typical Milling Operations With Flush Arbors Horizontal or Vertical



Precise SEMI-FLUSH MILLING ARBORS MADE IN USA

A series of adapters permits the use of cutters having holes smaller than 1". They extend the cutter 1.25 inches below the arbor holder providing better access with the smaller diameter cutters.

- The clamping force of the drawbar couples the nut directly to the cutter. The cutter becomes part of the spindle.
- Arbor holder is hardened and ground to eliminate cutter runout.
- Steel keys assure positive drive.
- Machine in either direction without unscrewing the nut.

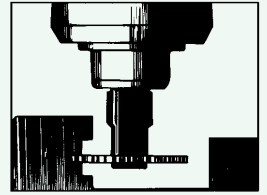

R8 Taper Stub Semi-Flush Arbors - Cutters to 1/2" Wide

Model No.	Cutter Hole Dia.	O.D.	Price Each
25400001	1"	1.50"	\$265.00
25400003	1-1/4"	1.75"	285.00



1" Straight Shank Semi-Flush Arbors - Cutters to 1/2" Wide

Model No.	Cutter Hole Dia.	O.D.	Price Each
25400005	1"	1.625"	\$265.00
25400007	1-1/4"	1.375"	285.00



Semi-Flush Adapter For 1" Arbors

Model No.	Cutter Hole Dia.	O.D.	Price Each
25400017	1/2"	7/8"	\$185.00



UNIVERSAL LATHE SPINDLE AND COLLET STOP
For Use with CNC, Manual Lathes & Indexing Heads

Fully adjustable to fit a wide variety of applications

- Cut time dramatically on jobs where the part must be registered in machine more than one time or where more than one part is to be machined.
- Just slide the body into the spindle of the machine, rotate the T-handle wrench which expands 3 keys, lock the body securely into position.
- When the chuck or collet is opened, and the next piece loaded into machine, all distances from the stop will repeat exactly.

- Design Features:**
- Completely self-centering
 - Only a few seconds to install
 - Greater rigidity - insures duplication
 - Cannot vibrate or change position once it is locked
 - Rejections cut to a minimum



Model No.	Dimensions			To Fit Spindle Size	List Price	Sale Price
	A	B	C			
S-00	11-1/4"	3-1/4"	-	9/16" to 23/32"	\$241.00	\$229.95
S-0	10-7/8"	4-5/16"	4-5/16"	3/4" to 15/16"	237.00	225.00
S-1	12-1/4"	4-1/2"	6"	1" to 1-1/4"	339.00	320.00
S-2-1	19"	6-7/16"	6-1/2"	1-5/16" to 1-11/16"	418.00	390.00
S-3-1	21-1/2"	7-7/8"	10-1/2"	1-3/4" to 2-7/16"	497.00	465.00
S-4-1	22-1/4"	9-1/4"	10-1/2"	2-1/2" to 3-1/2"	751.00	695.00
S-5	22-1/4"	12"	10-1/2"	3-5/8" to 4-1/2"	1073.00	985.00

Precise TOOLHOLDER BUSHINGS TYPE "C"

- Made of high quality tool steel.
- Tool Holder Bushing for universal use on all CNC turning machines to adapt a wide variety of boring bars, drills, reamers and shank type tools.
- Hardened and precision ground to highest concentricity.

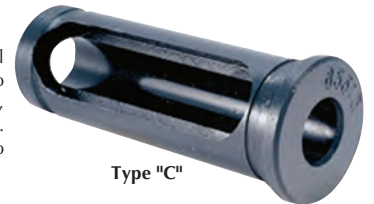

Model No.	O.D. Diameter	I.D. Diameter	Slot Length	Length to Shoulder	Price Each
3900-1911	3/4"	1/4"	1-7/8"	2-1/4"	\$39.95
3900-1913	3/4"	3/8"	1-7/8"	2-1/4"	39.95
3900-1914	3/4"	1/2"	1-7/8"	2-1/4"	39.95
3900-1915	1"	1/4"	2-3/8"	2-3/8"	\$41.95
3900-1917	1"	3/8"	2-3/8"	2-3/8"	41.95
3900-1918	1"	1/2"	2-3/8"	2-3/8"	41.95
3900-1919	1"	5/8"	2-3/8"	2-3/8"	41.95
3900-2910	1"	3/4"	2-3/8"	2-3/8"	41.95
3900-2911	1-1/4"	3/8"	2-7/8"	3-1/4"	\$46.00
3900-2912	1-1/4"	1/2"	2-7/8"	3-1/4"	46.00
3900-2913	1-1/4"	5/8"	2-7/8"	3-1/4"	46.00
3900-2914	1-1/4"	3/4"	2-7/8"	3-1/4"	46.00
3900-2916	1-1/4"	1"	2-7/8"	3-1/4"	46.00
3900-2918	1-1/2"	1/2"	3"	3-3/8"	\$52.00
3900-2919	1-1/2"	5/8"	3"	3-3/8"	52.00
3900-2920	1-1/2"	3/4"	3"	3-3/8"	52.00
3900-2922	1-1/2"	1"	3"	3-3/8"	52.00
3900-2923	1-1/2"	1-1/4"	3"	3-3/8"	52.00

ROYAL 5C PNEUMATIC COLLET CLOSER FOR MANUAL LATHES & GRINDERS

- The Royal 5C pneumatic collet closer enables 5C collets to be used on any manual lathe or workhead.
- This new model, based upon Royal's 50+ years of collet closer experience, has been designed for heavy use under the most demanding manufacturing conditions.
- Fast opening/closing action makes the Royal pneumatic collet closer a great choice for high production applications.
- Closer is very easy to actuate, resulting in minimal worker fatigue and maximum productivity.
- The air cylinder incorporates a large diameter piston, providing strong grip force on the workpiece.
- Royal 5C Pneumatic Collet Closer incorporates several modern safety features designed to help shops meet OSHA and NIOSH requirements. Unlike other collet closers, there are no exposed rotating parts on the outboard side of the machine.
- Pneumatic collet closer assembly includes air cylinder, custom-machined rear end spindle adapter, drawtube, and cam-lock collet adapter. Air controls sold separately.



.0003" TIR Guaranteed

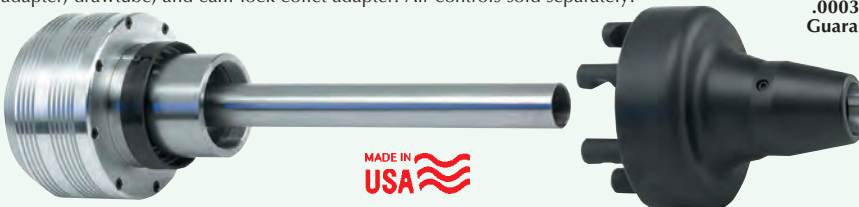

Model	Description	Price
16001	Air Control Kit w/Hand Valve	\$344.00
16002	Air Control Kit w/Foot Valve	\$542.00

Specifications:

- Drawtube Capacity (inches)1.06
- Cylinder O.D. (in.)5.94
- Max. Operating Speed (rpm)*.4,000*
- Max. Air Pressure (psi) 90
- Piston Surface Area (sq. in.)14.72
- Max. Drawtube Force (lbs.)1,325
- Max. Clamping Force (lbs.)4,520

Model No.	For lathes With Spindle Nose Type	Price Each	Model No.	For Lathes With Spindle Nose Type	Price Each
17200-1	A-3 or D1-3	\$2265.00	17204	A-8 or D1-8	\$3240.00
17201	A-4 or D1-4	2375.00	17210	Haas TL-1*	2425.00
17202	A-5 or D1-5	2615.00	17211	Haas TL-2*	2615.00
17203	A-6 or D1-6	2850.00	*Haas TL-1 & TL-2 are registered trademarks of Haas Automation, Inc.		



SUPER PRECISION QUICK CHANGE TOOL POSTS AND HOLDERS

GUARANTEED LASTING REPETITIVE ACCURACY TO WITHIN MILLIONTHS



FEATURES:

- Only a second to change tools.
- Rugged – no chatter or vibration.
- No time wasted with shims.
- Unlimited versatility.
- Safe and simple to operate.
- Speed your lathe operations up to 90%.
- Guaranteed.



The ALORIS Super Precision tool post provides built-in quick tool changing versatility and flexibility combined with wide range, positive control and repetitive accuracy to meet the most exacting working tolerances. Whether for tool room or production work, the Aloris line of tool posts and holders will save set-up time and increase production on all types of lathe operations from fine precision work to heavy duty cutting without chatter or vibration.

Complete Aloris Product Catalog Available Free Upon Request.

Aloris Super Precision Tool Post

Model No.	Lathe Capacity	Size Blank	Price Each
AXA	Swing up to 12"	2-1/2"	\$339.00
BXA	Swing from 10"-15"	3"	412.00
CXA	Swing from 13"-18"	3-1/2"	562.00
CA	Swing from 14"-20"	4"	707.00
DA	Swing from 17"-48"	5"	995.00
EA	Swing 25"	6"	1575.00



Heavy duty or larger

Price Does Not Include Tool Holders Or Tools

Turning & Facing Holder

No. 1

Takes various sizes of bits. Turning and facing tools can be locked in together. Saves time and labor when changing operations.



Model No.	Tool Bit	Fits Tool Post	Price Each
AXA-1	3/16"-1/2"	AXA	\$ 55.00
BXA-1	1/4"-5/8"	BXA	64.50
CXA-1	1/2"-3/4"	CXA	80.75
CA-1	1/2"-1"	CA	97.85
DA-1	1/2"-1-1/4"	DA	145.00
EA-1	3/4"-1-1/2"	EA	228.00

Boring, Turning & Facing Holder

No. 2

"V" groove holds round shank boring bars and tools as well as square tool bits.



Model No.	Tool Bit	Shank Dia.	Fits Tool Post	Price Each
AXA-2	3/16"-1/2"	7/16"	AXA	\$ 55.00
BXA-2	1/4"-5/8"	1/2"	BXA	64.50
CXA-2	1/2"-3/4"	3/4"	CXA	80.75
CA-2	1/2"-1"	13/16"	CA	97.85
DA-2	1/2"-1-1/4"	13/16"	DA	145.00
EA-2	3/4"-1-1/2"	1-1/4"	EA	228.00

Heavy Duty Boring Bar Holder

No. 4

Equipped with a split bushing to accommodate a boring bar of smaller diameter. It grips bar with extreme rigidity, cuts smoothly without chatter.



Model No.	Boring Bars	Fits Tool Post	Price Each
AXA-4	3/4" & 5/8"	AXA	\$120.65
BXA-4	1" & 3/4"	BXA	129.00
CXA-4	1" & 3/4"	CXA	157.75
CA-4	1-1/4" & 1"	CA	183.25
DA-4	1-1/2" & 1-1/4"	DA	246.00
EA-4	2" & 1-1/4"	EA	449.00

Extension Tool Holder

No. 13

A new addition to the versatile Aloris dovetail mounted quick-change tool holder series. The No. 13 provides an extremely rugged extended open slot featuring maximum rigidity for deep turning or facing operation.



Model No.	Boring Bars	Fits Tool Post	Price Each
AXA-13	3/16" - 1/2"	AXA	\$ 94.00
BXA-13	1/4" - 5/8"	BXA	106.40
CXA-13	1/2" - 3/4"	CXA	118.75
CA-13	1/2" - 1"	CA	141.50
DA-13	1/2" - 1-1/4"	DA	235.50
EA-13	3/4" - 1-1/2"	EA	350.00

Morse Taper Holder

No. 5

Drills with carriage by using power feed instead of tail stock. Easily centered.

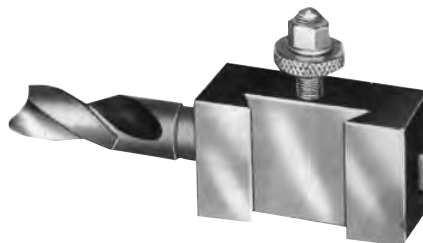

Model No.	Boring Bars	Fits Tool Post	Price Each
AXA-5	2 M.T.	AXA	\$ 89.25
BXA-5	2 M.T.	BXA	94.00
CXA-5	3 M.T.	CXA	117.75
CA-5	3 M.T.	CA	137.75
DA-5	4 M.T.	DA	203.00
EA-5	5 M.T.	EA	362.50

Universal Parting Blade Holder

No. 7

For bevel as well as T-type blades. Enables you to cut-off close to chuck. Absence of vibration prevents breaking blades.



Model No.	Taper Hole	Fits Tool Post	Price Each
AXA-7	1/2"	AXA	\$ 96.50
BXA-7	11/16"	BXA	118.75
CXA-7	3/4"	CXA	120.95
CA-7	7/8"	CA	162.00
DA-7	1-1/8"	DA	178.90
EA-7	1-1/8"	EA	243.95

Threading Holder

No. 8

This universal threading holder comes with an interchangeable high speed threading blade which has two cutting edges. You may now reverse your spindle and cut a thread without fear of hitting shoulders.



Blade Supplied

Model No.	Blade Supplied	Fits Tool Post	Price Each	Extra Blade
AXA-8	#P-10	AXA	\$117.75	\$51.00
BXA-8	#P-6	BXA	127.25	51.00
CXA-8	#P-6	CXA	143.45	51.00
CA-8	#P-4	CA	164.25	51.00
DA-8	#P-4	DA	206.00	51.00
EA-8	#P-4	EA	303.00	51.00

Knurling, Facing & Turning

No. 10

For turning and facing as well as knurling. Included with a set of high speed precision ground and lapped medium diamond knurls. Easily replaceable.



Model No.	Knurl Size	Tool Bit	Fits Tool Post	Price Each
AXA-10	3/4" x 3/8"	3/16"-1/2"	AXA	\$120.65
BXA-10	3/4" x 3/8"	1/4"-5/8"	BXA	141.50
CXA-10	3/4" x 3/8"	1/2"-3/4"	CXA	160.50
CA-10	3/4" x 3/8"	1/2"-1"	CA	165.00
DA-10	3/4" x 3/8"	1/2"-1-1/4"	DA	250.00

Combo CNC Bar Puller

- Mounts into tool slot on CNC turrets easily adjustable with knurls installed the range is 1/8"-2". Opposing forces on knurls create little or no force on the machine.
- Remove the two knurl lock screws, replace with bar grippers and use as a heavy duty bar puller.

1" Square Shank

MODEL No. AT-20
\$395.00

Less Knurls and Gripper Pads



Diamond Straight

No. AT-20G ... \$95.00 Pair Gripper Pads
No. AD-16 ... \$16.00 Ea. Diamond Knurls
No. AS-16 ... \$16.00 Ea. Straight Knurls (2 Required)



SUPER PRECISION TOOL HOLDERS

MULTIPLE TOOL HOLDER

Versatile, ideal for repetitive work: for gang set-ups or form tool.



Series No. 6

Model No.	Tool Bit	Fits Tool Post	Price Each
AXA-6	1/4"-1/2"	AXA	\$ 94.05
BXA-6	1/4"-1/2"	BXA	110.00
CXA-6	5/8"-5/8"	CXA	123.50
CA-6	1/2"-3/4"	CA	173.85
DA-6	1/2"-1"	DA	209.00
EA-6	6-3/4"-1-1/4"	EA	392.35

ADJUSTABLE KNURLING HOLDER

Excellent knurling is provided with this new type knurling holder. The self-centering tool is adjustable providing the ideal near-vertical-axis approach angle for a wide range of stock dia. There is minimized pressure on the spindle and cross-slide, and knurling of thin wall tubing is therefore easily performed. Precision Ground, high-speed medium diamond knurls are supplied unless otherwise specified.



Series No. 19

Model No.	Tool Bit	Fits Tool Post	Price Each
AXA-19	1/4"-1/2"	AXA	\$315.40
BXA-19	1/4"-1/2"	BXA	329.65
CXA-19	3/8"-5/8"	CXA	348.65
CA-19	1/2"-3/4"	CA	360.05
DA-19	1/2"-1"	DA	392.35

DOVETAIL CHUCK HOLDER NO. 35

The uniquely designed dovetail chuck holder permits quick and accurate mounting of drills, reamers, taps, boring bars, etc. And feed by means of your lathe's carriage power drive. The chuck is mounted in a recessed position for minimum overhang, permitting use of the entire usable length of the tool. Dovetail holder supplied complete with chuck and key.

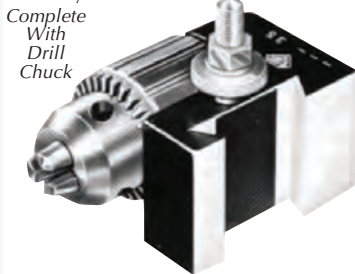

Complete With Drill Chuck

Model No.	Tool Bit	Fits Tool Post	Price Each
AXA-35	0-1/2"	AXA	\$234.65
BXA-35	0-1/2"	BXA	247.00
CXA-35	0-1/2"	CXA	260.30
CA-35	0-3/4"	CA	303.05
DA-35	0-3/4"	DA	342.00



FREE!
ALORIS
#84 CATALOG
UPON REQUEST

TURNING HOLDER FOR CARBIDE TRIANGULAR INSERTS

Accommodates standard triangular carbide inserts negative rake. Furnished with fully adjustable carbide chip-breaker and carbide shim to protect the holder.



Series No. 12

Model Positive	Model Negative	Carbide Insert	Price Each
AXA-12	AXA-12N	3/8" I.C.	\$134.90
BXA-12	BXA-12N	3/8" I.C.	145.35
CXA-12	CXA-12N	3/8" I.C.	158.65
CA-12	CA-12N	1/2" I.C.	175.75
DA-12	DA-12N	1/2" I.C.	228.00

COMBINATION TURNING AND FACING HOLDER FOR CARBIDE TRIANGULAR INSERTS

Accommodates standard triangular positive, rake inserts. Unique design permits both right hand and left hand turning and facing. Supplied with fully adjustable carbide chip-breakers and carbide shims to protect the holder.

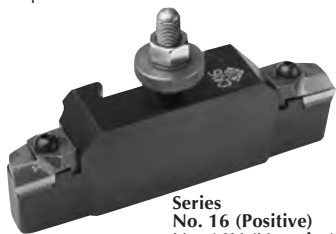

Series No. 16 (Positive)
No. 16N (Negative)

Model Positive	Model Negative	Carbide Insert	Price Each
AXA-16	AXA-16N	3/8" I.C.	\$184.30
BXA-16	BXA-16N	3/8" I.C.	203.30
CXA-16	CXA-16N	3/8" I.C.	228.00
CA-16	CA-16N	1/2" I.C.	253.65
DA-16	DA-16N	1/2" I.C.	285.00
EA-16	EA-16N	1/2" I.C.	412.30

TURNING TOOL HOLDERS POSITIVE AND NEGATIVE RAKE

Adjustable carbide chip-breaker provides excellent chip control.



Dim. A x C
AT-12-3 3/4" x 4-1/2"
AT-12-4 1" x 6"

Model Positive	Model Negative	Carbide Insert	Price Each
AT-12-3	AT-12N-3	3/8" I.C.	\$122.25
AT-12-4	AT-12N-4	3/8" I.C.	129.60

CARBIDE TRIANGLE INSERTS

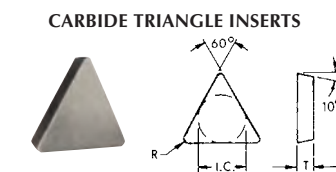

Positive Rake

Model Positive	Dimensions I.C. x T x R	Price Each
TPG-322	3/8" x 1/8" x 1/32"	\$3.95
TPG-432	1/2" x 3/16" x 1/32"	4.50

Model Negative	Dimensions I.C. x T x R	Price Each
TPG-321	3/8" x 1/8" x 1/32"	\$3.95
TPG-432	1/2" x 3/16" x 1/32"	4.50



SUPER PRECISION TOOL HOLDERS

UNIVERSAL TOOL HOLDERS

No. 20 and No. 22 FOR RIGHT OR LEFT HAND TURNING FACING, CHAMFERING & BORING

A unique design of model #20 holder provides for many angular turning, tracing and chamfering operations. The cartridge has 12 indexing positions at 15° intervals.

The model #22 with its two dovetail design leads to a wide range of applications by permitting front and rear turning, tracing, boring and facing operations.

Two-way adjustable rake for right or left hand turning with 5° cutting angle, positive stop.



No. 20

Cartridge Cradle

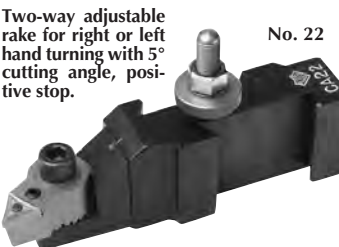

No. 22

Two-way adjustable rake for right or left hand turning with 5° cutting angle, positive stop.

Cartridge Cradle

Model No.	Fits Tool Post	With Cartridge	Price Each
AXA-20	AXA	CRT-20	\$187.00
BXA-20	BXA	CRT-20	200.00
CXA-20	CXA	CRT-20	215.00
CA-20	CA	CRT-20	249.00
AXA-22	AXA	CRT-20	\$228.00
BXA-22	BXA	CRT-20	256.50
CXA-22	CXA	CRT-20	276.50
CA-22	CA	CRT-30	276.50
DA-22	DA	CRT-30	360.00
EA-22	EA	CRT-30	449.00

CARBIDE CRT-20 AND CRT-30

Tool steel cartridge adjusts every 15° for right or left hand, facing or chamfering 12 positive lock positions. Exclusive positions lock with 2-way force holding insert down and tight against shoulder. Standard triangular carbide insert has 6 cutting edges.

Standard triangular carbide insert has 6 cutting edges.

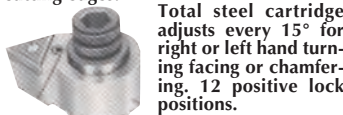

Total steel cartridge adjusts every 15° for right or left hand turning facing or chamfering, 12 positive lock positions.

Exclusive positive lock with 2-way force holding insert down and tight against shoulder.

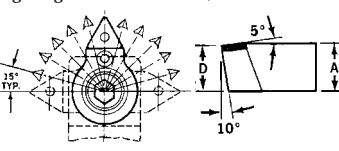

Cartridge No.	Dimensions A B C D	Insert I.C.
CRT-20	5/8", 1", 1-1/8", 9/16"	3/8"
CRT-30	7/8", 1-1/4", 1-11/16", 25/32"	1/2"

CARBIDGE ONLY

MODEL NO. CRT-20	MODEL NO. CRT-30
\$60.00	\$80.00

ADJUSTBLE-SHANK TOOL HOLDERS FOR RIGHT OR LEFT HAND TURNING FACING, OR CHAMFERING

The adjustable shank feature introduces added flexibility, turning the shank 90° permits choice of shank and cutting tool alignment. The cartridge, with its 12 indexed positions at 15° intervals, provide for managular turning operations.

Two-way adjustable rake with 5° cutting angle, positive stop.



Cartridge cradle lock screw



Cartridge lock screw

Pin

Model Positive	Shank Size	Cartridge Supplied	Price Each
AT-32	4" x 1" x 3/4"	CRT-20	\$175.50
AT-40	4-1/2" x 1-1/4" x 1"	CRT-30	206.90

CARBIDE TRIANGLE INSERTS

TNMG 5° Negative TNMP 5° Positive TNMS 15° Positive

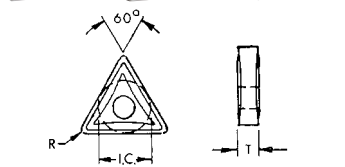

Insert No.	Dimensions I.C. T R	Price Each
TNMG-322	3/8" 1/8" 1/32"	\$3.50
TNMP-322	3/8" 3/16" 1/32"	3.50
TNMS-322	3/8" 3/16" 1/32"	9.50
TNMG-432	1/2" 3/16" 1/32"	\$3.95
TNMP-432	1/2" 3/16" 1/32"	3.95
TNMS-432	1/2" 3/16" 1/32"	10.50

Sold In Packages of 10 Only
Discount Does Not Apply To Inserts

5-C COLLET HOLDER Holds All 5-C Collets

Aloris 5-C holder can be used to hold a variety of shank tools, drills, reamers, C cores, taps, endrills, boring bars, and other tools.



Model No.	Center Height	Bloc Height	Fits Tool Post	Price Each
AXA-5C	15/16"	1-7/8"	AXA	\$155.00
BXA-5C	15/16"	1-7/8"	BXA	161.50
CXA-5C	1"	2"	CXA	182.50
CA-5C	1-1/8"	2-1/4"	CA	206.00
DA-5C	1-1/2"	3"	DA	290.00

5C Collets are not included



SUPER PRECISION TOOL HOLDERS

Adjustable Threading Holder For Right & Left-Hand Threading

The new Aloris Series 88 adjustable threading holder for right and left-hand threading is designed for use with the new Aloris AT1H, AT1V or AT2V dual insert threading holders with two carbide cutting tips. The key characteristic of the Series 88 holder is its adjustability feature which allows easy setting of the thread helix angle 10% to the left or right by means of two set screws, a direct-reading scale and built-in locking feature.

AT1H, AT1V and AT2V, can be positioned on the lower mounting surface for normal threading, or on the upper surface of the holder (with spindle direction reversed) for reverse threading without fear of shoulder damage.

88 Body

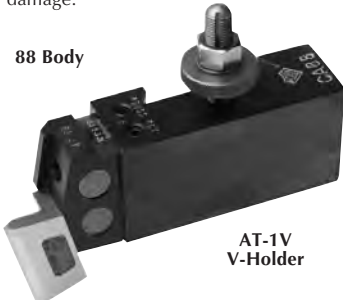

AT-1V V-Holder



AT-1H H-Holder



AT-2V V-Holder



"u" Blade Supplied

Model No.	Dimensions A B C D	Price Each
AXA-88	1-1/8"-1-5/8"-1-1/2"-2-1/4"	\$275.00
BXA-88	1-1/8"-1-3/4"-1-2/2"-2-1/4"	295.00
CXA-88	1-1/8"-2"-1-5/8"-2-1/4"	310.00
CA-88	1-1/8"-2-1/4"-1-5/8"-2-1/4"	340.00
DA-88	1-1/4"-2-3/4"-2"-2-5/8"	380.00

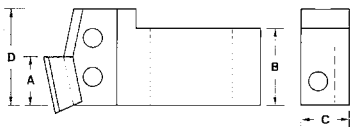

Threading Holders Holds Two 60° Inserts

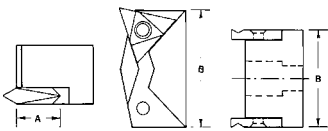

Model No.	I.C.	Dimensions A B	Price Each
AT-1V	3/8"	3/8" 3/4" Sq.	\$86.00
AT-2V	1/2"	1/2" 7/8" Sq.	93.00
AT-1H	3/8"	3/4" 1-1/4"	82.00

Inserts: External - Vertical 60° Triangle Threading

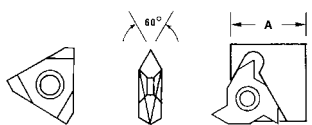

Model No.	Insert I.C.	Use With T.P.L.	Price Each
TPMC-32PV	3/8"	8 or More	AT-1V \$13.70
TPMC-43PV	1/2"	6 or More	AT-2V 19.20
TNMC-32NV	3/8"	8 or More	AT-1V 10.45
TNMC-43NV	1/2"	6 or More	AT-2V 14.80
ATP-31E	3/8"	8 or More	AT-1H 29.90

RH & LH (Specify)

Internal Threading Bars - R.H. and L.H.

Aloris ATB series threading bars can be used for internal right or left-hand threading. These bars accommodate standard triangular-shaped throwaway threading inserts in a hardened seat. A carbide holding screw is supplied.

The ATB series shank has three flat sides specially designed for use in Aloris boring bar holders No. 1, o, 2, No. 13 and No. 41.

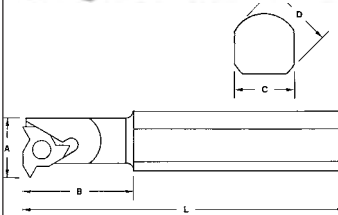

Order No. R.H. L.H.	Dimensions A B C D L	I.C.
ATB-1R or 1L	1/2, 7/8, 5/8, 3/4, 6-1/2"	1/4"
ATB-2R or 2L	3/4, 1-1/2, 5/8, 3/4, 7"	3/8"
ATB-3R or 3L	1, 2-1/4, 7/8, 1, 10"	3/8"
ATB-4R or 4L	1-3/16, 2-3/4, 1-1/16 1-1/4, 12"	3/8"
ATB-5R or 5L	1-7/16, 3-1/8, 1-1/4, 1-1/2, 14"	1/2"

Order No. Right	Order No. Left	Price Each
ATB-1R	ATB-1L	\$ 94.00
ATB-2R	ATB-2L	103.00
ATB-3R	ATB-3L	127.00
ATB-4R	ATB-4L	137.00
ATB-5R	ATB-5L	198.00

60° Internal Carbide Threading Inserts



Right-Hand	Left-Hand	Price Each
AIT-R60-1/4	AIT-L60-1/4	\$31.50 \$37.00
AIT-R60-3/8	AIT-L60-3/8	\$31.50 \$37.00
AIT-R60-1/2	AIT-L60-1/2	\$38.00 \$45.00



SUPER PRECISION TOOL HOLDERS

80° Diamond Shape Carbide Insert Tool Holders For Turning and Facing

Aloris series D80 and D80L dovetail holders accommodate all varieties of standard 80° diamond shaped carbide inserts, positive, negative or neutral rake and either left or right lead angle. Inserts are not supplied.

They are designed for use with Aloris quick change toolposts and allow turning and facing operations without removing the holder from the toolpost. Repeat positioning accuracy within millionths is assured when used with Aloris toolposts.

Right Hand & Left Hand

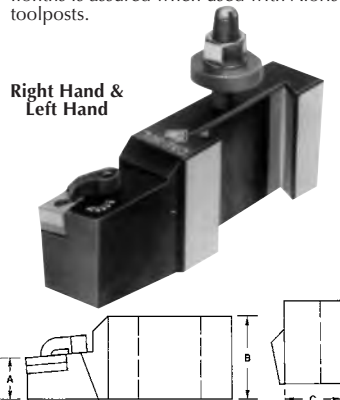

"R" RIGHT HAND "L" LEFT HAND

Model No.	Dimensions A B C	I.C.	Price Each
AXA-80R	1", 1-1/2", 1-1/16"	1/2"	\$163.00
AXA-80L	1", 1-1/2", 1-1/16"	1/2"	163.00
BXA-80R	1-1/16", 1-5/8", 1-1/16"	1/2"	180.00
BXA-80L	1-1/16", 1-5/8", 1-1/16"	1/2"	180.00
CXA-80R	1-7/16", 2", 1-1/4"	1/2"	189.00
CXA-80L	1-7/16", 2", 1-1/4"	1/2"	189.00
CA-80R	1-9/16", 2-1/4", 1-3/8"	5/8"	236.00
CA-80L	1-9/16", 2-1/4", 1-3/8"	5/8"	236.00
DA-80R	1-3/4", 2-7/8", 1-9/16"	5/8"	275.00
DA-80L	1-3/4", 2-7/8", 1-9/16"	5/8"	275.00
EA-80	2-3/8", 3-1/2", 2"	3/4"	340.00
EA-80L	2-3/8", 3-1/2", 2"	3/4"	340.00

80° Diamond Shape Carbide Inserts

- 0° negative rake.
- Honed with locking hole.
- Two molded chipbreakers.
- Lapped top and bottom.

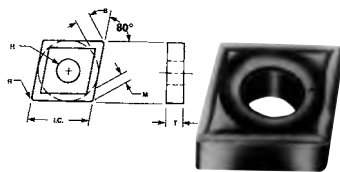

Order	I.C.	Thick	Radius	Price
CNMG-432	1/2"	3/16"	1/32"	\$3.00
CNMG-543	5/8"	1/4"	3/64"	4.95
CNMG-643	3/4"	1/4"	3/64"	5.95

Specify Grade: C2 or C5



FREE! COMPLETE ALORIS TOOL CATALOG AVAILABLE

Adjustable Cut-Off And Groove Holder

Designed for extremely high rigidity under heavy duty conditions and cool chatter-free operations at higher speeds.

Two different blades can be used with this holder; self-locking throwaway insert blade, or reversible blade with brazed-in carbide tips.

Adjustment of the blade position is simple, the locking is accomplished by one screw instead of the usual number of adjusting and clamping screws.

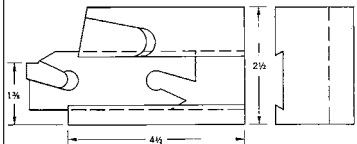

Model	A B	Blade Width	Price
AXA-71	15/16, 1-3/16"	1/8, 3/16 or 1/4	\$197.00
BXA-71	15/16, 2"	1/8, 3/16 or 1/4	200.00
CXA-71	1-3/8, 2-1/2"	1/8, 3/16 or 1/4	230.00
CA-71	1-7/16, 2-3/8"	3/16 or 1/4	240.00
DA-71	2, 3-1/4"	3/16 or 1/4	270.00
EA-71	2-1/16, 3-3/8"	3/16 or 1/4	360.00

Supplied With-out Blades

Tool Post Sets

Recommended For All Purpose Shop Use



SET No. 100-100 \$795.00

- AXA Tool Post
- AXA1 Holder
- AXA2 Holder
- AXA4 Holder
- AXA6 Holder
- AXA7 Holder
- AXA8 Holder

SET No. 200-200 \$945.00

- BXA Tool Post
- BXA1 Holder
- BXA2 Holder
- BXA4 Holder
- BXA6 Holder
- BXA7 Holder
- BXA8 Holder

SET No. 300-300 \$1175.00

- CXA Tool Post
- CXA1 Holder
- CXA2 Holder
- CXA4 Holder
- CXA6 Holder
- CXA7 Holder
- CXA8 Holder

SET No. 400-400 \$1475.00

- CA Tool Post
- CA1 Holder
- CA2 Holder
- CA4 Holder
- CA6 Holder
- CA7 Holder
- CA8 Holder

SPi SWISS MULTIQUICK 40 POSITION QUICK CHANGE TOOL HOLDER FOR ALL LATHES

- Swiss precision and perfection; internationally acclaimed by the leaders in industry.
- All parts, toolposts and holders are manufactured from high quality chrome steel, thru hardened.
- The splines of the toolpost and holders are precision ground for 0.0001" repeat accuracy.
- Cam-lock handle rigidly locks and quickly releases toolholder.
- 40 different angles (every 9°) are conveniently selected from position dial with marker.
- No limitations as to the number and types of tools to be used.
- Correct height of cutting edge is easily and accurately adjusted by a special set-screw built into each holder.
- Tools can be re-ground without removal from toolholder - setting remains unaltered.
- Holders are interchangeable with most other brand 40 position toolposts.



Toolposts

Size	Model No.	Price	Set No*	Price
Aa	71-210-9	\$406.75	71-201-8	\$963.30
A	71-230-7	688.15	71-203-4	1358.00
E	71-250-5	879.05	71-205-9 †	1753.00
B	71-270-3	1035.00	71-207-5 †	2094.00
C	71-290-1	1412.00	71-209-1 †	3027.00

* Set includes Toolpost with two "D" Holders, one "H" Holder and one "T" Holder with HSS cut-off blade.

† For the two "D" holders, one each of the two sizes included in this set are listed below.

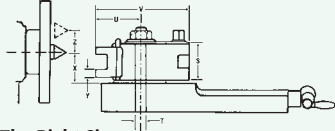

Choosing The Right Size

Swiss Multiquick Size	Aa	A	E	B	C
Approx. Lathe Swing	up to 9"	6-13"	10"-18"	13"-20"	18"-30"
Max. Horsepower Output	1	2	6	8	15
Height Adjustment	Z 15/32"	35/64"	45/64"	3/4"	1-5/16"
Thickness	Y 15/64"	5/16"	11/32"	17/32"	19/32"
Minimum Height*	X 47/64"	1-1/8"	1-9/64"	1-13/16"	2-3/16"
Overall Length	V 2-3/4"	3-15/16"	5-21/64"	5-29/32"	7-7/8"
Length	U 1-3/16"	1-57/64"	2-11/16"	2-51/64"	3-15/16"
Max. Bolt Opening	T 1/2"	25/32"	3/4"	1-1/4"	1-3/16"
Height	S 1-1/2"	2-1/8"	2-5/8"	2-61/64"	4-1/8"

* Based on using toolbit as per dimension D of "D" holder

"D" Turning and Facing Holder

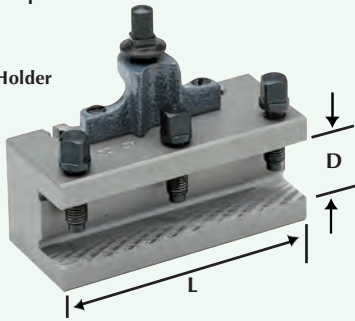

For Toolpost	D	L	Model No.	Price
Aa	1/2"	2"	71-211-7	\$153.10
A	3/4"	3-1/2"	71-231-5	189.85
E	3/4"	4"	71-251-3	229.80
E	1"	4"	71-252-1	237.25
B	1-1/4"	4-3/4"	71-271-1	306.40
B	1-1/4"	5-1/2"	71-272-9	325.00
C	1-9/16"	5-15/16"	71-291-9	441.40
C	1-9/16"	6-11/16"	71-292-7	441.40



"T" Cut-off Holder



"T" Cutoff Holders For Toolpost	Model No.	Price	HSS Blades T	HSS Blades E	Model No.	Price
Aa	71-214-1	\$168.00	5/64"	3/8"	71-341-2	\$80.20
A	71-234-9	248.95	7/64"	3/8"	71-345-3	78.95
E	71-254-7	306.55	3/32"	5/8"	71-342-0	76.10
B	71-274-5	387.60	1/8"	7/8"	71-343-8	93.55
C	71-294-3	527.30	3/16"	1"	71-344-6	104.05

"H" Boring Holders

For Toolpost	D	L	Model No.	Price
Aa	1/2"	2"	71-215-8	\$153.10
A	3/4"	3-3/8"	71-235-6	193.05
E	1"	4"	71-255-4	264.95
B	1-1/4"	5-1/8"	71-275-2	325.70
C	1-31/32"	6-5/16"	71-295-0	533.05

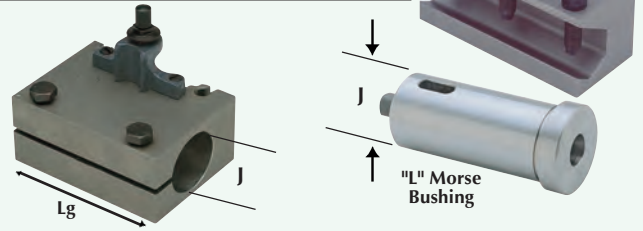

"J" Drilling and Boring Holders-"L" Morse Bushing

For Toolpost	Lg	J	L	Model No.	Price
Aa	2"	5/8"		71-216-6	\$173.25
A	3-3/8"	1-3/16"		71-236-4	\$238.35
Bushing		1-3/16"	MT 1	71-241-4	104.05
Bushing		1-3-16"	MT 2	71-242-2	104.05
E	4"	1-37/64"		71-256-2	\$288.40
Bushing		1-37/64"	MT 2	71-262-0	111.45
Bushing		1-37/64"	MT 3	71-263-8	127.95
Bushing		1-37/64"	MT 4	71-264-6	130.65
B	4-3/4"	1-37/64"		71-276-0	\$355.60
Bushing		1-37/64"	MT 2	71-262-0	111.45
Bushing		1-37/64"	MT 3	71-263-8	127.95
Bushing		1-37/64"	MT 4	71-264-6	130.65
C	6-5/16"	1-31/32"		71-296-8	\$569.30
Bushing		1-31/32"	MT 3	71-266-1	140.85
Bushing		1-31/32"	MT 4	71-267-9	144.00

Precise STEEL CLAMPING KITS

- Features:
- For Bridgeport type milling machines.
- Includes all the studs, nuts, step blocks & step clamps for any set-up.
- Includes fitted rack for easy mounting.

Consists of 52 pieces

- 24 studs, 4 each of 3", 4", 5", 6", 7", 8".
- 4 coupling nuts.
- 6 T-slots nuts.
- 6 flange nuts.
- 6 serrated end clamps.
- 6 step blocks.
- 1 holder

QUALITY IMPORT
MODEL No. SECK-625*
Reg. list \$69.95

MADE IN AMERICA
MODEL No. 20402P*
Reg. list \$124.95

\$49.95

\$79.95

Model No.	Table T-Slot	T-Slot Width	Stud Thrd. Size	Weight Set lbs.	Sale Price
SECK-380	3/8"	5/8"	5/16"-18	16	\$ 59.95
SECK-716	7/16"	11/16"	3/8"-16	18	52.95
SECK-500	1/2"	7/8"	3/8"-16	23	49.95
SECK-916	9/16"	7/8"	3/8"-16	23	59.95
SECK-910	9/16"	7/8"	1/2"-13	23	54.95
SECK-625*	5/8"	1"	1/2"-13	27	49.95
SECK-116	11/16"	1-1/8"	1/2"-13	27	65.00
SECK-111	11/16"	1-1/8"	5/8"-11	29	89.95
SECK-750	3/4"	1-1/4"	5/8"-11	29	79.95
SECK-136	13/16"	1-1/4"	5/8"-11	29	115.00

* For Bridgeport Type Milling Machines



ALORIS SUPER-PRECISION 4 PIECE TOOL-POST SETS



Each Set includes: Super Precision Wedge Style Tool Post, #1 Turning and Facing Holder for square shank tools, #2 Boring, Turning and Facing with V-groove for round shank tools as well as holding square shank tools, #7 Cut-off holder that uses parallel style blades or the new indexable blade that uses carbide cut-off and grooving inserts.

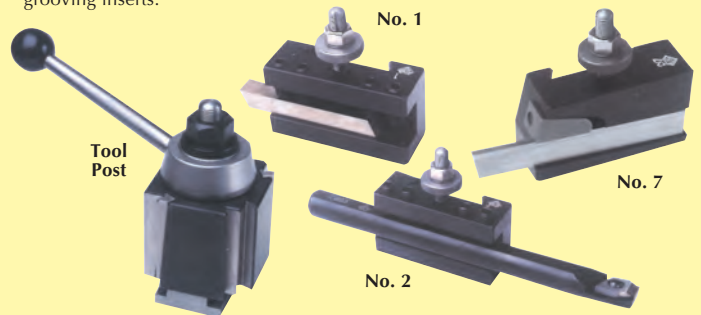

Model No.	Set Series	Lathe Swing	Sq. Tool Cap.	Rd. Tool Cap.	Blade Cap.	Sale Price
AXA-100	AXA	9-12"	3/16-1/2"	7/16"	1/2"	\$ 485.00
BXA-100	BXA	10-15"	1/4-5/8"	1/2"	11/16"	575.00
CXA-100	CXA	13-18"	1/2-3/4"	3/4"	3/4"	750.00
CA-100	CA	14-20"	1/2-1"	13-16"	7/8"	975.00
DA-100-1	DA	17-48"	1/2-1-1/4"	1"	1-1/8"	1285.00
EA-100	EA	17-48"	1/2-1-1/4"	1"	1-1/8"	1995.00

Precise QUICK CHANGE TOOLING SYSTEM Precise

SUPER ACCURACY – WEDGE TYPE FOR POSITIVE CLAMPING – INTERCHANGEABLE WITH ALORIS AND DORIAN

Wedge Type Tool Posts are precision engineered to assure repetitive accuracy. Advanced design provides built in quick tool changing versatility with positive rigidity to meet the most exacting working tolerances. Quickly and easily installed on an engine, bench or turret lathe for a wide range of operations, from fine precise work to heavy duty cutting.

FEATURES:

- All working parts hardened and ground.
- Maximum rigidity for chatter free performance.
- No time wasted with shims.
- Speed lathe operations 90%.
- Completely sealed for maintenance free operations.
- Takes only a few seconds to change tools.

Morse Taper Holder

Drills with carriage by using power feed instead of stock. Easily centered.

Series No. 5
No. 53

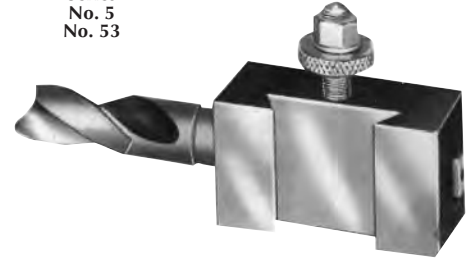

Model No.	Taper Hole	Fits Tool Post	Price Each
250-105	2 MT	250-111	\$26.50
250-205	2 MT	250-222	27.50
250-305	3 MT	250-333	31.00
250-405	3 MT	250-444	39.50
250-153	3 MT	250-111	\$34.00
250-253	3 MT	250-222	35.00
250-353	4 MT	250-333	37.00
250-453	4 MT	250-444	44.00

**TOOL HOLDERS
INTERCHANGEABLE WITH ALORIS
AND DORIAN**

Turning and Facing Holder

Takes various sizes of bits. Turning and facing tools can be locked in together. Saves time and labor when changing operations.

Series No. 1



Model No.	Tool Bit	Fits Tool Post	Price Each
250-101	3/16"-1/2"	250-111	\$14.95
250-201	1/4"-5/8"	250-222	17.50
250-301	1/2"-3/4"	250-333	25.50
250-401	1/2"-1"	250-444	34.50

Boring, Turning and Facing Holder

"V" groove round shank boring bars and tools as well as square tool bits.

Series No. 2

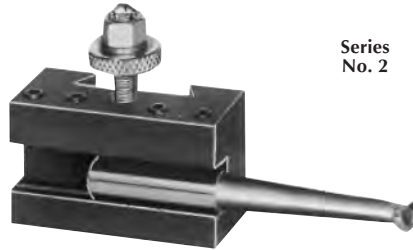

Model No.	Tool Bit	Shank Dia.	Fits Tool Post	Price Each
250-102	3/16"-1/2"	7/16"	250-111	\$15.95
250-202	1/4"-5/8"	1/2"	250-222	18.50
250-302	1/2"-3/4"	3/4"	250-333	29.50
250-402	1/2"-1"	13/16"	250-444	35.00

Universal Parting Blade Holder

For bevel as well as T-type blades. Enables you to cut close to chuck. Absence of vibration prevents breaking blades.

Series No. 7



Model No.	Blade Height	Fits Tool Post	Price Each
250-107	1/2"	250-111	\$25.50
250-207	11/16"	250-222	26.50
250-307	3/4"	250-333	39.00
250-407	7/8"	250-444	45.00

Turning & Facing For Triangle Carbide Inserts

Supplied with fully adjustable Carbide Chip breakers and carbide Shims

Series No. 16

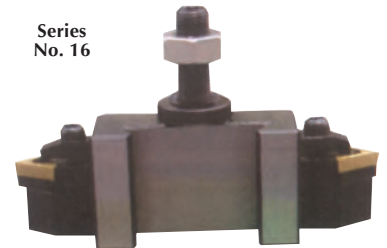

Model No.	Holder Capacity	Style Type	Price Each
250-701	7/8"	AXA	\$ 59.95
250-702	1"	BXA	75.00
250-703	1-3/16"	CXA	98.00
250-704	1-1/2"	CA	110.00

CARBIDE INSERTS TIN COATED

Model	LC	Thick	Insert	Price
404-1049	3/8"	5/32"	TCMT32.5	\$5.50
*404-0245	1/2"	3/16"	TCMT43.2	5.75

* For 250-704 Holder Type "CA"

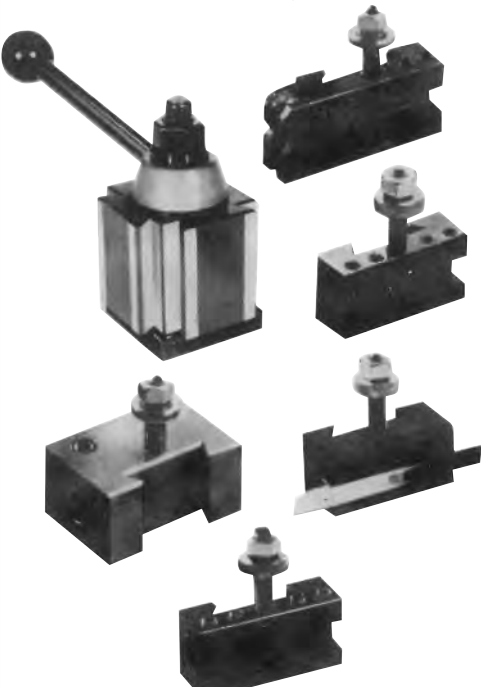

6 PIECE TOOL POST SETS

Complete Sets Consists of: 1 each Tool Post and Holders Style 1, 2, 4, 7 and 10

Model No.	Style Type	Fits lathe Size	Size Blank	Price Each
251-111	AXA	Up to 12"	2-1/2"	\$175.00
251-222	BXA	10" to 15"	3"	215.00
251-333	CXA	13" to 18"	3-1/2"	295.00
251-444	CA	14" to 20"	4"	395.00

TOOL POST ONLY WEDGE TYPE

Model No.	Style Type	Fits lathe Size	Size Blank	Price Each
250-111	AXA	Up to 12"	2-1/2"	\$ 88.00
250-222	BXA	10" to 15"	3"	115.00
250-333	CXA	13" to 18"	3-1/2"	150.00
250-444	CA	14" to 20"	4"	225.00

Heavy Duty Boring Holder

Equipped with a split bushing to accommodate a boring bar of smaller diameter. It grips with extreme rigidity, cuts smoothly without chatter.



Series No. 4
No. 41

Model No.	Boring Bars	Fits Tool Post	Price Each
250-104	3/4" & 5/8"	250-111	\$21.95
250-204	1" & 3/4"	250-222	27.50
250-304	1" & 3/4"	250-333	35.00
250-404	1-1/4" & 1"	250-444	44.50
250-141	1-1/2" & 3/4"	250-111	\$22.50
250-241	1-1/4" & 1"	250-222	31.00
250-341	1-1/4" & 1"	250-333	36.00
250-441	1-1/2" & 1-1/4"	250-444	48.00

Knurling, Facing & Turning

For turning and facing as well as knurling. Supplied with a set of high speed precision ground and lapped medium diamond knurls. Easily replaceable.

Series No. 10



Model No.	Knurl Size	Tool Bit	Price Each
250-110	3/4" x 3/8"	3/16"-1/2"	\$26.00
250-210	3/4" x 3/8"	1/4"-5/8"	29.00
250-310	3/4" x 3/8"	1/2"-3/4"	41.00
250-410	3/4" x 3/8"	1/2"-1"	45.00

Spindle Square

- Fully assembled with two AGD 2 or AGD dial indicators, .001", .0005", or .01mm graduations.
- Self Calibrating** – no other tools, shims, blocks etc. required to calibrate
- Large 2-1/4" or 1-1/4" diameter dial indicators for easy reading; .250 or .125" total range.
- Patented.



.....ALL STEEL

- 4" between contact points
- Ground surface, **Solid Steel Construction of body**
- Size is about 6 3/4 wide and 5 1/2 from top of shank to end of contact points
- Accuracy to .001 inch
- Weight is about 4 lbs. for shipping, with custom case



Model No.	Graduation	Total Range	Distance Centers	Dial Diameter	Price Each
NSS-001	.001"	.250"	4"	2-1/4"	\$159.95
NSS-002	.0005"	.125"	4"	2-1/4"	175.00
NSS-003	.0005"	.125"	3"	1-1/4"	175.00
NSS-004	.01mm	2.5mm	101.6mm	2-1/4"	175.00

Suburban VACUUM SINE CHUCKS

Vacuum Chucks

- Provides an excellent means for holding non-magnetic workpieces for light machining or grinding.
- Designed to bolt directly to a SineSet® sine plate of the same size & series with little or no indicating.
- Each chuck has three 1/4 NPT holes for mounting the vacuum gage, relief valve and hose fitting.
- The vacuum gage and relief valve included.
- All chucks have back and end rails for positive location of workpieces.

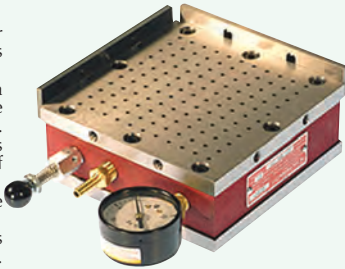

Model No.	Sine Series	Size L x W x H	Square & Parallel	Weight lbs.	Price Each
VC-66-S1	S1	6" x 6" x 2-1/4"	0.0002"	15	\$575.00
VC-612-S2	S2	12" x 6" x 2-1/4"	0.0003"	28	750.00
VC-618-S2	S2	18" x 6" x 2-1/4"	0.0004"	41	995.00

Vacuum Pumps

- All models are the oilless, motor-mount, rotary vane design for maximum performance with minimum upkeep.
- Each unit has internal mufflers and filters. The filters were specifically designed to be easily removed and replaced.
- The pumps have built-in thermal overload protection.
- Each model includes a support base, the proper fittings and six feet of reinforced hose.



Model	Electric Motor	PSI	Weight	Price
VCP-14-MM	1/4HP, 110-115/208-230V, 50-60Hz, 1 Phase	10	32 lbs.	\$475.00
VCP-34-MM	3/4HP, 110-115/208-230V, 50-60Hz, 1 Phase	10	54 lbs.	795.00

Note: Because electric motors are dual frequency, multi-voltage AC for worldwide applications, they are supplied without an electric cord, ready to be wired to user specifications

Suburban LAST WORD™ WHEEL DRESSER

The Last Word™ in Angle Tangent To Radius Wheel Dressing

- Reduces set-up & dressing time to a minimum.
- Wheel dressing is performed with wheel guard in place for operator safety.
- All actuation knobs are at the back of dresser, keeping operator's hands at a safe distance.
- Direct setting together with high precision lapped parts makes accurate dressing very simple.
- Original Last Word dresser works equally well on surface, O.D. & I.D. grinders. On O.D. & I.D. grinders it is simply clamped vertically on an angle plate.
- Large bearing surfaces & positive locking devices make this dresser the most rigid on the market.
- Manufactured of quality materials & engineered with service in mind, including adjustable gibs to compensate for wear, the Original Last Word dresser will give many years of satisfactory service with a minimum of upkeep.



MODEL No. LWD-800 **\$2395.00**
With Storage Case

Specifications:		
Convex Radii	0-2-1/4"	Center Height 3.400"
Concave Radii	0-4"	Max. Wheel 8"
Tangent Travel	1-7/8"	Overall Length 14"
		Weight 27 lbs.

EZ-TRAM "Simply The Fastest, Most Accurate Way To Get The Head Of Your Mill Square To The Table"

- EZ-TRAM allows the operator to quickly check and align the spindle of a vertical turret mill, perpendicular to the machine table without disturbing the work set-up (in most cases).
- Made of "SIMG" cast iron and precision lapped flat to within .000070" over entire gaging surface and parallel to within .00030" surface to surface.
- EZ-TRAM has a 15.75" diameter with a 1.8" wide gaging surface, fits over a 6" machine vise with swivel.
- MINI-TRAM has a 13" diameter with a 1.75" wide gaging surface and will fit over a 6" machine vise without a swivel base.
- MICRO-TRAM has a 10" diameter with a 1.6" wide gaging surface and will fit over a 4" machine vise.



MADE IN USA
Lifetime Warranty



Model	Description	Price
EZT-600S	E-Z Tram 15.75" diameter fits 6" Vises with swivel base	\$275.00
EZT-600	Mini-Tram 13" diameter fits 6" Milling Vises without swivel base	225.00
EZT-400	Micro-Tram 10" diameter fits 4" Milling Vises	175.00

Precise 40 POSITION QUICK-CHANGE TOOLING SYSTEM

- Designed to be the best quick-change tool post system in the industry for its accuracy, rigidity and productivity.
- Adjust to 40 different positions indicated by a marked position dial (index every 9°)
- Each tool holder's center height is adjusted by a thumbscrew.
- Tooling system for Lathes with a 6-30" Swing.

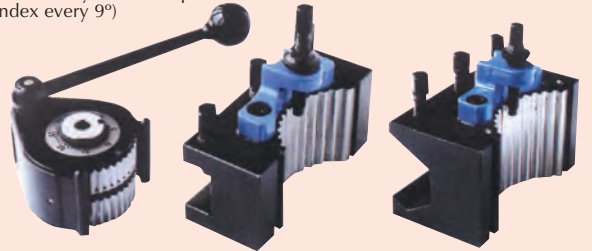

40 Position Tool Post

Model No.	Lathe Swing	Body Diameter	Max. Drive	Tool Post Type	Price Each
202-950	6"-13"	4.13"	3 H.P.	"A"	\$245.00
202-951	10"-18"	5.14"	6 H.P.	"E"	275.00
202-952	13"-20"	6.00"	9 H.P.	"B"	395.00
202-953	18"-30"	8.00"	8 H.P.	"C"	550.00

Turning & Facing Holders				Boring & Turning Holders			
Model No.	Max. Tool Bit	Fits Type	Price Each	Model No.	Max. Tool Bit	Fits Type	Price Each
202-954	3/4"	"A"	\$ 65.00	202-958	3/4"	"A"	\$ 79.00
202-932	3/4"	"E"	79.00	202-959	1"	"E"	95.00
202-955	1"	"E"	85.00	202-960	1-1/4"	"B"	110.00
202-956	1"	"B"	115.00	202-961	1-1/2"	"C"	165.00
202-953-1	1-1/4"	"B"	125.00				
202-957	1-1/4"	"C"	135.00				

Boring Bar Holders

Model No.	Hole Diameter	Holder Length	Fits Type	Price Each
900-053-1	1-3/16"	3.16"	"A"	\$100.00
900-054-1	1-5/8"	4.00"	"E"	129.00

Morse Taper Bushings

900-057-1	1 MT	"A"	\$ 22.50
900-058-1	2 MT	"A"	25.00
900-059-1	3 MT	"E"	35.00



KNEE MILL MANUAL MULTI-HARD STOP

- Up to 5 adjustable pre-set position hard stops that precisely control vertical travel.
- Center drill-drill-mill ect. without removing work piece.
- Slide in to active stop - pull back to clear - now in position for next stop, repeat.
- Excellent for "quick-change" set-up systems.
- Factory auto - stop is not interfered with or modified and functions as normal factory auto - stop.

MODEL No. SMS-300

\$149.95

MADE IN USA



EAGLE ROCK® 5C AIR COLLET FIXTURE

- Designed especially for high production applications. Their light weight and compact size permits the use of several units on indexing tables for custom applications or used individually for fast chucking of parts on milling machines and drill press.
- Air operation is double acting for "Power" opening and closing of collet. The collet is locked into position for positive depth location of work. These units operate efficiently and effectively on air pressure up to 150 PSI with upward clamping pressure exceeding 7.5 times line pressure. All bearings and moving parts are hardened and ground for accuracy and long life.

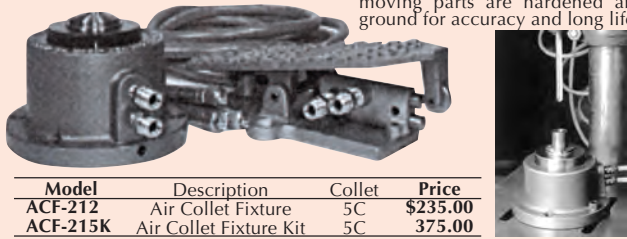

Model	Description	Collet	Price
ACF-212	Air Collet Fixture	5C	\$235.00
ACF-215K	Air Collet Fixture Kit	5C	375.00

EAGLE ROCK® WOODRUFF CUTTER GRINDING FIXTURE

- A simple grinding fixture for regrinding Woodruff Cutters with 1/2" shank.
- Spring stop adjusts to accommodate various cutter diameters and for the proper positioning of the cutter flutes.

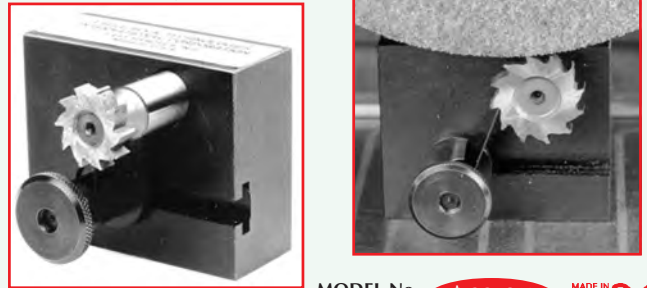

MODEL No. WCG-204 **\$69.95** **MADE IN USA**

EAGLE ROCK® MILLING CUTTER GRINDING FIXTURE

- An economical fixture for use on your surface grinder.
- Fully adjustable to accommodate straight or angle milling cutters up to 6" diameter and 1" width.
- A complete set of bushings is included to accommodate 7/8", 1", 1-1/4" and 1-1/2" cutter bores.

MODEL No. CGF-600 **\$220.00**

MADE IN USA



EAGLE ROCK® ANTI-BACKLASH RING SET

- A valuable time saver for your Lathes and Turning Centers.
- Every ring you will ever need for boring out your soft jaws on one convenient wooden rack.

MADE IN USA



Model	Description	Price
A1-220-10	16 rings 1" to 1-15/16" by 1/16" increments	\$ 92.00
A1-220-00	48 rings 1" to 3-15/16" by 1/16" increments	295.00

GENERAL DRILL GRINDING ATTACHMENT

A precision tool for accurately sharpening twist drills. For fractional drills 1/8 to 3/4"; for number size drills 30 to 1, for letter size drills A to Z and for millimeter size drills 3.0 to 19.0mm. Grinding wheel not included.

MADE IN USA

MODEL No. 825
Reg. \$42.50

\$29.95

Wt. 2 lbs.

Import



MODEL No. D4144

\$19.95



Precise END MILL CUTTER SHARPENER

- Features:**
- Complete with 2 spindles and 4 bushings. To accept 3/16", 3/8", 1/2", 5/8", 3/4", 7/8", 1" and 1-1/4" shank end mills.
 - Accepts cutters with diameters up to 12" and larger with use of riser blocks.
 - Spindle bearing require no air, hydraulic or delicate adjustments.
 - Normalized Meehanite body.
 - Rigid finger holder and bar for best precision finish.
 - Micrometer dial for setting adjusting finger for cutting edge clearance.
 - Nearly point contact assures no surface for dirt or grit to accumulate.
 - Rocker arm enables fast indexing and brings cutter to wheel.

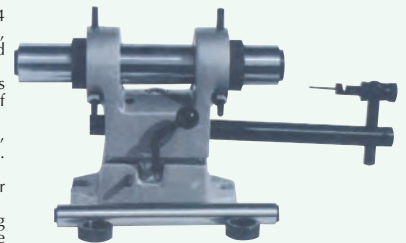

MODEL No. 202-3301 **\$199.95**
Reg. \$250.00

Weight 35lbs.
Base size . . . 7-1/16" x 3-15/16"

Precise QUICK ACTING KNURLING TOOL

- Extremely fast set-up.
- Knurling pressure is absorbed between 2 knurls.
- Depth of knurling impression can be pre-set for production work.
- Knurling arms are pivoted on snug fitting pins.
- Complete with one set of knurls, diamond, medium cut.

MODEL No. 1-200-6 **\$59.95**
0"- 2-1/4"



Model	Length	Shank	Capacity	Weight	Price
1-200-6	6"	1/2" x 5/8"	0"-2-1/4"	3-1/4 lbs.	\$59.95
1-200-8	8-1/4"	3/8" x 3/4"	0"-4-1/2"	5 lbs.	75.00

EAGLE ROCK® HI-LO DIAMOND GRINDING WHEEL DRESSER

- For Surface Grinders. Swings from 2" to 9" instantly. Eliminates time consuming up and down cranking of the spindle and saves wear on elevating screw. 1/4' karat diamond (3/8" x 2") included.

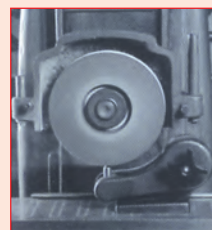

MADE IN USA
EAGLE ROCK
MODEL No. 21300
\$125.00

Import
Precise
MODEL No. HDD-300
\$69.95

Precise RADIUS & ANGLE DRESSER

- Positive setting of the diamond to absolute center with the special gage included with the dresser.
- Simple, fast, accurate radius setting no height gage or other set-up aids required. Radius is set on the grinder by measuring over the two pins or by inserting a gage block, as shown, for direct reading inside or outside radius is determined simply by sliding the dowel pin to the right for concave and the left for convex.
- 4 x 90 graduation in full 360° circle. Chrome plated.
- One push pull type knob for radius & angle control & for safer & faster operations.
- 5 minute vernier reading.

Specifications:

Convex radii . 0-2-1/4" Tangent
 Either side of center 1-7/8"
 Maximum diameter of wheel 8"
 Weight complete 35 lbs.
 Concave radii 0-4"
 Center line of tool 3.400"
 Overall length 14"
 Base size 7-1/16 x 3-15/16



Model RAD

\$299.95

Complete with
Diamond & Case

ANY WHEEL FORM. The grinding wheel may be dressed to any desired form-any combination of tangents and/or radii, either convex or concave.



Precise PROFILE DIAMOND RADIUS & ANGLE DRESSER

- Extremely accurate, this Radius and angle Dresser can dress 2 angles tangent to a radius in one continuous motion to within .0001" (0.002mm).
- Fast and easy set-ups without elaborate accessories; only tools needed are a micrometer and a hex key wrench.
- Set-up to dress 2 angles takes less than 15 seconds and 1 radius plus 2 angles approx. 3 minutes only.
- Precise and sharp contours, concave or convex, are consistently obtained at a full 180° range.
- Made from hardened, ground, and lapped alloy tool steel.
- No exposed wear surfaces, swivel on sealed bearings.
- Wheel dresser is furnished complete with base featuring one inch adjustment.
- Graduated micrometer knob provides fine adjustment to accurately dress small radii.

MODEL No.
PRA-110T
Reg. \$1030.00

\$595.00

Complete with
Diamond & Case
Made in China

SPECIFICATIONS:
Dressing Capacity:
8" Wheel Diameter
Range:
Convex Radii 0 to 1.500"
Concav Radii .030" to 1.500"
Height to center of diamond:

Overall Height:
7"
Base Dimensions:
4-3/4"x3-1/2"x1-1/4" high
Weight:
23 lbs.



Made In Taiwan



"MIGHTY MIDGET" RADIUS DRESSER

Chatter Resistant - Spring Loaded

- The "Mighty Midget" Radius Dresser avoids the necessity of removing the grinder wheel guard since the wheel is dressed from below.
- The shaft is of hardened and ground steel, turning in a cast iron bearing that is capable of the finest adjustment for wear and tension.
- All surface ground true and parallel from the hole.
- Adjustable 0° to 180° stop screws.
- 7" Max. wheel.
- Convex radius 1-3/4"
- Concave radius 4"

Imported
Precise
7" Wheel
MODEL No.
RD-7

\$69.95

W/Diamond



"MIGHTY MIDGET" ANGLE DRESSER

Chatter Resistant - Spring Loaded

- The hardened, spring loaded, entirely enclosed slide moves in a honed slide-block that is easily adjusted for wear.
- The spring loading puts a constant light load on the slide that is desirable for accurate work.
- The base angle plate is a heavy, precision ground alloy-iron casting, square on all side to an accuracy of .0002" per inch.
- The slide block pivots on a hardened and ground pivot-screw, with a sealed ball thrust bearing, locking into a hardened nut.
- Diamond and handle can be interchanged for convenience of operation.

Dimensions:
Angle Plate-
3" Width
3" Length
3" High

Import
Precise
MODEL No.
MLB-005

\$49.95

W/Diamond

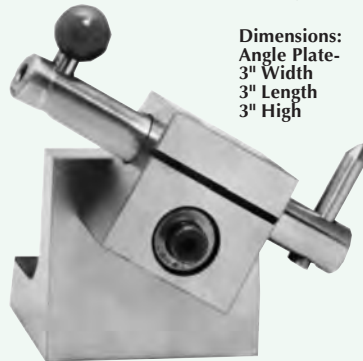

VISI OPTICAL RADIUS & ANGLE DRESSER

- 1° vernier markings for dressing angles.
- Magnification, through hole in the spindle, makes it possible for the operator to see how to dress the form on the grinding wheel.
- Dresser is tested and guaranteed for accuracy.
- Case included.

Specifications:

Overall height 4"
 Length 8-1/4"
 Swing arm 180°
 Max. size grinding wheel 8"
 Max. outside radius (on wheel) . . . 5/8" approx.
 Max. inside radius (on wheel) . . . 1" approx.
 Center height 2-1/2"
 Spindle 1" O.D.
 Weight 11 lbs.

MODEL No.
ORD-001

\$495.00

With
Fitted Case

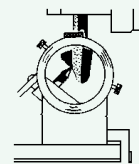
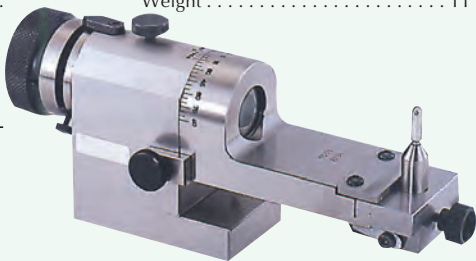

Grinding Wheel Dressing Application



Model No.	Description	Price
3900-0078	Convex Radius Diamond 3/8" x 2", .250" & up	\$22.50
3900-0077	Convex Radius Diamond 3/8" x 2", .125 - .250" Radius	21.95
3900-0086	Concave Radius Diamond 3/8" x 2", .010" Radius	24.95
3900-0087	Concave Radius Diamond 3/8" x 2", .015" Radius	25.95
3900-0089	Concave Radius Diamond 3/8" x 2", .020" Radius	25.95

EAGLE ROCK® END MILL/SHELL MILL 5-C COLLET GRINDING FIXTURE

- This fixture uses 5-C collets (no more bushing to loose) which means any shank size endmill from 1/16" to 1-1/8" can be ground.
- Shell mills can easily be held with straight shank arbors.
- The use of 5-C collets assures concentricity. Solid negative hall stops with 15° or 36° spacing fast easy set-ups.

Import
15° Index
Precise
MODEL No.
EMF-100

\$39.95

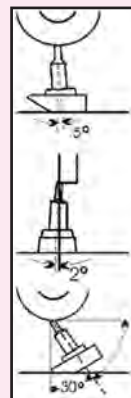

MADE IN
USA

EAGLE ROCK®

Model	Description	Price
A1-215	15° Index Standard Fixture	\$65.00
A1-236	36° Index Standard Fixture	75.00

Precise HI-LOW DIAMOND DRESSER



- Designed for use on all grinding machines.
- Dress O.D. and face of wheels.
- Adjustable to 7" height.
- Dress any width.
- Rugged construction.
- Includes diamond dresser: 3/8" x 3" (1/4 carat).

MODEL No.
HLD-174

\$59.95

Complete
With 1/4 Ct.
Diamond

Precise PRECISION Duplex DRESSER

Dress Any Custom width Up To 1-9/16

- Designed to simultaneously dress both sides of a grinding wheel, precisely and without deformation.
- Useful for thinning grinding wheels or dressing thin wheels.
- Tool steel construction & hardened through out to HRC 60 for life time use.

Specifications:

Max. width of wheel 1-9/16"
Max. dressing depth 1-9/16"
Min. dressing width 0.0079"
Graduation 0.0001"
Weight 71lbs.



MODEL No.
PDD-225 **\$179.95**

Accepts 1/4" Shank Diamond
(One Included)

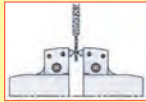

Taper Dressing

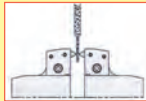

Parallel Dressing

Precise SINE DRESSER

- Combination sine system and crossfeed for dressing grinding wheel precise angles.
- Made in Taiwan.

MODEL No.
380-524

\$195.00



Specifications:
Range of Angles 0-60°
Distance of rolls center to center. . 2"
Accuracy within 0.0002"
Net weight 3.5 lbs.

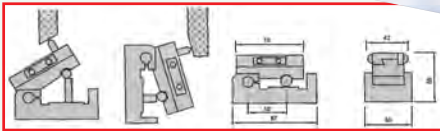

Harig TRU-DEX RADIUS DRESSER

- Tangent-radius wheel dresser handles wheels up to 12" diameter.
- Dresser radius up to 2-1/4" convex and 5" concave.
- 3.000" center height and tangent throw of 1-7/16" from center.
- Indexing every 15 degrees to +/- 10 seconds.
- Most accurate, easiest to use, and safest wheel dresser available.



MODEL No.
030-100
Reg. \$2550.00

\$2395.00

MADE IN
USA

Specifications:
Dresses wheels up to 12" diameter
Dresses radius up to 2-1/4" convex, 5" concave
Center height 3.000"
Indexing every 15 degrees to +/- 10 seconds
Tangent "throw" 1-7/16" from center
Weight 16 lbs.

No. 91002 O.D. Diamond
Nib #7 \$75.00

No. 91003 I.D. Diamond
Nib .020" \$78.00

DESMOND DIAMOND NIB DRESSER

MODEL No. DH-15

\$29.95

With Diamond

MADE IN
USA

- Designed for use on surface grinders.
- Holds diam proper 15° angle.
- Base dimension: 2-1/2" x 6".
- Key-way: 1/2" wide x 7/8".
- Includes diamond dresser 7/16" x 2" (1/4 carat).



Precise HAND DIAMOND DRESSER



- Dresser fitted with plastic handle.
- Shank diameter 7/16"; overall length 8".

Model No.	Diamond Size	List Price
HDD-552	1/3 Carat	\$ 6.95
HDD-553	1/2 Carat	8.95
HDD-554	3/4 Carat	12.95
HDD-555	1 Carat	18.95

- Beautiful chrome finish.
- High quality diamonds
- Ideal tool for dressing wheels for surface grinders, universal grinders, etc.

Precise BRAKE WHEEL

DRESSER FOR DIAMOND & CBN WHEELS

- This operation consists in turning the active part of the wheel in order to provide a regular and continuous contact between the rotating wheel and the piece to be worked.
- The brake turning device is designed for turning cup and peripheral wheels on machines with a vertical or horizontal spindle. Its robustness and handiness make it an indispensable device for precision work.
- Weight 10 lbs.



MODEL No.
BWD-100

\$375.00

No. BWD-101 Replacement Grinding Wheel (3" x 1" x 1/2") **\$19.95**

Precise DIAMOND DRESSERS

Knurl Shank 8" Long

- High quality diamonds.
- Ideal tool for dressing wheels for surface grinders, uni. grinders, etc.
- Beautiful chrome finish.

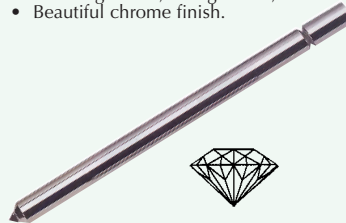

Precise SINGLE POINT DIAMOND DRESSERS

- High quality Diamonds.
- Ideal tool for dressing wheels for surface grinders, uni. grinders, etc.
- Beautiful chrome finish.



Approx. Carat	Shank Size	Model No.	Price Each
1/4	1/2" x 8"	DDK-1800	\$ 6.95
1/2	1/2" x 8"	DDK-1801	9.95
3/4	1/2" x 8"	DDK-1802	12.95
1	1/2" x 8"	DDK-1803	17.50
1-1/2	1/2" x 8"	DDK-1804	25.00
2	1/2" x 8"	DDK-1805	39.00
3	1/2" x 8"	DDK-1806	55.00

Carat	Shank	Model No.	Price
1/4 CT	1/4" x 1-1/2"	SPD-001	\$5.95
1/4 CT	3/8" x 3"	SPD-002	5.95
1/4 CT	7/16" x 3"	SPD-003	6.50
1/4 CT	1/2" x 3"	SPD-004	7.95
1/3 CT	3/8" x 3"	SPD-005	\$5.95
1/3 CT	7/16" x 3"	SPD-006	7.50
1/3 CT	1/2" x 3"	SPD-007	8.95
1/2 CT	3/8" x 3"	SPD-008	\$7.95
1/2 CT	7/16" x 3"	SPD-009	8.95
1/2 CT	1/2" x 3"	SPD-010	10.50
3/4 CT	3/8" x 3"	SPD-011	\$12.95
3/4 CT	7/16" x 3"	SPD-012	14.50
3/4 CT	1/2" x 3"	SPD-013	14.95
1 CT	3/8" x 3"	SPD-014	\$18.50
1 CT	7/16" x 3"	SPD-015	18.50
1 CT	1/2" x 3"	SPD-016	18.50
1/4 CT	3/8" x 6"	SPD-017	\$6.50
1/4 CT	7/16" x 6"	SPD-018	6.95
1/4 CT	1/2" x 6"	SPD-019	7.50
1/3 CT	3/8" x 6"	SPD-020	\$8.50
1/3 CT	7/16" x 6"	SPD-021	8.95
1/3 CT	1/2" x 6"	SPD-022	9.50
1/2 CT	3/8" x 6"	SPD-023	\$8.95
1/2 CT	7/16" x 6"	SPD-024	9.50
1/2 CT	1/2" x 6"	SPD-025	9.95
3/4 CT	3/8" x 6"	SPD-026	\$12.95
3/4 CT	7/16" x 6"	SPD-027	13.50
3/4 CT	1/2" x 6"	SPD-028	13.95
1 CT	3/8" x 6"	SPD-029	\$16.00
1 CT	7/16" x 6"	SPD-030	16.50
1 CT	1/2" x 6"	SPD-031	16.95

Precise DIAMOND CLUSTERS

Particularly efficient and economical for roughing and semifinishing.



Shank
Size
7/16" x 1"



Weight of Diamonds	No. of Diamonds	Model No.	Price Each
1 CT	5	DC-005	\$24.95
2 CT	7	DC-007	39.95

**Precise DIAMOND & CBN
WHEELS TYPE D1A1**

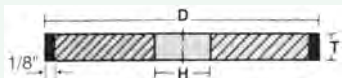

150 Grit 100 Concentration 1/8" Diamond Depth
100 Grit And 220 Grit are also available (Inquire)

Order No.	Dimensions			Diamond 505-	CBN 504-
	Dia.	T	Hole		
-2221	4"	1/16"	1-1/4"	\$49.50	\$ 85.00
-2222	4"	1/8"	1-1/4"	18.00	33.00
-2223	4"	1/4"	1-1/4"	37.50	41.00
-2224	5"	1/8"	1-1/4"	28.00	39.00
-2225	5"	1/4"	1-1/4"	30.00	78.00
-2226	6"	1/16"	1-1/4"	95.00	100.00
-2227	6"	1/8"	1-1/4"	20.00	39.00
-2228	6"	1/4"	1-1/4"	39.50	60.00
-2229	6"	3/8"	1-1/4"	65.00	98.00
-2230	6"	1/2"	1-1/4"	74.00	105.00
-2231	7"	1/4"	1-1/4"	49.50	66.00
-2232	7"	3/8"	1-1/4"	69.50	100.00
-2233	7"	1/2"	1-1/4"	94.00	115.00
-2234	10"	1/4"	3"	65.00	99.00
-2235	10"	1/2"	3"	120.00	185.00
-2236	12"	1/2"	5"	125.00	210.00
-2237	14"	1/2"	5"	160.00	325.00

**Precise DIAMOND & CBN
CUT-OFF WHEELS TYPE D1A1R**

- Use CBN on ferrous material, Use Diamond on non-ferrous material.
- Use to cut off carbide, Quartz, Glass, LED, etc.
- 150Grit 100% concentration.
- Resin Bond. • Diamond depth 1/4"



Order No.	Dimensions			Diamond 505-	CBN 504-
	Depth	Thru	Hole		
-2238	4"	.035"	1-1/4"	\$49.00	\$58.00
-2239	5"	.035"	1-1/4"	58.00	-
-2254	6"	.035"	1-1/4"	72.00	72.00
-2258	6"	.045"	1-1/4"	72.00	-
-2259	8"	.045"	1-1/4"	90.00	-
-2262	10"	.045"	1-1/4"	160.00	-

**Precise DIAMOND & CBN
CUT-OFF WHEELS TYPE D12V9**

- Use CBN on ferrous material, Use Diamond on non-ferrous material.
- Use for precision grinding of end mills.
- 150Grit 75% concentration.
- Resin Bond.

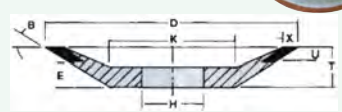

Order No.	Dimensions				Diamond 505-	CBN 504-
	D	T	X	U		
-2248	4"	1/2"	1/16"	1/4"	\$34.00	\$42.00
-2249	4"	1/2"	1/8"	1/4"	44.00	49.00
-2250	6"	3/4"	1/16"	1/4"	-	55.00
-2251	6"	3/4"	1/8"	1/4"	63.00	68.00

**Precise DIAMOND & CBN
DISH WHEELS TYPE D15V9**

100 Grit 75%
Concentration
Resin Bond



Order No.	Dimensions				Diamond 505-	CBN 504-
	D	T	X	U		
-2252	6"	3/4"	1/16"	1/4"	\$49.00	\$55.00
-2253	6"	3/4"	1/8"	1/4"	60.00	62.00

**Precise PLAIN CUT WHEELS
DIAMOND & CBN TYPE D6A2C**

For carbide tool grinders in 6" diameter
Diamonds on outer rim *75% Concentration
Bolt holes counter sunk. **100% Concentration

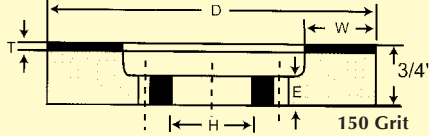

Order No.	Dimensions			Diamond 505-	CBN 504-
	T	D	W		
-2212**	1/8"	6"	3/4"	\$85.00	\$125.00
-2217**	1/8"	6"	1/2"	50.00	85.00
-2218*	1/16"	6"	3/4"	45.00	95.00
-2219*	1/16"	6"	1/2"	40.00	55.00
-2220*	1/16"	6"	1"	58.00	115.00

**Precise FLARE CUP WHEELS
DIAMOND & CBN TYPE D11V9**

For all-around
Tool Sharpening

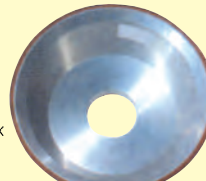
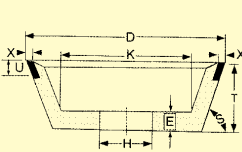

150 Grit
100 Concentration

1-1/4" Hole

Order No.	Dia. Depth	Dimensions			Diamond 505-	CBN 504-
		D	T	U		
-2210	1/8"	3-3/4"	1-1/2"	3/8"	\$30.00	\$68.00
-2211	1/8"	5"	1-3/4"	7/16"	65.00	65.00
-2213	1/16"	5"	1-3/4"	7/16"	40.00	79.00

**Precise FLARING CUP WHEELS
DIAMOND & CBN TYPE D11AZ**

1/8" Diamond Depth
With Diamond on Face
Resin Bond

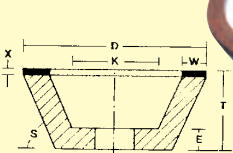

150 Grit
100 Concentration

1-1/4" Hole

Order No.	Dimensions			Diamond 505-	CBN 504-
	D	T	U		
-2242	3"	7/8"	3/8"	\$25.00	\$40.00
-2243	4"	1-1/4"	1/2"	34.00	57.00
-2244	5"	1-3/4"	3/8"	60.00	75.00

**Precise DISH WHEELS RESINOID
DIAMOND & CBN TYPE D12A2**

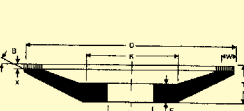

150 Grit
100 Concentration

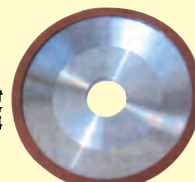

1/8" Diamond Depth

1-1/4" Hole

Order No.	D	Dimensions		Diamond 505-	CBN 504-
		Rim	Angle		
-2245	6"	3/16"	30°	\$35.00	\$55.00
-2246	6"	1/4"	30°	40.00	63.00
-2247	6"	3/5"	30°	66.00	92.00

**Precise CONCAVE RADIUS
DIAMOND DRESSERS**

MADE IN
USA



3/8 x 2" Shank
GN Style

Model	Radius	Price
3900-0086	.010"	\$24.95
3900-0087	.015"	25.95
3900-0088	.020"	25.95

**Precise CONVEX RADIUS
DIAMOND DRESSERS**

MADE IN
USA



Model	Radius	Price
3900-0077	.125 - .250"	\$21.95
3900-0078	.250" & up	22.50

**Precise VM CONVEX
RADIUS DIAMOND DRESSERS**

- Concentric radius tools.
- Special octahedron diamonds for fine work.
- Grade AAA 90°

MADE IN
USA

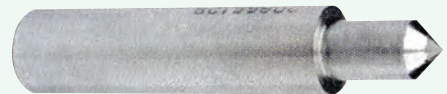

3/8 x 2" Shank

Grade AAA 90°
MODEL No.
3900-0097

\$23.75

**Precise SINGLE POINT
DIAMOND DRESSERS**



3/8 x 3" Shank
Octo Style

MADE IN
USA

7/16" x 3" Shank
Octo Style

Model No.	Carat (approx.)	Price Each	Model No.	Price Each
3900-0072	1/4	\$ 7.25	3900-0082	\$ 7.25
3900-0073	1/3	10.50	3900-0083	10.50
3900-0074	1/2	14.50	3900-0084	14.50
3900-0075	3/4	20.50	3900-0085	20.50
3900-0079	1	29.50	3900-0090	29.50

**Precise ELECTROPLEX
DIAMOND CUT-OFF WHEEL**

- Use to cut off the damaged ends of carbide cutting tools (end mills, reamers, drills, etc.)
- 100 grit.



Order No.	Diameter	Thick "T"	Hole "H"	Diamond Depth	Price Each
505-5000	2-1/4"	.24"	1/4"	1-1/4"	\$ 7.50
505-5001	6"	.042"	1-1/4"	1/8"	42.00

CLAMPING KITS AND COMPONENTS SINCE 1942

STEP BLOCK SETS



Heat Treated Steel Black Oxide Finish Blocks

Table with columns: Model, Consists Of, Price. Includes models 20801-1 and 20802-1.

Note: One Block is in two Pieces

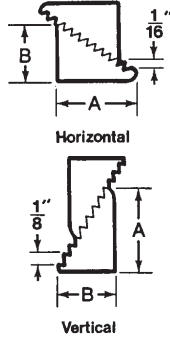

Table of Steel Blocks and Aluminum Blocks with columns: Model No., Capacity, Height, Price Each. Includes sub-sections for 1 inch and 2 inch wide blocks.

Note: One Block is Two Pieces

T-NUT AND STUD SETS

Use for clamping set-up on mills, boring machines, presses, etc. For table slots to 1-1/16"

Sets Consist of:

- 4 Studs of each length: 3", 4", 5", 6", 7", 8"
6 T-slot nuts to fit your machine
4 Coupling nuts, 4 Flanged nuts, 1-T-slot cleaner handy holder



PLAIN CLAMPS

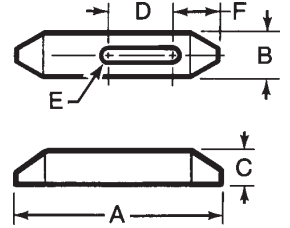

Table of Plain Clamps with columns: Model No., Bolt Size, Dimensions L x W x Thick, Price Each. Includes models 30401 through 30415.

STEP CLAMPS



Heat Treated Black Oxide Finish

Made In America

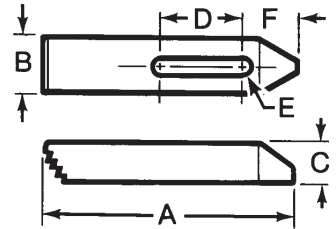

Step clamp teeth match all sizes of step blocks, steel or aluminum. Teeth lock securely and permit height adjustments in 1/8" increments.

FLAT WASHERS CASE HARDENED Black Oxide Finish



Priced at 10 Per Box

Table of Flat Washers with columns: Model No., Stud Size, Dimension A x B x C, Price Per Box. Includes models 42600 through 42611.

CLAMP SUPPORTS

Holds clamp in place while loading and unloading workpiece.



Table of Clamp Supports with columns: Model No., Stud Size, Free Length, Price Each. Includes models 50803 through 50806.

Table of Plain Clamps (continued) with columns: Model No., Bolt Size, Dimensions L x W x Thick, Price Each. Includes models 30501 through 30515.

TE-CO's clamping kits reduce the set-up time needed on milling machines, boring mills and for other machine table operation. All of the tools, studs, nuts and clamps are kept organized and in easy reach.

Each Kit Contains:

- 4 Studs of each length: 3", 4", 5", 6", 7", 8"
4 T-slot nuts, 4 Flanged nuts, 4 Coupling nuts, 6 Step blocks, 6 Step clamps, 1 "T" slot cleaner, 1 Handyholder

Super Sets



Shown On Wood Base and Metal Tray

All Steel Block And Clamps

Table of Super Sets with columns: Model No., Table Slot, Stud Size, Price Set. Includes kits with 1 inch and 1-1/2 inch wide step blocks.

* Metric Sets are Available (Inquire)

T-Slot Cleaner

Eliminates The Danger Of Removing Chips With Air

6" Length



MODEL 50101 Heated Treated Black Oxide Finish \$8.95 Box Of 10 Pieces

Precise STEEL CLAMPING KITS

- For Bridgeport type milling machines.
Includes all the studs, nuts, step blocks & step clamps for any set-up.
Includes fitted rack for easy mounting.

Consists of 52 pieces

- 24 studs, 4 each of 3", 4", 5", 6", 7", 8".
4 coupling nuts.
6 T-slots nuts.
6 flange nuts.
6 serrated end clamps.
6 step blocks.
1 holder



QUALITY IMPORT MODEL No. SECK-625 Reg. list \$69.95 \$49.95

MADE IN AMERICA MODEL No. 20402P* Reg. list \$124.95 \$79.95

Table of Steel Clamping Kits with columns: Model No., Table T-Slot, T-Slot Width, Stud Thrd. Size, Weight Set lbs., Sale Price. Includes models SECK-380 through SECK-136.

* For Bridgeport Type Milling machines



CLAMPING KITS

Clamping Kit contents may be used as 4 tee nut clamps or as 6 fixture clamps. Includes 2 hex keys and complete instructions in a durable storage case.

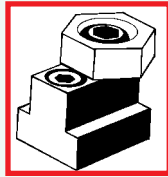

5/8" T-Slot

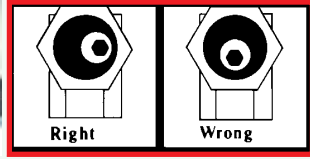

Right

Wrong



SET No. 10644

\$102.50

phase II

SET No. CGK-001

\$59.95

Model No.	T-Slot Size	Hex Width & Height	Set Price
10640	3/8"	5/8" x 3/16"	\$102.50
10641	7/16"	13/16" x 3/16"	102.50
10642	1/2"	13/16" x 1/4"	102.50
10643	9/16"	13/16" x 1/4"	102.50
10644	5/8"	1" x 3/8"	102.50
10646	11/16"	1" x 3/8"	102.50



T-SLOT TOE CLAMP

A low profile cam action clamp with positive downforce. This clamp is mounted in the T-slots of machine tables by sliding the clamps to the workpiece and tightening the locking screw.

- Two clamping edges.
- Smooth for machined surfaces.
- Serrated for rough cut material.



Model No.	T-Slot Size	Price
24128	9/16"	\$40.00
24148	5/8"	40.00
24168	11/16"	40.00
24188	3/4"	40.00

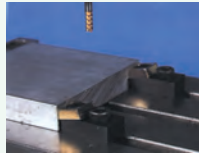

HEAVY-DUTY EDGE CLAMPS

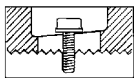

- Double acting adjustable jaw exerts clamping forces both in and down.
- "V" groove in nose allows a positive grip on round parts and corners.
- Removable aluminum nose cap prevents damage to workpiece.
- Tapered slot and serrated bottom prevent clamp from sliding back after tightening. If application requires a smooth clamp bottom, simply remove serrations by grinding.

Model No.	Height	Width	Length	Slot Length	Screw Size	Nose Style	Nose Thick-ness	Sale Price Each
33801	5/8"	1-1/4"	2-1/8"	3/8"	3/8"	LOW	7/32"	\$39.95
33802	5/8"	1-1/4"	2-1/8"	3/8"	3/8"	STD	5/8"	43.50
33803	5/8"	1-1/4"	4-1/4"	2"	3/8"	LOW	7/32"	44.75
33804	5/8"	1-1/4"	4-1/4"	2"	3/8"	STD	5/8"	47.00
33805	3/4"	1-1/2"	3-7/16"	3/4"	1/2"	LOW	3/8"	45.90
33806	3/4"	1-1/2"	3-7/16"	3/4"	1/2"	STD	3/4"	\$49.20
33807	3/4"	1-1/2"	5-3/8"	2-3/4"	1/2"	LOW	3/8"	48.28
33808	3/4"	1-1/2"	5-3/8"	2-3/4"	1/2"	STD	3/4"	50.50

WELDERS ANGLE CLAMP

- Copper plated spindle pivots allow moveable jaw to securely grip parts at 90°
- For holding material for right angle joining, assembling, welding or grinding.
- Self-centering jaw quickly adjusts to clamp workpieces, even accommodating pieces of different sizes. • Work surfaces, including base are milled.
- Made of high quality cast iron and is zinc plated. Spindle is copper plated to resist weld spatter. • Slotted holes are provided in the base for mounting.



MODEL No. EAC-125
Reg. \$69.50

\$49.95

Model No.	Miter Capacity	Jaw Height	Jaw Length	Weight	Sale Price
EAC-125	3-11/32"	1-3/8"	4-1/8"	11.5 lbs.	\$49.95
EAC-126	4-11/16"	2-3/8"	5-9/32"	23 lbs.	64.95



FIXTURE CLAMPS-CAM ACTION DESIGN

Mitee-Bite clamps are used whenever space-saving edge clamping is a benefit. They are simple to use and only require tapped holes in your fixture. A half turn tightens or loosens the workpiece.

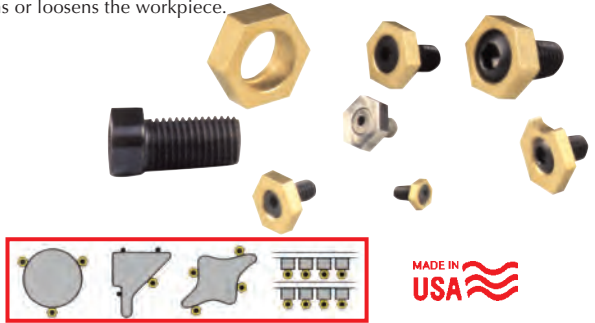

MADE IN USA

Model No.	Screw Size	Thread Length	Hex Size	Hex Height	Max. Holding Force	Total Throw	No. of Clamps Per Pkg	Sale Price
10202	8-32"	3/8"	5/16"	.110"	205 lbs.	.030	10	\$50.50
10204	1/4-20"	1/2"	5/8"	3/16"	800 lbs.	.040	10	53.00
10205	5/16-24"	1/2"	13/16"	3/16"	750 lbs.	.040	12	66.00
10206	3/8-16"	5/8"	1/4"	1/4"	2000 lbs.	.050	10	61.50
10208	1/2-13"	1"	1"	3/8"	4000 lbs.	.100	8	66.00
10210	5/8-11"	1-1/4"	1-3/16"	1/2"	6000 lbs.	.100	4	\$50.50



UNIFORCE CLAMPS

- Enables you to fixture more parts on the machine table.
- Increases production. • Minimizes tool changes. • Reduces wasted space.
- Holds two parts with equilateral clamping action.
- Ideal for clamping flat or round work pieces.

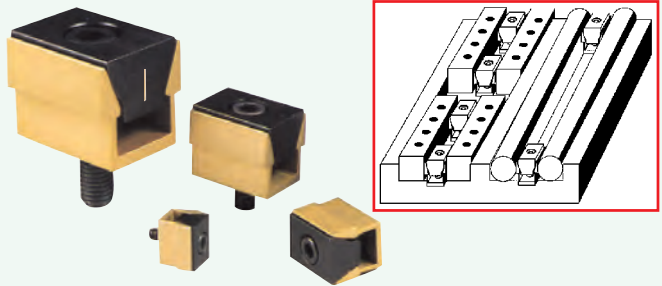

Model No.	Thread Size	Hex Key Size	Max. Spread	Holding Force lbs.	Clamps Per Pack	Sale Price
60500	8-32	9/64"	.565	500	8	\$ 62.75
60750	1/4-20	3/16"	.830	1500	6	63.50
61000	5/16-18	1/4"	1.120	2000	4	62.75
61500-1	1/2-13	3/8"	1.650	3500	2	104.50
62000	5/8-11	1/2"	2.175	6000	3	158.00

Precise UNIVERSAL H/V CNC TOOL TIGHTENING FIXTURE

- Multiple usage on tool holder tapers NMTB (ISO), CAT, BT & DIN.
- Efficiently designed for maximum protection of tool holder.
- Enables strong gripping power of cutting tools in horizontal & vertical positions
- Light weight and compact design for mounting on work table or tool cart.

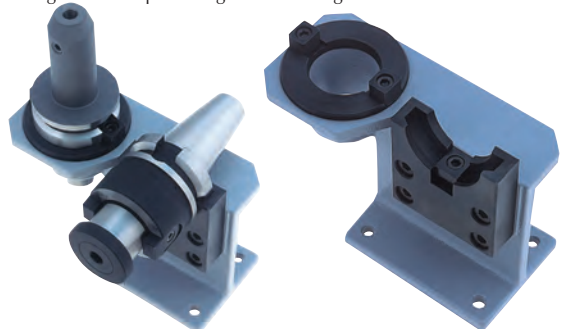

Model No.	Taper Size	Dimensions Height-Length-Width	Price Each
202-610	CAT/BT 30	4.25" x 7.09" x 3.78"	\$69.95
202-612	CAT/BT 40	4.25" x 7.09" x 3.78"	69.95
202-614	CAT/BT 50	5.91" x 9.84" x 4.72"	99.95

KANT TWIST CLAMPS THE STANDARD IN UNIVERSAL CLAMPING KANT TWIST

- Kant-Twist, totally U.S. made, is the standard in universal clamping devices.
- Combines the best features of "C" and parallel clamps.
- Kant-Twist clamps weigh approximately half as much as comparable C-clamps, yet are much stronger by actual test.
- The only "C" clamp with built-in "V" blocks.
- Provides new freedom of movement.
- Eliminates distorting and twisting.
- Provides three different gripping surfaces.



HIGH TENSILE STEEL CLAMPS W/COPPER PLATED JAWS

Model No.	Clamp Size	Depth Open "B"	Depth Closed "C"	List Price	Sale Price
KT-369	3/4"	3/8"	3/8"	\$13.65	\$12.25
KT-401-1	1"	1/2"	1/2"	14.75	13.25
KT-119	1-1/2"	1-1/8"	1"	16.80	14.95
KT-405-1	2"	1-1/8"	1-1/4"	19.70	17.70
KT-401	1"	1/2"	5/8"	\$13.65	\$12.25
KT-405	2"	1-1/8"	1-1/2"	16.45	14.75
KT-406	2-1/2"D	1-3/4"	1-3/4"	18.15	16.25
KT-410	3"	1-1/4"	2"	23.50	21.00
KT-415	4-1/2"	2-3/4"	3"	25.15	22.50
KT-420	6"	2-1/4"	3-1/4"	38.35	34.50
KT-421	6"D	4-5/8"	5-1/2"	41.80	37.50
KT-430	9"	3-3/8"	5-1/2"	109.05	98.00
KT-435	10"D	6"	7-1/2"	156.25	140.50
KT-440	12"	4-5/8"	7"	173.45	156.00
ALL STAINLESS STEEL					
KT-505	2"	1-1/8"	1-1/2"	\$41.00	\$36.90
KT-510-1	3"	1-3/8"	1-7/8"	54.50	49.00
KT-515-1	4-1/2"	2-3/8"	3"	63.05	56.70

"D" = Deep Throat *Multi-purpose clamp, includes adjustable stop for difficult clamping situations

COMFORT GRIP HANDLES FOR KANT-TWIST CLAMP

Makes repetitive use much easier! Apply maximum pressure with less effort! Very durable! Taps easily on and off! Made from high quality ABS plastic.

Model	For Clamp	Price
GR-145	1"	\$1.95
GR-146	2" & 2-1/2"	2.95
GR-147	3" & 4-1/2"	3.95
GR-148	6"	4.95



QUICK-GRIP SPRING CLAMPS

- Jaw contoured to hold round and odd shaped objects.
- Handles designed for comfortable hand span.
- Ergonomic non-slip handles.
- Removable pads are standard with every Quick-Grip spring clamp.

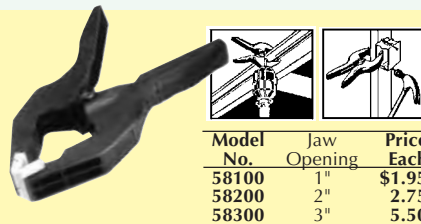

Model No.	Jaw Opening	Price Each
58100	1"	\$1.95
58200	2"	2.75
58300	3"	5.50

Precise NON-TIPPING PARALLELS

- Made of fine grained cast iron that has been stress relieved to eliminate distortion.
- Top is parallel to base within 0.0005". Matched pairs.
- Wide base provides more stability than standard parallels.

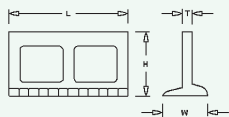

Quality Import



Matched Pairs

Dimensions				Wt.	Model No.	Price Pair
L	W	H	T	lbs.		
8"	3"	4-1/4"	5/8"	12	NTP-008	\$69.95
12"	4"	6-1/4"	3/4"	30	NTP-012	89.95

Starrett & Precise TOOLMAKERS PARALLEL CLAMPS

- These parallel clamps are designed for maximum strength and rigidity.
- A retaining ring holds the loose jaw in alignment when the clamp is being opened or closed.
- The clamps are made of steel, nicely finished and hardened.
- Starrett prices are for each clamp.
- Precise are priced per pair.



Starrett
MADE IN USA

Precise
Economy Import

Jaw Opening	Jaw Length	Starrett No.	Starrett Price (Each)	Precise No. (Pair)	Precise Price (Pair)
3/4"	1-5/8"	161-AA	\$36.50	-	-
1-1/4"	2"	161-A	36.90	TPC-001-1	\$ 8.95
1-3/4"	2-1/2"	161-B	39.60	TPC-002-1	9.95
2-1/4"	3"	161-C	40.50	TPC-003-1	12.95
2-3/4"	4"	161-D	46.80	TPC-004-1	15.00
3-1/2"	5"	161-E	53.00	TPC-005-1	26.50
4-1/2"	6"	-	-	TPC-006-1	38.00
6"	8"	-	-	TPC-008-1	59.50

PORTA-VISE CLAMP VISE

- Welding, metalworking, wood working, auto repair, construction and many more industrial uses.
- Quality finish keeps the tool looking great while protecting it from the elements.
- Non-rotating shaft and pad for precision placement without work deflection.
- Not affected by weld splatter thus increasing the useful life of the tool.
- Hex handle allows for use with a socket or wrench for speed and power.
- Can be completely disassembled for cleaning, lubricating or repair.
- Made from lightweight, durable aircraft quality aluminum.

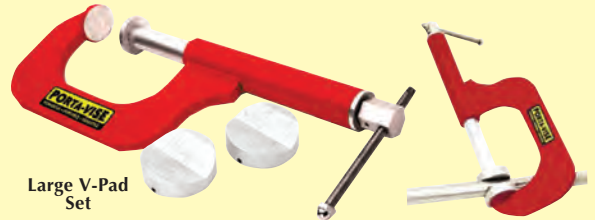

Model	Description	List	Sale
APC-800DRJ	8" Deep Reach Clamp w/2" Step Over	\$149.95	\$135.00
SM-V	Small V-Pad Set	24.95	19.50
LG-V	Large V-Pad Set	24.95	19.50

champagne®

URETHANE MAGNETIC VISE JAWS

- One touch magnetic setting.
- Long life urethane resin material.
- All purpose attachments in new design.
- Simple snap-in system for attachments.

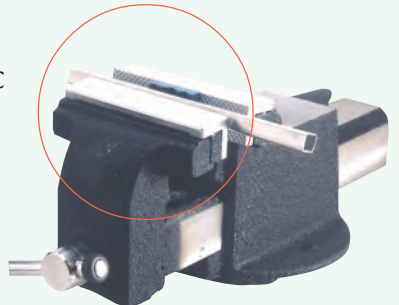

Model No.	Dimensions Lgth "A"	Hght "B"	"C" Width	Price Pair
VM-100	4"	1-1/4"	1-1/4"	\$5.95
VM-125	5"	1-1/8"	1-1/8"	6.95
VM-150	6"	1-1/8"	1-1/8"	6.95

STRONGHAND[®] EXPAND-O PLIERS

POWER Tools of Clamping

Unique, Reverse-Action Clamping Pliers!

- Jaws move in opposite directions to push against two surfaces.



Optional Pipe Adapters

Attach 1/2" NPT pipes for wide spreading jobs.

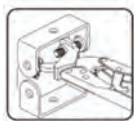

Expand brackets



Insert panel into U-channel

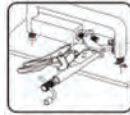

Align to fit holes

Model No.	Overall Length	Minimum Open	Stroke Inch	Clamp Pressure	Price Each
PE6	6-1/2"	1"	3/4"	500 lbs.	\$25.95
PE10	10"	1-3/8"	1-3/8"	900 lbs.	\$32.95
PEV6	6-1/2"	1"	3/4"	500 lbs.	\$41.95
PEV10	10"	1-3/8"	1-3/8"	900 lbs.	\$5.95
XDJ	Pipe Adapter	1-1/16" Length for PE6			\$ 5.50
XFJ	Pipe Adapter	1-3/8" Length for PE10			5.50

STRONGHAND[®] EXPAND-O PLIERS WITH V-PADS AND EXTENSION ROD

POWER Tools of Clamping

- One Magnetic V-Pad, One Standard V-Pad.
- Use the Extension Rod to increase reach by 1"-2".
- Use the bottom Adjustable magnetic V-Pad to set the pliers in place.
- When expanding, the two V-Pads instantly adjust to round or flat surfaces.

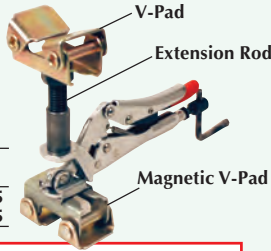

Model No.	Overall length	Clamp Pressure	Minimum Open	Stroke Inch	Price Each
PEV6	6-1/2"	500 lbs.	1"	3/4"	\$41.95
PEV10	10"	900 lbs.	1-3/8"	1-3/8"	65.95

STRONGHAND[®] SHARK CLAMPS

POWER Tools of Clamping

- Quick acting.
- Precise scissor action clamp.
- Pivoting hinge with mounting hole and serrations.
- Single-hand operation.



T-Handle

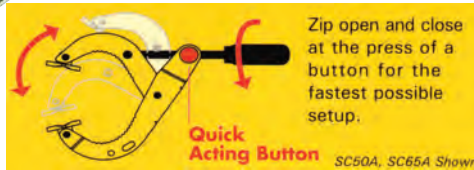

Quick Acting Button

SC50A, SC65A Shown

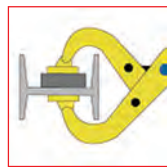

Curved Clamp Arm



Clamps Angled Surfaces

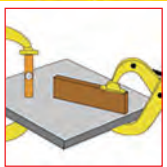

Precise Clamping

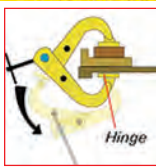

Swing Away Pad

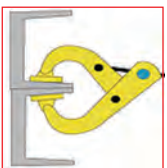

Clamp In Tight Spaces



Grip Teeth



Gang-Mount

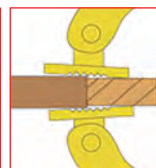

Clamps Uneven Thicknesses

Model No.	Description	Clamp Pressure	Opening Inch	Price Each
SC50	T-Handle	1000 lbs.	5"	\$25.50
SC50A	Straight Handle	200 lbs.	5"	22.00
SC65	T-Handle	1000 lbs.	6.5"	30.50
SC65A	Straight Handle	200 lbs.	6.5"	26.40
SCP	2 Sets (4 Pcs.) Replacement No-Mar, Slip-On Rubber Pads			\$ 5.50

GOOD HAND[®] TOGGLE CLAMPS

- All die-stamped steel parts are deburred, cleaned, and zinc-plated for a finish that resists corrosion and creates a smooth, easy to clean surface.
- Toggle mechanism designed to allow maximum clearance for ease of loading and unloading workpieces.
- Hand grips are covered with an oil and stain resistant red vinyl or red plastic for easy identification and to assure the safety and comfort of the operator.



Model No.	DE-STA-CO No.	Holding Capacity	Bar Type	Price Each
GH-101-A	201	110 lbs.	"u"	\$ 8.50
GH-12050	202	200 lbs.	Fixed	9.90
GH-12130	207	500 lbs.	Short "u"	12.75
GH-12265	210	750 lbs.	"u"	18.15



Model No.	DE-STA-CO No.	Holding Capacity	Bar Type	Price Each
GH-201	205-u	60 lbs.	"u"	\$ 6.60
GH-201-B	215-u	200 lbs.	"u"	9.50
GH-225-D	225-u	500 lbs.	"u"	11.25
GH-20235	235-u	750 lbs.	"u"	17.50

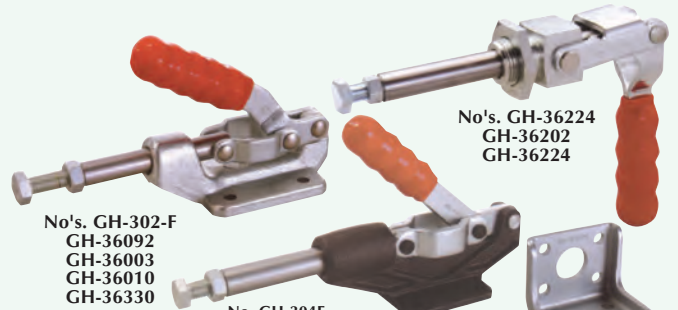

No's. GH-302-F
GH-36092
GH-36003
GH-36010
GH-36330

No. GH-304E
Has ductile Iron Base and Ground Shafts for close fit machining

No's. GH-36224
GH-36202
GH-36224

Mounting Plate

Model No.	DE-STA-CO No.	Holding Capacity	Bar Type	Stroke Inch	Price Each
GH-302-F	605	300 lbs.	Plunger	1.25"	\$14.85
GH-36092	609	400 lbs.	Plunger	1.25"	15.40
GH-36003	603	600 lbs.	Plunger	1.25"	19.80
GH-36010	610	800 lbs.	Plunger	1.63"	22.50
GH-36330	630	2,500 lbs.	Plunger	2"	36.85
GH-36202	602	200 lbs.	Plunger	.75"	14.25
GH-36204*	604	300 lbs.	Plunger	1.50	15.95
GH-36224*	624	700 lbs.	Plunger	2.63"	28.00
GH-304-E	-	850 lbs.	Plunger	1.65"	26.75

* Threaded Mounting Plates:

No. GH-36205 (for No. GH-36204) \$4.50
No. GH-36225 (for No. GH-36224) 2.50

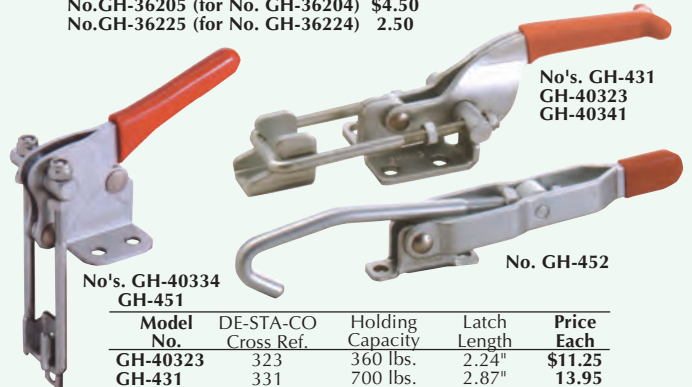

No's. GH-431
GH-40323
GH-40341

No. GH-452

No's. GH-40334
GH-451

Model No.	DE-STA-CO Cross Ref.	Holding Capacity	Latch Length	Price Each
GH-40323	323	360 lbs.	2.24"	\$11.25
GH-431	331	700 lbs.	2.87"	13.95
GH-40341	341	2,000 lbs.	4.50"	22.50
GH-40334	334	1,000 lbs.	3.09"	16.50
GH-451*	351	375 lbs.	5.5" Hook	11.25
GH-452**	351B	375 lbs.	5.5" Hook	11.40

*GH-451 Has Flanged Base **GH-452 Has Narrow Base

- The ease and speed of a Toggle Clamp combined with the new, unique Quick-Mount Slotted Base, and Knobbed Spindle.
- These Toggle Clamps are ideal for holding a workpiece in a positive location for quick and easy clamping in repetitious work.

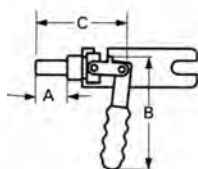
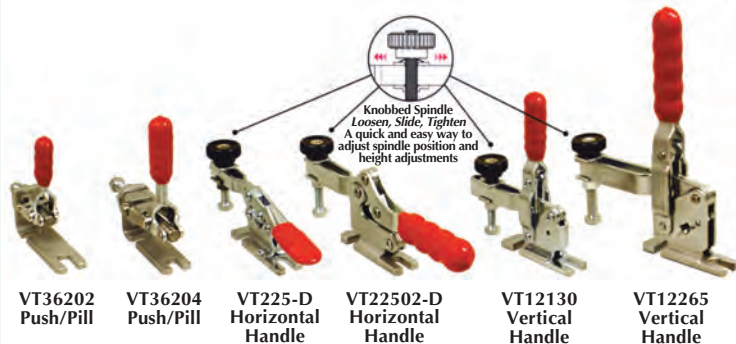

VT36202
VT36204

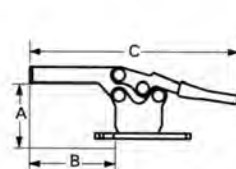

VT225-D
VT22502-D

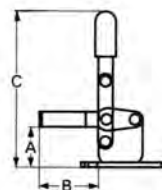

VT12130
VT12265

Uniform 2" Mounting Base

Model	Description	Capacity	A	B	C	Plunger Stroke	Weight	Price
VT36202	Push/Pull	200 lbs.	0.81	3.0	2.5	0.75	0.5 lb.	\$14.50
VT36204	Push/Pull	300 lbs.	1.56	3.9	4.5	1.50	0.8 lb.	15.95
VT225-D	Horizontal	500 lbs.	1.37	2.75	6.61	-	0.6 lb.	10.95
VT22502-B	Horizontal	550 lbs.	1.34	3.11	8.62	-	1.0 lb.	13.95
VT12130	Vertical	500 lbs.	1.25	2.81	5.50	-	0.8 lb.	15.95
VT12265	Vertical	750 lbs.	1.75	3.58	7.50	-	1.4 lbs.	17.95



AUTO-ADJUST TOGGLE CLAMPS

Auto-Adjust

The BESSEY® Auto-Adjust Toggle Clamp automatically adjusts to variations in work piece dimensions while maintaining constant clamping force.

Adaptable base plate

The large (2 1/4" by 2 1/2") flanged base is designed for use with 1/4" or M6 fasteners.

Adjustable clamping force

The integrated clamping force adjustment screw can be used to create an actually lbs. (max holding capacity 700 lbs.)



Horizontal
No.'s STC-HH50
STC-HH70



Incline
No. STC-HH25



Model No.	Opening Inch	Clamping Force	Holding Capacity	Price Each
STC-HH50	2"	25-550 lbs.	700 lbs.	\$21.95
STC-HH70	2-3/4"	25-550 lbs.	700 lbs.	22.95
STC-HH25	1"	25-550 lbs.	700 lbs.	23.95



CHAIN VISE CLAMP

- Fast initial setup. Socket head cap screws are used for mounting each end of the chain clamp to a subplate or T-slotted table.
- Each standard duty kit **No.20149** (clamping force up to 6,000 lbs) and heavy duty kit **No.20149HD** (clamping force up to 12,000 lbs) includes a cam-locking hook assembly, a take-up unit for adjusting chain tension, and a chain set.

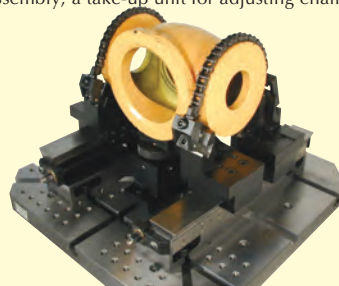

Plastic shoes snap into chain to protect finished surfaces

The Modular fixture above utilizes two chain clamps to secure the valve body casting. A standard Allen wrench is used to operate the cam-locking hook assembly



Model	Chain	Length	Price
20149	#50	40"	\$395.00
20149HD	#80	64"	695.00

Clamp Chain Accessories

10421-1	Clamp Chain Shoes for No. 20149	\$1.50
10421HD	Clamp Chain Shoes for No. 20149HD	1.95
9935	A044 Hitch Pins	1.50

Since workpiece sizes vary, differing lengths of chain may need to be assembled. Our new Hitch Pins which replace spring clips allow quicker and easier assembly & disassembly of chain sets.



PORTABLE - ECONOMY WELDING TABLE

- Three 1.1" (28mm) slots in the tabletop allow for insertion of clamps to reach any point on the table.
- Tabletop adjust to three positions: Horizontal, 30°, and Folded for Compact Storage and Mobility.
- Two retractable, perpendicular steel guide rails can be used as guides, stops, or clamping edges.
- Table easily moves about the work area on two sturdy casters.
- Adjustable Height. Table height adjusts from 26" - 32"



MODEL No.
TS-3020

\$159.95

Specifications:

Table Size 30"W x 20"L
Table Height Range 26" to 32"
Load Capacity 350 lbs.
Weight 44 lbs.



ASTRO PARTS WASHER

- Self draining - 20 gallon capacity.
- Parts basket for soaking small parts in solvent.
- Fusible link greatly reduces risk of fire hazards.
- 110 volt solvent pump.
- Complete unit is UL approved.



Model No.
4543
Reg. \$275.00

\$219.95

STRONGHAND® LOCKING C-CLAMP PLIERS

POWER Tools of Clamping

- Made of heat treated steel and nickel/chrome plated for strength and durability.
- Updated features help you work quickly, safely and efficiently.
- **Single Hand Release Handle.** Vinyl coated release handle made for comfort and ease.

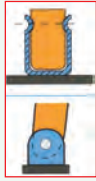

Rivet Swivel Pads on PR**S Models



Optional: Crank Handle No. PXH11 . . . \$2.95

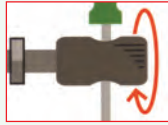

Large adjustment screw with a hole for easy torque

Model	Opening	Throat Depth	O.A.L.	Weight	Price
PR6	2-3/16"	1-13/16"	6-1/2"	0.5 lbs.	\$12.35
PR115	4"	3-1/4"	11"	2.0 lbs.	18.15
PR18	4-1/2"	10"	18"	3.0 lbs.	33.00
PR6S	2-3/16"	1-13/16"	6-1/2"	0.6 lbs.	\$14.30
PR115S	4"	3-1/4"	11"	2.2 lbs.	19.80
PR18S	4-1/2"	10"	18"	3.1 lbs.	35.00

STRONGHAND® ADJUSTABLE AND LONG REACH MULTI-PURPOSE PLIERS

POWER Tools of Clamping

PGA20 Adjustable Reach



PGA20S Adjustable Reach with Fixed Jaw

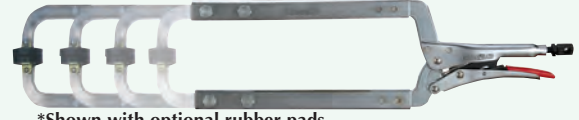

*Shown with optional rubber pads

PG204 Fixed Long Reach



Model No.	Overall Reach	Throat Depth	Opening Inch	Weight lbs.	Price Each
PGA20	23 to 29"	14"-16"-18"-20"	4"	4.8	\$39.50
PGA20S	23 to 29"	14"-16"-18"-20"	4"	4.8	39.50
PG204	21"	12-1/2"	4"	3.1	32.95
PP20	Fixed Rubber Pad (2 Sets Per Pack) for PG204, PGA20				\$ 6.50
PP208	Fixed Rubber Pad (2 Sets Per Pack) for PP20S				6.50

STRONGHAND® MULTI-PURPOSE PLIER

POWER Tools of Clamping

- One swivel pad spindle and a fixed head spindle for flexible clamping.
- Threaded jaw holes allow addition of accessories.

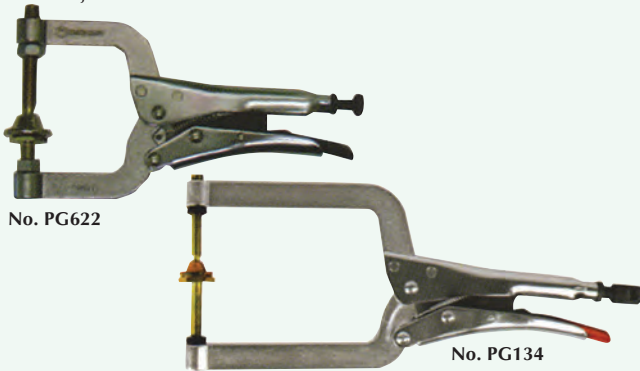

Model No.	Opening Inch	Throat Depth	Overall Length	Thread Size	Price Each
PG622	2-1/2"	2"	6"	M8	\$11.95
PG634	4"	3"	8-1/2"	M8	15.95
PG114	4"	3-1/2"	11"	3/8-16	19.80
PG134	4"	5-1/2"	13"	3/8-16	20.90

STRONGHAND® HAND CHAIN PLIERS

POWER Tools of Clamping

The Flexibility to clamp around odd shaped items!

- Clamp around odd or awkwardly shaped items.
- The ONLY Locking Chain Pliers with replaceable chains of various lengths! Chain lengths from 16" to 48"
- Hold two workpieces, or a group of materials securely in place while you work.
- Made of heat treated alloy steel for strength and durability.

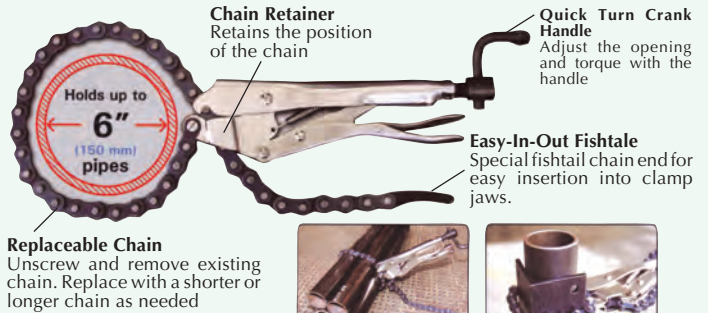

Model	Description	O.A.L.	Weight	Price
PC924	Standard Chain Pliers with 24" chain	9"	1.9 lbs.	\$28.50
PXC16	16" Replaceable Chain	16"	0.5 lbs.	6.50
PXC36	36" Replaceable Chain	36"	1.0 lbs.	15.50
PXC48	48" Replaceable Chain	48"	1.4 lbs.	19.75

STRONGHAND® GROUND HOG™ CLAMP

POWER Tools of Clamping

High clamping pressure improves arc stability and reduces power consumption.

- Prevents current restriction and allows a complete transfer of the electrical current.
- Controls the electrical current by isolating the contact surface and the cable connection.
- Get a smooth, continuous arc with no fade, and no heat transfer while improving cable life, and reducing power consumption.

The Ground Hog

- The groove design on the copperhead seals out weld spatter and reduces particle buildup.
- Side screw provides a secure cable connection.
- Ground Hog body rotates for cable positioning.

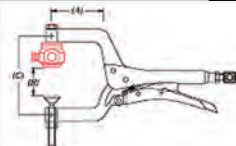

Model No.	Amperage/Cable Size	Dimensions A B C	Clamp Pressure	Overall Length	Price Each
GP-630	300A/2/0-0.427"	3" 1-1/4" 5/16-18	240 lbs.	6"	\$35.95
GP-950	450A/2/0-0.427"	3" 2-1/2" 3/8-16	400 lbs.	11"	44.00
GP-951	550A/3/0-0.427"	3" 2-1/2" 3/8-16	400 lbs.	11"	44.00

STRONGHAND® PIPE PLIERS

POWER Tools of Clamping

The Convenient Way to hold round or square tubes for butt-welding

- Wide opening allows the Pipe Pliers to hold up to 2-1/2" in diameter pipes.
- Adjustable top spindle for holding pipes of varying sizes.
- 2 large V-pads provide a better clamping surface.
- Magnetic bottom V-Pad securely holds the workpiece in place before clamping.
- 0° & 45° angle clip allows angled clamping.



Model No.	Min/Max Diameter	Throat Depth	Overall Length	Weight lbs.	Price Each
PG622V	1"-2"	2"	6"	0.8	\$14.25
PG634V	2"-3"	3"	8-1/2"	1.1	21.95
PG635V*	1-1/2"-2-1/2"	3"	8-1/2"	1.2	23.95
PG114V	1-1/2"-2-1/2"	3-1/2"	11"	2.8	24.95

*Pipe Plier with Adjustable Spindle & Magnetic Bottom V-Pad

STRONGHAND® ADJUST-O ON/OFF MAGNET SQUARE
POWER Tools of Clamping



- The fast and easy way to hold workpieces at 45° & 90°.
- Turn the magnet OFF while setting up, turn ON when you're ready to work. Easy and safe set-up!
- Easy to clean! Turn the magnet OFF and wipe.
- Ideal for round and square tubing, angle, and flat stock.
- Four models with pull forces from 30 lbs. to 130 lbs.



Model No.	Included Angle	Dimensions Inch	Magnetic Pull	Weight lbs.	Price Each
MSA-45	45-90°	4-3/8" x 3-3/4" x 1"	65 lbs.	1	\$34.95
MSA-46	45-90°	4-3/8" x 3-3/4" x 1-1/8"	90 lbs.	1.5	39.95
MSA-47	45-90°	6" x 5-1/8" x 1-1/4"	75 lbs	2.2	69.95
MSA-48	45-90°	6" x 5-1/8" x 1-3/8"	160 lbs.	3	79.95
MSA-53	30-45° 60-90°	6" x 5-1/8" x 1-3/8"	140 lbs.	3	79.95

STRONGHAND® ADJUST-O ANGLE MAGNET
POWER Tools of Clamping

- Hold flat and round work pieces.
- Bubble vial level.
- V-shape on top and bottom for round tubes.
- For precision angle placement. Vernier scale offers 1° reading.



On/Off Switch



Model No.	Angle Range	Dimensions Inch	Magnetic Pull	Weight lbs.	Price Each
MAV-120	30°-275°	7-3/4" x 7-3/4" x 3-3/4"	110 lbs.	5.3	\$249.95

STRONGHAND® ADJUST-O 90° DUAL SWITCHES ON/OFF MAGNET
POWER Tools of Clamping

- For professional jobs that demand strong hold down forces. It holds both flats and rounds.
- Our strongest magnet yet.
- Ground V and flat surfaces.
- Nickel/Chrome plated body.



On/Off Switch

MODEL No. MS2-80

\$125.00



Model No.	Angle Degree	Dimensions Inch	Magnetic Pull	Weight lbs.	Price Each
MS2-80	90°	6" x 6" x 1-1/2"	120 lbs.	2.7	\$125.00
MS2-90	90°	7-3/4" x 7-3/4" x 1-7/8"	265 lbs.	6.0	225.00

STRONGHAND® MAG-LEVEL WITH ON/OFF SWITCH
POWER Tools of Clamping

- The ON/OFF Switch on the Adjust-O Mag Level makes it easy to position.
- Worry free level sticks to steel structure. Magnet stay on top, under both flat and round surfaces

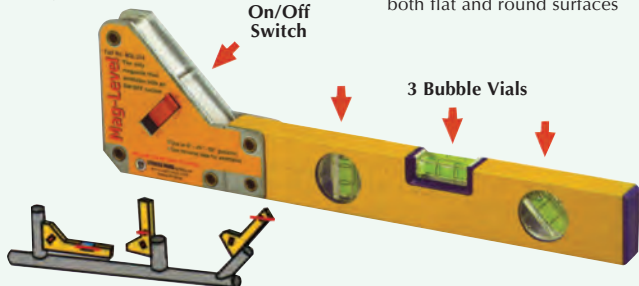

Model No.	Angle Degree	Dimensions Inch	Pull Force	Weight lbs.	Price Each
MSL-316	45°, 90°, 180°	4" x 16" x 1"	70 lbs.	2.0	\$62.50

STRONGHAND® SNAKE MAGNET
POWER Tools of Clamping

The Third Hand- Holds, Bends, Twists

- Comes complete with 2 magnetic pads and 1 spring clamp.



Model	Description	Pull Force	Weight	Price
MFC-312	12" Flex Cable, 1 Clamp 2 Adjustable Magnetic V-pads	18 lbs.	1 lb.	\$29.95
MFC-318	18" Flex Cable, 1 Clamp 2 Flat Magnetic V-pads	20 lbs.	1.4 lbs.	20.75

STRONGHAND® MULTI-ANGLE MAGNET
POWER Tools of Clamping

30°/60°, 45°, 90°

- This magnet has 30/60° edge as well as the standard 45° and right angle (90°) edge.
- The center hole makes it easier to handle. There are two small riveted holes for linking magnets together to add extra strength to the job.

Specifications:

Angles 30/60° 45°, 90
Dimensions 5-1/2" x 4-3/8" x 3/4"
Mag. Pull 55 x 60 x 81 lbs.
Weight 1.0 lbs.

MODEL No. MS-346C

\$16.95



STRONGHAND® POWERBASE™ GROUNDING MAGNET
POWER Tools of Clamping

- The PowerBase™ Grounding Magnet sets up quickly and easily. Start grounding instantly!
- Powerful rare earth magnet delivers heavy duty holding power.
- The "V" machined surface grips round parts.
- The copper connector stud is located on top and allows for a full 360° cable rotation.
- Rugged, compact steel housing for a fast and safe ground, even in tight



Turn OFF the Powerbase™ Grounding Magnet and metal chips fall away



Model No.	Amperage @60% Cycle	Dimensions Inch	Magnetic Force	Weight lbs.	Price Each
GM-203	300A	2" x 2" x 1.4"	75 lbs.	0.9	\$69.95
GM-205	500A	2" x 2.75" x 1.4"	110 lbs.	2.4	89.95

STRONGHAND® CORNER MAGNET
POWER Tools of Clamping

- Create 90° corners by holding from the outside, providing you with an unobstructed area for inside tack welds.
- One side corner "relief" provides clearance for tall lips.
- Use the outer edges of the Corner Magnet for setting up materials at 60°

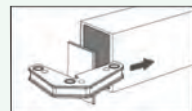
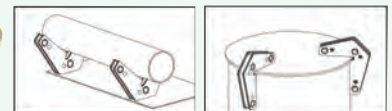

Model No.	Description	Dimensions Inch	Pull Force	Weight lbs.	Set Price
MST-327	Twin Pack 90° & 60°	3-1/4" x 3-3/4" x 5/8"	30 lbs.	0.4 lbs.	\$26.95

STRONGHAND® STANDARD MAGNETIC SQUARES

- Accurate 30°, 45°, 60°, 90° angles.
- Center hole for easy handling.



Model	Angles	Dimensions	Pull Force	Price
MS-45	45° & 90°	4-3/8" x 3-3/4" x 3/4"	65 lbs.	\$16.95
MS-60	60° & 90°	4-3/8" x 3-3/4" x 3/4"	55 lbs.	16.95

STRONGHAND® MINI-MAGNETS 2 & 3 AXIS

- Quickly and easily set-up 2 or 3 axis workpieces.
- Re-position while holding. Tap and slide workpieces to fix positioning, without removing the XYZ Mini Magnet.
- New magnetic face Plate features two rare earth disc magnets for 3rd axis holding. Turn the Magnetic Face Plate with your finger to desired position. Quickly snap together 2 or 3 axis set-ups for tack welding.



Interchangeable Magnetic Plate
Place on either side of the XYZ Mini Magnet. (Pull force 6 lbs.)

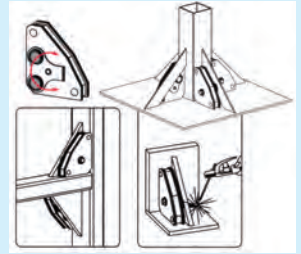

Model	Description	Dimensions	Pull Force	Price
MST-348	Twin Pack	2-5/16" x 2" x 7/8"	25 lbs.	\$21.00

STRONGHAND® 3rd AXIS MAGNETIC POSTS FOR ALL ADJUST-O MAGNETIC SQUARES

- Quickly and easily set-up 3-Axis workpieces.
- Use on either side of the magnet squares.
- Fits all MSA Adjust-O™ Magnet Squares.



Holding a 3-Axis workpiece.

3-Post Set
MODEL No. MXE-13 **\$14.50**

STRONGHAND® ADJUST-O-MAGNET SQUARE WITH ON-OFF SWITCH

- Work set-up - exclusive On/Off switch is easy to position and separate.
- Easy cleaning - enclosed edges.
- Storage - won't stick to other tools.

The Easiest Way To Join Metal For Welding!

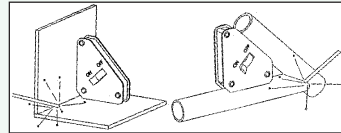

Model	Description	Specification	Pull Force	Weight	Price
MSA-45	45° x 90°	4-3/8" x 3-3/4" x 1"	30 lbs.	1 lb.	\$34.95
MSA-46	45° x 90°	4-3/8" x 3-3/4" x 1.5"	65 lbs.	1.5 lbs.	39.95
MSA-47	45° x 90°	6" x 5-1/8" x 1-1/4"	58 lbs.	2 lbs.	69.95
MSA-48	45° x 90°	6" x 5-1/8" x 1-1/4"	130 lbs.	2.5 lbs.	79.95
MS-45	45° x 90° x 135°	4-3/8" x 3-3/4" x 3/4"	58 lbs.	1 lb.	16.95
MS-60	60° x 90° x 30°	4-3/8" x 3-3/4" x 3/4"	58 lbs.	1 lb.	16.95



ASTRO MIG WELDING PLIERS

- Spatter removal from in and outside the nozzle and nozzle end.
- Tip removal and installation.
- Wire cutting/trimming/drawing.
- Nozzle removal and installation.
- Insulation bushing and installation.



MODEL No. 9408

\$10.95

CHIPPING HAMMER

- Comes with shock proof steel spring handle.
- Hardened and tempered head.



MODEL No. PCH-219

\$2.95

Vestil WELDING CYLINDER CARTS

- Cylinders are secured in cart with ø3/16" double twist chain.
- Model CYHT-2 includes a tool tray.
- Welded steel construction.
- Industrial grade powder coat yellow finish.



Model No.	Max. Cylinder Carry	Max. Cylinder Diameter	Weight Capacity	Wheel Size	Weight lbs.	Price Each
CYHT-1	2	9"	150 lbs.	10"	27 lbs.	\$119.00
CYHT-2	2	12"	250 lbs.	16"	41 lbs.	179.00

mini MULTI ANGLE WELDERS MAGNET 2-5/16" x 2" x 5/8"

- 30/60° edge, with the standard 45° and right angles.
- Large center holes for easier handling.
- Two center holes for easier handling.
- Useful in light duty applications.
- Convenient storage box.

Model No. MS346A4

\$10.95

Each



Six Pack With Storage Case
Model No. MS346AK

\$33.75

Precise CAM TYPE WELDING GAGE

For accurate calibration of butt and fillet type welds. Checks size of fillet welds, permissible tolerance of convexity, concavity, and reinforcement of butt welds

- Stainless steel construction.
- Inch and metric reading.
- Concave and convex preset sizes in accordance with AWS D1-1
- Made in Japan.
- Measuring gauge for weld bead.
- Application: measurement of bead build-up during welding works in general welding, construction, ship and bridge building, steel frame fabrication etc.

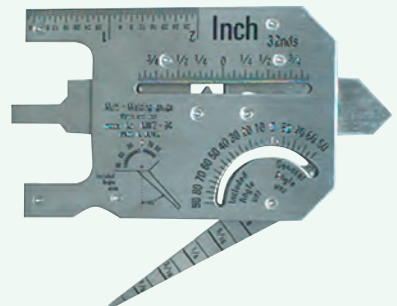

MODEL No. WG-001

\$39.95

GENERAL

PERMANENT ALNICO MAGNETS

- Aluminum, nickel, and cobalt alloy makes General's Alnico line of magnets strong, permanent and economical.
- Under normal working conditions and temperatures, Alnico magnets will retain their magnetic force indefinitely.
- Removable keepers insure permanence.

BUTTON TYPE ALNICO MAGNETS

- Button shaped magnet has almost unlimited applications.
- Retrieves screws and steel parts.
- Center hole in top of magnet for easy fastening.

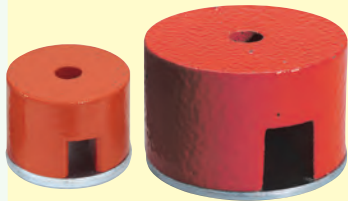

Order	Dia. x Ht.	Pull	Price
372-A	1/2" x 3/8"	1-1/2 lbs.	\$4.95
372-B	3/4" x 1/2"	4 lbs.	6.95
372-C	1" x 5/8"	6-1/2 lbs.	9.50
372-D	1-1/4" x 3/4"	14 lbs.	22.00
372-E	1-1/2" x 7/8"	18-1/2 lbs.	29.95

POT TYPE ALNICO MAGNETS

- Unique combination of strong magnet with insulating ring gives this magnet the superior holding power of larger ones.
- 1/4 x 20 tapped hole for attaching to fixture and machines.



Order	Dia. x Ht.	Pull	Price
374-A	11/16" x 5/8"	6 lbs.	\$11.50
374-B	13/16" x 3/4"	10 lbs.	13.25
374-C	1-1/16" x 1"	18 lbs.	17.50
374-D	1-3/8" x 1-3/4"	35 lbs.	18.50

BAR TYPE ALNICO MAGNETS

- For laboratory and shop use.
- May be used singularly, in pairs, or end to end in multiples.
- Dimensions are for single bars.
- Remove keepers for use.



Order	Dia. x Ht.	Price
373-2	3/8" x 5/8" x 2"	\$18.50

GENERAL

POWER ALNICO MAGNETS

- Strong magnetic pull for lifting, holding, sorting clamping, retrieving steel or iron parts.
- Hole in top of magnet for attaching conveyors, racks, and welding jigs.



Order	Width x Ht.	Pull	Price
370-2	1-1/8" x 3/4"	13 lbs.	\$12.95
370-4	1-1/2" x 1"	22 lbs.	19.95
370-6	1-3/4" x 1-3/8"	30 lbs.	28.95
370-8	2-3/16" x 1-13/16"	32 lbs.	45.00
370-10	2-7/16" x 2"	37 lbs.	60.00
370-12	2-5/8" x 2-1/4"	42 lbs.	70.00
370-16	3" x 2-1/2"	50 lbs.	95.00
370-24	2-1/2" x 1-13/16"	79 lbs.	125.00

ALNICO MAGNETS LABORATORY KIT

- An assortment of permanent Alnico magnets designed for laboratory use in schools, colleges, and other institutions.
- A valuable aid for demonstrating the principle of permanent magnets and plotting magnetic fields of various shapes.
- Kit consists of No. 888-10, No. 371, and 2 each No. 885-10.

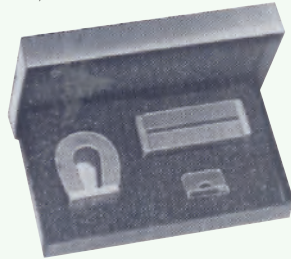

Order	Wt.	Price
390	9 oz.	\$28.95

NOTCHED ALNICO ROUND BAR MAGNETS

- Permanent Alnico round bar magnets are notched to show direction of polarity.
- Sold in pairs.



Order	Dia. x Len.	Wt.	Price Pr.
393-A	1/4" x 13/16"	1/2 oz.	\$4.95
393-B	5/16" x 1"	1 oz.	5.95

MAGNETIZER/DEMAGNETIZER

- Powerful permanent magnet for long lasting performance.
- Magnetizes and demagnetizes screwdrivers, tweezers, tool bits and other steel objects instantly.
- Cordless, handy to operate. Size 2.1 x 2 x 1.1".



MODEL NO. 40010-1
\$4.95

GENERAL

POCKET HORSESHOE ALNICO MAGNETS

- Small but powerful magnet.
- For retrieving small steel parts and screws from hard to get at places.

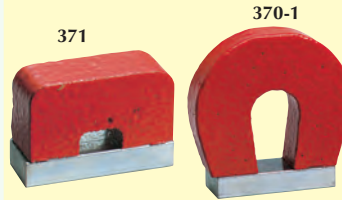

Order	Size	Pull	Price
371	3/4 oz.	1 lb.	\$4.50
370-1	1 oz.	2-1/4 lbs.	6.95

SHALLOW POT CAP MAGNETS

- These permanent, powerful magnets hold, lift and attract metal parts.
- Shallow depth permits use in applications which require small space.
- Center hole for fastening rods, bolts, and screws.



Model	Dia. x Ht.	Pull	Price
376A	1-1/8" x 1/4"	10 lbs.	4.50
376B	2" x 3/8"	20 lbs.	5.50
376C	2-1/4" x 7/16"	35 lbs.	7.50
376D	3-1/8" x 1/2"	50 lbs.	9.95

MAGNETIC ADJUSTABLE WELDING LINKS

- For holding steel plates in position for welding, brazing, and soldering.
- Eliminates need for clamps or temporary fastening.
- Constructed of two heavy duty Alnico magnetic blocks linked together with strong steel bar wing nuts for easy angle adjustment.

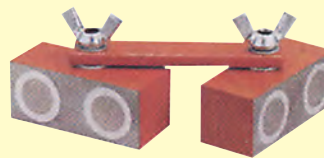

Order	Size of Block	Wt.	Price
375	2" x 1" x 1"	1-1/2 oz.	\$59.95

IMPORT

IMP-375 2" x 1" x 1" 1-1/2 oz. \$16.95

Precise MAGNETIZER DEMAGNETIZER

- Portable Non Contact
- Built-in protection switch to prevent overheating.
- Large parts can be magnetized or demagnetized with the aid of a steel bar at the center of the loop.
- 9-1/2" long x 4-1/2" wide. Opening 3" long x 2" wide.
- 110 volt, single phase.

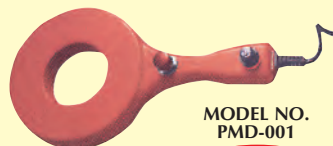

MODEL NO. PMD-001
\$19.95

GENERAL

MAGNETIC STRIPS

- Our flexible magnetic strips with adhesive backing adhere to most smooth surfaces.
- Holds small metal objects.
- Easily cut to desired length with scissors or knife.



Order No.	Size	Price
366	1/2" x 30"	\$2.95
367	1/2" x 10 ft.	6.95
368	1" x 30"	3.95
369	1" x 10 ft.	12.50
369-100	1" x 100 ft.	72.00

TELESCOPING MAGNETIC PICKUP

- Strong permanent Alnico magnet in nickel plated telescoping holder with pocket clip.
- Holder extends from 6" to 24".



MODEL 383X
\$8.50

FLEX-O-STIFF MAGNETIC PICKUP

- An excellent tool retrieving screws, nuts, tools, and other steel parts from inaccessible places.
- For garage, machine shop, and assembly plant.
- Has an 18" stiff pickup or an extra long 32" flexible retriever.

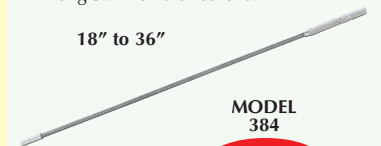

MODEL 384
\$9.95

POCKET MAGNETIC PICKUP

- Powerful permanent Alnico magnet in a knurled aluminum holder with pocket clip.
- Measures 5-1/2" overall.



NEW Stronger Magnet

MODEL 386-1
\$5.95

MAGNETIZER/DEMAGNETIZER MAGNET

- Powerful rare earth magnet specially designed for magnetizing and demagnetizing screwdrivers, nut runners, wrenches, taps, and small tools.
- Picks up and retrieves screws, nuts, and metallic particles.



MODEL 360
\$2.95



BISON PRECISION LIVE CENTERS

Machined from one piece of forging, hardened and precisely ground. Three precision, high quality bearings are protected by a special steel shield and neoprene seal. Live centers are lubricated with special grease and do not require any additional lubrication.



Made In Europe

Model No.	Morse Taper	Point Diameter	Body Diameter	Max. Work	Accuracy Runout	Sale Price
565-001	1MT	.59"	1.50"	220 lbs.	.0003"	\$ 99.00
565-101	1MT	.59"	1.50"	220 lbs.	.0002"	107.00
565-002	2MT	.70"	1.57"	460 lbs.	.0003"	105.00
565-102	2MT	.70"	1.57"	460 lbs.	.0001"	115.00
565-003	3MT	.98"	2.20"	925 lbs.	.0003"	\$125.00
565-103	3MT	.98"	2.20"	925 lbs.	.0001"	139.00
565-004	4MT	1.10"	2.52"	1850 lbs.	.0003"	148.00
565-104	4MT	1.10"	2.52"	1850 lbs.	.0001"	189.00
565-005	5MT	.161"	3.35"	4400 lbs.	.0004"	\$240.00
565-105	5MT	.161"	3.35"	4400 lbs.	.0002"	263.00
565-006	6MT	.248"	5.12"	7700 lbs.	.0004"	480.00
565-106	6MT	.248"	5.12"	7700 lbs.	.0002"	475.00



BISON INTERCHANGEABLE INSERT LIVE CENTER SETS

- Set is provided with the main body and seven different style inserts in a wooden case.
- Precision high quality bearings.
- Special sealing ring protects the bearings from coolant and dust.
- Center and inserts are made from forgings, hardened and precisely ground.
- Inserts are easily interchangeable.



Made In Europe

Set No.	Morse Taper	Max. RPM	Workpiece Weight	Accuracy Inch	Sale Price
570-002	2MT	5000	220 lbs.	.0008	\$345.00
570-003	3MT	4000	440 lbs.	.0008	390.00
570-004	4MT	3000	880 lbs.	.0008	535.00
570-005	5MT	2500	1770 lbs.	.0012	685.00
570-006	6MT	2000	3550 lbs.	.0012	1095.00



BISON ULTRA PRECISION ADJUSTABLE LIVE CENTERS, HEAVY DUTY, TRIPLE BEARING

Machined from one piece of forging, hardened and precisely ground. Three precision, high quality bearings are protected by a special steel shield and neoprene seal. Adjustable, ultra precision radial bearing reduces run out to minimum after much use.

Made In Europe



± 0.00006 T.I.R.

Model No.	Morse Taper	Max. Weight	Thrust @1000 RPM	Overall Length	Max. RPM	Sale Price
567-002	2MT	660 lbs.	400	5.41"	8000	\$169.00
567-003	3MT	1320 lbs.	530	6.53"	6000	185.00
567-004	4MT	2860 lbs.	770	7.89"	4500	235.00
567-005	5MT	4400 lbs.	990	9.80"	4000	285.00
567-006	6MT	8800 lbs.	1580	12.64"	3000	470.00



BISON NC QUAD BEARING LIVE CENTER HEAVY DUTY, HIGH SPEED: 7000-6000 R.P.M.

Made In Europe



Model No.	Morse Taper	Max. Weight	Max. RPM	Max. Runout	Point Length	Body Dia.	Sale Price
566-004	4MT	2200	7000	.0002"	1.91"	2.76"	\$240.00
566-005	5MT	4400	6000	.0002"	2.64"	3.47"	290.00

Precise INTERCHANGEABLE POINT LIVE CENTER KITS

- Used for CNC machines.
- Fine adjustment for better grip.
- Made of hardened tool steel and ground to high accuracy.
- Two special designed high-quality bearings.
- Can be lubricated through a hole on head for smooth operation and longer bearings life.
- Heat treated to HRC 60.

Kit Includes:
Live Center Body
3 of Bull Nose Point
2 of Cone Shape Point
1 Serrated Point
1 Wrench Tool



Model No.	Morse Taper	Max. RPM	Load Rate lbs.	List Price	Sale Price
3900-5052	2	5500	660	\$210.00	\$169.50
3900-5053	3	4500	880	235.00	199.50
3900-5054	4	4000	2640	265.00	225.00
3900-5055	5	3000	4400	295.00	245.00



BISON AUTOMATIC FACE DRIVERS FOR RH & LH OPERATIONS

The ideal holding device for a modern, high production lathe. Specially suited to repetition work. Slim design. All wearable parts hardened and ground. No service required. Spring loaded center. The carrier teeth based on hydroplastic medium adjust automatically to the work piece.

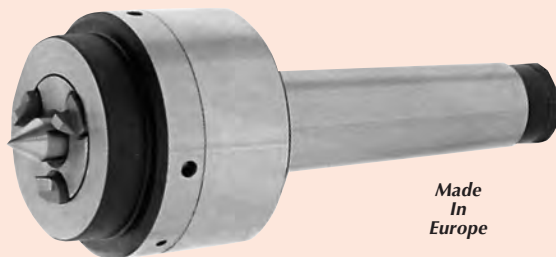

Made In Europe

Model No.	Morse Taper	Head Diameter	Clamp Range	Max. Workpiece	Max. Axial Load	Sale Price
590-041	4MT	2.68"	1.18-1.97	121 lbs.	2204 lbs.	\$535.00
590-043	4MT	3.19"	1.65-3.94	143 lbs.	2645 lbs.	535.00
590-051	5MT	2.68"	1.18-1.97	121 lbs.	2204 lbs.	575.00
590-053	5MT	3.19"	1.65-3.94	141 lbs.	2645 lbs.	695.00
590-054	5MT	3.54"	2.05-4.72	220 lbs.	4409 lbs.	825.00



BISON BULL NOSE LIVE CENTER TRIPLE BEARING DESIGN

Three matched bearings are preloaded at the factory. This provides good thrust and radial capabilities. The bearings are protected by a special seal. The head is made of high carbon alloy steel, heat treated to RC 61-63. 60 degree head angle. Centers are designed to hold pipe and hollow work.



Made In Europe

Model No.	Morse Taper	Large Diameter	Small Diameter	Max. Work	Max. Runout	Sale Price
575-010	1MT	1.97	0.79	220 lbs.	.0003"	\$ 91.00
575-020	2MT	2.36	1.18	400 lbs.	.0003"	105.00
575-021	2MT	3.15	1.18	660 lbs.	.0003"	165.00
575-030	3MT	3.15	1.18	770 lbs.	.0003"	168.00
575-031	3MT	3.93	1.57	1210 lbs.	.0003"	235.00
575-040	3MT	3.93	1.57	1320 lbs.	.0003"	225.00
575-042	4MT	5.51	2.76	1540 lbs.	.0004"	260.00
575-051	5MT	6.69	3.94	1653 lbs.	.0008"	325.00
575-060	6MT	11.50	7.09	4400 lbs.	.002"	1225.00



SKODA LIVE CENTERS
Made In Europe

Precise ECONOMY LIVE CENTERS

- The rotating spindle is extended right through the tapered shank.
- Two specially designed adjustable needle-roller bearings carry all radial loads.
- Heavy duty ball thrust bearing takes all axial thrust.
- Complete protection of bearings from the ingress of coolant, dirt or swarf is provided by the built in oil seal, which also prevents loss of lubricant.

60° Point



SKODA

Skoda Model	Morse Taper	Body Diameter & Length	Max. Load	Price Each
310-105	1 MT	1-3/8 x 4-3/8	200 lbs.	\$ 89.95
310-110	2 MT	1-1/2 x 5	600 lbs.	159.95
310-115	3 MT	1-7/8 x 6-1/4	900 lbs.	169.95
310-120	4 MT	2-3/16 x 7-1/2	1800 lbs.	199.95
310-125	5 MT	2-3/4 x 9-1/2	3000 lbs.	295.00
310-130	6 MT	3-1/2 x 12-3/4	7500 lbs.	450.00

PRECISE ECONOMY SERIES (Made in China)

Precise Model	Morse Taper	Body Diameter & Length	Max. Load	Price Each
ELC-1	1 MT	1-3/8 x 4-3/8	200 lbs.	\$ 19.95
ELC-2	2 MT	1-1/2 x 5	600 lbs.	24.95
ELC-3	3 MT	1-7/8 x 6-1/4	900 lbs.	31.95
ELC-4	4 MT	2-3/16 x 7-1/2	1800 lbs.	36.95
ELC-5	5 MT	2-3/4 x 9-1/2	3000 lbs.	49.95

Precise BULL NOSE LIVE CENTERS

- Ruggedly constructed for the machining of pipe, tubing or any hollow shaft.
- Ultra high quality taper roller bearings
- Thrust and roller bearings assure smooth and precise rotation.
- Specially heat-treated tool steel is used throughout.
- Precision ground finishes are maintained to guarantee a high level of durability and accuracy.



Head Taper
2MT 70°
3MT 75°
4MT 75°
5MT 75°

Model No.	Taper of Shank	Large Diameter	Small Diameter	Reg. Price	Sale Price
BLC-2	2MT	2-7/16"	1/2"	\$ 71.50	\$ 54.50
BLC-3A	3MT	4"	1-1/4"	103.00	99.95
BLC-3B	3MT	3"	3/4"	99.00	89.95
BLC-3C	3MT	3"	1-1/2"	180.00	145.00
BLC-4B	4MT	5"	1-3/8"	180.00	140.00
BLC-4C	4MT	6"	2"	200.00	165.00
BLC-5A	5MT	6"	1-3/8"	235.00	185.00
BLC-5C	5MT	8"	2-1/8"	525.00	485.00

Precise INTERCHANGABLE POINT LIVE CENTER SETS

- Seven interchangeable points.
- Body made of special tool steel hardened and ground with special taper mount for quick change of points.
- Precision needle bearings used for high accuracy and long life.
- Accuracy guaranteed to 12 to 39 10,000ths of center head.
- Can be used for heavy-duty work since point and body act like solid.
- Less heat is generated due to spring plate used at end of angular bearing.



Includes 7 Interchangeable Points

Set No.	Taper	Weight	Reg. Price	Sale Price
IPC-002	2MT	1.6 lbs.	\$125.00	\$ 99.50
IPC-003	3MT	2.45 lbs.	145.00	119.95
IPC-004	4MT	3.05 lbs.	155.00	129.95
IPC-005	5MT	7.95 lbs.	195.00	175.00



TOOLMEX CORPORATION

LIVE CENTERS

Precision Accuracy 0.0002"

- Machined from one piece of forging.
- Hardened and precisely ground.
- Spindle is made of high quality Alloy Steel, heat treated to RC 60-62.
- Centers are provided with three selected heavy duty precision bearings.
- Bearings are protected against dust and coolant.



Model No.	Morse Taper	Maximum Workpiece	RPM Max.	Weight lbs.	Sale Price
3-901-001	1 MT	220	6000	0.64	\$49.95
3-901-002	2 MT	750	6000	0-79	69.95
3-901-003	3 MT	900	5000	1.9	89.50
3-901-004	4 MT	2866	4000	3.15	105.00
3-901-005	5 MT	4409	3500	6.7	134.00
3-901-006	6 MT	8818	2500	15.9	295.00

Precise Morse Taper Drill Sleeves

- Use Morse Taper Sleeves for adapting Morse taper shanks to machines having larger Morse taper spindles



Sizes:
In Sets
1 of Each
Hole
1 MT
2 MT
3 MT
4 MT
Outside
2 MT
3 MT
4 MT
5 MT

4-PC SET
Soft Sleeve
Hardened Tang
SET No.
MTS-012

\$19.95

4-PC SET
Soft Sleeve
Hardened
Ground
SET No.
MTS-013

\$26.95

Model No.	Morse Taper Inside	Morse Taper Outside	Soft Sleeve Hardened Tang	Hardened & Ground Throughout
MTS-001	1MT	2MT	\$ 2.95	\$ 4.95
MTS-002	1MT	3MT	3.95	5.95
MTS-003	1MT	4MT	3.95	10.50
MTS-004	1MT	5MT	6.50	13.95
MTS-005	2MT	3MT	\$ 3.95	\$ 5.95
MTS-006	2MT	4MT	6.50	10.95
MTS-007	2MT	5MT	10.95	13.95
MTS-008	3MT	4MT	\$ 5.95	\$10.95
MTS-009	3MT	5MT	9.95	14.95
MTS-010	4MT	5MT	9.95	15.50
MTS-011	5MT	6MT	25.00	35.00

*Specify 'S' Soft or 'H' Hardened

Precise EXTENSION SOCKETS

- For adapting tools with Morse Taper Shanks to machines having smaller, same or larger Morse taper spindle.

Model No.	Morse Taper Hole Shank	Length Overall	Price Each	
ES-12	1	2	6-3/4"	\$ 8.95
ES-13	1	3	7-1/2"	9.50
ES-14	1	4	8-3/4"	13.50
ES-22	2	2	7-1/2"	8.95
ES-23	2	3	8"	9.50
ES-24	2	4	9-1/4"	13.50
ES-32	3	2	8-1/4"	12.75
ES-33	3	3	9"	12.75
ES-34	3	4	10"	12.75
ES-35	3	5	11-1/2"	20.00
ES-43	4	3	10-5/8"	19.50
ES-44	4	4	11-5/8"	19.50
ES-45	4	5	12-1/2"	21.00
ES-46	4	6	16"	55.00
ES-54	5	4	13-1/8"	40.00
ES-55	5	5	14-1/2"	45.00
ES-56	5	6	16"	58.00





BISON "ER" COLLETS & KITS - CONCENTRICITY TO 0.0004" GUARANTEED



- Wide holding range of each collet requires fewer collets and changes.
- Unique self-releasing system eliminates sticking.
- ER Mini-Collet Chucks allow for machining in tight locations with reduced outside nose diameter.

Made
In
Europe

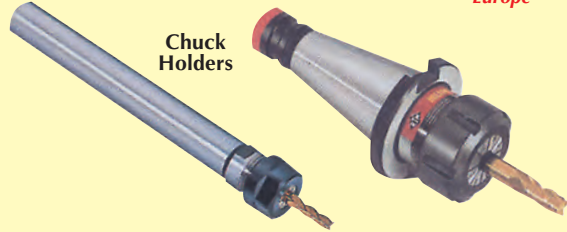

Chuck Holders



Complete
Kits



China

Collet Type/Collet Sizes in Kits	Shank	Chuck Holder Only		Complete kits		China Complete Kits	
		Model	Price	Model	Price	Model	Price
ER-11/1/32" - 1/4" (.020"-.275") 7 Collets	1/2" x 6"	171-1105	\$ 93.00	171-1115	\$209.95	202-154	\$129.95
	5/8" x 6"	171-1106	68.00	171-1116	209.95	202-143	135.00
ER-16/1/8" - 3/8" (.120"-.393") 7 Collets	5/8" x 6"	171-1606	\$ 71.25	171-1616	\$205.00	-	-
	3/4" x 6.5"	171-1607	71.25	171-1617	205.00	202-141	\$149.95
ER-20/1/8" - 1/2" (.120"-.511") 10 Collets	3/4" x 6"	171-2007	\$79.50	171-2017	\$259.00	-	-
	1" x 6.5"	171-2009	80.90	171-2019	259.00	-	-
ER-25/1/8" - 9/16" (.120"-.510") 12 Collets	3/4" x 6.5"	171-2303	\$105.50	171-2313	\$311.50	-	-
	1" x 6.5"	171-2305	105.50	171-2315	311.50	-	-
ER-32/1/8" - 3/4" (.120" x .751") 11 Collets	R-8	171-3008	\$113.50	171-3108	\$295.00	202-147	\$195.00
	NMTB-30	171-3030	82.75	171-3130	281.00	202-148	210.00
	NMTB-40	171-3040	86.50	171-3140	295.00	202-149	220.00
	MT-3	171-3003	100.00	171-3103	295.00	202-142	195.00
ER-40-1/18" - 1" (.120"-1.02") 15 Collets	1" x 3-3/4"	171-3001	100.00	171-3101	297.00	202-151	195.00
	R-8	171-4008	\$122.50	171-4108	\$405.00	202-130	\$239.95
	NMTB-40	171-4040	107.50	171-4140	382.50	202-132	275.00
	NMTB-50	171-4050	129.50	171-4150	415.00	-	-
	1" x 4-1/2"	171-4001	92.50	171-4101	381.00	-	-
	1-1/4" x 4-3/4"	171-4002	90.00	171-4102	382.00	-	-

*Extra Wrench and Clamping Nut Available. Please Inquire



BISON "ER" COLLETS & SETS - CONCENTRICITY TO 0.0004" GUARANTEED

- Due to the wide holding range of each collet, fewer collets and changes are required. 1/32" approx. collapse.
- Unique self-releasing system eliminates sticking.
- ER Mini-Collet Chucks allow for machining in tight locations with reduced outside nose diameter.



Made
In
Europe

Nominal Size	ER-11 No.	ER-11 Price	ER-16 No.	ER-16 Price	ER-20 No.	ER-20 Price	ER-25 No.	ER-25 Price	ER-32 No.	ER-32 Price	ER-40 No.	ER-40 Price	ER-50 No.	ER-50 Price
1/32"	171-112	\$18.95	171-162	\$16.95	-	-	-	-	-	-	-	-	-	-
1/16"	171-113	16.95	171-1621	12.95	171-203	\$13.95	171-2333	\$13.95	-	-	-	-	-	-
3/32"	171-114	16.95	171-1623	12.95	171-204	13.95	171-2335	13.95	171-328	\$16.50	-	-	-	-
1/8"	171-116	16.95	171-163*	12.95	171-205*	13.95	171-2337	13.95	171-330*	16.50	171-430*	\$19.95	-	-
5/32"	-	-	171-1630	12.95	171-206	13.95	171-2338*	13.95	171-332	16.50	171-432	19.95	-	-
3/16"	171-118	16.95	171-164*	12.95	171-207*	13.95	171-234	13.95	171-334*	16.50	171-434*	19.95	-	-
7/32"	171-120	16.95	171-165*	12.95	171-209*	12.95	171-236*	13.95	171-336	16.50	171-436	19.95	-	-
1/4"	171-122	16.95	171-166*	12.95	171-211*	13.95	171-238*	13.95	171-338*	16.50	171-438*	19.95	-	-
9/32"	-	-	171-1663	12.95	171-212	13.95	171-240	13.95	171-339	16.50	171-440	19.95	-	-
5/16"	-	-	171-167*	12.95	171-213*	13.95	171-242*	13.95	171-340	16.50	171-442*	19.95	-	-
11/32"	-	-	171-168*	12.95	171-215*	13.95	171-244*	13.95	171-344	16.50	171-444	19.95	-	-
3/8"	-	-	171-169*	12.95	171-217*	13.95	171-246*	13.95	171-346*	16.50	171-446*	19.95	-	-
13/32"	-	-	-	-	171-219*	13.95	171-248*	13.95	171-348*	16.50	171-448*	19.95	-	-
7/16"	-	-	-	-	171-221*	13.95	171-250*	13.95	171-350*	16.50	171-450*	19.95	-	-
15/32"	-	-	-	-	171-222	13.95	171-252*	13.95	171-352	16.50	171-452	19.95	-	-
1/2"	-	-	-	-	171-223*	13.95	171-254*	13.95	171-354	16.50	171-454	19.95	171-4959	\$54.95
17/32"	-	-	-	-	-	-	171-256*	13.95	171-356	16.50	171-456	19.95	-	-
9/16"	-	-	-	-	-	-	171-258*	13.95	171-358*	16.50	171-458*	19.95	-	-
19/32"	-	-	-	-	-	-	171-260	13.95	171-360	16.50	171-460	19.95	-	-
5/8"	-	-	-	-	-	-	171-262*	13.95	171-362*	16.50	171-462*	19.95	171-4967	54.95
21/32"	-	-	-	-	-	-	-	-	171-364	16.50	171-464	19.95	-	-
11/16"	-	-	-	-	-	-	-	-	171-366*	16.50	171-466*	19.95	171-4971	54.95
23/32"	-	-	-	-	-	-	-	-	171-368	16.50	171-468	19.95	-	-
3/4"	-	-	-	-	-	-	-	-	171-370*	16.50	171-470*	19.95	171-4975	54.95
25/32"	-	-	-	-	-	-	-	-	-	-	171-472	19.95	-	-
13/16"	-	-	-	-	-	-	-	-	-	-	171-474*	19.95	-	-
27/32"	-	-	-	-	-	-	-	-	-	-	171-476	19.95	-	-
7/8"	-	-	-	-	-	-	-	-	-	-	171-478*	19.95	-	-
29/32"	-	-	-	-	-	-	-	-	-	-	171-480	19.95	-	-
15/16"	-	-	-	-	-	-	-	-	-	-	171-482*	19.95	-	-
31/32"	-	-	-	-	-	-	-	-	-	-	171-484	19.95	-	-
1"	-	-	-	-	-	-	-	-	-	-	171-486*	19.95	171-4989	54.95
1-1/16"	-	-	-	-	-	-	-	-	-	-	-	-	-	-
1-1/8"	-	-	-	-	-	-	-	-	-	-	-	-	-	-
1-1/4"	-	-	-	-	-	-	-	-	-	-	-	-	171-4995	54.95
1-5/6"	-	-	-	-	-	-	-	-	-	-	-	-	-	-
Collet Set No.	(7 Piece Set) 171-125		(7 Piece Set) 171-195		(10 Piece Set) 171-225		(12 Piece Set) 171-295		(11 Piece Set) 171-395		(15 Piece Set) 171-495			
Collet Set Price	\$128.50		\$115.00		\$195.00		\$199.50		\$215.00		\$295.95			

SCM AMERICA WELER CHUCK For High Performance Machining

WELER REDUCTION SLEEVES

32mm \$99.50 Each

20mm \$88.00 Each

SWISS

CAT 40 CAT 50 (Coolant Thru Shank)

- .0001" Runout @ 2-1/2" x Diameter
- Slim Nose Design
- No Needle Bearings No Maintenance!
- Coolant thru the shank
- Balanced to G2.5 @ 20,000 RPM
- Screws to a positive stop
- Exceeds 380 ft/lb. of clamping force

Order No.	OD D	ID d
9020.20.03	20	3mm
9020.20/1/8	20	1/3
9020.20.04	20	4mm
9020.20.3/16	20	3/16
9020.20.05	20	5mm
9020.20.06	20	6mm
9020.20.1/4	20	1/4
9020.20.5/16	20	5/16
9020.20.08	20	8mm
9020.20.3/8	20	3/8
9020.20.10	20	10mm
9020.20.7/16	20	7/16
9020.20.12	20	12mm
9020.20.1/2	20	1/2
9020.20.14	20	14mm
9020.20.5/8	20	5/8
9020.20.16	20	16mm

Order No.	OD D	ID d
9020.32.06	32	6mm
9020.32.1/4	32	1/4
9020.32.5/16	32	5/16
9029.32.08	32	8mm
9020.32.3/8	32	3/8
9020.32.10	32	10mm
9020.32.7/16	32	7/16
9020.32.12	32	12mm
9020.32.1/2	32	1/2
9020.32.14	32	14mm
9020.32.5/8	32	5/8
9020.32.16	32	16mm
9020.32.18	32	18mm
9020.32.3/4	32	3/4
9020.32.20	32	20mm
9020.32.7/8	32	7/8
9020.32.24	32	24mm
9020.32.1	32	1

SCM AMERICA TAPPING SOLUTIONS Bilz Style Tension & Compression

Rigid

Bilz Type Tap Holders

Tap Size	Rigid		Torque Control	
	Size 1	Size 2	Size 1	Size 2
ANSI	\$39.95	\$55.00	\$105.00	\$135.00
Order #	Order #	Order #	Order #	
#0-6 M1.6	2, 3, 4	11-4036	1-4036	
#8 M4	5	11-4041	1-4041	
#10 M5	6	11-4048	1-4048	
#12	8	11-4054	1-4054	
1/4 M6	10	11-4063	1-4063	
5/16 M8	12, 1/4	11-4079	12-4079	
3/8 M10	5/16	11-4095	12-4095	
7/16 M11		11-4111	12-4111	
1/2 M12	3/8	11-4127	12-4127	
9/16 M14	7/16	11-4142	12-4142	
5/8 M16	1/2	12-4158	2-4158	
11/16 M18	9/16	12-4174	2-4174	
3/4	5/8	12-4190	2-4190	
13/16 M20		12-4206	2-4206	
7/8 M22	3/4	12-4222	2-4222	
1/8 NPT		12-4131C	1-4097C	
1/4 NPT		12-4166C	2-4131C	
3/8 NPT		12-4209C	2-4166C	
1/2 NPT			2-4209C	

Model No.	d	D	Gage Length	Holder Size	Price Each
324-40CAT	0.748	1.50	2.36	1	\$295.00
324-50CAT	0.748	1.50	2.44	1	\$379.00
326-40CAT	1.220	2.17	3.94	2	\$365.00
326-50CAT	1.220	2.17	3.27	2	\$310.00

SCM AMERICA SYNCROLIZE TAPPING SYSTEM The Quick Change Synchronized Rigid Tapping Solution

Size 1 Tap Capacity #0-1/2"

Order No.	Taper	Gage Length	Nose ø	Price Each
234-40CAT	Cat 40	2.087	1.693	\$265.00
234-50CAT	Cat 50	2.402	1.693	\$375.00
234-40BT	BT40	2.402	1.693	\$310.00
234-S254	1"SS	1.299	1.693	\$250.00

Size 2 Tap Capacity 3/8"-3/4"

Order No.	Collet Size	Nose ø	Price Each
234-ER16	ER16	0.945	\$195.00

ER25 Collets \$22.50 Each Swiss Collets

Inch Tap	Metric Tap	Collet Range	Model No.
3/8	M10	.354-.394	25-08
7/16	-	.315-.354	25-09
1/2	M12	.354-.394	25-10
9/16	M14	.394-.433	25-11
5/8	M16	.472-.512	25-13
11/16	M18	.512-.551	25-14
3/4	-	.551-.591	25-15

ER16 Collets \$21.00 Each Swiss Collets

Inch Tap	Metric Tap	Collet Range	Model No.
#0-6	M1.6-M3.5	.118-.157	16-04
8-10	M4, M5	.157-.197	16-05
12	-	.197-.236	16-06
1/4	M6	.236-.276	16-07
5/16	M7, M8	.315-.354	16-08
3/8	M10	.354-.394	16-09
7/16	-	.315-.354	16-10
1/2	M12	.354-.394	16-11

DORIAN HIGH PERFORMANCE BEARING LIVE CENTERS

Finally, a Live Center with Taper Bearings

- Taper bearings are used in the design of the headstocks to support the spindle. They are the most heavy-duty bearing type to support radial and axial forces. So, it only makes sense to use the same proven design concept on live centers as well.
- These live centers will allow for higher tool pressures, interrupted cuts and workpiece.

High Performance General Purpose

High Performance Heavy Duty

High Performance General Purpose

Model No.	Morse Taper	Max. RPM	Max. Weight lbs.	Thrust Load lbs.	List Price	Sale Price
48200	1	8500	96	365	\$193.00	\$184.00
48201	2	6000	220	792	217.00	206.00
48202	3	5000	572	1144	262.00	249.00
48203	4	4000	1078	1320	336.00	320.00
48204	5	3000	1672	1430	450.00	428.00
48205	6	2500	3388	3300	857.00	815.00

High Performance Heavy Duty

Model No.	Morse Taper	Max. RPM	Max. Weight lbs.	Thrust Load lbs.	List Price	Sale Price
48206	2	7500	506	1012	\$371.00	\$352.00
48207	3	6000	2090	1144	410.00	390.00
48208	4	4500	3300	1320	499.00	475.00
48209	5	2800	4400	2460	615.00	585.00
48210	6	2000	10560	3300	1347.00	1280.00
48211	6	1700	19800	6600	2895.00	2750.00



CNC END MILL HOLDERS ~ BALANCED AND CERTIFIED MAXIMUM TIR 0.0002" O.D. TO I.D.



Sowa Tool has developed a line of CNC tooling manufactured with a modified standard drive slot to properly equalize the weight. This change in tool design enables GS Tooling to meet tolerance machine spindles are made to. GS Tooling can run up to 30,000 RPM without putting unneeded stress on the machine spindle

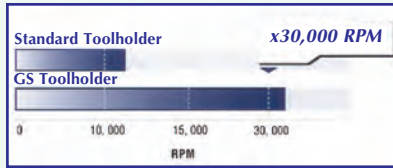

30X RPM

DIN Coolant Capability

Traverse Ground

Cat 40 End Mill Holders

Hole Diameter	Gage Length	Model No.	Sale
1/8"	1.38"	531-069	\$82.50
1/8"	2.50"	531-070	86.50
1/8"	4.00"	531-071	90.75
3/16"	1.38"	531-072	77.50
3/16"	2.50"	531-073	81.25
3/16"	4.00"	531-074	85.50
1/4"	1.38"	531-000	68.50
1/4"	2.50"	531-002	71.00
1/4"	4.00"	531-004	75.00
5/16"	1.38"	531-006	68.00
5/16"	2.50"	531-008	71.50
5/16"	4.00"	531-010	75.00
3/8"	1.38"	531-012	68.00
3/8"	2.50"	531-014	71.50
3/8"	4.00"	531-016	75.00
3/8"	5.00"	531-018	81.50
7/16"	2.50"	531-020	71.00
7/16"	4.00"	531-022	74.00
1/2"	1.75"	531-024	68.00
1/2"	2.50"	531-026	71.00
1/2"	4.00"	531-028	75.00
1/2"	5.00"	531-030	85.00
5/8"	1.75"	531-032	68.00
5/8"	3.00"	531-034	71.50
5/8"	4.00"	531-036	75.00
5/8"	5.50"	531-038	81.50
3/4"	1.75"	531-040	68.00
3/4"	3.00"	531-042	71.00
3/4"	4.00"	531-044	75.00
3/4"	5.50"	531-046	81.00
7/8"	1.75"	531-048	68.00
7/8"	3.50"	531-050	71.50
7/8"	6.00"	531-052	85.00
1"	2.00"	531-054	68.00
1"	4.00"	531-056	75.00
1"	6.00"	531-058	85.00
1-1/4"	4.00"	531-062	75.00
1-1/4"	6.00"	531-064	85.00
1-1/2"	4.50"	531-066	85.00
1-1/2"	6.00"	531-068	95.00



GS TOOLING

Meeting Today's Demand of Increased Speed and Spindle Life

REQUEST FREE!

COMPLETE TOOLING CATALOG



End Mill Holders/
Blank Bars

Shell Mill Holders/
Facemill Holders



Collet Chucks/
Collets

Right Angle Heads/
Spindle Speeders

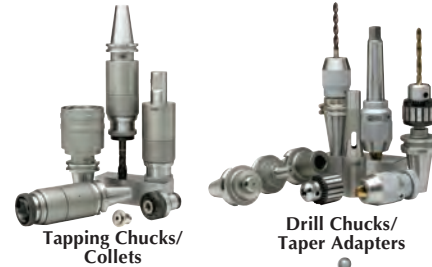

Tapping Chucks/
Collets

Drill Chucks/
Taper Adapters



Vices/Accessories

CAT 50 End Mill Holder

Hole Diameter	Gage Length	Model No.	Sale
1/4"	1.38"	531-082	\$105.00
1/4"	2.50"	531-084	105.00
5/16"	2.50"	531-092	101.00
5/16"	4.00"	531-094	101.00
3/8"	1.38"	531-098	95.00
3/8"	2.50"	531-100	95.00
3/8"	4.00"	531-102	105.00
7/16"	2.50"	531-108	90.00
7/16"	4.00"	531-110	100.00
7/16"	6.00"	531-112	110.00
1/2"	1.75"	531-116	95.00
1/2"	2.63"	531-118	95.00
1/2"	4.00"	531-120	105.00
9/16"	6.00"	531-133	114.00
5/8"	1.75"	531-126	95.00
5/8"	3.00"	531-128	95.00
5/8"	4.00"	531-130	105.00
3/4"	1.75"	531-136	95.00
3/4"	3.00"	531-138	95.00
3/4"	4.00"	531-140	105.00
3/4"	6.00"	531-142	114.00
7/8"	1.75"	531-146	95.00
7/8"	3.75"	531-148	94.00
7/8"	6.00"	531-150	115.00
1"	2.00"	531-152	95.00
1"	4.00"	531-154	98.00
1"	6.00"	531-156	115.00
1"	8.00"	531-158	130.00
1-1/4"	2.00"	531-160	109.00
1-1/4"	4.00"	531-162	115.00
1-1/4"	6.00"	531-164	125.00
1-1/4"	8.00"	531-166	145.00
1-1/2"	2.25"	531-168	109.00
1-1/2"	4.50"	531-170	115.00
1-1/2"	7.00"	531-172	130.00
2"	3.63"	531-176	125.00
2"	5.37"	531-178	140.00
2"	8.00"	531-180	150.00
2-1/2"	6.00"	531-184	175.00



HSK 63 END MILL HOLDERS



HSK 63 End Mill Holders

Hole Diameter	Gage Length	Model No.	Sale
3/16"	3.00"	536-002	\$184.00
3/16"	5.00"	536-004	204.00
1/4"	3.00"	536-006	184.00
1/4"	5.00"	536-008	204.00
5/16"	3.00"	536-010	184.00
5/16"	5.00"	536-012	204.00
3/8"	3.50"	536-014	194.00
3/8"	5.00"	536-016	214.00
7/16"	4.00"	536-018	184.00
7/16"	5.00"	536-020	204.00
1/2"	4.00"	536-022	194.00
1/2"	5.00"	536-024	214.00
5/8"	4.00"	536-026	194.00
5/8"	5.00"	536-028	214.00
3/4"	4.50"	536-030	194.00
3/4"	6.00"	536-032	214.00
1"	4.50"	536-034	204.00
1"	6.00"	536-036	225.00
1-1/4"	4.50"	536-038	215.00
1-1/4"	6.00"	536-040	235.00



HSK 100 END MILL HOLDERS



HSK 100 End Mill Holders

Hole Diameter	Gage Length	Model No.	Sale
3/16"	4.00"	536-042	\$310.00
3/16"	6.00"	536-044	339.00
1/4"	4.00"	536-046	252.00
1/4"	6.00"	536-048	270.00
5/16"	4.00"	536-050	252.00
5/16"	6.00"	536-052	270.00
3/8"	4.00"	536-054	252.00
3/8"	6.00"	536-056	270.00
7/16"	4.00"	536-058	252.00
7/16"	6.00"	536-060	281.00
1/2"	4.00"	536-062	252.00
1/2"	6.00"	536-064	271.00
5/8"	4.00"	536-066	252.00
5/8"	6.00"	536-068	272.00
3/4"	4.00"	536-070	252.00
3/4"	6.00"	536-072	272.00
1"	4.00"	536-074	267.00
1"	6.00"	536-076	291.00
1-1/4"	4.00"	536-078	283.00
1-1/4"	6.00"	536-080	305.00



BISON CATERPILLER V-FLANGE END MILL HOLDERS



- Produced according to AT3 specifications.
- Made of alloy forged steel for long, durable service life.
- Hardened to RC 52-56 and ground to endure maximum accuracy.
- End mill socket T.I.R. <0.0002"
- Through spindle coolant capability.

Made In Europe



CAT 40 TAPER

Model No.	Size Bore	Gage Length	Sale Price
185-405	1/8"	2-1/2"	\$90.00
185-407	3/16"	2-1/2"	91.00
185-409	1/4"	2-1/2"	89.00
185-4094	1/4"	4"	100.00
185-4115	5/16"	2-1/2"	81.00
185-4117	5/16"	4"	100.00
185-412	3/8"	2-1/2"	82.00
185-4122	3/8"	5"	92.00
185-4123	7/16"	2-1/2"	81.00
185-413	1/2"	3-3/4"	83.00
185-417	1/2"	5-1/2"	92.00
185-431	5/8"	3-3/4"	88.00
185-437	5/8"	5-1/2"	93.00
185-441	3/4"	3-3/4"	88.00
185-447	3/4"	5-1/2"	93.00
185-451	7/8"	4-1/8"	93.00
185-461	1"	6"	98.00
185-471	1-1/4"	4-5/8"	99.00
185-475	1-1/4"	6"	113.00
185-481	1-1/2"	4-5/8"	127.00
185-485	1-1/2"	6"	146.00

CAT 50 TAPER

Model No.	Size Bore	Gage Length	Sale Price
185-512	3/8"	4-1/2"	\$132.00
185-513	3/8"	6-1/2"	148.00
185-521	1/2"	2-5/8"	116.00
185-522	1/2"	4-5/8"	140.00
185-523	1/2"	6-5/8"	148.00
185-531	5/8"	3-3/4"	127.00
185-532	5/8"	5-3/4"	144.00
185-533	5/8"	7-3/4"	154.00
185-541	3/4"	3-3/4"	117.00
185-542	3/4"	5-3/4"	131.00
185-543	3/4"	7-3/4"	139.00
185-551	7/8"	3-3/4"	119.00
185-552	7/8"	5-3/4"	134.00
185-553	7/8"	7-3/4"	142.00
185-561	1"	4"	118.00
185-562	1"	6"	147.00
185-563	1"	8"	147.00
185-571	1-1/4"	4"	151.00
185-572	1-1/4"	6"	143.00
185-573	1-1/4"	8"	152.00
185-581	1-1/2"	4"	151.00
185-582	1-1/2"	6"	168.00
185-583	1-1/2"	8"	184.00
185-591	2"	5-5/8"	171.00
185-592	2"	7-5/8"	187.00
185-593	2"	9-5/8"	227.00
185-595	2-1/2"	6"	233.00

Draw Bar Threads:
CAT-40 5/8" - 11"
CAT-50 1" - 8"



BISON CAT V-FLANGE SHELL MILL HOLDERS



- Produced according to AT3
- Hardened up RC-52-56 and ground to ensure maximum accuracy.
- Made of alloy forged steel for long, durable service life.
- Retention knobs are sold separately.
- Shell mill pilot T.I.R. <0.0002".

Made In Europe

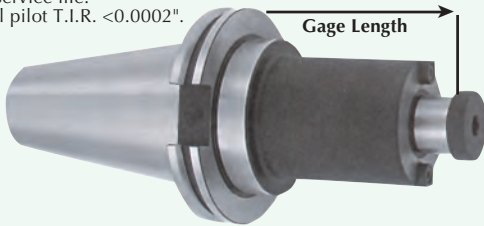

Model No.	CAT "V" Taper	Bore Dia. In Shell Mill	Gage Length	Sale Price
186-403	40	1/2"	1-3/8"	\$143.00
186-405	40	3/4"	1-3/8"	131.00
186-407	40	1"	2-1/16"	130.00
186-409	40	1-1/4"	2-1/8"	134.00
186-411	40	1-1/2"	2-13/16"	153.00
186-503	50	1-1/2"	1-1/2"	\$170.00
186-505	50	1-1/2"	3-1/2"	198.00
186-507	50	1-1/2"	5-1/2"	215.00
186-509	50	3/4"	1-1/2"	\$180.00
186-511	50	3/4"	3-1/2"	200.00
186-513	50	3/4"	5-1/2"	218.00
186-515	50	1"	2"	\$170.00
186-517	50	1"	4"	200.00
186-520	50	1"	10"	465.00
186-521	50	1-1/4"	1-1/2"	\$175.00
186-526	50	1-1/4"	12"	225.00
186-525	50	1-1/4"	5-1/2"	220.00
186-527	50	1-1/2"	2-13/32"	\$210.00
186-529	50	1-1/2"	4"	220.00
186-531	50	1-1/2"	6"	238.00
186-533	50	2"	2-13/32"	\$292.00
186-535	50	2"	4"	315.00
186-537	50	2"	6"	335.00



STRAIGHT SHANK COLLET HOLDERS



- All tool holders supplied are manufactured in the U.S.A. from high grade alloy steel, heat treated and processed to our own stringent specifications which far exceed industry standards.
- Our products are then black oxide coated which provides for an attractive appearance along with corrosion preventive qualities.

MADE IN USA

PrecisionTool Extension "Double Angle" Collet Holders

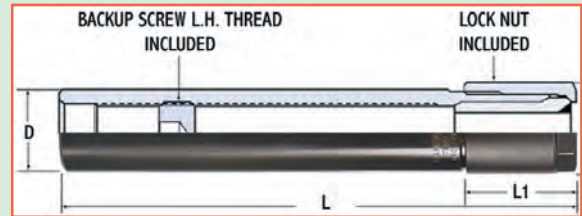

Model No.	Dimensions D x L x L1	Thru Hole	"DA" Series Collet	Holder Price
TE-500	.500" x 6.80" x 1.00"	1/4"	DA-300	\$62.00
TE-750	.750" x 7.10" x 1.34"	3/8"	DA-200	75.00
TE-100	1.000" x 7.30" x 1.54"	9/16"	DA-100	80.00
TE-125	1.250" x 7.30" x 1.54"	3/4"	DA-180	100.00

Model No.	Dimensions D x L x L1	Thru Hole	"DA" Series Collet	Holder Price
TS-500	.500" x 3.60" x .71"	1/4"	DA-300	\$62.00
TS-625	.625" x 3.75" x .71"	3/8"	DA-200	68.00
TS-750	.750" x 3.80" x .71"	3/8"	DA-200	75.00
TS-100	1.000" x 4.00" x .90"	9/16"	DA-100	80.00
TS-101	1.000" x 6.20" x .87"	3/4"	DA-180	107.00
TS-125	1.250" x 6.20" x .87"	3/4"	DA-180	110.00
TS-150	1.500" x 6.20" x .87"	3/4"	DA-180	112.00
TS-175	1.750" x 6.20" x .87"	3/4"	DA-180	118.00

* Extra Lock Nuts and Back-up Screws Available

Precision Collet Extension "ER" Collet Holders

MADE IN USA

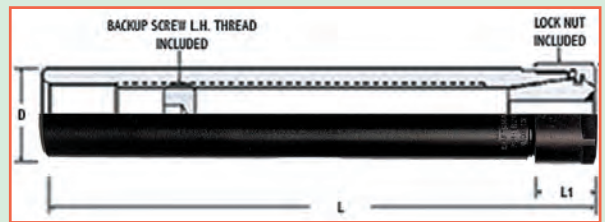

Model No.	Dimensions D x L x L1	Thru Hole	"ER" Series Collet	Holder Price
PCH-500	.500" x 6.65" x .47"	1/4"	ER-11	\$ 75.00
PCH-625	.625" x 6.65" x .47"	1/4"	ER-11	86.00
PCH-626	.625" x 7.10" x .68"	3/8"	ER-16	99.00
PCH-750	.750" x 7.10" x .68"	3/8"	ER-16	95.00
PCH-100	1.000" x 7.20" x .68"	3/8"	ER-16	99.00
PCH-101	1.000" x 7.20" x .78"	9/16"	ER-20	105.00
PCH-10L	1.000" x 10.50" x .78"	None	ER-20	165.00
PCH-125	1.250" x 7.25" x .84"	3/4"	ER-25	137.00

Model No.	Dimensions D x L x L1	Thru Hole	"ER" Series Collet	Holder Price
SPH-500	.500" x 3.50" x .47"	1/4"	ER-11	\$ 72.00
SPH-625	.625" x 3.50" x .47"	1/4"	ER-11	81.00
SPH-626	.625" x 3.65" x .68"	3/8"	ER-16	93.00
SPH-750	.750" x 3.65" x .68"	3/8"	ER-16	89.00
SPH-062	.625" x 3.75" x .78"	3/8"	ER-20	106.00
SPH-075	.750" x 3.75" x .78"	3/8"	ER-20	105.00
SPH-100	1.000" x 3.75" x .78"	9/16"	ER-20	100.00
SPH-101	1.000" x 6.10" x .84"	3/4"	ER-25	135.00
SPH-125	1.250" x 6.10" x .84"	3/4"	ER-25	120.00
SPH-126	1.000" x 6.20" x .95"	3/4"	ER-32	148.00
SPH-127	1.250" x 6.20" x .95"	3/4"	ER-32	132.00
SPH-150	1.500" x 6.20" x .95"	3/4"	ER-32	125.00

* Extra Lock Nuts and Back-up Screws Available

Precise SAW AND MILLING ARBORS



A) SAW AND MILLING CUTTER ARBOR

- Made of alloy forged steel. Hardened to RC 56-60 and ground.
- Face is held perpendicular to center line within 0.0004"
- Pilot diameter is sized for precision fit with cutter and is keyed for positive drive.
- Heavy duty locking RH nut and three arbor spacers are included.
- R-8 Shank with spacers.

Model No.	Arbor Diameter	Length Shoulder to Nut	Sale Price
SMA-1	1"	2"	\$44.95
SMA-2	1-1/4"	2"	49.95

B) VARI-SAW ARBORS

- Offers flexibility in sawing operations.
- Spring load mechanism accepts saw blades with hole diameter from 1/2" to 1"
- Blades are firmly secured in position with hex head screw.
- Holds all saws with 1/2", 5/8", 3/4", 7/8" and 1" holes.

Model	Shank Size	Price
VSA-500	1/2" x 2-1/8"	\$22.50
VSA-800	R-8 (Bridgeport)	35.95



PRECISION SLIM FIT TOOL HOLDERS CAT 40 & 50

Advanced Drawbar Design

Techniks Slim-Fit tool holders feature an internal drawbar design that provides greater holding power than ER coll holders, and they are more accurate at extended lengths

- Great accuracy at extended lengths.
- Balanced to 25,000 RPM at G2.5
- Use with Slim-Fit collets 7/64"-1/4"
- Narrow nose for excellent clearance.

Why Slim-Fit Collets hold tighter than ER



Slim-Fit collets are longer and the angle is flatter, so holding power is greater on the tool shank, which improves accuracy and extends cutting tool life.

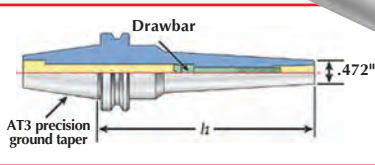
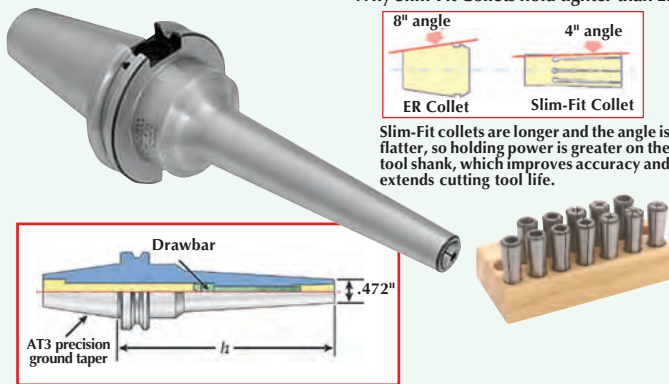

Model	Description	L1	Price
23654	CAT 40 x SBL6-3" Slim-Fit Toolholder	3"	\$189.00
23656	CAT 40 x SBL6-4" Slim-Fit Toolholder	4"	215.00
23658	CAT 40 x SBL6-6" Slim-Fit Toolholder	6"	275.00
23659	CAT 40 x SBL6-8" Slim-Fit Toolholder	8"	380.00
23672	CAT 50 x SBL6-3.5" Slim-Fit Toolholder	3.5"	\$315.00
23676	CAT 50 x SBL6-6" Slim-Fit Toolholder	6"	450.00

Slim-Fit Collets and Set

18743-7/64	Slim-Fit 7/64" Collet	\$54.00
18743-1/8	Slim-Fit 1/8" Collet	54.00
18743-9/64	Slim-Fit 9/64" Collet	54.00
18743-5/32	Slim-Fit 5/32" Collet	54.00
18743-11/64	Slim-Fit 11/64" Collet	54.00
18743-7/32	Slim-Fit 7/32" Collet	54.00
18743-15/64	Slim-Fit 15/64" Collet	54.00
18743-1/4	Slim-Fit 1/4" Collet	54.00
18743-12	12 Pc. Collet Set 1/8"-1/4" by 64ths (except 5/32" & 7/32nds). Plus 3mm to 6mm by 1mm	\$645.00

* Metric Individual Sizes Available (Inquire)

Precise R-8 END MILL HOLDERS

- Made of alloy forged steel for long, durable service life.
- Hardened and ground to ensure maximum accuracy.
- 8 piece set includes sizes: 1/4", 3/8", 1/2", 5/8", 3/4", 7/8", 1" & 1-1/4"



8 Piece Set No. R8E-8S **\$139.95**

Model	Bore	Price
R8E-1/8	1/8"	\$16.95
R8E-1/4	1/4"	16.95
R8E-3/16	3/16"	16.95
R8E-3/8	3/8"	16.95
R8E-1/2	1/2"	17.95
R8E-5/8	5/8"	18.50
R8E-3/4	3/4"	19.95
R8E-7/8	7/8"	19.95
R8E-1	1"	22.00
R8E-1-1/4	1-1/4"	23.95
R8E-1-1/2	1-1/2"	27.95

Precise R-8 SHELL END MILL ARBORS



5-Piece Set Sizes: 1/2", 3/4", 1", 1-1/4" & 1-1/2" No. RSE-006 **\$195.00**

Model No.	Dia. Bore in Shell End Mill	Dia. Range of std. Shell End Mill	Price Each
RSE-001	1/2"	1-1/4" to 1-1/2"	\$37.95
RSE-002	3/4"	1-1/4" to 2"	41.95
RSE-003	1"	2-1/4" to 2-3/4"	41.95
RSE-004	1-1/4"	3" to 3-1/2"	41.95
RSE-005	1-1/2"	4" to 5"	46.95

Precise SLITTING AND SLOTTING SAW ARBORS

- For saw-blade .001" to 3/16" thickness.
- Steel, heat treated shank, black oxide.
- All models furnished with 1/2" diameter shank.

SET No. CSA-440

\$24.95



Model No.	Flange Size	Blade Hole	Price Each
CSA-441	1/2"	1/4"	\$ 9.95
CSA-442	5/8"	3/8"	9.95
CSA-443	3/4"	1/2"	9.95
CSA-440	3 piece set of above		\$24.95
CSA-444	1"	5/8"	\$12.95

Precise SLITTING AND SLOTTING SAW ARBORS

Long, Precision Ground, Extra Rigid Arbors

- Steel, case hardened, and Black Oxide plated. We grind the shanks after machining and heat treating for best results.
- Bodies are ground to match the caps: Tolerances: +/- .003 concentricity from shank to mating bore of cap. +/- .001 square from shank to clamping surface of cap.



Model No.	Saw Hole	Body Diameter	Body Length	Shank Length	Shank Diameter	Price Each
Z1300	1/4"	1/2"	1"	1.700	1/2"	\$39.95
Z1305	3/8"	5/8"	1-3/16"	1.700	1/2"	39.95
Z1310	1/2"	3/4"	1-3/8"	1.700	1/2"	39.95
Z1315	5/8"	1"	1-1/2"	2.030	3/4"	42.50
Z1320	1"	1-1/2"	1-3/4"	2.030	3/4"	49.95
Z1325	1-1/4"	1-3/4"	2"	2.030	3/4"	52.00
Z1330	3 Piece Set Fits Saw Holes	1/4", 3/8", 1/2"				\$99.95
Z1335	3 Piece Set Fits Saw Holes	5/8", 1", 1-1/4"				125.00



BISON CAT-V-COLLET CHUCKS

- Through the spindle coolant capability.
- Collet seat taper T.I.R. <.0002"
- Retention Knobs are sold separately.

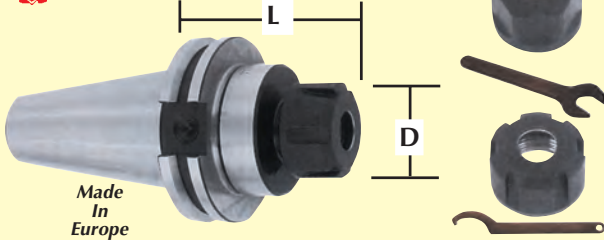

Made In Europe

Chuck No.	Chuck Type	Collet Series	Dimension D-L	Price Each
188-415	40 Cat	ER-16	1.3"-2.5"	\$138.50
188-417			1.3"-3"	138.50
188-418			1.3"-4"	145.00
188-420			1.38"-2.5"	\$140.00
188-422	40 Cat		1.38"-2.5"	143.00
188-424			1.65"-2.5"	\$142.00
188-426	40 Cat		1.65"-4"	142.00
188-430			1.97"-2.5"	\$149.00
188-431	40 Cat		1.97"-3"	149.00
188-432			1.97"-4"	148.00
188-443			2.4"-2.5"	\$143.00
188-440	40 Cat		2.4"-4"	146.00
188-520		ER-20	1.38"-4"	\$145.00
188-525		ER-25	1.65"-6"	154.00
188-532	50 Cat	ER-32	1.97"-6"	162.00
188-543		ER-40	2.4"-2.5"	175.00
188-545		ER-40	2.4"-4"	199.50



BISON DOUBLE ANGLE COLLET CHUCK

For "DA" Collets

Chuck No.	Chuck Type	Collet Series	Dimension D-L	Price Each
193-250		DA-100	1.09"-3.5"	\$177.00
193-150	40 Cat	DA-200	.86"-3"	177.00
193-415		DA-180	1.54"-2.75"	164.00
193-424		DA-180	1.54"-4"	168.00
193-524			1.54"-4"	\$202.00
193-526	50 Cat		1.54"-6"	210.00
193-528			1.54"-8"	222.00



BISON "TG" COLLET CHUCKS

For "TG" Collets

Chuck No.	Chuck Type	Collet Series	Dimension D-L	Price Each
180-401		TG-75	2.25"-3"	\$148.00
180-403	40 Cat	TG-100	2.5"-3"	147.00
180-404		TG-100	2.5"-4"	150.00
180-406		TG-100	2.5"-6"	183.00
180-503			2.5"-3.25"	\$164.00
180-504	50 Cat	TG-100	2.5"-3.5"	164.00
180-505			2.5"-5.5"	190.00
180-507			2.5"-7.5"	183.00
180-513			3.5"-3"	\$232.00
180-514	50 Cat	TG-150	3.5"-3.5"	262.50
180-517			3.5"-5.5"	253.00

BISON "BT" COLLET CHUCKS
(Available At Similar Savings)

Precise STRAIGHT SHANK STUB MILLING ARBORS



Hardened and Ground

Model No.	Shank Diameter	Arbor Diameter	Length To Nut	Shoulder	Sale Price
202-5320	1/2"	1/2"	1 1/2"	1"	\$32.95
202-5321	1/2"	5/8"	1"	1"	32.95
202-5322	1/2"	3/4"	1"	1"	32.95
202-5323	3/4"	3/4"	1"	1"	36.95
202-5324	3/4"	7/8"	1"	1"	36.95
202-5325	3/4"	1"	1"	1"	46.50
202-5326	3/4"	1-1/4"	1"	1"	55.00



BISON/TMX SEMI-FLUSH SLITTING SAW HOLDERS

Made In Europe

- Face is held perpendicular to centerline within 0.0002"
- Designed for slitting saws up to 5/16" thick.
- For wider cutters use a Stub Arbor Holder.
- Pilot diameter is sized for precision fit with cutter and is keyed for positive drive.
- Semi-flush nose cap gets in tight areas.
- Retention Knobs are sold separately.



Drawer Bar Thread:
Cat-40 5/8"
Cat-50 1-8"



Model No.	Arbor Taper	Saw Arbor Dia.	Arbor Length	Price Each
192-405	Cat-40	5/8"	4"	\$148.00
192-410	Cat-40	1"	4"	156.00
192-415	Cat-40	1-1/4"	4"	166.00
192-510	Cat-50	1"	4"	\$199.50
192-515	Cat-50	1"	6"	226.00
192-520	Cat-50	1-1/4"	4"	207.00
192-525	Cat-50	1-1/4"	6"	250.00



BISON/TMX FLOATING REAMER HOLDER

Made In Europe

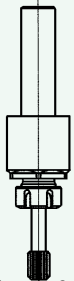

Model No.	Shank Size	Shank Length	ER Collet	Price Each
162-250	1"	4"	25	\$180.00
162-255	1-1/4"	4"	25	290.00

0.02"(0.5) Parallel Float +/- .0002"



VERTICAL TOGGLE CLAMPS

Spindle & Washer Included

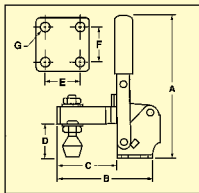

MODELS
GH-2265
GH-3016
Shown



MODELS
GH-2130
GH-3014
Shown

Model No.	Holding Capacity	Bar Type	Spindle Size	C	E	F	G	Sale Price
GH-2130	500 lbs.	U-Bar	5/16"-18	2-13/16"	3/4"	1-1/4"	5/32"	\$6.50
GH-2265	750 lbs.	U-Bar	3/8"-16	3-19/32"	1-1/4"	1-25/32"	21/64"	9.95
GH-3014	500 lbs.	Solid	5/16"-18	3-3/4"	3/4"	1-1/4"	5/32"	7.50
GH-3016	750 lbs.	Solid	3/8"-16	3-19/32"	1-1/4"	1-25/32"	21-64"	9.95



VERTEX R-8 RIGHT ANGLE MILLING ATTACHMENTS

- Suitable for most milling machines.
- Converts your vertical mill to a horizontal mill.
- Designed to simplify right angle work by reducing the need for special tooling and complex fixtures.
- For use on your R8 spindle with 3-3/8" overall diameter.
- Includes drawbar extension socket.
- Maximum speed 2000 RPM
- Made in Taiwan



Model No.	Description	Price
3012-1008	R8 Right angle head w/R8 stub milling arbor 1" Dia. Draw bar, Extension socket	\$595.00
3012-1018	Same as above plus horizontal milling arbor 1" Dia. and horizontal support and case	795.00



MILLING MACHINE ARBORS FOR 30 - 40 - 50 TAPER SPINDLES



- Milling Machine Arbors are made of top quality one piece forgings. Carefully heat treated and surfaces ground with extremely narrow tolerances assure a rigid setup and accurate machining operations. All threads are ground.
- Arbors are equipped with assorted width solid spacers and necessary running bushings with standard keyways and threaded arbor nut.

Style A



(End pilots 23/32" x 1-3/4")

Model No.	Taper & Style	Arbor Diameter	Length Shoulder to nut	Dia. of Running Bushing	No. of Bushings	Sale Price
PMA-001	30A	7/8"	10"	1-5/8"	1	\$265.00
PMA-002	30A	1"	10"	1-5/8"	1	285.00
PMA-003	30A	1-1/4"	10"	1-5/8"	1	318.00
PMA-038	30A	1-1/4"	10"	1-7/8"	1	247.00
PMA-004	40A	7/8"	10"	-	-	\$265.00
PMA-005	40A	7/8"	16"	1-7/8"	1	367.50
PMA-006	40A	1"	8"	-	-	\$290.00
PMA-039	40A	1"	10"	-	-	305.00
PMA-007	40A	1"	12"	-	-	350.00
PMA-008	40A	1"	16"	1-7/8"	1	415.00
PMA-009	40A	1-1/4"	8"	-	-	\$280.00
PMA-040	40A	1-1/4"	10"	-	-	335.00
PMA-010	40A	1-1/4"	12"	-	-	360.00
PMA-011	40A	1-1/4"	16"	1-7/8"	1	465.00
PMA-017	50A	7/8"	18"	2-1/8"	1	\$525.00
PMA-041	50A	1"	8"	-	-	\$310.00
PMA-018	50A	1"	12"	-	-	390.00
PMA-019	50A	1"	18"	2-1/8"	1	495.00
PMA-020	50A	1-1/4"	12"	-	-	\$455.00
PMA-021	50A	1-1/4"	18"	2-1/8"	1	550.00

Draw Bar Threads for #30 Taper 1/2"-13, #40 5/8"-11, #50 1"-8



Style B

Model No.	Taper & Style	Arbor Diameter	Length Shoulder to nut	Dia. of Running Bushing	No. of Bushings	Sale Price
PMA-043	30B	1"	2"	-	-	\$200.00
PMA-044	40B	7/8"	14"	1-7/8"	1	\$165.00
PMA-045	40B	7/8"	16"	1-7/8"	1	367.00
PMA-046	40B	1"	3"	-	-	\$175.00
PMA-012	40B	1"	14"	1-7/8"	1	385.00
PMA-014	40B	1"	20"	1-7/8"	1	483.00
PMA-047	40B	1-1/4"	3"	-	-	189.00
PMA-013	40B	1-1/4"	14"	1-7/8"	1	415.00
PMA-015	40B	1-1/4"	20"	1-7/8"	1	520.00
PMA-048	40B	1-1/2"	20"	2-1/8"	1	590.00
PMA-049	50B	1"	3-1/2"	-	-	229.00
PMA-022	50B	1"	15"	2-1/8"	1	420.00
PMA-023	50B	1"	18"	2-1/8"	2	463.00
PMA-024	50B	1"	24"	2-1/8"	2	550.00
PMA-025	50B	1-1/4"	15"	2-1/8"	1	\$470.00
PMA-026	50B	1-1/4"	18"	2-1/8"	2	510.00
PMA-027	50B	1-1/4"	24"	2-1/8"	2	575.00
PMA-028	50B	1-1/4"	30"	2-1/8"	2	735.00
PMA-029	50B	1-1/2"	18"	2-3/4"	2	\$545.00
PMA-030	50B	1-1/2"	24"	2-3/4"	2	655.00
PMA-031	50B	1-1/2"	30"	2-3/4"	2	815.00
PMA-032	50B	1-1/2"	36"	2-3/4"	2	850.00
PMA-033	50B	2"	24"	2-3/4"	2	\$785.00
PMA-034	50B	2"	30"	2-3/4"	2	875.00
PMA-035	50B	2"	36"	2-3/4"	2	860.00
PMA-036	50B	2-1/2"	36"	3-3/8"	2	1295.00
PMA-037	50B	1-1/4"	3-1/2"	-	-	\$242.00
PMA-038-1	50B	1-1/2"	3-1/2"	-	-	285.00

Draw Bar Threads for #30 Taper 1/2"-13, #40 5/8"-11, #50 1"-8



CAT V-FLANGE STUB MILLING ARBOR HOLDERS



- Shank taper accuracy AT3 or better.
- Made of alloy forged steel for long, durable service life.
- Hardened to RC 52-56 and ground to ensure maximum accuracy.
- Face is held perpendicular to centerline within 0.0002".
- Pilot diameter is sized for precision fit with cutter and is keyed for positive drive.
- Heavy duty locking RH nut and 5 arbor spacers are included - 1/16", 1/8", 1/4", 3/8", 3/4".
- Retention Knobs are sold separately.

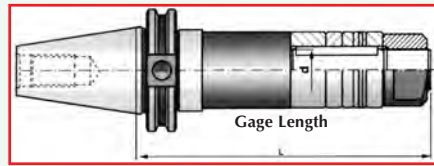

Model No.	CAT "V" Taper	Arbor Diameter	Gage Length	Sale Price
Drawer Bar Thread				
CAT 5/8"-11"				
CAT 1"-8"				
191-410		1"	7.0"	\$210.00
191-415	40	1-1/4"	7-1/4"	230.00
191-420		1-1/2"	7-1/2"	278.00
191-510		1"	7.0"	\$275.00
191-515		1"	9.0"	315.00
191-520	50	1-1/4"	7-1/4"	279.00
191-525		1-1/4"	9-1/4"	335.00
191-530		1-1/2"	7-1/2"	350.00
191-535		1-1/2"	9-1/2"	384.00



BISON CATERPILLAR V-FLANGE COLLET CHUCKS 40 & 50 TAPER

Completely Interchangeable With Erickson TG-100 And TG-150 Collet



#TG-100 Series Collets
3/32" to 1" by 64ths
\$19.95 Each

#TG-150 Series Collets
1/2" to 1-1/2" by 16ths
\$24.95 Each
1/2" to 1-1/2" (All 32nd & 64ths)
\$39.95 Each



Chuck No.	TG Collet Series	Collet Range	Taper No.	Overall Length	Price Each
180-403	TG-100	3/32"-1"	CAT-40	5-11/16"	\$150.00
180-404	TG-100	3/32"-1"	CAT-40	6-11/16"	153.00
180-406	TG-100	3/32"-1"	CAT-40	8-11/16"	192.00
180-503	TG-100	3/32"-1"	CAT-50	7-1/8"	\$170.00
180-504	TG-100	3/32"-1"	CAT-50	7-1/8"	170.00
180-505	TG-100	3/32"-1"	CAT-50	9-1/8"	198.00
180-513	TG-150	1/2"-1-1/2"	CAT-50	7"	\$240.00
180-514	TG-150	1/2"-1-1/2"	CAT-50	7-1/2"	275.00
180-517	TG-150	1/2"-1-1/2"	CAT-50	9-1/2"	265.00



CAT V-FLANGE ADAPTERS MORSE TAPER AND CAT 50 TO 40



- Produced according to AT3 specifications.
- Made of alloy forged steel for long, durable service life.
- Morse taper seat T.I.R. <0.0002".
- Hardened up RC-52-56 and ground to ensure maximum accuracy.
- Retention knobs are sold separately.



Model No.	CAT "V" Taper	"MT" Taper	Gage Length	Sale Price
183-402	40	2	2-3/16"	\$75.00
183-403	40	3	2-3/4"	78.50
183-404	40	4	3-9/16"	86.00
183-502	50	2	2"	\$126.00
183-503	50	3	2-1/2"	129.00
183-404	50	4	3-3/8"	142.00
183-505	50	5	3-3/4"	160.00
184-504	50 to hole taper 40			\$210.00

PACKER® 5C FIXTURE COLLETS

- The PACKER Fixture Collets are machinable collet blanks to accommodate an unlimited variety of workholding applications.
- With a little "Toolmaker Ingenuity", multiple cavities can be created to hold and machine multiple parts in a single setup.
- The threaded 5C back screw is removable and replacable to extend the life-cycle of the collet. When the threads are worn or damaged, the back screw is easily replaced. The fixture collet itself no longer needs to be discarded and remade.



Model No.	Diameter & Length	Price Each	Model No.	Diameter & Length	Price Each
48-5C-100	1" x 1"	\$37.50	48-5C-302	3" x 2"	\$115.00
48-5C-200	1" x 2"	80.00	48-5C-303	3" x 3"	135.00
48-5C-300	1" x 3"	95.00	48-5C-401	4" x 1"	105.00
48-5C-201	2" x 1"	65.00	48-5C-402	4" x 2"	125.00
48-5C-202	2" x 2"	82.00	48-5C-403	4" x 3"	145.00
48-5C-203	2" x 3"	105.00	48-5C-502	5" x 2"	195.00
48-5C-301	3" x 1"	95.00	48-5C-602	6" x 2"	200.00

BUSHETTE® COLLET TYPE TOOL HOLDERS

An excellent alternative to bushings. The BUSHETTE Tool Holders are designed especially for CNC Lathes and Turning Centers where tools must be practical and hard working to keep your machines competitive in today's tough market. Excellent for presetting backup tooling and setting up for your next job.

- All BUSHETTE's are fully hardened and precision ground. Available for 5C, R8, 3C, 3AT, 2MT and 3J Collets.
- Collet Stops are included with all 5C BUSHETTE's. A great way to make use of the Collets lying around the shop.



Type I Bushette Unobstructed "Through Hole" For 5C, 3C, 3AT and 3J Collets

The design of these collets allows for an unobstructed through hole. Tools extend beyond the back of the bushette



Type I

Type II Bushette Unobstructed "Through Hole" For R8 and 2MT Collets

The design of these collets do not allow tooling to extend beyond the interior depth of the collet.



Type II

Model No.	Collet Type	Diameter	Dimensions A x B x C	Price Each
33-2MT1000	2MT	1"	3-1/4" x 2-1/4" x 1-1/8"	\$ 71.00
33-2MT1250	2MT	1-1/4"	3-1/4" x 2-1/4" x 1-1/8"	76.00
33-2MT1500	2MT	1-1/2"	3-1/4" x 2-1/4" x 1-5/8"	79.50
33-2MT1750	2MT	1-3/4"	3-3/4" x 2-3/4" x 1-7/8"	87.00
33-2MT2000	2MT	2"	3-3/4" x 2-3/4" x 2-1/8"	84.00
33-3AT1000	3AT	1"	3-1/4" x 2-1/4" x 1-1/8"	84.50
33-3AT1250	3AT	1-1/4"	3.35" x 2-1/4" x 1-3/8"	84.50
33-3AT1500	3AT	1-1/2"	3.35" x 2-1/4" x 1-5/8"	84.50
33-3AT1750	3AT	1-3/4"	3.35" x 2-1/4" x 1-7/8"	101.50
33-3AT2000	3AT	2"	3.35" x 2-3/4" x 2-1/8"	101.50
33-3C1000	3C	1"	3-1/4" x 2-1/4" x 1-1/8"	101.50
33-3C1250	3C	1-1/4"	3.35" x 2-1/4" x 1-3/8"	107.50
33-3C1500	3C	1-1/2"	3.35" x 2-1/4" x 1-5/8"	155.00
33-3C1750	3C	1-3/4"	3.35" x 2-1/4" x 1-7/8"	178.00
33-3C2000	3C	2"	3.85" x 2-3/4" x 2-1/8"	105.00
33-5C1500	5C	1-1/2"	4-1/4" x 2" x 2"	107.00
33-5C1750	5C	1-3/4"	4-1/8" x 2-3/4" x 2"	120.00
33-5C2000	5C	2"	4-1/8" x 2-3/4" x 2-1/8"	139.00
33-5C2500	5C	2-1/2"	4-5/8" x 3-1/4" x 2-5/8"	162.00
33-R81500	R8	1-1/2"	4-7/8" x 3-1/2" x 1-3/4"	83.50
33-R81750	R8	1-3/4"	4-7/8" x 3-1/2" x 1-7/8"	95.50
33-R82000	R8	2"	4-7/8" x 3-1/2" x 2-1/8"	99.00

Precise EXPANDING MANDRELS

- Made of high grade tool steel.
- Precision-ground and heat-treated for maximum concentricity and holding power.
- A range from 1/2" thru 3-3/4" by 1/1000 can be covered by a total of 10 mandrels.
- Arbors are tapered, sleeves are flexible and size is obtained by moving sleeve along the arbor.

Hardened and Precision Ground



Model No.	Size Range	Arbor Length	Sleeve Length	Sleeves Furnished	Price Each
187501	1/2 to 9/16	5	2-1/2	1	\$31.50
187502	9/16 to 21/32	6	2-3/4	1	34.00
187503	21/32 to 3/4	7	2-3/4	1	38.00
187504	3/4 to 7/8	7	3-1/4	1	42.00
187505	7/8 to 1	7	3-1/4	1	48.50
187506	1 to 1-1/4	9	4	2	89.50
187507	1-1/4 to 1-1/2	9	4	2	100.00
187508	1-1/2 to 2	11-1/2	5	2	115.00
187509	1 to 2-3/4	14	6	2	205.00
187510	2-3/4 to 3-3/4	17	7	2	259.00

Precise EXPANDING MANDREL SETS

Model No.	Size Range	Mandrels In Set	Price Set
1880015	1/2" to 1"	5	\$148.50
1880068	1" to 1"	3	215.00
1880018	1/2" to 2"	8	355.00
1880010	1/2" to 3-3/4"	10	985.00

Precise SOLID LATHE MANDRELS

- These Mandrels are made of hardened tool steel which is accurately ground to size.
- Mandrels are slightly tapered with the size marked in the large end.
- Standard taper .0005 per inch.
- Sizes under 1" are .0005" undersize on small end.
- Sizes 1-1/16" to 3" are .001" undersize on small end.



Model No.	Dia. Inch	O.A. Length	Price Each	Model No.	Dia. Inch	O.A. Length	Price Each
187008	1/8"	2-1/2"	\$ 7.55	187060	15/16"	6-3/4"	\$ 18.40
187010	5/32"	3"	8.05	187062	31/32"	7"	18.40
187012	3/16"	3"	8.05	187064	1"	7"	18.40
187014	7/32"	3-3/4"	8.35	187068	1-1/16"	7-1/4"	23.53
187016	1/4"	3-3/4"	8.35	187072	1-1/8"	7-1/2"	23.35
187018	9/32"	4"	8.60	187076	1-3/16"	7-3/4"	27.45
187020	5/16"	4"	8.60	187080	1-1/4"	8"	27.45
187022	11/32"	4-1/4"	9.15	187084	1-5/16"	8-1/4"	33.20
187024	3/8"	4-1/4"	9.15	187088	1-3/8"	8-1/2"	33.20
187026	13/32"	4-1/2"	9.65	187092	1-7/16"	8-3/4"	38.45
187028	7/16"	4-1/2"	9.65	187096	1-1/2"	9"	38.45
187030	15/32"	5"	10.20	187136	1-9/16"	9-1/4"	43.60
187032	1/2"	5"	10.20	187140	1-5/8"	9-1/2"	43.60
187034	17/32"	5-1/4"	11.70	187144	1-11/16"	9-3/4"	49.45
187036	9/16"	5-1/4"	11.70	187148	1-3/4"	10"	49.45
187038	19/32"	5-1/2"	11.70	187152	1-13/16"	10-1/4"	55.85
187040	5/8"	5-1/2"	11.70	187156	1-7/8"	10-1/2"	55.85
187042	21/32"	5-3/4"	11.70	187160	1-15/16"	10-3/4"	61.70
187044	11/16"	5-3/4"	12.85	187200	2"	11"	61.70
187046	23/32"	6"	12.85	187208	2-1/8"	11-1/2"	68.70
187048	3/4"	6"	12.85	187216	2-1/4"	12"	75.50
187050	25/32"	6-1/4"	15.65	187224	2-3/8"	12"	82.40
187052	13/16"	6-1/4"	15.65	187232	2-1/2"	12-1/2"	91.00
187054	27/32"	6-1/2"	15.65	187240	2-5/8"	12-1/2"	117.35
187056	7/8"	6-1/2"	15.65	187248	2-3/4"	13"	127.50
187058	29/32"	6-3/4"	18.40	187256	2-7/8"	13"	140.65
				187300	3"	13"	151.20

Precise H/V TOOL SETTING FIXTURE

- Quick and easy way to set tool holders horizontal or vertical.



Model	Tool Shank	Sale
3900-4083	CAT30	\$ 65.00
3900-4084	CAT40	71.50
3900-4085	CAT50	129.50
202-2630	BT30	\$ 65.00
202-2632	BT40	71.50
202-2634	BT50	129.50



THREAD RESTORING TOOLS INTERNAL AND EXTERNAL THREADS Restores 60° Damaged Threads

• These hand tools automatically **adjust to any diameter and pitch**, can be used on left hand or right hand threads, both inch and metric and need no prior measurement of the thread.

• The blades are made of high quality hardened tool steel (internal tools' blades - HSS, external tools' blades - O1). The blades are guided by the existing undamaged section of thread, in order to regroove the damaged section.



External Thread Repair

Turn handle (A) to raise floating blades (B) Place the NES External tool over thread to be repaired

Turn handle (A) to lower floating blades into grooves of thread and tighten by hand only.

Turn the NES Extrenal tool in direction of arrow

Model No.	NES No.	Size Range	Pipe Range	Price Each
06001	NES-1A	5/32"-11/16", 4-18mm	up to 7/16"	\$ 59.95
02000	NES-2	3/8"-1-1/2", 17-38mm	3/8"-1-1/8"	89.95
03000	NES-3	1-1/4"-5", 32-128mm	1"-4-1/2"	199.95

Extra 60° Replacement Blade Set

00010	Blade For #NES-1A	\$18.50
00030	Blade For #NES-2	25.00
03010	Blade For #NES-3	35.00

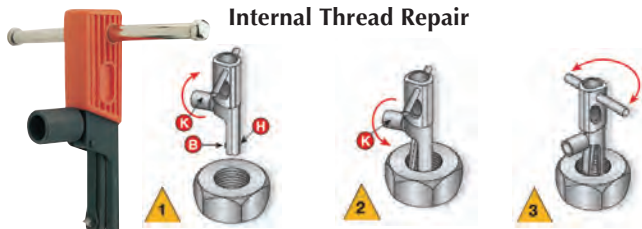

Internal Thread Repair

Turn knurled knob (K) to fully retract the blade (B) into the housing (H). Insert NES Internal tool into the threaded hole or bore to be repaired.

Turn knurled knob (K) to extend blade (B) into a thread groove on an undamaged section and tighten by hand only.

Rotate the NES Internal tool by the cross-rod, as shown, in the desired direction.

Model No.	NES No.	Size Range	Pipe Range	Price Each
07210	NES-21	5/32"-7/16", 8-11mm	1/16"-3/16"	\$ 69.95
07220	NES-22	1/2"-5/8", 12-16mm	1/4"-3/8"	69.95
07230	NES-23	11/16"-13/16", 16-20mm	3/8"-1/2"	75.00
07240	NES-24	7/8"-1-1/4", 22-32mm	1/2"-7/8"	99.50
07251	NES-25	1-1/4"-2-1/8", 32-54mm	7/8"-1-3/4"	175.00
07263	NES-26	1-1/4"-2-5/8", 32-68mm	7/8"-2-1/4"	250.00

Extra 60° Replacement Blade Set

07216	Blade For #NES-21	\$13.50
07226	Blade For #NES-22	12.50
07236	Blade For #NES-23	12.90
07246	Blade For #NES-24	13.50
07256	Blade For #NES-25 & 26	15.90

Note: 55° Replacement Blades are available for External & Internal Tools (Inquire)



ECONOMY THREAD MATE AND MINI KIT



Thread Mate

Model	Range	Pipe	Price
06040	5/32"-1/2", 4-13mm	0-1/4"	\$29.95
06046	Extra 60° Replacement Blade TMI Blade and Guide		\$19.50

Mini Kit

Model	Size	Range	Price	
01044	External	5-32"-1/2"	4-13mm	\$149.95
	Internal	12"-5/16"	5-8mm	
	Internal	5/16"-7/16"	8-11mm	

8 Nylon Pads



THREAD REPAIR SETS INTERNAL~EXTERNAL & COMBINATION Restores 60° Damaged Threads

External Sets



#01000

#01300

Model	Range	Contains	Price
01000	5/32"-1-1/2" (4-38mm)	NES-1A, 2	\$175.00
01300	5/32"-5" (4-128mm)	NES-1A, 2, 3 Extension Handle	399.50

Internal Sets



#01007-1

#01008

#01036

Model	Range	Contains	Price
01007-1	5/16"-13/16"	NES-21, 22, 23	\$199.50
01008	5/16"-1-1/4"	NES-21, 22, 23, 24	299.50
01036	7/8"-2-5/8"	NES-24, 25, 2 sleeves	325.00

Combination Sets External & Internal



#01015

#01017

#01025

Model	Range	Contains	Price
01015	5/32"-11/16"	External NES-1A Internal NES-21, 22	\$199.50
01017	5/32"-11/16"	External NES-1A Internal NES-21, 22, 23	250.00
01025	5/32"-1-1/2"	External NES-1A, 2 Internal NES-21, 22, 23 & 24	475.00

Nicholson® THREAD RESTORING FILES

- Used to restore damaged or worn external threads on bolts, pipes, etc.
- Each file will work with 8 different thread sizes.
- Available in 4 sizes and in a convenient 4-piece set.
- Caps are color coded:
#1=Black#2=Red#7=Green#8=Blue



4 Piece Set
1 each shown below
SET No.
33024
Reg. \$70.80

\$46.95

MADE IN USA

Model	Description	Price
33001	Reg. bolt 11-12, 1344-16-20-24 T.P.I.	\$12.95
33007	Ex. fine/Ex. coarse bolt 9-10, 12-16, 28-32 T.P.I.	12.95
33012	Reg.pipe 8-10, 11-1/2"-14, 16-18, 24-27 T.P.I.	12.95
33016	Metric bolt .75-1.0, 1.25-1.5, 1.75-2.0, 2.5-3mm	12.95



HIGH SPEED STEEL, TiN COATED or M35 COBALT STEP DRILLS & SETS

Uncoated, TiN Coated or Cobalt Ground From The Solid

Up to 13 different hole sizes without changing bits!

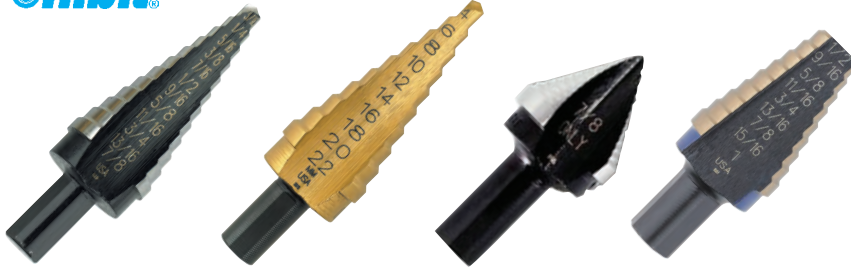

Inch • Self-Starting Multiple Hole Sizes

Metric • Self-Starting Multiple Hole Sizes

Inch • Self Starting Single Hole Size

Inch Hole Enlarging Bits

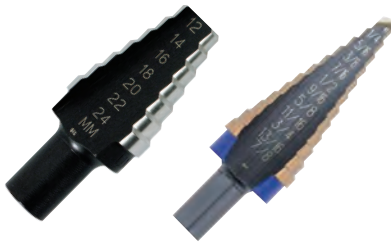

Metric • Hole Enlarging Bits

Cobalt



Comparative Life Test in Stainless Steel



Average Number of Holes Before Failure (In 16 Gauge Stainless Steel Plate)

Applications:

- Specialty step drill designed to machine a large number of different hole diameters with a single tool.
- Single cutting edge creates perfectly round holes in metal, plastic, wood and other thin materials without center punching.
- Conical design permits as many as 13 different size holes to be drilled with one drill.
- These drills, depending on the model, have a step 1/8" to 3/8" (3.5mm to 11mm) thick between sizes.
- Normally intended for use with thin materials.
- Two general variations are available for either self-starting hole or for enlarging existing holes.
- 20 different models are available to produce holes from 1/8" to 1-3/8" or 4mm to 35mm.
- The hardened, high speed steel drill body is available in either an uncoated style or with a TiN coating for longer life in tougher materials.
- Single flute design helps to ensure perfectly round holes in a wide range of ferrous, non-ferrous and non-metallic materials.

Features:

- Right hand (clockwise rotation) cutting direction.
- Single straight flute design.
- Multi-step design with progressively larger holes.
- Self-starting or hole enlarging style.
- Straight shank diameters of 1/4", 3/8" or 1/2" (6.5mm, 10mm or 13mm)
- Made in USA

Cobalt

- M35 grade provides high heat & abrasion resistance.
- Longest cutting life.
- 6 times longer life vs. competition.

Technical Data:

- Manufactured from high speed steel.
- 1/8" to 3/8" (3.5mm to 11mm)
- Ground from solid.
- Cylindrically ground.
- Bright finish.

STEP DRILL SETS

- High Speed Steel
- Tin Coated
- Cobalt



Model	Description	Contents	Price
10225-1	4 Piece Set, H.S.S. Steel, Uncoated	#1, 2, 4 & 21	\$159.50
10228	4 Piece Set, H.S.S. Steel with #1 TiN Coated	#1, 2, 3 & #1T	87.50
10502-1	3 Piece Set, H.S.S. Steel, Uncoated	#1, 2, & 3	69.95
105502ZR	3 Piece Set, TiN Coated	#1T, 2T, & 3T	75.00
10502CB	3 Piece Set, Cobalt	#1C, 2C, & 3C	92.95

SELF STARTING BITS

# of Sizes	Hole Sizes (& Increments)	Shank Diameter	Step Thickness	Model No.	H.S.S. UNCOATED		TiN COATED		COBALT	
					Order No.	Price Each	Order No.	Price Each	Order No.	Price Each
INCH- MULTIPLE HOLE SIZES										
13	1/8" to 1/2" by 32nds	1/4"	1/8"	#1	10231	\$19.90	15101	\$25.25	10231CB	\$25.25
6	3/16" to 1/2" by 1/16ths	1/4"	3/8"	#2	10232	19.90	15102	25.25	10232CB	25.25
9	1/4" to 3/4" by 1/16ths	3/8"	1/8"	#3	10233	34.50	15103	45.50	10233CB	50.00
12	3/16" to 7/8" by 1/16ths	3/8"	1/8"	#4	10234	42.25	15104	56.50	10234CB	60.00
10	1/4" to 1-3/8" by 1/8ths	1/2"	1/8"	#5	10235	75.00	-	-	-	-
METRIC - MULTIPLE HOLE SIZES										
9	4mm to 12mm by 1mm	6.5mm	5mm	1M	11101-1	\$18.95	16101	\$26.25	11101CB	\$27.95
5	4mm to 12mm by 2mm	6.5mm	11mm	2M	11102-1	29.50	16102-1	26.25	11102CB	27.95
7	6mm to 18mm by 2mm	10mm	5mm	3M	11103-2	35.75	16103	47.75	11103CB	49.95
10	4mm to 22mm by 2mm	10mm	5mm	4M	11104	42.25	16104	56.50	11104CB	59.50
13	5mm to 35mm by 2-3mm*	13mm	3.5mm	5M	11105-2	71.50	16105	100.00	-	-
INCH - SINGLE HOLE SIZES										
1	1/2"	1/4"	-	#10	10310-2	\$19.25	-	-	-	-
1	7/8"	3/8"	-	#11	10311-3	37.90	-	-	-	-
1	3/8"	1/4"	-	#12	10312-3	14.75	-	-	-	-
1	1-1/8"	1/2"	-	#13	10313-2	48.85	-	-	-	-
1	1-7/32"	1/2"	-	#14	10314-2	58.25	-	-	-	-

* Step sizes are 5, 7.5, 10, 13, 16, 19, 21, 23, 26, 29, 31, 33, 35mm

HOLE ENLARGING BITS

# of Holes	Hole Sizes (& Increments)	Pilot Hole Required	Shank Diameter	Step Thickness	Model No.	UNCOATED	
						Order No.	Price Each
INCH							
8	9/16" to 1"	1/2"	1/2"	1/8"	#20	10220	\$39.95
10	13/16 to 1-3/8"	3/4"	1/2"	1/8"	#21	10221	83.25
METRIC							
6	14mm to 24mm by 2mm	12mm	13mm	5mm	20M	11580	\$40.25
8	20mm to 34mm by 2mm	18mm	13mm	5mm	21M	11581	83.30

Precise TURNING HOLDERS
For use with H.S.S. and Cobalt Tool Bits



Offset: Straight, Right hand (Shown) or Left hand turning.

Order No.	Size of Holder	Size of Tool Bit	Offset S-R-L	Price Each
435101	5/16x5/16x3-3/8"	1/8"	Straight	\$11.95
440101	5/16x5/16x3-3/8"	1/8"	Right	11.95
445101	5/16x5/16x3-3/8"	1/8"	Left	11.95
435001	5/16x1/2x4"	3/16"	Straight	11.95
440011	5/16x1/2x4"	3/16"	Right	11.95
445011	5/16x1/2x4"	3/16"	Left	11.95
435012	5/16x3/4x4-1/2"	3/16"	Straight	\$11.95
440012	5/16x3/4x4-1/2"	3/16"	Right	11.95
445012	5/16x3/4x4-1/2"	3/16"	Left	11.95
435016	3/8 x 7/8 x 5"	1/4"	Straight	\$11.95
440016	3/8 x 7/8 x 5"	1/4"	Right	11.95
445016	3/8 x 7/8 x 5"	1/4"	Left	11.95
435020	1/2 x 1-1/8 x 6"	5/16"	Straight	\$14.95
440020	1/2 x 1-1/8 x 6"	5/16"	Right	14.95
445020	1/2 x 1-1/8 x 6"	5/16"	Left	14.95
435024	5/8 x 1-3/8 x 7"	3/8"	Straight	\$17.95
440024	5/8 x 1-3/8 x 7"	3/8"	Right	17.95
445024	5/8 x 1-3/8 x 7"	3/8"	Left	17.95
435028	3/4 x 1-5/8 x 8"	7/16"	Straight	\$23.95
440028	3/4 x 1-5/8 x 8"	7/16"	Right	23.95
445028	3/4 x 1-5/8 x 8"	7/16"	Left	23.95
435032	7/8 x 1-3/4 x 9"	1/2"	Straight	\$28.95
440032	7/8 x 1-3/4 x 9"	1/2"	Right	28.95
445032	7/8 x 1-3/4 x 9"	1/2"	Left	28.95

BORING BARS 45° & 90°

- Precision broached holes accept standard tool bits.
- Use in any typical boring operation.
- Made of stress resistant steel to minimize or eliminate vibration.
- Easily reworked to accept adjustable boring tips for high precision boring.

SET NO. **BBD-009** **\$26.95**

5 Piece



Model No.	Shank Dia.	Overall Length	Tool Bit	Price Each
BBD-001	1/4"	5"	5/32" Rd.	\$4.95
BBD-010	5/16"	5"	3/16" Rd.	9.95
BBD-002	3/8"	6"	3/16" Rd.	5.95
BBD-003	1/2"	6"	3/16" Rd.	8.95
BBD-030	9/16"	9"	3/16" Rd.	14.00
BBD-004	5/8"	10"	1/4" Sq.	9.95
BBD-005	3/4"	12"	1/4" Sq.	11.95
BBD-006	1"	12"	1/4" Sq.	14.00
BBD-007	1-1/4"	16"	1/2" Sq.	24.95
BBD-008	1-1/2"	18"	1/2" Sq.	30.00
BBD-009	5 Piece Set Includes 1 Each BBD-001,002,003,004 & 005			\$26.95

*Prices do not include tool bits

Precise TURNING TOOL HOLDERS

For use with Carbide Tipped Tool Bits



Offset: Straight, Right hand (Shown) or Left hand turning.

Order No.	Size of Holder	Size of Tool Bit	Offset S-R-L	Price Each
610016	3/8 x 15/16 x 6"	1/4"	Straight	\$13.50
610116	3/8 x 15/16 x 6"	1/4"	Right	13.50
610216	3/8 x 15/16 x 6"	1/4"	Left	13.50
610020	1/2 x 1-1/4 x 7"	5/16"	Straight	\$15.95
610120	1/2 x 1-1/4 x 7"	5/16"	Right	15.95
610220	1/2 x 1-1/4 x 7"	5/16"	Left	15.95
610024	5/8 x 1-1/2 x 8"	3/8"	Straight	\$17.95
610224	5/8 x 1-1/2 x 8"	3/8"	Right	17.95
610224	5/8 x 1-1/2 x 8"	3/8"	Left	17.95
610028	3/4 x 1-3/4 x 9"	7/16"	Straight	\$24.00
610128	3/4 x 1-3/4 x 9"	7/16"	Right	24.00
610228	3/4 x 1-3/4 x 9"	7/16"	Left	24.00
610032	7/8 x 1-7/8 x 10"	1/2"	Straight	\$26.95
610132	7/8 x 1-7/8 x 10"	1/2"	Right	26.95
610232	7/8 x 1-7/8 x 10"	1/2"	Left	26.95
610040	1 x 2-1/8 x 12"	5/8"	Straight	\$47.50
610140	1 x 2-1/8 x 12"	5/8"	Right	47.50
610240	1 x 2-1/8 x 12"	5/8"	Left	47.50

Precise TOOL HOLDERS
Cut-Off Tool Holders

For use with H.S.S. or Cobalt Cut-Off Blades



Offset: Straight, Right hand (Shown) or Left hand cutting.

NOTE: Prices do not include Cut-Off Blades.

Order No.	Size of Holder	Size of Blade	Offset S-R-L	Price Each
450032	5/16x3/4x4-1/2"	3/32x1/2"	Straight	\$11.95
455032	5/16x3/4x4-1/2"	3/32x1/2"	Right	11.95
460032	5/16x3/4x4-1/2"	3/32x1/2"	Left	11.95
450040	3/8 x 7/8 x 5"	3/32x5/8"	Straight	\$13.50
455040	3/8 x 7/8 x 5"	3/32x5/8"	Right	13.50
460040	3/8 x 7/8 x 5"	3/32x5/8"	Left	13.50
450048	1/2 x 1-1/8 x 6"	1/8x3/4"	Straight	\$14.50
455048	1/2 x 1-1/8 x 6"	1/8x3/4"	Right	14.50
460048	1/2 x 1-1/8 x 6"	1/8x3/4"	Left	14.50
450056	5/8 x 1-3/8 x 7"	1/8x7/8"	Straight	\$21.50
455056	5/8 x 1-3/8 x 7"	1/8x7/8"	Right	21.50
460056	5/8 x 1-3/8 x 7"	1/8x7/8"	Left	21.50
450064	3/4 x 1-5/8 x 8"	3/16x1"	Straight	\$30.50
455064	3/4 x 1-5/8 x 8"	3/16x1"	Right	30.50
460064	3/4 x 1-5/8 x 8"	3/16x1"	Left	30.50

Precise BORING TOOL HOLDER

- Each holder comes with one Double Ended Boring Bar (Tool Bits are not included.)



Order No.	Size of Holder	B/bar Diameter	Tool Bit Size	Price Each
070012	3/8x7/8x5-3/8"	9/16"	3/16"	\$39.95
070016	1/2x1-1/8x6-1/8"	3/4"	1/4"	46.50
070020	5/8x1-3/8x7-7/16"	15/16"	5/16"	53.00

Precise COBALT CUT-OFF BLADES

- M42-8% Cobalt, Ground Finish



Model No.	Size (Inches)	Cobalt Price
CO-1/2	3/32" x 1/2" x 4-1/2"	\$10.95
CO-5/8	3/32" x 5/8" x 5"	11.95
CO-3/4	1/8" x 3/4" x 6"	13.95
CO-7/8	1/8" x 7/8" x 7"	15.95
CO-1	3/16" x 1" x 8"	16.95

Precise BORING BARS WITH HOLDERS

- Tool steel with shiny black finish.
- Double ended boring bars have angle of 90° and 45°.
- Complete with screws and allen keys.



Order No.	Size of Holder	B/bar Diameter	Tool Bit Size	Price Each
210001	2-1/4x9/16"	4-1/2 x 3/8"	1/8"	\$7.95
210002	5-1/2x5/8"	5-1/4 x 7/16"	3/16"	7.95
210003	3"x3/4"	6-3/4 x 9/16"	1/4"	9.95
210004	3-3/4"x 1"	9-1/4 x 3/4"	5/16"	14.50
210005	11-1/2x 7/8"	4-1/2 x 1-1/4"	3/8"	23.00
210006	5-1/4x1-3/8"	13-1/2 x 1-1/8"	7/16"	32.00
210007	6" x 1/58"	15-1/2 x 1-1/4"	1/2"	42.50

Precise KNURLING TOOLS
Single Knurling Tool

- Shiny black finish.
- Holder size: 4"x 1/2"x 1/2"
- Knurl size: 3/4"x 1/4"x 1/4"
- Includes 1 medium cut H.S.S. Knurl.

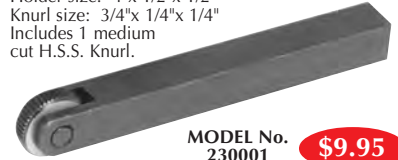

MODEL No. 230001 **\$9.95**

Pivot Head Knurling Tool

- Self adjusting pivot head.
- Shiny black finish.
- Holder size: 4-1/2"x 1/2"x 1/2"
- Knurl size: 3/4"x 3/8"x 1/4"
- Includes 1 pair of medium cut H.S.S. Knurls.

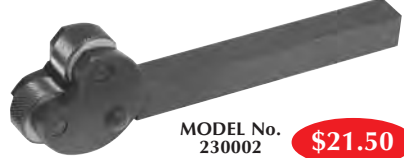

MODEL No. 230002 **\$21.50**

Self Centering Knurling Tool

- Shiny black finish.
- Includes 1 pair of medium cut H.S.S. knurls.



Order No.	Size of Holder	Knurl Dimensions	Price Each
230020	5/16 x 3/4 x 5"	5/8 x 5/16 x 7/32"	\$32.50
230100	3/8 x 7/8 x 5-1/2"	5/8 x 5/16 x 7/32"	35.00
230101	1/2 x 1-1/8 x 1-1/2"	3/4 x 3/8 x 1/4"	37.50
230102	5/8 x 1-3/8 x 7-1/2"	3/4 x 3/8 x 1/4"	37.50

Revolving Head Knurling Tools

- Shiny black finish.
- Includes 3 pairs of H.S.S. Knurls (coarse, medium, fine)



Order No.	Size of Holder	Knurl Dimensions	Price Each
233000	5/16 x 3/4 x 5"	5/8 x 5/16 x 7/32"	\$34.95
233500	1/2 x 1-1/8 x 6-1/2"	3/4 x 3/8 x 1/4"	34.95
233100	3/8 x 7/8 x 5-1/2"	5/8 x 5/16 x 7/32"	36.95
233102	5/8 x 1-3/8 x 7-1/2"	3/4 x 3/8 x 1/4"	36.95

Precise REPLACEMENT KNURLS

FINE, MEDIUM & COARSE PITCH WITH CHAMFERED EDGE



5/8" Dia. x 5/16" Wide x 7/32" Hole Size

Order No.	Pitch	T.P.I.	Diamond Price, Pair	Straight Price, Pair
210008	Coarse	14	\$10.95	\$10.95
210009	Medium	21	10.95	10.95
210010	Fine	33	10.95	10.95

3/4" Dia. x 3/8" Wide x 1/4" Hole Size

Order No.	Pitch	T.P.I.	Diamond Price, Pair	Straight Price, Pair
210011	Coarse	14	\$10.95	\$10.95
210012	Medium	21	10.95	10.95
210013	Fine	33	10.95	10.95

* When ordering knurls add "DL" for Diamond left hand and "DR" for Diamond right hand Pattern or "S" for Straight pattern after order number

BURR-BIT

TAPS & DEBURRS IN ONE OPERATION

- Deburs the top of the tapped hole while the tap is being withdrawn from the workpiece.
- No reversal cut in the chamber due to tool cutting only in reverse.
- Creates a chamfer for easy screw insertion; leaves no burr to clog the tapped hole.
- Used on N/C machining centers and transfer machines, saves a complete station and a cycle.
- Absence of burr eliminates rocking between mating surfaces.
- Deburs to consistent depth even though working pieces vary in thickness.
- No additional power required.
- Easy to install; simply slips over your tap.
- Resharpenable with simple radial relief grinding fixture.

90° or 120° Standard Ground Burr Bits (Specify)

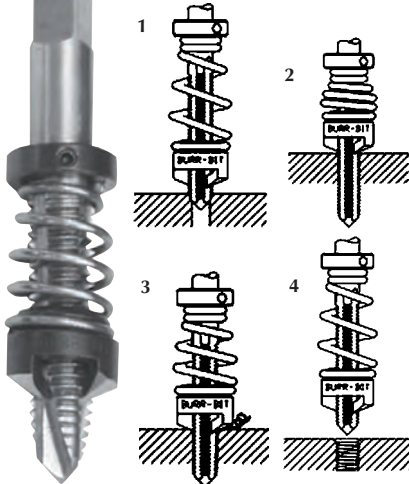

1. Drilled hole BURR-BIT does not operate. Tap performs normally.
2. Threading finished. Spring exerts cutting pressure on BURR-BIT.
3. Tap withdrawing. BURR-BIT now deburs.
4. Leaving clean chamfer.

U.S. UNC AND UNF TAPS

Tap Size	Model No. 2 or 4 Flute	Price Each	Model No. 3-Flute	Price Each
#2	BB-200	\$28.50	BB-3200	\$29.25
#3	BB-300	28.50	BB-3300	29.25
#4	BB-400	28.50	BB-3400	29.25
#5	BB-500	28.50	BB-3500	29.25
#6	BB-600	28.25	BB-3600	28.90
#8	BB-800	28.25	BB-3800	28.90
#10	BB-100	28.25	BB-3100	28.90
#12	BB-120	28.25	BB-3120	28.90
1/4	BB-130	29.00	BB-3130	29.50
5/16	BB-135	29.00	BB-3135	29.50
3/8	BB-140	34.50	BB-3140	35.80
7/16	BB-145	40.00	BB-3145	42.00
1/2	BB-150	40.00	BB-3150	42.00
9/16	BB-165	42.00	BB-3165	43.25
5/8	BB-170	42.00	BB-3170	43.25
3/4	BB-175	55.00	BB-3175	57.50
7/8	BB-180	55.00	BB-3180	-
1	BB-185	105.00	BB-3185	-
1-1/8	BB-190	105.00	BB-3190	-
1-1/4	BB-195	105.00	BB-3195	-

METRIC SIZES

M3	BM-300	\$24.00	BM-3300	\$25.00
M4	BM-400	25.50	BM-3400	25.50
M5	BM-500	26.25	BM-3500	26.25
M6	BM-600	28.75	BM-3600	28.75
M7	BM-700	30.60	BM-3700	30.60
M8	BM-800	32.50	BM-3800	31.25
M10	BM-100	36.28	BM-3100	32.25
M12	BM-120	37.50	BM-3120	36.50
M14	BM-140	45.00	BM-3140	37.50
M16	BM-160	47.50	BM-3160	45.00
M18	BM-180	60.00	BM-3180	47.80
M20	BM-200	62.50	BM-3200	-
M22	BM-220	68.75	BM-3220	-
M24	BM-224	81.25	BM-3240	-

*NPT and NPS are also available

CHAM-BIT

DRILL CHAMFER AND DEBURR IN ONE OPERATION

- Positioning for drill length can vary instantly.
- Patented locking device prevents any axial movement of Cham-Bit.
- Single point cutter assures concentricity.
- Drill acts as pilot to reduce chatter.
- Easily resharpened on any drill grinder without damage to the drill.
- Can provide an additional chamfer diameter to a multi-diameter drill.

90° Included Angle Cham Bit



Model No.	Fractional, Numbers Letter and Metric	Price Each
CR-100-Specify Size	1/8, #30, #29, #28, 9/64, #27, #26, #24, #23, 5/32, #22, #21, #19, #18, 11/64, #17, #16, #15 Metric: 3.0mm thru 4.5mm	\$31.03
CR-200-Specify Size	#14, #13, 3/16, #12, #11, #10, #9, #8, #7, 13/64, #6, #5, #4, #3, 7/32, #2, #1 Metric: 4.6mm thru 5.9mm	\$33.00
CR-300-Specify Size	A, 15/64, B, C, D, E, L, M, 19/64, N, H, I, J, K, 9/32, L, M, 19/64, N Metric: 6.0mm thru 7.6mm	\$30.90
CR-400-Specify Size	5/16, O, P, 21/64, Q, R, 11/32, S, T, 23/64, U, 3/8, V, W, 25/64, X, Y, 13/64, Z, 27/64, 7/16 Metric: 7.7mm thru 11mm	\$34.00
CR-500-Specify Size	29/64, 15/32, 31/64, 1/2, 33/64, 17/32, 35/64, 9/16, 37/64, 19/32, 39/64, 5/8, 41/64, 21/32, 43/64, 11/16, 45/64, 23/32, 47/64 Metric: 11.5mm thru 18.5mm	\$47.50
CR-600-Specify Size	3/4, 49/64, 25/32, 51/64, 13/16, 53/64, 27/32, 55/64 Metric: 19mm thru 22mm	\$61.45
CR-700-Specify Size	7/8, 57/64, 29/32, 59/64, 15/16, 61/64, 31/32, 63/64, 1 Metric: 22.5mm thru 25.5mm	\$69.00

Note: 82° Also Available (Inquire)

ACRO Needle-Eye Laps

For Fast, Accurate Lapping Of Small Holes

- Arco Needle-Eye Laps are unequaled for lapping small holes. Each of the 17 sizes, from .032" to .250", expand to the next larger size to accurately lap the complete range or sizes.
- Using Lap Expander or the new, exclusive Arco Lap Adjusting Tool, any degree of expansion is obtained with a flexibility that prevents seizing.

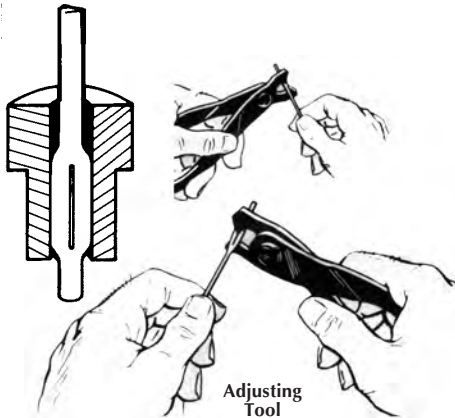

Needle Eye No.	Size Inch	Price Per Doz.	Needle Eye No.	Size Inch	Price Per Doz.
NE-030	.030	\$10.90	NE-090	.090	\$6.25
NE-032	.032	4.70	NE-104	.104	6.25
NE-040	.040	4.70	NE-120	.120	6.25
NE-046	.046	4.70	NE-135	.135	6.25
NE-054	.054	4.70	NE-155	.155	7.30
NE-062	.062	4.70	NE-170	.170	7.30
NE-070	.070	4.70	NE-187	.187	7.30
NE-079	.079	4.70	NE-218	.218	8.85
			NE-250	.250	9.35

NEA-100	Trial Assortment 17 Piece Set (.032" to .250")	\$10.00
ALT-100	Arco Adjusting Tool	\$10.00

TOLL FREE 1-800-526-4956
Fax 1-973-761-1494
E-Mail info@penntoolco.com

ACROlaps

For High Speed Lapping/Polishing/Deburring

- Arco laps insure fast, accurate lapping of long or short holes, 3/16" to 1" diameters. Instantly, accurately adjustable. Milled eccentric slots in brass barrel permit expansion of up to 15% or more by simply turning adjusting screw. No set-up time. No special equipment needed.
- Replacement parts, arbors, brass barrels and adjusting screws are available from stock.

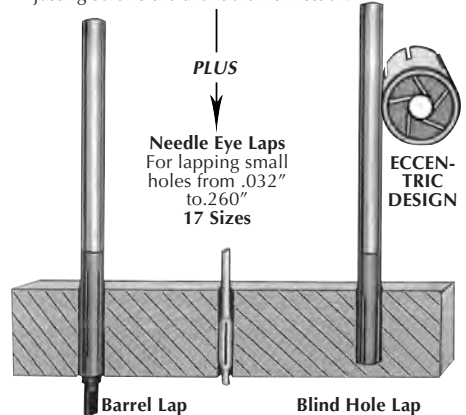

Barrel Laps	Blind Hole	Size Inch	Complete Price
BL-001	BH-001	1/8"	\$ 5.40
BL-002	BH-002	5/32"	5.70
BL-003	BH-003	3/16"	6.00
BL-004	BH-004	7/32"	6.50
BL-005	BH-005	1/4"	6.50
BL-006	BH-006	9/32"	6.60
BL-007	BH-007	5/16"	7.00
BL-008	BH-008	11/32"	7.20
BL-009	BH-009	3/8"	7.50
BL-010	BH-010	13/32"	7.60
BL-011	BH-011	7/16"	8.10
BL-012	BH-012	15/32"	8.30
BL-013	BH-013	1/2"	8.60
BL-014	BH-014	9/16"	9.40
BL-015	BH-015	5/8"	12.00
BL-016	BH-016	11/16"	12.20
BL-017	BH-017	3/4"	14.50
BL-017A	--	13/16"	14.75
BL-018	BH-018	7/8"	15.00
BL-019	BH-019	15/16"	15.20
BL-020	BH-020	1"	15.60
BL-025	--	1-1/16"	18.00
BL-021	BH-021	1-1/8"	19.00
BL-026	--	1-3/16"	20.00
BL-022	BH-022	1-1/4"	21.00
BL-027	BH-023	1-5/16"	22.00
BL-028	BH-024	1-3/8"	23.00
BL-029	BH-025	1-7/16"	24.00
BL-023	BH-026	1-1/2"	28.00

* Metric Sizes Available (Inquire)

ACRO Needle-Eye Laps

ACRO LAP SETS MOUNTED ON HARD WOOD HOLDER

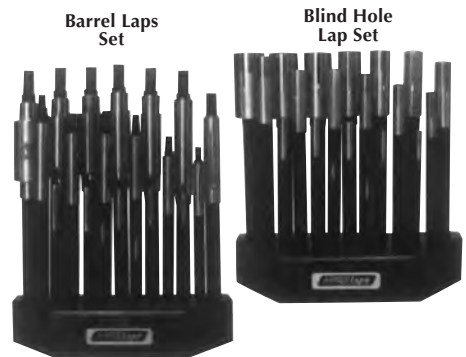

Barrel Laps	Blind Hole	Description Size Range	Set Price
BLS-100	BHS-100-1	6 Arco laps (3/16" to 1/2" by 1/16"ths)	\$ 56.00
BLS-200	BHS-200-1	13 Arco laps (3/16" to 5/8" by 1/32"nds)	90.00
BLS-800	BHS-800-1	18 Arco laps (3/16" to 1" by 32nds)	185.00

PENN TOOL Co.
Visit Us On The Web:
www.penntoolco.com

PREMIUM SURFACE-TREATED ~ JOBBERS LENGTH DRILLS ~ GENRAL PURPOSE JOBBERS LENGTH DRILLS



Ground From Solid

- 118° point.
- Designed for high performance drilling under varying speeds and feeds.
- Surface treatment increases abrasion resistance

Fractional Sizes

Size	Flute	Model	Price	Size	Flute	Model	Price
1/64	3/16	300-1/64	\$.41	23/64	3-1/2	300-23/64	\$1.17
1/32	1/2	300-1/32	.41	3/8	3-5/8	300-3/8	1.51
3/64	3/4	300-3/64	.41	25/64	3-3/4	300-25/64	1.51
1/16	7/8	300-1/16	.41	13/32	3-7/8	300-13/32	1.51
5/64	1	300-5/64	.41	27/64	3-15/16	300-27/64	1.79
3/32	1-1/4	300-3/32	.41	7/16	4-1/16	300-7/16	3.02
7/64	1-1/2	300-7/64	.41	29/64	4-3/16	300-29/64	3.02
1/8	1-5/8	300-1/8	.41	15/32	4-5/16	300-15/32	3.02
9/64	1-3/4	300-9/64	.48	31/64	4-3/8	300-31/64	3.02
5/32	2	300-5/32	.48	1/2	4-1/2	300-1/2	3.44
11/64	2-1/8	300-11/64	.51	33/64	4-13/16	300-33/64	3.44
3/16	2-5/16	300-3/16	.62	17/32	4-13/16	300-17/32	4.25
13/64	2-7/16	300-13/64	.62	35/64	4-13/16	300-35/64	4.68
7/32	2-1/2	300-7/32	.65	19/16	4-13/16	300-19/16	4.95
15/64	2-5/8	300-15/64	.65	37/64	4-13/16	300-37/64	4.95
1/4	2-3/4	300-1/4	.75	19/32	5-3/16	300-19/32	5.44
17/64	2-7/8	300-17/64	.90	39/64	5-3/16	300-39/64	5.44
9/32	2-15/16	300-9/32	.96	5/8	5-3/16	300-5/8	5.44
19/64	3-1/16	300-19/64	1.10	41/64	5-3/16	300-41/64	5.44
5/16	3-3/16	300-5/16	1.16	21/32	5-3/16	300-21/32	5.44
21/64	3-5/16	300-21/64	1.32	43/64	5-5/8	300-43/64	6.06
11/32	3-7/16	300-11/32	1.32	11/16	5-5/8	300-11/16	6.06



Ground From Solid

Letter Sizes

Size	Flute	Model	Price	Size	Flute	Model	Price
A	2-5/8	300-A	\$1.21	N	3-1/16	300-N	\$1.79
B	2-3/4	300-B	1.21	O	3-3/16	300-O	1.79
C	2-3/4	300-C	1.21	P	3-5/16	300-P	1.79
D	2-3/4	300-D	1.21	Q	3-7/16	300-Q	1.79
E	2-3/4	300-E	1.16	R	3-7/16	300-R	2.12
F	2-7/8	300-F	1.16	S	3-1/2	300-S	2.12
G	2-7/8	300-G	1.16	T	3-1/2	300-T	2.12
H	2-7/8	300-H	1.21	U	3-5/8	300-U	2.40
I	2-7/8	300-I	1.35	V	3-5/8	300-V	2.40
J	2-7/8	300-J	1.35	W	3-3/4	300-W	2.69
K	2-15/16	300-K	1.51	X	3-3/4	300-X	3.58
K	2-15/16	300-L	1.51	Y	3-7/8	300-Y	3.79
M	3-1/16	300-M	1.51	Z	3-7/8	300-Z	3.85

PREMIUM HSS TAPER SHANK DRILLS ~ 118°

Designed for drilling in many different materials and a wide range of applications. These drills features a surface treatment to improve chip flow and a taper shank made to American National Standard (Morse) dimensions. Black oxide finish for increased wear resistance and improved lubricity, reducing chip welding and galling.



Size Dia.	Shank Size	Flute Length	Overall Length	Model No.	Price Each	Size Dia.	Shank Size	Flute Length	Overall Length	Model No.	Price Each	Size Dia.	Shank Size	Flute Length	Overall Length	Model No.	Price Each
1/2	2MT	4-3/8	8-1/4	TSD-1/2	\$8.70	25/32	2MT	5-1/2	9-3/8	TSD-25/32	\$12.10	1-3/16	4MT	7-3/8	13	TSD-1-3/16	\$34.40
17/32	2MT	4-5/8	8-1/2	TSD-17/32	8.70	51/64	3MT	6-1/8	10-3/4	TSD-51/64	12.10	1-1/4	4MT	7-3/8	13-1/2	TSD-1-1/4	43.75
9/16	2MT	4-7/8	8-3/8	TSD-9/16	8.70	13/16	3MT	6-1/8	10-3/4	TSD-13/16	12.10	1-3/8	4MT	7-1/2	13-3/8	TSD-1-3/8	62.50
19/32	2MT	4-3/4	8-5/8	TSD-19/32	8.70	53/64	3MT	6-1/8	10-3/4	TSD-53/64	12.10	1-1/2	4MT	7-7/8	13-3/4	TSD-1-1/2	68.75
5/8	2MT	4-3/4	8-5/8	TSD-5/8	8.70	27/32	3MT	6-1/8	10-3/4	TSD-27/32	13.60	1-9/16	4MT	9-5/8	16-5/8	TSD-1-9/16	75.00
35/64	2MT	4-3/4	8-5/8	TSD-35/64	8.70	55/64	3MT	6-1/8	10-3/4	TSD-55/64	13.60	1-5/8	4MT	10	17	TSD-1-5/8	75.00
37/64	2MT	4-3/4	8-5/8	TSD-37/64	8.70	7/8	3MT	6-1/8	10-3/4	TSD-7/8	15.00	1-11/16	5MT	10-1/8	17-1/8	TSD-1-11/16	86.25
39/64	2MT	4-3/4	8-5/8	TSD-39/64	8.70	57/64	3MT	6-1/8	10-3/4	TSD-57/64	15.00	1-3/4	5MT	10-1/8	17-1/8	TSD-1-3/4	86.25
41/64	2MT	4-7/8	8-3/4	TSD-41/64	8.70	29/32	3MT	6-1/8	10-3/4	TSD-29/32	16.60	1-7/8	5MT	10-3/8	17-3/8	TSD-1-7/8	93.75
21/32	2MT	5-1/8	8-3/4	TSD-21/32	9.40	59/64	3MT	6-1/8	10-3/4	TSD-59/64	18.50	1-15/16	5MT	10-3/8	17-3/8	TSD-1-15/16	106.00
43/64	2MT	5-1/8	9	TSD-43/64	9.40	15/16	3MT	6-1/4	11	TSD-15/16	18.50	2	5MT	10-3/8	17-3/8	TSD-2	119.00
11/16	2MT	5-1/8	9	TSD-11/16	9.40	61/64	3MT	6-1/4	11	TSD-61/64	18.50	2-1/4	5MT	10-1/8	17-3/8	TSD-2-1/4	156.00
45/64	2MT	5-1/4	9	TSD-45/64	10.60	31/32	3MT	6-1/4	11	TSD-31/32	18.50	2-1/2	5MT	11-1/4	18-3/4	TSD-2-1/2	262.00
23/64	2MT	5-1/4	9-1/8	TSD-23/64	10.60	63/64	3MT	6-1/4	11-1/4	TSD-47/64	19.40	2-3/4	5MT	12-3/4	20-3/8	TSD-2-3/4	281.00
47/64	2MT	5-1/4	9-1/8	TSD-47/64	10.60	1	3MT	6-1/4	11-1/4	TSD-1	23.10	3	5MT	14	21-3/4	TSD-3	494.00
3/4	2MT	5-1/2	9-3/8	TSD-3/4	10.60	1-1/16	4MT	6-3/4	12-9/16	TSD-1-1/16	23.10	3-1/2	6MT	16-3/8	26-1/2	TSD-3-1/2	750.00
49/64	2MT	5-1/2	9-3/8	TSD-49/64	10.60	1-1/8	4MT	7-1/8	12-3/4	TSD-1-1/8	26.90	4	6MT	17-1/2	27-1/2	TSD-4	812.00

Note: Most sizes are available with 2MT, 3MT, 4MT, and 5 MT shanks if not list



Ground From Solid

Wire Gage Number Drills

Size	Flute	Model	Price	Size	Flute	Model	Price
1	2-5/8	300-1	\$.75	41	1-3/8	300-41	\$.49
2	2-5/8	300-2	.75	42	1-1/4	300-42	.49
3	2-1/2	300-3	.69	43	1-1/4	300-43	.49
4	2-1/2	300-4	.69	44	1-1/8	300-44	.49
5	2-1/2	300-5	.69	45	1-1/8	300-45	.49
6	2-1/2	300-6	.69	46	1-1/8	300-46	.49
7	2-7/16	300-7	.69	47	1	300-47	.49
8	2-7/16	300-8	.69	48	1	300-48	.49
9	2-7/16	300-9	.69	49	1	300-49	.49
10	2-7/16	300-10	.62	50	1	300-50	.46
11	2-5/16	300-11	.62	51	1	300-51	.46
12	2-5/16	300-12	.62	52	7/8	300-52	.46
13	2-5/16	300-13	.62	53	7/8	300-53	.46
14	2-3/16	300-14	.62	54	7/8	300-54	.46
15	2-3/16	300-15	.62	55	7/8	300-55	.46
16	2-3/16	300-16	.62	56	3/4	300-56	.46
17	2-3/16	300-17	.62	57	3/4	300-57	.46
18	2-1/8	300-18	.62	58	11/16	300-58	.46
19	2-1/8	300-19	.62	59	11/16	300-59	.46
20	2-1/8	300-20	.60	60	11/16	300-60	.46
21	2-1/8	300-21	.60	61	11/16	300-61	.46
22	2-1/8	300-22	.60	62	5/8	300-62	.46
23	2-1/8	300-23	.60	63	5/8	300-63	.41
24	2-1/8	300-24	.60	64	5/8	300-64	.41
25	2-1/8	300-25	.60	65	5/8	300-65	.41
26	2-1/8	300-26	.60	66	1/2	300-66	.41
27	2-1/8	300-27	.60	67	1/2	300-67	.41
28	1-5/8	300-28	.55	68	1/2	300-68	.41
29	1-5/8	300-29	.55	29	1/2	300-69	.41
30	1-5/8	300-30	.55	70	3/8	300-70	.41
31	1-5/8	300-31	.55	71	3/8	300-71	.41
32	1-5/8	300-32	.55	72	5/16	300-72	.41
33	1-1/2	300-33	.55	73	5/16	300-73	.41
34	1-1/2	300-34	.55	74	1/4	300-74	.41
35	1-1/2	300-35	.55	75	1/4	300-75	.41
36	1-17/16	300-36	.55	76	3/16	300-76	.41
37	1-17/16	300-37	.55	77	3/16	300-77	.41
38	1-17/16	300-38	.55	78	3/16	300-78	.41
39	1-3/8	300-39	.55	79	1/8	300-79	.41
40	1-3/8	300-40	.55	80	1/8	300-80	.41

PREMIUM HSS TAPER SHANK DRILL SETS

In Wood Case



Model	Description	Price
404-215	9 Pc. 1/2, 9/16, 5/8, 11/16, 3/4, 13/16, 7/8, 15/16, & 1	\$ 87.50
404-216	16 Pc. 1/2, 17/32, 9/16, 19/32, 5/8, 21/32, 11/16, 23/32, 3/4, 25/32, 13/16, 27/32, 7/8, 29/32, 15/16, & 1	156.00
404-217	6 Pc. 1-1/16, 1-1/8, 1-1/4, 1-5/16, 1-3/8, 1-1/2	\$206.00
404-218	22 Pc. 1/2, 17/32, 9/16, 19/32, 5/8, 21/32, 11/16, 23/32, 3/4, 25/32, 13/16, 27/32, 7/8, 29/32, 15/16, 1-1/16, 1-1/8, 1-1/4, 1-5/16, 1-3/8, & 1-1/2	344.00

PREMIUM COBALT JOBBER DRILLS

135° Split Point Drill. Standard helix drills for high tensile strength steels. Split point provides self-centering properties and secure positioning on work surface. Ground from solid and surface treated for true abrasion resistance. Heavy-duty construction for improved rigidity and strength.



Ground From Solid

Size	Flute	OAL	Model	Price	Size	Flute	OAL	Model	Price
1/16"	7/8"	1-7/8"	300C-1/16	\$.70	19/64"	3-1/6"	4-3/8"	300C-19/64	\$3.45
5/64	1"	2"	300C-5/64	.80	5/16"	3-3/16"	4-1/2"	300C-5/16	4.05
3/32"	1-1/4"	2-1/4"	300C-3/32	.80	21/64"	3-5/16"	4-5/8"	300C-21/64	4.60
7/64"	1-1/2"	2-5/8"	300C-7/64	.90	11/32"	3-7/16"	4-3/4"	300C-11/32	4.95
1/8"	1-5/8"	2-3/4"	300C-1/8	.90	23/64"	3-1/2"	4-7/8"	300C-23/64	4.95
9/64"	1-3/4"	2-7/8"	300C-9/64	.95	3/8"	3-5/8"	5"	300C-3/8	5.65
5/32"	2"	3-1/8"	300C-5/32	1.00	25/54"	3-3/4"	5-1/8"	300C-25/64	6.90
11/64"	2-1/8"	3-1/4"	300C-11/64	1.25	13/32"	3-7/8"	5-1/4"	300C-13/32	7.45
3/16"	2-5/16"	3-1/2"	300C-3/16	1.50	27/64"	3-15/16"	5-3/8"	300C-27/64	8.65
13/64"	2-7/16"	3-5/8"	300C-13/64	1.50	7/16"	4-1/16"	5-1/2"	300C-7/16	8.65
7/32"	2-1/2"	3-3/4"	300C-7/32	1.75	29/64"	4-3/16"	5-5/8"	300C-29/64	8.65
15/64"	2-5/8"	3-7/8"	300C-15/64	2.20	15/32"	4-5/16"	5-3/4"	300C-15/32	10.95
1/4"	2-3/4"	4"	300C-1/4	2.30	31/64"	4-3/8"	5-7/8"	300C-31/64	11.90
17/64"	2-7/8"	4-1/8"	300C-17/64	2.80	1/2"	4-1/2"	6"	300C-1/2	12.80
9/32"	2-15/16"	4-1/4"	300C-9/32	2.80	-	-	-	-	-

YG-1 N/C SPOTTING DRILLS

8% Cobalt ~ 90° or 120° Point

- For greater precision centering work on NC/CNC machines.
- A larger diameter in respect to the subsequent drilling tool allow to obtain the centering and chamfering simultaneously.
- Good chip removal and favorable centering.
- Chisel type.

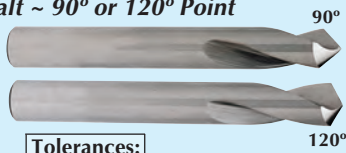

Tolerances:
Cutting Diameter +.000 / -.006"

Size	Flute Length	Overall Length	90° Model	120° Model	Sale Price
1/8"	.472"	1.93"	YG-081	YG-208	\$4.00
3/16"	.590"	2.44"	YG-121	YG-212	4.50
1/4"	.669"	2.76"	YG-161	YG-216	4.70
5/16"	.984"	3.11"	YG-201	YG-220	5.60
3/8"	.827"	3.50"	YG-241	YG-224	6.85
1/2"	.984"	4.02"	YG-321	YG-232	11.10
5/8"	1.575"	4.53"	YG-401	YG-240	15.35
3/4"	1.968"	5.16"	YG-481	YG-248	23.60
1"	1.968"	6.14"	YG-641	YG-264	38.75

NPT TAPER PIPE TAPS

High Speed Steel - Gound Thread



Model No.	Size & Thread	No. of Flutes	Thread Length	Price Each
NPT-1/16	1/16-27	4	11/16	\$ 3.70
NPT-1/8	1/8-27	4	3/4	4.95
NPT-1/4	1/4-28	4	1-1/16	6.20
NPT-3/8	3/8-18	4	1-1/16	6.90
NPT-1/2	1/2-14	4	1-3/8	9.95
NPT-3/4	3/4-14	4	1-3/8	17.45
NPT-1	1-11-1/2	5	1-3/4	23.75
NPT-1-1/4	1-1/4-11-1/2	5	1-3/4	34.40
NPT-1-1/2	1-1/2-11-1/2	7	1-3/4	49.40
NPT-2	2-11-1/2	7	1-3/4	86.90
NPT-2-1/2	2-1/2-8	8	1-3/4	206.00
NPT-3	3-8	8	2-9/16	294.00
NPT-3-1/2	3-1/2-8	9	2-5/8	438.00
NPT-4	4-8	9	3	619.00

Precise ADJUSTABLE TAP & REAMER WRENCHES

- Knurled steel handles, one end with cross hole.
- Jaws surface-hardened .020" deep.
- Hammertone baked enamel finish.

4 Piece Set
MODEL No.
ATW-034

\$26.40

Includes
0-3/4" Range



Model No.	Size	Tap Capacity	Pipe Tap Range	O.A.L.	Price Each
ATW-00	0	0-1/4"	-	5"	\$ 4.55
ATW-15	4	1/8"-3/8"	-	7"	5.60
ATW-02	5	3/16"-1/2"	1/8"-1/4"	11-1/2"	8.00
ATW-03	6	1/4"-3/4"	1/8"-3/8"	15-3/8"	11.45
ATW-04	7	1/4"-1-1/8"	1/8"-3/4"	20"	17.20
ATW-06	7-1/2	3/4"-1-1/2"	1/4"-1"	40"	57.45
ATW-08	8	1"-2-1/2"	1/2"-1-1/4"	54"	91.95

PREMIUM M35 COBALT SILVER & DEMMING DRILLS

Features:

- Size of shank is 1/2" diameter.
- 6" overall length, 3" flute length.



118° Point



Model	Size	Price	Model	Size	Price
COB-001	33/64	\$ 8.10	COB-017	3/4	\$13.10
COB-002	17/32	8.10	COB-018	49/64	13.10
COB-003	35/64	8.10	COB-019	25/32	13.10
COB-004	9/16	8.75	COB-020	53/64	13.60
COB-005	37/64	9.40	COB-021	27/32	14.90
COB-006	19/32	9.90	COB-022	55/64	14.90
COB-007	39/64	11.10	COB-023	7/8	14.90
COB-008	5/8	11.25	COB-024	57/64	16.10
COB-009	41/64	11.25	COB-025	29/32	16.80
COB-010	21/32	11.90	COB-026	59/64	17.40
COB-011	43/64	11.90	COB-027	15/16	18.60
COB-012	11/16	11.90	COB-028	61/64	19.40
COB-013	45/64	12.50	COB-029	31/32	19.90
COB-014	23/32	12.50	COB-030	63/64	20.60
COB-015	47/64	13.10	COB-031	1	22.40
COB-016	13/16	13.10	-	-	-
COB-033	16Pc. Set 17/32" to 1" 32nds		-	-	\$206.00
COB-034	32Pc. Set 33/64" to 1" by 64ths		-	-	288.00

PREMIUM SOLID CARBIDE JOBBERS DRILLS

For significant productive gains in even the most difficult holemaking operations designed for steel and cast irons

118° Point



Model No.	Size Inch	Flute Length	Overall Length	Price Each
SOD-001	1/16"	3/4"	1-1/2"	\$ 7.45
SOD-002	3/32"	1"	2"	8.70
SOD-003	1/8"	1-1/4"	2-1/4"	10.00
SOD-004	3/16"	1-5/8"	2-3/4"	14.40
SOD-005	1/4"	2"	3-1/4"	20.60
SOD-006	5/16"	2-3/8"	3-3/4"	26.30
SOD-007	3/8"	2-3/4"	4-1/4"	41.30
SOD-008	1/2"	3"	4-3/4"	44.40

PREMIUM H.S.S. SPIRAL POINT TAPS

- Spiral point taps were originated to solve the problem of chip packing and tap breakage in thru hole tapping.
- Spiral point taps shoot chips ahead of the cutting action, thus reducing loading and clogging in the flutes.



Ground Thread
Ground from Solid

Tap Size	Thread Limit	No. of Flutes	Thread Length	Model No.	Price Each	Price 10-Pack
0-80NF	H1	2	5/16"	3122-0-80	\$ 5.60	\$ 50.40
1-64 NC	H1	2	3/8"	3122-1-64	5.60	50.40
1-72 NF	H2	2	3/8"	3122-1-72	5.60	50.40
2-56 NC	H2	2	7/16"	3122-2-56	2.50	22.50
2-64 NF	H2	2	7/16"	3122-2-64	3.60	32.40
3-34 NC	H2	2	1/2"	3122-3-48	\$ 2.20	\$19.80
3-56 NF	H2	2	1/2"	3122-3-56	2.75	24.75
4-40 NC	H2	2	9/16"	3122-4-40	1.90	17.10
4-48 NF	H2	2	9/16"	3122-4-48	1.90	17.10
5-40 NC	H2	2	5/8"	3122-5-40	\$ 1.90	\$17.10
5-44 NF	H2	2	5/8"	3122-5-44	1.90	17.10
6-32 NC	H3	2	11/16"	3122-6-32	1.90	17.10
6-40 NF	H3	2	11/16"	3122-6-40	1.90	17.10
8-32 NC	H3	2	3/4"	3122-8-32	1.90	17.10
8-36 NF	H3	2	3/4"	3122-8-36	\$ 1.90	\$17.10
10-24 NC	H3	2	7/8"	3122-10-24	1.90	17.10
10-32 NF	H3	2	7/8"	3122-10-32	1.90	17.10
12-24 NC	H3	2	15/16"	3122-12-24	2.20	19.80
12-28 NF	H3	2	15/16"	3122-12-28	2.20	19.80
1/4-20 NC	H3	2	1"	3314-1/4-20	\$ 2.45	\$ 22.05
1/4-28 NF	H3	2	1"	3314-1/4-28	2.45	22.05
5/16-18 NC	H3	2	1-1/8"	3314-5/16-18	2.80	25.20
5/16-24 NF	H3	3	1-1/8"	3314-5/16-24	2.80	25.20
3/8-16 NC	H3	3	1-1/4"	3314-3/8-16	3.15	28.35
3/8-24 NF	H3	3	1-1/4"	3314-3/8-24	\$ 3.15	\$28.35
7/16-14 NC	H3	3	1-7/16"	3314-7/16-14	4.40	39.60
7/16-20 NF	H3	3	1-7/16"	3314-7/16-20	4.40	39.60
1/2-13 NC	H3	3	1-21/32"	3314-1/2-13	4.80	43.20
1/2-20 NF	H3	3	1-21/32"	3314-1/2-20	4.80	43.20
5/8-11 NC	H3	3	1-13/16"	3314-5/8-11	\$ 6.90	\$ 62.10
5/8-18 NF	H3	3	1-13/16"	3314-5/8-18	6.90	62.10
3/4-10 NC	H3	3	2"	3314-3/4-10	12.45	112.00
3/4-16 NF	H3	3	2"	3314-3/4-16	12.45	112.00
7/8-9	H3	3	2"	3314-7/8-9	16.60	149.40
1-8 NC	H3	3	2-1/2"	3314-1-8	16.60	149.40

Note: Hand taps, Taper, Plug & Bottoming at similar prices (Inquire)

BAC Industries **BIT-KEEPER**
Portable Drill Case

MADE IN USA
Bit-Keeper
(Empty)
MODEL No.
BBI-290
\$16.95

- Insert nicely holds most 29 pc. drill bit sets.
- Belt clip allows for easy portability.
- Easy to read fractional sizes.
- No more greasy dented cases for your bits.
- 1 replacement warranty.
- Long lasting compared to metal cases.
- Made of high-impact polymers to withstand worksite/shop abuse.
- Airtight/watertight cap keeps drill bits from rusting and corroding.



Bit-Keeper With 29 Pc. H.S.S. Drills
1/16 - 1/2 by 64ths
SET No. BBI-029
\$29.95

Precise SINGLE FLUTE COUNTERSINK SETS

- Single flute construction and low controlled relief provide chatterless operation and smooth surface finish.
- Ideal for chamfering, deburring and counter sinking.
- Available in 60°, 82° or 90°
- Made from high speed steel.

9 Pc. SET No. MCS-002 12 Pc. SET No. MCS-003

\$74.95 **\$199.95**



5 Pc. SET
No. MCS-001
\$42.95

No. of Pieces	Maximum Diameter	Available Angle (Specify)
5	1/4, 3/8, 1/2, 3/4 and 1	60°, 82°, 90°
9	3/16, 1/4, 5/16, 3/8, 1/2, 5/8, 3/4, 7/8, & 1	60°, 82°, 90°
12	3/16, 1/4, 5/16, 3/8, 1/2, 5/8, 3/4, 7/8, 1, 1-1/4, 1-1/2, & 2	60°, 82°, 90°

Precise SIX FLUTE COUNTERSINK SETS

- Chatterless countersinks are designed to give you fast shearing cuts.
- Made from high speed steel.
- Chip loads are generally smaller and chatter free machining is possible.
- Available in 60°, 82° or 90°

8 Pc. SET No. MCS-005 11 Pc. SET No. MCS-006

\$69.50 **\$139.95**



5 Pc. SET
No. MCS-004
\$36.50

No. Of Pieces	Maximum Diameter	Available Angle (Specify)
5	1/4, 3/8, 1/2, 3/4 & 1	60°, 82°, 90°
8	1/4, 5/16, 3/8, 1/2, 5/8, 3/4, 7/8 & 1	60°, 82°, 90°
10	3/16, 1/4, 5/16, 3/8, 1/2, 5/8, 3/4, 7/8, 1, 1-1/4 & 1-1/2	60°, 82°, 90°

Precise COUNTERSINK & DEBURRING SET

- High speed straight shank
- Choose 60°, 82° and 90°
- Sizes in Sets: CD-0, CD-1, CD-2, CD-3 & CD-4

60° SET No. 544S-60 90° SET No. 544S-90
\$29.95 **\$29.95**

82° SET No. 544S-82
\$29.95



Model No.	Angle 60°, 82°, 90°	Small Dia.	Large Dia.	Shank Dia.	Price Each
CD-0*	Specify Angle	1/16"	15/16"	1/4"	\$ 6.95
CD-1*		5/32"	13/32"	1/4"	6.95
CD-2*		3/16"	17/32"	1/4"	7.95
CD-3*		5/16"	25/32"	1/2"	12.95
CD-4*		9/16"	1-1/16"	1/2"	22.95
CD-5	82°	1/2"	15/64"	1/2"	\$32.00
CD-6	82°	3/4"	1-3/4"	5/8"	50.00
CD-7	82°	1"	2"	5/8"	65.00
CD-8	82°	1-1/4"	2-1/2"	3/4"	70.00

Precise H.S.S. DRILL SETS
Black Nitrate ~ 118° Point



No. DS-310



No. DS-290



No. 166-500



No. 306S

Set No.	Size Range	Number of drills	Sale Price
DS-290	1/16"-1/2" by 64ths	29	\$16.95
DS-160	#1 thru #60	60	24.95
DS-260	A thru Z	26	26.95
DS-680	#61 thru #80	20	9.95
DS-310	1-1/16"-1/2" by 64ths 1 thru 60, A thru Z	115	54.95

S&D Drill Sets 1/2" Shank			
166-500	9/16"-1" by 16ths	8	\$44.95
303S13	17/32"-1" by 32nds	16	69.95
303S32	33/64"-1" by 64ths	32	139.95
303S8	1-1/16"-1-1/2" by 16ths	8	119.95

S&D Drill Set 3/4" Shank			
306S	1-1/16" to 1-1/2" by 16ths	8	\$95.00



ZERO FLUTE COUNTERSINKS AND DEBURRING TOOL

- Micro-smooth CNC precision ground for clean smooth cutting without smearing.
- M35 Cobalt: 6% Tungsten, 5% Moly, 5% Cobalt - for long tool life in all types of materials.
- Cam relieved for totally chatter free cuts.
- Through-hole design that is easy to resharpen using a small grinding wheel in the cross-hole.

MADE IN USA
5 Piece*
SET No. 53519

Reg. \$125.00
\$99.95
60°, 82°, 90°
(Specify Angle)



Model No.	Angle	Head Diameter	Diameter of Cut Min	Diameter of Cut Max	Shank Diameter	Sale Price
53510	82°	*5/16"	7/64"	9/32"	1/4"	\$11.30
53511	82°	*3/8"	5/32"	11/32"	1/4"	12.90
53512	82°	*1/2"	11/64"	29/64"	5/16"	15.45
53513	82°	*5/8"	3/16"	37/64"	3/8"	17.75
53514	82°	*3/4"	1/4"	45/64"	3/8"	27.00
53515	82°	1"	19/64"	27/64"	3/8"	33.50
53516	82°	1-1/4"	27/64"	1-1/32"	1/2"	80.00
53518	4 Pc. Set 5/16", 3/8", 1/2", 5/8"					\$59.95
53519	5 Pc. set 5/16", 3/8", 1/2", 3/4", 1"					99.95

• Other Available Angles, 60°, 90° & 100° @ same price

PG GOLD P-COATED H.S.S. STEEL JOBBER LENGTH DRILLS 135° SPLIT POINT RIGHT HAND

- **Flute Geometry:** Right hand spiral, wider flutes
- **Point Angle:** 135° Split Point059 diameter and over.
- **Surface Treatment:** Bright body TiN coating on working part.
- **Application:** Drilling in steel, cast steel alloyed and Non-alloyed grey cast iron, graphite, malleable cast iron

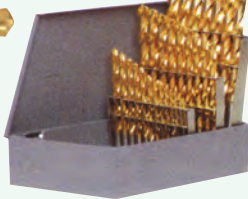

Package Quantities:
 10 Pieces of each
 3/64ths to 5/16ths
 5 Pieces of each
 21/64ths to 1/2"

Tolerance Diameter up to 1/8" 0~.0005"
Over 1/8" to 1/4" 0~.0005"
1/4" to 1/2" 0~.0010"

Model No.	Size Inch	Decimal Equivalent	Flute Length	List Price	Sale Price
113003	3/64	0.04688	3/4"	\$1.50	\$.60
182004	1/16	0.06250	7/8"	1.57	.94
182005	5/64	0.07813	1"	1.57	.94
182006	3/32	0.09375	1-1/4"	1.57	.94
182007	7/64	0.10938	1-1/2"	1.57	.94
182008	1/8	0.12500	1-5/8"	1.57	.94
182009	9/64	0.14063	1-3/4"	1.73	1.04
182010	5/32	0.15625	2"	1.77	1.06
182011	11/64	0.17188	2-1/8"	1.90	1.14
182012	3/16	0.18750	2-5/16"	2.10	1.26
182013	13/64	0.20313	2-7/16"	2.53	1.52
182014	7/32	0.21875	2-1/2"	2.67	1.60
182015	15/64	0.23438	2-5/8"	2.97	1.78
182016	1/4	0.25000	2-3/4"	3.13	1.88
182017	17/64	0.26563	2-7/8"	3.60	2.16
182018	9/32	0.28125	2-15/16"	3.93	2.36
182019	19/64	0.29688	3-1/16"	4.43	2.65
182020	5/16	0.31250	3-3/16"	4.73	2.84
182021	21/64	0.32813	3-5/16"	5.40	3.24
182022	11/32	0.34375	3-7/16"	5.90	3.92
182023	23/64	0.35938	3-1/2"	6.53	3.54
182024	3/8	0.37500	3-5/8"	6.53	3.39
182025	25/64	0.39063	3-3/4"	7.53	4.52
182026	13/32	0.40625	3-7/8"	7.93	4.75
182027	27/64	0.42188	3-15/16"	8.53	5.12
182028	7/16	0.43750	4-1/16"	9.30	5.58
182029	29/64	0.45313	4-3/16"	10.20	6.12
182030	15/32	0.46875	4-5/16"	10.73	6.44
182031	31/64	0.48438	4-3/8"	11.60	6.96
182032	1/2	0.50000	4-1/2"	12.03	7.21

Model	Size	Quantity	List Price	Sale Price
P182	1/16" to 1/2" by 64ths, 29pc. P-Drill Set		\$145.50	\$85.00
P139	A to Z, 26 Pc. P-Drill Set		159.50	95.50
P138	1 to 56, 56 Pc. P-Drill Set		109.50	65.50

palbit 90° INDEXABLE DOUBLE SIDED MILLING CUTTING EDGES

- Strong Pocket design.
- Wide chip gullets for maximum chip evacuation.
- Double sided technology.
- Through coolant.
- Satin nickel plating for longevity.

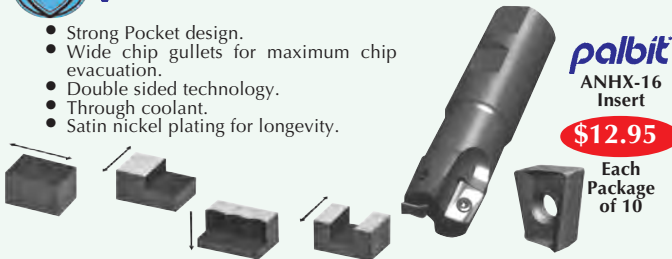

palbit
 ANHX-16
 Insert
\$12.95
 Each Package of 10

Model	Size	Shank	Flutes	Insert	Price
181-0601-0	1.25"	1.25"	2	ANHX-16	\$195.00
181-0602-0	1.50"	1.25"	3	ANHX-16	239.95
181-0603-0	2.00"	1.25"	4	ANHX-16	259.00

Precise FLY CUTTER HEAD SETS

Features:

- Made of durable hardened steel.
- Utilizes tool bits.
- Cuts flat and smooth surface with a single cut.
- Tool bits not included.



Model No.	Head Diameter	Shank Diameter	Tool Bit Size	Set Price
FC-R8	2-1/2"	R-8	3/8"	\$19.95
202-158	3/4"	1/2"	3/16"	\$12.95
	1-1/8"	1/2"	1/4"	
202-159	1-1/2"	1/2"	5/16"	\$24.95
	1-1/2"	3/4"	3/8"	
202-160	2"	3/4"	3/8"	\$29.95
	2-1/2"	3/4"	3/8"	
202-160	3/4"	1/2"	3/16"	\$29.95
	1-1/8"	1/2"	1/4"	
202-160	1-3/8"	1/2"	5/16"	\$29.95
	2"	1/2"	3/8"	
202-160	2-1/2"	5/8"	1/2"	\$29.95



VALCUT TREPANNING TOOLS

- The proven "Drag-Cut" trepanning method for efficient use in Bridgeport Mills, drill presses, etc. is now available in a cost saving square shank toolholder and cutter design.
- Amazing cutting performance in all types of materials.
- The cutter is drawn behind center at a specific angle and performs without any vibration and without hooking.
- The geometry of the patented cutter produces a chip which is smaller than the width of the groove to be cut.
- Clean bores up to 5-1/2" dia. are cut with hole type A cutters and clean discs are produced with type 1 cutters.
- Cobalt cutters for general trepanning applications, TiN coated cutters for hard to machine, exotic materials.
- Fast and easy set-ups for prototype work or production runs.
- Shank features 3 flats for positive holding and driving in 1/2" capacity drill chucks.
- Furnished complete with 1 hole type cobalt cutter a #VAL-150 center drill, rule for easy diameter setting and allen wrench



Model No.	Capacity Inch	Shank Diameter	Cutter Size	Cutting Depth	Price Each
VAL-140	3/4"-3"	1/2"	5mm	3/8"	\$188.75
Optional Tooling					
VAL-145	Toolholder for 5-1/2" diameter capacity				\$ 70.65
VAL-150	Hole Cutter Cobalt 5mm x 3/8" depth				22.40
VAL-152	Hole Cutter TiN coated 5mm x 3/8" depth				33.20
VAL-154	Disc Cutter Cobalt 5mm x 3/8" depth				22.40
VAL-155	Disc Cutter TiN coated 5mm x 3/8" depth				32.48
For Lathes					
VAL-081	7/8" x 7/8" x 5"	5mm	3/8" depth cutter		\$180.20
VAL-082	7/8" x 7/8" x 5"	6mm	1/2" depth cutter		187.45
VAL-083	1" x 7/8" x 5"	8mm	1-1/2" depth cutter		287.00

MURRAY THREAD REPAIR KITS



Unique patented design saves you time by avoiding the need for major disassembly or teardown of equipment to remove a damaged stud or hard to reach damaged bolt.

- Repairs damaged bolts faster than conventional thread repair tools.
- Eliminates the need for aftermarket replacement parts that are often too long, too short or the wrong hardness.
- Built for industrial use and made to withstand the conditions faced by the U.S. Military.
- Dies are designed and built to last, and have undergone thorough testing and inspections.
- Heat-treated, hardened, high-grade carbon steel meets the highest quality standards.
- Use deep well 6 point socket for ideal performance.



1. Pull apart the two halves of the Thread Repairer, taking care not to over stretch the retainer spring

2. Place the Die BEHIND the thread damage and release the spring tension

3. Turn the die COUNTER CLOCKWISE using a standard 6-point socket until repair is complete

Model	Size In Kit	Diameter	Price
SMK-100-1	1/4-20, 1/4-28, 5/16-18, 5/16-24, 3/8-16, 3/8-24	1"	\$ 99.95
SMK-200	7/16-14, 7/16-20, 1/2-13, 1/2-20, 9/16-12, 9/16-18	1"	105.00
SMK-300	1/2-13, 1/2-20, 9/16-12, 9/16-18, 5/8-11, 5/8-18	1-7/16"	125.00
SMK-400	3/4-10, 3/4-16, 7/8-9, 7/8-14, 1-8, 1-14	1-7/16"	175.00
Metric Sizes With Case			
SMK-500	5x.8mm, 6x1mm, 8x1mm, 8x1.25mm, 9x1mm, 9x1.25mm	1"	\$ 99.95
SMK-600	10x1mm, 10x1.25mm, 10x1.5mm	1"	105.00
SMK-700	11x1.5mm, 12x1.25mm, 12x1.50mm, 12x1.75mm, 14x1.25mm, 14x1.5mm, 16x2.0mm, 20x2.5mm, 24x3mm	1-7/16"	145.00

* Individual sizes Available (Inquire)

PAPANA® INDEXABLE BORING BAR KITS

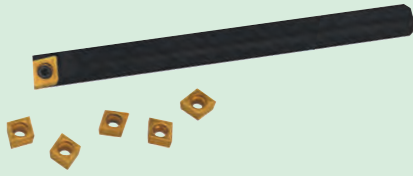

- Negative 5° end & side cutting angle.
- Positive 80° diamond CCMT inserts.

Shank Size	Minimum Bore	Inserts Style
.315" x 4"	.354	CCMT-2151
3/8" x 6"	.468	
1/2" x 7"	.600	
5/8" x 8"	.866	CCMT-3252
3/4" x 10"	.920	

Set No.	Included In Set	Special Price
870-515	3/8", 1/2" & 5/8" Boring Bars 2 Pcs. CCMT-21.51, tin inserts 4 Pcs. CCMT-32.52, tin inserts 2 Torx keys, 2 spare screws	\$165.00
870-510	1/2", 5/8" & 3/4" Boring Bars 6 Pcs. CCMT-32.52, tin inserts 1 Torx key, 1 spare screw	\$165.00
870-505	.315", 3/8", 1/2", 5/8", 3/4" Boring Bars 4 Pcs. CCMT-21.51, tin inserts 6 Pcs. CCMT-32.52, tin inserts 2 Torx keys, 2 spare screws	\$265.00
CCMT-2151	Tin coated carbide inserts	\$4.95
CCMT-3252	Tin coated carbide inserts	4.95

Precise H.S.S. STRAIGHT SHANK CHUCKING REAMER SETS

- Design for use in Turret lathes, screw machines, drill presses and all type of machine tool equipment.
- Ground with a 45° chamfer, suitable for reaming most materials.
- Made from high speed steel.



Set No.	Description	No. of Pieces	Set Price
MRC-3276	1/8" to 1/2" by 1/16"	7	\$ 54.95
MRC-3274	1/16" to 1/2" by 1/64"	29	139.95
MRC3275	.124 to .501 (over & undersize)	14	69.96
404-301	A to Z	26	\$ 98.00
404-326	#1 thru #60	60	165.00

Precise ADJUSTABLE BLADE REAMER SETS

- Each Reamer expands to the smallest size of next larger size.
- Reamers can be hand operated by use of wrenches. The size can be adjusted by moving the blades in tapered slots by means of loosening one nut and tightening the other.



7 Piece Set
1/4" - 15/16"
SET No.
ARB-023-1
\$59.95

Set	Range	Sizes	Price
ARB-023-1	1/4"-15/32"	(7) 8A-2A	\$ 59.95
ARB-024-1	15/32"-1-1/2"	(11) A-K	129.95

Precise TIN COATED DRILL SETS

With Index - High Speed Steel - Precision Ground

Tin Coated

- Offers outstanding wear resistance, reduces friction and prevents galling.
- Greatly increases tool life.
- Increased lubricity and chip flow provide better surface finish and reduced torque.
- Allows for increased speeds and feeds to improve productivity.

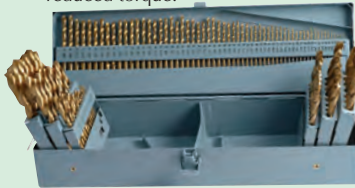

29 Pcs.
1/16"-1/2"
by 64ths
SET No.
7600-29
\$24.95



115 Pcs. 1/16-1/2 by 64ths #1-#60 A-Z

SET No.
TCD-115
\$59.95

Precise TIN COATED END MILL SET 2 AND 4 FLUTE

- By providing the tool with a very high surface hardness, (as well as a smoother micro finish) superior wear resistance is attained.
- Titanium nitride also reduces friction and acts as a thermal insulator, which reduces galling and chip welding.
- Even after reshaping, the tool surfaces that are coated contribute to longer life by slowing down the wear process.



20 Piece Set Consists Of:
One of Each, 2 & 4 Flute Mills
3/16", 1/4", 5/16", 3/8", 7/16"
with 3/8" shank, 1/2", 9/16" with
1/2" shank, 5/8" 11/16" with 5/8"
shank, 3/4" with 3/4" shank
SET No.
7600-20
\$79.95

10 Piece Set Consists Of:
One of Each, 4 Flute Mill
3/16", 1/4", 5/16", 3/8", 7/16" with
3/8" shank, 1/2", 9/16" with 1/2"
shank, 5/8" 11/16" with 5/8"
shank, 3/4" with 3/4" shank
SET No.
7600-10
\$59.95

Precise HIGH SPEED TAPS & SETS GROUND THREAD HAND TAPS

Plug Type



Series 3117 - Machine Screw

Tap Size	Thread Per Inch	No. of Flutes	Thread limits	Price Each
0	.80	2	H-2	\$3.50
1	64-72	2	H-2	2.50
2	56-64	2	H-2	2.50
3	48-56	2	H-2	1.50
4	40-48	2	H-2	1.50
5	40-44	2	H-2	1.50
6	32-40	2	H-2,3	1.25
8	32-36	2	H-2,3	1.25
10	24-32	2	H-3	1.25
12	24-28	2	H-3	1.50

#12550 Huot Metal Tap Case Only, \$15.75
Holds 19 Sizes From #0 to #12 NF & NC

MODEL No.
TAS-080
19 Taps
Fine & Coarse
#0 Thru #12
With Huot
Metal Case
\$59.95

MODEL No.
TAS-100
10 Pc. Set
Contains:
10 Taps
#4-40, #6-32
#8-32, #10-24
#10-32, #1/4-20
5/16-18, 3/8-16
1/2-13 & 5/8-11
\$49.95

Plug Type

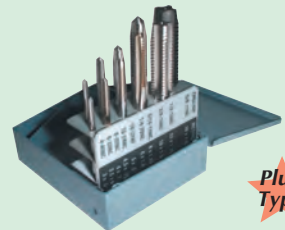

Series "31" - Fractional Sizes

Tap Size	Thread Per Inch	No. of Flutes	Thread limits	Price Each
1/4"	20-28	2	H-3	\$ 1.25
5/16"	18-24	2	H-3	1.50
3/8"	16-24	3	H-3	2.00
7/16"	14/20	3	H-3	2.75
1/2"	13-20	3	H-3	3.50
5/8"	11-18	3	H-3	5.50
3/4"	10-16	3	H-3	6.50
7/8"	9	3	H-4	8.50
1"	8-12	3	H-4	11.50

#12590 Huot Metal Tap Case Only, \$15.75
Holds 20 Sizes From 1/4" to 1/2" NF & NC

Precise ANNULAR CUTTERS HIGH SPEED STEEL

- For general purpose hole making.
- Made of high speed steel heat treated and tempered for maximum strength.
- Hardened and ground.
- 3/4" shank diameters with 2 flats.

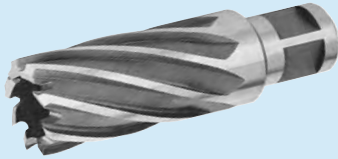

Size	1" Depth of Cut		2" Depth of Cut	
	Model	Price	Model	Price
7/16"	501-0437	\$18.80	502-0437	\$33.80
1/2"	501-0500	20.20	502-0500	34.70
9/16"	501-0562	22.80	502-0562	37.80
5/8"	501-0625	26.00	502-0625	40.80
11/16"	501-0687	27.10	502-0687	42.40
3/4"	501-0750	27.20	502-0750	45.10
13/16"	501-0812	29.20	502-0812	47.20
7/8"	501-0875	31.80	502-0875	48.40
15/16"	501-0937	33.60	502-0937	52.50
1"	501-1000	37.40	502-1000	56.50
1-1/16"	501-1062	39.10	502-1062	63.60
1-1/8"	501-1125	41.30	502-1125	66.50
1-3/16"	501-1187	42.40	502-1187	68.00
1-1/4"	501-1250	46.30	502-1250	78.10
1-5/16"	501-1312	48.00	502-1312	79.90
1-3/8"	501-1375	49.30	502-1375	81.50
1-7/16"	501-1437	52.00	502-1437	82.90
1-1/2"	501-1500	54.10	502-1500	92.60
1-9/16"	501-1562	56.20	502-1562	95.10
1-5/8"	501-1625	64.30	502-1625	100.30
1-11/16"	501-1687	67.40	502-1687	110.70
1-3/4"	501-1750	80.80	502-1750	126.80
1-13/16"	501-1812	82.40	502-1812	128.80
1-7/8"	501-1875	85.60	502-1875	133.00
1-15/16"	501-1937	87.40	502-1937	135.20
2"	501-2000	95.60	502-2000	148.20

RoyEL TOOL HOLDERS

- Reduce set-up and downtime by 50% or more.
- Eliminate accessories-no bushings, no collets, no extra jaws.
- Provide greater holding strength than ever along full length of jaws.
- Eliminate the cutting off of tool shanks.
- Eliminate the necessity to re-center when tools are removed for sharpening or replacement.
- Establish drill or tap depth easily from the flat face of the tool holder, eliminating all guess work.

Non Releasing (Shown) ADJUSTABLE FLOATING TAP HOLDERS



- The float is provided in both type of tap holders for greater accuracy in tapping.
- This compensates for any difference between the centerline of the turret and the spindle.

Non Releasing			
Model	Capacity	Shank	Price
00-RTH	.030"-.406"	5/8"	\$110.00
0-RTH	.030"-.565"	3/4"	120.00
2-RTH	.093"-.812"	1"	165.00

Releasing Type		
Model	Capacity	Price
00-RRTH	.030"-.406"	\$150.00
0-RRTH	.030"-.565"	170.00
2-RRTH	.093"-.812"	250.00
4-RRTH	.250"-1.281"	425.00



ADJUSTABLE DRILL, REAMER AND BORING HOLDERS

Model	Capacity	Shank	Price
00RDH-A	.030"-.406"	5/8" x 1-1/8"	\$ 70.00
00-RDH-H	.030"-.406"	5/8" x 2-3/8"	75.00
ORDH	.030"-.565"	3/4" x 1-15/16"	85.00
2RDH	.093"-.812"	1" x 2"	110.00
2RDH-A	.093"-.1.000"	1" x 2"	115.00

Large Capacity

3-RDH-1	.437"-1.500"	1-1/4" x 4"	\$180.00
4-RDH-1	.125"-1.500"	1-1/2" x 4"	180.00
5-RDH-1	.125"-1.500"	1-3/4" x 4"	185.00

Adjustable floating reamer holders are also available

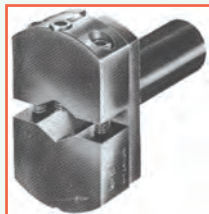

HOLE CUTTERS

- Features:**
- Use in hand-held air and electric drill motors.
 - Quick-centering pilot holds securely to workpiece.
 - Use in hand-held air and electric drill motors.
 - Use on sheet metal, thin-walled tubing, steel plate or any large-diameter shallow hole cutting operation.
 - Clean, burn-free and fast cutting.

SET No.
HC-6905
Reg. \$168.00

\$134.50

Contains:
1 Each: 1/2", 5/8"
3/4" & 1" with
Wood Block



MADE IN
USA

High
Speed
Steel

Model	Size	No. of Flutes	List Price	Sale Price
HCC-1250	1/2"	4	\$33.50	\$27.00
HCC-1252	9/16"	4	42.90	36.00
HCC-1254	5/8"	4	45.60	37.00
HCC-1256	11/16"	4	48.25	38.50
HCC-1258	3/4"	4	49.61	41.00
HCC-1260	13/16"	4	51.45	42.00
HCC-1262	7/8"	4	53.65	43.00
HCC-1264	29/32"	4	53.65	44.00
HCC-1266	15/16"	4	54.85	45.00
HCC-1268	1"	4	56.35	46.00

FLEXBAR

SIMUL-CUT FLY CUTTER SYSTEM

- Made of carbon steel and black oxide treatment to prevent corrosion.
- Precision machined and tapered for perfect balance to reduce vibration.
- 3/4" diameter shaft hardened and ground to fit collets and tool holder.
- 3/8" square broached hole accepts any 3/8" tool bits, carbide or high speed.

How Does it Work?
By setting the finishing tool bit lower than the roughing tool bit, roughing and finishing operations are achieved simultaneously.

Simul-Cut
By setting the finishing tool bit lower than the roughing tool bit, roughing and finishing operations are achieved simultaneously.

Complete Fly Cutting System Set

Consists of all 8 tools (3" to 10") with individual shanks, 2 tool bits, 1 hex wrench & a sturdy specially fitted case. machining range 0" to 10".
Set No. 19011



Individual Sizes

Model	Size	Price
19003	3" Fly Cutting Tool	\$108.00
19004	4" Fly Cutting Tool	120.00
19005	5" Fly Cutting Tool	130.00
19006	6" Fly Cutting Tool	142.00
19007	7" Fly Cutting Tool	155.00
19008	8" Fly Cutting Tool	165.00
19009	9" Fly Cutting Tool	175.00
19010-1	10" Fly Cutting Tool	185.00

SET No.
19011
Reg. \$1100.00

\$995.00

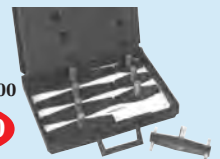

GEAR WRENCH TAP & DIE SETS With Ratcheting "T" Wrench

- All sets include ratcheting "T" wrench, small and medium tap adapters, die adapter, screw pitch gage and screwdriver.
- Ratcheting "T" wrench provides a 5° ratcheting arc for tapping tight, confined areas.
- Reversible lever on wrench to reverse action, eliminating hand over hand turning.



Model No.	No. of Pieces	Tap 7 Die Sizes	List Price	Sale Price
3885	40 Pc.	4-40 to 1/2-20	\$176.33	\$ 99.95
3886-1	40 Pc.	M-3 to M-12	176.33	99.95
3887	75 Pc.	4-40 to 1/2-20 M-3 to M-12	293.87	165.00
38880	5 Pc.	Without Taps & Dies	\$87.51	\$ 49.95

CLEVELAND H.S.S. & Cobalt DRILL SETS **MADE IN USA**
 The Name You've Trusted Since 1876 for Quality Cutting Tools



H.S.S. Jobber Length Bright Finish

Set	Size	Sizes	Angle	List	Sale
C72198	1/16"-1/2" x 64ths	29	118°	\$162.50	\$ 99.95
C00934	#1 thru #60	60	118°	138.50	85.50
C00939	A thru Z	26	118°	174.50	107.75
C01330	All 3 sets Above	115	118°	\$517.50	\$318.00
C72000	1mm thru 13mm by 0.5mm	118°	118°	\$190.00	\$117.00
Cobalt Heavy Duty Jobbers Length Straw Oxide					
C70365	1/16"-1/2" x 64ths	29	135°	\$297.00	\$183.50
C70366	#1 thru #60	60	135°	243.00	150.00
C00986	A thru Z	26	135°	307.00	189.50
C70367	All 3 sets Above	115	135°	\$874.00	\$539.50

PAFANA® CUT-OFF & GROOVING TOOL SYSTEM



All Sets Include:
 10 - Inserts, TiN Coated
 1 - Tool Blade
 1 - Tool Block
 (No. 19-5 Or No. 25-6)
 1 - Extractor & Hex Key

Made In Europe

• Applies for both right & left hand turning operations.

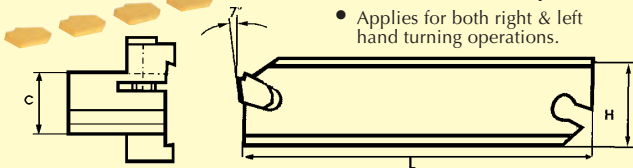

Set No.	Block Dim. Length x C"	Blade Dimensions L x H x W	Insert Supplied	Set Price
6-895-903	3.5" x 7.87"	4.33 x 1.02 x 1.22"	GTN-3	\$175.00
6-895-904	3.5" x 7.87"	4.33 x 1.02 x .161"	GTN-4	175.00
6-895-905	3.5" x 7.87"	4.33 x 1.02 x .170"	GTN-5	180.00

Extra Inserts: #GTN-3 \$3.95Ea. #GTN-4 \$4.50Ea. #GTN-5 \$4.75Ea.

MAUDLIN PRODUCTS STAINLESS STEEL TOOL WRAP

.002" Thick 50' or 100' Lengths, 10" or 20" Widths

Stainless steel tool wrap is used when heat treating tooling. The tooling is wrapped in the foil with the edges crimped to form an envelope. This will create an air-tight package that will prevent the loss of surface carbon during heat treating. The loss of surface carbon causes the tooling to become scaled and damaged. Using tool wrap not only protects your tooling from expensive repairs. It also eliminates the need for box packaging with charcoal or sawdust.

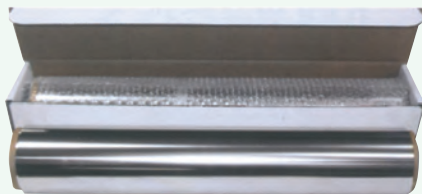

MADE IN USA

321 Stainless Steel

Model	Size L x W x Th.	List	Sale
321-10-50	50' x 10" x .002"	\$104.40	\$ 85.00
321-10-100	100' x 10" x .002"	196.00	160.00
321-20-50	50' x 20" x .002"	191.00	157.00
321-20-100	100' x 20" x .002"	369.00	295.00
309 Stainless - Annealed - High Temp			
309-10-50	50' x 10" x .002"	\$132.00	\$110.00
309-10-100	100' x 10" x .002"	251.00	210.00
309-20-50	50' x 20" x .002"	247.00	135.00
309-20-100	100' x 20" x .002"	480.00	395.00

Precise 21 PIECE COUNTERBORE SET
Interchangeable Pilot

Set Includes:

- 14 Pilots
 - 5/32" Shank: 0.187, 0.204, 0.213, 0.229, 1/4, 17/64, 9/32, 5/16, 21/64, 11/32, 3/8, 25/64, 13/32 & 7/16"
- 6 Counterbores:
 - 5/16, 3/8, 7/16, 1/2, 9/16", 5/8"
- 1 Holder:
 - 3/8" Shank.



SET No. 2007-0021
\$95.00

Precise COUNTERBORE SET 40 PIECES
Straight Shank • Interchangeable Pilot

SET No. 2007-0040
\$289.95



Set Includes:

- 26 Pilots
 - 3/32" Shank: 1/8, 5/32, 3/16 & 1/4"
 - 5/32" Shank: 3/16, 7/32, 1/4, 9/32, & 5/16"
 - 3/16" Shank: 1/4, 5/16, 3/8, 7/16 & 1/2"
 - 1/4" Shank: 5/16, 3/8, 7/16, 1/2, 9/16 & 5/8"
 - 5/16" Shank: 3/8, 7/16, 1/2, 9/16, 5/8 & 3/4"
- 13 Counterbores
 - 1/4" thru 1" by 16ths.
 - Supplied in fitted case.

Precise DOVETAIL CUTTERS 60° INDEXABLE

- Positive triangle inserts 15° clearance.
- A 90° slot must first be cut into the material allowing clearance for the dovetail neck during the final cut.
- Precision machine alignment pad integrated into each pocket ensures repeatability.



Insert No.	Dimensions I.C TH Rad.	Price Each
TDX21.51	1/4 x 3/32 x 1/64	\$6.95
TDX21.52	1/4 x 3/32 x 1/32	5.95
TDX321	3/8 x 1/8 x 1/64	9.95
TDX431	1/2 x 3/16 x 1/64	9.95

Tool Angles:
 Cutting Rake 15°
 Axial Rake +10°
 Radial Rake 14°

Model	Cutting	Shank	TDX Inserts	No. of Inserts	Price
404-191-1	1/2"	3/8"	TDX21.51	1	\$24.95
404-192	3/4"	3/8"	TDX21.52	2	32.95
404-193	1"	1/2"	TDX21.52	3	59.95
404-194	1-3/8"	5/8"	TDX321	3	62.00
404-195	1-7/8"	3/4"	TDX321	3	65.00
404-196	2-1/4"	1"	TDX431	3	79.95
404-197	2-1/2"	1"	TDX431	3	89.95

Note: Inserts Not Included

PAFANA® INDEXABLE CUTTING TOOLS
UNIVERSAL EXTERNAL THREADING TOOL HOLDERS

This new universal threading toolholder is designed for use with all most popular IC 3/8" (IC 9.525mm) inserts made by: Vardex, Sumitomo, Mitsubishi, Kennametal, Sandvik, Coromant, Pramer & Plansee Tizit, Korloy. Inserts are sold separately

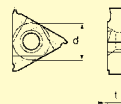

Made In Europe

Tool Holder	Shank Size	Shank Length	Sale Price
820-004-1	5/8" x 5/8"	4"	\$55.00
820-005-1	3/4" x 3/4"	5"	60.00
820-006-1	1" x 1"	6"	64.50

Specify Right or Left Hand

Tin Coat Insert
\$13.95 Each
 (Pack of 10)
 Specify Thread Pitch

Precise INDEXABLE BORING BARS

Screwdown Style, Positive Rake, 90° Lead

- Round shanks allow the operator to set positive or negative rake.
- Chipbreaker eliminates long stringer chips.
- A new cutting edge may be presented by simply indexing the insert.
- It is not necessary to tool from chuck or tool post.
- Complete with insert screw & C6 grade carbide insert.
- Uses .050" key.



Sets Includes:
C6 grade carbide insert,
wrench & wooden block.

1/2" Shank Boring Bars

Model No.	O.A.L. Length	Bore Depth	Min. Bore	Sale Price
404-7160	2-3/4"	1-1/4"	7/16"	\$ 17.50
404-7161	3-5/8"	2-1/8"	7/16"	17.50
404-7162	3"	1-1/2"	1/2"	17.50
404-7163	4"	2-1/2"	1/2"	17.50
404-7164	4 Pcs. Set (1 each of the Above)			\$ 69.95

5/8" Shank Boring Bars

404-7170	3"	1-1/4"	7/16"	\$18.50
404-7171	3-7/8"	2-1/8"	7/16"	18.50
404-7172	3-1/4"	1-1/2"	1/2"	18.50
404-7173	4-1/4"	2-1/2"	1/2"	18.50
404-7174	3-1/2"	1-3/4"	9/16"	18.50
404-7175	4-5/8"	2-7/8"	9/16"	18.50
404-7176	6 Pcs. Set (1 each of the Above)			\$ 110.00

3/4" Shank Boring Bars

404-7180	3-3/8"	1-3/8"	7/16"	\$ 22.50
404-7181	4-1/4"	2-1/4"	7/16"	22.50
404-7182	3-5/8"	1-5/8"	1/2"	22.50
404-7183	4-5/8"	2-5/8"	1/2"	25.00
404-7184	3-7/8"	1-7/8"	9/16"	22.50
404-7185	5"	3"	9/16"	24.50
404-7186	4-1/4"	2-1/4"	11/16"	25.00
404-7187	5-1/2"	3-1/2"	11/16"	25.00
404-7188	8 Pcs. Set (1 each of the Above)			\$129.95

Carbide Inserts

Order	Insert	Grade	I.C.	Radius	Price
404-7190	TCMT21.51	C2	1/4"	3/5"	\$4.25
404-7191	TCMT21.51	C6	1/4"	3/5"	4.25
404-7192	TCMT221	C2	1/4"	3/5"	4.25
404-7193	TCMT221	C6	1/4"	3/5"	4.90
404-7194	Replacement Screws 6 Pieces				\$4.90

Precise TURNING, FACING AND BORING SET

SET INCLUDES

- 1" square shank toolholder
- MWLNR164D (6" long).
- With Tin coated inserts 10 pcs.
- 1" diameter bar A16-MWLNR4 boring bar with through-the-bar coolant holes.
- 1" diameter shank.
- 12" long.
- F=.640"
- K= 14°
- Min. bore 1.200"

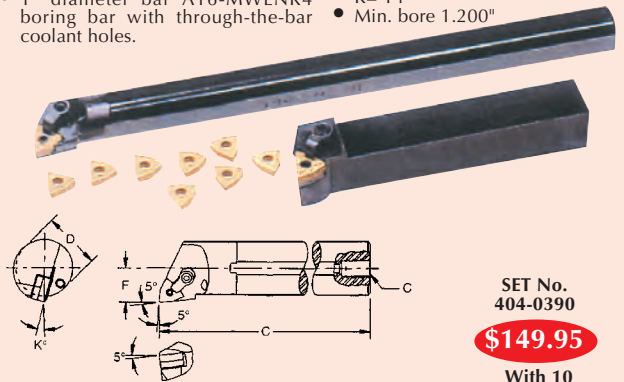

SET No.
404-0390

\$149.95

With 10
Tin Coated
Inserts

Replacement WMMG-432
Tricon Tin Coated
Inserts Order No. 404-0391 . . . \$5.50
(Sold in Packages of 10)

Precise 7 PC. INDEXABLE CARBIDE TURNING TOOLS

- A versatile and economical way to replace carbide tipped tool bits. Each tool cuts right, left or plunges.
- Positive rake cutting and built-in chip breaker groove.

Set Includes:

- 7Pcs Indexable carbide Turning Tools
- 7Pcs C6 inserts.
- 7Pcs Hex screws
- 3 Hex key

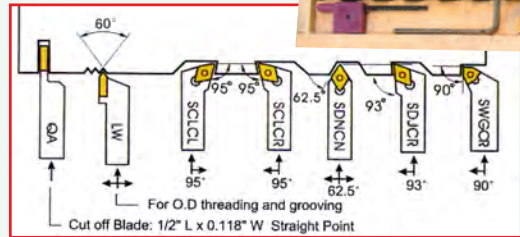

SETS

Model	Shank	O.A.L.	Sale
404-1050	1/4" Sq	3"	\$ 69.95
404-1051	3/8" Sq	3-1/2"	79.95
404-1052	1/2" Sq	4"	89.95
404-1053	5/8" Sq	4-1/2"	99.95
404-1054	3/4" Sq	4-1/2"	112.00

Replacements:
No. 404-1066
Screw
\$1.00
No. 404-1067
Finger Clamp
\$2.95

Carbide Inserts

For 1/4", 3/8" & 1/2" Shanks

Order No.	Tool Holder	Insert Type	Price Each
404-1055	SWGCR	WCMX	\$3.50
404-1056	S DNCN SDJCR	DCMT(1.5)	4.50
404-1057	SCLCR SCLCL	CCMT2(1.5)	4.50
424-3051	QA	CK3	9.90
404-1059	LW	JCL15-120	3.00

Carbide Inserts

For 5/8" & 3/4" Shanks

Order No.	Insert Type	Price Each
404-1069	WCMX3(2.5)	\$4.50
404-1060	DCMT3(2.5)	5.00
404-1061	CCMT3(2.5)	5.00
424-3051	CK3	9.90
404-1062	JCL20-120A	3.00



DRILL SETS



No. 18004
Shown

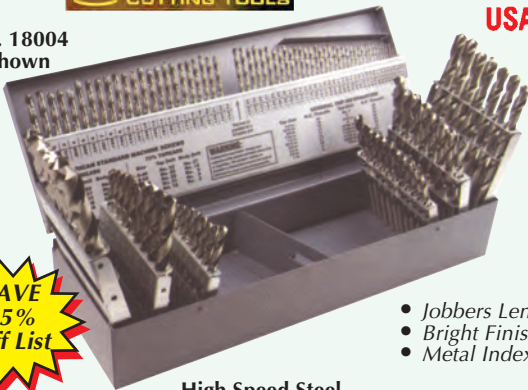

**SAVE
55%
Off List**

- Jobbers Length
- Bright Finish
- Metal Index Case

High Speed Steel

Set No.	Description	List	Sale
18144	29 Pcs. 1/16" to 1/2" by 64ths	\$201.00	\$ 95.00
18146	60 Pcs. #1 to #60	155.00	69.95
18147	"A" thru "Z" Letters 26 Pcs.	205.00	97.50
18106	#61 to #80 20 Pcs.	65.00	29.95
18004	3-in-1 combination 115 Pcs. 1/16-1/2 by 64ths, #1 to #60 A-Z	\$625.00	\$275.00

Precise MICRO DRILL SET

#60 TO #80 H.S.S. DRILLS WITH MICRO CHUCK

- Micro chuck with 20 piece jobber length drill set #60 to #80.
- Use with wire gauge drills in a drill press or hand held tools.
- Grip drills firmly and accurately in various sizes.
- Can be held in any 1/8" or 3/16" collet or larger adjustable drill chuck/Jobber length drill.
- HSS 118° point drills in metal index case.



SET No.
404-265-1
Reg. \$21.00

\$14.95

INDEXABLE FACE MILL

RH Cut

- New single design.
- Great efficiency.
- Cutters are provided with 1 Torx Key, set of Locking Screws, 1 Arbor screw and 1 Hex Key.

Tool Angles:

Cutting Rake Angle: -12° to -6°
Radial Rake Angle: -12° to -6°
Axial Rake Angle: 7° to 10°
Setting Angle: 90°

Use All Standard Shell Mill Arbors



Tin Coated Carbide Insert with Chip Breaker
No. KPA-503K
\$74.95
Per 10 Pack



Made In Europe

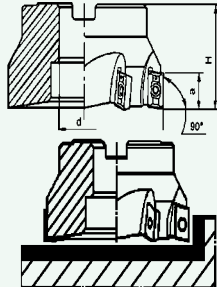

Cutter No.	Cutter Dia. (D)	Arbor Hole	No of Inserts	Sale Price
954-015	1-1/2"	1/2"	4	\$170.00
954-020	2"	3/4"	5	195.00
954-025	2-1/2"	1"	6	195.00
954-040	4"	1-1/4"	8	250.00
954-050	5"	1-1/2"	9	325.00
954-060	6"	2"	10	395.00
954-080	8"	2-1/2"	12	585.00

MAXI-MIZER FACE MILLING CUTTER

45° Lead Angle ~ RH Cut ~ 1/2" Square Insert

- Low horsepower consumption.
- Requires only one spare part.
- Body made of high grade tool steel forging, heat treated & ground.
- Shims not required.
- Inserts not required.

Tool Angles:

Setting Angle: 45°
Cutting Rake Angle: +10°
Radial Rake Angle: -9°
Axial Rake Angle: +20°



Carbide Tin Coated

Made In Europe

For Arbors w/NST,MT, R-8, CAT & BT Shanks, see our catalog or call

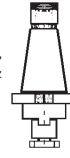

Cutter No.	Cutting Diameter	Arbor Hole	No. of Inserts	Sale Price
963-020	2-35/64"	3/4"	4	\$189.50
963-025	3-3/64"	3/4"	5	220.00
963-030	3-37/64"	1"	5	260.00
963-040	4-35/64"	1-1/4"	6	295.00
963-050	5-9/16"	1-1/2"	7	425.00
963-060	6-9/16"	2"	8	495.00



Insert No. SEH-42TL
\$69.95 Per 10 Pack with 45° Chipbreaker 1/2" square

Precise 90° SQUARE SHOULDER INDEXABLE FACE MILL

- This 90° major cutting edge angle square shoulder milling cutter is fitted with strong 110° positive triangular inserts allowing high depth of cut and feed per tooth.
- The clamping system (screw) makes quick and easy insert mounting (indexing) and removal.

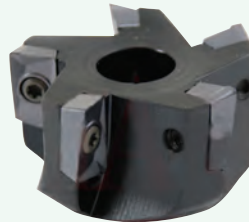

Tin Coated Carbide Insert with Chip Breaker
No. KPA-503K
\$74.95
Per 10 Pack

Model No.	Cutter Diameter	Arbor Hole	No. of Teeth	Use Insert	Price Each
263-200	2"	3/4"	3	APKT-33	\$ 84.95
263-250	2-1/2"	3/4"	4	APKT-33	99.50
263-300	3"	1"	5	APKT-33	119.00
263-400	4"	1-1/2"	5	APKT-33	135.00
263-500	5"	1-1/2"	6	APKT-33	152.00
263-600	6"	2"	10	APKT-33	185.00
263-800	8"	2-1/2"	12	APKT-33	275.00
KPA-503K	TiN Coated Carbide Insert #APKT-33				\$ 74.95 (10 Per Pack)

Precise SCREW TYPE ROUND INSERT INDEXABLE FACE MILL

- This multi-purpose milling cutter is fitted with strong round 11° positive inserts allowing high depth of cut.
- Compared to the body using 7° positive inserts, this cutter has a bigger clearance during profiling operations.



Use Insert No. RNMGM-120A
\$4.95 ea.
(Pack of 10)

Model No.	Cutter Diameter	Arbor Hole	No. of Inserts	Price Each
264-200	2"	3/4"	4	\$ 95.00
264-300	3"	1"	6	145.00
264-400	4"	1-1/2"	7	170.00
254-500	5"	1-1/2"	7	190.00

Precise SQUARE SHOULDER INDEXABLE END MILLS

- 90° square shoulder milling.
- Used for slotting and peripheral milling.
- Excellent alternative to HSS, cobalt and Carbide end mills for heavy material removal rates.
- Used standard APKT-1003 inserts (Not included).



Model No.	Cutter Diameter	Shank Diameter	Overall Length	Insert Type	Sale Price
5822-0375	3/8"	1/2"	3.00"	APKT10003x1	\$26.45
5822-0500	1/2"	5/8"	3.25"	APKT10003x1	27.95
5822-0625	5/8"	5/8"	3.25"	APKT10003x2	39.50
5822-0750	3/4"	3/4"	3.50"	APKT10003x3	54.00
5822-1000	1"	1"	3.50"	APKT10003x4	60.50
5822-1250	1-1/4"	1.25"	3.75"	APKT10003x4	69.50
5822-1500	1-1/4"	1.50"	4.25"	APKT10003x6	75.00
6010-4203	APKT-3000 x Inserts (Specify 1, 2, 3, 4 or 6)				\$10.95
5822-9999	Replacement Screws				1.95

Note: APKT Insert & 5822-9999 are sold (Pack of 10)

BISON/TMX TURBO FACE MILLING CUTTERS

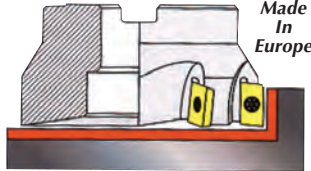
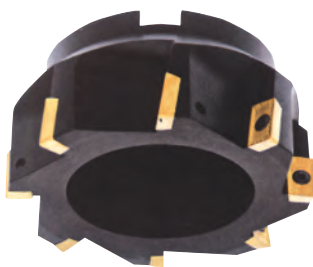

Made In Europe

Tool Angles:

Cutting Rake Angle: 11°, -8°-6°
Radial Rake Angle: -11°, -8°-6°
Axial Rake Angle: 7°, 9°
Setting Angle: 90°



Tin Coated Carbide Insert with Chip Breaker
No. KPA-503K
\$74.95
Per 10 Pack

- 90° KPA-503K inserts compliment this cutter's unique geometry.
- Irregularly spaced flutes allow faster stock removal, reduced harmonics and chattering.
- Minimizes heat and friction.

Cutter No.	Cutter Diameter	Arbor Hole	No. of Inserts	Sale Price
955-020	2"	3/4"	5	\$145.00
955-030	3"	1"	6	185.00
955-040	4"	1-1/4"	8	260.00
955-045	4"	1-1/2"	8	260.00

INDEXABLE END MILLS

RH Cut with Weldon or R8 Shank

- Reduces cutting forces.
- Maximum rigidity.
- Forged steel body.
- Cutters are provided with 1 Torx Key and set of Locking Screws.
- Inserts are sold separately.

Tool Angles:

Cutting Rake Angle: 11° to 13°
Radial Rake Angle: 11° to 13°
Axial Rake Angle: 6° to 10°
Setting Angle: 90°

Made In Europe

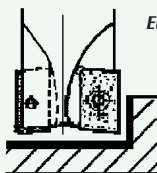

Carbide Insert Tin Coat W/Chipbreaker



No. KPA-503K
\$74.95 Pack Of 10

Cutter No.	Cutter Dia.	Shank Size	OAL Length	No of Inserts	Cutter Price
941-105	1"	R-8	5-27"/32"	2	\$155.00
941-110	1-1/4"	R-8	5-27"/32"	3	220.00
941-115	1-1/2"	R-8	6-1/8"	4	215.00
941-120	2"	R-8	6-1/8"	5	250.00
941-125	2-1/2"	R-8	6-1/8"	6	295.00

MULTI ~ ANGLE CUTTERS

- Can be used for chamfering straight and curved edges.
- Change chamfer angle with one quick easy adjustment.
- Comes with indexable carbide insert.
- Max. speed 6,000 RPM.
- Tool contains, 1) TPMT carbide insert, extra screws and Allen wrenches.



Model No.	Angle Range	Shank Size	Overall Length	Type	Price Each
TLP-290	10°-80°	3/4"	3-3/4"	Standard	\$225.00
TLP-291	10°-80°	1.0"	3-3/4"	Standard	225.00
Extra TiN Coated Inserts & Parts					
TPMT-2-1	IC-656 Inserts (Mini)				\$ 7.95
TPMT-331	IC-656 Inserts (Standard)				10.95

NIKCOLE Mini-Groove GROOVING & CUT-OFF KIT



- Features:**
- Unique method of creating narrow grooves & cut-off economically in a wide range of materials.
 - Dual cutting edge indexable inserts.
 - Locking screw holds inserts in place.
 - Inserts pocket design ensures repeatable cutting location.

- Set Includes:**
- 1 tool holder (1/2" SQ shank, 4-1/2" long).
 - 1 screw & Torx key.
 - Fitted case.
 - 5 carbide inserts grade C6-PV (tin coated).

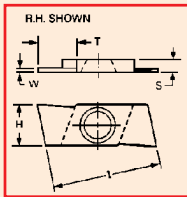

The Only System You Need For Grooving & Cut-Off Under .078"

W +.0009" (+.02MM)	T	H	S	I
.035"	.100"			
.043"	.235"			
.051"	.235"	.275"	.078"	.669"
.063"	.235"			
.073"	.235"			

MODEL No. GCK-001
\$149.95

dolfa COUNTERSINK END MILLS 45°, 60°, 82° & 90°



Tool Angles:
Cutting Rake Angle: +15°
Axial Rake Angle: 0°
Radial Rake Angle: 0°



Tin Coated Ground All Over "TDGW"

60° Positive Rake No. TDW-215K (Pack of 10) **\$49.95**

No. TDW-321K (Pack of 10) **\$65.00**

(Specify Angle)

Model No.	Cutter Body Min.	Cutter Body Max.	Shank Dia.	Available Angle	Price	Use Insert	Price Each
945-410	1/4"	9/16"	3/8"	45°	\$110.00	TDW-215K	\$49.95
945-420	3/4"	1-15/64"	3/4"	45°	195.00	TDW-321K	\$65.00
945-610	1/4"	21/32"	3/8"	60°	110.00	TDW-215K	\$49.95
945-810	1/4"	51/64"	3/8"	82°	110.00	TDW-215K	\$49.95
945-815	1/2"	1-11/32"	1/2"	82°	130.00	TDW-321K	\$65.00
945-820	3/4"	1-9/16"	3/4"		195.00		
945-910	1/4"	53/64"	3/8"	90°	110.00	TDW-215K	\$49.95
945-915	1/2"	1-25/64"	1/2"	90°	130.00	TDW-321K	\$65.00
945-920	3/4"	1-41/64"	3/4"		195.00		

*Note: CounterSinks Do Not Include Inserts

PAFANA BORING BARS

- For negative 80° diamond CNMG inserts.
- Negative 5° side & end cutting edge angle.

Tin Coated Insert No. CNMG-432N
\$35.00
(Package of 10)

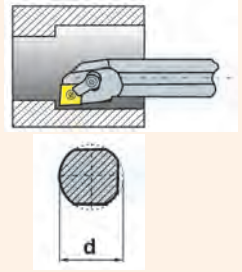
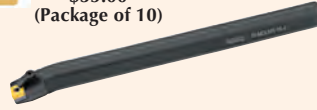

Number R-H	Number L-H	Shank d	Min. Bore	Overall Length	Price Each
760-164R	760-164L	1"	1.280	12"	\$ 92.50
760-204R	760-204L	1-1/4"	1.530	14"	103.00
760-244R	760-244L	1-1/2"	1.780	14"	118.50
760-284R	760-284L	1-3/4"	2.030	14"	144.50

PAFANA TOOL HOLDERS FOR TRIGON 80° WNMG INSERTS

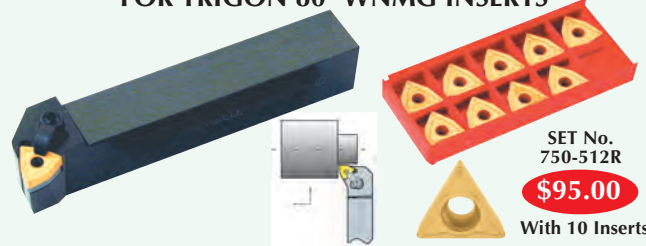

SET No. 750-512R

\$95.00

With 10 Inserts

Set No.	Shank Size	Overall Length	Set Price	Extra Inserts	Insert Price
750-512R	3/4"	4-1/2"	\$103.95	WNMG-432	\$36.50
750-516R	1"	6"	106.95	TiN Coated (Package of 10)	

PAFANA TOOL HOLDERS

STYLE: MCLNR/L For Negative 80° Diamond "CNMG" Tin coated inserts



SET No. 710-512R

\$95.00

With 10 Inserts

Set No.	Shank Size	Overall Length	Set Price	Insert No.	Extra Inserts
710-512R	3/4"	4-1/2"	\$ 95.00	CNMG-432M	\$35.00
710-516R	1"	6"	99.50		

PAFANA 5 Pc MINI TOOL HOLDER AND BORING BAR SET

Ideal for precision turning and boring. Quality storage case includes 1 wrench and 2 spare screws

Shank .315" Size: Square



SET No. 890-510 **\$199.95**

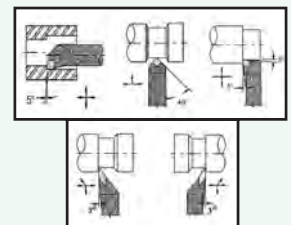

Contains: 1 L.H. Tool holder
10 Carbide Inserts 1 Neutral
2 R.H. Tool holders 1 Boring bar

Precise INDEXABLE CUT-OFF TOOL KITS ISCAR TYPE
All Tools are Interchangeable with ISCAR & other fine Brands!

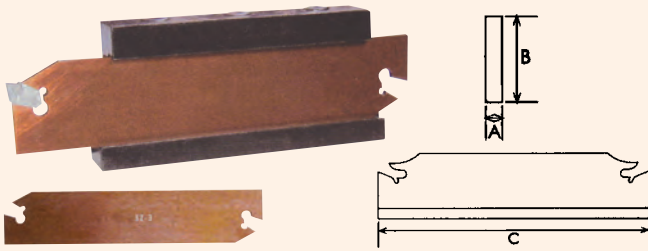

Individual Blades

Model No.	Insert Width	Blade Style	Dimensions C B		Price Each
3900-5311	.087 & .094"	26-2	4-5/16"	1-1/32"	\$39.95
3900-5312	.120"	26-3	4-5/16"	1-1/32"	39.95
3900-5314	.160"	26-4	4-5/16"	1-1/32"	39.95
3900-5316	.187 & .200"	26-5	4-5/16"	1-1/32"	\$39.95
3900-5317	.120"	32-3	5-7/8"	1-1/4"	47.50
3900-5318	.160"	32-4	5-7/8"	1-1/4"	47.50
3900-5319	.187 & .200"	32-5	5-7/8"	1-1/4"	\$47.50

- 15 Piece Kit**
- 1- 0.625" x 1.02" Tool Block
 - 1- 26-3 Blade
 - 10- C-6 GTN-3 Inserts
 - 1- Insert Holder
 - 1- Allen Wrench
 - 1- Fitted Case

5/8" Shank
KIT No.
3900-5359
\$115.00

- 16 Piece Kit**
- 1- 0.75" x 1.02" Tool Block
 - 1- 26-3 Blade
 - 1- 26-4 Blade
 - 5- C-6 GTN-3 Inserts
 - 5- C-6 GTN-4 Inserts
 - 2- Insert Holder
 - 1- Allen Wrench

3/4" Shank
KIT No.
3900-5361
\$129.50

- 22 Piece Kit**
- 1- 1.000" x 1.25" Tool Block
 - 2- 32-3 Blade
 - 2- 32-4 Blade
 - 2- 32-5 Blade
 - 4- C-6 GTN-3 Inserts
 - 4- C-6 GTN-4 Inserts
 - 4- C-6 GTN-5 Inserts
 - 1- Insert Holder
 - 1- Allen Wrench
 - 1- Fitted Case

1" Shank
KIT No.
3900-5364
\$225.00

Precise LITTLE HOGGER MILL SET

- Feed at an average rate of 12" per minute at 1600 RPM.
- Mill at 5 times the speed of high-speed tool.
- No loss of cutter size due to regrinding.
- New cutting edges in less than 1 minute.
- Set includes" a mill for round, square & triangle inserts.
- Extra Screws No. 404-6700..\$1.50



3 Piece Set
No. 404-670

\$54.95

Complete with
3 Inserts

Extra Inserts

Model No.	Cutting Diameter	Shank Size	Price Each	Insert No.	Insert Price
404-671	1.00"	3/4"	\$24.95	SNMG-322	\$2.95
404-672	1.00"	3/4"	28.95	RNMG-322	2.95
404-673	1.00"	3/4"	28.95	TNMG-322	3.50

PRO CNC QUICKCHANGE TOOLHOLDER CLAMP

- Just lift the handle, one motion clamping! (no twisting, screwing, etc.)
- The cam action of the handle creates high clamping forces that grip your toolholder flange tight!
- The Quickchange is manufactured from aircraft grade aluminum & protected with a hard anodized finished.
- Allows for simultaneous access to the tool, lock nut, set screw and pull stud. The quickchange is designed to easily mount to your workbench either horizontally or vertically.



Model No.	Taper Size	Price Each
QTC-001	CT or BT30	\$ 99.95
QTC-002	CT or BT40	119.95
QTC-003	CT or BT45	125.00
QTC-004	CT or BT50	129.50

MADE IN USA

Precise INDEXABLE END MILLS
Positive Rake 90° R.H. Cut

Tool Angles: Setting Rake 90°
Cutting Rake 0°
Axial Rake 0°

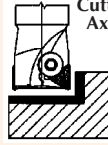

Cutter No.	Cutter Diameter	Shank Size	No. of Inserts	Insert Style	Cutter Price
901-002	1/2"	1/2"	1	TPG-21	\$20.00
901-005	3/4"	3/4"	2	TPG-21	24.50
901-010	1"	3/4"	2	TPG-22	29.50
901-015	1-1/4"	3/4"	2	TPG-32	35.00
901-020	1-1/2"	3/4"	3	TPG-32	40.00
901-030	2"	3/4"	3	TPG-32	50.00
901-065	1-1/4"	1"	2	TPG-32	\$32.50
901-067	1-3/8"	1"	2	TPG-32	38.50
901-070	1-1/2"	1"	3	TPG-32	42.50
901-075	1-3/4"	1"	3	TPG-32	48.50
901-080	2"	1"	3	TPG-32	54.50
901-510	1"	R-8	2	TPG-22	\$29.50
901-515	1-1/4"	R-8	2	TPG-22	32.50
901-520	1-1/2"	R-8	3	TPG-32	42.00
901-525	1-3/4"	R-8	3	TPG-32	48.00
901-530	2"	R-8	3	TPG-32	55.00
901-535	2-1/2"	R-8	4	TPG-32	65.00
901-540	3"	R-8	5	TPG-32	75.00

SETS

Set No.	Shank Size	Consists of Size	Set Price
901-500-1	3/4"	3/4", 7/8", 1"	\$165.00
901-501-1	3/4"	1-1/4", 1-1/2", 2"	275.00
901-502-1	3/4"	1", 1-1/4", 1-1/2", 2"	225.00
901-901-1	1"	1-1/4", 1-1/2", 2"	\$265.00
901-550-1	R-8	1", 1-1/4", 1-1/2"	\$240.00
901-551-1	R-8	1-1/4", 1-1/2", 2"	295.00
901-555-1	R-8	2", 2-1/2", 3"	595.00

*End mills are furnished without cutting inserts

(Sold In Packages of 10)
Precision Ground
Grade "C-2 or "C-5"

CARBIDE INSERTS



"Tin Coated"

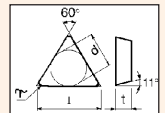

Insert	I.C.T x R	Price
TPG-21T	1/4" x 1/8" x 1/64"	\$3.50
TPG-22T	1/4" x 1/8" x 1/32"	3.50
TPG-32T	3/8" x 1/8" x 1/32"	3.75

JAVELIN MACHINE COOLANT FILTRATION SYSTEM
Extends Coolant Life by 100% - 300%

- Applications include turning, milling, deburring, grinding and burn tables: anywhere liquid may need to be filtered.
- Removes oils like tramp, hydraulic, gear, spindle and material protectants. Even removes paraffins from the new greased style machines.
- Works with any brand or type of machine coolant, even straight oils (when used with special filter bag.)
- Typical filter life is approximately 1 week, depending on material cleanliness, oiling schedule and any oil leaks the machine may have.



Javelin Kit:

Complete with
Mounting Hardware
12' x 1/2" Vinyl Feed Hose
(10) Filter Bags
Installation Instructions
Model No. MDL-400 . . . \$285.00

Magnetic Mount:
Provides over 90 lbs. of holding force
Allows versatile mounting options
All required hardware included
No. MLD-100 \$75.00

Filter Bags:
50 Filter Bags Per Box
No. MDL-200 \$195.00

Precise TOOL HOLDERS FOR SELF LOCK CUT-OFF INSERTS

- Inserts are securely held in place by a tapered locking system. No. additional clamping devices are required.
- Carbide insert No. GTN not included.

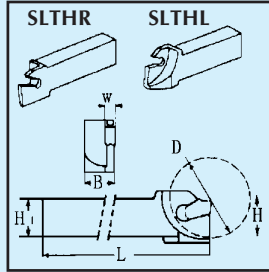

R.H. Model No.	L.H. Model No.	Tool Holder No.	Use Insert	Insert Width	H=H1	Sale Price
404-1260	404-1261	SLTH9.5-3	GTN-3	.120	3/8"	\$24.50
404-1262	404-1263	SLTH12.7-3	GTN-3	.120	1/2"	29.50
404-1264	404-1265	SLTH16-2	GTN-2	.187 & .094	5/8"	29.95
404-1266	404-1267	SLTH16-3	GTN-3	.120	5/8"	29.50
404-1268	404-1269	SLTH16-4	GTN-4	.160	5/8"	29.50
404-1270	404-1271	SLTH19-3	GTN-3	.120	3/4"	29.50
404-1272	404-1273	SLTH19-4	GTN-4	.160	3/4"	32.50
404-1274	404-1275	SLTH25.4-3	GTN-3	.120	1"	34.50
404-1276	-	SLTH25.4-4	GTN-4	.160	1"	34.50

Precise POSITIVE STOP ADJUSTABLE BLADES FOR SELF LOCK CUT-OFF INSERTS

- Adjustable cut-off and grooving positive stop blades.
- Designed for use with standard cut-off inserts.
- They feature a "Positive stop" to prevent insert drift and the blade pocket from spreading once the insert is set firmly in place.
- The insert's cutting edge location repeats accurately as a result of this.
- Prevents insert splitting under heavy feed and shock loads.
- The blade & insert geometry permits free chip flow, minimizing insert breakage due to chip build-up.

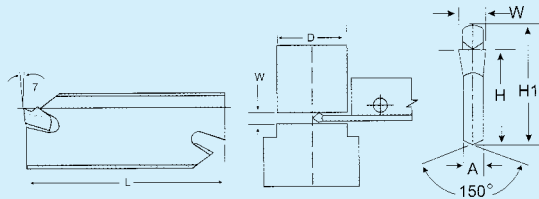

Model No.	Blade NCIH	Length	Width +/- .004"	H=H-1 53/64" 13/32"	Sale Price
404-0380	26-3-PS	4-5/16"	.120"	53/64" 1-1/32"	\$31.95
404-0381	26-4-PS	4-5/16"	.160"	53/64" 1-1/32"	31.95
404-0382	26-5-PS	4-5/16"	.187 & .200"	53/64" 1-1/4"	31.95
404-0383	26-6-PS	4-5/16"	.250"	63/64" 1-1/4"	\$31.95
404-0384	32-3-PS	5-7/8"	.120"	63/64" 1-1/4"	32.95
404-0385	32-4-PS	5-7/8"	.160"	63/64" 1-1/4"	34.00
404-0386	32-5-PS	5-7/8"	.187 & .200"	63/64" 1-1/4"	35.00
404-0387	32-6-PS	5-7/8"	.250"	63/64" 1-1/4"	35.00

CUT-OFF AND GROOVING CARBIDE INSERTS

- C5 general purpose grade for cutting all steels, stainless steels and high temperature alloy.
- C5-GC TIN coated carbide for cutting steels, stainless steels at higher speeds.

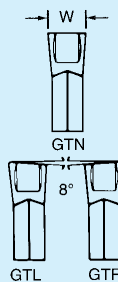
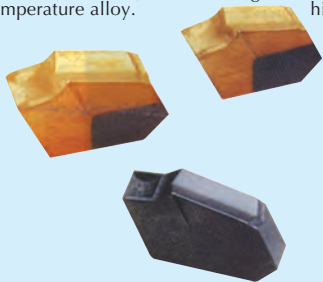

Uncoated Model No.	Tin Coat Model No.	Insert No.	Insert No. "W" width	Uncoated Price	Tin Coat Price
404-0415	404-0420	GTN-2	.087	\$3.50	\$3.95
404-0416	404-0421	GTN-3	.120	4.75	4.95
404-0417	404-0422	GTN-4	.160	5.00	5.75
404-0418	404-0423	GTN-5	.200	5.50	6.00
404-0419	404-0424	GTN-6	.250	6.00	6.95

Note: Specify "GTN" Neutral, "GTL" Left, "GTR" Right (Sold in package of 10)

Precise INDEXABLE CARBIDE COUNTERSINK & CHAMFER TOOLS

Positive rake for smooth cutting without chatter, carbide indexable, no tool reshaping needed. Comes with inserts. uses TPGH-321 & SPGH-433 inserts.

Imported 3 Pc SETS

- 1) Each of
- 1/4" x 3/4" x 1/2" Shank
- 1/2" x 1-3/4" x 1/2"
- 1-1/4" x 2-1/2" x 3/4"

SET	Angle	Price
404-240	82°	\$64.95
404-241	60°	
404-242	90°	



Individual Sizes made in U.S.A.

Model 60°	Model 82°	Model 90°	Dimensions Min x Max x Shank	Price Each
CC-060	CC-082	CC-090	1/8" x 1/2" x 3/8"	\$ 65.00
CC-160	CC-182	CC-190	1/4" x 3/4" x 1/2"	85.00
CC-260	CC-282	CC-290	1/2" x 1-3/4" x 1/2"	125.00
CC-360	CC-382	CC-390	1-1/4" x 2-1/2" x 3/4"	165.00

Carbide Inserts

Uncoated Model	Tin Coat Model	Insert No.	Uncoated Price	Tin Coat Price
404-256	404-257	TPGH-321	\$5.50	\$6.25
404-258	404-259	SPGH-433	6.50	8.75

Precise INDEXABLE BORING BARS

- Negative 5° end & slide cutting angle.
- Positive 80° diamond CCMT inserts (Not supplied)

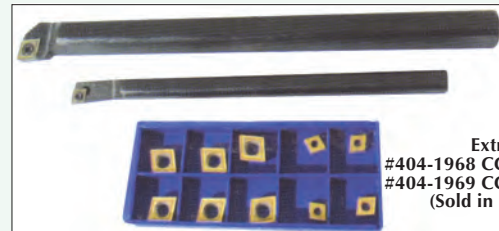

Extra Inserts:
#404-1968 CCMT-2151 \$4.95 ea.
#404-1969 CCMT-3252 \$4.95 ea.
(Sold in package of 10)

Model No.	Shank Size	Minimum Bore	Insert Type	Sale Price
404-1960	.315" x 4"	.354"	CCMT-2151	\$27.50
404-1961	3/8" x 6"	.468"		29.95
404-1962	1/2" x 7"	.600"		\$29.95
404-1963	5/8" x 8"	.866"	CCMT-3252	32.00
404-1964	3/4" x 10"	.920"		35.50

Precise MINI INDEXABLE END MILLS

- 1/2" shank.
- Position Rake.
- Complete with TPG-222 Carbide Insert.



Model No.	Cutting Diameter	Shank Size	Overall Length	Price Each
404-6511	1/2"	1/2"	3"	\$17.95
404-6512	9/16"	1/2"	3"	17.95
404-6513	5/8"	1/2"	3"	18.95
404-6510	3 Piece Set (1 of each size)			\$49.95
Carbide Insert				
TPG-222	1/64" Radius, 1/4" I.C., 1/8" Thick			\$2.95

Precise 6 PC. CARBIDE TIPPED TOOL BIT SET

3/8" Square Shank
SET No. 404-2048
\$19.95

1/2" Square Shank
SET No. 404-2049
\$21.95



Set Contains:
45° Left Angle 60° Point
45° Right Angle 1/8" x 5/16" Straight
30° Angle 15° Angle 7-1/4" OAL

With Wood Case

Precise FILLISTER HEAD SOLID COUNTERBORES

High Speed Steel



STRAIGHT SHANK

Fractional Sizes for Fillister Head Cap Screws

Model No.	Pilot & Cutting Size	Shank Dia.	OAL	Price Each
2-SC-1/4	1/4 x 13/32"	5/16"	3-5/8"	\$19.95
2-SC-5/16	5/16 x 15/32"	3/8"	4"	20.50
2-SC-3/8	3/8 x 19/32"	7/16"	4-3/8"	25.00
2-SC-7/16	7/16 x 21/32"	1/2"	4-3/4"	28.00
2-SC-1/2	1/2 x 25/32"	9/16"	5-1/8"	29.50

5 Piece Set
No. 502SA
Contains:
#2, #4, #6
#8 & #10

\$49.95

Machine Screw Sizes for Fillister Head Machine Screws

Model No.	Screw Size	Pilot Size	Cut Size	OAL	Price Each
2-SC-2	2	.085"	.155"	2-1/2"	\$9.95
2-SC-3	3	.098"	.176"	2-1/2"	9.95
2-SC-4	4	.111"	.198"	2-5/8"	9.95
2-SC-5	5	.124"	.220"	2-5/8"	10.95
2-SC-6	6	.137"	.241"	2-5/8"	10.95
2-SC-8	8	.163"	.285"	2-3/4"	11.50
2-SC-10	10	.189"	.328"	2-7/8"	12.50
2-SC-12	12	.215"	.372"	3"	15.00

4 Piece Set
No. 502SB
Contains:
1/4", 5/16",
3/8" & 1/2"

\$89.95

Precise 3-FLUTE SOCKET HEAD CAP SCREW COUNTERBORES

Features:

- 3-flute, right hand.
- For capscrew sizes.
- Solid pilot that is .001" to .001" undersize for ease entry



7 PC SET
MODEL 404-273

\$48.95

Includes: #6, 8, 10,
1/4, 5/16, 3/8, 1/2"

4 PC SET
MODEL 404-272-1

\$89.95

Includes:
1/2, 5/8, 3/4 & 1"

METRIC 7 PC SET
MODEL 404-275

\$59.95

Includes: 3MM,
4,5,6,8, 10 & 12mm

Model No.	Head Screw Size	Pilot Size	Cutter	Shank Diameter	OAL	Sale Price
82-555	#5	.141"	.221"	3/16"	3"	\$ 9.95
82-556	#6	.150"	.242"	7/32"	3"	6.95
82-557	#8	11/64"	19/64"	1/4"	3"	7.50
82-558	#10	13/64"	21/64"	5/16"	3-1/2"	7.95
82-559	1/4"	9/32"	13/32"	3/8"	5"	7.95
82-560	5/16"	11/32"	1/2"	7/16"	5"	9.95
82-561	3/8"	13/32"	19/32"	1/2"	6"	17.95
82-562	7/16"	15/32"	11/16"	1/2"	7"	17.50
82-563	1/2"	17/32"	25/32"	1/2"	7-1/2"	19.95
82-564	5/8"	21/32"	31/32"	3/4"	7-1/2"	23.95
82-565	3/4"	13/16"	1-3/16"	1"	8"	35.00
82-566	7/8"	13/16"	1-3/8"	1"	8"	39.00
82-567	1"	1-1/16"	1-11/16"	1"	10"	45.00
82-568	1"	1-1/16"	1-9/16"	1"	10"	55.00

ProMax DIAMOND PLATED BURR SETS



30 Piece Sets

Model	Shank	Grit	Price
24-060	3/32"	150	\$ 9.95
24-080	1/8"	100	14.95
24-080	1/8"	100	14.95

20 Piece Sets

24-061	3/32"	150	\$9.95
24-081	1/8"	150	9.95

Large Head Burr Sets

Model	Shank	Grit	Pieces	Price
24-062	3/32"	150	8	\$ 9.95
24-082	1/8"	150	8	9.95
24-083	1/8"	100	8	10.95
24-084	1/8"	50	8	10.95
24-090	1/4"	80	6	\$12.95
24-091	1/4"	50	5	11.95



Federal Tool Premium Import SOLID PILOT COUNTERBORES

Three Flute, Straight Shank

- Solid Pilot Counterbores are .001 - .002 undersize for ease of entry



SET No.
508S7

7 Piece SS Set
Contains 1 piece each:
No. 6, No. 10
1/4, 5/16, 3/8, 1/2
Supplied in Wood Block

\$177.00

SET No.
508S4

4 Piece SS Set
Contains 1 piece each:
No. 8, No. 10, 1/4, 3/8
Supplied in Wood Block

\$92.00

Model No.	Screw Size	Pilot and Cutting Diameter	Shank Diameter	Overall Length	Price Each
508-5	No. 5	.141 x .221"	3/16"	3"	\$19.50
508-6	No. 6	.150 x .242"	7/32"	3"	19.50
508-8	No. 8	11/64 x 19/64"	1/4"	3"	19.50
508-10	No.10	13/64 x 21/64"	5/16"	3-1/2"	20.64
508-1/4	1/4"	9/32 x 13/32"	3/8"	3"	23.50
508-5/16	5/16"	11/32 x 1/2"	7/16"	5"	25.65
508-3/8	3/8"	13/32 x 19/32"	1/2"	6"	29.30
508-7/16	7/16"	15/32 x 11/16"	1/2"	7"	35.02
508-1/2-1	1/2"	17/32 x 25/32"	1/2"	7-1/2"	39.90
508-1/2-2	1/2"	17/32 x 25/32"	3/4"	7-1/2"	39.90
508-1/2-3	1/2"	9/16 x 13/16"	3/4"	7-1/2"	39.90
508-5/8-1	5/8"	21/32 x 31/32"	3/4"	7-1/2"	57.37
508-5/8-2	5/8"	11/16 x 1"	3/4"	7-1/2"	57.37
508-3/4	3/4"	13/16 x 1-3/16"	1"	8"	81.22
508-7/8	7/8"	15/16 x 1-3/8"	1"	8"	122.11
508-1	1"	1-1/16 x 1-9/16"	1"	10"	158.47

METRIC, THREE FLUTE, STRAIGHT SHANK

Model No.	Screw Size	Pilot and Cutting Diameter	Shank Diameter	Overall Length	Price Each
508M-3	3mm	3.4 x 6mm	7/32"	3"	\$19.50
508M-4	4mm	4.5 x 8mm	5/16"	3-1/2"	19.50
508M-5	5mm	5.5 x 10mm	5/16"	4-1/2"	20.64
508M-6	6mm	6.6 x 11mm	1/2"	5"	23.50
508M-8	8mm	9 x 15mm	1/2"	6"	25.65
508M-10	10mm	11 x 18mm	1/2"	7"	29.30
508M-12	12mm	14 x 20mm	5/8"	7-1/2"	35.02
508M-14	14mm	15 x 24mm	3/4"	8"	39.90
508M-16	16mm	17 x 26mm	1"	9"	57.37
508M-20	20mm	21 x 33mm	1"	10"	81.22



COMBINED DRILL AND COUNTERSINK SET

60° Included Angle ~ Right Hand



Includes (1) Each Size:

#1, #2, #3, #4 & #5 Plain Type in a wooden round box with threaded screw cap.
Made In USA



MODEL No.
1000
Reg. \$50.00

\$39.95

Precise H.S.S. COMBINED TAP & DRILL

- Drill & tap in one step.
- 25° Helix provides proper cutting action for both drilling and tapping.
- 118° self-centering helical point eliminates the need for center punching or center drilling.
- Reduces the thrust required. H-2 pitch diameter for 4-40 NC, all others are H-3.



Model No.	Size	Overall Length	Drill Length	Drill Size	Thread Size	Sale Price
404-259-1	4-40 NC	1-7/8"	1/4"	.0910	3/8"	\$ 5.90
404-260	6-32 NC	2"	5/16"	.1115	15/32"	5.90
404-261	8-32 NC	2-1/8"	3/8"	.1375	33/64"	5.90
404-262	10-24 NC	2-3/8"	13/32"	.1545	5/8"	6.50
404-263	10-32 NF	2-3/8"	13/32"	.1635	9/16"	6.50
404-264	1/4-20 NC	2-1/2"	17/32"	.2080	13/16"	6.50
404-265	1/4-28 NF	2-1/2"	17/32"	.2200	23/32"	6.50
404-266	5/16-18 NC	2-27/32"	11/16"	.2660	31/32"	6.95
404-268	3/8-16 NC	3-3/8"	13/16"	.3225	1-1/8"	8.95
404-272	1/2-13 NC	4-1/16"	1-1/8"	.4350	1-15/32"	13.95

MICRO 100 MULTI-USE SOLID CARBIDE SINGLE END DRILL MILLS

Multi purpose tool for drilling, milling, chamfering, spotting and countersinking.



Tolerances:
Cutting Diameter
1/32" to 1/4": +.000 / -.002"
9/32" to 1" : +.000 / -.002"

Size	Shank Dia.	Flute Length	Overall Length	2-Flute Order no.	Sale Each	4-Flute Order no.	Sale Each
1/8"	1/8"	1/2"	1-1/2"	DM-125290	\$15.40	DM-125490	\$16.15
3/16"	3/16"	5/5"	2"	DM-187290	21.60	DM-187490	22.60
1/4"	1/4"	3/4"	2-1/2"	DM-250290	27.05	DM-250490	28.25
5/16"	5/16"	13/16"	2-1/2"	DM-312290	33.65	DM-312490	33.35
3/8"	3/8"	1"	2-1/2"	DM-375290	42.15	DM-375490	44.40
7/16"	7/16"	1"	2-3/4"	DM-437290	56.90	DM-437490	59.95
1/2"	1/2"	1"	3"	DM-500290	63.75	DM-500490	69.75
6/8"	6/8"	1-1/4"	3-1/2"	DM-625290	120.00	DM-625490	133.95
3/4"	3/4"	1-1/2"	4"	DM-750290	188.15	DM-750490	197.05

MICRO 100 AR & AL CARBIDE TIPPED TOOL BITS

- One grade of carbide for all materials and applications.
- Higher feeds and speeds. • Less machine down time.
- Excels in interrupted cuts. • Greater transverse rupture strength.
- Exceptional results on all heat treated materials/high tech alloys.



Right Hand Shown

Style AR Right Hand

Order No.	Size	1-5 Pcs.	6+ Pcs.
ARM-4	1/4"	\$12.25	\$11.05
ARM-5	5/16"	12.45	11.30
ARM-6	3/8"	13.00	11.85
ARM-8	1/2"	13.70	12.55
ARM-10	5/8"	22.40	21.25
ARM-12	3/4"	29.85	28.70

Style C- Square Nose
Style D- Pointed Nose
90° included
Style E- Threading Tool
60° included
Are Also Available

Style AL Left Hand

Order No.	Size	1-5 Pcs.	6+ Pcs.
ALM-4	1/4"	\$12.25	\$11.05
ALM-5	5/16"	12.45	11.30
ALM-6	3/8"	13.00	11.85
ALM-8	1/2"	13.70	12.55
ALM-10	5/8"	22.40	21.25
ALM-12	3/4"	29.85	28.70

MICRO 100 2 & 4 FLUTE MICROGRAIN SOLID CARBIDE SINGLE END MILLS

Straight Shank • Square Nose • Right Hand • Spiral Flute • Center Cutting • 30° Helix



Applications:

- High performance.

Features:

- Can attain optimum cutting speeds and feeds, maximum rigidity and virtually no tool deflection, allowing for much higher metal removal rates and far fewer regrinds.

Size	Shank Dia.	Flute Length	Overall Length	2-Flute Order no.	4-Flute Order no.	Sale Each
1/32"	1/8"	5/64"	1-1/2"	GEM-031-2	GEM-031-4	\$14.90
1/16"	1/8"	3/16"	1-1/2"	GEM-062-2	GEM-062-4	13.65
3/32"	1/8"	3/8"	1-1/2"	GEM-093-2	GEM-093-4	13.65
1/8"	1/8"	1/2"	1-1/2"	GEM-125-2	GEM-125-4	12.15
9/64"	3/16"	1/2"	2"	GEM-140-2	GEM-140-4	19.25
5/32"	3/16"	9/16"	2"	GEM-156-2	GEM-156-4	19.25
11/64"	3/16"	5/8"	2"	GEM-171-2	GEM-171-4	19.25
3/16"	3/16"	5/8"	2"	GEM-187-2	GEM-187-4	19.25

Size	Shank Dia.	Flute Length	Overall Length	2-Flute Order no.	4-Flute Order no.	Sale Each
13/64"	1/4"	5/8"	2-1/2"	GEM-203-2	GEM-203-4	\$24.05
7/32"	1/4"	5/8"	2-1/2"	GEM-218-2	GEM-218-4	24.05
15/64"	1/4"	3/4"	2-1/2"	GEM-234-2	GEM-234-4	24.05
1/4"	1/4"	3/4"	2-1/2"	GEM-250-2	GEM-250-4	24.05
5/16"	5/16"	13/16"	2-1/2"	GEM-312-2	GEM-312-4	28.00
3/8"	3/8"	7/8"	2-1/2"	GEM-375-2	GEM-375-4	29.75
1/2"	1/2"	1"	2-1/2"	GEM-500-2	GEM-500-4	55.15

- Coated, Metric & Stub sizes also available. Call for details.

MICRO 100 BRAZED BORING BARS "The Industry Standard"



Shank Diameter	Length	Right Hand Order No.	Left Hand Order No.	1-5 Sale Price	6+* Sale Price
1/4"	4"	TBB-250	TBBL-250	\$23.45	\$21.65
5/16"	5"	TBB-312	TBBL-312	24.25	22.55
3/8"	6"	TBB-375	TBBL-375	25.85	24.10
1/2"	7"	TBB-500	TBBL-500	31.65	29.90
5/8"	8"	TBB-625	TBBL-625	33.20	31.45
3/4"	9"	TBB-750	TBBL-750	34.75	33.05
1"	10"	TBB-001	TBBL-001	36.55	34.75

* Any Quantity of boring bar style(s) may be combined to achieve quantity rates

5 Pc. Set
Right Hand
TBB-5

\$129.95

5 Pc. Set
Left Hand
TBBL-5

\$129.95



Boring Bar Sets

Five Boring Bars

1/4", 3/8", 1/2", 5/8" and 3/4"

PLAIN TYPE COMBINED DRILLS & COUNTERSINKS 60° INCLUDED ANGLE - HIGH SPEED - Tin-COAT - SOLID CARBIDE

Precise
5 Piece Set
#1, #2, #3, #4
& #5 With Case
SET No. MDC-290

\$6.95

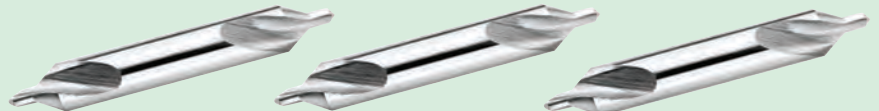
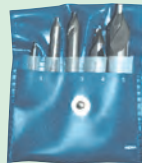

Precise
Imported

EDGE
U.S.A.

Size	Diameter		Overall Length	Precise High Speed		EDGE U.S.A. High Speed		EDGE U.S.A. H.S.S. Tin-Coat		EDGE U.S.A. Solid Carbide	
	Body	Drill		Model No.	Sale Price	Model No.	Sale Price	Model No.	Sale Price	Model No.	Sale Price
00	1/8"	.025"	1-1/4"	900-180	\$2.95	-	-	EDG26579	\$ 6.50	-	-
0	1/8"	1/32"	1-1/4"	900-181	1.95	EDG26506	\$3.75	EDG26578	6.50	-	-
1	1/8"	3/64"	1-1/4"	900-182	\$1.20	EDG26498	\$2.80	EDG26570	\$ 5.25	EDG26516	\$ 9.50
2	3/16"	5/64"	1-7/8"	900-183	1.20	EDG26499	2.95	EDG26571	5.50	EDG26517	14.50
3	1/4"	7/64"	2"	900-184	1.20	EDG26500	3.05	EDG26572	7.15	EDG26518	15.90
4	5/16"	1/8"	2-1/8"	900-185	1.20	EDG26501	3.20	EDG26573	7.30	EDG26519	21.50
5	7/16"	3/16"	2-3/4"	900-186	2.25	EDG26502	5.50	EDG26574	10.40	EDG26520	32.90
6	1/2"	7/32"	3"	900-187	3.95	EDG26503	8.25	EDG26575	16.50	EDG26521	44.00
7	5/8"	1/4"	3-1/4"	900-188	\$4.50	EDG26504	\$13.90	EDG26576	\$23.25	-	-
8	3/4"	5/16"	3-1/2"	900-189	7.50	EDG26505	19.75	EDG26577	38.00	-	-

Premium M-42-8% COBALT ROUGHING END MILLS

- Cobalt rods made by **Bohler of Germany**.
- Flutes are grounded by World-Class.
- ISO-9002 Factory. • **CNC Qualified**

Center Cutting
4-Flute



Model No.	Diameter		Length of Cut	Overall Length	Coarse Pitch	Fine Pitch
	Mill	Shank				
102-140	1/4"	3/8"	3/4"	2-1/2"	\$ 8.75	-
102-516	5/16"	3/8"	3/4"	2-1/2"	8.75	-
102-380	3/8"	3/8"	3/4"	2-1/2"	8.75	-
102-716	7/16"	3/8"	1"	2-3/4"	10.95	-
102-500	1/2"	1/2"	1-1/4"	3-1/4"	10.95	-
102-501	1/2"	1/2"	2"	4"	16.45	-
102-916	9/16"	1/2"	1-3/8"	3-3/8"	16.45	17.55
102-580	5/8"	5/8"	1-5/8"	3-3/4"	19.75	17.55
102-581	5/8"	5/8"	2-1/2"	4-5/8"	20.35	23.65
102-116	11/16"	5/8"	1-5/8"	3-3/4"	20.35	-
102-340	3/4"	3/4"	1-5/8"	3-3/4"	20.35	23.40
102-341	3/4"	3/4"	3"	5-1/4"	24.75	27.20
102-342	3/4"	3/4"	4"	6-1/2"	27.50	31.35
102-780	7/8"	3/4"	1-5/8"	4-1/8"	25.00	29.15
102-156	15/16"	3/4"	1-7/8"	4-1/8"	30.25	-
102-134	1"	3/4"	2"	4-1/4"	36.30	37.40
102-100	1"	1"	2"	4-1/2"	36.30	39.00
102-113	1"	1"	3"	5-1/2"	38.50	41.80
102-114	1"	1"	4"	6-1/2"	48.40	53.35
102-118	1"	1"	6"	8-1/2"	71.50	-

Add to Model No. Letter "C" for Coarse or Letter "F" For Fine Pitch

Premium M-42-8% COBALT ROUGHING END MILLS

- Cobalt rods made by **Bohler of Germany**.
- Flutes are grounded by World-Class.
- ISO-9002 Factory. • **CNC Qualified**

Center Cutting
3-Flute



Model No.	Diameter		Length of Cut	Overall Length	Price Each
	Mill	Shank			
100-250	1/4"	3/8"	3/4"	2-1/2"	\$ 9.85
100-516	5/16"	3/8"	3/4"	2-1/2"	9.85
100-380	3/8"	3/8"	3/4"	2-1/2"	9.85
100-500-1	1/2"	1/2"	1-1/4"	3-1/4"	13.20
100-580-1	5/8"	5/8"	1-5/8"	3-3/4"	17.60
100-340	3/4"	3/4"	1-5/8"	3-3/4"	23.65
100-100-1	1"	3/4"	2"	4-1/4"	38.50
100-101	1"	1"	2"	4-1/2"	39.05

Premium TILAN COATED M-42-8% COBALT ROUGHING END MILLS

- Cobalt rods made by **Bohler of Germany**.
- Flutes are grounded by World-Class.
- ISO-9002 Factory. • **CNC Qualified**

4-Flute
Center Cutting



Model No.	Diameter		Length of Cut	Overall Length	Price Each
	Mill	Shank			
101-250	1/4"	3/8"	3/4"	2-1/2"	\$ 9.85
101-516	5/16"	3/8"	3/4"	2-1/2"	9.85
101-380	3/8"	3/8"	3/4"	2-1/2"	9.85
101-500	1/2"	1/2"	1-1/4"	3-1/4"	12.05
101-580	5/8"	5/8"	1-5/8"	3-3/4"	16.45
101-340	3/4"	3/4"	1-5/8"	3-3/4"	21.45
101-100-1	1"	1"	2"	3-3/4"	32.45

Premium SOLID CARBIDE MICROGRAN TILAN COATED END MILLS

Best Quality Center Cutting



4 Flute No.	2 Flute No.	Dimensions		Length of Cut	Overall Length	Price Each
		Mill	Shank			
106-401	106-201	1/16"	1/8"	3/16"	1-1/2"	\$ 6.55
106-402	106-202	3/32"	1/8"	1/4"	1-1/2"	6.55
106-403	106-203	1/8"	1/8"	1/2"	1-1/2"	6.55
106-404	106-204	3/16"	3/16"	5/8"	2"	8.25
106-405	106-205	1/4"	1/4"	3/4"	2-1/2"	11.80
106-406	106-206	5/16"	5/16"	13/16"	2-1/2"	16.35
106-407	106-207	3/8"	3/8"	7/8"	2-1/2"	19.25
106-408	106-208	1/2"	1/2"	1"	3"	28.05
106-409	106-209	7/16"	7/16"	1"	2-3/4"	28.05
106-410	106-210	5/8"	5/8"	1-1/4"	3-1/2"	48.40
106-411	106-211	3/4"	3/4"	1-1/2"	4"	69.30

Premium M-42-8% COBALT END MILLS 4 FLUTE & 2 FLUTE

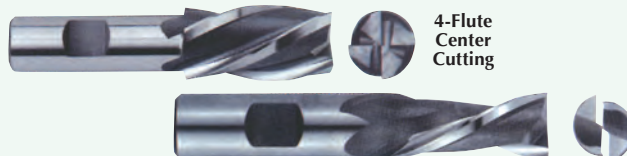

4-Flute
Center Cutting

4 Flute No.	2 Flute No.	Dimensions		Flute Length	Price Each
		Mill	Shank		
109-401	109-201	1/8"	3/8"	3/8"	\$ 5.45
109-402	109-202	3/16"	3/8"	1/2"	5.45
109-403	109-203	1/4"	3/8"	5/8"	5.45
109-404	109-204	5/16"	3/8"	3/4"	5.45
109-405	109-205	3/8"	3/8"	3/4"	5.45
109-406	-	7/16"	1/2"	1"	9.35
109-407	109-207	1/2"	1/2"	1-1/4"	9.35
109-408	109-208	9/16"	1/2"	1-3/8"	12.05
109-409	109-209	5/8"	5/8"	1-5/8"	13.50
109-410	109-210	11/16"	5/8"	1-5/8"	16.35
109-411	109-211	3/4"	3/4"	1-5/8"	16.45
109-412	109-212	13/16"	3/4"	7/8"	21.20
109-413	109-213	7/8"	3/4"	1-7/8"	23.65
109-414	109-214	15/16"	3/4"	1-7/8"	29.70
109-415	109-215	1"	3/4"	2"	29.15
109-416	109-216	1"	1"	2"	29.15

Premium M-42-8% COBALT DOUBLE END MILLS 4 FLUTE & 2 FLUTE



4-Flute No.	2-Flute No.	Dimensions		Flute Length	Price Each
		Mill	Shank		
190-401	190-201	1/8"	3/8"	3/8"	\$ 7.65
190-402	190-202	3/16"	3/8"	1/2"	7.65
190-403	190-203	1/4"	3/8"	5/8"	7.65
190-404	190-204	5/16"	3/8"	3/4"	7.65
190-405	190-205	3/8"	3/8"	3/4"	7.65
190-406	190-206	7/16"	1/2"	1"	10.95
190-407	190-207	1/2"	1/2"	1"	14.25
190-408	190-208	9/16"	5/8"	1-3/8"	19.80
190-409	190-209	5/8"	5/8"	1-3/8"	19.80
190-410	190-210	3/4"	3/4"	1-3/8"	24.20
190-411	190-211	3/4"	5/8"	1-3/8"	24.20
190-413	190-213	7/8"	1"	2"	29.15

Premium M-42-8% COBALT BALL END - END MILLS

4-Flute
Center Cutting



Model No.	Dimensions		Flute Length	Overall Length	Price Each
	Mill	Shank			
009-001	1/8"	3/8"	3/8"	2-5/16"	\$ 7.65
009-002	3/16"	3/8"	1/2"	2-3/8"	7.65
009-003	1/4"	3/8"	5/8"	2-1/2"	7.65
009-004	5/16"	3/8"	3/4"	2-1/2"	8.25
009-005	3/8"	3/8"	3/4"	2-1/2"	8.75
009-006	7/16"	1/2"	1"	2-3/4"	10.95
009-007	1/2"	1/2"	1-1/4"	3-1/4"	11.55
009-008	5/8"	5/8"	1-5/8"	3-3/4"	15.95
009-009	3/4"	3/4"	1-5/8"	4-1/2"	20.85
009-010	1"	1"	2"	4-1/2"	34.10

Premium M-42-8% COBALT LONG END MILLS 4-FLUTE

4-Flute
Center Cutting



Model No.	Dimensions		Flute Length	Overall Length	Price Each
	Mill	Shank			
090-001	1/4"	3/8"	1-1/4"	3-1/16"	\$ 8.25
090-002	3/8"	3/8"	1-1/2"	3-1/4"	8.25
090-003	1/2"	1/2"	2"	4"	10.95
090-004	5/8"	5/8"	2-1/2"	4-5/8"	20.35
090-005	3/4"	3/4"	3"	5-1/4"	24.20
090-006	1"	1"	4"	6-1/2"	39.60

Precise SOLID CARBIDE SINGLE END, END MILLS



Square End Micrograin



Square End Micrograin

2 Flute Model No.	4 Flute Model No.	Mill Dia.	Shank Dia.	Flute Length	OAL	Sale Price
200-1/16	400-1/16	1/16"	1/8"	3/16"	1-1/2"	\$ 6.55
200-1/8	400-1/8	1/8"	1/8"	1/2"	1-1/2"	5.80
200-5/32	400-5/32	5/32"	3/16"	9/16"	2"	8.25
200-3/16	400-3/16	3/16"	3/16"	5/8"	2"	7.60
200-7/32	400-7/32	7/32"	1/4"	5/8"	2-1/2"	10.45
200-1/4	400-1/4	1/4"	1/4"	3/4"	2-1/2"	8.35
200-5/16	400-5/16	5/16"	5/16"	13/16"	2-1/2"	11.55
200-3/8	400-3/8	3/8"	3/8"	7/8"	2-1/2"	14.20
200-7/16	400-7/16	7/16"	7/16"	2"	4"	19.80
200-1/2	400-1/2	1/2"	1/2"	1"	3"	21.45
200-5/8	400-5/8	5/8"	5/8"	1-1/4"	3-1/2"	42.35
200-3/4	400-3/4	3/4"	3/4"	1-1/2"	4"	60.50
200-1	400-1	1"	1"	1-1/2"	4"	101.75

* 32nd and 64th sizes not listed are available at similar savings. Please inquire

LONG LENGTHS

100-1/8	600-1/8	1/8"	1/8"	3/4"	2-1/4"	\$ 9.80
100-3/16	600-3/16	3/16"	3/16"	3/4"	2-1/4"	12.00
100-1/4	600-1/4	1/4"	1/4"	1-1/8"	3"	19.70
100-5/16	600-5/16	5/16"	5/16"	1-1/8"	3"	23.10
100-3/8-1	600-3/8	3/8"	3/8"	1-1/8"	3"	27.50
100-7/16	600-7/16	7/16"	7/16"	2"	4"	42.35
100-1/2-1	600-1/2	1/2"	1/2"	2"	4"	44.00
100-5/8-1	600-5/8	5/8"	5/8"	2-1/4"	5"	71.50
100-3/4	600-3/4	3/4"	3/4"	2-1/4"	5"	101.75
100-1-1	600-1	1"	1"	2-1/4"	5"	176.00

EXTRA LONG LENGTHS

110-1/8	610-1/8	1/8"	1/8"	1"	3"	\$12.65
110-3/16	610-3/16	3/16"	3/16"	1-1/8"	3"	17.05
110-1/4	610-1/4	1/4"	1/4"	1-1/2"	4"	24.20
110-5/16	610-5/16	5/16"	5/16"	1-5/8"	4"	33.00
110-3/8	610-3/8	3/8"	3/8"	1-3/4"	4"	33.55
110-7/16	610-7/16	7/16"	7/16"	3"	6"	55.00
110-1/2	610-1/2	1/2"	1/2"	3"	6"	60.50
110-5/8	610-5/8	5/8"	5/8"	3"	6"	115.50
110-3/4	610-3/4	3/4"	3/4"	3"	6"	143.00
110-1-1	610-1	1"	1"	3"	6"	203.50

Precise SOLID CARBIDE DOUBLE END, END MILLS



Square End Micrograin



Square End Micrograin

2 Flute Model No.	4 Flute Model No.	Mill Dia.	Shank Dia.	Flute Length	OAL	Sale Price
500-1/16	700-1/16	1/16"	1/8"	1/8"	1/16"	\$10.45
500-1/8	700-1/8	1/8"	1/8"	1/4"	1-1/2"	8.70
500-5/32	700-5/32	5/32"	3/16"	5/16"	2"	9.85
500-3/16	700-3/16	3/16"	3/16"	3/8"	2"	9.85
500-7/32	700-7/32	7/32"	1/4"	1/2"	2-1/2"	12.65
500-1/4	700-1/4	1/4"	1/4"	1/2"	2-1/2"	12.05
500-5/16	700-5/16	5/16"	5/16"	1/2"	2-1/2"	16.40
500-3/8	700-3/8	3/8"	3/8"	1/2"	2-1/2"	18.70
500-7/16	700-7/16	7/16"	1/2"	5/8"	3"	28.05
500-1/2	700-1/2	1/2"	1/2"	5/8"	3"	30.80

Precise SOLID CARBIDE BALL NOSE END MILLS

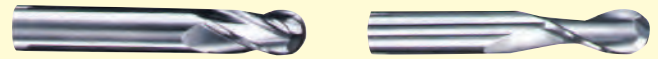

Ball End Micrograin



Ball End Micrograin

2 Flute Model No.	4 Flute Model No.	Mill Dia.	Shank Dia.	Flute Length	OAL	Sale Price
200B-1/16	400B-1/16	1/16"	1/8"	3/16"	1-1/2"	\$ 8.25
200B-1/8	400B-1/8	1/8"	1/8"	1/2"	1-1/2"	7.60
200B-5/32	400B-5/32	5/32"	3/16"	9/16"	2"	10.90
200B-3/16	400B-3/16	3/16"	3/16"	5/8"	2"	9.60
200B-7/32	400B-7/32	7/32"	1/4"	5/8"	2-1/2"	12.65
200B-1/4	400B-1/4	1/4"	1/4"	3/4"	2-1/2"	11.55
200B-5/16	400B-5/16	5/16"	5/16"	13/16"	2-1/2"	15.95
200B-3/8	400B-3/8	3/8"	3/8"	7/8"	2-1/2"	18.70
200B-7/16	400B-7/16	7/16"	7/16"	2"	4"	24.75
200B-1/2	400B-1/2	1/2"	1/2"	1"	3"	31.80
200B-5/8	400B-5/8	5/8"	5/8"	1-1/4"	3-1/2"	50.60
200B-3/4	400B-3/4	3/4"	3/4"	1-1/2"	4"	77.00
200B-1	400B-1	1"	1"	1-1/2"	4"	132.00

LONG LENGTHS

210-1/8	410-1/8	1/8"	1/8"	3/4"	2-1/4"	\$12.00
210-3/16	410-3/16	3/16"	3/16"	3/4"	2-1/4"	15.95
210-1/4	410-1/4	1/4"	1/4"	1-1/8"	3"	23.65
210-5/16	410-5/16	5/16"	5/16"	1-1/8"	3"	30.80
210-3/8	410-3/8	3/8"	3/8"	1-1/8"	3"	34.10
210-7/16	410-7/16	7/16"	7/16"	2"	4"	50.60
210-1/2	410-1/2	1/2"	1/2"	2"	4"	54.45
210-5/8	410-5/8	5/8"	5/8"	2-1/4"	5"	101.75
210-3/4	410-3/4	3/4"	3/4"	2-1/4"	5"	137.50
210-1	410-1	1"	1"	2-1/4"	5"	192.50

EXTRA LONG LENGTHS

220-1/8	420-1/8	1/8"	1/8"	1"	3"	\$23.65
220-3/16	420-3/16	3/16"	3/16"	1-1/8"	3"	21.45
220-1/4	420-1/4	1/4"	1/4"	1-1/2"	4"	28.05
220-5/16	420-5/16	5/16"	5/16"	1-5/8"	4"	39.60
220-3/8	420-3/8	3/8"	3/8"	1-3/4"	4"	42.35
220-7/16	420-7/16	7/16"	7/16"	3"	6"	63.25
220-1/2	420-1/2	1/2"	1/2"	3"	6"	80.20
220-5/8	420-5/8	5/8"	5/8"	3"	6"	130.90
220-3/4	420-3/4	3/4"	3/4"	3"	6"	181.50
220-1-1	420-1	1"	1"	3"	6"	258.50

Precise SOLID CARBIDE BALL NOSE END MILLS



Ball End Micrograin



Ball End Micrograin

2 Flute Model No.	4 Flute Model No.	Mill Dia.	Shank Dia.	Flute Length	OAL	Sale Price
404-618	404-608	1/16"	1/8"	3/4"	1-1/2"	\$12.00
404-619	404-609	1/8"	1/8"	1/4"	1-1/2"	10.45
404-620	404-610	5/32"	3/16"	5/16"	2"	13.75
404-601	404-611	3/16"	3/16"	3/8"	2"	13.75
404-602	404-612	7/32"	1/4"	1/2"	2-1/2"	15.40
404-603	404-613	1/4"	1/4"	1/2"	2-1/2"	17.60
404-604	404-614	5/16"	5/16"	1/2"	2-1/2"	23.10
404-605	404-615	3/8"	3/8"	1/2"	2-1/2"	23.65
404-606	404-616	7/16"	1/2"	5/8"	3"	37.40
404-607	404-617	1/2"	1/2"	5/8"	3"	39.60

Precise CUTTING TOOL SETS

High Speed Steel

6-Piece 4 Flute Double End Mill Set

SET No. EMS-500

\$27.50



7-Piece Chucking Reamer Set Straight Flute

SET No. CRS-700

\$49.50



Sizes:
1/8", 3/16", 1/4"
5/16", 3/8",
7/16" & 1/2"

Contains:
1/8", 3/16", 1/4", 5/16"
3/8" & 1/2"

Precise SCREW EXTRACTOR SET IN METAL INDEX CASE



SET No. 10200-1

\$21.95

With Case

Case Only No. 10200 \$6.95

Set Contains Screw Extractors and Drills as follows

Screw Extractor	For Screws	Drill Size
#1	1/8" - 1/4"	3/32"
#2	1/4" - 5/16"	1/8"
#3	5/16" - 7/16"	11/64"
#4	7/16" - 9/16"	15/64"
#5	9/16" - 3/4"	5/16"

Precise MAJOR REDUCTION IN HIGH SPEED END MILLS Precise

MULTI-FLUTE SINGLE END END MILLS High Speed Steel - Regular Length

Series "MFS"



Model No.	Mill Dia.	Shank Dia.	Length of Cut	No of Flutes	Sale Price
MFS-165	1/8"	3/8"	3/8"	4	\$ 3.80
MFS-166	5/32"	3/8"	3/8"	4	3.80
MFS-167	3/16"	3/8"	1/2"	4	3.80
MFS-168	7/32	3/8"	5/8"	4	3.80
MFS-169	1/4"	3/8"	5/8"	4	3.80
MFS-170	9/32"	3/8"	3/4"	4	3.80
MFS-171	5/16"	3/8"	3/4"	4	3.80
MFS-172	11/32"	3/8"	3/4"	4	7.15
MFS-173	3/8"	3/8"	3/4"	4	3.80
MFS-174	13/32"	3/8"	1"	4	9.35
MFS-175	7/16"	3/8"	1"	4	3.80
MFS-176	15/32"	3/8"	1"	4	9.35
MFS-177	1/2"	3/8"	1"	4	3.80
MFS-178	1/2"	1/2"	1-1/4"	4	\$ 5.25
MFS-179	9/16"	1/2"	1-3/8"	4	6.80
MFS-180	5/8"	1/2"	1-3/8"	4	7.40
MFS-181	11/16"	1/2"	1-5/8"	4	8.25
MFS-182	3/4"	1/2"	1-5/8"	4	8.80
MFS-183	13/16"	1/2"	1-7/8"	4	11.70
MFS-184	7/8"	1/2"	1-7/8"	4	11.70
MFS-186	15/16"	1/2"	1-7/8"	6	17.60
MFS-187	1"	1/2"	1-7/8"	4	30.80
MFS-188	1"	1/2"	1-7/8"	6	30.80
MFS-189	5/8"	5/8"	1-5/8"	4	\$ 8.25
MFS-190	11/16"	5/8"	1-5/8"	4	8.25
MFS-191	3/4"	5/8"	1-5/8"	4	8.85
MFS-192	13/16"	5/8"	1-7/8"	4	22.00
MFS-193	13/16"	5/8"	1-7/8"	6	22.00
MFS-194	7/8"	5/8"	1-7/8"	6	27.50
MFS-195	15/16"	5/8"	1-7/8"	6	27.50
MFS-196	1"	5/8"	1-7/8"	4	27.50
MFS-197	1"	5/8"	1-7/8"	6	27.50
MFS-198	3/4"	3/4"	1-5/8"	4	\$ 9.20
MFS-199	3/4"	3/4"	1-5/8"	6	19.80
MFS-200	13/16"	3/4"	1-7/8"	4	11.70
MFS-201	7/8"	3/4"	1-7/8"	4	11.70
MFS-202	7/8"	3/4"	1-7/8"	6	26.40
MFS-203	15/16"	3/4"	1-7/8"	4	29.70
MFS-204	1"	3/4"	1-7/8"	4	16.50
MFS-205	1"	3/4"	1-7/8"	6	27.50
MFS-206	1-1/16"	3/4"	2"	6	41.80
MFS-207	1-1/8"	3/4"	2"	6	46.20
MFS-208	1-3/16"	3/4"	2"	6	49.50
MFS-209	1-1/4"	3/4"	2"	6	49.50
MFS-210	1-5/16"	3/4"	2"	6	49.50
MFS-211	1-3/8"	3/4"	2"	6	49.50
MFS-212	1-7/16"	3/4"	2"	6	60.50
MFS-213	1-1/2"	3/4"	2"	6	60.50
MFS-214	1-5/8"	3/4"	2"	6	71.50
MFS-215	1-3/4"	3/4"	2"	6	82.50
MFS-216	2"	3/4"	2"	6	93.50
MFS-217	7/8"	7/8"	1-7/8"	4	\$11.55
MFS-218	15/16"	7/8"	1-7/8"	4	29.70
MFS-219	1"	7/8"	1-7/8"	4	33.00
MFS-220	1-1/8"	7/8"	2"	6	46.20
MFS-221	1-1/4"	7/8"	2"	4	51.70
MFS-222	1-1/4"	7/8"	2"	6	51.70
MFS-223	1"	1"	2"	4	\$27.50
MFS-224	1-1/8"	1"	2"	6	38.50
MFS-225	1-1/4"	1"	2"	6	55.00
MFS-226	1-3/8"	1"	2"	6	59.40
MFS-227	1-1/2"	1"	2"	6	66.00
MFS-228	1-1/2"	1"	2"	6	66.00
MFS-229	1-1/4"	1-1/4"	2"	6	\$38.50
MFS-230	1-1/4"	1-1/4"	2"	4	49.50
MFS-231	1-3/8"	1-1/4"	2"	6	60.50
MFS-232	1-1/2"	1-1/4"	2"	4	66.00
MFS-233	1-1/2"	1-1/4"	2"	6	66.00
MFS-234	1-5/8"	1-1/4"	2"	4	71.15
MFS-235	1-5/8"	1-1/4"	2"	6	71.15
MFS-236	1-3/4"	1-1/4"	2"	4	82.50
MFS-237	1-3/4"	1-1/4"	2"	6	82.50
MFS-238	1-7/8"	1-1/4"	2"	6	88.00
MFS-239	1-7/8"	1-1/4"	1"	8	88.00
MFS-240	2"	1-1/4"	2"	4	\$93.50
MFS-241	2"	1-1/4"	2"	6	93.50
MFS-242	2"	1-1/4"	2"	8	93.50

4-FLUTE DOUBLE END END MILLS High Speed Steel - Right Hand Cut

Series "MDM"



Model No.	Mill Dia.	Shank Dia.	Length of Cut	Overall Length	Sale Price
MDM-243	1/8"	3/8"	3/8"	3-1/16"	\$3.85
MDM-244	5/32"	3/8"	7/16"	3-1/8"	3.85
MDM-245	3/16"	3/8"	1/2"	3-1/4"	3.85
MDM-247	7/32"	3/8"	9/16"	3-1/4"	3.85
MDM-248	15/64"	3/8"	9/16"	3-1/2"	\$4.20
MDM-249	1/4"	3/8"	5/8"	3-3/8"	3.85
MDM-250	9/32"	3/8"	11/16"	3-3/8"	11.00
MDM-251	5/16"	3/8"	3/4"	3-1/2"	3.85
MDM-252	11/32"	3/8"	3/4"	3-1/2"	11.00
MDM-253	3/8"	3/8"	3/4"	3-1/2"	\$ 4.20
MDM-254	13/32"	1/2"	1"	4-1/8"	16.50
MDM-255	7/16"	1/2"	1"	4-1/8"	6.90
MDM-256	15/32"	1/2"	1"	4-1/8"	6.90
MDM-257	1/2"	1/2"	1"	4-1/8"	\$ 6.90
MDM-258	9/16"	5/8"	1-3/8"	5"	9.35
MDM-259	5/8"	5/8"	1-3/8"	5"	9.35
MDM-260	11/16"	3/4"	1-5/8"	5-5/8"	33.00
MDM-261	3/4"	3/4"	1-5/8"	5-5/8"	\$12.00
MDM-262	13/16"	7/8"	1-7/8"	6-1/8"	16.50
MDM-263	7/8"	7/8"	1-7/8"	6-1/8"	16.50
MDM-264	15/16"	1"	1-7/8"	6-1/8"	41.80
MDM-265	1"	1"	1-7/8"	6-1/8"	17.60

MULTI-FLUTE SINGLE END END MILLS - LONG - EXTRA LONG High speed steel - Right Hand Cut

Series "MLM"



Model No.	Mill Dia.	Shank Dia.	Length of Cut	No. of Flutes	Overall Length	Sale Price
MLM-266	1/4"	3/8"	1-1/4"	4	3-1/16"	\$ 5.24
MLM-267	5/16"	3/8"	1-3/8"	4	3-1/8"	5.25
MLM-268	3/8"	3/8"	1-1/2"	4	3-1/4"	5.25
MLM-269	7/16"	1/2"	1-3/4"	4	3-1/4"	13.20
MLM-270	1/2"	1/2"	2"	4	4"	7.40
MLM-271	5/8"	1/2"	2-1/2"	4	4-5/8"	10.95
MLM-272	3/4"	1/2"	3"	4	5-1/4"	24.75
MLM-273	5/8"	5/8"	2-1/2"	4	4-5/8"	\$10.95
MLM-274	3/4"	3/4"	3"	4	5-1/4"	13.20
MLM-275	1"	3/4"	4"	4	6-1/2"	41.80
MLM-276	1-1/8"	3/4"	4"	6	6-1/2"	57.20
MLM-277	1-1/4"	3/4"	4"	6	6-1/2"	66.00
MLM-278	7/8"	7/8"	3-1/2"	4	5-3/4"	\$16.50
MLM-279	1"	1"	4"	4	6-1/2"	21.45
MLM-280	1-1/8"	1"	4"	6	6-1/2"	27.50
MLM-281	1-1/4"	1"	4"	6	6-1/2"	58.30
MLM-282	1-3/8"	1"	4"	6	6-1/2"	69.30
MLM-283	1-1/2"	1"	4"	6	6-1/2"	79.20
MLM-284	1-1/4"	1-1/4"	4"	4	6-1/2"	\$66.00
MLM-285	1-1/4"	1-1/4"	4"	6	6-1/2"	66.00
MLM-286	1-1/2"	1-1/4"	4"	6	6-1/2"	82.50
MLM-287	1-3/4"	1-1/4"	4"	6	6-1/2"	99.00
MLM-288	2"	1-1/4"	4"	4	6-1/2"	121.00
MLM-289	2"	1-1/4"	4"	6	6-1/2"	121.00

Series "MXM"



Model No.	Mill Dia.	Shank Dia.	Length of Cut	No. of Flutes	Overall Length	Sale Price
MXM-291	1/4"	3/8"	1-3/4"	4	3-9/16"	\$11.55
MXM-292	5/16"	3/8"	2"	4	3-3/4"	12.05
MXM-293	3/8"	3/8"	2-1/2"	4	4-1/4"	13.20
MXM-294	1/2"	1/2"	3"	4	5"	17.60
MXM-295	5/8"	1/2"	4"	4	6-1/8"	28.60
MXM-296	3/4"	1/2"	4"	4	6-1/4"	36.30
MXM-297	5/8"	5/8"	4"	4	6-1/8"	\$29.70
MXM-298	3/4"	3/4"	4"	4	6-1/4"	36.30
MXM-299	7/8"	7/8"	5"	4	7-1/4"	46.20
MXM-300	1"	1"	6"	4	8-1/2"	55.00
MXM-301	1-1/4"	1-1/4"	6"	4	8-1/2"	104.50
MXM-302	1-1/4"	1-1/4"	6"	6	8-1/2"	\$108.90
MXM-303	1-1/2"	1-1/2"	8"	6	10-9/16"	165.00
MXM-304	2"	2"	8"	6	11-3/4"	214.50

MINIATURE END MILLS Double End - 3/16" Shank

Series "MET"



Series "MEF"



Mill Dia.	Length of Cut	Overall Length	2-Flute Price	4-Flute Price
1/16"	7/32"	2-1/2"	\$19.50	\$19.50
5/64"	7/32"	2-1/2"	19.50	19.50
3/32"	9/32"	2-5/8"	19.50	19.50
7/64"	5/32"	2"	19.50	19.50
1/8"	3/8"	2-1/4"	15.50	15.50
9/64"	13/32"	2-1/4"	15.50	15.50
5/32"	7/16"	2-1/4"	15.50	15.50
11/64"	1/2"	2-1/4"	15.50	15.50
3/16"	1/2"	2-1/4"	15.50	15.50

* Specify 2 or 4 Flute when ordering

Series "MLT"



Series "MLF"



Long Length - 3/16" Shank

Mill Dia.	Length of Cut	Overall Length	2-Flute Price	4-Flute Price
1/16"	7/32"	2-1/2"	\$19.50	\$19.50
3/32"	9/32"	2-5/8"	19.50	19.50
1/8"	3/4"	3-1/8"	19.50	19.50
5/32"	7/8"	3-1/4"	19.50	19.50
3/16"	1"	3-3/8"	19.50	19.50

MINIATURE BALL END MILLS 2-Flute - Double End - 3/16" Shank

Series "MBM"



High Speed Steel - Regular Length

Model No.	Mill Diameter	Length of Cut	Overall Length	Sale Price
MBM-304	1/32"	1/8"	2-1/4"	\$25.90
MBM-305	1/16"	1/8"	2-1/4"	25.90
MBM-306	3/32"	1/8"	2-1/4"	21.95
MBM-307	1/8"	1/8"	2-1/4"	21.95
MBM-308	5/32"	9/16"	2-1/4"	21.95
MBM-309	3/16"	1/8"	2-1/4"	21.95



LARGE PLASTIC WALL CHART

- **New Look! larger Size!** Redesigned for enhanced readability. Decimal equivalents. Tap drill for inch, metric and pipe threads. 24" x 36" printed on heavy duty .023" gage plastic with three punched holes across top for wall mounting.



Chart No. 1007

(Pack Of 10)
No.1007-2

\$6.95 Ea.

\$59.95

24" x 36"

Precise MAJOR REDUCTION IN HIGH SPEED END MILLS Precise

H.S.S. END MILLS High Speed - Right Hand - 2 Flute - Single End

Series "SMT"



Model No.	Mill Dia.	Shank Dia.	Cut Length	O/A Length	Sale Price
SMT-001	1/8"	3/8"	2-1/16"	2-5/16"	\$ 3.85
SMT-002	5/32"	3/8"	7/16"	2-5/16"	3.85
SMT-003	3/16"	3/8"	7/16"	2-5/16"	6.45
SMT-004	7/32"	3/8"	1/2"	2-5/16"	6.45
SMT-005	1/4"	3/8"	1/2"	2-5/16"	3.85
SMT-006	9/32"	3/8"	9/16"	2-5/16"	6.45
SMT-007	5/16"	3/8"	9/16"	2-5/16"	3.85
SMT-008	11/32"	3/8"	9/16"	2-5/16"	6.45
SMT-009	3/8"	3/8"	9/16"	2-5/16"	3.85
SMT-010	7/16"	3/8"	13/16"	2-1/2"	5.20
SMT-011	15/32"	3/8"	13/16"	2-1/2"	8.25
SMT-012	1/2"	3/8"	13/16"	2-1/2"	5.20
SMT-013	1/2"	1/2"	1"	3"	\$ 5.20
SMT-014	9/16"	1/2"	1-1/8"	3-1/8"	6.60
SMT-015	5/8"	1/2"	1-1/8"	3-1/8"	7.70
SMT-016	11/16"	1/2"	1-5/16"	3-5/16"	18.15
SMT-017	3/4"	1/2"	1-5/16"	3-5/16"	9.10
SMT-018	13/16"	1/2"	1-1/2"	3-5/8"	23.10
SMT-019	7/8"	1/2"	1-1/2"	3-5/8"	11.30
SMT-020	15/16"	1/2"	1-1/2"	3-5/8"	29.15
SMT-021	1"	1/2"	1-1/2"	3-5/8"	13.20
SMT-023	5/8"	5/8"	1-5/16"	3-7/16"	\$ 8.00
SMT-024	11/16"	5/8"	1-5/16"	3-7/16"	8.60
SMT-025	3/4"	5/8"	1-5/16"	3-7/16"	19.80
SMT-026	13/16"	5/8"	1-1/2"	3-5/8"	24.75
SMT-027	7/8"	5/8"	1-1/2"	3-5/8"	26.40
SMT-028	15/16"	5/8"	1-1/2"	3-5/8"	26.50
SMT-029	1"	5/8"	1-1/2"	3-5/8"	29.15
SMT-030	1-1/16"	5/8"	1-5/8"	3-7/8"	43.45
SMT-031	3/4"	3/4"	1-5/16"	3-7/16"	\$ 9.10
SMT-032	13/16"	3/4"	1-1/2"	3-3/4"	24.75
SMT-033	7/8"	3/4"	1-1/2"	3-3/4"	11.30
SMT-034	15/16"	3/4"	1-1/2"	3-3/4"	29.15
SMT-035	1"	3/4"	1-1/2"	3-3/4"	15.40
SMT-036	1-1/16"	3/4"	1-5/8"	3-7/8"	43.95
SMT-037	1-1/8"	3/4"	1-5/8"	3-7/8"	43.95
SMT-038	1-3/16"	3/4"	1-5/8"	3-7/8"	48.40
SMT-039	1-1/4"	3/4"	1-5/8"	3-7/8"	48.95
SMT-040	1-5/16"	3/4"	1-5/8"	3-7/8"	52.80
SMT-041	1-3/8"	3/4"	1-5/8"	3-7/8"	52.80
SMT-042	1-7/16"	3/4"	1-5/8"	3-7/8"	59.40
SMT-043	1-1/2"	3/4"	1-5/8"	3-7/8"	59.40
SMT-044	1-5/8"	3/4"	1-5/8"	3-7/8"	66.00
SMT-045	1-3/4"	3/4"	1-5/8"	3-7/8"	77.00
SMT-046	1-7/8"	3/4"	1-5/8"	3-7/8"	82.50
SMT-047	2"	3/4"	1-5/8"	3-7/8"	88.00
SMT-048	7/8"	7/8"	1-1/2"	3-3/4"	\$16.50
SMT-049	15/16"	7/8"	1-1/2"	3-3/4"	29.15
SMT-050	1"	7/8"	1-1/2"	3-3/4"	19.80
SMT-052	1-1/8"	7/8"	1-5/8"	3-7/8"	44.00
SMT-054	1"	1"	1-5/8"	4-1/8"	\$15.40
SMT-055	1-1/8"	1"	1-5/8"	4-1/8"	44.00
SMT-056	1-1/4"	1"	1-5/8"	4-1/8"	49.50
SMT-057	1-3/8"	1"	1-5/8"	4-1/8"	52.80
SMT-058	1-1/2"	1"	1-5/8"	4-1/8"	60.50
SMT-059	1-1/4"	1-1/4"	1-5/8"	4-1/8"	\$50.00
SMT-060	1-1/2"	1-1/4"	1-5/8"	4-1/8"	61.00
SMT-061	1-5/8"	1-1/4"	1-5/8"	4-1/8"	66.00
SMT-062	1-3/4"	1-1/4"	1-5/8"	4-1/8"	77.00
SMT-063	1-7/8"	1-1/4"	1-5/8"	4-1/8"	82.50
SMT-064	2"	1-1/4"	1-5/8"	4-1/8"	90.20
SMT-065	2"	1-1/4"	2-1/2"	5"	90.20
SMT-067	2-1/2"	2"	4"	7-5/8"	\$192.50

2-FLUTE DOUBLE END MILLS

High Speed - Right Hand Cut

Series "DMT"



Model No.	Mill Dia.	Shank Dia.	Length of Cut	O/A Length	Sale Price
DMT-069	1/8"	3/8"	3/8"	3-1/16"	\$ 4.35
DMT-070	5/32"	3/8"	7/16"	3-1/8"	4.35
DMT-071	3/16"	3/8"	7/16"	3-1/8"	4.35
DMT-073	7/32"	3/8"	1/2"	3-1/8"	4.35
DMT-075	1/4"	3/8"	1/2"	3-1/8"	\$ 4.35
DMT-076	9/32"	3/8"	9/16"	3-1/8"	4.35
DMT-077	5/16"	3/8"	9/16"	3-1/8"	4.35
DMT-078	11/32"	3/8"	9/16"	3-1/8"	4.35
DMT-079	3/8"	3/8"	9/16"	3-1/16"	4.35
DMT-080	13/32"	1/2"	13/16"	3-13/16"	\$ 6.55
DMT-081	7/16"	1/2"	13/16"	3-3/4"	6.55
DMT-082	15/32"	1/2"	13/16"	3-3/4"	6.55
DMT-083	1/2"	1/2"	13/16"	3-3/4"	6.55
DMT-084	9/16"	5/8"	1-1/8"	4-1/2"	\$ 9.35
DMT-085	5/8"	5/8"	1-1/8"	4-1/2"	9.35
DMT-086	11/16"	3/4"	1-5/16"	5"	11.55
DMT-087	3/4"	3/4"	1-5/16"	5"	13.15
DMT-088	13/16"	7/8"	1-9/16"	5-1/2"	\$30.80
DMT-089	7/8"	7/8"	1-9/16"	5-7/8"	20.90
DMT-091	1"	1"	1-5/8"	5-7/8"	27.50

2-FLUTE LONG END MILLS

High Speed - Right Hand Cut

Series "TLM"



Model No.	Mill Dia.	Shank Dia.	Length Below Shank	Length of Cut	Overall Length	Sale Price
TLM-121	1/4"	3/8"	1-1/2"	5/8"	3-1/16"	\$ 9.10
TLM-122	5/16"	3/8"	1-3/4"	3/4"	3-5/16"	9.85
TLM-123	3/8"	3/8"	1-3/4"	3/4"	3-5/16"	\$ 9.85
TLM-124	1/2"	1/2"	2-1/4"	1"	4"	15.10
TLM-125	5/8"	5/8"	2-3/4"	1-3/8"	4-5/8"	20.90
TLM-126	3/4"	3/4"	3-3/8"	1-5/8"	5-3/8"	27.50
TLM-127	7/8"	7/8"	4"	2"	6"	\$35.75
TLM-128	1"	1"	5"	2-1/2"	7-1/4"	48.40
TLM-129	1-1/4"	1-1/4"	5"	3"	7-1/4"	66.00

CORNER ROUNDING END MILLS - 4-FLUTE



Series "CRM"

Right Hand - Weldon Shank
High Speed Steel

Model No.	Radius Inches	Shank Dia.	Cutter Dia.	Overall Length	Price Each
CRM-130	1/16"	3/8"	7/16"	2-1/2"	\$ 6.35
CRM-131	3/32"	3/8"	1/2"	2-1/2"	6.35
CRM-132	1/8"	1/2"	5/8"	3"	7.50
CRM-133	5/32"	1/2"	3/4"	3"	8.25
CRM-134	3/16"	1/2, 3/4	7/8"	3"	13.25
CRM-135	1/4"	1/2, 3/4	1"	3-1/4"	17.20
CRM-136	9/32"	5/8"	1"	3"	17.80
CRM-137	5/16"	1/2, 3/4	1-1/8"	3-1/2"	17.80
CRM-138	3/8"	1/2, 3/4	1-1/4"	3-1/2"	25.30
CRM-139	3/8"	7/8"	1-1/4"	3-3/4"	25.30
CRM-140	7/16"	3/4, 1"	1-3/8"	4"	27.60
CRM-141	1/2"	3/4, 1"	1-1/2"	3-7/8"	40.25
CRM-142	5/8"	3/4, 1"	1-5/8"	4"	43.70
CRM-143	3/4"	3/4, 1"	1-7/8"	4"	48.30

*Specify Shank Diameter

DOVETAIL CUTTERS

High Speed Steel - Weldon Shank



Series "DTC"

Model No.	Cutter Dia.	Cutter Width	Shank Dia.	O/A Length	Angle	Price Each
DTC-144	3/8"	1/8"	3/8"	2-1/8"		\$15.80
DTC-145	1/2"	5/32"	3/8"	2-1/8"		12.10
DTC-146	3/4"	1/4"	3/8"	2-1/8"		15.80
DTC-147	1-3/8"	7/16"	5/8"	2-7/8"	45°	39.10
DTC-148	1-7/8"	9/16"	7/8"	3-1/4"		66.70
DTC-149	2-1/4"	5/8"	1"	3-3/4"		80.50
DTC-150	3/8"	1/8"	3/8"	2-1/8"		\$15.80
DTC-151	1/2"	1/4"	3/8"	2-1/8"		12.10
DTC-152	3/4"	5/16"	3/8"	2-1/8"		15.80
DTC-153	1-3/8"	9/16"	5/8"	2-7/8"	60°	39.10
DTC-154	1-7/8"	13/16"	7/8"	3-1/4"		66.70
DTC-155	2-1/4"	1-1/16"	1"	3-3/4"		80.50

2-FLUTE BALL END MILLS

Single End - High Speed - Right Hand Cut

Series "BEM"



Model No.	Mill Dia.	Shank Dia.	Length of Cut	Overall Length	Sale Price
BEM-092	1/8"	3/8"	3/8"	2-5/16"	\$ 6.55
BEM-093	3/16"	3/8"	1/2"	2-3/8"	6.55
BEM-094	1/4"	3/8"	5/8"	2-7/16"	6.55
BEM-095	5/16"	3/8"	3/4"	2-1/2"	6.90
BEM-096	3/8"	3/8"	3/4"	2-1/2"	7.70
BEM-097	7/16"	1/2"	1"	3"	\$ 9.35
BEM-098	1/2"	1/2"	1"	3"	9.35
BEM-099	9/16"	1/2"	1"	3"	13.75
BEM-100	5/8"	1/2"	1-3/8"	3-3/8"	14.85
BEM-101	5/8"	5/8"	1-3/8"	3-1/2"	14.85
BEM-102	3/4"	1/2"	1-3/8"	3-3/8"	\$18.15
BEM-103	3/4"	3/4"	1-5/8"	3-7/8"	18.15
BEM-104	7/8"	7/8"	2"	4-1/4"	24.20
BEM-105	1"	1"	2-1/4"	4-3/4"	29.70
BEM-106	1-1/8"	1"	2-1/4"	4-3/4"	35.20
BEM-107	1-1/4"	1-1/4"	2-1/2"	5"	\$59.40
BEM-108	1-3/8"	1-1/4"	2-1/2"	5"	66.00
BEM-109	1-1/2"	1-1/4"	2-1/2"	5"	70.40
BEM-110	2"	1-1/4"	2-1/2"	5"	102.80

2-FLUTE BALL END MILLS

Ball End
High Speed - Regular Length

Series "BED"



Model No.	Mill Dia.	Shank Dia.	Length of Cut	Overall Length	Sale Price
BED-111	1/8"	3/8"	3/8"	3-1/16"	\$ 8.75
BED-112	3/16"	3/8"	7/16"	3-1/8"	8.75
BED-113	1/4"	3/8"	1/2"	3-1/8"	8.75
BED-114	5/16"	3/8"	9/16"	3-1/8"	8.75
BED-115	3/8"	3/8"	9/16"	3-1/8"	8.75
BED-116	7/16"	1/2"	13/16"	3-3/4"	\$12.05
BED-117	1/2"	1/2"	13/16"	3-3/4"	12.05
BED-118	5/8"	5/8"	1-1/8"	4-1/2"	16.45
BED-119	3/4"	3/4"	1-5/16"	5"	24.15
BED-120	1"	1"	1-5/8"	5-7/8"	31.85

T-SLOT CUTTERS

High Speed Steel



Series "TSC"

Model No.	Bolt Size	Cutter Dia.	Cutter Thick	Shank Dia.	Overall Length	Price Each
TSC-156	1/4"	9/16"	15/64"	1/2"	2-19/32"	\$ 16.70
TSC-157	5/16"	21/32"	17/64"	1/2"	2-11/16"	19.00
TSC-158	3/8"	25/32"	21/64"	3/4"	3-1/4"	25.90
TSC-159	1/2"	31/32"	25/64"	3/4"	3-7/16"	29.30
TSC-160	5/8"	1-1/4"	31/64"	1"	3-15/16"	40.25
TSC-161	3/4"	1-15/32"	5/8"	1"	4-7/16"	46.60
TSC-162	1"	1-27/32"	53/64"	1-1/4"	4-13/16"	97.75
TSC-163	1-1/4"	2-7/32"	3/32"	1-1/4"	5-3/8"	143.75
TSC-164	1-1/2"	2-21/32"	1-11/32"	1-1/4"	5-29/32"	151.80

For More Savings
Visit Our Web Site
www.penntoolco.com

Precise CARBIDE TIPPED TOOL BITS



Style AR
Right Hand



Style AL
Left Hand



Style BR
Right Hand
15° Angle



Style BL
Left Hand
15° Angle

Grade C2
For
General
Purpose

Grade C6
For
Steel

Tool #	Shank Size	AR STYLE		AL STYLE		BR STYLE		BL STYLE		Sale Price
		C2 Order No.	C6 Order No.	C2 Order No.	C6 Order No.	C2 Order No.	C6 Order No.	C2 Order No.	C6 Order No.	
#4	1/4"	AR4-C2	AR4-C6	AL4-C2	AL4-C6	BR4-C2	BR4-C6	BL4-C2	BL4-C6	\$1.75
#5	5/16"	AR5-C2	AR5-C6	AL5-C2	AL5-C6	BR5-C2	BR5-C6	BL5-C2	BL5-C6	1.75
#6	3/8"	AR6-C2	AR6-C6	AL6-C2	AL6-C6	BR6-C2	BR6-C6	BL6-C2	BL6-C2	1.75
#8	1/2"	AR8-C2	AR8-C6	AL8-C2	AL8-C6	BR8-C2	BR8-C6	BL8-C2	BL8-C6	2.00
#10	5/8"	AR10-C2	AR10-C6	AL10-C2	AL10-C6	BR10-C2	BR10-C6	BL10-C2	BL10-C6	2.75
#12	3/4"	AR12-C2	AR12-C6	AL12-C2	AL12-C6	BR12-C2	BR12-C6	BL12-C2	BL12-C6	3.85

Grade C2
For
General
Purpose

Grade C6
For
Steel



Style C - Square Nose

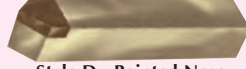

Style D - Pointed Nose
80° Included Angle

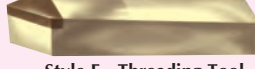

Style E - Threading Tool
60° Included Angle

Tool #	Shank Size	C STYLE		D STYLE		E STYLE		Sale Price
		C2 Order No.	C6 Order No.	C2 Order No.	C6 Order No.	C2 Order No.	C6 Order No.	
#4	1/4"	C4-C2	C4-C6	D4-C2	D4-C6	E4-C2	E4-C6	\$1.75
#5	5/16"	C5-C2	C5-C6	D5-C2	D5-C6	E5-C2	E5-C6	1.75
#6	3/8"	C6-C2	C6-C6	D6-C2	D6-C6	E6-C2	E6-C6	1.75
#8	1/2"	C8-C2	C8-C6	D8-C2	D8-C6	E8-C2	E8-C6	2.00
#10	5/8"	C10-C2	C10-C6	D10-C2	D10-C6	E10-C2	E10-C6	2.75
#12	3/4"	C12-C2	C12-C6	D12-C2	D12-C6	E12-C2	E12-C6	3.85

38 PCS Set Contains:

- 8pcs Style AR
- 8pcs Style AL
- 4pcs Style BR
- 4pcs Style BL
- 4pcs Style C
- 4pcs Style D
- 6pcs Style E

Order No.	Shank Size	Price
404-040	1/4"	\$34.95
404-041	5/16"	36.95
404-042	3/8"	39.95
404-043	1/2"	55.00

Precise 5-Pc. INDEXABLE TURNING TOOL HOLDER SETS

Includes:

- 2 each Style A, 1 left, 1 right for turning, facing, boring and chamfering.
- 2 each Style B, 1 left, 1 right for turning, facing and boring or wherever a lead angle can be used.
- 1 each Style E, for turning, facing, boring, chamfering, threading and "V" grooving.



3/8" Shank
SET No.
404-040-1
Reg. \$49.95

\$39.95

5 Styles
With Inserts

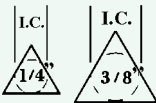

Set No.	Shank Size	Sale Price	Carbide Inserts	Grade	Price Each
404-039	1/4"	\$39.95	1/4" I.C.	C-6	\$4.25
404-040-1	3/8"	41.50	3/8" I.C.	404-046-1	4.25
404-041-1	1/2"	47.50	3/8" I.C.	Tin	\$5.50
404-042-1	5/8"	51.50	Coated		
404-043-1	3/4"	55.50		404-049-1	
404-044-1	1"	83.50			

Precise TAP AND DIE SETS

Includes:

1 each National coarse and National fine plug tap and die.

Tap wrenches, die holder, screw pitch gage, Chart, screwdriver and fitted case, plus 1/8-27 tap and die.

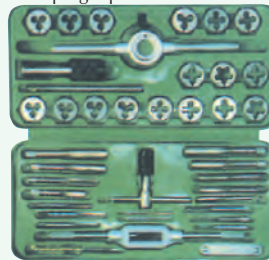

40 Piece Sets



45 Piece Sets

Model	Description - Range	Sale
404-707	40 Pcs. carbon steel #4 thru 1/2"	\$39.95
404-706	40 Pcs. H.S.S. steel #4 thru 1/2"	95.00
404-702	40 Pcs. carbon steel 3mm thru 12mm	\$39.95
404-705	40 Pcs. H.S.S. steel 3mm thru 12mm	95.00
404-700	45 Pcs. tungsten alloy steel 1/4" thru 1" 1-1/2" & 2" die diameter	\$99.95
404-701	6mm thru 24mm 1-1/2" & 2" die diameter	\$99.95

SABER MILL ULTRA-DEX TOOLING SYSTEM



11mm Insert Pocket (Use TiAlN #APKT-11T308 Inserts)					
Model No.	Shank "A" Size	Length Overall	"C" Dimension	No. of Inserts	Price Each
500-500	.500"	3.375"	.500"	1	\$ 89.00
622-625	.625"	3.375"	.625"	2	89.00
752-750*	.750"	3.375"	.750"	2	99.00
753-750*	.750"	3.375"	.750"	3	109.00
103-750	1.000"	4.000"	.750"	3	109.00
103-100	1.000"	4.000"	1.000"	3	119.00
104-100	1.000"	4.000"	1.000"	4	119.00
123-125-1	1.250"	4.000"	.750"	3	119.00
123-126-1	1.250"	4.000"	1.000"	3	119.00
16mm Insert Pocket (Use TiAlN #APKT-16T308 Inserts)					
100-102-1*	1.000"	4.000"	1.000"	2	\$109.00
125-102	1.250"	4.000"	1.000"	2	119.00
125-103	1.250"	4.000"	1.000"	3	119.00
150-153	1.250"	4.000"	1.000"	3	129.00

*Saber Mill Included In Kit Package

Model No.	Kits Contain Saber Mill, 10 TiAlN Inserts, 1 Torx Wrench, 3 Insert Screws	Price
SMK-752	#752-750 Saber Mill	\$109.00
SMK-753	#753-750 Saber Mill	119.00
SMK-100	#100-102 Saber Mill	149.00

Precise M2 HIGH SPEED & M42 COBALT TOOL BITS



Standard Square Tool Bits
High Speed & Cobalt

Size Square	M2 Ground	Price Each	M42 Cobalt	Price Each
1/8" x 2-1/2"	404-170	\$1.45	404-129	\$1.75
3/16" x 2-1/2"	404-171	1.45	404-130	1.75
1/4" x 2-1/2"	187-025	1.45	287-025	2.25
1/4" x 4"	200-071	2.45	200-020	3.50
1/4" x 6"	200-072	3.45	404-162	4.00
1/4" x 8"	200-073	4.95	200-022	8.00
5/16" x 2-1/2"	187-032	1.95	287-032	3.00
5/16" x 6"	404-141	3.75	404-147	5.50
3/8" x 3"	187-038	2.80	287-038	3.90
3/8" x 4"	404-142	3.65	200-027	5.50
3/8" x 6"	404-143	4.80	404-154	8.25
3/8" x 8"	200-079	7.50	404-155	11.00
7/16" x 3-1/2"	187-043	3.50	287-043	6.50
1/2" x 4"	187-050	4.50	287-050	8.50
1/2" x 6"	404-145	9.00	404-156	13.50
5/8" x 4-1/2"	404-177	8.50	404-136	13.95
3/4" x 5"	187-075	14.50	404-137	18.00
7/8" x 6"	404-179	15.50	404-138	29.95
1" x 7"	404-150	32.00	404-139	37.50

Packaging : Sizes 1/8" thru 1/2" 5 Pieces
5/8" thru 1" 1 Piece

Precise HIGH SPEED STEEL COMBINED DRILLS AND COUNTERSINKS



5 Pc. Set
#1 Thru #5
SET No.
MDC-290
\$6.95



60° Plain Type High Speed Steel

Model No.	Size	Diameter Body	Drill Drill	Drill Length	Overall Length	Price Each
900-179	000	1/8"	.020"	3/64"	1-1/4"	\$ 3.95
900-180	00	1/8"	.025"	1/16"	1-1/4"	2.95
900-181	0	1/8"	1/16"	3/64"	1-1/4"	1.95
900-182	1	1/8"	3/64"	3/64"	1-1/4"	1.20
900-183	2	3/16"	5/64"	5/64"	1-7/8"	1.20
900-184	3	1/4"	7/64"	7/64"	2"	1.20
900-185	4	5/16"	1/8"	1/8"	2-1/8"	1.20
900-186	5	7/16"	3/16"	3/16"	2-3/4"	2.25
900-187	6	1/2"	7/32"	7/32"	3"	3.95
900-188	7	5/8"	1/4"	1/4"	3-1/4"	4.50
900-189	8	3/4"	5/16"	5/16"	3-1/2"	7.50



60° Plain Type Long Length HSS

900-190	1	1/8"	3/64"	3/64"	3"	\$ 3.95
900-191	1	1/8"	3/64"	3/64"	4"	4.50
900-192	1	1/8"	3/64"	3/64"	5"	6.50
900-193	1	1/8"	3/64"	3/64"	6"	8.50
900-194	2	3/16"	5/64"	5/64"	4"	4.50
900-195	2	3/16"	5/64"	5/64"	5"	5.50
900-196	2	3/16"	5/64"	5/64"	6"	8.75
900-197	3	1/4"	7/64"	7/64"	4"	4.95
900-198	3	1/4"	7/64"	7/64"	5"	6.50
900-199	3	1/4"	7/64"	7/64"	6"	8.75
900-200	4	5/16"	1/8"	1/8"	4"	6.25
900-201	4	5/16"	1/8"	1/8"	5"	7.95
900-202	4	5/16"	1/8"	1/8"	6"	8.95
900-203	4-1/2	3/8"	9/64"	9/64"	4"	6.50
900-204	4-1/2	3/8"	9/64"	9/64"	5"	7.50
900-205	4-1/2	3/8"	9/64"	9/64"	6"	9.25
900-206	5	7/16"	3/16"	3/16"	4"	8.50
900-207	5	7/16"	3/16"	3/16"	5"	9.25
900-208	5	7/16"	3/16"	3/16"	6"	9.25
900-209	6	1/2"	7/32"	7/32"	5"	9.50
900-210	6	1/2"	7/32"	7/32"	6"	11.50
900-211	7	5/8"	1/4"	1/4"	6"	10.50
900-212	8	3/4"	5/16"	5/16"	6"	23.50

Precise SOLID CARBIDE COMBINED DRILLS AND COUNTERSINKS



60° Plain Type Solid Carbide

Model No.	Size	Diameter Body	Drill Drill	Drill Length	Overall Length	Price Each
EDG26516	1	1/8"	1/32"	1/16"	1/4"	\$ 9.50
EDG26517	2	3/16"	5/64"	5/64"	1-7/8"	14.50
EDG26518	3	1/4"	7/64"	7/64"	2"	15.90
EDG26519	4	5/16"	1/8"	1/8"	2-1/8"	21.50
EDG26520	5	7/16"	3/16"	3/16"	2-3/4"	32.90
EDG26521	6	1/2"	7/32"	7/32"	3"	44.00

60° Plain Type Long/Length Solid Carbide

900-179-1	3	1/4"	7/64"	7/64"	4"	\$28.50
900-180-1	4	5/16"	1/8"	1/8"	4"	39.50
900-181-1	5	7/16"	3/16"	3/16"	5"	49.50
900-182-1	6	1/2"	7/32"	7/32"	6"	74.50
900-183-1	7	5/8"	1/4"	1/4"	6"	125.00
900-184-1	8	3/4"	5/16"	5/16"	6"	135.00



HOLE CUTTERS HSS

- Eliminate Multi-step drilling
- Lower cost per hole.
- Better finishing.
- Longer tool life.
- More accurate and cleaner holes.

Diameter Inch	Model	Price Each	Model	Price Each
7/16"	530-110	\$26.70	532-210	\$37.25
1/2"	530-111	28.15	532-211	38.70
9/16"	530-113	28.15	532-213	38.70
5/8"	530-116	28.15	532-216	38.70
11/16"	530-119	28.15	532-219	38.70
3/4"	530-121	30.00	532-221	41.80
13/16"	530-124	33.00	532-224	44.50
7/8"	530-127	33.00	532-227	50.00
15/16"	530-130	35.50	532-230	53.00
1"	530-133	37.75	532-233	56.50
1-1/16"	530-136	40.00	532-236	59.60
1-1/8"	530-139	43.50	532-239	60.00
1-3/16"	530-142	45.45	532-242	62.15
1-1/4"	530-145	46.25	532-245	65.45
1-5/16"	530-148	50.90	532-248	70.00
1-3/8"	530-151	56.25	532-251	75.00
1-7/16"	530-154	61.80	532-254	81.80
1-1/2"	530-157	67.25	532-257	85.45
1-9/16"	530-160	70.90	532-260	91.45
1-5/8"	530-163	72.70	532-263	96.25
1-3/4"	530-169	83.60	532-269	109.00
1-7/8"	530-175	94.50	532-275	120.00
1-15/16"	530-178	98.15	532-278	127.00
2"	530-181	105.00	532-281	130.00



Set No.	Depth	Price
530-501	1"	\$175.00
530-502	2"	265.00

Ejector - Pilot Short #530-905 \$5.00
Ejector - Pilot Long #530-915 \$5.95

Precise TAP & DRILL SETS H.S.S. IN HUOT METAL INDEX CASE

- Conveniently combines taps with the corresponding tap drill along side of one another.



METRIC 18 PIECE SET SET No. TDS-300

\$49.95

Contains 1 Each: Tap Size (Plug)

M2.5 x 0.45, M3.0 x 0.50
M3.5 x 0.06, M4.0 x 0.70
M5.0 x 0.80, M6.0 x 1.0
M8.0 x 1.25, M10.0 x 1.50
M12 x 1.75

Tap Drill Metric

2.05, 2.50, 2.90, 3.30 4.20
5.00, 6.70, 8.50, 10.2mm

NATIONAL FINE 18 PIECE SET SET No. TDS-200

\$39.95

Contains 1 Each: Tap Size (Plug)

6-40, 8-36, 10-24, 10-32 1/4-28
15/16, 3/8-24, 7/16-20, 1/2-20
Tap Drill #36, #29, #25, #21, #3
#1, Q, 25/64, 29/64

NATIONAL COARSE 18 PIECE SET SET No. TDS-100

\$39.95

Contains 1 Each: Tap Size (Plug)
6-32, 8-32, 10-24, 10-32, 1/4-20,
5/16-18, 3/8-16, 7/16-14, 1/2-13
Tap Drill #36, #29, #25, #21, #7,
F, 5/16, U, 27/64

Precise CHIPPING HAMMER

- Comes with shock proof steel spring handle.
- Hardened and tempered head.



MODEL No.
PCH-218
\$2.95

Precise SISSOR CLAMPS

2 Pc. ALL PURPOSE

- Made of stainless steel.
- Serrated jaws provide a vise like grip when clamp is locked
- 7" curved, and 7" straight.



SET. No.
SCS-001
\$5.95

ROTABROACH™ HOLE CUTTER SETS SPRING LOADED PILOT



11,000 Series 5/16"

- 3X faster than twist drills or hole saws in sheet metal, plate and plastics up to 1/2" thick.
- Heat treated and precision ground tools can be used in hand held drills with chucks having 3/8" capacity or greater.
- Proven to cut round holes faster, virtually burr-free and with longer tool life than conventional tooling.

14,000 series 7/8" thru 2-1/2"

- Holecutters cut rather than tearing and deforming the stock as do typical hole saws, and have a spring loaded arbor system for quick slug ejection.



Set No.	Description	Price
11075	7 Cutters, 5/16" thru 3/4"	\$87.50
11077	7 Cutters, 8mm thru 20mm	87.50
SERIES 14,000		
14005	6 Cutters, 7/8" thru 2-1/2"	\$187.50



CARBIDE BEAR BURRS 1/4" SHANK



MADE IN USA

Features:

- ISO Certified.
- Bear Burrs from Grobet USA are a deeper, more aggressive cut than Double Cut Burrs, designed to handle your most challenging applications. With a deep aggressive tooth pattern, BEAR Burrs allow for improved chip control and rapid stock removal in harder materials with minimal chatter.
- Enhanced geometry and deep flute configuration for increased tooth strength.
- Longer tool life vs. conventional burrs.
- Maximum stock removal.
- Improved productivity and cost savings.



Set of 8 Pieces
MODEL No. 32-931SY
List \$141.00
\$109.95

Consists of:
SA-5, SC-5, SE-5,
SF-3, SF-5, SG-5
SL-3 & SL-4

Set of 5 Pieces
MODEL No. 32-951SY
List \$95.00
\$79.95

Consists of:
SA-5, SC-5, SE-5
SF-5 & SL-4

Cylinder Plain



Model No.	Head Diameter	Head Length	Overall Length	Shank	SCTI	Reg. Price	Sale Price
32-5465SY	1/4"	5/8"	2"	1/4"	SA1	\$ 8.25	\$ 6.50
32-552SY	3/8"	3/4"	2-1/2"	1/4"	SA3	12.25	9.95
32-55320SY	7/16"	1"	2-3/4"	1/4"	SA4	20.05	16.95
32-555SY	1/2"	1"	2-3/4"	1/4"	SA5	18.05	15.95
32-558SY	5/8"	1"	2-3/4"	1/4"	SA6	23.20	19.95

Oval



Model No.	Head Diameter	Head Length	Overall Length	Shank	SCTI	Reg. Price	Sale Price
32-663SY	3/8"	19/32"	2-11/32"	1/4"	SE3	\$12.20	\$10.50
32-666SY	1/2"	7/8"	2-5/8"	1/4"	SE5	17.60	14.95
32-669SY	5/8"	1"	2-3/4"	1/4"	SE6	25.60	21.50

Cylinder Radius



Model No.	Head Diameter	Head Length	Overall Length	Shank	SCTI	Reg. Price	Sale Price
32-618SY	3/8"	3/4"	2-1/2"	1/4"	SC3	\$13.40	\$11.50
32-61912SY	7/16"	1"	2-3/4"	1/4"	SC4	17.10	14.85
32-621SY	1/2"	1"	2-3/4"	1/4"	SC5	19.25	16.95
32-624SY	5/8"	1"	2-3/4"	1/4"	SC6	24.90	21.85

Tree Radius



Model No.	Head Diameter	Head Length	Overall Length	Shank	SCTI	Reg. Price	Sale Price
32-705SY	3/8"	3/4"	2-1/2"	1/4"	SF3	\$12.05	\$10.50
32-70602SY	7/16"	1"	2-3/4"	1/4"	SF4	16.30	14.50
32-70610SY	1/2"	3/4"	2-1/2"	1/4"	SF13	17.70	15.50
32-708SY	1/2"	1"	2-3/4"	1/4"	SF5	17.65	14.95
32-711SY	5/8"	1"	2-3/4"	1/4"	SF6	24.40	21.50

Cone Pointed



Model No.	Head Diameter	Head Length	Overall Length	Shank	SCTI	Reg. Price	Sale Price
32-7475SY 28°	3/8"	3/4"	2-1/2"	1/4"	SM4	\$15.75	\$13.75
32-750SY 28°	1/2"	1"	2-3/4"	1/4"	SM5	19.75	17.25
32-735SY 31°	5/8"	1-1/8"	2-7/8"	1/4"	SM6	25.60	21.50

Tree Pointed



Model No.	Head Diameter	Head Length	Overall Length	Shank	SCTI	Reg. Price	Sale Price
32-687SY	3/8"	3/4"	2-1/2"	1/4"	SG3	\$12.75	\$10.50
32-690SY	1/2"	3/4"	2-1/2"	1/4"	SG13	17.35	14.95
32-693SY	1/2"	1"	2-3/4"	1/4"	SG5	17.30	15.50
32-696SY	5/8"	1"	2-3/4"	1/4"	SG6	24.10	21.50

Cone Radius

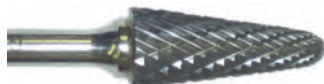

Model No.	Head Diameter	Head Length	Overall Length	Shank	SCTI	Reg. Price	Sale Price
32-726SY	3/8"	1-1/16"	2-13/16"	1/4"	SL3	\$14.50	\$12.50
32-729SY	1/2"	1-1/8"	2-7/8"	1/4"	SL4	18.65	15.95
32-73002SY	5/8"	1-3/16"	2-15/16"	1/4"	SL5	32.20	26.95
32-732SY	5/8"	1-5/16"	3-1/16"	1/4"	SL6	34.25	27.95

Ball



Model No.	Head Diameter	Head Length	Overall Length	Shank	SCTI	Reg. Price	Sale Price
32-645SY	3/8"	5/16"	2-1/16"	1/4"	SD3	\$11.00	\$ 9.50
32-64602SY	7/16"	3/8"	2-1/8"	1/4"	SD4	12.35	10.50
32-648SY	1/2"	7/16"	2-3/16"	1/4"	SD5	14.00	12.50
32-651SY	5/8"	9/16"	2-5/16"	1/4"	SD6	16.75	14.85

Precise CARBIDE BURR SETS 1/4" SHANK & 1/8" SHANK



Set No.	No. of Sizes	Shank Size	Cut Type	Included In Set	Price Set
505-1224	8	1/4"	Double	SA-1,SA-3,SC-1,SC-3,SE-1,SF-1,SF-3,SL-3	\$64.95
505-2018	9	1/4"	Double	SA-1,SA-3,SA-5,SC-1,SC-3,SC-5,SF-1,SF-3,SF-5	69.95
505-2015	12	1/4"	Double	SA-1,SA-14,SC-14,SC-1,SD-14,SD-1,SE-1,SF-1,SG-1,SM-2,SM-1,SN-1	62.00
505-1225	12	1/4"	Double	SA-1,SC-1,SD-1,SE-1,SF-1,SG-1,SH-1,SJ-1,SK-1,SL-1,SM-1,SN-1	73.50
505-2016	12	1/4"	Double	SA-42,SA-43,SC-41,SC-42,SD-42,SE-41,SF-42,SG-43,SH-41,SL-42,SM-43,SN-42	34.50
505-2017	7	1/8"	Double	1/4"x5/8" Cylindrical, 3/8"x3/4" Cylindrical, 1/4"x5/8" Cylindrical Ball, 3/8"x3/4" Cylindrical Ball, 1/4"x3/8" Oval, 1/4"x5/8" Round Tree and 3/8"x1-1/16" 14° Included Angle Radius End	62.00
505-1226	8	1/4"	Single	SA-1,SA-5,SC-5,SD-1,SD-5,SF-1,SF-5,SG-1	\$64.95
505-1228	12	1/4"	Single	SA-1,SA-14,SC-1,SC-14,SD-1,SD-14,SE-1,SF-1,SG-1,SM-1,SM-2,SN-2	64.95

Precise ABRASIVE HAND STONES

- Aluminum oxide stones are used for finishing of hardened steel.
- Silicon carbide stones are used for finishing of soft steel, cast iron, non ferrous metals as well as for edging of cemented carbides.
- Medium grit for Machinist's and Toolmakers.

Half-Round



Square



Size L x W	Alum. Oxide	Price A.O.	Silicon Carbide	Price S.C.
4 x 1/4	AL-156-1	\$3.95	SC-199-1	\$3.95
4 x 3/8	AL-157-1	4.75	SC-200-1	4.75
4 x 1/2	AL-158-1	4.95	SC-201-1	4.95
6 x 3/8	AL-159-1	\$5.95	SC-202-1	\$5.95
6 x 1/2	AL-160-1	6.50	SC-203-1	6.50
6 x 3/4	AL-161-1	6.95	SC-204-1	6.95
6 x 1	AL-162-1	8.95	SC-205-1	8.95

Size L x W	Alum. Oxide	Price A.O.	Silicon Carbide	Price S.C.
4 x 1/4	AL-110-1	\$2.50	SC-154-1	\$2.50
4 x 3/8	AL-111-1	2.75	SC-155-1	2.75
4 x 3/8	AL-112-1	2.95	SC-156-1	2.95
4 x 5/8	*AL-113-1	3.50		
6 x 3/8	AL-114-1	\$4.25	SC-158-1	\$4.25
6 x 1/2	AL-116-1	4.50	SC-159-1	4.50
6 x 5/8	AL-117-1	4.75	SC-160-1	4.75
6 x 3/4	AL-118-1	4.95	SC-161-1	4.95
6 x 1	AL-119-1	5.25	SC-162-1	5.25
8 x 3/4	*AL-120-1	\$650	*SC-163-1	\$650
8 x 1			*SC-164-1	6.95

*Limited Supply

Knife Blades



Size	Alum Oxide	Price	Grit
4 x 1 x 1/8 (back)	AL-163-1	\$4.95	Fine
4 x 1 x 1/8 (back)	AL-164-1	4.95	Medium
4 x 1 x 1/8 (back)	AL-164-2	4.95	Coarse

Slip Stones (Round Edge)



Triangle



Size	Alum Oxide	Price	Grit
4-1/2x1-3/4x38-1/8	AL-206-1	\$4.95	Fine
4-1/2x1-3/4x38-1/8	AL-207-1	4.95	Medium
4-1/2x1-3/4x38-1/8	AL-208-1	4.95	Coarse
	AL-209-1	\$12.95	All Three

Diamond Files



Size	Alum Oxide	Price	Grit
4 x 9/16 x 3/16	AL-173-1	\$6.95	Fine
4 x 9/16 x 3/16	AL-174-1	6.95	Medium
4 x 9/16 x 3/16	AL-175-1	6.95	Coarse

Combination Fine/Coarse Grit Bench Stones



Size Inch	Alum. Oxide	Price A.O.	Silicon Carbide	Price S.C.
4 x 1-1/2			*SC-210-1	\$11.95
4 x 1	AL-165	\$13.95	SC-210-2	17.95
4x1-3/4x5/8	AL-166-1	8.90	SC-211-1	10.95
5 x 2 x 3/4	AL-167-1	11.60	SC-212-1	14.95
6 x 2 x 1	AL-168-1	13.60	SC-213-1	17.85
8 x 2 x 1	AL-169-1	16.00	SC-214-1	21.10

*With finger grip

Point Files



Size	Alum Oxide	Price	Grit
3 x 5/16 (base)	AL-170-1	\$6.95	Fine
3 x 5/16 (base)	AL-171-1	6.95	Medium
3 x 5/16 (base)	AL-172-1	6.95	Coarse

VITRIFIED DRESSING STICKS

Aluminum Oxide (White) Square
For dressing CBN wheels; these sticks also work well for diamond wheels.



Silicon Oxide (Black) Square
Coarse grit and hard-grade are used for dressing conventional vitrified wheels.



Size L x W	Alum. Oxide	Price A.O.	Silicon Carbide	Price S.C.
6 x 1 x 1	AL-611	\$4.95	SC-611	\$4.95
8 x 1 x 1	AL-811	6.95	SC-811	5.95

Round



Size L x W	Alum. Oxide	Price A.O.	Silicon Carbide	Price S.C.
4 x 1/4	AL-146-2	\$3.95	SC-189-2	\$3.95
4 x 3/8	AL-146-1	4.25	SC-189-1	4.25
4 x 1/2	AL-147-1	4.50	SC-190-1	4.50
4 x 5/8	*AL-148-1	4.75	*SC-191-1	4.75
4 x 3/4	*AL-149-1	4.95	*SC-192-1	4.95
6 x 1/2	AL-150-1	\$4.95	SC-193-1	\$4.95
6 x 3/8	AL-151-1	5.25	SC-194-1	5.25
6 x 3/4	AL-152-1	5.50	SC-195-1	5.50
8 x 1	AL-153-1	5.95	SC-196-1	5.95
8 x 3/4	*AL-154-1	\$5.95	*SC-197-1	\$5.95
8 x 1	*AL-155-1	6.25	*SC-198-1	6.25

*Limited Supply



ARKANSAS SHARPENING STONES

The Finest Stone A Man Can Own

- Genuine natural hard Arkansas oilstone is the rarest and is accepted as the finest abrasive stone in existence.
- Ultra Hard Arkansas bench stones are extremely dense and will enable a user to polish an already sharpened edge to a finish beyond what other stones would yield.

- Hard Arkansas stone is the pure form of Novaculite rock and as such is found only in small deposits in the Washita Mountain area surrounding Hot Springs.

SLIP STONES



ROUND EDGE

Model	Size	Price
RS-43	3" x 2" x 1/4" x 1/16"	\$11.95
RS-44	4" x 2" x 3/8" x 1/8"	19.95

BENCH STONES

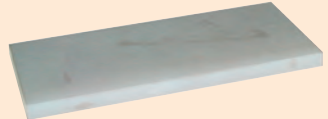

Model	Size	Price
AB-4	4" x 2" x 3/4"	\$19.95
AB-6	6" x 2" x 1"	39.95
AB-8	8" x 2" x 1"	59.95

UNMOUNTED STONES

Model	Size	Price
AB-4	4" x 2" x 3/4"	\$19.95
AB-6	6" x 2" x 1"	39.95
AB-8	8" x 2" x 1"	59.95

JEWELERS BENCH STONES

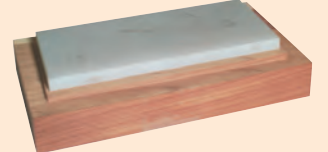

Model	Size	Price
JB-24	4" x 2" x 3/8"	\$19.95
JB-35	6" x 2" x 3/8"	34.95

BLOCK MOUNTED STONES

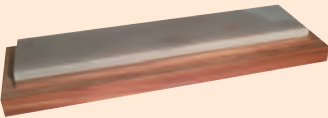

Model	Size	Price
MB-145	4" x 2" x 3/4" x 1"	\$23.95
MB-165	6" x 2" x 3/4" x 1"	43.95
MB-185	8" x 2" x 3/4" x 1"	65.00

NORTON ARKANSAS FILE

- A kit that provides a selection of the four most popular square, triangular, round and knife blade files.
- In ultra fine Hard Arkansas for honing and polishing a wide range of configurations.



SET No. NAF-839 **\$45.50**

NORTON ARKANSAS/INDIA 10 PIECE FILE SET

- Accommodates the complete range of finishing, honing and polishing applications.
- Contains a selection of the most popular file shapes/sizes in both fine grit India and ultra fine grit Hard Arkansas.



SET No. NCS-840 **\$89.50**

SQUARE FILES



Model	Size	Price
SF-321	4" x 1/4"	\$ 8.95
SF-341	4" x 3/8"	9.50
SF-351	4" x 1/2"	11.95

TRIANGLE FILES

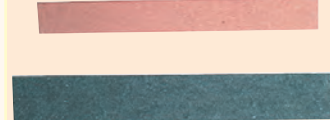

Model	Size	Price
TF-221	4" x 1/4"	\$ 8.95
TF-222	4" x 3/8"	9.50
TF-223	4" x 1/2"	11.95

ROUND FILES



Model	Size	Price
AF-411	4" x 1/4"	\$ 9.95
AF-412	4" x 3/8"	11.95
AF-413	4" x 1/2"	14.95

KNIFE FILES

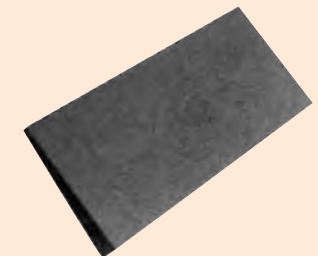

Model	Size	Price
AK-451	4" x 1" x 1/4" Base	\$ 9.95

FLAT FILES



Model	Size	Price
AF-451	3" x 1" x 3/8"	\$ 9.50
CP-513	3-1/2" x 2-1/2" x 3/8"	13.95

POINTED FILES

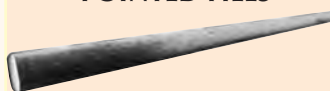

Model	Size	Price
AF-471	4" x 1/4" Base	\$14.95

DIAMOND FILES



Model	Size	Price
DF-744	4" x 1/2" x 3/16"	\$14.95

Precise HAND FILE SET - 5 PIECES

- For general purpose.
- Complete with durable handles.
- Shapes: Flat File, Round File, Square File, Three Square File & Half Round File.

12" Set
Model No.
3000-0055

\$14.95



SWISS PATTERN FILE SET

All files are 8 inches long and come pre-assembled with red plastic handle



- The quality in hardness and regularity.
- The efficient bite to the edges.
- Long life.

Each set includes:
Round Bastard Cut, Half Round Bastard, Mill Taper Second Cut, Flat Taper Bastard, 3 Square Second Cut.

SET No.
32-535
Reg \$56.50

\$44.95



AMERICAN PATTERN FILE SET



- Uniform cut for fast metal removal.
- Extremely durable.
- Unsurpassed in accuracy of shape and cut.
- Best results on steel, cast iron, wood and thermoplastics.

Each set includes:
Round, Half Round, Mill Taper, 3 Square and Flat Taper

Set	Size-Cut	List	Sale
32-520	8" Bastard	\$49.50	\$36.95
32-521	8" Second	52.00	37.95
32-522	10" Bastard	55.00	44.95
32-523	10" Second	59.00	45.95

Precise MINI DEBURRING & SCRAPER KIT

- Easy to reach the most inaccessible areas.
- Finishes workpiece perfectly.

KIT Includes:
Flat Diamond coated file, triangular scraper, swivel blade tool, rotating deburring tool, flat scraper

SET No.
2001-0228

\$29.95

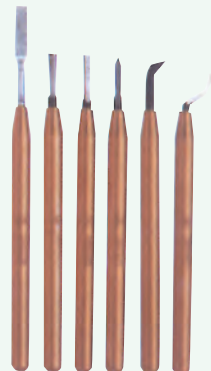

SHAVIV USA by varigus DEBURRING COUNTERSINK KITS

- The ultimate kits for chamfering and deburring work pieces. Use countersinks with 1/4" bit holder handle or any power tool.
- Each kit includes 3 different-sized solid HSS countersinks to chamfer a wide range of holes and materials.
- **FREE deburring Finishing Bit included!**



Tri-Flute Chamfering Kit



Zero Flute Chamfering Kit

Model No.	For Holes up to	Sale Price	Model No.	For Holes up to	Sale Price
90097	13/16", 5/8", 1/2"	\$36.95	90098	9/32"-13/16"	\$39.95

FREE

Finishing Bit w/B-12 Blade

GENERAL ULTRATECH DEBURRING SET

- Spring-loaded Speed-Chuck allows blade changes instantly.
- Nine interchangeable blades handle any deburring job.
- Additional blade and storage in fitted zippered case.
- Precision engineered 750 Series Versa-Grip handle for maximum performance.



Kit Contains 10 Blades:
1 Each blade for, steel, aluminum, copper, plastic
1 Each blade for, brass, cast iron, plastic
1 Each corner edge, triangle, square flat scraper

KIT No.
75409
Reg. \$31.95

\$24.95

With Zippered Case

Precise 4 PIECE DISPOSABLE DEBURRING SET

4 Piece Deburring Cutter Set features four separate color coded cutters. Each color indicates the material that the cutter is intended for.

- Colored sleeves rotate to lock and unlock blades for easy changing.
- Unique rounded head blades for safe deburring of drilled and machined holes and an almost unlimited amount of uses.
- Curved blades swivel freely to automatically follow shapes, contours and holes.



No.	Replacement Blades	Price
B-25	For Plastic	\$.75
B-10	For Steel	.95
B-20	For Brass	.95
B-30	For Aluminum	1.50

4 Piece Set
SET No.
52-483-777
Reg. \$12.95

\$10.50

Note: Blades are sold in Packages of 10 per pack

For Plastic
For Steel
For Brass
For Aluminum



UNIVERSAL DEBURRING, CLEANING & COUNTERSINK SET

- 1 Universal handle
- 2 Adapters.
- 1 Countersink for 20mm/.47" diameter
- 1 Countersink for 30mm/1.18" diameter.
- 2 Deburring blades.
- 4 cleaner blades, for sheet metal, small ridges, relieving corners and for narrow.
- Combined in a compact molded case.



A Complete Kit For Machine Shop Applications!

MODEL No.
52-483-888
Reg. \$59.95

\$29.95

Precise MINI DEBURRING AND SCRAPER KIT

- Easy to reach the most inaccessible areas.
- Finishes workpiece perfectly.

Kit Contains One of Each:

Flat diamond coated file,
triangular scraper,
round scraper,
swivel blade tool,
rotating deburring tool,
flat scraper.



MODEL No.
2001-0228

\$29.95

Precise RIFFLER FILE SETS *Economy Series*

Most popular shapes in a handy soft plastic folding case.



Set No.	Cut 0 or 2	Length O.A.L.	Pieces In Set	Double or Single End	Price Set
RFS-680	#0	6-7/8"	12	Double	\$15.95
RFS-682	#2	6-7/8"	12	Double	15.95
(Economy) Diamond Plated Riffler Files					
DMF-007	#2	7-1/2"	10	Double End	\$16.95
24-073	#2	5-1/2"	10	Single End	12.95

GRIT-BIT[®] SINTERED BORON CARBIDE TOUCH-UP FILES

- Sintered boron carbide grains are suspended in a touch matrix which resists grain pull-out and premature separation.
- Shapes and removes metal rapidly and cleanly.
- Best for touch-up of T/C and HSS tools already set up in machine tools. No need to disturb setup.
- One of the few honing tools you can really bear down on.
- Cemented onto sturdy 7" long handle with a 2X magnifier.
- Glaze is easily cleaned off with an ordinary pencil eraser.



Model	Usage	Grit	Shape	Price
GB-240	Rougher	240	Flat	\$36.95
GB-320	Honer	320	Flat	36.95
GB-400	Lapper	400	Flat	36.95
GB-600	Ultra	600	Flat	40.95
RGB-240	Rougher	240	Round	\$48.95
RGB-320	Honer	320	Round	48.95
RGB-400	Lapper	400	Round	48.95
RGB-600	Ultra	600	Round	52.95
TGB-240	Rougher	240	Triangle	\$48.95
TGB-320	Honer	320	Triangle	48.95
TGB-400	Lapper	400	Triangle	48.95
TGB-600	Ultra	600	Triangle	54.95

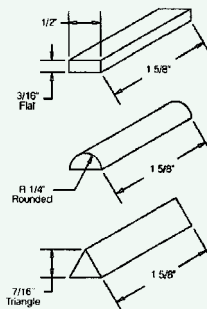

Precise SWISS PATTERN NEEDLE FILE SETS

Economy Series

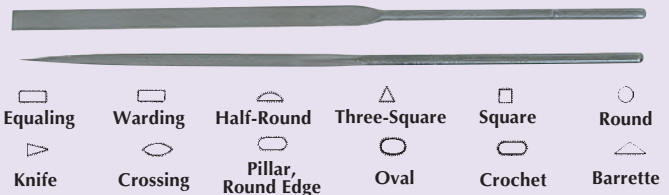

Set No.	Cut 0 or 2	Length O.A.L.	Pieces In Set	Type	Price Set	12 Piece Set
NFS-001	0	5-1/2"	12	Regular	\$5.95	\$5.95
NFS-002	2	5-1/2"	12	Regular	5.95	
Diamond Plated						
24-010	220 Grit	5-1/2"	10	Diamond	\$15.95	

Precise ADJUSTABLE SCRAPER & DEBURRING TOOL

Features:

- Adjustable blade for best suited working length.
- Reversible blade, finish ground at both ends.
- Hardened high speed steel blades, triangular profile, 3" long for long wear.
- Bull-nosed collet face serving as a nonmarring edge guide.
- Balanced, comfortable hand grip, 4-1/2" long.



Complete With Handle & One Straight Blade

MODEL No.
ASB-1

\$9.95

Replacement Blades

Model	Description	Price
ASB-2	Straight Blade	\$5.25
ASB-3	45° Blade	6.15
ASB-4	90° Blade	6.15

Precise UNIVERSAL SPRING WINDER

Make your own perfect springs. Tension or compression springs, electrical coils, etc., of any length or inside diameter made quickly and simply without the expense of setting up special machinery.

- Wire being fed through the handle ensures absolute safety in operation.
- The tension of the wire can be easily adjusted both before and, if required, during actual operation.
- Any thickness of wire can be used up to 3/16" diameter.
- Distance between the separate turns of the spring can be preselected and fixed in a reliable manner.
- Compact in design and easy in operation.



MODEL No.
14009

\$79.95



NEEDLE FILE HANDLE

- Accepts a variety of Diamond Needle and Riffler files.
- Groove feature ensures easy snap fit.
- Needle files snap into place effortlessly.
- Ergonomically designed handle.
- 3-1/2" overall length.



MODEL No.
NFH-350

\$2.50

Each

Precise HARDNESS TESTING FILE SET

- Practical, inexpensive method to quickly determine approximate hardness of heat treated work-pieces and materials.
- Indispensable for every machinist and heat treater.
- Handy, color coded set of 6 Testing Files covers nominal hardnesses from 40 Rc to 65 Rc in increments of 5 Rc.
- Special curved design design for easy access in hard to reach places.



SET No.
18750
Reg. \$99.95

\$89.95

With Fitted Case, Instructions and Conversion Chart



Nicholson® FILE SETS MADE IN USA American Pattern



6 Pc.



5 Pc.



7 Pc.

Set No.	Description	List	Sale
22062	6 Piece 4" file Set w/wood handle, 4" warding, half round, round, square, slim taper with handles (bastard cut)	\$63.50	\$49.95
22040-1	5 Piece General Purpose Set, 10" half round, 10" mill bastard, 8" mill bastard, 8" mill bastard smooth, 6" slim taper	\$63.00	\$49.50
22025-1	7 Piece Machinist Set 10" flat bastard, 10" flat smooth, 10" half round, 10" mill bastard, 10" round bastard, 10" square bastard, 7" slim taper & file cleaner	\$135.00	\$110.00
22030-1	9 Piece Maintenance Kit (not shown) 1 each 6" slim taper, 8" four-in-one hand, 8" half round bastard, 8" flat smooth, 10" round bastard, 10" half round, 10" mill bastard, 10" flat smooth, 10" flat bastard	\$147.00	\$120.00



WOOD FILE HANDLES Waxed White Birch



- Long ferrule.
- Zinc plate.
- Heavy steel.

Model	Use with	Length	Diameter	Bore Depth	Price
10100	for small sizes				\$.95
10101	#1 (for 3 to 6")	4"	1"	1/8 x 1-3/4"	.95
10102	#2 (for 6 to 8")	4-1/2"	1-3/16"	11/16 x 2"	1.00
10103	#3 (for 8 to 12")	5"	1-5/16"	1/4 x 2-3/4"	1.10
10104	#4 (for 12 to 16")	5-1/2"	1-7/16"	5/16 x 2-9/16"	1.15
10105	#5 (for 16 to 20")	6"	1-9/16"	11/32 x 2-9/16"	1.25



MAGNETIC DIAMOND TOOLHOLDER DRESSER MADE IN USA

- Use on any magnetic surface or machine table, angle plate, etc.
- Six specially designed high power permanent ceramic magnets fabricated into bottom holder to insure positive holding.
- Brass tipped thumb screw for quick release.

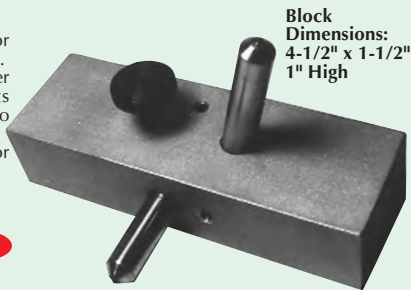

Block Dimensions:
4-1/2" x 1-1/2"
1" High

MODEL No. MDT-014 **\$69.95**
With 1/4 CT Diamond

Precise STATIC WHEEL BALANCERS

Wheel Type

- Ideal balancing grinding wheels, milling cutters, etc.
- True running discs, supported with low friction bearing performance.
- Maximum wheel dimensions: diameter, 6" width, weight 36 lbs.

Wheel Type
MODEL No. 57-038

\$450.00



Level Type

- Built-in spirit level for easy leveling sideways, back and forth.
- Maximum wheel dimensions: 10" diameter, 3-1/2" width, weight 15 lbs.

Level Type
MODEL No. 5-703-90

\$250.00

Arbors Not Included



Nicholson® FILE SET WITH ERGONOMIC HANDLES Rubber Coated Handles For Better Comfort and Control

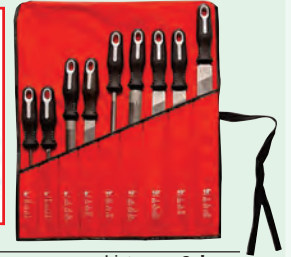

Model	Description	List	Sale
22015H	3 Pc. set 6" slim taper, round, mill bastard	\$35.50	\$29.95
22040H	5 Pc. set 10" half round & mill	\$69.50	\$57.95
22030H	9 Pc. set 12" mill bastard, 10" flat bastard mill, half round, 8" half round & flat bastard 6" slim taper, XX slim taper	\$162.00	\$135.00

Nicholson® THREAD RESTORING FILES

- Used to restore damaged or worn external threads on bolts, pipes, etc.
- Each file will work with 8 different thread sizes.
- Available in 4 sizes and in a convenient 4-piece set.
- Caps are color coded:
#1=Black #2=Red #7=Green #8=Blue

4 Piece Set
1 each shown below
SET No. 33024
Reg. \$72.00

\$59.95

MADE IN USA



Model	Description	Price
33001	Reg. bolt 11-12, 1344-15-20-24 T.P.I.	\$14.95
33007	Ex. Fine/Ex. Coarse bolt 9-10, 12-16, 28-32 T.P.I.	14.95
33012	Reg. Pipe 8-10, 11-1/2-14, 16-18, 24-27 T.P.I.	14.95
33016	Metric bolt .75-1.0, 1.25-1.5, 1.75-2.0, 2.5-3mm	14.95

Precise COOLANT TESTER Hand Held Refractometer

- Quickly and easily test cutting fluid concentration.
- Save on coolant and tool wear by maintaining proper dilution.
- Complete easy to use instructions and case included.
- Can also be used to check the coolant of a car.
- 0.2, 0.1% min. division, calibrate with water.

MODEL No. REF-101
0-10% (BRIX SCALE)

Use For low concentrations and synthetics. Includes auto temperature compensation
Reg. List \$139.95

\$69.95

MODEL No. REF-103
0-32% (BRIX SCALE)
Ideal for general purpose use. Includes auto temperature compensation
Reg. List \$119.95

\$69.95

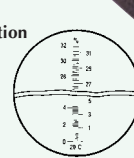

Precise MINI DIGITAL REFRACTOMETER

- This portable refractometer is a precision optical instrument which is designed to measure the concentration of soluble solids (almost 100% sugar) in aqueous solutions.
- The unit features automatic temperature compensation (ATC) which make temperature corrections unnecessary between 0 to 40°C (32-104°F)
- It utilizes the standardized Brix scale which is accurate and easy to read.



MODEL No. REF-121
Reg. \$595.00

\$495.00

With 9V Battery and Pouch

Specifications/Ranges

- Brix: 0 to 45% • Refractive Index (nD): 1.3330 to 1.4098 Nd
- Dimensions: 7.3 x 4.1 x 2.0" • Weight 8.8oz.

Lufkin® 25' POWER TAPE With Magnetic End Hook

- Easy one-person measurements of steel framing and any other ferrous metal surface.
- It's powerful dual magnets also allow it to serve as very effective long-reach magnetic pick-up tool to retrieve dropped fasteners, nails and more.
- This tape features a specially designed end hook that adjusts for an accurate measurement in any situation.



1" Wide
25' Length
MODEL No.
L-725M
Reg. \$14.95

\$9.95



ASTRO AUTOMATIC REWIND HOSE REEL 3/8" X 50 FT. WITH HOSE

- Spring located in the middle drum to ensure the stability of the whole unit.
- L-shaped base with groove reinforcement ensures stable support.
- 300 psi air hose reel.
- Automatic rewind.
- Solid rubber stopper.
- 4-way directional rollers.
- 2 position roller bracket assembly.
- Non-conductive hose.
- Multi-position mounting arm allows for floor, wall or ceiling mounting.



MODEL No.
3682
Reg. \$145.00

\$110.00

Sheffield FOLDING LOCK-BACK UTILITY KNIVES

- Sheffield folding utility knives are considered by many to be the best in the class
- Blade positively locks in the open position for safety.
 - Thumb button allows for one handed opening.
 - Fold to convenient carrying size. Pocket clip built in.
 - All Sheffield knives have a limited lifetime warranty.

MODEL No.
GNK-12113

\$9.95

MADE IN
USA

No. 12850-1
5 Pcs . . . \$1.25
No. 12282
100 Pc Utility
Blade Dispenser
\$19.95



Replacement Utility Blades
• Fits all standard utility knives
• Finest cutlery steel.



Precise 5 PIECE SNAP RING PLIER SET

- For internal rings of 3/8"-2" and external by a single pivot screw.



Set Includes:
3 Pc. Straight Tips (6", 6", 8")
2 Pc. 90° Offset Tips (5-1/2", 7-1/2")

SET No.
7019-0005

\$12.95

NORTECH VACUUM PRODUCTS® COMPRESSED AIR-POWERED VACUUM SYSTEM

Nortech 55 & 30 Gallon Complete vacuum Units generate high vacuum lift and flow instantly and effectively. Designed to handle the toughest cleaning jobs with speed and efficiency.

- Vacuum lift 185 (in H2O)
- Vacuum flow 89 (scfm)
- Min. compressor size 15 H.P.
- Vacuum generating head with standard cartridge filter.
- Drum and drum dolly.
- 2" or 1-1/2" x 20' standard duty vinyl vacuum hose.
- Metal wet/dry floor tool (12" wide) with 4" wand.
- 24" long metal crevice tool.
- 3/4" x 20' air supply hose with fittings.



Model	Description	Weight	Price
N551BCX	55 Gallon w/1-1/2" VAC Hose & Tools	113 lbs.	\$1195.00
N301BCX	30 Gallon w/1-1/2" VAC Hose & Tools	97 lbs.	1150.00

GUARDAIR GUN VACUUM KIT

Twice The Power of Standard Shop Vacuums

- High filtration collection bag with extended zipper for easy debris disposal
- Internal bag stiffener
- Trigger latch
- Uses standard shop compressed air to create high vacuum
- Convenient hanging eyelet
- 1/4" FNPT bottom or rear air inlets
- All Gun Vacs now use 29 SCFM @ 100 psi



KIT No.
1510-1
Reg. \$130.00 **\$125.00**
No. 1500A02 \$19.95
Extra High Filtration
Reusable Collection Bag

ALLPAX GASKET CUTTER SYSTEMS

- Unique patented locking system allows for quick and easy interchange of cutting heads.
- Dual cutting heads allow for cutting inner and outer dimensions at the same time.
- Cutting heads may also be used individually for precision cuts as shown on the right
- Cut a multitude of different materials including foam, cardboard, leather, rubber, fiber, plastic, gasket material and lead.



Model No.	Description	Set Price
100KH	11 Piece Punch Set, 10 punch Sizes: 1/8", 3/16", 1/4", 5/16", 3/8", 7/16", 1/2", 9/16", 5/8", 3/4"	\$175.00
100K16	16 piece Punch Set, 15 Punch Sizes: 1/8", 3/16", 1/4", 5/16", 3/8", 7/16", 1/2", 9/16", 5/8", 3/4", 7/8, 1", 1 - 1/16", 1 - 1/8", 1 - 3/16"	\$275.00
100K	27 Piece Punch Set, 25 Punch Sizes: 1/8", 3/16", 1/4", 5/16", 3/8", 7/16", 1/2", 9/16", 5/8", 3/4", 7/8, 1", 1 - 1/16", 1 - 1/8", 1 - 3/16", 1 - 1/4, 1 - 5/16, 1 - 3/8", 1 - 7/16", 1 - 1/2", 1 - 5/8", 1 - 11/16", 1 - 3/4", 1 - 7/8", 2"	\$525.00

* Also Available in Metric Sizes

Precise BRASS PIN PUNCH SET

- Made from 5/16" brass hexagonal stock.
- Ideal punches for working in no mar, no spark situations.
- Punch diameters are undersized approx. 0.005" (0.127mm)
- 3-1/2" (90mm) long.



Consists of 1 each:
1/16", 3/32", 1/8", 5/32",
3/16", 7/32", 1/4", 5/16"

SET No.
6300B

\$9.95

w/case

EZ RED "MONSTER" PICK-UP MAGNETS

- Neodymium rare earth magnet.
- Lift up to 10 lbs. horizontally or vertically.
- Removes broken axle pieces.
- Will start bolts in hard to reach places.



Model	Lift	Reach	Weight	Price
EZM-300	6 lbs.	30"	4 oz.	\$19.95
EZM-360	10 lbs.	36"	6 oz.	23.95
EZM-380	20 lbs.	38"	9 oz.	32.95
EZM-630	10 lbs.	22" - 38"	7 oz.	29.95

EZ RED WRIST MAG

- Super strong with 6 neodymium magnets!
- Rated to hold 6 pounds of steel parts.
- Revolutionary new product.
- Saves time by keeping steel parts close at hand.
- Ends the frustration of losing loose nuts & bolts.
- Magnets also hold tools.



MODEL No.
EZM-396

\$11.95



THE DOMINATOR SCREWDRIVER PRY BAR SETS

Features:

- Hardened and tempered for maximum durability.
- Capped end allows user to stike the pry bar.
- New two composite handle is ergonomically designed for a more comfortable and secure grip.



Model	Description	List Price	Sale Price
2331-8828	2 Pc. Curved Set 18 & 24"	\$73.79	\$47.82
2331-8825	3 Pc. Straight Set 7, 12 & 18"	81.87	65.50
2331-8826	3 Pc. Curved Set 7, 12 & 18"	81.87	65.50
2331-8820	3 Pc. Curved Set 12, 17 & 18"	81.87	53.06
2331-8827	3 Pc. Heavy Duty Set 18" Straight 24 & 36" Curved Set	160.77	128.62



ULTIMATE WORK GLOVES Ultimate Protection, Dexterity & Grip

- Premium GOATSKIN style offers superior comfort, flexibility & dexterity with smooth leather reinforcements in wear areas such as finger tips & palm.
- Ultimate resilience PIG GRAIN style offers continuous comfort & dexterity even after exposure to water or oil. With PVC reinforcements for exceptional gripping strength.



Extreme Dexterity

Superior Flexibility

Pig Grain With PVC Reinforced Fingers & Palms

Model	Size	Color	List	Sale
0912-M	Medium	Gold/Black	\$14.95	\$11.95
0912-L	Large	Gold/Black	14.95	Per Pair
0912-X	X-Large	Gold/Black	14.95	

Goatskin With Full Leather Reinforced Fingers & Palms

Model	Size	Color	w/Black	List	Sale
0914-M	Medium	Gold/Blue	w/Black	\$15.95	\$12.95
0914-L	Large	Gold/Blue	w/Black	15.95	Per Pair
0914-X	X-Large	Gold/Blue	w/Black	15.95	

Note: "Jumbo" XX-Large Sizes are also available



DOUBLE PALM WORK GLOVES

- Designed to outwear other leather palm gloves.
- Features an extra layer of leather on the palm, thumb, and index finger.
- Has a soft lining in the palm and a soft canvas rubberized safety cuff.



12 Pair
No. 022-PP
Reg. \$32.00

\$32.95

Per Dozen
Large Size Only

EZ RED FOLDING CREEPER CHAIR

- Folds up for E-Z storage.
- Powder coated steel frame.
- Rivited together.
- Heavy duty 2-1/2" casters.
- Super strong denier nylon seat.
- Weight: 8 lbs.



MODEL No.
EZB-100

\$29.95

GENERAL 8 PIECE TECHNICIAN'S MINI-PLIER SET

Mini Pliers are approximately 5" in overall length, allowing a greater deal of maneuverability in close quarter applications. Each pair of pliers also features a double-dipped cushion grip for exceptional comfort during repetitive use and serrated jaws for outstanding grip power, fully polished chrome vanadium steel head, and leaf spring operation.

Includes 1 each:

- Chain nose, serrated jaw pliers.
- Round nose pliers.
- Flat nose, smooth jaw pliers.
- Curved chain nose pliers.
- Long needle nose pliers.
- Oval head diagonal cutter.
- End cutter.
- Mini lineman's pliers.
- Double-dipped cushion grip.
- Includes fitted zipper case.

SET No.

938-1
Reg. \$41.00

\$35.95



STEELMAN. EyeLIGHTS

- Hands free.
- Ideal for all professional work: automotive, electrical, plumbing, etc.
- 4 AA alkaline batteries included.
- The plastic used in EyeLIGHTS is flexible. The fit for nose and sides can be adjusted by bending bows in and out.



MODEL No.
17200

\$12.95



AIR BLOW GUNS

Features:

- Blow guns limit tip pressure to 30 PSI or less.
- Safe at 150 PSI inlet pressure.
- Meets noise exposure standards

Rubber Tip

- Shaped to fit the hand.
- Hang-up hook

MODEL No. 601 **\$9.95**

Tamperproof Blowgun

- Tip permanently attached.
- OSHA compliant.

MODEL No. 600-SDL **\$9.95**



4 PIECE GROOVE JOINT PLIER SET

Heat treated from high grade steel. Rib and groove design locks jaws securely in place for a non slip grip. Lacquer coated to resist rust and corrosion. Sizes 6", 8", 10", 12". Includes blow mold storage tray.



SET No.
57080

\$15.95



5 PIECE 8" PROFESSIONAL PLIER SET

A combination of the most commonly used pliers in one handy set. Drop forged, heat treated carbon steel with double dipped cushion grip handles. Includes 1 pc. 8" diagonal pliers 1 pc. 8" long nose pliers. 1 pc. 8" end nipper pliers. 1 pc. 8" slip joint pliers. 1 pc. 8" groove joint pliers. Also includes 1 pc. heavy duty roll up pouch.



SET No.
57058

\$17.95



4 PIECE MINI PICK & HOOK SET

Hardened and tempered stainless steel blades. Square mechanics vinyl handle for a tight comfortable hold. Ideal for use on cotter keys, o-rings, springs and washers. Includes 1 pc. small angle hook, 1 pc. straight pick, 1 pc. full hook, and 1 pc. 90° hook.

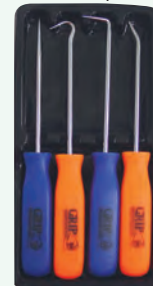

SET No.
46095

\$3.95

Precise DRIVE PIN PUNCH SET



Consists of: 5 Pcs. 8" long
1/8", 3/16", 1/4" & 5/16"
8 Pcs. 3" to 4" standard length 1/16",
3/32", 1/8", 3/16", 7/32",
1/4" & 5/16"

SET No.
DDP-84

\$16.95

Precise 3-PIECE SCRIBER AND SCRAPER SET

Fixed Two Point Scriber



Scriber/Scraper

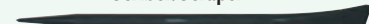

Solid Point Scriber

SET No. SSS-100

\$5.95

Precise CARBIDE TIPPED SCRIBER

No. CTS-300

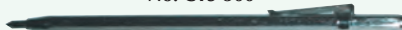

Carbide Tipped
Scriber
No. CTS-300

\$2.95



5 PIECE SNAP RING PLIER SET

Drop forged, heat treated steel. Deluxe double dipped handles. Pliers can be used for both internal and external retaining clips. Includes 1 pc. internal straight tip. 1 pc. internal 90° tip. 1 pc. external straight tip. 1 pc. external 90° tip. Size 7" includes blow mold storage tray.



SET No.
57135

\$15.95



14 PIECE PUNCH AND CHISEL SET

Heat treated, drop forged steel. Complete set for all your punching and chiseling needs. Includes 1 pc. center punch 4/32" x 3/8" x 8" x 5", 4 pc. pin punches 3/17" x 3/8" x 6", 4/32" x 3/8" x 5", 3/32" x 3/8" x 5", 1/4" x 1/2" x 6", 5 pc. cold chisels 1/2" x 3/8" x 6", 5/8" x 1/2" x 7", 3/4" x 5/8" x 7", 7/8" x 5/8" x 8", 1" x 3/4" x 1/2", and 4 pc. taper punches 6/17" x 5/8" x 10", 5/32" x 1/2" x 9", 2/15" x 1/2" x 10", 2/15" x 3/8" x 8-1/2".



SET No.
61104

\$16.95

Precise TRIANGULAR SCRAPER

- Useful tool for scraping, trimming and deburring metals, tubing and other materials.
- Hardened and tempered triple edge blade is secured in wood handle with steel ferrule.
- Available with solid cutting edges.



MODEL No.
MSS-300

\$3.95

FORDOM ROTATING BURR HOLDER

Get Organized

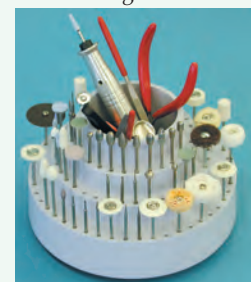

Burs and tools not included

MODEL No.
10080

\$14.95

For All size Burs

Organizes and stores all sizes accessories including 1/16", 3/32", 1/8" and 1/4" shanks. This compact unit is 7" wide is 7" wide by 4" high and holds 69-32" or 1/8" burs, 12-1/4" burs and 45-1/6" burs.

MODEL No.
10081

\$14.95

For 3/32" burs

Similar in size to the 10080, the 10081 rotating bur holder organizes 114-3/32 shank burs. It also features a handy 3" deep x 23/4" open cavity at top for storing workbench.



"INOMIC" INSULATED TOOLS ERGONOMIC DESIGN

1000 VOLT



- Advanced ergo design with tool mounted at 23° angle to grip for natural fatigue free use.
- Lever action handle with immediate 25% increase in force across entire field of movement.
- Low weight fibre-glass reinforced molded handles with soft grip zone at pressure areas.
- Heads drop forged chrome-vanadium premium tool steel, made by Wiha!
- Induction hardened cutting edges & jaws for longest tool life.
- Each tool includes a convenient jaw lock and handle return spring.
- Inomic insulated tools are individually tested to 10,000 volts for 1000 volt safety rating.
- All tools meet ASTM, EN/IEC, CSA, OSHA, NFPA insulation standards.

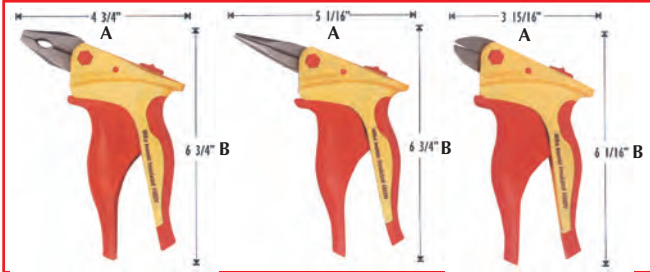

Model	Size A x B	Type	List	Sale
32850-1	4-3/4" x 6-3/4"	Comb. w/cutter	\$64.50	\$44.95
32852	5-1/16" x 6-3/4"	Long Nose w/cutter	64.50	44.95
32854	3-15/16" x 6-1/16"	Diagonal cutter	64.50	44.95



INSULATED POUCHED SETS 1000 VOLT

1000 VOLT



- Pliers & Cutters drop forged CVM tool steel.
- Jaws & Cutting edges induction hardened to 58/60 RC.
- Hard Chromed for best wear & corrosion resistance.
- Ergo molded two component soft grip handles.
- All tools tested to 10,000 volts for 1000 volt rating.



32873 3Pc. Set

32872 5Pc. Set

32871 3Pc. Set

Model	Contains	List	Sale
32873	6.3" Cutter, 8" Pliers, 8" Combo Pliers	\$144.00	\$99.95
32872	6.3" Cutter, 8" Pliers, Insulated Screwdrivers Slot: 1/8, 3/16" Phil: #2	116.00	79.95
32871	6.3" Cutter, 8" Pliers, Insulated Bit Holder Slot, Phil, Square Bits	116.00	79.95

Eklind BALL HEX BRIGHT L-WRENCH LONG ARM

- Bright finish for rust resistance.
- A Ball profile on the Long Arm provides 360° of rotation at up to 35° angle.
- The Long Arm is designed to allow access to hard-to-reach fasteners.
- Manufactured from the highest quality Eklind Alloy Steel.
- Available in popular inch and metric sizes.



Combination SET No. 13322 List \$40.00 **\$17.95** 22 Sizes Inch/Metric



Model No.	No. of Keys	Sizes in Sets	List Price	Sale Price
13313-1	13	Inch Sizes .050" - 3/8"	\$22.00	\$10.95
13709-1	9	Metric Sizes 1.5mm - 10.0mm	18.00	8.95
13322	22	Combo Set #13313-1 and #13709-1	40.00	17.95

Precise T-HANDLE TORX® 9PC. DRIVER SET

- Heat treated extruded S-2 alloy steel.
- Tamper design for today's tamper-proof screws.
- T-handle increase turning power and provide a comfortable grip.

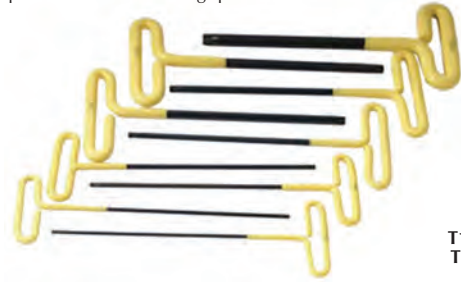

SET No. 7900-0001 **\$17.95**

Set Includes: T10, T15, T20, T25, T30, T40, T45, T50, T55

E-Z RED HEX BALL DRIVER SETS

- 20° ball type hex.
- 1/4" ratchet well in the end of the handle.
- Made with heavy duty SR2 steel.
- Bolster for extra torque.
- Comfortable micro grip handle.
- Lifetime warranty.



Set No.	Sizes in Set	Price
MXDS	9/64", 5/32", 3/16" 7/32", 1/4", 5/16", 3/8", 1/2"	\$39.95
MXDM	4mm, 5mm, 6mm, 7mm, 8mm 9mm, 10mm, 11mm, 12mm	42.95



GENERAL RESCUE + ONE

Auto Emergency Tool + Flashlight

- Shatters automotive side windows for emergency escapes.
- High-visibility red flashing emergency light.
- Magnets hold the tool to the vehicle.
- Bright white LED flashlight helps you see at night.
- Safety blade cuts seat belts.
- Includes: 3 "AAA" batteries



MODEL No. 7902 Reg. \$14.95 **\$9.50** 6 or More \$8.95 Ea.

SQUARE TOOLING PAD

Mounting block for construction balls. Adjustable-type Construction Balls can be set at any desired height, then locked in place with a setscrew (not furnished).

MODEL No. 54-STP250 **\$15.10**

Fits .250" Diameter Shank Tooling Balls

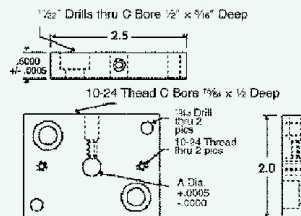

SK 3 PIECE FLEXIBLE PLIER SET

- Spring loaded for ease of use in repetitive applications.
- 180 degrees flexible handles provide easy operation at any angle.
- Durable cutting edges. Precision machined and hardened for extended service life.
- Slip resistant handles for user comfort and safety.

Unique Design For Difficult To Reach Areas



3-Pc Set
MODEL No. 89103 **\$49.95**
Reg. \$76.50



Model	Description	List	Sale
89117	7" Flexible Linesman Combination Pliers	\$28.00	\$19.95
89126	6.5" Flexible Diagonal Cutter Pliers	28.00	19.95
89137	7" Flexible Needle Nose Pliers	24.00	17.95
89103	3 Piece Flexible Needle Nose Pliers	\$76.50	\$49.95

SK WIDE CAPACITY TONGUE AND GROOVE PLIERS

- 3 point contact on working surfaces.
- 8 groove design for a wide range of applications.
- Flush rivet design for access in tight work spaces.
- Textured cushion grips for positive hold.
- Undercut tongue & groove for reduced slippage.
- Jaw capacity: 1/2" - 4"



MODEL No. 7412
Reg. \$67.85
\$46.95

MADE IN USA

SK SPLINE G-PRO RATCHETING WRENCH SETS

High tech ratcheting box end that delivers versatility, strength and accessibility. The spline shape works on 5 fasteners (spline, 6 point, 12 point, female Torx®, square) and even on 50% rounded fasteners. 90 tooth design delivers superior accessibility in tight spaces with a 4° swing arc. In addition, the non slip feature on the open end enables ease of use, and can be used on damaged fasteners that are up to 70% rounded. Lifetime warranty.



Spline End fits 5 fastener Styles & Rounded Off Hex



Only 4 Degree Swing Arc

Set	Description	Reg.	Sale
SK89200	9 Piece SAE Set in molded case 1/4", 5/16", 3/8", 7/16", 1/2", 9/16", 5/8", 11/16", 3/4"	\$162.33	\$150.95
SK89201	4 Piece SAE Set in molded case 13/16", 7/8", 15/16", 1"	143.13	122.95
SK89300	12 Piece Metric Set in molded case 8, 9, 10, 11, 12, 13, 14, 15, 16, 17, 18, 19mm	197.16	175.75
SK89301	5 Piece Metric Set in molded case 20, 21, 22, 23, 24mm	168.81	151.75

CHAN NEL LOCK CODE BLUE PLIERS

- Exclusive grip formula..Santropene core with TPR.
- Polished high-carbon drop-forged steel.
- Electronic coating to prevent rusting.
- Laser hardened cutting edges provide longer life & greater ease of cut.
- New code blue designation on each of the pliers makes it easier than ever to choose the right tool for the job.

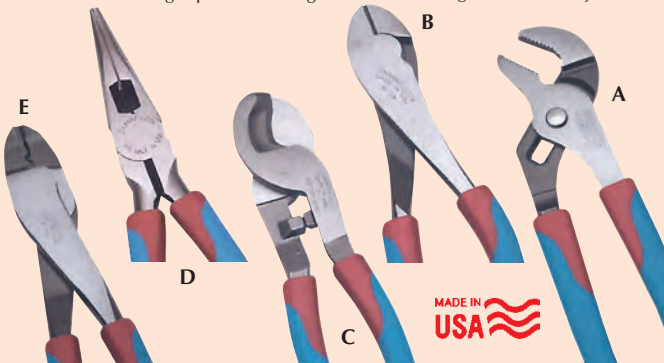

MADE IN USA

Model	Description	List	Sale
420CB	A) 9-1/2" Tongue & Groove • Capacity: 1-1/2"	\$24.65	\$16.95
338CB	B) 8" Cutting plier • Lap joint	27.15	19.95
911CB	C) 9-1/2" Cable cutter • Cuts up to 4/0 aluminum and up to 2/0 soft copper	34.10	24.95
318CB	D) 8-1/2" Long nose plier • With side cutter	36.10	26.95
909CB	E) 9-1/2" Crimping tool • For insulated and non-insulated solderless connections & terminals	30.50	23.50

8 Pc. Code Blue Super Plier Set In Roll-up Pouch Includes:
10" tongue-n-groove, 9-1/2" tongue-n-groove, 9" linemen's plier, 8" cutting plier, 8" end nip cutting plier, 9-1/2" cable cutter, 8-1/2" long nose with side cutter, 9-1/2" crimping and cutting tool plier. Storage pouch.
SET No. CBR-8 Reg. \$210.00 SALE \$165.00

LUTZ RATCHET SCREWDRIVER 15-in-One

A slight turn of the spring-loaded bit selector knob opens the chamber for easy access and storage - making the exchange of bits a snap.

- Engineered heavy-duty construction.
- Bits are made of 6150 hardened steel.
- Allows for extra torque.
- Large handle for extra gripping power.



SET No. 21000
\$13.95

Includes:
15-in-ONE Ratchet screwdriver
1/8" Slotted x #0 Phillips replacement bit
1/4" x 3/16" Slotted replacement bit
1/4" Slotted x #2 Phillips replacement bit
5/32" Slotted x #3 Phillips replacement bit
#1 x #2 Phillips replacement bit
T15 x T20 Torx® replacement bit
S1 x S2 Square replacement bit.

BONDHUS NUT DRIVERS - HOLLOW SHAFT SOFTFINISH® CUSHION GRIPS

- Hollow shafts allow for fit over extended bolts.
- Finally a Handle that makes Nut Drivers useful.
- Get 40% more power with Softfinish cushion grip.
- Soft ergonomic molded shape for maximum comfort.
- Heavy duty hollow shaft - 3.7" depth
- Hardened for maximum torque and wear resistance.
- Chrome plated anti corrosion finish.

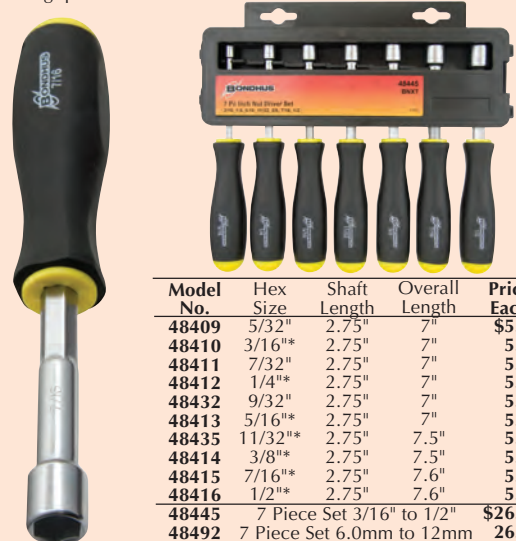

Model No.	Hex Size	Shaft Length	Overall Length	Price Each
48409	5/32"	2.75"	7"	\$5.50
48410	3/16"	2.75"	7"	5.50
48411	7/32"	2.75"	7"	5.50
48412	1/4"	2.75"	7"	5.50
48432	9/32"	2.75"	7"	5.50
48413	5/16"	2.75"	7"	5.75
48435	11/32"	2.75"	7.5"	5.75
48414	3/8"	2.75"	7.5"	5.95
48415	7/16"	2.75"	7.6"	5.95
48416	1/2"	2.75"	7.6"	5.95
48445	7 Piece Set 3/16" to 1/2"			\$26.95
48492	7 Piece Set 6.0mm to 12mm			26.95

* Supplied In Set



SELF-ADJUSTING PLIER Automatically Locks On Any Size

- Self adjusting jaws for simple one handed operation.
- No pinch, easy squeeze release lever- stays locked until you release it.
- Set and forget pressure adjustment - dial in the amount of gripping force, and forget it - regardless of the size object you want to grab.
- Chrome vanadium steel for long life. • No slip texture grip.
- Lifetime warranty.



Grab Thick
Grab Thin

Model	Description	List	Sale
06100	6" Curved Jaw	\$19.50	\$14.95
09300	7" Needle Nose	22.50	16.95
10100-4	10" Curved Jaw	23.00	17.25
80100-1	10" & 6" Curved & 7" Needle Combo Set	68.00	43.50
80200-1	10" & 6" Curved Combo Set	39.50	28.95
80300	10" Curved & 7" Needle Combo Set	40.50	29.95

metabo POWER MAXX 4.8 Volt CORDLESS DRILL/DRIVER KIT

- Excellent power for such a light and compact drill/driver - up to 80 in.-lbs. torque output - weighs just 1.46 lbs. including
- 20-level adjustable torque settings.
- 2-speed gear box 0-200/0-600 RPM.
- Easy forward/reverse selection.
- Spindle lock for ease of driving stubborn screws.
- Soft start motor for maximum precision and control.
- Spindle with hexagon recess for screwdriver bits.
- Sturdy metal gear housing.
- Angle bit driver attachment for working in the tight spots.

Kit Contents:

PowerMax Drill/driver, 2 batteries, charger, 1.4" soild steel keyless chuck, 1/4" hexbit chuck, offset hex bit angle drive attachment, molded storage case.



KIT No.
63520
Reg. List
\$289.00

\$149.95

Limited
Supply



#06207
10201-1
18201

Grab Thick
Grab Thin

Model	Description	List	Sale
06200	7" C-Clamp without swivel pad	\$21.50	\$16.25
06206	10" C-Clamp without swivel pad	26.50	18.50
10200-4	11" C-Clamp without swivel pad	29.95	23.50
18200-1	19" C-Clamp without swivel pad	44.50	32.25
06207	10" C-Clamp with swivel pad	26.95	\$19.85
10201-1	11" C-Clamp with swivel pad	32.50	25.40
18201	19" C-Clamp with swivel pad	46.00	37.00

CHAN NEL LOCK CONVERTABLE SNAP RING PLIERS INTERNAL & EXTERNAL

- Snap ring pliers.
- Converts from internal to external rings.
- Includes 5 tip sets. - .038 straight and 90°, .047 straight and 90°, .070 straight only



MODEL No.
907G
Reg. \$36.50

\$29.95

CHAN NEL LOCK CRIMPING AND WIRE STRIPPER

- Strips wire with no damage to conductor.
- Crimps insulated and non-insulated wire.

MODEL No.
CWT-908

\$22.95



BIT SELECTOR



- These handy sets include 10 hardened bits of chrome-vanadium-molybdenum steel.
- 1/4" magnetic bit holder can be used in power tools.
- Plastic storage box is compact, durable and light weight.
- Molded hex cavity turns box into handle for quick fastening jobs.
- Quick bit access with slide out drawer.

MODEL No.
79243

\$16.95



Set No.	10-Bits In Set with 1/4" Magnetic Adapter	Sale Price
79243	3) slotted 3/16", 1/4", 5/16" 4) Phillips #0, #1, #2, #3 3) Torx T10, T15, T20	\$16.95
79246	1) Each Hex 1/16", 5/64", 3/32", 7/64" 1/8", 9/64", 5/32", 3/16", 7/32", 1/4"	\$19.95
79256*	1) Each Hex(metric) 1.5, 2, 2.5, 3, 4.0, 5.0, 6.0, & 8.0mm	\$19.95
79242	1) Each Torx T5, T6, T7, T8, T9, T10, T15, T20, T25, T30	\$20.95

* This Set Consists of 8 bits (Not Ten)



Wiss METAL MASTER SHEARS



- Cuts left** from tight curves to straight lines. Recommended for cutting 18 gauge (.49") and lighter sheet metal. Red vinyl grips provide comfort.
- Cuts Right** from tight curves to straight lines. Recommended for cutting 18 gauge (.49") and lighter sheet metal. Has green nonslip vinyl grips for cutting comfort.
- Cuts Straight.** (Or wide curves left or right) Recommended for cutting 18 gauge (.49") and lighter sheet metal. Has yellow nonslip vinyl grips for cutting comfort.



Cuts Left

MODEL No.
M1R-001
List \$23.40

\$18.95



Cuts Right

MODEL No.
M2R-002
List \$23.40

\$18.95



Cuts Straight

MODEL No.
M3R-003
List \$23.40

\$18.95

Overall length 9-3/4", length of cut 1-3/8" to 1-1/2"

WISE-GRIP LOCKING PLIERS - The Original

- Built to be the strongest and toughest locking tool.
- Used for turning, cutting, tightening, clamping and twisting.
- High-grade alloy steel, heat treated for maximum toughness and durability.

STRAIGHT JAW "R"



Model	Length	Opening	Price
10-R	10"	1-1/4"	\$9.95
07-R	7"	1-1/8"	8.95

CURVED JAW "CR"



Model	Length	Opening	Price
12-LC	12"	3-1/8"	\$17.75
10-CR	10"	1-7/8"	10.45
07-CR	7"	1-5/8"	9.95

CURVED JAW & WIRE CUTTER "WR"

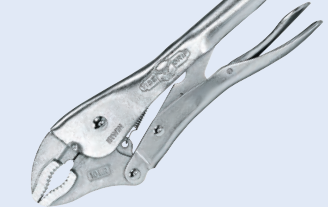

Model	Length	Opening	Price
10-WR	10"	1-7/8"	\$10.95
07-WR	7"	1-5/8"	9.95
05-WR	5"	1-1/8"	9.45
04-WR	4"	1-1/16"	8.95

LONG NOSE WITH WIRE CUTTER

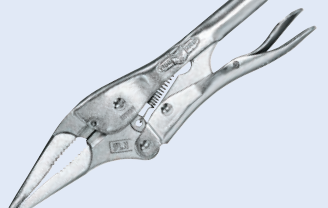

Model	Length	Opening	Price
09-LN	9"	3" at tip	\$12.95
06-LN	6"	2-1/4" at tip	10.95
04-LN	4"	1-7/8" at tip	9.95

WELDING CLAMP "09-R"



Model No.	Length O.A.L.	Jaw Capacity	Price Each
09-R	9"	2-1/4"	\$19.95

"C" CLAMPS

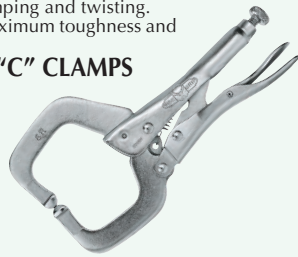

Model No.	Length O.A.L.	Jaw Adj.	Throat Depth	Price Each
06-R	6"	2"	1-1/2"	\$ 8.95
11-R	11"	3-3/4"	2-5/8"	16.95
18-R	18"	7"	10"	24.95
24-R	24"	10"	14"	29.95

"C" CLAMP WITH SWIVEL PADS



Model No.	Length O.A.L.	Jaw Adj.	Throat Depth	Price Each
04-SP	4"	1-5/8"	1-1/4"	\$ 9.95
06-SP	6"	2"	2"	11.75
11-SP	11"	3-3/4"	2-5/8"	16.45
18-SP	18"	7"	10"	32.95
24-SP	24"	10"	14"	25.95

CHAIN CLAMP



Model No.	Chain Length	Weight Each	Price Each
20-R	9"	27 oz.	\$24.95
20-EX	18" exten. chain		12.95
20-RP	18" repl. chain		12.95

SHEET METAL TOOL "08-R"



Model No.	Length O.A.L.	Jaw Capacity	Price Each
08-R	8"	3-3/8"	\$15.95

WISE-GRIP ROLL-UP TOOL KIT

Set No. 538-KB Reg. \$84.75
 Consists Of:
 1 Each Vise-Grip
 MODEL No. 10-R, 10-CR,
 07-WR, 06-LN, 05-WR



WISE-GRIP LOCKING WRENCH WITH CUTTER

Features:

- Locks on to three sides of hex fastener.
- Tremendous force can be applied without marring or slipping off the fastener.
- Each wrench adjusts to over 16 different wrench sizes.
- Jaw tips are knurled for better gripping.
- Built to last a lifetime.



MODEL NO. 4-WL
 Reg. List \$13.85
\$9.95

Model No.	Size Inch	Capacity Range	List Price	Sale Price
4-WL	4"	1/4"-9/16"	\$13.85	\$ 9.95
7-WL	7"	9/16"-3/4"	17.90	12.95
10-WL	10"	5/8"-1-1/8"	21.90	14.95

GENERAL COMPOUND TUBING BENDER

- Will bend copper, brass, thin wall tubing, steel aluminum, soft wire and rods.
- 180° bends in a single action.
- Bender has calibrated angle markings from 0° to 180° for making accurate left, right and offset bends.
- Ergonomically designed handles for greater comfort.
- Durable die cast alloy construction.
- Extra-long handle for greater leverage.



BENDS 4 TUBING SIZES
 3/16", 1/4"
 5/16", 3/8"
 MODEL No. 153
 Reg. \$31.75
\$24.95

GENERAL NUT SPLITTER

- Here is a real timesaver for removal of frozen, hard to remove rusted nuts.
- Only 4-3/4" long, this compact tool will split nuts up to 1/2" automotive series (3/4" or 19mm across flats).
- Standard 3/4" driving hex head for use with wrenches or sockets.
- Angled body for getting into hard-to-reach work areas.
- Replaceable hardened steel chisel point can be reversed to achieve best cutting angle.
- Made of high grade heat treated forged steel for durability. Plated and black oxide finishes to prevent rust.



MODEL No. 175
 Reg. \$29.90
\$22.95

JET DIE GRINDERS

- Lightweight yet powerful and compact design.
- Heavy-duty ball bearing construction for vibration-free performance.
- Durable precision machined and hardened steel gears.
- 1/4 horse power motor.
- 1/4" Shank collet capacity.



Model	Description	Sale
JNS-7033	Die Grinder 22000 RPM	\$39.95
JNS-7034	Angle Die Grinder 22000 RPM	59.95
JNS-7033E	Die Grinder 22000 RPM 6" Anvil	59.95
JNS-7032	Die Grinder 25000 RPM	32.95

JET REVERSIBLE DRILL WITH KEYLESS CHUCK

- Ball bearing and needle bearing construction for more efficient performance.
- Muffled handle exhaust for quiet operation.
- All pistol grip models have variable speed triggers for positive control.



Model	Capacity	List	Sale
JNS-4031KL	3/8"	\$100.00	\$69.95
JNS-4041KL	1/2"	110.00	79.95

Precise HELPING HAND MAGNIFIER

- Heavy cast iron base.
- Eliminates needless hand held efforts.
- Adjusts and locks at any desired angle.



MODEL No. HHM-018
\$16.95

Precise VACUUM BASE INDICATOR HOLDER WITH FINE ADJUSTMENT

- Ideal for granite plates and other non-magnetic smooth surfaces.
- Powerful 3" diameter suction disk.
- On/Off lever.
- Accepts both standard test and AGD indicators.
- Fine adjustable.



MODEL No. 401-513
\$29.95

EXAIR® 2-WAY DRUM PUMP

Reversible Drum Vac Can Fill or Empty A 55 Gallon Drum In 90 Seconds

- Two-way pump recovers or transfers coolants, liquid spills, hydraulic oils and more.
- Turn knob to fill or empty.
- No moving parts. • Maintenance free.
- Stainless steel construction.
- Safe - compressed air powered.
- Spill free - auto safety shutoff.



MODEL NO. 6196 Reversible Drum Vac System
Complete with two-way pump assembly (1/4 NPT), shutoff valve, 10' (3M) flexible vacuum hose (1-1/2"/38mm I.D.) with 90° quick release elbow connection, (1) aluminum wand (drum not included)

Reg. \$461.00

\$415.00

MODEL No. 6296 Deluxe Reversible Drum Vac System
Same as above and adds drum dolly, spill recovery kit, (2) extension wands, crevice tool and skimmer tool (drum not included)

Reg. \$722.50

\$695.00

MODEL No. 6901 Spill Recovery Kit
This optional kit includes a one-piece 54" (1372mm) ABS wand & 14" (356mm) double blade squeegee tool.

Reg. \$118.00

\$105.00

EXAIR® CHIP VAC

Eliminate Expensive Vacuums That Wear Out Quickly
Vacuum Chips Directly Into A 55 Gallon Drum



- Clean chips from fixtures, floors and work surfaces of machining centers, lathes saws, mills and other industrial equipment.
- No moving parts - compressed air powered. • Dust free operation.
- Keep materials separate for recycling.



- No motors to clog or wear out.
- Powerful cyclonic action.
- Easy to move from drum to drum.
- Quieter than electric vacuums.
- Includes all tools.

MODEL NO. 6193 Chip Vac System
Complete with the chip Vac, lever drum lid, shutoff valve, filter bag, 10' chemical resistant hose (1.5" I.D.), chip wand, extensions, crevice tool, brush, skimmer and floor tool (drum not included).

Reg. \$589.00

\$529.95

GRIP®

ADJUSTABLE WRENCHES

- Drop forged, heat treated steel.
- Heat polished and chrome plated.
- High visibility cushion.
- Accurate precision matched jaws.

4 Pc SET
6", 8", 10", 12"
No. 87042

\$14.95



Qualtech

DOCUMENT STAND

- Deluxe model includes adjustable height stand, three locking casters, locking tray beneath writing panel, side tray, solar powered calculator and clear hinged acrylic panels on display panel.
- Panels are yellow high impact polystyrene.



Standard Document Stand - 28 LBS.
No. 100S
Reg. \$372.00

\$315.00

Qualtech

DOCUMENT PROTECTORS

With 18" Flexible Arm

Protect valuable information from dirt, handling damage or loss in the shop, lab and warehouse. Save production space and prevent clutter.

- Flexible shaft with rugged clamp mount.
- Ideal for positioning information on machines, benches, desks, or wall.
- Holds twenty 8-1/2" x 11" or 11" x 17" pages flat.
- Ten durable vinyl transparent page protectors, supported by yellow wire frames.
- Easy to read and turn. pages can be quickly replaced to meet changing requirements.

8-1/2"x 11"
No. A700
Reg. \$212.00

\$175.00

11"x 17"
No. A700B
Reg. \$247.00

\$209.95



WALL OR BENCH MOUNT DOCUMENT STANDS

- Features yellow high impact polystyrene document holder and writing surface on heavy duty steel support.
- mounts easily to wall or bench top. includes two clips. 9" x 13" writing surface has hinged, clear plastic document protector.

Wall Mount
No. MSW-800
Reg. \$365.00

\$295.00

Bench Mount
No. MSB-800
Reg. \$365.00

\$295.00

Z-Limit ULTRA-SERIES

ERGONOMIC, LOW NOISE 1/4" AIR DIE GRINDER

- Rubber molded cushion grip.
- Air regulator on top.
- Safety throttle lever.
- Rear exhaust with silencer.
- 360 degree swivel air inlet.
- Low noise 79db(A)
- Free speed: 20,000 RPM.
- Air Inlet: 1/4" NPT.
- Hose size: 3/8"
- Air pressure: 90 PSI
- Air consumption: 4 CFM
- Overall Length: 7-3/8"
- Weight: 1.5 lbs.



MODEL No.
7609-0903

\$79.95

Z-Limit ULTRA-SERIES

ERGONOMIC, LOW NOISE 1/4" ANGLE AIR DIE GRINDER

- Rubber molded cushion grip.
- Air regulator on top.
- Safety throttle lever.
- Rear exhaust with silencer.
- 360 degree swivel air inlet.
- Low noise 79db(A)
- Free speed: 20,000 RPM.
- Air Inlet: 1/4" NPT.
- Hose size: 3/8"
- Air pressure: 90 PSI
- Air consumption: 4 CFM
- Overall Length: 6-11/16"
- Weight: 1.1 lbs.



MODEL No.
7609-0904

\$95.00

Precise PEDESTAL STAND

- Designed to accommodate most 6", 7", 8" and 10" bench grinders and buffers.
- Made of heavy duty cast iron with a 3-1/2" steel column.
- Unique design top allows most tools to be securely mounted with 4 bolts.



Top

Dimensions:
Height 31"
Table 11" x 10"
Weight 58 lbs.

MODEL No.
PS-160

\$65.00



CHAMPION[®] SPEED THREADER DIE SETS

- Single piece high speed die, permanently integrated into the die handle.
- "Easy-grip" handle is comfortable to use and eliminates slipping.
- Self-centering guide eliminates cross threading and ensures proper alignment everytime.
- Premium quality high speed steel die cuts new threads and repairs damaged threads.
- No more time wasted hunting for the right die.

MADE IN USA



Self-Centering Guide No More Cross Threads

- Self-centering guide ensures proper alignment.
- Simply insert rod or damaged bolt into guide.
- Turn clockwise to begin threading.

Model	Contains H.S.S. Die Sizes	Sale
ST-NC5	1/4, 5/16, 3/8, 7/16, 1/2 Coarse	\$59.95
ST-NF5	1/4, 5/16, 3/8, 7/16, 1/2 Fine (NF)	59.95
ST-MS5	6-32, 8-32, 10-24, 10-32, 12-24	59.95
ST-ME7	M3x.5, 3x.7, 5x.8, 6x1, 8x1.25, 10x1.5, 12x1.75 & cutting fluid	69.95

*Individual Sizes Available (Inquire)



AUTOMATIC LOCKING GROOVE PLIERS

- Patented mechanism maintains parallel jaws for optimal grip.
- Automatically grabs any size without adjusting.
- Fully automatic for true one-handed use.
- Limited lifetime warranty.
- Polypropylene, solvent resistant handles.



Model	Description	List	Sale
20600	6.5" Automatic Groove Pliers Soft Grip	\$14.00	\$10.95
20900	9.5" Automatic Groove Pliers Soft Grip	22.00	16.95
30600	6.5" Automatic Groove Pliers Dipped Handle	19.00	13.45
30900	9.5" Automatic Groove Pliers Dipped Handle	26.00	19.95

FLEXBAR SLIDE-TRACK LATHEGUARD

Heavy Duty 14 Gauge Steel Shields with LEXAN[®] windows mount over headstock and slide over chuck for maximum protection! Allows easy access to the point of operation when power is off.

- Fits conventional lathes and CNC machines. Two styles available: "Minor" & "Major".
- The "Minor" Slide-Track Latheguard features two 3/16" Thick Lexan windows. Being situated on the top and front inclined panels, these two windows provide excellent visibility for the operator. The front panel hinges up to allow access to the controls and settings of the machine - The "Minor" is designed to guard lathes having chucks ranging from 10" diameter up to 24" diameters.
- The "Major" Slide-Track Latheguard provides maximum operator protection on standard machines or large CNC lathes with chucks ranging from up to 48" diameter. These guards incorporate one Lexan front panel window and do not require a top window.
- Shields supplied with OSHA Orange Baked Enamel painted finish for long wear.

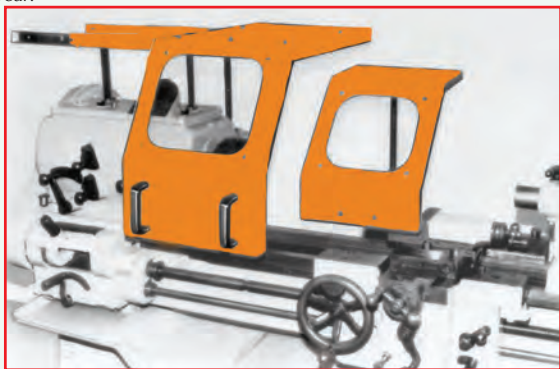

Slide-Track Latheguard (Left) Travelguard (Right) Not Supplied

Model No.	Chuck Capacity	Width/Height Slide Track	List Price	Sale Price
13079	24"	14" x 17.75"	\$1350.00	\$1275.00
13080	24"	24" x 17.75"	1390.00	1295.00
13081-1	28"	19.75" x 21.10"	1495.00	1395.00
13082	32"	19.75" x 23.00"	1540.00	1450.00
13083	40"	19.75" x 26.90"	1595.00	1495.00
13084	48"	19.75" x 30.75"	1695.00	1595.00

CRESCENT 140 PIECE PROFESSIONAL MECHANICAL TOOL SET

- New 140 piece tool set was designed for the professional tool user to include more sockets, more drive tools and more wrenches.
- Socket set includes 1/4", 3/8" & 1/2" quick release drive 72 Tooth Ratchets sizes and 7 extensions.
- All Chrome Vanadium set features 105 sockets in SAE/Metric, 6pt. and 12pt., 10 drive tools and 24 combination wrenches: 10 SAE sizes from 1/4" to 3/4" plus 14 metric sizes from 6mm thru 19mm.
- Packaged in a durable tri-fold carry case.
- Standard and Deep Sockets range from 5/32" to 7/8", 4mm to 18mm, 6 point and 12 point.
- Plus 3 Torx[®] and 7 Screwdriver Bit Sockets.

GUARANTEED FOREVER



SET No. CTK140CMP
Reg. \$250.00
\$169.95

With Fitted Carrying Case
22 lbs.

Precise COMBINATION WRENCH SETS

- Drop forged, heat treated alloy steel.
- Mirror finished and chrome plated.
- Precision machined open and boxed ends.
- V-cut for quick positioning and tight fastening.
- Heavy duty roll up vinyl pouch.



Model	Description	Price
89260	14 Piece Standard Lengths 3/8", 7/16", 1/2", 9/16", 5/8", 11/16", 3/4", 13/16", 7/8", 15/16", 1", 1-1/16", 1-1/8", 1-1/4"	\$49.95
7023-006	15 Piece Metric Standard Lengths 6mm, 8mm, 10mm, 11mm, 12mm, 13mm, 14mm, 15mm, 17mm, 19mm, 21mm, 22mm, 24mm	\$39.95

GRIP JUMBO COMBINATION WRENCH SETS



- Precision machined open and boxed ends.
- Raised panel provides added strength.
- Drop forged, chrome plated, heat treated steel.

89040

Set	Description	Price
89020	4 Piece Jumbo Combination 1-5/16", 1-3/8", 1-7/16", 1-1/2"	\$ 49.95
89040	4 Piece Combination 2", 2-1/8", 2-1/4", 2-1/2"	139.95
89080	10 Piece Combination 1-5/16", 1-3/8", 1-7/16", 1-1/2", 1-5/8", 1-11/16", 1-3/4", 1-13/16", 1-7/8", 2"	\$175.00



22 PIECE 1/4" DRIVE PRO SOCKET SETS

Dropped forged, heat treated, chrome vanadium steel. Chrome plated to resist rust and corrosion. Each set includes: 1 pc. 5" reversible quick release ratchet, 1 pc. 6" spinner handle, 1 pc. universal joint, 2 pc. extension bars (2", 6"), 7 pc. 1/4" deep sockets, 9 pc. 1/4" shallow sockets, 1 pc. blow mold case, Item #73105 SAE sizes - deep (1/4", 9/32", 5/16", 11/32", 3/8", 7/16", 1/2") Shallow (3/16", 7/32", 1/4", 9/32", 5/16", 11/32", 3/8", 7/16", 1/2"). Item #73100 mm sizes - deep (5.5mm, 6mm, 7mm, 8mm, 9mm, 10mm, 11mm), shallow (4mm, 5mm, 5.5mm, 6mm, 7mm, 8mm, 9mm, 10mm, 11mm)



Model	Description	Price
73105	22 Piece SAE Socket Set	\$26.95
73100	22 Piece Metric Socket Set	26.95



1/2" DRIVE 17 PIECE PRO SOCKET SETS

Drop forged, heat treated, chrome vanadium steel. Chrome plated to resist rust and corrosion. Each set includes 1 pc 10" reversible quick release ratchet. 1 pc. 5" extension bar, 1 pc. 15" flexible breaker bar, 13 pc. 1/2" shallow sockets, 1 pc. blow mold case, Item #73105 SAE sizes - 7/16", 1/2", 9/16", 5/8", 11/16", 3/4", 13/16", 7/8", 15/16", 1", 11/16", 11/8", 11/4". Item #73140 mm sizes - 10mm, 12mm, 13mm, 14mm, 17mm, 19mm, 20mm, 21mm, 22mm, 23mm, 24mm, 27mm.



Model	Description	Price
73145	17 Piece SAE Socket Set	\$49.95
73140	17 Piece Metric Socket Set	49.95



1" DRIVE 21 PIECE PRO SOCKET SETS

Industrial quality, hardened and tempered, triple chrome plated. Extra heavy duty 26" ratchet handle. Heavy duty metal case with carrying handle. Includes 16 pc. 12 point sockets 15/8", 1-11/16", 13/4", 1-13/16", 1-15/16", 2", 2-1/8", 2-3/16", 2-1/4", 2-3/8", 2-1/2", 2-5/8", 2-3/4", 2-15/16", 3", 3-1/8". 1 pc. 8" extension bar. 1 pc. 18" extension bar. and 1 pc. 22" sliding t-handle. Includes metal storage case.



SET No. 74020 **\$249.95**
1" Drive



3/4" DRIVE 21 PIECE PRO SOCKET SETS

Drop forged, heat treated,, triple chrome plated steel. Meets or exceeds ANSI specs. B107.1 6 point socket ensures correct fit and maximum surface contact. Both sets include 1 pc. 19-1/2" ratchet handle, 1 pc. 20" flex breaker bar, 2 pc. 4" and 8" extension bars, and blow mold storage case. Item #74042 sizes - 7/8", 15/16", 1", 11/16", 11/8", 13/16", 11/4", 15/16", 13/8", 17/16", 15/8", 13/4", 1-13/16", 17/7", 2" Item #74040 sizes - 19mm, 21mm, 22mm, 23mm, 24mm, 26mm, 27mm, 30mm, 38mm, 41mm, 46mm, 48mm, 50mm



Model	Description	Price
74042	21 Piece SAE Socket Set	\$79.95
74040	21 Piece Metric Socket Set	79.95



3/8" DRIVE 8 PIECE HEX BALL END BIT SET

Heat treated, chrome vanadium steel. Ball bit sockets provide full torque and leverage. Special ball end provides the convenience and speed of off axis rotation. Sizes - Item #71040 1/8", 5/32", 3/16", 7/32", 1/4", 5/16", 3/8". Item #71038 - 3mm, 4mm, 5mm, 6mm, 7mm, 8mm, 10mm. Both sets include 1 pc. socket holder.



Model	Description	Price
71040	8 Piece SAE Ball Set	\$13.95
71038	8 Piece Metric Ball Set	13.95



3/8" DRIVE 10 PIECE HEX BIT SET

Drop forged, heat treated, chrome vanadium steel. Satin finished to resist rust and corrosion. Includes 7 pc. SAE hex bits 1/8", 5/32", 3/16", 7/32", 1/4", 5/16", 3/8". 1 pc. #2 Phillips bit, 1 pc. 1/4" flat bit, 1 pc. socket rail



SET No. 71080 **\$8.95**



3/8" DRIVE 7 PIECE 6" LONG HEX BIT SET

Ideal for use in removing various auto parts while doing automotive repairs. Drop forged S2 chrome vanadium steel. Built-in hex screw allows for resizing of bits without having to replace the bit itself. length 6" Item #71028 - 1/8", 5/32", 3/16", 7/32", 1/4", 5/16", 3/8" Item #71027 - 3mm, 4mm, 5mm, 6mm, 7mm, 8mm, 10mm



SAE SET MODEL No. 71028 **\$22.95**

Metric MODEL No. 71027 **\$22.95**



3/8" DRIVE 7 PIECE 6" LONG TORX BIT SETS

Ideal for use in removing various auto parts while doing automotive repairs. Drop forged S2 chrome vanadium steel. Built-in hex screw allows for resizing of bits without having to replace the bit itself. length 6" Item #71031 sizes - T10, T15, T20, T25, T27, T30, T40 Item #71032 sizes - T10H, T15H, T20H, T25H, T27H, T30H, T40H



SAE SET MODEL No. 71032 **\$19.95**

Metric MODEL No. 71031 **\$19.95**



3/8" DRIVE 7 PIECE 6" LONG HEX BALL BIT SETS

Ideal for use in removing various auto parts while doing automotive repairs. Drop forged S2 chrome vanadium steel. Built-in hex screw allows for resizing of bits without having to replace the bit itself. length 6" Item #71037 - 1/8", 5/32", 3/16", 7/32", 1/4", 5/16", 3/8" Item #71036 - 3mm, 4mm, 6mm, 7mm, 8mm, 10mm



SAE SET MODEL No. 71037 **\$19.95**

Metric MODEL No. 71036 **\$19.95**



3/8" DRIVE 21 PIECE PRO SOCKET SETS

Drop forged, heat treated, chrome vanadium steel. Chrome plated to resist rust and corrosion. Each set includes 1 pc 8" reversible quick release ratchet. 2 pc. extension bars (1-3/4", 3") 8 pc. 3/8" deep sockets, 9 pc. 3/8" shallow sockets. 1 pc. blow mold case. Item #73105 SAE sizes - deep (3/8", 7/16", 1/2", 9/16", 5/8", 11/16", 3/4", 13/16") Shallow (3/8", 7/16", 1/2", 9/16", 5/8", 11/16", 3/4", 13/16", 7/8") Item #73120 mm sizes - deep (10mm, 11mm, 12mm, 13mm, 14mm, 15mm, 17mm, 19mm) shallow (9mm, 10mm, 11mm, 12mm, 13mm, 14mm, 15mm, 17mm, 19mm)



Model	Description	Price
73125	21 Piece SAE Socket Set	\$34.95
73120	21 Piece Metric Socket Set	34.95

Crescent® 170 Pc PROFESSIONAL TOOL SET

- 72 Tooth, 5° swing arc, quick release ratchets, 1/4", 3/8" & 1/2".
- (4 pc) extensions 3" to 6".
- 3/8" M to 1/4" F drive adapter.
- (46 pc) sockets, 1/4", 3/8", 1/2" Dr., standard and deep lengths from 3/16" to 7/8" and 4mm to 21mm. Plus 5/8" and 3/16" spark plug sockets.
- (18 pc) SAE hex keys in holder.
- (12 pc) combo wrenches: 5/16" to 5/8" & 10 to 15mm.
- (4 pc) screwdrivers, slotted and Phillips.
- (2 pc) pliers, long nose cutting and tongue and groove.
- Magnetized, 1/4" bit driver handle and (44 pc) Phillips, slotted, hex and Torx bits.
- (1 pc) adjustable wrench.

Fractional and Metric



Crescent Brand Tool Sets....tough enough to meet the new ANSI and ASME strength specifications 100%

SET No.
CTK-170
Reg. List
\$149.50

\$99.95



Crescent® PROFESSIONAL TOOL SETS

70 PIECE PROFESSIONAL SOCKET AND TOOL SET

- 72 tooth, 5° swing arc, quick release ratchets, 1/4" & 3/8".
- (2 pc) 3" extensions.
- 3/8" M to 1/4" F drive adapter.
- (16 pc) 1/4" Dr. std. length sockets 3/16" to 7/16" & 5 to 12mm.
- (10 pc) 3/8" Dr. std. length sockets 3/8" to 13/16" & 10 to 19mm.
- (12 pc) Combination wrenches: 3/8" to 1 1/16" & 10 to 17mm.
- Magnetized, 1/4" bit driver handle and (12 pc) Phillips, slotted, hex and Torx bits.
- (8 pc) Hex keys with holder.



SAE and
METRIC



MODEL No.
CTK70
Reg. \$69.50

\$49.95

GENERAL POWER PRECISION SCREWDRIVER

Precision use for Computers, Electronics, Industrial Applications, Hobbies and Crafts

- Quick change chuck.
- 10+ hours of power.
- 100+ RPM super-torque drive.
- Pull and reverse mode.
- Push and forward mode, On/Off switch.
- Ergonomically designed rubber cushion grip.



MODEL No.
PPS-500 **\$28.95**



MODEL No.
PPS-500
List \$33.50

\$26.95

Includes: 6-1/8" Bits



ARMSTRONG INDUSTRIAL HAND TOOLS ELECTRONIC TORQUE WRENCHES

Features:

- LCD screen with backlight for easy reading, enclosed in a shock resistant housing.
- Four simple buttons: power on/off, unit, torque target UP, and torque target DOWN.
- Buzzer and Red, Yellow, green lights to alert when target torque is reached.
- Accuracy: ± 2% CW, ± 3% CCW from 20% to 100% of rated capacity.
- 60 tooth gear with 6° ratcheting arc.
- Converts units: ft. -lbs., in.-lbs. or Nm.



Model 2332-1172 Shown



Model	Drive	Range	List Price	Sale Price
64-534	3/8"	10-100 ft.-lbs.	\$408.06	\$195.00
64-544	1/2"	25-250 ft.-lbs.	439.53	210.00

Precise HEAVY DUTY TIE DOWNS

- Heavy duty ratchet tie down.
- Quick automatic release.
- Safe and secure type.



Model	Size	Capacity	Price
8010-0002	1" x 15 ft.	1000 lbs.	\$ 6.95
8010-0001	2" x 27 ft.	6500 lbs.	32.95

Precise MICROMETER 10-150FT./LBS. TORQUE WRENCH

- 1/2" drive.
- Dual scale 10-150 ft/lbs.(1.4-20.7 m/kp) torque wrench.
- Micrometer adjusting, reversible ratcheting.
- Lock holds torque setting.
- Chrome plated alloy steel.
- Complete with conversion table chart.

MODEL No.
TWM-150

\$34.95



Precise BLUE TARPS

- Medium duty and light weight.
- Mildew resistant-water proof.
- Washable.
- Crack resistant down to 20°F.
- Rugged woven polyethylene fabric.
- Ideal for storage covers, boat covers, construction, etc.



Model	Cut Size	Price
8020-0005	10' x 16'	\$19.95
8020-0009	12' x 20'	29.95
8020-0018	18' x 24'	45.00
8020-0025	20' x 30'	59.95



INDUSTRIAL PRESS MACHINE SHOP TRADE SECRETS

By James Harvey 320 pp

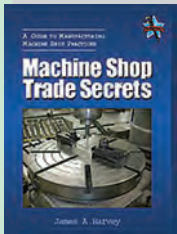

Written by an experienced machinist and plastic injection mold maker, this ground breaking manual will have users thinking and producing like experienced machinists. Machine shop trade secrets provides practical "how-to" information that can immediately be put to use to improve ones machining skills, craftsmanship and productivity. It is sure to be used and referred to time & again. Table of Contents: work fast. Get it right. Do it the easy way. Make 'em look good. Help for novices. More shop talk. The cutter caper. Threads and things. Help for engineers. Rotary magic. Taming warp. Be square. Mold making tips. Get your grinder goin'. The incredible CNC. Shop math wizardry. Odds and ends. Tell me something I don't know. Appendices. Index.

Book No. Reg. **\$31.95**
3227-2 \$41.95



FANUC CNC CUSTOM MACROS

By Peter Smid 336 pp., illus.



- Offers many practical do's and don'ts while covering all the popular Fanuc control systems exclusively.
- Provides the basis for exploring in great depth the extremely wide and rich field of programming tools that macros are.
- Numerous examples and sample programs are used throughout that serve as practical applications of the techniques presented and as the basis of ready-to-run macro programs.
- Includes a CD containing all of the sample programs.

Book No. Reg. **\$39.95**
3157-8 \$54.95

MACHINIST'S BEDSIDE READER

Must reading for machinists, apprentice machinists, gunsmiths, shop instructors and home shop machinists. The Machinist's Bedside Reader contains know-how and information that would take you countless hours to dig up on your own.

Volume 1 The Original	Volume 2 Bullseye Mixture New stories! New info! New update!	Volume 3 New Ideas New ideas, Working drawings, Tooling and notes on tools

Book No.	Description	Price
MBR-001	210 Pages, 106 illus volume 1	\$35.95
MBR-002	213 Pages, 106 illus volume 2	35.95
MBR-003	250 pages, 35 photos, 170 drawings	42.95
MBR-004	All 3 volumes Bedside Readers	\$103.50

ENGINEERS BLACK BOOK 6-1/2" x 4"

By Pat Rapp 168 Pages & Illustrations

- Data sheets and reference tables.
- Formulas.
- Inch/Metric conversion charts.
- Quick visual carbide insert identification charts.
- Speeds and feeds charts.
- Milling machine information.
- Nuts, bolts, and drill size identifications.
- Numerical control information.
- Includes a **FREE** aluminum drill point sharpening gage.
- All pages laminated.
- Equivalence charts.
- Everything you ever wanted to know about fasteners in both inch and metric standards.
- All pages are matt laminated and grease proof.
- Includes free aluminum drill & thread pitch gage.
- Fastener standards, technology, quality, tensioning, breaking loads, thread locking, torque tensioning and much more.
- History of screw threads.
- Fastener identification.

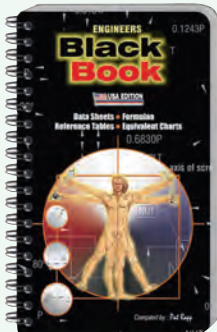

BOOK No. 6830P
Reg. \$26.00
\$23.50
With FREE Drill Point Sharpening Gage Inside Back Cover



29th EDITION MACHINERY'S HANDBOOK "The Bible of The Mechanical Industry for 125 Years"

Revised material...Properties, Treatment and Testing of materials, Dimensioning, Gaging and Measuring, Tool and Toolmaking, Manufacturing process. Updated Standards and Broad Math Coverage

- Machinery's Handbook has been the most popular reference work in metalworking, design, engineering and manufacturing facilities, and in technical schools and colleges throughout the world for nearly 100 years.
- The 29th edition of the "Bible of the Metalworking Industries" contains major revisions of existing content, as well as new material on a variety of topics.
- It is the essential reference for Mechanical, Manufacturing, and Industrial Engineers, Designers, Draftsmen, Toolmakers, Machinists, Engineering and Technology Students, and the serious Home Hobbyist.



500 Additional Pages

The Original Toolbox Edition
Reg. \$94.95

\$69.95

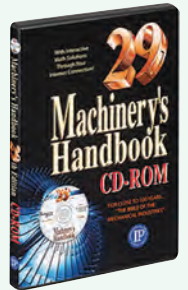

29th Edition Machinery's Handbook

Model	Description	Regular	Sale
2900-2	Original "ToolBox" 29th edition 5" x 7" 2,800 pages, thumb index	\$ 94.95	\$ 69.95
2901-9	"Large Print" 29th edition 7" x 10" 2,800 pages, thumb index	115.95	85.00
2903-3	29th edition handbook guide 280 pages	15.50	11.65
2911-8	Machinery's Handbook Pocket companion	21.95	16.50
3448-8	Machinery's Handbook Made Easy	29.95	23.95
29th Edition CD-ROM's			
2902-6	CD-ROM 29th edition	\$ 94.95	\$ 69.95
2904-0	CD-ROM & "Toolbox" edition	189.90	123.50
2905-7	CD-ROM & Large Print edition	210.90	136.50



See our all new Industrial Press publications "Auto-Cam" "CNC Programming" and 100 Rds of others on our website:
www.penntoolco.com

FASTENER BLACK BOOK 1st. EDITION By Pat Rapp 248 Pages & Illustrations

- Common workshop nuts, bolts, washers and nails.
- Detail information on most every type of fastener including torque type washers, pins & rivets.
- Its all here in a 6-1/2" x 4" format.
- Everything you ever wanted to know about fasteners in both inch and metric standards.
- All pages are matt laminated and grease proof.
- Includes free aluminum drill & thread pitch gage.
- Fastener standards, technology, quality, tensioning, breaking loads, thread locking, torque tensioning and much more.
- History of screw threads.
- Fastener identification.

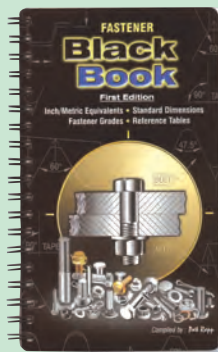

BOOK No. 8057-34
Reg. \$27.99
\$24.50
With FREE Drill & Thread Pitch Gage Inch & Metric



AUTOCAD EXERCISE WORK BOOKS ~ 2006 The Perfect Self-Study or Class Room Tutorial

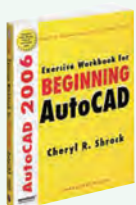

Beginning AutoCad
No. 3213-2
Reg. \$34.95
\$29.75

SAVE MORE BUY BOTH
SET No.8215-2
Reg. \$69.90
\$55.50



Advanced AutoCad
No. 3214-0
Reg. \$34.95
\$29.75

Book No. 3213-2 440 Pages & Illus. Totally updated for AutoCad 2006 and 2006 LT including the new and enhanced Commands, Dimensioning, hatching, Mtext, Dynamic Blocks, Dynamic Input and more. Ideal for classroom instruction or as a self-study tutorial, it provides only what you need without all the jargon.

Book No. 3214-0 440 Pages & Illus. Continue your AutoCad education with this companion to the "Beginning" workbook. Completely updated for AutoCad 2006 and 2006 LT software, workbook includes 21 non-intimidating, easy to follow lessons and 3 on-the-job type projects in Architecture, Electro-mechanical and Mechanical fields.



MACHINERY'S HANDBOOK POCKET COMPANION

- A unique visual presentation and detailed information encourages daily and quick use, helping users save time and labor.
- Provides immediate application of fundamental and reliable data.
- Includes reorganized, distilled and simplified material from Machinery's Handbook to increase usefulness while keeping the bulk down.
- Serves as a handy and more portable complement to Machinery's Handbook larger compilation of data, standards and text



318pp., Illus. by Dick Pohansih

INTRODUCTORY SPECIAL
BOOK No. 2802-9

\$16.50

This Could Be Your Best Little Helper Yet

MORSE CUTTING TOOLS POCKET SIZE MACHINIST GUIDES

- **Machinist's Practical Guide** - pocket size manual covering a wide range of practical information.
- **Guide For Taps** - this booklet contains all needed information for correct tapping work.
- **Guide For Carbide Tooling** - carbide and it's many tooling application are fully explained in this handy booklet. Included are design, application, geometrics, trouble-shooting, speeds and feeds.



Model	Description	List	Sale
1001	Machinist's Practical Guide		
1002	Machinist's Guide for Taps	\$8.95	\$6.95
1004	Machinist's Guide for Carbide Tooling	Each	Each
1006	All 3 of the above	\$26.85	\$19.95

Sequoia Publishing

POCKET REFERENCE
4th Edition 864Pages

This great little book is a concise all-purpose reference featuring hundreds of tables, maps, formulas, constants and conversions and it still fits in your shirt pocket. Goes where you go.

Book No. PR-5071
Reg. \$13.95

\$11.95

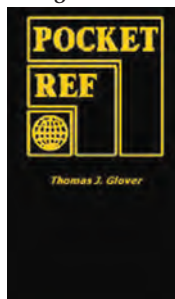

Sequoia Publishing

POCKET PC REFERENCE
14th Edition 1088 Pages

New Additions
Troubleshooting Tools
Wiring, Connectors & Pinouts
WinXP & 2000 Command
UNIX Command Reference
Startup Programs & Processes
Network Wiring & Standards
File Name Extensions
Country Domain Name Extensions

Book No. PPCR-5071
Reg. \$15.95

\$13.95



Plus Updated
CPU Processor Specs & Identification
Hard Drive Specs for 6,321 Drives
CD-ROM drive Specs for 1,817 Drives

IP INDUSTRIAL PRESS AUTOCAD POCKET REFERENCE

This indispensable aid and handy reference provides easy access to all the important fundamental commands, concepts, and How to information for the everyday use of AutoCAD. Its convenient compact size allows you to take it with you anywhere. Now you don't need to memorize command steps! Its perfect for students, teachers, and all AutoCAD users who are on the go and who need an occasional reminder on how to use a command.

- Provides a quick reference to most basic AutoCAD commands.
- Features easy-to-understand, step-by-step instructions.
- Includes AutoCAD releases 2004, 2005, and 2006.

304 Pages Reg. \$19.95
Book No. 3263-9 **\$16.95**

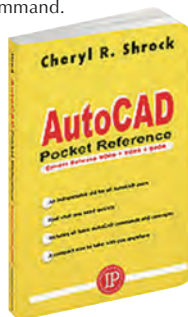

Sequoia Publishing

HANDYMAN IN YOUR POCKET
1st Edition 768 Pages

Let us introduce you to this amazing new shirt pocket reference designed specifically for handymen, maintenance people, engineers, scientists, industrial workers, contractors and builders.

It contains facts, tables and vital information and it fits in your shirt pocket.

Book No. HIY-5071
Reg. \$12.95

\$10.95

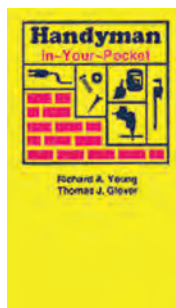

FLEXBAR SAFETY DRAINAGE MATS

- Mat design includes holes for drainage of fluids and collection of small debris from shop equipment.
- Traction bars on surface help keep soles of shoes dry & clean. • Color - Black.
- Underside knobs help keep mat in place.
- 100% all-purpose rubber construction.
- Edges are safety beveled on all four sides; overall thickness of mat is 1/2".



Model	Size	List	Sale
13475	3' x 5'	\$79.00	\$71.00
13476	3' x 10'	189.00	169.00
13477	3' x 20'	385.00	346.50

FLEXBAR SAFETY BUBBLE MATTING

- Constructed of domed bubble that the worker stands on allowing room for debris and fluids to settle.
- Yellow ramped borders offer high visibility and promote safety.
- Mat is molded using flexible natural rubber.
- Overall mat thickness is 1/2".
- Domed surface promotes blood circulation resulting in greater worker comfort and less fatigue.
- Color - Black mat with Yellow borders on all four sides.

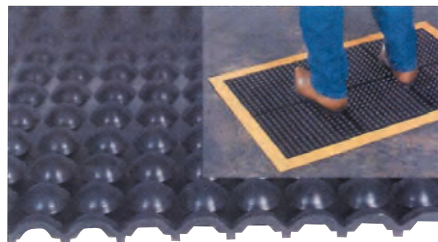

Model	Size	List	Sale
13480	2' x 3'	\$52.00	\$46.50
13481	3' x 4'	79.50	71.50

FLEXBAR ANTI-SLIP DIAMOND PLATE ANTI-FATIGUE SAFETY BORDERS

- Mat is constructed of a tough vinyl surface permanently bonded to a soft sponge base.
- Vinyl surface features molded in Diamond Plate pattern to promote secure footing.
- Wide bright yellow borders accent visibility and ramped edges on all sides facilitate easy access and promote safety.



Model	Size	List	Sale
13485	2' x 3'	\$59.50	\$53.50
13486	3' x 5'	133.00	119.50
13487	2' x 75'	Quote	-

Custom Mats up to 75' Available in 2', 3' or 4' widths upon request.

MORSE CUTTING TOOLS POCKET SIZE DECIMAL EQUIVALENT CHARTS

- **New Look larger Size** Decimal equivalents. Tap drill sizes for inch, metric and pipe threads. Size; 3-3/8" 7' printed on plastic.



Chart No. 1005

\$.95 Ea.

(Pack Of 10)
No. 1005-1

\$8.50

MORSE CUTTING TOOLS LARGE PLASTIC WALL CHART

- **New Look! larger Size!** Redesigned for enhanced readability. Decimal equivalents. Tap drill for inch, metric and pipe threads. 24" x 36" printed on heavy duty .023" gage plastic with three punched holes across top for wall mounting.



Chart No. 1007

\$6.95 Ea.

24" x 36"

(Pack Of 10)
No.1007-2

\$59.95



Kennedy METAL TOOL CHESTS AND TOOL BOXES Kennedy



MACHINISTS CHESTS

STYLE 520 7-DRAWERS
Drawers and top till wool felt-lined. Vinyl cushioned, steel core top handle. Six adjustable, zinc coated steel drawer dividers standard. Spring clips hold in place. Brown wrinkle finish.

MODEL No. 520
Reg. List \$361.50
\$229.50



Model	Drs	Width	Depth	Height
520	7	20-1/8"	8-1/2"	13-5/8"
Top Till		20"	8-3/8"	3-1/4"
Drawers	4	8-5/8"	7-1/2"	1"
	1	8-5/8"	7-1/2"	2"
	1	18-1/4"	7-1/2"	1-1/2"
35 lbs.	1	18-1/4"	7-1/2"	2-1/4"

STYLE 620 3-DRAWERS

Drawers and top till wool felt-lined. Vinyl cushioned, steel core top handle. Four adjustable, zinc coated steel drawer dividers standard. Spring clips hold in place. Brown wrinkle finish.

MODEL No. 620
Reg. List \$297.00
\$185.00



Model	Drs	Width	Depth	Height
620	3	20-1/8"	8-1/2"	13-5/8"
Top Till		20"	8-3/8"	3-1/4"
Drawers	1	18-1/4"	7-1/2"	1-1/2"
	1	18-1/4"	7-1/2"	2-1/4"
32 lbs.	1	18-1/4"	7-1/2"	3-1/8"

STYLE MC-22 2-DRAWERS ADD-ON BASE

Use with 620 and 520 chests. Top drawer wool felt-lined. Brown wrinkle finish.



MODEL No. MC-22
Reg. List \$207.50
\$129.95

Model	Drs	Width	Depth	Height
MC-22	2	21-5/8"	9-5/8"	7-7/8"
Drawers	1	18"	9-3/8"	1-1/2"
20 lbs.	1	18"	9-3/8"	3-1/2"

STYLE MC-28 2-DRAWERS ADD-ON BASE

Use with 526, 52511 and 3611 chests. Top drawer wool felt-lined. Brown wrinkle finish.



MODEL No. MC-28
Reg. List \$224.50
\$139.95
NOW

Model	Drs	Width	Depth	Height
MC-28	2	28-1/8"	9-5/8"	7-7/8"
Drawers	1	24-1/2"	9-3/8"	1-1/2"
23 lbs.	1	24-1/2"	9-3/8"	3-1/2"

STYLE 526 8-DRAWERS
Drawers and top till wool felt-lined. Six adjustable, zinc coated steel drawer dividers standard. Spring clips hold in place. Brown wrinkle finish.

MODEL No. 526
Reg. List \$457.75
\$295.00



Model	Drs	Width	Depth	Height
526	8	26-3/4"	8-1/2"	13-5/8"
Top Till		26-1/2"	8-3/8"	3-1/4"
Handbook		5-1/2"	7-1/2"	3-1/4"
Drawers	4	8-5/8"	7-1/2"	1"
	1	8-5/8"	7-1/2"	2"
	1	24-3/4"	7-1/2"	1-1/2"
35 lbs.	1	24-3/4"	7-1/2"	2-1/4"

STYLE 52611 11-DRAWERS

Drawers and top till wool felt-lined. Eight adjustable, zinc coated steel drawer dividers standard. Spring clips hold in place. Brown wrinkle finish.

MODEL No. 52611
Reg. List \$575.00
\$365.00



Model	Drs	Width	Depth	Height
52611	11	26-3/4"	8-1/2"	18"
Top Till		26-1/2"	8-3/8"	3-1/4"
Handbook		5-1/2"	7-1/2"	4-3/8"
Drawers	6	8-5/8"	7-1/2"	1"
	1	8-5/8"	7-1/2"	2"
	1	8-5/8"	7-1/2"	1-1/2"
	1	24-3/4"	7-1/2"	2-1/4"
56 lbs.	1	24-3/4"	7-1/2"	3-1/8"

STYLE 3611 11-DRAWERS

Felt covered bottom glides protect drop front panel from scratches. Comes with chrome side handles and six adjustable zinc coated steel drawer dividers standard. Spring clips hold in place. Brown wrinkle finish.



MODEL No. 3611
Reg. List \$992.50
\$640.00

Model	Drs	Width	Depth	Height
3611	11	26-1/8"	12"	18-7/8"
Top Till		26"	11-7/8"	2-5/8"
Handbook		5-1/2"	10-7/8"	5-1/2"
Drawers	6	7-5/8"	10-7/8"	1-1/4"
	1	7-5/8"	10-7/8"	2-5/8"
	2	23"	10-7/8"	2"
84 lbs.	1	23"	10-7/8"	3"

MECHANICS CHESTS

STYLE 263 3-DRAWERS

Drawers lock automatically when the lid is closed. Double lid stays safely hold lid open. Top till holds lift-out tray with socket set divider. Available in snap-in friction slides only. Choice of brown wrinkle or smooth red finish.

MODEL No. 263
Reg. List \$479.00
\$295.00



Model	Drs	Width	Depth	Height
263	3	26-1/8"	12"	14-3/4"
Top Till		26"	11-7/8"	2-5/8"
Tote Tray		19-1/2"	7-3/4"	3-3/8"
Drawers	1	23"	10-3/4"	2"
	1	23"	10-3/4"	3"
54 lbs.	1	23"	10-3/4"	4"

STYLE 266 6-DRAWERS

The mechanic's favorite chest for storage space and value. Top till holds lift-out tray with socket set divider. Available with friction slides only. Choice of brown wrinkle or smooth red finish.

MODEL No. 266
Reg. List \$575.00
\$365.00



Model	Drs	Width	Depth	Height
266	6	26-1/8"	12"	14-3/4"
Top Till		26"	11-7/8"	2-5/8"
Tote Tray		19-1/2"	7-3/4"	3-3/8"
Drawers	3	6-7/8"	10-3/4"	2"
	2	22-7/8"	10-3/4"	2"
62 lbs.	1	22-7/8"	10-3/4"	3"

STYLE 2602 2-DRAWERS ADD-ON BASE

Use with 263, 266 and 360 chests and 27", 29" or 34" roller cabinets. Available in snap-in friction slides only. Choice of brown wrinkle or smooth red finish.



MODEL No. 2602
Reg. List \$284.50
\$179.50

Model	Drs	Width	Depth	Height
2602	2	26-5/8"	12-1/2"	11-3/4"
Drawers	2	22-7/8"	10-7/8"	4-1/8"
40 lbs.				

STYLE 2600 CHEST RISER

Use with 263, 266 and 360 chests or 2602, 2603 and 2604 chest bases. Choice of brown wrinkle or smooth red finish.



MODEL No. 2600
Reg. List \$96.00
\$59.95

Model	Width	Depth	Height
2600	26-3/4"	12-1/2"	11-3/4"
19 lbs.			

STYLE 285 5-DRAWERS

STYLE 285X 5-DRAWERS
Full width drawers store and organize extra long tools. Fits on 27" wide roller cabinets; Model 285X has snap-in ball-bearing slides. Choice of brown wrinkle or smooth red finish.



MODEL No. 285
Reg. List \$637.00
\$395.00

MODEL No. 285X
Reg. List \$718.00
\$465.00



Model	Drs	Width	Depth	Height
85	5	27"	18"	16-5/8"
Drawers	4	23"	16-1/2"	2"
83 lbs.	1	23"	16-1/2"	4"
285X	Same dimensions as 285			
86 lbs.				

STYLE 360 10-DRAWERS

Right at home in a plant or auto maintenance bay. Top till holds lift-out tray with socket set divider. Fits on 27" or 29" wide roller cabinets. Available in friction slides only. Choice of brown wrinkle or smooth red finish.



MODEL No. 360-1
Reg. List \$823.00
\$525.00



Model	Drs	Width	Depth	Height
360	10	26-1/8"	12-1/16"	18-7/8"
Top Till		26"	11-7/8"	2-5/8"
Tote Tray		19-1/2"	7-3/4"	3-3/8"
Drawers	1	6-7/8"	10-3/4"	6-1/4"
	6	6-7/8"	10-3/4"	2"
	2	22-7/8"	10-3/4"	2"
84 lbs.	1	22-7/8"	10-3/4"	3"

MAINTENANCE MECHANIC

STYLE 2912X 12-DRAWERS

Made of heavyweight 18 gauge steel. Three full-length bottom drawers come with ball-bearing slides. Full-length aluminum drawer pulls and tubular high security lock standard. Fits model 2907X roller cabinet. Choice of brown wrinkle or smooth red finish.



MODEL No. 2912X
Reg. List \$1786.00
\$1125.00

With Ball Bearing Slides

Model	Drs	Width	Depth	Height
2912	12	28-1/4"	17-3/4"	19-3/4"
Top Till		28-1/8"	17-1/2"	2-5/8"
Drawers	9	7-1/2"	16-1/2"	1-3/4"
	2	25"	16-1/2"	1-3/4"
84 lbs.	1	25"	16-1/2"	3-7/8"



Kennedy ROLLER CABINETS

STYLE 21040B 4-DRAWERS

- Ball-bearing drawer slides on all drawers.
- Comes with 5 x 1-1/4" casters, tubular end handle and tubular high-security lock and key set.



MODEL
21040B
Reg. List
\$738.00
NOW

\$475.00

Overall Dimensions 21"W x 18"D x 34"H

Model	Drs.	Width	Depth	Height
21040B	2	16-1/2"	16-1/2"	2-3/4"
Drawers	1	16-1/2"	16-1/2"	6"
	1	16-1/2"	16-1/2"	9"

125 lbs.

MACHINIST'S CHEST/ROLLER CABINET COMBINATION

STYLE 520 7-DRAWERS MACHINIST CHEST

STYLE 21040B 4-DRAWER ROLLER CABINET



MODEL
520
Reg. List
\$361.50
NOW

\$229.50

MODEL
21040B
Reg. List
\$738.00
NOW

\$475.00

Buy Both and Save More

MODEL No.
52040
Reg. List
\$1099.50
NOW

\$615.00

STYLE 220 2-DRAWERS

Model 220 can be paired with Model 2005 cabinet for a handy home combo. Or, think of it as a tool chest you can take on the job or on a tip. Choice of brown wrinkle or smooth red finish.



MODEL No.
220
Reg. List
\$222.00
NOW

\$135.00



Model	Drs.	Width	Depth	Height
220	2	20-1/8"	8-5/8"	9-3/4"
Top Till		20"	8-3/8"	2-1/4"
Drawers	2	18-1/4"	7-3/8"	2-1/4"

19 lbs.

Kennedy roller cabinets come with the **Universal Drawer Slide System**. Full depth slide carrier channels provide support for the snap-in friction and ball-bearing drawer slides. Both types are interchangeable for maximum storage capabilities. **Roller cabinet "X" models come with ball-bearing drawer slides standard.** Two rigid and two swivel casters with toe locks are standard on all cabinets. Choice of brown wrinkle or smooth red finish.



Model No.
(297
Shown)

Model 273	Model 275	Model 277
Reg List \$738.00	Reg List \$881.00	Reg List \$1029.00
\$475.00	\$565.00	\$665.00

Model 273X	Model 275X	Model 277X
Reg List \$767.00	Reg List \$935.00	Reg List \$1112.00
\$495.00	\$595.00	\$715.00

Model	Drs.	Width	Depth	Height
273	3	27"	18"	35"
Drawers	2	23"	16-1/2"	4"
	1	23"	16-1/2"	6"
Compartment		24-1/8"	17-3/4"	11-1/4"

110 lbs.

273X Same dimensions as 273 with Ball Bearing Slides

Model	Drs.	Width	Depth	Height
275	5	27"	18"	35"
Drawers	3	23"	16-1/2"	2"
	2	23"	16-1/2"	4"
Compartment		24-1/8"	17-3/4"	11-1/4"

122 lbs.

275X Same dimensions as 275 with Ball Bearing Slides

Model	Drs.	Width	Depth	Height
273	7	27"	18"	35"
Drawers	3	23"	16-1/2"	2"
	3	23"	16-1/2"	4"
	1	23"	16-1/2"	6"

138 lbs.

277X Same dimensions as 277 with Ball Bearing Slides

Model 295	Model 297
Reg List \$970.00	Reg List \$1078.00
\$625.00	\$695.00

Model 295X	Model 297X
Reg List \$1018.00	Reg List \$1170.00
\$625.00	\$750.00

Model	Drs.	Width	Depth	Height
295	5	29"	20"	35"
Drawers	3	25"	18-1/2"	2"
	2	25"	18-1/2"	4"
Compartment		26-1/8"	19-3/4"	11-1/4"

141 lbs.

295X Same dimensions as 295 with Ball Bearing Slides

Model	Drs.	Width	Depth	Height
297	7	29"	20"	35"
Drawers	3	25"	18-1/2"	2"
	3	25"	18-1/2"	4"
	1	25"	18-1/2"	6"

159 lbs.

297X Same dimensions as 297 with Ball Bearing Slides



Kennedy MOBILE VERSA-BENCH

All Versa-Benches have 1/8" steel work surface. Floor lock, tubular end handle and four 8" x 2" roller bearing phenolic wheels standard. All models have padlockable doors. Load capacity 3600 lbs.



Model No
4810



Model No
6006-1



Model No
4800MP

STYLE 4810 10-DRAWERS

Comes with ten drawers and doors that can be padlocked for extra security. (Padlock not included.) Choice of Raven Black or Red finish.

STYLE 6006 6-DRAWERS

Six drawer unit comes with lock and two keys. Doors can be padlocked for extra security. (Padlock not included.) Choice of Raven Black or Red finish.

Model 4810	Model 6006-1
Reg List \$5294.00	Reg List \$4661.00
\$3395.00	\$2995.00

Model	Drs.	Width	Depth	Height
4810	10	48"	26"	35-7/8"
Drawers	2	30"	23-1/2"	1-3/4"
	3	10"	23-1/2"	4"
	3	1-5/8"	23-1/2"	1-3/4"
	1	12"	23-1/2"	10"
	1	43-7/8"	23-1/2"	5-3/8"

530 lbs.

Model	Drs.	Width	Depth	Height
6006-1	6	60-7/8"	32"	35-7/8"
	3	23"	16-1/2"	2"
	2	23"	16-1/2"	4"
	1	23"	16-1/2"	5"

Top Fr Comp 27-1/4" 28-1/2" 11-1/2"
Btm Fr Comp 27-1/4" 28-1/2" 14-3/8"
Back Comp 28-1/2" 9-1/4" 26"
478 lbs.

STYLE 4800 12-DRAWERS

- Ballbearing drawers slides on all drawers plus full-width pulls make opening drawers smoother and easier.
- Includes nonslip, open weave drawer liners.
- Two doors cover drawers and can be padlocked for security.
- Includes (2) 30 x 2" high drawers; (3) 30 x 4" high drawers; (3) 12 x 2" high drawers; (1) 12 x 10" high drawer and (1) 44 x 5" high drawer.
- Rhino coated MDF work surface protects cabinet top.
- Rugged 8 x 2" roller bearing phenolic wheels hold up to 3,600 lbs.

Model	Color	Dimensions	Weight	List	Sale
4800MP	Yellow	53" x 20" x 42-1/2"	540 lbs.	\$5657.00	\$3650.00
4801MP	Blue	53" x 20" x 42-1/2"	540 lbs.	5657.00	3650.00

Kennedy CANTILEVER TOOL BOX

- You'll like the way each opens to see all your tools at a glance.
- Movable/removable partitions and divider sets permit you to create six compartments in each of two ways.
- Quality plated locking hardware and steel core, vinyl cushioned handles make these boxes a pleasure to own and use.
- Model 1022 has divider for storing socket sets.
- Brown wrinkle finish.



MODEL No.
1022
LIST \$212.83

ALL STEEL \$135.00

22-1/8"L x 10"W x 12-5/8"D
21 lbs.

Kennedy PROFESSIONAL TOOL BOXES

- Include lift-out tray, vinyl coated, steel top handle.
- K20 and K24 trays have socket set divider.
- Model K32X also has plated side carry handles.
- Brown wrinkle finish.

ALL STEEL

Model	Dim. W x D x L	Lbs.	List	Sale
K20	20-1/8" x 8-5/8" x 9-3/4"	13	\$139.00	\$89.95
K24	24-1/8" x 8-5/8" x 9-3/4"	14.5	159.00	99.95



STYLE DS1 FOLDAWAY SHELF

Provide 2.4 square feet of added work surface. Raised sides keep tools from rolling off. Folds flat when not in use. Attaches to any 27, 29 or 34 inch wide roller cabinet. Choice of brown wrinkle or smooth red finish. 11 lbs. Dimensions: 20-1/8"W x 17-1/4"D 1"H.

MODEL No.
DS1
Reg. List
\$114.00
NOW

\$72.50



Kennedy HANG-ON CABINETS

5-Drawers Friction Slides		5-Drawers Ball-Bearing Slides	
185	205	185X	205X
Reg List \$529.00	Reg List \$588.50	Reg List \$598.00	Reg List \$650.00
NOW \$340.00	NOW \$375.00	NOW \$385.00	NOW \$420.00



Front facing drawers make it easy to reach all your tools. Internal drawer locking system. Cabinets bolt to either side of your roller cabinet. Use 185/185X with 27" wide roller cabinets; 205/205X with 29" wide roller cabinets. Choice of brown wrinkle or smooth red finish.

Model	Drs.	Width	Depth	Height
185	5	13-5/8"	18"	29"
Drawers	1	9-3/4"	16-1/2"	2"
	3	9-3/4"	16-1/2"	4"
71 lbs.	1	9-3/4"	16-1/2"	10"
185X	Same dimensions as 185			
76 lbs.	With Ball Bearing Slides			
205	5	13-5/8"	20"	29"
Drawers	1	9-3/4"	18-1/2"	2"
	3	9-3/4"	18-1/2"	4"
77 lbs.	1	9-3/4"	18-1/2"	10"
205X	Same dimensions as 205			
82 lbs.	With Ball Bearing Slides			



Kennedy

PROFESSIONAL SERIES COMBO

STYLE 4405 5-DRAWER Heavy-Duty Top Chest
STYLE 4410 10-DRAWER Heavy-Duty Roller Cabinet
 Made of 18 gauge steel. Full member ball bearing bearing slides come on all drawers. Full-length aluminum drawer pulls. Model 4405 has compartment with removable partial shelf and locking door. Drawer and locking door keyed alike with tubular high security locks. Model 4410 comes with tubular end handle, four 6" x 2" roller bearing casters with phenolic wheels, two 10" ball bearing wheels with solid rubber tires and two keyed alike tubular high security locks. Full-width drawer holds objects up to 39" long. Choice of brown wrinkle or smooth red finish.



MODEL 4405
Reg. List \$1700.00

MODEL 4410
Reg. List \$2962.00

\$1095.00

\$1895.00

Model	Drs.	Width	Depth	Height
4405	5	43-3/4"	20"	16-1/2"
Drawers	4	25"	18-1/2"	2"
	1	25"	18-1/2"	4"
Compartment		15-1/2"	19-3/8"	15-3/8"
137 lbs.				
4410	10	43-3/4"	20"	37-1/2"
Drawers	2	25"	18-1/2"	2"
	3	25"	18-1/2"	4"
	3	12"	18-1/2"	2"
	1	12"	18-1/2"	10"
316 lbs.	1	39-1/2"	18-1/2"	6"

Benchmark Series™

8-DRAWER TOP CHEST	11-DRAWER ROLLER CABINET
No. 46000-Red Gloss	No. 46003-Red Gloss
No. 46002-Black Wrinkle	No. 46005-Black Wrinkle
No. 46001-Burgundy Gloss	No. 46004-Burgundy Gloss

State-of-the-art tool storage for the professional mechanic. All drawers come with ball-bearing slides and heavy-duty, non-slipdrawer liner. Roller cabinet comes with chrome-plated steel side handle, top mat & 6" x 2" casters, keyless entry, push button locks on both units.



8-DRAWER 46" TOP CHEST
Reg. List \$2727.00

\$1750.00

11-DRAWER 46" ROLLER CABINET
Reg. List \$3294.00

\$2095.00

Model	Drs.	Width	Depth	Height
Chest	8	46"	24"	19"
Top Till		45-7/8"	23-3/4"	4-3/8"
Drawers	2	12-7/8"	22-1/2"	2"
	2	26-5/8"	22-1/2"	2"
	2	12-7/8"	22-1/2"	4"
230 lbs.	2	26-5/8"	22-1/2"	4"
Cabinet	11	46"	24"	42-5/8"
Drawers	2	12-7/8"	22-1/2"	2"
	3	12-7/8"	22-1/2"	4"
	3	26-5/8"	22-1/2"	4"
	1	42-1/8"	22-1/2"	4"
	1	12-7/8"	22-1/2"	6"
450 lbs.	1	26-5/8"	22-1/2"	6"

Kennedy VERSA-CARTS

5-Drawers Friction Slides		5-Drawers Ball-Bearing Slides	
415-1	435	415X	435X
Reg List \$1155.00	Reg List \$1217.00	Reg List \$1191.00	Reg List \$1272.00
\$750.00	\$785.00	\$770.00	\$820.00



Deck of 16 gauge steel with 1-1/2" high sides. Two 10" ball bearing wheels with solid rubber tires and two 5" x 2" swivel casters with toe locks, chrome plated tubular steel handle and attachment hardware standard. 1,000 lb. capacity. use 415/415X with 27" wide cabinets; 435/435X with 29" wide cabinets. Choice of brown wrinkle or smooth red finish.



Model	Drs.	Width	Depth	Height
415-1	5	41-1/8"	18-3/8"	36-1/4"
Drawers	1	16-1/2"	9-3/4"	2"
	3	16-1/2"	9-3/4"	4"
112 lbs.	1	16-1/2"	9-3/4"	10"
415X	Same dimensions as 415			
117 lbs.	With Ball Bearing Slides			
435	5	43-1/8"	20-1/4"	36-1/4"
Drawers	1	18-1/2"	9-3/4"	2"
	3	18-1/2"	9-3/4"	4"
131 lbs.	1	18-1/2"	9-3/4"	10"
435X	Same dimensions as 435			
136 lbs.	With Ball Bearing Slides			

Kennedy

SUPER SIZE TOP CHEST AND ROLLER CABINET



STYLE 3611 11-DRAWER MACHINIST CHEST

STYLE 297 7-DRAWER ROLLER CABINET

Buy Both and Save More!

MODEL 3611/297
Reg. List \$2070.50

\$1295.00

MACHINIST CHEST, BASE AND ROLLER CABINET COMBO



STYLE 52611 11-DRAWER MACHINIST CHEST

STYLE MC28 2-DRAWER CHEST BASE

STYLE 297 7-DRAWER ROLLER CABINET

Buy All Three and Save More

MODEL No. 1-299-3
Reg. List \$1877.50

NOW \$1185.00

THE CUTTERKART

STYLES 73240 AND 73250

Designed to provide machine shops with simple, effective, organized protective tool holder storage at a very affordable price. Weight capacity is 1200 lbs. 5" x 2" casters standard. Assembly required. Assembled dimensions:

29"L x 24"W x 38"H. Blue, durable baked powder coat. Model 73240 holds 56 #40 taper tool holders; model 73250 holds 40 #50 taper tool holders. Ship weight 80 lbs.



MODEL 73240
Reg. List \$727.00

\$465.00

MODEL 73250
Reg. List \$727.00

\$495.00





Kennedy MAINTENANCE CHEST AND CARTS

BALL BEARING DRAWERS!



STYLE 310X 10-DRAWER MAINTENANCE CART



STYLE 315X 15-DRAWER MAINTENANCE CART

Made of 16 gauge steel. Huge 39" x 18" work surface, full-width drawer pulls and tubular side handle for ease of handling. Two keyed-alike, high security tubular locks and four 5 x 2" sintered bearing casters standard. **Models 310 and 315** come standard with snap-in friction drawer slides; **Models 310X and 315X** come standard with ball-bearing slides. Choice of brown wrinkle or smooth red finish.

Model	Drs	Width	Depth	Height
310X	10	39-3/8"	18"	35"

210 lbs.

Model	Drs	Width	Depth	Height
315X	15	39-3/8"	18"	39"

260 lbs.

Model	Drs	Width	Depth	Height
305X	5	39-3/8"	18"	16-1/2"

102 lbs.

STYLE 305X 5-DRAWER MAINTENANCE CHEST

Use with Models 310, 310X, 315 and 315X maintenance carts. Comes with full-length drawer pulls and high security tubular lock. Compartment has removable partial shelf and locking door. Model 305 comes standard with snap-in friction drawer slides; **Model 305X** comes standard with ball-bearing drawer slides. Choice of brown wrinkle or smooth red finish.



MODEL No. **310X**
Reg. List \$1538.00
\$995.00



MODEL No. **315X**
Reg. List \$1899.00
\$1195.00



MODEL No. **305X**
Reg. List \$1251.00
\$795.00



Kennedy

Since 1911

America's Premier Industrial Tool Storage

MAPLE WORK SURFACE

- 1-1/2" thick butcher block maple top.
- Full-length laminations specially selected for grain and color match.
- Comes with care instructions.
- 39"W x 17-3/4"D x 1-1/2"H
- Model 80880 - Fits models 310, 310X, 315, 315X.

MODEL No. **80880**
Reg. List \$290.00
\$179.50



Kennedy Pro-Line MAINTENANCE CARTS

MAINTENANCE CARTS



Built to Work Built to Last

- High-gloss black powder finish.
- Heavy-welded steel construction.
- High-security tubular key locks.
- Ball-bearing drawer slides.
- Heavy-duty tubular side handle.
- Full-width aluminum drawer pulls.
- Heavy-duty roller-bearing casters.
- MDF worksurface.

Pro-Line 12-Drawer Maintenance Carts

- Extra-wide top drawer.
- 39" wide model includes 5"x 2" roller bearing casters.
- 41" wide model includes 6"x 2" roller bearing casters.



Pro-Line 7-Drawer with side Component

- MDF adjustable shelf inside compartment.
- Locking door.
- Includes 5" x 2" casters.

MODEL No. **10491-1**
Reg. \$1367.00
\$875.00

Drawers	Width	Depth	Height	Ship lbs.
7	39-3/8"	18"	35"	205
3	23"	16-1/2"	2"	
3	23"	16-1/2"	4"	
1	23"	16-1/2"	6"	
Compartment	10-3/4"	18"	28"	



Pro-Line 13-Drawers Maintenance Carts
MODEL No. **10492**
Reg. \$1816.00
\$1150.00

Drawers	Dimensions			Ship lbs.
	Width	Depth	Height	
13	39-3/8"	20"	39"	250
1	23"	16-1/2"	2"	
5	23"	16-1/2"	4"	
1	23"	16-1/2"	6"	
1	9-3/4"	16-1/2"	2"	
4	9-3/4"	16-1/2"	4"	
1	9-3/4"	16-1/2"	10"	

Pro-Line 13-Drawers Wider-Deeper-Higher
MODEL No. **10494-1**
Reg. \$2321.00
\$1375.00

Drawers	Dimensions			Ship lbs.
	Width	Depth	Height	
13	41-3/8"	20"	42"	275
1	25"	18-1/2"	2"	
5	25"	18-1/2"	4"	
1	25"	18-1/2"	6"	
1	9-3/4"	18-1/2"	2"	
4	9-3/4"	18-1/2"	4"	
1	9-3/4"	18-1/2"	10"	



MODEL No. **10493**
Reg. \$1923.00
\$1225.00

Drawers	Dimensions			Ship lbs.
	Width	Depth	Height	
12	39-3/8"	18"	39"	255
1	35-3/4"	16-1/2"	6"	
2	23"	16-1/2"	2"	
3	23"	16-1/2"	4"	
1	23"	16-1/2"	6"	
2	9-3/4"	16-1/2"	2"	
2	9-3/4"	16-1/2"	4"	
1	9-3/4"	16-1/2"	10"	

Pro-Line 12-Drawers Wider-Deeper-Higher
MODEL No. **10495**
Reg. \$2524.00
\$1595.00

Drawers	Dimensions			Ship lbs.
	Width	Depth	Height	
12	41-3/4"	18"	42"	280
1	37-3/4"	18-1/2"	6"	
2	25"	18-1/2"	2"	
3	25"	18-1/2"	4"	
1	25"	18-1/2"	6"	
2	9-3/4"	18-1/2"	2"	
2	9-3/4"	18-1/2"	4"	
1	9-3/4"	18-1/2"	10"	





Kennedy MAINTENANCE PRO TOOL CHEST AND ROLLER CART 53" WIDE

MADE IN USA

NEW! Maintenance Pro™ 8-Drawer Chest

- Includes gas shock lid stays, full-width drawer pulls, drawer liners in every drawer.
- Ergonomic side handle has soft rubber grip.
- Tubular high-security lock with two keys.
- 53"W x 18"D x 20"H

MODEL No. 5302MP **\$1195.00**
List \$1850.00

12-Drawer Roller Cart

- Ball bearing drawer slides on all drawers and large full-width drawer pulls.
- Ergonomic end handle has soft rubber grip
- Rugged 6" x 2" roller bearing casters and 10" wheels for maximum stability.
- Top drawer holds tools up to 49" long.
- Non-slip, open weave drawer liner.
- Heavy-duty top mat protects cabinet top.
- Tubular high security lock and two keys.
- 53"W x 18"D x 40-1/2"H

MODEL No. 5300MP **\$1850.00**
List \$2876.00

Choice of Colors



Add Color Code Number to Model # (5300MPOR for Citrus Orange)



Canopy

- Full access open storage, ideal for storing parts and tools.
- Twin gas struts open door.
- Secure double point locking system.
- Bolts to cabinet for security.
- Includes 30-piece assorted hook set.
- 53"W x 18"D x 20"H

MODEL No. 5350MP **\$825.00**
List \$1272.00

2 Shelf Locker

- Comes with locking door, two adjustable pull out shelves that operate on ball bearing slides and heavy duty top mat.
- Attaches to either side of roller cabinet.
- 13-5/8"W x 18"D x 33-1/8"H

MODEL No. 380MP **\$455.00**
List \$706.00

6-Drawer Side Cabinet

- Attaches to either side of roller cabinet.
- Comes with ball bearing slides on all drawers and heavy-duty top mat.
- Internal locking system secures drawers.
- 13-5/8"W x 18"D x 33-1/8"H

MODEL No. 382MP **\$575.00**
List \$889.00

Kennedy Pro-line MAINTENANCE CART



- Ball bearing drawer slides on all drawers and large full-width drawer pulls.
- Rugged 6" x 2" roller bearing casters and 10" wheels for maximum stability.
- Non-slip, open weave drawer liner.
- Durable, coated MDF work surface protects cabinet top.



MADE IN USA

MODEL No. 4400MPBL
List \$3155.00

\$1,995.00

10 Drawers

- Top drawer holds tools up to 39" long.
- Two tubular high security locks with two keys.
- 43-3/4"W x 20"D x 37-1/2"H

Kennedy Benchmark Series TOOL STORAGE 60" WIDE



8 Drawer Chest

- Tubular high-security lock and key set.
- Gas-shock lid stays.
- Ball-bearing slides come on all drawers.
- Heavy-duty, non-slip drawer liner in every drawer and chrome-plated steel slide handle.
- 60"W x 24"D x 19"H
- Model 60000BK- Black Finish
- Model 60000BL- Classic Blue Finish
- Model 60000BUR- Burgundy Finish
- Model 60000R- Red Finish

List \$3208.00 **\$1,995.00**

11 Drawer Chest

- Tubular high-security lock and key set.
- Ball-bearing slides come on all drawers.
- Heavy-duty, non-slip drawer liner in every drawer, top mat, chrome-plated steel slide handle and 6" x 2" casters
- 60"W x 24"D x 44-1/2"H

- Model 60121BK- Black Finish
 - Model 60121BL- Classic Blue Finish
 - Model 60121BUR- Burgundy Finish
 - Model 60121R- Red Finish
- List \$4700.00 **\$2,950.00**

KenCraft BY Kennedy CHESTS AND ROLLER CABINETS

Kennedy is proud to introduce its KenCraft line of products. An affordable line of Roller Cabinets, Hand Carry Toolboxes, and Tool Bags, tailored to meet the discriminating needs of the industrial user. Produced both domestically and abroad, the KenCraft line is built to meet the strict quality requirements determined by Kennedy Mfg. Co.



No 752700



No 752708

27" Pro Series Accessories

Model	Description	List	Sale
752700	Side Shelf Attachment	\$42.00	\$31.50
752708	Organizer Attachment	56.00	\$28.00

Model	Dimensions	Drawers	Weight	List	Sale
722709*	26-1/8" x 17-1/2" x 17"	9	125 lbs.	\$430.50	\$322.00
722609	26-1/4" x 12" x 17"	9	79 lbs.	353.25	265.00
722604	26-1/4" x 12" x 14-1/2"	4	62 lbs.	265.00	198.75
722603	26-3/4" x 12" x 9-7/8"	3	45 lbs.	\$206.00	\$154.50
722707*	26-3/4" x 18-1/4" x 39-3/8"	7	132 lbs.	\$637.00	\$477.75

* Metal Thickness: Body 1.0mm, Frame 1.0mm, Drawers 0.8mm
Drawer load capacity: 88 lbs.

Kennedy MACHINIST PRO™ 39" CHEST

- Gas Shock Lid Stay
- Non-Slip Draw Liner
- High Security Lock

MADE IN USA

MODEL No. 308X
Reg. \$1630.00



\$1015.00

Dimensions:
39-3/8"W x 18-3/8"H x 18"D
7742cu. inch capacity
Specify Color



Kennedy 52" Maintenance Pro™ SERIES

- Gas Shock Lid Stay
- Non-Slip Draw Liner
- High Security Lock

MADE IN USA

7-Drawer Chest

Dimensions:
51-5/8"W x 21-1/2"H x 20"D
21516cu. inch capacity
Net Wt. 320lbs./Sh Wt. 330lbs.

MODEL No. 5207MP
Reg. \$2672.00

\$1695.00

12-Drawer Roller Chest

Dimensions:
51-5/8"W x 42"H x 20"D
21516cu. inch capacity
Net Wt. 320lbs./Sh Wt. 330lbs.

MODEL No. 5212MP
Reg. \$3325.00

\$2150.00

Specify Color



Kennedy 53" Benchmark Series™

- Gas Shock Lid Stay
- Non-Slip Draw Liner
- High Security Lock

7-Drawer Chest

Dimensions:
53"W x 20-1/2"H x 24"D
16494cu. inch capacity
Net Wt. 260lbs./Sh Wt. 335lbs.

MODEL No. 53000
Reg. \$2040.00

\$1295.00

11-Drawer Roller Cabinet

Dimensions:
51-5/8"W x 42"H x 20"D
26815cu. inch capacity
Net Wt. 460lbs./Sh Wt. 485lbs.

MODEL No. 53001
Reg. \$3115.00

\$1995.00

MADE IN USA



Specify Color



Kennedy CUTTERKART™

Model No.	List	Sale
73240	\$782.00	\$499.50

- Pre-configured trolley holds up to 56 #40 taper tools
- Weight capacity of 1,200 lbs.
- Includes four metal and ABS plastic toolholder plates

Model No.	List	Sale
73250	\$782.00	\$499.50

- Pre-configured trolley holds up to 40 #50 taper tools
- Weight capacity of 1,200 lbs.
- Includes four metal and ABS plastic toolholder plates

Specifications:

Width 29"
Depth 24"
Height 28"
Weight 801 lbs.



- 5" x 2" roller bearing casters, two rigid and two swivel with brakes, roll across the roughest floors with ease

MADE IN USA



Kennedy MOBILE TOOLKARTS™

- Pre-configured ToolKarts come with six frames and plastic sockets.
- Additional tool frames, plastic sockets and trolley accessories must be added separately.
- Made of 18 gauge steel.

Model No.	List	Sale
73030	\$1851.00	\$1195.00

- Pre-configured trolley holds up to 42 #30 taper tools

Model No.	List	Sale
73040	\$1729.00	\$1095.00

- Pre-configured trolley holds up to 42 #40 taper tools

Model No.	List	Sale
73050	\$1630.00	\$1050.00

- Pre-configured trolley holds up to 36 #50 taper tools



Specifications:

Width 29"
Depth 24"
Height 38"
Load Capacity 1200 lbs.

ToolKarts include sturdy metal socket frames that hold a variety of sockets. Order pre-configured cart and add additional socket frames and toolholders as your storage requirements change. Or, custom-design your own ToolKart™

Kennedy 62" 17-DRAWER TRIPLE BANK CABINET

- Coated MDF work surface.
- Tubular Lock sets.
- Ergonomic end handle.
- Ball-bearing drawer slides.
- Full length drawer pulls.
- Aluminum corner trim.
- 6" x 2" roller bearing casters.

Dimensions: 62"W x 24"D x 43-1/2" H



MODEL No. 62017
Reg. \$5235.00

\$3100.00



To order, place the color code behind the model number.
Example, 62017BUR



CHEST & ROLLER CABINET 42" Wide Roller Cabinet



- Heavy 18 gauge metal construction.
- Ball bearing drawer slides.
- Powder coated paint for superior scratch and chemical resistance.
- Completely lockable.
- Large 5"x 2" heavy duty casters on rollers cabinet 2 lockable and 2 fixed.

6 Drawer Chest Plus Top Tray Area

Specifications:
41.3"W x 17.5"D x 21.5"H
Weight Capacity: 385 lbs.
Shipping Weight: 139 lbs.
MODEL No. TB4015A
Reg. \$408.00 **\$295.00**

5 Drawer Roller Cabinet

1-Compartment
42"W x 18"D x 33.6"H
Weight Capacity: 880 lbs.
Shipping Weight: 210 lbs.
MODEL No. TB4015B
Reg. \$625.00 **\$450.00**

SAVE MORE! MODEL No. TB4015CB **\$695.00**
BUY BOTH



PRO-TOOL STORAGE 41" WIDE

BALL BEARING SLIDES

- Heavy 16 gauge metal construction.
- 8 Ball bearing drawer slides.
- Powder coated paint for superior scratch and chemical resistance.
- Hydraulic lift top compartment.
- Completely lockable.
- Large 5"x 2" heavy duty casters on rollers cabinet 2 lockable and 2 fixed.
- Rubber lined drawers.

Dimensions:
8-Drawer Chest
41"x 17-1/2"x 21-1/2" H
Roller Cabinet
42" W x 18" D x 40" H
Color: Black or Teal
(Specify)

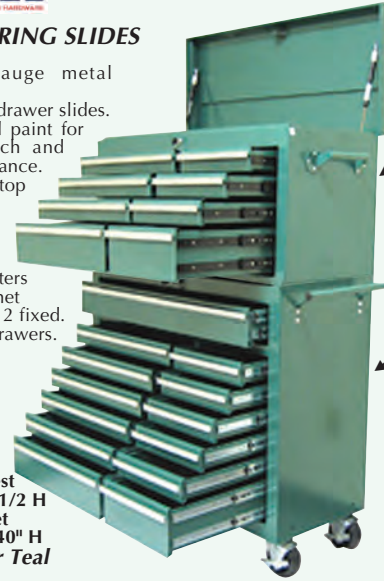

8-Drawer Master Chest
MODEL No. TBT-4008X
Reg. \$550.00

\$339.95

275 Lbs.
13-Drawer Master Roller Cabinet
MODEL No. TBR-4013X
Reg. \$795.00

\$525.00

322 Lbs.
Save More Buy Both!
MODEL No. TBR-4138
Reg. \$1345.00

\$845.00

597 Lbs.



PRO CHEST & ROLLER CABINET 36" WIDE BALL BEARING DRAWER SLIDES

- The Top Chest and Roller Cabinet have ball bearing slide drawers, recessed side handles, full length aluminum drawer pulls, EVA drawer liners, and a tough industrial black powder coat paint finish for scratch and corrosion resistance.
- Both Top Chest and Roller Cabinet are also made from durable cold rolled steel and has a maximum overall weight capacity of 660 lbs. and the Roller cabinet has 800 lbs. weight capacity.

Dimensions:
7-Drawer Top Chest
36"L x 16"W x 22"H
Top Tray
35.8"L x 15"D x 3.2"H
Roller Cabinet
36.6"L x 18.1"W x 36"H



7-Drawer Top Chest
MODEL No. TB-2108X
Reg. \$450.00

\$319.95

105 lbs.

7-Drawer Roller Cabinet
MODEL No. TB-2608X
Reg. \$595.00

\$475.00

184 lbs.

SAVE MORE! MODEL No. TB-3602X
Reg. \$1045.00

\$749.95



PRO CHEST & ROLLER CABINET 56" WIDE BALL BEARING DRAWER SLIDES

- The Top Chest has ball bearing slide drawers with double ball bearing slides on two drawers, internal locking system, two heavy duty steel side handles, full length aluminum drawer pulls, Gas hinges, EVA drawer liners, and a tough industrial black powder coat paint finish for corrosion and scratch resistance.
- They are both made from durable cold rolled steel have a maximum overall weight capacity of 660 lbs. for the Top Chest and 1760 lbs. for the Roller cabinet.

Dimensions:
7-Drawer Top Chest
56.6"L x 18.6"W x 20.7"H
Top Tray
55.3"L x 117.3"W x 3.7"H
Roller Cabinet with Casters
56"L x 20.1"W x 39.7"H



7-Drawer Top Chest
MODEL No. TB-5607A
Reg. \$695.00

\$495.95

204 lbs.

12-Drawer Roller Cabinet
MODEL No. TB-5607B
Reg. \$1150.00

\$825.00

375 lbs.

SAVE MORE! MODEL No. TB-5620X
Reg. \$1845.00

\$1250.00



72" ROLLER TOOL CABINET-14 DRAWER

- 14 Ball bearing slide drawers.
- Double Ball bearing slides on the top large drawer.
- Double ball bearing slides on the bottom 2 center drawers.
- Double ball bearing slides on the bottom right drawer.
- Quick release drawer slides.
- Shell is 18 gauge.
- Drawer liners.
- Rubber top mat/2mm.
- Full length aluminum drawer pulls.
- Heavy duty steel side handles.
- Upgraded 6" x 2" spring casters / 4swivel casters with brakes and 2 swivel casters with no brakes.



Specifications:
Overall: 71.4"W x 22.4"D
w/o casters x 35.2" H
Casters: 6" x 2"
Net Shipping: 505 lbs.
Shipping Weight: 620 lbs.

MODEL No. TB7207
List \$2995.00

\$1995.00



STAINLESS STEEL WORK BENCHES

- Welded construction.
- Durable 16 gauge Stainless.
- Premium polished shelves.
- 1-1/2" square tubular legs.
- 1-1/2" thick top.
- Stainless top is double formed around solid wood core.
- Bottom shelf is inset.
- 18 gauge one piece stainless wrap around shell.
- Adjustable feet allow for leveling on uneven surfaces.
- 1,200 lbs. capacity.
- Drawers are 4-1/4"H x 16"W x 16"D.
- Stainless Steel



No. VO-360 (Shown)

Model No.	Size L x W	Drawer Configuration	Weight lbs.	Price Each
VN-360	60" x 30"	No Drawers	174 lbs.	\$ 695.00
VN-372	72" x 30"	No Drawers	190 lbs.	745.00
VP-360	60" x 30"	3 Drawers on left	236 lbs.	1150.00
VP-372	72" x 30"	3 Drawers on left	252 lbs.	1195.00
VO-360	60" x 30"	3 Drawers across	240 lbs.	1150.00
VO-372	72" x 30"	3 Drawers across	256 lbs.	1195.00



WATERLOO PROFESSIONAL HEAVY DUTY TOOL STORAGE 41" AND 52" WIDE WATERLOO

- Built to handle the toughest environments, the Professional Series has all the features and durability to do the job while keeping tools securely stored.
- Sturdy side-wall construction, ball-bearing slides, a patented latching system, and backed by a 7 year limited warranty.



- The Professional Series features cabinets with full-width top drawers for long-tool storage, and chests with heavy-duty gas struts (select models). Offered in high-quality red or black (41" and 52" widths). A 41" stainless chest and cabinet combination completes the line. Options in this series include 6" x 2" industrial-strength casters and non-slip drawer liners.



PCH418RDL



PCH528BKL



PCA4111RDL



PCA5211BKL

PCH4111SSL/
PCA4111SSL



Professional
Heavy Use/ Heavy Capacity
Caster Load Rating Over 3,200 lbs. Per Unit (Optional Casters)
75 lb. Ball-Bearing Drawer Slides (Double Slides on Select Drawers)



Top Chests with Non-Slip Drawer Liners								
Model No.	Size	Drawers	Color	Dimensions	Weight	List	Sale	
PCH418RDL	41"	8	Red	40.5"W x 18"D x 20"H	156 lbs.	\$1167.00	\$850.00	
PCH418BKL	41"	8	Black	40.5"W x 18"D x 20"H	156 lbs.	1167.00	850.00	
PCH4111SSL	41"	11	Stainless Steel	40.5"W x 18"D x 20"H	166 lbs.	1298.00	970.00	
PCH528RDL	52"	8	Red	51"W x 18"D x 20"H	162 lbs.	1625.00	1195.00	
PCH528BKL	52"	8	Black	51"W x 18"D x 20"H	162 lbs.	1625.00	1195.00	

Roller Cabinets with Non-Slip Drawer Liners								
Model No.	Size	Drawers	Color	Dimensions	Weight	List	Sale	
PCA4111RDL	41"	11	Red	51.5"W x 20"D x 41"H	255 lbs.	\$1670.00	\$1250.00	
PCA4111BKL	41"	11	Black	51.5"W x 20"D x 41"H	255 lbs.	1670.00	1250.00	
PCA4111SSL	41"	12	Stainless Steel	42.5"W x 18"D x 40.5"H	240 lbs.	1895.00	1395.00	
PCA5211RDL	52"	11	Red	51.5"W x 20"D x 41"H	369 lbs.	2915.00	1995.00	
PCA5211BKL	52"	11	Black	51.5"W x 20"D x 41"H	369 lbs.	2915.00	1995.00	

Non-Slip Drawer Liners
Protect tools and keep them from sliding



ROLLER CABINET 41" WIDE WITH WOOD WORKING SURFACE

- Heavy 16 gauge metal construction.
- 8 ball bearing drawer slides.
- Powder coated paint for superior scratch and chemical resistance.
- Completely lockable.
- Large 5" x 2" heavy duty casters on rollers cabinet. 2 lockable and 2 fixed.
- Rubber lined drawers.



MODEL No.
TBR-4108X
Reg. \$650.00

\$525.00

F.O.B. California

Overall	W	D	H
with Casters	41"	18"	41.5"
1 Drawer	36.5"	16.1"	4.1"
1 Drawer	22.4"	16.1"	2"
2 Drawers	22.4"	16.1"	3.1"
1 Drawer	22.4"	16.1"	6.3"
1 Drawer	22.4"	16.1"	9.5"
Doored	12.7"	16.1"	24.7"
Compartment Capacity	144,33 cubic inch		
Shipping Weight	278 lbs.		
Color	Red		



ROLLING METAL TOOL CART 4 Drawers - Bottom Tray

- Four ball bearing slide drawers.
- External and internal locking mechanisms
- Prybar holders.
- Heavy duty side handle.
- Lock w/ two keys.
- Top storage tray.
- Bottom storage shelf.
- 5" x 1" casters.
- Oil and moisture resistant drawer liners.
- Hammertone flat gray powder coat paint finish.



MODEL No.
TC-400

\$275.00

Overall Dimensions
with Castors:
33.5"W x 17.5"D x 38.3"H



HAND TRUCK WITH FOLDOWN PLATFORM

This Hand Truck converts into a worker-friendly platform in seconds

- "P" Handle design.
- Aluminum construction.
- Nose Plate is 14" wide x 7-1/4" deep.
- Platform size is 13" wide x 30" long x 40" high.
- Hand truck capacity is 500 pounds.
- Platform capacity is 250 pounds.
- Wheels are 10" x 3-1/2" pneumatic tires.

MODEL No.
ALUM-PTB

\$299.95

35 lbs.



Kennedy PRO TOOL BOX

- Heavy duty, heavily plated hardware plus rolled and flattened body and lid edges for added strength.
- Vinyl cushioned steel core top handle.
- Lift-out tray.
- Brown wrinkle finish.



MODEL No.
5220B
List \$120.85

\$78.50



WOOD TOOL CHESTS American Red Oak

Chest Features:

- Solid American red oak construction with lock joint corners to insure strong, durable chest and drawer structure.
- Hand rubbed satin with lacquer coating.
- Polished chrome plated hardware.
- A green felt-lined interior provides extra protection for kept items and will prevent moisture from building up.

Roller Cabinet

Additional Features:

- Green felt lined interior provides cushioning - protective additional reversible top panel.
- Polished chrome plated hardware.
- Locking bar stows on side of the unit when not in use, and covers drawers in locked position.



Model No.	Description	Width	Depth	Height	Weight lbs.	List Price	Sale Price
GI-525	6 Drawer Oak Chest	20"	9"	11-1/2"	18	\$249.00	\$211.50
GI-530	8 Drawer Oak Chest	20"	10"	13-1/2"	23	299.00	249.95
GI-532	10 Drawer Oak Chest	24"	10"	16-1/4"	35	\$359.00	\$299.95
GI-532B	4 Drawer Base	25-1/8"	11-1/8"	10"	25	\$299.00	\$254.00
GI-532R	6 Drawer Roller Cabinet	31"	20-1/2"	34-1/2"	115	719.00	599.95
GI-532BRI	Consists of #GI-532, GI-532B, GI-532R					\$1377.00	\$1095.00



RED OAK CONSTRUCTION 11 DRAWER WOOD CHEST



- American Red Oak construction with tongue and groove joinery insures strength and durability.
- All-Loc Drawer Security System.
- Hardwood design provides protection from moisture.
- Green felt-lined interior provides cushioning.
- Hand rubbed stain with lacquer finish.
- Polished chrome plated hardware.
- Includes 2 keys for lock.
- The 21-1/2 inch width fits both Gerstner-International Roller Cabinets.

MODEL No.
GI-540
List. \$499.00

\$399.00

Dimensions:
GI-540 W x D x H
Overall: 21-1/2" x 11" x 24"
Top Well: 20-1/4" x 10" x 3-1/4"
6 Drawers: 9" x 9" x 1-1/4"
3 Drawers: 19-1/2" x 9" x 1-1/2"
2 Drawers: 19-1/2" x 9" x 3"



RED OAK UTILITY CARRYING CASE

- American Red Oak construction with tongue and groove joinery insures strength and durability.
- Hardwood design provides protection from moisture.
- Brown felt-lined interior provides cushioning.
- Hand rubbed stain with lacquer finish.
- Polished chrome plated hardware and rubber bumper feet - non marring.
- Padded leather top carrying handle for ease of portability.

MODEL No.
GI-515
Reg. \$159.00

\$135.00

Dimensions:
16"W x 8" Deep
9-3/4" Height
11 lbs.



"TUNE-UP" CASE

- The top opens and the front compartment has a sliding lift-out tray to hold your smaller parts with additional storage below the tray for pieces up to a 1-1/2 feet long. Behind the partition is an 8 inch deep compartment designed to hold the large 12oz spray cans and other items that must be kept upright for storage. There is also a full width drawer.
- Sturdy chrome hardware gives the chest added strength and durability while the non-marring rubber bumper feet allow you to set the chest down without fear of leaving scratches or dents.
- **With Gun Forks:** Custom gun forks feature adjustable openings for most guns, are designed to fit securely on the center partition of the case and small enough to store inside the drawer or under the sliding tray.
- Dimensions: 19" Wide, 9-1/4" Deep, 9-1/4" High.



MODEL NO. GI-519
REG. \$199.00 **\$159.00**



WITH GUN FORKS
MODEL NO. GI-519RC
REG. \$229.00 **\$189.00**



CHEST & ROLLER CABINETS



- Heavy 18 gauge metal construction.
- Ball bearing drawer slides.
- Powder coated paint for superior scratch and chemical resistance.
- Completely lockable.
- Large 5" x 2" heavy duty casters on rollers cabinet 2 lockable and 2 fixed.

6 Drawer Chest Plus Top Tray Area

Dimensions:
26.3"W x 12.4"D x 15.2"H
Capacity: 3567 cubic inch
Net Weight: 69 lbs.
Ship weight: 74 lbs.
MODEL No. TB2050BA
Reg. \$195.00 **\$129.95**

7 Drawer Roller Cabinet

Dimensions:
27.1"W x 18"D x 29"H
5" x 2" Casters
Capacity: 8828 Cubic inch
Net Weight: 143 lbs.
Ship Weight: 152 lbs.
MODEL No. TB2050BB
Reg. \$395.00 **\$319.95**

SAVE MORE! MODEL No. **\$435.00**
BUY BOTH TB205CB 219 lbs.



ROLLER WORK STATION

- Heavy 16 gauge metal construction.
- Ball bearing drawer slides.
- 800 lbs. load capacity.
- Completely lockable.
- Powder coated paint for superior scratch and chemical resistance.
- Large 5" x 2" heavy duty casters on rollers cabinet 2 lockable & 2 fixed

Solid Wooden Board

MODEL No.
TBR4108X
Reg. \$765.00 **\$549.95**

Specifications:
Dimensions OAL:
40.7"W x 18"D x 35"H
(41.4" High w/Casters)

	W	D	H
1) Drawer	35.7"	16"	4"
1) Drawer	22.4"	16"	2"
2) Drawers	22.4"	16"	3"
1) Drawer	22.4"	16"	6.3"
1) Drawer	22.4"	16"	9.5"

Door 12.7" 16" 24.7"
Compartment with shelves
Capacity: 14433 Cubic Inch
Net Weight: 227 lbs.
Ship Weight: 277 lbs.



KenCraft BY Kennedy Metal Hand Carry Tool Box

- Painted Steel Body with Plastic Reinforced Corners.
- Full-Length Aluminum Handle for Sturdy, Balanced grip.
- Model 732000 has 8 removable storage bins.
- Model 753200 has 5 removable storage bins.
- Secured with Double Clasp System

Dimensions:		
No.	732000	753200
Width	19-1/2"	23"
Depth	7-7/8"	9-3/4"
Height	9-7/8"	9-7/8"



Model	Description	Weight	List	Sale
732000	19" Red metal Handcarry Toolbox	6.5 lbs.	\$44.00	\$33.00
753200	23" Red metal Handcarry Toolbox	8 lbs.	56.00	42.00



ROLLING TOOL CART WITH LOCKABLE DRAWER

- One lockable drawer.
- Two trays.
- Bonus side tray.
- 4" x 1" casters / 2 wivel with locks - 2 fixed.
- Industrial powder coat paint finish.
- made from cold rolled steel.
- Rubber work surface.



RED (Shown)
MODEL No. TC-301CR
Reg. \$185.00
\$129.95

BLACK
MODEL No. TC-301CBL
Reg. \$185.00
\$129.95

Dimensions:
Overall: 36.8"W x 15.6"D x 32.5"H
Overall with Casters: 36.8"W x 15.6"D x 37.6"H



ROLLING TOOL CARTS

- Heavy duty 16 gauge metal construction.
- 300 lbs. load capacity
- 4" x 2" casters, 2 fixed and 2 swivel lockable.



Model No. TC-301A
Reg. \$95.00
\$79.95

Dimensions:
29"W x 15"D x 31"H
36 lbs.

- Easy to move caster wheels, 2 locking and 2 standard.
- Powder coat paint for superior scratch and chemical resistance.
- Three trays.



ROLLING METAL TOOL CART 5 DRAWERS, 2 TRAYS

- Easy to move 4" x 2" wheels, 2 locking and 2 standard.
- Powder coat paint for superior scratch and chemical resistance.
- Hydraulic spring.
- Stiffeners are mounted on both sides to hang up hooks.



MODEL No. TC-305
Reg. \$395.00
\$325.00

Specifications:
30.5"W x 16"D x 40"H
Weight: 188 lbs.
Color: Blue



ROLLING METAL TOOL CART 2 DRAWERS, 2 TRAYS

- Easy to move caster wheels, 2 locking and 2 standard.
- Powder coat paint for superior scratch and chemical resistance.
- Two trays.
- One ball bearing slide (BBS) drawer.



MODEL No. TC-320
Reg. \$225.00
\$189.95

Specifications:
30"W x 16"D x 4.5"H
Weight: 82 lbs.
Color: Red



ROLLING TOOL CARTS WITH DRAWER

- Heavy duty 16 gauge metal construction.
- 300 lbs. load capacity
- 4" x 2" casters, 2 fixed and 2 swivel lockable.



Model No. TC-301B
Reg. \$125.00
\$89.95

Dimensions:
29"W x 15"D x 31"H
51 lbs.

- 1-Drawer
- Easy to move caster wheels, 2 locking and 2 standard.
- Powder coat paint for superior scratch and chemical resistance.
- Three trays.



ROLLING METAL TOOL CART 2 DRAWERS-TELESCOPING HEIGHT TRAY

- Easy to move caster wheels, 2 locking and 2 standard.
- Powder coat paint for superior scratch and chemical resistance.
- Adjustable height.
- Two drawers.



MODEL No. TC-304CAB
Reg. \$180.00
\$145.00

Specifications:
31.7"W x 20.2"D x 33" to 45"H
Weight: 53 lbs.
Color: Red



ROLLING METAL TOOL CART 1 DRAWER, 2 TRAYS

- Easy to move caster wheels, 2 locking and 2 standard.
- Powder coat paint for superior scratch and chemical resistance.
- Two trays.
- One ball bearing slide (BBS) drawer.



MODEL No. TC-303D
Reg. \$125.00
\$99.95

Specifications:
30"W x 16"D x 37"H
Weight: 45 lbs.
Color: Red



VACUUM & BLOW GUN KIT

- This 2 in 1 tool can be used either as air blow gun, or as a air vacuum gun
- Use for cleaning or to suction dust, wood chips, metal shavings, glass, etc.
- Easy to switch from blowing function to suctioning function with simple switch of the main valve
- Ergonomically designed for user's comfort



MODEL No. 1745
\$39.95

Specifications:
Air Inlet: 1/4" NPT
Min Hose Size: 5/16" I.D.
Rec. Air Pressure: 90 PSI
Avg. Air Consumption: 3.36 CFM

Vacuum Level: 7.5 mmHg
Sound Level: 92 dBA
Length 5.7"
Weight: 1.47 lbs.

SUNEX TOOLS SERVICE CART
4 DRAWER ~ LOCKING TOP

- Cart includes: 3 drawer service cart with leg extensions, large locking screwdriver/pry bar holder, and side work bench.



RED
MODEL No.
8013ADLX
\$395.00



BLACK
MODEL No.
8013ABKDLX
\$395.00



BLUE
MODEL No.
8013ABLDLX
\$395.00

Specifications:

Load Capacity 350 lbs.
Height 32.5"
Length 30"
Width 16"
Drawer Depths:
Top Bin 3"
Twin Top Drawers 2"
Middle Drawer 2"
Bottom Drawer 4"
Bottom Shelf 3"
Weight 131 lbs.

SUNEX TOOLS SERVICE CART 5-DRAWER
WITH ACCESSORIES

- 5" oversized casters: 2 locking, 2 non-locking.
- 75% assembled, making it one of the easiest and quickest carts in the market to put together.
- With a flip top locking lid, 5 drawers all pre-assembled with common keyed locks, screwdriver/prybar holder, and side work shelf.
- EVA foam drawer liners included.
- Chrome 16 gauge steel frame and powder coated finish.



RED
MODEL No.
8045
\$395.00



BLACK
MODEL No.
8045BK
\$395.00



BLUE
MODEL No.
8045BL
\$395.00

Specifications:

Load Capacity 500 lbs.
Height 40"
Length 27"
Width 18.25"
Drawer Depths:
Top Bin 3"
Twin Small Drawers 2"
Top Large Drawer 2"
Middle Large Drawer 4"
Bottom Large Drawer 6"
Bottom Shelf 3"
Weight 116.8 lbs.

SUNEX TOOLS SERVICE CART
2 SHELVES WITH ANODIZED LEGS

- 4 Easy rolling heavy duty polyurethane swivel casters.
- Ergonomic grip handle.
- 2 durable polyethylene shelves.
- Anodized aluminum legs.



Specifications:

Load Capacity 350 lbs.
Height 35"
Length 36.25"
Width 18.5"
Shelf Length 29.5"
Shelf Width 16.75"
Shelf depth 2"
Weight 35 lbs.

MODEL No.
8032

\$149.95

SUNEX TOOLS SERVICE CART
3 SHELVES WITH ANODIZED LEGS

- 4 Easy rolling heavy duty polyurethane swivel casters.
- Ergonomic grip handle.
- 3 durable polyethylene shelves.
- Anodized aluminum legs.



MODEL No.
8033

\$159.95

Specifications:

Load Capacity 500 lbs.
Height 39.25"
Length 36.25"
Width 18.5"
Shelf Length 29.5"
Shelf Width 16.75"
Shelf Depth 2"
Weight 35 lbs.

EXCEL WORK BENCH
HEAVY DUTY

- Heavy duty 16 gauge metal construction.
- Drawer size: 13-5/8"W x 17"D x 4-5/8"H
- Durable working bench, tough & sturdy.
- Powder coat paint for superior scratch and chemical resistant.



Model
TSC-5911
(Shown)

No. TSC-5911
Load Capacity
2000 lbs.
Weight
176 lbs.

Model No.	Dimensions W x D x H	Drawers	Sale Price
TSC-5911	59"W x 25-1/2"D x 34"H	2	\$215.00

SUNEX TOOLS COMPACT SLIDE TOP
UTILITY CARTS

The new Sunex 8035 series is just the right mix of storage space and maneuverability. It's rugged construction provides a rated capacity of 450 pounds and enough tool storage space to accommodate the tools to complete any job.

- Locking top.
- Sliding top design creates additional work surface.
- 450 lbs. rated capacity.
- Includes (2) -3" deep matching drawers.
- Heavy duty.
- Oversized 5" casters and wheels.



RED
MODEL No.
8035R

\$349.95



BLACK
MODEL No.
8035

\$349.95



SIX WHEEL WOODEN
MOVERS DOLLY
1200 lbs. Capacity

No. HDOS-2224-SW Features:

- Dolly is non-tilting style.
- Solid deck design allows for use with smaller packages.
- Hand hole for carrying measures 5" x 1-1/2".
- Six caster design offers easy maneuverability.
- Six 4" diameter x 1-1/4" wide swivel polyurethane non-marking casters.
- Manufactured from durable 3/4" thick plywood components.

No. HDOC-2448-12 Features:

- Two rigid and four swivel polyurethane non-marking casters.
- Rigid casters are 5" diameter x 1-1/4" wide.
- Swivel casters are 4" diameter x 1-1/4" wide.
- Dolly is tilting style.
- Carpeted ends (24" x 12" each) offer additional protection.
- Open center design allows for easy carrying.
- Side boards are 24" long x 3-1/2" wide.



HDOS-2448



HDOC-2448

Model No.	Platform W x L x H	Capacity lbs.	Net Weight	Sale Price
HDOS-2448	24" x 48" x 6-1/2"	1200	28 lbs.	\$72.50
HDOC-2448	24" x 48" x 7-1/2"	1200	30 lbs.	69.95



MATERIAL HANDLING CUP DOLLIES ~ CAST, SEMI-STEEL

When you need to move just about anything with posts or even without posts these dollies are real people savers! They are compact triangular shaped dollies with a cup center; often called cup dollies or cup casters. One dolly is placed under each post or leg of the article you intend to move; once all posts have dollies you simply roll your article through doorways, onto elevators, down the street, into the truck, or across the room! The swivel wheels and tripod wheel arrangement allow the article to be moved in any direction; even top heavy articles go where you want them too safely and securely.

Dolly Carry Case



MADE IN USA



2" Wheel Material - Capacity (lbs.)/Dolly
Hard tread, black solid rubber: 375
Soft tread, black solid rubber: 225
Semi-steel: 450
Bondrelene - black plastic: 270
TuffBond - white plastic: 450

Model	Description	Price
2127-BP	Cup Dolly with Bondrelene - Black Plastic Wheel	\$59.95
2127-HT	Cup Dolly with Hard tread, Black Solid Rubber Wheel	59.95
2127-SS	Cup Dolly with Semi-Steel Wheel	59.95
2127-ST	Cup Dolly with Soft Tread, Black Solid Rubber Wheel	59.95
2127-WP	Cup Dolly with Tuffbond - White Plastic Wheel	75.00
3110020	Dolly Carry Case -Rugged Ballistic Nylon material with heavy duty plastic piping. Large tooth zipper and two handles for ease of use	38.95



SUPER DUTY DOLLIES

3" Wheel Material - Capacity (lbs.)/Dolly

Hard tread, black solid rubber: 630
Soft tread, black solid rubber: 375
Semi-steel: 750
Bondrelene - phenolic (shown): 750
TuffBond - white plastic: 750

Body: Cast semi-steel with 2" deep well, measuring 6-3/4" at the top and 5-1/4" at the bottom. Clearance is 1-1/4" from the floor



MADE IN USA



Model	Description	Price
3310-BP	Super Duty Dolly with Bondrelene - Phenolic Wheel	\$94.95
3310-HT	Super Duty Dolly with Hard tread, Black Solid Rubber Wheel	94.95
3310-SS	Super Duty Dolly with Semi-Steel Wheel	94.95
3310-ST	Super Duty Dolly with Soft Tread, Black Solid Rubber Wheel	94.95
3310-WP	Super Duty Dolly with Tuffbond - White Plastic Wheel	110.00



HEAVY DUTY DOLLIES

2-1/2" Wheel Material - Capacity (lbs.)/Dolly

Hard tread, black solid rubber: 525
Soft tread, black solid rubber: 330
Semi-steel: 525

Body: Cast semi-steel with 1-1/4" deep center hole measuring 1-3/4" at the top and 1-1/4" at the bottom



MADE IN USA

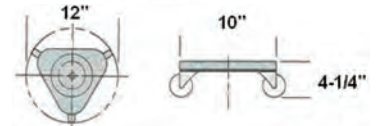

Model	Description	Price
2076-HT	Heavy Duty Dolly with Hard Tread, black solid rubber wheels	\$95.00
2076-SS	Heavy Duty Dolly with Semi-Steel wheels	95.00
2076-ST	Heavy Duty Dolly with Soft Tread, black solid rubber wheels	95.00



ALUMINUM BASE WIDE WHEEL CUP DOLLY

Body: Cast aluminum with 2" deep well, measuring 5" at the top and 3-3/16" at the bottom. Clearance is 1-9/16" from the floor

Wheels: 2" diameter x 1-11/16" face hard black plastic wheels
Weight Capacity: 600 lbs.



MADE IN USA

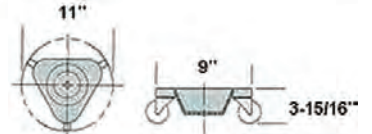

Model	Description	Price
2127AL	BOND Material Handling Aluminum Base Wide Wheel Cup Dolly	\$59.95
3110020	Dolly Carry Case -Rugged Ballistic Nylon material with heavy duty plastic piping. Large tooth zipper and two handles for ease of use	38.95



AUTO-SHIFT HYDRAULIC ELEVATING CART

2 Speed Foot Pump Automatically Shifts at 110 Pounds

- Capacity is 550 pounds.
- Platform size is 19-5/8" x 32-5/8"
- Lowered height is 13"
- Raised height is 35-3/4"
- Stroke: 2" per pump when empty and 1" per pump with load over 110 lbs.
- Handle height is 43-1/4"
- Wheel size is 5" diameter x 1-1/4" with two locking casters.
- Weight is 190 pounds.



MODEL No.
CRT-550AS

\$625.00



ELECTRICAL DRIVE MATERIAL HANDLING CART

- State of the art micro-controller ensures a smooth, comfortable, and controlled safer drive.
- Mid-wheel drive via sealed drive axle for short turning radius.
- 50 A/H sealed non-maintenance lead - acid batteries.
- On board charger.
- Independent braking system.
- Speed control lever.
- Emergency stop switch.
- Electronic regenerative disc brake.
- Key on/off switch.
- Climbs slopes safely up to 8 degrees.

MODEL No.
EMHC-2460

\$1995.00

- ✓ Variable speed dial
- ✓ Fingertip forward/reverse
- ✓ Internal charger
- ✓ Heavy duty motor
- ✓ (2) Foam filled drive wheels
- ✓ Horn & emergency stop button
- ✓ Foldable handle
- ✓ (4) Swivel casters



Specifications:
Platform size: 24" x 60"
Platform height: 11-2/3"
Speed (MPH): 4.8
Weight: 319 lbs.

Huot DRILL INDEXES

Features:

- Baked epoxy finish for durability.
- Panels stand upright, fold like book pages.
- Permanent raised embossed lettering and decimal equivalents.

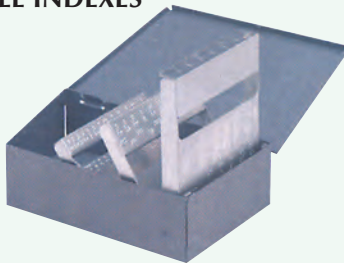

Jobber Drill Indexes

Model No.	Range	Weight	Price
29-1	1/16-1/2" x 64ths	1.26 lbs.	\$10.95
26-1	A-Z	1.25 lbs.	12.95
60-1	No. 1-60	.60 lbs.	10.95
20-1	No. 61-80	.13 lbs.	6.95
4025-1	1-13mm x .5mm	1.16 lbs.	10.95

TAP AND DRILL STAND

- For No. 2 through 1/2" NC and NF taps.
- ABS plastic

INCH
TAP & DRILL
STAND ONLY
MODEL No.
DTS-235

\$12.95

METRIC
TAP & DRILL
STAND ONLY
MODEL No.
DTS-432

\$12.95

45 Holes
2mm thru 14mm

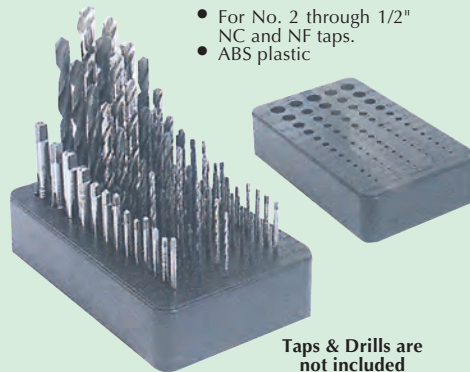

Taps & Drills are
not included

Huot METAL DRILL DISPENSERS

Features:

- Baked epoxy finish for long life.
- Heavy gauge fabricated steel cabinet and drawers.
- Stackable models, full drawer extension.
- Easy-to-read, permanent, durable identification strips show tool size and decimal equivalents too.

Buy All Three Fractional, Wire
& Lettered Dispensers & Save

MODEL No. 13031 **\$246.00**



Model No.	Description	Price
13000	Fractional 1/16-1/2" by 64ths	\$ 79.95
13025	Numbered 1-60 inclusive	99.00
13050	Letters A-Z	79.95
13031	All 3 of the above	246.00
13100	Metric 1mm to 6.9mm by 0.1mm	125.00
13040	#1 to #80 84 compartments	125.00
13075	1mm to 13mm by 0.5mm	95.00
13085	1mm to 25mm by 0.5mm	450.00

Huot COMBINATION DRILL INDEXES

Features:

- Baked epoxy finish for durability.
- Ideal for keeping all of the most commonly used drills handy.
- Holds up to 135 drills in one combination case.
- Indexed for size and decimal equivalent.



Model No.	Range	Weight	No. of Drills	List Price	Sale Price
11700	1/16-1/2" x 64ths	3.5 lbs.	115	\$45.00	\$39.95
11750	A-Z and No. 1-60 1/16-1/2" x 64ths A-Z and No. 1-80	3.75 lbs.	135	52.00	39.95
11825	1.0mm thru 13.0mm U.S. decimal equivalents are also shown for each size drill	4.0	118	125.00	95.00

Huot TOOLSCOOT™ TOOLCART FOR CNC V-FLANGE, BT, NMBT

- Durable nylon inserts on both shelves help protect tool holders.
- Lower shelf angled for quick, easy tool access from either side.
- Solid, interlocking side panel construction for maximum strength and stability.
- Two end storage trays with universal mounting holes for tool lock. Heavy duty 5" x 1-1/4" casters load rated at 1000 lbs.
- All steel painted with Huots durable Ecolo-Clad in red and black.



Model	Holds	Taper	List	Sale
13940	48	40 CAT, BT, NMBT	\$489.00	\$445.00
13950	36	50 CAT, BT, NMBT	489.00	445.00

Vertil ALUMINUM STORAGE CASES

- Protects contents from damage.
- Keeps contents clean & dry.
- Dual lock and hasps offer extra security.
- Durable & attractive embossed surface.
- Handle is recessed when not in use.
- Corner caps minimize damage.
- Two smaller boxes nest inside larger box.



Padlock the case to
secure contents
(not included)



Spring returned
handles are recessed
when not in use.



Interior is black felt

Model No.	Size	Dimensions W x D x H	Weight lbs.	Sale Price
CAS-190	Small	19" x 14-1/4" x 16-1/4"	13	\$ 75.00
CAS-210	Medium	21-1/2" x 16-1/4" x 19-1/4"	15	99.50
CAS-240	Large	24" x 18" x 20"	18	135.00

MASTAC T-SLOT CHIP BRUSH

- Made of Solvent and Impact Resistant Plastic.
- Safety guard protects knuckles from scraping metal chips.
- Heavy duty blade integrated into handle for added strength.



MODEL No.
MAS-280

\$14.50



KenCraft TOOL BAGS BY Kennedy

- Durable Polyester Material.
- Straps included.



No.
750800



No. 751000



No. 751200



No. 751621



No. 752018

Model	Description	Weight	List	Sale
750800	8" Electrician's Tool Bag	3 lbs.	\$38.50	\$28.50
751000	10" Bucket Bag w/38 Pockets	1.2 lbs.	28.00	21.00
751200	12" Tool Bag w/11 Pockets	3 lbs.	31.50	23.50
751621	16" Tool Bag w/21 Pockets	4.6 lbs.	40.60	30.50
752018	20" Tool Bag w/18 Pockets	5.8 lbs.	77.50	58.00

PHASE-A-MATIC PHASE CONVERTERS

Features:

- Uses include: lathes, mills, grinders, drills, saws, metal-working & woodworking equipment, etc.
- Permits operation of 220V, 3 phase motor on a single phase current.
- Switch gear.

Static Type

Medium Duty

Model No.	H.P. Motor	Wt lbs.	List Price	Sale Price
PAM-100	1/3-3/4 hp	2.03	\$135.00	\$122.50
PAM-200	3/4-1-1/2 hp	2.02	145.00	132.00
PAM-300	1-3 hp	2.02	165.00	151.90
PAM-600	3-5 hp	2.06	200.00	175.00
PAM-900	4-8 hp	2.09	235.00	205.50

Heavy Duty

Model No.	H.P. Motor	Wt lbs.	List Price	Sale Price
PAD-300	1-3 hp	2.08	\$225.00	\$191.00
PAD-600	3-5 hp	3.02	285.00	245.00
PAD-900	4-8 hp	4.00	320.00	284.00
PAD-1200	8-12 hp	5	465.00	385.00
PAD-1800	12-18 hp	21	845.00	695.00

Larger sizes available up to 50 H.P. Please call

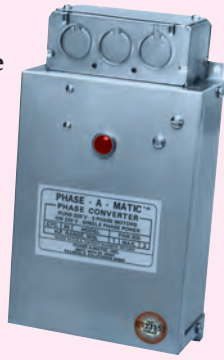

PHASE-A-MATIC ROTARY PHASE CONVERTERS

Run 3 Phase Equipment From Single Phase Power

- Heavily loaded applications.
- Quiet operation.
- Simple installation.
- Multi-motor operation.
- Multi-speed applications.
- Resistive load applications.
- No changing motors or switch gear.
- Full 12 month warranty.



Model No.	H.P. Rating	Shipping Weight	Mfg's Price	Sale Price
PRC-001	1	33 lbs.	\$695.00	\$585.00
PRC-002	2	41 lbs.	790.00	690.00
PRC-003	3	62 lbs.	890.00	795.00
PRC-005	5	70 lbs.	1150.00	995.00
PRC-007	7.5	106 lbs.	1650.00	1390.00
PRC-100	10	125 lbs.	1990.00	1795.00
PRC-150	15	208 lbs.	2600.00	2450.00
PRC-200	20	240 lbs.	3300.00	2795.00
PRC-300	30	320 lbs.	4550.00	3950.00

Precise DEMAGNETIZERS



- (A) Magnetizer/Demagnetizer
- Powerful permanent magnet for long lasting performance.
 - Magnetizes and demagnetizes screwdrivers, tweezers, tool bits and other steel objects instantly.
 - Cordless, handy to operate. Size 2.1" x 2" x 1.1".

MODEL 40010-1 \$6.95

- (B) Mini Magic Demagnetizer
- Thoroughly demagnetizes tools, dies, punches, cutters, parts, etc. Simply by sliding it over the surface of the item to be demagnetized. Made in U.S.A.
 - Pressing the single pole momentary-switch sets up a field of flux which neutralizes magnetism. Releasing the switch automatically shuts off the unit.
 - Complete with 5 feet of oil resistant cord.
 - 3-1/2" long x 1-3/4" wide x 1-3/4" high.
 - Single phase current.

MODEL MPD-270 \$99.95

- (C) Demagnetizer
- Effectively demagnetizes residual magnetism in tools, molds and other workpieces.
 - Convenient on-off switch.
 - 6-3/4" long, 4-1/4" wide, 3-1/4" high. Weight 11 lbs.
 - Surface area 47 square inches.
 - 120 volt single phase operation.

MODEL DM-5002 \$49.95



5C LEVER COLLET CLOSERS

The Best Lever Closer Made In USA



We Must Know the Following:

- Manufacturer of lathe
- Size of lathe
- O.D. of spindle
- Type of nose
- Taper I.D. of spindle
- Gage line (measurement of mouth of spindle of largest part of taper)

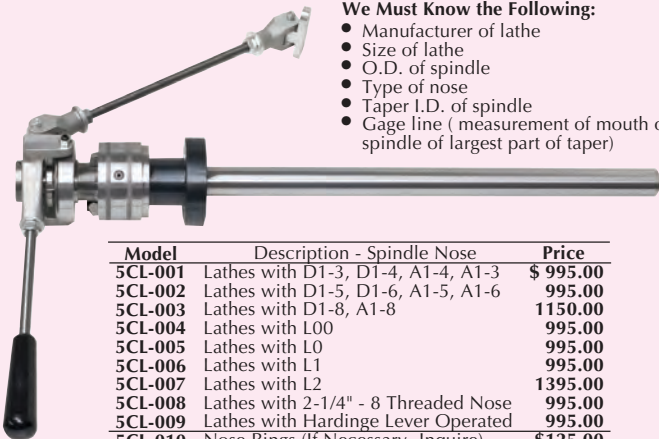

Model	Description - Spindle Nose	Price
5CL-001	Lathes with D1-3, D1-4, A1-4, A1-3	\$ 995.00
5CL-002	Lathes with D1-5, D1-6, A1-5, A1-6	995.00
5CL-003	Lathes with D1-8, A1-8	1150.00
5CL-004	Lathes with L00	995.00
5CL-005	Lathes with L0	995.00
5CL-006	Lathes with L1	995.00
5CL-007	Lathes with L2	1395.00
5CL-008	Lathes with 2-1/4" - 8 Threaded Nose	995.00
5CL-009	Lathes with Hardinge Lever Operated	995.00
5CL-010	Nose Rings (If Necessary- Inquire)	\$125.00

E-Z OIL SKIMMER FOR MACHINE TOOL COOLANT TANKS



- Belt Ampivots in 15 degree increments to allow use in deep or shallow tanks.
- Belt extends vertically up to 16" into tank.
- Plated steel framework and molded plastic housing.
- Comes with durable 1" wide polyurethane Belt.
- Easily replaceable Belt Wipers.
- Comes with three Mounting Brackets for barrel mount, flanged or straight wall tank mounts.
- Shipping weight approximately 11 pounds
- Assembled dimensions approximately 5-1/4" long x 6-1/8" wide x 31-1/2" high.
- Compact design permits convenient use in almost any location
- Efficiently removes up to a gallon or more of oil per hour depending on conditions.

Model	Description	Price
8709-001	10 E-Z Skim For machine Tool Coolant Tanks	\$395.00
6374-001	Fan Cooled Gear Motor	\$149.95
6374-001	E-Z Skim 1" Stainless Belt	19.95
6374-012	E-Z Skim 1" x 54" Poly Belt	19.95
6374-003	Belt Wiper Blades (2)	8.95

NOGA CHIP HOOK

For removing chips and cleaning the chip trays on your machines.

- Complete with a 5" special guard to protect your hand.
- NogaGrip handle designed for maximum comfort in your hand.
- For removing chips and cleaning the chip trays on your machines.
- Black finished steel hooks.
- Length: 24"
- Plastic protective cap.

No. SP2560

No. SP2600



Model	Description	Price
SP2560	24" Chip Hook	\$24.95
SP2600	Chip Shovel	7.50
SP2740	24" Chip Hook & Shovel	29.95

AQUAFLOW® COOLANT DISPENSER

- Spray settles on cutting tool and workpiece to be cooled instead of floating in surrounding air.
- Will not fog up your plant.
- As little as 25 PSI air supply operates Aquaflow efficiently.
- No special tank required.
- Quick and easy mounting.
- Magnetic stand has 30 lbs. pull chrome magnet that measures 2" dia. x 3/8" high. Includes precision swivel clamp and extension rod 1/4 x 6" long.



Model	Description	Price
ACD-758	Aquaflow® Only	\$45.00
ACD-759	Aquaflow® with Magnetic Stand	56.00
ACD-760	Magnetic Stand Only	25.00



MILITARY GLOVES

The Original Mechanix

- The NEW Original Glove is the most comfortable and best fitting ever.
- Featuring an out-of-the-way low profile TPR (Thermal Plastic Rubber) hook and loop cuff closure plus Lycra® insert panels between fingers.
- For performance, we use Clarino® synthetic leather palm as well as index, middle and ring fingertips.
- On top of all that, it has hidden interior seam stitching.



CAMO COYOTE COVERT BLACK



SIZE	CAMO	COYOTE	COVERT BLACK
Medium	MG71009	MG72009	MG55009
Large	MG71010	MG72010	MG55010
X-Large	MG71011	MG72011	MG55011
XX-Large	MG71012	MG72012	MG55012

Reg. \$24.95

\$19.95

Per Pair



MILITARY VENTILATED GLOVES

- Wearing gloves in extremely hot or humid climates can lead to excessive, uncomfortable handsweat, resulting in loss of valuable control.
- We've designed our Original Vent Glove to perform in the hottest climates yet minimize heat build up.
- Single-layer air-mesh allows airflow through the top while a synthetic perforated leather palm and air-mesh cuff keep it cool all the way around.



LIGHT GREY COVERT BLACK



SIZE	LIGHT GREY	COVERT BLACK
Medium	MGV00009	MGV55009
Large	MGV00010	MGV55010
X-Large	MGV00011	MGV55011
XX-Large	MGV00012	MGV55012

Reg. \$24.95

\$19.95

Per Pair



MILITARY M-PACT GLOVES

- With long wearing features like anatomic layered synthetic palm padded with EVA.
- With NEW flexible bonded TPR knuckle and finger ribs the M-Pact® is a tool for survival.
- It also features Lycra® finger panels, an ultra-sensitive fingertip pattern and low-profile elastic cuff.



CAMO COYOTE COVERT BLACK



SIZE	CAMO	COYOTE	COVERT BLACK
Medium	MMP71009	MMP72009	MMP55009
Large	MMP71010	MMP72010	MMP55010
X-Large	MMP71011	MMP72011	MMP55011
XX-Large	MMP71012	MMP72012	MMP55012

M-Pact
Reg. \$34.95

\$24.95

Per Pair



M-PACT 2 GLOVES

- Streamlined knuckle panel with high-density accordion design reduces impact
- High-profile, impact absorbing molded TPR (Thermal Plastic Rubber) finger protection
- Finger and thumb grippers made from non-slip rubberized Zeus™ Clarino® improve grip and control
- Sure grip rubberized palm panel material provides grip and longer wear.
- Neoprene cuff allows easier access with additional wrist protection and comfort.



BLACK COVERT (AS SHOWN) BLACK



SIZE	BLACK	COVERT BLACK
Medium	MP25009	MP255009
Large	MP25010	MP255010
X-Large	MP25011	MP255011
XX-Large	MP25012	MP255012

Reg. \$39.05

\$29.95

Per Pair



THE ORIGINAL GLOVE LIGHT

- The Glove Light combines the fit, feel and function of the Original® with an adjustable 8mm LED that gives you 25,000 MCD.
- With easily replaceable AAAA batteries that last 14 hours, your sure to get the job done on time
- 8mm light provides excellent illumination when needed
- TPR closure with hook and loop provides a secure fit
- Stretch spandex material ensures a comfortable fit
- Reinforcement panel in high wear areas for increased durability
- Velcro strips allow for many different light positions
- Anatomically designed reinforcement panels



Gold & Black	
Size	Model No.
Small	GL36-05-08
Medium	GL36-05-09
Large	GL36-05-10
X-Large	GL36-05-11
XX-Large	GL36-05-12

Reg. \$39.95

\$31.95

Bright Light
8mm LED provides 25,000 MCD in a unique detachable and repositionable housing



FASTFIT® ALL PURPOSE GLOVES

- Ideal for a wide range of jobs, the Lycra panels between the fingers offer comfort and mobility while a Clarino MWX-2 synthetic leather palm provides protection and grip.
- An angled elastic cuff allows easy entry and is padded for additional comfort.
- Durable, economical, and versatile.



BLACK BLUE YELLOW



SIZE	BLACK	BLUE	YELLOW
Medium	MMF06MB	MMF06ML	MMF06MY
Large	MMF06LB	MMF06LL	MMF06LY
X-Large	MMF06XB	MMF06XL	MMF06XY
XX-Large	MMF06XLB	MMF06XXL	MMF06XXY

Fast Fit
Reg. \$14.95

\$12.95

Per Pair



THE ORIGINAL TOUCHSCREEN GLOVE



- Stay connected to your touchscreen device on the job. Equipped with three finger conductivity and four designated contact points, the Original Touch glove allows you to manage your touch screen devices without removing your gloves and compromising safety. Highly conductive AX™ Connect mimics the human touch for easy navigation of all your touchscreen devices.
- Form fitting TrekDry® helps keep hands dry and comfortable.
- AX™ Connect touchscreen compatible material.



Touch
Form-fitting finger design for pinpoint touchscreen navigation



Four Contact Zones
Three-finger conductivity and a fourth contact point for easy touchscreen navigation

Size	Model No.
Small	MGT-08-008
Medium	MGT-08-009
Large	MGT-08-010
X-Large	MGT-08-011
XX-Large	MGT-08-012

Reg. \$26.99

\$22.95



MECHANIX WEAR



ANTI-STATIC BLACK SPANDEX GLOVES

CORDURA LOOP ON PALM SIDE OF CUFF FOR EASY ATTACHMENT TO PERSONNEL OR UNIFORM

When the very hands that protect our freedom need hand protection, look no further than our TAA Compliant line of gloves.

The "Original" Glove

- Military professionals deserve a glove that is designed to suit their needs. While Mechanix Wear® made its name in motorsports, we are no less serious about our tactical line of gloves. The versatile Original Glove fits innumerable tasks where general protection or extra grip is necessary. As with all of our gloves, we consistently update the Original using the most advanced technology and materials.

Table with 3 columns: Model, Size, Price Pr. for MGF55-08 to MGF55-12.



As a leading supplier of hand protection to the United States Military we invest time and effort into thinking about the best way to protect their hands so they don't have to.

The FastFit® Glove

- With improved contours for a better fit, our FastFit® Glove is the tool to use for everyday jobs. The glove incorporates a Clarino synthetic palm, Lycra panels between the fingers, and a two-way stretch Spandex padded back. A new taller cuff has been added to provide for a more secure fit and additional coverage, giving you the best combination of performance and economy.

Table with 3 columns: Model, Size, Price Pr. for MFF55-08 to MFF55-12.



The M-Pact® Covert Glove

- A glove that absorbs punishment so your hands don't. The M-Pact® Glove has been designed with an automatically engineered direct sonic welded rubber top and EVA foam palm pads for improved protection. For exceptional performance the glove gives you tapered finger stretch side panels and a new Spandex stretch panel thumb area. The wrap-around rubber molded wrist closure adds additional protection.

Table with 3 columns: Model, Size, Price Pr. for MPF55-08 to MPF55-12.



The M-Pact® 2 Covert Glove

- For super protection and superior fit, try the M-Pact® 2 Glove. Anatomically designed with advanced features that include tapered stretch side panels that form comfortably between fingers and a molded Neoprene cuff for a seamless fit to your wrist. We've also covered you by integrating impact absorbing molded rubber finger protection and EVA deep ribbed accordion knuckle protection. This glove has it all.

Table with 3 columns: Model, Size, Price Pr. for MP255-08 to MP255-12.



The M-Pact® 3 Covert Glove

- When you want all around heavy duty protection you want our M-Pact® 3 Glove. It starts with a Kevlar molded knuckle for superior protection. We then went a step further by adding impact absorbing, molded Thermal Plastic Rubber finger protection, along with an anatomically shaped multi-layer leather palm with EVA interior foam padding. And for comfort and flexibility, there's a heavy duty stretch panel and Spandex padded top.

Table with 3 columns: Model, Size, Price Pr. for MP355-08 to MP355-12.



All Leather Fabricators Glove

They don't get any tougher than this. The 100% Genuine Leather, heavy duty Fabricator Glove is a must-have for fabricators or anyone needing a sturdy leather glove. With heat resistant cowhide panels, palm and fingertip reinforcements, and dual-layer leather knuckle band, it comfortably handles all of the punishment you can dish out and then some. (Not TAA Compliant)

Table with 3 columns: Model, Size, Price Pr. for MFG-05-08 to MFG-05-12.



GREATLITE HALOGEN WORK LIGHTS

- Adjustable heads tilt and swivel for hands free directional lighting. Telescopic stands with folding legs for easy storage. Portable sled detaches from tripod. Foam grip handles. Wire grills for safety. Weatherproof On/Off switch.



250 Watt No. 32770



500 Watt No. 32771

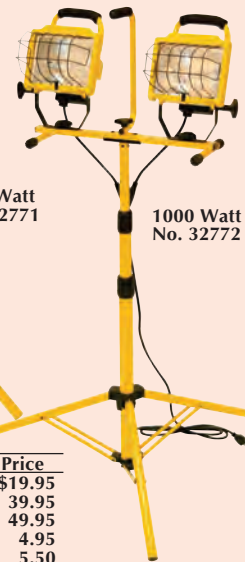

1000 Watt No. 32772

Table with 3 columns: Model, Description, Price for Greatlite work lights.



ASTRO WORKBENCH TABLE/SCAFFOLD 2 In 1 Convertible

- Workbench mode: The tool tray is designed to hold hand tools, fasteners and standard paint cans. The Medium-density fiberboard(MDF) work surface provides a robust surface for hammering, drilling, and woodworking needs. The ruler and protractor graphics on the MDF surface allow for accurate measurements. A graduated border around the decking allows for easy clamping onto the MDF surface. Unit extends to two different heights: 21.25" & 32.25" Unit capacity is 500lbs. in lower position.

- Scaffold Mode: When in scaffold mode it can be used as a sturdy standing surface for painting, remodeling, sanding and other common household tasks. Unit extends to two different heights: 21.25" & 32.25" Unit capacity is 500lbs. in lower position.



MODEL No. 55600 List \$236.00 \$159.95 60 lbs.



THE WORLDS FIRST TOUCHSCREEN WORKGLOVE

It Works Clean or Dirty



Now you can stay connected while on the job. You can use your touchscreen device as well as your phone, without removing your gloves. Whether you need it for analytic equipment, tracking progress on the jobsite, or simply getting that emergency phone call while working, the **TouchScreen** glove from Ironclad, with its exclusive **TS1™** palm material, is the first performance glove that makes this happen for you.

Exclusive TS1™ Palm Material Full Coverage, Conductive Synthetic leather palm and fingers

Seamless Rolled Fingertips For maximum conductivity, covering your entire palm and fingertips

Compression Cuff System Easy on/off operation with constant snug fit

Synthetic Leather Reinforcements Reinforced in critical areas for maximum durability

TPR Cuff Puller Get your glove in proper position faster

Terry Cloth Sweat Wipe Conveniently located on the back of the thumb

• This new material **TS1™** unlike other gloves with knitted material, chemical treatments or small fingertip sections, the Ironclad **TouchScreen** glove's exclusive **TS1™** material draws conductivity from the entire palm of your hand, which means **it works, clean or dirty**. It is machine washable, and it is also as strong and durable as the material that we use on the palm of our best selling performance work gloves. Lightweight, breathable material.



Model	Description	Size	List	Sale
TSG-02S	Touch Screen Gloves	Small	\$29.99	\$22.95
TSG-03M	Touch Screen Gloves	Medium	29.99	22.95
TSG-04L	Touch Screen Gloves	Large	29.99	22.95
TSG-05XL	Touch Screen Gloves	X Large	29.99	22.95
TSG-06XXL	Touch Screen Gloves	XX Large	29.99	22.95



MECHANIC GLOVES



- The all new Mechanic glove from Ironclad provides the perfect combination of dexterity, flexibility and durability. It's a low profile glove offering maximum dexterity while also retaining a high level of protection and abrasion resistance.
- Lightweight, breathable material
- Synthetic leather palm
- Seamless, rolled index finger
- Synthetic leather reinforced fourchettes



Compression Cuff System
Easy on/off operation with constant snug fit

Synthetic Leather Reinforcements
Reinforced in critical areas for maximum durability

TPR Cuff Puller
Get your glove in proper position faster

Terry Cloth Sweat Wipe
Conveniently located on the back of the thumb

Model	Description	Size	List	Sale
MGK-02S	Mechanics Glove	Small	\$24.95	\$19.95
MGK-02M	Mechanics Glove	Medium	24.95	19.95
MGK-02L	Mechanics Glove	Large	24.95	19.95
MGK-02XL	Mechanics Glove	X-Large	24.95	19.95
MGK-02XXL	Mechanics Glove	XX-Large	24.95	19.95



COLD CONDITION® GLOVES

- The first work glove to deliver warmth, comfort and full dexterity, this glove is windproof and water repellent to keep hands warm and dry.
- Ideal for any task where precision is desired in cold conditions.



Windproof, Water Repellent Membrane
Keeps hands warm & dry.

Duraclad® Reinforcements
Ironclad's Exclusive Abrasion Resistant Material.

Microfleece Liner
For warmth & comfort.



Model	Description	Size	List	Sale
CCG-02S	Cold Condition	Small	\$33.95	\$25.95
CCG-02M	Cold Condition	Medium	33.95	25.95
CCG-02L	Cold Condition	Large	33.95	25.95
CCG-02XL	Cold Condition	X-Large	33.95	25.95
CCG-02XXL	Cold Condition	XX-Large	33.95	25.95



VIBRATION IMPACT GLOVES



- This glove features gel padding in critical palm areas to minimize fatigue and the potential damage associated with power and impact tool use.
- Unlike foam padding, which compresses and quickly deteriorates, Ironclad's patented gel padding design excels at absorbing vibrations and impact, and lasts through the lifetime of the glove.
- Airprene knuckle impact protection



100% Silicone Gel Palm Pads
Energy absorbing, non-compressible

Patented ContourGrip® Palm Design
For maximum dexterity and control

DuPont™ Teflon® Treatment
Palm treatment for oil and water resistance

Synthetic Leather Reinforcements
Reinforced in critical areas for maximum durability

Terry Cloth Sweat Wipe
Conveniently located on the back of the thumb

Model	Description	Size	List	Sale
WWI-02S	Vibration Impact	Small	\$31.95	\$23.95
WWI-02M	Vibration Impact	Medium	31.95	23.95
WWI-02L	Vibration Impact	Large	31.95	23.95
WWI-02XL	Vibration Impact	X-Large	31.95	23.95
WWI-02XXL	Vibration Impact	XX-Large	31.95	23.95



HEATWORX® REINFORCED GLOVES

Up To 450°F

- Ironclad's patent pending Hotshield® palm technology combines high dexterity with heat, cut, abrasion and shrink resistance.
- Add to that oil repellency and washability, and you have a glove that truly does it all.



Kevlar® Inner Liner
For heat & cut resistance.

Kevlar® Blended Shell & Stitching
For durability & protection in high heat environments.

Ironclad Hotshield® Technology
Heat resistance without sacrificing dexterity.

Hotshield® Reinforcements
Reinforced in critical areas for maximum durability.

Patented Palm Design
Excellent dexterity & durability.



Model	Description	Size	List	Sale
HW-02S	Heatworks® Reinforced	Small	\$47.95	\$35.95
HW-02M	Heatworks® Reinforced	Medium	47.95	35.95
HW-02L	Heatworks® Reinforced	Large	47.95	35.95
HW-02XL	Heatworks® Reinforced	X-Large	47.95	35.95
HW-02XXL	Heatworks® Reinforced	XX-Large	47.95	35.95



PUSH-PULL TAPPER For Portable Power Tools

MODEL No.
PPT-717

\$229.95



- The American Gator Push-Pull Tapper is an instant reversing speed reduction unit made expressly for tapping and thread chasing.
- A speed reduction of 7 to 1 gives adequate power to tap all materials.
- Instant reversing means that the tap can be reversed without stopping the drill motor.
- The Push-Pull Tapper handles all taps up to 5/16" diameter and thread chasing to 1/2".
- The tap can be moved into and out of hole at operator's will.

Complete with:
Drill chuck adapter, wrench pin bushing wrench, and #6, #8 and #10 collets



MULTI-GRINDER

A new multi-purpose 1/8 hp machine, with variable speeds from 0 to 10,000 RPM

- Can be used as a carver, grinder, sander, polisher, buffer, etc.
- Includes, 31" long flexible shaft and handpiece which fits comfortably in your hand.
- The handpiece accepts a large variety of accessories with 1/8" shaft.
- Supplied with two 3/4" x 3" wheels, one grinding and one polishing.
- Measures: 8" W x 4-3/4" D x 6-1/2" H.

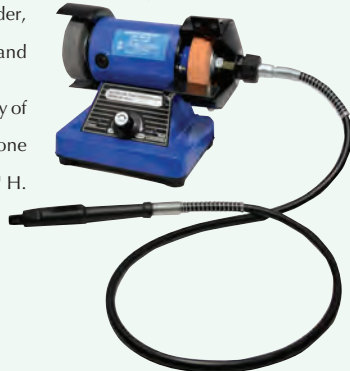

MODEL No.
47-0215

\$99.50

DREMEL CORDLESS MULTI-PRO® TOOL KITS

FEATURES

- Two-speed operation – 10,00 and 20,000 rpm.
- Three hour battery charger with LED charging indicator.
- Light, compact and easy to handle.
- Ball bearing shaft drive for smooth operation.
- Shaft lock button and a unique knurled collet nut make changing bits easy, so no wrench is required.

**2
Year
Warranty**



Kit No.	Kit Includes	List	Sale
8000-03	9.6V Cordless MultiPro® Tool, 10 assorted bits, Tool Storage case, Dremelite, Cordless battery pack, Cordless 3-hour charger, open end collet wrench	\$125.00	\$89.95
7700-02	7.2V Cordless MultiPro® Tool, 50 assorted bits, Quick start book, Small storage case, Cordless battery pack, Cordless 3-hour charger	\$75.00	\$59.95

DREMEL DIGITAL ROTARY TOOLS

- With variable speeds of 5,000-35,000, the Digital High-Speed Rotary Tool offers increased control and precision. The digital LCD readout displays accurate speed adjustments in 1,000-rpm increments.
- Features a tapered, balanced, ergonomic design and a "soft-start" system, which allows the tool to ease up to the selected speed for smooth, controlled handling.
- An electronic feedback controller enhances overall performance at low- and mid-range speeds, preventing the tool from "bogging down" when working with various materials, such as plastic, metal, stone and wood.
- The universal motor will run cool for long periods of time under various load conditions. The unique fan design maximizes airflow for cool motor performance.
- The high speed ball bearing design of the Digital ensures a smooth, quiet and continuous operation.



**5
Year
Warranty**

Kit No.	Kit Includes	List	Sale
3981-01	Digital Rotary Tool, 40 assorted bits/accessories Quick start book, Mid size window storage case, #4486 Dremel Keyless Chuck	\$150.00	\$105.95

DREMEL XPR ROTARY TOOL KIT 400-690 WITH MULTI SAW AND PLANER ATTACHMENT

- **NEW Dremel 400 Series XPR** high performance rotary tool
- **NEW XPR MultiSaw** attachment is ideal for cutting in tight spaces where other saws can't reach
- **NEW XPR Planer** attachment transforms the XPR tool into a planer making it ideal for planing stuck doors up to 2 1/4" thick
- **NEW Flex Light** attachment fits on your XPR tool and other Dremel tools and attachments to light up your work area
- **Flex Shaft** attachment for fine detail work and getting into hard-to-reach places
- **Cutting Guide** attachment turns your XPR rotary tool into a cut-out saw
- **Circle Cutter** attachment for cutting perfect circles in a variety of materials
- **90 Genuine Dremel accessories** with Mini storage cases



Variable Speed
5,000 to
35,000 RPM's
KIT No.
400-690
Reg. \$240.00

\$165.00

w/New XPR
Storage Case

**5
Year
Warranty**

DREMEL XPR ROTARY TOOL KIT 400-351

Kit No.	Kit Includes	List	Sale
400-351	400-XPR Rotary Tool, Flex Shaft attachment, Circle cutter attachment, Storage case, Lawn mower & garden tool sharpener, 51 Dremel accessories w/mini storage cases, Quick start book, 5 year warranty	\$145.00	\$99.95

DREMEL VersaTip™ TOOL

- Multipurpose tool for woodburning, soldering, hot knife cutting of styrofoam and plastics, cutting and fusing rope.
- By simply switching tips, the tool can be used for wood burning, leather crafting, stencil cutting, soldering, or hot-knife cutting of foam, plastics and rope.
- Superior burning and soldering capabilities
- Five different design tips provide maximum versatility
- Maximum tip temperature of 1,050° F for fast, dark and safe burning
- Tool stand protects tool from marking work surface
- Features a high-efficiency bronze core heating element that heats quickly, storage tube and tool stand.



MODEL No.
1550-T2
Reg. \$41.30

\$22.50



**2
Year
Warranty**

- Higher speeds 5,000 – 35,000 rpm, same as Dremel corded models.
- High capacity 10.8V Lithium-Ion battery pack for longer run times.
- Battery fuel gauge lets you know when its time to recharge.
- Variable speed to handle a greater range of applications with more precision.
- Small and lightweight for easier handling and less fatigue.
- Soft grip for superior comfort and balance.
- Accepts more than 150 Genuine Dremel® accessory bits.
- Can be used with a variety of versatile attachments.

KIT No.
8000-01
Reg. \$129.95
\$99.95

INCLUDES
Quick Start Book
Quick-Change Collet Nut
60 Assorted Accessories

Carrying Case
#855-01 Lithium-Ion Battery Pack
#856-01 3-hour Battery Charger
#90962 Open End Collet Wrench

metabo BURNISHER MACHINE

Sanding Deburring Scratch Removal
Polishing, Buffing and More



KIT No.
SE12-115
List \$1088.00
\$695.00



Kit Contains:
3-P80 sanding belt
2-2"x 4" P180 interleaved
1-Expansion roll for grinding
and polishing sleeves
1-Set of spacer rings
1-2"x 4" P280 Non-woven
nylon wheel
1-P80 flap wheel
1- Roller/spindle extension

Specifications:

Double insulated
vario tacho constamatic
(VTC) electronics
Long lasting motor
Spindle lock
Winding protection grid
High performance spiral
bevel gears
Variable speed controlled
by adjusting dial
Auto-stop carbon brushes

Specifications:

Maximum size 4.4" dia. x 4" length
Maximum torque 98 inch lbs.
No-load speed (RPM) 900-2810
Amps 10
Rated input watt 1200
Spindle thread 5/8"-11
Tool weight 6.25 Lbs.
Shipping weight 23.5 Lbs.
Length 13.5"

Weller® SOLDERING GUNS & KITS

- Universal all purpose gun.
- Dual-heat guns.
- Pistol grip design.
- Fingertip trigger selects high or low output.
- Ready to use in 6 seconds.
- High efficiency, tin plated copper tip.
- Light illuminates work.
- 2-wire cord 6 foot.

Kit Includes*:

- (1) Universal #8200 or (1) Professional heavy-duty #D550 soldering gun with standard tip.
- (1) Smoothing and (1) Cutting soldering tip.
- (1) Flux brush.
- (1) Soldering aid tool.
- (1) Coil of 40/60 rosin-core solder.
- (1) "Soldering Hints" instruction book.
- (1) Sturdy plastic carrying case.



Model	Volts	Watts	Temp Range	List	Sale
8200	120	140/100	1020°/900°F	\$49.95	\$43.95
D550	120	260/200	1100°/900°F	59.95	52.95
8200 PK*	Soldering Gun #8200 Kit			\$59.95	\$49.95
D550 PK*	Soldering Gun #D550 Kit			72.95	64.95

Replacement Tips

6150-1	Cutting Tip	\$6.95		
7135W	Standard Tip	\$6.95		
6160	Smoothing Tip	\$6.95		
8125W-1	Iron Plate Tip	\$6.95		
RCT-00	Rope Cutting Tip	\$7.95		

Weller® COLDHEAT® CORDLESS SOLDERING TOOL KIT

Using the patented ColdHeat system, the Weller pro Cordless melts solder instantly and is cool to the touch in just seconds. But unlike most other products using this new technology, the Weller Pro Cordless has the punch industrial professionals need to tin wire as large as 12 gauge or join wire from 18-25 gauge. With an average yield of 700 solder joints per pack of five AA alkaline batteries, it has what it takes to be an invaluable tool anywhere field soldering is required.



Heats Instantly
Cools Quickly!

KIT No.
CHT-100 **\$39.95**
Reg. \$44.95

Features:

- Portable: Cordless-Powered by 5 AA Alkaline Batteries (Not included)
- High-low power switch for small or large jobs.
- Bright white LED work light.
- Best results when used with 1mm (0.040") solder.
- Long life: Averages 700 solder joints per set of 5 AA Batteries.
- Comes Standard with the CHT3 chisel tip and deluxe case.

Includes:
Pro Soldering Tool
CHT-3 Chisel Tip, Storage Case

Model	Extra Tips	Price
No. CHT-1	Bevel 50°	\$11.95
No. CHT-2	Conical 61°	11.95
No. CHT-3	Chisel 61°	11.95

metabo PIPE & TUBE FINISHING SANDER/POLISHER

- Metabo INOX tools with VTC Electronic Speed Stabilization and Metabo Pyramid Abrasives.
- Finer finishes faster! The VTC electronics maintain the speed of the tools, even when fully engaged in the work, so your job is completed in the shortest time.
- Metabo Pyramid Abrasives shorten the time required to get to the final finish.
- The structured geometric placement of the abrasives allow finer grit sizes to remove more material while giving a consistent finish, eliminating steps required to get the required finish.



MODEL No.
RBE12-180
List \$1698.00
\$1095.00



Specifications:

Maximum pipe or disc diameter: 7"
Dimensions of grinding belt: 1-1/2" x 30"
Wrap angle (max): 270°
No-load speed: 521-1,673 ft./min
Amps: 10.0
Rated input watts: 1200
Tool weight: 9.1 lbs.
Shipping weight: 29.3 lbs.
Length: 20-1/4"

Standard Equipment:

Side Handle • Sanding belts 80 Grit Zirconia alumina • Carrying Case
Additional Belts:
1-1/2" x 30" Aluminum Oxide Belts, Zirconia, Alumina, Ceramic Grain, "Pyramid" Non-woven Nylon & Felt
Go to : www.penntolco.com

metabo ANGLE GRINDERS

- "Quick" rapid tool-less wheel change system.
- 2-position or 3-position side handle.
- Metabo slip clutch helps protect both the tool and operator should the wheel bind in the work.
- Auto-stop carbon brushes protect the motor and are easily replaced.
- Winding protection grid deflects harmful airborne debris.
- Spindle thread 5/8"-11; 7/8" arbor.
- Guard adjustment Wheel not included.
- W7-115 Quick, WPS7-115 Quick include inner flange and outer nut.



Model No.	Wheel Size	No Load RPM	Amps	List Price	Sale Price
W7-115Quick	4-1/2"	10,000	7	\$225.00	\$139.95



SOLDERING HOT AIR & TORCH KIT THE EXCALIBUR 3-IN-1 2500° FLAME

- A self igniting and cordless Soldering Iron, Hot Air Blower and Butane Torch complete in 1 great tool. The Piezo Electric instant ignition system provides a quick start up in any mode. Includes a wide range of tips, wrench, sponge and a tube of solder for all your needs.



KIT No.
SI-100 **\$49.95**
Reg. \$79.95 With 5 Interchangeable Tips & Case



Weller® CORDLESS SOLDERING IRON

- Powerful 6-watt/4.5 volt iron heats to working temperature 900° F in under 15 second..
- 120 solder joints per set of 3 alkaline batteries
- Batteries, lead-free solder, and tip removal tool included.
- Hundreds of uses... microelectronics, hobbies, small appliances, and more.

MODEL No.
BP-645MP
Reg. \$21.50
\$15.95

Save
35%



Includes:
Safety Cap
3 AAA Batteries
Lead Free Solder
and Conical Tip



MINI BRUTE

- New quick release arbor enables cutter changes in seconds.
- Motor is mounted to the frame in 3 points for greater rigidity.
- External coolant system features quick-release connectors.
- Motor housing manufactured from aluminum.
- 1-3/8" / 35mm cutter capacity.
- 1200 watt powerful motor.
- External coolant system.
- Easy to maneuver, weighs only 23 lbs.

MODEL No. AC35
Reg. \$1497.50
\$1095.00



Contains:
Carrying case, safety chain, tools, safety guard, external coolant system

Specifications:
No load speed 600RPM
Magnetic strength . . 2200Lbs
Arbor diameter 3/4"
Depth of cut 2"

MINI BRUTE - DRILL & TAPPER

- Cutting fluid reservoir built into arbor.
- "Quick-change" arbor support for conversion from cutter to drill chuck.
- Reversible handles for use in restrictive operating conditions.
- Corrosive resistant, tangle free cable from stand to drive unit.
- Wide, high density magnet for greater stability.
- Isolating power relay for improved handling safety.
- Reliable carrying case, safety strap, RB334 3/4" arbor, RB3212 1/2" drill chuck, RB3212 1/2" drill chuck, D-handle, cutting fluid, safety guard, chuck key, hex keys and spanner wrenches.

MODEL No. RB32-VSR
Reg. \$3619.00
\$2695.00



No. RB32T Tapping Attachment
\$450.00

Tap Holders From #6 to 7/8" 1/8" NPT to 1/2" NPT
\$95.00 Each (Specify)

Specifications:
Speed variable 0-550RPM
Cutter capacity 1-3/8"
Drill capacity 3/4"
Magnetic strength . . 2200lbs
Weight 28Lbs

MIGHTI BRUTE

- In response to the industry's demand for a lightweight machine yielding more cutting power, Champion proudly introduces the RB45 MightiBrute. But don't be fooled by the lightweight design.
- Fitted with a two-speed 1200 watt motor, the RB45 packs the drilling power of much heavier machines.
- Accommodates cutters up to 2" in diameter and twist drills up to 1".

Specifications:
No load speed 600RPM
Magnetic strength . . 2200Lbs
Arbor diameter 3/4"
Depth of cut 2"

MODEL No. RB45
Reg. \$3780.00
\$2795.00



PIPE SADDLE

- Pipe saddle enables RotoBrute machines to be used on convex surfaces, steel pipe and tubing; providing nonslip positioning and centered hole location.
- Easily assembled by sliding RotoBrute machine on to the saddle and tightening with adjustable ratchet straps, included.

MODEL No. RB32S
Reg. \$595.00
\$445.00



Inner Setting 2"-4-1/2"
Outer Setting 4-1/2"-18"

MEGA BRUTE ~ 4" CAPACITY

- Employing 1,260 watt Atlas Copco motor and many of the same features as the MiniBrute, the MegaBrute is one of the most powerful magnetic drills on the market.
- By removing the arbor, the MegaBrute stands ready to be used with taper shank drills and bridge reamers.
- Virtually maintenance free, the MegaBrute will deliver easy, effective performance for years to come.

Features:

- Cutting fluid reservoir built into the arbor
- Reversible traverse handles for use in restrictive operating conditions.
- Corrosive resistant, tangle free cable from stand to drill unit.
- Control panel situated conveniently on the same side as traverse handles.
- High density magnet for greater operating stability.
- Isolating power relay for improved handling safety.
- Includes metal carrying case, safety strap, RB634 3/4" arbor guard, drift key and hex keys.

Specifications:
Cutter capacity 4"
Drill capacity 1-1/4"
Magnetic strength . . 4100Lbs
Dimensions:
Height 18-7/8"
Width 4-1/2"
Length 9-5/8"
(4) Motor speeds:
. 220, 260, 350, 420



MODEL No. RB65
Reg. \$5224.00
\$3895.00

BRUTE LUBE

Champion's Brute Lube is a multipurpose cutting and tapping fluid specially formulated to extend tool life and reduce chip welding. Complies with OSHA regulations and contains no 1, 1, 1.

No.	Size	Price
XLU44	4 oz.	\$ 3.95
XLU16	16 oz.	11.95
XLU128	1 Gallon	65.00



GUARDAIR LAZER® SAFETY AIRGUN KITS

- Lazer safety air gun.
- Standard Venturi Nozzle.
- Booster Nozzle.
- Rubber Tip Nozzle
- 3" Venturi Extension
- 6" Venturi Extension
- 1/4" NPT male Industrial Interchange Connector.



Model	Description	List	Sale
LZR-600	Lazer Palm Switch Safety Air Gun Kit	\$35.00	\$29.95
LZR-650	Lazer Pistol Grip Safety Air Gun Kit	35.00	29.95

CUT-OFF TOOL

Features:

- Fast, quiet, 2-7/8" diameter.
- Contoured lever throttle with positive self-locking action.
- 360° rotatable chrome-plated spark guard.
- Built-in speed regulator.
- Cuts metal up to 3/4" thick.
- Free speed: 18,000 RPM.
- Air con: 4 CFM.
- 1/4" NPT air inlet.
- 3/8" ID air hose.
- Max. pressure: 90 PSI.

Model No. IR-326
Reg. \$90.00

\$59.95



1/4" HEAVY-DUTY DIE GRINDER

Features:

- Ball-bearing construction for longer tool life.
- Self locking throttle lever.
- Positive grip 1/4" capacity collet chuck.
- Free speed: 25,000 RPM.
- 1/4" NPT air inlet.
- 3/8" ID air hose.
- Air cons: 3 CFM.
- Max pressure: 90 PSI

Model No. IR-308A
Reg. \$138.00

\$89.95



3/8" HEAVY-DUTY DRILL

Features:

- Variable speed throttle.
- Light weight, compact design.
- Powerful 1/2 HP motor.
- Free speed: 2100 RPM.
- 1/4" NPT air inlet.
- 3/8" ID air hose.
- Max. pressure: 90 PSI

Model No. IR-7802A
Reg. \$170.00

\$119.95



CHICAGO PNEUMATIC MINI DRILLS

Features:

- Balanced, compact design with the power, speed and capacity for common drilling jobs makes these mini drills the ideal choice for most mechanic.
- Full 1/4 HP air motor and fast 2,700 RPM free speed.
- Comfortable ergonomic rubber grip.
- Fits into tight spots full sized drills can not.
- Precision feather trigger for easy super slow starts.
- Features an easy to access, rear mount FWD/REV switch.
- Reversible.
- Adjustable exhaust.
- Jacobs 1/4" keyed or keyless chuck.
- Air inlet size: 1/4"



Model	Description	Reg.	Sale
CP-201	Drill w/keyed chuck	\$174.50	\$129.95
CP-205	Drill w/keyless chuck	178.15	149.95

Milwaukee BANDFILE

Features:

- 5.5 Amp motor.
- Double insulated.
- 1/2" x 18" contact arm.
- 180° Adjustable head.
- 3 Position side handle.
- Grind, deburr, blend, clean, polish, surface or condition.

Model No. MIL-016
Reg. \$347.00

\$229.95



6" DUAL ACTION QUIET SANDER

Features:

- Vibration free.
- Balanced ball-bearing construction.
- Adjustable built-in regulator for positive speed control.
- Free speed: 10,000 RPM.
- 3/8" ID air hose.
- Air cons: 4 CFM.
- Max. pressure: 90 PSI.

Model No. IR-311A
Reg. \$90.00

\$59.95



1/4" MULTI-PURPOSE ANGLE DIE GRINDER

Features:

- Compact lightweight, easy to handle.
- Self locking throttle.
- Ball-bearing construction for durability.
- Precision machined gearing delivers maximum power transfer.
- Free speed: 20,000 RPM.
- 1/4" NPT air inlet.
- Air cons: 3 CFM.
- Max. pressure: 90 PSI.

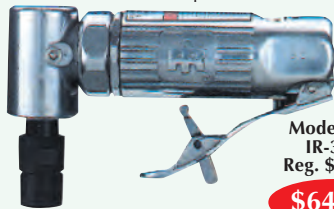

Model No. IR-301
Reg. \$90.00

\$64.95

3/8" HEAVY-DUTY REVERSIBLE DRILL

Features:

- Reversible motor with a quick reverse lever.
- Variable speed throttle for starting holes easily.
- Handles smoothly, a lightweight, compact drill.
- Powerful 1/2 HP motor.
- Max. pressure: 90 PSI.
- Free speed: 2,000 RPM.
- 1/4" NPT air inlet.
- 3/8" ID air hose.

Model No. IR-7802RA
Reg. \$237.00

\$149.95



SUPER-DUTY AIR HAMMER

Features:

- 3000 Blows per minute.
- Professional touch trigger for total control.
- Long life tool with tough one piece alloy barrel.
- Easy to maintain, with an "easy out" throttle valve assembly.
- 3/8" ID air hose.
- Air cons: 4 CFM.
- Max. pressure: 90 PSI.
- Front exhaust.



Model No. IR-121Q
Reg. \$169.95

\$99.50

4-1/2" SUPER-DUTY ANGLE GRINDER

Features:

- Powerful 8 HP motor.
- Unique motor controller eliminates overspeeding.
- Rear exhaust with piped away option.
- Composite grip for improved comfort.
- Locking lever with tease throttle for precision control.
- Lightweight design (weighs less than 4 lbs.).
- 3/8" ID air hose.
- Max. pressure: 90 PSI



Model No. IR-3445
Reg. \$341.00

\$265.00

3/8" REVERSIBLE RIGHT ANGLE DRILL

Features:

- Durable Jacobs multi-craft chuck.
- Reversible, with convenient control.
- Grease plug for easy preventive maintenance.
- Precision machine gearing ensures maximum power transfer and durability.
- 3/8" ID air hose.
- Max. pressure: 90 PSI
- Free Speed: 1800 RPM



Model No. IR-807
Reg. \$150.00

\$124.95

SUNEX TOOLS /PITPRO AIR ENGRAVING TOOL

- Air Inlet (NPT): 1/4"
- Hose Size (I.D.): 5/32"
- Air Pressure (PSI): 90 lbs.
- Overall Length: 6-1/2"
- For engraving on hard materials.
- Great for marking identification on tools and small parts.
- No lubrication is needed.
- Easy adjustable shut-off collar for adjusting the power.
- Comes with a 5 foot hose.



MODEL No. SX250

\$58.50

SUNEX TOOLS PENCIL DIE GRINDER

Kit Includes:

- 1 SX245 - 54,000 rpm Pencil Die Grinder
- 10 - 1/8" shank stones
- 2 - 9mm wrenches
- 1 - 1/4" coupler
- 1 - air tool oil bottle
- 1 - oiler

Specifications:

- Free Speed (RPM): 54,000
- Collet Size: 1/8"
- Air Inlet (NPT): 1/4"
- Hose Size (I.D.): 3/16"
- Air Pressure (PSI): 90 lbs.
- Air Consumption (CFM): 5.3
- Sound Level (dBA): 72
- Overall Length: 5-1/4"



MODEL No. SX245

\$66.50

3 lbs.

SUNEX TOOLS /PITPRO FULL SIZE RIGHT ANGLE DIE GRINDER KIT



- Features multi-purpose, PT2432 full sized right angle grinder (6-1/4" long).
- Includes 10 grinding stones and 8 abrasive discs
- Angled head ideal for working in tight spaces.
- Sturdy blow molded case makes it easy to store and carry.

- Speed of 20,000 RPMs.
- Includes internal regulator to control air pressure.
- Angled head makes it ideal for working in tight spaces.
- Grinder collet holds most 1/4" shank wheels, bits and other accessories.
- Features smooth-action safety lever throttle.
- Hooks up to any 1/4" air hose coupling.

Kit
MODEL No.
PT2432K
\$69.95

Specifications:
Free Speed (RPM): 20,000
Air Consumption (CFM): 4
Total Length: 6-1/4"

Die Grinder
MODEL No.
PT2432
\$46.00

SUNEX TOOLS /PITPRO 16 PIECE DIE GRINDER KIT

- Features multi-purpose, PT2430 full sized grinder (6-7/8" long).
- Includes 10 grinding stones!
- Straight drive grinder provides highest possible RPM's at 20,000.
- Sturdy blow molded case makes it easy to store and carry.

- Full-sized, 6-7/8" long body.
- Lightweight, only 1.32 lbs.
- Easy to handle.
- Full size to handle most general purpose to heavy-duty grinding applications.
- Ideal for grinding, deburring, porting and polishing.



Kit
MODEL No.
PT2430K
\$34.95

Specifications:
Free Speed (RPM): 20,000
Collet Size: 1/4"
Air consumption (CFM): 4
Air Inlet (NPT): 1/4"
Total Length: 6-7/8"

Die Grinder
MODEL No.
PT2430
\$21.95

SUNEX TOOLS /PITPRO 3/8" HIGH SPEED STRAIGHT DRILL 20,000 RPM

- Built in regulator to allow precise speed control.
- Solid Metal casing.
- Hooks up to a 1/4" air hose coupling.
- Rear exhaust directs air away from work area.
- Holds all standard 3/8" drill bits with Jacobs chuck.



SPECIFICATIONS:
Free speed (RPM): 20,000
Chuck capacity: 3/8"
Air consumption (CFM): 3
Total length: 9"

MODEL No.
PT2230
\$39.95

SUNEX TOOLS /PITPRO 3/8" STRAIGHT DRILL 2,500 RPM

- Built in regulator to allow precise speed control.
- Solid Metal casing.
- Hooks up to a 1/4" air hose coupling.
- Rear exhaust directs air away from work area.
- Holds all standard 3/8" drill bits with Jacobs chuck.



SPECIFICATIONS:
Free speed (RPM): 2,500
Chuck capacity: 3/8"
Spindle thread: 3/8"
Air consumption (CFM): 3
Total length: 9"

MODEL No.
PT2231
\$46.95
3 lbs.

SUNEX TOOLS /PITPRO MINI DIE GRINDER 25,000 RPM 1/4" COLLET CAPACITY

- Smallest die grinder in its class, only 4-3/4" long.
- Extremely lightweight, weighs less than 1 pound
- Easy to handle.
- Perfect for the tightest, most detailed jobs.



MODEL No.
PT2410
\$16.95

SPECIFICATIONS:
Free speed (RPM): 25,000
Collet size : 1/4"
Air consumption (CFM): 3
Air inlet (NPT): 1/4"
Total length: 4-3/4"

SUNEX TOOLS /PITPRO HEAVY DUTY EXT. SHAFT DIE GRINDER

- Built for heavy-duty applications.
- Extended length - over 10" long, works great in recessed areas.
- Straight drive to provide highest possible RPM's at 20,000.
- Holds most 1/3" shank wheels and bits.
- Variable speed throttle.
- Rear exhaust directs air away from work area.



SPECIFICATIONS:
Free speed (RPM): 20,000
Collet size: 1/4"
Air consumption (CFM): 4
Air inlet (NPT): 1/4"
Total length: 10-3/4"

MODEL No.
PT2240
\$39.95

SUNEX TOOLS 46 PIECE AIR TOOL SET

- Includes:**
- 1 PT140 1/2" Drive Impact Wrench
 - 8pc. Impact Socket Set
 - 3" Impact Socket Extension
 - 1 PT2430 Straight Die Grinder
 - 1/8" Collet
 - 10pc Grinding Stone Set with holder
 - 2 Spanner Wrench
 - 4mm Hex Wrench
 - 1 PT2235 150mm Air Hammer
 - 1 Spring Retainer
 - 4 Air Chisels
- Air Service Accessories Also Included:**
- Blow Gun with 4 tips
 - Tire Chuck and Inflation Needle
 - Quick Change Air Coupler
 - 3 Male Adapters
 - Teflon Tape
 - Air Tool Lubricant
 - 25ft. 3/8" Diameter Coil Air Hose
 - Blow Molded Storage Case



SET No.
PT2246
\$119.95

SUNEX TOOLS /PITPRO MINI RIGHT ANGLE DIE GRINDER

- Speed of 20,000 RPMs.
- Includes internal regulator to control air pressure.
- Angled head makes it ideal for working in tight spaces.
- Grinder collet holds most 1/4" shank wheels, bits and other accessories.
- Features smooth-action safety lever throttle.
- Hooks up to any 1/4" air hose coupling.



MODEL No.
PT2412
\$35.95

SPECIFICATIONS:
Free Speed (RPM): 20,000
Air consumption (CFM): 3
Total Length: 4-7/8"

SUNEX TOOLS /PITPRO 3" AIR POWERED CUT-OFF TOOL

- Free Speed (RPM): 20,000
- Air Consumptions: 4.0 CFM
- Cutting Wheel Size: 3"
- Air Pressure: 90 PSI
- Air Inlet: 1/4"
- Total Length: 7-3/8"
- Variable Speed Throttle.
- Steel guard protects user from sparks.
- Rear exhaust directs air away from work area.



MODEL No.
PT2710
\$24.95
2 lbs.

1/4" AIR DIE GRINDER

Features:

- Heavy-duty, light-weight construction.
- Ball bearing construction for long tool life.
- Variable speed throttle for positive speed control.
- Rear exhaust.
- 30 Day warranty.



Specifications:

Speed 22,000 rpm
 Air inlet 1/4" NPT
 Hose size 3/8" I.D.
 Air pressure 90 PSI
 Air consumption . . . 4 CFM
 Collet size 1/4"
 Length 6-3/4"
 Weight 1-1/8 lbs.

MODEL 5036

\$19.95

Optional Parts & Accessories

Model	Description	Price
5037	1/8" Collet	\$ 3.95
1032	1/4" Collet	11.95

1/4" ANGLE AIR DIE GRINDER



30 Day Warranty

MODEL 2332

\$34.95

Features:

Specifications:

Speed 22,000 rpm
 Air inlet 1/4" NPT
 Hose size 3/8" I.D.
 Air pressure 90 PSI
 Air consumption . . . 4 CFM
 Collet size 1/4"
 Length 6-1/3"
 Weight 1 lbs.

- Heavy-duty, light-weight construction.
- Ball bearing construction for long tool life.
- Variable speed throttle for positive speed control.
- Rear exhaust.
- Grease fitting in head.

Optional Parts & Accessories

Model	Description	Price
1026-1	1/8" Collet	\$11.95
1032	1/4" Collet	11.95

1/4" AIR DIE GRINDER COMBO

See Models 5036 & 2332 for features and specifications.

30 Day Warranty



SET No. 5032

\$49.95

**Includes:
1/4" die grinder &
1/4" angle die grinder.**

**Buy Both
Save More!**

1/4" AIR DIE GRINDER WITH 10 PIECE TOOL KIT

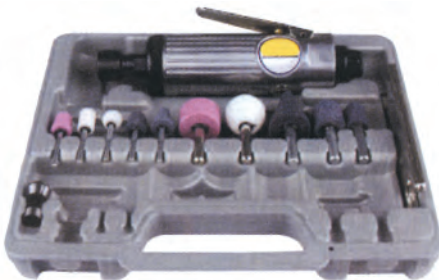

30 Day Warranty

Specifications:

Speed 22,000 rpm
 Air inlet 1/4" NPT
 Hose size 3/8" I.D.
 Air pressure 90 PSI
 Air consumption . . . 4 CFM
 Collet size 1/4"
 Length 6-3/4"
 Weight 1-1/8 lbs.

MODEL No. 1304

\$34.95

Includes: 1/4" die grinder (5036), 1/8" & 1/4" collets, 10 Piece mounted wheel set, fitted case.

1/4" AIR GRINDER WITH 36 PIECE TOOL KIT

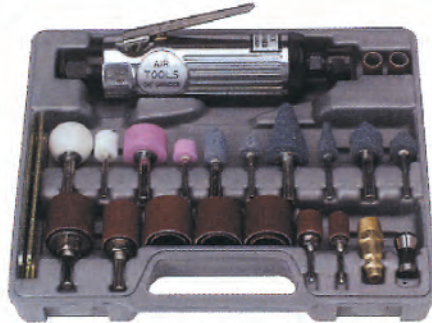

MODEL No. 1294

\$42.50

Specifications:

Speed 22,000 rpm
 Air inlet 1/4" NPT
 Hose size 3/8" I.D.
 Air pressure 90 PSI
 Air consumption . . . 4 CFM
 Collet size 1/4"

Includes: 1/4" die grinder (5036), 1/8" & 1/4" collets, 2 wrenches, 1/4" NPT connector, 10 Piece mounted wheels, 4 rubber sanding drums & 16 sanding sleeves

1/4" ANGLE AIR DIE GRINDER WITH 48 PIECE TOOL KIT

30 Day Warranty



Specifications:

Speed 22,000 rpm
 Air inlet 1/4" NPT
 Hose size 3/8" I.D.
 Air pressure 90 PSI
 Air consumption . . . 4 CFM
 Collet sizes 1/8" & 1/4"

MODEL No. 1296

\$69.95

Includes: 1/4" Angle die grinder (1306), wrench, 1/8" & 1/4" collets, 1/4" NPT connector, 10 piece mounted wheels, 4 rubber sanding drums, 16 sanding sleeves, 2 & 3" disc holders, 8 sanding discs.

1/4" MINI ANGLE AIR DIE GRINDER WITH FRONT EXHAUST

Features:

- Heavy-duty, light-weight construction.
- Ball bearing construction for long tool life.
- Variable speed throttle for positive speed control.
- Safety lock throttle.
- 30 Day warranty.



Specifications:

Speed 22,000 rpm
 Air inlet 1/4" NPT
 Hose size 3/8" I.D.
 Air pressure 90 PSI
 Air consumption . . . 4 CFM
 Collet size 1/4"
 Length 4-7/8"
 Weight 1 lb.

MODEL 1307

\$32.95

**1/8" Collet
MODEL No. 1026-1 \$11.95**

90° ANGLE DIE GRINDING AND SANDING KIT

- Kit includes 10 deburring stones, 5 each 2" and 3" sanding wheels, 2" and 3" arbors, wrenches, collet adapter and nozzle in fitted case.
- 90° die grinder: 22,000 RPM, 90 PSI, 4CFM.

**MODEL No. 51-268
Reg. \$95.00**

\$39.95



SUNEX 4" MINI ANGLE GRINDER

TOOLS

- Lots of power in compact size
- Lightweight design for ease of operation
- Grinder head guard standard
- Auxiliary side handle for greater operator control
- New mini size is great when working in tight areas



MODEL No. SX210

\$89.95

Specifications:

Free Speed (RPM) @ 90PSI : 2,500
 Air Inlet (NPT): 1/4
 Minimum Hose Size (I.D.): 3/8
 Recommended Air Pressure (PSI): 90
 Avg. Air Consumption (CFM): 5
 Sound Level (dBA): 85

Pad Size (In.): 4
 Height (In.): 3.5
 Length (In.): 8
 Weight (Lbs.): 4



ASTRO AIR BLOW GUNS

- Made of lightweight durable composite plastic.
- Ergonomically designed handle provides extra comfort and better grip.
- Angled nozzle easily gets into tight places.
- Air Inlet Thread NPT: 1/4"
- Air Pressure: 90-120psi
- Maximum Pressure: 230psi/16KGS
- Air Inlet: 1/4" NPT
- Average Air Consumption: 8CFM



Model No.	Nozzel Length	List Price	Sale Price
1731	4"	\$19.95	\$13.95
1732	10"	22.95	16.95
1733	16"	26.95	19.95
1734	28"	32.00	24.95
1735	40"	39.00	27.95

Precise INDUSTRIAL AIR TOOLS



3/8" STRAIGHT AIR DRILL



MODEL No. 1331 **\$65.00**

Features:

- Ball bearing construction
- Muffled handle exhaust for quiet operation.
- Planetary gearing for heavy duty use.
- Variable speed trigger.
- Complete with Jacobs chuck.
- Lever trigger for easy start/stop.

Specifications:

Speed 4500 RPM
 Air inlet 1/4" NPT
 Hose size 3/8" I.D.
 Air Pressure 90 PSI
 Air Consumption 4 CFM
 Chuck size 3/8"
 Spindle thread . . 3/8"-24
 Length 7-1/2"
 Weight 2 lbs.

3/8" REVERSIBLE ANGLE AIR DRILL



MODEL No. 1382 **\$79.95**

Features:

- Ball bearing construction
- Muffled handle exhaust for quiet operation.
- Planetary gearing for heavy duty use.
- Variable speed trigger.
- Complete with Jacobs chuck.
- Lever trigger for easy start/stop.
- Grease fitting in head.

Specifications:

Speed 1800 RPM
 Air inlet 1/4" NPT
 Hose size 3/8" I.D.
 Air Pressure 90 PSI
 Air Consumption 4 CFM
 Chuck size 3/8"
 Spindle thread 3/8"-24
 Length 7"
 Weight 4 lbs.

AIR GREASE GUN

- Need 40 PSI air
- Hold 500 gram grease.
- Takes standard grease cartridges.
- Flexible nozzle included.



MODEL No. 7600-0112

\$29.95



3/8" REVERSIBLE AIR DRILL



MODEL No. 1327

\$59.95

Features:

- Ball bearing construction
- Muffled handle exhaust for quiet operation.
- Planetary gearing for heavy duty use.
- Variable speed trigger.
- Complete with Jacobs chuck.

Specifications:

Speed 1800 RPM
 Air inlet 1/4" NPT
 Hose size 3/8" I.D.
 Air Consumption 4 CFM
 Chuck size 3/8"
 Spindle thread . . 3/8"-24
 Length 7"
 Weight 3 lbs.



1/2" REVERSIBLE AIR DRILL



MODEL 1381

\$79.95

500 RPM

Features:

- Ball bearing construction.
- Muffled handle exhaust for quiet operation.
- Planetary gearing for heavy-duty use.
- Variable speed trigger.
- Complete with Jacob's chuck.

Grinder Specifications:

Speed 500 rpm
 Air inlet 1/4" NPT
 Hose size 3/8" I.D.
 Air pressure 90 PSI
 Air consumption . . 4 CFM
 Chuck size 1/2"
 Spindle thread . . 3/8"-24
 Length 7"
 Weight 4 lbs.



1/2" NON-REVERSIBLE AIR DRILL

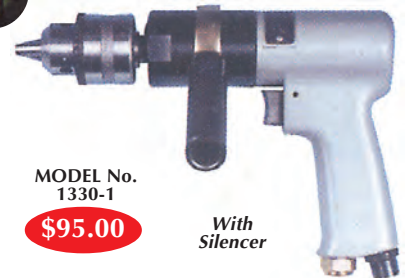

MODEL No. 1330-1

\$95.00

With Silencer

Features:

- Ball bearing construction
- Muffled handle exhaust for quiet operation.
- Planetary gearing for heavy duty use.
- Variable speed trigger.
- Complete with Jacobs chuck.

Specifications:

Speed 400 RPM
 Air inlet 1/4" NPT
 Hose size 3/8" I.D.
 Air Pressure 90 PSI
 Air Consumption 4 CFM
 Chuck size 1/2"
 Spindle thread . . 3/8"-24
 Length 7"
 Weight 7 lbs.

MICRO ANGLE AIR DIE GRINDER

Features:

- Lightweight design for fine detail work.
- 5 ft. braided hose with 13" protective outer loom.
- 1/8" collet.
- 30 day warranty.



MODEL 1301 **\$129.95**

Grinder Specifications:

Free speed 22,000 rpm
 Air inlet 1/8" NPT
 Hose size 5MM I.D.
 Air pressure 90 PSI
 Air consumption . . . 4 CFM
 Spindle thread . . 10-32 UNF
 Length 6-1/4"
 Weight 1/2 lbs.

MINIATURE 1/8" AIR DIE GRINDER

Features:

- Pen type grinder is ideal for access to confined areas.
- Operates at 54,000 RPM at 90 PSI.
- 5 ft. braided hose with 13" protective outer loom.
- 30 day warranty.
- Includes 1/8" collet, wrenches and quick connect coupler.



MODEL No. 1302

\$39.95

Replacement Collet MODEL 9808 \$10.00

Specifications:

Free speed: 54,000 rpm
 Collet size 1/8"
 Air inlet 1/8" NPT
 Hose size 5MM I.D.
 Air pressure 90 PSI
 Air consumption: 4 CFM
 Length 5-1/4"
 Weight 1/4 lbs.

3/8" AIR IMPACT WRENCH

Features:

- Built-in air regulator for positive speed and torque control.
- Ring socket retainer for rapid socket changes.
- Single hammer clutch mechanism.
- 30 day warranty.

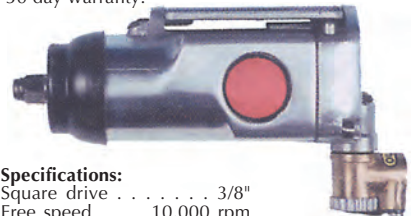

Specifications:

Square drive 3/8"
 Free speed 10,000 rpm
 Torque 3/8"
 Bolt capacity 75 ft.-lbs.
 Air inlet 1/4" NPT
 Hose size 3/8" I.D.
 Avg. air consumption . 4 CFM
 Length 5-1/2"
 Weight 2-1/8 lbs.

MODEL No. 1910

\$49.95



AIR ANGLE GRINDERS



- Features:**
- Powerful motor for maximum performance.
 - Lightweight aluminum housing to prevent operator fatigue.

Specifications:

Model	1332	1333
Pad size	4"	7"
Speed	12000 RPM	7000 RPM
Air inlet	1/4" NPT	1/4" NPT
Hose size	3/8" I.D.	3/8" I.D.
Air Pressure	90 PSI	90 PSI
Air Consumption	6 CFM	6 CFM
Spindle thread	3/8"-24	5/8"-11
Length	9"	13-1/2"
Weight	4 lbs.	8 lbs

\$119.98 **\$139.95**

Type 27 Depressed Center Wheels - Gemini

Model	Size D x T x H	Price
0712	4 x 1/4 x 5/8"	\$2.00
0744	7 x 1/4 x 7/8"	3.50

DUAL ACTION SANDER

- Features:**
- Dual acting sanding action for greater ease and coverage of surfaces
 - 30 Day warranty.



MODEL No. 1383

\$34.95

Specifications:

Free speed ... 10,000 RPM
 Pad Size ... 6"
 Spindle thread ... 5/16"-24"
 Air Inlet ... 1/4" NPT
 Hose size ... 3/8" I.D.
 Air pressure ... 90 PSI
 Air consumption ... 4 CFM
 Length ... 8-3/4"
 Weight ... 3-45 lbs.

20 Piece Combo Pack 6" PSA Cloth disc
MODEL No. 9714
\$20.00
Includes: 80 and 120 Grit

5" HIGH SPEED AIR SANDER

- Features:**
- Constant orbital stroke for fine finishing.
 - Dynamic counter-weight vibration isolators for low-speed sanding.
 - Automatic release throttle lever with positive stop action.
 - Heavy-duty balanced ball bearing construction.
 - Built-in regulator for positive speed control.



MODEL 1385

\$36.95

Specifications:

Pad size 3, 4-1/2"x 5-1/2"
 Speed ... 18,000 rpm
 Air inlet ... 1/4" NPT
 Hose size ... 3/8" I.D.
 Air pressure ... 90 PSI
 Air consumption ... 12 CFM
 Spindle thread ... 5/8"-11
 Length ... 16"
 Weight ... 5 lbs.

20 Piece Combo Pack 4-1/2" A/O Resin Fibre Disc
MODEL No. 9720
\$26.00
Includes: 36 and 60 Grit



7" ANGLE AIR SANDER



MODEL No. 1329

\$69.95

- Features:**
- Constant orbital stroke for fine finishing.
 - Dynamic counterweight vibration isolators for low vibration sanding.
 - Automatic release throttle lever with positive stop action.
 - Heavy-duty balanced ball bearing construction
 - Built-in regulator for positive speed control.

Specifications:

Pad size ... 7"
 Speed ... 4500 RPM
 Air inlet ... 1/4" NPT
 Hose size ... 3/8" I.D.
 Air Pressure ... 90 PSI
 Air Consumption 12 CFM
 Spindle thread ... 5/8"-11
 Length ... 16"
 Weight ... 5 lbs.

20 Piece Combo Pack 7" A/O Resin Fibre Disc
MODEL No. 9722
\$25.00
Includes: 36 and 60 Grit

Replacement Disc Pad
MODEL No. 9812 ... \$5.40

RANDOM ORBITAL AIR SANDERS

- Features:**
- Random orbit action leaves no swirl marks for a superior quality finish.
 - Compact size, lightweight and the lowest vibration maximize operator.
 - Built-in speed regulator.



Specifications:

MODEL	1386	1387
Pad size	5"	6"
Speed	10,000 rpm	10,000 rpm
Air inlet	1/8" NPT	1/4" NPT
Hose size	5MM I.D.	3/8 I.D.
Air pressure	90 PSI	90 PSI
Air consumption	4 CFM	4 CFM
Weight	6-1/2 lbs.	6-1/2 lbs.

PRICE **\$89.95** **\$92.50**

20 Pc. Combo Pack - 80 & 120 Grit

Model	Description	Price
9714	6" PSA Cloth Disc	\$20.00
9716	5" PSA Cloth Disc	15.00

JITTERBUG AIR SANDER

- Features:**
- Constant orbital stroke for fine finishing.
 - Dynamic counter-weight vibration isolators for low-vibration sanding.
 - Automatic release throttle lever with positive stop action.
 - Heavy-duty balanced ball bearing construction.
 - Built-in regular for positive speed control.

MODEL 1900

\$49.95



Specifications:

Pad size ... 3-2/3"x 6-1/2"
 Speed ... 8,000 rpm
 Air inlet ... 1/8" NPT
 Hose size ... 3/8" I.D.
 Air pressure ... 90 PSI
 Air consumption ... 4 CFM
 Length ... 7-3/8"
 Weight ... 4-1/3 lbs.

3-2/3 x 9" Paper Sand Sheets 120 Grit
MODEL No. 9922
\$39.95
200 per pack

Replacement Parts

Model	Description	Price
9986	102139 Paper Clamp	\$5.40
9987	102143 Sanding Pad	6.60
9988	102134 Bearing Housing	2.10
9989	102136 Ball Bearing	6.00

EZRED LED FLIP LIGHT

- Convenient accessibility: where you need it, when you need it.
- Rugged hook offers stationary positioning and easily stores into the light housing.
- The new foldable design is compact, easy to carry and store.



MODEL No. FL-1701
 Reg. \$ 69.95

\$44.95

With Charger 7 Hour On Time 2 Hour Charge Time



MINI-BELT SANDERS



16,000 RPM

- Features:**
- Lightweight and highly efficient sanders reduce arm fatigue.
 - Swing position grip rotates 360° for all-around positioning for operator comfort and convenience.
 - Rear exhaust directs air away from work.
 - Muffled handle exhaust for quiet operation.
 - Complete with two belts, hex wrench and hose nipple.

Model No.	Belt Size	Air Pressure	Length Folded	Length Max.	Price
1400	1/4" x 13"	85 PSI	10-7/16"	19-19/64"	\$ 89.95
1402	1/2" x 24"	85 PSI	23-1/2"	34-1/2"	99.95
1398	3/4" x 20-1/2"	85 PSI	11-14/16"	18-1/2"	109.95

Abrasive Belts

Grit	Model	Price	Model	Price	Model	Price
60X	0540	\$1.04	2100	\$1.10	2130	\$1.15
80X	0542	1.02	2102	1.06	2132	1.12
120X	0544	1.02	2106	1.03	2136	1.08
180X	0546	.99	-	-	-	-

SUNEX TOOLS 10 TON PORTA-JACK KIT

- Complete starter set.
- Powerful heavy duty ram cylinder.
- Spreader ram standard.
- New blow molded storage case, model has case and wheels.



MODEL No. 4910A

\$195.00

SET INCLUDES:
 83 lbs.
 Head pump, Hose, Cylinder ram, Spreader ram, Rubber head, Ram toe, Plunger toe, 90° V-base, Serrated saddle, Male thread adapter, Rubber faced flat base, Wedge head 1/2 ton, and assorted extension tubes.

1/2" AIR RATCHET WRENCH KIT

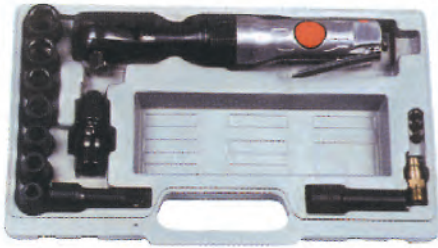

Features:

- Heavy-duty.
- Lightweight construction reduces operator fatigue.

Includes:

- 1/2" ratchet wrench.
- 7 pc. socket set.
- 3" extension bar.
- Universal joint.
- Case.
- 3 pc. screwdriver bit set.
- Screwdriver adapter.

Specifications:

Capacity 1/2"
 Speed 150 RPM
 Torque 50 ft.-lbs.
 Length 10"
 Weight 2-1/2 lbs.

MODEL No. 1380
\$49.95

1/2" IMPACT RATCHET WRENCH KIT

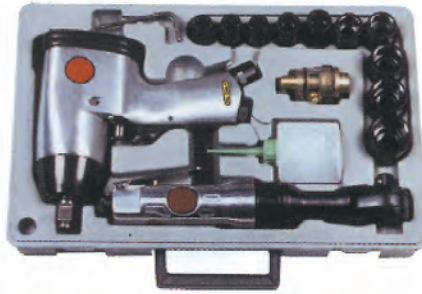

Features:

- Impact wrench has a built-in regulator for positive speed and torque control.
- Lightweight construction.

Includes:

- 1/2" impact wrench.
- 1/2" ratchet wrench.
- 10 pc. socket set.
- Mini oiler
- Hex key.
- Nipple.
- Oil pot.
- Case.

MODEL No. 1410-1
\$59.95

1/4" REVERSIBLE AIR SCREWDRIVER



MODEL No. 1413

\$74.95

Adjustable Clutch

Features:

- Excellent power-to-weight ratio handles tough jobs with minimal operator fatigue.
- Aluminum pistol grip handle with contoured trigger throttle.
- Quick change hex collet.
- 30 Day warranty

Specifications:

Speed 1800 RPM
 Capacity 1/4" Hex
 Torque 45-115 in.-lbs.
 Air inlet 1/4" NPT
 Hose size 3/8" I.D.
 Air Pressure 90 PSI
 Air Consumption 4 CFM
 Length 7"
 Weight 2-1/2 lbs.



1/4" AIR SCREWDRIVER



Features:

- Industrial type air screwdriver.
- Lever throttle for positive speed control.
- Positive clutch.
- 30 Day warranty.
- Forward and reverse.

MODEL No. 1414
\$89.95

Specifications:

Capacity 1/4"
 Speed 800 RPM
 Torque 45/145 in.-lbs.
 Length 11"
 Weight 2-1/3 lbs.



AIR NIBBLER

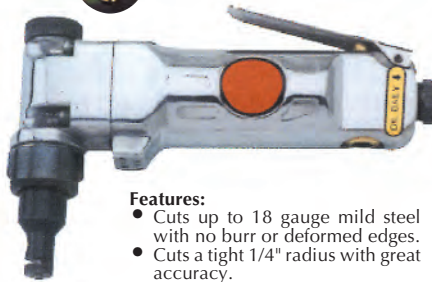

Features:

- Cuts up to 18 gauge mild steel with no burr or deformed edges.
- Cuts a tight 1/4" radius with great accuracy.
- Adjustable die guide.
- Lever throttle for positive speed control.
- 30 Day warranty

Specifications:

Strokes per minute 3500
 Air inlet 1/4" NPT
 Hose size 3/8" I.D.
 Air Pressure 90 PSI
 Air Consumption 4 CFM
 Length 7"
 Weight 2 lbs.

MODEL No. 1420
\$69.95

Spare Cutter No. 600-0126
\$18.00

SUNEX[®] AIR SHEARS

- Hardened shear head can cut up to 18 gauge steel
- Planetary gearing for long life and heavy duty use
- Bottom handle diffused exhaust for quiet operation and keeping air away from work surface
- Left Replacement blade RS227B17 \$12.00
- Right Replacement blade RS227B20 . . . \$12.00
- Center Replacement blade RS227B19 . . . \$17.50



Pistol Grip MODEL No. SX227B

\$99.95

Air Inlet Thread Size (NPTF) 1/4
 Average Air Consumption (CFM) . . 4
 Length (in.) 8.5
 Minimum Hose Size (I.D.) . . . 0.375
 Sound Level (dBA) 82
 Strokes Per Minute (SPM) 2500
 Weight (lbs.) 3

PALM AIR SANDER

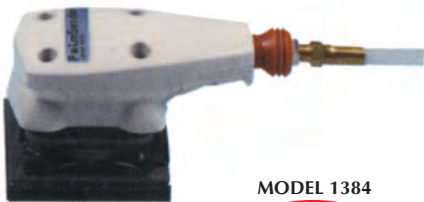

MODEL 1384
\$59.95

Features:

- Random orbit action leaves no swirl marks for a superior quality finish.
- Compact size, lightweight and the lowest vibration maximize operator.
- Built-in speed regulator.

Specifications:

Pad size 2-5/16"x 3-7/32"
 Speed 15,000 rpm
 Air inlet 1/4" NPT
 Hose size 3/8" I.D.
 Air pressure 90 PSI
 Air consumption 4 CFM
 Weight 6-1/2 lbs.

MAGNETIC ORGANIZER



MODEL No. MTR-012
\$9.95

- 12" long, mounts to wall.
- Great for Shop, Home or Office.
- Hold several tools at one time.

AIR BODY SAW



MODEL No. 1406
\$79.95

Features:

- 16 gauge (.0625") steel capacity.
- Lightweight design for easy movement.
- 30 Day warranty.

Specifications:

Cutting capacity steel 16 gauge (.0625")
 Speed 9000 RPM
 Air Inlet 1/4" NPT
 Hose size 1/4" I.D.
 Air pressure 90 PSI
 Air Consumption 5 CFM
 OAL 9-1/4"
 Weight 2 lbs.

Replacement Blade PK/5
 MODEL No. 1232 \$12.95

Precise INDUSTRIAL AIR TOOLS Precise

1/4" AIR RATCHET WRENCH

- Features:**
- Ball detent socket retainer.
 - 30 day warranty.



MODEL No.
1376

\$29.95

Specifications:

Square drive 1/4"
Free Speed 240 RPM
Torque 18 ft.-lbs.
Square drive 1/4"
Air inlet 1/4" NPT
Hose size 1/4" I.D.
Avg. air cons 3 CFM
Length 6-5/16"
Weight 1-1/10 lbs.

5 Pc. 1/4" Quick-Coupler Set

MODEL No. 1920-1 **\$6.65**

Includes: NPT female quick connector, NPT female/male stud, NPT double male coupler and 2 NPT male/male studs

3/8" AIR RATCHET

- Features:**
- Ball detent socket retainer.
 - Lightweight construction.
 - 30 day warranty.

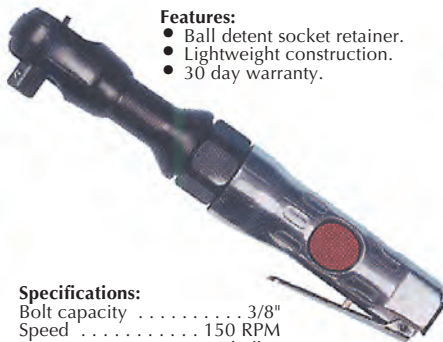

MODEL No.
1310-1

\$44.95

Specifications:

Bolt capacity 3/8"
Speed 150 RPM
Torque 50 ft.-lbs.
Square drive 3/8"
Air inlet 1/4" NPT
Hose size 3/8" I.D.
Avg. air cons 4 CFM
Length 10"
Weight 2-1/2 lbs.

Optional 8 Pc 3/8" Drive Socket Sets

Model	Range	Price
1220-1	5/16-3/4" - Standard	\$9.95
122	5/16-3/4" - Deep	9.95

1/2" HEAVY-DUTY" AIR WRENCH

- Features:**
- Ball detent socket retainer.
 - Lightweight construction.
 - 30 day warranty.

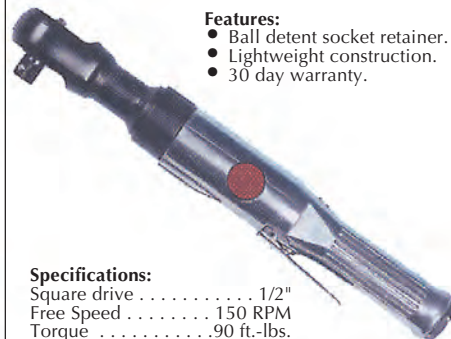

MODEL No.
1411-1

\$69.95

Specifications:

Square drive 1/2"
Free Speed 150 RPM
Torque 90 ft.-lbs.
Square drive 1/2"
Air inlet 1/4" NPT
Hose size 3/8" I.D.
Avg. air cons 5 CFM
Length 14-3/8"
Weight 4-2/5 lbs.

Optional 10 Pc 1/2" Drive Socket Set

Model	Range	Price
1224	1/2-1" - Standard	\$12.95

3/8" AIR IMPACT WRENCH

Features:

- Built-in air regulator for positive speed and torque control.
- Ring socket retainer allows for rapid socket changes.
- Front and rear bumper guards for protection.



MODEL No.
1908

\$49.95

Specifications:

Bolt capacity 3/8"
Speed 10000 RPM
Torque 75ft.-lbs.
Square drive 3/8"
Air inlet 1/4" NPT
Hose size 3/8" I.D.
Avg. air cons 3CFM
Length 5"
Weight 2-5/8 lbs.

Optional 8 Pc 3/8" Drive Socket Sets

Model	Range	Price
1220-1	5/16-3/4" - Standard	\$9.95
122	5/16-3/4" - Deep	9.95

1/2" AIR IMPACT WRENCH

Features:

- Built-in air regulator .
- Ring socket retainer allows for rapid socket changes.
- Front and rear bumper guards for protection.



MODEL No.
1338

\$59.95

Specifications:

Bolt capacity 5/8"
Speed 7000 RPM
Torque 280 ft.-lbs.
Square drive 1/2"
Air inlet 1/4" NPT
Hose size 3/8" I.D.
Avg. air cons 4 CFM
Length 7-1/4"
Weight 5-1/4 lbs.

Optional 10 Pc 1/2" Drive Socket Set

Model	Range	Price
1224	1/2-1" - Standard	\$12.95

3/4" AIR IMPACT WRENCH

Features:

- Built-in air regulator for positive speed and torque control.
- Ring socket retainer allows for rapid socket changes.
- Front and rear bumper guards for protection.



MODEL No.
1374

\$89.95

Specifications:

Bolt capacity 1"
Speed 4500 RPM
Torque 500 ft.-lbs.
Square drive 3/4"
Air inlet 1/4" NPT
Hose size 3/8" I.D.
Avg. air cons 7.5 CFM
Length 8"
Weight 10-1/5 lbs.

4 Pc. 1/4" Quick-Coupler Set

MODEL No. 1920-2 **\$6.65**

Includes: NPT female quick connector, NPT female/male stud, NPT double male coupler and 1 NPT male/male studs

3/8" SQUARE DRIVE IMPACT SOCKETS



STANDARD SET SHOWN

Model	Description	Price
1220-1	8-Pc Standard: 5/16", 3/8", 7/16", 1/2", 7/16", 5/8", 11/16", 3/4" & metal case	\$9.95
122	8-Pc Deep: 5/16", 3/8", 7/16", 1/2", 7/16", 5/8", 11/16", 3/4" & metal case	9.95

1/2" SQUARE DRIVE IMPACT SOCKETS



STANDARD SET SHOWN

Model	Description	Price
1224	11 Pc Standard: 1/2", 9/16", 5/8", 11/16", 3/4", 13/16", 7/8", 15/16", 1", 1-1/16", 1-1/8" & Metal Case	\$12.95
7358	15 Pc Deep: 3/8", 7/16", 1/2", 9/16", 5/8", 11/16", 3/4", 13/16", 7/8", 15/16", 1", 1-1/16", 1-1/8", 1-1/4"	29.95

20 PC. STANDARD S.A.E. AND METRIC COMBINATION SOCKET SET



MODEL 1228 **\$29.95**

Set Includes:

1", 7/16", 1/2", 9/16", 5/8", 11/16", 3/4", 13/16", 7/8", 15/16", 10Mmm, 11mm, 12mm, 13mm, 15mm, 17mm, 19mm, 21mm, 22mm, 24mm and metal case.



AIR NEEDLE SCALER



- Perfect for surface prep work involving the removal of rust, paint, weld slag, etc.
- Lightweight aluminum housing
- Hardened steel barrel
- Pistol design for comfort and control

Specifications:

Length 11-1/4"
Weight 4 lbs.
Min. Hose Size . . . 3/8"
Needle Dia. 1/8"
CFM 5
No. of Needles . . . 19
Air Inlet 1/4"
BPM 4500

MODEL No.
SX246
\$40.95

Replacement Needles - Pack of 19
MODEL 1276-1 \$14.00

Precise INDUSTRIAL AIR TOOLS



AIR NEEDLE SCALERS



Features:

- Heat-treated barrels and pistons.
- Wide angle chisel standard.
- Lever lock retainer on Model 2332 1432.
- 30 day warranty.

Specifications:

Speed 4,000 BPM
Needle diameter 3mm
Needles per tool 19 pc.
Air inlet 1/4" NPT
Air Pressure 90 PSI
Air Consumption 4 CFM
OAL 16-3/8"
Weight 5-3/4 lbs.

MODEL No.
SX247
\$87.50

Replacement Needles - Pack of 19
MODEL 1276-1 \$14.00

eXtreme light LED LIGHT Rechargeable Cordless

- 30 Super bright 100,000 hour floodlight style LED's.
- Shatter resistant ABS case.
- 10 hour cordless use between charging.
- Replaceable lens cover.
- Battery pack has 1000 charge cycles.
- Super strong swivel hook keeps light on the subject, not in your eyes.
- Powered by rechargeable NiMH battery pack.
- Protective grip and guards.

MODEL No.
EZL-3000
Reg. \$110.00
\$84.95



AIR PUNCH/CRIMPING TOOLS

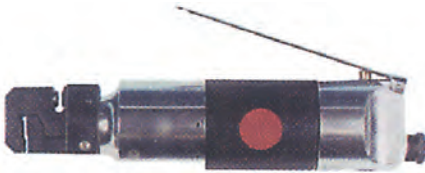

Features:

- Tool-in-one metalworking tool.
- 360° swivel head.
- Muffle handle exhaust for quiet operation.
- 30 day warranty.
- Crimps up to 14 gauge (.075") sheet metal and punch burr-free holes for welding applications.

5mm (.197")
MODEL No.
1416-1
\$54.95

Specifications:

Capacity steel . . . 0.8-1.4mm
Punch 5mm/8mm
Flange width 12mm
Air Pressure 90 PSI
Air Consumption . . . 4 CFM
Length 10"
Weight 4-11/5 lbs.

8mm (.315")
MODEL No.
1418-1
\$69.95



HYBRID PVC HOSE

- Lays flat.
- Rolls out & stores well.
- Flexible down to -40 degrees Fahrenheit.
- Resists kinking under pressure.

Specifications:

- Hose material: Hybrid PVC resin.
- Temperature range -40° Fahrenheit to +140°F
- Working pressure: 300 PSI
- Good abrasion resistance.
- Good Chemical resistance.



Model No.	Hose I.D.	Length Feet	Fitting NPT	Price Each
YB40504	1/4"	50'	1/4" NPT Male	\$29.95
YB41004	1/4"	100'	1/4" NPT Male	49.95
YB60504	3/8"	50'	1/4" NPT Male	42.95
YB61004	3/8"	100'	1/4" NPT Male	72.95



AIR TOOLS LUBRICANTS & CLEANER

Air Tool Lubricant

Features:

- Specially formulated non-detergent high-grade lubricant prolongs the service life of air tools, cylinders and accessories while showing maximum performance.
- Rust-proof while removing moisture as it lubricates.
- Easy-pour spout reduces waste of precious resources.

Prolongs Tool Life!



Model	Size	Price
2500 5948	4 oz.	\$ 3.74
2500 5950	16 oz.	6.25
2500 5952	1 Gallon	29.88

Air Tool Cleaner

Features:

- Removes varnish, sludge, rust and dirt.
- Prevents harmful build-up when used regularly.
- Improves performance of clogged or sluggish tools.
- Keeps tools running at maximum efficiency.



MODEL No.
2500 1000
\$3.94

4 oz.



AIR CLEAN UNITS

Features:

- Air clean unit removes solid particles and condenses moisture.
- The micro-fog lubricator lubricates pneumatic tools evenly.
- Steplless regulator accurately maintains air pressure.



Model	1940	1942	1944
Connection port	1/4" NPT	3/8" NPT	1/2" NPT
Max. temperature	150° F	150° F	150° F
Max. pressure	150 PSI	150 PSI	150 PSI
Dimensions (H x L x W)	10-1/4" x 7-1/2" x 4"	10-1/4" x 7-1/2" x 4"	10-1/4" x 7-1/2" x 4"
Net weight	5-1/2 lbs.	5-1/2 lbs.	5-1/2 lbs.
Price	\$29.95	\$29.95	\$29.95

NYLON AIR RECOIL HOSES

Features:

- 1/8" NPT threads on 1/4" hose.
- 3/8" NPT threads on 3/8" hose.
- Swivel head fitting with spring guards.
- Ideal for all air tools and related equipment.
- 30 day warranty.



Model	Size	Price
1930	1/4" x 25 ft.	\$ 7.95
1932	1/4" x 50 ft.	10.95
1934	3/8" x 25 ft.	8.95
1936	3/8" x 50 ft.	12.95

- The new in-line check valves will reduce initial dry cutting by holding fluid in the hose, ready for your next cutting operation.
- When a single line isn't enough, Modular Manifolds will allow any number of additional outlets in both 1/4" and 1/2" diameters.

1/4" SYSTEM – 1/4" I.D.



Model	Description	Price
40413	1/4" Hose Kit 13" Length with Fittings: 1/4", 1/8", 1/16" Nozzles 1/4", & 1/8" Male NPT Connector	\$7.95
45463	Acid Resistant Kit	10.65
40452	1/4" Flared Tubing Replacement Pack	30.85
	8 Segments 5-3/4" Long 4 Flare Nut Adapters 3/8" 4 Round Nozzles 1/8" 4 Round Nozzles 1/4" 1 Flare Nozzle 1"	
41474	1/4" 90° Nozzle Kit 1 Each: 1/16", 1/8" 1/4" & Spray Bar Nozzles	7.00
41475	1/4" Extended Element Kit with Element Clamps: 4 Extended Elements 1/4" 4 Element Clamps 1/4"	14.20
41401-1	Segment Pack (2-53/4" pcs.)	6.35
49420	Segments Bulk 25 ft.	140.00
49421	50 Foot Coil	280.00
45401	Acid Resistant (2-53/4" pcs.)	7.95
46420	25 ft. Acid Resistant	175.00
46421	50 ft. Acid Resistant	350.00
41476	4 Extended Elements 1/4"	9.45
49445	20 Extended Elements 1/4"	37.85
41477	4 Element Clamps 1/4"	7.00
49446	20 Element Clamps 1/4"	26.75
41402-1	4 Round Nozzles 1/16"	3.90
39422	50 Round Nozzles 1/16"	38.50
45402	4 Acid Resistant 1/16"	4.90
46422	50 Acid Resistant 1/16"	48.20
41403-1	4 Round Nozzles 1/8"	4.20
49423	50 Round Nozzles 1/8"	41.60
45403	4 Acid Resistant 1/8"	5.30
46423	50 Acid Resistant 1/8"	52.00
41404-1	4 Round Nozzles 1/4"	4.20
49424	50 Round Nozzles 1/4"	41.50
45404	4 Acid Resistant 1/4"	5.30
46424	50 Acid Resistant 1/4"	52.00
41470	4 90 (Nozzles) 1/16"	5.90
49439	20 90 (Nozzles) 1/16"	23.00
41471	4 90 (Nozzles) 1/8"	5.90
49440	20 90 (Nozzles) 1/8"	23.00
41472	4 90 (Nozzles) 1/4"	5.90
49441	20 90 (Nozzles) 1/4"	23.00
41473	2 90 (Spray Bar Nozzles 1/4")	6.35
49442	20 90 (Spray Bar Nozzles 1/4")	45.00
41407-1	2 Flare Nozzles 1"	6.35
49427	20 Flare Nozzles 1"	45.00
45407	2 Acid Resistant 1"	7.95
46427	20 Acid Resistant 1"	55.00
41405	4 NPT Connectors 1/8"	4.35
49425	50 NPT Connectors 1/8"	43.00
41405-1	4 Acid Resistant 1/8"	4.35
46425	50 Acid Resistant 1/8"	54.00
41406-1	4 NPT Connectors 1/4"	4.35
49426	50 NPT Connectors 1/4"	43.00
45406	4 Acid Resistant 1/4"	5.50
46426	50 Acid Resistant 1/4"	54.00

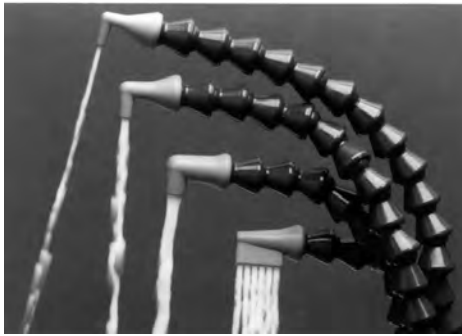

41408-1	2 Y Fittings 1/4"	\$ 6.50
49428	20 Y Fittings 1/4"	45.00
41409-1	4 Double Sockets 1/4"	4.90
49429	20 Double Sockets 1/4"	19.00
41411-1	4 1/4" Socket to 1/8" FNPT	5.50
49431	20 1/4" Socket to 1/8" FNPT	22.00
45411	4 Acid Resistant 1/8" FNPT	6.90
46431	20 Acid Resistant 1/8" FNPT	27.00
41412-1	4 Flare Nut Adapters 3/8"	6.50
49432	20 Flare Nut Adapters 3/8"	25.00
41414	4 Flare Nut Adapters 1/4"	6.50
49434	20 Flare Nut Adapters 1/4"	25.00
41415-1	2 Elbow Fittings 1/4"	6.50
49435	20 Elbow Fittings 1/4"	45.00
41416-1	2 T Fittings 1/4"	7.50
49436	20 T Fittings 1/4"	55.00

1/4" & 1/2" CIRCLE FLOW SYSTEM

Model	Description	Price
41479	1/4" Circle Flow Nozzle Kit 15 Side Flow Nozzles 1/4" 1 End Cap 1/4"	\$19.00
51837-1	1/2" Circle Flow Nozzle Kit 15 Side Flow Nozzles 1/2" 1 End Cap 1/2"	22.00
41478	4 Side Flow Nozzles 1/4" (4Pk)	7.50
51836	4 Side Flow Nozzles 1/2" (4Pk)	8.25
51838	4 End Caps 1/2" (4Pk)	4.90
41480	4 End Caps 1/4" (4Pk)	4.75

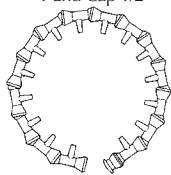

VALVES

Model	Description	Price
21192	2 Male NPT Valves 1/4"	\$11.00
29452	10 Male NPT Valves 1/4"	48.00
21193	2 Female NPT Valves 1/4"	10.90
29453	10 Female NPT Valves 1/4"	48.00
21194	2 In-Line Valves 1/4"	11.00
29454	1 In-Line Valves 1/4"	48.00
32092	2 Male NPT Valves 1/2"	13.50
39852	10 Male NPT Valves 1/2"	58.00
32093	2 Female NPT Valves 1/2"	13.50
39853	10 Female NPT Valves 1/2"	58.00
32094	2 In-Line Valves 1/2"	13.00
39854	10 In-Line Valves 1/2"	58.00

1/2" SYSTEM – 1/2" I.D.

Model	Description	Price
50813	1/2" Hose Kit 13" Length With Fittings: 1/4", 3/8", 1/2" Nozzles 3/8" & 1/2" Male NPT Connectors	\$9.90

Model	Description	Price
51832	90° Nozzle Kit 1 Each: 1/4", 3/8", 1/2" & Spray Bar Nozzles	\$ 8.25
51835	1/2" Extended Element Kit With Element Clamps: 4 Extended Elements 1/2" 4 Element Clamps 1/2"	16.50
51801	Segment Pack (2-51/2" pcs.)	7.50
59860	Segments Bulk 25 ft.	210.00
59861	50 Foot Coil	425.00
51833	4 Extended Elements 1/2"	10.90
59883	20 Extended Elements 1/2"	44.00
51834	4 Element Clamps 1/2"	8.50
59884	20 Element Clamps 1/2"	31.00
51806	4 Round Nozzles 1/4"	4.90
59866	50 Round Nozzles 1/4"	48.00
51802	4 Round Nozzles 3/8"	4.90
59862	50 Round Nozzles 3/8"	48.00
51803	4 Round Nozzles 1/2"	4.90
59863	50 Round Nozzles 1/2"	48.00
51828	4 90° Nozzles 1/4"	6.90
59878	20 90° Nozzles 1/4"	28.00
51829	4 90° Nozzles 3/8"	6.90
59879	20 90° Nozzles 3/8"	28.00
51830	4 90° Nozzles 1/2"	6.90
59880	20 90° Nozzles 1/2"	28.00
51831	2 90° Spray Bar Nozzles 1/2"	6.90
59881	20 90° Spray Bar Nozzles 1/2"	28.00
51807	2 Flare Nozzles 1 1/4"	7.50
59867	20 Flare Nozzles 1 1/4"	50.00
51809	2 Flare Nozzles 2 1/2"	8.90
59871	20 Flare Nozzles 2 1/2"	55.00
51804	4 NPT Connectors 3/8"	5.50
59864	50 NPT Connectors 3/8"	48.00
51805	4 NPT Connectors 1/2"	5.50
59865	50 NPT Connectors 1/2"	48.00
51808	2 Y Fittings 1/2"	7.50
59868	20 Y Fittings 1/2"	50.00
51822	2 Y Reducers 1/2" to 1/4"	7.50
59870	20 Y Reducers 1/2" to 1/4"	50.00
51821	2 Adapters 1/2" to 1/4"	5.50
59869	20 Adapters 1/2" to 1/4"	45.00
51811	4 Double Sockets 1/2"	5.50
59872	20 Double Sockets 1/2"	22.00
51823	4 Flare Nut Adapters 3/8"	6.90
59873	20 Flare Nut Adapters 3/8"	27.00
51824	2 Elbow Fittings 1/2"	7.25
59874	20 Elbow Fittings 1/2"	54.00
51825	2 T Fittings 1/2"	7.50
59875	20 T Fittings 1/2"	62.00

ASSEMBLY PLIERS

Model	Description	Price
78001	Hose Assembly Pliers, 1/4"	\$10.95
78002	Hose Assembly Pliers, 1/2"	10.95
78003	Set 1/2" and 1/4" Hose Assembly Pliers	19.75



MADE IN USA



1/4" SWIVEL NOZZLE 40

Model	Pack of	Price
41481	Pack of 2	\$ 9.50
49449	Pack of 20	67.00



.040" Holes

1/4" SWIVEL NOZZLE 60

Model	Pack of	Price
41482	Pack of 2	\$ 9.50
49450	Pack of 20	67.00



.060" Holes

2-1/2" SWIVEL NOZZLE 75

Model	Pack of	Price
41488	Pack of 2	\$ 9.90
49455	Pack of 20	72.00



.075" Holes

1" STRAIGHT FLOW NOZZLE

Model	Pack of	Price
41489	Pack of 2	\$ 6.50
49456	Pack of 20	41.00



1/4" FLAT SLOT 40 NOZZLE

Model	Pack of	Price
41483	Pack of 4	\$ 6.90
49451	Pack of 20	24.00



.040" Slot Height

1/4" FLAT SLOT 60 NOZZLE

Model	Pack of	Price
41484	Pack of 4	\$ 6.90
49452	Pack of 20	24.00



.060" Holes

1/4" FLAT 5 HOLE NOZZLE

Model	Pack of	Price
41485	Pack of 4	\$ 6.90
49493	Pack of 20	24.00

1/4" FLAT 7 HOLE NOZZLE

Model	Pack of	Price
41486	Pack of 4	\$ 6.90
49453	Pack of 20	24.00



.040" Holes

Model	Pack of	Price
41477	Pack of 4	\$ 7.50
49446	Pack of 20	24.50



1/4" EXTENDED ELBOWS

- Improved pressure ratings up to 110 psi using element clamps*. Lock in place for precise positioning.
 - Curved 90 degrees to accommodate tight spaces with a 1.75" bend radius.
 - Use with 90° Nozzle for a quick 180° turn.
 - Use with Side Flow Nozzles or T Fittings to create a complete rigid circle around the cutters.
 - Use with Extended Elements and clamps for a moderate pressure system.
- * Assumes use of Element Clamps on all joints and clamps fully tightened.



MADE IN USA

New!

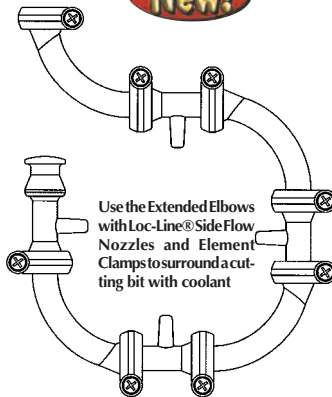

1/4" EXT. ELBOW KIT

MODEL 40472 \$19.95

- Includes:
- 4 Extended Elbows
 - 4 Element Clamps
 - 1/8" & 1/4" NPT Connectors
 - 1/4", 1/8", 1/16" Nozzles



1/4" MIXED ELEMENT KIT

MODEL 40473 \$19.95

- Includes:
- 2 Extended Elbows
 - 2 Extended Elements
 - 4 Element Clamps
 - 1/8" & 1/4" NPT Connectors
 - 1/4", 1/8", 1/16" Nozzles



1/4" EXTENDED ELBOWS

Model	Pack of	Price
41491	Pack of 4	\$ 9.90
49457	Pack of 20	34.00



1/4" ELEMENT CLAMP



Model	Pack of	Price
41477	Pack of 4	\$ 7.50
49446	Pack of 20	24.50

Wesco COOLANT PUMPS & TANKS

- Centrifugal pumps are designed as sturdy, low priced, dependable pumping units with exceptional performance and trouble free operation.
- Expressly built for those jobs which circulate coolant liquids and cutting oils separating the chips, grit and abrasives.
- Removable inner container separates and retains chips for fast, easy cleanup.



No. 521 Round



No. 1021 Thru No. 1041 Rectangle

Model	Size	Tank Size	Motor	Price
521	5 Gal.	12" dia. x 13"H	1/20HP	\$215.00
1021	10 Gal.	24"L x 12-1/2"W x 9-1/2"H	1/20HP	325.00
1025	10 Gal.	24"L x 12-1/2"W x 9-1/2"H	1/3HP	430.00
1030	20 Gal.	30"L x 16"W x 10"H	1/3HP	530.00
1035	20 Gal.	30"L x 16"W x 10"H	1/2HP	575.00
1036	36 Gal.	30"L x 16"W x 10"H	1/3HP	655.00
1040	36 Gal.	36"L x 18"W x 13"H	1/2HP	695.00

Wesco MIST COOLANT SYSTEM

Eliminates Dry Machining

- These systems are designed for easy adjustments away from the cutting edge for added safety and convenience.
- The heat of the tool and the part is rapidly and thoroughly dissipated because a sprayed coolant mist exposes a greater fluid surface area and is thus capable of absorbing more heat faster.
- This extends tool life for lower costs per part.
- All Mist units have 4' coolant lines. Additional Lengths add \$3.50 per foot.



Model	Gallons	Container	Outlets	Price
100-C	1 Gal.	Custom Plastic	1	\$ 99.95
102-C	1 Gal.	Custom Plastic	2	145.00
100-S	1 Gal.	Stainless	1	125.00
102-S	1 Gal.	Stainless	2	175.00

Wesco PARTS & ACCESSORIES



Model	Description	Price
WPL-1	Hose assembly w/ Flex & Valve	\$45.00
AMH-150	Adjustable Magnetic Holder	19.95

reprorubber



FLEXBAR METROLOGY CASTING MATERIAL

MAKES ACCURATE "HARD" REPRODUCTIONS IN 6 TO 8 MINUTES

- Exotic Metrology Grade Rubber.
- Self Curing in minutes.
- Virtually Perfect Replica casting Internal and External Forms.
- Non toxic.
- Easy to use.
- 100 times faster than RTV Silicones.
- No release agent is ever needed.



Supplied in two viscosities:

Thin Pour
 Model No. 16116
 Thin Pour 130mL Trial Kit
\$55.00
 Model No. 16135
 Thin Pour 380mL Kit
\$155.00
 Model No. 16131
 Reprorubber
 Putty - 7 lb. Kit
\$570.00

Quicksetting Putty
 Model No. 16129
 220mL Trial Kit
\$72.50
 Introductory Kit
 Light Blue
 Model No. 16130
 1-3/4lb. (520mL)
\$165.00



facsimile

FLEXBAR QUICK-SETTING COMPOUND

MAKES ACCURATE "HARD" REPRODUCTIONS IN 6 TO 8 MINUTES

Facsimile is a special plastic compound kit which is used for duplicating surface flats, roughness and for dimensional transfer of inaccessible locations. Many other applications are listed below and many more in our free 24 page applications booklet.

- Make duplicates or measuring, such as gages etc.
- Test surface geometry, flatness, microfinish, etc.
- Make permanent records of surface geometry.
- Make custom holding and nesting fixtures.
- Make quick jigs.
- Make excellent stylus patterns.
- Make instant molds and patterns
- Cast small run parts and prototypes.
- Mask, fill in and seal.



Introductory Kit
 1 lb. Kit No. 16000



Complete Kit
 Kit No. 16000
 1 lb. Kit Facsimile

\$85.00



Complete 1 lb. Kit Contains:
 Facimile Powder 1 lb. tray.
 1 - 120cc Facsimile liquid.
 1 - 60cc Flexbar Release Agent.
 1 - Powder Scoop.
 1 - Molding clay.
 10 - Disposable cups (graduated)
 10 - Wooden Spatulas
 1 - 1oz. polypropylene measuring cup
 1 - 24p Applications Booklet.

Complete Kit
 Kit No. 16003
 3 lb. Kit Facsimile

\$189.50

FLEXBAR FLEXBAR FIXTURING ALLOY

- Reusable low temperature melting Alloy (158°F) for supporting thin-walled sections which require machining. No. 15158 does not shrink upon solidification rather it exhibits slight "growth" so that it locks into the part being machined. After machining you simply melt it out in hot water.
- It melts at 54°F below boiling point of water so that when you go to use it you simply put it in a cast iron, stainless steel or porcelain lined pot and into hot water bath to melt it.
- Reusable many times,
- No drosses created owing to low heat required prior to pouring it.



MODEL No.
 15158
 1 lb. Cake

\$53.50



FLEXBAR FINE PROOFING ALLOY

Reuseable Low-Melting Alloy
 (Finest Grade)

- Melts at 116°F.
- Finest grade for metrology applications.

MODEL No.
 16117
 1 lb. Cake

\$210.00

Uses: Proofing Via Replication of:
 Dies - Moulds - Internal and External thread forms -
 Texture Check - Grooves Slots - O-ring Grooves - Gear Teeth - Splines-
 Surface Finish Replication - Extra Fine Fixturing - Checking Undercuts

FLEXBAR

MONOJET PRECISION DISPENSING SYRINGE

For Reprorubber Thin Pour & Facsimile

Provides user with an easy method of injecting pre-mixed reprorubber or facsimile into small holes, grooves or small spaces.



Model No. 16190
 10CC Syringe
\$29.95
 (Pac of 10)

.060" diameter curved tip for injecting reprorubber or Facsimile into small holes. Tip can be cut to allow greater flow.

FLEXBAR MACHINABLE WAX

To reduce your costs,time, and risk factors associated with Proofing CNC Tooling Programs, Training CNC Programmers or Demonstrating CNC Machinery and CAD/CAM Systems.

Machinable Wax unlike metal, plastic and wood, features all the properties necessary to meet the requirements of CNC and CAD/CAM program proofing. It's very machinable, dimensionally stable, safe to work with and very economical because it is reclaimable and remachinable.

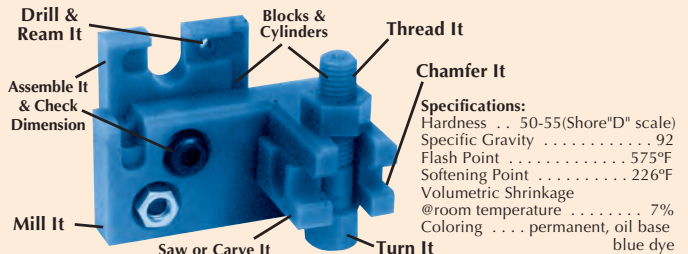

Machine Wax is available in Rectangular Blocks and Cylinders
 Custom sizes quoted on request.

Rectangle			Round		
Model	Size	Price	Model	Size	Price
15160	3" x 7" x 1.5"	\$15.00	15170	1.5" dia. x 12"	\$13.50
15161	3" x 7" x 3"	27.50	15165	2" dia. x 12"	14.95
15162	5" x 10" x 3"	64.00	15166	3" dia. x 12"	38.50
15163	6" x 12" x 3"	85.00	15167	4" dia. x 14"	59.95
15164	24" x 24" x 2"	369.50	15168	6" dia. x 18"	175.00

FLEXBAR

ROCKSETT™ ADHESIVE CERAMIC CEMENT

The All purpose engineering adhesive ceramic cement ... One grad does it all. Locks, Seals & Bonds - nuts, screws, shafts, keys, splines, pipes, flanges, etc. Incredible temperature resistance (-350°F) up to 2,015°F.

- Electrical insulation-for both A.C. and D.C. up to 20 Radio MHz (Mega/Hertz)
- Non-toxic- odorless - non-flammable.
- Long shelf life.
- No mixing or priming required.

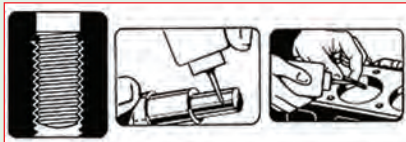

Model No.	Code (Rocksett)	Size	Dropper Bottle	Price Each
15014	R-2	2 oz.	Yes	\$ 9.95
15015	R-4	4 oz.	Yes	14.95
15016	R-6	1 Gal.	No	245.00

Best Cutting Fluid on the Planet!

Crazy Larry's Secret Lube®

Cures Poor Tool Life! Improves Finish!

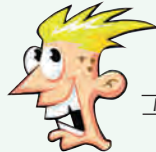

Use For:

- Tapping
- Drilling
- Milling
- Reaming
- Broaching
- Beveling

See Video's and Testimonials @

www.penntoolco.com

Model No.	Description	Price
PS-400	4 oz. Pump Spray	\$ 6.95
PS-800	8 oz. Pump Spray	9.25
4B-100	1 Gallon	95.00

SpillMaster SPILL CUPS Avoid Messy & Costly Spills

The SpillMaster is the perfect new container for cutting fluids and lubricants. It's unique design prevents spills, even when turned completely upside down! The SpillMaster is molded from durable polyethylene for years of use. It is available with a red, white or blue top and comes complete with an applicator brush.

Model	Description	Price
SPM001B	SpillMaster Blue Lid	\$5.95
SPM002R	SpillMaster Red Lid	5.95
SPM003W	SpillMaster White Lid	5.95



ChipMaster A Safe Way To Remove Chips



MODEL No. CMK-002

\$5.95



DUCT TAPE

THE TOUGHEST TAPE ON THE PLANET

- Bonds to things ordinary tapes can't, including brick, stucco, wood and more.
- Made with double thick adhesive, strong reinforced backing, and a tough all-weather shell, it's the biggest, strongest, toughest thing ever to happen to tape.



Size: 35 Yards x 1.88" Wide x 17 ML Thick
ROLL No. 60351
Reg. \$12.95 **\$9.95** Per Roll



GORILLA GLUE THE TOUGHEST GLUE ON THE PLANET

100% Waterproof - 100% Solvent Free

- Gorilla Brand Premium Glue is the all purpose, interior/exterior glue ideal for most repair and bonding needs.
- It's great for indoor/outdoor use, woodworking projects, as well as general repairs around the shop.
- Bonds wood, stone, metal, ceramic & more!

Model No.	Description	Price
50004-1	4 oz. Bottle Gorilla Glue	\$ 6.95
50008	8 oz. Bottle Gorilla Glue	11.95
50018-1	18 oz. Bottle Gorilla Glue	18.95
50036	36 oz. Bottle Gorilla Glue	29.95



MULTI-PURPOSE SYNTHETIC LUBRICANT

- Unique Teflon formula, works first as a penetrating spray before gelling to form a clear long lasting protective grease.
- Unlike other lubricants, Super Lube stays where you spray it and has excellent adhesion. It will not drip or run.
- Reduces friction.
- Prevents rust and corrosion.
- Repels dirt and water.
- Non-toxic, safe on rubber, plastic and other materials.
- Super lube is an excellent di-electric material.
- Works effectively in temperatures from -65° to +650°F.



Model	Description	Price
21030	3 Ounce Tube	\$4.95
31040	6 Ounce Aerosol	6.50
31110-1	11 Ounce Aerosol	8.25
51600	1 Quart Trigger Spray	19.95

FLEXBAR

LANO-LUBE™ MULTI-PURPOSE PURE LANOLIN

- Moisture free. • Stops rust • Always clean • No odor • Anti-seize properties
- Uses Include: Inspection • Gaging • Drilling Centers • Turning • Tapping



2 oz. Tube No. 11152-2

\$6.95

MADE IN USA

FLEXBAR



METROLOGY-GRADE SELF-CURING CASTING FORMULA

Quick Dispense Cartridge System Kits

Supplied in Two Viscosities

1) The Original Reprorubber Thin pour (green) ideal for internal-shape applications.

2) The New Reprorubber orange, medium body, multi-use formula for internal & external apps.

Reprorubber Quick Dispense cartridge System Kits contain everything you need to easily create highly accurate, zero shrinkage replicas. Each kit includes 1 each Repru-Mix II reusable dispensing gun, 6 each 50ml prefilled reprorubber disposable cartridges, 15 disposable mixing nozzles, 2 micro injector snap-on nozzles and a deluxe fitted carrying case.



Shown above: Quick dispense internal casting (left) and external casting (right) using the new Flexbar Repru-Mix II dispensing gun system.

Now available for use with Reprorubber prefilled cartridges:

Repru-Mix Dispensing Gun System & Kits

A mixing and dispensing system that enables you to make quick and accurate reprorubber replicas...without manual mixing and fuss.

Ordering Complete Kits

Model	Description	Sale
16300	Reprorubber thin pour (Green) quick dispense cartridge system kit complete	\$225.00
16305	Reprorubber orange (medium body) quick dispense cartridge system kit complete	225.00
16309	Reprorubber combo kit quick release cartridge system kit, includes 3 each thin pour & 3 each orange	225.00



Kit No. 16300, Green Reprorubber Thin Pour \$225.00



Kit No. 16309 Reprorubber System Refills Combo Thin Pour & Orange \$225.00

Model	Description	Sale
16301-1	Reprorubber thin pour (Green) 50ml cartridge, 1 pack	\$18.95
16302-1	Reprorubber thin pour (Green) 50ml cartridge, 6 pack	110.00
16306	Reprorubber orange (med. body) 50ml cartridges, 1 pack	18.95
16307	Reprorubber orange (med. body) 50ml cartridges, 6 pack	110.00
16311-2	Repru-mix II dispensing gun (reusable)	52.50
16313	Repru-mix II helix mixing nozzles, 15 pack	18.50
16316	Repru-mix II helix mixing nozzles, 100 pack	99.50
16315	Quick dispense cartridge system fitted case (without contents)	59.50
16314	Micro injector snap-on nozzle pack of 15	12.95

TRICO SPRAYMASTER® SPRAY UNITS



- Air and coolant are independently controlled by solid brass precision needle valves.
- Brass armored lines are a standard 5 foot length.
- 6 in. straight nozzle is designed so atomizing takes place at nozzle tip for enhanced pattern control.
- Mounting bracket included for easy installation.
- Liquid level gauge easily indicates coolant level at a glance.
- Polyethylene dimensions: 12-1/4"H x 10"W x 5-1/4"D
- Stainless steel dimensions: 9-3/8"H x 8-3/8"W x 5-1/4"D
- One gallon tank capacity.

Model	Description	Tank	List	Price
30542	Spraymaster, 1 Line	Polyethylene	\$287.00	\$249.95
30543	Spraymaster, 2 Lines	Polyethylene	296.00	259.95
30548	Spraymaster, 1 Line	Stainless Steel	288.00	255.00
30549	Spraymaster, 2 Lines	Stainless Steel	387.00	335.00

TRICO PORTABLE "DL" SPRAY UNIT With Magnetic Base

Provides cooling solutions for light duty machining and tool room applications. This dispenser is easy to install requiring only shop air and dropping the siphon line into a coolant tank.



MODEL No.
30655
Reg. \$95.00
\$79.95

TRICO
FREE!
One Gallon
Tri-Cool
Synthetic Coolant

TRICO TRI-COOL® SYNTHETIC COOLANT

- **Water-Soluble Coolant**
- Ideal for milling, sawing, tapping or grinding on ferrous and non-ferrous materials.
- Gives excellent rust protection, even at high dilutions.
- Increases speeds & feeds by up to 50% and tool life up to 100%
- Meets OSHA & EPA requirements-oil free, completely biodegradable.



MADE IN
USA

Model	Description	List	Sale
30656	1 Gallon Tri-Cool Synthetic	\$ 52.50	\$ 35.00
30657	5 Gallon Tri-Cool Synthetic	195.00	165.00
30658	55 Gallon Tri-Cool Synthetic	1750.00	1625.00

TRICO MICRO-DROP® LUBRICANTS

- Contains no sulphur or chlorinated derivatives.
- Non-corrosive, non-flammable, non-carcinogenic and non-drying.
- Meets OSHA and EPA requirements.
- When used in conjunction with the Micro-Drop® dispensing system, it will improve productivity while virtually eliminating waste and disposal problems.



MADE IN
USA

Model	Description	List	Sale
30659	1 Gallon Micro-Drop Synthetic	\$ 135.00	\$ 95.00
30662	5 Gallon Micro-Drop Synthetic	545.00	450.00
30663	55 Gallon Micro-Drop Synthetic	4950.00	4200.00
30648	1 Gallon Vegetable Based	\$ 125.00	\$ 95.00
30647	5 Gallon Vegetable Based	560.00	475.00
30646	55 Gallon Vegetable Based	5500.00	4800.00

AVNOGA COOLING SYSTEM

- Consists of a manifold & Loc-Line®.
- Flexible hose with a nozzle on top and a valve at the bottom.
- Assembled on the powerful popeye magnet.
- The plug attached can be replaced by a second Loc-Line® hose.
- Nozzle sizes include 1/16", 1/8" and 1/4".

MODEL No.
MC-1601
Reg. \$59.95
\$49.95

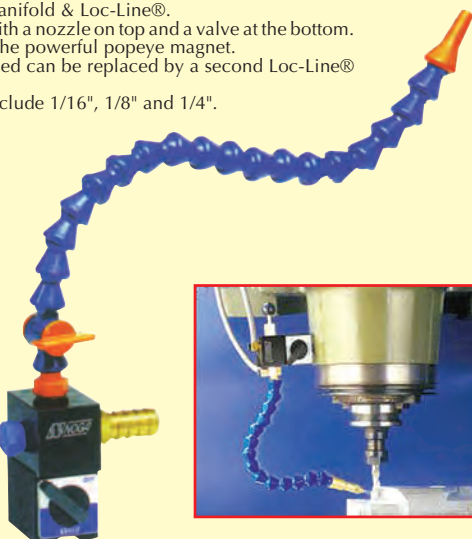

AVNOGA MINICOOL CUTTING FLUID & AIR APPLICATOR

- Using the VENTURI principle to spray an air + liquid mixture. It consists of the following basic elements:
- A control valve, spray unit, air line, syphon line and a powerful on/off Popeye magnet with "V" form base.
- The MINICOOL enables the user to easily control both the air flow rate and liquid rate.
- Stainless steel armoured syphon hose and air hose can be dropped into any fluid container.

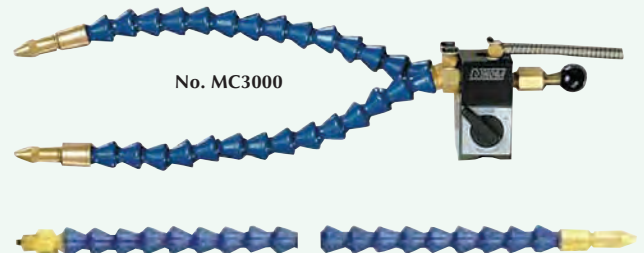

No. MC3000

Replacement Hose with Nozzle

Model	Description	Price
MC1700	Minicool Unit w/one 11" hose	\$ 95.00
MC3000	Minicool Unit w/two 11" hoses	125.00
MC0103	19" Replacement hose w/nozzle	32.50
MC0001	Extra nozzle tip	6.95

Precise MILL STOP, QUILL STOP AND WORK STOP

Millstop

- Rigid placement stop for milling set-ups with vises or angle plates.
- Use as holder for spray mist.
- 1/2" hole for T-slot. 3/8" dia. rod with 1/4" step.

MODEL No.
MSS-100

\$16.95



Work Stop

- Spring loaded work stop clamp for vises with a minimum protrusion of 1/16".
- Hardened steel body with 2 hardened guide pins.
- 1-1/2" wide, range 1/2"-7/8", height .50", step .38".

MODEL No.
QK-010

\$6.95



Quill Stop

- Fast On/Off clip action.
- Rapid depth setting on quill.
- Rigid clamping.
- Increase productivity - reduce cost.

MODEL No.
QS-218

\$8.95



1/2" - 20
Thread
For Mills

QUILL FEED HANDLES

Quill Feed Handle

- The long-needed time-saving accessory for Bridgeport operators.
- Flick of the wrist retracts pin from index plate of the quill feed mechanism and lets you move handle into any desired position.
- Spring pushes pin back from quill feed actuation up of down.

Engage

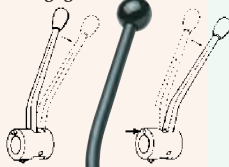

Disengage

MODEL QF-1

\$16.95

Precise QUICK QUILL FEED (KNEE FEED) ADAPTER

- Works with 1/2" power drill speeds up quill (knee) operation function as a power feed.
- Fits most mills with 5/8" diameter hub.
- heavy duty made, hardened steel.
- Flats cut on shaft for stronger power drill grip.



MODEL No.
3129-0015

\$19.50



HIGH SPEED PRECISION SPINDLE MOUNTS

- Faster cutting, more IPMs.
- No gears, No vanes.
- Ceramic bearings, direct drive.

- No maintenance, No oil.
- V-Flange compatible.
- TIR concentricity .0002"

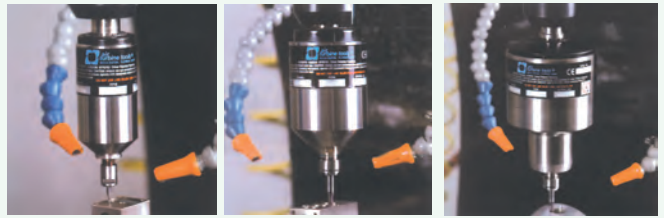

No. 602JS 40,000, 50,000, 65,000, 90,000 RPM

No. 625JS 30,000, 40,000, 50,000

No. 650JS 25,000, 30,000, 50,000

Model No.	Speed RPM	H.P. Rating	Body Diameter	Body Length	Shank Type*	Collet Type	Price Each
602JS	Specify	0.2 HP	1.56"	3.88"	3/4"	1/8" Collet	\$2294.00
625JS	Specify	0.45 HP	2.13"	4.51"	3/4"	1/4" ER	\$3095.00
650JS	Specify	0.88 HP	2.63" x 1.62"	5.20"	3/4"	1/4" ER	\$3995.00
30004	High Flow Filter						\$ 69.00
30003	High Filter and Regulator						112.50

Details and other specifications- See Our Website www.penntoolco.com

* Other Shanks available: HSK, Cat 40, Cat 50, BT-40 (Inquire)

FOREDOM® INDUSTRIAL FLEXIBLE SHAFT KITS

- More powerful 1/6 Horsepower Ball Bearing 18,000 RPM motor.
- Forward and reverse direction with switch motor.
- Optional: Double motor hanger with hand piece rest, adjustable rod.
- Lower operation temperatures for longer motor life.
- More efficient motor for less electricity consumption.
- Full 2 year warranty.

MADE IN USA



84 Piece Accessory Kit

"SR" Motor
1/6 H.P.
18,000 RPM's
115V, 1.7 amps
KIT No.
2272-1
Reg. \$446.00

\$295.00

Optional:
Variable Speed Control

MODEL
EMX-100
\$59.95

Foot
Control

FLEXBAR UNIVERSAL WORK POSITIONERS

- It's an excellent dial indicator holder.
- All metal parts used.
- Precision angled bearings interface and lock the ball precisely with a small turn of the locking knob. Excellent rigidity factor.
- Self-compensating, no need to disassemble to re-establish tension (sa with other designs).
- Right angle notch (for 90° positioning) can be swung to any point 360° and then locked.



Model	Description	Price
18001	Mounting Bottom Hole 3/8-16"	\$35.00
18002	Magnetic Base 90 lbs. pull 3-1/4" Diameter x .435" high	47.50



FLEXBAR FLEXI-VISE

- Positive locking of all parts in any position.
- Jaws hold flat, round or hexagonal components.
- Quickly reset to new angles.
- Vise adjust 360° in every plane.
- Aluminum jaws give positive gripping without damaging parts held.
- Jaw width: 1-1/2"
- Jaw capacity: 11/16"

MADE IN USA



MODEL No.
14006-1

\$129.95



DUMORE 1/10 HP HAND GRINDER

- Compact, power, 22,000 RPM.
- Grease-sealed ball bearings.
- Operates on 115V, AC/DC.
- Adaptable to hundreds of manufacturing operations finishing small holes, lapping, polishing, deburring, touching up, sharpening, chamfering.

22,000 RPM



MADE IN USA

Includes:
1/8" & 1/4" Collet chuck
8 Mounted wheels Dressing stone
Wrenches and Carrying case

MODEL No.
355V **\$395.00**

DREMEL® ELECTRIC ENGRAVER - SCRIBER WITH CARBIDE POINT

- At 7,200 strokes per minute, the 115V motor and carbide point make this engraver ideal for engraving on metal, plastic, glass, ceramic wood & even leather.
- Identify and personals your valuables.
- Use for decorative engraving.
- Holding area allows for extended use.
- Soft grip adds extra comfort & control.
- Includes replaceable carbide steel engraver point.

MODEL No. 290
Reg. List \$29.95

\$23.95



Extra Points
No. 7292 Carbide \$6.50
No. 7294 Diamond \$19.50

Visit Us On The Web: www.penntoolco.com

Page 337

FLEXBAR BANDSAW VISORGUARD™

- L shaped Lexan Shield, 6"H x 6"W x 4"D.
- Easy position handle.
- Adjustable tension 9" long Flexbar Arm permits correct setting of guard for each setup.
- Includes vertical angle mounting bracket with 11" of height adjustment.
- Kit includes mounting screws and self locking nuts. Simply drill and tap 2 holes and install.
- Installs on most band saws with 18" maximum throat height.



Model	Description	Price
13464	Band Saw Visorguard Kit-Complete with mounting bracket, Flexbar Arm, shield & all hardware	\$145.00
13465	Replacement Shield with handle	35.00
80063-6	Replacement Flexbar Arm Cable	14.75

FLEXBAR SPLASHGUARD

- Protects your eyes against chip and liquid burns.
- Safety shield on tilt-type magnetic stand (shield swivels 360° and locks positively where placed.)
- Overall height of stand: base to top of post is 9".
- Magnetic base is powerful.
- Shields are made of durable clear view plastic 1/8" thick.
- Concave and flat shields are interchangeable on all models (splashguard and eyeguard).



Magnetic Base With Concave Shield		Replacement Shield	
Model	Dimensions	Price	Model Package Qty. Price
13108	6" x 8"	\$24.75	13093 3 \$22.00
13109	8" x 10"	28.50	13094 3 31.00
13110	10" x 12"	33.00	13095 3 44.00
13111	12" x 16"	39.50	13096 3 54.00
13112	16" x 20"	49.50	13097 3 92.00
Magnetic Base With Flat Shield			
13115	6" x 8"	\$22.00	13120 3 \$15.00
13116	8" x 10"	24.00	13121 3 26.00
13117	10" x 12"	26.00	13122 3 31.00
13118	12" x 16"	29.50	13123 3 39.00
13119	16" x 20"	33.00	13124 3 47.00

FLEXBAR DRILL/CHUCK VISORGUARD™

Standard mount and new long reach mount. Provides operator protection from chips and broken drills on drill presses. Milling machines and other drilling equipment.

- Flexbar arm permits setting of guard at the correct height and angle for each setup.
- Special spring loaded shaft makes shield stay put - no springback.
- Wing shaped shield (90° angled) protects workers at adjacent machines.
- Flexbar locks rigid; has stainless aircraft grade tension cable.
- Can be installed in minutes on drill presses, mills, milling machines and others.



Dimensions:

- Shield size - 6" Wide x 6" High
- Flexbar arm - 10" long.

Model	Description	Price
13032	Drill/Chuck Visorguard- Complete with mounting bracket, Flexbar Arm and all hardware including mounting hole & thumbscrew for attaching coolant system	\$124.95
13032-L	30" Long reach Drill/Chuck Visorguard	179.50
13033	Replacement Shield	28.50
80063-6	Replacement cable- Ball & Thread Cable for Visorguard	14.75

FLEXBAR UNIVERSAL MOUNT MILL AND GRINDER GUARD

- Unique universal positioning design is fully adjustable.
- Frame/shield is mounted and supported by a heavy duty arm and swivel clamp allowing the operator to "custom fit" each guard as to overall length, angle and position.
- Wing-shaped frame/shield protects workers at adjacent machines.
- Long Reach Extension Kit #13262 permits positioning of guard up to 40" from mounting point.



Model	Description	Price
13258	Universal Mount Mill/Grinder Guard w/19"W x 16"H heavy duty shield	\$295.00
13259	Replacement Lexan Window for 13258	45.00
13260	Universal Mount Mill/Grinder Guard w/26-1/2"W x 16"H heavy duty shield	345.00
13261	Replacement Lexan Window for 13260	74.00
13262	Long Reach extension kit for Model No.s 13248 & 13260	180.00
	Includes adjustable extension arm & all connection mounting hardware	

FLEXBAR DRILL GUARD

Quality made of heavy duty material, Drillguard comes complete with installation and operation instruction. The Quill Ring (which holds cage housing) is made of heavy die-cast aluminum, with smooth finish.

- Complete operator vision and protection assured.
- Smooth telescopic action via patented spiral guide grooves-window caged housing moves up while drill comes down; hence cutting tool is totally guarded.
- For drill changes - simply pull down on housing. Three spring loaded ball catches disengage and the housing drops out. Conversely, it quickly snaps back in place.
- Inner cage moving down protects window hence the operator from metal slivers.



Fits Quill Diameter
Up to 2.75" to 2.626"

MODEL No. 13125-1 **\$124.95**

FLEXBAR PANEL GUARD

Portable, yet sturdy free standing guard... Ideal for separating or back guarding machines. Additional panels can be added to cover any size area



MADE IN
USA

Flexbar Panel Guards consist of 4 hinged panels with a pivot spine. Frames are extruded aluminum; inserts are replaceable; lower panels are safety colored, tempered masonite; upper panels are 1/8" thick, high impact resistant, transparent Lexan Panel Guard does not obstruct air circulation or visibility, yet confines chips and oil to machine area for easy cleanup.

MODEL No. 13035	Flexbar Panel Guard Basic 4-Panel Set Complete	Sale \$450.00
MODEL No. 13036	Flexbar Panel Guard 2-Panel Expansion Set	Sale \$250.00
MODEL No. 13037	Extra Slide-In Flexible Hinge (1 ea.)	\$14.00
*MODEL No. 13038	Top Cap (1 ea. per panel)	\$15.00
*Used to connect two or more Panel guard sets together		

FLEXBAR UNIVERSAL VISORGUARD™ EXTRA LARGE

- Flexbar arm permits setting of Visorguard at the correct height and angle for each setup.
- Flip shield up to load part and down for machining.
- Special spring loaded shaft makes shield stay put - no springback.
- Wing shaped shield protects workers at adjacent machines.
- Flexbar locks rigid; has stainless aircraft grade tension cable.
- Can be installed in minutes on CNC mills, conventional milling machines and others.



Flip up to change workpiece or tool . . . no loss in productivity!

Model	Description	Price
13047	30 to 36" reach Visorguard-complete with mounting bracket, Flexbar Arm and all hardware including #13054 shield, mounting hole & thumbscrew for attaching coolant system	\$179.00
13055	Visorguard, 16"x8", 10" long flexible arm complete with mounting bracket, and all hardware including mounting hole & thumbscrew for attaching coolant system	125.00
13048	Extra-wide Visorguard Universal with 24" x 8" shield for larger machines such as multi-spindles	194.00
13054	Replacement Shield 16" x 8"	29.85
13046	Replacement Shield 24" x 8"	46.50
13073	Replacement Shield 14-1/2" x 12"	46.50
13074	Replacement Shield 15" x 16"	52.00

FLEXBAR THE LEXAN FLEX-SHIELD

Protects Your Eyes Against Chip & Liquid Burns.
Safety Shield on Flexbar Universal Positioning Arm. Quick Cam Action Locking (Shield Swivels 360° and locks positively where placed).

- Overall height of Flexbar Stand: 14"
- Super Power Disc Mag. Base: 3.16" dia.
- Shields made of durable clear view Lexan - 1/8" thick.
- Choice of concave or flat.

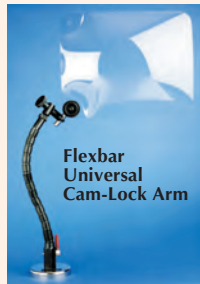

Concave Shield Models - Complete			
Model No.	Shield Size	Price	Sale
13313	6" x 8"	\$60.00	\$49.95
13314	8" x 10"	65.00	58.50
13315	10" x 12"	70.00	61.00
Flat Shield Models - Complete			
13316	6" x 8"	\$59.50	\$51.50
13317	8" x 10"	60.00	53.50
13318	10" x 12"	63.00	56.50



Lexan Replacement Shields - Carton of 3

Concave			Flat		
Model	Size	Price	Model	Size	Price
13093-L	6" x 8"	\$28.00	13120-L	6" x 8"	\$18.00
13094-L	8" x 10"	38.00	13121-L	8" x 10"	25.00
13095-L	10" x 12"	52.00	13122-L	10" x 12"	36.00

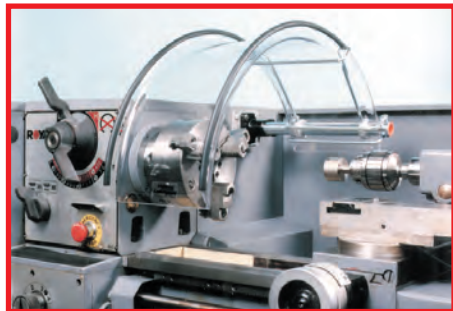

Prevent Accidents With



LATHEGUARD

Clear Lexan Semi-Circular Wrap-a-round Guards

- Heavy Duty Cast Mounting Bracket supplied.
- Heavy duty Chrome-plated extension tube and hardware.
- Ready to mount; all you do is affix mounting bracket with two screws.
- Back of shield is reinforced with plated wire-form housing.
- Locks in swing away or functional positions.

Exceeds O.S.H.A. Requirements



Neither razor sharp chips nor broken tool bits will penetrate the Lexan shield

- Rib reinforced
- Robust construction
- Light in weight
- Swing away easily

- Rib reinforced.
- Robust construction.
- Light in weight.
- Swings away easily.
- Replacement Shields available (Inquire)

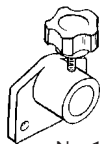

No. 13070

Model No.	Suggested Lathe Size	Center Height (Shield Height)	Use With Chuck	Shield Width	Shield Length	Tube Length	Reg. Price	Sale Price
12999	Very Small Lathes	3.9"	Up to 6" Dia.	6-1/4"	7.8"	10"	\$130.00	\$115.00
13060	6 to 12	6"	Up to 8" Dia.	6-1/4"	11.8"	10"	145.00	129.50
13061	12 to 16	8"	Up to 12" Dia.	8"	15.8"	11-1/2"	165.00	145.50
13062	16 to 20	10"	Up to 16" Dia.	8"	19.70"	13"	185.00	165.00
13064	20 to 24	13"	Up to 20" Dia.	8"	23.6"	13"	225.00	185.00

Latheguard Shield Complete With Hardware & Mounting Bracket No. 13070 (Above Left) Other Style Brackets Available

FLEXBAR TRAVELGUARD MADE IN USA

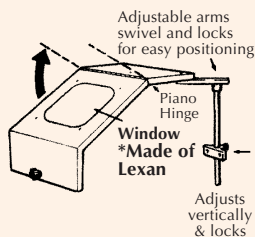

Adjustable arms swivel and locks for easy positioning

Piano Hinge

Window *Made of Lexan

Adjusts vertically & locks



Cross Slide Type Extra Heavy Duty O.E.M. Type for Lathes, Grinding Machines, Etc. Travels with Cross Slide Operator Protection Wherever Tool is cutting

- Easy to mount on cross slide (tool compound).
- Fully adjustable in all directions - forwards & frontwards.
- Heavy steel construction with thick Lexan window.
- Frame is 3/4" construction made of heavy gauge steel with high quality painted finish.
- Front panel is hinged and can be lifted for quick access to machine.

Model No. 13086 20" Chuck Max. Reg. \$259.50 Sale \$235.00
 Model No. 13087 28" Chuck Max. Reg. \$289.50 Sale \$265.00

FLEXBAR HEAVY DUTY LATHE CHUCK GUARDS 16" TO 49"

- Operational Mounting Brackets for various applications are available.
- Heavy Duty chrome plated extension tube and hardware for models #13250 & #13251.
- Ready to mount; all you do is affix mounting bracket with two screws.
- Locks in swing away or functional positions.
- Lexan window for easy viewing.



Models #13250 #13251



Models #13056 #13057 #13058

Model No.	Center Height	Use with Chucks	Price Each
13250	9.5"	up to 16"	\$285.00
13251	10.5"	up to 20"	315.00
13056	17-1/2"	20" to 30-1/2"	550.00
13057	20"	30-1/2" to 36"	625.00
13058	25-1/2"	39-1/2" to 49"	750.00

- A variety of chip shields are available. They are ideal for mills, drills, grinders, band saws, or similar equipment including woodworking machines.
- It keeps the chips and coolant contained. The shield can easily be moved in or out of position.

- For protection, the shield should be positioned between the point-of-operation hazard and the operator.
- The arms move into position easily to stop chips and can be moved out of the way for loading and unloading workpiece, changing tools or removing chips.

- These shields are furnished with a universal steel arm. These arms can be placed in almost any position. They mount easily to the frame or column of the machine and include standard mounting hardware.
- The shields offered are made of impact resistant 3/16" polycarbonate, selected for its toughness under impact to protect the operator.



Universal chip shield on a milling machine



Universal chip shield shown on a drill



Universal chip shield on a band saw

Model	Description	Price	Model	Description	Price
KYL-104	6" x 8" Flat with 21" Universal Arm	\$245.00	KYL-115	30° angle (10-3/8"Front) with 44" Universal Arm	\$285.00
KYL-105	6" x 8" Flat with 31" Universal Arm	255.00	KYL-116	90° Angle with 21" Universal Arm	285.00
KYL-106	6" x 8" Flat with 44" Universal Arm	265.00	KYL-117	90° Angle with 31" Universal Arm	290.00
KYL-107	10" x 12" Flat with 21" Universal Arm	255.00	KYL-118	90° Angle with 44" Universal Arm	298.00
KYL-108	10" x 12" Flat with 31" Universal Arm	265.00	KYL-119	8" x 10" Concave with 21" Universal Arm	350.00
KYL-109	10" x 12" Flat with 44" Universal Arm	275.00	KYL-120	8" x 10" Concave with 31" Universal Arm	365.00
KYL-110	30° Angle (7"Front) with 21" Universal Arm	250.00	KYL-121	8" x 10" Concave with 44" Universal Arm	378.00
KYL-111	30° Angle (7"Front) with 31" Universal Arm	260.00	KYL-122	10" x 12" Concave with 21" Universal Arm	368.00
KYL-112	30° Angle (7"Front) with 44" Universal Arm	265.00	KYL-123	10" x 12" Concave with 31" Universal Arm	380.00
KYL-113	30° Angle (10-3/8"Front) with 21" Universal Arm	268.00	KYL-124	10" x 12" Concave with 44" Universal Arm	390.00
KYL-114	30° Angle (10-3/8"Front) with 31" Universal Arm	275.00	CYF-016	Clamp Kit for attaching to table or ledge	\$ 29.50

Replacement Shields Available

Replacement Shields Available

FLEXBAR PIVOT MOUNT GRINDER GUARDS AND UNIVERSAL SHIELDS

- Heavy-duty swivel-lock positioning shield protects operator from flying grit and debris.
- Cast frame with virtually unbreakable 3/16" thick Lexan® shield will contain and deflect any wheel breakage.
- An extra heavy-duty steel pivot with locking knob connects the frame to the curved adjustable mounting bracket.

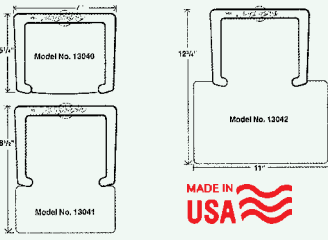

MADE IN
USA

Model	Shield Size	For Bench Grinder	Price
13040-1	5-1/2" x 5-3/4"	6", 7", 8"	\$ 99.50
13041	6-1/2" x 8-1/2"	8", 10"	115.00
13042	12-3/4" x 11"	10" and up	119.00
13043	Lexan® Replacement Shield for 13040-1		\$ 15.00
13044	Lexan® Replacement Shield for 13041		23.00
13045	Lexan® Replacement Shield for 13042		31.00

FLEXBAR DRILL PRESS VISORGUARD

Provides Operator Protection from Chips and Broken Bits on Drill Presses and Drilling Equipment



MODEL No. 13462
Drill Press Visorguard Kit
\$165.00

MODEL No. 13033
Replacement Shield
\$29.50

MODEL No. 13461
Extra Long 24"
Vertical Angle
\$55.00

MODEL No. 13463
Extra Long 28"
Horizontal Tube
\$49.00

MODEL No. 80063-1138
Replacement Flexarm Cable
\$14.50

FLEXBAR SENSING SAF-START PLUG SHORT CORD STYLE

- The inexpensive solution to OSHA. Anti-automatic Restart Protection without the high cost of magnetic motor starters. **This is a mandatory OSHA safety requirement.**
- **Operating characteristics.** With the sensing-SAF Start correctly installed on existing equipment, it will provide protections against unexpected start-up, motion, and motor burn-out in the following manner: **Voltage Drop or Power Interruption Protection.** In the event equipment, while being operated (switch in the "ON" position) should stop due to loss or drop of electrical power due to POWER FAILURE from any cause, the Sensing-Saf-Start will automatically disconnect and shut off power to the equipment, so that upon restoration of power, the equipment will not start up even though the power switch to the equipment is in the "ON" position.
- **Scope of Application and Standards** - The Sensing-Saf-Start is intended for installation on equipment which operates on 120 volts or 240 volts A.C. and which is connected to the source of electric power by means of a 3-wire flexible power cord. The following standards apply to machines driven by 120 volt motors:



Model	Description	Price
17025	Short extension cord style. 14" cord male plug end. 12" cord on female receptacle end. Rated 120 volts, A.C., 15-amp, 3/4 HP motor maximum, 50/60 cycle	\$139.50

FLEXBAR DELUXE™ GRINDER GUARDS
Heavy-Duty Lexan® Shield (3/16" thick) Guards Against Wheel Explosions!

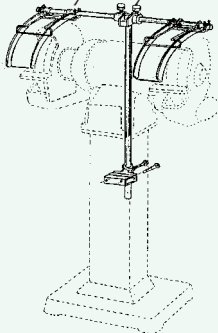

Designed to fit virtually all pedestal and bench grinders as well as buffers and speed lathes.

Fits Grinder/Buffer wheel diameter from 6" to 14"

All Units Include:

- 2 Curved Shield Assemblies.
- Vertical Post assembled with 2 mounting brackets.
- 2 each, 1 inch wide standoffs with hex head bolts and washers.
- 1 Vertical mounting bracket

* On Single Shield Models

- 1 each curved shield.
- Vertical post has one mounting bracket.
- Same as above
- Same as above

Grinder/Buffer Wheel Diameter	With Single Shield Model	Single Shield Price	Double Shield Model	Double Shield Price
6" or 7"	13390-S	\$219.00	13390-D	\$290.00
8"	13391-S	215.00	13391-D	315.00
10" & 12"	13392-S	219.00	13392-D	365.00
14"	13393-S	255.00	13393-D	415.00

*Please Specify "Left Mount" or "Right Mount" on Single-Shield Models.

Single Shield Models are listed for Single-Wheel Buffers etc., which are in existence

FLEXBAR CHIPGUARD™ DEFLECTORS

With Polycarbonate Shields Made of Lexan® (3/16" Thick)



- Swivel Base Positioner affords incredible variety of shield positioning instantly.
- Shield swivels 360° in two planes and 180° in 3rd plane.
- A small twist on locking knob positively locks all.
- Cantilever Design - leaves room for shield to cover work area.

Model No.	Shield Size A x B	Mag. Base Diameter	Price Each
13010	4" x 6"	2-5/8"	\$45.00
13011	6" x 8"	2-5/8"	52.00
13012	8" x 12"	2-5/8"	57.50

FLEXBAR TOTALGUARD 32"-44", 44"-56", 56"-76" TABLE GUARDS

SLIDE AND SWING ASIDE MILLING MACHINE GUARDS FULLY ADJUSTABLE FOR VERTICAL, HORIZONTAL AND C.N.C. MILLS

Available in three sizes to fit table lengths from 32" to 76". Heavy-duty construction with high impact resistant transparent Lexan panels (3/16" thick).

The Flexbar Totalguard is supplied in two separate assemblies which are mounted at either end of the table in just minutes. Model nos. 13089-H and 13090-H consist of two fixed side panels and two front sliding panels which allow the operator quick and easy access for loading and unloading large parts and castings.

Features:

- Fits all milling machines, horizontal or vertical and C.N.C. mills as well.
- Takes up no more than exact width of table.
- Lexan panels are crystal clear - good and thick and 25 times stronger than safety glass.
- Panels slide and swing aside quickly and smoothly for making setups; loading and unloading.
- Unlike patch quilt-type mill guards, still on the market, Totalguard does not have slots or apertures for hot chips to sneak through.
- Universal Mounting: Special tee-slot slugs fit all sizes of tee-slots so that Totalguard is installed in less than 5 minutes.
- All Lexan panels butt together like a perfect window when closed yet reveals the entire table bed when opened.

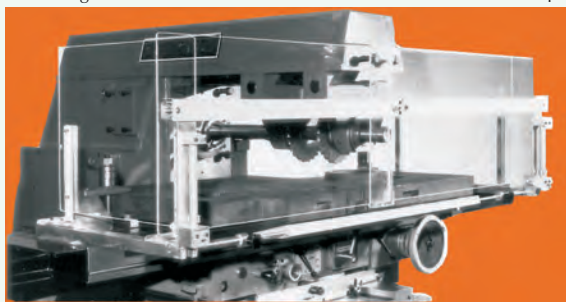

Model No.	For Table Length	Side Panel Height x Width	Front Panel Height	Price Each
13088-H	32"- 44"	23-5/8" x 19-1/2"	23-5/8"	\$1495.00
13089-H	44"- 56"	23-5/8" x 19-1/2"	23-5/8"	1650.00
13090-H	56"- 76"	23-5/8" x 19-1/2"	23-5/8"	1695.00

13145 Vise Panel covers the gap when two Front Panels cannot be completely closed due to protruding vise \$ 125.00

CARSON MAGNILAMP PRO™

Innovation In Quality Optics

- The MagniLamp™ is a 5", glass, 4x power, LED lighted, adjustable arm desk Magnifier.
- It has a fully adjustable head that extends to 10".
- It boasts 48 super bright LED lights.
- It has a protective cover to eliminate scratches & dust when not in-use.



MODEL No. CP-80
Reg. \$340.00

\$269.95
With AC/DC Adapter

Dimensions:
15.75" x 9" x 13.5"
Weight Boxed: 11 lbs.

FLEXBAR LEXAN VERSA-SHIELD

- The new, patent pending, tough 1/8" thick polycarbonate Versa-Shield offers clarity from its front or from its side plus resistance to impact, hot chips, oil, grease and splashing coolants.
- The **uniquely curved shape** directs chips away from the user and helps recycle coolants.
- The shield measures 12" wide by 11" high and is ideal for bench grinders, buffers, lathers, planers, spot welders and more.
- Versa-Shield is available on a rugged, flexible gooseneck arm or on a Flexbar Universal Positioning Arm with Quick Cam Action Locking.
- The **Flexbar Universal Positioning Arm** locks the shield positively where placed.



12" x 11" Shield Size On All Models

Model No.	Arm Type	Arm Length	Base Type	Price Each
13448	Flex Gooseneck	12"	3.16" Diameter Mag. Disc	\$44.50
13449	Flex Gooseneck	24"	3.16" Diameter Mag. Disc	53.00
13450	Universal Positioning Arm	14"	3.16" Diameter Mag. Disc	\$ 93.00
13451	Universal Positioning Arm	14"	C-Clamp 1-3/8" Capacity	93.00
13452	Universal Positioning Arm	14"	6" Diameter Weighted Base	123.00
13453	Universal Positioning Arm	14"	Vise-Grip Wrench	\$125.00
13455	Replacement Shield 12"W x 11"H			\$34.00

SMARTTOOL DIGITAL LEVELS WITH SMART ANGLE SENSOR INCLINATOR

- Displays in degrees, percent, and inches/foot
- Indestructible block acrylic vials
- Patented liquid sensor made in the USA
- 500 hour battery life (9 volt battery included)
- Patented calibration in both level and plumb
- Calibrate on any semi level surface without vials
- High visibility LCD display
- Display image flips when upside down
- Directional Listen and Level Audio tone at level and plumb or any angle
- Hold button freezes display
- 1 year warranty
- Custom, liquid inclinometer sensor is made in the U.S.A.
- Alternate zero sets any angle as 0°



24" Laser Level with Built-In Smart Angle Module Inclinator



Angle Sensor Stand Alone Module

Specifications:	Smart Sensor Accuracy	Smart Laser Accuracy	Angle Sensor Accuracy
Accuracy:	0.1°	0.05°	0.05°
Angle 0 and 90°	0.2°	0.2°	0.2°
All Others			
Resolution:			
Angle-.05 to+.05	.1°	.05°	
1 to 90°	.1°	.1°	
Range:	360°	360°	
Size:			
Length x Width x Height	6.63" x 1.4" x 2.1"		
Battery:			
	Standard 9V DC, 1500 hour Battery Life		

MADE IN USA

Model	Description	Price
92346	Angle Sensor Stand Alone Module 0.1° Accuracy	\$129.95
92395	Magnetic Angle Attachment for above	15.95
92437	24" Adjustable Laser Level with 0.1° Built-in Angle Sensor Module	199.95
92379	24" Smart level with Built-in Angle Sensor Module, w/out Laser	149.95
92325	48" Smart level with Built-in Angle Sensor Module, w/out Laser	169.95

EXAIR COLD GUN AIR COOLANT SYSTEM WITH MAGNETIC BASE

Replace Messy Mist System -
Improve Dry Machining With Clean, Cold Air!

- Produces a stream of clean air at 50°F below supply air temperature, with no moving parts.
- It will remove heat to prolong tool life and increase productivity on machining operations where flood cooling is not practical or desirable.
- Serves as a useful "spot cooler" on a variety of industrial processes.

Benefits Of The Cold Air System

- Improves production rates.
- Extends wheel life.
- Prevents burning.
- Extends life - reduces breakage.
- Improves tolerance control.
- Prevents smearing of metal or plastic.
- Finished part is dry.



Single Nozzle Unit
MODEL No. 5215
Reg. \$295.00
\$265.00

Dual Nozzle Unit
MODEL No. 5315
Reg. \$304.00
\$273.50

CRESS HEAT TREATING FURNACES From 300°F to 2250°F

- These furnaces are designed for general use in the shop, laboratory or factory where temperatures from 300°F to 2250°F are required.
- Temperature controls: Auto tuning microprocessor-base controller.
- The 133 has a bottom element mounted in grooves in floor and covered by refractory heart plate.
- Model 136 assaying furnace has no bottom element and the side elements are raised 1.75" above the floor to prevent burnout due to spillage.
- The easily operated, counter-balanced door is always away from operator.
- These models come equipped with two door safety switches. When door is opened, elements are disconnected from power source. Solid state zero voltage switching of power to elements.



Maximum Intermittent Temperature 2250°F
Maximum Continuous Temperature 2000°F

Overall Dimensions:
23-1/2"W x 26-1/2"L x 27"H

Model No.	Chamber Size	Input Power	Weight lbs.	Price Each
C133	11.5"W x 13"L x 8"H	3 KW	200	\$3495.00
C136	10-1/2"W x 13"L x 8"H	3 KW	200	\$3195.00

Precise WORK BENCH

48" x 19" Woodtop & Locking Handle

- Sturdy steel construction with a large wood work surface.
- 3 large drawers and a large lockable storage compartment.
- Sturdy steel construction.



While Supplies Last

Dimensions:
Storage Capacity: 7 cubic ft.
Storage dimensions: 25" x 18-1/2" x 16-1/2"
Surface dimensions: 48" x 19"
Height: 33"
Shipping weight: 81 lbs.

MODEL No. PWB-489
Reg. \$195.00

\$69.95

Un-Assembled



NEYTECH VULCAN HEAT TREATING FURNACES

- High performance hybrid muffle. Longer life, more durable than fiber, faster heating and cooling than fire brick.
- 3 muffle sizes, Modular design maximizes muffle size, minimizes furnace dimensions, saves space.
- 2 year warranty.
- Vertical lift door. Safe, directs heat away from operator, saves counter space, fingertip operation, integrated safety switch.
- 2 controller options, multistage digital programmable controller for precise time/temperature management or economical automatic single set point analog control.



9"W x 9"D x 7"H
Dial Analog
MODEL No. A-550
Reg. \$1450.00

\$1345.00



Model No.	Chamber Dimensions	Control Type	Max. Temp Range	Watts	Price
A-130	5.7"W x 5.2"D x 4.6"H	Dial Analog	2012° F	1400	\$1195.00
3-130	5.7"W x 5.2"D x 4.6"H	3-Stage Digital	2012° F	1400	\$1895.00
A-550	9"W x 9"D x 7"H	Dial Analog	2012° F	1800	\$1345.00
3-550	9"W x 9"D x 7"H	3-Stage Digital	2012° F	1800	\$2195.00
A-1750	14"W x 12.5"D x 10"H	Dial Analog	2012° F	3100	\$3295.00
3-1750	14"W x 12.5"D x 10"H	3-Stage Digital	2012° F	3100	\$4295.00

PolarCool EVAPORATOR COOLERS

- Cool the air in shops, garages and even outdoors up to 30°
- PolarCool coolers use stainless steel cabinets.
- Low water pump shut-off.
- Push-button LED control panel.
- GFI protection
- Evaporative cooling technology blows hot air through wet pads allow the heat to disappear as the water evaporates



No. POL-3000
\$1,295.00

No. POL-4601
\$1,995.00

No. POL-2502
\$2,875.00

No. POL-3502
\$3,995.95

Model No.	Description	Air Flow CFM	AC Power Volts Amps	Cooling Sq. Ft.	Water Capacity	Dimensions W H D	Shipping Weight
POL-2502	36" variable spd direct drive	10,800	115 10.0	1500	12.5 gal.	68" 53" 36"	340 lbs.
POL-3000	18" variable spd direct drive	3000	115 5.0	1500	10 gal.	24" 50" 20"	120 lbs.
POL-3502	48" single spd belt drive	4000	230 11.0	3000	13.5 gal.	80" 65" 36"	510 lbs.
POL-4601	24" variable spd direct drive	17,500	115 6.0	4000	9 gal.	43" 41" 36"	320 lbs.



CHAIN HOISTS 1/2 TO 3 TON

- Economical hand chain hoist designed for years of trouble free service.
- Steel construction with powder coating.
- Lightweight, compact design for tight applications.
- Needle bearing for smooth operations.
- Completely enclosed brake system for precise load spotting.



Model	Capacity	Lift	Weight	Price
101700	1/2 Ton	10 ft.	20 lbs.	\$145.00
101701	1/2 Ton	15 ft.	26 lbs.	165.00
101702	1/2 Ton	20 ft.	31 lbs.	195.00
101704	1 Ton	10 ft.	26 lbs.	\$160.00
101705	1 Ton	15 ft.	33 lbs.	190.00
101706	1 Ton	20 ft.	40 lbs.	215.00
101707	1-1/2 Ton	10 ft.	44 lbs.	\$200.00
101708	1-1/2 Ton	15 ft.	53 lbs.	225.00
101710	1-1/2 Ton	20 ft.	60 lbs.	265.00
101712	2 Ton	10 ft.	46 lbs.	\$245.00
101713	2 Ton	15 ft.	55 lbs.	275.00
101714	2 Ton	20 ft.	62 lbs.	310.00
101716	3 Ton	10 ft.	60 lbs.	\$325.00
101717	3 Ton	15 ft.	77 lbs.	395.00
101718	3 Ton	20 ft.	88 lbs.	450.00

JET HEAVY DUTY PLAIN TROLLEYS

- Mobilize your hoists. These trolleys will boost productivity 25%.
- Designed for low maintenance and trouble free operation.
- For use with wide flange H-beams, standard I-beams or curved track.
- Multiple spacer washers make adjustment quick and easy.
- Steel side plates feature built-in bumper guards.
- Proof tested with certificate.
- Hardened wheels with lubricated for life, double sealed ball bearings.
- Compliance: OSHA, ANSI/ASME B30.11 and 1330.17 standards.



Model No.	Capacity (Tons)	Beam Flange Width	Beam Height (Ft.)	Min. Radius (curves)	Sale Price
252005	1/2	2-1/2"-8"	4-19	39	\$ 85.00
252010	1	3"-8"	4-19	39	115.00
252015	1-1/2	3-1/4"-8"	4-19	43	175.00
252020	2	3-1/4"-8"	4-19	52	195.00
252030	3	4"-8"	5-19	51	395.00



ELECTRIC CHAIN HOISTS

- 1/8 ton to 5-ton capacities, single or three phase models.
- 10' 15', and 20' lifts standard, custom length lifts available.
- Easy to install, inspect and maintain.
- Totally enclosed steel plate construction with a durable powder coat finish.
- Gear train features lifetime lubrication, no oil changes required.
- Heavy-duty ventilated motor with thermal overload protection or reverse phase protection.
- Single phase models feature thermal overload protection.
- Three phase models feature reverse phase protection.
- Equipped with heavy-duty chain container.
- Reliable DC electromagnetic brake holds the load even if power is interrupted.
- Quick-connect wiring for power and push button controls.
- Upper and lower limit switches prevent over-travel.



Shown with Optional 4 Button Controller



Rated Capacity	Standard Lift	Weight lbs.	Model 1-Phase	Price 1-Phase	Model 3-Phase	Price 3-Phase
1/8 Ton	10 Ft.	34	110100	\$1095.00	-	-
1/8 Ton	15 Ft.	36	110115	\$1295.00	-	-
1/8 Ton	20 Ft.	38	110120	\$1350.00	-	-
1/4 Ton	10 Ft.	38	110110	\$1150.00	-	-
1/4 Ton	15 Ft.	39	110515	\$1595.00	-	-
1/4 Ton	20 Ft.	42	110500	\$1695.00	-	-
1/2 Ton	10 Ft.	108	121100	\$1695.00	123100	\$1495.00
1/2 Ton	15 Ft.	112	121150	\$1795.00	123150	\$1575.00
1/2 Ton	20 Ft.	114	121200-1	\$1895.00	123200	\$1625.00
1 Ton	10 Ft.	170	111000	\$1995.00	131000	\$1695.00
1 Ton	15 Ft.	174	111500	\$2050.00	131500	\$1750.00
1 Ton	20 Ft.	181	112000	\$2195.00	132000	\$1850.00
2 Ton	10 Ft.	185	211000	\$2295.00	231000	\$1850.00
2 Ton	15 Ft.	196	211500	\$2395.00	231500	\$1995.00
2 Ton	20 Ft.	205	212000	\$2495.00	232000	\$2100.00
3 Ton	10 Ft.	216	311000	\$2495.00	331000	\$2495.00
3 Ton	15 Ft.	232	311500	\$2595.00	331500	\$2500.00
3 Ton	20 Ft.	245	312000	\$2695.00	332000	\$2695.00
5 Ton	10 Ft.	236	511000	\$3395.00	531000	\$3295.00
5 Ton	15 Ft.	256	511500	\$3495.00	531500	\$3495.00
5 Ton	20 Ft.	275	512000	\$3650.00	530200	\$3695.00

Optional 4 Button Controller

No.152410	For 10' Lift	\$ 95.00
No.152415	For 15' Lift	99.00
No.152420	For 20' Lift	115.00



ALUMINUM GANTRY CRANES - LIGHTWEIGHT



* Hoist and Trolley not included

Lightweight

Quick Assembly

Ideal For Outdoor Use

- The adjustable Height Aluminum Gantry Crane combines lightweight and rigid, sturdy construction into one unit.
- The all aluminum construction of this gantry crane makes it corrosion resistant and perfect for outdoor use.
- The lightweight I-Beam allows height adjustment without the need of a hoist or fork truck.
- All pinned connections make it possible for single person set up and take down in just minutes. Included are two straps for allowing one person to transport the gantry crane in one neat package.
- (4) 8" 4-position swivel lock phenolic casters are standard.



Pneumatic Casters
4-way locking 12" x 3-1/2"
Capacity reduced to 1500 lbs.

MODEL No.
AHA-PNU
\$250.00
(Set of 4)



Total Locking
MODEL No.
AHS-TLC
\$145.00
(Set of 4)



"V" Groove
MODEL No.
AHA-V
\$219.00
(Set of 4)

Base Width 54" (All Models)

Model No.	*Beam Length	Flange Width	Beam Height	Adjustable Height	Base Width	Capacity lbs.	Weight lbs.	Price Each
HA2810	8'	3.375"	6"	7'8" to 10'2"	54"	2,000	280	\$2638.00
HA2812	8'	3.375"	6"	9'6" to 12'	54"	2,000	295	\$2769.00
HA21010	10'	3.375"	6"	7'8" to 10'2"	54"	2,000	294	\$2737.00
HA21012	10'	3.375"	6"	9'6" to 12'	54"	2,000	310	\$2882.00
HA21210	12'	4"	8"	7'8" to 10'2"	54"	2,000	325	\$3218.00
HA21212	12'	4"	8"	9'6" to 12'	54"	2,000	340	\$3377.00
HA4810	8'	4"	8"	7'8" to 10'2"	54"	4,000	360	\$3625.00
HA4812	8'	4"	8"	9'6" to 12'	54"	4,000	375	\$3833.00
HA41010	10'	4"	8"	7'8" to 10'2"	54"	4,000	405	\$4232.00
HA41012	10'	4"	8"	9'6" to 12'	54"	4,000	431	\$4586.00
HA41210	12'	4"	8"	7'8" to 10'2"	54"	4,000	421	\$4866.00
HA41212	12'	4"	8"	9'6" to 12'	54"	4,000	446	\$4852.00

* Deduct 12" for distance between upright.

• Usable "Trolley Travel" length between the uprights is overall length minus 12"



STEEL GANTRY CRANES

- Steel Gantry Cranes are designed for transporting and positioning materials.
- Solid steel construction will provide for years of service.
- Large 8" diameter locking phenolic casters with roller bearing will facilitate easy mobility from one area to another.
- Features quick setup design.
- Optional lever ratchet for easy one-person height adjustment (not for fixed height modes).
- Height is adjustable in 6" increments on adjustable-height models. Blue finish.

Optional:
Locking Swivel
Casters
#AHS-TLC
Set of (4)
2,000 & 4,000 lb.
\$145.00
#AHS-680
Set of (4)
6,000 & 8,000 lb.
\$325.00

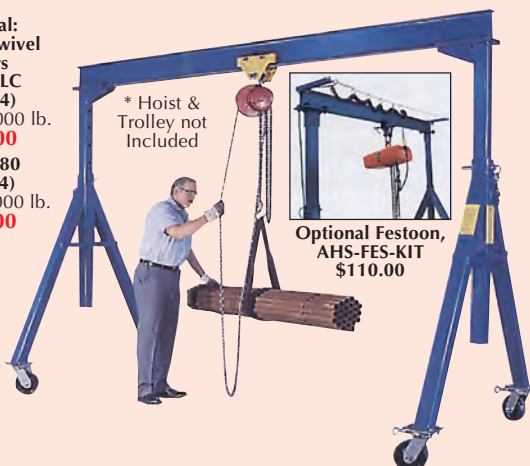

* Hoist & Trolley not Included

Optional Festoon,
AHS-FES-KIT
\$110.00

FIXED HEIGHT GANTRY CRANES

Model No.	Under I-Beam to Ground	*Beam Length	Beam Height	Base Width	Capacity (Pounds)	Shipping Weight	Price Each
HS-500	5'9"	8'	4"	48"	500	530 lbs.	\$1016.00
HS-2-10	10'	10'	5"	60"	2000	655 lbs.	\$1008.00
HS-2-15	10'	15'	6"	60"	2000	710 lbs.	\$1126.00
HS-2-20	10'	20'	8"	60"	2000	890 lbs.	\$1416.00
HS-4-10	10'	10'	8"	60"	4000	815 lbs.	\$1175.00
HS-4-15	10'	15'	8"	60"	4000	903 lbs.	\$1340.00
HS-4-20	10'	20'	60"	60"	4000	1142 lbs.	\$1972.00

ADJUSTABLE HEIGHT STEEL GANTRY CRANES

Model No.	Under I-Beam to Ground	*Beam Length	Beam Height	Base Width	Capacity (Pounds)	Shipping Weight	Price Each
HS-2-1012	9' to 12'	10'	5"	78"	2,000	890 lbs.	\$1938.00
HS-2-1014	11' to 14'	10'	5"	90"	2,000	996 lbs.	\$2138.00
HS-2-1512	9' to 12'	15'	6"	78"	2,000	978 lbs.	\$2131.00
HS-2-1514	11' to 14'	15'	6"	90"	2,000	1084 lbs.	\$2278.00
HS-2-2012	9' to 12'	20'	8"	78"	2,000	1066 lbs.	\$2257.00
HS-2-2014	11' to 14'	20'	8"	90"	2,000	1172 lbs.	\$2460.00
HS-4-1012	9' to 12'	10'	8"	78"	4,000	967 lbs.	\$2075.00
HS-4-1014	11' to 14'	10'	8"	90"	4,000	1071 lbs.	\$2247.00
HS-4-1512	9' to 12'	15'	8"	78"	4,000	1059 lbs.	\$2273.00
HS-4-1514	11' to 14'	15'	8"	90"	4,000	1264 lbs.	\$2655.00
HS-4-2012	9' to 12'	20'	10"	78"	4,000	1291 lbs.	\$2810.00
HS-4-2014	11' to 14'	20'	10"	90"	4,000	1395 lbs.	\$2995.00
HS-6-1012	9' to 12'	10'	8"	78"	6,000	998 lbs.	\$2142.00
HS-6-1014	11' to 14'	10'	8"	90"	6,000	1101 lbs.	\$2313.00
HS-6-1512	9' to 12'	15'	10"	78"	6,000	1195 lbs.	\$2508.00
HS-6-1514	11' to 14'	15'	10"	90"	6,000	1298 lbs.	\$2727.00
HS-6-2012	9' to 12'	20'	10"	78"	6,000	1322 lbs.	\$2782.00
HS-6-2014	11' to 14'	20'	10"	90"	6,000	1425 lbs.	\$3002.00
HS-8-1012	9' to 12'	10'	10"	78"	8,000	1103 lbs.	\$2370.00
HS-8-1014	11' to 14'	10'	10"	90"	8,000	1206 lbs.	\$2533.00
HS-8-1512	9' to 12'	15'	10"	78"	8,000	1230 lbs.	\$2605.00
HS-8-1514	11' to 14'	15'	10"	90"	8,000	1333 lbs.	\$2823.00
HS-8-2012	9' to 12'	20'	12"	78"	8,000	1485 lbs.	\$3236.00
HS-8-2014	11' to 14'	20'	12"	90"	8,000	1588 lbs.	\$3438.00



POWERED PALLET TRUCKS



#EPT-548 (Shown)

- Fully-powered pallet truck for easy and quick operation
- Includes fingertip Raise and Lower buttons.
- Easy-to-operate throttle for forward and reverse direction.
- Throttle offers infinite forward and reverse speeds.
- Battery charger is included. Horn is included.
- Safety bell reverse button is included.

With Batteries And Built-In Charger

Model No.	Capacity Lift	Service Range	Fork Size	Speed M.P.H.	Weight lbs.	Price Each
EPT-547	3000 lbs.	3.2" to 7.8"	25"W x 47"L	3.8	671	\$3844.00
EPT-548	4500 lbs.	3.4" to 7.8"	27"W x 48"L	3.8	1012	5959.00



ELEVATING TABLES Ergonomic ~ Hydraulic

- Minimize bending and lifting with these Portable Elevating Carts.
- Materials can be easily loaded onto cart from table, lowered to safe transporting height, and raised to unload at destination.
- Move easily on four polyurethane casters; two locking swivel and two rigid.
- All models feature a down speed control valve, manual hydraulic foot pump.
- All steel construction.



Model No.	Platform Size (W x L)	Capacity Pounds	Raised Height	Lowered Height	Sale Price
ECH-400	17-5/8" x 27-1/2"	400	29"	8-3/4"	\$395.00
ECH-750	19" x 32"	750	35"	11"	650.00
ECH-800	20" x 35-1/2"	800	51"	13"	850.00

Caster Size; No. ECH-400 is 4", ECH-750 and 800 are 5"



DC POWERED QUICKLIFT



Corrosion Resistant - Quiet

- Fully programmable state of the art motor controller allows for multiple adjustments to fit user's needs.
- All lift components concealed in lift column, no dangerous pinch points.
- Drifting/coasting of load is eliminated due to electromagnetic brake and drive screw design.
- Efficient and quiet screw design uses less power per pound to lift. • Cleanroom environments ideal.
- Adjustable handle height to suit each individual user's ergonomic conditions.
- Virtually maintenance free design.
- (2) Maintenance free batteries.
- On-board charger, self monitoring (no overcharging can occur).
- Lift speed adjustment at your fingertips.



Simple Touchpad allows for Lift Speed adjustment, Battery indicator display and Up/Down controls. Optional hand pendant with coil cord pictured.



Lightweight & Easy to Operate

Aluminum Frame

Model No.	Platform Size	Capacity Pounds	Raised Height	Lowered Height	Sale Price
PEL-88A	24"W x 19"L	175	57"	5-1/2"	\$2195.00
PEL-100A	24"W x 19"L	125	72"	5-1/2"	2295.00

Steel Frame

PEL-88	24"W x 19"L	175	57"	5-1/2"	\$1995.00
PEL-100	24"W x 19"L	125	72"	5-1/2"	2195.00
PEL-400-57	24"W x 20"L	400	57"	6-1/2"	2695.00
PEL-400-72	24"W x 20"L	400	72"	6-1/2"	2995.00



HYDRAULIC ELEVATING CARTS TRACTION DRIVE

- Powered front wheel drive cart makes maneuvering heavy loads virtually effortless.
- 24V DC Drive.
- Maintenance free batteries.
- Twist style throttle with reverse.
- Fully programmable motor controller.
- On-board battery charger included. (Indicator optional).



Rubber Grip Handles

Up/Down Hand Control

8 ft. Long Coil Cord

Model No.	Platform Size (W x L)	Capacity Pounds	Raised Height	Lowered Height	Price Complete
CTD-200	20" x 40"	2000	40"	16"	\$4250.00

Rubber Grip Handle



ERGONOMIC DESIGN DELUXE PALLET TRUCKS - 5,500 lbs. CAPACITY



5,500 lbs. Capacity

Triple-Formed Reinforced Steel Forks

- This pallet truck includes two articulating steering wheels and two front load rollers
- Ergonomic design requires only 75 lbs. of pulling force when fully loaded.
- Nose wheels are located on the front edge of each fork to assist in clean pallet entrance & exit.
- Steering wheels include bearing dust covers for added life.
- Reinforced triple-formed steel forks provide twice the strength of standard single-formed forks.
- Spring loaded loop handle automatically returns to vertical position when not in use.
- Equipped with internally mounted solid steel adjustable push rods.
- Chrome-plated hydraulic pump piston for long seal life.

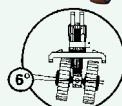

Model No.	Overall Fork Dim.	Service Range	Between Forks	Sale Price
PM5-2048	20"W x 48"L	2-7/8"-7-3/4"	7"	\$350.00
PM5-2748	27"W x 48"L	2-7/8"-7-3/4"	13"	370.00

Blue Blower BRINGS 300 CUBIC FEET OF COOLING AIR UP TO 30 FT.

- Moves 300 CFM of air up to 30 feet away.
- 115 VAC; 12' power cord; two built-in 15 amp grounded power outlets.



3-Speed MODEL No. BB3000 Reg. \$149.50 **\$92.75**



Heating Unit

- Attaches to Blue Blower.
- 115 volt, 1400 watt, 5300 BTU.
- Automatic over temperature shut-off.

MODEL No. BB1907 Reg. \$75.00 **\$39.95**



ALUMINUM THREAD PLATE PORTABLE TOOL BOXES

Secure your Tools and other belongings from theft!

- Rugged welded aluminum tread plate construction.
- Heavy duty weight capacity is 2,500 pounds.
- Hinged lid includes locking latch (lock not included)
- Carrying handles are welded to each end.
- Manufactured from 1/8" Thick aluminum tread plate.
- Optional fork pockets and casters are available for easier transportation.

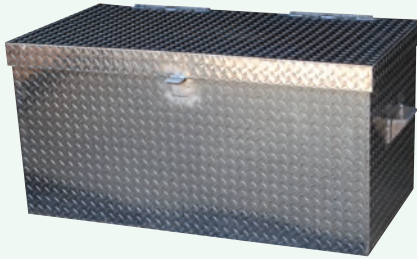

Locking Latch



Optional Fork Pockets and Optional Casters



Carrying Handles

Model No.	Size W x D x H	Weight lbs.	Price Each
APT-2448	48" x 24" x 24"	97	\$325.00
APT-2460	60" x 24" x 24"	132	380.00
APT-3060	60" x 24" x 30"	114	395.00
APT-3648	48" x 24" x 36"	117	415.00
APT-3660	60" x 24" x 36"	162	570.00
APT-C	Caster Kit-5" x 2" poly-on-wheels	28	\$ 58.00
APT-F	Fork Pocket 7-1/2"W x 2-1/2"H	48	118.00



POLYETHYLENE WORK BENCHES Stationary or Portable

- Solid top surface is for tough jobs that require a clean work surface.
- Units are shipped unassembled.
- Molded black high-density polyethylene construction
- Designed for use as a temporary or semi-permanent work surface.
- Grid top surface is ideal when work produces small scrap that can clutter work surfaces.



Solid Top No. WBT-4824S



Grid Top No. WBT-4824G

Model No.	Top Style	Shelf Style	Overall Size W x L x H	Capacity lbs.	Weight lbs.	Price Each
WBT-3624S	Solid	Grid	36" x 24" x 36"	580	31	\$155.00
WBT-4824S	Solid	Grid	48" x 24" x 36"	785	41	242.00
WBT-6624S	Solid	Grid	66" x 24" x 36"	1070	53	256.00
WBT-9624S	Solid	Grid	96" x 24" x 36"	1555	76	326.00
WBT-3624G	Grid	Grid	36" x 24" x 36"	500	29	137.00
WBT-4824G	Grid	Grid	48" x 24" x 36"	688	39	226.00
WBT-6624G	Grid	Grid	66" x 24" x 36"	925	48	231.00
WBT-9624G	Grid	Grid	96" x 24" x 36"	1350	70	273.00



PORTABLE FLOOR SCALES

- Portable floor scales are ideal for easy transportation and weighing of goods at multiple locations.
- Non-slip diamond plate surface, fold down low gradual ramps are fixed to the platform.
- Ramps make the scale ideal for wheeling pallet trucks, dollies, carts and containers on and off the platform.
- Four alloy steel load cells and deluxe stainless steel indicator head.
- Indexing accuracy is 1.1 pounds.



Model No.	Capacity lbs.	Platform Size	Size With Slopes W x L x H	Weight lbs.	Price Each
VPFS-3B	3,000	48" x 40"	60" x 78-3/4" x 2-3/8"	450	\$2,310.00
VPFS-3C	3,000	60" x 60"	71" x 98-1/2" x 2-3/8"	620	2,676.00



ELECTRONIC DIGITAL FLOOR SCALE DC Power With 115, 1 Phase Charger

- Low-profile scale is only 3-1/2" off the floor, allowing easy loading and unloading of heavy equipment weighing up to 5,000 lbs.
- Rugged design has a steel diamond treadplate top surface.
- The digital display stands 42" high.
- Optional Approach Ramp for pallet truck accessibility - order two for drive-on, drive-off convenience.

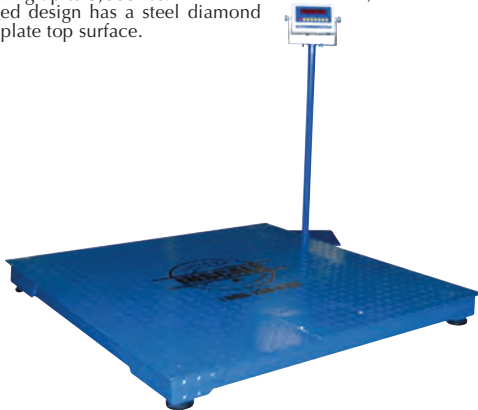

Model	Capacity lbs.	Size W x L x H	Weight lbs.	Price
Not Legal for Trade (Non-NTEP)				
S-44-5K	5,000	48" x 48" x 3-1/2"	225	\$1537.00
S-44-10K	10,000	48" x 48" x 3-1/2"	225	1637.00
S-55-5K	5,000	60" x 60" x 3-1/2"	340	1662.00
S-55-10K	10,000	60" x 60" x 3-1/2"	340	1762.00
Legal for Trade (NTEP)				
S-CFT-44-5K	5,000	48" x 48" x 3-1/2"	225	\$1662.00
S-CFT-44-10K	10,000	48" x 48" x 3-1/2"	225	1762.00
S-CFT-55-5K	5,000	60" x 60" x 3-1/2"	340	1812.00
S-CFT-55-10K	10,000	60" x 60" x 3-1/2"	340	1912.00
Approach Ramp Option (Order 2 For Off & On)				
R-CS-44	10,000	48" x 48" x 3-1/2"	150	\$504.00
R-CS-54	10,000	60" x 60" x 3-1/2"	190	554.00
Accessories				
SDP-100		Digital Printer		\$295.00
IBP-100		Internal Battery Pack with Charger		120.00



"U" SHAPED PLATFORM SCALE DC Power With 115, 1 Phase Charger

- The VPC U-Shaped Platform scales are constructed of heavy duty steel to withstand the most demanding industrial environments.
- U-Frame scales are designed specially to handle pallets, and they are easy to move and store.
- U-Shaped scales are suitable for weighing in a warehouse, storehouse or general use.
- U-Frame scales are light weight and can be easily moved by one person with two wheels and a handle.
- The scales come equipped with four heavy duty load cells and a deluxe stainless steel indicator head.



Model No.	Capacity lbs.	Indexing Accuracy	Resolution Step	Height Inch	Price Each
VPU-1	1,000	1 lb.	9 lbs.	4-3/4"	\$945.00
VPU-2	2,000	2 lbs.	22 lbs.	4-3/4"	945.00
VPU-4	4,000	4.5 lbs.	44 lbs.	4-3/4"	945.00
VPU-6	6,000	6.6 lbs.	44 lbs.	4-3/4"	945.00

BURR KING

VIBRATORY TUMBLERS

- Adjustable amplitude (for 10 qt. only)-finishing action can be set from aggressive cutting to fine polishing.
- 120 VAC voltage.



**Vibratory Tumblers
Work Three Times Faster
Than Conventional
Barrel Tumblers**

**MADE IN
USA**

Model No.	Working Capacity	Max. Load	Bowl Dia.	Bowl Radius	RPM 60Hz./50Hz.	Wt.	Sale Price
110SX	3 qt.	15 lbs.	10"	2-1/4"	2900/2400	13 lbs.	\$369.95
150SX	10 qt.	35 lbs.	15"	3"	1625/1325	27 lbs.	725.00
200SX	20 qt.	50 lbs.	17"	7-1/4"	1625/1325	32 lbs.	895.00

SPEED BLASTER

GRAVITY FEED HIGH EFFICIENCY SAND BLASTER

- ▶ Speed Blaster is fast, very fast. Connect one air line and go. That's it... No tanks, no supply lines, no hassles.
- ▶ A fully adjustable material control valve meters sand flow precisely. Gravity forces the particles into a hardened steel mixing chamber where they practically hit warp speed passing through a space age ceramic nozzle... this is a serious tool!

Features:

- Gravity Feed.
- Adjustable sand flow.
- Ceramic nozzle.
- One piece handle.
- Safety vented tank.
- Bright neon colors.
- Replaceable hardened steel mixing chamber.

Specifications:

Operating Pressure 60-125 PSI
 Working Pressure 100-125 PSI
 Air Consumption 12CFM-125PSI
 Fitting Size 1/4 NPT
 Container Capacity 26oz. (Volume)

MODEL No.
007-B
\$54.95



No. AC40093 25lb. Bag of Sand Blaster Abrasive **\$49.95**

SHOP TUFF TOOLS

VIBRATOR TUMBLER 1.25 Cu. Feet

- Tumbler is great for deburring and finishing operations.
- Inside Dimensions: 17.88" Long x 11.75" Wide x 11" Deep.
- 0-60 Min stand alone timer & on/off controls.
- Motor: 120V/60Hz, Power output: 500 watt (0.7HP)
- Polyurethane lining in tub reduces wear.
- 1.25 cu. foot capacity.



MODEL No.
STF-18VT
\$795.00

JET SHEARS~PNEUMATIC & HYDRAULIC

- Ideal for shearing mild steel as well as aluminum, brass, copper, zinc, lead & plastic.
- Twin pneumatic cylinders.
- Shear actuating pedal with foot guard.

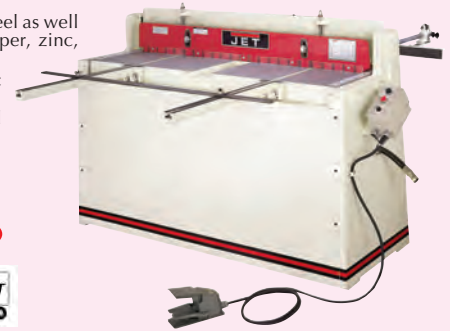

MODEL No.
755203
Reg. \$3799.00
\$3650.00



Model No.	755203
Type	Pneumatic
Capacity (Mild steel gauge)	16
Shearing length capacity (in.)	52
Back and front gauge capacity (in.)	25-1/2 and 28
Operating/Max. pressure (PSI)	85/100
Air consumption (approx. CFM)	25-13/32
Air consumption per stroke (approx. CFM)	1-13/32
Air hose inlet (NPT/in.)	5/8
Recommended air hose (in.)	1/2
Strokes per minute	40
Oil tank capacity (gallons)	N/A
Motor	N/A
Overall dimensions (in./L x W x H)	60 x 24 x 43
Shipping weight	1270 lbs.
Price	\$3650.00

StrongHandTools

WELDING TABLE FIXTUREPOINT

*An Affordable, Easy-to-use Modular Fixturing System.
Increase work quality and productivity!
Fixture at ANY POINT on the tabletop.*



16mm Holes
.16"(4mm) Thick Plate
2" x 2" Grid Pattern
36" x 24" Tabletop

MODEL NO.
TBH36244
\$275.00

One Table, Two Height Settings:
Tabletop: 6-1/4" Height - Leg Frame (included): 34" Height

*For Complete Description and Demo Video,
Got to our website www.penntoolco.com

StrongHandTools

FIXTUREPOINT KITS FOR WELDING TABLE

- The Fixturepoint System is ideal for the set-up of 2D frames. Use the Fixturepoint Kits to get started right away, working comfortably, safely, and efficiently for improved work quality, and productivity.
- Fixturepoint Clamps and Components can be inserted into the 16mm holes on the 36" x 24" tabletop for complete flexibility in Modular Fixturing.

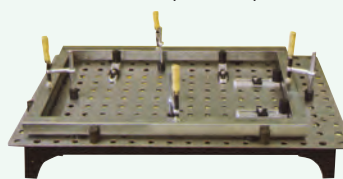

MODEL No.
TBHK100 **\$425.00**

Complete Modular Fixturing Kit for the set-up of 4x Square Tubing Frames
Kit Includes:

- No. TBH36244 Welding table
Clamps & Components
- 4 Inserta Clamps
 - 8 Magnetic Rests
 - 4 Positioning Stops
 - 4 Inserta Stops
 - 4 Stop bars
 - 4 Threaded Adapters

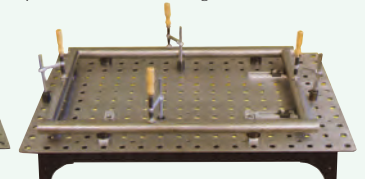

MODEL No.
TBHK200 **\$425.00**

Complete Modular Fixturing Kit for the set-up of 4x Round Tubing Frames
Kit Includes:

- No. TBH36244 Welding table
Clamps & Components
- 4 Inserta Clamps
 - 8 V-Blocks
 - 4 V-Spacers
 - 4 Stop bars
 - 4 Threaded Adapters

*For Complete Description and Demo Video,
Visit our website www.penntoolco.com

C & M TOPLINE VIBRATOR FINISHING DEBURRING MACHINE

Both Machines Include:

- 5" round discharge door, with discharge trough.
- Heavy gauge steel construction coated with rust-preventative enamel paint.
- Sound reduction cover & anchor bolts.
- Polyurethane liner made from the finest quality material available and oven cured.
- Complete fluid circulation system including pump, fluid container, all necessary hoses and fittings.
- Dividers are available for both machines.
- Also available in single or three phase and 220V, 50 Hz.



- Inside Tank Dimensions: Length 31", Depth 13", Width 13-1/2"
- Motor: 1HP, Single Phase, 110 Volts, 12.2 F.L.A. or 220 Volts, 6.2 F.L.A.
- Shipping Weight: 400 lbs.

3 Cubic Ft.
Model No.
CM-300DB **\$2495.00**
Reg. \$2695.00

- Inside Tank Dimensions: Length 35", Depth 18-3/4", Width 18"
- Motor: 3HP, Three Phase, 230 Volts, 8.8 F.L.A. or 440 Volts, 4.4 F.L.A.
- Shipping Weight: 740 lbs.

6.5 Cubic Ft.
Model No.
CM-600DB **\$4495.00**
Reg. \$4795.00

C & M TOPLINE VIBRATOR BOWLS

- Dump chute with polyurethane expansion plug and heavy bowl drain.
- Heavy duty polymer bowl.
- Adjustable amplitude. • Overall Height: 26-1/2"
- Sound cover. • Weight: 60 lbs.
- Working capacity: 1/2 cu. ft. (16 qt.)
- Motor: 1/2 HP, 115V, 60 Hz.



Model No.	Work Capacity	Chute Diameter	Motor H.P.	Height O.A.L.	Weight lbs.	Sale Price
TLV-25	1/4 cu. ft. (8 qt.)	2"	1/4, 115V	19-1/2"	40	\$ 650.00
TLV-50	1/2 cu. ft. (16 qt.)	2-1/2"	1/2, 115V	26-1/2"	60	945.00
TLV-75	3/4 cu. ft. (24 qt.)	3"	1/2, 115V	29"	70	1150.00
TLV-105*	Stand, Timer and Fluid System				52	\$ 475.00

* Consists of: **Stand**-Heavy duty, rotational molded polyethylene with rubber pads on the bottom. **Fluid System**-7 gallon pail, "Little Giant" pump, pump bracket flow valve, all necessary fittings and hoses. **Timer**-Stand or wall mounted six hour timer with separate switch for pump housed in a powder coated steel case with 7' cord.

MEDIA ~ CERAMIC & PLASTIC

CERAMIC MEDIA

GENERAL PURPOSE

"M" A high performance media, that has the unique combination of fast burr removal and low media loss. Good for mild steel and some aluminum alloys.

SUPER FAST CUTTING

"SF" A tough, fast cutting media where the primary concern is fast burr removal, resulting in slower time cycle. Primarily used on steel.

HIGH DENSITY

"DF" This media is more aggressive than the SF and will result in shorter run times. Excellent on all steel, especially stainless steel. The wear rate will be higher.

BRIGHT FINISH

"P" Contains no abrasives. Highly recommended for bright finishes.

PLASTIC MEDIA

GENERAL PURPOSE

"X" This is an excellent general purpose media for most aluminum alloys especially 6061-T6. It will produce fast burr removal, yet has good media life. This media has proven to be effective yet economical to use.

Ceramic Media



TRI-STAR

22° TRIANGLE

CYLINDER ANGLE

Plastic Media



CONES

PYRAMIDS

TRIANGLE

WEDGES

Ceramic Media - 50 Lbs. Box

Model	Shape	Size	Degree	Formula	Price
TRM-001	Tri-Star	5/8" x 3/8"	22°	"SF or "M"	\$69.50
TRM-002	Tri-Star	7/8" x 3/8"	22°	"SF"	67.50
TRM-003	Tri-Star	7/8" x 3/8"	22°	"DF"	75.00
TRM-004	Tri-Star	1-1/8" x 3/8"	22°	"SF"	67.50
TRM-005	Tri-Star	1-1/8" x 3/8"	22°	"M"	75.00
ACT-001	Tri-Angle	3/8" x 3/8"	22°	"SF or "M"	\$75.00
ACT-002	Tri-Angle	1/4" x 3/16"	22°	"SF"	98.50
ACC-004	Cylinder	5/8" x 1-1/8"	45°	"M"	\$67.50
ACC-005	Cylinder	3/16" x 3/8"	22°	"M"	93.50
ACC-006	Cylinder	3/8" x 5/8"	22°	"SF" or "P"	78.50
ACC-007	Cylinder	5/32" x 5/16"	22°	"SF"	155.00

Plastic Media - 50 lbs. Bag

PWM-001	Wedge	1" x 3/4"	-	"X"	\$ 98.50
PWM-002	Wedge	1-1/2" x 1"	-	"X"	95.00
PCM-003	Cone	1/2" x 9/16"	-	"X"	95.00
PCM-004	Cone	3/8" x 3/8"	-	"X"	120.00
PCM-005	Cone	7/8" x 7/8"	-	"X"	95.00
TPM-006	Triangle	5/8" x 1/2" x 3/8"	-	"X"	95.00
PPM-007	Pyramid	1/4" x 1/2" x 3/8"	-	"X"	155.00



HEAVY DUTY RATCHETING TIE DOWNS



- Top of the line ratchets with rubber handles
- High performance, easy and secure ratcheting system
- Heavy vinyl coated hooks prevent scratching
- Contains two 2 inches wide by 10 feet long, yellow webbed, durable straps

- Rubber Handle Ratchet and Release w/ vinyl coated hooks
- Easy and secure ratcheting system
- 2 inches wide x 27 feet long durable webbed strap
- 10,000 pounds load capacity and 3300 pounds WLL (working load limit)
- Camouflage strap with vinyl coated hooks

- This strap also includes our safety tag warnings and is D.O.T. approved.
- Easy and secure ratcheting system
- Double j-hooks or flat hooks.
- 2 inches wide x 27 feet long durable webbed strap

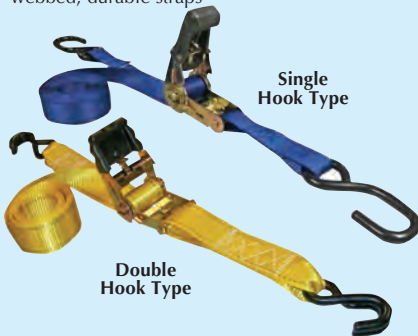

Single Hook Type

Double Hook Type

Load Capacity
10,000 lbs.
MODEL No.
ERK68655

\$26.95

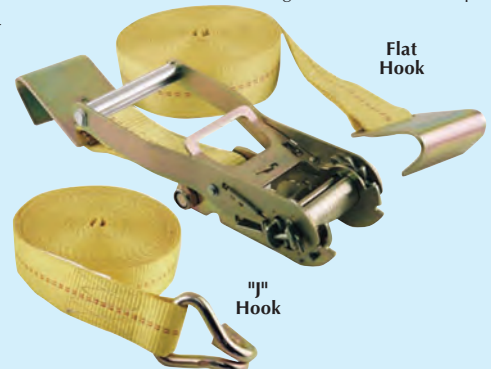

Flat Hook

"J" Hook

Model No.	Strap Size	Load Capacity	Hook Type	Price Each
ERK01415	1" x 10'	1,200 lbs.	Single	\$21.95
ERK01333	1" x 15'	2,000 lbs.	Single	22.95
ERK01326	1" x 25'	3,000 lbs.	Double	23.95
ERK34410	2" x 10'	4,000 lbs.	Double	32.95
ERK02400	2" x 25'	5,000 lbs.	Double	34.95

Model No.	Strap Size	Load Capacity	Hook Type	Price Each
ERK78627	2" x 27'	10,000 lbs.	"J"	\$21.95
ERK78527	2" x 27'	10,000 lbs.	Flat	29.95



BENCHTOP BLAST CABINET 24" x 14"

Features:

- Polythylene plastic construction.
- Trigger operated: 14 CFM @ 80-100 PSI



MODEL No.
E500
List \$210.00

\$189.00

Specifications:

Working Dimensions 28"W x 18" D
Top Opening 24" x 14"
Working Height 16" Rear - 12" Front
Gun Assembly:
Trigger Operated 5 CFM@80-100 PSI
Electrical 110 Volt
Shipping Weight 38 lbs. (UPS)

For Blast Media & Accessories
Visit our website - www.penntoolco.com
or call 1-800-526-4956

FULL TOP OPENING BLAST CABINET WITH SIDE OPENING 40" x 40" Foot Valve Operated

Features:

- Foot valve operation.
- 16 gauge steel construction.
- Switch/Receptacle.
- Unit is recycling.
- 24" rubber gloves.
- 90 CFM dust collector.
- Side door.
- Light is standard.



MODEL No.
4040-1
List \$1655.00

\$1550.00

Specifications:

Overall Dimensions 30H x 40D x 38"W
Working Dimensions 39H x 39D x 40"W
Side Door 18" x 28"
View Window 25" x 10"
Electrical Requirements 110VAC
Air Requirements 14CFM @ 90-100 PSI
Shipping Weight 345 lbs.

For Blast Media & Accessories
Visit our website - www.penntoolco.com
or call 1-800-526-4956

TWO DOOR OPENING BLASTER 60" x 35"

Features:

- DC 1,500 dust collector.
- 20 CFM tungsten carbide blast gun.
- Foot pedal operation.
- 2 incandescent light fixtures.
- 24" gloves.
- 16 gauge steel.
- Switch/Receptacle.
- Light is standard.

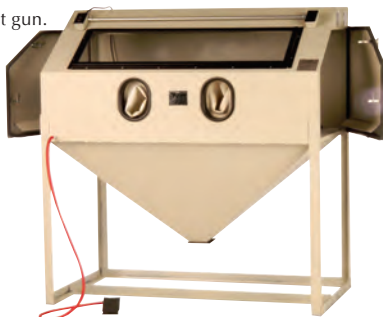

MODEL No.
6035
List \$1653.00

\$1550.00

For Blast Media & Accessories
Visit our website
www.penntoolco.com
or call 1-800-526-4956

Specifications:

Overall Dimensions 60-1/2L x 35-1/2W x 63"H
Working Dimensions 60W x 35D x 30"H
2 Side Doors 28-1/2" x 22-1/2"
View Window 45 x 12-1/4"
Electrical Requirements 110VAC
Air Requirements 20CFM @ 100 PSI
Shipping Weight 315 lbs.

ABRASIVE BLAST EQUIPMENT

TOP OPENING BLAST CABINET 36" x 24" Trigger Gun Operated

Features:

- Trigger gun operation.
- 16 gauge steel construction.
- Switch/Receptacle.
- Unit is recycling.
- 24" rubber gloves.
- 90 CFM dust collector.
- 18" x 12" side door.
- Light is standard.



MODEL No.
3624
List \$956.00

\$895.00

Specifications:

Overall Dimensions 59H x 25D x 37"W
Working Dimensions 24H x 24D x 36"W
View Window 25" x 10"
Electrical Requirements 110VAC
Air Requirements 14CFM @ 90-100 PSI
Shipping Weight 215 lbs.

For Blast Media & Accessories
Visit our website - www.penntoolco.com
or call 1-800-526-4956

FULL TOP OPENING BLAST CABINET 42" x 24" Trigger Operated

Features:

- Trigger operated.
- 16 gauge steel construction.
- Switch/Receptacle.
- Unit is recycling.
- 24" rubber gloves.
- 90 CFM dust collector.
- 18" x 12" Side door.
- Light is standard.



MODEL No.
4224
List \$1097.00

\$995.00

Specifications:

Overall Dimensions 60H x 46D x 45"W
Working Dimensions 24H x 24D x 42"W
View Window 25" x 10"
Electrical Requirements 110VAC
Air Requirements 14CFM @ 90-100 PSI
Shipping Weight 245 lbs.

For Blast Media & Accessories
Visit our website - www.penntoolco.com
or call 1-800-526-4956



FULL TOP AND SIDE OPENING 38" x 24" Foot Valve Operated

Features:

- Foot valve operation.
- 16 gauge steel construction.
- Switch/Receptacle.
- Unit is recycling.
- 24" rubber gloves.
- 90 CFM dust collector.
- Side door.
- Light is standard.



MODEL No.
3824
List \$1085.00

\$1030.00

Specifications:

Overall Dimensions 58H x 38-1/2D x 24-1/2"W
Working Dimensions 24H x 38D x 24"W
Side Door 16" x 19"
View Window 25" x 10"
Electrical Requirements 110VAC
Air Requirements 14CFM @ 90-100 PSI
Shipping Weight 225 lbs.

For Blast Media & Accessories
Visit our website - www.penntoolco.com
or call 1-800-526-4956

FULL TOP OPENING CABINET 48" x 26" Foot Valve Operated

Features:

- Foot valve operation.
- 16 gauge steel construction.
- Switch/Receptacle.
- Unit is recycling.
- 24" rubber gloves.
- 90 CFM dust collector.
- 12" x 18" side door.
- Light is standard.



MODEL No.
4826
List \$1270.00

\$1195.00

Specifications:

Overall Dimensions 59H x 26-1/2D x 48-1/2"W
Working Dimensions 26H x 26D x 48"W
View Window 25" x 10"
Electrical Requirements 110VAC
Air Requirements 14CFM @ 90-100 PSI
Shipping Weight 275 lbs.

For Blast Media & Accessories
Visit our website - www.penntoolco.com
or call 1-800-526-4956

SIDE DOOR OPENING BLASTER 36 x 24" Trigger Operated

Features:

- Cabinet, thick wall plastic (legs, steel construction).
- Light is standard.



MODEL No.
PK36
List \$310.00

\$289.95

Workpiece weight not to exceed 50 lbs.

For Blast Media & Accessories
Visit our website
www.penntoolco.com
or call 1-800-526-4956

Specifications:

Overall Dimensions 58H x 36-1/2W x 24"D
Working Dimensions 24H x 36W x 24"D
View Window 23" x 13"
Side Door 18" x 12"
Electrical Requirements 110V
Air Requirements 14CFM@90-100 PSI
Shipping Weight 75 lbs.

Dust collector not included



TIG WELDER

Weld Like The Pro's At Home!

- For Home or Light duty industrial use.
- Sturdy Metal Cabinet. • Solid State Electronics.
- 220 Volt single phase electric.
- Weld from .025" up to 3/16" mild steel or 1/4" aluminum
- Amperage range output: 10-160
- Infinitely variable output control. • Duty cycle 60%



MODEL No.

TIG-180

\$465.00

Includes:
Power source,
Electrode Holder,
Ground Cable with
Clamp & Power Cord



PLASMA CUTTING MACHINES

Cut Steel As Easy As Drawing A Line!

- Sturdy metal cabinets • Solid State Electronics.
- 220 Volt Single Phase Electric.
- Includes Hand Torch with Cable, Ground Cable with Clamp, and Power Cord.

Model No. PL-320

- Cut up to 5/16" Mild Steel
- Duty Cycle 60%
- Current Range 20-30 amp Output.
- Weight 18 lbs.

\$445.00



- Requires compressed air to operate / 3cfm@30-60 pounds (2hp compressor)

Model No. PL-500

- Cut up to 1/2" Mild Steel
- Duty Cycle 60%
- Variable Output Regulator
- Current Range 20-40 amp Output.
- Weight 28 lbs.

\$575.00



AC/DC INVERTER TIG WELDER

- For Home or Light duty industrial use.
- AC/DC TIG Welding
- AC Welding for aluminum and steel.
- Square Wave Output, stable arc, HF
- Duty cycle 60%
- 220 Volt single phase electric.
- Amperage range output: 10-250



MODEL No.

TIG-250

\$895.00

Includes:
MMA Function for Stick
Welding, TIG and Stick
Torches, Ground Clamp,
Power Cord and
Accessories



SOLAR POWER AUTO-DARKENING HELMET

- Comes ready to use no batteries to install.
- Features a solar cell power supply with high performance lithium battery backup.
- 6 years+ of backup battery life is normal.
- Changes from clear to dark in 1/20,000 second.
- User adjustable delay time returning to clear.
- User adjustable dark shade from shade 9 to 13. • Meets ANSI standard Z87.1
- 3.85" x 1.5" viewing area.
- Ratchet head gear.

MODEL No.

8070-1

Reg. \$169.20

\$115.95



WELDER CART



MODEL No.

WLC-202

\$95.00



MIG WELDERS

- For Home or Light duty industrial use.
- Sturdy Metal Cabinets. • Solid State Electronics.
- 220 Volt single phase electric.
- Machines include power source, MIG gun and cable, Ground cable with clamp, Spool of Weld Wire and Power cord.

Model No. MIG-190

- Weld Mild Steel from .025" up to 3/16" or .047" up to .080" aluminum
- Uses Flux core wire - No gas needed!
- Amperage range 50-120
- Weight 20 lbs.

\$275.00



Model No. MIG-300

- Weld Mild Steel from .025" up to 5/16" or .047" up to 1/4" aluminum
- Infinitely variable wire feed speed
- Variable output current
- Amperage range 40-180
- Use with Gas for best results
- Weight 22 lbs.

\$595.00



OXY-ACETYLENE WELDING SET

Comes Complete with:

- Torch Handle
- Cutting Attachment
- Check Valve
- Oxygen Regulator
- Acetylene Regulator
- Welding Tips #0, #2, #4
- Cutting Tips #1, #3
- 15' Twin Hose
- Sparklighter
- Goggles
- Tip Cleaners

SET No.

8080

Reg. \$345.00

\$219.95



DELUXE SOLAR AUTO-DARKENING HELMET

- Automatically changes filter screen from clear to dark in 1/25,000 Sec. (FASTER RESPONSE TIME)
- Variable shade adjustment - 9-13 DIN
- UV/IR Protection: Up To DIN 16 At All Times
- Utilizes high performance solar cells as power supply
- Meets EN, DIN, ISO & ANSI Z87.1 standards

MODEL No.

8075-1

Reg. \$155.35

\$99.95

**Split Second
Response Time!**



heinrich DEEP THROAT BENCH PUNCH

MADE IN USA



- Full eight-inch depth allows maximum utility for punching wide stock... punches to the center of a 16 inch circle.
- Double crank handle drive provides easy operation.
- Body is ductile iron and wearing parts are hardened and ground.

MODEL No. MWT-600 **\$549.95**

With 1/4" Round Punch & Die 44 Lbs.

Optional:
Round Punch & Die Sets
1/64" to 1/2" by 1/64ths (Specify)
\$22.50 Per Set
Square Punch & Die Sets
1/8" to 1/2" by 16ths (Specify)
\$95.00 Per Set

Precise UNIVERSAL MINI BENDER

- Forms wire, flat metal and tubing into clamps, handles, brackets hooks, coils and more.
- Makes sharp angle bends up to 5/16" diameter rod and 1"x 1/8" flat metal.
- Made of hardened tool steel.
- Mounts on a work bench or held in a vise.
- Kit includes: 3-Circle pins (3/16", 1/4" & 1/2" diameter), 1 of each: Circle die (1" diameter), form Pin Flower, Sharp Angle and Gauge.

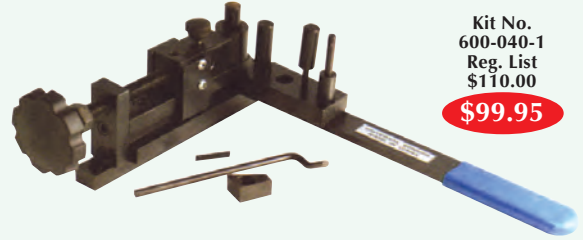

Kit No. 600-040-1
Reg. List \$110.00

\$99.95

heinrich PORTABLE SHEAR

1/8" Mild Steel ~ 5/16" Round

MADE IN USA

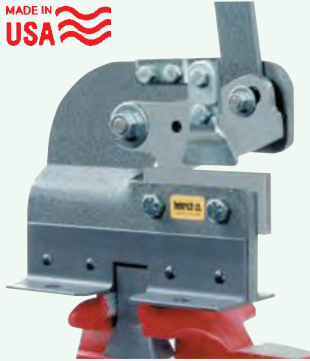

- The latch is hinged to fold out of the way for bench mounting. Frame constructed to permit shearing of wide sheets, straight cuts or outside curves. Tool steel blades interchangeable and easily removed for shapping.
- Outstanding design feature is a hinged latch. Which, when clamped lengthwise or crosswise in a vise, provides a firm mounting. Easily portable to the job.

MODEL No. MWT-100

\$379.95

17 Lbs.

Precise SHEET METAL CUTTER

- Used for mild steel with 16 gauge capacity.
- Adjustable rollers can be used for straight or curved cuts.
- 2" throat.
- Can be mounted to work bench or hel in a vise.
- Base dimension: 3" x2-1/2" with 2 mounting holes.
- Handle length 11".
- Overall height (less handle): 4-3/4".



MODEL No. 600-401

\$29.95

heinrich HANDNIB

A Combination Nibbler, Shear & Rod Cutter - For Vise Or Bench Mounting

MADE IN USA

- Double crank construction makes operation easy. Body is cast steel; tool steel blades and rod cutting dies are interchangeable and may be sharpened. All wearing parts are hardened and ground.
- Nibbles irregular shapes, inside or outside. Inside nibbling depth of cut 4" from any outside edge.
- The vise-mounting latch is hinged to fold out of the way for bench mounting. Frame construction allows shearing of wide sheets, straight cuts outside curves.

MODEL No. MWT-400

\$749.95

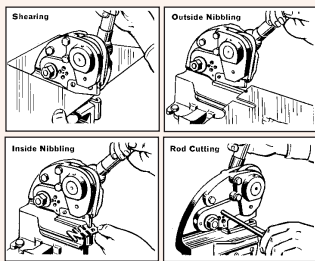

Specifications:
Mild Steel . . . 3/16"
Rounds . . . 3/16", 1/4", 5/16", 3/8"
Weight . . . 18 lbs.

Precise HEAVY DUTY UNIVERSAL BENDER

- Heavy duty bender with bending capacity of 29 tons.
- Making radius, rings spirals, angle bending and more.
- Maximum capacity for round bars: 5/8" diameter.
- Maximum capacity for square bar: 19/32".
- Maximum capacity for flat bar: 1-3/16" x 5/16".
- Fully adjustable.
- Bolt on working bench or stand.
- Handle is removable for convenience application.



MODEL No. 600-042

\$275.00

53 Lbs.

BEVERLY METAL CUTTING THROAT SHEARS

Model No. B-300 (Shown)



- Ideal all-purpose metal cutting tools as they permit any desired cut in heavy gauges, yet handle lighter metals without distortion.
- Geared rack and pinion makes heavy metal cutting easy.
- Unique shoulder design allows work to be turned in any position during the cut.
- Upper and lower blades are position to provided a clean, knurl-free cut, regardless of material.

Pneumatic Shear Also Available (Inquire)



Model No.	B-100-1	B-200	B-300
Capacity:			
Mild Steel	14 Gauge	10 Gauge	3/16" Gauge
Stainless	18 Gauge	14 Gauge	10 Gauge
Height (Less handle)	14"	15"	15"
Handle	18"	24"	30"
Width	7"	9"	9"
Depth	9"	9"	14"
Blade length:			
Lower	4-1/4"	4-3/8"	5-5/8"
Length of Cut	3"	3-1/8"	4-1/4"
Weight	181 lbs.	35 lbs.	58 lbs.
Price	\$650.00	\$870.00	\$1275.00

Precise RING ROLLER

- High quality precision machined roller forms rings out of hot rolled flat stock metal.
- Sizes up to 3/16" x 1" and up to 1/4" round.
- Create rings from 3" diameter to as large as you need.
- All surfaces are heat treated and hardened for long life.
- Create chandeliers, plant holders, ornamental iron work and more.
- handle: 13-1/2" long
Weight: 13-1/4 lbs.



MODEL 180-020

\$69.95

BAILEIGH MANUAL RING ROLL BENDER

- The R-M10 roller has a powerful manual drive system that allows for complete rings
- Manual adjustment of top roll
- manually powered
- Great for doing complete circles
- Hardened standard tooling for long life
- A wide array of optional tooling sets are available.



MODEL No.
R-M10
\$1550.00

Capacity	Size	Min. Dia.
Pipe	1" (Sch.40)	28"
Round Tube	1.25" (.078")	31.5"
Square Tube	1.2" (.078")	35"
Angle Iron	1.25" (.157")	30"
Solid Square	.75"	20"
Solid Round	.875"	20"
Flat Bar Easy Way	2" (.375)	15.75"
Flat Bar Hard Way	.75" (.188)	6.5"
Roll Adjustment	Manual	
Pinch	Single	
Shaft Diameter	1.181"	
Roll Diameter		
Upper	3.86"	
Lower	4.65"	
Shaft Center Distance	6.7"(lower rolls)	
Driven Rolls	2"	
Speeds	N/A	
Motor	N/A	
Power Requirement	Manual	
Shipping Dimensions (L/W/H)	60" / 44" / 68"	
Weight	435 lbs.	

PALMGREN DEBURRING/CHAMFERING MACHINE

- Palmgren's line-up of edge finishing machines effectively deburr, chamfer and bevels edges on flat and square metal and plastics.
- Makes short work deburring projects the "go-to" machine for edge finishing.
- Bevel angle 45 degrees
- Minimum material thickness 1/8"
- maximum bevel depth up to 1/8"
- 3/4 horsepower, 110 volt.



MODEL No.
82300
\$459.95

WOODWARD FAB THROATLESS HAND SHEARS

- Throatless design.
- Cuts up to 3/16" steel.
- Shears up to 3/8" round bar.
- Adjustable work hold down.
- Arched top blade allows effortless cutting throughout the stroke.
- Heavy steel frame.



Model No.	Blade Length	Weight lbs.	Price Each
PHS-500	5"	27 lbs.	\$105.00
PHS-800	8"	40 lbs.	115.00
PHS-100	10"	50 lbs.	145.00
PHS-120	12"	65 lbs.	160.00

WOODWARD FAB SUPER DUTY SHRINKER STRETCHER

- "Super Duty" tool features a 3" deep throat, with heavy reinforced cast iron frame to prevent "Yawning" or flexing allowing forming metal faster than lighter weight tools.
- Model WFSS-SD will form sheet metal up to 18 gauge thickness or aluminum up to 1/16" thick.
- The ideal tool for making those hard to find patch panels around windshield corners, trunk seals, wheel well openings or custom sheet metal edges and corners.



MODEL No.
WFSS11
Stand
\$109.95

Super Duty
MODEL No
WFSS-SD
\$389.95



SHOP FOX TRACK SAW AND GUIDE RAIL

This is a great portable option for accurately cutting sheet goods without a table saw or panel saw, especially when regularly switching job sites. This Track Saw features a plunge action and riving knife for unmatched safety over conventional circular saws. However, when used by itself without the guide rail, this saw is a highly accurate, bevel-cutting circular saw. The Guide Rail features a non-slip base and can be joined to additional Guide Rails for longer continuous cuts.

Specifications:

- Motor: 120V, 9A, 1.1 kW, 5500 RPM
- Blade rim speed: 9070 ft/min
- Blade diameter: 160mm (6-1/4")
- Included blade type: 48 tooth, carbide tip
- Arbor size: 20mm
- Cutting Capacity:
With track: 1-33/32" @ 90°, 1-7/16" @ 45°
Without track: 2-5/32" @ 90°, 1-5/8" @ 45°
- Shipping Weight: 24 lbs.

Features:

- Anti kickback design with spring loaded riving knife.
- Low profile blade guard for cuts as close as 5/8" from wall
- 1-1/2" dust port for collection to a shop vacuum or a dust collection system
- Anti-slip surface on underside for secure grip
- Sliding surfaces for smooth machine operation
- Ensures accurate, splinter free cuts.
- Includes 55" track, clamps, and saw blade.

Includes:

- 55" Track
- Accessory Pack (2 Clamps, 1 Rail Connector, 1 Flip Stop, and 1 Stabilizer)
- 48T Replacement Blade

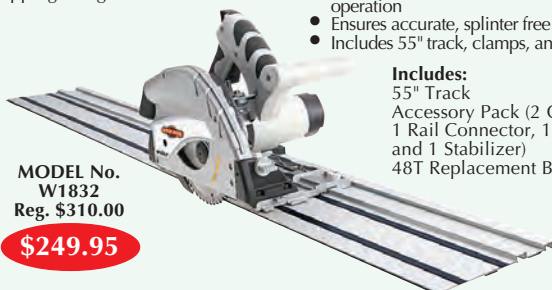

MODEL No.
W1832
Reg. \$310.00
\$249.95

BAILEIGH RING ROLLER AND PLATE ROLLER RADIUS GAUGES

- It is now possible to measure the curvature of an arc quickly, easily and accurately. Instantly measure anything from hand-railing to door-way arches, or anything that is curved.
- It is easy to replicate curves made on machines such as Ring Rollers and Plate Rolls.
- Included with each radius gauge is the variable arc attachment. Used together with either the Inside radius gauge or the outside radius gauge the variable arc will allow the user to transfer any arc to another medium easily by tracing along the variable-arc.



Inside Radius Gauge
MODEL No. IRG-3600
\$150.00

Outside Radius Gauge
MODEL No. ORG-3600
\$150.00

WOODWARD FAB

POWER RING ROLL BENDER

- Horizontal or Vertical Operation
- 30mm Spindles

- Speed 9 rpm
- 1 1/2 HP, 220 Volt Single Phase
- Weight 650 Pounds

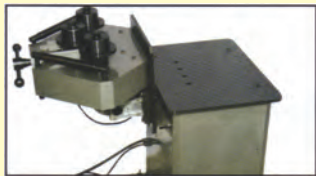

Horizontal Position

Specifications

	Size	Min. Diameter
Pipe	1.5" x 1.45" wall	28"
Round Tube	2.375" x .078" wall	28"
Square Tube	1.5" x .025" wall	39"
Angle Iron	1.5" x 3/16"	22"
Solid Square	1.25"	20"
Solid Round	1.375"	24"
Flat Bar	3" x 1/2"	15"

MODEL No. WFR30

\$3095.00

Additional Tooling

Max. Size	Min. Diameter	Model	Price
15mm	24"	WFPR154	\$540.00
20mm	Round		
25mm			
30mm			
1-1/2" x 1-1/2" x 3/16"	16" angle out	WFPR155	\$580.00
1-1/2" x 1-1/2" x 3/16"	16" angle in	WFPR156	\$580.00
35mm, 40mm, 45mm		WFPR1511	\$1490.00
50mm, 55mm, 60mm			



DELTA 10" PROFESSIONAL RADIAL ARM SAW

The RS830 includes Stand, 1-1/2HP, 120/240V Motor, automatic blade brake, 10" Saw Blade, Blade wrenches, instructional manual.

- Cast-iron track, column and column support for rigidity and continued accuracy.
- Depth-of-cut control handle and locking levers are positioned above the table for easy access
- Steel stand for sturdy support
- Extra-large table provides support for wide panels or large work pieces
- Provides greater cutting capacity for crosscutting nominal 2" thick stock up to 16" wide
- Miter cutting capacities in nominal 2" thick stock are 10-1/2" at 45° left and 11" at 45° right



MODEL No. RS830
Reg. \$1995.00

\$1695.00

5 YEAR WARRANTY

Motor Control: On-off, key lock switch
Blade Diameter: 10" x 5/8" arbor
Crosscut Capacity (1" depth of cut): 16"
Miter at 45° R and L (1" depth of cut)-
L: 10-1/2"; R: 11"
Maximum out rip: 26-1/2"
Dado Capacity: 13/16"
Depth of Cut at 90°: approx. 2-3/4"
Max 45° Bevel Cut: approx. 2-1/2"
Bevel Stops: 0°, 45° and 90°
Miter Stops: R and L 0° and 45°
Table Size: 27"x44" Table Height: 33-3/4"
Height On stand: 57"
Width: 44" Length: 34"
Weight: 166 lbs Shipping Weight: 185.5 lbs

WOODWARD FAB HYDRAULIC PIPE AND TUBE BENDER

- Bends up to 2 inch diameter.
- Includes 2 die choices.
- Degree ring. • Casters
- 110 volt, 300 pounds.



MODEL No. WFPB1000

\$2650.00

WOODWARD FAB

MANUAL TUBE AND PIPE BENDER

- Bends up to 2" diameter tubing
- CNC machined components
- 36" height
- Includes 36" handle and engraved degree ring



MODEL No. WFB2

\$295.00

Stand MODEL No. WFB5-2

\$95.00

Dies for Above

WFBBDT-1	Tubing Die 3/4" x 3'	Radius	\$147.00
WFBBDT-2	Tubing Die 7/8" x 3"	Radius	147.00
WFBBDT-3	Tubing Die 1" x 3"	Radius	149.00
WFBBDT-4	Tubing Die 1-1/8" x 3'	Radius	155.00
WFBBDT-5	Tubing Die 1-1/4" x 4"	Radius	189.00
WFBBDT-6	Tubing Die 1-1/2" x 5"	Radius	189.00
WFBBDT-7	Tubing Die 1-5/8" x 5"	Radius	199.00
WFBBDT-8	Tubing Die 1-3/4" x 6"	Radius	229.00
WFBBDT-9	Tubing Die 2" x 6"	Radius	249.00
WFBBDT-10	Square Die 1/2" x 3'	Radius	175.00
WFBBDT-11	Square Die 3/4" x 4"	Radius	200.00
WFBBDT-12	Square Die 1" x 4"	Radius	200.00
WFBBDT-13	Square Die 1" x 6"	Radius	245.00
WFBBDT-14	Square Die 1-1/4" x 5"	Radius	225.00
WFBBDT-15	Square Die 1-1/2" x 6"	Radius	280.00

Stand must be secured to the floor or heavy plate for operation

WOODWARD FAB PLANISHING HAMMER

- A well constructed machine.
- Throat depth 19-5/8"
- Uses shop air 50-100 PSI, 4 CFM.
- Features quick adjust anvil height/pressure.
- Weight: 60 lbs.
- Includes floor stand, 3 anvil (1", 2", 3" Radius), air motor, foot pedal.



MODEL No. WFPL2

\$295.00

WOODWARD FAB ENGLISH WHEEL

- Throat depth 28"
- Heavy duty construction
- 8" top wheel
- Quick release lower anvil
- Features precision ball bearings
- Includes floor stand, 5 pieces radius anvils (2-3/8", 3", 5", 8-1/2", 12") and one flat wheel
- Height 60", weight 150 pounds.



MODEL No. WFEW2

\$640.00

Precise THROATLESS SHEAR

- Turns your workpiece at any angle for straight, curved or irregular cuts.
- 18"L handle gives you plenty of leverage for cutting stainless steel, mild steel or aluminum.
- Replaceable 4" hardened alloy steel cutting blades.
- 3 holes for mounting.
- Dimensions: 8-1/4"L x 7"W x 27-1/4"H, 16-1/2 lbs.



MODEL 150-100

\$239.95

Replacement Blades (2 pcs)
No. 150-101
\$34.95



ROPER WHITNEY MAGNA-BEND 5 IN 1 Electromagnetic Sheet Metal Bending Brake

- The unique electromagnetic design of the keeper clamping system allows you to form many complex shapes not possible before.
- Magna-bend can handle all regular shapes in light ferrous and non-ferrous sheet metal (up to 4" wide 18 ga.) in a simpler, less time consuming and efficient manner.
- A wide variety of complex shapes can be formed with Magna-bend. These include rolled edges up 330°, partial length bends, closed shapes, unlimited depth for boxes and heavier material bends (up to 10 ga.) in shorter widths.



MODEL No.
MBB4181
\$2950.00



MADE IN
USA

Specifications:

Input Voltage: 115V, single phase, 60 hertz. **Input current:** 12 amps. **Duty cycle:** 20%

Maximum Bend Length: 49.38" Or 51" with manual location of keeper.

Full Length Bend Capacity: with 1.5" lip (extension piece fitted to bending beam) 18 Ga. in mild steel or non-ferrous material. (Typical Bend Radius-.16")

Minimum Reverse Bend: 1.5" with work support; .75" without work support.

Keepers (Clamping Members): Furnished with 11 keepers - 3/4", 1", 1-3/8", 1-7/8", 2-3/4", 3-3/4", 4-3/4", 6", 12", 21-5/8", and full length 51-1/4".

Net Weight: 275 lbs. **Shipping Weight:** 300 lbs.



ROPER WHITNEY RADIUS MASTER

- Roper Whitney's Radius Master is a must for every fabricating shop. It's a hydraulically operated, self contained unit for making radii in mild steel from 27 gauge up to 7 gauge without having to make blade adjustments and no setup.

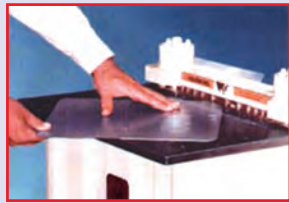

- The Radius Master comes standard with 11 radii from 1/8" to 1"-1/8, 3/16, 1/4, 5/16, 3/8, 7/16, 1/2, 5/8, 3/4, 7/8, & 1". Special size radii may also be ordered up to 3" maximum radii

Specifications:

- Operated on 115 volts 1.0 amps and 80 psi shop air with safety foot switch as standard equipment.
- Height: 40 inches. • Length: 25 inches.
- Width: 20 inches.

Model	Description	Price
188111911	Radius Master with 11 radii 1/8"-1"	\$6995.00
188111913	Radius Master 911 with large radii rated for 14 gauge material 1-1/4", 1-1/2", 1-3/4", 2"	9950.00
188111912	Radius Master 911 with large metric radii 30mm, 35mm, 40mm, 50mm	9950.00



SHEET METAL BENDING BRAKE

- 36" length straight brake.
- 18 gauge capacity mild steel, 16 gauge (1/16") aluminum.
- Bends up to 120 degrees.
- Dual cam lock hold down handles.
- High quality commercial construction.
- Includes floor stand.
- Height 41-1/2"
- Weight 170 pounds.



Bend your own
repair brackets fast!
Easy to operate



MODEL No.
WFB-36
\$385.00



PERMANENT RARE EARTH MAGNETIC POWERLIFT

Powerlift® Rare Earth Lifting magnets - Designed for thick, non-flexing material. These compact, yet powerful Rare Earth lift magnets can be used on flat or round surfaces and contain an internal release on/off device that does not contact or damage the surface of the part being lifted. Permanent magnetic lifts also eliminate the fear of dropping the load being lifted due to power failures.

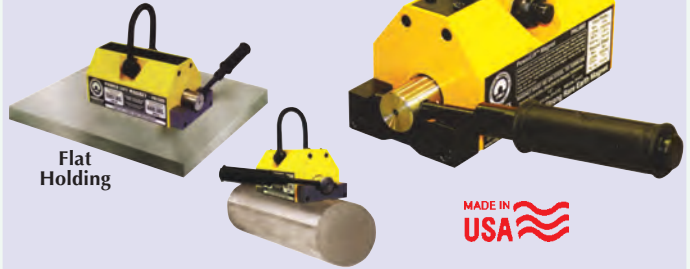

Flat
Holding

MADE IN
USA

Model No.	Holding Flat	Holding Round	Overall Length	Magnet Width	Weight lbs.	Price Each
PNL0250	250 lbs.	125 lbs.	5"	2-5/8"	7	\$ 295.00
PNL0800	800 lbs.	400 lbs.	7-7/8"	3-5/8"	22	695.00
PNL1600	1600 lbs.	800 lbs.	10-3/4"	4-7/8"	53	1295.00
PNL2500	2500 lbs.	1250 lbs.	12-5/8"	7-1/8"	110	1995.00
PNL5000	5000 lbs.	2500 lbs.	16-1/2"	9-1/4"	276	3350.00



BASIC MAGNETIC LIFT

400 Lbs, 1,000 Lbs and 1500 Lbs Lift

- Permanent ceramic lift magnet perfect for basic, flat steel lifting applications.
- Featuring a lightweight and durable stainless steel design.
- The basic lift has a full width cam to release the magnet from the steel surface and a tall lift lug for easy use with crane hooks and slings.

Features: The Basic Lift offers good value for your customer's dollar with strong lifting capacity and basic lifting.

Features: Full width cam release, large lift lug, Lightweight design, Durable stainless steel casing, Heat resistant up to 300°F (148°C) and 1.2.1 design factor. Available in 3 models with either 400 lb., 100lb., or 1500 lb. lift capacities. Made In USA



Model No.	Lift lbs.	Size (L x W x H)	Weight lbs.	Price Each
BL0400	400	6-1/2" x 6-1/2" x 5"	13	\$295.00
BL1000	1000	9-1/2" x 6-1/2" x 5"	18	395.00
BL1500	1500	13-3/4" x 6-1/2" x 5"	28	550.00



TURBO BURR DEBURRING TOOLS

Perfect for deburring and edge finishing and nonferrous metals, plastics, stainless steel, aluminum, laminates and printed circuit boards

Specifications:

- Air turbine motor.
- Transports easily and conveniently to the work site.
- For use a both a hand and a bench tool.
- Puts a safety edge on sheet metal in one pass.
- Breaks sharp edges on parts, at mill, saw or shear.
- Deburs one side.

With closed bottom "V" block
Suitable for most applications
For materials .015" to .130"



Specifications:

- Rotation 55,000 RPM (no load speed)
- Air consumption 5 to 11 CFM-lubrication not needed
- Air pressure 60 to 120 PSI
- Air hose 1/4"
- Burr type: 1/4" diameter x 2" length overall-solid carbide
- Depth of bevel 0 to .075" at 45°
- Feed speeds Up to 2" per second
- Weight 3.5 lbs. (1.6kg)

MODEL No.
HTB-60S

\$469.95

Mighty BRUTE SHEET METAL BENDING BRAKES

- All aluminum brakes that produce bends up to 90° degrees.
- Pre-drilled base mounts to your workbench (bolt not included).
- Ideal for shops, schools, hobbyists, service trucks, body shops, heating and air conditioning ducts, production runs and more!
- Excellent alternative to heavy and expensive industrial brakes.



Model No.	Material Length	Gauge Capacity	Weight lbs.	Price Each
MMB-180	18"	18 Gauge sheet metal/ 16 Gauge aluminum	3.5	\$39.95
MMB-300-1	30"	18 Gauge sheet metal/ 16 Gauge aluminum	11	99.95
MMB-400	40"	20 Gauge sheet metal/ 18 Gauge aluminum	50	349.95

Precise PIPE TUBING NOTCHER

- Make perfect joints for secure welds.
- Use with your electric drill or drill press.
- Notch from 0° to 45° in 1" increments accurately.
- Drill press NOT included.
- 3/4" spindle size.
- 2" pipe capacity.
- 7-1/2 lbs. tool weight.
- Requires 14" clearance between chuck and table.
- Use with 1/2" chuck.

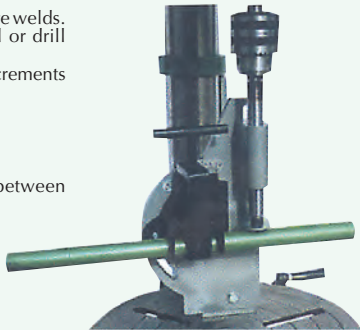

MODEL
160-020

\$79.95

Precise BEAD ROLLER KIT

- Cut, form, roll beads and make perfect flanges with one bench top tool.
- Save money and shop space.
- Comes with 1/4", 3/8" and 1/2" bead mandrels; and 18-1/4" shearing mandrel.
- Sheet metal capacity: 18 gauge.
- Perfect for auto body workers - make your own wheel tubs, battery trays, dash-boards, fire walls, floor pans and other sheet metal parts and accessories.
- Throat depth: 18-1/4".



MODEL
180-001

\$139.95

Bead Roll Fence attachment

Helps make accurate beads, bends & cuts

No. 180-002

\$18.00



Top Tech® 12" MANUAL ROLLING MACHINE



Specifications:
Max. Plate Thickness: 2.5mm
Max. Plate length: 12"
Max. Diameter: ø5mm
Net Weight: 23 lbs.

MODEL No.
TRB-300-1

\$134.95

Less Vise

Mighty ROD BENDER

- Constructed of 3" x 3" aluminum base 1" with 12" handle, 7/8"
- Installs on any vise.
- Bends metals to any shape and degree of angle.
- Bends solid, round, square and flat.
- Includes dies to bend inside diameters of 1/2", 3/4", 1", 1-1/4" and 1-1/2".
- Works on solid materials up to 3/8"



Mighty JUMBO ROD BENDER

- Constructed of 4" x 6" aluminum base 1" thick with 16" handle, 7/8" diameter.
- Includes dies to bend inside diameters of 3/8", 3/4", 2", 3", 4".
- All other specifications the same as the Mighty Rod Bender.



Model	Capacity	Weight	Price
MRB-001	Up to 1-1/2" inside dia. bends	2.5 lbs.	\$31.95
JRB-002	Up to 4" inside dia. bends	7 lbs.	49.95

Precise HYDRAULIC TUBING/PIPE BENDERS

- Top bending configuration.
- Work throughout the whole ram stroke.
- 3-leg stand.
- With automatic return.
- Capable for bending low-carbon steel, stainless steel & nonferrous metal pipes.
- Model No. HBP-100 has 7 bending dies for pipe diameters: 1/2", 3/4", 1", 1-1/4", 1-1/2", 2", 2-1/2"
- Model No. HPB-200 has 8 bending dies for pipe diameters: 1/2", 3/4", 1", 1-1/4", 1-1/2", 2", 2-1/2", 3"

Model No. HBP-100
Horizontal Model



No.'s HBP-200
Vertical Model

Model No.	Hydraulic Press	Ram Stroke	Weight lbs.	Sale Price
HBP-100	10 Ton	6-1/8"	123	\$295.00
HBP-200	10 Ton	9-1/2"	145	325.00

Precise BOX & PAN BRAKE - 12" & 24"

- Fully adjustable cams for bending from 0 degree to 135 degree.
- A fine touch machine for clean, straight edge forming.
- Hardened steel box fingers are easily removed or repositioned.

12"
MODEL No.
600-430

\$224.98



Model No.	Blade Width	Gauge Capacity	No. of Box Fingers	Weight lbs.	Sale Price
600-430	12"	20 Gauge	1"/1, 2"/2, 3"/1, 4"/1	50	\$224.98
600-431	24"	18 Gauge	1"/1, 2"/1, 3"/1, 8"/1, 10"/1	100	299.95



THROATLESS ROTARY SHEAR

- Easily cut any shape up to 1/8" thick.
- Forged steel frame.
- Ratcheting head.
- Adjustable cutter.
- Adjustable work stop.



MODEL No. WFMS

\$179.95



ROPER WHITNEY 12" BENCH SHEAR

- The RBS-112 shear is portable with a full opening of 13". Its divided work surface allows use of the full length. Other features include: choice of ruler placement for short strokes, front steel rule, protective front and rear plastic shields for safety latch locks.

MODEL No. **MADE IN USA** RBS-112

\$615.00

Imported MODEL No. 860-400

\$349.95



Specifications:

Height	11"
Length	23"
Width	14"
Weight	27 lbs.
Capacity:	
Brass	.025
Steel	24 ga.
Aluminum	20 ga.
Plastic (FLX)	1/8"

Precise 40" BENDING/CUTTING MACHINE

- Bends metal as thick as 19 gauge
- Works with aluminum, copper, zinc and steel.
- Foldable stand for easy transport and storage.
- Great for metal fabrication at the shop or on the job site.
- Sturdy all-steel frame construction.
- M2 high speed steel cutter.



MODEL No. 110-0401

\$145.00

Limited Supplies

Specifications:

Width	40"
Gauge Capacity Bending	19Ga.
Cutting	20Ga.
Stand Height	35"
Weight	143 lbs.



SHRINKER STRETCHER

- Ideal for creating repair panels for wheel openings, windshields, etc.
- Produce curves as tight as 3" radius.
- Cast iron frame.
- Works mild steel up to 18 ga and aluminum up to 16 ga.
- Drilled bottom for bench mounting or clamp in a bench vise.



MODEL No. WFSS11 Stand

\$109.95



MODEL No. WFSS10

\$179.95

Includes: 2 Jaw set Change Jaws in seconds



PIPE/TUBE BENDING KIT



- Make smooth kink free bends easy.
- Rugged cast iron construction.
- Threaded adjustment.
- Extension handle.
- Mount to a bench top or clamp in a vise.
- Kit includes storage case, cast iron base, handle cast iron dies 3/8", 1/2", 5/8", 9/16", 3/4", 7/8", for rounds and 3/4", 1" for square tube.

Kit No. SPB-100

\$229.95



ROPER WHITNEY 25" BENCH SHEAR

- The bench shear is precision made, of the highest quality, engineered to provide precise shearing, long life dependability and the utmost in serviceability.
- It features top and bottom blades that are interchangeable, automatic material hold-down, large work surface, finger safety guard, and easy to reach steel front gauge.

MODEL No. 140071250

\$1650.00



Specifications:

Maximum Shear Length	25"
Maximum Back Gage Length	12.5"
Maximum Front Gage Length	12"
Shipping Weight	230 lbs.

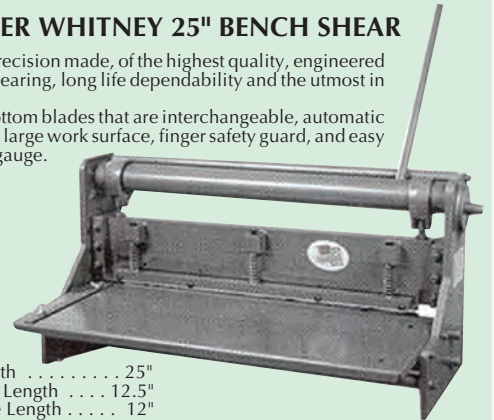

Precise COMPACT BENDER

- Make standard or unique at home or in the field. Costs less money and takes less time than it would to buy new ones.

- Floor model 38" overall height, Bench model 12" overall height, both models have 10" square base and lightweight make it perfect to mount virtually anywhere in the shop or in the field.
- Includes: 1", 1-1/4", 1-1/2", 1-3/4", 2", 2-1/2" and 3" round dies and a right angle die.
- 5/16" x 1-1/4" or 1/4" x 2" mild steel capacity.
- 5/8" round or square solid rod capacity.
- Handle telescopes to 44".



Optional: Twisting Attachment

- Bring out beauty in ornamental metal piece.
- Make spiral twists in square rod.
- Various length pieces can be twisted creating a beautiful spiral effect.
- Capacity: 1/2" pickets, 36" long.
- Metal type; hot rolled square mild steel.

No. 170-004 \$49.95

Bench MODEL 170-002

\$89.95

Floor MODEL 170-001

\$99.95

Precise LEVER SHEARS

- Ideal machine for shearing sheet, steel, bars and rods.
- Hardened and tempered replaceable blades.
- Long handles provides plenty of shearing torque.
- Comes with predrilled holes to bolt down to work bench.



Model No.	Capacity Plate	Flat Bar	Blade Length	Approx. Weight	Price Each
MSM-1460	1/8"	1-1/2" x .057"	6"	26 lbs.	\$59.95
MSM-1461	3/16"	1-3/4" x 3/16"	8"	43 lbs.	74.95
MSM-1462	1/4"	1-7/8" x 3/16"	10"	50 lbs.	79.95
MSM-1463	3/8"	1-7/8" x 3/16"	12"	75 lbs.	110.00

WOODWARD FAB MANUAL IRON WORKER

- Shears up to 3/4" Rods, Rounds or Squares
- Shears Angle Iron up to 2.25" x 3/16"
- Shears T Iron up to 2-1/4"
- 4" Long High Chrome Shear Blades
- Adjustable Hold Downs
- Cast Iron Frame
- Gear Drive Cam
- Throatless Shear Cuts up to 5/16" Plate
- Handle is 6' long - allow for ceiling height if bench mounted.



MODEL No. WFIW-100
\$475.00
Weight 250 lbs.

WOODWARD FAB MANUAL PUNCH

- 6.25" Throat Depth
- Punch up to 3/16" thick steel
- Gear Drive Cam = Less Effort Needed
- Weight 200 lbs
- Includes a complete set of punches - 1/8", 3/16", 1/4", 5/16", 3/8", 7/16", 1/2", 9/16", 5/8"



MODEL No. WFP-20
\$575.00
Weight 200 lbs.

WOODWARD FAB TUBING ROLLER

- Chain drive bottom rolls
- Adjustable height stand
- Includes 1", 1-1/2" and 2" round tube dies
- Works up to .090" wall thickness mild steel or 1/8" aluminum
- Weight 200 lbs.



MODEL No. WFTR5
\$675.00

- 1" Diameter = 9" Radius
- 1-1/2" Diameter = 15" Radius
- 2" Diameter = 30" Radius

WOODWARD FAB SQUARE CORNER NOTCHER

- Foot operated
- 16 gauge (1/16") capacity mild steel
- 3" x 3" blades
- Adjustable work stops
- Adjustable blade gap
- Any sized notch can be made with multiple hits



MODEL No. WFNSN
\$595.00

BAILEIGH MANUAL ROLL BENDER

- The R-M3 metal ring roller is perfect for any typical sheet metal shop for bending small rod up to 1/4".
- It has fine adjustment for the top roll and to power this machine there is a manual hand crank.



MODEL No. R-M3
\$145.00

Specifications:
Capacity solid round: .25"
Capacity flat bar: 1" (.1875")
Minimum diameter: 3"
Handle length: 13.5"
Weight: 18 lbs.

WOODWARD FAB MANUAL ROLL BENDER

- Roll up to 1-1/2" tubing as small as 20" diameter.
- Includes 1-1/2" tube die.
- Works up to .080" wall round tube



MODEL No. WFTR-45
\$425.00

WOODWARD FAB MULTI ARBOR PRESSES

- Features 2" diameter Ram.
- Constructed from 1/2" Thick Plate.
- Creates up to 3 tons of force.
- Throat depth 12"
- Throat Height 7-1/2"
- Maximum opening 4-1/2"
- Table 4" x 7"
- Handle 30"
- Size 21" Deep x 19" High x 5" Wide



MODEL No. WFFP-12
\$419.95

No. WFP-ST
Floor Stand
w/casters
29" High
\$190.00
80 lbs.



#WFP12-L
Louver Tool
3/16" x 2-1/4"
• Cuts up to .040 mild steel or 1/16" aluminum
\$345.00



#WFP12-N
Corner Notcher
1-3/4" x 1-3/4"
• Notch up to 3/16" Steel
\$155.00



#WFP12-B
Bending Brake Die
4" Length
• Bend up to 3/16" Steel
\$140.00



#WFP12-S
Shear Die 4-3/8" Length
• Cuts up to 1/16" Steel
\$155.00

WOODWARD FAB PRO HYDRAULIC PRESS

All The Features You Look For In An Industrial Press

- Convenient hand pump
- Heavy duty ram
- Easy to read pressure gauge
- Press plates included
- Thick bed
- Wide frame



Model	Tons	Height	Stroke	Inside	Weight	Price
PR-102	10	41"	7"	14-1/2"W	120 lbs.	\$239.95
PR-103	12	61"	7"	18-1/2"W	165 lbs.	285.00
PR-104	20	69"	7-1/2"	19-1/2"W	220 lbs.	375.00

WOODWARD FAB PLANISHING HAMMER

- 24" Throat depth
- Heavy 4" x 4" construction
- Industrial air hammer at 4600 beats per minute
- Includes in-line oiler, pressure regulator and foot pedal
- Works up to 1/16" (16ga.) mild steel



MODEL No. VFPH
\$775.00



WOODWARD FAB POWER BEAD ROLLER

- Work up to 1/16" mild steel
- 12" throat depth
- Adjustable fence
- Massive 1-1/2" diameter spindles
- Forward-Reverse foot pedal
- 220 volt single phase
- Includes 1/2" bead die, 1/2" 45 degree die, shearing die
- Weight 1300 pounds



MODEL No. WFBR218
\$2195.00

WOODWARD FAB ENGLISH WHEEL

- 37-3/4" Throat depth
- Extra deep throat
- Works up to 1/16" (16ga.) mild steel
- Wheels can be turned 90 degrees
- Cam operated quick release on lower wheel
- Hardened and polished wheels
- 6" top wheel
- Includes a complete set of 6 wheels
- Free video included

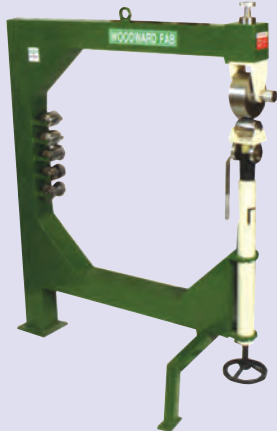

MODEL No. WFEW
\$1150.00

WOODWARD FAB BRACKET MAKER

- Forms flats up to 2-3/4" x 1/4"
- Forms rounds up to 3/8"
- Includes 90° tools and radius tools
- Degree ring with stops
- Length stop
- Weight 70 pounds

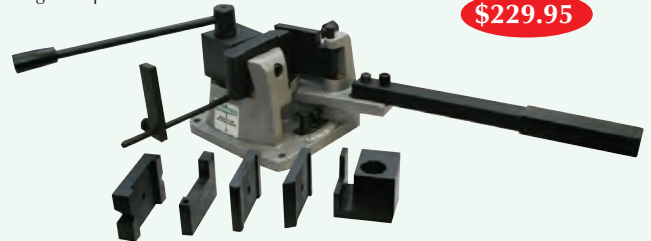

MODEL No. VFUB
\$229.95

WOODWARD FAB MONSTER WHEEL

- A whopping 44" throat depth
- 7" top wheel
- Super wide 3" anvils
- Quick release lower anvil
- Foot operated height adjustment
- Smooth as silk ball bearing spindles
- 72" overall height
- Includes 4 radius anvils and 1 flat anvil
- Weight 400 pounds



MODEL No. WFEW44
\$1725.00

WOODWARD FAB BEAD ROLLING MACHINE

- Super heavy duty
- Solid cast iron non-flex frame
- 20" throat depth
- 1" diameter spindles
- Works up to 18 gauge mild steel like butter or 1/16" aluminum
- 43" tall.



MODEL No. VFBR20
\$575.00

Includes floor stand and 6 sets of dies:

- 1/4" round bead die
- 1/2" round bead die
- 1/16" step die
- 1/8" step die
- 1/4" step die
- 1 set of shearing dies

WOODWARD FAB POWER BEAD ROLLER

- 23" throat depth
- 18 gauge capacity steel
- Adjustable fence
- 1/3 HP, 110 volt
- Includes floor stand, 3 step dies, 3 bead dies and 1 shearing die
- Weight 95 pounds

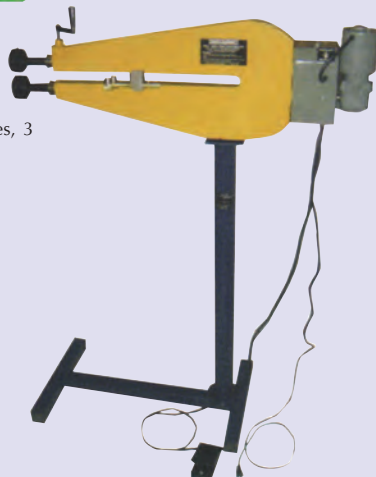

MODEL No. WFBR23
\$1075.00

WOODWARD FAB DEBURRING/CHAMFERING MACHINE

- This tool utilizes a standard cup style grinding wheel for deburring/chamfering the edges of any ferrous material including heat hardened edges. Complete parts appear to have been precision finished on a surface grinder.
- Bevel angle 45 degrees.
- Minimum material thickness 1/8"
- Maximum bevel depth up to 1/8"
- 1/3 horsepower, 110 volt.

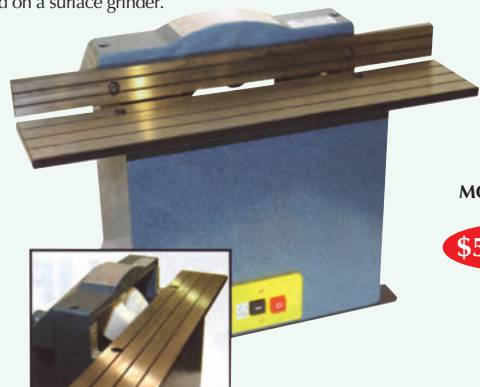

MODEL No. 82304
\$539.95

3 IN 1 SHEAR, BRAKE & ROLL

- Combo shear, brake & roll in 1 compact machine.
- Right or left hand operation.
- Shear can used for mild steel, aluminum, brass, copper, lead, plastic and zinc.
- Brake equipped with easily removable fingers that permit, channel, box and other complex bending.
- Slip rolls are precision turned and ground.



No. SBR-400S Floor Stand for 40" Shear . . . \$149.95
No. SBR-500S Floor Stand for 52" Shear . . . 195.00

Specifications:	SBR-120	SBR-300	SBR-400	SBR-500
Shearing Capacity	12" x 20 gauge	30" x 20 gauge	40" x 20 gauge	52" x 20 gauge
Bending Capacity	12" x 20 gauge	30" x 20 gauge	40" x 20 gauge	52" x 20 gauge
Rolling Capacity	12" x 20 gauge	30" x 20 gauge	40" x 20 gauge	52" x 20 gauge
Width of upper dies	1/4", 3/8", 1", (2), 2", 3", 4"	1", 2", 3", 6", 8", 10"	1", 1-1/2", 2", 2-1/2", 4", 7", 10", 15"	1", 1-1/2", 2", 2-1/2", 4", 7", 9", 10", 15"
Overall Dimensions	26"L x 16"W	34"L x 18"W	40"L x 18"W	56"L x 22"W
Shipping Wt. (approx.)	100 lbs.	325 lbs.	380 lbs.	770 lbs.
Price	\$279.95	\$650.00	\$950.00	\$1750.00

HAND NOTCHER

- The heavy cast iron construction allows the notcher to be used to side shear 6 inches of material to it's rated capacity and the throat behind the upper ram is beveled on one side to permit long strips of material to pass without restriction.

- Notches of more than 90° can be accomplished in 2 operations. The upper blades can be reversed for a "nose to heel" cutting action and the ram stroke can be controlled by means of two set screws to permit limited throat piercing knockout operations.

Hand Notcher Specifications:

Max. Force 4 Ton
Max. Capacity - Mild Steel 16 GA.
Stroke 3/4"
Table size 18" x 12"
Weight 275 lbs.



Hand Notcher MODEL YN-16

\$550.00

ROTARY MACHINE

- Rotary machine with interchangeable rolls is a versatile forming tool for the manual performance of numerous sheet metal operations.
- This features a solid cast, enclosed frame and smooth meshing machine gears.

- Material can be fed through the rolls in either direction by selecting the proper arbor. The forming pressure of rolls is controlled by the crank on top of the frame.
- This unit comes with 5 sets of standard rolls, hand crank, spanner and bench vise clamp.



MODEL RMU-220

\$345.00

Specifications

Maximum capacity - mild steel 22 gauge
Throat 17 inch
Distance, shaft-center to center 2 inch
Shipping weight 88 lbs.

BIRMINGHAM HYDRAULIC SHEARS

- A rugged frame, tool steel blades, quality workmanship and outstanding design techniques combine to provide a useful tool with a long dependable life.
- A full integrated 3HP hydraulic pump & tank unit mounted under the shear bed. Double acting cylinders with sealed lines, pressure relief valve and electrically operated hydraulic valve complete the system.
- Safety features include finger guard and front arm extensions.
- Structural braces are provided for added rigidity and for support for hydraulic system.
- Electric controls include a remote foot switch, motor starter, transformer and selector for single stroke or continuous operation.
- The upper arm returns to the top of the stroke from any position if the operator removes his foot from the guard foot switch.

Standard Equipment

- 1) High carbon, high chrome alloy-tool steel blades. 4-edge bottom blade, 2-edge upper blade
- 2) Finger guard
- 3) Back gauge
- 4) Front gauge
- 5) Side gauge
- 6) Spring actuated holddown bar to ensure even pressure
- 7) Fully hydraulic system and safety overload protection system



	Hydraulic	
Model	H-5214	H-5210
Capacity mild steel	14GA	10GA
Back gauge range	24"	24"
Front gauge range	24"	24"
Bed length	52"	52"
Motor	3 HP	5 HP
Shipping Weight	1900 lbs.	3000 lbs.
Price	\$5995.00	\$8995.00

*Larger size available (Inquire)



LOCKING FORMER PITTSBURGH TYPE

- Made in Taiwan.
- ISO9001 certified.
- Heavy welded all steel construction.
- Standard Pittsburgh Attachment
- Standard round flange attachment Double Seam Roll and Drive Cleat Roll.
- ACME side can be operated at same time.
- Heavy duty castor wheels for easy moving.
- One year warranty for parts.



Specifications:

Model	PL-20E	PL-16E
Capacity	20 Ga. to 26 Ga.	16 Ga. to 20 Ga.
Depth of pocket	5/16"	1/2"
Feeding speed	32 FPM	23 FPM
Main motor	1.5HP, 110V	5-1/2"HP, 220V, 3HP
Weight approx.	458 lbs.	628 lbs.
Machine Dimensions		
L x W x H	36" x 23" x 43"	43" x 27" x 48"
Price	\$2,800.00	\$6,500.00

- Includes:**
- Standard Pittsburgh attachment #PA-20E.
 - Flange attachment # FA-20E, installed.
 - Drive cleat roll # DCR-20E, installed.
 - Double seam roll # DSR-20E.

Optional:

- #SSR-20E Standing seam roll & right angle roll Set for No. PL-20E **\$795.00**
- #SSR-16E Standing seam roll & right angle roll Set for No. PL-16E **\$895.00**

BAILEIGH NC HYDRAULIC PRESS BRAKE 33 TON

- The **BP-3363NC** press brake has 33 tons of bending force over its full 63" frame.
- The frame on this hydraulic press brake is made from fully welded steel plate designed to give minimum amounts of deflection as well as offer maximum rigidity.
- It also features a heavy duty torque tube that connects a pair of hydraulic cylinders ensuring accuracy to .04mm.
- As with all Baileigh Industrial press brakes, the **BP-3363NC** uses only top quality components from manufacturers like, NOK, Siemens, and Omron.
- For the safety conscience, a fully integrated light curtains are also part of this great package.
- Another nice feature of the **BP-3363NC** press brake is a two axis DRO that monitors the powered back gauge and the bend depth making this one easy to use press brake at an incredible price.
- All bending functions, whether it is full auto or jog mode, are controlled by a foot pedal.
- The **BP-3363NC** comes standard with a gooseneck punch and a three sided multi-vee bottom die.

MODEL No.
BP-3363NC

\$8750.00

Specifications:

Table Length 63"
Gauge Length 23.62"
Return Speed 2.36" / sec.
Throat Depth 6.3"
Stroke Distance 3.54"
Approach Speed 2" / sec
Back Gauge Motor 1/2 HP
Bending Speed6" / sec.
Main Motor 3 HP
Distance Between Housings 49.2"
Distance From Table To Ram 12.5"
Power 220V / 3-phase
Shipping Weight 2,860 lbs.
Shipping Dimensions 75" x 38" x 69"



BAILEIGH CNC HYDRAULIC PRESS BRAKE 33 TON

- The **BP-3363CNC** press brake has an easy to use programmable two axis CNC controller integrated right from the factory that has the ability to hold 40 programs, each with its own unique number for easy identification, and will also keep a piece count for those large production runs.
- The frame on this CNC hydraulic press brake is made from fully welded steel plate designed to give minimum amounts of deflection as well as offer maximum rigidity when using all 33 tons over its full length of 63".
- The **BP-3363CNC** also features a heavy duty torque tube that connects a pair of hydraulic cylinders ensuring accuracy to .04mm.
- The **BP-3363CNC** runs on 220V three phase power and uses only top quality components from manufacturers like, NOK, Siemens, and Omron.
- All bending functions, whether it is full auto or jog mode, are controlled by a foot pedal.
- The **BP-3363CNC** comes standard with a gooseneck punch and a three sided multi-vee bottom die; fully integrated light curtains are also part of this great package.

MODEL No.
BP-3363CNC

\$15,995.00

Specifications:

Table Length 63"
Gauge Length 23.62"
Return Speed 2.36" / sec.
Throat Depth 6.3"
Stroke Distance 3.54"
Approach Speed 2" / sec
Back Gauge Motor 1/2 HP
Bending Speed6" / sec.
Main Motor 3 HP
Distance Between Housings 49.2"
Distance From Table To Ram 12.5"
Power 220V / 3-phase
Shipping Weight 2900 LBS
Shipping Dimensions 75" x 38" x 69"



WOODWARD FAB BOX & PAN BENDING BRAKE

Here Comes The Boss-16

- This new machine is the BOSS among 16 gauge brakes.
- The BOSS-16 features the world's thickest fingers to prevent deflection making more accurate bends possible.
- It also features extra heavy trusses and braces for added strength and bronze bearing at the pivot points.

MODEL No.
BOSS-16

\$1095.00

Specifications:

Capacity: 16 gauge (1/16") mild steel, 20 gauge stainless steel
Length: 48-1/4"
Maximum box depth: 4"
Removable fingers: 2", 3", 4"
Bend angle step: 0-130 degrees
Floor stand included: Yes
Counterweight included: Yes
Upper beam is adjustable for radius bending.
Weight: 590 pounds!!!

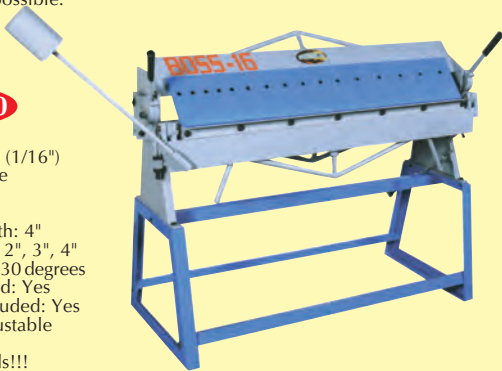

WOODWARD FAB ELITE SLIP ROLLS

With the Elite roll you can select from 2 different speeds. We have added another spindle to the gear box so by changing the crank handle position, you can either roll 1 to 1 ratio for fast forming of thin material or select 3-1/2 to 1 gear ratio for rolling thicker material with ease.

- The Elite roll uses a single front mounted hand wheel for adjusting the rear roll for varying radii.
- The Elite roll also uses a single hand wheel to adjust the bottom wheel for material thickness.
- With a single handle the upper roll will lift to remove work pieces.
- With a simple adjustment you can also roll tapers up to 15 degrees.
- There is a longitudinal groove the length of the rear roll for more aggressive forming.
- Capacity 16 gauge (1/16") mild steel, 20 gauge stainless steel.
- Precision: hardened and round rolls, 2-3/8" diameter drive rolls, 2-1/2" rear adjustable roll.
- Rugged: Fully enclosed gear box, Cast iron end plates, Wire grooves for rolling wire 1/6", 1/8", 3/16", 1/4"



Model	Description	Price
ELI-240	Slip Roll, 24" Roll Length 475 lbs.	\$ 975.00
ELI-410	Slip Roll, 41" Roll Length 550 lbs.	1250.00
ELI-500	Slip Roll, 50-1/2" Roll Length 565 lbs.	1550.00

BAILEIGH ANGLE FINDER

The Angle Finder or tubing bender plane of bend degree indicator is a must for any fabricator who is working with hand railing, auto chassis, etc., anything that requires an accurate rotation of the previous bend completed, before performing the next bend.



- Attach the to the following end of tube or pipe before bending, complete a bend and rotate material accurately to desired degree and before next bend.
- Digital indicator accurately detects where plane of bend is within total 360° rotation in 180°
- Fits 3/4" OD, up to 3.5" OD
- Ensures that pipe or tube stays on a level plane.
- Immediate payback due to material savings when tube bending.
- Perfect for all applications that require more than one bend in material.

MODEL No.
AF-360DH

\$149.95

Precise 37" AND 52" FOOT SHEAR

- Shear mild steel up to 16 gauge and aluminum, brass, bronze, copper and plastic. Includes reversible high carbon, high chrome alloy tool steel blade for twice the life of standard non-reversible blades.
- Comes with finger guard, back gauge, front and side gauge, and spring actuated hold-down bar.

37"
MODEL No.
FTS-370

\$1395.00



52"
MODEL No.
FTS-520

\$1595.00

Specifications:

Model No.	Cutting Length	Cutting Capacity	Capacity Front	Gauge Back	Weight lbs.	Price Each
FTS-370	37"	16 Gauge	13"	32"	772	\$1395.00
FTS-520	52"	16 Gauge	13"	26-1/2'	1188	1595.00

BIRMINGHAM HEAVY DUTY FLOOR TYPE BOX AND PAN BRAKE 48" x 12 GAUGE

- Suitable for many types of metal forming.
- All body sections are steel welded.
- Heavy duty truss rods & brakes.
- Precise bed & beam alignment.
- Two large size, cast iron counter forming.
- Stop rods.
- Precision bearings on apron.
- Ten segments included- 3", 4", 5" & 20" wide.



MODEL No.
V-412-6

\$1995.00

Specifications:

Bending Length	48"	Beam Adjustment	1"
Capacity, Mild Steel	12 GA	Min. Reverse Bend	5/16"
Stainless Steel	16 GA	Weight	2300 lbs.
Bending Angle	0-135°	Overall Dimensions	70"L x 27"W x 32"H

Precise BENCH SLIP ROLLS

- All rolls are made of polished, turned and ground high grade carbon steel.
- Rigid construction for long life and precision operation.
- Rolls are driven by gears.
- Wire grooves are standard.



12" Slip Roll
MODEL No.
SLR-120

\$135.00

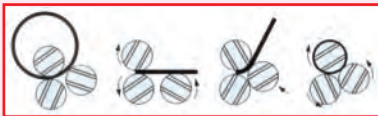

Model No.	Length & Gauge	Roll Diameter	Wire Form Grooves	Weight lbs.	Price Each
SLR-120	12" x 20GA	1"	1/8", 1/4" & 3/8"	37.5	\$135.00
SLR-240	24" x 20GA	2"	3/16", 1/4" & 5/16"	142	295.00
SLR-360	36" x 17GA	2"	1/8", 3/16" & 1/4"	175	375.00
SLR-500	50" x 16GA	3"	1/8", 3/16" & 1/4"	363	650.00
SLR-501	Stand for 50" Slip Roll			55	\$120.00

Precise SHEET METAL BENCH 48" PAN AND BOX BRAKE

- 48" width is suitable for many framing operations.
- Ruggedly built.
- Hardened steel box fingers are easily removed or repositioned.
- Left and right beam control levers for easy operation.
- Large contour balanced brake handle for brake past 90° to 135°



Specifications:

Capacity (mild steel)	16 gauge
Brake Range	0-135°
No. of finger	2"5, 3"6, 4"5
Footprint	52" x 12"
Weight	368 lbs.

MODEL No.
NU-4816C
Reg. \$750.00

\$695.00

Floor Stand #SMB-480 \$120.00

BAILEIGH MANUAL ROTARY DRAW BENDER

- Unique ratcheting mechanism allows user to easily bend material by simply pulling a lever while remaining in one place.
- Quick release counter-die allows bends to pull out in seconds with no disassembly required.
- Highly visible degree dial for accuracy.
- No pins to move or re-engage to reach maximum bend angle of 206°. This is accomplished by the ratcheting mechanism and the anti-reverse stop-latch which keeps tension on the material during the entire bend cycle.
- Color-coded dies are easily identifiable and interchangeable with all RMD products

MODEL No.
RDB-100

\$2,295.00

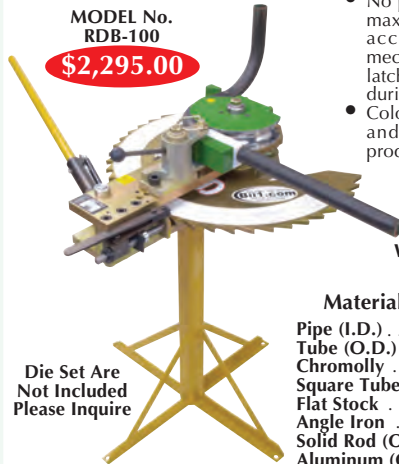

Die Set Are
Not Included
Please Inquire

Specifications
Height: 42"
Length: 42"
Width: 22"
Weight: 150 lbs.

Maximum CLR: 7"
Max Bend: 206°
Capacity: 1"
Schedule 40

Material	Maximum Capacity	Max Wall Thickness
Pipe (I.D.)	1"	Schedule 40
Tube (O.D.)	1-3/4"	.095"
Chromolly	1-1/2"	.083"
Square Tube	1" x 1"	.125"
Flat Stock	1/4" x 1-1/2"	-
Angle Iron	1" x 1" x 3/16"	-
Solid Rod (O.D.)	1"	.125"
Aluminum (O.D.)	2"	.125"
Stainless (O.D.)	1-1/2"	.083"

BIRMINGHAM POWERED SLIP ROLL

- All rolls are made of polished, turned and ground high grade carbon steel.
- Rolls were driven by gears.
- Rigid construction for long life and precision operation.
- Front mounted handle to lift upper roll for easy workpiece removal.
- Wire grooves are standard.

50" x 16 GA
MODEL No.
BSX-5016C

\$2295.00



No. BSX-5016E
(Shown)

Model No.	Max. Roll Length	Max. Roll Thickness	Diameter Rolls	Motor H.P.	Weight lbs.	Price Each
PR-1020	40"	14GA.	2"	2 HP	650	\$2295.00
PR-1300	52"	12GA.	3-1/2"	2 HP	1,200	3295.00
PR-1550	60"	10GA.	4-3/4"	3 HP	1,800	4295.00
BSX-5016C	50"	16GA.	3"	1 HP	800	2295.00
BSX-5016E*	50"	16GA.	3"	1 HP	800	3295.00

*No. BSX-5016E is made in Taiwan. All others are made in China

JET HAND NOTCHER

- Made of cast iron.
- Capable of notching virtually any shearable material.
- Can notch angles of more than 90° through a two step process.
- Easy-to-read front gauges.
- Heavy-duty cutting blade.

MODEL No.
HN-16N
Reg. \$769.00

\$645.00



Specifications:

Cutting Capacity (Gauge)	16
Piercing Capacity (Gauge)	18
Maximum Notch (Inch)	7
Stroke (Inch)	3/4"
Overall Dimensions (L x W x H)	24" x 21" x 26"
Net Weight	66 lbs.



Model 754017 S-16N stand for HN-16N hand notcher \$195.00

NATIONAL PNEUMATIC AIR SHEARS

- National offers three heavy duty all cast iron body shears. These air shears are standard with four cutting edge high carbon extensions, table gauges, back gauges, and heavy duty foot switch.



Optional:
57" Squaring Arm
No. NA5200
\$675.00



Model	NA3612	NA5216	NA5212
Capacity:			
Mild Steel	12 Gauge	16 Gauge	12 Gauge
Stainless	16 Gauge	20 Gauge	16 Gauge
Cutting Length	36"	52"	52"
Strokes Per Minute	40	40	40
Shipping Weight	1100 lbs.	1400 lbs.	1600 lbs.
List Price	\$6900.00	\$6200.00	\$7800.00
Sale Price	\$6550.00	\$5890.00	\$7400.00

NATIONAL HYDRAULIC SHEARS

4' X 1/4" Ga, 6' x 1/4" Ga, 8' x 1/4" Ga, 10' x 1/4" Ga.
7-1/2 H.P. ~ Quick Adjusting Back Gauge



Optional:

- Front Operated Digital Back gauge No. NBG-100.
- Squaring Arm No. NSA-100



Model No.	Capacity Mild Steel	Cutting Length	Strokes Per Min.	Shipping Weight	Sale Price
NH-4825	1/4"/6.4mm	48"	20	5000 lbs.	\$16,650.00
NH-7225	1/4"/6.4mm	72"	20	6000 lbs.	21,550.00
NH-9625	1/4"/6.4mm	96"	12	7000 lbs.	26,000.00
NH-1205	1/4"/6.4mm	120"	12	9000 lbs.	30,000.00
NSA-100	Squaring Arm				\$ 780.00
NBG-100	Power Back Gauge w/Digital Readout				6,400.00

NATIONAL HYDRAULIC SHEARS

HEAVY DUTY-1800 RPM-3 TO 5 H.P.
Standard High Carbon High Chrome Blades



Optional:

- Squaring arm
- Front operated digital backgauge

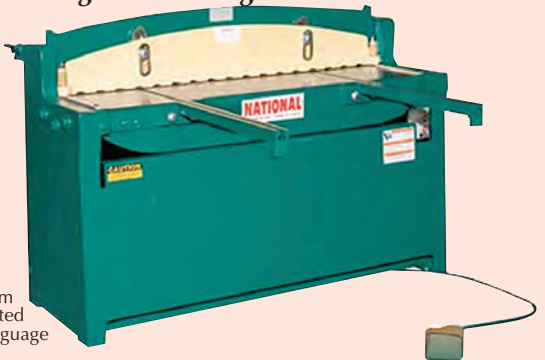

Model No.	Capacity Mild Steel	Cutting Length	Weight lbs.	List Price	Sale Price
NH3612	12 Gauge	36"	1200	\$ 7950.00	\$ 7550.00
NH5216	16 Gauge	52"	1400	7250.00	6885.00
NH5212	12 Gauge	52"	1600	9400.00	8930.00
NH5210	10 Gauge	52"	1950	1140.00	10800.00
NSA52	Squaring Arm			\$ 675.00	\$ 650.00
NBG52	Power Back Gauge w/Digital Readout			5700.00	5400.00

NATIONAL POWER ROLL FORMING MACHINE

- Standard with forward and reverse drum switch, quick release upper roll, positive chain drive.
- Heavy duty gear box, front guard for additional safety, heavy duty stand is standard.
- Three precision turned, ground, and polished high carbon steel rolls.
- Extra heavy duty end frames with quick release handle on the right front for speedy production forming.
- The drive train is powered with a heavy duty precision reduction gear box to assure durability and long life. The electric panel and gear box are housed in a ventilated stand for speedy production.



Model	NR-4816	NR-7216
Capacity	16 Gauge	16 Gauge
Maximum Forming Length	48-1/4"	72-1/4"
Diameter of Roll	3"	4"
Minimum Forming Radius	1-1/2"	2"
Wire Grooves (optional)	3/8", 1/2", 5/8"	3/8", 1/2", 5/8"
Roll Speed	18 RPM/14.13 sfpm	18 RPM/14.13 sfpm
Motor: 110-220 Single Ph.	1 HP	1 HP
208-220-440 3 Ph		
Floor Space	64"L x 37"W x 44-1/2"H	88"L x 26"W x 43-3/4"H
Weight	970 lbs.	1740 lbs.
Price	\$6150.00	\$7450.00

NATIONAL BOX AND PAN BRAKES

- Standard with 2", 3" and 4" finger widths, stop rods for repeat bends, two large counterweights, and precision bearings on the apron. • All steel body construction with extra heavy tie rods for minimum deflection.



Model	U4812	U7216	U7212	U9616
Capacity: Mild Steel	12 Ga.	16 Ga.	12 Ga.	16 Ga.
Stainless	16 Ga.	20 Ga.	16 Ga.	20 Ga.
Max. Bending Length	49"	73"	73"	97"
Max. Depth of Box	4"	4"	4"	4"
Finger Width	2", 3", 4"	2", 3", 4"	2", 3", 4"	2", 3", 4"
Weight	1150 lbs.	1850 lbs.	2100 lbs.	2200 lbs.
List Price	\$3950.00	\$4500.00	\$4900.00	\$5300.00
Sale Price	\$3750.00	\$4275.00	\$4650.00	\$5035.00

GMC HYDRAULIC SHEARS

- Made In Taiwan.
- ISO 9001 certified.
- HD all steel construction for maximum rigidity.
- High grade carbon/chrome alloy steel blades and hardened to 62 hrc, 2-edge indexable upper blade and 4-edge indexable bottom blade.

- Full length with full view finger guard.
- Front supports and (2) side gauges.
- Safety type foot pedal control.
- Jog, single or auto cycle operation modes.
- Spring hold-downs.
- German logic quiet hydraulic system.



Standard Equipment:

- 24" one-side handwheel operated manual back gauge
- 2 each 24" front support arms.
- 2 each 14" side gauges with inlaid inch/metric scale.
- Removable safety foot pedal control.
- One set of blades.
- Full length finger guard.
- Tool box with tools.
- Spring hold-downs.



Model	HS-0410	HS-0414	HS-0510
Mild Steel	53" x 10Ga.	53" x 14Ga.	62" x 10Ga.
Stainless Steel	53" x 14Ga.	53" x 18Ga.	62" x 14Ga.
Blade Length	53"	52"	62"
Strokes per Minute	37	37	30
Hold-downs:	8 Pieces	8 Pieces	9 Pieces
Front Support Length	24"	24"	24"
Manual Back Gauge	24"	24"	24"
Top Blade Rake Angle	1.5 degree	1.5 degree	1.5 degree
Hydraulic Oil Tank	20 Gal.	17 Gal.	20 Gal.
Main Motor	5HP, 220V	3HP, 220V	5HP, 220V
Machine Weight	3,150 lbs.	1,950 lbs.	3,850 lbs.
Dimensions Approx.	80"x38"x58"	80"x38"x57"	88"x39"x58"
Price	\$8,400.00	\$6,300.00	\$11,995.00

Model	HS-0610	HS-0810	HS-1010
Mild Steel	82" x 10Ga.	101" x 10Ga.	123" x 10Ga.
Stainless Steel	82" x 14Ga.	101" x 14Ga.	123" x 14Ga.
Blade Length	82"	101"	123"
Strokes per Minute	25	20	16
Hold-downs:	10 Pieces	12 Pieces	16 Pieces
Front Support Length	24"	24"	24"
Manual Back Gauge	24"	24"	24"
Top Blade Rake Angle	1.5 degree	1.5 degree	1.5 degree
Hydraulic Oil Tank	25 Gal.	25 Gal.	30 Gal.
Main Motor	5HP, 200V	5HP, 220V	7-1/2HP, 220V
Machine Weight	4,350 lbs.	6,050 lbs.	6,650 lbs.
Dimensions Approx.	110"x39"x58"	136"x39"x58"	160"x39"x58"
Price	\$11,250.00	\$14,000.00	\$20,750.00

GMC ELECTRICAL POWER SHEARS



- Made in Taiwan.
- ISO 9001 Certified.
- HD all steel construction for maximum rigidity.
- Spring hold-downs.
- High grade carbon/chrome alloy steel blades and hardened to 62 hrc, 2-edge indexable upper blade and 4-edge indexable bottom blade.
- Full length with full view finger guard.
- (2) Front supports and 40" squaring arm.
- Safety type foot pedal control.
- Jog, single automatic cycle operation modes.
- One year industrial warranty.

Model	EPS-410	EPS-811
Cutting Capacity:		
Mild Steel	49" x 10Ga.	98" x 11Ga.
Stainless Steel	49" x 14Ga.	98" x 15Ga.
Blade Length	49"	98"
Strokes per Minute (SPM)	47	47
Hold-downs: numbers	12	12
Front Support Arm Length	24"	24"
Manual Back Gauge	24"	24"
Top Blade Rake Angle	1.5 degree	1.5 degree
Main Motor	7-1/2HP, 220V	10HP, 220V
Weight lbs.	3,350 lbs.	4,650 lbs.
Price	\$7,550.00	\$11,250.00

Standard Equipment:

- 24" Manual back gauge with inch/metric dual scale.
- Manual back gauge is one side operated by handwheel.
- 2 each 224" front support arms
- 40" squaring arm with inlaid inch/metric dual scale.
- Spring independent hold-downs.
- Full length finger guard.
- Removable safety foot pedal control.
- One set blades & operation manual.

GMC HEAVY DUTY HYDRAULIC BOX AND PAN BRAKE



- 100% made in Taiwan.
- ISO 9001 certified.
- Hydraulic adjustment for opening.
- Hydraulic power clamping for workpiece.
- 1" manual beam adjustment (front and Back)
- Maximum bending angle 135°.
- Heavy welded all steel construction for maximum rigidity.
- Hydraulic logic system centrally located and quiet.
- A wide guidebody ensures strong, stable, smooth & accurate movement.
- Total 2"/6"/12"/18"/24" pieces fingers assortment.
- Central control panels on each side for convenient operation.
- Jog and auto operation modes.
- Overload protection and disconnect switch.
- One year warranty for parts.

Standard Equipment

- Assorted fingers
- Hydraulic clamping system.
- (2) safety protection side gauges.
- Foot pedal control for hydraulic clamping.
- Angle Set-up Control.

Optional Equipment

- HBB-1012** One piece straight finger to convert to Straight Hydraulic Brakes for all Models **\$2,800.00**
- HBB-1013** Miniki NC Control for angle degree set-up **\$3,700.00**
(Just key in degree number to set it up)

Model No.	Max. Bending Length	Capacity Mild Steel	Capacity Stainless Steel	Max. Box Depth	Large Beam Opening	Oil Tank Gal.	Main Motor HP	Mach Weight lbs.	Overall Dimensions Inch	Price Each
HBB-0412	4'	12 Ga.	16 Ga.	6"	8"	10	2 HP	2,350	83 x 46 x 62	\$10,995.00
HBB-0410	4'	10 Ga.	12 Ga.	6"	8"	10	5 HP	4,150	88 x 51 x 67	12,450.00
HBB-0612	6'	12 Ga.	16 Ga.	6"	8"	10	2 HP	4,350	106 x 41 x 67	13,450.00
HBB-0610	6'	10 Ga.	12 Ga.	6"	8"	15	5 HP	5,350	110 x 43 x 69	15,375.00
HBB-0812	8'2"	12 Ga.	16 Ga.	6"	8"	15	3 HP	5,650	132 x 41 x 67	16,350.00
HBB-0810	8'2"	10 Ga.	14 Ga.	6"	8"	15	5 HP	6,650	141 x 43 x 69	18,275.00
HBB-1014	10'	14 Ga.	18 Ga.	6"	8"	20	3 HP	6,150	153 x 46 x 66	17,300.00
HBB-1010	10'	10 Ga.	12 Ga.	6"	8"	25	5 HP	8,150	157 x 46 x 69	19,995.00



HYDRAULIC PLATE BENDING ROLL MACHINES

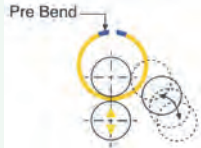
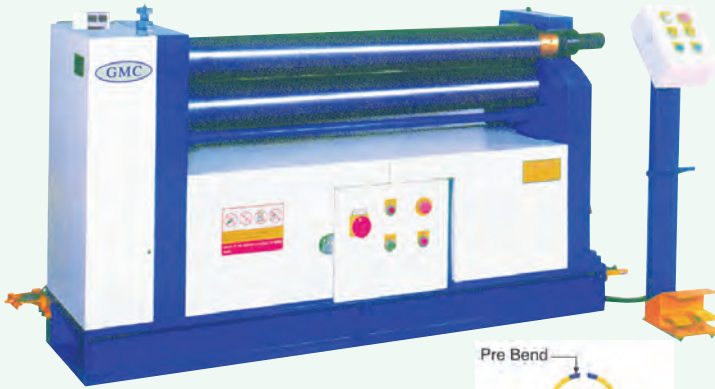

- Made In Taiwan.
- ISO 9001 Certified.
- Easy swing - out top roller.
- Standard cone attachment installed.
- 1 each LED indicator for bending roll position.
- Safety line all around the machine for emergency stop.
- Heavy Duty all steel welded machine construction.
- German Hydraulic logic system centrally located and quiet.
- Bending roll is hydraulic powered up/down & tilting adjustment.
- Planetary reduction gear and pump.
- All three rolls are made of high grade alloy steel.
- All rolls run forward and reverse.
- Safety type foot pedal control.
- Overload protection and disconnect switch.
- Power source 208V/220V or 460V, 3 phase.
- One year industrial warranty.

Specifications:	HBR-0425	HBR-0525	HBR-06316	HBR-0625
Roll Capacity				
Mild Steel	4' x 1/4"	5' x 1/4"	6' x 3/16"	6' x 1/4"
Stainless Steel	4' x 3/16"	5' x 3/16"	6' x 11Ga.	6' x 3/16"
Min. Roll Dia.	7"	7-1/2"	7-1/2"	8-1/2"
Rolls Length	4'3"	5'1"	7-7/8"	6'8"
Rolls Diameter	5-1/2"	6"	6'8"	6-1/4"
Pre-Bend	0.20"	0.20"	0.18"	0.20"
Rolls Speed	178"/min	178"/min	178"/min	178"/min
Rolls Opening	3/8"	3/8"	3/8"	3/8"
Oil Tank Cap.	15 Gal.	17 Gal.	17 Gal.	30 Gal.
Main Motor	5HP	5HP	5HP	5HP
Mach. Weight	4,550 lbs.	5,250 lbs.	6,650 lbs.	8,850 lbs.
Dimensions	91" x 36" x 56"	103" x 36" x 56"	126" x 36" x 56"	126" x 36" x 56"
Price	\$13,000.00	\$16,000.00	\$17,500.00	\$18,500.00



HEAVY DUTY POWER BENDING ROLLS

- ISO 9001 Certified.
- Taiwan Machines.
- 3-rollers are driven to perform high accuracy.
- Adjustable cone attachment included.
- 3/8", 1/2" and 5/8" grooves on rollers.
- One wheel one-side operated for bending roll.
- One wheel one-site operated for pinch roll (E Model is powered)
- Heavy duty casting frame.
- Heavy duty all steel welded construction.
- 1/3 of full length in middle of roller is straight, and two ends with crown to get perfect round performance.
- Easy swing-out top roller.
- Safety line all around the machine for emergency stop.
- All rolls run forward and reverse.
- Safety type forward/reverse foot pedal.
- Power source 220V, (option: 440V, 3 Phase)
- One year industrial warranty for parts.
- E Models come with motorized bending roll up/down w/push button and digital display for easy operation of repeat jobs.



Specifications:

Model	PBR-0412E	PBR-04316E	PBR-0425E
Capacity Mild Steel	4'3" x 12Ga.	4'3" x 3/16"	4'3" x 1/4"
Capacity Stainless Steel	4'3" x 16Ga.	4' x 11Ga.	4'3" x 11Ga.
Roll Diameter	3-1/2"	4-3/4"	6-1/4"
Min. Bending Diameter	4-3/4"	6"	8-1/4"
Pre-Bend	0.07"	0.16"	0.25"
Roll Speed ft/min.	20	20	20
Rolls Opening	1/2"	1/2"	1/2"
Main Motor HP	2HP	3HP	3HP
Weight Approx.	1950 lbs.	2550 lbs.	3890 lbs.
Overall Dimensions	78" x 30" x 50"	78" x 30" x 52"	78" x 33" x 52"
Price	\$6,500.00	\$8,550.00	\$10,500.00

Model	PBR-0510E	PBR-0610E
Capacity Mild Steel	5'1" x 10Ga.	6'8" x 10Ga.
Capacity Stainless Steel	5'1" x 14Ga.	6'8" x 14Ga.
Roll Diameter	4-3/4"	5"
Min. Bending Diameter	6"	6-3/4"
Pre-Bend	0.12"	0.12"
Roll Speed ft/min.	20	20
Rolls Opening	1/2"	1/2"
Main Motor HP	3HP	3HP
Weight Approx.	3050 lbs.	3850 lbs.
Overall Dimensions	96" x 32" x 52"	106" x 33" x 52"
Price	\$8,560.00	\$11,450.00



HYDRAULIC NOTCHER



- Made in Taiwan.
- ISO 9001 certified.
- Super large table.
- All steel construction.
- Safety finger guards.
- (2) quick change gauges.
- Foot pedal control.
- Quiet hydraulic system.
- One year warranty.

Specifications:	HN-08HA	HN-25HA
Max. Capacity: Mild Steel (C.R.S.)	8 Ga.	1/4"
Max. Capacity: Stainless Steel	12 Ga.	3/16"
Min. Notching Thickness	26 Ga.	22 Ga.
Notching Thickness	90 degree	90 degree
Max. Cutting Length	10"	10"
Stroke Per Minute	12	12
Table Dimensions L x W	32" x 26"	32" x 26"
Hydraulic Oil Tank Capacity	12 Gal.	15 Gal.
Main Motor	5-1/2HP, 220V, 3-Phase	7-1/2HP, 220V
Machine Weight	1,850 lbs.	2,650 lbs.
Machine Dimensions L x W x H	37" x 35" x 48"	40" x 36" x 50"
Price	\$7,450.00	\$7,695.00



8 Gauge
MODEL No.
HN-08HA
\$7,450.00

1/4" Capacity
MODEL No.
HN-25HA
\$9,350.00

BAILEIGH HYDRAULIC SHOP PRESS

- The HSP-10H also comes standard with its own set of Vee blocks and removable ram cap that will allow the operator to use a wide variety of tooling.
- Like all Baileigh Industrial shop presses the HSP-10H has a movable cylinder that moves left or right within the frame of the press.

Specifications:

Max Capacity: 10 ton
Working Width: 13.5"
Moveable Cylinder: Yes
Cylinder Stroke: 7"
Piston Rod Diameter: 1-1/2"
Piston Head Diameter: 2"
Power Requirement: Manual
Shipping Weight: 115 lbs.

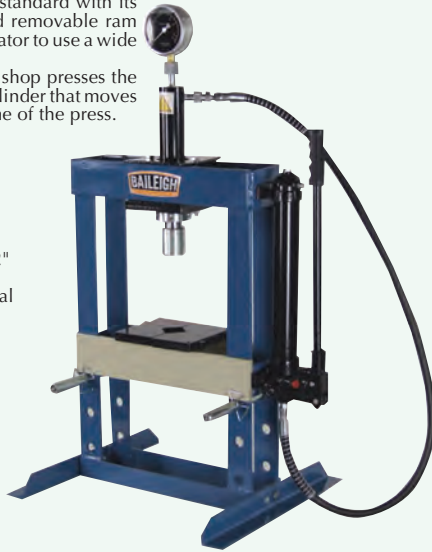

10 Ton
MODEL No.
HSP-10H
\$295.00

BAILEIGH MAGNETIC DRILLS

- The steel cast frame is as strong as they come and the 110V industrial motor will offer years of trouble free use.
- The magnet on the MD-3500 magnetic drilling machine has a whopping 13000N of adhesion strength to hold onto just about any angle imaginable.
- The magnet on the MD-6000 mag drill has a 18000N of adhesion strength to hold onto just about any angle imaginable.
- A two speed on Model MD-6000 spins at a 260rpms on low speed and 460rpms on the high speed setting.
- The drills include, a gravity feed coolant system helps with the longevity of the tooling and making the cuts faster and more efficient.
- Both models also has an industry standard 3/4" spindle, making it easy to locate tooling anywhere.



MODEL No.
MD-3500
\$595.00

MODEL No.
MD-6000
\$995.00

Model	MD-3500	MD-6000
Maximum Stroke	7.5"	8.25"
Annular Cutter Capacity	1/2" to 1-3/8"	1/2" to 2-3/8"
Cutter Depth	2"	3"
Twist Drill Capacity	1/16" to 1/2"	3/32" to 5/8"
Spindle Holder	3/4"	3/4"
No Load RPM	595	260/460
Magnetic Adhesion	13000N	18000N
Power Requirements	110V 60hz	110V 60hz
Shipping Weight	40 lbs.	64 lbs.

Heck TRACE-A-PUNCH® NIBBLERS

Features:

- Cuts most materials including plastic, stainless steel and titanium without burrs or distortion.
- Makes blanks from a template without a blank die for try out.
- Fills gaps between hand filling and the steel rule die.
- Accepts standard punches.
- Size of blank limited only by what operator can handle.
- Easily adjustable to thickness of material.



Distortion & Burr-Free Cutting At 40" Per Minute

Model No.	Cutting Capacity	Throat Depth	Motor & Volt	Weight lbs.	Price Each
TRP-3C	1/8"	6-3/4"	1-1/2 H.P. 110/220/1	150	\$1895.00
TRP-4C	3/16"	16"	2 H.P. 220/460/3	480	3350.00
TRP-4	3/16"	16"	3 H.P. 220/460/3	500	3650.00

DAKE ARBOR PRESSES

Single Leverage

- Shimmed ram cap permits take-up for potential wear.
- Smooth action gears permit finite ram control.
- Pedestals available for models 01002, 01005, 01006
- Adjustable handle allows convenient handle positioning.
- Base opening and slotted table plate for arbor work (models X and Y have a solid plate).
- Table plate on models 01004, 01005, 01006. Solid table on 01001, 01002.



Ratchet Leverage

- Ratchet device permits lever to be used in most convenient position.
- Counterweight returns lever quickly after downstroke.
- Handwheel advanced ram to work quickly.
- Pedestals available for models 01001, 02002, 02004

Single Leverage

Model No.	Approx. Capacity	Dia. Arbor	Max. Work Arbor	Capacity Over Table	Height Inch	Leverage Ratio	Wt. lbs.	Sale Price
01001	1 ton	7"	-	4-1/2"	9"	25-1	25	\$280.00
01002	1-1/2 tons	9"	-	7-3/4"	14-1/2"	32-1	60	408.50
01004	1 ton	7"	1"	5"	9-3/8"	25-1	25	280.00
01005	1-1/2 tons	9"	1"	7-3/4"	14-1/2"	32-1	70	408.50
01006	3 tons	14"	2"	11-1/2"	19"	36-1	130	617.50

Ratchet Leverage

Model No.	Approx. Capacity	Dia. Arbor	Max. Work Arbor	Capacity Over Table	Height Inch	Leverage Ratio	Wt. lbs.	Sale Price
02001	3 tons	14"	2"	11-1/2"	19"	48-1	145	\$ 875.00
02002	3 tons	14"	2"	18-1/4"	28"	48-1	196	1375.00
02003	3 tons	35"	2"	12"	24-3/8"	48-1	425	2465.00
02007	3 tons	14"	2"	11-1/2"	18-1/2"	48-1	125	925.00
02004	5 tons	20"	4"	16"	28-1/2"	55-1	450	2800.00
02006	5 tons	20"	5-1/4"	26"	58"	55-1	1045	5415.00

BAILEIGH CHAMFERING & DEBURRING MACHINE

- Bench top beveling machine that can be used for weld preparation or simple deburring of metal such as mild steel or aluminum.
- This chamfering machine can bevel close to a 1/4", from 15- 45 degrees. It requires a simple 110 volt circuit to operate the cutting mill up to 2800 RPM.



MODEL No.
CM-6-1
\$695.00

Specifications:

Chamfer Size: 0 - .236
Chamfer Angle: 15 - 45 deg.
Blade RPM: 2,800 RPM
Motor: 1.5 HP
Power Requirement: 110 volt
Shipping Dimensions(L/W/H):
16" / 20" / 20"
Shipping Weight: 180 lbs

Heck BEVEL-MILL

- Plate bevelers for weld preparation.
- Fast, accurate cutting and easy to use.
- Adjustable angle 15-45 degrees.
- Special design Baldor 110 volt motors.
- Uses standard square carbide inserts with 4 cutting edges.
- Includes carbide cutters, pipe beveling attachment, bevel tube and instructions.



Model	Description	Price
7000	3/8" Maximum Bevel Depth, 1/2 HP	\$1725.00
8000-1	5/8" Maximum Bevel Depth, 1 HP	2295.00
410-3	Replacement Cutters 10 pk for 7000/8000-1	55.00
9000	7/8" Maximum Bevel Depth 1-1/2 HP	2795.00
625	Replacement Cutters 10 pk for 900	85.00

SUNEX TOOLS HYDRAULIC SHOP PRESSES 12 TON AND 20 TON

Used for various shop applications including straightening, bending, and removing/installing gears, bearings and bushings.

- **RapidRise** bottle jack extends ram six times faster to the load than a standard jack.
- **USA built welded press frame** to prevent excessive flexing under maximum load.
- Reinforced head bolster for added strength.
- Heavy duty return springs for fast ram retraction.
- Pair of bed plates and ram head included.

Model	5212	5220
Capacity (Tons)	12	20
Overall Height	61.5"	64.5"
Base Width	26"	26"
Throat Open	3.75 to 36"	1.5 to 33"
Throat Width	20"	24.5"
Ram Stroke	6.1"	6"
Weight	200 lbs.	265 lbs.
Price	\$395.00	\$495.00



SUNEX TOOLS HYDRAULIC SHOP PRESSES 50 TON

- **USA built** welded press frame to prevent excessive flexing under maximum load.
- Reinforced head bolster for added strength.
- Dual pump pistons provide quicker ram extension to the work load and easier pumping under load.
- Pump includes overload valve to prevent against overloading.
- Winch with non-slip safety clutch and steel cable rollers for easy raising and lowering of press bed.
- 4" diameter gauge reads US tons and corresponding metric tons.
- Heavy duty internal return springs for fast ram retraction.
- Pair of bed plates and ram head included.

Model	5250-1
Capacity (Tons)	50
Overall Height	74"
Base Width	35"
Vertical Throat	1.5 to 34"
Throat Width	35"
Ram Stroke	6.75"
Ram Diameter	2"
Cylinder Bore	3.5"
Weight lbs.	513
Price	\$1695.00



SUNEX TOOLS AIR/HYDRAULIC SHOP PRESSES 100 TON ~ 150 TON

- **USA built** welded press frame to prevent excessive flexing under maximum load.
- Reinforced head bolster for added strength.
- Air/hydraulic pump for quicker cycling times by depressing air valve at the end of a four foot air line.
- 4" diameter gauge reads US tons and corresponding metric tons.
- Heavy duty internal return springs for fast ram retraction.
- Pair of bed plates and ram head included.
- Winch with non-slip safety clutch and steel cable rollers for easy raising and lowering of press bed.

Model	52100-1	52150
Capacity (Tons)	100@100PSI	150@100PSI
Overall Height	78"	78"
Base Width	36"	36"
Throat Open	1 to 32"	1 to 28"
Throat Width	34"	36"
Ram Stroke	7"	7"
Ram Diameter	2.5"	3"
Cylinder Bore	5.5"	6.5"
Weight lbs.	1106	1550
Price	\$5200.00	\$7500.00



SUNEX TOOLS ELECTRO/HYDRAULIC SHOP PRESSES 40 TON & 50 TON

- **USA built** welded press frame to prevent excessive flexing under maximum load.
- Reinforced head bolster for added strength.
- HP Emerson electric motor, 110 volt.
- Two speed pump with remote pendant control.
- 4" diameter gauge reads internal working pressure and force in tons.
- Heavy duty internal return springs for fast ram retraction.
- Pair of bed plates and ram head included.
- Winch with non-slip safety clutch and steel cable rollers for easy raising and lowering of press bed with 50 Ton Model 5250EP.

Model	5240EP	5250EP
Capacity (Tons)	40	50
Overall Height	76.25"	74"
Base Width	32"	35"
Throat Open	1 to 40"	1.5 to 34"
Throat Width	32"	35"
Ram Stroke	8.25"	8.25"
Ram Diameter	2"	2"
Cylinder Bore	6"	6"
Weight lbs.	540	582
Price	\$3995.00	\$5500.00

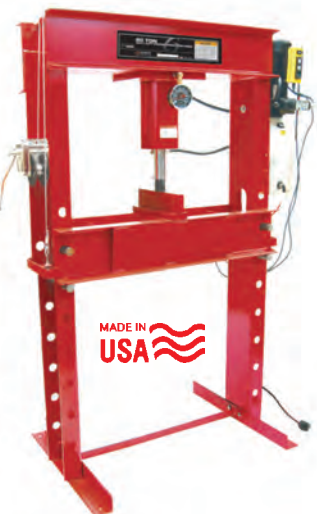

SUNEX TOOLS SHOP PRESS ACCESSORIES BED PLATES & V-BLOCKS

PUNCHES

- All Punches, Bed Plates and V-Blocks are made of precision machined, cold finished 1018 steel and are yellow zinc plated for durability.

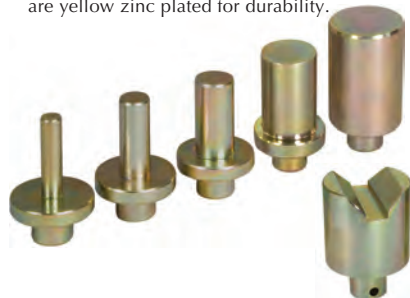

Model No.	Punch Diameter	For Presses	Price Each
212028	1/2"	12 to 50 Ton	\$29.95
212029	3/4"	12 to 50 Ton	29.95
212031	1"	12 to 50 Ton	29.95
212032	1-1/2"	12 to 50 Ton	34.95
212033	2"	100 to 150 Ton	34.95
212105	3"	100 to 150 Ton	36.95
212106*	3"	100 to 150 Ton	75.00

* Has V-Groove



Model No.	Plate Size	For Presses	Price Each
212038	1" x 3" x 14"	12 to 20 Ton	\$102.00
212039	1" x 3" x 16"	40 to 50 Ton	116.00
212041	2" x 4" x 20"	100 to 150 Ton	575.00
212027*	3" x 3" x 14"	12 to 20 Ton	495.00
212053*	3" x 3" x 16"	40 to 50 Ton	950.00
212104*	2" x 4" x 20"	100 to 150 Ton	695.00
212037**	3/4" x 12" x 14-1/2"		245.00

* V-Blocks (Pairs)

** No. 212037 12 to 20 Tons (Price Each)

SUNEX TOOLS BEARING SPLITTERS & SET



Model No.	Spread From - To	Distance Between Adj. Screws	Price Each
185002	1/4" to 15/16"	1-11/16"	\$22.95
185005	1/8" to 2"	2-7/16"	28.95
185007	1-3/4" to 5-7/8"	6"	77.50
185025	1/2" to 4-5/8"	4-3/8"	58.50
185026	1/2" to 9"	6"	115.00
185050	5/8" to 8"	7-1/8"	215.00
185055	Set of 4 with Storage Case, 1 Each No. 185002, 185005, 185025, 185026		\$325.00

DAKE THE NEW 50 TON DURA-PRESS

Built tough for the metalworking craftsman. A press and a name you can depend on for your most difficult pressing applications. This substantial press has a heavy duty, arc-welded channel steel frame and a large 6" bore hydraulic cylinder. Operating pressure is low for long life and safety. The new, easy to use "joystick" 4-way valve is standard equipment for precise ram control. If you need repeatability, the optional remote pressure control can be installed at any time. The 16" stroke is long enough for broaching. Single phase for plug and press.

Specifications:

Capacity: 50 tons
 Rams travel: 16"
 Bore: 6" Ram: 4"
 Operating PSI: 3,537 @ 50 tons
 Horse Power: 2 HP
 120/220 volt - 1PH
 Controls: Joystick operation
 Pressing speed: 11" IPM
 Return speed: 20" IPM
 Max. Ram to table: 41-3/4"
 Min. Ram to table: 0"
 Width between uprights: 44"
 Width between table channels: 8-1/4"
 Floor space: 55" x 36"
 Height: 94"
 Weight: 1,550 lbs.



MODEL No.
DDP-500

\$6125.00

JET 24" PLANISHING HAMMER

- Smooths beads and forms mild steel sheet metal up to 16 gauge.
- Smooths beads and forms aluminum and cooper up to 1/8" thick.
- Machine supplied with 2-pair of upper and anvil die sets.
- 3-position airflow regulates speeds of pneumatic hammer.
- Machine controlled with 110vac foot control.
- 2-die set brackets.
- Quick change of upper dies.

Specifications:

Frame tube size 4" x 4"
 Throat 24"
 Head opening 2-1/2"
 Maximum pressure (PSI) 90
 Air consumption (CFM) 8.8
 3-speed regulator (bits per min)-
 4400-4600/3200-3500/1800-2000
 Noise level (dB) 92.26-104.3
 Approx. weight 220 lbs.



MODEL No.
PH-24

\$1650.00

JET 45" ENGLISH WHEEL

- Rolls beads and forms mild steel sheet metal up to 16 gauge.
- Rolls beads and forms aluminum and cooper up to 1/8" thick.
- Machine supplied with 10 anvils and 4 rolling wheels.
- Three sets of popular fender groove shaping wheels.
- Screw lift assembly designed for comfortability and precise pressure setup.
- Quick cam handle releases the work piece.
- Both wheels swivel 90°
- Quick wheel change without using any tooling.
- Throat 45"
- Wheels supplied with sealed bearings for smooth operation.
- Heavy duty frame.
- Storage brackets for rolling and anvil wheels.
- Rolling wheels 6" diameter.

Specifications:

Frame tube size 4" x 4"
 Throat 45"
 Head opening 6"
 Head and anvil sit swivel 90°
 Rolling wheels diameter 6"
 Dimensions HxWxD 64" x 31" x 58"
 Approx. weight 550 lbs



MODEL No.
WH-45

\$2475.00

DAKE HAND-HYDRAULIC PRESSES



- Hand operation for economical performance.
- Rapid ram return starts ram return as soon as release valve is opened and may be stopped at any point by closing the valve.
- By-pass hole prevents excessive ram extension.
- Adjustable table permits easy vertical movement by means of self locking hoist.
- Rapid screw traverse of ram permits quick, easy movement of the ram by means of a convenient handwheel.
- Movable workhead is roller mounted on ball bearings for off-center positioning (except 25 ton model).

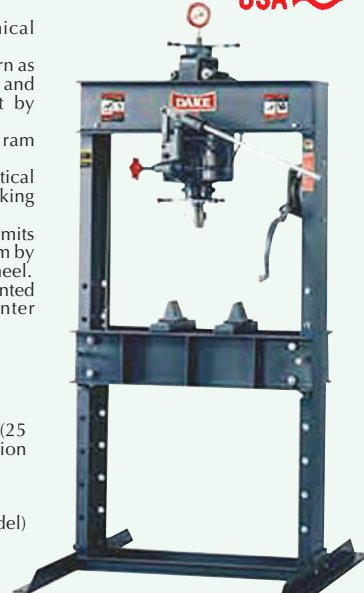

Includes:

- Frame.
- Two forged steel table plates (25 ton model has two combination table plates with V-blocks).
- Workhead.
- Flat ram nose.
- V-ram nose (except 25 ton model)
- Pressure gage.
- Self-locking table hoist.

Specifications:

MODEL	07001	07002	07003	07005
Capacity (Tons)	25	50	75	125
Height overall	76"	85"	87"	95"
Floor Space	30x42-1/2"	36x43-1/2"	36x55"	66x42"
Table Travel	35"	35"	30"	25"
Screw Travel	5"	7"	7"	8"
Max. Work Width	33-1/2"	32-3/4"	44"	48"
Max. Work Height	39"	40"	36"	25"
Max. Work Arbor	5-3/16"	7-1/4"	8-1/4"	12-1/8"
Ram Travel	5"	4"	4-1/2"	8"
Weight	450 lbs.	810 lbs.	1,245 lbs.	2,750 lbs.
Sale	\$2,995.00	\$3,985.00	\$4,845.00	\$13,700.00

DAKE THE NEW POWER HAMMER

Built tough for the metalworking craftsman.

Opens up a whole new world of metal shaping creativity. Ideal tool for fabricating one-of-a-kind or impossible-to-find replacement parts. Design and form custom hot rod, motorcycle, aviation and sheet metal parts that are works of art in your own shop. You can stretch, shrink, planish, dome, jog, bead and shape complex sheet metal parts using standard dies. If you can't buy it build it yourself on a Dake power hammer.



Specifications:

16 gauge steel capacity
 11 gauge aluminum capacity (Annealed 3003H14)
 120 volt - use it anywhere
 Horse power - 1HP
 900 strokes per minute hammer speed
 18" throat
 7" maximum opening with infinitely adjustable bottom die holder
 One set of thumbnail shrinking dies included as standard equipment
 Die set; industry standard 3/4" (19mm) square tool post for standard shrinking or stretching square shank die sets
 Wheels on base included for portability & storage
 24" wide x 33" long x 56" high, 320 lbs.
 Complete with manual, instructional video, and 1 year warranty
 Patent pending



MODEL No.
DPH-100

\$5995.00

DEWALT 4-1/2" ANGLE GRINDERS

- Jam-Pot low profile gear case provides precise gear alignment.
- Quick change wheel release allows the user to remove wheels without using a wrench.
- Over-sized, protected spindle lock button.
- E-clutch™ shuts the grinder off during a sudden stall.
- Dust Ejection System™ increases durability.
- Two position side handle, depressed center wheel, adjustable.



No. D28402
Paddle
Switch

No. D2810
Switch
Slide

Model	Amps	RPM	Length	Weight	List	Sale
D28110	7.0	11,000	10.75"	4.1 lbs.	\$111.30	\$ 69.95
D28402	10.0	11,000	11.25"	4.6 lbs.	165.00	109.95

DAKE H-FRAME HYDRAULIC PRESSES

- Fast, efficient single speed hand pump with adjustable mounting for maximum ergonomic operation.
- Large diameter, single acting polished piston with internal spring return to eliminate external pinch points.
- Convenient top mounted gauge reads in tons and psi to monitor pressure.
- Furnished with both a threaded flat ram nose for pressing and straightening work, and a step reduced ram nose for bearing and bushing work.
- The hydraulic pressing cylinder can be relocated right or left of center for unusual work pieces.
- Table can be adjusted for maximum or minimum vertical opening to accommodate a variety of work pieces and to minimize required ram travel.
- Combination table plates and v-blocks can be easily reconfigured for a variety of pressing applications.
- Like all Dake brand products, the presses are furnished complete and backed by field and factory support waiting to assist you.

Specifications:
Capacity ... 10 Tons
Stroke 6"
Width between uprights ... 16-3/4"
Width between table chnls 3"
Max ram to table 16"
Ram travel 6"
Height ... 36" & 60"
Weight lbs. ... 137 & 149



60" Height
MODEL No.
72210

\$470.00



36" Height
MODEL No.
72200

\$290.00

BIRMINGHAM LOCK FORMING MACHINE

- Stand is ARC welded steel with heavy top plate.
- All steel forming head, hardened and ground shafts, case hardened steel forming rolls, machine cut gear and needle type roller bearing throughout.

MODEL No.
LFM-200

\$2495.00

ISO
9002



Optional:
Flange Attachment
Standard
Lock Formed In Board
5/16" (8mm)

Specifications:
Capacity: 20 to 26GA. Use approximately 1" of material.
Depth of Pocket: 5/16" width of hammer-over edge adjustable up to 3/8"

Speed: 25 feet per minute.
Motor: 1 HP 110V, single phase.
Drive: V-belt
Dimensions: 36" x 16.5" x 36.5"
Net Weight: Approx. 320 lbs.

Optional: Roll Mounted on Outboard Shafts

Model	DSR-20	DCR-20	FA-20	RAR-20
Rolls	Double Seam Roll Set	Drive Cleat Roll Set	Flange Attachment	Right Angle Roll Set
Capacity	20-26GA	20-26GA	20-26GA	20-26GA
Materials	1"	2-1/8"	up to 3/16"	up to 3/8"
Size	3/8" Seam	1-1/8" Width	up to 3/16" Height	up to 3/8" Height
Price	\$395.00	\$395.00	\$695.00	\$295.00

Precise HYDRAULIC PRESSES 12 And 20 TON

- For pressure, bending and straightening operations.
- Open side heavy duty construction allow work on the longest work pieces.
- Raise and lower table for the best working distance possible.
- Spring return ram speed up your work.
- Get tremendous pressure with very little effort.

12 Ton
MODEL No.
HYD-012

\$199.95

Model	HYD-012	HYD-020
Ton Pressure	12 Ton	20 Ton
Working Distance	3-1/4" to 28-1/4"	0" to 32"
Width Between Channels	16-3/8"	22-1/4"
Overall Dimensions	53-1/4" x 19-1/2"D	60"H x 26"D
	19-1/2"W	26-1/2"W
Shipping Weight	122 lbs.	200 lbs.
Price	\$199.95	\$495.00



JET HYDRAULIC SHOP PRESSES

- For pressing, bending and straightening operations.
- East-to-use hand operated with pressure gauge for direct pressure readings.
- Tables raise and lower easily with use of hand crank on the 15-, 35- and 60- ton models.
- Side frames are open for inserting long material.
- Fast setup ram extension screw.
- Ram moves laterally for added versatility (15- and 35- ton models)



Specifications:

Model	HP-5A	HP-15A	HP-35A
Capacity	5 Tons	15 Tons	35 Tons
Ram Diameter	1-3/4"	2-1/2"	3"
Piston Stroke	4"	4-1/2"	4-3/4"
Screw Stroke	3"	3-1/8"	4"
Height	51-1/2"	65"	68"
Weight	154 lbs.	431 lbs.	704 lbs.
Reg. Price	\$1250.00	\$2199.00	\$3850.00
Sale Price	\$995.00	\$1875.00	\$3195.00

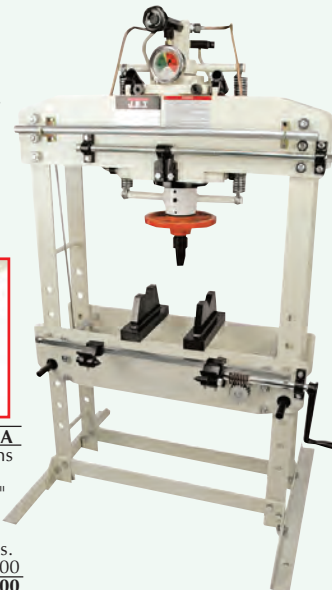

Precise ARBOR PRESSES



- Single Lever**
- Precision Made.
 - 4-Position anvil.
 - Steel rams.
 - Steel pinions.
 - Heavy stub teeth.
 - Heavy castings.

- Ratchet Type**
- Ratchet device permits lever can be used in most convenient position.
 - Heavy-duty casting frame.
 - Hand wheel advances ram to work quickly.



Single Lever						
Model No.	Capacity Tons	Press Weight	Max. Work Diameter	Capacity Over Table	Wt. lbs.	Sale Price
AP-050	1/2	11"	6-1/2"	4-1/2"	25	\$49.95
AP-100	1	12"	8"	5-1/4"	40	69.95
AP-200	2	17"	13"	8-1/2"	90	165.00
AP-300	3	22"	15"	12-1/2"	160	179.95
AP-500	5	35"	18"	35"	325	595.00
Ratchet Type						
AP-020	2	1-1/2"	11-7/8"	8-1/2"	116	\$199.95
AP-030	3	21-1/2"	12"	12-5/8"	132	279.95
AP-600	5	35"	17"	15"	440	750.00



DRILL BIT SHARPENERS - NEW & IMPROVED "X" MODELS



MODEL DD-350X

The DD-350X is a value-priced drill bit sharpener ideal for the shop that uses the most common bit styles and works mainly in wood and light metals.

- NEW! Easy, front-loading chuck.
- Sharpens 3/32"-1/2" standard-twist bits.
- Sharpens high speed steel, masonry, carbide, and TiN-coated.
- NEW! Simplified alignment and sharpening procedures.
- User replaceable diamond sharpening wheel.
- Durable construction.



MODEL No. DD-350X
Reg. \$112.95
\$59.95

Pencil Sharpener Ease

MODEL DD-500X

Sharpens a full range of bits - including split points and the 135° bits used in drilling hardened metals. Does everything the 350X does, plus:

- Sharpens split-point bits 3/32"-1/2" for faster penetration, and less drill bit "walking".
- Creates split-point bits from standard bits.
- NEW! Quick Change diamond sharpening wheel, no tools needed.
- NEW! Variable Alignment lets you adjust chisel and relief angles.



MODEL No. DD-500X
Reg. \$163.95
\$119.95

MODEL DD-750X

Built to handle larger drill bits - up to 3/4" and offer additional custom flexibility. Does everything the 500X does, Plus:

- Now sharpens 3/32"-3/4" bits with one heavy-duty chuck.
- NEW! Custom Point - choose any angle from 115° to 140°.
- NEW! Adjustable Material Take-Off (MTO) so you can touch up a slightly dull bit or deep grind for a heavily damaged bit.



MODEL No. DD-750X
Reg. \$197.95
\$139.95
With Polyethylene Carrying Storage Case

DAREX E90B PRECISION END MILL SHARPENER

- Sharpen end mill flutes up to six inches long.
- Sharpens 1/16"-2" end mill diameters.
- Sharpens 2, 3, 4 and 6 flute end mills (optional 5 & 8 flute collars available)
- Includes 5" CBN cup wheel for HSS end mills.
- Optional diamond wheel available for carbide end mills.
- Floating easy-pull air spindle.
- Includes 3/16", 3/8", 1/2", 5/8" 3/4" and 1" 5C collet set.
- Optional 1-1/4, 1-1/2 and 2 collet adapters available for larger shank sizes.



MODEL No. E90B
Reg. \$3498.00
\$3295.00
3/16" - 1" Capacity



Included

With Sharpener!

- E90B Sharpener
- 5" CBN Cup Wheel
- 6 Pc. 5C Collet Set 3/16" - 1"

DAREX V390 INDUSTRIAL DRILL SHARPENER

- Sharpens drill diameters 1/8"-3/4"
- Borazon wheel for sharpening HSS & cobalt drills.
- Grinds point angles from 118-140°
- Perfect for small to medium sized shops.



Included

With Sharpener!

- CBN wheel.
- 1/8-3/4" chuck.

Specifications:

Motor 1/4 HP, 115V
Point angle versatility . . . 118° to 140°
Weight 25 lbs.

1/8"-3/4" Capacity
MODEL No. V390
Reg. \$1498.00
\$1395.00

Specifications:

Motor 115 VAC, 3.2 amp
1/4 HP 60hz 3450 RPM
Dimensions . . . 17.5 x 17 x 10.75"
Weight 72 lbs.

Optional Accessories:

Model	Description	Price
PP08624GF	Diamond Cup Wheel	\$255.00
PP08626GF	CBN Cup Wheel	255.00

Replacement Wheels

Model	Description	Price
PP11115GF	CBN Replacement Wheel	\$219.95
PP11125GF	Diamond Wheel for Cobalt & H.S.S.	219.95
SA-11638	Morse Taper Chuck	265.00

DAREX TOOL SHARPENER X-PANDABLE DAREX

- Basic unit sharpens standard and point split dills from 118° to 150°.
- Optional attachments sharpen other cutting tools including step dill, bad points, large dills, Weldon and single flute countersink.
- An upgrade-able sharpener that grows with your needs.

MODEL XT-3000
Reg. \$3598.00
\$3495.00



Features:

- 2 wheels in machine - a sharpening wheel & a point split wheel. Sharpen HSS or carbide tools. CBN or diamond wheels included.
- No tools necessary for any adjustments on machine or attachments.
- Vacuum port and grit tray.
- EZ adjustable split depth & split angle.
- Adjustable point splitting.
- Adjustable point relief.

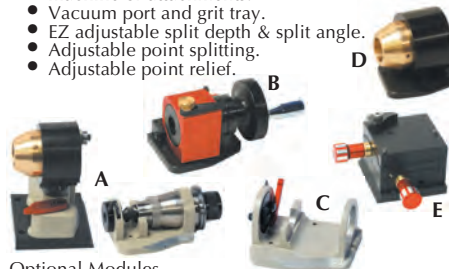

Optional Modules

A) Large Drill Module - 3 piece module includes: Sharpening fixture, alignment & chuck
No. LDM-3000 \$649.00
Capacity: 21mm - 30mm (.826 - 1.182)

B) Countersink Module - 1 piece module includes: Sharpening fixture, & 2 collets (1/4" & 1/2")
No. CTM-3000 \$495.00
Sharpens Weldon & single lip counter sinks

XT3000 Base Unit Specifications:

- Acceptable drill diameter: 3mm (.118, 1/8 inch) - 21mm (.826, 13/16 inch).
- Acceptable drill length: Unlimited maximum, two-inch minimum.
- Adjustable point angle range: 118° - 150°.
- 2 chucks - meets or exceeds National Aerospace Standards for lip height variation and accuracy.
- Motor - Emerson 1/4 hp - 3450 rpm - rated continuous duty.
- Weight - 60 lbs.

C) Step Drill Module - 3 piece module includes: Chuck sharpening & alignment fixture
Max pilot size - 13mm (.5 inch, 1/2 inch)
Max drill body size - 21mm (.826, 13/16 inch)
No. SDM-3000 \$450.00

D) Sheet Metal Point (Brad Point) Module
1 piece module includes: Sharpening fixture
No. SMP-3000 \$375.00
Capacity: 3mm - 21mm (.118-.826)

E) Radial XY Table - 1 piece required with the countersink, step drill and sheet metal point modules
No. RXY-3000 \$345.00



BENCH GRINDERS 6" 1/2 H.P.~ 8" 3/4 H.P.

- Bright, flexible work light.
- 6' long foot power cord.
- Has two 6" grit wheels: coarse 36 and medium 60.
- Each wheel has protective spark guard and adjustable eye shield.
- Mounting holes and rubber feet make grinder easy to mount on a stand (optional #5003) or use on an approved worktable or work bench.
- Conveniently placed, easy to use on/off switch.
- Cast iron base for durability.
- Ball bearing construction for smooth operation.
- 1/2" Arbor accepts standard 6" wheel for 6" grinder.
- 5/8" Arbor accepts standard 8" wheel for 8" grinder.
- UL & CSA listed and meets OSHA requirements.



Model	Wheel	RPM	Motor	Price
5001A	6"	3450	1/2 H.P. 115V	\$95.00
5002A	8"	3450	3/4 H.P. 115V	109.95
5003	Sturdy Stand, Pre-drilled mounting holes, Fits both sizes			59.95

PALMGREN PEDESTALS

Features:

- Designed to accommodate most 6", 7", 8" and 10" bench tools.
- Made of heavy duty cast iron with a 3-1/2" steel column. Built-in waterpost provides quenching workpiece after grinding.
- Unique design top allows most tools to be securely mounted with 4 bolts.
- Height: 31-3/4".
- Table size: 10-1/2" x 11"
- Base size: 15" x 16-1/2".

MODEL No.
70101

Reg. \$125.00 **\$89.95**

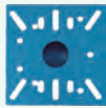

PALMGREN BENCH GRINDERS

Features:

- Base, motor housing and end-shields made from cast iron, cast aluminum and steel.
- Voltage 120/240V 1-phase PSC motor prewired for 120V.
- CSA NRT/C certified, OSHA compliant.
- Dust collection port and hoses on all models except #82061.
- Large cast aluminum tool rests tilt for angle grinding
- Includes tool rest, spark arrester, eyeshields, one 36 grit and on 60 grit grinding wheel, and 6 ft. 3 conductor power cord.

Model No.	Wheel Dia.	Wheel Grit	RPM	Motor HP	Wheel Bore	Reg. Price	Sale Price
82061	6"	36 & 60	3450	1/3	1/2"	\$125.00	\$99.00
82081	8"	36 & 60	3450	3/4	5/8"	225.00	185.00
82101	10"	36 & 60	1725	1	1"	395.00	365.00

PALMGREN BUFFERS

Features:

- Base, motor housing and end shields made from cast iron, cast aluminum and steel.
- CSA NRT/C certified. OSHA compliant.
- For buffing and polishing on all types of materials.
- Includes wheel flanges and 3-conductor power cord.

Model No.	Wheel Dia.	RPM	Motor HP	Wheel Bore	Reg. Price	Sale Price
82063	6"	3450	1/2	1/2"	\$130.00	\$119.95
82083	8"	3450	3/4	5/8"	198.00	165.00



MICRO MILLING MACHINE

This Micro Mill is perfect for matching high precision small parts for working models. It includes a digital depth readout, compound slide table as well as a micro downfeed knob and variable speed control.

Specifications:

- Motor: 0.2HP, 2A, 110V, 1 Phase
- Drilling Capacity: 1/4"
- Spindle Taper: JT1
- Spindle Travel: 1-1/2"
- Headstock Travel: 7-3/4"
- Spindle to column distance: 6-1/2"
- Table Travel, longitudinal: 2-3/4"
- Table travel, cross: 5-1/2"
- Table Size: 3-1/2" x 8"
- Column Swivel: 360°
- Speeds: low range: 0-3,600 high range: 0-5,000
- Shipping Weight: 31 lbs.



MODEL No.
M1036
Reg. \$500.00

\$395.00

Less Vise

Optional:

- No. M1038 Quickvise \$35.00
- No. M1037 Quickchange collet set with arbor and 5 collets: 3/64", 5/64", 5/32", 3/16" & 1/4" \$145.00



BELT & DISC SANDER 1" x 42" or 2" x 42" with 8" Disc

- Hinged idler wheel cover.
- Power Taper Attachment off, allows for mounting an optional flex shaft, used to do carving, drum sanding, deburring and dozens of other jobs.
- Deluxe miter gauge that turns and locks for common angles 45° both left and right.

Model No.	J-4002	J-41002
Belt Size	1" x 2"	2" x 42"
Belt Speed	3000 SFPM	3100 SFPM
Belt Table	6-1/8" x 7-1/8"	10" x 6"
Disk Size	8"	8"
Disc Speed	1725 RPM	3450 RPM
Disc Table	4" x 10"	10-3/4" x 7-1/2"
Motor	1/3 H.P. 115V	3/4 H.P. 115V
Weight	62 lbs.	80 lbs.
Price	\$445.00	\$450.00



10" & 12" DISC SANDERS

10" Features

- 1/2 HP motor, 1 phase.
- 10" aluminum disc.
- 6" x 11" table.
- 45° down, 15° up tilt.

12" Features

- 1 HP motor, 1 Phase.
- 12" aluminum disc.
- 8" x 14" table.
- 45° down, 15° up tilt.



Model	Description	Price
DS-10	10" Disc Sander	\$425.00
DS-10V	10" Disc Sander w/enclosed stand and vacuum dust system	950.00
DS-12	12" Disc Sander	750.00
DS-12V	12" Disc Sander w/enclosed stand and vacuum dust system	1295.00
MG-10	Mitre Gauge for 10"	26.95
MG-12	Mitre Gauge for 12"	29.95

PALMGREN BENCH TOP BELT/DISC SANDERS

- Designed for professional use in factories, foundries, garages and shops.
- Capacitor motors supply the extra current required during start-up and running under load.
- Large diameter armature shaft with shielded ball bearings.
- For general purpose sanding and finishing on metal, wood, plastic and other materials.
- Disc and belt tables tilt.
- Tables have a graduated scale to show angle of tilt.
- Belt housing tilts from vertical to horizontal for sanding long pieces (except #67581081-8")
- Dust collection ports.
- Dual voltage 120/240V 1-phase 60HZ PSC motor, prewired for 120V.
- Includes one medium grit belt, one medium grit PSA sanding disc and mitre gauge.
- Two year warranty.



No. 81061



No. 81091
Horizontal

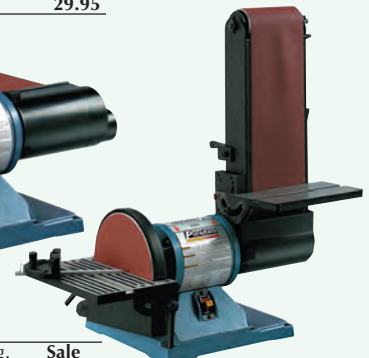

No. 81091
Vertical

Model	Disc Size	Belt Size	HP	Amps	Disc Speed	Belt Speed	Weight	Reg. Price	Sale Price
81061	6"	2" x 42"	1/3	3.5/1.75	3450 FPM	4400 FPM	30 lbs.	\$199.50	\$165.00
81091	9"	6" x 48"	1	9.0/4.5	3100 FPM	3100 FPM	87 lbs.	585.00	495.00

BALDOR 6" CARBIDE TOOL GRINDER

1/2 H.P. 3600 Idle RPM's



- Standard equipment includes large tool table for each wheel, machine tool lamp, protractor type tool rest and coolant pot with spout.

1/2 H.P. 115V
MODEL No.
500-002
Reg. List
\$1470.00

\$1395.00

Less Wheels
Silicon Carbide
Wheels, 60 & 100 Grit



\$45.00 Each

MADE IN USA

BALDOR INDUSTRIAL GRINDERS

- Built for heavy duty grinding, powered by 1/3 HP Baldor split-phase motor.
- Slim design provides extra clearance for grinding odd shaped pieces.
- Gated exhaust type guards accommodate a standard 3" wet/dry vacuum hose, on models 600RE, 712R and 812RE.
- Adjustable stamp steel tool rest, spark breaks and eye shields.
- Grinder supplied with one coarse (36) grit and one medium (60) grit aluminum oxide grinding wheel.
- Wheel and wire wheel brush (.014 wire).
- Base mounted on/off switch and rubber feet to minimize vibration.
- Includes 8ft. 3-conductor power cord.

* 612R & 712R have Non-exhaust type wheel guards.



MADE IN USA
UL SF

3600 R.P.M.'s

Model No.	Wheel Size	Horse Power	Voltage Phase	Shipping Weight	Price Each
600RE	6" x 3/4" x 1/2"	1/3	115	30 lbs.	\$279.95
612R*	6" x 3/4" x 1/2"	1/3	115	29 lbs.	318.00
712R*	7" x 1" x 5/8"	1/2	115/230	46 lbs.	469.95
712RE	7" x 1" x 5/8"	1/2	115/230	70 lbs.	555.00
812RE	8" x 1" x 3/4"	3/4	115/230	99 lbs.	925.00

BALDOR 6" DIAMOND WHEEL TOOL GRINDER

- Equipped with a locked, double row bearing, for use with diamond wheels.
- Wheel flanges are guaranteed not to exceed .002 T.I.R. at the periphery.
- Powered with a 1/2 horsepower heavy duty reversible motor.

PLATED DIAMOND 6" GRINDING WHEELS

MODEL No. 522
Reg. List \$1653.00

\$1550.00

Less Wheels



For fast carbide removal or fine finish very cool cutting without corner breakdown.

- 6" diameter • 1-1/4" hole. • 3/4" thick.
- 100% concentration plated wheels.

Model	Grit	Grade	Price
505-212	120	Medium	\$95.00
505-336	150	Fine	95.00

*Other Grits Available (Inquire)

BALDOR PEDESTALS



Red
GA-16R

Red
GA-20R

Red
GA-20R

Red
GA-14R

Grey
GA-16

Grey
GA-16E

Steel
GA-20E

Grey
GA-14

MADE IN USA

Model	Description	Price
GA-16	Cast Iron Pedestal, 32-7/8" High for 6", 7", 8", 10" Grinders/Buffers	\$450.00
GA-16E	Steel Pedestal	285.00
GA-20	Cast Iron Pedestal, 30" High for 12" & 14" Grinders/Buffers	725.00
GA-20E	Steel Pedestal, 30" High for 12" & 14" Grinder/Buffers	325.00
GA-14	Fabricated Steel Pedestal, 34-1/2" High for 6", 7", 8", 10" Grinders/Buffers	330.00



PRECISION 3" CUT-OFF SAW

- Easy to setup and operate.
 - Cuts a wide range of materials.
 - Uses safe, inexpensive cutting wheels.
 - Makes precision cuts.
 - Thin, high-speed wheel leaves minimal burr.
- Features:
- High speed spindle with sealed ball bearings.
 - Rubberized deburring wheel
 - Industrial quality timing belt.
 - Industrial grade on-off switch.
 - .035 x 3" dia. fully reinforced cut-off wheels.
 - 10,000 RPM 1/5 HP motor.
 - Precision machine tool quality vice with reversible jaw attachments.

MODEL No.
CTS-300-1

\$495.00

Cut Off Saw
with Mitre Vise

Complete
11 lbs. 115 Volts



MODEL No. CTS-300-M
\$495.00



MADE IN USA

Abrasive Cut-Off Wheels. Reinforced 3" x .035" - .040" x 1/4" Hole

Model	Best Suited For Cutting	Price
ACO-301	Stainless Steel, Nickel alloys, Mild Steel	\$ 4.95
CCO-302	Aluminum, Copper, Brass	4.95
FCO-303	Tool Steel, Hardened Steel, Alloys	4.95
EXL-201	Unitized Deburr Wheel, 1-1/2" x 1/4" x 1/8"	6.50
CSO-501	Combination cut off wheel & Deburr kit (2 each of the above)	35.00

Note: The cutting wheels listed above have been selected and developed specifically for the Coastal 3" saw. They are balanced wheels, and are formulated for optimum cutting and life. We recommend only these parts for replacements.

MINI MITER 3" CHOP SAW

4000 RPM's
200 Watt
Motor



- Saw head moves laterally making it possible to get extremely close to the vise holding the workpiece when making the cut affording a vibration-free and burr-free cut.
- Ergonomically correct grip with integrated switch and saw head release mechanism.
- Continually adjustable (may be tightened in any position) round table made of pressure-cast aluminum swivels 45° in both directions with positive stops at 15° intervals.
- Integrated tightening mechanism with self-centering clamps. V-groove for round pieces. Front side groove for clamping thin work pieces.

MODEL No.
37-160

\$295.00

With Carbide
Tipped Wheel

No. 28-729 Resin-bond cut-off wheel
3-1/8" x 1/32" x 3/8" **\$4.95 Each**

No. 28-732 Carbide tipped saw blade
3-1/8" x 1/16" x 3/8" **\$45.00**



BALDOR

DUST CONTROL UNITS

- Complete with hoses, fittings and brackets.
- Totally enclosed, fan-cooled industrial motor.
- Equipped with air control valve.
- Comes with reusable, chemically treated, flame-retardant, cloth filter bag.
- Quiet operation.

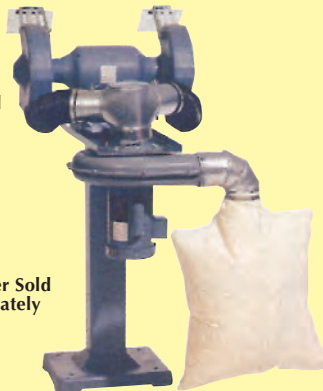

Grinder Sold Separately

115V, 1Ph, 60Hz with switch, Plug & Cord

Model No.	Grinding Wheel Diameter	Max. Width	Weight lbs.	Sale Price
DC-700	7"	1"	63	\$1325.00
DC-800	8"	1"	62	1325.00
DC-100	10"	1"	63	1325.00
DC-120	12"	2"	69	1425.00
DC-14-3	14"	4"	74	2325.00

Replacement Filter Bags

Model	Description	Sale
ARB-1	For 7, 8, 10 & 12"	\$ 95.00
ARB-2	For 14"	135.00

BALDOR BUFFERS 1Ph



Features:

- Special felt seals protect ball bearings against dust and dirt.
- Supplied with 3-conductor cord, plug and switch.
- Designed to meet OSHA standards.



Model No.	HP	Volt	RPM	Arbor Diameter	Weight lbs.	List Price	Sale Price
114	1/4	115	1,800	1/2"	22 lbs.	\$374.00	\$335.00
111	1/3	115	3,600	1/2"	22 lbs.	374.00	335.00
332B	3/4	115/230	1,800	3/4"	56 lbs.	735.00	660.00
333B	3/4	115/230	3,600	3/4"	57 lbs.	735.00	660.00

Additional Models Available (Inquire)

DEWALT HEAVY DUTY BENCH GRINDERS

- Powerful induction motor for heavy duty grinding operations.
- Industrial cast iron base and motor housing provide durability and prolong life
- Precision machined aluminum tool rests allow the user to accurately position work.
- Rear exhaust ports in wheel guards for smoother operation.
- 12-1/2" distance between wheels for longer and larger grinding applications.

Includes:

- 36 grit wheel.
- 60 grit wheel.
- Eye shields.
- Spark deflectors.
- Tool rests.
- Adjusting wrench.



Model No.	H.P.	Wheel Size	Max. RPM	Amps	Weight lbs.	List Price	Sale Price
DW756	5/8	6" x 1/2"	3450	4.0	28.5	\$158.00	\$109.50
DW758	3/4	8" x 5/8"	3600	4.2	39.5	218.00	139.59

WILTON 2" x 72" SQUARE WHEEL GRINDERS

- Infinitely variable speeds 1100 to 6000 sfpm (4126AC).
- Latest AC inverter variable speed technology (4126AC).
- Continuous speed adjustment while in operation.
- Easy to view sfpm readout.



MODEL No. 4103
Reg. \$3050.00

\$2395.00



Model No.	4126AC (Variable Speed)	4103
Belt size (in./W x L)	2 x 72	2 x 72
Belt speed (SFPM)	1100 to 6000	4600
Contact Wheel	8	8
Contact Wheel Durometer	70	70
Motor	1HP, 115V, 1Ph, AC Inverter	1HP, 115/230V, 1Ph
Net Weight (lbs.)	163	115
List Price	\$4099.00	\$3050.00
Sale Price	\$3195.00	\$2395.00

JET PEDESTAL STAND

- Heavy-duty cast iron construction provides strength and durability.
- Wide stance base gives you a stable grinder workstation.



MODEL No. JBS-2A
Reg. \$77.25

\$69.95

Specifications

Mounting Surface (L x W/in.)	11 x 10
Overall Height (Inch)	31
Net Weight (lbs.)	46



SKODA PREMIUM SHARPENING MACHINES

- Double-bearing grinding unit (reduces wear)
- Drill tightened design with bearing device.
- Adjustable trimming angle.



Model No.	326-130	326-134
Drill Capacity	2mm-13mm	8mm-30mm
Point Angle	85° - 140°	85° - 140°
Power	110/220V, 50/60Hz	110/220V, 50/60Hz
Motor	90 watts	450 watts
RPM	6000	4000
Weight	23 lbs.	55 lbs.
List Price	\$1434.00	\$3284.00
Sale Price	\$1065.00	\$2395.00

Standard Equipment 326-130

- ER20 Collets, 2.5mm-13mm (12pcs.)
- CBN Dia. Wheel #200x1pcs. (for HSS drill)
- 3mm & 4mm Hexagon (Hex.) wrench x1 pc. each

Standard Equipment 326-134

- ER40 Collets, 12mm-26mm (15pcs.)
- CBN Dia. Wheel #200x1pcs. (for HSS drill)
- 3mm & 4mm Hexagon (Hex.) wrench x1 pc. each



GRINDER GUARDS

Designed to Fit Virtually All Pedestal and Bench Grinders

- Full width protection.
- Built-in fluorescent light.
- lexan impact-resistant visor.
- Heavy gauge steel construction.
- Permanent mounting, bolts to any grinder (bench or pedestal).
- OSHA orange.



Model	Description	Price
13019	Grinder Guard fits grinders with up to 8" wheels (7" wheels on Baldor grinders)	\$495.00
13020	Grinder Guards fits grinders with 8" to 12" wheels	545.00
13021	Lexan replacement shield 27" x 9-1/2" (For Model 13019 and 13020)	120.00

KALAMAZOO BELT SANDERS MADE IN USA

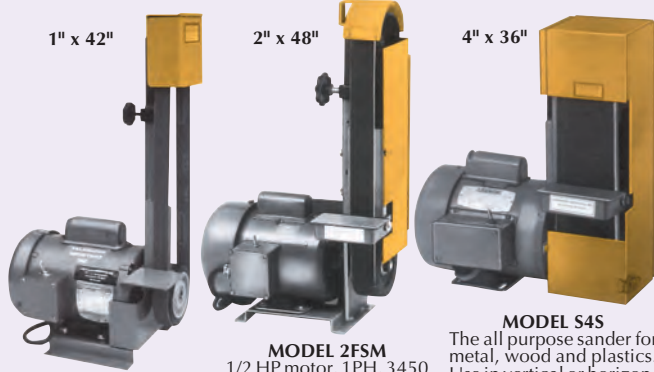

MODEL 1SM
1/3 HP motor, 1 PH, 1725 RPM. 1" x 42" belt, 4" contact wheel, tilt table. Vertical sander only. 1800 SFPM. Wt. 32 lbs.

\$279.95

MODEL 2FSM
1/2 HP motor, 1PH, 3450 RPM. 2" x 48" belt, 5" contact wheel, tilt table and removable platen. Full hinged guard for quick belt change. Vertical or horizontal position. 4500 SFPM. Wt. 48 lbs.

\$425.00

MODEL S4S
The all purpose sander for metal, wood and plastics. Use in vertical or horizontal position. 1/2 HP, 1 PH TEFC motor. 3450 RPM (1HP motor available) 4" x 36" belt with full OSHA guard, easy opening side door for belt change. Wt. 50 lbs.

\$645.00



6" x 48" BELT AND 10" DISC COMBINATION SANDER

MODEL No. W1676
List \$625.00

\$519.95



Specifications:

- Motor size: 1 HP, 110/220V, Single-phase, 3,450 RPM
- Precision ground cast iron table
- Belt size: 6" x 48"
- Disc size: computer-balanced 10" cast iron
- Belt release: Quick change
- Belt speed: 1,900 FPM
- Disc speed: 2,420 FPM
- Switch: Safety disconnect type
- Stand: Cabinet style, powder coated paint
- Power cord size: 10' x 14 Gauge
- Heavy-duty miter gauge
- Powder coated paint
- Dust ports: 2-1/2" for disc and 2" for belt
- All ball bearing construction
- Footprint: 17-3/4" wide x 15" deep
- Approx. shipping weight: 170 lbs.



Extra Accessories

Model No.	Description	Price
6036	4" x 48" A.O. Cloth Belts 36 Grit	\$4.50
6060	4" x 48" A.O. Cloth Belts 60 Grit	4.20
6080	4" x 48" A.O. Cloth Belts 80 Grit	4.50
6120	4" x 48" A.O. Cloth Belts 120 Grit	3.90
6150	4" x 48" A.O. Cloth Belts 150 Grit	3.90
6180	4" x 48" A.O. Cloth Belts 180 Grit	3.90
6240-1	4" x 48" A.O. Cloth Belts 240 Grit	3.90
1838	10" PSA Aluminum Oxide Cloth Disc 60 Grit	\$3.75

Precise 6" x 48" BELT/9" DISC BELT/DISC SANDER

- Motor: 1/2" HP, 3450 RPM.
- Belt size: 6 x 48 inches.
- Tilts and locks at any angle between 0 degrees and 90 degrees.
- Disc diameter: 9 inches.
- Table: tilts and locks between 0 degrees and 45 degrees for precision angle sanding. Removable for either disc or belt use.
- With steel stand and industrial on-off switch.



Extra 6" x 48" Sanding Belts 40 thru 320 Grit \$2.95 Each-Your Choice
Extra 9" Abrasive Discs 50-80-100 Grit \$2.75 Specify Grit

MODEL No. SB-948

\$199.95

Complete 105 Lbs.



TRADESMAN COMBINATION 6" X 48" BELT & 10" DISC FINISHING MACHINE

Jet's disc finishing machine is a versatile machine designed as an economical workshop tool. Applications include: contour sanding, flat panel sanding, deburring, grinding and finishing. The cast iron construction, as well as a host of other quality features, enhance the value of this economical machine.

- 6" x 48" belt. • 10" disc.
- Two cast iron tilting tables for mitering applications. • Removable safety key switch.
- Full access to the belt when tilted in the horizontal position.
- Dust collection shrouds on belt and disc.
- Quick-release tension mechanism makes belt changes quick and easy.
- Enclosed base protects motor from sanding dust.
- Floor stand included (some assembly required)

MODEL No. 414550K

Reg. \$899.00

\$845.00

Specifications:

Belt Size 6" x 48"
Disc Size 10"
Belt Speed 1650 SFPM
Disc Speed 2100 RPM
Motor 115v, 1 Ph., 1HP
Dust collection shrouds Standard (2)
Weight 215 lbs.



HEAVY DUTY BELT & DISC MACHINE

- 6" x 48" abrasive belt finisher (2850 SFPM) and 12" abrasive disc (1960 RPM) sander.
- Handles virtually all deburring, chamfering and finishing operations.
- Cast iron head and tables.
- Belt operates at any angle.
- Fine thread adjustment for easy belt tracking.
- Fully machined, balanced disc runs vibration free.
- Heavy duty one piece steel stand.

1-1/2 H.P. 115/230V 1 Phase
MODEL No. J-4200A
Reg. \$2299.00

\$1795.00

327 lbs.

Extra 6" x 48" Sanding Belts 40 thru 320 Grit \$2.95 Each-Your Choice
Extra 12" Abrasive Discs 50-80-100 Grit \$2.95 Specify Grit



COMBINATION DISC/BELT SANDER 12" Disc ~ 6" x 48" Belt ~ 1-1/2 H.P.

- This Heavy-Duty Combination Sander uses a 6" x 48" belt, a 12" disc, and a 1-1/2 HP motor to tackle your toughest sanding operations.
- Uses a direct ball bearing drive from the motor to the sanding disc and belt to deliver a maintenance and vibration free positive torque flow.
- For increased sanding versatility and control, both cast iron tables accept the miter gauge.

MODEL No. W1712
List \$815.00

\$645.00

Specifications:

- Motor: 1-1/2 HP, 110V, 12A, Single-phase, 1,725 RPM
- Tables: Precision ground cast iron (2)
- Sanding belt size: 6" x 48"
- Disc size: 12" (Disc is computer balanced)
- Belt release: Quick change
- Sanding belt speed: 878 FPM
- Disc speed: 1,725 RPM
- Switch: ON/OFF toggle with safety key
- Stand: Cabinet style, powder coated paint
- Heavy-duty miter gauge
- Powder coated paint
- Dust ports: 2" and 2-1/2"
- Bearings: Shielded ball bearing construction
- Approximate shipping weight: 178 lbs.





DISC SANDER 12" 1 H.P., TEFC Direct Drive Motor

- Specifications:**
- Precision-ground cast iron table
 - Ball bearing construction
 - Miter gauge included
 - 6' power cord
 - Safety key operated switch
 - 2" dust port
 - Motor size: 1 HP, 110V

- Motor speed: 1,725 RPM
- Disc size: 12"
- Table tilt: 0-45°
- Table size: 17-1/2"W x 8-1/4"D
- Footprint: 13"W x 10"D
- Overall height: 13-1/2"
- Approximate shipping weight: 74 lbs.

MODEL No.
W1828
List \$360.00

\$275.00



Model No.	Description	Price Each
52421	12" Coated Aluminum Oxide Coated PSA Disc 60 Grit	\$4.00
52441	12" Coated Aluminum Oxide Coated PSA Disc 80 Grit	3.95
52461	12" Coated Aluminum Oxide Coated PSA Disc 1000 Grit	3.95

* Sold 2 per Pack and are priced each

BURR KING

1-1/2" x 60" ABRASIVE BELT GRINDER

- Belt speed 8000 units.
- Steel backup platen.
- Adjustable work rest.
- Contact wheel grinding.
- Contour and loose belt grinding.
- Rear wheel quick change for quick belt replacement.
- Belt tracking adjustment.
- Positive belt tracking.

MADE IN
USA

Model No.
70100-1



Model	Description	Weight	Price
70100-1	1-1/2 HP Motor, 115/230V, 1Ph.	90 lbs.	\$2095.00
70300*	1-1/2 HP Motor, 230/460V, 3Ph.	90 lbs.	2675.00
70500*	2 HP Motor, 230/460V, 3Ph.	97 lbs.	2695.00
70700*	3 HP Motor, 230/460V, 3Ph.	108 lbs.	2795.00
746A	Pedestal with adapter plate	65 lbs.	325.00

Optional radius & internal grinding attachment

Model	Width	Wheel Size	Weight	Price
1400-1	1/2"	7/16, 5/8, 1 & 1-1/2"	8 lbs.	\$550.00
1411-2	1"	9/16, 5/8, 1 & 1-1/2"	8 lbs.	578.00
1412-2	2"	9/16, 5/8, 1 & 1-1/2"	8 lbs.	578.00

* Includes Magnetic Starters for 3 Phase Machines

KI KALAMAZOO INDUSTRIES 2"x 72" MULTI PURPOSE SANDER

- Multi purpose sander for grinding, shaping, contouring, flat work, angles, snagging and roughing.
- Platen rotates 360 degrees for many different shapes and styles of sanding.
- Versatile for quick change contact wheel with various angles easy to change.

MODEL No. S272
2"x72" Sander Only
5400 SFPM
1 HP 3450 RPM

\$1,525.00

MODEL No. S272S
Same As Above
With Heavy Duty
Stand Legs

\$1,695.00

MODEL No. S272V
As Shown With
DVC-6 Dust
Collector

\$2,650.00

No. S272V
(Shown)



Manual Switch.
5400 SFPM.
2"x 72" belt.
1HP, 3450RPM motor, available in 1Ph or 3Ph.
1-1/2" and 3" contact wheels standard on machine.
5" and 8" diameter contact wheel optional.
#CW5 or #CW8 8"x 5" tilting cast iron table with slot.



DISC SANDER 15" WITH BRAKE

- The large tilting cast iron table and rigid disc platen produce true, flat edges from 45° to 90°

Specifications:

- Motor: 1-1/2 HP, 220V, single phase, 12A, 1725 RPM.
- Disc: 15" PSA
- Table tilt: +15 to -45°
- Precision ground cast iron table.
- Table size: 20"W x 12"D
- Floor to table height: 37"
- Ball bearing construction.
- Powder coated paint.
- Safety switch with disabling key.
- Dust port: 2-1/2"
- Footprint: 26"W x 20-1/2"D
- Overall height: 46"
- Approx. shipping weight: 221 lbs.



Cabinet Stand with
Storage Shelving



Dual Miter Cast
Iron Table

MODEL No.
W1815
List \$1330.00

\$1050.00



BALDOR 2" x 48" HEAVY DUTY STATIONARY ABRASIVE BELT GRINDER

- Excellent for flat surfacing, chamfering, rounding or squaring.
- 1-1/2 Hp, 115/230 volts, 1 Ph. motor for extra-high torque.
- Totally enclosed, fan-cooled, ball-bearing, construction.
- Grinding rate of 3600 idle RPM's.
- Belt tracking by manual adjustment.
- 7" diameter serrated contact wheel.

Non Pivotal
MODEL No.
2048-151
Reg. \$1585.00

\$1,395.00

Pivotal
3 Positions
MODEL No.
2048-151TD
Reg. \$1733.00

\$1,550.00

MADE IN
USA



FULL
3 YEAR
WARRANTY

KI KALAMAZOO 4" BELT SANDER WITH BUILT-IN DUST COLLECTOR

- All purpose sander for metal, wood and plastics. Use in vertical or horizontal position. 1/2HP, 1Ph TEFC motor. 3450 RPM (1 HP motor available). 4"x36" belt with full OSHA guard, easy opening side door for belt change.
- With dust collector, cord and switch. Weight 120 lbs.

MODEL No.
S4SV
With 1/2H.P. Motor
OSHA Guard & Dust
Collector

\$1,195.00

MODEL No.
S4SV-1
With 1H.P. Motor
OSHA Guard & Dust
Collector

\$1,350.00

4" x 36" Abrasive Sanding Belts
50, 80 & 100 Grit (Specify Grit)
\$4.95





TOOL POST GRINDER KITS



Features:

- Equipped with grease sealed for life ball bearings; no lubrication required.
- Mount on any machine tool. Although used principally on lathes, exclusive features make THEMAC grinders a natural for mounting on shapers, planers, etc. Units can be operated in vertical or horizontal position.
- Eccentric spindle tube (THEMAC exclusive) provides for positive manual belt adjustment, assuring proper belt tension at all times.
- The circumferentially adjustable grinding spindle (THEMAC exclusive) can be locked and operated in any position within range of adjustment.

Included With Grinders!

- 1- Extension spindle for external grinding with 2 each wheel collars, 1 and 2"
- 1- Extension spindle for internal grinding with arbor, 2 wheel collars and 3/4 to 1-1/4" range
- *1 Chuck extension spindle with 1/8" collet
- *1 Diamond dresser
- 1- Wheel guard
- 1- Belt guard
- 1- Wrench set
- 1- Set of pulleys
- 1- Bets set
- 1- Carrying case
- 1- T-bolt clamp
- 1- cord with 3 prong grounding plug

* Not Included on Model J-40



MEDIUM DUTY EXTERNAL GRINDING

Accessories Included:

- 3 grinding wheels.
 - 5 x 3/8 x 1/2"
 - 3 x 1/2 x 1/2"
 - 2-12 z 1/2 x 1/2"
- 2 wheel collars - 1" & 2"

Recommended for Lathes with a 12 - 15" Swing

MODEL No. J-40*

\$1995.00

Specifications:

Motor	1/2 HP, 115V, AC-DC
Speed Range	4,200 - 9,000 RPM
Max. wheel capacity	5"
Machine weight	20 lbs.
Shipping weight	25 lbs.

MEDIUM DUTY INTERNAL & EXTERNAL GRINDING

Accessories Included:

- 2 grinding wheels.
 - 4 x 3/8" x 3/8", 2 x 3/8" x 3/8"
- 3 mounted wheels
 - 1/4 x 1/4 x 3/8", 2 x 3/8 x 3/8", 1 x 1/4 x 1/4"
- 2 recessed wheels
 - 3/8 x 1/4 x 1/8", 3/4 x 1/4 x 1/8"

Recommended for Lathes with a 9 - 13" Swing

MODEL No. J-35

\$2195.00

Specifications:

Motor	1/3 HP, 115V, AC-DC
Speed Range	5,500 - 45,000 RPM
Max. wheel capacity	4"
Machine weight	16 lbs.
Shipping weight	22 lbs.

MEDIUM DUTY INTERNAL & EXTERNAL GRINDING

Accessories Included:

- 4 grinding wheels.
 - 5 x 3/8 x 1/2", 2-1/2 x 1/2 x 1/2"
 - 4 x 1/2 x 1/2", 1-1/2 x 1/4 x 1/4"
- 3 mounted wheels
 - 1/4 x 1/4 x 1/8", 1 x 1/4 x 1/4"
 - 1/2 x 1/4 x 1/8"

Recommended for Lathes with a 12 - 15" Swing

MODEL No. J-45

\$2650.00

Specifications:

Motor	1/2 HP, 115V, AC-DC
Speed Range	4,200 - 42,000 RPM
Max. wheel capacity	5"
Machine weight	20 lbs.
Shipping weight	25 lbs.

HEAVY DUTY INTERNAL & EXTERNAL GRINDING

Accessories Included:

- 4 grinding wheels.
 - 6 x 1/2 x 3/4", 2-1/2 x 1/2 x 1/2"
 - 4 x 1/2 x 1/2", 1-1/2 x 1/4 x 1/4"
- 3 mounted wheels
 - 1/4 x 1/4 x 1/8", 1 x 1/4 x 1/4"
 - 1/2 x 1/4 x 1/8"
- 2 wheel collars - 2-1/2"

Recommended for Lathes with a 13" Swing or Larger

MODEL No. J-7

\$3295.00

Specifications:

Motor	1 HP, 115V, AC-DC
Speed Range	3,900 - 27,000 RPM
Max. wheel capacity	6"
Machine weight	34 lbs.
Shipping weight	56 lbs.



KALAMAZOO 6" BELT SANDERS

6" x 48" & 6" x 60"



- 3 HP motor.
- Manual switch.
- Reversible platen till work table.
- 6" x 48" belt & 6" x 60" belt.
- Variable position.
- Direct drive (coupling)
- Cast iron frame.
- Quick belt release.
- Full safety guard.
- Heavy duty steel stand.
- With Vacuum system.

6" x 48"
3H.P., 1Ph, 220/440V
MODEL No. S6MV-1

\$2495.00

6" x 48"
3H.P., 3Ph, 220/440V
MODEL No. S6MV-3

\$2495.00

6" x 60"
3H.P., 1Ph, 220/440V
MODEL No. S660MV-1

\$2595.00

6" x 60"
3H.P., 3Ph, 220/440V
MODEL No. S660MV-3

\$2595.00



KALAMAZOO 6" X 48" BELT SANDER & 12" DISC SANDER COMBINATION



Belt Machine Features:

- 6" x 48" belt.
- 2,800 SFM.
- 6" x 10" table.

Disc Machine Features:

- 12" aluminum disc.
- 2,500 RPM
- 8" x 14" cast iron table.

Belt & Disc Combo Without Dust Collector

3H.P., 3Ph, 220/440V
MODEL No. S612-3

\$2275.00

Belt & Disc Combo Without Dust Collector

3H.P., 1Ph, 110/220V
MODEL No. S612-1

\$2175.00

Belt & Disc Combo With Dust Collector

3H.P., 3Ph, 220/440V
MODEL No. S612V-3

\$2350.00

Belt & Disc Combo With Dust Collector

3H.P., 1Ph, 110/220V
MODEL No. S612V-1

\$2350.00

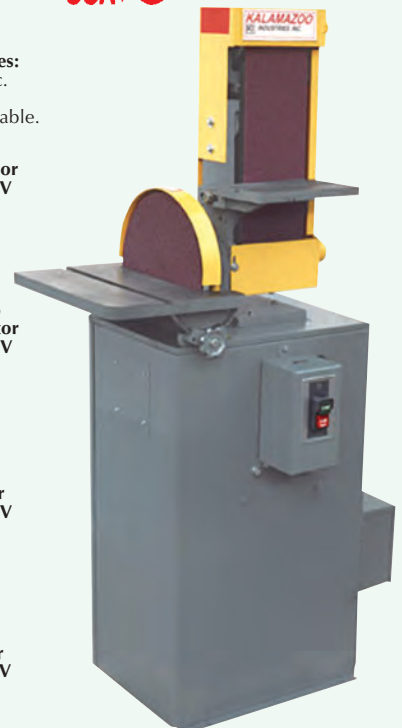



CUT-OFF SAWS With Baldor Heavy Duty Motor

Features:

- Economical saw for very shop
- Rugged cast iron base, trunnion and overam.
- Wheel arbor, sealed ball bearing.
- Adjustable work length stop and down stop.
- Manual switch.
- Abrasive wheels not included.



Double Reinforced
Cut-Off Wheels



MODEL
K10B
(Shown)

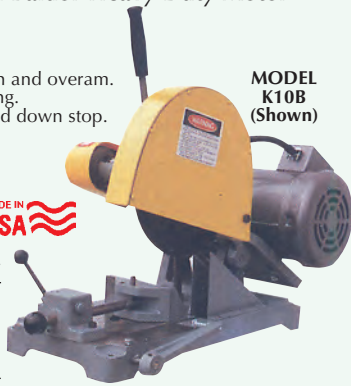

Model	Size	Price
7004-1	7" x 1/16" x 1/2"	\$ 4.50
8004	8" x 1/16" x 1/2"	5.75
1006-1	10" x 3/32" x 5/8"	7.95
1206	12" x 3/32" x 1"	9.75
1406-1	14" x 3/32" x 1"	13.50

Model No.	Blade Size	Capacity Solid	Spindle R.P.M.	Motor H.P.	Weight lbs.	Sale Price
K7B	7" x 1/16" x 1/2"	1" x 2"	4800	1 H.P.	75	\$ 650.00
K8B	8" x 1/16" x 1/2"	1-1/2" x 2"	4900	3 H.P.	90	775.00
K10B	10" x 3/32" x 5/8"	1-1/2" x 2-1/2"	3450	3 H.P.	110	925.00
K12B*	12" x 1/8" x 1"	2-1/2" x 3"	4400	5 H.P.	205	1995.00
K12SS*	Same as above	with Floor Stand			280	2175.00
K14*	14" x 1/8" x 1"	14" x 18" x 1"	4400	5 H.P.	210	2025.00
K14SS*	Same as above	with Floor Stand			290	2095.00

*3 Phase 220V or 440 V (Specify)



10" & 14" MITER CUT-OFF SAWS

10" Model Features:

- 3 HP, 1 PH or 3 PH - less wheel.
- 5/8" spindle-ball bearing.
- Angles 0° to 45° either way.
- Positive index holes.

- Up and down stops.
- 2 camlock vise.
- Lever lock for table.
- 1-1/2" solid to 2-1/2" pipe capacity.

10" MODEL No.
KM-10

\$1295.00

Specify:
1 Phase
110V/220V
or 3 Phase
220V/440V



14" MODEL No.
KM-14

\$2950.00

3 Phase 220/440V

14" Model Features:

- 5 HP, 3Ph 200/440V - less wheel.
- 1" spindle.
- Angles 0° to 45° either way.

- Front lever lock.
- Heavy duty stand.
- 2-1/2" solid to 3" pipe capacity.
- Single phase 220V also available.



PIVOT ARM COLD SAWS

STANDARD FEATURES:

Designed for quick, clean and accurate cutting of carbon steel, stainless steels and other ferrous materials. All saws are equipped with manual saw head and vise, material stop, flood coolant with pump and IP55 control handle.

SPECIAL FEATURES:

Model PCS-225 features 1 HP, 1-Phase, 110V motor with 50 RPM blade speed and 45° left miter cut.

Model PCS-250 features 1 HP motor available in 1 or 3 phase, metal base with coolant tank, 45 RPM blade speed along with anti-burr clamp and 45° left miter cut.

Model PCS-315 features 30 & 60 RPM blade speed. Metal base with coolant tank helical gears in an oil bath, quick release vise system and anti-burr clamp with 45° left and right miter cut and material support roller.

Specifications	Bench Type	Floor Type	Floor Type
Model	PCS-225	PCS-250	PCS-315
Maximum Blade Diameter	9"	10"	14"
Motor HP	1	1	2/3
Speeds	50	45	30/60
Weight	83 lbs.	155 lbs.	465 lbs.
Sale	\$939.95	\$2250.00	\$4995.00

Model	90°	45°	90°	45°	90°	45°	90°	45°
PCS-225	1"	1/2"	2-1/2"	2"	2-1/4"	2-1/4"	2-1/2" x 2"	1-1/2" x 1"
PCS-250	1/2"	3/4"	2-3/4"	2-1/2"	2-1/4"	2"	3-1/2" x 1-3/4"	2-3/4" x 1-3/4"
PCS-315	2"	1-1/2"	4-1/2"	4"	4"	3-1/3"	5-1/8" x 3-1/8"	3-1/3"

Note: Replacement Blades Available (Inquire)

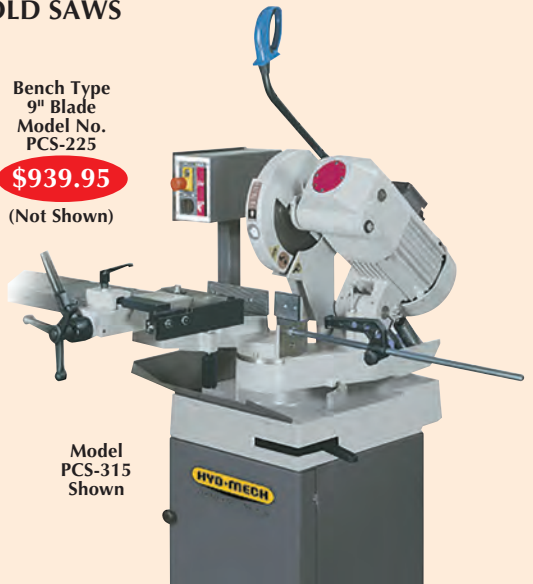

Bench Type
9" Blade
Model No.
PCS-225

\$939.95

(Not Shown)

Model
PCS-315
Shown



ZIP MITER BANDSAW 7" & 8-3/4"

- Adjustable hydraulic feed system.
- Eccentric shaft, ball bearing.
- heavy-duty cast iron saw head and sturdy base.
- Mitering capability to 60°.
- Convenient control panel.

7"
MODEL No.
414464

\$2750.00

8-3/4"
MODEL No.
414467

\$3850.00

Model No.	414464	414467
Cutting Capacity		
Round at 90° (in.)	7	8-3/4
Round at 45° (in.)	4-1/2	6-1/4
Round at 60° (in.)	2-3/4	3-1/2
Rectangle at 90° (in.)	8-7/8 x 6	9-3/8 x 4-1/2
Rectangle at 45° (in.)	4-7/8 x 4-5/16	6-1/8 x 4-1/2
Rectangle at 60° (in.)	2-3/4 x 2-3/4	3-1/2 x 3-7/8
Blade Size (in.)	3/4 x .035 x 82	3/4 x .035 x 96-1/2
Blade Wheel Dia. (in.)	10-1/2	11-5/8
Blade Speeds (SFPM)	137, 275	1 x .035 x 96-1/2
Blade Height (in.)	35-7/8	38-7/16
Motor	1HP, 230V, 3Ph	1.5HP, 230V, 3Ph
Net Weight	375	476



COMBINATION 6" BELT AND CHAMFERING MACHINE

6" Belt Sander

- Contour finishing, mitering, flat finishing just to name a few applications.

Chamfering

- Easily adjustable chamfering machine manages additional finishing jobs such as: beveling and deburring on flats and squares of ferrous and non-ferrous materials.

Belt Machine

Belt size (in./W x L)	6" x 48"
Belt speed (SFPM)	2850
Table size (in.)	7-3/8" x 14-3/4"
Table tilt	450 out, 20° in
Miter gauge groove (in.)	3/8" x 3/4"
Motor	1-1/2HP, 115/230V, 1Ph
Platen (in.)	6-1/4" x 14-3/4"

Chamfering Machine

Min. length of workpiece (in.)	3.5
Max. cut at 45° (in.)	1/4"
Max. cut at 15° (in.)	3/16"
Bevel angle	15-45°
Inserts	3" milling cutter head with 8 replaceable carbide inserts

Overall dimensions (in./W x D x H)	25-1/2 x 19 x 57-1/2 (width when belt is in horizontal position)
Net weight (lbs)	250



Combination
Belt & Chamfering
MODEL No.
4500

Reg. \$1905.00

\$1695.00



METAL CUTTING BAND SAW 4" x 6" Horizontal and Vertical

This economical, portable, easy-to-use, 3-speed bandsaw is an excellent choice for small or large projects where you must cut a variety of metals, plastics, or wood. When the vertical cutting attachment is installed, the saw is able to make vertical cuts for your unique cutting requirements.

MODEL No.
W1715
List \$445.00

\$349.95



Specifications:

- Blade included
- Automatic shutoff
- Three cutting speeds
- Ball bearing construction
- Vertical cutting attachment
- Handles and wheels for portability
- Motor: 3/4 HP, 110V, single-phase 1,725 RPM
- Max. cut (round stock) dia.: 4-1/2"
- Max. cut (rectangular stock): 4" x 6"
- Blade speeds: 78 FPM @ 40 RPM, 108 FPM @ 60 RPM, 180 FPM @ 80 RPM
- Blade size: 64-1/2" x 1/2" x 0.025"
- Approx. shipping weight: 139 lbs.



Starrett
Premium Blades
1/2" x .025" x 64-1/2"
No. BSB-1264
\$11.95 Each
6, 8, 10 or 12 T.P.I.



SWIVEL HEAD 5" X 6" METAL CUTTING BAND SAW

A bandsaw is a must for any metal shop, and with three speeds, an automatic shut off, and ball bearing blade guides, this bandsaw comes equipped with many important performance features. As an added feature, it has a swiveling headstock so there is no fussing with establishing the cut angle at the vise! Just set the workpiece length, and swivel the headstock to an angle between -45° to +60° and make the cut.

- Motor: 1/3 HP, 110V/220V, Single-phase, 60Hz, 1720 RPM
- Amps: 7 @ 110V, 3.5 @ 220V
- Drive: V-belt
- Transmission: sealed worm gear
- Max. capacity rectangular @ 0°: 5" x 6"
- Max. capacity circular @ 0°: 5"
- Max. capacity rectangular @ ±45°: 2-15/16" x 3-3/4"
- Max. capacity circular @ ±45°: 3-3/4"
- Max. capacity rectangular @ +60°: 1-3/4" x 2-3/16"
- Max. capacity circular @ +60°: 1-3/4"
- Blade speeds: 80, 120, 200 FPM
- Overall height: horizontal 42-1/2"; vertical 54-3/4"
- Floor to table height: 29"
- Overall width: 23-3/8"
- Overall length: 39"
- Overall bed: 19-1/4" x 13-1/2" x 3"
- Footprint: 26-1/2" x 20-1/2"
- Angular cuts: -45° to +60°
- Blade size: 64-1/2" x 1/2"
- All ball bearing drive wheel and blade guides
- Approximate shipping weight: 176 lbs.

MODEL No.
M1013
List \$1050.00

\$839.95

Extra Blades
No. 3S-1264
\$11.95
6, 8, 10 or 12 TPI



18" VERTICAL METAL CUTTING BAND SAW

A variable frequency drive speed control with digital readout that provides infinitely variable blade speeds for any metal cutting application. Just turn the speed control dial for on-the-fly speed changes. Inverter motor technology takes advantage of 3-phase control using 220V, single phase power. The vertical cutting configuration also makes feeding the work through the band saw for intricate cuts easy with plenty of control against the massive cast iron table. This Vertical Metal Cutting Band Saw is the ideal band saw for any metal fabrication work.

Features:

- Variable frequency drive speed control
- Left and right table tilting control
- Upper and lower blade guides
- Rack and pinion adjustment on upper blade guide support
- Precision-ground cast iron table
- Fully balanced cast aluminum wheels with rubber tires
- Quick-release blade tension
- Steel guide blocks
- Two dust ports
- Wheel brush on lower wheel
- Upper blade guide scale with magnified cursor
- Twin drive belts
- Includes rip fence and miter gauge

MODEL No.
M1113
List \$2610.00

\$1995.00

Specifications:

- Motor: 1-1/2 H.P., 220V, 1 Ph, 1725 RPM, 5.1 Amps.
- Maximum cutting height: 12"
- Throat capacity: 17- 1/2"
- Blade length: 133"
- Blade size range: 1/8" - 1-1/4"
- Blade speed: variable, 150 - 3000 FPM
- Table tilt: 45° right, 10° left
- Floor to table height: 37- 1/4"
- Table size: 18" x 24"
- Overall Dimensions: 76"H x 47"W x 26"D
- Approx. shipping weight: 375 lbs.

Bi-Metal Extra Blades
133" x 1/2", 3/4" or 1" Wide: .032" Th.
Any T.P.I. \$49.50 ea.



9" x 16" HORIZONTAL BANDSAW

- Features 3 ball bearings per side on the blade guides for optimal control and accuracy.
- Both blade control arms are adjustable allowing them to be positioned as close to the cut as possible.
- Chip tray, hydraulic downfeed, coolant pump, nozzle, work stop and hinged blade-wheel doors for easy access.



MODEL No.
M1054
List \$4665.00

\$3450.00

Features:

- Centralized control panel on top of saw bow.
- Heavy-duty, all steel, one-piece base.
- Adjustable hydraulic down-feed - just dial your feed rate on the control panel.
- Max. capacity rectangular @ 90 degrees: 5" x 10"
- Quick release vise for fast job changes.
- Blade wheels have heavy-duty ball bearings.
- Magnetic safety switch. • Miter cutting ability.

Specifications:

- Motor size: 1-1/2 H.P., 220V, single phase.
- Blade size: 1-1/16" x .035" x 121-1/2"
- Blade speeds: 114, 196, 288, 377 FPM
- Max. capacity rectangular @ 90 degrees: 5" x 10"
- Max. capacity round @ 90 degrees: 10"
- Max. capacity rectangular @ ±45 degrees: 7" x 9-3/8"
- Max. capacity round @ ±45 degrees: 6"
- Miter cutting capacity: 45 degrees • Approx. shipping weight: 733 lbs.



METAL CUTTING BAND SAW 7" X 12"

- Great for production shops, this 7" x 12" Metal Cutting Bandsaw can handle larger jobs and features rectangular and circular cutting capacities, angle cutting ability, four blade speeds, internal coolant system, quick setting vise, hydraulic down feed control and automatic shut-off.
- Wheels and a handle add mobility for even greater convenience.

Features:

- Automatic shutoff
- Hydraulic feed control
- Quick positioning vise
- Coolant system
- Chip Tray
- Includes blade & vertical saw table

MODEL No.
M1014
List \$1495.00

\$1175.00

Made In
ISO 9001 Factory



Specifications:

- Motor: 1 HP, 110V/220V, single-phase, previred 110V
- Blade size: 93" x 3/4"
- Max. capacity circular @ 90°: 7"
- Max. capacity rectangular @ 90°: 7" x 12"
- Max. capacity circular @ 45°: 5"
- Max. capacity rectangular @ 45°: 4-3/4" x 4-1/2"
- Blade speeds: 80, 130, 180, 235 FPM
- Overall dimensions: 48"L x 16"W x 37-5/8"H
- Footprint: 13" x 38"
- Coolant capacity: 1-1/2 gal.
- Approximate shipping weight: 330 lbs.



Top Tech® MITRE SWIVEL HEAD BAND SAW
Machine & Tools 7" x 12" Horizontal/Vertical and Coolant System

- New Tru-Lock rapid vise swivels 45°
- Leveling pads for stability
- Built-in coolant system.
- Rapid approach vise.
- Roller cabinet.
- Automatic shut-off
- Blade guides-roller.
- Bearing solid adjustable.
- Band tension adjustment.
- Blade chip brush, safe guards and vertical saw table.
- The head swivels 45° to the right
- Supplied with Bi-metal blade.

Specifications:

Blade Speeds: (4) 90, 135, 195, 255 (F.P.M's)
Motor & Electricals: 1 H.P., 110V
Blade Size: 93" x 3/4" x .032"
Weight: 418 lbs.

Cutting Capacity	
90°	7"
	7" x 12"
±45°	5"
	4-3/4" x 4-7/8"

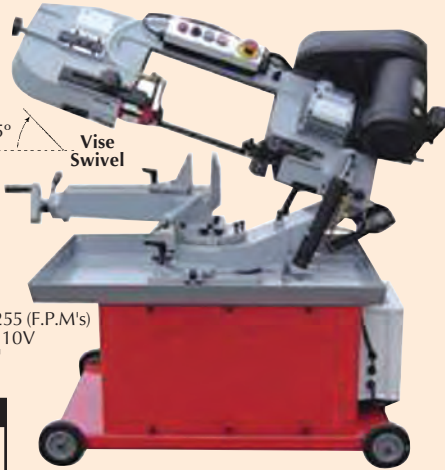

MODEL No. BS-712R
Reg. \$1695.00 **\$1495.00**

Top Tech® HORIZONTAL BAND SAW
Machine & Tools 7" X 12" WET CUTTING

- Quick acting vise which allows angle cutting to 45°.
- Recirculating coolant system.
- Automatic shut-off when cut is complete.
- Hydraulic feed system.

Starrett

Flexible Back Blades
No. 16442 6 TPI \$18.95
No. 15926 10 TPI \$18.95
Bi-Metal Blades
No. 14283 14 TPI \$39.95

Specifications:

Blade Speed (4) 85, 130, 130, 180, 285, FPM
Max Cutting:
● Round 7.2"
■ Square 7.2" x 12.2"
Blade Size: 93" x 3/4" x .032"
Motor: 1 H.P. 110/220V, 1 Ph
(Pre-wired 220V, 1 PH)



MODEL No. TSG-5018
Reg. \$1395.00
\$1195.00

JET EQUIPMENT & TOOLS 7" x 12" HORIZONTAL/VERTICAL BANDSAW W/COOLANT SYSTEM

- UL listed motor.
- Heavy cast iron bow and bed.
- Hydraulic downfeed for ease of cut
- Vertical worktable.
- Hardened and ground worm gear.
- Roller cabinet with builtin chip tray.
- Automatic shut-off after cut.

MODEL No. 414459
Reg. \$1649.00

\$1295.00 **2 YEAR WARRANTY**



LENOX Bi-Metal Blades M-42
93" x 3/4" x .035" Vari-tooth
6-10 TPI, 8-12 TPI, 10-14 TPI
No. LEN-035 \$29.95 Each (Specify)

Specifications:

Cutting Capacity:
Round at 90° 7"
Round at 45° 4-1/2"
Rectangle at 90° 7" x 11"
Rectangle at 45° 5" x 4-1/2"
Throat Depth 7"
Vertical Worktable 9-3/8" x 10"
Vise Swivels 45°
Blade Size 3/4" x .035 x 93"
Blade Speeds (SFPM) 80, 130, 180, 285
Blade Wheel Dia. 11-3/4"
Bed Height 23"
Motor: 3/4HP, 115/230V, 1Ph, Prewired 115V
Floor Space Required:
20-1/2"L x 49-1/2"W x 38"H
Net Weight 330lbs.

ARFA BY RONG FU 10" x 18" BAND SAW
HORIZONTAL WITH HYDRAULIC FEED

- Hydraulic cylinder.
- Built-in coolant system.
- Heavy duty cast iron working table.
- Quick positioning vise.
- Hardened & ground worm gears.
- Band tensioning adjustment.
- Blade chip brush, safe guards.
- Automatic shut-off.



4-Speed
MODEL No. RF-1018B
\$3495.00

Specifications:

Cutting capacity 10" round
10" x 18" square
10" x 12" angular
Blade size 1" x 0.037"x121-5/8"
Blade speeds 114,296,288,377 FPM
Variable speeds . . . 95 to 402 FPM
Motor 2 HP/220V/3Phase
Weight 682 lbs.

JET EQUIPMENT & TOOLS 14" VERTICAL METAL/WOOD COMBINATION BAND SAW

- Wilton's 14" Vertical Band Saws are specially designed to effectively cut a variety of materials including wood, plastic, bakelite, composites, ferrous and non-ferrous metals.
- Versatile and dependable, these premier saws are capable of contour cutting, straight cutting and resawing. • The saws can also cut delicate curves in both thick or thin stock.

Standard Features:

- Cast iron frame.
- Mitre gauge.
- Dust chute
- Solid, one piece steel base for extra stability
- Conveniently located on/off switch.
- Saw blade.

Specifications:

Motor 1 HP, 115V, 1PH.
Blade Speed: Model No. 8201K
39, 57, 107, 196, 278, 3300 SFPM
Model No. 821VS vari speed 90 to 3300 SFPM
Blade Size 92-1/2" x 3/8" x .025"
Weight 234 lbs.
Capacity 6" Underguide
. 12" with 6" Riser
. 13-1/2" Blade to Frame

Optional:

No. 80217 Rip Fence \$79.95	No. 80218 6" Riser Block \$84.00	Variable Speed MODEL No. 8201VS Reg. \$2099.00	6-Speed MODEL No. 8201K Reg. \$1699.00
No. 80219 92-1/2"x 3/8"x .025" Blades \$14.95		\$1795.00	\$1195.00



ACER REPLACEMENT MILLING HEAD WITH TROUBLE FREE INVERTER DRIVE

- Specify Bridgeport gray or ACER Beige color!
- Electrical Cabinet With Inverter & Resister Included.
- Made in Taiwan.
- 420 lbs
- Add \$400 for 440V for all models.
- Add \$65 for Adjustment Gear if other than ACER Machine

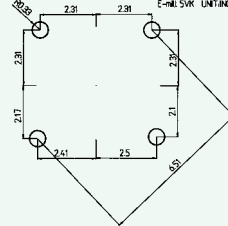

40NST Spindle
0-3650 RPM
5-H.P.
MODEL No. MO360
Reg. \$4500.00

\$3295.00

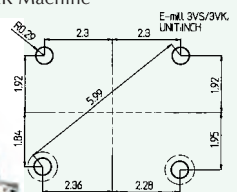

R-8 Spindle
0-4500 RPM
3-H.P.
MODEL No. MO380
Reg. \$4500.00

\$3850.00



HORIZONTAL BANDSAW 7" x 12" & 7" x 11"

- Cuts metal and more.
- 3/4" blade standard.
- Hydraulic descent.
- Direct drive.
- Blade tension device.
- **Single mitering (Model 712MS)**
- Horizontal and vertical cutting capabilities.
- Manual controlled descent.



MODEL No. BS-712MS (Shown)

Model	BS-712M	BS-712MS
Blade Size	3/4"	3/4"
Motor	1 HP, 110V	1 HP, 110V
Blade Speed	125', 215', 270/min	125', 215', 270/min
Mitering	Vise	Head Swivel
Weight	318 lbs.	396 lbs.
Cutting Profile		
Degrees	90/45	90/45
Round	7"x4.33"	7"x4.13"
Square	7"x4.33"	7"x4.13"
Rectangle	7" x 11"	7" x 10.23"/4.72 x 4.13"
Vertical	11.75"	11"
Price	\$1695.00	\$2195.00



HORIZONTAL BANDSAWS 13-1/2" And 16"

- Manual Model BS-916M**
- Cuts metal and more.
 - 1" Blade standard.
 - Hydraulic descent.
 - Automatic shut-off.
 - 4 Blade speeds.
- MODEL No. BS-300M**
- Cuts metal and more.
 - 1" Blade standard.
 - Hydraulic vise, feed & return
 - Automatic shut-off.



MODEL No. BS-300M (Shown)

Model	BS-916M	BS-300M
Blade Size	1".035"/119.48"	1".035"/129.92"
Blade Speed	82', 132', 170', 235'/min.	66', 131', 167', 233'/min.
Blade Tension Device	Yes	Yes
Motor	1.5 HP, 220V, 1 Phase	2 HP, 220V, 1 Phase
Length	67"	70"
Weight	660 lbs.	800 lbs.
Cutting Profile		
Degrees	90/45	90/45
Round	8.85"/6.5"	9.84"/7.5"
Square	8.85"/6.5"	9.84"/7.5"
Rectangle	8.86" x 13.5"/8.86" x 6.5"	9.84"/16.33"/7.48"
Price	\$3595.00	\$4395.00



HORIZONTAL BANDSAWS Single Swivel Mitering

- Cuts metal and more.
- 1" blade standard.
- Hydraulic and manual feed.
- Variable speed DC motor.
- Single mitering (swivel)
- Direct drive.
- Quick vise feature.
- Blade tension device.



MODEL No. BS-250M (Shown)

Model	BS-210M	BS-250M
Blade Speed	1"	1"
Variable Speed	66'-280'/min.	66'-280'/min.
Motor	1.5 HP, 110V	2 HP, 110V
Mitering	Single Swivel	Single Swivel
Weight	344 lbs.	475 lbs.
Cutting Profile		
Degrees	90/45/60	90/45/60
Round	6.99"/4.72"/2.75"	8.93"/5.90"/3.54"
Square	6.69"/4.33"/2.36"	8.66"/5.70"/3.54"
Rectangle	8.26" x 6.69"	10.23" x 4.33"
Price	\$2450.00	\$3225.00



HORIZONTAL BANDSAW 13" x 20" Capacity with 45° Mitering Head

- Cuts metal and more.
- 1-1/4" blade standard.
- Hydraulic.
- Variable-speed.
- Automatic shut-off.
- Quick vise feature.
- Manual controlled descent.
- Blade Tension Device.

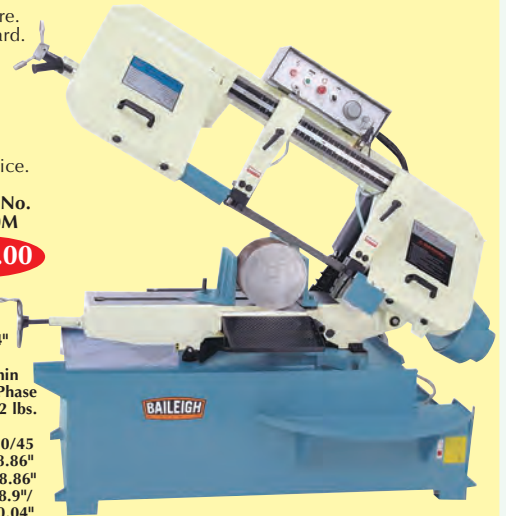

MODEL No. BS-330M

\$9650.00

- Specifications:**
- Blade size 1-1/4"
 - Variable blade speed- 66'-264'/min
 - Motor . . . 3HP, 220V, 3-Phase
 - Weight 1322 lbs.
- Cutting Profile**
- Degrees 90/45
 - Round 13"/8.86"
 - Square 13"/8.86"
 - Rectangle 13"x18.9"/11.02"x10.04"

Precise ADJUSTABLE ROLLER TABLES

- All heavy gauge steel welded construction.
- Galvanized steel ball bearing rollers.
- Non-marring floor pads.



871-510



871-512

Model No.	Roller Width	Height Adjustment	Weight Capacity	Price Each
871-512	16"	26"-43"	175 lbs.	\$ 79.95
871-510	16"	22"-38"	900 lbs.	125.00



16" GEAR HEAD DRILL PRESS

- To reduce flexing this gear head drill press uses an ample column with a diameter of 4"
- The gear head also can be adjusted up or down on the column.
- The transmission offers multiple speeds that are perfect for drilling and tapping an array of different materials.
- The DP-1000G comes standard with a halogen light and protective guarding.



MODEL No. DP-1000G

\$2095.00

- Specifications:**
- Drill Capacity: 1"
 - Tapping Capacity: m16
 - Spindle Speed: 130 - 2348 rpm
 - Spindle Travel: 5.3"
 - Table Dimensions (L/W): 19.75" / 13.75"
 - Base Dimensions (L/W): 15.5" / 19.5"
 - Motor: 1.5 HP
 - Power Requirements: 110 volt
 - Shipping Dimensions (L/W/H): 66" / 23" / 29"
 - Shipping Weight: 750 lbs

JET EQUIPMENT & TOOLS 5" x 6" HORIZONTAL/VERTICAL BAND SAW

Features:

- Motor 1/2 HP, 115/220V 1 Ph
- 3 Blade speeds
- 80/120/200 SFPM
- Auto shut off after cut.
- Pre-wired UL listed motor.
- 115 lbs.
- Exclusive design, heavy duty 14 gauge stand.
- Deluxe enclosed stand with handle and wheels for easy movement.



Specifications:

Round capacity at 90° 5"
 Round capacity at 45° 3"
 Rectangle capacity at 90° 5" x 6"
 Rectangle capacity at 45° 5" x 3"

Starrett

Premium Blades
 1/2" x .025" x 64-1/2"
 No. BSB-1264
\$11.95 Each
 6, 8, 10 or 12 T.P.I.



MODEL No.
414458
Reg. \$999.00

\$895.95

Includes:

- Vertical work table
- Carbon steel blade
- Adjustable material stop

JET EQUIPMENT & TOOLS SWIVEL HEAD 5" x 6" BANDSAW

- Head swivels for a max. cut at 45° & 60°.
- Hydraulic down feed control.
- Quick action vise.
- Deluxe enclosed stand with handle and wheels for easy movement.
- Ball bearing drive wheel and blade guides.
- Sealed worm gear transmission.
- UL listed motor.



MODEL No.
414457
Reg. \$999.00

\$925.00

Specifications:

Round Cap @90° 5"
 Rectangle @90° 6" x 5"
 Blade Size . . 1/2"x.025"x64-1/2"
 Blade Speed 80, 120, 200
 Motor . . .1/2H.P. 115/220V, 1Ph
 Shipping Weight 172 lbs.

ARFA BY RONG FU SWIVEL HEAD 7" X 12" HORIZONTAL/VERTICAL BAND SAW Hydraulic Feed and Coolant Pump

- New Tru-Lock rapid vise swivels 45°
- Leveling pads for stability
- Built-in coolant system.
- Rapid approach vise.
- Roller cabinet.
- Automatic shut-off
- Blade guides-roller. Bearing solid adjustable.
- Band tension adjustment.
- Blade chip brush, safe guards and vertical saw table.

+45°
-45°



Specifications:

Blade Speeds: (4) 98, 164, 246, 328 (F.P.M's)
 Motor & Electricals: 3/4 H.P., 110V
 Blade Size: 94-1/2" x 3/4" x .032"
 Weight: 363 lbs.

Cutting Capacity	
0°	7" 7" x 8-1/4"
±45°	5" 3-1/3" x 5-1/2"

MODEL No.
RF-712DR
Reg. \$1895.00

\$1695.00
Complete

JET EQUIPMENT & TOOLS HORIZONTAL BANDSAW 5" X 8" WET CUTTING

A steel heat-treated worm driving a bronze worm gear gives smooth and quiet operations of the gear box assembly. The Wilton oil bath drive train extends the production life of the machine parts. The blade guides adjust fully in three planes. The saw's sliding guide arm permits positioning close to the cut.

- Adjustable hydraulic feed system.
- Adjustable ball bearing guides.
- Automatic shut off at end of cut.
- Ball bearing rear blade guides.
- Wet cutting saw includes 1 gallon capacity coolant system, 115V/PH, complete with hose, flexible nozzle, shut-off valve, tank and baffle.
- Eccentric shaft & ball bearing side blade guides.



MODEL No.
414451
Reg. \$1095.00

\$895.00

Replacement Blades:
 68-1/2"x .025" x 1/2"
 8 TPI, 10 TPI, 14 TPI
 Carbon Steel \$14.95 Ea.
 BI-Metal \$29.95 Ea.

Cutting capacity

Round: 5"
 Rectangle: 7-1/2" x 5"
 Flat stock: 8 x 1
 45°: 4-1/2 x 5
 Blade size: 1/2" x .025" x 68-1/2"
 Wheel speeds: 85-125-200
 Blade wheels: 7-1/2"
 Height of work table: 23-1/2"
 Motor: 1/2 HP, capacitor start, 1725 RPM
 Overall Dim. (in./L x W x H): 37 x 16 x 37,
 machine measure horizontal with stand
 Net weight: 165 lbs.

HYD-MECH MITERING BAND SAWS The Rock Solid Solution



DM-10-1 (Shown)

- The HYD MECH DM Series are double-miter machines that provides exceptional cutting capability. These versatile saws save operator set-up time and the compact design makes them ideal for use in tight working spaces.
- Cast iron head and vises are designed for rigidity and to absorb vibrations and ensure accuracy during cutting. From user-friendly operator controls, to easily accessible electrical panels and cabinets, each DM series machine is solidly built to give max productivity.

Specifications		DM-6-1	DM-10-1	DM-12-1
Capacity 90°	Rectangular	4" x 7.75"	7.75" x 11"	12.875" x 12.5"
	Square	6.25"	9"	10.125"
	Round	6.25"	9.75"	11.75"
Capacity 45°	Rectangular	2.25" x 5.5"	8.25" x 7"	10" x 7.75"
	Square	2.25" x 4.5"	6.25" x 4.5"	10" x 7.75"
	Round	4.5"	7"	10"
Capacity 60°	Rectangular	3.75"	5"	10.125"
	Square	5"	7"	10.125"
	Round	4.5"	5.75"	10.125"
Blade	Blade Dimensions	7' 9"	9' 8"	10' 11"
	Blade Drive	3/4"	1"	1"
	Blade Wheel Diameter	2-2.3 HP	2-2.5 HP	2-2.5 HP
Overall	Blade Speed	140-280 SFM	140-280 SFM	130-260 SFM
	Coolant Tank Capacity	3.5 US Gal	3.5 US Gal	
	Table Height	34"	34"	34"
	Machine Weight	688 Lbs	1,003 Lbs	1,480 lbs.
	Machine Dimensions	57"	70"	70"
Price	Width	38"	30"	30"
	length	72"	72"	72"
	Height	\$4500.00	\$7200.00	\$8400.00

ACCU-TAPPER TAPPING MACHINE

Tapping, Deburring, Thread Chasing, Counter Sinking, Chamfering Thread Chasing, Assembly and Polishing All-In-One

- To operate, just flip the switch, place the workpiece against the tap and apply pressure. When pressure is released, the tapper automatically reverses. Sliding backing plate design holds true relationship between tap and workpiece so very small holes can be tapped without tap breakage.
- Tapping capacity in steel is 0 to 1/4" diameter; soft metal 0 to 5/16" diameter, plastics 0 to 3/4" diameter.
- Units are equipped with a 1/3 hp, 115 VAC, 60 Hz, 1725 rpm motor; adjustable stops for controlling hole depth.
- Single-speed machine** has a 1/2" chuck and operates at 600 rpm.
- Two-speed machine** has a 1/2" chuck and operates at 400 and 600 rpm. The slower speed allows machine to also be used with chamfering, deburring and counter boring tools with a shank up to 1/2" diameter OD threading can be performed when a die holder is used.



Single Speed
MODEL No.
AT-2000
\$1395.00

Two Speed
MODEL No.
AT-2100
\$1495.00



Typical parts machined with an Accu-Tapper Tapping Machine

Top Tech® RADIAL DRILL PRESS Machine & Tools Tilt Head & Tilt Table

- The versatile head will tilt $\pm 45^\circ$ and swivel 360° to bring it to the work either on or off the table.
- Supplied with 1/2" key type drill chuck.

Specifications	Bench Model	Floor Model
Max Drilling Capacity	5/8"	3/4"
Spindle Travel	4"	4"
Spindle Taper	MT2	MT2
Column Diameter	2.40"	2.90"
Turret Column Dia.	2.40"	2.40"
Turret Travel	12"	12"
Spindle Speed (5)	390, 850, 1500, 2200, 300 RPM $\pm 45^\circ$	390, 850, 1500, 2200, 300 RPM $\pm 45^\circ$
Head Tilt		
Max. Distance Spindle To Table	18.8"	43"
Spindle To Base	22"	50.4"
Spindle To Column	17.2"	16"
Table Size	9"x 9.2"	10-1/2"x 10-1/2"
Base Size	17.2"x 10.4"	24"x 14"
Motor	3/4HP 110/220V	3/4HP 110/220V
Weight	94-1/2 LBS	145 LBS
MODEL No.	RDM-160	RDM-120
PRICE	\$195.00	\$249.95



ROSCAMAT® TAPPING ARM - PNEUMATIC MACHINES

- The Series 200 standard machine consists of a radial arm to a tilting arm that is balanced by a pneumatic damper.
- The tilting arm fixes to the head member and the pneumatic motor both of them moving perpendicularly to the work piece.
- The TSVII Pneumatic motor is available in 2 speeds 350 or 750 RPM.
- The swivel motor mount (optional) offers the ability to tap in a vertical and horizontal position.
- The tap holder is mounted directly to the pneumatic motor with a quick change system that utilizes common SCM tap adapter system.
- This system offers a Rigid adapters for through holes and easy to machine materials and a Torque control adapter that offers added safety for blind holes and difficult to machine materials.



37" Reach
26" Height

Rigid Type

Torque Control



Accessories: Tapping Tables, Mounting Clamps, Floor Columns (Inquire)

TAP ADAPTERS

Tap Size	Rigid Type	Price Each	Torque Control	Price Each
#0-6"	11600	\$36.00	11800	\$89.95
#8"	11602	36.00	11801	89.95
#10"	11604	36.00	11802	89.95
1/4"	11606	36.00	11804	89.95
5/16"	11607	36.00	11805	89.95
3/8"	11608	36.00	11806	89.95
7/16"	11611	36.00	11807	89.95
1/2"	11612	36.00	11808	89.95
9/16"	11613	36.00	11809	89.95
1/8"NPT	11609	36.00	11810	89.95

Model No.	Speed Tap RPM Capacity	Motor Type	Price Each
200-350	350 RPM 0-9/16"	Vertical	\$3795.00
200-750	750 RPM 0-3/8"	Vertical	3795.00
200-350VH	350 RPM 0-9/16"	Vertical/Horizontal	4195.00
200-750VH	750 RPM 0-3/8"	Vertical/Horizontal	4195.00

PALMGREN ARBOR PRESSES

Sturdy, cast-iron construction. Removable machined steel anvil provides accurate work support in four slot positions. Rugged steel ram is driven by a machined pinion. Punches or tools may be added to the end of the ram with the aid of a magnetic insert. Base drilled for mounting on a bench or pedestal.

- Arbor press #61101 is equipped with a handwheel to perform light and quick press work.
- Arbor press #61302 Ratcheting 3 Ton Arbor Press allows the operator to maintain the arm in the optimal leverage position with consistent application of force.
- Arbor press #61302 has more clearance over the table for broaching or pressing large items. It is counterweighted for rapid handle return and has a quick ram advance via the press's side-mounted handwheel.
- Arbor press #70103 press stand provides a sturdy base and optimal height for easy operation. It has a slot on the top for pieces which need to extend below the base of the press table. Stand comes with built cup for catching expressed pieces. Base and top are cast iron with a body of welded steel. Fits all 2-4 ton presses.

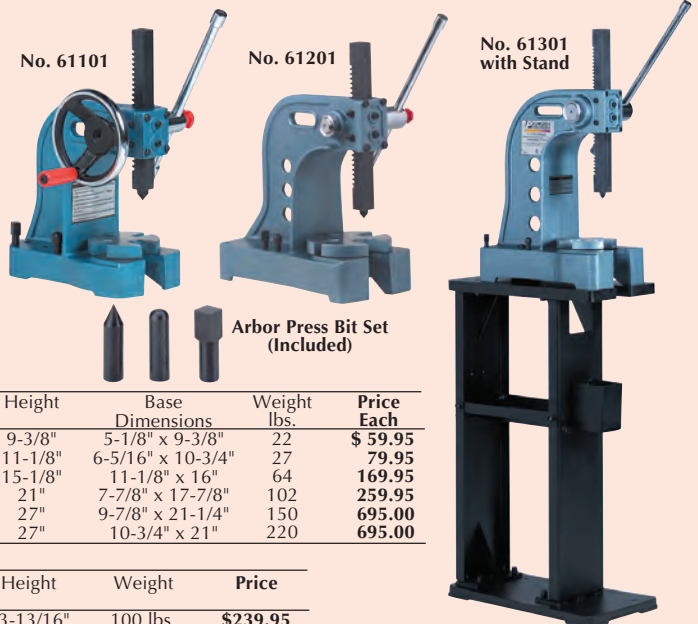

No. 61101

No. 61201

No. 61301 with Stand

Arbor Press Bit Set (Included)

Model No.	Force Ton	Swing	Anvil Diameter	Max. Work Height	Ram Dimensions	Height	Base Dimensions	Weight lbs.	Price Each
61051	0.5	7-1/2"	3-3/8"	4-1/2"	3/4" x 3/4"	9-3/8"	5-1/8" x 9-3/8"	22	\$ 59.95
61101-1	1.0	8"	4-7/16"	6-1/8"	1" x 1"	11-1/8"	6-5/16" x 10-3/4"	27	79.95
61201	2.0	11-7/8"	6-5/8"	8"	1-1/4" x 1-1/4"	15-1/8"	11-1/8" x 16"	64	169.95
61301	3.0	12-1/2"	6-5/8"	12-5/8"	1-1/2" x 1-1/2"	21"	7-7/8" x 17-7/8"	102	259.95
61302*	3.0	13-3/4"	7-13/16"	17-15/16"	1-1/4" x 1-1/4"	27"	9-7/8" x 21-1/4"	150	695.00
61401	4.0	16-3/4"	15-3/4"	15-3/4"	1-3/4" x 1-3/4"	27"	10-3/4" x 21"	220	695.00

*Ratchet Press

Arbor Press Stand

Model No.	Top Dimensions	Base Dimensions	Height	Weight	Price
70103	11-13/16" x 22-1/16"	11-13/16" x 22-1/4"	33-13/16"	100 lbs.	\$239.95



POWER MILLING TABLE FEEDS FOR B'PORT TYPE MILLS



- Higher torque than competitive models.
- Controlled feed rate.
- Smooth finish, regulated control eliminates most second finish cuts.
- Automatic shutoff at the end of a cut with electric limit switches.
- Superior thermal characteristics for higher loading.
- Easy installation with mounting hardware kits for more than seventy mills.
- Trouble-free performance; light-weight motor minimizes table deflection problems; safety clutch with limit switch design eliminates damage to lead screw or feed if a hard stop is encountered.



Model	Torque	Feed Type	Price
200-140	140 lbs.	Table "X"	\$629.95
200-150	150 lbs.	Table "X"	695.00
251-140	140 lbs.	9" Cross "Y"	\$722.00
250-140	140 lbs.	12" Cross "Y"	719.00
251-150	150 lbs.	9" Cross "Y"	825.00
250-150	150 lbs.	12" Cross "Y"	795.00
280-140	140 lbs.	Knee "Z"	\$720.00

**B'Port Table Feed
140 Lbs. Torque
Reg. \$660.00
MODEL No.
200-140**

\$629.95



POWER KNEE FEED THE NEW 200 LBS TORQUE

*More Power ~ Lifts The Heaviest
Knee On The Market*

Specifications:

- Mounting hardware kits available to precisely fit most milling machines.
- Semi-automated machining on most knee mills up to 5 HP.
- Peak torque: to 200 in-lb./22.6 Nm (half-wave series motor).
- Intermittent torque: 150 in-lb/17 Nm.
- Continuous torque: 120 in-lb/13.0 Nm.
- Variable feed rate: knee 0-12 IPM/0-305mm/min.
- Helical gearing and torque limiting friction safety clutch with new and improved gear.
- Electrical: 110V, 50/60 Hz, 4.0 amps.
- Approx. weight; 21 lbs./9.4 kg.
- One year warranty, parts and labor.



\$695.95

ALIGN POWER MILLING TABLE FEED 150 lbs. TORQUE AVERAGE

- 150 lbs. torque average
- Special electrical relay protects against damage caused by power failure.
- New and stronger design assures long trouble free life.
- Electrical & mechanical parts are made for easy maintenance.
- Rapid breaking, full range, variable speed control, Built-in slipclutch action to protect plastic gear.



Made In Taiwan

**Table Feed X-Axis
AL-400SX**

\$375.00



Model No.	Torque Rating	Description Type	Special Price
AL-400S	Ave. 150, Max. 550In-lbs.	0-200 RPM	
AL-400SX	150 lbs.	Longitudinal X-axis	\$375.00
AL-400SY	150 lbs.	Cross Feed Y-axis	425.00
AL-400SZ	150 lbs.	Knee Feed Z-axis	425.00
AL-500S	Ave. 150, Max. 650In-lbs.	0-200 RPM	
AL-500SX	150 lbs.	Longitudinal X-axis	\$395.00
AL-500SY	150 lbs.	Cross Feed Y-axis	450.00
AL-500SZ	150 lbs.	Knee Feed Z-axis	450.00
AL-99SP	135 lbs.	Longitudinal X-axis	\$330.00
A-0100-03		Replacement Bevel Gear	\$65.00
A-0934-4		Replacement Nylon Gear	35.00

A&T UNIVERSAL POWER DRAWER BAR

- The ADB-123 includes specially designed & patented Universal Mounting Flange that adapts to all "Taiwanese Made" Republic Lagun, Kondia & Bridgeport Mills. • Top quality impact wrench used.
- Unique adjustable draw bar feature enables the operator to preset length of draw bar - No special draw bar required!
- 10 minute simple & easy installation on all vari speed mills, CNC machines & step pulley heads. • Requires only 80 PSI of compressed air to operate.



**For Variable Speed Mills
MODEL No.
ADB-123**

\$495.00

**For Step Pulley Mills
MODEL No.
ADB-123SP**

\$495.00

MILL SAVER WAY COVERS

- The Mill Saver is a high quality, way cover system designed to shield your mill's column and ways from abrasive chips and debris that cause premature wear and tear and bind up of the knee and table.
- Prolong the life of your mill and help retain machining precision with the one and only Mill Saver.
- Fits standard Bridgeport type mills.



**SET No.
99-218**

\$79.95

Includes: high quality, fully serviceable die cast top bracket with front and rear rubber covers.



POWERLOCK™ POWER DRAWERBARS FOR BRIDGEPORT TYPE MILLING MACHINES

- Available for most manual & CNC Mills with standard R-8 collets or 30 or 40 Taper tool holders.
- Power Drawbars reduce tool change time and allow more cutting time in the cycle. This eliminates waste
- The whole process using Kurt automatic or mechanical Power Locks cuts the tool change time to 1/4 of the time required to change tools manually with wrenches. An added benefit is consistent on the drawbar rod.
- Operates on shop air supply, filter/lubricator, regulator and gauge included with each unit- provides Clean oiled air to ensure long life.

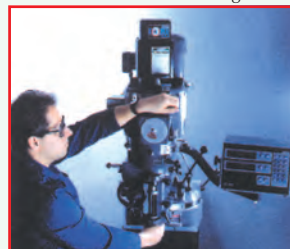

**Automatic Type
MODEL No.
BR-1000
Reg. List
\$775.00**

\$736.00

Specify your Mill name when ordering

**Manual Type
MODEL No.
BR-6000
Reg. List
\$625.00**

\$575.00

Specify your Mill name when ordering

Targa HAND OPERATED SURFACE GRINDER

Features:

- The table slides on 36 precision ball bearings. You can move it with fingertip pressure.
- Ball bearings do not require periodic disassembly and cleaning.
- 7" wheel, 6" x 12" travel.
- 3/4 H.P. motor, 1 phase, 3500 rpm.
- Includes 5" x 10" magnetic chuck.

Made in Taiwan

MODEL No. GSG-12B

\$2495.00

W/5"x10" Mag. Chuck
Less Cabinet Stand

Optional: Cabinet Base
MODEL No. GSG-12S

\$245.00

Specifications:

Table travel longitudinal	12-5/8"
Crossfeed	6-11/16"
Height under 7" dia. wheel	5-1/2"
Speed	3500 RPM
Graduations	0.001"
Working surface	5-1/4" x 12-1/4"
Weight	451 lbs.



CLAUSING 20" VARIABLE SPEED DRILL PRESS

Dial to the best RPM for the tool and material while the job is running, with a Clausing LOW/HIGH Variable Speed Drill Press

- Heavy-duty precision head... all bearing surfaces are precision bored simultaneously for exact alignment. Eight ball bearings support the drive and spindle, lower spindle bearing has a double row to absorb both radial and thrust loads.
- 3 MT spindle... with 6-1/2" travel, 2-1/2" diameter quill and micrometer depth stop.
- 4" column with 1/2" thick wall for great rigidity, accuracy.
- Precision ground 22" x 19" oil trough table, handles large parts and fixtures.

MODEL No. 2274-1

Reg. \$4305.00

\$3995.00

Model	2277-1	2274-1
Variable Speed	150-2000	300-2000
Motor	1-1/2 H.P.	1-1/2 H.P.
Table Size	22" x 19"	22" x 19"
Quill Size	2-1/2"	2-1/2"
Spindle Travel	6-1/2"	6-1/2"
Column Size	66"	66"
Weight	630 lbs.	630 lbs.
Price	\$4450.00	\$3995.00



VERTICAL SLOTTING HEAD

- Forms indicate shapes extruded dies and vise-type clamping flange (Easy mounting and discharging)
- Mounts on the rear of the V-Ram (suitable for any Bridgeport type mills).
- Easy adjustment to make any key or groove on cone or tilted surface.
- Swing the turret 180° to position it over the table and ready to work.
- Uses a Vertical tool motion to shape and slot.

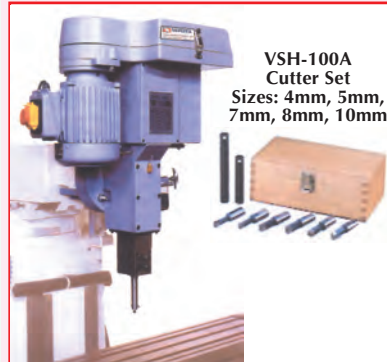

VSH-100A Cutter Set
Sizes: 4mm, 5mm, 7mm, 8mm, 10mm

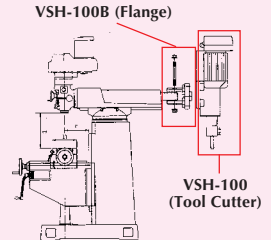

Specifications:
Stroke 0-5"
Strokes Per Min 35, 54, 79, 112, 160
Motor Speed 1370 RPM
Motor 3/4 H.P. 220V, 3 Phase

Model	Description	Price
VSH-100	Vertical Slotting Head	\$2795.00
VSH-100A	Cutter Set	395.00
VSH-100B	Flange	295.00

EAGLE ROCK SHAPLANE RADIUS TOOLS

- A simple and accurate way to turn a radius.
- Each unit features a rigid cast iron construction for an accurate chatter-free operation and long life. The gearing is fully enclosed to prevent the entrance of any chips or foreign matter.
- Extension handles are included to keep your hands away from the hot chips while feeding the tool.
- All tools use 1/4" square tool bits except for the No. 24804 which uses a 3/8" square tool bit.

MADE IN USA

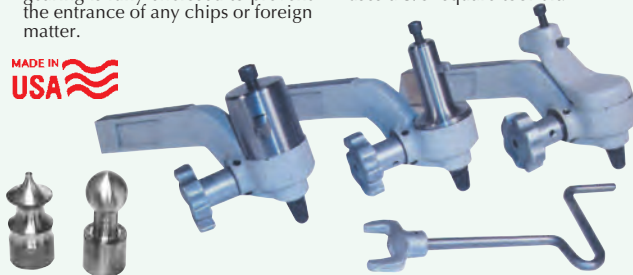

Model	Radius	Range	Shank	List	Sale
24801	Convex	Max. 2-1/2" Dia. Ball	1-1/4" x 9/16" x 6"	\$345.00	\$295.00
24803	Concave	Min. 1/2" Radius	1-1/4" x 9/16" x 6"	345.00	295.00
24804	Concave	Min. 1" Radius	1-1/4" x 9/16" x 6"	345.00	295.00
24805	Convex	Max. 1-5/8" Dia. Ball	1" x 3/8" x 4"	325.00	265.00
24806	Concave	Min. 3/8" Radius	1" x 3/8" x 4"	325.00	265.00
24807	Concave	Min. 3/4" Radius	1" x 3/8" x 4"	325.00	265.00

No. 24801, 24803 and 24804 are for lathes 13" and over.
No. 24805, 24806 and 24807 are for lathes 9" to 13"

HOLDRIDGE RADII-CUTTER - CUTS AND FORMS CONCAVE, CONVEX, SPHERICAL SHAPES

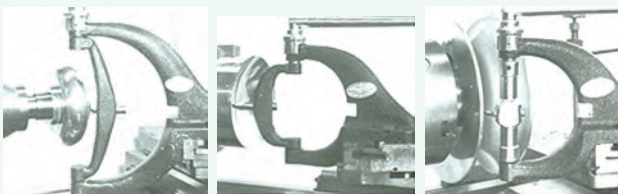

MODEL 3-ST Standard And 3-DL Deluxe

The small Model 3-ST Radii-Cutter is specially designed for all small lathes, will cut from 0 to 3" diameter convex ball shapes and from 0 to 3" concave sockets to radius depth. By reversing the yoke, sockets up to 8" may be formed, however, radius depth will be minus 17/32" to allow for the "boss line" of the tool. Two additional straight spindle yokes and two additional tool bits as well as a dial calibrated in degrees are supplied in the deluxe model for forming pipe bending dies, form rollers, etc. Compound height from base of the tool to the centerline is 1". Tool may be shimmed to fit various model lathes and turret lathes.

MODEL No. 3-ST - **\$650.00** MODEL No. 3-DL - **\$895.00**

MODEL 8-DL Deluxe Rad II Cutter Set

The Model 8-DL fits all medium and large lathes and will cut from 0 to 8" convex ball shapes and from 0 to 8" concave sockets to radius depth. By reversing the large "C" yoke sockets up to 20" may be formed, however, the radius depth will be minus 3/4" to allow the "boss line" of the Radii-Cutter. Compound height from the base of the tool to the centerline is adjustable from 1-5/8" to 1-3/4". Tool may be shimmed to fit various model lathes and turret lathes.

MODEL No. 8-DL Deluxe - **\$1995.00**

Power Drive Unit For 12-DL

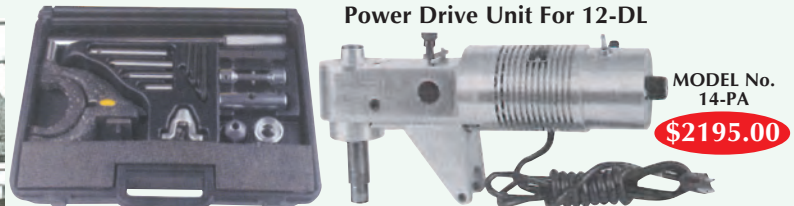

MODEL No. 14-PA
\$2195.00

MODEL 4-ST Standard And 4-DL Deluxe

The popular Model 4-ST Radii-Cutter for medium lathes will cut from 0 to 4" diameter convex ball shapes and from 0 to 4" concave sockets to radius depth. By reversing the "C" yoke, sockets up to 12" in diameter may be formed. However, radius depth will be minus 17/32" to allow for the "boss line" of the tool. Compound height from the base of the tool to the centerline is adjustable from 1-5/8" to 1-3/4". Tool may be shimmed to fit various model lathes and turret lathes.

MODEL No. 4-ST - **\$750.00** MODEL No. 4-DL - **\$1150.00**

MODEL 12-DL Deluxe Rad II Cutter Set

The Model 12-DL fits lathes 15" and larger and will cut from 0 to 12" diameter convex ball shapes and from 0 to 12" concave sockets to radius depth. By reversing the "C" yokes, larger diameter sockets may be formed up to 24" depending upon capacity of lathe. The radius depth will be minus 3/4" to allow for the "boss line" of the Radii-Cutter. Compound height from the base of the tool to the centerline is adjustable from 1-5/8" to 1-3/4". Tool may be shimmed to fit various model lathes and turret lathes.

MODEL No. 12-DL Deluxe - **\$2750.00**

BIRMINGHAM PRECISION SURFACE GRINDERS 6" X 18" AND 8" X 18"

Model No.	WSG-618	WSG-818
Table Size	6" x 18"	8" x 18"
Max. grinding length	18-1/2"	19-3/4"
Max. grinding width	6-1/2"	8-1/4"
Max. distance from spindle center to table	15-3/4"	19"-3/4"
Max. longitudinal travel	19"	21-5/8"
Max. cross travel	7"	9"
Longitudinal travel-per revolution	4-1/8"	3-15/16"
Cross travel per revolution	.2"	.2"
Cross travel per graduation	.0008"	.0008"
Vertical travel per revolution	.05"	.05"
Vertical travel per graduation	.00025"	.00025"
Peripheral speed of wheel	110 FT/S	110 FT/S
Spindle speed	3600 RPM	3600 RPM
Grinding wheel size	8"x1/2"x1-1/4"	8"x1/2"x1-1/4"
Spindle motor	2 HP	2 HP
Dust collector motor	1/2 HP	1/2 HP
Coolant pump	0.05 HP	0.05 HP
Lubricating pump	0.02 HP	0.02 HP
Dimensions (LxWxH)	55"x39"x71"	59"x47"x72"
Net weight lbs.	1600	2350
Price	\$6495.00	\$6995.00

- Standard Equipment:**
- Standard Permanent Magnet Chuck.
 - Grinding wheel.
 - Grinding wheel flange.
 - Wheel balance arbor.
 - Diamond wheel dresser.
 - Working light system.
 - Tool box.
 - Hoisting set.
 - Leveling pads.
 - Coolant system.



6" x 18"
MODEL No. WSG-618
Reg. \$7500.00 **\$6495.00**

- Features:**
- Hardened steel table ways with precision ball bearings for smooth and easy table traverse.
 - Class 7 high precision angular contact ball bearing spindle.
 - One piece heavy cast base for good stability.
 - Automatic lubrication system.
 - Hardened and ground lead screws for wheel head up and cross movement.
 - Powerful 2 HP spindle motor.

Harig/SIMCO BUR-BEAYER DEBURRING MACHINE

- Fast, safe, easy to operate.
- Ideal for steel, aluminum and plastic.
- Cutter has minimum exposure to protect operator.
- Table is fixed at standard 45 degrees.
- Table moves up and down to easily adjust depth of cut.
- Table lifts to change cutter.
- Extra quiet, vibration free, variable speed permanent magnet motor.
- One piece cast aluminum housing.
- Includes one 18-Flute Cutter.
- **Optional Guide (p/n 265-50)** permits deburring the O.D. of flat rounds.
- Full repair service and replacement parts available.

MODEL No. 245-100-1
Reg. \$1695.00

\$1575.00

With Cutter

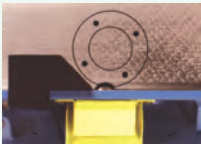

Optional Guide



Specifications:

Motor 3/4 horsepower
Variable speed . . up to 7,000 rpm (no load)
Electrical 115V - 60Hz
Table 12" long x 4" high
Overall size 10" x 10" x 7" high
Weight 30 Lbs.

Replacement Cutter



Model	Description	Price
BB-35Q	27-Flute cutter for fine finishes minimum depth chamfers on steel	\$110.00
BB-35R	Borazon abrasive wheel deburrs stainless and hardened steel	130.00
BB-35N	9- Flute cutter deburrs and chamfers aluminum, plastic & cast iron	75.00
BB-35S	Crosshatch cutter for fine finish deburring of steel	80.00
BB-35P	18-Flute cutter for medium finish chamfers on steel to 1/8" (most popular)	85.00
265-50	Optional Guide	\$215.00



IRON WORKER 45 Ton 4 Stations

- 45-ton punch station (1-1/8" in 1/2")
- Keyed punch ram for safety
- 4-1/4" throat depth
- 2" die holder
- Punch nut with wrench and stripper
- One round punch & die: max. diameter 1"
- Adjustable electric stroke control with scale
- Tool table work area
- Machine stand with punch & die & tooling storage rack



MODEL No. FAB-45
Reg. \$6390.00
\$5995.00

Standard Equipment:

45 ton punch station (1-1/8" in 1/2"), Keyed punch ram, 4-1/4" Throat Depth, 2" Die Holder, Jam nut w/Wrench & stripper, One Round punch & die: Maximum diameter 1", Adjustable electric stroke control w/Scale, 3 in 1 Combination tool (includes angle shear -3" x 3" x 5/16", 6" Flat bar shear-3/8" x 6" & 3/4" Rod shear), Tool table work area, Machine stand w/ Punch & die & tooling storage rack, 110 volt electrics, All guards comply w/ANSI B 11-5 standards, Three year warranty.

SINGLE OPERATOR
4 STATIONS

Visit our website for all

Scotchman products
www.pennoolco.com



CONQUEST INDUSTRIES 20" DISC SANDER/GRINDER HEAVY DUTY

- Used for metal, wood, fiberglass and plastic.
- Equipped with a Dayton "On-Off" reversing switch.
- Dynamically balanced aluminum grinding disc.
- Two color powder coated fabricated surfaces.
- Low sound emission.
- Powered by a Baldor motor.
- Miter gage standard.

2 H.P.
220V 3PH
MODEL No. CDS-200
Reg. \$2185.00
\$2095.00

Specifications:

Working Table = 27.25 x 15"
Working height = 37.5"
Bolt-down base.
Disc Size = 20"
Motor - 2HP, 208-230/450V {6-5.6/2.9 amps} 60 cycle 1740rpm Three Phase
Direct motor drive.
Table can be tilted 35° upward, 45° downward
Rack mechanism for raising & lowering table.
32" x 30" floor space required.
Machine weight = 310 pounds



1.5H.P.
115/220V
1 Phase
MODEL No. CDS-201
Reg. \$2185.00
\$2095.00

MADE IN USA
One Year Warranty



Tilts downward a full 45°
Tilts upward 35°

NORTON 20" Abrasive Cloth PSA Discs

No. 36710 36 Grit \$16.95 ea.
No. 36711 50 Grit \$15.50 ea.
No. 36712 60 Grit \$14.50 ea.
No. 36706 80 Grit \$13.75 ea.
No. 36700 100 to 240 \$13.50 ea.
(Specify Grit)

Optional:
No. DG-010 Dust Shoot (4 Port) \$200.00
No. DB-795 Dynamic brake on motor \$795.00



LATHE 10" x 20"

An excellent small-sized lathe with an impressive 9-3/4" swing and 21" distance between centers, the Model M1016 offers handy accessories like 5" 3-jaw chuck, eye shield, and 4-way turret tool post.



MODEL No. M1016
List \$1900.00

\$1450.00

Optional:
Digital Readout
No. D3692 \$195.00



Standard Equipment:

- 5" 3-jaw chuck
- Cross slide table
- 11 change gears
- 2 dead centers
- 4-way turret tool post
- Eye shield
- Forward/reverse switch with emergency stop

Specifications:

- Lathe motor size: 3/4 HP, 110V, single-phase
- Motor speed: 1,725 RPM
- Swing: 9-3/4"
- Swing over cross slide: 6"
- Distance between centers: 21"
- Spindle bore: 3/4"
- Spindle taper: MT #3
- Tailstock taper: MT #2
- Tailstock barrel travel: 1/2"

- Cross slide travel: 4-1/4"
- Compound travel: 2-1/4"
- Number of speeds: 6
- Lathe speeds: 150, 240, 490, 750, 1200, 2400 RPM
- Range of threads (inches): 8 TPI - 40 TPI in 12 steps (Gear changes required)
- Range of threads (metric): 12 @ 0.4-3.0mm
- Approximate shipping weight: 353 lbs.



LATHE 9" x 19"

This bench sized lathe has all the features and precision of the larger lathes, but at a fraction of the cost. Why pay for extra capacity when most lathe projects are well within the capability of this great tool.

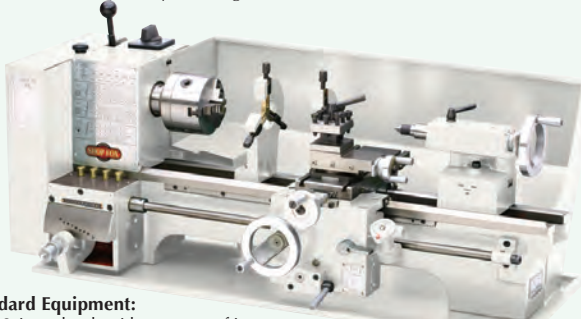

Standard Equipment:

- 4" 3-jaw chuck with two sets of jaws.
- 7-1/4" 4-jaw chuck with reversible jaws
- Steady rest • Face plate
- Follow rest • 4-way tool post
- MT #2 dead center
- MT #3 dead center
- MT #2 live center
- Extra C-type tool post
- Includes tool box & tool kit

Specifications:

- Motor: 3/4 HP, 110V, single-phase
- Swing over bed: 9"
- Swing over cross slide: 5"
- Distance between centers: 19"
- Spindle bore: 3/4"
- Spindle thread 39mm x 4mm pitch
- Spindle nose taper: MT #3
- Number of speeds: 6
- Range of speeds: 130 - 2,000 RPM
- Lead screw: 9/16" - 16 TPI
- Compound travel: 1-7/8"
- Cross slide travel: 4-1/4"
- Carriage travel: 16"

MODEL No. M1049
List \$1465.00

\$995.00

Optional Stand
No. M1050 \$150.00



- Maximum tool size: 3/8" x 3/8"
- Tailstock barrel travel: 1-9/16"
- Tailstock barrel taper: MT #2
- Number of longitudinal feeds: 18
- Range of longitudinal feeds: 0.0023" - 0.013"
- Number of inch threads: 27
- Range of inch threads: 8 - 56 TPI
- Number of metric threads: 11
- Range of metric threads: 0.05 - 3.0mm
- Overall dimensions: 36-1/2"W x 22"L x 15"H
- Approximate shipping weight: 293 lbs.

Precise 7" x 12" MINI BENCH LATHE

Variable Speed 0-2500 RPM's

- 1/2 HP, UL approved. Used for drilling, boring, taper cutting, threading cylinder turning and counterfacing. Includes 3" 3-jaw chuck with 5/8 center hole. Automatic feed cutting. Thread inch dial.

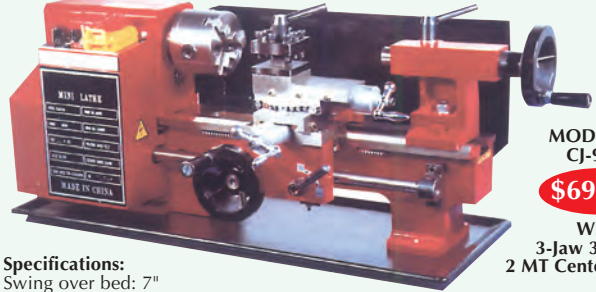

MODEL No. CJ-9518

\$695.95

With:
3-Jaw 3" Chuck Set
2 MT Center, Gear Set

Specifications:

- Swing over bed: 7"
- Distance between centers Model 300: 12"
- Hole through spindle: 3/4"
- Spindle taper: MT#3
- Tailstock taper: MT#2
- Spindle speed: Low range 0-1100rpm, High range 0-2500rpm

- Motor: 1/2 H.P. 110V
- Range of threads: Metric 0.4-2.0MM (10 thread pitches) Imperial 12-52 TPI (8 thread pitches)
- Net/Gross weight: 81/88 lbs.



MINI-LATHE 6" X 10"

- This Model M1015 Mini-Lathe is a perfect lathe for someone who wants a durable and well-designed machine that can fit in a small location.
- This Mini-Lathe gives model makers, toolmakers, gun hobbyists, and the weekend machinist a way to economically produce small precision parts, threaded parts, fittings, and dies.

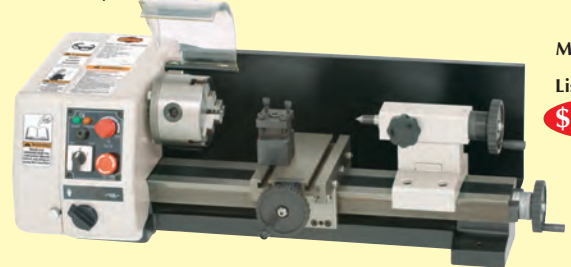

MODEL No. M1015
List \$740.00

\$575.00

Specifications:

- Motor: 1/5" HP, 110V, single-phase
- Swing over bed: 6"
- Distance between centers: 10"
- Cross slide travel: 2-3/8"
- Spindle bore: 3/8"
- Spindle speed: 100-2000 RPM
- Spindle taper: MT #2
- Tailstock taper: MT #1
- Approximate shipping weight: 64 lbs.

Standard Equipment

- 3" 3-jaw chuckw/internal & external jaws.
- 4 hex wrenches
- Double ended wrench
- Socket head wrench
- MT#1 dead center
- Oil cup • Chuck key
- Fuse • (2) T-nuts
- Thread cutting kit



9" x 20" BENCH LATHE BELT DRIVE

- Spindle is supported by precision tapered roller bearings.
- Hardened and ground bedways.
- Standard 1-1/2" x 8" TPI spindle nose allows many after-market accessories to be used.
- A reversing switch is included for added versatility.
- Backlash adjustments are provided throughout the carriage.
- The tailstock can be adjusted for taper cuts.
- Quick change gear box provides a wide range of inch and metric threads.



3/4 H.P.
1Ph, 115V
MODEL No. BD-920N
Reg. \$2349.00

\$1995.00

Less Stand
Included
With lathe

- 7" 4-jaw chuck with threaded backplate.
- 4" 3-jaw chuck with threaded backplate.
- faceplate
- Steady rest
- 4-way tool post
- Metric change gears
- Centers
- Threading dial
- Toolbox and tools

Specifications:

- Swing over bed 8-3/4"
- Distance between centers 20"
- Hole through spindle 25/32"
- Taper in tailstock spindle 2MT
- Taper in spindle speeds (6) 130-2,000 RPM
- Range of inch threads (27) 8-56 TPI
- Range of metric threads (11) .05-3.0mm
- Weight 235 lbs
- Motor 3/4H.P., 115V, 1Ph



Optional:
No. S-920N Stand
\$295.00



ROTMAG MAGNETIC CLEAN-UP TOOL

- Quickly and easily pick up sharp metal chips, fasteners and small metal parts.
- Simply wave it over magnetic and safely dispose by pulling back the knob

Save 25%
Off List

No machinist should
be without one!



MODEL No. RMX7
List Price \$60.00

\$44.95





COMBO LATHE/MILL

- Machinists will not want to pass up this versatile machine. Great for turning, cutting threads, drilling and milling small projects, this combo lathe is packed with extra add-ons like a 4-way turret tool post, 9-1/2" faceplate, 4" 3-jaw chuck, and a built-in rotating vise.
- Features a 16-1/2" swing over bed, 11-1/2" swing over saddle, 19-3/16" distance between centers, 3/4" spindle bore, and MT #3 tapers.

Features:

- T-slots in cross slide
- Cuts inch and metric threads.
- Turret tool post
- Tailstock offsets 1/2"
- Built-in vise

Standard Equipment:

- 4" 3-jaw chuck
- 1/2" drill chuck
- MT #3 chuck arbor
- 2 dead centers
- Change gears
- 5" backplate
- 9-1/2" faceplate

MODEL No.
M1018
List \$1950.00

\$1545.00



- Motor size: 3/4 HP, 110V, single-phase
- Swing over bed: 16-1/2"
- Swing over saddle: 11-1/2"
- Distance between centers: 19-3/16"
- Spindle bore: 3/4"
- Lathe spindle taper: MT #3
- Mill/Drill spindle taper: MT #3
- Tailstock taper: MT #3
- Draw bar: 3/8"-16 TPI
- Tailstock barrel travel: 1-1/2"
- Cross slide travel: 4-1/2"
- Number of Mill/Drill speeds: 14
- Mill/Drill speeds: 117, 150, 220, 290, 276, 345, 360, 440, 450, 575, 640, 836, 1000, 1300 RPM
- Number of Lathe speeds: 7
- Lathe speeds: 160, 300, 375, 470, 600, 870, 1360 RPM
- Thread range (inches): 27 @ 8 - 120 TPI
- Thread range (metric): 18 @ .2 - 3.0 mm
- Approximate shipping weight: 475 lbs.



3-1 COMBINATION LATHE Mill ~ Drill Press

- The **MLD-1030** combines 3 machines into one small package, giving the operator the choice for milling, drilling, or performing lathe operations.
- Precision ground and hardened ways ensure long life and years of machining
- Adjustable RPM from 50-2000 and includes a digital read out for accurate cutting speed.
- Steady rest, follow rest, three jaw chuck, and cabinet stand are just a few of the options that come standard on this mill drill lathe.
- The milling and drilling head feature a column style base with adjustable depth.
- A digital readout will help to keep the depth of cut a precise as possible.



MODEL No.
MLD-1030
\$2995.00
Complete

Specifications: Lathe

Distance Between Centers : 21.5"/29.5"
Swing Over Bed : 9.75"
Swing Over Cross Slide : 5.7"
Width of Bed : 5.3"
Taper of Spindle Bore: MT 4
Speed: 50-2000 RPM / Variable
Range of Longitudinal Feed: .003"-.008"
Range of Inch Threads: 8-56 T.P.I
Range of Metric Threads: .2 -3.5mm
Top Slide Travel : 2"
Cross Slide Travel : 4.5"

Tailstock Quill Travel: 2"
Taper of Tailstock Quill : MT 2
Motor: 1hp Voltage: 120V
HEADSTOCK Chunk Size: 5"

Specifications: Milling/Drilling

Taper of Spindle Bore : MT2
Spindle Stroke: 2"
Spindle Speed: 50-2250 RPM Variable
Max. Distance Spindle to Table: 11"
Max. Distance Spindle to Column: 6.5"
Motor: 3/4 hp Voltage: 120V
Weight: 429lbs



BENCH LATHE 10" x 26"

Just like larger lathes, changing the thread selections is quick and easy on our M1099 10" x 26" Bench Lathe. Instead of swapping change gears for each thread selection, merely refer to the thread chart and rotate the alpha and numeric dials on the quick change gearbox to make the thread change. This six speed lathe also has extended length hardened and ground precision bedways, 1" spindle bore, a selection of chucks, face plate and other accessories.

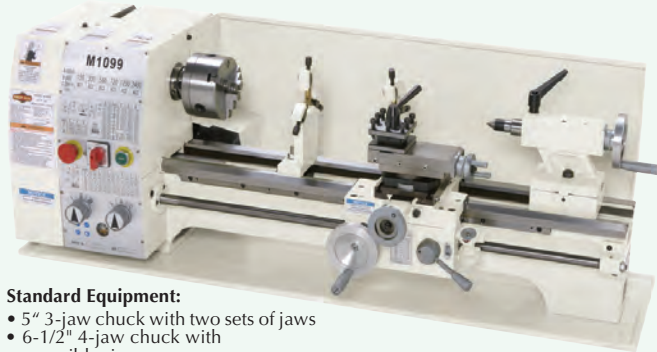

Standard Equipment:

- 5" 3-jaw chuck with two sets of jaws
- 6-1/2" 4-jaw chuck with reversible jaws
- Steady rest
- Follow rest
- MT#3 dead center
- 4-way tool post
- Face plate
- Tool box & tool kit



MODEL No.
M1099
List \$2280.00

\$1575.00

Specifications:

- Motor: 1 HP, 110V, single-phase
- Swing over bed: 9-5/8"
- Swing over cross slide: 6-1/8"
- Distance between centers: 26"
- Spindle bore: 1"
- Spindle thread: 1-3/4" x 8 TPI
- Spindle nose taper: MT#4
- Number of speeds: 6
- Range of speeds: 150, 300, 560, 720, 1200, 2400 RPM
- Lead screw: 3/4" - 12 TPI
- Compound travel: 3-1/2"
- Cross slide travel: 6-1/2"
- Carriage travel: 22-1/2"
- Maximum tool size: 3/8" x 3/8"
- Tailstock barrel travel: 2-1/2"
- Tailstock barrel taper: MT#3
- Number of longitudinal feeds: 9
- Range of longitudinal feeds: 0.0023 - 0.013
- Number of inch threads: 33
- Range of inch threads: 8 - 72 TPI
- Number of metric threads: 26
- Range of metric threads: 0.25 - 3.5mm
- Overall dimensions: 32"W x 50"L x 16-5/8"H
- Approximate shipping weight: 440 lbs.

BIRMINGHAM /ACCORD 12" x 36" GEARED HEAD GAP BED PRECISION ENGINE LATHE

- Hardened and ground bedways and splined shafts in headstock.
- 9 speeds all geared headstock from 60 to 1500 ppm.
- 1-1/2HP single phase 220v motor.
- Emergency stop button equipped on the front of headstock.
- Jog button for easy engagement and inching spindle.
- Extra safety switch shuts down machine entirely for changing belt or gear for threading cutting.
- Built in full size splash guard.



MODEL No.
YCL-1236GH
\$2995.00

Complete with:

- 6" 3 jaw chuck, 8" 4 jaw chuck, Dead center,
- Change gears, Chip pan, D1-4 back plate,
- Reduction sleeve, Steady rest, Follow rest,
- 10" face plate, Full length splash guard,
- 4-way tool post
- Range of cross feeds 0.0003937-0.0105 40 kinds
- Diameter of lead screw 7/8"
- Pitch threads of lead screw 8
- Travel of tailstock quill 4"
- Diameter of tailstock 1-1/4"
- Taper hole of tailstock MT No. 3
- Main motor power 1-1/2 HP
- Overall dimension of lathe L x W x H 70" x 29-5/8" x 50"
- Range of longitudinal feeds 0.0012 - 0.0311 40 kinds
- Net weight 926 lbs.



SOUTH BEND 8" X 18" VARIABLE SPEED BENCH LATHE 8K™

- High quality cogged belts are used for power transmission and reduced vibration
- Hardened and ground signature South Bend® Three V-way bed
- Electronic digital display variable speed controls
- Threading dial indicator
- Emergency stop button
- Inch and metric graduations on tailstock barrel as well as handwheel collars

An Amazingly Heavy Duty Benchtop Lathe Built in the true South Bend Fashion



MODEL No. SB1001 **\$3495.00**

Includes:

- 4" 3-jaw chuck with back plate & reversible jaws
- 4-Way tool post
- MT #4.5 to MT #3 Morse Taper spindle sleeve
- MT #2 dead center
- MT #3 dead center
- Complete set of change gears
- Hex wrench set
- Oil gun
- Tailstock locking wrench
- Tool box

Optional:

- No. SB1468 5" 4-jaw chuck w/D1-3 back plate **\$250.00**
- No. SB1469 6" Faceplate, D1-3 mount **\$139.95**
- No. SB1470 Steady rest **\$350.00**
- No. SB1471 Follow rest **\$295.00**

Specifications:

- Swing over bed: 8"
- Distance between centers: 18"
- Swing over cross slide: 5"
- Swing over saddle: 5"
- Cross slide travel: 3-1/4"
- Compound travel: 2-5/8"
- Carriage travel: 17-5/8"
- Spindle nose: D1-3
- Spindle bore: 1-1/8"
- Spindle taper: MT #3
- Spindle speeds: (variable) 50 – 2300 RPM
- Tailstock taper: MT #2
- Tailstock barrel travel: 1-3/4"
- Tailstock barrel diameter: 1-3/16"
- Inch threads: (12) 10 – 32 TPI
- Metric threads: (12) 0.4 – 3.0 mm
- Longitudinal feed range: 0.003 – 0.006 in./rev.
- Voltage/phase/amps: 120V, single-phase, 10A
- Spindle motor: 1-1/2 HP
- Overall size: 40"W x 18"D x 19"H
- Approximate shipping weight: 268 lbs.

SOUTH BEND 10" X 28" CLASSIC 10K® LATHE

This "new" 10K lathe has the traditional South Bend lines as well as many modern innovations. 1200 RPM 1 HP motor, D1-3 camlock spindle, serpentine multi-groove belt drive system with a Gates® belt, T-slotted cross slide, tailstock barrel with 3.149" travel, inch and metric threading ability and much, much more. South Bend's Signature three v-way bed is hardened and precision ground, and the 28" MODEL No. SB1002



MODEL No. SB1002

\$5495.00

Less Stand

Specifications:

- Swing over bed: 9.84"
- Distance between centers: 28"
- Swing over cross slide: 5.625"
- Width of bed: 5.928"
- Cross slide travel: 5.118"
- Compound slide travel: 1.77"
- Spindle nose: D1-3 camlock
- Spindle bore: 0.86" • Spindle taper: MT #3
- Spindle speeds: (8) from 60 – 1200 RPM
- Tailstock taper: MT #2 • Tailstock travel: 3.149"
- Tailstock barrel diameter: 1.18"
- Inch thread range: 8 to 224 tpi (40)
- Metric thread range: 0.5 to 3.5 mm (17 available)
- Longitudinal feed range: 0.0014 to 0.0131 IPR
- Cross feed range: 0.0004 to 0.0131 IPR
- Number of feed selections: 16
- Spindle motor size: 1 HP
- Voltage: 110V/220V, single-phase, 60 cycle
- Machine footprint: 25" x 56"
- Approximate shipping weight of lathe: 656 lbs.

Includes:

- Allen-Bradley electrical components
- Signature South Bend three V-way bed
- Tool kit
- 5" 3-jaw scroll chuck
- 4-way tool post
- MT #2 dead center
- MT #3 carbide-tipped dead center

Optional:

- No. SB1035 Stand **\$1295.00**
- No. SB1450 Steady rest **\$185.00**
- No. SB1451 Follow rest **\$150.00**
- No. SB1452 Faceplate **\$160.00**
- No. SB1316 D1-6 Back Plate **\$89.95**

GMC PRECISION ENGINE LATHE

Inverter Drive - Variable Speed - Heavy Duty

- ISO 9001 certified.
- Full geared-head precision Engine Lathe with foot brake.
- Quick change gearbox for fast and easy threading set up.
- Inverter drive main motor 5HP, 220V, 1 phase or 3HP, 220V, 3 Phase.
- Electronic variable speeds from 20 to 2,500 RPM with HI/LOW gears.
- Spindle is balanced, hardened and precision ground.
- All gears and shafts are hardened and precision ground.
- Guideways induction hardened and precision ground.
- Automatic lubrication system in headstock and feedbox.
- One year warranty for parts.

Standard Equipment

- 6" 3-jaw chuck with set reversible jaws.
- 8" 4-jaw chuck with set reversible jaws.
- 10" Face plate
- 3-3/4" large steady rest.
- 2" follow rest.
- Removable gap.
- Coolant system with dual coolant nozzles.
- Halogen work light.
- 4-way tool post.
- Full length splash guard.
- (2) dead centers and (1) reducing sleeve.
- Thread chasing dial.
- Foot brake.
- Tool box.



MODEL No. GML-1440VS **\$7425.00**



Specifications:

- Max. Swing over bed: 14"
- Max. length of workpiece/ Max. length of cutting: 40"
- Max. Swing over cross slide: 8-1/4"
- Max. Swing in gap: 19-1/4"
- Width of bed: 8-1/2"
- Spindle bore: 1-1/2", D1-4
- Taper of spindle center: M.T.#5
- Spindle speeds, Variable: Low: 20-400RPM High: 300-2,500RPM
- Longitudinal feeds: 0.002-0.03 IPR, 36 kinds
- Cross feeds: 0.0008-0.010 IPR, 36 kinds
- Inch threads: 4-112 TPI, 56 kinds
- Metric threads: 0.1-7.0mm, 44 kinds
- Diametral Pitch threads: 16-112 DP, 32 kinds
- Modual threads: 0.1-1.75mm, 34 kinds
- Max. travel of top slide: 4-1/4"
- Max. travel of cross slide: 7-1/4"
- Diameter of tailstock quill: 1-1/2"
- Max. Travel of tailstock quill: 4"
- Taper of tailstock quill center: M.T.#3
- Main motor: 3HP, 220V, 3 Phase or 5HP, 220V, 1 Phase
- Coolant pump: 1/16HP, 220V, 1 Phase
- Net weight, approx: 1,830 lbs.
- Overall dimensions LxWxH: 70" x 35" x 59"

GMC PRECISION ENGINE LATHE

14" x 40" ~ High Speed 70-2000 RPM

- ISO 9001 certified
- Full Geared-head precision Engine Lathe with foot brake
- Heavy Duty main motor 3HP, 220V, 1 phase
- Heavy Duty guideway width 8 1/2"
- 8 spindle speeds from 70-2,000 rpm, speeds: 70/115/190/300/460/755/1255/2000 rpm
- Quick Change Gear Box for fast and easy threading set up
- 56 kinds of inch threads, and 44 kinds of metric threads
- Spindle is balanced, hardened and precision ground
- All gears and shafts are hardened and precision ground
- Guideways induction hardened and precision ground
- Automatic lubrication system in headstock and feed box
- One year warranty for parts

MODEL No. GMC1440BGF

\$4,495.00

Plus FREE Freight

Equipped With:

- 6" 3-jaw chuck with set reversible jaws
- 8" 4-jaw chuck with set reversible jaws
- 10" Face plate
- 3" large steady rest
- 2" follow rest
- Removeable gap
- Foot brake
- Coolant system
- Halogen work light
- 4-way tools post
- Full length splash guard
- (2) dead centers and (1) reducing sleeve
- Thread chasing dial
- Tool box

Specifications:

- | | | | |
|--------------------------|----------------------------|---------------------------------|---------------------------------|
| Swing over Bed | 14" | Inch Threads | 8-112 TPI, 38 kinds |
| Distance between Centers | 40" | Metric Threads | 0.4-7.2 mm, 28 kinds |
| Swing over Cross Slide | 8-1/4" | Diametral Pitch Threads | 8-112 DP, 36 kinds |
| Swing in Gap | 19-1/4" | Module Threads | 0.2 – 3 mm, 26 kinds |
| Width of Bed | 8-1/2" | Travel of Top Slide | 4-1/4" |
| Spindle Bore | 1-1/2" | Travel of Cross Slide | 7-1/4" |
| Taper of Spindle Center | 5 MT | Spindle Speeds, 8 Steps | 65-2000 RPM |
| Spindle Speeds | 70-2,000 rpm / 8 steps | Taper of Tailstock quill center | 3 MT |
| Longitudinal Feeds | 0.002-0.03 IPR, 36 kinds | Main Motor | 3 HP, 220V, 1phase, |
| Cross Feeds | 0.0008-0.010 IPR, 36 kinds | Coolant Pump | for 3 Phase add \$200.00 |
| | | Net Weight, approx. | 1,730 lbs. |



BIRMINGHAM / ACCORD 13" X 40" GEAR HEAD BENCH LATHE WITH FLOOR STAND

- Lathe bed is constructed of high tensile strength cast iron, rigid structure with hardened and ground ways.
- Precision main spindle loaded on high quality precision bearings (2ea) 30212-30210.
- 8 speed headstock with 70 to 2000 RPM. Speed changes by headstock quick change lever action.
- Permanently filtered oil headstock bath provides clean running oil for long life of bearings & gears.
- 2HP main motor - Heavy duty for its class, wired 220 single phase.
- Manufacture includes heavy duty floor stands, along with full length splash guard as standard equipment.



MODEL No.
YCL-1340GH
\$3695.00

Complete with:
8" 3 jaw chuck, 10" 4 jaw chuck,
Floor stand, Splash guard,
Steady & follow rest,
4-way tool post, Back plates

Specifications:

Swing over bed	13"	(Morse taper)	D1-4
Swing over cross slide	8"	Tailstock spindle taper	MT-3
Swing over gap	18-3/4"	Range of spindle speed	.8 speeds 70-2000
Width of gap	7-7/8"	Lead screw diameter	7/8"
Distance between centers	40"	Feed rod diameter	3/4"
Length of bed	65-1/4"	Thread per inch of lead screw	.40
Width of bed	7-3/8"	Thread cutting range	Metric 0.25-11
Hole thru spindle	1-3/8"		Inch 4-112 TPI
Tailstock spindle travel	3-3/4"	Main spindle motor	2HP-220v-1PH
Cross slide travel	6-7/8"	Net weight w/27" stand	.1,100lbs
Top tool slide travel	3-3/4"		
Saddle travel	35-1/4"		
Headstock spindle taper	MT-5		

BIRMINGHAM / ACCORD 16" PRECISION HIGH SPEED GEARED HEAD LATHE 7-1/2 H.P.



16"x 40"
MODEL No.
YCL-1640
\$10,500.00
Complete

- Heavy duty D1-6 main spindle is supported by tapered roller and ball bearings.
- Hardened and ground bedway.
- Cast from high tensile cast iron in a rigid construction.
- Hardened and ground headstock gears.
- Carriage-mounted spindle control lever.
- Spindle foot brake.
- Magnetic controls.

Equipped With:

8 3-jaw chuck & adapter	Gap bed	Steady rest
12 4-jaw chuck & adapter	Center MT#4	Follow rest
4-way tool post	Center sleeve MT #6 x 4	Rear splash guard
Thread dial	Work lamp	1/8 HP coolant pump
	Face plate 14"	Tool kit & box

Model	YCL-1640 (16" x 40")	YCL-1660 (16" x 60")	
Swing over bed	16"	Taper of spindle bore	MT#6
Swing over cross slide	8-13/16"	Tailstock quill taper	MT#4
Distance between centers	40"/60"	Tailstock quill travel	4-3/4"
Swing over gap	25-1/8"	Cross slide travel	11-3/8"
Width of bed	11-13/16"	Compound rest travel	4-3/4"
Number of spindle speeds	12	Metric threads	0.1-1-14.0mm (41)
Range of spindle speeds	25-2000 RPM	Logitudinal	0.0011" 0.633"
Spindle bore	2-9/32"	Inch threads	2-112 TPI (60)
Spindle nose	D1-6 Camlock	Cross feeds	0.00033-0.01837"
Taper of spindle bore	MT#6	Motor and electrical	5-1/2HP, 220V, 3PH
Tailstock quill taper	MT#4	Machine net weight	4290 lbs.
Price	\$10,500.00		
			\$11,995.00

GMC TOOLROOM LATHE WITH EVS ELECTRONIC VARIABLE SPEED

- Precision angular contact ball bearings.
- Inch/Metric quick change gear box.
- Hardened and precision ground bedways.
- Turcite B bearing surface between carriage and bed.
- Independent variable speed while cutting.
- Thread length control stops with fine adjustment..
- Spindle runout is within 50 millionths of an inch or less.

Made In
Taiwan
ISO-9001
Factory



- Included With Lathe
- Drive Plate
 - Headstock center
 - Drive dog
 - Drive gear
 - 5C collet closer
 - Operation manual

Specifications:

Spindle capacities:		Tailstock spindle taper	2MT
with round 5C collet	1-1/16"	Tailstock spindle travel	3-3/4"
with expanding chucks	3"	Main motor	5HP, 2 speeds, 220X, 3PH
with step chucks	1-1/16 to 6"	Lead screw dia.	1-8 thread per inch
with jaw chucks	5"	36 thread cuts	11-108 DPI
Spindle nose (taper)(I.D.)	5C(10")	36 thread lead	0.275-2.7mm
Spindle nose (taper)(O.D.)	4"	Weight	2,090 lbs.
Variable spindle speed	0-3000 RPM		
	for 6" 3-jaw chucks		
Variable spindle speed	0-4000 RPM		
	for 5C collet		

MODEL No.
TL-618EVS
Reg. **\$26,000.00**
Shown with
Optional Accessories

\$23,995.00

Optional Accessories

Model	Description	Price
VIC-360	Vertical Cutoff slide	\$850.00
VIC-363	Steady Rest	750.00
VIC-368	6" 3-Jaw Chuck	825.00
VIC-364	6" 4-Jaw Chuck	525.00





Clausing/Colchester Geared Head Lathes
Are the standard of the industry for performance and quality at a reasonable price



Clausing Metosa E-Series Lathes
Education Series lathes have enhanced safety making them ideal for classroom and toolroom applications



A line of affordable heavy-duty precision manual and CNC knee mills with a wide range of 2 or 3 axes CNC control options and features found only on higher priced machines. Clausing CNC mills can be operated as manual machines with DRO, semi-automatic or full CNC operation



The Industry's Leading Belt Drive, Heavy-duty 20" Drills:

- Heavy-duty cast iron construction
- Variable speed.
- 2 speed range models available
- Drilling capacity: 1-1/4"
- Air hydraulic or positive gear-driven power feeds.
- Multiple spindle models available



Swivel Head Miter Horizontal Bandsaws: make angle cuts without swinging the material.

- Accurate angle cuts from 0° for 90° cuts & up to 60° angle cuts.
- Capacity up to 13" round & 11"x17.7" rectangular at 90°
- 2HP drive motor
- Variable blade speed



A line of low cost High performance Highly Accurate, Manual & Hydraulic Surface Grinders.

- High precision cartridge spindle
- Anti-wear guide ways
- Rigid cast-iron construction
- Enlarged column and base

For detailed catalogs of the full line of Clausing Machine Tools visit our web site: www.penntoolco.com
or e-mail us and request an electronic (PDF) catalog at: info@penntoolco.com

Behind every Clausing product is the Clausing Service Center, a separate facility designed solely to support our customers' parts & service needs. With more than 50,000 parts in inventory, the service center can provide parts for machines you may have purchased more than 50 years ago... and 95% of all parts orders are shipped within 24 hours! In addition to supplying parts, we have a staff of highly qualified technicians available to solve problems.

Finish Pro FINISHING ~ DEBURRING MACHINES



Features:

- Digital control.
- Motorized table lift.
- Variable speed conveyor.
- Conveyor forward & reverse.
- Belt safety overtravel switches.
- Electronic eye belt tracking.
- 4 heavy duty Jackscrew table support.
- 8" large contract roller.
- Belt overtravel safety switch.
- Door safety interlock
- Belt tracking adjustment.
- Quick release belt change.
- Double infeed & outfeed pinch rolls.
- Conveyor belt tracking system.
- Safety system with disc brake.
- Table height digital readout.
- Load meter.
- 208/230/460 Volt, 3-Phase.
- Wet dust collector & ducting.(Optional)

Model	FP-1460	FP-2560	FP-4075
Max. part width	12-1/2"	40"	24"
Abrasive belt size	14" x 60"	40-1/2" x 75"	25" x 60"
Contact roller size	8" diameter	8" diameter	8" diameter
Passline height	34"-37"	34"-37"	34"-37"
Max. thickness capacity	3-1/8"	3-1/8"	3-1/8"
Conveyor drive speeds	6-30 FPM	8-40 FPM	8 FPM
infeed conveyor length	20"	20"	20"
Dust collector capacity	1,100 CFM	1,800 CFM	1,100 CFM
Main motor	7.5HP, 230V/460V, 3-Ph	15HP, 230V/460V, 3-Ph	10HP, 230V/460V, 3-Ph
Conveyor motor	3/4HP, 230V/460V, 3-Ph	1.5HP, 230V/460V, 3-Ph	1HP, 230V/460V, 3-Ph
Table lifting motor	1/4HP, 230V/460V, 3-Ph	1HP, 230V/460V, 3-Ph	1HP, 230V/460V, 3-Ph
Net weight motor	1,850 lbs.	4,460 lbs.	2,950 lbs.
Machine Dim. LxWxH	49" x 35" x 69"	76" x 88" x 81"	55" x 63" x 69"
Price	\$9,995.00	\$11,300.00	\$16,950.00

Optional:

- 1) Heavy duty wet dust collector, stainless steel construction . . . No. WDC-FP \$6650.00
- 2) Ducting package No. FP-DP \$1100.00



Finish Pro WET FINISHING ~ DEBURRING MACHINES

- Air dryer for parts.
- Variable speed conveyor
- Motorized table lift with digital readout.
- Infeed & outfeed water squeezing rollers.
- Coolant/Filter system with auto paper feeding.
- Stainless steel construction where needed.
- Conveyor forward and reverse.
- Belt safety overtravel switches.
- Main motor load meter.
- Electronic eye belt tracking.
- 4-jackscrew table support.
- Double infeed and outfeed pinch rolls.
- Conveyor belt tracking system.
- Safety system with air disc brake.
- Quick release and fast belt change.
- 208/230 or 460 Volt, 3 Phase.

Model	FP-1460W	FP-2560W
Max. part width	12-1/2"	24"
Abrasive belt size	14" x 60"	25" x 60"
Contact roller size	8" diameter	8" diameter
Passline height	34"-37"	34"-37"
Max. thickness capacity	3-1/8"	3-1/8"
Conveyor drive speeds	6-30 FPM	8-40 FPM
Infeed conveyor length	20"	20"
Jackscrew	Heavy duty (4) jackscrews	Heavy duty (4) jackscrews
Main motor	7.5HP, 230V/460V, 3Ph	10HP, 230V/460V, 3Ph
Conveyor motor	3/4HP, 230V/460V, 3Ph	1HP, 230V/460V, 3Ph
Table lifting motor	1/4HP, 230V/460V, 3Ph	1HP, 230V/460V, 3Ph
Coolant/filter motor	1/2HP, 230V/460V, 3Ph	1HP, 230V/460V, 3Ph
Air dryer motor	1/2HP, 230V/460V, 3Ph	3/4HP, 230V/460V, 3Ph
Net weight motor	2,750 lbs.	3,850 lbs.
Machine Dim. LxWxH	50" x 59" x 69"	71" x 65" x 73"
Price	\$22,000.00	\$32,700.00

RONG FU

MINI RADIAL R-8 SPINDLE MILL/DRILL MACHINE

Head Rotates 360°



MODEL No. RF-35
Reg. List \$2995.00

\$2495.00

Shown On Optional Base
No. RF-35B

Optional Accessories:

Box Table
T-Slots on two faces for clamping:
11" L x 7-7/8" W x 7-7/8" H
Weight 55 lbs.
MODEL No. RF-35T \$295.00

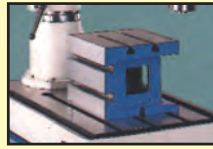

Heavy-Duty Machine Stand
35" L x 26.8" W x 25.3" H
MODEL No. RF-35B \$395.00



Specifications:

Motor: 1-1/2 H.P.
. 220V/440V 3 Phase
Spindle Stroke: 5.2"
Spindle Taper: R8
Swing: 38-1/2"
Work Table: 22" x 20"
Speeds: (5) 340 to 3000 rpm
T-slots: (3) 5/8"
Crosstravel: 15.2"
Column Diameter: 4.6"
Dimensions: 37.4" x 25" x 46"
Head Swivel: 360°
Weight with Stand: 660lbs

BAILEIGH
INDUSTRIAL

**VERTICAL MILLING MACHINE
9-1/2" x 31-1/2" TABLE - R8 SPINDLE**

- The casting of the machine is forged using Meehanite® for extra rigidity meaning, less vibration, offering better tolerances and longer tool life.
- The spindle on the head an industry standard R-8 which allows tooling to be sourced anywhere.
- The 9" x 31" table of the milling machine is hardened, then surface ground and finally polished offering a longer and more precise life.
- The X axis has a power feed for convenience and ease of use. The milling machine has a belt driven head producing speeds as low as 20 rpm and up to 2400 RPM.
- A halogen work light is also included with this great package.



MODEL No.
VM-931E-1

\$5,295.00

With "X" Axis
Power Table
Feed

Specifications:

Drilling Capacity: 2"
Tapping Capacity: 16mm
Face Milling Capacity: 3"
Spindle Taper: R8
Spindle Travel: 4.7"
X-Axis Travel: 15.7"
Y-Axis Travel: 9"
Table Size: 31.5" x 9.5"
T-Slots: 5/8"
Spindle Speed: 200-2400 RPM
Motor: 1.5 HP
Coolant Motor: 1/8 HP
Shipping Size: 45" x 44" x 87"
Shipping Weight: 1760 lbs.

**ACCORD /LEADER 16" x 40" GEARED HEAD ENGINE LATHE
With FREE Taper Attachment and Dual Axis Digital Readout
A \$1500.00 VALUE!**

- Bed constructed of high tensile strength cast iron.
- Hardened and ground ways.
- Precision class 30212-30210 main spindle bearings.
- 16 speed head stock 45 to 1,800 RPM.
- Permanently filtered headstock oil bath.
- 5 HP motor drive - heavy duty for its class.
- Totally enclosed QuickChange Gear Box.
- Full length Foot Brake and Coolant System.



MODEL No.
KGL-1640
Reg. \$12,500.00

\$8,995.00

F.O.B.
Warehouse

Standard Equipment:

- UniQ/Sino Dual Axis Digital Readout
- Taper attachment
- 5 HP Main Motor
- 3 Jaw chuck
- 4 Jaw chuck

- Face plate
- Steady rest
- Follow rest
- 4 way tool post
- Thread dial
- Removable gap
- Full length Foot Brake

- Coolant system
- Rear splash guard
- Dead Centers and Sleeve
- Operation and parts manual
- Halogen work lamp

Specifications:

Swing over bed 16"
Swing over cross slide 10"
Swing in gap 23-1/4"
Length of gap 9"
Center height 8"
Distance between center 40"
Width of bed 10"
Max tool size 3/4" X 3/4"
Max travel of cross slide 6-7/8"
Max travel of compound 5-1/2"
Spindle bore 2"

Spindle nose D1-6
Taper of Spindle MT#6
Spindle speed (16) 45-1,800 RPM
Inch thread (45) 2 - 72 TPI
Metric threads (39) 0.2 - 14 mm
Leadscrew pitch 4 TPI
Cross Feed .0001" - 0.0335
Longitudinal feeds (35) 0.002"-0.067
Quill travel 4-3/4"
Quill diameter 2"
Quill taper MT#4
Main motor 5HP/3Ph/220

**ACER ELECTRONIC VARIABLE SPEED
"E" LATHES 14" AND 17" SWING**

- Accept both single phase and three phase power.
- Low maintenance and down time cost due to fewer gears in headstock.
- Constant Surface Speed (optional)
- Electronic and mechanical brake for fast spin spindle stops internal threading.
- No RPM gear changer break down, accurate reading on RPM to prolong tool life.
- Spindle speed could be adjusted to best condition during cutting.
- Save energy cost up to 35%
- 17" models are also available in 40" and 80" Center distance.
- 1 year warranty.

Standard Equipment:

- 1440: 6" 3-Jaw chuck, 8" 4-Jaw chuck, steady and follow rest, halogen worklight, toolbox, 4-way tool post, 10" face plate, splash guard and micrometer work stop.
- 1760: 10" 3-Jaw chuck, 4-way tool post, steady rest, halogen worklight, chuck guard, splash guard, 14" face plate & 3-Jaw and 4-Jaw adapter plate.



Optional:
With Newall
Dual Axis Digital Readout
No. E70 Installed
for No.1440V
Add . . . \$2600.00
for No.1760G
Add . . . \$2900.00

Model No.	1440V	1760G
Swing	14"	17"
Swing Over Gap	20-3/4"	26"
Swing Over Crossslide	8-3/4"	9-5/8"
Distance between Centers	40"	60"
Spindle Type	D1-4	D1-6
Spindle Hole Diameter	1-1/2"	2-1/4"
Spindle Speeds	36-2200 RPM (infinite)	25-2200 RPM (infinite)
Cross Slide Travel	8-5/8"	8-5/8"
Tailstock Taper	3MT	4MT
Metric Pitch Threads	(30) .4-7mm	(22) .5-7mm
Inch Pitch Threads	(32) 3-56 TPI	(36) 4-56 TPI
Motor	3HP, 220V	7.5HP, 220V
Weight	1520 lbs.	3950 lbs.
Price	\$9,995.00	\$18,995.00



HEAVY DUTY 12 SPEED DRILL PRESSES - 5" SPINDLE TRAVEL

Features:

- Rapid and easy speed changes with a swing mount motor and pulley.
- Heavy cast-iron quill handle is rubber finished for comfortable use.
- Cast-iron head, base and table; tubular steel column.
- Maximum spindle run-out of 0.001".
- Long spindle travel of 5" (6" travel on 20" drill press).
- MT2 spindle taper (MT3 on 20" drill press).
- Precision ground work table can be tilted 45° both right and left and rotates 360° around column. Includes coolant trough and 5/8" T-slots.
- Hardened steel rack and pinion with locking mechanism for easy table height adjustment.
- Quick-change vertical depth-stop for accurate and repeatable feed length.
- Dual-voltage, 115/230 volt, 1 phase operation. Prewired for 115 Volt.
- Each machine includes a drill chuck and arbor.
- Each drill chuck includes a safety eject key.
- Locking power switch prevents unauthorized use.



Model No.	Type	Motor	Drill Capacity	Spindle Travel	Speed Range	Spindle Taper	Table Size	Column Diameter	Weight	Reg. Price	Sale Price
80110-1	10" Bench	1/2HP, 1PH, 115V	5/8"	5"	240-3080 RPM	MT2	12" x 12"	2.84"	220 lbs.	\$225.00	\$179.00
80156	15" Floor	1/2HP, 1PH, 115V	5/8"	5"	240-3080 RPM	MT2	12" x 12"	2.84"	238 lbs.	595.00	495.00
80174	17" Floor	3/4HP, 1PH, 115V	5/8"	5"	240-3080 RPM	MT2	12" x 12"	3.15"	249 lbs.	685.00	595.00
80207	20" Floor	1HP, 1PH, 115V	1"	6"	190-2450 RPM	MT3	18" x 16"	3.62"	380 lbs.	995.00	845.00



VARIABLE SPEED DRILL PRESSES

The accurate machining and precision components of these Palmgren Drill Presses ensure drilling accuracy. The rugged cast iron head, column, table and base minimize vibration enabling smoother and safer use. The heavy gauge steel pulley cover provides quiet operation.

- For general purpose shop work.
- Variable speed drive with digital readout makes for simple and accurate RPM adjustment.
- Dual voltage (110/220V) design (pre-wired for 110V); single phase.
- Spindle taper MT3; spindle travel 5".
- Quill diameter 2.16"
- Table size 13" x 16"



Model No.	Swing Inch	Variable Speed	Column Size	Sale Price
80152	15"	300-3000	3"	\$1750.00
80202-1	20"	300-3000	4"	2595.00

DELTA 18" LASER DRILL PRESS

- Auto-Tensioning Belt Drive System allows for fast and easy speed changes while maximizing transmission efficiency with consistent belt tension and motor alignment.
- Full 6" Quill Stroke for deeper drilling applications and Best-In-Class capacity.
- Oversized Woodworker's Table with patented design bevels 0°-90° left and right, tilts forward 0°-48°, features T-slots for clamping, and a removable center insert for through-table drilling.
- Micro-Adjustable Depth Stops and Independent Depth Scale allows the user to zero the scale and set up for repetitive drilling, quickly and easily.

Specifications:

Motor: 3/4 HP
 Motor Control: On/Off Rocker Switch
 Speeds: 16 (170-3000)
 Table Size: 20 x 14"
 Table Tilt/L/R: 0-90° Forward 0-48°
 Table Insert: 3.75 x 3.75 x 0.75
 Column Diameter: 80mm
 Spindle Taper: Morse #2
 Chuck Taper: Jacobs #3

Quill Diameter: 52mm
 Quill Stroke: 6"
 Key Chuck Capacity: 5/8"
 Chuck to Table Capacity: 22.25"
 Chuck to Base Capacity: 42.5"
 Height: 70"
 Width: 20"
 Depth: 28"
 Weight: 240 lbs
 Shipping Weight: 261 lbs

MODEL No. 18-900L

Reg. \$1295.00

\$1195.00



20" VARIABLE SPEED DRILL PRESS

- Variable spindle speeds from 300 to 2000 RPM
- External #3 Morse Taper
- Front mounted positive control depth stop
- 6" Quill travel. • Massive 3" quill diameter
- Heavy duty cast iron design
- Large precision ground T-Slot production table for easy set ups • Machined T-Slotted base
- Front or side rack and worm gear table raiser
- Table rotates 360° around the column

Specifications:

Max Distance Spindle to Table 30-1/4"
 T-Slots Number and Size 2 x 5/8"
 T-Slot Centers 7-7/16"
 Work Table Weight Capacity 176 lbs.
 Column Diameter 4-1/2"
 Drilling Capacity Cast Iron 1-1/4"
 Drilling Capacity Mild Steel 1"
 Tapping Capacity Cast Iron 3/4"
 Tapping Capacity Mild Steel 5/8"
 Quill Travel 6"
 Table Size 18-1/8 X 14-3/4"
 Distance Column to Spindle 10-7/16"
 Spindle Distance to Base 43-5/16"
 Base Work Table 14-3/4 x 11-13/16"
 Max Distance - Spindle to Table 30-1/4"
 Spindle Travel 6"
 Swing (2) 20"
 Table Dimensions 18-1/8 x 14-3/4"
 Base Dimensions (LxWxH) 27-1/2 x 19-1/4 x 6"

Model	Description	Price
354221	20" Drill Press 2 H.P. 110/220V 1 Ph	\$3450.00
354223	20" Drill Press 2 H.P. 220/440V 3 Ph	3450.00



15" VARIABLE SPEED DRILL PRESS

- Speeds from 400 to 5000 RPM
- Handwheel adjustment sets the speeds
- Large 2-1/4" quill allows greater accuracy
- 3" Column diameter for maximum head support
- Full bearing support on quill for maximum spindle stiffness
- 6" stroke for deep hole application
- Accurate depth stop for precise hole depths
- 1/2" drill chuck & arbor
- Safety collar

Specifications:

Drilling Capacity Cast iron 5/8"
 Drilling Capacity Mild Steel 1/2"
 Column Diameter 3"
 Distance Column to Spindle 15"
 Range of Spindle Speeds 400 to 5000 RPM
 Spindle Travel 6"
 Spindle Distance to Base 44-1/2"
 Max Distance Spindle to Table 25-3/4"
 Table Size 15" x 18"
 Table Travel 16-3/4"
 T-Slots Number and Size 2 & 1/2"
 T-Slot Centers 5-5/16"
 Work Table Weight Capacity 90 lbs.
 Spindle Taper MT-2
 Base Dimensions LxWxH 20-7/8"x14-3/16"x3-1/8"
 Base Work Table 12-1/8" x 1-13/16"
 Base Slots Number & Size 2 & 1/2"
 Motor 1HP, 115/230V, 1Ph, Prewired 115V
 Overall Dimensions LxWxH 30" x 20" x 71"
 Net Weight 426 lbs.

MODEL No. 3545501

List \$2499.00

\$1995.00



JET 20" GEARED HEAD DRILL PRESS

EQUIPMENT & TOOLS

- Heavy duty design allows a variety of precision drilling applications.
- Easy to read internal depth gauge (GHD-20)
- **Three power down feeds (GHD-20PF .004, .007, .01)**
- Calibrated fine down feed built-in.
- Built-in spindle lock.
- Head tilts left or right.
- Easy accessible table raiser.
- Large production table and T-slotted.

Standard Equipment

- T-slotted worktable.
- Drill chuck arbor.
- Draw bar.

MODEL No.
GHD-20

\$3750.00

Without Power
Downfeed

MODEL No.
GHD-20PF

\$4195.00

With Power
Downfeed

Specifications

Model	GHD-20/GHD-20PF
Cast Iron Drilling Capacity	1-1/2"
Steel Drilling Capacity	1-1/4"
Column Diameter	4-1/2"
Distance Spindle to Column(max./in.)	10"
Spindle Taper	MT-3
Spindle Travel (GHD-20)	5"
Spindle Travel (GHD-20PF)Manual	4-1/2"
Spindle Travel (GHD-20PF)Auto	4-1/4"
Quill Diameter	3"
Spindle Distance to Base	44-3/8"
Spindle Distance to Table	30-7/8"
Table Size	21-1/4" x 18-1/2"
T-slots, number & size	2 & 5/8"
T-slot centers	6-1/4"
Number of Spindle Speeds	12
Range of Spindle Speeds (RPM)	60 & 3000
Number of Powerfeeds (GHD-20PF)	3
Range of Powerfeeds	.004, .007, .01
Motor	2HP, 3 Ph, 2-speed, 230 V only
Overall Dimensions (LxWxH)	32" x 24" x 71"
Net Weight	660 lbs.

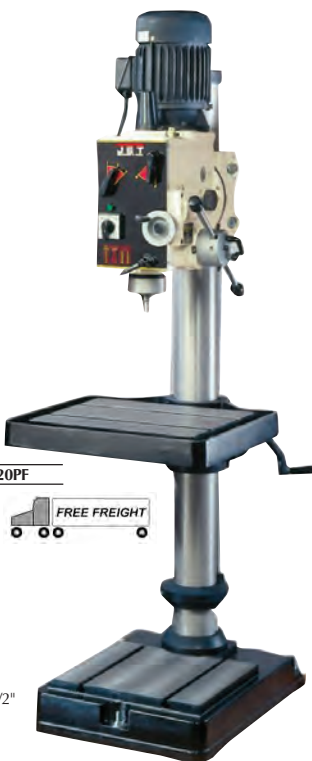

JET 20" GEARED HEAD DRILL PRESS AND TAPPING PRESS

EQUIPMENT & TOOLS

- Heavy duty design allows a variety of precision drilling and tapping applications.
- Easy to read internal depth gauge
- **Three power down feeds (GHD-20PFT .004, .007, .01)**
- Calibrated fine down feed built-in.
- Built-in spindle lock.
- Head tilts left or right.
- Easy accessible table raiser.
- Large production table and T-slotted.

Standard Equipment

- **Integrated tapping and reversing controls.**
- T-slotted worktable.
- Drill chuck arbor.
- Draw bar.

MODEL No.
GHD-20T

\$4495.00

Without Power
Downfeed

MODEL No.
GHD-20PFT

\$4795.00

With Power
Downfeed

Specifications

Model	GHD-20T/GHD-20PFT
Cast Iron Drilling Capacity	1-1/2"
Cast Iron Tapping Capacity	13/16"
Steel Drilling Capacity	1-1/4"
Column Diameter	4-1/2"
Distance Spindle to Column(max./in.)	10"
Spindle Taper	MT-3
Spindle Travel:	
Manual	5"
Auto	
Tapping	4-7/8"
Quill Diameter	3"
Spindle Distance to Base	44-3/8"
Spindle Distance to Table	30-7/8"
Table Size	21-1/4" x 18-1/2"
T-slots, number & size	2 & 5/8"
T-slot centers	6-1/4"
Number of Spindle Speeds	12
Range of Spindle Speeds (RPM)	60 & 3000
Motor	2HP, 3 Ph, 2-speed, 230 V
Overall Dimensions (LxWxH)	32" x 24" x 71"
Net Weight	670 lbs.



BAILEIGH 16" VARIABLE SPEED INVERTER DRILL PRESS

- The **DP-1000VS** variable speed drill press has a very wide column to eliminate flexing when drilling at full capacity. The base and table are made from a very rigid casting adding to the strength of this 1" maximum capacity drilling machine.
- The inverter driven head allows the machinist or fabricator to run tooling at the proper speed for each drill or tap size available. Running at the exact speed extends tooling life, something that can't be accomplished on other drills like pulley driven styles. The **DP-1000VS** drill press also comes standard with a coolant system, guarding and a halogen light.

MODEL No.
DP-1000VS

\$2995.00

Specifications:

Drill Capacity: 1"
Tapping Capacity: 5/8"
Spindle Speed: 150 - 3000 rpm
Swing: 16"
Spindle Taper: MT3
Spindle Travel: 5.3"
Spindle Nose to Table: 23.8"
Spindle Nose to Base: 45.3"
Quill Diameter: 2.44"
Column Diameter: 3.62"
Table Dimensions (L/W): 18.1" / 14.2"
Table Slot: 5/8"
Base Dimensions (L/W): 27" / 19"
Motor Main: 2 HP
Motor Coolant: 1/8 HP
Power Requirements: 220 volt / 1 Phase
Shipping Dimensions (L/W/H): 32" / 24" / 79"
Shipping Weight: 579 lbs



BAILEIGH 20" VARIABLE SPEED DRILL PRESSES 4MT SPINDLE

- Baileigh's heavy duty drill presses have a wide column for extra support to reduce flexing during heavy drilling sessions.
- These machines have a powerful inverter driven head that is controlled through a speed potentiometer dial and digital read out for displaying actual quill RPM.
- Model **DP-1500VS** heavy duty drill press comes with powerdown feed and a quality auto reversing tap feature.
- This variable speed drill press uses a heavy #4 Morse Taper to transfer the power from the spindle to the quill. To further the rigidity the base and table are made of a heavy casting with very large T-slots to secure vise or material. The base includes a powerful coolant system that is sprayed out at the quill behind a quality splash and safety guard.

Specifications:

	DP-1250VS	DP-1500VS
Drill Capacity:	1.5"	1.5"
Tapping Capacity:	3/4"	15/16"
Spindle Speed High:	245-2000 RPM	245-2000 RPM
Spindle Speed Low:	85-540 RPM	85-540 RPM
Swing:	20.8"	20.8"
Spindle Taper:	MT4	MT4
Spindle Travel:	5.9"	5.9"
Spindle Nose to Table:	36.41"	22.75"
Spindle Nose to Base:	48.22"	40.75"
Quill Diameter:	2.95"	2.95"
Quill Feed DP-1500VS only	-	.0078"/.004", .002"
Column Diameter:	4.52"	4.52"
Table Dimensions (L/W):	22"/18.5"	22"/18.5"
Table Slot:	5/8"	5/8"
Base Dimensions (L/W):	27"/19"	27"/19"
Motor Main:	2HP	2HP
Motor Coolant:	1/8HP	1/8HP
Power Requirements:	220V/1Phase	220V/1Phase
Shipping Dimensions (L/W/H):	40"/25"/83"	40"/25"/83"
Shipping Weight:	847 lbs.	902 lbs.
Price	\$4195.00	\$4795.00

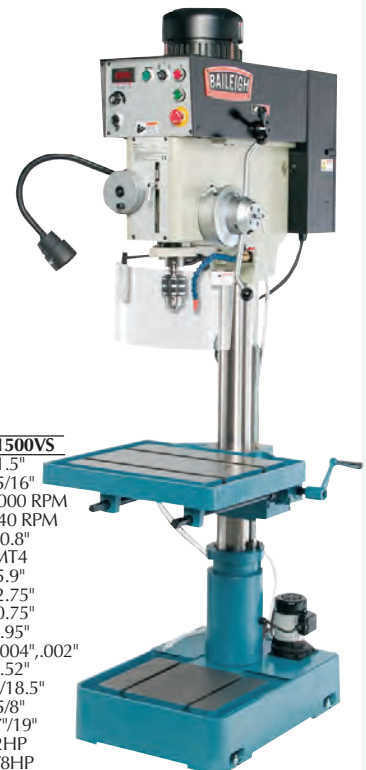

Top Tech® MINI MILLING AND DRILLING MACHINE

Machine & Tools

- Work head can swivel $\pm 45^\circ$.
- Excellent quality Mini Mill/Drill machine.
- The head has a 2-speed gearbox for increased torque. It is powered by a 1/2 H.P. electronic variable-speed-controlled motor.
- All slides utilize dovetail construction for max rigidity.
- The table is hardened and ground.

Specifications:

Drilling capacity: 1/2"
End milling capacity: 5/8"
Face milling capacity: 1-3/8"
Headstock travel(Z): 7.1"
Table size: 5"x 16"
Spindle travel: 2-1/2"
Cross travel (x): 8.8"
Longitudinal travel (Y): 6.4"
Head swivels: -45° to $+45^\circ$
Output power: 1/2H.P. 110V
Spindle speed:
Low range 0-1500 RPM
High range 0-2500 RPM
Spindle taper: MT#2 x 3/8"-16 Thread
T-slot: 1/2"

MODEL No.
XJ-9510
\$1195.00

Less Drill
Chuck &
Arbor
(150 Lbs.)

SET No. CMT-007 \$59.95
2 M.T. Collet Set
1/8" thru 1/2" by 1/16ths
SET No. ERS-258 \$125.00
2MT ER-16 Collet Holder
& (8) ER Collets 3/32"-3/8"
No. TT-500 \$19.95
1/2" Key Type Drill Chuck
& 2MT Threaded Arbor



Swivel
Head



BENCHTOP DRILL PRESS

- This mini drill press offers excellent control
- Infinitely variable speeds are in three ranges: low (0-5000rpm), medium (0-6500rpm) and high (0-8500rpm)
- Jacobs chuck spindle accommodates drill shanks up to 6.5mm
- Work surface is die-cast for durability
- With a platform measuring only 6-3/4" x 6-3/4"
- UL/CE certified and ISO-9001
- Speed: up to 8500 RPM
- One year warranty

MODEL No.
28-618
\$79.95

Specifications:

Rated voltage: 110-120v
Rated power: 100w
Rated frequency: 60Hz
Rated current: 1.1A
Drilling diameter (MAX): metal 1/8", non-metallic 1/4"
Drilling stroke: 1"
Distance between main axle end to worktable (MAX): 8"
Shipping Weight: 10 lbs



Top Tech® DRILL PRESSES - HEAVY DUTY - INDUSTRIAL QUALITY

Machine & Tools

Heavy Duty Casting - Ball Bearing - Table Tilts $\pm 45^\circ$

- Hinged metal belt and pulley cover coupled with quick adjustment motor mount allow rapid changing of speeds.
- Rotating, tilting crank-operated work table with quick release clamp.
- Motor and frame included.
- Conveniently located on/off switch.
- Quality drill chuck and key included.
- Quick adjustment depth gauge and stop.
- Slotted work table and base.
- Adjustment spindle return spring.
- All ball-bearing motors and spindles.

Specifications:	Bench Models		Floor Models		
	Model	100-1120	100-1251	100-1321	100-1351
Swing	13-1/2"	15"	18"	20"	20"
Drilling Capacity	3/4"	1"	1-1/4"	1-1/4"	1-1/4"
Spindle Travel	3"	3"	4-3/4"	4-3/4"	4-3/4"
Spindle Taper	2 MT	3 MT	4 MT	4 MT	4 MT
Speed, No.	12	12	9	12	12
Speeds, RPM	210-3840	210-3840	150-2020	190-2320	190-2320
Motor, 1 Phase	3/4 HP	3/4 HP	1 HP	1-1/2 HP	1-1/2 HP
Overall Height	39"	62"	67-1/2"	67-1/2"	67-1/2"
Column Diameter	2.8"	2.8"	3.68"	3.68"	3.68"
Table Size	11.6" x 11.6"	12" x 12"	14-1/2" x 14-1/2"	17" x 19"	17" x 19"
Base Size	10" x 17-1/2"	10" x 20"	15" x 25"	18" x 23"	18" x 23"
Net Weight	116 lbs.	170 lbs.	297 lbs.	308 lbs.	308 lbs.
Price Complete	\$179.95	\$259.95	\$449.95	\$549.95	\$549.95



(Not Shown)
Bench Model
100-1120
Floor Model
100-1251
100-1321

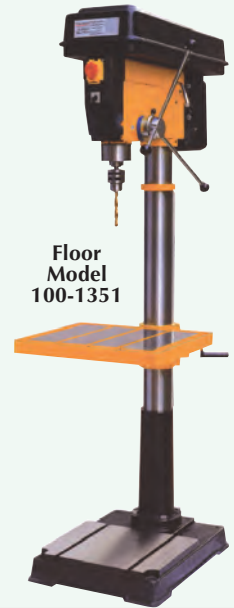

Floor
Model
100-1351



R-8 Spindle
Power Downfeed
Drilling/Milling
Machine
MODEL No.
DMF-40
\$2695.00

Top Tech® DRILLING AND MILLING MACHINES - GEARED HEAD

Machine & Tools

With Power Down Feed

- Milling drilling, tapping, boring, and reaming.
- Head swivels 360° .
- Fine Feed Handwheel
- Forward and Reversing Switch.
- Positive spindle locks.
- Heavy-duty tapered roller bearing spindle.
- Adjustable gibs on milling table
- Gear drive, lower noise.
- Halogen lamp.
- Built in coolant system.

MODEL No.	DMF-40	DM-30H
Drilling capacity	2"	2"
Milling capacity	5" Face Mill	-
Spindle Taper	R-8	4 M.T.
Spindle travel	5"	5"
No. of spindle speeds	6	6
Spindle speed, RPM	90-1900	90-1900
Max distance, spindle to worktable	24-1/2"	28-1/2"
Max distance, spindle to base	47-1/2"	47-1/2"
*Milling table size	24"x 7-1/2"	-
Travel "X" & "Y"	15"x 7-1/2"	-
*Size of drilling table	-	21-1/2"x 19"
Diameter of column	4-1/2"	4-1/2"
Overall dimensions	32"x 27"x 79"	32"x 27"x 79"
Base dimension	26-1/2"x 18"	26-1/2"x 18"
Motor	1-1/2 H.P., 110/220V, 1 Phase	1-1/2 H.P., 110/220V, 1 Phase
Weight	850 Lbs.	850 Lbs.

4 M.T. Spindle
Power Down Feed
Drilling Machine
MODEL No.
DM-30H
\$2995.00



Cameron MICRO DRILL PRESS

- Safety belt & pulley guard.
- High speed balanced motor has three speeds 9500, 17,000, 30,000 RPM
- Special rack & pinion feed design.
- 1/8" precision keyless chuck.
- Precision slotted worktable.
- Super precision spindle bearings.
- Spindle has a .0001" TIR.



5" Depth Spindle to Column MODEL No. 164-D3
16" Depth Spindle to Column MODEL No. MD-700-D3

\$1295.00

\$1495.00

Both Models Equipped with:
1/8" Keyless Chuck, 1/2" Range Dial Indicator with Depth Attachment, V-Belt and Safety Guard

Specifications:

Max. work height 5-3/4"
Chuck center to mounting column spindle travel 1-1/4"
Spindle speeds (3) 9500, 17000, 30000 RPM
Table size 4" x 4"
Motor 115V
Overall dimensions:
L x W x H 11-3/4" x 7" x 17"
Net weight 11 lbs.



MODEL No. 164-D3 (Shown)

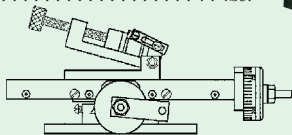

X-Y Table & Vise with Tilt Base

Optional Accessories

No. 164-VC	Variable speed control	\$175.00
No. 164-XY	X-Y positioning table with 3-1/2" X-axis & 2-1/2" Y-axis travel	495.00
No. 164-V	1-1/2" vise with tilt base	195.00
No. 164-RT	3-1/2" Rotary table with mounting hardware	345.00
No. 164-AP	Angle plate for use with rotary table & X-Y table	95.00



MICRO SENSITIVE PRECISION DRILLING MACHINE



Features:

- Smooth, easy and quiet operation.
- Adjustable, sensitive quill lever.
- Quill travel.
- Infinitely variable spindle speeds. 200-20,000 RPM over two belt ranges (Low ratio: 200-4000 RPM; High ratio: 1000-20,000 RPM)
- Spindle runout .0002" TIR.
- Dial gage .001" for accurate depth.
- Dial gage zero-set knob.
- Course depth dial .1" div.
- Fine grain, ground cast iron base.
- Column height 12"
- Self contained motor.
- On/Off switch.
- ALBRECHT chuck inch version.

MODEL No. M-7000

\$1895.00



* Deep Throat and 18" column height available:
No. M-7040 \$2495.00



ROTOMAG MAGNETIC CLEAN-UP TOOL

- Quickly and easily pick up sharp metal chips, fasteners and small metal parts.
- Simply wave it over magnetic and safely dispose by pulling back the knob

Save 25% Off List No machinist should be without one!



MODEL No. RMX7
List Price \$39.95
Sale

\$29.95



MAGBORE PORTABLE MAGNETIC DRILL PRESS ~ 770 LBS. HOLDING

- Compact, lightweight, easy to carry and maneuver. Once set, it holds positively for the most precise drill positioning.
- Simple, strong and easy, magnetically attracts or releases, even on plates as thin as 1/52 inch. (5mm).
- Weighs just over 12 lbs. (w/o drill) yet solid and firm enough for precise drilling.



Magbore MODEL No. KCD-001

\$795.00

Drill Not Included

Power Requirements (Single Phase) AC 110-120V
Magnet dimensions 4" dia. x 2-3/8"
Overall size (without drill) Width 9"
Height 9.5" lowered
Holding power of magnet 770 LBF measured on 1" thick mild steel
Maximum stroke 3.9"

Milwaukee Magnum Hole Shooters

Model	Capacity	RPM	Price
0234-6	1/2"	0-850	\$179.95
0244-1	1/2"	0-600	179.95
0224-1	3/8"	0-1200	168.00
0124-1	1/4"	0-2000	165.00

Drills are not included with the Magbore, but can be purchased separately.

Precise MINIATURE HIGH SPEED DRILL PRESS

- Precise small hole drilling with 3 step pully motor, 5000, 6500, 8500 RPM (3 speeds).
- U.L. approved powerful motor for long trouble free life.
- Equipped with 1/4" drill chuck.

Specifications:

Spindle Travel: 1"
Dimensions: L x W x H:
10" x 6-1/2" x 16"
Distance between Chuck & column: 4-1/4"
Distance between Chuck & bench base: 7"

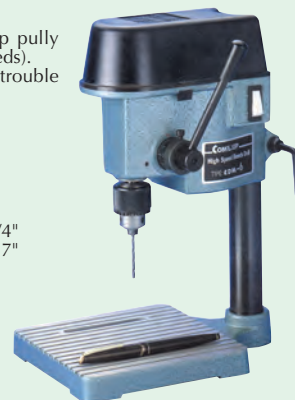

MODEL No. CDM-6

\$149.95

RONG FU 20" VARI SPEED, 3 M.T. DRILL PRESS WITH POWER DOWN FEED

This heavy duty, power feed variable speed drill press is now available in an economical package, capable of handling a wide range or your drilling and hole finishing operations. Ideal production, tool room, maintenance department, fabri shop or training school applications and built for continuous use.

Features:

- 2 speed motor vari-speed range: 150-2000 RPM's
- Spindle power down feed by 4 step feeds : 0.10mm -0.15mm - 0.23mm -0.30mm per revolution.
- Deluxe handle knobs.
- Deluxe belt cover.
- Massive 3" diameter quill provides rigidity during operation.

Specifications:

Drilling capacity 1-1/2"
Swing 18"
Max. distance spindle to table 38-1/2"
Max distance spindle to table 39"
Spindle taper MT#3
Spindle travel 6-1/2"
Column diameter 4-1/2"
4 step power down feed. 0.01 - .015 - 0.23 - 0.30
Range of spindle spds. 150-2000rpm
Table size 21-1/4" x 18-1/2"
T-slot size/number 5/8"
Motor 3 phase 1-1/2 H.P.
Net/Gross weight 615/685 lbs.
Overall machine height 74"



With Power Down Feed MODEL No. RF-40152F

\$2,995.00



DELUXE MILLING & TAPPING MACHINE WITH DOVETAIL COLUMN

- This mill is further fortified with a quick-tilt headstock for horizontal milling, 1 HP brushless motor, a multi-function digital depth scale on the quill, push-button speed control and digital spindle tachometer.
- The quick reversing tapping feature also makes hole threading simple. Just put the machine in "tapping mode", start the tap, and when the thread is completed, push the button at the end of the rack levers and the spindle reverses.
- The back-lit digital tachometer tells you the precise spindle speed for matching tooling and material.

Specifications:

- Motor: 1HP, 220V, brushless DC w/ step-up transformer, 110V operation
- Spindle taper: R-8 • Swing 18"
- Spindle travel: 2-7/8"
- Table size: 6-1/4" x 21-5/8"
- Table travel (cross): 5-3/4"
- Table travel (longitudinal): 15-7/8"
- Headstock travel: 14-7/8"
- Drilling capacity: 1"
- Max. face cutter diameter: 2"
- Quill diameter: 60mm"
- Variable speed: 100 - 1750 RPM
- Approximate shipping weight: 436 lbs.

Optional:

- #D3694 Power Table Feed \$275.00
- #D3693 Angle Worktable \$95.00
- #D3695 Horizontal MillingWork Table \$145.00

MODEL No. M1111
List \$2700.00

\$2100.00



Head Rotates 90° L & R



MILLING & DRILLING MACHINE With Dovetail Column ~ Variable Speed

- The Z-axis handwheel with the fully geared lift system easily lifts and lowers the headstock
- A 3/4 HP reversible variable-speed universal motor drives an all-steel geared Hi/Lo range gearbox which drives the 60mm diameter quill and R-8 spindle.
- The precision ground cast iron milling table with coolant troughs and drain will accept an aftermarket coolant system and power feed.
- Outstanding X and Y table travel of 5-3/4" x 15-1/2"

Specifications:

- Motor: 3/4HP, 110V, Single phase, Universal
- Spindle taper: R-8
- Spindle travel: 85mm
- Swing: 18"
- Headstock travel: 14-7/8"
- Drilling capacity: 1"
- Max. face cutter diameter: 2"
- Quill diameter: 60mm
- Variable speed: 0 - 1000, 0 - 2000 RPM (Hi-lo gearbox)
- Approximate shipping weight: 445 lbs.
- Table Size: 6" x 21"

Optional:

- #D3694 Power Table Feed \$275.00
- #D3693 Angle Worktable \$95.00
- #D3695 Horizontal MillingWork Table \$145.00

MODEL No. M1110
List \$2200.00

\$1695.00



MICRO DRILL PRESS 1/64" to 1/4"

- High quality machined work table of ribbed die-cast aluminum (work table size 8-1/2" x 4-3/4") providing an adjustable parallel fence with scale.
- Solid, hard-chromed steel column is 11" high and has a diameter of 3/4". The powerful motor, which is built into the super stable die-cast head of the machine, runs very quiet and has a long life expectancy.
- Power transmission by 3 step aluminum pulleys and flat belt provides 3 spindle speeds of 1800, 4700 and 8500 RPM allowing triple torque at lower speeds.
- Chrome feed lever has a practical adjustable drilling depth gauge.

- The spindle is essentially free of play as a result of the three high quality ball bearing assemblies. It is recessed for the insertion of MICROMOT steel collets, but also threaded for attaching drill chucks with 3/8" thread.
- The spindle has an extremely high rotational accuracy and a 1-3/16" feed. The quill diameter is 1-1/4" with return spring, the throat depth is 5-1/2". The unit provides quick coarse height adjustment of headstock via clamp lever. The max. height is 5-1/2"

Micro Drill Press
MODEL No. 38-128

\$299.95

Includes:
6 steel collets
1/32", 1/16", 5/64",
3/32", 7/64", 1/8",
1/64" - 1/4" Rohm
Drill Chuck
(Less Vise)



"X" - "Y" Compound Table

Optional Accessories

No. 27-100	High Precision Compound Table 7-7/8" x 2-3/4", BT-Slots, 0.05mm Grad. Travel: X-5-9/32", Y-2-3/4"	\$129.95
28-132	Machine Vise, 2-25/64" Jaw Width, 1-11/32" Opening, V-Groove	\$29.95

Top Tech® UNIVERSAL MACHINE VISES

Machine & Tools



Model	UMV-500	UMV-100	UMV-125
Axis Swing	2 Axis	3-Axis	3-Axis
Jaw Width	2"	4"	5"
Jaw Height	1"	1-7/8"	1-7/8"
Jaw Opening	2"	3-7/8"	3-7/8"
Net Weight	8 lbs.	59 lbs.	62 lbs.
Price	\$85.00	\$179.50	\$199.50



MICRO MILLING MACHINE For Lab, Electronics, Model Building

- Stable base of cast iron.
- Both vertical column and compound table are of treated, high quality aluminum.
- All axes are play-free and have adjustable slides.
- The headstock, made of die cast aluminum, houses the 24 pole balanced special motor and provides stability even at high operating speeds . Six triple slit, hardened MICROMOT steel collets come with the machine and cover shank sizes of 1/32", 1/16", 5/64", 3/32", 7/64" and 1/8"
- The table is fitted with three T-slots of 15/32" x 15/64" x 15/64"
- An adjustable ruler scale eases the positioning of the work piece.
- All hand wheels are zero adjustable with 1 revolution=3/64" (1.0mm), 1 division=.002" (0.05mm).

Specifications:

- Speeds . . . 5000 - 20,000 RPM variable
- Table size 7-7/8"x2-3/4"
- X-Y Travel 5-17/64" & 1-13/16"
- Vertical Travel 2-3/4"
- Footprint Size 5-7/64"x8-55/64"
- Overall Height 13-25/64"
- Max. Power 1/8 H.P.
- Volts 110-120V AC, 60Hz
- Weight 15.5 lbs.

MODEL No. 37-110

\$495.00

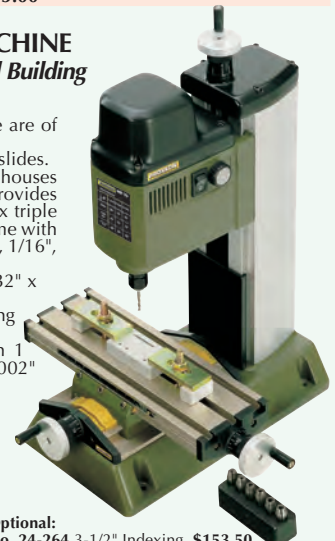

Optional:

- No. 24-264 3-1/2" Indexing Rotary Table \$153.50
- No. 28-941 3 Jaw keyless chuck \$16.50
- 1/32" - 1/8" Precision Vise 2-3/4"L \$68.00
- 1-13/16" Jaw Width, 1-3/16" Jaw Cap



MICRO MILL/DRILL

- This Micro Mill is perfect for machining high precision small parts for working models.
- It includes a digital depth readout, compound slide table, and a micro downfeed knob and variable speed control.

Specifications:

- Motor: 0.2 HP, 2A, 110V, single-phase
- Drilling capacity: 1/4"
- Spindle taper: JT1
- Spindle travel: 1-1/2"
- Headstock travel: 7-3/4"
- Spindle to column distance: 6-1/2"
- Table travel (longitudinal): 2-3/4"
- Table travel (cross): 5-1/2"
- Table size: 3-1/2" X 8"
- Column swivel: 360 degrees
- Speeds:
Low range: 0-3600
High range: 0-500
- Approximate shipping weight: 52 lbs.



Optional:
No. M1037 Collets \$150.00



MODEL No. M1036
Reg. \$495.00

\$395.00

With Compound Table Less Quickvise

Precise MINI MILLING AND DRILLING MACHINE

- Work head can swivel $\pm 45^\circ$.
- Excellent quality Mini Mill/Drill machine.
- The head has a 2-speed gearbox for increased torque. It is powered by a 350W electronic variable-speed-controlled motor.
- The head has a 2-speed gearbox for increased torque.
- It is powered by a 350W electronic variable-speed-controlled motor.
- All slides Utilize dovetail construction for maximum rigidity.
- The table is hardened and ground with 1/2" "T" - slots.

Specifications:

Drilling capacity: 1/2"
 End milling capacity: 5/8"
 face milling capacity: 1-3/8"
 Headstock travel(Z): 7.1"
 Cross axis(x): 4"
 Longitudinal axis(Y): 8.66"
 Head swivels: -45° to $+45^\circ$
 Output power: 1/2H.P. 110V
 Spindle speed:
 Low range 0-1100 RPM
 High range 0-2500 RPM
 Spindle taper: MT#3
 T-slot: 1/2"
 Weight: 150 Lbs.

MODEL No.
 XJ-9510-1

\$725.00

Mill Head Tilts 45°
 left or right



Tilting
 Column

Top Tech® GEARED HEAD MILL/DRILL

Machine & Tools Dovetail Column ~ Swivel head $\pm 90^\circ$

- Milling, drilling, tapping, boring, reaming.
- Capacity, cast iron: 1-9/16", mild steel: 1-1/4".
- Massive 3" diameter quill.
- Zero setting dials.
- Full 5" spindle stroke.
- 21" swing.
- Head tilt 90° right and left.
- Forward/reverse switch.
- Zinc alloy handle wheels.
- Fine downfeed calibrated.

Optional:
 UNIQU Dual
 Axis Digital
 Readout
 No. UNI-917
\$549.95

Optional:
 Power Table
 Feed "X" Axis
 Table Feed
 No. AL-99SP
\$330.00



MODEL No.
 DM-45

\$1,695.00

With
 Power Down Feed
 MODEL No.
 DM-45PF

\$1,995.00

Optional:
 Cabinet Stand
 No. DMS-45
\$169.95



Specifications:

Face mill capacity 3"
 End mill capacity 1-1/4"
 Swing 21"
 Max. distance,
 Spindle to table 18-1/2"
 Spindle to taper R-8
 Spindle stroke 5"
 Table size 32" x 9-1/2"
 Table travel 20" x 9"
 Quill diameter 3"
 Spindle speeds:(6) 75-1600 RPM
 T-slot size 9/16"
 Motor 2HP, 110/220 1Ph
 Weight 750 Lbs.

Top Tech® BENCH KNEE MILL ~ R-8 SPINDLE

Machine & Tools

- Precision bored and honed milling head.
- Precision ground worktable.
- Tilting and swiveling head.
- With micro-feed handwheel and lever downfeed.

MODEL No.
 DM-150

\$1995.00

Optional:
 Cabinet Floor Stand
 No. DMS-45
\$169.95

Specifications:

Working table size
 26-1/2" x 6"
 Working table longitudinal travel
 14-1/2"
 Working table cross travel . . . 6"
 Spindle taper R8
 Spindle stroke 3.2"
 Spindle speed (9) 200-2300 RPM
 Max. distance Spindle to table
 11.2"
 Head tilt left/right $\pm 45^\circ$
 Head swivel 360°
 Motor 1 HP, 110/220V 1Ph
 Weight (N/G) 583/778 lbs.



Top Tech® RADIAL DRILL/MILL

Machine & Tools

- Very easy to operate.
- Strong iron casting column.
- Belt drive, low noise.
- Box table dimensions:
 10-1/2" x 13" x 9-1/2"
- Cross slide table dimensions:
 6-1/2" x 14"

Specifications:

Max. drilling capacity:
 7/8"
 Max. milling capacity
 (Face Milling) . . . 2-1/2"
 Max. milling capacity
 (End Milling) 1/2"
 Column dia. 6-1/2"
 Spindle taper R8
 Spindle stroke 5.2"
 Spindle speeds: 210,
 380, 710, 1200, 2000
 Max. track 20"
 Radial rise-fall stroke:
 14-3/4"
 Power and speed of
 Motor 1 H.P.
 Overall height . . . 54"
 Base dimension 35" x 20"
 Weight . . 780/880 lbs.

MODEL No.
 RDM-200

\$1695.00

Equipped with
 Box Table and
 "X" "Y" Cross
 Slide Table



Top Tech® MILLING/DRILLING MACHINE

Machine & Tools

R-8 Spindle With Cabinet Stand

- UL listed electronics.
- Extra large worktable.
- Hinged belt cover allows faster speed changing.
- Forward and reversing switch.
- R-8 spindle taper.
- Positive and easy to read internal depth gauge.
- Magnetic contactors.

1-1/2 H.P. 110/220V
 1-1/2 Phase
 23" x 7-1/2" Table
 MODEL No. DM-25

\$995.00

2 H.P. 110/220V
 1 Phase
 28-1/2" x 8-1/4" Table
 MODEL No. DM-30

\$1195.00

With FREE
 Cabinet
 Stand
 A \$125.00 Value



Specifications	DM-25	DM-30
Swing	15-7/8"	16-3/8"
Table Size	23" x 7-1/2"	28-1/2" x 8-1/4"
Table Travel X & Y	14-1/2" x 6-1/4"	18-1/8" x 6-1/4"
Table T-Slot	1/2" (4 slots)	1/2" (4 slots)
Spindle Speed	95-2610 RPM	140-2436RPM
	12 Steps	12 Steps
Spindle Taper	R-8	R-8
Spindle Travel	4"	5"
Max. Spindle Nose To Table	15"	18"
T-Slot Size	9/16"	9/16"
Head Swivels	360°	360°
Column Diameter	3-1/2"	4-1/2"
Capacity:		
Drill	1"	1-9/16"
End Mill	1"	1-1/2"
Face Mill	2-1/2"	2-1/2"
Motor	1-1/2HP 110/220V	2HP 110/220V
	1 Phase	1 Phase
Machine Height	39-1/4"	44"
Stand Height	27-1/4"	27-1/4"
Machine Weight N/G	594/704 lbs.	660/770 lbs.

Optional:
 Power Table
 Feed
 "X" Axis No.
 AL-99SP
\$330.00

ARFA BY RONG FU MILLING/DRILLING MACHINE - R-8 SPINDLE

- UL listed electronics.
- Extra large worktable.
- Hinged belt cover allows faster speed changing.
- Forward and reversing switch.
- R-8 spindle taper.
- Positive and easy to read internal depth gauge.
- Magnetic contactors.
- Supplied with face mill, drill press vise and chuck.
- Model RF-31N2F with 6 power down feeds (3) .0027", .0047", .007" per revolutions and 2 speed motor.

1 H.P.
110V, 1 Phase
MODEL No.
RF-25
\$1095.00

1-1/2 H.P.
110V/220V, 1 Phase
MODEL No.
RF-31
\$1395.95

With Power
Down Feed
2 H.P. 220V
3 Phase
MODEL No.
RF-31N2F
\$2195.00

Optional:
Power Table
Feed (X Axis)
No. AL-99SP
\$330.00
Cabinet Stand
All Models
No. RF-30S
\$275.00



Made in Taiwan

Optional:
Uniq/Sino
Dual Axis
Digital Readout
10" x 20" Travel
No. UNI-917
\$549.95



SPECIFICATIONS:	RF-25	RF-31	RF-31N2F
Drilling Capacity:	1"	1-1/4"	1-1/4"
Face Mill Capacity:	2-1/2"	3"	3"
End Mill Capacity:	1/2"	3/4"	3/4"
Swing:	16-3/8"	16-3/8"	16-3/8"
Maximum Distance Spindle:	15"	18"	18"
Nose to Table:	R-8	R-8	R-8
Spindle Travel:	4"	5"	5"
Quill Diameter:	2-1/2"	3"	3"
Head Swivel:	360°	360°	360°
Column Diameter:	3-5/8"	4-1/2"	4-1/2"
Number of Spindle Speeds:	12	12	24
Range of Spindle Speeds(RPM):	115-2600	150-3000	150-3000
Maximum Table Travel:	12-3/4"	19-3/4"	19-3/4"
Cross Travel:	6"	7"	7"
Working Surface of Table:	7-1/2" x 23" 9/16"	8-1/4" x 28-3/4" 5/8"	8-1/4" x 28-3/4" 5/8"
T-Slot Size*	36-1/2L x 37-1/2W x 35-1/2H	42-1/2Lx39-3/4"W	42-1/2Lx39-3/4"W
Overall Dimensions:	12-1/2" x 19-3/4"	15-3/4" x 23-3/4"	15-3/4" x 23-3/4"
Base Dimensions:	407 lbs.	660 lbs.	660 lbs.
Net Weight (Approx):			

ARFA BY RONG FU BORING & MILLING MACHINE MULTI-PURPOSE GEARED HEAD With Dovetail Column Forward & Reversing Switch

MODEL No.
JFC-45

\$3995.00
Single Speed
60-1500 RPM
1-1/2 H.P. 110/220V
1 Phase Motor

MODEL No.
JFC-N2F-1
with Power Down Feed
0.12, 0.18-0.25mm
Per revolution

\$4495.00
Single Speed
60-1500 RPM
1-1/2 H.P. 110/220V
1 Phase Motor

Optional:
Uniq/Sino
Dual Axis
Digital Readout
10" x 20" Travel
No. UNI-917
\$549.95



Specifications:
Drilling Cast iron 9/16"
Capacity Mild Steel 1-1/4"
Face mill capacity 4"
Cross 8.4"
End Mill capacity 1-1/4"
Swing 21-5/8"
Max. distance to table 17-1/2"
Spindle taper R-8
Spindle stroke5"
Quill diameter 3"
Spindle speed:
Single speed motor 60-1500 rpm

Made in Taiwan



Head Tilts
90° Left & Right

Optional
Power Table
Feed "X" Axis
125lbs. Torque
MODEL No.
AL-99SP
\$330.00

Optional
Deluxe
Cabinet Stand
MODEL No.
RF-30S
\$275.00

T-slot size 9/16"
Table size 32" x 9-1/2"
Table travel:
Longitudinal 20.8"
Cross 8.4"
Overall height 68-5/8"
Length 30-7/8"
Width 43-1/4"
Motor:
Weight 726 lbs.
*Spindle power down feed
Rate per/rev: 0.12, 0.18, 0.25mm



VERTICAL & HORIZONTAL MILLING MACHINE 9" X 39"~R8

- ISO 9001 certified
- It can do either vertical or horizontal milling
- Table rotates 45 degree left and right
- Recycled Coolant system included
- High precision P5 spindle bearings
- Hardened & ground dovetail guideways
- Hand scraped precision ways
- Hardened & ground table and ground table T-slots
- Precision ground ACME leadscrews
- Adjustable ways
- Front and rear rubber way covers
- Tool box with tools
- Power source 220V , 1 phase
- One year industrial warranty for parts

MODEL No.
GMM939SPKG
\$5595.00



Standard Equipment

- SINO DRO, 2 axis, installed
- Table power feed X, installed
- Coolant system with base tray
- (2) 1" & 1-1/4" arbors with spacers- for horizontal spindle
- Right angle support for horizontal spindle
- Halogen work light
- R8-MT3 arbor adapter
- 1/2" drill chuck with chuck arbor
- MT3 /MT2 sleeve adapter
- Way covers, Tool box & manual
- One manual draw bar

Specifications:

Table Size: 9-1/2"x39-3/8"
Table rotation: 45°, right & left
Ram turret rotation: 180 degree
Spindle tilting : 90°, right & left
End milling capacity: 1"
Face milling capacity: 4"
Drilling capacity for cast iron: 1-1/4"
Drilling capacity for mild steel: 1"
X Axis Travel-Longitudinal: 23-1/2"
X travel with power feed: 23-1/2"
Y Axis Travel - cross: 8-1/2"
Z Axis Travel - knee up/down: 12-1/2"
Max. distance spindle to column: 26-3/4"
Max. distance spindle to table: 14-1/2"
Vertical spindle motor: 3HP, 220V, 1 Phase
Horizontal spindle motor: 2HP, 220V, 1 Phase

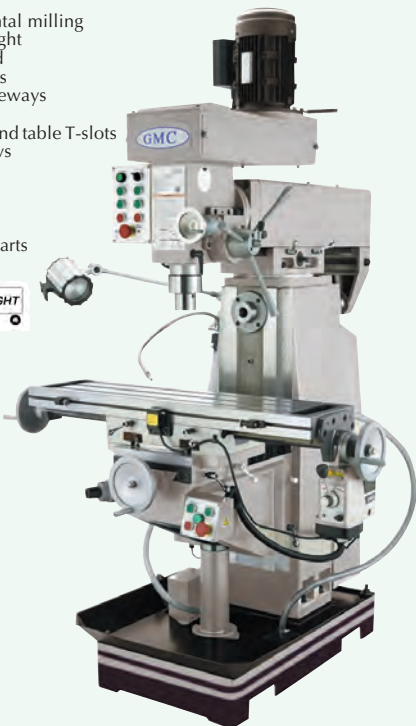

Spindle Taper Type: R8
Ram travel: 11"
Table T-slot size: 5/8" x 3 slots
Vertical Spindle speeds, 9 speeds: 285 to 2300 RPM
Horizontal spindle speeds, 8 speeds: 72 to 1300 RPM
Quill (Spindle) diameter: 3-1/2"
Quill (Spindle) travel: 5"
Coolant pump: 1/8 HP, 220V, 1 phase
Weight: 2050 lbs.
Machine Dimensions LxWxH: 51"x48"x82"

ARFA By RONG FU VARIABLE SPEED 0-3150 RPM'S Milling/Drilling Machines

- Features:
- Head moves up and down via rack and pinion drive.
- Massive diameter quill provides high rigidity.
- Mechanical clutch for downfeed, works well with small to large hole drilling.
- Micro feed on spindle for precise work.
- R8 spindle tapers provide a maximum of 32mm drilling capacity in mild steel.
- Positive depth stop for quick and easy feeding.

MODEL No.
RF-31VF

Made in Taiwan

\$2,195.00

With Power
Down Feed
(Shown)

Optional:
"X" Axis Power Table feed
No. AL-99SP
\$330.00
Cabinet Stand
Stand No. RF-30S
\$275.00

Specifications:

Drilling capacity in mild steel 1-1/4"
Face mill capacity in mild steel 3"
End mill capacity in mild steel 3/4"
Spindle drive Step pulley
Max. spindle nose to column surface: 6.8"
Max. spindle nose to table 17.8"
Spindle taper R8
Spindle travel 5.2"
Quill diameter 3"
Column diameter 4.6"
No. of power down feed:
..... 0.12-0.18-0.25 per/rev.
Range of spindle speed (RPM) 0-3150
Working surface of table 29" x 8-1/2"
T-slot (4) 5/8"
Overall height (L x W x H) without stand:
..... 1136 x 1097 x 1245mm
Motor 1-1/2 HP 220V 3 Phase
Net/Gross weight 594/726 lbs.

- Spindle auto-return function after feeding.
- Spindle fitted with heavy-duty taper roller bearings.
- Spindle over travel protection prevents damage to transmission gears.
- Spindle power down feed in 3 step selection.
- With 1-1/2 HP inverter control system provides 0-3150 rpm variable speed range.





ACCORD MILLING MACHINES 9" x 49" Table - R8 Spindle

- High Quality Built completely in Taiwan both Milling Head and Meehanite Casting Seasoned Body. Certified
- Built to ISO 9002 Industrial Standards
- Ultra Precision Spindle Assembly
- Power Down Feed
- Smooth Running Quiet 16 Speed Stephead or Variable speed
- Lever operated Spindle Brake
- Hardened and Precision Ground Table with hand scraped ways
- Class 7 angular contact bearings
- Ram Locking System U.S. Patent #4990039 Utilizing 6 T-Bolts
- Chrome Satin Dials with easy to read graduation
- Dual Locking Saddle Locks
- Precision Leadscrews with thrust bearings
- Double wall column
- Anti-Backlash adjustment
- Built in flood coolant reservoir in base.

16-Speed
MODEL No.
ACM-2S
\$5,795.00

Variable Speed
MODEL No.
ACM-2V
\$6,295.00

Specifications:

	ACM-2S	ACM-2V
Table Size	9" x 49"	9" x 49"
Way Table	Dovetail	Dovetail
T-Slots	5/8" x 3	5/8" x 3
Longitudinal Travel	35-1/2"	35-1/2"
Cross Travel	12-1/2"	12-1/2"
Vertical Knee Travel	16"	16"
Ram Travel	12"	12"
Quill feeds per rev	0.0015"-0.003"-0.006"	0.0015"-0.003"-0.006"
Quill Travel	5"	5"
Spindle Taper	R-8	R-8
Quill Diameter	3-3/8"	3-3/8"
Head Swivel LH/RH	90°-90°	90°-90°
Head Tilt forward/back	45°-45°	45°-45°
Ram Swivel	360°	360°
Motor Rating 2 speed	3HP 3Phase	3HP 3Phase
Spindle Speed Type	Step Pulley	Vari Speed
Spindle Speeds	80-5400	65-4200
Spindle Steps	16	infinite
Weight	2,200 lbs.	2,200 lbs.



Optional:
No. D-1000X Servo Power Table Feed
\$349.95

Optional:
No. UNI-949 Dual Axis Digital Readout Kit
\$549.95

Bridgeport VERTICAL MILLING MACHINE VARIABLE SPEED ~ 9" X 49" TABLE

For more than 70 years, the Bridgeport Series 1 Standard Mill - the original, all-purpose mill - has been the "real thing" in milling, drilling, and boring for metalworking shops throughout the world. Today, the Series 1 Standard continues to fulfill the industry's need for an accurate, reliable, and versatile mill.

Series 1 Standard Features:

- 9" x 49" table.
- 750 lbs. maximum table load.
- R8 spindle taper.
- 5" Quill travel.
- 3HP/3Ph/208/230/460V motor.
- Class 7 precision spindle and anti-friction bearings.
- One shot lubrication system.
- Built-in fine powered quill down feed.
- Rapid adjusting-fine positioning micrometer (educated nut).
- OSHA approved standard cutter guard.
- Chrome dovetail ways and gibbs.
- One year warranty.
- F.O.B. Warehouse.
- Shipping Weight: 2195 lbs.

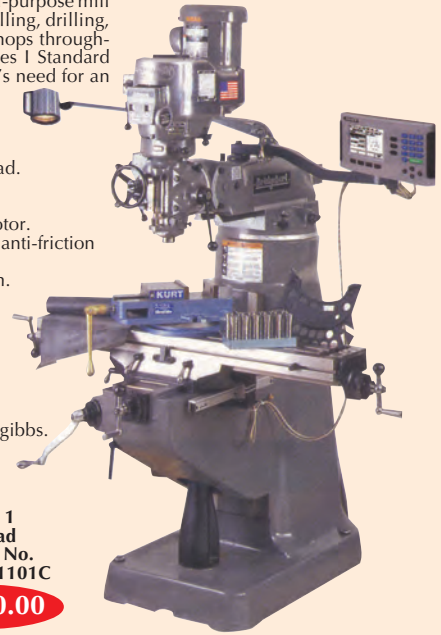

Series 1
2J Head
MODEL No.
RL30-3061101C
\$16,950.00

The Bridgeport Mill Pictured is shown with Optional Accessories:

Model	Description	Price
64PKA059	12" x 36" Mitutoyo Dual Axis Digital Read Out	\$1195.00
D-1000X	Servo "X" Axis Power Table Feed	369.95
D-1000Y	Servo "Y" Axis Power Table Feed	419.95
D-1000Z	Servo "Z" Axis Power Table Feed	449.95
BR-1000	Servo Power Drawbar	695.00
D-688	Kurt 6" Milling Vise	549.95
SECK-625	52 Piece Clamping Kit	49.95
810-011	R8 Collet Set 1/8" thru 3/4" by 1/16ths	129.95
HMS-001	Halogen Machine Lamp	149.95

BIRMINGHAM VERTICAL MILLS 9" x 49" Table - R8 Spindle

- Each machine casting is aged & stabilized.
- Ground ways on Z axis. • Work table 9" x 49".
- Hardened & Ground work table. • Hardened & Ground ways on X&Y axis.
- Chromed & Ground spindle quill. • Precise internal - ground, spindle bore.
- Double locked on RAM, Table & knee. • Double brass - nut backlashnut.
- X axis travel 35". • Y axis travel 12". • Z axis travel 17".
- Quill diameter 0-3-3/8". • Class - 7 spindle bearings.

Variable Speed



Variable Speed
MODEL No.
B3V-800

\$5895.00

Variable Speed
With Digital
Read-out & Power
Table Feed
MODEL No.
B3V-800P

\$6595.00

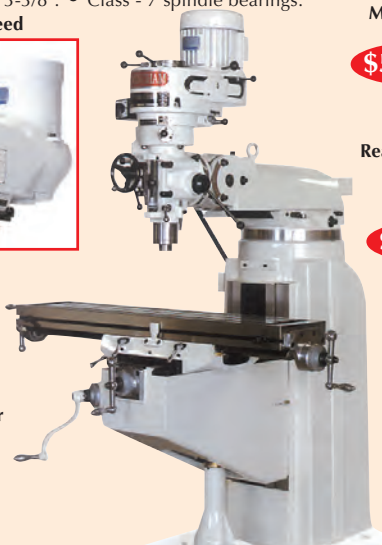

16-Speed
MODEL No.
B3S-800
\$5295.00

16-Speed
With Digital
Read-out & Power
Table Feed
MODEL No.
B3S-800P

\$5995.00

Optional:
1 H.P. 1Phase
Add \$200.00

Specifications:	B3V-800	B3S-800
Quill Travel	5" (125mm)	5" (125mm)
Quill Feed Speed	0.002", 0.004", 0.006"/REV	0.0508, 0.1016, 0.1524/REV
Spindle Taper	R8	R8
Spindle Speed	60-4300 RPM (Variable)	90-5600RPM (16 Step)
Longitudinal Travel, Manual	35-1/2"	35-1/2"
Cross Travel	13-1/4"	13-1/4"
Net Weight	2500 lbs.	2600 lbs.
Spindle Motor	3H.P. 3Phase, 220V/440V	3H.P. 3Phase, 220V/440V
Optional	2 H.P. 220V 1 Phase	2 H.P. 220V 1 Phase

BIRMINGHAM HEAVY DUTY 10" x 54" TABLE VERTICAL MILLING MACHINE

- Hardened & ground square way, column & knee.
- The vertical head may be tilted to 90 degrees from the vertical position to accommodate a wide range of work requirements.
- Power down feed and power up feed.
- Micrometer depth stop is graduated in 0.001 inches.
- Counter balanced quill and spindle provides extreme sensitivity for operator touch.
- Machine castings offers maximum rigidity and stability by incorporating extra wide slideways and extra heavy ribbing in the construction.
- Each machine casting is aged and stabilized.

16 Speed
With Digital
Read-Out & Power
Table Feed
MODEL No.
BPS-1054CP

\$6295.00

16 Speed
MODEL No.
BPS-1054C

\$5595.00

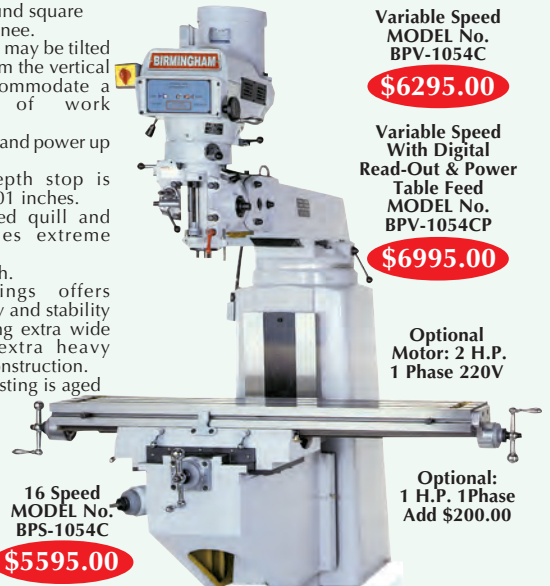

Variable Speed
MODEL No.
BPV-1054C

\$6295.00

Variable Speed
With Digital
Read-Out & Power
Table Feed
MODEL No.
BPV-1054CP

\$6995.00

Optional
Motor: 2 H.P.
1 Phase 220V

Optional:
1 H.P. 1Phase
Add \$200.00

Specifications:	Model BPS-1054C	Model BVP-1054C
Table Size	10" x 54"	10" x 54"
Longitudinal traverse hand only	38"	38"
Cross Travel	16"	16"
Vertical Travel	18"	18"
Quill Feeds	0.0015", 0.003", 0.006" Rev	0.0015", 0.003", 0.006" Rev
Quill Travel	5"	5"
Spindle Taper	R8	R8
Spindle Speed	90-5600RPM (16 Step)	60-4300RPM (Variable)
Motor	3HP 220/440V 3Ph	3HP 220/440V 3Ph
Optional	2HP 220V 1 Phase	2HP 220V 1 Phase
Table load capacity	800 lbs.	800 lbs.
Weight	3500 lbs.	3600 lbs.
Price	\$5595.00	\$6295.00

GMC MILLING MACHINE 9" X 49" TABLE
Meehanite Casting Made In Taiwan

Standard Features:

- Taiwan mill
- "Meehanite" casting
- "Turcite B" coating on ways
- R8 spindle, variable speeds
- 9"x 49" hardened/ground table
- Tilting & rotating head
- Hardened/ground dovetail guideways
- Precision ground ACME leadscrews
- Hand scraped precision ways
- Hand and power spindle feeds
- Chromed ground quill (spindle)
- Built-in coolant system body

Variable Speed
MODEL No.
GMC-949V

\$6595.00

Variable Speed
with Digital
Readout and
Power Table Feed

MODEL No.
GMC-949VP

\$6895.00

Plus FREE!
Shipping



Plus FREE!
Shipping

Specifications:

Table size 9" x 49"
Table load cap. 650 Lbs.
X Axis travel 36"
Y Axis travel 12"
Z Axis travel 16"
Ram travel 12"
Spindle taper R8
Spindle Motor 3HP
Spindle speeds:
68-4,300 RPM variable speeds

Spindle diameter 3-3/8"
Spindle travel 5"
Table T-slot size 5/8" x 3"
Head swivel, R/L 90°
Head tilting F/B 45/45°
Ram swivel 360°
Spindle to table 18"/0"
Spindle to column 19"/7"
Net weight 2,650 Lbs.
Dimensions 63"x 57"x 83"

GMC MILLING MACHINE 10" X 54" TABLE
Meehanite Casting Made In Taiwan

Standard Features:

- Taiwan mill
- "Meehanite" casting
- "Turcite B" coating on ways
- R8 spindle, variable speeds
- 10"x 54" hardened/ground table
- Tilting & rotating head
- Hand and power spindle feeds
- Precision ground ACME leadscrews
- Hardened/ground square ways
- Chromed ground quill (spindle)
- Built-in coolant system body
- Hardened/ground dovetail guideways

Variable Speed
MODEL No.
GMC-1054V

\$7495.00

Variable Speed
with Digital
Readout and
Power Table Feed

MODEL No.
GM-1054VP

\$7895.00

Plus FREE!
Shipping

Plus FREE!
Shipping



Specifications:

Table size 10" x 54"
Table load cap. 750 Lbs.
X Axis travel 36"
Y Axis travel 16-1/2"
Z Axis travel 16-1/2"
Ram travel 22-1/2"
Spindle taper R8
Spindle Motor 3HP
Spindle speeds:
68-4,300 RPM variable speeds

Spindle diameter 3-3/8"
Spindle travel 5"
Table T-slot size 5/8" x 3"
Head swivel, R/L 90°
Head tilting F/B 45/45°
Ram swivel 360°
Spindle to table 17"/0"
Spindle to column 27"/4"
Net weight 4,050 Lbs.
Dimensions 79"x 67"x 91"

CUTTERMASTER

TOOL AND END MILL SHARPENER

Features:

- High-grade American castings; completely machined, ground and assembled in the U.S.
- Tilting motor +35/-8 degrees
- Balanced grinding spindle
- Machined steel X, Y tables with dovetail ways
- 360 degree swivel for tapered and chamfer grinding
- Triple-dipped chrome air bearing spindle
- Index collar for end grinding
- Table feed graduations in .001" (.02 mm)

Specifications:

X-axis table travel 6"
Y-axis travel 9"
Motor 1/3HP, 450RPM, 110V or 220V
Cutting tool capacity 2" shank, 10.5 flute length
Grinding wheel Adjustment to .001"

Included With Grinder:

- 5" Aluminum oxide cup, wheel 60 grit.
- Halogen light with magnifying glass.
- Air bearing fixture. **No. CM-02**
- Instruction manual & video.
- Air filter.

Optional Attachments:

- No. CM-03 \$1250.00**
Radius Attachment
- No. CM-05 \$585.00**
Dual Positioning
Pneumatic Finger
- No. CM-08 \$95.00**
Taper Attachment
for End Mills

MADE IN
USA



MODEL No.
CM-010
Reg. \$3696.00

\$3295.00



Cup Wheels

- No. CM-20 \$60.00**
Premium Pink aluminum oxide - 60 Grit. General purpose use for high speed steel.
- No. CM-22 \$195.00**
Blue Ceramic. Harder than aluminum oxide, they hold their form better, and allow for heavier material removal per pass.
- No. CM-30 \$275.00**
Diamond. 1/16" depth, 75 concentration. For use with carbide tools only. 500 grit.

Dish Wheels

- No. CM-25 \$95.00**
6" Blue Ceramic with 1-1/4" arbor.
- No. CM-26 \$125.00**
6" Pink aluminum oxide with 1-1/4" arbor.
- No. CM-33 \$260.00**
6" Diamond dish, 1-1/4" arbor, 150 grit.
- No. CM-34 \$250.00**
6" CBN dish, 1-1/4" arbor, 120 grit.



No. CM-03

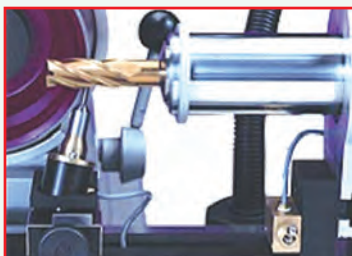

No. CM-05



No. CM-08



No. CM-10



Cup Wheels

Dish Wheels

Clausing VARIABLE SPEED VERTICAL KNEE MILLS

The Clausing Knee Mills are one of the heaviest in it's class and is equipped with a powerful spindle drive motor and an infinitely variable speed drive offering a speed range of 75 to 3800 RPM

- Meehanite Castings for superior rigidity and wear resistance.
- Hardened & Ground X, Y & Z ways.
- X/Y ways coated with Turcite B
- Columns & Knee way covers.
- T-slots are ground to provide reference edge for positioning your workpiece.
- Hardened & ground table surface.
- Hardened & ground spindle.
- Chromed & ground quill.
- Chromed X, Y & Z leadscrews.
- Double nut leadscrew for backlash compensation.
- ABEC 7/CP4 spindle bearings.
- Coolant system w/pump & switch.
- Flexible segmented coolant nozzle.
- Chromed Y screw covers and one-piece wipers.
- AC Rapid Vertical Drive (4VSQ) 85-4350 RPM
- Variable Speed Drive
- Articulating Head for Compound Angles
- Worm gear angular positioning of head in two directions
- Handwheel for fine quill feed
- Adjustable automatic feed disengagement for quill feed
- Micrometer depth stop
- Reversing switch for clockwise or counter clockwise operation
- ISO 40 Spindle (4VSQ)
- Spindle Brake (Hand operated)
- R-8 or ISO 30 Spindle (2VS & 3VS)
- One-shot Lubrication
- Halogen Work Light
- Tool Kit, Test and Accuracy Chart
- Knee Assist on (4VSQ)



Clausing HEAVY DUTY (EVS) ELECTRONIC VARIABLE SPEED VARIABLE SPEED VERTICAL KNEE MILL

Clausing's line of Heavy Duty EVS Mills are easy to operate, require less maintenance than mechanical variable speed machines and offer features found only on higher priced EVS Mills

- Quick and accurate rpm setting
- Convenient, head mounted, easy to use control panel
- LCD spindle speed display
- Up to 4 hp spindle motor standard
- Spindle brake with auto power off
- Totally enclosed electric's with Yaskawa A.C. inverter variable speed drive
- Carbon steel, hardened and ground, chrome plated quill
- Coolant system
- Up to 11" x 58" table size
- Meehanite castings for superior rigidity
- Hardened and ground table with 3 ground T-slots
- Double nuts for easy backlash adjustment
- Up to 38.2" X axis travel, 16" Y axis travel, 17.7" knee travel and 5" quill travel
- All ways are hardened and ground with Turcite B coating on X and Y axis ways for wear resistance and smooth operation



The LCD Display allows the operator to select spindle speeds quickly and accurately

Head mounted Easy to Use Controls

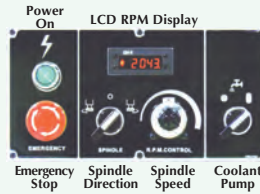

Model	Description	Price
CLA-2VS	Clausing 9" x 49" Mill 3HP Dovetail Column	\$ 9,995.00
CLA-3VS	Clausing 10" x 54" Mill 3HP Dovetail Column	11,995.00
CLA-4SQ	Clausing 10" x 54" Mill 5HP Square Column	25,450.00

* Detail Specification Please Visit Our Website @ www.penntoolco.com

Model	Description	Price
400EVS	Clausing 10" x 50" EVS Mill 3HP	\$15,495.00
450EVS	Clausing 10" x 54" EVS Mill 3HP	16,895.00
500EVS	Clausing 11" x 58" EVS Mill 4HP	17,995.00

* Detail Specification Please Visit Our Website @ www.penntoolco.com



ACCORD MILLING MACHINES 10" x 54" Table - R8 Spindle - Variable Speed

- High Quality Built completely in Taiwan both Milling Head and Meehanite Casting Seasoned Body. Certified
- Built to ISO 9002 Industrial Standards
- Ultra Precision Spindle Assembly
- Power Down Feed
- Smooth Running Quiet Variable speed motor drive
- Lever operated Spindle Brake
- Hardened and Precision Ground Table with hand scraped ways
- Class 7 angular contact bearings
- Ram Locking System U.S. Patent #4990039 Utilizing 6 T-Bolts
- Chrome Satin Dials with easy to read graduation
- Dual Locking Saddle Locks
- Precision Leadscrews with thrust bearings
- Double wall column
- Anti-Backlash adjustment
- Built in flood coolant reservoir in base.

On Double "V" Body Slide
MODEL No. ACM-3VV

\$6795.00

On "Square" Body Slide
MODEL No. ACM-3V

\$7295.00

Specifications:

Table Size	10" x 54"
Way Table	Dovetail
T-Slots	39-1/2"
Longitudinal Travel	16-1/2"
Cross Travel	18"
Vertical Knee Travel	12-1/4"
Ram Travel	3-5/8"
Quill feeds per rev	0.0015"-0.003-0.006"
Quill Travel	5"
Spindle Taper	R-8
Quill Diameter	3-3/8"
Head Swivel LH/RH	90°-90°
Head Tilt forward/back	45°-45°
Ram Swivel	360°
Motor Rating 2 speed	3HP 3Phase
Spindle Speed Type	Vari Speed
Spindle Speeds	65-4200
Weight	3,400 lbs.



Optional:
No. D-1000X Servo Power Table Feed
\$349.95

No. UNI-154 Dual Axis Digital Readout Kit
\$549.95

No. ACI-100 AC Inverter Drive Head with Baldor Motor
Add: **\$995.00**



ACER CNC BED MILL 3 AXIS FAGOR 8055i/A3 CNC CONTROLLER

- 5HP variable speed, 0 to 3650 RPM, Toshiba Vector Drive & Inverter Motor
- Machine can run on 220V single or three phase power (440V optional)
- Large - Extra large Travels, in X-28", Y-20", Z-21" and 24" centerline of spindle to machine column accommodates large work pieces
- Under 25.5" of spindle nose to table makes machining tall parts easy
- The Bed Mill includes a heavy duty CAT-40 taper spindle, auto lubrication, dual "E" stops, USB port and a large graphic display panel
- Massive 4600 lbs. weight & certified Meehanite casting which provides vibration free and precise milling
- Reliable & popular Fagor 8055i 3 Axis conversational or G/M code control offers user versatility manual, or CNC and is CAD/CAM compatible
- Precision hardened & ground w/ Turcite B way



MODEL No. E-1050B-3

\$28,950.00

For Optional Accessories and Specifications Visit Our Website www.penntoolco.com

Specifications:

Working Surface	10" x 50"
T-slot Number Size	3, 5/8"
Table Load	1320 lbs.
Spindle Center to Column Face	23.62"
Quill Diameter	4"
Quill Travel	5"
Spindle Taper	Cat #40
Power Quill Feeds (In/Rev.)	0.0015", 0.003", 0.006"
Machine Dimensions X x Y x Z	72.44" x 78.74" x 100"
Packing Dimensions X x Y x Z	61.02" x 70.08" x 88.58"
Net Weight	4411 lbs.
Gross Weight	4609 lbs.

ACCU II CNC VERTICAL MILLING MACHINES WITH

CENTROID CONTROL NO. M400S

Standard Main Features:

- High speed 3D contouring.
- English, French, Spanish and Chinese language display.
- 15" crystal-clear monitor.
- Easy switch from CNC to manual.
- PC based with floppy & RS232, LAN ready, mouse and keyboard.
- 32 bit digital signal processor.
- Heavy duty servo motors.
- Turcite "B" coating on ways.
- High grade casting.
- High precision C3 class ground ballscrews with double nuts, pre-loaded, angular contact bearings.
- Tech support and full one year warranty.
- Includes manuals and training video tape.

Standard Features:

- CNC Computer
- PC Based.
- Upgradeable software.
- 3.5" Floppy Disk Drive.
- Internal solid state hard drive.
- 15" Color LCD display.
- LAN Ready, RS232, mouse, keyboard and parallel ports.
- Digital fiber optics.

**FREE
On Day
On-Site
Training
& Setup**

Certified Nationwide Support

Factory trained and certified technicians provide training, sales, service and support. No matter where you are, we make sure qualified support is available.

- M & G code programming.
- Display • Operation.
- High speed machining.
- Tool library.
- Conventional programming.
- Control operation panel.

For **CENTROID** Controller Specifications & Options Click www.penntoolco.com or request **ACCU II** CNC Milling Catalog



ISO-9001

MADE IN USA

Print to Part...In Minutes

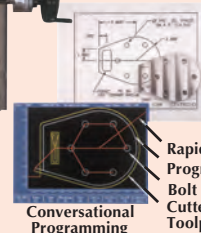

Conversational Programming



Rapids in Red
Programmed Tool Paths
Bolt Holes in White
Cutter Compensated
Toolpaths in Yellow

Equipped With **CENTROID** No. M400S Control

Model	Description	Price
AC-2V-2	2-Axis R-8, 9" x 49" Table, Vari-Speed 3 H.P.	\$22,995.00
AC-3KV-2	2-Axis R-8, 10" x 54" Table, Vari-Speed 3 H.P.	24,995.00
AC-3KVF-2	2-Axis R-8, 10" x 54" Table, Inverter Drive 3 H.P.	26,995.00
AC-2V-3	3-Axis R-8, 9" x 49" Table, Vari-Speed 3 H.P.	\$24,995.00
AC-3KV-3	3-Axis R-8, 10" x 54" Table, Vari-Speed 3 H.P.	26,995.00
AC-3KVF-3	3-Axis R-8, 10" x 54" Table, Inverter Drive 3 H.P.	27,995.00
AC-4KV-3	3-Axis Cat40, 10" x 54" Table, Vari-Speed 5 H.P.	27,995.00
AC-4KVF-3	3-Axis Cat40, 10" x 54" Table, Inverter Drive 5 H.P.	29,995.00



TWISTER SPEED LATHES

Uses 5C Collets

THE LAST WORD IN PRECISION PARTS FINISHING

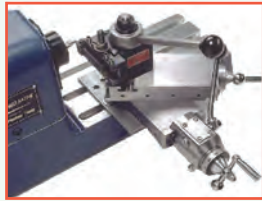

Two axis slide shown with hand lever actuator (Inquire)

The Twister is a full-featured speed lathe, designed exclusively for quick, single-purpose operations, such as burr removal, polishing, and gaging of small parts with hand-held tools. Rugged and easy to use, it allows work to be performed close to CNC lathe. The Twister's quick setup and rapid cycle time permits processing of parts in less time with less effort.

MODEL No. LT-1BR



MADE IN USA

MODEL No. LT-2BR



Lever action ball bearing collet closer, with microfine tension adjustment, for instant chucking and release of parts.

Large rubber feet resist movement for portable use

Spindle nose is shrouded for maximum possible operator safety, the spindle lock provides fast collet changes.

The LT-1BR is a rugged and durable lathe specifically designed for hand-held tooling in dry environments.

Model	Optional Features	Price
LTH	High Variable Speed 0 to 3500 RPM	\$ 200.00
LYU	Ultra Low Variable Speed 0 to 800 RPM	100.00
TF	Twin Foot Switch Forward & Reverse	250.00
VF	Variable Speed Foot Switch	400.00
LT-805	1-Axis Cross Slide	\$1350.00
LT-810	Dual Actuator	900.00

Our cross slide can be equipped with an .850" hand lever actuator, a natural for part-off burr removal or chamfering operations

LT-815	Tailstock	\$1850.00
--------	-----------	-----------

Specifications	LT-1BR	LT-2BR
Speed Range	0-2600 RPM	0-2600 RPM
Horse Power	1/12 HP Cont.	1/12 HP Cont.
Power Required	120 VAC, 5A	120 VAC, 5A
Spindle Max. T.I.T.	.0015	.0005
Spindle Thru Hole	1.100"	1.100"
Spindle Height	3" w/feet	4.125"
Dimensions	13"W x 10"H x 18"D	24"W x 14"H x 18"D
Weight	54 lbs.	79 lbs.
Price	\$2795.00	\$3895.00

BIRMINGHAM / ACCORD VERTICAL BAND SAWS - FLOOR MODELS



Models KB-36 KB-45

- Large capacity welder.
- Blade cutter.
- Blade grinder.
- Worklamp.
- Chip blower.
- Variable speed transmission.
- Instruction manual and parts list.

**Precision
Made In
Taiwan**



Models KV-50 KV-60 KV100

Model	Description	Price
2016 0007	100' x 1/8", .025" 18 TPI	\$ 90.09
2016 0012	100' x 3/16", .025" 4 TPI	86.06
2016 0039	100' x 1/4", .025" 10 TPI	74.80
2016 0111	100' x 1/2", .025" 14 TPI	81.23
2016 0153	100' x 5/8", .032" 10 TPI	113.40

Model	KB-36	KB-45	KV-50	KV-60	KV-100
Cutting Throat Depth	14"	17-15/16"	20-1/2"	23-5/8"	39-3/8"
Capacity Max. Work Height	9-1/16"	10-1/16"	12-3/8"	11-13/16"	11-13/16"
Table Size	19-1/2" x 15-1/4"	23-1/2" x 19-1/2"	26" x 27-1/2"	26" x 27-1/2"	26" x 27-1/2"
Table Inclination(2-Ways)	15"	15"	L5" R15"	L5" R15"	L5" R15"
Table Stroke	111-13/16"	137-3/8"	13-25/32"	13-25/32"	13-25/32"
Saw Blade Length	1/8" - 5/8"	1/8" - 5/8"	153	156-5/16"	178-5/8"
Saw Blade Width	65-295 FPM	85-375 FPM	Low 65-280 FPM	High 400-1640 FPM	
Saw Blade Speeds	2.4KVA 1/8"-5/8"	2.4KVA 1/8"-5/8"	4.2KVA 1/8"-13/16"	4.2KVA 1/8"-13/16"	4.2KVA 1/8"-13/16"
Butt Welder Capacity	1HP, 220V, 1Ph	1HP, 220V, 3Ph	2HP, 220V, 3Ph	2HP, 220V, 3Ph	2HP, 220V, 3Ph
Drive Motor	551 lbs.	660 lbs.	650 lbs.	850 lbs.	950 lbs.
Net Weight (approx.)	683 lbs.	814 lbs.	770 lbs.	970 lbs.	1070 lbs.
Gross Weight (approx.)	37-3/16x22x72-13/16"	43-11/16x26x79-1/4"	57x43-5/16x84-5/16"	62x43-5/16x84-5/16"	75-5/8x43-5/16x84-5/16"
Measurement (LxWxH)					
Price	\$2495.00	\$2995.00	\$4295.00	\$4995.00	\$5995.00



IR Ingersoll-Rand ROTARY SCREW TOTAL AIR SYSTEM (TAS)

- Each compressor package comes with 230/460-3-60 ODP electric motor, air-cooled after-cooler to reduce discharge air temperatures, full voltage motor starter mounted and wired (wired for 230-3-60 voltage standard), dual control (AS&S and constant speed control), low sound/full sheet metal enclosure, package pre-filter, 8000-hour rated ultra coolant, spin-on oil filter and separator element, A.S.M.E. coded horizontal receiver tank with manual drain and NEMA-1 electric protection.



Total Air System (TAS)

- TAS packages come standard with "Energy Star" cycling refrigerated air dryer with stainless steel heat exchanger, integrated compressor and dryer controls for optimum operation, panel mounted dew point indicator, dual filter (both pre and after) mounted and piped, single point condensate drain system with electric drain (115-volt), and high efficiency moisture separator.

Price Includes Start-Up Kit \$110.00 Value

Model	H.P.	CFM	Max. PSI	Receiver	Weight	Price
UP65TAS125	5	18.5	125/150	80 Gallon	430 lbs.	\$6780.00
UP67TAS125	7.5	28	125/150	80 Gallon	450 lbs.	7540.00
UP610TAS12	10	38	125/150	80 Gallon	475 lbs.	8460.00
UP615CTAS1	15	55	150	80 Gallon	490 lbs.	9220.00

IR Ingersoll-Rand SINGLE STAGE ELECTRIC AIR COMPRESSOR

When performance is defined by maximum operating pressure, increased air flow and extended duty cycles, Ingersoll-Rand is the product of choice. You will get a compressor that features maximum air power, reliable precision engineered components and a durable design that is built to last.



- 100% continuous duty applications
- High capacity compressor (upto 18.1 cfm @ 90 PSI) with 60 gallon vertical tank
- Efficient finger valves that are easy to maintain

Specifications

Model SS3L3	Model SS5L3
Motor 3HP 230V, 1 Phase	Motor 5HP 230V, 1 Phase
Tank Size 60 Gallon Vertical	Tank Size 60 Gallon Vertical
ACFM 11.3@ 90 PSI	ACFM 18.1@ 90 PSI
Max. PSI 125	Max. PSI 125
Size L x W x H 23" x 20" x 66"	Size L x W x H 30" x 20" x 71"
Weight 300 lbs.	Weight 310 lbs.
Price \$675.00	Price \$1050.00

Start-up Kit Included In Price



ROTARY BARREL TUMBLERS

Provide outstanding polishing and smoothing. These units offer ease of use, excellent durability and quiet, water tight operation

One-Barrel

3 lbs. capacity tumbler features a heavy gauge steel base, water-tight, molded rubber barrel, and thermally protected motor



MODEL No. 47-781
Reg \$165.00
\$135.00
110V

Two-Barrel

Versatile, two barrel 6 lbs. capacity tumbler uses 3 lbs. long-life, molded rubber barrels. Ideal for small batches of jewelry. Continuous-duty, fan cooled motor with overload protection. Ship weight 9 lbs.



MODEL No. 47-782
Reg \$210.00
\$169.95
110V

Heavy-Duty Tumbler

Professional quality tumbler features a larger more powerful, continuous-duty fan cooled motor with overload protection. Steel hexagon barrel with removable liner ensures long, efficient and quiet operation. 15 lbs. capacity, with a five year warranty on the barrel and liner. Ship weight 18 lbs.

MODEL No. 47-780
Reg \$345.00
\$275.00
110V



IR Ingersoll-Rand GAS POWERED AIR COMPRESSOR WITH 30 GALLON TANK

- For fleet and field service applications, count on Two-stage, Gas-powered air compressors from Ingersoll-Rand.
- Ideal for remote pneumatic applications, emergency production line needs and other situations where electrical power is scarce, these compressors deliver the air you need, when and where you need it.
- Featuring truck-bed mounting, these compressors include electronic ignition, idle engine control, a 30-gallon ASME receiver, an OSHA approved fully enclosed belt guard and a weather-resistant powder-coat paint finish.
- Choice of Honda or Kohler engine.
- Advanced safety features including low oil-level shutdown for gas engines.

With HONDA
13 H.P. Engine
MODEL No.
247513GH

\$2695.00



With KOEHLER
14 H.P. Engine
MODEL No.
247514GH

\$2395.00

Price Includes Start-Up Kit \$110.00 Value

IR Ingersoll-Rand TWO STAGE ELECTRIC AIR COMPRESSORS

- Each "Premium" unit includes a two-stage, 100% cast iron pump, ODP electric motor, mounted & wired magnetic motor starter, automatic start & stop control with a NEMA 1 pressure switch, and a ASME coded air receiver tank.
- Fully packaged models include an aircooled aftercooler, low oil level shutdown switch and an automatic drain valve.
- 5 and 7.5 HP units are equipped with automatic start and stop controls, and 10 HP units and above include dual control regulation with constant speed control.



Price Includes Start-Up Kit \$110.00 Value

Max. Pressure 175 (PSIG)

Model No.	Motor H.P.	Receiver Size/Type	Weight lbs.	Price Each
2475N5-V	5	80 Gallon/Vertical	597	\$2265.00
2475N7-5V	7-1/2	80 Gallon/Vertical	611	2480.00
2545K10-V	10	120 Gallon/Vertical	920	3050.00
2545E10-V	10	120 Gallon/Horizontal	920	\$2890.00
710015-V	15	120 Gallon/Horizontal	1297	3830.00
15TE20-P	20	120 Gallon/Horizontal	1597	7260.00



REVO COMPACT MAGNETIC DRILLING SYSTEM

- With a powerful and reliable motor, 7/16" - 1.3/8" cutter capacity, a new and improved durable arbor and an industry proven magnetic adhesion unit.
- The REVO R322 is designed for easy application and optimum safety with a new easily accessible and simple to use control panel, improved lifting handles and in built security location for the safety strap.
- Easily portable, lightweight and easy to use, all at a really competitive price.
- Proven and reliable magnet for maximum adhesion
- Dual carrying handles
- Reversible handles for use in awkward situations
- Corrosive resistant, tangle-free cable from stand to drill unit
- New and improved control panel for safe and easy use
- "No Volt Release" switch for improved safety handling

With a new rugged carry case, cutting fluid, safety guard, safety strap, allen keys and drill chuck

Specifications:

Motor	850 Watts
Cutter Capacity	.1-3/8"
No-Load Speed	.690 RPM
Magnetic Strength	2,200 lbs.
Internal Arbor Diameter	3/4"
Depth of Cut	2"
Electrical	50-60 Hz
Weight	26 lbs.



MODEL No. REV-322
Reg. \$730.00
\$675.00



HIGH PRECISION CNC LATHES WITH NEW SIEMANS 808D CONTROLLER



- ISO 9001 certified
- Ease-of-use new version SIEMENS 808D CNC control with conversational programming features, for CNC beginner and easy program and set up.
- CNC programmable spindle speeds from 21 to 1,620 rpm
- Large spindle bore 3-1/32", D1-8
- Full enclosure safety front and rear guards
- One-piece solid cast iron machine base
- Heavy Duty guideway width 14"
- Electrical automatic 4-way turret toolpost
- MPG Metal handwheel for X & Z

- Fully ballscrews enclosure
- Can use standard flash card for transfer programs and networking FTP
- USB port
- High speed machining
- Popular Ease-of-use Conversational programming, Conversational leads you to go through programming your part, just fill in the blanks and check the graphic. Select from all canned cycles, such as, profiling, material removing, roughing and finishing, inside & outside threading, line, arc, drilling and floating tapping, cut-off, grooving, ring, chamfering
- G code and M code programming

- CSS-constant surface speeds
- CAD/CAM connector & Tools library
- Tool length & radius compensation
- Spindle is balanced, hardened and precision ground
- Spindle is supported at 3-point by high precision bearings
- All gears and shafts are hardened and precision ground
- Guideways induction hardened and precision ground
- Automatic lubrication system for ballscrews and guideways
- Automatic lubrication system in headstock and feed box
- One year industrial warranty for parts



Standard Equipment:

- 10" manual 3-jaw chuck with set reversible jaws
- Electric automatic turret 4-position toolpost
- MPG for both X & Z axis movement
- Coolant system • Work light
- Slide safety front doors
- Full enclosure safety front and rear guards
- Tool box and leveling pads

Model No.	CNC-1640PF	CNC-1660PF	Model No.	CNC-1640PF	CNC-1660PF
Max. Swing Over Bed	16"	16"	Taper of Tailstock Quill Center	M.T. #5	M.T. #5
Max. length of Workpiece	40"	60"	Auto Turret Toolpost	4 Positions	4 Positions
Max. Cutting length	32"	52"	Max. Tool Size for Auto Turret Toolpost	1" x 1"	1" x 1"
Max. Swing Over Cross Slide	8"	8"	Max. Travel for X Axis	11"	11"
Max. Turning Diameter Over Bed	12"	12"	Max. Travel for Z Axis	35"	55"
Width of Bed	14"	14"	Main Motor	10HP, 220V, 3 Phase	10HP, 220V, 3 Phase
Spindle Bore	3-1/32", D1-8	3-1/32", D1-8	Coolant Pump	1/8HP, 220V, 3 Phase	1/8HP, 220V, 3 Phase
Taper of Spindle Center	M.T. #6	M.T. #6	Auto Lubrication	1/16HP, 220V, 3 Phase	1/16HP, 220V, 3 Phase
Spindle Speeds, CNC Programmable	21-1,620 RPM	21-1,620 RPM	Net Weight, approx.	5,650 lbs.	6,150 lbs.
Diameter of Tailstock Quill	3"	3"	Overall Dimensions L x W x H	110" x 75" x 86"	129" x 75" x 86"
Max. Travel of Tailstock Quill (manual)	6"	6"			
Price	\$26,950.00	\$28,950.00			

INDEX

A

Abrasive Stones 287

Acro Laps 265

Accu-Rite DRO's 93

Air Collet Fixture 195

Air Compressors 401

Air Grinders 324, 337

Air Hose 331, 332

Air Tools, All Kinds 324 thru 331

Angle Blocks 152, 173

Angle Dressers 239

Angle Clamp 244

Angle Gage 116, 358

Angle Plates:

 Giant 187, 188

 Precision 185

 Solid, Slotted 187

 Step 172

 Tilt 185

 V-Angle 187

Arbors 223, 231, 255 thru 261

Arbor Presses 364, 367, 380

Arkansas Stones 287

B

Ball Gage 5, 174

Ball Hex Drivers 166

Baldor Grinders 370

Band Saws 376, 379

Bases Magnetic 50

Belt Sanders 372, 373, 374

Bench Centers 190, 191

Bench Grinders 369

Bench Vise 207, 212

Benders 350, 352

Blast Cabinets 348

Blocks:

 1-2-3 124, 172

 Angle 173

 Gage 84

 Magnetic 173, 180, 182

 Space 174, 179

 V-Type 124, 172

Blow Guns 293, 323

Brakes, Box & Pan 354, 359, 360

C

Books, Machinery 302

Bore Gage 5, 64, 68

Bore Gage Setting Master 3

Borescope 129, 139

Boring Bars 270, 273

Boring Heads 226, 227

Broach Sets 189

Burr Bits 265

Burrs, Carbide 286

Calculators 141, 170

Calibration Testers 49

Calipers:

 Brown & Sharpe 6, 9

 Dial 6, 8

 Electronic 6, 7, 8, 10, 28

 Fowler 7, 9, 10, 13

 Geartooth 12, 65

 Mahr 29, 48

 Mitutoyo 6

 Vernier 8, 11

Cal-X-Tender 9

Carbide End Mills 279, 281

Carbide Tool Bits 279, 284

Centers, Live 252, 255

Center Drills 279, 285

Centers, Bench 190, 191

Centers, Electric 192

Center Punches 121, 123

Chain Hoists 343

Chamfer Gage 66

Chick CNC Vises 202

Chuck Arbors 223

Chucks:

 Jaws 219

 Keyless 220, 221

 Key Type 218, 220

 Lathe 214 thru 218

 Magnetic 183, 184

 Vacume 237

Circle Cutter 160

Clamps, C 213

Clamps, Kant Twist 245

Clamps, Mitee-Bite 244

Clamps, Parallel 245

Clamps, Toggle 246

Clamping Kits & Components 242

Clinometer 128

CNC/G-Coder 129

D

CNC Tool Cart 309

CNC Tool Tightening 244

Co-AX Indicator 40, 68

Coating Thickness Gage 88

Cold Gun Air Coolant 342

Collets:

 5C 228, 229

 R-8 228, 229

 ER Type 254

 Expanding 230

 Rubber Flex 225

Collet Block, 5C 192

Collet Chuck 222

Collet Closer, Air 231

Collet Closer, Lever 317

Collet Fixture, 5C 191, 192

Collet Holder, Rack 119, 228

Collet Indexers 191, 193

Collet stops 228

Comparator, Optical 2, 80

Coolant Pumps 333, 336

Coolant Tester 290

Counterbores 272, 278

Counter Sinks 268, 277

Cutter Grinder 398

Cut-Off Saw 370, 375

Data Collection 4

Demagnetizers 317

Deburring Machines 357, 383

Depth Gages 65, 72

Dial Calipers, Outside 6, 8

Dial Calipers, Inside 66

Dial Indicators:

 AGD Type 35

 Brown & Sharpe 42

 Compac 44

 Electronic 14, 34 thru 41

 Fowler 3, 38, 42

 Mahr/Federal 40

 Mitutoyo 14, 34 thru 40

 Starrett 47

Diamond Dressers 239, 240

Diamond Wheels 241

Digital Calipers 6 thru 13

Digital Readout Kits 3, 70, 93, 94

Digimatic Indicators 34 thru 41

Digital Levels 2, 107

Digital Scales 94

E

Dividers 78, 122

Dividing Heads 198

Document Stands 298

Dollies 315

Drafting Instruments 155

Dremel Tool Kits 321

Drill Point Gage 115

Drill Case 316

Drill Doctor 368

Drills 266, 268, 270

Drills, Center 279

Drills, Step 263

Drill Grinder 103

Drill Presses:

 Bench 390, 392

 Floor 390, 392, 393

 Magnetic 323, 364

 Radial 380, 389

Drill Sets 268, 270, 273

Drill Sharpener 103, 368

Drive Pin Punch Set 121

Duct Tape 335

Durometers 69, 84, 87, 89

Dust Collectors 391

Edge Finders:

 Audible 125

 Electronic 125

 Magnetic 122

 Mechanical 125

Electronic:

 Depth Caliper Gage 13

 Depth Micrometers 72, 73

 Digital Calipers 2, 6, 7, 8, 10

 Height Gages 69

 Indicators 34 thru 41

 Micrometers 3, 14, 16, 18

 Scriber 119

Electro Spark Engraver 118

Engraver, Electronic 118

End Mill Holders 256, 258

End Mill Sharpener 239

End Mills 280 thru 283

End Mills, Indexable 269, 274, 275

English Wheel 352, 357

ER Collets & Holders 254

Etalon Micrometers 20

Etching Pen 121

INDEX

Etch-O-Matic 118
 Extractors, Screw-Bolt 166
 Eye Loupes 128, 130, 137

F

Face Mills 274
 Facsmile 334
 Files:
 Diamond 289
 Hardness Test 289
 Needle 289
 Sets 288, 290
 Fixturing Alloy 334
 Flashlights 118, 123
 Fly Cutters 229, 269, 271
 Force Gage 89
 Furnaces 342

G

Gage Blocks 96, 99
 Gage Block Accessories 52
 Gage System 76, 77
 Gages:
 Acme 116
 Angle 116
 Ball 5
 Bore 5, 64, 65, 68
 Caliper Gages 66, 67
 Chamfer 66
 Compression 24
 Countersink 71
 Depth 65, 72
 Dial Thickness Gage 71
 Drill Point 115
 Force 89
 Height 69, 74
 Hole 66, 115, 124
 Gear Tooth 116
 General Ultra Tech 10
 Groove Master 8, 66
 Lathe 171
 Lathe CNC 402
 Pin 5, 96, 97, 98
 Planer 175
 Radius 116, 126
 Ring 100
 Snap 83, 189
 Surface 48, 50, 124
 Taper 127
 Telescoping 98, 124
 Tension 24
 Thickness 71, 116
 Thread 100, 116
 Tool Setting 105, 104
 Vibration 88
 Welding 250
 Wire 101
 Gantry Cranes 343
 Gear Tooth Caliper 11, 65
 Gloves 298, 318, 320
 Granite Plates 102
 Grease Guns 327
 Grinders, Air 325, 326
 Grinders, Bench:
 Baldor 370
 Carbide 370
 Grinding Fixtures 193, 196, 238

H

Haimer 3-D Sensor 41
 Hammers:
 Aluminum 159
 Ball Peen 156, 154
 Brass, Copper 156
 Dead Blow 156, 158
 Lead 156
 Sledge 157
 Soft Face 158
 Handles, Pin Gage 96
 Hardness Testers 69, 84
 Harig Grind-All Fixture 193
 Heat Treating Furnace 342
 Height Gages:
 Digital/Dial 75
 Electronic 69, 74, 75, 76
 Vernier 75
 Hex Wrenches 166, 168
 Hoists 343
 Holders, Indicator 50 thru 62
 Hole Cutters 271, 285
 Hole Punch 159
 Hole Gage Sets 124, 126
 Holelike Bore Gage 64
 Hose Reel 291
 Hydraulic Press 364, 366

I

Indexers, 5C Collet 191, 192, 193
 Indexing Spacers 194, 198
 Indicators:
 AGD Contact Points 57, 61
 Brown & Sharpe 42
 CO-AX 40, 68
 ComPac 44
 Dial/AGD 35, 43
 Dial Test 42
 Electronic 34 thru 41
 Fowler 3, 38, 42
 GEM 45

Holders 50 thru 60
 Indicol 46
 Interapid 42
 Mahr/Federal 40, 42
 Mitutoyo 34, 44
 Starrett 47
 Wireless 67

Indicator Stands:
 Granite 50, 52
 Magnetic 50, 53
 Steel 51, 52

Indicating Micrometers 15, 21
 Indical 68
 Infrared Thermometers 92
 Intertest 70
 Iron Worker 356
 Insulation Tester 91
 Interface, USB 6, 16
 Intramikes 54

J

Jack Set 180
 Jewelers Screwdrivers 160

K

Kant Twist Clamps 245
 Kennedy Tool Boxes 304 thru 310
 Knurling Tool 238, 264
 Kurt Vises 260

L

Lapping Plates 194
 Lamps 141, 142
 Laser Micrometer 27
 Lathes:
 Gear Head 385, 386, 389
 Small 384
 Safety Guards 339
 Speed 400
 Lathe Chucks 215 thru 218
 Levels 2, 99, 107, 108
 Lifting Tables 344
 Lights 141, 142, 151
 Live Centers 252, 255
 Lock Forming Machine 358, 367

M

Machinery Handbooks 302
 Machinist Calc 141, 170
 Magnets 181, 249, 251
 Magnetic Bases 50, 54, 56
 Magnetic Blocks 173, 180
 Magnetic Chucks 183, 184
 Magnetic Drill Press 323, 364
 Magnetic Lift 353
 Magnetic Picks-ups 138
 Magnetic Sine Plate 176
 Magnetic Sweepers 140

Magnifiers:
 Bausch & Lomb 130, 135
 Borescope 129
 Carson 146 thru 150
 Eye Loupes 128, 130
 Inspection 131, 141
 Optical Comparators 130
 Optimisor 132
 Mats 303
 Meyer Pin Gages 97
 Measurlink Software 4
 Measuring Tapes 291

Micrometers:
 Bench 12
 Blade 15
 Brown & Sharpe 6, 20, 22
 Deep Throat 24
 Depth 72, 73
 Digital 3, 14, 16, 18
 Disc 15, 26
 Electronic 3, 14, 16, 18
 Etalon 20
 Fowler E-Z Read 16, 17
 Groove 54
 Heads 23, 27
 Hole 54
 Indicating 15, 21
 Inside 15, 19, 67
 Interchangeable 16, 23, 25
 Laser Scan 27
 Mahr/Federal 29
 Mitutoyo 2, 12, 14
 Multi-Anvil 26, 28
 Outside 2, 14
 Point 26
 Sets 17, 22, 25, 32
 Stand 15
 Starrett 47
 Thread 25
 Tubing 25
 V-Anvil 15, 16, 25
 Microscope 81, 128
 Milling Arbors 254 thru 260

Milling Machines:
 CNC 400, 402
 Bench 394, 396
 Gear Head 389, 395
 Rong-Fu Mill/Drill 396
 Vertical 389, 396, 397
 Milling Table 194
 Mirrors 136, 138
 Mitutoyo Digital Readout 3, 95
 Mitutoyo Electronic Calipers 6, 8
 Moisture Meters 90
 Multiplexer 4

Notchers **N** 354, 358, 363

O

Oditest 70
 Oil Skimmer 317
 Optical Comparator 2, 80, 129

P

Pallet Jacks 344
 Parallel Separators 200
 Parallels:
 Adjustable 124
 Magnetic 180, 182
 Precision 175
 Thin 175
 Wavy 175
 Phase Converters 317
 PI-Tapes 114
 Pick Up & Retrieval Tools 133, 140
 Pin Gages 5, 96, 97
 Pliers 295, 299
 Pliers, Vise Grip 294, 297
 Planer Gage 175
 Plates:
 Angle 186, 187, 188
 Granite 103
 Tilt 185
 Power Hammer 354, 366
 Power Drawer Bar 381
 Presetters 190
 Presses, Hydraulic 365, 367
 Protractors 115
 Bevel 110
 Dial 110
 Magnetic Base 111, 114, 107
 Vernier 112, 115
 PRO-360, 3600 2, 107
 Pro-Tronic 2, 107
 Punches Center 121, 123
 Punch, Former 193
 Punch, Grinder 193, 195
 Punch Sets 121
 Punches Arc 169

Q

Quick Change Tooling 232 thru 236
 Quill Kits 95
 Quill Stops & Handle 200, 337

R

Radial Arm Drill Press 380
 Radial Arm Saw 352
 Radius Dressers 192, 237, 239
 Radius Gage 116, 126
 Radius Tools 240
 Reamers 270
 Ring Gages 100
 Ring Set 238
 Roper Whitney 353, 355
 Rotary Tables 199
 Rotary Table, Tilting 198
 Rout-A-Burr 151, 152, 153
 Rules 112

S

Safety Shields 338, 340
 Sand Blaster 348
 Sander, Disc Belt 369, 383
 Saw, Cut-Off 370, 375
 Scales 112
 Scales, Digital 94
 Scheer-Tumico 25
 Scraper, Rout-A-Burr 151, 152, 153
 Scribes 119, 123
 Screw Chart 103
 Screwchecker 115
 Screwdrivers 160
 Servo Table Feeds 2, 381
 Setting Gages 104, 115
 Shears 351, 355, 358
 Sheet Metal Gage 155
 Shim Punch 159
 Shopmath Software 126
 Sine Bars 176, 179
 Sine Plates 176, 185
 Sine Vises 176, 177
 Slip Rolls 359, 360, 363
 Socket Sets 299, 301
 Software 4
 Soldering Gun 322
 Spacers, Indexing 198
 Space Blocks 174, 179
 SPI Pro-Tronic Level 107
 Spindle Square 170, 171
 Spin Index, 5C Collet 191
 Spin Rolls 266
 Squares:
 Combination 113, 126
 Cylinder 179
 Magnetic 249
 Pivot 111
 Solid & Sets 100

Stamps, Steel 122
 Standards 104, 105
 Starrett Tools 47, 126
 Standard Gage 30, 31
 Stones, Sharpening 159, 287
 Straight Edge 188
 Stroboscope 91
 Surftest 26, 83
 Surface Gage 48, 50, 124
 Surface Grinders 382, 383
 Surface Roughness Gage 82, 83, 106, 119

T

Tables, Rotary 194, 199
 Tables Work 314
 Table Feeds, Power 2, 381
 Tables, Milling/Drilling 194
 Tachometer 87, 91
 Taps 267
 Tap & Die Sets 284
 Tap Extractors 118
 Tap Wrench 118, 120
 Tapped Hole Location Gages 181
 Tapper, Hand 225
 Tapping Heads 225, 380
 Tapes, Measuring 291
 Telescopes 149
 Telescoping Gage 98, 124
 Tesa-Hite 2, 75
 Tester, Coolant 290
 Thermometers 92
 Thread Checkers 103
 Thermo Meters 90
 Thread Gages 100, 116
 Thread Restoring 262, 269, 290
 Thread Triangles 58
 Thread Wires 101, 119
 Tie Downs 301, 347
 Tool Bits 284
 Tooling Balls 5
 Tool Boxes & Chests:
 Metal 304 thru 311
 Wood 312
 Tool Holders, Lathe 232, 264
 Tool Post Grinder 374
 Tool Setters 5, 190
 Tool Wrap 272
 Torque Wrench 301
 Trams 171, 237
 Trammels 160
 Transfer Punches 121
 Transfer Screws 122, 123
 Trepanning Tools 269
 Trigabore 5
 Tubing Cutters 164
 Tumblers, Deburring 346
 Tweezers 161, 162

U

USB Input Tool 6, 16
 Unibits 263
 U-Wave Wireless 78

V

Vacume Systems 291, 298, 313
 V-Blocks:
 Granite 102
 Magnetic 180, 181
 Toolmakers 124, 126, 173
 Vernier Calipers 8, 11
 Video Borescope 129, 132
 Video Scopes 69, 132, 137, 144
 Vision System 69
 Vise Handles 200

Vises:
 Air 209
 2-Piece 210
 2-Way 207
 3-Way 207, 210
 Bench 207, 212
 CNC, Kurt, Chick 200, 202
 Cross Slide 197, 208
 Drill Press 208
 Grip Master 208
 Jaws 196, 206
 Magnetic 210
 Milling 199, 200, 202, 204
 Panavise 211
 Pin 164
 Shaft 208
 Sine 176, 177
 Speed 207
 Superlock 210
 Tilting 199
 Toolmakers 176, 177, 195
 Vacuum 160
 Wilton 197, 205, 207, 210

W

Wee Blocks 179
 Weight Scales 345
 Welding 349
 Wheel Dressers 240
 Wiggler/Center Finder 122
 Wood Tool Chests 312
 Wrench Sets 166, 299
 Wrenches, Impact 330
 Wrenches, Hex Torx 166
 Wrenches, Tap 118
 Wrenches, Vise Grip 248