

iDISPLAY™

BY OUTFORM™



Product Catalog



Tablets/Displays



Enterprise



4K Media Player



Tower



iShelf



Window Light Show™

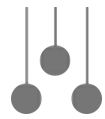

Kinetic LED Light Show™

iDISPLAY™ Product Catalog

Introduction

Welcome to iDISPLAY™ product catalog. This edition will ensure that you have access to a definitive and detailed catalog to our world-class portfolio. Both product sales brochures as well as product specification sheets have been included for your use. Used individually or collectively, this catalog is meant to assist you in the marketing and sales of iDISPLAY™ to your clients. The electronic catalog is navigable and will provide you all iDISPLAY™ product information at the touch of a click.

For pricing or more detailed product information, please contact your local iDISPLAY™ sales representative or contact us at www.outform.com/contact

iDISPLAY™

The iDISPLAY™ brand of touch screen tablets and displays is a wholly owned subsidiary of Outform. iDISPLAY™ utilizes proprietary technology and industrial grade materials for maximum performance in commercial environments. From supermarkets to restaurants to apparel retail, we study every aspect of your business to determine how our solutions can help you create new sources of customer value and competitive differentiation.

OUTFORM

Outform is a full-service, brand implementation firm that delivers innovation to store environments that both excite and incite shoppers. We enhance brand presence through creative, intelligent solutions that inspire behavior and motivate purchase. From ideation & discovery to design & deployment, our teams produce impactful solutions that generate brand equity, advocacy and Return on Investment. Specializing in both complex retail executions and in retail-ready interactive kiosks, Outform creates engaging, disruptive displays with state of the art technologies that support in-store activation and drive sales.

USA

Outform, Inc. (East Coast)
82 NE 26th St.
Miami, FL 33137 USA
+1.800.204.0524
www.outform.com

UK

Outform Ltd.
Millenium House, Humber Road, London
NW2 6DW, United Kingdom
+44 (0) 845.4606.111

iDISPLAY™ Product Line

iDISPLAY™ Tablet 8"	11
iDISPLAY™ Tablet 10.1"	13
iDISPLAY™ Tablet 13.3"	15
iDISPLAY™ Tablet 15.6"	17
iDISPLAY™ Tablet 18.5"	19
iDISPLAY™ Tablet 21.5"	21
iDISPLAY™ Tablet 24"	23
iDISPLAY™ Tablet 27"	25
iDISPLAY™ Tablet 32"	27
iDISPLAY™ Tablet 43"	29
iDISPLAY™ Tablet 55"	31
iDISPLAY™ Ad Display 15.6", 18.5", 21.5"	33
iDISPLAY™ Enterprise	37
iDISPLAY™ 4K MediaPlayer	41
iDISPLAY™ Tower	44
iDISPLAY™ iSHELF 2	46
Window Light Show™	48
Kinetic Light Show™	51

iDISPLAY™ Interactive Tablets

8" 10.1" 13.3" 15.6" 18.5" 21.5" 24" 27" 32" 43" 55"



Interactive tablets serve to educate customers about a retailer's latest products, guests about their hotel's services or employees about their company's most recent events, while ensuring that messaging across the various communication channels and multiple locations remains current, consistent and most importantly, personalized. Operating on Android OS, iDisplay™ provides a broad portfolio of tablets that run looping and static marketing media as well as various content applications that attract, engage and inform your customers on your products & services.

*3G optional, pending carrier compatibility/availability.
 For more information about iDISPLAY™ Tablets
 please visit our website: www.outform.com/iDisplay-Tablets

OUTFORM™



Tablet Features

- Sizes: 8", 10.1", 13.3", 15.6", 18.5", 21.5", 24", 27", 32", 43", 55"
- Lightweight design
- Multi-touch screen
- WiFi
- Versatile display options

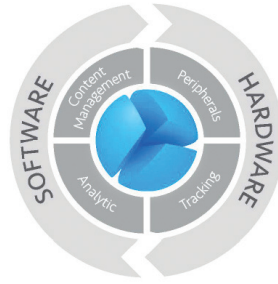

Pulse Management**

Tablet administrator, remote content and Mobile Device Management (MDM) for cloud based device management, applications, security and analytics.

**Subscription based



Business Applications

Multiple ports and peripheral options to expand display functionality for target marketing, mobile POS and consumer.



3G Modem USB dongle

Mobile broad band internet connectivity for location based advertising and device tracking.



Screen Orientation

Tablets operate in both portrait and landscape modes to deliver a host of unique consumer experiences.

Fixtures

Counter stands, floor stands, wall, shelf and table brackets.



*3G optional, pending carrier compatibility/availability.
 For more information about iDISPLAY™ Tablets
 please visit our website: www.outform.com/iDisplay-Tablets

iDisplay Tablet 8" UIT408



iDisplay Tablet 10.1" UIT410



iDisplay Tablet 13.3" UIT413



iDisplay Tablet 15.6" UIT415



iDisplay Tablet 18.5" UIT418



iDisplay Tablet 21.5" UIT421



iDisplay Tablet 24" UIT424



iDisplay Tablet 27" UIT427



iDisplay Tablet 32" UIT432



iDisplay Tablet 43" UIT443B-B01



iDisplay Tablet 55" UIT455B-B01



*3G optional, pending carrier compatibility/availability.
 For more information about iDISPLAY™ Tablets
 please visit our website: www.outform.com/iDisplay-Tablets

Tablet Screen Size		8"	10.1"	13.3"	15.6"	18.5"	21.5"
Model Number		UIT408B-B01	UIT410B-B02	UIT413B-B01	UIT415B-B01	UIT418B-B01	UIT421B-B01
Panel	Resolution	1280 x 800 Pixels	1280 x 800 Pixels	1920 x 1080 Pixels	1920 x 1080 Pixels	1366 x 768 Pixels	1920 x 1080 Pixels
	Brightness	280 cd/m ²	340 cd/m ²	300 cd/m ²	300 cd/m ²	250 cd/m ²	250 cd/m ²
	Contrast Ratio	900	800	1000	700	1000	3000
	Aspect Ratio	16.9					
	Active Area Size (W x H)	172.2 x 107.6mm	216.96 x 135.6mm	293.76 x 165.24mm	344.16 x 193.59mm	409.8 x 230.4mm	476.64 x 268.11mm
	Viewing Angle Touch	80°/80°/80°/80°	80°/89°/80°/89°	90°/90°/90°/90°	89°/89°/89°/89°	85°/85°/80°/80°	89°/89°/89°/89°
	Touch Technology	Capacitive G+G, 5 point	Capacitive G+G 10 point	Capacitive G+G, 10 point	Capacitive G+G, 10 point	Capacitive G+G, 10 point	Capacitive G+G, 10 point
Hardware and OS	CPU	RK3188, Cortex-A9, up to 1.6GHz Quad Core	RK3188, Cortex-A9, up to 1.6GHz Quad Core	RK3188, Cortex-A9, up to 1.6GHz Quad Core	RK3288, Cortex-A, up to 1.8 GHz Quad Core	RK3288, Cortex-A, up to 1.8GHz Quad Core	RK3288, Cortex-A17, up to 1.8GHz Quad Core
	GPU	Mali 400 MP4, 600MHz	Mali 400 MP4, 600MHz	Mali 400 MP4, 600MHz	Mali T764	Mali T764	Mali T764
	Internal Memory	1GB, DDR3	1GB, DDR3	1GB, DDR3	2GB, DDR3	2GB, DDR3	2GB, DDR3
	Flash Memory	8GB	8GB	16GB	16GB	16GB	16GB
	Operating System	Android 4.4 / 5.1					
	Battery	N/A	N/A	N/A	N/A	N/A	N/A
Video/Image	Video Formats	3GP, MP4, AVI, MKV, FLV, MOV					
	Video Codecs	MPG-1, MPG-2, MPG-4, H.263, H.264, VC-1, RV, VP6/VP8, MVC					
	Image Formats	JPG, JPEG, PNG, BMP					
	HDMI Output	Mini HDMI	Mini HDMI	Mini HDMI	N/A	N/A	N/A
	Playback Software	Built-in software allows for easy setup of a playlist of videos and/or stills which can be looped infinitely without any additional software. Alternatively, any installed app can be auto-started upon boot-up.					
Audio	Speakers	1W x 2	1W x 2	2W x 2	3W x 2	3W x 2	2W x 2
	Audio Codecs	MP3, WMA, AAC, FLAC, WAV					
Communications	Bluetooth	4.0					
	Wi-Fi	802.11 b/g/n 2.4GHz	802.11 b/g/n 2.4GHz	802.11 b/g/n 2.4GHz	802.11 b/g/n 2.4GHz	802.11 b/g/n 2.4GHz	802.11 b/g/n 2.4GHz
	Wired Ethernet	100M/1000M	100M/1000M	100M/1000M through external USB dongle (Optional)	100M/1000M	100M/1000M	100M/1000M
	Wireless 3G	Through internal Mini- PCIE card (Optional)	Through internal Mini-PCIE card (Optional)	Through external USB dongle (Optional)	Through internal USB dongle (Optional)	Through external USB dongle (Optional)	Through internal USB dongle (Optional)
General Information	Color	Black	Black	Black (Standard), White (Optional)	Black (Standard), White (Optional)	Black (Standard), White (Optional)	Black (Standard), White (Optional)

*3G optional, pending carrier compatibility/availability.
For more information about iDISPLAY™ Tablets
please visit our website: www.outform.com/iDisplay-Tablets

OUTFORM™

Tablet Screen Size		8"	10.1"	13.3"	15.6"	18.5"	21.5"
Model Number		UIT408B-B01	UIT410B-B02	UIT413B-B01	UIT415B-B01	UIT418B-B01	UIT421B-B01
General Information	Color	Black	Black	Black (Standard), White (Optional)	Black (Standard), White (Optional)	Black (Standard), White (Optional)	Black (Standard), White (Optional)
	Camera	No Camera (Standard), 5MP (Optional)	No Camera (Standard), 5MP (Optional)	N/A	Front 2MP	N/A	Front 2MP
	I/O Ports	DC, Mini HDMI, 3.5mm Audio Output Jack, USB 2.0 Host x 2, Micro USB 2.0 OTG x 1, RJ45	USB 2.0 Host x 3, RJ45, Micro USB 2.0 OTG x 1, 3.5mm Audio Jack, Mini HDMI, DC	DC, Micro SD, Mini HDMI, 3.5mm Audio Output Jack, Micro USB 2.0 Host x 1, Micro USB 2.0 OTG x 1	DC, 3.5mm Audio Output Jack, USB 2.0 Host x 1, USB 2.0 OTG x 1, RJ45	DC, 3.5mm Audio Output Jack, USB 2.0 Host x 3, Mini USB 2.0 OTG x 1, RJ45, SD	DC, 3.5mm Audio Output Jack, USB 2.0 Host x 1, USB 2.0 OTG x 1, RJ45
	Included in Box	Display Unit, Power Adapter, Power Cable, VESA 75mm to 100mm Bracket, User Manual, Warranty	Display Unit, Power Adapter, Power Cable, User Manual, Warranty	Display Unit, Power Adapter, Power Cable, User Manual, Warranty	Display Unit, Power Adapter, Power Cable, User Manual, Warranty	Display Unit, Power Adapter, Power Cable, User Manual, Warranty	Display Unit, Power Adapter, Power Cable, User Manual, Warranty
	Optional Accessories	Floor stand, Counter stand (S), Shelf clip, Adjustable shelf clip, Wall bracket, Rotating bracket	Floor stand, Counter stand (S), Shelf clip, Adjustable shelf clip, Wall bracket, Rotating bracket	Floor stand, Counter stand (L), Shelf clip, Adjustable shelf clip, Wall bracket, Rotating bracket	Floor stand, Counter stand (L), Shelf clip, Adjustable shelf clip, Wall bracket, Rotating bracket	Floor stand, Counter stand (L), Shelf clip, Adjustable shelf clip, Wall bracket, Rotating bracket	Floor stand, Counter stand (L), Shelf clip, Adjustable shelf clip, Wall bracket, Rotating bracket
	Sensors	G-Sensor (3-Axis accelerometer)	G-Sensor (3-Axis accelerometer)	G-Sensor (3-Axis accelerometer)	G-Sensor (3-Axis accelerometer)	G-Sensor (3-Axis accelerometer)	G-Sensor (3-Axis accelerometer)
	Power Input	12V/2A	12V/2A	5V/3A	12V/2A	12V/2A	12V/2A
	Power Consumption	15W (max)	14W (max)	12W (max)	25W (max)	25W (max)	30W (max)
	Power Over Ethernet	Through RJ45	Through RJ45	N/A	Through RJ45	N/A	N/A
	Operating Temperature	0-40 °C					
	Relative Humidity	85%					
Certification	Display Unit: ROHS, FCC and CE compliant Power Supply Unit: UL, FCC and CE compliant Battery and RTC Battery: UL and UN38.3 compliant	Display Unit: ROHS, FCC and CE compliant Power Supply Unit: UL, FCC and CE compliant Battery: UL and UN38.3 compliant	Display Unit: ROHS, FCC and CE compliant Power Supply Unit: UL, FCC and CE compliant Battery and RTC Battery: UL and UN38.3 compliant	Display Unit: ROHS, FCC and CE compliant Power Supply Unit: UL, FCC and CE compliant Battery and RTC Battery: UL and UN38.3 compliant	Display Unit: ROHS, FCC and CE compliant Power Supply Unit: UL, FCC and CE compliant	Display Unit: ROHS, FCC and CE compliant Power Supply Unit: UL, FCC and CE compliant	Display Unit: ROHS, FCC and CE compliant Power Supply Unit: UL, FCC and CE compliant
Dimensions	Size (L x W x H)	212 x 147 x 30mm	265 x 176 x 33mm	338 x 218 x 25mm	405 x 254 x 38mm	467 x 288 x 36mm	537 x 328 x 36mm
	Product Weight	0.55kg	0.78kg	1.48kg	2.72kg	4.53kg	4.8kg
	Gift Box Size	344x 215 x 65mm	400 x 225 x 70mm	388 x 318 x 78mm	628 x 308 x 89mm	525 x 394 x 110mm	756 x 393 x 99mm
	Master Carton Size	360 x 285 x 235mm	420 x 225 x 245mm	413 x 400 x 340mm	646 x 330 x 196mm	545 x 415 x 350mm	775 x 425 x 220mm
	Master Carton Weight	5kg	4.7kg	11kg	7.92kg	13.7kg	14.1kg
	Units per Master Carton	4pcs	3pcs	5pcs	2pcs	3pcs	2pcs

*3G optional, pending carrier compatibility/availability.
For more information about iDISPLAY™ Tablets
please visit our website: www.outform.com/iDisplay-Tablets

Tablet Screen Size		24"	27"	32"	43"	55"
Model Number		UIT424B-B01	UIT427B-B01	UIT432B-B01	UIT443B-B01	UIT455B-B01
Panel Information	Resolution	1920 x 1080 Pixels	1920 x 1080 Pixels	1920 x 1080 Pixels	1920 x 1080 Pixels	1920 x 1080 Pixels
	Brightness	250 cd/m ²	250 cd/m ²	250 cd/m ²	300 cd/m ²	305 cd/m ²
	Contrast Ratio	1000	1000	3000	1200	4000
	Aspect Ratio	16:9				
	Active Area Size (W x H)	527.2 x 296.67mm	579.6 x 336.15mm	698.4 x 392.85mm	942.20 x 530.4mm	1207.60 x 678.40mm
	Viewing Angle Touch	85°/85°/80°/80°	85°/85°/80°/80°	89°/89°/89°/89°	89°/89°/89°/89°	89°/89°/89°/89°
	Touch Technology	Capacitive G+G, 10 point	Capacitive G+G, 10 point	Capacitive G+G, 10 point	Capacitive G+G, 10 point	Capacitive G+G, 10 point
Hardware and OS	CPU	RK3288, Cortex-A17, up to 1.8GHz Quad Core	RK3288, Cortex-A17, up to 1.8GHz Quad Core	RK3288, Cortex-A17, up to 1.8GHz Quad Core	RK3288, Cortex-A17, up to 1.8GHz Quad Core	RK3288, Cortex-A17, up to 1.8GHz Quad Core
	GPU	Mali T764	Mali T764	Mali T764	Mali T764	Mali T764
	Internal Memory	2GB, DDR3	2GB, DDR3	2GB, DDR3	2GB, DDR3	2GB, DDR3
	Flash Memory	16GB	16GB	16GB	16GB	16GB
	Operating System	Android 4.4 / 5.1				
	Battery	N/A	N/A	N/A	N/A	N/A
Video/Image	Video Formats	3GP, MP4, AVI, MKV, FLV, MOV				
	Video Codecs	MPG-1, MPG-2, MPG-4, H.263, H.264, VC-1, RV, VP6/VP8, MVC				
	Image Formats	JPG, JPEG, PNG, BMP				
	HDMI Output	HDMI	HDMI	HDMI	HDMI	N/A
	Playback Software	Built-in software allows for easy setup of a playlist of videos and/or stills which can be looped infinitely without any additional software. Alternatively, any installed app can be auto-started upon boot-up.				
Audio	Speakers	3W x 2	3W x 2	3W x 2	5W x 2	5W x 2
	Audio Codecs	MP3, WMA, AAC, FLAC, WAV				
Communications	Bluetooth	4.0				
	Wi-Fi	802.11 b/g/n 2.4GHz	802.11 b/g/n 2.4GHz	802.11 b/g/n 2.4GHz	802.11 b/g/n 2.4GHz	802.11 b/g/n 2.4GHz
	Wired Ethernet	100M/1000M	100M/1000M	100M/1000M	100M/1000M	100M/1000M
	Wireless 3G	Through external USB dongle (Optional)	Through external USB dongle (Optional)	Through external USB dongle (Optional)	Through external USB dongle (Optional)	Through external USB dongle (Optional)

*3G optional, pending carrier compatibility/availability.
For more information about iDISPLAY™ Tablets
please visit our website: www.outform.com/iDisplay-Tablets

Tablet Screen Size		24"	27"	32"	43"	55"
Model Number		UIT424B-B01	UIT427B-B01	UIT432B-B01	UIT443B-B01	UIT455B-B01
General Information	Color	Black (Standard), White (Optional)	Black (Standard), White (Optional)	Black (Standard), White (Optional)	Black (Standard), White (Optional)	Black (Standard), White (Optional)
	Camera	N/A	N/A	N/A	N/A	N/A
	I/O Ports	DC, 3.5mm Audio Output Jack, USB 2.0 Host x 2, Mini USB 2.0 OTG x 1, RJ45, HDMI	DC, 3.5mm Audio Output Jack, USB 2.0 Host x 2, Mini USB 2.0 OTG x 1, RJ45, SD, HDMI	DC, 3.5mm Audio Output Jack, USB 2.0 Host x 2, Mini USB 2.0 OTG x 1, RJ45, SD, HDMI	SD, 3.5mm Audio Output Jack, Mini USB 2.0 OTG x 1, USB 2.0 HOST x 2, HDMI, DC	SD, 3.5mm Audio Output Jack, USB 2.0 OTG x 1, USB 2.0 HOST x 2, HDMI, DC
	Included in Box	Display Unit, Power Adapter, Power Cable, User Manual, Warranty	Display Unit, Power Adapter, Power Cable, User Manual, Warranty	Display Unit, Power Adapter, Power Cable, User Manual, Warranty	Display Unit, Power Adapter, Power Cable, User Manual, Warranty	Display Unit, Power Adapter, Power Cable, User Manual, Warranty
	Optional Accessories	Floor stand, Counter stand	Floor stand, Counter stand	Floor stand, Counter stand		
	Sensors	G-Sensor (3-Axis accelerometer)	G-Sensor (3-Axis accelerometer)	G-Sensor (3-Axis accelerometer)	G-Sensor (3-Axis accelerometer)	G-Sensor (3-Axis accelerometer)
	Power Input	12V/4A	12V/4A	12V/5A	AC100-240V	AC100-240V
	Power Consumption	35W (max)	40W (max)	50W (max)		14W (max)
	Power Over Ethernet	N/A	N/A	N/A	N/A	
	Operating Temperature	0-40 °C				
	Relative Humidity	85%				
Certification	Display Unit: ROHS, FCC and CE complaint Power Supply Unit: UL, FCC and CE compliant	Display Unit: ROHS, FCC and CE complaint Power Supply Unit: UL, FCC and CE compliant	Display Unit: ROHS, FCC and CE complaint Power Supply Unit: UL, FCC and CE compliant	Display Unit: ROHS, FCC and CE complaint Power Supply Unit: UL, FCC and CE compliant	Display Unit: ROHS, FCC and CE complaint Power Supply Unit: UL, FCC and CE compliant	Display Unit: ROHS, FCC and CE complaint Power Supply Unit: UL, FCC and CE compliant
Dimensions	Size (L x W x H)	577 x 346 x 36mm	652 x 392 x 36mm	747 x 446 x 39mm	990 x 589 x 53mm	1263.18 x 747.28 x 56.5mm
	Product Weight	5.9kg	6.95kg	8.03kg	18.1kg	29kg
	Gift Box Size	655 x 455 x 115mm	680 x 501 x 120mm	862 x 555 x 135mm	1156 x 792 x 160mm	
	Master Carton Size	670 x 473 x 250mm	740 x 250 x 515mm	880 x 580 x 150mm	1180 x 817 x 178mm	
	Master Carton Weight	15.3kg	18.9kg	13kg	20.1kg	
	Units per Master Carton	2pcs	2pc	1pc	1pc	1pc

*3G optional, pending carrier compatibility/availability.
For more information about iDISPLAY™ Tablets
please visit our website: www.outform.com/iDisplay-Tablets

iDISPLAY™ Tablet 8"

UIT408



The iDISPLAY Tablet 8" is designed as an interactive display for any location. Operating on an Android operating system and powered by Pulse technology, this slim and elegant display includes all of the solutions needed for commercial locations. Attach to any standard TV/monitor VESA bracket and simply turn on the power. It is a fully interactive commercial display that uses capacitive touch, built in WiFi and LAN, and a host of integrated features that work in either landscape or portrait format. With the option to expand to 3G services*, this is an amazing, interactive digital display that creates an engaging, memorable consumer experience.



*3G optional, pending carrier compatibility/availability.
For more information about iDISPLAY™ Tablets
please visit our website: www.outform.com/iDisplay-Tablets

iDISPLAY™ Tablet 8" Model Number: UIT408B

Panel Information	Screen Size	8"
	Resolution	1280 x 800 Pixels
	Brightness	280 cd/m ²
	Contrast Ratio	900
	Aspect Ratio	16:10
	Active Area Size (WxH)	172.2 x 107.6mm
	Viewing Angle Touch	80°/80°(H), 80°/80°(V)
	Touch Technology	Capacitive G+C 5 point
Hardware and OS	CPU	RK3188, Cortex-A9, up to 1.6GHz Quad Core
	GPU	Mali 400 MP4, 600MHz
	Internal Memory	1GB, DDR3
	Flash Memory	8GB
	Operating System	Android 4.4 / 5.1
	Battery	No Battery (Standard)
Video/Images	Video Formats	3GP, MP4, AVI, MKV, FLV, MOV
	Video Codecs	MPG-1, MPG-2, MPG-4, H.263, H.264, VC-1, RV, VP6/VP8, MVC
	Image Formats	JPG/JPEG, PNG, BMP
	HDMI Output	Mini HDMI
	Playback Software	Built-in software allows for easy setup of a playlist of videos and/or stills which can be looped infinitely without any additional software. Alternatively, any installed app can be auto-started upon boot-up.
Audio	Speakers	1W x 2
	Audio Codecs	MP3, WMA, AAC, FLAC, WAV
Communications	Bluetooth	4.0
	Wi-Fi	802.11 b/g/n 2.4GHz
	Wired Ethernet	100M/1000M, RJ45
	Wireless 3G	Through internal Mini-PCIE Card (Optional)
General information	Color	Black
	Camera	No Camera (Standard), 5MP (Optional)
	I/O ports	DC, Mini HDMI, 3.5mm Audio Output Jack, USB 2.0 Host x 2, Micro USB 2.0 OTG x 1, RJ45
	Included in Box	Display Unit, Power Adapter, VESA 75mm to 100mm Bracket, Power Cable, User Manual, Warranty
	Optional Accessories	Floor stand, counter stand (L), shelf clip, adjustable shelf clip, wall bracket, rotating bracket
	Sensors	G-Sensor (3-Axis accelerometer)
	Power Input	12V/2A
	Power Consumption	15W (max)
	Power Over Ethernet	Through RJ45
	Operating Temperature	0-40 °C
	Relative Humidity	85%
	Certifications	Display Unit: ROHS, FCC and CE complaint Power Supply Unit: UL, FCC and CE compliant Battery: UL, UN38.3
	Dimensions	Size (L x W x H)
Product Weight		0.55kg
Gift Box Size		344 x 215 x 65mm
Master Carton Size		360 x 285 x 235mm
Master Carton Weight		5kg
Units per Master Carton		4pcs

*3G optional, pending carrier compatibility/availability.
For more information about iDISPLAY™ Tablets
please visit our website: www.outform.com/iDisplay-Tablets

OUTFORM™

iDISPLAY™ Tablet 10.1" UIT410B-B02



The iDISPLAY Tablet 10.1" is designed as an interactive display for any location. Operating on an Android operating system and powered by Pulse technology, this slim and elegant display includes all of the solutions needed for commercial locations. Attach to any standard TV/monitor VESA bracket and simply turn on the power. It is a fully interactive commercial display that uses capacitive touch, built in WiFi and LAN, and a host of integrated features that work in either landscape or portrait format. With the option to expand to 3G services*, this is an amazing, interactive digital display that creates an engaging, memorable consumer experience.

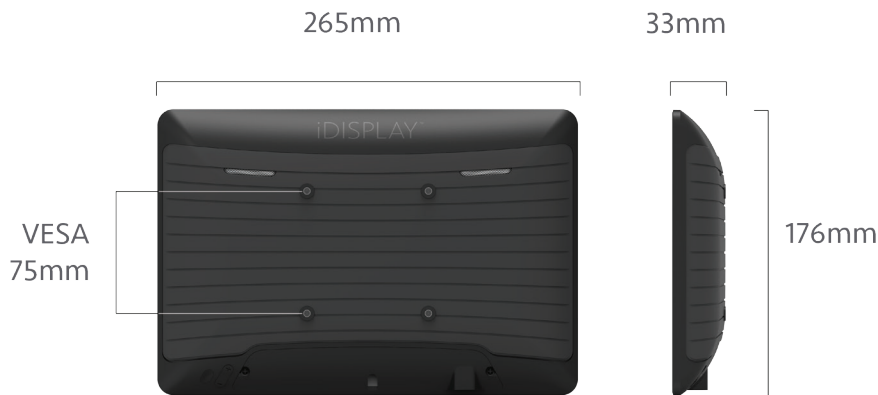

*3G optional, pending carrier compatibility/availability.
For more information about iDISPLAY™ Tablets
please visit our website: www.outform.com/iDisplay-Tablets

Panel Information	Screen Size	10.1"
	Resolution	1280 x 800 Pixels
	Brightness	340 cd/m ²
	Contrast Ratio	800
	Aspect Ratio	16:9
	Active Area Size (WxH)	216.96 x 135.6mm
	Viewing Angle Touch	80°/89°(H), 80°/89°(V)
	Touch Technology	Capacitive G+G 10 point
Hardware and OS	CPU	RK3188, Cortex-A9, up to 1.6GHz Quad Core
	GPU	Mali 400 MP4, 600MHz
	Internal Memory	1GB, DDR3
	Flash Memory	8GB
	Operating System	Android 4.4 / 5.1
	Battery	N/A
Video/Images	Video Formats	3GP, MP4, AVI, MKV, FLV, MOV
	Video Codecs	MPG-1, MPG-2, MPG-4, H.263, H.264, VC-1, RV, VP6/VP8, MVC
	Image Formats	JPG/JPEG, PNG, BMP
	HDMI Output	Mini HDMI
	Playback Software	Built-in software allows for easy setup of a playlist of videos and/or stills which can be looped infinitely without any additional software. Alternatively, any installed app can be auto-started upon boot-up. without any additional software. Alternatively, any installed app can be auto-started upon boot-up.
Audio	Speakers	1W x 2
	Audio Codecs	MP3, WMA, AAC, FLAC, WAV
Communications	Bluetooth	4.0
	Wi-Fi	802.11 b/g/n 2.4GHz
	Wired Ethernet	10M/100M, RJ45
	Wireless 3G	Through internal Mini-PCIE Card (Optional)
General information	Color	Black
	Camera	Option 1: No camera Option 2: With 5mp camera
	I/O ports	USB 2.0 Host x 3, RJ45, Micro USB 2.0 OTG x 1, 3.5mm Audio Jack, Mini HDMI, DC
	Included in Box	Display Unit, Power Adapter, Power Cable, User Manual, Warranty
	Optional Accessories	Floor stand, counter stand (L), shelf clip, adjustable shelf clip, wall bracket, rotating bracket
	Sensors	G-Sensor (3-Axis accelerometer)
	Power Input	12V/2A
	Power Consumption	14W (max)
	Power Over Ethernet	Through RJ45
	Operating Temperature	0-40 °C
	Relative Humidity	85%
	Certifications	Display Unit: ROHS, FCC and CE complaint Power Supply Unit: UL, FCC and CE compliant Battery: UL, UN38.3
	Dimensions	Size (L x W x H)
Product Weight		0.78kg
Gift Box Size		400 x 225 x 70mm
Master Carton Size		415 x 225 x 245mm
Master Carton Weight		4.7kg
Units per Master Carton		3pcs

iDISPLAY™ Tablet 13.3" UIT413



The iDISPLAY Tablet 10.1" is designed as an interactive display for any location. Operating on an Android operating system and powered by Pulse technology, this slim and elegant display includes all of the solutions needed for commercial locations. Attach to any standard TV/monitor VESA bracket and simply turn on the power. It is a fully interactive commercial display that uses capacitive touch, built in WiFi and LAN, and a host of integrated features that work in either landscape or portrait format. With the option to expand to 3G services*, this is an amazing, interactive digital display that creates an engaging, memorable consumer experience.

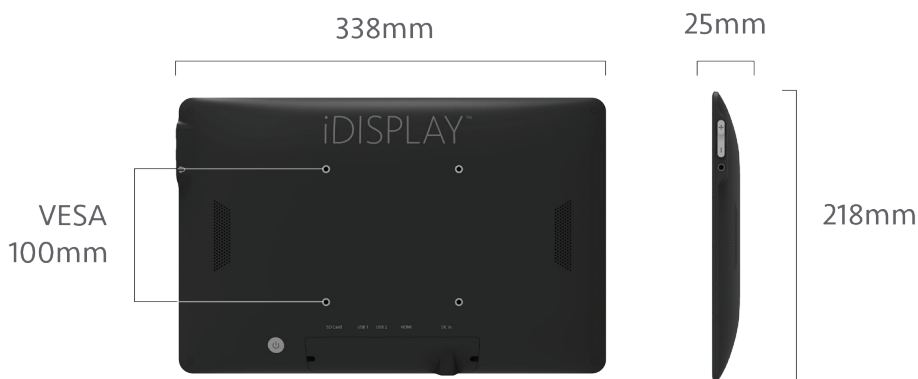

*3G optional, pending carrier compatibility/availability.
For more information about iDISPLAY™ Tablets
please visit our website: www.outform.com/iDisplay-Tablets

iDISPLAY™ Tablet 13.3" Model Number: UIT413B

Panel Information	Screen Size	13.3"	
	Resolution	1920 x 1080 Pixels	
	Brightness	300 cd/m ²	
	Contrast Ratio	1000	
	Aspect Ratio	16:9	
	Active Area Size (WxH)	293.76 x 165.24mm	
	Viewing Angle Touch	90°/90°(H), 90°/90°(V)	
	Touch Technology	Capacitive G+G 10 point	
Hardware and OS	CPU	RK3188, Cortex-A9, up to 1.6GHz Quad Core	
	GPU	Mali 400 MP4, 600MHz	
	Internal Memory	1GB, DDR3	
	Flash Memory	16GB	
	Operating System	Android 4.4 / 5.1	
	Battery	N/A	
Video/Images	Video Formats	3GP, MP4, AVI, MKV, FLV, MOV	
	Video Codecs	MPG-1, MPG-2, MPG-4, H.263, H.264, VC-1, RV, VP6/VP8, MVC	
	Image Formats	JPG/JPEG, PNG, BMP	
	HDMI Output	Mini HDMI	
	Playback Software	Built-in software allows for easy setup of a playlist of videos and/or stills which can be looped infinitely without any additional software. Alternatively, any installed app can be auto-started upon boot-up.	
Audio	Speakers	2W x 2	
	Audio Codecs	MP3, WMA, AAC, FLAC, WAV	
Communications	Bluetooth	4.0	
	Wi-Fi	802.11 b/g/n 2.4GHz	
	Wired Ethernet	10M/100M, through external USB dongle (Optional)	
	Wireless 3G	Through external USB dongle (Optional)	
General information	Color	Black (Standard), White (Optional)	
	Camera	N/A	
	I/O ports	Micro SD, Micro USB 2.0 Host x 1, Micro USB 2.0 OTG x 1, Mini HDMI, DC, 3.5mm Audio Jack	
	Included in Box	Display Unit, Power Adapter, Power Cable, User Manual, Warranty	
	Optional Accessories	Floor stand, counter stand (L), shelf clip, adjustable shelf clip, wall bracket, rotating bracket	
	Sensors	G-Sensor (3-Axis accelerometer)	
	Power Input	5V/2.5A	
	Power Consumption	10W (max)	
	Power Over Ethernet	N/A	
	Operating Temperature	0-40 °C	
	Relative Humidity	85%	
	Certifications		Display Unit: ROHS, FCC and CE complaint
			Power Supply Unit: UL, FCC and CE compliant
Dimensions	Size (L x W x H)	338 x 218 x 25mm	
	Product Weight	1.48kg	
	Gift Box Size	388 x 318 x 78mm	
	Master Carton Size	413 x 400 x 340mm	
	Master Carton Weight	11kg	
	Units per Master Carton	5pcs	

*3G optional, pending carrier compatibility/availability.
For more information about iDISPLAY™ Tablets
please visit our website: www.outform.com/iDisplay-Tablets



iDISPLAY™ Tablet 15.6" UIT415



The iDISPLAY Tablet 15.6" is designed as an interactive display for any location. Operating on an Android operating system and powered by Pulse technology, this slim and elegant display includes all of the solutions needed for commercial locations. Attach to any standard TV/monitor VESA bracket and simply turn on the power. It is a fully interactive commercial display that uses capacitive touch, built in WiFi and LAN, and a host of integrated features that work in either landscape or portrait format. With the option to expand to 3G services*, this is an amazing, interactive digital display that creates an engaging, memorable consumer experience.



*3G optional, pending carrier compatibility/availability.
For more information about iDISPLAY™ Tablets
please visit our website: www.outform.com/iDisplay-Tablets

iDISPLAY™ Tablet 15.6" Model Number: UIT415B-B02

Panel Information	Screen Size	15.6"
	Resolution	1920 x 1080 Pixels
	Brightness	300 cd/m ²
	Contrast Ratio	700
	Aspect Ratio	16:9
	Active Area Size (WxH)	344.16 x 193.59mm
	Viewing Angle Touch	89°/89°(H), 89°/89°(V)
	Touch Technology	Capacitive G+G 10 point
Hardware and OS	CPU	RK3288, Cortex-A17, up to 1.8GHz Quad Core
	GPU	Mali T764
	Internal Memory	2GB, DDR3
	Flash Memory	16GB
	Operating System	Android 4.4 / 5.1
	Battery	N/A
Video/Images	Video Formats	3GP, MP4, AVI, MKV, FLV, MOV
	Video Codecs	MPG-1, MPG-2, MPG-4, H.263, H.264, VC-1, RV, VP6/VP8, MVC
	Image Formats	JPG/JPEG, PNG, BMP
	HDMI Output	N/A
	Playback Software	Built-in software allows for easy setup of a playlist of videos and/or stills which can be looped infinitely without any additional software. Alternatively, any installed app can be auto-started upon boot-up.
Audio	Speakers	3W x 2
	Audio Codecs	MP3, WMA, AAC, FLAC, WAV
Communications	Bluetooth	4.0
	Wi-Fi	802.11 b/g/n 2.4GHz (AP6212)
	Wired Ethernet	100M/1000M, RJ45
	Wireless 3G	Through internal USB dongle (Optional)
General information	Color	Black (Standard), White (Optional)
	Camera	Front 2MP
	I/O ports	DC, 3.5mm Audio Output Jack, USB 2.0 Host x 1, USB 2.0 OTG X 1, RJ45
	Included in Box	Display Unit, Power Adapter, Power Cable, User Manual, Warranty
	Optional Accessories	Floor stand, Counter stand (L), Shelf clip, Adjustable shelf clip, Wall bracket, Rotating bracket
	Sensors	G-Sensor (3-Axis accelerometer)
	Power Input	12V/3A
	Power Consumption	25W (max)
	Power Over Ethernet	Through RJ45
	Operating Temperature	0-40 °C
	Relative Humidity	85%
	Certifications	Display Unit: ROHS, FCC and CE complaint Power Supply Unit: UL, FCC and CE compliant
	Dimensions	Size (L x W x H)
Product Weight		2.72kg
Gift Box Size		628 x 308 x 89mm
Master Carton Size		646 x 330 x 196mm
Master Carton Weight		7.92kg
Units per Master Carton		2pcs

*3G optional, pending carrier compatibility/availability.
For more information about iDISPLAY™ Tablets
please visit our website: www.outform.com/iDisplay-Tablets



iDISPLAY™ Tablet 18.5" UIT418



The iDISPLAY Tablet 18.5" is designed as an freestanding or wall based interactive display. Operating on an Android operating system and powered by Pulse technology, this slim and elegant display includes all of the solutions needed for commercial locations. Attach to any standard TV/monitor VESA bracket and simply turn on the power. It is a fully interactive commercial display that uses capacitive touch, built in WiFi and LAN, and a host of integrated features that work in either landscape or portrait format. With the option to expand to 3G services*, this is an amazing, medium-sized screen interactive digital display that creates an engaging, memorable consumer experience.

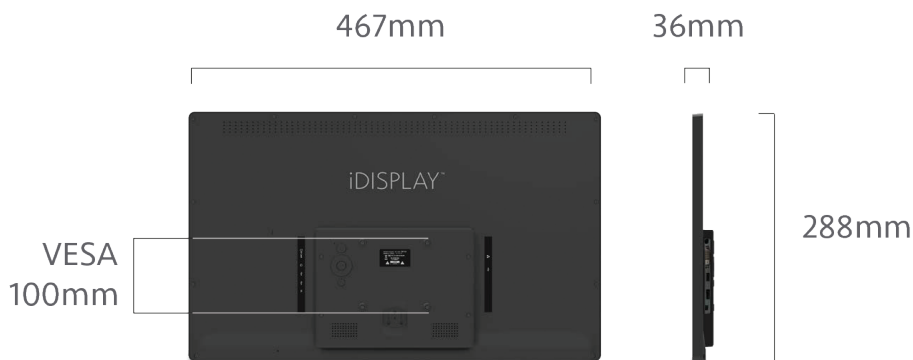

*3G optional, pending carrier compatibility/availability.
For more information about iDISPLAY™ Tablets
please visit our website: www.outform.com/iDisplay-Tablets

Panel Information	Screen Size	18.5"
	Resolution	1366 x 768 Pixels
	Brightness	250 cd/m ²
	Contrast Ratio	1000
	Aspect Ratio	16:9
	Active Area Size (WxH)	409.8 x 230.4mm
	Viewing Angle Touch	85°/85°(H), 80°/80°(V)
	Touch Technology	Capacitive G+C 10 point
Hardware and OS	CPU	RK3288, Cortex-A17, up to 1.8GHz Quad Core
	GPU	Mali T764
	Internal Memory	2GB, DDR3
	Flash Memory	16GB
	Operating System	Android 4.4 / 5.1
	Battery	N/A
Video/Images	Video Formats	3GP, MP4, AVI, MKV, FLV, MOV
	Video Codecs	MPG-1, MPG-2, MPG-4, H.263, H.264, VC-1, RV, VP6/VP8, MVC
	Image Formats	JPG/JPEG, PNG, BMP
	HDMI Output	HDMI
	Playback Software	Built-in software allows for easy setup of a playlist of videos and/or stills which can be looped infinitely without any additional software. Alternatively, any installed app can be auto-started upon boot-up.
Audio	Speakers	3W x 2
	Audio Codecs	MP3, WMA, AAC, FLAC, WAV
Communications	Bluetooth	4.0
	Wi-Fi	802.11 b/g/n 2.4GHz
	Wired Ethernet	100M/1000M
	Wireless 3G	Through internal USB dongle (Optional)
General information	Color	Black (Standard), White (Optional)
	Camera	N/A
	I/O ports	SD, 3.5mm Audio Jack, Mini USB 2.0 OTG x 1, USB 2.0 Host x 3, HDMI, DC, RJ45
	Included in Box	Display Unit, Power Adapter, Power Cable, User Manual, Warranty
	Optional Accessories	Floor stand, Counter Stand
	Sensors	G-Sensor (3-Axis accelerometer)
	Power Input	12V/3A
	Power Consumption	25W (max)
	Power Over Ethernet	N/A
	Operating Temperature	0-40 °C
	Relative Humidity	85%
	Certifications	Display Unit: ROHS, FCC and CE complaint Power Supply Unit: UL, FCC and CE compliant
	Dimensions	Size (L x W x H)
Product Weight		4.53kg
Gift Box Size		525 x 394 x 110mm
Master Carton Size		545 x 415 x 350mm
Master Carton Weight		13.7kg
Units per Master Carton		3pcs

*3G optional, pending carrier compatibility/availability.
For more information about iDISPLAY™ Tablets
please visit our website: www.outform.com/iDisplay-Tablets

iDISPLAY™ Tablet 21.5" UIT421



The iDISPLAY Tablet 21.5" is designed as an freestanding or wall based interactive display. Operating on an Android operating system and powered by Pulse technology, this slim and elegant display includes all of the solutions needed for commercial locations. Attach to any standard TV/monitor VESA bracket and simply turn on the power. It is a fully interactive commercial display that uses capacitive touch, built in WiFi and LAN, and a host of integrated features that work in either landscape or portrait format. With the option to expand to 3G services*, this is an amazing, medium-sized screen interactive digital display that creates an engaging, memorable consumer experience.



*3G optional, pending carrier compatibility/availability.
For more information about iDISPLAY™ Tablets
please visit our website: www.outform.com/iDisplay-Tablets

iDISPLAY™ Tablet 21.5" Model Number: UIT421B

Panel Information	Screen Size	21.5"
	Resolution	1920 x 1080 Pixels
	Brightness	250 cd/m ²
	Contrast Ratio	3000
	Aspect Ratio	16:9
	Active Area Size (WxH)	476.64 x 268.11mm
	Viewing Angle Touch	89°/89°(H), 89°/89°(V)
	Touch Technology	Capacitive G+G 10 point
Hardware and OS	CPU	RK3288, Cortex-A17, up to 1.8GHz Quad Core
	GPU	Mali T764
	Internal Memory	2GB, DDR3
	Flash Memory	16GB
	Operating System	Android 4.4 / 5.1
	Battery	N/A
	Video/Images	Video Formats
Video Codecs		MPG-1, MPG-2, MPG-4, H.263, H.264, VC-1, RV, VP6/VP8, MVC
Image Formats		JPG/JPEG, PNG, BMP
HDMI Output		N/A
Playback Software		Built-in software allows for easy setup of a playlist of videos and/or stills which can be looped infinitely without any additional software. Alternatively, any installed app can be auto-started upon boot-up.
Audio	Speakers	2W x 2
	Audio Codecs	MP3, WMA, AAC, FLAC, WAV
Communications	Bluetooth	4.0
	Wi-Fi	802.11 b/g/n 2.4GHz
	Wired Ethernet	100M/1000M
	Wireless 3G	Through internal USB dongle (Optional)
General information	Color	Black (Standard), White (Optional)
	Camera	Front 2MP
	I/O ports	3.5mm Audio Jack, RJ45, USB 2.0 Host x 1, USB 2.0 OTG x 1, DC
	Included in Box	Display Unit, Power Adapter, Power Cable, User Manual, Warranty
	Optional Accessories	Floor stand, Counter Stand
	Sensors	G-Sensor (3-Axis accelerometer)
	Power Input	12V/3A
	Power Consumption	30W (max)
	Power Over Ethernet	N/A
	Operating Temperature	0-40 °C
	Relative Humidity	85%
	Certifications	Display Unit: ROHS, FCC and CE complaint Power Supply Unit: UL, FCC and CE compliant
	Dimensions	Size (L x W x H)
Product Weight		4.8kg
Gift Box Size		756 x 393 x 99mm
Master Carton Size		775 x 425 x 220mm
Master Carton Weight		14.1kg
Units per Master Carton		2pcs

*3G optional, pending carrier compatibility/availability.
For more information about iDISPLAY™ Tablets
please visit our website: www.outform.com/iDisplay-Tablets



iDISPLAY™ Tablet 24"

UIT424



The iDISPLAY Tablet 24" is designed as an freestanding or wall based interactive display. Operating on an Android operating system and powered by Pulse technology, this slim and elegant display includes all of the solutions needed for commercial locations. Attach to any standard TV/monitor VESA bracket and simply turn on the power. It is a fully interactive commercial display that uses capacitive touch, built in WiFi and LAN, and a host of integrated features that work in either landscape or portrait format. With the option to expand to 3G services*, this is an amazing, large screen interactive digital display that creates an engaging, memorable consumer experience.

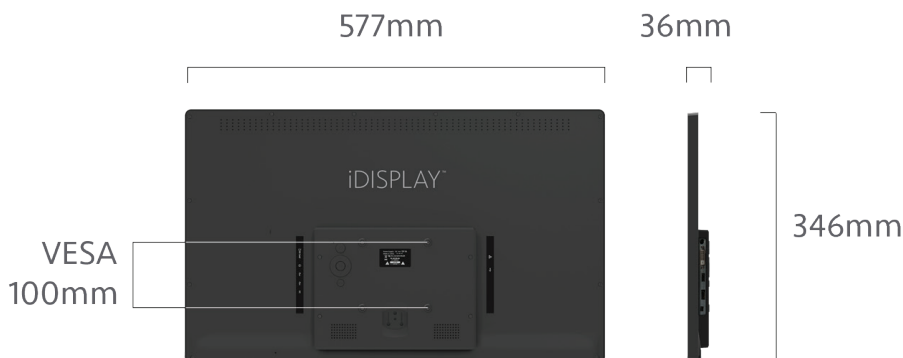

*3G optional, pending carrier compatibility/availability.
For more information about iDISPLAY™ Tablets
please visit our website: www.outform.com/iDisplay-Tablets

iDISPLAY™ Tablet 24" Model Number: UIT424B

Panel Information	Screen Size	24"
	Resolution	1920 x 1080 Pixels
	Brightness	250 cd/m ²
	Contrast Ratio	1000
	Aspect Ratio	16:9
	Active Area Size (WxH)	527.2 x 296.67mm
	Viewing Angle Touch	85°/85°(H), 80°/80°(V)
	Touch Technology	Capacitive G+G 10 point
Hardware and OS	CPU	RK3288, Cortex-A17, up to 1.8GHz Quad Core
	GPU	Mali T764
	Internal Memory	2GB, DDR3
	Flash Memory	16GB
	Operating System	Android 4.4 / 5.1
	Battery	N/A
	Video/Images	Video Formats
Video Codecs		MPG-1, MPG-2, MPG-4, H.263, H.264, VC-1, RV, VP6/VP8, MVC
Image Formats		JPG/JPEG, PNG, BMP
HDMI Output		HDMI
Playback Software		Built-in software allows for easy setup of a playlist of videos and/or stills which can be looped infinitely without any additional software. Alternatively, any installed app can be auto-started upon boot-up.
Audio		Speakers
	Audio Codecs	MP3, WMA, AAC, FLAC, WAV
Communications	Bluetooth	4.0
	Wi-Fi	802.11 b/g/n 2.4GHz
	Wired Ethernet	100M/1000M
	Wireless 3G	Through external USB dongle (Optional)
General information	Color	Black (Standard), White (Optional)
	Camera	N/A
	I/O ports	SD, 3.5mm Audio Jack, Mini USB 2.0 OTG x 1, USB 2.0 Host x 2, HDMI, DC, RJ45
	Included in Box	Display Unit, Power Adapter, Power Cable, User Manual, Warranty
	Optional Accessories	Floor stand, Counter Stand
	Sensors	G-Sensor (3-Axis accelerometer)
	Power Input	12V/4A
	Power Consumption	35W (max)
	Power Over Ethernet	N/A
	Operating Temperature	0-40 °C
	Relative Humidity	85%
	Certifications	Display Unit: ROHS, FCC and CE complaint Power Supply Unit: UL, FCC and CE compliant
	Dimensions	Size (L x W x H)
Product Weight		5.9kg
Gift Box Size		655 x 455 x 115mm
Master Carton Size		670 x 473 x 250mm
Master Carton Weight		15.3kg
Units per Master Carton		2pcs

*3G optional, pending carrier compatibility/availability.
 For more information about iDISPLAY™ Tablets
 please visit our website: www.outform.com/iDisplay-Tablets



iDISPLAY™ Tablet 27"

UIT427



The iDISPLAY Tablet 27" is designed as an freestanding or wall based interactive display. Operating on an Android operating system and powered by Pulse technology, this slim and elegant display includes all of the solutions needed for commercial locations. Attach to any standard TV/monitor VESA bracket and simply turn on the power. It is a fully interactive commercial display that uses capacitive touch, built in WiFi and LAN, and a host of integrated features that work in either landscape or portrait format. With the option to expand to 3G services*, this is an amazing, large screen interactive digital display that creates an engaging, memorable consumer experience.

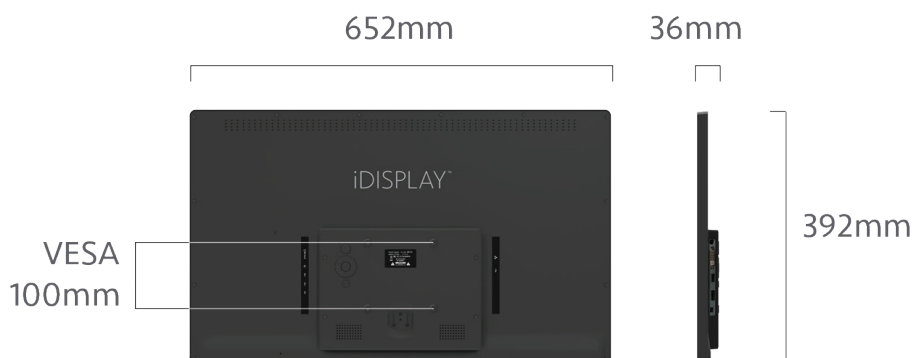

*3G optional, pending carrier compatibility/availability.
For more information about iDISPLAY™ Tablets
please visit our website: www.outform.com/iDisplay-Tablets

iDISPLAY™ Tablet 27" Model Number: UIT427B

Panel Information	Screen Size	27"
	Resolution	1920 x 1080 Pixels
	Brightness	250 cd/m ²
	Contrast Ratio	1000
	Aspect Ratio	16:9
	Active Area Size (WxH)	579.6 x 336.15mm
	Viewing Angle Touch	85°/85°(H), 80°/80°(V)
	Touch Technology	Capacitive G+C 10 point
Hardware and OS	CPU	RK3288, Cortex-A17, up to 1.8GHz Quad Core
	GPU	Mali T764
	Internal Memory	2GB, DDR3
	Flash Memory	16GB
	Operating System	Android 4.4 / 5.1
	Battery	N/A
Video/Images	Video Formats	3GP, MP4, AVI, MKV, FLV, MOV
	Video Codecs	MPG-1, MPG-2, MPG-4, H.263, H.264, VC-1, RV, VP6/VP8, MVC
	Image Formats	JPG/JPEG, PNG, BMP
	HDMI Output	HDMI
	Playback Software	Built-in software allows for easy setup of a playlist of videos and/or stills which can be looped infinitely without any additional software. Alternatively, any installed app can be auto-started upon boot-up.
Audio	Speakers	3W x 2
	Audio Codecs	MP3, WMA, AAC, FLAC, WAV
Communications	Bluetooth	4.0
	Wi-Fi	802.11 b/g/n 2.4GHz
	Wired Ethernet	100M/1000M
	Wireless 3G	Through external USB dongle (optional)
General information	Color	Black (Standard), White (Optional)
	Camera	N/A
	I/O ports	SD, 3.5mm Audio Jack, Mini USB 2.0 OTG x 1, USB 2.0 Host x 2, DC, RJ45
	Included in Box	Display Unit, Power Adapter, Power Cable, User Manual, Warranty
	Optional Accessories	Floor stand, Counter Stand
	Sensors	G-Sensor (3-Axis accelerometer)
	Power Input	12V/4A
	Power Consumption	40W (max)
	Power Over Ethernet	N/A
	Operating Temperature	0-40 °C
	Relative Humidity	85%
	Certifications	Display Unit: ROHS, FCC and CE complaint Power Supply Unit: UL, FCC and CE compliant
	Dimensions	Size (L x W x H)
Product Weight		6.95kg
Gift Box Size		680 x 501 x 120mm
Master Carton Size		740 x 515 x 250mm
Master Carton Weight		18.9kg
Units per Master Carton		2pcs

*3G optional, pending carrier compatibility/availability.
For more information about iDISPLAY™ Tablets
please visit our website: www.outform.com/iDisplay-Tablets



iDISPLAY™ Tablet 32"

UIT432



The iDISPLAY Tablet 32" is designed as an freestanding or wall based interactive display. Operating on an Android operating system and powered by Pulse technology, this slim and elegant display includes all of the solutions needed for commercial locations. Attach to any standard TV/monitor VESA bracket and simply turn on the power. It is a fully interactive commercial display that uses capacitive touch, built in WiFi and LAN, and a host of integrated features that work in either landscape or portrait format. With the option to expand to 3G services*, this is an amazing, large screen interactive digital display that creates an engaging, memorable consumer experience.

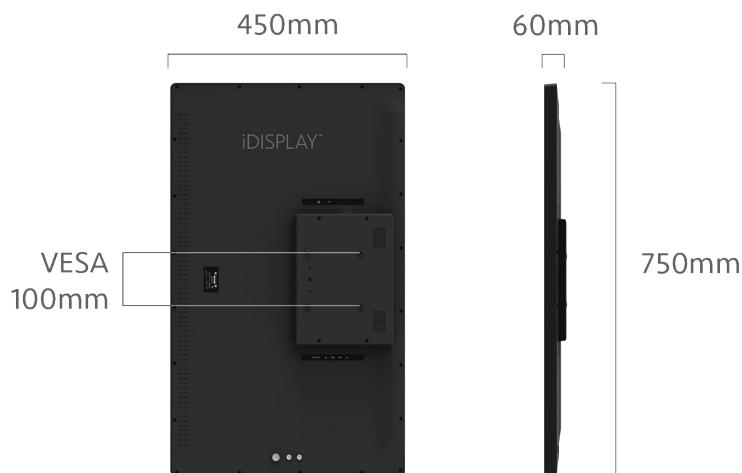

*3G optional, pending carrier compatibility/availability.
For more information about iDISPLAY™ Tablets
please visit our website: www.outform.com/iDisplay-Tablets

iDISPLAY™ Tablet 32" Model Number: UIT432B

Panel Information	Screen Size	32"
	Resolution	1920 x 1080 Pixels
	Brightness	250 cd/m ²
	Contrast Ratio	3000
	Aspect Ratio	16:9
	Active Area Size (WxH)	698.4 x 392.85mm
	Viewing Angle Touch	89°/89°(H), 89°/89°(V)
	Touch Technology	Capacitive G+G 10 point
Hardware and OS	CPU	RK3288, Cortex-A17, up to 1.8GHz Quad Core
	GPU	Mali T764
	Internal Memory	2GB, DDR3
	Flash Memory	16GB
	Operating System	Android 4.4 / 5.1
	Battery	N/A
	Video/Images	Video Formats
Video Codecs		MPG-1, MPG-2, MPG-4, H.263, H.264, VC-1, RV, VP6/VP8, MVC
Image Formats		JPG/JPEG, PNG, BMP
HDMI Output		HDMI
Playback Software		Built-in software allows for easy setup of a playlist of videos and/or stills which can be looped infinitely without any additional software. Alternatively, any installed app can be auto-started upon boot-up.
Audio		Speakers
	Audio Codecs	MP3, WMA, AAC, FLAC, WAV
Communications	Bluetooth	4.0
	Wi-Fi	802.11 b/g/n 2.4GHz
	Wired Ethernet	100M/1000M
	Wireless 3G	Through external USB dongle (optional)
General information	Color	Black (Standard), White (Optional)
	Camera	N/A
	I/O ports	SD, 3.5mm Audio Jack, Mini USB 2.0 OTG x 1, USB 2.0 Host x 2, DC, RJ45, HDMI
	Included in Box	Display Unit, Power Adapter, Power Cable, User Manual, Warranty
	Optional Accessories	Floor stand
	Sensors	G-Sensor (3-Axis accelerometer)
	Power Input	12V/5A
	Power Consumption	50W (max)
	Power Over Ethernet	N/A
	Operating Temperature	0-40 °C
	Relative Humidity	85%
	Certifications	Display Unit: ROHS, FCC and CE complaint Power Supply Unit: UL, FCC and CE compliant
	Dimensions	Size (L x W x H)
Product Weight		8.03kg
Gift Box Size		862 x 555 x 135mm
Master Carton Size		880 x 580 x 150mm
Master Carton Weight		13kg
Units per Master Carton		1pcs

*3G optional, pending carrier compatibility/availability.
For more information about iDISPLAY™ Tablets
please visit our website: www.outform.com/iDisplay-Tablets



iDISPLAY™ Tablet 43" UIT443B-B01

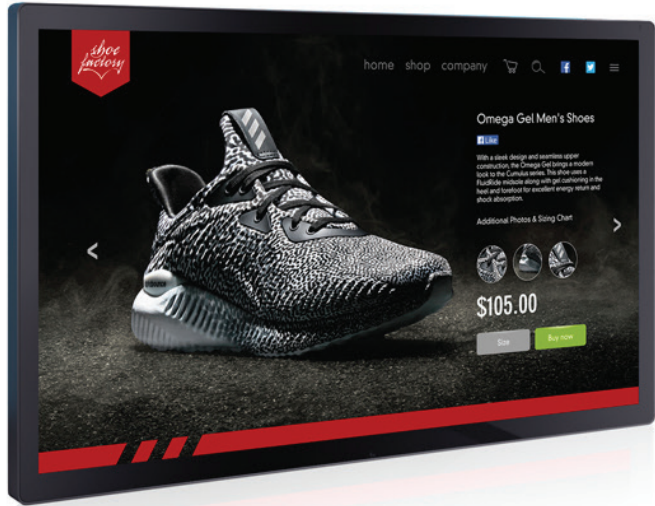

The iDISPLAY Tablet 43" is designed as an freestanding or wall based interactive display. Operating on an Android operating system and powered by Pulse technology, this slim and elegant display includes all of the solutions needed for commercial locations. Attach to any standard TV/monitor VESA bracket and simply turn on the power. It is a fully interactive commercial display that uses capacitive touch, built in WiFi and LAN, and a host of integrated features that work in either landscape or portrait format. With the option to expand to 3G services*, this is an amazing, large screen interactive digital display that creates an engaging, memorable consumer experience.

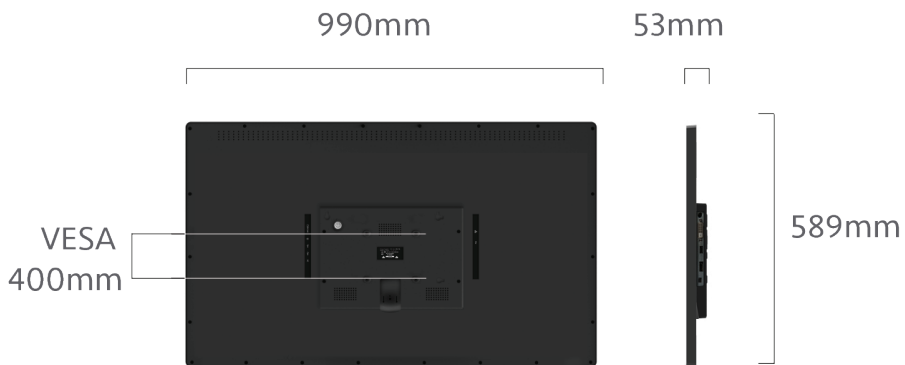

*3G optional, pending carrier compatibility/availability.
For more information about iDISPLAY™ Tablets
please visit our website: www.outform.com/iDisplay-Tablets

iDISPLAY™ Tablet 43" Model Number: UIT443B

Panel Information	Screen Size	43"
	Resolution	1920 x 1080 Pixels
	Brightness	300 cd/m ²
	Contrast Ratio	1200
	Aspect Ratio	16:9
	Active Area Size (WxH)	942.20 x 530.4mm
	Viewing Angle Touch	89°/89°(H), 89°/89°(V)
	Touch Technology	Capacitive G+G 5 point
Hardware and OS	CPU	RK3288, Cortex-A17, up to 1.8GHz Quad Core
	GPU	Mali T764
	Internal Memory	2GB, DDR3
	Flash Memory	16GB
	Operating System	Android 4.4 / 5.1
	Battery	N/A
Video/Images	Video Formats	3GP, MP4, AVI, MKV, FLV, MOV
	Video Codecs	MPG-1, MPG-2, MPG-4, H.263, H.264, VC-1, RV, VP6/VP8, MVC
	Image Formats	JPG/JPEG, PNG, BMP
	HDMI Output	Mini HDMI
	Playback Software	Built-in software allows for easy setup of a playlist of videos and/or stills which can be looped infinitely without any additional software. Alternatively, any installed app can be auto-started upon boot-up.
Audio	Speakers	5W x 2
	Audio Codecs	MP3, WMA, AAC, FLAC, WAV
Communications	Bluetooth	4.0
	Wi-Fi	802.11 b/g/n 2.4GHz
	Wired Ethernet	100M/1000M
	Wireless 3G	Through external USB dongle (Optional)
General information	Color	Black (Standard), White (Optional)
	Camera	N/A
	I/O ports	SD, 3.5mm Audio Output Jack, Mini USB 2.0 OTG x 1, USB 2.0 HOST x 2, DC, HDMI
	Included in Box	Display Unit, Power Cable, User Manual, Warranty
	Optional Accessories	N/A
	Sensors	G-Sensor (3-Axis accelerometer)
	Power Input	AC100-240V
	Power Consumption	100W
	Power Over Ethernet	N/A
	Operating Temperature	0-50 °C
	Relative Humidity	85%
	Certifications	Display Unit: ROHS, FCC and CE complaint Power Supply Unit: UL, FCC and CE compliant
Dimensions	Size (L x W x H)	990 x 589 x 53mm
	Product Weight	18.1kg
	Gift Box Size	1156 x 792 x 160mm
	Master Carton Size	1180 x 817 x 178mm
	Master Carton Weight	20.1kg
	Units per Master Carton	1pcs

*3G optional, pending carrier compatibility/availability.
For more information about iDISPLAY™ Tablets
please visit our website: www.outform.com/iDisplay-Tablets

OUTFORM™

iDISPLAY™ Tablet 55" UIT455B



The iDISPLAY Tablet 55" is designed as an freestanding or wall based interactive display. Operating on an Android operating system and powered by Pulse technology, this slim and elegant display includes all of the solutions needed for commercial locations. Attach to any standard TV/monitor VESA bracket and simply turn on the power. It is a fully interactive commercial display that uses capacitive touch, built in WiFi and LAN, and a host of integrated features that work in either landscape or portrait format. With the option to expand to 3G services*, this is an amazing, large screen interactive digital display that creates an engaging, memorable consumer experience.

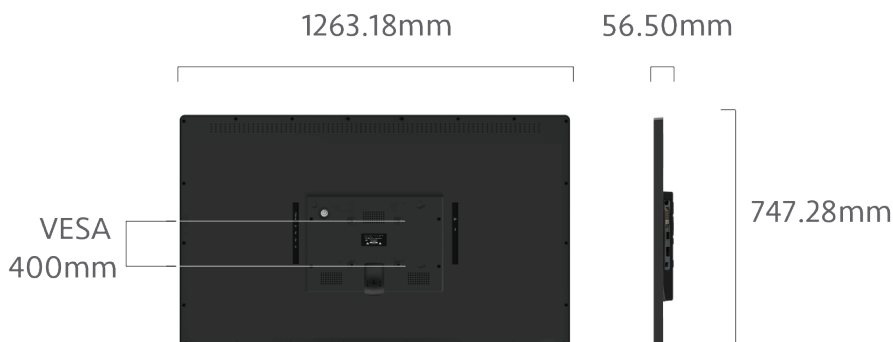

*3G optional, pending carrier compatibility/availability.
For more information about iDISPLAY™ Tablets
please visit our website: www.outform.com/iDisplay-Tablets

iDISPLAY™ Tablet 55" Model Number: UIT455B

Panel Information	Screen Size	55"
	Resolution	1920 x 1080 Pixels
	Brightness	350 cd/m ²
	Contrast Ratio	4000
	Aspect Ratio	16:9
	Active Area Size (WxH)	1207.60 x 678.40mm
	Viewing Angle Touch	89°/89°(H), 89°/89°(V)
	Touch Technology	Capacitive G+G 5 point
Hardware and OS	CPU	RK3288, Cortex-A17, up to 1.8GHz Quad Core
	GPU	Mali T764
	Internal Memory	2GB, DDR3
	Flash Memory	16GB
	Operating System	Android 4.4 / 5.1
	Battery	N/A
Video/Images	Video Formats	3GP, MP4, AVI, MKV, FLV, MOV
	Video Codecs	MPG-1, MPG-2, MPG-4, H.263, H.264, VC-1, RV, VP6/VP8, MVC
	Image Formats	JPG/JPEG, PNG, BMP
	HDMI Output	Yes
	Playback Software	Built-in software allows for easy setup of a playlist of videos and/or stills which can be looped infinitely without any additional software. Alternatively, any installed app can be auto-started upon boot-up.
Audio	Speakers	5W x 2
	Audio Codecs	MP3, WMA, AAC, FLAC, WAV
Communications	Bluetooth	4.0
	Wi-Fi	802.11 b/g/n 2.4GHz
	Wired Ethernet	10M/100M
	Wireless 3G	Through external USB dongle (Optional)
General information	Color	Black (Standard), White (Optional)
	Camera	N/A
	I/O ports	SD, 3.5mm Audio Output Jack, USB 2.0 OTG x 1, USB 2.0 HOST x 2, DC, HDMI
	Included in Box	Display Unit, Power Cable, User Manual, Warranty
	Optional Accessories	N/A
	Sensors	G-Sensor (3-Axis accelerometer)
	Power Input	AC100-240V
	Power Consumption	120W (max)
	Power Over Ethernet	N/A
	Operating Temperature	0-50 °C
	Relative Humidity	85%
	Certifications	Display Unit: ROHS, FCC and CE complaint Power Supply Unit: UL, FCC and CE compliant
Dimensions	Size (L x W x H)	1263.18 x 747.28 x 56.5mm
	Product Weight	31.6kg
	Gift Box Size	N/A
	Master Carton Size	1435 x 1020 x 175mm
	Master Carton Weight	40.2kg
	Units per Master Carton	1pcs

*3G optional, pending carrier compatibility/availability.
For more information about iDISPLAY™ Tablets
please visit our website: www.outform.com/iDisplay-Tablets



iDISPLAY™ Advertising Displays

15.6" 18.5" 21.5"



The compact all-in-one Android Advertising Displays are a great solution for brands and retailers to advertise their digital marketing message in a commercial location. Operating on an Android OS and powered by Pulse technology, these compact screens include all the features of a giant Android tablet, without the touch screen capability. These devices are compatible with standard TV/monitor Vesa brackets and are ready out of the box as soon as you turn on the power. With an integrated media player, a host of built-in signage and connectivity options (embedded WiFi, LAN and 3G USB-dongle), these displays are capable of remote updates for your digital signage content. With high viewing angles and a small footprint, it is well suited as a free standing floor or wall display, in portrait and landscape format.

*3G optional, pending carrier compatibility/availability.
For more information about iDISPLAY™ Tablets
please visit our website: www.outform.com/iDisplay-Tablets

OUTFORM™

iDISPLAY™ Tablet 15.6" Model Number: UIA415-B01

Panel Information	Screen Size	15.6"
	Resolution	1920 x 1080 Pixels
	Brightness	300 cd/m ²
	Contrast Ratio	700
	Aspect Ratio	16.9
	Active Area Size (WxH)	344.16 x 193.59mm
	Viewing Angle Touch	89°/89°(H), 89°/89°(V)
	Touch Technology	N/A
Hardware and OS	CPU	RK3 88, Cortex-A, up to 1. GHz Quad Core
	GPU	Mali T764
	Internal Memory	2GB, DDR3
	Flash Memory	16GB
	Operating System	Android 4.4 / 5.1
	Battery	N/A
	Video/Images	Video Formats
Video Codecs		MPG-1, MPG-2, MPG-4, H.263, H.264, VC-1, RV, VP6/VP8, MVC
Image Formats		JPG JPEG, PNG, BMP
HDMI Output		N/A
Playback Software		Built-in software allows for easy setup of a playlist of videos and/or stills which can be looped infinitely without any additional software. Alternatively, any installed app can be auto-started upon boot-up.
Audio	Speakers	3W x 2
	Audio Codecs	MP3, WMA, AAC, FLAC, WAV
Communications	Bluetooth	4.0
	Wi-Fi	802.11 b/g/n
	Wired Ethernet	100M/1000M
	Wireless 3G	Through internal Mini-PCIE Card (Optional)
General information	Color	Black (Standard), White (Optional)
	Camera	Front 2MP
	I/O ports	DC, 3.5mm Audio Output Jack, USB 2.0 Host x 1, USB 2.0 OTG X 1, RJ45
	Included in Box	Display Unit, Power Adapter, Power Cable, User Manual, Warranty
	Optional Accessories	Floor stand, Counter stand (L), Shelf clip, Adjustable Shelf clip, Wall bracket, Rotating bracket
	Sensors	G-Sensor (3-Axis accelerometer)
	Power Input	12V/ A
	Power Consumption	25W (max)
	Power Over Ethernet	Through RJ45
	Operating Temperature	0-40 °C
	Relative Humidity	85%
	Certifications	Display Unit: ROHS, FCC and CE complaint Power Supply Unit: UL, FCC and CE compliant
	Dimensions	Size (L x W x H)
Product Weight		2.72kg
Gift Box Size		628 x 308 x 89mm
Master Carton Size		415 x 225 x 245mm
Master Carton Weight		7.92kg
Units per Master Carton		2pcs

*3G optional, pending carrier compatibility/availability.
For more information about iDISPLAY™ Tablets
please visit our website: www.outform.com/iDisplay-Tablets



Panel Information	Screen Size	18.5"
	Resolution	1366 x 768 Pixels
	Brightness	250 cd/m ²
	Contrast Ratio	1000
	Aspect Ratio	16.9
	Active Area Size (WxH)	409.8 x 230.4mm
	Viewing Angle Touch	85°/85°/ 80°/80°
	Touch Technology	N/A
Hardware and OS	CPU	RK3288, Cortex-A17, up to 1.8 GHz Quad Core
	GPU	Mali T764
	Internal Memory	2GB, DDR3
	Flash Memory	16GB
	Operating System	Android 4.4 / 5.1
	Battery	N/A
Video/Images	Video Formats	3GP, MP4, AVI, MKV, FLV, MOV
	Video Codecs	MPG-1, MPG-2, MPG-4, H.263, H.264, VC-1, RV, VP6/VP8, MVC
	Image Formats	JPG, JPEG, PNG, BMP
	HDMI Output	J F OK
	Playback Software	Built-in software allows for easy setup of a playlist of videos and/or stills which can be looped infinitely without any additional software. Alternatively, any installed app can be auto-started upon boot-up.
Audio	Speakers	3W x 2
	Audio Codecs	MP3, WMA, AAC, FLAC, WAV
Communications	Bluetooth	4.0
	Wi-Fi	802.11 b/g/n 2.4GHz
	Wired Ethernet	100M/1000M
	Wireless 3G	Through external USB dongle (Optional)
General information	Color	Black (Standard), White (Optional)
	Camera	Front 2MP
	I/O ports	SD, 3.5mm Audio Jack, Mini USB 2.0 OTG x 1, USB 2.0 Host x 3, HDMI, DC, RJ45
	Included in Box	Display Unit, Power Adapter, Power Cable, User Manual, Warranty
	Optional Accessories	Floor stand, Counter stand (L), Shelf clip, Adjustable Shelf clip, Wall bracket, Rotating bracket
	Sensors	G-Sensor (3-Axis accelerometer)
	Power Input	12V/ 3A
	Power Consumption	25W (max)
	Power Over Ethernet	N/A
	Operating Temperature	0-40 °C
	Relative Humidity	85%
	Certifications	Display Unit: ROHS, FCC and CE complaint Power Supply Unit: UL, FCC and CE compliant
Dimensions	Size (L x W x H)	467 x 288 x 36mm
	Product Weight	4.53kg
	Gift Box Size	525 x 394 x 110mm
	Master Carton Size	545 x 415 x 350mm
	Master Carton Weight	13.7kg
	Units per Master Carton	3pcs

iDISPLAY™ 21.5" Model Number: UIT421B-B01

Panel Information	Screen Size	21.5"
	Resolution	1920 x 1080 Pixels
	Brightness	250 cd/m ²
	Contrast Ratio	3000
	Aspect Ratio	16.9
	Active Area Size (WxH)	476.64 x 268.11mm
	Viewing Angle Touch	89°/89°/ 89°/89°
	Touch Technology	N/A
Hardware and OS	CPU	RK3288, Cortex-A17, up to 1.8 GHz Quad Core
	GPU	Mali T764
	Internal Memory	2GB, DDR3
	Flash Memory	16GB
	Operating System	Android 4.4 / 5.1
	Battery	N/A
	Video/Images	Video Formats
Video Codecs		MPG-1, MPG-2, MPG-4, H.263, H.264, VC-1, RV, VP6/VP8, MVC
Image Formats		JPG, JPEG, PNG, BMP
HDMI Output		N/A
Playback Software		Built-in software allows for easy setup of a playlist of videos and/or stills which can be looped infinitely without any additional software. Alternatively, any installed app can be auto-started upon boot-up.
Audio	Speakers	2W x 2
	Audio Codecs	MP3, WMA, AAC, FLAC, WAV
Communications	Bluetooth	4.0
	Wi-Fi	802.11 b/g/n 2.4GHz
	Wired Ethernet	100M/1000M
	Wireless 3G	Through internal USB dongle (Optional)
General information	Color	Black (Standard), White (Optional)
	Camera	Front 2MP
	I/O ports	SD, 3.5mm Audio Output Jack, USB 2.0 Host x 1, USB 2.0 OTG x 1, RJ45
	Included in Box	Display Unit, Power Adapter, Power Cable, User Manual, Warranty
	Optional Accessories	Floor stand, Counter stand (L), Shelf clip, Adjustable Shelf clip, Wall bracket, Rotating bracket
	Sensors	G-Sensor (3-Axis accelerometer)
	Power Input	12V/ 3A
	Power Consumption	30W (max)
	Power Over Ethernet	N/A
	Operating Temperature	0-40 °C
	Relative Humidity	85%
	Certifications	Display Unit: ROHS, FCC and CE complaint Power Supply Unit: UL, FCC and CE compliant
	Dimensions	Size (L x W x H)
Product Weight		4.8kg
Gift Box Size		756 x 393 x 99mm
Master Carton Size		775 x 425 x 220mm
Master Carton Weight		14.1kg
Units per Master Carton		2pcs

*3G optional, pending carrier compatibility/availability.
For more information about iDISPLAY™ Tablets
please visit our website: www.outform.com/iDisplay-Tablets



iDISPLAY™ Enterprise



Equipping businesses and sales associates to serve customers with instant product information, service options or event information, when and where they need it, is the solution iDISPLAY™ Enterprise delivers. The iDISPLAY™ Enterprise is an integrated, portable self-service kiosk, digital concierge and mobile POS (Point of Sale), all-in-one. With its innovative design, user-friendly interface and versatile use, the iDISPLAY™ Enterprise is sure to increase customer engagement with your brand and help convert your consumers into shoppers.

*3G optional, pending carrier compatibility/availability.
For more information about iDISPLAY™ Tablets
please visit our website: www.outform.com/iDisplay-Tablets

OUTFORM™



Smart Connection Gesture technology

Gesture software with NFC (Near Field Communication) for easy docking and release, no key required



Hands-Free

Tablet handle serves as a kickstand to facilitate keyboard use



All-In-One Kiosk

iDISPLAY™ Enterprise integrates hardware, device management and software for a stand-alone, cost-effective solution



Business Applications

Multiple ports and peripheral options to expand display functionality for target marketing, mobile POS and consumer engagement metrics

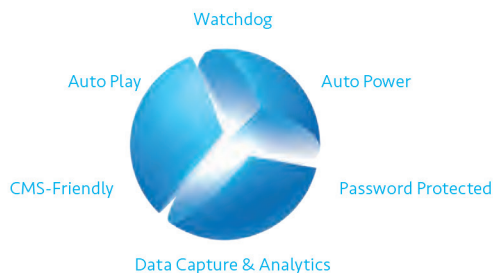

Pulse Management**

Tablet administrator, remote content and Mobile Device Management (MDM) for cloud based device management, applications, security and analytics.

**Subscription based



Portable

Tablet comfort-grip handle permits tablet, associate and customer portability

*3G optional, pending carrier compatibility/availability.
For more information about iDISPLAY™ Tablets please visit our website: www.outform.com/iDisplay-Tablets

iDISPLAY™ Enterprise Model Number: UITX310-B

Panel Information	Screen Size	10.1"
	Resolution	1920 x 1200 Pixels
	Brightness	300 cd/m ²
	Contrast Ratio	800
	Aspect Ratio	16:10
	Active Area Size (WxH)	216.516 x 135.6mm
	Viewing Angle Touch	89°/89°/89°/89°
	Touch Technology	Capacitive G+C, 10 point
Hardware and OS	CPU	RK3288, Cortex-A17, 1.8GHz Quad Core
	GPU	Mali T764, 600MHz
	Internal Memory	2GB, LPDDR2
	Flash Memory	8GB
	Operating System	Android 4.4.4 Kit Kat
	Battery	8400mAh (charging: 5-6hrs / discharging @ 720: 6hrs / discharging standby: 14 days)
	Video/Images	Video Formats
Video Codecs		MPG-1, MPG-2, MPG-4, H.263, H.264, VC-1, RV, VP6/VP8, MVC
Image Formats		JPG/JPEG, PNG, BMP
HDMI Output		N/A
Playback Software		Built-in software allows for easy setup of a playlist of videos and/or stills which can be looped infinitely without any additional software. Alternatively, any installed app can be auto-started upon boot-up.
Audio		Speakers
	Audio Codecs	MP3, WMA, AAC, FLAC, WAV
Communications	Bluetooth	4.0
	Wi-Fi	802.11b/g/n (supports 2.4 GHz)
	Wired Ethernet	10M/100M, RJ45
	Wireless 3G	N/A
General information	Color	Black
	Camera	Front 2.0MP / Back 5.0 MP
	I/O ports (Tablet)	3.5mm audio output jack, 16 pin counter stand port
	I/O ports (Stand)	DC, RJ45, USB 2.0 Host x 1, USB 2.0 OTG x 1, 16pin tablet port, NFC card reader
	Included In Box (Tablet)	Display unit, user manual, warranty
	Included In Box (Stand)	Stand unit, user manual, warranty, power supply, 4 NFC cards, rear back port cover, 2 back port cover screws
	Accessories	Security cable
	Sensors	G-Sensor (3-Axis accelerometer)
	Power Input (Stand)	12V/3A
	Power Consumption	30W (max)
	Operation Temperature	0-40 °C
	Relative Humidity	85%
	Certifications	Display Unit: FCC, FCC ID and CE compliant Stand Unit: ROHS, FCC and CE compliant Power Supply Unit: UL, FCC and CE compliant Battery: UL and UN38.3 compliant

*3G optional, pending carrier compatibility/availability.
For more information about iDISPLAY™ Tablets
please visit our website: www.outform.com/iDisplay-Tablets



iDISPLAY™ Enterprise Model Number: UITX310-B

Dimensions (Tablet)	Size (L x W x H)	261 x 53 x 180mm
	Product Weight	0.82kg
	Gift Box Size	300 x 78 x 225mm
	Master Carton Size	485 x 325 x 420mm
	Master Carton Weight	13kg
	Units per Master Carton	10pcs
Dimensions (Stand)	Size (L x W x H)	210 x 161 x 197mm
	Product Weight	1.65kg
	Gift Box Size	265 x 217 x 251mm
	Master Carton Size	548 x 452 x 272mm
	Master Carton Weight	10.94kg
	Units per Master Carton	4pcs

*3G optional, pending carrier compatibility/availability.
For more information about iDISPLAY™ Tablets
please visit our website: www.outform.com/iDisplay-Tablets

OUTFORM™

iDISPLAY™ 4K Media Player



Disruptive, engaging media in reshaping the digital signage industry, and 4K resolution is leading the charge. With four times the resolution capacity compared to that of full HD (High Definition), the iDISPLAY™ 4K Media Player delivers powerful performance in a sleek, compact design. The iDISPLAY™ 4K Media Player connects to all digital signage networks to stream movies, photos and online video (media) over a wired or wireless network.

Pulse Management provides a tablet/player administrator, device manager and CMS (content management system) to configure display settings and content management for consistent, controlled and branded user experiences across thousands of displays from a single dashboard. Pulse's remote monitoring service ensures that devices are powered up and secured, guarantees that content is deployed and running and that store associates are focused on selling.

Play your media or content applications on any screen anywhere.



4K Resolution

- Cinema standard resolution for digital signage & video
- Superior graphic performance
- Configurable to play all video, no cropping or stretching

Pulse Management**

Tablet administrator, remote content and Mobile Device Management (MDM) for cloud based device management, applications, security and analytics.

**Subscription based

Digital Signage

- Digital signage and video extension applications
- 4K ecosystem/screen interoperability
- CMS (Content Management System) friendly



Hardware & Design

- Quad Core
- HDMI, WiFi, Ethernet, 3G*
- Built-in memory
- Small footprint



Business Applications

USB port to interface with external portable devices and peripheral options to expand player functionality

*3G optional, pending carrier compatibility/availability.
For more information about iDISPLAY™ Tablets please visit our website: www.outform.com/iDisplay-Tablets

Hardware and OS	CPU	RK3288, Cortex-A17, 1.8GHz Quad Core
	GPU	Mali T764, 600MHz
	Internal Memory	2GB, DDR3
	Flash Memory	8GB
	Operating System	Android 4.4.2 Kit Kat
	Battery	N/A
Video/Images	Video Formats	3GP, MP4, AVI, MKV, FLV, MOV
	Video Codecs	MPG-1, MPG-2, MPG-4, H.263, H.264, VC-1, RV, VP6/VP8, MVC
	Image Formats	JPG/JPEG, PNG, BMP
	HDMI Output	Supports 4K output (H.264 @ 25 FPS, H.265 @ 30 FPS)
	Playback Software	Built-in software allows for easy setup of a playlist of videos and/or stills which can be looped infinitely without any additional software. Alternatively, any installed app can be auto-started upon boot-up.
Audio	Speakers	N/A
	Audio Codecs	MP3, WMA, AAC, FLAC, WAV
Communications	Bluetooth	4.0
	Wi-Fi	802.11b/g/n (supports 2.4 GHz)
	Wired Ethernet	10M/100M, RJ45
	Wireless 3G	Through external USB dongle (optional)
General information	Color	Black
	Camera	N/A
	I/O ports	DC, micro SD, HDMI, AV, RJ45, USB 2.0 Host x 1, USB 2.0 OTG x 1, optical
	Included in Box	Player unit, power adapter, power cables, user manual, warranty, mini mouse
	Accessories	N/A
	Sensors	N/A
	Power Input	5V/2A
	Power Consumption	6W (max)
	Operation Temperature	0-40 °C
	Relative Humidity	85%
	Certifications	Player Unit: FCC, FCC ID and CE compliant Power Supply Unit: UL, FCC and CE compliant
Dimensions	Size (L x W x H)	132.5 x 31.3 x 103.1mm
	Product Weight	0.27Kg
	Gift Box Size	260 x 58 x 225mm
	Master Carton Size	475 x 290 x 325mm
	Master Carton Weight	9.4kg
	Units per Master Carton	10pcs

iDISPLAY™ Tower



Maximize the effectiveness of your retail merchandising with the tower from iDISPLAY™. The tower is an attractive, customizable free-standing display designed to bring your product to life through both product exposition and digital media. Your product commands presence, showcased in a beautiful transparent case housed above a large, 38" ultra-bright LCD. Run various forms of digital media for advertising campaigns, product introductions or seasonal promotions. Create life-sized imagery to attract and engage your customers, build brand awareness and stand out from the competition. The display may also be branded with your logo or product marketings. Content may be changed as often as you like, extending the life of your display while keeping your brand fresh in the eyes of your consumer.

*3G optional, pending carrier compatibility/availability.
For more information about iDISPLAY™ Tablets
please visit our website: www.outform.com/iDisplay-Tablets

OUTFORM™

iDISPLAY™ Tower Model Number: UIK1038

Panel Information	Screen Size	38"
	Resolution	1920 x 502 Pixels
	Brightness	1000 cd/m2
	Contrast Ratio	7000
	Aspect Ratio	16:4.2
	Active Area Size (WxH)	243.2 x 930.2mm
	Viewing Angle Touch	89°/89°/89°/89°
	Touch Technology	N/A
Hardware and OS	CPU	ARM, Cortex-A9, 1GHz Quad Core
	GPU	N/A
	Internal Memory	1GB, DDR3
	Flash Memory	8GB
	Operating System	Android 4.0.4
	Battery	N/A
	Video/Images	Video Formats
Video Codecs		MPG-1, MPG-2, MPG-4, H.264, XVID
Image Formats		JPG/JPEG, PNG, BMP
HDMI Output		N/A
Playback Software		Built-in software allows for easy setup of a playlist of videos and/or stills which can be looped infinitely without any additional software. Alternatively, any installed app can be auto-started upon boot-up.
Audio	Speakers	N/A
	Audio Codecs	MP3, MP4, 3GP, AAC, WAV
Communications	Bluetooth	2.1
	Wi-Fi	802.11b/g/n
	Wired Ethernet	10M/100M, RJ45
	Wireless 3G	N/A
General information	Color	Black, White
	Camera	N/A
	I/O ports	DC, 3.5mm audio output jack, RJ45, USB 2.0 Host x 1, USB 2.0 OTG x 1, 6 pin for "Connect Box" (optional)
	Included in Box	Tower unit, power adapter, power cables, user manual, warranty
	Accessories	N/A
	Sensors	N/A
	Power Input	12V/5A
	Power Consumption	60W (max)
	Operation Temperature	0-40 °C
	Relative Humidity	40-70%
	Certifications	Display Unit: ROHS, FCC and CE compliant Power Supply Unit: UL, FCC and CE compliant
Dimensions	Size (L x W x H)	400 x 400 x 1423mm
	Product Weight	43kg
	Gift Box Size	540 x 470 x 1730mm
	Master Carton Size	Individual units shipped
	Master Carton Weight	73kg
	Units per Master Carton	1pcs

*3G optional, pending carrier compatibility/availability.
 For more information about iDISPLAY™ Tablets
 please visit our website: www.outform.com/iDisplay-Tablets



iDISPLAY™ iShelf 2

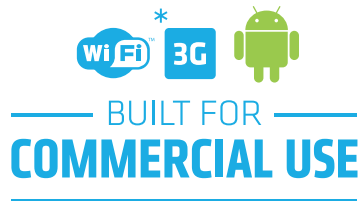

The iSHELF 2 is a 7" interactive digital shelf-talker used to attract and communicate with customers as they shop in aisle throughout the store. Attached to the edge of the shelf, this compact display may be branded and used to advertise special scale, introduce a new product or marketing campaign or share other product information through static images or video messaging. The iSHELF 2 is an effective tool that draws attention and invites participation with your brand at shelf, breaking through much of the visual noise that occurs in the last three feet of the sale. Battery power as an option, the iSHELF 2 does not require a dedicated power source and can be placed virtually anywhere throughout the store. Display deployment and media uploads are so simple, an iSHELF 2 program may be managed by store associates, eliminating the need for technical installation and support.

iDISPLAY™ iShelf 2 Model Number: UID0025

Panel Information	Screen Size	7"
	Resolution	800 x 480
	Brightness	250 cd/m2
	Contrast Ratio	500
	Aspect Ratio	16:9
	Active Area Size (WxH)	154.08 x 85.92mm
	Viewing Angle Touch	50°/70°/70°/70°
	Touch Technology	N/A
Hardware and OS	CPU	Samsung Q248
	GPU	N/A
	Internal Memory	1 GB, DRAM
	Flash Memory	N/A
	Operating System	N/A
	Battery	D cell batteries x 8 (not included)
	Video/Images	Video Formats
Video Codecs		XVID, DIVX 4, DIVX 5
Image Formats		JPG/JPEG, BMP
HDMI Output		N/A
Playback Software		Built-in software allows for easy setup of a playlist of videos and/or stills which can be looped infinitely without any additional software. Alternatively, any installed app can be auto-started upon boot-up.
Audio	Speakers	1.5W x 2
	Audio Codecs	MP3, WMA, WAV
Communications	Bluetooth	N/A
	Wi-Fi	N/A
	Wired Ethernet	N/A
	Wireless 3G	N/A
General information	Color	Silver (Standard), Red (Optional), Black (Optional) and Customized
	Camera	N/A
	I/O ports	DC, USB 2.0 Host x 1
	Included in Box	Shelf display unit, power adapter, power cables, user manual, warranty
	Accessories	iSHELF clip
	Sensors	N/A
	Power Input	5V/1.5A
	Power Consumption	5W (max)
	Operation Temperature	0-40 °C
	Relative Humidity	40-70%
	Certifications	Display Unit: ROHS, FCC and CE compliant Power Supply Unit: FCC and CE compliant
	Dimensions	Size (L x W x H)
Product Weight		0.85kg
Gift Box Size		482 x 156 x 118mm
Master Carton Size		612 x 495 x 340mm
Master Carton Weight		18.5kg
Units per Master Carton		10pcs

*3G optional, pending carrier compatibility/availability.
 For more information about iDISPLAY™ Tablets
 please visit our website: www.outform.com/iDisplay-Tablets

OUTFORM™

Window Light Show™



Create customer excitement through a stunning visual experience in your storefront or retail window. The WLS (Window Light Show™) is a unique LED signage that can drive traffic, promote your brand or simply create retail ambiance to enhance customer experience.

A great vehicle for brands to tell their story in a unique way, The Window Light Show™ breaks through random messaging that competes for customers' attention in store. Unlike video walls, this large light canvas is transparent and does not obstruct store merchandising and can be viewed from all angles, in and outside of the store. Retailers today need to make their store campaigns more compelling than ever before. The Window Light Show™ may be the answer to the customer attraction you are looking for.

Video Wall or Window Light Show™ for your next campaign?

Purchase Considerations	Video Wall	Window Light Show™
Campaign ROI (Return on Investment)	X	V
Transparent merchandising	X	V
Custoizable size	X	V
Visible in and outside of store	X	V
Text and ambient messaging	V	X
HD (High Definition) messaging	V	V
Increase sales & brand awareness	V	V

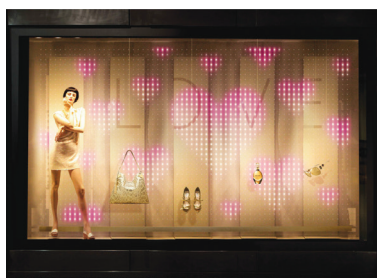

Store Environments

Multiple sizes and form factors to fit every retail environment.

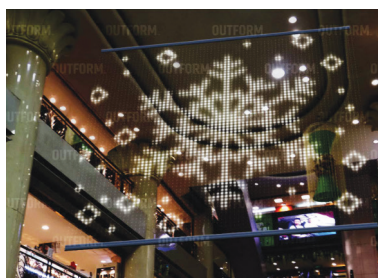

Custom Content

Custom digital animation to attract store traffic, promote brand campaigns and create retail ambiance.



LED Lighting

Efficient, versatile and long lasting light source to maximize your displays investment and operability.



Lights Command Attention

Capture attention or create ambiance? Onset of motion, changes in brightness, dramatic color transformations and unique imagery are used in the Window Light Show™ to capture attention and evoke emotion at retail for more.

*3G optional, pending carrier compatibility/availability.
 For more information about iDISPLAY™ Tablets
 please visit our website: www.outform.com/iDisplay-Tablets

Window Light Show™ Model Number: UWLS001-UWLS012

CODE	DESCRIPTION	LED*	BRIGHTNESS cd/unit**	PITCH***	PCB BAR	PANEL	COLUMN	ROW	TOTAL LED	WIDTH x HEIGHT****
UWLS007	Small	1	2,949	3	12	5	60	64	3,840	1,986 mm x 2,140 mm
UWLS008	Small	2	2,949	3	12	5	60	64	7,680	1,986 mm x 2,140 mm
UWLS001	Small	1	737	6	8	4	32	32	1,024	2,046 mm x 2,082 mm
UWLS002	Small	2	737	6	8	4	32	32	2,048	2,046 mm x 2,082 mm
UWLS009	Medium	1	3,686	3	12	7	84	64	5,376	2,736 mm x 2,140 mm
UWLS010	Medium	2	3,686	3	12	7	84	64	10,752	2,736 mm x 2,140 mm
UWLS003	Medium	1	922	6	8	5	40	32	1,280	2,526 mm x 2,082 mm
UWLS004	Medium	2	922	6	8	5	40	32	2,560	2,526 mm x 2,082 mm
UWLS011	Large	1	4,424	3	12	8	96	64	6,144	3,113 mm x 2,140 mm
UWLS012	Large	2	4,424	3	12	8	96	64	12,288	3,113 mm x 2,140 mm
UWLS005	Large	1	1,106	6	8	6	48	32	1,536	2,940 mm x 2,082 mm
UWLS006	Large	2	1,106	6	8	6	48	32	3,072	2,940 mm x 2,082 mm

* LED = 1 X LED (1 Front) / 2 X LED (1 Front + 1 Back)
 ** Brightness, cd/unit = candela per squer meter/luminance
 *** Pitch = Distance between LED's (width apart) on PCB Bar
 **** Plus Cable-to-ceiling

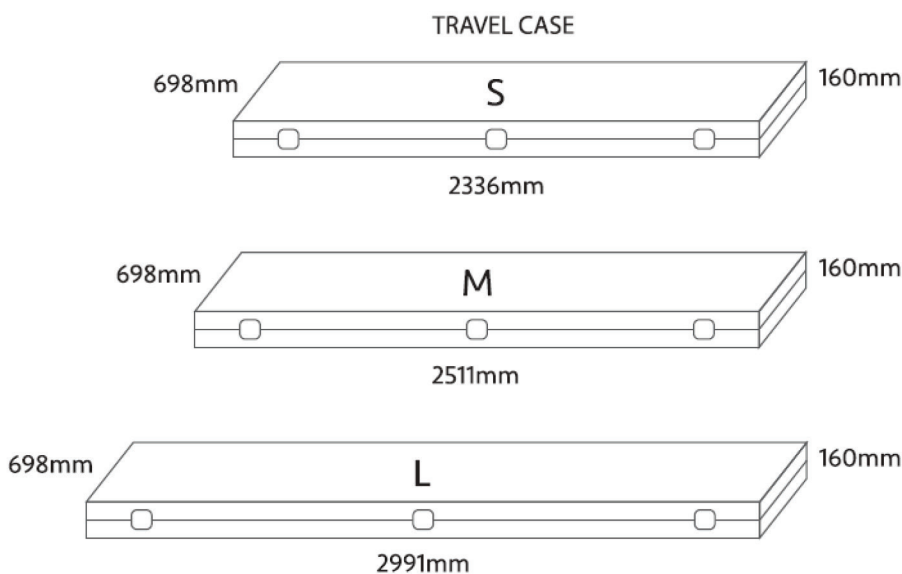
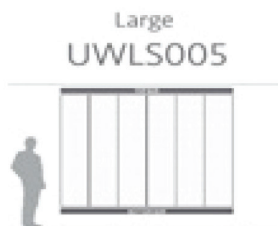

*3G optional, pending carrier compatibility/availability.
 For more information about iDISPLAY™ Tablets
 please visit our website: www.outform.com/iDisplay-Tablets



Kinetic Light Show™

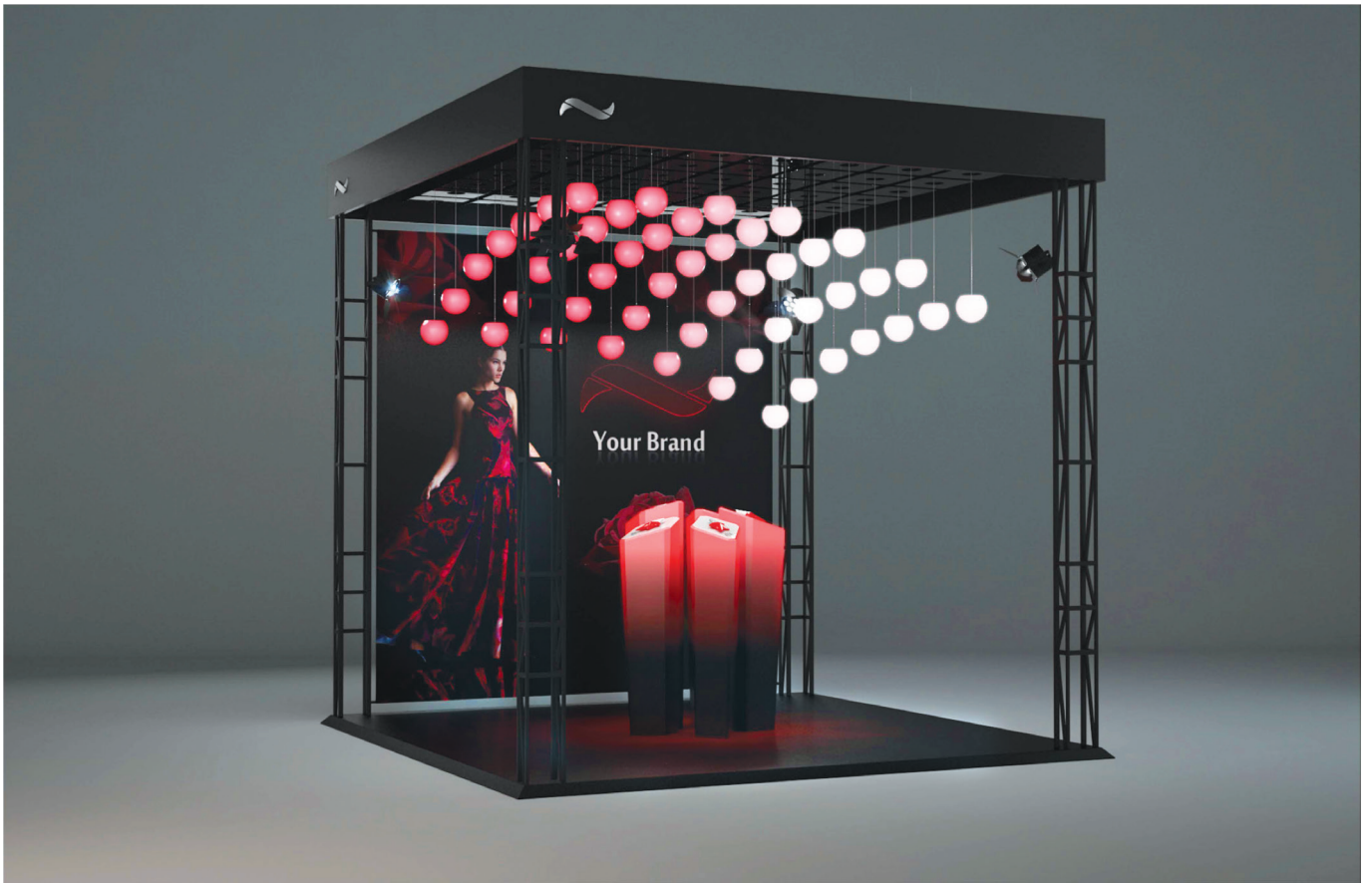

At Outform, when we dream it, we do it. We took inspiration from the art and entertainment world and combined it with our passion for dynamic retail and hospitality experiences to create the Kinetic Light Show™. Demanding attention with a unique play of light, color, and motion, the Kinetic Light Show™ creates mesmerizing choreographed visuals that transform ordinary surroundings into works of art.

*3G optional, pending carrier compatibility/availability.
For more information about iDISPLAY™ Tablets
please visit our website: www.outform.com/iDisplay-Tablets

OUTFORM™

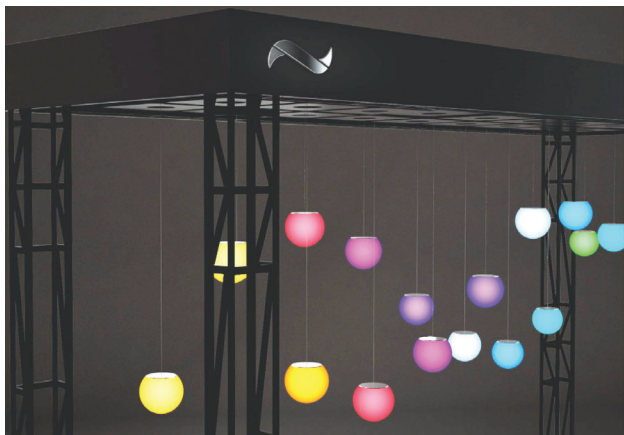

Choreographed Movement & Color

The Kinetic light show™ performs precise Choreographed sequences that leave people amazed. Each LED light globe has a full range of color and luminosity, making the possibilities endless! Whether you're in need of a unique color story or seasonal promotion, the Kinetic has you covered. Full control of height, speed, color, and luminance makes the Kinetic a great choice for any brand, product, or season.

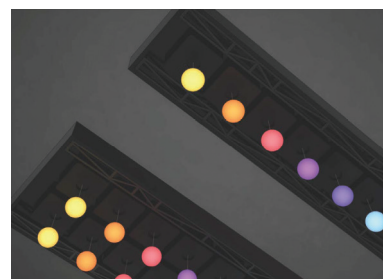

Wow Effects

The Kinetic Light Show™ wows from afar with stimulating movement and lighting. The result is an increase in dwell time and consideration.

Versatile Applications

With a wide range of applications from retail to hospitality, this display is completely adjustable for specific height requirements, installation needs, and sizes.

Modular

Compose your base units with either one or two rows of lights in a variety of configurations or create larger display matrices for even more visual impact.

System Diagram

The Kinetic Window Display is controlled by a series of wireless sub controllers that coordinate movement with individual LED elements. Each row's sub controller communicates directly to the programmable main controller, enabling both Base-of-use and limited wiring and excessive clutter needed for each display.

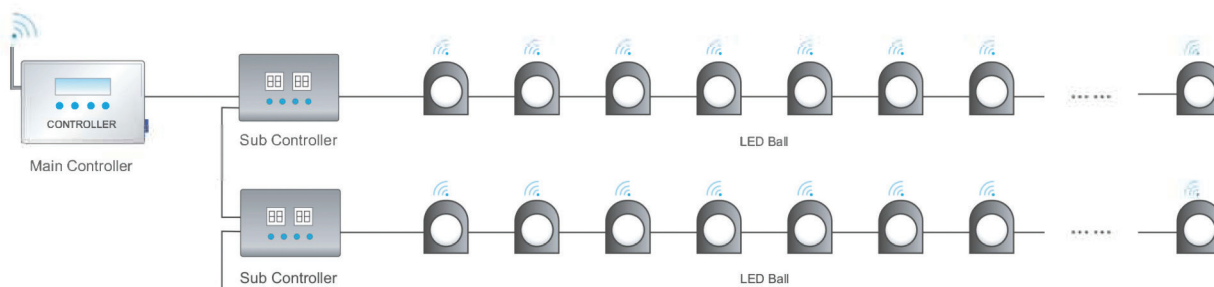

*3G optional, pending carrier compatibility/availability.
 For more information about iDISPLAY™ Tablets
 please visit our website: www.outform.com/iDisplay-Tablets

Specifications

Item:	MB16
Working voltage:	AC 100~240V
Power:	About 40W
Size:	ø20cm ball
Kinetic distance:	< 2M
Max speed:	0.5 meters per second
LED qty:	16 pcs per ball
Wireless control distance:	< 15M

*Standard Capacity Battery

Battery capacity:	2,000 mah
Charging time:	4H
Continuous working time:	5H (Color gradually changing effect)

*High Capacity Battery (Under development)

Battery capacity:	4,000 mah
Charging time:	8H
Continuous working time:	10H (Color gradually changing effect)

* Alternative

Control Mode



K-SY-308-W-KB Wireless Master Controller

Size:	190L×140W×45H mm
Remote control distance:	20m (Without obstacle)
Wireless frequency:	2.4GHz
Output port:	RJ45×1
Max power:	10W
Working temperature:	-15°C~60°C
SD Card:	4G
Cover color:	Silver
Working voltage:	DC7.5V
Power plug:	Power adapter
Capacity:	16 pcs Sub Controller
Function:	Change the display effect of the LED ball wirelessly. Send the moving style and speed to the LED ball from the repeater by network cable.



SY-308-KB Sub Controller

Size:	165L×120W×40H mm
Output channel:	1 channels
Output signal:	RS-485
Output port:	Rj45*1
Max power:	5W
Working temperature:	-15°C~60°C
Cover color:	Black
Working voltage:	AC110V/220V
Power plug:	By customer's request
Capacity:	16 pcs LED Ball
Function:	Process the motion command of the main-controller and control the stepper motor on the top tray.

System diagram

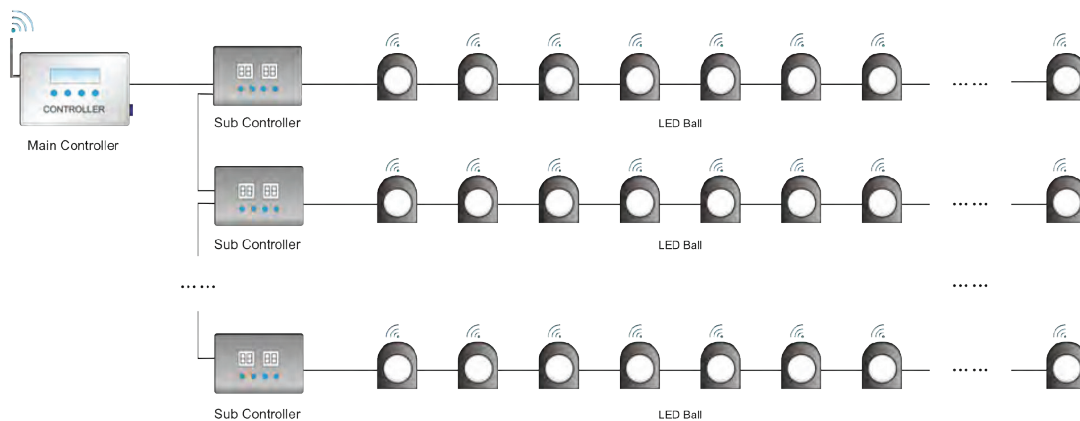

*3G optional, pending carrier compatibility/availability.
 For more information about iDISPLAY™ Tablets
 please visit our website: www.outform.com/iDisplay-Tablets

Product unit list

Item	Description	Order Quantity	Unit
LED Ball	Including the control box, carton box	1-49	Set
LED Ball	Including the control box, carton box	50-299	Set
LED Ball	Including the control box, carton box	300-999	Set
LED Ball	Including the control box, carton box	More than 1,000	Set
Main Controller	Max for 16pcs sub controller including software		PC
Sub Controller	Max for 16pcs LED Ball		PC

Kinetic LED Light Show™ Model Number: ULKS001

One row, 2 meters

Item	Description	Order Quantity	Unit
LED Ball	Including the control box	5	Set
Main Controller	Including software	1	PC
Sub Controller	One for 5pcs LED Ball	1	PC
Top plate	Iron, spray painting, including wooden case. The price is estimated.	1	Set

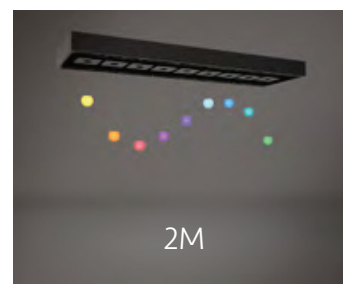

Kinetic LED Light Show™ Model Number: ULKS003

One row, 2.5 meters

Item	Description	Order Quantity	Unit
LED Ball	Including the control box	6	Set
Main Controller	Including software	1	PC
Sub Controller	One for 6pcs LED Ball	1	PC
Top plate	Iron, spray painting, including wooden case. The price is estimated.	1	Set

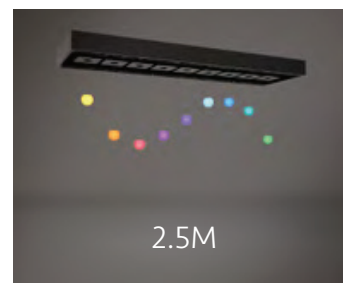

Kinetic LED Light Show™ Model Number: ULKS005

One row, 3 meters

Item	Description	Order Quantity	Unit
LED Ball	Including the control box	7	Set
Main Controller	Including software	1	PC
Sub Controller	One for 7pcs LED Ball	1	PC
Top plate	Iron, spray painting, including wooden case. The price is estimated.	1	Set



*3G optional, pending carrier compatibility/availability.
For more information about iDISPLAY™ Tablets
please visit our website: www.outform.com/iDisplay-Tablets

Kinetic LED Light Show™ Model Number: ULKS002 | Two rows, 2 meters

Item	Description	Order Quantity	Unit
LED Ball	Including the control box	10	Set
Main Controller	Including software	1	PC
Sub Controller	One for two rows, 10 pcs LED Ball	1	PC
Top plate	Iron, spray painting, including wooden case. The price is estimated.	1	Set



Kinetic LED Light Show™ Model Number: ULKS004 | Two rows, 2.5 meters

Item	Description	Order Quantity	Unit
LED Ball	Including the control box	12	Set
Main Controller	Including software	1	PC
Sub Controller	One for two rows, 12 pcs LED Ball	1	PC
Top plate	Iron, spray painting, including wooden case. The price is estimated.	1	Set



Kinetic LED Light Show™ Model Number: ULKS006 | Two rows, 3 meters

Item	Description	Order Quantity	Unit
LED Ball	Including the control box	14	Set
Main Controller	Including software	1	PC
Sub Controller	One for two rows, 14 pcs LED Ball	1	PC
Top plate	Iron, spray painting, including wooden case. The price is estimated.	1	Set

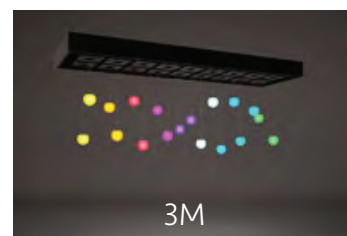

Kinetic LED Light Show™ Model Number: ULKS101 | Matrix, 2 x 2 meters

Item	Description	Order Quantity	Unit
LED Ball	Including the control box	25	Set
Main Controller	Including software	1	PC
Sub Controller	One for two rows, 10 pcs LED Ball	3	PC
Top plate	Iron, spray painting, truss support, including wooden case packing. The price is estimated.	1	Set

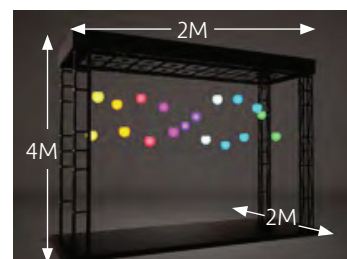

Kinetic LED Light Show™ Model Number: ULKS102 | Matrix, 3 x 3 meters

Item	Description	Order Quantity	Unit
LED Ball	Including the control box	49	Set
Main Controller	Including software	1	PC
Sub Controller	One for two rows, 14 pcs LED Ball	4	PC
Top plate	Iron, spray painting, truss support, including wooden case packing. The price is estimated.	1	Set

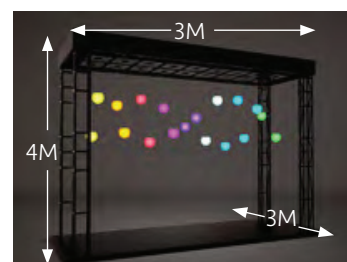

Kinetic LED Light Show™ Model Number: ULKS103 | Matrix, 4 x 4 meters

Item	Description	Order Quantity	Unit
LED Ball	Including the control box	100	Set
Main Controller	Including software	1	PC
Sub Controller	One for two rows, 10 pcs LED Ball	10	PC
Top plate	Iron, spray painting, truss support, including wooden case packing. The price is estimated.	1	Set

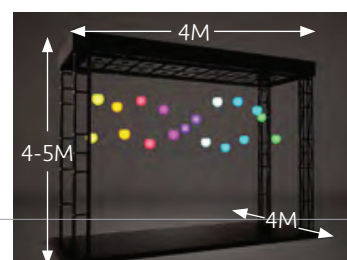

*3G optional, pending carrier compatibility/availability.
For more information about iDISPLAY™ Tablets
please visit our website: www.outform.com/iDisplay-Tablets



iDISPLAY™

BY OUTFORM™



Product Catalog



Tablets/Displays



Enterprise



4K Media Player



Tower



iShelf



Window Light Show™

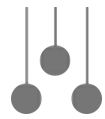

Kinetic LED Light Show™