

RADIO

2100 Miles Distance

Clifford J. Dow of Wailuku,
Maui, Hawaiian Islands,
received eighteen (18)
Western Amateur Stations
by using

REMLER RECEIVING APPARATUS and CUNNINGHAM TUBES

Dow's aerial was strung from a palm tree to his radio room—less than 75 feet in length.

This is one of the most remarkable records made in the history of amateur radio—being the only Hawaiian station that has ever heard mainland amateurs.



Dealers: There is an exclusive and very profitable proposition for you on Remler apparatus. Write for full particulars.

Amateurs: Write for 32-page Remler Bulletin.

REMLER RADIO MFG. CO.

248 First Street E. T. CUNNINGHAM
San Francisco, Cal. General Manager

154 W. Lake Street

Chicago, Ill.

Digitized by Google

CUNNINGHAM TUBES

for

HOME RECEIVING EQUIPMENTS



CUNNINGHAM
C-300
GAS CONTENT
DETECTOR

\$5⁰⁰

*Amplifies
as it
Detects*



The trade mark GE is the guarantee of these quality tubes. Each tube is built to most rigid specifications.

CUNNINGHAM Type C-300 Gas Content Detector Tube is the ideal tube to use in Home Receiving sets for clear reception of Radio Telephone Concerts, Market Reports and other news features which are sent out daily all over the country.

Nationally recognized as the one tube which gives the most satisfactory results for any type Receiving Set applicable to wave lengths between 100 and 3000 meters for both spark and C. W. Telegraph and Telephone, this Cunningham Detector Tube is recognized as the standard tube throughout the radio field.

In addition to its remarkable detector properties, low B. battery, quietness in operation, it is a free and persistent oscillator for regenerative amplification and C. W. reception and functions without distortion of the received signals.

The unusually fine results which have come through the operation of this tube in connection with home receiving sets have brought us many enthusiastic indorsements from users.

Write for further particulars to your nearest dealer, or write to us direct.

BEMLER APPARATUS RADIATES QUALITY

CUNNINGHAM TUBES MEET EVERY AMATEUR REQUIREMENT

Trading as

AUDIOTRON MFG. COMPANY

248 First Street
San Francisco, Calif.

154 West Lake Street
Chicago, Illinois

Reduce those QRN Atmospherics NOW—with Burgess "B" Batteries

Noiseless! That describes Burgess "B" Batteries. *Absolutely* noiseless! Weak and distant audio frequency signals can be received with multi-stage amplifiers and Burgess "B" Batteries because Burgess "B" Batteries *do not drown out signals.*

Burgess "B" Batteries guarantee clear receiving. They will increase the efficiency of any receiving set. They are cheapest in hours of service. And they are sold by all reliable dealers in radio equipment. Look for the black and white stripes. If you can't get Burgess "B" from your dealer, just drop a line to us, care Dept. A.

BURGESS BATTERY COMPANY

General Sales Office
HARRIS TRUST BLDG., CHICAGO
Stock Carried at

Chicago, Ill.
Madison, Wis.
Kansas City, Mo.
St. Paul, Minn.
Winnipeg, Man.



RADIO

Established 1917 as Pacific Radio News

Volume IV

for APRIL, 1922

Number 4

CONTENTS for APRIL, 1922

	Page
Radiatorial Comment.....	9
Report of the Washington Radio Conference.....	10
By MAX LOEWENTHAL	
Radio Construction in China.....	11
By CHARLES R. GRUBBS	
Design and Construction of 10-Watt C. W. Transmitter.....	14
By J. B. DOW	
Radio Broadcasting Stations of the United States.....	17
Construction and Operation of a Crystal Detector Set.....	18
By U. S. BUREAU OF STANDARDS	
The Intermediate Circuit and Eliminating the Grid Battery.....	21
By HUGH R. SPRADO	
Scratchi Starts Business Career.....	22
By DAVID P. GIBBONS	
The Radio Face.....	23
The Wail of a Wireless Bug's Wife.....	23
By BERNICE M. HARRISON	
The DX Bringer-In.....	23
By STUART A. HENDRICK	
A Radio Primer: Ether Waves.....	24
By H. A. EVELETH	
How to Finish Your Cabinet.....	25
By B. H. LINDEN	
Texas Market Radio News Service.....	25
Resistance in Radio Circuits.....	26
By CHAS. K. FULGHUM	
Construction of a Wavemeter for Tuning Transmitters.....	27
By GEO. F. PATRICK	
Queries and Replies on C. W. Practice.....	28
By GERALD M. BEST	
How to Design a C. W. Antenna for 200 Meters.....	28
By GERALD M. BEST	
Radio 3FS.....	29
By C. J. BENZING	
The Fallacy of too Much Amplification.....	29
By LAWRENCE MOTT	
Digest of Recent Radio Patents.....	30
With the U. S. Radio Inspector.....	31
Milwaukee Amateurs' Radio Club.....	32
In the Eastern States.....	32
New Apparatus and Supplies From the Radio Manufacturers.....	34
Calls Heard.....	36

RADIO is Published Monthly by the
Pacific Radio Publishing Co., Inc.,
Pacific Building, San Francisco, Calif.

ARTHUR H. HALLORAN, *Editor.*
LAWRENCE MOTT, *Associate Editor.*
GERALD M. BEST, *Technical Adviser.*
O. SCHUWENDT, *Engineering Draughtsman.*
H. W. DICKOW, *Advertising Manager.*
Branch Offices: 147 Sixth Ave., New York City;
1307 Hartford Bldg., Chicago; 18 Boylston St., Boston;
140 So. Oxford St., Los Angeles, Cal.

Advertising Forms Close on the First of the Month
Preceding Date of Issue

Issued Monthly, 20c a copy. Subscription price \$2.00 per year in the U. S., \$2.50 per year elsewhere. Instructions for change of address should be sent to the publisher two weeks before the date they are to go into effect. Both old and new addresses must always be given.

Entered as second-class matter at the Post Office at San Francisco, Calif., under the Act of March 3, 1879.

Copyright, 1922, by the Pacific Radio Publishing Co.

Forecast of Contributions for May Issue



Volney G. Mathison

The story of the adventures of a radio engineer in Alaska was unavoidably omitted from this issue, but will appear soon, as will also another Samuel Jones story called "A Phoney Freeze-Out." Mr. Mathison, in addition to being a contributor of fiction to the magazines, is one of the pioneer radio ship operators, his eight years of commercial experience having taken him all over the world. He holds an extra first class license. Of interest to amateur and commercial operators alike will be a forthcoming treatise from him on "The Professional Radio Operator."

In the May issue B. F. McNamee will have a simple account of the action of "The Vacuum Tube as a Detector," written for the layman.

D. B. McGown, assistant radio inspector, will have two fine articles, one on "Radio Storage Batteries," giving practical information that will enable anyone to take proper care of either lead or nickel-iron batteries, and one on "How to Make a Two Stage Amplifier." An early issue will also contain, as a continuation of his series on commercial apparatus, "Navy Standard Transmitters."

Chas. K. Fulghum, whose article on "Resistance in Radio Circuits" in this issue will be helpful to many, will present an instructive paper on "The Radio Wave," what it is and some of the fundamental phenomena associated with its propagation, for the benefit of the amateurs.

Gerald M. Best and Ralph Heintz have written a detailed account of the C. W. transmitter soon to be put on the air from Hawaii by C. J. Dow. This will give the practical details that will enable anyone to construct a set consisting of two 50 watt tubes in a Hartley self-rectifying I. C. W. circuit.

H. A. Eveleth will continue his "Radio Primer" with a talk on "Aerials." J. B. Dow has another interesting chapter ready for his "C. W. Manual," and there will be a wealth of valuable data in the usual departments of the paper.



Confucius has said:
 "The accomplishment
 of great things
 consists
 in doing small things
 Well ———
 Perfection of
 detail ———"

makes the
Globe Receiver



What
 it is =

The Grebe CR-5 Receiver

Licensed under
 Armstrong U. S. Patent
 No. 1,118,149

GREBE RADIO
 Doctor Wm.

RADIO APPARATUS

Distributors of Reliable Radio Apparatus to Dealers, Schools, Colleges, Radio Clubs and Experimenters All Over the World!

"PITTSO"
SERVICE DISTRIBUTES "RADIO CORPORATION'S" PRODUCTS
ALL OVER THE WORLD!
TRY US AND SEE!



"PITTSO"
NOW HAS TWO STORES! BOTH
CARRY "RADIO CORPORATION'S"
COMPLETE LINE.
ORDER TODAY!

AMPLIFIERS

- No. DA Westinghouse, Detector and two stage in mahogany cabinet. . . . \$68.00
- No. RORR Grebe, two stage with automatic filament control jacks. . . . 55.00
- No. RORD Grebe, Det. and two stage with automatic fl. control jacks. . . . 75.00
- No. 2684 Amrad, Det. and two stage in mahogany cabinet. Splendid value. . . 47.50

AMPLIFYING TRANSFORMERS

- No. UV-712 Radio Corporation. . . . 7.00
- No. QO Clapp-Eastham, semi-mounted. . 4.00
- No. QO Clapp-Eastham, fully mounted . 5.00
- No. 50 Chelsea, new type. 4.50

ANTENNA WIRE

- "Pittsco" No. 14 Hard drawn copper (80 ft. per lb.), per lb. 2.25
- "Pittsco" 7 strand No. 22 tinned copper, per ft.01
- 500 ft. 4.25
- 1000 ft. Special value at. 7.50
- "Pittsco" 7 strand No. 20 phosphor bronze, per ft.02
- 500 ft. special value at. 7.50

"B" BATTERIES

- No. 7628 Standard 22.5 Volts, small. . 1.50
- No. 7625 Standard 22.5 Volts, large. . 2.65
- No. 7600 Standard 22.5 Volts, variable 1 1/2 to 2 1/2 Volts. 3.00
- No. 7650 Standard 22.5 Volts, large, variable, 15 variations. 3.50
- No. 768 Eveready 22.5 volts small. . . 2.25
- No. 766 Eveready 22.5 volts large, 1 1/2 to 2 1/2 volts. 3.00
- No. 627 Ace, 45 volts, variable. 3.50

COILS (Duo-lateral)

- DL-25 \$1.40 DL-300 1.75
- DL-85 1.40 DL-400 1.80
- DL-50 1.50 DL-500 2.00
- DL-75 1.50 DL-600 2.15
- DL-100 1.55 DL-750 2.35
- DL-150 1.60 DL-1000 2.60
- DL-200 1.65 DL-1250 3.00
- DL-250 1.70 DL-1500 3.50

COIL MOUNTINGS

- No. LC-100 DeForest 3 coil mounting with gears, reduced price. 6.00
- No. LC-101 DeForest 3 coil mounting with gears and wooden base. 9.50
- No. 400 Remler 8 coil mounting with base and extension handles. 6.50

CONDENSERS (For CW work)

- No. UC-1014 Radio Corp. .002 MF, 8000 volts. 2.00
- No. UC-1015 Radio Corp. .0008, .0004, .0005 MFD, 7500 volts. 5.40
- No. UC-1803 Radio Corp. .000025 MF, 10000 volts. 5.00
- No. UC-1806 Radio Corp. .002 MF, 6000 volts. 7.00

CONDENSERS (Grid and plate types)

- No. UC-570 Radio Corp. .0025 MF. . . \$2.00
- No. UC-569 Radio Corp. .001 MF. . . 1.50
- No. UC-568 Radio Corp. .0005 MF. . . 1.35
- No. UC-567 Radio Corp. .00025 MF. . 1.20
- No. UX-548 Radio Corp. Condenser meg.50

CONDENSERS (Filter type)

- No. UC-1631 Radio Corp. .5 MF 750 volts. 1.35
- No. UC-1632 Radio Corp. 1 MF 750 volts. 1.85
- No. UC-1634 Radio Corp. .5 MF 1750 volts. 1.50
- No. UC-1635 Radio Corp. 1 MF 1750 volts. 2.00

C. W. INDUCTANCES

- No. UL-1008 Radio Corporation. . . . 11.00
- No. P-1 Acme 8.00

C. W. POWER TRANSFORMERS

- No. UP-1638 Radio Corp. 325 watts. . 25.00
- No. UP-1016 Radio Corp. 750 watts. . 38.50
- Acme 200 Watt 850-550 Volts Mtd. . 20.00
- Acme 200 Watt 850-550 Volts unmtd. . 16.00

FILTER REACTORS

- No. UP-1626 160 Milliampers. 11.50
- No. UP-1627 300 Milliampers. 15.75

GRID LEAKS (Radio Corporation)

- No. UP-1719 For 5 Watt Tubes. . . . 1.10
- No. UP-1718 For 50 Watt Tubes. . . . 1.65
- No. UP-576 1/2, 1, 1.5, 2 or 8 megohms ea. complete with mounting. 1.25
- Grid leaks only, each.75

HOT WIRE METERS

- No. P-1 Roller-Smith 0-2.5 Amperes, Bush mtg. Special value at. 4.75
- No. UM-580 Radio Corp. 0-2.5 Amps. . 6.00
- No. UM-588 Radio Corp. 0-5 Amps. . . 6.25

JACKS (Radio type)

- No. 61 Patent open jack.70
- No. 62 Patent closed jack.85
- No. 63 Patent 2 circuit. 1.00
- No. 65 Patent three spring Automatic filament control type. 1.20
- No. 66 Patent five spring A. F. C. . . . 1.50

LOUD SPEAKERS

- No. R-8 Radio Magnavox, new type horn, very latest model. 45.00
- No. P-1 Vocaloid, station type. . . . 30.00
- No. 400-W Federal Pleiophones. . . . 14.00

RECEIVING SETS (Crystal)

- "Aerliola Jr.," Westinghouse, complete with Brandes "Superior" phones. . . 25.00
- "Radiola," DeForest, complete with Brandes "Superior" phones. 25.00
- Radio Service Type S-8 without phones, splendid value. 7.50

MAGNETIC MODULATORS

- No. UT-1684 1/4 to 1 1/4 Amperes. . . . \$9.50
- No. UT-1857 1 1/4 to 3 1/2 Amperes. . . 12.50
- No. UT-1687 3/4 to 5 Amperes. 17.00

RECTIFYING DEVICES

- No. UV-216 Radio Corp. "Kenotron" 20 Watt type for UV-202 tubes. . . . 7.50
- No. UV-217 Radio Corp. "Kenotron" 150 Watt type for UV-208 tubes. . . . 26.50
- No. P-1 DeForest 20 Watt Rectifying tube for use with 5 watt tubes. 7.00

RECTIFYING DEVICES (for "A" Batteries)

- No. P-1 Tungar, 5 ampere type, complete with bulb. 38.00
- No. P-2 Tungar, 2 ampere type with Bulb. 18.00
- No. P-3 FF Battery Booster, 5 amp. type. 15.00

REGENERATIVE RECEIVERS

- No. CR-8 Grebe "Relay-Special" 175-680 meters. 65.00
- No. CR-5 Grebe 175-3000 meters, "Super-special" complete set. 80.00
- No. CR-8 Grebe 175-1000 meters, complete set, latest "Relay-Special". . . 80.00
- No. CR-9 Grebe 175-8000 meters, complete set with det. and 2 stage amplifier self contained, "A Master-piece". 130.00
- No. RA Westinghouse, 160-700 meters, very selective, mahogany cabinet. . . 68.00
- No. RO Westinghouse, RA receiver and DA Det. Amplifier combined in one cabinet, a splendid unit, compact. . . 130.00

TELEPHONES

- No. 56 Murdock 2000 ohm double. . . . 5.00
- No. 56 Murdock 3000 ohm double. . . . 6.00
- No. CW-834 Western Electric 2200 ohms. 15.00
- Brandes, "Superior" with new headband. 8.00
- Brandes "Trans-Atlantics" with new headband. 13.00
- Brandes "Navy Type" with new headband. 14.00
- Baldwins Type C. 12.00
- Baldwins Type E. 13.00
- Baldwins Type F. 14.00
- Baldwins Type C unit only. 6.00
- Federal A. and N. Type 2200 ohms. . . 8.00
- Federal A. and N. Type 3200 ohms. . . 10.50

VACUUM TUBES

- No. UV-200 Radiotron detector. 5.00
- No. UV-201 Radiotron amplifier. . . . 6.50
- No. UV-202 Radiotron 5 watt. 8.00
- No. UV-203 Radiotron 50 watt. 30.00
- No. UV-204 Radiotron 250 watt. 110.00

Note:—All Radiotrons sent postage and insurance prepaid anywhere in U. S. A. Send us your orders for Radiotrons.

"LET 'PITTSO' products, SUPER-SERVICE and delivery solve your RADIO problems"

SEND US YOUR ORDERS TODAY!

Send ten cents for Catalog No. 22. Over 100 pages, over 150 illustrations, over 600 items

F. D. PITTS CO., Inc., 12 Park Square, Boston, Mass. Branch—Woolworth Bldg., 193 Westminster St., Providence, R. I.



Warp-Proof, Weather-Proof Radio Panels and Tubes

FORMICA panels and tubes absorb no moisture. They do not swell because of dampness, or shrink because of dryness. They keep their shape, and keep also their high dielectric strength and perfect insulating quality.

Dealers sell Formica in the right sized sheets for the panel you want to build. These dealers get it from us cut to size, or cut it themselves. All you need to produce a handsome panel is a drill.

The finish is high gloss—black or brown—is very handsome and produces a result you will always be proud of. Formica keeps its good looks, too. By sanding it you can easily produce a handsome satin finish.

Formica sheets are solid Formica—all the way through. There is no cheap moisture absorbing material in the middle that will cause warping and power losses later. Insist on the best radio insulation approved by the Navy and the Signal Corps.

Dealers: Formica is the most widely known and accepted radio insulation. It goes into about 90 per cent of the sets which amateurs build for themselves and they are following manufacturers and commercial companies in their preference for Formica. We can supply you promptly with 42 by 36 sheets, or smaller sizes already cut for Radio panels. You can always get Formica and in any quantity!

The Formica Insulation Company,
4616 Spring Grove Ave.,
Cincinnati, Ohio.

FORMICA

Made from Anhydrous Redmanol Resins

SHEETS TUBES RODS

When AL. JOLSON sings and laughs



"Though April Showers may come your way," sings Al Jolson, and the words are broadcasted to a radio audience of fifty thousand that weeps and laughs with him.

It is the Radiotron that has helped to make this achievement possible—to bring the broadcasted voice of a great comedian, or a great pulpit orator, or a great singer into thousands of homes.

Probably most of those who listened to Al Jolson recently heard him with the aid of Radiotron UV-200 made for the Radio Corporation of America.

Two forms of these remarkable Radiotrons are made for reception. They are known as Radiotron UV-200 and Radiotron UV-201.

Radiotron UV-200 is used for detection. This is a long-lived, highly sensitive detector tube which can be operated with one standard plate battery. Price, \$5.00.

Radiotron UV-201 is a magnifying tube. It magnifies the telephone currents and is free from tube "noises". In cascade radio and audio frequency amplifying circuits UV-201 magnifies without distortion. It is an ideal tone-frequency amplifier where long-distance reception is desired on short wave-lengths. Price \$6.50.

Ask Your Nearest Dealer for Radiotrons.



Radio Corporation of America

SALES DEPARTMENT, SUITE 1804
233 BROADWAY, NEW YORK CITY



Let us do the machine work~



Do the wiring yourself and~

Save 20% or More on the Cost of High-Grade Radio Instruments!



Multiple Wave Tuner—Here you obtain in a single instrument the equipment to receive all classes of signals on all known wave-lengths—150 to 25,000 meters. Minimum number of controls provide extreme simplicity of operation, yet the design renders the tuning especially sensitive and selective.

Price, completely assembled, F. O. B. New York, \$45.00

Set of 18 DL Coils, to receive all the most used wave-lengths, \$40.00.



Detector and Two-Step Amplifier—Your choice of two types, Commercial or Amateur. The commercial type is assembled from the most costly, efficient units available. Radio Corporation UV-712 transformers and General Radio tube receptacles typify the quality thru-out. The Amateur type is an exact duplicate, except that transformers and sockets of high efficiency, but lower cost, are used.

Prices, F. O. B. New York:

Commercial type, unwired..... \$55.00
Amateur type, unwired..... 47.00

Here is clear saving of \$10.00 in either case, thru the "Standard" Plan.

THERE are two parts in the building of radio apparatus; first the actual panel drilling and assembling, and second, the wiring.

The first is essentially machine work. At the same time, because it is machine work, it is really the less expensive part of the entire assembly.

The wiring, which is hand work, is the expensive part and also the part which you can do just as well yourself. The Standard Plan gives you an opportunity to secure commercial grade correctly assembled apparatus at prices only slightly more than you would pay for the individual instruments.

The Standard Plan ASSEMBLED but not WIRED!

The Standard Assembling Company makes a complete line of parts—fully ASSEMBLED but not WIRED. The actual machine work is done in a splendidly equipped factory. The workmanship is not excelled anywhere. The individual instruments and parts are of the highest quality obtainable and are bought in tremendous quantities at big discounts.

The wiring, which is expensive hand work, is left for you to finish. You can incorporate your own circuit if you wish, or, you can follow the wiring diagrams which are provided with every instrument.

Take advantage of the Standard Plan and save the expensive wiring costs. Only in this way can you get fully assembled high quality apparatus at such low prices.

Take this opportunity to try the Standard Plan at our Risk!

So confident are we that you will be delighted with the Standard Plan, that we will ship any Standard instrument for your inspection without obligation. Simply send a deposit of $\frac{1}{3}$ the purchase price with your order. Examine the instrument carefully. If satisfactory remit the balance, but if you are not fully convinced that Standard apparatus is the best value in radio today, simply return the instrument and your deposit will be refunded less carrying charges.

STANDARD ASSEMBLING COMPANY

Dept. A, 19 Bridge St., N. Y. C.

If you do not wish to order at once, at least send 2c for the complete details of the Standard Plan and descriptive literature of all Standard instruments. This coupon is for your convenience. We suggest that you fill it in now, so that you can get the Standard bulletins in time to save money on your next purchase.

Standard Assembling Company,
Dept. A, 19 Bridge Street, N. Y. C.
Please detail of the Standard Plan by return mail.

Name.....
Address.....
City.....
State.....



Medal and Diploma received at World's Columbian Exposition, Chicago, 1898



INSULATION MADE IN AMERICA Louis Steinberger's Patents



Medal and Diploma received at World's Fair, St. Louis, 1904



ELECTROSE ADJUSTABLE AIR-GAP ARC INSULATORS PATENTED Radio Frequency Radio Telegraph Radio Telephony X-Ray Apparatus Damped or Sustained Voltage

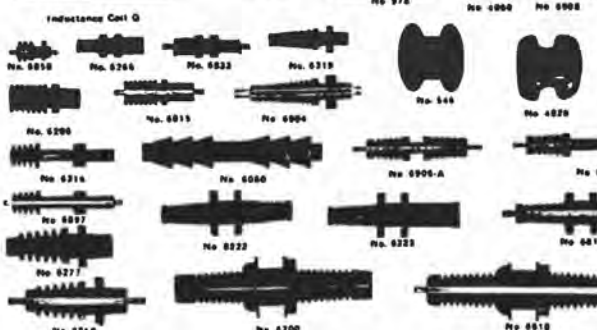

"Electrose" is made in a number of grades for various requirements, each grade possessing special characteristics. Insulators and Insulating parts and devices of special sizes and forms, designed and made to order.

SOLE MANUFACTURERS



60-82 Washington St. 27-37 York St. 66-76 Front St. 1-23 Flint St. Brooklyn, N. Y., America

Tell them that you saw it in RADIO

Radiatorial Comment

PRELIMINARY recommendations from the Washington Radio Conference Committees allocate twenty bands of waves between 150 and 6000 meters, urge that control of radio communication be vested in the Department of Commerce, and suggest that the radio telephone be given the status of a public utility. The wavelength allocations are as follows:

Below 150 meters—Reserved.
150 to 200 meters—Amateurs, exclusive.
200 to 275 meters—Schools and amateurs.
275 to 285 meters—Police broadcasting.
310 meters—Special amateur telegraphy.
310 to 435 meters—Private and toll broadcasting.
500 to 525 meters—Aircraft telephony and telegraphy.
525 to 650 meters—Mobile radio telegraphy.
650 to 700 meters—Mobile radio telephony.
700 to 750 meters—Government and public broadcasting, 700 miles inland.
750 to 800 meters—Radio compass, exclusive.
850 to 950 meters—Aircraft telegraphy and telephony.
950 to 1050 meters—Radio beacons, exclusive.
1050 to 1500 meters—Government and public broadcasting.
1500 to 1550 meters—Aircraft telephony and telegraphy.
1550 to 1650 meters—Fixed stations, non-exclusive.
1850 to 2250 meters—Government broadcasting, non-exclusive.
2500 to 2680 meters—Mobile service, non-exclusive.
2850 to 3800 meters—Fixed service, radio telephony.
5000 to 6000 meters—Trans-oceanic radio telephone experiments.

From these it will be noted that ample privileges are to be extended to amateurs and to radiophone broadcasting. The committees' final report will be given about April first, after consideration of comments from various interests to whom this information has been transmitted. Thereafter the recommendations will probably be embodied in a bill to be submitted to Congress.

FOR three months have we reported the consistent work of 6ZAC of Hawaii. Without blare of trumpets and with the simplest receiving set he is hearing stations thousands of miles away. His work sets a record that has not yet been equalled in amateur circles. So it is with pleasure that many readers will learn that he will soon be on the air with his own transmitter and many a fine-eared operator, who thinks he can receive, will be given an opportunity to learn whether he can receive as well as he can send.

Because of the severe static conditions usually found in the Islands such a feat has hitherto been considered impossible. Several years ago navy officials using seven stages of amplification were unable to hear Pacific Coast stations during a pre-arranged test. With a loose coupler, detector and one stage of amplification, Mr. Dow is hearing spark stations in the fifth, sixth and seventh districts and C. W. stations in these as well as in the eighth and ninth districts. Among others, he reports NOF at Anacostia, B. C., a distance of 4800 miles along the great circle!

FROM the report of the Washington Radio Conference, as printed elsewhere in these columns, it is evident that some little time will elapse before the present etheric chaos can be corrected by law. The report is interesting in

that it succinctly presents the viewpoints of the many conflicting interests involved and points the way to an equitable allocation of wave lengths.

But until the final recommendations of the committee are made law by Congress some plan of "live and help live" should be worked out in each part of the country. Voluntary restrictions by some plan, such as the Chicago plan or the Pacific plan, will prove helpful in each locality.

The essence of such voluntary restriction is co-operation, working together and playing together harmoniously for the good of the radio game. This is in accord with the fundamental principle of Americanism that in union there is strength and that the will of the majority is the only will to be considered safe relative to policies involving any body of individuals. Any plan adopted should be built to an ideal.

The ideal plan for amateur radio is one which will afford equitable privileges to the receptor station interested in radiophone broadcasts, the amateur operator interested in local work, and the dx hound who wants to annihilate miles with watts. This ideal now can be attained only by a gentlemen's agreement as to what in the opinion of the majority will provide the greatest good for the greatest number.

Such a plan would call for preliminary decisions by local groups and final decision by representatives from a large number of groups. This was the method used in the preparation of the Pacific Plan, which, while not yet perfect, is admirably adapted to provide the most favorable working conditions for all. Wherever enforced it is functioning satisfactorily.

But of far greater importance than the adoption of a plan is loyalty by all to whatever plan may be adopted by the majority. In general, we are loyal to that thing which protects our own interest. But the protection can be continued only as long as loyalty continues. No plan will work if a dx man disputes the traffic officer's order to discontinue the use of high power local work, if an operator refuses to put out NA or to recognize IM, or if some ambitious amateur puts his spark on the air during the concert period.

A gentleman's agreement is an agreement between gentlemen and needs no bond. Our traffic officers are our servants, telling us how to conform to our own rules for our own good and sacrificing their time for the welfare of all. They exercise an authority backed up by the power of the radio inspector. Their orders should be obeyed.

Should we find a Bolshevik in our midst, let us deal gently with him. He is ignorant and is to be taught rather than fought. He misunderstands and his misunderstanding should be removed by education. But if he still refuses to conform voluntarily, we still have the power to compel him to consider the privileges of other people as superior to his own.

Report of the Washington Radio Conference

By Max Loewenthal, Official Delegate from the Pacific Radio Trade Association

THIS epoch-making conference, destined to evolve conclusions of immeasurable benefit to the radio industry, not only in view of the magnitude and scope of the problems under discussion and the importance of the recommendations which will result from these deliberations, but also in view of the prominence of the members of the commission and those attending the conference, as voluntary witnesses and advisers, was opened in the conference room of the Department of Commerce, Washington, D. C., on Monday, February 27th by Secretary of Commerce Herbert Hoover.

The official commission appointed by Secretary Hoover at the suggestion of President Harding consisted of the following members:

Dr. S. W. Stratton, chairman (director of Bureau of Standards, Department of Commerce).

This report summarizes the testimony given before the Committee by representatives of radio manufacturers, trade associations, amateur associations, electric power companies, telephone companies, ship operators, newspapers and others interested in the regulation of radio communication.

There were present during the two-day conference representatives of various public service corporations, manufacturing companies, radio telephone users, commercial and amateur, from coast to coast, to the number of about 125, as well as representatives from the various government bureaus, the army and navy,

Boy Scout and trade associations, many representatives of the press and commercial bodies, in order to present their views concerning the situation brought about by recent strides in broadcasting and the need for allocating the ether waves so as to permit the greatest use of wireless telephony for commercial purposes and amateur development.

Secretary Hoover, who might be called "the personal representative of the American small boy," in view of the interest he has shown in the past and repeatedly evidenced during the course of the convention, opened the proceedings with



Leaders in Washington Radio Conference. Left to right, front row, Secretary of Commerce Herbert Hoover, Postmaster General Will Hays, Gen. George O. Squier, Congressman W. H. White, of Maine; former Congressman Shirley. Back row, Dr. Louis Cohen, consulting engineer for War Department; Prof. C. M. Jansky Jr., Edwin H. Armstrong, Columbia University; Harry F. Breckel, Dr. Alfred Goldsmith, New York City.

Major General George O. Squier, War Department.
 Capt. Samuel W. Bryant, U. S. N., Navy Department.
 Mr. J. C. Edgerton, supt., Radio Service, Postoffice Department.
 Mr. W. A. Wheeler, Bureau of Markets and Crop Estimates, Department of Agriculture.
 Representative Wallace H. White, Jr., of Maine.
 Mr. R. B. Howell, of Omaha, Nebraska.
 Dr. Alfred N. Goldsmith, secretary, Institute of Radio Engineers, New York, N. Y.
 Mr. Hiram Percy Maxim, president, American Radio Relay League, Hartford, Conn.
 Prof. L. A. Hazeltine, Stevens Institute of Technology, Hoboken, N. J.
 Mr. D. B. Carson, Commissioner of Navigation, Department of Commerce.
 Prof. C. M. Jansky, Jr., University of Minnesota.
 Senator Frank B. Kellogg, of Minnesota.
 Mr. Edwin H. Armstrong, Columbia University, New York, N. Y.

an address which was heartily received by those in attendance. Mr. Hoover's interest in the situation was further evidenced by his continuous presence during all of the proceedings over which he presided and during which he asked many pertinent questions.

OPENING ADDRESS BY SECRETARY HOOVER

It is the purpose of this conference to inquire into the critical situation that has now arisen through the astonishing development of the wireless telephone; to advise the Department of Commerce as to the application of its present powers of regulation, and further to formulate such recommendations to Congress as to the legislation necessary. This is one of the few instances where the country is unanimous in its desire for more regulation.

We have witnessed in the last four or five months one of the most astounding things that has come under my observation of American life. This department estimates that today over 600,000 (one estimate being 1,000,000) persons possess wireless telephone receiving sets, whereas there were less than 50,000 such sets a year ago. We

Continued on page 44

程工電線無國中

By Charles R. Grubbs

THE characters above, reading from left to right, are "Chung Kwok, Mo Tsein Tien Koong Chuen," and taken literally mean "middle kingdom without wires electrical work engine(ering)," or "Radio Construction in China." Radio is a new art in China and, like all other innovations in that country, there are no words with which to exactly describe the subject. So existing words are used descriptively to meet the emergency. Usually they are very apt in the description, as the above caption testifies. A motorboat is a "fire boat," and a railway train is a "fire carriage," while an automobile is a "fire carriage to go anywhere."

A few words as to the geographical and political status of South China will explain why radio construction was undertaken there.

The valley of the Si Kiang, or West River, extends through two provinces of South China, Kwang Tung and Kwang Si (east country and west country), where is being made history upon which the progress of all China hinges. Kwang Tung, with the rich delta lands of the West River and the fertile valley of the North River, has the two principal cities, Hong Kong and Canton. In the little territory scarcely larger than the state of Kentucky twenty-nine million people live. Agriculturally inclined and commercially aggressive, the people of this province are peace loving, studious, philosophical and thrifty. Most of the Chinese living in foreign lands and studying in foreign universities are from Kwang Tung; and therefore if foreign ideas and inventions are accepted into China they usually enter by way of Kwang Tung. It was to be expected that radio, the newest and most useful of arts, would get its first real start in the southern part of China.

In marked contrast to Kwang Tung is the mountainous province of Kwang Si; the land, while rich in undeveloped mineral resources, is poor agriculturally, and hundreds of years of fighting with neighboring provinces has reduced the population from 15,000,000 to less than 7,000,000 people. These were the militarists of China.

An unusually successful raid in 1917 gained control for the Kwang Si troops of the whole of Kwang Tung province, and for three years they ruled with the hands of vandals. High taxes were collected on anything and everything; gambling concessions were sold; if they couldn't get the money any other way they took it. As quickly as possible all money was moved from Kwang Tung to Kwang Si. Railroads

were to be built and equipped, highways to be laid out, and communication was to be fostered in Kwang Si, all at the expense of the richer province of Kwang Tung.

A radio station was to be erected at Wuchow, one large enough for communication directly with Pekin, 1200 miles distant. They estimated about 10 kw. It is not very clear just how this estimate was arrived at, but the money was appropriated and an American-educated Chinese was sent to the United States to purchase this station, together with other machinery.

Upon arrival in the states, an American radio engineer advised this representative that 10 kw. would not be sufficient and stated that nothing less than a 25 kw. arc should be used. Due to the large ferrous deposits in the country, and the exceptionally heavy type of atmospherics encountered, it is the opinion of the writer that at certain times of the year a 100 kw. arc would have difficulty in consistently covering this distance. There is a minimum of static in the winter months.

It was then decided to use this appropriation, which was not enough to buy a 25 kw. arc, in the purchase of a number of small radio sets. De Forest radiophones and receivers, with 110 volt Genco light farm sets for a source of power, were selected.

Messrs. Slocum and Halleck, radio engineers of San Francisco, were sent on to China to prepare for the erection of these sets. Before this apparatus could arrive in China the Kwang Tung

people, under the leadership of Sun Yat Sen, Chen Chiung-ming, and others, had revolted, the Kwang Si militarists were driven out, leaving Slocum and Halleck nothing to do but to return to the states, and the radio shipment on its arrival was seized by the people who had really paid for it.

Some few months later the writer was called upon by the Chinese in control to furnish them with advice and other services incidental to the erection of these stations.

FROM San Francisco to Hong Kong was the usual uneventful trip, listening to the old reliables, KPH, KET, NPL, NPM, the amateurs trying to strangle each other, "that will be all for now" from the California Theater. "We'll have another" from the sergeant, the Japanese stations and others. Off the Japanese coast we heard the tube sets which were being tested out, but of course were not able to understand what was said; it sounded like "Ho-o Rin Ahh" and "Ichi, Ehr, Sahn, Seu," repeated over and over.

Although the Japanese and also the Chinese are required to



Sketch Map of South China, Showing Location of Stations



Station CN at Canton. Built by German Engineers in 1907

know the international code, together with the use of English, the code which they use for their own language would appeal to the chap who has a hard time to memorize the code. It only has ten characters and is a number code, each of the words being represented by four of these characters. For instance the numeral 5438 could represent the longest word in their language or the shortest as the case might be. Many of the ship operators are puzzled when they hear this code as it seems to be made up of letters, numbers, and Morse. Continental N is 1, D is 2, B is 3, - . . . is 4, and so on with the Morse L for zero. A code book is furnished to each operator with the Chinese characters and its corresponding code number listed.

Upon arrival at Canton, a conference was called by the officials in order that the best and most advantageous locations could be selected for the stations, that a complete communication network of the entire province would result. We had many of these conferences during the course of the work and they were mostly alike in that each took up the greater part of a day with tea, ceremony, and difficulty of exact understanding. It was decided that ten stations would be put up immediately and simultaneously even though a large portion of the construction material still had to be purchased. It is no easy thing to buy construction material of any description in China and it is especially difficult when it is desired in quantity and of a specialized nature.

The six 1 kw. stations proposed are shown on the map; in addition there were to be two ship stations of $\frac{1}{2}$ kw., and two 100 watt stations in the vicinity of Canton.

About sixteen spark stations were already in operation at various points on land and small river boats in and around Canton. These had been installed fifteen years previously by German engineers and even though they each carried a Chinese "chop" they had all the earmarks of Slaby-Arco and Telefunken sets.

The largest of these stations at Canton, CN, had a sending radius of less than 60 miles. An idea of the size of the antenna for this station may be had by studying the waterfront view shown herewith. The masts are 220 ft. high and 680 ft. apart. There is a four-wire grid suspended between these masts, each wire seven strands of No. 14 copper, which makes a very heavy antenna. All four wires are brought to the lead-in insulator from the east end of the grid. Then from this point through the oscillation transformer to the ground.



Construction on Shiu Hing Station

The ground consists of two heavy copper wires laid out radially into the river. The oscillation transformer is made up of 25 turns of No. 4 solid copper on a cylindrical wooden frame. Taps were taken off this for the closed circuit, which consisted of a large glass plate condenser and a spark coil or open core transformer, the primary of which was fed directly off the 100 volt, 50 cycle lighting main. This transformer, 24 in. long and 8 in. in diameter, was completely encased in hard rubber to keep out the moisture.

Originally there had been a straight spark gap, but someone had fitted a rotary gap on a fan motor. At that the overall efficiency did not go very high as is indicated by the fact that with an input of 1 kw. they were able to put into the antenna less than two amperes. With the size of that antenna the surprising thing is that they were able to do as well as that. The emitted wave was so broad that there were no "humps."

The receiver was 2 ft. high with a long, multipoint lever switch which opened all the circuits at once. Fixed coupling inductances, locally made condensers, variable, and a single low ohmage phone made up the rest of the set.

We connected to this antenna an audion receiver, one-step, Baldwin phones, and the Chinese operators were afraid to use it because it hurt their ears.

ONE of the first things which had to be done was to make a complete test of all the apparatus in the shipment. For some unexplainable reason this radio material had not been crated or prepared for export shipment



*Radio Station at Shek Chong
View of Pearl River, Canton*

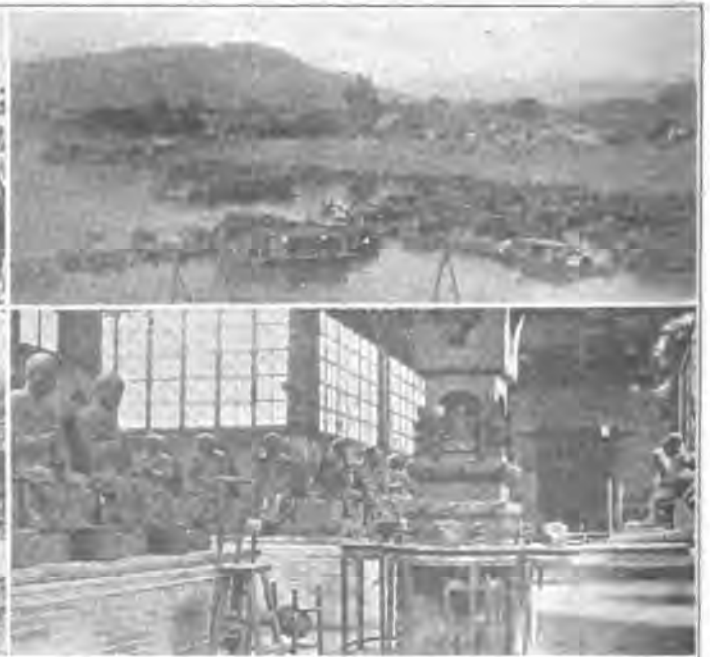

*Hotel Reservations, Shiu Chow
Temple of 500 Genii, Canton*



Wu Chow Harbor

and as it had been handled four times in transit, considerable damage had resulted.

To make matters more complicated, the white ants had eaten into the cases and the oak cabinets were little more than shells. White ants or "ahn hi" as they are called, are the "wouf-hongs" of China. The Chinese will seriously tell you that the little insects will cheerfully eat anything that they come to, including lead and gold and silver.

Needless to say we did not try the experiment, but rigged up a cyanide room and made short work of them. The ship's fumigating method was entirely new to the natives, for they knew of no way to rid themselves of the pests other than fire and kerosene; the former of course could not be considered while the latter is not effective.

Many of the Chinese believe that the white ants are caused by the moisture in the air, and will affirm that there is no other possible way in which the ants can get a start. At times one is tempted to believe them. The high humidity is capable of bringing on all sorts of calamities to electrical machinery. It was next to impossible to keep the magnetos in operation on the aeroplanes, while the damage caused by the moisture was disastrous to the coils, transformers, and condensers of the radio sets.

The woodwork had also suffered from the moisture. It did not seem to affect the length of the board, but the width was increased nearly a half inch in each foot. In the winter months this same board will shrink back to normal, so that it does no good to make the board to size. The solution is teak wood cabinets, which are not so susceptible to moisture.

The entire shipment had been there for five months or more subject to this moisture, and the high voltage generators were in no condition to deliver the 1500 volts required. Each piece that would require this treatment was baked at 180°F in an oven, rigged up temporarily, before being tested.

One of the Genco light sets and a set of storage batteries was set up, men were taught to run it and the testing was started. The results were discouraging, but we managed to sort out enough pieces to carry on, thinking to repair the rest at a later date. Three men were afterwards kept busy for a period of two months in repairing storage battery plates alone and a lot of the apparatus could not be salvaged at all.

The first three stations were put up in Canton, a 1 kw. at CN's old site, and the other two 100 watt stations at a distance of three and twelve miles respectively.

We were now ready to commence the work on some of the outlying stations. Shiu Hing, 60 miles up the West River, being the next on our plan, arrangements were made for a "lighter" or large cargo boat and the lighting generator, transmitter, power panel, receiver, motor generator set, and other material was loaded on by coolies. The masts were to be towed astern.

Three days later (time is no object in China) we were able to pull the diplomatic strings and cut the necessary red tape to get a steamboat to tow us up the river.

THE trip up the West River is beautiful at any time of the year; through a rich delta country, the greenest of green rice fields, well tilled, with never the sign of a weed, quaint "dobe" houses with straw thatched roofs, picturesque river temples, sampans (boats) and lily ponds. Nothing is raised in China to which is not attached a food value and lilies are no exception; the lotus lily has an edible seed similar to pease but richer, and the root is something like the potato. They call it the poor man's potato.

About forty miles of this and we left the sluggish waters of the delta region and came into the more swiftly running part of the river where the mountains start. The Shiu Hing gorges, where the river is forced to pass between two mountains by an ancient landslide, was passed and soon after the boat was anchored along the river bank at Shiu Hing.

The rain had suddenly decided to come down in torrents

Continued on page 58



Chinese Steam Shovel
On the Way to Market



Celestial Centrifugal Pump
Rapid Locomotion in China

The C. W. Manual

Fourth Installment

By J. B. Dow, Ensign U. S. N.

The Design and Construction of a 10 Watt C. W. Transmitter, I. C. W. Transmitter and Phone Set Using Direct Current

IN conformity with the policy adopted in the preceding chapter of stating the conditions affecting the design and construction of apparatus under consideration, the following statements are made with reference to the subject matter:

1. A Hartley oscillating circuit wherein two 5 watt tubes are employed as oscillators, will be used in conjunction with the Heising system of modulation employing two similar tubes as modulators.

2. With a small antenna, the apparatus must function at frequencies corresponding to wavelengths between 200 and 375 meters.

3. The various integral pieces of apparatus, except the radiating system, sources of power supply and attendant filter and rectifier systems must be so mounted as to comprise a complete unit.



Fig. 30. Front View of 10-Watt Phone Set.

4. An efficient self contained switching arrangement must be provided in order that the operator may transmit signals of any of the following characteristics at will: viz, C. W., I. C. W., and phone.

5. Efficiency in operation combined with ruggedness in construction will be considered as of paramount importance.

Figs. 30, 31, and 32 show three views of the completed apparatus. Fig. 33 is a schematic diagram of the circuit. It will be observed by reference to the figures that much of the apparatus was obtained from the market; for example, the indicating instruments, filament rheostats, receptacles, modulation transformer, choke coils, and switches. The constructor will do well in following this practice, since, in most cases, it will be the more economical. However, full constructional details will be found elsewhere in the manual for much of the above mentioned apparatus.

In the construction of this unit, recourse will be given first to apparatus comprising the basic electrical parts of the circuit—since the arrangement of these parts in the circuit depends to a great extent upon the constructor's adherence to the specifications given. In most cases, considerable tolerance is allowed.

The details of the condenser inserted in the circuit between the plate and coupling tap on the variable inductance are shown in Fig. 34. As will be seen by reference to this figure, the condenser is merely an ordinary mica dielectric device having a capacity of approximately 0.01 micro-farad. It is mounted as in Fig. 32 upon the inside surface of the backboard under the oscillator tube sub-panel.

The radio-frequency choke coil shown in the same figure consists of a 250 turn honeycomb mounted upon the bracket which is detailed in Fig. 35.

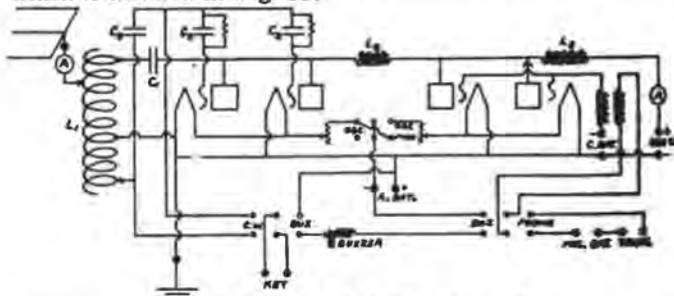

Fig. 33. Diagram of 10-Watt Phone Set.

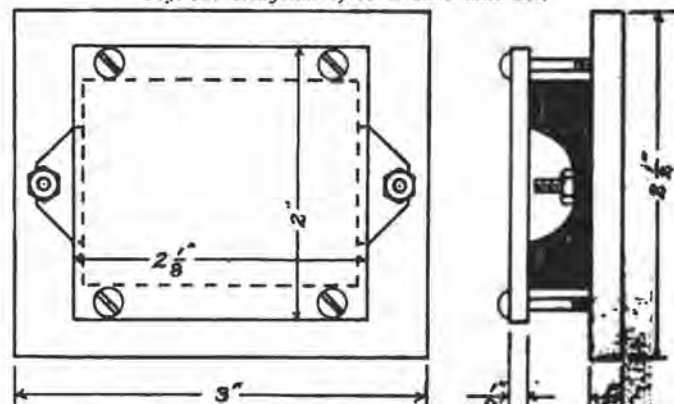

Fig. 34. Details of Condenser in Circuit Between Plate and Coupling Tap. Capacity, 0.01 mf., 50 pieces copper foil 1.75 x 1.25 in. between 51 pieces 5 mil ruby mica 2 x 1.5 in.

The mounting for the modulation transformer and radio-frequency choke coil is shown in Fig. 31. Complete details for the construction of the modulation transformer are given in Fig. 26. If the reader desires to construct an audio frequency choke to take the place of the one shown in Fig. 31, he may do so by following the details of Fig. 29 (see March RADIO).

The attention of the reader will now be turned to the grid circuit in Fig. 33. It will be observed that this is a branched circuit consisting of three small grid capacities and two large resistances. The individual grid condensers should have a capacity of approximately 0.0005 micro-farad, and should be shunted by a suitable grid leak resistance. For Western Electric Co. oxide-coated filament tubes, this resistance should have a value of about 10,000 ohms. Some manufacturers recommend that with their tubes, the capacity-grid-leak-resistance system comprise a resistance of 5000 ohms in conjunction with a capacity of 0.002 micro-farad.

Three sheets of copper foil 2 by 3 inches separated with thin mica may be used with the grid leak shown in Fig. 27 for each of the oscillator tubes of Fig. 33.

The third condenser in this system is one of similar construction. By manipulating the upper left hand switch of Fig. 30, a small telegraph key is shunted across this condenser for the transmission of C. W. signals. When thrown to the opposite side, this switch inserts the key in the buzzer circuit for the transmission of I. C. W. signals. In this latter position, the two disengaged switch points must be short-circuited to cut the key condenser out of circuit. It may be well to point out here that the resistance of the key condenser, as measured by means of a megger, should be infinity. If this resistance is of any finite value, in all probability the circuit will oscillate with the key in the released position. A leaky key will often cause the same trouble. This condenser, as well as the grid condensers and leaks, are mounted atop the upper horizontal panel of Fig. 32.

Two $2\frac{1}{2}$ ohm rheostats and one 7 ohm rheostat serve to control the modulator and oscillator filaments and the buzzer, respectively. An added refinement, though an unnecessary one if good tubes are used, would be the introduction of a separate rheostat for each filament.

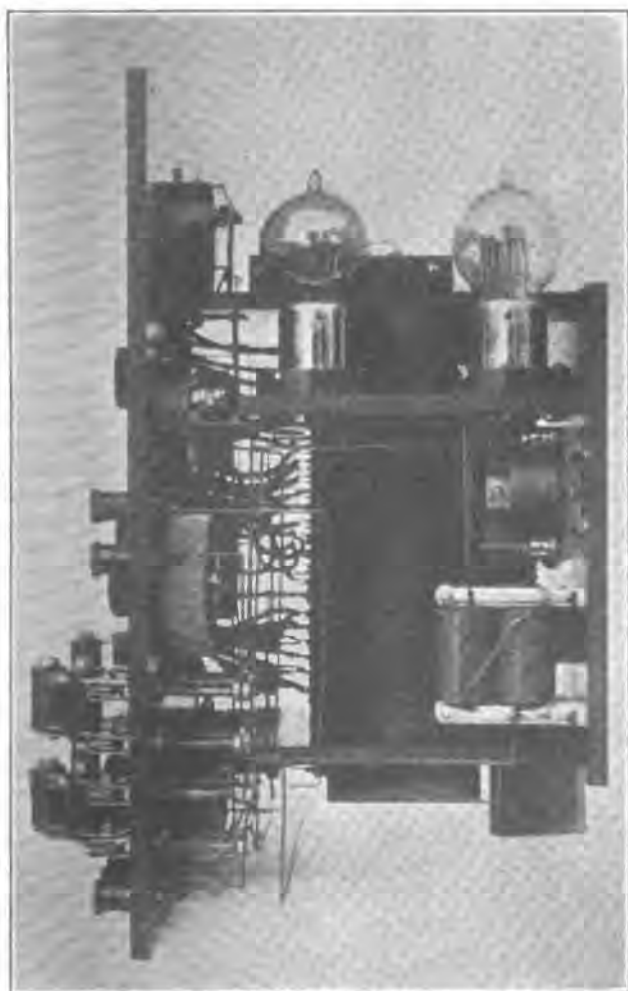

Fig. 31. Right Profile of 10-Watt Set, Showing Location of Modulation Transformer and Audio-Frequency Choke Coil. Note location of Key Condenser Under Lower Sub-panel.

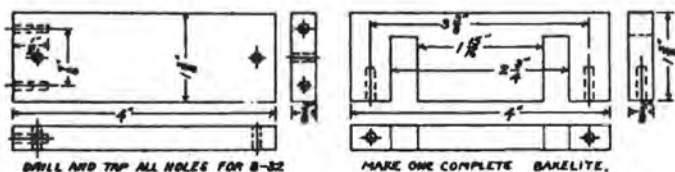

Fig. 35. Dimensions of Bracket for Mounting Honeycomb Coil.

The variable inductance, which is supported between the upper and lower sub-panels of Fig. 31, consists of a Bakelite tube (see Fig. 36 for details) 9 in. long and 5 in. in diameter. It is threaded for 8 in. of its length, leaving a $\frac{1}{2}$ in. margin on each end and wound with 48 turns of 10 by No. 30 enamel insulated wire twisted three cord. A slightly better design of Litz for use with alternating currents of the frequencies corresponding to wavelengths between 200 and 375 meters, could be developed with No. 38 enameled wire. The increased difficulties resulting from the use of such small wire, particularly in regard to making the taps, soldering, etc., would not warrant its use, however. Taps should be provided as indicated in the accompanying table. In making connections to this type of conductor, considerable time and care is required.

The small brass lugs shown in Fig. 36 should be soldered to the Litz in the following manner as the respective turns are wound upon the tube: Clamp a small electric soldering iron between the jaws of a bench vise to steady same. The iron should be previously tinned in order to hold a small globule of solder on the flat part of the point. Immerse the

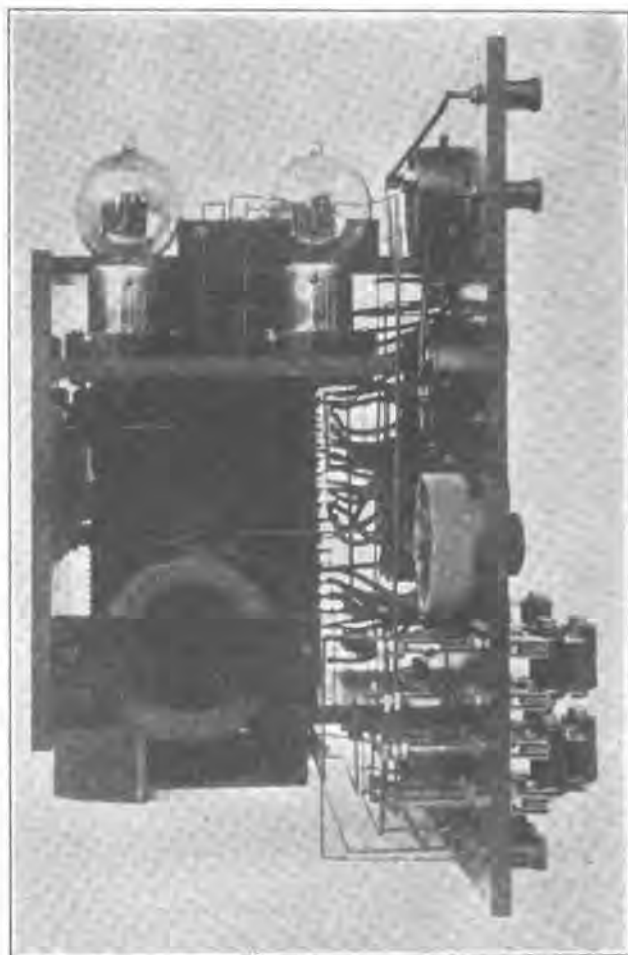

Fig. 32. Left Profile of 10-Watt Set, Showing Location of Radio-Frequency Choke Coil and Plate Series Condenser.

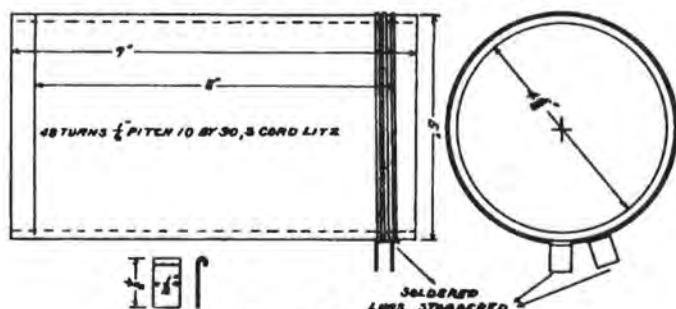

Fig. 36. Details of Variable Inductance.

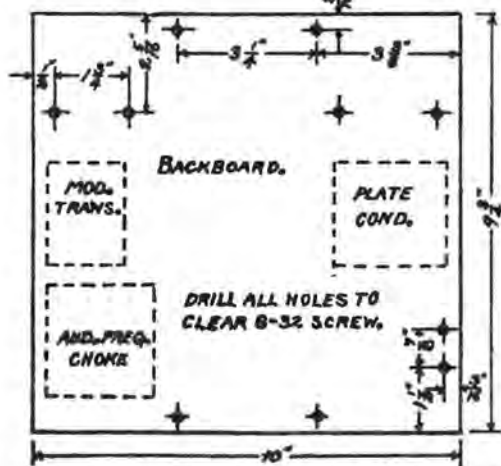
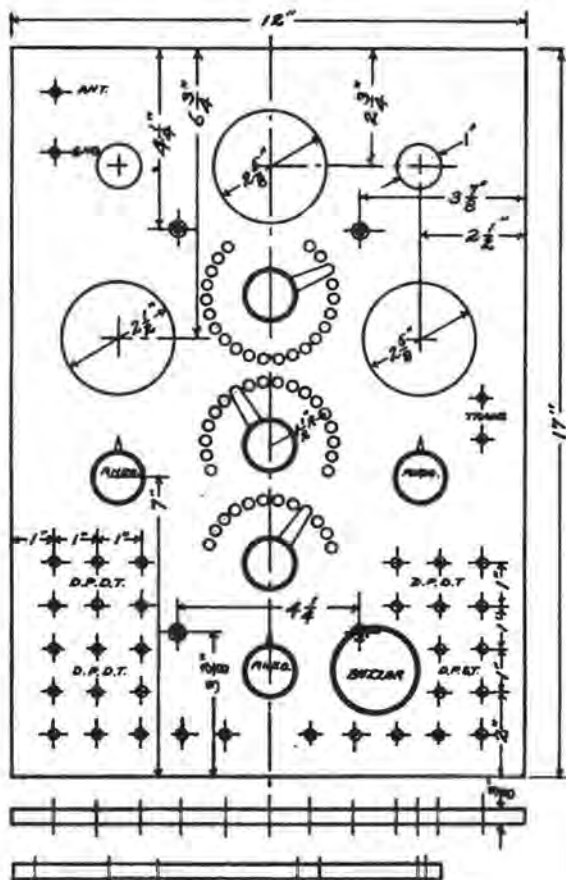

Fig. 37. Main Panel and Backboard Layout.

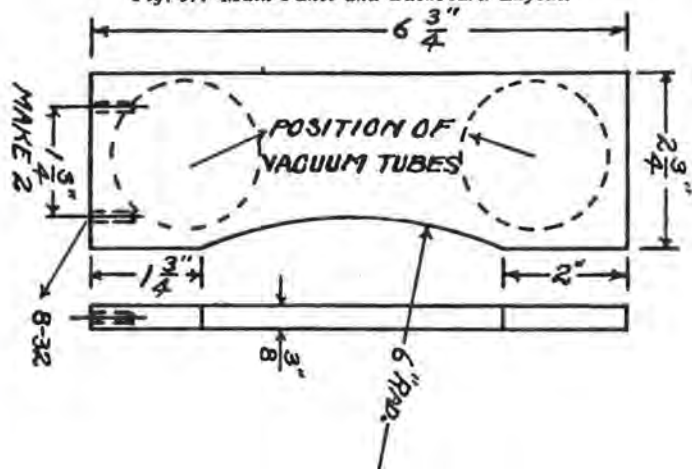

Fig. 38a. Layout of Sub-panel

conductor in this hot solder at the point to be tapped, adding solder if necessary. Holding the wire in this position, scrape carefully with a sharp knife. The enamel, now softened and

GRID TAPS	COUPLING TAPS	WAVELENGTH TAPS	TURN	LUGS
10	10	10	1	22
11	11	11	2	21
12	12	12	3	20
13	13	13	4	19
14	14	14	5	18
15	15	15	6	17
16	16	16	7	16
17	17	17	8	15
18	18	18	9	14
19	19	19	10	13
20	20	20	11	12
21	21	21	12	11
22	22	22	13	10
23	23	23	14	9
24	24	24	15	8
25	25	25	16	7
26	26	26	17	6
27	27	27	18	5
28	28	28	19	4
29	29	29	20	3
30	30	30	21	2
31	31	31	22	1
32	32	32	23	
33	33	33	24	
34	34	34	25	
35	35	35	26	
36	36	36	27	
37	37	37	28	
38	38	38	29	
39	39	39	30	
40	40	40	31	
41	41	41	32	
42	42	42	33	
43	43	43	34	
44	44	44	35	
45	45	45	36	
46	46	46	37	
47	47	47	38	
48	48	48	39	

Table Showing Grid Taps and Switch Connections. In Table to Left Column B Indicates the 48 Turns of Litz, C Shows Position of Lugs, A, D and E, Connections of Various Switch Points. The "Coupling" and "Wavelength" Switches Have 15 Common Connections as

partially charred by the heat, will float to the surface of the globule and can be removed with ease. Using a small piece of solid wire solder as an instrument, apply a small amount of good anti-corrosive soldering paste to the heated section of the conductor, and, if same is properly cleaned as suggested above, the whole should become a solid mass at this

Continued on page 59

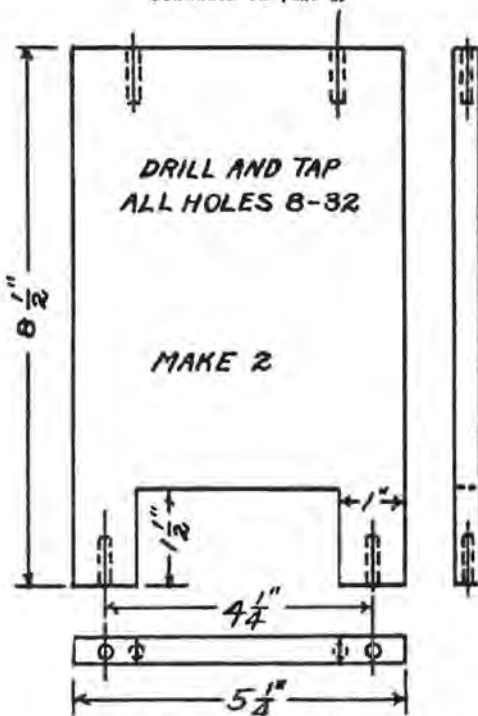

Fig. 38b. Layout of Sub-panel

Radio Broadcasting Stations of the United States

First District

WGI—American Radio & Research Corporation, Medford Hillside, Mass. 8 p. m. daily; sermon and sacred music Sunday. Babson business report, Liberty Bond quotations and popular music Monday; bedtime story for children Tuesday and Thursday; radio talks Friday; popular music and lecture every night.

From this list anyone may tune his receiving set to receive the news, concerts, lectures and sermons that are "on the air" throughout the country. Corrections, changes and additions will be published hereafter. Unless otherwise noted, broadcasting is on 360 meters.

WGY—General Electric Co., 1 River Road, Schenectady, N. Y. Union College—Schenectady, N. Y. Music at irregular intervals.

Fourth District

4CD—Carter Electric Co., Atlanta, Ga. Sunday, Tuesday and Thursday, 7:30 to 8:00 p. m.; music and news services.

Fifth District

WGH—Montgomery Light & Power Co., 111 Dexter Ave., Montgomery, Ala. Daily 11:05 a. m. and 5:05 p. m., weather forecasts; Sunday, 8:30-9:30, address or sermon and sacred music; Tuesday, Thursday and Saturday, 8:30-9:30 p. m., educational matters, farm bulletins, crop statistics, stock quotations and concert.

WRR—Police and Fire Signal Department, 2012 Main St., Dallas, Texas. 7:00 p. m., daily police bulletin, weather and sports; 8:30-9:00, music; Sunday, 11:00 a. m. and 7:30 p. m., church service. Radio Equipment Co., Dallas, Texas. University of Texas, Austin, Texas. Schedule to be announced later. "Texas Radio Market News Service."

Roswell Gas & Electric Co., Roswell, New Mexico.

Sixth District

KZY—Atlantic-Pacific Radio Supplies Co., Rock Ridge, Oakland, Calif. Daily, except Sunday, 3:30-4:30 p. m., concert; 6:45-7:00 p. m., press; Sunday, 11:00 a. m. to 12:15 p. m., sermon and sacred music; 3:00 to 4:00 p. m., concert; Wednesday, 7:30-8:15 p. m., concert; Saturday, 8:15-9:00 p. m., concert.

KDN—Leo J. Meyberg Co., Fairmont Hotel, San Francisco. Daily, except Sunday, 4:30-5:30, markets, press and concert; 7:00-7:15, financial and weather; Sunday, 10:00-11:00 a. m., concert; Monday, 8:30-9:00, concert; Thursday, 7:30-8:30, concert.

KZC—Western Radio Electric Co., Kinema Theatre, Los Angeles, Calif. Daily, except Sunday, 5:00-

5:30 p. m., press; Tuesday, Wednesday and Friday, music.

KZM—Western Wireless School, Hotel Oakland, Oakland, Calif. Daily except Sunday, 7:15-7:30 p. m., sports and foreign news; Tuesday, 7:30-8:15 p. m., concert, Friday, 8:15-9:00 p. m., concert.

KLP—Colin B. Kennedy Co., Los Altos, Calif. Sunday, 4:00-5:00 p. m., concert; Monday, 7:30-8:30 p. m., Industrial News and concert; Thursday, 8:30-9:00 p. m., concert.

KGC—Electric Lighting Supply Co., 5118 Harold Way, Hollywood, Calif. Monday and Friday, 7:30-8:30, concert.

KYJ—Leo J. Meyberg Co., Hamburger's Department Store, Los Angeles, Calif. Daily, except Sunday, 4:00-5:00 p. m., Monday, Thursday and Saturday, 8:00-9:00 p. m., concert, weather, market and general news.

KWG—Portable Wireless Telephone Co., Stockton, Calif. Daily, except Sunday, 4:00-5:00 p. m., press and markets; Sunday, 2:00-3:00 p. m., concert; Tuesday and Friday, 8:00-9:00 p. m., concert.

KJQ—C. O. Gould, 615 E. Main St., Stockton, Calif. Wednesday, 7:00-8:00 p. m., concert.

KVQ—J. C. Hobrecht, Sacramento Bee, Sacramento, Calif. Daily, except Sunday, 5:30-6:30 p. m., press and concert; Wednesday and Saturday, 8:00-9:00, concert.

KJJ—The Radio Shop, Sunnyvale, Calif. Tuesday, 8:15-9:00 p. m., concert; Friday, 7:30-8:15 p. m.

KOW—Herrold Laboratories, 425 So. First St., San Jose, Calif. Sunday, 5:00-6:00 p. m., concert; Wednesday, 8:15-9:00 p. m., concert.

6XAM—Warner Bros., Oakland, Calif. Sunday, Tuesday and Friday, 12:15-1:00 p. m., concert; Saturday, 7:30-8:15 p. m., concert.

AGI—Signal Corps, Presidio, San Francisco. Sunday, 7:00-9:00 p. m., concert and instruction.

KFU—Precision Shop, Gridley, Calif. Sunday, 3:00-4:00 p. m., concert; Monday and Thursday, 8:00-9:00 p. m., concert.

Maxwell Electric Co., Hotel Claremont, Berkeley, Calif. Sunday, 1:00-2:00 p. m. and 6:00-7:00 p. m., concert.

DDV—Noble Electric Works, Monterey, Calif. No schedule yet assigned.

KUO—Examiner, San Francisco. No schedule yet assigned.

Continued on page 56

American Radio Research Corp. Station at Medford Hillside, Mass.



WGB—C. D. Tuska Co., Hartford, Conn. 425 meters; concerts on Tuesday, Thursday and Saturday evenings.

WBZ—Westinghouse Electric & Mfg. Co., Springfield, Mass. Music and news 8:00 p. m. Monday, Wednesday and Friday; church service Sunday, 7:00 p. m.

Second District

WNO—Wireless Telephone Co. of Hudson County, 997 Bergen Ave., Jersey City, N. J.

WDT—Ship Owners' Radio Service, 80 Washington St., New York City.

WDY—Radio Corporation of America, Roselle Park, N. J. Closed; to be replaced by large station located in New York City.

WJZ—Westinghouse Elec. & Mfg. Co., 95 Orange St., Newark, N. J. Daily except Sunday; music every hour from 11 a. m. to 6 p. m. on the hour; weather, 11:00 a. m., 12:00 m., 5:00 and 10:01 p. m.; shipping news, 2:05 p. m. (except Saturday); agricultural reports, 12:00 m. and 6:00 p. m.; Children's Hour, Tuesday at 7:00 p. m.; Arlington time daily at 9:52 p. m.; music on Tuesday, Thursday, Saturday and Sunday, 8:20 p. m. until 10:00 p. m.; Radio Chapel, Sunday 3:00 p. m.

Construction and Operation of a Crystal-Detector Radio Receiving Equipment

(Prepared by the U. S. Bureau of Standards, at the request of the States Relations Service of the U. S. Department of Agriculture for the use of boys and girls radio clubs)

THIS article tells how to construct the entire receiving station, including antenna as well as a crystal-detector receiving set. This station will enable one to hear the messages sent from medium-power transmitting stations within an area about the size of a large city, and to hear high-power stations within 50 miles, provided the waves used by those stations have wave frequencies between 500 and 1500 kilocycles per second (i. e., wave lengths between 600 and 200 meters). Much greater distances are often covered, especially at night. If a person constructs the coil and other parts as indicated, the total cost of this set can be kept down to about \$6.00. If, however, a specially efficient outfit is desired, the cost may be about \$15.00.

ESSENTIAL PARTS OF RECEIVING STATION

There are five essential parts: the antenna, lightning switch, ground connections, receiving set, and phone. The received signals come into the receiving set through the antenna and ground connection. In the receiving set they are converted into an electric current which produces the sound in the "phone." The phone is either one or a pair of telephone receivers worn on the head of the listener.

The purpose of the lightning switch is to protect the receiving set from damage by lightning. It is used to connect the antenna directly to ground when the receiving station is not being used. When the antenna and the connection to the ground are properly made and the lightning switch is closed, an antenna acts as a lightning rod and is a protection rather than a source of danger to the building.

The principal part of the station is the "receiving set." In the set described herein it is subdivided into two parts, the "tuner" and the "detector," and in more complicated sets still other elements are added.

THE ANTENNA, LIGHTNING SWITCH, AND GROUND CONNECTIONS

The antenna is simply a wire suspended between two elevated points. Wherever there are two buildings, or a house and a tree, or two trees with one of them very close to the house, it relieves one of the need of erecting one or both antenna supports. The antenna should not be less than 30 feet above the ground and its length should be about 75 ft. (See Fig. 1.) While this figure indicates a horizontal antenna, it is not important that it be strictly horizontal. It is in

fact desirable to have the far end as high as possible. The "lead-in" wire or drop-wire from the antenna itself should run as directly as possible to the lightning switch. If the position of the adjoining buildings or trees is such that the distance between them is greater than about 85 ft., the antenna can still be held to a 75 ft. distance between the insulators by increasing the length of the piece of rope (D) to which the far end of the antenna is attached. The rope (H) tying the antenna insulator to the house should not be lengthened to overcome this difficulty, because by so doing the antenna "lead-in" or drop-wire (J) would be lengthened.

any unglazed porcelain is used as insulators, it should be boiled in paraffin the same as the wood. Regular antenna insulators are advertised on the market, but the two improvised types just mentioned will be satisfactory for an amateur receiving antenna.

F is the antenna about 75 ft. between the insulators E and G. The wire may be No. 14 or 16 copper wire either bare or insulated. The end of the antenna farthest from the receiving set may be secured to the insulator (E) by any satisfactory method, being careful not to kink the wire. Draw the other end of the antenna wire through the other insulator (G) to a point where the two

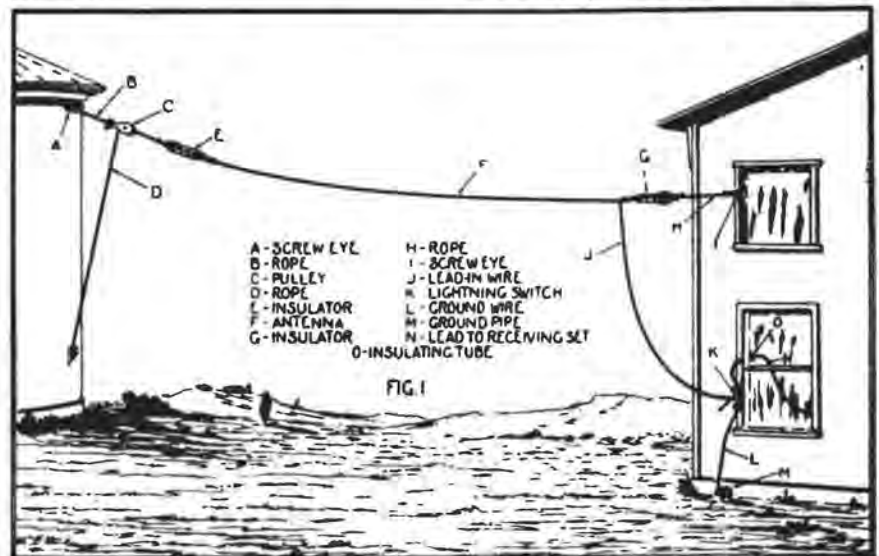

Details of Parts.—The parts will be mentioned here by reference to the letters appearing in Figs. 1 and 2.

A and I are screw eyes sufficiently strong to anchor the antenna at the ends.

B and H are pieces of rope $\frac{3}{8}$ or $\frac{1}{2}$ inch in diameter, just long enough to allow the antenna to swing clear of the two supports.

D is a piece of $\frac{3}{8}$ or $\frac{1}{2}$ inch rope sufficiently long to make the distance between E and G about 75 ft.

C is a single-block pulley which may be used if readily available.

E and G are two insulators which may be constructed of any dry hard wood of sufficient strength to withstand the strain of the antenna; blocks about $1\frac{1}{2} \times 2 \times 10$ in. will serve. The holes should be drilled as shown in Fig. 1 sufficiently far from the ends to give proper strength. If wood is used the insulators should be boiled in paraffin for about 1 hour. If porcelain wiring cleats are available they may be substituted instead of the wood insulators. If

insulators are separated by about 75 ft., twist the insulator (G) so as to form an anchor as shown in Fig. 1. The remainder of the antenna wire (J) which now constitutes the "lead-in" or drop-wire should be just long enough to reach the lightning switch.

K is the lightning switch. For the purpose of a small antenna this switch may be the ordinary porcelain-base, 30 ampere, single-pole double-throw battery switch. These switches as ordinarily available, have a porcelain base about 1 by 4 in. The "lead-in" wire (J) is attached to this switch at the middle point. The switch blade should always be thrown to the lower clip when the receiving set is not actually being used and to the upper clip when it is desired to receive signals.

L is the ground wire for the lightning switch; it may be a piece of the same size wire as used in the antenna, of sufficient length to reach from the lower clip of the lightning switch (K) to the clamp on the ground rod (M).

M is a piece of iron pipe or rod driven 3 to 6 ft. into the ground, preferably where the ground is moist, and extending a sufficient distance above the ground in order that the ground clamp may be fastened to it. Scrape the rust or paint from the pipe before driving in the ground.

N is a wire leading from the upper clip of the lightning switch through the porcelain tube (O) to the receiving set binding post marked "antenna."

O is a porcelain tube of sufficient length to reach through the window casing or wall. This tube should be mounted in the casing or wall so that it slopes down toward the outside of the building. This is done to keep the rain from following the tube through the wall to the interior.

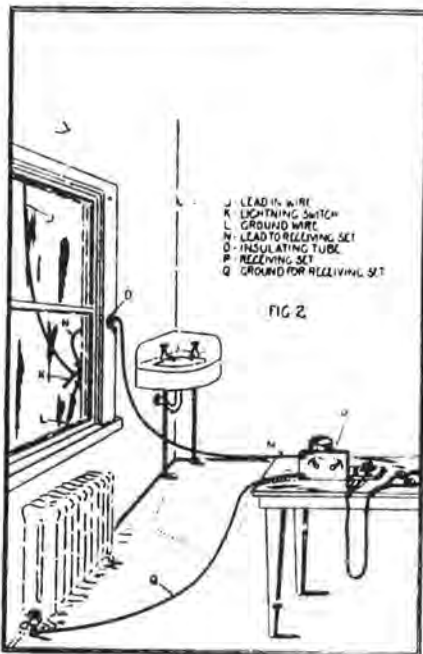

Fig. 2 shows the radio receiving set installed in some part of the house.

P is the receiving set which is described in detail below.

N is the wire leading from the "antenna" binding post of the receiving set through the porcelain tube to the upper clip of the lightning switch. This wire, as well as the wire shown by Q, should be insulated and preferably flexible. A piece of ordinary lamp cord might be unbraided and serve for these two leads.

Q is a piece of flexible wire leading from the receiving set binding post marked "ground" to a water pipe, heating system or some other metallic conductor to ground, except M, Fig. 1. If there are no water pipes nor radiators in the room in which the receiving set is located, the wire should be run out of doors and connected to a special "ground" below the window, which shall not be the same as the "ground" for the lightning switch. It is essential that for the best operation of the receiving set this "ground" be of the very best type. If the soil near the house is dry it is

necessary to drive one or more pipes or rods sufficiently deep to encounter moist earth and connect the ground wire to the pipes or rods. This distance will ordinarily not exceed 6 ft. Where clay soil is encountered this distance may be reduced to 3 ft., while in sandy soil it may be increased to 10 ft. If some other metallic conductor, such as the casing of a drilled well, is not far from the window, it will be a satisfactory "ground."

TUNER, DETECTOR AND PHONE

The detector and phone will have to be purchased. The tuner and certain accessories can be made at home.

Tuner (R, Fig. 3)—This is a piece of cardboard or other non-metallic tubing with turns of copper wire wound around it. The cardboard tubing may be an oatmeal box. Its construction is described in detail below.

Crystal Detector (S, Fig. 3)—The construction of a crystal detector may be of very simple design and quite satisfactory. The crystal, as it is ordinarily purchased, may be unmounted or mounted in a little block of metal. For mechanical reasons the mounted type may be more satisfactory, but that is of no great consequence. It is very important, however, that a very good tested crystal be used. It is probable also that a galena crystal will be more satisfactory to the beginner.

The crystal detector may be made up of a tested crystal, three wood screws, short piece of copper wire, a nail, set-screw type of binding post, and a wood knob or cork. The tested crystal is held in position on the wood base by three brass wood-screws as shown at 1, Fig. 3. A bare copper wire may be wrapped

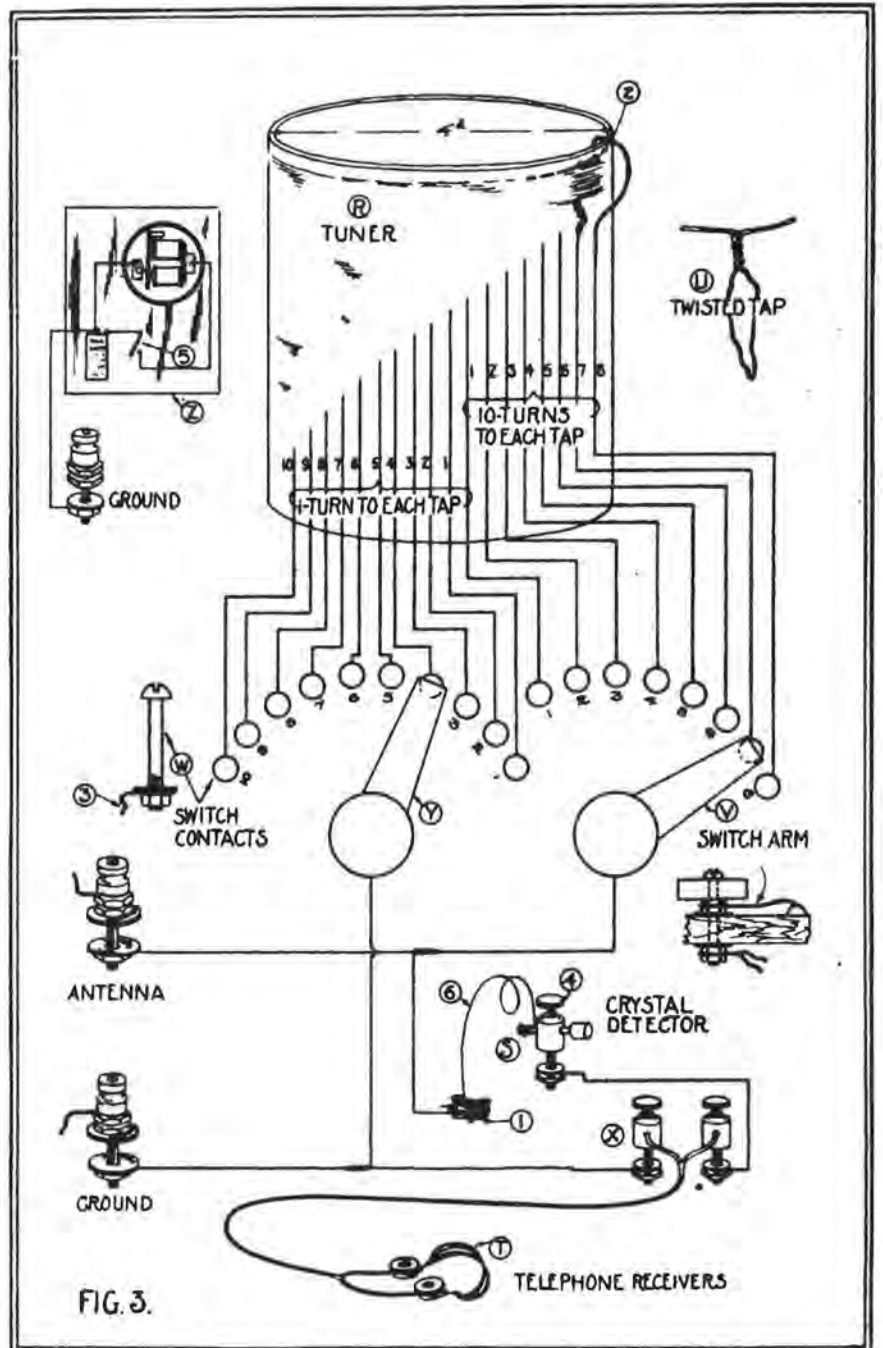

FIG. 3.

tightly around the three brass screws for contact. The assembling of the rest of the crystal detector is quite clearly shown in Fig. 3.

Phone (T, Fig. 3)—It is desirable to use a pair of telephone receivers connected by a head band, usually called a double telephone headset. The telephone receivers may be any of the standard commercial makes having a resistance of between 2000 and 3000 ohms. The double telephone receivers will cost more than all the other parts of the station combined, but it is desirable to get them, especially if one plans to improve his receiving set later. If one does not care to invest in a set of double telephone receivers, a single telephone receiver with a head band may be used; it gives results somewhat less satisfactory.

Accessories—Under the heading of accessory equipment may be listed binding posts, switch arms, switch contacts, test-buzzer, dry battery, and boards on which to mount the complete apparatus. The binding posts, switch arms and switch contacts may all be purchased from dealers who handle such goods or they may be quite readily improvised at home. There is nothing peculiar about the pieces of wood on which the equipment is mounted. They may be obtained from a dry packing-box and covered with paraffin to keep out moisture.

DETAILS OF CONSTRUCTION

The following is a detailed description of the method of winding the coil, construction of the wood panels, and mounting and wiring the apparatus:

Tuner—See R, Fig. 3. Having supplied oneself with a piece of cardboard tubing 4 in. in diameter and about $\frac{1}{2}$ pound of No. 24 (or No. 26) double cotton covered copper wire, one is ready to start the winding of the tuner. Punch two holes in the tube about $\frac{1}{2}$ in. from one end as shown at 2 on Fig. 3. Weave the wire through these holes in such a way that the end of the wire will be quite firmly anchored, leaving about 12 inches of the wire free for connections. Start with the remainder of the wire to wrap the several turns in a single layer about the tube, tightly and closely together. After 10 complete turns have been wound on the tube hold those turns snugly while a tap is being taken off. This tap is made by making a 6 in. loop of the wire and twisting it together at such a place that it will be slightly staggered from the first tap. This method of taking off taps is shown quite clearly at U, Fig. 3. Proceed in this manner until 7 twisted taps have been taken off at every 10 turns. After these first 70 turns have been wound on the tube then take off a 6 in. twisted tap for every succeeding single turn until 10 additional turns have been wound on the tube. After winding the last turn of wire anchor the end by weaving it through

two holes punched in the tube much as was done at the start, leaving about 12 in. of wire free for connecting. It is to be understood that each of the 18 taps is slightly staggered from the one just above, so that the several taps will not be bunched along one line on the cardboard tube. See Fig. 3. It would be advisable, after winding the tuner as just described, to dip the tuner in hot paraffin. This will help to exclude moisture.

Upright Panel and Base—Having completed the tuner to this point, set it aside and construct the upright panel shown in Fig. 4. This panel may be a piece of wood approximately $\frac{1}{2}$ in. thick. The position of the several holes for the binding posts, switch arms and switch contacts may first be laid out and drilled.

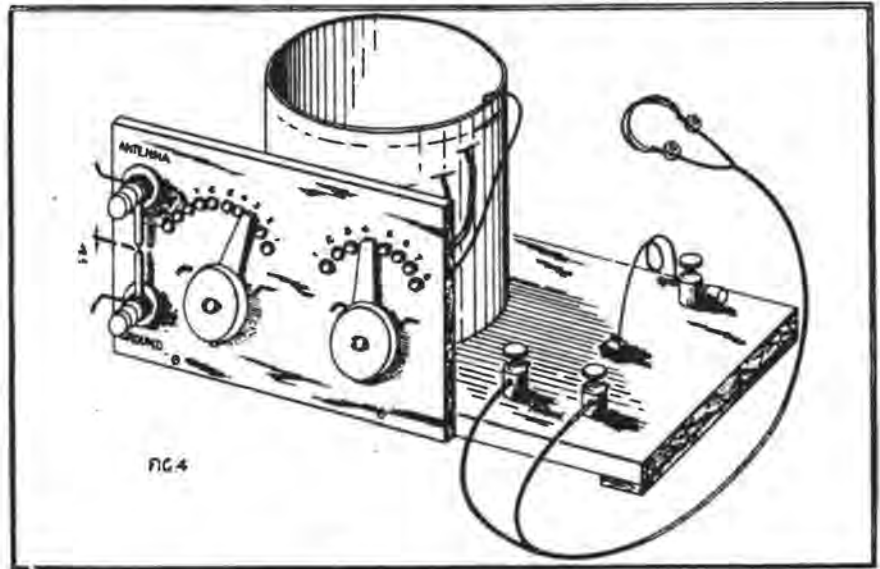

The "antenna" and "ground" binding posts may be ordinary $\frac{1}{8}$ in. brass bolts of sufficient length and supplied with three nuts and two washers. The first nut binds the bolt to the panel, the second nut holds one of the short pieces of stiff wire, while the third nut holds the antenna or ground wire as the case may be. The switch arm with knob shown at V, Fig. 3, may be purchased in the assembled form or it may be constructed from a thin slice cut from a broom handle and a bolt of sufficient length equipped with four nuts and two washers together with a narrow strip of thin brass somewhat as shown. The switch contacts (W, Fig. 3) may be of the regular type furnished for this purpose or they may be brass bolts equipped with one nut and one washer each or they may even be nails driven through the panel with an individual tap fastened under the head or soldered to the projection of the nail through the panel. The switch contacts should be just close enough that the switch arm will not drop between the contacts, but also far enough apart that the switch arm can be set so as to touch only one contact at a time.

The telephone binding post should

preferably be of the set screw type as shown at X, Fig. 3.

INSTRUCTIONS FOR WIRING

Having constructed the several parts just mentioned and mounted them on the wood base, one is ready to connect the several taps to the switch contacts and attach the other necessary wires. Scrape the cotton insulation from the loop ends of the sixteen twisted taps as well as from the ends of the two single taps coming from the first and last turns. Fasten the bare ends of these wires to the proper switch contacts as shown by the corresponding numbers in Fig. 3. One should be careful not to cut or break any of the looped taps. It would be preferable to fasten the connecting wires to the switch contacts by binding them

between the washer and the nut as shown at 3, Fig. 3. A wire is run from the back of the binding post marked "ground" (Fig. 3) to the back of the left-hand switch-arm bolt (Y), thence to underneath the left-hand binding post marked "phones." A wire is then run from underneath the right-hand binding post marked "phones" to underneath the binding post (4, Fig. 3), which forms a part of the crystal detector. A piece of No. 24 bare copper wire about $2\frac{1}{2}$ in. long, one end of which is twisted tightly around the nail (the nail passing through binding post 4), the other end of which rests gently by its own weight on the crystal (1). The bare copper wire which was wrapped tightly around the three brass wood-screws holding the crystal in place is lead to and fastened at the rear of the right-hand switch arm bolt (v), thence to the upper left-hand binding post marked "antenna." As much as possible of this wiring is shown in Fig. 3.

DIRECTIONS FOR OPERATING

After all the parts of this crystal-detector radio receiving set have been constructed and assembled the first essential

Continued on page 68

THE INTERMEDIATE CIRCUIT

By HUGH R. SPRADO

THE present crowded condition of the ether on short wavelengths, especially on 200 meters and on the radiophone concert wave, has forced the writer to make numerous experiments in the attempt to eliminate, or at least greatly decrease, the interference encountered.

In order that others may benefit through the results of these experiments, this as well as other papers have been written. One of the first successful circuits discovered, or rather, unearthed from ancient history, was the intermediate tuning circuit. This circuit was used in the early days of radio by the British Marconi Company in their magnetic detector receivers, but was finally discarded because of its inefficiency when used with magnetic or crystal detectors; the trouble lying in the fact that the increased selectivity offered, was offset by the loss in signal strength, which could

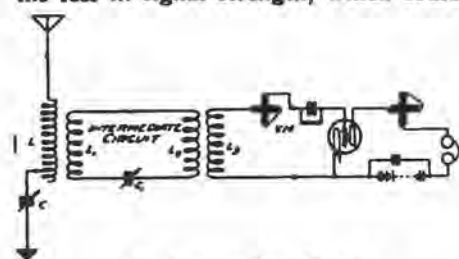

The Intermediate Circuit

not be afforded in those early days of low power transmitters and insensitive detectors. However, the vacuum tube detector and its N stage amplifier has brought back the possibility of this circuit.

The circuit consists essentially of an antenna tuning circuit composed of the primary of a variocoupler L in series with a tuning condenser C; an intermediate circuit of extremely low resistance composing secondary L₁, second primary L₂ and variable condenser C₁ in series; and a standard regenerative receiver secondary L₃ and grid variometer.

The selectivity of the circuit depends primarily upon the intermediate circuit L₁, C₁, L₂. The main requisite in this intermediate circuit is low resistance, and without this essential it is of little advantage. The secondary L₁ and primary L₂ should be wound with small copper tubing having as thin a wall as is possible to obtain. Should it be impossible to obtain copper tubing, No. 10 copper wire can be substituted. The variable condenser should have a maximum capacity not exceeding .0005 mf. and must have low resistance. Coto-

Coil, or General Radio Company's type No. 182 condensers are recommended. The dimensions of the coils are dependent upon the wavelength range desired.

To adjust the circuit for an incoming signal, the antenna circuit is first tuned to approximately the wavelength of the transmitting station and with the coupling between antenna and intermediate circuit, and intermediate circuit and secondary fairly close, the intermediate circuit is adjusted to resonance with the antenna. The secondary or tube circuit is now adjusted for maximum signal strength. When all these adjustments have been made, loosen the coupling between the various circuits slowly, returning for resonance for each change in coupling. The coupling should be made as loose as is consistent with good signal strength. It will now be found that a fractional part of a degree on the intermediate condenser will completely erase the signal, and interference from stations only a few meters off of the working wave will be greatly decreased.

It is extremely important that no energy from the antenna circuit be coupled directly into the tube circuit. This is possible if the two coupling coils are in close proximity unless thoroughly shielded. It is advisable to separate the two couplers several feet and arrange the coils so they are at right angles. To test for any direct coupling effects, tune all circuits to resonance with some station that is transmitting a loud signal. Keeping all adjustments as made, open the intermediate circuit completely by removing some connecting wire. If the signal is still heard, energy is being transferred directly to the tube circuit and good selectivity cannot be secured. It will be necessary to further increase the distance between the couplers or rearrange their position until no signal is heard in the telephones. This test should be made with full amplification.

When all adjustments of coils have been made as outlined, the circuit will give great selectivity and, in many instances, louder and clearer signals than the single coupled receiver. Due to its extreme selectivity, the operator may have some difficulty in finding a certain station, but his efforts will be well repaid by the freedom from interference.

This intermediate circuit can also be calibrated and used as a receiving wave meter for checking the wavelengths of transmitting stations. A very accurate wavelength check can be made if the coupling is kept sufficiently loose to prevent any reaction between circuits. Accuracies within one-half of one per cent are possible on weak signals and one-tenth of one per cent on strong signals.

In conclusion, the writer wishes to imbed one fact: *The intermediate circuit must be of extremely low resistance to be effective.*

ELIMINATING THE GRID BATTERY

By HUGH R. SPRADO

IN all radiophone transmitter circuits using the Heising constant current system of modulating the oscillator tube output, a negative grid potential is required on the grid of the modulator tube. This grid potential, or grid biasing as it is called, is the most important adjustment on a radiophone transmitter and, when overlooked, is the cause of most of the distortion in transmitting speech.

Practically every schematic drawing of a Heising modulator shows a battery of dry cells in the modulator grid circuit to maintain the necessary negative potential. As a result, the experimenter uses dry cells; which in time become inoperative and noisy, causing all sorts of queer noises to be transmitted.

Fig. 1 shows a circuit by means of which the battery of dry cells can be dispensed with and a far more constant and automatic grid potential maintained. For simplicity, only the modulator tube connections are shown in the figure. P and S are the primary and secondary respectively of the modulation transformer.

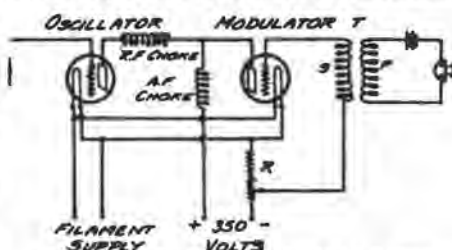

Circuit for Eliminating the Grid Battery.

R is a variable resistance of sufficient capacity to carry the combined oscillator and modulator plate currents without excessive heating. This resistance is connected in series with the negative high voltage lead to the tube filaments and carries the total plate current of the oscillator and modulator tubes.

Any current passing through this resistance will cause a certain potential drop across its terminals, and it is this potential drop that we will use as a negative bias for the modulator grid.

Assuming that we are using two 5 watt Radiotrons, one as an oscillator and one as a modulator and also assuming that the proper grid potential for these tubes is negative twenty volts, we will find by Ohms Law that, with a combined plate current to both tubes of 100 milliamperes, the potential drop across a resistance of 200 ohms will be 20 volts.

Where

$$I = .1 \text{ ampere}$$

$$E = 20 \text{ volts}$$

$$R = \frac{E}{I} = \frac{20}{.1} = 200 \text{ ohms}$$

As this resistance is in series with the negative lead to the filament, the grid of the modulator will consequently be

Continued on page 74

Scratchi Starts Business Careering

By David P. Gibbons

To Editor "RADIO" (which amplifies its percolation in high-stepping fashion):

DEAREST SIR:

You will be quite glad, maybe so, to be inform that my Cousin Scratchi has obtained for himself new radio position and are again very joyously in synchrony with all mealtimes. He have now become gracious dispenser of knobs, dials and binding posts for wireless retailer who require only experts of supreme type. He extend to me permit to visit him and inspect the high-value stockup in showoff cases. I do so and while my cousin are giving lucid lecture to lady with little boy on oppositeness of vacuum bulb from rayolite crystals, I regard among the glassy shelves for some up-to-the-moment send and receive equipments, but fail to expose any such. Instead of these I gaze in upon some E. I. Co.'s model one slip coil tuners, and also many ancient audion detecting panels which are large and awkward as operator's trunk. When Scratchi discover that lady and little boy are even dumber than appearance, he supply hasty excusing and tell them come along again any time—not matter when, and he then explode to me how he propound to become great plute in radio gameplay.

"Are not some brains necessity to become that way?" I ask to find out.

"Those which I possess are very sufficient for purpose," he make rapid give-back to me. "Since I attain to touch up large groups of radio-buying public through generous square inch messages in truthful part of 'RADIO'."

"Mightbe then you have obtained learned degree from corresponding university for high paying adwriting experts?" I accuse him.

"Assuredly not," response of Cousin Scratchi, "as new system which I devolve are mostly composed of prize contesting and donating free souvenir objects for each cash sum which customer forward. For instant, with every A. P. A. tube, which are most sensible known to radiartist, I shall inclose one Lessgo Tuner, which last month at Ketchifcan, Alaska, make ten old sea dogs bark out 'Gosh ding your shandigaffs! Wot next!! Wot

next!!!' Also with each Half-Ready B battery I shall wrap up one Gall Radio Delay Machine, which do everything which operator should do and have no intelligence either."

"How then," I say, "can you acquire difficult cash money when making such costly giveaways?"

"Because I shall also have for selling other equipments to go along with these, such as half dozen vary condensers, resisting coils, storing cells, without which donations are silent as Sphinx," he explainate. "Yes, silenter than two Sphinxes," he add in afterthink.

"What style of contest have you in head?" I wonder at him.

"With aid of Hon. Man, who know something of these, I shall derange new one each issue," quote Scratchi. "First one will be contest in snappy sending and snippy receiving and will be confined excludedly to old timer operators. Old timers are those who first learn of ships when Von Tirpletz and Hon. Hearst are sinking entire Pig's Island put-out daily on front page. In order to save country old timer made confidence talk with Embarcadero ship—candling person who supply him 1st class uniform and 1st class license for small down payment, and he then take part in many warmish engagements in San Pedro and Coos Bay sectors. He also accept slight bonus while doing so, which are much wiser than bearing around many tons of communicating wire at front with Signalling Core and seeking bonus two years after lucky comeback, among loud shouts of 'Stick up! Bums!!' and so on from reformed profiteers. Special prize for this test shall be beautiful hammered glass cuspidor of two trip capacity."

"When will this be yanked off?" I depose.

"Soon as all old timers are on beach once again," he quack, "and next prize struggle after this will be grand free-for-everybody QRM contest which shall be open to all, whether amateurs, professionals or admiraline operators. This

event will be pulled over on Mile Rock Lighthouse at one minute to noon whistle and object are to compose wireless bloc against time and weather signals, and make foolish listeners still more foolish. Prize in this contest will be one-way tickets to Russia on first maru passing out, for the ten members with most solid domes."

"Are experts from glorious navy invite to partake in these premium winnings?" I rogate.

"Cannot allow such," moan my cousin, "since NPX, NPE and NPW now are world champions in long period sleeping contest, and can win all such prizes without moving fingers."

"Do business need much of this pepping?" I interfere.

"Mine do," he make spreckely answer, "and in few months I shall retire to classy bungalow in Burlingame like all successful hootchleggers."

You see then Mr. Editor that my Cousin believe that radiogame are now beyond well known corner where business have been turning around for several past months, and hoping you are the same, I remain,

Your valued reader,
HILOLI NOGO.



Business Before Pleasure



The trouble is, whenever a guy comes out with a great invention, everyone thinks he's a nut.



Ralph Kline, Noted Character Impersonator, Exhibits Successively, Scepticism, Surprise, Realization, Interference, and Finally Complete Radio Satisfaction. Pictures Used by Courtesy San Francisco Bulletin.

THE RADIO FACE

Have you a "wireless face?" There has been the "speed face," the "motor face" and the "airplane face." Now comes the "face" that is acquired from listening to a wireless telephone concert. It is the face of radio satisfaction with the smile that refuses to come off. It is the face of contentment.

The "wireless face" is the face of the future. When every home shall have a wireless telephone in it, and broadcasted concerts are as common as debts, the general expression will be one of continued pleasure. If you would be down to date, install a wireless set, sit down before your mirror, and watch your "wireless face" grow.

THE WAIL OF A WIRELESS BUG'S WIFE

By BERNICE M. HARRISON

SAY, girls, if you think you've a grudge against life, just list to this wail from a wireless bug's wife.

I clean up my house, now real spic and span, then comes—a cyclone? No, just my man. Whang! goes a bottle on my clean kitchen floor. Some acid flies out and runs through the door. It rambles along 'neath the pretty new rug, while I stand and bless (?) my radio bug.

He looks so abused that I have to let up, and to hug me, he drops some lead on a cup. To cheer me he tells of a wonderful plan, "to cut out short circuits in any ash pan."

When he's out late at nights, "at other bugs' homes," he tells me he's been "to sift out some ohms."

He's forever at changing his station around. We sleep on antennae and cook on the ground. For breakfast we always, to please that big kid, have pancakes because they're baked on a grid. Our milk must always go through a condenser, or sometimes his language would hardly pass censor.

But then—I half think his mind's not quite right, for tell me, I pray, why should he bake a light? He's talking so much about "controlling jack." When I ask who that is, he just turns his back. Then sometimes he talks of "tuning a wave." It worries me sick to hear that bug rave. He talks of "mounting" on some kind of "plug," and "charging a

battery," and something to "lug." The use of such slang, I just can't approve. He's got to reform, or someone will move. He's been "binding posts," and he says, "switching points," but I can't believe he's been "soldering his joints."

He has a new chum, whom he calls "Mike A." Now that may be who is leading my dear boy astray. "Resistance" he's talking from morning till night, and of "choking" someone till I'm fainting from fright.

There's wires in the parlor and strung through the doors. There's boxes and tables and things on the floors. The coal's on the lawn, for the shed's full of trash. It's enough to make any wife do something rash.

Oh girls! If you think you'd like married life, consider the wail of a wireless bug's wife.

THE D.X. BRINGER-IN

An All-Wave Receiver

By STUART A. HENDRICK, 2BJG

HEREWITH are pictures and diagrams of a receiver that will regenerate, oscillate and detect up to 30,000 meters, bringing in arcs from all over the world on detector tube alone. It has no dead-end losses as the long wave part is disconnected from the rest of the circuit while not in use. Signals will not fade after removing hand from knob. No shielding is necessary. No switches or contacts are necessary over the entire range. It is easily tuned, having but one wavelength control, one vernier and a regenerative control.

The picture of the rear of the set shows a variometer and a coil on the side of it. This coil contains the fixed primary and secondary windings. It is 3 in. in diameter and 4 in. long. The secondary nearest the variometer has 50 turns of No. 18 wire, D. C. C., and the primary has 20 turns of No. 18 D. C. C. wire 1/8 in. away from the secondary wound upon the same tube. This coil is the secret of the sharp tuning and regeneration.

Two variable condensers are used to tune these coils, a .001 mfd. across the secondary, and a .0015 mfd. either in shunt or series with the primary. The secondary condenser tunes extremely sharp and the primary condenser is used



Front and Rear View of Set as the vernier. The variometer controls the regeneration.

This makes a fine short wave set, which is the equal of any on the market today, and does away with the hard tuning of the ordinary two-variometer set. The wavelength may be calibrated directly upon the secondary condenser scale.

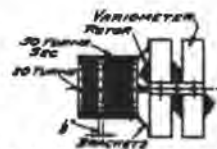
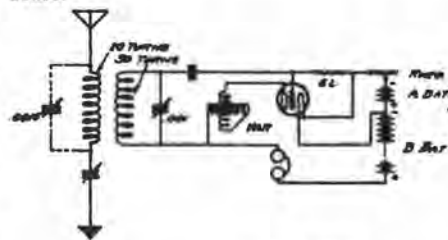

Circuit Diagram

To get the long waves, the set should be loaded with honeycomb or similar coils in the primary, secondary and plate circuits at the place marked X in the circuit diagram. These can be movable or fixed, but the correct polarity will have to be found by experimentation. Plugs and jacks or key-switches may be used to insert these loading coils in the circuit. The grid condenser is rather critical, and should be made by clamping two copper strips 1x1/4 in. on each side of a piece of .003 (3 mil.) mica.

A Radio Primer

By H. A. Eveleth

THE ETHER

THERE seems to be a general impression among people who are not acquainted with the principles of wireless communication that the air is the medium by which wireless signals are transmitted. They hear the received signals as sound and naturally assume that the receiving instrument has the faculty for picking up sound waves sent out from the transmitting station. This is, of course, not so.

The medium of transmission of wireless signals is the so-called ether, a "something" which is believed to exist throughout all space. Scientists cannot describe it with certainty nor give definite proof of its existence, but they assume that it must exist in order to account for the phenomena of light, heat and certain electrical effects. For instance, we receive light and heat from the sun, a distance of some 93,000,000 miles. Now those light and heat rays must be carried by a medium just as your voice is carried by the air. Several hundred miles above the surface of the earth there is no air. Therefore light and heat waves from the sun must be carried by some other medium, which is called the ether. Observations show that the ether must exist between the molecules of all matter, in fact the earth rushing through it at a velocity of thousands of miles an hour causes no displacement of the ether, in other words the ether passes through the earth like air through a sieve; further, that it is of an extremely elastic nature, so much so that a disturbance of the ether at any point immediately spreads out in all directions just as the sound waves spread out when a gun is fired.

Air waves travel about 1100 feet per second while ether waves have a velocity of about 186,000 miles per second. This terrific velocity, which according to the Einstein theory is the greatest that can be attained in the universe, can be quite accurately measured. Light, heat and wireless waves are all forms of ether waves. You can create sound waves by making a "noise." You can create water waves by tossing a stone into water. The function of the wireless transmitter is to create ether waves and the function of the wireless receiver is to detect those ether waves and change them to sound waves which can be heard and understood.

WAVE MOTION

IF you toss a stone into a pond of water a series of waves spread out in all directions over its surface. If it is a small stone it will generate a series of small waves quite near together, while a larger stone will set up bigger waves

which are not so close together. The distance between two successive crests of two waves is called the wavelength. In the case of these water waves it may be a few inches or it may be several feet. The larger wave is what you might call a higher wave and it is said to have more amplitude than the smaller wave. It has more energy and can do more work, such as lifting a piece of drift wood, because it was generated by a larger stone.

A series of waves in the ether, or wave-train as it is called, is created whenever a flow of electricity takes place. The particles of which electricity is composed, called electrons (the exact nature of which is not known) have a "grip" on the ether, so to speak, and cause a stress or strain to be set up in the ether whenever a movement of electricity takes place. By reason of its great elasticity this disturbance in the ether spreads in all directions in the form of ether waves, with the velocity of light, 186,000 miles per second. The smallest ether disturbance, even that caused by the flow of current when ringing a bell, sets up ether waves which travel to an indefinite distance. Our problem is to improve our receiving apparatus rather than our transmitting apparatus. Ether waves can be sent around the earth with an expenditure of little energy. The problem is to perfect our apparatus so that it will detect waves of extremely small amplitude. At present our trans-oceanic stations have to employ hundreds of kilowatt of power because the receiving apparatus will not detect the signals if less power is used.

WAVELENGTH

THE law says that amateur stations shall not transmit on a wavelength greater than 200 meters. Just what does wavelength mean?

Going back to our water analogy we said that the wavelength is the horizontal distance between two successive wave crests. So in the case of ether waves a wavelength of 200 meters would mean that the horizontal distance between two successive crests is 200 meters. A meter is a little over 39 inches.

We said that ether waves have a velocity of 186,000 miles per second. This is equal to about 300,000,000 meters per second. Remember this is not theory; it can be shown by experiment. Since the velocity of ether waves is practically the same under all conditions if we know the wavelength we can tell how many waves there are per second, or what the rate of vibration is, in other words, the frequency. For instance, a wavelength of 300 meters would represent a frequency of one million cycles per sec-

ond because 300 million divided by 300 gives one million. The present practical limits of wavelength range for radio communication are 150 meters to 20,000 meters, which represents a vibration range of from two million to 15,000 per second which would be inaudible. The average human ear cannot "hear" sound waves below forty nor above 10,000 vibrations per second. So it is apparent that "radio-frequencies," as they are called, are inaudible. Hence our receiving apparatus must reduce the radio-frequencies to audio-frequencies, so they can be heard, and this is the function of the detector in the receiving apparatus. The detector rectifies the high frequency radio current to an audio pulsating direct current which can be heard in the receivers.

All light and heat waves are ether waves of extremely short wavelength and high frequency. Your eyes detect ether light waves and your nerves ether heat waves. The different frequencies of ether light waves determine the different colors. Heat waves consist of 20 trillions to 300 trillions of vibrations per second; light waves 430 trillions to 740 trillions per second and ultra-violet and X-rays 870 trillions to 1500 trillions per second.

ABSORPTION, REFLECTION, REFRACTION AND DIFFRACTION OF ELECTRIC WAVES

CONSIDERABLE energy is absorbed from ether waves as they travel over the country. Irregular country, that is, rough and hilly with forests, absorbs more energy than level country. Foliage absorbs energy from the advancing wave, hence a station located in heavily wooded territory can transmit farther during the winter months than during the summer months. Bear in mind that trees are more or less conductive and tend to absorb energy just as aerials do, in fact trees have been used as aerials for receiving messages by connecting a wire to spikes driven into the tree trunks. Buildings absorb energy; in fact any object extending into the air and grounded tends to rob the ether waves of energy. The better conductor the object is the more energy it absorbs.

All soils absorb energy to a certain extent. The greatest distances of communication can be accomplished over salt water. The absorption over some soils is 30 times as great as over salt water.

Much greater distances can be covered at night than during the day. This is thought to be due to ionization of the higher atmosphere by ultra-violet light from the sun, which makes the air conducting and hence absorbs energy.

Continued on page 55

How to Finish Your Cabinet

By B. H. Linden, Assistant Radio Inspector

TOO much stress cannot be laid on the importance of a properly finished cabinet in the neat appearance of a radio station. Most amateurs do not realize this, or otherwise their stations would bear witness to this fact. Is it because the pocket book is too slim and the lack of knowledge is such that the amateur becomes satisfied with almost anything for a covering of a set that justly deserves better? If so, then this article will not go amiss.

When one contemplates the construction of a building, the foundation is of the utmost importance and so it is with the finishing of a piece of wood. First see that all planer marks are removed and that a flat, smooth surface is obtained by the usual method of scraping and sandpapering; always use a block when sandpapering, as this insures a flat surface, doing away with the possibility of having mounds and hollows which would show up in a highly finished cabinet. It is surprising how polishing the surface of an object brings out the defects that exist which otherwise might hardly be noticeable.

There are various kinds of stains that may be employed for a satisfactory coloring. Among them are alcohol, oil, turpentine and water stains. The alcohol and water stains have a tendency to raise the grain of the wood so as to make finishing more difficult, but on the other hand their use results in a clean, bright looking completed work. Johnson's wood stains are recommended, as the writer has obtained some very excellent results with their use. Otherwise, powdered aniline with alcohol may be used. As aniline is a coal tar product, any solvent derived from coal tar, such as benzol, can be used. Aniline and water make a very good water stain. Umber in its raw state, calcined or burnt can be used with either water or oil. It is the same with ochre. As umber and ochre are of ferruginous clays and can be found in various forms and colors, they make a very permanent stain when used with boiled linseed oil and turpentine, also allowing a variety of colors when mixed.

If it is desired to give gum wood a rich golden finish, simply mix sufficient turpentine with boiled linseed oil so as to make it flow easily and apply to the natural wood with a brush. As gum is a fine grained wood, the oil, in addition to its staining qualities, acts as a splendid filler, drying very hard.

Turpentine and lampblack make a reasonable as well as excellent stain for oak and pine. This combination should be applied with a brush and rubbed off before dry. The mixture should be

rather thick, about the consistency of priming paint. Various shades may be had by the addition of ochre and umber.

In building up a body to work upon, shellac may be used entirely, three coats of shellac and a flooding coat of varnish, or just varnish alone. If the work must be completed in a short time, the first method should be employed as shellac dries so quickly; it being possible to finish a cabinet in one day. When varnish is used, three days at least, should be allowed. Remember the importance of shellacing and, especially, varnishing in a warm and dust-proof place, also that the brush to be used should be free from dust particles. Extreme care should be exercised in sandpapering or steelwooling between each application of either varnish or shellac.

After the drying of the final coat, when pores of the wood should be entirely filled, everything should be ready for the last steps to be taken for obtaining the lustre and polish which is so much desired. There are two means whereby this end can be accomplished; one is by the use of rottenstone and the other by means of French polishing. The former is by far the easier, but sometimes the latter is preferred.

When rottenstone is to be the polishing medium, then a felt pad, one-quarter inch thick, should be mounted on a hand block and used to do the rubbing with. Rottenstone and water applied freely with plenty of "elbow grease" will obtain the desired results. Obviously, washing and then dry polishing with a clean cloth is necessary after rottenstoning. A dull gloss finish may be obtained by using oil with rottenstone instead of water.

French polishing is a great deal more tedious. A rubbing pad must be made of a woolen core and a linen covering. This pad is partially saturated with alcohol and a small amount of shellac, while a very few drops of raw linseed oil are sprinkled on the piece to be finished so as to prevent sticking. Now, with a continuous circular movement with the pad on the object to be polished, the body of shellac or varnish can be loosened and moved around gradually so as to obtain a very smooth surface, after which the pad is allowed to dry out by lengthy rubbing when a high polish will be obtained.

In order to French polish properly, some practice on material not needed will be necessary, as the first attempt usually turns out to be a failure. If one learns the art of French polishing, scratches, watermarks, weather checks, etc., can be removed from furniture and the original lustre and finish brought back by just

using the above mentioned pad, with alcohol and raw linseed oil, on the old body, without any further application. Similarly, the original lustre may be brought back on automobile bodies when the varnish is still intact.

TEXAS RADIO MARKET NEWS SERVICE

Plans to install agricultural market news for Texas daily by radiophone have been completed after a conference between officials of the State Department of Agriculture, State Department of Markets and Warehouse, the University of Texas and the Federal Bureau of Markets and Crop Estimates, Washington, D. C. The necessity for a general diffusion of reliable information fresh from the loom is evidenced by a growing public desire from all trades and professions, manifested in the great number of constant inquiries and requests received daily by state officials for information.

The plan is to obtain daily market reports from the central markets of the country through the Kansas City office of the United States Bureau of Markets and Crop Estimates and from other sections of the country through other agencies. The data will be collected by the State Department of Agriculture, compiled by the State Markets and Warehouse Department, and disseminated by the University of Texas. The news will be broadcasted through the University high power radio station each day to the various radio receiving stations throughout the state promptly at a given time, which time will be announced later.

It is thought that this service will be of greatest value to farmers, farmers' organizations, distributors of farm products and commercial organizations, but any individual, association or organizations may also receive it free of cost by installing a simple radio receiving apparatus which can be had at a small cost.

Texas has many radio clubs, and literally hundreds of radio receiving stations fully equipped to receive radiophone messages. It is probable that the Chambers of Commerce in each town or city will wish to make their organization the radio news center for the community by posting bulletins and relaying the news by telephone to interested parties. It is contemplated, if possible, to release the news from Austin at a time which would seem most convenient for the press.

Geo. Endress, who represented the University of Texas in the conference, will have charge of the university radio station, and J. Austen Hunter has been designated as a joint representative of the

Continued on page 52

Resistance in Radio Circuits

By Charles K. Fulghum

IT IS the purpose of this article to explain to the reader the "hows" and "whys" of resistance in circuits oscillating at radio frequencies. The effect of resistance on the various elements of such circuits will be dealt with in such a way that the amateur may grasp the importance of its proper distribution in such circuits.

The loss of electrical energy due to the electronic structure of a conductor carrying an electrical current, and depending on the proportions and qualities of that conductor, may be expressed in terms of resistance. Since resistance in any circuit represents power loss it is desirable to minimize it. This is especially true of radio circuits where resistance not alone represents power loss but may seriously interfere with the proper functioning of that particular circuit.

Direct currents flowing in a conductor are evenly distributed through it, but we find that alternating currents of radio frequencies have a tendency to flow on the surface of the conductor. This "skin effect" increases with the frequency and at very high frequencies the current flows entirely on the surface of the conductor. The resistance of conductors carrying such currents depends largely on the surface condition of the conductor. The form that the conductor takes has been found, also, to greatly alter the resistance. This high frequency resistance has been calculated for certain forms of conductors and the ratio of d.c. resistance to a.c. resistance at various frequencies has been determined.

Copper tubing has been found to offer the least resistance to currents of radio frequencies and its use in radio circuits has met with wide favor. Copper strip is also used, but the edge effect presents a drawback to its use in certain forms of apparatus, especially the oscillation transformer.

Stranded wires of a variety of forms have been designed to lower the high frequency resistance. The use of such wire is particularly recommended in the construction of inductances of high values.

For a minimum of resistance to high frequency currents of large values, a conductor composed of parallel strands widely separated, has been proposed. Such antenna, correctly constructed and designed, offer a minimum of ohmic resistance and a maximum of radiation surface.

Considering the radio circuit and resistance in general, it may be said that aside from the power losses entailed by the resistance in the circuit, it also has the effect of increasing the damping of the oscillations taking place in that circuit and of lowering the "sharpness of reson-

ance." Increasing the resistance in such a circuit will cause it to tune "broad," all other constants remaining the same. Since selectivity is a most desirable feature in the receiving unit, it would be well to look to the minimization of the resistance in that part of your apparatus. In wave meter work the problem of resistance should be seriously considered. As the resistance will vary with the frequency, it is well to calibrate the instrument at a number of frequencies, especially if it is to be used as a decremeter. This resistance measurement is made by the U. S. Bureau of Standards.

Since the antenna may be considered as a simple radio circuit, it is apparent that if we want sharp tuning and a "persistent" antenna, we should keep the ohmic resistance of the system as low as possible.

While considering antennae systems an explanation of the term "radiation resistance" would not be out of place. Since radiation represents power loss we may express this loss in terms of resistance. Thus "radiation resistance" is merely an expression of power loss by radiation. It varies inversely as the square of the wavelength, and is proportional to the square of the current flowing at the anti-node of the antenna.

The effect of resistance on the various components of the oscillating circuit is very marked. This is especially true of the capacity elements of such circuits. Serious losses may take place in radio circuits due to poor condensers, or condensers with imperfect connections.

A perfect condenser when introduced in to the radio circuit will not add to the resistance of that circuit. Such a condition is not realized in practice, however. In a resistance the current and voltage are in phase with each other, but in a condenser the current is 90° out of phase with the voltage.

A condenser placed in a circuit that is in oscillation acts as a conductor by virtue of its capacity, but if we put a condenser that is imperfect, i. e., one that introduces resistance into the circuit, in such a circuit we will cause serious power losses. These losses depend upon the resistance caused by the condenser and upon the frequency of the oscillations occurring in the circuit.

Should we use a condenser with an imperfect dielectric or one with leakage between the plates, we would find that these losses grow less as the frequency is increased. A condenser with a resistance in series, however, causes power loss which increases with the frequency. This resistance may be caused by imperfect connections or by poor contact between the plates. The resistance of the plates is usually small and its effect may be con-

sidered negligible.

The effect of resistance upon the inductance in the circuit is not as serious a consideration as its effect on the capacity. In general, the resistance should be kept as low as possible. In designing inductances, especially if they are to be used in wave meter work, the amateur should use wire that will not unduly increase the resistance of the circuit in which it is used and the inductance itself should be designed with a minimum of resistance in view. There are proper proportions for inductances which will keep the resistance at radio frequencies at a minimum. These data may be found in various texts on the design of radio apparatus and the reader can gain much aid from the publications of the Bureau of Standards.

In thermionic tube circuits the grid leak often plays an important part. The grid leak may be defined as a non-inductive resistance element shunted across the grid condenser. It functions as a leakage path for the negative charge which accumulates on the grid. Were it not for this resistance, the charge would become so great as to paralyze the action of the tube. In power tubes of high rating this charge may represent a current of fairly high amperage. The necessity of employing resistances that will adequately handle this current is apparent.

It may puzzle some readers why the specification "non-inductive" is made. Altho the current that flows in this circuit is really d.c., it is rapidly fluctuating, and possesses the characteristics of an a.c. Were a resistance used that was inductive, i. e., a coil of wire of the required resistance, it would act as a choke and prevent the proper action of the tube. Shunted across the condenser it would act too, as a frequency trap.

In receiving units using vacuum tubes, the resistance of the receivers used is an important item. Some amateurs think that it is upon the resistance that the sensitiveness of the receiver depends, but this is not true. Using vacuum tubes it is necessary that the impedance of the receiver equals that of the tube used. The same is true of inter-valve transformers and of telephone transformers if they are used. The sensitiveness of the receiver is dependent, however, upon the number of ampere turns producing a maximum magnetic flux in the poles and diaphragm.

It is hoped that the above outline will give the reader something to think about and that he will, after reading this make a serious study of the connections in that "pile of junk" (father's words), that he so proudly designates as a "real re-generator."

Construction of a Wavemeter for Tuning C. W. Transmitters

By George F. Patrick

A WAVEMETER for amateur work having a range of from 150 to 450 meters may be put together at a low cost by any club or individual. A calibrated variable air condenser, an inductance of known value, and a thermo mil-ammeter or current squared meter are required. The coil may be home-made if desired, although it may be purchased for less than \$2.00 from one of the radio supply houses. The condenser and mil-ammeter may be purchased at a cost of \$20 or less for both.

of the manufacturers who put out coil units for use on receiver panels, with instructions to measure its inductance accurately and mark the value plainly on the coil. Its slight expense is preferable to buying material, making a form, calculating the size and number of turns, winding, and then most important of all, calibrating a coil.

Variable air condensers of .001 microfarad capacity may be purchased for from \$5 to \$10, depending on the mounting. It pays to buy the better class for wave meter use, as those having a skeleton mounting leave the plates exposed and liable to be bent or disarranged through handling, which would disturb the calibration. In ordering, stipulate that an accurate calibration curve must accompany the condenser unless there are means at hand for calibration. As a rule such means are lacking in the amateur station.

A mil-ammeter with full scale reading of 100 mils is suitable and such may be purchased for about \$10. Two strips of brass or copper $\frac{1}{8}$ in. thick by 1 in. wide and 6 in. long, with one end of each strip drilled to fit over the two binding posts of the condenser and the ends drilled to take one connection post of the coil and the mil-ammeter respectively, complete the wave meter. The mil-ammeter and coil are connected by a straight piece of low resistance wire just long enough to reach both connections. The coil and meter mountings and the assembly are shown herewith.

The wavelengths values may now be computed and the curve constructed using the values furnished with the coil and condenser and the formula

$$WL = 59.6 \sqrt{LC}$$

wavelength being expressed in meters, capacity (C) in micro-farads and inductance (L) in centimeters. If the inductance of the coil is given in microhenries multiply this value by one thousand to convert into centimeters.

If the company furnishing the condenser does not furnish a calibration curve, but only maximum and minimum values of the condenser it will be necessary to construct a curve. This however, amounts only to marking the points of maximum and minimum capacity on a sheet of co-ordinate paper and drawing a straight line between the two points, the curve approximating a straight line. From this curve we read the condenser capacity at 10, 20, 30, 40, 60, 80, 100, 130 and 170 degrees of the condenser scale. In the curve shown herewith for

example, these values would be .000097, .00015, .0002, .000255, .00036, .00047, .000575, .000735, and .00095 mf. respectively. Figuring the wavelength for these values, using the value of 57,000 cm. for our coil and the above formula we obtain wavelengths of 140, 174, 201, 227, 270, 308, 341, 386, and 439 respectively. Plotting these values against condenser scale degrees on a sheet of co-ordinate paper we obtain the wavelength curve. If desirable a paper scale may be

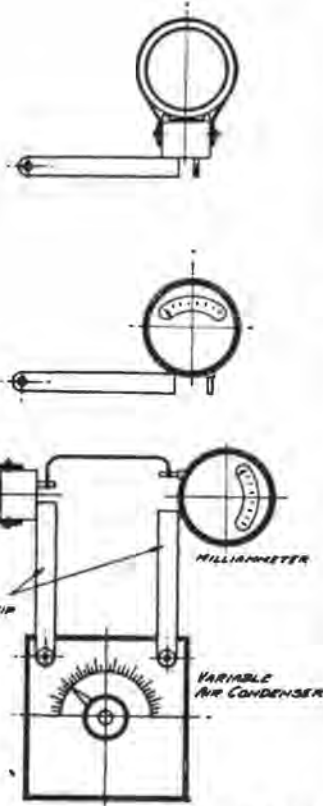

Meter Assembly, Below, with Details of Coil and Meter Mounting, Above.

The coil should be of rigid construction so that its turns and shape will not be disturbed in handling, as this would cause a slight change in its inductance value. It should preferably be of Litz wire and of honeycomb, duo-lateral, or lattice winding in order to keep the distributed capacity at a minimum. This is not necessary, however, as any kind of wire or winding will do where approximation is sufficient and very accurate results are not sought. An inductance value of 57 microhenries in such a coil when used with an air condenser of .001 microfarad capacity at full scale will give a range of 150 to 450 meters wavelength.

The better way is to order such a coil of 57 microhenries inductance from one

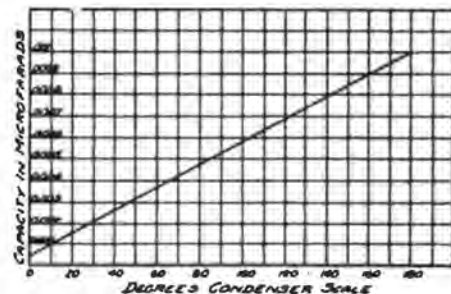

Calibration Curve of Condenser

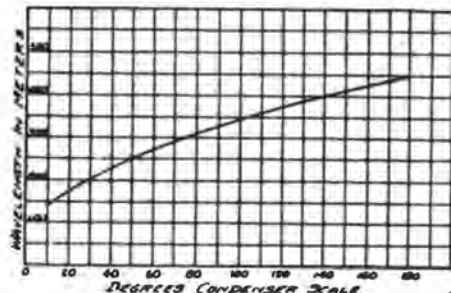

Wavelength Curve

pasted on the condenser top and the wavelengths marked opposite every five degrees of the scale. This will allow direct reading instead of having to refer to the curve. If another calibration wave meter is available the better way is to calibrate the new instrument from it, using it as a driver by means of a buzzer and marking the resonant point on the meter being calibrated as indicated by a crystal and telephones connected across the condenser. Two coils, one of 30 microhenries and one of 60 microhenries, with calibration curves for each would be better than one of 57 microhenries and would give better results. It must be understood that there will be inaccuracies more or less pronounced in such a wave meter. The only way in which these can be avoided is by very careful design and construction and laboratory calibration. Such a meter however will prove useful around a station and the cost is not prohibitive.

Queries & Replies on C.W. practice by Gerald M. Best, Technical Advisor.

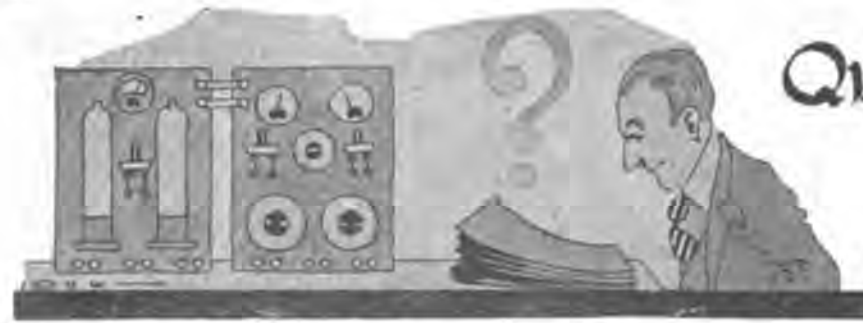

Question: I am sending a circuit for an I. C. W. transmitter, using a spark coil for the plate supply. This works well on one 5 watt tube. Would a British spark coil, 3 or 4 inch size, furnish sufficient power to supply a 50 watt power tube in this circuit?

W. A. B., Soneham, Mass.

Answer: I doubt very much if the spark coil you have would furnish the power necessary for a 50 watt tube. You can make your transmitter more flexible by making the following changes shown in Fig. 1.

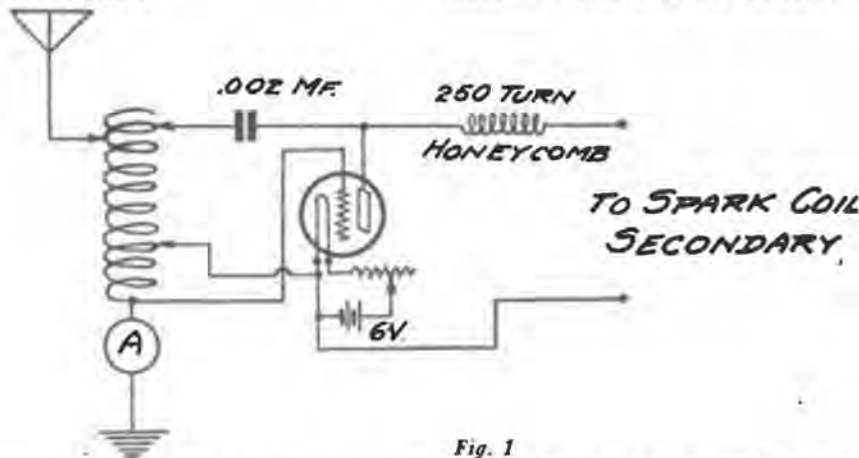

Question: Kindly furnish me with the name of a book covering the manufacture or construction of relays for wireless control.

B. M. M., Spokane, Wash.

Answer: With the exception of occasional articles written for the various radio publications, by experimenters interested in such work, there are no books on the subject. If you are interested in the purchase of a relay, however, I would suggest that you write to J. E. Jones, Box 22, Palo Alto, Calif., who is distributor for the Hall Recording Relay.

Question: Please tell me which antenna would be most suitable for receiving 360-meter concerts; one wire 150 feet long, or four wires 75 feet long, the former being the easiest for me to construct.

E. W. F., Dixon, Calif.

Answer: If the antenna is to be used for receiving only, by all means use the single wire 150 feet long, as such an aerial, together with the lead-in and ground leads, would have a fundamental wavelength just about right for the 360 meter music.

Question: Please publish a diagram of a two-step audio frequency amplifier to include automatic filament control, using Remler cam switches instead of jacks, and same "A" and "B" batteries. Please give me a circuit for a 4-jar electrolytic rectifier for charging batteries.

P. E. R.

Answer: Fig. 1 on page 29 of the March number of RADIO answers all of your questions except the Remler cam switch. If you use automatic filament control jacks you cannot also use cam switches. Which do you prefer? The

HOW TO DESIGN A C.W. ANTENNA FOR 200 METERS

By GERALD M. BEST

A FEW days ago I heard two C.W. enthusiasts comparing notes with each other via the air route, one being sharp on 200 meters and the other somewhere around 230 meters. The one with the higher wavelength was complaining of his inability to make his C.W. set oscillate on 200 meters and he was asking the other for advice as to what changes he should make in his inductances, series condenser, and other apparatus, in order to get down to the legal wavelength. There is every reason to believe that the seat of the trouble lay not in his apparatus, but in his antenna system, which probably had a fundamental wavelength so far above 200 meters as to render work on that wave impossible.

This seems to be the experience of many beginners in C.W. They construct a large antenna, perhaps 150 ft. long and 50 ft. high, and when they begin transmitting, to their dismay they discover that the lowest wavelength at which the transmitter will function is well above 200 meters and no adjustments will persuade the set to oscillate on or below the legal wave.

It is for those amateurs who are in such a difficulty, that I review briefly the reasons why a small antenna is better for C.W. work than a large one.

We have had a regular epidemic of freak antennae of late, ranging from wired cage types to bed springs and screen doors. Thanks to Ensign Dow's discourse on "Why the Cage Antenna?" in the March number of RADIO, it will not be necessary at this time to give any particular reasons why the cage types are no better, if as good, as the flat tops. Neither will I quarrel with the advocates of the "fan" antenna. The latter takes up a lot of room, which few of us have to spare, and is expensive to construct. Hence, I will assume that one of the flat top types, such as the "T", inverted "L" or slanting "L" of four wires, will be the one most commonly used in C.W. transmission.

There are two principal reasons why it is highly desirable when using C.W. to have an antenna system with a fundamental wavelength well below 200 meters. One is to thus avoid the use of a series condenser, which not only re-

Fig. 1
circuit for the 4-jar rectifier is shown in Fig. 2.

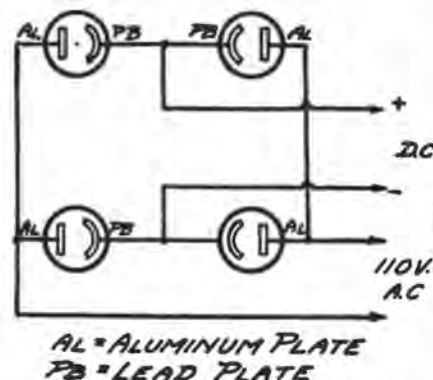

Fig. 2

Question: In the Armstrong super-heterodyne circuit shown in February Radio, what coils will have to be changed in order to increase the wave length of the set? Should the heterodyne oscillator coils be variable?

I. A. N., Lockport, N. Y.

Answer: The antenna tuned circuit coils, and the Heterodyne Oscillator coils

C. W. Association of America

Founded by Lawrence Mott

RADIO 3FS

By C. J. BENZING

Following is description of station 3FS, at 2425 S. Twelfth St., Philadelphia, Pa.:

Transmitter when heard by 6XAD and 7FQ was only 10 watts with radiation of 2 amps, using rectified a.c. and 550 volts. The rectifier consisted of 12 jars (6 on a side). Rectifier consists of 1/2 inch strips aluminum and lead plate 1/16 inch thickness, and saturated borax solution. Have since increased power to 15 watts with 16 jars and plate voltage of 700. Radiation, 2.6 amps. Using Colpits circuit with high voltage across ground condenser. My receiver consists of home-made regenerator with



Radio 3FS

1 step of audio amplification. The antenna is of the inverted L type, 60 ft. high at free end, and 50 at lead-in end. 6 wires spaced 3 ft; 3/8" pipe for spreaders. Masts are iron pipe. The guy wires and masts are grounded, being connected in with regular ground, which consists of water gas and drain pipes. Antenna 45 ft. long.

Station 3FS C. W. transmitter has been in operation since August, 1921, and has been heard in every district.

ASSOCIATE EDITOR'S NOTE: It will be remembered that I made especial mention of Mr. Benzing's wonderful work—on 2 five watt tubes—in March RADIO. But it is only fair for me to add that this photograph of his transmitter and receiving apparatus is as astounding to me, as it well must be to all who understand C. W. work! I repeat my statement of last month, to the effect that I have had great pleasure in working 3FS on many occasions—as our logs will show. He

6XAD will not be on the air regularly between April 1 and Oct. 1 due to increasing QRN, and because of his duties as game warden during the fishing season at Catalina Island.

is always QRK at Avalon, Catalina Island, Calif., and when QRM and QRN permit I work him with as much ease as a local on the neighboring mainland!

I would point out that in 3FS we have no huge outlay of money invested in intricate, farcial and useless apparatus! We see no 250 watt tubes lying side-by-side, like a lot of pot-bellied, drunken soldiers! We see no maze of wiring—cob-web fashion—everywhere! 3FS brags of no marvelous antenna and ground systems! The photograph shows no 4-5-6-7-8 steps of amplification!

No! In this photograph we are shown such a set as practically ANY amateur can afford. Modest, very neat, and marvelously efficient, I present to our readers that which, to my mind—and I have worked many Eastern C. W. stations—is as MODEL, inexpensive C. W. set of apparatus as I believe exists in the U. S.! And I would point out to them that are interested, and who might become interested in C. W. transmission, that Mr. Benzing is in the heart of a great city, with all the attendant radio difficulties of imperfect grounds, inadequate space for aerial, losses from nearby metals, etc. YET his signals reach unto 6XAD with unvarying clarity and precision!

Compare these two results:

1. From the shores of the Atlantic Ocean to Scotland—ALL OVER WATER—on 990 admitted watts.

2. From the center of a great city—across the entire United States on TEN watts!

Further remarks are superfluous! (Saving to remark that 3FS received 6XAD on but TWO-steps of amplification.)

THE FALLACY OF MUCH AMPLIFICATION

By LAWRENCE MOTT

IN the last issue I briefly took up the matter of having been able to reach great distances from my station—6XAD, on Catalina Island, California—with but four five-watt tubes, on a wavelength of 220 meters. Since that time there have been numerous DX stations worked

by me, and reporting me, on this small set, whose calls I give further along.

The objective of this article is to once and for all time disprove the alleged theory to the effect that many stages of amplification are imperative for DX reception. For the last month I have been working 3AQR (Hershey, Pa.), 8BUM and 8BSS (Syracuse, N. Y.), 8AWP (Syracuse, N. Y.), and 3ALN (Washington, D. C.) with great regularity—delivering messages to these stations on four five-watt tubes!

So much for this.

I propose now, to briefly quote from the hundreds of cards that I have—in order to show the kind of apparatus that my signals have been received on—all over the United States and Canada. These facts will amply speak for themselves.

- 1BLN (Westfield, Mass.) on detector only.
- 2F (Brooklyn, N. Y.) on detector and 2-step.
- 3ALN (Washington, D. C.) on detector only.
- 3BHY (Philadelphia, Pa.) on detector only.
- 3CA (Roanoke, Virginia) on 2-step.
- 3CG (Newton, New Jersey) on 2-step.
- 3HJ (Harverford, Pa.) on 1-step.
- 3BF (Roanoke, Virginia) on 1-step.
- 3JJ (Washington, D. C.) on detector only.
- 3JI (Toronto, Canada) on home-made spider-web. No ampli.
- 3FS (Philadelphia, Pa.) on 1-step.
- 3NB (Canadian, Sarina, Ontario) on 1-step.
- 3JK (Canadian, Toronto) on spider-web and 1-step.
- 4CB (Canadian, Morse, Sask.) on 2-step.
- 4CO (Decatur, Georgia) on detector only.
- 5OP (Houston, Texas) on 1-step.
- 5HK (Oklahoma City, Okla.) on 2-step.
- 5ZA (Roswell, New Mexico) on 2-step.
- 7FI (Pullman, Washington) on 2-step.
- 7GO (Salem, Oregon) with aerial and ground CUT OUT and 1-step.
- 7RN (Cashmere, Washington) 1-step.
- 8JL (Cleveland, Ohio) on 1-step.
- 8AGK (Lancaster, N. Y.) on 2-step.
- 8AMK (Rochester, N. Y.) on 2-step.
- 8BRL (Crafton, Pa.) on 1-step.
- 8BMX (Buffalo, N. Y.) pickle tube only.
- 8BDG (Cleveland, Ohio) detector only.
- 8EW (Crafton, Pa.) detector only.
- 8JQ (Washington, Pa.) 1-step.
- 8AMM (Webster, N. Y.) on 2-step.
- 8BK (Cleveland, Ohio) 1-step.
- 8GY (Euclid, Ohio) on 1-step.
- 8AXI (Syracuse, N. Y.) on 2-step.
- 8IZ (Milan, Ohio) on 1-step.
- 8KW (Buffalo, N. Y.) detector (pickle-tube) only.
- 8ZAC (Barnesville, Ohio) detector only.
- 8BXX (Norwalk, Ohio) detector only.
- 8WO (Buffalo, N. Y.) "pickle tube."
- 9DTM (Denver, Colo.) 1-step.
- 9DVA (Denver, Colo.) 2-step.
- 9AOG (Lawrence, Kansas) 2-step.
- 9JQ (St. Louis, Mo.) on 1-step.
- 9RC (Chicago, Ill.) on 2-step.
- 9BAD (Ellendale, N. Dakota) detector only.
- 9NX (Wichita, Kansas) 1-step.
- 9AIF (Sioux Falls, S. Dakota) 2-step.
- 9LW (Wahpeton, N. Dakota) 2-step.
- 9AJA (Chicago, Ill.) 1-step.
- 9ZN (Chicago, Ill.) "all over room on 2-step."
- 9ASN (St. Paul, Minn.) on 2-step.
- 9AIG (Sioux Falls, S. Dakota) on 2-step.
- 9XAQ (Boulder, Colo.) on 1-step.
- 9DZE (Wichita, Kansas) detector only.

And so it goes, through a LONG list of other stations! It will be remarked that in NO case is more than 2-steps

Continued on page 60

DIGEST OF RECENT RADIO PATENTS



Prepared by White, Proast & Evans, Patent Attorneys, San Francisco, who have been particularly active in the radio field for many years, and from whom may be obtained further information regarding any of the patents listed below.

H. D. Arnold, Pat. No. 1,403,475; Jan. 17, 1922. Vacuum tube circuits.

A tandem connection of amplifier tubes is described, in which the output circuit of the first tube includes an impedance such as 25 and 28 in series with the plate battery 27. The input circuit of the second tube is connected across this impedance through a condenser 26 which prevents the direct current from battery 27 from flowing in this circuit. The input circuit is also bridged by the resistance 29, so that a direct electrical connection may be had between the grid and filament of this input circuit.

O. B. Blackwell, Pat. No. 1,403,835; Jan. 17, 1922. Frequency control system.

This patent describes a scheme for controlling, from a single distant station, the frequencies used by groups of transmitting and receiving stations. The master control station transmits a definite fundamental frequency energy to all of the stations. Each of these stations, however, is equipped with proper devices to modify the frequency and to amplify the energy to the desired values. This may be accomplished by proper modulators, filters, etc.

I. Langmuir, Reissue No. 15,278; Jan. 31, 1922. Electron discharge apparatus.

An evacuated 3-electrode tube is described, in which the grid is wound as a flat helix on a frame support, this helix enclosing the heated filament forming the cathode. The anode is also formed of fine wire stretched in zig-zag formation on hooks 12 supported on a forked member 13. It is claimed that this construction lends rigidity and reliability to the device.

R. M. Allen, Pat. No. 1,401,121; Dec. 27, 1921. Mounting for vacuum tubes.

In order to prevent injurious vibrations from disturbing the relative spacing of the electrodes in a vacuum tube, it is mounted on a resilient member 12, such as sponge rubber.

H. S. Read, Pat. No. 1,403,566; Jan. 17, 1922. Vacuum tube repeater circuits.

A tandem vacuum tube arrangement is described, consisting of the two tubes 2 and 3. The arrangement seeks to wipe out any inherent fluctuations in the direct current source 13 which is included in the output circuits of both tubes 2 and 3. Such fluctuations even if relatively small are objectionable since they, too, are amplified and distort the signal. To regulate this current a regulator tube 22 is used, inserted in the battery circuit of tube 2, its impedance being made dependent upon the current flow through this circuit. This is accomplished by causing the potential difference between the filament 20 and grid 25 to be dependent upon the drop across the resistance 19 which is in series in the battery circuit. If the current through battery 13 tends to vary, the potential drop across 19 varies, and regulates the potential of grid 25 to minimize this variation. The regulator tube 22 also prevents variations in the space current between electrodes 4 and 6.

J. R. Carson, Pat. No. 1,403,841; Jan. 17, 1922. Frequency control system.

A system is described in which a master control station radiates energy at several frequencies to intercommunicating stations. These in turn manipulate the frequencies by special apparatus at each station to provide their own definite transmitting frequencies and modulating frequencies. At the master control station there is generated a modulating frequency too low for radio transmission, such as 10,000 cycles, and used merely for obtaining variants from the radio frequencies generated there. By the aid of this system, definite ranges of frequencies may be assigned to intercommunicating stations.

H. J. Round and G. M. Wright, Pat. No. 1,403,640; Jan. 17, 1922. Wireless telegraphy.

A system of aeriels ABC and ADE for direction finding is described. Each loop in-

cludes a coil JK or GH with which a third exploring coil L is in close mutual induction. The whole system can then be tuned by proper variation in the condenser M connected to the exploring coil L, since the aeriels are aperiodic closed loops. It is thus unnecessary to choose very accurately the dimensions of the aeriels, which would otherwise be the case if open aeriels were used. Close tuning is an essential for direction finding in this system, and the present invention provides an easy way to accomplish this result.

F. S. McCullough, Pat. No. 1,403,700; Jan. 17, 1922. Apparatus for directing transmission of electromagnetic waves.

The transmitting circuit of this directive system consists of a source of radio frequency

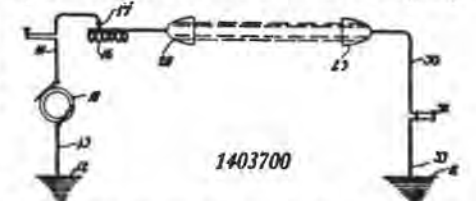

oscillations 10, an inductance 16 and the special paraboloid shaped capacity 20, which gives the system its directive properties. This member is formed of flat ribbon to provide a skeletonized surface. The receiving system also includes an identically formed member 25.

Radio broadcasting of congressional speeches at Washington is provided for in a resolution introduced by Representative Brennan of Washington. Brennan explained that in introducing the resolution he had in mind the placing of radio communication under close observation of Congress at a time when bills are being introduced looking to its development and control and to the encouraging of experimentation and study by amateurs.

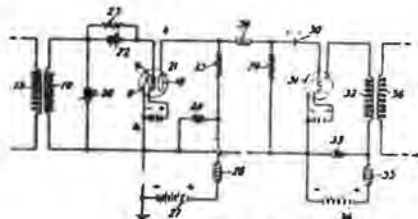

1403475

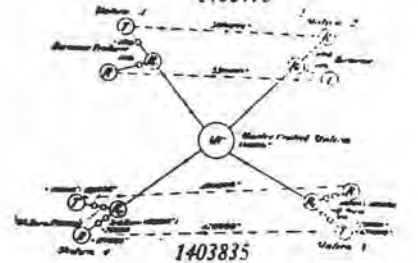

1403835

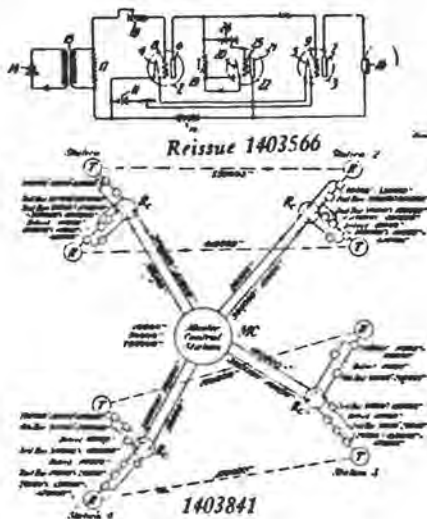

Reissue 1403566

1403841

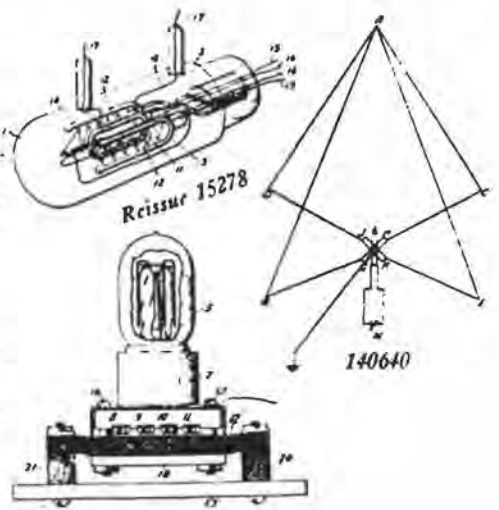

Reissue 15278

140640

1401121



With THE U-S-Radio Inspector

CONDUCTED BY MAJOR J.F. DILLON



A MONTHLY DEPARTMENT OF INFORMATION FOR OUR READERS

Questions and Answers

Question: I have recently changed my a. c. W. set to a phone, using pure dc. on the plates, but I want to use C. W. telegraph, also. Will I have to return my license for correction?

H. J. N., Oakland.

Answer: No. If you are already licensed for C. W. there is no limit on the use of C. W., I. C. W., or telephone, provided, of course, that it is operated according to law.

Question: How may an amateur prepare for a commercial license?

K. N. K., Kansas.

Answer: Attendance at a good radio school is the simplest and quickest way. Amateur experience only counts 5 per cent, while a total experience credit of 20 per cent is allowed by the regulations. School experience, provided the applicant has attended a resident school for at least three months, will count 10 per cent. An amateur remote from such schools may obtain a reasonable mark, but in general, it will require much closer attention to detail, and more thoro personal study than if the candidate has attended school. There are many good text books on the market which will prepare a student for the examination, and in addition the "Radio Laws and Regulations of the U. S." should be carefully studied. This may be procured from the "Superintendent of Documents, Government Printing Office, Washington, D. C." for 15c. (Stamps not accepted.)

Question: I recently failed for an amateur operator's license. May I apply for a commercial license before the three months have elapsed? H. D., Berkeley.

Answer: No. You must wait three months. There is no alternative.

Question: What is the lowest class and grade of operator's license that a person may hold to act as operator of a broadcasting station? J. G. F., Sacramento.

Answer: At least a Commercial Second Class, Third Grade License will be required. Anyone holding a higher grade of license may, naturally, serve.

Question: Can the holder of a Commercial First Class License have his license renewed without examination, if his entire service has been in a broadcasting station? Same.

Answer: No. The holder would only be eligible for a Commercial SECOND Class License. The grade would be determined by the man's service, and his ability as an operator—i. e., his ability to copy 25 words per minute.

Question: May amateurs use apparatus infringing on certain patents? H. G., Seattle.

Answer: The Department of Commerce has no jurisdiction over the patent rights of any person, or persons, and does not take cognizance of any such particulars. This is a matter for the owners of the patents to take up, it is believed, altho no definite information is at hand regarding the exact details of the patent laws.

Question: Can a person not an American citizen get a U. S. amateur or commercial license? A. C., Los Angeles.

Answer: There is no law against such a

person getting a license as an operator, but he cannot be granted a station license.

Question: If the above answer is "no," can he obtain a license if he has lived here two years, intends to continue here and his parents have taken out their first papers?

Answer: Station licenses can be granted only after final papers have been taken out.

Question: Why is it advantageous to have the poles of a telephone receiver permanently magnetized?

Answer: The answer, if given complete, requires quite a lengthy explanation. The magnitude of the attraction and repulsion between the magnetic core and the diaphragm depends, not only upon the strength of the field created by the varying current through the coils, but upon the strength of the permanent magnetic field as well. The force of attraction between the poles and the diaphragm varies inversely as the square of the distance separating them and directly as the square of the magnetic force acting upon them.

Let us take for an example the case of a simple electric magnet in a receiver in which the alternate positive and negative current impulses create a magnetic field of X and -X, respectively. The corresponding difference in field strength according to the above would be the difference in their squares. If we let X equal 10, the squares become 100 and 100, and the difference therefore is 200. Let us assume that a force varying 200 units displaces the diaphragm 1 mm. We will now replace the soft iron core of the magnet with one permanently magnetized, having a field strength of say 20, and then apply the same current as before. Now the field strength due to the positive current impulse will be added to the steady field, i. e., 20 plus 10, or 30, and when the negative impulse acts upon it the strength will be reduced by a like amount—20—10, or ten, and the corresponding squares will be 100 and 900 respectively, and the difference will be 800, and since a variation of 200 displaced the diaphragm 1 mm in the case of the simple electro-magnet, the displacement due to the action of the permanent magnet will be four times as great, and the amplitude of the current produced in the receivers will be increased in the same proportion.

The fact should be kept in mind that if the permanent magnetic field strength is increased until the diaphragm becomes saturated, that the effect of any current variation in the coils of the magnet will be almost negligible, and in that case the permanent magnet becomes a disadvantage. It will be thus seen that there is a distinct relation between the thickness of the diaphragms and the strength of the magnetic field. Neither the core nor the diaphragm should be nearly magnetically saturated if the optimum results are to be obtained.

J. F. DILLON,
Radio Inspector.

Question: How far can I transmit on a 5 watt tube? H. L. K., S. F., Cal.

Answer: This is entirely a matter of guess-work. A 5 watt tube set might work several hundred miles, under favorable conditions, and then again it might work only 50 miles, or so. It depends on so many factors, that no estimate can be given. Why not try and see?

COMMON OPERATING FAULTS

By D. B. McGown,
Assistant Radio Inspector

How many operators, either amateur or commercial, know the contents of the rules and regulations books? Not many, I warrant, know all the rules, and set forms for the various operations, such as calling, answering, send, counting the check, etc. Of course I admit that generally speaking many of these people get along well enough, and usually manage to get their business off in some sort of a fashion.

It is usually possible to tell the first time an operator calls whether or not he is a "lid," to use the common term. A man may call strictly according to regulations, and still come in this class, and, in some cases, he may break every rule of the game—at times—and still not be as much of a "ham" as the first man. However, in most instances, the man who, by following the rules as laid down, shows that he is a gentleman, and he is the man who will in the long run gain the respect of his fellows, even tho he starts out as a green-horn. Take, for instance, the fellow who calls long windedly. In the first place he is violating the law, but aside from that he generally is making himself a nuisance to all within hearing—which is usually a large number—and then he often doesn't get any better service, if as good. Then there are the "high power birds" who open up anywhere and call with all the power their set will put out. These are just a few instances where men show themselves up more truly than they realize by what they do, and not how they do it.

The use of excessive power and the long calling and testing habits are several of the worst that operators can get into. The use of excessive power is usually either through carelessness, or a general "don't care" attitude. What is the sense in starting up and calling a nearby station which is known to be within easy range, using everything the set will put out to do it? It not only wastes energy and puts the receiving operator in an unpleasant frame of mind, often expressed by his operating, but does far more serious damage in the way of interference. Many stations are able to transmit far beyond their normal receiving range, and when they are using high power for local or nearby work, they only are making trouble for someone else—and always running the chance of interfering with a distress call that they can't hear.

The long callers are nearly as bad. If a station can't get your call, or can't hear you call him without repetition after repetition in the call, what chance is there that he will be able to receive the business you have for him? Usually the two stations will fool around for a long time and block traffic generally, and then after all find that the receiving station can't get the business, he will report QST, or something of the kind. This is sometimes done to prevent relaying, apparently with the idea that it is very wonderful to work long distances, etc., but usually better service can be obtained if the business is relayed thru a nearer station, and again, less power can be used than when working the extreme long ranges.

The testers are absolutely the worst class of offenders that exist. I refer to two classes

Continued on page 72

MILWAUKEE AMATEURS' RADIO CLUB

By L. S. BAIRD, Past President

The Milwaukee Amateurs' Radio Club was founded in January, 1917, by L. S. Baird, A. C. Kletsch Jr., J. B. Hitz, and Alonzo Pawling. In its pre-war existence it could have been characterized as the junior amateur radio organization of the city. This existence being one of but a few months, all the early members were drawn from but a limited section of the city.

Previous to the founding of the Milwaukee Amateurs' Radio Club two of the local high schools had organized radio clubs, and one or two other attempts were made to found local wireless clubs, but with one exception none endured long. This exception was the Milwaukee Radio Association, which at the time of the founding of the Milwaukee Amateurs' Radio Club constituted the senior radio association of Milwaukee. This association did not survive the war and period of government ban on amateur radio activities. Its post-war membership was absorbed by the Milwaukee Amateurs' Radio Club. Among these members were Robert Miregler, C. F. Bates, L. J. Prahl, and L. A. Degner. The Milwaukee Boy Scout Radio Club was founded at about the same time, but existed for only a short period while its members were receiving instruction in elementary radio from a member of the faculty of the School of Engineering. Some of its members joined the Milwaukee Amateurs' Radio Club.

In the spring of 1919 and shortly after the government ban on amateur radio activities was removed, a meeting of the Milwaukee Amateurs' Radio Club was held and plans were made for the coming club season of 1919-1920. A careful survey of the city was made and a list of all amateurs was compiled. This list was the nucleus of the complete record of all amateurs in the city that the club now keeps. The trustees' room of the Milwaukee Public Museum, which has a seating capacity of about one hundred, was secured as a meeting place.

At the first meetings in the fall of 1919 a new constitution was adopted and officers elected and installed. The officers were: L. S. Baird, president; C. N. Crapo, vice-president; R. A. Teschan, secretary; T. V. Weston, treasurer; and R. A. Pelishek, business manager. Others prominent in the direction were C. S. Polachek, C. M. Prinslow, A. C. Kletsch Jr., and A. B. Lord.

The club became affiliated with the American Radio Relay League, Inc., and L. A. Degner, a member, was appointed city manager. Many other events, both business and social, took place this year.

The club opened the season of 1920-1921 with L. S. Baird, chairman of the board of directors; C. N. Crapo, president; A. B. Lord, vice-president; Louis Heyman, secretary; and E. W. Ruppenthal, treasurer and business manager. Mr. Crapo succeeded Mr. Degner as city manager for the American Radio Relay League, Inc. Meetings were held this season in a lecture room in the Old Insurance Bldg., obtained thru the courtesy of the School of Engineering of Milwaukee. The Milwaukee membership of the now defunct Wisconsin Radio League, which had been founded by M. B. Grogan and R. F. Laidlaw, was absorbed by the club. Mr. Grogan became the Milwaukee Amateurs' Radio Club's publicity manager. Before the organization of the Milwaukee Radio Executive Council, the Club became affiliated with the Chicago Executive Council (Radio). The "Chicago Plan" for control of radio traffic was adopted and enforced first by the club and then by the Milwaukee Council. It was thru the efforts of the leaders of the club that the Milwaukee Radio Executive Council was formed. This club and several others

are represented in the council. The season was closed by a successful social and dance held in the dining room of the St. James Episcopal Church.

The season of 1921-1922 was opened with the following officers: L. S. Baird, past president; C. N. Crapo, chairman of the board of direction; D. J. Gellerup, president; H. F. Wareing, vice-president; L. W. Klingbiel, secretary; and E. W. Ruppenthal, treasurer and business manager.

The club meets weekly at 8 on Monday evenings, except the third Monday of each month, in the trustees' room of the Milwaukee Public Museum. Visitors and prospective members are welcome at all meetings. At meetings when outside speakers are not present, members present papers and informal discussions take place.

This year the club has embarked on an extensive lecture program. An attempt has been made to secure from the ranks of employees of Milwaukee's electrical industries a number of men who could lecture on some subject that has points in common with radio communication. Some of the lectures that have been given and some that remain to be given are: December 8, 1921, "The National Electrical Code and Its Application to Radio Signaling Apparatus," by A. C. Schultz, electrical inspector, Wisconsin Inspection Bureau; January 23, 1922, "Serving the Radio Amateur," by W. S. Wilder, Sc. B., E. E., Electrical Testing Division, The Milwaukee Electric Railway and Light Co.; February 13, 1922, "The Theory of the Electron Tube," by R. C. Siegel, Sc. B., The University of Wisconsin, 1921; February 27, 1922, "Some Possibilities in the Development of Electron Discharge Apparatus," by Arthur Simon, member I. R. E., electrical engineer, Cutler-Hammer Mfg. Co.; March 13, 1922, "Storage Batteries," by J. P. Schroeter, electrical engineer, formerly consulting engineer, American School of Correspondence, Chicago, Ill. All radio men and other interested persons are invited to attend.

The club has several committees thru which much of its work is accomplished. Membership in one or more of these committees entitles the radio amateur to become actively engaged in the solution of the problems of local radio organization. There is a committee on interference and relay which has for its duty to co-operate with the A. R. R. L. city manager in the solving of problems of local radio traffic. Some other committees, the work of which is obvious from their names, are the committee on papers and publications, program committee, publicity committee, and the committee on research and development. The work of the last named committee is shortly to be transferred to a radio laboratory founded by several radio club members.

Membership appeals alike to the "DX" man, the radio experimenter, the beginner, and to those who have only a set for the reception of radio broadcasts. There are three classes of membership, viz.: member, associate, and junior. Dues for the first two classes are fifty cents a month and for juniors, twenty-five cents. An initiation fee of one dollar is charged. The direction of the club is especially desirous of having for members all local members of the A. R. R. L., making the club a real local section of the League.

There are several other radio clubs in Milwaukee and its suburbs, three of which are affiliated with this club thru the Milwaukee Radio Executive Council. They are as follows: Wauwatosa Radio Club, meeting on Monday evenings in the Wauwatosa High School; West Allis Radio Club, meeting on Friday evenings in the West Allis Public Library; South Side Radio Club of Milwaukee, meeting on Wednesday evenings in the South Side Branch of the Public Library.

Although the Milwaukee Amateurs' Radio Club has a centrally located meeting hall and embraces a city-wide membership, its direction realizes the expediency of having additional radio clubs in the suburbs and various sections of the city. The Milwaukee metropolitan district is large enough and boasts a sufficient number of amateurs to make it a multi-club one. The direction of this club does not view these contemporary clubs as competitors, but as organizations striving with this club to make Milwaukee's radio organization a success.

Milwaukee's radio traffic organization and traffic conditions will be discussed in another article under the heading of the Milwaukee Radio Executive Council.

The executive office to which all club correspondence should be addressed is 601 Enterprise Building, Second and Sycamore Streets, Milwaukee, Wisconsin.

"IN THE EASTERN STATES"

By WILLIAM S. HALSTEAD, 2LH

1ARY of Burlington, Vt., is very QSA on both C.W. and spark. 1ARY was the second best station to get across to Godley.

1BR of Exeter, N. H., is doing some fine work on his 10 watt C.W. set. He has worked as far south as Philadelphia on phone, which is very good work considering the power used and the distance, 700 miles.

1BCG has left the air as suddenly as he went on. Rumor has it that he will be on soon again tho. Look out for your fones, you 6th district owls!

1AFV ought to work Japan soon by the way in which he makes the "cans" rattle in the east.

The C.W. craze seems to be at its height in the first district. Practically all the d. x. stations have changed to C.W. or are using C.W. in conjunction with their spark sets.

2BK is still splitting our diaphragms. His spark has been heard in Scotland, England, California, etc. Wonder where next?

2AID now has a 5 watt C.W. set. His old spark has hit the trail to Long Island. 2AID is putting over an ampere into the aerial with wonderful results for a 5 watt set. He seems to reach out nearly as good as on his spark.

2DK has also changed to C.W. with very good results. He is using a 50 watt tube.

Down in Brooklyn the latest is: "Sparks may come, and sparks may go, but NAH goes on forever."

2UA has been off the air for over a month. He expects to get going again very soon, but he is trying to get a good pole first.

2AWF is putting the capital city of the Empire state on the map. For the benefit of those who don't know where the capital is, might say that it is Albany.

2XI of Schenectady is "knocking" all the tubes around Albany and Troy.

2OM is still handling messages by the carload and making his "O" shorter every time. Wonder what 2SM will say? Hi.

Everybody has gone "nuts" over radio in the vicinity of New York City. WJZ and WDY are the reasons.

8ML is making all kinds of records with his 10 watt set. His latest is to 6ALP in Long Beach, Calif.

8LX has also been doing some real distance work thru to California.

4GL and 3ZO come in thru the second and first districts like locals. 4GL is more like an express, tho. And when he goes—Oh Boy! Talk about Omnigraphs racing!

3ZA is helping put the messages thru the third district.

41B is one of the real relay stations with an OW at the key. And she can rattle the key, too! 4GL will soon have a new rival in the 40 per league.



UP-1368 Power Transformer
325 Watts.....\$25.00



UP-414 Microphone Trans-
former..... \$7.25



UV-712 Amplifying Trans-
former.....\$ 7.00



UP-415 Plate Circuit
Reactor..... \$5.75

General Electric Transformers and Reactors FOR C.W. Transmission and Reception

The Radio Corporation line of transformers (manufactured by the General Electric Co.) offers a unit for every need in assembling a C. W. Transmitting or Receiving Set. A few of the items constituting this line are shown here.

We are Western Jobbers for the following high grade lines of Radio Equipment and carry in San Francisco the largest, carefully selected stock of quality apparatus in the West.

Radio Corporation of America
(Westinghouse and General
Electric Apparatus)
General Radio Co.
Adams-Morgan Co. (Paragon
Apparatus)
Remler Radio Mfg. Co.
Federal Tel. and Tel. Co.

Signal Electric Mfg. Co.
Western Electric Phones
Burgess Battery Co.
Magnavox Co.
Wm. J. Murdock Co.
Baldwin Telephones
Wireless Press Books
Weston Instruments

The Radio Corporation's C. W. Manual and Catalogue contains a great deal of useful information, especially for those interested in C. W. Transmission. It will be sent upon receipt of 25 cents.

Bulletins describing the Kennedy line of high quality Radio Receivers will be sent free upon request.

THE COLIN B. KENNEDY COMPANY
INCORPORATED
RIALTO BUILDING
SAN FRANCISCO

KLOSNER VERNIER RHEO-STAT

A useful form of vernier rheostat has recently been put on the market by the Klosner Improved Apparatus Co. of New York City. It is equipped with a single knob for both rough and fine adjustments, and is claimed to give quick and positive results with the most critical tube. As may be noted from



Klosner Vernier Rheostat

the picture it has a condensite base and knob and phosphor bronze contact springs, all metal parts being nickel plated. It has a diameter of 2½ in., and should prove highly valuable for the control of filament current to detector and amplifier tubes in the receiving set.

NEW RADIO CATALOGS

A handsome catalog of radio equipment has been issued by the Karlows Radio Co. of Rock Island, Ill. In this 48-page 9x12 book many interesting and useful types of radio apparatus are illustrated and described, including the Hall recording relay, complete receiving sets, spark and tube sending sets, and parts of all kinds. In addition to complete hook-ups, there are many miscellaneous items of radio interest.

Catalog H from the De Forest Radio Telephone & Telegraph Co. of New York City shows the complete line of De Forest radio equipment suitable for amateur and commercial use. A brief and simple treatment is given of the theory of radio communication and of the vacuum tube.

Radio Catalog No. R-2, from Julius Andrae & Sons Co. of Milwaukee, is concerned with radio receiving and transmitting equipment for telephone and telegraph. In its 84 pages, 6x9, will be found pictures, descriptions and prices of complete sets and parts from most of the standard manufacturers of apparatus for sending and receiving. Especial attention is given to parts for C. W. transmitters.

New bulletins from the Robinson Specialty Co. of Keyport, N. J., show the "Q R" vernier adjuster for attachment to any receiver so as to eliminate the effect of body capacity, and the "Q R" loud speaker for use without extra batteries on one-four stages of amplification.

The Surdam Rotary Spark Gap is detailed in a folder from the Star Machine Co., San Diego, Calif.

The Western Radio Electric Co. of Los Angeles has completed the installation of the Kinema-Brack Shops radiophone for broadcasting concerts from the Kinema Theater and news bulletins from the Los Angeles Examiner. The station was opened with a concert from the Victor Herbert orchestra. Receiving sets are being put in by all the West Coast Theaters, Inc., chain.

A NEW LOUD SPEAKER

A new and improved type of loud speaker for hearing radio concerts, news and speeches is announced by The Radio Appliance Company of San Francisco. This consists of a Baldwin phone and a scientifically designed tone chamber housed in a Kennedy No. 525 walnut cabinet 5x12½x8½ in.



It is believed that this will fill a long felt want for a handsome, compact unit, uniform in appearance with the rest of a receiving set. Because of the specially designed tone chamber the sounds are purer and more pleasing than is possible with the ordinary horn.

C. R. Kierulff of Los Angeles is supervising the installation of a 50 watt radio telephone broadcasting station for the Los Angeles Times. The equipment was designed by L. F. Fuller, chief engineer of the Colin B. Kennedy Co. of San Francisco. Dean Farran will be the operator in charge.

LETTERS TO THE EDITOR

Sir.—Will you pardon me if I presume to criticize one of your editorials in the March issue.

I think I know to whom you refer and if I am correct I agree with you that we should keep our eye on them and resent at least some of their efforts. There are certain interests that are trying to take unto themselves for selfish purposes more power than is their right.

However, your words may be construed in a number of ways, and under some constructions they are rather dangerous advice. You begin by condemning selfishness and end by seemingly advocating the most extreme kind of selfishness. No term could be more selfish than "personal liberty." This term has been much used of late years in another connection, but whether we are speaking of the use of alcoholic drinks or of wireless it is true that the rights of the individual stop where they interfere with the rights of others. *Whenever people come in contact with each other there can be no such thing as complete personal liberty.* The whole system of laws of the Republic depends on this principle. If one were to follow your advice literally he could "sit on the key" all day and stop all other radio work in the vicinity, but if we tried to stop him he could say, "You are interfering with my personal liberty."

A number of amateurs to whom I have shown your editorial think you mean the A. R. R. L. I sincerely hope they are wrong, for I think this organization deserves much praise for the work it is doing. There is no "personal domination" in it, for no amateur in the country is denied membership and all members have a voice in electing the directors. I admit it sometimes tries to impose certain regulations, such as certain listening periods, upon all of us whether members or not. Of course it has no legal right to do so. But you cannot find anything in any of these regulations that points to a selfish motive behind them; and they are always of such a nature that if we all take an interest in them and abide by them we will all be benefited by them. Here is certainly a case where we can afford to forget our "rights," and in so doing bring greater pleasure and profit to all amateurs, ourselves included.

Very truly yours,

H. K. DUNN,

Opr. at 8YR.

Asst. Prof. Physics.

Miami University, Oxford, Ohio.

Feb. 28, 1922.

RADIO BOOK REVIEWS

"WIRELESS IN THE HOME"—By Lee de Forest; 32 page pamphlet, 4¼x6¼ in. Published by De Forest Radio Telephone & Telegraph Co., New York City. Price 15 cents.

This is a popular account of radio as a hobby. It tells of the fascination of radio telegraphy and telephony. It explains the essentials of an amateur radio receiving station, including the aerial, tuning coil, detector, condenser, telephone and amplifier, in terms so simple that any one can read and understand it. Finally it gives a description of a crystal and a vacuum tube receiver and a two step amplifier.

"THE RADIO EXPERIMENTER'S HANDBOOK"—By M. B. Sleeper; 138 pages 4x6¼. Published by De Forest Radio Telephone & Telegraph Co., New York City. Price \$1.

When a boy first becomes interested in radio he has many questions in mind for which he cannot find understandable answers in the more advanced texts. In this little book the author tries to tell you what you want to know. He omits all theoretical and mathematical discussion and confines his treatment to simple and practical matters. He first tells what makes the wireless work and then describes the apparatus used in simple damped wave transmitting and receiving sets, giving diagrams of connections and telling how to set up and operate the equipment which has been bought. A brief account is given of how the audion works, what is an undamped wave, and how it may be transmitted, received, and amplified. The book is concluded by a chapter on radio rules and regulations. While of little value to the advanced worker, the entire book will be helpful to the beginner.

Theater managers of New York are contemplating the use of wireless telephony to replace orchestras. Vaudeville theaters and musical shows could not avail themselves of melodies from the air, and will continue to pay from \$75 up for their leaders, and a minimum of \$52 weekly for their musicians. But theaters with dramatic offerings and the picture houses could save a tidy sum by the installation of wireless receiving stations.

A sending set and an audion for his receiver is the first thing that Vallimar Gilbert, an adopted boy, of San Francisco, wanted to get when notified that he was the heir unexpectedly to \$180,000 from the estate of Jay Moncrief of New York. He prefers "the kind you put up yourself."



The
**Harko Senior
V. T.
Radio Receiver
\$21.00
Guaranteed**

This HARKO SENIOR RADIO RECEIVER has been developed to supply the demand for a low priced, efficient receiving outfit, having a range of from 150 to 600 meters, thus bringing in on the average amateur antenna-amateur stations, radio telephones and commercial stations, operating up to and including 600 meters.

This instrument is a combination tuner and audion detector. It consists of a tapped inductance, a Crosley Variable Condenser, a Crosley Model "a" Rheostat, a Crosley V. T. Socket, a Crosley Grid Condenser and Leak. The hook up is special—of our own design.

These parts are mounted on a panel of formica. The surface is ground; the binding posts marked and the whole thing mounted in a mahogany finished cabinet. Cords with clips extend through the back of the cabinet to be attached to the "B" batteries.

From our Minneapolis station we have picked up Chicago, Detroit, and Cleveland. On rare occasions we have heard Pittsburg.

This set is very efficient and the price is remarkably LOW.

**Price complete as described without
TUBE, "B" BATTERY, "A" BATTERY or PHONES
Only
\$21.00**

Absolutely guaranteed or your money back

We can furnish a Crosley Two-Step Amplifier to work with this Senior Radio Receiver for the low price of \$25.00.

The United Radio Schools

Radio Engineers

500 Delaware Street S. E.

Minneapolis, Minnesota

SPECIAL NOTE: We are prepared to furnish "Principles of Radio Telegraphy, in loose leaf form, prepared for self instruction by Prof. C. M. Jansky of the University of Minnesota, for \$7.50—just what the amateur needs to "bone up" on radio

1 BCG-Greenwich — First to Get Across Mr. Cronkhite Put It Over with This Set

Read remarkable power of this outfit on page 25, Jan. "Wireless Age" and page 29, Feb. "Q. S. T."

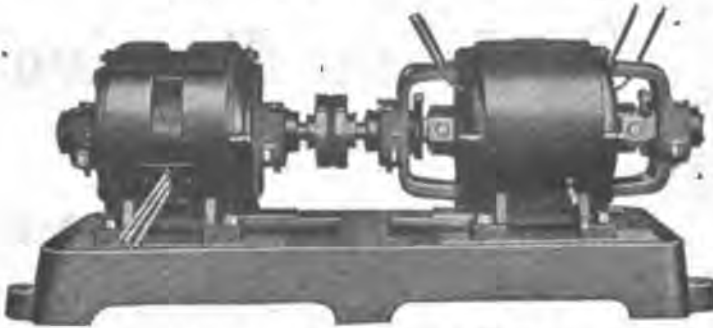

2 Unit — 4 Bearing — 1500 Watt

2 FD-Flushing, Got Across with Similar Set
1 IRU-Hartford, also; but with a 250-Watt Set

1 BKA - Glenbrook Put It Over with This

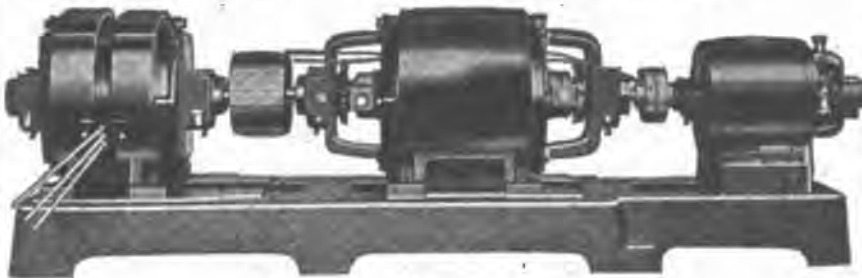

3 Unit — 500 Watt Outfit

9 HK - Clinton, Iowa, Goes Coast to Coast with This Little Set



2 Bearing 100 Watt

These (and other) Institutions Use Our Motor-Generators

- Mass. Institute of Technology
- Queens University, Canada
- College St. Croix, Canada
- University of Missouri
- University of Iowa
- Billings Polytechnic, Montana
- Philadelphia School of Wt.
- Northwestern School of Wt.
- Clark University, Worcester

- Princeton University
- Fordham University
- University of So. Dakota
- Rice Institute, Texas
- University of Florida
- Denver School of Mines
- Hammond Radio Research Lab.
- Asbury Park Radio School
- La Fayette College, Easton, Pa.

WRITE FOR BULLETIN 237

ELECTRIC SPECIALTY CO.

MOTORS • DYNAMOTORS • GENERATORS • MOTOR GENERATORS
225 SOUTH STREET

TRADE "ESCO" MARK

Stamford, Conn., U. S. A.

Pioneers in Developing High Voltage D. C. Generators

CALLS HEARD



Readers are invited to send in lists of calls heard from stations distant 250 miles or more from their own station.

BY SCP, HOLLAND, MICH.

(2arb), 2arm, 2bfu, (2bmu), 2bk, 2cl, (2fp), (2ju), 2om, 2pa, 2ajd, 2ok, (2pb), 4cz, 4ez, 4dh, 4bz, 4gs, 5by, 5er, (5fo), 5uk, 5iq, 5ia, 5pg, 5tu, 5aa, 5al, 5amp, 5arf, (5aco), (5afal), (5afb), 5alg, (5ain), 5ala, (5alk), (5akq), 5akv, (5ama), 5ano, 5aog, 5ard, 5are, 5ata, (5aum), (5auv), (5ave), (5avt), (5axn), 5axo, 5ayx, (5las), (5bbu), (5bey), 5bep, (5ben), 5biv, (5blw), 5bun, (5bt), 5bwd, (5bxo), 5brx, (5can), 5cnc, 5cs, 5ch, (5cb), 5cf, 5ew, 5fi, 5ft, (5ip), (5ij), (5ma), 5ol, 5qq, (5ep), (5uc), (5yn), (5yy), (5z), (5wd), 5agp, 5aw, 5ab, (5ac), (5ad), 5acc, 5aff, (5agr), (5am), 5alf, 5air, (5aiu), (5ajh), (5ajp), (5au), 5amc, 5amr, (5ano), (5aob), (5ao), 5apc, (5ars), (5as), (5ask), (5aub), 5aul, 5avp, (5aw), 5ayb, 5aza, (5az), (5bc), (5bij), (5das), (5dbu), (5dgv), 5dhd, (5dha), (5del), (5dkv), (5dlz), 5dlld, 5dmm, 5doo, (5dra), 5dnd, 5dov, 5dtn, 5dyu, 5dyw, 5dzm, 5drw, 5dyz, 5dms, 5dai, 5dak, 5af, 5ar, 5au, 5bp, 5ak, 5bf, (5ep), (5a), 5fu, (5gn), (5gr), 5hm, (5ib), 5ia, 5jn, 5iv, 5il, 5ma, 5ms, (5nn), 5mq, 5nq, 5oa, (5ox), (5ou), 5ur, (5pd), 5pl, 5pl, (5rc), (5to), 5ti, 5tl, (5uh), (5uu), (5v), 5vv, 5wi, 5al, 5ye, 5zn, (Can 3gn).

BY SAIF, BAKERSFIELD, CAL.

Spark-5xu, (5sa), 5es, 5eah, (5aan), (5abw), 5abz, 5ack, 5ada, 5all, (5ach), 5afn, (5act), 5acp, (5ab), 5ahp, 5ahv, 5aid, 5aio, 5ajr, 5ak, (5aki), (5alp), 5alf, 5amk, (5ang), 5aor, 5app, 5ark, (5ao), 5aah, 5atg, (5atv), 5av, 5avb, 5avv, 5awb, 5awt, 5awz, 5ba, 5ba, 5bas, 5bcj, (5bch), 5bm, 5cv, (5ca), 5cb, 5ca, (5cc), 5fb, (5fk), (5fl), 5gl, 5gt, 5gz, 5ib, 5ia, 5iv, (5ic), (5lc), 5ng, (5mh), (5od), 5ob, 5pi, (5po), 5pr, (5qr), 5ej, 5et, 5eu, 5to, (5tu), (5tv), 5uo, 5vz, (5va), (5vb), 5vr, 5vs, 5za, 5zal, (5zam), 5ed, 5ak, 5au, (5ax), (5as), 7bb, 7bj, 7bk, 7br, 7ck, 7il, 7ig, 7j, 7kl, 7m, 7n, 7o, 7mf, 7mh, 7mp, (7my), 7d, 7vo, 7ya, 7yz, 7yl, 7aj, 7am, 7st, 7su, 7sv, 8ap, Canadian 9ax, Canadian 9bd, 9yae, 9yal.

C. W.—4t, (5aa), 5aat (fone-cw-icw), (5ale), (5aln), (5ak), 5akw, 5aos, 5arc, 5as, (5av), 5atg, (5aul), 5avv, 5awt, 5oc, (5on), (5gr), (5id), 5ij, (5ka), (5ky)-(5wl), 5rr, (5xad), (5xaf), (5xb), (5sa), 5sal, 5sb, 5st, 5sa, 7xf (cw-icw-ione), 8am, 8av, 9aja, (5amb), 9ayv, 9dl, 9dth, (9dtn), (9dva), 9uz, (9wd), (9zsq), Canadian 9bd, cl8.

BY SAHQ, LA HABRA, CALIF.

(5if), 5of, 5xu, 5xi, 5sa, 5aj, (5ah), 5ak, (5as), 5er, 5ca, 5df, (5ep), (5ex), 5fh, 5fk, 5gr, 5gf, 5gz, 5ho, 5in, (5ko), 5km, 5ka, 5oc, 5ob, 5pc, 5pl, (5pol), 5qr, 5rs, (5rv), 5uo, (5tu), (5vk), 5vm, (5vh), 5vx, 5za-cw, (5zb), 5sa, 5ab, 5ak, 5au, (5ax), 5aa, (5aab), 5ak, 5ast, (5abw), 5abz, 5ada, (5ach), 5ad, 5aac, 5afp, 5ah, (5arl), 5alf, (5aki), 5ala, 5aly, 5ale, 5amk, (5ain), (5aor), 5arw, 5asj, (5ath), 5atg, 5atu, (5aur), 5arv, 5aul-cw, 5awb, (5awt-cw), 7bh, 7bl, 7bl, 7in, 7kl, 7l, 7ly, 7me, 7mf, 7mp, 7ot, 7iv, 7j, 7vo, 7ad, 7ag, 7am, (7at), 7su, 7sv, 7ya, 7yg, 7cn, (7om), 9ax, 9dz, 9v, 9avr.

HEARD AT 6AWT, 663 UNION ST., SAN FRANCISCO, CAL., JAN. 7 TO FEB. 29

Sparks—5ak Canadian, 5hk, 5ea, 5er, 5hh, (5k), 5lc, (5mb), 5ms, 5od, 5ob, 5ol, 5qr, 5tc, 5tr, 5adl, 5ach, 5afp, 5ahl, 5abp, 5ahq, (5aib), (5aif), 5aio, 5ajb, (5alu), 5amn, 5avd, 5avr, 5awe, (5bai), 5sal, 7ax, (7bb), (7bc), 7bb, 7bj, (7bk), 7cc, 7cp, 7ed, 7fi, (7go), 7g, 7hl, 7iw, 7jw, (7kj), 7km, 7ly, (7mf), 7mp, 7my, 7nl, 7nn, 7om, (7tj), 7ya, 7yg, 7aj, 7am, 7sp, (7st), 7su, 7sv, 9ax Canadian, (9bd Canadian), cl8.

C. W.—(4cb Canadian), 5sa, (5ou), 5oa, 5eb, (5ef), (5en), 5jd, (5gd), (5ka), (5ky-voice buzzer), (5rr), 5sa, (5sf), 5ag, (5sz), 5aag, 5ach, (5aif), (5ale), (5ao), (5xad), 7cc, 7nl, 7mw, 7we, 7xi, 8il, (9bd Canadian), 9ps, 9wd, 9amb, 9bar, 9dva, 9saf-voice, cl8. Anyone hearing 6awt pse 8 al.

BY 6ZAC CLIFFORD J. DOW, WALLUKE, T. H. FROM JANUARY 1 TO FEB. 19

Sparks—5tq, 5xu, 5sa, 5ss, 5auu, 5atv, 5ob, 5obr, 5ez, 5he, 5lc, 5zb, 5ak, 5ar, 5az, 7bh, 7jd, 7ya, 7yz, 7sd, 7j, 7am, 7at, 7su, 9mc, 9yae.

C. W.—5sa 5ant, (5pt 7), 5atg, 5aos, 5ang, 5aif, 5ef, 5en, 5jd, 5xad, 5xaf, 5xw, 5ssad, 5saf, 5ab, 5aja, 7nl, 7u, 7rn, 7zi, 8ags, 8bf, 8uk, 9amb, 9aja, 9dvi, 9hw, 9wd, 9nxz, 9xab, 9saf, kxy, cl8, kzop, nol, nmw, sc3, xfl, Canadian 4cb, qsa.

Have had a qsl confirming xfl reception. Langley Field, Hampton, Va., in charge of Sgt. Blair. Says using 450 watts of a 1 kw de Forest fone and Cw set. Would appreciate at least a card in acknowledgement of the reports I've tendered various stations whose address is known to me, and would be pleased to hear from those listed above who have not had direct word from me.

"Pen" Brand Variable Condenser with binding posts—

The "Pen" variable condenser is manufactured with two binding posts to which connection can easily and conveniently be made *without soldering*. Constructed with a special *adjusting screw* by means of which the plate adjustment can be tightened to prevent slipping. Accurately made, exceptionally high quality, remarkably low price, complete with the improvements described—

3 plate....\$2.10 11 plate....\$2.60
23 plate....\$3.45 43 plate....\$4.60

43 PLATE
\$4.60



\$12.50 CESCO 1-STAGE AMPLIFIER

Why pay more? Carefully made of standard parts and beautifully finished throughout—measures up to the usual high CESCO standards of service and efficiency. It will stand the gaff. And the low price represents a big saving to you—\$12.50 as illustrated, post-paid to any address in the U. S. Order now to insure prompt delivery.

"Radio Supplies that R right"



California Electric Supply Co.
643 MISSION ST. - SAN FRANCISCO - CAL.

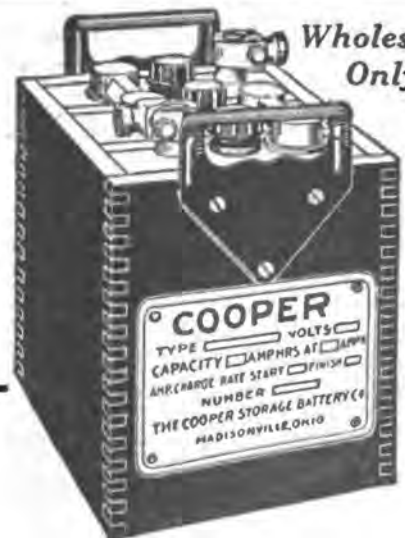

Wholesale Only

Cooper RADIO Batteries

GUARANTEED FOR TWO YEARS

A Special Size for Every Radio Requirement

Every part in the Cooper Radio Battery, regardless of its importance, is constructed of the finest quality of material and is designed and tested to withstand the most severe service.

DEALERS AND MANUFACTURERS: Write for Complete Details. Let Us Figure on Your Requirements.

The Cooper-California Co.
PACIFIC COAST UNIT

1034 Geary Street

San Francisco, Cal.



Protection

of your bulbs against burning out is positively assured by the

RADECO SAFETY FUSE

(PATENT PENDING)

can be used on any standard bulb used in any standard socket. Slips directly on filament terminals.

4 for \$1

Order by mail or from your dealer
Carrying capacity $\frac{1}{2}$, $\frac{3}{4}$, 1, 1 $\frac{1}{2}$, 2, 2 $\frac{1}{2}$ and 3 amperes.
Will also protect other delicate electrical instruments.

Radio Equipment Co.

630 Washington St.,
Boston, Mass.
Boston's Oldest Exclusive
Radio Store

DEALERS!

Demand for the Radeco Safety Fuse, as you would expect is strong and growing fast. It yields a tidy profit and brings trade to your store. Write today for Dealers Price List.

RTS

The New RTS Standard Detector Panel will please all amateurs. Sent complete without tube two batteries for only 5.95 Postpaid by Inter-fer for only 5.95 insured Parcel Post

Send for complete circulars now
Radio Testing Stat'n, Dept. A, Binghamton, N. Y.

CONNECTIGUT RADIO EQUIPMENT

Variable Condensers, Transmitters, Head Bands, Panel Switches, Etc.

Connecticut Tel. & Elec. Co., Meriden, Conn.

BY 2ZF BK SALE

2fp-ac-cw, 4by can. 7, 8tu, (6j-cw), 8yq, (5aa-cw), (6ab), (6en), (6op), (6gk), (6gt), (6iv), (6jd-cw), (6lc), (6mb), (6po), (6qr), (6tu), (6vz), (6ab), (6ak), (6ax), (6ag), (6at-cw), (6au), (6av), (6bc), (6bn), (6bf), (6bh), (6bi), (6bv), (6am), (6an), (6ba), (6be), (6bdk), (6bh) phone, 6zaq-cw very qsa, (7ba), (7bk), (7ck), (7cc-cw), (7nw), (7nx), (7ly), (7mf), (7mp), (7nn), (7om), (7qt), (7t), (7ya), (7y), (7am), (7so, 7at, 7sv, 7zb, 7su, 8jl-cw, 8vj-cw, 8az-cw, 8brl-cw, 8nx-cw, 9wd-cw, 9aja-cw, 9amb-cw, 9ayu-cw, (9ayu-cw 7), 9bex-cw, 9bji-cw, 9dtm-cw, (9dva-cw), 9zaq-cw, (9bd can.).

BY SAHS, E. SAN DIEGO, CALIF.

With crystal without amplification

5hk, 6if, 6mj, 6xj, 6xu, 6yq, 6aa, 6ax, 6ak, 6as, 6av, 6bm, 6cp, 6cs, 6dd, 6dr, 6er, 6ew, 6ex, 6fb, 6fi, 6fn, 6ft, 6g, 6gp, 6gt, 6gz, 6hf, 6ho, 6is, 6iv, 6ja, 6jw, 6jy, 6km, 6ky, 6ks, 6lo, 6lu, 6mx, 6oc, 6ob, 6ol, 6pj, 6po, 6pp, 6pr, 6pw, 6qk, 6qy, 6re, 6rs, 6sa, 6aj, 6et, 6tu, 6tv, 6uo, 6up, 6uw, 6vm, 6vo, 6vz, 6va, 6wv-icw, 6wa, 6rh, 6se, 6ak, 6su, 6ax, 6sa, 6am, 6aa, 6ak, 6au, 6ab, 6abp, 6abu, 6abz, 6acr, 6ad, 6ae, 6aw, 6as, 6af, 6ain, 6ap, 6ag, 6ap, 6ah, 6ahq, 6ahp, 6ahv, 6aic, 6aif, 6aio, 6air, 6ajv, 6ajz, 6akt, 6ala, 6ald, 6ale-cw, 6alk, 6amk, 6amq-cw, 6ang, 6ani, 6anp, 6ame, 6ar, 6ape, 6aph, 6app, 6apv, 6aqk, 6ar, 6arv, 6ard, 6are, 6ark, 6ase, 6as, 6asv, 6ato, 6atf, 6ath, 6atu, 6auu, 6avv, 6avd, 6avr, 6avv, 6awh, 6awi, 6awt, 6awv, (6bas), 6bbr, 6bca, 6bcj, 6bca, 6bb, 6bj, 6br, 6ck, 6cw, 6in, 6jd, 6kb, 6lu, 6ly, 6mf, 6mo, 6mp, 6q, 6ya, 6yt, 6zj, 6zj, 6zm, 6zt, 6au, 6ac, 9amb-cw, 9ayw, 9dae.

BY SAKE, DAILY CITY, CALIF.

With one tube

5aa, 6da, 6ek, 6en, (6fk), 6ft, (6gf), (6ic), 6is, 6kc, 6lc, 6lu, 6mh, (6qr), (6to), (6vs), 6ak, 6av, 6ay, 6ad, (6afn), (6ag), (6ahq), (6aif), 6aio, 6aju, 6ajh, 6aki, 6ale, 6aos, 6ape, 6av, (6ax), 6ato, (6mf), (6hf), 6tj, 6au, 6zj, 6za, 6zk, 6ob, 6ot, 6in, 6na, 6ya, 6zt, 6zx, 6zu, 6zj, 6zo, 6bd.

BY TED FRENCHIE, LOS ANGELES, CAL.

5aa, 6xu, 6ah, 6ak, 6as, 6acm, 6aif, 6aat, 6ale, 6agf, 6abz, 6aj, 6ap, 6av, 6ark, 6ahf, 6apv, 6aah, 6aak, 6au, 6ach, 6afn, 6aid, 6ape, 6aph, 6cv, 6ex, 6gf, 6gr, 6gt, 6ic, 6ij, 6km, 6oc, 6sa, 6se, 6sk, 6su, 6ax, 6as, 6ar, 6xz-music, 6hft, wv6-music-fone, 6ag, 6bk, 6bj, 6ex, 6ed, 6in, 6jd, 6mf, 6tj, 6ya, 6yg, 6za, 6zj, 6zt, 6zu, 6iw, 6ka, 6abm, 6dva, 6bji.

BY GATN, FALLON, NEVADA

kit, 9zaf, dd5, ag1, kw2, 6xg, kdw, kdf, 6zd, 6aa, 6at, 6vm, 6fc, cl8, 6ty, 6at, kay, vaw. Rosewell Electric Light Co., Rosewell, N. M., Radio Equipment Co., Dallas, Texas, Hobrecht, Sacramento, Northwestern Radio Mfg. Co., Portland, Kinema Theater, Los Angeles, 6an, 6ak.

BY 9BD, VANCOUVER, B. C.

C. W.—4eb Can., 4oo wiring 9ps, Feb. 26 12:40 a.m., (6bi) Can., (6bd) Can., (6ak), 5aa, (6ale), (6awt), 6au, 6eb, 6en, (6gy), (6jd), (6ka), 6ams, 6xw, 6zad, 6za, (6af), 6as, 6aal, 6ak, 6aaq, kic concerte, kry, 6vm, klg, 6sav, (7oe), 7ln, 7ms, 7oc, 7ba, (7qe), 7qt, 7rn chopper icw, 7vb, 7nf, kfc, 7xf, cl8, 7pe, 7yt, 7fg, 8bk ac-cw, Feb. 26 12:04 a.m. clg 9ps & 9bag, 8ags Feb. 26, vy constant & qsa 12 p.m. to 2 a.m., 9amb, 9ps, 9bag, 9kp, 9yas, 9saf, 9ays.

Spark—Canadian "5's" too numerous, (6ae), (6ab), (6ark), 6abz, 6abw, 6ac, (6agf), 6ajr, (6afn), qra pee? 6atg, 6bb, (6ch), 6dm, (6ex), (6hc), 6hp, (6fh), (6gx), (6gr), (6ic), (6km), 6lc, (6po), 6qr, 6tc, (6tu), (6vz), (6wa), 6xb, 6ak, 6sr, 6az, 6zal, (6sam), 6amk, 6arh, (6bk), (6bi), 6bb, 6br, (6bc), 6ck, 6cn, (6ba), 6ed, (6ge), (6h), 6iy, (6jw), 6mi, 6mu, 6nn, 6nz, 6nl, (6mp), 6hf, 6ly, (6kb), 6qn, (6wm), (6ti), (6zt), 6zj, 6om, 6zm, 6yl, 6ya, 6yj, 6zp, 9yae, cl8.

BY 6XAF, PIEDMONT, CALIF., DURING FEBRUARY

C. W. only—(5aa), 6xu, 6cu, 6ea, (6en), (6jd), 6ka, 6ky, 6pt, 6rr, 6ab, 6af, 6sg, 6sa, (6alf), 6alu, (6zad), 6zaq, 6qt, 6bir, 6dva, 6zaq, 9saf, 9bd (Canadian).

CALLS HEARD BY 6TV

6by, 6ew, 6fa, 6fo, 6hk, 6ir, 6is, (6if), 6lb, 6mf, 6mk, 6na, 6of, 6tu, 6ug, 6xb, 6xj, 6xu, 6y, 6yq, (5aa), 6saf, 6sam, 6as, (6ahq), 6acy, 6ad, 6ada, 6ah, (6amn), (6aib), (6sau), 6afn, (6asv), (6aah), (6alu), (6aki), 6alc, 6acr, (6aha), 6atg-cw, 6ald, 6abw, 6avr, (6ath), 6akw, (6afp), (6awx), 6agp, 6bhg, 6cu, (6en), (6ea), (6it), (6gt), (6gp), (6gd-cw), (6iv), 6is, 6jd, (6ka), 6kh, 6ka-cw and spk, (6kc), (6ky-cw, 6km, (6mh), (6od), 6ol, 6pe, 6qk, (6re), (6to), 6tf, 6uo, 6va, 6xad-cw, (6z), (6x), 6bk, 6fi, 6ya, 6zo, 9aag, 9acg, 9amb, 9ays, 9alu, (9dug), (9dad), 9dth, 9nx-cw, 9xaq.

HEARD BY DUDLEY NEBEKER, PIEDMONT, CALIFORNIA

Spark 5aa, 6ak, 6aak, 6au, 6aat, 6as, 6abz, 6acr, 6acy, 6ad, 6ah, 6aci, 6aew, 6afn, 6afy, 6agf, 6agp, 6ahp, 6ahq, 6ahs, 6aid, 6aif, 6aio, 6aiv, 6aiz, 6aly, 6ajr, 6aki, 6ale, 6alu, 6ana, 6anp, 6arc, 6ard, 6ark, 6asv, 6atf, 6awh, 6awm, 6cw, 6eb, 6en, 6ff, 6fh, 6gf, 6gn, 6gv, 6gt, 6gy, 6hf, 6ic, 6im, 6ir, 6is, 6iv, 6j, 6jl, 6kc, 6km, 6lc, 6lu, 6lv, 6mx, 6od, 6ol, 6ov, 6ps, 6qf, 6qr, 6es, 6ek, 6eq, 6tf, 6to, 6uo, 6xo, 6za, 6ab, 6ag, 6ar, 6ar, 6xu, 6za, 6zsa, 6zad, 6zal, 6bk, 6br, 6bj, 6ck, 6cn, 6ed, 6hf, 6jd, 6ke, 6mf, 6my, 6mu, 6nf, 6nz, 6om, 6tj, 6vo, 6vz, 6ya, 6yj, 6zm, 6zp, 6zu, 6au, (cl8, Seattle, Wash.), 9bd, 9am, 9saf, Canadian.

C. W.—5aa, 6aat, 6aif, 6aiv, 6alu, 6aos, 6asv, 6awp, 6cu, 6en, 6ir, 6iv, 6ny, 6sa, 6ab, 6af, 6ag, 6an, 6ar, 6az, 6xad, 6zaq, 6zad, 6cn, 6nf, 6zt, 6wm, 6yt, 9saf, Canadian.

Tell them that you saw it in RADIO

MAKE YOUR OWN

Aware of the fact of the scarcity of radio material with which to assemble your own set, we have listed below a list of items we have in stock NOW. However, if you need something not listed, write us and if it is to be had, we have it.

BAKELITE

Insist on the genuine Grade XX Bakelite dialecto. This is the best for radio insulation. Cut to any size... \$2.25 per lb.

CABINETS

Your home-made set might be the best in the world for receiving or sending, but it won't look anything if it isn't enclosed in a nice looking cabinet. We have a stock of solid oak cabinets, fumed finish and wax polished. Sizes:

7 x 7	\$3.00
7 x 12	3.25
6 x 14	3.25
7 x 18	4.25

All cabinets are hinged top, rabbite $\frac{1}{4}$ " for panel.

TUBING

Spaghetti tubing covering your wiring makes your set look 100 per cent better, besides adding to its efficiency. We have two colors, yellow and black in 2 $\frac{1}{2}$ feet lengths at 18 cents each length. Specify whether for 14 or 18 gauge wire.

ROTORS

Good rotors are hard to get at this time, but we are fortunate. We have a lot and they are good.

3 $\frac{1}{2}$ inch dia.	\$0.70 ea.
4 inch dia.	1.00 ea.

These rotors are already drilled for shaft.

Special small size "B" batteries, 22 $\frac{1}{2}$ volts, at \$0.80 ea.

Best galena, double tested crystals mounted in highly polished metal. \$0.30 ea. Same as above, but unmounted... .15 ea.

Beacon lights the way for radio service

BEACON RADIO ELECTRIC COMPANY
246 Greenwich Street,
New York City

The 'QSA' Line of Radio Equipment

Larger business has made necessary larger space and larger stock. So we have moved into new quarters where we will be better able than ever to supply your wants. Items listed below are in stock for immediate delivery.

Radiotron UV 202 5 Watt Power Tube	..	\$8.00
Federal No. 226-W Amplifying Transformer	7.00
Paragon VT Socket No. 80	1.00
PADA Panel Mounting Rheostat	1.00
Eveready No. 778 Variable "B" Battery	3.00	
Catalog of "QSA" equipment sent for 10 cents which will be refunded on initial purchase or FREE with order from this advertisement. Get on our mailing list. We have something interesting to say to you each month.		

INDEPENDENT RADIO SUPPLY CO.

3239 Ogden Ave., Chicago, Ills.

FORMICA PANELS

Black Sheets, Both Sides Polished
You can get panels cut to order from this high quality material and it will cost you only \$0.02 per sq. in. 3/16" thick.
Immediate Shipment - Postage Prepaid
DAVID RADIO SUPPLY CO.
R. A. Box 388, Reedley, Calif.

"B" BATTERIES

AN EVEREADY PRODUCT

43V. Batteries, tapped	\$4.50
22 $\frac{1}{2}$ V. Batteries, Navy Type	3.00
22 $\frac{1}{2}$ V. Batteries, Commercial Type	2.00

Letter two types especially adapted to Cunningham and Radiotron Tubes.
Postage Prepaid Anywhere in U. S.

ETS-HOKIN & GALVAN

Wireless Engineers

10 Mission Street San Francisco

This special Radio Battery has all the Willard Threaded Rubber Battery features that are applicable to Radio work —plus many new ones found only in this battery.



Bring Your Set Up-to-Date with this All-Rubber Radio Battery

It's just as important in receiving, to have a good battery as to have a reliable and efficient set.

The Willard All-Rubber Radio Battery was designed and is being used especially for radio work. It gives you the same reliability in wireless work as the starting and lighting battery has always given in motor cars. These batteries are available at a considerable less cost than the motor car battery.

Willard Radio Batteries are made with the same care, and have the same Threaded Rubber Insulation as the larger batteries.

An important Radio feature is the All-Rubber Case. Cells and case are a solid piece of rubber that absolutely prevents leakage from cell to cell or to the ground, thus doing away with one of the most troublesome sources of noise.

Threaded Rubber Insulation and case are both tested with 24,000 volt wireless transformers before assembly. Freedom from leakage is thus assured.

For details about the Radio Battery, go to the nearest Willard Battery Station, or write us direct.

WILLARD STORAGE BATTERY CO., Cleveland, Ohio

Made in Canada by the Willard Storage Battery Company of Canada, Limited, Toronto, Ontario

Willard **THREADED RUBBER BATTERY**

Listen to the World with Tresco Tuners

TRESCO SUPER-UNIVERSAL TUNER



Cabinet 12x17½ inches.
Formica or Hard Rubber Panel.
Weight, 15 lbs.; shipping, 25 lbs.
Wave length range, 160-25,000 M.
Tuners inside—three, AS, BS, KS.

Recommended by users of the Bureau of Market Reports and guaranteed to get all the wireless signals, either CW, spark, or telephone within the range of the sending station. This is the only tuner in the world that has this range of wave lengths and gets the signals on the smallest possible single wire aerial. Arlington time, Annapolis, San Diego signals clearly read through even a violent thunder storm.

Nearly all stations in the United States of the Bureau of Markets come in on this tuner in the center of the United States, and no point in the country would prevent the reception of these signals. It is recommended for the Farmer, Bureau of Markets, Schools, Colleges, etc. There is nothing about it to get out of order or need replacing except the high voltage batteries, a replacement of which costs only a few dollars. We ship only by express. We do not ship without testing and calibrating with your bulb, and each one is absolutely guaranteed to do just as we claim or we will refund your money. You do not need to know anything about wireless to operate this tuner or to get the signals and telephone reports. Cabinet is highly polished and all parts nickel finish. If you wish extra loud signals you may use one or two step amplifier, as posts are provided on the tuner for this purpose. We recommend Baldwin or Brown phones. We only sell this tuner assembled and calibrated to your bulb ordered with the set. It is complete with all that is needed except a pair of phones and a few dry cells to light the filament of the Audion. Ready to use when it arrives with all directions so that a child can operate it. Priced at \$100.00, F. O. B. Factory.

Licensed under Armstrong Patent No. 1113149.

OUR CATALOG FOR 10 CENTS

TRESCO, DAVENPORT, IOWA

HOMCHARGE YOUR BATTERY for A Nickle

A perfect rectifier at last, fully automatic and foolproof in every respect. It can be operated by anyone.

THE HOMCHARGER

connects to any alternating current socket, gives a taper charge—will fully charge any "A" battery overnight. It is self-polarizing. Connect your battery either way and it will always charge. Automatically disconnects battery when power is interrupted. Restarts charging when connections are restored. Adjustable for wave form, frequency and voltage. Contains only one moving and two wearing parts, lasting thousands of hours, replaceable as a unit for \$1.00. The highest charging rate, greatest efficiency, and simplest of any rectifier selling for less than \$100.00. Bulletin 628 proves it. Ask for your copy.

Manufactured in sizes for charging three or six cell batteries from both alternating and direct current circuits. Cannot injure battery—will last a lifetime—approved by underwriters—satisfaction guaranteed. For sale by all radio, electrical and accessory dealers or shipped express prepaid for purchase price only \$18.50 (\$20 west of Rockies).

Attention Motorists

Send for special Bulletin 68 showing how easy it is to "HOMCHARGE" your battery.

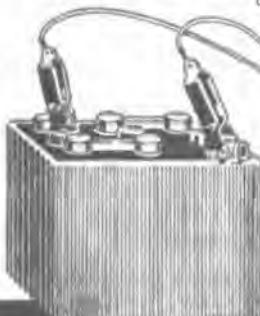

The Automatic Electrical Devices Co.
117 WEST THIRD ST., CINCINNATI, OHIO.
Canadian Distributors—Pouley & Moody, Ltd., Toronto

BY SAOW. 469 LIME ST., RIVERSIDE, CALIF.
Spark 6if, 6of, 5xu, 5yq, 5sa, 5aj, 6ah, 6aa, 6cp, 6ep, 6ex, 6fh, 6gf, 6gr, 6gz, 6hc, 6km, 6ob, 6pj, 6po, 6pr, 6qk, 6qr, 6aj, 6to, 6tu, 6tv, 6uw, 6vk, 6vz, 6wa, 6xb, 6af, 6ak, 6au, 6ax, 6as, 6ab, 6aa, 6abm, 6abz, 6ac, 6ad, 6afp, 6agf, 6ahd, 6ahu, 6abz, 6aha, 6aif, 6ain, 6ai, 6aj, 6akr, 6alv, 6ami, 6amk, 6ang, 6aor, 6aif, 6aam, 6aav, 6ath, 6atq, 6atu, 6auu, 6avf, 6awh, 6aac, 6aam, 6ab, 6bcb, 6bcj, 6bds, 6bfe, 6bgh, 6bip, 6biu, 7ck, 7dp, 7fl, 7hy, 7jw, 7jd, 7ln, 7ly, 7mf, 7mp, 7ty, 7ya, 7yj, 7yg, 7z, 7sm, 7st, 7su, 7sv, cl-8, ra-6.
C. W.—4ul, 5aa, 6xu, 6ak, 6gd, 6cy, 6iv, 6ij, 6ky, 6my, 6pi, 6vm, 6aa, 6af, 6as, 6ag, 6aaf, 6aif, 6akw, 6alc, 6aaz, 6awp, 6awt, 6xaf, 6bgz, 6bif, 6bbg, 7xb, 7zc, 9wh, 9wd, 9ay, 9amb, 9bji, 9dtm, 9dva, 9saf.
Phone—6aag, 6bgz, 9saf, dd-5, klc, kwg, kyj, kog, kso, ksy.

HEARD BY CASSELBERRY, 630 PLUMAS ST., RENO, NEV. GREBE CR-5 & 1 TUBE
6ao, 6au, 6aad, 6aab, 6acy, 6ad, 6af, 6alo, 6ah, 6ajh, 6ak, 6atf, 6avr, 6bsj, 6da, 6dm, 6fk, 6gh, 6gi, 6gz, 6ik, 6jr, 6jw, 6ke, 6km, 6le, 6od, 6of, 6qz, 6ab, 7ek, 7ed, 7mp, 7nn, 7nw, 7ya, 7zu.
C. W. & I. C. W.—4cb (Canadian), 5aa, 6aag, 6aat, 6alu, 6aoy, 6awp (phone), 6aav, 6bm, 6cu, 6en, 6gy, 6js, 6ka, 6kb, 6ky (phone), 6ag, 6af, 6an, 6ss, 7mf, 7nf, 7qt, 9dva, 9zaq.

HEARD AND WORKED BY 6VK, OAKLAND, CAL.
(6avr), (6aau), (6aak), (6acy), (6ad), (6ab), (6af), (6ah), (6ahv), (6ahp), (6ain), (6aif), (6aio), (6ab), (6ao), (6ald), (6amn), (6aoc), (6ark), (6awz), (6da), (6fh), (6gi), (6gz), (6hy), (6is), (6iv), (6jy), (6ka), (6kc), (6lc), (6ms), (6ol), (6od), (6pc), (6pr), (6sf), (6ss), (6al), (6bb), (6b), (6cn), (6ed), (6fi), (6gl), (6hf), (6mo), (6mf), (6vo), (6st), (6ya), (6abk), (6ax) and (6bd) (Canadian).
C. W.—6aa, 6aif, 6aaz, 6aa, 6eb, 6en, (6ii), 6jd, 6ss, 6sn, 6xad, cl8.

CALLS HEARD BY TWO MEDFORD, ORE.
Spark—6aj, 6ed, 6cv, 6il, (6dp), 6ca, 6eb, 6en, 6ez, 6fk, 6fh, 6gt, 6gz, 6id, (6ig), (6iv), 6ke, 6kn, 6lo, 6lr, 6ob, 6ot, 6ol, (6pr), 6qa, 6re, (6to), 6uo, 6vv, 6za, 6ab, 6ar, 6ag, 6ak, 6au, 6abw, 6abz, (6abz), 6aw, 6af, (6afn), (6agf), 6agu, 6ags, (6apb), (6aio), (6aiz), (6ain), 6alv, 6aor, 6aos, 6amf, (6amk), 6aru, 6atg, (6ath), (6atv), 6avb, 6avf, 6avr, 6awh, 6igw, 6zaf, 7bb, 7ed, 7ek, 7cw, (7ge), 7ku, 7hf, 7hi, 7hm, (7iw), (7jd), 7eb, 7ke, 7kz, (7kk), 7ln, (7mp), (7me), (7na), 7ob, 7ot, 7oy, 7rb, 7t, 7yk, 7yz, 7wz, 7zd, 7yg, 7yi, (7yl), 7ya, 7ai, 7ap, 7am, 7an, 7st, 7zu, 7aa, 9bd (Canadian).
C. W.—6gy, (6vm), 6aat, (6aif), 6ale, (6awf), (7mf), 7rn, (7iq), 4cb (Canadian), 9ajb.

BY TIP, BILLINGS, MONT.
Spark—6al, 6by, 6co, 6ew, 6fo, 6hk, 6if, 6la, 6lo, 6of, 6pg, 6xb, 6xo, 6yi, 6yq, 6sa, 6zad, 6aac, 6an, 6ao, 6sz, 6acb, 6ala, 6amk, 6ath, 6atq, 6awh, 6at, 6it, 6ot, 6ve, 6ej, 6tt, 6tv, 6wv, 6zb, 6aa, 6sam, 6av, 6az, 6as, 7an, 7aws, 7ba, 7cd, 7ek, 7fm, 7hm, 7im, 7jd, 7kb, 7lu, 7ly, 7mf, 7mo, 7mp, 7na, 7om, 7sb, 7ya, 7yg, 7yi, 7yj, 7yl, 7yo, 7ab, 7aj, 7am, 7zo, 7aa, 7at, 7au, 7av, 7bp, 7acn, 7acq, 7acy, 7agn, 7aig, 7aiw, 7ajs, 7apn, 7apt, 7aqe, 7ayg, 7ava, 7aan, 7aul, 7auu, 7avv, 7ava, 7aww, 7axu, 7ayw, 7bdp, 7bdt, 7bow, 7dka, 7dka, 7dpp, 7doc, 7ddk, 7dva, 7dzc, 7ee, 7enc, 7fx, 7lv, 7iw, 7uv, 7vi, 7vx, 7ti, 7wi, 7wu, 7xag, 7ya, 7yoc, 7yne, 7yok, 7yal, 7yam, 7yay, 7ym, 7yp, 7yq, 7zao, 7za, 7zeb.
C. W.—6za, 6aif, 6ala, 6alu, 6atg, 6apd, 6en, 6pd, 6vm, 6wg, 7rad, 6zaq, 6zg, 6za, 6at, 6az, 7zd, 7zf, 7aa, 7abi, 7acj, 7agn, 7aib, 7aja, 7aje, 7ajp, 7aka, 7aky, 7amb, 7aqv, 7avy, 7aau, 7ays, 7ayv, 7bvp, 7bbf, 7bbk, 7bjl, 7bvi, 7bm, 7del, 7byn, 7fm, 7bb, 7jd, 7jl, 7j, 7nk, 7uz, 7pg, 7wu, 7wd, 7xai, 7zaq, 7zi, 7yc, 7yz, 9aj.

BY GAVM, 2218 K ST., SACRAMENTO, CALIF.
C. W.—4bc, 4cb, 5za, 6aif, 6atg, 6cu, 6sa, 6aos, 6aa, 6bcd, 6ka, 6el, 6xag, 6ek, 6ij, 6ale, 6en, 6af, 6alu, 7af, 7ax, 7agz, 7bk, 7aja, 7amb, 7wd.
Spark—6aeb, 6ia, 6ald, 6gt, 6hy, 6ko, 6bgl, 6od, 6alu, 6aif, 6auc, 6avr, 6bft, 6aud, 6jw, 6aoc, 6ol, 6bif, 6amn, 6qk, 6sal, 6gp, 6to, 6awh, 6ti, 6acy, 6biu, 6ic, 6adl, 6iy, 6aio, 6ba, 6ajb, 6bh, 6iv, 6aak, 6ala, 6ia, 7zo, 7en, 7om, 7na, 7st, (7mf), 7qn, 7vk, 7ly, 7ka, 7abk, 7ed, 7an, 7hf, 7ki, 7ot, 7ab, 7aw, 7su, 7mp, 7ju, 7ek, 7tk, 7to, 7kb, 7sv, 7in, 7i. Anyone hearing 6avm pcc qnl.

NY 7NW, HOQUIAM, WASH.
6ak-cw, 6bb, 6bm, 6cv, 6dr, 6eb, 6en-cw, 6ez, 6ff, 6fh, 6gf, 6gr, 6gz, 6hc, 6ij-cw, 6ic, 6lu, 6kg, 6oh, 6po, 6qk, (6qr), 6rm-cw, 6au, 6to, 6uo, 6vo, 6wv, 6vz, 6xz-ione, 6ah, 6aa, 6ak, 6am, 6ar, 6au, 6az, 6aa-cw-ione, 6aav, 6abw, 6abv-cw-epk, 6acr, 6aci, 6afn, 6agf, 6alv, 6aif, (6ale-cw), 6alp, 6aly, 6amk, 6aos-cw, 6ark, 6aru, 6ath, 6atv, 6avv, 6bbr, 6bec, 6zao-cw, 6aan, 6aa-cw, 6zam, 6zao, 7ab-cw, 7bc, 7bb, (7bi), 7br, 7ek, 7en, 7cw, 7ed, 7fb, (7fi), 7ge, 7gj, 7gn, (7hd), 7in, 7io, (7iw), 7iy, 7jd, 7jl, 7kb, (7ke), 7kg, 7ka, 7in, 7iw, 7md, 7mi, 7mu, 7my, 7nu, (7ok), 7om, 7rn-cw, (7w), 7ti, 7tq-cw, 7vo, 7wi, 7wm, 7zf-ione, 7ya, 7yj, 7yf-ione-epk, 7zj, 7zm, 7st, 9az-cw-epk Canadian, 9bd Canadian, 9zaf-cw, cl8-ione.

BY SAFO SAN FRANCISCO, ON 1 TUBE
6od, 6gi, 6hy, 6su, 6wr, 6er, 6abw, 6alu, 6aak, 6el, 6en, 6aoy, 6aaz, 6da, 6fk, 6gp, 6hk, 6ka, 6lo, 6mb, 6mn, 6ol, 6pp, 6ak, 6wi, 6abg, 6aab, 6acy, 6adl, 6ad, 6aca, 6ahu, 6aib, 6all, 6ajb, 6ale, 6alu, 6ab, 6aou, 6avd, 6avy, 6je, 6ky, 7bb, 7hf, 7in, 7kb, 7iw, 7am, 7kg, 7kp, 7st, 7su, 7zd, 7ti, 7jw, 7nn, 7oz, 7to, 7ak, 7ki, 7ap, and 7ya.
Worked—6ka, 6eb, 6is, 7ed, 7mf, 7zj.

BY 7MF, EUGENE, OREGON
Spark—6if, 6hk, 6sa, 6iw, 6yl, 6xu, 6's and 7's too numerous, 6ar, 6as, 6jw, 6als, 6an, 6wv, Canadian (6bi), (6fe), (6ak), (6bd), (6ax), 6aau.
C. W.—6ot, 6an, 6zn, 6dr, 6il, 6w, 6gv, 6jl, 6bz, 6zv, (vy-aa), 6el, 6bif (7), 6boz, 6aj, 6an, 6aan, 6amb, 6wd, 6ns, 6rv, 6bbf, 6un, 6ayv, 6aup, 6doc, 6zi, 6zaz, 9dtm, 2se, 1bcg Canadian, 4cb, (6bd), (6az), 6aw.

DISCOMFORT ELIMINATED ~
~ LIMITATIONS REMOVED



RADIO
enjoyment
under difficulties



MAGNAVOX multiplies comfort and pleasure

No receiving set is complete without a Radio MAGNAVOX. No receiving set can even approach its best results or entire usefulness without a MAGNAVOX. Radio MAGNAVOX is the world's standard loudspeaker. "World's Standard" because its famous movable coil and other patented mechanical features make its marvelous performance positively and exclusively its own. There is NO substitute for the Radio MAGNAVOX.

Properly energized, it will reproduce with equal facility and without distortion either radio music, radio messages, or radio telephone speech in volume so that any audience from a small family circle to a vast public assembly may distinctly hear every tone, every word, and every modulation.

It is easy to hook up—you simply substitute the MAGNAVOX for your head set, sit back, listen, and enjoy. No adjustments necessary. Where power amplification is desired, use a 2-stage or 3-stage MAGNAVOX Power Amplifier, such as is shown in the illustration at the right.

Make your set complete now. Make it the source of pride and center of enjoyment it should be. Go to your dealer today, and tell him to give you prices and full particulars on the world's standard loudspeaking apparatus—the Radio MAGNAVOX and the MAGNAVOX new POWER AMPLIFIERS.

THE MAGNAVOX CO.—General Office—OAKLAND, CALIFORNIA
NEW YORK OFFICE—370 7th Ave.—PENN. TERMINAL BLDG.

In writing, please address the MAGNAVOX office nearest you.



MAGNAVOX



The
reproducer
with the
movable coil

Radio MAGNAVOX—the reproducer with the movable coil, world's standard loudspeaker. Type R-3, illustrated, with 14" horn, \$45. At your dealer.

Magnavox New Power Amplifiers



Add one of these to your set to get greater sound intensity and larger volume from your MAGNAVOX, without distortion. New 2-stage and 3-stage types, for use with transmitter tubes and high plate voltages. Simply throw the switches to operate. Solid mahogany case. Sits either flat or on edge. Ask your dealer for prices and particulars.

There is no substitute for the Radio *Magnavox*

Here's The Receiving Set—You are Looking For—

The Clapp-Eastman Type HR Regenerative Receiver—price \$35.00

You can pay more money for a receiving set—if you want to—but you can't get any better results or greater satisfaction at any price.

Since we put this set on the market, we've been literally swamped with orders. Dealers, radio "fans," novices—everybody who has tried the instrument has become a booster for it.

Regeneration is perfect on all wavelengths between 180 and 825 meters. The range or distance from which signals are received and the clear, sharp tones are a revelation to the experienced radio man as well as to the person who "listens in" for the first time.

The specifications tell the story to the expert and the C-E guarantee of satisfaction protects every purchaser of a Clapp-Eastman Type H. R. Regenerative Receiving Set—expert and amateur alike.

If you're looking for 100% satisfaction—regardless of price—ask your dealer to show you this set. He may be temporarily out, but it's well worth waiting for—or you can write us direct.

If you haven't already received a copy, you should send 6c in stamps for the C-E Radio Catalog—it covers every essential radio requirement.



Licensed under Armstrong U. S. Patent 1113149.

SPECIFICATIONS

- Panel**—Formica, handsomely finished.
- Cabinet**—Dark Oak, varnish finish.
- Condenser**—Balanced type, 2 Rotary, 3 Stationary plates. Built on Vernier.
- Dials**—Indestructible metal. White figures on black ground.
- Antenna Inductance**—Wound in Formica Tube.
- Plate Inductance**—Wound on molded ball.
- Binding Posts**—Nickel-plated brass.
- Switch**—Fan Blade.
- Rheostat**—C.E. Type H 400.
- Circuit**—Single circuit regenerative. Licensed under Armstrong U. S. Patent No. 1113149.
- "B" Battery**—Contained in compartment inside cabinet or external as desired.

Clapp-Eastman Company

Radio Engineers and Manufacturers

140 MAIN STREET CAMBRIDGE, MASS.

California Representatives: LEO J. MEYBERG CO., San Francisco and Los Angeles

Very DESIRABLE Supplies

A complete stock of Radio Parts and Supplies, Cunningham, Radiotron, Atlantic-Pacific TUBES in stock for immediate delivery.

Fresh stock of "B" Batteries at all Voltages, 22½, 43, 86 and 108. Prompt Attention given to Mail Orders.

Operating "K. V. Q." broadcasting every evening, 5:30 to 6:30. Listen for us.

Send for Catalog

Hobrecht's

1014-6th Sacramento Main 654



Tell them that you saw it in RADIO

BY THE, EUGENE, ORE.

Spark—Canadian (5ak), 9bd, (7ba), (7bc), 7bg, (7bb), (7b), (7bk), (7bs), 7cn, 7zj, 7hd, 7hi, (7iy), 7ke, (7kj), (7nw), 7uz, (7oh), (7om), (7tj), 7vo, (7vz), 7sj, 7zm, 7at, 7su, (6ab), (6aa), 6bb, 6ch, 6cs, (6ex), (6fh), 6fk, (6gr), 6qt, 6gz, 6hc, (6hp), 6is, 6iv, 6kc, 6km, 6ms, 6od, (6oh), 6ol, 6om, 6po, (6pr), (6qr), 6rs, 6et, (6tu), 6uo, 6uq, (6vk), (6vx), 6auu, 6abm, (6abw), (6abz), 6acr, 6acy, 6aoc, (6afn), (6agf), 6agp, 6ahq, 6aif, 6aih, 6ain, 6aix, 6ajt, 6akt, 6ald, 6alk, (6aln), 6alv, (6amk), (6ang), 6ano, (6aor), 6arc, (6ark), 6atf, 6atu, 6stv, 6auc, 6auu, 6aal, (6abr), (6bcj), (6bgn), 6bhq, 6bin, 6biu.

C. W.—Canadian 4cb, 6aat, (6abz), 6en, (6ji), 6ale, 6es, 6vm, 6awt, (cl3), 9amb, 7aav, 7ce.

BY 6BAJ, PASADENA, CALIF.

5sa (spk-cw), 6ad, 6ah, 6ak (spk-cw), (6as), 6cp, 6dp, 6ex, 6fh, 6gf, 6gr, 6gz, 6hc, 6iv, 6km, 6tu, 6oc, 6ob, 6ot, 6pj, (6pr), 6qr, 6to, (6tu), 6tv, 6uo, 6vk, (6vx), 6ws, 6xb, 6ab, 6ak, 6au, (6ax), (6az), 6aab, 6aau, 6aat, 6abm, (6abw), 6abz, 6afn, 6agf, 6aif, 6aiw, 6alc(cw), (6alv), 6amk, 6ang, 6aor, 6aph, 6ark, 6awb, 6bak, 6bas, (6br), (6bs), 6bg, 6biu, 7bd, 7bk, (7j), 7jd, 7jw, 7in, 7iw, 7mf, 7of, 7tj, 7sj, 7st, 9go, 9bd (Canadian).

BY 6RR, 416 N. GOWER ST., LOS ANGELES, CAL.

Spark—6sa, 5yq, 5xu, 5sj, 6ak, 6qr, 6nm, 6ot, 6ej, 6tv, 6pj, 6uo, 6wv, 6zh, 6ak, 6au, 6az, 6sz, 6agf, 6ain, 6amk, 6awb, 7jd, 7mf, 7ya, 7yg, 7zj, 7sm, 7st, 7su, 7ss, 9yal, 9xz, cl8.

C. W.—5sak, 6ec, 6gd, 6ku, 6pj, 6pt, 6nm, 6nx, 6vm, 6aa, 6ab, 6za, 6ac, 6aat, 6aag, 6aif, 6ale, 6av, 6az, 6av, 6awp, 6aaf, 6zak, 6zak, 6as, 6af, 7ce, 7og, 7tg, 8vy, 8jl, 8xv, 8ay, 8aga, 8box, 8ax, 9bd, 9jd, 9xz, 9ji, 9ba, 9hv, 9pe, 9wd, 9wu, 9pm, 9ru, 9al, 9sv, 9aig, 9aja, 9aks, 9amb, 9ayu, 9bez, 9bj, 9dth, 9dum, 9dva, 9zaq, 9saf, 9sac, cl8, gr8, kdq, agj, bf2, wv8, nof, Canadian, 9bd, 4cb.

BY 6ASJ, OAKLAND, CALIF.

Spark—6acy, 6agk, 6ahq, 6ajr, 6ald, 6alu, 6amn, 6aoc, 6avy, 6ea, 6fh, 6fk, 6lc, 6od, 6ol, 6bk, 7iw, 7mf, 7mp, 6tj, 7zn, 7at, 9bd, (Canadian).

C. W.—4cb, 5ck, 5sa, 6ac, 6af, 6aaz, 6arv, (6cu), 6eb, 6en, 6gd, 6jd, 6ka, 6ky, 6pi, 6rr, 6xad, 6xag, 6sa, 6sn, 6ar, 6sz, 7ce, 7nz, 7ny, 7qt, 7in, 7rm, 7iq, 9ays, 9bd (Canadian), 9hs-kn, 9kp, 9pe, 9wd.

BY 6AUA, CANTON, OHIO

Spark—1ahl, 1az, 1on, 1xz, 2aje, 2bej, 2bdc, 2bb, 2bi, 2fp, 2gk, 2om, 2tf, 2ag, 2aab, 2ahk, 2ata, 2arv, 2bex, 2cg, 2cm, 2el, 2fo, 2og, 2ud, 2wi, 2zm, 2zr, 4az, 4cz, 4cy, 5cj, 5bk, 5py, 5za, 5zb, 5xp, 5ru, 5ya, 5ye, 5yw, 5al, 5aw, 5sa, (8's too numerous to list), 6aac, 6aoc, 6aak, 6aab, 6alo, 6arr, 6arg, 6axu, 6asa, 6ac, 6bec, 6bg, 6ca, 6eb, 6dfx, 6ddq, 6dca, 6dfo, 6dao, 6dar, 6diw, 6db, 6dy, 6fm, 6fe, 6gk, 6gz, 6hr, 6io, 6jl, 6ju, 6ke, 6kl, 6me, 6ok, 6os, 6ql, 6rc, 6ry, 6el, 6tv, 6uu, 6wk, 6wn, 6on, 6wt, 6wu, 6ze, 6xi, 6am, 6uz, 6ya, 6yb, 6yc, 6ya, 6ya, 6ye, 6ym, 6yo, 6zan, 6al, 6aj.

C. W.—1aab, 1agi, 1abl, 1ary, 1aw, 1bog, 1bdi, 1bdj, 1bel, 1bem, 1bes, 1brg, 1lvb, 1bkq, 1lca, 1bg, 1cmk, 1df, 1qn, 1rd, 1ta, 1xa, 1xj, 2afp, 2ayu, 2ajf, 2axz, 2arv, 2beb, 2bfa, 2bq, 2bej, 2ecd, 2jw, 2no, 2aq, 2va, 2ak, 2an, 2ako, 2and, 2aak, 2ast, 2agp, 2acr, 2arm, 2br, 2bex, 2bgv, 2biy, 2btj, 2blf, 2bec, 2bfu, 2bav, 2bd, 2brc, 2brx, 2cbq, 2cm, 2fr, 2ig, 2kg, 2ko, 2sw, 2ar, 2sa, 2ay, 2az, 2bk, 2by, 2ew, 2ft, 2gk, 2gl, 2kk, 2il, 2pe, 2ya, 2yb, 2zc, 2aam, 2an, 2ex, 2dq, 2ek, 2fv, 2ix, 2ji, 2kj, 2la, 2nd, 2na, 2py, 2uu, 2ya, 2zo, 2als, 2am, 2bn, (8's too numerous to list), 6aad, 6aaf, 6azf, 6ajf, 6akd, 6aja, 6als, 6ajb, 6ams, 6arg, 6atv, 6aft, 6ayb, 6aif, 6arv, 6amv, 6aay, 6as, 6at, 6bjb, 6bfa, 6bwa, 6blf, 6bdl, 6brl, 6cp, 6dci, 6dew, 6dtj, 6dts, 6dta, 6dam, 6dva, 6db, 6dj, 6fs, 6hk, 6hw, 6ii, 6io, 6jl, 6jn, 6ju, 6kr, 6ks, 6lx, 6oz, 6ps, 6qa, 6qe, 6ry, 6ej, 6ev, 6aj, 6xi, 6am, 6yam, 6yaf, 6yb, 6ye, 6zac, 6za, 6zy, 6xy, 6mz, 6mz, 6mz).

Font—1ze, 2zb, 3an, 3ao, 8apu, 8ht, 8ju, 8zso, 8yz, 8zv, 8dka, 8qb, 8yw, nof, wbl, wcy, wnh, wja.

BY STATION 600, SAN FRANCISCO

4cb, 4bq, 5sa, 6ak, (6cu), 6es, 6ef, 6en, (6gy), 6jd, 6jq, 6ka, 6lf, 6nx, (6oc), 6za, 6an, 6ss, 6fn, 6arv, 7za, 7in, 7nz, 7ge, 7zf, 8bk, 8yv, 8az, 8brl, 8cd, 8kp, 8pa, (9wd), 9aau, 9aja, 9ays, 9dth, 9saf, 9bd (Canadian) also—6aby, (6aif), (6ale), (6ams), (6aoi), (6aoy), 6aqt, 6alu, 6and, (6aad), 6zaq, (6bcd).

All C. W. stations; 5-watt C. W. here and .6 amps. radiation.

OUR SHOP

has better facilities than yours has. Let us do your work. We have facilities for cutting, drilling, buffing, and graining panels. We carry in stock Formica and Condensite-Celoron.

- 3/16" Formica, per sq. in. 2½c
- 1/4" Formica, per sq. in. 3½c
- 3/16" Condensite Veneer, per sq. in. 1½c

Write us for estimate on a panel for your set, drilled and finished.

RADIO PANEL SHOP

1103 S. 3rd St., Evansville, Ind.

ELMCO

Elmco Senior Tuner with or without crystal detector.
 Elmco Junior Tuner with or without crystal detector.

150 to 700 Meters
 HIGHLY EFFICIENT

Super Crystal - Detector Receiving Sets Inductively
 Coupled. Sharpest Tuning. Positive Shielding.

Write for Catalog and Prices

ELMCO SHIELDED APPARATUS
 THE ELECTRIC MACHINE CORPORATION
 Indianapolis, Indiana

**DO YOU TAKE ONLY
 "HALF WAY" PRIDE IN
 YOUR RADIO WORK?**



It is impossible for the radio-electrician—professional or
 amateur—to take real pride in his work with inferior
 or "half way" instruments.

Whether in the first-grade—or taking a "P. G." in the great School of Radio, you owe it to
 yourself to be particular to the point of "fussiness" over your equipment.
 Consult Radio experts, teachers and students who know about

"SIGNAL"

Then check up Signal wireless apparatus with other makes, price for price, feature for
 feature. If you do this your choice will invariably be—"SIGNAL."
 Write us today for literature, names of users and nearest distributor.

SIGNAL ELECTRIC MANUFACTURING CO.
 MENOMINEE, MICH.

Everything for the Radio Novice and Professional

COLD FACTS

Craig, Alaska, 10-21-21.

Exp. Inf. Service,
45 Pinehurst Ave., N. Y. C.

Gentlemen:—

Received parts of your 160 to 1000 meter Receiver, just completed the set and given same a few days test.

Am very much pleased and wish to state that it is the best Receiver I have ever worked. The latest commercial receivers approach yours very closely in selectivity. Can copy stations 1000 miles distant thru interference by stations of equal power only 100 miles distant, both tuned to 600 meters. Some of the Pacific Coast Amateurs come in QSA without regeneration. Heartily recommend your Blue Print Design to anyone wanting to build a first class receiver.

(Signed)

WINFIELD S. H. WOOD.

Craig, Alaska, 11-22-21.

Exp. Inf. Service.

45 Pinehurst Ave., N. Y. C.

Gentlemen:—

On 600 meters I get everything on the Pacific Coast. Stations 1500 to 2000 miles come in very loud. I get ships and I K. W. Land Stations in the Hawaiian Islands fine.

What I consider the best work of your Receiver is in Phone work. After a few days test I was able to get the Avalon Phone fine and since have heard them nightly and sometimes an hour before dark. After a few nights adjustment was able to get the bulletins and music from the Fairmont Hotel, San Francisco. Next I picked up the music from the Post Intelligencer Office, Seattle. (Note: The last mentioned phone is only 10 Watt.) Have never heard this feat duplicated. *Everything on one bulb.*

(Signed)

WINFIELD S. H. WOOD.

THIS RECEIVER WAS BUILT FROM ONE OF OUR 22 BLUE PRINT DESIGNS

By building your own, you can have the very best at a minimum cost.

Bulletin 24 gives full particulars—mailed on request.

Experimenters' Information Service

45 Pinehurst Avenue, New York City

CROSLY HARKO SENIOR RADIO RECEIVER



Complete tuner and audion detector assembled on a formica or other high grade dielectric panel, mounted complete in mahogany finish cabinet. Range, 150 to 600 meters, non-regenerative hook-up. Price without battery, tube or phones.....\$16.00

CROSLY TWO-STEP AMPLIFIER



Complete with amplifying transformers, sockets, rheostats, switch, binding posts, etc., mounted on formica panel in mahogany finished cabinet. Price complete as shown in illustration.....\$25.00
We make a complete line of radio apparatus.
"It's better—and costs less"
Send for circulars.

CROSLY MFG. CO.

Radio Dept. P-5 Cincinnati, Ohio

RADIO CLUB SECRETARIES

Write for Our Special Club
Subscription Plan.

"RADIO," San Francisco, Cal.

THE 6TH EDITION IS READY!

IT INCLUDES ALL THE
LATEST PRICES
ON EVERYTHING.

SEND NOW
FOR YOUR FREE COPY
OF THIS
INDISPENSABLE PRICE
DICTIONARY.

WESTERN RADIO ELECTRIC CO.

637 So. Hope St. 274 Twelfth St.
Los Angeles, Cal. Oakland, Cal.

Operating Kinema Radiophone
Los Angeles

Wanted

a representative with practical
radio experience in every locality. A
paying proposition for live wires. No
capital required.

A. K. LAING RADIO CO.
Dept. N. Hanover, N. H.

WASHINGTON RADIO CONFERENCE

Continued from page 10

are indeed today upon the threshold of a new means of widespread communication of intelligence that has the most profound importance from the point of view of public education and public welfare. The comparative cheapness with which receiving stations can be installed, and the fact that the genius of the American boy is equal to construction of such stations within the limits of his own savings, bid fair to make the possession of receiving sets almost universal in the American home.

I think that it will be agreed at the outset that the use of the radio telephone for communication between single individuals as in the case of the ordinary telephone is a perfectly hopeless notion. Obviously if ten million telephone subscribers are crying through the air for their mates they will never make a junction; the ether will be filled with frantic chaos, with no communication of any kind possible. In other words, the wireless telephone has one definite field, and that is for spread of certain pre-determined material of public interest from central stations. This material must be limited to news, to education, to entertainment, and the communication of such commercial matters as are of importance to large groups of the community at the same time.

It is therefore primarily a question of broadcasting, and it becomes of primary public interest to say who is to do the broadcasting, under what circumstances, and with what type of material. It is inconceivable that we should allow so great a possibility for service, for news, for entertainment, for education, and for vital commercial purposes, to be drowned in advertising chatter, or for commercial purposes that can be quite well served by our other means of communication.

Congress some few years ago authorized the Secretary of Commerce to license radio sending stations, and to impose certain conditions in the licenses designed to prevent interference between the stations and to serve the public good. This legislation was drawn before the development of the telephone was of consequential importance. Until the last four or five months there has been but little difficulty in handling these regulations, because sending purposes have been largely confined to radio telegraph, and to a very small extent to the radio telephone. The extraordinary development of the radio telephone, however, has brought us face to face with an entirely new condition upon which licenses should be issued. It raises questions to to what extension in the powers of the department should be requested of Congress in order that the maximum public good shall be secured from the development of this great invention. During the last five months, while this extraordinary rapid installation has been in progress, I and my colleagues in this department have felt that we should take a very conservative attitude on the issuance of sending licenses, and I am able to inform you that there are today, outside of government broadcasting stations and the field authorized to the American boy, but few licenses outstanding—and these are limited to a small proportion of the number of the available wavelengths. We have therefore kept the field clear for constructive development. The experience gained indicates that the time has arrived not only when this large mass of subscribers need protection as to the noises which fill their instruments, but also when there must be measures to stop the interferences which have already grown up between even the limited number of sending stations which threaten to destroy them all.

The problem is one of most intensely technical character, but is not one without hope

of fairly complete solution. Fortunately, the sending of radio telephone messages can be arranged in wavelengths sufficiently far apart so as not to interfere with each other, and receivers can at their option tune their receiving instruments to the different wave bands. With the improvement in the art and in the delicacy of instruments, the distance between wavelengths may eventually decrease and thus the number of layers of messages increase. Furthermore, it is possible to increase the number of sending stations and thus the variety of material, if the power applied to certain wavelengths is limited so as to circumscribe the area of distribution from a given station. Beyond this again certain times a day may be set aside within certain wavelengths for certain types of information.

With the permutations possible to work out in different wavelengths, in different geographical areas, in different times of day, we should be able to make it possible for the owner of a receiving instrument, by tuning his instrument to different wavelengths, at different times, to possess himself of a great variety of entertainment, information, news, etc., at his own option. Even if we use all the ingenuity possible I do not believe there are enough permutations to allow unlimited numbers of sending stations.

One of the problems that enter into this whole question is that of who is to support the sending stations. In certain countries, the government has prohibited the use of receiving instruments except upon payment of a fee, out of which are supported government sending stations. I believe that such a plan would most seriously limit the development of the art and its and its social possibilities and that it is almost impossible to control. I believe that we ought to allow anyone to put in receiving stations who wishes to do so. But the immediate problem arises of who will do the broadcasting, and what will be his purpose. It is at once obvious that our universities, our technical schools, our government bureaus, are all of them willing and anxious to distribute material of extremely valuable order without remuneration. Also judging from the applications we have had, any number of merchants are prepared to distribute entertainment provided they are allowed to interlard discussion as to the approaching remnant sale. Many of the larger newspaper publishers are asking for licenses to install broadcasting sets in which news and entertainment will be distributed, and the commercial companies are requesting licenses for the establishment of systematic distribution of news and entertainment conditional upon their being given permission to undertake commercial broadcasting of one kind or another.

It is my belief that, with the variations that can be given through different wavelengths, through different times of day, and through the staggering of stations of different wavelengths in different parts of the country, it will be possible to accommodate the most proper demands and at the same time to protect that precious thing—the American small boy, to whom so much of this rapid expansion of interest is due.

It is, however, a problem of regulation, if we are to get the maximum use. It is one of the few instances that I know of where the whole industry and country is earnestly praying for more regulation. Regulation will need to be policed, if there is not to be great prejudice to the majority, and thus the celestial system—at least the other part of it—comes within the province of the policeman. Fortunately the art permits such a policeman by listening in to detect those ether hogs that are endangering the traffic.

There is involved, however, in all of this regulation the necessity to so establish public right over the ether roads that there may be no national regret that we have parted with

RADIO FREQUENCY AMMETERS



Type 127A



Type 127B

HOT WIRE AMMETERS

All transmitting sets, and continuous wave sets in particular, require ammeters to obtain the best results. You cannot depend on the other fellow's ear. The circuits from input to output must be adjusted by ammeters.

The hot wire ammeter is the universal meter for this service. It is adapted for direct current, low frequency alternating current and for radio frequency. It can be checked at any time on direct current and will be equally accurate on radio frequency. As this action depends on the fundamental I²R law, it always measures actual effective amperes.

We recommend for this service our Type 127 hot wire ammeter. This meter employs a platinum expansion element and is rugged and reliable. The diameter is three inches and this meter is made in front-of-panel and flush-mounting models. It is supplied in a variety of convenient ranges. The price is also right.

PRICE \$7.75

SEND FOR FREE RADIO BULLETIN 910C

GENERAL RADIO COMPANY

MASSACHUSETTS AVENUE AND WINDSOR STREET
CAMBRIDGE 39 MASSACHUSETTS

Standardise on General Radio Equipment Throughout.

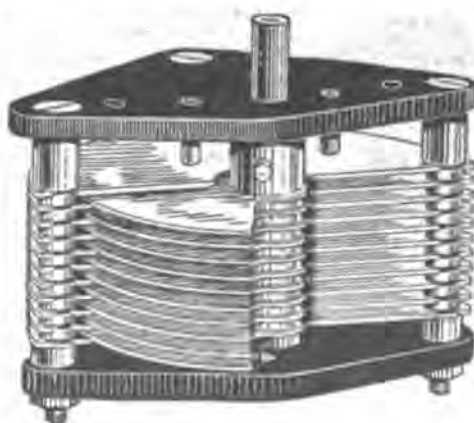

HECO VARIABLE CONDENSERS

Made in 23 and 43-plate. Spacing of plates and casting of pillars and plates give uniform capacity at all times. Spring bearings assure even tension and good contact. Parts made and assembled under direct supervision of our radio engineers.

No. 100 23-plate .0005 MFD List....\$4.00

No. 200 43-plate .001 MFD List....\$4.50

Prices do not include knob, dial, or scale.

Special proposition open to jobbers and dealers.

We can positively guarantee
24 hours shipments on all
orders.

HATFIELD ELECTRIC COMPANY
INDIANAPOLIS, IND.

Gould, the Light Man Says

Why suffer delay?

when you can get a complete radio set or parts from our complete stock, ready for IMMEDIATE shipment?

Through foresight we have the best assortment and variety of radio equipment at standard prices.

SPECIAL ATTENTION TO MAIL ORDERS

Cunningham Detectors \$5.00.

A. P. Amplifiers \$6.50.

SETS SOLD ON TIME PAYMENTS TO RESPONSIBLE PARTIES

Send for Price List and Music Schedule



WIRELESS APPARATUS
PARTS AND SUPPLIES

Gould The Light Man
Radio Phone Station
615 E. MAIN ST. Stockton

Member Pacific Radio Trade Association

"ILLINOIS" THE RELIABLE MADE RIGHT - STAYS RIGHT



STYLE No. 1.

STYLE NO. 2.

Three Styles: No. 1, Panel; No. 2, Open Type as shown; No. 3, Fully Encased. Anti Profftear. Less than pre-war prices. Fully assembled and tested.

	Style No. 1	No. 2	No. 3
67 Plates,	\$7.00	\$8.00	\$8.50
48 "	3.50	4.50	4.75
28 "	2.75	3.75	4.00
18 "	2.25	3.25	3.50

Money back if not satisfied. Just return condenser within 10 days by insured Parcel Post.

Options:—With Style No. 1—Instead of Scale and Pointer, a 3. inch Metal Dial at 50 cents extra, or a 3. inch Bakelite Dial at \$1.00 extra. Large Knobs. Both excellent values. Or we will, if desired, supply the Condenser with smooth 3/16 inch center staff, without Scale, Knob and Pointer, at 15 cents off the list to those who prefer to supply their own dial.

Vernier with single movable plate applied to 13, 28 or 48 plate condenser, \$3.00 extra.

We allow no discounts except 5 per cent on orders of 6 or more.

Sent Prepaid on Receipt of Price

Except: Pacific States, Alaska, Hawaii, Philippines and Canal Zone add 10c. Canada add 25c.

Foreign Orders other than Canada not solicited.



VERNIER

G. F. JOHNSON, 625 Black Ave.

Springfield, Illinois

Tell them that you saw it in RADIO

a great national asset into uncontrolled hands. I believe this conference with the high skill that it represents will be able to determine upon a method which should give satisfaction in all directions, and should stimulate the creation of a new addition to our national life.

TESTIMONY FROM A. H. GRISWOLD

The first witness called by the commission was A. H. Griswold, of the American Tel. and Tel. Co. He stated that his company's interests lie primarily in whatever relation radio telephony bears to public service. He stated that in his opinion the only real service which could be rendered through this means was for telephoning across wide stretches of water or from ship to shore or from airships to ground stations. He said that he knew of only one commercial application, namely the service given between Catalina Island and the mainland.

In regard to broadcasting he stated that his company is now constructing a sending station in New York which will be ready for service soon. It is the intention to lease this station to the public and not to give any definite program. His company, he stated, does not intend to promote the art of wireless telephony, but to give public service only by enabling a subscriber of their wire system to be directly connected to the wireless system. In his opinion it is difficult to subdivide transmission service, as there are not enough wavelengths to do this. He did, however, make the following suggestions as to the proper allocation:

Public radio telephone service, 325 to 425 meters.

Ship work, 1600 to 2200 meters.

International service, 4000 to 5000 meters.

Short range telephony, 100 to 150 meters.

In his opinion there are only 30 available wavelengths.

In answer to a question by Congressman White, Mr. Griswold stated that in his opinion there should be one governmental responsibility and that such control should be through the allocation of wavelengths. He stated further that the limit of their New York station would be transmission over 100 to 150 miles and that no service rates had been decided upon.

General Squier expressed the opinion that general broadcasting might interfere with all other service everywhere and that one radio station might do more harm than 1,000,000 miles of wire. Mr. Griswold thought that the only service which should be set apart would be that for international business and ship use. He thought also that every man should have the right to do broadcasting for his own business, but on short waves only.

In reply to a question by Secretary Hoover in regard to the patent situation, Mr. Griswold stated that two years ago the General Electric Co. and the American Tel. and Tel. Co. had at the request of the Government agreed to sell appliances. The former radio telegraph instruments and the latter radio telephone instruments. Thereafter certain rights were transferred by these companies to the Radio Corporation of America and the Western Electric Co. and later the Westinghouse Co. came into the field through an arrangement with the General Electric Co.

STATEMENTS FROM RADIO CORPORATION REPRESENTATIVES

E. P. Edwards, manager of the radio department of the General Electric Co., was then requested by Secretary Hoover to testify. In his opinion the biggest advantages derived from radio telephony were those secured to the farmer. He thought that broadcasting in general should be curbed. He stated that the cost of a large sending installation is about \$15,000, and that it costs about \$2000 per month for the technical operation of such a plant. Furthermore that such an installa-

tion should be operated through a public service corporation. Also that daylight broadcasting for commercial purposes should be encouraged and that light and power companies and the U. S. Forest Service should have free access to such facilities. In his opinion there should be no limitation placed on the sale of receiving apparatus.

Mr. Edwards then gave the following account of the mutual agreement which exists between the large corporations:

The Westinghouse and General Electric Companies make radio appliances under license of the Radio Corporation and this is cross-licensed under certain telephone patents. The Radio Corporation can only sell General Electric and Westinghouse equipment and then only in the experimental and amateur field. The General Electric Co. sells about 51 different radio items, but in a few days expects to have a low-priced complete receiving set on the market. In his opinion the Radio Corporation could get business amounting to about \$50,000,000, but that they are not equipped at this time to take on this amount of business. He said that his company is preparing to make about 60,000 large amplifier tubes per month, and that they are preparing to triple their tube production.

J. W. Elwood, secretary of the Radio Corporation of America, was called to the stand and stated that he will give full contract data in regard to the relation of his company to the other large companies to the commission for their own use. He admitted that his company was far behind in the filling of their orders and that they receive as many as 600 telegrams in one day. In reply to a question regarding interference from stations, he remarked that last year there was more human interference than God interference. In his opinion the relative importance of wavelength allocation should be as follows:

- First—Government.
- Second—Civil departments of the Government, such as agriculture, postoffice, forest service, etc.
- Third—Protection of life and property.
- Fourth—Education.
- Fifth—Entertainment.
- Sixth—Amateur service.
- Seventh—Public service.

He felt that the amateur should be amply recognized and encouraged and also that all transmitting stations should be properly controlled by the Government through legislation.

L. R. Krumm of the Westinghouse, E. N. M. Co., then testified, stating that his company was the pioneer in general broadcasting and that they have stations at Pittsburgh, Springfield, Newark and Chicago and that these stations furnish high-class entertainment, also that they realize that in deciding upon legislation the interests of the receivers are more vital than those of the broadcasters, for while there are but few of the latter there must be nearly 1,000,000 of the former. He thought that a range of between 300 and 400 meters should be prescribed for such service. He stated that his company intends to extend their service and that they will transmit church services from chimes to collections. He thought that all public service for business in the daytime and entertainment in the evening could be taken care of by 12 to 15 stations. He stated that his company is making 5 different types of receiving sets, varying in price from \$25 to \$300, and that while they are now making 25,000 of the cheap sets per month they can see no drop in the sales for a long time, as long as the quality of the broadcasting programs is maintained. At this point Mr. Griswold stated that the license agreement forbids connection between the A. T. & T. lines and the wireless service.

Congressman White wanted to know whether a state franchise or a tax on broad-

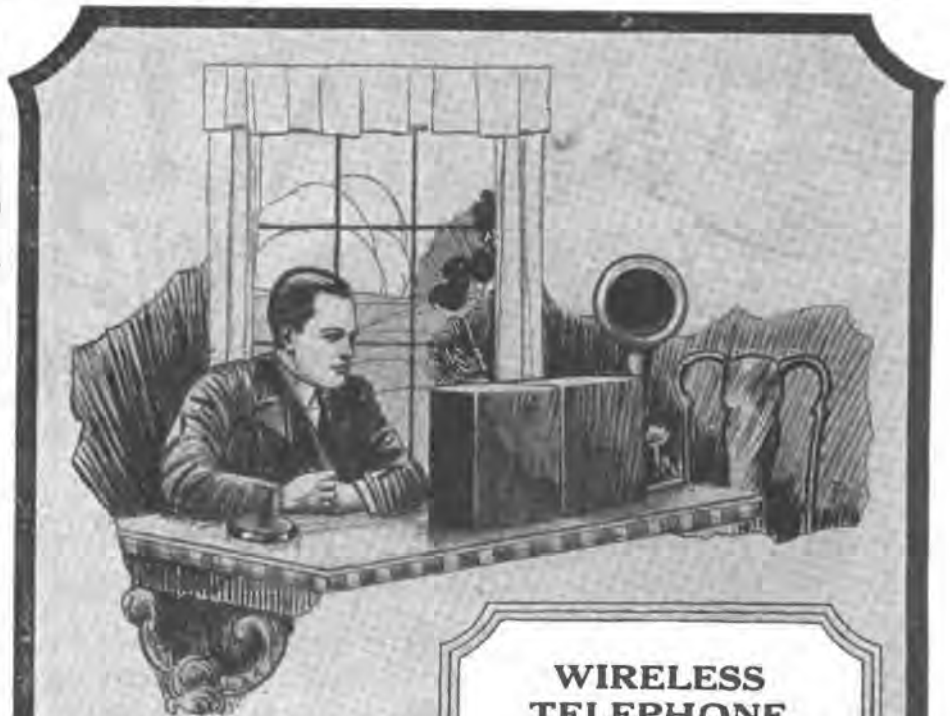

ATLANTIC RADIO CO. Inc.

727 BOYLSTON ST.
BOSTON 9 MASS.
BRANCH
15 TEMPLE STREET
PORTLAND MAINE

WIRELESS TELEPHONE broadcasting

makes radio today more intensely interesting than ever before. We show on this page a complete receiving outfit, assembled from our comprehensive stocks. We recommend every item of this station without reservation, for both wireless telephone and telegraph reception. It consists of:

- Westinghouse Tuner \$88.00
- Westinghouse Detector and Two-Step Amplifier 68.00
- (The Westinghouse RC set—a combination of these two instruments in one cabinet, is also offered for \$130.00 complete.)
- The Radio Magnavox \$45.00
- Radiotron Detector tubes 5.00
- Radiotron Amplifier tubes 6.50
- Radisco Better "B" Batteries 2.65
- Storage Battery, "Yale" 6-60 18.00

For weaker signals we recommend:
Baldwin Phones, type "C" 12.00
Baldwin Phones, type "E" 13.00
Western Electric Signal Corps Type Phone 15.00

Complete receiving station, exactly as shown above, including tubes, batteries, Magnavox, and Western Electric Phones, with instructions for operating, \$236.00.

Tell your friends who are starting in radio about Atlantic service, both in the stores and by mail. They will thank you sincerely for recommending a house where you know they will be treated courteously and encouraged to continue their interest in radio.

Our Special "Radio Broadcasting" literature gladly sent on request to the readers of "RADIO" and their friends.

Variometers Couplers \$3.75 Each

Wound but unassembled \$3.00 Each

These instruments embody best workmanship and materials, all wooden parts genuine mahogany, coupler primary wound on Formica tubing. Wound to arrange maximum results for short wave work. Shafts 3/16 inch. With Chelsea Dial and Knob \$1 extra. Send for bulletin describing panels, parts and other apparatus.

FREDERICK WINKLER, JR
304 Columbus Av., New York, N. Y.

Tell them that you saw it in RADIO

WIRELESS CATALOGUE

WHETHER you are interested in a complete radio receiving outfit, or a half a dozen binding posts, you'll find the particular instrument, best for your needs, in Corwin's catalogue. Send 10 cents, (credited to your first order) for your copy today! Where's the nearest mail box?

A.H. CORWIN & CO.
4 West Park St. Dept. G
Newark New Jersey



WHAT!
YOU HAVE NOT?
FOR THE LOVE OF PETE!
WHY NOT! YOU'VE
MISSED
HALF YOUR
RADIO LIFE!

CAN U GESS WHOSE AD THIS IS? WRITE US.
 \$1 TO THE FIRST TEN CORRECT ONES. 50¢ NEXT 10!



\$10.00

Sold on a money back guarantee. If your dealer cannot supply you order direct from this ad. Write for Bulletin No. 100L.

Dealers—Write for our Special Proposition.

LEE ELECTRIC AND MANUFACTURING CO.
 SAN FRANCISCO

LEMCO
 EQUIPMENT

COMPLETE LEMCO RADIO TELEPHONE RECEIVING OUTFIT

tunes to wave length up to 900 meters

No. 840A, consisting of: 1 No. 840 Crystal set (a complete self-contained, highly efficient and very selective set mounted in a very attractive mahogany finished cabinet), 1 No. 56 Murdock 2000 ohm Head-set, 150 ft. Copper Aerial wire, 4 porcelain insulators, 1 Antenna switch (single pole double throw), and 1 Ground Clamp.

Price Complete Shipped Anywhere in the United States, \$17.00.

No. 390 Supersensitive Radiosite mounted in soft metal; will fit 1/2 inch cup \$ 6.50
 No. LD-10 Lemco Audion Panel 6.50
 No. 331 Grid Condenser with adjustable Grid Leak capacity 0.00025 M.F.40
 No. 330 Grid Condenser without adjustable Grid Leak capacity 0.00025 M.F. .35

RADIOPHONE RECEIVING SETS

OUR POPULAR PRICED SETS BRING IN THAT MUSIC CLEAR AS A BELL

Write for Prices on

CRYSTAL RECEIVERS, AUDION DETECTOR SETS and TWO STAGE AMPLIFIERS

Pamphlet D101 Mailed on Request

RADIO DIVISION

H. E. WILLIAMSON ELECTRIC Co.

316 UNION ST.

SEATTLE

Tell them that you saw it in RADIO

casting stations had ever been suggested and Mr. Krumm thought not, to the best of his knowledge.

H. W. Nichols, Western Electric Company, then expressed the opinion that the only real important service rendered by wireless telephony is ship service or exceptional island service and that this should be done at short wavelengths. He stated that for two-way telephone work 10,000 cycles would be required, that for 300 meter service 1,000,000 cycles have to be used and for 400 meters about 700,000 cycles, so that in view of this relationship 25 messages could be sent in each direction. He expressed the opinion that very little advertising would be done in broadcasting and also stated that a movement was on foot tending to the manufacture of receiving apparatus by his company.

CONSIDERATION OF THE PACIFIC PLAN

Max Loewenthal, representing the Pacific Radio Trade Association, was then requested by Secretary Hoover to state the manner in which various problems had been approached and solved on the Pacific Coast. He dwelt at some length on the splendid spirit of co-operation evidenced on the coast which has resulted in the preparation and execution of a broadcasting schedule which has met with the approval of all interests concerned and permits of little or no interference. This schedule is based on a time schedule rather than on wavelengths, as all the broadcasting is being done on 360 meters. He expressed the opinion that such a basis could be worked out to advantage in most localities by local interests. Considerable interest was manifested by the commission in this method of solving the problem through co-operation, and through the policing power transferred to and accepted by local radio clubs, who assume such duty by authority of the U. S. Radio Inspector. Copies of the various schedules and plan were given to the commission. He stated in conclusion that he believes the use of the ether should be standardized and supervised and not commercialized or monopolized.

THE SHIP OPERATORS' SIDE

C. B. Cooper, vice-president and general manager of the Ship Owners Radio Service, then appeared before the commission and stated that in his opinion the most important service which can be rendered by radio is the service from ship to shore and vice versa: He thought that for amateur broadcasting, which is important, 200 to 225 meters should be reserved, having reference to spark work. For C. W. transmission 225 to 275 meters, for spark sets 275 meters, and for special work 325 to 350 meters. For advertising broadcasting 400 meters, for general broadcasting, like concerts, 1500 to 1700 meters, for commercial broadcasting 900 to 1200 meters. He stated that his company handles about one-third of all the service of the Shipping Board.

Congressman White expressed an opinion that Congress might do well not to try to legislate according to wavelength.

THE AMATEURS' SIDE

Secretary Hoover then called P. F. Godley, of the American Radio Relay League, to present the case of the amateurs to the commission. Mr. Godley made the statement that in his opinion, or rather that of most of the amateurs throughout the country, the large interests are trying to curtail the rights of the amateur and that these interests believe that the receiving sets of the amateurs are interfering with the service which they are trying to give. Also that the manufacturing companies believe that the novices can only use sets with a single knob, while in his opinion sets with several knobs for proper tuning should be produced. He suggested that wavelengths varying from 150 to 275

meters be employed and that 1200 to 1800 meters be reserved for the broadcasting stations. In his opinion "fading in" is negligible with longer wavelengths.

At this juncture Secretary Hoover interjected a few remarks with considerable emphasis to the effect that it is his intention and he knows it is the sense of the commission to protect the interests of the amateur to the fullest extent. And that he will, using his own words, sit on any misrepresentation as to their intentions and that he is very solicitous for the American boy and the radio amateur.

In answer to a question by Mr. Maxim as to whether the public can use selective receivers, Mr. Godley stated that the spark for the amateur should be kept below 200 meters. Secretary Hoover thought that most of the nuisance through interference has been created by the amateurs themselves. Mr. Godley thought that self-policing by radio clubs would probably keep the amateurs in line, but that this should be done through governmental regulation. He suggested the following schedule of wave allocation: For the first year man 150 to 175 meters, for telephone, spark or C. W. For the second year man, spark 175 to 200, modulated C. W. 200 to 225, telephone 225 to 250, pure D. C. C. W. 250 to 275. In his opinion sending amateurs should be compelled to take out operators' licenses. Secretary Hoover thought that then we should have regulation over all receiving equipment sold, in answer to which Mr. Godley said that to simplify this matter all radiating receivers should be considered unlawful.

K. B. Warner, secretary of the American Radio Relay League, supported Mr. Godley's plan of regulation and expressed the opinion that the operators would all be willing to pay license fees. He also did not approve in general of cheap or one knob sets. He stated that he has known of cases where 360 meter service interfered with ship traffic in New York Bay. He then made a plea for the necessity of writing the amateur interests into the new law. Congressman White thought that it might be well to license all transmitting receiving sets. Mr. Griswold stated that he was not so sure about the amateurs not wanting the cheap sets, but was anxious to get further information on this subject.

L. C. F. Harle of the Federal T. & T. Co., then testified, stating that in his opinion the entire question of broadcasting was an enormous experiment. He suggested the following wave allocation: For amateurs, 150 to 250 meters; for broadcasting, 3 sets of bands, 1 from 300 to 500, another 500 to 700 and another 800 to 900. He said that for commercial ship work 300 meters is no longer used. He expressed the opinion that the amateur is largely responsible for the wonderful radio development.

THE PUBLIC SERVICE SIDE

F. A. Allner, chairman of the Radio Committee of the N. E. L. A., then put in a plea for the central station, which are at times greatly in need of wireless service in order that service may be secured between various stations and sub-stations, especially when other service has been interrupted through storms. He stated that under no circumstances would any broadcasting be indulged in. He suggested the most flexible regulation.

Frank E. Doremus, of the Detroit News, then made an eloquent plea in behalf of newspaper interests, expressing the opinion that broadcasting service can best be given through such means. He stated that in and about Detroit about 250,000 receiving sets are in use and that the service which his paper is giving is being received with general satisfaction.



Price

\$5⁰⁰

Super Standard Vario-Coupler

Single turn variations cover entire primary winding on the Formica tube. For both table and panel mounting. 1/4" Brass rods in Rotors. Binding post connections. Green silk wire. Range, 150-600 Meters.

NEW KNOB AND DIAL \$1.00 SOCKETS \$1.00
IMMEDIATE DELIVERY

New Non-Regenerative Sets \$32.50
In Cabinet with Detector Unit Included

MANUFACTURERS—JOBBER—DEALERS
OUR NEW CATALOG IS READY

Our new catalog is ready with complete descriptions and illustrations of our entire line. Variometers, Vario-couplers, Detectors, Amplifiers, Dials, Sockets, Rheostats, Non-Regenerative Receiving Sets, Binding Posts, Contact Knobs, Stop Pins, Switch Levers, Complete and Small Accessories.

We Are Territorial Distributors For

Radio Corporation, Westinghouse, Magnavox, Baldwin, Remier, Cunningham,	Riley-Klotz "Arkay Horn" Acme, Weston and Jewell Meters	Federal, Rhamstine, Hipco B Batteries, Cooper Storage Batteries, A. P. Tubes, etc.
--	--	---

Send Us Your Orders for Head Sets, Dials and Knobs,
Sockets, Magnavox, Arkay Horns

The MARSHALL-GERKEN CO.

Manufacturers & Jobbers
Toledo, Ohio



"B" STORAGE BATTERIES



The newest development in plate batteries is the Pasted Plate storage cell. These cells, in sets of 11 or multiples of 11, will deliver a Constant Voltage without hissing or internal discharge noises. The plates are separated by Rubber and Wood Insulation and are immersed in Jelly Electrolyte. The batteries will operate for about 150 Hours at usual radio service discharge rate and are recharged by means of a chemical rectifier on the 110v. service.

WESTINGHOUSE, 11 cells, 22 volts, complete.....	\$9.40
SNELL CELLS, 11 cells, 22 volts, without case.....	4.40
SNELL CELLS, 11 cells, complete.....	5.50
Chemical Rectifier	1.25

4733 Geary St. **Mann & Snell** San Francisco, Cal.

New Catalog E6 FREE
Just off the press

Keep up-to-date. Learn about all the big recent improvements in radio apparatus. 84 pages chock full of best and biggest values of America's 51 leading manufacturers. Most complete, includes everything.

14-Hour Service
We Pay All Shipping Charges
Get the Latest
Don't Buy Till You See This Catalog
Writes for Big Free Catalog Today

TWO N-S LEADERS:
Red-Head Radio phones, 8000 ohms, military head band with cord complete, **\$8**
Arlington Tested Crystals, Galena or Silicon. Certified super-sensitive. Per crystal **25c**

THE NEWMAN-STERN COMPANY
Newman-Stern Bldg. Cleveland, Ohio

HI-GEE

Quality and Service

- Hi-Gee Vario-couplers \$5.00
 - Hi-Gee Variometers 3.60
 - Knocked set of parts, two variometers and coupler, all windings in place, with all hardware 5.75
 - Same, assembled 10.20
 - Hi-Gee "B" battery, 22 1/2 v.90
 - Same, tapped 1.10
 - Hi-Gee best "B" battery—compares with any, regardless of price 1.20
 - Hi-Gee Storage Batteries, the best lighting batteries on the market and guaranteed for two years. Quality batteries at price of inferior batteries:
 - 6 volt, 60 amperes \$12.95
 - 6 volt, 80 to 100 amperes 20.95
 - 6 volt, Ford starting batteries, 11 plate, hand made 15.00
 - Hi-Gee Unassembled Receiver, two variometers, vario-coupler cabinet, Formica panel 7x18, quartered oak cabinet. All windings in place. Nothing like it at the price 17.90
 - Hi-Gee Cabinet as above 4.85
 - Smaller cabinet, with 7x12 panel 4.15
 - Electron Relays 4.50
 - 5 Watt transmitting tubes 7.50
- Hi-Gee has a full line of parts. Tell us your wants. We can supply them, and give service. If in a hurry send your orders to

Hi-Gee Radio Manufacturing Co. :: Marion, Ill.

The Radio Shop

321 West 40th Street
INDIANAPOLIS, INDIANA

REPAIRING AND REWINDING OF ALL MAKES OF RADIO RECEIVERS

If you have a pair of telephone receivers we can wind them to any Ohms you desire.

Special this Month

6 Volt 80 Ampere Hour Battery Guaranteed Two Years.

Secretary Hoover stated that the question of licensing might involve a more difficult problem, namely, as to whether the Government can be held responsible for the moral and intellectual welfare of the people, for the question might come up continuously as to what constitutes a right form of information for broadcasting in order to reach a decision as to whether a license should or should not be withdrawn. In a humorous vein he suggested one wavelength for a prize fight and another for a sermon, if it is thought desirable that both be transmitted. Ex-Congressman Shirley thought that the Government should regulate and not censor. Secretary Hoover replied that by having at least two sending stations in a city competition might be created and in that manner might lead to a higher moral tone.

H. R. Young, representing the National Retail Dry Goods Association, stated that it is the intention of dry goods stores to broadcast for educational purposes only and that they do not advocate the use of wireless service for advertising purposes. He admitted, of course, that indirectly the store would be benefited through the sale of appliances. At this juncture Secretary Hoover interjected the thought that if every department store in the 260 cities in the U. S. wanted a license for broadcasting or only one in each city would want such a license, there would not be enough wavelengths to serve the purpose.

P. E. Wiggin, of the Radio Electric Co., Pittsburgh, stated that in his opinion 500 members of the Pittsburgh Radio Club would all be willing to pay a \$2 license fee and another \$10 for an operator's license.

F. P. Guthrie, of the U. S. Shipping Board, stated that there were 3 important factors which he would like to bring before the commission.

James Edgerton
L. A. Harter
Heave Percy Maxon
Agnes Hedmond
W. R. Larson
S. V. Stratton
George A. Aquier
A. H. Brown
E. H. Armstrong
C. M. Jansky Jr.
W. D. Wheeler
Herbert Hoover

Signatures of some radio notables at the conference

First—That there is no real need for wireless telephone equipment for ships.
Second—That 300 meter service is not desired by the board.
Third—That the large interests are not permitting the board to buy tubes because they believe that they will be used for the purpose of making money with them, which has been a hardship in many cases.
A representative of the Boy Scouts of America made an eloquent plea for closer cooperation between the various U. S. departments and the broadcasting stations so that the younger element of a community in par-

"M. P. M." STANDARD HIGHEST-TEST DETECTOR MINERAL

NOTE.—M. P. M. saves Detector Bulbs and Batteries. Obtain CLEAR and LOUD music by using M. P. M. for Detector and save your Batteries for your Amplifier; Two-Stage is plenty. M. P. M. also excels when used with any simple Detector Outfit. Results are marvelous! GET

"M. P. M." NOW!
AT YOUR DEALER—or mail \$1, Bill, M. O. or Check to
MILLION POINT MINERAL CO.
San Francisco (Calif.) Office—
1254 Clay St.
DEALERS—If you want to handle the best Mineral on Earth, write for attractive trade proposition.

The McTighe Storage B Battery

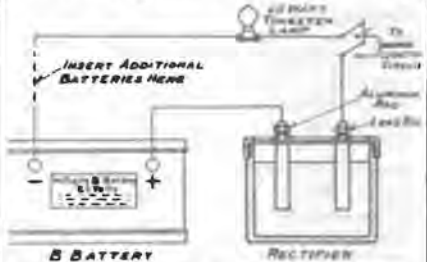

The McTighe Alkaline B Battery is the most satisfactory source of plate potential. All noises due to defective B Batteries eliminated.
Can be charged from any lighting circuit. Not injured by short circuit, overcharging, or standing idle.
The McTighe Storage B Battery, 24 volts \$4.00
Rectifier 1.50
Rubber Syringe for filling25
Add postage—Battery, 2 pounds.
Rectifier, 1 pound.

Dealers:—Write for our proposition.
The McTighe Battery Co.
WILKINSBURG, PA.

NEW MOTORS

FOR ALL PURPOSES
STANDARD MOTOR PRODUCTS DELIVERY

ALL SIZES UP TO 5 H.P.
We Specialize In Small Motors & Generators
ALL PHASES AND FREQUENCIES. IN STOCK AT ALL TIMES
Largest exclusive Mail Order Small Motor dealers in the world
CHAS. H. JOHNSTON, Box 38 West End, Pittsburgh, Pa.

WIRELESS, TELEPHONE GENERATORS
500 VOLT - 100 WATT - 3400 R. P. M.
FOR MOUNTING MOTOR GENERATOR SETS

\$28.50 EACH

WRITE FOR CATALOG

RADIO BLUE PRINTS

A COMPLETE PAIR OF 500 OHM HOOPERS FOR BLUE PRINT REFERENCE

WILL COST ONLY 25¢

EACH ON A SEPARATE SHEET. THEY'RE MAKING A HIT

VT RADIO-PHONE CIRCUITS IS 97-501

VT

THE PLAN BUREAU
1929 M'CAULSAND AVE. ST. LOUIS, MO.

READ THIS TAPE

You don't have to be a professional operator to read the high speed traffic that is going thru the air. The Hall Radio Relay will copy messages at any speed automatically and register these messages on tape. Note the border of this advertisement. It is a sample of the relay recording tape that is made possible thru the use of the Hall Radio Relay.

THERE is nothing complicated about the Hall Radio Relay. You just hook it to your set in place of the phones and the recorder will copy the signals of either damped or undamped wave stations regardless of speed. On a recent test the relay was in operation all night and hundreds of messages were accurately recorded. This is an ideal instrument for the reliable recording of weather report, news matter or stock quotations.

The Hall Radio Relay is taking the amateur world by storm. Within six months your station will not be up-to-date if you do not use a Hall Radio Relay.

Don't labor with a pad and pencil—trying to put down the traffic. Let the relay solve this tiresome problem. The tape is easy to read. Note the distinctiveness between the dots and dashes.

If a fellow pounds the brass a wee bit too fast for you, start the relay and copy every word he has to say. Then tell him to "speed up the bug." Yes—and thru Q. R. M. too.

We will gladly demonstrate this RELAY and RECORDER and show you its advantages over the ordinary system. It is being used for the most exacting requirements in many parts of the country. It is priced exceedingly low for such a device, and is guaranteed to give satisfactory service. Get in touch with us at once.

J. EDWARD JONES

Post Office Box 22

Palo Alto, California

Exclusive Western Distributor for the KARLOWA RADIO CO., Rock Island, Ill.
Sole Manufacturers of the HALL RADIO RELAY

Our beautiful 55 page radio catalog describing in detail the HALL RADIO RELAY and other high class radio equipment will be sent to you for 15 cents.

PRICE of RELAY complete with motor blower **\$125.00**

PRICE of RECORDER with motor drive..... **35.00**

8 HOUR SERVICE!

Our Radio Mail Order Service is gaining much popularity on account of the FAST SERVICE. We ship your order within eight hours of its receipt. After you tire of waiting days—or maybe weeks—for your supplies, try Warner Brothers' Radio Mail Order Service and you will use no other. Following are a few items that we have in stock:

VACUUM TUBES

OS00 Cunningham Detector.....	\$5.00
OS01 Cunningham Amplifier.....	6.50
OS02 Cunningham 5 Watt Power.....	8.00
OS03 Cunningham 50 Watt Power.....	30.00
AP ELBOTION RELAY.....	5.00
AP VT Amplifier.....	6.50
DEFOREST Rectifier.....	9.75
RADIOTRON 250 Watt Power Tube.....	110.00

SOCKETS

92 REMLER Socket.....	\$1.50
158 GENERAL RADIO.....	1.50
550 MURDOCK.....	1.00
DEFOREST Moulded Bakelite.....	1.10
CROSBY Porcelain.....	.60

RHEOSTATS

REMLER Jr.....	\$1.90
PADA—with new Knob.....	1.00
GENERAL RADIO No. 214 7 ohm or 2 1/2 Amp. 2 ohm.....	2.50
DEFOREST, new type.....	1.25
PARAGON.....	1.50
MURDOCK 580.....	1.00

WIRELESS SHOP VARIABLE CONDENSERS

Approximate Maximum Capacity	
No. 20 2 Plate, Vernier Condenser.....	\$2.00
No. 70 7 Plate, .0001 m. f.....	2.35
No. 130 13 Plate, .0002 m. f.....	2.75
No. 170 17 Plate, .0003 m. f.....	3.15
No. 230 23 Plate, .0005 m. f.....	3.50
No. 310 31 Plate, .0007 m. f.....	4.30
No. 430 43 Plate, .001 m. f.....	5.25
No. 630 63 Plate, .0015 m. f.....	7.50

AMPLIFYING TRANSFORMERS

UV-712 Radio Corporation.....	\$7.00
231A GENERAL RADIO.....	5.00
226W FEDERAL.....	7.00
A2 ACME, unmounted.....	4.50
A2 ACME, semi-mounted.....	5.00
A2 Fully mounted.....	7.00
Thordarson.....	4.00

METERS

GENERAL RADIO TYPE—	
0-1 Hotwire.....	\$7.75
0-2 1/2 Hotwire.....	7.75
0-5 Hotwire.....	7.75
0-10 Hotwire.....	7.75

VARIOMETERS

REMLER 505 Moulded Bakelite.....	\$6.00
OUR OWN TYPE.....	4.50

JEWELL METERS—	
Pattern 54 DC Standard.....	8.00
Pattern 54 DC 0-500 V.....	16.90
Pattern 54 DC 0-1000 V.....	23.00
Pattern 54 DC 0-1500 V.....	29.90
Pattern 54 DC 0-2000 V.....	35.00
Pattern 65 Radio Frequency Thermo Couple	
Pattern 14 AC Standard Readings.....	12.00
.....	8.00

REMLER APPARATUS

510 Jr. Rheostats.....	\$1.00
511 Rheostats.....	1.75
513 3 Amp. Rheostats.....	1.75
92 VT Socket.....	1.50
350 Audion Detector Panel.....	8.00
351 Amp. Panel.....	6.00
353 Amp. Panel.....	9.00
400 3 Coil Mounting.....	6.50
96 Variable Grid Leak.....	.60
97 Grid Condenser.....	.35

JACKS AND PLUGS

FEDERAL 1421 Open Circuit Jack.....	.70
FEDERAL 1422 Single Circuit Jack.....	.85
FEDERAL 1423 Double Circuit Jack.....	1.00
FEDERAL 1435 Automatic Filament Control Jack	
FEDERAL 1438 Automatic Filament Control Jack.....	1.20
WESTERN ELECTRIC Plugs.....	1.50
FEDERAL Plugs.....	2.00
PACENT UNIVERSAL.....	1.25
NEW FEDERAL Universal Plug.....	1.75
BEAMSTONE Plug and Jack, complete.....	1.60

VARIO-COUPERS

REMLER 503 Vario-Coupler.....	\$5.40
REMLER 505 Coupler on Unit Panel.....	12.75
OUR OWN TYPE.....	3.75

REMLER QSA HONEYCOMB COILS ALL SIZES AT STANDARD PRICES.

Now that you have read the list, get that order into the mails without delay. If there is something that you want and don't see it listed here, write us anyway and we will get it for you. Our two stores save still more time in getting your apparatus in a hurry. Enjoy the pleasure of real service for a change. Send us your orders.

WARNER BROTHERS

TWO STORES

San Francisco.
350 Market Street
Phone Douglas 4639

Oakland, Cal.
22nd & Telegraph Ave.
Phone Lakeside 8223

Tell them that you saw it in RADIO

NORTHWESTERN RADIO

A Superior Line of Receiving Apparatus



Detector and two stage amplifier Type SR-2.
Size of panel 10 1-2x12 3-4. Complete less
tubes and battery \$70 f.o.b., Portland.

A detector and two stage amplifier that will give you results. This instrument is in use in many stations in the Northwest and its performance is a proven fact. You must see this set to appreciate its value. Material and workmanship are the best.

Specifications — Panel quarter inch grade XX bakelite dilecto. Gorton pantograph engraving. Oak Cabinet finished in flemish oak.

Knobs and dials are machined from sheet bakelite and turn TRUE. All socket supports are constructed of bakelite and cast aluminum.

Write for Catalog

NORTHWESTERN RADIO MANUFACTURING CO.

1556 East Taylor Street

Portland, Oregon

WE USED OUR BEAN

IN DESIGNING

THE PARKIN DIAL RHEOSTAT (pat. pending) and by mounting the resistance element in a circular groove in the back of a 3" molded Bakelite dial eliminated one part and saved you the cost of a dial. The groove being recessed, allows the dial to clear the panel by the usual distance of 1-16". An off position is provided and a stop on the dial engages the stationary contact at the extreme positions. The 360-degree rotation insures fine adjustment. A brass bearing insures a true running dial and smooth action.

All figures and graduations are filled with brilliant white enamel. All brass parts nickel plated. Bakelite knob. Resistance is 5 ohms, carrying capacity 2 amps.

No. 77 Parkin Dial Rheostat, postpaid.....\$1.75

FOR SALE BY ALL LEADING DEALERS

Send for free catalog, No. 5, describing our complete line.

Dealers: Write for proposition.

PARKIN MFG. CO.

SAN RAFAEL, CALIF.

A VACUUM TUBE FREE

Send us three subscriptions to "RADIO" and we will send you a Vacuum Tube of any Standard make. (Receiving tube only)

RADIO Pacific Building San Francisco

Tell them that you saw it in RADIO

ticular, might receive important information direct from Government sources, even to the extent of having them listen in to debates in Congress and have the prominent Government officials talk directly to the youth of the country.

Dr. Stratton, the chairman of the commission, then asked for any further remarks from anyone in attendance and as there were no further suggestions offered he adjourned the hearing after thanking everyone for their cooperation with the commission. He stated that the committees would require probably ten days or longer to report and that some recommendations would probably be made tending towards some legislation by Congress giving the Department of Commerce broad discretionary powers for the regulation of all sending and receiving stations.

TEXAS RADIO MARKET NEWS SERVICE

Continued from page 25

Markets and Warehouse Department and the Department of Agriculture, who in addition to his other duties, will for the present have charge of the office details of the "Texas Radio Market News Service," and those wishing further information will please address, J. Austen Hunter, Assistant Marketing Agent, Texas Radio Market News Service, Austin, Texas.

INDOOR COIL AERIAL

Chart and tables giving number of turns for wave lengths from 0 to 3600 meters, 50c; 3600 to 24000, 50c. Stamps not accepted.



G. A. DAVIS & CO.,
2371 Champlain St.,
Washington, D. C.

KEYSTONE WIRE CO.

Introduces to the
Radio World

Cory Phones

Clear—Sensitive—Load

THESE receivers are specially designed for radio reception by Chas. Cory & Son, Inc., makers of telephone equipment for the U. S. Navy for over 76 years. The experience, skilled workmanship, and rigid inspection back of Cory phones makes them the best value ever offered. Neither clearness nor sensitiveness has been sacrificed to obtain volume.

Finest materials are used throughout. Cloth covered adjustable head band. Aluminum cases, composition ear caps, nickel-plated magnets. Resistance, 2000 ohms. The price is \$3.00 a pair including parcel post charges to any address in the United States. Terms, full payment with order, or one-half with order and balance, C.O.D. Safe delivery guaranteed. Shipment at once.

KEYSTONE WIRE CO.

"Wire for every wireless purpose"

418 Connell Building, Scranton, Pa.

Mail address—P.O.B. 120, Scranton, Pa.

A Dependable and Serviceable Battery at Low Cost

No. 766— **EVEREADY**



Order from your regular dealer and specify No. 766 Eveready Wireless Battery.

This is just the thing for the amateur—will give long, and valuable service and can be absolutely relied upon to deliver a clear, steady current.

This battery has 1 negative and 5 positive leads, each having a flat brass strip with a 3/16-inch hole in the end for connection with the binding posts. These 5 positive leads allow a range of 16½, 18, 19½, 21 and 22½ volts in steps of 1½ volts.

15 cells connected in series and packed in a strong box make this battery substantial and easily handled. All cells are solidly packed and are sealed in paraffine and packed with ½-inch of sealing wax, rendering a weather proof unit and one that will withstand practically all variations of climate and temperature.

This Wireless B Battery has been standardized for use in the United States Navy.

And the price—only \$3.00.

Made in San Francisco by

NATIONAL CARBON CO., INC.
599 EIGHTH STREET

Compare it with ANY
It SPEAKS for ITSELF



Pat's
Pend'g **PRICE \$12.00**
F. O. B. New York City

**INTRODUCING THE
KING "AM-PLI-TONE"
A RADIO SURPRISE**

**LISTEN TO THE CONCERTS, NEWS AND
DANCE WITH A KING "AM-PLI-TONE"**

Just slip your head phones on the "AM-PLI-TONE" and you and your friends will be *SURPRISED!*

Polished cast aluminum body with nickel plated base and horn. No sheet metal is used. The tinny sound is left out. The volume is *DOUBLED* because *TWO* head phones are blended into one *POWERFUL* tone.

A big hit, a big seller, and immediate deliveries. Dealers and distributors, what more can you ask? Write today for territory—KING "AM-PLI-TONE."

NOTICE—All infringers of this device will be vigorously prosecuted.

82 Church St., New York City

6 Volt Storage Batteries

FOR RADIO USE

60 Ampere Hour Capacity
NINE PLATES PER CELL **\$15.00**

Built for Service

Realizing the demand for a most reliable and serviceable storage battery for radio work, we have developed two standard batteries that will be ideal for every radio requirement. These batteries are **NEW** in every respect and they are priced within your means.

6 VOLT-90 A.H.
11 Plates Per Cell
\$17.50

Besides manufacturing our own storage batteries we have a stock of rebuilt batteries that we offer to the radio trade at attractive prices. Write for a list of rebuilt batteries or drop in and look them over.

2-Year Guarantee on All Batteries

MAIL ORDERS PROMPTLY FILLED

Dealers: Write us for information on how to boost your Battery Sales

STORAGE **"Ledox"** BATTERIES

Manufactured by—

LARSON & ZINNAMON

439 Golden Gate Ave., San Francisco, Calif.

Radio men in San Francisco and the Bay Cities are invited to inspect our battery manufacturing plant. An experienced Radio man has designed storage batteries that will meet the most exacting requirements for radio work.

Brach Radio Lightning Arresters

For Radio Telegraph and Radio Telephone Receiving Stations



The National Electric Code Permits the use of Vacuum Tube Protectors in place of the Grounding Switch Formerly Required.

The Brach Radio Protector Tube Meets the Requirements

Where Radio Transmitters are Operated from Public Service Mains, two Brach Radio Protectors connected in series, with midpoint grounded, furnish the least expensive, and the best protection against surges. Price \$3.00.

Order early to make sure of obtaining a supply. Patents allowed and pending. Manufacturers of Lightning Arresters, Signal, Telephone and Wireless Specialties.

L. S. BRACH MFG. CO.

127-129 Sussex Ave., Newark, N. J.

Watch Our Ad for Bargains

Order those cw supplies from us. 10% off list on all orders for cw supplies received by us during March.
22 1/2 volt Hi-Gee B-bat plain 90 cents
22 1/2 volt Hi-Gee B-bat tapped \$1.10

If that burnt-out tube is not broken we allow you 50c on the purchase price of any new tube.

CITIZEN'S RADIO SERVICE STATION
P. O. Box 155, Mattoon, Illinois

We Want You

to write us today for full details on our new subscription agency. You can make many extra dollars in your spare time. Write NOW.

RADIO
Pacific Bldg., San Francisco, Cal.

Immediate Delivery

on all standard makes of Radio Apparatus. No matter what instrument you desire, send us your order for quick shipment. Chicago Amateurs: Come and inspect our new apparatus. Open all day Saturday.

Chicago Radio Apparatus Co.
Inc.

415 South Dearborn St. Chicago, Ill.
New Ground Floor Salesroom

"Aerial Wire"

SPECIAL

150 feet No. 14 copper wire, \$1.00

100 feet Stranded copper wire, \$1.00

EMPIRE RADIO EQUIPMENT CO.

271 West 125th St., New York City

Radio Storage Batteries

4 Volt Special

\$5.00

6 Volt Special

\$7.50

22 Volt Special

\$25.00

Warranted for 12 months

INTERNATIONAL BATTERY CO.

112 Louis St., N. W.

GRAND RAPIDS

MICH.

A RADIO PRIMER

Continued from page 24

The range of communication varies from day to day due to the electrical condition of the atmosphere. When the weather is warm the moisture in the air is usually heavily charged with electricity. The static electricity, as it is called, not only absorbs energy, but collects on the receiving aerial and makes considerable noise in the receiving instrument which interferes with the reception of radio signals. For this reason better distances can be covered during winter than during summer.

You can reflect light waves with a mirror; "radio waves," that is the waves used in radio communication, are reflected by conducting surfaces such as heavily charged clouds or bodies of electrified air.

Radio waves are subject to refraction, a bending action which takes place when they pass through atmosphere of varying density. You can study the refraction of light waves by holding a stick in a bowl of water at an angle; the stick appears to be bent. Refraction changes the direction of radio waves.

Radio waves are also subject to diffraction, or a bending around objects in their path such as mountains. The mountain sets up counter waves and an electrical shadow exists on the lee side similar to the conditions which exist when a rock is in the path of water waves.

Unusual long distance "freak" messages are the result of combinations of reflection, refraction and non-absorption.

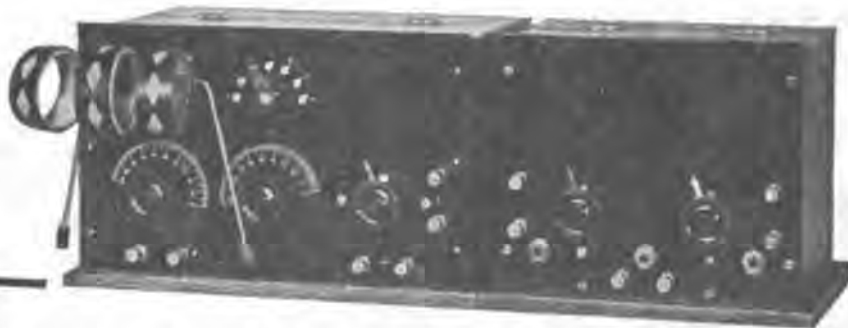

HERE'S THE RECEIVER THAT GETS THEM ALL

Does It Work?---Yes!

LONG WAVES

POZ on one tube, Nauen, Germany.
POZ 6 inches from the phone on two steps in the day time.

SHORT WAVES

7MF Bozeman, Montana, at 8 P. M. through the concert.
The Avalon phone all over a room 20 x 15 in Mill Valley, Calif.

Does It Amplify?---Yes!

From a concert 50 miles away. On the first step 15 feet from phones.
On detector 5 feet from phones. On the second step 75 feet from phones.
These signals were easily readable. Just a plain head set was used, with Magnavox 5 blocks.

Is It Easy To Work?---Yes!

Yes, all this was done by an amateur of one month's experience.

Has It Quality?---Yes!

The best that there is. Remler dials, General Radio transformers, Pen Brand condensers, Federal jacks, Formica panel, etc.

THE PRICE—The tuner-detector combined \$35. The two step amplifier \$45. (No Bulbs or Batteries.)

The detector-tuner panel complete with 6 volt 60 ampere hour A battery, 43 volt B battery phones, antenna, bulbs, etc., installed complete. Working in your home, \$75.
The tuner-detector and amplifier panels complete with 6 volt 100 ampere hour battery, coils, phones, bulbs, B batteries and antenna, complete. Installed in your home, ready to work, \$150.

Personal

1230
Polk St.



Service

San
Francisco

PHONE PROSPECT 230

Ask SORSINC



The highly professional service which our seasoned radio men give—backed by complete stocks of the leading lines of equipment—make it well worth your while to ASK

SORSINC

before buying. We know from experience what each piece of apparatus will do.

Our Interesting Booklet—the most comprehensive in print, sent for 6 cents in stamps. Get your copy now!

SHIP OWNERS
RADIO SERVICE INC.

80 Washington St., New York, N. Y.
Branch Offices and Dealers Everywhere
"The Largest Radio Chain Store System in the World"
SORSINC, 80 Washington St., New York, N. Y.
Herewith 6 cents in stamps to pay mailing expense on my copy of your latest booklet.



STANDARD RADIO HORNS

7 inch Bell, 19 inches High \$7.50
5 inch Bell, 14 inches High \$5.00

Standard Metal Mfg. Co
NEWARK, N. J. U. S. A.

SOMETHING NEW

Made to Please You and Priced to Please
Your Pocketbook

By departing from conventional design in audion sockets we have combined the advantages of all, the disadvantages of none and a price lower than any. Think of it—a sturdy, easily mounted socket that is heat proof, has bakelite-dielecto insulation, handy binding posts, etc., all for 75c.



Type 126, Tube Socket
Price 75c Postpaid

And here's a smooth running rheostat that takes panel space 2 inches in diameter, needs one hole to mount, has six ohm resistance, all off and all on positions and a brass panel bushing. Priced at 90c.



Type 122 Rheostat
Price 90c Postpaid

THE WILCOX LABORATORIES
LANSING, DEPT. J., MICHIGAN



We Have It!

The Leo J. Meyberg Co.

is now prepared to fill your order on

RADIO CORPORATION APPARATUS

DISTRIBUTORS FOR the following well-known manufacturers:

Radio Corporation of America, General Electric Co., Westinghouse Electric and Manufacturing Company

Adams Morgan Co., (Paragon)
Federal Tel. and Tel. Co.
Signal Electric Mfg. Co.
Remler Radio Mfg. Co.
Wireless Press Books
Wm. J. Murdock Co.
Baldwin Telephones
Cunningham Tubes
Chelsea Radio Co.
Eveready Batteries
General Radio Co.
Acme Apparatus
Pacnet Essentials
Clapp Eastham
Magnavox Co.
Frost Phones
C. Brandes



New printed 6th District Call Book now ready. 50 cents postpaid.

Dealers: Order your copies to supply the immediate demand.

LEO J. MEYBERG CO.

Operating the Fairmont Hotel
Radio Station KDN, San Francisco

Operating Hamburger's
Radio Station KYJ, Los Angeles

Send two-cent stamp for NEW Concert Schedule.

San Francisco, Cal.
428 Market Street

950 South Flower Street
Los Angeles, Cal.

BROADCASTING STATIONS OF U. S.

Continued from page 17

The Emporium, San Francisco.
Daily, except Sunday, 10:00-11:00 a. m. and 2:30-3:30 p. m., music after April 15.

Seventh District

KFC—Post-Intelligencer, 600 Pine St., Seattle, Wash. News, music and special entertainment each evening.

Ship Owners' Radio Service, Wooster Bldg., Portland, Ore.

Hallock & Watkins, 192 Post St., Portland, Ore.

Northwestern Radio Mfg. Co., Portland, Ore.

Eighth District

KDKA—Westinghouse Electric & Mfg. Co., Pittsburgh, Pa. Daily, except Sunday, music 10:00-10:15 a. m. and 12:30-1:00, 2:00-2:20 and 4:00-4:20 p. m., with special Saturday concert 3:00-4:00 p. m.; bedtime stories, 7:30 p. m.; press, 7:45; special features and vander-ville acts, 8:00 p. m.; music and news, 8:30-9:30; Sunday, church service, 10:45 a. m., 3:00 p. m. and 7:30 p. m.

WBL—The Detroit News, 615 Lafayette Bldg., Detroit, Mich. Daily, except Sunday, 11:30-11:55 a. m. and 3:30-4:00 p. m., phonograph music; 7:00-8:30 p. m., special musical programs by selected artists.

KQV—Doubleday-Hill Electric Co., 719 Liberty Ave., Pittsburgh, Pa. Daily except Saturday and Sunday, music, 4:30-5:00 p. m.; Sunday 1:00-1:30 p. m. and 4:00 to 5:00 p. m.; Monday, Wednesday and Friday, 9:30 to 10:30 p. m.

WDZ—Marshall-Gerken Co., 27 Ontario Ave., Toledo, Ohio.

WPB—Pittsburgh Gazette - Times, Gazette Square, Pittsburgh, Pa.

WMH—Precision Equipment Co., Cincinnati, Ohio. Monday, Wednesday and Saturday, 8:15-10:00 p. m., music, speeches and news; daily 485 meters; 11:00 a. m. and 4:00 p. m., weather reports.

Ninth District

WOV—R. B. Howell, 1802 Farum St., Omaha, Neb.

WHA—University of Wisconsin, Madison, Wis. Daily, except Sunday, weather reports at 12:35 p. m., Friday at 8:15 p. m.; special music and other dates as announced. Midnight to 1:00 a. m., university news on 410 meters.

WLB—University of Minnesota, Minneapolis, Minn. 485 meters; daily 12 noon, weather and stock reports; 7:30 p. m., wheat and potato market; 7:45 p.m. Wednesday only, music, 360 meters.

WLK—Hamilton Mfg. Co., 2011 North Alabama St., Indianapolis, Ind. Sunday, 8:00-8:55, religious, vocal and instrumental music; Tuesday, 8:00-8:55 p. m., jazz, vocal and instrumental music; 9:00-10:00 p. m., local theater numbers and news items; Thursday, 8:00-8:55, special numbers from local singers and orchestras, stories, news and speeches.

KYW—Westinghouse Electric & Mfg. Co., 111 W. Washington St., Chicago, Ill. Daily, except Sunday, 9:30, 10:00, 10:30, 11:00, 11:30 and 12:00 a. m. and 2:45 p. m., stock and market reports; 2:15, 4:15 and 6:00 p. m., news and market reports; 7:00 p. m., summary of financial report; 7:30 p. m., children's bedtime story; 8:00-9:00 p. m., musical program; 9:00 p. m., news and sports; Sunday, 3:30 p. m., Radio Chapel.

9XAB—Western Radio Co., Kansas City, Mo. Market reports and weather forecast, 11:30 a. m. and 2:30 p. m.; concerts in the evening.

9ZAF—Reynolds Radio Co., Denver, Colo. News twice daily and concert Sunday evening.

ACME APPARATUS

Audio Frequency Amplifying Transformer, semi mounted, type A-2.....	\$5.00
Single Choke Coil, 1.5 henry, 150 milliamperes.....	4.00
Single Choke Coil, 1.5 henry, 500 milliamperes.....	6.00
Double Choke Coil, 1.5 henry, 150 milliamperes.....	6.00
Double Choke Coil, 1.5 henry, 500 milliamperes.....	8.00
C. W. Filter Condenser, 2 microfarads, 750 volts.....	2.00
C. W. Inductance, 30 turns each tapt, 5 terminals, type L-1.....	8.00
C. W. Grid Coil, 25 turns tapt at 15 turns, type G-1.....	2.00
C. W. Transformer, 75 watts, for two 5 watt tubes.....	17.00
C. W. Transformer, 200 watts, for four 5 watt tubes & rectifiers.....	23.00
C. W. Transformer, 300 watts, for one 50 watt tube and rectifiers.....	28.00
C. W. Transformer, 600 watts, for two 50 watt tubes.....	38.00
Filament Heating Transformer, 75 watt, with rheostat & condenser.....	13.00
Filament Heating Transformer, 150 watt, with rheostat & condenser.....	17.00
Filament Heating Transformer, 300 watt, with rheostat & condenser.....	22.00
Plate Transformer, 250 watts, for six 5 watt or one 50 watt tubes.....	23.00
Plate Transformer, 500 watts, for two 50 watt tubes.....	28.00
Spark Power Transformer, 500 watts, with 250 watt tap.....	22.00

GENERAL RADIO APPARATUS

Audio Frequency Amplifying Transformer, type 231-A.....	5.00
Modulation Transformer, type 231-M, for 5 watt tubes.....	5.00
Hot Wire Ammeter, type 127-A, flush mounting, 100 milliamperes.....	9.00
Hot Wire Ammeter, type 127-A, flush mounting, all other ranges.....	7.75
Hot Wire Ammeter, type 127-C, portable, 100 milliamperes.....	10.00
Hot Wire Ammeter, type 127-C, portable, all other ranges.....	9.00
High Frequency Buzzer, type 178-A, front of panel mounting.....	2.00
High Frequency Buzzer, type 178-B, back of panel mounting.....	2.00
Calibrated Variable Air Condenser in case, type 247-A, .001 mfd.....	5.50
Variable Air Condenser, unmounted, type 247-B, .001 mfd.....	3.25
Knob and Dial for type 247-B condenser.....	.50
Four Step Inductance, type 226-A, 140 to 1000 meters.....	6.00
Four Step Inductance, type 226-B, 400 to 3000 meters.....	6.00
Four Step Inductance, type 226-C, 1100 to 8000 meters.....	6.00
Four Step Inductance, type 226-D, 3000 to 22000 meters.....	6.00
Potentiometer, type 214-A, .80 ohms.....	4.00
Potentiometer, type 214-A, 400 ohms.....	4.00
Rheostat, type 214-A, back of panel mounting, 2 ohms, 2.5 amps.....	2.50
Rheostat, type 214-A, back of panel mounting, 7 ohms, 1.5 amps.....	2.50
Rheostat, type 214-A, back of panel mounting, 80 ohms, .5 amp.....	3.50
Rheostat, type 214-A, back of panel mounting, 400 ohms, .1 amp.....	3.50
Vacuum Tube Socket, type 156, universal.....	1.50
Direct Reading Wavemeter, type 174, 130 to 3000 meters.....	68.00
Audibility Meter, type 164, 1 to 2000.....	36.00

PAUL F. JOHNSON 90 North Los Robles Ave.

Dept. R.

Pasadena, Calif.

"SHAMCO PRODUCTS"

Amateurs: Send 5c in stamps today for our new Catalog L showing complete line of parts, raw materials and high grade apparatus.

Dealers: Write for our attractive proposition.

THE SHOTTON RADIO MFG. COMPANY, INC.

8 Market St. Albany, N. Y.

All
Wizard Batteries
Are
Absolutely
Guaranteed

FROM MANUFACTURER TO USER

ALL BATTERIES SENT POSTPAID

Buy direct from the manufacturer and receive a Fresh Battery
Announcing Wizard's 2 New Improved Type "B" Batteries

No. 1632—1 tap 45 Volt Var. Battery,

Size 6x5x2 3/4 in. (Wt. 3 3/4 lbs.) Price... \$3.80

No. 1630—6 tap 27 Volt Var. Battery,

Size 6x3x2 3/4 in. (Wt. 2 1/2 lbs.) Price... 1.80

These new types are not made of the same size cells as a small size "B" Battery. The volume of one of the cells in these types is 4.7 cu. inches as compared with 2.5 cu. inches, the volume of a cell used in small "B's". You can easily see that the life of these two types are almost double the life of the small "B's".

OTHER WIZARD TYPES

Cat. No.	Size	Taps	Vltge	Weight	Price	Cat. No.	Size	Taps	Vltge	Weight	Price
1623 Plain	2 1/2 x 2 3/4	5	22 1/2	1 lb.	\$1.00	1625 Variable	3 x 4 x 6 1/4	5	22 1/2	5 lbs.	\$3.25
1623 Variable	2 1/2 x 2 3/4	5	22 1/2	1 lb.	1.20	1626 Plain	3 x 3 x 6 1/4	45	10 lbs.	2.75	
1626 Plain	3 x 4 x 6 1/4	22 1/2	5 lbs.	1.85	1626 Variable	3 x 3 x 6 1/4	0	45	10 lbs.	4.15	

Send all money orders to

Write for Bulletin No. 6

WIZARD BATTERY CO. Dept. P 1315 42d St., Brooklyn, N. Y.

MURDOCK No. 56 RADIO RECEIVER



2000 Ohm Double Set

\$5.00

3000 Ohm Double Set

\$6.00

Reliable Service Unequaled Values
Guaranteed to Satisfy

Sold on 14 Days' Trial—Money Back if not Satisfied

Wm. J. Murdock Co.

BUY MURDOCK APPARATUS
FROM YOUR DEALER

PACIFIC SALES OFFICE

509 Mission St. San Francisco, Cal.

"INSULATE"

(Moulded Composition)

Also

"HI-HEET"

Insulations

100 { Different Style Knobs, Binding
Posts, etc., in Stock for
Immediate Shipment

To Order
Specials
of Any Article

Inset on "INSULATE" When
Ordering Through Your
Local Dealer

GENERAL INSULATE CO.

1111 Atlantic Ave.

Brooklyn, N. Y.

RADIO IN CHINA

Continued from page 13

as it very often does in China, and we had to ride in sedan chairs to the Yamen or magistrate's building, where we presented our credentials. As the city officials had not been expecting us yet, no provision had been made for quarters, but with the usual Chinese hospitality they gave us the best that they had, with all sorts of apologies.

The immediate problem was to transport the masts and all to the station site, which was nearly a mile and a half inside the city. Most Chinese cities have walls around them, walls with small gates and the gates have semi-circular compounds outside them. The streets are very narrow, averaging 7 ft., and there are many right angled turns.

Several contractors were called in (we did the most of our work on a contract basis) and asked to bid on this job, but the only man who would consider it gave us a fantastic story about the necessity of breaking holes in the city walls, repairing the holes afterwards, of building matchwork bridges over the roofs of the houses at the street turns, and of the great army of coolies which he would have to employ to carry the masts; he ended up by giving his price of "baat sap ng mun," or about \$45.00 gold. As there was about seven tons to be moved we did not see how he could do it at that price, especially under the conditions as he stated them. He was awarded the contract.

The writer then returned to Canton to arrange for the carrying forward of the plans for the other stations, and that contractor still prides himself on having put one over on the foreign engineer.

The truth of the matter was that the contractor, by virtue of knowing the country so well, was able to float the poles back down the river for a couple of miles, into a canal and in back of the city. One hole had to be cut into the wall and then he had a straight street of only a quarter of a mile to carry them. When this was discovered later we had a good laugh over it, but we still maintain that we had the best of the bargain.

The "Bell and Drum" tower was allotted to us for a station room and operators' quarters. This building was so named because of its having a large bell and a larger drum which served the purpose of warning the inhabitants of the city of any attempted invasion by hostile troops or bandits.

The masts for the Shiu Hing station were set 250 feet apart in a line of east and west, that giving the best directional effect with Canton. Each mast was raised in three sections, making a total of 160 ft. high. They were guyed at each joint and also at the top, in four directions. The joints were made by lapping the top of one section to the lower end of the next section, and secured by two iron clamps or bands made from $\frac{3}{4}$ " x $2\frac{1}{2}$ " strap iron. Trouble was experienced in getting these bands made up by the blacksmith, as he did not believe in working to size. We finally had the bands all made the same size and trimmed the poles to fit the bands.

Before raising, the poles were shaved smoothly and creosoted, then the first section was set in cement, and the remaining two sections were successfully pulled up through the bands by means of rope blocks and a hand windlass. This part of the construction always drew a large crowd, many of the curious even getting in the way of the riggers and interfering with their work. The project could have been successfully commercialized right there by merely charging an admission fee.

Six 7/22 bronze wires spaced $3\frac{1}{2}$ ft. apart on fir spreaders made the antenna. The lead-in was taken off one end. This gave a natural period of 485 meters.

In addition to a regular ground made by digging down 10 ft., where we found wet earth, and burying a bundle of copper wires in charcoal, we laid out a counterpoise, fan

shaped, under the antenna, and just under the surface of the earth.

A cement foundation was laid for the Genco set and the 55 cell storage battery. The masonry contractor knew all about cement mixtures, as he "had mixed all the concrete for a mission building"; we had a hard time convincing him that a 1-2-4 mixture of cement, sand, and gravel would hold up. He had been taught differently and said that it would all fall to pieces, that it would never set, and that he would lose his reputation. Finally we told him that we would take the responsibility, and he was then happy.

Most of this work had to be directed by means of the sign language, owing to the fact that our interpreter was taken sick. The workmen are very quick at grasping an idea and for a period of three weeks we made out quite well by giving orders in pantomime.

The motor-generator, the panels and the lead-in were installed, the wiring run and the construction crew moved on to the next station, which was further up on the West River at Wuchow.

The construction details of the other stations were similar to Shiu Hing, and the same difficulties were encountered. About the only difference was that of time. Where it took six weeks to build the first station, the last on the list was completed in a total of nine days. Incidentally the last station was a better piece of work.

THE C. W. MANUAL

Continued from page 16

point, to which the small brass lugs of Fig. 36 may be soldered quite easily. Care and practice will expedite the whole process of soldering a tap to about three minutes.

In Fig. 30, it will be observed that three multi-contact tuning switches are provided; the points, of course, are connected to the lugs on the inductance in accordance with the table, Fig. 37, and the switch arms, to the antenna (via radiation ammeter), to the plate condenser, and to the key condenser, respectively, as shown in Fig. 33. No details are given for these multi-contact switches, nor the changeover switches shown in the same figure.

The buzzer for interrupting the continuous waves into small groups at audio frequency, is shown in the lower right corner of Fig. 30, and its control rheostat is in the lower center of the same figure.

The indicating instruments must be selected with due consideration to the type of tubes that will ultimately be used. In the original apparatus herein described, the author used a milliammeter with a scale reading to 100, which restricted its use to the measurement of the current to the oscillator tubes only.

Western Electric Co. tubes have been used at all times with this apparatus, which made the use of a 5 ampere filament ammeter possible.

In constructing this apparatus for use with any type of 5 watt tube on the market at the present time, it is suggested that a milliammeter reading to 300 milliamperes be used in the plate circuit, that an ammeter reading to 10 amperes be used in the filament circuit, and that a radiation ammeter reading to 1.5 to 2 amperes be used in the antenna lead. As a matter of information, in connection with this latter instrument, the radiation, using two 5 watt tubes as oscillators, will vary from 1 to 1.3 amperes at the most efficient wavelength.

Details for the construction of the various panels and sub-panels will be found in Figs. 37 and 38. These panels are constructed of $\frac{3}{8}$ in. Bakelite sheet. The details of the cabinet for this apparatus are left to the constructor. It may be stated, however, that one having inside dimensions not smaller than 11 by 16 by $9\frac{1}{4}$ inches deep is recommended.

< STANRAD >

Variometers Vario Couplers



\$5^{ea.} The Heart of the Modern Receiver \$5^{ea.}

STANRAD VARIOMETERS and COUPLERS are unexcelled for real short wave work—175-375 meters. Low range means high efficiency; construction is of the best; forms specially treated to resist moisture; primary of coupler wound on genuine Formica tubing

At Your Dealers or Direct

STANDARD RADIO COMPANY

1048 So. Olive St., Los Angeles, California

IMMEDIATE SHIPMENTS!



No. 27



No. 28

DEALERS
WRITE



No. 33



Dial No. 23



No. 24



No. 3500



No. 3501

THE

RADIO ELECTRIC CO.

3807 Fifth Ave. N.

Pittsburgh, Pa.

Radio Frequency Transformers

The R. T.—1 Transformer Works on All Standard Makes of Tubes

For Amateur and
Broadcasting
Range 175-500



Type RT-1,
Price \$6.00

Mr. Amateur: Hook up a radio transformer ahead of your detector and get acquainted with stations you have not heard before.

The Type RT—1

Transformer of special R. F. iron core construction. (Patent pending.)
Transformer having complete shielding.
Transformer covering the amateur wave-length efficiently.
Transformer giving maximum amplification per stage.
Transformer designed by former Government radio engineers
Commercial and special range R. F. transformers supplied

Radio Service Laboratories Asbury Park, New Jersey
INC.

10c. Charges Your Storage Battery AT HOME WITH AN F-F Booster



So You will never have to give up in disgust when working a distant station. Is it not gratifying to feel Your Filament Battery will always be ready when needed? You know what it's like to have friends call to Listen In & then find your battery dead. The F-F Battery Booster is a rugged Charging Apparatus, un-failing in its ability to deliver service day and night; requiring no skill to operate; charges automatically and operates unattended. Screw Plug in lamp socket, Snap CLIPS on Battery Terminals and watch the gravity come up. AMMETER shows amount of current flowing. Everything Complete in Compact Self-Contained Portable CHARGING UNIT. F-F BATTERY BOOSTERS are Automatic FULL WAVE MAGNETIC RECTIFIERS with Infusible Carbon Electrodes, for 105-125 Volt 60 Cycle A. C. These Types Last a Lifetime. PRE-WAR PRICES:

Bantam Type 6 Charges 6 Volt Batteries at 6 Amperes.....	\$15
Bantam Type 12 Charges 12 Volt Batteries at 5 Amperes.....	\$15
Type 166 Charges 6 Volt Batteries at 12 Amperes.....	\$24
Type 1612 Charges 12 Volt Batteries at 7 Amperes.....	\$24
Type 1626 Combination Type Charges both 6 and 12 Volt Batteries at 12 and 7 Amperes.....	\$3

The Larger Types are recommended for large batteries, or where time is limited. Shipping Weights Complete With Ammeter & Clips 12 to 15 lbs. Send check for Prompt Express Shipment. If via Parcel Post have remittance include Postage & Insurance charges, or order us to ship Type desired C.O.D. Order Now, or Write Immediately for FREE Descriptive BOOSTER & ROTARY Bulletins 22 & 23A.

FRANCE MFG. CO. General Offices and Works: CLEVELAND, OHIO, U. S. A.
Canadian Rep.: Battery Service & Sales Co., Hamilton, Ontario, Can.

Do You Want

REAL SERVICE?

Let us have your order, learn what REAL SERVICE means. Shipments made within 24 hours.

SEND FOR YOUR COPY OF
CATALOGUE No. 22

THE SERVICE RADIO EQUIPMENT COMPANY
DESIGNERS — MANUFACTURERS — DISTRIBUTORS
225 Superior Street Toledo, Ohio

FALLACY OF TOO MUCH AMPLIFICATION

Continued from page 29

used. In the majority of cases but 1-step, and in some cases—even as far as Buffalo, N. Y.—only a "pickle tube" was used!

It will also be remarked that in these cases we have no *all-way* transmission over the Atlantic Ocean—at all! The above splendid reception work was done *all overland!*

Mr. Dow, 6ZAC, at Wailuku, Honolulu, writes: "You are very QSD on 1-step and all over the room on 2."

WHERE, then, enters the idiotic fallacy of multi-stages of amplification, with their attendant expense of tubes, upkeep, numerous storage and "B" batteries, etc?

It is, to my mind, little short of the criminal to foist upon the rapidly-growing amateur class the entirely erroneous belief that vast power to send, and much amplification to receive, are obligatory! Nothing could be further from the truth, and it is to this end that I herewith take pleasure in exposing the fallacy!

UNPREMEDITATED TRANSCON. WORK

By MAJOR LAWRENCE MOTT,

O. R. C. Signal Corps, U. S. A.

By dint of liberal use of the Western Union, and by a large patronizing of one Uncle Sam's postoffices, there have—in the past—been DX signals arranged for, listened for—and heard!

I believe, however, that I err not when I say that to 3ALN, the station of H. F. Hastings, situate at 905 "B" street, Washington, N. E., D. C., goes the prize of PRIZES for effective DX reception—and transmission! An honor in which 6XAD is privileged to share—with all due modesty—and so forth!

Mr. Hastings and I had been exchanging letters with regard to our signals—as each could hear t'other very well—when, on the night of February 16th he was plainly heard, working an "8" station. As soon as he cleared I called him, and he came back at me—at once. Time: 12:34 a. m.—PCT. I briefly asked him if conditions were such, with him, that he could take a message, to which he replied: "R—OK—GA!"

I sent him the following:

"Jordan Mott—Biscayne Yacht Club—Miami—Florida. First transcon to Washington DC—sig. Law"

3ALN at once came back with: "Nr 1—R—Nr 1—R—FB"—etc.—etc.

From my father, at Miami, I have received word that Mr. Hastings was so good as to forward the message via Western Union, from Washington, and it was correct in every particular.

On the night of March 5th-6th—at 1:09 a. m.—PCT—I had been working some "8's"—and heard, beneath a lot of

QST QSP All Amateurs QSQ QSL
HALLOCK & WATSON RADIO SERVICE Announce

THE OPENING OF THEIR RADIO SUPPLY STORE IN PORTLAND, OREGON, WITH A COMPLETE STOCK OF RADIO TELEPHONE AND TELEGRAPH EQUIPMENT OF STANDARD MAKES.

PERSONNEL

J. H. HALLOCK
 Formerly Radio Construction
 Engineer, U. S. Navy Dept.
 and Federal Telegraph Co.

C. H. WATSON
 Formerly in charge U. S.
 Naval Radio Laboratory,
 Mare Island, California.

We believe we have the **MOST EFFICIENT** short wave receiving equipment on the market today and would like you to prove that statement to your own satisfaction.



Northwestern Variometer
 Mounted \$10.00

We refer to the new **UNIT VARIOMETER** and **VARIOCOUPLER** built by the Northwestern Radio Mfg. Co. of Portland, with whom we are co-operating in design work and whom we also represent as exclusive distributors.

Here are a few points of design that make the efficiency of the set apparent:

- NO DIELECTRIC WHATEVER** in or around the field of the coils, thereby reducing the dielectric hysteresis to a minimum—"NOTHING THERE BUT THE WIRE."
- NO SPRING OR BEARING CONTACTS** between stator and rotor. Flexible conductors permanently connected to binding posts in rear.
- NO moulded material** to warp or chip. Panel, knobs and dials machined from XX bakelite.
- NO small, high resistance wire**; No. 20 double SILK thruout.
- NO binding posts or switch points** on fronts of panels.



Northwestern Variometer
 Unmounted \$6.50

AND FURTHERMORE—NO TROUBLE getting that distant fone station. We're putting Avalon on the Magnavox with an indoor antenna in a first story flat!

INCIDENTALLY our 100 watt fone will be in operation the latter part of March. Drop us a line and get acquainted.

HALLOCK & WATSON RADIO SERVICE

192 Park Street

Portland, Oregon

A New Type of Superior Loud Speaker

The Most Artistic Loud Speaker Manufactured.

Improve the appearance of your receiving outfit and increase the loudness and quality of the music and speech

The TRACO LOUD SPEAKER

fills a long felt want for a compact unit—uniform in appearance with the rest of the set and giving much better results than are possible with the ordinary horn.

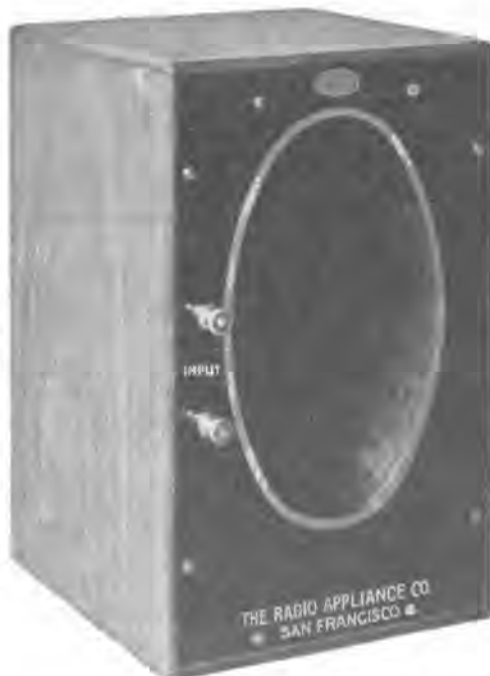

HIGHLY FINISHED WALNUT CABINET

will make this instrument a beautiful addition to your most elaborate receiver. Combines a Baldwin phone and a scientifically designed tone chamber, assembled in Kennedy 525 Walnut Cabinet, 8" long x 12½" x 8½".

Write for Prices and Information regarding other New Radio Accessories.

THE RADIO APPLIANCE CO.

961 Pine Street, San Francisco, California

Tell them that you saw it in RADIO

Phone Kearny 2778

PACIFIC RADIO SCHOOL

ARC & SPARK SYSTEMS

Hours:

1 to 5 P. M.

7 to 9 P. M.

433 Call Bldg.,

San Francisco, Cal.

Send for descriptive circular.

You Are Invited to Visit

San Francisco's Finest Electrical, Phonograph and Radio Store
Sonora Phonographs

Featuring
Colin B. Kennedy
& Westinghouse
Apparatus

Complete Stock
of Parts

Dealers:

Write for our
proposition

H. E. Newbery Electric Company
359 Sutter Street, San Francisco Phone Sutter 6361



BALDWIN

Loud Speaker

As illustrated—without plug

\$12.00

MAIL
ORDERS

—RADIO INSTITUTE—

OF AMERICA

Conducted by the greatest and most experienced radio telegraph organization in the world.

Thorough training given in radio operating, traffic, and in damped and undamped systems.

Tuition ten dollars a month for either the day or evening sessions or both combined.

Prospectus mailed on request

RADIO CORPORATION OF AMERICA

Phone Douglas 3030

331 New Call Bldg., San Francisco

Try **REYNOLDS RADIO** Service
"9ZAF" from DENVER "9ZAF"

Kennedy—RECEIVING OUTFITS—Grebe

Phones

Baldwin
Murdock

Brandes
Federal

Antenna Wire

Aluminum No. 14, per lb. (about
250 ft.) \$1.00
Copper No. 14, per lb. (about 90 ft.) .60

REYNOLDS RADIO CO., Inc. 613 19th Street
DISTRIBUTORS - DEALERS DENVER, COLO.

Distributors - Dealers

Write for Proposition

QRM, and uncomfortable QRN—a "3" station calling me. By dint of ear-straining I finally made him out to be 3ALN—and very QSA, when the local—and infernal—interference permitted ANYTHING to be heard! I shot back: "R—QRM—and QRN—but GA—GA—." He came back with: "Hr—Nr—r—to 6XAD—sending picture tomorrow—sig. 3ALN."

In brief, the above are the extraordinarily good results of that which I call "unpremeditated" transcontinental work! In here reporting it I have omitted the numerous preambles to the message—the oft-repeated calls and signs—as these are, of course, understood to have been exchanged. The message to me from 3ALN refers to a letter of mine, in which asked for a photograph of his station for reproduction in RADIO.

It will carefully be noted that 3ALN uses but one 50 watt tube, ICW, and that 6XAD was using its now "famous" smallest transmitter. But little can be added.

The results speak volubly for themselves!

CONSTRUCTION OF CRYSTAL SET

Continued from page 30

operation is to adjust the little piece of wire, which rests lightly on the crystal, to a sensitive point. This may be accomplished in several different ways; the use of a miniature buzzer transmitter is very satisfactory. Assuming that the most sensitive point on the crystal has been found by method described in paragraph below, "The Test Buzzer," the rest of the operation is to get the radio receiving set in resonance or in tune with the station from which one wishes to hear messages. The tuning of the receiving set is attained by adjusting the inductance of the tuner. That is, one or both of the switch arms are rotated until the proper number of turns of wire of the tuner are made a part of the metallic circuit between the antenna and ground, so that together with the capacity of the antenna the receiving circuit is in resonance with the particular transmitting station. It will be remembered that there are 10 turns of wire between each of the first 8 switch contacts and only one turn of wire between each 2 of the other contacts. The tuning of the receiving set is best accomplished by setting the right-hand switch arm on contact (1) and rotating the left-hand switch arm over all its contacts. If the desired signals are not heard, move the right-hand switch arm to contact (2) and again rotate the left-hand switch arm throughout its range. Proceed in this manner until the desired signals are heard.

It will be advantageous for the one using this radio receiving equipment to find out the wave frequencies (wave-

To Receive Broadcasting Radiophones----

THE RADIOHOME RECEIVER



The Radiohome Receiver

doubtless, appear unfamiliar to the amateur field. Yet we have been manufacturing these sets for some time—for the general public. The Radiohome Receiver has a simple, two-slide tuning circuit with a range of 145-800 meters, a vacuum tube detector, and grid leak and rheostat. The price—less tube, batteries, receivers and antenna—is \$36. In a cabinet that is identical in size and finish with the cabinet of the Radiohome, is the DT-800, two-step amplifier. Three phone jacks are embodied in this instrument for detector, 1st step and 2nd step. Less tubes and batteries the price is \$35. We believe you will find no other set on the market to compare with this combination for the reception of radiophone programs by the newcomer in the field.

Catalogue H, listing ALL DeForest Equipment has been out three weeks. It is yours for 12 cents in stamps.

THE DT-800 AMPLIFIER

Every amateur is frequently being asked for advice as to what set should be purchased for the reception of radio telephone programs of music, news and stories. Many an amateur hesitates to recommend the standard amateur equipment as, to the average citizen, such terms as coupling, condenser, tube and "B" battery, mean nothing, and his friends would be confused and bewildered by the array of controls on the average set.

We illustrate two pieces of radio receiving apparatus which will, doubtless, appear unfamiliar to the amateur field. Yet we have been manufacturing these sets for some time—for the general public. The Radiohome Receiver has a simple, two-slide tuning circuit with a range of 145-800 meters, a vacuum tube detector, and grid leak and rheostat. The price—less tube, batteries, receivers and antenna—is \$36. In a cabinet that is identical in size and finish with the cabinet of the Radiohome, is the DT-800, two-step amplifier.



The DT-800 Two-Step Amplifier

DEFOREST RADIO TELEPHONE & TELEGRAPH COMPANY

NEW YORK CITY

Western Distributors: Atlantic-Pacific Radio Supplies Co., Henry M. Shaw, Pres. 638 Mission St., San Francisco.

DO YOU HAVE TO BE SHOWN?

That "Missouri" Service is of the better kind. Real Service. That we actually ship orders a few hours after we receive them, that we have a large and very complete stock of all standard apparatus and parts from which we fill your order, on hand at all times. Therefore "Missouri" is ready to show you. Send us a trial order.

REGENERATIVE RECEIVERS		HOT WIRE METERS		VACUUM TUBES	
No. CR-3 Grebe 175-680 Meters Relay Special	\$65.00	No. 127 Gen. Radio 1-5-10 Amps.	\$7.75	No. UV-200 Radiotrons Det.	\$5.00
No. CR-5 Grebe 175-8,000 Meter Ideal Receiver	80.00	No. 25 Jewel 0-10 Amps.	15.00	No. UV-201 Radiotrons Amplifier	6.50
No. CR-8 Grebe 175-1,000 Meters with Tube Control	80.00	PIRCO APPARATUS		No. UV-202 Radiotrons 5 Watt.	8.00
No. CR-9 Grebe 175-8,000 Meters with Det. & 2 Stage Amp.	130.00	Saco-Clad Amp. Transformer	5.00	No. UV-203 Radiotrons 50 Watt.	30.00
No. CR-6 Grebe 175-680 Meters with Det. & 2 Stage Amp.	160.00	V. T. Sockets Single	1.10	No. UV-204 Radiotrons 250 Watt.	110.00
No. ZRF Olapp-Eastham	38.00	V. T. Sockets Double	2.30	Send us your orders for Radiotrons—our stock is complete.	
No. RA Westinghouse	65.00	V. T. Sockets Triple	3.50	AMPLIFYING TRANSFORMERS	
TELEPHONES		Vocaloud Stationtype	30.00	No. UV-712 Radio Corp.	7.00
No. 56 Murdock 2,000 OHM.	5.00	Vocaloud Laboratory	25.00	No. AMEAD	4.50
No. 56 Murdock 3,000 OHM.	6.00	Miget Tuner	15.00	No. QO Olapp-Eastham	4.00
No. C Baldwins	12.00	Miget V. T. Control	11.00	No. A-2 Acme	5.00
No. E Baldwins	13.00	Tuner Det. & 2 Stage Amp.	56.00	No. 226W Federal	7.50
No. F Baldwins	14.00	Bull Dog Plug Flat.	2.00	INSULATORS AND WIRE	
No. Brandes Superior	8.00	Bull Dog Plug Round.	2.50	No. 498 Electrose Ball Type.	.40
C. W. INDUCTANCES		RHEOSTATS		No. 449 Electrose 5-inch.	.50
No. 181 Tuska Cap. Feedback.	7.50	No. 813 Remler 3 Amp.	1.75	No. 497 Electrose 10-inch.	1.00
No. 182 Tuska Split Filament.	10.00	No. 810 Remler 4 Ohm.	1.00	No. 262 Electrose Leadin.	1.25
No. 183 Tuska Grid-Tickler.	12.50	No. 560 Murdock	1.00	No. 264 Electrose Leadin.	2.50
FILTERS		No. 214 Gen. Radio	2.50	BRAIDED AEROPLANE ANTENNA	
No. 170 Tuska	15.00	No. 25 Paragon	1.50	Wire.....	75c per 100 feet
No. UP-1626 Radio Corp.	11.50	ROTARY GAPS		Bare Copper 80 ft. to the pound—	40c per lb.
		No. 443 Murdock	18.50	VT. DETECTORS	
		No. Benwood Bakelite	22.00	No. Y-1 Acme	10.00
		No. Benwood Sink With Motor.	60.00	No. RORA Grebe Cabinet.	8.50
		"B" BATTERIES			
		No. 768 Eveready	2.00		
		No. 766 Eveready	3.00		

We have a complete stock of standard apparatus. If there is anything that you can not find in the above list just send your order for it at the regular list price and it will be shipped at once to you.

SEND YOUR ORDER IN NOW!

Your Order Will Receive Our Prompt, Careful and Appreciative Attention

Our Motto

WE GIVE ALL WE CAN FOR WHAT WE GET
Instead—OF GETTING ALL WE CAN FOR WHAT WE GIVE

MISSOURI RADIO SUPPLY COMPANY.

4623 Maryland Avenue

Dept. G

St. Louis, U. S. A.

Radio Frequency Amplifier



Two Type 5000 Transformers in Tandem for 2 stage control
Pat. Applied For

There is nothing that opens up a wider field on the receiving end for the amateur and experimenter, than radio frequency amplification.

After an extensive investigation of the various types of tube couplings possible for radio frequency amplification, we have developed the above units (two are shown) with a view to giving maximum efficiency and greatest ease of control, at a reasonable price.

Tuning each stage is not necessary. Only one adjustment necessary to cover fairly wide bands of wave-lengths with several stages.

Transformers for several stages can be mounted in tandem with single control which greatly simplifies the manipulation of the set.

Remember that radio frequency amplification will increase the range, the selectivity and the satisfaction you can get from your receiver. A loop antenna will be far more effective with radio frequency amplification.

These units will cover wave-lengths from 180 to 750 meters.

TYPE 5000 RADIO FREQUENCY AMPLIFYING TRANSFORMERS,
PRICE \$5.50

For Single Stage (without Knob and Pointer)

COTO-COIL CO. 87 WILLARD AVE.,
PROVIDENCE, R. I.

AMATEURS!

Have you seen the latest publication devoted exclusively to Citizen Radio?

THE MODULATOR

fills a long felt want. It contains real C.W. data and plenty of "hammy" news and fun. THE MODULATOR is unique in that it is the only magazine "Written for Amateurs by Amateurs". Get aboard NOW, fellows, while the subscription rate is low. \$1.00 per year, 10 cents per copy.

THE MODULATOR PUBLISHING COMPANY

140 Pearl Street New York City

Manufacturers of

C W

Apparatus and

ONE TO SIX STAGE AMPLIFYING RECEIVING SETS

Send 10c for catalogue

The American Radio Sales & Service Co.
MANSFIELD OHIO

length) used by the several radio transmitting stations in his immediate vicinity.

The Test Buzzer (Z, Fig. 3)—As mentioned previously, it is easy to find the more sensitive spots on the crystal by using a test buzzer. The test buzzer is used as a miniature local transmitting set. When connected to the receiving set as shown at Z, Fig. 3, the current produced by the buzzer will be converted into sound by the telephone receivers and the crystal, the loudness of the sound depending on what part of the crystal is in contact with the fine wire. To find the most sensitive spot connect the test buzzer to the receiving set as directed, close the switch (5, Fig. 3) (and if necessary adjust the buzzer armature so that a clear note is emitted by the buzzer), set the right-hand switch arm on contact point No. 8, fasten the telephone receivers to the binding posts marked "phones," loosen the set screw of the binding post slightly and change the position of the fine wire (6, Fig. 3) to several positions of contact with the crystal unit until the loudest sound is heard in the phones, then tighten the binding post set screw (4) slightly.

APPROXIMATE COST OF PARTS

The following list shows the approximate cost of the parts used in the construction of this radio receiving station. The total cost will depend largely on the kind of apparatus purchased and on the number of parts constructed at home.

Antenna—	
Wire—Copper, bare or insulated, No. 14, 100 to 150 ft., about	.75
Rope— $\frac{1}{8}$ or $\frac{1}{4}$ inch. 2c per foot.	
2 insulators, porcelain	.20
1 pulley	.15
Lightning switch—30 ampere battery switch	.80
1 porcelain tube	.10
Ground connections—	
Wire (same kind as antenna wire.)	
1 clamp	.15
1 iron pipe or rod	.25
Receiving set—	
$\frac{1}{2}$ pound No. 24 copper wire double cotton covered	.75
1 cardboard box	
2 switch knobs and blades complete	1.00
18 switch contacts and nuts	.75
3 binding posts—set screw type	.45
2 binding posts—any type	.80
1 crystal—tested	.25
8 wood screws, brass, $\frac{1}{4}$ in. long	.08
Wood for panels (from packing box.)	
2 pounds paraffin	.80
Lamp cord, 2 to 8c per ft.	
Test buzzer	.50
Dry battery	.80
Telephone receivers	4.00 to \$8.00*
Total	\$11.00 \$15.00

If nothing but the antenna wire, lightning switch, porcelain tube, crystal, telephone receiver, bolts and buzzer are purchased this total can be reduced to about \$6.00.

*Still more efficient and expensive telephone receivers are available at prices ranging to about \$20.00.

High Conductivity—High Strength



The pure copper exterior of the wire conducts all radio waves due to "skin effect" of high frequency currents. This conducting metal is permanently welded to the high strength steel core.

You will be proud of your antenna when built of Copperweld—

It will not stretch nor sag.

A tight antenna insures clear receiving.

**RADIO DEPARTMENT
COPPER CLAD STEEL CO.**

Braddock P. O., Rankin, Pa.

Buy Copperweld In Cartons

100 or 200 ft. lengths

THE ONE BEST WAY—PACENTIZE!

Why fuss about with binding posts and unsightly frayed wires when Pacent Radio Essentials will allow you to change connections in the twinkling of an eye? This Pacent combination was made to work as a unit in overcoming all connection problems in both receiving and transmitting apparatus. When the Plug, Twin-Adapter and Multi-jack are used together, they replace no less than fourteen binding posts!



PRICE \$1.25

PACENT UNIVERSAL PLUG

This plug was the first real radio plug to make an appearance and it remains the first radio plug in quality. A solderless, biting contact is made which will not give rise to disturbing noises. You can use the Pacent Plug with 'phones, Duo-Lateral Coils, microphones, keys, etc. The Pacent Plug fits any jack. With its soft, velvety black finish it will add a touch of beauty to any receiver.

Catalog No. 50 PACENT UNIVERSAL PLUG, Price \$1.25



PRICE \$1.50

PACENT TWIN-ADAPTER

You can't put two plugs in a single jack, but you can make a single jack serve the purpose of two jacks with a Pacent Twin-Adapter. Just insert the Twin-Adapter and presto!—the usefulness of the jack is multiplied by two. Just the thing to use with a loud speaker; tune with the 'phones and then plug in the loud speaker. The Twin-Adapter has a multitude of uses in C. W. work.

Catalog No. 51 Pacent Twin-Adapter, Price \$1.50



PRICE \$1.50

PACENT MULTI-JACK

Here is another worthy member of the Pacent plug and jack combination. This is really three independent jacks built into a beautiful composition base. Screwed to the side of a receiving outfit it will allow three sets of 'phones to be plugged in or two sets of 'phones and a loud speaker. It may also be screwed to the table or the testing board. All standard plugs will fit into it, but it was designed especially for use with the Pacent Universal Plug or Pacent Twin-Adapter.

Catalog No. 52 PACENT MULTI-JACK, Price \$1.50

Send for copy of circular N100

See the Pacent Radio Essentials at your dealers.

Dealers and Jobbers—Write for our sales plan



PACENT ELECTRIC COMPANY

INCORPORATED

LOUIS GERARD PACENT, President

150 NASSAU STREET

NEW YORK CITY

Member Associated Manufacturers of Electrical Supplies

NO RADIO SET COMPLETE

Without ACE "B" Batteries

BETTER SERVICE  LONGER LIFE

ANNOUNCING

the new Ace 4½ Volt Block Battery. If your B Battery is a trifle weak connect an Ace 4½ Volt Block Battery and note the improvement.

5 Block Batteries connected together is equal to 1-22½-volt Navy type B Battery. The main features are Standard Battery Binding Post, which eliminate the necessity of soldering terminals, and the fact that in case one cell would go dead it would only be necessary to discard one 4½-volt unit and not a complete "B" Battery, size 4" x 3" x 1¼", weight 1 lb.

Price 50 cts.

This cut shows the Ace special 45 volt variable battery which is going strong and showing the way as to being the one Battery to meet all "B" Battery requirements. Size 6x5x2½, weight 3½ lbs. Price.....\$3.50



OTHER ACE TYPES

Cat. No.	Plain	Size	Voltage	Lbs.	Taps	Price	Write for catalog No. 20.
823	Plain	2½ x 2x2½	22½	1		\$1.50	Ace Batteries are for sale by all first class radio dealers. Write for catalog.
823	Variable	2½ x 2x3½	22½	1	5	1.75	
825	Plain	3 x 4x6½	22½	5		2.50	
825	Variable	3 x 4x6½	22½	5	5	3.00	
828	Plain	3 x 6x6½	45	10		5.00	
828	Variable	3 x 6x6½	45	10	6	6.00	

264 Atlantic Ave. ACE BATTERY MFG. CORP. Dept. P Brooklyn, N. Y.

THE OSCILLATOR

Published by THE RADIO ENGINEERING SOCIETY of PITTSBURGH, Inc.

◆ ◆
Ten Cents Per Copy : One Dollar Per Year

◆ ◆
Address

BUSINESS MANAGER

5590 POCUSSET STREET, SQUIRREL HILL
PITTSBURGH, PA.

Heard the Latest?

Ray-Di-Co's Prices Are Down

Increased production and demand for Ray-Di-Co's Motor Generators makes possible a big reduction in prices. The following table gives correct sizes of machines to use:

Type	Watts	Capacity in Tubes	Volts	M. A.	Driving Power	Price
Midget	15	1-UV202	300	50	110 V. A.C. or D.C.	\$42.85
Dynamotor	15	1-UV202	350	50	6 Volt D.C.	45.00
ST4	40	2-UV202	350	114	110 V. A.C.	64.75
ST15	150	6-UV202	500	300	110 V. A.C.	97.50
ST25	250	2-UV203	1000	250	110 V. A.C.	138.50

Above motors 60 Cycle. Other voltages and frequencies at slight additional cost.

IMMEDIATE DELIVERY

Mail Orders given prompt attention. If your dealer cannot supply you, order direct from this ad.

Ray-Di-Co. Organization

1547C N. Wells Street

Chicago, Ill., U. S. A.

The range of a radio set, whether transmitter or receiver, is variable. To say that a set has a range of sixty or of one hundred miles is wrong, as the distance of reception depends upon many factors. The range of transmission is greater over water than over land, greater at night than during the day, and is decreased by electrical disturbances in the atmosphere. The skill of the receiving operator is also an important factor.

KEYSTONE RHEOSTAT



The "Keystone" is one of the finest constructed rheostats on the market, and is made of the best heat resisting and durable material possible to obtain. Neat in appearance, is 2¼" diam., ¼" deep, and ¼" shaft. All parts are made of brass, and pointer is of heavy brass, nickel plated and polished. Resistance is 6 ohms, 1½ amps. carrying capacity. Can be easily mounted on back of panel by only drilling two holes, also dial can be used, instead of the knob and pointer furnished. Resistance is wound tightly on an insulating strip and can not become loose. Sold on a guarantee of satisfaction or purchase price will be refunded.

PRICE \$1.25

Amateurs and constructors, don't miss sending 5 cents in stamps for our complete set of bulletins on raw materials, machine screws, wire, standard apparatus, audion and amplifying apparatus, and save money and time.

Keystone Radio Company
Greenville, Penn.

PANELS

Of Gumwood Black Finish

Treated with a special process made by us. Will not Warp or Shrink and is not effected by Temperature changes. Waterproof and possesses High Dielectric properties. Easily machined and will not Crack or BREAK. Looks as good as Bakelite. We are prepared to ship promptly the following sizes:

8" x 6" ¼" thick.....	\$.60	8" x 12" ¼" thick.....	\$1.50
8" x 7" ¼" thick.....	.75	8" x 14" ¼" thick.....	1.75
8" x 10½" ¼" thick.....	1.00	12" x 14" ¼" thick.....	2.25
8" x 12" ¼" thick.....	1.25	12" x 21" ¼" thick.....	3.00

Strips 3½ x 8; 3½ x 8; \$4.00 each; 3½ x 10, 3½ x 12, \$3.00 each; 3½ x 16, \$7.75 each.

Add Postage for 1 lb. for Panels up to 8 x 12 ¼"; and 2 lbs. for larger sizes.

We will be pleased to quote prices on these panels cut to a different size on receipt of your specifications. NO FREE SAMPLES.

TENSO MFG. CO., Marshall, Minn.



Mica Grid Condenser and Grid Leak Mountings

From .0005 to .00025 MFD.....	\$.50
From .0003 to .0005 MFD.....	.65
Grid Leak Mounting only.....	.25
Grid Leak Clips, 12 for.....	.25
Alum. Condenser Plates (Kolster Type)	
Rotor or Stator, each.....	\$.05
Spaces 5/16" x ¼" thick, dozen.....	.16
Spaces ¼" x ¼" thick, dozen.....	.08
Triple Coil Mounting.....	5.00
2 Coil Mountings.....	3.50
Plugs for Mountings.....	.50

Kindly add 5c for Postage

MONTROSE MFG. CO.

619 St. John's Place, Dept. E. BRLYN, N. Y.

For Prompt Shipments—BENWOOD

"WORLD WIDE MAIL ORDER SERVICE"



THE above photo shows our new 3-story building in the heart of the St. Louis business district. Our mail order department is complete in itself and we give you immediate service on all mail orders.

Amplifying Transformers	
Acme—mounted	\$5.00
Acme—unmounted	4.50
Clapp-Eastham	4.00
Thordarson—Shielded	4.00
Rhamstine	3.50
Antennae Wire	
Benwood No. 14 Spec. per 100 ft.	35c
7 strands No. 22 per ft.	1c
7 strands No. 20 per ft.	1½c
Aeroplane Special per 100 ft.	50c
Audion Control Panels	
Remler	\$8.00
Acme	10.00
Paragon	6.00
Benwood	9.50
"E" Batteries	
Burgess small 22½ V	\$2.25
Burgess tapped 22½ V	2.75
Burgess large 22½ V	3.00
Buzzers	
Benwood test buzzer	\$0.60
Century high frequency	2.50
Condensers (Grid)	
Benwood Universal Grid condenser and leak	\$1.00
Condensers (Variable)	
Chelsea No. 1 Mounted	\$5.00
Chelsea No. 1 Unmounted	4.75
Chelsea No. 2 Mounted	4.50
Chelsea No. 2 Unmounted	4.25
Murdock No. 368	4.75
Murdock No. 368	4.00
DeForest knocked down	3.75
DeForest knocked down large	4.75
Crystal Detectors	
Murdock	\$0.80
DeForest (dustproof)	2.60
Galena and silicon	.25
Dials	
Benwood Nickel or Brass Metal with knob	\$1.50
Chelsea Dial and Knob	1.00
Clapp-Eastham Dial and Knob	.75
Tuska Dial and Knob	1.50
Corwin (large)	1.50
Insulators	
Electrose (ball type)	\$0.35
Electros 4 in.	.45
Electros 10 in.	.85

Jacks	
Federal, open circuit	\$0.70
Federal, closed circuit	.85
Federal Double Circuit	1.00
Federal, with filament control	1.50
Rhamstine Double Circuit	.85
Plugs	
Firth Bull Dog grip	\$2.50
Federal	2.00
Pacnet	2.00

Send for Catalog
Send 10c in stamps for the new Benwood Radio Catalog comprising the latest price directory.

Rheostats	
Fada (filament)	\$1.00
Fada (power)	1.85
General Radio	2.50
DeForest	1.85
Clapp-Eastham (panel)	.90
Murdock (panel)	1.00
Remler	1.00
Paragon	1.50

Sockets	
Benwood (bakelite) panel or table mounting	\$1.50
Remler (bakelite)	1.50
Rhamstine (bakelite and metal)	1.00
Murdock Moulded	1.00
General Radio Moulded	1.50
Crosley (porcelain)	.60

Telephone Receivers	
Baldwin Type "C"	\$12.00
Baldwin Type "E"	13.00
Baldwin Type "F" small	14.00
Baldwin single "6" unit for loud speakers	6.00
Murdock No. 56 2000 ohm	5.00
Murdock No. 56 3000 ohm	6.00
Brandes superior	8.00

Variometers	
Benwood assembled	\$5.00
Benwood knock down	4.00
Clapp-Eastham	5.75
Remler moulded	6.00

Variocouplers	
Benwood (assembled)	\$4.00
Benwood K D	3.50
Clapp-Eastham	6.75
Vacuum Tubes	
Cunningham UV-300	\$5.00
Cunningham UV-301	6.50
Cunningham UV-302	8.00
A-P detector	5.00
A-P amplifier	6.50

Jewell Meters, Any Style Made	
O—2½ amp thermo couple	\$12.00
O—300 milliamps	8.00
O—500 DC Volts	14.00
O—1000 DC Volts	23.00
Pattern 74 AC Meters	8.00
General Radio (all types)	7.75

Microphones	
DeForest (hand)	\$5.00
Federal (hand)	7.50
Federal (panel)	5.25
Federal (desk)	6.50

OW Inductance	
Benwood knock down 25 turn	\$6.75
Benwood Assembled 25 turn	8.50
Benwood 50 turn size	15.00

Modulation Transformers	
General Radio	\$5.00
Acme	5.00
Rhamstine	4.50
Clapp-Eastham	4.50

OW Condensers	
Benwood (tested 2000 volts)	\$2.00

Choke Coils	
Acme 1½ Henry 500MA	\$6.00
Acme 1½ Henry Double	8.00
Ideal 1 Henry 200MA	5.00
Ideal Henry 200 Double	7.00

Power Transformers	
Acme 200 Watt 550 V 12 V	\$16.00
Acme 200 Watt 550 Mounted 20.00	
All other sizes in stock.	

Filament Heating Transformers	
Thordarson 80 Watt 8 Volt	\$8.00
Thordarson 100 Watt 12 V	12.00
Acme 75 Watt 10 V mounted	12.00
Acme 75 Watt 10 Volt unmounted	9.00

THE BENWOOD CO., Inc.

1113 OLIVE STREET
ST. LOUIS, MO.

A REAL DETECTOR

THINK IT OVER. WHEN YOU CAN BUY A COMPLETE AUDION CONTROL UNIT FOR \$5.00, does it pay you to buy the separate instruments and mount them in your set?

The NEW NO. 40 WIRELESS SHOP AUDION CONTROL UNIT is complete in every detail, and includes a socket, filament rheostat, mica grid condenser and mica bypass condenser. It is easily attached to your panel by only two screws, and can be wired into your set in a jiffy.

WHAT MORE COULD YOU WANT? Every detail is complete. Each and every part is manufactured by THE WIRELESS SHOP—A GUARANTEE THAT YOU WILL GET A REAL BARGAIN, AND A STRICTLY QUALITY PRODUCT. ASK THE OTHER FELLOWS.

And the Amplifier Unit to Match the Detector

The No. 41 Amplifier unit is identical to the detector in general construction, with the addition of a high grade shell type amplifying transformer, which is mounted directly on the back of the socket shelf. And this unit costs you ONLY \$11.00. We can also furnish the front formica panel, with all holes drilled, panels engraved, and all necessary parts for completing the set, less the case. All of these parts are fully described and listed in our new BULLETIN No. 3, which will be mailed to you upon request. Where shall we send yours?

USING "WIRELESS SHOP" STANDARD UNITS, YOU CAN BUILD UP A COMPLETE 2-STEP AMPLIFIER, INCLUDING 2 No. 41 AMPLIFIER UNITS, ONE GORTON ENGRAVED PANEL with all holes drilled, 2 SPECIAL GORTON ENGRAVED RHEOSTAT DIALS WITH KNOBS, 2 "WIRELESS SHOP" JACKS, and 8 RUBBER TOPPED BINDING POSTS, for the sum of only.....



\$5.00

AND REMEMBER—QUALITY WILL ALWAYS PREDOMINATE WITH

THE WIRELESS SHOP

A. J. EDGCOMB

1262 WEST SECOND STREET

LOS ANGELES, CAL.

Federal Junior

THE receiver, when used with the proper antenna, is capable of receiving signals from radio telephone broadcasting and amateur stations within a range of 15 to 30 miles and of receiving ship and shore radio stations within a range of 100 to 500 miles depending upon the height of the antenna and on the power of the transmitting station.

THE FEDERAL JR. is, in itself a complete receiving set requiring nothing more than the aerial wires for its operation. It is most ruggedly and simply constructed, beautiful in appearance, simple in its operation and absolutely reliable. No batteries or other source of power is required for its operation nor are replacements of any kind ever required.

Federal Telephone &
Telegraph Co.
Buffalo, N. Y.

San Francisco Branch
693 Mission St.



Price in U. S. A.
\$25.00

DEALERS
Write for proposition



C. W. QUERIES AND REPLIES

Continued from page 28

will have to be changed, both sets increasing in size in about the same proportion. The following table will give you an idea of what you would need for reception over a wavelength range of 175-3000 meters:

Wavelength	Number of Turns		
	Primary	Secondary	Het. Osc.
150-300	25	35	25
300-800	35	75	50
800-3000	75	150	100

For wavelengths of over 3000 meters, the 50,000 cycle tuned circuit would have to be changed to one of lower frequency for best results, say to about 30,000 cycles, and honeycomb coils of about 1250 turns each would then be necessary. The Heterodyne Oscillator coils should be variable since some tubes require a closer coupling than others.

Question: What would be the wave length range of my two loose couplers, one having 180 turns 5 inches in diameter in the primary, and a secondary of 250 turns 4 and 1/2 inches in diameter, each coil having 9 taps equally spaced, and the other having half the number of turns in each coil. N. N., S. F.

Answer: Approximately 175 to 2500 meters for the larger, and 150 to 1000 meters for the smaller loose coupler.

Question: Please give the number of turns of No. 24 S. C. C. wire on a 4-inch bakelite tube, necessary to tune from 400 to 20,000 meters, with the number of taps and the inductance of the coil. This coil would be used in a single coil circuit with an air condenser and dead end switch. ? , Lima, Ohio.

Answer: It will require an inductance of 150 millihenrys to reach 20,000 meters. For waves up to 2500 meters, a group of four bank wound coils of 20, 35, 75 and 150 turns each will be required, and bank windings of 400 and 750 turns each will be necessary to complete the coil for the 20,000 meter wave. This applies, of course, only to the single coil circuit you wish to use. The dead end switch will work very well in this circuit.

DESIGN OF C. W. ANTENNA

Continued from page 28

duces the radiation, but adds to the adjustments of the transmitter, if the series condenser is variable, as is generally the case. If the fundamental wavelength of the antenna is 175 meters or less, no series condenser will be necessary, and whatever variations are required in the antenna circuit of the transmitter may be made by varying the number of turns in the antenna inductance.

The other reason is that the wavelength will surely be within the law, and this is by far the most important consideration for obvious reasons.

Continued on page 70

This loud speaker has many unusual features, first and foremost being the swivel adjusting device which allows the horn to be swung into any desirable position. Secondly, it is constructed in such a manner that a simple turn of an adjusting screw will allow almost any kind of a head phone being used for the loud speaker.



RICHMOND Loud Speaker

Price without phone

\$7.00

F. O. B. Richmond

With Baldwin phone

\$12.50

A 3-foot green cord included with every loud speaker. This loud speaker can be supplied with or without phone. It will be a valuable addition to your station as the workmanship is excellent.

The stand is of Mahogany finished wood. Write for our price list on other makes of radio equipment. We carry a large stock of standard parts and supplies and construct equipment to your order.

429 BARRETT AVENUE
RICHMOND, CALIFORNIA

RYAN RADIO COMPANY

“CHELSEA”

No. 50 Amplifying Transformer

was designed for use with the present day models of vacuum tubes, and when so used produces remarkable amplification, with minimum noise. It is well adapted for table mounting or may be panel mounted in any position.

Terminals are marked for best connection. Only highest grade materials and workmanship employed. Its high efficiency together with its neat appearance and compactness, makes it a predominating feature in any radio receiving equipment.



IMMEDIATE DELIVERY

Price as shown, \$4.50
Unmounted . . \$3.75

Bulletin sent upon request.
Purchase from your dealer.
If he does not have it, send to us.

CHELSEA RADIO COMPANY
150-156 Fifth St. Chelsea, Mass.

SERVICE-TESTED RADIO EQUIPMENT

We have determined to secure a portion of the radio business on the Pacific Coast and realize that to do so we must offer some inducement to make our efforts successful. Our idea of the reasons that Western amateurs do not purchase from Eastern markets on a larger scale is that we dealers are located too far away from our customers. To eliminate objections arising from this handicap we have inaugurated our "SERVICE-TESTED" plan of selling equipment. Every article which we ship out will be tested thoroughly in our laboratories before it is sent to our customer. There will be no such things as tubes which do not oscillate or "B" batteries which go dead in a short time for the simple reason that any of these articles will be exhaustively tested in ACTUAL SERVICE before the purchaser receives it.

Secondly we will pay all postage charges on orders exceeding \$5.00. This will make our equipment even cheaper than it can be bought on the coast where prices are often higher than listed by the manufacturer. It is needless to mention that our prices are strictly list as can be seen by the following list:

Radio Corporation Products

We are distributors and jobbers for the Radio Corporation of America and always carry a complete stock of their apparatus. We list below their complete line and in addition can supply you with the Radio Corporation C. W. instruction book at 25c per copy.

Item	VACUUM TUBES	List Price	Item	KENETRON RECTIFIERS	List Price
1	Radiotron (detector) UV-200	\$ 5.00	6	20-watt Kenotron, UV-216	\$ 7.50
2	Radiotron (amplifier) UV-201	6.50	7	150-watt Kenotron, UV-217	26.50
3	Radiotron (5-watt) UV-202	8.00	VACUUM TUBE SOCKETS		
4	Radiotron (50-watt) UV-203	20.00	8	Porcelain Socket (for UV-200, 201, 202, 216) UR-542	1.00
5	Radiotron (250-watt) UV-204	110.00	9	Porcelain Socket (for UV-203 and UV-217) UT-541	2.50
POWER TRANSFORMERS FOR C.W. SETS			10	Bakelite Socket (for UV-200, 201, 202, 216) UP-552	1.50
12	325-watt, UP-1348	25.00	11	Mountings (250-watt tube) UT-501, UT-502	3.00
13	750-watt, UP-1016	35.50	SPECIAL CONDENSERS FOR C.W. SETS		
	A-Filament heating Transformer for UV-204, UP-1633		25	Antenna Series Condenser, 7500 V., .0003, .0004, .0005 mfd., UC-1015	5.40
	B-Power Transformer for UV-204, UP-1636		26	Plate and Grid Condenser-3000 V., .002 mfd., UC-1014	3.00
C.W. ACCESSORIES			27	Special Condenser-10,000 V., .00025 mfd., UC-1803	5.00
14	Oscillation Transformer UL-1008	11.00	28	Special Condenser-.002 mfd., 6000 V., UC-1806	7.00
15	Magnetic Modulator (1/4 to 1 1/4 amp.) UP-1643	9.50	VACUUM TUBE DETECTOR ACCESSORIES		
16	Magnetic Modulator (3/4 to 3 1/4 amp.) UT-1367	12.00	29	Intervalve Amplifying Transformer, UV-712	7.00
17	Magnetic Modulator (3/4 to 5 amp.) UT-1367	17.00	40	Special "A" Battery Potentiometer, PR-535	2.00
18	Filter Reactor (160 mill amp.) UP-1626	11.50	41	Tabular Grid and Plate Condenser	
19	Filter Reactor (300 mill amp.) UP-1627	15.75		.00025 mfd. UC-567	1.25
20	Plate Circuit Reactor, UP-415	5.75		.0005 mfd. UC-568	1.25
21	Filter Condenser 1/4 mfd.-750 V., UC-1631	1.25		.001 mfd. UC-569	1.50
22	Filter Condenser, 1 mfd.-750 V., UC-1632	1.50		.0025 mfd. UC-570	2.00
23	Filter Condenser, 1/4 mfd.-1750 V., UC-1634	1.50	42	Grid Leaks	
24	Filter Condenser, 1 mfd.-1750 V., UC-1635	2.00		UP-509, .05 megohm	UP-518, .75 megohm
25	Transmitter Grid Leak (5-watt tubes), 5000 ohms UP-1719	1.10		UP-510, .1	UP-519, 1.0
26	Transmitter Grid Leak (50 and 250-watt tubes), 5000 ohms, UP-1718	1.65		UP-511, .15	UP-520, 1.25
27	Antenna Ammeter, 0-2.5 amp., UM-530	6.00		UP-512, .20	UP-521, 1.5
28	Antenna Ammeter, 0-5 amp., UM-533	6.25		UP-513, .25	UP-522, 1.75
29	Sending Key UQ-809	5.00		UP-514, .30	UP-523, 2.00
30	Microphone Transformer UP-414	7.25		UP-515, .40	UP-524, 2.50
31	Filament Rheostat (for UV-200, 201 and 202) PR-535	3.00		UP-516, .50	UP-525, 3.00
32	Filament Rheostat (for UV-203 and 204) PT-537	10.00		UP-517, .60	UP-526, 4.00
33	Rotary Grid Chopper PX-1638	7.25		UP-527, 6.00	each 99.75
34	Shaft Bushings for 1/4" or 1/8" motor shaft	.20	43	Grid Leak Mounting UX-543	each .50

Send 15c for our complete literature

ELECTRICAL SPECIALTY COMPANY, 48-50 South Front Street, Columbus, Ohio

Another **TELMACO** Achievement

The Telmacophone

Here is the height of Telmaco perfection. Equipped with Baldwin Type C Unit. Inverted horn, reflected tone. Equal to any other horn twice its length. Designed and perfected by expert acousticians. Complete in every detail.

Don't be misled into buying a loud speaker offered for less, and expect satisfaction; for a loud speaker of quality cannot be sold for less. Only after the most exhaustive tests and comparisons with the other loud speakers; and only after the most thorough research, laboratory tests and field demonstrations has the Telmacophone been perfected, and offered now, for the first time to the public.

Telmaco Amplifiers, Receivers, Detectors, Variometers, and Variocouplers have earned a national reputation for quality endurance, and satisfaction not excelled by any other line. You can expect equal satisfaction from the Telmacophone.

If you haven't our complete catalog "T," be sure to write for it now.

Dealers! We are distributors for nearly all standard lines. Full discounts on the Telmacophone. Write for proposition on our complete line.



No extras to buy.
Nothing to get
out of order.

Price without Baldwin Unit, but with cap attached \$14.00.

We advise the purchase of the Telmacophone without Unit for those who have Baldwin Unit of their own.

RADIO DIVISION

TELEPHONE MAINTENANCE CO.

17 N. La Salle St.

Chicago, Ill.

BIESSMAN STORAGE "B" BATTERY



Here's What the Radio World Has Long Been Looking for. No "B" to be replaced. Takes care of Detector and Amplifier.

Twenty-four cells, individually tapped permitting use of any voltage from 2 to 50 volts in steps of two volts each.

Electrolyte is semi-solid; cannot spill or leak. Container is one piece cast composition block. Highly polished and neat in appearance. Pasted type plate especially developed for Radio Service.

Battery may be charged with any vibrating rectifier by using the circuit provided with battery. Copy of instructions furnished with each battery.

Price \$14.00.

Jobbers and Dealers! Write for proposition without delay.

RADIO DIVISION, TELEPHONE MAINTENANCE CO., 17 N. La Salle St., Chicago, Ill.

Now comes the question of how large the antenna may be and yet keep within the agreed limits. For maximum results on 200 meters, the total length of the antenna, including the antenna proper, lead-in and ground wire, should not exceed 100 ft., with 125 ft. as an absolute limit. This rule holds true for practically any style of antenna construction, and if the antenna greatly exceeds 125 ft., the C.W. transmitter will simply refuse to oscillate on 200 meters, no matter how many adjustments are made. In other words, to avoid using a series condenser, limit the length over all to 100 ft. If a series condenser is desired, or is to be tolerated, then the length may be 125 ft.

Let us take a practical problem as an illustration of how your antenna dimensions may be determined. An amateur has a single mast 60 ft. high, which he proposes to place at the far end of a slanting, inverted "L" antenna, the lower end of which will be fastened to the roof of his home, say at a height of 20 ft., and he desires to know how long the antenna proper can be, as well as the location of the pole.

Deducting 20 ft. for the lead-in and ground lead, from the 100 ft. total, the antenna can be 80 ft., measured from the top of the mast to the lead-in. By the simple formula of the square of the hypotenuse of a right triangle being equal to the sum of the squares of the two sides, where the 80 ft. antenna is the hypotenuse and one side is the 60 ft. mast less 20 ft. for the lead-in, we find that 70 ft. is approximately the correct distance from the base of the mast to the point directly under the lower end of the antenna. If the mast were 80 ft., then this distance is reduced to 55 ft., and so on in proportion to the height of the mast. The most difficult case of the slanting antenna is taken mainly because it is a favorite in cities, where backyards are small, and C.W. enthusiasts plentiful. Where the two supports are of the same height, simply deduct the length of the lead-in from the total allowable length and the remainder will give you the number of feet in the antenna proper.

Just a word in regard to insulation. If you have a four-wire flat top, don't place an insulator at each end of each separate wire. A single insulator placed at each end of the antenna will give four times the insulation, since when you have the former condition, there would be the equivalent of four resistances in parallel to ground, or one-fourth the resistance of one insulator. This point is often overlooked and is important from an economic standpoint as well as being more efficient electrically.

To some readers this discussion may seem very elementary, but it is quite apparent from the numerous questions received by the writer, that it is necessary.

Tell them that you saw it in RADIO

"If a man writes a better book, preach a better sermon or make a better mouse-trap than his neighbor; though he built his house in the woods, the World will make a beaten path to his door."—Emerson

FIRCO JACKS

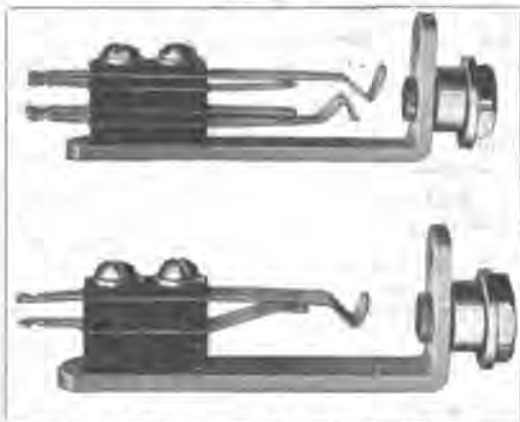

FIRCO Jacks were not offered until our engineers were assured they had produced the best Jack on the Market. They are now working on some very radical innovations in Firco products, which will be announced in an early issue of this magazine.

These Jacks have heavy Sterling Silver Contacts, Special Alloy nickel-silver springs, giving highest resiliency.

- Type 200 J Double circuit closed\$1.00
- Type 201 J Single circuit closed85
- Type 202 J Single circuit open70
- Type 203 J Five Spring automatic filament control 1.50
- Type 204 J Three Spring automatic filament control 1.20

The Famous Seibt Condensers

Capacity Meters, Frequency Meters, and other Precision Instruments are now controlled absolutely by us. We have purchased the patent rights and will continue to be exclusive distributors.

A Word to Our Dealers

We are overburdened with orders, but with increased production we are doing our best to keep up with the insistent demand. We ask you to be a little patient on Vocaloud deliveries. Station type now \$35; Laboratory type \$30.

Place your orders now for June and July requirements so you will be in line for prompt delivery.

JOHN FIRTH & CO., Inc.

18 Broadway

New York

NOTICE

Radio—7XC

The Northwest Radio Service Co., the largest Radio Supply house in the Northwest has moved to 1637 Westlake Avenue Seattle

where a larger stock of up-to-the-minute radio equipment has been received. If you want fast Service, send your order to us. Service is our middle name, and incidentally the corner stone of our success. Remember the new address

Murdock, DeForest, Radio Corporation, Radisco, A.-P. and other standard lines.

Builders of "PUGET" RADIO PRODUCTS—None Better

Tell them that you saw it in RADIO

CREMATE-YOUR SPARK COIL

By THEO. MCKEON

If this article is published, I hope the guys that still dust their spark-coil contacts will put the ashes of them in a can and bury them among old relics. You ask: "Didn't you use one yourself?" Certainly; but read on: I had one or two, as is always the case with a beginner, along with my crystal detector and loose coupler. Night after night I punctured the ether for twelve miles on a single Ford coil. It was when the audion came to our town circle that I wanted to rise. An audiotron and a storage battery soon was at my disposal. In a couple of months I was happily hearing the singing rotary gaps. From then on I began to despair at the sound of the "static machines" which broke into the music so often.

I oiled some of the dry wheels, and soon had my head thinking about a transformer. No sooner said than done, I was at the operating table, two spark coils in hand. These I dissected, taking out the secondaries, then binding them on to a suitable laminated core, and forming a primary of 400 turns of No. 14 D. C. C. on a core of the same length. I made a closed core transformer which, although it took 200 watts from the line, sent far more audible signals to Seattle—30 miles as the crow travels—than did my former rock-crusher.

Now, fellers, it would cost you practically nothing to build your transformer from your spark coils. A recent article by Chas. Dalziel attracted my attention, and I may honestly say there is not a reliable ham on the brass that does not curse the spark coils.

Why not try C. W.? Each issue of the RADIO displays very simple tube circuits, some very good ones, with the cost as low as that bicycle you want. You can wind your own choke coils and transformers with but little cost.

I have not erected my station at Paso Robles yet, but expect to by fall. I will be one of the many "C. W. and fone" uplifters, and another "6" on the key, formerly "7FX."

6XAD HEARD IN ALASKA

G. E. Maddox, operator on U. S. L. H. T. "Fern," writes from Ketchikan, Alaska, under date of February 16: "As soon as I completed my short wave set and hooked it up, the very first static I heard was you, calling 6ZAC, Dow, Wailuku, Honolulu. We were in Funter Bay, Alaska, which is nearly entirely surrounded by high mountains, the distance to you being nearly 1826 miles in an air line and almost all of it overland. Your signals are very QSA every night all over southeast Alaska, and I have no trouble in copying everything you send.

O-BOY!!! READY TO SHIP!!!

SHORT WAVE TUNERS—Range up to 650 meters. Price.....\$65.00

SHORT WAVE TUNERS—Knockdown. Consisting of:—

Two variometers	One variocoupler
Two primary switches	Six binding posts
Two switch stops	Fourteen switch points

Formica panel 6½" x 18"

Complete Price\$45.00

Detector and two stage amplifiers. Size of panel, 8"x8½". Price.... 70.00

Two stage amplifiers. Size of panel, 5¾"x8". Price..... 50.00

VARIOMETERS—5" long by 2 7/8" wide by 5" high. List..... 8.50

VARIOCOUPERS—5" dia. by over all height 4¼". List..... 6.75

CONDENSERS—43 Plate Type. List..... 5.00

21 Plate Type. List..... 3.75

STORAGE BATTERIES—Special 6 Volt, 60 Ampere hour..... 12.35

ESTIMATES FURNISHED ON RECEIVING,
TRANSMITTING AND 'PHONE SETS BUILT
TO YOUR OWN IDEA AND SPECIFICA-
TION.

FULL LINE OF ALL STANDARD MAKES
OF RADIO APPARATUS

Concerts every evening from 7:30 to 10:30 p. m.,
except Wednesday and Saturday.

Bronx Radio Equipment Company

687 Courtlandt Ave., Cor. 154th St. BRONX, N. Y. C.

Five blocks North 149th St. Subway and "L" Station

NOVO SPECIAL!

Real "B" Batter-
ies. The ones we
have all dreamed
about. Size 6¼"
x 3¾".

COMMON OPERATING FAULTS

Continued from page 31

of people. First, the operators that start up at sea, and test, and fool around for a while, sending V's and calling; and second, to the boneheads who test and attempt to tune their sets while the ship is in port, and especially, the shop men and others who have a perfect right to tune and test under proper conditions.

When at sea, it is usually only necessary to make a few small changes in the modern quenched set to bring it up to normal working efficiency; the addition or sorting out of a gap or two, and a few small adjustments of coupling, the adjustment of the antenna inductance, and the exact proper point on the field rheostat are all that should be touched to clear the "note," and usually these all could be carried up while calling, and certainly could be completed when the preamble of a message is being sent, altho this should have the operator's complete attention, due to the possibility of error. There is no excuse for an operator to start up and tune and test for ten minutes before he starts to send. Such actions show one of two things. Either that the man is a "hog" and doesn't care for the rights of others on the air, or that he is absolutely ignorant of the way to handle his set. In either case he had better find some more suitable occupation—in a soup kitchen, for example—or mend his ways. There is no room for him in the modern radio business.

The testers who go aboard the ship when in port are even worse than the first mentioned class. A more senseless, and pigheaded, and selfish attitude cannot be imagined than that possessed by the man (?) who starts up a ship set and proceeds to tune and test for a period of uncertain duration without listening in or signing off. There are, fortunately, very few of such men in the radio game, still there must be some, otherwise how would so much of the unaccounted for interference be caused?

Possibly I have been too hard on the "shore-going" men; possibly ship operators themselves are guilty. The license of a ship station states that the station is licensed to be operated "while the vessel is being navigated." This does not, and cannot mean that this is permission to operate as it pleases the operator when the ship is tied to the dock, or at anchor. If it is necessary to test, why not start the set and make a single dash, simply to see if the set will radiate, if you are listening in, and just want to see that it is O. K.? Few do this, even tho they are so selfish that they want to get ashore, or off on their own business, and the result is that they test and fool around until it pleases them to stop. To my way of thinking, such men should be simply eliminated from the radio field whenever and wherever caught. It is hoped that it will be possible at some time to locate the exact ship where unauthorized, unsigned testing is carried on, by radio compass, and to punish the party who has been doing the dirty work. The elimination of a few of such troublemakers would go far towards deterring others from trying the same tactics, who cannot be reached by any regulations or rules, but thru fear of the results only.

The life of a vacuum tube can be lengthened by care in not using too much current to heat the filaments. The simplest index is to employ a voltmeter in shunt with the filament terminals. After observing the voltage at which each tube gives the best results this voltage should never be exceeded. The voltage from a storage battery is highest when the battery is fully charged, at which time especial care should be exercised.

\$35.00
DETECTOR AND
TWO-STEP AMPLIFIER
\$35.00

Satisfaction!

That's what the Proud-
foot Detector and Amplifier
is built to give. The Price
was made to fit your pocket-
book.



Maximum Amplification. No Howling
Plug for fones furnished with each instrument.
Automatic filament control by plug \$10.00
additional.

Detector and One-Stage Amplifier

\$25.00

* duplicate of above only one unit less.

G. M. PROUDFOOT

361 E. OHIO ST.

CHICAGO

LEARNERS SETS



With code, instructions, and the AJAX
BUZZER, \$1.80.

60c—AJAX HYTONE BUZZERS—60c
external tone adjustments. All postpaid.

AJAX ELECTRIC CO.

8 Palmer St., Cambridge, 38, Mass.

Write for Our
LIBERAL SUBSCRIPTION PLAN
"RADIO," San Francisco, Cal.

Cabinets and Wood Work For Radio Apparatus

For the amateur and the manufacturer
Your choice of design, wood and finish.
Send rough sketch and specifications for
quotation.

Formica cut to size and polished, 1 cent
per square inch per each 1/16 of an
inch in thickness.

Orders large or small given prompt at-
tention.

PACIFIC RADIO EXCHANGE

433 Call Bldg.,
S. F., Calif.

Tell them that you saw it in RADIO

RHAMSTINE★

Produced the Adapt-O-Phone for a Listening World



Developed from a special study of the requirements of a Radio Age, the Rhamstine★ Adapt-O-Phone brings added satisfaction to your hours "listening in". Scientifically designed and balanced so that the sounds from your two receivers are clearly and correctly amplified. The Adapt-O-Phone is twenty inches high, attractively finished and reasonably priced.

\$12.00

Without receivers.

Add 25c for postage and packing.
West of Rocky Mountains, 40c.

The Rhamstine★ Amplify- ing Transformer

Price **\$3.50** Postage
10c



Many thousands of users of the Rhamstine★ Amplifying Transformers are convinced of its excellent characteristics. Precision and strict economy in manufacturing, coupled with correct designing have been largely responsible for its success.

You can buy it with the assurance it will give you satisfaction.

Circulars upon request. Dealers wanted everywhere.

Manufactured by

J. THOS. RHAMSTINE★

2152 E. Larned Street

Detroit, Michigan

★ Maker of Radio Products



*Amplify your
signals with
ACME Transformers*

SPECIALIZATION in building transformers as in all other lines results in a high degree of efficiency. Whether you build your own apparatus or buy assembled outfits insist on the use of proven units. Acme Transformers in your vacuum tube amplifier equipment magnify voice and music as well as code without distortion and without howling. They are priced as low as specialized quantity production permits, with due regard for quality. At all Radio dealers.

**ACME
APPARATUS CO.**
182 Massachusetts Ave.
CAMBRIDGE, MASS.

Transformers & Radio Engineers & Mfrs.

**NOVO
Vacuum Tube
"B" Batteries**

FOR

Wireless Sets

22½ to 100 Volts

19 Different Sizes

Plain and Variable

FULLY GUARANTEED

Noiseless in Operation

Write for catalog and prices

**Novo Manu-
facturing Co.**

424 W. 33d St. 531 So. Dearborn St.
NEW YORK CHICAGO

**ELIMINATING THE GRID
BATTERY**

Continued from page 21

20 volts negative in respect to the filament.

An outstanding feature is the practically automatic control of the grid potential with increasing or decreasing plate voltages. As the plate potential applied to the tubes is raised, the plate current increases. However, this increase in plate current causes an increase in the drop across the series resistance and this increase drop makes the grid more negative; which is essential. Any decrease in plate current will be accompanied by a proportional decrease drop in grid potential. In this way, any changes in plate supply voltage will be compensated for by proportional changes in grid potential.

By making this resistance variable in twenty ohm steps, the grid bias potential can be changed in 2 volt steps. This is important in adjusting the modulator plate current to the proper value.

In the event that a speech amplifier tube is used to amplify the voice currents before reaching the modulator tube proper, another tap can be taken off of this same resistance to supply the proper negative potential for the speech amplifier tube.

**DIRECTIVE RECEPTION
AND INTERFERENCE
ELIMINATION**

By HUGH R. SPRADO

Owing to the great interest taken in the article on "Directive Reception and Interference Elimination," in March RADIO, and the numerous requests for additional information on the various parts that make up an Antenna-Loop Barrage, the following may be of value to the experimenter.

The first question which arises is the size of loop for short wave work. An excellent article on loops, appearing in the November issue of Q. S. T., tells us that the proper loop size is four to six feet square, having six turns of wire spaced approximately ¼" apart.

Referring to the "Antenna-Loop Barrage," circuit shown in Figure 6, on page 17, of March RADIO.

The antenna variable condenser capacity should be between .0005 and .001 MF. maximum.

The series variable resistance in the antenna circuit should be in the order of 5000 to 10,000 ohms. Five 25 watt 220 volt Mazda lamps in series serve the purpose admirably, the variation in resistance from lamp to lamp being sufficiently close to give proper adjustment. The coupling coils shown in the circuit can be either honeycomb windings or standard variocouplers.

The variable condenser C. should be of .0005 max. capacity.

BAKELITE-DILECTO

The standard insulating material for all radio work. Water-proof, permanent, strong, used by all important manufacturers of wireless apparatus and others requiring the utmost in insulation.

Furnished in sheets, rods, tubes and special shapes

We also manufacture VULCANIZED FIBRE and CONTINENTAL-BAKELITE in sheets, rods, tubes and special shapes, and CONITE, a special insulation, in sheets or rolls from .005" to .020" thick.

Let us show how our standard products can be made to solve your insulation problems. Pacific Coast dealers carry a full stock of Bakelite-Dilecto, Vulcanized Fibre, Continental-Bakelite and Conite.

THE CONTINENTAL FIBRE CO.

NEWARK, DELAWARE

DUCOMMUN HARDWARE CO., 219 Central Ave., Los Angeles, Cal.

CALIFORNIA ELECTRIC SUPPLY CO., 843 Mission St., San Francisco

332 S. Michigan Ave., Chicago, Ill.

411 S. Main St., Los Angeles, Cal.

89 Wellington St. W., Toronto, Ont., Canada.

233 Broadway, New York City
525 Market St., San Francisco, Cal.
301 Fifth Ave., Pittsburgh, Pa.

Tell them that you saw it in RADIO

The Wireless Pioneers of Today Are The Leaders of Tomorrow

The amazing expansion of Wireless astonished the World—Wonderful opportunities are opening up every day on land and sea. Here is your chance to get in on the "ground floor" of a profitable profession, in your spare time, and enjoy the interesting study of this new means of communication—

Up To \$10,000 A Year Is Earned By Many Men.

The fascinating profession of Wireless is calling on you to share in its gigantic future—the field is wide—hundreds of big-pay positions are waiting—waiting for more men—more men like you

Don't hesitate but get into Wireless now and in a few years you will have climbed the ladder of success and can make your pick of the biggest jobs in industry—Wireless is the fastest-growing invention in the world—a few years ago it was practically unknown—now it offers such genuine opportunities for success, how can you pass it up? Grow up with Wireless, travel hand in hand with its expansion and cash in on the splendid advantages of this uncrowded, solidly employed field of work.

Start now—be a pioneer in Wireless—tomorrow you will have a job that will allow you to save more money than you can earn ordinarily in a single year! Every vessel on the sea must have from one to five operators. Openings are constantly available for operators, salesmen, mechanics, executives, engineers, in the land station areas—in a few years you can work yourself up to the \$10,000 a year class, where every man hopes to land but few ever get.

Fit yourself for the place—let us help you do it. The National Radio Institute is a leader in Radio Instruction today because it was a pioneer of yesterday—from the inception of the first glimmering of the science, our school had its birth, and from then on has forged ahead until the National Radio Institute occupies the most important position of any Radio School in America!

It makes no difference how little you know about Wireless. Step by step we take you through the various stages and turn you out a full fledged Radio Operator worthy of the name! It doesn't take long either—just a few short months of pleasant study, one hour or less than that a day—and you are a success.

Our methods have been carefully planned and we believe that our "Learn By Doing" idea has done more to simplify the study of wireless than any other mode of instruction ever offered!

The wonderful Natrometer is loaned you to practise with—a complete set to teach you the code—then upon completion of the course you are given a high grade receiving set of your very own to catch the messages from the air, music, speech, etc.

Get Your Instruction From The Largest School

The National Radio Institute was the first school of its kind to teach Wireless by mail. Today it is the largest in America. Situated in Washington, the heart of our country's Radio activity, we keep constantly in touch with the newest developments in the science of Wireless. The Institute is close by the Bureau of Standards where the latest wireless inventions are tested and perfected; it is near the Department of Commerce where Government examinations are made up and held. Two of the largest Radio stations in the world, Annapolis and Arlington, are only a few miles away!

The National Radio Institute is officially recognized by the Department of Commerce, and at Government examinations its diploma is credited with ten points in the student's favor. The U. S. Shipping Board heads its list of recommended schools with the National Radio Institute. Every employer of Radio operators knows the class of students we turn out, and looks to us as the best source for competent operators to fill the places they have open.

Already more than 8,000 students have taken up their life's work through the instruction received from us; our graduates are holding important positions all over the world.

You, too, can fit yourself to fill one of these fine jobs by allowing us to train you in your spare time at home!

A Complete Course in Wireless

No matter what field of wireless you are interested in, the National Radio Course is for you. If you have just purchased a wireless receiving set and want to learn more about it—if you have an amateur license and want to get a First Class Commercial License so you can hold the Big Jobs—if you are tired of listening to music only and want to "listen in" on code messages—if you are a beginner and want to know wireless from the ground up—you need the National Radio Course, because this is the one course that teaches EVERYTHING.

We keep our instruction right up to date, and include the latest developments in wireless knowledge. You not only learn how to send and receive code messages as fast as any expert, but you also learn how to build wireless apparatus, how to install it, maintain it, operate it, how to keep it in repair. The one course teaches the two big branches of Radio—Wireless Telegraphy, the wireless of dots and dashes, and Wireless Telephony, the wireless of the voice. You learn the use of the Radio Compass, the latest and most important invention in this wonderful field. You learn the duties of an operator, an executive, a mechanic, a salesman of Radio equipment—in fact everything you want to know about wireless can be found in this one, all-comprehensive course.

Mail Coupon For Free Book

It makes no difference how little you know about Wireless, or whether you are a man or a woman, you can train yourself for a splendid position. If you have had a common school education or better, you can easily learn Wireless in your spare time at home through our wonderful Automatic Self-Instruction method.

It cost nothing to get our interesting illustrated booklet, "Wireless, the Opportunity of Today." Send for this booklet and full facts about the National Radio Institute and its complete course today. Fill out and mail the coupon at once. But please do not waste your time if you are not genuinely interested. Our book is not for triflers, but for serious-minded men and young men.

We Want To Hear From Men Who Mean Business!

The chief purpose of the National Radio Institute is to prepare men to take up Radio Work in a Commercial way and to help those already interested as Amateurs to realize their ambition to become expert on the subject.

The opportunity for competent Radio Operators with practical training is unlimited. But there is no room in the Wireless Field for men who do not want to succeed.

A Wireless Operator holds an important position—he is no mere employee but an expert when trained by us, who is responsible for every message he receives and every message he sends—thousands look to him for the knowledge his training conveys to them—so it takes a man who wants to be somebody—a man with sufficient intelligence to realize that he is head and shoulders above the ordinary professions that crowd him on every side!

Plenty of people write us about instruction who think that with a week's study they can become proficient.

We do not want anyone to get that idea.

It takes four to six months to master the subject.

No mere curiosity seeker or interested person who just thinks he wants to be a Radio Operator should apply for information.

If you are tired of doing things that thousands of other men can do as well as you and work for less money—

If you are disgusted with labor conditions, strikes, lockouts, shut-downs, unemployment—why, here's your chance to enter a field where such things are practically unknown!

But bear in mind—**WE WANT MEN WHO ARE FIRED WITH AMBITION AND WANT TO PUSH AHEAD OF THE COMMON CROWD!**

This is the kind of students that command good salaries and quick promotion.

WHAT KIND OF A MAN ARE YOU?

(Signed) E. R. HAAS,
Director.

NATIONAL RADIO INSTITUTE

Radio Headquarters

Dept. 1048 1345 Pennsylvania Avenue, N. W. Washington, D. C.

(Coupon)

National Radio Institute, Dept. 1048
Radio Headquarters,
1345 Pennsylvania Ave., N. W.
Washington, D. C.

Send me your FREE book "Wireless, the Opportunity of Today," which explains your Home Study Course in Wireless Telegraphy and Wireless Telephony. I am truly interested!

Name

Address

City State

Northern Radio Bugs:-

You stand a better chance of getting your apparatus from us than from anyone else in the Pacific Northwest because we carry the largest stock of all reliable makes of radio apparatus.

SERVICE

is what you get when you order from us. Ask anybody who has tried our service. Intelligent—Speedy—Reliable. Let us serve you, too.

Northern Radio & Electric Co.

606 PINE ST.

SEATTLE, WASH.

When Winding Those Coils For Your Set Use DUDLO MAGNET WIRE

The Magnet Wire designed especially to meet the requirements of radio apparatus construction.

APPROVED AND USED BY THE GOVERNMENT AND THE LARGEST MANUFACTURERS OF RADIO APPARATUS.

Where accuracy to gauge and uniformly high quality of insulation are essential the best results can be obtained with Dudlo Wire.

Dudlo Magnet Wire is sold by best dealers everywhere in attractive packages containing $\frac{1}{4}$, $\frac{1}{2}$, 1 pound of wire.

Dudlo Manufacturing Co.

FORT WAYNE

INDIANA

Specialists in the manufacture of Bare and Tinned Copper Wire
Enamel, Cotton and Silk Insulated Magnet Wire.
Windings for all electrical purposes.



Dealers—If you jobber is not prepared to supply your requirements write

A. S. Lindstrom

111 New Montgomery St.
San Francisco, Calif.
Western Representative

PHONES AND CALLS HEARD ON KOPS (KXGAIW) SAN PEDRO TO ALASKA AND RETURN (M. S. COOLCHA)

Feb. 12 (Just out San Pedro 6 p.m.) 7-9 p.m. 9nd a number of times.

Feb. 13 (150 miles north Pedro) 5.30 p.m. Sacto. Bee (kvq); 7.30 p.m. Los Alto; 8.30 p.m. Fairmont Hotel; 9 p.m. Seattle P. I. vry qsa.

Feb. 14 (80 miles north S. F.) 3.30 p.m. Hotel Oakland; 4.30 p.m. Fairmont Hotel; 6 p.m. kvq Sacto. Bee; 6.35 p.m. 6snj calling 6ak fone qsa; 6.40 p.m. 6snj vry clear and qsa.

Feb. 16 (125 miles South Flattery) 4 p.m. Seattle P. I.; 4.30 p.m. kvq Stockton qsa; 6 p.m. Seattle P. I.; 6.35 p.m. 6 snj calling 6ak (fone) vry qsa; 6.45 p.m. Atlantic Pacific Radio Supplies Co.; 7 p.m. Fairmont Hotel; 7.15 p.m. Hotel Oakland; 7.30 p.m. Fairmont; 8.30 p.m. Los Alto.

Feb. 17 (100 miles north Seattle) 8 p.m. kij (?) Radio Shop; 8.15 p.m. Hotel Oakland; 8.30 p.m. kvq Stockton.

Feb. 18 (350 miles north Seattle) 6 p.m. kvq Sacto. Bee; 8.30 p.m. Rocklin (?) vry qsa (Jass orchestra); 5.45 p.m. kvq Sacto Bee; 8.50 p.m. Seattle P. I.; 8.59 p.m. 6vm (cw) vry qsa; 9.05 p.m. 7sm de cl8 spk qsa; 9.06 p.m. 6ax de 6sam; 9.07 p.m. 6amn de 6ax; 9.15 p.m. 6amn de 6qr; 9.10 p.m. 7bx de 7st; 9.13 p.m. 6fj de 6bm; 9.14 p.m. 6qr de 7ge.

Feb. 19 (550 miles north Seattle) 6.45 p.m. Seattle P. I.; 7.22 p.m. 6sa de 6ss (cw) vry qsa; 7.45 p.m. agl Presidio qsa; 8 p.m. Seattle P. I.; 9.36 p.m. 7bk spk qsa; 9.42 p.m. 6sau qsa but qsa bad; 9.45 p.m. 6ajh de 6ax vry qsa.

MAKE NO MISTAKE!

THE KLOSNER VERNIER RHEOSTAT



Patent Pending

is the only Vernier Rheostat made having the exclusive feature of using but

One Single Knob

for both rough and fine adjustments. This feature allows the symmetrical appearance of the single knob to be retained when mounted on a panel with other instruments, and, at the same time adds to the simplicity and ease of operation in obtaining the necessary fine adjustments for best results from the modern critical vacuum tubes, especially when receiving phone and C. W. signals.

We invite comparison with any other filament rheostat now made.

Look for the name KLOSSNER moulded on the base.

Your dealer has them, or send direct to us.

Price \$1.50

Shipping Weight, One Pound
A Two Cent Stamp Brings
Interesting Literature.

Made Only by The Originators

Klossner Improved

Apparatus Company

2404 Crotona Ave., New York City, N. Y.
Dept. R

Q. S. A. COILS

what sizes do you need?

Send us your ORDERS. You pay the Postman when goods arrive next day. Immediate shipments.

THE CROSLY FOUR-PRONG V-T SOCKET

One piece of porcelain, the same as used in vacuum tubes for insulating the four prongs, given free with each Cunningham C-300 at \$5.00; or C-301 at \$6.50. Add 25c for mailing

CALIFORNIA RADIO LABORATORY
P. O. Box 463 - Hanford, Calif.

COMPLETE LINE OF HIGHEST GRADE WIRELESS OUTFITS

Send 15 cents in stamps or cash
for illustrated catalog "R"

FREED-EISEMANN RADIO CORPORATION

255 Fourth Ave. New York City
Manufacturers of High and Low Power Radio Apparatus

**KENNEDY
EQUIPMENT**

All types of this well-known equipment for every purpose. Universal and Intermediate Receivers.



**GREBE
APPARATUS**

CR-5 and other types. Amplifiers to match. These receivers made in various types to cover all wave-length ranges.



**HERROLD
Laboratories**



KENNEDY EQUIPMENT,
GREBE APPARATUS,
ACME C. W. EQUIPMENT,
SIGNAL PRODUCTS,
A. P. TUBES, ALL TYPES,
CUNNINGHAM TUBES,
WESTINGHOUSE SETS,



and many other well known makes. Tell us your wants. We are here to serve you.



**467 South 1st Street
San Jose, California**



**SMALL
PARTS**

Everything needed in the line of small parts for building your own sets can be purchased from us. Binding posts, knobs, switches, etc.



**MAIL
ORDERS**

We give you the same service on mail orders as you receive in our store. Send us your next list of supplies.

RADIOADS

A CLASSIFIED ADVERTISING SECTION READ BY 30,000 BUYERS

The rate per word is three cents, net. Remittance must accompany all advertisements. Include name and address when counting words. ADS FOR THE MAY ISSUE MUST REACH US BY APRIL FIRST

TRANSMITTING APPARATUS

1/2 kw Telefunken 500 cycle transmitter mounted, heavy engraved bakelite panel, aluminum angle frame complete with meters key rheostat, self-excited generator and AC motor mounted on rubber, spare gaps condensers \$300.

Radiohone on bakelite panel, with two new VT2s transmitter, switches condensers, dynamotor 30-350 volts \$50. All P. O. B. Seattle, Fotos. Obradovic, 5108 Meridian, Seattle.

FOR SALE: 1/2 kw Spark Set; Packard transformer, glass plate oil immersed condenser, Westrad O. T. Antennae switch, quenched gap, \$50. Lloyd West, Riverside, Calif.

FOR SALE \$35 or exchange for C.W. stuff. Old type 1-2 K.W. Thord, sending set complete. Enclosed, nearly silent. Frank Jones, 6A JF, 1822 Hearst Ave., Berkeley, Calif.

FOR SALE: Thordarson Type E. Transformer \$20; .007 Dubilier condenser #15; Benwood gap, aluminum case 10 point and 1-8 H.P., 8450 R.F.M. Westinghouse induction motor, \$30 complete; Murdock O.T., \$8.50. C. Schneider, 76 Canelli Ave., San Francisco.

FOR SALE: Spk. Transmitter of 6AFO. 1-2 K. W. Thordarson transformer type R. S., Dubilier Condenser 14,000 volts, .007 MFD, 1 Murdock O. T., 1 rotary gap, \$39 cash. B. B. Ellis, Jr., 848 24th Ave., San Francisco.

C. W. APPARATUS

ATTENTION, AMATEURS! A 10 or 100 watt C.W. transmitter circuit and complete constructional and technical data using alternating current plate supply, full wave self rectification. Blue prints complete, \$2.00. 500 miles on a 20 watt Radiophone using 4 5-watt power tubes and rectified alternating current plate supply. Blueprints, complete constructional and technical data for \$8.00. Frederick H. Graening, 282 Oregon Ave., Dundee, Ill.

DOUBLE YOUR CW AND RADIOPHONE RANGE! You can easily do it without adding another piece of apparatus or greatly changing your set. The new "Master Circuit" is the secret. Tested by many prominent ARRL stations, it more than doubles range of each station. One five watt set puts twenty watts into antenna; easily sends 2000 miles; tones 1000. Think of it! It's absolutely the best circuit out. Ideal for 200 meters. Guaranteed to double or increase your range regardless of what it is now. Send \$2 for complete confidential photoprints of this wonder circuit. Get it working for you—be the first in your town—surprise your friends by your phenomenal results. Order today—immediately! Master Engineering Company, Department R, Omaha.

FOR SALE: Complete new 10 watt I. C. W. telegraph set, including Power & Filament Transformer, antenna and filament ammeters, tubes, rheostats, key, protection, etc., mounted on heavy bakelite, with oak base. This set will radiate 2 amperes on 200 meters. Price \$125.00 complete. F. O. B. Oakland, Calif. Photo and detailed description sent on request. A. P. Tryon, 109 Greenbank Ave., Piedmont, Calif.

INSTRUCTION

BEUMA YELSBURG—TWO HUNDRED beginners tell how memorized wireless code in thirty minutes to two hours. Booklet, 10 red stamps. Dodge, Box 220, Mamaroneck, N. Y.

TELEGRAPHY—(Morse and Wireless) and Railway Accounting taught thoroughly; big salaries; great opportunities. Oldest, largest school. All expenses low—can earn large part. Catalogue free. DODGE'S INSTITUTE, Haas St., Valparaiso, Indiana.

3JI is calling! Stand by for one minute, please! I want to call your attention to my SHORT METHOD OF LEARNING THE CONTINENTAL CODE. Printed on highly glazed cardboard, 7x6 1/2 in. 85c brings it to you with a copy of INTERNATIONAL ABBREVIATIONS, free! 3JI now signing off. Hope to hear from you later. Oh, I forgot to tell you: I Pay Parcel Post Insured. G. W. CALVERT, LANSDALE, PENNA.

FOR SALE: Lessons of I.C.S. Complete Electrical Engineering and of Complete Civil Engineering Course with drawing plates. Either course \$16.00. Robert C. Smith, 484 W. Milford St., Glendale, Calif.

RECEIVING APPARATUS

TUBING INDUCTANCES. SPECIAL! Fibre tubing, 12"x3"x1/4"; thick wall. Tube wound with insulated wire. Includes 2 rods 1/4 inch square and 2 sliders. All ready to assemble, \$3.75. Same in cardboard, \$3.00. Same in Condensite Celoron, \$4.25. We pay P. P. insured. STAR CABINET & RADIO SHOP, LANSDALE, PENNA.

FOR SALE: Radio Apparatus Co. Undamped set, type 93. Write if interested. Russell Huckstep, 9DGX, Lebanon, Indiana.

Double slide tuner, Tesco tuner, three coil mounting, plugs, coils, condensers, all used, good condition. Fred W. Adams, Flanigan, Nevada.

FOR SALE: Regenerative Receiver, CB-5 style, only \$30; short wave receiver, \$25, perfect condition. Ralph Haynes, 1286 American Ave., Long Beach, Calif.

FOR SALE: 2 600-meter Regeneratives at \$30 each. Cost \$50. Cabinet \$5 extra. 1 600-meter Regenerative in cabinet, \$50. Cost \$125. 1 Audion panel, \$5. This apparatus is slightly shopworn, but in very good working condition. Linden Radio Laboratories, Box 29, Linden, Cal.

FOR SALE: 600-20,000 meter Receiver, including Radiotron, \$85. Ten mile Radiophone complete, operates on 60 volt "B" battery, \$35. Box 205, Williamsport, Penna.

25c! For Hook-up diagram for combination long and short wave receiver 180 to 20,000 meters. Stations heard here in Lansdale on set of this hook-up (3JI) include Pittsburg (KDKA), Concerts and others too numerous to mention. Instructions with print and prices of parts accompany hook-up diagram. Immediate delivery. I pay postage. G. W. CALVERT, LANSDALE, PENNA.

FOR SALE: DeForest E.S. 200; 3 honeycomb coil receiver, tunes from 100 to 25,000 meters. Complete set, honeycomb coils 25 to 500 inclusive. Three step amplifier in cabinet, with or without transformers. Chelias 43 plate variable condenser. Will sell lot or each piece of apparatus separate. White or call. Phone, Automatic 23278. Charles T. Sharp, 407 West 23rd St., Los Angeles, Calif.

PHONE BINDING POST SPECIAL! Bell Buoy Binding Post (our original design and make). Removable head. Highly nickelled. Wire guaranteed to stay right where you put it. 15c each; 6 for 75c; 12 for \$1.45. Also Fada Non-Removable Head Binding Posts 15c each, 6 for 85c, 12 for \$1.65. We pay Parcel Post Insured. STAR CABINET & RADIO SHOP, LANSDALE, PENNA.

HAVE QUANTITY SALESMAN'S SAMPLE REGENERATIVES for sale half price. Just the set you want. Wonderfully efficient. Made of best materials by master craftsmen. Encased in beautiful grained leather covered cabinet. Easy to operate; no capacity effects. A wonder for CW and phones. Equals a Paragon. Will be placed on market soon, retailing at fifty-five dollars; will sacrifice samples at \$24 each. This is a bargain. Every one in excellent condition; like new. Fully guaranteed. Grasp this opportunity—order one today—now! (Photo free.) Master Engineering Company, Department R, Omaha.

Okay Detector Panel. 1 1/2 amp. Rheostat, Fused Socket, Jack Formica Panel. \$6.75, prepaid. Money back if unsatisfactory. Okay Laboratories, Brazil, Ind.

Triple coil mountings with gears, new, \$6.00. Masco storage battery, 6V60 amp., \$10.00. QSA coil, 300-100-50-35-25—all \$6.25. Splitedorf 1" spark coil, \$4.50. Clapp-Eastman 43 plate condenser, \$3.25. Milwaukee Radio Lab., 910 Third St., Milwaukee.

8000 meter honeycombs, 4 taps \$1.50. 2 filament Audiotrons \$5. Regenerative sets \$5. Write. Lubcke, 1441 6th St., Alameda, Calif.

BAGGAIN: Combination receiver, consisting of honeycomb mounting, two variometers, variocoupler, three variable condensers, anticapacity cam switches, detector and three step amplifier and tubes, Federal transformers, etc., panel sixteen by twenty by nine deep \$100. H. E. Williams, Vallejo, California.

FOR SALE: Complete set of 18 new Q.S.A. Honeycomb Coils (extra 75 and 50) with a new stand. Cost \$39.00; first \$29.00 takes them. Hyman, 1708 W. 23d St., Los Angeles, Calif.

MISCELLANEOUS

STOP! LOOK! and AOT! V.T.'s and ACCESSORIES. With each of the listed tubes RADIOTRON U. V. 200 \$5.00 and A. P. detectors \$5.00; RADIOTRON U. V. 201 \$6.50 and A. P. amplifiers \$6.50. We will supply free of charge your choice of either of these five premiums: Latest FADA Rheostat \$1.00, No. 8.10 Remler Bakelite Smooth Running Rheostat \$1.00, Paragon V.T. Socket \$1.00, Murdock V.T. Socket, improved contact type, \$1.00, or CROSLY Porcelain Panel or Base Mounting V.T. Socket, \$0.60. Either of the FEDERAL single, closed or double circuit jacks listed respectively at \$0.70, \$0.85 and \$1.00 will be given as premiums with each FEDERAL 226W Amplifying Transformer \$7.00 or R.C. of A.U.V. 712 \$7.00 and the U.V. 1714 Radio Frequency Amplifying Transformer. FADA 5 ampere NICHROME Power Rheostats \$1.35 or R.C. of A.U.R. 542 Porcelain V.T. Socket supplied free of charge with each \$8.00 U.V. 202 5-watt RADIOTRON Power Tubes, for C.W. or Radiophone Transmission. We absolutely guarantee the foregoing apparatus. Only new and high grade equipment carried in stock. Unsatisfactory goods subject to return within five days. Twelve hour service. Postage and insurance prepaid by us, thereby saving time and money. Remember us. THE KEHLER RADIO LABORATORIES, Dept. P. Abilene, Kansas.

Condensite Celoron Panels, cut to your specifications, 3/16 in. thick, 2 1/4 sq. in. Condensite, Celoron Tubing, 4 in. diameter, 1/16 in. wall, \$1.50 per ft. 3 in. diameter by 1/16 in. wall \$1.25 per ft. STAR CABINET & RADIO SHOP, LANSDALE, PENNA.

FOR SALE: \$500 worth of high grade radio apparatus for \$200. 1-ESCO Motor Generator set 500 volt D. C., 25 amps.; 110 volt 60 cycle A.C. \$50 1-10 watt Radio Telephone Transmitter, with 2-VT 2's. Voice, buzzer and C.W. Complete, \$75. 150 to 25,000 meters Honeycomb Coil Receiver with 3 stage amplifier, including tubes and "B" battery, all in one cabinet. Complete, \$75. H. O. Snyder, 995 Pine St., San Francisco, Calif.

Say, O. M.! We will wind inductances to your specifications. Cardboard, Fibre, or Condensite Celoron. STAR CABINET & RADIO SHOP, LANSDALE, PENNA.

Audion Renewals—Any type single stem, tungsten filament, detectors repaired for \$2.75; amplifiers as above, \$3; 5 watt power tubes, \$4; VT-1 oxide filaments and to use 20-85 volts "B", \$3.50. Terms cash, or C.O.D. plus charges. Trimount Laboratory, Milford, Mass.

WIRE SPECIAL! THIS ISSUE ONLY! 1/2 lb. spools D. C. C. No. 28 wire, 80c; 24 D. C. C. (just the thing for your inside aerial) 100 ft. coils, 75c; 22 7-strand copper aerial wire 100 ft., 80c; 250 ft., \$1.80; 300 ft., \$2.25; 500 ft., \$3.50; 1000 ft., \$6.90. Cash or Money Order. We pay Parcel-Insured Postage. STAR CABINET & RADIO SHOP, LANSDALE, PENNA.

WILL TRADE: 1 16-dial omniograph in perfect condition; 1 set of short wave Turney Spider Webs, new; 1 Lineman's Portable Aluminum Phone, type No. 332a, with leather case; 1 W.E. 3 bar magneto; one Federal Phonograph, new—for a Detector two step amplifier of standard make. D. W. Papst, Sisson, Calif.

SMALL PARTS. Let us know your wants in screws, nuts, knobs, magnet wire, etc. Give us a chance to estimate on your apparatus. We can surprise you. Long Radio Works, Cornelius, Oregon.

RADIO BOOKS

"Arc Radio Manual," published by the engineers of the Federal Telegraph Company of San Francisco, and written in simple, interesting manner. Well illustrated with diagrams and photographs of the various types of arc radio apparatus used on shipboard and in shore stations. Price \$2.50 per copy, postpaid in the U. S. For sale by Pacific Radio Pub. Co., Pacific Bldg., San Francisco.

"License Quiz Book," for passing the U. S. Government radio examinations. The most popular selling radio book. Contains 106 pages of radio information. 80 illustrations. 250 questions and answers. Deals with every new radio development. Price \$1.00 per copy, postpaid anywhere in the U. S., or given free with a one year subscription to "RADIO," Pacific Radio Pub. Co., Pacific Bldg., San Francisco.

New Somerville (Red Bakelite) Tube Socket 75c

1. MOULDED in one piece, from REAL NATURAL color Bakelite, having very low leakage losses.
2. ABSENCE of metal shell, eliminates ground hum.
3. The phosphor bronze contact springs are Laminated, and their shape permits a wiping contact on the sides of tube pins, as well as the usual contact with the extremities.
4. Contacts are arranged with maximum spacing to take care of high voltages used with power tubes.
5. Terminals are larger than usual, to permit the use of heavy conducting wires.

DON'T FORGET THESE EXCLUSIVE FEATURES:

Somerville 22½ V. "B" Battery Now Ready, \$1.75

Has 5 positive knurled Terminals, 16½ V., 18 V., 19½ V., 21 V., and 22½ Volts. Made to our specifications by one of the world's foremost Battery Manufacturers. Twice the capacity of the small signal corps size. Should last six to nine months.

Somerville Honeycomb Coil Plug 55c

For panel Mounting. With side coil-strap plates, for mounting. H. C. Coils 60c each.

Somerville Condensers

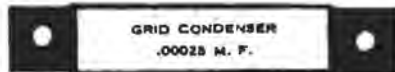

The Line Now Complete

Grid Condenser, .00025 MFD.....	\$0.25
Above, with ½ Meg. Grid leak.....	.40
Grid Condenser, .0005 MFD.....	.25
Above, with 1 Meg. Grid leak.....	.40
Phone Condensers, .001 MFD.....	.25
Phone Condensers, .002 MFD.....	.40
Phone Condensers, .005 MFD.....	.70

Quadrupled Production of Our Famous C. W. Condenser Enables Us to Make a New Price Schedule:

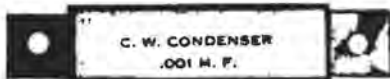

1000 V. C. W. Condenser, .0005 MFD.....	\$0.80
1000 V. C. W. Condenser, .001 MFD.....	.60
1000 V. C. W. Condenser, .002 MFD.....	.80
750 V. C. W. Condenser, .005 MFD.....	.80
500 V. C. W. Condenser, .01 MFD.....	1.00

Above rates are for D.C. only. When used with A.C. a safety factor of 75% should be observed. Each Condenser is tested at double above ratings, and any found defective, should be returned for replacement.



Somerville Mica Condenser

Mounted Between Bakelite. Power Factor, 1 ½, 500 Volts.
 .00025 mfd. .0005 mfd.
 .001 mfd. .002 mfd.
 \$1.00 Postpaid

Somerville Dial Indicators

For 3/16", 1/4" and 5/16" Shafts. 4" Dial, \$1.75; 3 ¾" Dial, \$1.60; Knob only, 80c.

Postpaid from us by return mail, or from your local dealer. This is the first metal dial with flanged knob and has the following exclusive advantages over imitations:
 The knob is of real Bakelite and will retain shape and finish.
 The Dial is of brass, heavily plated with real silver, and coated with a special non-peeling lacquer, which preserves the silver finish long after nickel dipped and "German" silver dials are mottled and tarnished.
 The heavy brass bushings and special Method of assembly, assures a dial which runs true on the shaft.
 The surface finish permits writing call letters on the lower calibration space.
 The dial is insulated from shaft bushing, and when grounded, acts as a shield from capacity effects from body.
INSIST ON THE ORIGINAL AND BEST.

Everymans Section

The AERIOLA-SENIOR is admirably adapted for the Hotel room or Apartment as well as for an extended camping trip. It does away with the bulky storage battery, which must be charged constantly, as the Vacuum tube requires but 1/25th the energy of the regular tube, and operates on a single dry cell and small "B" Battery.
 COMPLETE, with tube and two batteries and \$8.00 pair head phones, \$67.25. Postpaid east of Mississippi. West of Mississippi, \$1.00 Extra.
 Temporary antenna may be made from a pound roll of annunciator wire. Price, 70c.
 Standard Westinghouse antenna outfit, \$7.50.

SPECIALS: Amrad "S" Tube (rectifier), \$7.50.
 Porcelain socket for above, 15c.
 HOLTZER-CABOT PHONES, \$8.00.
 2200 Ohms with Patent universal Plug, \$1.00 Extra.
 CHIRAD K-D SHORTWAVE SET, \$10.00; 2 Variometers, 1 Variocoupler.
 CONDENSITE CELERON PANELS, 8/16" thick cut to size, per square inch, 3c.
 IF YOUR DEALER DOES NOT YET CARRY SOMERVILLE PRODUCTS send us your entire order and find out why our mail order service is so popular. We pay the postage.
 Our "ADD-A-PAGE" catalog sent for 25c or free with your initial order.



SOMERVILLE RADIO LABORATORY
 RETAIL - SALES - DIVISION
 176-178 WASHINGTON ST., BOSTON, MASS.



A Free Radio Bureau of Information

was opened on March 8th on the 2nd floor of the Glackner Bldg., corner Fulton and Greenwich St., New York. This Bureau is opened in the interests of the general public.

A great number of sets are on daily display here, fully connected and in actual operation. Prospective buyers are thus able to listen to various makes of apparatus in actual operation, and furthermore to see for themselves just how the hook ups are made.

Bi-weekly lectures on hook ups, theory, etc., will be given at the Bureau. The department will be equipped to calibrate instruments and furnish exhaustive data on the various phases of the subject of Radio. Current copies of radio publications will be available. The public is cordially invited to make use of this Bureau.

Our Motto Is

“RADIO FOR EVERYBODY”

and everything for Radio

We carry on hand ready for delivery a comprehensive stock of all kinds and sorts of radio apparatus and parts.

Complete Sets \$15^{.00} to \$300^{.00}

Write for Catalog

AMERICAN ELECTRO TECHNICAL APPLIANCE COMPANY

Glackner Building, corner Fulton & Greenwich St.
New York City.

20 CENTS

Honolulu comes to Continental

From far-off Honolulu they send to Continental for prompt, accurate attention to mail orders.

This letter speaks for itself.

You who live much nearer,

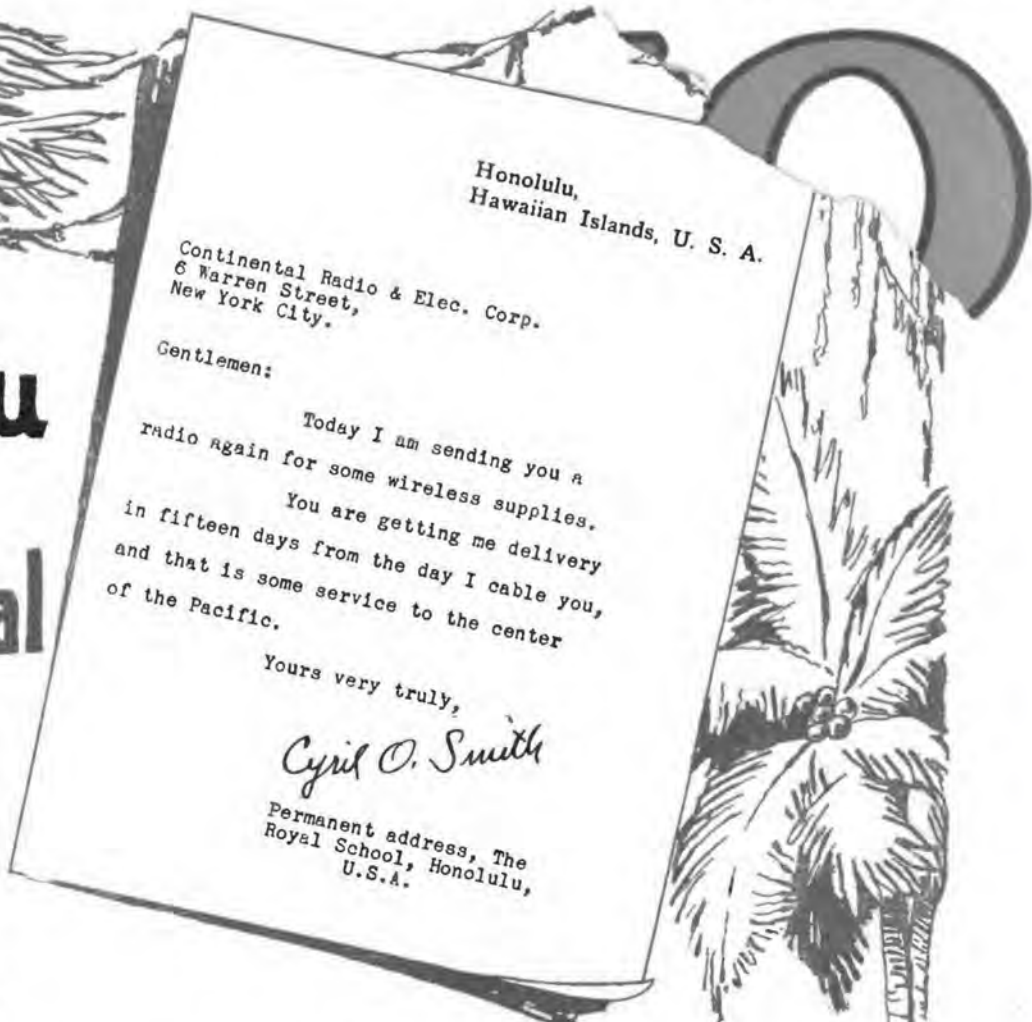

Have You Tried Continental Service?



Send for free leaflets describing Paragon R. A. Ten and the Creco Transformer.

New Catalog of Modern Radio Equipment, 35 cents.



HE Wireless Telephone broadcasting is bringing the wonders of wireless daily into the homes of thousands who never dreamed of having a radio set before, as well as to advanced amateurs.

We are prepared to supply complete Wireless Telephone receiving outfits as low as \$15.00! And of course we guarantee "Continental Service" to the purchaser to see that he gets perfect satisfaction.

Our comprehensive assortments include: The Marvel Set, \$15.00 complete; the Aeriola Jr., \$25.00; the DeForest Every-man Receiver, \$25.00; the Westinghouse R. A. set, \$68.00; the Westinghouse R. C. set, \$130.00; the Paragon R. A. 10 receiver—unexcelled for C. W. reception, \$59.50; and the new Grebe CR9, \$130.00. Orders by mail for any of these sets filled immediately.

CONTINENTAL Radio & Electric Corp.

DEPT. G4

6 WARREN STREET

NEW YORK

Use

A-P

Tubes
Apparatus

for efficiency



A-P
CHOPPERS

The Chopper used at KZY—(Oakland, Cal.) heard 2,500 miles distant in South America. Listen for it in the air. Mounted on 1/20 H. P. 110 volt, 60 cycle Westinghouse induction motor. Rotors have either 20 or 30 segments, giving 600 or 900 cycle note. When ordering specify the note desired. Price, f.o.b. San Francisco—\$27.50.



A-P
INDUCTANCES

Pattern 10—Number 12—hard-drawn copper wire, wound on 5 in. grooved Bakelite Tubing, spaced 6 turns to the inch, copper taps every 2 turns. Price in U. S. A.—\$4.50. Pattern 5—same as above, except wound on 4 in. Tubing and spaced 8 turns to the inch. Price in U. S. A.—\$4.25.



The A-P
ELECTRON
RELAY

—the most sensitive detector of spark signals known to the radio art. Equipped with the SHAW standard 4-prong base.

Price—\$5.



The A-P VT
AMPLIFIER
OSCILLATOR

—the Amplifier used by the U. S. Navy. "Use the tube," the Navy uses." Equipped with the SHAW standard 4-prong base.

Price—\$6.50.

—the chopper heard from
San Francisco to So. America

A-P tubes are licensed by the Radio Corporation of America under the deForest Audion and Fleming patents for amateur and experimental use in radio communication.

Ask your dealer for A-P tubes by name. If he does not have them, order direct—remittance must accompany order.

ATLANTIC-PACIFIC RADIO SUPPLIES CO.

Henry M. Shaw, President

638 MISSION STREET, SAN FRANCISCO, CALIFORNIA
EASTERN OFFICE, 5 KIRK PLACE, NEWARK, N. J.

CONSULTING—DESIGNING—CONSTRUCTION—RADIO ENGINEERS

National Distributors for Moorhead Laboratories, Inc., Manufacturers A-P Vacuum Tubes
Operating KZY, Rock Ridge Radio Station, Oakland, California

"the tubes that are used by those who know"

This file including all text and images are from scans of a private personal collection and have been scanned for archival and research purposes. This file may be freely distributed, but not sold on ebay or on any commercial sites, catalogs, booths or kiosks, either as reprints or by electronic methods. This file may be downloaded without charge from the Radio Researchers Group website at <http://www.otrr.org/>

Please help in the preservation of old time radio by supporting legitimate organizations who strive to preserve and restore the programs and related information.