

PORTABLE LIFT (MWL)



MODEL NAME	DP-3072MWL	DP-3084MWL	PD-9080MWL	DP-9092MWL
Format	4:3	4:3	16:9	16:9
Gain	1.0	1.0	1.0	1.0
Screen Material	Matte White	Matte White	Matte White	Matte White
Viewing Size (W x H) (mm)	1460 x 1100	1707 x 1280	1770 x 995	2030 x 1145
Diagonal Viewing (Inch)	72	84	80	92
Black Border R & L (mm)	35	35	28	28
Black Border Bottom (mm)	642	800	1018	820
Black Border Top (mm)	35	25	25	25
Weight (Net) (Kgs)	5.2	8.0	6.1	7.9
Case Dimensions (W x D x H) (mm)	1620 x 60.19 x 77	1867 x 60.19 x 77	1930 x 60.19 x 77	2190 x 60.19 x 77

PANOVIEW MWL

This unique, portable screen is easy to use and very stable with high quality alloy casing and self standing format. The Panoview Pull-Up is an ideal screen for travelling, whether it's from room to room or around the country.

Panoview MWL screens are available in both business presentation (4:3) and home cinema (16:9) formats. These screens are also ideal for rental companies when you're unable to mount a screen to the wall or a ceiling.



During use, two support legs which are otherwise hidden conveniently slide out from under the casing. The support legs come with height adjustable floor stands for use on uneven surfaces. For additional vertical stability, the support bar comes with an additional height adjustable floor stand.

The patented one-way lock allows the back support to be fully secure and easily adjustable. The multi-purpose handle is not only used for pulling and retracting the screen, but for securing the screen to the support bar too. This prevents the screen from falling or shifting positions.

Introducing Panoview Screens

Panoview offer a wide selection of quality front projection screens suitable for any situation, from small meeting to large conference rooms and great for home cinema applications.

All Panoview screens are built to a high standard and are rigorously checked and tested throughout the production process to ensure the highest possible build quality and finish.

Panoview's unrivalled understanding of both the market place and emerging technologies has allowed us to use our expertise to further expand our product offering to cater for every requirement, whilst still delivering great value.

The screens are available in several styles including wall/ceiling mountable, manual pull-down and electric with In-Site I/R, fixed frame and portable lift all in Matte White 1.0 gain.

Panoview screens are available in a wide range of sizes and styles that will fit any home and lifestyle, making them the ideal partner for your projector.

* Gain Explained

Gain is a measurement of the reflectivity of any screen or projection surface. The gain number represents the ratio of the light that is reflected from the screen as compared to the light reflected from a standard white surface. A screen with a gain of 1.0 will reflect the same amount of light as that from a white board. Higher gain levels are not always necessarily better for all situations. For example, with a high gain screen the viewing angle is decreased. This means the image may not appear uniformly bright from angles outside the viewing area. High gain screens are best used in environments where ambient light is an issue and projector positioning is favourable and benefits from a high gain surface.

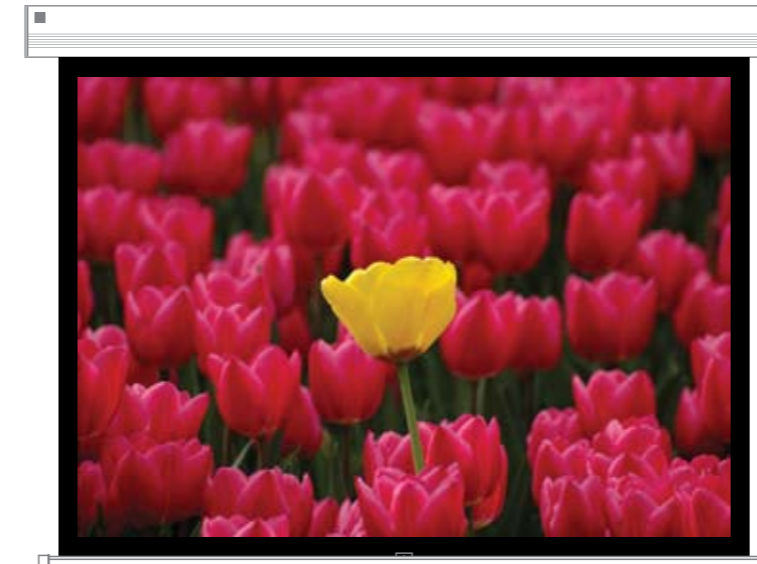

Optoma

Optoma Europe Limited
42 Caxton Way, Watford Business Park, Watford, Hertfordshire. WD18 8QZ
Tel: +44 (0) 1923 691800 Fax: +44 (0) 1923 691888

www.optoma.eu

© 2005 Optoma Europe Ltd. All rights reserved. All content on this brochure is protected by copyright. Panoview is a trademark of Optoma Corporation. Errors and omissions excepted, all specifications are subject to change without notice. Screen images are for illustration purposes only.

Panoview
Professional
Projection Screen

www.panoview.eu

MANUAL PULL-DOWN (PMG+)

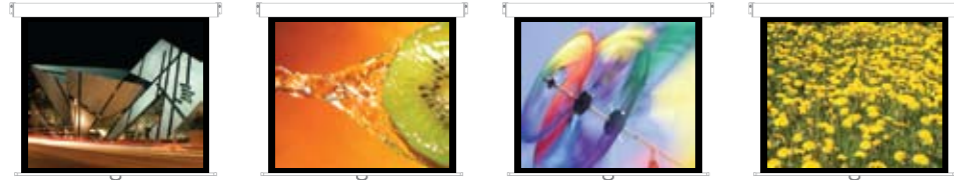

MODEL NAME	DS-3072PMG+	DS-3084PMG+	DS-3100PMG+	DS-3120PMG+
Format	4:3	4:3	4:3	4:3
Gain	1.0	1.0	1.0	1.0
Screen Material	Matte White	Matte White	Matte White	Matte White
Viewing Size (W x H) (mm)	1460 x 1100	1710 x 1280	2030 x 1520	2656 x 1494
Diagonal Viewing (Inch)	72	84	100	120
Black Border R & L (mm)	25	40	50	47
Black Border Bottom (mm)	35	30	40	40
Black Border Top (mm)	80	80	80	80
Weight (Net) (Kgs)	9.5	10.7	11.6	14.1
Case Dimensions (W x D x H) (mm)	1604 x 78 x 79 (including brackets)	1854 x 78 x 79 (including brackets)	2227 x 78 x 79 (including brackets)	2847 x 78 x 79 (including brackets)

MOTORISED (EGA)



DS-9084PMG+	DS-9092PMG+	DS-9106PMG+	DS-9120PMG+	DE-3072EGA	DE-3100EGA
16:9	16:9	16:9	16:9	4:3	4:3
1.0	1.0	1.0	1.0	1.0	1.0
Matte White	Matte White	Matte White	Matte White	Glass-Fibre Matte White	Glass-Fibre Matte White
1860 x 1045	2030 x 1145	2340 x 1320	2656 x 1494	1460 x 1100	2030 x 1524
84	92	106	120	72	100
40	50	47	50	30	50
35	45	45	45	20	40
300	300	300	300	80	80
10.0	11.6	14.0	22.0	8.5	12.2
2004 x 78 x 79 (including brackets)	2227 x 78 x 79 (including brackets)	2537 x 78 x 79 (including brackets)	2847 x 78 x 79 (including brackets)	1666 x 95.4 x 90.4	2236 x 95.4 x 90.4



DE-3120EGA	DE-9072EGA	DE-9092EGA	DE-9106EGA	DE-9120EGA
4:3	16:9	16:9	16:9	16:9
1.0	1.0	1.0	1.0	1.0
Glass-Fibre Matte White	Glass-Fibre Matte White	Glass-Fibre Matte White	Glass-Fibre Matte White	Glass-Fibre Matte White
2340 x 1755	1594 x 896	2030 x 1145	2340 x 1320	2656 x 1494
120	72	92	106	120
47	50	50	50	50
45	35	40	40	40
80	300	300	300	300
15.3	7.3	11.8	13.3	14.8
2606 x 95.4 x 90.4	1799 x 95.4 x 90.4	2236 x 95.4 x 90.4	2661 x 90.4 x 95.4	2983 x 90.4 x 95.4

PANOVIEW PMG+

The best products can only be made with the best materials and the highest grade of screen fabrics. Panoview uses the most professionally made screen fabrics to reflect the truest, most vivid and dynamic images.

PMG+ projection screens are popular because they are inexpensive and easy to operate. Panoview Manual Screens offer several outstanding features.

Controlled Screen Return

Panoview PMG+ Manual Screens feature Speed Reduction-Retraction. Simply pull down lightly to release the locking mechanism, let go and the screen will slowly return to the casing.

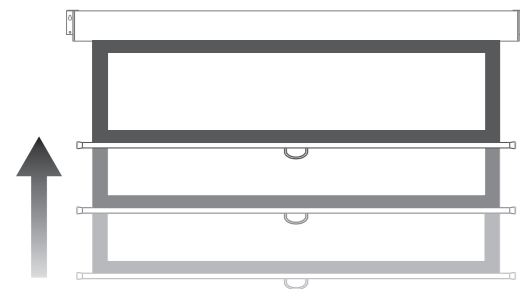

Viewing angle for Matte White fabric is 160 degrees at 1.0 gain

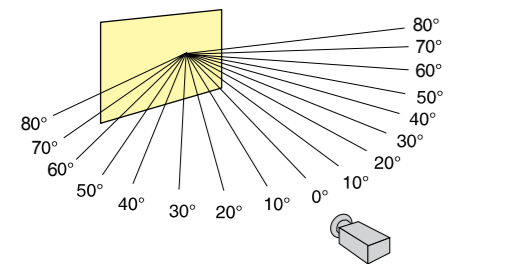

Selflock

Pull down the screen and hold for 3 seconds, then release. The screen will stay at the desired position.

Panoview's matte white fabric is composed of 4 different layers, including a sheet of weaved fibre-glass which helps stop static electricity and most importantly prevent wrinkles and waves. The screen fabric consists of a special material that helps prevent the loss of light, making it compatible with virtually every projector.

The fabrics are designed to be fire, water, and mold resistant and can be cleaned if required. The outside surface of the matte white screen has microdots that are made with PVC technology. This surface helps with creating the best possible reflection, whilst new advances in screen technology help keep our matte white screen flat and retain its shape and effectiveness over longer periods of time.

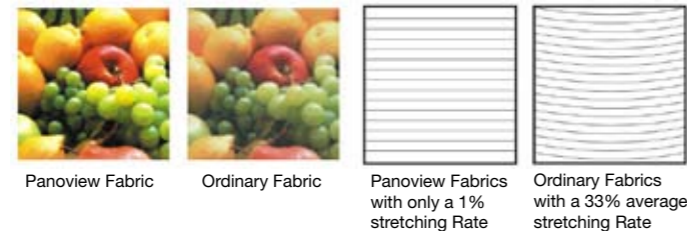
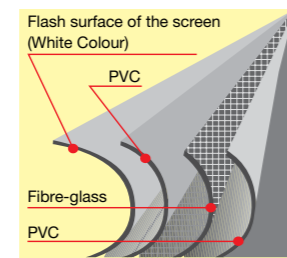

PANOVIEW EGA

Panoview EGA is one of the only screens on the market that has built in IR remote control, tubular motor and multi functional mounting. The screens aluminium casing has an override switch located at the end of the case and depending on installation both the built-in I/R and external infrared remote systems can be used.

With a tubular motor at the heart of your motorized EGA screen and built in I/R your ready to hang and use your screen in minutes.

Tubular Motor

The EGA's tubular motor will insure a smooth and stable operation and ensure years of reliable and trouble-free use.

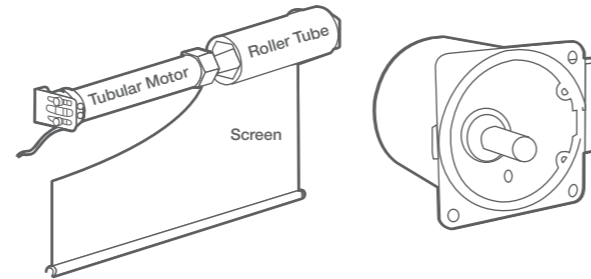

Tubular Motor

Sync Motor

Wired Manual Control Unit

Providing the same manual functionality as the central control but without the RS232 option, this unit plugs directly into the screen's integrated control interface.



Panoview Integrated Control System

Panoview's integrated control system includes an in-line switch, built-in remote control system, 12v trigger, RS232 and external infrared receiver. This all-in-one integrated system ensures a screen that is suited for the most demanding of applications.

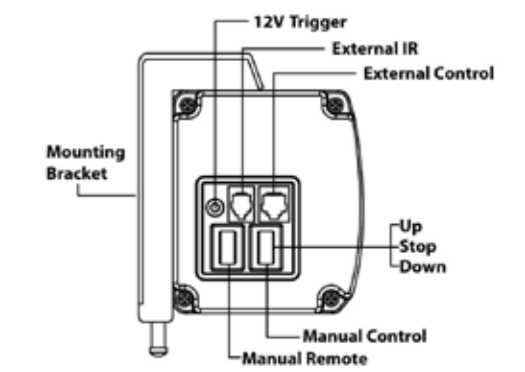
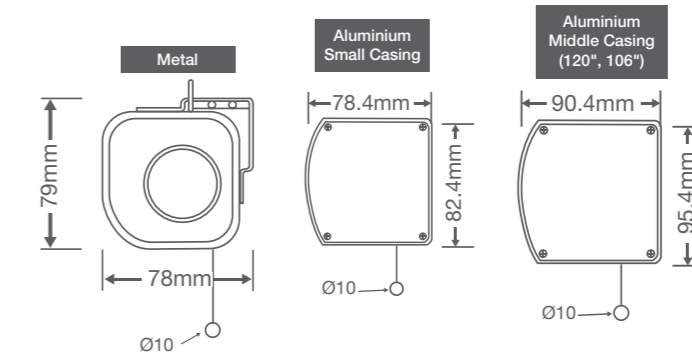

Multi-Functional Mounting Brackets



The floating L-bracket design allows for horizontal adjustments and therefore the brackets can be fixed at any preferred point on the screen casing.