



National Science Foundation

# DESKTOP STUDY

---

**Exploring the Feasibility of a  
Science Monitoring And Reliable Telecommunications (SMART)  
Fiber Optic Cable System Connecting**



**August 2022**

DESKTOP STUDY PREPARED BY:



GLOBAL BROADBAND SOLUTIONS, LLC  
A HUBZone Certified Company

**PUBLIC RELEASE VERSION**



**PUBLIC RELEASE VERSION: OCTOBER 2023**

This document is a redacted version of the full 2022 Desktop Study;  
it excludes information not suitable for public release.



## *Note To Reader*

**T**he Antarctica to Australia – New Zealand Desktop Study was developed as a comprehensive technical report to determine the feasibility of building a sensor-equipped submarine fiber optic cable system in the Southern Ocean.

This first-of-its-kind project, led by the National Science Foundation, seeks to expand communications and research-sharing capabilities from McMurdo Station, an important United States research base in Antarctica, to Australia and New Zealand.

The Antarctic Science Monitoring And Reliable Telecommunications (SMART) cable system presents a unique opportunity to collect subsea data in near-real time, while increasing communications and access between this distant continent and the rest of the world.

The original Comprehensive Desktop Study was submitted to the National Science Foundation in August 2022.

*We thank all who contributed to the development of this publicly available version of the desktop study.*



DISCLAIMER: Any opinions, findings, and conclusions or recommendations expressed in this document are those of the author(s) and do not necessarily reflect the views of the National Science Foundation. The contents, including graphics, provide examples and samples of the proposed cable project and are for illustrative purposes. Portions of the Desktop Study (e.g., main narrative, appendices, etc.) have been redacted due to the commercial business proprietary nature of the information, information that is of a deliberative nature, and information subject to potential restriction in compliance with OMB Circular A-11. Areas of redaction are so noted by a footnote or other appropriate indicators.

Graphics, navigation charts, and bathymetry information are included for illustrative purposes to display potential proposed cable routes and are used with permissions through fair use, publicly available information, or purchased datasets (e.g., Esri, AutoCAD, Global Mapper, etc.). Images of McMurdo Station were provided by the National Science Foundation. Graphics using Google Products follow the Use Policy with GBS Registration and attributions. Some graphics were created using ArcGIS® software by Esri, ArcGIS® and ArcMap™ and are the intellectual property of Esri and are used herein under license. Copyright © Esri. All rights reserved. For more information about Esri® software, please visit [www.esri.com](http://www.esri.com).



# INNOVATION

Harnessing the Potential of

Science and Technology

For a Powerful Future.



*Some portions of this document may have been modified to ensure the information was suitable for public release.*



● SUMMARY OF

# CONTENTS



1

## Introduction & Executive Summary

NSF Introduction; 2021 Antarctic Workshop Summary

---

Science Monitoring And Reliable Telecommunications Cables

---

Executive Summary

---

2

## Comprehensive Desktop Study

Table of Contents, List of Tables, List of Figures

---

Final Desktop Study Report

---

Redacted Appendices

---

3

## More Information

Index

---

Desktop Study Preparation Team

---

National Science Foundation Contact Information

---





● PROMOTING

# INNOVATION



*The intersection of science and technology  
is a place of exciting innovation.*

**Antarctica** is a unique frontier with many environmental, biological, and geological discoveries yet to be made; it is also a technological frontier as it is the only remaining continent without submarine fiber optic communications, relying on low-bandwidth satellite for information transmission. The addition of a new SMART cable system could open a world of discovery, scientific excitement, and international engagement.

**The National Science Foundation** seeks to explore the construction of the SMART cable system through strategic partnerships among government, science, and emerging technology sectors to promote scientific discoveries via the U.S. Antarctic Program.



● ANTARCTICA TO AUSTRALIA - NEW ZEALAND

# SMART CABLE SYSTEM



The National Science Foundation

**McMurdo Station is the largest U.S. Antarctic Program research station.** It is managed by the NSF's Office of Polar Programs and serves as the logistical entry and staging point for the bulk of U.S. activity in Antarctica.

McMurdo Station provides the essential logistical hub for U.S. science research in Antarctica. Essentially a self-contained small town with a population that can reach 1,000, it represents the largest single human outpost in Antarctica, yet shares a single Internet network service that ranks its speed 68<sup>th</sup> out of 184 countries for median household speed.

As a result, the NSF's Office of Polar Programs and the NSF Office of Advanced Cyberinfrastructure are exploring the feasibility of a Science Monitoring and Reliable Telecommunications (SMART) Submarine Fiber Optic Cable system connecting McMurdo Station with the global Research and Education Network Infrastructure via Australia or New Zealand.

This Desktop Study examines a preliminary cable route, potential landings, optimal technical design, and the installation and maintenance options for this innovative cable connection.

*~Patrick Smith, 2023*





# ● SETTING THE FOUNDATION FOR THE DESKTOP STUDY



“The IceCube Neutrino Observatory, South Pole Telescope, and BICEP/Keck, for example, **currently produces >1 TB of data per day, but only transmits on the order of 100GB per day via satellite.** This results in reduced data quality, limits timely measurement feedback, inhibits the ability to respond to transient events, and causes other operational headaches. In the coming decades, plans for these South Pole scientific platforms will result in **ten times greater data volumes** than today. Increased bandwidth is essential for the continued progress of U.S. and international research in Antarctica.”

*2021 Antarctic Subsea Cable Workshop Report  
(Neff et al., 2021 pg.9)*



**2021 Antarctic Subsea Cable Workshop Report:  
High-Speed Connectivity Needs to Advance US  
Antarctic Science**



October 1, 2021

## The 2021 Antarctic Workshop

In June 2021, more than 100 participants from science, technology, government, and industry gathered to address questions around the value and feasibility of deploying a new submarine fiber optic cable system to McMurdo Station in a virtual “ANTARCTIC SUBSEA CABLE WORKSHOP.” The results were published in an October 2021 report (Neff et al., 2021).





## WORKSHOP FINDINGS

# 2021 Antarctic Subsea Cable Workshop Report: High-Speed Connectivity Needs to Advance U.S. Antarctic Science

The projected Scientific Monitoring and Reliable Telecommunications (SMART) cable system would provide meaningful solutions to four fundamental challenges expressed in the 2021 Antarctic Subsea Cable Workshop Report which the NSF would like to address:

**FINDING 1:** Existing and future Antarctic research would be significantly enhanced if bandwidth limitations were eliminated through the availability of a modern submarine fiber optic cable system.

**FINDING 2:** A new SMART submarine cable could be constructed with embedded instrumentation that would itself enable meaningful new research and understanding of the Southern Ocean and Antarctica.

**FINDING 3:** Robust bandwidth for interpersonal connectivity for scientists and staff, if thoughtfully approached, could be transformative for research and work functions, participation in Antarctic science, education, engagement, and community wellbeing.

**FINDING 4:** Construction of a new SMART cable that provides essentially unlimited bandwidth to McMurdo is feasible and could also serve as the platform to extend connectivity to deep-field research sites as well as critical research programs at Amundsen-Scott South Pole Station. This level of connectivity can transform the science and research platforms for future generations. (Neff et al., 2021)



(Klein, 2020)



- Science Monitoring And Reliable Telecommunications (SMART) Cables

# EMERGING TECHNOLOGY

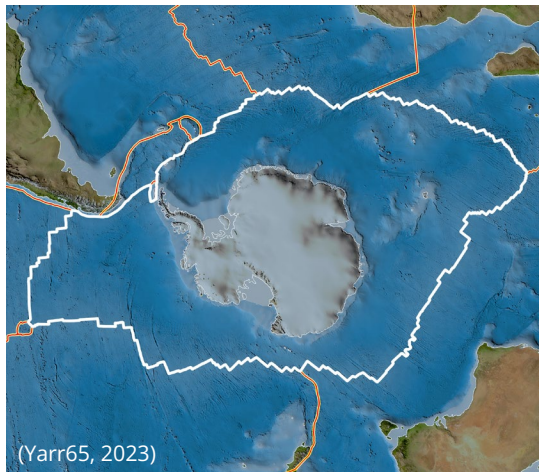
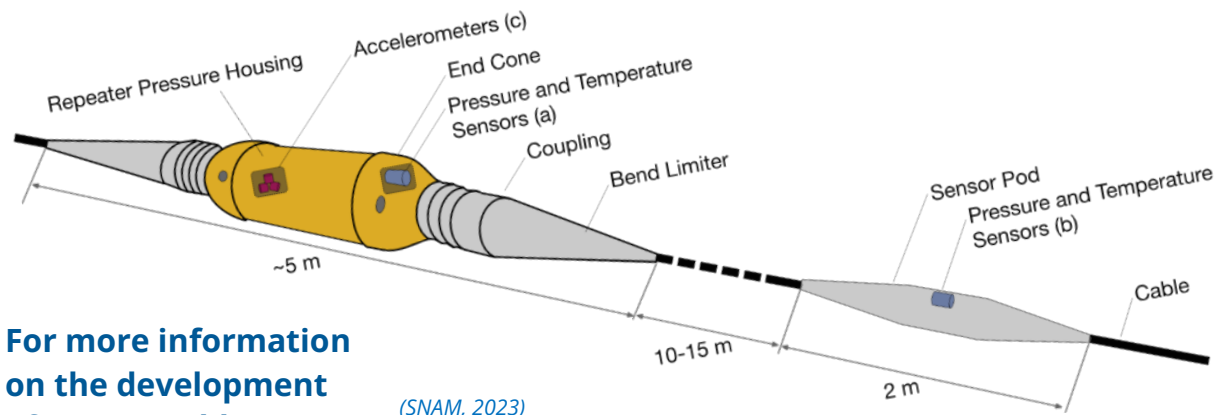

Figure 0-1. Tectonic plates across the Antarctic region.

An Antarctic SMART cable presents a unique opportunity to capture largely undiscovered information in the Southern Ocean.

A SMART cable is a submarine fiber optic cable that is equipped with specially designed sensors which collect information including seismic data, ocean temperature, and pressure. This technology could significantly enhance tsunami and earthquake early warning efforts, as well as provide valuable insight for marine research, climate change, and sea level rise. The NSF OPP, the Antarctic science community, and academic researchers are collaborating with commercial SFOC suppliers to shape and further exciting SMART cable developments.



**For more information on the development of SMART cable technology, see [Section 18.0, Scientific Sensors.](#)**

Figure 0-2. Illustration of a repeater housing showing two possible sensor mounting locations ((a) on the end of repeater housing under the bell housing or (b) in an external pod. Accelerometers are mounted inside the pressure housing (c)).



(OanaG, 2023)

**The Antarctic SMART Cable will transform research and information sharing, giving the world a glimpse into life beneath the ice.**

Figure 0-3. A view of an iceberg in Antarctica.

## **Distributed Acoustic Sensing System**

A second sensing technology being considered for the Antarctic cable involves including extra fiber optic strands (within the cable) which are dedicated to sensing vibrations occurring along the cable.

Distributed Acoustic Sensing (DAS) technology is made possible by shore-based lasers called DAS Interrogators sending thousands of light pulses down a strand of “dark fiber” (an optical fiber strand not used for communications). The dark fiber strand is dedicated to measuring the light pulses which are reflected back, or “backscattered,” down the length of

the cable, to the DAS Interrogator. The DAS Interrogator “interprets” the vibrations by decoding the interruptions in the pulse rhythms; complex algorithms analyze the disturbances in the pulses to determine what is causing the vibration.

DAS is utilized as a vibration sensor array, providing opportunity for geophysical sensing and undersea monitoring along the length of a fiber optic or power cable.

DAS technology is currently used in both terrestrial and submarine cable systems.



### **Research in Real-Time**

Multiple sensing technologies give the seabed a “voice,” offering access to near real-time undersea data.



### **High Speed Connection**

An Antarctic cable could relay data at 1-10 Terabits per second (Tbps), enabling high speed communications.

DESKTOP STUDY: FINAL REPORT

# EXECUTIVE SUMMARY



Figure ES-0-1. A visualization of clouds forming over Antarctica.

## Leveraging Technology to Build Connectivity, Collaboration and Community



**Global Broadband Solutions, LLC (GBS) is pleased to support the National Science Foundation (NSF)** in the execution of this comprehensive Australia and New Zealand to Antarctica Submarine Fiber Optic Cable (SFOC) Desktop Study (DTS).

This DTS provides NSF with a detailed report containing the necessary information for designing an SFOC in the Antarctic region closest to the McMurdo Station, and several other NSF identified landing points in New Zealand, Australia, Macquarie Island,

as well as other potential sites for high-speed, low-latency telecommunications and scientific data transport purposes.

The cable system can provide essential telecommunications services to McMurdo Station and has the capability to incorporate **"Science Monitoring Cables,"** also known as Science Monitoring And Reliable Telecommunications (SMART) cables, to support the current and ongoing scientific projects, programs, and missions in the region.



**This Desktop Study is a comprehensive National Science Foundation reference for Submarine Fiber Optic Cable development, stakeholder communications, planning, infrastructure decision making, resource allocation, business case analysis, requirements development, and acquisition strategy.**

The objective of the DTS is to provide NSF, for the first time, with a detailed report containing the necessary information for understanding the feasibility, route, cable protection, Rough Order of Magnitude (ROM) cost, and estimated schedule for landing a SMART cable at up to five potential NSF-specified landing sites:

- McMurdo Station main cable landing, located at 77° 51' 1.6452"S and 166° 40' 5.4408"E
- Invercargill main cable landing, located at 46°26'17.78"S and 168°13'57.20"E
- A pre-existing alternative main cable landing near Sydney
- Macquarie Island optional branch landing, located at 54° 29' 59.1792"S and 158° 56' 13.509"E
- Terra Nova Bay, Antarctica, optional branch/festoon landings



*(Lucibella, 2017)*

Figure ES-0-2. The icebreaking vessel, the Polar Star, approaches McMurdo Base.



The primary SFOC routes identified and provided by NSF for development and analysis were selected to connect an Antarctic landing point with onward connectivity to commercial, research, or academic telecommunications service providers in New Zealand or Australia for interconnection to the World Wide Web (WWW). Each proposed route was developed to include an optional branch landing at Macquarie Island and an optional branch pointed toward other Antarctic research locations in the Terra Nova Bay area, having the potential to connect to international Antarctic stations located there.

The DTS also identified two technically feasible route alternatives, each with optional routes to Macquarie and the Terra Nova Bay area.

1. Routing for a suitable landing location on the South Island of New Zealand, and
2. Routing for a suitable landing location on the southeastern coast of Australia.

This DTS report provides the critical components required to support a Marine Route Survey (MRS) and detailed system design. Elements of the DTS include necessary detailed descriptions, ROM cost estimates to support business case analysis of this system and other telecommunications-based alternatives, permitting requirements, as well as the proposed landing sites. While the DTS is focused on the SFOC system between NSF specified-landing sites, additional terrestrial analysis was incorporated to identify Cable Landing Station (CLS) locations at each site.

This Desktop Study is the first step in the process to develop a Submarine Fiber Optic Cable system and provides the baseline route, initial permitting assessment, Rough Order of Magnitude cost estimates for future steps including surveys, other required studies, permitting feasibility, design, implementation, operations, administration, maintenance, and repair of the system.



*(Rejcek, 2015)*

Figure ES-0-3. The United States Coast Guard vessel, the Polar Star, nears McMurdo Base.



### SFOC Development Process

There are six major phases for the development and implementation of an SFOC, with each phase containing major tasks and supporting sub-tasks (Figure ES-0-4). The DTS is part of the initial Planning phase (Figure ES-0-4, Column 1), determines feasibility, and is the basis for the next steps in final requirements, permitting, acquisition, design, and implementation.

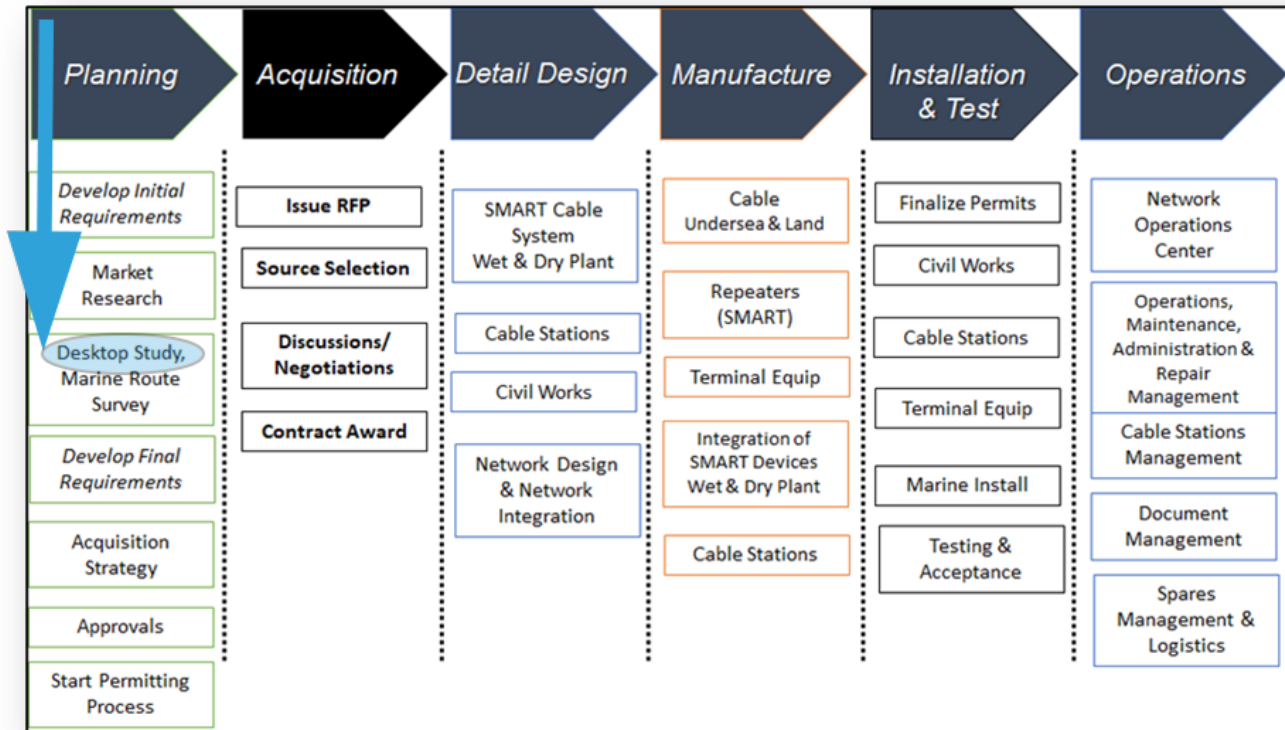

(Koopalethes, 2022)

Figure ES-0-4. Submarine Fiber Optic Cable Development Process.

The DTS provides the early-planning information needed to launch the next phases, to include business case analysis of alternatives, permitting feasibility, and the route that is the basis for the MRS. The MRS can be conducted in the Planning phase or the Detail Design phase. Conducting the MRS in the Planning phase, using supplier approved representatives, can save schedule, potentially reduce costs, and provide the system buyer with a fully designed route as part of the acquisition process. The route(s), as outlined in the DTS report, are the foundation of the MRS development.



## Data Collection

The GBS Team conducted comprehensive research and development of the DTS through the collection, evaluation, and integration of the most up-to-date data and information from Government, academic, and commercial source databases, Admiralty charts, open-source and academic research, bathymetric data, Earth science research papers, natural and man-made hazards data, geographic and meteorological studies, desktop and on-site visits, and analysis by SFOC Subject Matter Experts (SMEs). GBS had a specific focus on “Antarctic-unique” requirements, to include science sensor accommodation, ice scour risk, sea state/sea ice cover conditions, Antarctic Treaty environmental compliance requirements as implemented by the United States Government, ice breaking vessel requirements, and polar region operational requirements for marine survey vessels and cable ships.

Travel to landing sites by the DTS Team for data/information collection was strictly limited and the Team worked remotely with on-site and local personnel to complete the GBS comprehensive site survey form. Travel limitations during the project included:

- No travel to Antarctica; information gathered by working closely with NSF personnel (Project Managers, Infrastructure support personnel, and others, as recommended and available) who made arrangements for technical data transfer of site related information.
- Travel to Australia and New Zealand was extremely limited due to COVID-19 concerns and quarantine restrictions which necessitated arrangements for technical collaboration and consultation with local site SMEs.

## Branching Unit Locations

GBS identified Branching Unit (BU) Locations for additional cable branch extensions to the Australian Antarctic program research station on Macquarie Island, as well as a potential extension to international Antarctic research stations located in the general vicinity of Terra Nova Bay, Antarctica. Other areas of scientific research were identified along the cable routes in coordination with the NSF Project Manager (PM) and the NSF’s scientific stakeholder community.



*(Becker, 2016)*

Figure ES-0-5. A view of Macquarie Island.





**The Desktop Study identified two routes that support the National Science Foundation requirement.**

- 1. The first route is from Invercargill, New Zealand, to McMurdo, with a BU landing at Macquarie Island.**
- 2. The second route is from an existing Horizontal Directional Drill (HDD) bore landing in Clovelly Beach, Australia, to McMurdo, with a BU landing at Macquarie Island.**

Both routes provide additional BUs to serve the areas mentioned above, as well as areas that were identified through dialogue with NSF's scientific stakeholder community during report development for inclusion of prospective seismic sensing capabilities.

As will be exhibited throughout the DTS Report, both routes are considered technically feasible and inclusive of SMART cable technology. The SFOC is designed to minimize system subsea hazards and risks along the entire route(s).

### **Analysis of Alternatives**

The DTS process included research, development, and evaluation of two routes to address the requirements of minimizing risks to the cable, while allowing for the SMART capabilities as outlined in the Performance Work Statement (PWS). The results of the information collection process were used in the assessment of NSF provided SFOC landing points, probable landing approaches, near-shore cable protection requirements, landing site conditions, necessary civil works (e.g., trenching, BMH, cable landing stations, power requirements, etc.), and identification of initial regulatory requirements, including identification of required permits and environmental approvals.

The following Analysis of Alternatives (AoA) summarizes the two routes based on critical factors, including technical capability, budget, permitting, landings, and ability to support the scientific community.



## Australia and New Zealand – Antarctica DTS Route Options Analysis of Alternatives (AoA) Comparison<sup>1</sup>

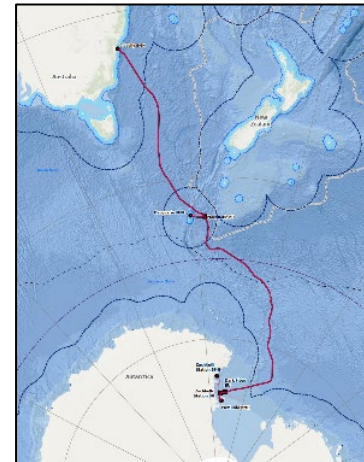
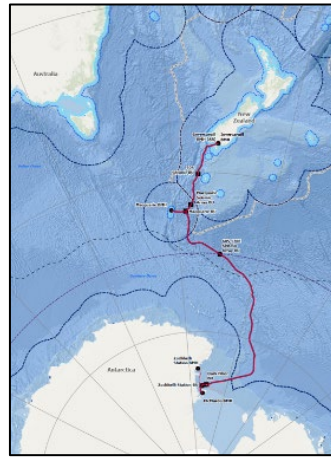

	New Zealand (NZ) – Antarctica	Australia (AU) - Antarctica
<b>System Length (km)</b>	4,913.858	6,423.966
<b>Estimated number of Repeaters</b>	50-55	65-70
<b>Capable of supporting SMART or scientific sensing nodes</b>	Yes	Yes
<b>Percentage of Route in Areas of Scientific Interest</b>	~90%	~65%
<b>Data Center Connectivity</b>	Planned (DataGrid); NZ	Existing (Equinix); AU
<b>Terrestrial Backhaul to datacenter</b>	Build Required; Potential to be built by Data Center provider (NZ)	Existing Conduits Full; Build Required (AU)
<b>Onward connectivity to other major global locations</b>	Yes	Yes
<b>Cable Crossings</b>	0	8+
<b>Branches to support nearshore monitoring in the Ross Sea area</b>	Yes	Yes
<b>Branches to support initial science community areas of interest</b>	5	3

<sup>1</sup> Cost information has been redacted for commercial proprietary reasons.



**Based on the Analysis of Alternatives, the recommended route for the system would be from New Zealand to McMurdo Station.**

While both route options are technically feasible and can incorporate SMART cable technology and connect to the WWW for global transport of NSF data and information, the New Zealand to McMurdo Station route is recommended for the following reasons:

- This is a shorter system route thereby providing the lowest cost alternative.
- This route presents the ability to serve additional subsea areas identified to date by the NSF's scientific stakeholder community.
- This route poses the lowest relative trawler-type vessel fishing risk.
- There are no current cable crossings to be engineered and managed.

Additional discussion with the NSF's scientific stakeholder community will follow based on the recommended DTS route.

Figure ES-0-6 identifies the placement of seismic arrays along the route which would enhance scientific research; there are three potential arrays possible along the New Zealand to Antarctica route, whereas the Australia route would only accommodate one array.

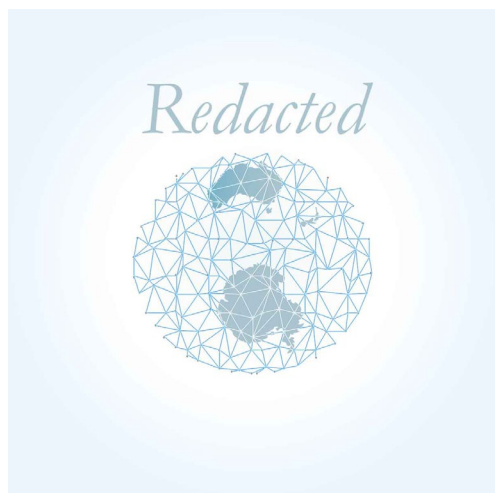

Figure ES-0-6. [Redacted]. Feedback from Scientific Community; potential seismic arrays on the main cable route in New Zealand.



## Route Design

The proposed Antarctica to Australia/New Zealand (AU/NZ) DTS SFOC route was developed based on the landing site locations specified by NSF, with numerous SMEs reviewing all aspects of the end-to-end cable route. Additionally, local SMEs in Australia, New Zealand, NSF, and McMurdo Station were consulted and provided support related to conducting detailed site survey reports, identification of local infrastructure, environmental requirements, McMurdo Base requirements, and other essential SFOC development factors.

SMEs evaluated numerous design criteria considerations during the cable route development process with the objective of reducing the overall risk to the cable system while maintaining the shortest and best scientific sensor deployment route possible. The main system trunk between New Zealand or Australia and McMurdo Station also identified Branching Unit (BU) locations. These BU locations are required for connection to Macquarie Island, other optional landing points, and potential locations for scientific sensor deployments. The full route summary can be found in Section 2.0 of the DTS.

SMEs conducted detailed analyses of potential routes to locate the subsea cable on the lowest grade and risk seabed. Areas considered government-owned, environmentally sensitive and/or controlled seabed assets, as well as seabed areas, were avoided. Avoidance of the environmentally sensitive areas was purposeful to incorporate environmental permitting restrictions, however, such restrictions did constrain the subsea route.

At locations where the DTS route crossed existing submarine cables, the crossing locations were chosen to provide the optimal crossing angles and avoid proximity to repeaters to avoid potential cable maintenance operations. The cable route was developed by GBS SMEs incorporating all DTS information and determined to be technically feasible and meet all the criteria of the DTS requirements.

## Permitting and Authorizations

The process of preparation, submission of required documents with supporting information, and responses to interrogatories to secure the necessary authorizations and permits for the installation and operation of the SFOC, is detailed and time-consuming. The DTS permitting section (Section 3.0) is the result of a detailed review of the environmental and other requirements at each of the landing locations. Section 3.0 provides an initial assessment of the permits required to install and operate a system in these areas.

The office of the Senior Advisor, Environment, Polar Programs, NSF, has the requisite expertise and understanding of the process for addressing environmental, authorization, and permitting requirements in Antarctica in accordance with The Antarctic Treaty. It is this office that should be the lead for securing required permits and authorizations in the Antarctic for developing and operating the SFOC with the support of SFOC SMEs.

A set of permitting matrices was developed and supplied to NSF as part of the DTS to allow for a



future Permitting Feasibility Study (PFS) at the selected locations to complete the permitting application and approval process. The permitting process may be initiated as early as practicable; however, the process cannot be completed without the full results of the MRS to incorporate into the permitting applications. Such detailed seabed environment details and route information must be completed for inclusion in the Environmental Assessments (EAs) required for each jurisdiction in which permits are required. Every landing has these requirements to receive permits and permissions to install, operate, and maintain an SFOC system. The permitting process, subject to regulatory jurisdiction for each location, can take 18-24 months, or more.

Authorizations for all actions within the Antarctic, defined as the area south of 60-degree South Latitude, including all ice shelves, are covered by the Antarctic Treaty System (ATS). The Antarctic Treaty (Treaty) regulates international cooperation in Antarctica. The Treaty was signed by 12 countries with active research in and around Antarctica, on 1 December 1959, and was entered into force on 23 June 1961.

Permitting requirements for McMurdo, which are governed by the Treaty, as well as requirements for landings in New Zealand, Australia, and Macquarie, are all addressed in Section 3.0 of the DTS Report, and all locations have been assessed and determined to be achievable for permitting an SFOC to all identified landing points. Senior Environmental and authorization advisors for the NSF Polar Programs Office who have critical local knowledge and understanding of the processes should be utilized in this process.

### **Scientific Sensing**

Beyond the determination of SFOC feasibility, the development and implementation of Scientific Sensing is not part of this DTS requirement; however, DTS Section 18.0 provides an overview of some of the developing SMART and Distributed Acoustic Sensing (DAS) systems and capabilities.

The technical capability of Scientific Sensing in an SFOC from Antarctica to Australia or New Zealand can be accomplished through multiple methods, some of which are available today, and others that are in development. Using a Branching Unit with a scientific array has been utilized in many applications and is technically feasible and currently available as an option for the scientific BU's identified in the route(s). SMART cable and repeater technology is currently in development, and DAS technology, which uses the fiber optic cable as a sensor along the fiber path, has been used in existing submarine and terrestrial fiber optic cable systems. Each of these technologies can be integrated into the DTS systems.



## Executive Summary Closing

To summarize, the DTS Report covers the research and development of two trunk routes:

- The first from Invercargill, New Zealand, to McMurdo, with optional BU landings at Macquarie Island and the Terra Nova Bay area.
- The second route from an existing HDD bore in Clovelly Beach, Australia, to McMurdo, with optional BU landings at Macquarie Island and the Terra Nova Bay area.

Each of these routes is technically feasible, minimizes risks as much as practicable along the route, and provides the ability to add SMART sensor capabilities on the system. When the two routes were compared through an AoA, the route from New Zealand to McMurdo was recommended due to a lower cost for coverage (both routes cover a comparable geographic area), a shorter length (thereby reducing external threats from anchors and fishing), and landing point proximity to a proposed major data center.

**The Desktop Study is the first step and foundation of the development of a Submarine Fiber Optic Cable system. It is the underpinning for determining the technical feasibility, initial permitting assessment, ROM cost estimates, and initial route development data.**

**This information is used to support the next steps in the system design, which include a Marine Route Survey, permitting, and, ultimately, the final design, implementation, operation, maintenance, administration, and repair of the National Science Foundation cable system.**





## Executive Summary References

- Becker, B. (2016, October 14). *Government invests in new station on Macquarie Island*. Australian Government, Australian Antarctic Program. Retrieved March 2022 from <https://www.antarctica.gov.au/news/2016/government-invests-in-new-station-on-macquarie-island//>
- Kekesi, A. (2011, September 11). *Clouds Over Antarctica* [Photograph]. NASA/Goddard Space Flight Center Scientific Visualization Studio. Retrieved July 2023 from [https://svs.gsfc.nasa.gov/3856#section\\_credits](https://svs.gsfc.nasa.gov/3856#section_credits)
- Klein, N. (2020). *McMurdo Base Station* [Photograph]. United States Antarctic Program. Retrieved July 2023 from [Photolib.usap.gov](https://photolib.usap.gov)
- Koopalethes, N. (2022). *GBS LLC Antarctic SFOC project overview presentation* [PowerPoint slide]. Retrieved July 2023 from [corporate@gbs1.com](mailto:corporate@gbs1.com)
- Lucibella, M. (2017, January 17). *Polar Star approaches McMurdo Base* [Photograph]. United States Antarctic Program. Retrieved July 2023 from [Photolib.usap.gov](https://photolib.usap.gov)
- Neff, P.D., Andreasen, J.R., Roop, H.A., Pundsack, J., Howe, B., Jacobs, G., Lassner, D., Yoshimi, G., and Timm, K. (2021). *2021 Antarctic Subsea Cable Workshop Report: High-Speed Connectivity Needs to Advance U.S. Antarctic Science*. October 1, 2021. University of Minnesota, Saint Paul, MN, USA. Retrieved March 22 from <https://drive.google.com/file/d/1Ao4Hz6-bBheFMpGSR4nMvSZJ9kHpjj0o/view>
- OanaG. (2023). *Ocean Floor Iceberg, Antarctica* [Photograph]. Adobe Stock #334861062. Retrieved July 2023 from <https://stock.adobe.com/images/ocean-floor-iceberg-antarctica/334861062>
- Rejcek, P. (2015, January 26). *USCG Polar Star near McMurdo Base* [Photograph]. United States Antarctic Program. Retrieved July 2023 from [Photolib.usap.gov](https://photolib.usap.gov)
- Sistema Nacional de Alarma de Maremotos (SNAM). 2023. *Submarine fiber optic cables and the opportunity for strengthening current early tsunami warning and monitoring in the South Pacific*, Rear Admiral Arturo Oxley, Director, 19-20 January 2023, Honolulu, Hawaii 9th Workshop on “Joint Task Force on SMART Cables” [PowerPoint]. Retrieved August 14, 2023 from <https://www.itu.int/en/ITU-T/Workshops-and-Seminars/2023/0119/Pages/default.aspx>



Smith, P.D. (2023). *Enabling science with a subsea fiber optic cable for McMurdo Station, Antarctica* [PowerPoint slides]. National Science Foundation, Office of Polar Programs presentation to the Council of Managers of National Antarctic Programs 20th COMNAP Symposium “Innovations & Collaborations” 26 June 2023, Annual General Meeting (AGM) 35 (2023), Hobart, Tasmania. Retrieved August 14, 2023 from <https://youtu.be/U4Bz1JN0vv0>

Yarr65. (2023). *Outlined Antarctica plate. Satellite imagery* [Photograph]. Adobe Stock #347797643. Retrieved July 2023 from <https://stock.adobe.com/images/outlined-antarctica-plate-satellite-imagery-a/347797643>





● AU/NZ – ANTARCTICA DESKTOP STUDY

# THE FINAL REPORT



*(Powell, 2022)*

Figure ES-0-7. Aerial view of McMurdo Station.





## Table of Contents

- SETTING THE FOUNDATION ..... 8**
- The 2021 Antarctic Workshop ..... 8**
- WORKSHOP FINDINGS ..... 9**
- Science Monitoring And Reliable Telecommunications (SMART) Cables ..... 10**
- EXECUTIVE SUMMARY ..... 12**
- Executive Summary References ..... 23
- Table of Contents ..... i**
- List of Tables ..... vi**
- List of Figures ..... vii**
- List of Key Acronyms and Abbreviations ..... xiv**
- 1.0 DESKTOP STUDY (DTS) DEVELOPMENT METHODOLOGY ..... 1-1**
- 1.1. SFOC Risk Table ..... 1-2
- 2.0 ROUTE AND LANDING SITE APPROACH IDENTIFICATION ..... 2-1**
- 2.1. General Route Selection Discussion and Rationale ..... 2-1
- 2.2. Sydney Route Description ..... 2-4
- 2.3. Macquarie Route Description ..... 2-7
- 2.4. Invercargill, New Zealand, to McMurdo Station Route Description ..... 2-9
- 2.5. Invercargill – NZ Cable Protection Zone Recommendation ..... 2-20
- 2.6. Sydney Terrestrial Route ..... 2-22
- 2.7. References ..... 2-23
- 3.0 PERMITTING, RIGHT OF WAY AND REGULATORY REQUIREMENTS ..... 3-1**
- 3.1. Australia ..... 3-2
- 3.1.1. Maritime Boundaries ..... 3-5
- 3.1.2. Cable Carrier and/or Operator License ..... 3-7
- 3.1.3. Terrestrial and Marine EA ..... 3-7
- 3.1.4. Terrestrial Cable System Installation ..... 3-10
- 3.1.5. Marine and Seabed User Agreements ..... 3-11
- 3.1.6. Australia References ..... 3-12
- 3.2. New Zealand ..... 3-13
- 3.2.1. New Zealand Maritime Zones ..... 3-15
- 3.2.2. Permitting Summary ..... 3-17
- 3.2.3. Resource Management Act 1991 ..... 3-18
- 3.2.4. The Role of Councils ..... 3-19



- 3.2.5. Exclusive Economic Zone and Environmental Protection Authority (EPA) 3-31
- 3.2.6. Other New Zealand legislation ..... 3-35
- 3.3. Antarctica ..... 3-38
  - 3.3.1. The Antarctic Treaty (Treaty) and the Antarctic Treaty System (System) . 3-39
  - 3.3.2. Protocol on Environmental Protection to the Antarctic Treaty (Protocol) 3-40
  - 3.3.3. Environmental Impact Assessment (EIA)..... 3-43
  - 3.3.4. EIA Review - Antarctic Treaty Consultative Meeting (ATCM) and Committee for Environmental Protection (CEP) ..... 3-46
  - 3.3.5. Other Considerations..... 3-47
  - 3.3.6. Antarctica References ..... 3-55
- 4.0 IDENTIFICATION OF GEOLOGICAL RISKS ..... 4-1**
  - 4.1. Regional Geology and Tectonic Setting ..... 4-1
  - 4.2. Australia ..... 4-3
    - 4.2.1. Seabed and Coastal Geology ..... 4-3
    - 4.2.2. Seismic Hazards..... 4-6
    - 4.2.3. Tsunami Hazards ..... 4-7
    - 4.2.4. Volcanic Hazards ..... 4-8
    - 4.2.5. Hydrothermal Hazards ..... 4-8
    - 4.2.6. Slope Stability..... 4-8
  - 4.3. New Zealand ..... 4-9
    - 4.3.1. Seabed and Coastal Geology ..... 4-9
    - 4.3.2. Seismic Hazards..... 4-12
    - 4.3.3. Tsunami Hazards..... 4-13
    - 4.3.4. Volcanic Hazards ..... 4-13
    - 4.3.5. Hydrothermal Hazards ..... 4-13
    - 4.3.6. Turbidity Currents and Sediment Movement from Shelf to Basin ..... 4-13
  - 4.4. Antarctica..... 4-15
    - 4.4.1. Seabed and Coastal Geology ..... 4-15
    - 4.4.2. Seismic Hazards..... 4-16
    - 4.4.3. Tsunami Hazards..... 4-16
    - 4.4.4. Volcanic Hazards ..... 4-17
    - 4.4.5. Hydrothermal Hazards ..... 4-18
    - 4.4.6. Turbidity Currents and Sediment Movement from Shelf to Basin ..... 4-18
  - 4.5. References..... 4-19
- 5.0 CLIMATOLOGY REPORT ..... 5-1**
  - 5.1. Regional / Transit..... 5-1
  - 5.2. Australia ..... 5-3



- 5.2.1. Temperature and Precipitation ..... 5-3
- 5.2.2. Winds..... 5-5
- 5.2.3. Weather Patterns ..... 5-6
- 5.2.4. Hazardous Weather ..... 5-6
- 5.3. New Zealand ..... 5-7
  - 5.3.1. Temperature and Precipitation ..... 5-7
  - 5.3.2. Winds..... 5-8
  - 5.3.3. Weather Patterns ..... 5-8
  - 5.3.4. Hazardous Weather ..... 5-8
- 5.4. Antarctica..... 5-9
  - 5.4.1. Temperature and Precipitation ..... 5-9
  - 5.4.2. Winds..... 5-10
  - 5.4.3. Weather Patterns ..... 5-10
  - 5.4.4. Hazardous Weather ..... 5-10
- 5.5. References..... 5-11
- 6.0 OCEANOGRAPHY REPORT ..... 6-1**
  - 6.1. Regional ..... 6-1
    - 6.1.1. Currents ..... 6-1
    - 6.1.2. Waves ..... 6-4
  - 6.2. Australia ..... 6-8
    - 6.2.1. Water Levels ..... 6-8
    - 6.2.2. Currents ..... 6-8
    - 6.2.3. Water Temperatures..... 6-9
    - 6.2.4. Waves ..... 6-9
  - 6.3. New Zealand ..... 6-14
    - 6.3.1. Water Levels ..... 6-14
    - 6.3.2. Currents ..... 6-14
    - 6.3.3. Water Temperatures..... 6-14
    - 6.3.4. Waves ..... 6-15
  - 6.4. Antarctica..... 6-19
    - 6.4.1. Water Levels ..... 6-19
    - 6.4.2. Currents ..... 6-19
    - 6.4.3. Water Temperatures..... 6-19
    - 6.4.4. Waves ..... 6-19
    - 6.4.5. Ice..... 6-20
    - 6.4.6. Ice Scour ..... 6-22
    - 6.4.7. Ice Shelf Collapse..... 6-24



6.5. References.....	6-27
<b>7.0 COMMERCIAL OPERATIONS, RESTRICTED AREAS, AND OBSTRUCTIONS REPORT.....</b>	<b>7-1</b>
7.1. Australia.....	7-1
7.1.1. Ports and Shipping Activity .....	7-1
7.1.2. Southern Sydney Protection Zone and Submarine Cables .....	7-2
7.1.3. Anchoring Areas .....	7-5
7.1.4. Defense Areas.....	7-7
7.1.5. Fisheries.....	7-7
7.1.6. Automatic Identification System (AIS).....	7-19
7.2. New Zealand .....	7-23
7.2.1. Ports and Shipping Activity .....	7-23
7.2.2. Cable Protection Zones and Submarine Cables.....	7-24
7.2.3. Fisheries and Pelagic fish .....	7-24
7.2.4. Automatic Identification System (AIS).....	7-28
7.3. Antarctica.....	7-33
7.3.1. Debris.....	7-33
7.3.2. Fisheries.....	7-34
7.3.3. Illegal, Unreported, and Unregulated (IUU) Fishing .....	7-36
7.3.4. Automatic Identification System .....	7-42
7.4. References.....	7-47
<b>8.0 BIOLOGICAL FACTORS REPORT.....</b>	<b>8-1</b>
8.1. Australia.....	8-1
8.1.1. Protected Areas .....	8-3
8.1.2. Terrestrial Protected Areas.....	8-5
8.1.3. Marine Protected Areas.....	8-5
8.1.4. Vegetation.....	8-7
8.1.5. Marine Aquatic Ecology .....	8-8
8.1.6. Local and Migratory Birds .....	8-10
8.1.7. Marine Mammals.....	8-11
8.1.8. Biosecurity.....	8-12
8.2. New Zealand .....	8-13
8.2.1. Marine Protected Areas and Restricted Activities.....	8-13
8.2.2. General Environmental Setting .....	8-19
8.2.3. Biological Communities .....	8-20
8.2.4. Vegetation.....	8-20
8.2.5. Dune Communities .....	8-21



- 8.2.6. Aquatic Ecology..... 8-22
- 8.2.7. Amphibians ..... 8-23
- 8.2.8. Avifauna ..... 8-23
- 8.2.9. Environmental Monitoring..... 8-24
- 8.2.10. Invasive Pest Species ..... 8-24
- 8.3. Antarctica..... 8-25
  - 8.3.1. General Setting ..... 8-25
  - 8.3.2. Benthic Habitats and Biological Communities ..... 8-25
  - 8.3.3. Pelagic Megafauna, Marine Mammals and Birds..... 8-29
  - 8.3.4. Plankton and Primary Production..... 8-30
  - 8.3.5. Marine Protected Areas..... 8-31
  - 8.3.6. Habitat Areas of Particular Concern ..... 8-37
  - 8.3.7. Conservation Significant Species..... 8-39
  - 8.3.8. Environmental Pollutants ..... 8-39
- 8.4. References..... 8-41
- 9.0 REGULATORY AND ENVIRONMENTAL FACTORS REPORT ..... 9-1**
- 10.0 LANDING SITE REPORTS ..... 10-1**
  - 10.1. Australia (Sydney) Site Visit Report..... 10-1
  - 10.2. New Zealand (Invercargill) Site Visit Report..... 10-9
  - 10.3. Macquarie Island Site Survey Report..... 10-16
  - 10.4. McMurdo Station Antarctica Site Survey Report ..... 10-22
  - 10.5. References..... 10-32
- 11.0 CONSIDERATIONS FOR BRANCHING UNIT SPUR (BU) / STUB ADDITIONS..... 11-1**
  - 11.1. References..... 11-6
- 12.0 [REDACTED] RECOMMENDATIONS FOR PROJECT MANAGEMENT..... 12-1**
- 13.0 [REDACTED] CONSIDERATIONS FOR SUSTAINMENT ..... 13-1**
- 14.0 MARINE OPERATIONS RELATIVE TO WET PLANT DEVELOPMENT ..... 14-1**
  - 14.1. References..... 14-14
- 15.0 [TEXT REDACTED] MARINE ROUTE SURVEY (MRS) ..... 15-1**
  - 15.1. References..... 15-5
- 16.0 [REDACTED] ROUGH ORDER OF MAGNITUDE (ROM) COST ESTIMATES ..... 16-1**
- 17.0 [REDACTED] SFOC POTENTIAL COMMERCIAL SYSTEM ..... 17-1**
- 18.0 SCIENTIFIC SENSORS..... 18-1**
  - 18.1. SMART Cables and Repeaters..... 18-1
  - 18.2. Dark Fiber Distributed Acoustic Sensing (DAS) ..... 18-8



18.3. References..... 18-9

**19.0 [REDACTED] APPENDICES ..... 19-1**

**20.0 INDEX ..... 20-1**

**21.0 Desktop Study Preparation Team ..... 21-1**

**CONTACT OFFICE OF POLAR PROGRAMS..... 21-2**

## List of Tables

Table 1-1. Submarine Fiber Optic Cable (SFOC) Risk Table. .... 1-3

Table 1-2. Risks Descriptions Table..... 1-4

Table 3-1. Other Relevant Legislation Considered ..... 3-9

Table 3-2. Environment Southland Contact Information..... 3-25

Table 3-3. Te Runanga o Ngai Tahu Contact Information..... 3-28

Table 5-1. Temperature Averages and Extremes, Sydney Airport (Station 066037)..... 5-3

Table 5-2. Precipitation Statistics, Sydney Airport (Station 066037) ..... 5-4

Table 5-3. Temperature Averages and Extremes, Macquarie Island (Station 300004) ..... 5-4

Table 5-4. Mean Monthly Precipitation [mm], Macquarie Island (Station 300004)..... 5-4

Table 5-5. Wind Statistics, Sydney Airport (Station 066037)..... 5-5

Table 5-6. Wind Statistics, Macquarie Island (Station 300004) ..... 5-5

Table 5-7. Temperature Averages and Extremes, Invercargill Aero..... 5-7

Table 5-8. Mean Monthly Precipitation [mm], Invercargill Area Stations..... 5-7

Table 5-9. Wind Statistics, Invercargill Area Stations..... 5-8

Table 5-10. Wind Gust Statistics, Invercargill Area Stations ..... 5-8

Table 5-11. Temperature Averages and Extremes, McMurdo Station ..... 5-9

Table 5-12. Precipitation Statistics, McMurdo Station..... 5-9

Table 5-13. Wind Statistics, McMurdo Station ..... 5-10

Table 6-1. Campbell Island Significant Wave Height Statistics..... 6-6

Table 6-2. Sydney Significant Wave Height Statistics ..... 6-11

Table 6-3. Significant Wave Height Statistics - 250 km SW of Invercargill Landing ..... 6-17

Table 7-1. [Redacted] Existing Cables in the Southern Sydney Protection Zone ..... 7-4

Table 7-2. Australian Communications and Media Authority (ACMA) Contact Information ..... 7-5

Table 7-3. Coordinates for the Peak Area in the Southern Sydney Protection Zone..... 7-6

Table 8-1. Environmental and Educational Values of New River Estuary..... 8-19

Table 9-1. Location of Regulatory and Environmental Factors Discussions ..... 9-1



## List of Figures

Figure 0-1. Tectonic plates across the Antarctic region..... 10

Figure 0-2. Illustration of a repeater housing showing two possible sensor mounting locations ((a) on the end of repeater housing under the bell housing or (b) in an external pod. Accelerometers are mounted inside the pressure housing (c). ..... 10

Figure 0-3. A view of an iceberg in Antarctica ..... 11

Figure ES-0-1. A visualization of clouds forming over Antarctica. .... 12

Figure ES-0-2. The icebreaking vessel, the Polar Star, approaches McMurdo Base. .... 13

Figure ES-0-3. The United States Coast Guard vessel, the Polar Star, nears McMurdo Base..... 14

Figure ES-0-4. Submarine Fiber Optic Cable Development Process. .... 15

Figure ES-0-5. A view of Macquarie Island. .... 16

Figure ES-0-6. [Redacted]. Feedback from Scientific Community; potential seismic arrays on the main cable route in New Zealand..... 19

Figure ES-0-7. Aerial view of McMurdo Station. .... xxv

Figure 2-1. New Zealand to McMurdo Station Route Chart.....2-2

Figure 2-2. Australia to McMurdo Station Route Chart. ....2-3

Figure 2-3. [Redacted]. Beach manhole.....2-4

Figure 2-4. Egress from horizontal directional drill exit point and cable crossings. ....2-5

Figure 2-5. Cable protection zone and existing cable crossings. ....2-5

Figure 2-6. Seamounts and geologic features along the proposed route between Australia and Macquarie. ....2-6

Figure 2-7. Macquarie Ridge crossing profile.....2-6

Figure 2-8. Macquarie Ridge crossing to branching unit.....2-7

Figure 2-9. Australia - McMurdo depth profile. ....2-7

Figure 2-10. Macquarie Island branching unit. ....2-8

Figure 2-11. Macquarie landing approach.....2-8

Figure 2-12. Macquarie depth profile.....2-9

Figure 2-13. New Zealand - McMurdo depth profile.....2-9

Figure 2-14. Oreti Beach North (Alternate) landing. .... 2-10

Figure 2-15. Oreti Beach, New Zealand: Primary (southern route) and Alternate (northern route) landings..... 2-10

Figure 2-16. Primary landing. .... 2-11

Figure 2-17. Oreti Beach visitor activity. .... 2-12

Figure 2-18. New Zealand Solander Trough descent..... 2-13

Figure 2-19. Puysegur Trench and Solander Trough contour map..... 2-13

Figure 2-20. Seafloor contours near Auckland Islands showing variability and high relief. .... 2-14

Figure 2-21. Proposed cable placement in Southwest Pacific Basin through Fractured Zones..... 2-15

Figure 2-22. Approach to Ross Sea and McMurdo Sound, Antarctica..... 2-16





Figure 2-23. Approach to Hut Point Peninsula, Antarctica..... 2-17

Figure 2-24. Approach to McMurdo Station, Antarctica. .... 2-18

Figure 2-25. McMurdo Landing Site Options "A" and "B". (Notional routes supplied by NSF.) ..... 2-19

Figure 2-26. McMurdo Landing Site icebergs..... 2-20

Figure 2-27. Cable Protection Zones example from Cook Strait Nautical Chart. .... 2-21

Figure 2-28. Cable Protection Zones example from Invercargill Landing and Cable Protection Zone Nautical Chart..... 2-21

Figure 2-29. [Redacted]. Existing terrestrial route and notional terrestrial route for proposed cable project. .... 2-22

Figure 3-1. [Redacted]. Sydney Permitting Requirements. ....3-3

Figure 3-2. [Redacted]. Sample Sydney Excel Permit Matrix .....3-4

Figure 3-3. [Redacted]. Macquarie Island Permitting Requirements. ....3-4

Figure 3-4. [Redacted]. Sample Macquarie Excel Permit Matrix. ....3-5

Figure 3-5. Australia’s Maritime Boundary Zone Definitions.....3-6

Figure 3-6. Australia’s Maritime Features, Limits and Zones.....3-6

Figure 3-7. [Redacted]. New Zealand Permitting Summary..... 3-14

Figure 3-8. [Redacted]. Sample New Zealand Excel Permit Matrix..... 3-15

Figure 3-9. New Zealand Maritime Zones..... 3-16

Figure 3-10. [Redacted]. Sample McMurdo Station Excel Permit Matrix. .... 3-39

Figure 3-11. Geographic boundaries of the Commission on the Conservation of Antarctic Marine Living Resources (CCAMLR) (Antarctic Convergence) and Treaty (south of 60th parallel). .... 3-50

Figure 3-12. Ross Sea Region Marine Protected Areas..... 3-52

Figure 4-1. Project Overview and Macquarie Triple Junction. ....4-3

Figure 4-2. Clovelly Approach and Landing Site Geology.....4-4

Figure 4-3. Macquarie Ridge Bathymetry. ....4-6

Figure 4-4. Seismic Activity in Project Area (Earthquakes since 2000). ....4-7

Figure 4-5. Bathymetry Along Proposed Cable Route – Solander Trough..... 4-10

Figure 4-6. Invercargill Approach and Terrestrial Route. .... 4-11

Figure 4-7. [Redacted]. Box Model of the Solander Trough..... 4-12

Figure 4-8. Proposed Cable Route Through the Southern Pacific Ocean and Antarctic Continental Margin. .... 4-14

Figure 4-9. Bathymetry on Approach to McMurdo Station..... 4-15

Figure 5-1. [Redacted]. Surface Winds in Project Area with Superimposed General Atmospheric Circulation Patterns.....5-2

Figure 5-2. [Redacted]. Number of Days per Month with Gale-force Winds.....5-6

Figure 6-1. Global Ocean Circulation – the Great Ocean Conveyor Belt.....6-1

Figure 6-2. [Redacted]. Major Ocean Currents Around New Zealand.....6-2

Figure 6-3. Currents at Seven Locations along Route, adapted from HYCOM Model.....6-3

Figure 6-4. Significant Wave Height Rose, Campbell Island Moored and Drifting Deployments 1-3, July 2017 - Dec 2020 (with gaps; 3.5 years of data in total). ....6-4



Figure 6-5. Campbell Island Significant Wave Height Histogram and Exceedance Curve.....6-5

Figure 6-6. Campbell Island Monthly and Daily Wave Statistics - Significant Wave Height (m).....6-6

Figure 6-7. Campbell Island Percent of Time Significant Wave Height < 2 meters.....6-7

Figure 6-8. Current Meter Data Offshore of Sydney.....6-9

Figure 6-9. Significant Wave Height Rose, Sydney buoy, 1992-2022 ..... 6-10

Figure 6-10. Sydney Significant Wave Height Histogram and Exceedance Curve..... 6-11

Figure 6-11. Sydney Monthly and Daily Significant Wave Height Statistics. .... 6-12

Figure 6-12. Sydney Percent of Time Significant Wave Height < 2 meters. .... 6-13

Figure 6-13. Significant Wave Height Rose, NZ Wave Data Hindcast, 1993-2019. .... 6-15

Figure 6-14. Significant Wave Height, 250 km SW of Invercargill Landing, Histogram and Exceedance Curve. .... 6-16

Figure 6-15. Monthly and Daily Significant Wave Height Statistics, 250 km SW of Invercargill Landing..... 6-17

Figure 6-16. Percent of Time Significant Wave Height < 2 meters, 250 km SW of Invercargill Landing..... 6-18

Figure 6-17. McMurdo Station icebergs, 2020. .... 6-22

Figure 6-18. [Redacted]. Seabed Ice Scour Illustration..... 6-23

Figure 6-19. Antarctic Vulnerability to Localized Ice Shelf Collapse..... 6-25

Figure 7-1. [Redacted]. Major Ports and Vessel Traffic Density off Sydney, Australia, in 2021, for All Vessel Types.....7-2

Figure 7-2. Southern Sydney Protection Zone.....7-3

Figure 7-3. The Peak Anchoring Area Located Inside the Southern Sydney Protection Zone. ....7-6

Figure 7-4. [Redacted]. Australia Defense Practice and Training Areas Offshore Sydney.....7-7

Figure 7-5. Map of the Eastern Tuna and Billfish Fishery, <https://www.afma.gov.au/fisheries/eastern-tuna-and-billfish-fishery#referenced-section-8>, image courtesy of the Australian Fisheries Management Authority © .....7-9

Figure 7-6. Map of the Eastern Skipjack Fishery, <https://www.afma.gov.au/species/skipjack-tuna#referenced-section-4>, image courtesy of the Australian Fisheries Management Authority © ..... 7-10

Figure 7-7. Small Pelagic Fishery – Map of sub-areas, <https://www.afma.gov.au/fisheries/small-pelagic-fishery#referenced-section-8>, image courtesy of the Australian Fisheries Management Authority ©..... 7-11

Figure 7-8. Map of the Southern and Eastern Scalefish and Shark Fishery,..... 7-13

Figure 7-9. Map of the area of the Southern Bluefin Tuna Fishery, <https://www.afma.gov.au/fisheries/southern-bluefin-tuna-fishery#referenced-section-8>, image courtesy of the Australian Fisheries Management Authority © ..... 7-14



Figure 7-10. Map of the Southern Bluefin Tuna (SBT) zone, <https://www.afma.gov.au/commercial-fishers/management-arrangements/southern-bluefin-tuna-sbt-zone>, image courtesy of the Australian Fisheries Management Authority ©..... 7-15

Figure 7-11. Map of the area of the Southern Jig Squid Fishery, <https://www.afma.gov.au/fisheries/southern-squid-jig-fishery#referenced-section-8>, image courtesy of the Australian Fisheries Management Authority © ..... 7-16

Figure 7-12. Squid jigging, Methods and gear | Australian Fisheries Management Authority (afma.gov.au), image courtesy of the Australian Fisheries Management Authority ..... 7-17

Figure 7-13. Map of the Macquarie Island Fishery, <https://www.afma.gov.au/fisheries/macquarie-island-toothfish-fishery#referenced-section-8>, image courtesy of the Australian Fisheries Management Authority © ..... 7-18

Figure 7-14. AIS Vessel Density along the Australia-Antarctica Route..... 7-20

Figure 7-15. AIS Vessel Track Rendered by Vessel Type..... 7-21

Figure 7-17. [Redacted]. Major Ports and Vessel Traffic Density around South Island, New Zealand. .... 7-24

Figure 7-18. New Zealand National Aquatic Biodiversity Information System Site example. .... 7-26

Figure 7-19. New Zealand fishing activity example..... 7-27

Figure 7-20. Foveaux Strait Oyster Fishery (OYU5)..... 7-28

Figure 7-21. AIS Vessel Density Along the Australia-Antarctica Route. .... 7-30

Figure 7-22. AIS Vessel Track Rendered by Vessel Type. .... 7-31

Figure 7-24. Winter Quarters Bay Debris Field. .... 7-33

Figure 7-25. Ross Sea Fishing Spatial Management Area..... 7-34

Figure 7-26. Benthic Bioregions of the Ross Sea. .... 7-35

Figure 7-27. [Redacted]. Ross Sea Fishing Activity example. .... 7-40

Figure 7-28. IUU Vessel Tracker. .... 7-41

Figure 7-29. Ross Sea Fishing Activity example..... 7-42

Figure 7-30. Ross Sea AIS Vessel Track Density. .... 7-44

Figure 7-31. AIS Vessel Track Rendered by Vessel Type. .... 7-45

Figure 7-32. AIS Pings by Month and Vessel Type Highlighting the Seasonality of Fishing (dark blue)..... 7-46

Figure 8-1. Sydney Landing Location. ....8-2

Figure 8-2. Clovelly Beach BMH Location. ....8-2

Figure 8-3. Australian Antarctic Division’s Research Center on Macquarie Island Isthmus with Buckles Bay in Foreground. ....8-3

Figure 8-4. Australian Marine Cable Route.....8-4

Figure 8-5. Macquarie Island Marine Park. ....8-6

Figure 8-6. Coastline Habitat of Sandy Point Peninsula, Invercargill..... 8-14

Figure 8-7. Coastline Habitat of Sandy Point Peninsula, Invercargill..... 8-15



Figure 8-8. Set Nets in Invercargill Area..... 8-16

Figure 8-9. Benthic Protection Areas Near Invercargill Areas of concern..... 8-17

Figure 8-10. [Redacted]. Sandy Point Vegetation Zones..... 8-21

Figure 8-11. Cross-sectional Diagram of Subtidal Study Site in McMurdo Sound, Antarctica. Diagram. .... 8-29

Figure 8-12. Commission for the Conservation of Antarctic Marine Living Resources Convention Area Statistical Areas. .... 8-32

Figure 8-13. The Ross Sea Region MPA..... 8-34

Figure 8-14. The Ross Sea Region MPA and Habitat Zones. .... 8-35

Figure 8-15. Benthic Regionalization of the Ross Sea Area..... 8-36

Figure 8-16. ASPAs in the Ross Sea Region..... 8-37

Figure 10-1. Looking north from Dolphins Point Cliffs towards Clovelly Beach..... 10-2

Figure 10-4. Clovelly Beach looking northeast from headland with beach manhole back along the horizontal directional drill route. .... 10-5

Figure 10-5. An approximate manhole location (buried under grass). .... 10-6

Figure 10-6. The Alexandria Data Center..... 10-7

Figure 10-7. The Equinix SY4 Data Center. .... 10-8

Figure 10-8. Sydney landing site chart. .... 10-9

Figure 10-9. Aerial view of Oreti Beach, facing south. .... 10-10

Figure 10-11. End of Dunns Road, facing south toward Oreti Beach, bound by dunes on either side of the roadway. .... 10-11

Figure 10-12. Walkway on northern side of Dunns Road, inland of Oreti Beach, carpark on right side of image..... 10-12

Figure 10-13. Carpark and picnic area on the northern side of Dunns Road, inland of Oreti Beach..... 10-12

Figure 10-14. Existing conduits (e.g., power) are located on the northern side of bridge.... 10-13

Figure 10-15. Gated access to land south of the data center site..... 10-14

Figure 10-16. Invercargill landing site chart. .... 10-15

Figure 10-17. Proposed landing site and terrestrial route to communications building area. .... 10-17

Figure 10-18. Sample map showing Macquarie Island buildings and structures. .... 10-18

Figure 10-19. Macquarie Island isthmus to the island plateau..... 10-19

Figure 10-20. View of Macquarie Island research station and proposed landing site as seen from communications building..... 10-20

Figure 10-22. Macquarie Landing research landing station site chart. .... 10-21

Figure 10-23. Sample Landing Site “A” and Proposed Terrestrial Route to New Data Center. .... 10-22

Figure 10-24. Sample landing site “A” and “B” proposed terrestrial routes to new data center. .... 10-23

Figure 10-25. Sample horizontal directional drill/beach manhole site for landing site “A”... 10-23

Figure 10-26. Sample work area location for horizontal directional drill/beach manhole for landing site “B”..... 10-24

Figure 10-27. Sample of McMurdo Station horizontal directional drill laydown area..... 10-24



Figure 10-28. Example of horizontal directional drill bore and cable installation. .... 10-25

Figure 10-29. New data center under construction at McMurdo Station. .... 10-26

Figure 10-30. Sample of power feed equipment, equipment racks, and battery plant. .... 10-27

Figure 10-31. [Redacted] Example of Spellman 3-Bay power feed equipment rack system. .... 10-28

Figure 10-32. Example of a prefabricated power feed equipment shelter. .... 10-29

Figure 10-33. Examples of custom, modular, and prefabricated cable landing stations. .... 10-29

Figure 10-34. [Redacted]. Example of submarine line terminating equipment. .... 10-30

Figure 10-35. McMurdo Landing Site Chart. .... 10-31

Figure 11-1. Example of Northern Science Branching Units. .... 11-1

Figure 11-2. Example of "50 South" Future Science branching unit. .... 11-2

Figure 11-3. Example of Macquarie Future Science branching unit. .... 11-3

Figure 11-4. Example of "60S 170E" Future Science branching unit. .... 11-3

Figure 11-5. Example of dark fiber and Terra Nova Bay area branching unit and possible routing. .... 11-4

Figure 11-6. Examples of branching units. .... 11-5

Figure 14-1a. SubCom Reliance Class cable installation vessel. .... 14-2

Figure 14-1b. SubCom Reliance Class cable installation vessel. .... 14-3

Figure 14-1c. SubCom Reliance Class cable installation vessel. .... 14-4

Figure 14-2. Alcatel Submarine Networks Ile de Class Cable Installation Vessel. .... 14-5

Figure 14-3. Submarine fiber optic cable components. .... 14-6

Figure 14-4. Submarine fiber optic cable types. .... 14-7

Figure 14-5. Example of submarine fiber optic cable burial plow operational diagram. .... 14-8

Figure 14-6. Example of horizontal directional drilling. .... 14-9

Figure 14-7. Example of beach manhole installation. .... 14-9

Figure 14-8. [Redacted]. Example design of a submarine fiber optic cable ocean ground bed anode design. .... 14-10

Figure 14-9. [Redacted]. Example of sea earth ground plate and earth ground cable. .... 14-11

Figure 14-10. [Redacted]. Example of horizontal directional drill ground cable installation. .... 14-11

Figure 14-11. [Redacted]. Remote Sea Earth Diagram. .... 14-12

Figure 14-12. Example of submarine fiber optic cable surface lay installation. .... 14-12

Figure 15-1. Research Vessel / Icebreaker Nathaniel B. Palmer. .... 15-1

Figure 15-2. Research Vessel Laura Bassi – Ice Breaker Class. .... 15-2

Figure 15-3. Research Vessel Ocean Titan. .... 15-3

Figure 15-4. Example of marine route survey vessel and equipment array. .... 15-4

Figure 18-1. Illustration of a repeater housing showing two possible sensor mounting locations: (a) on the end of repeater housing under the bell housing or (b) in an external pod. Accelerometers are mounted inside the pressure housing (c). .... 18-4

Figure 18-2. Conceptual diagram of scientific repeater sensor and telecommunications. .... 18-5

Figure 18-3. Conceptual block diagram of SMART cable functionality. .... 18-5



Figure 18-4. Conceptual diagram of interleaved sensor nodes. .... 18-6  
Figure 18-5. Conceptual block diagram of a science node connected to a branch cable. .... 18-6  
Figure 18-6. Conceptual block diagram of sensor nodes connected to a branch cable..... 18-7



## List of Key Acronyms and Abbreviations

AEE	Assessment of Environmental Effects (New Zealand)
AoA	Analysis of Alternatives
ACMA	Australian Communications and Media Authority
AFMA	Australian Fisheries Management Authority
AMSA	Australian Government, Australian Maritime Safety Authority
ASPA	Antarctic Specially Protected Area
ATCM	Antarctic Treaty Consultative Meeting
ATS	Antarctic Treaty System
BMH	Beach Manhole
BU	Branching Unit
CEE	Comprehensive Environmental Evaluation
CEP	Committee for Environmental Protection
CLS	Cable Landing Station
CPZ	Cable Protection Zone
CRE	Cable Route Engineering
CZ	Contiguous Zone
DAWE	Department of Agriculture, Water, and the Environment (Australian Government)
DOC	Department of Conservation (New Zealand)
DoD	Department of Defense
DTS	Desktop Study
EA	Environmental Assessment
EEZ	Exclusive Economic Zone
EIA	Environmental Impact Assessment
EP	Environmental Protection
EPA	Environmental Protection Agency (U.S.)



EPA	Environmental Protection Authority (New Zealand)
FAD	Fish Aggregation Device
GBS	Global Broadband Solutions, LLC
GIS	Geographic Information System
HDD	Horizontal Directional Drill
HSNO	Hazardous Substance and New Organism Act (New Zealand)
ICPC	International Cable Protection Committee
IS	In-Service
IUU	Illegal, Unreported and Unregulated
KM	Kilometer
LAT	Lowest Astronomical Tide
LME	Line Monitoring Equipment
LWM	Low Water Mark
M	Meter
MBES	Multibeam Echosounder
MHW	Mean High Water
MIAC	Macquarie Island Advisory Committee
MMPA	Marine Mammal Protection Act
MoT	Ministry of Transport (New Zealand)
MPA	Marine Protected Area
MRS	Marine Route Survey
NASA	National Aeronautics and Space Administration
NAVFAC	Naval Facilities Engineering Command
NEPA	National Environmental Policy Act
NGA	National Geospatial-Intelligence Agency
NIMA	National Intelligence Mapping Agency
NMFS	National Marine Fisheries Service (NOAA)





NMS	Network Management System
NOAA	National Oceanic and Atmospheric Administration
NSCPO	Naval Seafloor Cable Protection Office
NSF	National Science Foundation
NWP	Nationwide Permit
OGB	Ocean Ground Bed
OPP	Office of Polar Programs
OSS	Out of Service
PFE	Power Feed Equipment
PMP	Project Management Plan
PoP	Period of Performance
Protocol	Refers to the Protocol on Environmental Protection to the Antarctic Treaty
PWS	Performance Work Statement
RAA	Reserve Activity Assessment (Tasmania)
RFI	Request for Information
RNZAF	Royal New Zealand Air Force
ROL	Road Occupancy License (Australia)
ROM	Rough Order of Magnitude
RPL	Route Position List
RPS	Regional Policy Statement (New Zealand)
RWG	Route Working Group
SAT	Secretariat of the Antarctic Treaty
SBP	Sub-bottom Profiler
SFOC	Submarine Fiber Optic Cable
SLD	Straight Line Diagram
SLR	Sea Level Rise
SLTE	Submarine Line Terminating Equipment



SMART	Science Monitoring And Reliable Telecommunications
SME	Subject Matter Expert
SPMMA	South Pacific Marine Maintenance Agreement
SSPZ	Southern Sydney Protection Zone
SSR	Site Survey Report
SSS	Side-Scan Sonar
System	Refers to the Antarctic Treaty System
Treaty	Refers to the The Antarctic Treaty
TS	Territorial Sea
TSB	Territorial Sea Baseline
UNCLOS	United Nations Convention on the Law of the Sea
USACE	United States Army Corps of Engineers
USAP	United States Antarctic Program
USC	United States Code
USCG	United States Coast Guard
USGS	United States Geological Survey
USFWS	United States Fish and Wildlife Service
VME	Vulnerable Marine Ecosystems
WD	Water Depth





# DESKTOP STUDY (DTS) DEVELOPMENT METHODOLOGY





## 1.0 DESKTOP STUDY (DTS) DEVELOPMENT METHODOLOGY

This NSF AU/NZ to Antarctica DTS Report was conducted to support the development of an SFOC based communications transport capability from Australia or New Zealand to Antarctica, using a repeatered fiber optic cable, with the potential for SMART cable capabilities. The DTS Report was developed in accordance with the requirements of the Performance Work Statement (PWS) and the guidance provided by International Cable Protection Committee (ICPC) Recommendation 9, “Minimum Technical Requirements for a Desktop Study.” References specific to each task are found at the end of each report section.

### Submission

Global Broadband Solutions, LLC (GBS) submits this Desktop Study with its DTS Team of Tetra Tech Inc., and Arnos Telecommunication Services. Specific sections were prepared by Subject Matter Experts (SMEs) in these areas. The cable route was developed by GBS SMEs in coordination with other Team member support and review, as well as reviewed with the Naval Seafloor Cable Protection Office (NSCPO) to ensure the route met all requirements of the NSCPO and avoided any conflicts with U.S. Government subsea infrastructure.

### Sources

The DTS Team utilized open-source, publicly-available data, directly from the National Science Foundation and from the National Oceanographic and Atmospheric Administration (NOAA), the National Aeronautics and Space Administration (NASA), the National Geospatial Intelligence Agency (NGA), the National Intelligence Mapping Agency (NIMA), and the United States Geological Survey (USGS). Details of the compilation of the route development and description are found in Section 2.0 of the DTS Report.

### Approach

The GBS Team Project Management approach utilized a SME Focus as outlined throughout the Project Management Plan (PMP) documentation submitted at project kick-off. Specific SMEs in all areas of the SFOC development life cycle were utilized to ensure expert level review of all areas of the DTS report. The critical components of the DTS output (System Landings; System Rough-Order-of-Magnitude (ROM) Pricing; Cable Protection and Routing) all received input and review by SMEs in their respective areas.

As part of the DTS, the GBS Team researched and identified the potential permits and regulatory requirements for the SFOC route and landing the SFOC at the required end points. Regulatory permits and environmental requirements are included, listing permits, points of contact and other relevant information. The GBS Project Manager (PM) assigned permit research to the most



experienced (i.e., Australian/New Zealand personnel where relevant) resources and SMEs as required.

GBS consulted with the NSF Office of Polar Programs regarding environmental compliance unique to Antarctica. Based on this research, the GBS Team permitting SMEs developed the GBS-formatted permitting matrices that identify all permitting and regulatory requirements for each area of the route and landing sites. The PM monitored progress on the permitting requirements throughout the project.

## Process

Because of the global conditions during the Period of Performance (PoP) and to mitigate Covid-19 travel issues to Australia and New Zealand, the GBS Team utilized local resources to conduct Site surveys and evaluate potential landing locations using the GBS Comprehensive Site Survey Report (SSR) template that was analyzed by GBS Team SMEs related to the landing conditions, approach, and other factors. GBS worked directly with NSF PMs to gather landing information and any relevant data on the Antarctic site due to the inability to access the site during the project period.

GBS conducted internal weekly Team status reports and provided detailed monthly reports and Interim Progress Review (IPR) briefings to relevant stakeholders as required. This DTS report utilized the above methodology to leverage SME and other resources to compile all sections of the research and documentation required to develop the recommended DTS SFOC system routes. The DTS routes have been determined to be technically feasible and mitigate known risks to increase survivability, provide the critical inputs for the Marine Route Survey (MRS), and ultimately support the implementation of an SFOC system between Australia or New Zealand and Antarctica.

### 1.1. SFOC Risk Table

In the design of Submarine telecommunication cable systems, the cable route engineers factor in major cable survivability risks when choosing a route and identifying cable landing sites. Both Table 1-1 and Table 1-2 identify some of the risks associated with the cable landing route areas.

Some of the risks are contingent on Government and regional restrictions while others are natural, geological, or biological factors. Submarine telecommunication cables have been landed worldwide in many different environmentally challenging locations. Risk mitigation has been designed into the DTS routes outlined in this report to protect the cable system and maintain its designed life cycle.



**Table 1-1. Submarine Fiber Optic Cable (SFOC) Risk Table.**

<b>SFOC CABLE RISK MATRIX</b>	<b>SYDNEY AU</b>	<b>INVERCARGILL NZ</b>	<b>MACQUARIE ISLAND AU</b>	<b>MCMURDO STATION AQ</b>
Existing Underground Infrastructure	YES	NO	YES	YES
Site analysis required from As-Builts	YES	YES	YES	YES
Pre-laid Shore End Required	NO	YES	YES	NO
Technical limitations	NO	NO	YES	YES
Ice Scouring	NO	NO	NO	YES
Seasonal Ice Movement	NO	NO	NO	YES
Seismic Activity	YES	YES	YES	NO
Commercial Fishing Activity	YES	YES	YES	YES
Anchoring	YES	YES	YES	NO
Geological Risks	YES	YES	YES	YES
Cable Crossings	YES	NO	NO	NO
Pipeline Crossings	YES	NO	NO	NO
Cable Protection Zone	YES	NO	NO	NO
Restriction Zones	YES	YES	YES	YES
Ice Access for cable repair required	NO	NO	NO	YES
Multiple Cable Landings	YES	NO	NO	NO
HDD Required	YES	NO	NO	YES
Landing Site Access restrictions	NO	NO	YES	YES



**Table 1-2. Risks Descriptions Table.**

<b>RISKS DESCRIPTION</b>	
<b>Existing Underground Infrastructure</b>	Cable landing sites can have existing utilities buried and previously installed, careful examination of the as-built data and regional utility organization needs to be coordinated with the route engineering design team.
<b>Site Analysis Required from As-Built Documentation</b>	Cable landing shore and terrestrial sites may have as-built documentation with different agencies. All data and physical verification of these utilities needs to be verified for the final system design.
<b>Pre-Laid Shore End Required</b>	Does the shore landing site have the required water depth of 20 m for SFOC installation vessels? If not, a shallow draft vessel will be required to pre-lay the SFOC in this location.
<b>Technical Limitations</b>	Does the site have technical limitations for the system, existing infrastructure for the new SFOC system, power, and terrestrial conduit routes? This information allows the designers to factor in requirements needed for the SFOC system.
<b>Ice Scouring</b>	Does the site have any visible ice scouring on the seabed in the SFOC installation area? The seabed will need a Marine Route Survey to determine the sea floor ice disturbance in order that the SFOC can be installed or buried to protect the cable infrastructure.
<b>Seasonal Ice Movement</b>	Does the site have any visible seasonal ice movement on the seabed or water column in the SFOC installation area? This area needs a Marine Route Survey to determine the ice disturbance so the SFOC can be installed or buried under the affected area.
<b>Seismic Activity</b>	Does the terrestrial or subsea area have any recorded seismic activity that needs to be designed into the system for avoidance or protection requirements?



<p><b>Commercial Fishing Activity</b></p>	<p>Is there any commercial fishing activity near shore or offshore that may disturb the cable installation? What type of fishing is done, type of fishing gear and water depth the fishing activity is happening? This all determines cable route, installation, and cable type. Some areas have or can have Cable Protection Zones (CPZ) which are important to subsea cable and pipeline survivability.</p>
<p><b>Anchoring</b></p>	<p>Does the near shore or offshore area have recreational or commercial ship anchoring activity? The route needs to be examined for this activity as it can determine the route location, installation type, cable type, and required protection measures. Some areas have or can have CPZs, which are important to subsea cable and pipeline survivability.</p>
<p><b>Geological Risks</b></p>	<p>Does the near shore or offshore deeper water area have any Geological risks? These could be slopes, ridges, valleys, or subsea outcroppings that can cause a submarine cable to have a suspension or abrasion to the cable in water energy from storms and/or tidal activity. The cable route engineers use this information to design the cable route in avoidance of these areas and determine the cable type and installation method.</p>
<p><b>Cable or Pipeline Crossings</b></p>	<p>Does the cable route have any known in service or out of service subsea cable or pipeline crossings? There are agreed upon crossing guidelines for this type of crossing that include installation crossing angles and protection, as well as identification for future systems or repairs. The International Cable Protection Committee (ICPC) has documentation that commercial and government owned cable systems follow for best industry practices.</p>
<p><b>Cable Protection Zone</b></p>	<p>Does the cable route approaching the landing area have a CPZ already indicated on nautical charts?</p> <p>Some areas for new cable installations have guidelines or requirements on how to apply for this designation and have the areas noted on all publicly available nautical charts for both commercial and recreational use.</p>





<p><b>Restriction Zones</b></p>	<p>Many cable landings and routes have restricted areas for many different reasons. Some are environmentally sensitive areas, research areas, previous dumping grounds, historical UXO areas, commercial utility installations, and other areas identified as restricted. The cable route engineers use the known data to route and mitigate these areas for route design and installation.</p>
<p><b>Ice Access For Cable Repair Required</b></p>	<p>If there is seasonal ice that is on the cable route, a plan needs to be in place should a cable disturbance or break occur and seafloor access is required. Plans have been designed for this type of repair and vessels identified with known equipment for subsea cable repair.</p>
<p><b>Multiple Cable Landings</b></p>	<p>Are there other subsea cable systems landing in the same area? The route engineers will use this information to route the new cable around and identify the spacing required for future repair or recovery of the cable. The ICPC has guidelines for the installation of cable in the proximity of in service and out of service cables and pipelines.</p>
<p><b>HDD Required</b></p>	<p>Is Horizontal Directional Drilling (HDD) required to install a subsea cable conduit for the landing site of an SFOC system? Many countries and regions have environmental or geological requirements for this type of cable to least disturb the shore features when installing a new cable. This is taken into consideration by the cable route engineers when designing the cable landings.</p>
<p><b>Landing Site Access Restrictions</b></p>	<p>Are there physical or regional restrictions for site access or equipment required for the SFOC installation? In remote locations there are numerous limitations on equipment, meteorological limitations, and resource factors that need to be planned into the system installation.</p>



# ROUTE LANDING SITE APPROACH IDENTIFICATION





## 2.0 ROUTE AND LANDING SITE APPROACH IDENTIFICATION

### 2.1. General Route Selection Discussion and Rationale

The proposed AU/NZ to Antarctica DTS SFOC route was developed based on the landing site locations supplied by NSF, with numerous SMEs reviewing all aspects of the cable route. Additionally, local SMEs in Australia, New Zealand, NSF, and McMurdo Station were consulted and provided support related to the local infrastructure, environmental requirements, base requirements, and other factors.

There were numerous design criteria considerations during the cable route selection process in the DTS, all with the intention of reducing overall risk to the cable system while maintaining the shortest and best scientific sensor deployment route possible. As a result of the DTS, the cable route from New Zealand to McMurdo Station (Figure 2-1) is 4,913.86 kilometers (km) and the optional branch into Macquarie Island is 204.4 kilometers. There is also an alternative landing in Sydney, Australia into an existing Horizontal Directional Drilled (HDD) conduit that has been evaluated in the DTS, with a total distance of the Australia to McMurdo Station route (Figure 2-2) of 6,423.97 km. The main system between New Zealand or Australia and McMurdo Station also has Branching Unit (BU) locations identified. These BU locations are for Macquarie Island, other optional landings, and possible locations for scientific sensor deployments.

Significant effort to place this cable system on the perceived lowest grade and roughness seabed was undertaken; however, measures had to be taken to avoid government-owned, environmentally sensitive and/or controlled seabed assets and seabed areas. Avoidance of the environmentally sensitive areas was purposeful to avoid environmental permitting restrictions, but also constrained the route's direction.

Where the DTS route crosses existing submarine cable systems, crossing locations were chosen to provide the best crossing angle and avoid proximity with repeaters which would aid in any potential cable maintenance operations. The cable route was developed by GBS SMEs in coordination with Tetra Tech engineering support and review, as well as reviewed with the U.S. Naval Seafloor Cable Protection Office (NSCPO), Australian Government Telecommunications Security Risk Branch, and New Zealand POC to ensure the route met all requirements of local subsea route criteria, identified all crossings, and avoided any conflicts with Government subsea infrastructure.

The approach to Sydney and traversing the submarine cable route protection zone shelf was highly constrained by existing cable system placements, charted military areas, and dumping sites. Given the lack of route flexibility for planning the placement of the cable and resulting proximity to potentially hazardous seabed surface and seabed subsurface obstructions, special



attention to the cable route survey plan will be needed in order to secure a risk mitigated cable corridor.

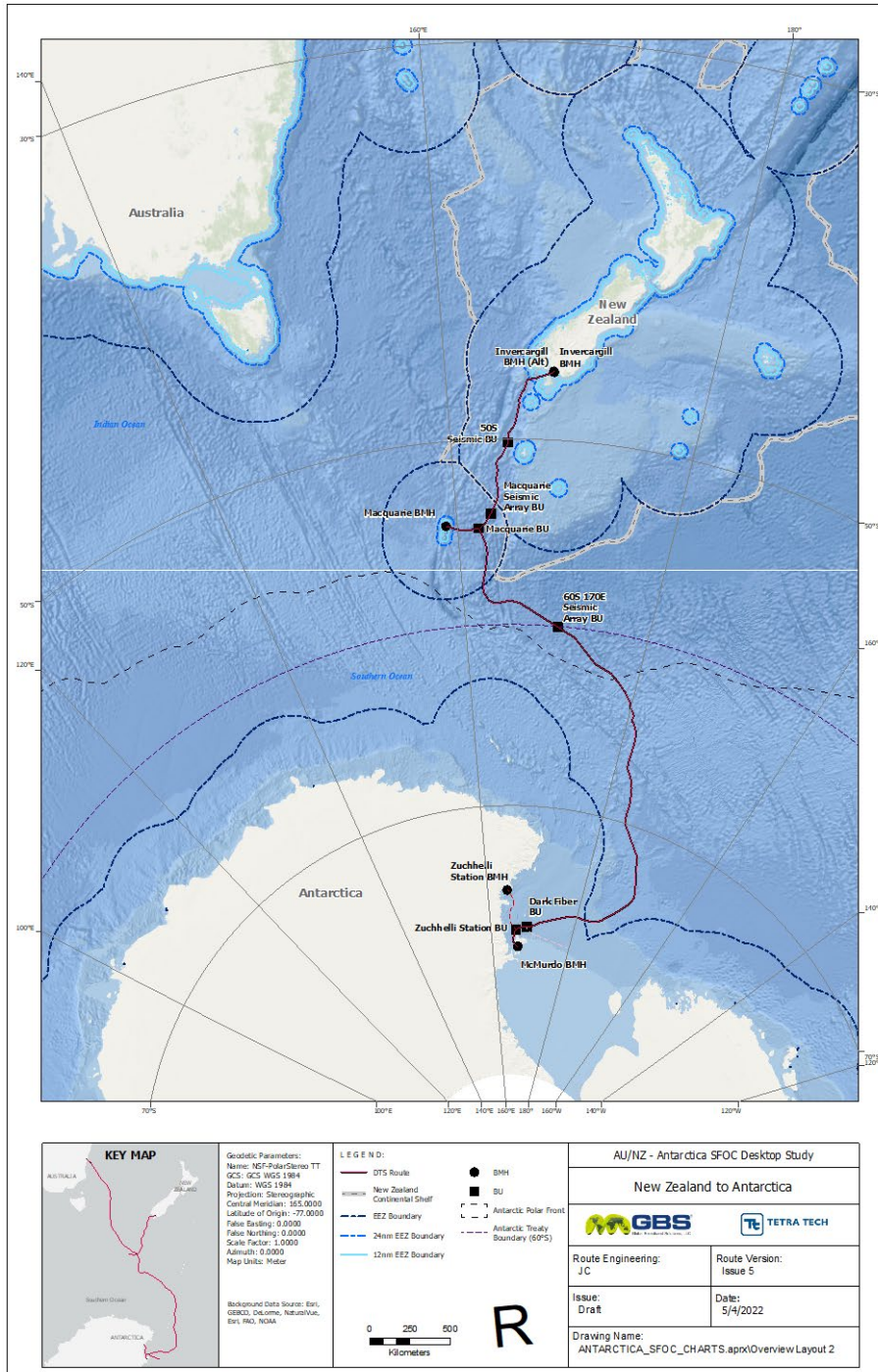

Figure 2-1. New Zealand to McMurdo Station Route Chart.

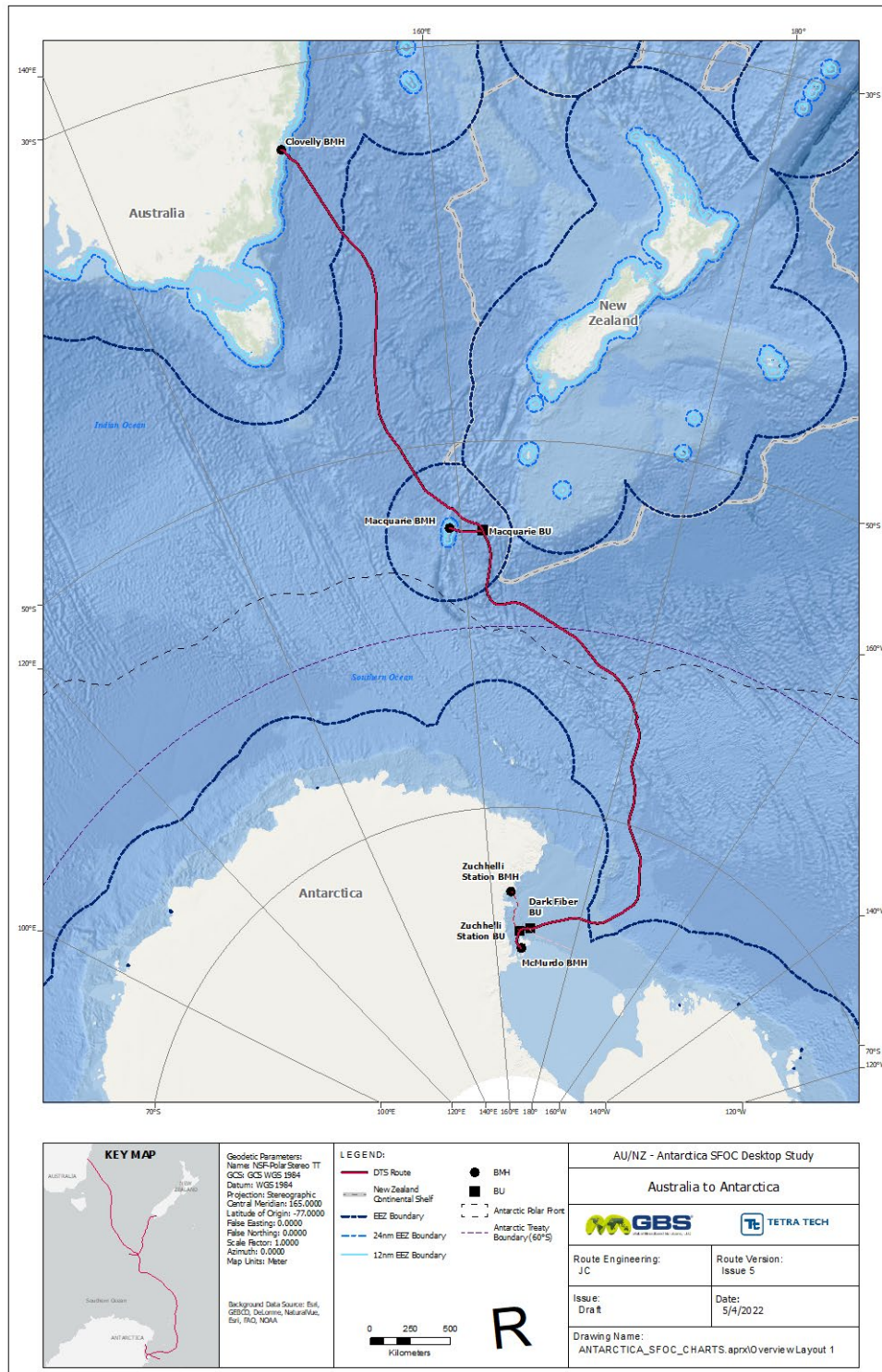

Figure 2-2. Australia to McMurdo Station Route Chart.

The detailed route description below will outline notable route information starting from Sydney, AU towards the Macquarie BU, then describing the remaining routes.

## 2.2.Sydney Route Description

### *Clovelly, Sydney, Australia (AU) to Macquarie BU*

The Australia landing at Clovelly utilizes a pre-existing Beach Manhole (BMH).

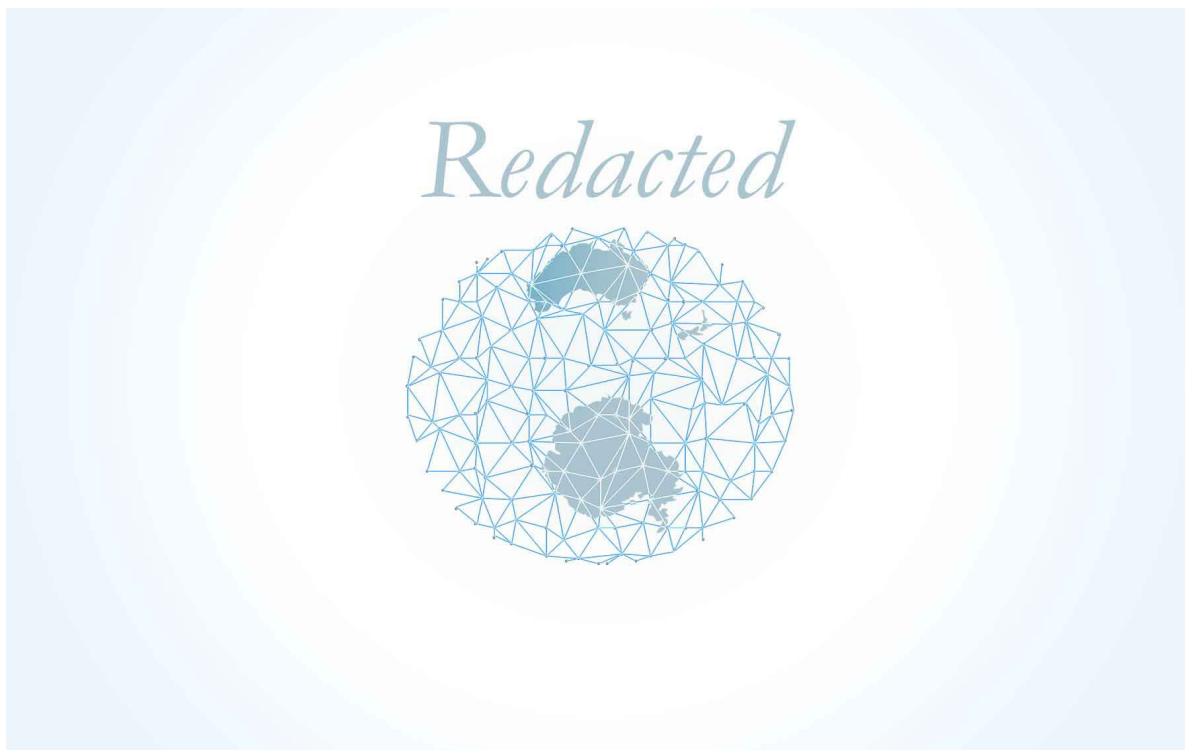

Figure 2-3. [Redacted]. Beach manhole.

The egress from Clovelly includes eight (8) cable crossings within the southern Sydney Cable Protection Zone. Each of the cable crossings will require specialized crossing agreements given the spacing is less than 2 times water depth with less than ideal crossing angles (per the ICPC recommendations), making installation, as well as future maintenance operations hazardous to existing cables.

The cable will exit the HDD and immediately cross two (2) cables, requiring a 40-degree crossing angle in order to set up an east-south-east parallel run between two other cables Figure 2-4.

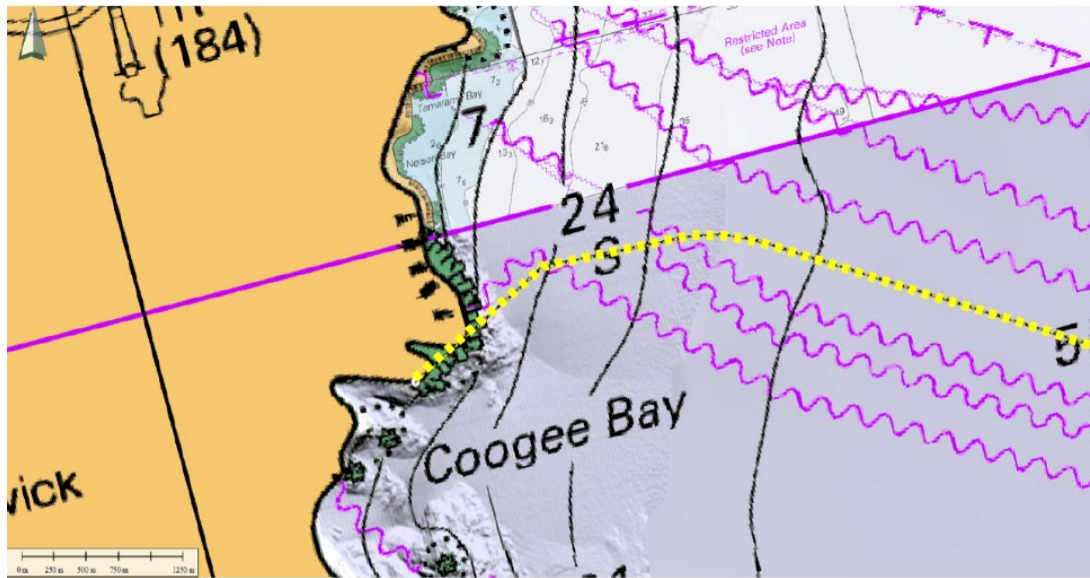

Figure 2-4. Egress from horizontal directional drill exit point and cable crossings.

The cable then proceeds to a crossing turn due south (Figure 2-5), crossing three (3) cables at approximately 60 degrees and continuing south-east on the previous heading, running parallel down slope towards the shelf break. The route then crosses the last previously crossed cable at 80 degrees before performing an s-turn on the upper slope, crossing two (2) more cables at approximately 60 degrees before proceeding down the continental shelf. Landing in this area will require critical crossing agreements, critical monitoring of anchoring vessels and fishing activity.

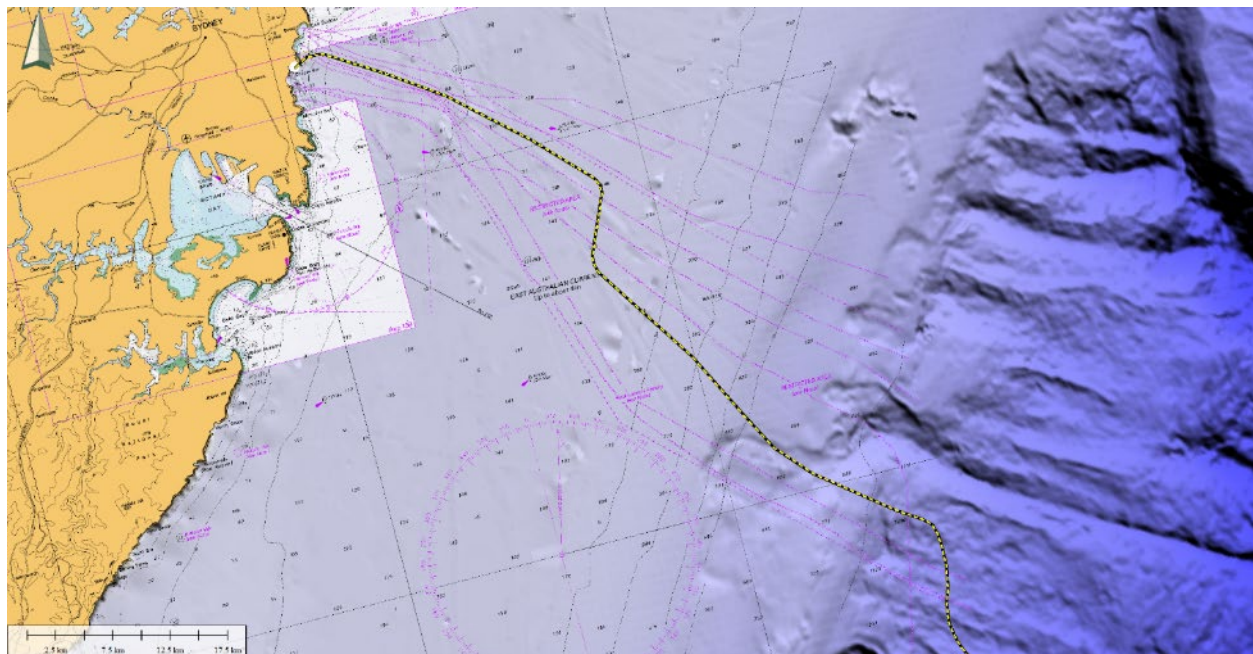

Figure 2-5. Cable protection zone and existing cable crossings.



The cable route then proceeds at full ocean depth south-south-east towards the Macquarie Ridge over seemingly benign seabed. The presence of seamounts along the route and potential discovery of un-surveyed seamounts and other geological hazards is a possibility (Figure 2-6).

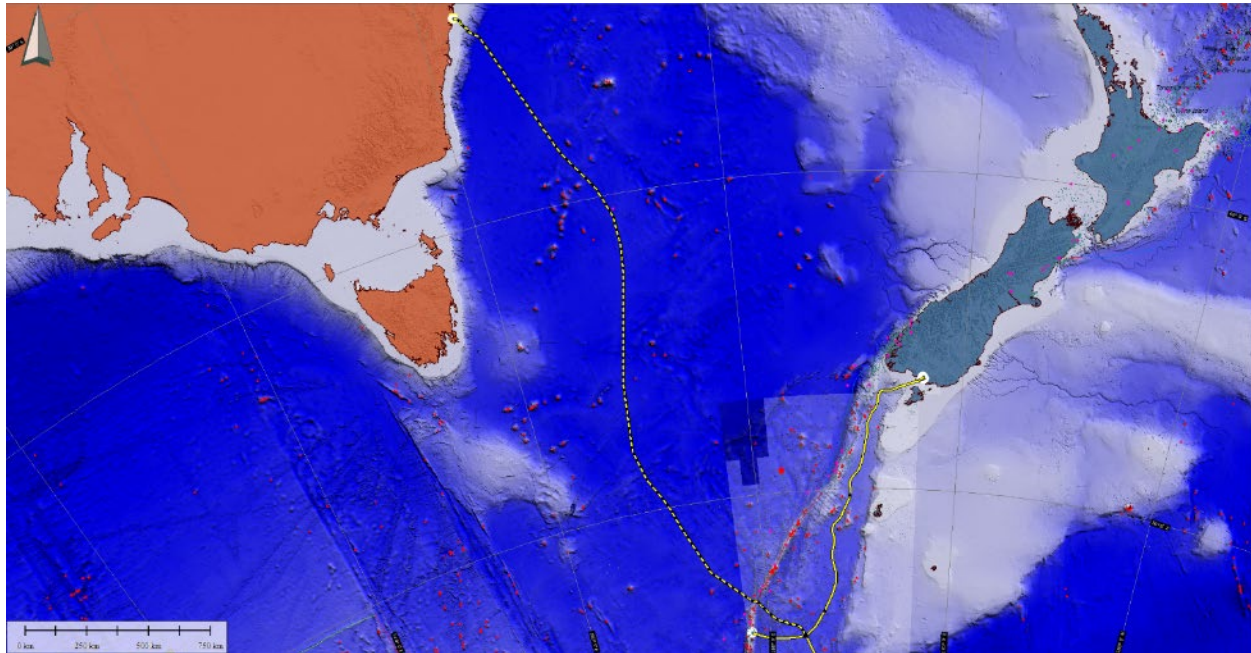

Figure 2-6. Seamounts and geologic features along the proposed route between Australia and Macquarie.

The traversal over the Macquarie Ridge to the BU has been chosen for a location with the least amount of overall vertical rise (Figure 2-7), but that rise is still over 1,000 meters with an unknown double ridge extension that is more prevalent along the Macquarie Ridge to the south (Figure 2-8).

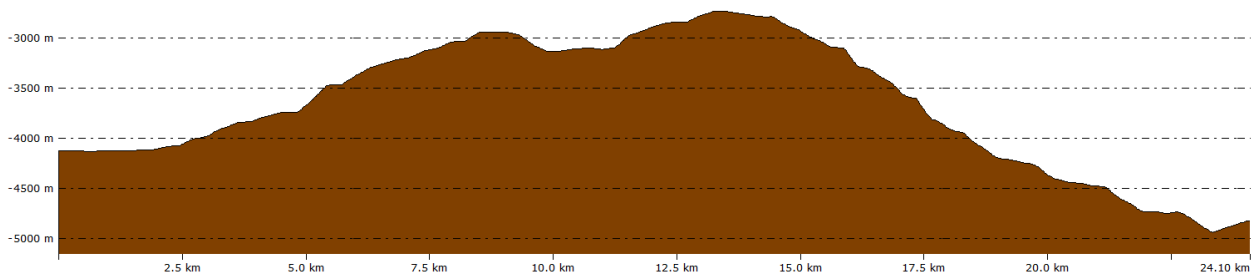

Figure 2-7. Macquarie Ridge crossing profile.



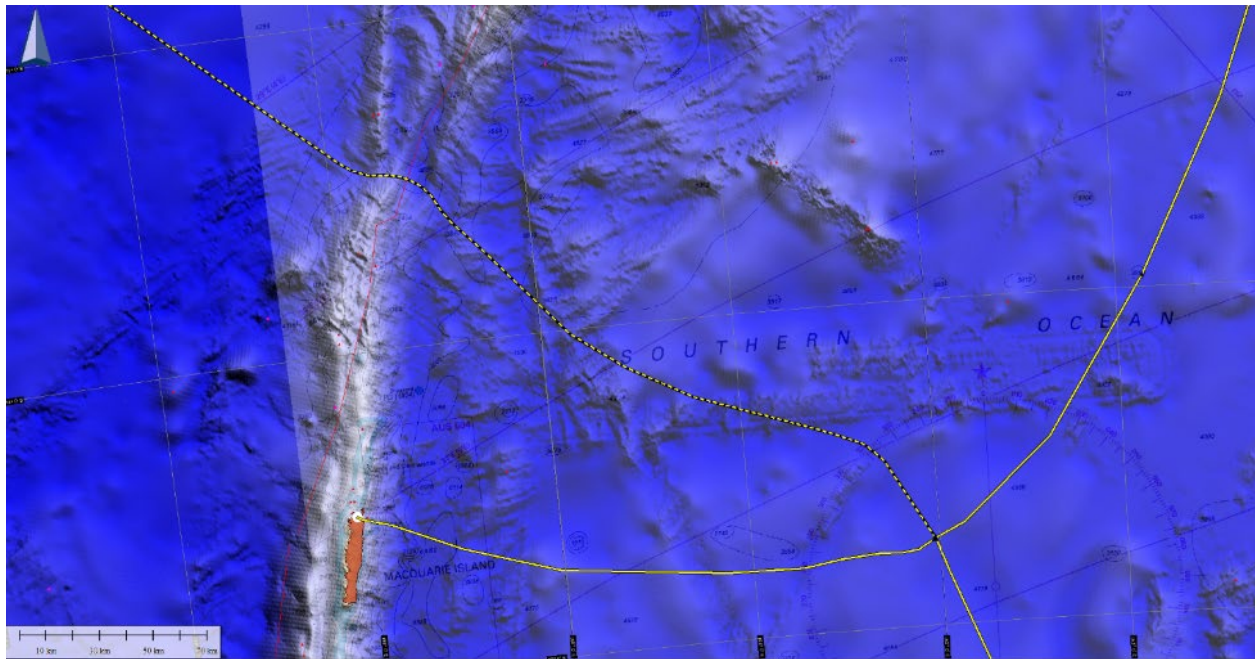

Figure 2-8. Macquarie Ridge crossing to branching unit.

The approach to the Macquarie BU will require traversing ridges and seamounts that will only be identified and resolved during the cable route survey (Figure 2-9).

The remainder of the route, from the Macquarie BU to McMurdo Station, is identical to the route described in the Invercargill to McMurdo Station route description in Section 2.4 below.

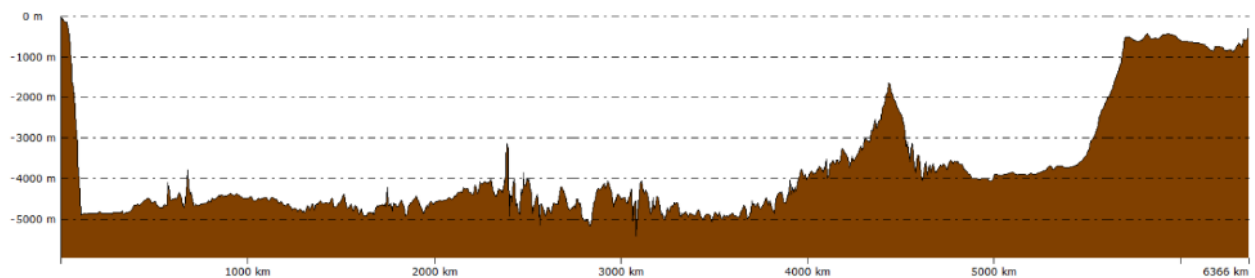

Figure 2-9. Australia - McMurdo depth profile.

### 2.3. Macquarie Route Description

The Macquarie Island BU is located at 54° 44.00736' S, 161° 58.54485' E in a water depth of 4,800 meters (Figure 2-10). The BU is situated in a convenient flat seabed location to serve as the BU for either the New Zealand or Australia route backbone options. The route proceeds west from the BU towards Macquarie Island past two seamounts located north of the route before proceeding up the steep slope of the Macquarie Ridge towards the direct landing (Figure 2-11).



This landing site can have a near shore direct landing from the cable ship without the need for HDD. Water depths and seafloor route will need a marine survey for a definitive route.



Figure 2-10. Macquarie Island branching unit.



Figure 2-11. Macquarie landing approach.

The route proceeds through a nearshore gap in the rock and coral before landing at the BMH on Macquarie Island located at 54° 29.97785' S, 158° 56.21549' E with an elevation of 3 meters above Mean High Water (MHW) having an overall 3D cable length of 204.4 km (Figure 2-12).

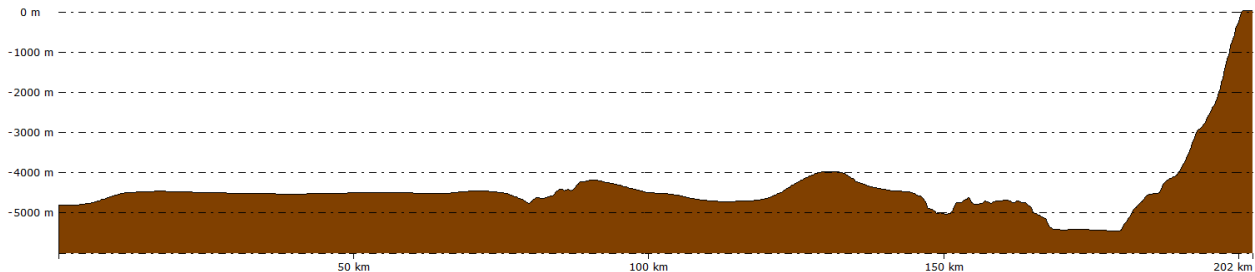

Figure 2-12. Macquarie depth profile.

### 2.4. Invercargill, New Zealand, to McMurdo Station Route Description

The New Zealand landing at Oreti Beach along Dunns Road was provided by NSF based on preliminary conversations with a supplier to maximize future onshore and offshore route locations and backhaul conduits (Figure 2-13, Figure 2-14 and Figure 2-15).

Before addressing the primary landing location, it is worth mentioning an alternative landing site BMH at Oreti Beach North Entrance off Ferry Road was identified at coordinates 46° 23.48931' S, 168° 11.88846' E with an elevation of 2.4 meters above MHW. This site has a shorter and potentially less technical terrestrial route to the planned Datacenter Cable Landing Station (CLS). However, if a commercial entity lands at the southern Oreti Beach primary landing it would be beneficial for NSF to leverage the infrastructure and permitting groundwork to save planning and installation time, as well as reduce the incremental environmental impact in the region.

The landing sites in this region are very shallow and will require detailed marine survey and burial installation plan. A separate shallow water near shore vessel will be required as well as a direct lay burial plan. It is recommended that this area have a Cable Protection Zone (CPZ) to protect the buried cable installation from anchoring and fishing activity.

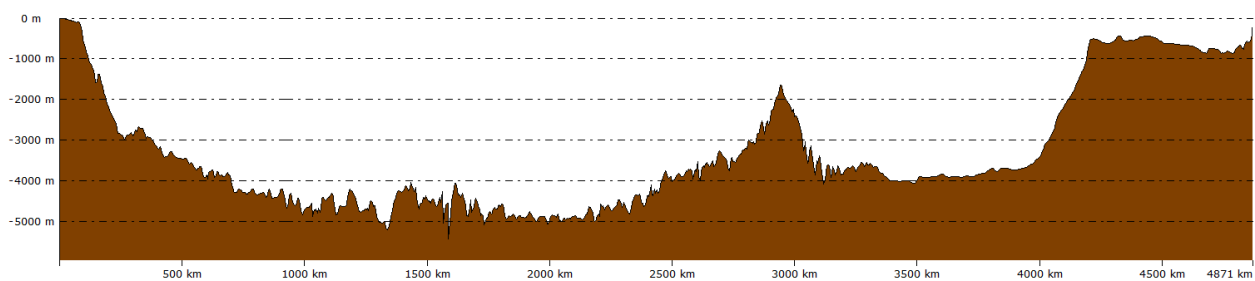

Figure 2-13. New Zealand - McMurdo depth profile.



Figure 2-14. Oreti Beach North (Alternate) landing.

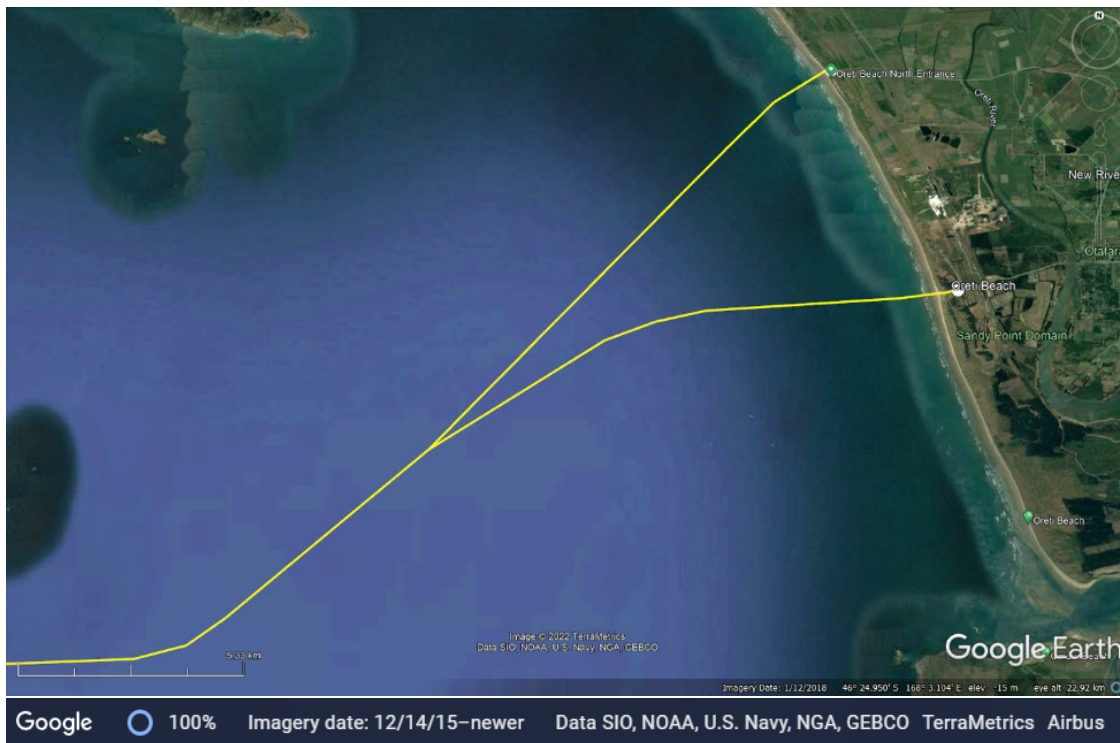

Figure 2-15. Oreti Beach, New Zealand: Primary (southern route) and Alternate (northern route) landings.

The primary BMH for the New Zealand end of the cable is located on the north side of Dunns Road with an elevation of 5.8 meters above MHW near Oreti Beach (Figure 2-16).



Figure 2-16. Primary landing.

The route will land directly onto Oreti Beach (Figure 2-17), a popular 26 km stretch of sandy beach visited by beach goers, surfers, mountain bikers, horseback riders and motor vehicle enthusiasts, most notably a testing and racing site for Burt Munro’s modified Indian motorcycle which was featured in the movie ‘The World’s Fastest Indian.’ Numerous recreational motorsport tracks and facilities can be found in the area, suggesting a high recreational usage of the beach and neighboring roads.



*(The Swim Guide, 2002)*

Figure 2-17. Oreti Beach visitor activity.

The egress from the car park to the surf zone is slightly downhill, following the same gradual slope that continues offshore for 7 to 8 kilometers, before reaching safe water depths for the main cable lay ship in approximately 20 meters Water Depth (WD). Between the beach and the start of conventional lay, the route will bypass a charted wreck in 15 meters WD and remain north of Halfway Rocks, which is located on the 20-meter WD contour, suggesting possible rock outcropping in that depth regime.

The route then diverts due west into Foveaux Strait until safely past Escape Reefs and Raratoka Island to the north and Stewart Island to the south. The route continues west and begins its descent into the Solander Trough about 20 km south of Solander Island (Figure 2-18).

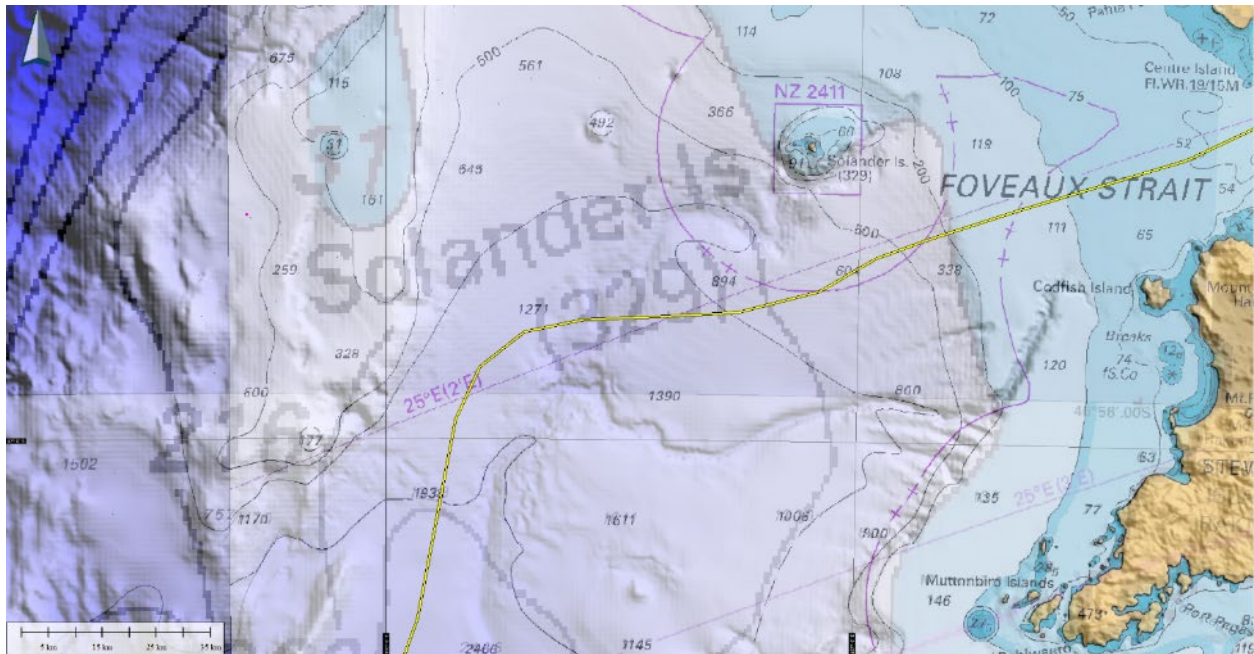
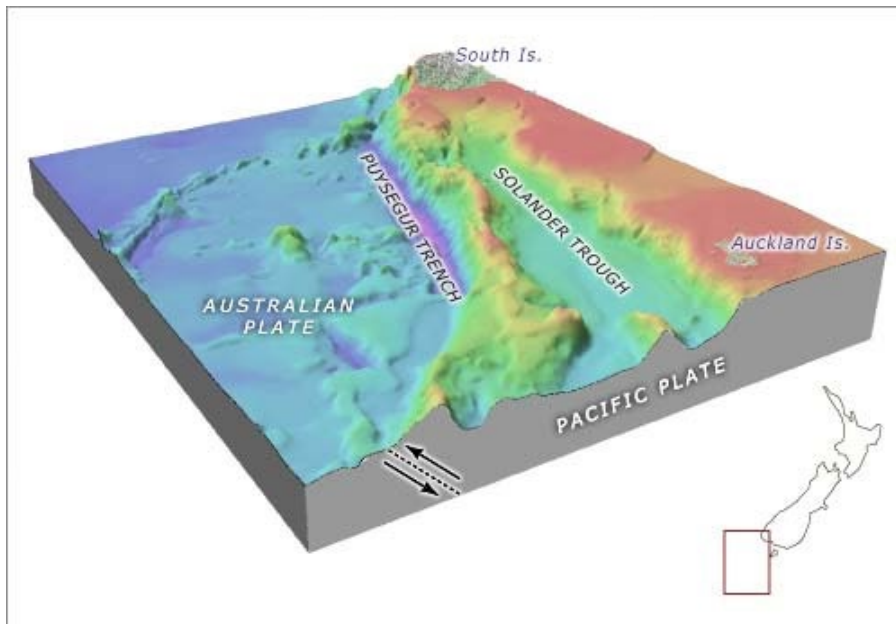

Figure 2-18. New Zealand Solander Trough descent.

As the route descends into the Solander Trough, there are submarine canyons to the north and south, which the route diverts around by maintaining a westerly direction. The route then continues due south towards the Macquarie BU navigating around ridges, seamounts, and troughs travelling between the Macquarie Ridge and Auckland Escarpment (Figure 2-19).



(Lewis et al., 2006)

Figure 2-19. Puysegur Trench and Solander Trough contour map.

The Solander Trough is generally space constrained with respect to cable safety but is scientifically important to traverse and safer than crossing the Puysegur Trench or Macquarie Ridge (Figure 2-20).

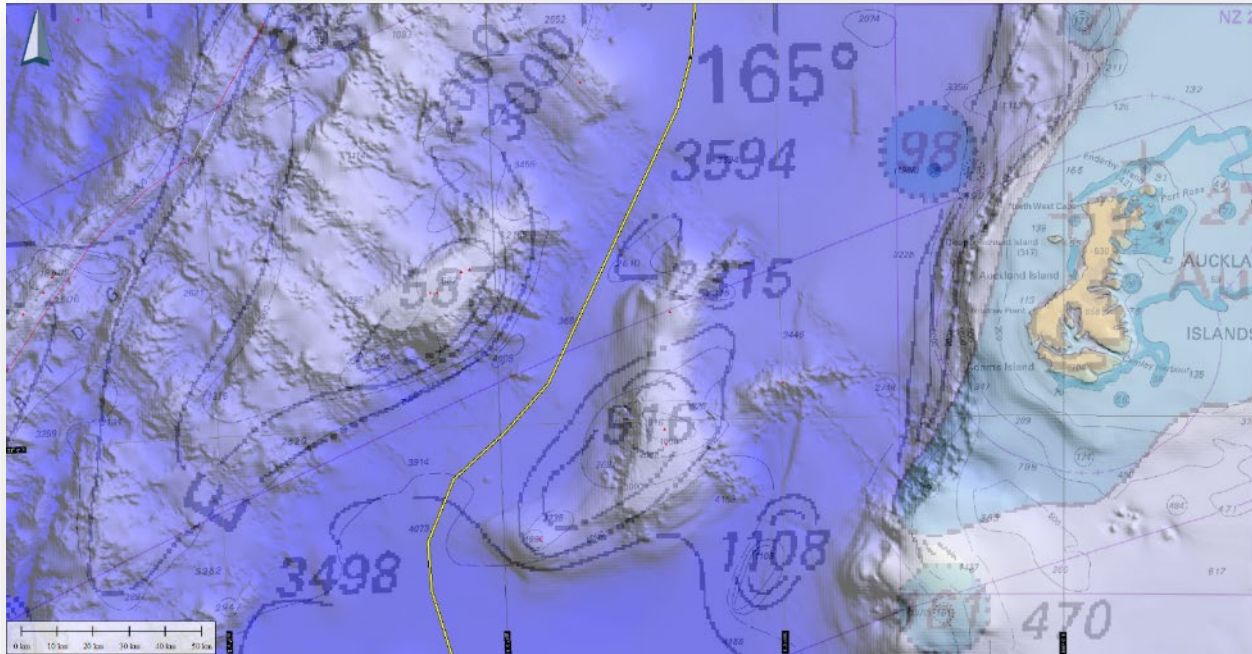

Figure 2-20. Seafloor contours near Auckland Islands showing variability and high relief.





The route placement due west of the Auckland Islands is constrained by the Macquarie Ridge to the west and a large seamount to the east as seen in Figure 2-21. Seismic activity is to be expected, as well as deep water currents.

The Macquarie BU is situated within the Emerald Basin at approximately 4,800 meters WD. The global bathymetry suggests a relatively flat bottom for placement of the BU; however, localized slopes are to be expected during the cable route survey and placement will be finalized post-survey.

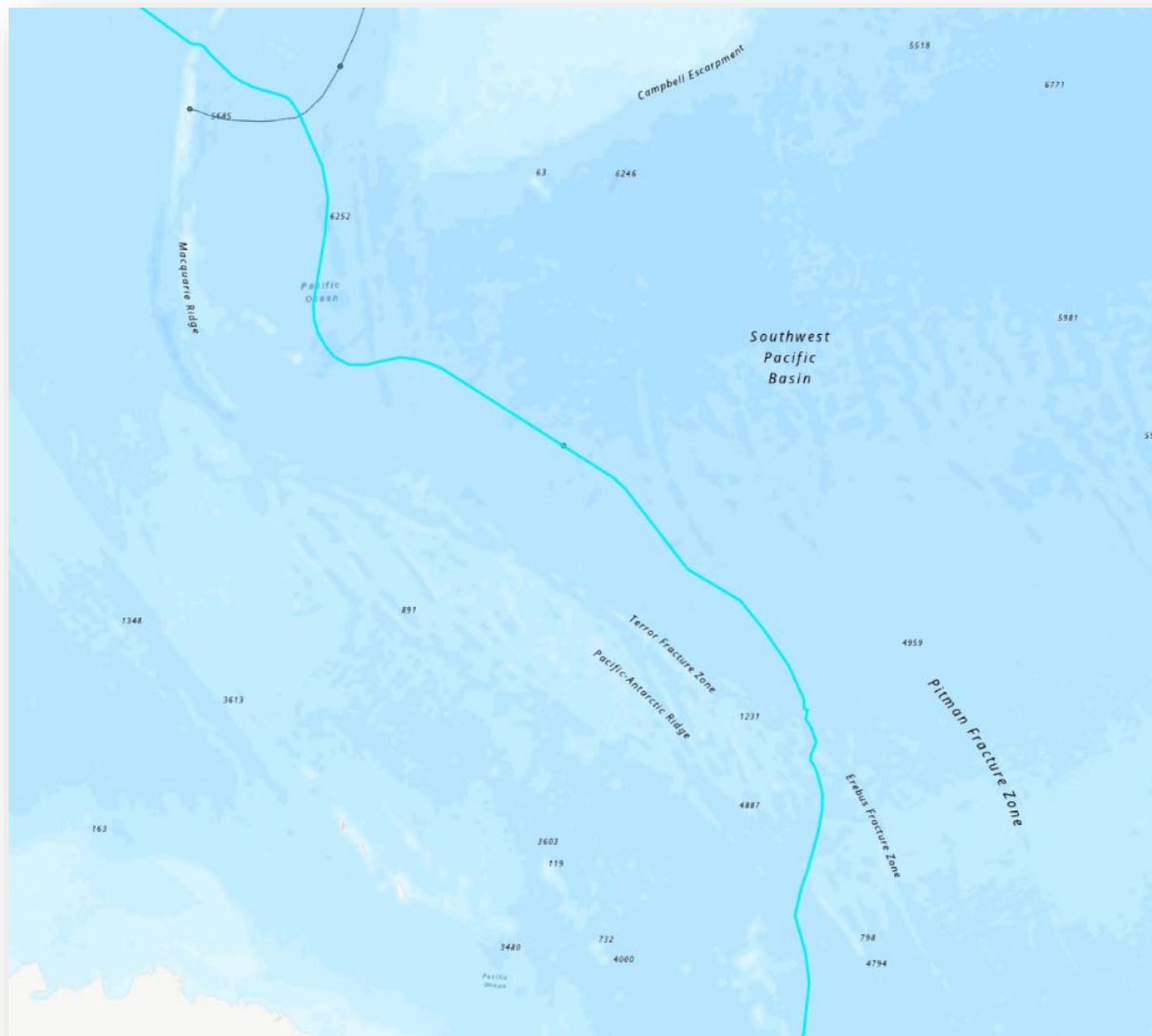

Figure 2-21. Proposed cable placement in Southwest Pacific Basin through Fractured Zones.

The route then heads south-east towards the Pittman Fracture Zone, but diverts south, crossing the Erebus Fracture Zone and Terror Fracture Zone over the Pacific-Antarctic Ridge (Figure 2-22). The chosen route avoids high-relief bathymetry as much as possible while traversing the ridge. Localized slopes and hazards due to seismic events, such as seabed movement, slumping and the unlikely emergence of hotspots could impact the cable anywhere along or near the fracture zones.

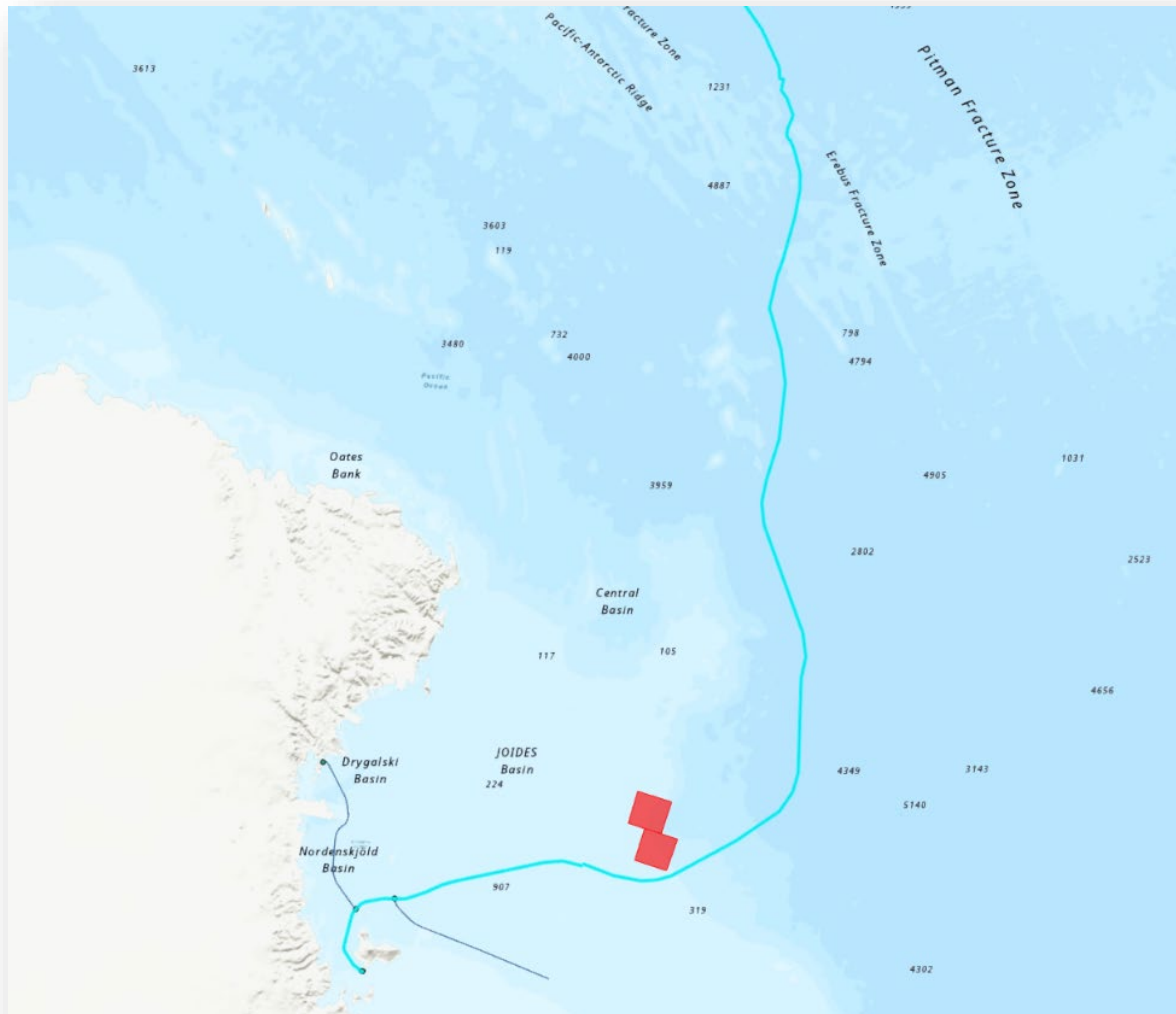

Figure 2-22. Approach to Ross Sea and McMurdo Sound, Antarctica.

After crossing the Pacific-Antarctic Ridge, the route heads due south, passing east of the Tangaroa Seamount before heading south-west past the Vulnerable Marine Ecosystem (VME) zones denoted as red polygons in Figure 2-22 to the North and up the Ross Sea continental rise south of Hillary Canyon.



The route then proceeds west into McMurdo Sound north of Beaufort Island before hooking south around the east side of Ross Island into McMurdo Sound.

The approach through McMurdo Sound and to Hut Point Peninsula and ultimately McMurdo Station traverses in water depths greater than 500 meters until the northward turn up the slope south of Winter Quarters Bay (Figure 2-23).

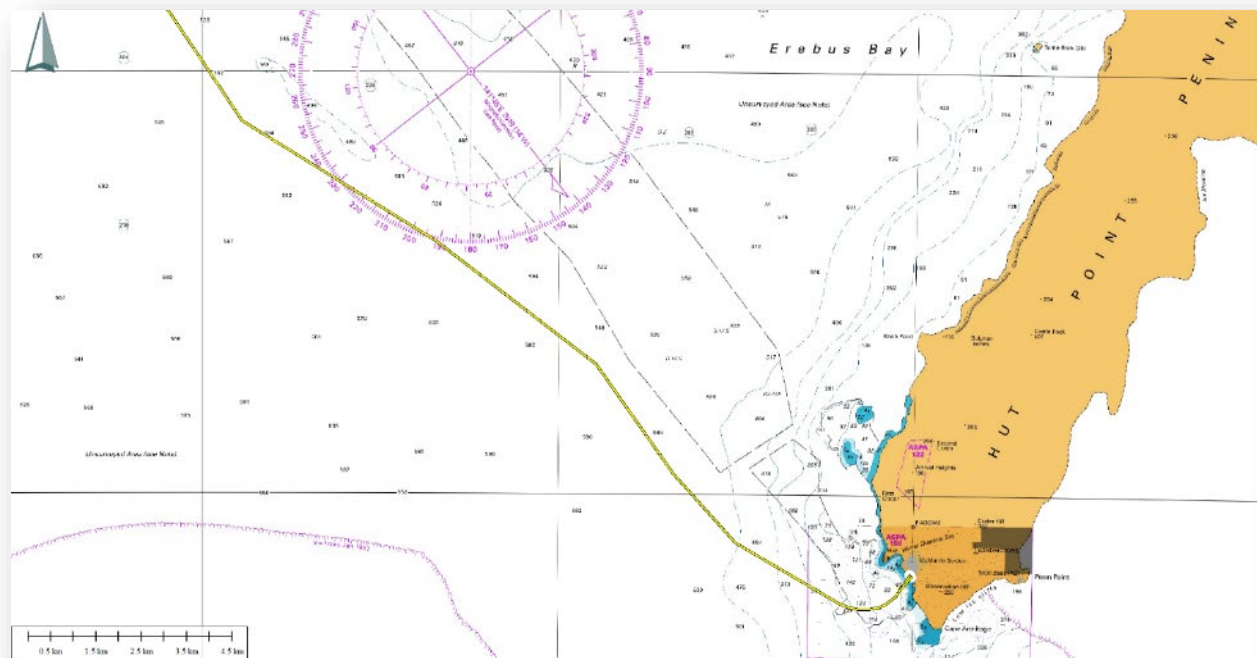

Figure 2-23. Approach to Hut Point Peninsula, Antarctica.

The steep slope to McMurdo Station is helpful in protecting against bergy bits that can calve off the tabular icebergs, limiting the length of cable on the seabed exposed to such a rare event. The HDD exit point is planned for 30 meters water depth (WD) based on McMurdo diver observations that sea and fast ice have not interacted or scarred the seabed in depths of 30 meters. Another positive indicator the ice does not regularly interact with the seabed is the preserved state of the debris field within and south of Winter Quarters Bay. The HDD exit will ultimately be positioned after the results of the cable route survey are analyzed (Figure 2-24). The Antarctic landings do not lend themselves to a direct shore landing, only HDD as the yearly fast sea ice interaction with the shallow depths can damage the cable installation.

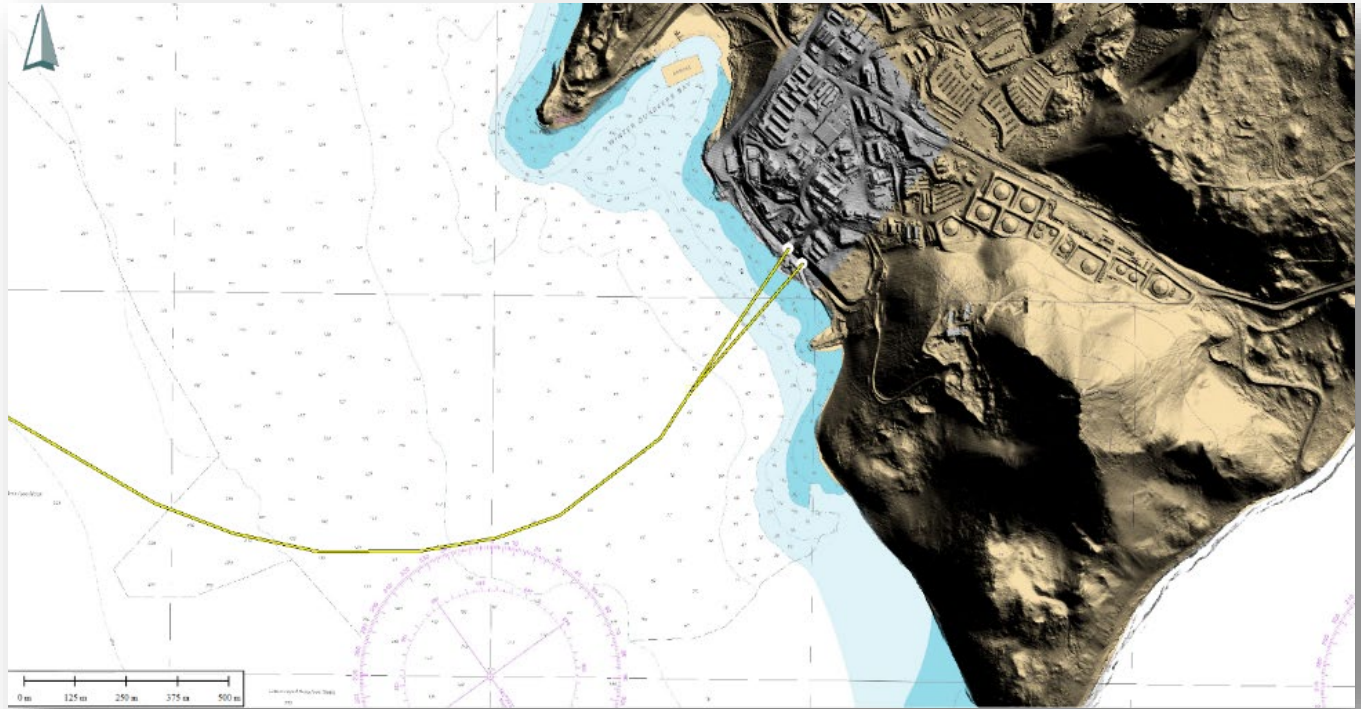

Figure 2-24. Approach to McMurdo Station, Antarctica.

The landing at McMurdo Station is at coordinates 77° 50.93493' S, 166° 39.82901' E, with an elevation of 1.9 meters above MHW. An optional landing point “B” was identified near the primary landing to facilitate an alternate HDD point, BMH, and terrestrial route (Figure 2-25).

The conceptual terrestrial routes outlined in the image below were supplied by NSF Civil operations and depict the use of existing utilidor right-of-way, new utilidor, burial etc. to get to the new data center which is the subsea cable termination point. Terrestrial installations and manhole installations will all follow MCM design procedure and requirements.



*(National Science Foundation, 2022)*

Figure 2-25. McMurdo Landing Site Options "A" and "B". (Notional routes supplied by NSF.)

Ice scouring on the seabed in this area was described by the MCM Dive Operations Manager as not visible in water depths of 30 m or more, however, there are historical photos of icebergs broken off from the main ice shelf which are seen in the landing areas (Figure 2-26). This reinforces the need for a detailed Marine Route Survey in this area and the Ross Sea region. The MRS data will provide the cable engineering group with the information needed to build the proper cable and burial assessment required for this landing. The engineering and design would also impact warranty on the system.



*(NSF/Erin Herd, 2020)*

Figure 2-26 McMurdo Landing Site icebergs.

## 2.5. Invercargill – NZ Cable Protection Zone Recommendation

The New Zealand Ministry of Transport set in place a policy for protecting New Zealand’s undersea cables and pipelines. The submarine cables and pipelines around New Zealand carry their electricity, telecommunications, and energy sources such as oil and gas. These cables are vital to New Zealand’s power and communications systems and to the New Zealand economy. Fishing or anchoring around these cables can potentially cause serious harm to the cables. Even hooking a cable with a fishing line or lightweight anchor can do real damage to a cable’s protective outer layer. Damage to cables creates significant risk of power cuts and telecommunications service outages, which can take a lot of time and be costly, particularly in this geographic region.



Cable Protection Zones (CPZs) were put in place to protect these vital undersea infrastructure systems (Figure 2-27 and Figure 2-28). All anchoring and most types of fishing are banned in CPZs to prevent cable damage. These examples demonstrate what would be recommended in this area by a Marine Route Survey.

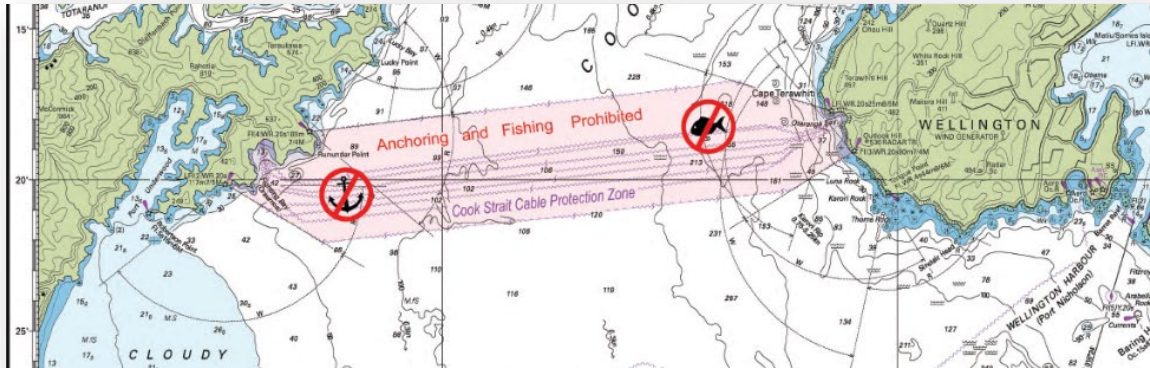

*(Toitū Te Whenua Land Information New Zealand, 2022)*

Figure 2-27. Cable Protection Zones example from Cook Strait Nautical Chart.

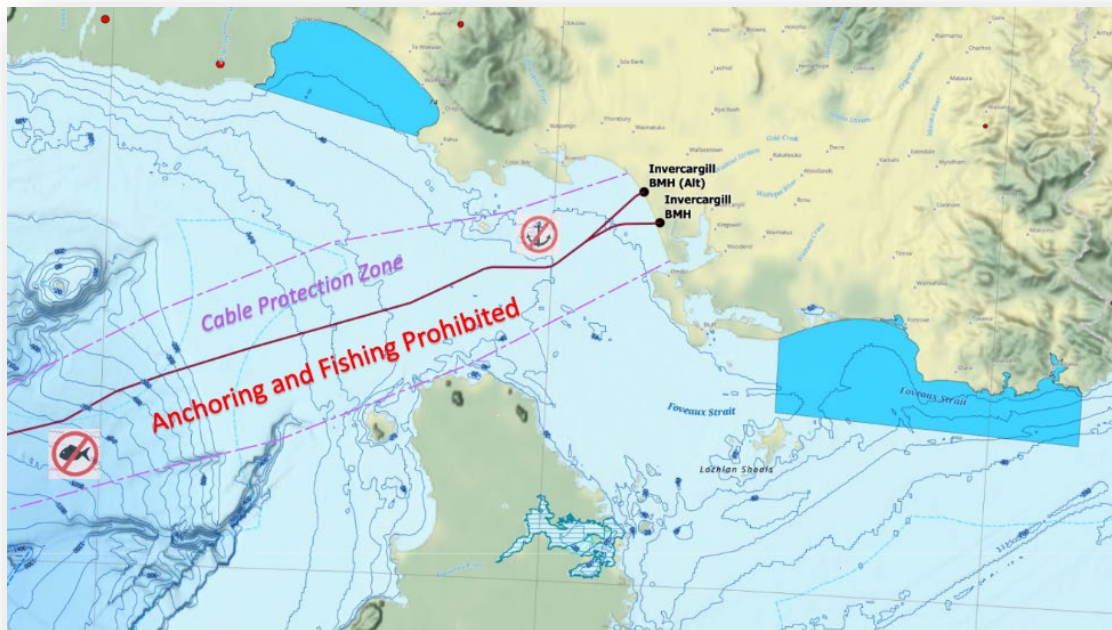

*(Toitū Te Whenua Land Information New Zealand, 2022a)*

Figure 2-28. Cable Protection Zones example from Invercargill Landing and Cable Protection Zone Nautical Chart.



To establish a CPZ, a cable system may apply to the:

Ministry of Transport  
PO Box 3175  
Wellington  
New Zealand

The application must include:

1. Area to be protected
2. Proposed construction of the cable or pipeline
3. Purpose for the cable or pipeline
4. Timeframe for laying the cable or pipeline
5. Consultation you undertook to satisfy the requirements of section 12(2) of the Act

Different types of ships or fishing operations may be eligible for exemptions or variations from the standard prohibitions under the Act. These may arise as a result of consultation with the fishing industry, for example, and you should include these details in your application.

- CPZ information from “Protecting New Zealand's Undersea Cables | Ministry of Transport; New Zealand Ministry of Transport 2020 publication:  
<https://www.transport.govt.nz/about-us/what-we-do/queries/protecting-new-zealands-undersea-cables/>

## 2.6. Sydney Terrestrial Route

While we have identified that there is an existing HDD conduit available, there are no available terrestrial conduits that lead to one of the inland data centers. Therefore, a new terrestrial route will need to be identified and a conduit constructed for this project. The area between the cable beach landings and the data centers is located approximately 8 km inland in a primarily a residential and commercial urban area of Sydney (Figure 2-29).

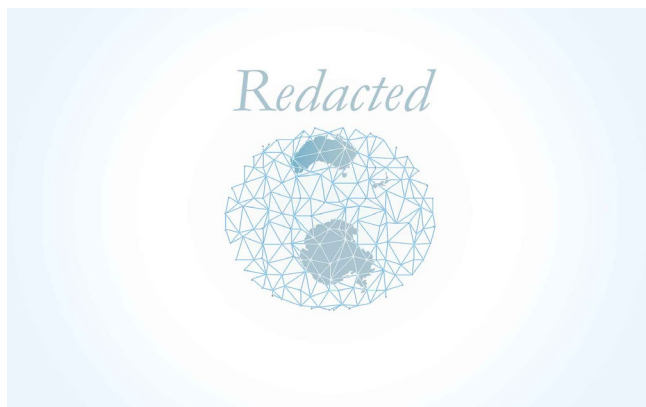

Figure 2-29. [Redacted]. Existing terrestrial route and notional terrestrial route for proposed cable project.





## 2.7. References

- Lewis, K, Nodder, S.D., Carter, L. (2006). Seafloor geology – Active plate boundaries *Puysegur Trench and Solander Trough Perspective* [Photograph]. Te Ara - the Encyclopedia of New Zealand, <http://www.TeAra.govt.nz/en/map/5586/puysegur-trench>
- Map Data [Oreti Beach Closeup]. Google Earth. (2022).  
<https://earth.google.com/web/search/macquarie/@-46.43822354,168.23568004,4.94051867a,611.01065563d,35y,-104.40669318h,57.83058487t,0r/data=CnQaShJECiUweDg5YzZjNjM2ZjE1NmU5YmQ6MHgxZDBiNjl4NjVhYzhIMDM3GejpbX2i-UNAlEVCD86nyVLAKgltYWNxdWFyaWUYAiABliYKJAnz1mwutShHwBFGnlDnPEdHwBnN5iwUyg5IQCFDUWtHtP1kQA>
- Map Data [Oreti Beach]. Google Earth. (2022).  
[https://earth.google.com/web/search/macquarie/@-46.46776982,168.16480929,4.99574376a,24148.52494314d,35y,10.35199021h,38.58639894t,0r/data=CigijgokCfPWbC61KEfAEUaeUOc8R0fAGc3mLBTkDmVAIUNRa0e0\\_WRA](https://earth.google.com/web/search/macquarie/@-46.46776982,168.16480929,4.99574376a,24148.52494314d,35y,10.35199021h,38.58639894t,0r/data=CigijgokCfPWbC61KEfAEUaeUOc8R0fAGc3mLBTkDmVAIUNRa0e0_WRA)
- Map Data [Macquarie]. Google Earth. (2022).  
[https://earth.google.com/web/search/macquarie+island/@-54.49890644,158.93776242,4.30272267a,1073.53466994d,35y,51.40702018h,0t,0r/data=CnsaURJLCiUweGE5MDkxZWJmYmMwOTYwYzE6MHg0OTI2Y2QwNjg0YzYzM3MjZjZGYe9UMB2T0vAlfjetTJh22NAKhBtYWNxdWFyaWUgaXNsYW5kGAEGASImCiQJQnomje\\_5Q0ARXD1dtvL4Q0AZYNmW-xbjUsAhPP3bmkXKUsA](https://earth.google.com/web/search/macquarie+island/@-54.49890644,158.93776242,4.30272267a,1073.53466994d,35y,51.40702018h,0t,0r/data=CnsaURJLCiUweGE5MDkxZWJmYmMwOTYwYzE6MHg0OTI2Y2QwNjg0YzYzM3MjZjZGYe9UMB2T0vAlfjetTJh22NAKhBtYWNxdWFyaWUgaXNsYW5kGAEGASImCiQJQnomje_5Q0ARXD1dtvL4Q0AZYNmW-xbjUsAhPP3bmkXKUsA)
- National Science Foundation. (2022). McMurdo Station [Photographs].
- NSF. 2020. McMurdo landing site icebergs [Photograph]. Heard, E., McMurdo NSF Station Manager.
- The Swim Guide. (2002). Oreti Beach at Dunns Road [Photograph]. Retrieved May 5, 2022, from, <https://www.theswimguide.org/beach/6976>
- Toitū Te Whenua Land Information New Zealand. (2022). Chart NZ 46 Cook Strait. Retrieved August 10, 2023, from, <https://data.linz.govt.nz/layer/51245-chart-nz-46-cook-strait/> (File reference: NZ4601.tif)
- Toitū Te Whenua Land Information New Zealand. (2022a). Electronic Navigational Charts [Basemap]. Retrieved August 10, 2023, from, <https://data.linz.govt.nz/layer/50544-cable-area-polygon-hydro-122k-190k/>



# PERMITTING, RIGHT OF WAY AND REGULATORY REQUIREMENTS





### 3.0 PERMITTING, RIGHT OF WAY AND REGULATORY REQUIREMENTS

This section of the DTS addresses Permitting, Right of Way (ROW), Seabed Occupancy and Regulatory requirements related to the design, installation, and maintenance of an SFOC system. These matters require a great deal of upfront information collection, which must be further validated through detailed fieldwork, before submission to the relevant authorities.

Section 3.0 of the DTS describes the processes and regulatory requirements for this information gathering to ensure proper permitting planning and authorizations for the proposed SFOC. This section is intended to present preliminary information to guide project development for future research, field work and investigations including but not limited to the Permitting Feasibility Study (PFS) and Marine Route Survey (MRS). Section 3.0 is structured according to the proposed DTS route by country (i.e., Australia, New Zealand, Antarctica), by landings by country or continent, and then any sub-jurisdiction requirements.

**NOTE: To apply for any of the authorizations and permits outlined in Section 3.0, a Permitting Feasibility Study should be conducted to confirm exact requirements for permitting and authorizations for the proposed Submarine Fiber Optic Cable.**

**In addition, a Marine Route Survey must be completed to supply information for the various environmental assessments and cable installations for each jurisdiction. Landings and installations have requirements to receive authorizations, permits, and permissions to design, install, operate, and maintain a Submarine Fiber Optic Cable system which are identified and confirmed in a Permitting Feasibility Study.**



*A decorative view of Australia, New Zealand, and surrounding islands.*

### **3.1. Australia**

SFOC system planning, installation, and operation requires various forms of approvals from Australian, State, and local level government agencies. Additionally, key stakeholders, such as third-party marine and seabed users, need to be notified of the proposed activity.

The following sections describe each of the relevant permits and approvals required for the installation of the Australian component of the SFOC. The following information has been provided to NSF for each required permit:

- Permit name/description/activity
- Permit granting authority and point of contact details
- Estimated time for activity or permit approval
- Supporting documents required for application submission
- Dependencies (list of predecessor permits)
- Estimated costs and fees

Permits and approvals required for the installation and operation of an SFOC project include the four key categories of information listed below, and are explained in the corresponding sections:

- 3.1.2 Cable carrier/operator license
- 3.1.3 Terrestrial and marine environmental assessment
- 3.1.4 Terrestrial cable system installation
- 3.1.5 Marine and seabed user agreements.



The permits and permissions required for the cable landings in Australia, including the Sydney and Macquarie Island, are summarized in Figure 3-1, Figure 3-2, Figure 3-3, and Figure 3-4.

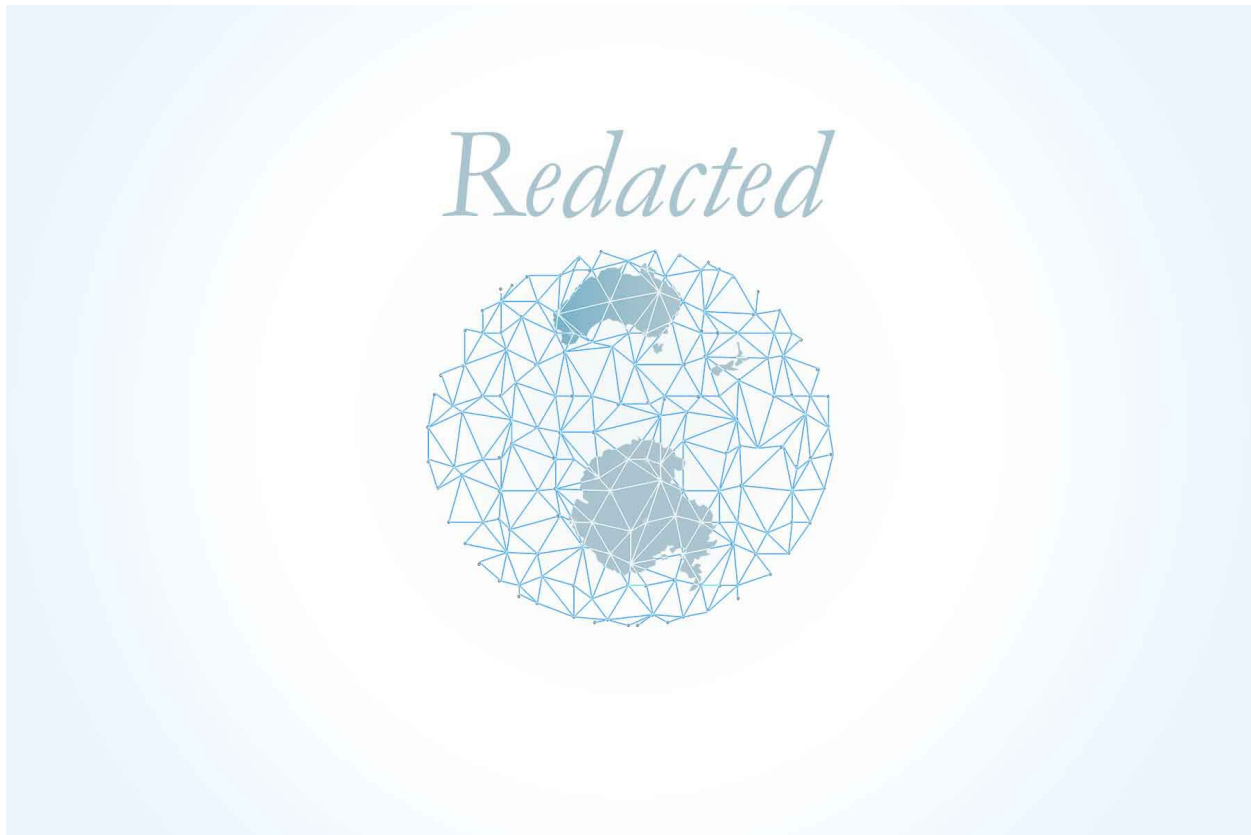

Figure 3-1. [Redacted]. Sydney Permitting Requirements.

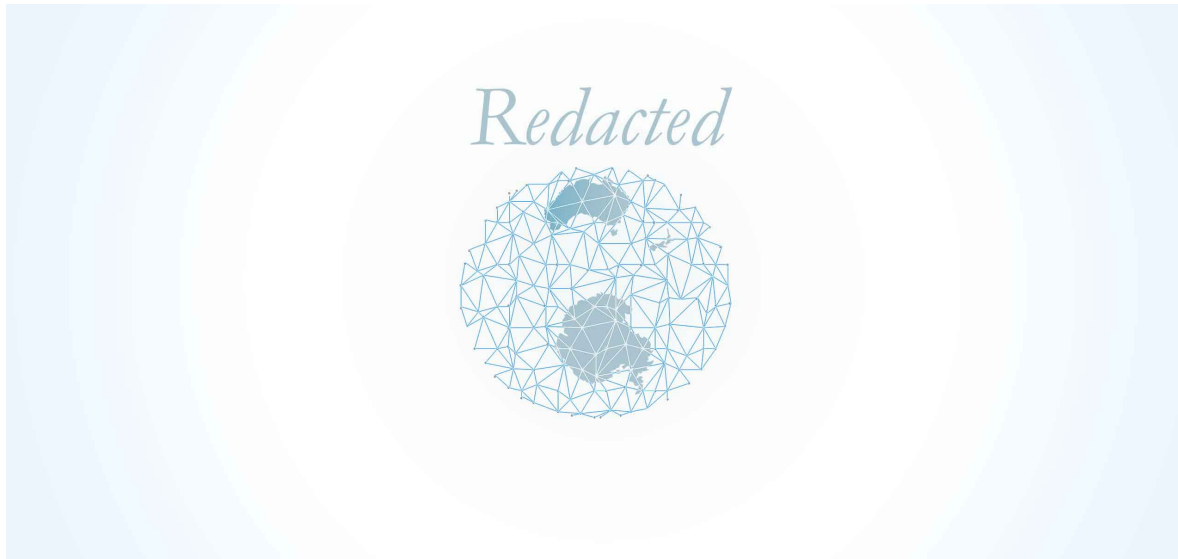

Figure 3-2. [Redacted]. Sample Sydney Excel Permit Matrix

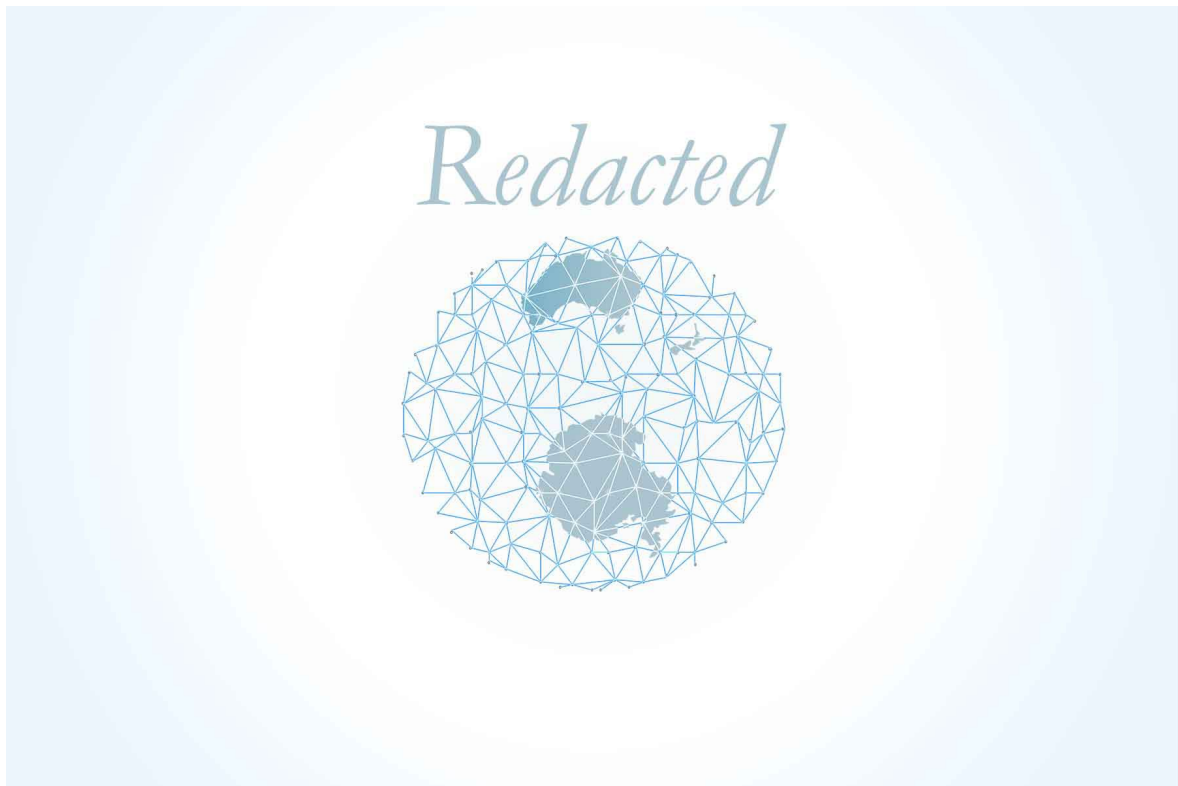

Figure 3-3. [Redacted]. Macquarie Island Permitting Requirements.



Figure 3-4. [Redacted]. Sample Macquarie Excel Permit Matrix.

### 3.1.1. Maritime Boundaries

The permitting process begins by having a thorough grasp of maritime boundaries. For a project of this size, where boundaries traverse multiple countries and continents, it is essential to maintain detailed maps and take note of all legislation that governs those areas. This will include national and international regulations – the origins of which may span decades to more than one hundred years.

**International:** The United Nations Convention on the Law of the Sea (UNCLOS) established the framework for the territorial sea baseline and maritime zone boundaries and created rules that must be followed by all member countries regarding maritime boundaries, access to the various marine zones, and management of resources and activities within those boundaries. The Convention was ratified by Australia in 1994.

**National:** Delineation of Australia’s maritime boundaries is managed by Geoscience Australia (<https://www.ga.gov.au/scientific-topics/marine/jurisdiction/australia>).

Australia’s maritime zones are shown in Figure 3-5 and the relationship between the zones are shown in Figure 3-6.

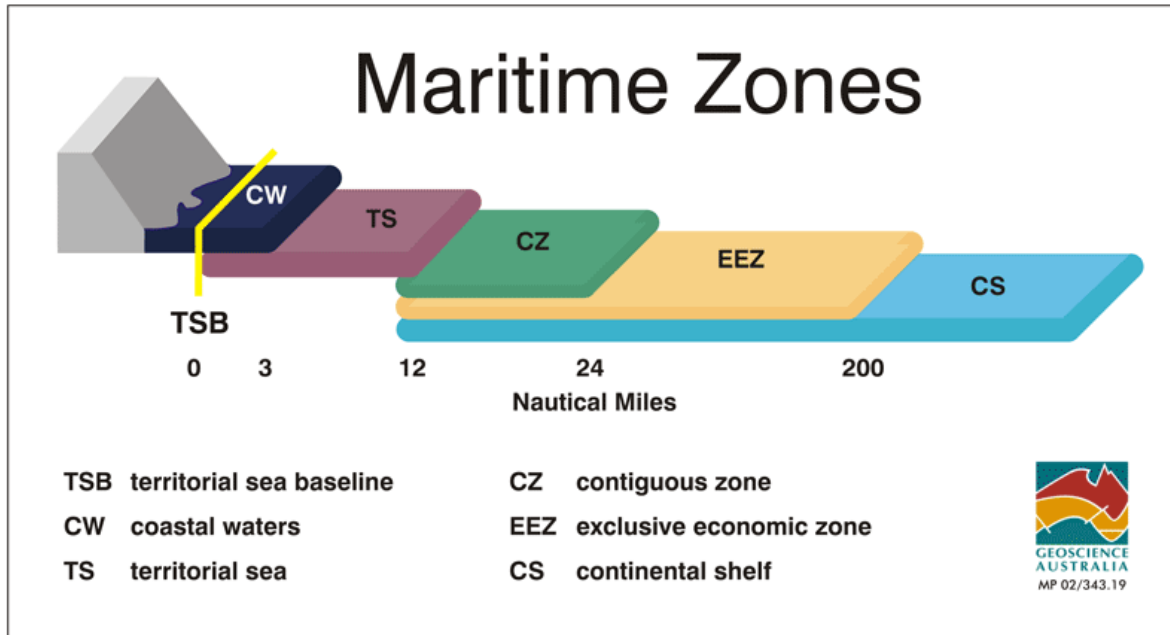

(Geoscience Australia)

Figure 3-5. Australia’s Maritime Boundary Zone Definitions.

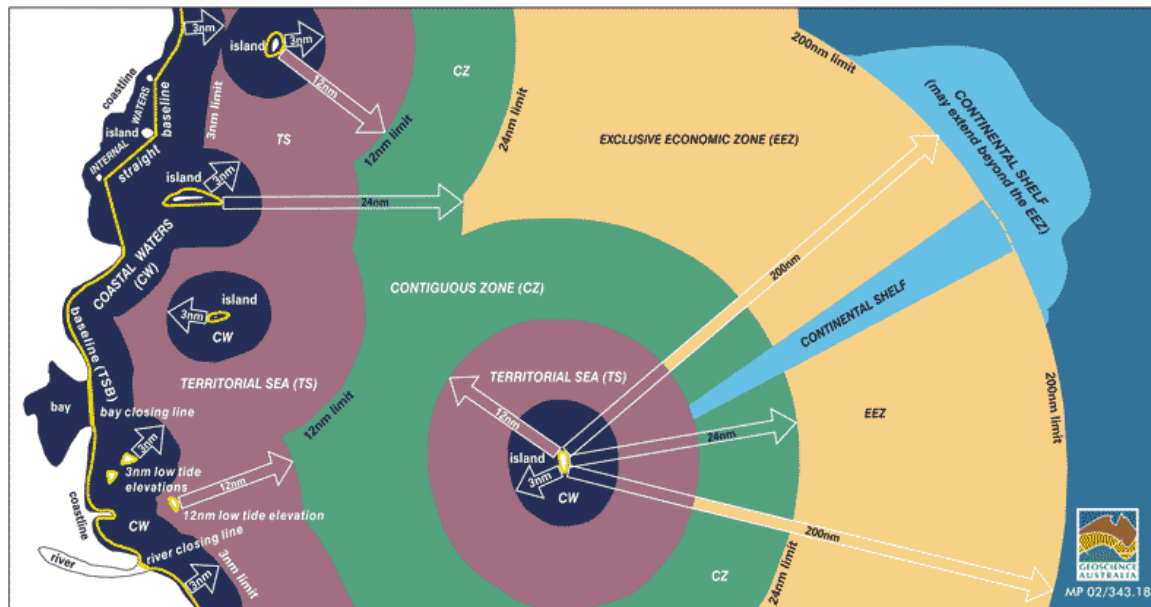

(Geoscience Australia)

Figure 3-6. Australia’s Maritime Features, Limits and Zones.

Domestically, the *Seas and Submerged Lands Act 1973* declares Commonwealth sovereignty over the Territorial Sea (TS) and certain Commonwealth rights in respect of the Contiguous Zone (CZ),





Hydrographic charts, upon which the territorial sea baseline along the coast is based, is Lowest Astronomical Tide (LAT).

### **3.1.2. Cable Carrier and/or Operator License**

A carrier license under the Commonwealth Telecommunications Act 1997 is required prior to the installation of the SFOC that connects to Australia. The act is governed by the Australian Communications and Media Authority (ACMA). Any carrier who intends to install a submarine cable in Australian waters must apply for a permit from ACMA.

Under the act, and in accordance with ACMA, installation of submarine cables requires an environmental assessment to be undertaken unless the installation is exempt. As existing BMH and HDD facilities will be used for the project, the low impact installation (as defined in subclause 6(3) of Schedule 3 of the act and Telecommunications (Low-impact Facilities) Determination 2018) does not require an environmental assessment.

The Sydney landing site is located within the designated Southern Sydney Protection Zone which recognizes submarine communications cables as nationally important infrastructure and aims to protect them from human interferences. A Protection Zone permit application to the ACMA will be required under the Telecommunications Act 1997.

In summary,

- Apply for Carrier License from the ACMA
- Requires environmental assessment unless exempt
- Requires Cable Protection Zone permit from ACMA

### **3.1.3. Terrestrial and Marine EA**

The following regulatory approvals are required for the installation of an SFOC system in Australia and its territories, particularly for the branching unit to Macquarie Island.

#### ***Commonwealth Environment Protection and Biodiversity Conservation Act 1999***

The project will require referral to the Australian Government Department of Agriculture, Water, and the Environment (DAWE) under the Environment Protection and Biodiversity Conservation Act 1999 (EPBC Act). This Act governs the protection of the environment, including Matters of National Environmental Significance, such as Commonwealth-listed threatened and migratory species and Commonwealth marine parks.

To determine whether a proposed activity requires assessment and approval under the EPBC Act, a referral must be submitted to the Commonwealth Minister for the Environment via the



online portal. Following a period of public exhibition of the referral, the Minister or her delegate will determine whether the proposed activity is a ‘controlled action’ and requires assessment under the EPBC Act or ‘not a controlled action.’

A pre-lodgment meeting with DAWE and desktop biological study (terrestrial and marine aspects) will need to be completed prior to submission of the referral. Following acceptance of the referral, DAWE has 20 business days to determine whether the action is a ‘controlled action’ or ‘not a controlled action.’ If the Minister or her delegate determines the action is a controlled action, then a determination will need to be made on the level of assessment required to address potential significant impacts on affected Matters of National Environmental Significance.

### *EA Under Commonwealth and State Legislation*

Submarine and onshore telecommunication cables are exempt from Commonwealth and State government planning approval under certain circumstances. The activities must be low impact and not in an environmentally sensitive area as defined in the relevant legislation and planning policies.

An environmental impact assessment will be required to determine whether the proposed activities will or will not have a significant impact on environmentally sensitive areas and associated environmental values.

Terrestrial and marine surveys will be required to determine the presence of environmentally sensitive species and areas along the entire proposed SFOC route. Findings from the terrestrial and marine surveys will inform the environmental impact assessment which will be provided to Commonwealth and State government agencies to inform their decisions.

The proposed SFOC will traverse environmentally sensitive areas on the Macquarie Island segment defined in relevant Commonwealth and State legislation and planning policies, including Macquarie Island World Heritage Area (Cwlth), Macquarie Island Marine Park (Cwlth) and Macquarie Island Nature Reserve (Tas). Bilateral agreements between the Commonwealth and State governments allows for a single assessment process considering impacts on matters of national and state environmental significance. A bilateral agreement is currently in place between the Australian and Tasmanian governments and could be applied to the project, if the Australian Government determines this is the most efficient approvals pathway and that impacts on the Commonwealth marine area can be adequately addressed by that process. If the Australian Government does not support use of the bilateral agreement for the Commonwealth marine area, separate environmental assessments will be required, i.e., one under the EPBC Act and one under relevant Tasmanian legislation. Preparation of an environmental assessment can take between 9 and 12 months to complete, in addition to regulatory decision periods.



### *Tasmanian National Parks and Reserves Management Act 2002*

The Macquarie Island Nature Reserve covers the entire island and up to 3 nautical miles (5.5 km) offshore. Any proposed developments within this area must comply with the Tasmanian National Parks and Reserves Management Act 2002 and Macquarie Island Nature Reserve and World Heritage Area Management Plan 2006.

Under the Act, the project will be subject to the Reserve Activity Assessment (RAA) process to determine whether the proposed activities will impact environmentally significant species or areas. A meeting with representatives from Tasmania Parks and Wildlife Services will be required to determine the applicable level of assessment. The RAA will assess potential impacts from installation of the SFOC, as well as seek approval for entering the Macquarie Island Marine Park.

Terrestrial and marine surveys will be required to inform the RAA process. Depending on the level of assessment required, the approval process may take between 4 and 18 months. The RAA process could be completed under a bilateral agreement with the Australian Government as a single consolidated impact assessment.

### *Other Relevant Legislation*

Table 3-1 provides a summary of additional Commonwealth and State legislation that should be considered as part of the installation of the proposed SFOC.

**Table 3-1. Other Relevant Legislation Considered**

Legislation	Relevance to the project
Commonwealth Historic Shipwrecks Act 1976	This purpose of this act is to preserve and protect historic wrecks and relics in Australian waters. No historic wrecks were identified along the cable route. Any wrecks identified during marine surveys would be under the jurisdiction of this act.
Commonwealth Native Title Act 1993	This act recognizes the land rights of the Indigenous persons of Australia. No native title applications or determinations exist along the cable route.
Defense Force Regulations 1952	This act outlines the regulations relating to Australia’s military interests. As described in this act, the Australian Department of Defense must be notified of intent to enter any Defense training areas, including vessel movements.
NSW Coastal Protection Act 1979	This act includes provisions for the use and occupation of the coastal region in New South Wales. As existing BMH and HDD facilities will be used for this project, installation of the SFOC is exempt from further assessment under this legislation based on other SFOC projects’ experience.
NSW Environmental Planning and Assessment Act 1979	The objective of this act is to preserve the environmental values within New South Wales. As existing facilities will be used for this project, no further approvals are required under this act.



Legislation	Relevance to the project
NSW State Environmental Planning Policy Infrastructure 2007	The purpose of this policy is to streamline the planning and processing in New South Wales. Telecommunication facilities are covered by this policy and are exempt from development applications.

In summary,

- Referral submitted to Commonwealth Minister for the Environment via the online portal.
- Pre-lodgment meeting with DAWE and Desktop Biological Study prior to Referral submission.
- Environment impact assessments (9-12 months), terrestrial and marine surveys must be completed in advance to inform agencies for decisions.
- Reserve Activity Assessment (RAA) – meetings, terrestrial and marine surveys.
- Shipwrecks identified.
- Indigenous persons rights cannot be infringed along route.
- Notification to Defense.

### 3.1.4. Terrestrial Cable System Installation

The following permits and approvals may be required for the installation of the terrestrial cable route.

#### *Road occupancy license under the NSW Roads Act 1993*

Where terrestrial cable installation locations occupy traffic lanes or footpaths of arterial roads, a Road Occupancy License (ROL) is required. The license is issued by the relevant road authority to allow the works to be undertaken in a safe manner. A traffic control plan will need to be prepared prior to commencement of works to manage potential disruptions to traffic, pedestrian and cyclist movements. An allowance of 10 business days should be included for this process.

#### *Ground excavations*

Prior to any ground disturbance works, a Dial Before You Dig search needs to be completed to identify any underground services and infrastructure. An allowance of two business days should be included to receive results.



### *Consultation with Randwick City Council*

In accordance with the Local Environment Plan, prior to any ground disturbance works the relevant local government should be consulted. For this project, Randwick City Council should be notified of the proposed activities, including intent to access the existing BMH at Clovelly and construction works along the terrestrial cable route.

In summary,

- Road Occupancy License (ROL) based on traffic control plan
- Dial Before You Dig search
- Notification of Randwick City Council

### **3.1.5. Marine and Seabed User Agreements**

Where applicable, agreements should be established between NSF and other marine and seabed users for the completion of marine surveys and marine cable installation. Within the Southern Sydney Protection Zone, a proponent must notify other cable owners no later than 21 days before the proposed activity (i.e., marine survey, cable installation).



### 3.1.6. Australia References

- Balazh, A. Earth at night and the light of cities. Australia and New Zealand [Photograph]. Adobe Stock #272806518. [https://stock.adobe.com/images/earth-at-night-and-the-light-of-cities-australia-and-new-zealand/272806518?prev\\_url=detail](https://stock.adobe.com/images/earth-at-night-and-the-light-of-cities-australia-and-new-zealand/272806518?prev_url=detail)
- DPIE. (2021). New South Wales rock units. Geological Survey of New South Wales, Department of Regional NSW, Maitland. Accessed 2022 from <https://search.geoscience.nsw.gov.au/product/9232>
- Esri. (2022). ArcGIS Desktop: Release 3.0. Redlands, CA: Environmental Systems Research Institute. [Data source for many GIS maps]
- Geoscience Australia. (2013a). Maritime Zones Australia. Retrieved August 8, 2023 from [https://commons.wikimedia.org/wiki/File:Maritime\\_zones\\_Australia.gif](https://commons.wikimedia.org/wiki/File:Maritime_zones_Australia.gif). Image is licensed under the Creative Commons Attribution 3.0 Australia license. No changes were made from original file.
- National Institute of Water & Atmospheric Research, Ltd. (NIWA). (2016a). New Zealand Bathymetry. Sourced from surveys by NIWA and Land Information New Zealand (LINZ). Mitchell, J.S., Mackay, K.A., Neil, H.L., Mackay, E.J., Pallentin, A., Notman P., 2012. Undersea New Zealand, 1:5,000,000. NIWA Chart, Miscellaneous Series No. 92.
- NIWA. (2016b). New Zealand Contours. Sourced from surveys by NIWA and Land Information New Zealand (LINZ). Retrieved August 29, 2023 from [https://dc.niwa.co.nz/niwa\\_dc/srv/api/records/a883d5f5-5b60-1b5d-a159-50b99134a5a7](https://dc.niwa.co.nz/niwa_dc/srv/api/records/a883d5f5-5b60-1b5d-a159-50b99134a5a7)
- Michael, K.P., Forman, J., Hulston, D., Bilewitch, J., & Moss, G. (2019). Foveaux Strait oyster and Bonamia surveys, February 2017. New Zealand Fisheries Assessment Report 2019/46, September. <https://www.mpi.govt.nz/dmsdocument/37008/direct>. Source: Ministry for Primary Industries and licensed by MPI for re-use under the Creative Commons Attribution 4.0 International license. No changes were made from original file.
- Parmelee, D.E., Kyle, P.R. Kurz, M.D. Marrero, S.M. & Phillips, F.M. (2015). A new Holocene eruptive history of Erebus volcano, Antarctica using cosmogenic <sup>3</sup>He and <sup>36</sup>Cl exposure ages. *Quaternary Geochronology*, 30(Part A): 114-131. <https://doi.org/10.1016/j.quageo.2015.09.001>



*A decorative view of New Zealand.*

### 3.2. New Zealand

The likely permitting steps and requirements for the Invercargill landing (terminating at the beach manhole) can be summarized as follows:

- **Coastal Permit:** Obtained via Resource Consent granted by Environment Southland (in accordance with requirements of Regional Coastal Plan and Southland Land and Water Plan). Anticipated timeframe of 30 days for decision from Council regarding application, assuming application contains all necessary information. This process may take longer however, due to sensitivities and the need for engagement between various Territorial Authorities. A conservative timing estimate would be three months.
- **Land use Permit:** Obtained via Resource Consent granted by Invercargill City Council (in accordance with requirements of District Plan). Anticipated timeframe of 20 days for decision from Council regarding application, assuming application contains all necessary information.

The relevant consent applications to each of the relevant Territorial Authorities can be submitted simultaneously; it is likely that the regulators will consult one another regarding the project.

- Submission of documentation to EPA regarding matters in the EEZ (at least 40 days before the activity occurs, and then following completion of activity).

- Consultation with various stakeholder groups e.g., Iwi. (at least 25 days before the activity occurs in terms of the EPA requirements in the EEZ; the views expressed by Iwi groups must accompany the application for Resource Consent, therefore consultation is to occur prior to submission of the application).

The permitting summary is provided in Figure 3-7 and the detailed permitting matrix is provided in Figure 3-8. The permitting and regulatory process is described in the sections below.

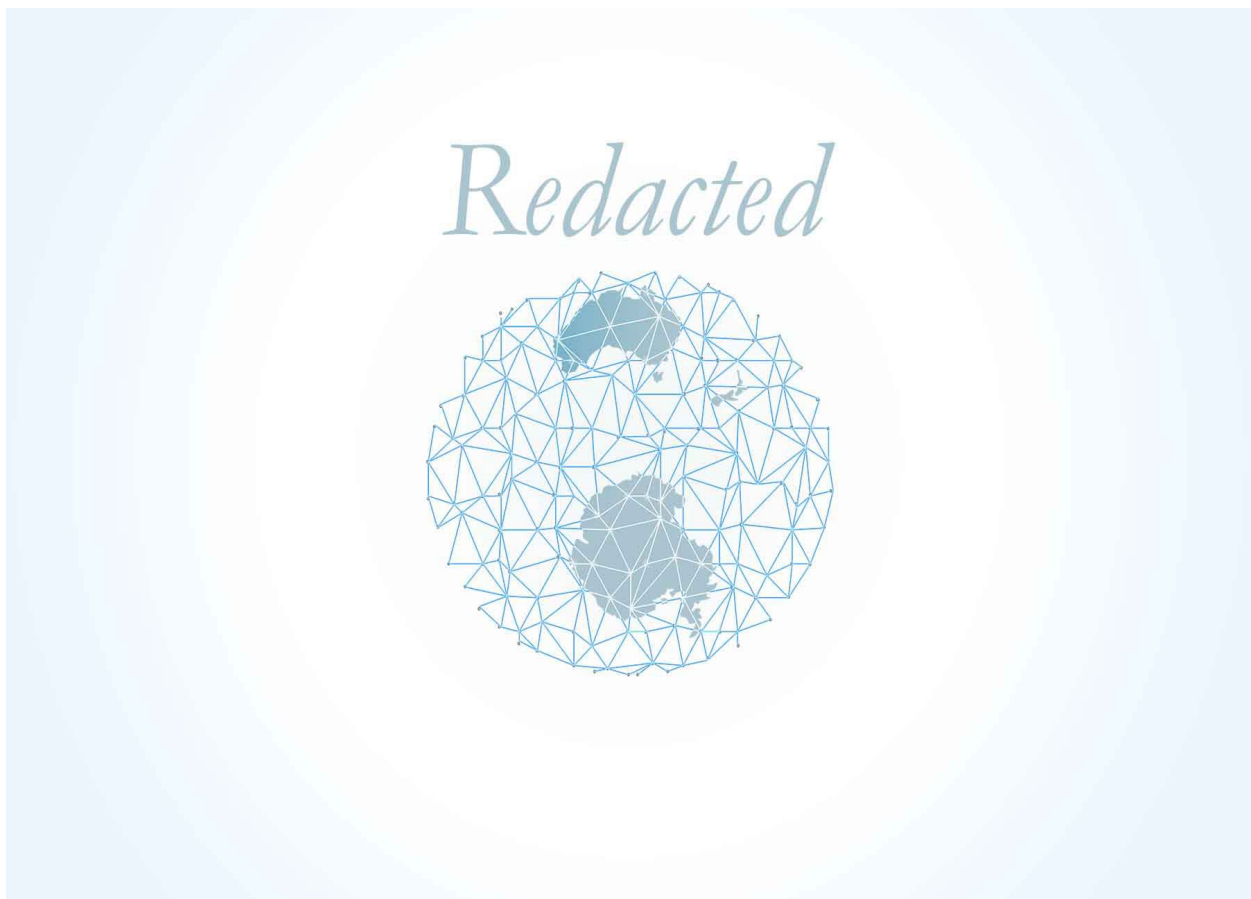

Figure 3-7. [Redacted]. New Zealand Permitting Summary.



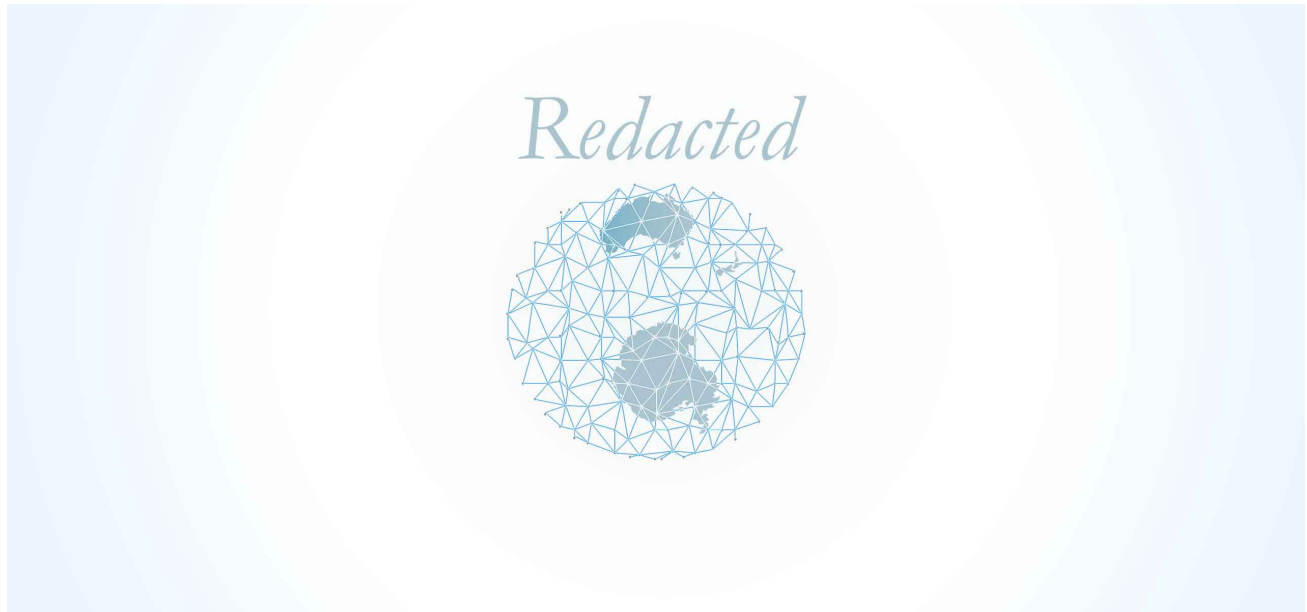

Figure 3-8. [Redacted]. Sample New Zealand Excel Permit Matrix.

### 3.2.1. New Zealand Maritime Zones

The proposed SFOC traverses all recognized maritime zones of New Zealand. Consequently, the project planning, installation, and operation process requires consideration, notification and approvals procedures from various government agencies and related entities to be completed. Additionally, notice and consultation with other stakeholders and interested third parties regarding development works and resource access, if any are present along the planned cable route, must be made. These procedures are outlined further below.

Under the United Nations Convention on the Law of the Sea (UNCLOS), there are various maritime zones defined generally by their distance from the land, but more precisely, as their distance from the Territorial Sea Baseline (TSB). New Zealand ratified UNCLOS in 1996.

New Zealand's main maritime zones are shown in Figure 3-9 and are described in the ensuing sections.

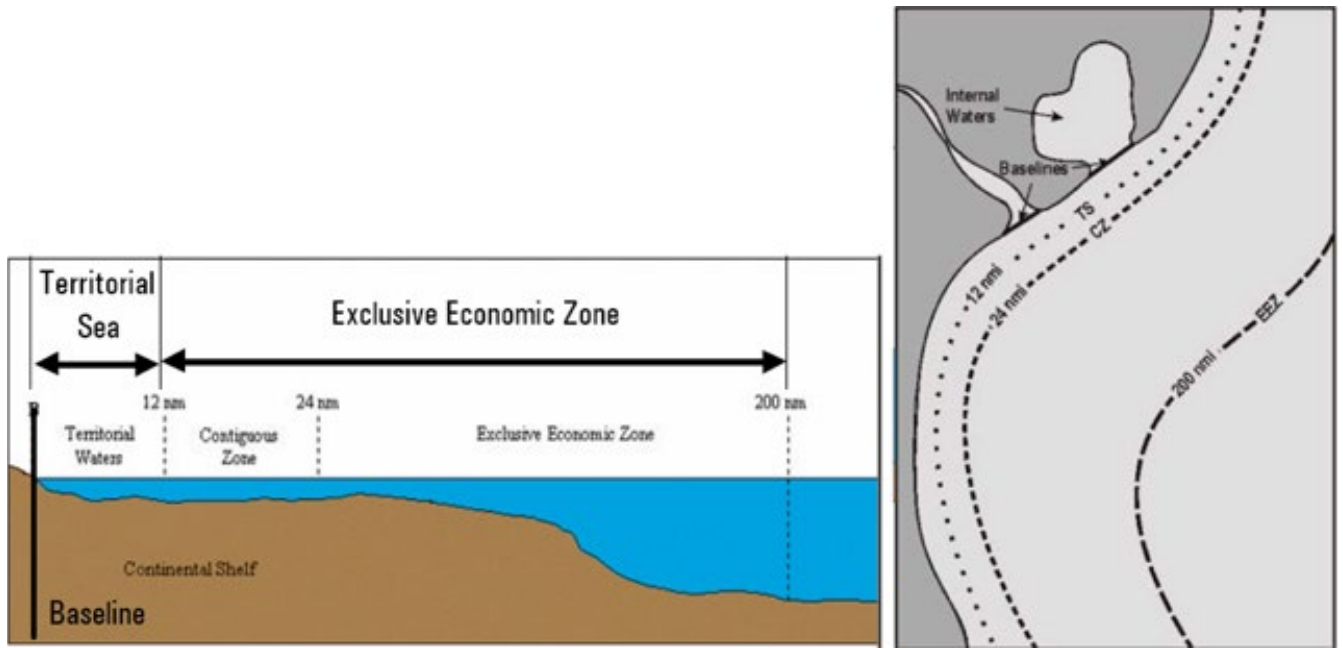

(Toitū Te Whenua LINZ, n.d)

Figure 3-9. New Zealand Maritime Zones

### *Inland Waters Landward of the Baseline*

The internal waters are all those areas of the sea that are on the inside of New Zealand, including any areas of the sea that are on the landward side of the baseline of the territorial sea of New Zealand.

### *Territorial Sea Baseline -12 Nautical Miles*

The Territorial Sea is an area of water not exceeding 12 nautical miles (1 nautical mile is equal to 1,852 meters) in width which is measured seaward from the territorial sea baseline. The territorial sea is part of New Zealand’s sovereign territory. The government’s power to govern this marine area is the same as on land, although other states have rights established under international law, such as ‘innocent passage’ of their vessels.

### *Contiguous Zone 12-24 Nautical Miles*

The contiguous zone lies on the seaward side of the territorial sea, extending from 12 to 24 nautical miles from the low-water mark. It overlaps with the EEZ. This is not part of New Zealand’s territory. Under UNCLOS, in addition to the rights New Zealand has in this area as part of the EEZ, New Zealand has the right to police the area to prevent or punish infringements (of customs, fiscal, immigration or sanitary laws and regulations) in its territory or territorial sea.



### *Exclusive Economic Zone (EEZ) 12-200 Nautical Miles*

The EEZ is an area of sea beyond and adjacent to the territorial sea. The outer limit of the Exclusive Economic Zone cannot exceed 200 nautical miles from the territorial sea baseline. Where the New Zealand EEZ abuts the maritime zone of another nation, a median line between the nations is agreed. The EEZ is not part of New Zealand's territory, but under UNCLOS, New Zealand has sovereign rights for the purpose of exploring, exploiting, conserving, and managing all of its living and non-living natural resources. These resources include marine life, oil, gas and minerals and energy produced from water, currents, and winds. Other countries retain the freedom of navigation and over-flight and can lay submarine cables and pipelines within New Zealand's EEZ.

### *Continental Shelf 12-350 Nautical Miles*

Continental shelf refers to the seabed and subsoil of those submarine areas that extend beyond the territorial limits of New Zealand, throughout the natural prolongation of the land territory of New Zealand, to the outer edge of the continental margin, or to a distance of 200 nautical miles from the baselines from which the breadth of the territorial sea is measured (as described in Sections 5 and 6 [and 6A] of the Territorial Sea and Exclusive Economic Zone Act 1977) where the outer edge of the continental margin does not extend to that distance. The continental shelf is essentially the area that surrounds a landmass where the sea is relatively shallow compared to the open ocean. It is geologically part of the land, and, under international law, a state has exclusive rights over the non-living resources (e.g., minerals) and sedimentary species (e.g., oysters and sponges) in and on the seabed.

### *Beyond the Continental Shelf*

The seabed and subsoil beyond the continental shelves of New Zealand and other countries is called 'The Area.' The water column outside the territorial sea and EEZ of New Zealand and other countries is the high seas. All states have 'freedom of the high seas' which includes freedom of navigation, overflight, laying cables and pipelines, constructing artificial installations, fishing, and scientific research. This is not owned by any particular country but vested in humankind as a whole and administered by the International Seabed Authority. No state can claim or exercise sovereignty or sovereign rights over the Area.

## **3.2.2. Permitting Summary**

The permitting process to land a submarine cable in New Zealand centers primarily on the Resource Management Act 1991 (RMA), which is the primary national environmental management legislation. The RMA is available at: <https://legislation.govt.nz/act/public/1991/0069/latest/DLM230265.html>. Territorial Authorities



(which include city, regional, district and unitary authorities) administer the RMA and control which activities are permitted, which can be permitted through resource consent, and which activities are prohibited. The resource management rules differ between districts and regions. With 11 regional councils, 61 city or district councils, and six unitary councils in New Zealand, it is best not to assume that because a consent wasn't needed in one town, that one won't be needed in another. There are also differences within a city, district, or region.

In the Southland region of New Zealand, the Territorial Authorities include Environment Southland Regional Council (Environment Southland), Invercargill City Council and Southland District Council. Territorial Authorities are generally responsible for various aspects of resource management including roading, agriculture, reserves, waste management, water management, building consents and land use and subdivision. These entities also have relationships with Iwi and other government and community organizations. These Territorial Authorities oversee certain aspects of the resource consent process, which is the process of obtaining permission for an activity that might affect the environment that isn't already allowed for in the relevant management plans that apply in the jurisdictional area.

The Environment Southland, Invercargill City Council regulatory processes, as well as the Environmental Protection Authority (EPA) requirements for projects located in New Zealand's Exclusive Economic Zone, are described further in the following sections.

### 3.2.3. Resource Management Act 1991

The purpose of the Resource Management Act 1991 (RMA) is to promote the sustainable management of natural and physical resources. The RMA requires that all persons exercising functions and powers under it, in relation to managing the use, development, and protection of natural and physical resources, shall:

- Recognize and provide for the specified matters of national importance listed in Section 6.
- Have particular regard to the other matters listed in Section 7.
- Take into account the principles of the Treaty of Waitangi (Te Tiriti o Waitangi).

Under Sections 13, 14 and 15 of the RMA, many activities involving the beds of lakes and rivers, water or water bodies, and the discharge of contaminants into water can only occur if they are expressly allowed by a rule in a regional plan, or by a resource consent. Section 30 of the RMA gives regional councils specific functions relating the control of the use of any land (including the beds of lakes and rivers) for the purposes of soil conservation, water quality, water quantity and the maintenance of ecosystems in water bodies, and the avoidance or mitigation of natural hazards. Regional councils also have functions relating to controlling the planting of plants in the beds of lakes and rivers, the maintenance of indigenous biological diversity and the integration

of strategic infrastructure and land use.

The RMA is the main law governing how people interact with natural resources. As well as managing air, soil, freshwater and the coastal marine area (to the 12 nautical mile Territorial Sea jurisdiction limit), the RMA regulates land use and the provision of infrastructure, which are integral components of New Zealand's resource management system.

People can use natural resources if doing so is allowed under the RMA or permitted by a resource consent. A resource consent is permission from the local council for an activity that might affect the environment, and that isn't allowed 'as of right' in the district or regional plan.

The RMA classifies activities into six classes: permitted, controlled, restricted discretionary, discretionary, non-complying and prohibited. These different classes determine aspects such as whether a resource consent is required before carrying out the activity, what will be considered when making a decision on a resource consent application and whether a resource consent must, may or may not be granted. Rules in regional and district plans determine within which category an activity falls.

- **A restricted discretionary activity** must comply with any requirements, conditions and permissions specified in the RMA, regulations or relevant plan and requires a resource consent before it can be carried out. Council can exercise discretion as to whether or not to grant consent, and to impose conditions, but only in respect of those matters over which it has restricted its discretion in the plan or over which discretion is restricted in national environmental standards or other regulations.
- **A permitted activity** may be carried out without the need for a resource consent so long as it complies with any requirements, conditions and permissions specified in the RMA, in any regulations, and in any applicable plans or proposed plans.

#### 3.2.4. The Role of Councils

There are currently 11 regional councils in New Zealand with boundaries broadly coinciding with water catchment areas. The Local Government Act 2002 requires that regional councils have a key role under the RMA, which charges them with the integrated management of the natural and physical resources of a region. A district in New Zealand is a territorial authority area governed by a district council as a second tier of local government in New Zealand, below regional councils.

Regional councils are responsible for the administration of many environmental and public transport matters, while the district councils administer local roads and reserves, sewerage, building consents, the land use and subdivision aspects of resource management, and other local matters.



Under Section 67(3) of the RMA, a regional plan must give effect to any operative national policy statement. There are currently four operative National Policy Statements and one operative New Zealand Coastal Policy Statement:

- National Policy Statement for Freshwater Management 2014 (as amended in 2017)
- National Policy Statement for Renewable Electricity Generation 2011
- National Policy Statement on Urban Development Capacity 2016
- National Policy Statement on Electricity Transmission 2008
- New Zealand Coastal Policy Statement 2010

Making decisions under the RMA is usually the responsibility of Territorial Authorities, i.e., regional and district/city councils, in their role of consent authorities. They do this through regional policy statements, plans, and resource consents. There are five types of resource consent: Land-use consent, Subdivision consent, Coastal permit, Water permit, Discharge permit.

Regional Councils are generally responsible for environmental and public transport matters. Regional Councils prepare regional policy statements and regional plans to assist the Council to carry out its functions under the RMA which include:

- Integrated management of the natural and physical resources of the region
- Ensuring there is sufficient development capacity in relation to housing and business land
- Soil conservation
- Water quality and quantity (freshwater and seawater)
- Air, water, and land pollution
- Biodiversity conservation
- Marine and freshwater ecosystems
- Natural hazards (avoidance and mitigation)
- Contaminated land (identification and monitoring)
- Activities in the coastal marine area (in conjunction with the Minister of Conservation)
- Introduction of plants into water bodies
- Allocation of water (freshwater and seawater) and contaminant discharge capacity
- Strategic integration of infrastructure with land use

Regional Councils also have a general duty to monitor *inter alia* the state of the environment of the region, the efficiency and effectiveness of policies and methods in policy statements and



plans and the exercise of resource consents within the region. Regional Councils must also make available to the public information enabling the public to be better informed about the role of the council and information enabling the public to participate effectively under the RMA. The proposed cable site is in the Southland region of the South Island and the Southland Regional Council holds regulatory authority, along with the Southland District Council and Invercargill City Council.

### *Southland Regional Council (Environment Southland)*

The Environment Southland [plans page](#) lists a range of activities which are "permitted." This means a resource consent is not required provided an activity meets the conditions of the relevant permitted activity rule.

In the Southland region, there are various resource management plans developed by the Southland Regional Council under the RMA.

The proposed **Southland Water and Land Plan** is intended to provide direction and guidance regarding the sustainable use, development and protection of water and land resources in the Southland region. This Plan fits within, and is influenced by, an RMA framework of national, regional, and local policy documents. The proposed Southland Water and Land Plan is currently in a formal Environment Court process. The plan has been divided into two parts – Topic A and Topic B. The court has heard from all parties in relation to Topic A and released an interim decision on this topic in late December 2019. The next steps and the timing will be determined by the court. The plan will be final once the court issues its final decision and any appeals to the High Court are considered. It is not certain when this will be, but it is unlikely to occur before the end of the year. The decisions version of the proposed plan supersedes the notified version. The decisions version of the proposed Southland Water and Land Plan has legal effect from 4 April 2018, but the existing operative plans still have full legal effect and weight. Some existing activities have been allowed (permitted) by the operative plans, but they require a resource consent under the proposed plan. In some cases, existing activities may continue without consent if the effects are the same or similar in character, intensity, and scale, if an entity was carrying out the activity before the notification of the decisions on the proposed plan (4 April 2018). Existing Use Rights need to be discussed with the council consents team.

For the avoidance of doubt, no rule in the Southland Water and Land Plan currently applies in the coastal marine area.

The **Regional Coastal Plan** has effect over the **Coastal Marine Area**. Southland's coastal marine area extends from the line of mean high-water springs out to the 12-nautical mile territorial sea limit (22.2 km) from Awarua Point to Brothers Point. This covers over 3,000 kilometers of coastline; approximately one seventh of the New Zealand coastline. The Regional Coastal Plan sets out how Environment Southland will carry out its resource management responsibilities in

the CMA.

The values of Southland's coast are described, and issues of management identified. Fundamental principles in the management of the Coastal Marine Area are set out and then sections of the plan deal with specific matters, including estuaries, coastal water, air, occupation, the seabed and foreshore, structures in the coast, coastal processes and protection works, cruise ships and other ships in internal waters, recreational activities, marine farming, surface water activities, financial contributions, and bonds to be made.

**The regulatory framework is explained below.**

**The Coastal Marine Area is defined by** Section 2 of the Resource Management Act as:

The foreshore, seabed and coastal water, and the air space above the water -

- a) of which the seaward boundary is the outer limits of the territorial sea;
- b) of which the landward boundary is the line of mean high-water springs, except that where that line crosses a river, the landward boundary at that point shall be whichever is the lesser of -
- c) one kilometer upstream from the mouth of the river; or
- d) the point upstream that is calculated by multiplying the width of the river mouth by 5.

For the parts of the activity within the Coastal Marine Area, the rules from the **Coastal Plan** apply (see [https://www.es.govt.nz/repository/libraries/id:26gi9ayo517q9stt81sd/hierarchy/about-us/plans-and-strategies/regional-plans/coastal-plan/documents/coastal\\_plan\\_december\\_2013.pdf](https://www.es.govt.nz/repository/libraries/id:26gi9ayo517q9stt81sd/hierarchy/about-us/plans-and-strategies/regional-plans/coastal-plan/documents/coastal_plan_december_2013.pdf)); Environment Southland, 2013); otherwise, the rules of the proposed **Southland Water and Land Plan** apply.

Section 12(1) states that "No person may, in the coastal marine area,

- a) reclaim or drain any foreshore or seabed; or
- b) erect, reconstruct, place, alter, extend, remove, or demolish any structure or any part of a structure that is fixed in, on, under, or over any foreshore or seabed; or
- c) disturb any foreshore or seabed (including by excavating, drilling, or tunneling) in a manner that has or is likely to have an adverse effect on the foreshore or seabed (other than for the purpose of lawfully harvesting any plant or animal); or
- d) deposit in, on, or under any foreshore or seabed any substance in a manner that has or is likely to have an adverse effect on the foreshore or seabed; or
- e) destroy, damage, or disturb any foreshore or seabed (other than for the purpose of lawfully harvesting any plant or animal) in a manner that has or is likely to have an adverse effect on plants or animals or their habitat; or



- f) introduce or plant any exotic or introduced plant in, on, or under the foreshore or seabed - unless expressly allowed by a rule in a regional coastal plan and in any relevant proposed regional coastal plan or a resource consent."

### **Coastal Plan Rules that will be triggered by laying of a submarine cable at Sandy Point (RMA - Territorial Sea), are as follows:**

#### **Rule 9.1.7 - Occupation by submarine lines or submarine cables.**

Submarine lines or submarine cables used for communication purposes may be required in the coastal marine area to ensure all members of the community can have access to telecommunications. These lines or cables are provided for in a different manner to suspended lines as the nature of their effects is likely to be different, particularly once installed. There may be some adverse effects at the time of construction, while any ongoing adverse effect can be avoided, remedied, or mitigated by appropriate design and consent conditions. Accordingly, these line and cables have been provided for as restricted discretionary activities.

Except as provided elsewhere in the Plan occupation by submarine lines or submarine cables in, on or under the bed of the coastal marine area is a **restricted discretionary activity**. The Council shall restrict its discretion to the following matters:

- a) any effect on public access and recreational opportunities
- b) any effect on recognized navigation routes and anchorages
- c) any effect on benthic ecology
- d) any effect on the stability of the seabed and foreshore
- e) any effect on amenity values where the shore end of any submarine line is visible
- f) any effect on cultural, heritage or archaeological values
- g) any effect on areas of significant indigenous vegetation and significant habitats of indigenous fauna
- h) any effect on the economic wellbeing of people and communities.

#### **Rule 9.1.8 - Occupation of cables and lines on existing lawful structures**

The occupation of cables and lines on lawfully established structures may be necessary for communication purposes. In circumstances where the cable or line is securely fixed and taut against the structure, the adverse effects are considered to be minimal.

Occupation of cables and lines on existing lawful structures, provided the cables or lines are securely fixed and taut against the structure is a **permitted** activity.

#### **Rule 10.2.4 Deposition of material on the seabed**

This Rule provides a process for considering the effects of human initiated deposition activity on



the seabed. Deposition can have major impacts on the biota within the coastal marine environment. It can cause changes physically and chemically leading to biological change. Organisms that have adapted to specific habitats cannot adjust to the sudden changes resulting from deposition. This may lead to the displacement of some species and an alteration of community composition. There is a specific concern regarding the effects of deposition on benthic ecosystems. The disposal of contaminated material, obtained from dredging or excavations within the coastal marine area, into another part of the coastal marine area needs to consider the effects of disposal on the receiving environment.

#### Rule 11.2.10 - Placement of submarine lines or cables

Except as provided elsewhere in the Plan placement of submarine lines or submarine cables in, on or under the bed of the coastal marine area is a restricted discretionary activity. The Council shall restrict its discretion to the following matters:

- a) any effect on public access and recreational opportunities
- b) any effect on recognized navigation routes and anchorages
- c) any effect on benthic ecology
- d) any effect on the stability of the seabed and foreshore
- e) any effect on amenity values where the shore end of any submarine line is visible
- f) any effect on cultural, heritage or archaeological values as listed in Appendix 8 of the [Regional Coastal Plan for Southland](#)
- g) any effect on areas of significant indigenous vegetation or significant habitats of indigenous fauna
- h) any effects on the economic well-being of people and communities.

Submarine lines or cables used for communication purposes may be required in the coastal marine area to ensure all members of the community can have access to telecommunications. These lines or cables are provided for in a different manner to suspended lines, as the nature of their effects is likely to be different, particularly once installed. There may be some adverse effects at the time of construction, while any ongoing adverse effect can be avoided, remedied, or mitigated by appropriate design and consent conditions. Accordingly, these lines have been provided for as restricted discretionary activities.

#### *Resource Consent*

There are five types of resource consents associated with the various Regional Plans.

The Ministry for the Environment's guide, "Applying for a Resource Consent," provides detail to help with understanding the resource consent process. Environment Southland strongly recommends review of this document before preparing a consent application.



The same [website](#) also provides an overview of the main stages of the application process. The two resource consents which are likely to be most relevant for the SFOC project are: the Coastal Permit authorized by the Regional Council and the Land-use consent authorized by the Environment Southland Regional Council (with potential jurisdictional/regulatory overlap with Southland District Council and Invercargill City Council). Environment Southland can advise on which resource consents will be required before the application is submitted.

Environment Southland recommends discussing the proposal with the council and others potentially affected by it while the proposal is being developed and prior to submitting the application for resource consent. Contact information for the duty consents officer is provided in Table 3-2. They also offer a free half-hour meeting to discuss resource consent requirements and any other questions before the application is submitted for processing.

**Table 3-2. Environment Southland Contact Information**

Contact	Address for Service
Environment Southland Duty Consents Officer	Tel: 0800 76 88 45 Email: <a href="mailto:service@es.govt.nz">service@es.govt.nz</a>

Based on the rules and requirements of the Regional Coastal Plan for Southland, an application for resource consent to obtain a coastal permit in order to undertake project works (which are likely to be categorized by council as **'restricted discretionary activities'**) will need to be made to Environment Southland. Generally, an application for a resource consent is required when:

- A proposed activity is not specifically addressed in the plan
- A proposed activity cannot meet the conditions of a relevant permitted activity rule; and/or
- A proposed activity is listed as a controlled, restricted discretionary, discretionary, or non-complying activity.

Resource consent is typically required to:

- Dam, divert, take and/or use water;
- Undertake activities in the coastal marine area;
- Undertake activities in/over/near waterbodies;
- Discharge contaminants to air, land or water;
- And/or use land for certain activities.



Part A and Part B of required resource consent application are available, respectively, at:

- <https://www.es.govt.nz/repository/libraries/id:26gi9ayo517q9stt81sd/hierarchy/environment/consents/consent-forms/documents/Part%20A%20-%20Application%20General%20Details.pdf>
- [https://www.es.govt.nz/repository/libraries/id:26gi9ayo517q9stt81sd/hierarchy/environment/consents/consent-forms/documents/part-b-by-topic/apply-for-a-coastal-permit/part\\_b\\_-\\_coastal\\_permit\\_not\\_whitebait\\_stand\\_.pdf](https://www.es.govt.nz/repository/libraries/id:26gi9ayo517q9stt81sd/hierarchy/environment/consents/consent-forms/documents/part-b-by-topic/apply-for-a-coastal-permit/part_b_-_coastal_permit_not_whitebait_stand_.pdf)

The resource consent application process will require the preparation of an **Assessment of Environmental Effects (AEE)** and should include the following:

- The list of activities and their description (including engineering diagrams showing the dimensions and position of structures).
- The proposed date of commencement of the activity and the proposed date of completion.
- Description of the existing environment and the assessment of marine life; wetlands, wildlife habitats or bird nesting habitats; other activities occurring in the same area; areas of aesthetic, cultural, heritage or scientific value; waste discharges, water takes, monitoring sites. This is to include photographs, maps or aerial photographs showing the locations of activities, nearby waterbodies, wetlands, estuaries and wildlife habitat, and the locations of other existing coastal activities in proximity to the proposed activity.
- The current condition of the beach (e.g., degrading/aggrading/signs of shoreline erosion), nature of seabed (e.g., muddy, sandy, silty, rock,) and if other activities have altered the seabed or foreshore.
- Assessment of effects on the coastal environment in the short term and long term, and assessment of effects on any other users of the coastal area where the proposed activity will occur. This should consider:
  - The effects on the broader community, including any social, economic, and cultural effects on items such as aesthetic, recreational, scientific, historical, spiritual, or cultural value, or other exceptional value, for present or future generations;
  - Physical effects on the locality such as landscape and visual effects; and
  - Ecosystem effects including on plants or animals and any physical disturbance of habitats and natural and physical resources.
- Discharge of contaminants into the environment, including any reasonable emissions of noise, and options for the treatment and disposal of pollutants; any



- risk to the broader community, or the environment through natural hazards or the use of hazardous substances or hazardous installations.
- Description of the monitoring or mitigation measures to be undertaken to help avoiding, remedy or mitigate the actual or potential effects on the environment, including measures to minimize the release of silt, sediment, concrete, and other contaminants into the water for construction works.
  - Description of any possible alternative locations or methods for undertaking the activity and why these alternatives have not been selected.
  - Evidence of any consultation undertaken for the application. This may include (but not be limited to) consultation with adjoining landowners, other consent holders in the immediate area, iwi, government departments/ministries, territorial authorities, advisory bodies, non-governmental organizations, industry representatives.
  - Assessment of whether the proposed activity is contrary to any of the relevant provisions of the New Zealand Coastal Policy Statement; Regional Policy Statement for Southland; Regional Coastal Plan for Southland; any other relevant Resource Management Regulations or National Environmental Standards.

A guide to preparing an AEE is provided by the Ministry for the Environment and is available online here: <https://environment.govt.nz/assets/Publications/Files/aee-guide-aug06.pdf>. An additional guide for assessing the completeness of the AEE and ensuring it meets the requirements in Schedule 4 of the Resource Management Act 1991 (RMA) is provided here: <https://www.qualityplanning.org.nz/node/564>. It is important to confirm completeness prior to submitting the application to avoid delays in the permitting process.

Depending on whether the Council determines that the scope of works presents an issue to the navigational safety of water users, which is likely, a Coastal Permit Technical Comment may need to be filled out and submitted to the Harbormaster for comment. This will need to be done before the resource consent application is made to Environment Southland. The form should be completed and included with any consent application for an activity in a navigable water body that affects, or may affect, navigational safety. This includes applications for the installation, extension, or removal of a structure in a navigable water body, any reclamation, and any commercial surface water activity in any navigable water body. The Coastal Permit Technical Comment form is available from Environment Southland at:

- <https://www.es.govt.nz/repository/libraries/id:26gi9ayo517q9stt81sd/hierarchy/environment/consents/consent-forms/documents/part-b-by-topic/extract-gravel/Harbormaster%20Technical%20Comment%20-%20Navigational%20Safety%20-%20APP-%20XXXX.pdf?msclkid=378952b1af3911ec88089870b248b608>



### Consultation with Stakeholders

To support the application, supplementary information derived from consultation with ‘affected persons’ will be required, including sports and recreation clubs, government departments/ministries (e.g., Department of Commerce [DOC]), Maritime NZ and Iwi groups which claim interest (this needs to be done before an application is made to Environment Southland).

The Marine and Coastal Area (Takutai Moana) Act 2011 provides a legal framework for iwi, hapu and whanau interested to be recognized in the marine and coastal areas around New Zealand. It gives groups the chance to obtain Customary Marine Title, which recognizes that the group has an interest in a specific area of the coast and gives the group certain rights. Environment Southland has been notified of four Customary Marine Title applications for coastal waters in Southland, lodged with the High Court.

Currently, all prospective applicants for resource consents for coastal activities in Southland must, before making the resource consent application to Environment Southland:

- Identify which iwi groups have applied for Customary Marine Title in the area affected by the resource consent application
- Notify the iwi groups (using the contact details below) and 'seek their views' on the application
- Provide with the consent application any views expressed by the iwi groups

Environment Southland will consider the views of the Customary Marine Title group when making decisions on coastal resource consent applications. If Customary Marine Title is awarded to these groups, activities requiring a resource consent (including controlled activities) will not be able to be undertaken unless an 'RMA permission right' has been obtained from the group.

The Sandy Point area, where the proposed cable landing is located, is under an area with special interests to Te Runanga o Ngai Tahu and the local Iwi group, Te Ao Marama.

- Contact information for local southern iwi Te Ao Marama is: [office@tami.maori.nz](mailto:office@tami.maori.nz), phone 03 931 1242.
- Contact information for Te Runanga o Ngai Tahu and Te Aomarama is provided in Table 3-3:

**Table 3-3. Te Runanga o Ngai Tahu Contact Information**

Contact	Contact Details
Te Rūnanga o Ngāi Tahu Whānui	<a href="mailto:Rachael.brown@bellgully.com">Rachael.brown@bellgully.com</a> <a href="mailto:George.dawson@bellgully.com">George.dawson@bellgully.com</a>



---

[info@ngaitahu.iwi.nz](mailto:info@ngaitahu.iwi.nz)

or

Te Rūnanga o Ngāi Tahu

PO Box 13046

Christchurch 8141

Tel: +64 3 366 4344

---

If affected parties have been identified, proponents will need to talk about their plans with them and include their written approval forms (Council can provide these) with the application. Any site plans should also be signed by the affected parties and attached to these forms. Affected parties do not have to provide written approval if they oppose the proposal. If proponents cannot get written approval from them, the consent application may be notified. This means the affected parties would have the opportunity to make a submission and speak at a hearing before Council. Alternatively, proponents can reconsider their proposal and redesign it in a way that does not affect those parties.

### *Invercargill City Council*

The Invercargill City Council Planning and Resource Management Division carries out the Council's functions and responsibilities as prescribed in the Resource Management Act 1991. This includes the development and administration of the District Plan, processing resource consents, and undertaking environmental education initiatives. Other responsibilities include the management of the contract for valuation services.

The District Plan classifies different kinds of activities:

- Controlled activities – always granted resource consent, but council can impose conditions on the consent to minimize environmental effects.
- Restricted discretionary activities – can grant or decline consent, and impose conditions that relate only to the matters listed in the District Plan
- Discretionary activities – can grant or decline consent and impose conditions relating to anything which might have an environmental effect.
- Non-complying activities – can only grant consent if the adverse environmental effects are minor, or if the application meets the District Plan's objectives and policies. Council can impose conditions relating to anything which might have an environmental effect.

The area inland of Oreti Beach, including the dune habitat, is classified as Rural under the Invercargill City Council District Plan. Consultation will be required with Invercargill City Council regarding any earthworks at Oreti Beach and Dunns Road, where the proposed beach manhole



is to be located and disturbance along the road corridor is anticipated. Several Rules in the District Plan are likely to apply, however the discretionary nature of the activities in the context of the rules is to be assessed by council. Following initial consultation, a certificate of compliance may be issued if the council determines that activities do not require resource consent. If the extent of works is deemed to require a land use resource consent, i.e., requires a Land Use permit, then the resource consent application process must be followed.

Special conditions are also likely to apply to the coastal ecosystems due the designation of the area as a Reserve, i.e., the proposed cable landing site being within the Sandy Point Domain. Invercargill City Council will have discretion as to which activities are permitted, prohibited and/or require a resource consent, and any additional conditions, in the context of Sandy Point Domain.

The land use consent application form is available at: <https://icc.govt.nz/wp-content/uploads/2014/11/Planning-Land-Use-Consent.pdf>

If required by both Invercargill City Council and Environment Southland, the same Assessment of Environmental Effects can likely be submitted to both regulatory agencies. Alternatively, a targeted AEE that only applies to the activities regulated by the District Plan could be prepared. It is anticipated that a degree of crossover and consultation between the councils will occur. The same process for consultation with affected parties will apply for the consent application to the Invercargill City Council as it did for Environment Southland.

The Affected Persons Written Approval form is available at: <https://icc.govt.nz/wp-content/uploads/2014/11/Planning-Affected-Persons-Written-Approval.pdf>.

Traffic and public access management protocols are likely to be required during the period of works. It is also likely that works undertaken within the legal boundaries of State Highways and other roads will require the written approval of the New Zealand Transport Agency as well as the Invercargill City Council.

### *Southland District Council*

Southland District Council is responsible for the land parcels outside of the Invercargill City Council jurisdictional boundary (as defined in the District Plan). Southland District Council manages infrastructure and amenities including roads, urban and rural water supplies, sewerage schemes, cemeteries, community halls, community housing units, libraries, reserves, and parks. Its role encompasses the management and improvement of physical assets such as roads and bridges, but also the wider Southland communities' social, economic, cultural, and environmental wellbeing. The proposed data center location would fall under the jurisdiction of the Southland District Council. A building consent will be required to construct the data center, and other requirements may apply depending on the nature and extent of work. Conditions can be put on resource consents to ensure that an activity is carried out as stated in the application or as



revised by the decision and that adverse effects are mitigated or remedied. For example, on a large-scale subdivision or construction project, a condition may be imposed requiring a Landscape Management Plan to be produced that describes how, what, when and by whom any landscaping activities would be undertaken and maintained, for example weed control. The provisions of the Fourth Schedule of the Act set out the general requirements for matters to be included in an AEE of a proposal on the environment, to accompany applications for resource and subdivision consents. As with the Environment Southland Regional Council and Invercargill City Council, the Southland District Council recommends communication ahead of an application for resource consent and can provide resource consent advice.

The resource consent application form and associated information requirements are available at: <https://www.southlanddc.govt.nz/home-and-property/resource-planning/district-plan/the-plan/>

- <https://www.southlanddc.govt.nz/assets/Planning-Resource-Consent/District-Plan/6.1-Information-for-Resource-Consents.pdf>
- <https://www.southlanddc.govt.nz/services/do-it-online/apply-for-it/planning-and-resource-consents/>

An overview of the consent application process for Southland District Council is available at:

- <https://www.southlanddc.govt.nz/home-and-property/resource-planning/forms-and-guides/>
- <https://www.southlanddc.govt.nz/assets/Planning-Resource-Consent/Resource-Consent-Guides/Resource-Consent-Application-Guide.pdf>

### **3.2.5. Exclusive Economic Zone and Environmental Protection Authority (EPA)**

New Zealand law sets the activities that can take place in offshore waters. Beyond the coastal marine area (12 nautical mile Territorial Sea maritime zone boundary), the regulatory regime provided by the Exclusive Economic Zone and Continental Shelf (Environmental Effects) Act 2012 (EEZ Act) is administered by the Environmental Protection Authority and designed to cover previously unregulated activities beyond the 12 nautical mile jurisdiction of the RMA. Pursuant to the EEZ Act are the Exclusive Economic Zone and Continental Shelf (Environmental Effects—Permitted Activities) Regulations 2013.

The EEZ Act sets up a management and decision-making framework for managing the effects of activities in the EEZ and Continental Shelf. Within this framework, the Ministry for the Environment is empowered to make regulations to cover technical matters, including by classifying activities as permitted, discretionary, or prohibited, which are defined as follows:



- Permitted activities can proceed subject to compliance with any relevant conditions and are generally localized or would have a low impact on the marine environment. They include: laying, maintenance, and removal of seafloor cables; burials at sea; exploration and prospecting activities; and some types of discharge.
- Prohibited activities are effectively banned and no Marine Consent can be issued for them.
- Discretionary activities are subject to a Marine Consent application process.

Under the EEZ Act, laying of submarine cables is usually considered a permitted activity. Therefore, no Resource Consent is required, and a Marine Consent from EPA is not needed, but the activity must meet some terms and conditions to be carried out lawfully. The rules for permitted and discretionary activities are in the following Regulations:

- Exclusive Economic Zone and Continental Shelf (Environmental Effects - Permitted Activities) Regulations 2013
- Exclusive Economic Zone and Continental Shelf (Environmental Effects - Non-Notified Activities) Regulations 2014
- Exclusive Economic Zone and Continental Shelf (Discharge and Dumping) Regulations 2015
- Exclusive Economic Zone and Continental Shelf (Environmental Effects – Burial at Sea) Regulations 2015

In general, before a permitted activity commences, the proponent must contact the EPA and provide information about what they intend to do. This is required by law for certain activities. This makes sure that we can assess that what they propose is permitted, and that they aren't inadvertently planning to do anything illegal. For most activities affected iwi, hapū, customary marine title groups and protected customary rights groups must also be informed in advance.

EPA also monitor reports on the activity once it is underway to ensure the rules are followed. They may also inspect the operations if there is a risk of non-compliance. Generally, the law requires a report to be sent to EPA with details about how the activity was undertaken and showing that it was performed legally.

### *Requirements for Permitted Activities under EEZ Regulations*

The EEZ regulations permit the placement of a submarine cable on or under the seabed, or the removal of a submarine cable from the seabed, provided the entity undertaking the activity:

- Notifies the Environmental Protection Authority (EPA) at least 40 working days before the activity commences;



- Notifies iwi, hapū, customary marine title groups and protected customary rights groups at least 25 working days before the activity commences;
- Notifies the EPA within 24 hours of the date on which the person commences the activity;
- Notifies the EPA within 24 hours of the date on which the person completes the activity concerned; and
- Provides the EPA with a post-activity report detailing the activity undertaken, the dates, the location, estimates of the activity's environmental footprint (including an estimate of volume of material removed, if applicable).

The regulations also require the EPA to monitor permitted activities to determine whether they are being undertaken in accordance with any conditions imposed by the Permitted Activities regulations.

Form 1, Form 2, Form 3 and Form 4 of the Exclusive Economic Zone and Continental Shelf (Environmental Effects - Permitted Activities) Regulations 2013 need to be completed, as follows:

#### **Form 1: Pre-activity notification to EPA**

- Details of person undertaking permitted activity
- General description of permitted activity
- Timing of permitted activity
- Location of permitted activity
- Other information
  - Name of ship or ships involved in activity
  - International call sign or vessel number of the ship or ships involved
  - Associated license number (under the Continental Shelf Act 1964)
  - Associated permit number (under the Crown Minerals Act 1991)

#### **Form 2: Pre-activity notification of relevant iwi**

The person/entity intending to undertake a permitted activity must notify EPA, iwi, hapū, customary marine title groups and protected customary rights groups as soon as practicable when they receive notice that a permitted activity has commenced or has been completed.

#### **Form 3: Initial environmental assessment and sensitive environments contingency plan**

- Describe the activity concerned;
- State the coordinates of the area within which the activity will be conducted;



- Describe in general terms (using the best available information) the environment likely to be encountered when the activity is being undertaken;
- Identify and describe any sensitive environments that are likely to exist within the area; and
- Detail the methods that will be used to undertake the activity.

In relation to any sensitive environment that is likely to be encountered,

- Assess the feasibility of carrying out the activity in another location
- Assess, in the following order, the feasibility of measures that could be taken to:
  - reduce the amount of contact with the seabed:
  - carry out alternative lower-impact activities:
  - change the methods of operation to lower the impact of the activity on the environment.

The plan must incorporate the best available information, which means the best information that, in the circumstances, is available without unreasonable cost, effort, or time.

#### Form 4: Post-activity report, including:

- Details of person undertaking permitted activity
- Description of permitted activity
- Location of permitted activity
- Details of environment of area where activity undertaken
- Environmental footprint of activity
- Details of measures taken to avoid, mitigate, or remedy adverse effects on the sensitive environment

All forms related to the Exclusive Economic Zone and Continental Shelf (Environmental Effects - Permitted Activities) Regulations 2013 are available at:

- <https://www.legislation.govt.nz/regulation/public/2013/0283/latest/DLM5270655.html>

In summary,

- Notify Councils
- Follow Rules outlined in the Regional Coastal Plan
- Resource consent application process will require the preparation of an Assessment of Environmental Effects (AEE)
- Consult Stakeholders

- Invercargill City Council land use consent application form
- Request building consent from the Southland District Council for the data center
- Contact EPA using appropriate forms.

### 3.2.6. Other New Zealand legislation

Additional legislation may apply to the Invercargill landing, or activities in NZ waters, which are discussed below.

#### *Marine Mammal Protection Act 1978*

The Marine Mammal Protection Act (MMPA) (1978) provides for the protection, conservation and management of marine mammals in New Zealand and its territorial waters, including within 12 nautical miles of the Ross Dependency and the internal waters of the Ross Sea. The MMPA is administered by the Department of Conservation. Under the Act, a permit from the Minister of Conservation is required to hold in captivity or take a marine mammal (seal, whale, dolphin, porpoise, dugong, or manatee), whether alive or dead. Application forms and further information are available from: <http://www.doc.govt.nz/get-involved/apply-forpermits/interacting-with-marine-mammals/>.

#### *Biosecurity Act 1993*

The Biosecurity Act (1993) is administered by the Ministry for Primary Industries (MPI) and aims to exclude unwanted organisms from New Zealand. Under the Act, the importation of any plants, animals or plant or animal products requires an Import Health Permit. This applies also to media which could harbor organisms (e.g., water and soil). The Act also contains requirements for ensuring aircraft, ships and containers entering New Zealand are pest and soil free, and for import and disposal of human waste, medical waste, and food waste.

#### *Maritime Transport Act 1994*

The Maritime Transport Act 1994 is the primary legislation that describes the role and functions of Maritime New Zealand. It sets out the legal framework for maritime safety and protection of the marine environment, including:

- licensing of ships and crew
- investigation of maritime accidents
- offences, response for oil spills planning and preparedness
- other aspects of maritime law such as salvage, liability for pollution damage, limitation of liability, and compensation.



Regulations made under the Maritime Transport Act 1994 include:

- Maritime Levies Regulations 2016
- Maritime Transport Act (Conventions) Order 1994/273
- Maritime Transport (Fund Convention) Levies Order 1996/337
- Maritime Transport (Maximum amounts of liability for pollution damage) Order 2003
- Oil Pollution Levies Order 2013/154
- Oil Pollution Levies Order 2016
- Maritime (Offences) Regulations 1998/444
- Maritime Transport (Infringement Fees for Offences Relating To Major Maritime Events) Regulations 1999/243
- Maritime Transport Act (Marine Protection Conventions) Order 1999/263
- Shipping (Charges) Regulations 2016
- Marine Protection (Offences) Regulations 1998/205.

This Act also provides for the Minister of Transport and Governor General to make maritime and marine protection rules. These rules contain the detailed standards and requirements that the maritime community are required to comply with. The Maritime New Zealand Director is responsible for enforcing this Act however the Ministry of Transport (MoT) administers it. The MoT is responsible for this legislation and for making recommendations to the Government if it needs to be improved or changed in any way.

### *Hazardous Substances and New Organisms Act 1996*

The purpose of the Hazardous Substances and New Organisms Act (1996) is to protect the environment, and the health and safety of people and communities, by preventing or managing the adverse effects of hazardous substances and new organisms. This Act is administered by the Environmental Protection Authority (EPA). Under the Act, approval is required to import a species that has not been brought into New Zealand since the Act came into force. The Act provides for rapid assessment of applications to import species that cannot survive in the New Zealand environment. Soil and water samples being imported to New Zealand may contain micro-organisms. If the samples are being imported to study the micro-organisms, a Hazardous Substance and New Organism (HSNO) Act approval must be sought. If, however, the samples are being imported for analysis to which the presence or absence of micro-organisms is irrelevant, no approval is required (although normal MPI controls apply – see Biosecurity Act information above). Further information can be accessed from the EPA website at: [www.epa.govt.nz](http://www.epa.govt.nz) The hazardous substances part of the Act requires that all chemicals and hazardous substances are



registered and handled in accordance with specified controls. This is managed by WorkSafe New Zealand (<http://www.worksafe.govt.nz/worksafe>). Import of hazardous waste is controlled under the Customs and Excise Act 1996 (see above). Under the Customs and Excise Act 1996 and the Imports and Exports (Restrictions) Prohibition Order (No 2) 2004, import of hazardous waste into New Zealand requires a permit from the EPA.

### *Animal Welfare Act 1999*

Under the Animal Welfare Act (1999), no one may carry out research, testing, or teaching involving the use of animals (including mammals, birds, fish and other animals including some invertebrates as defined under the Act) unless they are by contract working under an approved code of ethical conduct. Most research institutions have an Animal Ethics Committee (AEC) with an approved code. AEC approval is required before commencing any work involving animals in Antarctica. Further information is available from the Ministry for Primary Industries website: <https://www.mpi.govt.nz/protection-and-response/animal-welfare/>.

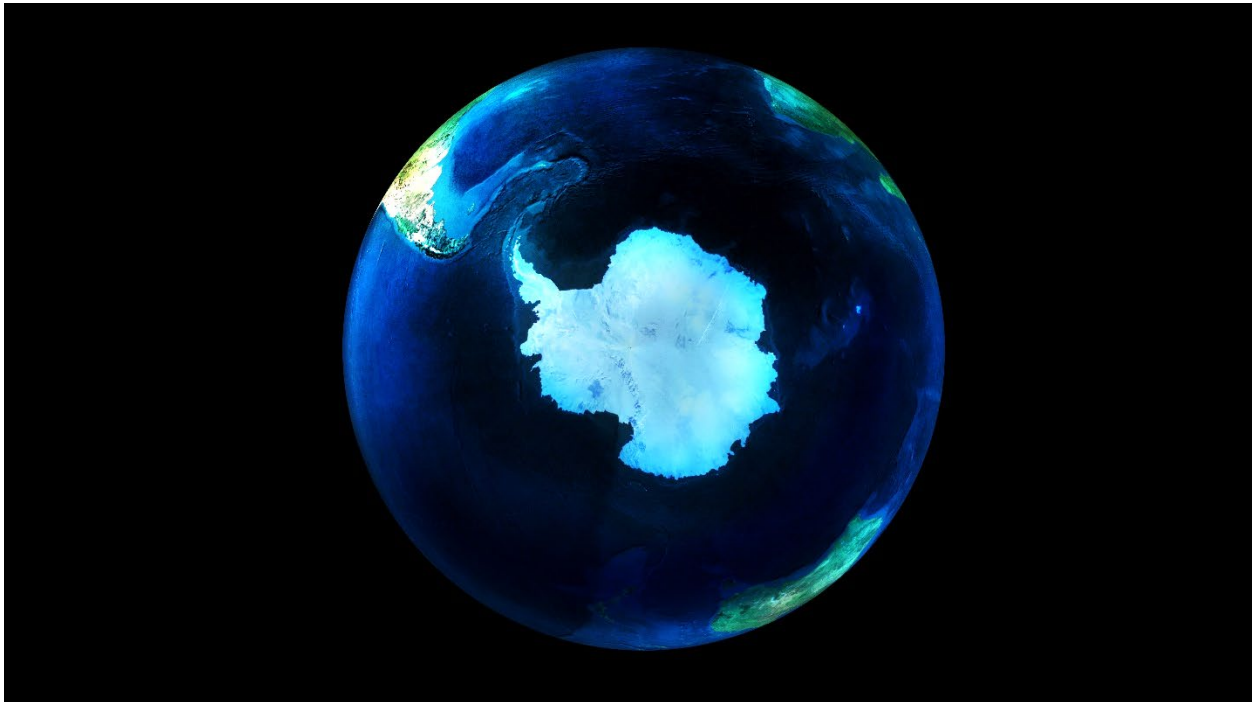

*A decorative view of Antarctica.*

### 3.3. Antarctica

Authorizations for all actions within the Antarctic, defined as that area south of 60-degree South Latitude, including all ice shelves, are covered by the Antarctic Treaty System (System). The System includes the Antarctic Treaty (Treaty), described further in Section 3.3.1, and a collection of agreements that foster peaceful use and freedom of scientific investigation and cooperation in Antarctica (ATS, 1959; ATS, 1991).

Authorizations and any permits for the installation and operation of the SFOC are necessary and take time to prepare, submit, review, and receive approvals. The most conservative approach to ensure appropriate and timely approvals are received is to conduct a Permitting Feasibility Study. The information presented in this DTS introduces the regulatory processes and timelines required to conduct projects in Antarctica. Authorizations are required prior to any activities in the region, including survey and cable installation (e.g., terrestrial, pre-laid shore end, main-lay, landing, terminal station, right-of-way). The proposed project must be reviewed and approved through a consultative process required by the System. Only after initial consultation and the completion of a PFS, can authorization requirements and timelines be confirmed. A preliminary listing of authorizations and agencies associated with this review and/or approvals are provided in Figure 3-10.



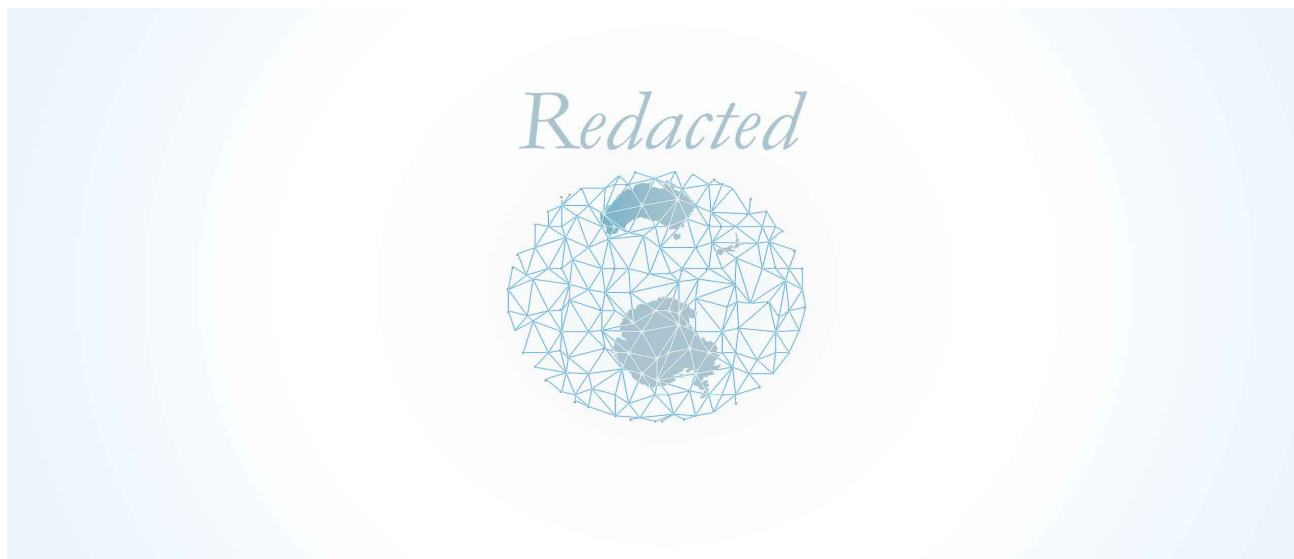

Figure 3-10. [Redacted]. Sample McMurdo Station Excel Permit Matrix.

### 3.3.1. The Antarctic Treaty (Treaty) and the Antarctic Treaty System (System)

The Antarctic Treaty (Treaty) regulates international cooperation in Antarctica. The Treaty was signed by 12 countries with active research in and around Antarctica, on 1 December 1959, and was entered into force on 23 June 1961. The total number of Parties to the Treaty today is 54 (ATS, 2022a; USDOS, 2021, 2022). The Treaty is comprised of 14 Articles that regulate international relations with respect to Antarctica, with the main purpose to establish Antarctica as a scientific preserve that shall be used for peaceful purposes (ATS, 1959; SAT, 2016). The Treaty also provides the right of inspection between Treaty members, including scientific stations, vessels, aircraft, and cargo, representation at meetings with the other Contracting Parties, and bans military activity, nuclear testing, and disposal of nuclear waste.

The Treaty, and related agreements including the Protocol on Environmental Protection to the Antarctic Treaty (Protocol), reaffirms conservation principles for the protection of the Antarctic environment and dependent associated ecosystems (ATS, 1991; SAT, 2016). The Antarctic Treaty System (System) as defined in Article I of the Protocol "*means the Antarctic Treaty, the measures in effect under that Treaty, its associated separate international instruments in force and the measures in effect under those instruments*" (ATS, 1991, p. 2). The System seeks to protect Antarctica and surrounding waters for peaceful, international, collaborative, scientific research and free exchange of scientific observations and results.



### 3.3.2. Protocol on Environmental Protection to the Antarctic Treaty (Protocol)

The Treaty identifies protections to environmental stewardship through the Protocol, which was signed on 4 October 1991 in Madrid and entered into force on 14 January 1998 (ATS, 1991; SAT, 2016, 2022b; USDOS, 2022). In the Protocol, the Parties commit themselves to the comprehensive protection of the Antarctic environment and dependent and associated ecosystems, and designate Antarctica as a natural reserve devoted to peace and science (ATS, 1991).

The Protocol on Environmental Protection to the Antarctic Treaty is comprised of 27 Articles and six (6) Annexes and *“establishes the framework for comprehensive protection of the Antarctic environment and is commonly referred to as the Madrid Protocol”* (SAT, 2016, p. 7).

Annexes I to IV were adopted in 1991 together with the Protocol and entered into force in 1998 (SAT, 2022b). Annex V on Area Protection and Management was adopted separately by the 16th Antarctic Treaty Consultative Meeting (ATCM) in 1991 and entered into force on 24 May 2002, and Annex VI on Liability Arising from Environmental Emergencies was adopted by the 28<sup>th</sup> ATCM in Stockholm in 2005 and will enter into force once approved by all Consultative Parties (ATS, 2005, 2022b; SAT, 2016). The Protocol and Annexes I-V listed below can be downloaded from the Antarctic Treaty System website (<https://www.ats.aq/e/protocol.html>), and Annex VI can be retrieved from [https://documents.ats.aq/recatt/att249\\_e.pdf](https://documents.ats.aq/recatt/att249_e.pdf).

- Annex I Environmental Impact Assessment
- Annex II Conservation of Antarctic Fauna and Flora
- Annex III Waste Disposal and Waste Management
- Annex IV Prevention of Marine Pollution
- Annex V Area Protection and Management
- Annex VI Liability Arising from Environmental Emergencies

Many of the Annexes will apply to the proposed SFOC, but the most relevant articles of the Protocol and Annexes for initial planning are described in the following sections:

- Protocol Article 3 – Environmental Principles
- Protocol Article 8 – Environmental Impact Assessment
- Protocol Annex 1 – Environmental Impact Assessment

Before the Articles and Annexes are reviewed in detail, it is important to note that because of the requirements they represent, any work done in the Antarctic must first be evaluated for environmental impacts; if the work meets certain criteria, then several different environmental impact assessments must be performed in advance of any (i.e. SFOC) work or research beginning to predetermine the impacts the project may have on the environment.



**The Protocol includes specific protections for the Antarctic environment which all parties associated with the Project must abide by.**

This DTS examines the three Protocol Articles most relevant to this project: Articles 3 and 8, and Annex 1, which will determine the environmental assessments needed.

### *Protocol Article 3 Environmental Principles and “Activities”*

Protocol Article 3 Environmental Principles states, “The protection of the Antarctic environment and dependent and associated ecosystems and the intrinsic value of Antarctica, including its wilderness and aesthetic values and its value as an area for the conduct of scientific research, in particular research essential to understanding the global environment, shall be fundamental considerations in the planning and conduct of all **activities** in the Antarctic Treaty area” (ATS, 1991).

Specific considerations for planning and conducting **activities** in the region require review through the EIA process prior to commencement of activities and are outlined further in the Protocol and guidelines for preparing an EIA in the Antarctic (ATS, 1991; ATS, 2016). These activities include scientific research, preservation, tourism, governmental/non-governmental actions, and associated logistical support.

The proposed SFOC involves a cross-section of these activities and will therefore be designed, planned, and conducted to comply with the environmental principles in Article 3 of the Protocol to:

- Limit adverse impacts on the Antarctic environment and dependent and associated ecosystems;
- Avoid significant effects on climate, weather, water and air quality, biological and ecological systems, and the terrestrial, glacial, or marine environments;
- Allow prior assessments of, and informed judgments about, possible impacts on the Antarctic environment and dependent and associated ecosystems and on the value of Antarctica for the conduct of scientific research;
- Accord priority to scientific research and to preserve the value of Antarctica as an area for the conduct of such research, including research essential to understanding the global environment; and,
- Provide advance notice to other Contracting Parties in accordance with Treaty Article VII (5) of all expeditions, including associated logistic support activities.



### *Protocol Article 8 Environmental Impact Assessment*

Article 8 of the Protocol pertains to specific environmental impacts that result from activities in the Antarctic. Activities including research, tourism, and all other governmental and non-governmental activities mentioned in the Treaty must follow assessment procedures outlined in Article 8 and Annex I. Three levels of impacts identified in Article 8, and further described in Annex I, are those activities having (ATS, 1991; ATS, 1991a):

- (a) less than a minor or transitory impact;
- (b) a minor or transitory impact; or
- (c) more than a minor or transitory impact.

The Guidelines for Environmental Impact Assessment in Antarctica provide background information for proposed activities, more specifically that '*activities in the Antarctic Treaty area shall be planned and conducted on the basis of information sufficient to allow prior assessments of, and informed judgments about, their possible impacts on the Antarctic environment and dependent and associated ecosystems and on the value of Antarctica for the conduct of scientific research*' (ATS, 2016, p. 2). Combined, the Articles, Annexes and Guidelines relate to any changes in activity, both an increase and decrease or changes in facilities, including decommissioning, etc. to protect Antarctica and its dependent and associated ecosystems (ATS, 2016).

**The proposed Project will require an environmental assessment at one of the three levels listed above.** These levels are discussed in detail in Protocol Annex I Environmental Impact Assessment. The design, installation, and maintenance of the SFOC will ensure that the assessment procedures set out in Protocol are applied during the PFS, MRS and any Project planning to determine the level of environmental assessment needed.

### *Annex I to the Protocol on Environmental Protection to the Antarctic Treaty – Environmental Impact Assessment*

Annex I to the Protocol on Environmental Protection to the Antarctic Treaty pertains to EIAs. There are 8 Articles in Annex I EIA which define the required environmental assessment process. Both Annex I and Article 8, along with guidelines to complete an EIA in the Antarctic, are used to determine how the Project will impact the environment in Antarctica and produce an early baseline which may change as the process moves to more in-depth evaluation. **This initial baseline is necessary to start the Project planning and determine which level of the environmental assessment is needed.**

Project planning will begin at Annex I Article 1 Preliminary Stage; it progresses based on the level of environmental impact that the project will have on the Antarctic environment. This process is described further in Section 3.3.3. The Annex I articles are described as follows (ATS, 1991a, 2016):



1. **Article 1 Preliminary Stage** determines that activities *have less than a minor or transitory impact and the activity may proceed forthwith*.
2. **Article 2 Initial Environmental Evaluation** is an activity that *has more than a minor or transitory impact* and then must include (a) a description of the proposed activity, including its purpose, location, duration and intensity; and (b) consideration of alternatives to the proposed activity and any impacts that the activity may have, including consideration of cumulative impacts in the light of existing and known planned activities. The activity may proceed provided appropriate procedures are in place to assess and verify the impact of the activity as documented in the Initial Environmental Evaluation.
3. **Article 3 Comprehensive Environmental Evaluation** (CEE) is needed when the Initial Environmental Evaluation (or otherwise) results conclude that an activity may *have more than a minor or transitory impact*.
4. **Article 4 Decisions to be Based on CEE** allows for the proposed activity to proceed either in original or modified form.
5. **Article 5 Monitoring** includes key environmental indicators that assess and verify impacts following the completion of a CEE to provide regular and verifiable records of impacts to (a) enable assessments to be made of the extent to which such impacts are consistent with the Protocol; and (b) provide information useful for minimizing or mitigating impacts, and, where appropriate, information on the need for suspension, cancellation or modification of the activity.
6. **Article 6 Circulation of Information** ensures that information be circulated to Parties, forwarded to the Committee on Environmental Protection (CEP), and made publicly available including information related to Article 1, 2 and 3.
7. **Article 7 Cases of Emergency** relating to safety of human life or of ships, aircraft or equipment and facilities of high value or the protection of the environment which provide for activities to take place without the completion of the above mentioned procedures, but notice is provided to all Parties and to the Committee within 90 days of those activities with an explanation of activities.
8. **Article 8 Amendment or Modification** provides for changes to this Annex following Article IX of the Treaty.

### 3.3.3. Environmental Impact Assessment (EIA)

These three documents, Article 8 of the Protocol, Annex I, and Guidelines for EIA in Antarctica, set forth important environmental principles that guide environmental protection in Antarctica; they establish the requirements for Environmental Impact Assessments (EIAs), the three categories of environmental impacts – *less than minor or transitory impact*, *minor or transitory impact*, *more than a minor or transitory impact* – and the review process (ATS, 1991a; ATS, 2016).

The varying level of environmental impact requires varying levels of evaluation and review. In the Preliminary Stage of the EIA, environmental impacts are to be assessed and considered in



accordance with appropriate national procedures prior to commencement to determine if they have *less than a minor or transitory impact* (see Protocol Article 3, Protocol Annex I Article 1; ATS, 2016, p. 2). In general, the Preliminary Stage includes the following: scope of the activity, cumulative impacts, detrimental effects to the Antarctic Treaty Area, environmentally safe operations, monitoring, and capacity to respond to accidents (ATS, 2016). The results of the Preliminary Stage can either, *“proceed, be preceded by an IEE if predicted impacts are likely to be no more than minor or transitory, or be preceded by a CEE if the predicted impacts are to be more than minor or transitory”* (ATS, 2016, p. 3). Unless it has been determined that an activity will have less than a minor or transitory impact, or unless a CEE is being prepared (following Article 3 of Annex I), then an IEE is prepared (ATS, 1991a). Thus, if the proposed activity is determined to have, or potentially have, *a minor or transitory impact, or more than a minor or transitory impact*, then an IEE is prepared for prior assessment. If an IEE indicates or if it is otherwise determined that the proposed activity is likely to have *more than a minor or transitory impact*, a CEE is prepared and follows a specific sequence for review described in Guidelines for EIA in Antarctica (ATS, 2016). The requirements for the IEE and CEE, and the review process are outlined in the Guidelines (see ATS, 2016 Figure 1 Steps of the EIA process for Antarctic Activities, p. 5) and subsections of this DTS.

The proposed Project requirements may change during design and planning phases. It is generally recommended to start with the IEE and move into the draft CEE, if required. In making the determination to proceed with an IEE or CEE, refer to Annex I of the Protocol which states, *“Although the key to decide whether an activity shall be preceded by an IEE or a CEE is the concept of “minor or transitory impact”, no agreement on this term has so far been reached...The difficulty with defining “minor or transitory impact” appears to be due to the dependence of a number of variables associated with each activity and each environmental context”* (ATS, 2016, p. 3). The Guidelines outline elements to include in a project plan that may be used for review and interpretation in EIAs for individual, site-specific activities which are related to Article 8 and Annex I of the Protocol that can be used for further development of this proposed Project (ATS, 2016).

### *Initial Environmental Evaluation (IEE)*

The environmental assessment must contain sufficient detail to assess whether the proposed activity may have *more than a minor or transitory impact* on the Antarctic environment following Article 8 of the Protocol, Annex I, and Guidelines for EIA in Antarctica (Guidelines) (ATS, 2016). The Guidelines describe the need for *sufficient information to allow prior assessments of and informed judgements about possible impacts on the Antarctic environment and dependent and associated ecosystems* (see ATS, 2016, p. 2). Information to develop the EIA includes consultation to gather the best available information, professional advice, technical expertise for proposed activities, and a review of past projects. It is also reviewed by national authorities to decide whether a CEE is required, or the project moves to the implementation and review phase (ATS, 2005; ATS, 2016).



Information required in the EIA process includes (see Annex I, Article 2.1 (a)(b); ATS, 2016):

- A description of the proposed activity, including purpose, location, duration, and intensity; and,
- Consideration of alternatives to the proposed activity and any impacts that the activity may have, including consideration of cumulative impacts in light of existing and known planned activities).

Some aspects of the proposed activities associated with the SFOC Project may be able to move forward with an IEE. This possibility would need to be explored during the PFS. As data is gathered and the Project details become clearer, preparation of a CEE may be required.

### *Comprehensive Environmental Evaluation (CEE)*

A draft CEE is prepared if the determination during the EIA process has been made that a proposed project includes impacts that are *likely to cause more than minor or transitory impacts* (ATS, 2016; ATS, 2005). Draft CEEs are developed following Annex I, Guidelines for EIA in Antarctica and appropriate national procedures, authorizations and/or permits which may include monitoring, and should include consultation with technical experts in subject matter and the EIA process, and a review of previous EIAs (see EIA database <https://www.ats.aq/devAS/EP/EIAList?lang=e> also referenced in ATS, 2016, p. 6 ) (ATS, 2005; ATS, 2016).

As per Article 3.2. a CEE shall include (SAT, 2016) (see also <https://www.ats.aq/e/eia.html>):

- a) a description of the proposed activity including its purpose, location, duration and intensity, and possible alternatives to the activity, including the alternative of not proceeding, and the consequences of those alternatives;
- i) a description of the initial environmental reference state with which predicted changes are to be compared and a prediction of the future environmental reference state in the absence of the proposed activity;
- j) a description of the methods and data used to forecast the impacts of the proposed activity;
- k) estimation of the nature, extent, duration, and intensity of the likely direct impacts of the proposed activity;
- l) consideration of possible indirect or second order impacts of the proposed activity;
- m) consideration of cumulative impacts of the proposed activity in the light of existing activities and other known planned activities;
- n) identification of measures, including monitoring programs, that could be taken to minimize or mitigate impacts of the proposed activity and to detect unforeseen impacts and that could provide early warning of any adverse effects of the activity as well as to deal promptly and effectively with accidents;



- o) identification of unavoidable impacts of the proposed activity;
- p) consideration of the effects of the proposed activity on the conduct of scientific research and on other existing uses and values;
- q) an identification of gaps in knowledge and uncertainties encountered in compiling the information required under this paragraph;
- r) a non-technical summary of the information provided under this paragraph; and
- s) the name and address of the person or organization which prepared the CEE and the address to which comments thereon should be directed.

Due to the scope and nature of the proposed marine and terrestrial activities associated with an SFOC project, a draft CEE may be required with the following estimated timeline (ATS, 2016):

- Draft CEE is made publicly available and circulated to all Parties, which shall also make it publicly available for comment - 90 days comment period (Annex 1 Article 3 (3));
- Draft CEE forwarded to the Committee at same time as circulated to all Parties – at least 120 days prior to upcoming ATCM (Annex 1 Article 3 (4));
- 15-month limitation for receipt of comments from Committee from the date of the circulation of the draft CEE;
- 60-days before project commencement – Address/summarize all comments and produce Final CEE and circulate to all Parties which make them publicly available in the Antarctic Treaty area.

### **3.3.4. EIA Review - Antarctic Treaty Consultative Meeting (ATCM) and Committee for Environmental Protection (CEP)**

Proposed projects in the Treaty region require review and content of an EIA is based on the level of impact to the environment. The Protocol, more specifically, Articles 10, 11 and 12 outline the *comprehensive protection of the Antarctic environment and dependent and associated ecosystems* which occur by ATCMs and the CEP. These Articles illustrate the relationship of the ATCM and CEP, and describe CEP function, reporting, and membership including the invitation of the Scientific Committee on Antarctic Research (SCAR) and the Scientific Committee for the Conservation of Antarctic Marine Living Resources (CCAMLR) as observers in sessions (ATS, 1991; CCAMLR, 1980; SCAR, 2022).

The annual meeting of the Treaty Consultative Parties is called the ATCM. The CEP meeting is concurrent with the ATCM and pertains to environmental protections related to the Treaty and Protocol. The CEPs function is to provide advice and formulate recommendations to the Parties in consultation with SCAR, CCAMLR, and other relevant scientific, environmental, and technical organizations (ATS, 1991, Article 12).





The CEP can meet to review proposed projects outside of the annual ATCM meeting (see ATCM schedule <https://www.ats.aq/e/atcm.html>). The CEP Chair can convene an Intercessional Contact Group (ICG) to consider draft CEEs and consult with CEP Members following specific procedures (see [http://www.ats.aq/documents/cep/CEE\\_Procedures\\_e.pdf](http://www.ats.aq/documents/cep/CEE_Procedures_e.pdf)). The ICGs can report on draft CEEs during upcoming CEP meetings (ATS, 2016). Then, the CEP, as an expert advisory body, can provide advice and formulate recommendations to the ATCM related to EIAs at their annual meetings (ATS, 2016; SAT, 2016).

In Summary:

- Preliminary Stage submission and review to determine the need for an IEE and/or CEE
- Draft EIA documentation, developed following appropriate national procedures, authorizations and/or permits which may include monitoring information, are circulated to all Parties, and made publicly available through the System
- EIA review by the ATCM must be submitted at least 120 days prior to the upcoming meeting for consideration
- The maximum time for ATCM review is no longer than 15 months from the date of circulation of the draft
- Public comment period lasts for 90 days
- Final EIA includes comments on the draft and is circulated to all Parties and to make publicly available at a minimum of 60 days prior to activities is completed to address and summarize all comments.

EIA authors need to incorporate and coordinate the timing of submissions, reviews, comments, and approvals with field activities (e.g., survey, construction, etc.) due to accessibility of McMurdo Station and region due to ice cover. The timeline for the submission and review of an EIA is important when considering the need for several orchestrated steps to align with the ATCM meeting schedule (see CEP [http://www.ats.aq/documents/cep/CEE\\_Procedures\\_e.pdf](http://www.ats.aq/documents/cep/CEE_Procedures_e.pdf) and ATCM <https://www.ats.aq/e/committee.html>), consultations, and a period for comments from the international community and public comment.

### 3.3.5. Other Considerations

Due to the unique characteristics and international and national protections for the Antarctic region, a PFS should be conducted to identify all required authorizations, permissions, and permits prior to the commencement of any activities in the region. The EIA process and requirements in earlier sections of this document illustrate the complexity and estimates of time



necessary to complete the early phases of an SFOC to McMurdo Station. The following subsections outline other considerations for moving forward with the Project and should be confirmed by a PFS.

### *National Oceanic and Atmospheric Administration and The Marine Mammal Protection Act*

The Marine Mammal Protection Act (MMPA) includes incidental take, harm, entanglement, or disruption of animals during surveying and/or construction during cable-laying. The National Oceanic and Atmospheric Administration (NOAA) and National Marine Fisheries Service (NMFS) [also known as NOAA Fisheries and NOAA/NMFS] MMPA has two types of permits, the Scientific Research and Enhancement Permits for Marine Mammals, and Incidental Harassment Authorization (IHA) (NOAA/NMFS, 2022a). The former includes activities related to scientific research which should not apply to project activities for MRS and construction-related efforts. The latter is completed through consultation between the NSF and NOAA/NMFS Incidental Take Program and examines proposed MRS and construction activities to determine if adverse effects may occur. MRS activities typically include sub-surface imaging, grab samples, etc. and construction includes a proposed HDD. If permitting is required, the consultation and review process may take months to over a year for review and application materials can be found on the NOAA/NMFS website (NOAA/NMFS, 2022b).

### *Antarctic Conservation Act and Permits (ACA)*

The Antarctic Conservation Act as amended by the Antarctic Science, Tourism, and Conservation Act, requires a permit for activities including the take of “native animals or birds, engage in harmful interference, enter ASPAs [Antarctic Specially Protected Areas], introduce nonindigenous species into Antarctica, or import/export any Antarctic fauna and flora into/from the United States” (NSF, n.d.). NSF OPP coordinates the sharing of information related to science, tourism, and conservation within the OPP, NOAA/NMFS MMPA and the Antarctic Treaty and the Protocol on Environmental Protection to the Antarctic Treaty through the CEE. Antarctic Conservation Act permits are required as they relate to the proposed research projects and activities that may engage in harmful interference, may enter ASPAs, and/or possibly introduce species to Antarctica, and/or introduce substances designated as waste, discharge designated waste (NSF, 2022c).

### *Convention on the Conservation of Antarctic Marine Living Resources (CCAMLR)*

The Commission on the Conservation of Antarctic Marine Living Resources (CCAMLR) was established for the purpose of *protecting and conserving the marine living resources in the waters surrounding Antarctica* (NOAA/IA, 2022). Article I defines the geographic region and the



overarching concept of living marine resources: *to the Antarctic marine living resources of the area south of 60° South Latitude and to the Antarctic marine living resources of the area between that latitude and the Antarctic Convergence which form part of the Antarctic marine ecosystem* (Convention on the Conservation of Antarctic Marine Living Resources art. 1, opened for signature 20 May 1980, 33 U.S.T. 3476, 1329 U.N.T.S. 47; CCAMLR, 1980; refer also to <https://www.ccamlr.org/en/organisation/camlr-convention-text#1>). The boundary is defined using the Antarctic Convergence and overlaps with the Treaty (south of 60<sup>th</sup> parallel) in some areas (Figure 3-11–Hogweard Antarctic Convergence). CCAMLR defines the Antarctic Convergence in Article I(4) as a line “joining the following points along parallels of latitude and meridians of longitude: 50 °S, 0 °; 50 °S, 30 °E; 45 °S, 30 °E; 45 °S, 80 °E; 55 °S, 80 °E; 55 °S, 150 °E; 60 °S, 150 °E; 60 °S, 50 °W; 50 °S, 50 °W; 50 °S, 0 °” (CCAMLR, 1980).

The Convention on the Conservation of Antarctic Marine Living Resources (CCAMLR) was initiated in 1980 due to concerns regarding the exploitation of food sources for Antarctic organisms including finfish, mollusks, crustaceans, and sea birds found in the Antarctic Convergence (CCAMLR, 2022). As a result, a conference was held and a Convention was developed and went into force in 1982 to conserve marine resources, establish the structure of the Commission, provide for an advisory Scientific Committee and subsequent working groups, and to outline international cooperation.

CCAMLR uses an ecosystem-based approach is used to address living marine resources for approximately 10% of the Earth’s oceans, and incorporates standards designed to ensure the conservation of populations and the Antarctic marine ecosystem as a whole (NOAA/IA, 2022). CCAMLR should be consulted for current conservation measures when preparing an EIA to review current environmental protections, marine protected areas, listed species, regulations, notifications, etc. The 2021-2022 Schedule of Conservation Measures in Force can be found at the CCAMLR [website](#) (CCAMLR, 2022a,b).

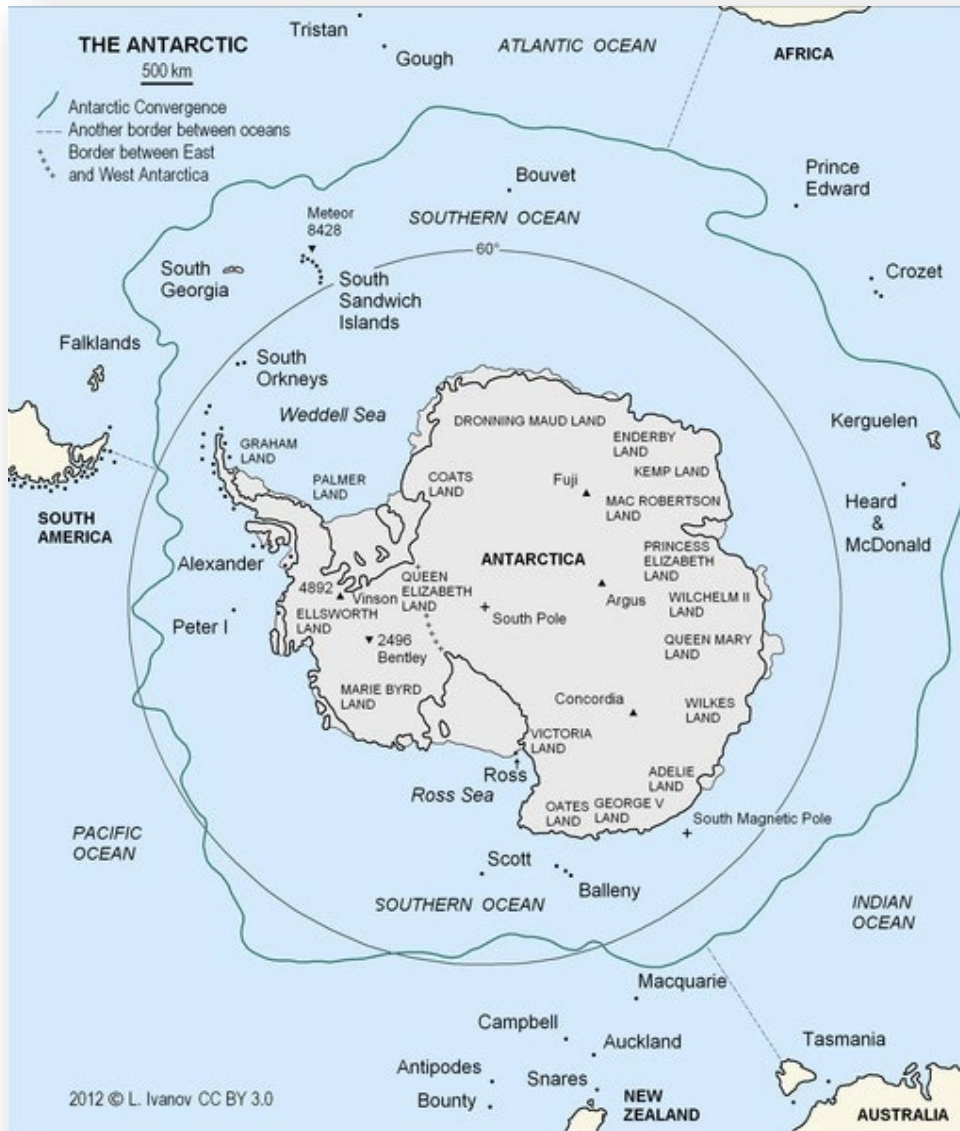

(Wikimedia Commons (Hogweard, 2015))

Figure 3-11. Geographic boundaries of the Commission on the Conservation of Antarctic Marine Living Resources (CCAMLR) (Antarctic Convergence) and Treaty (south of 60th parallel).

CCAMLR’s focus on reducing risks associated with harvesting and incidental take by vessels permitted in the area includes licensing, monitoring, and inspection, with additional measures to address Illegal, Unreported and Unregulated (IUU) vessels (CCAMLR, 2022a,b). Vessels are permitted to enter the area and CCAMLR maintains a list of vessels from participating countries



(see participating countries:

[http://www.austlii.edu.au/au/other/dfat/treaty\\_list/depository/CCAMLR.html](http://www.austlii.edu.au/au/other/dfat/treaty_list/depository/CCAMLR.html)) which are licensed for fishing (see list of registered and non-CCAMLR registered). There is an annual meeting of the Standing Committee on Implementation and Compliance (CCAMLR, 2022c).

CCAMLR is comprised of 25 member states and the European Union. CCAMLR members are members of the Scientific Committee and designate a qualified representative/expert advisor to be the primary point of contact for Committee matters. The Scientific Committee meets as often as necessary to fulfil its functions; regular meetings of the Committee are typically held annually (see CCAMLR Rules of Procedure of the Scientific Committee Basic Documents Part 4 Rule 4 [https://www.ccamlr.org/en/system/files/e-pt4\\_2.pdf](https://www.ccamlr.org/en/system/files/e-pt4_2.pdf)). Meeting materials are distributed a minimum of 100 days prior to meetings and supplementary items for the meeting agenda are submitted no later than 65 days before the beginning of the meeting with background information (see Rules 5 and 6 CCAMLR [https://www.ccamlr.org/en/system/files/e-pt4\\_2.pdf](https://www.ccamlr.org/en/system/files/e-pt4_2.pdf)). Conservation measures and resolutions in accordance with Article IX are available on the CCAMLR website (<https://cm.ccamlr.org/>) and the most recent Schedule of Conservation Measures in Force were adopted at the 40<sup>th</sup> meeting 18-29 October 2021 (<https://www.ccamlr.org/en/system/files/e-schedule2021-22.pdf>).

### *Ross Sea Region Marine Protected Area (MPA)*

CCAMLR established a marine protected area (MPA) in the Ross Sea encompassing than 1.5 million square kilometers of the Ross Sea around Antarctica with an accompanying research and monitoring plan and a Special Research Zone (Figure 3-12) (CCAMLR, 2016). The MPA was designated in 2016 and entered into force on 1 December 2017 (Brooks et al., 2021; NZDC, 2022). During CCAMLR's 35th annual meeting, which concluded on 28 October 2016, in Hobart, Australia, after initial proposal by the U.S. and New Zealand, the MPA was adopted by consensus (NOAA, 2022). The features within the MPA include seamounts and habitats used by fish, invertebrates, mammals, birds during part of all or a portion of their lifecycle; 1.1 million square kilometers are termed *general protection zone* where no commercial fishing will be allowed for at least 35 years (NOAA, 2022).

The MPA designation seeks to “achieve a suite of specific objectives, which include: to conserve biodiversity, ecological structure, and ecosystem dynamics and function throughout the Ross Sea Region; to protect ecosystem processes, core distributions of species, vulnerable habitats, and areas of importance to the life cycles of toothfish, seals and penguins; to promote research (including monitoring); and to provide reference areas for studying and separating the impacts of environmental change and fishing (Brooks et al., 2021; CCAMLR, 2016).

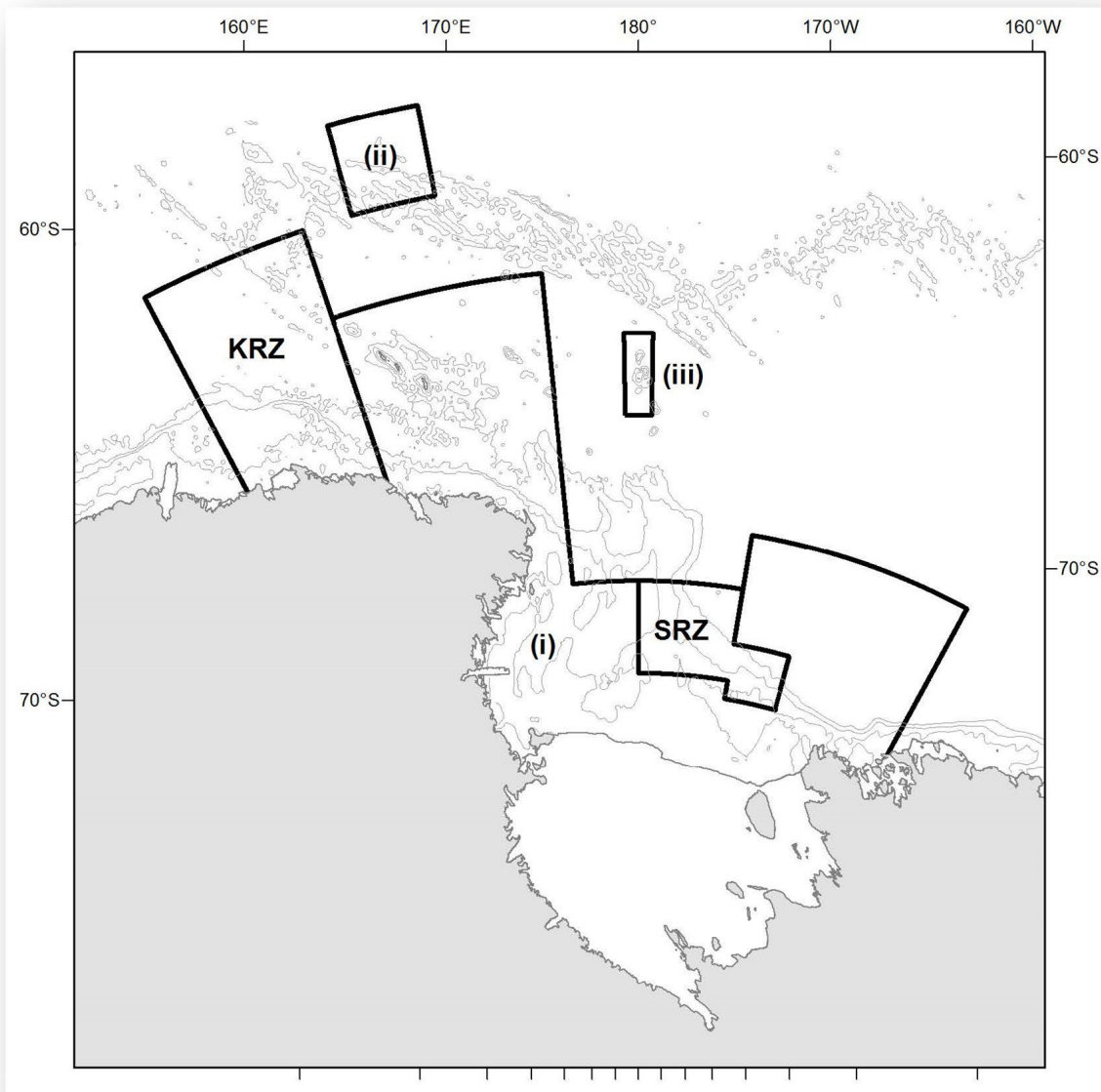

(CCAMLR)

Figure 3-12. Ross Sea Region Marine Protected Areas.

### *Antarctic Specially Protected Area (ASPAs)*

In the Protocol, Annex V Management of Protected Areas provides for consideration and designation of ASPAs and Antarctic Specially Managed Areas (ASMAs) which “protect outstanding environmental, scientific, historic and aesthetic or wilderness values and scientific research” (SAT, 2016 p.10). If permits are necessary, the Protocol requires the CEP to provide input and



recommendations to the Parties of the Treaty (SAT, 2016 p.11). Management plans for ASPAs and SMAs should be consulted to identify current requirements (ATCM, 2022).

Proposed activities within ASPAs should be included within a CEE and reviewed by the CEP. The Treaty may require permissions for field activities within ASPAs. Consult the current ASPA Management Plan to ensure that the proposed activities (e.g., sampling, sample sites, transportation, equipment used and length of time, etc.) and any measures that will be taken to address restoration if impacts are expected to occur and reports provided to the permitting entity(ies) once activities are completed (e.g., evidence of damage, etc.). National authorities issue permits for entry and activity within ASPAs to meet the current requirements of the Treaty and Protocol review process. A PFS can confirm requirements for ASPAs and if this information must be included in an EIA, if required.

### *Vulnerable Marine Ecosystem (VMEs)*

Vulnerable Marine Ecosystems are described as benthic ecosystems associated with seamounts, hydrothermal vents, deep-sea trenches, submarine canyons, oceanic ridges, etc. (CCAMLR, 2022d).

CCAMLR establishes conservation measures to protect these slow growing benthic ecosystems in the Southern Ocean to limit fisheries that may have detrimental impacts to these habitats in addition to Illegal, Unreported and Unregulated (IUU) in Antarctic waters. A PFS can confirm the requirements of VMEs and ensure the most current information about registered VMEs within the project footprint and confirm the most up-to-date licensed vessels approved by CCAMLR to fish in the region to determine cable risks and to initiate consultation with affected fishing interests through this process and if needed, additional stakeholder engagement with fishing companies and/or individuals. The Registry of VMEs is maintained by the CCAMLR (CCAMLR, 2022d; see VME Registry <https://www.ccamlr.org/en/document/data/ccamlr-vme-registry>).

### *Environmental Policy and Compliance*

Environmental policies and compliance may include contractor activities such as those related to Environmental Health and Safety programs including field operations and those activities in support of field operations and recognizes the need to preserve the unique environment of Antarctica while meeting the goals of the USAP. The Antarctic Support Contract (ASC) should be reviewed for the most up-to-date requirements and subcontractor agreements, equipment, etc. to ensure EPC compliance with the Treaty Protocol and USAP requirements as well as a PFS conducted to evaluate required authorizations for construction-related activities.

### *Related Considerations for McMurdo Station - New Zealand*

The anticipated approvals and considerations for the proposed Project in Antarctic waters related



to the cable connection to New Zealand are listed below and in earlier portions of this DTS. Other NZ legislation such as the Marine Mammal Protection Act 1978, and the Animal Welfare Act 1999, are also both relevant and practical to implement in Antarctica, and therefore applicable to the conditions of the (Ross) Dependency. A PFS will confirm required authorizations, approvals, and permits for the proposed Project.

- Provide advance notification and EIA under Antarctica (Environmental Protection) Act 1994
- Acquire permit under Antarctica (Environmental Protection) Act 1994
- Acquire permit under Marine Mammal Protection Act 1978
- Acquire permit under Antarctic Marine Living Resources Act





### 3.3.6. Antarctica References

- Secretariat of the Antarctic Treaty (ATS). (1959). *The Antarctic Treaty*. Retrieved March 17, 2022 from <https://www.ats.aq/e/antarctictreaty.html>
- ATS. (1991). *The Protocol on Environmental Protection to the Antarctic Treaty: Environmental Protocol*. Retrieved March 14, 2022 from <https://www.ats.aq/e/protocol.html>
- ATS. (2005). *Environmental Impact Assessment: Circulation of information: Resolution 1 (2005) - ATCM XXVIII - CEP VIII, Stockholm*. Retrieved July 20, 2022 from <https://www.ats.aq/devAS/Meetings/Measure?lang=e&id=346>
- ATS. (2016). *Guidelines for Environmental Impact Assessment in Antarctica Annex to Resolution 1 (2016) ATCM XXXIX – CEP XIX, Santiago*. Retrieved March 14, 2022 from [http://www.ats.aq/documents/recatt/Att605\\_e.pdf](http://www.ats.aq/documents/recatt/Att605_e.pdf)
- ATS. (2017). *Procedures for intersessional CEP consideration of draft CEEs*. Retrieved July 30, 2022 from [http://www.ats.aq/documents/cep/CEE\\_Procedures\\_e.pdf](http://www.ats.aq/documents/cep/CEE_Procedures_e.pdf)
- ATS. (2022a). *Committee for Environmental Protection (CEP) Handbook*. Retrieved March 2022 from <https://www.ats.aq/devAS/EP/CEPHandbook?lang=e#>
- ATS. (2022b). *Meeting Documents Archive*. Retrieved March 2022 from <https://www.ats.aq/devAS/Meetings/DocDatabase?lang=e>
- Brooks, C.M., Bloom, E., Kavanagh, A., Nocito, E.S., Watters, G.M., & Weller, J. (2021). The Ross Sea, Antarctica: A highly protected MPA in international waters. *Marine Policy* 134, 104795, <https://doi.org/10.1016/j.marpol.2021.104795>
- Convention for the Conservation of Antarctic Marine Living Resources (CCAMLR). (1980). *Text of the Convention on the Conservation of Antarctic Marine Living Resources. Basic Documents, Part 1*. Canberra, Australia 7-20 May 1980. Retrieved March 14, 2022 from [https://www.ccamlr.org/en/system/files/e-pt1\\_3.pdf](https://www.ccamlr.org/en/system/files/e-pt1_3.pdf)
- CCAMLR. (2016). *Conservation Measure 91-05 (2016). Ross Sea Region Marine Protected Area*. Retrieved March 14, 2022 from <https://cm.ccamlr.org/en/measure-91-05-2016>
- CCAMLR. (2022a). *Conservation Measures*. Retrieved March 14, 2022 from <https://www.ccamlr.org/en/conservation-and-management/conservation-and-managment>
- CCAMLR. (2022b). *Schedule of Conservation Measures in Force 2021-2022. 40th Meeting of the Commission October 18-29 2021*. Retrieved March 14, 2022 from <https://www.ccamlr.org/en/system/files/e-schedule2021-22.pdf>



- CCAMLR. (2022c). *Standing Committee on Implementation and Compliance (SCIC)*. Retrieved March 2022 from <https://www.ccamlr.org/en/document/publications/terms-reference-and-organisation-work-standing-committee-implementation-and>
- CCAMLR. (2022d). *Vulnerable Marine Ecosystems (VMEs)*. Retrieved March 14, 2022 from <https://www.ccamlr.org/en/compliance/vulnerable-marine-ecosystems-vmes> and <https://www.ccamlr.org/en/document/data/ccamlr-vme-registry>
- Environment Southland. (2013). *Regional Coastal Plan for Southland*. Retrieved August 11, 2023 from [https://www.es.govt.nz/repository/libraries/id:26gi9ayo517q9stt81sd/hierarchy/about-us/plans-and-strategies/regional-plans/coastal-plan/documents/coastal\\_plan\\_december\\_2013.pdf](https://www.es.govt.nz/repository/libraries/id:26gi9ayo517q9stt81sd/hierarchy/about-us/plans-and-strategies/regional-plans/coastal-plan/documents/coastal_plan_december_2013.pdf)
- Geoscience Australia. (2013a). *Maritime Zones Australia* [Image]. Retrieved August 8, 2023 from [https://commons.wikimedia.org/wiki/File:Maritime\\_zones\\_Australia.gif](https://commons.wikimedia.org/wiki/File:Maritime_zones_Australia.gif) Image is licensed under the Creative Commons Attribution 3.0 Australia license. No changes were made from original file.
- Geoscience Australia. (2013b). *Relationship of maritime features, limits, and zones*. Retrieved August 8, 2023 from [https://commons.wikimedia.org/wiki/File:Maritime\\_features\\_limits\\_zones\\_Australia.gif](https://commons.wikimedia.org/wiki/File:Maritime_features_limits_zones_Australia.gif). Image is licensed under the Creative Commons Attribution 3.0 Australia license. No changes were made from original file.
- Hogweard. (2015). *Geographic boundaries of the CCAMLR (Antarctic Convergence) and Treaty (south of 60th parallel)*. Wikimedia Commons. Retrieved March 14, 2022 from <https://upload.wikimedia.org/wikipedia/commons/thumb/0/00/Antarctic-Convergence-Map.TIF/lossy-page1-514px-Antarctic-Convergence-Map.TIF.jpg>
- National Oceanic and Atmospheric Administration (NOAA). (2022). *Marine Protected Area in Antarctica's Ross Sea: International Affairs*. Retrieved March 14, 2022 from <https://www.fisheries.noaa.gov/national/international-affairs/marine-protected-area-antarctic-ross-sea>
- National Science Foundation (NSF). (2022). *Polar Programs: Antarctic Conservation Act (ACA) and Permits*. Retrieved March 22, 2022 from <https://www.nsf.gov/geo/opp/antarct/aca/aca.jsp>
- NSF. (n.d.) *Antarctic Conservation Act Permit Application Form: NSF Form 1078*. Retrieved March 22, 2022 from [https://www.nsf.gov/geo/opp/antarct/aca/nsf01151/ACA\\_permit\\_form\\_2019\\_2022.pdf](https://www.nsf.gov/geo/opp/antarct/aca/nsf01151/ACA_permit_form_2019_2022.pdf)



- New Zealand Department of Conservation Te Papa Atawha (NZDC). (2022). *Ross Sea region Marine Protected Area*. Retrieved July 19, 2022 from <https://www.doc.govt.nz/about-us/international-agreements/antarctica-treaty-system/ross-sea-region-marine-protected-area/>
- New Zealand Ministry for the Environment. (2021a). *Applying for a resource consent*. Publication date 1 February 2021. Retrieved August 11, 2023 from <https://environment.govt.nz/publications/applying-for-a-resource-consent/>
- New Zealand Ministry for the Environment. (2021b). *Getting involved in the resource consent process*. Publication date 13 April 2021. Retrieved August 11, 2023 from <https://environment.govt.nz/guides/getting-involved-in-the-resource-consent-process/>
- NOAA/National Marine Fisheries Service (NMFS). (2022a). *NOAA/NMFS Protected Resources Permits and Authorizations: Incidental Take Authorizations Under the Marine Mammal Protection Act*. Retrieved March 14, 2022 from <https://www.fisheries.noaa.gov/topic/laws-policies#marine-mammal-protection-act>
- NOAA/NMFS. (2022b, January). *Authorizations and Permits for Protected Species (APPS). Online Application Instructions and Help Document*. NOAA/NMFS Oregon Department of Fish and Wildlife. Retrieved March 22, 2022 from [https://apps.nmfs.noaa.gov/docs/title\\_pg\\_and\\_toc.pdf?id=20220411](https://apps.nmfs.noaa.gov/docs/title_pg_and_toc.pdf?id=20220411)
- NOAA/International Affairs (IA). (2022). *Commission for the Conservation of Antarctic Marine Living Resources*. Retrieved March 14, 2022 from <https://www.fisheries.noaa.gov/west-coast/international-affairs/commission-conservation-antarctic-marine-living-resources>
- Scientific Committee on Antarctic Research (SCAR). (2022). *SCAR Code of Conduct for Geosciences Field Research Activities in Antarctica: Attachment A [DRAFT] 2019 ATCM and CEP*. Prague, Czech Republic. Retrieved March 14, 2022 from <https://www.scar.org/antarctic-treaty/actm-papers/atcm-xlii-and-cep-xxii-2019-prague-czech-republic/5320-atcm42-att090/file/>
- Toitū Te Whenua LINZ (Land Information New Zealand). (n.d.) *New Zealand's maritime zone*. <https://www.linz.govt.nz/guidance/marine-information/charts/maritime-boundary-definitions>
- U.S. Department of State (USDOS). (2021). *Antarctic Treaty*. Retrieved March 17, 2022 from <https://2009-2017.state.gov/t/avc/trty/193967.htm>
- USDOS. (2022). *02. Protocol on Environmental Protection to the Antarctic Treaty*. Retrieved July 17, 2022 from <https://www.state.gov/protocol-antarctic-treaty/>



National Science Foundation



# IDENTIFICATION OF GEOLOGICAL RISKS





## 4.0 IDENTIFICATION OF GEOLOGICAL RISKS

This section describes the geological conditions and potential hazards that may be present in the Project area. Geological features along the AU/NZ to Antarctica route that could present hazardous conditions for the submarine cable are described in this section. These features include:

- Active tectonic plate boundaries and associated seismic hazards, such as plate movement, earthquakes and liquefaction;
- Sediment movement, slope failure and turbidity currents within coastal, continental shelf and deep marine settings;
- Proximal and distal tsunami hazards; and
- Volcanic and hydrothermal hazards.

### 4.1. Regional Geology and Tectonic Setting

The study area comprises a large region of the South Pacific between the landing sites of Sydney in Australia, Invercargill in New Zealand, and McMurdo Station on Ross Island, in Antarctica. These sites, and the respective continental masses that they sit upon are separated by large bodies of water that range from approximately 500 meters (m) to 5,000 m including the Tasman Sea, South Pacific Ocean, and Ross Sea. The geological history of the region is dominated by the interactions between the Indo-Australian, Pacific, and Antarctic plates over the last several hundred million years.

The modern Indo-Australian and Pacific plate boundary is a complex one and displays many changes over its extent, from subduction of the Pacific Plate below the Indo-Australian Plate in the North Island of New Zealand to a strike-slip relationship along the South Island. These movements have resulted in rapid uplift and the growth of the Southern Alps. The Foveaux Strait separates the South Island from the small, rugged mass of Stewart Island on the continental shelf.

The Puysegur Trench (up to 6000 m deep) formed due to the subduction of the Indo-Australian Plate under the Pacific Plate south of New Zealand (a reverse of relationship to the North) (Stern, 2004). It lies to the west of the northern tip of the Macquarie Ridge, which separates the trench from the Solander Trough. To the west is the expanse of the Tasman Basin, which extends across the distance from New Zealand to Australia.

The Solander Trough (or Solander Basin) is a bathymetric low and sedimentary depocenter bound to the west by the Puysegur Ridge and to the east by the Campbell Plateau. Eocene in age, the Solander Trough formed through rifting associated with the plate boundary and the Puysegur Ridge. The trough extends roughly 500 kilometers (km) along a NE to SW lineament as it gently



slopes from 100 m to 3000 m depth (Patel et al., 2021).

The Solander Trough merges southward into the relatively flat abyssal seafloor of the Emerald Basin (~5000 m depth) (Carter and McCave, 1997; Patel et al., 2021). The Emerald Basin extends in a NNE-SSW direction, opening towards the SW Pacific Basin. The Emerald Basin–Solander Trough-system is considered the southernmost part and the starting point of the ENZOSS (Eastern New Zealand Oceanic Sedimentary System (Carter et al., 1996) a system of regional sediment recycling driven by deep oceanic currents around the plateau located east of the New Zealand shelf. The Hjort Plateau, located east of the Hjort Ridge and south of Emerald Basin rises to depths of 1000 m to 3500 m and comprises numerous scarps, lineaments, and volcanic edifices (Mekel et al., 2003).

The Macquarie Ridge (or Macquarie Ridge Complex) represents the submarine expression of the Indo-Australian and Pacific plate boundary south of New Zealand. It has undergone an extensive and rapid evolution, encompassing divergent, transform and convergent relative plate motion dating from 40 million years ago (Ma) to the present day (Massell, 2000). The Macquarie Ridge is 1600 km long and between 10 and 40 km wide. It comprises a rugged bathymetry and is generally shallower than 1000 m depth along the length of its axis (Schuur et al., 1998; Massell, 2000). It is one of the steepest underwater topographies on Earth, being nearly 6000 m tall but only 40 km wide (Massell, 2000). Macquarie Island, the only above surface representation of the ridge, is a unique type of ophiolite (uplifted and exposed oceanic crust), and because of this is listed as a UNESCO World Heritage Site (Conway, 2011).

The Macquarie Triple Junction Zone (Figure 4-1) marks the transform fault boundary system where the Indo-Australian, Pacific and Antarctic plates collide and interact. It is thought to have been active since ~48 Ma (Meckel et al., 2003). To the east of this point the plate boundary transitions into the Pacific-Antarctic Ridge.

The Ross Sea sits within the Ross Embayment of Antarctica. It overlies a deep Antarctic continental shelf; an average of 500 m depth compared to 130 m for most shelves. The shelf formed as a result of glacial marine sedimentary deposition during multiple advances and retreats of the Antarctic Ice Sheet during the Oligocene and later (Luyendyk et al., 2003). The deepest basement rocks of the shelf are faulted into multiple graben/basin systems aligned in a NNE to SSW orientation. Ross Island, where McMurdo Station is situated, is comprised of four large, basaltic volcanoes (Parmelee et al., 2015). Mt Erebus, the only one of the four that is active, is the southernmost active volcano in the world. The stratovolcano frequently has lava lakes in its 250 m wide summit crater and is primarily monitored by satellite.

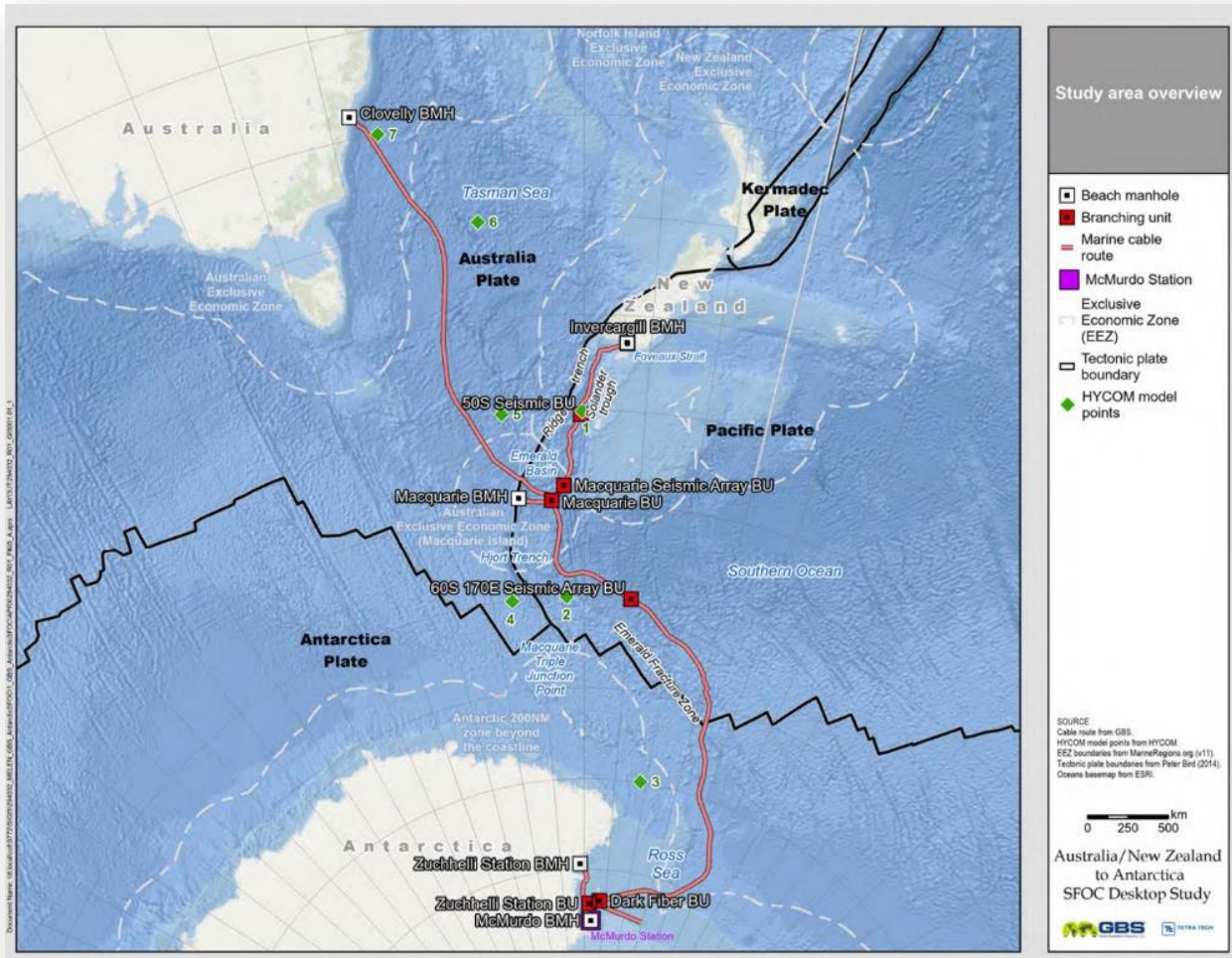

(HYCOM, n.d.; MarineRegions.org, 2019; Bird, P., & and Ahlenius, H., 2014; Esri et al., n.d.a.)

Figure 4-1. Project Overview and Macquarie Triple Junction.

## 4.2. Australia

The proposed Sydney landing site is located on a section of coastal cliffs near Coogee Beach, Sydney. From here the route traverses the narrow continental shelf of Australia, across the Tasman Sea and then crosses the Macquarie Ridge before reaching the Macquarie BU.

### 4.2.1. Seabed and Coastal Geology

Published geology (Herbert, 1983) indicates that the Sydney cliff sections at the landing site are comprised of the Hawksbury Sandstone, a medium to coarse-grained quartz sandstone with minor shale and laminate lenses (Figure 4-2). The sandstone is approx. Triassic (~240 Ma) in age and part of the Sydney Basin sedimentary succession. In places, the Hawkesbury Sandstone is



overlain by marine-deposited and aeolian-reworked fine- to coarse-grained quartz-lithic sand (termed Botany Sands) with abundant carbonate and sporadic humic debris within stabilized dunes.

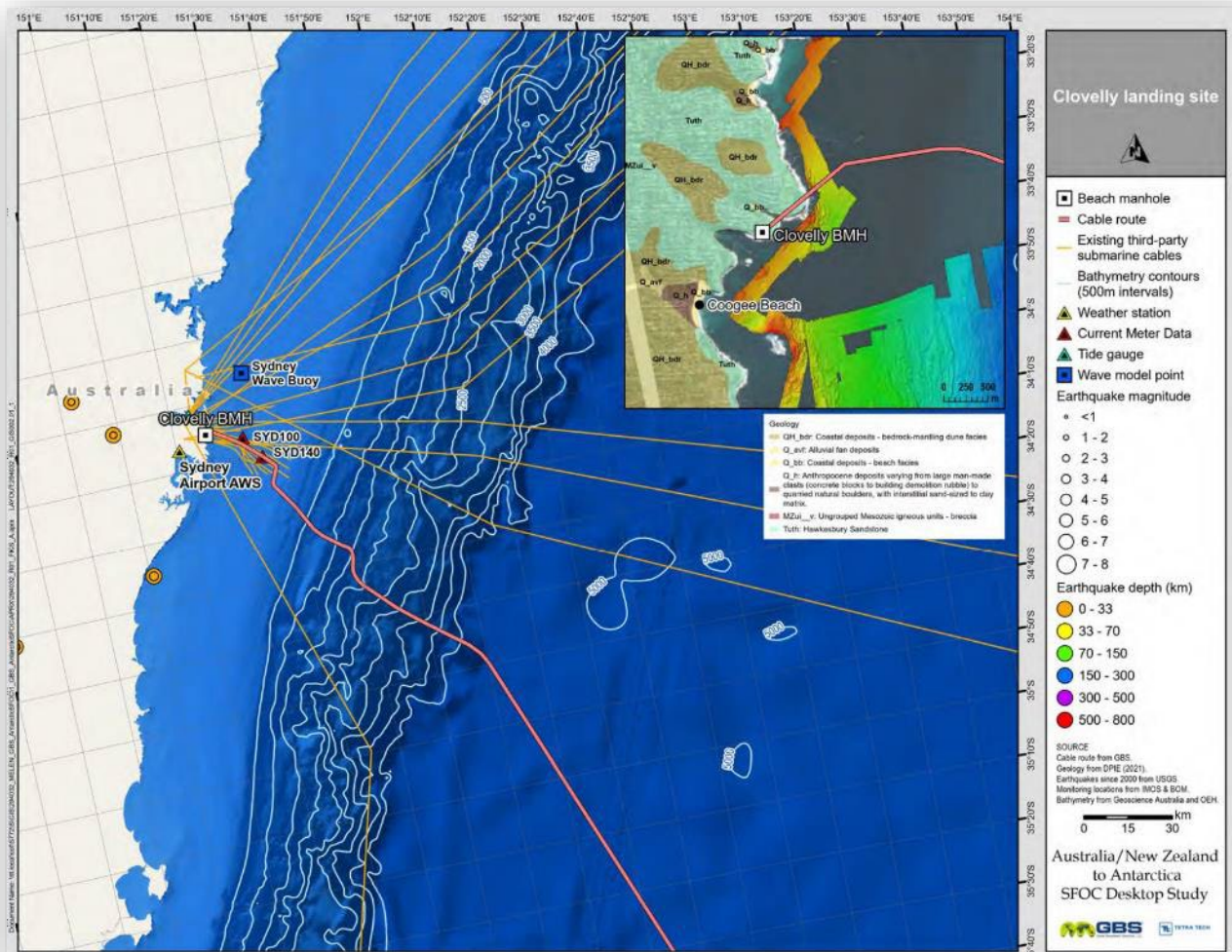

(DPIE, 2021; USGS, 2022.; IMOS, n.d.; BOM, 2022; Geoscience Australia, 2009a,b; and OEI, 2017)

Figure 4-2. Clovelly Approach and Landing Site Geology.

This landing would take advantage of an existing HDD conduit and beach manhole, but a new terrestrial conduit to the data center would be needed. The area between the cable beach landings and the data centers located approximately 8 km inland is primarily a residential and commercial urban area of Sydney. Our assessment has not identified any significant geological features which would impact the development of a terrestrial alignment for the proposed cable.

Immediately offshore, the proximal Sydney coastal floor is comprised of rocky reefs (likely of Hawkesbury Sandstone or related Sydney Basin units) and sands of varying compositions, ranging





from fine to coarse grained, with varied mud and carbonate shell abundances (OEH, 2017). Based on bathymetric maps of the shallow coastline (OEH, 2016) the sandstone (and related units) may extend as much as 3 km outwards (to approx. 40 m to 50 m depth).

The Australian continental shelf is narrow (50 km wide) with a steep continental rise. The sea floor is comprised of mostly terrigenous and calcareous sands and muds. The Tasman Basin seafloor is comprised mostly of calcareous globigerina ooze and pelagic clays. With some sands and muds interpreted as having been transported via fan systems from the shelf (Krause, 1967; Conolly, 1969; Standard, 1961).

The Macquarie Ridge is very steep and rugged, rising to 6,000 m over only 20 km on either flank (Figure 4-3). The seafloor is composed of alkaline to sub-alkaline basaltic pillow lavas, massive and sheet lava flows, lava talus, volcanoclastic breccia, diabase, and gabbro (Conway, 2011). Much of this material was formed during effusive mid-ocean ridge volcanism at the relic Macquarie spreading center, and has since been sheared, accreted, and exhumed along the modern transpressional plate boundary (Conway, 2011).

Macquarie Island, the sole exposed section of the Macquarie Ridge is comprised of similar materials - uplifted ocean floor, volcanic breccia, pillow lavas, and sediments (Conway, 2011). The proposed landing site is located on Macquarie Island near Australia's subantarctic research base, the Macquarie Island Station. No significant geologic features are expected to impact the development of a terrestrial route for the proposed cable.

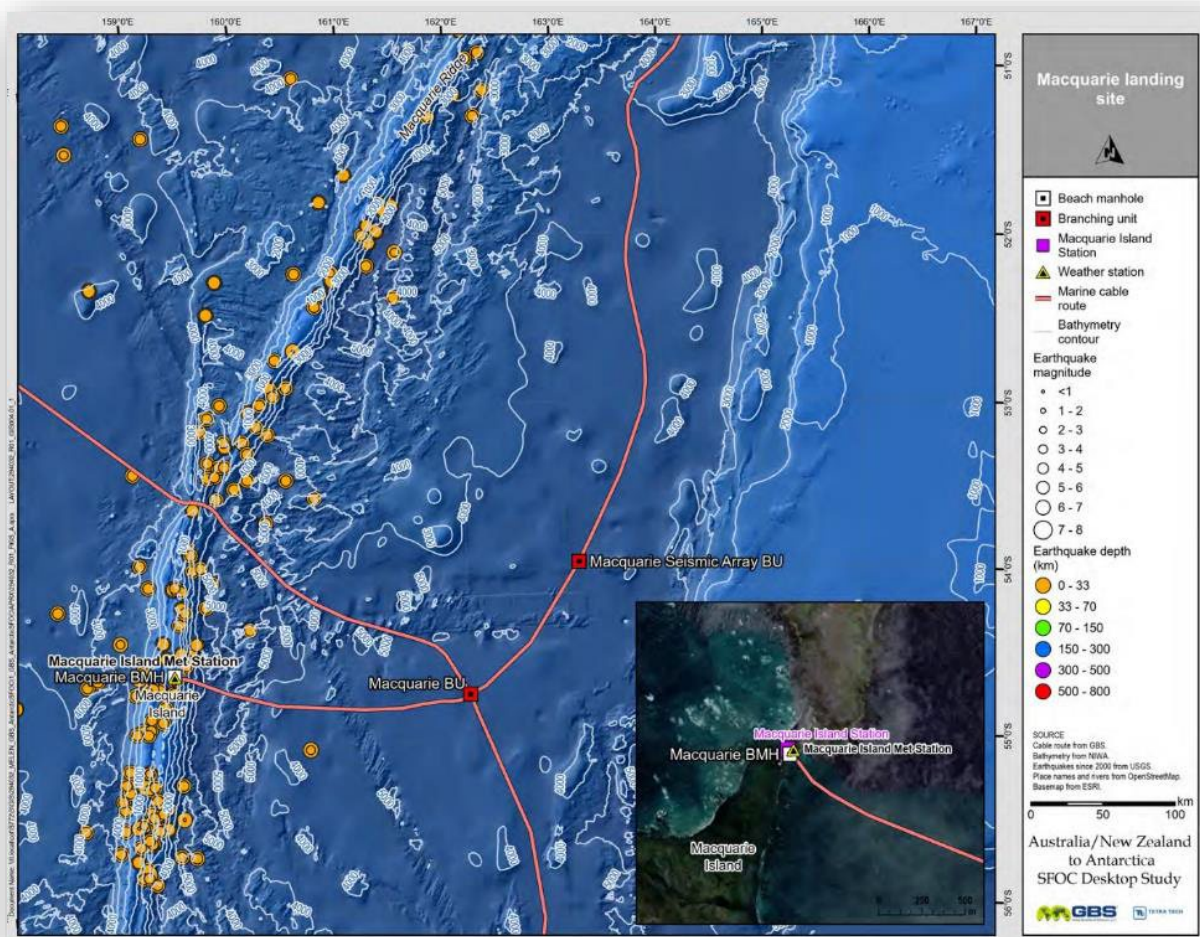

(NIWA, 2016; USGS, 2022.; OpenStreetMap, n.d.; Esri et al., n.d.b.)

Figure 4-3. Macquarie Ridge Bathymetry.

### 4.2.2. Seismic Hazards

The Sydney Basin experiences infrequent seismicity due to its distance from plate tectonic boundaries (Estrada et al., 2016). Most earthquakes near Sydney occur under the Blue Mountains and are associated with the Lapstone Structural Complex. A paleo seismological study by Clark (2010) estimates that maximum earthquake magnitudes ~M 7.0 might occur with an average frequency of between 1-2 million years.

The Tasman Basin appears to be relatively seismically inactive and is not anticipated to present a significant hazard to the submarine cable.

The Macquarie Ridge is associated with the active Indo-Australian and Pacific plate boundary. Earthquakes frequently occur and are dominantly shallow (0 km to 33 km depths). A powerful



strike-slip earthquake occurred on 23 May 1989, 250 km north of the Macquarie Islands (Magnitude 8.2) – and is possibly the largest intraoceanic event of the 20th century (Anderson, 1990).

The recent seismic history has been considered as part of this assessment which has identified areas of relatively high and low seismicity. These are shown in Figure 4-4. From a geological risk perspective, it is preferable to avoid the areas of known higher relative seismicity, although this may be unavoidable in some cases.

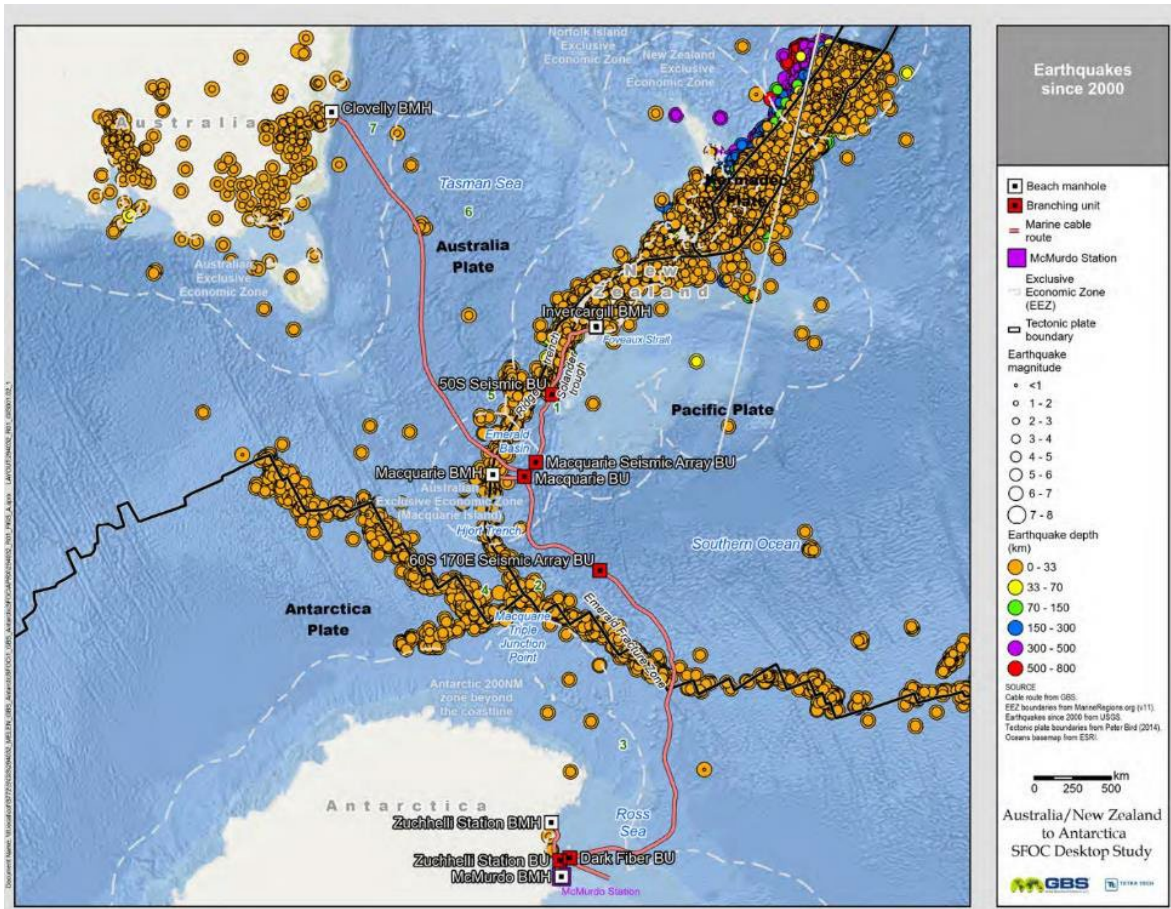

(MarineRegions.org, 2019; USGS, 2022; Bird, P., & Ahlenius, H., 2014; Esri et al., n.d.a.)  
 Figure 4-4. Seismic Activity in Project Area (Earthquakes since 2000).

### 4.2.3. Tsunami Hazards

Tsunamis present a potential hazard primarily at the cable landings to land-based infrastructure. The tsunami hazard present at the Sydney and Macquarie Island landings is described in the following sections.

### *Sydney*

Tsunami hazards are most likely to be earthquake-generated and sourced from distant areas such as the Puysegur Ridge. A study by Dall'Osso et al. (2009) considers existing exposure to tsunamis to be relatively low along the Sydney coastline, but this could increase significantly under higher sea level conditions caused by combinations of tide and/or long-term sea level rise. Generally, there is a higher risk of disruption in shallower waters.

### *Macquarie Island*

The research station and cable landing are situated on a thin (200 m), low-lying (Approx. 5 m maximum elevation) strip of Macquarie Island and are likely highly susceptible to tsunami inundation. Potential earthquake-induced tsunamis are likely to be sourced from either the Puysegur Ridge, Macquarie Ridge or further afield such as the South American coast (e.g., Peru). Slope failures within the flanks of the Macquarie Ridge proximal to Macquarie Island could potentially generate localized tsunami.

#### **4.2.4. Volcanic Hazards**

No volcanic hazards are expected in this section of route, either on the continental shelf or within the Tasman Basin and on Macquarie Ridge.

#### **4.2.5. Hydrothermal Hazards**

There is little evidence to suggest the widespread presence of hydrothermal zones along the continental shelf of Australia or within the Tasman Basin.

There is little evidence of widespread presence of hydrothermal zones along the Macquarie Ridge. Unmapped localized zones may be present, and if any are identified during the marine route survey, the cable should be routed around them.

#### **4.2.6. Slope Stability**

##### *Turbidity Currents and Sediment Movement from Shelf to Basin*

Many submarine canyons exist along the eastern continental margin of Australia. The distribution and morphology reflect the plate tectonic history of the continent since the break-up of Gondwana and long-term processes associated with canyon development that vary at regional to local scales. Canyons may be topographically complex or simple in form, and are highly variable in size, with planar areas ranging from 1 km<sup>2</sup> to 4695 km<sup>2</sup> (Huang et al., 2014). They vary in extent across the outer continental shelf and continental slope to abyssal plain. Most canyons are well separated from the coast and river mouths. From a geological risk perspective,



intersection with any submarine canyons or active sediment pathways should be avoided, where possible.

### *Slope Failures, Turbidity Currents and Sediment Movement*

The topography of the Macquarie Ridge is rugged, steep, and highly variable. It is likely that many sedimentary transport systems exist (e.g., submarine canyons) that extend perpendicular to the axis of the plate boundary. Analysis and bathymetric studies of the seafloor in detail is required to ascertain the exact nature and structure of any sedimentary pathways that occur within the areas that may influence the cable route. If identified during the marine route survey, the cable route should be adjusted as necessary to avoid intersection with active sediment pathways, particularly at right angles to the direction of transport.

## **4.3. New Zealand**

This section of route comprises the onshore pathway from the proposed data center location to the proposed Oreti Beach landing site, as well as the offshore pathway from Oreti Beach to the Macquarie BU.

### **4.3.1. Seabed and Coastal Geology**

Oreti Beach is a relatively flat, sandy beach that gradually transitions into the shallow continental shelf of the Foveaux Strait. The almost featureless seafloor slopes gently westward from depths between 20 m and 80 m and is comprised mostly of cobbles, gravels, and coarse sands with varying abundances of calcareous material (Cullen, 1967). The Solander Trough is connected to the Foveaux Strait via a system of submarine canyons (Figure 4-5). The seafloor of the trough is comprised mostly of sand and mud. Carbonate content can reach 40% to 60% within the southern parts of the trough (Bostock et al., 2019). A cluster of seamounts separates the Solander Trough from the Emerald Basin, where the sediment cover transitions into current-swept muds, alternating with manganese nodules and a dense, benthic nepheloid layer (Carter & Wilkin, 1999).

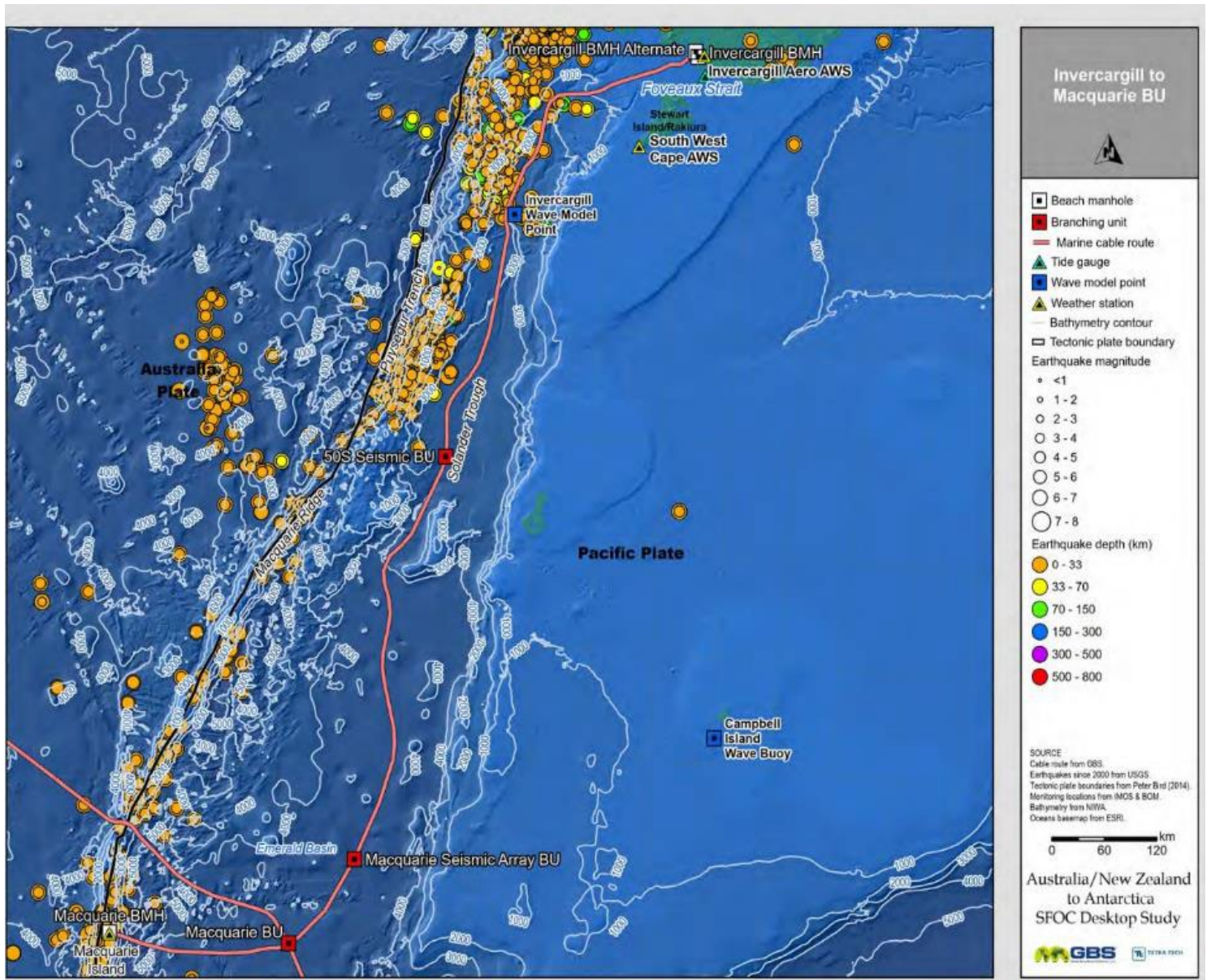

(USGS, 2022; Bird, P., & Ahlenius, H., 2014; IMOS, n.d.; BOM, 2022; NIWA, 2016a,b; Esri et al., n.d.a.)

Figure 4-5. Bathymetry Along Proposed Cable Route – Solander Trough.

From the landing site at Oreti Beach, the terrestrial route will connect to a data center located several kilometers north of Invercargill city (Figure 4-6). The approx. 20 km route traverses residential and commercial urban areas, rural farmland and coastal dunes and beach sands. Published geological mapping (Turnbull & Allibone, 2003) indicates the landscape is dominated by numerous Pleistocene to Holocene clastic sediments defined as alluvial gravels, sands, and silts (with possible isolated pockets of loess and peats). Many units are linked to estuary and tributary systems as well as active and relict sedimentary fans. These are underlain by Late Cretaceous to Permian basement rocks of New Zealand. Various degrees of weathering are



reported within the recent sediments.

Our assessment of the general area of consideration has not identified any significant geological features which would impact on the creation of a terrestrial alignment of the proposed cable. Although the sedimentary soils are of an age and composition which may be considered susceptible to liquefaction the area is not considered to be any higher risk than many other locations in New Zealand where similar infrastructure has been successfully installed and maintained.

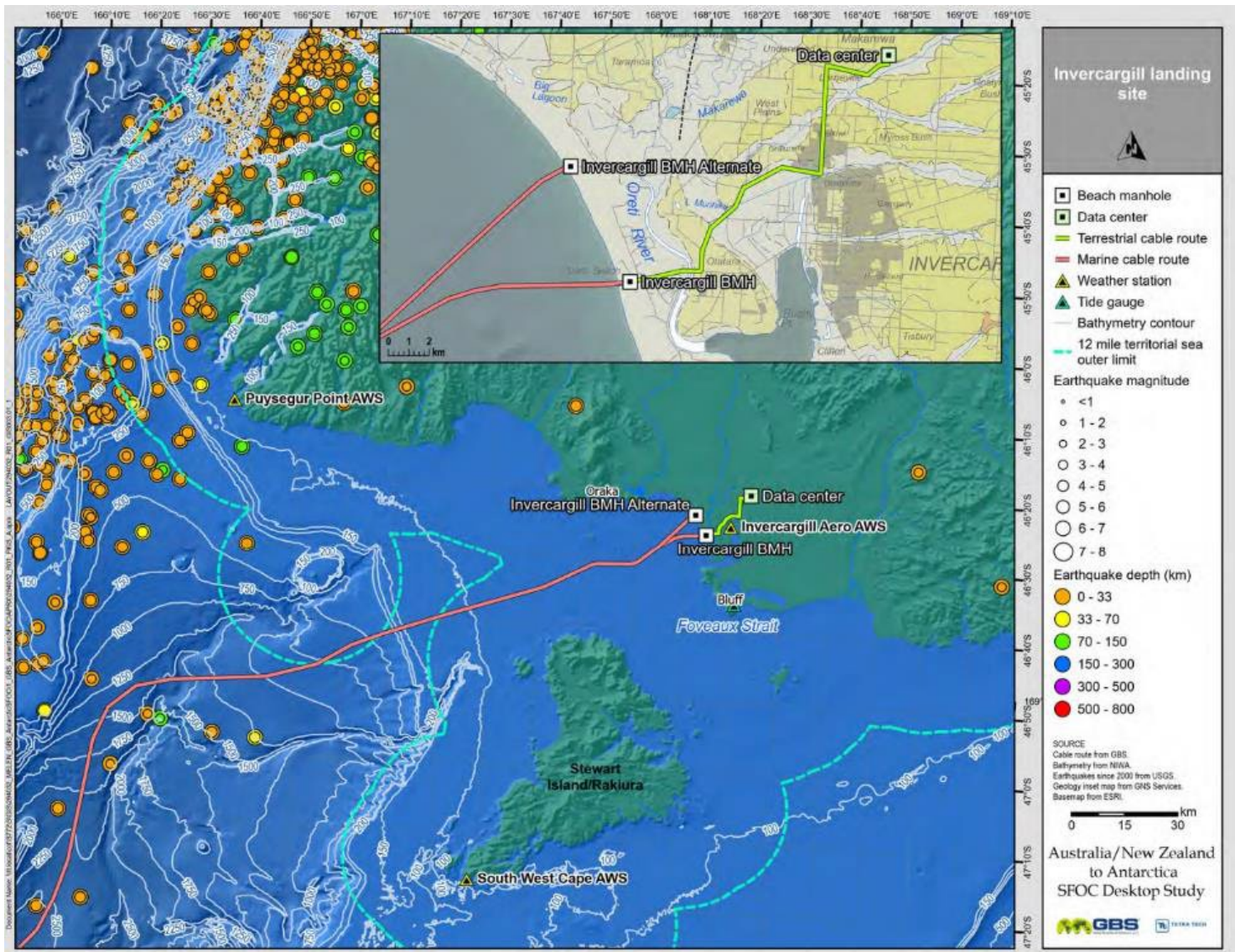

(NIWA, 2016a,b; USGS, 2022; GNS Science, n.d.; Esri et al., n.d.a.)  
 Figure 4-6. Invercargill Approach and Terrestrial Route.



### 4.3.2. Seismic Hazards

The onshore Invercargill region is a relatively seismically inactive region of New Zealand. Activity along the plate boundary to the west is significant, however, and can produce large earthquakes. Ground shaking intensities of greater than MMVII (Modified Mercalli 7) in Invercargill were reported by Glassey (2006) as having a probability of less than 2% in 50 years, a return period of approximately 2500 years or greater. The probability of earthquake shaking strong enough to cause liquefaction in Invercargill is considered low by the standards of many New Zealand cities (e.g., Wellington, Stirling et al., 2002) however a 2012 report shows that the Invercargill area and its surrounding geological units occupy a range of categorizations from Negligible, Moderately and Very Highly susceptible to liquefaction (Glassey & Heron, 2012).

A faulting zone exists within the northern Solander Trough, the Tauru Fault is highlighted in the literature (e.g., Patel et al., 2021) and considered active (Figure 4-7). Little information can be identified of the magnitude or timescales of movement along this fault.

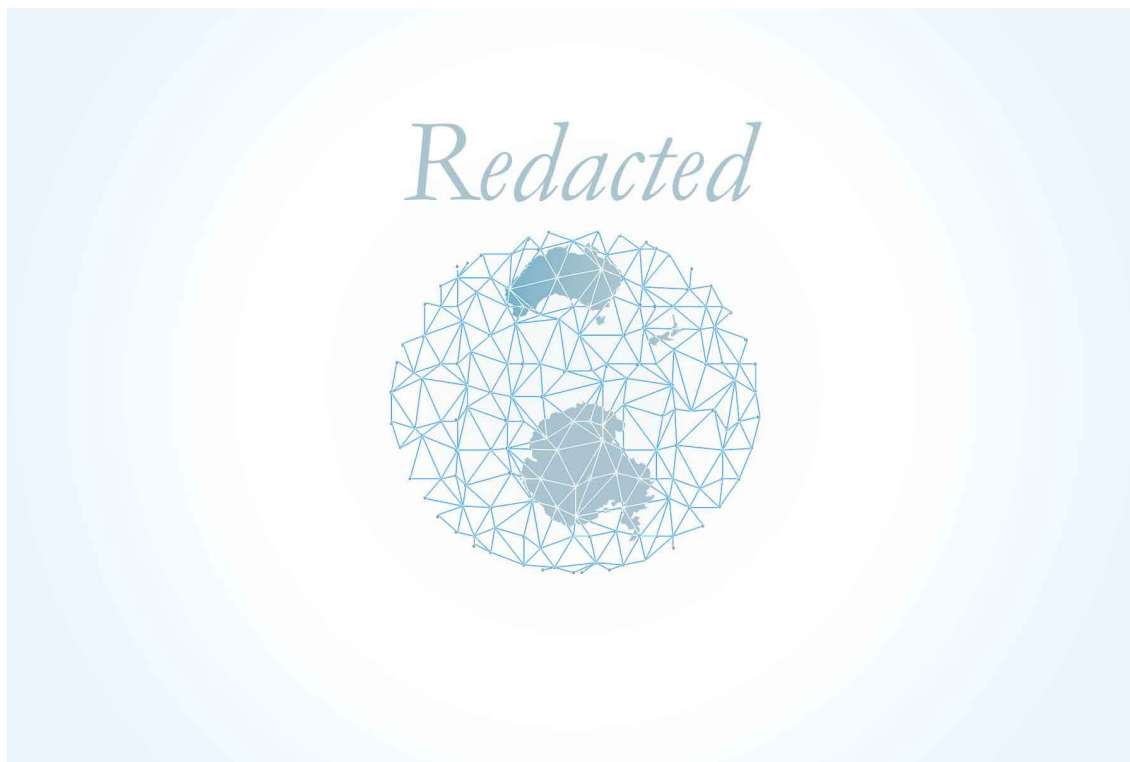

*(Adapted from Patel et al., 2021.)*

Figure 4-7. [Redacted]. Box Model of the Solander Trough

The Tauru fault can be seen in black near the head of the trough.

Significant seismic activity occurs along the extent of the plate boundaries. The recent seismic history has been considered as part of this assessment and has identified areas of relatively higher and lower seismicity. Please refer to Figure 4-4 in Section 4.2.2. From a geological risk



perspective, it is preferable to avoid the areas of known higher relative seismicity.

#### **4.3.3. Tsunami Hazards**

In a report produced by GNS Science (Power, 2013) the maximum amplitude of a 500-year return period event (50th percentile) near Invercargill is approx. 5 m height. Tsunamis are most likely to be sourced from the Puysegur Ridge and Peru, although other locations within New Zealand (such as the Kermadec Arc) and further afield are potential source locations.

Tsunami inundation could affect the landing site infrastructure and the cable within the shallow near-shore environment at Oreti Beach. However, risk to the cable and any associated infrastructure is likely to reduce with distance further inland.

#### **4.3.4. Volcanic Hazards**

There is no evidence of significant volcanic hazards in this region. Solander Island (Hautere) volcano located approx. 60 km off the coast of the South Island is most likely extinct; although recent studies have revealed that the last eruption was much more recent than previously believed (as young as 150 thousand years ago) (Morteimer et al., 2008).

#### **4.3.5. Hydrothermal Hazards**

There is little evidence to suggest the presence of hydrothermal zones. Unmapped localized zones may be present, particularly along the extent of the Macquarie Ridge and active plate boundaries. It is preferable to avoid any identified hydrothermal zones.

#### **4.3.6. Turbidity Currents and Sediment Movement from Shelf to Basin**

The channel system at the head of the Solander Trough is the primary pathway for sediment gravity flows that descend along its axis (Patel et al., 2021). It is unclear how active these sediment pathway systems are. The channels were the most active during glacial low-stand conditions when sediment was supplied to the shelf edge and are inferred to have been mostly inactive during the Holocene. Little sediment has been observed in the Solander Trough at latitudes south of Auckland Island, thought to be due to strong currents of the Subantarctic Front which penetrates Macquarie Ridge at circa 53.5°S (Bostock et al., 2019; Carter & McCave, 1997). Terrigenous sediment is observed extending into the Emerald Basin. The total accumulated sediment thickness reduces markedly from 1,200 m in the trough, to 800 m in the basin close to the sea mounts (Carter & McCave, 1997) indicating significant interception by these topographic highs.

Erosion is likely actively taking place. Bottom current speeds of 20 cm/s and greater have been observed and are thought to be due to bottom currents flowing through the gaps in the



Macquarie Ridge (Carter & McCave, 1997; Carter & Wilkin, 1999).

It is unknown if seismic activity (earthquakes and faulting), which is shown in Figure 4-8, contributes to sediment gravity flows along the Solander Trough. Steep sided levees along the flanks of the trough and other steep slopes (such as the south edge of Solander volcano) represent possible sources of sediment gravity flows. From a geological risk perspective, smoother, less steep topographies that avoid intersection with canyons and other sediment pathways are preferable.

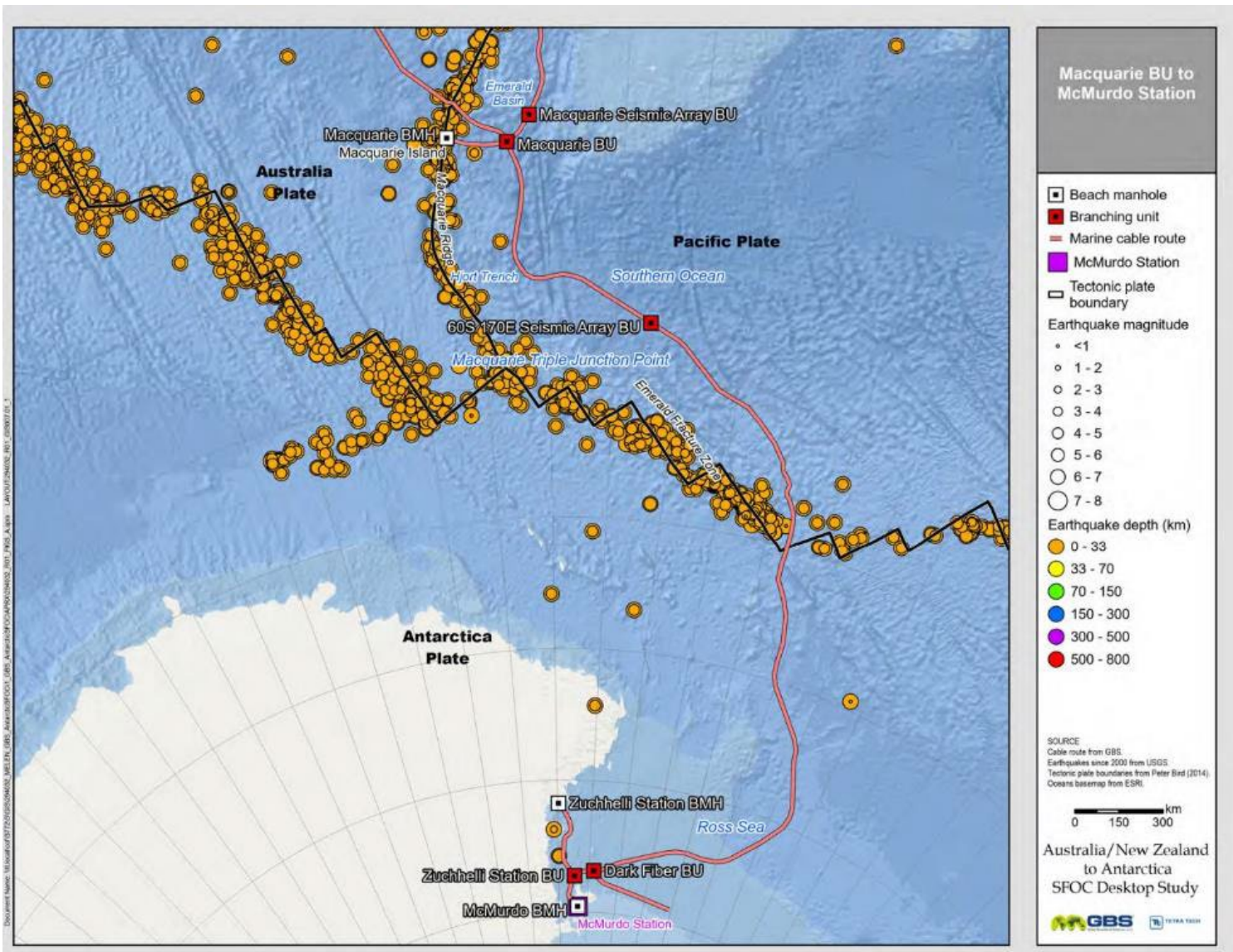

(USGS, 2022.; Bird, P., & Ahlenius, H., 2014; Esri et al., n.d.a.)

Figure 4-8. Proposed Cable Route Through the Southern Pacific Ocean and Antarctic Continental Margin.



## 4.4. Antarctica

South of Macquarie Island the proposed route traverses the remainder of the Emerald Basin and Hjort Plateau before crossing the Antarctic-Pacific plate boundary where it climbs the Antarctic continental margin into the Ross Sea and Ice Shelf (Figure 4-7).

### 4.4.1. Seabed and Coastal Geology

The Ross Sea overlies a deep continental shelf with an average depth of approx. 500 m (Figure 4-9) (Davey, 2004). It formed during the Oligocene and later as a series of glacial marine sedimentary units deposited during multiple advances and retreats of the Antarctic Ice Sheet across the sea floor. The rocks of the shelf are faulted into multiple graben/basin systems that are aligned in an approx. NNE to SSW orientation (Davey, 1981). Glacial deposits vary greatly over short distances.

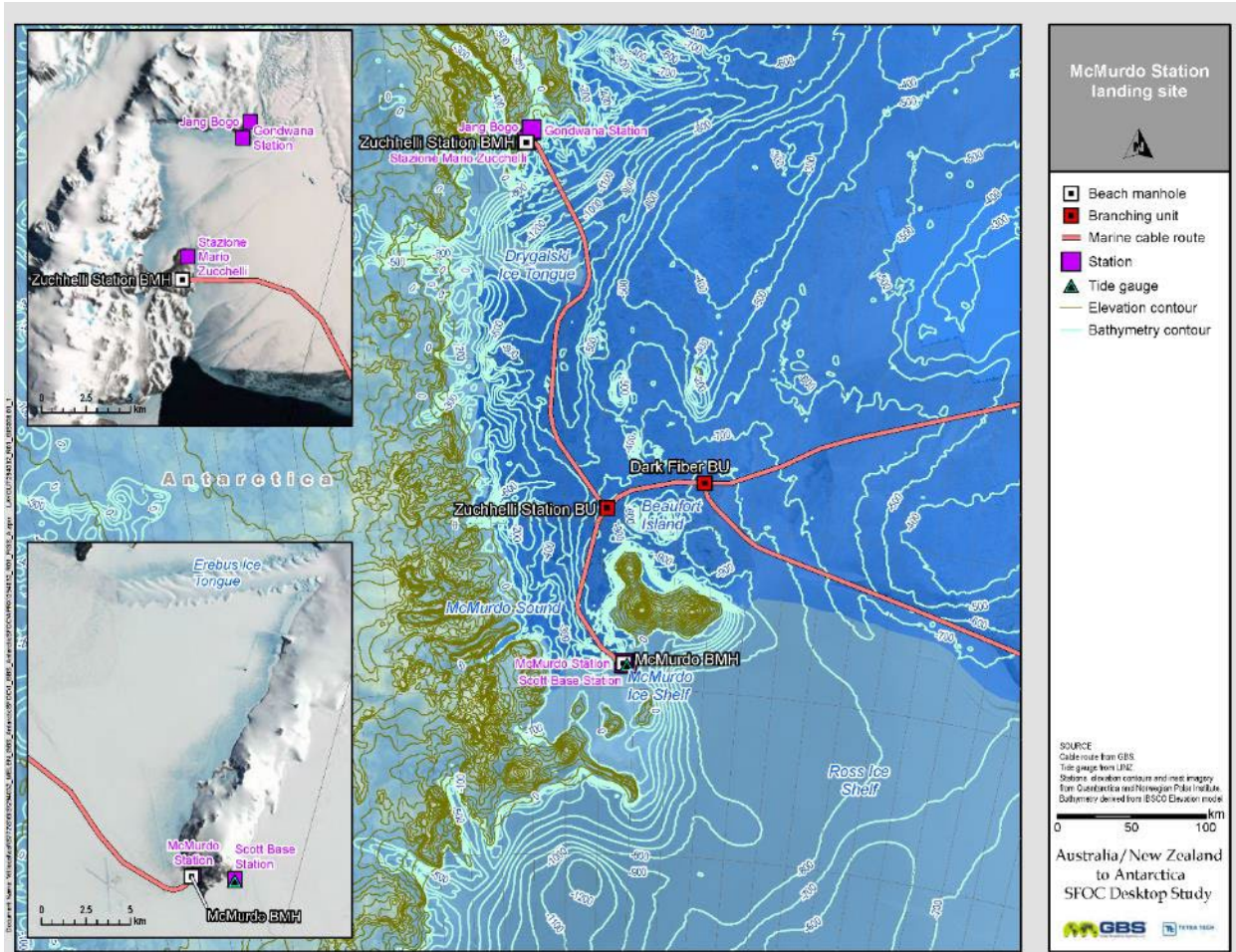

(LINZ, 2022; NIWA, 2016a,b; USGS, 2022; GNS Science, n.d.; Quantarctica, n.d.; IBSCO, 2013a,b)

Figure 4-9. Bathymetry on Approach to McMurdo Station.



The Ross Ice Shelf is the world's largest body of floating ice, lying at the head of the Ross Sea (Rignot et al., 2013). The near vertical ice front to the open sea is more than 600 km long and between 15 m and 50 m high above the water surface (Scheffel et al., 1980). The mean ice thickness is approx. 300 m along a line at about 79°S latitude (Rafferty, 2011). The shelf moves 1 m to 3 m outwards per day, with freezing water and glacial input adding to the bulk of the ice.

McMurdo Station is located on Hut Point Peninsula, a narrow stretch of land on Ross Island. Ross Island is formed from four large volcanoes that are dominantly basaltic. The substrate is likely comprised of in-situ or reworked volcanic lavas and breccias. There are no significant geological features which should impact the development of the terrestrial route to the data center.

#### 4.4.2. Seismic Hazards

There is both a potential earthquake shaking and a tsunami hazard to McMurdo Station from local earthquake sources. The Antarctic Plate is viewed as relatively seismically inactive for a continental plate (Reading, 2002), however studies have shown that its seismic activity is comparable to that of other plates of similar size and kinematics (Okal, 1981). The apparent lack of activity may in part be due to the lack of seismic stations (Burbidge et al., 2020) although ice may also play a role in suppressing earthquake shaking (Reading, 2007).

The largest instrumentally recorded earthquakes on the Antarctic plate have occurred at its offshore boundaries. In 1998, a M 8.1 earthquake occurred near the Balleny Islands, and in 2013, a M 7.7 earthquake occurred in the Scotia Sea. Both produced small instrumentally observed tsunamis at distant tide-gauge stations (Burbidge et al., 2020). The largest earthquakes in recent recorded history within the Ross Sea have occurred in the west; a M 5.5 in 1993, and a M 5.1 in 2012.

Henrys et al. (2008) identified several normal faults in the Ross Sea rift basin west and northwest of Ross Island using seismic data. In particular, there is a small normal fault just east of the Hut Point Peninsula, which may be associated with the line of volcanism passing through Mt. Erebus and Mt. Bird and to the area of rifting north of Ross Island (Naish et al., 2007).

If significant loss of ice were to occur from the ice sheets, the isostatic rebound effect may lead to additional earthquakes (McGuire, 2012), although this is thought to be a relatively slow process operating on timescales of centuries.

#### 4.4.3. Tsunami Hazards

A tsunami from a distant source could be a very rare, but plausible onshore hazard to McMurdo Station. In an assessment of distal source tsunami (more than three hours travel time) for Scott Base by Burbidge et al. (2020), the largest tsunamis from a distant source comes from the Mexican part of the Central American subduction zone. Other sources of significant tsunami were the Tonga Trench and Kermadec-Hikurangi subduction zones to the north of New Zealand and



the Hjort Trench subduction zone to the south of New Zealand. Burbidge et al. (2020) concluded that the maximum tsunami in the Ross Sea from large events could become quite high (up to as much as 6 m) and that a tsunami of about 1.4 m offshore is a potential inundation hazard. In addition to the tsunami itself, the amount of inundation would also depend on the tide at the time of the tsunami and any potential sea level rise due to global warming. A unique factor is the potential effect of the ice shelf on tsunamis traveling in the Ross Sea (Burbidge et al., 2020). The bedrock beneath the Ross Ice Shelf can be as deep as 1 km from the Mean Sea Level and the ice shelf only grounds on a few high points within the sub ice shelf cavity.

In addition to distant earthquakes, Burbidge et al. (2020) recognized that tsunamis may also be generated from the following sources:

- Rockfall and icefall landslides into the sea from Ross Island or Victoria Land (a region of eastern Antarctica).
- Submarine landslides on the continental shelf edge.
- Volcanic events on Ross Island or Victoria Land volcanoes.
- Glacier or ice shelf calving events, and iceberg capsizing.
- Local earthquakes.

Several of the above processes may become more frequent due to climate change, and the time frames over which these take place are variable and poorly constrained (e.g., Burbidge et al., 2020):

- Rock and ice falls: if melting and refreezing of ice happens more frequently and more likely late in the summer each year.
- Submarine landslides: if the nature and volume of sediment deposition changes due to retreat of ice shelves and deglaciation.
- Volcanic events: due to isostatic rebound and/or changes in sub-surface pressure if the weight of ice reduces.
- Glacier or ice shelf calving: if the calving process accelerates and/or changes in style.

The absence of historically recorded events in McMurdo Sound from these sources, and the very few reports of similar tsunami-causing events elsewhere in Antarctica, provides some reassurance that the current-day hazard posed by these sources is low (e.g., Burbidge et al., 2020). However, this must be interpreted in the context of a short historic record (about 75 years), generally low population, and sparse instrumentation.

#### **4.4.4. Volcanic Hazards**

Mt. Erebus volcano has a well-established historic and geologic record of explosive eruptions.



Strombolian eruptions in the main crater, which often houses lava lakes, have been commonly observed since regular monitoring commenced in 1972 (Caldwell & Kyle, 1994). Eruptions can produce ejecta that reach a few hundred meters from the main crater. Occasionally (e.g., in 1984) the frequency and energy of the Strombolian eruptions increase to eject material up to 1 km from the vent in the main crater. Phreatomagmatic eruptions, caused by steam build-up, can occur (e.g., in 1993), and ash ejection from the main crater was recorded on 15 December 1997 (Harpel et al., 2004). Ten lava flows have been recorded in the rock-record during a period of effusive activity dating between 8.5 and 4.5 ka (Parmelee et al., 2015). 37 phreatomagmatic eruptions are recorded in englacial tephra on Mt Erebus, erupted between 71 thousand years ago to only several hundred years ago (Harpel et al., 2008). These eruptions were found between 2 km and 20 km from the main crater. One eruption in this sequence at 39 ka is thought to be Plinian in scale, affecting areas up to 200 km away in East Antarctica.

Ballistic ejecta from Strombolian eruptions and lava flows are unlikely to pose a hazard to McMurdo Station, but ash fall from large scale (e.g., sub-Plinian to Plinian) magmatic and phreatomagmatic eruptions could have a potential effect. Significant ash fall can accumulate on roofs and other structures causing them to collapse from the weight. Ash fall is unlikely to damage buried infrastructure such as cables.

#### **4.4.5. Hydrothermal Hazards**

There is little literature recording the presence of hydrothermal zones within the Macquarie Triple Junction Zone or along the Antarctic-Pacific Ridge. Unmapped localized zones may be present.

#### **4.4.6. Turbidity Currents and Sediment Movement from Shelf to Basin**

There are some possible active sediment pathways within the basin and graben structures within the Ross Sea e.g., Wilson Canyon.

## 4.5. References

- Anderson, H. (1990). The 1989 MacQuarie Ridge Earthquake and its contribution to the regional seismic moment budget. *Geophysical Research Letters*, 17(7), 1013-1016, <https://doi.org/10.1029/GL017i007p01013>
- Bird, P., & Ahlenius, H. (2014). PB2002\_plates, Tectonic Plates and Boundaries. ESRI Living Atlas. Retrieved August 2022 from <https://www.arcgis.com/home/item.html?id=5113817f8b00453494fd5cf64c099ef9>. GIS data derived by Ahlenius, H. (2014) from Bird, P. (2003). An updated digital model of plate boundaries. *Geochemistry Geophysics Geosystems*, 4(3), 1027. Retrieved August 2022 from <https://agupubs.onlinelibrary.wiley.com/doi/full/10.1029/2001GC000252>
- Bostock, H., Jenkins, C., Mackay, K., Carter, L., Nodder, S., Orpin, A., Pallentin, A., & Wysoczanski, R. (2019). Distribution of surficial sediments in the ocean around New Zealand/Aotearoa. Part A: continental slope and deep ocean. *New Zealand Journal of Geology and Geophysics*, 62:1, 1-23, <https://doi.org/10.1080/00288306.2018.1523198>
- Burbidge, D., Power, W., Gusman, A., Wang, X., Lukovic, B., Black, J., & Martin, A.P. (2020). *The Scott Base redevelopment: Ross Sea geological hazards*. New Zealand Society for Earthquake Engineering (NZSEE) 2020 Annual Conference. Retrieved August 29, 2023 from <https://repo.nzsee.org.nz/handle/nzsee/1739>
- Caldwell, D.A., & Kyle, P.R. (1994). Mineralogy and geochemistry of ejecta erupted from Mount Erebus, Antarctica, between 1972 and 1986. In P.R. Kyle, (Ed.), *Volcanological and Environmental Studies of Mount Erebus, Antarctica*, pp. 147-162. American Geophysical Union, Washington, DC. Retrieved August 29, 2023 from <http://ndl.ethernet.edu.et/bitstream/123456789/30187/1/Philip%20R%20Kyle.pdf#page=158> [page does not load but document automatically uploads]
- Carter, L., & McCave, I. (1997). The sedimentary regime beneath the deep western boundary current inflow to the Southwest Pacific Ocean. *Journal of Sedimentary Research*, 67, 1005–1017, <https://doi.org/10.1306/D42686B2-2B26-11D7-8648000102C1865D>
- Carter, L., Carter, R. M., McCave, I. N., & Gamble, J. (1996). Regional sediment recycling in the abyssal Southwest Pacific Ocean. *Geology*, 24, 735–738, [https://doi.org/10.1130/0091-7613\(1996\)024<0735:RSRITA>2.3.CO;2](https://doi.org/10.1130/0091-7613(1996)024<0735:RSRITA>2.3.CO;2)
- Carter, L., & Wilkin, J.L. (1999). Abyssal circulation around New Zealand: A comparison between observations and a global circulation model. *Marine Geology*, 159, 221-239.



- Clark, D. (2010). Large earthquake recurrence in New South Wales: implications for earthquake hazard. *Australian Geomechanics Society Sydney Symposium October 2010*, pp. 27-36.
- Conolly, R. (1969). Western Tasman Sea Floor. *New Zealand Journal of Geology and Geophysics*, 12:1, 310-343. <https://doi.org/10.1080/00288306.1969.10420238>
- Conway, C.E. (2011). *The volcano-tectonic evolution of the Macquarie Ridge Complex, Australia-Pacific plate boundary south of New Zealand*. [Unpublished MSc thesis, Victoria University of Wellington]. Retrieved August 29, 2023 from <https://researcharchive.vuw.ac.nz/xmlui/handle/10063/2122>
- Cullen, D. (1967). *The Submarine Geology of Foveaux Strait*. New Zealand Department of Scientific and Industrial Research. Bulletin 184. New Zealand Oceanographic Institute Memoir No.33. [https://docs.niwa.co.nz/library/public/Memoir%20033\\_Submrine\\_Geology\\_Foveaux\\_Strait%20-%201967.pdf](https://docs.niwa.co.nz/library/public/Memoir%20033_Submrine_Geology_Foveaux_Strait%20-%201967.pdf)
- Dall’Osso, F., Gonella, M., Gabbianelli, G., Withycombe, G., & Dominey-Howes, D. (2009). Assessing the vulnerability of buildings to tsunami in Sydney. *Nat. Hazards Earth Syst. Sci.*, 9, 2015–2026. <https://doi.org/10.5194/nhess-9-1557-2009>
- Davey, F.J. (1981). Geophysical studies in the Ross Sea region. *Journal of the Royal Society of New Zealand*, 11(4), 465-479, <https://doi.org/10.1080/03036758.1981.10423336>
- Davey F. J. (2004). *Ross Sea Bathymetry, 1:2 000 000, version 1.0*. Institute of Geological & Nuclear Sciences geophysical map 16. Institute of Geological & Nuclear Sciences Limited, Lower Hutt, New Zealand.
- DPIE. (2021). New South Wales rock units. Geological Survey of New South Wales, Department of Regional NSW, Maitland. Accessed 2022 from <https://search.geoscience.nsw.gov.au/product/9232>
- Esri. (2022). ArcGIS Desktop: Release 3.0. Redlands, CA: Environmental Systems Research Institute. [Data source for many GIS maps].
- Esri, Garmin, GEBCO, NOAA NGDC. (n.d.a.). World Ocean Base. Basemap in ArcGIS Pro v. 3.0. [https://services.arcgisonline.com/arcgis/rest/services/Ocean/World\\_Ocean\\_Base/MapServer](https://services.arcgisonline.com/arcgis/rest/services/Ocean/World_Ocean_Base/MapServer)
- Esri, DigitalGlobe, GeoEye, i-cubed, USDA FSA, AEX, Getmapping, Aerogrid, IGN, IGP, swisstopo, and the GIS User Community. (n.d.b). World Imagery. Basemap in ArcGIS Pro v. 3.0.





- Estrada, B., de Ambrosis, A., & Bertuzzi, R. (2016). Seismic Design of Tunnels in the Sydney Region: Selection of Earthquake Parameters and Approach. *Australian Earthquake Engineering Society 2016 Conference, Nov 25-27, Melbourne, Victoria*. <https://aees.org.au/wp-content/uploads/2018/06/347-Estrada-et-al.pdf>
- Geoscience Australia. (2009a). *Australian Bathymetry DEM, June 2009*. Commonwealth of Australia (Geoscience Australia). Retrieved March 2022 from <https://ecat.ga.gov.au/geonetwork/srv/eng/catalog.search#/metadata/67703>
- Geoscience Australia. (2009b). *Australian Bathymetry Contours, June 2009*. Commonwealth of Australia (Geoscience Australia). Retrieved March 2022 from <https://ecat.ga.gov.au/geonetwork/srv/eng/catalog.search#/metadata/67703>
- Glasse, P.J. (2006). *Geological hazards: Southland District Council Lifelines study*. GNS Science Consultancy report 2006/100. June 2006.
- Glasse, P.J., & Heron, D.W. (2012). *Amplified Ground Shaking and Liquefaction Susceptibility, Invercargill City*. GNS Science Consultancy Report 2012/014. 10p. <https://icc.govt.nz/wp-content/uploads/2014/11/Liquefaction-Report-2012.pdf>
- GNS Science. (n.d.) New Zealand GNS 1:250K Geology. Retrieved March 2022 from <https://catalogue.data.govt.nz/dataset/nzl-gns-1-250k-geology-3rd-edition>
- Harpel, C.J. Kyle, P.R. Esser, R.P. McIntosh, W.C. & Caldwell, D.A. (2004). 40Ar/39Ar dating of the eruptive history of Mount Erebus, Antarctica: summit flows, tephra, and caldera collapse. *Bulletin of Volcanology*, 66(8), 687-702. <https://doi.org/10.1007/s00445-004-0349-7>
- Henry, S.A., Wilson, T.J., Fielding, C.R., Hall, J., & Naish, T.R. (2008). Tectonic history of mid-Miocene to present southern Victoria Land Basin, inferred from seismic stratigraphy in McMurdo Sound, Antarctica. *Earth and Atmospheric Sciences*, 285. doi:10.3133/of2007-1047.srp049 (Retrieved August 29, 2023 from <http://digitalcommons.unl.edu/geosciencefacpub/285> And <https://pubs.usgs.gov/of/2007/1047/srp/srp049/>)
- Herbert, C. (1983). *Sydney 1:100 000 Geological Sheet 9130*. 1st edition. Geological Survey of New South Wales, Sydney.
- Huang, Z., Nichol, S., Harris, P., & Caley, M. (2014). Classification of submarine canyons of the Australian continental margin. *Marine Geology*, 357. <https://doi.org/10.1016/j.margeo.2014.07.007>
- HYCOM. (n.d.). Hybrid Coordinate Ocean Model. Retrieved April 2022 from <https://www.hycom.org/dataserver/gofs-3pt1/analysis>



International Bathymetric Chart of the Southern Ocean (IBSCO). (2013a). *Antarctica elevation and bathymetry contours derived from above IBCSO\_ElevationModel\_Bed500m*. Derived from Arndt, J. E., Schenke, H.W., Jakobsson, M., Nitsche, F.O., Buys, G., Goleby, B. Rebesco, M., Bohoyo, F., Hong, J., Black, J., Greku, R., Udintsev, G.I., Barrios, F., Reynoso-Peralta, W.I., Taise, M., Wigley, R. (2013). The International Bathymetric Chart of the Southern Ocean (IBSCO) Version 1.0—A new bathymetric compilation covering circum-Antarctic waters, *Geophysical Research Letters*, 40, 3111–3117. <https://doi.org/10.1002/grl.50413>

IBSCO. (2013b). *Digital elevation model International Bathymetric Chart of the Southern Ocean*. Retrieved August 29, 2023 from <https://ibcso.org/>

Arndt, J. E., Schenke, H.W., Jakobsson, M., Nitsche, F.O., Buys, G., Goleby, B. Rebesco, M., Bohoyo, F., Hong, J., Black, J., Greku, R., Udintsev, G.I., Barrios, F., Reynoso-Peralta, W.I., Taise, M., Wigley, R. (2013). The International Bathymetric Chart of the Southern Ocean (IBSCO) Version 1.0—A new bathymetric compilation covering circum-Antarctic waters, *Geophysical Research Letters*, 40, 3111–3117. <https://doi.org/10.1002/grl.50413>.

Integrated Marine Observing System (IMOS). (n.d.). ADCP Locations. Accessed April 2022 from [http://oceancurrent.imos.org.au/timeseries/ANMN\\_P34/mapst/10\\_Syd\\_vmean\\_1.html](http://oceancurrent.imos.org.au/timeseries/ANMN_P34/mapst/10_Syd_vmean_1.html)

Krause, D.C. (1967). Bathymetry and Geologic Structure of the North-western Tasman Sea - Coral Sea - South Solomon Sea area of the South-western Pacific Ocean. New Zealand Oceanographic Institute Memoir No. 28. LINZ. 2022. Tide Gauges, Scott Base, Antarctica. Retrieved March 2022 from <https://www.linz.govt.nz/sea/tides/tide-predictions/scott-base>

Land Information New Zealand (LINZ). 2022. *Tide Gauges, Scott Base, Antarctica*. Retrieved March 2022 from <https://www.linz.govt.nz/products-services/tides-and-tidal-streams/tide-predictions>

Luyendyk, B.P., Wilson, D.S., & Siddoway, C. S. (2003). Eastern margin of the Ross Sea Rift in western Marie Byrd Land, Antarctica: Crustal structure and tectonic development. *Geochemistry, Geophysics, Geosystems*, 4, 1090. <https://doi.org/10.1029/2002GC000462>

MarineRegions.org. (2019). Maritime Boundaries v.11. Retrieved August 2022 from <http://www.marineregions.org/downloads.php>

Massell, C., Coffin, M. F., Mann, P., Mosher, S., Frohlich, C., Duncan, C. S., Karner, G., Ramsay, D., & Lebrun J.F. (2000). Neotectonics of the Macquarie Ridge Complex, Australia-Pacific plate boundary. *Journal of Geophysical Research*, 105(B6), 13457-13480. <https://doi.org/10.1029/1999JB900408>



- McGuire, B. (2012). *Waking the Giant: How a Changing Climate Triggers Earthquakes, Tsunamis and Volcanoes*. Oxford University Press.
- Meckel, T. A., Coffin, M. F., Mosher, S., Symonds, P., Bernardel, G., & Mann, P. (2003). Underthrusting at the Hjort Trench, Australian-Pacific plate boundary: Incipient subduction? *Geochemistry, Geophysics, Geosystems*, 4(12), 1099. <https://doi.org/10.1029/2002GC000498>
- Mortimer, N., Gans, P. B., & Mildenhall D. C. (2008). A middle-late Quaternary age for the adakitic arc volcanics of Hautere (Solander Island), Southern Ocean. *Journal of Volcanology and Geothermal Research*, 178, 701-707. <https://doi.org/10.1016/j.jvolgeores.2008.09.003>
- Naish, T.R., Powell, R.D., & Levy, R.H. (2007). Background to the ANDRILL McMurdo Ice Shelf Project (Antarctica) and initial science volume. *ANDRILL Research and Publications*, 29. <http://digitalcommons.unl.edu/andrillrespub/29>
- National Institute of Water & Atmospheric Research, Ltd. (NIWA). (2016a). New Zealand Bathymetry. Sourced from surveys by NIWA and Land Information New Zealand (LINZ). Mitchell, J.S., Mackay, K.A., Neil, H.L., Mackay, E.J., Pallentin, A., Notman P., 2012. Undersea New Zealand, 1:5,000,000. NIWA Chart, Miscellaneous Series No. 92.
- NIWA. (2016b). New Zealand Contours. Sourced from surveys by NIWA and Land Information New Zealand (LINZ). Retrieved August 29, 2023 from [https://dc.niwa.co.nz/niwa\\_dc/srv/api/records/a883d5f5-5b60-1b5d-a159-50b99134a5a7](https://dc.niwa.co.nz/niwa_dc/srv/api/records/a883d5f5-5b60-1b5d-a159-50b99134a5a7)
- Office of Environment and Heritage (OEH), New South Wales Government. (2016). NSW Office of Environment and Heritage (OEH) Multi-beam Bathymetry Surveys. Dataset. Retrieved August 29, 2023 <https://researchdata.edu.au/nsw-office-environment-bathymetry-surveys/955084>
- OEH. (2017). NSW Office of Environment and Heritage (OEH) Single-beam Bathymetry and Coastal Topography Surveys. Dataset. Retrieved August 29, 2023 from <https://researchdata.edu.au/nsw-office-environment-topography-surveys/967069>
- Okal, E.A. (1981). Intraplate seismicity of Antarctica and tectonic implications. *Earth and Planetary Science Letters*, 52, 397-409. [https://doi.org/10.1016/0012-821X\(81\)90192-8](https://doi.org/10.1016/0012-821X(81)90192-8)
- OpenStreetMap. (n.d.). OpenStreetMap. Retrieved March 2022 from <https://osmdata.openstreetmap.de/>



- Parmelee, D.E., Kyle, P.R. Kurz, M.D. Marrero, S.M. & Phillips, F.M. (2015). A new Holocene eruptive history of Erebus volcano, Antarctica using cosmogenic  $^3\text{He}$  and  $^{36}\text{Cl}$  exposure ages. *Quaternary Geochronology*, 30(Part A): 114-131. <https://doi.org/10.1016/j.quageo.2015.09.001>
- Patel, J., Sutherland, R., Gurnis, M., Van Avendonk, H., Gulick, S.P.S, Shuck, B, Stock, J., & Hightower, E. (2021). Stratigraphic architecture of Solander Basin records Southern Ocean currents and subduction initiation beneath southwest New Zealand. *Basin Research*, 33(1), 403–426. <https://doi.org/10.1111/bre.12473>
- Power, W. L. (compiler). (2013). *Review of Tsunami Hazard in New Zealand (2013 Update)*, GNS Science Consultancy Report 2013/131. 222 p. Chapter 6–Probabilistic-Modelling. Retrieved August 29, 2023 from <https://www.civildefence.govt.nz/assets/Uploads/publications/GNS-CR2013-131-Tsunami-Report-6-Probabilistic-Modelling.pdf>
- Quantarctica. (n.d.). Antarctica listed facilities and subantarctic stations. Quantarctica and the Norwegian Polar Institute. Retrieved August 29, 2023 from <https://www.npolar.no/en/quantarctica/>
- Rafferty, J.P. (Editor). 2011. *Glaciers, Sea Ice, and Ice Formation*. Chicago (IL): Britannica Educational Publishers. 255 p.
- Reading, A.M. (2002). Antarctic seismicity and neotectonics. In J.A. Gamble, D.N.B. Skinner, S.A. Henrys (Editors), *Antarctica at the close of a millennium: proceedings of the 8th International Symposium on Antarctic Earth Sciences*, Wellington, 1999. Wellington (NZ), p. 479-484. Royal Society of New Zealand. *Bulletin of the Royal Society of New Zealand*, 35. Retrieved August 29, 2023 from [https://figshare.utas.edu.au/articles/chapter/Antarctic\\_seismicity\\_and\\_neotectonics/23249927](https://figshare.utas.edu.au/articles/chapter/Antarctic_seismicity_and_neotectonics/23249927)
- Reading, A.M. (2007). The seismicity of the Antarctic plate. In S.S. Mazzotti (Editor), *Continental intraplate earthquakes: science, hazard, and policy issues*, p. 285. Boulder (CO): Geological Society of America. Special papers Geological Society of America, 425. Retrieved August 29, 2023 from [https://www.academia.edu/27695270/The\\_seismicity\\_of\\_the\\_Antarctic\\_plate](https://www.academia.edu/27695270/The_seismicity_of_the_Antarctic_plate)
- Rignot, E., Jacobs, S., Mouginot, J., & Scheuchl, B. (2013). Iceshelf melting around Antarctica. *Science*, 341(6143), 266– 270. <https://doi.org/10.1126/science.1235798>
- Scheffel, R.L., & Wernet, S.J. (Editors). (1980). *Natural Wonders of the World*. Pleasantville (NY): Reader's Digest Association. 463 p.



- Schuur, C. L., Coffin, M. F., Frohlich, C., Massell, C. G., Karner, G. D., Ramsay, D., & Caress, D. W. (1998). Sedimentary regimes at the Macquarie Ridge Complex; interaction of Southern Ocean circulation and plate boundary bathymetry. *Paleoceanography*, 13, 646-670, <https://doi.org/10.1029/98PA02357>
- Standard, J. (1961). Submarine Geology of the Tasman Sea. *GSA Bulletin*, 72(12), 1777–1788. [https://doi.org/10.1130/0016-7606\(1961\)72\[1777:SGOTTS\]2.0.CO;2](https://doi.org/10.1130/0016-7606(1961)72[1777:SGOTTS]2.0.CO;2)
- Stern, R.J. (2004). Subduction initiation: Spontaneous and induced. *Earth and Planetary Science Letters*, 226, 275–292. <https://doi.org/10.1016/j.epsl.2004.08.007>
- Stirling, M.W., McVerry, G.H., & Berryman, K.R. (2002). A new seismic hazard model of New Zealand. *Bulletin of the Seismic Society of America*, 92, 1878-1903. <https://doi.org/10.1785/0120010156>
- Turnbull, I.M., & Allibone, A.H. (compilers). (2003). Geology of the Murihiku area: scale 1:250,000. Lower Hutt: Institute of Geological & Nuclear Sciences Limited. Institute of Geological & Nuclear Sciences 1:250,000 geological map 20. 74 p. + 1 folded map.
- U.S. Geological Survey (USGS), Earthquake Hazards Program. (2022). Advanced National Seismic System (ANSS) Comprehensive Catalog of Earthquake Events and Products. Retrieved March 2022 from <https://doi.org/10.5066/F7MS3QZH>



National Science Foundation



# CLIMATOLOGY REPORT





## 5.0 CLIMATOLOGY REPORT

Current weather patterns (meteorology) and long-term weather averages (climatology), need to be considered when designing the cable system between Australia, New Zealand, and Antarctica. Sydney, Australia, has humid subtropical climate that shifts from mild and cool in winter (June – August) to hot in the summer (December – February). In Sydney, the wet season runs January through June and the dry season from July through December. There is a potential reduction in tropical cyclone activity in the area during El Niño years.

Macquarie Island has a moderate climate, despite the high latitude, due to stable sea surface temperatures, with daily mean temperatures only varying approximately 4° C, from 3.3° C in June (winter) to a high of 7.1° C in January (summer). Precipitation on Macquarie Island is relatively consistent throughout the year with the least amount of rain fall between June and November. Macquarie Island frequently has gale force and higher winds with the summer months (November – February) being the most likely to have less stormy conditions.

The cable landing in Invercargill, New Zealand, has a marine climate with moderate air temperatures. The location is typically subjected to the prevailing westerly winds at the subtropical latitudes, but also sees southerly outbreaks of polar air masses. The daily mean temperature is highest in December through February (summer). Precipitation is relatively consistent throughout the year, but the highest precipitation is in May and June.

At the landing in McMurdo, Antarctica, the average low temperatures are below -20 °C from March to September, and extreme lows in the autumn, winter and spring months (March through October) are below -40°C. The cold air has extremely low humidity resulting in low annual precipitation and classification of the area as a desert. Most of the precipitation falls as snow, with the most snowfall in February, May, and June. The cold temperatures, strong winds, wind chill, and extremely low humidity are significant hazards to personnel and equipment.

Regional variations in temperature, precipitation, winds, and storms are further discussed in the following sections. Each section below also states whether data were available for download from a public source, or if the primary source of information was studies and summaries conducted by others, including academic literature or government websites and reports.

### 5.1. Regional / Transit

The proposed cable route covers 44 degrees of latitude, from 34 °S in Sydney, Australia, to McMurdo Station, Antarctica, at 78 °S. The project traverses global-scale atmospheric circulation cells which are identified as the Hadley cell, Ferrel cell, and Polar cell (Figure 5-1). The Hadley cell forms as equatorial air is heated and forced to travel south. This air starts at the speed of Earth's rotation at the equator, and as it moves south at height, it is forced to the left by the Coriolis



effect. The air also increases in velocity, creating the westerly subtropical Jetstream at altitude. This air cools and sinks and returns north to the equator. This eastward-directed return flow is the Trade Winds.

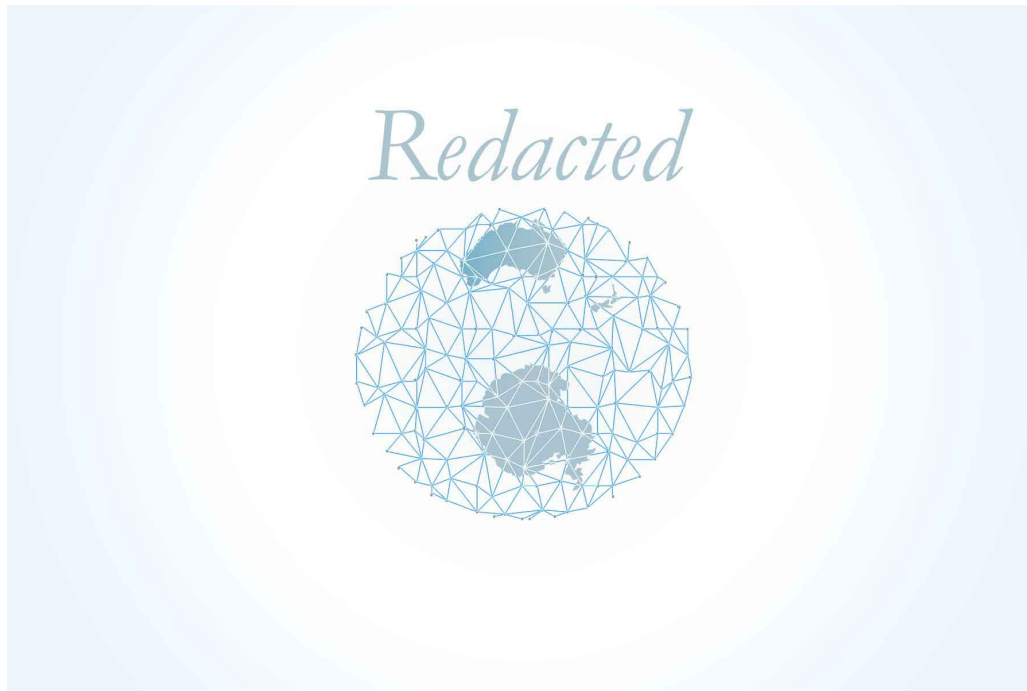

(ECMWF model, via windy.com)

Figure 5-1. [Redacted]. Surface Winds in Project Area with Superimposed General Atmospheric Circulation Patterns

A similar pattern occurs over the Antarctic continent and South Pole as Polar Cells. The ocean provides relative warmth to the air mass over Antarctica, causing air to rise around the edge of the continent, moving towards the South Pole at height, and returning to the coast extremely dry and cold, deflecting to the left to become an easterly wind.

In between these two heat-driven circulation cells, the mid-latitude Ferrel Cells operate, with air sinking at 30 °S alongside the Hadley air moving poleward, and air rising alongside Polar Cell air moving towards the Equator at height. The deflection of the poleward-moving air to the left produces a band of westerly winds between 40 °S and 50 °S (the Roaring Forties). Since there is no major landmass, these winds travel uninterrupted around the Southern Ocean, driving ocean currents and large waves (please refer to Section 6.0 for additional details).

This idealized view of global wind patterns only exists in an average sense – actual weather is influenced by local topography and chaos over a wide spatial scale. A snapshot of the surface wind field in Figure 5-1 shows two or three strong westerly wind systems related to low- or high-pressure centers propagating westward. The winds rotating around a pressure center are symmetric in speed relative to the pressure center, but since the whole system is moving





westward, the winds towards the west are reinforced from the point of view of a stationary observer, and easterly winds are, on average, suppressed.

**AUSTRALIA**

**5.2. Australia**

Weather patterns and climate for the portion of the project in Australia and Australian waters are discussed in the following sections.

**5.2.1. Temperature and Precipitation**

Temperature and precipitation information for the Sydney and Macquarie Island areas are summarized in this section.

*Sydney*

The climate in the vicinity of the proposed cable landing in Sydney is humid subtropical, shifting from mild and cool in winter (June to August) to hot in the summer (December to February). The climate is moderated by the proximity of the city to the ocean, with no extreme seasonal differences. The daily mean temperature varies from a low in July of 12.7 °C to a high of 22.8 °C in January. Monthly average temperatures recorded at the Sydney Airport, Australian Bureau of Meteorology (AusBOM) Station 066037, are provided in Table 5-1.

Precipitation in Sydney is the lowest from July through December, ranging from 59.6 mm to 80.2 mm during these months (Table 5-2). Annual rainfall at the Sydney airport is 1080.4 mm, with rainfall occurring on an average of 129 days per year.

**Table 5-1. Temperature Averages and Extremes, Sydney Airport (Station 066037)**

	Jan	Feb	Mar	Apr	May	Jun	Jul	Aug	Sep	Oct	Nov	Dec
<b>Record high °C</b>	46.4	42.9	41.2	36.8	30.0	26.8	27.0	31.1	35.6	39.1	43.4	43.2
<b>Average high °C</b>	26.7	26.5	25.4	23.0	20.2	17.7	17.2	18.4	20.7	22.7	24.2	25.9
<b>Daily mean °C</b>	22.8	22.6	21.3	18.8	15.8	13.6	12.7	13.5	16.0	18.0	19.7	21.4
<b>Average low °C</b>	19.0	19.1	17.6	14.3	11.1	8.8	7.3	8.3	10.6	13.4	15.6	17.6
<b>Record low °C</b>	9.7	11.2	7.4	6.1	3.0	1.0	-0.1	1.2	2.3	4.8	5.9	8.2

*(AusBOM, 2022a)*



**Table 5-2. Precipitation Statistics, Sydney Airport (Station 066037)**

	Jan	Feb	Mar	Apr	May	Jun	Jul	Aug	Sep	Oct	Nov	Dec
<b>Mean Monthly Precipitation (mm)</b>	93.9	117	120.7	105	95.2	124.5	68.9	75.7	59.6	70.1	80.2	72.9
<b>Average # of Precipitation Days</b>	11.3	11.7	12.6	11	10.7	11.4	9.2	8.9	9.3	10.7	11.3	10.6

(AusBOM, 2022a)

### Macquarie Island

Temperatures on Macquarie Island are moderate, despite the high latitude, due to the stable sea surface temperatures. The annual temperatures range from a daily mean of 3.3 C in June and July (winter) to a high of 7.1 C and 7 C in January and February (summer), respectively. Monthly temperature statistics for Macquarie Island are presented in Table 5-3.

Precipitation at Macquarie Island is relatively consistent throughout the year with the least amount of rain fall between June and November. The annual rainfall on the island is 997.2 mm (Table 5-4) which is distributed over an average of 317 days per year. There are very few hours of sunshine available at this location.

**Table 5-3. Temperature Averages and Extremes, Macquarie Island (Station 300004)**

	Jan	Feb	Mar	Apr	May	Jun	Jul	Aug	Sep	Oct	Nov	Dec
<b>Record high °C</b>	13.6	17	12.6	12.2	10	10.6	8.3	8.5	8.6	10.3	11.6	14.4
<b>Average high °C</b>	8.8	8.7	8	7	5.9	5.1	4.9	5.1	5.4	5.8	6.6	8
<b>Daily mean °C</b>	7.1	7	6.4	5.4	4.2	3.3	3.3	3.4	3.5	3.9	4.6	6.1
<b>Average low °C</b>	5.3	5.3	4.8	3.7	2.6	1.6	1.6	1.6	1.6	2	2.8	4.3
<b>Record low °C</b>	0.6	-0.6	-2.3	-4.5	-6.8	-7	-9.4	-8.9	-8.7	-4.6	-3.9	-1.7

(AusBOM, 2022b)

**Table 5-4. Mean Monthly Precipitation [mm], Macquarie Island (Station 300004)**

	Jan	Feb	Mar	Apr	May	Jun	Jul	Aug	Sep	Oct	Nov	Dec
<b>Monthly Mean Precipitation [mm]</b>	88.9	86.2	101.3	93.5	86.8	77.6	74.5	76	75.9	77.6	73.8	81

(AusBOM, 2022b)



### 5.2.2. Winds

Wind patterns for the Sydney and Macquarie Island areas are described in this section.

#### Sydney

Wind patterns in and around the project area provided in Table 5-5 were recorded and/or estimated from data collected at the Sydney Airport. The station data summary provided information on the maximum wind gust in each month based on over 80 years of data. Average wind speeds tend to be highest in the summer (December – February) but higher winds are also present into late autumn (November) and early spring (February).

**Table 5-5. Wind Statistics, Sydney Airport (Station 066037)**

	Jan	Feb	Mar	Apr	May	Jun	Jul	Aug	Sep	Oct	Nov	Dec
<b>Monthly Mean Wind Speed (kts)</b>	11.6	11.0	10.3	9.5	9.3	9.6	9.6	10.0	10.4	10.8	11.6	11.6
<b>Max Wind Gust (kts)</b>	82.1	58.3	69.1	65.9	70.2	70.2	58.9	62.1	59.9	68.0	82.1	68.0

(AusBOM, 2022a)

#### Macquarie Island

Raw wind data was not readily available, but summaries indicate the record consists entirely of westerly, northwesterly, and southwesterly winds due to the island’s location in the middle of the prevailing westerlies (Table 5-6).

Figure 5-2, reproduced from Streten (1988), shows the number of days per month with gale-force winds (>17 m/s or 34 knots) at the Macquarie Island station; the summer months of November through February are the most likely months to find less stormy conditions.

**Table 5-6. Wind Statistics, Macquarie Island (Station 300004)**

	Jan	Feb	Mar	Apr	May	Jun	Jul	Aug	Sep	Oct	Nov	Dec
<b>Monthly Mean Wind Speed [kts]</b>	17.5	18.5	19.6	19.9	19.2	18.4	18.1	18.7	19.4	19.7	18.5	17.5
<b>Max Wind Gust [kts]</b>	91.3	78.3	97.2	92.3	92.3	91.3	96.1	85.3	99.9	86.9	76.1	86.4

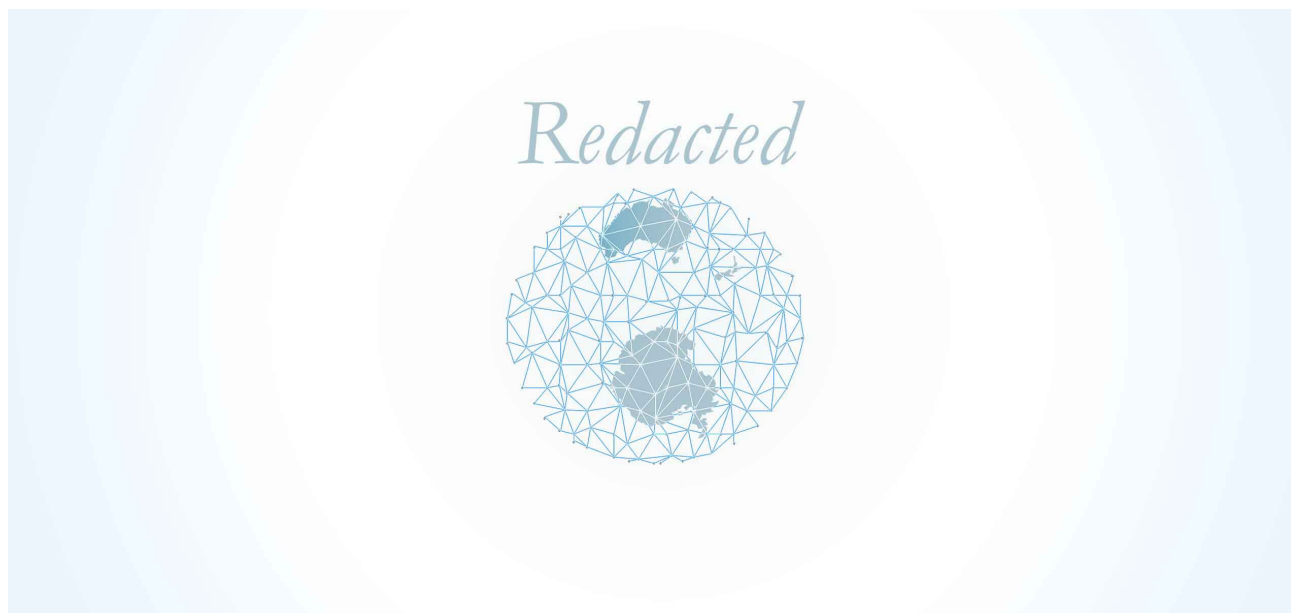

(AusBOM, 2022b)

Figure 5-2. [Redacted]. Number of Days per Month with Gale-force Winds.

### 5.2.3. Weather Patterns

The El Niño / Southern Oscillation has an effect on the Sydney area climate, but much of the literature discusses extremes in rainfall, i.e., drought and floods, which are less relevant to this project. There is, however, a potential reduction in tropical cyclone activity during El Niño years (AusBOM, 2021).

### 5.2.4. Hazardous Weather

#### *Sydney*

Sydney is subject to local thunderstorms and regional low-pressure systems termed “East Coast Lows.” These can strengthen quickly, i.e., overnight and drive high waves. The Australian Bureau of Meteorology records severe thunderstorms, defined as having >2 cm hail, >90 km/h (48.5 knot) wind gusts, flash flooding *or* tornadoes. There were about 1000 such events over the period 2000-2019 in all of New South Wales; 120 of these were in the Sydney region. There are approximately six severe thunderstorms per year near Sydney by this rough measure.

#### *Macquarie Island*

Storms – westerly-propagating low-pressure systems are frequent and severe in the Southern Ocean. Streten (1988) states that fronts or low-pressure systems pass Macquarie Island every five to six days. Additionally, there are gale force winds (>17 m/s or 34 knots) 4 – 10 days per



month and the strongest wind gusts recorded between 1948 and 1983 were 900-100 knots.

An analysis of the frequency of (relatively) calm wave conditions is provided in Section 6.2.4. A more complete metocean analysis could download model-predicted winds at multiple locations along the cable route and assess extreme wind frequencies.

**NEW ZEALAND**

**5.3. New Zealand**

**5.3.1. Temperature and Precipitation**

The cable landing in Invercargill, New Zealand, has a marine climate with moderate air temperatures. The location is typically subjected to the prevailing westerly winds at the subtropical latitudes, but also sees southerly outbreaks of polar air masses. The daily mean is highest from December through February (summer), ranging from 13 – 14.2°C and lowest from May to July (winter), ranging from 5.3° to 8°C. Monthly temperature statistics are presented in Table 5-7.

Precipitation in Invercargill is relatively consistent throughout the year. Rainfall at three stations close to the proposed landing site range from 1,148 to 2,463 mm annually, with the highest monthly precipitation in May and June of 120 and 125 mm, respectively (Table 5-8).

**Table 5-7. Temperature Averages and Extremes, Invercargill Aero**

	Jan	Feb	Mar	Apr	May	Jun	Jul	Aug	Sep	Oct	Nov	Dec
<b>Record high °C</b>	33.8	32.1	28.8	25.5	20.9	18.4	16.7	21	23.1	24.6	27.5	28.8
<b>Average high °C</b>	18.7	18.6	17.1	14.9	12.3	10	9.5	11.1	13.1	14.4	15.8	17.5
<b>Daily mean °C</b>	14.2	13.9	12.5	10.4	8	5.9	5.3	6.6	8.5	9.9	11.4	13
<b>Average low °C</b>	9.6	9.3	7.9	5.8	3.8	1.9	1	2.2	4	5.4	7	8.6
<b>Record low °C</b>	-0.9	-2.4	-2.4	-4.9	-6.9	-7.4	-9.0	-8.0	-4.5	-3.2	-2.0	-0.4

*(Macara, 2013)*

**Table 5-8. Mean Monthly Precipitation [mm], Invercargill Area Stations**

	Jan	Feb	Mar	Apr	May	Jun	Jul	Aug	Sep	Oct	Nov	Dec
<b>Southwest Cape AWS</b>	108	93	115	104	120	125	107	108	111	106	109	107
<b>Puysegur Point</b>	241	179	212	215	228	211	192	193	196	186	203	207
<b>Invercargill Aero</b>	115	87	97	96	114	104	85	76	84	95	90	105

*(Macara, 2013)*



### 5.3.2. Winds

The dominant wind direction at Invercargill Airport is from the west-southwest as winds are steered by the presence of Stewart Island, while at Puysegur Point, winds from the southeast are more common. The mean monthly wind speeds are presented for these three stations in Table 5-9. Gusts are common in all seasons (Table 5-10), though spring (Sep-Nov) has the highest wind speeds, ranging from 21.8 to 22.5 knots, and winter (Jun-Aug), ranging from 6.7-22.5 knots.

**Table 5-9. Wind Statistics, Invercargill Area Stations**

Mean Monthly Wind Speed (knots)												
Location	Jan	Feb	Mar	Apr	May	Jun	Jul	Aug	Sep	Oct	Nov	Dec
Southwest Cape AWS	20.4	19.0	21.0	19.9	21.6	20.4	18.9	19.9	22.5	22.0	21.8	19.7
Puysegur Point	16.3	15.1	16.2	14.8	15.4	14.2	13.3	14.3	16.7	17.0	16.7	15.7
Invercargill Aero	10.4	9.5	9.2	8.7	8.4	7.7	6.7	7.3	9.3	10.6	11.0	10.2

(Macara, 2013)

**Table 5-10. Wind Gust Statistics, Invercargill Area Stations**

Days per Year with Wind Gusts over Thresholds		
Location	>33 knots	>50 knots
Southwest Cape AWS	257	120
Puysegur Point	210	73
Invercargill Aero	109	15

(Macara, 2013)

### 5.3.3. Weather Patterns

Regional climate patterns that influence weather near Invercargill include the El Niño-Southern Oscillation (ENSO), the Interdecadal Pacific Oscillation (IPO), and the Southern Annular Mode (SAM) also known as the Antarctic Oscillation. There are complex interactions between these patterns. In general, a positive SAM brings fewer storms to New Zealand and stronger winds and more storms in the Southern Ocean and Antarctica. The SAM has been in a positive phase more often than not for the past few years (NIWA 2021).

### 5.3.4. Hazardous Weather

Storms bringing high winds and heavy rain are the main weather hazard in the Invercargill area. River crossings have the potential to cause damage during flood events, severing data and power connections.



**ANTARCTICA**

**5.4. Antarctica**

The route leaves the mid-latitude westerly wind belt around 60 °S and enters the Ross Sea around 70 °S. A prevailing wind called the Ross Ice Shelf Air Stream transports cold continental air in a generally northeastward direction over the entire Ross Sea, guided by topography and mesoscale weather patterns.

**5.4.1. Temperature and Precipitation**

Average low temperatures are below -20 °C from March to September, and extreme lows in the autumn, winter and spring months (March through October) are below -40 °C (Table 5-11). Air this cold can hold almost no moisture, so the McMurdo environment also has extremely low humidity. In fact, the average annual precipitation of 21.6 cm classifies the area as a desert. Most of the precipitation falls as snow, with the most snow fall in February, May, June and (Table 5-12). The average number of snowy days appears higher than the number of precipitation days; this may be due to the counting of blowing snow which is not new precipitation.

**Table 5-11. Temperature Averages and Extremes, McMurdo Station**

	Jan	Feb	Mar	Apr	May	Jun	Jul	Aug	Sep	Oct	Nov	Dec
<b>Record high °C</b>	10.2	5.9	-1.1	0	-1.3	3.3	-4.4	-2	-3.7	4.5	10	10.8
<b>Average high °C</b>	-0.6	-7.3	-16.2	-17.3	-21	-20.4	-21.7	-22.7	-20.8	-14.3	-6.5	-0.4
<b>Daily mean °C</b>	-2.8	-8.8	-17.3	-20.9	-23.3	-22.9	-25.8	-27.4	-25.7	-19.4	-9.7	-3.5
<b>Average low °C</b>	-4.6	-11.4	-21.3	-23.4	-26.5	-26.8	-28.4	-29.5	-27.5	-19.8	-10.9	-4.4
<b>Record low °C</b>	-22.1	-25	-43.3	-41.9	-44.8	-43.9	-50.6	-49.4	-45.1	-40	-28.5	-18

(NOAA, 2022)

**Table 5-12. Precipitation Statistics, McMurdo Station**

	Jan	Feb	Mar	Apr	May	Jun	Jul	Aug	Sep	Oct	Nov	Dec
<b>Average Precipitation (cm)</b>	1.6	2.9	1.5	1.8	2.1	2.8	1.7	1.3	1.0	2.0	1.2	1.4
<b>Average Snowfall (cm)</b>	6.6	22.4	11.4	12.7	17	17.8	14	6.6	7.6	13.5	8.4	10.4
<b>Average # of Precipitation Days</b>	2.6	4.7	3.2	4.5	5.5	5.7	4.7	4.1	3	3.2	2.4	2.5
<b>Average # of Snowy Days</b>	12.8	17.6	17.8	16.4	16.2	15.6	15.3	14.5	13.3	14.5	13.5	13.8

(NOAA, 2022)



### 5.4.2. Winds

The western Ross Sea is the most active source of mesoscale cyclones in the region (Carrasco et al., 2003). As these storms interact with the Transantarctic Mountains that separate the Ross Sea from the Antarctic interior, they can generate gale-force winds at McMurdo. More storms were found by analysis of weather stations than satellite imagery as there is not always enough moisture for the characteristic clouds to be observed. Weaker events tend to approach McMurdo from the northeast, while stronger events overtop the mountains and approach from the south. Extreme wind events are discussed in the hazardous weather section below.

Table 5-13 summarizes monthly average wind speeds at McMurdo Station. There are dozens of weather stations nearby, and complex local topography produces local changes to the wind regime. Unfortunately, wind gust data or summaries were not easily retrieved at this location, though this information may be available by making direct contact with researchers. The relatively low average wind speeds may be somewhat misleading; the NOAA data may be over-averaged.

**Table 5-13. Wind Statistics, McMurdo Station**

	Jan	Feb	Mar	Apr	May	Jun	Jul	Aug	Sep	Oct	Nov	Dec
<b>Monthly Mean Wind Speed [kts]</b>	8.7	11.7	13.2	12.2	12.2	12.6	11.3	11.1	10.9	10.7	9.5	8.9

(NOAA, 2022)

### 5.4.3. Weather Patterns

Changes in the Antarctic Oscillation, also termed the Southern Annular Mode, can see the band of strong westerly winds move to the north or south. A positive phase of the SAM can bring stormier weather and oceanic heat to the Ross Sea, reducing sea ice extent (Simmonds & King, 2004; NIWA, 2021).

### 5.4.4. Hazardous Weather

Cold weather and wind chill are significant hazards to personnel and equipment at McMurdo.

Extremely low humidity offers a static electricity hazard to electronics, as well as the ability to dry out materials at a rapid rate (wood, rubber, etc.).

Strong winds are a hazard at McMurdo. Weber et al. (2016) characterized extreme wind events in the McMurdo area with a 15 m/s (29 knot) threshold and found up to eight such events per year. The storm of record in May 2004 saw 94-knot winds at a nearby station (the McMurdo anemometer was destroyed during this event).

Blowing snow compounds the wind hazard at more moderate wind speeds; when winds are





greater than 48 knots station policies prohibit travel other than inside enclosed vehicles with ratios; when winds are over 55 knots outdoor activity is not permitted. Blowing snow, besides reducing visibility, can buildup on structures.

## 5.5. References

- Australian Bureau of Meteorology (AusBOM). (2021). *What is El Niño and how does it impact Australia*. Retrieved March 2022 from <http://www.bom.gov.au/climate/updates/articles/a008-el-nino-and-australia.shtml>
- AusBOM. (2022a). *Australian Bureau of Meteorology Monthly Climate Statistics – Sydney Airport*. Retrieved March 2022 from [http://www.bom.gov.au/climate/averages/tables/cw\\_066037.shtml](http://www.bom.gov.au/climate/averages/tables/cw_066037.shtml)
- AusBOM (2022b). *Australian Bureau of Meteorology Monthly Climate Statistics – Macquarie Island*. Retrieved March 2022 from [http://www.bom.gov.au/climate/averages/tables/cw\\_300004.shtml](http://www.bom.gov.au/climate/averages/tables/cw_300004.shtml)
- Carrasco, J.F., Bromwich, D.H., & Monaghan, A.J. (2003). Distribution and characteristics of mesoscale cycles in the Antarctic: Ross Sea Eastward to the Weddel Sea. *American Meteorological Society*, 131, 239. [https://doi.org/10.1175/1520-0493\(2003\)131%3C0289:DACOMC%3E2.0.CO;2](https://doi.org/10.1175/1520-0493(2003)131%3C0289:DACOMC%3E2.0.CO;2)
- Macara, G.R. (2013). *The Climate and Weather of Southland*. 2nd Edition. NIWA Science and Technology Series No. 63.
- National Institute of Water and Atmospheric Research (NIWA). (2021) *Southern Annular Mode*. Retrieved February 2022 from <https://niwa.co.nz/climate/information-and-resources/southern-annular-mode>
- National Oceanic and Atmospheric Administration (NOAA). (2022). *McMurdo Sound Climate Normals 1961–1990*. National Oceanic and Atmospheric Administration, National Centers for Environmental Information. Retrieved August 29, 2023 from <https://www.ncei.noaa.gov/metadata/geoportals/rest/metadata/item/gov.noaa.ncdc:C01619/html#>
- Simmonds, I., & King, J.C. (2004). Global and hemispheric climate variations affecting the Southern Ocean. *Antarctic Science*, 16(4), 401-13. <https://www.cambridge.org/core/journals/antarctic-science/article/abs/global-and-hemispheric-climate-variations-affecting-the-southern-ocean/5D5C54A8D1A9DD453FA51703EEE98D8F>



Streten, N.A. (1988). The climate of Macquarie Island and its role in atmospheric monitoring. *Papers and Proceedings of the Royal Society of Tasmania 1988*, 122(1), 91-106.  
[https://eprints.utas.edu.au/13869/4/1988\\_Streten\\_climate\\_of\\_Macquarie\\_Island.pdf](https://eprints.utas.edu.au/13869/4/1988_Streten_climate_of_Macquarie_Island.pdf)

Weber, N.J., Lazzara, M.A., Keller, L.M., & Cassano, J.J. (2016). The extreme wind events in the Ross Island Region of Antarctica. *Weather and Forecasting*, 31(3), 985-1000.  
Retrieved March 2022 from <https://par.nsf.gov/servlets/purl/10026175>



National Science Foundation



# OCEANOGRAPHY REPORT





## 6.0 OCEANOGRAPHY REPORT

This section summarizes the oceanography, including wave and current climate, water levels, and ocean temperature parameters along the proposed cable route and landing sites. The types of hazards from ice and icebergs around McMurdo Station are also discussed.

Each section states whether data was downloaded and analyzed or whether data summaries published by others were relied upon. Data that was not readily available was summarized from academic literature or government websites and reports.

### 6.1. Regional

#### 6.1.1. Currents

Across the Pacific Ocean there are several layers of currents that flow in different directions at different water depths. Currents along the surface are primarily wind dominated while subsurface currents are dictated by the water temperature and salt content, which is called thermohaline circulation. Thermohaline circulation, in combination with surface currents, creates the global current cycles known as the great ocean conveyor belt shown in Figure 6-1 (Williams and Ferrigno, 2012). The project area will generally see cold deep water moving east-northeast and warm shallower currents moving east. The Southland Current (SC) and the Westland Current (WC) are related to the Subtropical Front (STF), which separates the global water masses of Subantarctic Water (SAW) and Subtropical Water (STW). The East Australian Current (EAC) and its extension (EACx) transport warm subtropical water to the Tasman Sea.

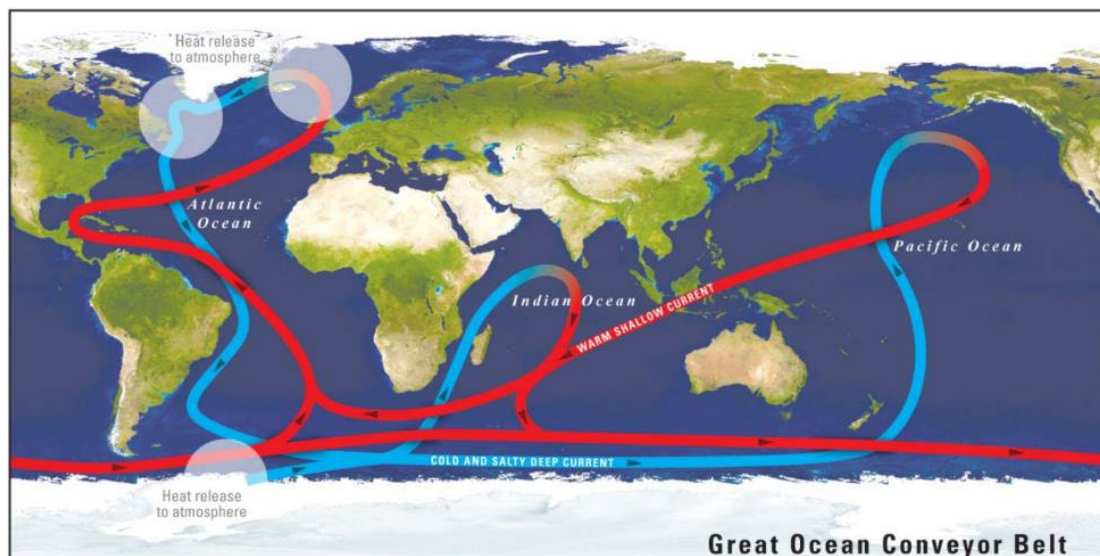

(Williams and Ferrigno, 2012)

Figure 6-1. Global Ocean Circulation – the Great Ocean Conveyor Belt.



The Southland Current (SC) is a subtropical front (STF) that separates the subtropical water masses from the uniformly cold Subantarctic water mass in the project area south of New Zealand. This interface is normally around 45 °S, but it is diverted farther south by the NZ landmass. The SC and the Westland Current (WC) are related to the Subtropical Front (STF), which separates the global water masses of Subantarctic Water (SAW) and Subtropical Water (STW). The East Australian Current (EAC) and its extension (EACx) transport warm subtropical water to the Tasman Sea. The Antarctic Circumpolar Current (ACC) and its bounding fronts dominate the proposed cable path (Figure 6-2).

The ACC is forced by the persistent westerly (eastward) winds, which in turn are driven by global atmospheric circulation cells. Within the ACC there are multiple fronts, which are the boundaries between water masses along which currents can concentrate. The Subantarctic Front (SAF) flows across Macquarie Ridge and can scour sediment in topographic gaps where flow is concentrated, or as eddies impinge upon sloping seafloor (Chiswell et al., 2015). The Ross Sea Gyre is a clockwise-rotating current pattern that spins off of the ACC; mean currents near the cable route on the west side of the Ross Sea are therefore northward on average (Dotto et al., 2018). The East Australian Current is a western boundary current that brings warm water from the tropics south along Australia’s east coast.

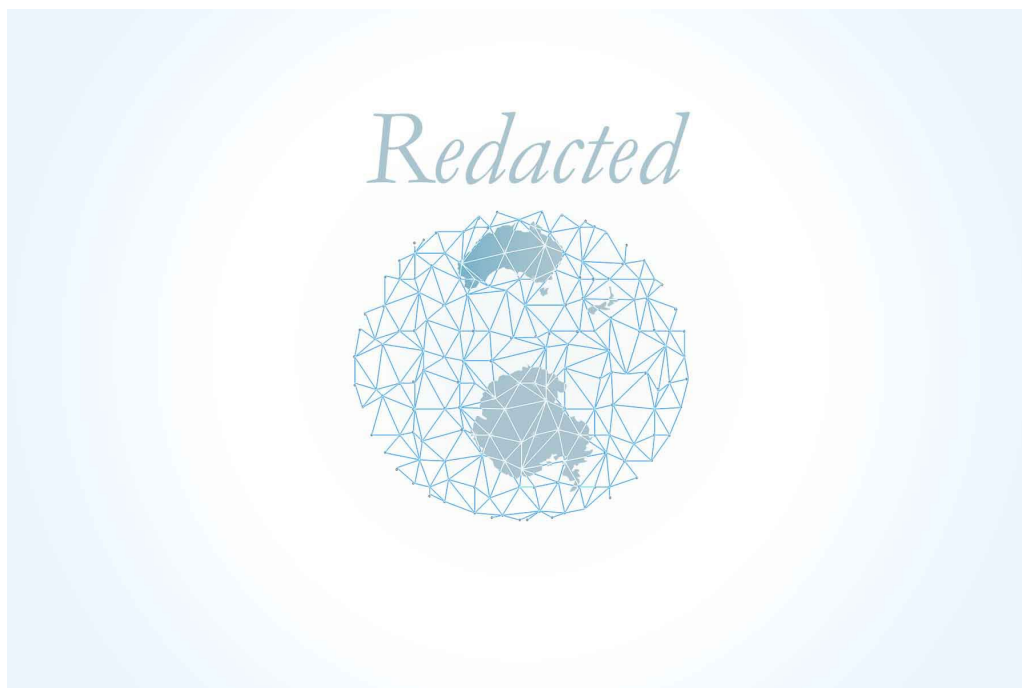

Figure 6-2. [Redacted]. Major Ocean Currents Around New Zealand.

A time series of predicted ocean currents were extracted at seven locations along the cable route from the global ocean model hybrid isopycnal-sigma-pressure (generalized) coordinate ocean model (called Hybrid Coordinate Ocean Model or HYCOM). The HYCOM model is maintained by



the U.S. National Ocean Partnership Program and funded by the U.S. Office of Naval Research (HYCOM, n.d.). The model simulates global ocean currents but not tidal currents, which become unimportant far from shore. The locations, comprised of 7 points numbered in Figure 6-3, were spaced every ten degrees of latitude. Point 7 is offshore of the Australian shelf and is within the area covered by the East Australian Current. Just over three years of data were retrieved at each location.

In general, surface currents at Points 1-6 along the Tasman and Southern Ocean routes are less than 1 knot (0.5 m/s) and rarely up to 1.5 knots (0.77 m/s). Bottom currents at the same six points are generally less than 0.3 knots (0.15 m/s). At Point 7, the East Australian Current reaches up to 4 knots (2 m/s) and is over 1.5 knots (0.75 m/s) about half the time.

The currents predicted by HYCOM do not include tides, as tidal currents in the open ocean are negligible. Tidal currents will be discussed in each landing locations section below.

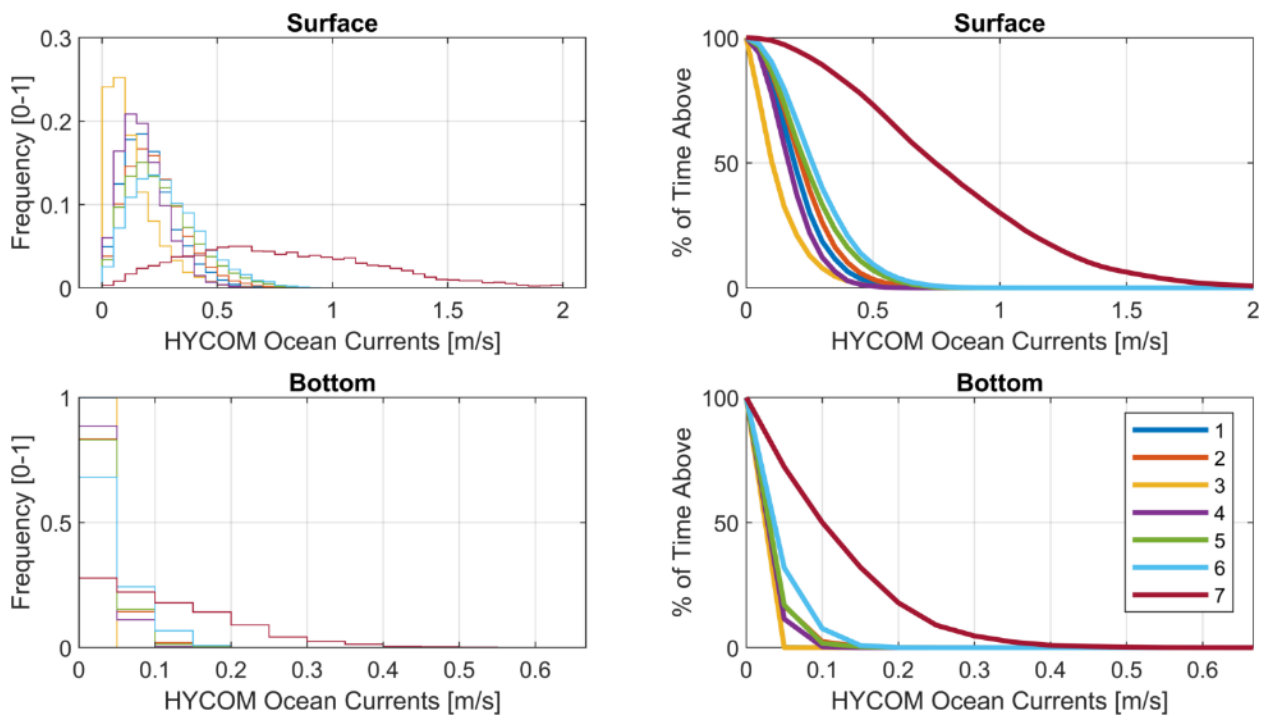

(Data sourced from HYCOM, n.d.)

Figure 6-3. Currents at Seven Locations along Route, adapted from HYCOM Model.

### 6.1.2. Waves

The wave climate in the Southern Ocean is both extreme and poorly measured. The near-constant westerly winds and unlimited fetch produce some of the largest waves in the world.

While data availability is poor, recent buoy measurements at Campbell Island provide a mid-route summary of conditions (McComb et al., 2021). The wave rose in Figure 6-4 summarizes the significant wave height from 3 moored and 2 drifting buoy deployments south of Campbell Island.

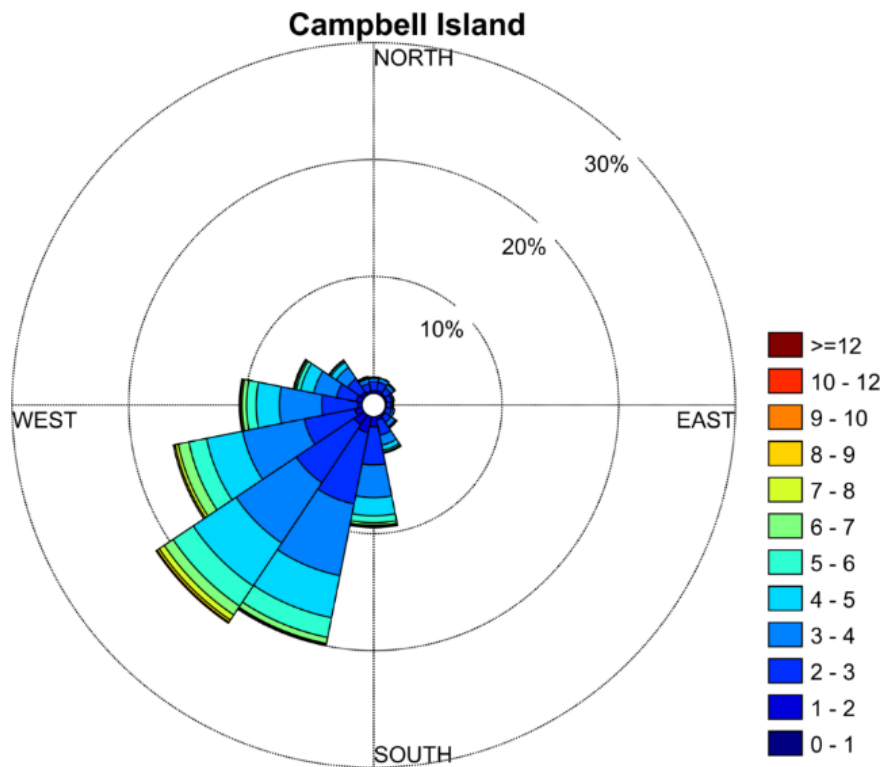

*(Data sourced from McComb et al., 2021, via Metocean Solutions, LTD)*

Figure 6-4. Significant Wave Height Rose, Campbell Island Moored and Drifting Deployments 1-3, July 2017 - Dec 2020 (with gaps; 3.5 years of data in total).

*Note:* This rose plots the direction that waves are coming from. The drifting buoy dataset, while not located in the same exact location, came about when the buoy broke free from its moorings and continued in a westerly direction until recovered or lost.

The annual distribution of significant wave heights is plotted in Figure 6-5 as a histogram and exceedance curve. The right-hand plot shows the percentage of time significant wave heights are above the thresholds on the x-axis. Significant wave heights are above two and four meters 94% and 30% of the time, respectively. The median significant wave height is 3.4 meters.



The wave climate heights in the south pacific region vary seasonally. Table 6-1 summarizes the significant wave height statistics from the Campbell Island buoy deployments by month. The mean wave height is  $\geq 3.0$  meters year-round and  $\geq 3.5$  meters March through October. Monthly maximum wave heights are  $\geq 7.7$  meters year round and  $\geq 9.9$  meters April – June and in October. The data are plotted in Figure 6-6, aggregating data by month (thick lines) and by day (thin lines). The largest waves are seen in the winter months of May - July, however waves over 2 meters are common in every month.

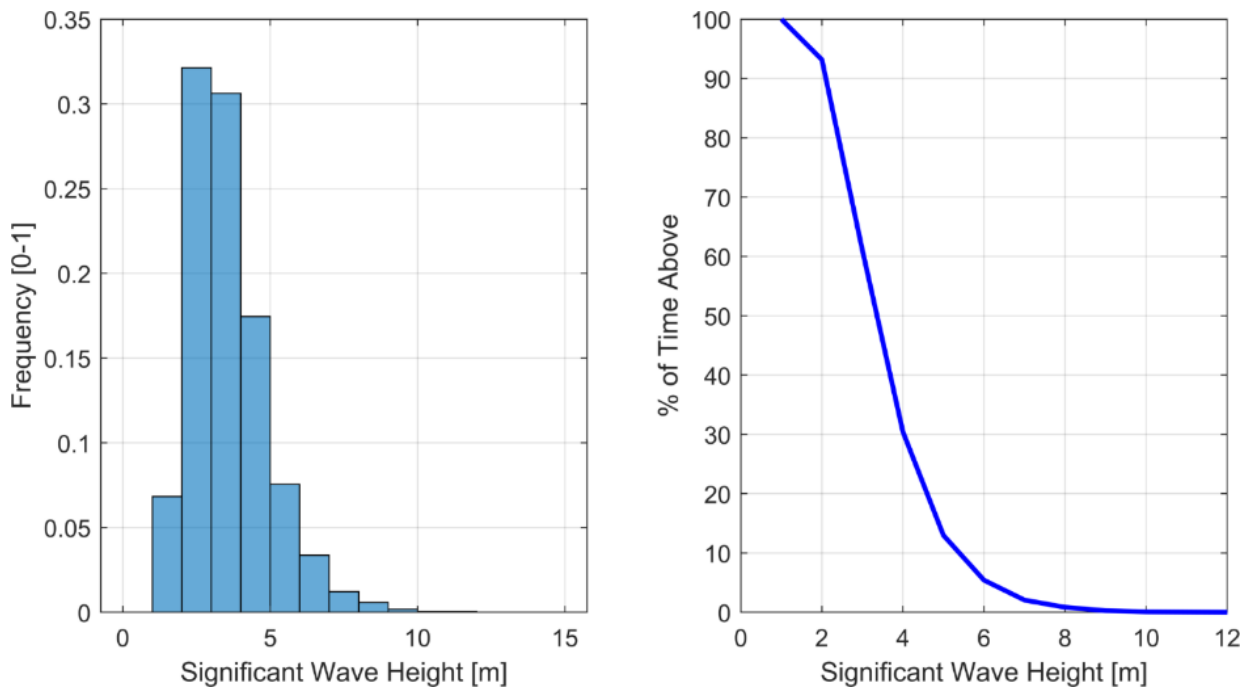

*(Data sourced from McComb et al., 2021, via Metocean Solutions, LTD)*

Figure 6-5. Campbell Island Significant Wave Height Histogram and Exceedance Curve.

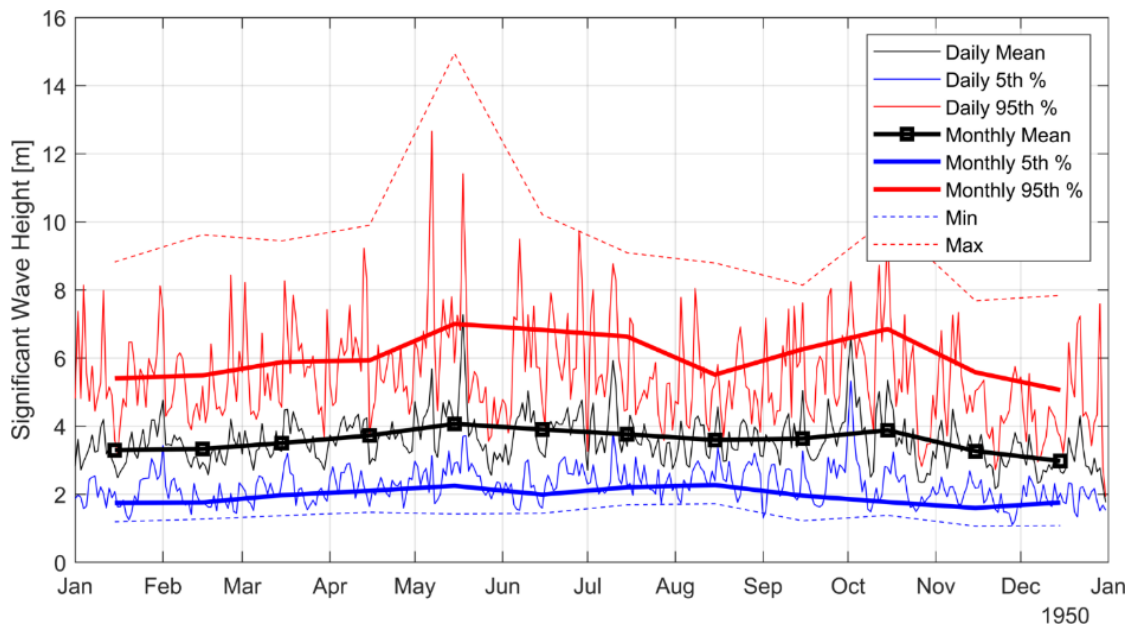



**Table 6-1. Campbell Island Significant Wave Height Statistics**

	Month (meters)											
	Jan	Feb	Mar	Apr	May	Jun	Jul	Aug	Sep	Oct	Nov	Dec
Mean	3.3	3.3	3.5	3.7	4.1	3.9	3.8	3.6	3.6	3.9	3.3	3.0
Minimum	1.2	1.3	1.4	1.5	1.4	1.4	1.7	1.7	1.2	1.4	1.1	1.1
5 <sup>th</sup> Percentile	1.7	1.8	2.0	2.1	2.2	2.0	2.2	2.3	2.0	1.8	1.6	1.8
Median	3.0	3.2	3.2	3.5	3.7	3.7	3.5	3.4	3.4	3.5	3.1	2.7
95 <sup>th</sup> Percentile	5.4	5.5	5.9	5.9	7.0	6.8	6.6	5.5	6.3	6.9	5.6	5.1
Maximum	8.8	9.6	9.4	9.9	14.9	10.2	9.1	8.8	8.1	10.1	7.7	7.8
Months of Data	3.3	3.3	3.5	3.7	4.1	3.9	3.8	3.6	3.6	3.9	3.3	3.0
% of Time Under 2m	10%	12%	6%	3%	2%	5%	1%	2%	6%	9%	12%	12%

(Data sourced from McComb et al., 2021, via Metocean Solutions, LTD)



(Data sourced from McComb et al., 2021, via Metocean Solutions, LTD)

Figure 6-6. Campbell Island Monthly and Daily Wave Statistics - Significant Wave Height (m).

A threshold analysis was conducted using a significant wave height of 2 meters. The results in Figure 6-7 show that there is a ~10% chance of waves below 2 meters in the months from November to February. Looking at the same data in terms of consecutive days under the 2-meter threshold, there are only 29 consecutive 24-hour periods of relative calm in a year, and only one or two consecutive 48-hour periods of calm. The highest likelihood of a calm weather window is



found in December to February, but storms are nearly guaranteed to interrupt any multi-day survey or installation effort.

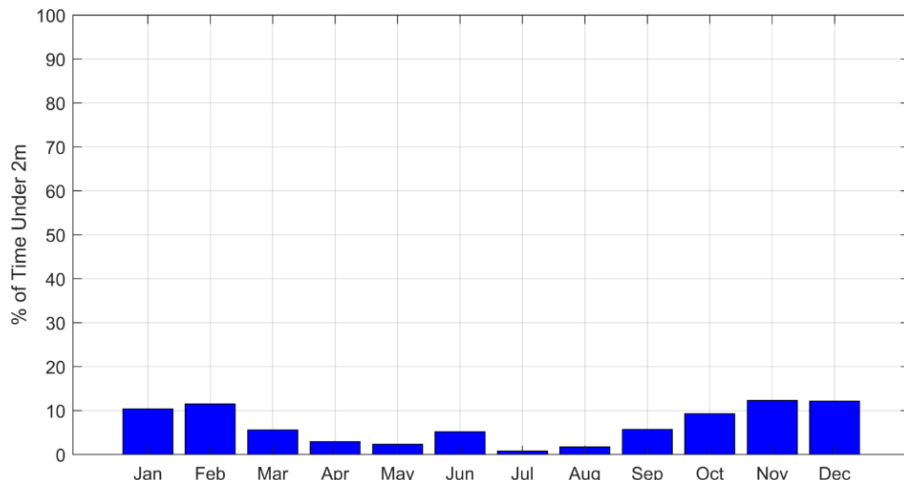

*(Data sourced from McComb et al., 2021, via Metocean Solutions, LTD)*

Figure 6-7. Campbell Island Percent of Time Significant Wave Height < 2 meters.

Note that in all of the above plots, the significant wave height represents an average of the upper 1/3 of wave heights observed. The maximum wave height is often statistically expressed as double the significant wave height; the true maximum of such a distribution is rarely known. The maximum wave recorded by the Campbell Island buoy was a newsworthy 23.8 meters during an event where the significant wave height was 14.9 meters (<https://www.metocean.co.nz/news/2018/5/9/a-record-wave-height-measured-in-the-southern-ocean>).

## AUSTRALIA

### 6.2. Australia

#### 6.2.1. Water Levels

Tides around Sydney are semidiurnal, with two tides per day of unequal amplitude. A 54-year record of water level data was retrieved from the tide gauge at Fort Denison, within Sydney Harbor (AusBoM, 2022). Sydney has a typical daily tidal range of 1.65 m during spring tides and 0.9 m during neap tides. The local vertical datum is the Australian Height Datum (AHD). The mean sea level at Fort Denison is 0.038 m AHD for the period 1966-2016, and annual mean water levels vary from -0.15 m to + 0.14 AHD on a decadal timescale. The highest still water level (tide, storm surge and wind setup, but not waves or sea level rise) expected annually is 1.24 m AHD; the 50-year and 100-year return period still water levels are 1.41 and 1.44 m respectively (DECCW NSW, 2010). Sea level rise planning guidelines in DECCW NSW (2010) for the years 2050 and 2100 add 0.34 m and 0.84 m to these values; these values are potentially underestimates given the date of the reference.

#### 6.2.2. Currents

Currents offshore of the narrow continental shelf near Sydney are dominated by the East Australian Current, which is a western boundary current that travels along the shelf break and generates, or devolves into, a series of eddies. On average, the EAC separates from the shelf just north of Sydney's latitude (Oke et al., 2019). Sections 6.1.1 and 7.1 discuss the EAC and currents within the EAC. The currents between the shelf break and shore respond to the EAC and to local winds and have been difficult to reproduce for some models (Cancet et al., 2019) so these are summarized based on current meter data available from Australia's Integrated Marine Observing System (IMOS Oceancurrent, 2022).

Tidal currents are much smaller than non-tidal currents offshore of Sydney. Current data from acoustic doppler current profiling (ADCP) instruments in 100m and 140m of water, located 11.5 and 18 km offshore of Sydney respectively, were available from IMOS. An example of currents at the two instruments and three different depths are shown in Figure 6-8. Bottom currents of up to 0.80 m/s (1.56 knots) are seen at 100m depth, and up to 1.00 m/s (1.04 knots) at 140 m depth. Currents beyond the shelf break are dominated by the East Australian Current.

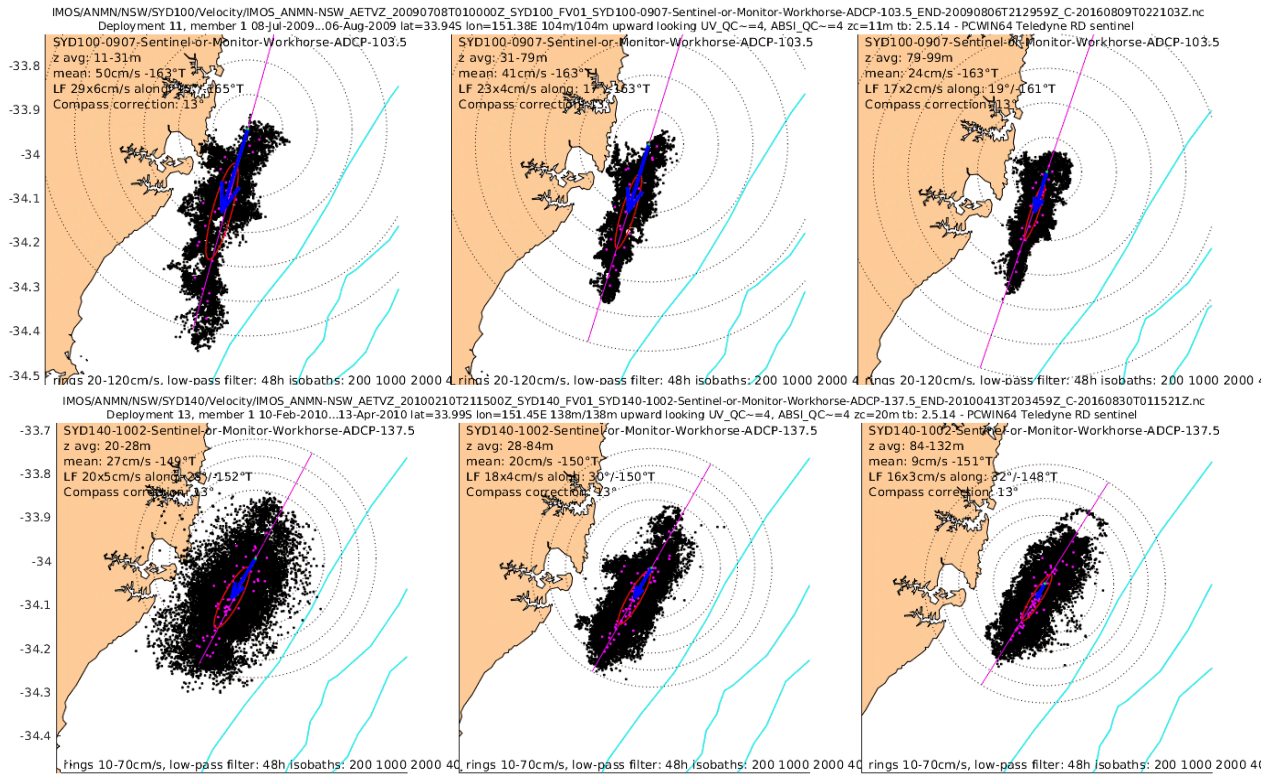

(IMOS Oceancurrent, 2022)

Figure 6-8. Current Meter Data Offshore of Sydney.

Upper plots are from an instrument in ~100m of water; lower plots at ~140m depth. For each instrument, the left-hand panel shows near-surface currents and the right panel near-bottom currents. Each dotted circle represents 0.20 m/s of current velocity. These images show approximately one month's worth of currents and was selected out of ~5 years of data based on the highest speeds.

### 6.2.3. Water Temperatures

The Waverider buoy offshore of Sydney recorded over ten years of sea surface temperature. The warmest temperatures are seen in the months of February – April. The 95<sup>th</sup> percentile temperature was 23.7 °C. Cooler temperatures are seen in August – September, with a 5<sup>th</sup> percentile temperature of 17.2 °C.

### 6.2.4. Waves

The wave climate offshore of Sydney was characterized by a Waverider buoy, with data available from Manly Hydraulics Laboratory (MHL) (AODN, n.d.) or the Australian Ocean Data Network.

The wave rose in Figure 6-9 shows the direction that waves are coming from and summarizes the significant wave height at the Sydney buoy for the 20-year period of record between 1992 and 2022.

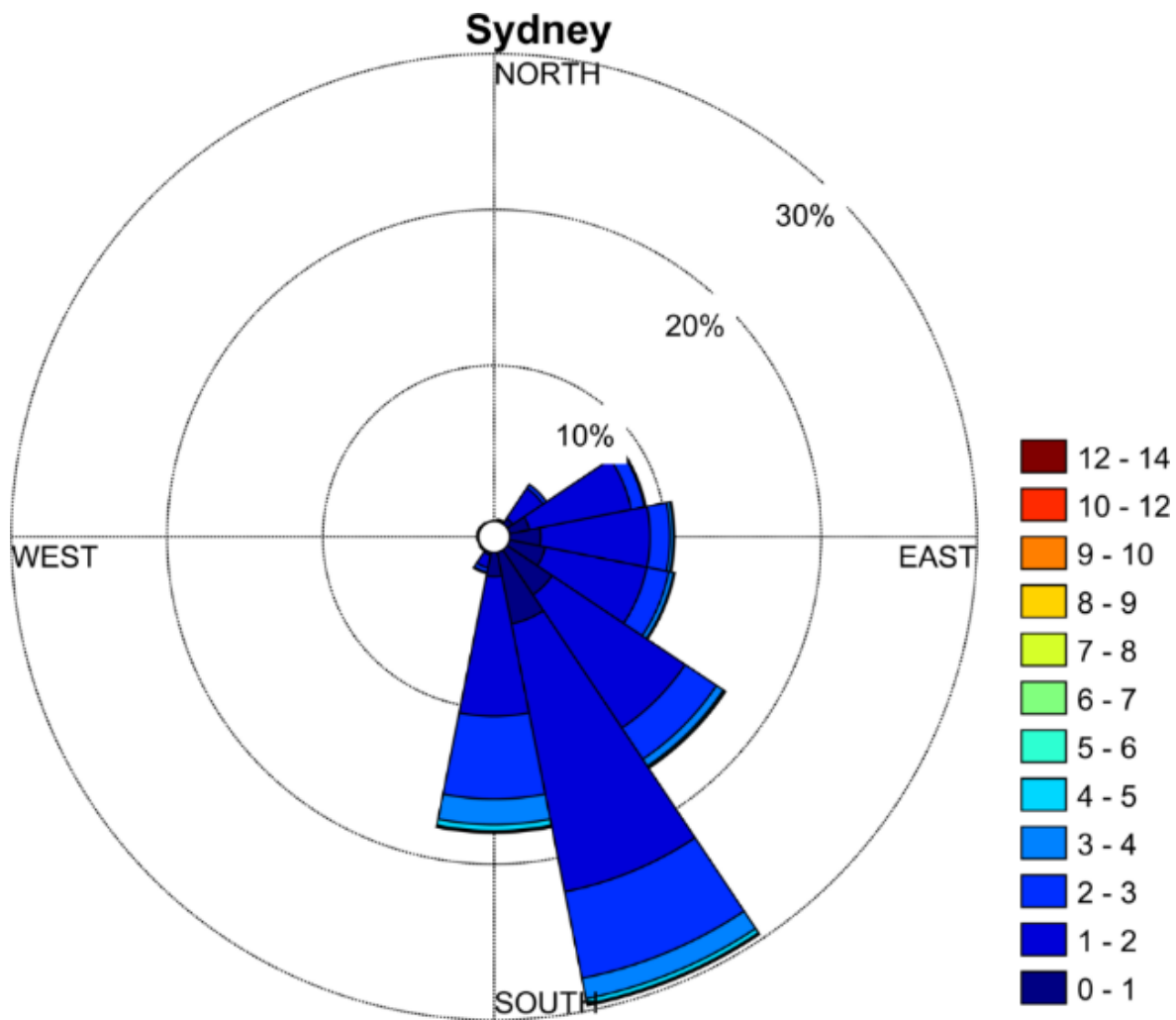

(Data sourced from MHL, n.d.; AODN, n.d.)

Figure 6-9. Significant Wave Height Rose, Sydney buoy, 1992-2022.

*Note:* This rose plots the direction that waves are coming from.

The annual distribution of significant wave heights is plotted in Figure 6-10 as a histogram and exceedance curve. The right-hand plot shows the percentage of time significant wave heights are above the thresholds on the x-axis. Significant wave heights are above 2 meters 23% of the time, and the median significant wave height is 1.6 meters.

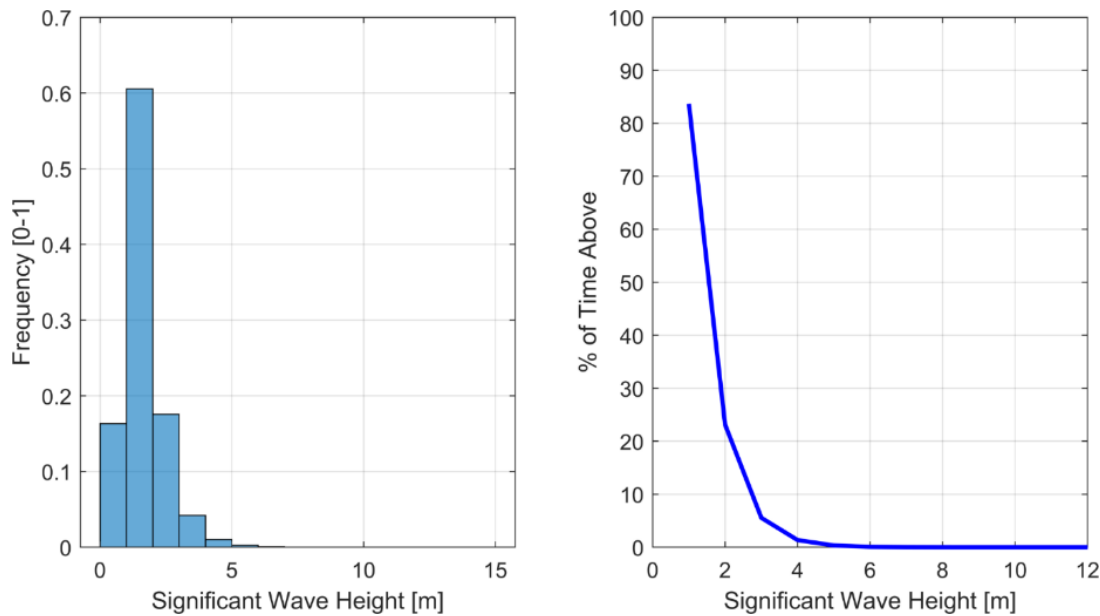

(Data sourced from MHL, n.d.; AODN, n.d.)

Figure 6-10. Sydney Significant Wave Height Histogram and Exceedance Curve

The wave climate varies seasonally. Table 6-2 summarize the significant wave height statistics from the Sydney buoy data by month. The mean wave height is  $\leq 1.77$  meters year-round. The data are plotted in Figure 6-11, aggregating data by month (thick lines) and by day (thin lines). The largest waves are seen in the winter months of June - July, but all months have a mean wave height of below 2 meters.

**Table 6-2. Sydney Significant Wave Height Statistics**

	Month (meters)											
	Jan	Feb	Mar	Apr	May	Jun	Jul	Aug	Sep	Oct	Nov	Dec
<b>Mean</b>	1.59	1.65	1.70	1.67	1.66	1.77	1.64	1.56	1.55	1.60	1.61	1.55
<b>Minimum</b>	0.49	0.60	0.59	0.38	0.38	0.39	0.39	0.40	0.45	0.40	0.38	0.42
<b>5<sup>th</sup> Percentile</b>	0.90	0.93	0.91	0.81	0.72	0.71	0.71	0.70	0.78	0.80	0.86	0.83
<b>Median</b>	1.48	1.51	1.51	1.48	1.49	1.52	1.43	1.35	1.39	1.46	1.44	1.43
<b>95<sup>th</sup> Percentile</b>	2.69	2.86	3.17	3.13	3.17	3.65	3.28	3.11	2.90	2.96	2.92	2.69
<b>Maximum</b>	4.92	5.53	6.61	8.06	8.43	7.76	6.96	6.41	6.18	6.17	6.22	5.49
<b>Months of Data</b>	18.6	19.1	19.3	21.0	20.7	21.3	22.7	21.4	21.5	21.7	20.9	20.9
<b>% of Time Under 2m</b>	81%	78%	75%	74%	71%	70%	74%	79%	80%	80%	79%	82%

(Sydney Waverider Buoy, via Australian Ocean Data Network)

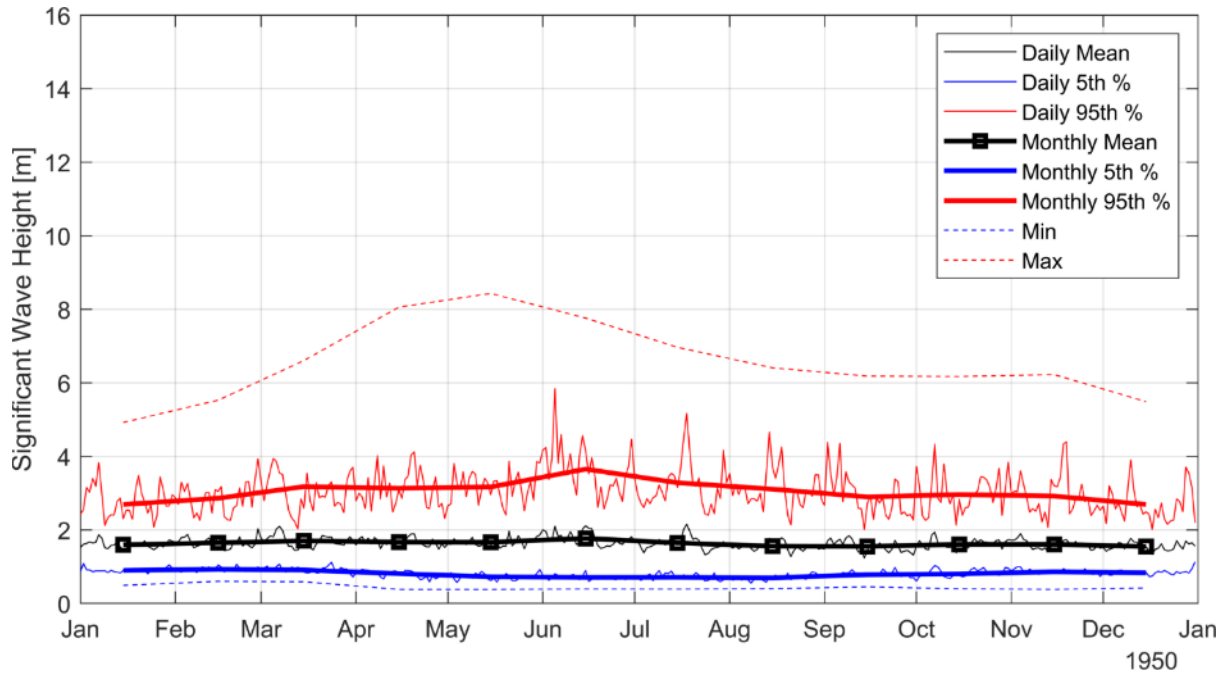

*(Sydney Waverider Buoy, via Australian Ocean Data Network)*

Figure 6-11. Sydney Monthly and Daily Significant Wave Height Statistics.

A threshold analysis was conducted using a significant wave height of 2 meters. The results in Figure 6-12 show that there is a ~80% chance of waves below 2 meters in the months from September to January.

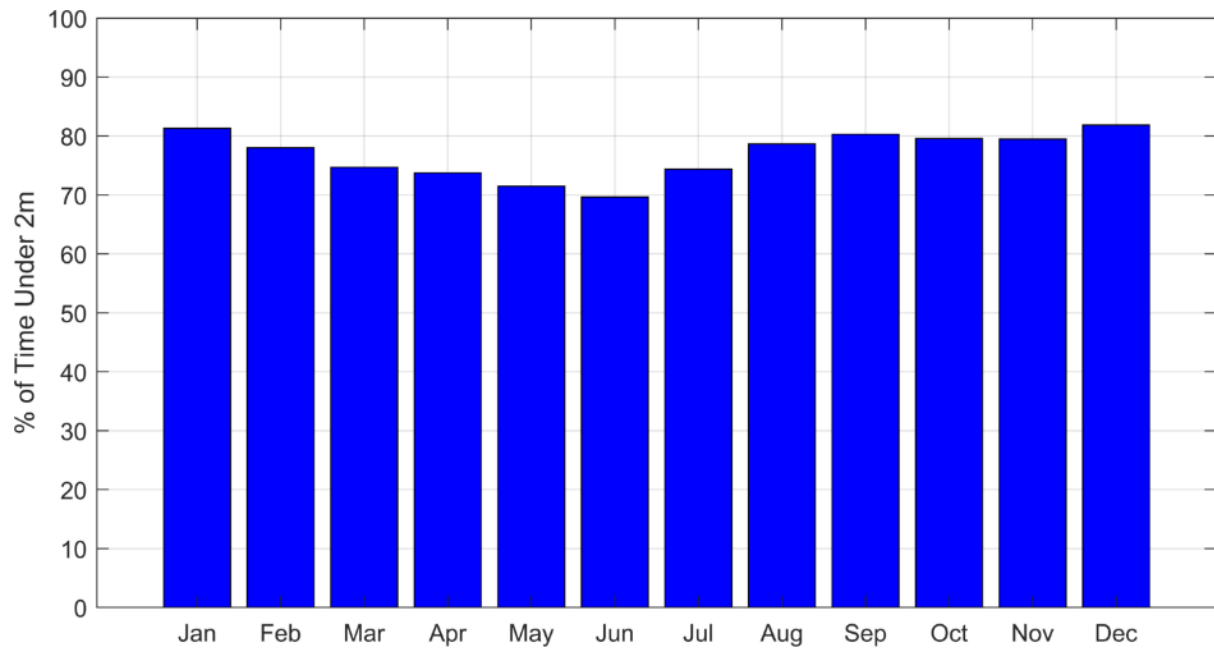

*(Data sourced from MHL, n.d.; AODN, n.d.)*

Figure 6-12. Sydney Percent of Time Significant Wave Height < 2 meters.



## NEW ZEALAND

### 6.3. New Zealand

#### 6.3.1. Water Levels

Tides in the vicinity of Invercargill are semidiurnal, with two tides per day of near-equal amplitude. The port of Bluff, adjacent to the proposed landing site, has a mean tidal range of 2.25 m during spring tides and 1.33 during neap tides. The historical local vertical datum is the Bluff Vertical Datum 1955 (BVD-55), which was set such that 0.0 m BVD-55 was the mean sea level from 1918 to 1934. At present, mean sea level has risen to 0.13 m BVD-55, and the highest astronomical tide is estimated as 1.48 m BVD-55.

Non-tidal influences on water level include climate and weather patterns, which can alter mean sea level by +/- 0.2 m. Mean sea level is highest in the month of May (NIWA). An analysis of the combined effects of extreme storm surge and tides (but NOT sea level rise) concluded that the 50-year return period water level could reach 2.44 m BVD-55, and the 100-year return period water level could reach 2.49 m BVD-55.

Sea Level Rise (SLR) is expected to continue such that these extreme events are much more common. NIWA (2018) indicates that after a sea level rise of 0.45 m, the 100-year extreme water level event would be an annual occurrence. The potential impacts of SLR on coastal erosion are discussed in Section 4.0.

#### 6.3.2. Currents

Currents in Foveaux Strait are dominated by the M2 semidiurnal tide and can reach speeds of 1.2 m/s (2.33 knots). The Southland Current enhances the eastward tidal currents to some degree, though more of the Southland Current water travels south around Stewart Island. Tidal currents are also strong over the Campbell Plateau (Stevens et al., 2021).

#### 6.3.3. Water Temperatures

Water temperature data was not readily available for download, although time series of model predictions and satellite measurements do exist. A dataset at the nearby port of Bluff was summarized by NZ's Ministry for the Environment. The maximum Sea Surface Temperature (SST) was 17.2 °C, the mean was 12.1 °C and the minimum was 6.9 °C.

### 6.3.4. Waves

The wave climate in Foveaux Strait was characterized based on a wave hindcast product described in Albuquerque et al. (2018) and retrieved from <https://uoa-eresearch.github.io/waves/hindcast.html> (Albuquerque et al., n.d.) in March 2022. The model extracted data from a point 250 km SW of the landing site.

The wave rose in Figure 6-13 rose plots the direction that waves are coming from and summarizes the significant wave height from 19 years of simulated wave conditions. This data is valid in deep water; a nearshore wave transformation modelling study would be required to predict the wave climate impinging on the landing location.

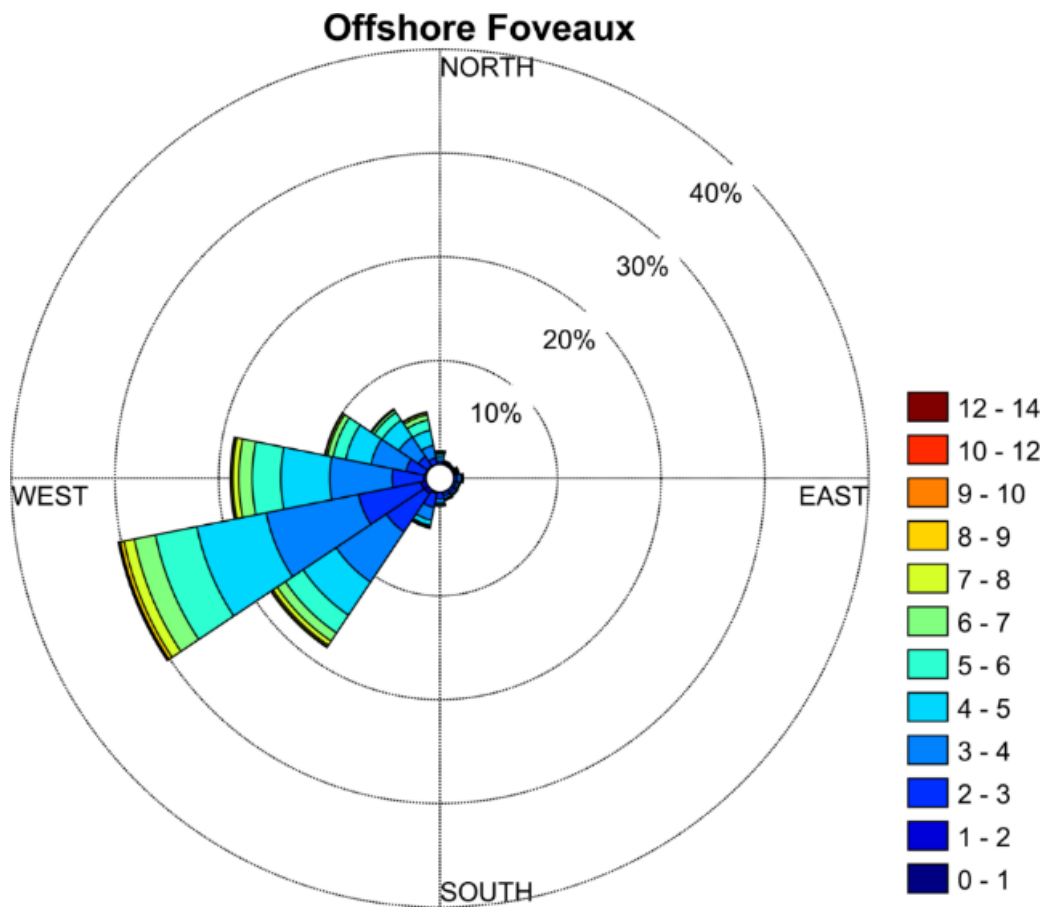

*(Data sourced from Albuquerque et al., n.d.)*

Figure 6-13. Significant Wave Height Rose, NZ Wave Data Hindcast, 1993-2019.

*Note:* This rose plots the direction that waves are coming from.

The annual distribution of significant wave heights is plotted in Figure 6-14 as a histogram and

exceedance curve. The right-hand plot shows the percentage of time significant wave heights are above the thresholds on the x-axis. Significant wave heights are above 2 meters 98% of the time, and the median significant wave height is 3.9 meters.

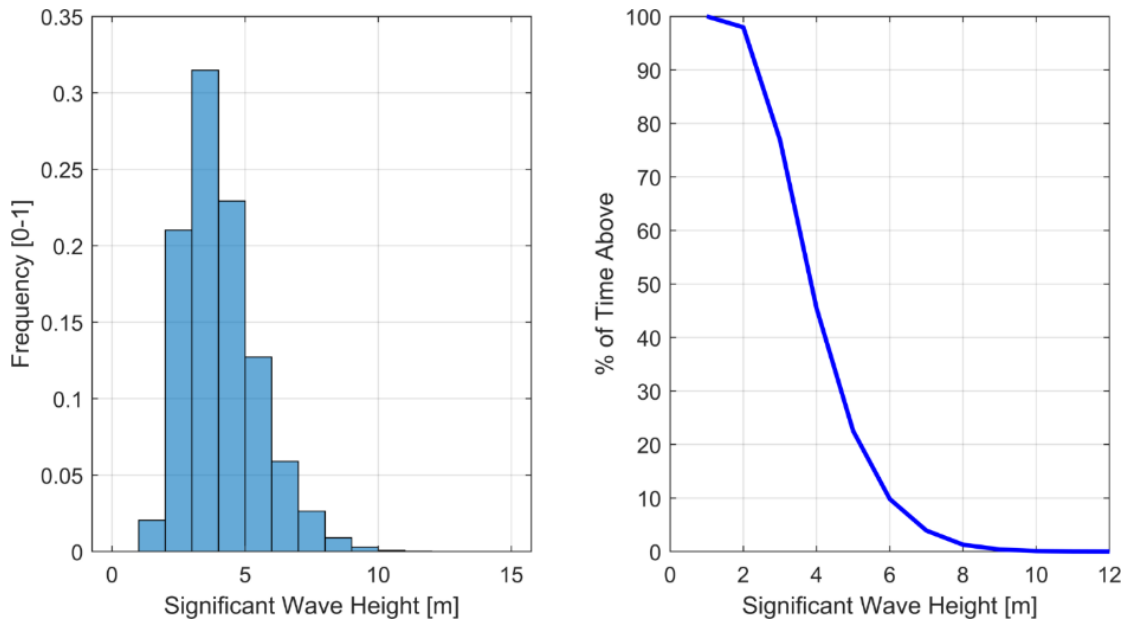

*(Data sourced from Albuquerque et al., n.d.)*

Figure 6-14. Significant Wave Height, 250 km SW of Invercargill Landing, Histogram and Exceedance Curve.

The wave climate varies seasonally, though storm-related variability within individual months is greater than the differences between monthly means. Table 6-3 splits the significant wave height statistics from this location 250 km SW of the Invercargill landing by month. The data are plotted in Figure 6-15, aggregating data by month (thick lines) and by day (thin lines). The largest waves are seen in the winter months of May – September, however waves over 2 meters are common every month.



**Table 6-3. Significant Wave Height Statistics - 250 km SW of Invercargill Landing**

	Month (meters)											
	Jan	Feb	Mar	Apr	May	Jun	Jul	Aug	Sep	Oct	Nov	Dec
Mean	3.6	3.5	3.9	4.2	4.5	4.4	4.3	4.4	4.4	4.4	3.9	3.5
Minimum	1.4	1.4	1.6	1.8	1.4	1.2	1.5	1.6	1.7	1.5	1.4	1.4
5 <sup>th</sup> Percentile	2.0	2.0	2.3	2.4	2.4	2.4	2.5	2.6	2.5	2.5	2.2	2.0
Median	3.4	3.3	3.7	3.9	4.2	4.1	4.1	4.1	4.2	4.2	3.7	3.3
95 <sup>th</sup> Percentile	6.0	5.6	6.3	6.7	7.4	7.5	7.1	7.0	7.1	7.0	6.1	5.5
Maximum	10.4	10.6	9.9	12.3	12.9	12.4	9.8	11.3	12.8	10.7	10.9	10.0
Years of Data	27	27	27	27	27	27	27	27	27	27	27	27
% of Time Under 2m	5%	4%	2%	0%	1%	1%	1%	0%	1%	1%	3%	5%

(Albuquerque et al., 2018)

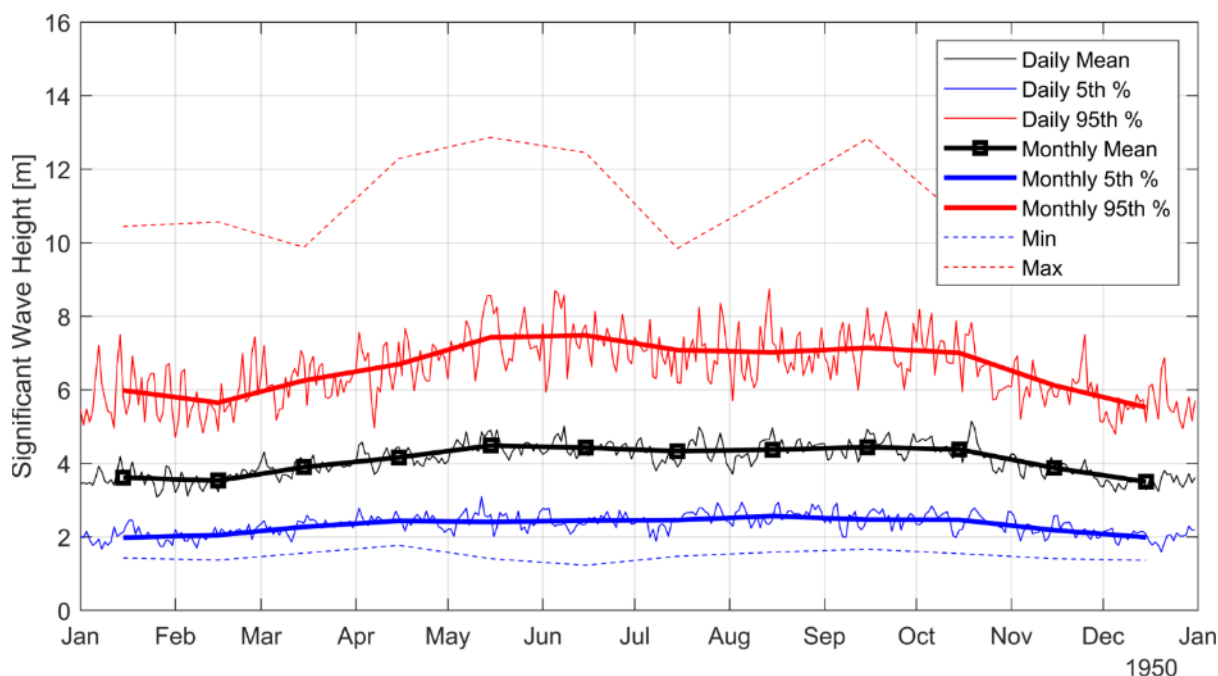

(Data sourced from Albuquerque et al., n.d.)

Figure 6-15. Monthly and Daily Significant Wave Height Statistics, 250 km SW of Invercargill Landing.

A threshold analysis was conducted using a significant wave height of 2 meters. The results in Figure 6-16 show that there is only a ~5% chance of waves below 2 meters in the month of December and January. Looking at the same data in terms of consecutive days under the 2-meter threshold, there are only 8 consecutive 24-hour periods of relative calm in a year at the model



extract point 250 km SW of the landing site, and only one or two consecutive 48-hour periods of calm. The highest likelihood of a calm weather window is found in December to February, but storms are guaranteed to interrupt any multi-day survey or installation effort. Note that these threshold statistical analyses can be quickly rerun for sea states of interest, and that the model source data includes splitting swell from wind waves. If the installation or survey vessel response to different wave periods is relevant and known a more detailed weather window analysis can be completed with the data in hand.

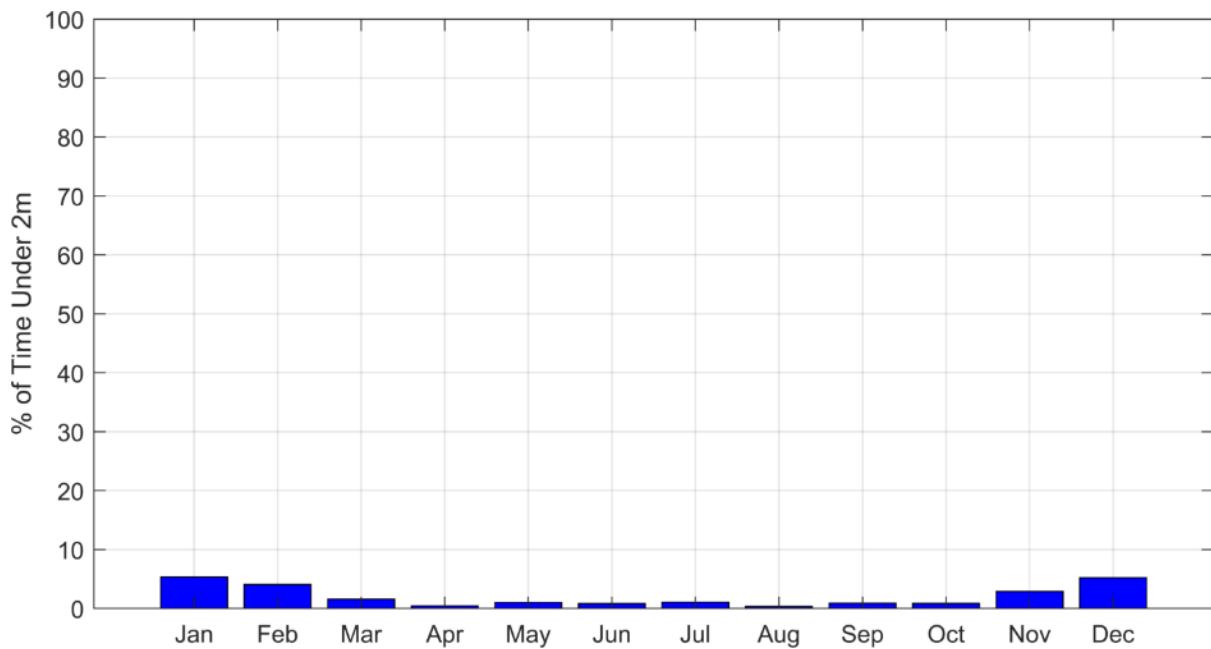

*(Data sourced from Albuquerque et al., n.d.)*

Figure 6-16. Percent of Time Significant Wave Height < 2 meters, 250 km SW of Invercargill Landing.



## ANTARCTICA

### 6.4. Antarctica

#### 6.4.1. Water Levels

There are permanent tide gauges at Scott Base, 2.5 km east of McMurdo Station and at Cape Roberts 128 km to the northwest. Tides at McMurdo are usually diurnal, with one high and one low tide per day. The semidiurnal tide (M2 constituent) is weak throughout the Pacific section of the Southern Ocean (Ray et al., 2021). The tidal range at both McMurdo and Cape Roberts varies on a 13.66-day cycle, with nearly no tidal range when the orbital path of the moon crosses the equator and the two dominant tidal constituents (K1 and O1) cancel each other out. A typical tidal range is around a meter, while the maximum tidal range is 2 meters, which includes positive and negative observed storm surge (West et al., 2006). Non-tidal influences on water level include the inverted barometer effect from passing weather patterns, wind setup, and seasonal changes in water level. These effects, lumped into the term storm surge, were observed to alter sea level by up to 0.41 m over a relatively short period of record (Goring & Pyne, 2003).

#### 6.4.2. Currents

Current data at 14 locations within McMurdo Sound showed mostly weak currents. Most locations had an average current speed below 0.30 m/s (0.58 knots), with only anecdotal evidence of currents of 0.50 m/s (~1 knot) anywhere within Winter Quarters Bay.

#### 6.4.3. Water Temperatures

Supercooled water flows out from the McMurdo Ice Shelf cavity into McMurdo Sound. During winter, McMurdo Sound water is close to or below its freezing point, providing the conditions necessary for generating frazil and anchor ice in the water column and sea ice on the water surface, discussed below (Leonard et al., 2021). Instrumentation at the McMurdo jetty recorded an average sea surface temperature of -1.8 °C, varying between -1.9 °C and -0.67 °C over a one-year period of record.

#### 6.4.4. Waves

Wave action will be inhibited by sea ice for much of the year in McMurdo Sound. During open water, the most common winds from the south and east will generate minimal waves due to the limited fetch in these directions. Minimal wave data are available at McMurdo Station proper, but



measurements elsewhere in McMurdo Sound did not find waves greater than 1 m in height (West et al., 2006).

#### 6.4.5. Ice

Three main forms of ice are examined for potential hazards to the installation, operation, and maintenance of the cable system. Sea ice, icebergs, and frazil or anchor ice can all potentially affect the cable.

##### *Sea Ice*

Sea ice is formed from the freezing of seawater at the surface. It can be attached to land, termed fast ice, or free-floating pack ice. Fast ice is common every year in the immediate vicinity of McMurdo Station, forming in March or April and breaking up and moving out in summer of the next year (Leonard et al., 2021).

The prevailing winds in McMurdo Sound (from the south or east, towards the north) drag sea ice away from the land or shelf ice and open up polynya, which are areas of open water amidst ice. Polynya can also form due to warm ocean currents, though wind appears dominant in the McMurdo Polynya. Polynya support further ice formation as ocean water is exposed directly to cold air temperatures (Rack et al., 2021). New sea ice covers large areas of McMurdo Sound and the Ross Sea, but is not particularly thick. Sea ice in McMurdo Sound is on average 2 meters thick; the average of the thickest 10% of McMurdo Sound sea ice was 7.6 m thick (Rack et al., 2021).

Forces on sea ice including winds and currents can buckle and or force sea ice above itself, creating pressure ridges which were measured by Rack et al. (2013) to be approximately 3 to 11 m thick. This is still floating ice, so the hazard to a cable is limited to shallow water, except in shallow locations where sea ice, and especially thick sea ice ridges may contact the seabed. The thickest deformed ice is downwind of polynya, so not as likely to impinge upon the landing site. Still, ice forces must be considered when designing the cable landing.

There is a limit to how thick sea ice can grow in situ due to its own insulating effect between cold air temperatures and seawater. Sea ice formation also expels brine, as ice is fresh, increasing the salinity of surrounding water. The behavior of sea ice can be altered by the presence of icebergs. Meltwater from icebergs freshens the upper layer of the ocean, which makes it easier to form sea ice. Icebergs can also physically shelter sea ice from winds and support fast ice if the iceberg is grounded.

##### *Ice Shelves and Icebergs*

Most of Antarctica is covered in ice sheets, which are formed over millennia by precipitation over the Antarctic continent. Ice flows downslope to the sea at rates of meters to hundreds of meters per year. An ice shelf occurs when a land-sourced ice sheet flows out over the ocean. The



grounding line is the point where the ice sheet detaches from the sea floor. Ice shelves are much thicker than sea ice.

McMurdo Ice Shelf and Ross Ice Shelf are adjacent to the project site. The seaward edge of the McMurdo Ice shelf is on the order of 10-30 m thick (Rack et al., 2013). The Ross Ice Shelf is 250-400 m thick at the seaward edge (Fretwell et al., 2013). Ice shelves lose mass to melting by relatively warm ocean water and to calving, where the unsupported ice cracks and forms icebergs. Iceberg size is hugely variable and can be the size of small countries down to house-sized 'bergy bits' and car-sized 'growlers.'

Icebergs can scrape along the seafloor, making plough marks up to 10 m deep. A direct iceberg impact to a seafloor cable from the scour of an iceberg keel would be catastrophic to a surface laid or buried cable, regardless of the armoring on the cable. The only suitable mitigation from large icebergs is avoidance or minimization of traverse of areas where iceberg keel impacts on the seabed are possible.

The track of icebergs is determined by winds and ocean currents. A catalog of track marks from the largest icebergs was reviewed and no large (>5km in length) icebergs were found to enter McMurdo Sound (Budge and Long, 2017). It appears difficult for a large ice shelf iceberg to reach the landing site against the prevailing winds. Large icebergs have partially blocked the entrance to McMurdo Sound, retaining sea ice for longer than usual and hindering ship access (Leonard et al., 2021). The iceberg catalog does not track the thousands of smaller icebergs that still may be hundreds of meters in draft. There remains uncertainty over how likely these are to reach the landing site but could be kept out by sea ice, prevailing winds bathymetric sills or shoals capable of impeding the progress of the ice.

Other local iceberg sources include ice tongues, e.g., from Erebus which is up to 50 m thick (Holdsworth, 1982) and Drygalski glaciers (300m thick, Fretwell et al., 2013). These calve rarely but represent a deeper draft iceberg than might otherwise enter McMurdo Sound.

### *Frazil and Anchor Ice*

Frazil ice is the term for solid ice particles that form in flowing, supercooled water. They start as small platelets and can quickly aggregate or attach to surfaces. Frazil ice accumulates underneath sea ice and can attach and then thicken the sea ice.

Anchor ice forms when supercooled water and the subsequent frazil ice encounters a surface on which crystallization can commence. The ice builds up on the surface, which can include the sea floor, organisms, and manmade objects (like the eponymous ship's anchor). The conditions for anchor ice formation occur in McMurdo Sound. Factors in formation include rising fresh meltwater from Ross Ice Shelf combined with cooling from the McMurdo polynya.

Anchor ice buildup on the cable is a hazard. Anchor ice has been observed to lift sediment, vegetation, and organisms from the bottom, resulting in areas denuded of fragile organisms. The





upper limit of anchor ice thickness is not clear, but it has been observed to lift armor protection and the cable itself (Wilt, 2013). Anchor ice has not been observed deeper than 33 m in McMurdo Sound, but the precise reasons for this depth limitation have not been explained and lack of observation, rather than lack of ice, remains possible (Mager et al., 2013). Sufficient pressure and salinity likely inhibit ice formation, but a permanent hard surface such as the cable would invite anchor ice formation any time conditions were favorable.

#### 6.4.6. Ice Scour

The McMurdo Station landing location necessitates a cable that traverses the Ross Sea region of Antarctica. It is understood that warming sea surface temperatures, dynamic sea ice extents, and regional glacial retreat will affect biophysical characteristics of the region including loss of sea ice, changing rates of seabed scour and chemical changes in sea water. These, in turn, spur benthic community and structure changes, as well as changes to water flow and currents. Deregibus et al. (2017) documented changes associated with the loss of sea ice, specifically land-fast ice, or ice



*(Image supplied by Erin Heard, MCM NSF Station Manager, 2020)*

Figure 6-17 McMurdo Station icebergs, 2020.



that is secured to the seafloor or land. Research estimates of sea ice production in the Ross Sea, may have been overstated previously due to an underestimation of the oceanographic connectivity of sea ice dynamics and the subsequent changes in salinity and the thermohaline circulation, varied areas of open water, etc. (Dai et al., 2020).

Ice scouring occurs when floating ice scrapes the seabed resulting in gouges. Icebergs and glaciers impact the biophysical characteristics of the seabed during grounding at varying depths and in different ways. Ice keels cause these scours and the depth variations associated with impacts (15 – 25 cm to 100+ m) in polar regions range from the more frequent shallow low-draft ice in nearshore areas (0.25 – 1 m) to larger sea ice in deeper locations (10-30 m).

Additionally, scouring, caused by an ice keel, not only creates a groove in the seabed, but also berms and fractures that may reoccur or shift over time (Conlan et al., 1998) (Figure 6-18). Many of these events would also present a significant risk to even armored and buried cables. This reinforces the need for an accurate detailed Marine Route Survey of the cable route.

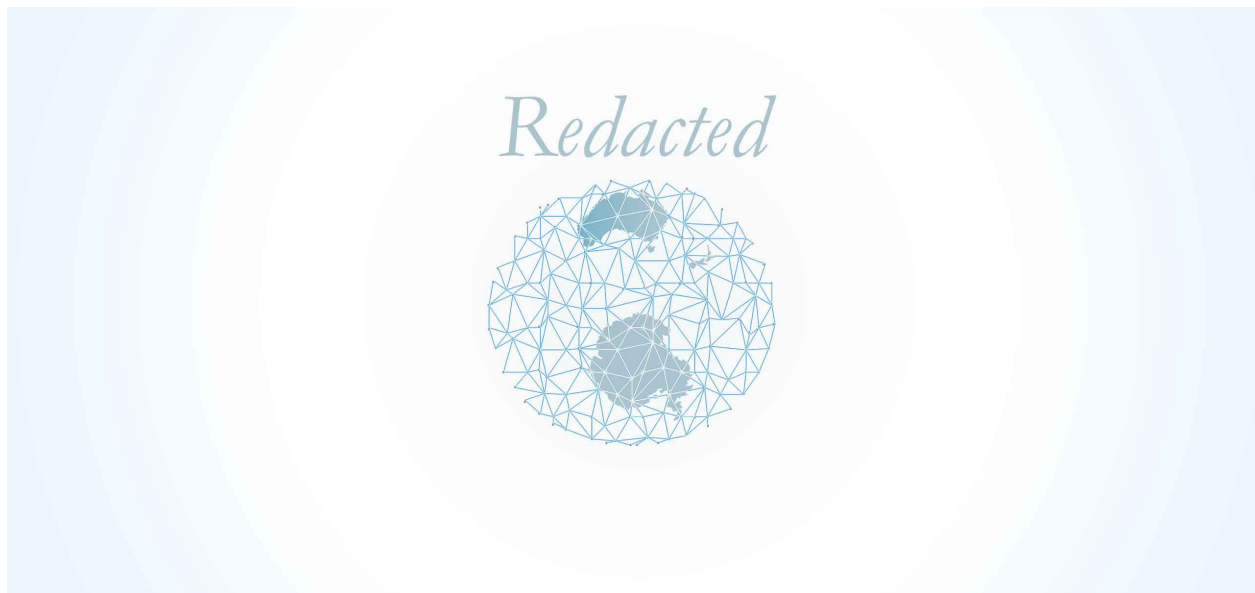

(Conlan et al., 1998)

Figure 6-18. [Redacted]. Seabed Ice Scour Illustration.

Wilson (2018) highlights several issues related to the movement of sea ice including: sea ice pressure ridges, coastal ice accumulations, icebergs and 'berggy bits' (icebergs from glaciers or ice shelves), 'strudel scour' (freshwater movement within the ice core moves so quickly it 'jets' the sea floor), and coastal erosion assisted by one or more of these processes. These risks, should be considered, using existing research from the area or other, representative data from other regions (poles), throughout the project lifecycle. They may influence preferred, pre-survey routes, HDD and burial designs, installation preparation as well as being a component of operation and maintenance (O&M) planning.



In Arctic environments, the thawing and subsequent refreeze of sea water in areas of finer sediments such as silt, sand, and fine gravel, causes some of the largest, annual sediment migrations. This is often an autumnal process as winter re-establishes itself in the Arctic and is, therefore, somewhat counterintuitive. A spring thaw with its associated flows and increased river speeds would be assumed to be the only major period of erosion however, it is the pre-winter period of temperature variability that has been known to reshape beachfronts and shallow areas as the materials are either entrained within newly formed ice or pushed by ice as it establishes itself into sizeable formations. Additionally, research conducted using geophysical mapping and coring methods has identified deep-draft ice scour which occurred throughout glacial periods and which are indications of changes in Arctic Ocean ice shelf/sheet (Kirchner et al., 2013).

Any approach to an Antarctic cable landing will carry some level of associated risk. If ice keels can be avoided by not traversing shallow waters beneath floating ice formations, this risk of cable damage may be mitigated. The shoreline at the landing, however, may experience seabed scour from land fast ice and the changing levels thereof. HDD can likely mitigate this, depending on the length of the bore and the depth of punch out as compared to the depth where ice impacts are observed. Cable planning in an environment as harsh as Antarctica has been successfully executed in the Arctic, however these Arctic examples remain merely anecdotal and specific surveys, observations, and scientific modeling, and careful detailed engineering design will be key to successful cable planning. The HDD drilling itself may be complicated by local environmental factors, as well as the site-specific geological conditions. Careful planning will be needed to ensure the proper location for the landfall can be selected to mitigate and minimize these risks and challenges.

#### **6.4.7. Ice Shelf Collapse**

The Antarctic Ice Sheet is believed to be vulnerable to localized ice shelf collapse due to climate-driven effects with surface-melt-driven hydrofracture and warm water sub-shelf dynamics (Martin et al., 2019) (Figure 6-19). While there has been some study in the region, ice shelf dynamics data may be limited due to low-resolution models and the impacts of warmer climates influencing the Antarctic Ice Sheet and sea ice movement. Higher resolution models and a broader range of datasets (e.g., sea ice properties, sea surface temperature, sea surface height, atmospheric parameters, marine biology, terrestrial cryospheric connections, in situ data collection, etc.) were included as research needs in a 2017 study that was focused on reducing uncertainty and promoting innovation, calibration, and validation capabilities (Pope et al., 2017). If acquired, this data may provide valuable insights to the proposed project site and support system design, installation planning and O&M.

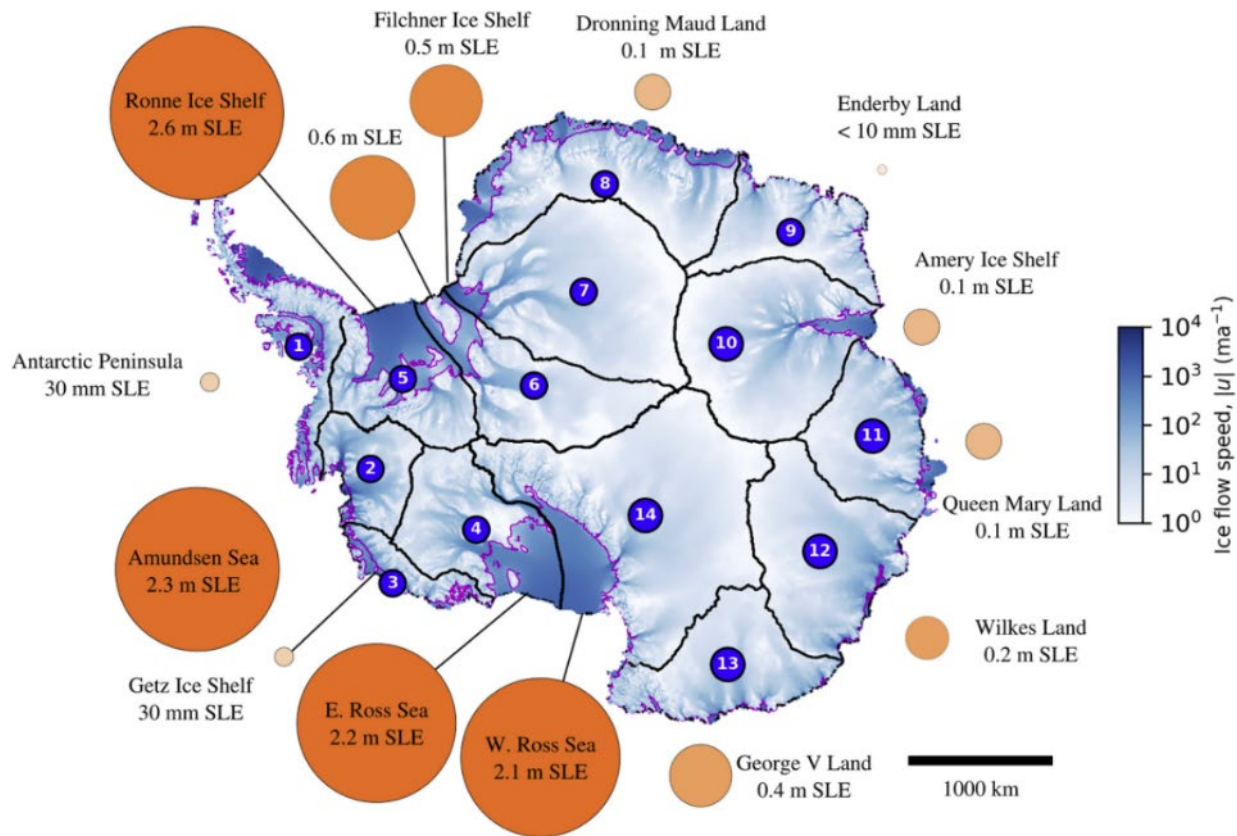

(Martin et al., 2019)

Figure 6-19. Antarctic Vulnerability to Localized Ice Shelf Collapse.

NSF funding support is being used to update sea ice models, and one example is ROSETTA-Ice — Ross Ice Shelf (RIS), Antarctica project (USGS, 2019). ROSETTA combines ocean interactions on the Ross Ice Shelf to the underlying regional bathymetry to obtain a more accurate picture of changes in the region (USGS, 2019). Research and ongoing monitoring also contribute to knowledge and information critical for offshore project development and include sea ice thickness in the Ross Sea region (Ackley et al., 2020; Griggs & Bamber, 2011) and predicting seasonal sea ice extents (Sea Ice Prediction Network South) (Reader, 2020). Climatic changes, such as the Washington Post article that noted warm weather episodes over the eastern Antarctic ice sheet (50-90 degrees above normal) and causing significant melt in the region (Samenow & Patel, 2022) illustrate the variability of changes, which are important to track in support of risk evaluations associated with a perspective cable and the need for routing, burial, protections, etc. (Wilson, et al., 2018).

Initial modeled flow speed is shown in shaded blue in Figure 6-19. Magenta lines indicate initial grounding-line locations. Mass lost above flotation (eustatic sea level equivalent [SLE]) after 1,000 years of extreme, sustained ice shelf thinning originating in the numbered sectors is illustrated by the adjacent circle area (Martin et al., 2019).



These increases in melt and flows may impact the movement of water, ice, and sediments in the region. Additional study, including measurements of these processes should be considered to be included in the Marine Route Survey, such that any changes reported may be taken into consideration during final landfall siting, detailed route design, and before HDD and cable installation operations. Additionally, areas highlighted as representing the greater risk of change to local ice, water, and seabed conditions should be targeted for re-survey during the operational phase of the cable lifetime, so that problems with cable stability and protection may be remediated before cable faults occur.

## 6.5. References

- Ackley, S.F., Stammerjohn, S., Maksym, T., Smith, M., Cassano, J., Guess, P., Tison, J.-L., Delille, B., Loose, B., Sedwick, P., DePzace, L., Roach, L., & Parno, L. (2020). Sea-ice production and air/ice/ocean/biogeochemistry interactions in the Ross Sea during the PIPERS 2017 autumn field campaign. *Annals of Glaciology*, 61(82), 181-195. <https://www.cambridge.org/core/journals/annals-of-glaciology/article/seaice-production-and-airiceoceanbiogeochemistry-interactions-in-the-ross-sea-during-the-pipers-2017-autumn-field-campaign/E6284693F017C6BD6B8174D19937E36F>
- Albuquerque, J., Antolinez, J.A.A., Rueda, A., Mendez, F.J., & Coco, G. (2018). Directional correction of modeled sea and swell wave heights using satellite altimeter data. *Ocean Modelling*, 131, 103-114. <https://doi.org/10.1016/j.ocemod.2018.09.001>
- Albuquerque, J., Antolinez, J.A.A., Rueda, A., Gorman, R., Mendez, F.J., & Coco, G. (n.d.). *A high resolution 20-year portioned hindcast for the New Zealand area*. Retrieved March 2022 from <https://uoa-eresearch.github.io/waves/hindcast.html#NZ-HIST-000-HSIGN-Hsig@1993-01-01%2000:00>
- Australian Ocean Data Network (AODN). (n.d.). *Manly Hydraulics Laboratory – Sydney Offshore Wave Data Buoy (WAVESYD)*. Retrieved March 2022 from <https://catalogue.aodn.org.au/geonetwork/srv/eng/catalog.search#/metadata/1c026e34-a978-4a5d-be97-d6e03a4b328a>
- AusBoM. (2022). *Fort Denison, Sydney hourly water level data*. National Tidal Centre, Bureau of Meteorology (Australia). <https://www.psmsl.org/data/obtaining/stations/65.php>
- Budge, J.S., & Long, D.G. (2017). A comprehensive database for Antarctic iceberg tracking using scatterometer data. *IEEE Journal of Selected Topics in Applied Earth Observations*, 11(2). <https://doi.org/10.1109/JSTARS.2017.2784186>
- Cancet, M., Griffin, D., Cahill, M., Chapron, B., Johannessen, J., Donlon, C. (2019). Evaluation of GlobeCurrent surface ocean current products: A case study in Australia. *Remote Sensing of Environment*, 1, 71-93. <https://doi.org/10.1016/j.rse.2018.10.029>
- Chiswell, S.M., Bostock, H.C., Sutton, P., & Williams, M. (2015, May). Physical oceanography of the deep seas around New Zealand: A review. *New Zealand Journal of Marine and Freshwater Research*, 49(2), 1-32. <https://doi.org/10.1080/00288330.2014.992918>
- Conlan, K.E., Lenihan, H.S., Kvittek, R.G., & Oliver, J.S. (1998). Ice scour disturbance to benthic communities in the Canadian High Arctic. *Marine Ecology Progress Series*, 166, 1-16. <https://www.int-res.com/articles/meps/166/m166p001.pdf>



- Dai, L., Xie, H., Ackley, S.F., & Mestas-Nunez, A.M. (2020). Ice production in Ross Ice Shelf polynyas during 2017-2018 from Sentinel-1 SAR images. *Remote Sensing*, 12, 1484. <https://www.mdpi.com/2072-4292/12/9/1484/pdf>
- Department of Environment, Climate Change and Water (DECCW) NSW. (2010). Coastal Risk Management Guide: Incorporating sea level rise benchmarks in coastal risk assessments. Retrieved February 2022 from <https://www.environment.nsw.gov.au/resources/water/coasts/10760CoastRiskManGde.pdf>
- Deregibus, D., Quartino, M.L., Zacher, K., Campana, G.L., & Barnes, D.K.A. (2017). Understanding the link between sea ice, ice scour and Antarctic benthic biodiversity—the need for cross-station and international collaboration. *Polar Record*, 53(2), 143–152. <https://doi.org/10.1017/S0032247416000875>
- Dotto, T.S., Naveira Garabato, A., Bacon, S., Tsamados, M., Holland, P.R., Hooley, J., Frajka-Williams, E., Ridout, A., Meredith, M.P. (2018). Variability of the Ross Gyre, Southern Ocean: Drivers and responses revealed by satellite altimetry. *Geophysical Research Letters*, 2018 45(12), 6195-204. <https://doi.org/10.1029/2018GL078607>
- Fretwell, P., Pritchard, H. D., Vaughan, D. G., Bamber, J. L., Barrand, N. E., Bell, R., Bianchi, C., Bingham, R. G., Blankenship, D. D., Casassa, G., Catania, G., Callens, D., Conway, H., Cook, A. J., Corr, H. F. J., Damaske, D., Damm, V., Ferraccioli, F., Forsberg, R., Fujita, S., Gim, Y., Gogineni, P., Griggs, J. A., Hindmarsh, R. C. A., Holmlund, P., Holt, J. W., Jacobel, R. W., Jenkins, A., Jokat, W., Jordan, T., King, E. C., Kohler, J., Krabill, W., Riger-Kusk, M., Langley, K. A., Leitchenkov, G., Leuschen, C., Luyendyk, B. P., Matsuoka, K., Mouginot, J., Nitsche, F. O., Nogi, Y., Nost, O. A., Popov, S. V., Rignot, E., Ripplin, D. M., Rivera, A., Roberts, J., Ross, N., Siegert, M. J., Smith, A. M., Steinhage, D., Studinger, M., Sun, B., Tinto, B. K., Welch, B. C., Wilson, D., Young, D. A., Xiangbin, C., & Zirizzotti, A. (2013). Bedmap2: improved ice bed, surface and thickness datasets for Antarctica. *The Cryosphere*, 7, 375-393. <https://doi.org/10.5194/tc-7-375-2013>
- Goring, D.G. & Pyne, A. (2003). Observations of sea-level variability in Ross Sea, Antarctica. *New Zealand Journal of Marine and Freshwater Research*, 37(2), 241-249. <https://doi.org/10.1080/00288330.2003.9517162>
- Griggs, J.A., & Bamber, J.L. 2011. Antarctic ice-shelf thickness from satellite radar altimetry. *Journal of Glaciology*, 57(203), 485–498. <https://doi.org/10.3189/002214311796905659>
- Heard, E., MCM NSF Station Manager. (2020). McMurdo Station Icebergs 2020 [Photograph].
- Holdsworth, G. (1982). Dynamics of Erebus Glacier Tongue. *Annals of Glaciology*, 3, 131-137. <https://doi.org/10.3189/S0260305500002652>



- HYCOM. (n.d.). *Hybrid Coordinate Ocean Model*. Retrieved March 2022 from <https://www.hycom.org/>
- IMOS Oceancurrent. (2022). Sydney-area IMOS moored instruments SYD100 and SYD140. Retrieved March 2022 from [http://oceancurrent.imos.org.au/timeseries/ANMN\\_P34/mapst/10\\_Syd\\_vmean\\_1.html](http://oceancurrent.imos.org.au/timeseries/ANMN_P34/mapst/10_Syd_vmean_1.html)
- Kirchner, N., Furrer, R., Jakobsson, M., Zwally, H.J., Robbins & J.W. (2013). Statistical modeling of a former Arctic Ocean ice shelf complex using Antarctic analogies. *Journal Geophysical Research*, 118(2), 1105-1117. <https://doi.org/10.1002/jgrf.20077>
- Leonard, G.H., Turner, K.E., Richter, M.E., Whittaker, M.S., & Smith, I.J. (2021). Brief communication: The anomalous winter 2019 sea-ice conditions in McMurdo Sound, Antarctica. *The Cryosphere*, 15(10), 4999-5006. <https://doi.org/10.5194/tc-15-4999-2021>
- Mager, S.M., Smith, I.J., Kempema, E.W., Thomson, B.J., & Leonard, G.H. (2013). Anchor ice in polar oceans. *Progress in Physical Geography: Earth and Environment*, 37(4), 468–483. <https://doi.org/10.1177/0309133313479815>
- Manly Hydraulics Laboratory (MHL). (2022). *Sydney (SYDDOW) wave data*. Retrieved March 2022 from <https://mhl.nsw.gov.au/Station-SYDDOW> [Note: access restricted to Australia.]
- Martin, D.F, Cornford, S.L., & Payne, A.J. (2019). Millennial-scale vulnerability of the Antarctic ice sheet to regional ice shelf collapse. *Geophysical Research Letters* 46(3), 1467–1475. <https://doi.org/10.1029/2018GL081229>
- McComb, P., Garrett, S., Durrant, T. & Perez, J. (2021). Directional wave buoy data measured near Campbell Island, New Zealand. *Scientific Data*, 8, 239. <https://doi.org/10.1038/s41597-021-01025-3>
- New Zealand Ministry for the Environment (NZ MfE). (2022). *Mean, maximum and minimum coastal sea surface temperature (1953–2014)*. New Zealand’s Environment Reporting Series: The Ministry for the Environment and Statistics New Zealand. Retrieved February 2022 from <https://data.mfe.govt.nz/table/52524-mean-maximum-and-minimum-coastal-sea-surface-temperature-19532014/metadata/>
- New Zealand National Institute of Water and Atmospheric Research (NIWA). (2018). *Southland Climate Change Impact Assessment*. Prepared for Environment Southland, Invercargill City Council, Southland District Council and Gore District Council. August 2018. Retrieved August 29, 2023 from <https://niwa.co.nz/sites/niwa.co.nz/files/Southland%20climate%20change%20report%202018.pdf>





- Oke, P.R., Roughan, M., Cetina-Heredia, P., Pilo, G.S., Ridgway, K.R., Rykova, T., Archer, M.R., Coleman, R.C., Kerry, C.G., Rocha, C., Schaeffer, A. (2019). Revisiting the circulation of the East Australian Current: Its path, separation, and eddy field. *Progress in Oceanography*, 176, 102139. <https://doi.org/10.1016/j.pocean.2019.102139>
- Pope, J.O., Holland, P.R., Orr, A., Marshall, G.J., & Phillips, T. (2017). The impacts of El Nino on the observed sea ice budget of West Antarctica. *Geophysical Research Letters*, 44(12), 6200-6208. <https://doi.org/10.1002/2017GL073414>
- Rack, W., Haas, C., & Langhorne, P.J. (2013). Airborne thickness and freeboard measurements over the McMurdo Ice Shelf, Antarctica, and implications for ice density. *Journal of Geophysical Research: Oceans*, 118(11), 5899-907. <https://doi.org/10.1002/2013JC009084>
- Rack, W., Price, D., Haas, C., Langhorne, P.J., & Leonard, G.H. (2021, January 16). Sea ice thickness in the Western Ross Sea. *Geophysical Research Letters*, 48(1), e2020GL090866. <https://doi.org/10.1029/2020GL090866>
- Ray, R.D., Larson, K.M., & Haines, B.J. (2021). New determinations of tides on the north-western Ross Ice Shelf. *Antarctic Science*, 33(1), 89-102. <https://doi.org/10.1017/S0954102020000498>
- Readering, C. (2020, December 15). Update #1 for the Ross Sea and McMurdo Sound Seasonal Outlook 2020-2021. Retrieved August 29, 2023 from [https://usicecenter.gov/pub/ross\\_sea\\_seasonal\\_outlook\\_2020-2021.pdf](https://usicecenter.gov/pub/ross_sea_seasonal_outlook_2020-2021.pdf)
- Samenow, J., & Patel, K. (2022, March 18). It's 70 degrees warmer than normal in eastern Antarctica. Scientists are flabbergasted. *Washington Post*. <https://www.washingtonpost.com/weather/2022/03/18/antarctica-heat-wave-climate-change/>
- Stevens, C.L., O'Callaghan, J.M., Chiswell, S.M., & Hadfield, M.G. (2021). Physical oceanography of New Zealand/Aotearoa shelf seas – a review. *New Zealand Journal of Marine and Freshwater Research*, 55(1), 6-45. <https://doi.org/10.1080/00288330.2019.1588746>
- U.S. Geological Survey (USGS). (2019, June 20). ROSETTA-Ice — Ross Ice Shelf, Antarctica. Geology, Geophysics, and Geochemistry Science Center. Retrieved March 22, 2022 from <https://www.usgs.gov/centers/geology%2C-geophysics%2C-and-geochemistry-science-center/science/rosetta-ice-ross-ice-shelf>
- West, B.A., Gagnon, I.F., & Wosnik, M. (2016). *Tidal Energy Resource Assessment for McMurdo Station, Antarctica*. USACE ERDC/CRREL report TR-16-17. December 2006. Retrieved August 29, 2023 from <https://usace.contentdm.oclc.org/digital/api/collection/p266001coll1/id/4221/download>



- Williams, R.S., Jr., & Ferrigno, J.G., eds. (2012). *State of the Earth's cryosphere at the beginning of the 21st century—Glaciers, global snow cover, floating ice, and permafrost and periglacial environments*. U.S. Geological Survey Professional Paper 1386–A, 546 p. Retrieved March 20, 2022 from <https://pubs.usgs.gov/pp/p1386a/index.html>
- Wilson, D.J., Bertram, R.A., Needham, E.F., van de Flierdt, T., Welsh, K.J., McKay, R.M., Mazumder, A., Riesselman, C.R., Jimenez-Espejo, F.J. & Escutia, C. (2018). Ice loss from the East Antarctic Ice Sheet during late Pleistocene interglacials. *Nature* 561, 383–386 (2018). <https://doi.org/10.1038/s41586-018-0501-8>
- Wilt, G. (2013). *A New Challenge to Arctic Cable Installation--Frazil Ice*. SubOptic. <https://dx.doi.org/10.13140/2.1.5094.7525>



# COMMERCIAL OPERATIONS, RESTRICTED AREAS AND OBSTRUCTIONS REPORT





## 7.0 COMMERCIAL OPERATIONS, RESTRICTED AREAS, AND OBSTRUCTIONS REPORT

Commercial operations, restricted areas and obstructions in the Project area are described in the following sections.

### AUSTRALIA

#### 7.1. Australia

Offshore Sydney is a congested region for the proposed cable, with most of Australia's submarine cable connections with the world coming into the Sydney area. In addition, East Coast ports of Newcastle to the north, Sydney Harbor, and Botany Bay to the south, are some of the largest and busiest in Australia.

##### 7.1.1. Ports and Shipping Activity

Australia relies heavily on sea transport for most of its imports and exports by weight (AMSA, 2020) and some of Australia's busiest ports are found on the East Coast in Queensland and New South Wales. Newcastle Harbor, located approximately 140 km north from the proposed cable landing, is the largest port on the East Coast with over 2,200 trade vessels visiting the port each year exporting coal, grain, vegetable oils, alumina, fertilizer, and ore concentrates (Port Authority of New South Wales, 2022).

The proposed cable landing at Clovelly Beach is located between Sydney Harbor to the north approximately 12 km and Port Botany located approximately 12 km to the south. Sydney Harbor is Australia's busiest waterway with recreational, passenger and working vessels sharing the water with approximately 1200 large commercial vessels that include cruise ships that call into Sydney's two cruise terminals. Newcastle Harbor is the largest port on the East Coast with over 2,200 trade vessels.

In addition, with 85 per cent of the population living within 100 km of the coast, recreational boating is a very popular pastime for many Australians. There are very few areas in the Australian marine environment where international and domestic vessel activity does not occur. Figure 7-1 shows vessel traffic density along the East Coast to and from and between the major ports on the East Coast in 2021.

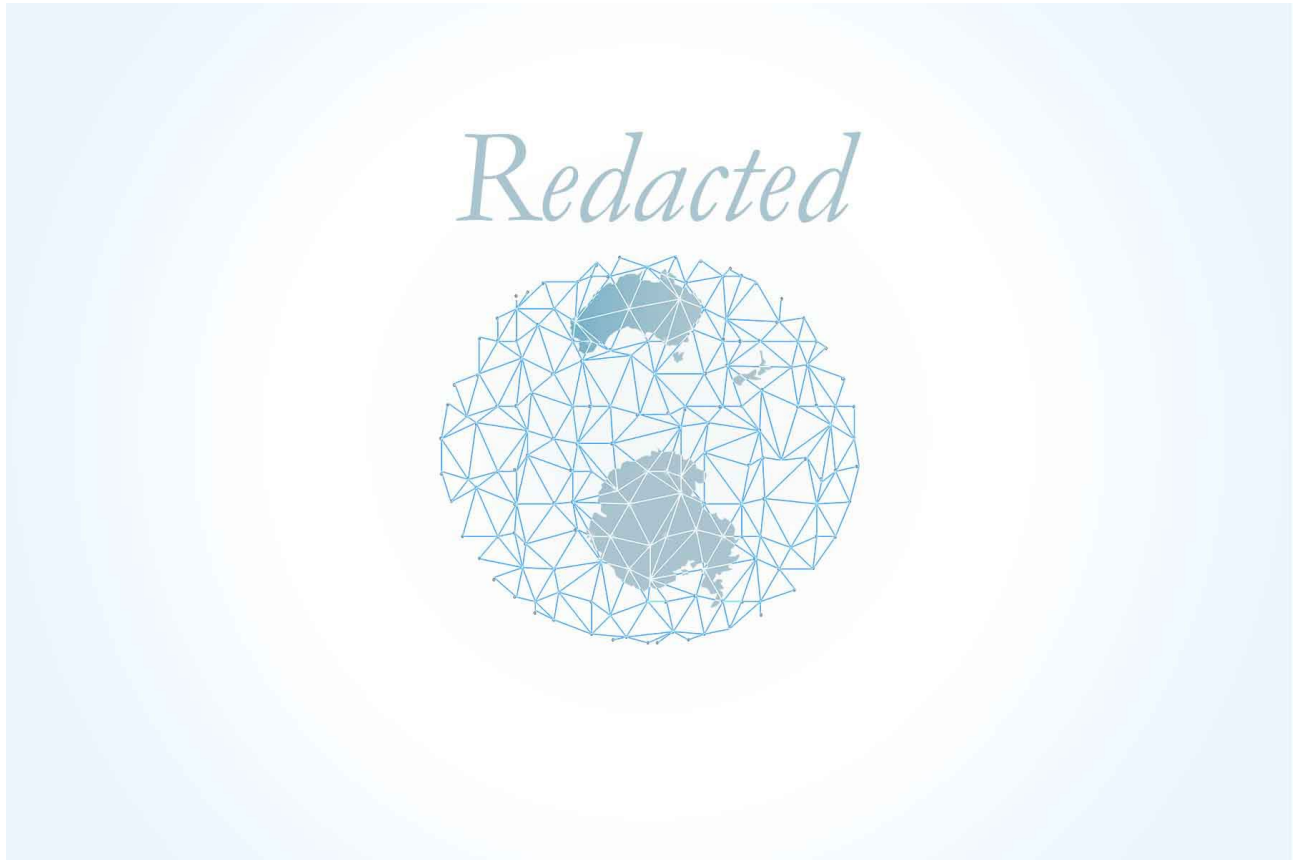
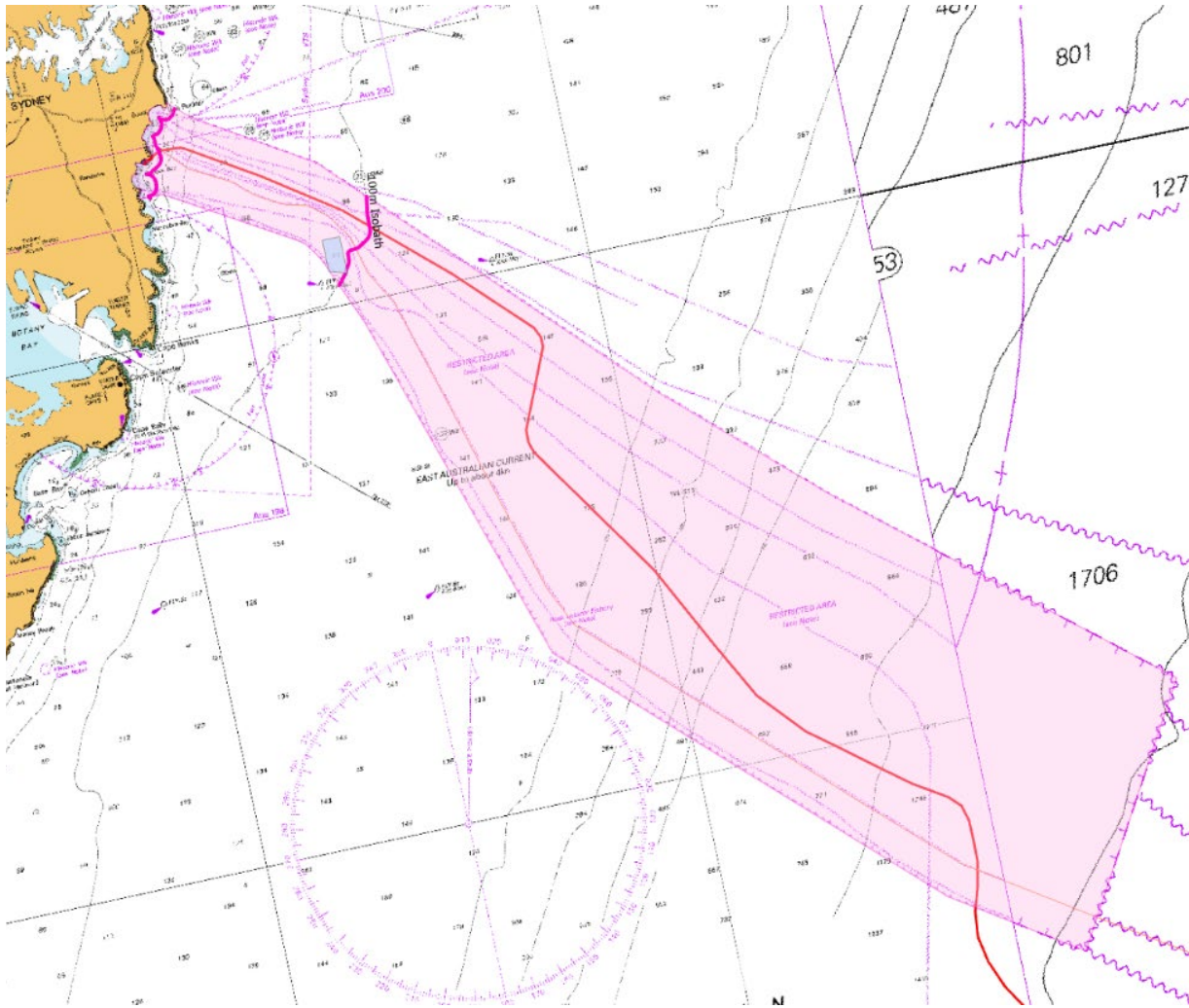

Figure 7-1. [Redacted]. Major Ports and Vessel Traffic Density off Sydney, Australia, in 2021, for All Vessel Types.

### **7.1.2. Southern Sydney Protection Zone and Submarine Cables**

Two cable protection areas are in place off the Sydney, Australia coastline to help protect the numerous submarine cables coming in from around the world that make landfall in the area. The Northern Sydney Protection Zone is located north of the Project area off Narrabeen Beach and does not impact the proposed Project. The Southern Sydney Protection Zone (SSPZ) extends 55km (30 nautical miles) offshore from Tamarama and Clovelly beaches, and to a depth of 2,000 meters (Figure 7-2).



(ACMA, 2007)

Figure 7-2. Southern Sydney Protection Zone.

The SSPZ currently includes seven other In-Service (IS) cable systems (Table 7-1). The proposed cable crosses several of these IS cables, as well as Out Of Service (OOS) cables, within the SSPZ. A cable crossing matrix has been compiled based on publicly available information gathered at the time of this DTS. If the Sydney landing is selected as the preferred landing for the project, a more thorough investigation needs to be conducted to identify all cables crossed, confirm status of those cables, refine crossing angles, and determine all crossing agreements that will need to be negotiated.



**Table 7-1. [Redacted] Existing Cables in the Southern Sydney Protection Zone**

Cable	Owner	Year Installed	Status
-------	-------	----------------	--------

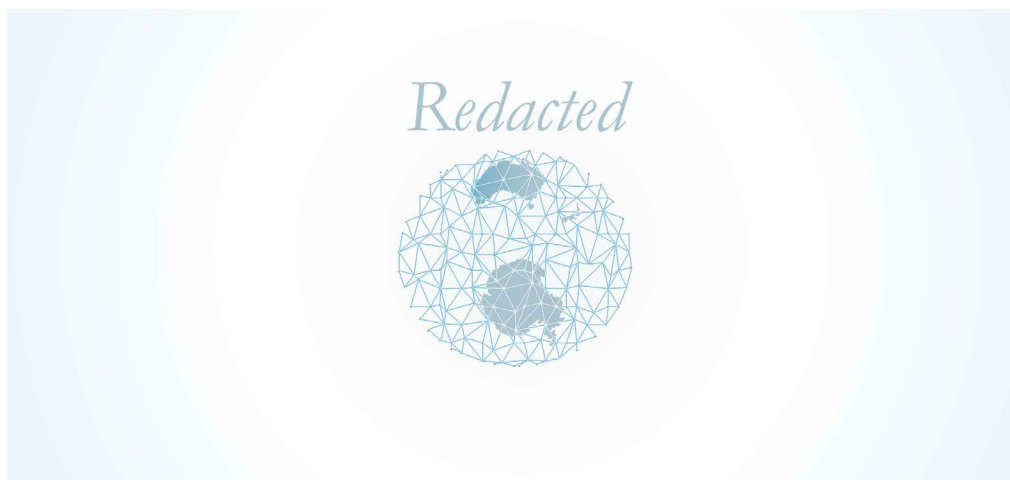

Cable crossings, where possible, were kept at 60° or greater, particularly in proposed burial areas. As a minimum, crossing angles abide by the ICPC recommendation adhering to angles greater than 45° in order to ensure operational maintenance activities are not compromised. For any intended cable crossings, crossing agreements will be obtained from cable owners prior to installation. For crossing of OOS cables, confirmation of the cables status as OOS will also need to be obtained prior to installation operations. In addition, a route clearance and pre-lay grapnel run should be completed prior to installation.

To protect these submarine cables, the following activities are prohibited within the SSPZ (ACMA, 2007):

- 1) Use, tow, operate or suspend from a ship any trawl gear designed to work on or near the seabed, or a mid-water trawl.
- 2) Use, tow, operate or suspend from a ship a dredge, including for scallop dredging.
- 3) Use, tow, operate or suspend from a ship a demersal longline, including setlines and trotlines.
- 4) Establish, maintain or use a spoil ground or other ocean disposal point (including dumping materials at sea).
- 5) Scuttle or attempt to scuttle a ship.
- 6) Use, tow, operate or suspend from a ship a structure moored to the seabed with the primary function of attracting fish for capture, such as a fish aggregating device (FAD).
- 7) Use, tow, operate or suspend from a ship a Scottish or Danish seine.
- 8) Use, tow, operate or suspend from a ship any type of net, rope, chain, or other object used in fishing operations that can touch the seabed.



Limited bottom contact activities are allowed in the SSPZ based on three depth zones:

- 1) 0-500 m from low water mark,
- 2) 500 m from low water mark to 100 m water depth,
- 3) 100 m water depth to the end of the zone at a water depth of 2,000 m.

These restricted activities include limited anchoring, fishing, and bottom contact activities, including cable installations and maintenance activities, so long as the existing submarine cables are not impacted.

To get permission to do any restricted work activities in the SSPZ requires the following:

1. Contact the cable owners at least 21 days before the planned activity.
2. Follow the consultation process set out in the declarations for each zone.

The seabed in the approach to the proposed Sydney landing is very congested with existing IS and OOS submarine cables. Early engagement of cable owners of existing cables that may need to be crossed is highly recommended to facilitate reaching an agreement on the manner of any proposed crossing or close approach of the proposed cable system.

Any questions regarding operations and requirements within the SSPZ should be directed to the contact listed in Table 7-2.

**Table 7-2. Australian Communications and Media Authority (ACMA) Contact Information**

Contact	Email	Tel	Post
ACMA	<a href="mailto:subcableenquiries@acma.gov.au">subcableenquiries@acma.gov.au</a>	1300 850 115	The Manager, Networks and National Interest Section Australian Communications and Media Authority PO Box 13112 Law Courts Melbourne VIC 8010

### 7.1.3. Anchoring Areas

Anchoring is permitted inside the SSPZ between 0 and 500 m distance from the low water mark. Between 500 m distance from the low-water mark and 100 m water depth, limited anchoring is permitted, with slightly heavier anchors ( $\leq 30$  kg) allowed in the area known as the Peak. The Peak is defined by the four coordinates in Table 7-3 and shown in Figure 7-3. Anchoring is not permitted within the SSPZ in water depths greater than 100 m.



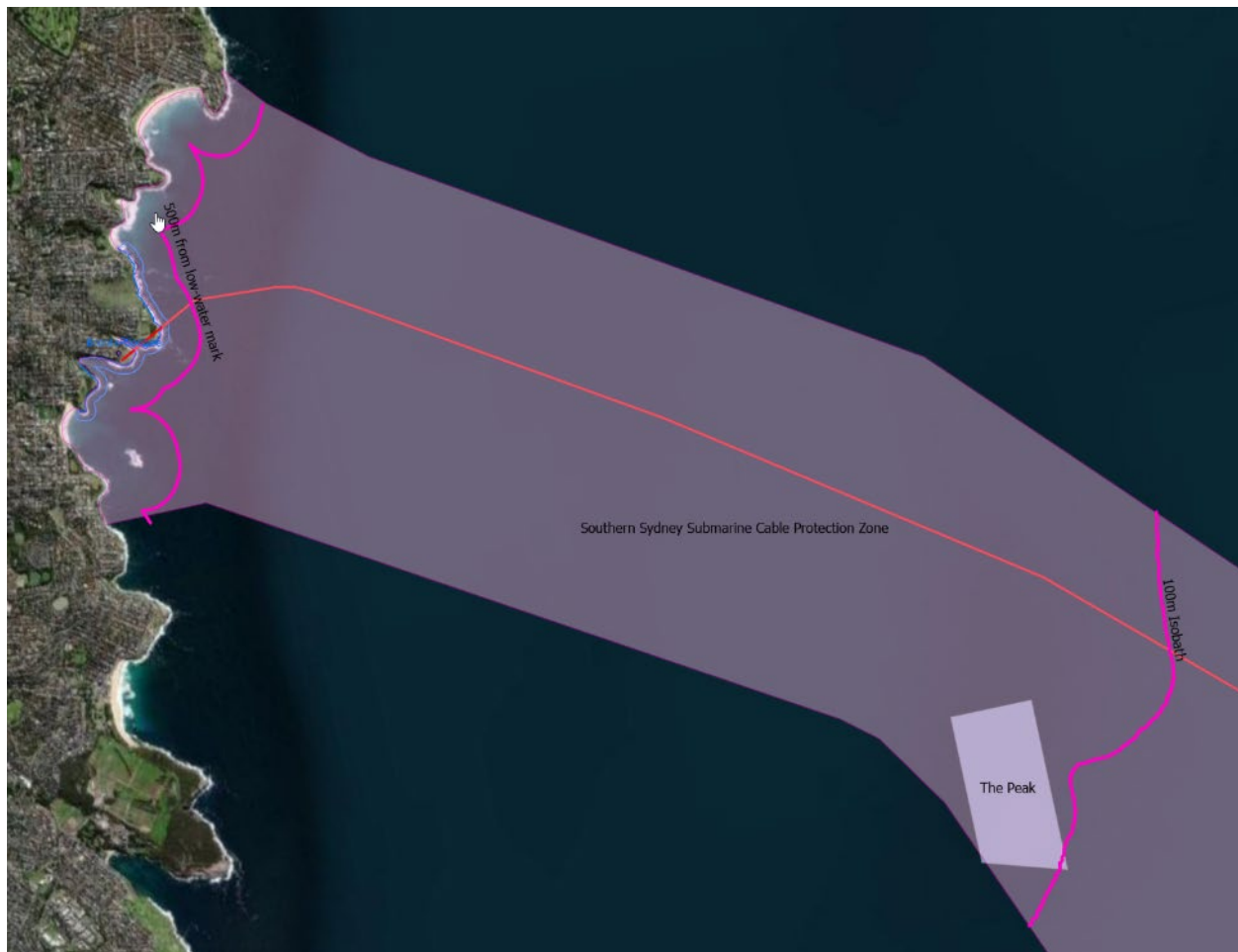

**Table 7-3. Coordinates for the Peak Area in the Southern Sydney Protection Zone**

Point number	Latitude	Longitude
1	33° 58' 06.00" S	151° 21' 18.00" E
2	33° 58' 06.00" S	151° 21' 54.00" E
3	33° 59' 09.00" S	151° 21' 54.00" E
4	33° 59' 09.00" S	151° 21' 18.00" E

(ACMA, 2022)

Note: All other prohibitions and restrictions on permitted activities within the SSPZ still apply.



(ACMA, 2007)

Figure 7-3. The Peak Anchoring Area Located Inside the Southern Sydney Protection Zone.



### 7.1.4. Defense Areas

The proposed route may pass through defense and training areas that overlap the SSPZ. The Australian Communications and Media Authority has a memorandum of understanding with the Australian Department of Defense (AU DoD) that outlines which military operations may be carried out within these defense areas, including: the use of explosives, the direction for firing ammunition, use of inert practice rounds, and the use of targets.

Cable owners should consult with the AU DoD prior to accessing existing or installing a new cable in a defense practice zone to negotiate appropriate access arrangements. In addition, coordination with AU DoD will be needed before entry into the defense areas for marine survey, installation or maintenance operations.

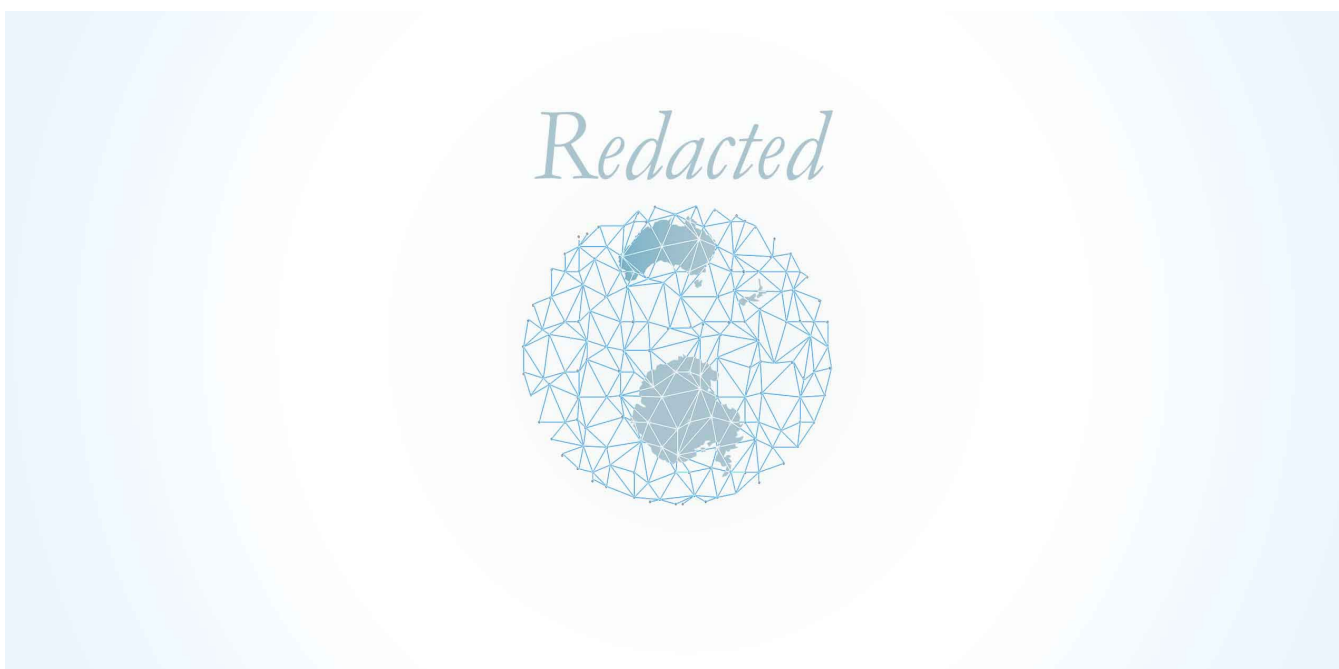

Figure 7-4. [Redacted]. Australia Defense Practice and Training Areas Offshore Sydney.

### 7.1.5. Fisheries

Fisheries in Australia are managed by the Australian Fisheries Management Authority (AFMA). Information on the fisheries described below can be found on the AFMA website (AFMA, 2022).

#### *Tuna and Billfish Fishery*

The Tuna and Billfish Fishery of Australia includes the following species:

- Albacore Tuna (*Thunnus alulunga*) – found at depths up to 200 m.
- Bigeye Tuna (*Thunnus obesus*) – found at depths up to 250 m.



- Yellowfin Tuna (*Thunnus albacares*) – found at depths up to 250 m.
- Broadbill Swordfish (*Xiphias gladius*) – found at depths up to 550 m.
- Striped Marlin (*Kajikia audax*) – found at depths up to 289 m.

These pelagic fishes are highly migratory and swim over large distances and between countries. As such, they are managed by the Western and Central Pacific Fisheries Commission which includes a large number of countries, with Australia being the leader. Annually, the Commission convenes and reviews data from catch, effort and scientific information for all member countries and discuss management techniques and if restrictions need to be enacted.

These species are caught with mainly longline and minor line, including handline, troll, rod and reel. The fishing season begins on 1 January and runs for 12 months. Fishing rights are allocated by AFMA and are transferable between fishers. The area for the Eastern Tuna and Billfish Fishery is shown in Figure 7-5.

Currently there are:

- 81 longline boat statutory fishing rights.
- 84 minor line boat statutory fishing rights.
- 1,076,026 quota statutory fishing rights for each quota species.
- 11 Coral Sea zone statutory fishing rights.

Management of this fishery also includes closures, three of which are in effect:

- Coral Sea – the Coral Sea zone is part of the Eastern Tuna and Billfish Fishery, but fishers must get a separate permit to fish in this area.
- Lord Howe Island – no fishing is allowed within 12 nm of Lord Howe Island.
- Norfolk Island – no fishing is allowed within the vicinity of Norfolk Island.

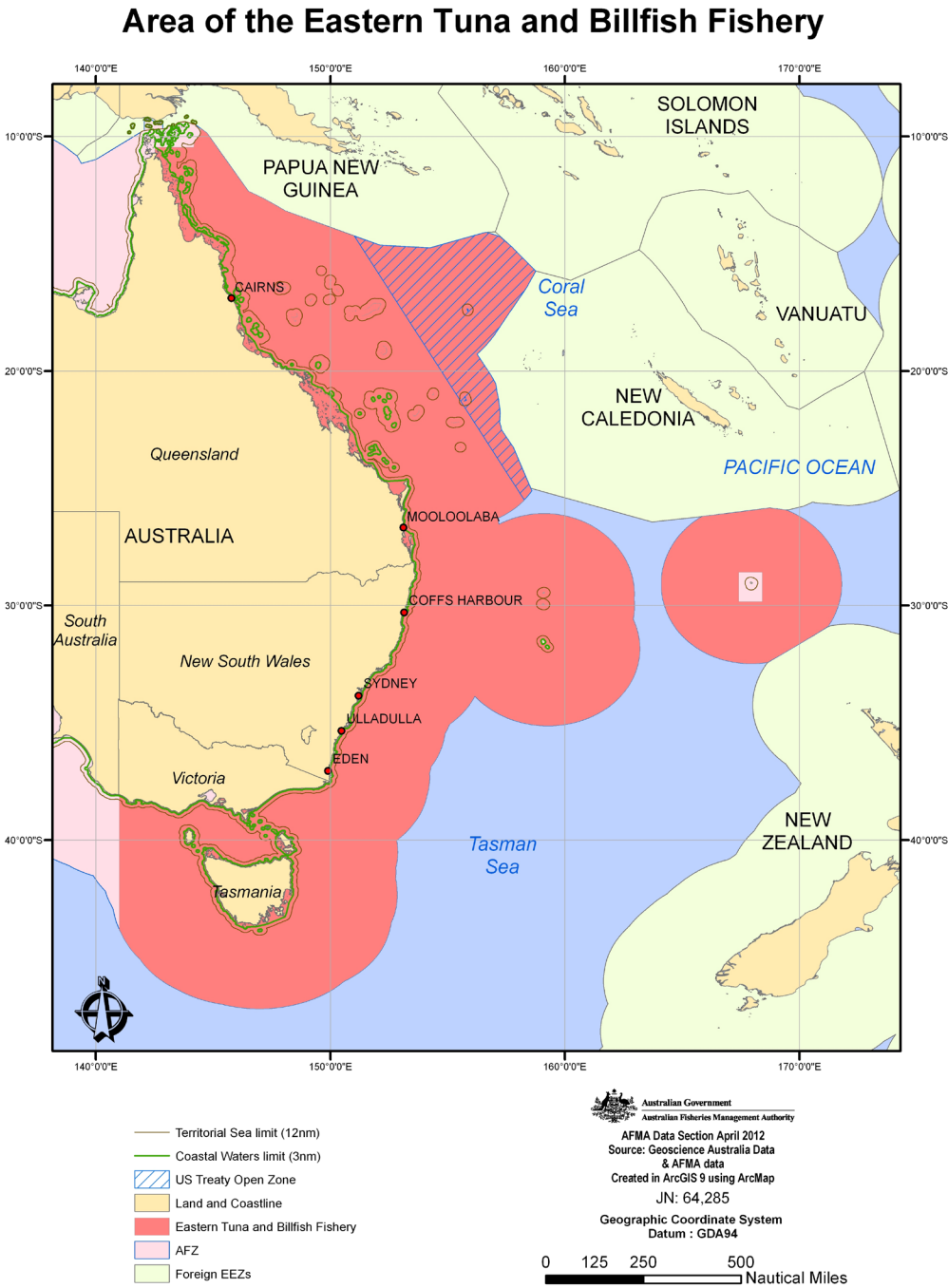

Figure 7-5. Map of the Eastern Tuna and Billfish Fishery, <https://www.afma.gov.au/fisheries/eastern-tuna-and-billfish-fishery#referenced-section-8>, image courtesy of the Australian Fisheries Management Authority ©



### Skipjack Tuna Fishery

The Skipjack Tuna Fishery covers the entire sea area surrounding Australia out to 200 nm from the coast and is split into two sectors: east and west (Figure 7-6). For the purposes of this study, the focus is on the Eastern Skipjack Tuna Fishery. This fishery includes the migratory Indian Ocean Skipjack Tuna (*Katsuwonus pelamis*) which can be found up to depths of 260 m. There are currently 19 permits for the Eastern Skipjack Tuna Fishery, none of which are held by an Australian fishing boat and the fishery is currently inactive. When active, the primary method used to catch Skipjack Tuna is by purse seine.

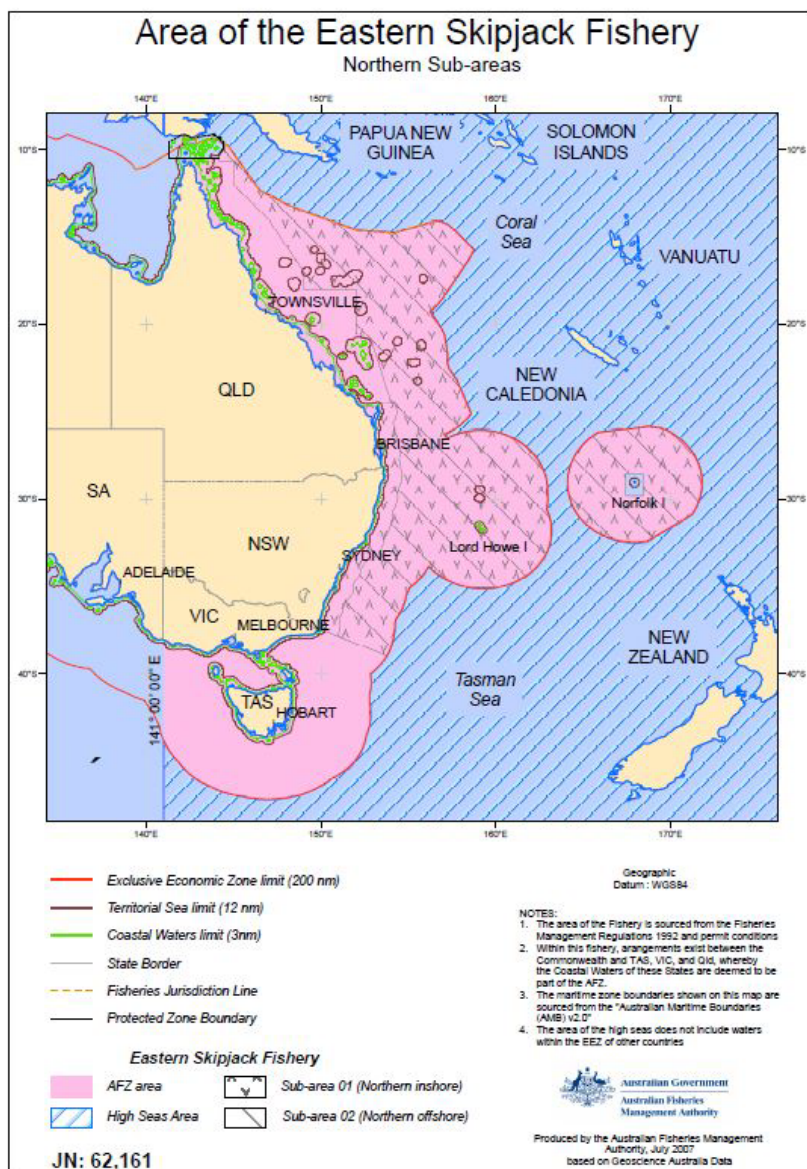

Figure 7-6. Map of the Eastern Skipjack Fishery, <https://www.afma.gov.au/species/skipjack-tuna#referenced-section-4>, image courtesy of the Australian Fisheries Management Authority ©



### Small Pelagic Fishery

The Small Pelagic Fishery is another fishery that is divided into two sectors: east and west as there is evidence of separate stocks (Figure 7-7). For the purposes of this study, the focus is on the Eastern Small Pelagic Fishery which includes the following species:

- Australian Sardine (*Sardinops sagax*) – found at depths up to 200 m.
- Blue Mackerel East (*Scomber australasicus*) – found at depths up to 200 m.
- Jack Mackerel East (*Trachurus declivis*, *T. murphyi*) – found at depths up to 20-3000 m.
- Redbait East (*Emmelichthys nitidus*) – found at depths up to 20-500 m.

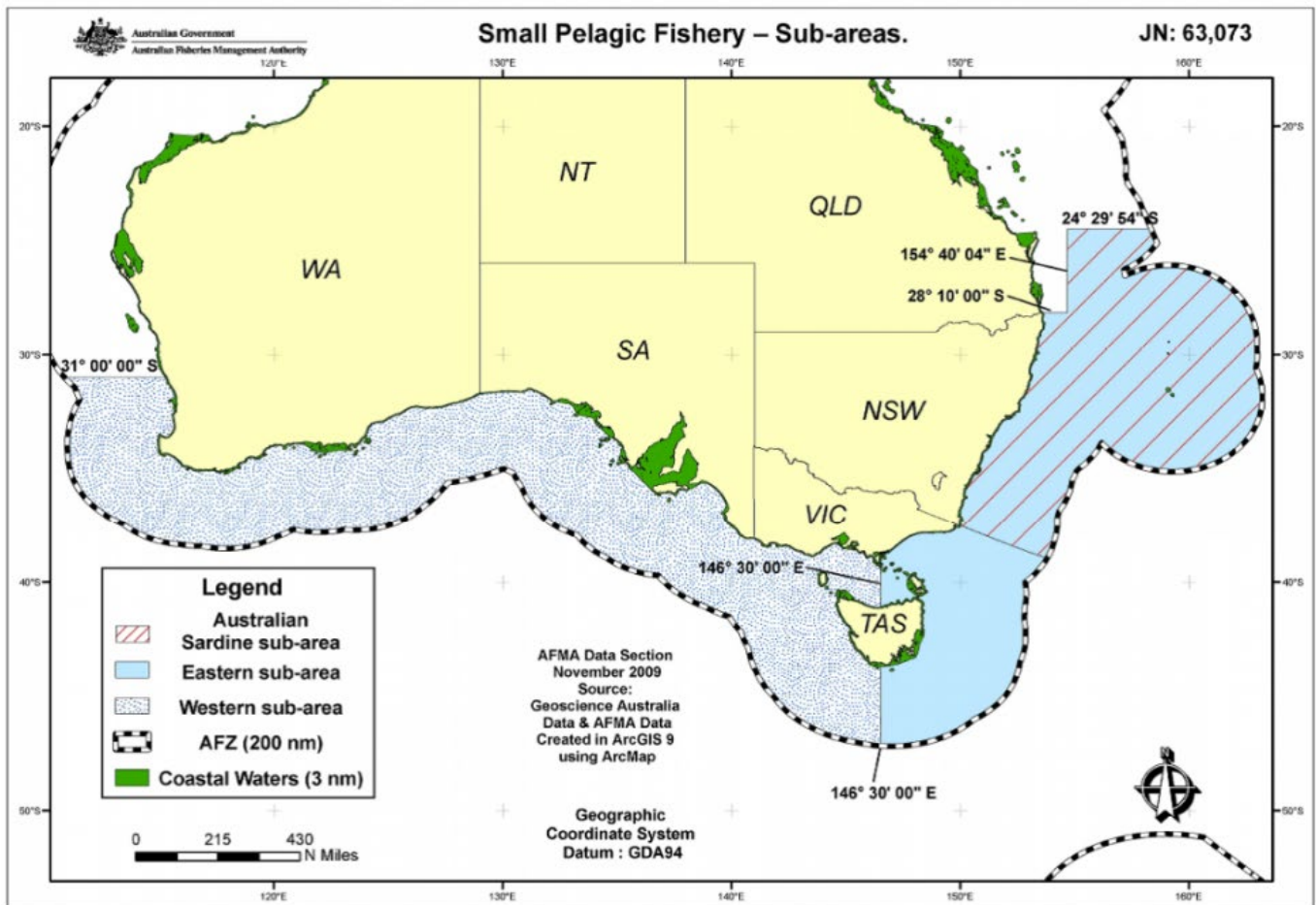

Figure 7-7. Small Pelagic Fishery – Map of sub-areas, <https://www.afma.gov.au/fisheries/small-pelagic-fishery#referenced-section-8>, image courtesy of the Australian Fisheries Management Authority ©



The fishing season is for 12 months, beginning on 1 May with various methods of fishing gear deployed in this fishery, which include: midwater trawl, purse seine, jigging, and minor lines. However, the primary method used by fishers is the midwater trawl and purse seine to catch the target species.

### *Southern and Eastern Scalefish and Shark Fishery*

The Southern and Eastern Scalefish and Shark Fishery is a multi-sector and multi-species fishery in the waters surrounding Australia, as can be seen in the fishery map display in Figure 7-8. This fishery includes the following species:

- Blue Grenadier (*Macruronus novaezelandiae*) – found at depths up to 200-700 m.
- Tiger Flathead (*Neoplatycephalus richardsoni*) – found at depths up to 10-400 m.
- Silver Warehou (*Seriolella punctata*) – found at depths up to 50-600 m.
- Gummy Shark (*Mustelus antarcticus*) – found at depths up to 80-350 m.
- Pink Ling (*Genypterus blacodes*) – found at depths up to 20-1000 m.
- Easter School Whiting (*Sillago flindersi*) – found at depths up to 180 m.

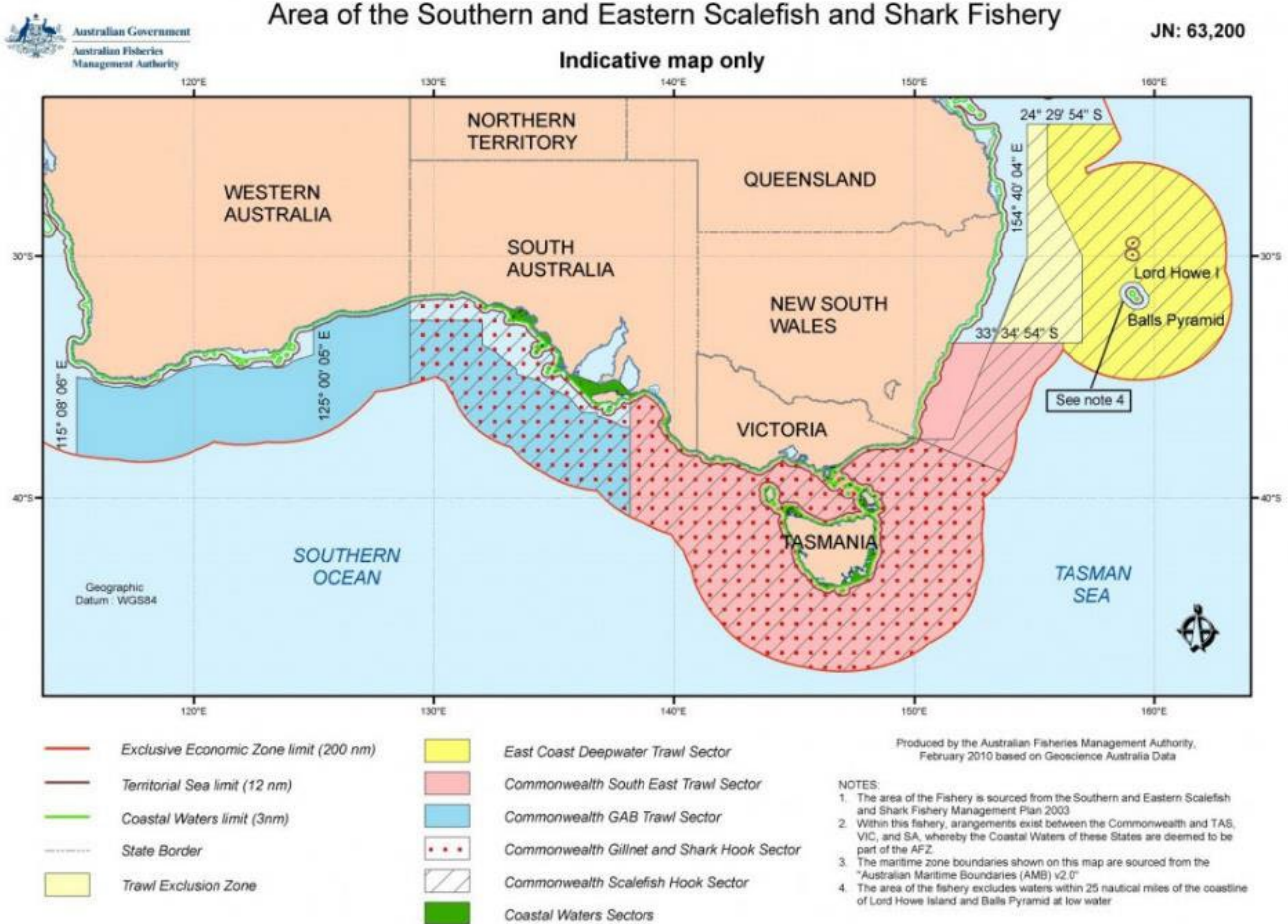

Figure 7-8. Map of the Southern and Eastern Scalefish and Shark Fishery, <https://www.afma.gov.au/fisheries/southern-and-eastern-scalefish-and-shark-fishery#referenced-section-8>, image courtesy of the Australian Fisheries Management Authority ©

This fishery issues permits that allow various types of fishing gear, including: Danish seine, bottom trawl, midwater trawl, pair trawl, purse seine, bottom longline, automatic longline, dropline, demersal gillnet and traps. The season lasts for 12 months beginning on 1 May. Currently there are 57 trawl statutory fishing rights, 37 scalefish hook statutory fishing rights, 61 shark gillnet statutory fishing rights, and 13 shark hook statutory fishing rights.





### Southern Bluefin Tuna Fishery

Found up to depths of 500 m, Southern Bluefin Tuna (*Thunnus maccoyii*) is the targeted species in this fishery. For commercial fishers in Australia, purse seines are the primary method for catching these fish, but pelagic longlines are also utilized. Once caught, fish are transferred to permanent floating farms called pontoons where they will stay until large enough to be sold. The season lasts for 12 months beginning on 1 December. The sea area included in the Southern Bluefin Tuna Fishery is shown in Figure 7-9.

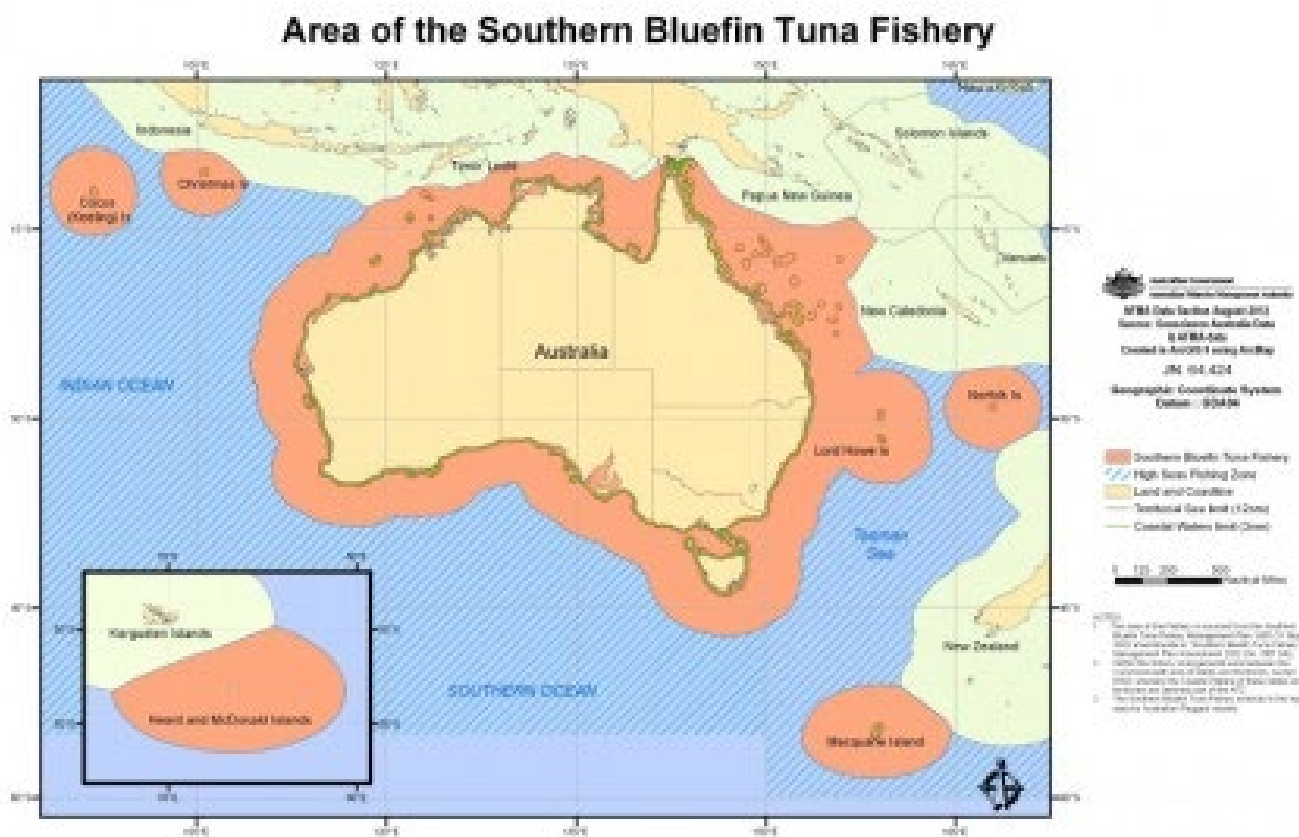

Figure 7-9. Map of the area of the Southern Bluefin Tuna Fishery, <https://www.afma.gov.au/fisheries/southern-bluefin-tuna-fishery#referenced-section-8>, image courtesy of the Australian Fisheries Management Authority ©

Between May and October, the waters off NSW and Victoria are cooler and Southern Bluefin Tuna migrate through these areas. Fishers in the Eastern Tuna and Billfish Fishery are also allowed to catch Southern Bluefin Tuna during these months. To manage the catch of Southern Bluefin Tuna off the Australian east coast, AFMA puts specific zones in place, which are reviewed weekly and are set in relation to sea surface temperature and currents. As of 8 June 2021, the Southern Bluefin Tuna zone commences at latitude 35°00' S, longitude 150°49' S and extends due east, as shown in Figure 7-9.

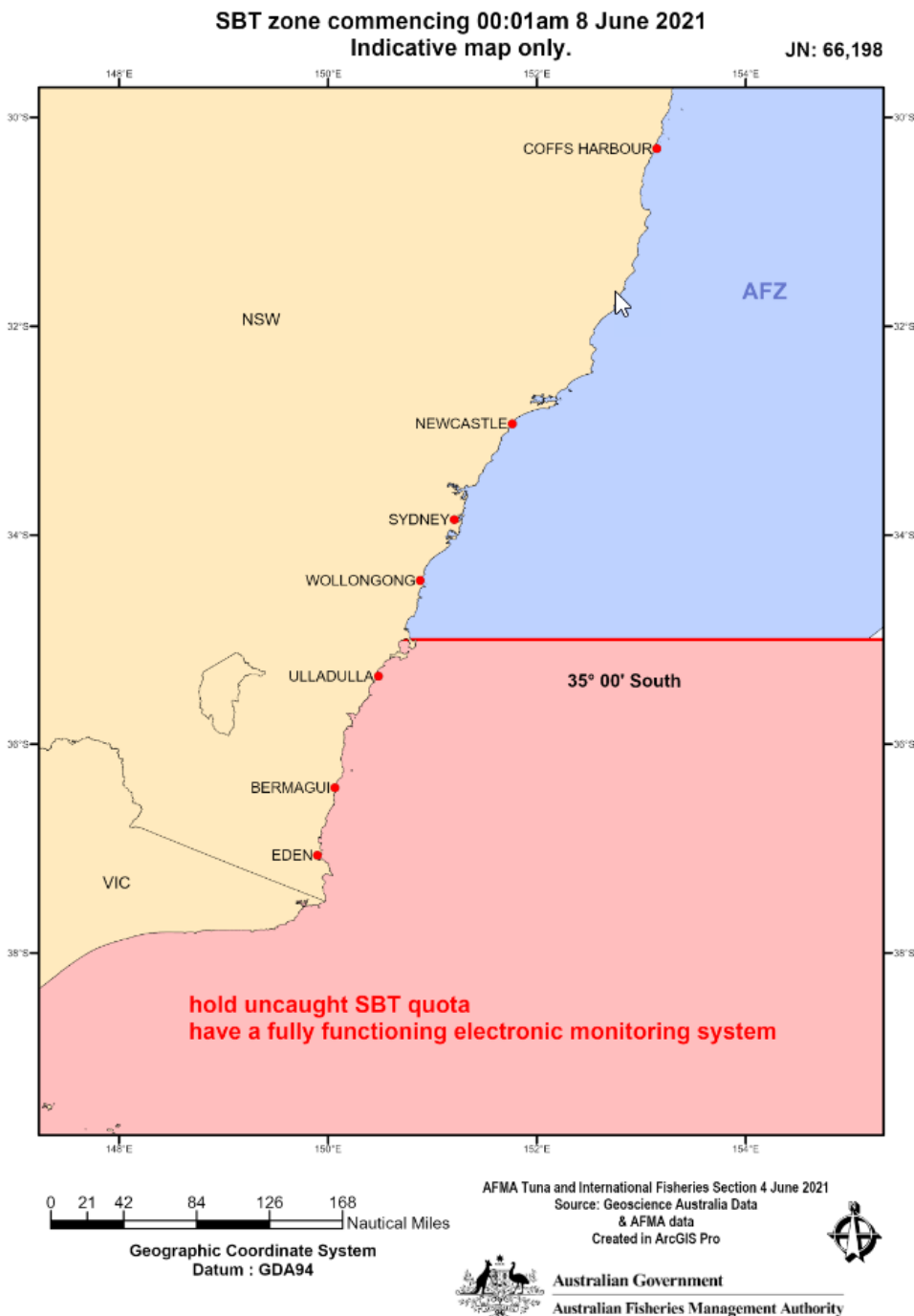

Figure 7-10. Map of the Southern Bluefin Tuna (SBT) zone, <https://www.afma.gov.au/commercial-fishers/management-arrangements/southern-bluefin-tuna-sbt-zone>, image courtesy of the Australian Fisheries Management Authority ©



### Southern Squid Jig Fishery

The Southern Squid Jig Fishery is shown in Figure 7-11. This single species and low impact fishery on Gould's Squid (*Nototodarus gouldi*) utilizes a single method of capture: Squid Jigging. An example of a squid jigging machine is shown in Figure 7-12. The season begins on 1 January and lasts for 12 months.

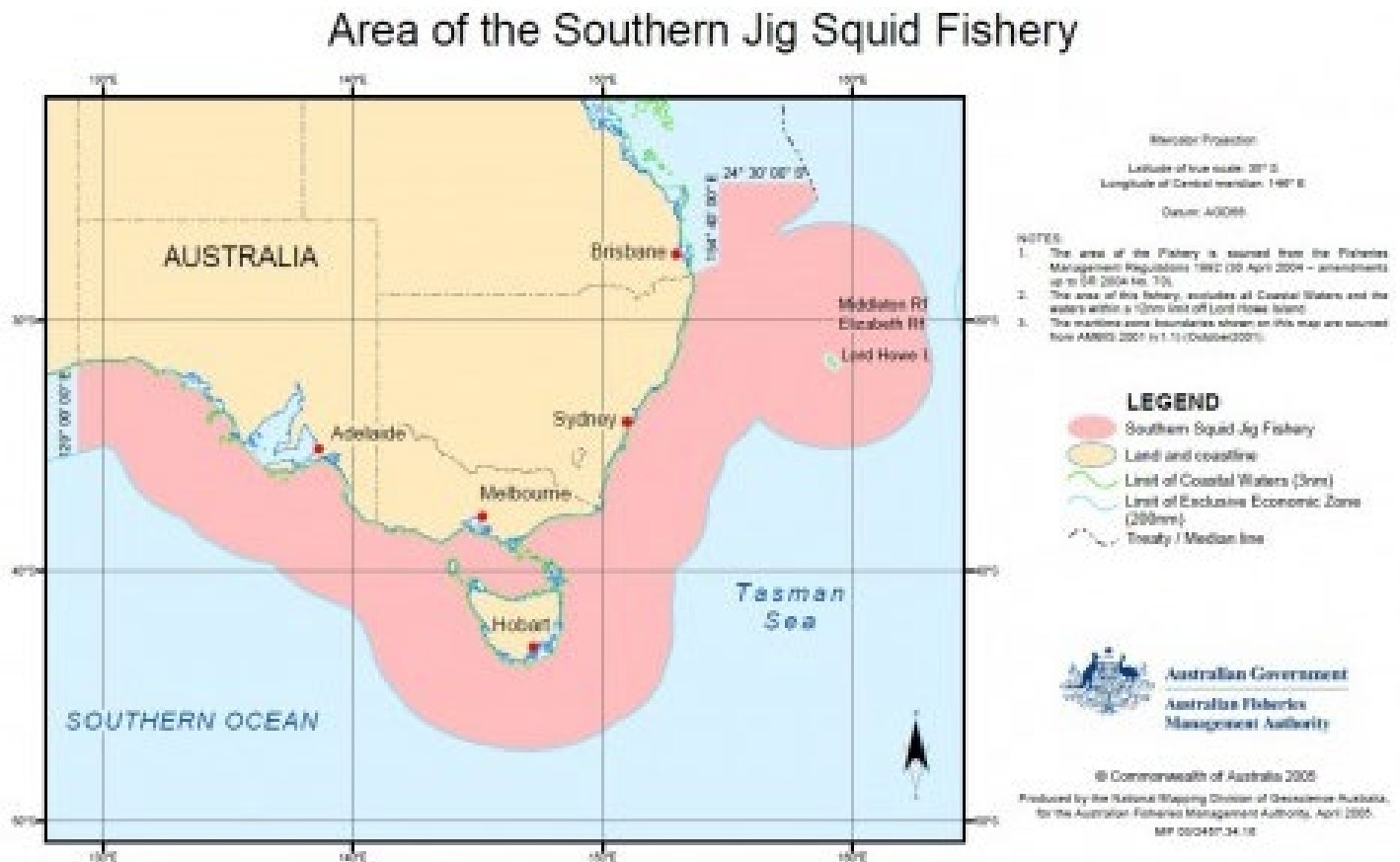

Figure 7-11. Map of the area of the Southern Jig Squid Fishery, <https://www.afma.gov.au/fisheries/southern-squid-jig-fishery#referenced-section-8>, image courtesy of the Australian Fisheries Management Authority ©

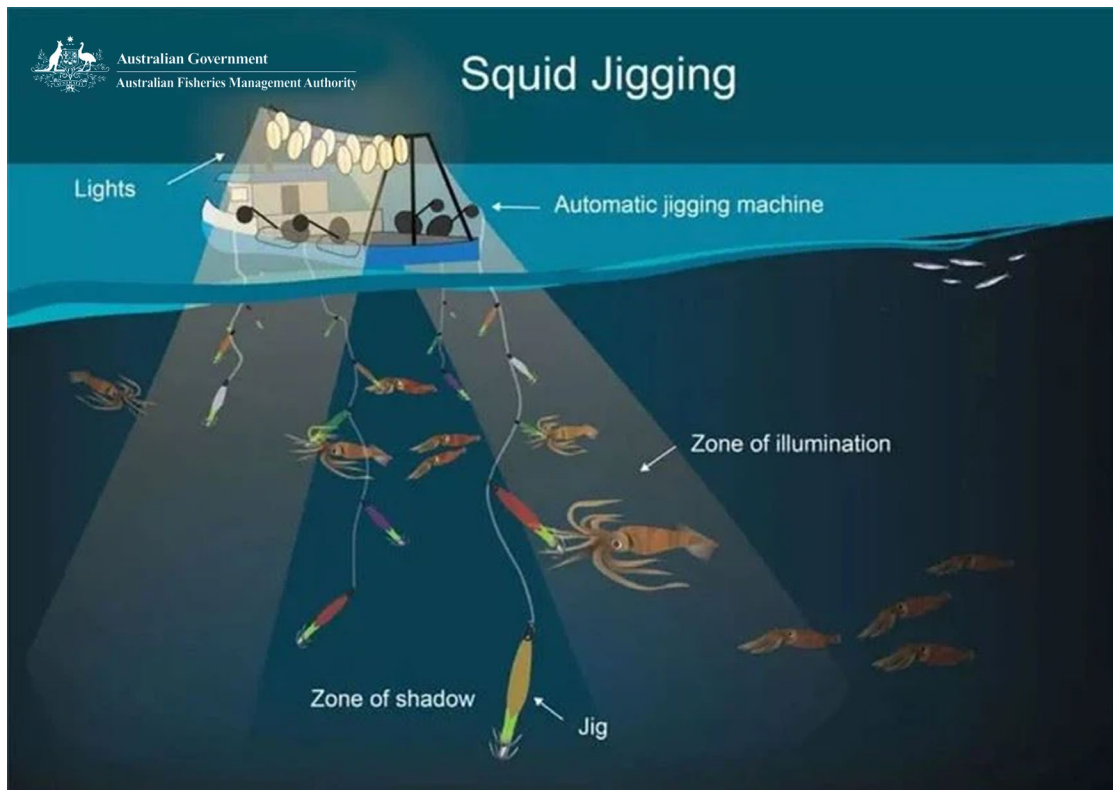

Figure 7-12. Squid jigging, Methods and gear | Australian Fisheries Management Authority ([afma.gov.au](http://afma.gov.au)), image courtesy of the Australian Fisheries Management Authority

A mechanically powered machine with 20 to 25 jigs attached to each line. The machine is operated over waters of the continental shelf at night between depths of 60-120 m.

### *Macquarie Island Toothfish Fishery*

Patagonian Toothfish (*Dissostichus eleginoides*) are found at depths of 50-3000 m in waters around seamounts and continental shelves and is targeted by licensed fishers in the Australian waters surrounding Macquarie Island (Figure 7-13). The primary fishing method is to use longline fishing gear (demersal or bottom longline). The fishing season begins on 15 April and lasts for 12 months and there are currently 20,000 quota statutory fishing rights. Though the Macquarie Island Toothfish Fishery is not part of the CCAMLR, AFMA requires that fisheries in areas adjacent to CCAMLR governed waters are managed in an equivalent manner to the CCAMLR requirements. CCAMLR is discussed in more detail in Sections EIA Review - Antarctic Treaty Consultative Meeting (ATCM) and Committee for Environmental Protection (CEP) 3.3.4, 3.3.5, 7.1.5 and 7.3.2.



## Map of the Macquarie Island Fishery

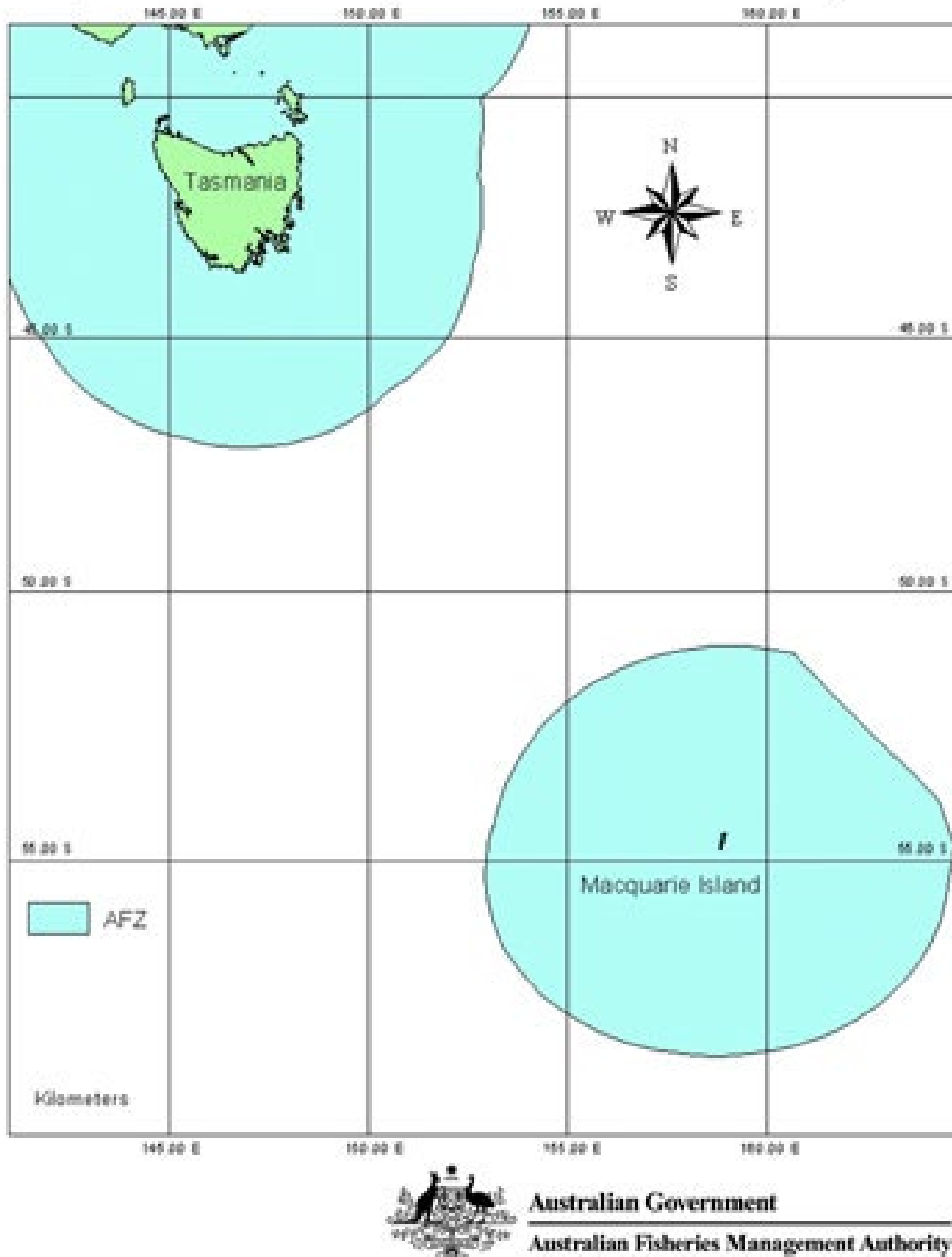

Figure 7-13. Map of the Macquarie Island Fishery, <https://www.afma.gov.au/fisheries/macquarie-island-toothfish-fishery#referenced-section-8>, image courtesy of the Australian Fisheries Management Authority ©



### 7.1.6. Automatic Identification System (AIS)

An Automatic Identification System provides data to improve situational awareness and navigational safety for vessel operation offshore through the broadcasting of identifying parameters, type, status, location, heading, and speed of vessels, such that these particulars can be received and plotted by other nearby vessels. Although the primary objective is the avoidance of collisions, this data provides a wealth of information when properly recorded and archived. Records of AIS broadcasts can be used to reconstruct vessel tracks, along with dates and times of transits worldwide. This information can be used to extract vessel statistical patterns spatially and temporally providing invaluable information to can be used to better understand risks of external aggression along a cable route.

In order to better understand shipping and fishing related risks to the proposed cable along the route between Australia and Antarctica, this study sourced AIS datasets from VesselFinder Ltd., a commercial AIS data provider. The dataset covers the period from October 2019 through March of 2022. The AIS study area was located in international waters just outside of and slightly overlapping the Australian EEZ within the Tasman Sea and was selected because the publicly available vessel tracks showed a concentration of tracks in this area. AIS data points were processed with ArcGIS Pro to recreate vessel tracks, retaining particulars about the vessel, vessel type, and date and time of the tracks.

An overall vessel track density plot was produced utilizing a workflow to generate a heat-map style raster image to illustrate areas of the most spatially dense vessel activity (Figure 7-14). Most of the traffic is organized into a corridor of predominantly east-west oriented tracks along the northern portion of the data and a more intense, narrow band of traffic with a similar orientation across the southern portion of the data area, though it is clear that there exists a variety of orientations within the middle of the data area. The DTS route crosses the corridors of better-organized traffic nearly perpendicularly, which minimizes the risks and potential complications of interactions with transiting vessels during the installation.

By rendering the individual ship tracks according to the type of vessels, Figure 7-15 illustrates the more orderly patterns of commercial shipping traffic, including cargo, tanker, and passenger traffic, while the fishing vessel traffic (red) are more sporadic, as fishing efforts target specific areas of seabed based on seabed features and bathymetry. While the DTS Route does traverse an area that is fished, it avoids the areas of most intense fishing activity based on the AIS data.

By taking the same data and analyzing by month and by vessel type, it can be seen in Figure 7-16 that there exists a strong seasonality to the traffic over the timeline of the study (October 2019 through March 2022). Fishing efforts substantially overtake all other vessel traffic types for the months of April, May, and June, with May representing over 5 times the number of AIS observations than the average of all other months outside of this fishing season.

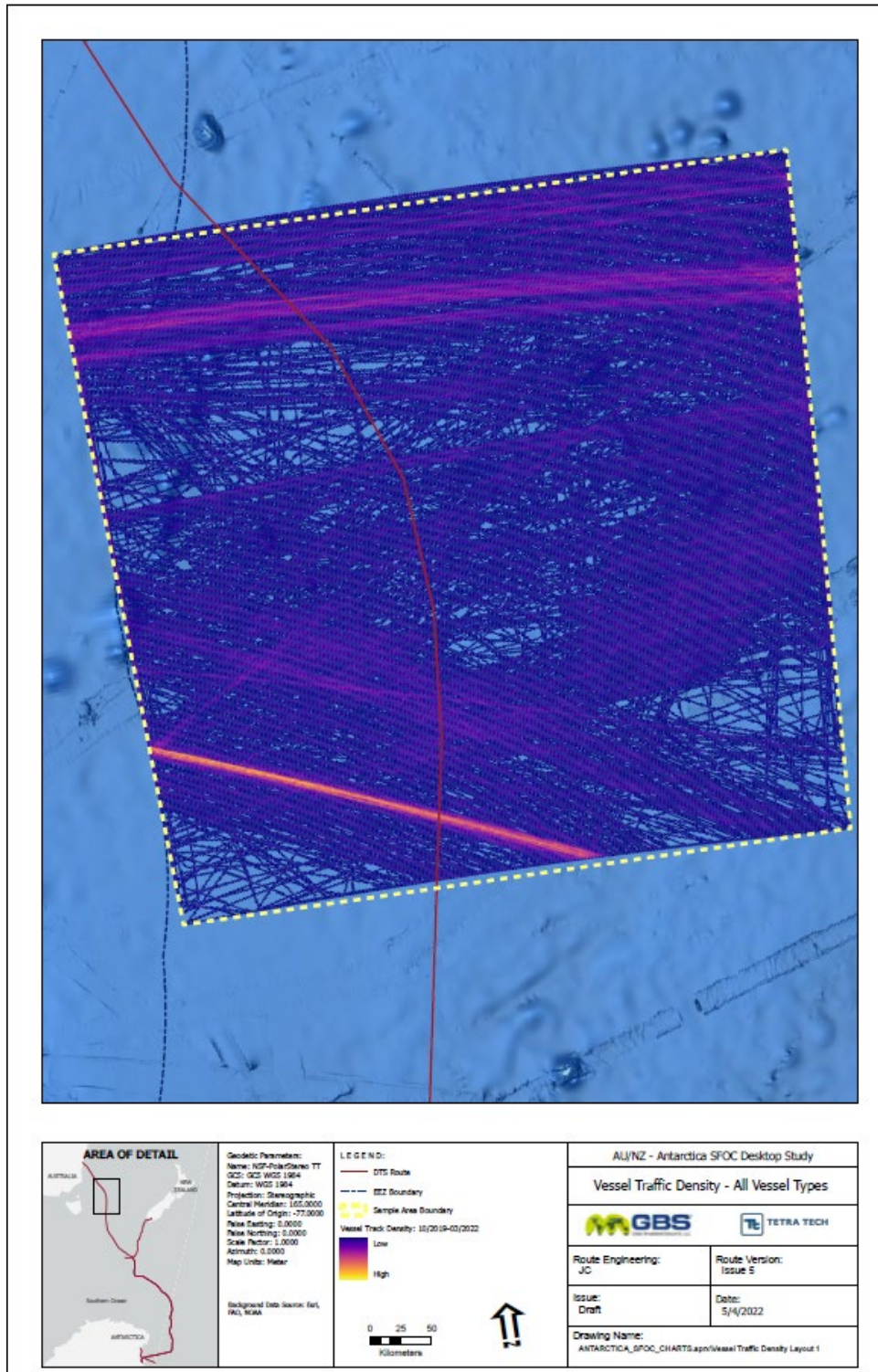

(Data sourced from VesselFinder Ltd., 2022)

Figure 7-14. AIS Vessel Density along the Australia-Antarctica Route.

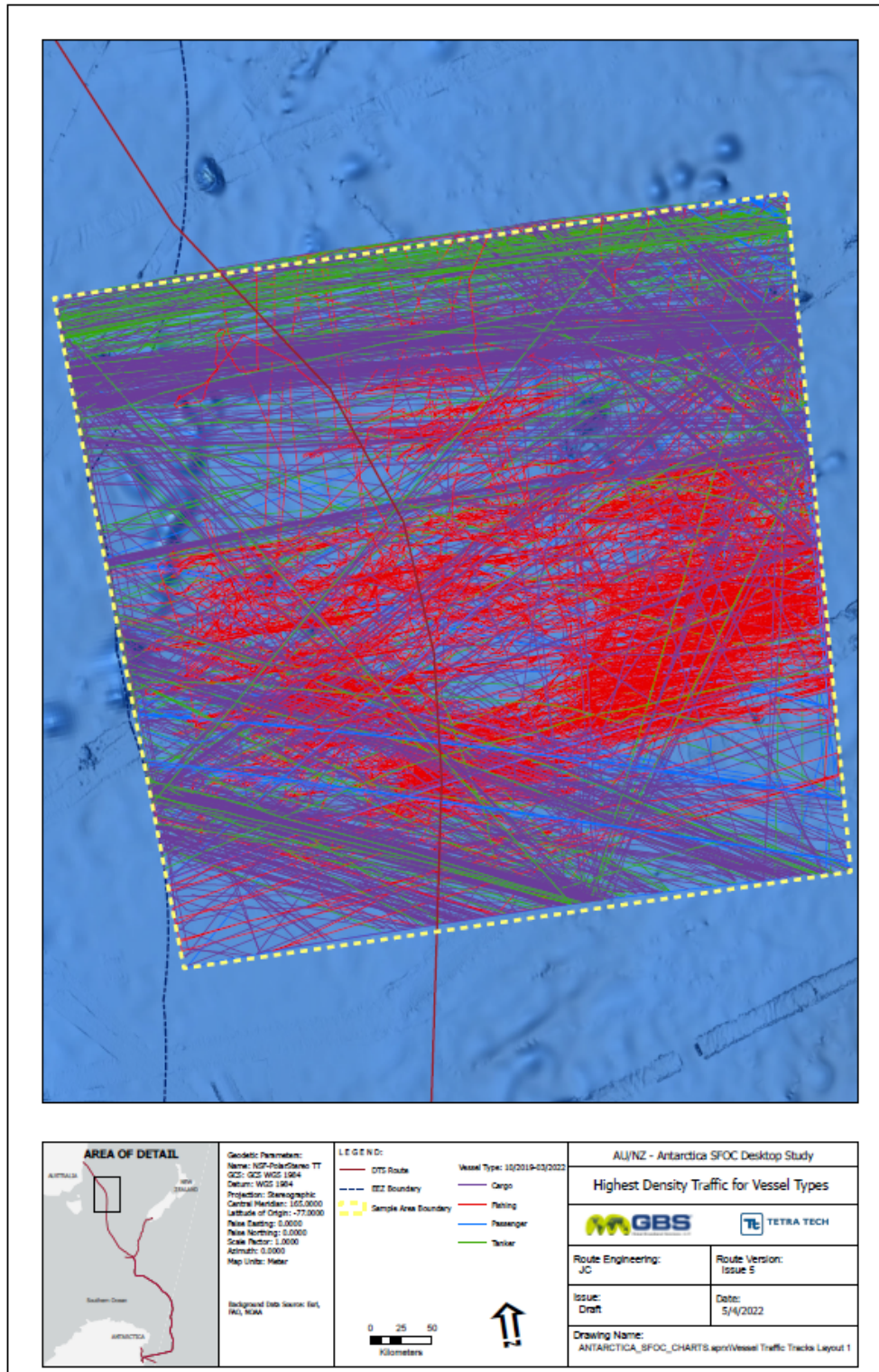

(Data sourced from VesselFinder Ltd., 2022)

Figure 7-15. AIS Vessel Track Rendered by Vessel Type.



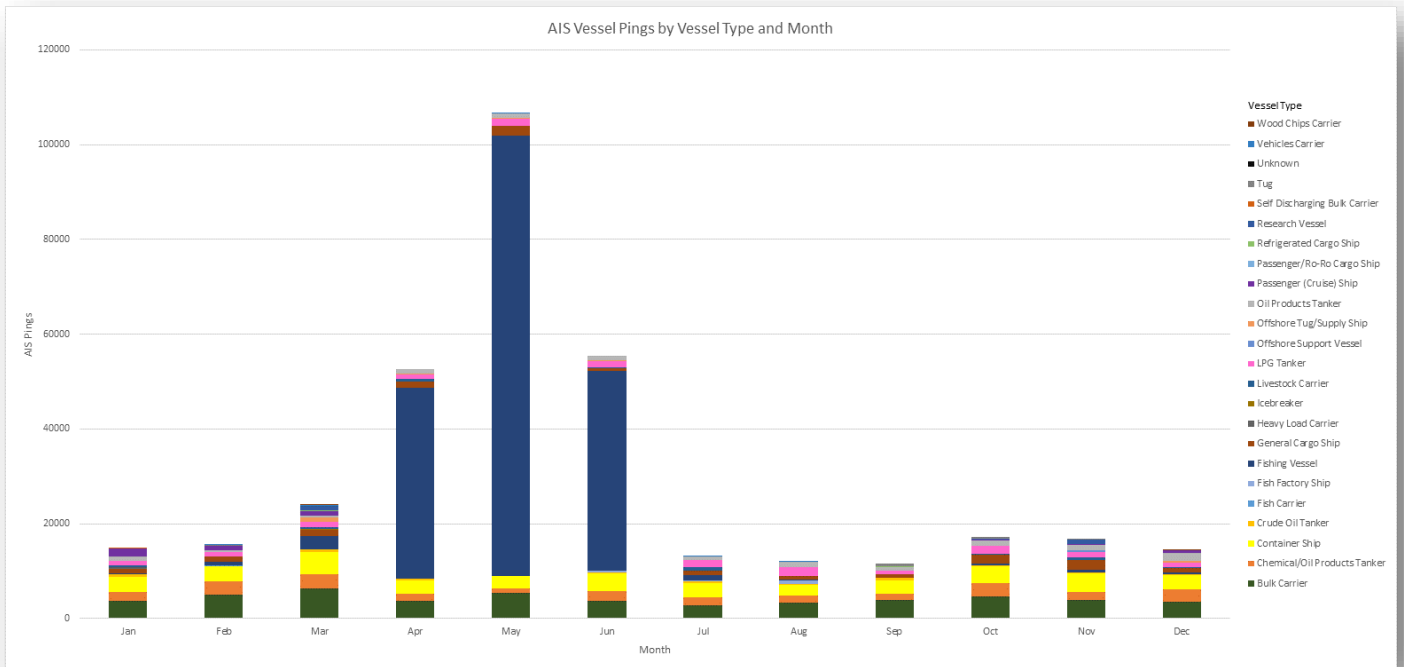

(Data sourced from VesselFinder Ltd., 2022)

Figure 7-16. AIS Pings by Month and Vessel Type Highlighting the Seasonality of Fishing (dark blue).



## NEW ZEALAND

### 7.2. New Zealand

#### 7.2.1. Ports and Shipping Activity

The largest port in the South Island is Lyttleton Port, located on the coast of Canterbury, just south of Christchurch in New Zealand. The types of vessels at Lyttleton are typically container ship (22%), sailing vessel (17%), bulk carrier (14%), oil/chemical tanker (8%), and pleasure craft (6%). Scientific crews and resupply vessels en route to McMurdo Station, Antarctica, typically work out of Lyttleton Port. The maximum length of vessels recorded to having entered this port is 295 m, and the maximum draft is 12.1 m (MarineTraffic, 2022).

Dunedin Port is another medium-sized port on South Island's East Coast between Invercargill and Christchurch servicing bulk carriers (14%), fishing (10%), fishing vessels (10%), sailing vessels (10%), and trawlers (8%). Vessel traffic between Australia and Tasmania and ports along South Island's East Coast and North Island moves along the southern coast of South Island off the proposed cable landing location.

The Port of Bluff is located just east of the proposed cable landing. The port is medium-sized, comprised of bulk carrier (28%), fishing (11%), oil/chemical tanker (10%), container ship (9%), and pleasure craft (6%). The maximum length of the vessels recorded to having entered this port is 268 meters and the maximum draught is 9.8 meters. The port offers a full suite of marine services including pilotage, towage and berthage, cargo facilities and warehousing. The port operates 24 hours a day, 364 days a year.

Figure 7-17 shows the vessel traffic patterns in 2021 around the South Island.

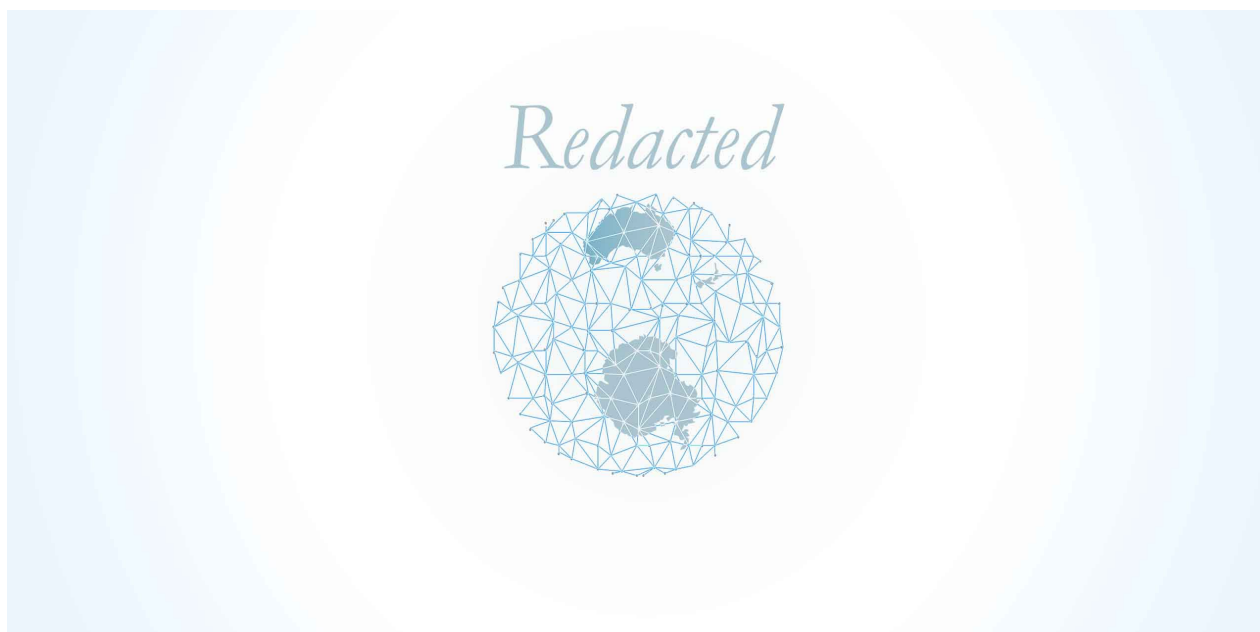

Figure 7-17. [Redacted]. Major Ports and Vessel Traffic Density around South Island, New Zealand.

### 7.2.2. Cable Protection Zones and Submarine Cables

There are currently no other submarine cables coming into the Invercargill area on South Island. With the development of the data center however, additional cables are expected. The cable route crosses the continental shelf in an area of relatively high vessel traffic and is a popular fishing area. To protect the cable from external aggression caused by fishing activities and vessel anchors, the establishment of a cable protection area should be considered. On North Island, numerous cable protection areas have already been established, where all anchoring and most types of fishing are banned to prevent cable damage.

The process for establishing a Cable Protection Zone is specified in Section 12 of the Submarine Cables and Pipeline Protection Act 1996, which can be found here: [Submarine Cables and Pipelines Protection Act 1996 No 22 \(as of 28 October 2021\), Public Act Contents – New Zealand Legislation](#). Additional information can be found through the New Zealand Ministry of Transport (<https://www.transport.govt.nz/about-us/what-we-do/queries/protecting-new-zealands-undersea-cables/>).

### 7.2.3. Fisheries and Pelagic fish

Locally, in the littoral zone and at wadable depths, Oreti Beach is used recreationally for flounder and yellow belly fishing. Flounder fishing is reasonably popular in the cleaner waters towards the mouth of New River Estuary, at the southern end of Sandy Point Domain and off parts of Oreti Beach. Fishing for estuarine and sea-run brown trout occurs in the Oreti River and, at a bend just



north of the Water Ski Club, fishermen can be seen at most times of the year.

During the late spring and early summer months, yellow-eyed mullet swim up the Oreti river. A favorite fishing spot is in the vicinity of the Dunns Road bridge. Whitebait travel into Cooper's Creek and possibly one or two of the side channels which drain the Oreti River.

Further offshore, there is substantial fishing effort in Southland waters (Fishing Management Area 5 (FMA5)). The reported commercial catch for the 12-month period to 09/30/2021 was about 20,000 tons, refer to: <https://fs.fish.govt.nz/Page.aspx?pk=41&tk=99&ey=2021> and the New Zealand Ministry for Primary Industries National Aquatic Biodiversity System (NABIS) interactive web-based mapping portal (NABIS, n.d.) as shown in Figure 7-18.

The most substantial fin-fish fishery is likely the southern blue cod (benthic to 150 m and generally the most important recreational finfish in Southland). These are taken in inshore domestic fisheries with very little deepwater catch, predominantly by line fishing, but also longlining, set netting, potting and spearfishing. Spawning occurs in late winter and spring within inshore and mid-shelf waters.

Rock lobster / crayfish are also caught using pots and traps, mainly between June through November. In the past, many blue cod fishers were primarily rock lobster fishers. The amount of effort in the blue cod fishery tends to depend on the success of the rock lobster season, with weather conditions in Southland affecting the number of 'fishable days.'

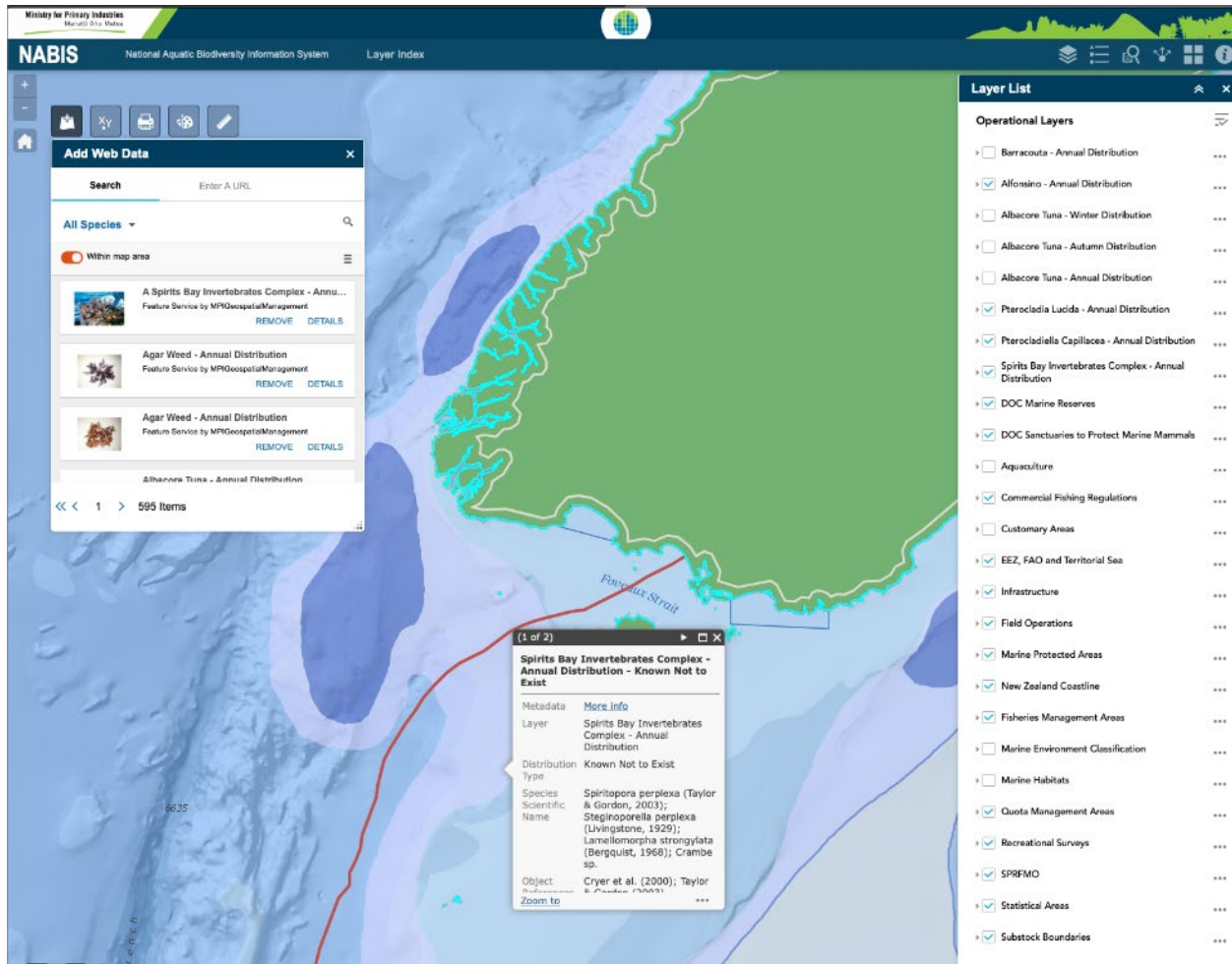

(NABIS, n.d.)

Figure 7-18. New Zealand National Aquatic Biodiversity Information System Site example.

A restriction exists on bottom long-lining by vessels >30 m in length in the Solander Trench and a restriction on trawl vessels >46 m in overall length from operating in the territorial sea (partial overlap with the Project area) and some selected areas outside the territorial sea. Many species (e.g., rubyfish, hoki, barracouta, mackerels, frostfish, and southern blue whiting) are being caught by middle-depth trawls.

Pelagic fish in New Zealand’s southern inshore subtropical waters include tuna (skipjack, albacore, and yellowfin), billfish (marlin, swordfish), red snapper (*Centroberyx affinis*), and brown trout (*Salmo trutta*). Overall, the waters in Foveaux strait are highly productive, invigorated by a warm current flow through from the west. Reefs just out from Bluff Harbour (south of Invercargill), around the numerous islands and islets in Foveaux Strait, support blue cod fishing; trumpeter, tarakihi and school sharks are also commonly caught. Typically, pelagic, and oceanic pelagic fish are some of the most widely distributed marine species due to dynamic shifts in currents and food availability.

Fishing activity off of South Island is concentrated along the shelf break and around Solander Island, as shown in Figure 7-19.

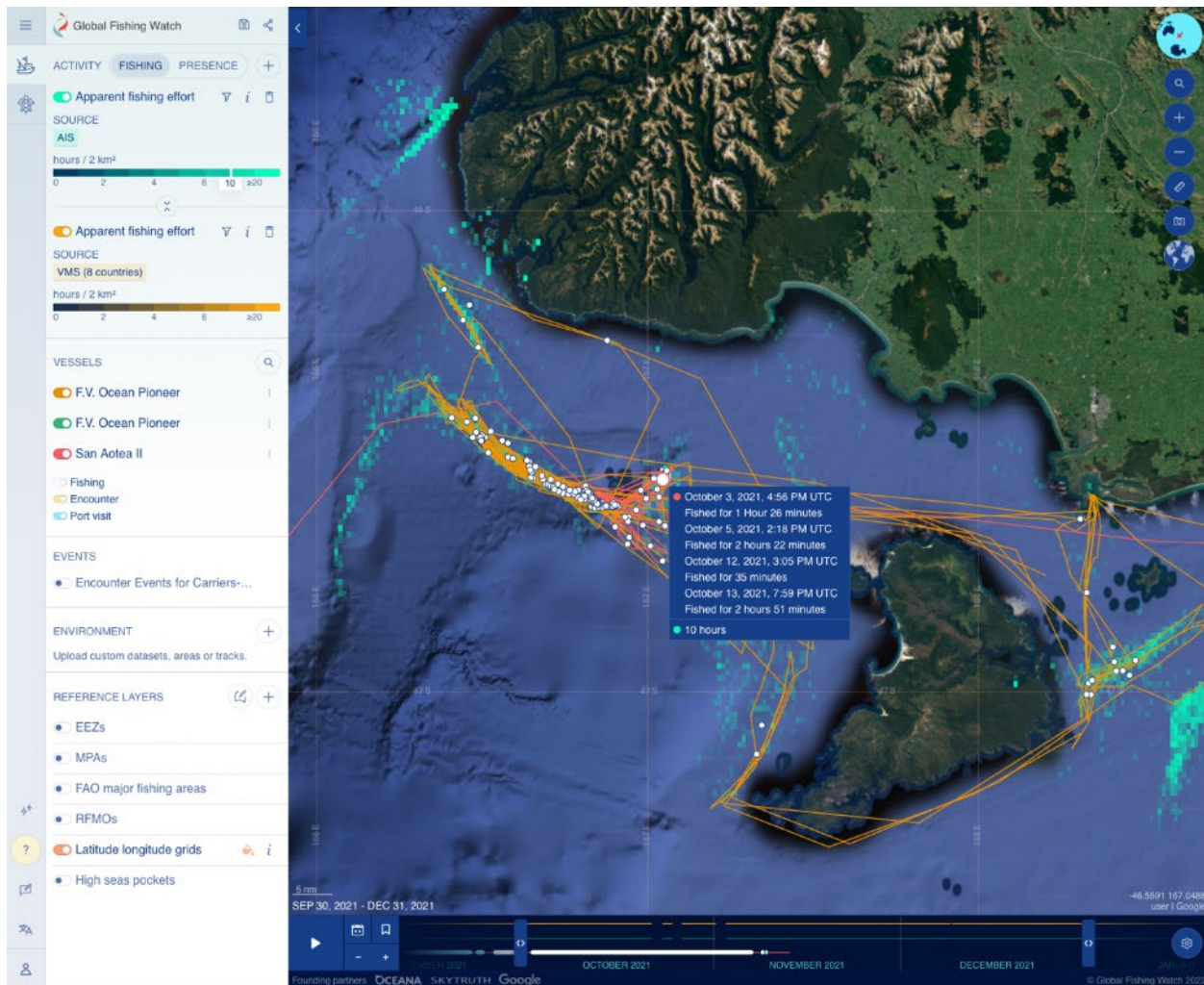

(Copyright 2022, Global Fishing Watch, Inc., Accessed March 2022)<sup>2</sup>

Figure 7-19. New Zealand fishing activity example.

In Foveaux Strait, roughly between Ruapuke Island to the east and the northern portion of Stewart Island to the west, a substantial oyster fishery exists (Figure 7-17). The Foveaux Strait oyster fishery (OYU 5) is a high value, iconic fishery that has been fished for over 140 years. Oysters (*Ostrea chilensis*) are an important customary (taonga), recreational, and commercial species, and are important to the socioeconomics of Bluff and Invercargill. The OYU 5 stock is

<sup>2</sup> Global Fishing Watch has made every attempt to ensure the completeness, accuracy and reliability of the information provided on this Site. However, due to the nature and inherent limitations in source materials for information provided, Global Fishing Watch qualifies all designations of vessel fishing activity, including synonyms of the term “fishing activity,” such as “fishing” or “fishing effort,” as “apparent,” rather than certain. And accordingly, the information is provided “as is” without warranty of any kind.



part of the Group 1 stocks in the draft National Fisheries Plan for Inshore Shellfish, and is also subject to an approved collaborative fisheries plan, the Foveaux Strait Oyster Fisheries Plan (Ministry of Fisheries, 2009). The main beds are found between 20 and 50 m depth, though dredge oysters occur from the intertidal zone to the deepest parts of the strait. While oysters occur over an area of 100 square nautical miles, commercially fishable grounds occur in an area of about 121 square nautical miles mainly along the central regions of the strait in depths of 16.5 to 38.4 m (Ministry of Fisheries, 2009).

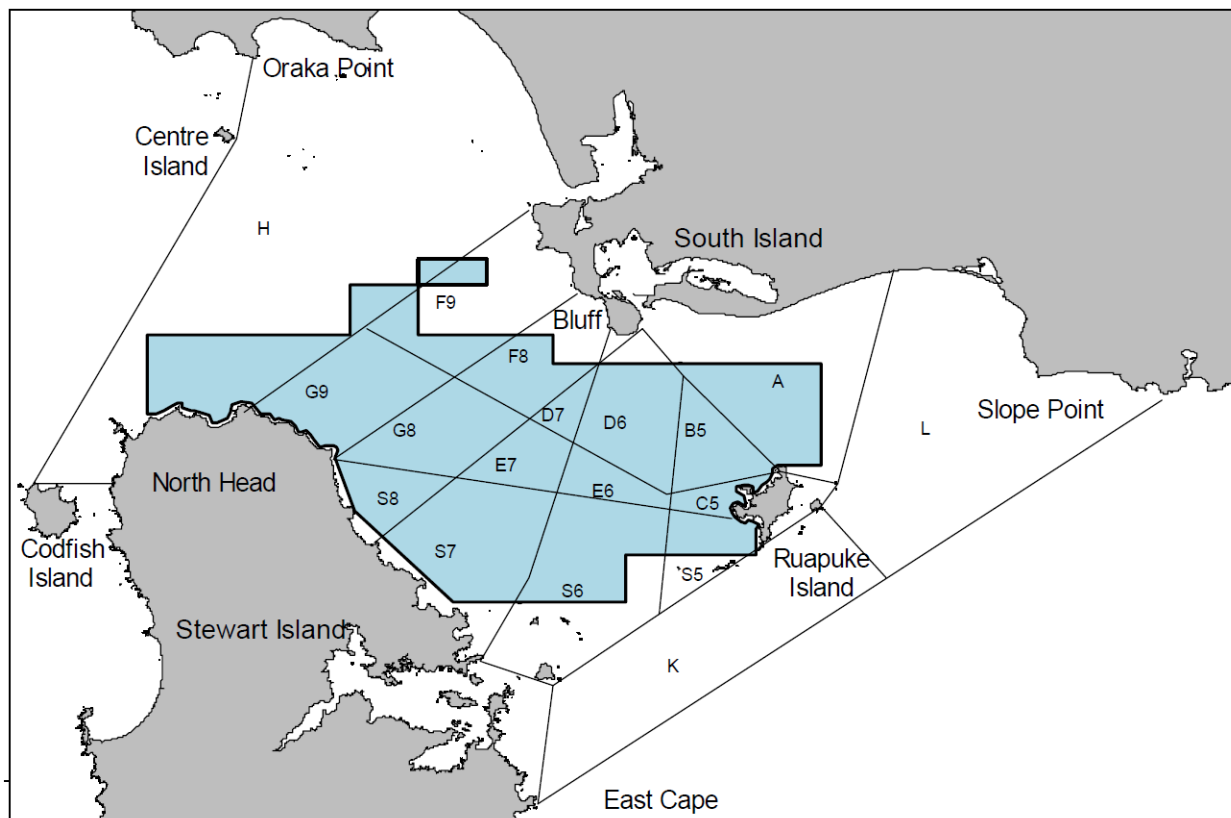

(Michael et al., 2019)

Figure 7-20. Foveaux Strait Oyster Fishery (OYU5).

### 7.2.4. Automatic Identification System (AIS)

An AIS study was done for the area south of South Island to better understand shipping and fishing related risks to the proposed cable along the route out of Invercargill, New Zealand. As was done for areas off Australia and Antarctica, this study sourced AIS datasets from VesselFinder Ltd., a commercial AIS data provider. The dataset covered the period from October 2019 through May of 2022. The AIS study area was located from the South Island shoreline to the southwest approximately 430 km along the Solander Trough. The area was selected to better understand what types of vessels pass through the area and any temporal variability in the activity. AIS data



points were processed with ArcGIS Pro to recreate vessel tracks, retaining particulars about the vessel, vessel type, and date and time of the tracks.

An overall vessel track density plot was produced utilizing a workflow to generate a heat-map style raster image to illustrate areas of the most spatially dense vessel activity (Figure 7-14). Most of the traffic is organized into a corridor of predominantly east-west oriented tracks along the southern coast of South Island, around Solander Island, and around and between Stewart Island and Auckland Islands located east of the proposed route. By rendering the individual ship tracks according to the type of vessels, Figure 7-15 illustrates the distinct band of east-west commercial shipping traffic, including cargo, tanker, and passenger traffic, while the fishing vessel traffic (red) are more sporadic, as fishing efforts target specific areas of seabed based on seabed features and bathymetry such as the shelf break, bathymetric highs and islands. The proposed DTS route crosses the band of relatively dense east-west traffic passing through Foveaux Strait nearly perpendicularly, which minimizes the risks and potential complications of interactions with transiting vessels during the installation.

By taking the same data and analyzing by month and by vessel type, it can be seen in Figure 7-23 that, while most of the vessel types are consistent throughout the year, the Fishing Vessels and Fish Factory Ships tend to increase in January through March and September to November over the timeline of the study (October 2019 through May 2022). In comparison, fishing efforts are negligible in the winter months of June through August. These windows should be considered when planning survey and installation activities to minimize interaction with fishing efforts where possible.



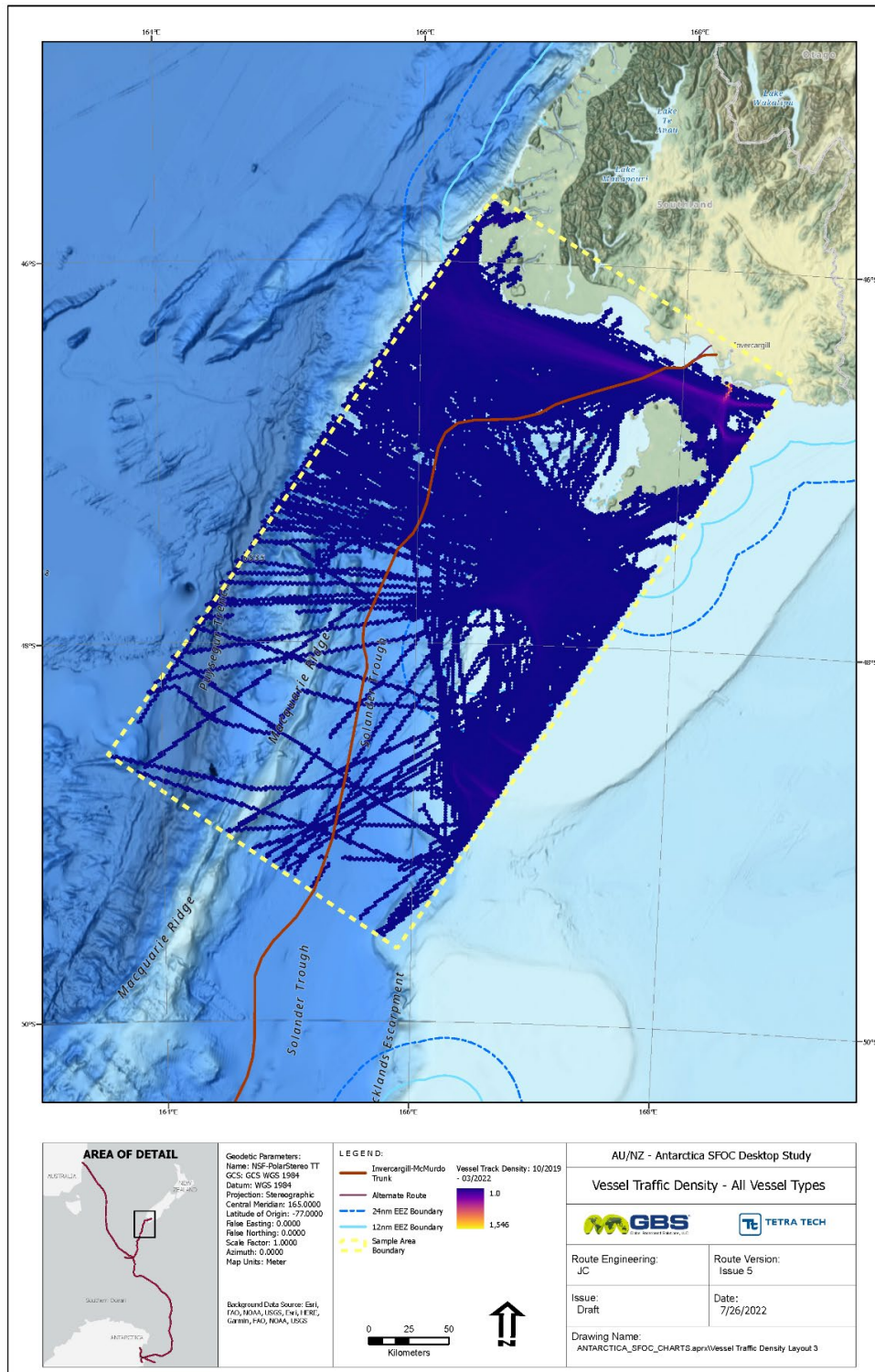

(Data sourced from VesselFinder Ltd., 2022)

Figure 7-21. AIS Vessel Density Along the Australia-Antarctica Route.

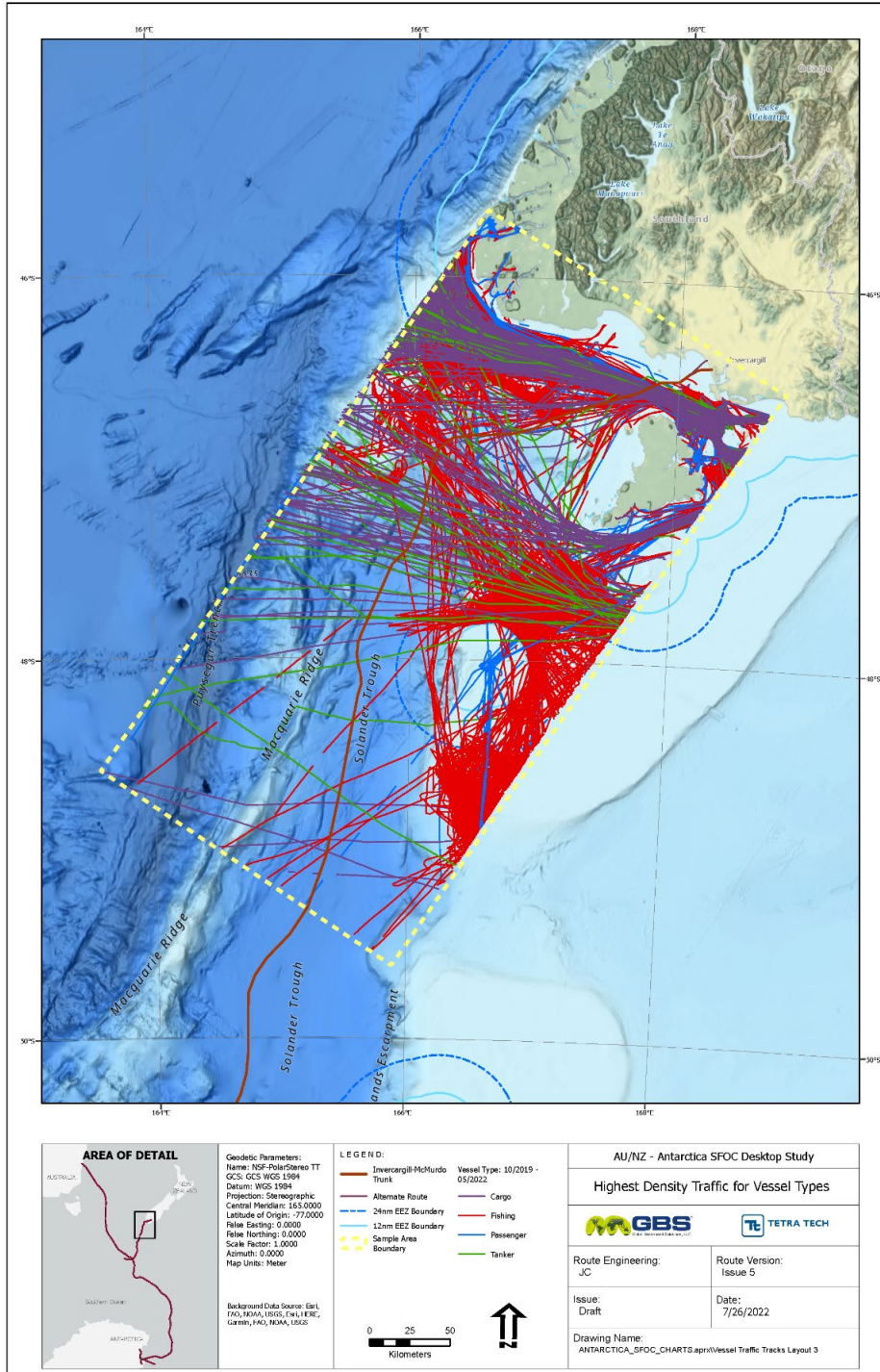

(Data sourced from VesselFinder Ltd., 2022)

Figure 7-22. AIS Vessel Track Rendered by Vessel Type.

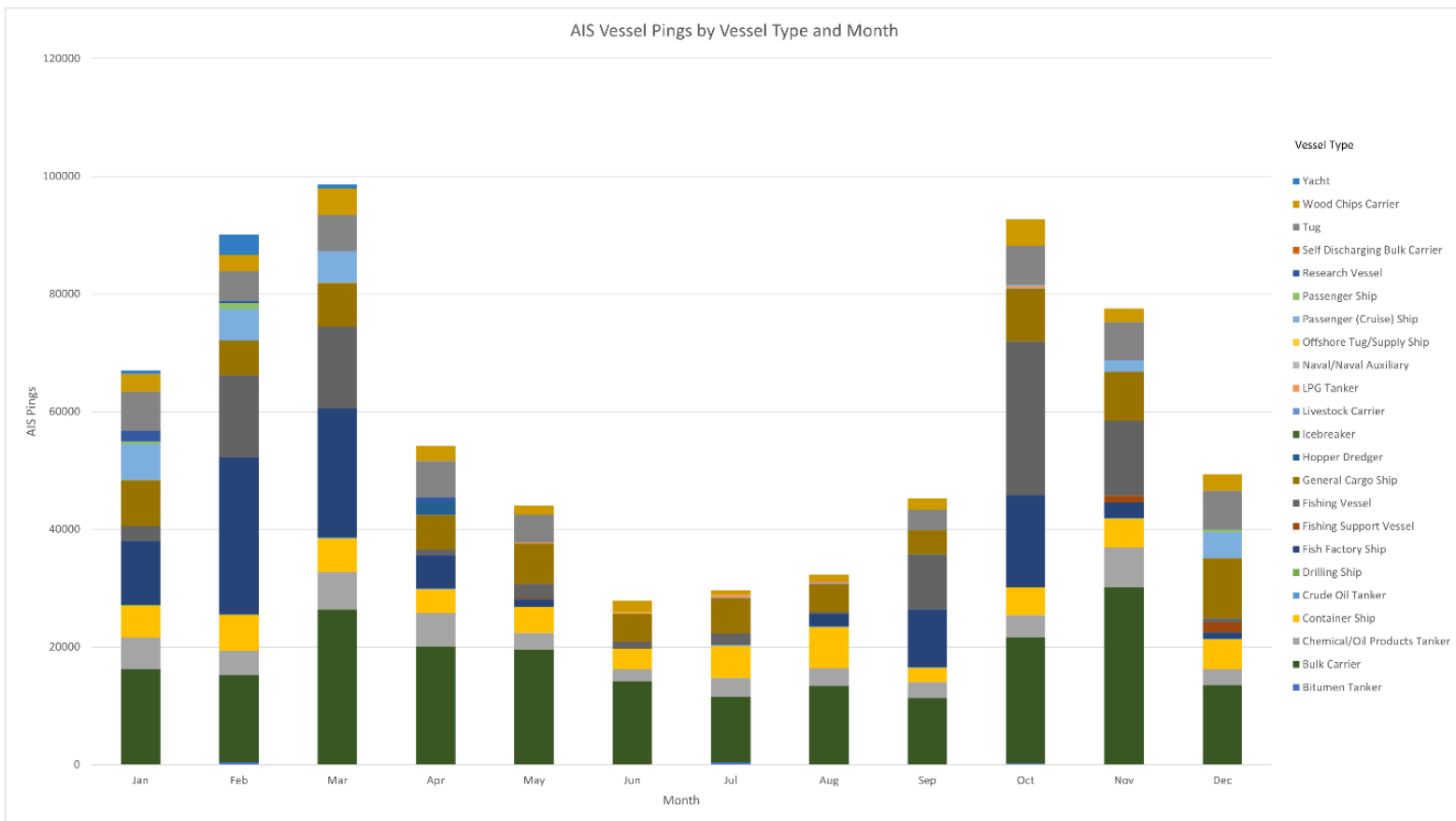

(Data sourced from VesselFinder Ltd., 2022)

Figure 7-23. AIS Pings by Month and Vessel Type Highlighting the Seasonality of Fishing (Fishing Vessels in dark gray, Fishing Factory Ships in dark blue).

**ANTARCTICA**

**7.3. Antarctica**

**7.3.1. Debris**

An anthropogenic debris survey was conducted in Winter Quarters Bay near the McMurdo Station landing during austral summers over a three-year period in 1994, 1995, and 1996. The survey was conducted using SCUBA, ROV, underwater videography, GPS mapping, and acoustic remote sensing. Debris mapped included vehicles, barrels, and large shipping containers. The mapped debris field is shown in relation to the proposed route in Figure 7-24. While the debris appear to be concentrated in the nearshore, there were items detected along the edges of the survey area; so it is possible that some additional debris may be encountered in the HDD area.

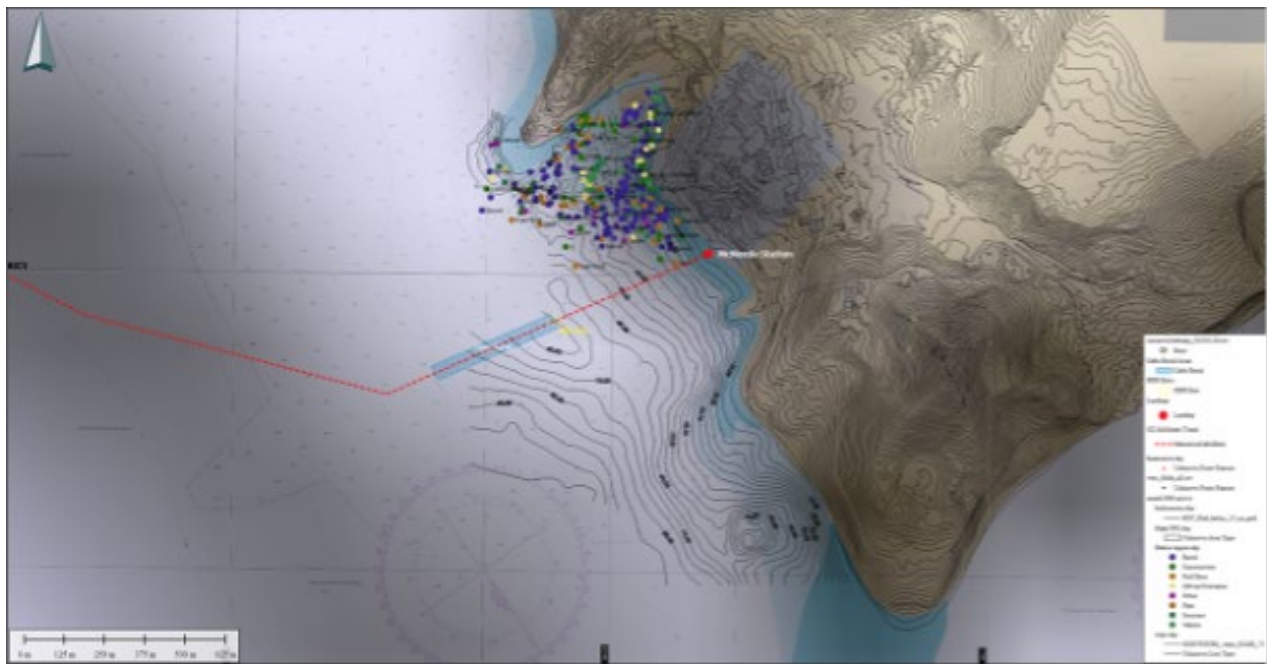

*(Bretz et al., 1998)*

Figure 7-24. Winter Quarters Bay Debris Field.



### 7.3.2. Fisheries

The New Zealand National Institute of Water and Atmospheric Research (NIWA) have developed a bioregionalization of the Ross Sea area to design a spatial management framework for the Ross Sea region, a primary input into the design of the Ross Sea MPA (<https://niwa.co.nz/fisheries/research-projects/antarctic-fisheries-research/spatial-management-of-the-ross-sea>). Benthic bioregionalization in the Ross Sea is shown on Figure 7-25 and Figure 7-26.

**The fishery is managed differently depending on the region and specific environmental protection and fishery management objectives in the region.**

A bioregionalisation process was undertaken to identify where areas of similar characteristics were, and how they could be grouped into *bioregions*.

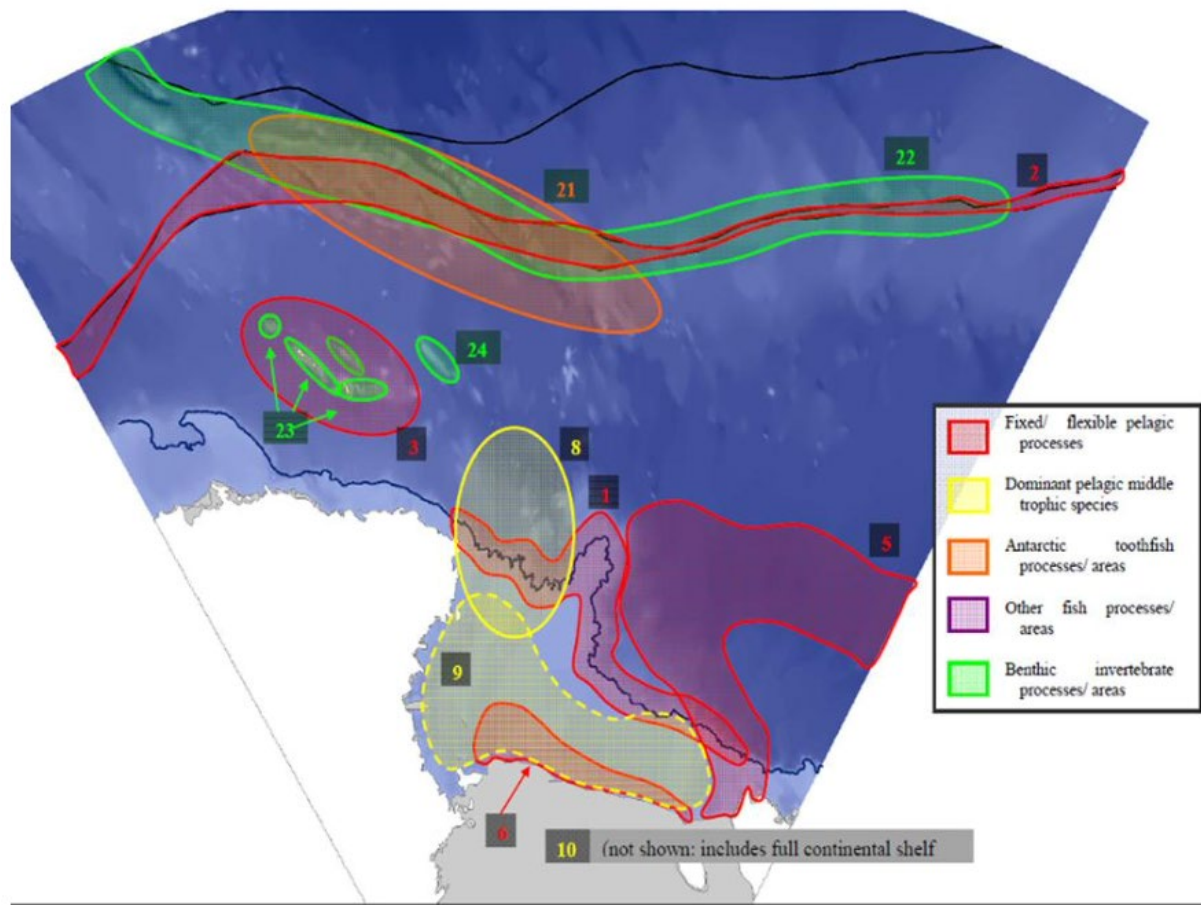

Compiling the spatial distributions of key species (polygons) in the Ross Sea area (termed Bioregionalisation) is helped to design a spatial management framework for the Ross Sea region and was a primary input into the design of the Ross Sea Marine Protected Area (MPA). [NIWA]

(NIWA, n.d.)

Figure 7-25. Ross Sea Fishing Spatial Management Area.

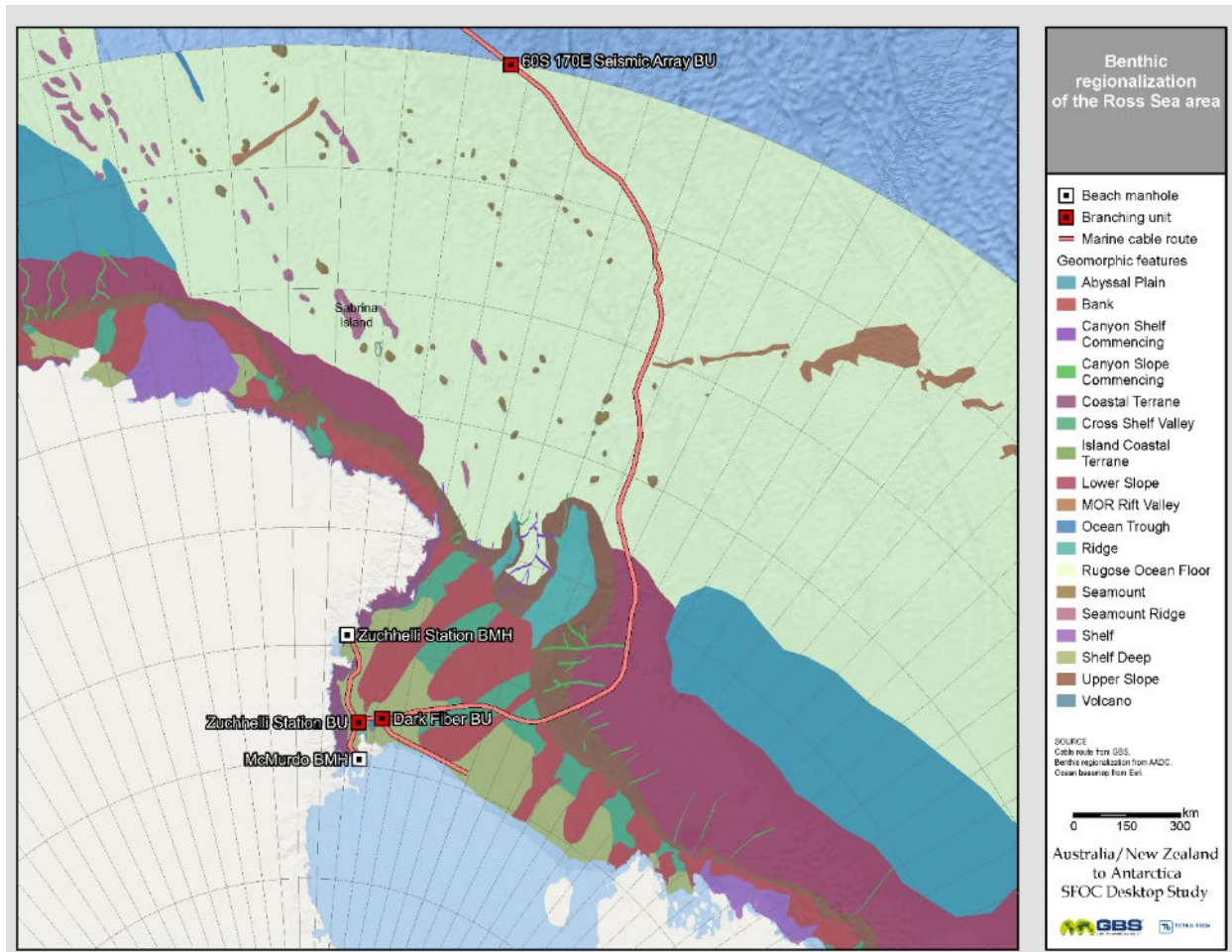

(Terauds, 2016; Esri et al., n.d.)

Figure 7-26. Benthic Bioregions of the Ross Sea.

The fishing season for toothfish in the Ross Sea spans December to March (austral summer). CCAMLR governs small scale fishing permits in the Ross Sea (within the Special Research Zone [SRZ]). Separate catch limits are used to control fishing in the North (north of 70° South), Slope, and SRZ.

Patagonian toothfish (*Dissostichus eleginoides*) and Antarctic toothfish (*Dissostichus mawsoni*) are targeted by licensed fisheries in the Southern Ocean, using mainly bottom-set longlines in depths between 300 to 2,200 m, though primarily between 1,200 to 1,800 m. These species may also be caught by trawl and pot. Both species of toothfish are sought after in restaurants and high-end markets worldwide. There are 13 licensed fisheries currently targeting toothfish in CCAMLR Statistical Areas 48, 58 and 88, including seven exploratory fisheries.

Antarctic krill may be taken in the Southern Ocean in CCAMLR Statistical Subareas 48.1 to 48.4,

Subarea 48.6 and Divisions 58.4.1 and 58.4.2. Fishing vessels operate midwater trawls and beam trawls in depths of 0–250 m. Vessels may use a continuous fishing system which transports krill from the codend of the net to the vessel while the vessel is trawling. Pumps may also be used to clear nets hauled alongside the vessels. The fisheries in Subareas 48.1 to 48.4, and Divisions 58.4.1 and 58.4.2 are established fisheries, and the fishery in Subarea 48.6 is an exploratory fishery. However, fishing is currently only conducted in Subareas 48.1 to 48.4.

Mackerel icefish (*Champscephalus gunnari*) is targeted by licensed fisheries in the Southern Ocean using midwater trawls at South Georgia in Subarea 48.3 and using both bottom and midwater trawls at Heard and McDonald Islands in Division 58.5.2. These established fisheries are reviewed annually by CCAMLR's Working Group on Fish Stock Assessment (WG-FSA) and the Scientific Committee. See annual Fishery Reports. The Commission's agreed limits for the current fishing season are defined in the Conservation measures. This species was heavily exploited in the 1970s and 1980s. Concern over the levels of exploitation in these fisheries, and the high annual variability in catches, led to the closure of the fisheries in the early 1990s. Nowadays, fisheries on mackerel icefish may only occur within two years of a survey if sufficient stock is assessed to be available.

### 7.3.3. Illegal, Unreported, and Unregulated (IUU) Fishing

IUU fishing can include fishing without authorization, ignoring catch limits, operating in closed areas, and fishing with prohibited gear or for prohibited fish or wildlife. These activities are often destructive to essential habitat, severely deplete fish populations, and threaten global food security. Forced labor and human rights abuses are also commonly associated with IUU fishing. In the context of the project, IUU fishing represents a risk to infrastructure and the operation of the SFOC.

IUU fishing is a low-risk, high-reward activity, especially on the high seas where a fragmented legal framework and lack of effective enforcement allows it to thrive. The remote location of the Ross Sea has meant the ecosystem has been relatively isolated from the typical fishing pressures the Southern Ocean has been subject to in the past, and the majority of IUU catch is taken in developing nations with weak governance.

The highly prized toothfish, sometimes referred to as 'white gold,' have been targeted IUU fishing vessels. The most valuable fishing grounds are in the Southern Ocean, around sub-Antarctic islands. Fishing for toothfish started in Antarctic waters in the 1980s. Large amounts of IUU activity were observed in mid-1990s, reaching at least 4 and up to 6 times the regulated catch in 1997 (Agnew, 2000). IUU fishing for toothfish in the Convention Area was estimated to be over six times the catch reported by authorized fishing vessels. In 1997 the scientific committee of CCAMLR concluded that IUU fishing was "causing the likely collapse of the populations of several species of albatross (Diomedidae) and of white-chinned petrels (*Procellaria aequinoctialis*), as well as the potential collapse of the *Dissostichus* stocks". At that time, CCAMLR was aware that other



Antarctic marine stocks had not recovered from overfishing in the 1970's and identified that addressing IUU fishing was a critical need. The Catch Document Scheme was adopted in 1999, which aims to reduce unregulated fishing through trade-related measures.

IUU fishing was reduced following the 'crisis situation,' but increased again and reached a new peak in 2002. IUU operators reduced the probability of detection and sanctioning through several measures, including using offshore fleet support, coordination of fleet movements, faking distress signals and collection of intelligence on Australian fisheries control operations.

CCAMLR and other international regulations require registered fishing vessels in these waters to report any sightings of IUU vessels. The Flag States of the sighted vessels are notified and encouraged to investigate the activities of such vessels and to advise CCAMLR of steps taken to investigate and eliminate IUU activity in the Convention Area.

CCAMLR has formal Arrangements in place with three Regional Fisheries Management Organizations with convention areas adjacent to the northern border of the CCAMLR Convention Area. Links to their IUU vessel lists are given below and include:

- SPRFMO: [www.sprfmo.int/measures/iuu-lists/](http://www.sprfmo.int/measures/iuu-lists/);
- SEAFO: [www.seafo.org/Management/IUU](http://www.seafo.org/Management/IUU); and
- SIOFA: [www.apsoi.org/mcs/iuu-vessels](http://www.apsoi.org/mcs/iuu-vessels)

CCAMLR also maintain Contracting Party IUU Vessel Lists and Non-Contracting Party IUU Vessel Lists at:

- Link: <https://www.ccamlr.org/en/compliance/contracting-party-iuu-vessel-list>
- Link: <https://www.ccamlr.org/en/compliance/iuu-vessel-lists>

Österblom and Sumaila (2011) noted that global IUU catch has been estimated to range between 11 and 26 million tons annually, with a total catch value of between US\$ 10 and 23.5 billion dollars. IUU fishing for Patagonian *Dissostichus eleginoides* and Antarctic *D. mawsoni* toothfish in the Southern Ocean constituted <0.2% (by weight and value) of these global estimates. It is estimated there are currently between 20 to 30 vessels involved in IUU fishing for toothfish. One of the problems is that some vessels are registered under a 'flag of convenience,' taking advantage of deficient vessel monitoring by the flag States involved.

IUU fishing has not historically been a major problem in the Ross Sea. However, Antarctic Toothfish is a valuable species and is at risk from IUU fishing activity. A range of steps have been taken to discourage IUU fishing in the Ross Sea. Over the last few seasons, an increasing number of known IUU vessels have been operating in or near the Ross Sea. New Zealand contributes practical support to efforts to combat IUU fishing activities in the CCAMLR area. This support includes aerial patrolling of the Ross Sea and the inspection of toothfish vessels that enter port in New Zealand. These activities help to ensure that such vessels are authorized to operate in the CCAMLR Area and do so in accordance with relevant CCAMLR Conservation Measures.





Inspections and aerial patrols undertaken by New Zealand have been successful on a number of occasions and as a result vessels such as the *Paloma V* have been IUU listed by CCAMLR. Australia, France, United Kingdom, and New Zealand use ship-based, aerial and satellite surveillance to perform extensive searches of the Southern Ocean for IUU fishing.

Sightings of illegal fishing vessels are typically recorded by the Royal New Zealand Air Force (RNZAF) and reported to the CCAMLR headquarters in Hobart. In 2008, a RNZAF patrol sighted and interrogated an illegal (unregistered) Spanish fishing vessel located 1500 km south of Invercargill. The New Zealand government responded to the incident stating that ‘the sighting was of very great concern’ and that ‘vessels such as this have wreaked havoc on the valuable toothfish stocks, causing considerable environmental damage, including to Antarctic seabirds over the years’ (Beehive, 2008). CCAMLR observations from fisheries observers suggest that IUU fisheries pose a significant risk to sea bird populations via an unmitigated seabird bycatch.

In 2006, it was reported that IUU vessels had begun using new gear, such as gillnets (or drift nets). Observations over one fishing season suggest up to 10 IUU vessels where using gillnets able to catch up to 10 tons of toothfish per day, constituting 5 to 10 times the rate of the legal longline method (Young, 2012).

In their report of the 29<sup>th</sup> meeting, the Commission reviewed advice from SCIC and the Scientific Committee on the current level of IUU fishing. Seven vessels had been reported to have engaged in IUU fishing in the Convention Area during 2009/10 and all were believed to be using gillnets. The Commission noted advice from the Scientific Committee on the changing nature of IUU fishing in the Convention Area, including the increasing level of IUU activities close to the continent and the increasing uncertainty surrounding estimates of IUU catches by gillnets. The Scientific Committee reiterated its previous advice that CCAMLR was still not aware of the full impact of gillnet fishing (SC-CCAMLR-XXIX, paragraphs 6.5 and 6.6). The Commission expressed its concern that the estimates of IUU catches had risen since 2009 and concluded that, despite progress in the control of nationals and the implementation of the CDS, IUU fishing did not appear to be significantly declining. Several members expressed the view that CCAMLR appeared to be unable to further control IUU fishing and was therefore not fulfilling the objectives of Article II of the Convention and, in turn, the Antarctic Treaty. The Commission agreed with the Scientific Committee that, given the uncertainty surrounding gillnet catch rates, future estimates of IUU should focus on the level of effort, rather than the level of catches.

Response actions following the identification of IUU fishing include the banning of trade in fish from the vessel and refusing access to members ports from the vessel. The information is shared by the RNZAF to CCAMLR meaning that 25 nations are made aware of the vessel’s activities. CCAMLR has adopted conservation measures to specifically address the threat of IUU fishing including the establishment of the Contracting Party IUU Vessel List (Conservation Measure 10-06) and the Non-Contracting Party IUU Vessel List (Conservation Measure 10-07) and the control of nationals (Conservation Measure 10-08). The typical mitigation measures of a licensed



fishing operation are often not upheld on IUU vessels and more intensive/destructive fishing techniques are used.

In 2011, the Australian Government noted that IUU fishing remains a significant threat to marine living resources in the high seas of the CCAMLR Convention Area. Sightings of IUU vessels in the past few years have reported that vessels fishing for toothfish in the Southern Ocean are employing gillnetting as their primary method. The potential detrimental effects of gillnetting on marine ecosystems are well documented and can be severe. These include large quantities of by-catch, ghost fishing by lost or discarded gillnets, and large-scale habitat disturbance due to nets dragging along the sea floor. Deep-sea gillnets pose a huge risk to almost all marine life, including marine mammals due to their indiscriminate nature. In the CCAMLR Area there is significant concern about the impacts of gillnets on non-target species especially sharks and rays.

The nature of recent IUU fishing has changed from the operational styles of the mid-1990s and it is now often a highly sophisticated form of transnational organized crime with:

- Sophisticated control of vessel movements
- Complex logistics, including chartering tankers to refuel vessels at sea, specially built and modified vessels, and the use of ports in states which give little scrutiny to vessel movements and catch landings
- Use of active intelligence gathering about States' enforcement efforts
- Use of complex corporate arrangements and legal advice to exploit weaknesses in national and international fisheries and corporate law and to disguise the real owners and beneficiaries of IUU fishing
- Use of weak State regulatory regimes to flag vessels and fraudulently obtain validation of catch documents needed for market access
- Use of complex arrangements to 'launder' catches
- Strong evidence of corrupt conduct in support of IUU fishing by some States' officials
- A small number of beneficiaries controlling nearly all IUU fishing for toothfish
- Substantial and well-financed legal challenges when vessels are arrested.

Figure 7-27 shows the estimated weight of toothfish (*Dissostichus* spp.) caught by IUU fishing in the Southern Ocean between 1995 and 2009. Estimates are derived from vessel sightings and reports of undocumented landings by national compliance programs, the licensed fishing industry, or other sources and calculated by fishing season (e.g., 1996/1997) each austral summer.

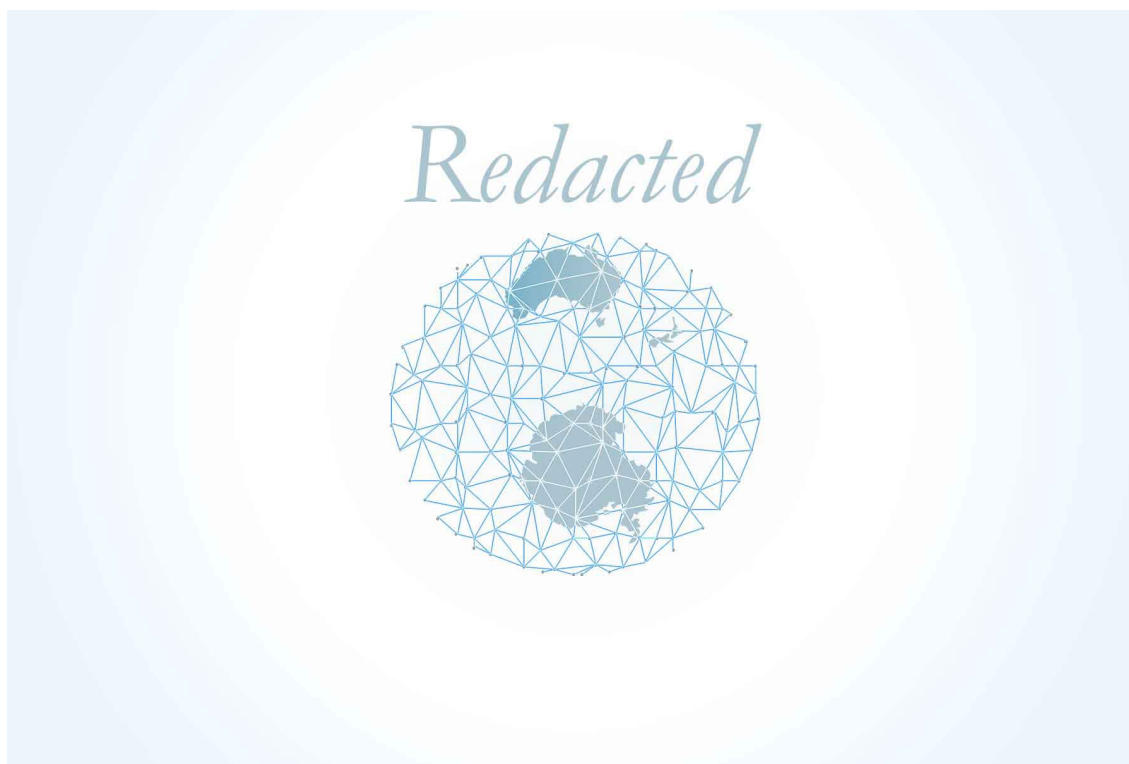

Figure 7-27. [Redacted]. Ross Sea Fishing Activity example.

Although it is believed that the level of IUU fishing in the Convention Area has declined it remains a concern for the Commission and has the potential to undermine CCAMLR's conservation objectives. Further, despite the isolated location and formation of the Ross Sea region MPA in 2017, IUU fishing remains widespread in these waters. IUU accounts for approximately 10 to 17% of the Antarctic toothfish fishery and poses potentially significant impacts to the marine environment (ASOC, 2021).

The Combined IUU Fishing Vessel List (<https://iuu-vessels.org/iuu>) site provides the best available, up to date information on all fishing vessels that appear on the IUU vessels lists published by Regional Fisheries Management Organizations (RFMOs) and related organizations. The Vessel List is used as follows:

- The 'Search' tab provides an overview of all vessels contained on the site, including vessels that are currently IUU listed, and vessels that have been delisted.
- Searches are run against all information fields, including current and historic information. Users enter any information they wish to search against into the field provided, including vessel name, flag, callsign, IMO, registration number, owner, or operator name etc.



- Search can include / exclude vessels listed by RFMOs, and those that are Currently Listed / Delisted, using the checkboxes. Filter according to vessel status (e.g., Active, Sunk, Broken Up).

Oceana (<https://usa.oceana.org>) also maintain the IUU Vessel Tracker that allows users to track vessels currently included on the regional fishery management organizations’ (RFMOs) IUU fishing vessel lists. The IUU Vessel Tracker shows ships’ names, fishing activity, and locations in near real time together with EEZs (Flanders Marine Institute, 2019) and marine protected areas.

IUU Vessel Tracker was created using Automatic Identification System (AIS) data from Global Fishing Watch. IUU Vessel Tracker uses data from Trygg Mat Tracking’s Combined IUU Vessel List ([www.iuu-vessels.org](http://www.iuu-vessels.org)), which provides the best available, up-to-date information on all fishing vessels that appear on the IUU vessels lists. This source is compiled from RFMO IUU lists, online vessel databases, national fisheries authorities, and Interpol. Only vessels currently broadcasting their AIS devices are visible on IUU Vessel Tracker. As of June 2021, there are 168 vessels listed on RFMO’s IUU vessel lists.

Figure 7-28 illustrates the IUU Vessel Tracker map and shows 464 records between 3 June and 3 July 2022. None of the events overlap with project areas or the Ross Sea MPA.

Figure 7-29 shows an example of Ross Sea Fishing Activity.

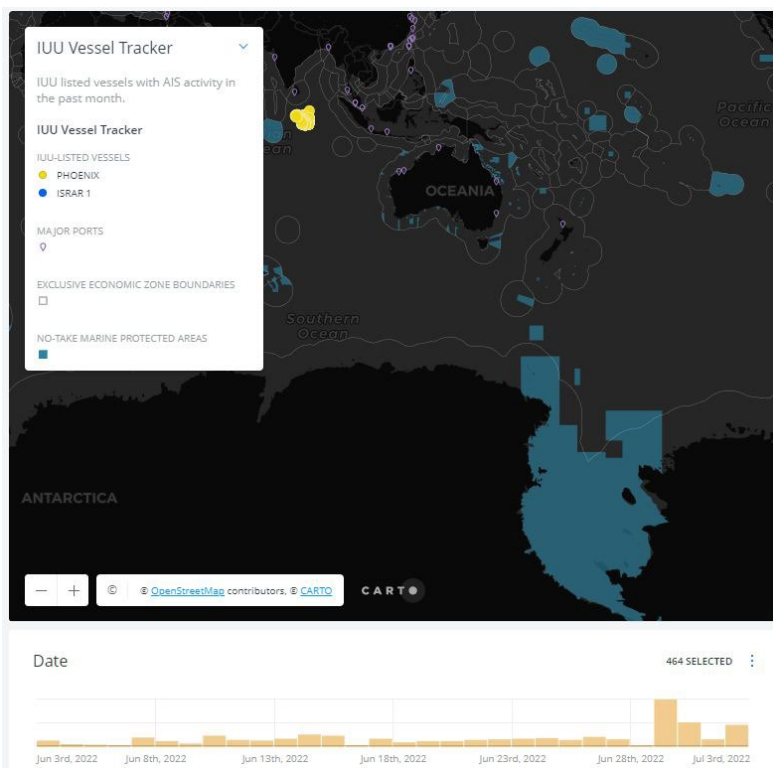

(Copyright 2022, Global Fishing Watch, Inc.; Accessed July 2022 using the IUU Vessel Tracker)

Figure 7-28. IUU Vessel Tracker.

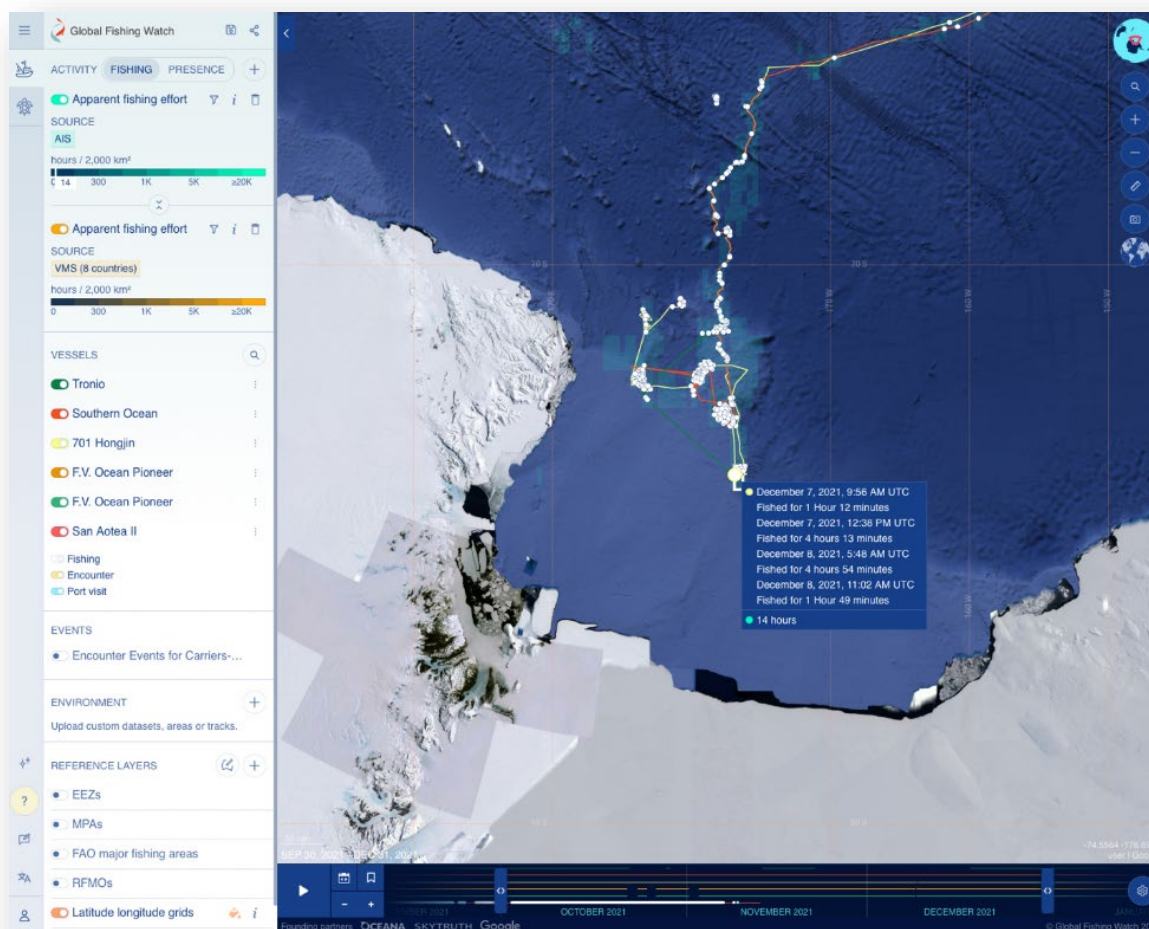

(Copyright 2022, Global Fishing Watch, Inc.; Accessed March 2022)

Figure 7-29. Ross Sea Fishing Activity example.

### 7.3.4. Automatic Identification System

In order to better understand shipping and fishing related risks to the cable route, this study sourced an AIS dataset from VesselFinder Ltd., a commercial AIS data provider, for further analysis for the route areas of the Ross Sea on the approach to Antarctica. The dataset covers the period from October 2019 through March of 2022. The AIS study area covers the Ross Sea out to approximately the Terror Fracture Zone. AIS data points were processed with ArcGIS Pro to recreate vessel tracks, retaining particulars about the vessel, vessel type, and date and time of the tracks.

An overall vessel track density plot was produced utilizing a workflow to generate a heat-map



style raster to illustrate areas of the most spatially dense vessel activity (Figure 7-30). Most of the traffic consists of either fairly direct routes, oriented to reach ports, research facilities, or field work areas, or less organized lines representing fishing vessels traversing areas along seabed features and depth contours. The proposed DTS route crosses through areas of lower overall vessel intensity and avoids the areas of highest vessel track density.

By rendering the individual ship tracks according to the type of vessels, Figure 7-31 illustrates the more orderly patterns of shipping traffic, including cargo, tanker, and passenger traffic, while the fishing vessel traffic (red) are more sporadic, as fishing efforts target specific areas of seabed based on seabed features and bathymetry. The DTS route avoids the areas of the highest fishing vessel track density.

By taking the same data and analyzing by month and by vessel type, it can be seen in Figure 7-32 that there exists a strong seasonality to the traffic over the timeline of the study (October 2019 through March 2022). Fishing efforts substantially overtake all other vessel traffic types for the months of November, December, and January with December representing the highest number of AIS observations of fishing vessels. The months of April through October have little to virtually no AIS observations within the dataset.

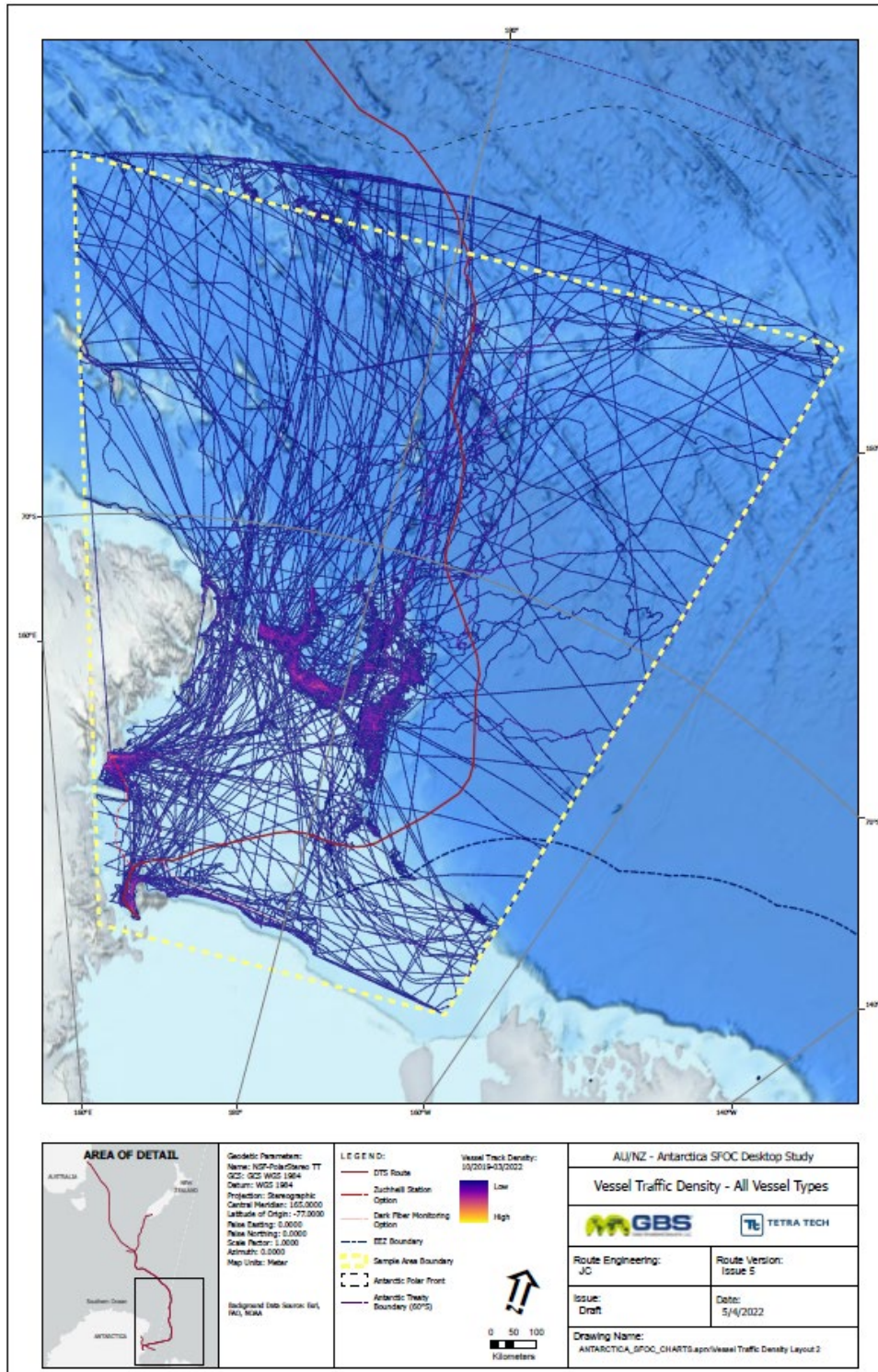

(Data sourced from VesselFinder Ltd., 2022)

Figure 7-30. Ross Sea AIS Vessel Track Density.

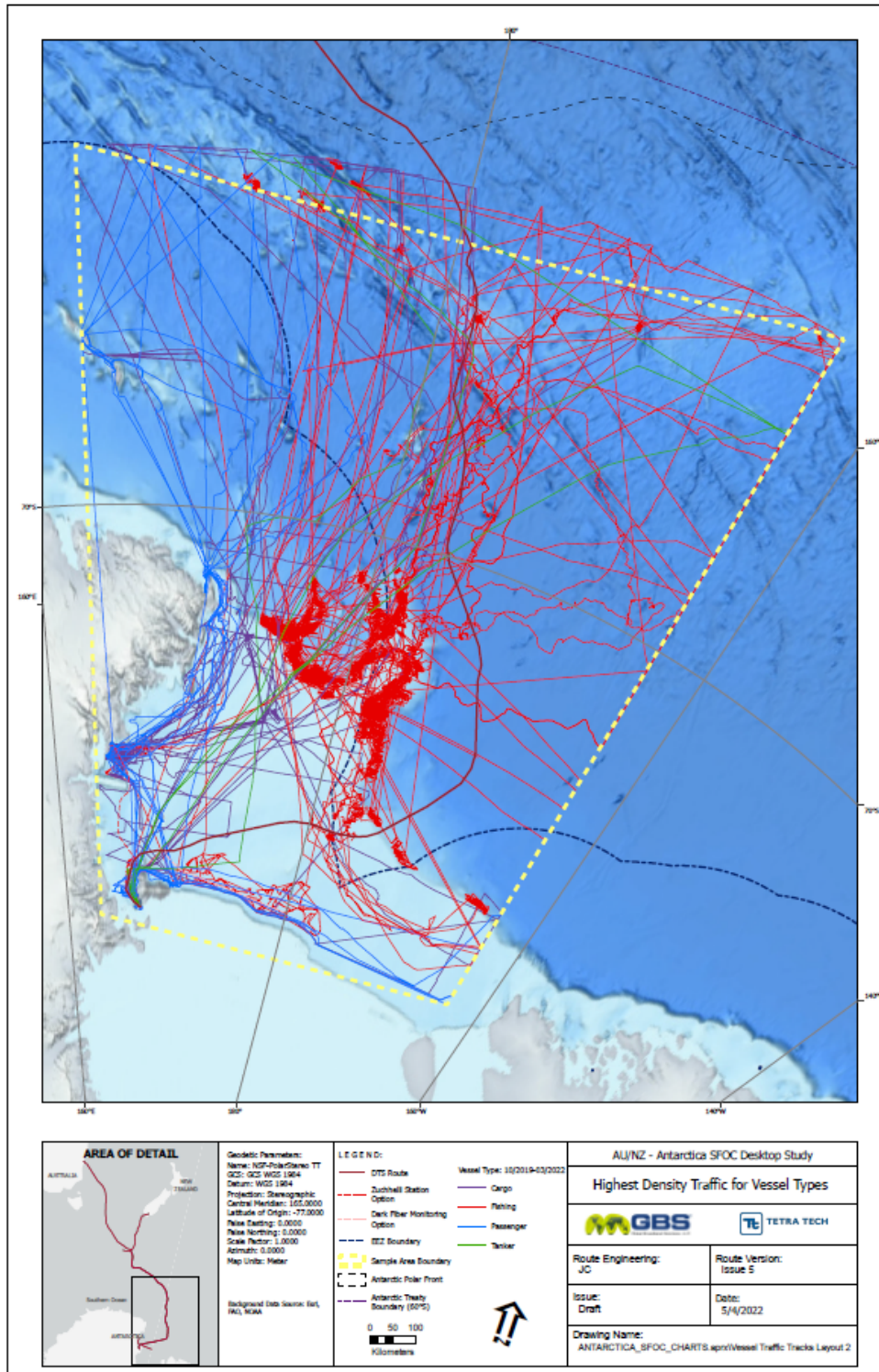

(Data sourced from VesselFinder Ltd., 2022)

Figure 7-31. AIS Vessel Track Rendered by Vessel Type.



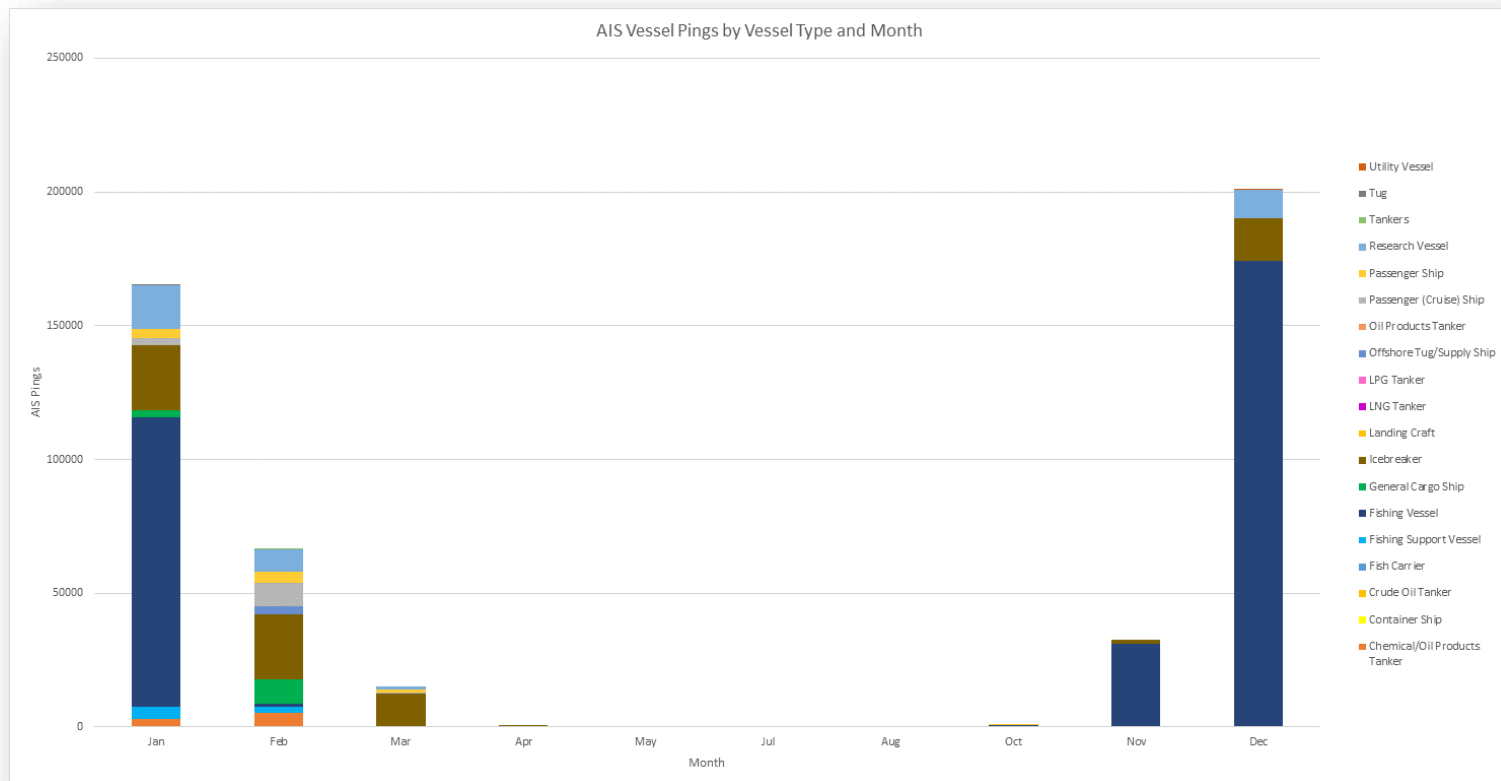

(Data sourced from VesselFinder Ltd., 2022)

Figure 7-32. AIS Pings by Month and Vessel Type Highlighting the Seasonality of Fishing (dark blue).



## 7.4. References

- Agnew, D.J. (2000). The illegal and unregulated fishery for toothfish in the Southern Ocean, and the CCAMLR catch documentation scheme. *Marine Policy*, 24, 361–374.  
[https://doi.org/10.1016/S0308-597X\(00\)00012-9](https://doi.org/10.1016/S0308-597X(00)00012-9)
- Antarctic and Southern Ocean Coalition (ASOC). (2021). *Antarctic and Southern Ocean Coalition: Ross Sea Preservation*. Retrieved January 19, 2022 from  
<https://www.asoc.org/advocacy/marine-protected-areas/ross-sea>
- Australian Communications and Media Authority (ACMA). (2007). Submarine Cable (Southern Sydney Protection Zone) Declaration 2007, Telecommunications Act 1997. Federal Register of Legislative Instruments F2007L02217. Retrieved April 2, 2022, from <https://www.legislation.gov.au/Series/F2007L02217>
- Australian Government, Australian Fisheries Management Authority (AFMA). (2022). Retrieved August 4, 2022, from <https://www.afma.gov.au/>
- Australian Government, Australian Maritime Safety Authority (AMSA). (2020). *Port State control Australia – 2020 Annual Report*. Retrieved August 4, 2022, from <https://www.amsa.gov.au/port-state-control-australia-2020-annual-report>
- Beehive. (2008, January 17). *Illegal fishing vessel found in the Ross Sea*. Rick Barker (author). Retrieved August 4, 2022 from <https://www.beehive.govt.nz/release/illegal-fishing-vessel-found-ross-sea>
- Bretz, C. K., Kvitek, R. G., & Iampietro, P. J. (1998). A case study in the application of spatial data acquisition tools and multimedia GIS for environmental monitoring and management in Antarctica. *Antarctic Journal of the U.S.*, 7, 11-13.
- Esri, Garmin, GEBCO, & NOAA NGDC. (n.d.). *World Ocean Base. Basemap in ArcGIS Pro v. 3.0*.  
[https://services.arcgisonline.com/arcgis/rest/services/Ocean/World\\_Ocean\\_Base/MapServer](https://services.arcgisonline.com/arcgis/rest/services/Ocean/World_Ocean_Base/MapServer)
- Flanders Marine Institute. (2019). *Maritime Boundaries Geodatabase: Maritime Boundaries and Exclusive Economic Zones (200NM), version 11*. <https://www.marineregions.org/> and <https://doi.org/10.14284/386>
- Port of Lyttelton (NZ Lyt) details - departures, expected arrivals and port calls: AIS Marinetraffic. MarineTraffic.com. (n.d.).  
<https://www.marinetraffic.com/en/ais/details/ports/1322?name=LYTTELTON&country=New-Zealand>



- Michael, K.P., Forman, J., Hulston, D., Bilewitch, J., & Moss, G. (2019). Foveaux Strait oyster and *Bonamia* surveys, February 2017. New Zealand Fisheries Assessment Report 2019/46, September. <https://www.mpi.govt.nz/dmsdocument/37008/direct>. Source: [Ministry for Primary Industries](#) and licensed by MPI for re-use under the [Creative Commons Attribution 4.0 International license](#). No changes were made from original file.
- National Biodiversity Information System (NABIS). (n.d.). [Web-based mapping portal.] Ministry for Primary Industries. Retrieved March 2022 from <http://www.nabis.govt.nz/>
- New Zealand National Institute of Water and Atmospheric Research (NIWA). (n.d.) *Spatial management of the Ross Sea*. Retrieved August 29, 2023 from <https://niwa.co.nz/fisheries/research-projects/antarctic-fisheries-research/spatial-management-of-the-ross-sea>
- Österblom, H., & Sumaila, R. 2011. Toothfish crises, actor diversity and the emergence of compliance mechanisms in the Southern Ocean. *Global Environmental Change*, 21, 972-982. <https://doi.org/10.1016/j.gloenvcha.2011.04.013>
- Port Authority of New South Wales. (2022). *Keeping the ports of NSW safe, secure and open to the world*. Retrieved August 4, 2022, from <https://www.portauthoritynsw.com.au/>
- Terauds, A. (2016). An update to the Antarctic Specially Protected Areas (ASPAs) March 2016, Ver. 1, *Australian Antarctic Data Centre*. doi:10.4225/15/572995579CD36.
- VesselFinder Ltd. (2022). *Vessel Movements Report*, October 1, 2019, through March 31, 2022, for three areas. Data received April 2022.
- Young, Peter (Director). (2012). *The Last Ocean: The Toothfish and the Battle for Antarctica's Soul: Synopsis* [Film]. Written by Richard Langston and Peter Young. Retrieved August 29, 2023 from <https://www.thelastoceanfilm.com/synopsis/>



National Science Foundation



# BIOLOGICAL FACTORS REPORT





## 8.0 BIOLOGICAL FACTORS REPORT

This section outlines the main biological factors, including key taxa and habitats, relevant to the project.

### AUSTRALIA

#### 8.1. Australia

The preferred landing site for the Australian component of the project is at Clovelly Beach, Sydney. The installation of the cable using an existing BMH, and Horizontal Directional Drilling (HDD) conduit will minimize potential impacts to the terrestrial and marine environment (Figure 8-1). The Clovelly Beach landing site is located within a suburban area which has been developed for residential and recreational purposes. The BMH site is located within a grassed area adjacent to a garden planted as part of landscaping for the public carpark facility known as Forsyth Park (Figure 8-2). A local road (Victory Street) is located west of the BMH, which is buried.

The proposed landing site at Macquarie Island is in Buckles Bay on the northeastern coastline (Figure 8-3). The landing site is located adjacent to the Australian Antarctic Division's Macquarie Island research center within Zone A (Services Zone) declared under the Macquarie Island Nature Reserve and World Heritage Area Management Plan (PWS, 2006). Within Zone A, construction and/or placement of buildings and facilities required to support scientific research programs are permitted. Supplies for the research center are landed in Buckles Bay which is the only safe anchorage on the island due to the prevailing northwesterly and westerly winds.

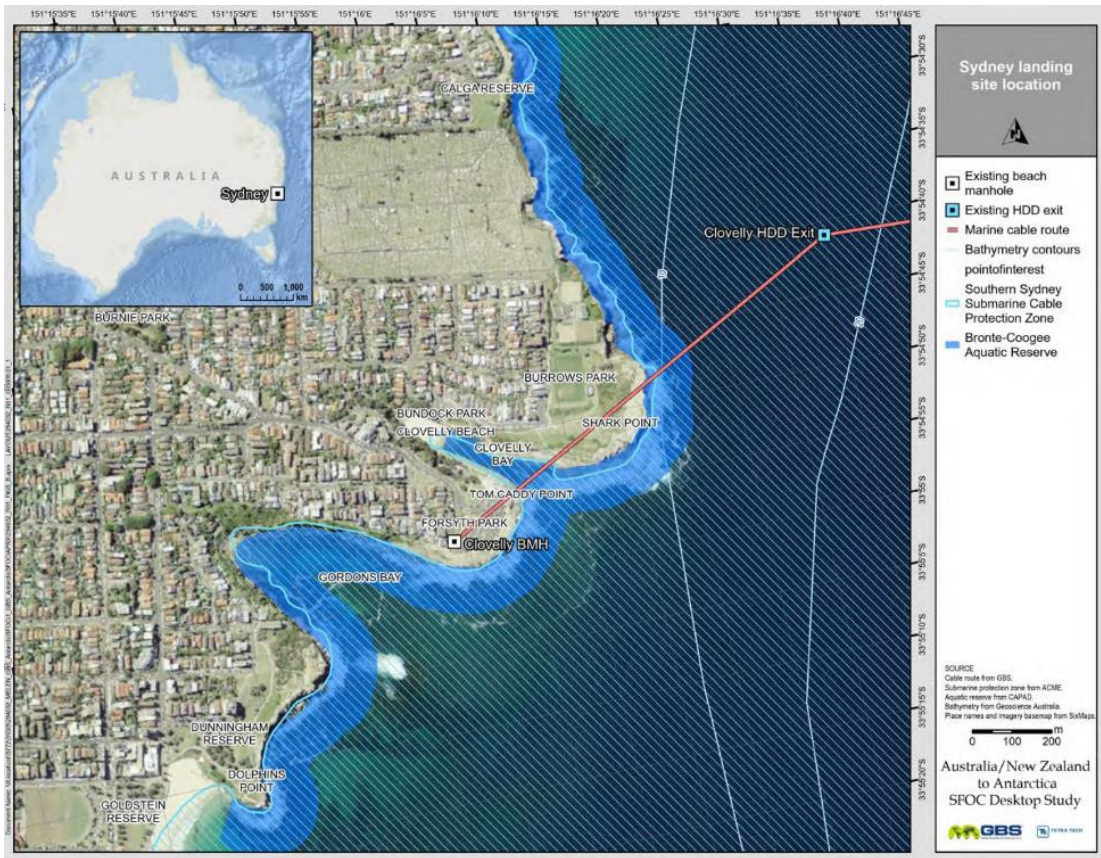

(ACMA, 2007; CAPAD, 2021; Geoscience Australia, 2009; SixMAPS, n.d.)

Figure 8-1. Sydney Landing Location.



(Photo credit: NSF © 2022)

Figure 8-2. Clovelly Beach BMH Location.



*(Photo credit: Australian Antarctic Division, 2021)*

Figure 8-3. Australian Antarctic Division's Research Center on Macquarie Island Isthmus with Buckles Bay in Foreground.

### **8.1.1. Protected Areas**

The cable route crosses the NSW coast via the existing HDD conduit under the Bronte-Coogee Aquatic Reserve and nearshore rocky environment. From the HDD conduit end, the cable route travels southeast across the Australian Economic Exclusion Zone (EEZ) to the proposed branching unit east of Macquarie Island where it joins the New Zealand marine cable route and Antarctic marine cable route (Figure 8-4). The total length of this marine cable route is approximately 2,624 km.

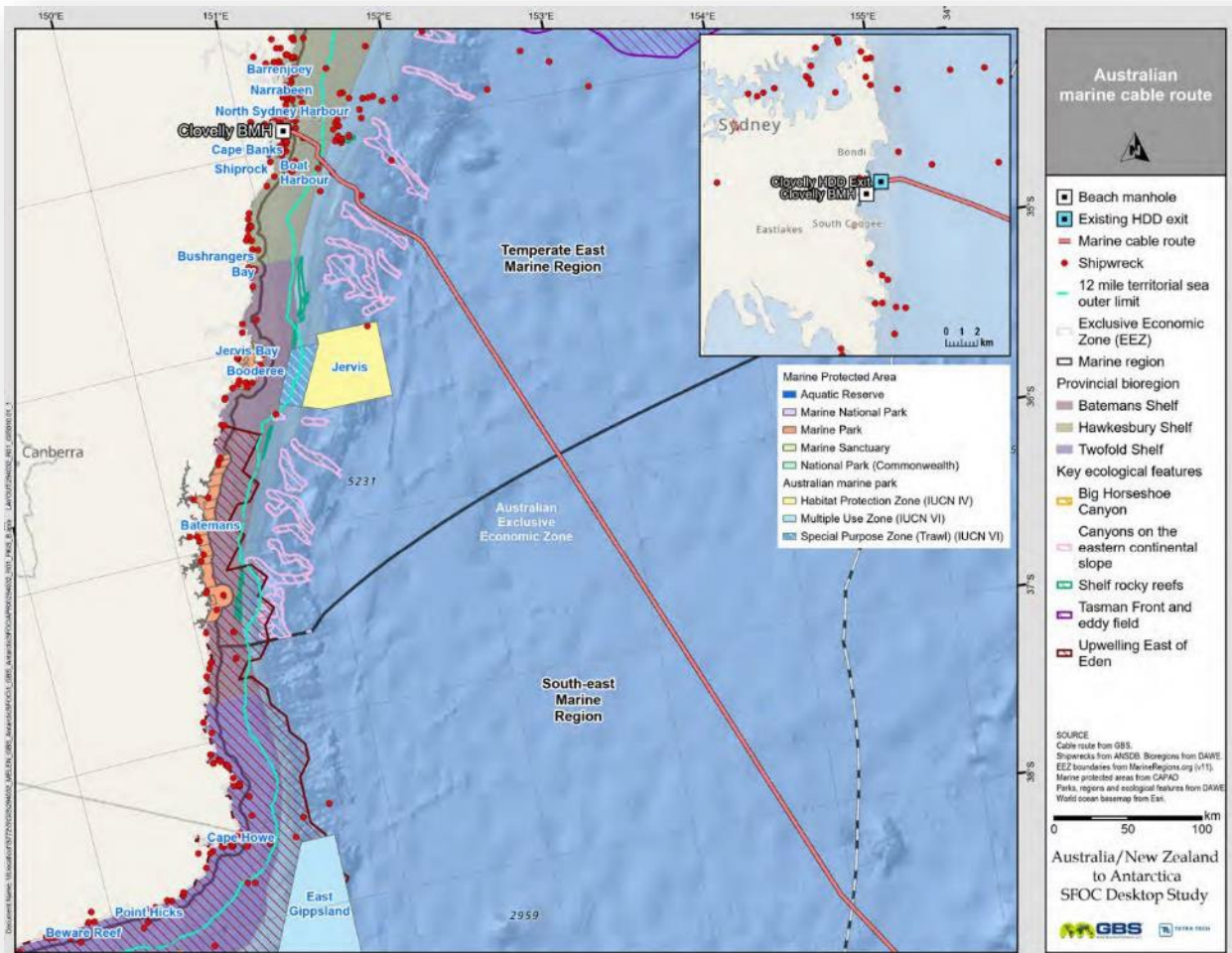

(Australian National Shipwrecks Database [ANSDB], n.d.; MarineRegions.org, 2019; CAPAD, 2021; DAWE, 2006; Esri, n.d.a.)

Figure 8-4. Australian Marine Cable Route.

The proposed cable route intersects several terrestrial and marine protected areas. The following sections provide a summary of the key relevant areas.



## 8.1.2. Terrestrial Protected Areas

### *Macquarie Island World Heritage Area*

Macquarie Island, and the surrounding waters to a distance of 12 nautical miles, were declared a World Heritage Area in 1997. Macquarie Island and the surrounding waters were recognized for the following outstanding universal values (DAWE, 2021):

- Criterion (vii) – the remote landscape and dramatic changes in vegetation provide an outstanding spectacle of wild, natural beauty with large congregations of penguins, seals, and other marine wildlife.
- Criterion (viii) – the landform provides a unique opportunity to study geological features and processes of oceanic crust formation and plate boundary dynamics, as it is only place on earth where rocks from the earth's mantle (6 km below the ocean floor) are actively exposed above sea level.

### *Macquarie Island Nature Reserve*

The Macquarie Island Nature Reserve, declared under the Tasmanian *National Parks and Wildlife Act 1970*, covers the island and surrounding seas extending up to 3 nautical miles offshore. Similar to the World Heritage listing, the nature reserve was recognized for unique biodiversity and geological diversity.

## 8.1.3. Marine Protected Areas

The Australian marine cable is located within the Temperate East Marine and South-east Marine regions. Within these marine regions, provincial bioregions that contain distinct biodiversity characteristics, such as marine species, benthic communities and habitats have been defined. The cable route crosses two provincial bioregions, namely (refer to Figure 8-4 above):

- Central Eastern Province
- Macquarie Island Province

### *Central Eastern Province*

The Central Eastern Province is in warm temperate waters and is predominately located on abyssal plain and deep ocean floor (DEWHA, 2009). Water depths within the bioregion range from 170 m to 5,100 m, with approximately 80% of the area containing water depths between 4,000 m and 5,000 m (DEWHA, 2009). Given the predominance of abyssal plain within this bioregion, there is a strong presence of endemism among demersal species. Of the 630 demersal species estimated to be within the bioregion, 56 species have been identified as endemic (DEWHA, 2009).



### Macquarie Island Province

The Macquarie Island Province covers an area of approximately 477,000 km<sup>2</sup> and encompasses Macquarie Island and the surrounding waters to the boundary of the Australian EEZ. The bioregion is predominately located on abyssal plain and deep ocean floor and contains the deepest seabed environment in the Australian EEZ due to the presence of a well-developed trench system (DEH, 2005). The bioregion does not correspond with any demersal fish habitats; however, it does encompass endemic fish species and other fauna associated with Macquarie Island.

### Macquarie Island Marine Park

The Macquarie Island Marine Park extends east from Macquarie Island out to the Australian EEZ and covers approximately 16.2 million hectares. The marine park is divided into two zones, a central sanctuary zone bounded by habitat protection zones to the north and south (Figure 8-5). The sanctuary zone provides the highest level of protection for pelagic and shore birds and other marine life and is managed to minimize disturbance to the environment from human activities.

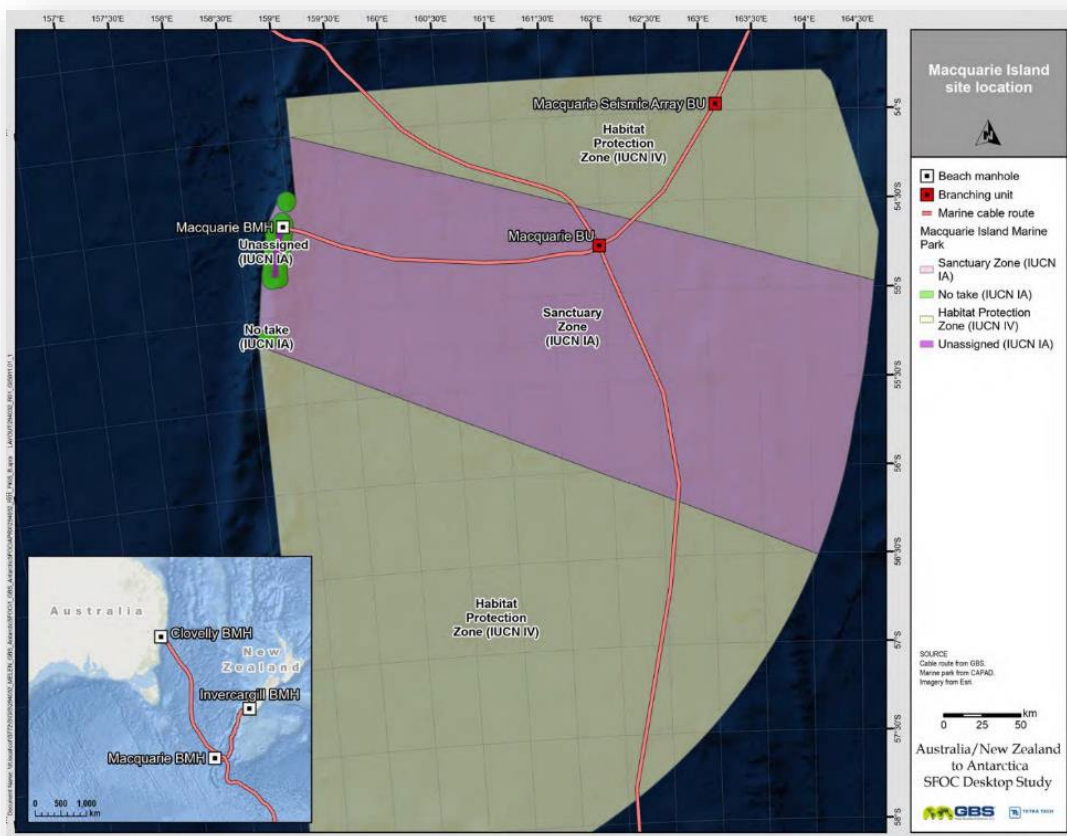

(CAPAD, 2021; Esri, n.d.b.)

Figure 8-5. Macquarie Island Marine Park.

Within this zone only scientific research is allowed. The proposed Macquarie Island segment is located within the Sanctuary Zone. Commercial fishing is restricted in the Habitat Protection Zones to the north and south to protect sensitive habitats.

#### 8.1.4. Vegetation

##### *Sydney (Clovelly) Landing Site*

Based on the findings of the site survey, supplemented by a review of available aerial imagery, the Sydney (Clovelly) landing site is highly modified. Five threatened ecological communities listed under the Commonwealth *Environment Protection and Biodiversity Conservation Act 1999* (EPBC Act) were identified as potentially occurring within the 5 km protected matters search area. These include:

- Coastal Swamp Oak (*Casuarina glauca*) Forest of New South Wales and Southeast Queensland ecological community – Endangered
- Coastal Swamp Sclerophyll Forest of New South Wales and Southeast Queensland – Endangered
- Coastal Upland Swamps in the Sydney Basin Bioregion – Endangered
- Eastern Suburbs Banksia Scrub of the Sydney Region – Critically Endangered
- River-flat eucalypt forest on coastal floodplains of southern New South Wales and eastern Victoria – Critically Endangered.

The critically endangered Eastern Suburbs Banksia Scrub of the Sydney Region persists on the rocky headlands of Malabar Headland National Park located approximately 4.5 km south of Clovelly. No threatened ecological communities are mapped in vicinity of Clovelly.

Given the high level of disturbance and modification at the Sydney (Clovelly) landing site and lack of remnant native vegetation, it is unlikely that these communities are present in the vicinity of the BMH and HDD conduit.

The desktop review (EPBC protected matters search) identified 14 threatened terrestrial flora species that have the potential to occur at or surrounding the landing site. No threatened flora was identified during the site visit as the site is in planted grasses adjacent to gardens planted for landscaping purposes.

Given the previous disturbance of the landing site and the surrounding area and lack of suitable habitat, it is unlikely that threatened flora species occur at the landing site. Further investigations would be required to determine the presence of these species.



### *Macquarie Island Landing Site*

The isolation of Macquarie Island from other landmasses has resulted in limited diversity of terrestrial vegetation communities and flora species, however the flora species present are endemic and specialized for the conditions. The prevailing climatic conditions (i.e., high wind speeds) have resulted in little to no tree or shrub vegetation being present on the island. There are 45 vascular plant species on Macquarie Island, of which four are endemic and two are considered pest species which are considered to be eradicated (NRE, 2016). Mosses also account for a considerable component of vegetation on the island, with over 79 species recorded (NRE, 2016). The most significant impact to Macquarie Island vegetation has been the introduction of rabbits and the subsequent decrease in palatable species (NRE, 2016). Biosecurity and the control of invasive pests and pathogens has been identified a key threat to sub-Antarctic Island biodiversity due to predicted changes in climate (NRE, 2016). For example, changes in interspecies competition and presence of new plant pathogens (i.e., *Azorella dieback*) due to changes in climate.

Listed threatened flora species known to occur on Macquarie Island are:

- Macquarie cushions (*Azorella macquariensis*) – Critically Endangered
- Windswept helmet-orchid (*Corybas dienemus*) – Critically Endangered
- Grooved helmet-orchid (*Corybas sulcatus*) - Critically Endangered
- Subantarctic bedstraw (*Galium antarcticum*) - Critically Endangered.

The vegetation surrounding the landing site is classified as beaches and rocky shore areas, as well as closed tall herb vegetation (PWS, 2006). Closed tall herb vegetation includes tall tussock grassland that occurs along coastal terraces and sheltered, well-drained valleys (PWS, 2006).

Given existing disturbance at the landing site and surrounding area caused by establishment of the research center, it is unlikely that threatened flora species occur in this area.

The rocky intertidal and subtidal areas of Macquarie Island support a diverse range of marine flora species, such as seaweeds, lichens, and algae. These marine plants provide habitat and food sources for a wide range of marine animals.

#### **8.1.5. Marine Aquatic Ecology**

The Sydney (Clovelly) HDD conduit exit point is located within temperate rocky reef habitat which is known to support a range of marine species, including species of State and national conservation significance. Rocky reef habitat provides important refuge and feeding opportunities for a diverse range of fish species, with carnivorous species using the rocky habitat as cover to ambush their prey (DPI, 2022).

The desktop review (EPBC protected matters search) identified six listed threatened fish species



as potentially occurring in the vicinity of the HDD conduit exit point. These include:

- Black rock cod (*Epinephelus daemeli*) – Vulnerable
- White's seahorse (*Hippocampus whitei*) – Endangered
- Macquarie perch (*Macquaria australasica*) – Endangered
- Australian grayling (*Prototroctes maraena*) – Vulnerable
- Blue warehou (*Seriolella brama*) – Conservation Dependent
- Southern bluefin tuna (*Thunnus maccoyii*) - Conservation Dependent.

As marine plants and organisms will colonize submarine infrastructure and in turn provide habitat for fish and marine species, White's seahorse may be present in rocky reef habitat at or near the HDD conduit exit. Diver surveys to establish this (and other threatened) species presence at the HDD conduit exit point are likely to be required.

From the HDD conduit exit point to a depth of approximately 60 m, the benthic habitats include a mix of open soft sandy seabed and patches of rocky reef. Further investigations will be required to establish a cable route that minimizes impacts on deep water rocky reef habitat to the extent practicable.

Fifty-one listed marine threatened species were identified by desktop review as potentially occurring along the marine cable route and in the waters surrounding the Macquarie Island landing site. These species include:

- Fifteen fish, including seven shark species.
- Thirty marine bird species.
- One coral species, namely cauliflower soft coral (*Dendronephthya australis*).
- Five marine reptiles.

Distribution of cauliflower soft coral has only been confirmed in a number of estuaries, including Sydney Harbour, Botany Bay, and Jervis Bay (DPI, 2019). Sydney Harbor and Botany Bay are approximately 9 km north and south of Clovelly respectively. Jervis Bay is over 130 km south of Clovelly. Given these distances, the limited distribution and the species preferred estuarine habitat, it is unlikely this species will occur in vicinity of the cable route.

The marine shelf area surrounding Macquarie Island is limited, and provides a small, isolated area of shallow water in the transition zone between Antarctic and subantarctic waters. To date, a total of 12 benthic fish species and 21 pelagic fish species have been recorded in the waters surrounding Macquarie Island (PWS, 2006). Squid are commonly found in the water surrounding Macquarie Island and are thought to be an important food source for albatrosses and southern elephant seals (PWS, 2006).

Further investigations would be required to confirm the presence of these species or suitable



habitat in relation to the marine cable route and the Macquarie Island landing site.

### 8.1.6. Local and Migratory Birds

The EPBC Act protected matters search identified 37 listed threatened bird species as potentially occurring near the Clovelly landing site. Given the high level of disturbance and modification, the BMH site is unlikely to provide viable habitat for these species. The surrounding waters and rocky cliffs may provide suitable foraging habitat and roosting sites. Some listed marine and migratory species, such as albatross and petrel species, are known to forage in waters off the NSW coastline.

Findings from the desktop review identified 30 marine or migratory bird species as potentially occurring along the marine cable route and near the Macquarie Island landing site.

Over 90 bird species, including more than 60 non-breeding or vagrant species, have been recorded on Macquarie Island. Penguins, such as king penguins (*Aptenodytes patagonicus*), gentoo penguins (*Pygoscelis papua*) and royal penguins (*Eudyptes schlegeli*) are the most abundant breeding species currently present on the island. Gentoo and rockhopper penguins are known to breed and roost in the area surrounding the research center with nest sites varying between years.

The following listed threatened bird species are known to occur on Macquarie Island:

- Antarctic tern (*Sterna vittata bethunei*) – Endangered
- Black-browed albatross (*Thalassarche melanophris*) – Vulnerable
- Blue petrel (*Halobaena caerulea*) – Vulnerable
- Campbell albatross (*Thalassarche impavida*) – Vulnerable
- Grey-headed albatross (*Thalassarche chrysostoma*) – Endangered
- Light mantled sooty albatross (*Phoebastria palpebrata*) – Migratory
- Macquarie Island shag (*Leucocarbo atriceps purpurascens*) – Vulnerable
- Shy albatross (*Thalassarche cauta*) – Endangered
- Soft-plumaged petrel (*Pterodroma mollis*) – Vulnerable
- Sooty albatross (*Phoebastria fusca*) – Vulnerable
- Southern royal albatross (*Diomedea epomophora*) – Vulnerable
- Wandering albatross (*Diomedea exulans*) – Vulnerable
- White-headed petrel (*Pterodroma lessonii*) – Migratory
- White-throated needletail (*Hirundapus caudacutus*) – Vulnerable

In 2002, Macquarie Island was listed as critical breeding habitat for wandering albatrosses and



grey-headed albatrosses under the EPBC Act.

### 8.1.7. Marine Mammals

The desktop review (EPBC protected matters search) identified two listed threatened marine mammal species as potentially occurring in the vicinity of the BMH site and HDD conduit. These are:

- Blue whale (*Balaenoptera musculus*)
- Southern right whale (*Eubalaena australis*).

Both species are known to occur in temperate and sub-polar waters between 20°S and 70°S. Blue whales prefer open seas and therefore limit movements in coastal waters. Southern right whales migrate up the eastern Australian coast in winter to calve in warmer waters off the NSW and Queensland coasts (DSEWPC, 2012). Female whales calve and nurse in waters as shallow as 10 m.

Ten listed marine mammals were identified during the desktop review as potentially occurring along the Australian marine cable route and in the waters surrounding the Macquarie Island landing site. These species include:

- Sei whale (*Balaenoptera borealis*)
- Blue whale (*Balaenoptera musculus*)
- Fin whale (*Balaenoptera physalus*)
- Southern right whale (*Eubalaena australis*)
- Humpback whale (*Megaptera novaeangliae*)
- Subantarctic fur-seal (*Arctocephalus tropicalis*)
- Southern elephant seal (*Mirounga leonina*)
- Sperm whale (*Physeter macrocephalus*)
- Antarctic minke whale (*Balaenoptera bonaerensis*)
- Killer whale (*Orcinus orca*).

Macquarie Island provides habitat for other marine mammals including seals, whales, and dolphins (i.e., killer whales). Colonies of New Zealand fur-seals (*Arctocephalus forsteri*), subantarctic fur-seals (*Arctocephalus tropicalis*), Antarctic fur-seals (*Arctocephalus gazella*) and southern elephant seals (*Mirounga leonine*) are known to inhabit the island. Other species, such as Hooker's sea lion (*Phocarctos hookeri*) and leopard seals (*Hydrurga leptonyx*), visit the island during winter and spring (PWS, 2006).

Killer whales (*Orcinus orca*) are the most common marine species observed and are recorded throughout the year. Longfin pilot whales (*Globicephala melaene*) are also occasionally recorded in small pods offshore (PWS, 2006).



In 2017, National Guidelines for Whale and Dolphin Watching (DEE, 2017) were released to provide guidance on managing interactions with whales and dolphins in Commonwealth waters. The guidelines stipulate approach distances to minimize disturbing whales and dolphins under different circumstances. Although these guidelines apply to whale and dolphin watching, they may be applied to cable laying activities, particularly support vessel operations.

EPBC Act Policy Statement 2.1 Interaction between offshore seismic exploration and whales (DEWHA, 2008) applies to seabed geophysical surveys using seismic survey methods. The project will need to comply with this policy if geophysical surveys are required at the Sydney and Macquarie Island landing sites approaches or along the submarine cable routes in Australian waters.

### **8.1.8. Biosecurity**

The introduction of invasive flora and fauna species is a key threat to the biodiversity on Macquarie Island. Currently, three invasive fauna species are known to occur on the island, namely European rabbits, common rat, and house mouse (PWS, 2006). These species have resulted in widespread impacts to palatable plant species. Eradication programs are currently in place, with monitoring suggesting that these invasive species population are declining. Further monitoring is underway to determine whether any invasive marine species are present (PWS, 2006).

To manage the risk of introducing invasive species to Macquarie Island, the Australian Antarctic Division implements a range of strict biosecurity measures. The project will be required to comply with these measures during cable laying and land activities.



## NEW ZEALAND

### 8.2. New Zealand

#### 8.2.1. Marine Protected Areas and Restricted Activities

There is a mataitai reserve on the southern portion of Oreti Beach and Sandy Point Domain (Figure 8-6) foredune that extends from the Waimatuku River mouth to the southern end of the beach, and 1 km out from the high tide level. Matters of Kaitiakitanga are relevant to the use and development of resources in all areas. Māitaitai reserves are marine areas where specific additional fishing rules and restrictions apply, specifically provided for in the Fisheries (South Island Customary Fishing) Regulations 1999 in fulfilment and in accordance with statutory provisions of the Treaty of Waitangi (Fisheries Claims) Settlement Act 1992 and the 1997 Ngāi Tahu Deed of Settlement. This reserve area represents a ban on all commercial or recreational fishing in this area, to recognize and provide for taiāpure (local fisheries).

The proposed cable landing route does not cross any Department of Conservation (DOC) listed marine reserves or MPA. The protected areas, aside from the Sandy Point Domain (in which the landing is located), closest to the proposed landing (Figure 8-7) are the Catlins Coast Marine Mammal Sanctuary and the Te Waewae Bay Marine Mammal Sanctuary (DOC, 2022). Fisheries restrictions on the Southland coast include the following protections:

- Set net prohibited areas (from Invercargill to Dunedin) (Figure 8-8)
- Blue cod management area (take/size limits)
- Specified seasons and gear restrictions for takes of shellfish (i.e., dredge oysters, scallops etc.) and rock lobster.

In deeper waters within the sub-Antarctic deep, the proposed alignment crosses the BPA17 boundary, which is an area where dredge and bottom trawling is prohibited under the Fisheries (Benthic Protection Areas) Regulations 2007 (Figure 8-9).

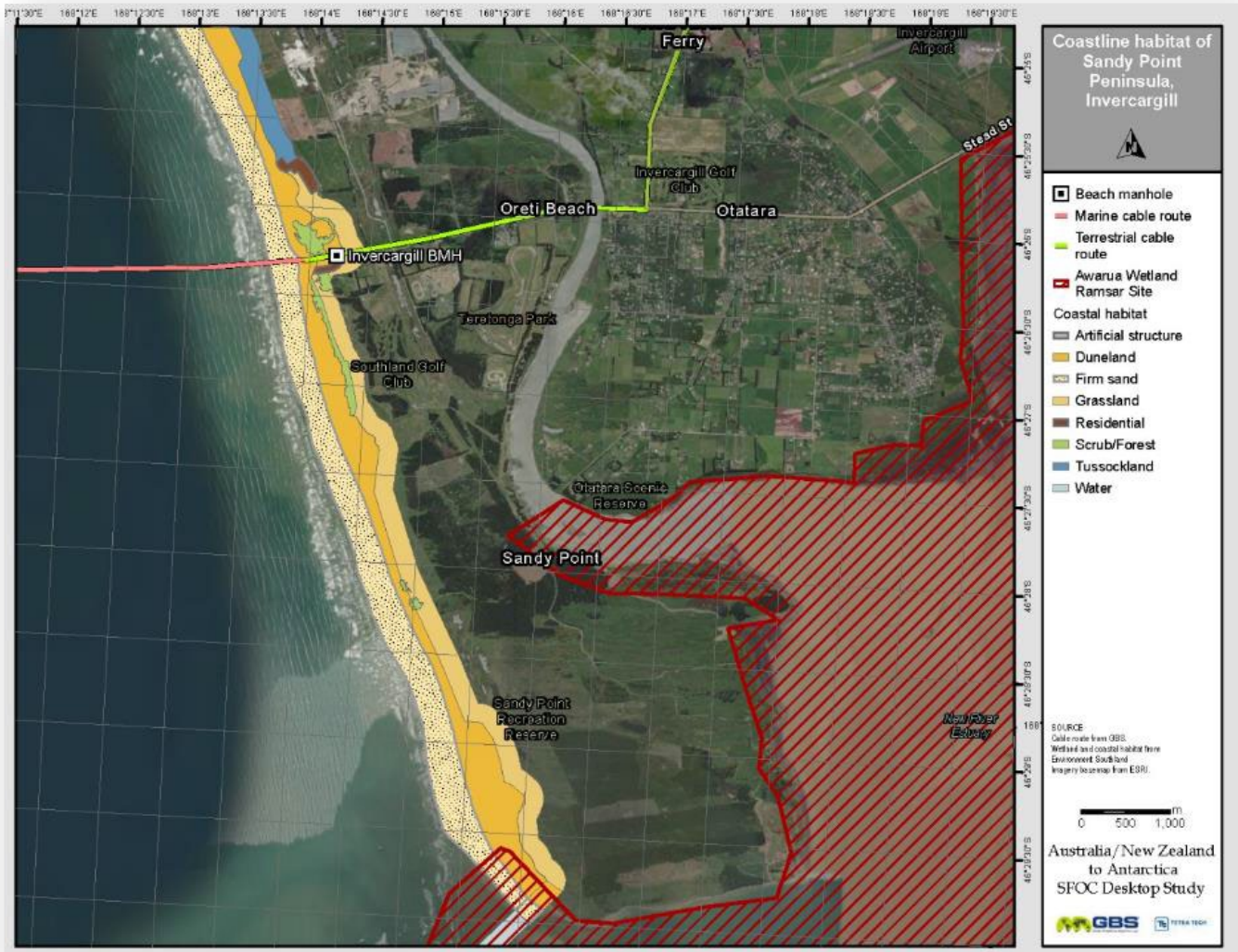

(Environment Southland, 2008; Esri, n.d.b.)

Figure 8-6. Coastline Habitat of Sandy Point Peninsula, Invercargill.

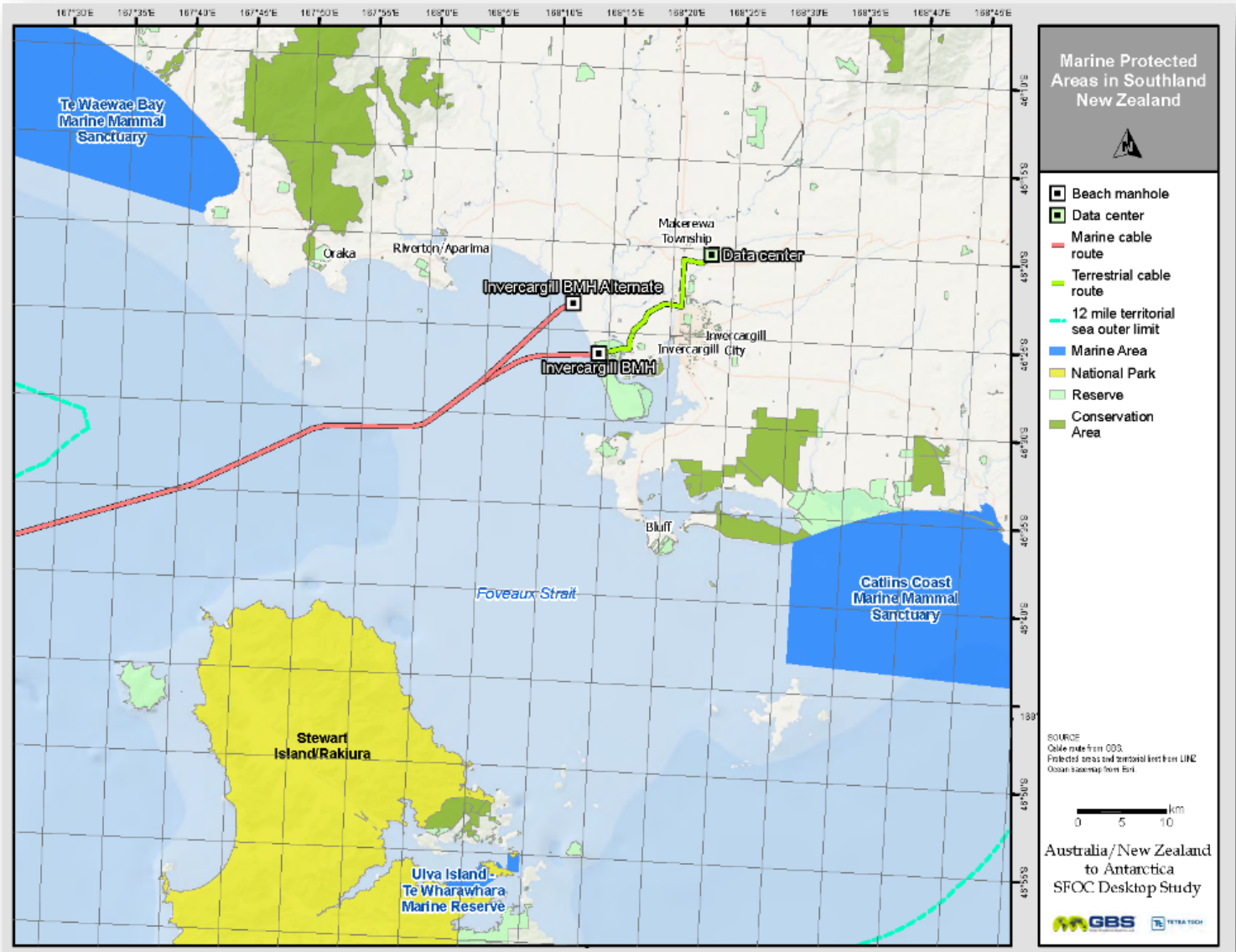

(LINZ, n.d.; Esri, n.d.a.)

Figure 8-7. Coastline Habitat of Sandy Point Peninsula, Invercargill.

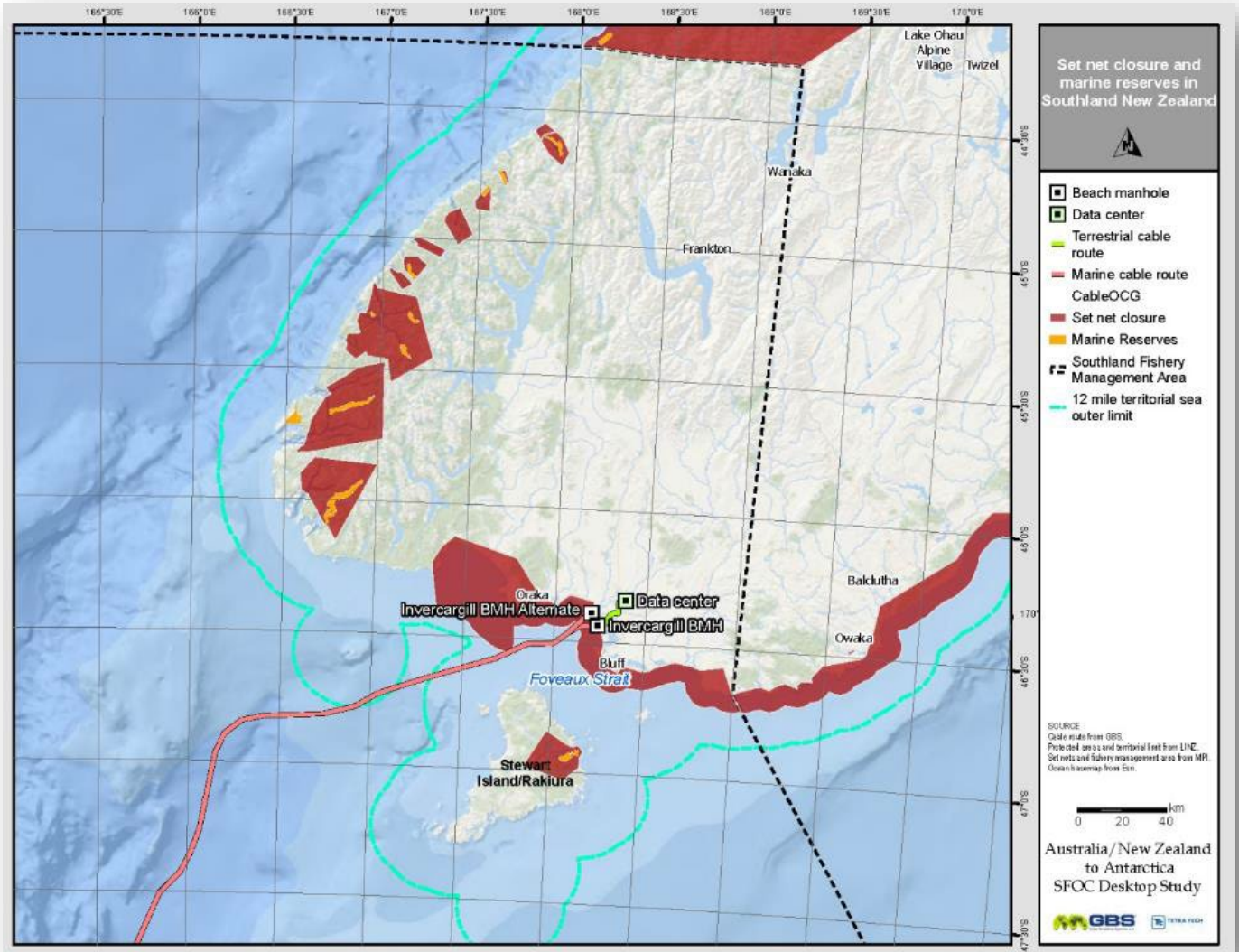

(LINZ, n.d.; Ministry for Private Industries [MPI], n.d.a.; Esri, n.d.a.)

Figure 8-8. Set Nets in Invercargill Area.

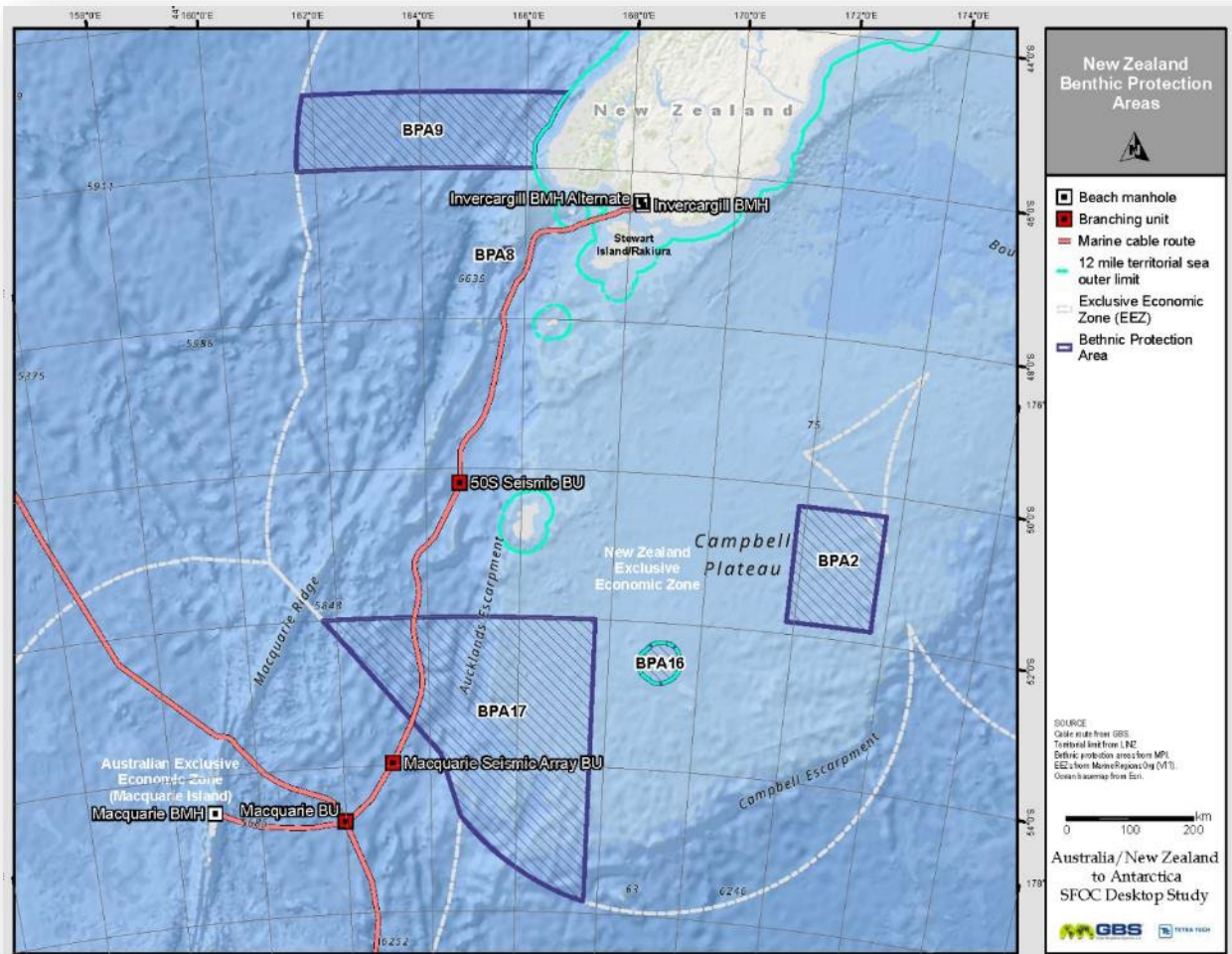

(LINZ, n.d.; MPI, n.d.; MarineRegions.org, 2019; Esri, n.d.a.)

Figure 8-9. Benthic Protection Areas Near Invercargill Areas of concern.

Sandy Point Domain is classified as a Recreation Reserve pursuant to Section 17 of the Reserves Act 1977. Reserves are classified under the Reserves Act 1977 according to their dominant characteristics, use and current and future values.

Sandy Point Domain has also been classified as an Environmental Reserve within the Invercargill City Council Park categories. Environmental Reserves are managed for the purpose of environmental protection and passive recreation. They are made up of predominantly natural areas and may contain remnants of forest, tussock or grassland, wetlands or sand dunes.

Reserves are classified to ensure their control, management, development, use, and preservation is for the appropriate purposes. They may have special scenic, historic, or environmental values that set them apart from other “recreational” type reserves. Management of Sandy Point has



been divided into Recreation, Environment, and Forestry following management zones, with passive recreation being predominant over most of the area. The proximity of Sandy Point Domain to Invercargill makes it a valuable educational resource. It is within easy reach for school parties for outdoor education, thus avoiding the necessity to make long journeys for the purposes of studying plant ecology. It also provides the public at large with varying areas of native vegetation, which can be enjoyed by the simple pleasures of walking or just sitting and observing.

The area is vulnerable to any development, as the removal of vegetation cover can result in a blow out with a hole created in the dune wall, allowing sand to travel east for some direction. This can have a marked impact on activities and vegetation within the Domain. It is important that any activity that may be allowed in this area is controlled and managed so as not to have any detrimental effect on the area. The low habitat of any vegetation and the openness that this creates makes any buildings or structures highly visible for some distance. From the top of some dunes, considerable views can be gained of the surrounding landscape. There are clustered groups of windblown *Pinus radiata* and *Macrocarpa* scattered within this zone, but the plants are often restricted to growing along the ground because of the strong coastal winds.

The Sandy Point Domain states that “The importance of Sandy Point Domain as a wildlife habitat cannot be over-stressed. All existing habitat areas should be retained and, where necessary, enhanced by planting with suitable vegetation.”

The policies and objectives for Sandy Point Domain are documented in the Sandy Point Domain Management Plan. When considering an application to develop or change part of a reserve, Council will consider the existing character of the reserve, including:

- The existing and potential use of the reserve.
- The natural and built environment.
- The surrounding landscape and the use of neighboring land.
- The purpose and classification of the reserve under the Reserves Act 1977 and the management objectives stated in the current Reserve Management Plan.

Before any development is implemented, it must be established that there is a need for such development and that what is proposed will be of benefit to the reserve and to those using it.

While unlikely to be affected by project activities, the nearby New River Estuary is also of high educational value; Table 8-1 outlines these values.



**Table 8-1. Environmental and Educational Values of New River Estuary**

Mouth of New River Estuary to Sandy Point	Sandy Point to West's Point
<p><b>Values:</b></p> <ul style="list-style-type: none"> <li>(i) Least modified part of New River Estuary</li> <li>(ii) Marine in nature and relatively clear water</li> <li>(iii) One of the most navigable areas of estuary</li> <li>(iv) No Spartina</li> <li>(v) Best water quality within the estuary</li> <li>(vi) Popular for floundering</li> <li>(vii) Moderately popular for bathing</li> <li>(viii) Adjacent to domain</li> <li>(ix) Semi-remote, vehicular access</li> <li>(x) Sandy foreshore</li> <li>(xi) Part of a loop including Oreti Beach and Sandy Point Domain used by runners, mountain bikers and horse trekkers</li> <li>(xii) Pipi and cockle beds, blue mussels present</li> </ul> <p><b>Issues:</b></p> <ul style="list-style-type: none"> <li>(i) Eroding shoreline</li> <li>(ii) Sedimentation</li> </ul>	<p><b>Values:</b></p> <ul style="list-style-type: none"> <li>(i) High recreational value                             <ul style="list-style-type: none"> <li>- generally firm sediments but soft near streams or small embayments</li> <li>- good access</li> <li>- sheltered from westerlies</li> <li>- includes a boat launching area</li> </ul> </li> <li>(ii) High visual amenity                             <ul style="list-style-type: none"> <li>- lack of modification</li> <li>- natural vegetation on shoreline</li> <li>- provides an outlook from adjacent picnic areas</li> <li>- source of open space</li> <li>- tranquil environment</li> </ul> </li> <li>(iii) High Maori value                             <ul style="list-style-type: none"> <li>- mahika kai, cockles and pipis and flounder</li> <li>- wahi tapu on adjacent land</li> <li>- site of former kaik</li> </ul> </li> <li>(iv) High heritage value                             <ul style="list-style-type: none"> <li>- site of early whaling base</li> <li>- one of earliest settled areas in greater Invercargill</li> </ul> </li> <li>(v) High educational value                             <ul style="list-style-type: none"> <li>- good access and reasonable biodiversity</li> </ul> </li> </ul> <p><b>Issues:</b></p> <ul style="list-style-type: none"> <li>(i) Isolated patches of Spartina</li> <li>(ii) Gradual erosion of shoreline</li> <li>(iii) Inappropriate access</li> </ul>

### 8.2.2. General Environmental Setting

The proposed landing area intersects the Southland coast 7.5 km north of the southern extent of the 26-km-long Oreti Beach, the central bay of three lying on the Foveaux Strait coast. On the east, it is bounded by the lower reaches of the Oreti River and the New River Estuary, and on the west bounded by the waters of Foveaux Strait.

The landing area is situated within Sandy Point Domain, a large sand and shingle peninsula formed at the mouth of the Oreti River. The Peninsula lies in an approximately northwest/southeasterly direction, and its northern end is bounded by the private property of the Fosbender estate.

Oreti Beach is fairly broad, with 300 m of exposed beach flat at low tide and comprises smooth

beach sands. A littoral or transverse dune system extends for the entire length of Oreti Beach but becomes progressively smaller at its southern end. Behind this littoral dune system, a series of lateral dunes extend across the peninsula. The lateral dunes are mostly marked on the eastern half of the peninsula, particularly in the area north of Dunns Road and south of the Waterski Club. They attain their greatest development in the vicinity of Daffodil Bay.

To the south (beyond the immediacy of the proposed cable landing area, the beach and dunes transition to an estuarine environment at New River Estuary (surrounding Sandy Point), a large 'tidal lagoon' type estuary (area 4,100 ha) characterized by soft, anoxic mud-dominated sediments. This shallow estuary (mean depth ~2m) is bordered by a mix of vegetation and land uses (urban, bush, and grazed pasture). The estuary has been significantly affected by urban and rural development over the past 150 years. This includes large areas of reclaimed land, urban discharges including treated sewage and untreated stormwater, past landfill leaching, and agricultural activities and run-off further up the catchment. The estuary receives freshwater from a large, predominantly agricultural catchment, which includes both the Oreti and Waihopai Rivers.

The area is managed by Invercargill City Council (ICC) with Sandy Point Domain considered a valuable recreation area (2000 ha) by the local community comprising beach, river, estuary, and forest habitats.

### 8.2.3. Biological Communities

An inventory of the flora and fauna that are known to exist in the Environmental Reserves of Invercargill is provided at: <https://icc.govt.nz/parks-and-reserves/environmental-reserves/list-of-flora-and-fauna/>

The Sandy Point Domain Management Plan also describes the ecological context and biological communities of the area <https://icc.govt.nz/wp-content/uploads/2014/10/Sandy-Point-Domain-Management-Plan-July-2013.pdf>

The most relevant biological communities are summarized below.

### 8.2.4. Vegetation

Sandy Point Domain is rich in indigenous plant species and contains a varied selection of vegetation habitat zones. It constitutes the richest biodiversity area within proximity to Invercargill and more than 220 different native plants have been recorded. Some of the plants which grow on Sandy Point do not occur elsewhere in the Invercargill district, while others are uncommon. The coastal dune areas are dominated by sand tussock grasslands and pingao sedge lands, with some turfs associated with swales and small dune lakes. Otatara also has the best remaining example of coastal totara and totara-matai sand dune forests in New Zealand. While substantial modification of the original vegetation has occurred, some remains in a relatively





undisturbed state, including the marram zone which is the foremost protective area for Sandy Point Domain (see Figure 8-10).

The vegetation closest to the landing is a dune zone of marram grass (an introduced species which stabilizes the dunes), with flax behind this, as well as sand fescue and mosses. The significant sand dune and sand plain forest remnants of the Otatara-Sandy Point area have been ranked as nationally representative (ICC, 2014). The ICC states that every effort must be made to ensure their continuing stability.

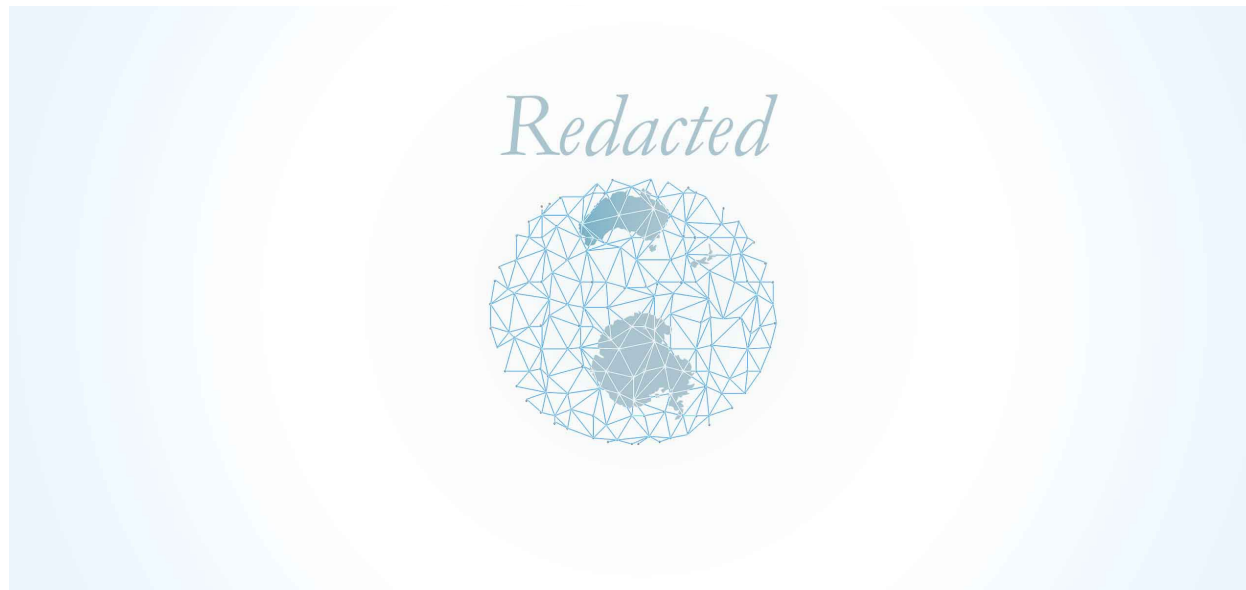

Figure 8-10. [Redacted]. Sandy Point Vegetation Zones.

More broadly, this area has the only example of a sequence of totara, totara-matai and mixed podocarp forest remnants on differently aged sand dune and sand plain surfaces in New Zealand. Although fragmented, the forest remnants are large enough and connected enough to ensure their future viability/survival. In other areas native plants have regenerated or have been planted to protect native wildlife and increase the beautification of the Invercargill District.

### 8.2.5. Dune Communities

The most common species found in the sand dunes is the common sand hopper (*Talorchestia quoyoni*) which is found living under and feeding on seaweed, driftwood, and the roots of marram grass. Early in summer, March flies (*Dilophns nigrostigma*) are very numerous around flowering lupins. The bumble bee (*Bombus terrestris*) and the orange, purple and yellow beetle (*Zorian minutum*) can also be seen feeding on the lupin flowers. Ants (*Prolasius advena* and *Monomorium antarcticus*) are found living under the lupins along with the common slater (*Porcellio scaber*), the large black beetle (*Cilibe* sp) and the ground beetle (*Mecodema* sp). Three species of centipede and two species of millipedes were found living in the sand dunes. Eight species of spider (*Lycosa*



sp, *Lycosa hilaris*, *Diea* sp, *Allotrochosa shavinslandi*, *Sidymella* sp, *Araneus subcompta* and *Araaneus* sp.) have been found in the sand dunes. Living amongst flax is the jumping spider (*Trite planiceps*). Many more species are also to be present, possibly including the katipo spider. Butterflies and moths found in the sand dunes include the tussock butterfly (*Argyrophenga antipodum*), cabbage white butterfly (*Pieris rapae*), common copper butterfly (*Lycaena salustis*), magpie moth (*Nyctemera annulata*), common grass moth (*Crambus flexuosellus*) and the porina moth (*Porina umbraculata*). Two species of beetle live under the driftwood on the beach. They are the rove beetle (*Creophilus* sp) and the sand beetle (*Thelyphassa limbata*).

### 8.2.6. Aquatic Ecology

Some 14 species of fish have been recorded from the waters on and around Sandy Point Domain. Most occur in the New River Estuary with only one or two fresh-water species occurring:

- Sand flounder *Rhombosolea plebian*
- Yellow-bellied flounder *Rhombosolea leporine*
- Green-backed flounder *Rhombosolea taperina*
- Black flounder *Rhombosolea novaezelandiae*
- Sole *Peltorhamphus novaezelandiae*
- Long-finned eel *Anguila dieffenbachia*
- Short-finned eel *Anguila australis schmidtii*
- Lamprey *Geotria australis*
- Yellow-eyed mullet *Aldrichetta fosteri*
- Smelt *Retropinna*
- Whitebait *Galaxis maculatus* and probably several other *G fasciatus* make up the bulk of the whitebait species.
- Brown trout *Salmo trutta*
- Stargazer *Leptoscopus macopygus huttoni*
- Globefish *Sphiroedes richiei*
- Red cod or hoka *Physiculus bachus*

The New River Estuary supports a wide range of habitats and species including extensive mud and sand flats, as well as ecologically significant cockle (*Austrovenus stutchburyi*) and seagrass beds (*Zostera muelleri*). Fish species such as flounder (*Rhombosolea plebeian*), eel (*Anguilla dieffenbachia*), white bait (*Galaxiidae*) and grey mullet (*Mugil cephalus*) are also known to inhabit this area along with various types of shellfish. Stevens and Robertson (2012) reported that dense seagrass beds occur in the lower estuary near Omaui, in the eastern arm, and near the Oreti



River mouth. Seagrass appeared in relatively good condition with healthy growth, little fine mud, and no obvious macroalgal smothering. These habitats provide nursery and feeding grounds for a range of invertebrates and fish. In the eastern portion of the estuary, seagrass was primarily observed in sandier sediments, and beds tended to be less dense than in the north. *Zostera muelleri* shoots with a <1 % cover were observed throughout the eastern side of the estuary. Seagrass beds are important ecologically because they enhance primary production and nutrient cycling, stabilize sediments, and elevate biodiversity. Seasonal variations in nutrient inputs, temperature and flow regime cause periodic growth in aquatic plant communities (Roberts, et al., 2021).

The estuarine mudflats and salt marshes which fringe the Oreti River provide habitat to a suite of native diadromous fish. Species which have been known to occur include the Longfin eel (*Anguilla dieffenbachia*), classified as 'At risk – Declining,' shortfin eel (*Anguilla australis*) and various species of the Galaxiidae family (Whitebait species) (ICC, 2016). The Oreti River is also well known as a trophy trout fishing river. The Oreti River is also known to provide habitat to a non-migratory Alpine galaxias (*Galaxias aucuspondylus Stokell*). The Alpine galaxias species is considered neither common or widely distributed compared when with other galaxias species; this species has been known to occur throughout the freshwater zones of the Oreti River and is classed as 'nationally vulnerable' under the New Zealand Threat Classification System (Bonnett, 1992; Dunn et al., 2017).

Large schools of dolphin (up to hundreds) have been recorded as sometimes entering the estuary. It is presumed that they are either the Dusky dolphin or Hector's dolphin. Individual New Zealand Fur Seals (*Arctocephalus forsteri*) occasionally enter the estuary and have been recorded as swimming up either the Waihopai or Oreti Rivers.

### 8.2.7. Amphibians

Two species of introduced frog occur and form an important part of the ecological community. The golden bell frog (*Littoria raniformis*) is found mainly in the ponds in the northern part of Sandy Point Domain and. The brown tree frog (*Littoria ewingii*) is found wherever there is sufficient moisture for the adults to survive. The tadpoles of both species provide one of the principal sources of food for bitterns which frequent the area. A skink and two gecko species, including the green tree gecko, are said to occur.

### 8.2.8. Avifauna

At least 86 different species of bird have been recorded in the Domain itself or on the surrounding waters. This includes the yellow-eyed penguin (*Medadryptes antipodes*) and the southern blue penguin (*Eudyptula minor minor*). Both are occasional visitors usually when in molt, that breed along Southland coasts.

### 8.2.9. Environmental Monitoring

Over the last 10 years, the Oreti River has seen a decline in visual clarity as well as an increase in long filamentous algae cover and periphyton biomass generally. The dissolved oxygen levels across the site monitored are classed primarily in the A and B states with approximately 60% of the monitored sites requiring improvement to meet regional freshwater objectives (Environment Southland, 2019). Additional monitoring data indicates that:

- Between 2010 and 2019, 60-70% of monitoring sites managed by Environment Southland showed acceptable levels of E. coli with respect to national standards regarding human health.
- Between 2010 and 2019, 70-80% of monitoring sites managed by Environment Southland showed acceptable levels of nitrogen with respect to national standards regarding human health.

The 'New River Estuary Macroalgal Monitoring 2018' report combined with the 'New River Estuary Review of Water Quality data' show that regions of the upper estuary are under stress and showing eutrophication. There is excessive macroalgal growth including sediment quality decline and high concentrations of chlorophyll-a in the water column. Chlorophyll-a was used as an indicator of eutrophic conditions in the water column and is a color pigment present in many types of algae that can give an indication of how much algae is present in the water column. Nuisance blooms of macroalgae (*Ulva* and *Gracilaria*), failure to meet fecal bacterial guidelines regarding swimming and gathering shellfish, and sedimentation problems are common within the estuary.

Despite the presence of these issues, human use, and ecological values of large parts of the estuary remain high. Action is proposed to be taken to improve the environmental values, particularly in areas where the condition is poor.

### 8.2.10. Invasive Pest Species

Recent monitoring from Environment Southland has shown significant and expanding growths of opportunistic nuisance macroalgae *Agarophyton chilense* in and around the New River Estuary (Roberts et al., 2021). The 2021 reporting noted significant losses of high-value sea grass communities in New River Estuary (82% when compared with 2001 baseline). This is partially attributed to excess nutrient levels, smothering of fine sediment, declining sediment oxygenation and macroalgal overgrowth associated with land use activities further up the Oreti and Waihopai catchments.

As shown in Roberts et al. (2021), some areas of the nearshore/estuarine environment were so eutrophic that macroalgae appeared not able to survive. Recent reporting shows a number of shallow intertidal areas covered with toxic algal growth (cyanotoxins).



The Regional Pest Management Strategy defines gorse (*Ulex europeaus*) as a 'containment pest plant' and requires that gorse be destroyed within 10 meters of any property boundary where the neighboring property is free of gorse. Gorse, over time, can damage fences and render them ineffective in controlling stock. The control and eradication of weeds on Council reserves is the responsibility of the Invercargill City Council Parks Division. The effective control of weeds is undertaken to comply with the Regional Pest Management Strategy for Southland.

## ANTARCTICA

### 8.3. Antarctica

#### 8.3.1. General Setting

McMurdo Sound is located in Antarctica, approximately 3,500 km south of New Zealand. The northern side of the sound connects to the Ross Sea which, due to a wind-driven oceanic gyre, provides a flow of nutrient rich waters into the sound. The circulation of nutrients into the sound supports an abundance of plankton which in turn promotes complex marine biodiversity throughout this area. The Ross Sea benthic ecoregion is generally characterized as a very cold seabed with high sea ice duration.

The proposed landing point at McMurdo Station is largely characterized as uninhabited shoreline overlain by ice sheet and snow for most of the year. Less than 10% of McMurdo Sound's shoreline is free of ice year-round and narrow gaps in the ice provide access by ship to the established scientific research stations. Research by Halpern et al. (2008) determined that the region had the lowest level of disturbance from anthropogenic impacts when compared with the rest of the world's oceans.

#### 8.3.2. Benthic Habitats and Biological Communities

The structure of benthic communities in McMurdo Sound (and elsewhere around Antarctica) is primarily governed by the pattern and severity of natural disturbances from ice scour and the formation of anchor ice. Many benthic species have restricted depth ranges and depth-related factors can be strong barriers to dispersal of benthic species in the region. In the McMurdo Sound region, ice floes from the near-by Ross Ice Shelf occasionally scrape the bottom as they move with the tides and currents during the breakup period. This scouring can occur to depths of at least 15 m, depending on the size of the floe (Crockett & White, 1997). Though ice scouring by drifting floes will occur only rarely at any given location, the slow growth rates of benthic



organisms in the region results in very long recovery periods following such a disturbance event. Even at low disturbance frequencies, sessile benthic species will be absent. The importance of these physical stresses led to the characterization of shallow-water benthic communities into three vertical zones. According to this scheme, Zone 1 consists of the communities within depths down to 15 m, and Zone 3 represents the communities below 33 m, in which anchor ice formation has not been observed. Zone 2 constitutes the transition area between Zones 1 and 3.

As put forth by Crockett and White (1997), the Zones are summarized as follows:

### *Zone 1*

The shallow Zone 1 represents the most highly disturbed benthos, in which anchor ice forms continuous mats on the substrates and in which ice scour generally occurs every year. At Cape Annitage and Hut Point, this region of regular disturbance was found to extend consistently to a depth of approximately 15 m. Zone 1 areas have "a general organic barrenness," in which the combination of abrasion from moving masses of ice and heavy anchor-ice formation effectively removes any life forms that become established annually. Fauna of Zone 1 is, therefore, characterized by motile detritus feeders and their predators. The most common life forms encountered in these areas include detritus-feeding sea urchins (*Sterechinus neumayeri*), sea stars (*Odontaster validus*), and scavengers such as nemertean worms (*Parbolasia* sp.). Isopods (*Glyptonotus antarcticum*), sea spiders (pycnogonids), and fish occasionally may be found.

### *Zone 2*

The upper limit of Zone 2 is found at about 15 m, and likely represents the lower level of predictable annual removal of sessile fauna by ice scouring and heavy anchor ice formation. The lower limit of Zone 2 is abrupt and predictable at 33 m. Very slow-growing sponges cannot survive for long at depths below 33 m due to periodic disturbance. Because the frequency and severity of physical disturbance from ice phenomena decreases with depth through Zone 2, a vertical gradient exists in which species diversity, abundance, and growth all gradually increase concomitantly. Faunal assemblages, therefore, change gradually over an extended range through Zone 2 until the undisturbed, complex communities of Zone 3 are found. Though most of the motile fauna found in Zone 1 also are found in Zone 2, numerous sessile animals not found in Zone 1 may be found in Zone 2. The frequency with which these forms are encountered increases with depth through Zone 2. Common species in Zone 2 that are not typically found in Zone 1 include actinarians (*Isotelia anrartica*, *Urticinopsis antarctica*, *Hormathia lacunijera*); stolonifera (*Clavularia frankliniana*); and hydrozoans (*Tubzilaria hodgsoni*, *Lampra pawula*). Toward the lower portion of Zone 2, scattered individuals of the hydroid *Halecium arborcum* and occasional clumps of sponges also may appear.



### Zone 3

Zone 3 begins abruptly at 33 m. Ice scouring is rare (but not absent) below this depth. Although this represents a sharp physical boundary beneath which disturbance from anchor ice is absent, changes in the faunal communities remain much less distinct because of the continued (though less frequent) disturbance from ice scouring. Zone 3 fauna consists of a complex sponge spicule mat community. This sponge spicule mat is typically at least 1 m thickness, and is, therefore, dominated by a vertical structure. In contrast, benthic communities in Zones 1 and 2 maintain a strictly horizontal structure. The sponge spicule mat comprises numerous intermingled sponge species along with species of mollusk as well as polychaetes and bryozoans. Species diversity is considerably higher than that found in Zones 1 or 2. Dearborn (1965) recorded more than 12,500 individuals of an undetermined number of the various species within a cubic decimeter of the sponge mat. Feeding upon the sponges were several species of asteroids and nudibranchs, which constitute the most conspicuous motile representatives of Zone 3 fauna. Detritus feeders are present.

Below the level of periodic ice scouring, benthic communities are typically dominated by sessile, particle-feeding organisms including hexactinellid sponges, desmosponges, hydroids, tunicates, polyzoans, sedentary polychaetes, lamellibranch mollusks, actinarians, scleractinian corals, and holothurians. Because of their slow growth rates, these organisms cannot exist where disturbance occurs.

Brueggeman (<http://peterbrueggeman.com/nsf/fguide/>) compiled a seven-volume underwater field guide to Ross Island and McMurdo Sound, describing many of the various taxa present, including:

- Porifera: demosponges, glass sponges, calcareous sponges
- Cnidaria: anemones, soft coral, medusae, siphonophores, hydroids, jellyfish
- Mollusca: nudibranchs, pteropods, gastropods, bivalves, chitons, octopus
- Echinodermata: sea stars, urchins, brittle stars, sea cucumbers, crinoids
- Arthropoda: sea spiders, amphipods, isopods, copepods, krill, ostracods, mysids, tanaids, barnacles, shrimp
- Chordata: salps, ascidians, tunicates, fish, penguins, marine mammals
- Protoctista: foraminiferans, amoeba, algae, diatoms

Other Phyla: comb jellies, ctenophores, proboscis worms, bryozoans, brachiopods, lamp shells, arrow worms, polychaetes, bristle worms, featherduster worms, leeches.

There are at least 22 endemic mollusks (11.5% of documented species) and 16% of documented gastropods are endemic (Harris & Whiteway, 2009; Arango et al., 2011).

Another study (Cummings et al., 2002) by the National Institute of Water and Atmosphere (NIWA)



quantified patterns of biodiversity and benthic communities in McMurdo Sound. This study found a strong coupling between physical and biological processes in the Antarctic coastal environment as well as between water column and seafloor ecology. There were large differences in habitat structure, macroalgae and microphytobenthic standing stock between locations. The New Harbour habitat is dominated by soft sediments while Cape Evans is dominated by rocks and boulders interspersed with soft sediments and abundant macroalgae. Although Dunlop Island and Spike Cape are more similar to Cape Evans than New Harbour, there are also distinct differences between all three. The red alga *Phyllophora antarctica* and encrusting coralline algae are present at Dunlop Island, Spike Cape and Cape Evans, and their abundances differed between locations. New Harbour sediments had the lowest chlorophyll and phaeophytin biomass of the four locations, while Cape Evans sediments had the highest levels. In addition, a higher proportion of the microphytobenthic biomass was in a degraded state at Spike Cape and New Harbour. There were also differences in the diversity and composition of large epibenthic taxa, and macro-infauna between locations.

In general, the physical habitats in McMurdo Sound are highly variable but can be defined by three major habitat categories (Cummings et al., 2002):

- **Crustose/bare rock:** consisting of rocky sea floor (fist – large boulder) with varying cover of the encrusting coralline algae.
- **Phyllophora:** denoting areas covered by the red macroalgae *Phyllophora antarctica*. The red macroalgae is most commonly observed in crevices and cracks in rocks or attached to spines of the sea urchin *Sterechinus neumayeri*.
- **Coarse sediments with detritus:** found between rocks and boulders, in depressions and as larger scoria fields. Often larger coarser sediments were covered with fine sediment, microphytobenthos and detritus (fragments of degrading macroalgae).

McMurdo Sound has a relatively small range of marine flora, limited to just a few species of macroalgae (Figure 8-11). The three most dominant species of red algae include *Iridaea cordata*, *Phyllophora antarctica* and *Leptopytum colmanicum* (Miller & Pearse, 1991). In this area sea ice covers the water's surface for most of the year. Past research has described volcanic gravel beaches at the intersection of land and sea. The gravel beach slopes down to a 3.5 m shelf which is covered by a heavy flocculant layer of benthic diatoms (Miller & Pearse, 1991). The bed rock outcrops atop of this shelf support a range of benthic invertebrates including types of Sea stars (*Odontaster validus*), Sea urchins (*Sterechinus neumayeri*) and Gastropods (*Neobuccinum eatoni*) (Miller & Pearse, 1991).



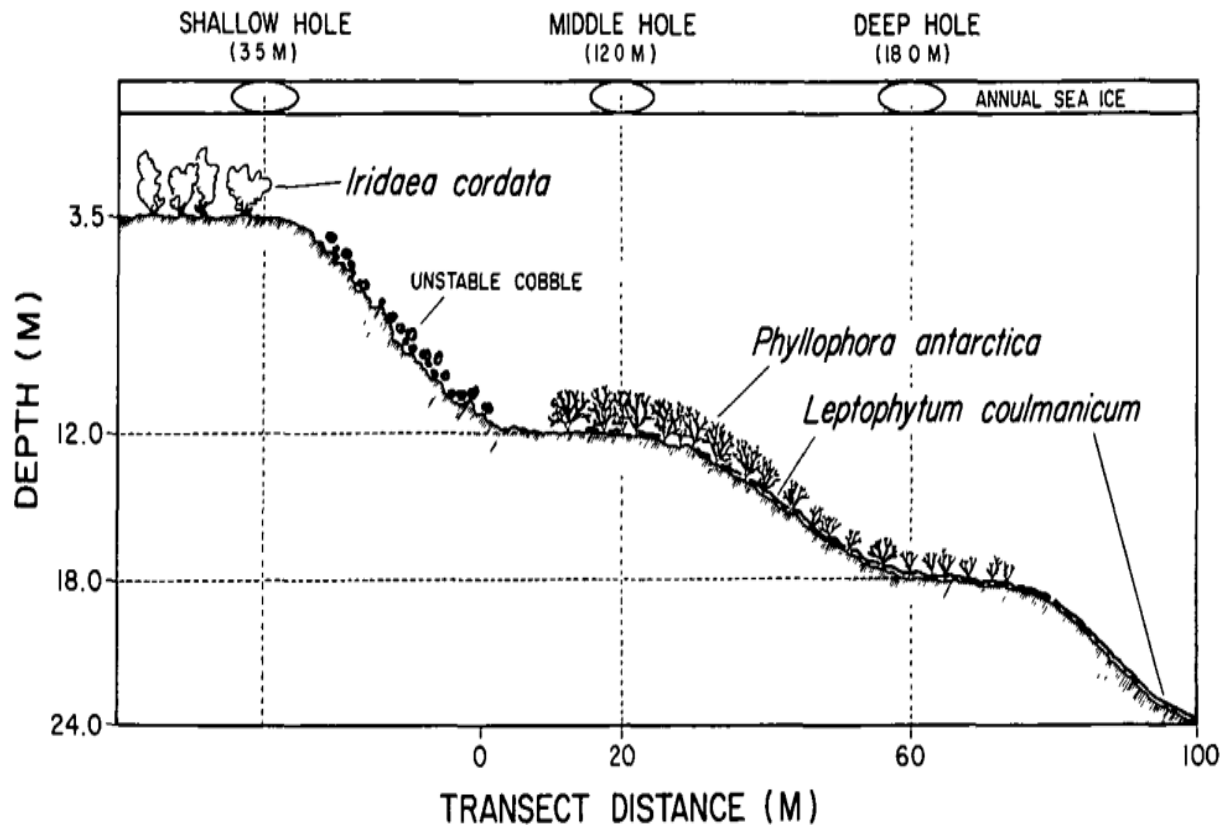

(Extracted from Miller & Pearse, 1991)

Figure 8-11. Cross-sectional Diagram of Subtidal Study Site in McMurdo Sound, Antarctica. Diagram.

### 8.3.3. Pelagic Megafauna, Marine Mammals and Birds

The Ross Sea and McMurdo Sound specifically provide habitat to a rich diversity of marine mammal and bird species. The main species that have been identified within the vicinity of the proposed project area are: Emperor Penguins (*Aptenodytes forsteri*), Adeliae Penguins (*Pygoscelis adeliae*), Weddell seals (*Leptonychotes weddellii*), Leopard seals (*Hydrurga leptonyx*), Crabeater seals (*Lobodon carcinophaga*), Ross seals (*Ommatophoca rossii*), Arnoux's beaked whales (*Berardius arnuxii*), Killer whales (*Orcinus orca*) and Antarctic minke whales (*Balaenoptera bonaerensis*) (MMPATF, 2022). Type C killer whales are a distinct species of specialist fish-feeder orca known to prey on Antarctic toothfish during part of the summer season. Type C killer whales are thought to comprise the majority of all killer whales in the Ross Sea shelf, where they appear to be highly resident during the summer, foraging preferentially around and under fast ice in the marginal ice zone of the Ross Sea polynya or coastal polynyas. Distributions outside of the summer season are unknown (Pinkerton & Sharp, 2012).



Antarctic silverfish (*Pleuragramma antarctica*) are the species most responsible for trophic energy transfer to higher trophic levels in the highly productive Ross Sea shelf ecosystem, constituting 40% of the total diet of top predators here. Trophic models indicate that Antarctic silverfish have a very high 'ecological importance' in the Ross Sea shelf ecosystem, meaning that even minor changes in the abundance of Antarctic silverfish can be expected to propagate through the food web to affect other species.

Krill are extremely important because they are the main diet for most of the marine predators (penguins, seals, whales, fish) in the Southern Ocean. At the same time krill themselves are the major grazer of primary production within their range. Krill plays the important role of re-packaging vast amounts of primary production into their own body by grazing micro-size phytoplankton to make them available for marine predators. Because of this role they are called the 'keystone species' in the Southern Ocean ecosystem. Antarctic krill are also regarded as one of the most abundant animal species on the planet. Crystal krill (*Euphausia crystallorophias*) are an important prey species for penguins and crabeater seals, and also for Antarctic silverfish which in turn support the full suite of abundant top predator populations in the Ross Sea shelf ecosystem. Trophic models indicate that crystal krill have a high 'ecological importance' in the Ross Sea shelf ecosystem.

The Ross Sea slope is the preferred adult feeding ground for the Ross Sea region Antarctic toothfish (*Dissostichus mawsoni*) stock. Available evidence indicates that toothfish sequentially inhabit a series of habitats in the Ross Sea region and subarea 88.2 as part of a large-scale life-cycle migration and periodic spawning migrations. Antarctic toothfish are known to spawn on seamounts and underwater features of the Pacific Antarctic Ridge in the north of the Ross Sea region. In the northwest, ocean currents associated with the Ross Gyre are thought to supply fertilized eggs and larvae to the Balleny Islands and westward to the Antarctic continent west of the Ross Sea (Pinkerton & Sharp, 2012).

#### **8.3.4. Plankton and Primary Production**

In polar regions such as McMurdo Sound, the distribution of biomass and rates of autotrophic production are highly seasonal. McMurdo Sound's high latitude means that daylight hours change dramatically throughout the year; daylight hours are as low as 6.2 hours per day nearing the end of August and as high as 24 hours per day by 22 October (Rivkin, 1991).

Strong seasonal differences in sea ice cover and consequently light penetration regimes cause food inputs to benthic communities to be pulsed in nature (Cummings et al., 2002). The seasonal variation in food availability indicated that benthic invertebrates have adapted to rely on multiple food sources for survival (i.e., settling phytoplankton, settling sea ice algae, benthic diatoms, detritus, macroalgae and the lateral advection of re-suspended matter).

Changes in daylight throughout the year cause sea ice thickness to change by approximately



1.7 m throughout any given year. Sea ice acts as a barrier to light entering the water column, at times of the year where this is thickest, it will cause autotrophic production to decrease.

As shown in Rivkin (1991), autochthonous phytoplankton production decreases dramatically between the austral winter and early spring. The prolonged periods of light and darkness impose a temporal partitioning of heterotrophic and primary production in this region which affects all resident omnivorous and herbivorous fauna. More research is needed on how seasonal variations in key food sources such as phytoplankton effect the frequency and occurrence of predatory species within McMurdo Sound. Although irradiance (light intensity) in this environment changes steeply with depth, other parameters such as temperature, salinity and dissolved oxygen remain stable and unchanged throughout the water column (see Oceanographic factors).

Mysids were collected at 25 stations in the Ross Sea and five species were represented (DSIR, 1965).

### 8.3.5. Marine Protected Areas

Numerous MPAs are in place in the Ross Sea and approach to the cable landing at McMurdo Station.

The Antarctic Treaty 1959 is the governing document that is concerned with ensuring a lasting free and peaceful status for the continent. The treaty includes protocols and regulations for the protection of the Antarctic environment. In 1991, The Protocol on Environmental Protection to the Antarctic Treaty was set up which designates Antarctica as a 'natural reserve, devoted to peace and science.' The protocol prohibits a range of activities such as mining and sets detailed rules on matters such as the protection of plants and animals in this area (MFAT, 2022).

In 1982, by international convention, the Commission for the Conservation of Antarctic Marine Living Resources (CCAMLR) was set up with the goal of preserving Antarctic marine life (Figure 8-12). CCAMLR is responsible for designating and regulating MPAs in the Southern Ocean. In 2017, CCAMLR, New Zealand and the United States led a collaborative effort to establish the Ross Sea region MPA which now covers 1.55 million km<sup>2</sup> of ocean from the ice edge to the deep ocean and is the largest marine protected area in the world (Figure 8-13).

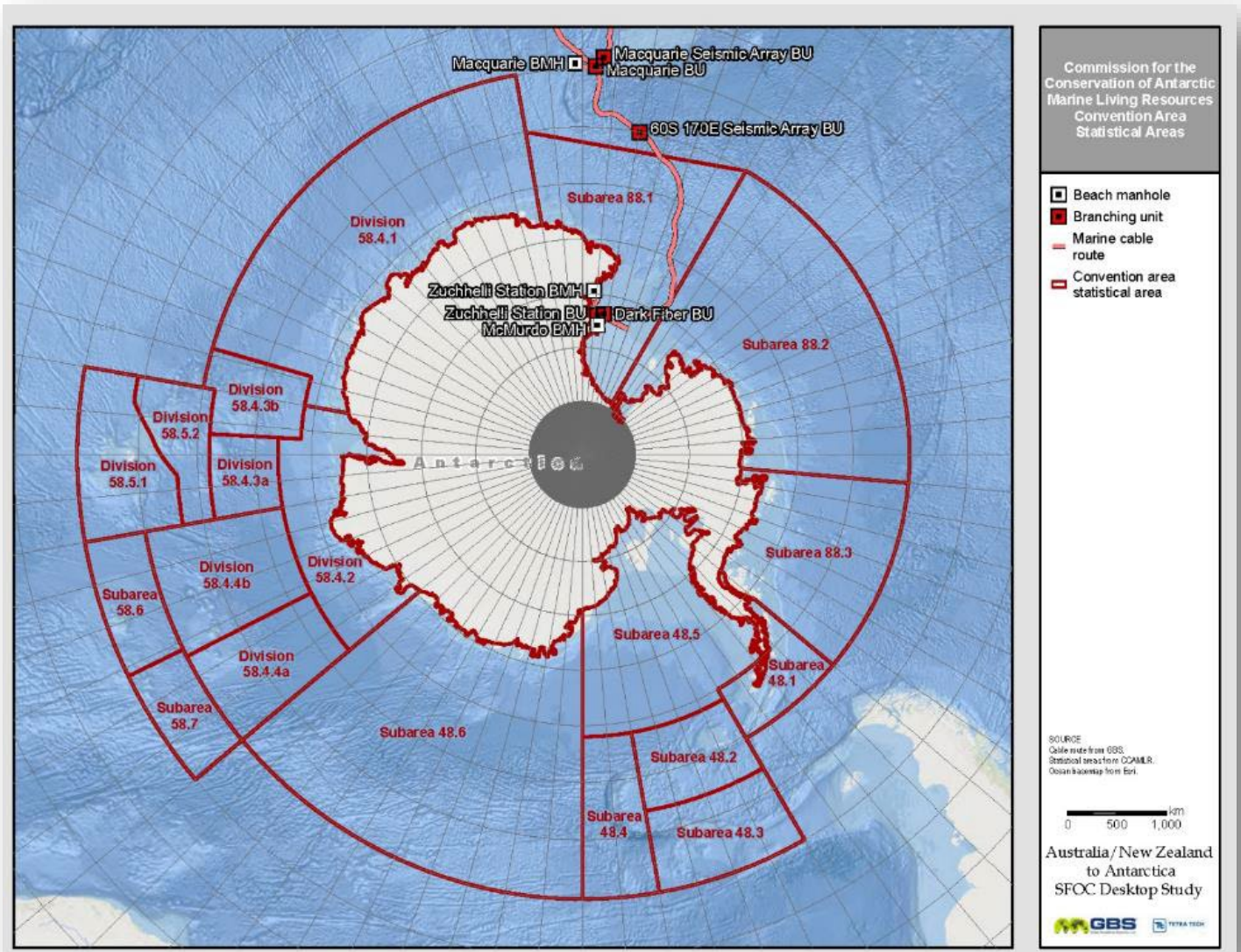

(CCAMLR, 2022; Esri, n.d.a.)

Figure 8-12. Commission for the Conservation of Antarctic Marine Living Resources Convention Area Statistical Areas.



The MPA seeks to balance sustainable fishing, science interests and marine protection for rare and vulnerable benthic species, representative habitats, and areas of importance for ecosystem integrity. The MPA is also designed to support scientific research. A research and monitoring plan has been developed to guide research relating to the MPA. Scientific research is based around the MPA objectives, including:

- Threat mitigation: to protect the region's ecosystems from threats
- Representativeness: to protect an adequate proportion of the marine environments in the region
- Scientific reference: the MPA encompasses areas with little or no fishing so we can understand how intact marine ecosystems work

The Ross Sea region MPA is divided into three distinct zones each with slightly different levels of protection. A bioregionalization process was undertaken to identify where areas of similar characteristics were, and how they could be grouped into bioregions. In the Ross Sea, NIWA see: <https://niwa.co.nz/fisheries/research-projects/antarctic-fisheries-research/spatial-management-of-the-ross-sea>) have compiled the spatial distributions of key species (polygons) in the Ross Sea area (termed Bioregionalization), to help design a spatial management framework for the Ross Sea region. This was a primary input into the design of the Ross Sea MPA. NIWA also identified the regions that are of fishable depths (red polygons filled with grey shading), and the four main regions of the Ross Sea region (North, Balleny Islands, Slope, Shelf). Areas open to fishing are red polygons outside the MPA. An additional benthic regionalization is presented in Figure 8.15.

The spatial extent and coverage of specific zones is depicted below in Figure 8-13, Figure 8-14, and Figure 8-15.

The MPA has three zones, each with different restrictions, as follows:

- General Protection Zone (GPZ): No commercial fishing is allowed. Covers 1.12 million km<sup>2</sup> (72%) of the MPA including Balleny Islands, Ross Sea shelf and parts of the Ross Sea slope (Figure 8-13 - GPZi) Northern seamounts (Figure 8-13 - GPZii), Scott seamount (Figure 8-13 - GPZiii).
- Special Research Zone (SRZ): Allows limited fishing for krill and toothfish
- Krill Research Zone (KRZ): Allows controlled research fishing for krill, in accordance with the objectives with the MPA.

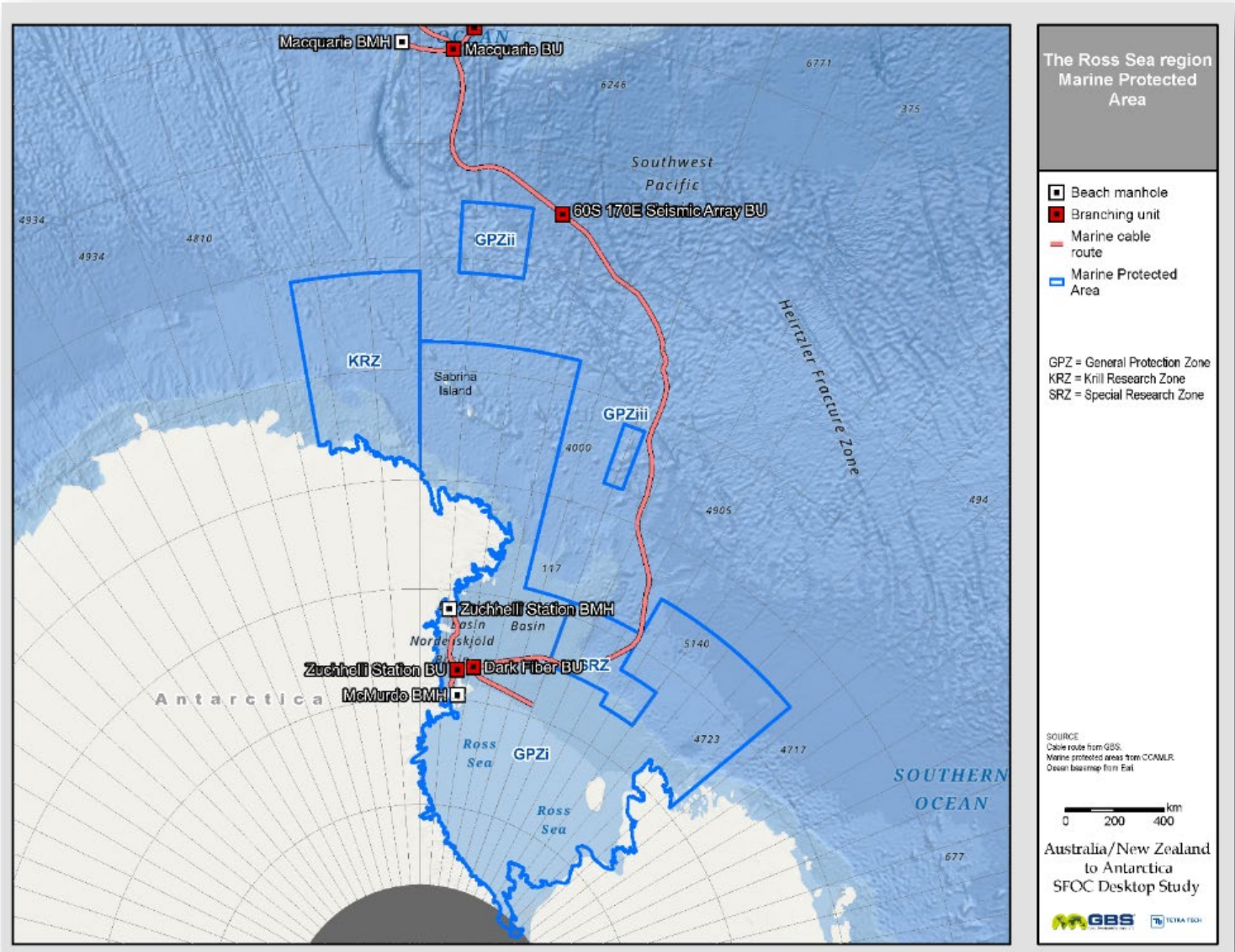

(CCAMLR, 2022; Esri, n.d.a.)

Figure 8-13. The Ross Sea Region MPA.

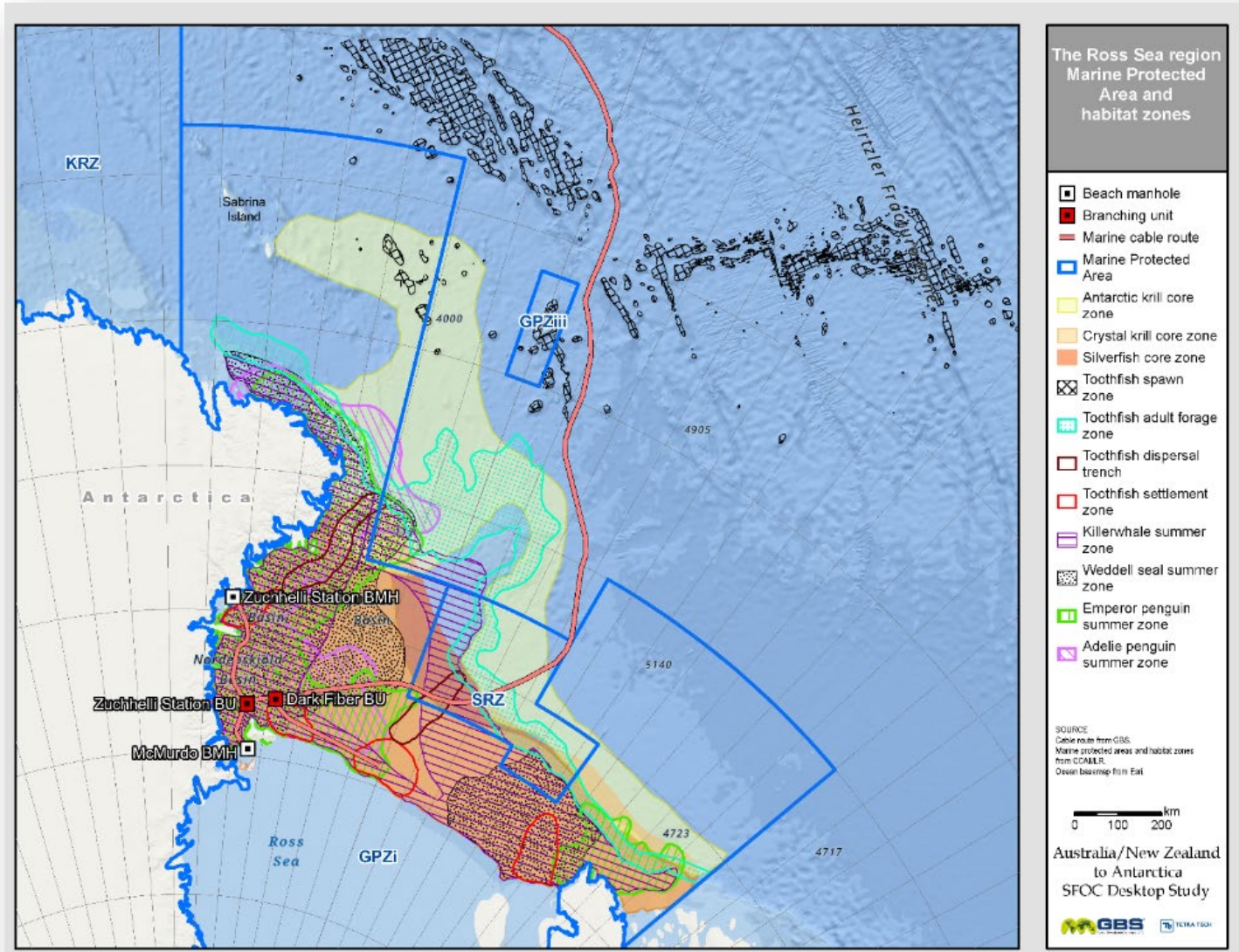

(CCAMLR, 2022; CCAMLR, n.d.; Esri, n.d.a.)

Figure 8-14. The Ross Sea Region MPA and Habitat Zones.

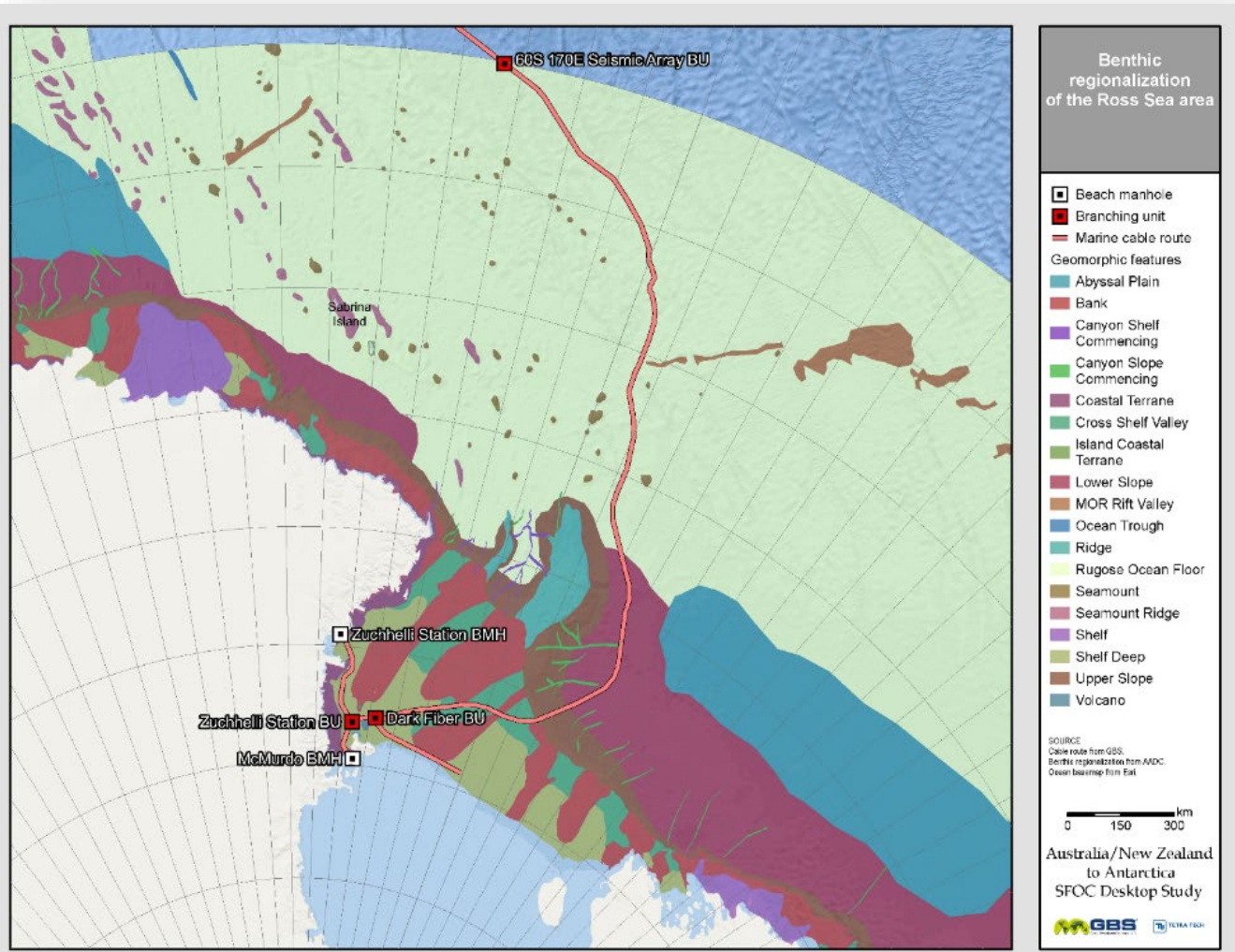

(Terauds, 2016; Esri, n.d.a.)

Figure 8-15. Benthic Regionalization of the Ross Sea Area.

ASPAs also exist in the Ross Sea region. ASPAs also exist in the Ross Sea region. These are shown in Figure 8-16. ASPAs were formerly designated as Specially Protected Areas (SPAs) and Sites of Special Scientific Interest (SSSIs). We have conducted a review of the ASPAs in the area and indicated four ASPAs that are near the SFOC route.

Full management plans for each area can be downloaded from the Antarctica New Zealand website at: [www.antarcticanz.govt.nz/environment/2594](http://www.antarcticanz.govt.nz/environment/2594).



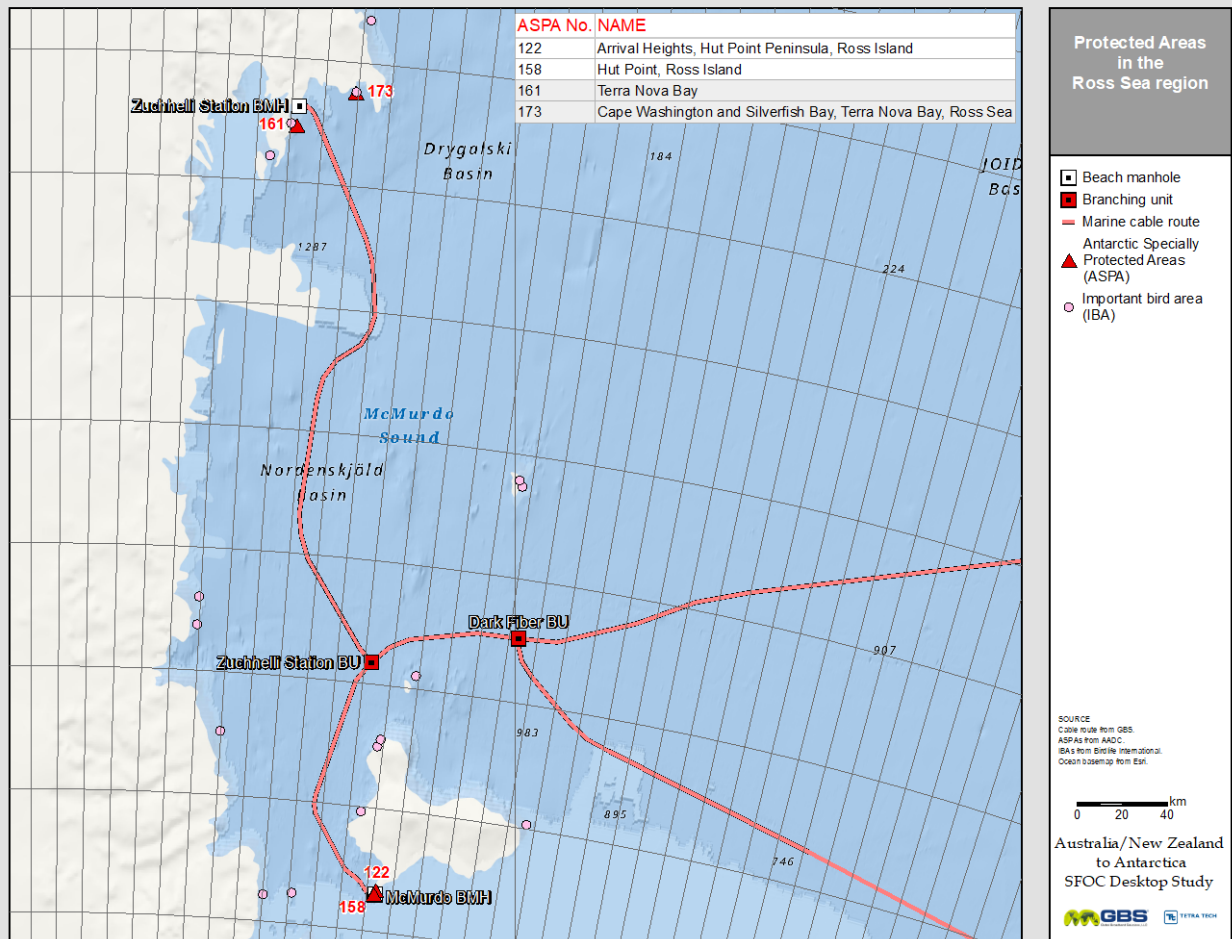

(Terauds, 2016; Harris et al., 2016; Esri, n.d.a.)

Figure 8-16. ASPAs in the Ross Sea Region.

### 8.3.6. Habitat Areas of Particular Concern

Pinkerton and Sharp (2012) outline several important habitat locations and features in the Ross Sea which are of pertinence to the project:

- Terra Nova Bay includes a consistent and highly productive polynya and provides an important nursery area for post-larvae and juvenile silverfish.
- The continental slope near Cape Adare has been observed to support dense communities of vulnerable benthic taxa, where the narrow continental shelf and prevailing currents provide localized refuge from iceberg scour.



- McMurdo Sound includes notable and diverse benthic communities and is the area of considerable scientific exploration. Its location at the terrestrial-marine interface adjacent to the McMurdo Dry Valley ASMA enhances its relevance for protection.
- The Ross Sea Shelf Front in combination with dynamic summer ice cover forms a zone of elevated productivity that is actively targeted by pelagic top predators, including seabirds, pinnipeds, and cetaceans.
- The Polar Front is an oceanic transition zone marked by enhanced productivity and targeted seabird foraging.
- The Balleny Islands chain is unique in the region, with steep topographic features formed by volcanic activity, and associated unique and poorly studied benthic communities. The area around the Balleny Islands is characterized by complex oceanographic conditions arising from intersecting ocean currents, a recurrent deep-water polynya, and also transient polynyas. These conditions boost local marine productivity and provide access to pelagic prey species (including Antarctic krill and possibly Antarctic silverfish) important for top predators. The islands support populations of at least four species of seal and ten species of seabirds, many of which are spatially constrained during the breeding season to forage only in the vicinity of breeding colonies on the islands. Of particular scientific interest are breeding colonies of chinstrap penguins that constitute an extreme distributional anomaly, the next nearest colony being more than 4000 km distant. The area is also important for several whale species, in particular humpback whales which appear to annually migrate almost exclusively to this area within the Ross Sea region.
- In the Ross Sea region Antarctic krill in association with the continental slope and in close proximity to the northern Victoria Land coast support large populations of top predators, including greater than 50% of the Ross Sea population of Adelie penguins at Cape Adare. Further north Antarctic krill are likely the single most important species supporting trophic ecosystem function, including in the vicinity of the Balleny Islands.
- The Ross Sea region supports more than a million breeding pairs (38% of the world population) of Adelie penguins at colonies on the Victoria Coast. Summer foraging areas have been mapped via satellite tagging. Future fisheries for pelagic resources (e.g., krill) within the foraging range of these colonies could threaten these populations and disrupt ongoing scientific research in which penguins serve as sensitive indicators of ecosystem function and long-term environmental change. Protection of the western Ross Sea shelf and the continental slope near Cape Adare has been noted as an objective in the protection of these penguin



populations from localized prey depletion affecting their breeding success and safeguarding the integrity of scientific monitoring.

### 8.3.7. Conservation Significant Species

The marine environment of the Ross Sea is currently being surveyed by the International Union for Conservation of Nature (IUCN, 2022) with the intention of assessing the region's species conservation values against global standards (i.e., the IUCN Red List of Threatened Species and the Red List of Ecosystems). Currently, only a small number of assessments have been made in this region and include the:

- Antarctic Blue Whale (*Balanoptera musculus spp. intermedia*). IUCN listed as Critically Endangered. This species is the largest on the planet, measuring up to 32 m and weighing up to 400,000 pounds. Due to commercial whaling efforts between 1904 to 1972, species numbers declined from around 125,000 individuals in 1926 to approximately 3000 in 2018 (WWF, 2022).
- Antarctic shallow invertebrate dominated ecosystem type. IUCN listed as Near Threatened. These unique shallow-water communities mostly consist of low light-adapted invertebrates which rely on sea ice to create shallow but dark marine environments. Climate change is likely to cause an early melting of seasonal sea ice in parts of Antarctica coastline, which will dramatically increase the amount of light reaching the shallow seabed. This is predicted to result in ecological regime shifts, in which invertebrate-dominated communities are replaced by macroalgal beds (Clark et al., 2015).

### 8.3.8. Environmental Pollutants

As early as the late 1960s, concerns were expressed about heavy contamination accumulating in Winter Quarters Bay because of activities at McMurdo Station. The anthropogenic effects on associated ecological communities are associated with toxic contaminants and solid waste. For many years, solid waste was placed on the ice surface as a disposal method, which resulted in the accumulation of large quantities of waste materials in and around the bay. Initial concerns were with the potential impacts to benthic communities in the bay from organic enrichment. Before the outfall was moved further offshore in 1991, the sewage discharge likely flowed along the shore and along the tidal cracks and entered the bay.

A report by Dayton and Robilliard (1971) discussed inorganic litter on sediments around McMurdo Station and was assumed to apply equally to the bay. They reported from inspections in 1967 to 1968 that "inorganic litter on the bottom at McMurdo is dramatic: fuel lines, barrels, honey buckets, rope, clothing, tractors, pieces of airplanes, thousands of beer cans and many other types of trash are everywhere." They pointed out that though the litter is an eyesore, it

probably has not seriously damaged benthic biota and the most serious effect was the covering of the bottom, which eliminates all sponges. The debris covering the bottom was expected to degrade very slowly if at all. While concern for contaminants including sewage was expressed, no data were collected on chemical contaminants. In 1974, a large bed of clam shells was observed on the surface of bay sediments. The shells were piled several deep over the surface of the bottom and covered an area about 75 m long by 25 m wide at a depth of 25 m. The surface sediment was reddish-brown to light brown silt, but subsurface sediments were black and smelled strongly of petroleum hydrocarbons. Sediment samples were subsequently collected, analyzed, and determined to contain approximately 0.23% petroleum hydrocarbons by dry weight of sediment. The hydrocarbons appeared to be lubricating oil and possibly heavy residual or Bunker C fuel rather than diesel fuel. The mechanism of contamination was not determined, but the clam bed was directly under the area in which tankers load fuel. When the site was revisited in 1978, the community was unchanged, and the smell of oil on the sediments was still strong (Crockett & White, 1997).

Toxic materials have also accumulated in the bay, and ecological changes have occurred, due to sediments being contaminated with PCBs, metals, and hydrocarbon fuels. Crockett and White (1997) reported that sediments of Winters Bay are generally mixed with a thick, oily residue and that this material may constitute a physical barrier to some benthic life forms, either by effectively preventing organisms from attaching to the substrate or by effectively smothering them. Changes in community structure evident along pollution gradients, were described by Lenihan and Oliver (1995) and included increased frequencies of polychaete worms with relatively opportunistic life histories and simultaneous decreases in sedentary or suspension feeding groups as the levels of contamination increase. The opportunistic species dominating Winter Quarters Bay at that time were relatively small animals with short generation times, high proportions of ovigerous individuals, high larval availability, and good colonizing ability. The dominant species in relatively uncontaminated areas were not opportunistic, and included tube-dwelling polychaetes, suspension feeding infaunal anemones and bivalves, while many of the dominant species within the transition zone were intermediate in this respect.

The concentrations of total hydrocarbons (THC), polychlorinated biphenyls (PCB), polyaromatic hydrocarbons (PAH), and trace metals (Cu, Zn, Cd, Pb, Hg and As) in marine sediments off Scott Base (NZ) were examined by Negri et al. (2006) and compared them with sediments near the highly polluted McMurdo Station (U.S.) as well as less impacted sites including Turtle Rock and Cape Evans. The Antarctic mollusk, *Laternula elliptica* and three common sponge species were also analyzed for trace metals. The mean THC concentration in sediments from Scott Base was three-fold higher than the pristine site, Turtle Rock, but 10-fold lower than samples from McMurdo Station. McMurdo Station sediments also contained the highest concentrations of PAHs, PCBs and the trace metals, Cu, Zn, Pb, Cd and Hg. Copper was significantly higher in bivalves from McMurdo Station than other sites. Trace metal concentrations in sponges were generally consistent within sites but no spatial patterns were apparent.



It is possible that disturbance activities associated with cable laying may mobilize and resuspend contaminated sediments.

#### 8.4. References

- Arango, C., Soler Membrives, A., & Miller, K. (2011). Genetic differentiation in the Circum-Antarctic sea spider *Nymphon australe* (Pycnogonida; Nymphonidae). *Deep Sea Research Part II: Topical Studies in Oceanography*, 58, 212–219. <https://doi.org/10.1016/j.dsr2.2010.05.019>
- Australian Communications and Media Authority (ACMA). (2007). Submarine Cable (Southern Sydney Protection Zone) Declaration 2007, Telecommunications Act 1997. Federal Register of Legislative Instruments F2007L02217. Retrieved April 2, 2022, from <https://www.legislation.gov.au/Series/F2007L02217>
- Bonnett, M. L. 1992. Spawning in sympatric alpine galaxias (*Galaxias paucispondylus* Stokell) and longjawed galaxias (*G. prognathus* Stokell) in a South Island, New Zealand, high-country stream. Retrieved August 29, 2023 from <https://ir.canterbury.ac.nz/bitstreams/5c86ace9-c194-4d84-88d7-03414655f077/download>
- Commission for the Conservation of Antarctic Marine Living Resources (CCAMLR). (2022). *Marine Protected Areas*. Commission for the Conservation of Antarctic Marine Living Resources sourced from the Secretariat's Data Centre. Retrieved March 2022 from <https://www.ccamlr.org/en/science/marine-protected-areas-mpas>
- CCAMLR. (n.d.). *Habitat zones from CCAMLR GIS rsmmpa-baseline-data-v2*. Retrieved March 2022 from <https://data.ccamlr.org/dataset/rsmmpa-baseline-data-v2> Note: CCAMLR sign-in required for access.
- Collaborative Australian Protected Areas Database (CAPAD). (2021). CAPAD2020\_marine GIS data layer. Commonwealth of Australia 2021. Retrieved March 2022 from <https://www.environment.gov.au/fed/catalog/search/resource/details.page?uuid=%7B4448CADC-9DA8-43D1-A48F-48149FD5FCFD%7D>
- Clark, G. F., Raymond, B., Riddle, M. J., Stark, J. S., & Johnston, E. L. (2015). Vulnerability of Antarctic shallow invertebrate-dominated ecosystems. *Austral Ecology*, 40(4), 482-491. <https://doi.org/10.1111/aec.12237>
- Crockett, A. B., & White, G. J. (1997). *Comprehensive Characterization Report on Winter Quarters Bay, McMurdo Station, Antarctica*. Report. January 1, 1997. Idaho Falls, Idaho. Retrieved August 29, 2023 from [https://digital.library.unt.edu/ark:/67531/metadc685959/m2/1/high\\_res\\_d/491395.pdf](https://digital.library.unt.edu/ark:/67531/metadc685959/m2/1/high_res_d/491395.pdf)



Cummings, V., Thrush, S., Andrew, N., Norkko, A., Funnell, G., Budd, R., Hewitt, J., Gibbs, M., Mercer, S., Marriott, P., & Anderson, O. (2002). Ecology and biodiversity of coastal benthic communities in McMurdo Sound, Ross Sea: emerging results. Prepared by National Institute for Water and Atmosphere (NIWA) for Ministry of Fisheries. Auckland, New Zealand.

Australian Department of Agriculture, Water and the Environment (DAWE). (2006). Integrated Marine and Coastal Regionalisation of Australia (IMCRA) v4.0 - Provincial Bioregions. (c) Commonwealth of Australia, Australian Government Department of Agriculture, Water and the Environment. Retrieved March 2022 from <http://www.environment.gov.au/fed/catalog/search/resource/details.page?uuid=%7BE6EE998E-2800-424F-A1E9-D489E71E99BB%7D>

Australian Department of Agriculture, Water and the Environment (DAWE). (2021). *World Heritage Places – Macquarie Island*. Retrieved April 14, 2022 from <https://www.awe.gov.au/parks-heritage/heritage/places/world/macquarie-island#outstanding-universal-value>

Australian Department of Environment and Heritage (DEH). 2005. *PB24 – Macquarie Island Province. 2005 National Marine Bioregionalisation of Australia*. Retrieved March 2022 from <https://parksaustralia.gov.au/marine/pub/scientific-publications/archive/pb24.pdf>

Australian Government Department of Sustainability, Environment, Water, Population and Communities (DSEWPC). (2012). Conservation Management Plan for the Southern Right Whale: A Recovery Plan under the Environment Protection and Biodiversity Conservation Act 1999 2011–2021. Retrieved August 29, 2023 from <https://www.dcceew.gov.au/environment/biodiversity/threatened/recovery-plans/conservation-management-plan-southern-right-whale-recovery-plan-2011-2021>

Dayton, P. K. & Robilliard, G. A. 1971. Implications of pollution to the McMurdo Sound benthos. *Antarctic Journal of the United States*. 8:53-56.

Dearborn, J.H. (1965). Ecological and faunistic investigations of the marine benthos at McMurdo Sound, Antarctica. Doctoral dissertation, Stanford University, Stanford, California, 1965.

Australian Government Department of the Environment, Water, Heritage and the Arts (DEWHA). (2008). *EPBC Act Policy Statement 2.1 – Interaction between offshore seismic exploration and whales*. September 2008. Accessed March 2022 from <https://www.dcceew.gov.au/sites/default/files/documents/seismic-whales.pdf>

DEWHA. (2009). *East Marine Bioregional Plan Bioregional Profile – a description of the ecosystems, conservation values and uses of the East Marine Region*. Accessed March 2022 from



<https://parksaustralia.gov.au/marine/management/resources/scientific-publications/east-marine-bioregional-plan-bioregional-profile-description-ecosystems-conservation-values/>

New Zealand Department of Conservation (DOC). 2022. Marine mammal sanctuaries. Accessed March 2022 from <https://www.doc.govt.nz/nature/habitats/marine/other-marine-protection/catlins-coast/>; <https://www.doc.govt.nz/nature/habitats/marine/other-marine-protection/te-waewae-bay/>

Department of Primary Industries (DPI). (2022). *Marine habitats*. Accessed April 14, 2022 from <https://www.dpi.nsw.gov.au/fishing/habitat/aquatic-habitats/marine>

DPI. (2019). Cauliflower Soft Coral *Dendronephthya australis*. Fisheries Scientific Committee. Accessed April 14, 2022 from [https://www.dpi.nsw.gov.au/\\_data/assets/pdf\\_file/0018/1203039/dendronephthya-australis.pdf](https://www.dpi.nsw.gov.au/_data/assets/pdf_file/0018/1203039/dendronephthya-australis.pdf)

New Zealand Department of Scientific and Industrial Research (DSIR). (1965). The Fauna of the Ross Sea, Part 4. New Zealand Oceanographic Institute Memoir No. 27. Accessed February 2022 from [https://docs.niwa.co.nz/library/public/Memoir%2027\\_The%20Fauna%20of%20the%20Ross%20Sea%20\(Part%204\)%20Mysidacea%20and%20Sipunculoidea%20-%201965.pdf](https://docs.niwa.co.nz/library/public/Memoir%2027_The%20Fauna%20of%20the%20Ross%20Sea%20(Part%204)%20Mysidacea%20and%20Sipunculoidea%20-%201965.pdf)

Dunn, N. R., Allibone, R. M., Closs, G., Crow, S., David, B. O., Goodman, J., Griffiths, M.H., Jack, D Ling, N., Waters, J.M. & Rolfe, J. R. (2018). *Conservation status of New Zealand freshwater fishes*, 2017. Publishing Team, Department of Conservation. Accessed March 2022 from <https://www.doc.govt.nz/Documents/science-and-technical/nztcs24entire.pdf>

Environment Southland. 2008. Awarua Wetland Ramsar Site and Coastal Habitat Assessments completed by Barry Robertson and Leigh Stevens. GIS data layer. Received via email request to [helpdesk@es.govt.nz](mailto:helpdesk@es.govt.nz)

Environment Southland. (2019). *Current Environmental State and the 'Gap' to Draft Freshwater Objectives for Southland: Technical Report. No 2019-12*. Environment Southland Regional Council Te Taiao Tongo (December 2019) ISBN 987-0-909043-68-1. Retrieved August 29, 2023 from <https://contentapi.datacomsphere.com.au/v1/h%3Aes/repository/libraries/id:26gi9ayo517q9stt81sd/hierarchy/document-library/reports/Values%20and%20Objectives%20reports%20-%20People%2C%20Water%20and%20Land/Current%20environmental%20state%20and%20the%20E2%80%9Cgap%20to%20draft%20freshwater%20objectives%20for%20Southland%20%28December%202019%29.pdf>

Esri, Garmin, GEBCO, NOAA NGDC. (n.d.a.). World Ocean Base. Basemap in ArcGIS Pro v. 3.0.



[https://services.arcgisonline.com/arcgis/rest/services/Ocean/World\\_Ocean\\_Base/MapServer](https://services.arcgisonline.com/arcgis/rest/services/Ocean/World_Ocean_Base/MapServer)

Esri, DigitalGlobe, GeoEye, i-cubed, USDA FSA, AEX, Getmapping, Aerogrid, IGN, IGP, swisstopo, and the GIS User Community. (n.d.b.). World Imagery. Basemap in ArcGIS Pro v. 3.0. (n.d.b.).

Geoscience Australia. (2009). *Australian Bathymetry Contours, June 2009*. Commonwealth of Australia (Geoscience Australia). Retrieved March 2022 from <https://ecat.ga.gov.au/geonetwork/srv/eng/catalog.search#/metadata/67703>

Halpern, B. S., Walbridge, S., Selkoe, K. A., Kappel, C. V., Micheli, F., d'Agrosa, C., ... & Watson, R. (2008). A Global Map of Human Impact on Marine Ecosystems. *Science*, 319: 948-952, <http://dx.doi.org/10.1126/science.1149345>

Harris, P., & Whiteway, T. (2009). High seas marine protected areas: Benthic environmental conservation priorities from a GIS analysis of global ocean biophysical data. *Ocean & Coastal Management*, 52, 22–38. <https://doi.org/10.1016/j.ocecoaman.2008.09.009>

Harris, C., Fishpool, L., Lascelles, B., & Lorenz, K. (2016). *Important Bird Areas in Antarctica*. *Antarctic Environments Portal*. Birdlife International. Retrieved March 2022 from <http://datazone.birdlife.org/site/results?thrlev1=ampersandthrlev2=ampersandkw=ampersandreg=1ampersandcty=8ampersandsnm=ampersandfam=0ampersandgen=0ampersandspc=ampersandcmn=>

Invercargill City Council (ICC). (2014). *Otatara Scenic Reserve Management Plan*. Invercargill City Council Parks Division. Retrieved February 2022 from <https://icc.govt.nz/wp-content/uploads/2014/10/Otatara-Scenic-Reserve-Plan-2014.pdf>

ICC. (2016). *Sandy Point Domain*. Retrieved February 11, 2022 from <https://icc.govt.nz/wp-content/uploads/2016/05/SandyPointBrochure2016.pdf>

Lenihan, H. S., & Oliver, J.S. (1995). Anthropogenic and Natural Disturbances to Marine Benthic Communities in Antarctica. *Ecological Applications*, 5(3), 1-326. Retrieved August 29, 2023 from <https://www.jstor.org/stable/1942024>

Land Information New Zealand (LINZ). (n.d.a.). Protected Areas and New Zealand 12 mile territorial sea outer limit. Sourced from the Land Information New Zealand (LINZ) Data Service and licensed for reuse under the CC BY 4.0 license. Accessed March 2022 from [https://catalogue.data.govt.nz/dataset/protected-areas5#dataset-resources & 12 Mile Territorial Sea Outer Limit - New Zealand Hydrographic Authority | New Zealand | GIS Data Map Mapping | LINZ Data Service](https://catalogue.data.govt.nz/dataset/protected-areas5#dataset-resources&12%20Mile%20Territorial%20Sea%20Outer%20Limit%20-%20New%20Zealand%20Hydrographic%20Authority%20|%20New%20Zealand%20GIS%20Data%20Map%20Mapping%20|%20LINZ%20Data%20Service)

MarineRegions.org. (2019). *Maritime Boundaries v.11*. Retrieved August 2022 from <http://www.marineregions.org/downloads.php>





- Miller, K.A. & Pearse, J. (1991). Ecological Studies of Seaweeds in McMurdo Sound, Antarctica. *Integrative and Comparative Biology*, 31, 35-48.  
<https://doi.org/10.1093/icb/31.1.35> Retrieved March 2022 from  
[https://www.researchgate.net/publication/240591353\\_Ecological\\_Studies\\_of\\_Seaweeds\\_in\\_McMurdo\\_Sound\\_Antarctica](https://www.researchgate.net/publication/240591353_Ecological_Studies_of_Seaweeds_in_McMurdo_Sound_Antarctica)
- Ministry for Private Industries (MPI). (n.d.a.). Set Netting Prohibitions, Set Netting Restrictions and Benthic Protection Areas. GIS data layers. Retrieved March 2022 from <https://catalogue.data.govt.nz/dataset/set-netting-prohibitions> and <https://catalogue.data.govt.nz/dataset/set-netting-restrictions> and <https://catalogue.data.govt.nz/dataset/benthic-protection-areas>
- New Zealand Foreign Affairs Trade Manatū Aorere (MFAT). (2022). *The Antarctic Treaty System*. The protocol on Environmental Protection to the Antarctic Treaty. Retrieved January 28, 2022 from <https://www.mfat.govt.nz/en/environment/antarctica-and-the-southern-ocean/the-antarctic-treaty-system/>
- Negri, A., Burns, K., Boyle, S., Brinkman, D., & Webster, N. (2006). “Contamination.” In MMPATF, *Marine Mammal Protected Areas Task Force. Ross Sea Ecosystem IMMA*. Retrieved January 28, 2022 from <https://www.marinemammalhabitat.org/portfolio-item/ross-sea-ecosystem-imma/>
- Parks and Wildlife Service of Tasmania (PWS). (2006). *Macquarie Island Nature Reserve and World Heritage Area - Management Plan 2006*. Parks and Wildlife Service. Department of Tourism, Arts and the Environment, Hobart. Retrieved March 2002 from <https://envirojustice.org.au/wp-content/uploads/evidence/world-heritage-properties/Macquarie%20Island%20Nature%20Reserve%20and%20World%20Heritage%20Area%20Management%20Plan%202006.pdf>
- Pinkerton, H., & Sharp, B. (2012). Preliminary plan for research and monitoring in the Ross Sea region, in association with spatial marine protection. National Institute of Water and Atmospheric Research, Ministry for Primary Industries, Wellington. Document request available from <https://meetings.ccamlr.org/en/wg-emm-12/57>
- Rivkin, R B. (1991). Seasonal Patterns of Planktonic Production in McMurdo Sound, Antarctica. *American Zoology*, 31, 5-16. <https://doi.org/10.1093/icb/31.1.5>
- Roberts, K., Stevens, L., & Forrest, B. (2021). *Macroalgae and Seagrass Monitoring of New River Estuary 2019-2020*. Prepared by Salt Ecology for Environment Southland. Invercargill, New Zealand. Retrieved March 2022 from Environment Southland at <https://www.es.govt.nz/repository/libraries/id:26gi9ayo517q9stt81sd/hierarchy/document-library/reports/science-reports/Macroalgal%20and%20Seagrass%20Monitoring%20of%20New%20River%20Estuary%202019-2020.pdf>



- SiXMAPS. (n.d.). Pointofinterest. Spatial Services Spatial Services, a business unit of the NSW Department of Customer Service (DCS). The service includes external imagery sourced from © Sinclair Knight Merz, ©SPOT image [Image]. Retrieved March 2002 from <https://maps.six.nsw.gov.au/clipnship.html>
- Stevens, L., & Robertson, B. (2012). *New River Estuary 2012: Broad Scale Habitat Mapping*. Prepared by Wriggle Coastal Management for Environment Southland. Nelson, New Zealand. Retrieved August 29, 2023 from <https://www.es.govt.nz/repository/libraries/id:26gi9ayo517q9stt81sd/hierarchy/environment/water/estuaries/documents/estuarine-reports/new-river-2012-broad-scale-2012.pdf>
- Tasmanian Department of Natural Resources and Environment (NRE). (2016). *Forest to Fjaeldmark: Macquarie Island vegetation*. Retrieved March 2022 from <https://nre.tas.gov.au/conservation/flora-of-tasmania/from-forest-to-fjaeldmark-descriptions-of-tasmanias-vegetation>
- Terauds, A. (2016) An update to the Antarctic Specially Protected Areas (ASPAs) March 2016, Ver. 1, Australian Antarctic Data Centre (AADC) Metadata record. <https://doi.org/10.4225/15/572995579CD36>. Retrieved March 31, 2022 from <https://data.aad.gov.au/metadata/records/SOBC>
- World Wildlife Federation (WWF). (2022). *Meet the biggest animal in the world: The Antarctic blue whale*. Retrieved February 9, 2022 from <https://www.worldwildlife.org/stories/meet-the-biggest-animal-in-the-world#:~:text=The%20Antarctic%20blue%20whale%20%28Balaenoptera%20musculus%20sp.%20Intermedia%29,consumes%20around%207936%20pounds%20of%20krill%20per%20day>



National Science Foundation



# REGULATORY AND ENVIRONMENTAL FACTORS REPORT





## 9.0 REGULATORY AND ENVIRONMENTAL FACTORS REPORT

Regulatory and environmental factors are described in detail throughout the report. Please refer to Table 9-1 for the location of the information requested for this section in the Project Work Statement.

**Table 9-1. Location of Regulatory and Environmental Factors Discussions**

	PWS Request	Location
	Maritime Boundaries	Section 3
	Marine Sanctuaries/Protected Area	Section 8
	Statutory Requirements, Permitting	Section 3
	Required Environmental Approvals	Section 3
	Permitting Points of Contact	Section 3
	Marine Operations Considerations – Lack of Cable Protection Zone for Invercargill	Section 2
	Marine Operations Considerations – Implications of Polar Code compliance on Cable Ship and hydrographic survey ship availability	Section 15 [Partially Redacted]
	Marine Operations Considerations – Icebreaker escort support requirements in Antarctic waters, if any	Section 15 [Partially Redacted]
	Marine Operations Considerations – Implications of Cable Ship availability with capability to work in expected sea ice and sea state conditions (world-wide identification of vessels, likelihood of access)	Section 15 [Partially Redacted]
	Marine Operations Considerations – Availability of hydrographic survey vessels capable of operating in Western Ross Sea	Section 15 [Partially Redacted]
	Marine Operations Considerations – Cost variability due to schedule variability and expected Cable Ship and hydrographic survey vessel day-rates	Section 15 [Partially Redacted]



# LANDING SITE REPORTS





## 10.0 LANDING SITE REPORTS

In-person site visits were conducted at the proposed Sydney, Australia, and Invercargill, New Zealand, SFOC landing locations. These visits are presented in Sections 10.1 and 10.2, respectively.

Site visit reports for Macquarie Island and McMurdo Station landings were assembled using information provided by NSF, including on-the-ground information from McMurdo Station, and publicly available information. A summary is provided in Sections 10.3 and 10.4, respectively.

### 10.1. Australia (Sydney) Site Visit Report

The site visit to the proposed SFOC landing in Sydney, Australia was performed by the GBS Team on Friday, 4 March 2022. The Team visited existing SFOC landings sites at Coogee Beach and Clovelly Beach and the Alexandria and Equinix SY4 data centers located approximately eight to nine kilometers inland, which are the connection points for existing systems. An available HDD conduit and constructed BMH make this landing point option a preferred option. However, there are no terrestrial conduits available, and a new terrestrial route would need to be constructed for the proposed cable.

The site visit is described in the following text with photos.

The Team first visited the location at Coogee Beach, provided in the PWS for the proposed cable landing at 33° 55' 5.9046"S and 151° 15' 36.5508"E. Numerous photos were taken in the Coogee Beach area to document conditions at and around this location and the BMH was identified in the park (Figure 10-1, Figure 10-2, and Figure 10-3).



*(NSF, 2022)*

Figure 10-1. Looking north from Dolphins Point Cliffs towards Clovelly Beach.



*(NSF, 2022)*

Figure 10-2. A potential cable landing area on Coogee Beach.





*(NSF, 2022)*

Figure 10-3. A BMH near Coogee Beach.

The Team then visited Clovelly Beach, approximately 800 m north. The BMH location could not be located during the visit, and we were later informed that the BMH is buried. Pictures of the BMH location and vicinity are provided in Figure 10-4 and Figure 10-5.

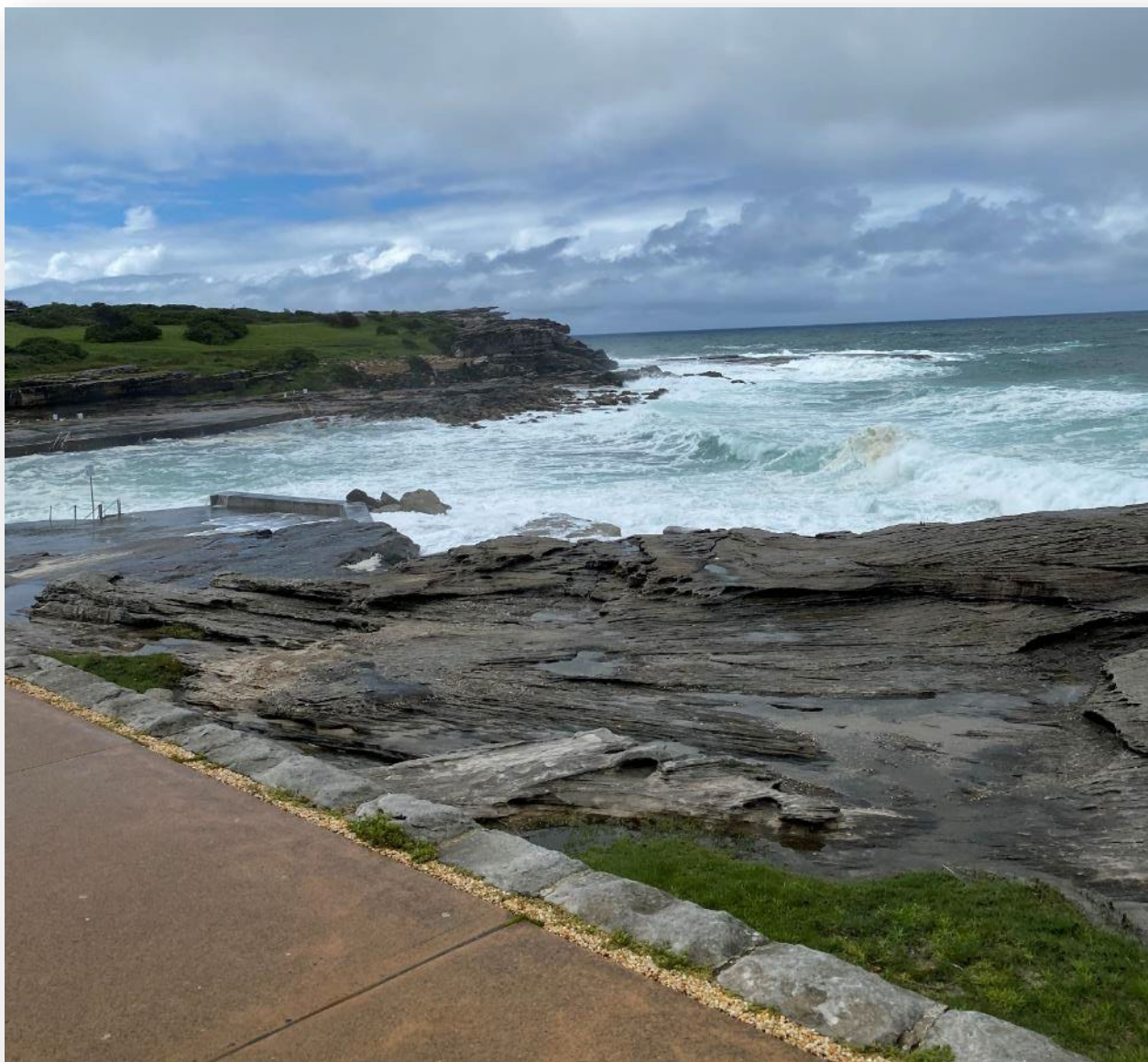

*(NSF, 2022)*

Figure 10-4. Clovelly Beach looking northeast from headland with beach manhole back along the horizontal directional drill route.



*(NSF, 2022)*

Figure 10-5. An approximate manhole location (buried under grass).

The Team then drove to the Alexandria data center (Figure 10-6) and then to the nearby Equinix SY4 data center (Figure 10-7). A chart of the Sydney landing site is provided in Figure 10-8.



*(NSF, 2022)*

Figure 10-6. The Alexandria Data Center.



*(NSF, 2022)*

Figure 10-7. The Equinix SY4 Data Center.



Figure 10-8. Sydney landing site chart.

## 10.2. New Zealand (Invercargill) Site Visit Report

The site visit to the proposed SFOC landing at Oreti Beach, Invercargill was conducted on Tuesday, 8 March 2022, by the GBS Team. Oreti Beach is characterized as a broad, flat, and gently sloping beach and dune environment. A substantial vegetated dune formation exists at the cessation of the high-water mark. The dunes are intact, aside from where a break exists at Dunns

Road, which provides the primary vehicular access to the southern portion of the beach. At this location, works are likely to involve a shore end landing (unless permitting requires otherwise) that will be trenched from the BMH into the sea and buried at a minimum of 2m depth. It will also use articulated pipe on shore from the beach manhole to at least the mean low water mark. The dune habitat represents an ecological constraint that is subject to regulatory and stakeholder e.g., Iwi oversight.

Selected imagery from the site is provided below in Figure 10-9 through Figure 10-14. Additional photographic imagery from the site is available if required.



(NSF, 2022)

Figure 10-9. Aerial view of Oreti Beach, facing south.



*(NSF, 2022)*

Figure 10-10. Oreti Beach, facing north toward Dunns Road, bound by dunes on either side of the road.



*(NSF, 2022)*

Figure 10-11. End of Dunns Road, facing south toward Oreti Beach, bound by dunes on either side of the roadway.





*(NSF, 2022)*

Figure 10-12. Walkway on northern side of Dunns Road, inland of Oreti Beach, carpark on right side of image.



*(NSF, 2022)*

Figure 10-13. Carpark and picnic area on the northern side of Dunns Road, inland of Oreti Beach.



*(NSF, 2022)*

Figure 10-14. Existing conduits (e.g., power) are located on the northern side of bridge.

During the site visit, reconnaissance at the Makarewa data center site location was also completed. The site is located several hundred meters to the north of a gated and fenced agricultural plot (Figure 10-15) and is somewhat elevated relative to the surrounding pastoral land. A chart of the Invercargill landing site is provided in Figure 10-16.



*(NSF, 2022)*

Figure 10-15. Gated access to land south of the data center site.



Figure 10-16. Invercargill landing site chart.



### 10.3. Macquarie Island Site Survey Report

This site was desktop surveyed with the support of NSF Office of Polar programs, to include plans, charts, and images. The GBS DTS Team also discovered publicly available supporting documentation for the site survey. The landing point coordinates were supplied in the DTS contract. The Team developed and reviewed the landing site, approach by sea and determined the best landing site for a shore end landing (Figure 10-17).

Macquarie Island is a Research Station comprised of over 40 buildings and smaller structures housing scientific equipment and experiments (Figure 10-18 through Figure 10-20). Proposals to carry out scientific research programs are considered by several committees, including the Macquarie Island Advisory Committee (MIAC) which liaises between the Department of Parks, Wildlife & Heritage and other organizations. The Antarctic Division of the Federal Department of the Arts, Sport, Environment, Tourism & Territories which owns the Station and has supported much of the work, reduced its mission in 2007. This may encourage a change of patronage. Both the Bureau of Meteorology and the international geological community are to continue their research and monitoring programs; and educational tourist interest in the Reserve will grow in future.

Macquarie Island lies in the Southern Ocean nearly halfway between Australia and Antarctica, approximately 1,470 km south-southeast of Tasmania and 1,130 km southwest of New Zealand between 54 °29' to 54 °47'S and 158 °47' to 158 °58'E.

A profile of the proposed Macquarie Island shore end landing and chart of the landing siting are provided in Figure 10-21 and Figure 10-22.



Figure 10-17. Proposed landing site and terrestrial route to communications building area.

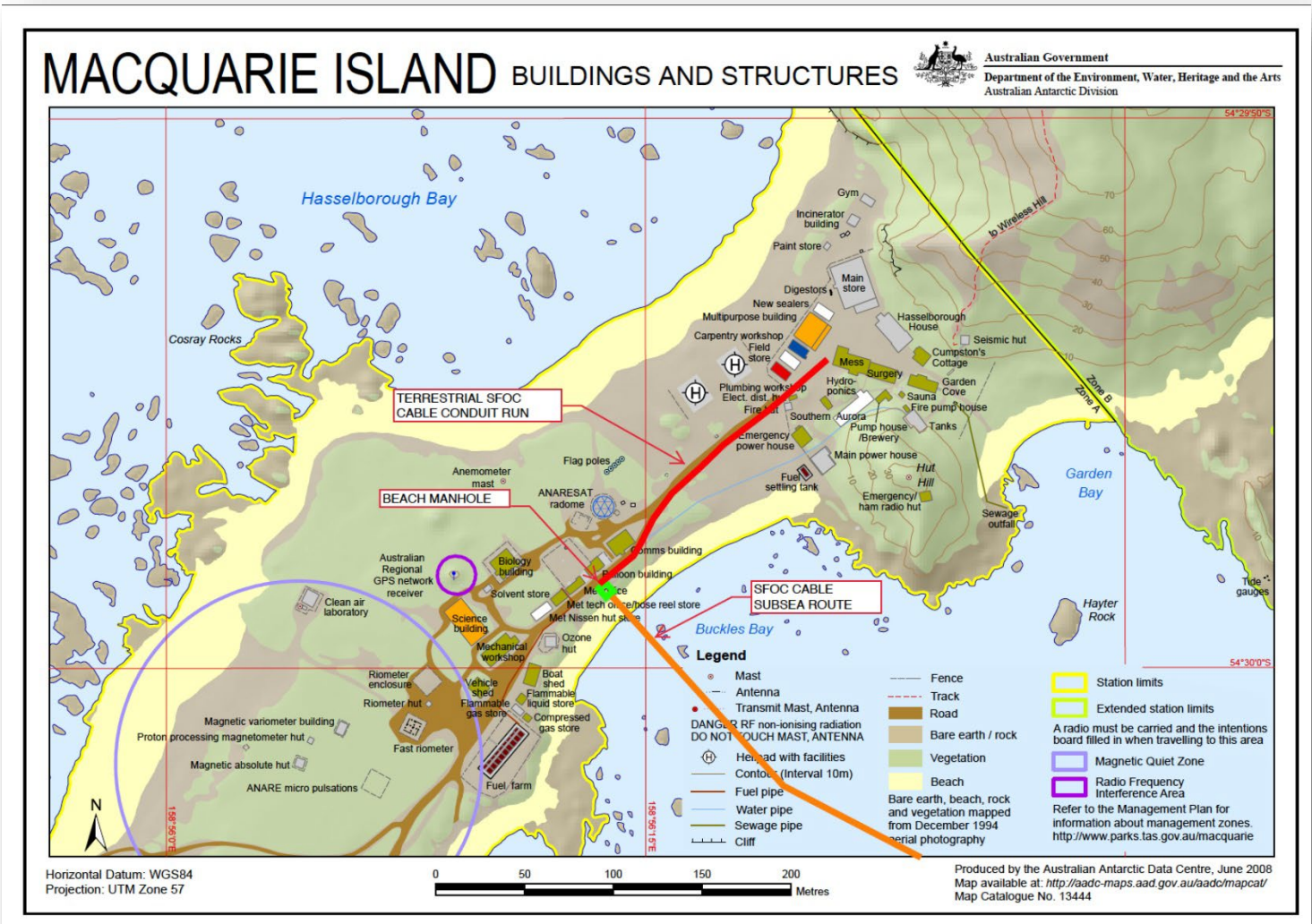

(Australian Government, 2008)

Figure 10-18. Sample map showing Macquarie Island buildings and structures.



24 JUNE 2021



**Macquarie Island isthmus to the island plateau** Photo: Barry Becker

*(Becker, B., 2021)*

Figure 10-19. Macquarie Island isthmus to the island plateau.



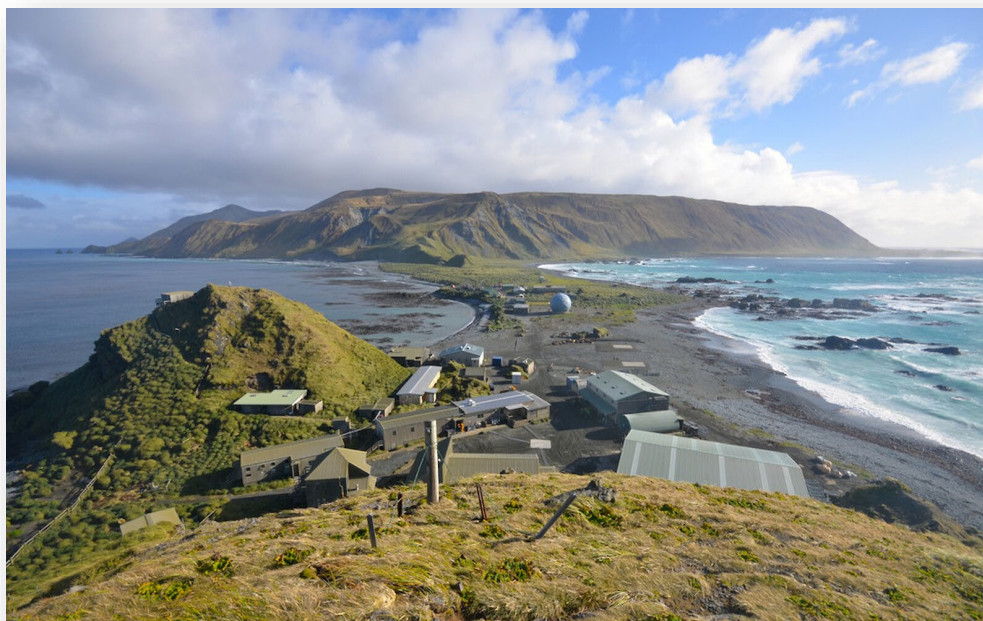

(Becker, B., 2018)

Figure 10-20. View of Macquarie Island research station and proposed landing site as seen from communications building.

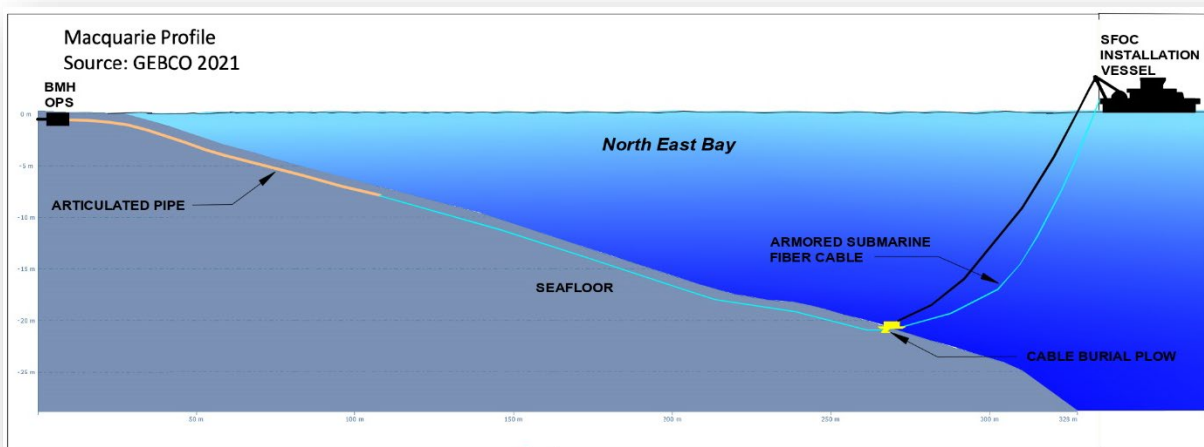

Figure 10-21. Example of Macquarie Island proposed shore end landing operations profile.





### 10.4. McMurdo Station Antarctica Site Survey Report

The site was surveyed with the support of NSF Office of Polar Programs personnel, to include plans, charts, images, and routing reviews were shared with GBS for this site review.

Landing Point “A” was the supplied contract Lat/Long location and the NSF Team reviewed proposed routes for the terrestrial cable to the New Data Center (Figure 10-23). The Team developed and reviewed two routes to the data center (Figure 10-24 through Figure 10-27). The study was also supplied current heavy equipment available at the station that may be able to support installation operations. An example of the McMurdo HDD bore and cable installation is provided in Figure 10-28.

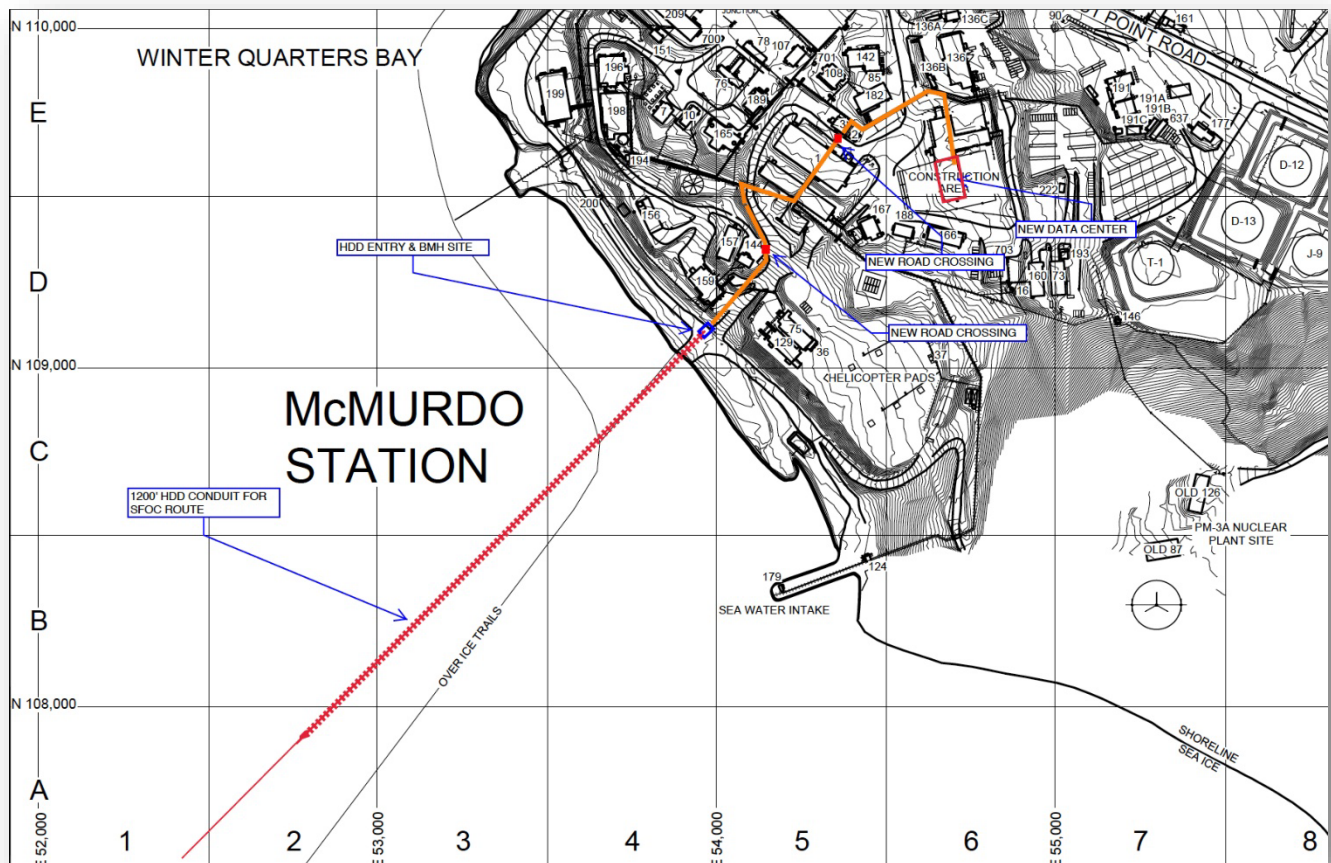

(NSF, 2022)

Figure 10-23. Sample Landing Site “A” and Proposed Terrestrial Route to New Data Center.



(NSF, 2022)

Figure 10-24. Sample landing site “A” and “B” proposed terrestrial routes to new data center.



(NSF, 2022)

Figure 10-25. Sample horizontal directional drill/beach manhole site for landing site “A”.



(NSF, 2022)

Figure 10-26. Sample work area location for horizontal directional drill/beach manhole for landing site “B”.

HDD conduit is recommended for this site to get the cable offshore below any sea ice scouring activity or seasonal ice movement risk to the cable. HDD operations can be conducted on either landing site “A” or “B”. A fresh water supply is required for HDD drilling operations, along with specialized containers and drilling gear which will require delivery to the site. McMurdo station does have heavy equipment on site that will aid in the requirement for the drilling and installation operations. ok

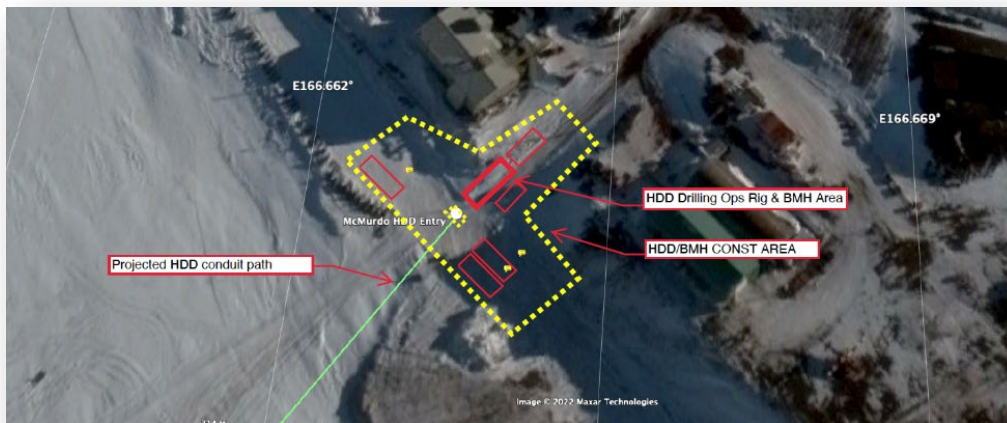

(NSF, 2022)

Figure 10-27. Sample of McMurdo Station horizontal directional drill laydown area.

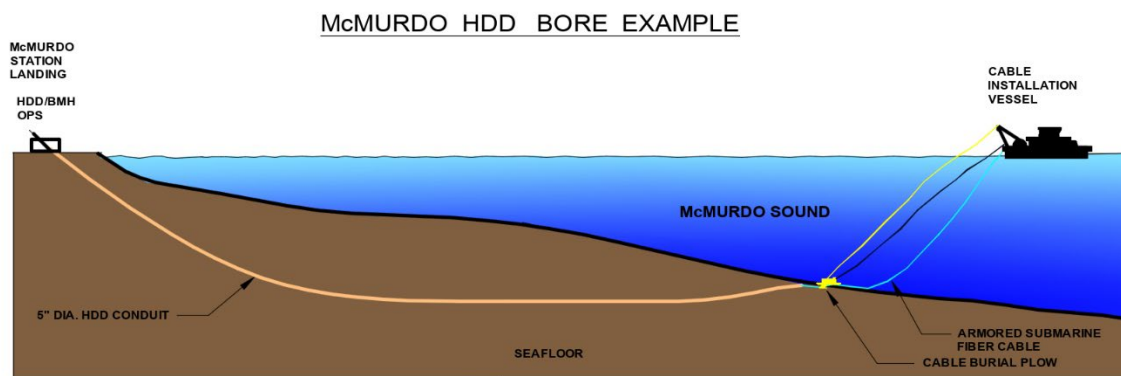

Figure 10-28. Example of horizontal directional drill bore and cable installation.

The GBS DTS Team also spoke with the McMurdo Dive operations center as part of the review. Local knowledge of diving operations and supporting equipment was reviewed. The commercial dive operations team confirmed that a contracted dive team for the cable installation near shore would be able to use existing equipment on site and the dive operations conditions near the HDD operations area. The HDD contractor would be required to develop their own dive and operations plans for any construction at this site, however, the purpose of the site visit form is to gather information to support future operational planning.

### *McMurdo Station New Data Center*

A new data center is currently under construction, designated BL004: IT&C Primary Operations Center (Figure 10-29). This data center will be the Cable Landing Station (CLS) for the McMurdo station and could also possibly house the Power Feed Equipment (PFE) for the subsea cable system and science nodes.

New Power and Ground will be required for the new Submarine Fiber Optic Cable System (SFOC). For initial design considerations, an 18 kV PFE system would be recommended for powering the subsea repeaters, Bus, and potential scientific monitoring capabilities.

The PFE is traditionally located in the CLS if room is available. A three bay Spellman Power Feed Rack system is recommended and additionally a -48v Battery plant is also required (Figure 10-30 and Figure 10-31). The New McMurdo Data Center does indicate a Power Distribution Room and a Battery Plant room, we do not know if this is sufficient to be used for the subsea system. Also, we do not know if there is room for the required 3 Bay PFE racks and a battery plant. In many locations a Prefabricated PFE station will be used that will independently house this equipment and be used in the system design. The images below are a sample of the 3-Bay equipment racks, floor plan, prefabricated structure.



*(NSF, 2022)*

Figure 10-29. New data center under construction at McMurdo Station.

The ground system for an SFOC traditionally uses an Ocean Ground Bed (OGB) and earth ground system. The OGB can be designed to be installed offshore with a separate conductive ground plate and separate cable. There is also a remote sea earth OGB system that can be installed on the cable and the conductive ground wire is inside the cable. The station earth ground is supplied by the New Data Center. The McMurdo Station may already have an OGB cable that is used for Station Ground and this SFOC design team would need to test the system to determine if it suitable for the system.

If there is not sufficient room in the new Data Center for the PFE system a new prefabricated building can be built and shipped to the site (Figure 10-32). There are many options for a CLS or PFE structure and they can be custom built, modular, or prefabricated to support all sizes and configurations. Some additional examples of these structures can be found in Figure 10-33.

The Submarine Line Terminating Equipment (SLTE) for the system could be located with the PFE in a CLS, or in the Data Center. The preferred location would be the Data Center for connectivity to other communications equipment. The SLTE would likely take one rack at the initial capacity and would require a DC rectifier if no DC power plant was available as a second rack. An additional rack to support the Line Monitoring Equipment (LME), Network Management System (NMS) and other items would also be required. The total footprint of the SLTE would be

approximately 3 racks, dependent on the requirement for a DC rectifier and the future expansion required. A sample SLTE rack layout as described above can be found in (Figure 10-34. Scientific sensing requirements on the cable would potentially require additional rack space and would be determined based on the selected technology.

A chart of the McMurdo landing site is provided as Figure 10-35.

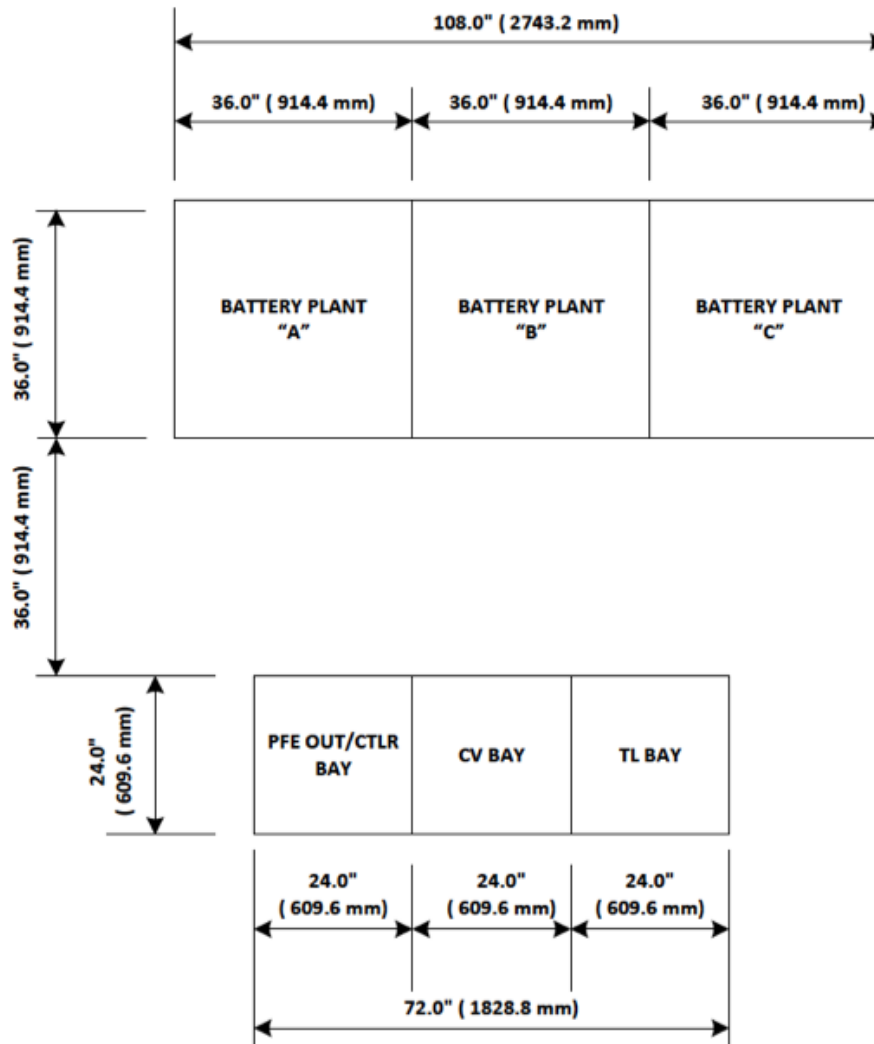
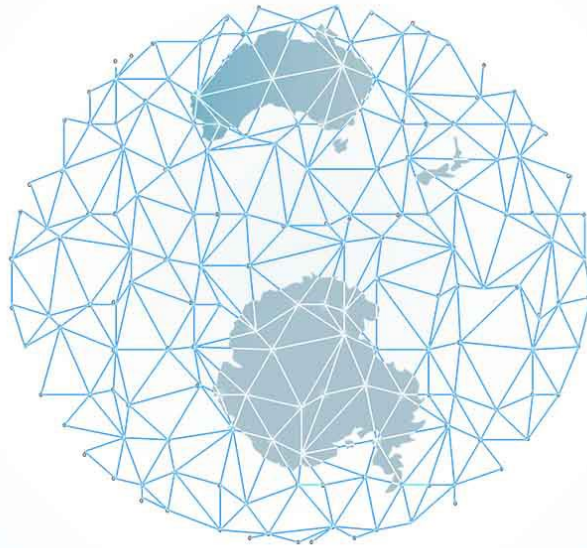

Figure 10-30. Sample of power feed equipment, equipment racks, and battery plant.



*Redacted*



*(Spellman High Voltage Electronics Corporation, 2022)*

Figure 10-31. [Redacted] Example of Spellman 3-Bay power feed equipment rack system.



*(NSF, 2022)*

Figure 10-32. Example of a prefabricated power feed equipment shelter.



*(DXN, 2020; AMSS, 2023)*

Figure 10-33. Examples of custom, modular, and prefabricated cable landing stations.

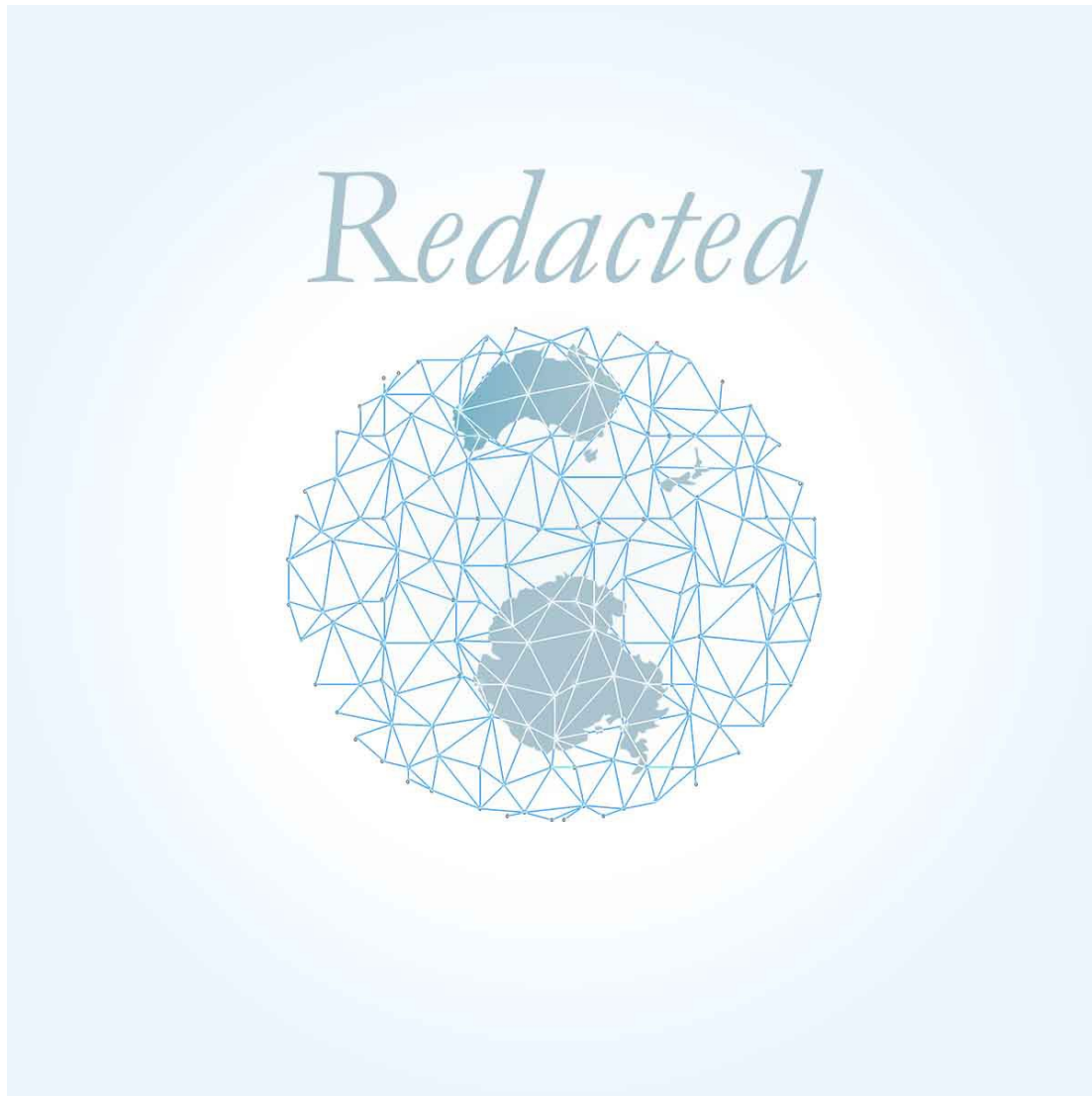

*(Adapted from: Spellman, 2023)*

Figure 10-34. [Redacted]. Example of submarine line terminating equipment.

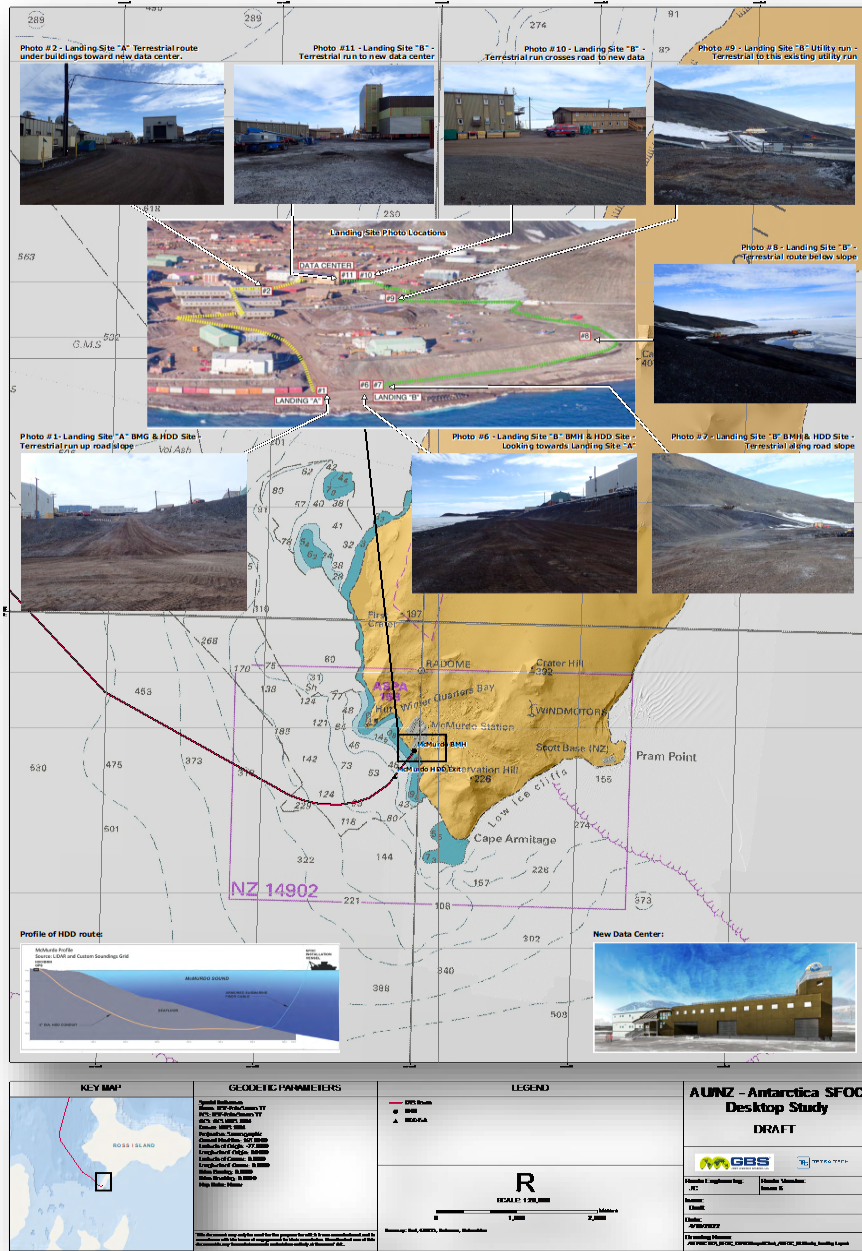

Figure 10-35. McMurdo Landing Site Chart.



## 10.5. References

- AMSS. 2023. [Photograph], From, <https://amsands.com/sectors/communications/> (11 August 2023)
- Australian Government, Department of the Environment, Water, Heritage and the Arts, Australian Antarctic Division, 2008. Macquarie Island Buildings and Structures [Graphic]. Produced by the Australian Antarctic Data Center, June 2008, Map available at: [https://data.aad.gov.au/aadc/mapcat/display\\_map.cfm?map\\_id=13444](https://data.aad.gov.au/aadc/mapcat/display_map.cfm?map_id=13444) Map Catalogue No. 13444.
- Becker, B. 2018. Tasmanian based company to manage new Macquarie Island research station build [Photograph]. Australian Government, Australian Antarctic Program (6 July 2018), From, <https://www.antarctica.gov.au/news/2018/tasmanian-based-company-to-manage-new-macquarie-island-research-station-build/>
- Becker, B. 2021. Public comment sought on Macquarie Island station renovation [Photograph]. Australian Government, Australian Antarctic Program (24 June 2021), From, <https://www.antarctica.gov.au/news/2021/public-comment-sought-on-macquarie-island-station-renovation/>
- DXN. 2020. DXN Limited signs Teletok for three modular cable landing stations [Photograph], From, <https://dxn.solutions/dxn-limited-signs-teletok-for-three-modular-cable-landing-stations/> (2 March 2020)



# CONSIDERATIONS FOR BRANCHING UNIT SPUR (BU) & STUB ADDITIONS



## 11.0 CONSIDERATIONS FOR BRANCHING UNIT SPUR (BU) / STUB ADDITIONS

The DTS system has been designed with routing to support the scientific research community and other future landing locations.

A total of five (5) BU locations are planned in the DTS to support future science arrays or onward connections to other Antarctic scientific research locations (Figure 11-1). Additional workshops and dialogue with the scientific community will follow the DTS to identify any additional locations that may be desired. Additional workshops will be required to determine additional locations or the potential to include dark fiber Distributed Acoustic Sensing (DAS) capabilities.

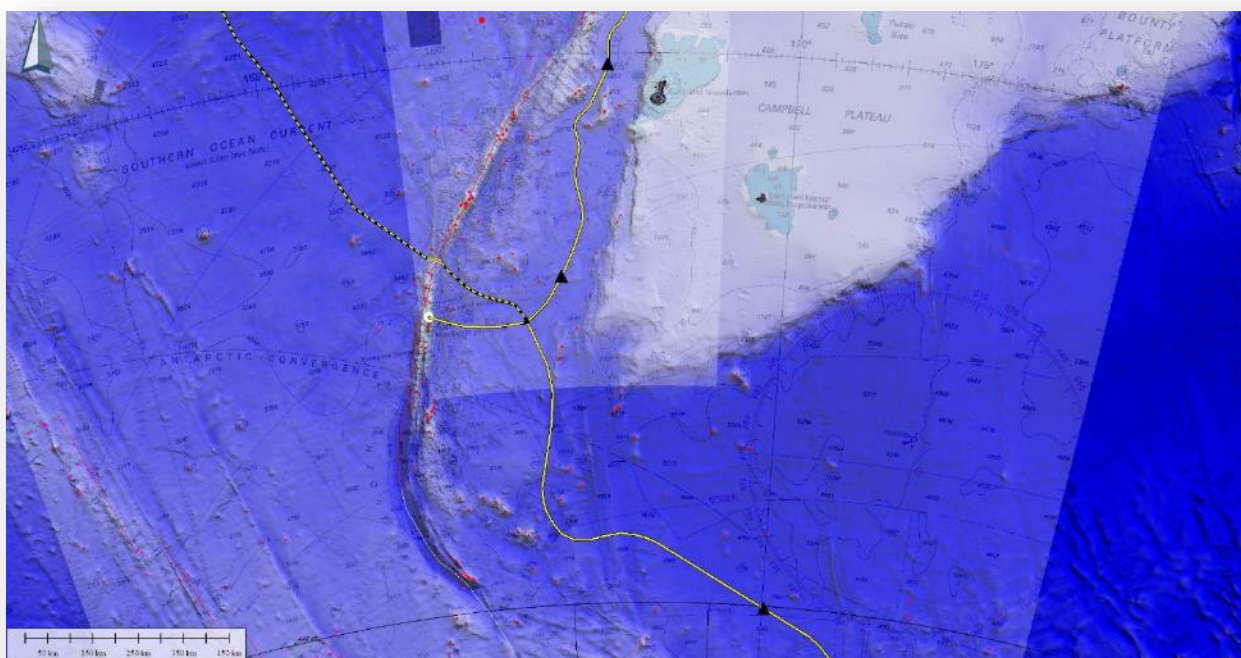

*(Adapted from: Global Mapper, 2023)*

Figure 11-1. Example of Northern Science Branching Units.

The “50 South” BU, located east of the Auckland Islands at 50° 11.53470' S, 164° 42.33038' E in 3,610 meters of water along the NZ-AQ route (Figure 11-2), is meant to support a future science array with multiple nodes. It is anticipated that this array would extend west-north-west to capture seismic events related to the Puysegur Trench and other ocean science data.

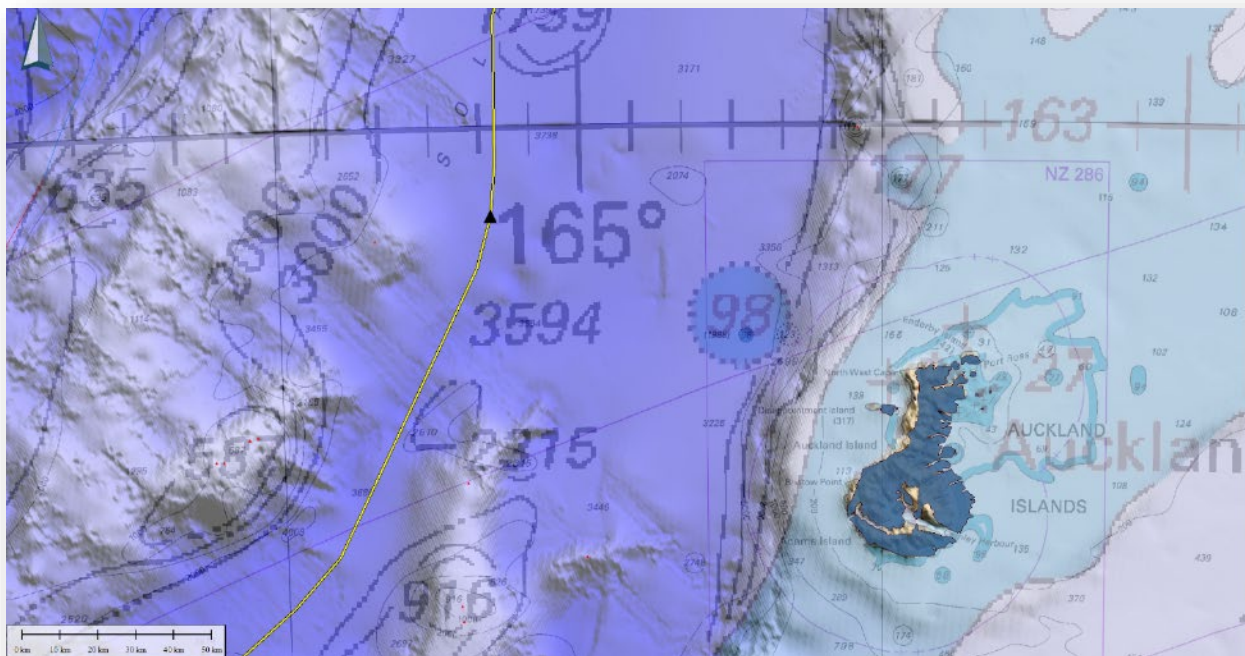

*(Adapted from: Global Mapper, 2023)*

Figure 11-2. Example of "50 South" Future Science branching unit.

If practical, SMART capable repeaters should be placed between the continental shelf of New Zealand and the "50 South" BU. During the design, if technology and funding permits, the entirety of the cable route could consist of SMART repeaters, spaced approximately 80-120 km apart along the route.

The "Macquarie Science BU," located 115 km north-east of the Macquarie BU at 53° 57.85534' S, 163° 8.51041' E in 4,630 meters of water, would be utilized for a future science array with multiple nodes (Figure 11-3). These nodes are also planned to extend towards the Macquarie Ridge to the west.



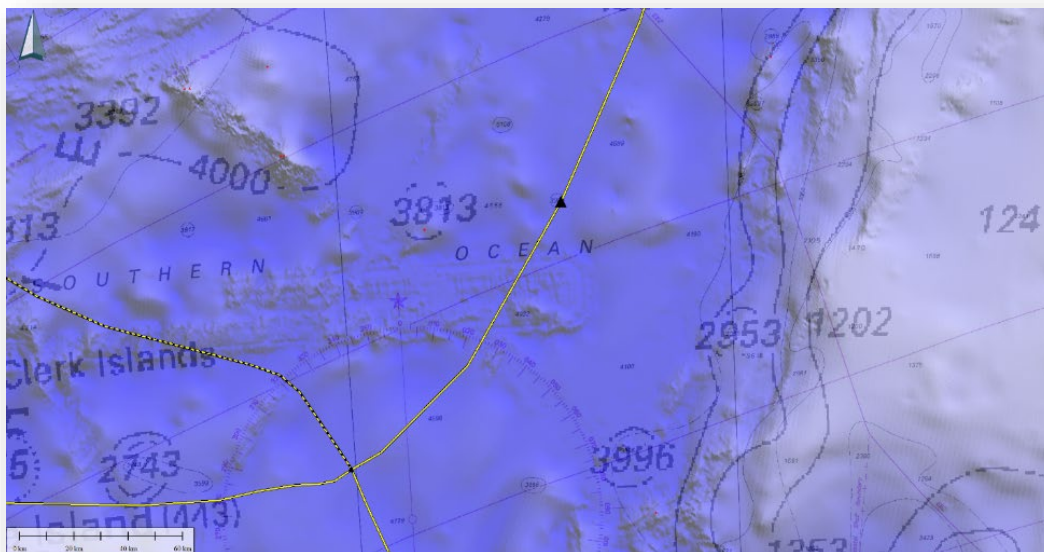

*(Adapted from: Global Mapper, 2023)*

Figure 11-3. Example of Macquarie Future Science branching unit.

The “60S 170E Science BU” is located north of the Antarctic Ridge at 60° 2.77023' S, 170° 4.79645' E in 4,960 meters of water to support future study of the Pacific-Antarctic Ridge and various fracture zones located to the south of the BU (Figure 11-4).

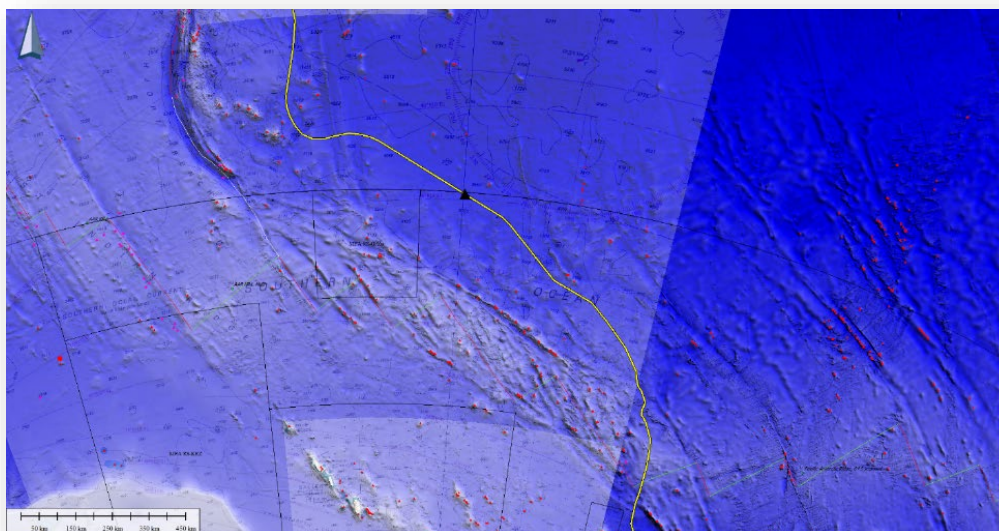

*(Adapted from: Global Mapper, 2023)*

Figure 11-4. Example of “60S 170E” Future Science branching unit.

The “Dark Fiber” BU is located at 76° 44.40937' S, 168° 40.03828' E in 840 meters of water to support a pair of dark fibers originating from McMurdo Station that extend along the Ross Ice Shelf to the Glomar Challenger Basin (Figure 11-5) to support SMART and fiber sensing.

The Terra Nova Bay area BU is in 860 meters of water and will support a future route which will allow for additional Antarctic research locations (Figure 11-5).

Examples of BU and BU designs are shown in Figure 11-6.

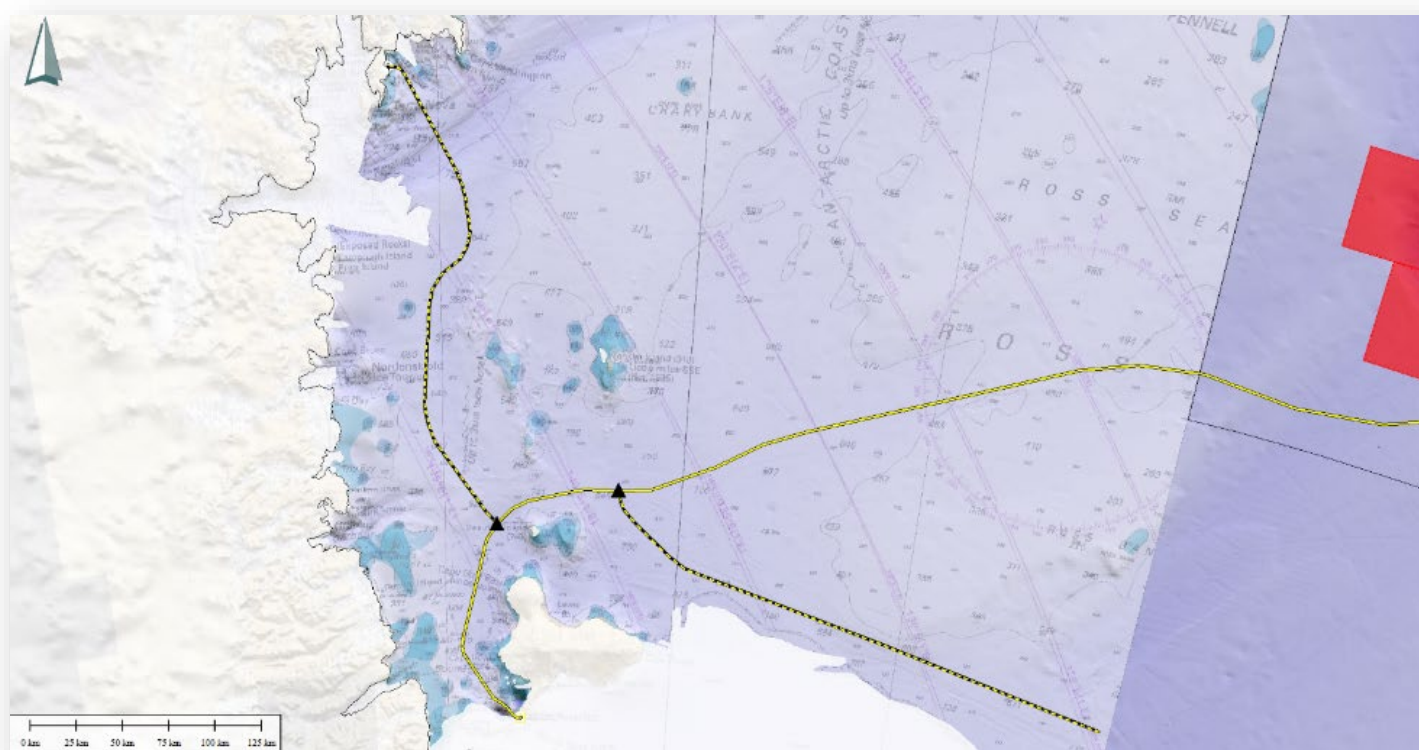
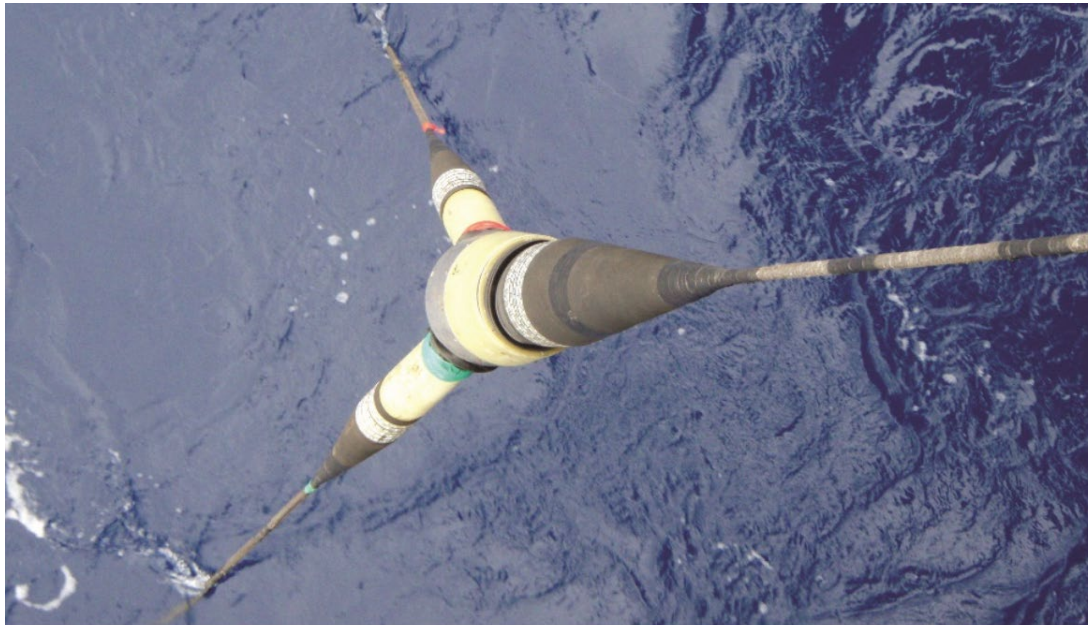

Figure 11-5. Example of dark fiber and Terra Nova Bay area branching unit and possible routing.



*(Enderby Wharf, 2023; Meyer, 2010)*



*(Courtesy of SubCom)*

Figure 11-6. Examples of branching units.



## 11.1. References

Enderby Wharf. 2023. Optical Fibre Cable – Branching Unit (ASN) [Photograph]. From, <https://enderbywharf.wordpress.com/optical-fibre-cable/> (11 August 2023).

Meyer, D. 2010. Aboard an Alcatel-Lucent undersea cable ship (photos) [Photograph]. From, <https://www.cnet.com/pictures/aboard-an-alcatel-lucent-undersea-cable-ship-photos/12/> (5 September 2010).



# RECOMMENDATIONS FOR PROJECT MANAGEMENT





## 12.0 [REDACTED] RECOMMENDATIONS FOR PROJECT MANAGEMENT

This document is a redacted version of the full Desktop Study that excludes information not suitable for public release.



# CONSIDERATIONS FOR SUSTAINMENT





## 13.0 [REDACTED] CONSIDERATIONS FOR SUSTAINMENT

This document is a redacted version of the full Desktop Study that excludes information not suitable for public release.





# MARINE OPERATIONS RELATIVE TO WET PLANT DEVELOPMENT





## 14.0 MARINE OPERATIONS RELATIVE TO WET PLANT DEVELOPMENT

This section of the DTS will assess the impact of marine operations relative to wet plant development, specifically focused on the Antarctic considerations of the wet plant, marine operations, and cable installation; however, the other route locations will also be addressed in relation to this topic. The non-Antarctic areas of the route will consist of standard SFOC system marine operations and installation. The approach and landing at McMurdo Station will require operations to be conducted during the Antarctic summer months (likely in January through March) and may be subject to Cable Ship and hydrographic survey ship availability and operations arising from the International Maritime Organization Polar Code compliance requirements and International Association of Classification Societies Unified Requirements for Polar Class Ships. Strategic planning must be accomplished as this period is a very busy time in the Port for ship operations. Ice free conditions are subject to change each year.

Based on the DTS route and recent ice coverage trends, an Ice Class vessel should not be required for the McMurdo Station installation. It is very likely that Icebreaker and potentially small tugboat support in Antarctic waters will be an insurance requirement for marine suppliers to operate in the Antarctic waters, along with satellite ice tracking to mitigate any potential risk to the Cable Ship during operations. The system supplier will have Remote Operated Vehicle (ROV) capabilities to conduct any required operations, however, this will likely not be required at the McMurdo landing area because burial is not expected to be required based on available information, subject to the MRS results.

The recommendation for the marine installation and the MRS would be that the operations were coordinated in conjunction with the annual icebreaking operations into McMurdo to support the final route design, timing, and to leverage the existing vessel during its time of transit and operations into McMurdo. Although, there are other commercially leased icebreaker alternatives to USCG assets, the geographic location will require significant transit time and cost versus using the annual ice breaking route, which will coincide with the required timing of marine operations. The required operational time for the MRS and installation in the Antarctic waters will be a small window (2-3 weeks) given the HDD landing punchout is planned at a depth to mitigate ice scour and obviate the need for burial. Surface laid cable will install at a much faster rate than burial. Depending on conditions and water depths, surface lay of a cable can occur at up to 6-7 knots (11-13 km/hr) and burial at about 1 knot (1.85 km/hr) or less.

The project will be planned to avoid the presence of sea ice to the maximum extent and to allow continuous safe operations.

## Marine Vessels

Each of the major SFOC suppliers will have Cable Ships with capability to work and maneuver in the expected sea ice and sea state conditions based on the assumption that an ice breaker and other smaller support vessels are required to reduce the risk of sea ice related issues. For installation, a cable installation ship and various support vessels will be deployed to install the marine cable. The cable installation ship will have the capability to carry all of the fiber optic cable required so that installation can be completed in one season. The cable ships required to install this type of system, in these conditions would be Cable Installation that meet at least the requirements of the Reliance Class (SubCom) (Figure 14-1) and Ile de Class (ASN) vessels (Figure 14-2). Based on the time of year and insurance requirements, there may need to be ice breaker support in the Ross Sea area into McMurdo.

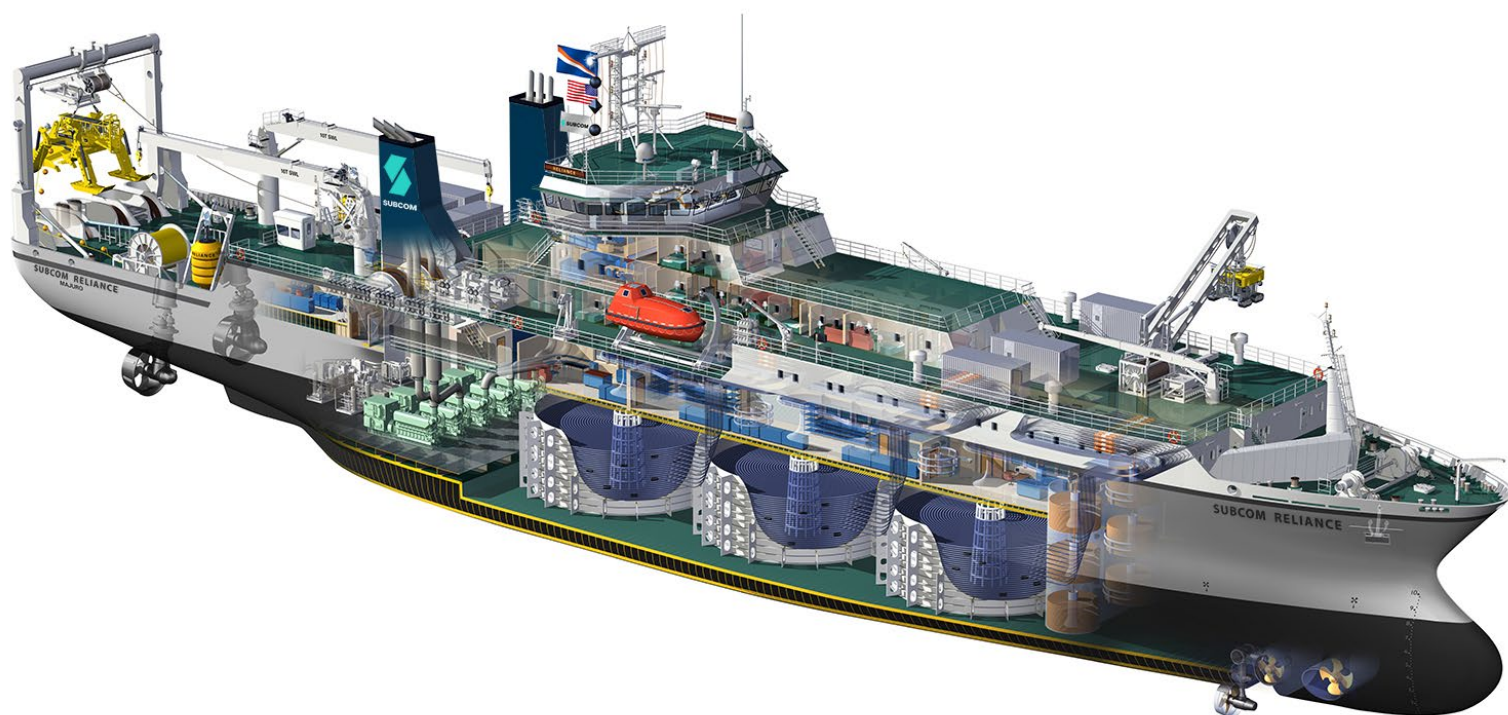

*(Courtesy of SubCom)*

Figure 14-1a. SubCom Reliance Class cable installation vessel.



*(Courtesy of SubCom)*

Figure 14-1b. SubCom Reliance Class cable installation vessel.



*(Courtesy of SubCom)*

Figure 14-2c. SubCom Reliance Class cable installation vessel.



*(Tossell, 2018)*

Figure 14-3. Alcatel Submarine Networks Ile de Class Cable Installation Vessel.

## Submarine Cable Components

Figure 14-3 and Figure 14-4 demonstrate the components of an SFOC cable, the diameter and the different types of armoring that are used depending on the water depth and seabed conditions.

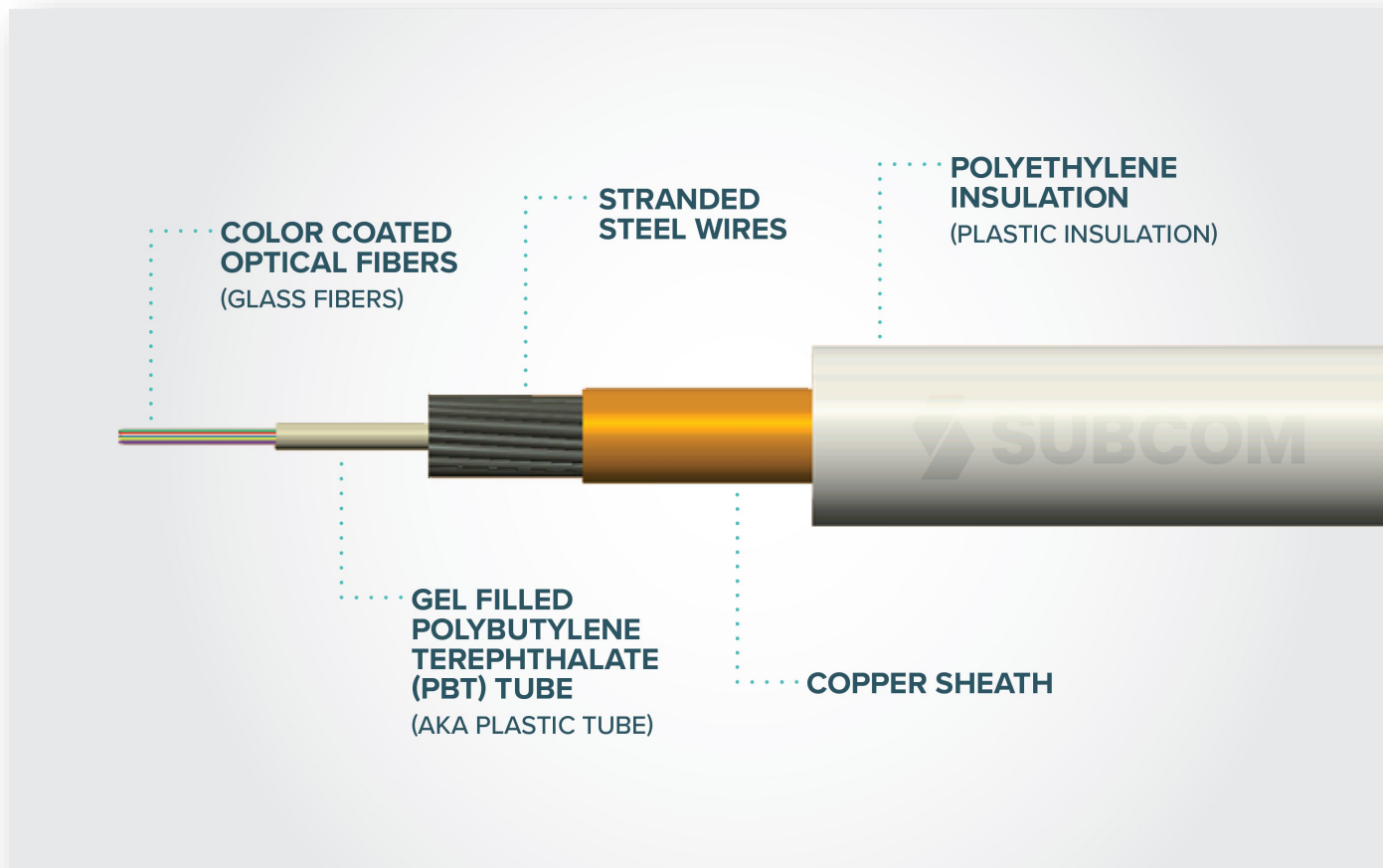

*(Courtesy of SubCom)*

Figure 14-4. Submarine fiber optic cable components.

## Subsea Fiber Optic Cable

### SL Lightweight (LW) Cable...

- Serves as the core for all armored cables
- Is designed for depths > 2500 meters  
*(largest percentage of deployment)*

### Subsea Cables...

- Protect optical fibers and electrical conductor
- Withstand harsh environmental conditions for 25 years
- Are durable, yet flexible to support system deployment, recovery, repair & re-deployment
- Are non-threatening to the subsea environment
- Survive a variety of stresses: temperature, tension, torsion, pressure, chemical exposure, bending/flexing

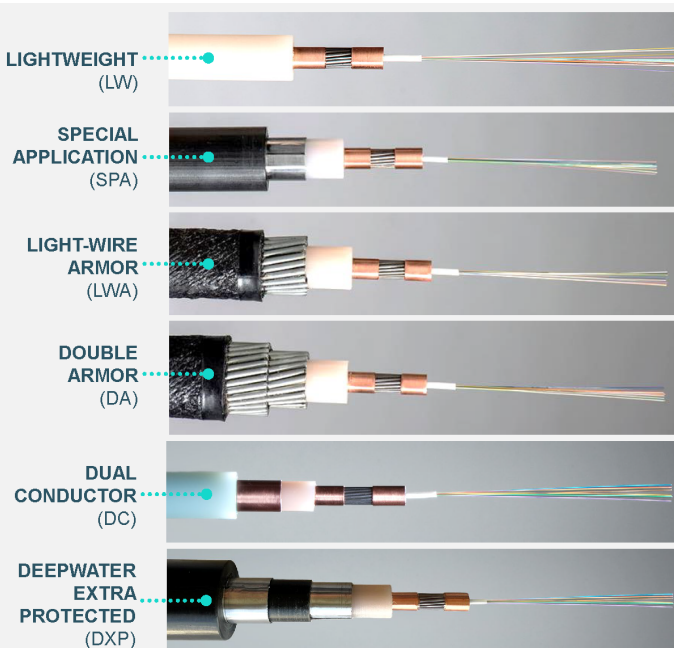

*(Courtesy of SubCom)*

Figure 14-5. Submarine fiber optic cable types.



## Cable Burial Assessment

After the completion of the DTS, a full MRS (Geophysical for the full route and Geotechnical in areas of potential burial) and final burial assessment will need to be conducted prior to the final wet plant design and development. This will include the analysis of the survey data to complete the Cable Route Engineering (CRE) and burial assessment. CRE will determine the amount of cable armoring and transitions based on seabed conditions, risk, and Water Depth (WD). The MRS and burial survey as described will determine where cable burial is possible or required and where the cable will be laid upon the seabed floor. Burial of the fiber optic cable will occur where physical conditions or maritime use requires additional protection. A diagram of typical SFOC burial plow operations is provided in Figure 14-5.

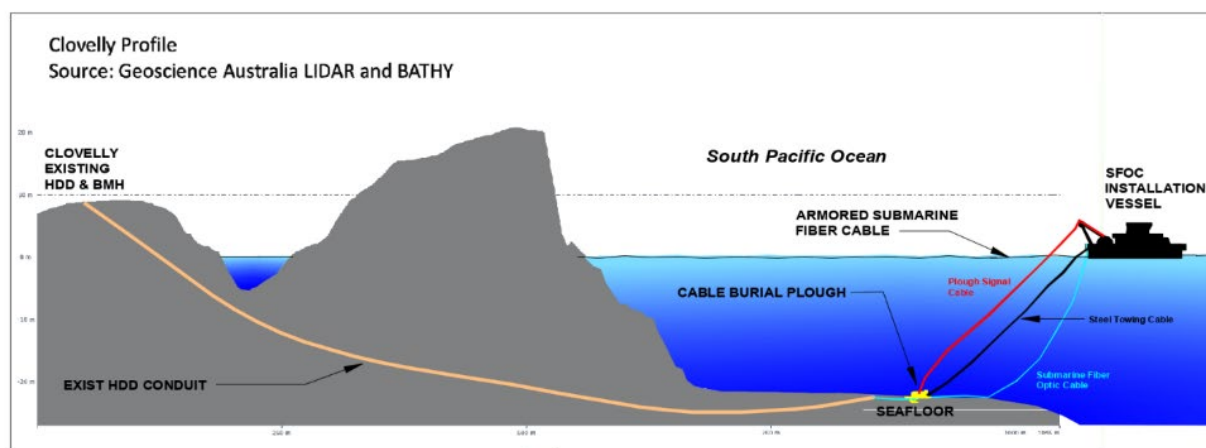

Figure 14-6. Example of submarine fiber optic cable burial plow operational diagram.

## Marine Installation Plan

As part of the final RPL, SLD and system design, a slack plan and marine installation plan will be developed to ensure that the cable will lay on the seabed floor as designed during marine installation. The Cable Ship will use the final system design and a software system will be used to control the navigation of the vessel and cable pay out speeds to ensure the cable is accurately placed in its planned route position. These operations for this potential cable system can all be conducted by industry standard and purpose-built cable laying vessels and does not require ice class capability. Cable protection and armoring recommendations have been made to the NSF, and this will be used as the baseline information to support the follow-on MRS that will develop the final cable protection, armoring, and burial requirements. This will also include the final repeater and BU placement in the route.

The McMurdo and the optional Terra Nova Bay area landing sites would utilize an HDD landing

as outlined in the DTS (Figure 14-6). During marine operations and installation, the end of the HDD conduit will be located using a magnetometer, and the conduit will be unearthed, if required. When the cable gets close to the shore and the HDD end has been uncovered, divers will be deployed from the cable ship and will pull the cable through the HDD using a winch or small excavator. The cable may be kept afloat using buoys which are removed as the cable pull progresses into the bore pipe. The cable will be pulled into a buried concrete Beach Manhole (BMH) where the cable will be anchored and transitioned to terrestrial fiber optic and power cable (Figure 14-7). A Pre-Lay Grapnel Run (PLGR) is advisable in this area and areas of potential burial to make sure the cable route is clear of any seafloor debris.

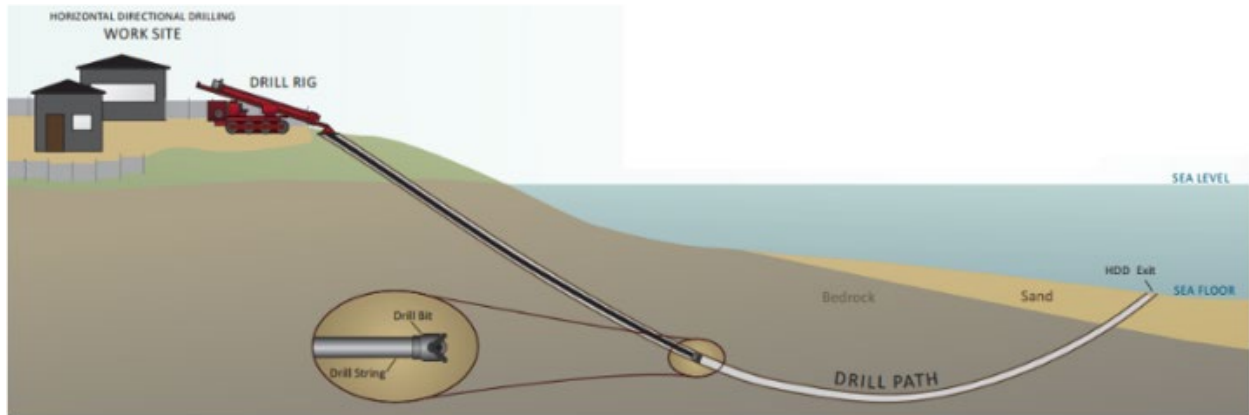

(Hadlee & Brunton Limited, 2023)

Figure 14-7. Example of horizontal directional drilling.

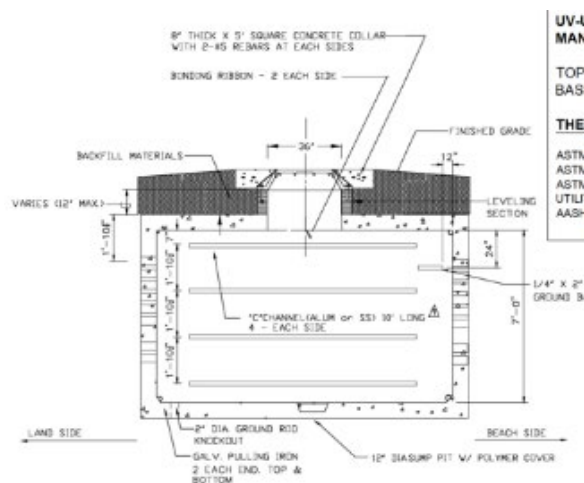

Figure 14-8. Example of beach manhole installation.

Since the SFOC will be a repeated system, it will require Power Feed Equipment (PFE) and the installation of an OGB. In the Arctic there are four successfully used methods of installing an SFOC



OGB. Site surveys are recommended for measurement of earth resistivity and access to the sea, if required for the installation of the OGB system. The most common method in many OGB systems is the placement of electrodes that are inserted into the ground below the low mean water table for best conductivity to the sea water ground (Figure 14-8). The exact number of electrodes inserted for the system are designed by using the site earth resistivity measurements and the requirements for power on the system. The electrodes are then connected in tandem to one wire which is run into the BMH and then connected to an earth cable in the conduit running to the CLS and then connected to the system PFE. In polar regions, this method is not typical, as the earth resistivity may not meet the requirements.

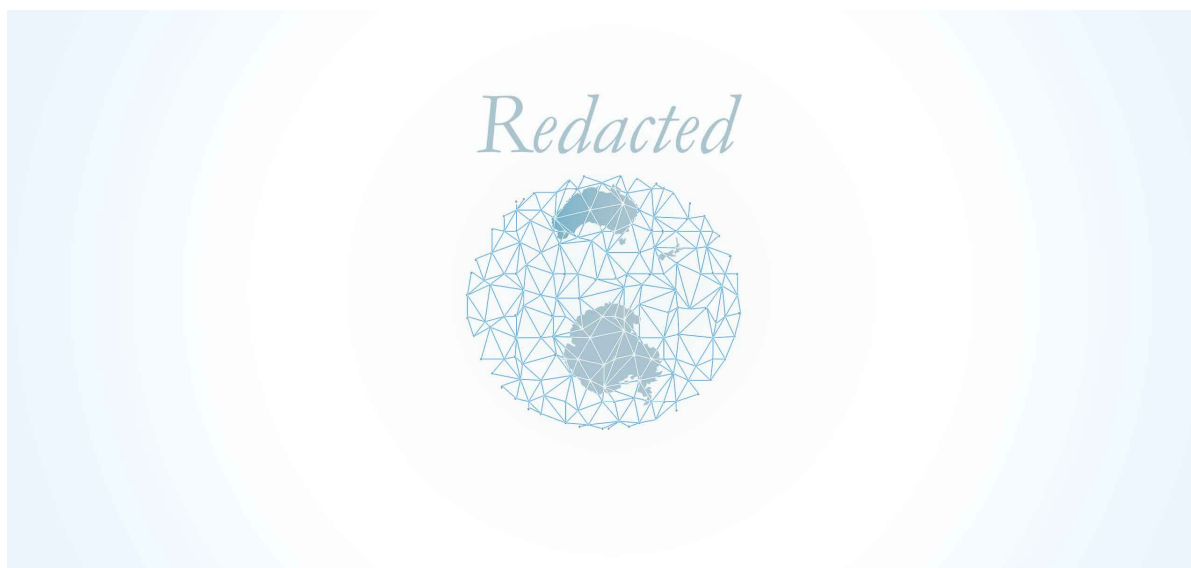

Figure 14-9. [Redacted]. Example design of a submarine fiber optic cable ocean ground bed anode design.

The second method used is the integration of a System Earth Sea Plate (SEP). This is a steel plate sized to the systems requirements and usually about a 2-meter (6.6') diameter round plate that weighs approximately one (1) ton (Figure 14-9). The plate is usually placed into a jetted hole in the seabed floor and then the seafloor restored. The plate is placed in the water to a depth that seasonal sea ice will not affect or disturb the plate. The plate is connected to a cable sized for the system requirements and then trench and run to the BMH for connection to the CLS ground cable connected to the PFE.

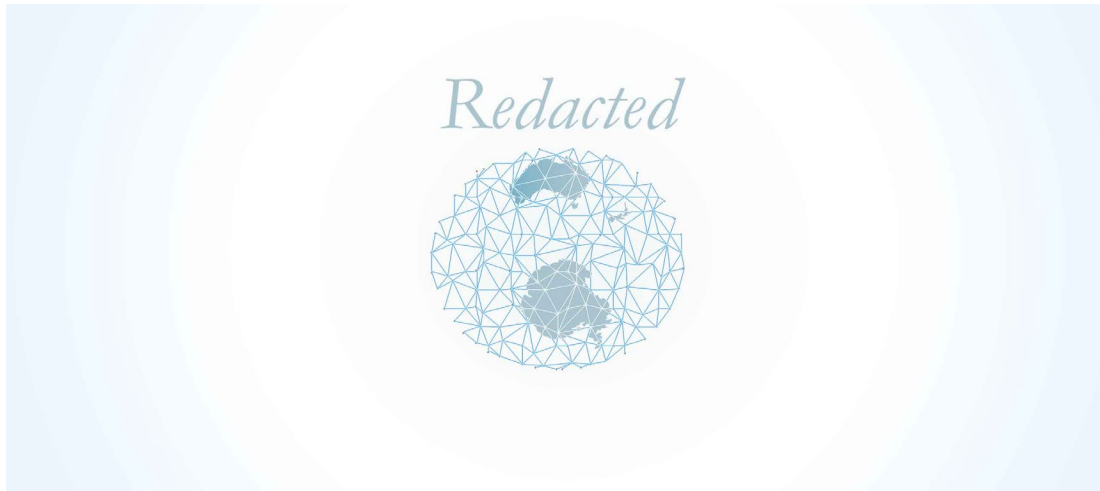

Figure 14-10. [Redacted]. Example of sea earth ground plate and earth ground cable.

A third option is the use of the Horizontally Directional Drilled (HDD) steel bore pipe. This bore pipe in most cases is at least 400 m in length and runs deep into the earth under the sea floor and then punches out on the seafloor past the seasonal ice depth. A series of exothermic welds are used to attach a sea earth ground cable to the steel bore pipe. This is done on the surface bore pipe entrance hole. The cable is then placed into a conduit and run into the BMH, connecting it to the cable in the conduit running to the CLS and then connected to the system PFE (Figure 14-10).

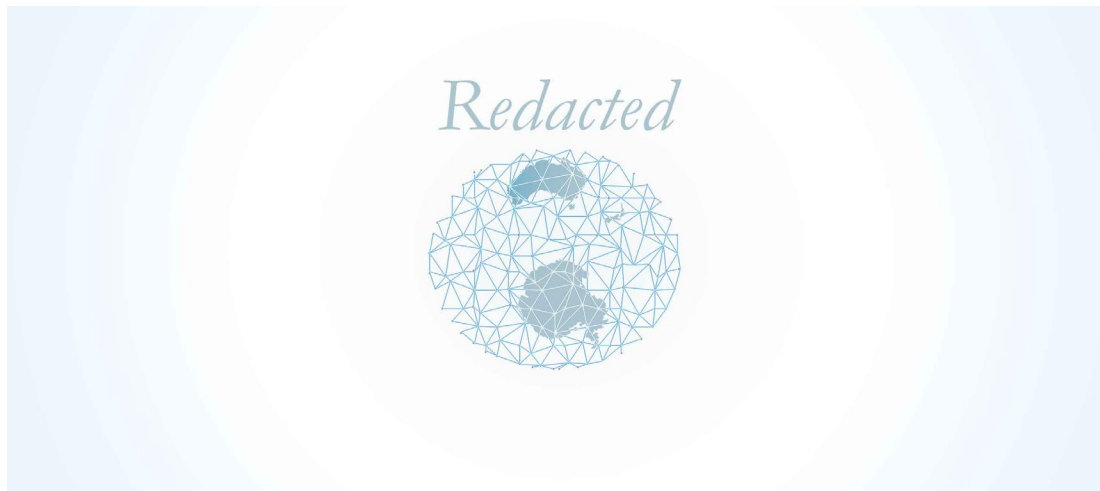

Figure 14-11. [Redacted]. Example of horizontal directional drill ground cable installation.

A final option is a Remote Sea Earth Cable, where some cable suppliers have attached anodes to the submarine cable on the seafloor. These anodes are usually about 100 m past the HDD bore pipe exit on the seafloor. They are attached at the cable manufacturing facility and the earth cable is woven in to the SFOC cable and is split out in the BMH connecting it to cable in the conduit running to the CLS and then connected to the system PFE.

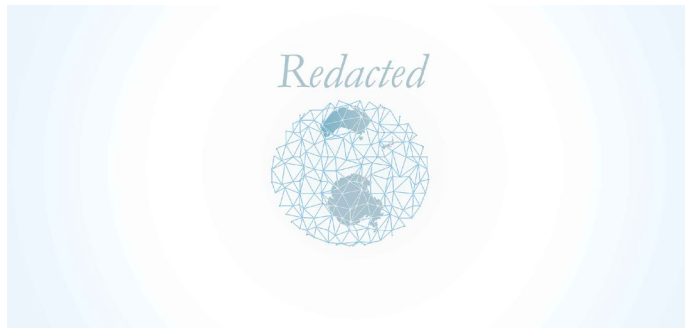

Figure 14-12. [Redacted]. Remote Sea Earth Diagram.

The system installation will be a combination of surface lay and some burial along the route, mostly nearshore as identified in the RPL. Route Clearance (RC) would be conducted in areas where there may be Out of Service (OOS) cables that need to be cleared. On the DTS routes, there is one OOS cable off Clovelly Beach and no others have been identified. Where burial is required, a Pre-Lay Grapnel Run (PLGR) would be conducted prior to the cable lay in those areas to ensure the path is clear for the submarine plow, deployed from the marine installation vessel, that will bury the cable into the seabed as the vessel installs along the cable route. The plow will cut through the seabed and as the plow transits forward, the sediment is placed back into the trench to cover the cable with no seabed sediment removed during cable installation activities (Figure 14-12). A Post-Lay Inspection and Burial (PLIB) operation would need to be conducted as part of marine operations at any splices, burial areas that would not allow plow operations and at the crossing of any other telecommunications cables or pipelines.

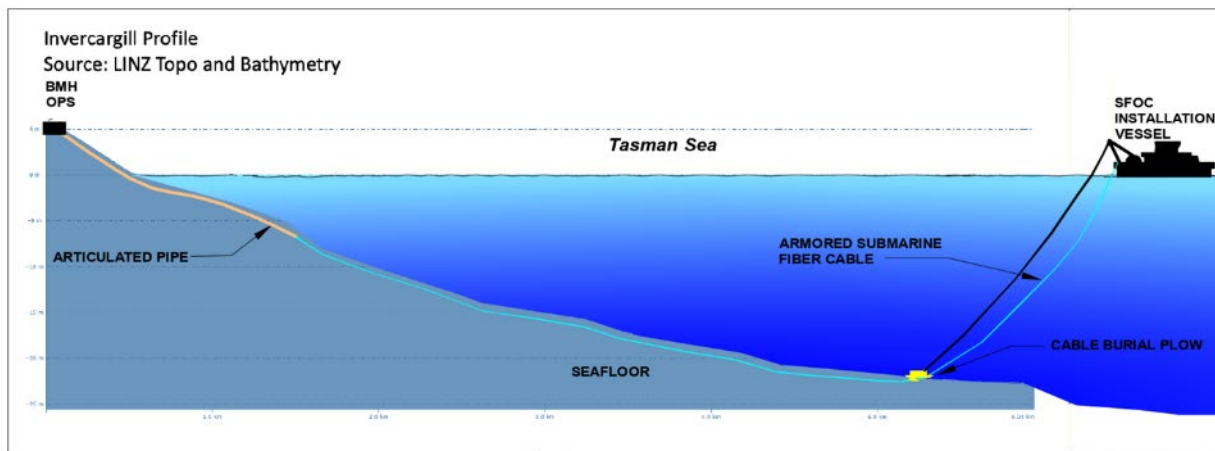

Figure 14-13. Example of submarine fiber optic cable surface lay installation.

Like McMurdo, the optional Sydney, Australia landing will utilize HDD, however, it would be an existing HDD conduit in Clovelly Beach as outlined in Section 1.0 of this report. This conduit would be purchased as part of the project and the OGB would potentially be connected to an existing system if available, or through a newly installed electrode field. An Australia system would also require the crossing of at least 6 cables in the Australia Cable Protection Zone on the landing



approach to Clovelly Beach. Crossing agreements would be required to be in place prior to the installation if the Australia Route were selected.

The landings at Invercargill, New Zealand, and Macquarie Island would be direct lay through a trench onshore as described in Section 2.3 and Section 2.4 and into a BMH, where the SFOC would be transitioned to terrestrial fiber optic and power cable. The OGB options at these locations would be a buried electrode field or a sea plate solution. The landings would also require a pre-laid shore end (PLSE), where a barge or smaller vessel is deployed into areas to act as the cable ship to deploy the cable if the water depths to operate the large cable ship (>15-20m water depth) is further offshore.

## 14.1. References

- Carter L., Burnett D., Drew S., Marle G., Hagadorn L., Bartlett-McNeil D., and Irvine N. (2009). Submarine Cables and the Oceans – Connecting the World. UNEP-WCMC Biodiversity Series No. 31. ICPC/UNEP/UNEP-WCMC. [Photograph], From, p. 18, <https://www.iscpc.org/documents/?id=132> (11 August 2023)
- Carter L., Burnett D., Drew S., Marle G., Hagadorn L., Bartlett-McNeil D., and Irvine N. (2009a). Submarine Cables and the Oceans – Connecting the World. UNEP-WCMC Biodiversity Series No. 31. ICPC/UNEP/UNEP-WCMC. [Photograph] Figure 2.4, p. 19, From, [https://www.google.com/url?sa=i&url=https%3A%2F%2Fwww.iscpc.org%2Fdocuments%2F%3Fid%3D132&psig=AOvVaw0QLouZPSHac\\_0KdcgFVWW1&ust=1691873074889000&source=images&cd=vfe&opi=89978449&ved=0CBAQ3YkBahcKEwiQx5WcvNWAAxUAAAAAHQAAAAQBA](https://www.google.com/url?sa=i&url=https%3A%2F%2Fwww.iscpc.org%2Fdocuments%2F%3Fid%3D132&psig=AOvVaw0QLouZPSHac_0KdcgFVWW1&ust=1691873074889000&source=images&cd=vfe&opi=89978449&ved=0CBAQ3YkBahcKEwiQx5WcvNWAAxUAAAAAHQAAAAQBA) (11 August 2023)
- Hadlee & Brunton Limited. 2023. What is horizontal directional drilling. Shore approach: Pilot Hole Drilling [Photograph]. From, <https://www.hadleeandbrunton.co.nz/what-is-horizontal-directional-drilling/> (11 August 2023)
- Tossell, D. 2018. Top of the world Arctic Broadband Summit, Sapporo June 2018, David Tossell Director of Marine Engineering, Alcatel Submarine Networks [PowerPoint], From, <https://arcticeconomiccouncil.com/wp-content/uploads/2018/07/Tossell-David.pdf> (11 August 2023)



National Science Foundation



# MARINE ROUTE SURVEY







## 15.0 [TEXT REDACTED] MARINE ROUTE SURVEY (MRS)

This document is a redacted version of the full Desktop Study that excludes information not suitable for public release.

---

### *Nathaniel B. Palmer*

Research Vessel / Icebreaker

---

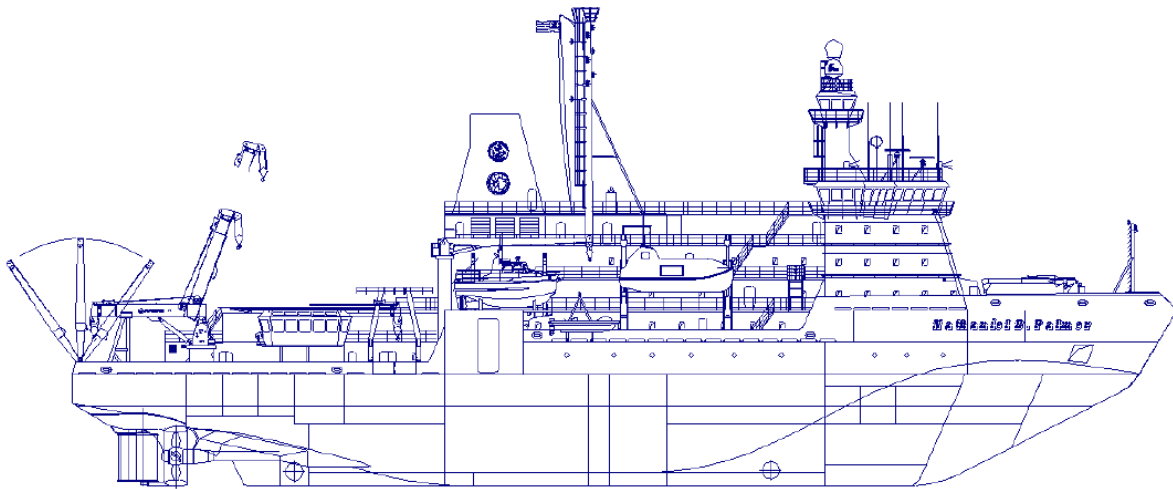

(USAP, 2023)

Figure 15-1. Research Vessel / Icebreaker Nathaniel B. Palmer



*(OGS, 2023)*

Figure 15-2. Research Vessel Laura Bassi – Ice Breaker Class.



*(Pacific Survey Group, 2023)*

Figure 15-3. Research Vessel Ocean Titan.

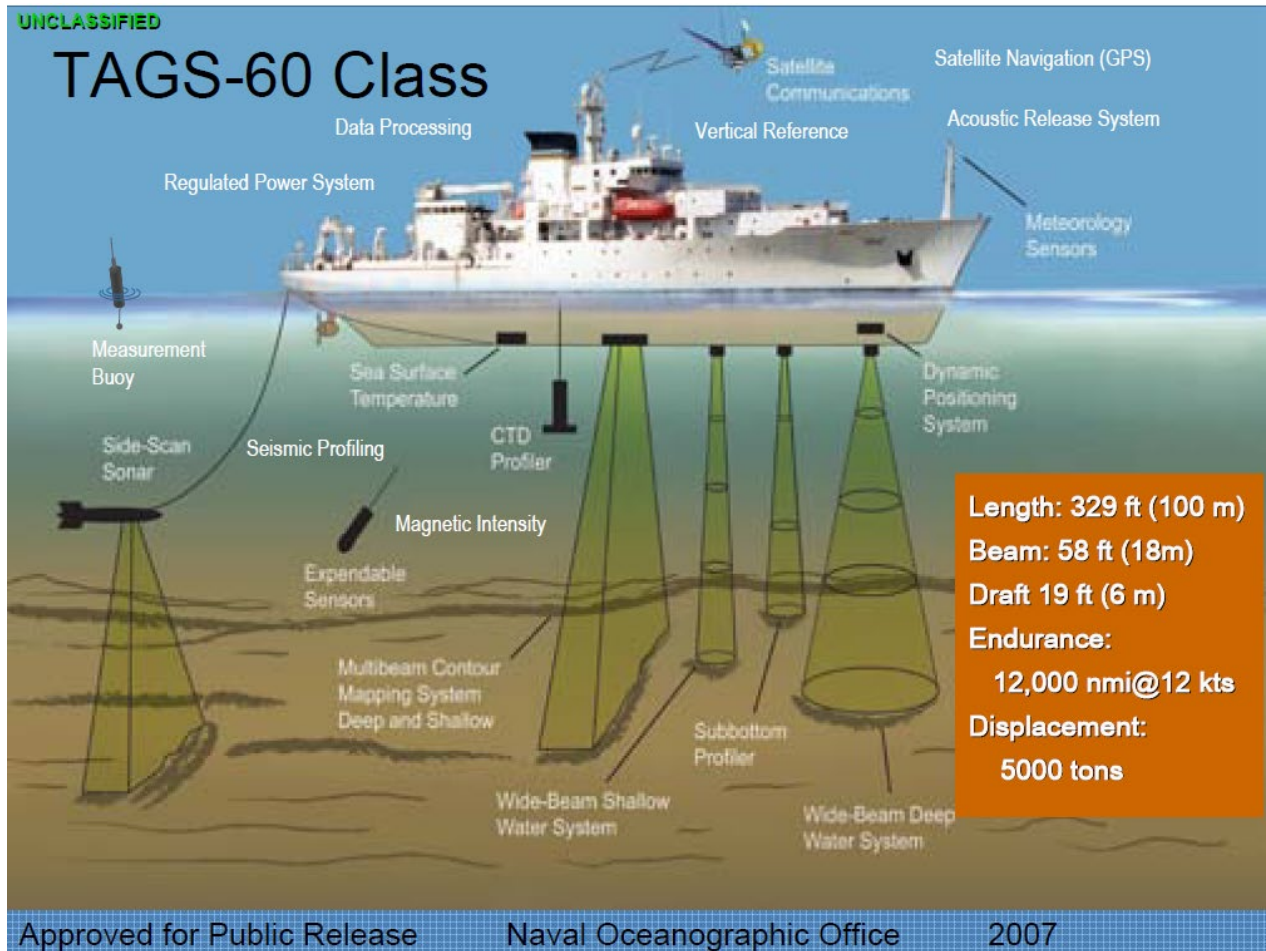

*(Naval Oceanographic Office, 2023)*

Figure 15-4. Example of marine route survey vessel and equipment array.



## 15.1. References

Istituto Nazionale di Oceanografia e di Geofisica Sperimentale (OGS). 2023. R/V Laura Bassi vessel specification sheet [Photograph]. From, [https://www.ogs.it/sites/default/files/laura\\_bassi\\_specifications.pdf](https://www.ogs.it/sites/default/files/laura_bassi_specifications.pdf) (20 July 2023)

Naval Oceanographic Office. 2023. Overview for 7<sup>th</sup> NIOHC Pattaya, Thailand 27 Feb – 2 March 2007, John Cousins, Captain, U.S. Navy, Commanding Officer [PowerPoint]. From, [https://legacy.iho.int/mtg\\_docs/rhc/NIOHC/NIOHC7/NIOHC7\\_15\\_US-National\\_Report.pdf](https://legacy.iho.int/mtg_docs/rhc/NIOHC/NIOHC7/NIOHC7_15_US-National_Report.pdf) (20 July 2023)

Pacific Survey Group. 2023. Ocean Titan specifications sheet [Photograph]. From, <https://psgllc.com/vessels/ocean-rover-2> (20 July 2023)

United States Antarctic Program (USAP). 2023. Research Vessel / Icebreaker Nathaniel B. Palmer - ASC-18-200 [Image]. From, [https://www.usap.gov/usapgov/vesselscienceandoperations/documents/nbp\\_guide.pdf](https://www.usap.gov/usapgov/vesselscienceandoperations/documents/nbp_guide.pdf) (20 July 2023)



# ROM COST ESTIMATES





## 16.0 [REDACTED] ROUGH ORDER OF MAGNITUDE (ROM) COST ESTIMATES

This document is a redacted version of the full Desktop Study that excludes information not suitable for public release.



# SFOC POTENTIAL COMMERCIAL SYSTEM







## 17.0 [REDACTED] SFOC POTENTIAL COMMERCIAL SYSTEM

This document is a redacted version of the full Desktop Study that excludes information not suitable for public release.



National Science Foundation



# SCIENTIFIC SENSING





## 18.0 SCIENTIFIC SENSORS

The technical capability of Scientific Sensing in an SFOC from Antarctica to Australia or New Zealand can be accomplished through multiple methods, some of which are available today and others that are in development. Using a Branching Unit with a scientific array has been utilized in many applications and is a technically feasible and currently available option for the scientific BU's identified in the route(s). Additionally, Science Monitoring And Reliable Telecommunications (SMART) cable and repeater technology is currently in development, as well as Distributed Acoustic Sensing (DAS), which uses the fiber optic cable as a sensor along the fiber path. Each of these technologies has the potential to be integrated into the DTS systems. Beyond the determination of feasibility, the development and implementation of Scientific Sensing is not part of the DTS requirement, however, this section provides an overview of some of the developing SMART and DAS systems and capabilities.

### 18.1. SMART Cables and Repeaters

The SMART cable initiative is a developing area of scientific research where the goal is to integrate and utilize a sensor network within an SFOC system to collect scientific data to allow better understanding, planning and notifications related to climate change, sea level rise, ocean warming, tsunamis, and earthquakes. This is currently being developed within the scientific community as well as in cooperation with commercial SFOC suppliers who are working to develop SMART capabilities.

The following summaries in this section demonstrate the potential and key players in the development of this technology.

#### **Subsea Data Systems SMART Repeater Sensor System Development**

**Prepared by: Dr. Matt Fouch ([matt.fouch@subseadatasystems.com](mailto:matt.fouch@subseadatasystems.com))**

Subsea Data Systems (SDS) has recently demonstrated a prototype Sensor Monitoring And Reliable Telecommunications (SMART) repeater sensor system comprising a low noise, dual range seismic sensor, pressure sensor, temperature sensor, and embedded server. The seismic sensor provides a dynamic range from 0.8 ng to 2.0 g with self-noise levels below 2 ng/ $\sqrt{\text{Hz}}$  over the band from 0.1 to 100 Hz, with substantial response at lower frequencies (0.05 Hz and below). The pressure sensor provides absolute accuracy of 3 kPa and resolution of 30 Pa at a sampling rate of 100 Hz. The temperature sensor provides accuracy of  $\pm 0.001^\circ\text{C}$ . The embedded server streams real-time data using the Standard Exchange of Earthquake Data (SEED) format, providing out-of-the-box compatibility with existing data processing applications used by major seismic



data repositories. The design of the prototype sensor subsystem incorporates features such as electrical power isolation to allow compatibility with telecommunications functions in a dual-use cable system. The total power consumption of the sensor system is less than 3.0 W (excluding communications interfaces).

SDS anticipates further development within the next twelve months focused on mechanical, electrical, and optical integration into repeaters. SDS will offer this solution to both telecommunication system operators and system suppliers. SDS would like to thank the National Science Foundation for funding and support through the Directorate for Technology, Innovation and Partnerships (TIP) Small Business Innovation Research (SBIR) program (award #TIP-2104205).

## SMART Cables

The information provided in this section has been developed by Stephen Lentz, Director Network Development at Ocean Specialists, Inc. **Email:** [slentz@oceanspecialists.com](mailto:slentz@oceanspecialists.com)

### Introduction

The ocean is key to understanding societal threats including climate change, sea level rise, ocean warming, tsunamis, and earthquakes. Because the ocean is difficult and costly to monitor, we lack fundamental data needed to adequately model, understand, and address these threats.

One solution is to integrate sensors into future undersea telecommunications cables. This is the mission of the SMART subsea cables initiative (**Science Monitoring And Reliable Telecommunications**). SMART sensors would “piggyback” on the power and communications infrastructure of a million kilometers of undersea fiber optic cable and thousands of repeaters, creating the potential for seafloor-based global ocean observing at a modest incremental cost. Initial sensors would measure temperature, pressure, and seismic acceleration. The resulting data would address two critical scientific and societal issues: the long-term need for sustained climate-quality data from the under-sampled ocean (e.g., deep ocean temperature, sea level, and circulation), and the near-term need for improvements to global tsunami warning networks. A Joint Task Force (JTF) led by three U.N. agencies (ITU/WMO/UNESCO-IOC) is working to bring this initiative to fruition. See <https://www.itu.int/en/ITU-T/climatechange/task-force-sc/Pages/default.aspx>, and *SMART Cables for Observing the Global Ocean: Science and Implementation* (Howe et al., 2018), a white paper under review as part of the OceanObs’19 conference process.

Deployment of oceanographic sensors on new subsea telecommunication cables presents a



promising technique for obtaining the extensive, longitudinal, real-time data that are critical for understanding and managing urgent environmental issues such as climate change and tsunami hazard mitigation. Such sensors can provide important environmental data from multiple sites in the deep ocean that are otherwise difficult and expensive to secure in real-time and over decadal time scales. Suitable sensors are already deployed on dedicated cabled ocean research observatories.

### **Sensor Integration into Telecommunications Cables**

A subsea fiber optic communications system comprises the cable (with varying layers of protection depending on water depth, seabed conditions, and potential risks), pressure housings containing erbium doped fiber amplifiers (EDFAs) (referred to as “repeaters”) spaced at intervals from 60 to 150 km, power feed equipment (PFE) that delivers a controlled direct current to the repeaters through the cable’s single electrical conductor, and terminal station equipment (TSE) to transmit and receive signals on the optical fiber strands within the cable. Systems may include branching units (BUs) to provide connections to locations along the main cable route. Lengths range from less than 100 km to greater than 10,000 km. Systems of less than 500 km do not require repeaters and are generally not candidates for inclusion of SMART capabilities. Regional systems with lengths up to 2,500 km are ideal for the inclusion of sensor capabilities because these systems have sufficient design margin and can usually accommodate additional fibers to carry sensor data. Ocean spanning cables of 6,000 km or more are the most challenging. Successful operation of shorter SMART cables will be needed before sensor functions can be introduced into the longest cables.

The repeater is housed in a cylindrical pressure vessel typically 30 cm in diameter and 60–120 cm in length. Together with couplings and strain relief, the entire repeater assembly is 3–5 m long (Figure 18-1). The repeater houses EDFAs, which provide signal gain. The current generation of cable systems can have up to sixteen fibers (eight bi-directional pairs) and work is underway to allow even higher fiber counts.

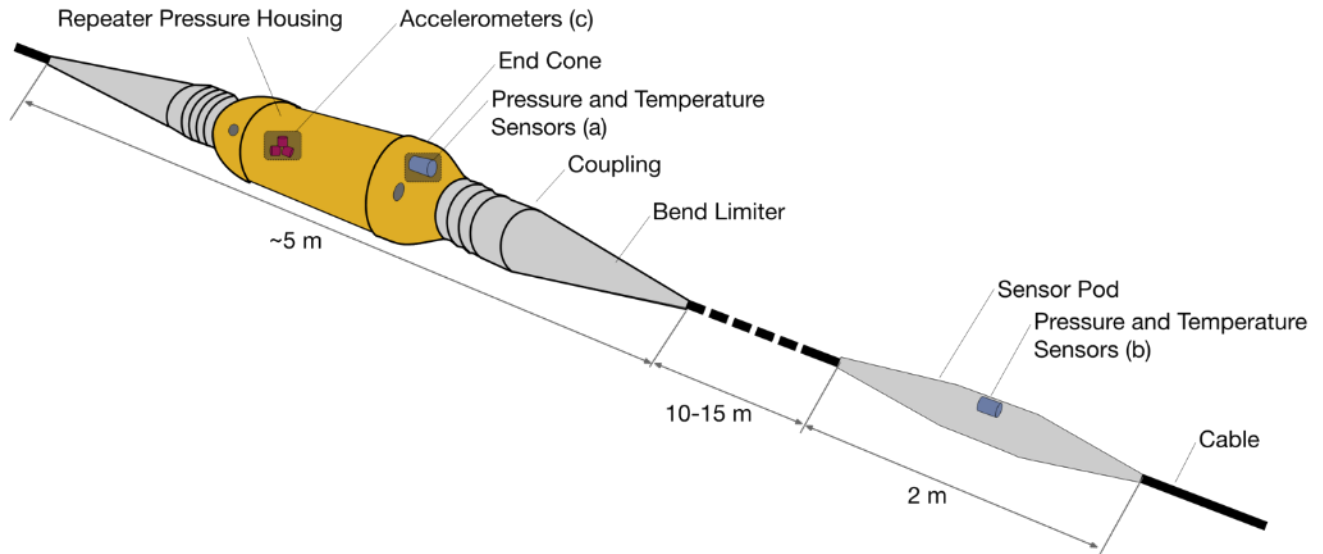

(SNAM, 2023)

Figure 18-1. Illustration of a repeater housing showing two possible sensor mounting locations: (a) on the end of repeater housing under the bell housing or (b) in an external pod. Accelerometers are mounted inside the pressure housing (c).

The development of a SMART cable project would be able to use a fully integrated SMART repeaters in the main telecommunications pathway (Figure 18-2). This is a significant step from the demonstration system which will deploy SMART repeaters only in a branch which is isolated from the telecommunications system.

### SMART Repeater & Sensor Cable System

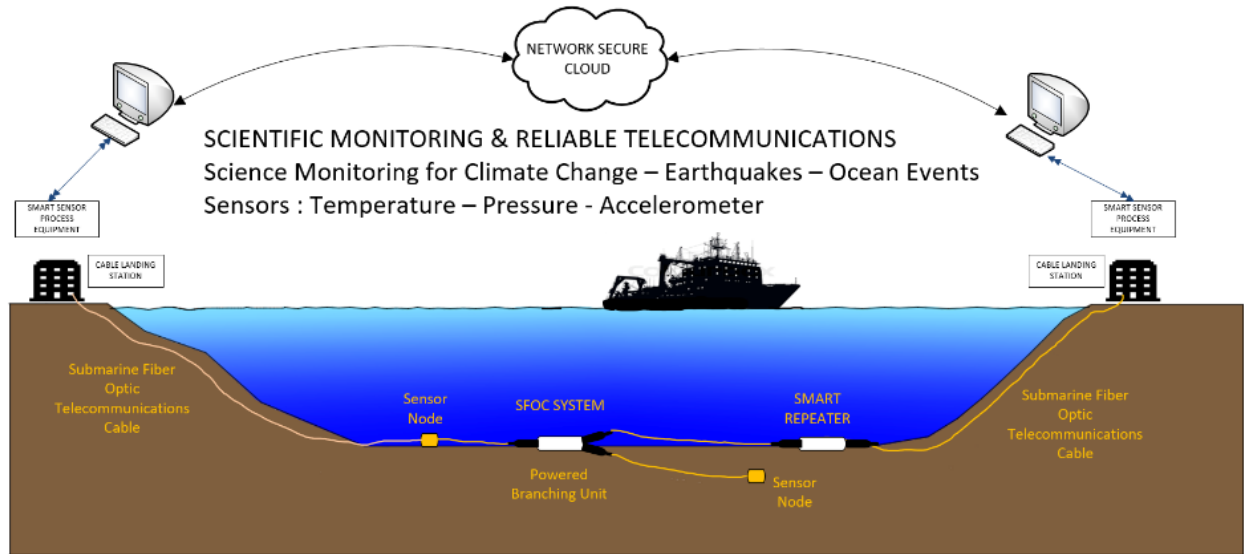

Figure 18-2. Conceptual diagram of scientific repeater sensor and telecommunications.

Two alternative approaches may also be considered if the SMART cable technology does not advance as anticipated. The first is to add SMART sensors to the cable in separate housings from the repeaters (Figure 18-3). This alternative is less desirable because it defeats one of the main purposes using SMART technology, i.e., to avoid introducing additional submerged housings into the cable system. However, if a true SMART repeater is not yet available, this option would still allow sensor nodes to be integrated into the cable (Figure 18-4). The housings, cable couplings, and power supply components of the sensor nodes would be engineered and qualified to the same standards as standard repeaters.

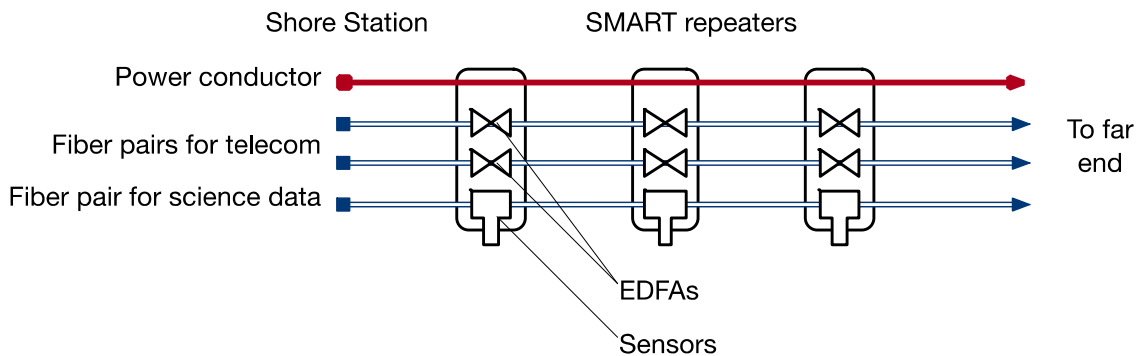

Figure 18-3. Conceptual block diagram of SMART cable functionality.

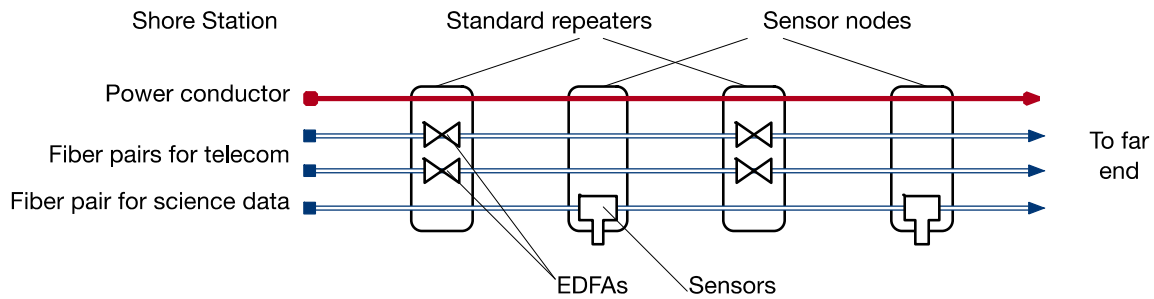

Figure 18-4. Conceptual diagram of interleaved sensor nodes.

A second, and least desirable, alternative is to include an additional power conductor and fibers in the shore ends of the cable so that it can support science platforms (Figure 18-5) or a string of sensors (Figure 18-6) on a separate cable branch. (Note this last option is essentially the same configuration as that planned for the demonstration system.) The branch point would be placed from 10 to 30 km from shore at the margin of the abyssal plain. This approach does not provide sensor capability along the entire cable, but only at a few points near each landing station. The science platform must be deployed separately and an ROV is needed to make the final connection to the submarine cable. The use of dual conductor cable adds operational overhead because the tooling and skills needed for repair must be maintained. Nevertheless, if SMART repeaters are not available in any form, this option could be pursued to provide some sensor capability.

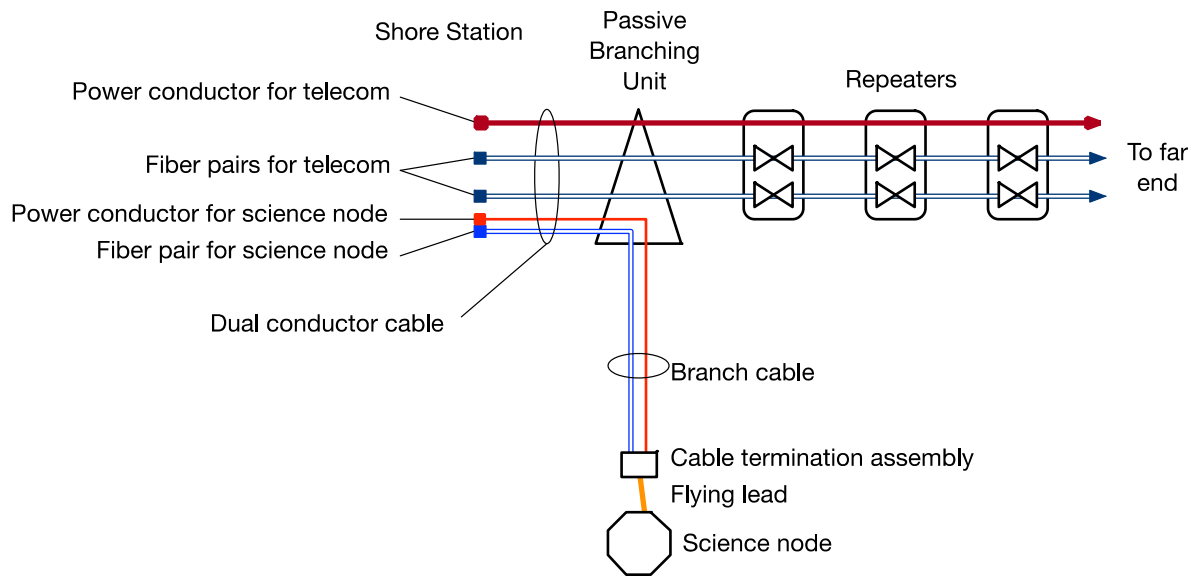

Figure 18-5. Conceptual block diagram of a science node connected to a branch cable.



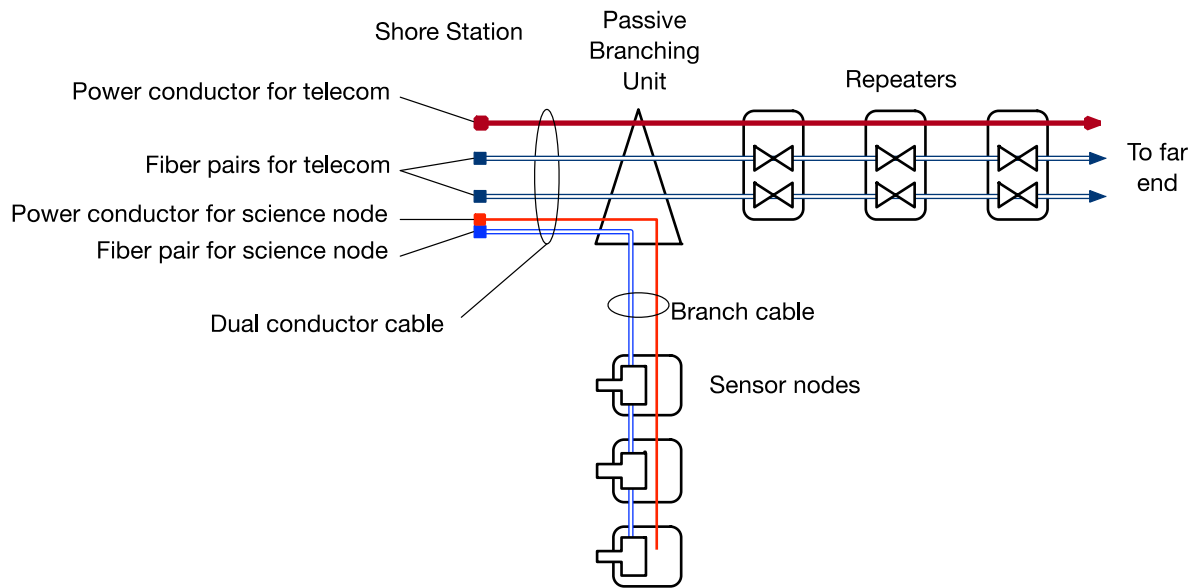

Figure 18-6. Conceptual block diagram of sensor nodes connected to a branch cable.



## 18.2. Dark Fiber Distributed Acoustic Sensing (DAS)

Distributed Acoustic Sensing (DAS) is a technology that utilizes spans of fiber optic cable to enable continuous, real-time measurements along the entire length of the cable. This developing area of technology has shown the potential for detection of seismic activity, vessel traffic, currents, and other factors. There have been a number of scientific papers that demonstrate this capability with two of the paper abstracts and references below.

### **Optical Interferometry-Based Array Of Seafloor Environmental Sensors Using A Transoceanic Submarine Cable**

G. MarraD. M. FairweatherV. KamalovP. GaynorM. CantonoS. MulhollandB. Baptiej. C. CastellanosG. VagenasJ.-O. GaudronJ. KronjägerI. R. HillM. Schioppol. Barbeito EdreiraK. A. BurrowsC. ClivatiD. CalonicoA. Curtis

#### **Abstract**

Optical fiber-based sensing technology can drastically improve Earth observations by enabling the use of existing submarine communication cables as seafloor sensors. Previous interferometric and polarization-based techniques demonstrated environmental sensing over cable lengths up to 10,500 kilometers. However, measurements were limited to the integrated changes over the entire length of the cable. We demonstrate the detection of earthquakes and ocean signals on individual spans between repeaters of a 5860-kilometer-long transatlantic cable rather than the whole cable. By applying this technique to the existing undersea communication cables, which have a repeater-to-repeater span length of 45 to 90 kilometers, the largely unmonitored ocean floor could be instrumented with thousands of permanent real-time environmental sensors without changes to the underwater infrastructure.

### **Illuminating Seafloor Faults And Ocean Dynamics With Dark Fiber Distributed Acoustic Sensing**

N.J. Lindsey, T. C. Dawe, J. B. Ajo-Franklin

#### **Abstract**

Distributed fiber-optic sensing technology coupled to existing subsea cables (dark fiber) allows observation of ocean and solid earth phenomena. We used an optical fiber from the cable supporting the Monterey Accelerated Research System during a 4-day maintenance period with a distributed acoustic sensing (DAS) instrument operating onshore, creating a ~10,000-

component, 20-kilometer-long seismic array. Recordings of a minor earthquake wavefield identified multiple submarine fault zones. Ambient noise was dominated by shoaling ocean surface waves but also contained observations of in situ secondary microseism generation, post-low-tide bores, storm-induced sediment transport, infragravity waves, and breaking internal waves. DAS amplitudes in the microseism band tracked sea-state dynamics during a storm cycle in the northern Pacific. These observations highlight this method's potential for marine geophysics.

### 18.3. References

- Howe, B. M., Arbic, B. K., Aucan, J., Barnes, C. R., Bayliff, N., Becker, N., ... & Weinstein, S. (2019). SMART cables for observing the global ocean: science and implementation. *Frontiers in Marine Science*, 6, 424. <https://doi.org/10.3389/fmars.2019.00424>
- Hughes, C. W., Williams, J., Blaker, A., Coward, A., & Stepanov, V. (2018). A window on the deep ocean: the special value of ocean bottom pressure for monitoring the large-scale, deep-ocean circulation. *Progress in Oceanography*, 161, 19-46. <https://doi.org/10.1016/j.pocean.2018.01.011>
- Lindsey, N. J., Dawe, T. C., & Ajo-Franklin, J. B. (2019). Illuminating seafloor faults and ocean dynamics with dark fiber distributed acoustic sensing. *Science*, 366(6469), 1103-1107. <https://doi.org/10.1126/science.aay5881>
- Marra, G., Fairweather, D. M., Kamalov, V., Gaynor, P., Cantono, M., Mulholland, S., ... & Curtis, A. (2022). Optical interferometry-based array of seafloor environmental sensors using a transoceanic submarine cable. *Science*, 376(6595), 874-879. <https://doi.org/10.1126/science.abo1939>
- Sistema Nacional de Alarma de Maremotos (SNAM). (2023). Submarine fiber optic cables and the opportunity for strengthening current early tsunami warning and monitoring in the South Pacific, Rear Admiral Arturo Oxley, Director, 19-20 January 2023, Honolulu, Hawaii 9<sup>th</sup> Workshop on “Joint Task Force on SMART Cables” [PowerPoint]. From, <https://www.itu.int/en/ITU-T/Workshops-and-Seminars/2023/0119/Pages/default.aspx> (14 August 2023)



## 19.0 [REDACTED] APPENDICES

***Not available for public release.***

Appendix A – DTS Route Position List (RPL) and Straight-Line Diagram (SLD)

Appendix B – Site Visit Reports

Appendix C – Charts

Appendix D – Permitting Requirement Matrices

Appendix E – Cable Crossings

Appendix F – MRS ROM

Appendix G – SFOC Implementation and Sustainment ROM Cost

Appendix H – Ice Scour Data

Appendix I – SMART Cables

Appendix J – SFOC Cable Installation Vessels

Appendix K – GIS Data





## 20.0 INDEX

ACMA.....	3-7, 7-5, 7-6
Adelie penguins .....	8-38
Anchor ice .....	6-21, 6-29
Anchoring.....	1-5, 7-5, 7-6
Antarctic Conservation Act .....	3-48
Antarctic Oscillation.....	5-8, 5-10
Antarctic Specially Protected Area.....	3-48
Antarctic Treaty 16, 20, 21, xiv, xvi, xvii, 3-38, 3-39, 3-40, 3-41, 3-42, 3-44, 3-46, 3-48, 7-17, 7-38, 8-31	
Antarctic Treaty System.....	21, xiv, xvii, 3-38, 3-39, 3-40
Arctic.....	6-24, 6-27, 6-29, 6-31, 14-9, 14-14, 21-1
array.....	21, 11-1, 11-2, 18-1, 18-8, 18-9
Automatic Identification System (AIS) .....	7-19
Beach Manhole .....	xiv, 2-4, 14-9
Biosecurity Act .....	3-35, 3-36
BMHxiv, 2-4, 2-9, 2-11, 2-18, 3-7, 3-9, 3-11, 8-1, 8-2, 8-7, 8-10, 8-11, 10-1, 10-4, 10-10, 14-9, 14-10, 14-11, 14-13	
cable landing....	13, 17, 1-2, 3-28, 3-30, 4-8, 5-1, 5-3, 5-7, 6-20, 6-24, 7-1, 7-23, 8-13, 8-20, 8-31, 10-1
Cable Landing Station .....	xiv, 2-9, 10-25
Cable Protection Zone .xiv, 1-5, 2-4, 2-5, 2-9, 2-20, 3-7, 9-1, 14-12	
Cable Protection Zones .....	1-5, 2-21, 7-24
Cable Route Engineering (CRE) .....	14-8
Cape Adare .....	8-37, 8-38
carrier license .....	3-7
CCAMLR3-48, 3-49, 3-50, 3-51, 3-52, 3-53, 7-17, 7-35, 7-36, 7-37, 7-38, 8-31	
CCMALR .....	3-46
Clovelly.17, 22, 2-4, 3-11, 4-4, 7-1, 7-2, 8-1, 8-2, 8-7, 8-8, 8-9, 8-10, 10-1, 10-4, 14-12	
Coastal Permit.....	3-13, 3-25, 3-27
Coastal Plan Rules.....	3-23
Commission for the Conservation of Antarctic Marine Living Resources (CCAMLR).....	8-31
Covid-19.....	1-2
CPZ.....	xiv, 1-5, 2-9, 2-22
CPZs .....	1-5, 2-21
data center..	3-30, 4-4, 4-10, 4-16, 7-24, 10-6, 10-13, 10-22, 10-25
Distributed Acoustic Sensing	
DAS.....	21, 11-1, 18-1, 18-8, 18-9
Distributed Acoustic Sensing (DAS).....	21, 11-1, 18-1, 18-8
DoD .....	xiv, 7-7
Dr. Matt Fouch	
Fouch, Dr. Matt.....	18-1
DTS Route.....	18, 7-19, 19-1
EEZ.....	xiv, 3-13, 3-14, 3-16, 3-17, 3-31, 3-32, 7-19, 8-3, 8-6
EIA .xiv, 3-41, 3-42, 3-43, 3-44, 3-45, 3-46, 3-47, 3-49, 3-53, 3-54, 7-17	
El Niño .....	5-6, 5-8
environmental impact assessment.....	3-8
Environmental Protection Authority xv, 3-18, 3-31, 3-32, 3-36	
EPA ...	xiv, xv, 3-13, 3-14, 3-18, 3-31, 3-32, 3-33, 3-35, 3-36
fishery 7-8, 7-10, 7-11, 7-12, 7-13, 7-14, 7-16, 7-25, 7-27, 7-36	
Foveaux Strait....	2-12, 4-1, 4-9, 6-14, 6-15, 7-26, 7-27, 8-19
Frazil ice.....	6-21
glaciers .....	xiv, 6-21, 6-23
hapū .....	3-32
HDD 17, 22, xv, 1-6, 2-1, 2-4, 2-5, 2-17, 2-18, 2-22, 3-7, 3-9, 3-48, 4-4, 6-23, 6-24, 6-26, 7-33, 8-1, 8-3, 8-7, 8-8, 8-9, 8-11, 10-22, 10-24, 10-25, 14-1, 14-8, 14-11, 14-12	
Hillary Canyon .....	2-16
humpback whales.....	8-38
Hut Point Peninsula.....	2-17, 4-16
Ice Class vessel .....	14-1
ice scour .....	16, 6-24, 6-28, 8-25, 8-26, 14-1
Ice Scour.....	6-22, 6-23, 19-1
Ice Shelf.....	4-15, 4-23, 6-19, 6-21, 6-24, 6-25, 6-28, 6-30
Icebergs .....	6-20, 6-21, 6-23, 6-28
Interim Progress Review .....	1-2
International Cable Protection Committee (ICPC)....	1-1, 1-5
Invercargill 13, 17, 22, 2-7, 2-9, 2-20, 3-13, 3-18, 3-21, 3-25, 3-29, 3-30, 3-35, 4-1, 4-10, 4-11, 4-12, 4-13, 5-1, 5-7, 5-8, 6-14, 6-16, 6-17, 6-18, 7-23, 7-24, 7-26, 7-27, 7-28, 7-38, 8-13, 8-14, 8-15, 8-16, 8-17, 8-18, 8-19, 8-20, 8-21, 8-25, 9-1, 10-1, 10-9, 10-13, 10-15, 14-13	
IPR .....	1-2
iwi3-27, 3-28, 3-29, 3-32, 3-33	
Iwi3-14, 3-18, 3-28, 10-10	
krill.....	7-35, 8-27, 8-30, 8-33, 8-38
Krill .....	8-30, 8-33
Land use Permit.....	3-13
Macquarie Island...13, 16, 17, 22, xv, 2-1, 2-7, 2-8, 2-9, 3-3, 3-4, 3-7, 3-8, 3-9, 4-2, 4-5, 4-7, 4-8, 4-15, 5-1, 5-3, 5-4, 5-5, 5-6, 7-17, 8-1, 8-3, 8-5, 8-6, 8-8, 8-9, 8-10, 8-11, 8-12, 10-1, 10-16, 10-18, 14-13	
Macquarie Ridge	2-6, 2-7, 2-13, 2-14, 2-15, 4-1, 4-2, 4-3, 4-5, 4-6, 4-8, 4-9, 4-13, 4-14, 6-2, 11-2
Makarewa .....	10-13



Marine Mammal Protection Act ..... 3-35, 3-48, 3-54

Marine Route Survey ... 14, 22, xv, 1-2, 2-19, 3-1, 6-23, 6-26

marine survey ..... 16, 1-4, 2-8, 2-9, 3-11, 7-7

Maritime Transport Act ..... 3-35, 3-36

McMurdo Sound 2-16, 2-17, 4-17, 6-19, 6-20, 6-21, 6-22, 8-25, 8-27, 8-28, 8-29, 8-30, 8-31, 8-38

McMurdo Station... 12, 13, 19, 20, 2-1, 2-2, 2-3, 2-7, 2-9, 2-17, 2-18, 3-39, 3-47, 3-48, 3-53, 4-1, 4-2, 4-15, 4-16, 4-18, 5-1, 5-9, 5-10, 6-19, 6-20, 6-22, 7-23, 7-33, 8-25, 8-31, 8-39, 8-40, 10-1, 10-22, 10-25, 10-26, 11-4, 14-1

MRS..14, 15, xv, 1-2, 2-19, 3-1, 3-42, 3-48, 14-1, 14-8, 15-1, 19-1

National Aeronautics and Space Administration (NASA) 1-1

National Intelligence Mapping Agency ..... xv, 1-1

National Intelligence Mapping Agency (NIMA)..... 1-1

National Oceanographic and Atmospheric Administration (NOAA) ..... 1-1

Naval Seafloor Cable Protection Office..... xvi, 1-1, 2-1

New Zealand Transport Agency ..... 3-30

NIMA ..... xv, 1-1

NSCPO ..... xvi, 1-1, 2-1

Office of Polar Programs..... xvi, 1-2, 10-22

Oreti Beach ...2-9, 2-10, 2-11, 2-12, 3-29, 4-9, 4-10, 4-13, 7-24, 8-13, 8-19, 10-9

Permit Feasibility Study ..... 3-1

Permitting Feasibility Study .....21, 3-38

PFS ..... 21, 3-1, 3-42, 3-45, 3-47, 3-53, 3-54

Pittman Fracture Zone ..... 2-16

Port ..... 7-1, 7-23

Protocol . xvi, 3-39, 3-40, 3-41, 3-42, 3-43, 3-44, 3-46, 3-48, 3-52, 3-53, 8-31

Puysegur Trench ..... 2-14, 4-1, 11-1

PWS.....17, xvi, 1-1, 8-1, 8-8, 8-9, 8-11, 8-12, 9-1, 10-1

RAA ..... xvi, 3-9, 3-10

regulatory approval ..... 3-7

Reserve Activity Assessment..... xvi, 3-9

Resource Management Act 1991..... 3-17, 3-18, 3-27, 3-29

ROM..... 14, 22, xvi, 1-1, 15-1, 16-1, 19-1

ROSETTA-Ice — Ross Ice Shelf (RIS) ..... 6-25

Ross Dependency..... 3-35

Ross Ice Shelf ..... 4-16, 4-17, 5-9, 6-21, 8-25, 11-4

Ross Sea ..18, 2-16, 3-35, 3-51, 3-52, 4-1, 4-2, 4-15, 4-16, 4-17, 4-18, 5-9, 5-10, 6-2, 6-20, 6-22, 6-25, 7-34, 7-35, 7-40, 7-42, 7-44, 8-25, 8-29, 8-30, 8-31, 8-33, 8-34, 8-35, 8-36, 8-37, 8-38, 8-39, 9-1

Ross Sea Shelf..... 8-38

Route Position List (RPL)..... 19-1

RPL..... xvi, 14-8, 14-12, 19-1

Sea Level Rise ..... xvi, 6-14

*Seas and Submerged Lands Act 1973* ..... 3-6

Sensor Monitoring And Reliable Telecommunications (SMART)..... 18-1

SENSORS..... 18-1

silverfish ..... 8-30, 8-37, 8-38

Site Survey Report..... xvii, 1-2, 10-16, 10-22

SLR..... xvi, 6-14

SMART ..... 1, 3, 10, 12, 13, 17, 18, 19, 21, 22, xvii, 1-1, 11-2, 11-4, 18-1, 18-2, 18-3, 18-4, 18-5, 18-6, 18-9, 19-1, 21-1

SMART cable ..... 1-1, 18-4, 18-5

Solander Trough. 2-12, 2-13, 2-14, 4-1, 4-2, 4-9, 4-10, 4-12, 4-13, 4-14

Squid ..... 7-16, 8-9

SSR..... xvii, 1-2

Stephen Lentz  
Lentz, Stephen ..... 18-2

Subsea Data Systems..... 18-1

Sydney .xvii, 2-1, 2-4, 2-22, 3-3, 3-4, 3-7, 3-11, 4-1, 4-3, 4-4, 4-6, 4-7, 4-8, 5-1, 5-3, 5-4, 5-5, 5-6, 6-8, 6-9, 6-10, 6-11, 6-12, 6-13, 6-29, 7-1, 7-2, 7-3, 7-4, 7-5, 7-6, 7-7, 8-1, 8-2, 8-7, 8-8, 8-9, 8-12, 10-1, 10-6, 10-9, 14-12

Tangaroa Seamount ..... 2-16

Terra Nova Bay ..... 13, 16, 8-37

Territorial Sea .... xvii, 3-6, 3-15, 3-16, 3-17, 3-19, 3-23, 3-31

Territorial Sea Baseline..... xvii, 3-15, 3-16

the National Geospatial Intelligence Agency (NGA) ..... 1-1

Toothfish ..... 7-17, 7-35

UNCLOS ..... xvii, 3-5, 3-15, 3-16, 3-17

United Nations Convention on the Law of the Sea .xvii, 3-5, 3-15

United States Geological Survey (USGS)..... 1-1

US Naval Seafloor Cable Protection Office (NSCPO)..... 2-1

USGS ..... xvii, 1-1, 6-25

Vulnerable Marine Ecosystem..... 2-16, 3-53

warranty..... 2-19

Winter Quarters Bay .....2-17, 6-19, 7-33, 8-39, 8-40



## 21.0 Desktop Study Preparation Team

**Project Lead:**



**Project Partners:**



Arnos Telecommunications Services

Global Broadband Solutions, LLC (GBS), is an SBA HUBZone Certified Small Business, providing U.S. Government and commercial clients with expertise and specialized labor for all matters relating to Submarine Fiber Optic Cable (SFOC) system design, planning, special studies, business case analysis, acquisition, implementation, operations, maintenance, administration, and repair. For nearly three decades, GBS has provided advanced telecommunication system services across seven continents and five oceans, supporting critical infrastructure projects with complex and sensitive requirements.

GBS expertise includes:

- Delivering comprehensive desktop studies and conducting marine route surveys for thousands of kilometers of submarine cable systems.
- Providing global environmental permitting guidance and administration, including managing crossing agreements and conducting environmental assessments.
- Supporting Arctic cable infrastructure and understanding Polar impacts, ice hazards, and atypical terrain requirements for undersea cable installation and maintenance.
- Partnering with multi-disciplinary consortiums for research and deployment of SMART cable and maritime sensor technologies.
- Liaising with multiple Federal Agencies to foster the deployment of emerging technologies for undersea research and telecommunications.
- Advancing the mission to integrate subsea cable technology and scientific research by building a secure telecommunications system that improves data collection and transmission while reducing impacts to the environment where cable is placed.

GBS is a member of the International Cable Protection Committee (ICPC) and the United Nations IOC/UNESCO Joint Task Force (JTF) on SMART Cables.

[www.GBS1.com](http://www.GBS1.com)



# National Science Foundation



**FOR MORE INFORMATION**

**CONTACT OFFICE OF POLAR PROGRAMS**

**EXTERNAL COMMUNICATIONS,  
NATIONAL SCIENCE FOUNDATION**

[oppcomms@nsf.gov](mailto:oppcomms@nsf.gov)