

Enclosure 4

**Clean copy of the Safety Analysis Report,
Revision 30**

SAFETY ANALYSIS REPORT

Revision 30

Summary of Changes for Revision 29		
Issue / Date	Change	Description of Change
29a 11-08-10	LBDCR 10-0105 10-12-2010	SAR Chapter 11 to Clarify and Accurately describe testing and Turnover process to transfer System (SSC) ownership from URENCO USA Projects to URENCO USA Operations CC-EG-2010-0353 70.72: 2010-0691
	LBDCR 10-0108 10-27-2010	This proposed change restores the SAR compliance item commitment to be consistent with the ISA Summary and NRC correspondence NEF-04-00031-NRC CC-LS-2010-0025 70.72: 2010-0682
29b 12-15-10	LBDCR-10-0110 11-03-10	Additional weighing system for receipt of feed cylinders on UBC pad. CC-MS-2010-0012; 70.72 = 2010-0708
	LBDCR-10-0095 11-03-10	Revise accident sequences to include the entire CRDB inventory and take credit for IROFS. CC-EG-2010-0291; 70.72 = 2010-0575
	LBDCR-10-0111 11-12-10	Table 3.4- add note to IROFS42 and reflect NRC approval for exception to License condition 20 CC-LS-2010-0029; 70.72 = 2010-0738
	LBDCR-10-0049 11-18-10	Clarify the GEVS charcoal filter testing CC-EG-2010-0113; 70.72 = 2010-0747
	LBDCR-10-0114 12-15-10	Organizational change-delete Director Quality & Regulatory affairs and transfer responsibilities to the VP of Compliance. CC-LS-2010-0028; 70.72 = 2010-0772
29c 01-06-11	LBDCR-10-0117 12-15-10	Add coil doors to SBM1001 First floor CC-EG-2010-0372; 70.72 = 2010-0806
	LBDCR-10-0103 10-08-10	Revising Section 1, 2, 4 and 11 CC-EG-2010-0324; 70.72= 2010-0821
	LBDCR-11-0001 12-27-10	Implementation of Fire Protection IROFS LAR-10-08

Summary of Changes for Revision 29		
Issue / Date	Change	Description of Change
30 01-06-11	N/A	Submittal to NRC for non substantial changes previously approved by LES

Table of Contents

1.0	General Information	1.0-1
1.1	Facility and Process Description	1.1-1
	1.1.1 Facility Location, Site Layout, and Surrounding Characteristics	1.1-3
	1.1.2 Facilities Description	1.1-3
	1.1.3 Process Descriptions	1.1-6
	1.1.3.1 Process Overview.....	1.1-6
	1.1.3.2 Process System Descriptions.....	1.1-7
	1.1.4 Raw Materials, By-Products, Wastes, And Finished Products.....	1.1-8
1.2	Institutional Information	1.2-1
	1.2.1 Corporate Identity.....	1.2-1
	1.2.1.1 Licensee	1.2-1
	1.2.1.2 Organization and Management of Applicant	1.2-1
	1.2.1.3 Address of the Enrichment Plant and Legal Site Description	1.2-2
	1.2.2 Financial Information.....	1.2-3
	1.2.3 Type, Quantity, and Form of Licensed Material	1.2-5
	1.2.4 Requested Licenses and Authorized Uses	1.2-5
	1.2.5 Special Exemptions or Special Authorizations.....	1.2-5
	1.2.6 Security of Classified Information.....	1.2-7
1.3	Site Description	1.3-1
	1.3.1 Site Geography	1.3-1
	1.3.1.1 Site Location Specifics	1.3-2
	1.3.1.2 Features of Potential Impact to Accident Analysis	1.3-2
	1.3.2 Demographics	1.3-2
	1.3.2.1 Latest Census Results.....	1.3-3
	1.3.2.2 Description, Distance, And Direction To Nearby Population Areas.....	1.3-3
	1.3.2.3 Proximity to Public Facilities – Schools, Hospitals, Parks	1.3-4
	1.3.2.4 Nearby Industrial Facilities (Includes Nuclear Facilities)	1.3-4
	1.3.2.5 Land Use Within Eight Kilometers (Five Mile) Radius, Uses Of Nearby Bodies Of Water	1.3-5
	1.3.3 Meteorology	1.3-5
	1.3.3.1 Primary Wind Directions And Average Wind Speeds.....	1.3-6
	1.3.3.2 Annual Precipitation – Amounts and Forms	1.3-6
	1.3.3.3 Severe Weather.....	1.3-7

Table of Contents

1.3.4	Hydrology	1.3-8
1.3.4.1	Characteristics Of Nearby Rivers, Streams, And Other Bodies Of Water	1.3-8
1.3.4.2	Depth To The Groundwater Table.....	1.3-9
1.3.4.3	Groundwater Hydrology.....	1.3-9
1.3.4.4	Characteristics Of The Uppermost Aquifer.....	1.3-10
1.3.4.5	Design Basis Flood Events Used For Accident Analysis.....	1.3-10
1.3.5	Geology.....	1.3-10
1.3.5.1	Characteristics Of Soil Types And Bedrock.....	1.3-11
1.3.5.2	Earthquake Magnitudes And Return Periods	1.3-11
1.3.5.3	Other Geologic Hazards	1.3-12
1.4	References.....	1.4-1
1.5	Chapter 1 Tables.....	1.5-1
1.6	Chapter 1 Figures	1.6-1
2.0	Organization and Administration	2.0-1
2.1	Organizational Structure	2.1-1
2.1.1	Corporate Functions, Responsibilities, and Authorities.....	2.1-1
2.1.2	Project Organization.....	2.1-2
2.1.3	Operating Organization	2.1-2
2.1.4	Transition From Project to Operations	2.1-3
2.2	Key Management Positions	2.2-5
2.2.1	Operating Organization	2.2-5
2.2.2	Shift Crew Composition.....	2.2-11
2.2.3	Safety Review Committee.....	2.2-11
2.2.4	Personnel Qualification Requirements.....	2.2-12
2.3	Administration	2.3-1
2.3.1	Configuration Management.....	2.3-1
2.3.2	Maintenance.....	2.3-1
2.3.3	Training and Qualifications.....	2.3-2
2.3.4	Procedures.....	2.3-2
2.3.5	Audits and Assessments.....	2.3-3
2.3.5.1	Safety Review Committee	2.3-3
2.3.5.2	Quality Assurance Department.....	2.3-3
2.3.5.3	Facility Operating Organization	2.3-3
2.3.5.4	Audited Organizations	2.3-3

Table of Contents

2.3.6	Incident Investigations.....	2.3-4
2.3.7	Employee Concerns.....	2.3-4
2.3.8	Records Management.....	2.3-4
2.3.9	Written Agreements with Offsite Emergency Resources	2.3-5
2.4	References.....	2.4-1
2.5	Chapter 2 Figures	2.5-1
3.0	Safety Program Commitments	3.0-1
3.1	Safety Program	3.1-1
3.1.1	Process Safety Information.....	3.1-1
3.1.2	Integrated Safety Analysis	3.1-2
3.1.3	Management Measures	3.1-3
3.2	Integrated Safety Analysis Methods.....	3.2-1
3.2.1	Hazard Identification	3.2-2
3.2.2	HAZOP Hazard Analysis Method.....	3.2-5
3.2.3	What-If/Checklist Hazard Analysis Method	3.2-6
3.2.4	Failure Modes and Effects Analysis (FMEA) Hazard Analysis Method.....	3.2-7
3.2.5	Risk Matrix Development	3.2-7
3.2.5.1	Consequence Analysis Method	3.2-7
3.2.5.2	Likelihood Evaluation Method.....	3.2-8
3.2.5.3	Risk Matrix.....	3.2-9
3.2.6	Risk Index Evaluation Summary	3.2-10
3.3	Integrated Safety Analysis Team	3.3-1
3.4	Compliance Item Commitments	3.4-1
3.4.1	For accident sequences PT3-5, PB1-3, FR1-1, FR1-2, FR2-1, FR2-2, DS1-1, DS1-2, DS2-1, DS2-2, DS3-1, DS3-2, SW1-1, SW1-2, LW1-2, LW1-3, RD1-1, and EC3-1	3.4-1
3.4.2	For Administrative Control IROFS that involve “use of” a component or device.	3.4-1
3.4.3	For Administrative Control IROFS that involve “verification of” a state or condition.....	3.4-1
3.4.4	For Administrative Control IROFS that involve “independent sampling,”	3.4-1
3.4.5	For IROFS and IROFS with Enhanced Failure Probability Index Numbers ..	3.4-2
3.4.6	Upon completion of the design of IROFS.....	3.4-2
3.4.7	The applicable guidance of the following industry standards, guidance documents and regulatory guides	3.4-2
3.4.8	The actual seismic design detailed approach for NEF IROFS.....	3.4-3

Table of Contents

3.4.9 To support the final design of the NEF.....3.4-3

3.4.10 Intentionally Blank.....3.4-4

3.4.11 The Separations Building Modules are designed as Type I-B Construction by the NMCBC and as Type II (222) Construction by NFPA 220.3.4-4

3.4.12 The floors of the Cascade Halls have a floor profile quality classification of flat in accordance with ACI 117 to aid in the transport of assembled centrifuges. .3.4-4

3.4.13 The Technical Services Building is designed as Type II-B Construction by the NMCBC and as Type II (000) Construction by NFPA 220.3.4-4

3.4.14 The Cylinder Receipt and Dispatch Building is designed as Type I-B Construction by the NMCBC and as Type II (222) Construction by NFPA 220.3.4-4

3.4.15 The Centrifuge Assembly Building (CAB) is designed as Type II-B Construction by the NMCBC and as Type II (000) Construction by NFPA 220.3.4-4

3.4.16 As protection of CAB investments (centrifuges and equipment) against the deleterious effects of airborne contaminants, the CAB construction will provide for an ISO 14644-1 Class 8.....3.4-4

3.4.17 The floors of the CAB Assembled Centrifuge Storage Area have a floor profile quality classification of flat in accordance with ACI 117 to aid in the transport of assembled centrifuges.3.4-4

3.4.18 For QL-1F periodic review of UL and FM recall data UUSA will perform an annual review of UL and FM websites for identification of recall data associated with fire protection basic components.....3.4-4

3.4.19 The Central Utilities Building is designed to meet the occupant and exiting requirements set by the International Fire Code and the New Mexico Commercial Building Code.....3.4-4

3.4.20 The Administration Building is designed to meet the occupant and exiting requirements set by the International Fire Code and the New Mexico Commercial Building Code.....3.4-4

3.4.21 The Central Utilities Building and the Administration Building are designed as Type II-B Construction by the NMCBC and as Type II (000) Construction by NFPA 220.....3.4-4

3.4.22 The following codes and standards are generally applicable to the structural design of the National Enrichment Facility:.....3.4-4

3.4.23 Structural Design Loads.....3.4-5

3.4.24 Natural UF₆ feed is received at the NEF in Department of Transportation (DOT) 7A, Type A cylinders from a conversion plant. The cylinders are ANSI N14.1, 48Y cylinders. Approximately 20 kg of UF₆ feed material was received at the National Enrichment Facility in ANSI N14.1 30B cylinders to support Hot Acceptance Testing in the CTF.....3.4-6

3.4.25 Applicable codes and standards for process systems are reflected in Tables 3.3-1 through 3.3-7.....3.4-6

3.4.26 Product Liquid Sampling Autoclave3.4-6

Table of Contents

3.4.27	Pumped Extract GEVS.....	3.4-6
3.4.28	Cylinder Receipt and Dispatch Building (CRDB) GEVS	3.4-7
3.4.29	Centrifuge Test and Post Mortem Facilities Exhaust Filtration System	3.4-7
3.4.30	In response to Bulletin 2003, LES will not purchase UF ₆ cylinders with the 1-in Hunt valves installed nor purchase any replacement 1-in valves from Hunt.	3.4-8
3.4.31	The containers used for intercontinental shipping are International Organization for Standardization Series 1 freight containers that are supplied in accordance with the ISO 668 Standard.....	3.4-8
3.4.32	Applicable codes and standards for utility and support systems are reflected in Table 3.3-8.....	3.4-8
3.4.33	Exhaust flow from the potentially contaminated rooms.....	3.4-8
3.4.34	The Electrical System design complies with the following codes and standards.	3.4-8
3.4.35	The criticality safety for tanks that are not “geometrically safe” or “geometrically favorable”	3.4-8
3.4.36	UF ₆ cylinders with faulty valves are serviced in the Ventilated Room.....	3.4-9
3.4.37	IROFS will be designed, constructed, tested and maintained to QA Level 1, with the following exceptions,	3.4-9
3.4.38	For those IROFS requiring operator actions	3.4-10
3.4.39	LES will review the topography of the NEF/LES site and surrounding relevant area.....	3.4-10
3.4.40	The Product Stations design will be based on ETC4069917-1 design drawings.	3.4-10
3.4.41	The Assay Sampling Rig shall exhaust to a gaseous effluent ventilation system with safe-by-design attributes.	3.4-10
3.4.42	Administrative Control IROFS Support Equipment	3.4-10
3.5	References.....	3.5-1
3.6	Chapter 3 Tables.....	3.6-1
4.0	Radiation Protection.....	4.0-1
4.1	Commitment to Radiation Protection Program Implementation	4.1-1
4.1.1	Responsibilities of Key Program Personnel.....	4.1-2
4.1.1.1	Plant Manager	4.1-2
4.1.1.2	Chemistry Services Manager	4.1-2
4.1.1.3	Environmental Compliance Officer	4.1-2
4.1.1.5	Shift Operations Manager.....	4.1-3
4.1.1.6	Facility Personnel.....	4.1-3
4.1.2	Staffing of the Radiation Protection Program.....	4.1-3
4.1.3	Independence of the Radiation Protection Program	4.1-4

Table of Contents

4.1.4	Radiation Safety Committee	4.1-4
4.2	Commitment to an ALARA Program	4.2-1
4.2.1	ALARA Committee	4.2-1
4.3	Organization and Personnel Qualifications	4.3-1
4.4	Commitment to Written Procedures	4.4-1
4.4.1	Radiation Work Permits	4.4-1
4.5	Training Commitments	4.5-1
4.5.1	Radiation Protection Training.....	4.5-2
4.6	Ventilation and Respiratory Protection Programs Commitments	4.6-1
4.6.1	Ventilation Program.....	4.6-1
4.6.2	Respiratory Protection Program.....	4.6-2
4.7	Radiation Surveys and Monitoring Programs Commitments.....	4.7-1
4.7.1	Radiological Areas	4.7-3
4.7.1.1	Unrestricted Area.....	4.7-3
4.7.1.2	Restricted Area.....	4.7-3
4.7.1.3	Radiologically Controlled Area (RCA)	4.7-4
4.7.1.4	Controlled Area.....	4.7-4
4.7.2	Access and Egress Control.....	4.7-5
4.7.3	Posting for Radiological Hazardous Awareness	4.7-5
4.7.4	Protective Clothing and Equipment.....	4.7-5
4.7.5	Personnel Monitoring for External Exposures.....	4.7-6
4.7.6	Personnel Monitoring for Internal Exposures	4.7-6
4.7.7	Local Control Points	4.7-6
4.7.8	Personnel Decontamination.....	4.7-7
4.7.9	Storage Areas	4.7-7
4.8	Contamination and Radiation Control	4.8-1
4.8.1	Internal Exposures	4.8-1
4.8.1.1	Bioassay	4.8-2
4.8.1.2	Air Monitoring and Sampling	4.8-2
4.8.2	External Exposures.....	4.8-3
4.8.3	Procedures.....	4.8-3
4.8.4	Instrumentation	4.8-4
4.8.4.1	Friskers.....	4.8-4
4.8.4.2	Hand and Foot Monitors	4.8-4

Table of Contents

4.8.4.3	Personnel Contamination Monitors (PCMs)	4.8-4
4.8.5	Contamination Control	4.8-4
4.8.5.1	Surface Contamination	4.8-4
4.9	Maintenance Areas-Methods and Procedures for Contamination Control	4.9-1
4.9.1	Decontamination Workshop	4.9-1
4.9.2	Contaminated Material Handling Room	4.9-1
4.10	Decontamination Policy and Provisions	4.10-3
4.11	Additional Program Commitments	4.11-1
4.11.1	Leak-Testing Byproduct Material Sources	4.11-1
4.11.2	Records and Reports	4.11-1
4.12	References	4.12-1
4.13	Chapter 4 Tables	4.13-1
4.14	Chapter 4 Figures	4.14-1
5.0	Nuclear Criticality Safety	5.0-1
5.1	The Nuclear Criticality Safety (NCS) Program	5.1-1
5.1.1	Management of the Nuclear Criticality Safety (NCS) Program	5.1-1
5.1.2	Control Methods for Prevention of Criticality	5.1-2
5.1.3	Safe Margins against Criticality	5.1-5
5.1.4	Description of Safety Criteria	5.1-6
5.1.5	Organization and Administration	5.1-6
5.2	Methodologies and Technical Practices	5.2-1
5.2.1	Methodology	5.2-1
5.2.1.1	Methods Validation	5.2-1
5.2.1.2	Limits on Control and Controlled Parameters	5.2-2
5.2.1.3	General Nuclear Criticality Safety Methodology	5.2-3
5.2.1.4	Nuclear Criticality Safety Analyses	5.2-5
5.2.1.5	Additional Nuclear Criticality Safety Analyses Commitments	5.2-6
5.2.1.6	Nuclear Criticality Safety Evaluations (NCSE)	5.2-7
5.2.1.7	Additional Nuclear Criticality Safety Evaluations Commitments	5.2-8

Table of Contents

5.3	Criticality Accident Alarm System (CAAS)	5.3-1
5.4	Reporting.....	5.4-1
5.5	References.....	5.5-1
5.6	Chapter 5 Table	5.6-1
6.0	Chemical Process Safety	6.0-1
6.1	Chemical Information	6.1-1
6.1.1	Chemical Screening and Classification.....	6.1-1
6.1.1.1	Chemicals of Concern (Class 1).....	6.1-1
6.1.1.2	Interaction Chemicals (Class 2).....	6.1-2
6.1.1.3	Incidental Chemicals (Class 3).....	6.1-2
6.1.2	Chemicals of Concern - Properties	6.1-3
6.1.2.1	Uranium Hexafluoride - Chemical Properties	6.1-3
6.1.2.2	Hydrogen Fluoride (HF) - Chemical Properties	6.1-4
6.1.2.3	Uranyl Fluoride - Chemical Properties.....	6.1-5
6.2	Chemical Process Information	6.2-1
6.2.1	Chemistry and Chemical Reactions.....	6.2-1
6.2.1.1	UF ₆ and Water	6.2-1
6.2.1.2	UF ₆ and Interaction Chemicals	6.2-2
6.2.1.3	UF ₆ and Construction Materials.....	6.2-5
6.2.2	Process - General Enrichment Process	6.2-6
6.2.3	Process System Descriptions	6.2-8
6.2.4	Utility and Support System Descriptions	6.2-8
6.2.5	Safety Features.....	6.2-8
6.3	Chemical Hazards Analysis	6.3-1
6.3.1	Integrated Safety Analysis	6.3-1
6.3.2	Consequence Analysis Methodology	6.3-1
6.3.2.1	Defining Consequence Severity Categories.....	6.3-1
6.3.2.2	Chemical Release Scenarios	6.3-4
6.3.2.3	Source Term.....	6.3-4
6.3.2.4	Chemical Hazard Evaluation	6.3-5
6.4	Chemical Safety Assurance	6.4-1
6.4.1	Management Structure and Concepts	6.4-1
6.4.2	System Design.....	6.4-1
6.4.2.1	Physical Barriers.....	6.4-2

Table of Contents

6.4.2.2	Mitigative Features	6.4-2
6.4.2.3	Baseline Design Criteria and Defense-In-Depth.....	6.4-3
6.4.3	Configuration Management.....	6.4-3
6.4.4	Maintenance.....	6.4-3
6.4.5	Training	6.4-4
6.4.6	Procedures.....	6.4-4
6.4.7	Chemical Safety Audits	6.4-5
6.4.8	Emergency Planning	6.4-6
6.4.9	Incident Investigation and Corrective Actions	6.4-6
6.5	References.....	6.5-1
6.6	Chapter 6 Tables.....	6.6-1
6.7	Chapter 6 Figure	6.7-1
7.0	Fire Safety.....	7.0-1
7.1	Fire Safety Management Measures	7.1-1
7.1.1	Fire Protection IROFS.....	7.1-1
7.1.2	Management Policy and Direction	7.1-1
7.1.3	Fire Prevention.....	7.1-2
7.1.4	Inspection, Testing, and Maintenance of Fire Protection Systems	7.1-2
7.1.5	Emergency Organization Qualifications, Drills and Training.....	7.1-2
7.1.6	Pre-Fire Plans	7.1-3
7.2	Fire Hazards Analysis	7.2-1
7.3	Facility Design	7.3-1
7.3.1	Building Construction	7.3-1
7.3.2	Fire Area Determination and Fire Barriers	7.3-2
7.3.3	Electrical Installation	7.3-2
7.3.4	Life Safety	7.3-2
7.3.5	Ventilation	7.3-3
7.3.6	Drainage.....	7.3-4
7.3.7	Lightning Protection	7.3-4
7.3.8	Criticality Concerns	7.3-4
7.3.9	Hydrogen Control	7.3-4
7.3.10	Environmental Concerns.....	7.3-5
7.3.11	Physical Security Concerns	7.3-5
7.3.12	Baseline Design Criteria and Defense-In-Depth	7.3-5

Table of Contents

7.4	Process Fire Safety	7.4-1
7.5	Fire Protection and Emergency Response	7.5-1
7.5.1	Fire Protection System.....	7.5-1
7.5.1.1	Fire Water Supply and Distribution System.....	7.5-1
7.5.1.2	Standpipe and Hose Systems	7.5-3
7.5.1.3	Portable Extinguishers.....	7.5-3
7.5.1.4	Automatic Suppression Systems.....	7.5-3
7.5.1.5	Fire Detection Systems	7.5-4
7.5.1.6	Manual Alarm Systems.....	7.5-4
7.5.1.7	Fire Alarm System.....	7.5-4
7.5.2	Fire Emergency Response.....	7.5-5
7.5.2.1	Fire Brigade.....	7.5-5
7.5.2.2	Off-Site Organizations	7.5-5
7.6	References.....	7.6-1
7.7	Chapter 7 Figures	7.7-1
8.0	Emergency Management.....	8.0-1
8.1	References.....	8.1-1
9.0	Environmental Protection	9.0-1
9.1	Environmental Report	9.1-1
9.1.1	Date of Application.....	9.1-1
9.1.2	Environmental Considerations	9.1-1
9.1.2.1	Description of the Proposed Action	9.1-1
9.1.2.2	Purpose of Proposed Action.....	9.1-1
9.1.2.3	Description of the Affected Environment	9.1-2
9.1.2.4	Discussion of Considerations	9.1-2
9.1.3	Analysis of Effects of Proposed Action and Alternatives.....	9.1-3
9.1.4	Status of Compliance.....	9.1-3
9.1.5	Adverse Information.....	9.1-4
9.2	Environmental Protection Measures	9.2-1
9.2.1	Radiation Safety.....	9.2-1
9.2.2	Effluent and Environmental Controls and Monitoring.....	9.2-1
9.2.2.1	Effluent Monitoring.....	9.2-2
9.2.2.2	Environmental Monitoring.....	9.2-2
9.2.3	Integrated Safety Analysis	9.2-3

Table of Contents

9.3 References.....9.3-1

10.0 Decommissioning..... 10.0-1

10.1 Site-Specific Cost Estimate..... 10.1-1

 10.1.1 Cost Estimate Structure 10.1-1

 10.1.2 Facility Description..... 10.1-1

 10.1.3 Decommissioning Cost Estimate 10.1-1

 10.1.3.1 Summary of Costs..... 10.1-1

 10.1.3.2 Major Assumptions..... 10.1-2

 10.1.4 Decommissioning Strategy 10.1-2

 10.1.5 Decommissioning Design Features 10.1-3

 10.1.5.1 Overview..... 10.1-3

 10.1.5.2 Radioactive Contamination Control..... 10.1-3

 10.1.5.3 Worker Exposure and Waste Volume Control..... 10.1-4

 10.1.5.4 Management Organization 10.1-5

 10.1.5.5 Health and Safety..... 10.1-5

 10.1.5.6 Waste Management 10.1-5

 10.1.5.7 Security/Material Control 10.1-5

 10.1.5.8 Record Keeping..... 10.1-6

 10.1.6 Decommissioning Process..... 10.1-7

 10.1.6.1 Overview..... 10.1-7

 10.1.6.2 Decontamination Facility Construction 10.1-8

 10.1.6.3 System Cleaning 10.1-8

 10.1.6.4 Dismantling..... 10.1-8

 10.1.6.5 Decontamination..... 10.1-9

 10.1.6.6 Salvage of Equipment and Materials..... 10.1-9

 10.1.6.7 Disposal..... 10.1-9

 10.1.6.8 Final Radiation Survey 10.1-10

 10.1.7 Decontamination Facilities 10.1-10

 10.1.7.1 Overview..... 10.1-10

 10.1.7.2 Facilities Description..... 10.1-10

 10.1.7.3 Procedures 10.1-11

 10.1.7.4 Results..... 10.1-12

 10.1.7.5 Decommissioning Impact on Integrated Safety Analysis (ISA) 10.1-12

Table of Contents

10.2	Financial Assurance Mechanism	10.2-1
10.2.1	Decommissioning Funding Mechanism	10.2-1
10.2.2	Adjusting Decommissioning Costs and Funding	10.2-2
10.2.3	Recordkeeping Plans Related to Decommissioning Funding	10.2-3
10.3	Tails Disposition	10.3-1
10.4	References	10.4-1
10.5	Chapter 10 Tables	10.5-1
	Component	10.5-2
	Number of Components	10.5-2
	Dimensions of Components	10.5-2
	Total Dimensions	10.5-2
	Component	10.5-3
	Number of Components	10.5-3
	Dimensions of Components	10.5-3
	Total Dimensions	10.5-3
10.6	Chapter 10 Figures	10.6-1
10.7	Appendix 10A - Payment Surety Bond	10.7-1
10.8	Appendix B - Standby Trust Agreement	10.8-1
10.9	Appendix 10C - Standby Trust Agreement Schedules	10.9-1
10.10	Appendix 10D - Specimen Certificate of Events	10.10-1
10.11	Appendix 10E - Specimen Certificate of Resolution	10.11-1
10.12	Appendix 10F - Letter of Acknowledgment	10.12-1
11.0	Management Measures	11.0-1
11.1	Configuration Management (CM)	11.1-1
11.1.1	Configuration Management Policy	11.1-1
11.1.2	Configuration Management Scope	11.1-2
11.1.3	Scope of Structures, Systems, and Components	11.1-2
11.1.4	Configuration Management Applications	11.1-3
11.1.5	Interfaces with Other Management Measures	11.1-3
11.1.6	Design Requirements	11.1-4
11.1.6.1	Configuration Management Controls of the Design Requirements	11.1-5
11.1.7	Document Control	11.1-6
11.1.8	Change Control	11.1-7
11.1.8.1	Design Phase	11.1-7

Table of Contents

11.1.8.2	Construction Phase	11.1-7
11.1.8.3	Operations Phase.....	11.1-7
11.1.9	Assessments.....	11.1-8
11.2	Maintenance.....	11.2-1
11.2.1	Maintenance Program Description.....	11.2-1
11.2.2	Maintenance Interfaces and Functions	11.2-1
11.2.3	Surveillance Monitoring.....	11.2-2
11.2.4	Corrective Maintenance	11.2-2
11.2.5	Preventive Maintenance.....	11.2-3
11.2.6	Functional Testing.....	11.2-3
11.2.6.1	Functional Testing Objectives	11.2-4
11.2.6.2	Content and Format Requirements for Test Procedures.....	11.2-4
11.2.6.3	IROFS Preoperational Functional Testing.....	11.2-5
11.2.6.4	IROFS Operational Functional Testing.....	11.2-5
11.3	Training and Qualifications.....	11.3-1
11.3.1	Organization and Management of the Training Function	11.3-1
11.3.2	Analysis and Identification of Functional Areas Requiring Training	11.3-2
11.3.3	Position Training Requirements	11.3-2
11.3.3.1	General Employee Training.....	11.3-3
11.3.3.2	Technical Training	11.3-5
11.3.4	Basis and Objectives for Training	11.3-8
11.3.5	Organization of Instruction, Using Lesson Plans and Other Training Guides.....	11.3-9
11.3.6	Evaluation of Trainee Learning	11.3-9
11.3.7	Conduct of On-the-Job Training.....	11.3-9
11.3.8	Evaluation of Training Effectiveness	11.3-9
11.3.9	Personnel Qualification	11.3-10
11.3.10	Periodic Personnel Evaluations	11.3-10
11.4	Procedures Development and Implementation	11.4-1
11.4.1	Preparation of Procedures	11.4-3
11.4.2	Administrative Procedures	11.4-3
11.4.3	Procedures.....	11.4-4
11.4.4	Changes to Procedures	11.4-6
11.4.5	Distribution of Procedures.....	11.4-7

Table of Contents

11.5	Audits and Assessments	11.5-1
11.5.1	ASSESSMENTS	11.5-1
11.5.2	AUDITS	11.5-2
11.6	Incident Investigations and Corrective Action Process	11.6-1
11.7	Records Management.....	11.7-1
11.8	Other QA Elements	11.8-1
11.9	References.....	11.9-1
12.0	PHASED OPERATION	12.0-1
12.1	INITIAL PLANT OPERATIONS (IPO)	12.1-1
12.2	Production Phases 1a and 1b	12.2-1
12.2.1	Facility Differences for Production Phase 1a and 1b	12.2-1
12.2.1.1	Separations Building Modules	12.2-1
12.2.1.2	Technical Services Building (TSB)	12.2-2
12.2.1.3	Cylinder Receipt and Dispatch Building (CRDB).....	12.2-3
12.2.1.4	Uranium Byproduct Cylinder (UBC) Storage Pad.....	12.2-7
12.2.1.5	Central Utilities Building (CUB).....	12.2-7
12.2.1.6	Administration Building	12.2-7
12.2.1.7	Site Security Buildings.....	12.2-7
12.2.2	Process Differences for Initial Production Phase 1a and 1b	12.2-7
12.2.2.1	UF ₆ Feed System	12.2-7
12.2.2.2	Cascade System	12.2-8
12.2.2.3	Product Take-off System	12.2-8
12.2.2.4	Tails Take-off System.....	12.2-8
12.2.2.5	Product Blending System	12.2-8
12.2.2.6	Product Liquid Sampling System.....	12.2-9
12.2.2.7	Contingency Dump System	12.2-9
12.2.2.8	Gaseous Effluent Vent Systems (GEVS)	12.2-9
12.2.2.9	Material Handling Processes.....	12.2-10
12.2.3	Utility and Support System Differences for Production Phase 1a and 1b	12.2-12
12.2.3.1	Centrifuge Cooling Water System (CCWS).....	12.2-12
12.2.3.2	Reserved	12.2-12
12.2.3.3	Solid Waste Collection System.....	12.2-12
12.2.3.4	Decontamination Workshop	12.2-12

Table of Contents

12.2.3.5	PFPE Oil Recovery System.....	12.2-12
12.2.3.6	Ventilated Room.....	12.2-13
12.2.3.7	Chemical Laboratory	12.2-13
12.2.4	Safety Significance.....	12.2-13
12.3	Production Phase 2.....	12.3-1
12.4	Production Phase 3.....	12.4-1
12.5	Production Phase 4.....	12.5-1

List of Tables

Table 1.1-1	Estimated Annual Gaseous Effluent.....	1.5-1
Table 1.1-2	Estimated Annual Radiological and Mixed Wastes ¹	1.5-2
Table 1.1-3	Estimated Annual Liquid Effluent.....	1.5-2
Table 1.1-4	Estimated Annual Non-Radiological Wastes	1.5-3
Table 1.1-5	Annual Hazardous Construction Wastes	1.5-4
Table 1.2-1	Type, Quantity and Form of Licensed Material.....	1.5-4
Table 3.1-1	HAZOP Guidewords	3.6-1
Table 3.1-2	ISA HAZOP Table Sample Format.....	3.6-2
Table 3.1-3	Consequence Severity Categories Based on 10 CFR 70.61.....	3.6-3
Table 3.1-4	Chemical Dose Information	3.6-4
Table 3.1-5	Likelihood Categories Based on 10 CFR 70.61.....	3.6-4
Table 3.1-6	Risk Matrix with Risk Index Values.....	3.6-5
Table 3.1-7	(Not Used)	3.6-5
Table 3.1-8	Determination of Likelihood Category.....	3.6-5
Table 3.1-9	Failure Frequency Index Numbers	3.6-6
Table 3.1-10	Failure Probability Index Numbers.....	3.6-8
Table 3.1-11	Failure Duration Index Numbers.....	3.6-8
Table 3.3-1	Cascade System Codes and Standards.....	3.6-9
Table 3.3-2	Product Take-off System Codes and Standards	3.6-9
Table 3.3-3	Tails Take-off System Codes and Standards	3.6-10
Table 3.3-4	Product Blending System Codes and Standards.....	3.6-10
Table 3.3-5	Product Liquid Sampling System Codes and Standards.....	3.6-11
Table 3.3-6	Contingency Dump System Codes and Standards	3.6-11
Table 3.3-7	GEVS Codes and Standards	3.6-12
Table 3.3-8	Utility and Support Systems Codes and Standards.....	3.6-13
Table 3.4-1	Administrative Control IROFS Support Equipment.....	3.6-15
Table 4.1-1	Administrative Radiation Exposure Limits	4.13-2
Table 4.1-2	Estimated Dose Rates	4.13-2
Table 4.1-3	Estimated Individual Exposures.....	4.13-2
Table 4.7-1	Radiation Emitted from Natural UF ₆ Feed	4.13-3
Table 5.1-1	Safe Values for Uniform Aqueous Solutions of Enriched UO ₂ F ₂	5.6-2
Table 5.1-2	Safety Criteria for Buildings/Systems/Components	5.6-3
Table 5.2-1	Uranium Experiments Used for Validation.....	5.6-4

List of Tables

Table 6.1-1	Chemicals – Hazardous Properties	6.6-2
Table 6.1-2	Separations Building Modules	6.6-3
Table 6.1-3	Centrifuge Assembly Building (CAB)	6.6-4
Table 6.1-4	Cylinder Receipt and Dispatch Building.....	6.6-5
Table 6.1-5	Physical Properties of UF ₆	6.6-6
Table 6.2-1	Properties of Chemical Adsorbents	6.6-6
Table 6.2-2	UF ₆ Corrosion Rates.....	6.6-7
Table 6.2-3	Materials of Construction for UF ₆ Systems	6.6-7
Table 6.3-1	ERPG and AEGL Level Definitions.....	6.6-8
Table 6.3-2	Licensed Material Chemical Consequence Categories	6.6-9
Table 6.3-3	ERPG and AEGL values for HF.....	6.6-9
Table 6.3-4	ERPG and AEGL values for Uranium Hexafluoride (as soluble U)	6.6-10
Table 6.3-5	Definition of Consequence Severity Categories	6.6-10
Table 6.3-6	Health Effects from Intake of Soluble Uranium.....	6.6-10
Table 10.1-1A	Number and Dimensions of Facility Components.....	10.5-2
Table 10.1-1B	Number and Dimensions of Facility Components.....	10.5-3
Table 10.1-1C	Number and Dimensions of Facility Components.....	10.5-4
Table 10.1-1D	Number and Dimensions of Facility Components.....	10.5-5
Table 10.1-1E	Number and Dimensions of Facility Components.....	10.5-6
Table 10.1-1F	Number and Dimensions of Facility Components.....	10.5-7
Table 10.1-2	Planning and Preparation	10.5-8
Table 10.1-3	Decontamination or Dismantling of Radioactive Components (Man-Hours).....	10.5-9
Table 10.1-4	Restoration of Contaminated Areas on Facility Grounds (Work Days)...	10.5-10
Table 10.1-5	Final Radiation Survey.....	10.5-10
Table 10.1-6	Site Stabilization and Long-Term Surveillance (Work Days)	10.5-11
Table 10.1-7	Total Work Days by Labor Category (Based on a 7.5 hr Working Day) .	10.5-12
Table 10.1-8	Worker Unit Cost Schedule	10.5-13
Table 10.1-9	Total Labor Costs by Major Decommissioning Task (\$000).....	10.5-14
Table 10.1-10	Packaging, Shipping and Disposal of Radioactive Wastes (Excluding Labor Costs)	10.5-15
Table 10.1-11	Equipment and Supply Costs (Excluded Containers).....	10.5-16
Table 10.1-12	Laboratory Costs	10.5-17
Table 10.1-13	Period Dependent Costs.....	10.5-18
Table 10.1-14	Total Decommissioning Costs	10.5-19

List of Tables

Table 10.3-1	Summary of Depleted UF6 Disposal Costs from Four Sources	10.5-21
Table 10.3-2	DOE-UDS August 29, 2002, Contract Quantities and Costs	10.5-22

List of Figures

Figure Legend	Sheet 1 of 3	xiii
Figure Legend	Sheet 2 of 3	xiv
Figure Legend	Sheet 3 of 3	xv
Figure 1.1-1	State Map	1.6-2
Figure 1.1-2	County Map	1.6-3
Figure 1.1-3	Plot Plan (1 Mile Radius)	1.6-4
Figure 1.1-4	Facility Layout (Site Plan) with Site Boundary and Controlled Access Area Boundary	1.6-5
Figure 1.1-5	Separations Building Module 1001 First Floor	1.6-6
Figure 1.1-6	Separations Building Module 1001 Second Floor	1.6-7
Figure 1.1-7	Separations Building Module 1001 Third Floor	1.6-8
Figure 1.1-8	Separations Building Module 1001 UF ₆ Handling Area Equipment Location	1.6-9
Figure 1.1-9	Separations Building Module 1003 First Floor	1.6-11
Figure 1.1-10	Separations Building Module 1003 Second Floor	1.6-12
Figure 1.1-11	Separations Building Module 1003 Third Floor	1.6-13
Figure 1.1-12	Separations Building Module 1003 UF ₆ Handling Area Equipment Location	1.6-14
Figure 1.1-13	Technical Services Building First Floor	1.6-15
Figure 1.1-14	Technical Services Building Second Floor	1.6-16
Figure 1.1-15	Centrifuge Assembly Building First Floor	1.6-17
Figure 1.1-16	Centrifuge Assembly Building Second Floor	1.6-18
Figure 1.1-17	Cylinder Receipt and Dispatch Building First Floor	1.6-19
Figure 1.1-18	Central Utilities Building First Floor	1.6-20
Figure 1.3-1	Radial Sectors (5 Mile Radius) Organization and Administration	1.6-21
Figure 2.1-2	LES National Enrichment Facility Operating Organization	2.5-2
Figure 4.7-1	Uranium and Decay Products of Interest	4.14-2
Figure 4.7-2	Projected Radiological Zones	4.14-3
Figure 6.1-1	UF ₆ Phase Diagram	6.7-2
Figure 6.1-2	Densities of Solid and Liquid UF ₆	6.7-3
Figure 7.5-1	Exterior Fire Protection System Overall Site Plan Sheet 1 of 2	7.7-3
Figure 7.5-1	Exterior Fire Protection System Overall Site Plan Sheet 2 of 2	7.7-3
Figure 10.1-1	Conceptual Decommissioning Schedule	10.6-1

ACRONYMS AND ABBREVIATIONS

AC	alternating current
ACI	American Concrete Institute
ADEM	Alabama Department of Environmental Management
AEA	Atomic Energy Act
AEP	American Electric Power
AEGL	Acute Exposure Guideline Level
AHU	air handling unit
AISC	American Institute of Steel Construction
ALARA	as low as reasonably achievable
ALI	Annual Limit on Intake
ANPR	Advance Notice of Proposed Rulemaking
ANS	American Nuclear Society
ANSI	American National Standards Institute
AP	air particulate
APE	area of potential effects
AQB	Air Quality Bureau
ASCE	American Society of Civil Engineers
ASLB	Atomic Safety and Licensing Board
ASME	American Society of Mechanical Engineers
ASNT	American Society of Nondestructive Testing
ASTM	American Society for Testing Materials
ATSDR	Agency for Toxic Substances and Disease Registry
AVLIS	Atomic Vapor Laser Isotope Separation
BDC	baseline design criteria
BEA	Bureau of Economic Analysis
BLM	Bureau of Land Management
BMP	Best Management Practices
BNFL	British Nuclear Fuels
BNFL-EL	British Nuclear Fuels – Enrichment Limited
BOD	biochemical oxygen demand
BS	Bachelor of Science
CA	Controlled Area
CAA	Clean Air Act
CAAS	Criticality Accident Alarm System
CAB	Centrifuge Assembly Building

ACRONYMS AND ABBREVIATIONS

CAM	Continuous Air Monitor
CAP	Corrective Action Program
CBG	Census Block Group
CEDE	Committed Effective Dose Equivalent
CEQ	Council on Environmental Quality
CERCLA	Comprehensive Environmental Response, Compensation, and Liability Act
CFO	Chief Financial Officer
CFR	Code of Federal Regulations
CHP	certified health physicist
CIS	Commonwealth of Independent States
CM	configuration management
COD	chemical oxygen demand
CRDB	Cylinder Receipt and Dispatch Building
CUB	Central Utilities Building
CVRF	Central Volume Reduction Facility
CWA	Clean Water Act
D&D	decontamination and decommissioning
DAC	derived air concentration
DBA	design basis accident
DBE	design basis earthquake
DCF	dose conversion factor
DE	Dose Equivalent
DEIS	Draft Environmental Impact Statement
DI	deionized
DOC	United States Department of Commerce
DOE	United States Department of Energy
DOI	United States Department of Interior
DOT	United States Department of Transportation
E	east
EDE	Effective Dose Equivalent
EECP	Entry/Exit Control Point
EIA	Energy Information Administration
EIS	Environmental Impact Statement
EJ	Environmental Justice
EMS	Emergency Medical Services

ACRONYMS AND ABBREVIATIONS

EOC	Emergency Operations Center
EPA	United States Environmental Protection Agency
EPCRA	Emergency Planning and Community Right-to-Know Act
EPRI	Electric Power Research Institute
eqs.	equations
ER	Environmental Report
ERPG	Emergency Response Planning Guideline
ENE	east north east
ESE	east south east
ETTP	East Tennessee Technology Park
FEIS	Final Environmental Impact Statement
FEMA	Federal Emergency Management Agency
FHA	fire hazards analysis
FNMC	Fundamental Nuclear Material Control
FR	Federal Register
FWPCA	Federal Water Pollution Control Act
GDP	Gaseous Diffusion Plant
GET	General Employee Training
GEVS	Gaseous Effluent Vent System
GPS	Global Positioning System
HEPA	high efficiency particulate air
HEU	highly enriched uranium
HMTA	Hazardous Materials Transportation Act
HS&E	Health, Safety, and Environment
HUD	United States Department of Housing and Urban Development
HVAC	heating, ventilating, and air conditioning
HWA	Hazardous Waste Act
HWB	Hazardous Waste Bureau
IAEA	International Atomic Energy Agency
ICRP	International Commission on Radiological Protection
INFL	International Nuclear Fuels Plc
I/O or I-O	input/output
IPD	Implicit Price Deflator
IROFS	items relied on for safety
ISA	Integrated Safety Analysis

ACRONYMS AND ABBREVIATIONS

ISO	International Organization for Standardization
JCIDA	Jackson County Industrial Development Authority
LAN	local area network
LCC	local control center
LCD	local climatic data
L _{dn}	Day-Night Average Sound Level
L _{eq}	Equivalent Sound Level
LES	Louisiana Energy Services
LEU	low enriched uranium
LLC	Limited Liability Company
LLD	lower limits of detection
LLNL	Lawrence Livermore National Laboratory
LLW	low-level waste
LOI	local operator interface
LQ	Location Quotients
LTA	lost time accident
LTC	load tap changer
LTTS	Low Temperature Take-off Station
M&TE	measuring and test equipment
MAPEP	Mixed Analyte Performance Evaluation Program
max.	maximum
MC&A	material control and accountability
MCL	maximum contaminant level
MCNP	Monte Carlo N-Particle
MDA	minimum detectable activity
MDC	minimum detectable concentration
ME&I	mechanical, electrical and instrumentation
min.	minimum
MM	modified mercalli
MMI	modified mercalli intensity
MOU	Memorandum of Understanding
MOX	mixed oxide fuel
MUA	multi-attribute utility analysis
N	north
NAAQS	National Ambient Air Quality Standards

ACRONYMS AND ABBREVIATIONS

NASA	National Aeronautic Space Administration
NCA	Noise Control Act
NCRP	National Council on Radiological Protection and Measurements
NCS	nuclear criticality safety
NCSE	nuclear criticality safety evaluation
NDA	Non-destructive assessment
NE	Northeast
NEF	National Enrichment Facility
NEI	Nuclear Energy Institute
NEPA	National Environmental Policy Act
NESHAPS	National Emission Standards for Hazardous Air Pollutants
NFPA	National Fire Protection Association
NHPA	National Historic Preservation Act
NELAC	National Environmental Laboratory Accreditation Conference
NIOSH	National Institute of Occupational Safety and Health
NIST	National Institute of Standards and Technology
NM	New Mexico
NMAC	New Mexico Administrative Code
NMDGF	New Mexico Department of Game and Fish
NMED	New Mexico Environmental Department
NMHWB	New Mexico Hazardous Waste Bureau
NMRPR	New Mexico Radiation Protection Regulations
NMSA	New Mexico State Agency
NMSE	New Mexico State Engineer
NMSHPO	New Mexico State Historic Preservation Office
NMSLO	New Mexico State Land Office
NMSS	Nuclear Material Safety and Safeguards
NMWQB	New Mexico Water Quality Bureau
NMWQCC	New Mexico Quality Control Commission
NNE	north-northeast
NNW	north-northwest
No.	number
NOAA	National Oceanic and Atmospheric Administration
NOI	Notice of Intent
NPDES	National Pollutant Discharge Elimination System

ACRONYMS AND ABBREVIATIONS

NPDWS	National Primary Drinking Water Standard
NRC	United States Nuclear Regulatory Commission
NRHP	National Register of Historic Places
NSDWS	National Secondary Drinking Water Standard
NSPS	New Source Performance Standards
NSR	New Source Review
NTS	Nevada Test Site
NWS	National Weather Service
NW	northwest
OEPA	Ohio Environmental Protection Agency
ORNL	Oak Ridge National Laboratory
OSHA	Occupational Safety and Health Administration
OVEC	Ohio Valley Electric Corporation
P&IDs	pipng and instrumentation diagrams
p.	page
PA	public address
PCM	Personnel Contamination Monitor
PEL	Permissible Exposure Level
PFPE	perfluorinated polyether
PGA	peak ground acceleration
pH	measure of the acidity or alkalinity
PHA	Process Hazard Analysis
Ph.D.	Doctor of Philosophy
PIA	Potentially Impacted Area
PLC	Programmable Logic Controllers
PM	preventive maintenance
PM _{2.5}	particulates $\leq 2.5\mu\text{m}$
PM ₁₀	particulates $\leq 10\mu\text{m}$
PMF	probable maximum flood
PMP	Probable Maximum Precipitation
PMWP	Probable Maximum Winter Precipitation
PORTS	Portsmouth Gaseous Diffusion Plant
POTW	Publicly Owned Treatment Works
pp.	pages
PRC	Peoples Republic of China

ACRONYMS AND ABBREVIATIONS

PSAR	Preliminary Safety Analysis Report
PSP	Physical Security Plan
QA	quality assurance
QAPD	Quality Assurance Program Description
QC	Quality Control
RCB	Radiation Control Bureau
RCRA	Resource Conservation and Recovery Act
RCA	Radiologically Controlled Area
RCZ	radiation control zone
REIS	Regional Economic Information System
REMP	Radiological Environmental Monitoring Program
RIMS	Regional Input-Output Modeling System
ROI	Region of Interest or Radius of Influence
RTE	Rare Threatened and Endangered
RWP	radiation work permit
S	south
SAR	Safety Analysis Report
SBM	Separations Building Module
Sc.D.	Doctor of Science
SCRAM	Support Center for Regulatory Air Models
SDWA	Safe Drinking Water Act
SE	southeast
SER	Safety Evaluation Report
SHPO	State Historic Preservation Officer
SILEX	Separation of Isotopes by Laser Excitation
SNM	special nuclear material
SPCC	spill prevention, control, and countermeasures
SPL	Sound Level Pressure
SRC	Safety Review Committee
SSC	structure, system, and component
SSE	safe shutdown earthquake
SSE	south-southeast
SSW	south-southwest
STEL	short term exposure limits
STP	standard temperature and pressure

ACRONYMS AND ABBREVIATIONS

SVOC	semivolatile organic compounds
SW	southwest
SWPPP	Storm Water Pollution Prevention Plan
TDEC	Tennessee Department of Environment and Conservation
TDS	Total Dissolved Solids
TEDE	total effective dose equivalent
TLD	thermoluminescent dosimeter
TN	Tennessee
TSB	Technical Services Building
TSP	total suspended particulates
TVA	Tennessee Valley Authority
TWA	time weighted average
TWDB	Texas Water Development Board
TX	Texas
UBC	Uranium byproduct cylinder
UCL	Urenco Capenhurst Limited
UCN	Ultra-Centrifuge Netherlands NV
UNAMAP	Users Network for Applied Modeling of Air Pollution
UPS	uninterruptible power supply
US	United States
USACE	United States Army Corps of Engineers
UNSCEAR	United Nations Scientific Committee on the Effects of Atomic Radiation
USDA	United States Department of Agriculture
USFWS	United States Fish and Wildlife Service
USGS	United States Geological Survey
UV	ultraviolet
VOC	volatile organic compound
W	West
WCS	Waste Control Specialists
WIPP	Waste Isolation Pilot Plant
WMA	wildlife management area
WNA	World Nuclear Association
WNW	west-northwest
WQB	Water Quality Bureau
WQCC	Water Quality Control Commission

ACRONYMS AND ABBREVIATIONS

WSW west-southwest

UNITS OF MEASURE

Bq	Becquerel
BTU	British thermal unit
°C	degrees Celsius
Ci	curie
cm	centimeter
d	day
dB	decibel
dba	decibel A-weighted
dpm	disintegrations per minute
°F	degrees Fahrenheit
ft	feet
g	gram
g _a	gravitational acceleration
gal	gallon
gpm	gallons per minute
Gy	Gray
ha	hectares
hp	horsepower
hr	hour
Hz	hertz (cycle per second)
in	inch
in. H ₂ O	inches of water (column)
J	Joule
kg	kilogram
km	kilometer
kWh	kilowatt-hour
L	liter
lb	pound
lbs	pounds
m	meter
mbar abs	millibar absolute
mbarg	millibar gauge
MBq	megabecquerel
mi	mile
min	minute

UNITS OF MEASURE

M _N	local magnitude
Mo	month
msl	mean sea level
MT or t	metric ton
MTU	Metric ton uranium
oz	ounce
Pa	pascal
ppb	parts per billion
ppm	parts per million
psia	pounds per square inch absolute
psig	pounds per square inch gauge
R	Roentgen
rad	radiation absorbed dose
rem	Roentgen equivalent man
scfm	standard cubic feet per minute
s	second
Sv	sievert
SWU	separative work unit
μmhos	micromhos
V	volt
VA	volt-ampere
W	watt
%	weight percent
χ/Q	atmospheric concentration per unit source
yd	yard
yr	year
σ	standard deviation
Pico (p)	X 10 ⁻¹²
Nano (n)	X 10 ⁻⁹
Micro (μ)	X 10 ⁻⁶
Milli (m)	X 10 ⁻³
Centi (c)	X 10 ⁻²
Kilo (k)	X 10 ³
Mega (M)	X 10 ⁶

List of Figures

VALVES		VALVES (cont'd)		PIPING LINE FEATURES & GENERAL EQUIPMENT (cont'd)		PIPING LINE FEATURES & GENERAL EQUIPMENT (cont'd)	
1.3.1		PR215	DIVERTER VALVE	1.2.22	VACUUM FLANGE (WITH TEST CONNECTION) UCL ONLY	PR165A	T STRAINER
1.3.2		PR148	TANDEM BLOWDOWN VALVE	1.2.23	VACUUM FLANGE UCL ONLY (WITHOUT TEST CONNECTION)	PR155	AIR INLET FILTER
1.3.3		PR181E	ROTARY VALVE	1.2.24	ORIFICE PLATE	PR157	BASKET FILTER
1.3.4		PR233	3-WAY MD PORT CLOSED (SIDE CLOSE)	1.2.25	VENTURI	PR158	BASKET FILTER WITH DRAIN VALVE
1.3.5		PR233A	3-WAY MD PORT CLOSED (SIDE OPEN)	1.2.26	SCREWED END CAP	PR241	LOOP SEAL
1.3.6		PR234	CAMFLEX VALVE	1.2.27	WELDED END CAP	PR168	VORTEX BREAKER
1.3.7		PR235	TRIPLE DUTY VALVE	1.2.28	HOSE CONNECTOR	PR142	VERT TO ATMOSPHERE
1.3.8		PR236	BALANCE/CIRCUIT SETTER VALVE	1.2.29	QUICK RELEASE COUPLING	PR141	VENT THRU ROOF
1.3.9		PR236	HIGH PURITY UPS/STREAM PURGE POINTS	1.2.30	POINT OF CHANGE OF MATERIAL OR SYSTEM RESPONSIBILITY	PR143	VENT THRU ROOF WITH COVER
1.3.10		PR237A	HIGH PURITY DOWNS/STREAM PURGE POINTS	1.2.31	AREA OR PACKAGE BOUNDARY	PR211	SAFETY SHOWER & EYE WASH
1.3.11		PR237B	HIGH PURITY UPS/STREAM AND DOWNS/STREAM PURGE POINTS	1.2.32	ARROW FOR INLET OR OUTLET AT CONTINUATION INTERFACE	PR195	VESSEL INSULATION "X" DENOTES THICKNESS
1.3.12		PIPING LINE FEATURES & GENERAL EQUIPMENT		1.2.33	INTERFACE OF QUALITY REQUIREMENTS (QS) UD ONLY	PR131A	INSULATION ELECTRIC TRACED
1.3.13		1.2.1	CONCENTRIC REDUCER	1.2.34	INTERFACE OF SUB SYSTEM (FI) UD ONLY	PR131B	INSULATION STEAM TRACED
1.3.14		1.2.2	ECCENTRIC REDUCER (FLUSH TOP)	1.2.35	INTERFACE OF FUNCTION UNIT (FU) UD ONLY	PIPE LINES	
1.3.15		1.2.3	ECCENTRIC REDUCER (FLUSH BOTTOM)	1.2.36	INTERFACE OF COMPONENT UD ONLY	1.11	PROCESS LINES
1.3.16		1.2.4	FLEXIBLE PIPE OR BELLOWS (FLANGED)	1.2.37	LGE LINE CONTINUATION	1.12	HEAT TRACED PROCESS LINE (A1 DENOTES TRACING SYSTEM)
1.3.17		1.2.5	SPRAY	PR132	TEMPORARY STRAINER	1.13	INSTRUMENT SIGNAL LINE
1.3.18		1.2.6	SPRAY BAR	PR133	GENERIC COMPONENT	1.14	LINE CONNECTION
1.3.19		1.2.7	SIGHT FLOW INDICATOR	PR134	FLAME ARRESTER	1.15	LINE CROSSING - UNCONNECTED (SECONDARY LINE BROKEN, VERTICAL LINE BROKEN WHERE PRIMARY LINES CROSS)
PR172		1.2.8	SIPHON DRAIN	PR135	REMOVABLE SPOOL PIECE	1.16	DIRECTION OF FLOW
PR173		1.2.9	VENT TO ATMOSPHERE	PR153	ROTATING SPRAY BALL	1.17	INDICATION OF FALL
PR177		1.2.10	STRAINER OR FILTER (BASIC SYMBOL)	PR154	FIXED SPRAY BALL	1.18	INSULATED PROCESS LINE
PR181		1.2.11	STRAINER "Y" TYPE (FLANGED)	PR158	SIGHT GLASS LIGHT	1.19	VACUUM INSULATED LINE
PR183		1.2.12	STRAINER BUCKET TYPE (FLANGED)	PR169	EXPANSION JOINT	1.111	STREAM NUMBER
PR185		1.2.13	TRAP DRAIN (eg. CONDENSATE RELEASE)	PR184	START-UP STRAINER		
PR171		1.2.14	TRAP VENT (eg. AUTOMATIC AIR VENT)	PR143	SIMPLEX STRAINER		
PR191		1.2.15	DRAIN	PR164	DUPLEX STRAINER		
PR171		1.2.16	BURSTING DISC (FLANGE AND PIPE MAY BE ADDED TO DUTLET IF REQUIRED)	PR166	Y STRAINER WITH VALVE		
PR189		1.2.17	WEIGHING DEVICE (INCLUDING LOAD CELLS)				
PR187		1.2.18	STACK				
PR187		1.2.19	FLANGE				
PR197		1.2.21	BLANK FLANGE				
PR196		1.2.21	KLEIN COUPLING (KF FLANGE)				
PR198							
PR199							
PR175							
PR184							
PR180							
PR180A							
PR141							
PR211							

List of Figures

VESSEL & TANKS	HEAT TRANSFER EQUIPMENT	PUMPS & COMPRESSOR	PUMPS & COMPRESSOR (cont'd)	OTHER EQUIPMENT	
1.6.1 PRESSURE VESSEL (BASIC SYMBOL)	1.5.1 HEAT EXCHANGER (BASIC SYMBOL)	1.7.1 PUMP (LIQUID) (BASIC SYMBOL)	PR118 ROTARY	2.1.9 ROLL AIR FILTER	
1.6.2 PACKED VESSEL (BASIC SYMBOL)	1.5.2 HEAT EXCHANGER (BASIC SYMBOL)	1.7.2 COMPRESSOR (BASIC SYMBOL)	PR133 RECIPROICATION COMPRESSOR	2.1.11 SILENCER	
1.6.3 AUTOCLAVE	1.5.3 HEATING / COOLING COIL (BASIC SYMBOL)	1.7.3 CENTRIFUGAL PUMP	PR187 VACUUM PUMP	2.1.11 AIR COOLER	
1.6.4 OPEN TANK	1.5.4 HEATING ELEMENT (INDICATES ELECTRICAL)	3.1.1 VACUUM PUMP (TYPE NOT SPECIFIED)	PR135 PROGRESSIVE CAVITY	2.1.12 AIR HEATER	
1.6.5 TANK WITH REMOVABLE COVER	1.5.5 VESSEL WITH EXTERNAL HEATING / COOLING COIL	3.1.2 SLIDING VANE ROTARY VACUUM PUMP	VACUUM EQUIPMENT		
1.6.6 CLOSED TANK	1.5.6 VESSEL WITH INTERNAL HEATING / COOLING COIL	3.1.3 ROOTS VACUUM PUMP	3.2.1 OIL TRAP	2.1.13 FAN (BASIC SYMBOL)	
1.6.7 INSULATED VESSEL	1.5.7 VESSEL WITH HEATING / COOLING JACKET	3.1.4 HIGH PRESSURE COMPRESSOR	3.2.2 ADSORPTION TRAP (BASIC SYMBOL)	2.1.14 AXIAL FAN	
1.6.8 VACUUM INSULATED VESSEL	1.5.8 SHELL AND TUBE HEAT EXCHANGER	3.1.5 DIFFUSION PUMP	3.2.3 UFG CYLINDER 30" AND 48"	2.1.15 CENTRIFUGAL FAN	
1.6.9 VESSEL WITH JACKET	1.5.9 PLATE HEAT EXCHANGER	3.1.6 GETTER PUMP	3.2.4 SAMPLE BOTTLE	2.1.1 DAMPER SINGLE LEAF	
1.6.11 BARREL OR DRUM	1.5.11 FINNED TUBE HEAT EXCHANGER	PR102 CENTRIFUGAL (SIDE DISCHARGE)	3.2.5 LIQUID NITROGEN DEWAR	2.1.2 DAMPER MULTI LEAF PARALLEL BLADE	
1.6.11 GAS CYLINDER	1.5.12 COOLING TOWER (FORCED DRAUGHT FANS INCLUDED AS APPROPRIATE) (BASIC SYMBOL)	PR103 ROTARY WITH PRESSURE RELIEF	3.2.6 FILTER CARTRIDGE HOLDER	2.1.3 DAMPER MULTI LEAF OPPOSED BLADE	
1.6.12 STIRRING DEVICE	TRANSPORT EQUIPMENT		3.2.7 FILTER CARTRIDGE HOLDER WITH FILTER	2.1.4 NON RETURN DAMPER	
1.6.13 ION EXCHANGE FILTER	PR136 TANK CAR	PR104 SUMP	3.2.8 MONOBED FILTER	2.1.5 AIR FILTER	
PR217 DISHED BOTTOM	PR137 TANK TRUCK	PR105 METERING	3.2.9 MIXED-BED FILTER	2.1.6 HIGH EFFICIENCY AIR FILTER	
	OTHER EQUIPMENT		3.2.10 ABSORPTION FILTER (OIL COLLECTION)	2.1.7 ACTIVATED CARBON AIR FILTER	
	PR138 PULSATION DAMPENERS	1.7.4_LGE AIR DIAPHRAGM	3.2.11 COLD TRAP	2.1.8 ELECTROSTATIC AIR FILTER	
	PR111 EJECTOR	PR134 SINGLE DIAPHRAGM		1.7.5_LGE CENTRIFUGE	
	PR126 SPRAY DESUPERHEATER			NOZZLES	
	PR139 STATIC MIXER			1.7.5_LGE SIDE ENTRY	
	PR148 EDUCTOR MIXER			PR101B FLANGED	
	1.7.4_LGE FILTER PRESS			PR101C FLANGED 1/2" AND GREATER	
				PR101D NARROWWAY	

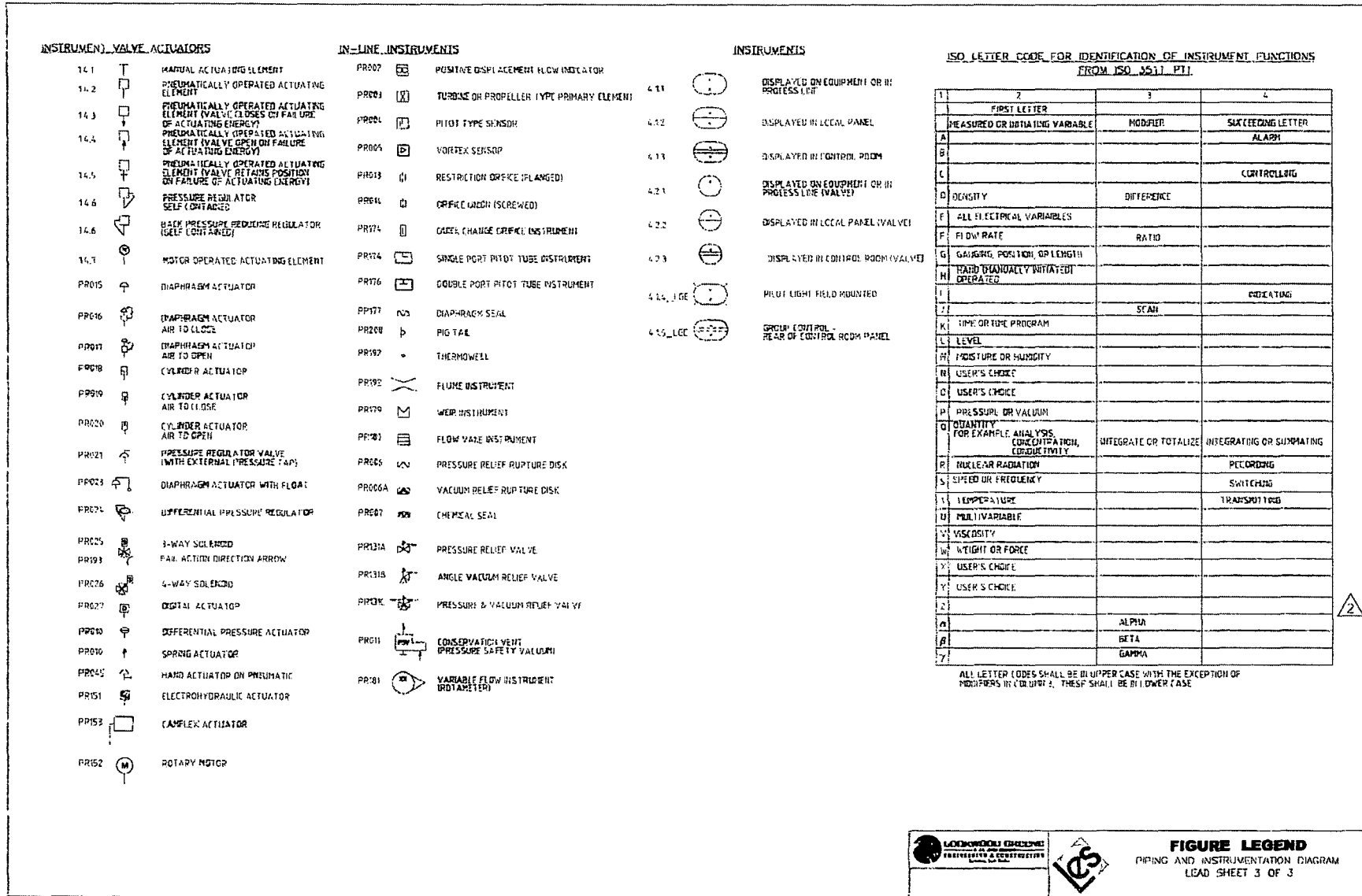

FIGURE LEGEND
PIPING AND INSTRUMENTATION DIAGRAM
LEAD SHEET 2 OF 3

Figure Legend

Sheet 2 of 3

List of Figures



1.0 General Information

1.0 General Information

This section contains a general description and purpose of the Louisiana Energy Services (LES) National Enrichment Facility (NEF). The facility enriches uranium for producing nuclear fuel for use in commercial power plants. This Safety Analysis Report (SAR) follows the format recommended by NUREG-1520, Standard Review Plan for the Review of a License Application for a Fuel Cycle Facility. The level of detail provided in this chapter is appropriate for general familiarization and understanding of the facility and processes. The information is to be used as background for the more detailed descriptions provided in other chapters of the license application. Cross-references to the more detailed descriptions are provided in this chapter. This chapter also provides information on the corporate structure and economic qualifications of LES.

It is not practical to refer to a specific edition of each code, standard, NRC document, etc throughout the text of this document. Instead, the approved edition of each reference that is applicable to the design, construction, or operation of the NEF is listed in ISAS Table 3.0-1.

1.1 Facility and Process Description

1.1 Facility and Process Description

The NEF, a state-of-the-art process plant, is located in southeastern New Mexico in Lea County approximately 0.8 km (0.5 mi) west of the Texas state border. This location is approximately 8 km (5 mi) due east of Eunice and 32 km (20 mi) south of Hobbs.

The geographic location of the facility is shown on Figures 1.1-1, State Map, and 1.1-2, County Map.

This uranium enrichment plant is based on a highly reliable gas centrifuge process. The plant is designed to separate a feed stream containing the naturally occurring proportions of uranium isotopes into a product stream - enriched in the uranium-235 (^{235}U) isotope and a tails stream - depleted in the ^{235}U isotope. The process, entirely physical in nature, takes advantage of the tendency of materials of differing density to segregate in the force field produced by a centrifuge. The chemical form of the working material of the plant, uranium hexafluoride (UF_6), does not require chemical transformations at any stage of the process. This process enriches natural UF_6 , containing approximately 0.711% ^{235}U to a UF_6 product, containing ^{235}U enriched up to 5 %.

The nominal capacity of the facility is 3 million separative work units (SWU) per year. The maximum gross output of the facility is slightly greater than 3 million SWU thus allowing for a production margin for centrifuge failures and occasional production losses during the operational lifetime of the facility.

Feed is received at the plant in specially designed cylinders containing up to 12.7 MT (14 tons) of UF_6 . The cylinders are inspected and weighed in the Cylinder Receipt and Dispatch Building (CRDB) or UBC Storage Pad and transferred to the Separations Building Modules (SBMs). SBMs are divided into two Cascade Halls, and each Cascade Hall is comprised of multiple cascades. Each Cascade Hall produces enriched UF_6 at a specified assay (% ^{235}U), so two different assays could be produced at one time in an SBM.

The enrichment process, housed in the SBMs, is comprised of four major elements: UF_6 Feed System, Cascade System, Product Take-off System, and Tails Take-off System. Other product related functions include the Product Blending and Liquid Sampling Systems, and Contingency Dump System. Supporting functions include sample analysis, equipment decontamination and rebuild, liquid effluent treatment and solid waste management.

The major equipment used in the UF_6 feed process are Solid Feed Stations. Feed cylinders are loaded into Solid Feed Stations; vented for removal of light gases, primarily air and hydrogen fluoride (HF). The light gases and UF_6 gas generated during venting are routed to the Feed Purification Subsystem where the UF_6 is desublimed. Upon completion of venting, the feed cylinder is heated to sublime the UF_6 for use as feed gas for the centrifuges.

The major pieces of equipment in the Feed Purification Subsystem are UF_6 Cold Traps, a Vacuum Pump/Chemical Trap Sets, and a Low Temperature Take-off Stations (LTTS). The Feed Purification Subsystem removes any light gases such as air and HF from the UF_6 prior to introduction into the cascades. UF_6 is captured in UF_6 Cold Traps and ultimately recycled as feed, while HF is captured on chemical traps.

1.1 Facility and Process Description

After purification, UF₆ from the Solid Feed Stations is routed to the Cascade System. Pressure in all process lines is subatmospheric.

Gaseous UF₆ from the Solid Feed Stations is routed to the centrifuge cascades. Each centrifuge has a thin-walled, vertical, cylindrically shaped rotor that spins around a central post within an outer casing. Feed, product, and tails streams enter and leave the centrifuge through the central post. Control valves, restrictor orifices, and controllers provide uniform flow of product and tails.

Depleted UF₆ exiting the cascades are transported from the high vacuum of the centrifuge for desublimation into Uranium Byproduct Cylinders (UBCs) at subatmospheric pressure. The primary equipment of the Tails Take-off System is the vacuum pumps and the Tails Low Temperature Take-off Stations (LTTS). Chilled air flows over cylinders in the Tails LTTS to effect the desublimation. Filling of the cylinders is monitored with a load cell system, and filled cylinders are transferred to an outdoor storage area (UBC Storage Pad).

Enriched UF₆ from the cascades is desublimed in a Product Take-off System comprised of vacuum pumps, Product Low Temperature Take-off Stations (LTTS), UF₆ Cold Traps, and Vacuum Pump/Chemical Trap Sets. The pumps transport the UF₆ from the cascades to the Product LTTS at subatmospheric pressure. The heat of desublimation of the UF₆ is removed by cooling air routed through the LTTS. The product stream normally contains small amounts of light gases that may have passed through the centrifuges. Therefore, a UF₆ Cold Trap and Vacuum Pump/Trap Set are provided to vent these gases from the product cylinder. Any UF₆ captured in the cold trap is periodically transferred to another product cylinder for use as product or blending stock. Filling of the product cylinders is monitored with a load cell system, and filled cylinders are transferred to the Product Liquid Sampling System for sampling.

Sampling is performed to verify product assay level ($\% \text{ } ^{235}\text{U}$). The Product Liquid Sampling Autoclave is an electrically heated, closed pressure vessel used to liquefy the UF₆ and allow collection of a sample. The autoclave is fitted with a hydraulic tilting mechanism that elevates one end of the autoclave so that liquid UF₆ pours into a sampling manifold connected to the cylinder valve. After sampling, the autoclave is brought back to the horizontal position and the cylinder is indirectly cooled by water flowing through coils located on the outer shell of the autoclave.

LES customers may require product at enrichment levels other than that produced by a single Cascade Hall. Therefore, the plant has the capability to blend enriched UF₆ from two donor cylinders of different assays into a product receiver cylinder. The Product Blending System is comprised of two Blending Donor Stations and two Blending Receiver Stations, where each station can hold one 30B cylinder. The Donor Stations are similar to the Solid Feed Stations described earlier. The Receiver Station is similar to the Low-Temperature Take-off Stations described earlier.

Support functions, including sample analysis, equipment decontamination and rebuild, liquid effluent treatment and solid waste management are conducted in the Cylinder Receipt and Dispatch Building (CRDB). Decontamination, primarily of pumps and valves, uses solutions of citric acid. Sampling includes a Chemical Laboratory for verifying product UF₆ assay, and an Environmental Monitoring Laboratory (in the TSB). Liquid effluent is collected and treated and monitored before discharge to the Treated Effluent Evaporation Basin, a double-lined evaporative basin with leak detection.

1.1 Facility and Process Description

1.1.1 Facility Location, Site Layout, and Surrounding Characteristics

Site features are well suited for the location of a uranium enrichment facility as evidenced by its favorable conditions of hydrology, geology, seismology and meteorology as well as good transportation routes for transporting feed and product by truck.

The facility is located on approximately 220 ha (543 acres) of land in Section 32 of Lea County, New Mexico. The Separations Building Modules, Administration Building, Cylinder Receipt and Dispatch Building, Centrifuge Assembly Building, Central Utilities Building, Technical Services Building, and UBC Storage Pad are located approximately in the center of the Section. A Plot Plan of the facility is shown in Figure 1.1-3, Plot Plan (1 Mile Radius). The Facility Layout (Site Plan) depicting the Site Boundary and Controlled Area Boundary is shown in Figure 1.1-4, Facility Layout (Site Plan) with Site Boundary and Controlled Access Area Boundary.

The site lies along the north side of New Mexico Highway 234. It is relatively flat with slight undulations in elevation ranging from 1,033 to 1,061 m (3,390 to 3,430 ft) above mean sea level (msl). The overall slope direction is to the southwest. During the construction phase, a fence runs along the perimeter of the property. A 254-mm (10-in) diameter, underground carbon dioxide pipeline owned by Trinity Pipeline LLC, traverses the site from southeast to northwest. A 406-mm (16-in) diameter, underground natural gas pipeline, owned by the Sid Richardson Energy Services Company, is located along the south property line, paralleling New Mexico Highway 234.

The nearest community is Eunice, approximately 8 km (5 mi) from the site. There are no residences, schools, stores or other population centers within a 1.6 km (1 mi) radius of the site.

Additional details of proximity to nearby populations are provided in the Environmental Report.

1.1.2 Facilities Description

The major structures and areas of the facility are outlined below.

Separations Building Modules (SBMs)

(See 12.2.1.1) The overall layout of Separations Building Module 1001 (SBM-1001) is presented in Figures 1.1-5 through 1.1-8. The overall layout of SBM-1003 is presented in Figures 1.1-9 through 1.1-12. Each SBM consists of two Cascade Halls, each having multiple cascades with each cascade having many centrifuges. The major functional areas of the SBMs are:

- Cascade Halls (2)
- Process Services Corridor
- UF₆ Handling Area

Source material and special nuclear material (SNM) are used or produced in the SBMs.

Technical Services Building (TSB)

(See 12.2.1.2) The overall layout of the Technical Services Building (TSB) is presented in Figures 1.1-13, Technical Services Building First Floor, and 1.1-14, Technical Services Building

1.1 Facility and Process Description

Second Floor. The TSB contains support areas for the facility. It also acts as the secure point of entry to the SBMs and the Cylinder Receipt and Dispatch Building (CRDB). The major functional areas of the TSB are:

- Environmental Monitoring Laboratory
- Medical Room
- Break Room
- Control Room
- Emergency Operations Center
- Training Room
- Central Alarm Station (CAS)

The Security Diesel Generator provides backup 480 volt power to selected security and security related equipment during a loss of normal power. The Security Diesel Generator is not a requirement for safe operation of the plant. The Security Diesel Generator is designed for outdoor use and will be located south of the TSB. The fuel oil storage tank is sized for 24 hours of continuous operation at 100 percent rated power output.

Centrifuge Assembly Building (CAB)

This building is used to assemble centrifuges before they are moved into the SBMs and installed in the cascades. The overall layout of the Centrifuge Assembly Building (CAB) is presented in Figures 1.1-15 and 1.1-16. The Centrifuge Assembly Building is located adjacent to the Cylinder Receipt and Dispatch Building. The major functional areas of the CAB are:

- Centrifuge Component Storage Area
- Centrifuge Assembly Area
- Assembled Centrifuge Storage Area
- Centrifuge Test Facility (CTF)
- Centrifuge Post Mortem Facility (PMF)

Source material and SNM are used and produced in the CTF and PMF.

Administration Building

(See 12.2.1.6) The general office areas are located in the Administration Building. Personnel enter the Administration Building and general office areas via the main lobby.

Security Building

(See 12.2.1.7) The main site Security Building is located at the entrance to the plant. It functions as a security checkpoint for incoming and outgoing personnel. Employees and visitors that have access approval are screened at this location.

The Security Building also contains a Visitor Center. There are adequate physical barriers, locked doors, etc. to separate the visitor accessible areas from areas designed to support security functions.

1.1 Facility and Process Description

A smaller Gatehouse has been placed at the secondary site entrance. Common carriers, such as mail delivery trucks, are screened at this location.

The Entrance Exit Control Point (EECP) is located in the Main Security Building. All personnel access to the facility occurs at this location. Vehicular traffic passes through a security checkpoint before being allowed to park. Parking is located outside of the Controlled Access Area (CAA) security fence. Personnel enter the Security Building area via the main lobby. Personnel requiring access to the facility areas or the CAA must pass through the EECP. The EECP is designed to facilitate and control the passage of authorized facility personnel and visitors.

Entry to the facility area from the Security Building is only possible through the EECP.

Cylinder Receipt and Dispatch Building

(See 12.2.1.3) The overall layout of the Cylinder Receipt and Dispatch Building (CRDB) is presented in Figure 1.1-17, Cylinder Receipt and Dispatch Building First Floor. The CRDB is located between two SBMs, north of the Technical Services Building. This building contains equipment to receive, inspect, weigh and temporarily store cylinders of feed UF₆ sent to the plant; temporarily store, inspect, weigh, and ship cylinders of enriched UF₆ to facility customers; receive, inspect, weigh, and temporarily store clean empty product and UBCs prior to being filled in the SBMs; and inspect, weigh, and transfer filled UBCs to the UBC Storage Pad. The CRDB also contains various laboratories and maintenance facilities necessary to safely operate and maintain the facility.

The functions of the Cylinder Receipt and Dispatch Building are:

Outside the Cylinder Receipt and Dispatch Building's Bunkered Area:

- Loading and unloading of cylinders
- Inventory weighing
- Preparation and storage of protective cylinder overpacks
- Storage of clean empty and empty UBCs
- Buffer storage of feed cylinders
- Semi-finished product storage
- Final product storage
- Prepared cylinder storage
- Staging (temporary storage) of tails and empty feed cylinders

Inside the Cylinder Receipt and Dispatch Building's Bunkered Area:

- Equipment decontamination
- Rebuilding of vacuum pumps
- UF₆ cylinder valve repair
- Solid waste collection and packaging
- Collection and treatment of liquid effluents

1.1 Facility and Process Description

- Contaminated material handling
- Mass spectrometry and chemical analysis
- Radiation monitoring
- Filtration and exhaust of gaseous effluent through Gaseous Effluent Vent Systems (GEVS)
- HVAC (supporting radiological and non-radiological portions of the CRDB)

Source material and SNM are used in the CRDB.

Uranium Byproduct Cylinder (UBC) Storage Pad

(See 12.2.1.4) The facility utilizes an area outside of the CRDB, the UBC Storage Pad, for storage of cylinders containing UF_6 that is depleted in ^{235}U . The UBC Storage Pad also provides buffered storage for full and empty feed cylinders. The cylinder contents are stored under vacuum in corrosion-resistant ANSI N14.1 Model 48Y cylinders. Additionally, the UBC Storage Pad provides buffered storage for clean, empty Model 30B product cylinders.

The UBC storage area layout is designed for moving the cylinders with a transporter/mover (e.g., a semi-tractor trailer) and a crane. A transporter/mover moves the UBCs from the CRDB to the UBC Storage Pad entrance. A single girder mobile gantry crane removes the cylinders from the transporter/mover and places them in the UBC Storage Pad. The mobile gantry crane is designed to double stack the cylinders in the storage area.

Source material is used in this area.

Central Utilities Building

(See 12.2.1.5) The Central Utilities Building (CUB) is shown on Figure 1.1-18, Central Utilities Building First Floor. The Central Utilities Building houses two diesel generators, which provide the site with standby power. The rooms housing the diesel generators are constructed independent of each other with adequate provisions made for maintenance, equipment removal and equipment replacement. The building also contains Electrical Rooms/Areas, an Air Compressor Area, and Centrifuge Cooling Water System.

1.1.3 Process Descriptions

This section provides a description of the various processes analyzed as part of the Integrated Safety Analysis. A brief overview of the entire enrichment process is provided followed by an overview of each major process system.

1.1.3.1 Process Overview

The primary function of the facility is to enrich natural uranium hexafluoride (UF_6) by separating a feed stream containing the naturally occurring proportions of uranium isotopes into a product stream enriched in ^{235}U and a tails stream depleted in the ^{235}U isotope. The feed material for the enrichment process is uranium hexafluoride (UF_6) with a natural composition of isotopes ^{234}U , ^{235}U , and ^{238}U . The enrichment process is a mechanical separation of isotopes using a fast rotating cylinder (centrifuge) based on a difference in centrifugal forces due to differences in molecular weight of the uranic isotopes. No chemical changes or nuclear reactions take place. The feed, product, and tails streams are all in the form of UF_6 .

1.1 Facility and Process Description

1.1.3.2 Process System Descriptions

An overview of the four enrichment process systems and the two enrichment support systems is discussed below.

Numerous substances associated with the enrichment process could pose hazards if they were released into the environment. Chapter 6, Chemical Process Safety, contains a discussion of the criteria and identification of the chemicals of concern at the NEF and concludes that uranium hexafluoride (UF_6) is the only chemical of concern that will be used at the facility. Chapter 6, Chemical Process Safety, also identifies the locations where UF_6 is stored or used in the facility and includes a detailed discussion and description of the hazardous characteristics of UF_6 as well as a detailed listing of other chemicals that are in use at the facility.

The enrichment process is comprised of the following major systems:

UF_6 Feed System

(See 12.2.2.1) The first step in the process is the receipt of the feed cylinders and preparation to feed the UF_6 through the enrichment process.

Natural UF_6 feed is received at the NEF in 48Y cylinders from a conversion plant. Pressure in the feed cylinders is below atmospheric (vacuum) and the UF_6 is in solid form.

The function of the UF_6 Feed System is to provide a continuous supply of gaseous UF_6 from the feed cylinders to the cascades. There are five¹ Solid Feed Stations per Cascade Hall.

Cascade System

(See 12.2.2.2) The function of the Cascade System is to receive gaseous UF_6 from the UF_6 Feed System and enrich the ^{235}U isotope in the UF_6 to a maximum of 5 w/o.

Multiple gas centrifuges make up arrays called cascades. The cascades separate gaseous UF_6 feed with a natural uranium isotopic concentration (0.711 w/o ^{235}U) into two process flow streams – product and tails. The product stream is the enriched UF_6 stream, from 2 - 5 w/o ^{235}U , with an average of 4.5 w/o ^{235}U . The tails stream is UF_6 that has been depleted of ^{235}U isotope to 0.20 - 0.34 w/o ^{235}U , with an average of 0.32 w/o ^{235}U .

Product Take-off System

(See 12.2.2.3) The function of the Product Take-off System is to provide continuous withdrawal of the enriched gaseous UF_6 product from the cascades and to purge and dispose of light gas impurities from the enrichment process.

The product streams leaving the cascades are brought together into one common manifold from the Cascade Hall. The product stream is transported via a train of vacuum pumps to Product LTTs in the UF_6 Handling Area. There are five Product LTTs per Cascade Hall.

The Product Take-off System also contains a system to purge light gases (typically air and HF) from the enrichment process. This system consists of UF_6 Cold Traps which capture UF_6 while leaving the light gas in a gaseous state. The cold trap is followed by product vent Vacuum

1.1 Facility and Process Description

Pump/Trap Sets, each consisting of a carbon trap, an alumina trap, and a vacuum pump. The carbon trap removes small traces of UF₆ and the alumina trap removes any HF from the product gas.

Tails Take-off System

(See 12.2.2.4) The primary function of the Tails Take-off System is to provide continuous withdrawal of the gaseous UF₆ tails from the cascades. A secondary function of this system is to provide a means for removal of UF₆ from the centrifuge cascades under abnormal conditions.

The tails stream exits each Cascade Hall via a primary header, goes through a pumping train, and then to Tails LTTS in the UF₆ Handling Area. There are eight Tails LTTS per Cascade Hall. In addition to the four primary systems listed above, there are two major support systems:

Product Blending System

(See 12.2.2.5) The primary function of the Product Blending System is to provide a means to fill 30B cylinders with UF₆ at a specific enrichment of ²³⁵U to meet customer requirements. This is accomplished by blending (mixing) UF₆ at two different enrichment levels to one specific enrichment level. The system can also be used to transfer product from a 30B cylinder to another 30B cylinder without blending.

This system consists of Blending Donor Stations (which are similar to the Solid Feed Stations) and Blending Receiver Stations (which are similar to the Product LTTS) described under the primary systems.

Product Liquid Sampling System

(See 12.2.2.6) The function of the Product Liquid Sampling System is to obtain an assay sample from filled product 30B cylinders. The sample is used to validate the exact enrichment level of UF₆ in the filled product cylinders before the cylinders are sent to the fuel processor.

The Product Liquid Sampling System is one of two systems at NEF that changes solid UF₆ to liquid UF₆. The Sub-Sampling System also changes solid UF₆ to liquid UF₆.

1.1.4 Raw Materials, By-Products, Wastes, And Finished Products

The facility handles Special Nuclear Material of ²³⁵U contained in uranium enriched above natural but less than or equal to 5.0 w/o in the ²³⁵U isotope. The ²³⁵U is in the form of uranium hexafluoride (UF₆). The facility processes approximately 690 feed cylinders (Model 48Y), 350 product cylinders (Model 30B), and 625 UBCs (Model 48Y) per year.

LES does not propose possession of any reflectors or moderators with special characteristics.

Solid Waste Management

(See 12.2.3.3) Solid waste generated at the NEF will be grouped into industrial (non-hazardous), radioactive, hazardous, and mixed waste categories. In addition, solid radioactive and mixed waste is further segregated according to the quantity of liquid that is not readily separable from the solid material. The solid waste management systems are comprised of a set

1.1 Facility and Process Description

of facilities, administrative procedures, and practices that provide for the collection, temporary storage, processing, and transportation for disposal of categorized solid waste in accordance with regulatory requirements. All solid radioactive wastes generated are Class A low-level wastes (LLW) as defined in 10 CFR 61 (CFR, 2003a).

Radioactive waste is collected in labeled containers in each Radiation Area and transferred to the Solid Waste Collection Room for processing. Suitable waste will be volume-reduced, and all radioactive waste will be disposed of at a licensed LLW disposal facility.

Hazardous waste and a small amount of mixed waste are generated at the NEF. These wastes are also collected at the point of generation and transferred to the Solid Waste Collection Room. Any mixed waste that may be processed to meet land disposal requirements may be treated in its original collection container and shipped as LLW for disposal.

Industrial waste, including miscellaneous trash, filters, resins and paper is shipped offsite for compaction and then sent to a licensed waste landfill.

Effluent Systems

The following NEF systems handle wastes and effluent.

- Pumped Extract GEVS
- CRDB GEVS
- Confinement Ventilation function of CRDB HVAC System
- Liquid Effluent Collection and Treatment System
- Centrifuge Test and Post Mortem Facilities Exhaust Filtration System
- Sewage System
- Solid Waste Collection System
- Decontamination System
- PFPE Oil Recovery System

Effluent Quantities

Quantities of radioactive and non-radioactive wastes and effluent are estimated and shown in the tables referenced in this section. The tables include quantities and average uranium concentrations. Portions of the waste considered hazardous or mixed are identified. The following tables address plant effluents:

- Table 1.1-1, Estimated Annual Gaseous Effluent
- Table 1.1-2, Estimated Annual Radiological and Mixed Wastes
- Table 1.1-3, Estimated Annual Liquid Effluent
- Table 1.1-4, Estimated Annual Non-Radiological Wastes

Radioactive concentration limits and handling for liquid wastes and effluents are detailed in the Environmental Report.

1.1 Facility and Process Description

The waste and effluent estimates described in the tables listed above were developed specifically for the NEF. Each system was analyzed to determine the wastes and effluents generated during operation. These values were analyzed and a waste disposal path was developed for each. LES considered the facility site, facility operation, applicable Urenco experience, applicable regulations, and the existing U.S. waste processing/disposal infrastructure during the development of the paths. The Liquid Effluent Collection and Treatment System and the Solid Waste Collection System were designed to meet these criteria.

Construction Wastes

During construction, efforts are made to minimize the environmental impact. Erosion, sedimentation, dust, smoke, noise, unsightly landscape, and waste disposal are controlled to practical levels and applicable regulatory limits. Wastes generated during site preparation and construction will be varied, depending on the activities in progress. The bulk of the wastes will consist of non-hazardous materials such as packing materials, paper and scrap lumber. These wastes will be transported off site to an approved landfill. It is estimated that the NEF will generate a non-compacted average waste volume of 3,058 m³ (4,000 yd³) annually.

Hazardous type wastes that may be generated during construction have been identified and annual quantities estimated are shown in Table 1.1-5, Annual Hazardous Construction Wastes. Any of these wastes that are generated will be handled by approved methods and shipped off site to approved disposal sites.

Management and disposal of all wastes from the NEF site will be performed by personnel trained to properly identify, store, and ship wastes, audit vendors, direct and conduct spill cleanup, provide interface with state agencies, maintain inventories and provide annual reports.

A Spill Prevention, Control and Countermeasure Plan (SPCC) will be implemented during construction to minimize the possibility of spills of hazardous substances, minimize environmental impact of any spills and ensure prompt and appropriate remediation. The SPCC plan will identify sources, locations and quantities of potential spills and response measures. The plan will identify individuals and their responsibilities for implementation of the plan and provide for prompt notifications of state and local authorities.

1.2 Institutional Information

1.2 Institutional Information

This section addresses the details of the applicant's corporate identity and location, applicant's ownership organization and financial information, type, quarterly, and form of licensed material to be used at the facility, and the type(s) of license(s) being applied for.

1.2.1 Corporate Identity

1.2.1.1 Licensee

The Licensee's name, address, and principal office are as follows:

Louisiana Energy Services, L.L.C.
P.O. Box 1789
275 Highway 176
Eunice, NM 88231

1.2.1.2 Organization and Management of Applicant

Louisiana Energy Services (LES), L.L.C. is a Delaware limited liability company. It has been formed solely to provide uranium enrichment services for commercial nuclear power plants. LES has one, 100% owned subsidiary, operating as a limited liability company, formed for the purpose of purchasing Industrial Revenue Bonds and no divisions. The ownership of LES is as follows:

1. Urenco Investments, Inc. (UII) (a Delaware corporation and wholly-owned subsidiary of Urenco Limited, a corporation formed under the laws of the United Kingdom ("Urenco") and owned in equal shares by BNFL Enrichment Limited ("BNFL-EL"), Ultra-Centrifuge Nederland NV ("UCN"), and Uranit GmbH ("Uranit") companies formed under English, Dutch and German law, respectively; BNFL-EL is wholly-owned by British Nuclear Fuels plc, which is wholly-owned by the Government of the United Kingdom; UCN is 99% owned by the Government of the Netherlands, with the remaining 1% owned collectively by the Royal Dutch Shell Group, DSM, Koninklijke Philips Electronics N.V. and Stork N.V.; Uranit is owned by Eon Kernkraft GmbH (50%) and RWE Power AG (50%), which are corporations formed under laws of the Federal Republic of Germany). UII holds 29.16% (as of December 31, 2006) of the membership units and has 100% of the voting power. It is anticipated that the membership units for UII will increase to more than 50% before the end of 2007 as UII has provided the majority of the funding in 2007.
2. Urenco Deelnemingen B.V. (a Netherlands corporation and wholly-owned subsidiary of Urenco Investments Inc. The ownership of Urenco Investments Inc. is explicitly described above. Urenco Deelnemingen B.V. holds 70.84% of the membership units (as of December 31, 2006) and has 0% of the voting power. It is anticipated that the membership units for UDE will recede to less than 50% before the end of 2007 as UII has provided the majority of the funding in 2007.

The President of LES is Gregory OD Smith. The President reports to the Board of Managers. The Board of Managers are:

1.2 Institutional Information

- Dr. Helmut Engelbrecht
Chief Executive Officer
Urenco Limited
18 Oxford Road
Marlow Bucks
SL7 2NL, United Kingdom

Dr. Engelbrecht is a citizen of the Federal Republic of Germany

- Mr. Bart Le Blanc
Chief Financial Officer
Urenco Limited
18 Oxford Road
Marlow Bucks
SL7 2NL, United Kingdom

Mr. Le Blanc is a citizen of the Netherlands

- Dr. Charles W. Pryor, Jr.
Chairman of the Board of Urenco Investments
Urenco Investments, Inc.
1560 Wilson Blvd., Suite 300
Arlington, VA 22209, 2463

Dr. Pryor is a citizen of the United States of America

The Vice President - Operations is the primary regulatory contact and is responsible for the safe operation of the National Enrichment Facility. LES' principal location for business is Eunice, New Mexico. The facility will be located in Lea County near Eunice, New Mexico. No other companies will be present or operating on the NEF site other than services specifically contracted by LES.

Foreign Ownership, Control and Influence (FOCI) of LES is addressed in the NEF Standard Practice Procedures for the Protection of Classified Matter, Appendix 1 – FOCI Package. The NRC in their letter dated, March 24, 2003, has stated "...that while the mere presence of foreign ownership would not preclude grant of the application, any foreign relationship must be examined to determine whether it is inimical to the common defense and security [of the United States]". (NRC, 2003) The FOCI Package mentioned above provides sufficient information for this examination to be conducted.

1.2.1.3 Address of the Enrichment Plant and Legal Site Description

The NEF is physically located approximately 8 km (5 mi) east of Eunice, New Mexico adjacent to New Mexico Highway 234 in Lea County. The legal description is as follows:

A PARCEL OF LAND WITHIN SECTION 32, TOWNSHIP 21 SOUTH, RANGE 38 EAST, NEW MEXICO PRINCIPAL MERIDIAN, LEA COUNTY, NEW MEXICO,

1.2 Institutional Information

BEGINNING at the one-quarter corner between Sections 31 and 32, (a found GLO brass cap on a 2-in iron pipe);

THENCE N00°38'22"W along the section line between Sections 31 and 32 a distance of 2638.37 feet to the corner of Sections 29, 32, 31 and 30, (a found GLO brass cap on a 2-in iron pipe);

THENCE N89°18'08"E along the section line between Sections 29 and 32 a distance of 2640.69 feet to a set 5/8-in rebar with a 2-in aluminum cap marked "MUTH PLS 13239";

THENCE N89°18'08"E along the section line between Sections 29 and 32 a distance of 2640.69 feet to the corner of Sections 28, 33, 32 and 29, (a found GLO brass cap on a 2-in iron pipe);

THENCE S00°39'20"E along the section line between Sections 32 and 33 a distance of 2640.49 feet to the one-quarter corner between Sections 32 and 33, (a found GLO brass cap on a 1-in iron pipe);

THENCE S00°41'56"E along the section line between Sections 32 and 33 a distance of 2324.52 feet to a found railroad iron marking the right-of-way for New Mexico State Highway No. 234; from whence the corner of Sections 33 and 32 of Township 21 South, Range 38 East, and Sections 4 and 5 of Township 22 South, Range 38 East (a found 1/2-in rebar) bears S00°41'56"E a distance of 340.08 ft;

THENCE N80°10'49"W along the observed northerly right-of-way line of New Mexico State Highway No. 234 a distance of 5377.12 ft to a point of intersection with the section line between Sections 31 and 32 (set 5/8-in rebar with a 2-in aluminum cap marked "MUTH PLS 13239"); from whence the corner of Sections 31 and 32 of Township 21 South, Range 38 East, and Sections 6 and 5 of Township 22 South, Range 38 East (a found GLO brass cap on a 2-in iron pipe) bears S00°35'16"E a distance of 1321.66 ft;

THENCE N00°35'16"W along the section line between Sections 31 and 32 a distance of 1345.14 to the POINT OF BEGINNING

Said Parcel CONTAINS 542.80 ACRES more or less

1.2.2 Financial Information

LES estimates the total cost of the NEF to be approximately \$1.2 billion (in 2002 dollars), excluding escalation, contingency, interest, tails disposition, decommissioning, and any replacement equipment required during the life of the facility.

There are financial qualifications to be met before a license can be issued. LES acknowledges the use of the following Commission-approved criteria as described in Policy Issues Associated with the Licensing of a Uranium Facility; Issue 3, Financial Qualifications (LES, 2002) in determining if the project is financially feasible:

1. Construction of the facility shall not commence before funding (except decommissioning funding, and liability insurance as discussed below) is fully committed. Of this full funding (equity and debt), the applicant must have in place before constructing the

1.2 Institutional Information

associated capacity: (a) a minimum of equity contributions of 30% of project costs from the parents; and (b) firm commitments ensuring funds for the remaining project costs.

2. LES shall not proceed with the project unless it has in place long-term enrichment contracts (i.e., five years) with prices sufficient to cover both construction and operation costs, including a return on investment, for the entire term of the contracts.
3. In accordance with the approved Exemption from certain provisions of 10 CFR 40.36 as discussed in Section 1.2.5 of this SAR, decommissioning funding will be provided incrementally. Therefore, receipt of UF₆ into a building shall not commence before the final executed copies of the reviewed financial assurance instruments for that building are provided to the NRC.

LES shall in accordance with 10 CFR 140.13b, (CFR, 2003I), prior to and throughout operation, have and maintain nuclear liability insurance in the type and amounts the Commission considers appropriate up to a limit of \$300 million to cover liability claims arising out of any occurrence within the United States, causing, within or outside the United States, bodily injury, sickness, disease, or death, or loss of or damage to property, or loss of use of property, arising out of or resulting from the radioactive, toxic, explosive, or other hazardous properties of chemical compounds containing source or special nuclear material.

The amounts of nuclear energy liability insurance required may be furnished and maintained in the form of:

1. An effective facility form (non-indemnified facility) policy of nuclear energy liability insurance from American Nuclear Insurers and/or Mutual Atomic Energy Liability underwriters; or
2. Such other type of nuclear energy liability insurance as the Commission may approve; or
3. A combination of the foregoing.
4. \$5 million to receive and maintain onsite, an inventory of ≤ 50 kg of natural or depleted UF₆ as "test material".
5. \$300 million to receive and maintain onsite, an inventory > 50 kg of UF₆ on site as "feed material".

If the form of liability insurance will be other than an effective facility form (non-indemnified facility) policy of nuclear energy liability insurance from American Nuclear Insurers and/or Mutual Atomic Energy Liability Underwriters, such form will be provided to the Nuclear Regulatory Commission by LES. The effective date of this incremental insurance will be no later than the date that LES takes possession of the above specified quantity and enrichment of UF₆.

Effective November 26, 2002, nuclear energy liability Facility Form policy number NF-0350 was issued to LES for the planned NEF with the limit of liability of \$1,000,000. This standby limit will apply until the plant takes possession of UF₆ in a quantity listed in #4 or #5 above, at which time it is anticipated that the liability insurance coverage limit will be increased to \$5 million for "test material", or the \$300 million limit for quantities of UF₆ in excess of the 50 kg "test material" limit. Until such time as LES takes possession of source material UF₆, the effects described in 10 CFR 140.13b involving source material are not possible. Therefore, the \$1,000,000 standby liability policy, in addition to appropriate construction coverage, is considered to be sufficient for

1.2 Institutional Information

the construction phase. LES will provide proof of liability insurance of a type and in the amounts to cover liability claims required by 10 CFR 140.13b prior to taking possession of source material.

Information indicating how reasonable assurance will be provided that funds will be available to decommission the facility as required by 10 CFR 70.22(a)(9) (CFR, 2003b), 10 CFR 70.25 (CFR, 2003c), and 10 CFR 40.36 (CFR, 2003d) is described in detail in Chapter 10, Decommissioning.

1.2.3 Type, Quantity, and Form of Licensed Material

LES is licensed to acquire, deliver, receive, possess, produce, use, transfer, and/or store special nuclear material (SNM) meeting the criteria of special nuclear material of low strategic significance as described in 10 CFR 70.4 (CFR, 2003e). Details are provided in Table 1.2-1, Type, Quantity, and Form of Licensed Material. Byproduct materials and selected SNM sources are presented in the current version of SNM-2010.

1.2.4 Requested Licenses and Authorized Uses

LES is engaged in the production and selling of uranium enrichment services to electric utilities for the purpose of manufacturing fuel to be used to produce electricity in commercial nuclear power plants.

This application is for the necessary licenses issued under 10 CFR 70 (CFR, 2003f), 10 CFR 30 (CFR, 2003g) and 10 CFR 40 (CFR, 2003h) to construct, own, use and operate the facilities described herein as an integral part of the uranium enrichment facility. This includes licenses for source, special nuclear material and byproduct material. The period of time for which the license is requested is 30 years.

See Section 1.1, Facility and Process Description for a summary, non-technical narrative description of the enrichment activities utilized in NEF.

1.2.5 Special Exemptions or Special Authorizations

In accordance with 10 CFR 40.14 (CFR, 2005a), "Specific exemptions," and 10 CFR 70.17 (CFR, 2005b), "Specific exemptions," LES requests exemptions from certain provisions of 10 CFR 40.36 (CFR, 2005c), "Financial assurance and recordkeeping for decommissioning," paragraph (d), and 10 CFR 70.25 (CFR, 2005d), "Financial assurance and recordkeeping for decommissioning," paragraph (e). Specifically, 10 CFR 40.36(d) (CFR, 2005c) and

10 CFR 70.25(e) (CFR, 2005d) both state in part that "...the decommissioning funding plan must also contain a certification by the licensee that financial assurance for decommissioning has been provided in the amount of the cost estimate for decommissioning...." As stated in Section 10.2.1, "Decommissioning Funding Mechanism," of the SAR since LES intends to sequentially install and operate modules of the enrichment equipment over time, providing financial assurance for decommissioning during the operating life of the NEF at a rate that is in proportion to the decommissioning liability for these facilities as they are phased in satisfies the requirements of this regulation without imposing the financial burden of maintaining the entire financial coverage for facilities and material that are not yet in existence. The same basis applies to decommissioning funding assurance for depleted uranium byproduct. As also stated

1.2 Institutional Information

in Section 10.2.1 of the SAR, LES proposes to provide financial assurance for the disposition of depleted uranium byproduct at a rate in proportion to the amount of accumulated depleted uranium byproduct onsite up to the maximum amount of the depleted uranium byproduct produced by the NEF.

The justification for this proposal to provide decommissioning funding assurance on a forward-looking incremental basis is LES' commitment to update the decommissioning cost estimates and to provide to the NRC a revised funding instrument for facility decommissioning at a minimum prior to the operation of each facility module. With respect to the depleted uranium byproduct, LES commits to updating the decommissioning cost estimates on an annual forward-looking incremental basis and to providing the NRC revised funding instruments that reflect these projections of depleted uranium byproduct production. The long-term nature of enrichment contracts allows LES to accurately predict the production of depleted uranium byproduct. If any adjustments to the funding assurance were determined to be needed during the annual period due to production variations, they would be made promptly and a revised funding instrument would be provided to the NRC.

LES requests that exemptions from the provisions of 10 CFR 40.36(d) (CFR, 2005c) and 10 CFR 70.25(e) (CFR, 2005d) described above be granted. In support of this request, LES provides the following information relative to the criteria in 10 CFR 40.14 (CFR, 2005a) and 10 CFR 70.17 (CFR, 2005b).

Granting the exemption is authorized by law

There is no statutory prohibition to providing decommissioning funding assurance on an incremental basis. In fact, the NRC has previously accepted an incremental approach to decommissioning funding assurance for the United States Enrichment Corporation's operation of its gaseous diffusion plants.

Granting the exemptions will not endanger life or property or the common defense and security

Allowing the decommissioning funding assurance for the NEF to be provided on a forward-looking incremental basis continues to ensure that adequate funds are available at any point in time after licensed material is introduced onto the NEF site to decommission the facility and disposition any depleted uranium byproduct possessed by LES. Accordingly, life, property, or the common defense and security will not be endangered by the NEF once it is permanently shutdown.

Granting the exemptions is otherwise in the public interest

Providing an alternative, diverse, and secure domestic source of enrichment services in support of the nuclear power industry that supplies 20% of the nation's electricity is clearly in the public benefit. Providing decommissioning funding assurance on an incremental basis will ensure that adequate financial assurance is available when required. Imposing the requirement to provide decommissioning funding assurance for the entire facility and all depleted uranium byproduct that would be produced over the NEF licensed operating period results in a significant unnecessary financial hardship. Accordingly, the granting of these exemptions is in the public interest.

1.2 Institutional Information

Since the granting of this exemption does not satisfy any of the criteria for categorical exclusion delineated in 10 CFR 51.22 (CFR, 2005e), "Criteria for categorical exclusion; identification of licensing and regulatory actions eligible for categorical exclusion or otherwise not requiring environmental review," nor the criteria requiring an environmental impact statement in

10 CFR 51.20 (CFR, 2005f), "Criteria for and identification of licensing and regulatory actions requiring environmental impact statements," an environmental assessment is required in accordance with 10 CFR 51.21 (CFR, 2005g), "Criteria for and identification of licensing and regulatory actions requiring environmental assessments." Accordingly, LES proposes that the NRC make a finding of no significant impact based on the following information addressing the provisions of 10 CFR 50.30 (CFR, 2005h), "Environmental assessment."

Need for the proposed action

Granting of the requested exemption will allow LES to satisfy the applicable decommissioning funding assurance requirements for the NEF without imposing an unnecessary financial burden on LES.

Alternatives as required by Section 102(2)(E) of the National Environmental Policy Act (NEPA)

The only alternative to granting the requested exemption is to not grant it. The significant financial burden that would be imposed on LES by not granting the requested exemption is unnecessary.

The environmental impacts of the proposed action and alternatives as appropriate

Granting the requested exemption will not result in environmental impacts in addition to those delineated in the ER for the NEF since adequate funds will continue to be available to decommission the NEF and disposition any depleted uranium byproduct possessed by LES at any point in time after licensed material is introduced onto the NEF site. The environmental impact of not granting the requested exemption could potentially be the loss of an alternate, diverse, and secure domestic source of enrichment services for the nuclear power industry that supplies 20% of the nation's electricity.

A list of agencies and persons consulted and identification of sources used

The NRC Project Manager for the NEF was contacted. The NEF license application was used as a source.

Based on the above information, LES proposes that, if this exemption request is granted, the NRC reach a finding of no significant impact in accordance with 10 CFR 51.32 (CFR, 2005i), "Finding of no significant impact."

1.2.6 Security of Classified Information

Access to restricted data or national security information shall be controlled in accordance with 10 CFR 10 (CFR, 2003i), 25 (CFR, 2003j), and 95 (CFR, 2003k). This application does contain classified information that has been submitted under separate correspondence.

1.3 Site Description-

1.3 Site Description

The NEF is located in southeastern New Mexico in Lea County near the border of Andrews County, Texas. The site consists of land north of New Mexico Highway 234 within Section 32 of Township 21 S, Range 38 E. The nearest communities are Eunice, about 8 km (5 mi) due west and Hobbs about 32 km (20 mi) north of the site. The area surrounding the site consists of vacant land and industrial properties. A railroad spur borders the site to the north. Further north is a sand/aggregate quarry operated by the Wallach Concrete Company. The quarry owner leases land space to a "produced water" reclamation company, Sundance Services, which maintains three small "produced water" lagoons. There is also a man-made pond stocked with fish on the quarry property.

A vacant parcel of land, Section 33, is immediately to the east. Section 33 borders the New Mexico/Texas state line that is 0.8 km (0.5 mi) east of the site. Several disconnected power poles are situated in front of Section 33, parallel to New Mexico Highway 234. Land further east, in Texas, is occupied by Waste Control Specialists (WCS), LLC. WCS possesses a radioactive materials license from Texas, an NRC Agreement state, and is licensed to treat and temporarily store low-level radioactive waste. Land east of WCS is occupied by the Letter B Ranch.

High power utility lines run in a north-south direction near the property line of WCS, parallel to the New Mexico/Texas state line.

To the southeast, across New Mexico Highway 234, is the Lea County Landfill.

Land further north, south and west has mostly been developed by the oil and gas industry.

An underground CO₂ pipeline owned by Trinity Pipeline, LLC, originally running southeast-northwest, now relocated to north south at the western boundary traverses the property. An underground natural gas pipeline owned by the Sid Richardson Energy Services Company is located along the south property line, paralleling New Mexico Highway 234.

An active railroad line, operated by the Texas-New Mexico Railroad, runs parallel to New Mexico Highway 18 and just east of Eunice within 8 km (5 mi) of Section 32. There is also an active railroad spur that runs from the Texas-New Mexico Railroad line, along the north boundary of Section 32 and terminates at the WCS facility.

Figure 1.3-1, Five Mile Radius, Radial Sectors, shows the physical features surrounding the facility to an 8 km (5 mi) radius.

1.3.1 Site Geography

Site features are well suited for the location of a uranium enrichment facility as evidenced by the favorable conditions of hydrology, geology, seismology and meteorology as well as good transportation routes for transporting feed and product by truck.

1.3 Site Description

1.3.1.1 Site Location Specifics

The proposed 220 ha (543 acre) site is located within Section 32 of Township 21 S in southeastern New Mexico in Lea County approximately 0.8 km (0.5 mi) west of the Texas state border, 51 km (32 mi) west-north-west of Andrews, Texas and 523 km (325 mi) southeast of Albuquerque, New Mexico. This location is 8 km (5 mi) due east of Eunice and 32 km (20 mi) south of Hobbs. The geographic location of the facility is shown on Figures 1.1-1, State Map, and 1.1-2, County Map.

The approximate center of the NEF is at latitude 32 degrees, 26 minutes, 1.74 seconds North and longitude 103 degrees, 4 minutes, 43.47 seconds West. Section 32 is currently owned by the State of New Mexico and is being acquired by LES through a state land swap arrangement. Until the land swap is completed, LES has been granted a 35 year easement by the State of New Mexico for site access and control.

Figure 1.1-4, Facility Layout (Site Plan) with Site Boundary and Controlled Access Area Boundary, shows the site property boundary, including the Controlled Access Area and the general layout of the buildings.

1.3.1.2 Features of Potential Impact to Accident Analysis

The NEF site is located in the Pecos Plains Section of the Great Plains Province. Site topography is relatively level, with an overall gradual rise in elevation from the southwest to the northeast. An area comprised of small sand hills exists along the west property line. There are no mountain ranges in the immediate vicinity. Earthquakes in the region are isolated or occur in small clusters of low to moderate size events toward the Rio Grande Valley of New Mexico and southeast of the NEF site in Texas.

An underground natural gas pipeline owned by the Sid Richardson Energy Services Company is located along the south property line, paralleling New Mexico Highway 234.

An underground CO₂ pipeline owned by Trinity Pipeline, LLC, running southeast-northwest, originally traversed the property. This pipeline has been relocated to the western edge of the NEF site property boundary.

New Mexico Highway 234 runs parallel to the southern property line. New Mexico Highway 234 intersects New Mexico Highway 18 about 4 km (2.5 mi) to the west.

An active railroad line operated by the Texas-New Mexico Railroad runs parallel to Highway 18 and just east of Eunice within 8 km (5 mi) of Section 32.

1.3.2 Demographics

This section provides the census results for the facility site area, and includes specific information about populations, public facilities (schools, hospitals, parks, etc.) and land and water use near the site.

1.3 Site Description

1.3.2.1 Latest Census Results

The combined population of the two counties in the NEF vicinity, based on the 2000 U.S. Census is 68,515, which represents a 2.3% decrease from the 1990 population of 70,130. This decrease is counter to the trends for the states of New Mexico and Texas which had population increases of 20.1% and 22.8%, respectively during the same decade. Over that 10 year period, Lea County, New Mexico, where the site is located, had a growth decrease of 0.5%. The growth decrease in Andrews County, Texas was 9.3%. Lea County experienced a sharp but short population increase in the mid-1980's due to an influx of petroleum industry jobs. That influx caused its population to increase to over 65,000 during that period.

Based on projections made using historic data, the population of Lea County, New Mexico and Andrews County, Texas is likely to grow more slowly than their respective states over the next 30 years (the anticipated license period of the NEF).

Based on U. S. census data the minority populations of the Lea County New Mexico and Andrews County Texas as of 2000 were 32.9% and 22.9%, respectively. These percentages are consistent with their respective state averages of 34.7% and 26.4%.

The low income population of Lea County, New Mexico and Andrews County, Texas are 21.1% and 16.4% respectively. These percentages are consistent with their respective state averages of 18.4% and 15.4%. Within the site area the percentage of population below the poverty level is significantly lower in both states.

1.3.2.2 Description, Distance, And Direction To Nearby Population Areas

The NEF site is in Lea County, New Mexico near the border of Andrews County, Texas. The nearest community is Eunice, approximately 8 km (5 mi) east of the site. Other population centers are at distances from the site as follows:

- Hobbs, Lea County, New Mexico: 32 km (20 mi north)
- Jal, Lea County, New Mexico: 37 km (23 mi south)
- Lovington, Lea County New Mexico: 64 km (39 mi north-northwest)
- Andrews, Andrews County Texas: 51 km (32 mi east)
- Seminole, Gaines County Texas: 51 km (32 mi east-northeast)
- Denver City, Gaines County, Texas: 65 km (40 mi) north-northeast

Aside from these communities, the population density around the site is extremely low. The nearest large population center (>100,000) is Midland-Odessa, Texas which is approximately 103 km (64 mi) to the southeast.

1.3 Site Description

1.3.2.3 Proximity to Public Facilities – Schools, Hospitals, Parks

The Eunice First Assembly of God Church is located about 9 km (5.4 mi) from the site.

There are two hospitals in the vicinity of the site. The Lea Regional Medical Center is located in Hobbs, New Mexico about 32 km (20 mi) north of the NEF site. This 250-bed hospital can handle acute and stable chronic care patients. In Lovington, New Mexico, 64 km (39 mi) north-northwest of the site, Covenant Medical Systems manages Nor-Lea Hospital, a full-service, 27-bed facility.

Eunice Senior Center is located about 9 km (5.4 mi) from the site.

There are four educational facilities within about 8 km (5 mi) of the NEF site, all in Eunice, New Mexico. These include an elementary school, a middle school, a high school, and a private K-12 school.

Eunice Fire and Rescue and the Eunice Police Department are located approximately 8 km (5 mi) from the site.

The Eunice Golf Course is located approximately 14.7 km (9.4 mi) from the site.

1.3.2.4 Nearby Industrial Facilities (Includes Nuclear Facilities)

Nuclear Facilities

There are no nuclear production facilities located within 32 km (20 mi) of the site, therefore neither environmental nor emergency preparedness interactions between facilities is required.

Non-Nuclear Facilities

The site is bordered to the north by railroad tracks beyond which is a quarry operated by Wallach Concrete Company. The quarry owner leases land space to Sundance Services, a reclamation company that maintains three small “produced water” lagoons.

Lea County operates a landfill on the south side of Section 33 across New Mexico State Highway 234, approximately 1 km (0.6 mi) from the center of the site.

A vacant parcel of land is immediately east of the site. Land further east, in Texas, is occupied by WCS. WCS possesses a radioactive materials license from Texas, an NRC Agreement state, and is licensed to treat and temporarily store low-level radioactive waste.

Dynegy's Midstream Services Plant is located 6 km (4 mi) from the site. This facility is engaged in the gathering and processing of natural gas for the subsequent fractionation, storage, and transportation of natural gas liquids.

An underground CO₂ pipeline, running southeast-northwest, originally traversed the property. This underground CO₂ pipeline has been relocated to the western edge of the property boundary.

1.3 Site Description

An underground natural gas pipeline is located along the south property line, paralleling New Mexico Highway 234.

Eunice maintains water supply tanks approximately 8 km (5 mi) north and 8 km (5 mi) south of the site.

Land further north, south and west of the site has mostly been developed by the oil and gas industry.

The Eunice Airport is situated about 8 km (5 mi) west of the town center. The nearest commercial carrier airport is Lea County Regional Airport in Hobbs, New Mexico about 40 km (25 mi) north-northwest of the site. A major commercial airport in Midland-Odessa, Texas is approximately 103 km (64 mi) to the southeast.

1.3.2.5 Land Use Within Eight Kilometers (Five Mile) Radius, Uses Of Nearby Bodies Of Water

The site and vicinity are within the southern part of the Llano Estacado or Staked Plains, which is a remnant of the Southern High Plains. The site area overlies prolific oil and gas geologic formations of the Pennsylvanian and Permian age.

Onsite soils consist of fine sand, loamy fine sand and loose sands surrounding large barren sand dunes and are common to areas used for rangeland and wildlife habitat.

Surrounding property consists of vacant land and industrial developments. Gas and oil field operations are widespread in the area, but significant petroleum potential is absent within 5 to 8 km (3 to 5 mi) of the site.

More than 98% of the area within an 8 km (5 mi) radius of the NEF is an extensive area of open land on which livestock wander and graze. Built-up land (1.2%) and barren land (0.3%) constitute the other two land use classifications in the site vicinity.

Baker Spring, an intermittent surface water feature, is situated a little over 1.6 km (1 mi) northeast of the NEF site.

The facility will make no use of either surface water or groundwater supply from the site. A site Stormwater Detention Basin will discharge to the ground and a site sewer system will send sanitary wastewater to the City of Eunice Wastewater Treatment Plant with a Groundwater Discharge Permit/Plan from the New Mexico Water Quality Bureau. Six septic tanks, each with one or more leach fields, may be installed as a backup to the sanitary waste system. No significant adverse changes are expected in site hydrology as a result of construction or operation of the NEF. Section 4, Environmental Impacts, of the Environmental Report addresses potential for impacts on site hydrology as a result of activities on the site.

1.3.3 Meteorology

In this section, data characterizing the meteorology (e.g., winds, precipitation, and severe weather) for the site are presented.

1.3 Site Description

1.3.3.1 Primary Wind Directions And Average Wind Speeds

The meteorological conditions at the NEF have been evaluated and summarized in order to characterize the site climatology and to provide a basis for predicting the dispersion of gaseous effluents.

Meteorological data from the National Weather Service (NWS) site at Midland-Odessa, Texas, indicate an annual mean wind speed of 4.9 m/s (11.0 mi/hr). The prevailing wind direction is wind from the south. The maximum five-second wind speed is 31.3 m/sec (70 mph) from 200 degrees with respect to true north.

By comparison, the data from Roswell, New Mexico indicate the annual mean wind speed is 3.7 m/s (8.2 mi/hr) and the prevailing wind direction is wind from the south-southeast. The maximum five-second wind speed is 27.7 m/sec (62 mph) from 270 degrees with respect to true north.

These and additional data are discussed and further analyzed in the Environment Report.

1.3.3.2 Annual Precipitation – Amounts and Forms

The NEF site is located in the Southeast Plains of New Mexico near the Texas border. The climate is typical of a semi-arid region, with generally mild temperatures, low precipitation and humidity, and a high evaporation rate. Vegetation consists mainly of native grasses and some mesquite trees. During the winter, the weather is often dominated by a high-pressure system located in the central part of the western United States and a low-pressure system located in north-central Mexico. During the summer, the region is affected by a low-pressure system normally located over Arizona.

The normal annual total rainfall as measured in Hobbs, New Mexico is 46.1 cm (18.15 in). Precipitation amounts range from an average of 1.22 cm (0.48 in) in March to 7.95 cm (3.13 in) in September. Record maximum and minimum monthly totals are 35.13 cm (13.83 in) and zero respectively. (WRCC, 2003)

The normal annual total rainfall in Midland-Odessa, Texas, is 37.6 cm (14.8 in). Precipitation amounts range from an average of 1.1 cm (0.42 in) in March to 5.9 cm (2.31 in) in September. Record maximum and minimum monthly totals are 24.6 cm (9.70 in) and zero, respectively. The highest 24-hour precipitation total was 15.2 cm (5.99 in) in July 1968 (NOAA, 2002a).

The normal annual rainfall total as measured in Roswell, New Mexico, is 33.9 cm (13.34 in). Record maximum and minimum monthly totals are 17.50 cm (6.88 in) and zero, respectively (NOAA, 2002b, 2002a). The highest 24-hour precipitation total was 12.47 cm (4.91 in) in July 1981 (NOAA, 2002b).

Snowfall in Midland-Odessa, Texas, averages 13.0 cm (5.1 in) per year. Maximum monthly snowfall/ice pellets of 24.9 cm (9.8 in) fell in December 1998. The maximum amount of snowfall/ice pellets to fall in 24 hours was 24.9 cm (9.8 in) in December 1998 (NOAA, 2002a).

Snowfall in Roswell, New Mexico averages 30.2 cm (11.9 in) per year. Maximum monthly snowfall/ice pellets of 53.3 cm (21.0 in) fell in December 1997. The maximum amount of snowfall/ice pellets to fall in 24 hours was 41.91 cm (16.5 in) in February 1988 (NOAA, 2002b).

1.3 Site Description

Additional details on rainfall and snowfall are provided in the Environmental Report.

The design basis ground snow load was developed using the methodology prescribed in the NRC Site Analysis Branch Position for Winter Precipitation Loads (NRC, 1975). The prescribed load to be included in the combination of normal live loads is based on the weight of the 100 year snowfall or snowpack whichever is greater. The winter precipitation load to be included in the combination of extreme live loads is based on the sum of the weight of the 100 year snowpack and the weight of the 48 hour Probable Maximum Winter Precipitation (PMWP) for the month corresponding to the selected snowpack.

The 100 year mean recurrence ground snow load was calculated to be 58.5 kg/m² (12 lb/ft²), and the applicable PMWP was calculated to be 96.6 kg/m² (19.8 psf). The addition of these two figures results in a design load of 155.1 kg/m² (32 lb/ft²).

1.3.3.3 Severe Weather

Tornadoes

Tornadoes occur infrequently in the vicinity of the NEF. Only two tornadoes were reported in Lea County, New Mexico, (Grazulis, 1993) from 1880-1989. Across the state line, only one tornado was reported in Andrews County, Texas, (Grazulis, 1993) from 1880-1989.

Tornadoes are commonly classified by their intensities. The F-Scale classification of tornados is based on the appearance of the damage that the tornado causes. There are six classifications, F0 to F5, with an F0 tornado having winds of 61-116 km/hr (40-72 mi/hr) and an F5 tornado having winds of 420-520 km/hr (261-318 mi/hr) (AMS, 1996). The two tornadoes reported in Lea County were estimated to be F2 tornadoes (Grazulis, 1993).

The design parameters applicable to the design tornado with a period of recurrence of 100,000 years are as follows:

Design Wind Speed	302 km/hr	188 mi/hr
Radius of damaging winds	130 m	425 ft
Atmospheric pressure change (APC)	-390 kg/m ²	-80 lb/ft ²
Rate of APC	-146 kg/m ² /s	-30 lb/ft ² /s

Hurricanes

Hurricanes, or tropical cyclones, are low-pressure weather systems that develop over the tropical oceans. Hurricanes are fueled by the relatively warm tropical ocean water and lose their intensity quickly once they make landfall. Since the NEF is located about 805 km (500 mi) from the coast, it is most likely that any hurricane that tracked towards the site would have dissipated to the tropical depression stage, that is, wind speeds less than 63 km/hr (39 mi/hr), before it reached the NEF. Hurricanes are therefore not considered a threat to the NEF.

1.3 Site Description

Thunderstorms and Lightning Strikes

Thunderstorms occur during every month but are most common in the spring and summer months. Thunderstorms occur an average of 36.4 days/year in Midland/Odessa (based on a 54-year period of record (NOAA, 2002a). The seasonal averages are: 11 days in spring (March through May); 17.4 days in summer (June through August); 6.7 days in fall (September through November); and 1.3 days in winter (December through February).

The current methodology for estimating lightning strike frequencies includes consideration of the attractive area of structures (Marshall, 1973). This method consists of determining the number of lightning flashes to earth per year per square kilometer and then defining an area over which the structure can be expected to attract a lightning strike.

Using this methodology, the attractive area of the facility structures has been conservatively determined to be 0.071 km². Using 4 flashes to earth per year per square kilometer (2.1 flashes to earth per year per square mile) (NWS, 2003b) it can be estimated that the NEF will experience approximately 1.36 flashes to earth per year.

Sandstorms

Blowing sand or dust may occur occasionally in the area due to the combination of strong winds, sparse vegetation, and the semi-arid climate. High winds associated with thunderstorms are frequently a source of localized blowing dust. Dust storms that cover an extensive region are rare, and those that reduce visibility to less than 1.61 km (1 mile) occur only with the strongest pressure gradients such as those associated with intense extratropical cyclones which occasionally form in the area during winter and early spring (DOE, 2003).

1.3.4 Hydrology

The hydrology information presented for the NEF was based on a subsurface investigation initiated at the NEF site in September 2003. Extensive subsurface investigations for a nearby facility, WCS, located to the east of the NEF site, have also provided hydrogeologic data that was used in planning the NEF surface investigation. Other literature searches were also conducted to obtain reference material.

The NEF site itself contains no surface water bodies or surface drainage features. Essentially all the precipitation that occurs at the site is subject to infiltration and/or evapotranspiration. Groundwater was encountered at depths of 65 to 68 m (214 to 222 ft). Significant quantities of groundwater are only found at depths over 340 m (1,115 ft) where cover for that aquifer is provided by 323 to 333 m (1,060 to 1,092 ft) or more of clay.

1.3.4.1 Characteristics Of Nearby Rivers, Streams, And Other Bodies Of Water

The climate in southeast New Mexico is semi-arid. Precipitation averages only 33 to 38 cm (13 to 15 in) a year. Evaporation and transpiration rates are high. This results in minimal, if any surface water occurrence or groundwater recharge.

1.3 Site Description

The NEF site contains no surface drainage features, such as arroyos or buffalo wallows. The site topography is relatively flat. Some localized depressions exist, due to eolian processes, but the size of these features is too small to be of significance with respect to surface water collection.

1.3.4.2 Depth To The Groundwater Table

The site subsurface investigation performed during September 2003 had two main objectives:

1) to delineate the depth to the top of the Chinle Formation red bed clay that exists beneath the NEF site to assess the potential for saturated conditions above the red beds, and 2) to complete three monitoring wells in the siltstone layer beneath the red beds to monitor water level and water quality within this thin horizon of perched intermittent saturation. The presence of the thick Chinle clay beneath the site essentially isolates the deep and shallow hydrologic systems. Groundwater occurring within the red bed clay occurs at three distinct and distant elevations. Approximately 65 to 68 m (214 to 222 ft) beneath the land surface, within the red bed unit, is a siltstone or silty sandstone unit with some saturation. Because it is a low permeability formation that does not yield groundwater very readily it is not considered to be an aquifer. This siltstone layer is hydraulically isolated from the near surface hydrologic conditions due to the presence of a thick clay sequence above it.

The next water bearing unit below the saturated siltstone horizon is a saturated 30.5-meter (100 foot) thick sandstone horizon approximately 183 m (600 ft) below land surface, which overlies the Santa Rosa formation. The Santa Rosa formation is the third water bearing unit and is located about 340 m (1,115 ft) below land surface. Between the siltstone and sandstone saturated horizons and the Santa Rosa formation lie a number of layers of sandstones, siltstones, and shales. Hydraulic connection between the siltstone and sandstone saturated horizons and the Santa Rosa formation is non-existent.

No withdrawals or injection of groundwater will be made as a result of operation of the NEF facility. Thus, there will be no affect on any inter-aquifer water flow.

1.3.4.3 Groundwater Hydrology

The climate in southeast New Mexico is semi-arid, and evapotranspiration processes are significant enough to short-circuit any potential groundwater recharge. There is some evidence for shallow (near-surface) groundwater occurrence in areas to the north at the Wallach Concrete plant. These conditions are intermittent and limited. The typical geologic cross section at that location consists of a layer of caliche at the surface, referred to as the "caprock." In some areas the caprock is missing and the sand and gravel are exposed at the surface. The caprock is generally fractured and, following precipitation events may allow infiltration that quickly bypasses any roots from surface vegetation. In addition, there are areas where the sand and gravel outcrop may allow rapid infiltration of precipitation. These conditions have led to instances of minor amounts of perched groundwater at the base of the sand and gravel unit, atop the red beds of the Chinle Formation.

Conditions at the NEF site are different than at the Wallach Concrete site. The caprock is not present at the NEF site. Therefore, rapid infiltration through fractured caliche does not contribute to localized recharge at the NEF site.

1.3 Site Description

Another instance of possible saturation above the Chinle clay may be seen at Baker Spring, just to the northeast of the NEF site where the caprock ends. The surface water is intermittent, and water typically flows from Baker Spring only after precipitation events. Some water may seep from the sand and gravel unit beneath the caprock, but deep infiltration of water is impeded by the low permeability of the Chinle clay in the area. This condition does not exist at the NEF site due to the absence of the caprock and the low permeability surface soils.

A third instance of localized shallow groundwater occurrence exists to the east of the NEF site where several windmills on the WCS property were formerly used to supply water for live stock tanks. These windmills tapped small saturated lenses above the Chinle Formation red beds, but the amount of groundwater in these zones was limited.

1.3.4.4 Characteristics Of The Uppermost Aquifer

The first occurrence of a well-defined aquifer is approximately 340 m (1,115 ft) below land surface, within the Santa Rosa formation. No impacts are expected to the aquifer from the NEF because of the depth of the Santa Rosa formation, the thick Chinle clay overburden, and the fact that the NEF will not consume surface or groundwater or discharge to the surrounding area.

Treated liquid effluents are discharged to the onsite Treated Effluent Evaporative Basin, a double-lined evaporative basin with leak detection.

1.3.4.5 Design Basis Flood Events Used For Accident Analysis

The closest water conveyance is Monument Draw; a typically dry, intermittent stream located about 4 km (2.5 mi) west of the site. Since there are no bodies of water in the immediate vicinity of the site, flood is not a design basis event for the NEF. Additionally a diversion ditch is strategically located to deflect surface runoff from adjacent land away from the facility structures on the site.

The only potential flooding of the plant results from local intense rainfall. Flood protection against the local Probable Maximum Precipitation (PMP) is provided by establishing the facility floor level above the calculated depth of ponded water caused by the local PMP. The CUB contains a sub-floor level cable spreading room. Access to the cable spreading room is via enclosed ladders at either end of that room.

1.3.5 Geology

This section provides information about the characteristics of soil types and bedrock of the NEF site and its vicinity and design-basis earthquake magnitudes and return periods. The WCS site in Texas and the former proposed Atomic Vapor Laser Isotope Separation (AVLIS) site, located in Section 33, have both been thoroughly studied in recent years in preparation for construction of other facilities. A review of those documents and related materials provides a significant description of geological conditions pertinent to the NEF site. In addition, LES performed field confirmation, where necessary, in order to clarify any questions about regional or site-specific conditions.

1.3 Site Description

The NEF site is located in New Mexico immediately west of the Texas border about 48 km (30 mi) from the extreme southeast corner of the state and about 96 km (80 mi) east of the Pecos River. The site is contained in the Eunice NE, Texas-New Mexico USGS topographic quadrangle (USGS, 1979). This location is near the boundary between the Pecos Plains Section to the west; and the Southern High Plains Section of the Great Plains province to the east. The boundary between the two sections is the Mescalero Escarpment, locally referred to as Mescalero Ridge.

NEF site elevations range between +1033 and +1045 m (+3390 and +3430 ft) (msl). The finished site grade is about +1041 m (+3415 ft) msl.

Surface exposures of geologic units at the site include surficial eolian deposits and Tertiary-aged alluvium. These overlie Triassic red-bed clay which overlies sedimentary rock. The principal underlying geologic structure is the Central Basin Platform which divides the Permian Basin into the Midland and Delaware sub-basins.

1.3.5.1 Characteristics Of Soil Types And Bedrock

The dominant subsurface structural feature of this region is the Permian Basin. This 250 million-year-old feature is the source of the Region's prolific oil and gas reserves.

The NEF site is located within the Central Permian Basin Platform area, where the top of the Permian deposits are approximately 434 to 480 m (1,425 to 1,575 ft) below ground surface. Overlying the Permian are the sedimentary rocks of the Triassic Age Dockum Group.

Soil development in the region is generally limited due to its semi-arid climate. The site has a minor thickness of soil (generally less than 0.4 m (1.4 ft)) developed from subaerial weathering. A small deposit of active dune sand is present at the southwest corner of the site. The U. S. Department of Agriculture soil survey for Lea County, New Mexico (USDA, 1974) categorizes site soils as hummocky loamy (silty) fine sand with moderately rapid permeability and slow runoff, well-drained non-calcareous loose sand, active dune sand and dune-associated sands.

Recent deposits are primarily dune sands derived from Permian and Triassic rocks of the Permian Basin. These Mescalero (dune) Sands cover over 80% of Lea County and are generally described as fine to medium-grained and reddish brown in color. The USDA Soil Survey of Lea County identifies the dune sands at the site as either the Brownsfield-Springer Association of reddish brown fine to loamy fine sands; or the Gomez series of brown to yellowish brown loamy fine sand (USDA, 1974).

1.3.5.2 Earthquake Magnitudes And Return Periods

The majority of earthquakes in the United States are located in the tectonically active western portion of the country. However, areas within New Mexico and the southwestern United States also experience earthquakes, although at a lower rate and at lower intensities. Earthquakes in the region around the NEF site include isolated and small clusters of low to moderate size events toward the Rio Grande Valley of New Mexico and in Texas, southeast of the NEF site.

The largest earthquake within 322 km (200 mi) of the NEF is the August 16, 1931 earthquake located near Valentine, Texas. This earthquake has an estimated magnitude of 6.0 to 6.4 and

1.3 Site Description

produced a maximum epicentral intensity of VIII on the Modified Mercalli Intensity (MMI) Scale. The intensity observed at the NEF site is IV on the MMI scale.

A site-specific probabilistic seismic hazard analysis was performed for the NEF site using the seismic source zone geometries and earthquake recurrence models. The modeling included attenuation models suited for the regional and local seismic wave transmission characteristics.

Total seismic ground motion hazard to a site results from summation of ground motion effects from all distant and local seismically active areas. The 250-year and 475-year return period peak horizontal ground accelerations are estimated at 0.024 g and 0.036 g, respectively. The 10,000 year return period peak horizontal ground acceleration is estimated at 0.15 g. This return period is equivalent to a mean annual probability of E-4. The associated peak vertical ground motion is estimated at 0.10 g.

1.3.5.3 Other Geologic Hazards

There are no other known geologic hazards that would adversely impact the NEF site.

1.4 References

1.4 References

Edition of Codes, Standards, NRC Documents, etc that are not listed below are given in ISAS Table 3.0-1.

AMS, 1996. Glossary of Weather and Climate, With Related Oceanic and Hydrologic Terms, American Meteorological Society, 1996.

CFR, 2003a. Title 10, Code of Federal Regulations, Part 61, Licensing Requirements for Land Disposal of Radioactive Waste, 2003.

CFR, 2003b. Title 10, Code of Federal Regulations, Section 70.22, Contents of Applications, 2003.

CFR, 2003c. Title 10, Code of Federal Regulations, Section 70.25, Financial Assurance and Recordkeeping for Decommissioning, 2003.

CFR, 2003d. Title 10, Code of federal Regulations, Section 40.36, Financial Assurance and Recordkeeping for Decommissioning, 2003.

CFR, 2003e. Title 10, Code of Federal Regulations, Section 70.4, Definitions, 2003.

CFR, 2003f. Title 10, Code of Federal Regulations, Part 70, Domestic Licensing of Special Nuclear Material, 2003.

CFR, 2003g. Title 10, Code of Federal Regulations, Part 30, Rules of General Applicability to Domestic Licensing of Byproduct Material, 2003.

CFR, 2003h. Title 10, Code of Federal Regulations, Part 40, Domestic Licensing of Source Material, 2003.

CFR, 2003i. Title 10, Code of Federal Regulations, Part 10, Criteria and Procedures for Determining Eligibility for Access to Restricted Data or National Security Information or an Employment Clearance, 2003.

CFR, 2003j. Title 10, Code of Federal Regulations, Part 25, Access Authorization for Licensed Personnel, 2003.

CFR, 2003k. Title 10, Code of Federal Regulations, Part 95, Security Facility Approval and Safeguarding of National Security Information and Restricted Data, 2003.

CFR, 2003l. Title 10, Code of Federal Regulations, Section 140.13b, Amount of liability insurance required for uranium enrichment facilities, 2003.

CFR, 2005a. Title 10, Code of Federal Regulations, Section 40.14, Specific exemptions, 2005.

CFR, 2005b. Title 10, Code of Federal Regulations, Section 70.17, Specific exemptions, 2005.

CFR, 2005c. Title 10, Code of Federal Regulations, Section 40.36(d), Financial assurance and recordkeeping for decommissioning, 2005.

1.4 References

CFR, 2005d. Title 10, Code of federal Regulations, Section 70.25(e), Financial assurance and recordkeeping for decommissioning, 2005.

CFR, 2005e. Title 10, Code of Federal Regulations, Section 51.22, Criteria for categorical exclusion; identification of licensing and regulatory actions eligible for categorical exclusion or otherwise not requiring environmental review, 2005.

CFR, 2005f. Title 10, Code of Federal Regulations, Section 51.20, Criteria for and identification of licensing and regulatory actions requiring environmental impact statements, 2005.

CFR, 2005g. Title 10, Code of Federal Regulations, Section 51.21, Criteria for and identification of licensing and regulatory actions requiring environmental assessments, 2005.

CFR, 2005h. Title 10, Code of Federal Regulations, Section 50.30, Environmental assessment, 2005.

CFR, 2005i. Title 10, Code of Federal Regulations, Section 51.32, Finding of no significant impact, 2005.

DOE, 2003. WIPP Contact-Handled (CH) Waste Safety Analysis Report (SAR), DOE/WIPP-95-2065 Rev. 7, June 2003.

Grazulis, 1993. Significant Tornadoes, 1680-1991, Environmental Films, Thomas P. Grazulis, July 1993.

LES, 2002. Letter to U.S. Nuclear Regulatory Commission, Document Control Desk, from Peter L. Lenny, Louisiana Energy Services, April 24, 2002.

Marshall, 1973. Lightning Protection, J. L. Marshall, 1973.

NOAA, 2002a. Local Climatological Data Annual Summary with Comparative Data for Midland-Odessa, Texas, National Oceanic and Atmospheric Administration, ISSN 0198-5124, 2002.

NOAA, 2002b. Local Climatological Data Annual Summary with Comparative Data for Roswell, New Mexico, National Oceanic and Atmospheric Administration, ISSN 0198-3512, 2002.

NRC, 1975. Site Analysis Branch Position-Winter Precipitation Loads, U.S. Nuclear Regulatory Commission, March 1975.

NRC, 2003. Letter from R. C. Pierson, Director, Division of Fuel Cycle Safety and Safeguards, NRC to R. M. Krich, Director of Licensing, LES, March, 2003.

NWS, 2003. Colorado Lightning Resource Center, National Weather Service, 2003.

USDA, 1974. Soil Survey, Lea County, New Mexico, U. S. Department of Agriculture, January, 1974.

USGS, 1979. Topographic Quadrangle Map for Eunice NE, Texas-New Mexico, 1:24,000 scale, U. S. Geological Survey, Photorevised 1979.

1.4 References

WRCC, 2003. Hobbs, New Mexico, NCDC 1971-2000 Monthly Normals, Western Regional Climate Center, Desert Research Institute, 2003.

1.5 Chapter 1 Tables

1.5 Chapter 1 Tables

Table 1.1-1 Estimated Annual Gaseous Effluent

Area	Quantity (yr ⁻¹)	Discharge Rate m ³ /yr (SCF/yr) (STP ³)
GEVS (Note 1)	NA	2.3 x 10 ⁸ @ Standard Temperature and Pressure (STP) (8.09 x 10 ⁹)
HVAC Systems		
Radiological Areas	NA	1.5 x 10 ⁹ (5.17 x 10 ¹⁰)
Non-Radiological Areas	N/A	1.0 x 10 ⁹ (3.54 x 10 ¹⁰)
Total Gaseous HVAC Discharge	NA	2.47 x 10 ⁹ (8.71 x 10 ¹⁰)
Constituents:		
Helium	440 m ³ @ (STP) (15,536 ft ³)	NA
Nitrogen	52 m ³ @ (STP) (1,836 ft ³)	NA
Ethanol	40 L (10.6 gal)	NA
Laboratory Compounds	Traces (HF) (NA)	NA
Argon	190 m ³ (6,709 ft ³)	NA
Hydrogen Fluoride	< 1.0 kg (< 2.2 lb)	NA
Uranium	< 10 g (< 0.0221 lb)	NA
Methylene Chloride	610 L (161 gal)	NA

N/A – Not applicable

Note 1. This includes the monitored gaseous discharges from Pumped Extract GEVS, CRDB GEVS, and the Centrifuge Test and Post Mortem Facilities Exhaust Filtration System.

1.5 Chapter 1 Tables

Table 1.1-2 Estimated Annual Radiological and Mixed Wastes¹

Waste Type	Radiological Waste		Mixed Waste ¹	
	Total Mass kg (lb)	Uranium Content kg (lb)	Total Mass kg (lb)	Uranium Content kg (lb)
Activated Carbon	300 (662)	25 (55)	-	-
Activated Alumina	2160 (4763)	2.2 (4.9)	-	-
PFPE Oil Recovery Sludge	20 (44)	5 (11)	-	-
Liquid Waste Treatment Sludge	400 (882)	57 (126)	-	-
Activated Sodium Fluoride ²	-	-	-	-
Assorted Materials (paper, packing, clothing, wipes, etc.)	2100 (4,631)	30 (66)	-	-
Ventilation Filters	61,464 (135,506)	5.5 (12)	-	-
Non-Metallic Components	5000 (11,025)	Trace ³	-	-
Miscellaneous Mixed Wastes (organic compounds) ⁴			50 (110)	2 (4.4)
Combustible Waste	3,500 (7,718)	Trace ⁴	-	-
Scrap Metal	12,000 (26,460)	Trace ⁴	-	-

Table 1.1-3 Estimated Annual Liquid Effluent

Summation of Liquid Effluents (excluding utilities)	Gal/Day	Gal/Yr	Liters/sec
Floor Washings, Misc. condensates, and Lab effluent	17	6,112	0.0
Degreaser Water	3	980	0.0
Citric Acid	2	719	0.0
Hand Wash and Shower Water	1,520	554,820	0.1
Total Liquid Effluents	1,542	562,631	0.1

¹ Valves were based on initial licensed facility design. More accurate forecasts of waste generation volumes will be based on operating history along with process knowledge.

² A mixed waste is a low-level radioactive containing listed or characteristic of hazardous wastes as specified in 40 CFR 261, Subparts C and D.

³ No sodium fluoride (NaF) wastes are produced on an annual basis. The contingency dump system NaF traps are not expected to saturate over the life of the plant.

⁴ Trace is defined as not detectable above naturally occurring background concentrations.

⁵ Representative organic compounds consist of acetone, toluene, ethanol, and petroleum ether.

1.5 Chapter 1 Tables

Table 1.1-4 Estimated Annual Non-Radiological Wastes

Waste	Annual Quantity
Spent Blasting Sand*	125 kg (275 lbs)
Miscellaneous Combustible Waste*	9000 kg (19,800 lbs)
Cutting Machine Oils	45 L (11.9 gal)
Spent Degreasing Water (from ME&I workshop)	1 m ³ (264 gal)
Spent Demineralizer Water (from ME&I workshop)	200 L (53 gal)
Empty Spray Paint Cans*	20 ea
Empty Cutting Oil Cans	20 ea
Empty Propane Gas Cylinders*	5 ea
Acetone*	27 L (7.1 gal)
Toluene*	2 L (0.5 gal)
Degreaser Solvent SS25*	2.4 L (0.6 gal)
Petroleum Ether*	10 L (2.6 gal)
Diatomaceous Earth*	10 kg (22 lbs)
Miscellaneous Scrap metal	2,800 kg (6.147 lbs)
Motor Oils (For internal combustion. engines)	3,400 L (895 gal)
Oil Filters	250 ea
Air Filters (vehicles)	50 ea
Air Filters (building ventilation)	160,652 kg (354,200 lb)
Hydrocarbon Sludge*	10 kg (22 lbs)
Methylene Chloride*	1850 L (487 gal)

* Hazardous waste as defined in Title 40, Code of Federal Regulations, Part 261, Identification and listing of hazardous waste, 2003. (in part or whole)

1.5 Chapter 1 Tables

Table 1.1-5 Annual Hazardous Construction Wastes

Waste Type	Annual Quantity
Paint, Solvents, Thinners, Organics	1,134 L (3,000 gal)
Petroleum Products – Oils, Lubricants	1,134 L (3,000 gal)
Sulfuric Acid (Batteries)	380 L (100 gal)
Adhesives, Resins, Sealers, Caulking	910 kg (2,000 lbs)
Lead (Batteries)	91 kg (200 lbs)
Pesticide	380 L (100 gal)

Table 1.2-1 Type, Quantity and Form of Licensed Material

Source and/or Special Nuclear Material	Physical and Chemical Form	Maximum Amount to be Possessed at Any One Time
Uranium (natural and depleted) and daughter products	Physical: Solid, Liquid and Gas Chemical: UF ₆ , UF ₄ , UO ₂ F ₂ , oxides and other compounds	136,120,000 kg
Uranium enriched in isotope ²³⁵ U up to 5% by weight and uranium daughter products	Physical: Solid, Liquid, and Gas Chemical: UF ₆ , UF ₄ , UO ₂ F ₂ , oxides and other compounds	545,000 kg
⁹⁹ Tc, transuranic isotopes and other contamination	Any	Amount that exists as contamination as a consequence of the historical feed of recycled uranium at other facilities ⁽¹⁾

- (1) To minimize potential sources of contamination of UF₆, such as ⁹⁹Tc, LES will require UF₆ suppliers to provide Commercial Natural UF₆ in accordance with ASTM C 787, "Standard Specification for Uranium Hexafluoride for Enrichment." In addition, cylinder suppliers will be required to preclude use of cylinders that, in the past, have contained reprocessed UF₆, unless they have been decontaminated. Periodic audits of suppliers will be performed to provide assurance that these requirements are satisfied.

1.6 Chapter 1 Figures

1.6 Chapter 1 Figures

1.6 Chapter 1 Figures

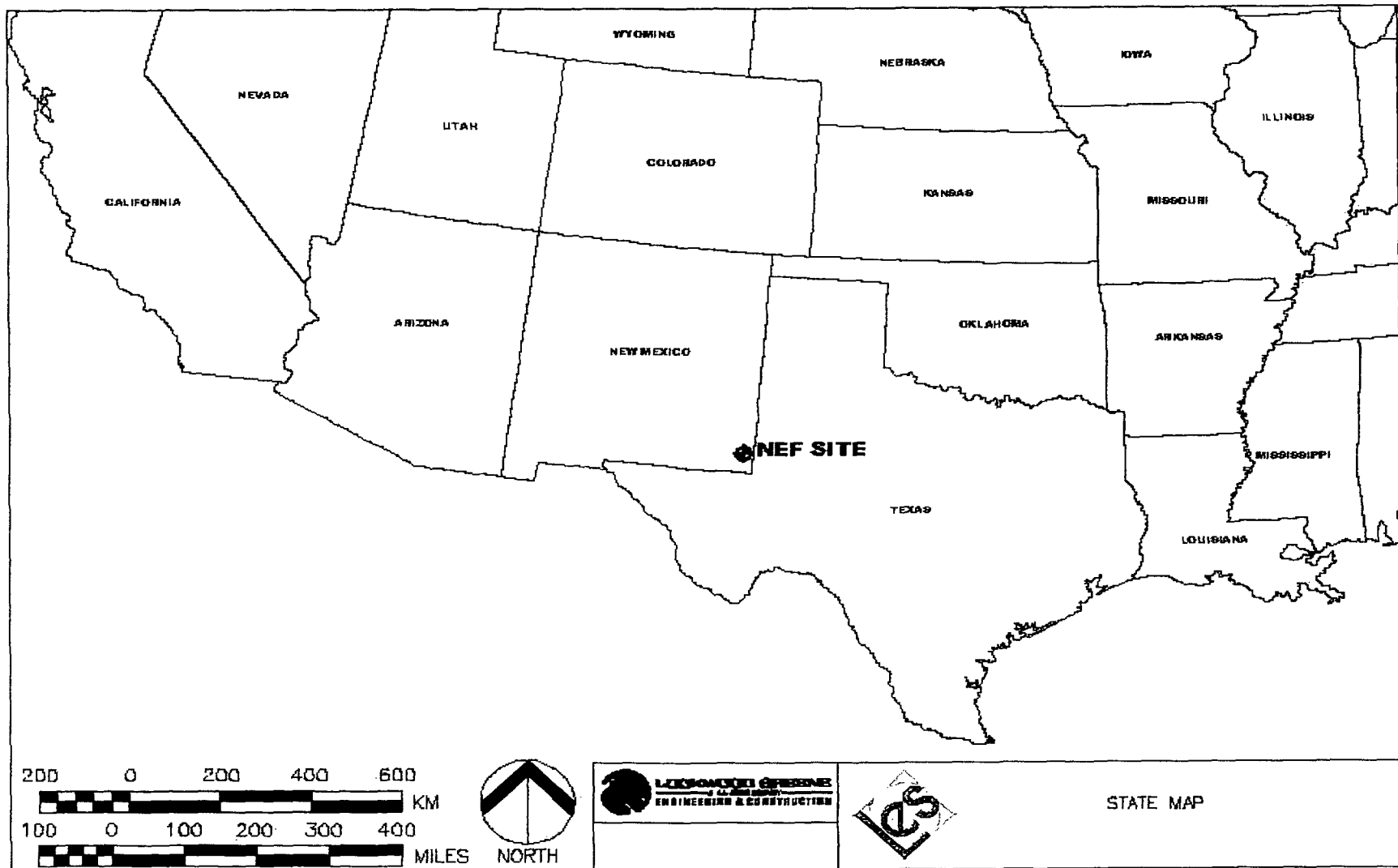

Figure 1.1-1 State Map

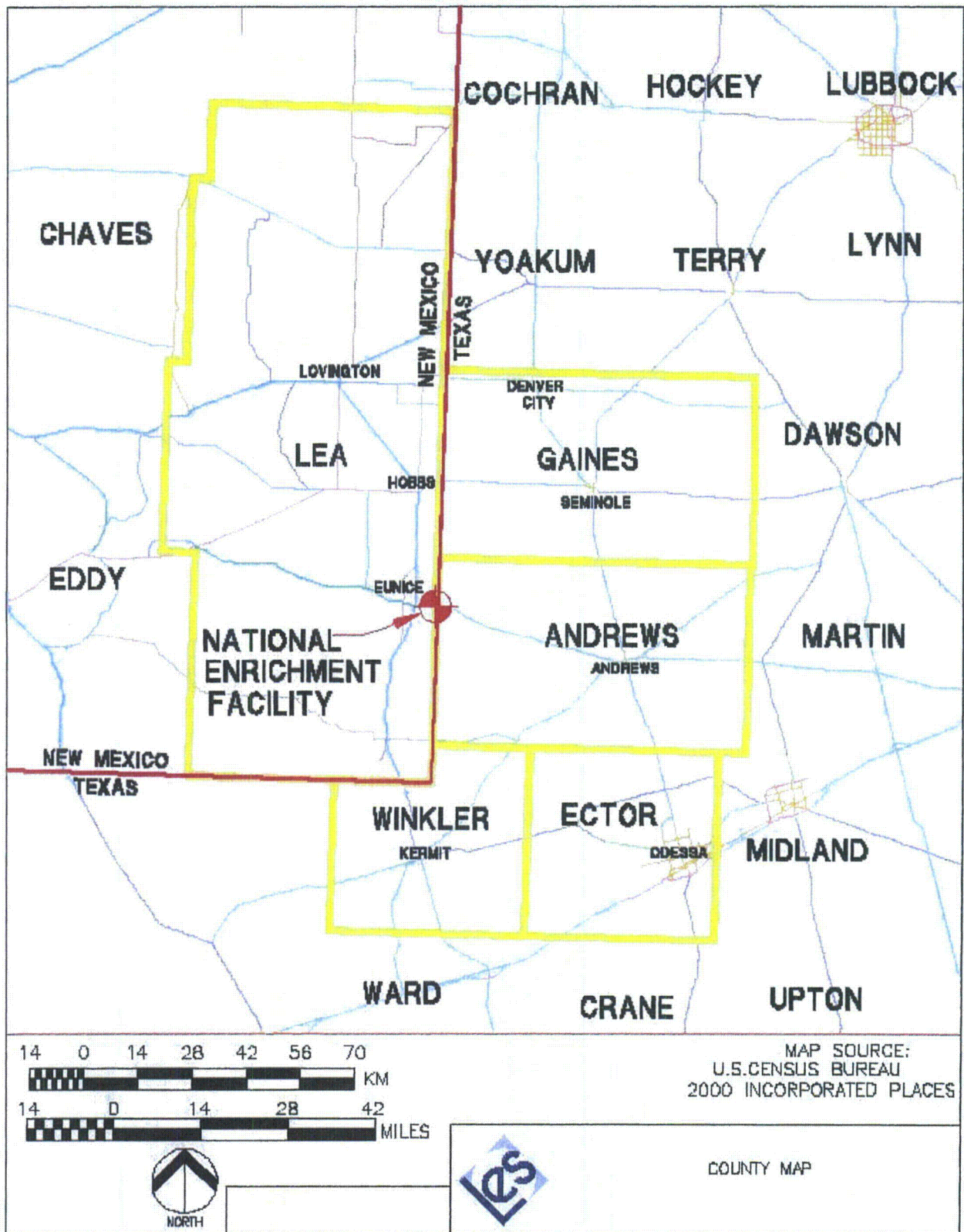

Figure 1.1-2 County Map

1.6 Chapter 1 Figures

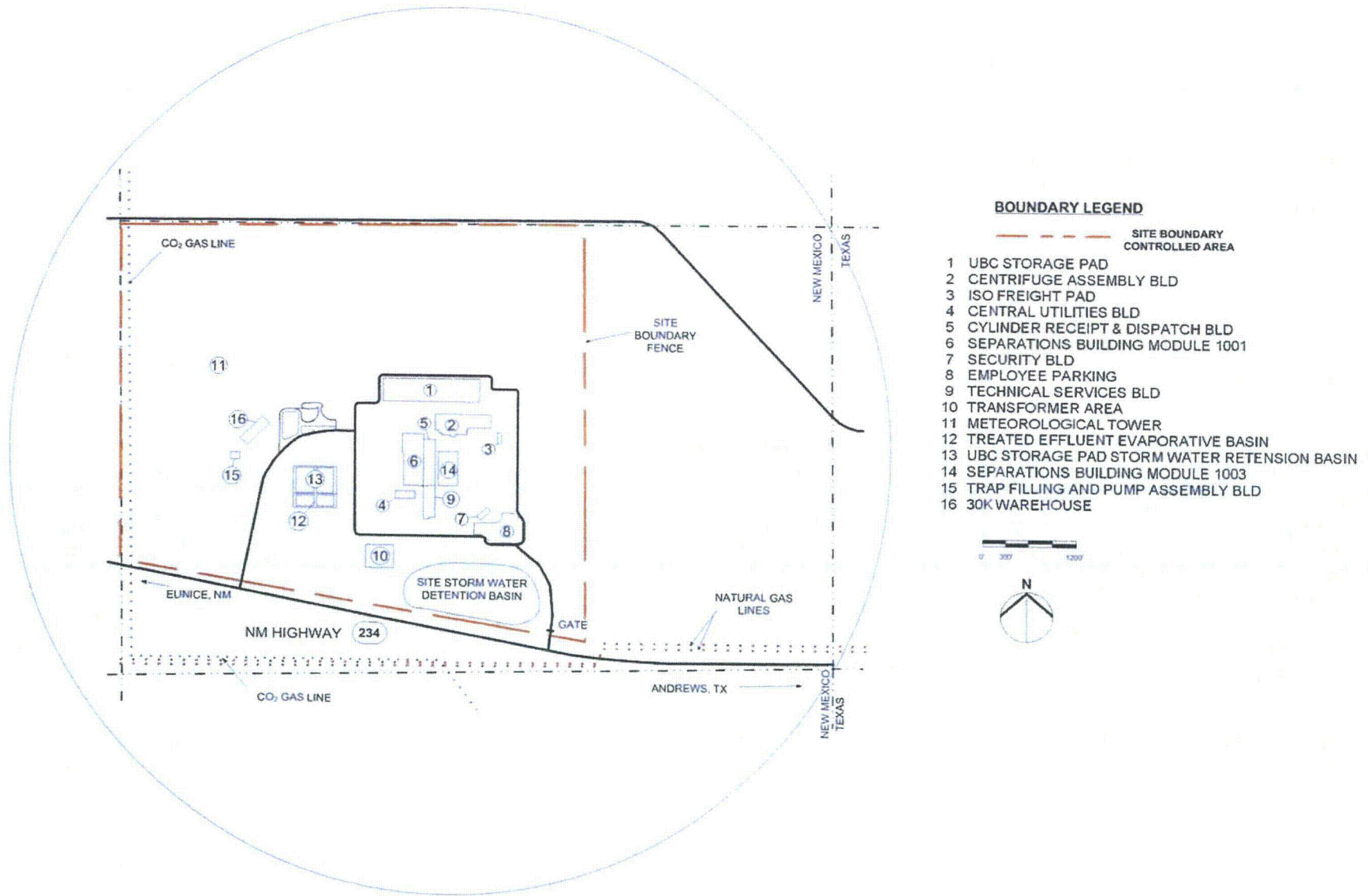
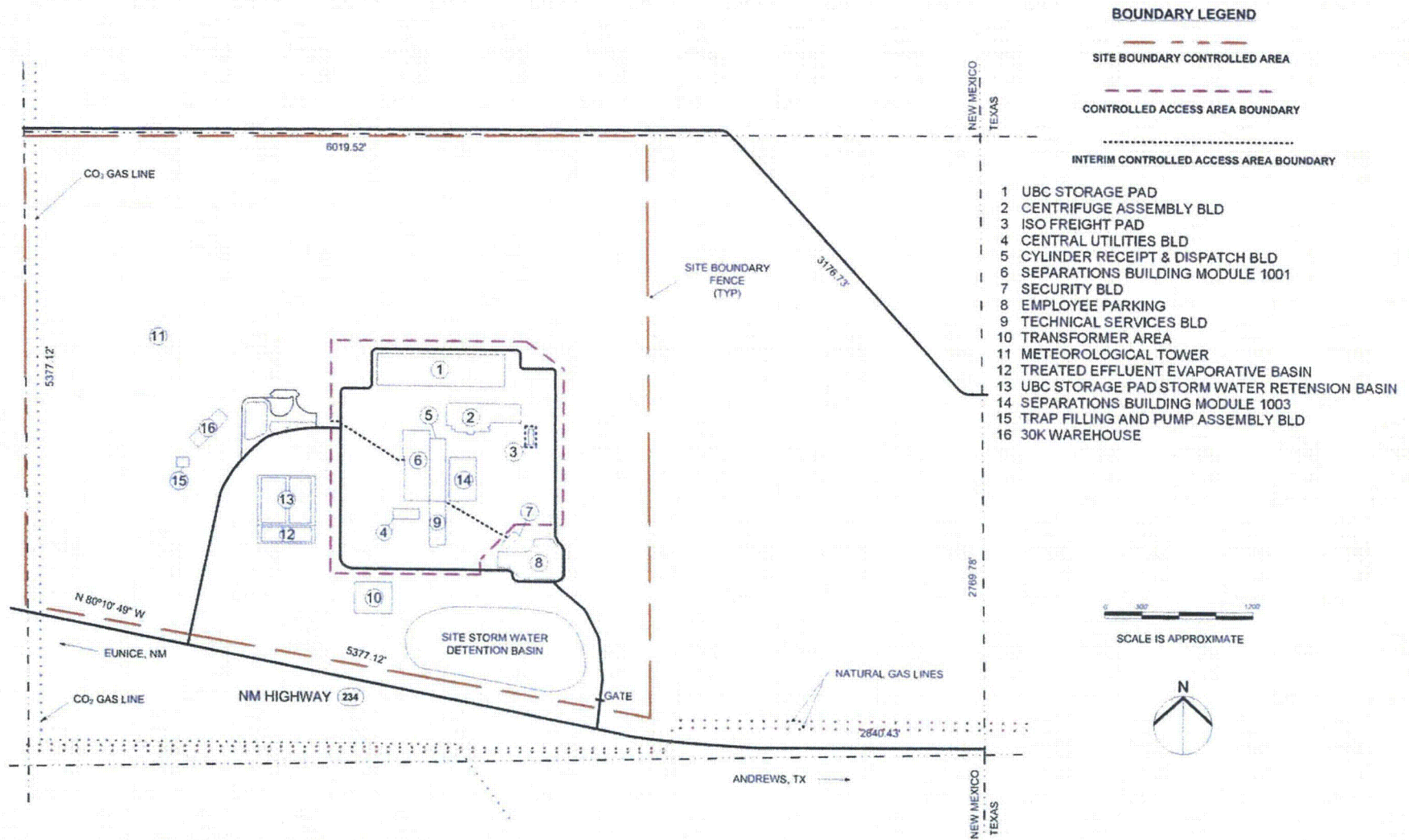

Figure 1.1-3 Plot Plan (1 Mile Radius)

1.6 Chapter 1 Figures



1.6 Chapter 1 Figures

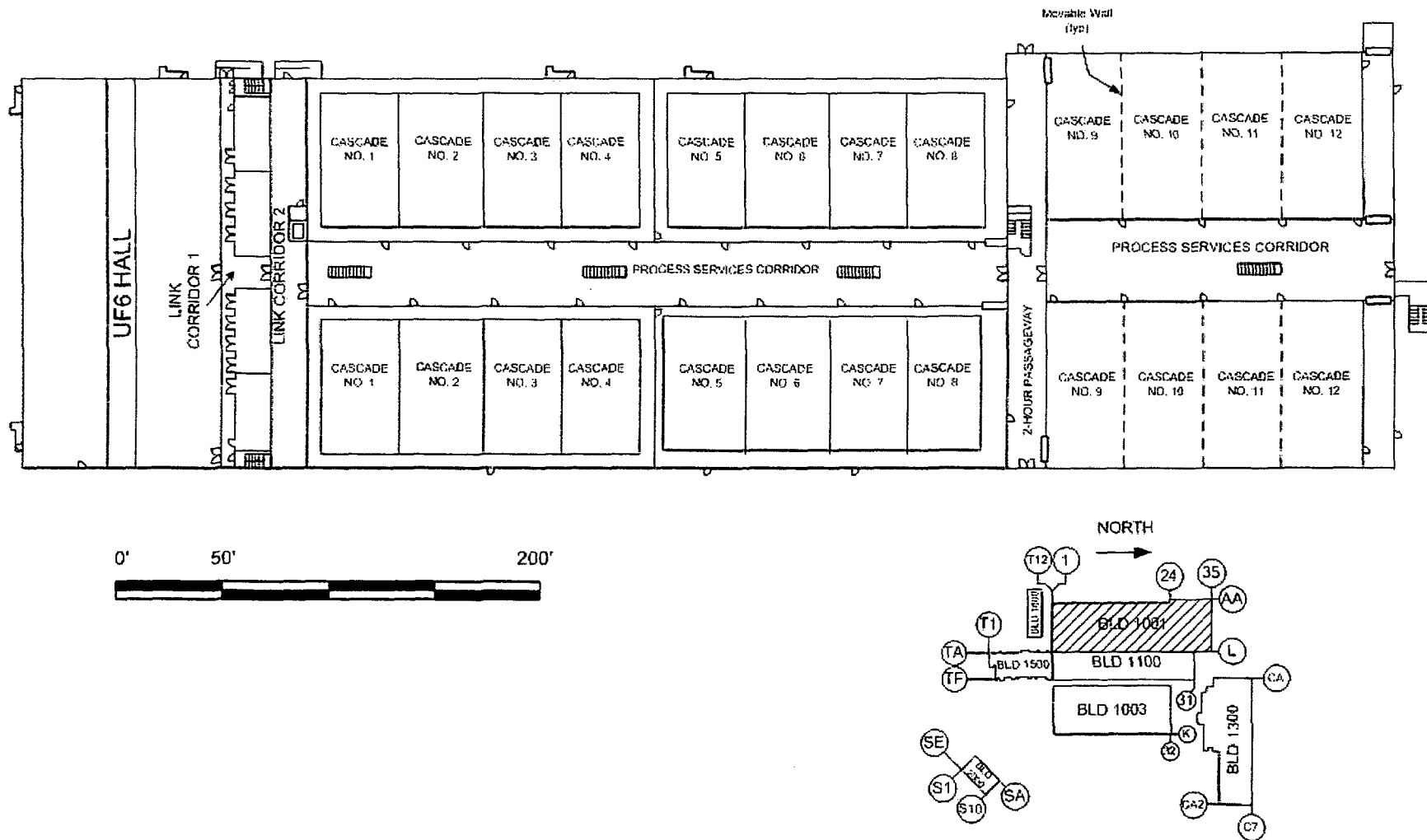

Figure 1.1-5 Separations Building Module 1001 First Floor

1.6 Chapter 1 Figures

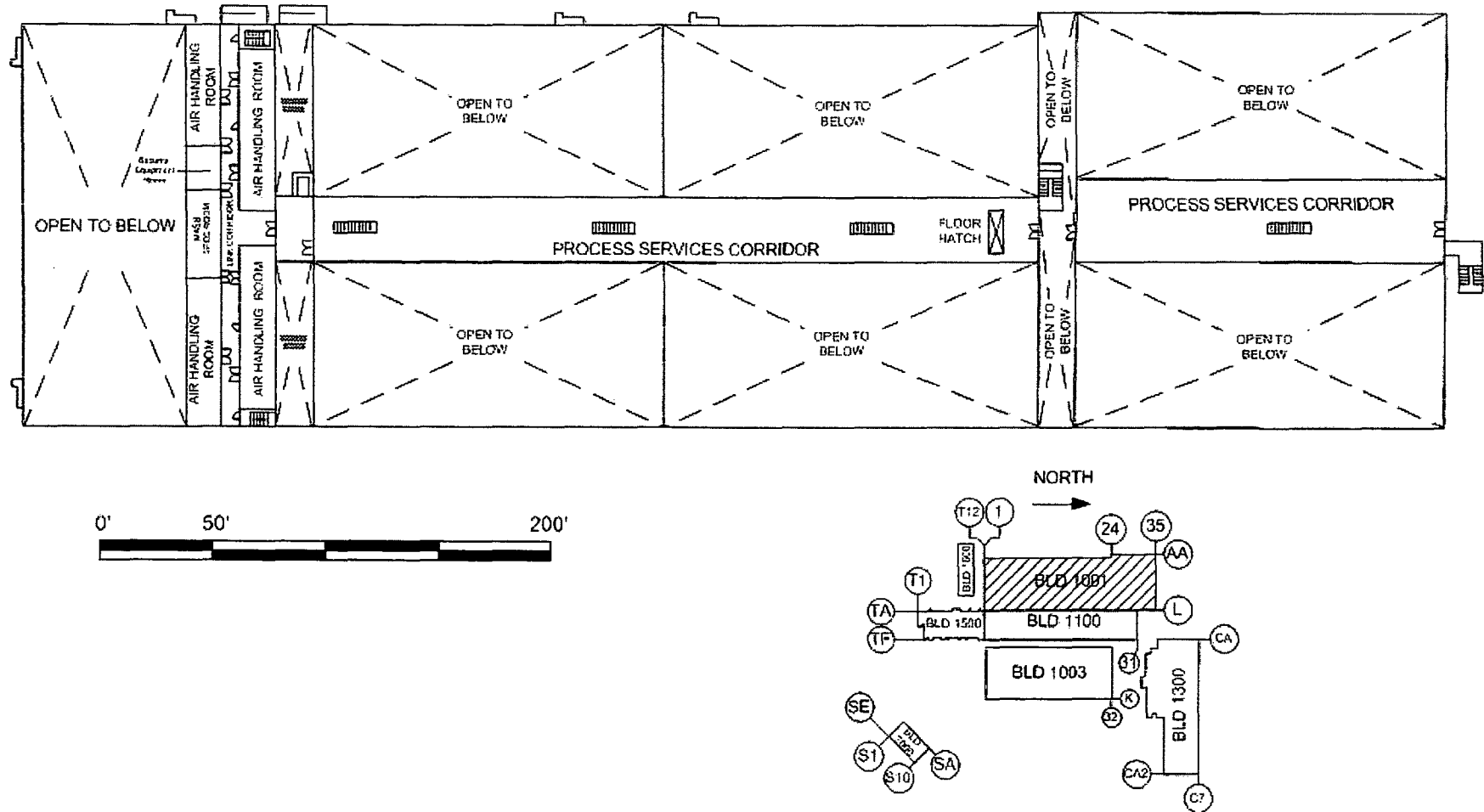

Figure 1.1-6 Separations Building Module 1001 Second Floor

1.6 Chapter 1 Figures

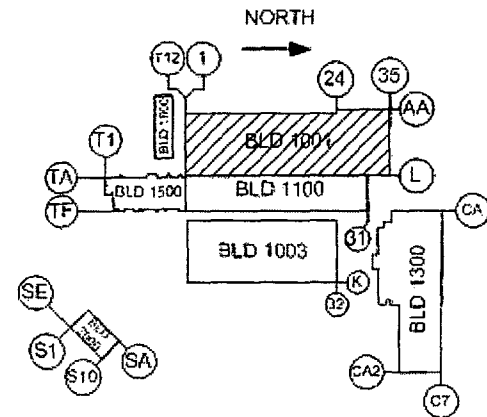
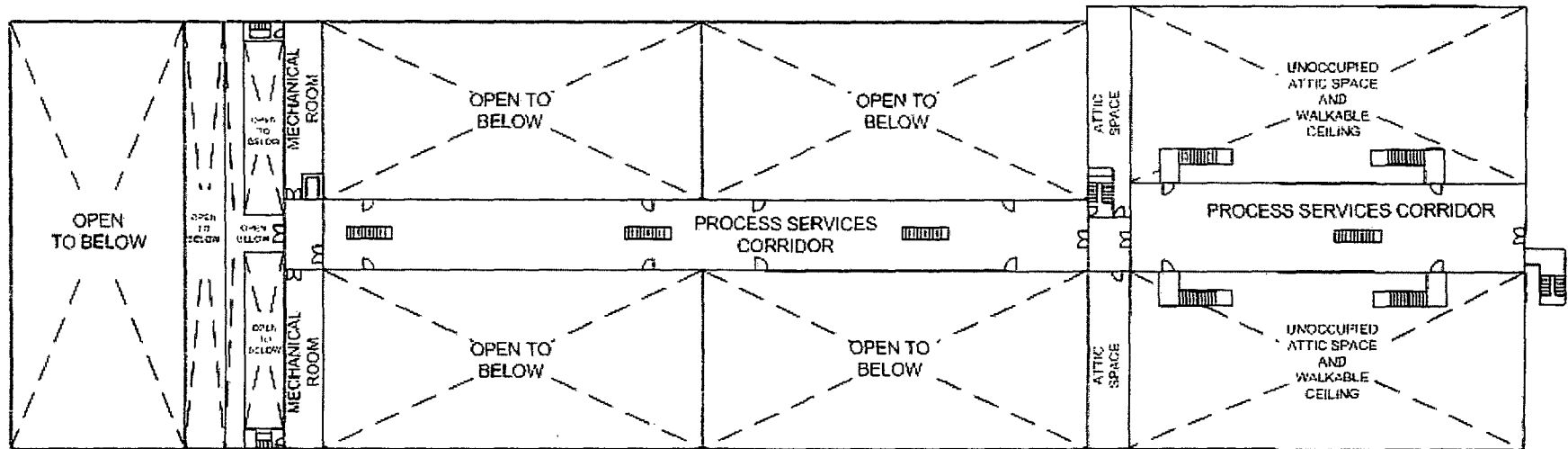

Figure 1.1-7 Separations Building Module 1001 Third Floor

1.6 Chapter 1 Figures

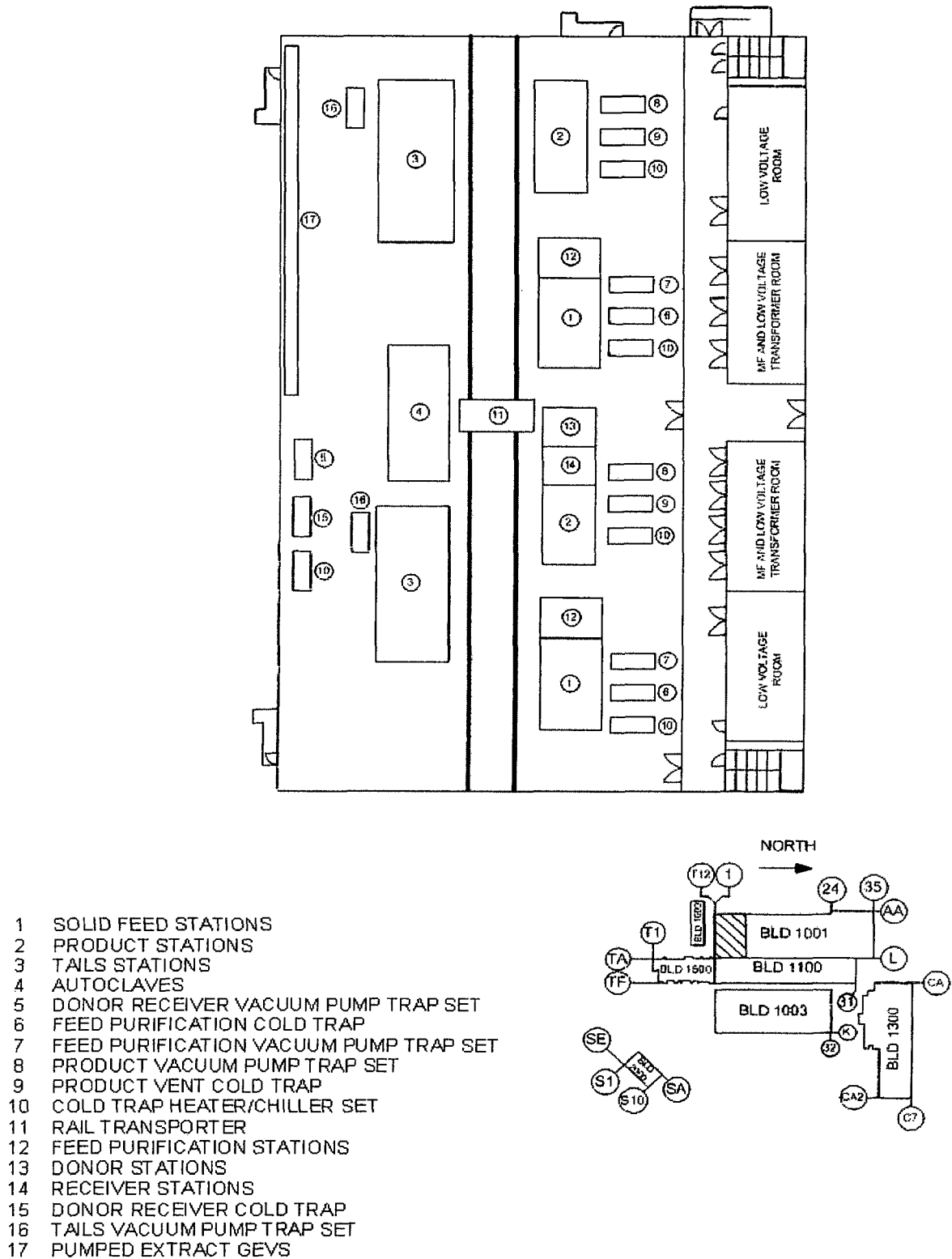

Figure 1.1-8 Separations Building Module 1001 UF₆ Handling Area Equipment Location

1.6 Chapter 1 Figures

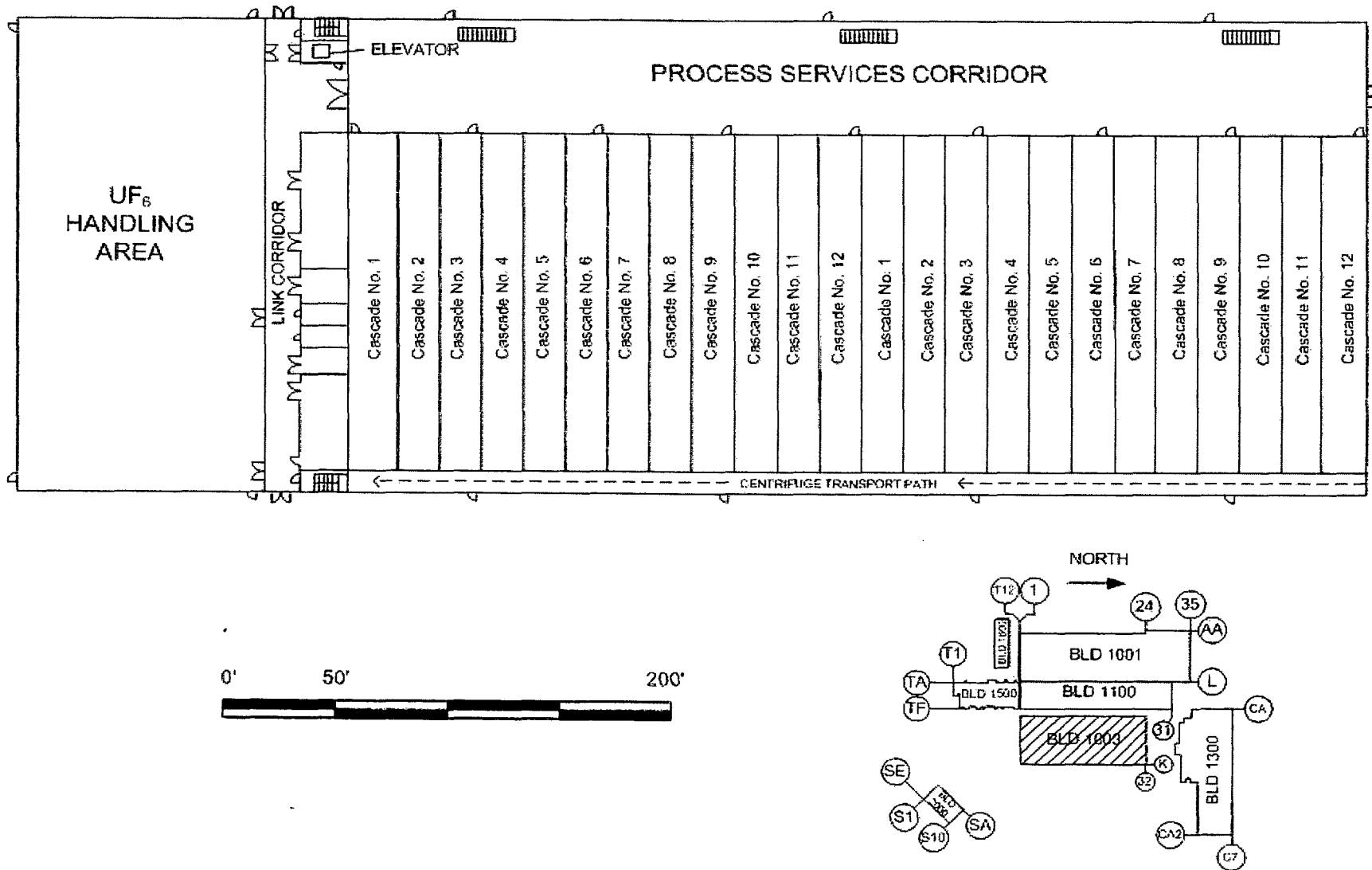
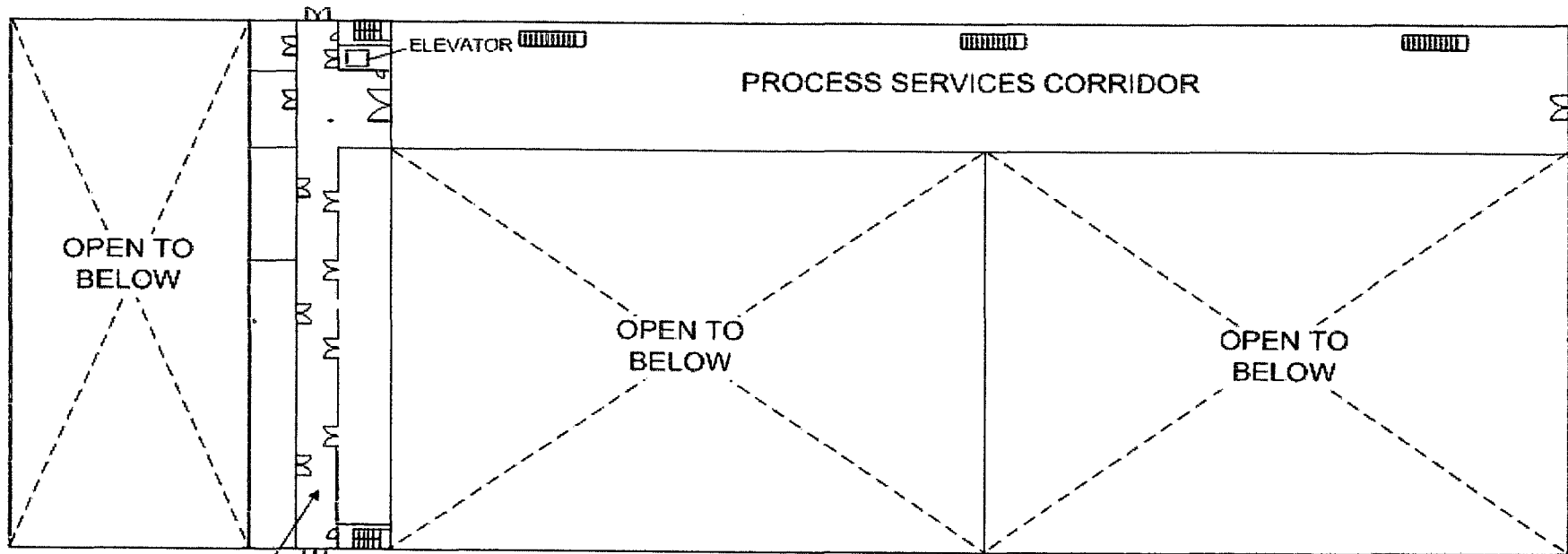

Figure 1.1-9 Separations Building Module 1003 First Floor

1.6 Chapter 1 Figures



LINK CORRIDOR

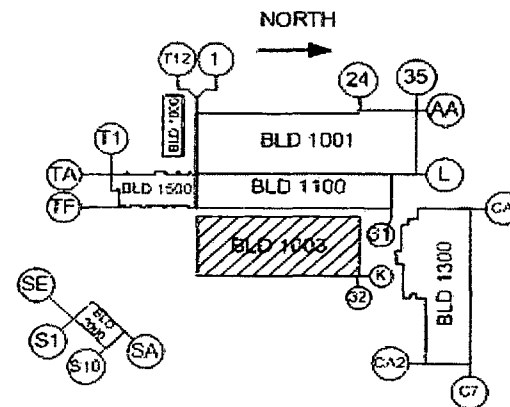

Figure 1.1-10 Separations Building Module 1003 Second Floor

1.6 Chapter 1 Figures

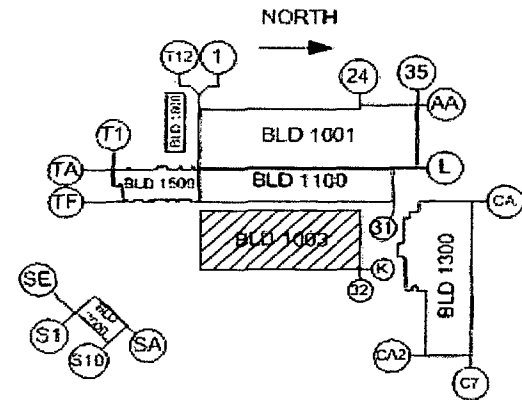
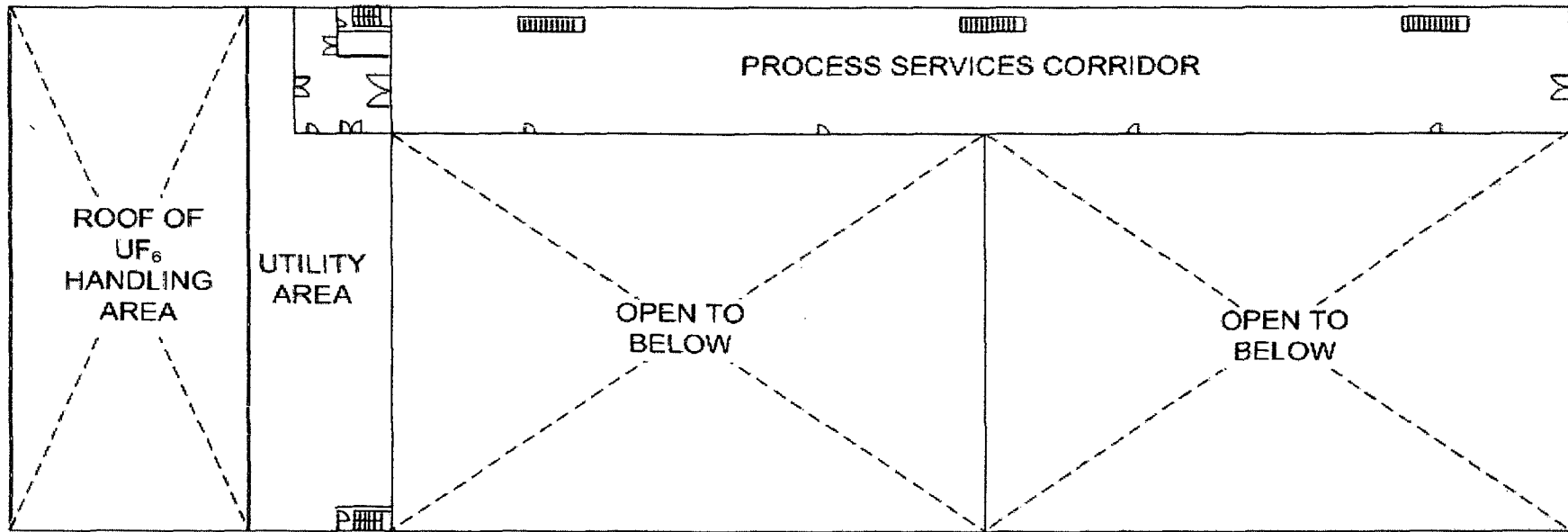
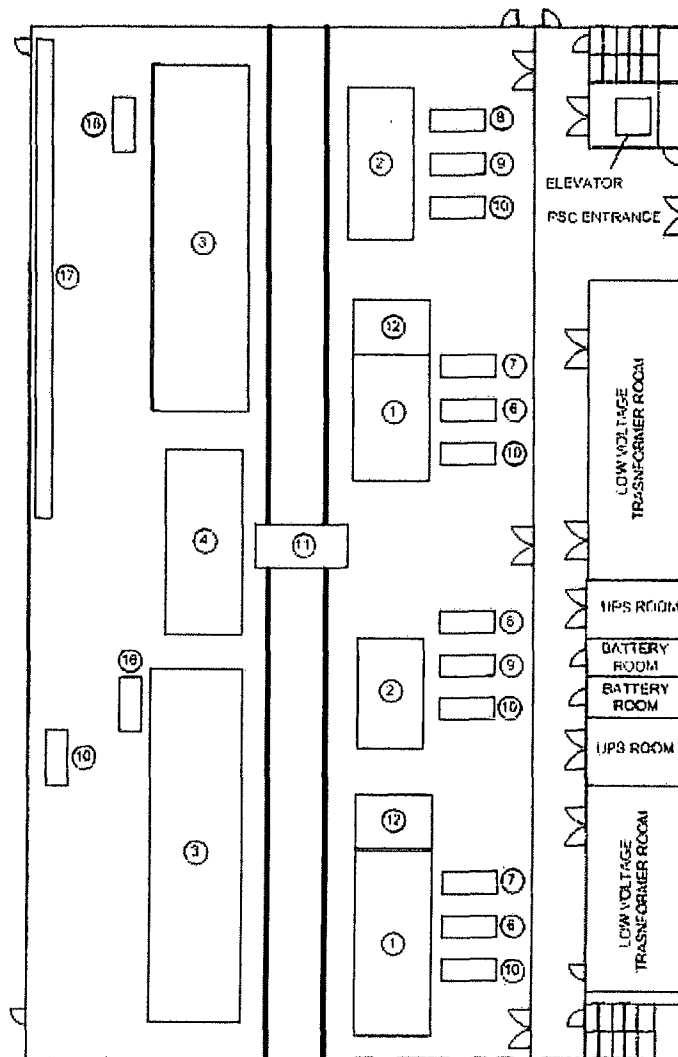

Figure 1.1-11 Separations Building Module 1003 Third Floor

1.6 Chapter 1 Figures



- 1 SOLID FEED STATIONS
- 2 PRODUCT STATIONS
- 3 TAILS STATIONS
- 4 AUTOCLAVES
- 6 FEED PURIFICATION COLD TRAP
- 7 FEED PURIFICATION VACUUM PUMP TRAP SET
- 8 PRODUCT VACUUM PUMP TRAP SET
- 9 PRODUCT VENT COLD TRAP
- 10 COLD TRAP HEATER/CHILLER SET
- 11 RAIL TRANSPORTER
- 12 FEED PURIFICATION STATIONS
- 16 TAILS VACUUM PUMP TRAP SET
- 17 PUMPED EXTRACT GEVS

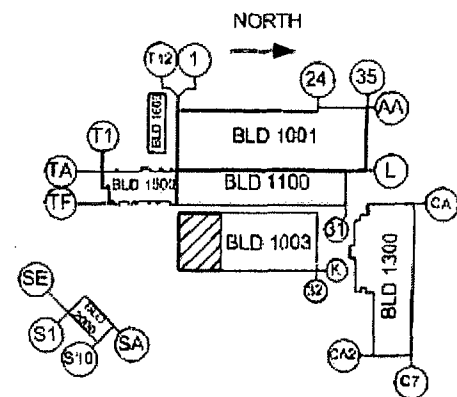

Figure 1.1-12 Separations Building Module 1003 UF₆ Handling Area Equipment Location

1.6 Chapter 1 Figures

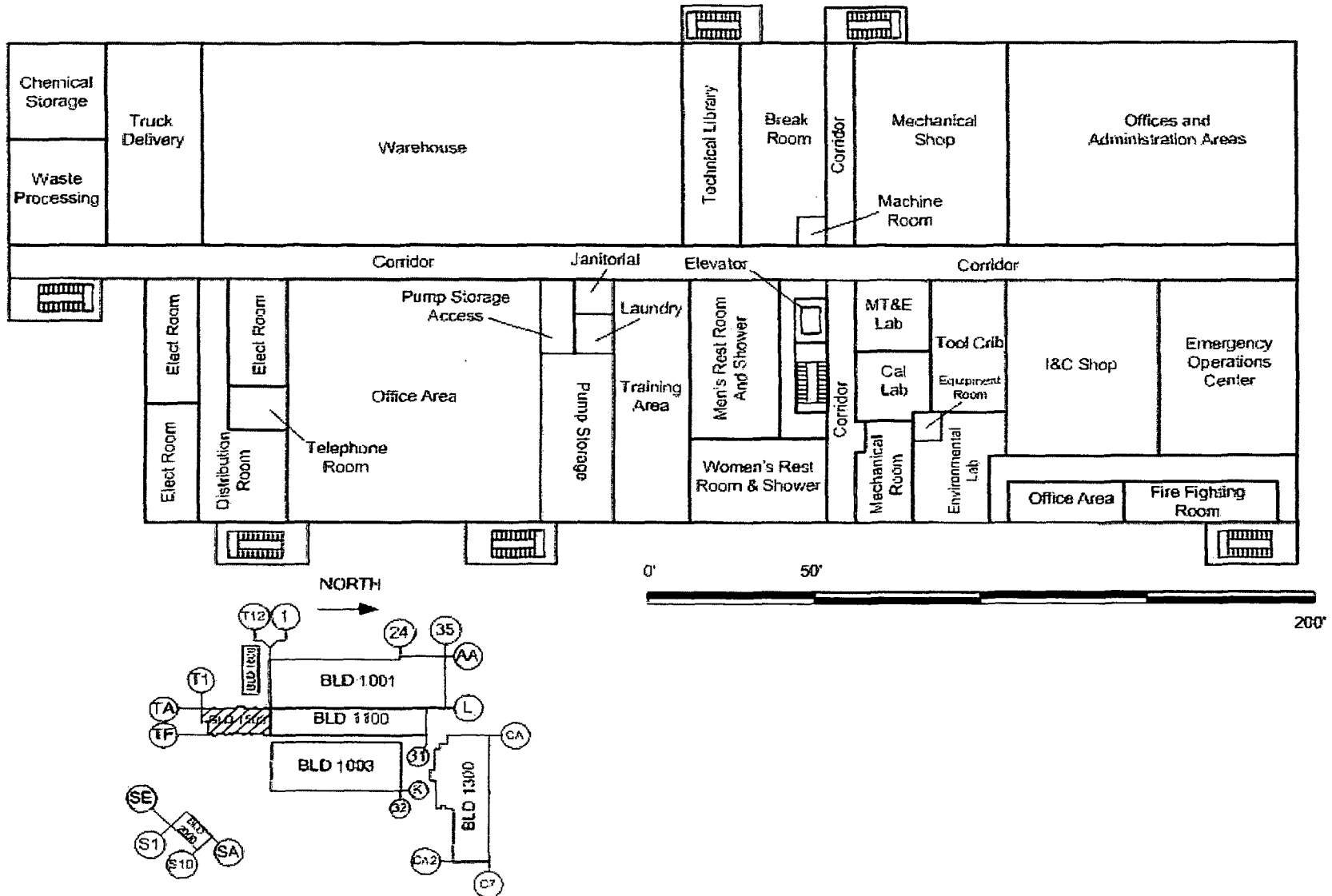

Figure 1.1-13 Technical Services Building First Floor

1.6 Chapter 1 Figures

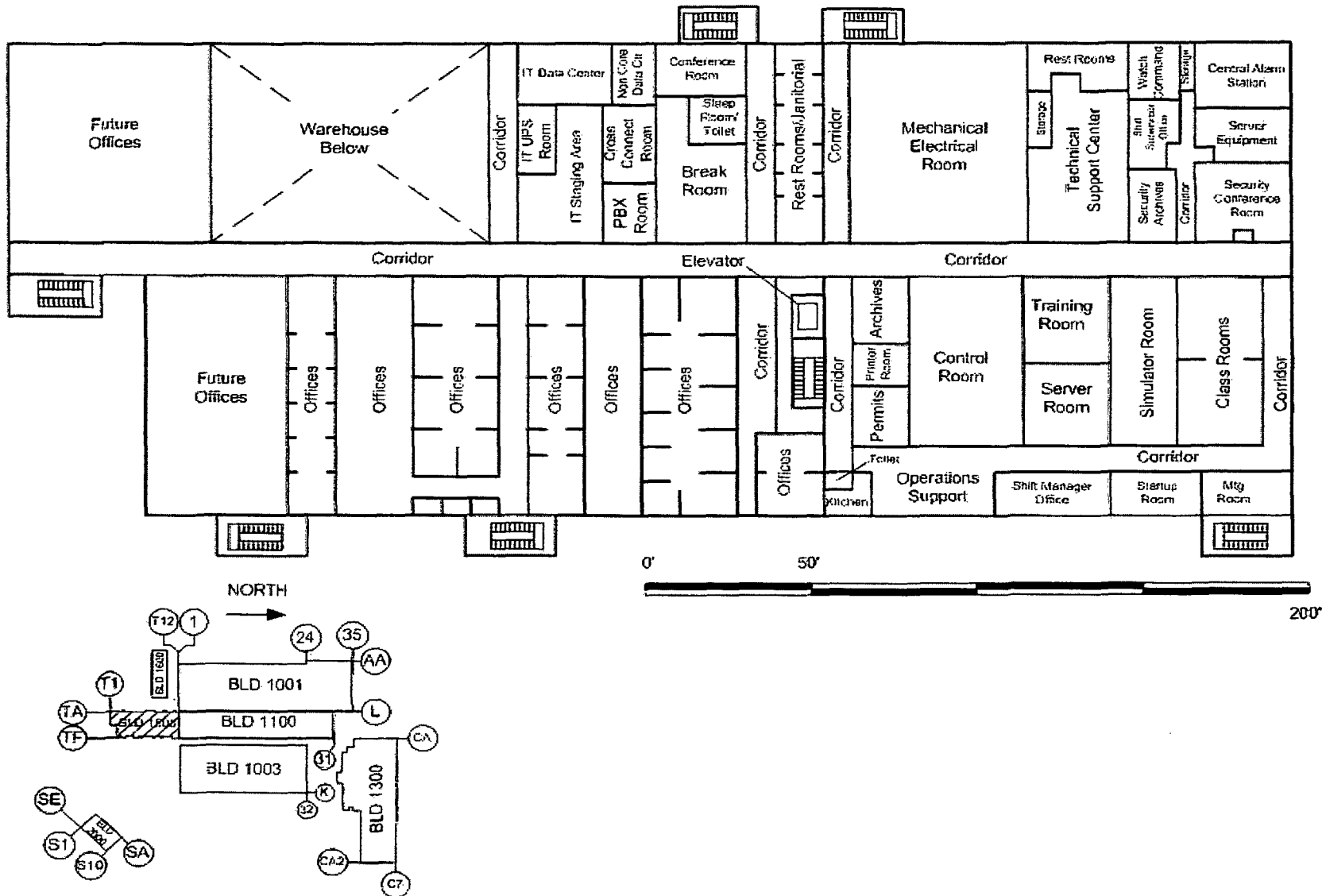

Figure 1.1-14 Technical Services Building Second Floor

1.6 Chapter 1 Figures

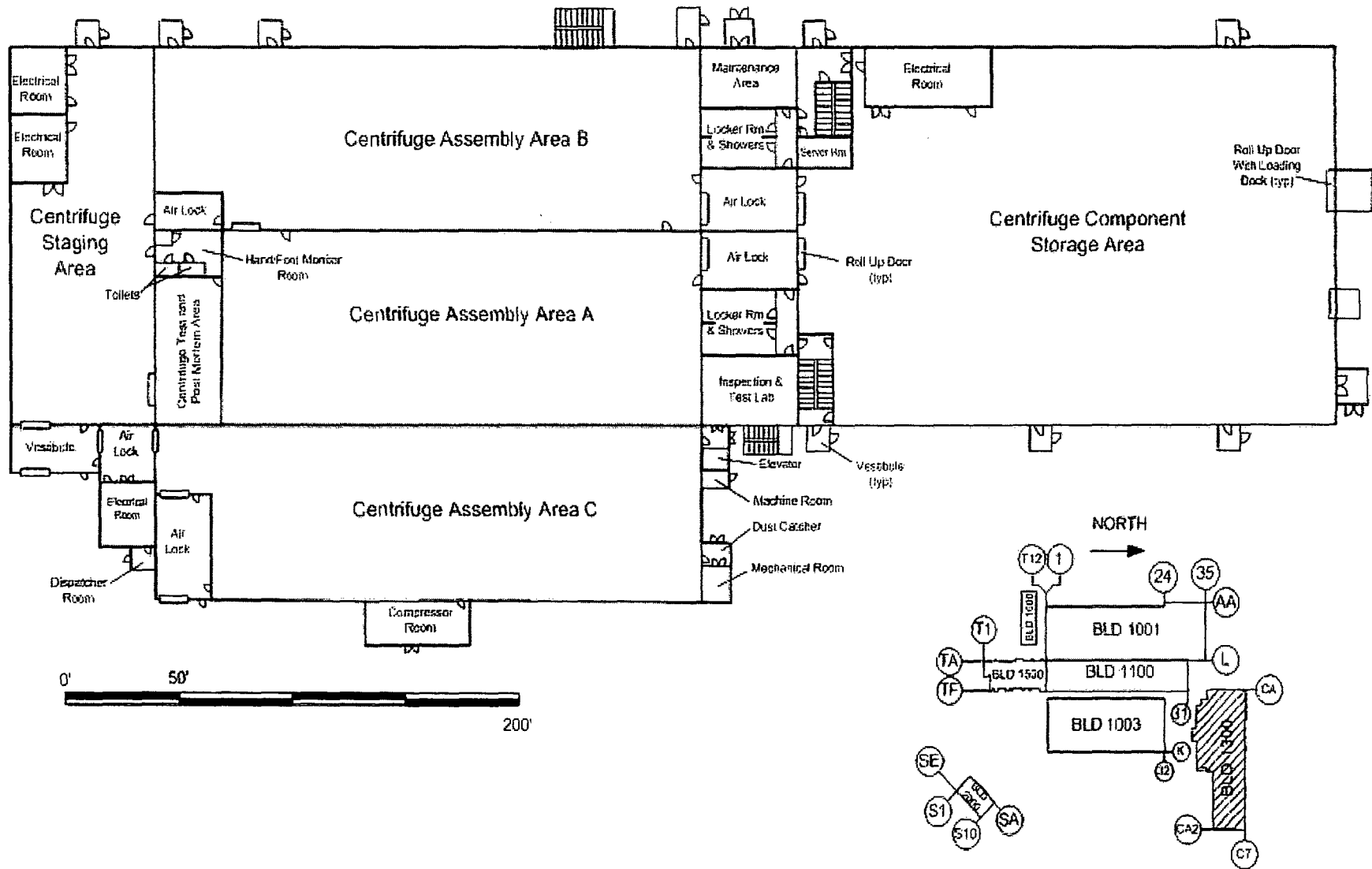

Figure 1.1-15 Centrifuge Assembly Building First Floor

1.6 Chapter 1 Figures

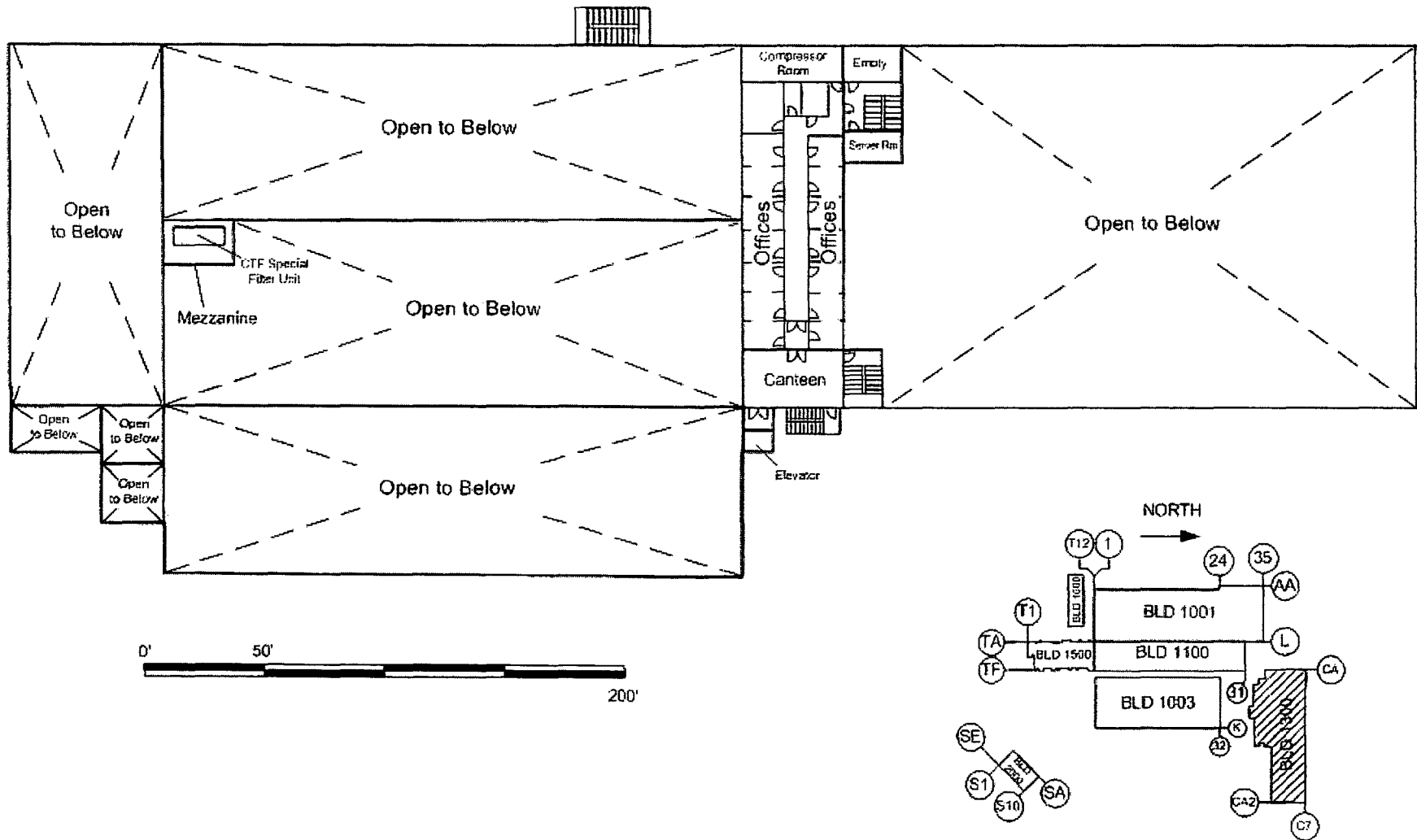

Figure 1.1-16 Centrifuge Assembly Building Second Floor

1.6 Chapter 1 Figures

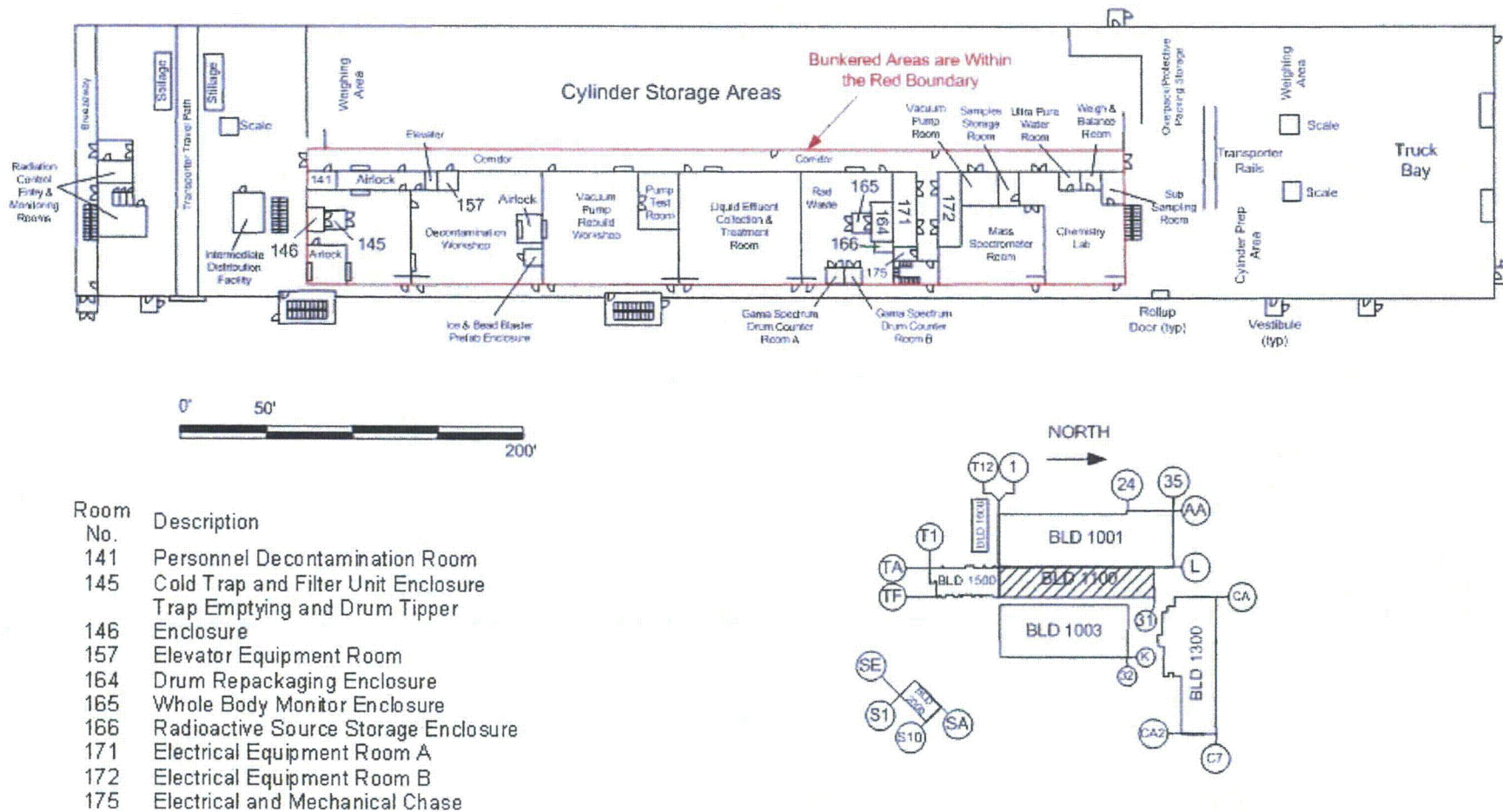

Figure 1.1-17 Cylinder Receipt and Dispatch Building First Floor

1.6 Chapter 1 Figures

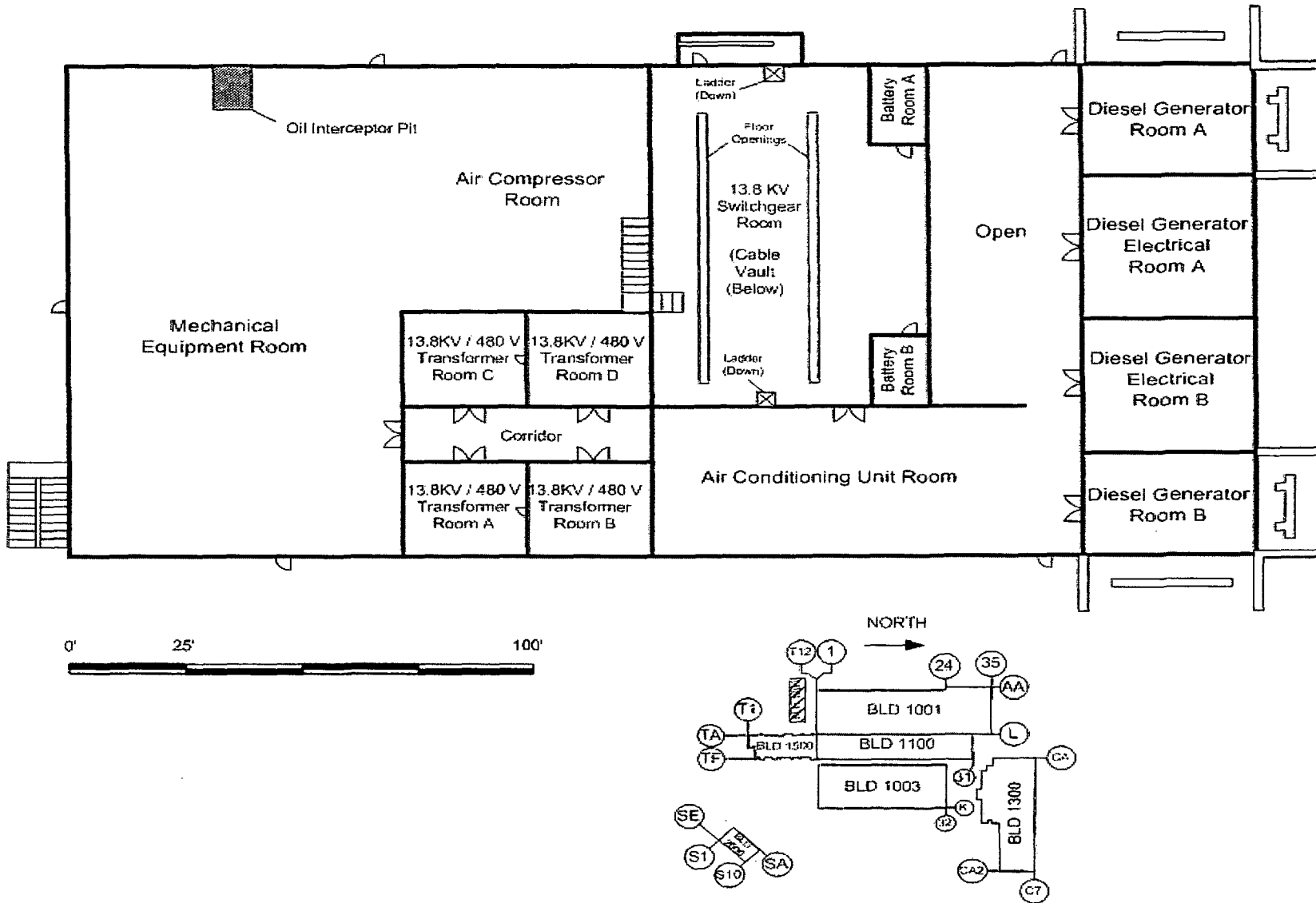

Figure 1.1-18 Central Utilities Building First Floor

1.6 Chapter 1 Figures

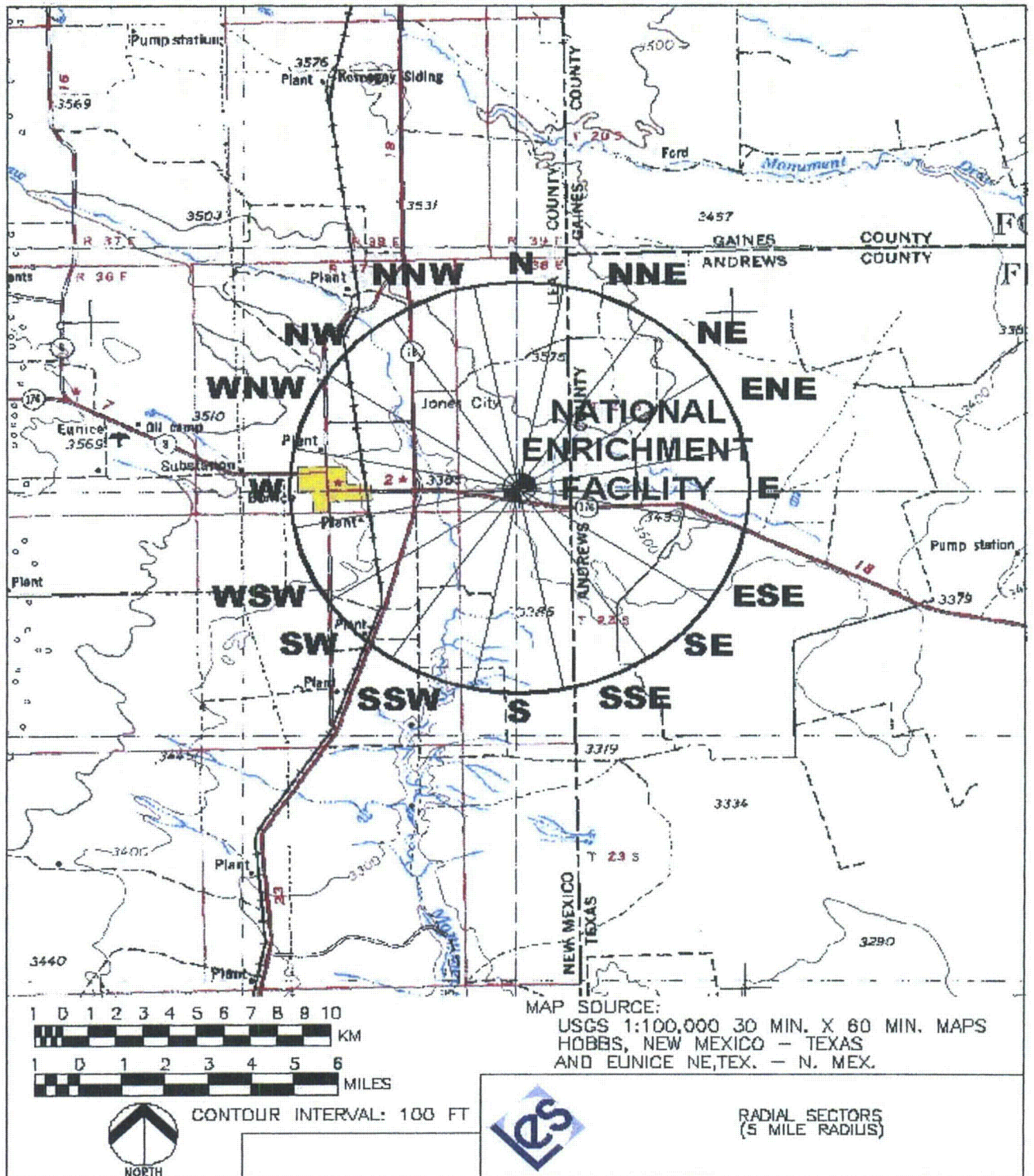

Figure 1.3-1 Radial Sectors (5 Mile Radius) Organization and Administration

2.0 Organization and Administration

2.0 Organization and Administration

This chapter describes the management system and administrative procedures for the effective implementation of Health, Safety, and Environmental (HS&E) functions at the Louisiana Energy Services (LES) enrichment facility. The chapter presents the organizations responsible for managing the design, construction, operation, and decommissioning of the facility. The key management and supervisory positions and functions are described including the personnel qualifications for each key position at the facility.

The LES policy is to maintain a safe work place for its employees and to assure operational compliance within the terms and conditions of the license and applicable regulations. The Vice President – Operations is the Plant Manager. The Plant Manager has overall responsibility for safety and compliance to this policy. In particular, LES employs the principle of keeping radiation and chemical exposures to employees and the general public as low as reasonably achievable (ALARA).

The information provided in this chapter, the corresponding regulatory requirement, and the section of NUREG-1520, Chapter 2 in which the NRC acceptance criteria are presented is summarized below.

2.0 Organization and Administration

Information Category and Requirement	10 CFR 70 Citation	NUREG-1520 Chapter 2 Reference
Section 2.1 Organizational Structure		
<ul style="list-style-type: none"> • Functional description of specific organization groups responsible for managing the design, construction, and operation of the facility 	70.22(a)(6)	2.4.3
<ul style="list-style-type: none"> • Management controls and communications among organizational units 	70.22(a)(8)	2.4.3
<ul style="list-style-type: none"> • Startup and transition to operations 	70.22(a)(6)	2.4.3
Section 2.2 Key Management Positions		
<ul style="list-style-type: none"> • Qualifications, responsibilities, and authorities for key management personnel 	70.22(a)(6)	2.4.3
Section 2.3 Administration		
<ul style="list-style-type: none"> • Effective implementation of HS&E functions using written procedures 	70.22(a)(8)	2.4.3
<ul style="list-style-type: none"> • Reporting of unsafe conditions or activities 	70.62(a)	2.4.3
<ul style="list-style-type: none"> • Commitment to establish formal management measures to ensure availability of IROFS 	70.62(d)	2.4.3
<ul style="list-style-type: none"> • Written agreements with offsite emergency resources 	70.22(i)	2.4.3

2.1 Organizational Structure

2.1 Organizational Structure

The LES organizational structure is described in the following sections. The organizational structure indicates the lines of communication and management control of activities associated with the design, construction, operation, and decommissioning of the facility.

2.1.1 Corporate Functions, Responsibilities, and Authorities

LES is a registered limited liability company formed solely to provide uranium enrichment services for commercial nuclear power plants. The LES company organization and management structure is described in Chapter 1, Section 1.2, Institutional Information.

Lea County, New Mexico has accepted the LES proposal to develop the NEF. Lea County has issued its Industrial Revenue Bond (National Enrichment Facility Project) Series 2004 in the maximum aggregate principal amount of \$400,000,000 to accomplish the acquisition, construction and installation of the project pursuant to the County Industrial Revenue Bond Act, Chapter 4, Article 59 NMSA 1978 Compilation, as amended. The Project is comprised of the land, buildings, and equipment.

Under the Act, Lea County is authorized to acquire industrial revenue projects to be located within Lea County but outside the boundaries of any incorporated municipality for the purpose of promoting industry and trade by inducing manufacturing, industrial and commercial enterprises to locate or expand in the State of New Mexico, and for promoting a sound and proper balance in the State of New Mexico between agriculture, commerce, and industry. Lea County will lease the project to LES, and LES will be responsible for the construction and operation of the facility. Upon expiration of the Bond after 30 years, LES will purchase the project.

The County has no power under the Act to operate the project as a business or otherwise or to use or acquire the project property for any purpose, except as lessor thereof under the terms of the lease.

In the exercise of any remedies provided in the lease, the County shall not take any action at law or in equity that could result in the Issuer obtaining possession of the project property or operating the project as a business or otherwise.

LES is responsible for the design, quality assurance, construction, operation, and decommissioning of the enrichment facility. The President of LES reports to the LES Board of Managers as described in Section 1.2.

The President receives policy direction from the LES Board of Managers. Reporting to the President is the Vice President - Operations & Chief Nuclear Officer, the Vice President - Project, Vice President - Compliance and General Counsel, and Chief Financial Officer. The Quality Assurance Manager reports to the Vice President of Compliance/General Counsel for functional day to day activities and has a direct line of communication to the Vice President – Operations & Chief Nuclear Officer and President for stop work authority. The Health Safety & Environmental Manager reports to the Vice President of Compliance/General Counsel. The HS&E Manager has a direct line of communication to the Vice President - Operations & Chief Nuclear Officer for all matters concerning safety during operations, design and construction. Figure 2.1-2, LES National Enrichment Facility Operating Organization shows the authority and lines of communication.

2.1 Organizational Structure

2.1.2 Project Organization

As the owner of the enrichment technology and operator of the enrichment facilities in Europe, LES has contracted Urenco Limited to prepare the reference design for the facility, while an architect/engineering (A/E) was contracted to further specify structures and systems of the facility, and ensure the reference design meets all applicable U.S. codes and standards. A contractor specializing in site evaluations was contracted to perform the site selection evaluation. A nuclear consulting company was contracted to conduct the site characterization, perform the Integrated Safety Analysis and to support development of the license application.

During the construction phase, preparation of construction documents and construction itself are contracted to qualified contractors. The Vice President of Project is responsible for managing, construction, construction turnover testing activities, and overall design responsibility. The Director of Engineering reports to the Vice President of Project and is the responsible design authority during construction. The Procurement Director is responsible for the procurement. Contractor QA Programs will be reviewed by LES QA and must be approved before work can start.

Urenco and ETC will design, manufacture and deliver to the site the centrifuges necessary for facility operation. In addition, Urenco is supplying technical assistance and consultation for the facility. URENCO has extensive experience in the gas centrifuge uranium enrichment process since it operates three gas centrifuge uranium enrichment plants in Europe. URENCO is conducting technical reviews of the design activities to ensure the design of the enrichment facility is in accordance with the reference design information.

Procurement activities are coordinated by the LES Procurement Director. For procurement involving the use of vendors located outside the U.S., LES selects vendors only after a determination that their quality assurance programs meet the LES requirements. Any components supplied to LES are designed to meet applicable domestic industry code requirements or their equivalents as stated by the equipment specifications. The Procurement Director reports directly to the Chief Financial Officer which reports to the President.

The Vice President of Project is responsible for managing the work and contracts. The lines of communication of key management positions within the engineering and construction organization are shown in Figure 2.1-2.

Position descriptions of key management personnel in the design and construction organization will be accessible to all affected personnel and the NRC.

2.1.3 Operating Organization

The operating organization for LES is shown in Figure 2.1-2, LES National Enrichment Facility Operating Organization. LES has direct responsibility for preoperational testing, initial start-up, operation and maintenance of the facility.

The Vice President – Operations is the Plant Manager and Chief Nuclear Officer and reports to the President. The Plant Manager is responsible for the overall operation and administration of the enrichment facility after formal turnover from Project and acceptance by Operations. He is also responsible for ensuring the facility complies with all applicable regulatory requirements. In

2.1 Organizational Structure

the discharge of these responsibilities, the Plant Manager directs the activities of the following groups:

- Security
- Operations
- Technical Services
- Plant Support
- Training & Support Services

The responsibilities, authorities and lines of communication of key management positions within the operating organization are discussed in Section 2.2, Key Management Positions.

Position descriptions for key management personnel in the operating organization will be accessible to all affected personnel and to the NRC.

2.1.4 Transition From Project to Operations

LES is responsible for the design, quality assurance, construction, testing, initial startup, operation, and decommissioning of the facility.

The National Enrichment Facility (NEF) has commenced operation with the first cascade (Cascade 101) being commissioned and placed into service. Construction activities will continue as each subsequent cascade is commissioned and placed into service. Due to the process system modular design, each cascade can be isolated from one another. This allows the construction, commissioning and operation of new cascades as well as the removal and replacement of existing centrifuges/cascades to continue while the remaining cascades are in operation. This modular design approach also supports the addition of subsequent Separations Building Modules (SBM) and extension modules with cascades in operation.

The focus of the organization has shifted from the project to construction turnover, initial start-up and operation of each facility system and subsequent cascades. LES has provided for staffing of the LES NEF Operating Organization to ensure smooth transition from construction activities to operation activities. The Health, Safety, and Environmental Manager and Plant Support Director have the authority to report safety concerns directly to the Vice President - Operations & Chief Nuclear Officer (as shown in Figure 2.1-2) for HS&E matters related to operations, design or construction. These positions are intentionally provided stop work authority at the Vice President - Operations & Chief Nuclear Officer level to provide significant continued focus on the health, safety, and environment goals during design, construction, and operations. URENCO, which has been operating gas centrifuge enrichment facilities in Europe for over 30 years, will have personnel integrated into the LES organization to provide technical support during startup of the facility and transition into the operations phase.

As the construction of systems is completed, the systems will undergo acceptance testing followed by turnover from the project organization to the operations organization. The turnover will include the physical systems and corresponding design information and records. Following turnover, the operating organization will be responsible for system maintenance and configuration management. The design basis for the facility is maintained during the transition from project to operations through the configuration management system described in Chapter 11, Management Measures.

2.2 Key Management Positions

2.2 Key Management Positions

This section describes the functional positions responsible for managing the operation of the facility. The facility is staffed at sufficient levels prior to operation to allow for training, procedure development, and other pre-operational activities.

The responsibilities, authorities and lines of communication for each key management position are provided in this section. Responsible managers have the authority to delegate tasks to other individuals; however, the responsible manager retains the ultimate responsibility and accountability for implementing the applicable requirements. Management responsibilities, supervisory responsibilities, and the criticality safety engineering staff responsibilities related to nuclear criticality safety are in accordance with ANSI/ANS-8.19, Administrative Practices for Nuclear Criticality Safety.

The LES Corporate and Operating Organization and lines of communication are shown in Figure 2.1-2.

2.2.1 Operating Organization

The functions and responsibilities of key facility management are described in the following paragraphs. Additional detailed responsibilities related to nuclear criticality safety for key management positions and remaining supervisory and criticality safety staff are in accordance with ANSI/ANS-8.19. Some position titles have been changed to better reflect the actual responsibilities of the position. Similarly, some operating functions have been assigned to different managers to better reflect the operating organization presently used at Urenco and U. S. nuclear facilities.

A. Vice President – Operations & Chief Nuclear Officer

The Vice President – Operations & Chief Nuclear Officer reports to the President and is a critical member of the leadership team for LES, with the ultimate responsibility for the nuclear safety, industrial safety, security, and operations of the facility. The Vice President – Operations & Chief Nuclear Officer is ultimately responsible for completion and safe operation of the NEF and has stop work authority for both the project and operations at the NEF.

The Vice President – Operations & Chief Nuclear Officer is also responsible for ensuring the facility complies with all applicable regulatory requirements. The Vice President – Operations & Chief Nuclear Officer is the Plant Manager. The Plant Manager has direct responsibility for operation of the facility in a safe, reliable and efficient manner. The Plant Manager is responsible for proper selection of staff for all key positions including positions on the Safety Review Committee. The Plant Manager is responsible for the protection of the facility staff and the general public from radiation and chemical exposure and/or any other consequences of an accident at the facility and also bears the responsibility for compliance with the facility license.

B. Vice President- Compliance/General Counsel

The Vice President – Compliance/General Counsel has the overall responsibility for the development of the LES QA Program and assures its compliance with applicable regulations, codes, and standards. The Vice President – Compliance/General Counsel also has

2.2 Key Management Positions

responsibility for coordinating facility activities to evaluate and assist LES organizations in maintaining compliance with applicable Nuclear Regulatory Commission (NRC) requirements.

C. Quality Assurance Manager

The Quality Assurance Manager reports to the Vice President of Compliance/General Counsel and has overall responsibility for the management and implementation of the LES QAPD.

The facility line managers and their staff who are responsible for performing quality-affecting work are responsible for ensuring implementation of and compliance with the QAPD. The QA Manager position maintains reporting relationship independence from management positions at the facility. The QA Manager has a direct relationship with the Vice President - Operations and Chief Nuclear Officer and President for quality concerns with Performance Assessment and Feedback or HS&E. The QA Manager has sufficient independence for all issues affecting quality. In addition the QA Manager has a reporting relationship with the Vice President - Operations and Chief Nuclear Officer and President for adequate stop work authority.

D. Health Safety and Environmental Manager

The Health Safety and Environmental Manager reports to the Vice President of Compliance/General Counsel and has the responsibility for assuring safety at the facility through activities including health and safety activities associated with nuclear criticality safety, industrial safety, and chemical safety. The Health Safety and Environmental Manager works with the other facility managers to ensure consistent interpretations of health safety, and environmental requirements, performs independent reviews, and supports facility and operations change control reviews.

This position has a line of communications to the Vice President - Operations and Chief Nuclear Officer to ensure objective health, safety, and environmental audit, review, and control activities are maintained. This position is provided a reporting relationship to the Vice President – Operations & Chief Nuclear Officer level for stop work authority.

E. Operations Director

The Operations Director reports to the Plant Manager and has the responsibility for Shift Operations, Operations Support, Logistics Services, Chemistry and Environmental Services (Waste Analysis, Effluent Monitoring, and Product Assay), and Commissioning and Acceptance. This includes such activities as ensuring the correct and safe operation of UF₆ processes, proper handling of UF₆, and the identification and mitigation of any off normal operating conditions, UF₆ cylinder management (including transportation licensing), directing the scheduling of enrichment operations to ensure smooth production, ensuring proper material and equipment are available for the facility, developing and maintaining production schedules and procedures for enrichment services, ensuring that cylinders of uranium hexafluoride are received and routed correctly at the facility, all transportation licensing and plant and environmental analysis. In the event of the absence of the Plant Manager, the Operations Director may assume the responsibilities and authorities of the Plant Manager.

F. Technical Services Director

The Technical Services Director reports to the Plant Manager and is the operations NEF Design Authority with responsibility for approving any modifications to operating portions of the facility

2.2 Key Management Positions

(i.e., portions of the facility that have been formally turned over from the Project and accepted by Operations). The Technical Services Director assumes responsibility for all remaining NEF Design Authority responsibilities for the operating portions of the facility after formal turnover from the Project. NEF Design Authority responsibilities include approving design standards and design criteria, preparing and reviewing the NEF Functional Specification, leading the development and resolution of key technical issues, approving the NEF approved design, and establishing processes for design and configuration control. During the operations phase, after turnover, this also includes technical support for facility modifications (including administration of the configuration management system) and design support for operations and maintenance. Other responsibilities that reside solely with the Technical Services Director include facility management (facility maintenance, warehouse management, and outsourced maintenance supervision), and contamination control (decontamination and waste treatment). The Technical Services Director is also responsible for records management. In the event of the absence of the Plant Manager, the Technical Services Director may assume the responsibilities and authorities of the Plant Manager.

G. Plant Support Director

The Plant Support Director reports to the Plant Manager and has the responsibility for emergency planning, material accountability (Safeguards), and Radiation Protection. This position has the MC&A responsibility for the submission of NRC MC&A reports. This position also ensures proper contamination control. The Plant Support Director, in coordination with the Director, Human Resources & Communications, has the responsibility for providing information about the facility and LES to the public and media, including ensuring that the public and media receive accurate and up-to-date information during an abnormal event at the facility. In the event of the absence of the Plant Manager, the Plant Support Director may assume the responsibilities and authorities of the Plant Manager.

This position reports to the Vice President - Operations and Chief Nuclear Officer to ensure objective nuclear safety audit, review, and control activities are maintained independent of the Operations Director. This position is intentionally provided a reporting relationship to the Vice President - Operations & Chief Nuclear Officer level for stop work authority.

H. Commissioning & Acceptance Manager

The Commissioning & Acceptance Manager reports to the Operations Director and has the responsibility for the turnover and commissioning SSCs.

I. Performance Assessment and Feedback Manager

The Performance Assessment and Feedback Manager reports to the Vice President of Compliance/General Counsel and has the responsibility for organizational performance metrics, and implementing the Corrective Action Program (CAP), Nonconformance Process and Industry Experience Program.

J. Quality Assurance Inspectors

The Quality Assurance Inspectors report to the Quality Assurance Manager (via a designated supervisory position, if applicable) and have the responsibility for performing inspections related to the implementation of the LES QAPD.

2.2 Key Management Positions

K. Quality Assurance Auditors

The Quality Assurance Auditors report to the Quality Assurance Manager (via a designated supervisory position, if applicable) and have the responsibility for performing audits related to the implementation of the LES QAPD.

L. Quality Assurance Technical Support

The Quality Assurance Technical Support personnel report to the Quality Assurance Manager (via a designated supervisory position, if applicable) and have the responsibility for providing technical support related to the implementation of the LES QAPD.

M. Emergency Preparedness Manager

The Emergency Preparedness Manager reports to the Plant Support Director and has the responsibility for ensuring the facility remains prepared to react and respond to any emergency situation that may arise. This includes emergency preparedness training of facility personnel, facility support personnel, the training of, and coordination with, offsite emergency response organizations (EROs), and conducting periodic drills to ensure facility personnel and offsite response organization personnel training is maintained up to date.

N. Director of Engineering

The Director of Engineering reports to the Vice President Project and has responsible for developing and managing the URENCO USA Project engineering personnel, procedures, processes and programs to ensure the construction and configuration of the facility is in accordance with the approved design and licensing basis. Ensure Project engineering procedures and design products are adequately reviewed, approved and controlled to comply with license and regulatory requirements.

O. Environmental Compliance Officer

The Environmental Compliance Officer reports to the Health, Safety, and Environmental Manager and has the responsibility for coordinating facility activities to ensure all local, state and federal environmental regulations are met. This includes conducting the radiological environmental monitoring program and coordination of the submission of periodic reports with the Chemistry and Environmental Services organization to appropriate regulating organizations of effluents from the facility.

P. Radiation Protection Manager

The Radiation Protection Manager reports to the Plant Support Director and has the responsibility for implementing the Radiation Protection program. These duties include the training of personnel in use of equipment, control of radiation exposure of personnel, and continuous determination of the radiological status of the facility.

In matters involving radiological protection, the Radiation Protection Manager has direct access to the Plant Manager.

Q. Industrial Safety Officer

The Industrial Safety Officer reports to the Health, Safety, and Environmental Manager and has the responsibility for the implementation of facility industrial safety programs and procedures. This shall include programs and procedures for training individuals in safety. The Industrial

2.2 Key Management Positions

Safety Officer is also responsible for the preparation and/or review of chemical safety programs and procedures for the facility.

R. Fire Protection Officer

The Fire Protection Officer reports to the Health, Safety and Environmental Manager and has the responsibility for maintaining the performance of the facility fire protection systems.

S. Criticality Safety Officer

Criticality Safety Officer reports to the Health, Safety, and Environmental Manager and is responsible for implementing the Criticality Safety Program in the operating organization, including ensuring that periodic nuclear criticality safety assessments are performed and reported.

T. Criticality Safety Engineers

Criticality Safety Engineers report to the Engineering Manager and are responsible for the preparation and/or review of nuclear safety criticality evaluations and analysis. Nuclear criticality safety evaluations and analyses require independent review by a second Criticality Safety Engineer.

U. Deleted

V. Shift Operations Manager

The Shift Operations Manager reports to the Operations Director, and has the responsibility of directing the day-to-day operation of the facility. This includes such activities as ensuring the correct and safe operation of UF₆ processes, proper handling of UF₆, and the identification and mitigation of any off normal operating conditions.

W. Shift Managers

The Shift Managers report to the Shift Operations Manager and have the responsibility for ensuring safe operation of enrichment equipment and support equipment. Each Shift Manager directs assigned personnel in order to provide enrichment services in a safe, efficient manner.

X. Safeguards Manager

The Safeguards Manager reports to the Plant Support Director and has the responsibility for ensuring the proper implementation of the FNMC Plan. This position is separate from and independent of the Operations, Technical Services, Construction and Performance Assessment and Feedback departments to ensure a definite division between the safeguards group and the other departments. In matters involving safeguards, the Plant Support Director, which the Safeguards Manager reports to, has direct access to the Vice President - Operations & Chief Nuclear Officer.

Y. Chemistry Services Manager

The Chemistry Services Manager reports to the Operations Director and has the responsibility for the implementation of chemistry analysis programs and procedures for the facility. Chemistry Analysis Activities includes effluent sample collection, chemical and radioactive analysis of effluents, comparison of effluent analysis results to limits, and reporting of chemical analysis of effluents to appropriate regulatory agencies.

2.2 Key Management Positions

Z. Logistics Services Manager

The Logistics Services Manager reports to the Director of Operations and is responsible for production planning, transport planning, uranium administration, safeguards operational support and materials handling, ensuring that cylinders of uranium hexafluoride are received and routed correctly at the facility, and all transportation licensing is properly implemented and maintained.

AA. Engineering Manager

The Engineering Manager reports to the Technical Services Director upon formal turnover of NEF Design Authority responsibilities from Project Engineering to the Technical Services Director. The Engineering Manager has the responsibility for providing engineering and technical support at the facility and maintaining the configuration management system. During the operations phase, the Engineering Manager is responsible for the development of all design changes to the plant and in support of the NEF Design Authority manages and controls the design basis. During all phases of design, construction and operation the Engineering Manager supports the NEF Design Authority by developing and maintaining the processes for design and configuration control and providing technical support for review of proposed changes to the approved design.

BB. Maintenance Manager

The Maintenance Manager reports to the Technical Services Director and has the responsibility of directing and scheduling maintenance activities to ensure proper operation of the facility, including preparation and implementation of maintenance, surveillance, and test procedures. This includes activities such as repair and preventive maintenance of facility equipment. The Maintenance Manager is responsible for plant systems availability and reliability as well as for coordinating and maintaining testing programs for the facility, including the testing of systems and components to ensure the systems and components are functioning as specified in design documents.

CC. Security Manager

The Security Manager reports to the Vice President of Operations and has the responsibility for directing the activities of security personnel to ensure the physical protection of the facility. The Security Manager is also responsible for the protection of classified matter at the facility and obtaining security clearances for facility personnel and support personnel.

DD. Information Services Manager

The Information Services Manager reports to the Technical Services Director and has the responsibility for adequately controlling documents at the facility.

EE. Training and Support Services Manager

The Training and Support Services Manager reports to the Vice President of Operations and has the responsibility for conducting training and maintaining training records for personnel at the facility. In the event of the absence of the Plant Manager, the Training and Support Services Manager may assume the responsibilities and authorities of the Plant Manager.

FF. Procurement Director

The Procurement Director reports to the Chief Financial Officer and has the responsibility for ensuring spare parts and other materials needed for operation of the facility are ordered, received, inspected and stored properly.

2.2 Key Management Positions

GG. Deleted

HH. Deleted

2.2.2 Shift Crew Composition

The minimum operating shift crew consists of a Shift Manager (or Deputy Shift Manager in the absence of the Shift Manager), one Control Room operator, one operator for each SBM, security personnel, and one Radiation Protection Staff member or operator trained to monitor and perform routine radiological protection activities and certain, time-critical, radiation protective actions described in the NEF Emergency Plan. When only one SBM is in operation, a minimum of two operators is required.

At least one criticality safety engineer or the criticality safety officer will be available, with appropriate ability to be contacted by the Shift Manager, to respond to any routine request or emergency condition. This availability may be offsite if adequate communication ability is provided to allow response as needed.

2.2.3 Safety Review Committee

The facility maintains a Safety Review Committee (SRC) to assist with the safe operation of the facility. The SRC reports to the Plant Manager and provides technical and administrative review and audit of operations that could impact plant worker, public safety and environmental impacts. The scope of activities reviewed and audited by the SRC shall, as a minimum, include the following:

- Radiation protection
- Nuclear criticality safety
- Hazardous chemical safety
- Industrial safety including fire protection
- Environmental protection
- ALARA policy implementation
- Changes in facility design or operations.

The SRC shall conduct at least one facility audit per year for the above areas.

The Safety Review Committee shall be composed of at least five members, including the Chairman. Members of the SRC may be from the LES corporate office or technical staff. The five members shall include experts on operations and all safety disciplines (criticality, radiological, chemical, industrial). The Chairman, members and alternate members of the Safety Review Committee shall be formally appointed by the Plant Manager, shall have an academic degree in an engineering or physical science field; and, in addition, shall have a minimum of five years of technical experience, of which a minimum of three years shall relate directly to one or more of the safety disciplines (criticality, radiological, chemical, industrial).

The Safety Review Committee shall meet at least once per calendar quarter.

Review meetings shall be held within 30 days of any incident that is reportable to the NRC. These meetings may be combined with regular meetings. Following a reportable incident, the

2.2 Key Management Positions

SRC shall review the incident's causes, the responses, and both specific and generic corrective actions to ensure resolution of the problem is implemented.

A written report of each SRC meeting and audit shall be forwarded to the Plant Manager and appropriate Managers within 30 days and be retained in accordance with the records management system.

2.2.4 Personnel Qualification Requirements

The minimum qualification requirements for the facility functions that are directly responsible for its safe operation shall be as outlined below consistent with NUREG-1520. This includes the facility manager (Plant Manager), Operations Manager, Shift Managers, and managers for various safety and environmental disciplines. The nuclear experience of each individual shall be determined to be acceptable by the Vice President - Operations and Chief Nuclear Officer. "Responsible nuclear experience" for these positions shall include (a) responsibility for and contributions towards support of facility(s) in the nuclear fuel cycle (e.g., mining, milling, processing, conversion, enrichment, fuel fabrication, reactor use, storage, fuel processing or final disposition of waste), and (b) experience with chemical materials and/or processes. Relevant work experience of at least five years, in addition to the minimum experience requirements specified in the section, may be substituted for educational Bachelor's degree requirements. The Vice President - Operations and Chief Nuclear Officer may approve different experience requirements for key positions. Approval of different requirements shall be done in writing and only on a case-by-case basis.

The assignment of individuals to the Manager positions reporting directly to the Plant Manager, and to positions on the SRC, shall be approved by the Plant Manager. Assignments to all other staff positions shall be made within the normal administrative practices of the facility.

The actual qualifications of the individuals assigned to the key facility positions described in Section 2.2.1, Operating Organization will be maintained in the employee personnel files or other appropriate file at the facility. Development and maintenance of qualification records and training programs are the responsibility of the Training and Support Services Manager.

A. Deleted

B. Vice President – Operations & Chief Nuclear Officer

The President of LES, based on the individual's experience, proven ability in management of large scale facilities, and overall leadership qualities, appoints the Vice President - Operations & Chief Nuclear Officer.

This appointment by the President of LES reflects confidence in the individual's ability as effective programs, operations, regulatory, and business manager. The Vice President - Operations & Chief Nuclear Officer shall have, as a minimum, a bachelor's degree (or equivalent) and at least ten years related experience and/or training, or twenty years of related experience.

The Vice President – Operations & Chief Nuclear Officer is the Plant Manager, who is the overall manager of the facility. The Plant Manager shall be knowledgeable of the enrichment process, enrichment process controls and ancillary processes, criticality safety control, chemical safety, industrial safety, and radiation protection program concepts as they apply to the overall

2.2 Key Management Positions

safety of a nuclear facility. The Plant Manager shall have, as a minimum, a bachelor's degree (or equivalent) in an engineering or scientific field and ten years of responsible nuclear experience.

C. Quality Assurance Manager

The Quality Assurance Manager shall have, as a minimum, a bachelor's degree (or equivalent) in an engineering or scientific field and at least six years of responsible nuclear experience in the implementation of a quality assurance program. The QA Manager shall have at least four years experience in a QA organization at a nuclear facility.

D. Health, Safety, and Environmental Manager

The Health, Safety, and Environmental Manager shall have, as a minimum, a bachelor's degree (or equivalent) in an engineering or scientific field and at least five years of responsible nuclear experience in HS&E or related disciplines. The Health, Safety, and Environmental Manager shall also have at least one year of experience/familiarity associated with nuclear criticality safety programs.

E. Operations Director

The Operations Director shall have, as a minimum, a bachelor's degree (or equivalent) in an engineering or scientific field and four years of responsible nuclear experience.

F. Shift Operations Manager

The Shift Operations Manager shall have, as a minimum, a bachelor's degree (or equivalent) in an engineering or scientific field and four years of responsible nuclear experience.

G. Technical Services Director

The Technical Services Director shall have, as a minimum, a bachelor's degree (or equivalent) in an engineering or scientific field and four years of responsible nuclear experience.

H. Plant Support Director

The Plant Support Director shall have, as a minimum, a bachelor's degree (or equivalent) in an engineering or scientific field and four years of responsible nuclear experience.

I. Emergency Preparedness Manager

The Emergency Preparedness Manager shall have a bachelor's degree (or equivalent) and a minimum of six years of experience in the implementation and supervision of emergency plans and procedures, at least three of which must be at a nuclear facility. No credit for academic training may be taken toward fulfilling this experience requirement.

2.2 Key Management Positions

J. Director of Engineering

The Director of Engineering shall have a bachelor's degree in an engineering or science field and a minimum of 5 years of appropriate, responsible nuclear experience in implementing and supervising an engineering organization.

K. Environmental Compliance Officer

The Environmental Compliance Officer shall have a bachelor's degree (or equivalent) and a minimum of five years of appropriate, responsible experience in implementing and supervising a nuclear environmental compliance program.

L. Radiation Protection Manager

The Radiation Protection Manager shall have, as a minimum, a bachelor's degree (or equivalent) in an engineering or scientific field and three years of responsible nuclear experience associated with implementation of a Radiation Protection program.

M. Industrial Safety Officer

The Industrial Safety Officer shall have a minimum of two years experience in the preparation and/or review of chemical safety programs and procedures and shall have, as a minimum, a bachelor's degree (or equivalent) in either an engineering or a scientific field and three years of appropriate, responsible nuclear experience associated with implementation of a facility industrial and chemical safety program.

N. Criticality Safety Officer

Criticality Safety Officer (CSO) shall have experience in the implementation of a criticality safety program. This individual shall hold a Bachelor of Science or Bachelor of Arts degree in an engineering or scientific field and have successfully completed a training program, applicable to the scope of operations, in the physics of criticality and in associated safety practices. In addition, the CSO shall have at least two years of experience performing criticality safety analyses.

The CSO is a technical position with responsibility for oversight of the program. For this reason, the CSO shall have educational and experience requirements equal to or greater than those of a Criticality Safety Engineer as defined in Section 2.2.4.O.

O. Criticality Safety Engineers

The Criticality Safety Engineers shall hold a Bachelor of Science or Bachelor of Arts degree in an engineering or scientific field and have successfully completed a training program, applicable to the scope of operations, in the physics of criticality and in associated safety practices. In addition, these individuals shall have at least two years of experience performing criticality safety analyses.

Should a change to the facility require a nuclear criticality safety evaluation or analysis, an individual who, as a minimum, possesses the equivalent qualifications of the Criticality Safety Engineer shall perform the evaluation or analysis. An independent review of the evaluation or analysis, shall be performed by a second Criticality Safety Engineer with the same minimum qualifications.

P. Deleted

2.2 Key Management Positions

Q. Shift Managers

Shift Managers shall have High School Diplomas (or equivalent) and a minimum of five years of appropriate operating experience at a nuclear or chemical process facility.

R. Logistics Services Manager

The Logistics Services Manager shall have, as a minimum, a bachelor's degree (or equivalent) and have a minimum of three years of appropriate, responsible experience in implementing and supervising a logistics program.

S. Safeguards Manager

The Safeguards Manager shall have as a minimum a bachelor's degree in an engineering or scientific field, and five years of experience in the management of a safeguards program for Special Nuclear Material, including responsibilities for material control and accounting. No credit for academic training may be taken toward fulfilling this experience requirement.

T. Chemistry Services Manager

The Chemistry Services Manager shall have, as a minimum, a bachelor's degree (or equivalent) in an engineering or a scientific field and three years of appropriate, responsible nuclear experience associated with implementation of a facility chemistry program.

U. Engineering Manager

The Engineering Manager shall have, as a minimum, a bachelor's degree (or equivalent) in an engineering or scientific field and have a minimum of five years of appropriate, responsible experience in implementing and supervising a nuclear engineering program.

V. Maintenance Manager

The Maintenance Manager shall have, as a minimum, a bachelor's degree (or equivalent) in an engineering or scientific field and four years of responsible nuclear experience.

W. Security Manager

The Security Manager shall have a bachelor's degree (or equivalent) and five years of experience or an associates degree (or equivalent) and ten years of experience. Experience must be in the management of physical security at a facility requiring security capabilities similar to that required for the facility.

X. Training and Support Services Manager

The Training and Support Services Manager shall have a minimum of five years of appropriate, responsible experience in implementing and supervising a training program.

Y. Fire Protection Officer

The Fire Protection Officer shall have bachelor's degree (or equivalent) and shall be trained in the field of fire protection and have practical day-to-day experience at nuclear facilities.

Z. Information Services Manager

The Information Services Manager shall have a minimum of three years of appropriate, responsible experience in implementing and supervising a document control program.

2.2 Key Management Positions

AA. Performance Assessment and Feedback Manager

The Performance Assessment and Feedback Manager shall have, as a minimum, a bachelor's degree (or equivalent) in an engineering or scientific field and four years of responsible nuclear experience.

BB. Procurement Director

The Procurement Director shall have, as a minimum, a bachelor's degree (or equivalent) and have a minimum of three years of appropriate, responsible experience in implementing and supervising a procurement program.

CC. Deleted

DD. Vice President of Compliance/General Counsel

The Vice President of Compliance/General Counsel shall have, as a minimum, a bachelor's degree (or equivalent) in an engineering or scientific field and have a minimum of six years of appropriate, responsible nuclear experience of which at least four year are in the areas of quality and/or regulatory experience.

2.3 Administration

2.3 Administration

This section summarizes how the activities that are essential for implementation of the management measures and other HS&E functions are documented in formally approved, written procedures, prepared in compliance with a formal document control program. The mechanism for reporting potentially unsafe conditions or activities to the Plant Support organization and facility management is also summarized. Details of the management measures are provided in Chapter 11, Management Measures.

2.3.1 Configuration Management

Configuration management is provided for Items Relied On For Safety (IROFS) throughout facility design, construction, testing, and operation. Configuration management provides the means to establish and maintain a technical baseline for the facility based on clearly defined requirements. During design, construction, and operations (until formal turnover to the Technical Services Director), –Project Engineering has responsibility for configuration management through the design control process. Selected documentation is controlled under the configuration management system in accordance with appropriate QA procedures associated with design control, document control, and records management. Design changes to IROFS undergo formal review, including interdisciplinary reviews as appropriate, in accordance with these procedures.

Configuration management provides the means to establish and maintain the essential features of the design basis of IROFS. As the project progresses from design and construction to operation, configuration management is maintained by the facility engineering organization as the overall focus of activities changes.

Additional details on Configuration Management are provided in Chapter 11, Management Measures.

2.3.2 Maintenance

The maintenance program will be implemented for the operations phase of the facility. Preventive maintenance activities, surveillance, and performance trending provide reasonable and continuing assurance that IROFS will be available and reliable to perform their safety functions.

The purpose of planned and scheduled maintenance for IROFS is to ensure that the equipment and controls are kept in a condition of readiness to perform the planned and designed functions when required. Appropriate plant management is responsible for ensuring the operational readiness of IROFS under this control. For this reason, the maintenance function is administratively closely coupled to operations. The maintenance organization plans, schedules, tracks, and maintains records for maintenance activities.

Maintenance activities generally fall into the following categories:

- Corrective maintenance
- Preventive maintenance
- Surveillance/monitoring

2.3 Administration

- Functional testing.

These maintenance categories are discussed in detail in Chapter 11, Management Measures.

2.3.3 Training and Qualifications

Prescribed training programs shall be established for NEF employees. General Employee Training shall be provided to employees prior to receiving unescorted access, and shall address safety preparedness for all safety disciplines (criticality, radiological, chemical, industrial), ALARA practices, and emergency procedures. In-depth training programs shall be provided to individuals depending on job requirements in the areas of radiological safety (for all personnel with access to a Radiologically Controlled Area (RCA)) and in criticality safety control. Nuclear criticality safety training shall satisfy the recommendations of ANSI/ANS-8.20, Nuclear Criticality Safety Training. Continuing training of personnel previously trained shall be performed for radiological and criticality safety at least annually, and shall include updating and changes in required skills. The training program shall include methods for verifying training effectiveness, such as written tests, actual demonstration of skills, and where required by regulation, maintaining a current and valid license demonstrating qualification. Changes to training shall be implemented if indicated due to incidents potentially compromising safety, or if changes are made to facilities or processes.

The training programs and maintenance of the training program records at the facility are the responsibility of the Training and Support Services Manager. Accurate records are maintained on each employee's qualifications, experience, and training. The employee training file shall include records of all general employee training, technical training, and employee development training conducted at the facility. The employee training file shall also contain records of special company sponsored training conducted by others. The training records for each individual are maintained so that they are accurate and retrievable. Training records are retained in accordance with the records management system.

Additional details on the facility training program are provided in Chapter 11, Management Measures.

2.3.4 Procedures

Activities involving licensed materials will be conducted through the use of approved, written procedures. Applicable procedure and training requirements will be satisfied before use of the procedure. Procedures will be used to control activities in order to ensure the activities are carried out in a safe manner.

Generally, four types of plant procedures are used to control activities: operating procedures, administrative procedures, maintenance procedures, and emergency procedures. Operating procedures, developed for workstation and control room operators, are used to directly control process operations. Administrative procedures are written by each department as necessary to control activities that support process operations, including management measures (e.g. configuration management, training and record-keeping). Maintenance procedures address preventive and corrective maintenance, surveillance (includes calibration, inspection, and other surveillance testing), functional testing following maintenance, and requirements for pre-maintenance activity involving reviews of the work to be performed and reviews of

2.3 Administration

procedures. Emergency procedures address the preplanned actions of operators and other plant personnel in the event of an emergency.

Policies and procedures will be developed to ensure that there are ties between major plant safety functions such as the ISA, management measures for items relied on for safety (IROFS), radiation safety, nuclear criticality safety, fire safety, chemical safety, environmental monitoring, and emergency planning.

Chapter 11 details the use of procedures, including development, revision, and distribution and control.

2.3.5 Audits and Assessments

The LES QA Program requires periodic audits to confirm that activities affecting quality comply with the QAPD and that the QAPD is being implemented effectively. Also included in the QAPD are requirements to perform periodic Management Assessments.

Additional details on audits and assessments are provided in Chapter 11, Management Measures.

2.3.5.1 Safety Review Committee

The Safety Review Committee (SRC) provides technical and administrative review of facility operations that could impact plant worker and public safety. Details on the SRC and the scope of activities reviewed by the SRC are provided in Section 2.2.3, Safety Review Committee.

2.3.5.2 Quality Assurance Department

The Quality Assurance Department conducts periodic audits of activities associated with the facility, in order to verify the facility's compliance with established procedures in accordance with the QAPD. The LES Quality Assurance Program Description is included in Chapter 11, Management Measures as Appendix A.

2.3.5.3 Facility Operating Organization

The facility operating organization shall provide, as part of the normal duties of supervisory personnel, timely and continuing monitoring of operating activities to assist the Plant Manager in keeping abreast of general facility conditions and to verify that the day-to-day operating activities are conducted safely and in accordance with applicable administrative controls.

These continuing monitoring activities are considered to be an integral part of the routine supervisory function and are important to the safety of the facility operation.

2.3.5.4 Audited Organizations

Audited organizations shall assure that findings are evaluated and corrected in a timely manner in accordance with the QAPD Sections 16, Corrective Action and 18, Audits.

2.3 Administration

2.3.6 Incident Investigations

The Corrective Action Program (CAP) is described in detail in Section 11.6 and the QAPD Section 16, Corrective Action. Each event is considered in terms of its requirements for reporting in accordance with regulations and is evaluated to determine the level of investigation required. These evaluations and investigations are conducted in accordance with approved CAP procedures. The depth of the investigation depends upon the severity of the incident in terms of the levels of uranium released and/or the degree of potential for exposure of workers, the public or the environment.

2.3.7 Employee Concerns

Employees who feel that safety or quality is being compromised have the right and responsibility to initiate the "stop work" process in accordance with the applicable project or facility procedures to ensure the work environment is placed in a safe condition.

Employees also have access to various resources to ensure their safety or quality concerns are addressed, including:

- line management or other facility management (e.g., Performance Assessment and Feedback Management, Plant Manager, HS&E Manager, Plant Support Director, Vice President of Compliance/General Counsel)
- the facility safety organization (i.e., any of the safety engineers or managers)
- NRC's requirements under 10 CFR 19, Notices, Instructions and Reports to Workers: Inspection and Investigations (CFR, 2003a)
- LES CAP - a simple mechanism available for use by any person at the NEF site for reporting unusual events and potentially unsafe conditions or activities.

2.3.8 Records Management

Procedures are established which control the preparation and issuance of documents such as manuals, instructions, drawings, procedures, specifications, and supplier-supplied documents, including any changes thereto. Measures are established to ensure documents, including revisions, are adequately reviewed, approved, and released for use by authorized personnel.

Document control procedures require documents to be transmitted and received in a timely manner at appropriate locations including the location where the prescribed activity is to be performed. Controlled copies of these documents and their revisions are distributed to and used by the persons performing the activity.

Superseded documents are destroyed or are retained only when they have been properly labeled. Indexes of current documents are maintained and controlled.

The QA Program assigns responsibility for verifying QA record retention to the QA Manager. Applicable design specifications, procurement documents, or other documents specify the QA records to be generated by, supplied to, or held, in accordance with approved procedures. QA records are not considered valid until they are authenticated and dated by authorized personnel.

2.3 Administration

Additional details on the records management program are provided in Chapter 11, Management Measures.

2.3.9 Written Agreements with Offsite Emergency Resources

The plans for coping with emergencies at the facility are presented in detail in the Emergency Plan. The Emergency Plan includes a description of the facility emergency response organization and interfaces with off-site EROs. Written agreements between the facility and off-site EROs, including the local fire department, the local law enforcement agency, ambulance/rescue units, and medical services and facilities have been established.

Coordination with participating government agencies (State, Counties) is vital to the safety and health of plant personnel and the general public. The principal state and local agencies/organizations having responsibilities for radiological or other hazardous material emergencies for the facility are:

- A. New Mexico Department of Public Safety
- B. New Mexico Department of Homeland Security and Emergency Management
- C. Eunice Emergency Response Services
- D. Hobbs Emergency Response Services

Details of the interfaces with these agencies are provided in Section 4 of the Emergency Plan.

2.4 References

2.4 References

Edition of Codes, Standards, NRC Documents, etc that are not listed below are given in ISAS Table 3.0-1.

CFR, 2003a. Title 10, Code of Federal Regulations, Part 19, Notices, Instructions and Reports to Workers: Inspection and Investigations, 2003.

CFR, 2003b. Title 10, Code of Federal Regulations, Part 40, Domestic Licensing of Source Material, 2003.

CFR, 2003c. Title 10, Code of Federal Regulations, Part 70, Domestic Licensing of Special Nuclear Material, 2003.

NRC, 1992. Proposed Method for Regulating Major Materials Licensees, NUREG-1324, U.S. Nuclear Regulatory Commission, 1992.

NRC, 2002. Standard Review Plan for the Review of a License Application for a Fuel Cycle Facility, NUREG-1520, U.S. Nuclear Regulatory Commission, March 2002.

2.5 Chapter 2 Figures

2.5 Chapter 2 Figures

2.5 Chapter 2 Figures

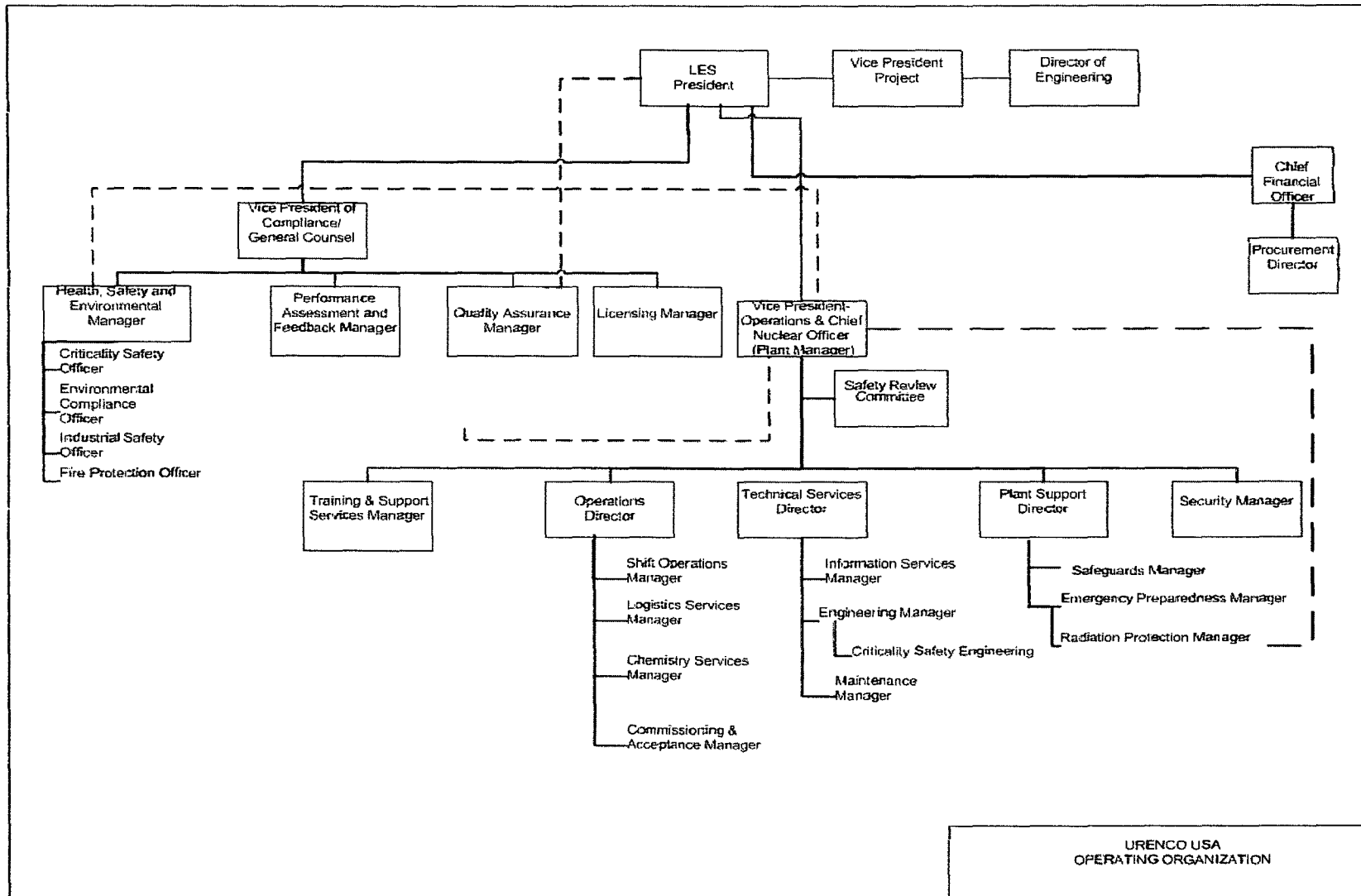

Figure 2.1-2 LES National Enrichment Facility Operating Organization

3.0 Safety Program Commitments

3.0 Safety Program Commitments

This section presents the commitments pertaining to the facility's safety program including the performance of an ISA. 10 CFR Part 70 (CFR, 2003b) contains a number of specific safety program requirements related to the integrated safety analysis (ISA). These include the primary requirements that an ISA be conducted, and that it evaluate and show that the facility complies with the performance requirements of 10 CFR 70.61 (CFR, 2003c).

3.1 Safety Program

3.1 Safety Program

The three elements of the safety program defined in 10 CFR 70.62(a) (CFR, 2003d) are addressed below.

3.1.1 Process Safety Information

- A. LES has compiled and maintains up-to-date documentation of process safety information. Written process-safety information is used in updating the ISA and in identifying and understanding the hazards associated with the processes. The compilation of written process-safety information includes information pertaining to:
1. The hazards of all materials used or produced in the process, which includes information on chemical and physical properties such as are included on Material Safety Data Sheets meeting the requirements of 29 CFR 1910.1200(g) (CFR, 2003e).
 2. Technology of the process which includes block flow diagrams or simplified process flow diagrams, a brief outline of the process chemistry, safe upper and lower limits for controlled parameters (e.g., temperature, pressure, flow, and concentration), and evaluation of the health and safety consequences of process deviations.
 3. Equipment used in the process including general information on topics such as the materials of construction, piping and instrumentation diagrams (P&IDs), ventilation, design codes and standards employed, material and energy balances, engineered IROFS, equipment essential to support administrative IROFS, electrical classification, and relief system design and design basis.

The process-safety information described above is maintained up-to-date by the configuration management program described in Section 11.1, Configuration Management.

- B. LES has developed procedures and criteria for changing the ISA. This includes implementation of a facility change mechanism that meets the requirements of 10 CFR 70.72 (CFR, 2003f).

The development and implementation of procedures is described in Section 11.4, Procedures Development and Implementation.

- C. LES uses personnel with the appropriate experience and expertise in engineering and process operations to maintain the ISA. The ISA Team for the various processes consists of individuals who are knowledgeable in the ISA method(s) and the operation, hazards, and safety design criteria of the particular process. Training and qualifications of individuals responsible for maintaining the ISA are described in Section 11.3, Training and Qualifications, Section 2.2, Key Management Positions, and Section 3.2, Integrated Safety Analysis Team.

3.1 Safety Program

3.1.2 Integrated Safety Analysis

- A. LES has conducted an ISA for each process, such that it identifies (i) radiological hazards, (ii) chemical hazards that could increase radiological risk, (iii) facility hazards that could increase radiological risk, (iv) potential accident sequences, (v) consequences and likelihood of each accident sequence and (vi) IROFS including the assumptions and conditions under which they support compliance with the performance requirements of 10 CFR 70.61 (CFR, 2003c).

A synopsis of the results of the ISA, including the information specified in 10 CFR 70.65(b) (CFR, 2003a), is provided in the National Enrichment Facility Integrated Safety Analysis Summary.

- B. LES has implemented programs to maintain the ISA and supporting documentation so that it is accurate and up-to-date. Changes to the ISA Summary are submitted to the NRC, in accordance with 10 CFR 70.72(d)(1) and (3) (CFR, 2003f). The ISA update process accounts for any changes made to the facility or its processes. This update will also verify that initiating event frequencies and IROFS reliability values assumed in the ISA remain valid. Any changes required to the ISA as a result of the update process will be included in a revision to the ISA. Management policies, organizational responsibilities, revision time frame, and procedures to perform and approve revisions to the ISA are outlined in Chapter 11.0, Management Measures. Evaluation of any facility changes or changes in the process safety information that may alter the parameters of an accident sequence is by the ISA method(s) as described in the ISA Summary Document. For any revisions to the ISA, personnel having qualifications similar to those of ISA team members who conducted the original ISA are used.
- C. Personnel used to update and maintain the ISA and ISA Summary are trained in the ISA method(s) and are suitably qualified. Training and Qualification of personnel used to update or maintain the ISA are described in Section 11.3, Training and Qualifications.
- D. Proposed changes to the facility or its operations are evaluated using the ISA method(s). New or additional IROFS and appropriate management measures are designated as required. The adequacy of existing IROFS and associated management measures are promptly evaluated to determine if they are impacted by changes to the facility and/or its processes. If a proposed change results in a new type of accident sequence or increases the consequences or likelihood of a previously analyzed accident sequence within the context of 10 CFR 70.61 (CFR, 2003c), the adequacy of existing IROFS and associated management measures are promptly evaluated and the necessary changes are made, if required.
- E. Unacceptable performance deficiencies associated with IROFS are addressed that are identified through updates to the ISA.
- F. Written procedures are maintained on site. Section 11.4, Procedures Development and Implementation, discusses the procedures program.
- G. All IROFS are maintained so that they are available and reliable when needed.

3.1 Safety Program

3.1.3 Management Measures

Management measures are functions applied to IROFS, and any items that may affect the function of IROFS. IROFS management measures ensure compliance with the performance requirements assumed in the ISA documentation. The measures are applied to particular structures, systems, equipment, components, and activities of personnel, and may be graded commensurate with the reduction of the risk attributable to that IROFS. The IROFS management measures shall ensure that these structures, systems, equipment, components, and activities of personnel within the identified IROFS boundary are designed, implemented, and maintained, as necessary, to ensure they are available and reliable to perform their function when needed, to comply with the performance requirements assumed in the ISA documentation.

The following types of management measures are required by the 10 CFR 70.4 (CFR, 2003b) definition of management measures. The description for each management measure reflects the general requirements applicable to each IROFS. Any management measure that deviates from the general requirements described in this section, which are consistent with the performance requirements assumed in the ISA documentation, are discussed in the National Enrichment Facility Integrated Safety Analysis Summary.

Configuration Management

The configuration management program is required by 10 CFR 70.72 (CFR, 2003f) and establishes a system to evaluate, implement, and track each change to the site, structures, processes, systems, equipment, components, computer programs, and activities of personnel. Configuration management of IROFS, and any items that may affect the function of IROFS, is applied to all items identified within the scope of the IROFS boundary. Any change to structures, systems, equipment, components, and activities of personnel within the identified IROFS boundary must be evaluated before the change is implemented. If the change requires an amendment to the License, Nuclear Regulatory Commission approval is required prior to implementation.

Maintenance

Maintenance of engineered IROFS, and any items that may affect the function of IROFS, encompasses planned surveillance testing and preventative maintenance, as well as unplanned corrective maintenance. Implementation of approved configuration management changes to hardware is also generally performed as a planned maintenance function.

Planned surveillance testing (e.g., functional/performance testing, instrument calibrations) monitors the integrity and capability of IROFS, and any items that may affect the function of IROFS, to ensure they are available and reliable to perform their function when needed, to comply with the performance requirements assumed in the ISA documentation. All necessary periodic surveillance testing is generally performed on an annual frequency (any exceptions credited within the ISA are discussed in the National Enrichment Facility Integrated Safety Analysis Summary).

Planned preventative maintenance (PM) includes periodic refurbishment, partial or complete overhaul, or replacement of engineered IROFS, as necessary, to ensure the continued availability and reliability of the safety function assumed in the ISA documentation. In

3.1 Safety Program

determining the frequency of any PM, consideration is given to appropriately balancing the objective of preventing failures through maintenance, against the objective of minimizing unavailability of IROFS because of PM. In addition, feedback from PM and corrective maintenance and the results of incident investigations and identified root causes are used, as appropriate, to modify the frequency or scope of PM.

Planned maintenance on engineered IROFS, or any items that may affect the function of IROFS, that do not have redundant functions available, will provide for compensatory measures to be put into place to ensure that the IROFS function is performed until it is put back into service.

For an IROFS that is found to be degraded or impaired by planned operations, maintenance, or construction activities: a compensatory measure may be used to ensure that the function of the IROFS is compensated until it is returned to service. For example, a continuous fire watch may be used to compensate for a degraded IROFS barrier.

Corrective maintenance involves repair or replacement of equipment that has unexpectedly degraded or failed. Corrective maintenance restores the equipment to acceptable performance through a planned, systematic, controlled, and documented approach for the repair and replacement activities.

Following any maintenance on IROFS, and before returning an IROFS to operational status, functional testing of the IROFS, as necessary, is performed to ensure the IROFS is capable of performing its intended safety function.

Training and Qualifications

IROFS, and any items that may affect the function of IROFS, require that personnel involved at each level (from design through and including any assumed process implementation steps or actions) have and maintain the appropriate training and qualifications. Employees are provided with training to establish the knowledge foundation and on-the-job training to develop work performance skills. For process implemented steps or actions, a needs/job analysis is performed and tasks are identified to ensure that appropriate training is provided to personnel working on tasks related to IROFS. Minimum training requirements are developed for those positions whose activities are related to IROFS. Initial identification of job-specific training requirements is based on experience. Entry-level criteria (e.g., education, technical background, and/or experience) for these positions are contained in position descriptions.

Qualification is indicated by successful completion of prescribed training, demonstration of the ability to perform assigned tasks, and where required by regulation, maintaining a current and valid license or certification.

Continuing training is provided, as required, to maintain proficiency in specific knowledge and skill related activities. For all IROFS, and any items that may affect the function of IROFS, involving process implemented steps or actions, annual refresher training or requalification is generally required as identified in the needs/job analysis referenced in the previous paragraph. (any exceptions credited within the ISA are discussed in the National Enrichment Facility Integrated Safety Analysis Summary).

3.1 Safety Program

Procedures

All activities involving IROFS, and any items that may affect the function of IROFS, are conducted in accordance with approved procedures. Each of the other IROFS management measures (e.g., configuration management, maintenance, training) is implemented via approved procedures. These procedures are intended to provide a pre-planned method of conducting the activity in order to eliminate errors due to on-the-spot analysis and judgments.

All procedures are sufficiently detailed that qualified individuals can perform the required functions without direct supervision. However, written procedures cannot address all contingencies and operating conditions. Therefore, they contain a degree of flexibility appropriate to the activities being performed. Procedural guidance exists to identify the manner in which procedures are to be implemented. For example, routine procedural actions may not require the procedure to be present during implementation of the actions, while complex jobs, or checking with numerous sequences may require valve alignment checks, approved operator aids, or in-hand procedures that are referenced directly when the job is conducted.

To support the requirement to minimize challenges to IROFS, and any items that may affect the function of IROFS, specific procedures for abnormal events are also provided. These procedures are based on a sequence of observations and actions to prevent or mitigate the consequences of an abnormal situation.

Audits and Assessments

Audits are focused on verifying compliance with regulatory and procedural requirements and licensing commitments. Assessments are focused on effectiveness of activities and ensuring that IROFS are reliable and are available to perform their intended safety functions as documented in the ISA. The frequency of audits and assessments is based upon the status and safety importance of the activities being performed and upon work history. However, at a minimum, all activities associated with maintaining IROFS will generally be audited or assessed on an annual basis (any exceptions credited within the ISA are discussed in the National Enrichment Facility Integrated Safety Analysis Summary).

Incident Investigations

Incident investigations are conducted within the Corrective Action Program (CAP). Incidents associated with IROFS, and any items that may affect the function of IROFS, encompass a range of items, including (a) processes that behave in unexpected ways, (b) procedural activities not performed in accordance with the approved procedure, (c) discovered deficiency, degradation, or non-conformance with an IROFS, or any items that may affect the function of IROFS. Additionally, audit and assessment results are tracked in the Corrective Action Program.

Feedback from the results of incident investigations and identified root causes are used, as appropriate, to modify management measures to provide continued assurance that the reliability and availability of IROFS remain consistent with the performance requirements assumed in the ISA documentation.

3.1 Safety Program

Records Management

All records associated with IROFS, and any items that may affect the function of IROFS, shall be managed in a controlled and systematic manner in order to provide identifiable and retrievable documentation. Applicable design specifications, procurement documents, or other documents specify the QA records to be generated by, supplied to, or held, in accordance with approved procedures are included.

Other Quality Assurance Elements

Other quality assurance elements associated with IROFS, or any items that may affect the function of IROFS, that are required to ensure the IROFS is available and reliable to perform the function when needed to comply with the performance requirements assumed in the ISA documentation, are discussed in the National Enrichment Facility Integrated Safety Analysis Summary.

3.2 Integrated Safety Analysis Methods

3.2 Integrated Safety Analysis Methods

This section outlines the approach utilized for performing the integrated safety analysis (ISA) of the process accident sequences. The approach used for performing the ISA is consistent with Example Procedure for Accident Sequence Evaluation, Appendix A to Chapter 3 of NUREG-1520. This approach employs a semi-quantitative risk index method for categorizing accident sequences in terms of their likelihood of occurrence and their consequences of concern. The risk index method framework identifies which accident sequences have consequences that could exceed the performance requirements of

10 CFR 70.61 (CFR, 2003c) and, therefore, require designation of items relied on for safety (IROFS) and supporting management measures. Descriptions of these general types of higher consequence accident sequences are reported in the ISA Summary.

The ISA is a systematic analysis to identify plant and external hazards and the potential for initiating accident sequences, the potential accident sequences, the likelihood and consequences, and the IROFS.

The hazard and operability (HAZOP) analysis method was used initially to identify hazards for the Uranium Hexafluoride (UF₆) process systems and Technical Services Building (TSB) systems. This method is consistent with the guidance provided in NUREG-1513. The choice of a particular method or combination of methods is dependent upon a number of factors including:

- Analysis problem characteristics
- Motivation for the study
- Perceived risk associated with the subject process or activity
- Resource availability and analyst/management preference
- Type of information available to perform the study
- Type of results needed

To satisfy NRC requirements as defined in Part 70, a method should be chosen that is capable of identifying specific accident/event sequences in addition to the safety controls that prevent such accidents or mitigate their consequences. The HAZOP method has this capability.

NUREG-1513 identifies several methods in addition to the HAZOP method (i.e., What-If/Checklist and Failure Modes and Effects Analysis (FMEA)) that may be implemented. The guidance from NUREG-1513 will be followed for selection of a hazard analysis method.

The ISA Team reviewed the hazard identified for the “credible worst-case” consequences. All credible high or intermediate severity consequence accident scenarios were assigned accident sequence identifiers, accident sequence descriptions, and a risk index determination was made.

The risk index method is regarded as a screening method, not as a definitive method of proving the adequacy or inadequacy of the IROFS for any particular accident.

The tabular accident summary resulting from the ISA identifies, for each sequence, which engineered or administrative IROFS must fail to allow the occurrence of consequences that exceed the levels identified in 10 CFR 70.61 (CFR, 2003c).

3.2 Integrated Safety Analysis Methods

For this license application, two ISA Teams were formed. This was necessary because the sensitive nature of some of the facility design information related to the enrichment process required the use of personnel with the appropriate national security clearances. This team performed the ISA on the Cascade System, Contingency Dump System, Centrifuge Test System and the Centrifuge Post Mortem System. This ISA Team is referred to as the Classified ISA Team. The Non-Classified Team, referred to in the remainder of this text as the ISA Team, performed the ISA on the remainder of the facility systems and structures. In addition, the (non-classified) ISA Team performed the External Events and Fire Hazard Assessment for the entire facility.

In preparing for the ISA, the Accident Analysis in the Safety Analysis Report (LES, 1993) for the Claiborne Enrichment Center was reviewed. In addition, experienced personnel with familiarity with the gas centrifuge enrichment technology safety analysis were used on the ISA Team. This provides a good peer check of the final ISA results.

A procedure was developed to guide the conduct of the ISA. This procedure was used by both teams. In addition, there were common participants on both teams to further integrate the approaches employed by both teams. These steps were taken to ensure the consistency of the results of the two teams. A non-classified summary of the results of the Classified ISA has been prepared and incorporated into the ISA Summary.

3.2.1 Hazard Identification

The hazard and operability (HAZOP) analysis method was used for identifying the hazards for the Uranium Hexafluoride (UF_6) process systems and Cylinder Receipt and Dispatch Building systems. This method is consistent with the guidance provided in NUREG-1513 and NUREG-1520. The hazards identification process results in identification of physical, radiological or chemical characteristics that have the potential for causing harm to site workers, the public, or to the environment. Hazards are identified through a systematic review process that entails the use of system descriptions, piping and instrumentation diagrams, process flow diagrams, plot plans, topographic maps, utility system drawings, and specifications of major process equipment. In addition, criticality hazards identification were performed for the areas of the facility where fissile material is expected to be present. The criticality safety analyses contain information about the location and geometry of the fissile material and other materials in the process, for both normal and credible abnormal conditions. The ISA input information is included in the ISA documentation and is available to be verified as part of an on-site review.

The hazard identification process documents materials that are:

- Radioactive
- Fissile
- Flammable
- Explosive
- Toxic
- Reactive.

The hazard identification also identifies potentially hazardous process conditions. Most hazards were assessed individually for the potential impact on the discrete components of the process

3.2 Integrated Safety Analysis Methods

systems. However, for hazards from fires (external to the process system) and external events (seismic, severe weather, etc.), the hazards were assessed on a facility wide basis.

For the purpose of evaluating the impacts of fire hazards, the ISA team considered the following:

- Postulated the development of a fire occurring in in-situ combustibles from an unidentified ignition source (e.g., electrical shorting, or other source)
- Postulated the development of a fire occurring in transient combustibles from an unidentified ignition source (e.g., electrical shorting, or other source)
- Evaluated the uranic content in the space and its configuration (e.g., UF₆ solid/gas in cylinders, UF₆ gas in piping, UF₆ and/or byproducts bound on chemical traps, Uranyl Fluoride (UO₂F₂) particulate on solid waste or in solution). The appropriate configuration was considered relative to the likelihood of the target releasing its uranic content as a result of a fire in the area.

In order to assess the potential severity of a given fire and the resulting failures to critical systems, the facility Fire Hazard Analysis was consulted. However, since the design supporting the license submittal for this facility is not yet at the detailed design stage, detailed in-situ combustible loading and in-situ combustible configuration information is not yet available. Therefore, in order to place reasonable and conservative bounds on the fire scenarios analyzed, the ISA Team estimated in-situ combustible loadings based on information of the in-situ combustible loading from Urenco's Almelo SP-5 plant (on which the National Enrichment Facility (NEF) design is based). This information from SP-5 indicates that in-situ combustible loads are expected to be very low.

The Fire Safety Management Program will limit the allowable quantity of transient combustibles in critical plant areas (i.e., uranium areas). Nevertheless, the ISA Team still assumed the presence of moderate quantities of ordinary (Class A) combustibles (e.g., trash, packing materials, maintenance items or packaging, etc.) in excess of anticipated procedural limits. This was not considered a failure of the associated administrative IROFS feature for controlling/minimizing transient combustible loading in all radiation/uranium areas. Failure of the IROFS is connoted as the presence of extreme or severe quantities of transients (e.g., large piles of combustible solids, bulk quantities of flammable/combustible liquids or gases, etc.). The Urenco ISA Team representatives all indicated that these types of transient combustible conditions do not occur in the European plants. Accordingly, and given the orientation and training that facility employees will receive indicating that these types of fire hazards are unacceptable, the administrative IROFS preventing severe accumulations has been assigned a high degree of reliability.

Fires that involve additional in-situ or transient combustibles from outside each respective fire area could result in exposure of additional uranic content being released in a fire beyond the quantities assumed above. For this reason, fire barriers are needed to ensure that fires cannot propagate from non-uranium containing areas into uranium (U) areas or from one U area to another U area (unless the uranium content in the space is insignificant, i.e., would be a low consequence event). Fire barriers shall be designed with adequate safety margin such that the total combustible loading (in-situ and transient) allowed to expose the barrier will not exceed 80% of the hourly fire resistance rating of the barrier.

3.2 Integrated Safety Analysis Methods

For external events, the impacts were evaluated for the following hazards:

External events were considered at the site and facility level versus at individual system nodes. Specific external event HAZOP guidewords were developed for use during the external event portion of the ISA. The external event ISA considered both natural phenomena and man-made hazards. During the external event ISA team meeting, each area of the plant was discussed as to whether or not it could be adversely affected by the specific external event under consideration. If so, specific consequences were then discussed. If the consequences were known or assumed to be high, then a specific design basis with a likelihood of highly unlikely would be selected.

Given that external events were considered at the facility level, the ISA for external events was performed after the ISA team meetings for all plant systems were completed. This provided the best opportunity to perform the ISA at the site or facility level. Each external event was assessed for both the uncontrolled case and then for the controlled case. The controlled cases could be a specific design basis for that external event, IROFS or a combination of both. An Accident Sequence and Risk matrix was prepared for each external event.

External events evaluated included:

- Seismic
- Tornado, Tornado Missile and High Wind
- Snow and Ice
- Flooding
- Local Precipitation
- Other (Transportation and Nearby Facility Accidents)
- Aircraft
- Pipelines
- Highway
- Other Nearby Facilities
- Railroad
- Internal Flooding from On-Site Above Ground Liquid Storage Tanks.

The ISA is intended to give assurance that the potential failures, hazards, accident sequences, scenarios, and IROFS have been investigated in an integrated fashion, so as to adequately consider common mode and common cause situations. Included in this integrated review is the identification of IROFS function that may be simultaneously beneficial and harmful with respect to different hazards, and interactions that might not have been considered in the previously completed sub-analyses. This review is intended to ensure that the designation of one IROFS does not negate the preventive or mitigation function of another IROFS. An integration checklist is used by the ISA Team as a guide to facilitate the integrated review process.

Some items that warrant special consideration during the integration process are:

- Common mode failures and common cause situations.

3.2 Integrated Safety Analysis Methods

- Support system failures such as loss of electrical power or city water. Such failures can have a simultaneous effect on multiple systems.
- Divergent impacts of IROFS. Assurance must be provided that the negative impacts of an IROFS, if any, do not outweigh the positive impacts; i.e., to ensure that the application of an IROFS for one safety function does not degrade the defense-in-depth of an unrelated safety function.
- Other safety and mitigating factors that do not achieve the status of IROFS that could impact system performance.
- Identification of scenarios, events, or event sequences with multiple impacts, i.e. impacts on chemical safety, fire safety, criticality safety, and/or radiation safety. For example, a flood might cause both a loss of containment and moderation impacts.
- Potential interactions between processes, systems, areas, and buildings; any interdependence of systems, or potential transfer of energy or materials.
- Major hazards or events, which tend to be common cause situations leading to interactions between processes, systems, buildings, etc.

3.2.2 HAZOP Hazard Analysis Method

As noted above, the HAZOP method was used to identify the process hazards. The HAZOP process hazard analysis (PHA) method is consistent with the guidance provided in NUREG-1513. Implementation of the HAZOP method was accomplished by either validating the Urenco HAZOPs for the NEF design or performing a new HAZOP for systems where there were no existing HAZOPs. In general, new HAZOPs were performed for the Cylinder Receipt and Dispatch Building (CRDB) systems. In cases for which there was an existing HAZOP, the ISA Team, through the validation process, developed a new HAZOP.

For the UF₆ process systems, this portion of the ISA was a validation of the HAZOPs provided by Urenco. The validation process involved workshop meetings with the ISA Team. In the workshop meeting, the ISA Team challenged the results of the Urenco HAZOPs. As necessary the HAZOPs were revised/updated to be consistent with the requirements identified in

10 CFR 70 (CFR, 2003b) and as further described in NUREG-1513 and NUREG-1520.

To validate the Urenco HAZOPs, the ISA Team followed the HAZOP process as discussed in Guidelines for Hazard Evaluation Procedures (AIChE, 1992). Additional steps performed in this validation that are not identified in the above reference include:

- The ISA Team created a list of deviations for the UF₆ process, other processes in which the deviation could potentially impact the UF₆ process, and for external events (i.e., deviations from normal weather or external activities).
- For each potential hazard, the ISA Team considered the causes, including potential interactions among materials. Then, for each cause, the ISA Team considered the consequences and consequence severity category for the consequences of interest (Criticality Events, Chemical Releases, Radiation Exposure, Environment impacts). A statement of "No Safety Issue" was noted in the system HAZOP table for consequences of no interest such as maintenance problems or industrial personnel accidents.

3.2 Integrated Safety Analysis Methods

- In addition to identification of safeguards, the ISA Team also considered any existing design features that could mitigate/reduce the consequences.
- For each external event hazard, the ISA Team determined if the external hazard is credible (i.e., external event initiating frequency >10⁻⁶ per year).

The Urenco HAZOP was modified to reflect the ISA Team's input in the areas of hazards, causes, consequences, safeguards and mitigating features.

The same process as above was followed for the CRDB systems, except that instead of using the validation process, the ISA Team developed a completely new HAZOP. This HAZOP was then used as the hazard identification input into the remainder of the process.

The results of the ISA Team workshops are summarized in the ISA HAZOP Table, which forms the basis of the hazards portion of the Hazard and Risk Determination Analysis. The HAZOP tables are contained in the ISA documentation. The format for this table, which has spaces for describing the node under consideration and the date of the workshop, is provided in Table 3.1-2, ISA HAZOP Table Sample Format. This table is divided into 7 columns:

GUIDEWORD	Identifies the Guideword under consideration.
HAZARD	Identifies any issues that are raised.
CAUSES	Lists any and all causes of the hazard noted.
CONSEQUENCES	Identifies the potential and worst case consequence and consequences severity category if the hazard goes uncontrolled.
SAFEGUARDS	Identifies the engineered and/or administrative protection designed to prevent the hazard from occurring.
MITIGATION	Identifies any protection, engineered or otherwise, that can mitigate/reduce the consequences.
COMMENTS	Notes any comments and any actions requiring resolution.

This approach was used for all of the process system hazard identifications. The "Fire" and "External Events" guidewords were handled as a facility-wide assessment and were not explicitly covered in each system hazard evaluation.

The results of the HAZOP are used directly as input to the risk matrix development.

3.2.3 What-If/Checklist Hazard Analysis Method

The guidance from NUREG-1513 is followed for the What-If/Checklist hazard analysis method selection. The What-If/Checklist Analysis technique is a combination of two hazard evaluation methods: What-If Analysis and Checklist Analysis. The method is performed by an ISA Team with personnel experienced with the subject process. The ISA Team uses the What-If Analysis technique to brainstorm various types of process accidents that can occur. Then the ISA Team uses one or more checklists to help fill in any gaps that may have been missed. Rather than focusing on a specific list of design or operating features, checklists used in a What-If/Checklist Analysis are more general and focus on sources of hazards and accidents.

A What-If/Checklist Analysis consists of the following steps: (1) preparing for the review, (2) developing a list of What-If questions and issues, (3) using a checklist to cover any gaps, (4) evaluating each of the questions and issues, and (5) documenting the results.

3.2 Integrated Safety Analysis Methods

For each What-If question, the ISA Team determines the likelihood, consequences, safeguards, and acceptability of risk. The ISA Team meetings results are summarized in the What-If/Checklist, which forms the Hazard and Risk Determination Analysis basis.

3.2.4 Failure Modes and Effects Analysis (FMEA) Hazard Analysis Method

The guidance from NUREG-1513 recommends the FMEA hazard analysis method use. The FMEA is a systematic method for examining the effects of component failures on system performance. To perform the FMEA, an individual analyst lists all the components in the system under review, as well as all the failure modes for these components. The ISA Team made of analysts familiar with the system then identifies the hazards associated with each component failure and suggests corrective actions when appropriate.

The FMAE technique:

- Defines physical system bounds
- Determines the effect of each component failure mode
- Identifies safeguards to protect against the causes and/or consequences of each component failure mode
- Lists system components and postulates failure mode for each component and each physical bound
- Suggests actions for improving the system if the risk is deemed unacceptable

3.2.5 Risk Matrix Development

3.2.5.1 Consequence Analysis Method

10 CFR 70.61 (CFR, 2003c) specifies two categories for accident sequence consequences: "high consequences" and "intermediate consequences." Implicitly there is a third category for accidents that produce consequences less than "intermediate." These are referred to as "low consequence" accident sequences. The primary purpose of PHA is to identify all uncontrolled and unmitigated accident sequences. These accident sequences are then categorized into one of the three consequence categories (high, intermediate, low) based on their forecast radiological, chemical, and/or environmental impacts.

For evaluating the magnitude of the accident consequences, calculations were performed using the methodology described in the ISA documentation. Because the consequences of concern are the chemotoxic exposure to HF and UO_2F_2 , the dispersion methodology discussed in Section 6.3.2 was used. The dose consequences for all of the accident sequences were evaluated and compared to the criteria for "high" and "intermediate" consequences. The inventory of uranic material for each accident considered was dependent on the specific accident sequence. For criticality accidents, the consequences were conservatively assumed to be high for both the public and workers.

Table 3.1-3, Consequence Severity Categories Based on 10 CFR 70.61, presents the radiological and chemical consequence severity limits of 10 CFR 70.61 (CFR, 2003c) for each of the three accident consequence categories. Table 3.1-4, Chemical Dose Information, provides information on the chemical dose limits specific to the NEF.

3.2 Integrated Safety Analysis Methods

3.2.5.2 Likelihood Evaluation Method

10 CFR 70.61 (CFR, 2003c) also specifies the permissible likelihood of occurrence of accident sequences of different consequences. "High consequence" accident sequences must be "highly unlikely" and "intermediate consequence" accident sequences must be "unlikely." Implicitly, accidents in the "low consequence" category can have a likelihood of occurrence less than "unlikely" or simply "not unlikely." Table 3.1-5, Likelihood Categories Based on 10 CFR 70.61, shows the likelihood of occurrence limits of 10 CFR 70.61 (CFR, 2003c) for each of the three likelihood categories.

The definitions of "not unlikely" and "unlikely" are taken from NUREG-1520. The definition of "highly unlikely" is taken from NUREG-1520. Additionally, a qualitative determination of "highly unlikely" can apply to passive design component features (e.g., tanks, piping, cylinders, etc.) of the facility that do not rely on human interface to perform the criticality safety function (i.e., termed "safe-by-design"). Safe-by-design components are those components that by their physical size or arrangement have been shown to have a $k_{\text{eff}} < 0.95$. The definition of safe-by-design components encompasses two different categories of components. The first category includes those components that are safe-by-volume, safe-by-diameter or safe-by-slab thickness. A set of generic conservative criticality calculations has determined the maximum volume, diameter, or slab thickness (i.e., safe value) that would result in a $k_{\text{eff}} < 0.95$. A component in this category has a volume, diameter or slab thickness that is less than the associated safe value resulting from the generic conservative criticality calculations and therefore the k_{eff} associated with this component is < 0.95 . The components in the second category require a more detailed criticality analysis (i.e., a criticality analysis of the physical arrangement of the component's design configuration) to show that k_{eff} is < 0.95 . In the second category of components, the design configuration is not bounded by the results of the generic conservative criticality calculations for maximum volume, diameter, or slab thickness that would result in a $k_{\text{eff}} < 0.95$. Examples of components in this second category are the product pumps that have volumes greater than the safe-by-volume value, but are shown by specific criticality analysis to have a $k_{\text{eff}} < 0.95$.

For failure of passive safe-by-design components to be considered "highly unlikely," these components must also meet the criterion that the only potential means to effect a change that might result in a failure to function, would be to implement a design change (i.e., geometry deformation as a result of a credible process deviation or event does not adversely impact the performance of the safety function). The evaluation of the potential to adversely impact the safety function of these passive design features includes consideration of potential mechanisms to cause bulging, corrosion, and breach of confinement/leakage and subsequent accumulation of material. The evaluation further includes consideration of adequate controls to ensure that the double contingency principle is met. For each of these passive design components, it must be concluded, that there is no credible means to effect a geometry change that might result in a failure of the safety function and that significant margin exists. For components that are safe-by-volume, safe-by-diameter, or safe-by-slab thickness (i.e., first category of safe-by-design components), significant margin is defined as a margin of at least 10%, during both normal and upset conditions, between the actual design parameter value of the component and the value of the corresponding critical design attribute. For components that require a more detailed criticality analysis (i.e., second category of safe-by-design components), significant margin is defined as $k_{\text{eff}} < 0.95$, where $k_{\text{eff}} = k_{\text{calc}} + 3\sigma_{\text{calc}}$. This margin is considered acceptable since the calculation of k_{eff} also conservatively assumes the components are full of uranic breakdown material at maximum enrichment, the worst credible moderation conditions exist, and the worst

3.2 Integrated Safety Analysis Methods

credible reflection conditions exist. In addition, the configuration management system required by 10 CFR 70.72 (implemented by the NEF Configuration Management Program) ensures the maintenance of the safety function of these features and assures compliance with the double contingency principle, as well as the defense-in-depth criterion of 10 CFR 70.64(b).

The definition of "not credible" is also taken from NUREG-1520. If an event is not credible, IROFS are not required to prevent or mitigate the event. The fact that an event is not "credible" must not depend on any facility feature that could credibly fail to function. One cannot claim that a process does not need IROFS because it is "not credible" due to characteristics provided by IROFS. The implication of "credible" in 10 CFR 70.61 (CFR, 2003c) is that events that are not "credible" may be neglected.

Any one of the following independent acceptable sets of qualities could define an event as not credible:

- a. An external event for which the frequency of occurrence can conservatively be estimated as less than once in a million years
- b. A process deviation that consists of a sequence of many unlikely human actions or errors for which there is no reason or motive (In determining that there is no reason for such actions, a wide range of possible motives, short of intent to cause harm, must be considered. Necessarily, no such sequence of events can ever have actually happened in any fuel cycle facility.)
- c. Process deviations for which there is a convincing argument, given physical laws that they are not possible, or are unquestionably extremely unlikely.

3.2.5.3 Risk Matrix

The three categories of consequence and likelihood can be displayed as a 3 x 3 risk index matrix. By assigning a number to each category of consequence and likelihood, a qualitative risk index can be calculated for each combination of consequence and likelihood. The risk index equals the product of the integers assigned to the respective consequence and likelihood categories. The risk index matrix, along with computed risk index values, is illustrated in Table 3.1-6, Risk Matrix with Risk Index Values. The shaded blocks identify accidents of which the consequences and likelihoods yield an unacceptable risk index and for which IROFS must be applied.

The risk indices can initially be used to examine whether the consequences of an uncontrolled and unmitigated accident sequence (i.e., without any IROFS) could exceed the performance requirements of 10 CFR 70.61 (CFR, 2003c). If the performance requirements could be exceeded, IROFS are designated to prevent the accident or to mitigate its consequences to an acceptable level. A risk index value less than or equal to four means the accident sequence is acceptably protected and/or mitigated. If the risk index of an uncontrolled and unmitigated accident sequence exceeds four, the likelihood of the accident must be reduced through designation of IROFS. In this risk index method, the likelihood index for the uncontrolled and unmitigated accident sequence is adjusted by adding a score corresponding to the type and number of IROFS that have been designated.

3.2 Integrated Safety Analysis Methods

3.2.6 Risk Index Evaluation Summary

The results of the ISA are summarized in tabular form. This table includes the accident sequences identified for this facility. The accident sequences were not grouped as a single accident type but instead were listed individually in the table. The Table has columns for the initiating event and for IROFS. IROFS may be mitigative or preventive. Mitigative IROFS are measures that reduce the consequences of an accident. The phrase “uncontrolled and/or unmitigated consequences” describes the results when the system of existing preventive IROFS fails and existing mitigation also fails. Mitigated consequences result when the preventive IROFS fail, but mitigative measures succeed. Index numbers are assigned to initiating events, IROFS failure events, and mitigation failure events, based on the reliability characteristics of these items.

With redundant IROFS and in certain other cases, there are sequences in which an initiating event places the system in a vulnerable state. While the system is in this vulnerable state, an IROFS must fail for the accident to result. Thus, the frequency of the accident depends on the frequency of the first event, the duration of vulnerability, and the frequency of the second IROFS failure. For this reason, the duration of the vulnerable state is considered, and a duration index is assigned. The values of all index numbers for a sequence, depending on the number of events involved, are added to obtain a total likelihood index, T. Accident sequences are then assigned to one of the three likelihood categories of the risk matrix, depending on the value of this index in accordance with Table 3.1-8, Determination of Likelihood Category.

The values of index numbers in accident sequences are assigned considering the criteria in Tables 3.1-9 through 3.1-11. Each table applies to a different type of event. Table 3.1-9, Failure Frequency Index Numbers, applies to events that have frequencies of occurrence, such as initiating events and certain IROFS failures. Failure Probability Index Numbers are evaluated based on operating experience, (either from Urenco or the National Enrichment Facility, as appropriate) or analyses. When failure probabilities are required for an event, Table 3.1-10, Failure Probability Index Numbers, provides the index values. Table 3.1-11, Failure Duration Index Numbers, provides index numbers for durations of failure. These are used in certain accident sequences where two IROFS must simultaneously be in a failed state. In this case, one of the two controlled parameters will fail first. It is then necessary to consider the duration that the system remains vulnerable to failure of the second. This period of vulnerability can be terminated in several ways. The first failure may be “fail-safe” or be continuously monitored, thus alerting the operator when it fails so that the system may be quickly placed in a safe state. Or the IROFS may be subject to periodic surveillance tests for hidden failures. When hidden failures are possible, these surveillance intervals limit the duration that the system is in a vulnerable state. The reverse sequences, where the second IROFS fails first, should be considered as a separate accident sequence. This is necessary because the failure frequency and the duration of outage of the first and the second IROFS may differ. The values of these duration indices are not merely judgmental. They are directly related to the time intervals used for surveillance and the time needed to render the system safe.

The duration of failure is accounted for in establishing the overall likelihood that an accident sequence will continue to the defined consequence. Thus, the time to discover and repair the failure is accounted for in establishing the risk of the postulated accident.

The total likelihood index is the sum of the indices for all the events in the sequence, including those for duration. Consequences are assigned to one of the three consequence categories of

3.2 Integrated Safety Analysis Methods

the risk matrix, based on calculations or estimates of the actual consequences of the accident sequence. The consequence categories are based on the levels identified in 10 CFR 70.61 (CFR, 2003c). Multiple types of consequences can result from the same event. The consequence category is chosen for the most severe consequence.

In summarizing the ISA results, Table 3.7-1, Accident Sequence and Risk Index, provides two risk indices for each accident sequence to permit evaluation of the risk significance of the IROFS involved. To measure whether an IROFS has high risk significance, the table provides an “uncontrolled risk index,” determined by modeling the sequence with all IROFS as failed

(i.e., not contributing to a lower likelihood). In addition, a “controlled risk index” is also calculated, taking credit for the low likelihood and duration of IROFS failures. When an accident sequence has an uncontrolled risk index exceeding four but a controlled risk index of less than four, the IROFS involved have a high risk significance because they are relied on to achieve acceptable safety performance. Thus, use of these indices permits evaluation of the possible benefit of improving IROFS and also whether a relaxation may be acceptable.

3.3 Integrated Safety Analysis Team

3.3 Integrated Safety Analysis Team

There were two ISA Teams that were employed in the ISA. The first team worked on the non-classified portions of the facility and is referred to in the text as the ISA Team. The second team, referred to as the Classified ISA Team, performed the ISA on the classified elements of the facility. Both teams were selected with credentials consistent with the requirements in

10 CFR 70.65 (CFR, 2003a) and the guidance provided in NUREG-1520. To facilitate consistency of results, common membership was dictated as demonstrated below

(i.e., some members of the Non-Classified Team participated on the Classified Team. One of the members of the Classified Team participated in the ISA Team Leader Training, which was conducted prior to initiating the ISA. In addition, the Classified ISA Team Leader observed some of the non-classified ISA Team meetings.

The ISA was performed by a team with expertise in engineering, safety analysis and enrichment process operations. The team included personnel with experience and knowledge specific to each process or system being evaluated. The team was comprised of individuals who have experience, individually or collectively, in:

- Nuclear criticality safety
- Radiological safety
- Fire safety
- Chemical process safety
- Operations and maintenance
- ISA methods.

The ISA team leader was trained and knowledgeable in the ISA method(s) chosen for the hazard and accidents evaluations. Collectively, the team had an understanding of all process operations and hazards under evaluation.

The ISA Manager was responsible for the overall direction of the ISA. The process expertise was provided by the Urenco personnel on the team. In addition, the Team Leader has an adequate understanding of the process operations and hazards evaluated in the ISA, but is not the responsible cognizant engineer or enrichment process expert.

3.4 Compliance Item Commitments

3.4 Compliance Item Commitments

- 3.4.1 For accident sequences PT3-5, PB1-3, FR1-1, FR1-2, FR2-1, FR2-2, DS1-1, DS1-2, DS2-1, DS2-2, DS3-1, DS3-2, SW1-1, SW1-2, LW1-2, LW1-3, RD1-1, and EC3-1,** an Initiating Event Frequency (IEF) index number of “-2” may be assigned based on evidence from the operating history of similar designed Urenco European plants. Detailed justifications for the IEF index numbers of “-2” will be developed during detailed design. If the detailed justification does not support the IEF index number of “-2,” then the IEF index number assigned and the associated accident sequence(s) will be re-evaluated and revised, as necessary, consistent with overall ISA methodology.
- 3.4.2 For Administrative Control IROFS that involve “use of” a component or device,** a Failure Probability Index Number (FPIN) of “-2” may be assigned provided the IROFS is a routine, simple, action that either: (1) involves only one or two decision points or (2) is highly detailed in the associated implementing procedure. Alternately, an FPIN of “-3” may be assigned for this type of IROFS provided the criteria specified above for an FPIN of “-2” are met and the IROFS is enhanced by requiring independent verification of the safety function. This enhancement shall meet the requirements for independent verification identified in item 3.4.5 below. If these criteria cannot be met, then the FPIN assigned to the IROFS and the associated accident sequence(s) will be re-evaluated and revised, as necessary, consistent with the overall ISA methodology.
- 3.4.3 For Administrative Control IROFS that involve “verification of” a state or condition,** an FPIN of “-2” may be assigned provided the IROFS is a routine action performed by one person, with proceduralized, objective, acceptance criteria. Alternately, an FPIN of “-3” may be assigned for this type of IROFS provided the criteria specified above for an FPIN of “-2” are met and the IROFS is enhanced by requiring independent verification of the safety function. This enhancement shall meet the requirements for independent verification identified in item 3.4.5 below. If these criteria cannot be met, then the FPIN assigned to the IROFS and the associated accident sequence(s) will be re-evaluated and revised, as necessary, consistent with the overall ISA methodology.
- 3.4.4 For Administrative Control IROFS that involve “independent sampling,”** different samples are obtained and an FPIN of “-2” may be assigned provided at least three of the following four criteria are met.
1. Different methods/techniques are used for sample analysis.
 2. Samples are obtained from different locations.
 3. Samples are obtained at different times. The time period between collection of the different samples shall be sufficient to ensure results are meaningful and representative of the material sampled.
 4. Samples are obtained by different personnel.

3.4 Compliance Item Commitments

If at least three of the above criteria cannot be met, then the FPIN assigned to the IROFS and the associated accident sequence(s) will be re-evaluated and revised, as necessary, consistent with the overall ISA methodology.

- 3.4.5 For IROFS and IROFS with Enhanced Failure Probability Index Numbers** (i.e., enhanced IROFS) that require “independent verification” of a safety function, the independent verification shall be independent with respect to personnel and personnel interface. Specifically, a second qualified individual, operating independently (e.g., not at the same time or not at the same location) of the individual assigned the responsibility to perform the required task, shall, as applicable, verify that the required task (i.e., safety function) has been performed correctly (e.g., verify a condition), or re-perform the task (i.e., safety function), and confirm acceptable results before additional action(s) can be taken which potentially negatively impact the safety function of the IROFS. The required task and independent verification shall be implemented by procedure and documented by initials or signatures of the individuals responsible for each task. In addition, the individuals performing the tasks shall be qualified to perform, for the particular system or process (as applicable) involved, the tasks required and shall possess operating knowledge of the particular system or process (as applicable) involved and its relationship to facility safety. The requirements for independent verification are consistent with the applicable guidance provided in ANSI/ANS-3.2, Administrative Controls and Quality Assurance for the Operational Phase of Nuclear Power Plants.
- 3.4.6 Upon completion of the design of IROFS**, the IROFS boundaries will be defined. In defining the boundaries for each IROFS, Louisiana Energy Services procedure “IROFS Boundary Definitions” will be used. This procedure requires the identification of each support system and component necessary to ensure the IROFS is capable of performing its specified safety function.
- 3.4.7 The applicable guidance of the following industry standards**, guidance documents and regulatory guides shall be used for the design, procurement, installation, testing, and maintenance of IROFS at the NEF.
- a. Institute of Electrical and Electronics Engineers (IEEE) standard IEEE 603, “IEEE Standard Criteria for Safety Systems for Nuclear Power Generating Stations”
 - b. IEEE standard 384, “IEEE Standard Criteria for Independence of Class IE Equipment and Circuits”
 - c. Branch Technical Position HICB-11, “Guidance on Application and Qualification of Isolation Devices,” from NUREG-0800, “Standard Review Plan for the Review of Safety Analysis Reports for Nuclear Power Plants”
 - d. Regulatory Guide 1.75, “Physical Independence of Electric Systems” e. IEEE standard 344, “IEEE Recommended Practices for Seismic Qualification of Class 1E Equipment for Nuclear Power Generating Stations”
 - f. Regulatory Guide 1.100, “Seismic Qualification of Electric and Mechanical Equipment for Nuclear Power Plants”
 - g. American National Standards Institute (ANSI)/Instrumentation, Systems, and Automation Society (ISA)-S67.04, Part 1, “Setpoints for Nuclear Safety-Related Instrumentation”

3.4 Compliance Item Commitments

- h. Regulatory Guide 3.17, "Earthquake Instrumentation for Fuel Reprocessing Plants," (for IROFS26 only)
- i. IEEE standard 338, "IEEE Standard Criteria for Periodic Surveillance Testing of Nuclear Power Generating Station Safety Systems"
- j. Branch Technical Position HICB-17, "Guidance on Self-Test and Surveillance Test Provisions," from NUREG-0800, "Standard Review Plan for the Review of Safety Analysis Reports for Nuclear Power Plants"
- k. Regulatory Guide 1.118, "Periodic Testing of Electric Power and Protection Systems"
- l. IEEE standard 518, "IEEE Guide for Installation of Electrical Equipment to Minimize Electrical Noise Inputs to Controllers from External Sources"
- m. IEEE standard 1050, "IEEE Guide for Instrumentation and Control Equipment Grounding in Generating Stations"
- n. IEEE standard 279, "Criteria for Protection Systems for Nuclear Power Generating Stations" (for separation and isolation)

3.4.8 The actual seismic design detailed approach for NEF IROFS will be based on the DOE-STD-1020 or the ASCE Standard Seismic Design Criteria (ASCE43) method, or in the case of IROFS27e only, on the AISC Manual of Steel Construction and ACI 318. The seismic design will be finalized prior to detailed design.

3.4.9 To support the final design of the NEF, additional soil borings were collected from the NEF site. Laboratory testing was performed on soil samples and additional in-situ testing was performed to determine static and dynamic soil properties. Using the soil information obtained, the following activities were conducted.

- The assessment of soil liquefaction potential was performed using the applicable guidance of Regulatory Guide 1.198, Procedures and Criteria for Assessing Seismic Soil Liquefaction at Nuclear Power Plant Sites.
- Allowable bearing pressures provided in the ISA Summary were refined using the applicable methods of Naval Facilities Engineering Command Design Manual NAVFAC DM-7.02, Foundations and Earth Structures; Foundation Engineering Handbook, H.F. Winterkorn and H.Y. Fang, or Foundation Analysis and Design, J.E. Bowles,.
- Building settlement analysis was performed using the applicable methods of NAVFAC DM-7.01, Soil Mechanics; and Foundation Engineering Handbook, H.F. Winterkorn and H.Y. Fang. The acceptance criteria for the building settlement analysis was based on Urenco design criteria for allowable total and differential settlement of equipment and buildings.

3.4 Compliance Item Commitments

- 3.4.10 Intentionally Blank**
- 3.4.11 The Separations Building Modules** are designed as Type I-B Construction by the NMCBC and as Type II (222) Construction by NFPA 220.
- 3.4.12 The floors of the Cascade Halls** have a floor profile quality classification of flat in accordance with ACI 117 to aid in the transport of assembled centrifuges.
- 3.4.13 The Technical Services Building** is designed as Type II-B Construction by the NMCBC and as Type II (000) Construction by NFPA 220.
- 3.4.14 The Cylinder Receipt and Dispatch Building** is designed as Type I-B Construction by the NMCBC and as Type II (222) Construction by NFPA 220.
- 3.4.15 The Centrifuge Assembly Building (CAB)** is designed as Type II-B Construction by the NMCBC and as Type II (000) Construction by NFPA 220.
- 3.4.16 As protection of CAB investments** (centrifuges and equipment) against the deleterious effects of airborne contaminants, the CAB construction will provide for an ISO 14644-1 Class 8.
- 3.4.17 The floors of the CAB Assembled Centrifuge Storage Area** have a floor profile quality classification of flat in accordance with ACI 117 to aid in the transport of assembled centrifuges.
- 3.4.18 For QL-1F periodic review of UL and FM recall data** UUSA will perform an annual review of UL and FM websites for identification of recall data associated with fire protection basic components.
- 3.4.19 The Central Utilities Building** is designed to meet the occupant and exiting requirements set by the International Fire Code and the New Mexico Commercial Building Code.
- 3.4.20 The Administration Building** is designed to meet the occupant and exiting requirements set by the International Fire Code and the New Mexico Commercial Building Code.
- 3.4.21 The Central Utilities Building and the Administration Building** are designed as Type II-B Construction by the NMCBC and as Type II (000) Construction by NFPA 220.
- 3.4.22 The following codes and standards** are generally applicable to the structural design of the National Enrichment Facility:
- New Mexico Commercial Building Code
 - International Building Code
 - ASCE 7, Minimum Design Loads for Buildings and Other Structures
 - ACI 318, Building Code Requirements for Structural Concrete
 - ACI 349, Code Requirements for Nuclear Safety Related Concrete Structures

3.4 Compliance Item Commitments

- AISC Manual of Steel Construction
- ANSI/AISC N690, American National Standard Specification for the Design, Fabrication, and Erection of Steel Safety-Related Structures for Nuclear Facilities
- PCI Design Handbook
- American Society of Testing and Materials

3.4.23 Structural Design Loads

- a. Wind loadings for structures are in accordance with provisions of the International Building Code and Section 6.5 of ASCE 7.
- b. For reinforced concrete targets, the formulas used to establish the missile depth of penetration (x) and scabbing thickness (ts) are based on the Modified National Defense Research Committee Formula (NDRC) (ASCE, 58) and the Army Corps of Engineers Formula (ACE) (ASCE, 58) respectively.
- c. Per Section C.7.2.1 of ACI 349, the concrete thickness required to resist hard missiles shall be at least 1.2 times the scabbing thickness, ts. Punching shear is calculated and checked against the requirements of ACI 349, Section C.7.2.3.
- d. For steel targets, the formula used to establish the perforation thickness is the Ballistic Research Laboratory (BRL) Formula (ASCE, 58).
- e. All buildings and structures, including such items as equipment supports, are designed to withstand the earthquake loads defined in Sections 1615 through 1617 of the International Building Code.
- f. Extreme snow loadings on roofs of safety significant structures are based on a ground snow load of 32 lb/ft². The snow load for safety significant structures is enveloped by the general 40 lb/ft² roof live load with the exception of drift areas. Drift areas (where load can exceed 40 lb/ft²) are evaluated when required for each structure.
Quality Level 3 structures will as a minimum, meet the IBC requirements for snow loading.
- g. Load combinations for concrete structures and components for the safety significant structures are based on ACI 349 except for SBMs which may be based on ACI 318. Load combinations for other concrete structures are based on (ACI 318). All concrete structures are designed using the ACI Strength Design Method (ACI 318).
- h. Load combinations for steel structures and components for all buildings are provided in ISAS Section 3.3.2.2.8. All structural steel is designed using the AISC Allowable Stress Method (AISC, Manual of Steel Construction).
- i. Design live loads, including impact loads, used are in accordance with Section 4.0 and Table 4-1 of ASCE 7.
- j. During detailed design of specific buildings and areas, pressure loads due to postulated truck and pipeline explosions will be considered. The pressure loads will be developed in accordance with the underlying assumptions used in the explosion hazard assessments described in Sections 3.2.1.2.1 and 3.2.2.4 of the ISA Summary. These buildings and areas include: Separations Building Modules (UF₆ Handling Area, Process Services Corridor and Cascade Halls), and the Cylinder Receipt and Dispatch Building Bunkered Area. ISA Summary section 3.3.1, Buildings and Major Components, describes these buildings.

3.4 Compliance Item Commitments

3.4.24 Natural UF₆ feed is received at the NEF in Department of Transportation (DOT) 7A, Type A cylinders from a conversion plant. The cylinders are ANSI N14.1, 48Y cylinders. Approximately 20 kg of UF₆ feed material was received at the National Enrichment Facility in ANSI N14.1 30B cylinders to support Hot Acceptance Testing in the CTF.

3.4.25 Applicable codes and standards for process systems are reflected in Tables 3.3-1 through 3.3-7.

3.4.26 Product Liquid Sampling Autoclave

- a. The pressure vessel is designed and fabricated in accordance with the requirements of ASME Section VIII, Division 1, with the exception that the pressure relief devices specified in Sections UG-125 through 137 are not be provided due to the potential for release of hazardous material to the environment through a pressure relief device. Instead, two independent and diverse automatic trips of the autoclave heaters and fan motor are provided to eliminate the heat input and preclude approaching the autoclave design pressure. A large margin exists between the autoclave design pressure 12 bar (174 psia) and the maximum allowable working pressure 1.8 bar (26 psia). The fail-safe design included two independent and diverse automatic trips of the autoclave heaters and fan motor. This meets requirements of ASME Code Case 2211-1 which is listed in ISA Summary Table 3.0-2, Licensing Code Cases of Record. The pressure vessel is also tested and stamped to the requirements of ASME Section VIII, Division 1 rules and is registered with the National Board.
- b. The autoclave is designed and tested to ensure leak tight integrity is maintained.
- c. The autoclave door seal is leak tested and inspected prior to each autoclave sample sequence.

3.4.27 Pumped Extract GEVS

NOTE: The Heating Ventilation and Air Conditioning (HVAC) systems and Gaseous Effluent Vent Systems (GEVS) for the NEF are undergoing redesign. After these design changes are finalized the information in applicable sections of this report (e.g., 3.4.28 Cylinder Receipt and Dispatch Building, 4.6.1 Ventilation Program, 7.3.5 Ventilation, and 10.1.6 Decommissioning, etc.) will be revised as necessary and in accordance with 10 CRF 70.72. The final design will be evaluated in accordance with the requirements of 10 CFR 70.72 prior to requirements for operational readiness.

- a. The Pumped Extract GEVS provides for continuous monitoring and periodic sampling of the gaseous effluent in the exhaust stack in accordance with the guidance in Regulatory Guide 4.16.
- b. The design and in-place testing of the Pumped Extract GEVS will be consistent with the applicable guidance in Regulatory Guide 1.140, ASME AG-1, and ASME N510. The system includes impregnated activated carbon filters for HF removal. As such, the portions of Regulatory Guide 1.140, ASME AG-1, and ASME N510, which address activated carbon filters for radioiodine removal, are not applicable. The prefilter efficiency (60-65%) is based on testing in accordance with ASME AG-1. The HEPA filter efficiency (99.97%) is based on removal of 0.3 micron particles when tested in accordance with ASME-AG-1. The impregnated carbon filter efficiency

3.4 Compliance Item Commitments

(99%) for removal of HF is based on Urenco operating experience and specifications. In-place testing and inspections of the HEPA filters will be performed in accordance with the guidance in Regulatory Guide 1.140. The frequency for performance of in-place HEPA filter testing and the acceptance criteria for penetration and leakage (or bypass) will be consistent with the guidance in Regulatory Guide 1.140. Qualification testing, to verify HF removal efficiency, of the impregnated activated carbon will be performed using ASTM D6646, modified to reflect removal of HF instead of hydrogen sulfide or using an actual in situ test such as described in ETC4044158 (Qualification of Safety by Shape GEVS Filters). Laboratory testing of samples from the impregnated carbon filters will be performed on an annual basis. Throughout the useful life of the impregnated activated carbon, the impregnate is progressively consumed. The laboratory testing will determine the impregnate content within the sample. The amount of impregnate present in the sample is indicative of the remaining life of carbon filter for removal of HF. Carbon filter replacement will be based on the remaining absorption capacity. The remaining filters will be replaced based on differential pressure readings (i.e., filter loading). There is no fixed frequency for filter replacement.

3.4.28 Cylinder Receipt and Dispatch Building (CRDB) GEVS

- a. The CRDB GEVS provides for continuous monitoring and periodic sampling of the gaseous effluent in the exhaust stack in accordance with the guidance in Regulatory Guide 4.16.
- b. The design and in-place testing of the CRDB GEVS will be consistent with the applicable guidance in Regulatory Guide 1.140, ASME AG-1, and ASME N510. The system includes an impregnated activated carbon filter for HF removal. As such, the portions of Regulatory Guide 1.140, ASME AG-1, and ASME N510, which address activated carbon filters for radioiodine removal are not applicable. The prefilter efficiency (85%) is based on testing in accordance with ASME AG-1. The HEPA filter efficiency (99.97%) is based on removal of 0.3 micron particles when tested in accordance with ASME-AG-1. The impregnated carbon filter efficiency (99%) for removal of HF is based on Urenco specifications. In-place testing and inspections of the filters will be performed in accordance with the guidance in Regulatory Guide 1.140. The frequency for performance of in-place filter testing and the acceptance criteria for penetration and leakage (or bypass) will be consistent with the guidance in Regulatory Guide 1.140. Qualification testing, to verify HF removal efficiency, of the impregnated charcoal will be performed using ASTM D6646, modified to reflect removal of HF instead of hydrogen sulfide. Laboratory testing of samples from the impregnated activated carbon filters will be performed on an annual basis. Throughout the useful life of the impregnated carbon, the impregnate is progressively consumed. The laboratory testing will determine the impregnate content within the sample. The amount of impregnate present in the sample is indicative of the remaining life of carbon filter for removal of HF.

3.4.29 Centrifuge Test and Post Mortem Facilities Exhaust Filtration System

The Centrifuge Test and Post Mortem Facilities Exhaust Filtration System provides for continuous monitoring and periodic sampling of the gaseous effluent in the exhaust stack in accordance with the guidance in Regulatory Guide 4.16.

3.4 Compliance Item Commitments

- 3.4.30 In response to Bulletin 2003**, LES will not purchase UF₆ cylinders with the 1-in Hunt valves installed nor purchase any replacement 1-in valves from Hunt.

In the unlikely event that any cylinders are received at the NEF with the 1-in Hunt valves installed, the following actions will be taken.

- If the cylinder is empty, the valve will be replaced before the cylinder is used in the facility.
- If the cylinder is filled, a safety justification to support continued use of the cylinder until the valve can be replaced will be developed or the valve will be replaced in accordance with NEF procedures.

No cylinders with the 1-in Hunt valve installed will be used as UBCs.

- 3.4.31 The containers used for intercontinental shipping** are International Organization for Standardization Series 1 freight containers that are supplied in accordance with the ISO 668 Standard.

- 3.4.32 Applicable codes and standards** for utility and support systems are reflected in Table 3.3-8.

- 3.4.33 Exhaust flow from the potentially contaminated rooms** (i.e., Ventilated Room and Decontamination Workshop) of the CRDB is filtered by a pre-filter, activated carbon filter and HEPA filter and is then released through an exhaust stack. The exhaust stack flow is continuously monitored for alpha and HF. The stack exhaust is periodically sampled. The continuous monitoring and periodic sampling is in accordance with the guidance in Regulatory Guide 4.16.

- 3.4.34 The Electrical System design complies with the following codes and standards.**

- IEEE C2, National Electrical Safety Code
- New Mexico Electric Code (based on the National Electric Code, NFPA 70)
- NFPA 70E, Standard for Electrical Safety in the Workplace

- 3.4.35 The criticality safety for tanks** that are not “geometrically safe” or “geometrically favorable” will utilize two independent IROFS for mass control, one IROFS is referred to as “bookkeeping measures” and the second IROFS is referred to as “sampled and analyzed,” e.g., tank contents are sampled and analyzed before being transferred to another tank or out of the system. The “bookkeeping measures” is a process to calculate the potential mass of uranium in the tank for any batch operation to ensure that no tank holds more than a safe mass of uranium. This calculated mass of uranium is then compared to a mass limit, which is based on the double-batching limit on mass of uranium in a vessel from the criticality safety analyses. The “bookkeeping measures” process is described in further detail below.

- For NEF, the “bookkeeping measures” are only applied to tanks where the mass of uranium involved, even when double batching is considered, is far below the safe value. Bookkeeping measures are a documented running inventory estimate of the total uranium mass in a particular tank. The mass inventory for each batch operation is calculated based on the mass of material to be transferred during each

3.4 Compliance Item Commitments

batch operation and the mass inventory in the tank prior to the addition of the material from the batch operation.

- There are two types of batch operations that are considered. The first type is liquid transfer between tanks based on moving a volume of liquid with uranic material present in the volume. The second is transferring a number of components into the tank with the uranic material contained within or on the components transferred in each batch operation. For both types of operations, the initial mass inventory is set after emptying, cleaning, and readying the tank for receipt of uranic material. For each batch operation, the amount of uranic material to be transferred during a particular batch operation is estimated. This quantity of material is then credited/debited to/from each tank as appropriate. A new mass inventory in each tank is calculated. The calculated receiving tank mass inventory is compared to the mass limit for the tank prior to the transfer.
- For the second type, a transfer of a number of facility components into an open tank during a batch operation, the mass inventory on/within the components is estimated, and that mass credited to the receiving tank. The final mass inventory in the tank is calculated and the total is compared to the mass limit for the tank prior to the transfer. Open tanks associated with this system are located in the Decontamination Workshop.

3.4.36 UF₆ cylinders with faulty valves are serviced in the Ventilated Room. In the Ventilated Room, the faulty valve is removed and the threaded connection in the cylinder is inspected. A new valve is then installed in accordance with the requirements of ANSI N-14.1.

3.4.37 IROFS will be designed, constructed, tested and maintained to QA Level 1, with the following exceptions,

- IROFS27e which will be designated and analyzed to QA Level 1, and will be constructed, tested, and maintained to QA Level 1 Graded.
- Fire protection features designated as IROFS which will be designed, procured, constructed, tested, and maintained to QA Level 1-Fire Protection (QL-1F)

IROFS will comply with design requirements established by the ISA and the applicable codes and standards (Listed in ISAS Table 3.0-1). IROFS components and their designs will be of proven technology for their intended application. These IROFS components and systems will be qualified to perform their required safety functions under normal and accident conditions for which they are credited, e.g., pressure, temperature, humidity, seismic motion, electromagnetic interference, and radio-frequency interference, as required by the ISA. IROFS components and systems will be qualified using the applicable guidance in Institute of Electrical and Electronics Engineers (IEEE) standard IEEE-323, "IEEE Standard for Qualifying Class 1E Equipment for Nuclear Power Generating Stations". Additionally, non-IROFS components and systems will be qualified to withstand environmental stress caused by environmental and dynamic service conditions under which their failure could prevent satisfactory accomplishment of the IROFS safety functions. Furthermore, IROFS components and systems will be designed, procured, installed, tested, and maintained using the applicable guidance in Regulatory Guide 1.180, "Guidelines for Evaluating Electromagnetic and Radio-Frequency Interference in Safety-Related Instrumentation

3.4 Compliance Item Commitments

and Control Systems,”. IROFS systems will be designed and maintained consistent with the reliability assumptions in the ISA. Redundant IROFS systems will be separate and independent from each other. IROFS systems will be designed to be fail-safe. In addition, IROFS systems will be designed such that process control system failures will not affect the ability of the IROFS systems to perform their required safety functions. Plant control systems will not be used to perform IROFS functions. Installation of IROFS systems will be in accordance with engineering specifications and manufacturer’s recommendations. Required testing and calibration of IROFS will be consistent with the assumptions of the ISA and setpoint calculations, as applicable. For hardware IROFS involving instrumentation which provides automatic prevention or mitigation of events, setpoint calculations are performed in accordance with a setpoint methodology, which is consistent with the applicable guidance provided in Regulatory Guide 1.105, “Setpoints for Safety-Related Instrumentation”.

Administrative Control IROFS Support Equipment is defined separately in § 3.4.42

- 3.4.38** For those IROFS requiring operator actions, a human factors engineering review of the human-system interfaces shall be conducted using the applicable guidance in NUREG-0700, “Human-System Interface Design Review Guidelines,” and NUREG-0711, “Human Factors Engineering Program Review Model.”
- 3.4.39** **LES will review the topography** of the NEF/LES site and surrounding relevant area, out to the boundaries of the drainage basin, for any natural or man made changes. This review will be performed every five years unless significant topography changes are identified between reviews. In the event of changes that could affect the calculation of the maximum possible flood level, LES will re-evaluate the flooding analysis to ensure that all Separations Building Modules (SBMs) abnormal condition calculations are still bounding.
- 3.4.40** **The Product Stations design will be based on ETC4069917-1** design drawings. The internal station design size of approximately 9’7” does not accommodate a 48-inch feed cylinder. Blending donor and receiver station designs do not accommodate 48-inch cylinders. Product cylinders, as designed, cannot physically connect to a feed station. Therefore, potential for re-feeding enriched materials does not exist. Future construction and design efforts will be consistent. Any modification to station designs or product cylinder connection points will be re-evaluated and revised consistent with overall ISA methodology including criticality reviews.
- 3.4.41** **The Assay Sampling Rig** shall exhaust to a gaseous effluent ventilation system with safe-by-design attributes. At final design, this rig will be evaluated for criticality concerns and IROFS or other controls will be identified in compliance with 10 CFR 70.61.
- 3.4.42** **Administrative Control IROFS Support Equipment** contain attributes that are required by the worker to fulfill the Administrative Control IROFS. The attributes are verified to ensure that the worker can perform the IROFS safety function. Support Equipment is in the Administrative Control IROFS boundary. Many of the actions are to prevent an event and upon failure of indication, actions would be implemented to stop continued operation or not start the operation. However, to enhance worker action and direction to prevent events, Support Equipment was identified and included

3.4 Compliance Item Commitments

in the boundary. The attributes of Support Equipment are controlled through the applicable management measures. For example, the attribute of “accurate and reliable indication” is controlled through the calibration and testing which is part of the Maintenance Function Testing Program.

Support Equipment is listed in Table 3.4-1, Administrative Control IROFS Support Equipment. This table contains Support Equipment and other equipment, other equipment is not inside the Administrative Control IROFS boundary; normally such equipment is QL-3. Equipment Attributes are in the Administrative Control IROFS boundary.

Management measures are applied to the attributes of Administrative Control IROFS Support Equipment and other equipment attributes. Management measures are also applied to Administrative Control IROFS Support Equipment as defined in the Quality Assurance Program Description for QL-2AC equipment.

3.5 References

3.5 References

Edition of Codes, Standards, NRC Documents, etc that are not listed below are given in ISAS Table 3.0-1.

CFR, 2003a. Title 10, Code of Federal Regulations, Section 70.65, Additional content of applications, 2003.

CFR, 2003b. Title 10, Code of Federal Regulations, Part 70, Domestic Licensing of Special Nuclear Material, 2003.

CFR, 2003c. Title 10, Code of Federal Regulations, Section 70.61, Performance requirements, 2003.

CFR, 2003d. Title 10, Code of Federal Regulations, Section 70.62, Safety program and integrated safety analysis, 2003.

CFR, 2003e. Title 29, Code of Federal Regulations, Section 1910, Occupational Safety and Health Standards, 2003.

CFR, 2003f. Title 10, Code of Federal Regulations, Section 70.72, Facility changes and change process, 2003.

LES, 1993. Claiborne Enrichment Center Safety Analysis Report, Louisiana Energy Services, December 1993.

3.6 Chapter 3 Tables

3.6 Chapter 3 Tables

Table 3.1-1 HAZOP Guidewords

UF₆ PROCESS GUIDEWORDS			
Less Heat	Corrosion	Maintenance	No Flow
More Heat	Loss of Services	Criticality	Reverse Flow
Less Pressure	Toxicity	Effluents/Waste	Less Uranium
More Pressure	Contamination	Internal Missile	More Uranium
Impact/Drop	Loss of Containment	Less Flow	Light Gas
Fire (Process, internal, other)	Radiation	More Flow	External Event
NON UF₆ PROCESS GUIDEWORDS			
High Flow	Low Pressure	Impact/Drop	More Uranium
Low Flow	High Temperature	Corrosion	External Event
No Flow	Low Temperature	Loss of Services	Startup
Reverse Flow	Fire	Toxicity	Shutdown
High Level	High Contamination	Radiation	Internal Missile
Low Level	Rupture	Maintenance	
High Pressure	Loss of Containment	Criticality	
EXTERNAL EVENTS POTENTIAL CAUSES			
Construction on Site	Hurricane	Seismic	Transport Hazard Off-Site
Flooding	Industrial Hazard Off-site	Tornado	External Fire
Airplane	Snow/Ice	Local Intense Precipitation	

3.6 Chapter 3 Tables

Table 3.1-2 ISA HAZOP Table Sample Format

ISA HAZOP NODE:		DESCRIPTION :			DATE:	PAGE:
GUIDEWORD	HAZARD	CAUSE	CONSEQUENCE	SAFEGUARDS	MITIGATING FACTORS	COMMENTS

3.6 Chapter 3 Tables

Table 3.1-3 Consequence Severity Categories Based on 10 CFR 70.61

	Workers	Offsite Public	Environment
Category 3 High Consequence	Radiation Dose (RD) >1 Sievert (Sv) (100 rem) Chemical Dose (CD) > AEGL-3 for HF CD > AEGL-3 for U	RD > 0.25 Sv (25 rem) 30 mg sol U intake CD > AEGL-2	—
Category 2 Intermediate Consequence	0.25 Sv (25 rem) < RD ≤ 1 Sv (100 rem) AEGL-2 < CD ≤ AEGL-3 for HF AEGL-2 < CD ≤ AEGL for U	0.05 Sv (5 rem) < RD ≤ 0.25 Sv (25 rem) AEGL-1 < CD ≤ AEGL-2	Radioactive release > 5000 x Table 2 Appendix B of 10 CFR Part 20
Category 1 Low Consequence	Accidents of lower radiological and chemical exposures than those above in this column	Accidents of lower radiological and chemical exposures than those above in this column	Radioactive releases with lower effects than those referenced above in this column

Notes:

* The worker that causes the release is expected to immediately sense and recognize the release and will not receive a dose significantly greater than a worker elsewhere in the room.

3.6 Chapter 3 Tables

Table 3.1-4 Chemical Dose Information

	High Consequence (Category 3)	Intermediate Consequence (Category 2)
Worker	> 146 mg U/m ³ > 139 mg HF/m ³	> 19 mg U/m ³ > 78 mg HF/m ³
Public (outside controlled area) (30-min exposure)	> 13 mg U/m ³ > 28 mg HF/m ³	> 2.4 mg U/m ³ > 0.8 mg HF/m ³

Table 3.1-5 Likelihood Categories Based on 10 CFR 70.61

	Likelihood Category	Probability of Occurrence*
Not Unlikely	3	More than 10 ⁻⁴ per-event per-year
Unlikely	2	Between 10 ⁻⁴ and 10 ⁻⁵ per-event per-year
Highly Unlikely	1	Less than 10 ⁻⁵ per-event per-year

*Based on approximate order-of-magnitude ranges

3.6 Chapter 3 Tables

Table 3.1-6 Risk Matrix with Risk Index Values

Severity of Consequences	Likelihood of Occurrence		
	Likelihood Category 1 Highly Unlikely (1)	Likelihood Category 2 Unlikely (2)	Likelihood Category 3 Not Unlikely (3)
Consequence Category 3 High (3)	Acceptable Risk 3	Unacceptable Risk 6	Unacceptable Risk 9
Consequence Category 2 Intermediate (2)	Acceptable Risk 2	Acceptable Risk 4	Unacceptable Risk 6
Consequence Category 1 Low (1)	Acceptable Risk 1	Acceptable Risk 2	Acceptable Risk 3

Table 3.1-7 (Not Used)

Table 3.1-8 Determination of Likelihood Category

Likelihood Category	Likelihood Index T (= sum of index numbers)
1	$T \leq -5$
2	$-5 < T \leq -4$
3	$-4 < T$

3.6 Chapter 3 Tables

Table 3.1-9 Failure Frequency Index Numbers

Frequency Index No.	Based On Evidence	Based On Type Of IROFS**	Comments
-6*	External event with freq. < 10 ⁻⁶ /yr		If initiating event, no IROFS needed.
-5*	Initiating event with freq. < 10 ⁻⁵ /yr		For passive safe-by-design components or systems, failure is considered highly unlikely when no potential failure mode (e.g., bulging, corrosion, or leakage) exists, as discussed in Section 3.1.3.2, significant margin exists*** and these components and systems have been placed under configuration management.
-4*	No failures in 30 years for hundreds of similar IROFS in industry	Exceptionally robust passive engineered IROFS (PEC), or an inherently safe process, or two independent active engineered IROFS (AECs), PECs, or enhanced admin. IROFS	Rarely can be justified by evidence. Further, most types of single IROFS have been observed to fail
-3*	No failures in 30 years for tens of similar IROFS in industry	A single IROFS with redundant parts, each a PEC or AEC	
-2*	No failure of this type in this facility in 30 years	A single PEC	
-1*	A few failures may occur during facility lifetime	A single AEC, an enhanced admin. IROFS, an admin. IROFS with large margin, or a redundant admin. IROFS	
0	Failures occur every 1 to 3 years	A single administrative IROFS	
1	Several occurrences per year	Frequent event, inadequate IROFS	Not for IROFS, just initiating events
2	Occurs every week or more often	Very frequent event, inadequate IROFS	Not for IROFS, just initiating events

*Indices less than (more negative than) -1 should not be assigned to IROFS unless the configuration management, auditing, and other management measures are of high quality, because, without these measures, the IROFS may be changed or not maintained.

**The index value assigned to an IROFS of a given type in column 3 may be one value higher or lower than the value given in column 1. Criteria justifying assignment of the lower (more negative) value should be given in the narrative describing ISA methods. Exceptions require individual justification.

***For components that are safe-by-volume, safe-by-diameter, or safe-by-slab thickness, significant margin is defined as a margin of at least 10%, during both normal and upset conditions, between the actual design parameter value of the component and the value of the critical design attribute. For

3.6 Chapter 3 Tables

components that require a more detailed criticality analysis, significant margin is defined as $k_{\text{eff}} < 0.95$, where $k_{\text{eff}} = k_{\text{calc}} + 3\sigma_{\text{calc}}$.

3.6 Chapter 3 Tables

Table 3.1-10 Failure Probability Index Numbers

Probability Index No.	Probability of Failure on Demand	Based on Type of IROFS	Comments
-6*	10^{-6}		If initiating event, no IROFS needed.
-4 or -5*	$10^{-4} - 10^{-5}$	Exceptionally robust passive engineered IROFS (PEC), or an inherently safe process, or two redundant IROFS more robust than simple admin. IROFS (AEC, PEC, or enhanced admin.)	Can rarely be justified by evidence. Most types of single IROFS have been observed to fail
-3 or -4*	$10^{-3} - 10^{-4}$	A single passive engineered IROFS (PEC) or an active engineered IROFS (AEC) with high availability	
-2 or -3*	$10^{-2} - 10^{-3}$	A single active engineered IROFS, or an enhanced admin. IROFS, or an admin. IROFS for routine planned operations	
-1 or -2	$10^{-1} - 10^{-2}$	An admin. IROFS that must be performed in response to a rare unplanned demand	

*Indices less than (more negative than) -1 should not be assigned to IROFS unless the configuration management, auditing, and other management measures are of high quality, because, without these measures, the IROFS may be changed or not maintained.

Table 3.1-11 Failure Duration Index Numbers

Duration Index No.	Avg. Failure Duration	Duration in Years	Comments
1	More than 3 yrs	10	
0	1 yr	1	
-1	1 mo	0.1	Formal monitoring to justify indices less than -1
-2	A few days	0.01	
-3	8 hrs	0.001	
-4	1 hr	10^{-4}	
-5	5 min	10^{-5}	

3.6 Chapter 3 Tables

Table 3.3-1 Cascade System Codes and Standards

The Centrifuge Machine Passive Isolation Devices is designed, constructed, tested, and maintained to QA Level 1.
Rotating equipment is designed in accordance with the appropriate industry codes and standards.
Heat transfer equipment is designed in accordance with the appropriate industry codes and standards.
All miscellaneous equipment is designed in accordance with the appropriate industry codes and standards.
All process piping in the Cascade System shall meet or exceed the requirements of American Society of Mechanical Engineers, Process Piping, ASME B31.3.
The design of electrical systems and components in the Cascade System is in conformance with the requirements of the National Electrical Safety Code, IEEE C2, and New Mexico Electric Code (based on the National Electric Code, NFPA 70), and appropriate industry codes and standards.

Editions of Codes, Standards, NRC Documents, etc are listed in ISAS Table 3.0-1.

Table 3.3-2 Product Take-off System Codes and Standards

The equipment IROFS are designed, constructed, tested, and maintained to QA Level 1.
Rotating equipment is designed in accordance with the appropriate industry codes and standards. There is no QA Level 1 rotating equipment in the Product Take-off System.
Heat transfer equipment is designed in accordance with the appropriate industry codes and standards. There is no QA Level 1 heat transfer equipment in the Product Take-off System.
Material handling equipment is designed in accordance with the appropriate industry codes and standards and the requirements of the Occupational Safety and Health Administration. There is no QA Level 1 material handling equipment in the Product Take-off System.
All miscellaneous equipment is designed in accordance with the appropriate industry codes and standards. There is no QA Level 1 miscellaneous equipment in the Product Take-off System.
All process piping in the Product Take-off System shall meet or exceed the requirements of American Society of Mechanical Engineers, Process Piping, ASME B31.3.
All 30-in cylinders used in the Product Take-off System comply with the requirements of ANSI N14.1, Uranium Hexafluoride Packaging for Transport.

Editions of Codes, Standards, NRC Documents, etc are listed in ISAS Table 3.0-1.

3.6 Chapter 3 Tables

Table 3.3-3 Tails Take-off System Codes and Standards

The equipment IROFS are designed, constructed, tested, and maintained to QA Level 1.
Rotating equipment is designed in accordance with the appropriate industry codes and standards. There is no QA Level 1 rotating equipment in the Tails Take-off System.
Heat transfer equipment is designed in accordance with the appropriate industry codes and standards. There is no QA Level 1 heat transfer equipment in the Tails Take-off System.
Material handling equipment is designed in accordance with the appropriate industry codes and standards and the requirements of the Occupational Safety and Health Administration. There is no QA Level 1 material handling equipment in the Tails Take-off System.
All miscellaneous equipment is designed in accordance with the appropriate industry codes and standards. There is no QA Level 1 miscellaneous equipment in the Tails Take-off System.
All process piping in the Tails Take-off System shall meet or exceed the requirements of American Society of Mechanical Engineers, Process Piping, ASME B31.3.
All 48-in cylinders used in the Tails Take-off System comply with the requirements of ANSI N14.1, Uranium Hexafluoride Packaging for Transport.

Editions of Codes, Standards, NRC Documents, etc are listed in ISAS Table 3.0-1.

Table 3.3-4 Product Blending System Codes and Standards

The equipment IROFS are designed, constructed, tested, and maintained to QA Level 1.
Rotating equipment is designed in accordance with the appropriate industry codes and standards. There is no QA Level 1 rotating equipment in the Product Blending System.
Heat transfer equipment is designed in accordance with the appropriate industry codes and standards. There is no QA Level 1 heat transfer equipment in the Product Blending System.
Material handling equipment is designed in accordance with the appropriate industry codes and standards and the requirements of the Occupational Safety and Health Administration. There is no QA Level 1 material handling equipment in the Product Blending System.
All miscellaneous equipment is designed in accordance with the appropriate industry codes and standards. There is no QA Level 1 miscellaneous equipment in the Product Blending System.
All process piping in the Product Blending System shall meet or exceed the requirements of American Society of Mechanical Engineers, Process Piping, ASME B31.3.
All 30-in cylinders used in the Product Blending System comply with the requirements of ANSI N14.1, Uranium Hexafluoride Packaging for Transport.

Editions of Codes, Standards, NRC Documents, etc are listed in ISAS Table 3.0-1.

3.6 Chapter 3 Tables

Table 3.3-5 Product Liquid Sampling System Codes and Standards

The equipment IROFS are designed, constructed, tested, and maintained to QA Level 1.
Product Liquid Sampling Autoclaves and their supports are designed to meet the requirements of the American Society of Mechanical Engineers (ASME), Boiler and Pressure Vessel Code, Section VIII, Division I.
Rotating equipment is designed in accordance with the appropriate industry codes and standards. There is no QA Level 1 rotating equipment in the Product Liquid Sampling System.
Heat transfer equipment is designed in accordance with the appropriate industry codes and standards. There is no QA Level 1 heat transfer equipment in the Product Liquid Sampling System.
Material handling equipment is designed in accordance with the appropriate industry codes and standards and the requirements of the Occupational Safety and Health Administration. There is no QA Level 1 material handling equipment in the Product Liquid Sampling System.
All miscellaneous equipment is designed in accordance with the appropriate industry codes and standards. There is no QA Level 1 miscellaneous equipment in the Product Liquid Sampling System.
All process piping in the Product Liquid Sampling System shall meet or exceed the requirements of American Society of Mechanical Engineers, Process Piping, ASME B31.3.
All 1.5-in and 30-in cylinders used in the Product Liquid Sampling System comply with the requirements of ANSI N14.1, Uranium Hexafluoride Packaging for Transport.

Editions of Codes, Standards, NRC Documents, etc are listed in ISAS Table 3.0-1.

Table 3.3-6 Contingency Dump System Codes and Standards

The equipment IROFS are designed, constructed, tested, and maintained to QA Level 1.
Rotating equipment is designed in accordance with the appropriate industry codes and standards. There is no QA Level 1 rotating equipment in the Contingency Dump System.
Heat transfer equipment is designed in accordance with the appropriate industry codes and standards. There is no QA Level 1 heat transfer equipment in the Contingency Dump System.
All miscellaneous equipment is designed in accordance with the appropriate industry codes and standards. There is no QA Level 1 miscellaneous equipment in the Contingency Dump System.
All process piping in the Contingency Dump System meets or exceeds the requirements of American Society of Mechanical Engineers, Process Piping, ASME B31.3.

Editions of Codes, Standards, NRC Documents, etc are listed in ISAS Table 3.0-1.

3.6 Chapter 3 Tables

Table 3.3-7 GEVS Codes and Standards

Equipment Type	Code or Standard
Air Handling Units	NFPA 90A AMCA Pub. 99 AMCA Pub. 261 ARI 430 NEMA MG 1
Fans/Motors	AMCA 210 ASHRAE 51 ASHRAE Systems and Equipment NEMA MG1
Coils	ANSI/ARI 410
Air Cleaning Devices	ASME AG-1 ERDA 76-21 ANSI/ASME N509 ANSI/ASME N510 ASTM D6646 (See Note 1) ANSI/AWS-D1-1.1 (for Pumped Extract GEVS) ANSI/AWS-D1.3 (for Pumped Extract GEVS) ANSI/AWS-D9.1 (for CRDB GEVS)
Dampers	

Editions of Codes, Standards, NRC Documents, etc are listed in ISAS Table 3.0-1.

Note 1. Qualification testing, to verify HF removal efficiency, of the impregnated carbon will be performed using ASTM D6646, modified to reflect removal of HF instead of hydrogen sulfide or using an actual in situ test such as described in ETC4044158 (Qualification of Safe by Shape GEVS Filters).

3.6 Chapter 3 Tables

Table 3.3-8 Utility and Support Systems Codes and Standards

ACI 318, Building Code Requirements for Structural Concrete.
ACI 349, Code Requirements for Nuclear Safety Related Concrete Structures.
AICHE, Guidelines for Hazard Evaluation Procedures.
AISC Manual of Steel Construction – Allowable Stress Design
ANSI N14.1, American National Standard for Nuclear Materials - Uranium Hexafluoride Packaging for Transport.
ANSI N15.5, Statistical Terminology and Notation for Nuclear Materials Management.
ASCE 58, Structural Analysis and Design of Nuclear Plant Facilities, Manuals and Reports on Engineering Practice.
ASCE 7, Minimum Design Loads for Building and Other Structures.
ASME B31.3, Process Piping.
ASME, Boiler and Pressure Vessel Code, Section VIII, Division 1.
ASME, NQA-1, Quality Assurance Requirements for Nuclear Facility Applications.
ASTM C761 - Standard Test Methods for Chemical, Mass Spectrometric, Spectrochemical, Nuclear, and Radiochemical Analysis of Uranium Hexafluoride.
ASTM E 814, Fire Tests of Through-Penetration Fire Stops.
ERDA 76-21, Nuclear Air Cleaning Handbook.
IEEE 336, Standard Installation, Inspection, and Testing Requirements for Power, Instrumentation, and Control Equipment at Nuclear Facilities.
IEEE C2, National Electrical Safety Code.
IFC, International Fire Code
ISO 668, Series 1 Freight Containers - Classification, Dimensions and Ratings.
NFPA 1, Fire Prevention Code.
NFPA 10, Portable Fire Extinguishers.
NFPA 12, Carbon Dioxide Systems.
NFPA 13, Installation of Sprinkler Systems.
NFPA 14, Standpipe, Private Hydrant and Hose Systems.
NFPA 15, Water Spray Fixed Systems for Fire Protection.
NFPA 20, Installation of Stationary Pumps.
NFPA 2001, Clean Agent Fire Extinguishing Systems.
NFPA 22, Water Tanks for Private Fire Protection.
NFPA 221, Fire Walls and Fire Barrier Walls.
NFPA 24, Private Fire Service Mains and Their Appurtenances.
NFPA 25, Water Based Fire Protection Systems.
NFPA 30, Flammable and Combustible Liquids Code.

3.6 Chapter 3 Tables

Table 3.3-8 Utility and Support Systems Codes and Standards

NFPA 5000, Building Construction and Safety Code.
NFPA 54, National Fuel Gas Code.
NFPA 55, Compressed & Liquefied Gases in Cylinders.
NFPA 58, Liquefied Petroleum Gas Code.
NFPA 600 Industrial Fire Brigades.
New Mexico Electric Code (based on the National Electric Code, NFPA 70)
NFPA 704, Standard System for the Identification of the Hazards of Materials for Emergency Response.
NFPA 72, National Fire Alarm Code.
NFPA 75, Electronic Computer/Data Processing Systems.
NFPA 780, Lightning Protection Systems.
NFPA 80, Fire Doors and Fire Windows.
NFPA 801, Fire Protection for Facilities Handling Radioactive Materials.
NFPA 80A, Exterior Fire Exposures.
NFPA 90A, Installation of Air Conditioning and Ventilating Systems.
NFPA 90B, Installation of Warm Air Heating and Air Conditioning Systems.
NFPA 91, Exhaust Systems for Air Conveying of Materials.
NFPA, Fire Protection Handbook, Section 9, Chapter 30, Nuclear Facilities.
NFPA 110, Standard for Emergency and Standby Power Systems.
NFPA 111, Standard on Stored Electrical Energy Emergency and Standby Power Systems.
NFPA 70E, Standard for Electrical Safety in the Workplace.
NFPA 79, Electrical Standard for Industrial Machinery.
PCI Design Handbook.
International Building Code (as amended by the NMCBC).
Uniform Mechanical Code (as amended by the New Mexico Mechanical Code).
Uniform Plumbing Code (as amended by the New Mexico Plumbing Code).

Editions of Codes, Standards, NRC Documents, etc are listed in Table 3.0-1.

3.6 Chapter 3 Tables

Table 3.4-1 Administrative Control IROFS Support Equipment						
IROFS	Monitoring Support Equipment	Other Equipment	Equipment Attributes	Operated Support Equipment	Other Equipment	Equipment Attributes
IROFS14a	None	Two independent instruments for determining gross ^{235}U content	Accurate and reliable indication	None	None	None
IROFS14b	None	Two independent instruments for determining gross ^{235}U content	Accurate and reliable indication	None	None	None
IROFS16a	None	Instrument for viewing cylinder internal	None	None	None	None
	None *(Note 1)	M&TE Instrument *(Note 1)	Accurate and reliable indication	None	None	None
	Pressure instrument *(Note 2)	None	Accurate and reliable indication	None	None	None
IROFS30a	None	None	None	None	None	None
IROFS30b	None	Oil analyzer	Accurate and reliable indication	None	None	None
IROFS30c	None	Oil analyzer	Accurate and reliable indication	None	None	None
IROFS31a	None	Instrument for determining gross ^{235}U content, independent of IROFS31b	Accurate and reliable indication	None	None	None
IROFS31b	None	Instrument for determining gross ^{235}U content, independent of IROFS31a	Accurate and reliable indication	None	None	None

3.6 Chapter 3 Tables

IROFS	Monitoring Support Equipment	Other Equipment	Equipment Attributes	Operated Support Equipment	Other Equipment	Equipment Attributes
IROFS31c	None	None	None	None	None	None
IROFS36c	None	Fuel Tank	Fuel Tank Volume	None	None	None
IROFS36e	None	Fuel Tank	Fuel Tank Volume	None	None	None
	None	UBC Storage Pad Slope	Slope of the Pad to prevent excess pooling	None	None	None
IROFS36f	None	None	None	None	None	None
IROFS36g	None	None	None	None	Landscape Equipment	None
IROFS38	Weighing Scale System including local digital readout from weighing system at the cylinder stations *(Notes 2 and 3)	None	Accurate and reliable indication	Select independent isolation valves *(Note2)	None	Valve closure
IROFS39a	None	None	None	None	None	None
IROFS39b	None	None	None	None	None	None
IROFS39c	None	None	None	None	None	None
IROFS39d	None	None	None	None	None	None
IROFS42	Product Station Weighing Scale System including local digital readout from weighing system at the product stations *(Notes 2 and 3)	None	Accurate and reliable indication	None	None	None
IROFS50a	None	None	None	None	Barriers	Visible and

3.6 Chapter 3 Tables

Table 3.4-1 Administrative Control IROFS Support Equipment						
IROFS	Monitoring Support Equipment	Other Equipment	Equipment Attributes	Operated Support Equipment	Other Equipment	Equipment Attributes
						substantial
IROFS50b	None	None	None	None	Barriers	Visible and substantial
IROFS50c	None	None	None	None	Barriers	Visible and substantial
IROFS50d	None	None	None	None	Barriers	Visible
IROFS50e	None	None	None	None	None	None
IROFS50f	None	None	None	None	Barriers	Visible and substantial
IROFS50g	None	None	None	None	Barriers	Visible
IROFS50h	None	None	None	None	Barriers	Visible and substantial
IROFSC22	1) Weigh Scale System including local digital readout from weighing system at cylinder station *(Notes 2 and 3)	None	1) Accurate and reliable indication	Select independent isolation valves *(Note 2)	None	Valve closure
	2) vent system cold trap load cells *(Notes 2 and 3)		2) Accurate and reliable indication			
<p>*(Note 1) M&TE will be used for Initial Plant Operations until the in-line process instrumentation is installed. The M&TE is QA Level 3 equipment calibrated in accordance with the Maintenance Management Measure. The permanently installed pressure instrument will meet the requirements for QA Level 2AC.</p> <p>*(Note 2) Support Equipment meets the requirements for QA Level 2AC.</p> <p>*(Note 3) An exception to License Condition 20 has been approved by the NRC for this equipment.</p>						

4.0 Radiation Protection

4.0 Radiation Protection

This chapter describes the facility Radiation Protection Program. The Radiation Protection Program protects the radiological health and safety of workers and complies with the regulatory requirements in 10 CFR 19 (CFR, 2003a), 20 (CFR, 2003b) and 70 (CFR, 2003c).

The information provided in this chapter, the corresponding regulatory requirement and the NRC acceptance criteria from NUREG-1520, Chapter 4 is summarized in the table below. Information beyond that required by the Standard Review Plan is included.

Information Category and Requirement	10 CFR Citation	NUREG-1520 Chapter 4 Reference
Section 4.1 Commitment to Radiation Protection Program Implementation	10 CFR 20.1101, Subpart B	4.4.1.3
Section 4.2 Commitment to an ALARA Program	10 CFR 20.1101	4.4.2.3
Section 4.3 Organization and Personnel Qualifications	10 CFR 70.22	4.4.3.3
Section 4.4 Commitment to Written Procedures	10 CFR 70.22(a)(8)	4.4.4.3
Section 4.5 Training Commitments	10 CFR 19.12 & 10 CFR 20.2110	4.4.5.3
Section 4.6 Ventilation and Respiratory Protection Programs Commitments	10 CFR 20, Subpart H	4.4.6.3
Section 4.7 Radiation Surveys and Monitoring Programs Commitments	10 CFR 20, Subparts F, C, L, M	4.4.7.3
Section 4.8 Contamination and Radiation Control	N/A	N/A
Section 4.9 Maintenance Areas - Methods and Procedures for Contamination Control	N/A	N/A
Section 4.10 Decontamination Policy and Provisions	N/A	N/A
Section 4.11 Additional Program Commitments	N/A	4.4.8.3

4.1 Commitment to Radiation Protection Program Implementation

4.1 Commitment to Radiation Protection Program Implementation

The radiation program meets the requirements of 10 CFR 20 (CFR, 2003b), Subpart B, Radiation Protection Programs, and is consistent with the guidance provided in Regulatory Guide 8.2, Guide for Administrative Practice in Radiation Monitoring. The facility develops, documents and implements its Radiation Protection Program commensurate with the risks posed by a uranium enrichment operation. The facility uses, to the extent practicable, procedures and engineering controls based upon sound radiation protection principles to achieve occupational doses and doses to members of the public that are as low as reasonably achievable (ALARA). The radiation program content and implementation are reviewed at least annually as required by 10 CFR 20.1101(c) (CFR, 2003d). In addition, in accordance with 10 CFR 20.1101(d) (CFR, 2003d) constraints on atmospheric releases are established for the NEF such that no member of the public would be expected to receive a total effective dose equivalent in excess of 0.1 mSv/yr (10 mrem/yr) from these releases. Additional information regarding compliance with 10 CFR 20.1101(d) is provided in Section 9.2.

Protection of plant personnel requires (a) surveillance of and control over the radiation exposure of personnel; and (b) maintaining the exposure of all personnel not only within permissible limits, but "as low as is reasonably achievable," in compliance with applicable regulations and license conditions. The objectives of Radiation Protection are to prevent acute radiation injuries (nonstochastic or deterministic effects) and to limit the potential risks of probabilistic (stochastic) effects (which may result from chronic occupational exposure) to an acceptable level.

The facility's philosophy for radiation protection is reflected in the establishment of a Radiation Protection Program that has the specific purpose of maintaining occupational radiation exposures ALARA. The program includes written procedures, periodic assessments of work practices and internal/external doses received, work plans and the personnel and equipment required to ensure implementation of ALARA goal.

The facility's administrative personnel exposure limits are set below the limits specified in 10 CFR 20 (CFR, 2003b) to provide assurance that legal radiation exposure limits are not exceeded and that the ALARA principle is emphasized. The facility administrative exposure limits are given in Table 4.1-1, Administrative Radiation Exposure Limits. Estimates of the facility area radiation dose rates and individual personnel exposures, during normal operations, are shown in Table 4.1-2, Estimated Dose Rates and Table 4.1-3, Estimated Individual Exposures. These estimates are based upon the operating experience of similar Urenco facilities in Europe.

The annual dose equivalent accrued by a typical radiation worker at a uranium enrichment plant is low. At the Urenco Capenhurst plant, the maximum annual worker dose equivalent was 3.1 mSv (310 mrem), 2.2 mSv (220 mrem), 2.8 mSv (280 mrem), 2.7 mSv (270 mrem) and 2.3 mSv (230 mrem) during the years 1998 through 2002, respectively. For each of these same years, the average annual worker dose equivalent was approximately 0.2 mSv (20 mrem) (Urenco, 2000; Urenco, 2001; Urenco, 2002).

The radiation exposure policy and control measures for personnel are set up in accordance with requirements of 10 CFR 20 (CFR, 2003b) and the guidance of applicable Regulatory Guides. Recommendations from the International Commission on Radiological Protection (ICRP) and the National Council on Radiation Protection and Measurements (NCRP) may also be used in the formulation and evolution of the facility Radiation Protection Program.

4.1 Commitment to Radiation Protection Program Implementation

The facility corrective action process is implemented if (1) personnel dose monitoring results exceed the administrative personnel limits; or if an incident results in airborne occupational exposures exceeding the administrative limits or (2) the dose limits in 10 CFR 20 (CFR, 2003b), Appendix B or 10 CFR 70.61 (CFR, 2003e) are exceeded.

The information developed from the corrective action process is used to improve radiation protection practices and to preclude the recurrence of similar incidents. If an incident as described in item two above occurs, the NRC is informed of the corrective action taken or planned to prevent recurrence and the schedule established by the facility to achieve full compliance. The corrective action process and incident investigation process are described in Section 11.6, Incident Investigations and Corrective Action Process.

4.1.1 Responsibilities of Key Program Personnel

This section describes the Radiation Protection Program's organizational structure and the responsibilities of key personnel are discussed. These personnel play an important role in the protection of workers, the environment and implementation of the ALARA program. Chapter 2, Organization and Administration, discusses the facility organization and administration in further detail. Section 2.2, Key Management Positions of Chapter 2, presents a detailed discussion of the responsibilities of key management personnel.

4.1.1.1 Plant Manager

The Plant Manager is responsible for all aspects of facility operation, including the protection of all persons against radiation exposure resulting from facility operations and materials, and for compliance with applicable NRC regulations and the facility license.

4.1.1.2 Chemistry Services Manager

The Chemistry Services Manager reports to the Operations Director and has the responsibility for directing the activities that ensure the facility maintains compliance with appropriate rules, regulations, and codes. The compliance responsibilities are activities associated with nuclear safety and monitoring radioactive effluents.

4.1.1.3 Environmental Compliance Officer

The Environmental Compliance Officer reports to the Health, Safety, and Environmental Manager and has the responsibility for coordination facility activities to ensure all local, state and federal environmental regulations are met.

4.1.1.4 Radiation Protection Manager

The Radiation Protection Manager reports to the Plant Support Director and is responsible for implementing the Radiation Protection Program. In matters involving radiological protection, the Radiation Protection Manager has direct access to the Plant Manager.

The Radiation Protection Manager is responsible for:

- Establishing the Radiation Protection Program
- Generating and maintaining procedures associated with the program

4.1 Commitment to Radiation Protection Program Implementation

- Reviewing and auditing the efficacy of the program in complying with NRC and other governmental regulations and applicable Regulatory Guides
- Modifying the program based upon experience and facility history
- Adequately staffing the Radiation Protection group to implement the Radiation Protection Program
- Establishing and maintaining an ALARA program and assuring it is practiced by all personnel
- Establishing and maintaining a respirator usage program
- Monitoring worker doses, both internal and external
- Complying with the radioactive materials possession limits for the facility as related to calibration and performance check sources
- Supports the Recycling Manager in the handling of radioactive wastes for disposal
- Calibration and quality assurance of all radiological instrumentation, including verification of required Lower Limits of Detection or alarm levels
- Establishing and maintaining a radiation safety training program for personnel working in Restricted Areas and any Radiologically Controlled Area (RCA)
- Performing audits of the Radiation Protection Program on an annual basis
- Posting in any RCA, and within these areas, posting: Radiation, Airborne Radioactivity, High Radiation and Contaminated Areas as appropriate; and developing occupancy guidelines for these areas as needed.

4.1.1.5 Shift Operations Manager

The Shift Operations Manager is responsible for operating the facility safely and in accordance with procedures so that any effluents released to the environment and all exposures to the public and facility personnel are within the limits specified in applicable regulations, procedures and guidance documents.

4.1.1.6 Facility Personnel

Facility personnel are required to work safely and to follow the rules, regulations and procedures that have been established for their protection and the protection of the public. Personnel whose duties require (1) working with radioactive material, (2) entering radiation areas, (3) controlling facility operations that could affect effluent releases, or (4) directing the activities of others, are trained such that they understand and effectively carry out their responsibilities.

4.1.2 Staffing of the Radiation Protection Program

Only suitably trained radiation protection personnel are employed at the facility. Members of the Radiation Protection Program staff are trained and qualified consistent with the guidance provided in American National Standards Institute (ANSI) standard 3.1, Selection, Qualification and Training of Personnel for Nuclear Power Plants.

Radiation Protection Program resources in terms of staffing and equipment are provided to implement an effective Radiation Protection Program and response to emergencies in accordance with the Emergency Plan. Staffing of the Radiation Protection Program consists of the Radiation Protection Manager and Radiation Protection Program staff members who are

4.1 Commitment to Radiation Protection Program Implementation

radiation protection technician qualified. In addition, there are task qualified personnel outside of the Radiation Protection Department to handle routine radiation protection functions as necessary, and to provide additional response capability in an emergency. The radiation protection technician staffing level is reassessed as the workload and plant expands.

4.1.3 Independence of the Radiation Protection Program

The Radiation Protection Program is independent of the facility's routine operations. This independence ensures that the Radiation Protection Program maintains its objectivity and is focused only on implementing sound radiation protection principles necessary to achieve occupational doses and doses to members of the public that are ALARA. As previously noted in Section 4.1.1.3, Radiation Protection Manager, that in matters involving radiological protection, the Radiation Protection Manager has direct access to the Plant Manager.

4.1.4 Radiation Safety Committee

The Radiation Safety Committee meets periodically to review, in accordance with 10 CFR 20.1101(c) (CFR, 2003d), the status of projects, measure performance, look for trends and to review radiation safety aspects of facility operations. The Radiation Protection Manager chairs the Radiation Safety Committee. Radiation Safety Committee members are from quality assurance, operations, maintenance, and technical support, as deemed appropriate by the Plant Manager.

The objectives of the Radiation Safety Committee are to maintain a high standard of radiation protection in all facility operations. The Radiation Safety Committee reviews the content and implementation of the Radiation Protection Program at a working level and strives to improve the program by reviewing exposure trends, the results of audits, regulatory inspections, worker suggestions, survey results, exposure incidents, etc.

The maximum interval between meetings may not exceed 180 days. A written report of each Radiation Safety Committee meeting is forwarded to all Managers.

4.2 Commitment to an ALARA Program

4.2 Commitment to an ALARA Program

Section 4.1, Commitment to Radiation Protection Program Implementation, above states the facility's commitment to the implementation of an ALARA program. The objective of the program is to make every reasonable effort to maintain facility exposures to radiation as far below the dose limits of 10 CFR 20.1201 (CFR, 2003f) as is practical and to maintain radiation exposures to members of the public such that they are not expected to receive the dose limits of 10 CFR 20.1101(d) (CFR, 2003d). The design and implementation of the ALARA program is consistent with the guidance provided in Regulatory Guides 8.2, 8.13, 8.29, and 8.37. The operation of the facility is consistent with the guidance provided in Regulatory Guide 8.10.

Annual doses to individual personnel are maintained ALARA. In addition, the annual collective dose to personnel (i.e., the sum of all annual individual doses, expressed in person-Sv or person-rem) is maintained ALARA. The dose equivalent to the embryo/fetus is maintained below the limits of 10 CFR 20.1208 (CFR, 2003g).

The Radiation Protection Program is written and implemented to ensure that it is comprehensive and effective. The written program documents policies that are implemented to ensure the ALARA goal is met. Facility procedures are written so that they incorporate the ALARA philosophy into the routine operations of the facility and ensure that exposures are consistent with 10 CFR 20.1101 (CFR, 2003d) limits. As discussed in Section 4.7, Radiation Surveys and Monitoring Programs Commitments, RCAs or Restricted Areas designated as RCAs are established within the facility to support the ALARA commitment by minimizing the spread of contamination and reduce unnecessary exposure of personnel to radiation.

Specific goals of the ALARA program include maintaining occupational exposures as well as environmental releases as far below regulatory limits as is reasonably achievable. The ALARA concept is also incorporated into the design of the facility by providing adequate space for ease of maintenance in areas with higher dose rates, reducing the length of time required to complete the task, thereby reducing the time of exposure. Areas where facility personnel spend significant amounts of time are designed to maintain the lowest dose rates reasonably achievable.

The Radiation Protection Manager is responsible for implementing the ALARA program and ensuring that adequate resources are committed to make the program effective. The Radiation Protection Manager prepares an annual ALARA program evaluation report. The report reviews (1) radiological exposure and effluent release data for trends, (2) audits and inspections, (3) use, maintenance and surveillance of equipment used for exposure and effluent control, and (4) other issues, as appropriate, that may influence the effectiveness of the radiation protection/ALARA programs. Copies of the report are submitted to the Plant Manager, Radiation Safety Committee, and the Safety Review Committee.

4.2.1 ALARA Committee

The Safety Review Committee (SRC) fulfills the duties of the ALARA Committee and meets at least quarterly. Additional details concerning the membership and qualifications of the SRC are provided in Chapter 2, Organization and Administration.

4.2 Commitment to an ALARA Program

Programs for improving the effectiveness of equipment used for effluent and exposure control are evaluated by the SRC and recommendations are documented in writing. The implementation of the committee's recommendations is tracked to completion via the Corrective Action Program, which is described in Section 11.6, Incident Investigations and Correction Action Process.

The SRC also reviews the effectiveness of the ALARA program and determines if exposures, releases and contamination levels are in accordance with the ALARA concept. It also evaluates the results of assessments made by the radiation protection organization, reports of facility radiation levels, contamination levels, and employee exposures for identified categories of workers and types of operations. The committee is responsible for ensuring that the occupational radiation exposure dose limits of 10 CFR 20 (CFR, 2003b) are not exceeded under normal operations. The committee determines if there are any upward trends in personnel exposures, environmental releases and facility contamination levels.

The ALARA program facilitates interaction between radiation protection and operations personnel by being comprised staff members from those organizations. The SRC periodically reviews the goals and objectives of the ALARA program and incorporates, as appropriate, new technologies or approaches and operating procedures or changes that could cost-effectively reduce potential radiation exposures.

4.3 Organization and Personnel Qualifications

4.3 Organization and Personnel Qualifications

The regulation 10 CFR 70.22 (CFR, 2003h) requires that the technical qualifications, including training and experience of facility staff be provided in the license application. This information is provided in this section.

The Radiation Protection Program staff is assigned responsibility for implementation of the Radiation Protection Program functions. Only suitably trained radiation protection personnel are employed at the facility. Staffing is consistent with the guidance provided in Regulatory Guides 8.2 and 8.10.

The Radiation Protection Manager's qualification requirements are described in Section 2.2.4. As stated in Section 4.1.2, Staffing of the Radiation Protection Program, other members of the Radiation Protection Program staff are trained and qualified consistent with the guidance provided in American National Standards Institute (ANSI) standard 3.1, Selection, Qualification and Training of Personnel for Nuclear Power Plants.

The Radiation Protection Manager reports to the Plant Support Director and has the responsibility for establishing and implementing the Radiation Protection Program. Duties include training of personnel in use of equipment, control of radiation exposure of personnel, continuous determination and evaluation of the radiological status of the facility. The radiological environmental monitoring program is a function of the Environmental Compliance Officer. The facility organization chart establishes clear organizational relationships among the radiation protection staff and the other facility line managers. The facility operating organization is described in Chapter 2, Organization and Administration.

In all matters involving radiological protection, the Radiation Protection Manager has direct access to the Plant Manager. The Radiation Protection Manager is skilled in the interpretation of radiation protection data and regulations. The Radiation Protection Manager is also familiar with the operation of the facility and radiation protection concerns relevant to the facility. The Radiation Protection Manager is a resource for radiation safety management decisions.

4.4 Commitment to Written Procedures

4.4 Commitment to Written Procedures

All operations at LES involving licensed materials are conducted through the use of procedures as required by 10 CFR 70.22(8) (CFR, 2003h). Radiation protection procedures are prepared, reviewed and approved to carry out activities related to the radiation protection program. Procedures are used to control radiation protection activities to ensure that the activities are carried out in a safe, effective and consistent manner. Radiation protection procedures are reviewed and revised as necessary, to incorporate any facility or operational changes or changes in the License Basis Documents.

The radiation protection procedures are assigned to qualified personnel. Initial procedure drafts are reviewed by members of the facility staff and other personnel with enrichment plant operating experience. The Radiation Protection Manager (or a designee who has the qualifications of the Radiation Protection Manager) reviews and approves procedures as well as proposed revisions to procedures.

4.4.1 Radiation Work Permits

All work performed in a Radiologically Controlled Area (RCA) is performed in accordance with a Radiation Work Permit (RWP). The RWP provides a description of the activities and summarizes the results of recent dose rate surveys, contamination surveys, airborne radioactivity results, etc. The RWP specifies the precautions to be taken by those performing the task. The RWP requires approval by the Radiation Protection Manager or designee. The designee must meet the requirements of Section 4.1.2, Staffing of the Radiation Protection Program. RWPs have a predetermined period of validity with a specified expiration or termination time.

RWPs are issued for routinely performed activities for extended durations in areas where radiological conditions are well characterized and not expected to change, such as tours of the plant by shift personnel or the changing of cylinders. A new RWP is not issued for routine activities where radiological conditions are not expected to change.

Listed below are requirements of the RWP procedures.

- The Radiation Protection Manager or designee is responsible for determining the need for, issuing and closing out RWPs
- Planned activities or changes to activities inside RCAs or work with licensed materials are reviewed by the Radiation Protection Manager or designee for the potential to cause radiation exposures to exceed action levels or to produce radioactive contamination
- RWPs include requirements for any necessary radiological safety controls, personnel monitoring devices, protective clothing, respiratory protective equipment, air sampling equipment and the attendance of radiation protection technicians at the work location
- RWPs clearly define and limit the work activities to which they apply. A RWP is closed out when the applicable work activity for which it was written is completed and terminated
- RWPs are retained as a record until termination of the license requiring the record in compliance with 10 CFR 20.2103 (CFR, 2003v).

4.5 Training Commitments

4.5 Training Commitments

The design and implementation of the radiation protection training program complies with the requirements of 10 CFR 19.12 (CFR, 2003i). Records are maintained in accordance with 10 CFR 20.2110 (CFR, 2003j).

The development and implementation of the radiation protection training program is consistent with the training development guidance provided in the following regulatory guidance documents:

- Regulatory Guide 8.10-Operating Philosophy for Maintaining Occupational Radiation Exposures As Low As Is Reasonably Achievable
- Regulatory Guide 8.13-Instructions Concerning Prenatal Radiation Exposure
- Regulatory Guide 8.29-Instructions Concerning Risks From Occupational Radiation Exposure
- ASTM E1168-Radiological Protection Training for Nuclear Facility Workers.

Personnel entering the Radiologically Controlled Areas (RCAs) receive training that is commensurate with the radiological hazard to which they may be exposed.

The level of radiation protection training is based on the potential radiological health risks associated with an employee's work responsibilities. In accordance with provisions of 10 CFR 19.12 (CFR, 2003i) any individual working at the facility that is likely to receive in a year a dose in excess of 1 mSv (100 mrem) is:

- A. Kept informed of the storage, transfer, or use of radioactive material
- B. Instructed in the health protection problems associated with exposure to radiation and radioactive material, in precautions or procedures to minimize exposure, and in the purposes and functions of protective devices employed
- C. Required to observe, to the extent within the worker's control, the applicable provisions of the NRC regulations and licenses for the protection of personnel from exposure to radiation and radioactive material
- D. Instructed of their responsibility to report promptly to the facility management, any condition which may cause a violation of NRC regulations and licenses or unnecessary exposure to radiation and radioactive material
- E. Instructed in the appropriate response to warnings made in the event of any unusual occurrence or malfunction that may involve exposure to radiation and radioactive material
- F. Advised of the various notifications and reports to individuals that a worker may request in accordance with 10 CFR 19.13 (CFR, 2003k).

The radiation protection training program takes into consideration a worker's normally assigned work activities. Abnormal situations involving exposure to radiation and radioactive material, which can reasonably be expected to occur during the life of the facility, are also evaluated and factored into the training. The extent of these instructions is commensurate with the potential radiological health protection problems present in the work place.

4.5 Training Commitments

Continuing Training of personnel with RCA access is performed for radiological, chemical, industrial, and criticality safety at least annually. The continuing training program also provides information on position specific/related procedure changes as appropriate and updating and changes in required skills. Changes to training are implemented, as necessary due to any incidents potentially compromising safety or if changes are made to the facility or processes. Training Records are maintained in accordance with LES records management system. Training programs are established in accordance with Section 11.3, Training and Qualifications. The radiation protection training program is evaluated at least annually to ensure it remains current and adequate to assure worker safety.

The specifics of the Radiation Protection Training are described in the following section.

4.5.1 Radiation Protection Training

Radiation protection training emphasizes the high level of importance placed on the radiological safety of plant personnel and the public. Task specific training is provided for the various types of job functions (e.g., operator, maintenance radiation protection technician, contractor personnel) commensurate with the radiation safety responsibilities associated with each position. Visitors are escorted by trained personnel while in an RCA. Visitors to the RCA receive a radiological briefing commensurate with their entry in accordance with 10 CFR 19.12.

Personnel access procedures ensure the completion of nuclear safety worker training prior to permitting unescorted access into an RCA. Training sessions covering criticality safety, radiation protection and emergency procedures are conducted on a regular basis to accommodate new employees or those requiring continuing training. Continuing training is conducted when necessary to address changes in policies, procedures, requirements and the ISA.

Specific topics covered in the training program are listed in Chapter 11, Management Measures, Section 11.3.3.1.1. The training provided includes the requirements of 10 CFR 19 (CFR, 2003a).

Individuals attending these sessions must pass an initial examination covering the training contents to assure the understanding of the training. The effectiveness of the training programs is evaluated by audits and assessments

I Records are maintained for each employee documenting the training date, scope of the training, identity of the trainer(s), any test results and other associated information by the Training staff.

Content of the radiation protection program is reviewed and updated through curriculum meetings at least every two years by the Radiation Protection Manager to ensure that the programs are current and adequate.

4.6 Ventilation and Respiratory Protection Programs Commitments

4.6 Ventilation and Respiratory Protection Programs Commitments

The regulations contained in 10 CFR 20 (CFR, 2003b), Subpart H, define the required elements of the facility respiratory protection and ventilation programs. This section describes the design and management measures taken to ensure that the installed ventilation and containment systems operate effectively. This section also describes the worker respiratory protection program.

The design of the ventilation and respiratory protection programs is consistent with the guidance contained in the following documents:

- Regulatory Guide 8.24-Health Physics Surveys During Enriched Uranium-235 Processing and Fuel Fabrication
- ANSI N510-Testing of Nuclear Air Cleaning Systems
- ERDA 76-21-Nuclear Air Cleaning Handbook
- NCRP Report No. 127-Operational Radiation Safety Program
- Regulatory Guide 8.15-Acceptable Programs for Respiratory Protection

4.6.1 Ventilation Program

The confinement of uranium and the attenuation of its associated radiation are a design requirement for the facility. The internal radiation exposure of workers is controlled primarily by the containment of UF_6 within process equipment. The entire UF_6 enrichment process, except for liquid sampling, is operated under a partial vacuum so that leaks are into the system and not into work areas.

Building ventilation systems control the temperature and the humidity of the air inside the building. Note: Not all buildings will have humidity control. Ventilation systems serving potentially contaminated areas include design features that provide for confinement of radiological contamination and exhaust 100% of the air handled to the environment through the exhaust stacks. The ventilation systems for potentially contaminated areas are designed to maintain the potentially contaminated areas at a slightly negative pressure relative to the uncontaminated areas. This ensures that the airflow direction is from areas of little or no contamination to areas of higher contamination.

Process vents from the SBMs are collected by the Pumped Extract GEVS. Process vents in the CRDB (including fume hoods) are collected by the CRDB GEVS and by the Confinement Ventilation function of HVAC system. Air released from the Centrifuge Test Facility and the Centrifuge Post Mortem Facilities is filtered by the Centrifuge Test and Post Mortem Facilities Exhaust Filtration System prior to release. The systems operate slightly below atmospheric pressure to remove potentially hazardous vapors and particulate from confined areas of the plant. The systems contain particulate and carbon adsorption filters to remove radioactive materials from the gas stream prior to release from the plant. GEVS have continuous HF monitors upstream and downstream of the filters and in the exhaust stack with high level alarms to inform operators of UF_6 releases in the plant. In the Centrifuge Test and Post Mortem Facility exhaust filtration system, a continuous HF monitor is provided in the exhaust stack.

Normal operation of the facility will not result in a release of radioactive material that exceeds regulatory limits. Ventilation systems for areas that do not have the potential for contamination

4.6 Ventilation and Respiratory Protection Programs Commitments

are not monitored for radioactivity since radioactive material is not handled or processed in these areas. No emergency ventilation systems are provided for operation when the normal ventilation systems are shut down.

Several measures ensure effective operation of the ventilation systems. Differential pressure across High Efficiency Particulate Air (HEPA) filters in potentially contaminated ventilation exhaust systems is monitored monthly or automatically monitored and alarmed. Operating procedures specify limits and set points on the differential pressure consistent with manufacturers' recommendations. Filters are changed if they fail to function properly or if the differential pressure exceeds the manufacturers' ratings.

Filter inspection, testing, maintenance and change out criteria are specified in written procedures. Change-out frequency is based on considerations of filter loading, operating experience, differential pressure data and any UF₆ releases indicated by HF alarms.

Air flow rates at exhausted enclosures and close-capture points, when in use, are adequate to preclude escape of airborne uranium and minimize the potential for intake by workers. Air flow rates are checked monthly when in use and after modification of any hood, exhausted enclosure, close-capture point equipment or ventilation system serving these barriers.

The various programs that pertain to preventive and corrective maintenance are described in Chapter 11, Sections 11.2.2, Corrective Maintenance and 11.2.3, Preventive Maintenance respectively.

4.6.2 Respiratory Protection Program

The facility uses process and engineering controls to control the concentration of radioactive material in air. However, there may be instances when it is not practical to apply process or other engineering controls. When it is not practical to control the concentrations of radioactive material in the air to values below those that define an airborne radioactivity area, other means are implemented to maintain the total effective dose equivalent ALARA. In these cases, the ALARA goal is met by an increase in monitoring and the limitation of intakes by one or more of the following means:

- A. Control of access
- B. Limitation of exposure times
- C. Use of respiratory protection equipment
- D. Other controls, as available and appropriate.

If an ALARA analysis is performed to determine whether or not respirators should be used, safety factors other than radiological factors may be considered. The impact of respirator use on workers' industrial health and safety is factored into decisions to use respirators.

When respiratory protection equipment is used to limit the intake of radioactive material, only National Institute of Occupational Safety and Health (NIOSH) certified equipment is used. The respiratory protection program meets the requirements of 10 CFR 20 (CFR, 2003b), Subpart H (Respiratory Protection and Controls to Restrict Internal Exposure in Restricted Areas).

The respiratory protection program includes the following elements:

4.6 Ventilation and Respiratory Protection Programs Commitments

- A. Air sampling to identify the potential hazard, select proper equipment and estimate doses
- B. Surveys and, when necessary, bioassays to evaluate actual intakes
- C. Performance testing of respirators for operability (user seal check for face sealing devices and functional check for others) immediately prior to each use.
- D. Written procedures for the following:
 - 1. Monitoring, including air sampling and bioassays
 - 2. Supervision and training of respirator users
 - 3. Fit testing
 - 4. Respirator selection
 - 5. Breathing air quality
 - 6. Inventory and control
 - 7. Storage, issuance, maintenance, repair, testing, and quality assurance of respiratory protection equipment
 - 8. Record keeping
 - 9. Limitations on periods of respirator use and relief from respirator use.
- E. Determination by a physician, or designee working under the physician's license, that the individual user is medically fit to use respiratory protection equipment:
 - 1. Before the initial fitting of a face sealing respirator
 - 2. Before the first field use of non-face sealing respirators
 - 3. Either every 12 months thereafter, or periodically at a frequency determined by a physician.
- F. A respirator fit test requires a minimum fit factor of at least 10 times the Assigned Protection Factor (APF) for negative pressure devices, and a fit factor of at least 500 for any positive pressure, continuous flow, and pressure-demand devices. The fit testing is performed before the first field use of tight fitting, face-sealing respirators. Subsequent testing is performed at least annually thereafter. Fit testing must be performed with the facepiece operating in the negative pressure mode.
 - 1. Each user is informed that they may leave the area at any time for relief from respirator use in the event of equipment malfunction, physical or psychological distress, procedural or communication failure, significant deterioration of operating conditions, or any other conditions that might require such relief.
 - 2. In the selection and use of respirators, the facility provides for vision correction, adequate communication, low temperature work environments, and the concurrent use of other safety or radiological protection equipment. Radiological protection equipment is used in such a way as not to interfere with the proper operation of the respirator.
 - 3. Standby rescue persons are used whenever one-piece atmosphere-supplying suits are in use. Standby rescue personnel are also used when any combination of supplied air respiratory protection device and personnel protective equipment is in use that presents difficulty for the wearer to remove the equipment. The standby personnel are equipped with respiratory protection devices or other apparatus appropriate for the potential hazards. The standby rescue personnel observe and maintain continuous communication with the workers (visual, voice, signal line, telephone, radio, or other suitable means). The rescue personnel are

4.6 Ventilation and Respiratory Protection Programs Commitments

immediately available to assist the workers in case of a failure of the air supply or for any other emergency. The Radiation Protection Manager, in consultation with the Industrial Safety Officer, specifies the number of standby rescue personnel that must be immediately available to assist all users of this type of equipment and to provide effective emergency rescue if needed.

4. If atmosphere-supplying respirators are used, they must be supplied with respirable air of grade D quality or better as defined by the Compressed Gas Association in publication G-7.1, Commodity Specification for Air and included in the regulations of the Occupational Safety and Health Administration (29 CFR 1910.134(i)(1)(ii)(A) through (E) (CFR, 2003)).
5. No objects, materials or substances (such as facial hair), or any conditions that interfere with the face-to-facepiece seal or valve function, and that are under the control of the respirator wearer, are allowed between the skin of the wearer's face and the sealing surface of a tight-fitting respirator facepiece.

The dose to individuals from the intake of airborne radioactive material is estimated by dividing the ambient air concentration outside the respirator by the assigned protection factor. If the actual dose is later found to be greater than that estimated initially, the corrected value is used. If the dose is later found to be less than the estimated dose, the lower corrected value may be used.

Records of the respiratory protection program (including training for respirator use and maintenance) are maintained in accordance with the facility records management program as described in Section 11.7, Records Management. Respiratory protection procedures are revised as necessary whenever changes are made to the facility, processing or equipment.

4.7 Radiation Surveys and Monitoring Programs Commitments

4.7 Radiation Surveys and Monitoring Programs Commitments

Radiation surveys are conducted for two purposes: (1) to ascertain radiation levels, concentrations of radioactive materials, and potential radiological hazards that could be present in the facility; and (2) to detect releases of radioactive material from facility equipment and operations. Radiation surveys focus on those areas of the facility identified in the ISA where the occupational radiation dose limits could potentially be exceeded. Measurements of airborne radioactive material and/or bioassays are used to determine that internal occupational exposures to radiation do not exceed the dose limits specified in 10 CFR 20 (CFR, 2003b), Subpart C.

Written procedures for the radiation survey and monitoring programs assure compliance with the requirements of 10 CFR 20 (CFR, 2003b) Subpart F (Surveys and Monitoring), Subpart C (Occupational Dose Limits), Subpart L (Records) and Subpart M (Reports).

The radiation survey and monitoring programs are consistent with the guidance provided in the following references:

- Regulatory Guide 8.2-Guide for Administrative Practice in Radiation Monitoring
- Regulatory Guide 8.13-Instructions Concerning Prenatal Radiation Exposure
- Regulatory Guide 8.28-Audible Alarm Dosimeters
- Regulatory Guide 8.36-Radiation Protection to the Embryo/Fetus
- Regulatory Guide 8.4-Direct-Reading and Indirect-Reading Pocket Dosimeters
- Regulatory Guide 8.7- Instructions for Recording and Reporting Occupational Radiation Exposure Data
- Regulatory Guide 8.9-Acceptable Concepts, Models, Equations, and Assumptions for a Bioassay Program
- Regulatory Guide 8.24-Health Physics Surveys During Enriched Uranium-235 Processing and Fuel Fabrication
- Regulatory Guide 8.25-Air Sampling in the Workplace
- Regulatory Guide 8.30-Health Physics Surveys in Uranium Recovery Facilities
- Regulatory Guide 8.34-Monitoring Criteria and Methods To Calculate Occupational Radiation Doses
- NUREG-1400-Air Sampling in the Workplace
- ANSI/HPS N13.1-Sampling and Monitoring Releases of Airborne Radioactive Substances from the Stacks and Ducts of Nuclear Facilities
- ANSI N323-Radiation Protection Instrumentation Test and Calibration
- ANSI N13.11-Dosimetry-Personnel Dosimetry Performance-Criteria for Testing
- ANSI N13.15-Radiation Detectors-Personnel Thermoluminescence Dosimetry Systems-Performance
- ANSI/HPS N13.22-Bioassay Program for Uranium
- ANSI/HPS N13.30-Performance Criteria for Radiobioassay
- ANSI N13.6, Practice for Occupational Radiation Exposure Records Systems

4.7 Radiation Surveys and Monitoring Programs Commitments

Facility procedures include an outline of the program objectives, sampling procedures and data analysis methods. Equipment selection is based on the type of radiation being monitored. Procedures are prepared for each of the instruments used and specify the frequency and method of calibration. Maintenance and calibration are in accordance with the manufacturers' recommendations. Specific types of instruments used in the facility are discussed below.

The survey program procedures specify the frequency of measurements and record keeping and reporting requirements. As stated in Section 4.1, Commitment to Radiation Protection Program Implementation, the facility corrective action process is implemented if: 1) personnel dose monitoring results or personnel contamination levels exceed the administrative personnel limits; or if an incident results in airborne occupational exposures exceeding the administrative limits, or 2) the limits in 10 CFR 20, Appendix B (CFR, 2003m) or 10 CFR 70.61 (CFR, 2003e) are exceeded. In the event the occupational dose limits given in 10 CFR 20 (CFR, 2003b), Subpart C are exceeded, notification of the NRC is in accordance with the requirements of 10 CFR 20, Subpart M—Reports.

All personnel who require individual monitoring of external occupational dose per 10 CFR 20.1502(a) are required to wear personnel monitoring devices that are supplied by a vendor that holds dosimetry accreditation from the National Voluntary Laboratory Accreditation Program. In addition, personnel are required to monitor themselves for contamination prior to exiting an RCA where the potential for airborne radioactivity or surface contamination may exist.

Continuous airborne radioactivity monitors provide indication of the airborne activity levels in RCAs of the facility. Monitoring instruments for airborne alpha emitters are provided at different locations throughout facility. These monitors are designed to detect alpha emitters in the air, which would indicate the potential for uranium contamination. When deemed necessary, portable air samplers may be used to collect a sample on filter paper for subsequent analysis in the laboratory.

Monitors in locations classified as Airborne Radioactivity Areas are equipped with alarms. The alarm is activated when airborne radioactivity levels exceed predetermined limits. The limits are set with consideration being given to both toxicity and radioactivity. The operating history of the facility, changes in technology, changes in room functions and design, and changes in regulations may necessitate adjustment of the monitors.

Continuous monitoring of direct radiation exposure rates is not typically needed because the uranium processed in the facility is handled in closed containers. The radionuclides of interest are primarily alpha and beta emitters. The decay data and decay chains for these radionuclides are shown in Table 4.7-1, Radiation Emitted from Natural UF₆ Feed, and Figure 4.7-1, Uranium and Decay Products of Interest, respectively. However, electronic dosimeters may be prescribed for specific work evolutions, as warning devices in areas where dose rates may vary or as alternate dosimetry for visitors or workers who are escorted into the RCA and do not require monitoring per 10 CFR 20.1502(a).

Alpha and beta radiation cannot penetrate the container walls. Typical area radiation monitors measure gamma radiation. At this facility, the gamma radiation is not present at sufficient levels to provide representative indications. Instead, periodic radiation monitoring for contamination is performed with portable survey meters and "wipe tests" are taken to evaluate radiological conditions in the facility.

4.7 Radiation Surveys and Monitoring Programs Commitments

Calibration is performed in accordance with written procedures and documented prior to the initial use of each airflow measurement instrument (used to measure flow rates for air or effluent sampling) and each radioactivity measurement instrument. Periodic operability checks are performed in accordance with written established procedures. Calibrations are performed and documented on each airflow measurement and radioactivity measurement instrument at least annually (or according to manufacturers' recommendations, whichever is more frequent), after failing an operability check, after modifications or repairs to the instrument that could affect its proper response, or when it is believed that the instrument has been damaged.

Unreliable instruments are removed from service until repairs are completed. Portal monitors, hand and foot monitors and friskers have the required sensitivity to detect alpha contamination on personnel to ensure that radioactive materials do not spread to the areas outside the Restricted Areas.

4.7.1 Radiological Areas

Radiological Areas within the facility have been established to (1) control the spread of contamination, (2) control personnel access to avoid unnecessary exposure of personnel to radiation, and (3) control access to radioactive sources present in the facility. Table 4.1-2, Estimated Dose Rates, lists general dose rate estimates for the facility. These dose estimates were prepared based upon historical data from operating Urenco centrifuge enrichment facilities. Areas associated with higher dose rates may be restricted from general access, as determined by facility management. Areas where facility personnel spend substantial amounts of time are designed to minimize the exposure received (ALARA) when routine tasks are performed.

The following subsections describe how the facility Radiation Protection Program is implemented to protect site workers and the general public.

4.7.1.1 Unrestricted Area

NRC regulation 10 CFR 20.1003 (CFR, 2003n) defines an Unrestricted Area as an area, access to which is neither limited nor controlled by the licensee. The area adjacent to the facility site where LES does not normally exercise access control is an Unrestricted Area. This area can be accessed by members of the public, indigenous wildlife, or by facility personnel. The Unrestricted Area is governed by the limits in 10 CFR 20.1301 (CFR, 2003o). The total effective dose equivalent to individual members of the public from the licensed operation may not exceed 1 mSv (100 mrem) in a year (exclusive of background radiation). The dose in any Unrestricted Area from external sources may not exceed 0.02 mSv (2 mrem) in any one hour. In addition to the NRC limit, the Environmental Protection Agency, in 40 CFR 190 (CFR, 2003p), imposes annual dose equivalent limits of 0.25 mSv (25 mrem) to the whole body, 0.75 mSv (75 mrem) to the thyroid, and 0.25 mSv (25 mrem) to any other organ of any member of the public as the result of exposures to planned discharges of radioactive materials to the general environment from uranium fuel cycle operations and to radiation from these operations.

4.7.1.2 Restricted Area

The NRC defines a Restricted Area as an area, access to which is limited by the licensee for the purpose of protecting individuals against undue risks from exposure to radiation and radioactive materials. The Restricted Area is depicted in Figure 4.7-2 Projected Radiological Zones.

4.7 Radiation Surveys and Monitoring Programs Commitments

4.7.1.3 Radiologically Controlled Area (RCA)

An area within the Restricted Area where radiological hazards may exist that require progressive radiological access controls. Contamination monitoring equipment is located at RCA egress points where loose contamination exists. Personnel who have not been trained in radiological hazard awareness and radiological work practices are not allowed access to a RCA without a trained escort.

The areas defined below may exist within an RCA. These areas may be temporary or permanent. The areas are posted to inform workers of the potential hazard in the area and to help prevent the spread of contamination. These areas are conspicuously posted in accordance with the requirements of 10 CFR 20.1902 (CFR, 2003q).

- An area in which radiation levels could result in an individual receiving a dose equivalent in excess of 0.05 mSv (5 mrem) in 1 hr at 30 cm (11.8 in) from the radiation source or from any surface that the radiation penetrates is designated a "Radiation Area" as defined in 10 CFR 20.1003 (CFR, 2003n).
- An "Airborne Radioactivity Area" means a room, enclosure, or area in which airborne radioactive materials, composed wholly or partly of licensed material, exist in concentrations (1) In excess of the derived air concentrations (DACs) specified in Appendix B (CFR, 2003m), to 10 CFR 20.1001 - 20.2401, or (2) To such a degree that an individual present in the area without respiratory protective equipment could exceed, during the hours an individual is present in a week, an intake of 0.6% of the annual limit on intake (ALI) or 12 DAC-hours. Note that entry into this area does not automatically require the wearing of a respirator.
- A "High Radiation Area" is an area, accessible to individuals, in which radiation levels could result in an individual receiving a dose equivalent in excess of 1 mSv (100 mrem) in 1 hour at 30 cm (11.8 in) from the radiation source or from any surface that the radiation penetrates. No examples of this type of area are expected during routine operation of the facility. This designation is provided here only for the purposes of emergency situations (drills and actual events).
- LES defines a "Contaminated Area" as an area where removable contamination levels are above 16.7 Bq/100 cm² (1,000 dpm/100 cm²) of alpha or beta/gamma activity.

The NRC limits the soluble uranium intake of an individual to 10 milligrams in a week in consideration of chemical toxicity. Areas where the intake of soluble uranium in one week is likely to exceed 1 milligram are posted.

4.7.1.4 Controlled Area

The NRC defines a Controlled Area as an area, outside of a Restricted Area but inside the site boundary, access to which can be limited by the licensee for any reason. The area of the plant within the perimeter fence but outside any Restricted Area is part of the Controlled Area. Due to the presence of the fence, members of the public do not have direct access to this Controlled Area of the site and must be processed by security and authorized to enter the site. Training for access to a Controlled Area is provided commensurate with the radiological hazard.

Site visitors include delivery people, tour guests and service personnel who are temporary, transient occupants of the Controlled Area. Area monitoring demonstrates compliance with

4.7 Radiation Surveys and Monitoring Programs Commitments

public exposure limits for such visitors. Individuals who are contractor or facility employees and who work only in the Controlled Area are occupationally exposed but typically exclude from individual monitoring requirements under 10 CFR 20.1502.

4.7.2 Access and Egress Control

The facility establishes and implements an access control program that ensures that (a) signs, labels, and other access controls are properly posted and operative, (b) RCAs are established to prevent the spread of contamination and are identified with appropriate signs, and (c) step-off pads, change facilities, protective clothing facilities, and personnel monitoring instruments are provided in sufficient quantities and locations. Access control is by administrative methods and may be physically controlled for security reasons.

Access to and egress from an RCA is through a local control point. A monitor (frisker), step-off pad and container for any discarded protective clothing is provided as necessary at the egress point from these areas to prevent the spread of contamination.

Action levels for skin and personal clothing contamination at the point of egress from an RCA and any additional designated areas within an RCA (e.g., a Contaminated Area which is provided with a step-off pad and frisker) shall not exceed 16.7 Bq/100 cm² (1,000 dpm/100 cm²) of alpha or beta/gamma contamination. Clothing contaminated above egress limits shall not be released unless it can be decontaminated to within these limits. If skin or other parts of the body are contaminated above egress limits, reasonable steps shall be undertaken to effect decontamination.

4.7.3 Posting for Radiological Hazardous Awareness

Radiological hazard awareness training is provided through a General Employee Training program. Radiological hazards are identified throughout the Restricted Area and barriers, postings, and labeling per the requirements of 10 CFR 20, Subpart J (CFR, 2003q) are established. Radioactive material storage locations are posted "Caution Radioactive Material". Radioactive material in transit between storage locations is attended by an individual to control the radiological hazard and radioactive material.

4.7.4 Protective Clothing and Equipment

The proper use of protective clothing and respiratory protection equipment can minimize internal and external exposures to radioactivity. Personnel working in areas that are classified as Airborne Radioactivity Areas or Contaminated Areas must wear appropriate protective clothing as prescribed by the RWP. If the areas containing the surface contamination can be isolated from adjacent work areas via a barrier such that dispersible material is not likely to be transferred beyond the area of contamination, personnel working in the adjacent area are not required to wear protective clothing.

Radiation protection management and associated technical staff are responsible for determining the need for protective clothing in each work area.

4.7 Radiation Surveys and Monitoring Programs Commitments

4.7.5 Personnel Monitoring for External Exposures

If the individual is anticipated to receive a dose in excess of 10 CFR 20.1502 or it is required by the RWP, that individual will be issued a thermoluminescent dosimeters (TLD). Personnel whose duties routinely require them to enter an RCA wear individual external dosimetry devices, e.g., TLDs that are sensitive to beta, gamma and neutron radiation. Appropriate neutron survey meters are also available to the Radiation Protection staff. External dosimetry devices are evaluated at an established frequency (e.g. quarterly, semiannually, etc.) to ascertain external exposures. Administrative limits on radiation exposure are provided in Table 4.1-1, Administrative Radiation Exposure Limits.

Anytime an administrative limit is exceeded, the Radiation Protection Manager is informed. The Radiation Protection Manager is responsible for determining the need for and recommending investigations or corrective actions to the responsible Manager(s). Copies of the Radiation Protection Manager's recommendations are provided to the Safety Review Committee.

4.7.6 Personnel Monitoring for Internal Exposures

Internal exposures for personnel wearing external dosimetry devices are evaluated as required via direct bioassay (e.g. in vivo body counting), indirect bioassay (e.g., urinalysis), or an equivalent technique. For soluble (Class D) uranium, 10 CFR 20.1201(e) (CFR, 2003f) limits worker intake to no more than 10 milligrams of soluble uranium in a week. This is to protect workers from the toxic chemical effects of inhaling Class D uranium. Air monitoring in Airborne Radioactivity Areas is performed as necessary to supplement the bioassay program. Alarm setpoints on the air monitors in RCAs are used to provide an indication that internal exposures may be approaching the action limit.

If the facility annual administrative limit is exceeded as determined from bioassay results, then an investigation is performed and documented to determine what types of activities may have contributed to the worker's internal exposure. The action limit is based on ALARA principles. Other factors such as the biological elimination of uranium are considered. This investigation may include, but is not limited to procedural reviews, efficiency studies of the air handling system, and work practices. Evaluation of Doses

Dose evaluations may be performed at more frequent intervals and should be performed when reasonable suspicion exists regarding an abnormal exposure. The internal and external exposure values are summed in accordance with 10 CFR 20.1202 (CFR, 2003r). Procedures for the evaluation and summation of doses are based on the guidance contained in Regulatory Guides 8.7 and 8.34.

4.7.7 Local Control Points

Monitor stations Local Control Points are the entry and exit points for RCAs where loose surface contamination is likely to exist. Monitors are provided, as required, to detect radioactive contamination on personnel and their personal items, including hard hats. All personnel are required to monitor themselves, any hand-carried personal items, and hard hats prior to exiting an RCA. Radiation protection management is responsible for Local Control Point provision and maintenance. Local Control Point locations are evaluated and established as necessary in response to changes in the facility radiological conditions.

4.7 Radiation Surveys and Monitoring Programs Commitments

4.7.8 Personnel Decontamination

- A personnel decontamination area is provided to handle cases of accidental radioactive contamination. A hand washing sink and a shower are provided for contamination removal.

4.7.9 Storage Areas

Storage areas are provided for the following items:

- Protective (i.e., anti-contamination) clothing
- Respiratory protection equipment
- Personnel Decontamination supplies
- Radiation protection supplies.

4.8 Contamination and Radiation Control

4.8 Contamination and Radiation Control

The goal of maintaining occupational internal and external radiation exposures ALARA encompasses the individual's dose as well as the collective dose of the entire working population. Since the total effective dose equivalent (TEDE) is the sum of the internal and external exposures, the Radiation Protection Program addresses both contamination control and external radiation protection.

Listed below are examples of design and operating considerations that are implemented at the facility to reduce personnel radiation exposures:

- The enrichment process, with the exception of Liquid Sampling, is maintained under sub atmospheric pressure. The constant containment of UF₆ precludes direct contact with radioactive materials by personnel.
- Self-monitoring is required upon exit from an RCA. Personnel are required to notify a member of the radiation protection staff if contamination is detected.
- All personnel are trained in emergency evacuation procedures in accordance with the facility Emergency Plan.
- Air flow rates at exhausted enclosures and close-capture points, when in use, are adequate to preclude escape of airborne uranium and minimize the potential for intake by workers. Air flow rates are checked monthly when in use and after modification of any hood, exhausted enclosure, close-capture point equipment or ventilation system serving these barriers.

4.8.1 Internal Exposures

Because the radionuclides present in this facility under routine operations are primarily alpha and beta emitters (with some low-energy gamma rays), the potential for significant internal exposure is greater than that for external exposure. Parameters important to determining internal doses are:

- The quantity of radioactive material taken into the body
- The chemical form of the radioactive material
- The type and half-life of radionuclide involved
- The time interval over which the material remains in the body.

The principal modes by which radioactive material can be taken into the body are:

- Inhalation
- Ingestion
- Absorption through the skin
- Injection through wounds.

4.8 Contamination and Radiation Control

4.8.1.1 Bioassay

Internal radiological exposures are evaluated as noted in Section 4.7.6, Personnel Monitoring for Internal Exposures. Based on the results of air sample monitoring data, bioassays are performed for all personnel who are likely to have had an intake of one milligram of uranium during a week. This is 10% of the 10 mg (3.5 E-4 oz) in a week regulatory limit (10 CFR 20.1201(e) (CFR, 2003f)) for intake of Class D uranium. The bioassay program has a sensitivity of 5 µg/L (7 E-7 oz/gal) of uranium concentration, assuming that the sample is taken within ten days of the postulated intake and that at least 1.4 L (0.37 gal) of sample is available from a 24-hour sampling period. Until urinalysis results indicate less than 15 µg/L (2.0 E-6 oz/gal) of uranium concentration, workers are restricted from activities that could routinely or accidentally result in internal exposures to soluble uranium.

It might not be possible to achieve a sensitivity of 5 µg/L (7 E-7 oz/gal); if for example, all reasonable attempts to obtain a 1.4 L (0.37 gal) 24-hour sample within 10 days fail. In such a case, the sample is analyzed for uranium concentration (if measurable) and the worker's intake is estimated using other available data.

4.8.1.2 Air Monitoring and Sampling

Airborne activity in work areas is regularly determined in accordance with written procedures. Continuous air sampling in airborne radioactivity areas may be performed to complement the bioassay program. Using the values specified in 10 CFR 20 Appendix B (CFR, 2003m), if a worker could have inhaled radionuclide concentrations that are likely to exceed 12 DAC-hours in one week (seven days), then bioassay is conducted within 72 hours after the suspected or known exposure. Follow-up bioassay measurements are conducted to determine the committed effective dose equivalent. Until urinalysis results indicate less than 15 micrograms per liter uranium concentration, workers are restricted from activities that could routinely or accidentally result in internal exposures to soluble uranium.

Active on-line monitors for airborne alpha emitters are used to measure representative airborne concentrations of radionuclides that may be due to facility operation. On-line monitoring for gross alpha activity is performed assuming all the alpha activity is due to uranium. When airborne activity data is used for dose calculations, the assumption is that all the activity is due to ²³⁴U, class D material. The lower limit of detection is either 0.02 mg (7.16 E-7 oz) of uranium in the total sample or 3.7 nBq/mL (1 E-13 µCi/mL) gross alpha concentration. An action level is established at 1 mg (3.53 E-5 oz) of total uranium likely to be inhaled by a worker in seven days.

Monitors are permanently located in RCAs. These permanent monitors are operated to collect continuous samples. When air sampling is conducted using continuous air sampling devices, the filters are changed and analyzed at the following frequencies:

- Weekly and following any indication of release that might lead to airborne concentrations of uranium that are likely to exceed (1) 1 Derived Air Concentration (DAC) (most likely uranium isotopes), or (2) the total uranium action level of one milligram of total uranium inhaled in one week.
- Each Shift, following modification of process equipment or process control, and following detection of any event (e.g., leakage, spillage or blockage of process equipment) that are

4.8 Contamination and Radiation Control

likely to exceed (1) 1 DAC (most likely uranium isotopes), or (2) the total uranium action level of one milligram inhaled by a worker in one week.

The representativeness of the air samplers shall be checked annually and when significant process or equipment changes have been made. Facility procedures specify how representativeness is determined.

Plant areas surveyed as described in this section include as a minimum UF₆ processing areas, decontamination areas, waste processing areas and laboratories. Continuous air monitors (e.g., stationary samplers or personnel lapel samplers) may be substituted when appropriate, as when continuous monitoring may not be reasonably achieved.

Action levels are based on trending of data collected during facility operation. Investigations are performed if airborne activity:

- A. Exceeds 1 DAC (most likely uranium isotopes).
- B. Shows a short-term increase of a factor of 10 over historical data from the previous 12 months.

Corrective actions include investigation of the adverse trend and an evaluation of the need for changes, consistent with the principles of ALARA.

4.8.2 External Exposures

The potential for significant external exposure to personnel under routine operating conditions is less significant than that for internal exposures. This is primarily due to the nature of the radionuclides present in the facility.

Parameters important in determining dose from external exposures are:

- The length of time the worker remains in the radiation field
- The intensity of the radiation field
- The portion of the body receiving the dose.

Historical data from European facilities of similar construction and representative operations show relatively low doses compared to nuclear power plant doses.

4.8.3 Procedures

Procedures are provided in the following areas to administratively control personnel radiation exposure:

- Operation
- Design
- Maintenance
- Modification
- Decontamination
- Surveillance

4.8 Contamination and Radiation Control

- Procurement.

4.8.4 Instrumentation

Three basic types of personnel monitoring equipment are used at the facility. These are count rate meters (as known as "friskers"), hand/foot monitors, and Personnel Contamination Monitors.

4.8.4.1 Friskers

Hand held friskers are typically placed in locations where conditions restrict the use of other monitors or for short-term use as necessary to ensure effective control of the spread of contamination. Instructions for the use of these instruments are part of nuclear safety worker training.

4.8.4.2 Hand and Foot Monitors

These typically consist of multiple detectors arranged to monitor only hands and feet. Instructions for the use of these monitors are part of nuclear safety worker training. Hand and foot monitors are used in applications where "pass-throughs" are frequent and where hand and foot monitoring is the major requirement.

4.8.4.3 Personnel Contamination Monitors (PCMs)

These typically consist of multiple detectors arranged to monitor the whole body. PCMs can quickly scan large surface areas of the body and may be used where the number of personnel existing an area, available space, etc., makes their use advantageous. A contamination monitor is placed at the local control point within the RCA. Personnel exiting the RCA are required to use a full body contamination monitor to check for contamination on their body. If the PCM is out of service an alternative method of monitoring is required (e.g. friskers).

4.8.5 Contamination Control

Small contamination areas may be roped off or otherwise segregated from the rest of an RCA. Appropriate clothing and/or other equipment is used to minimize exposure to radioactive material and prevent the spread of contamination. The entire RCA is not posted as a Contaminated Area.

4.8.5.1 Surface Contamination

Contamination surveys are performed in all UF₆ process areas. Additional routine surveys are performed in non-UF₆ process areas, including selected areas normally not suspected to be contaminated. Monitoring includes direct radiation and removable contamination measurements. Survey procedures are based on the potential for contamination of an area and operational experience. Selected areas within RCA are surveyed at least weekly. The lunch room and change rooms are outside the RCA and are surveyed at least weekly.

Removable surface contamination present on a surface can be transferred to a dry smear paper by rubbing with moderate pressure. The facility uses various instruments such as proportional

4.8 Contamination and Radiation Control

counters, alpha scintillation counters and thin window Geiger-Mueller tubes, to evaluate contamination levels.

If surface contamination levels exceed the following levels, clean-up of the contamination is initiated within 24 hours of the completion of the analysis:

- Removable contamination: 83.3 Bq/100 cm² (5000 dpm/100 cm²) alpha or beta/gamma
- Fixed contamination: 4.2 kBq/100 cm² (250,000 dpm/100 cm²) alpha or beta/gamma

4.9 Maintenance Areas-Methods and Procedures for Contamination Control

4.9 Maintenance Areas-Methods and Procedures for Contamination Control

Designing processes and equipment that contain radioactive material to require as little maintenance as possible ensures that personnel radiation exposures are ALARA. Additional exposure reductions are achieved by:

- A. Removing as much radioactive material as possible from the equipment and the area prior to maintenance, thereby reducing the intensity of the radiation field
- B. Providing adequate space for ease of maintenance reducing the length of time required to complete the task, thereby reducing the time of exposure
- C. Preparing and using procedures that contain specifications for tools and equipment needed to complete the job
- D. Proper job planning, including practice on mockups
- E. Previews of previous similar jobs
- F. Identification and communication of the highest contamination areas to the workers prior to the start of work.

4.9.1 Decontamination Workshop

(See 12.2.3.4) The Decontamination Workshop and Decontamination System are located in the same room in the CRDB. The Decontamination Workshop contains an area to break down and strip contaminated equipment and to decontaminate the equipment and its components. The decontamination systems in the workshop are designed to remove radioactive contamination from contaminated materials and equipment. The only significant forms of radioactive contamination found in the facility are uranium hexafluoride (UF_6), uranium tetrafluoride (UF_4) and uranyl fluoride (UO_2F_2).

One of the functions of the Decontamination Workshop is to provide a maintenance facility for both UF_6 pumps and for vacuum pumps. The workshop is used for the temporary storage and subsequent dismantling of failed pumps. The dismantling area is in physical proximity to the decontamination train, in which the dismantled pump components are processed.

The process carried out within the Decontamination Workshop begins with receipt and storage of contaminated pumps, out-gassing, Perfluorinated Polyether (PFPE) oil removal and storage, and pump stripping. The dismantling, maintenance, and decontamination of other plant components besides pumps is also routine and includes valves, piping, instruments, sample bottles, tools, and scrap metal. Personnel entry into the facility is via a sub-change facility. This area has the required contamination area access controls, washing and monitoring facilities.

The decontamination part of the process consists of a series of steps following equipment disassembly including degreasing, decontamination, drying, and inspection. Items from uranium hexafluoride systems, waste handling systems, and miscellaneous other items are decontaminated in this system.

4.9.2 Contaminated Material Handling Room

The Contaminated Material Handling Room, located in the CRDB, provides an area for storage of protective clothing drums and other material/waste containers that have been assayed and released from the Safeguards item control program. This area will normally provide storage for

4.9 Maintenance Areas-Methods and Procedures for Contamination Control

containers awaiting Radiation Protection survey to be either unconditionally released or transferred to the solid waste collection system for additional processing. In addition, the Contaminated Material Handling Room will contain cabinets and bins with supplies to support the waste program and a connection to the CRDB GEVS to support ventilation engineering controls when required.

4.10 Decontamination Policy and Provisions

4.10 Decontamination Policy and Provisions

Removing radioactive material from equipment, to the extent reasonably possible prior to servicing reduces exposures to personnel who work around and service contaminated equipment. Surface contamination is removed to minimize its spread to other areas of the facility. Surfaces such as floors and walls are designed to be smooth, nonporous and free of cracks so that they can be more easily decontaminated.

Decontamination facilities and procedures for the CRDB and the SBMs have been discussed above. For the remaining areas of the SBMs, CRDB, and CAB, decontamination requirements involve only localized clean-up at areas where maintenance has been or is being performed that involves opening a uranium-containing system.

The facility follows 10 CFR 20, Subpart E, for the abandonment or release for unrestricted use of surfaces and premises.

4.11 Additional Program Commitments

4.11 Additional Program Commitments

The following are additional program commitments related to the Radiation Protection Program.

4.11.1 Leak-Testing Byproduct Material Sources

In addition to the uranium processed at the facility, other sources of radioactivity are used. These sources are small calibration sources used for instrument calibration and response checking. These byproduct material sources may be in solid, liquid, or gaseous form; the sources may be sealed or unsealed. Both types of sources present a small radiation exposure risk to facility workers. For limits of possession for radioactive material types, quantities, and forms see current version of SNM-2010. Leak-testing of sources, available for use, is performed semi-annually using standard wipe protocols. Sources found to be leaking (contamination levels $\geq 0.005\mu\text{Ci}$) shall be removed from service and properly disposed of.

4.11.2 Records and Reports

The facility meets the following regulations for the additional program commitments applicable to records and reports:

- 10 CFR 20 (CFR, 2003b), Subpart L (Records), Subpart M (Reports)
- Section 70.61 (Performance requirements) (CFR, 2003e)
- Section 70.74 (Additional reporting requirements) (CFR, 2003s).

The facility Records Management program is described in Section 11.7, Records Management. The facility maintains records of the radiation protection program (including program provisions, audits, and reviews of the program content and implementation), radiation survey results (air sampling, bioassays, external-exposure data from monitoring of individuals, internal intakes of radioactive material), and results of corrective action program referrals, RWPs and planned special exposures. The facility maintains complete records of the Radiation Protection Program for at least the life of the facility.

By procedure, the facility will report to the NRC, within the time specified in 10 CFR 20.2202 (CFR, 2003t) and 10 CFR 70.74 (CFR, 2003s), any event that results in an occupational exposure to radiation exceeding the dose limits in 10 CFR 20 (CFR, 2003b). The facility will prepare and submit to the NRC an annual report of the results of individual monitoring, as required by 10 CFR 20.2206(b) (CFR, 2003u).

As previously noted in this chapter, LES will refer to the facility's corrective action program any radiation incident that results in an occupational exposure that exceeds the dose limits in 10 CFR 20, Appendix B (CFR, 2003m), or is required to be reported per 10 CFR 70.74 (CFR, 2003s). The facility reports to the NRC both the corrective action taken (or planned) to protect against a recurrence and the proposed schedule to achieve compliance with the applicable license condition or conditions.

4.12 References

4.12 References

Edition of Codes, Standards, NRC Documents, etc that are not listed below are given in ISAS Table 3.0-1.

CFR, 2003a. Title 10, Code of Federal Regulations, Part 19, Notices, Instructions, and Reports to Workers: Inspections and Investigations, 2003.

CFR, 2003b. Title 10, Code of Federal Regulations, Part 20, Standards for Protection Against Radiation, 2003.

CFR, 2003c. Title 10, Code of Federal Regulations, Part 70, Domestic Licensing of Special Nuclear Material, 2003.

CFR, 2003d. Title 10, Code of Federal Regulations, Section 20.1101, Radiation protection programs, 2003.

CFR, 2003e. Title 10, Code of Federal Regulations, Section 70.61, Performance requirements, 2003.

CFR, 2003f. Title 10, Code of Federal Regulations, Section 20.1201, Occupational dose limits for adults, 2003.

CFR, 2003g. Title 10, Code of Federal Regulations, Section 20.1208, Dose equivalent to an embryo/fetus, 2003.

CFR, 2003h. Title 10, Code of Federal Regulations, Section 70.22, Contents of applications, 2003.

CFR, 2003i. Title 10, Code of Federal Regulations, Section 19.12, Instructions to workers, 2003.

CFR, 2003j. Title 10, Code of Federal Regulations, Section 20.2110, Form of records, 2003.

CFR, 2003k. Title 10, Code of Federal Regulations, Section 19.13, Notifications and reports to individuals, 2003.

CFR, 2003l. Title 29, Code of Federal Regulations, Part 1910, Occupational Safety and Health Standards, 2003.

CFR, 2003m. Title 10, Code of Federal Regulations, Part 20, Appendix B, Annual Limits on Intakes (ALIs) and Derived Air Concentrations (DACs) of Radionuclides for Occupational Exposure; Effluent Concentrations; Concentrations for Release to Sewerage, 2003.

CFR, 2003n. Title 10, Code of Federal Regulations, Section 20.1003, Definitions, 2003.

CFR, 2003o. Title 10, Code of Federal Regulations, Section 20.1301, Dose limits for individual members of the public, 2003.

4.12 References

CFR, 2003p. Title 40, Code of Federal Regulations, Part 190, Environmental Radiation Protection Standard For Nuclear Power Operations, 2003.

CFR, 2003q. Title 10, Code of Federal Regulation, Section 20.1902, Posting requirements, 2003.

CFR, 2003r. Title 10, Code of Federal Regulations, Section 20.1202, Compliance with requirements for summation of external and internal does, 2003.

CFR, 2003s. Title 10, Code of Federal Regulations, Section 70.74, Additional reporting requirements, 2003.

CFR, 2003t. Title 10, Code of Federal Regulations, Section 20.2202, Method for obtaining approval of proposed disposal procedures, 2003.

CFR, 2003u. Title 10, Code of Federal Regulations, Section 20.2206, Transfer for disposal and manifests, 2003.

CFR 2003v. Title 10, Code of Federal Regulations, Section 20.2103, Records of Surveys, 2003.

Urenco, 2000. Health, Safety and Environmental Report, Urenco (Capenhurst) Limited, 2000.

Urenco, 2001. Health, Safety and Environmental Report, Urenco (Capenhurst) Limited, 2001.

Urenco, 2002. Health, Safety and Environmental Report, Urenco (Capenhurst) Limited, 2002.

4.13 Chapter 4 Tables

4.13 Chapter 4 Tables

4.13 Chapter 4 Tables

Table 4.1-1 Administrative Radiation Exposure Limits

	Administrative Limit
Total Effective Dose Equivalent (TEDE)	10 mSv/yr (1000 mrem/yr)

Notes:

- a) Excludes accident situations
- b) No routine extremity or skin monitoring is required
- c) TEDE is the sum of internal dose and external dose received during routine operations
- d) NRC limit is 50 mSv/yr (5000 mrem/yr)

Table 4.1-2 Estimated Dose Rates

Area or Component	Dose Rate, mSv/hr (mrem/hr)
Plant general area (excluding Separations Building Modules)	< 1 E-4 (< 0.01)
Separations Building Module 1001 – Cascade Halls	5 E-4 (0.05)
Separations Building Module 1001 – UF ₆ Handling Area & Process Services Corridor	1 E-3 (0.1)
Separations Building Module 1003 – Cascade Halls	TBD
Separations Building Module 1003 - UF ₆ Handling Area & Process Services Corridor	TBD
Empty used UF ₆ shipping cylinder	0.1 on contact (10.0) 0.01 at 1 m (1.0)
Full UF ₆ shipping cylinder	0.05 on contact (5.0) 2 E-3 at 1 m (0.2)

Table 4.1-3 Estimated Individual Exposures

Position	Annual Dose ^(a) mSv (mrem)
General Office Staff	< 0.05 (< 5.0)
Typical Operations & Maintenance Technician	1 (100)
Typical Cylinder Handler	3 (300)

(a) The average worker exposure at the Urenco Capenhurst facility during the years 1998 through 2002 was approximately 0.2 mSv (20 mrem) (Urenco, 2000; Urenco, 2001; Urenco, 2002)

4.13 Chapter 4 Tables

Table 4.7-1 Radiation Emitted from Natural UF₆ Feed

Element	Nuclide Symbol	Half-Life	Maximum Radiation Energies (MeV) and Intensities		
			alpha (α)	beta (β)	gamma (γ)
92 uranium	²³⁸ U	4.5E+9 yr	4.15 25%	none	0.013 8.8%
90 thorium	²³¹ Th	26 hr	4.20 75%	0.39 ~100%	0.025 14.7%
90 thorium	²³⁴ Th	24 d	none	0.19 73% 0.10 27%	0.06 3.8% 0.09 5.4%
91 protactinium	²³⁴ Pa	1.2 min	none	2.28 99%	0.766 0.21% 1.001 0.60%
92 uranium	²³⁴ U	2.5E+5 yr	4.72 28% 4.78 72%	none	0.053 0.12%
92 uranium	²³⁵ U	7.04E+8 yr	4.37 17% 4.40 55% 4.60 14%	none	0.143 12% 0.185 54% 0.205 6%

For limits of possession for radioactive material types, quantities, and forms see current version of SNM-2010.

4.14 Chapter 4 Figures

4.14 Chapter 4 Figures

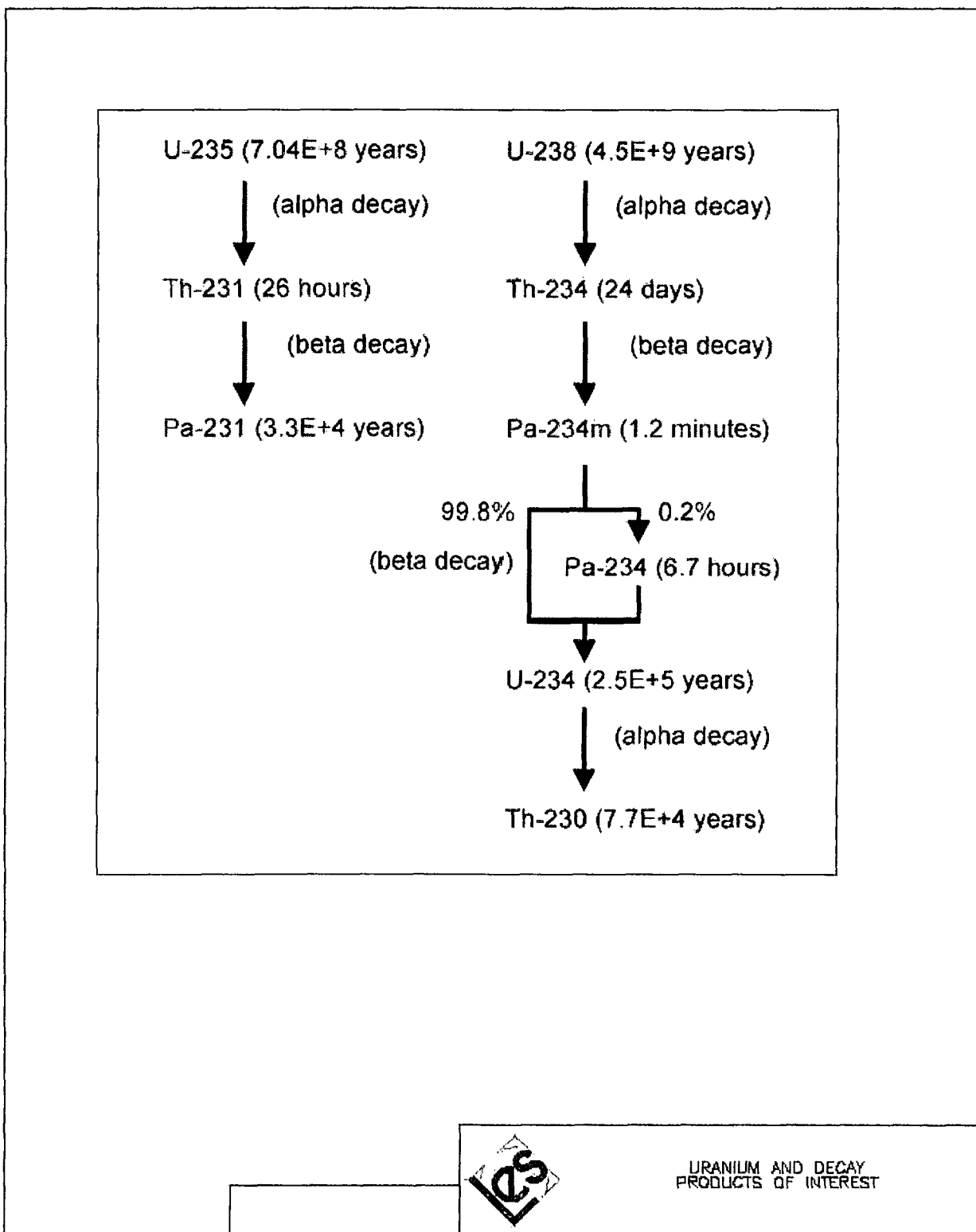

URANIUM AND DECAY PRODUCTS OF INTEREST

4.14 Chapter 4 Figures

Figure 4.7-1 Uranium and Decay Products of Interest

4.14 Chapter 4 Figures

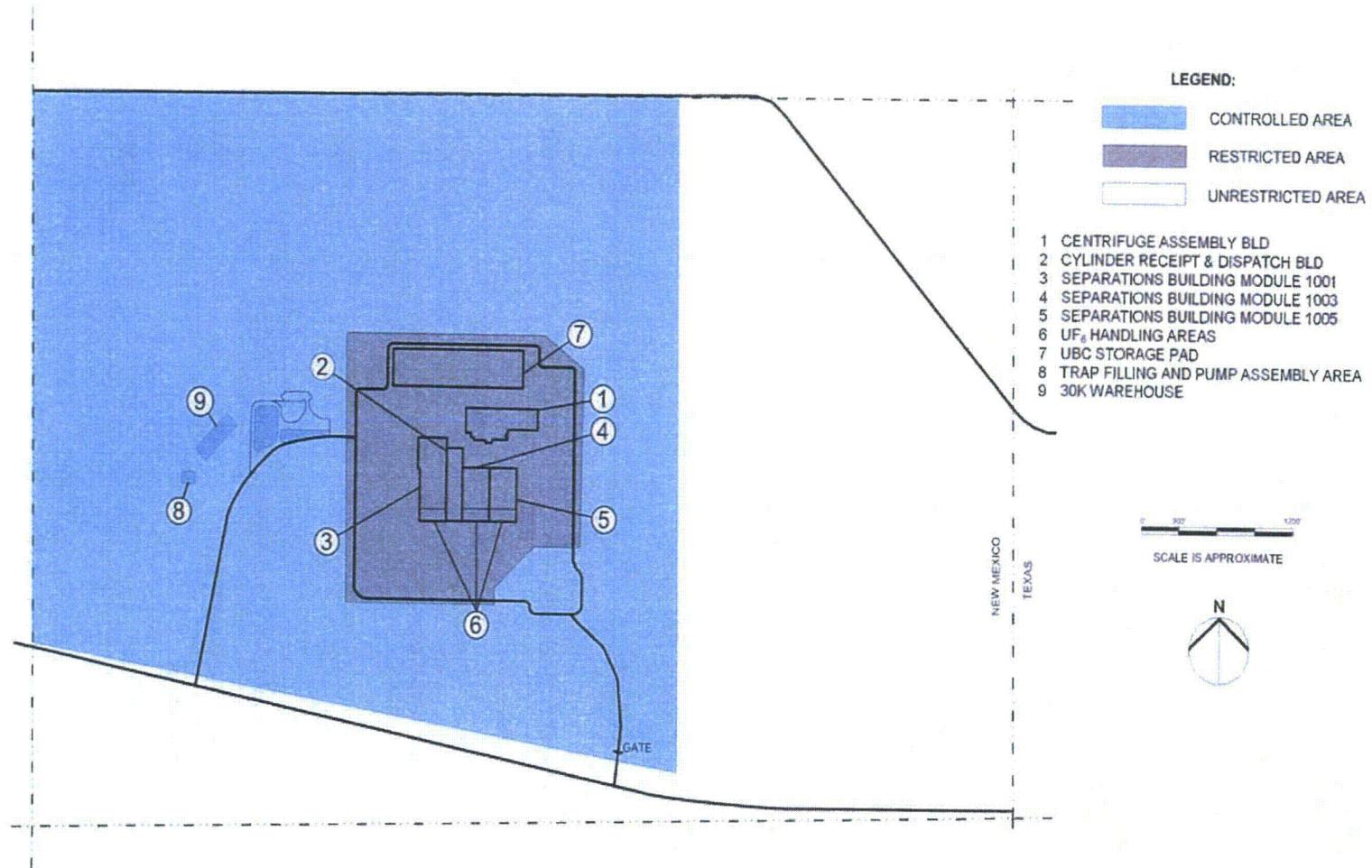

Figure 4.7-2 Projected Radiological Zones

5.0 Nuclear Criticality Safety

5.0 Nuclear Criticality Safety

The Nuclear Criticality Safety Program for the National Enrichment Facility (NEF) is in accordance with U.S. Nuclear Regulatory Commission (NRC) Regulatory Guide 3.71, Nuclear Criticality Safety Standards for Fuels and Material Facilities. Regulatory Guide 3.71 provides guidance on complying with the applicable portions of NRC regulations, including 10 CFR 70 (CFR, 2003a), by describing procedures for preventing nuclear criticality accidents in operations involving handling, processing, storing, and transporting special nuclear material (SNM) at fuel and material facilities. The facility is committed to following the guidelines in this regulatory guide for specific ANSI/ANS criticality safety standards with the exception of ANSI/ANS-8.9, "Nuclear Criticality Safety Criteria for Steel-Pipe Intersections Containing Aqueous Solutions of Fissile Material." Piping configurations containing aqueous solutions of fissile material will be evaluated in accordance with ANSI/ANS-8.1, using validated methods to determine subcritical limits.

The information provided in this chapter, the corresponding regulatory requirements, and the section of NUREG-1520, Chapter 5 in which the NRC acceptance criteria are presented is summarized below.

Information Category and Requirement	10 CFR 70 Citation	NUREG-1520 Chapter 5 Reference
Section 5.1 Nuclear Criticality Safety (NCS) Program		
Management of the NCS Program	70.61(d) 70.64(a)	5.4.3.1
Control Methods for Prevention of Criticality	70.61	5.4.3.4.2
Safe Margins Against Criticality	70.61	5.4.3.4.2
Description of Safety Criteria	70.61	5.4.3.4.2
Organization and Administration	70.61	5.4.3.2
Section 5.2 Methodologies and Technical Practices		
Methodology	70.61	5.4.3.4.1 5.4.3.4.4 5.4.3.4.6
Section 5.3 Criticality Accident Alarm System (CAAS)		
Criticality Accident Alarm System	70.24	5.4.3.4.3
Section 5.4 Reporting		
Reporting Requirements	Appendix A	5.4.3.4.7 (7)

5.1 The Nuclear Criticality Safety (NCS) Program

5.1 The Nuclear Criticality Safety (NCS) Program

The facility has been designed and will be constructed and operated such that a nuclear criticality event is prevented, and to meet the regulatory requirements of 10 CFR 70 (CFR, 2003a). Nuclear criticality safety at the facility is assured by designing the facility, systems and components with safety margins such that safe conditions are maintained under normal and abnormal process conditions and any credible accident. Items Relied On For Safety (IROFS) identified to ensure subcriticality are discussed in the NEF Integrated Safety Analysis Summary.

5.1.1 Management of the Nuclear Criticality Safety (NCS) Program

The NCS criteria in Section 5.2, Methodologies and Technical Practices, are used for managing criticality safety and include adherence to the double contingency principle as stated in the ANSI/ANS-8.1, Nuclear Criticality Safety In Operations with Fissionable Materials Outside Reactors. The adopted double contingency principle states "process design should incorporate sufficient factors of safety to require at least two unlikely, independent, and concurrent changes in process conditions before a criticality accident is possible." Each process that has accident sequences that could result in an inadvertent nuclear criticality at the NEF meets the double contingency principle. The NEF meets the double contingency principle in that process design incorporates sufficient factors of safety to require at least two unlikely, independent, and concurrent changes in process conditions before a criticality accident is possible.

The plant will produce no greater than 5.0 % enrichment. However, as additional conservatism, most nuclear criticality safety analyses for enriched material are performed assuming a ²³⁵U enrichment of 6.0 %_o, and include appropriate margins to safety. The exceptions to this are the systems and components associated with a cascade dump which are analyzed assuming 1.5 %_o. These include the Contingency Dump System equipment and piping on the 2nd floor of the Process Services Area and the Tails Take-off System. In accordance with 10 CFR 70.61(d) (CFR, 2003b), the general criticality safety philosophy is to prevent accidental uranium enrichment excesses, provide geometrical safety when practical, provide for moderation controls within the UF₆ processes and impose strict mass limits on containers of aqueous, solvent based, or acid solutions containing uranium. Interaction controls provide for safe movement and storage of components. Plant and equipment features assure prevention of excessive enrichment. The plant is divided into distinctly separate Assay Units (called Cascade Halls) with no common UF₆ piping. UF₆ blending is done in a physically separate portion of the plant. Process piping, individual centrifuges and chemical traps other than the contingency dump chemical traps, are safe by limits placed on their diameters. Product cylinders rely upon uranium enrichment, moderation control and mass limits to protect against the possibility of a criticality event. Each of the liquid effluent collection tanks that hold uranium in solution is mass controlled, as none are geometrically safe. As required by 10 CFR 70.64(a) (CFR, 2003c), by observing the double contingency principle throughout the plant, a criticality accident is prevented. In addition to the double contingency principle, effective management of the NCS Program includes:

- An NCS program to meet the regulatory requirements of 10 CFR 70 (CFR, 2003a) will be developed, implemented, and maintained.
- Safety parameters and procedures will be established.
- The NCS program structure, including definition of the responsibilities and authorities of key program personnel will be provided.

5.1 The Nuclear Criticality Safety (NCS) Program

- The NCS methodologies and technical practices will be kept applicable to current configuration by means of the configuration management function. The NCS program will be upgraded, as necessary, to reflect changes in the ISA or NCS methodologies and to modify operating and maintenance procedures in ways that could reduce the likelihood of occurrence of an inadvertent nuclear criticality.
- The NCS program will be used to establish and maintain NCS safety limits and NCS operating limits for IROFS in nuclear processes and a commitment to maintain adequate management measures to ensure the availability and reliability of the IROFS.
- NCS postings will be provided and maintained current.
- NCS emergency procedure training will be provided.
- The NCS baseline design criteria requirements in 10 CFR 70.64(a) (CFR, 2003c) will be adhered to.
- The NCS program will be used to evaluate modifications to operations, to recommend process parameter changes necessary to maintain the safe operation of the facility, and to select appropriate IROFS and management measures.
- The NCS program will be used to promptly detect NCS deficiencies by means of operational inspections, audits, and investigations. Deficiencies will be entered into the corrective action program so as to prevent recurrence of unacceptable performance deficiencies in IROFS, NCS function or management measures.
- NCS program records will be retained as described in Section 11.7, Records Management.

Training will be provided to individuals who handle nuclear material at the facility in criticality safety. The training is based upon the training program described in ANSI/ANS-8.20, Nuclear Criticality Safety Training. The training program is developed and implemented with input from the criticality safety staff, training staff, and management. The training focuses on the following:

- Appreciation of the physics of nuclear criticality safety.
- Information obtained from the analysis of jobs and tasks in accordance with Section 11.3.

Additional discussion of management measures is provided in Chapter 11, Management Measures.

5.1.2 Control Methods for Prevention of Criticality

The major controlling parameters used in the facility are enrichment control, geometry control, moderation control, and/or limitations on the mass as a function of enrichment. In addition, reflection, interaction, and heterogeneous effects are important parameters considered and applied where appropriate in nuclear criticality safety analyses. Nuclear Criticality Safety Evaluations and Analyses are used to identify the significant parameters affected within a particular system. All assumptions relating to process, equipment, material function, and operation, including credible abnormal conditions, are justified, documented, and independently reviewed. Where possible, passive engineered controls are used to ensure nuclear criticality safety. The determination of the safe values of the major controlling parameters used to control criticality in the facility is described below.

Moderation control is in accordance with ANSI/ANS-8.22, Nuclear Criticality Safety Based on Limiting and Controlling Moderators. However, for the purposes of the criticality analyses, it is assumed that UF_6 comes in contact with water to produce aqueous solutions of UO_2F_2 as

5.1 The Nuclear Criticality Safety (NCS) Program

described in Section 5.2.1.3.3, Uranium Accumulation and Moderation Assumption. A uniform aqueous solution of UO_2F_2 , and a fixed enrichment are conservatively modeled using MONK8A (SA, 2001) and the JEF2.2 library. Criticality analyses were performed to determine the maximum value of a parameter to yield $k_{\text{eff}} = 1$. The criticality analyses were then repeated to determine the maximum value of the parameter to yield a $k_{\text{eff}} = 0.95$. Table 5.1-1, Safe Values for Uniform Aqueous Solution of Enriched UO_2F_2 , shows both the critical and safe limits for 5.0 w/o and 6.0 w/o .

Table 5.1-2, Safety Criteria for Buildings/ Systems/Components, lists the safety criteria of Table 5.1-1, Safe Values for Uniform Aqueous Solutions of Enriched UO_2F_2 , which are used as control parameters to prevent a nuclear criticality event. Although the NEF will be limited to 5.0 w/o enrichment, as additional conservatism, the values in Table 5.1-2, Safety Criteria for Buildings/Systems/ Components, represent the limits based on 6.0 w/o enrichment except for the Contingency Dump System equipment and piping on the 2nd floor of the Process Services Area and the Tails Take-off System which are limited to 1.5 w/o ^{235}U .

The values on Table 5.1-1 are chosen to be critically safe when optimum light water moderation exists and reflection is considered within isolated systems. The conservative modeling techniques provide for more conservative values than provided in ANSI/ANS-8.1. The product cylinders are only safe under conditions of limited moderation and enrichment. In such cases, both design and operating procedures are used to assure that these limits are not exceeded.

All Separation Plant components, which handle enriched UF_6 , other than the Type 30B cylinders and the first stage UF_6 pumps and contingency dump chemical traps, are safe by geometry. Centrifuge array criticality is precluded by a probability argument with multiple operational procedure barriers. Total moderator or H/U ratio control as appropriate precludes product cylinder criticality.

In the Cylinder Receipt and Dispatch Building criticality safety for uranium loaded liquids is ensured by limiting the mass of uranium in any single tank to less than or equal to 12.2 kg U (26.9 lb U). Individual liquid storage bottles are safe by volume. Interaction in storage arrays is accounted for.

Based on the criticality analyses, the control parameters applied to NEF are as follows:

Enrichment

Enrichment is controlled to limit the percent ^{235}U within any process vessel or container to a maximum of 5% except for the systems and components associated with a cascade dump. For added conservatism the systems controlled to 5% are analyzed at 6%.

Assuming a product enrichment of 6% limits the upper bound for the average cascade enrichment to less than 1.5%, the systems and components associated with a cascade dump (Tails Take-off System, Contingency Sump System) are conservatively analyzed at 1.5%

Geometry/Volume

Geometry/volume control may be used to ensure criticality safety within specific process operations or vessels, and within storage containers.

The geometry/volume limits are chosen to ensure $k_{\text{eff}} = k_{\text{calc}} + 3 \sigma_{\text{calc}} < 0.95$.

5.1 The Nuclear Criticality Safety (NCS) Program

The safe values of geometry/volume in Table 5.1-1 define the characteristic dimension of importance for a single unit such that nuclear criticality safety is not dependent on any other parameter assuming 6 % ^{235}U for safety margin.

Moderation

Water and oil are the moderators considered in NEF. At NEF the only system where moderation is used as a control parameter is in the product cylinders. Moderation control is established consistent with the guidelines of ANSI/ANS-8.22 and incorporates the criteria below:

- Controls are established to limit the amount of moderation entering the cylinders.
- When moderation is the only parameter used for criticality control, the following additional criteria are applied. These controls assure that at least two independent controls would have to fail before a criticality accident is possible.
 - Two independent controls are utilized to verify cylinder moderator content.
 - These controls are established to monitor and limit uncontrolled moderator prior to returning a cylinder to production thereby limiting the amount of uncontrolled moderator from entering a system to an acceptable limit.
 - The evaluation of the cylinders under moderation control includes the establishment of limits for the ratio of maximum moderator-to-fissile material for both normal operating and credible abnormal conditions. This analysis has been supported by parametric studies.
- When moderation is not considered a control parameter, either optimum moderation or worst case H/U ratio is assumed when performing criticality safety analysis.

Mass

Mass control may be utilized to limit the quantity of uranium within specific process operations, vessels, or storage containers. Mass control may be used on its own or in combination with other control methods. Analysis or sampling is employed to verify the mass of the material. Conservative administrative limits for each operation are specified in the operating procedures.

Whenever mass control is established for a container, records are maintained for mass transfers into and out of the container. Establishment of mass limits for a container involves consideration of potential moderation, reflection, geometry, spacing, and enrichment. The evaluation considers normal operations and credible abnormal conditions for determination of the operating mass limit for the container and for the definition of subsequent controls necessary to prevent reaching the safety limits. When only administrative controls are used for mass controlled systems, double batching is conservatively assumed in the analysis.

Reflection

Reflection is considered when performing Nuclear Criticality Safety Evaluations and Analyses. The possibility of full water reflection is considered but the layout of the NEF is a very open design and it is highly unlikely that those vessels and plant components requiring criticality control could become flooded from a source of water within the plant. In addition, automatic sprinklers are excluded from SBMs and the CRDB. Fire protection standpipes are located in enclosed stairwells, or are arranged such that flooding from these sources is highly unlikely.

5.1 The Nuclear Criticality Safety (NCS) Program

Therefore, full water reflection of vessels has therefore been discounted. However, some select analyses have been performed using full reflection for conservatism. Partial reflection of

2.5 cm (0.984 in) of water is assumed where limited moderating materials (including humans) may be present. It is recognized that concrete can be a more efficient reflector than water; therefore, it is modeled in analyses where it is present. When moderation control is identified in the ISA Summary, it is established consistent with the guidelines of ANSI/ANS-8.22.

Interaction

Nuclear criticality safety evaluations and analyses consider the potential effects of interaction. A non-interacting unit is defined as a unit that is spaced an approved distance from other units such that the multiplication of the subject unit is not increased. Units may be considered non-interacting when they are separated by more than 60 cm (23.6 inches).

If a unit is considered interacting, nuclear criticality safety analyses are performed. Individual unit multiplication and array interaction are evaluated using the Monte Carlo computer code MONK8A to ensure $k_{\text{eff}} = k_{\text{calc}} + 3 \sigma_{\text{calc}} < 0.95$.

Neutron Absorbers

Neutron Absorption is a factor in almost all of the materials at the NEF. The normal absorption of neutrons in standard materials used in the construction and processes at the NEF (uranium, fluorine, water, steel, etc.) is not specifically excluded as a criticality control parameter.

Models incorporate conservative values (e.g., material compositions and equipment dimensions), which are validated at receipt, after installation or during surveillances.

Additional materials such as cadmium and boron for which the sole purpose would be to absorb neutrons are not incorporated in NEF processes. Solutions of absorbers are not used as a criticality control mechanism.

Concentration and Density

NEF does not use either concentration or density as a criticality control parameter.

5.1.3 Safe Margins against Criticality

Process operations require establishment of criticality safety limits. The facility UF₆ systems involve mostly gaseous operations. These operations are carried out under reduced atmospheric conditions (vacuum) or at slightly elevated pressures not exceeding three atmospheres. It is highly unlikely that any size changes of process piping, cylinders, cold traps, or chemical traps under these conditions, would lead to a criticality situation because a volume or mass limit may be exceeded.

Within the Separations Building Modules, significant accumulations of enriched UF₆ reside only in the Product Low Temperature Take-off Stations, Product Liquid Sampling Autoclaves, Product Blending System or the UF₆ cold traps. All these, except the UF₆ cold traps (which are safe-by-design), contain the UF₆ in 30B cylinders. All these significant accumulations are within enclosures protecting them from water ingress. The facility design has minimized the possibility of accidental moderation by eliminating direct water contact with these cylinders of accumulated

5.1 The Nuclear Criticality Safety (NCS) Program

UF₆. In addition, the facility's stringent procedural controls for enriching UF₆ assure that it does not become unacceptably hydrogen moderated while in process. The plant's UF₆ systems operating procedures contain safeguards against loss of moderation control (ANSI/ANS 8.22). No neutron poisons are relied upon to assure criticality safety.

5.1.4 Description of Safety Criteria

Each portion of the plant, system, or component that may possibly contain enriched uranium is designed with criticality safety as an objective. Table 5.1-2, Safety Criteria for Buildings/Systems/Components, shows how the safety criteria of Table 5.1-1, Safe Values for Uniform Aqueous Solutions of Enriched UO₂F₂, are applied to the facility to prevent a nuclear criticality event. Although the NEF will be limited to 5.0 % enrichment, as additional conservatism, the values in Table 5.1-2, represent the limits based on 6.0 % enrichment with the exception of the Tails Take-off and Contingency Dump Systems. These systems are limited to the maximum process system average enrichment, 1.5%.

Where there are significant in-process accumulations of enriched uranium as UF₆, the plant design includes multiple features to minimize the possibilities for breakdown of the moderation control limits. These features eliminate direct ingress of water to product cylinders while in process.

5.1.5 Organization and Administration

The criticality safety organization is responsible for implementing the Nuclear Criticality Safety Program.

The Criticality Safety Officer reports to the Health, Safety, and Environmental Manager as described in Chapter 2, Organization and Administration. The Health, Safety, and Environmental Manager is accountable for overall criticality safety of the facility, is administratively independent of production responsibilities, and has the authority to shut down potentially unsafe operations.

Designated responsibilities of the Criticality Safety Officer include the following:

- Establish the Nuclear Criticality Safety Program, including design criteria, procedures, and training
- Assess normal and credible abnormal conditions
- Determine criticality safety limits for controlled parameters, with input from the Criticality Safety Engineers
- Develop and validate methods to support nuclear criticality safety evaluations (NCSEs) (i.e., non-calculation engineering judgments regarding whether existing criticality safety analyses bound the issue being evaluated or whether new or revised safety analyses are required)
- Specify criticality safety control requirements and functionality
- Provide advice and counsel on criticality safety control measures
- Support emergency response planning and events
- Evaluate the effectiveness of the Nuclear Criticality Safety Program using audits and assessments

5.1 The Nuclear Criticality Safety (NCS) Program

- Provide criticality safety postings that identify administrative controls for operators in applicable work areas.

Criticality Safety Engineers will be provided in sufficient number to support the program technically. They are responsible for the following:

- Provide criticality safety support for integrated safety analyses and configuration control
- Perform NCS analyses (i.e., calculations), write NCS evaluations, and approve proposed changes in process conditions on equipment involving fissionable material

Qualified Criticality Safety Engineers may also perform tasks associated with Criticality Safety program implementation and assessment.

The minimum qualifications for the Criticality Safety Officer and the Criticality Safety Engineer are described in Section 2.2.4. The Health and Safety Manager has the authority and responsibility to assign and direct activities for the Criticality Safety Program. The Criticality Safety Officer is responsible for implementation of the NCS program.

The NEF implements the intent of the administrative practices for criticality safety, as contained in Section 4.1.1 of American National Standards Institute/American Nuclear Society (ANSI/ANS)-8.1, Nuclear Criticality Safety in Operations with Fissionable Materials Outside Reactors. A policy will be established whereby personnel shall report defective NCS conditions and perform actions only in accordance with written, approved procedures. Unless a specific procedure deals with the situation, personnel shall report defective NCS conditions and take no action until the situation has been evaluated and recovery procedures provided.

5.2 Methodologies and Technical Practices

5.2 Methodologies and Technical Practices

This section describes the methodologies and technical practices used to perform the Nuclear Criticality Safety (NCS) analyses and NCS evaluations. The determination of the NCS controlled parameters and their application and the determination of the NCS limits on IROFS are also presented.

5.2.1 Methodology

MONK8A (SA, 2001) is a powerful Monte Carlo tool for nuclear criticality safety analysis. The advanced geometry modeling capability and detailed continuous energy collision modeling treatments provide realistic 3-dimensional models for an accurate simulation of neutronic behavior to provide the best estimate neutron multiplication factor, k-effective. Complex models can be simply set up and verified. Additionally, MONK8A (SA, 2001) has demonstrable accuracy over a wide range of applications and is distributed with a validation database comprising critical experiments covering uranium, plutonium and mixed systems over a wide range of moderation and reflection. The experiments selected are regarded as being representative of systems that are widely encountered in the nuclear industry, particularly with respect to chemical plant operations, transportation and storage. The validation database is subject to on-going review and enhancement. A categorization option is available in MONK8A (SA, 2001) to assist the criticality analyst in determining the type of system being assessed and provides a quick check that a calculation is adequately covered by validation cases.

5.2.1.1 Methods Validation

The validation process establishes method bias by comparing measured results from laboratory critical experiments to method-calculated results for the same systems. The verification and validation processes are controlled and documented. The validation establishes a method bias by correlating the results of critical experiments with results calculated for the same systems by the method being validated. Critical experiments are selected to be representative of the systems to be evaluated in specific design applications. The range of experimental conditions encompassed by a selected set of benchmark experiments establishes the area of applicability over which the calculated method bias is applicable. Benchmark experiments are selected that resemble as closely as practical the systems being evaluated in the design application.

The extensive validation database contains a number of experiments applicable to this application involving low and intermediate-enriched uranium. The MONK8A (SA, 2001) code with the JEF2.2 library was validated against these experiments which are provided in the International Handbook of Evaluated Criticality Safety Benchmark Experiments (NEA, 2002) and NUREG/CR-1071. The experiments chosen are provided in Table 5.2-1, Uranium Experiments Used for Validation, along with a brief description. The overall mean calculated value from these 93 configurations is 1.0017 ± 0.0045 and the results are provided in the MONK8A Validation and Verification report (see AREVA in ISAS table 3.0-1).

MONK8A is distributed in ready-to-run executable form. This approach provides the user with a level of quality assurance consistent with the needs of safety analysis. The traceability from source code to executable code is maintained by the code vendor.

5.2 Methodologies and Technical Practices

In accordance with the guidance in NUREG-1520, code validation for the specific application has been performed (see AREVA in ISAS table 3.0-1). Specifically, the experiments provided in Table 5.2-1, Uranium Experiments Used for Validation, were calculated and documented in the MONK8A Validation and Verification report (see AREVA in ISAS table 3.0-1) for the National Enrichment Facility. In addition, the MONK8A Validation and Verification report (see AREVA in ISAS table 3.0-1) satisfies the commitment to ANSI/ANS-8.1 and includes details of computer codes used, operations, recipes for choosing code options (where applicable), cross sections sets, and any numerical parameters necessary to describe the input.

The MONK8A computer code and JEF2.2 library are within the scope of the Quality Assurance Program.

5.2.1.2 Limits on Control and Controlled Parameters

The validation process established a bias by comparing calculations to measured critical experiments. With the bias determined, an upper safety limit (USL) can be determined using the following equation from NUREG/CR-6698, Guide for Validation of Nuclear Criticality Safety Calculational Methodology:

$$USL = 1.0 + \text{Bias} - \sigma_{\text{Bias}} - \Delta_{\text{SM}} - \Delta_{\text{AOA}}$$

Where the critical experiments are assumed to have a k_{eff} of unity, and the bias was determined by comparison of calculation to experiment. From Section 5.2.1.1, Methods Validation, the bias is positive and since a positive bias may be non-conservative, the bias is set to zero. The σ_{Bias} from the MONK8A Validation and Verification (see AREVA in ISAS table 3.0-1) is 0.0085 and a value of 0.05 is assigned to the subcritical margin, Δ_{SM} . The term Δ_{AOA} is an additional subcritical margin to account for extensions in the area of applicability. Since the experiments in the benchmark are representative of the application, the term Δ_{AOA} is set to zero for systems and components not associated with the Contingency Dump System. For the Contingency Dump System, it was necessary to extrapolate the area of applicability to include 1.5% enrichment and the term Δ_{AOA} is set to 0.0014 to account for this extrapolation. Thus, the USL becomes:

- $USL = 1 + 0 - 0.0085 - 0.05 = 0.9415$ (for systems and components NOT associated with the Contingency Dump System)
- $USL = 1 + 0 - 0.0085 - 0.05 - 0.0014 = 0.9401$ (for the Contingency Dump System and Tails Take-off System)

NUREG/CR-6698 indicates that the following condition be demonstrated for all normal and credible abnormal operating conditions:

$$k_{\text{calc}} + 2 \sigma_{\text{calc}} < USL$$

The risk of an accidental criticality resulting from NEF operations is inherently low. The low risk warrants the use of an alternate approach.

5.2 Methodologies and Technical Practices

At the low enrichment limits established for the NEF, sufficient mass of enriched uranic material cannot be accumulated to achieve criticality without moderation. Uranium in the centrifuge plant is inherently a very dry, unmoderated material. Centrifuge separation operations at NEF do not include solutions of enriched uranium. For most components that form part of the centrifuge plant or are connected to it, sufficient mass of moderated uranium can only accumulate by reaction between UF_6 and moisture in air leaking into plant process systems, leading to the accumulation of uranic breakdown material. Due to the high vacuum requirements for the normal operation of the facility, air inleakage into the process systems is controlled to very low levels and thus the highly moderated condition assumed represents an abnormal condition. In addition, excessive air in-leakage would result in a loss of vacuum, which in turn would cause the affected centrifuges to crash (self destruct) and the enrichment process in the affected centrifuges to stop. As such, buildup of additional mass of moderated uranic breakdown material, such that component becomes filled with sufficient mass of enriched uranic material for criticality, is precluded. Even when accumulated in large UF_6 cylinders or cold traps, neither UF_6 nor UO_2F_2 can achieve criticality without moderation at the low enrichment limit established for the NEF.

Therefore, due to the low risk of accidental criticality associated with NEF operations and the margin that exists in the design and operation of the NEF with respect to nuclear criticality safety, a margin of subcriticality for safety of 0.05 (i.e., $k_{eff} = k_{calc} + 3\sigma_{calc} < 0.95$) is adequate to ensure subcriticality is maintained under normal and abnormal credible conditions. As such, the NEF will be designed using the equation:

$$k_{eff} = k_{calc} + 3\sigma_{calc} < 0.95$$

5.2.1.3 General Nuclear Criticality Safety Methodology

The NCS analyses results provide values of k-effective (k_{eff}) to conservatively meet the upper safety limit. The following sections provide a description of the major assumptions used in the NCS analyses.

5.2.1.3.1 Reflection Assumption

The layout of the NEF is a very open design and it is not considered credible that those vessels and plant components requiring criticality control could become flooded from a source of water within the plant. Full water reflection of vessels has therefore been discounted. However, where appropriate, spurious reflection due to walls, fixtures, personnel, etc. has been accounted for by assuming 2.5 cm (0.984 in) of water reflection around vessels.

5.2.1.3.2 Enrichment Assumption

Enrichment is controlled to limit the percent ^{235}U within any process vessel or container to a maximum of 5% except for the systems and components associated with a cascade dump. For added conservatism the systems controlled to 5% are analyzed at 6%.

Assuming a product enrichment is 6% limits the upper bound for the average cascade enrichment to less than 1.5% the systems and components associates with a cascade dump (Tails Take-off System. Contingency Dump System) are conservatively analyzed at 1.5%

5.2 Methodologies and Technical Practices

5.2.1.3.3 Uranium Accumulation and Moderation Assumption

Most components that form part of the centrifuge plant or are connected to it assume that any accumulation of uranium is taken to be in the form of a uranyl fluoride/water mixture at a maximum H/U atomic ratio of 7 (exceptions are discussed in the associated nuclear criticality safety analyses documentation). The ratio is based on the assumption that significant quantities of moderated uranium could only accumulate by reaction between UF₆ and moisture in air leaking into the plant. Due to the high vacuum requirements of a centrifuge plant, in-leakage is controlled at very low levels and thus the H/U ratio of 7 represents an abnormal condition. The maximum H/U ratio of 7 for the uranyl fluoride-water mixture is derived as follows:

The stoichiometric reaction between UF₆ and water vapor in the presence of excess UF₆ can be represented by the equation:

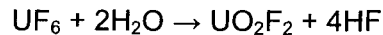

Due to its hygroscopic nature, the resulting uranyl fluoride is likely to form a hydrate compound. Experimental studies (Lychev, 1990) suggest that solid hydrates of compositions UO₂F₂·1.5H₂O and UO₂F₂·2H₂O can form in the presence of water vapor, the former composition being the stable form on exposure to atmosphere.

It is assumed that the hydrate UO₂F₂·1.5H₂O is formed and, additionally, that the HF produced by the UF₆/water vapor reaction is also retained in the uranic breakdown to give an overall reaction represented by:



For the MONK8A (SA, 2001) calculations, the composition of the breakdown product was simplified to UO₂F₂·3.5H₂O that gives the same H/U ratio of 7 as above.

In the case of oils, UF₆ pumps and vacuum pumps use a fully fluorinated perfluorinated polyether (PFPE) type lubricant. Mixtures of UF₆ and PFPE oil would be a less conservative case than a uranyl fluoride/water mixture, since the maximum HF solubility in PFPE is only about 0.1 %. Therefore, the uranyl fluoride/water mixture assumption provides additional conservatism in this case.

5.2.1.3.4 Vessel Movement Assumption

The limits placed on movement of an individual vessel or a specified batch of vessels containing enriched uranium are specified in the facility procedures or work plans, both of which are reviewed by Nuclear Criticality Safety. Specified limits may not be required based on bounding or process/system-specific NCS evaluations or analysis.

Of the subset of individual vessels or groups of vessels that do not have specified controls but are bounded by a the single-parameter SBD limits in Table 5.1-1, separation must be maintained at least 60 cm (23.6 in) from any other enriched uranium.

Vessels or groups of vessels that do not comply with either of the statements above must not be moved without the written approval of the Criticality Safety Officer.

5.2 Methodologies and Technical Practices

5.2.1.3.5 Pump Free Volume Assumption

There are two types of pumps used in product and dump systems of the plant:

- The vacuum pumps (product and dump) are rotary vane pumps. In the enrichment plant fixed equipment, these are assumed to have a free volume of 14 L (3.7 gal) and are modeled as a cylinder in MONK8A (SA, 2001). This adequately covers all models likely to be purchased.
- The UF₆ pumping units are a combination unit of two pumps, one 500 m³/hr (17,656 ft³/hr) pump with a free volume of 8.52 L (2.25 gal) modeled as a cylinder, and a larger 2000 m³/hr (70,626 ft³/hr) pump which is modeled explicitly according to manufacturer's drawings.

5.2.1.4 Nuclear Criticality Safety Analyses

Nuclear criticality safety is analyzed for the design features of the plant system or component and for the operating practices that relate to maintaining criticality safety. The analysis of individual systems or components and their interaction with other systems or components containing enriched uranium is performed to assure the criticality safety criteria are met. The nuclear criticality safety analyses and the safe values in Table 5.1-1, Safe Values for Uniform Aqueous Solution of Enriched UO₂F₂, provide a basis for the plant design and criticality hazards identification performed as part of the Integrated Safety Analysis.

Each portion of the plant, system, or component that may possibly contain enriched uranium is designed with criticality safety as an objective. Table 5.1-2, Safety Criteria for Buildings/Systems/Components, shows how the safe values of Table 5.1-1, are applied to the facility design to prevent a nuclear criticality event. The NEF is designed and operated in accordance with the parameters provided in Table 5.1-2. The Integrated Safety Analysis reviewed the facility design and operation and identified Items Relied On For Safety to ensure that criticality does not pose an unacceptable risk.

Where there are significant in-process accumulations of enriched uranium as UF₆ the plant design includes multiple features to minimize the possibilities for breakdown of the moderation control limits. These features eliminate direct ingress of water to product cylinders while in process.

Each NCS analysis includes, as a minimum, the following information.

- A discussion of the scope of the analysis and a description of the system(s)/process(es) being analyzed.
- A discussion of the methodology used in the criticality calculations, which includes the validated computer codes and cross section library used and the k_{eff} limit used (0.95).
- A discussion of assumptions (e.g. reflection, enrichment, uranium accumulation, moderation, movement of vessels, component dimensions) and the details concerning the assumptions applicable to the analysis.
- A discussion on the system(s)/process(es) analyzed and the analysis performed, including a description of the accident or abnormal conditions assumed.
- A discussion of the analysis results, including identification of required limits and controls.

5.2 Methodologies and Technical Practices

During the design, construction and operations phases of NEF, the NCS analysis is performed by a criticality safety engineer and independently reviewed by a second criticality safety engineer. During the operation of NEF, the NCS analysis is performed by a criticality safety engineer, independently reviewed by a second criticality safety engineer and approved by the Engineering Manger or the Criticality Safety Engineering Supervisor. Only qualified criticality safety engineers can perform NCS analyses and associated independent review.

5.2.1.5 Additional Nuclear Criticality Safety Analyses Commitments

The NEF NCS analyses were performed using the above methodologies and assumptions. NCS analyses also meet the following:

- NCS analyses are performed using acceptable methodologies.
- Methods are validated and used only within demonstrated acceptable ranges.
- The analyses adhere to ANSI/ANS-8.1 as it relates to methodologies.
- The validation report statement in Regulatory Guide 3.71 is as follows: LES has demonstrated (1) the adequacy of the margin of safety for subcriticality by assuring that the margin is large compared to the uncertainty in the calculated value of k_{eff} , (2) that the calculation of k_{eff} is based on a set of variables whose values lie in a range for which the methodology used to determine k_{eff} has been validated, and (3) that trends in the bias support the extension of the methodology to areas outside the area or areas of applicability.
- A specific reference to (including the date and revision number) and summary description of either a manual or a documented, reviewed, and approved validation report for each methodology are included. Any change in the reference manual or validation report will be reported to the NRC by letter.
- The reference manual and documented reviewed validation report will be kept at the facility.
- The reference manual and validation report are incorporated into the configuration management program.
- The NCS analyses are performed in accordance with the methods specified and incorporated in the configuration management program.
- The NCS methodologies and technical practices in NUREG-1520, Section 5.4.3.4, are used to analyze NCS accident sequences in operations and processes.
- The acceptance criteria in NUREG-1520, Section 3.4, as they relate to: identification of NCS accident sequences, consequences of NCS accident sequences, likelihood of NCS accident sequences, and descriptions of IROFS for NCS accident sequences are met.
- NCS controls and controlled parameters to assure that under normal and credible abnormal conditions, all nuclear processes are subcritical, including use of an approved margin of subcriticality for safety are used.
- As stated in ANSI/ANS-8.1, process specifications incorporate margins to protect against uncertainties in process variables and against a limit being accidentally exceeded.
- ANSI/ANS-8.7, as it relates to the requirements for subcriticality of operations, the margin of subcriticality for safety, and the selection of controls required by 10 CFR 70.61(d) (CFR, 2003b), is used.
- ANSI/ANS-8.10, as modified by Regulatory Guide 3.71, as it relates to the determination of consequences of NCS accident sequences, is used.

5.2 Methodologies and Technical Practices

- If administrative k_{eff} margins for normal and credible abnormal conditions are used, NRC pre-approval of the administrative margins will be sought.
- Subcritical limits for k_{eff} calculations such that: $k_{\text{eff}} \text{ subcritical} = 1.0 - \text{bias} - \text{margin}$, where the margin includes adequate allowance for uncertainty in the methodology, data, and bias to assure subcriticality are used.
- Studies to correlate the change in a value of a controlled parameter and its k_{eff} value are performed. The studies include changing the value of one controlled parameter and determining its effect on another controlled parameter and k_{eff} .
- The double contingency principle is met. The double contingency principle is used in determining NCS controls and IROFS.
- The acceptance criteria in NUREG-1520 Section 3.4, as they relate to subcriticality of operations and margin of subcriticality for safety, are met.

5.2.1.6 Nuclear Criticality Safety Evaluations (NCSE)

For any change (i.e., new design or operation, or modification to the facility or to activities of personnel, e.g., site structures, systems, components, computer programs, processes, operating procedures, management measures), that involves or could affect uranium, a NCSE shall be prepared and approved. Prior to implementing the change, it shall be determined that the entire process will be subcritical (with approved margin for safety) under both normal and credible abnormal conditions. If this condition cannot be shown with the NCSE, either a new or revised NCS analysis will be generated that meets the criteria, or the change will not be made.

The NCSE shall determine and explicitly identify the controlled parameters and associated limits upon which NCS depends, assuring that no single inadvertent departure from a procedure could cause an inadvertent nuclear criticality and that the safety basis of the facility will be maintained during the lifetime of the facility. The evaluation ensures that all potentially affected uranic processes are evaluated to determine the effect of the change on the safety basis of the process, including the effect on bounding process assumptions, on the reliability and availability of NCS controls, and on the NCS of connected processes.

The NCSE process involves a review of the proposed change, discussions with the subject matter experts to determine the processes which need to be considered, development of the controls necessary to meet the double contingency principle, and identification of the assumptions and equipment (e.g., physical controls and/or management measures) needed to ensure criticality safety.

Engineering judgment of the criticality safety engineer is used to ascertain the criticality impact of the proposed change. The basis for this judgment is documented with sufficient detail in the NCSE to allow the independent review by a second criticality safety engineer to confirm the conclusions of the judgment of results. Each NCSE includes, as a minimum, the following information.

- A discussion of the scope of the evaluation, a description of the system(s)/process(es) being evaluated, and identification of the applicable nuclear criticality safety analysis
- A discussion to demonstrate the applicable nuclear criticality safety analysis is bounding for the condition evaluated.

5.2 Methodologies and Technical Practices

- A discussion of the impact on the facility criticality safety basis, including effect on bounding process assumptions, on reliability and availability NCS controls, and on the nuclear criticality safety of connected system(s)/process(es).
- A discussion of the evaluation results, including (1) identification of assumptions and equipment needed to ensure nuclear criticality safety is maintained and (2) identification of limits and controls necessary to ensure the double contingency principle is maintained.

The NCSE is performed and documented by a criticality safety engineer. Once the NCSE is completed and the independent review by a criticality safety engineer is performed and documented, the Engineering Manager or the Criticality Safety Engineering Supervisor approves the NCSE. Only criticality safety engineers who have successfully met the requirements specified in the qualification procedure can perform NCSEs and associated independent review.

The above process for NCSEs is in accordance with ANSI/ANS 8.19.

5.2.1.7 Additional Nuclear Criticality Safety Evaluations Commitments

NCSEs also meet the following:

- The NCSEs are performed in accordance with the procedures specified and incorporated in the configuration management program.
- The NCS methodologies and technical practices in NUREG-1520, Sections 5.4.3.4.1(10)(a), (b), (d) and (e), are used to evaluate NCS accident sequences in operations and processes.
- The acceptance criteria in NUREG-1520, Section 3.4, as they relate to: identification of NCS accident sequences, consequences of NCS accident sequences, likelihood of NCS accident sequences, and descriptions of IROFS for NCS accident sequences are met.
- NCS controls and controlled parameters to assure that under normal and credible abnormal conditions, all nuclear processes are subcritical, including use of an approved margin of subcriticality for safety are used.
- The double contingency principle is met. The double contingency principle is used in determining NCS controls and IROFS.
- The acceptance criteria in NUREG-1520 Section 3.4, as they relate to subcriticality of operations and margin of subcriticality for safety, are met.

5.3 Criticality Accident Alarm System (CAAS)

5.3 Criticality Accident Alarm System (CAAS)

The facility is provided with a Criticality Accident Alarm System (CAAS) as required by 10 CFR 70.24, (CFR, 2003d). Areas where Special Nuclear Material (SNM) is handled, used, or stored in amounts at or above the 10 CFR 70.24 (CFR, 2003d) mass limits are provided with CAAS coverage. Emergency management measures are covered in the facility Emergency Plan.

5.4 Reporting

5.4 Reporting

The following are NCS Program commitments related to event reporting:

- A program for evaluating the criticality significance of NCS events will be provided and an apparatus will be in place for making the required notification to the NRC Operations Center. Qualified individuals will make the determination of significance of NCS events. The determination of loss or degradation of IROFS or double contingency principle compliance will be made against the license and 10 CFR 70 Appendix A (CFR, 2003f).
- The reporting criteria of 10 CFR 70 Appendix A and the report content requirements of 10 CFR 70.50 (CFR, 2003g) will be incorporated into the facility emergency procedures.
- The necessary report based on whether the IROFS credited were lost, irrespective of whether the safety limits of the associated parameters were actually exceeded will be issued.
- If it cannot be ascertained within one hour of whether the criteria of 10 CFR 70 Appendix A (CFR, 2003f) Paragraph (a) or (b) apply, the event will be treated as a one-hour reportable event.

5.5 References

5.5 References

Edition of Codes, Standards, NRC Documents, etc that are not listed below are given in ISAS Table 3.0-1.

CFR, 2003a. Title 10, Code of Federal Regulations, Part 70, Domestic Licensing of Special Nuclear Material, 2003.

CFR, 2003b. Title 10, Code of Federal Regulations, Section 70.61, Performance requirements, 2003.

CFR, 2003c. Title 10, Code of Federal Regulations, Section 70.64, Requirements for new facilities or new processes at existing facilities, 2003.

CFR, 2003d. Title 10, Code of Federal Regulations, Section 70.24, Criticality accident requirements, 2003.

CFR, 2003e. Title 10, Code of Federal Regulations, Section 70.72, Facility changes and change process, 2003.

CFR, 2003f. Title 10, Code of Federal Regulations, Part 70, Appendix A, Reportable Safety Events, 2003.

CFR, 2003g. Title 10, Code of Federal Regulations, Section 70.50, Reporting requirements, 2003.

Lychev, 1990. Crystalline Hydrates of Uranyl Fluoride at 20°C, Lychev, Mikhalev and Suglobov. Journal of Soviet Radiochemistry, Vol 32, 1990.

NEA, 2002. International Handbook of Evaluated Criticality Safety Benchmark Experiments, NEA/NSC/DOC(95)03, Nuclear Energy Agency, September 2002 Edition.

SA, 2001. Serco Assurance, ANSWERS Software Service, "Users Guide for Version 8 ANSWERS/MONK(98) 6," 1987-2001.

5.6 Chapter 5 Table

5.6 Chapter 5 Table

5.6 Chapter 5 Table

Table 5.1-1 Safe Values for Uniform Aqueous Solutions of Enriched UO_2F_2

Parameter	Critical Value $k_{\text{eff}} = 1.0$	Safe Value $k_{\text{eff}} = 0.95$	Safety Factor
Values for 5.0 % enrichment			
Volume	30.3 L (8.0 gal)	22.9 L (6.1 gal)	0.76
Cylinder Diameter	26.6cm(10.5 in)	23.9 cm (9.4 in)	0.90
Slab Thickness	12.8 cm (5.0 in)	11.1 cm (4.4 in)	0.87
Water Mass	18.5 kg H_2O (40.8 lb H_2O)	14.2 kg H_2O (31.1 lb H_2O)	0.77
Areal Density	11.8 g/cm^2 (24.2 lb/ft^2)	9.9 g/cm^2 (20.3 lb/ft^2)	0.84
Uranium Mass	36.7 kg U (80.9 lb U)		
- no double batching		26.8 kg U (59.1 lb U)	0.73
- double batching		16.5 kg U (36.4 lb U)	0.45
Values for 6.0 % enrichment			
Volume	25.3 L (6.7 gal)	19.3 L (5.1 gal)	0.76
Cylinder Diameter	24.8 cm (9.8 in)	22.4 cm (8.8 in)	0.90
Slab Thickness	11.6 cm (4.6in)	10.1 cm (4.0 in)	0.87
Water Mass	15.4 kg H_2O (34.0 lb H_2O)	11.9 kg H_2O (26.2 lb H_2O)	0.77
Areal Density	9.4 g/cm^2 (19.3 lb/ft^2)	7.9 g/cm^2 (16.2 lb/ft^2)	0.84
Uranium Mass	27 kg U (59.5 lb U)		
- no double batching		20.1 kg U (29.7 kg UF_6)	0.74
- double batching		12.2 kg U (26.9 lb U)	0.45

5.6 Chapter 5 Table

Table 5.1-2 Safety Criteria for Buildings/Systems/Components

Building/System/Component	Control Mechanism	Safety Criteria
Enrichment	Enrichment	5.0 w/o (6 w/o ²³⁵ U used in NCS)
Centrifuges	Diameter	< 22.4 cm (8.8 in)
Product Cylinders (30B)	Moderation	H < 0.98 kg (2.16 lb)
UF ₆ Piping	Diameter	< 22.4 cm (8.8 in)
Chemical Traps	Diameter	< 22.4 cm (8.8 in)
Product Cold Trap	Diameter	< 22.4 cm (8.8 in)
Contingency Dump System Tails System	Enrichment	1.5 w/o ²³⁵ U (used in NCS)
Tanks	Mass	< 12.2 kg U (26.9 lb U)
Feed Cylinders	Enrichment	< 0.72 w/o ²³⁵ U
Uranium Byproduct Cylinders	Enrichment	< 0.72 w/o ²³⁵ U
UF ₆ Pumps	Volume	< 19.3 L (5.1 gal)
Individual Uranic Liquid Containers, e.g., PFPE Oil Bottle, Laboratory Flask, Mop Bucket	Volume	< 19.3 L (5.1 gal)
Vacuum Cleaners Oil Containers	Volume	<19.3 L (5.1 gal)

5.6 Chapter 5 Table

Table 5.2-1 Uranium Experiments Used for Validation

MONK8A Case	Case Description	Number of Experiments	Handbook Reference
25	Low-enriched damp U ₃ O ₈ powder in cubic aluminum cans	10	NUREG/CR-1071
42	MARACAS Program: Polythene reflected critical configurations with low enriched and low moderated uranium dioxide powder U(5) O ₂	18	LEU-COMP-THERM-049
43	Low-enriched uranyl nitrate solutions	3	LEU-SOL-THERM-002
51	Low-enriched uranium solutions (new STACY experiments)	7	LEU-SOL-THERM-004
63	Boron carbide absorber rods in uranyl nitrate (5.6 % enriched)	3	LEU-SOL-THERM-005
69	Critical arrays of polyethylene-moderated U(30)F ₄ -Polytetrafluoroethylene one-inch cubes	29	LEU-COMP-THERM-001
71	STACY: 28 cm thick slabs of 10 % enriched uranyl nitrate solutions, water reflected	7	LEU-SOL-THERM-016
80	STACY: Unreflected 10 % enriched uranyl nitrate solution in a 60 cm diameter cylindrical tank	5	LEU-SOL-THERM-007
81	STACY: Concrete reflected 10 % enriched uranyl nitrate solution reflected by concrete	4	LEU-SOL-THERM-008
84	STACY: Borated concrete reflected 10 % enriched uranyl nitrate solution in a 60 cm diameter cylindrical tank	3	LEU-SOL-THERM-009
85	STACY: Polyethylene reflected 10 % enriched uranyl nitrate solution in a 60 cm diameter cylindrical tank	4	LEU-SOL-THERM-010

6.0 Chemical Process Safety

6.0 Chemical Process Safety

This chapter describes the Louisiana Energy Services (LES) plan for managing chemical process safety and demonstrating that chemical process safety controls meet the requirements of 10 CFR 70 (CFR, 2003a) thereby providing reasonable assurance that the health and safety of the public and facility employees is protected. The chapter describes the chemical classification process, the hazards of chemicals of concern, process interactions with chemicals affecting licensed material and/or hazardous chemicals produced from licensed material, the methodology for evaluating hazardous chemical consequences, and the chemical safety assurance features.

The NEF chemical process safety program meets the acceptance criteria in Chapter 6 of NUREG-1520 and complies with 10 CFR 70.61 (CFR, 2003b), 70.62 (CFR, 2003c) and 70.64 (CFR, 2003d).

The information provided in this chapter, the corresponding regulatory requirement and the section of NUREG-1520 Chapter 6 in which the NRC acceptance criteria are presented are summarized below:

Information Category and Requirement	10 CFR 70 Citation	NUREG-1520 Chapter 5 Reference
Section 6.1 Chemical Information		
• Properties and Hazards	70.62(c)(1)(ii)	6.4.3.1
Section 6.2 Chemical Process Information		
• General Information	70.65(b)(3)	6.4.3.1
• Design Basis, Materials, Parameters	70.62(b)	6.4.3.1
• Process Chemistry, Chemical Interaction		6.4.3.2
Section 6.3 Chemical Hazards Analysis		
• Methodology, Scenarios, Evaluation	70.65(b)(3)	6.4.3.2
Section 6.4 Chemical Safety Assurance		
• Management, Configuration Control, Design, BDC, Maintenance, Training, Procedures, Audits, Emergency Planning, Incident Investigation	70.65(b)(4)	6.4.3.2 6.4.3.3

6.1 Chemical Information

6.1 Chemical Information

This section addresses the criteria utilized to classify all site chemicals based on their potential for harm and as defined by regulatory requirements. It also presents information on the properties of selected chemicals. Chemical formulas in this Chapter utilize subscripting per standard convention.

6.1.1 Chemical Screening and Classification

A Chemical Safety Program tracks the general locations of hazardous chemicals onsite and the specific hazards associated with each chemical. Each chemical at the NEF has been classified into one of three categories (NEF Classes): Chemicals of Concern (Class 1), Interaction Chemicals (Class 2), or Incidental Chemicals (Class 3). The definition of each classification is provided below.

6.1.1.1 Chemicals of Concern (Class 1)

Chemicals of Concern (NEF Class 1) are determined based on one or more characteristics of the chemical and/or the quantity in storage/use at the facility. For licensed material or hazardous chemicals produced from licensed materials, chemicals of concern are those that, in the event of release have the potential to exceed any of the concentrations defined in 10 CFR 70 (CFR, 2003a) as listed below.

High Risk Chemicals of Concern

1. An acute worker dose of 1 Sv (100 rem) or greater total effective dose equivalent.
2. An acute dose of 0.25 Sv (25 rem) or greater total effective dose equivalent to any individual located outside the controlled area.
3. An intake of 30 mg or greater of uranium in soluble form by any individual located outside the controlled area.
4. An acute chemical exposure to an individual from licensed material or hazardous chemicals produced from licensed material that:
 - (i) Could endanger the life of a worker, or
 - (ii) Could lead to irreversible or other serious, long-lasting health effects to any individual located outside the controlled area.

Intermediate Risk Chemicals of Concern

1. An acute worker dose of 0.25 Sv (25 rem) or greater total effective dose equivalent.
2. An acute dose of 0.05 Sv (5 rem) or greater total effective dose equivalent to any individual located outside the controlled area.
3. A 24-hour averaged release of radioactive material outside the restricted area in concentrations exceeding 5000 times the values in Table 2 of Appendix B to 10 CFR 20 (CFR, 2003e).
4. An acute chemical exposure to an individual from licensed material or hazardous chemicals produced from licensed material that:
 - (i) Could lead to irreversible or other serious, long-lasting health effects to a worker, or

6.1 Chemical Information

- (ii) Could cause mild transient health effects to any individual located outside the controlled area.

Non-Licensed Chemicals of Concern

For those chemicals that are not related to licensed materials, chemicals of concern are those that are listed and handled above threshold quantities of either of the following standards:

1. 29 CFR 1910.119 (CFR, 2003f) – OSHA Process Safety Management
2. 40 CFR, 68 (CFR, 2003g) – EPA Risk Management Program.

These chemicals represent, based on their inherent toxic, reactive, or flammable properties, a potential for severe chemical release and/or acute chemical exposure to an individual that:

- (i) Could endanger the life of a worker, or
- (ii) Could lead to irreversible or other serious, long-lasting health effects to any individual located outside the controlled area.

It is noted here, that uranium hexafluoride (UF_6) is the only licensed material-related chemical of concern (NEF Class 1) that will be used at the facility. There are no non-licensed chemicals of concern at the facility. Table 6.1-1 identifies the hazards associated with UF_6 , UO_2F_2 , and HF; only UF_6 is considered to be process chemical. Tables 6.1-2 – 6.1-4 identify the locations and amounts of UF_6 , UO_2F_2 , and HF that will be present at the site.

6.1.1.2 Interaction Chemicals (Class 2)

Interaction chemicals (NEF Class 2) are those chemicals/chemical systems that require evaluation for their potential to precipitate or propagate accidents in chemical of concern (NEF Class 1) systems, but by themselves are not chemicals of concern.

6.1.1.3 Incidental Chemicals (Class 3)

The facility will use other chemicals that are neither chemicals of concern nor interaction chemicals. Some of these incidental chemicals (NEF Class 3) include those that have the potential to result in injurious occupational and/or environmental exposure, but represent no potential for acute exposure to the public and which via their nature, quantity, and/or use, have no potential for impacting chemicals of concern (NEF Class 1).

These chemicals will not be subject to chemical process safety controls. Controls will be placed on incidental chemical storage, use and handling as necessary and as follows:

1. General occupational chemical safety controls will be in place for protection of facility employees in the storage, handling, and use of all chemicals as required by 29 CFR 1910 (CFR, 2003h)
2. Environmental protection controls required to prevent and/or mitigate environmental damage due to spills and discharges and to control anticipated effluents and waste are detailed in Chapter 9, Environmental Protection, and the NEF Environmental Report.

6.1 Chemical Information

6.1.2 Chemicals of Concern - Properties

This section summarizes the chemical properties for chemicals of concern and their key byproducts.

6.1.2.1 Uranium Hexafluoride - Chemical Properties

6.1.2.1.1 Physical

Uranium hexafluoride (UF_6) is a chemical compound consisting of one atom of uranium combined with six atoms of fluorine. It is the chemical form of uranium that is used during the uranium enrichment process.

UF_6 can be a solid, liquid, or gas, depending on its temperature and pressure. Multiple phases coexist in equilibrium only under exact combinations of temperature and pressure. These properties are shown in Figure 6.1-1, UF_6 Phase Diagram, which presents the different physical forms of UF_6 as a function of temperature and pressure. The three phases are identified as regions on the diagram separated by lines representing a plot of equilibrium combinations of temperature and pressure. These boundaries all converge at one unique point on the diagram, called the triple point, where all three phases coexist in equilibrium. The triple point of UF_6 is 64°C (147°F) and 152 kPa (22 psia).

Liquid UF_6 is formed only at temperatures and pressures greater than the triple point. Below the triple point, solid UF_6 will change phase directly to UF_6 gas (sublimation) when the temperature is raised and/or the pressure is lowered at continuous points along the solid/gas interface line. This will occur without the UF_6 progressing through a liquid phase. Solid UF_6 is a white, dense, crystalline material that resembles rock salt. Both liquid and gaseous UF_6 are colorless.

Pure UF_6 follows its phase diagram consistently regardless of isotopic content. Impurities in a UF_6 cylinder will cause deviations in the normal phase behavior. The most common gaseous impurities in UF_6 feed are air and HF which are generated from the reaction of UF_6 with moisture in the air. Since these light gas impurities have a higher vapor pressure than UF_6 , their presence can be detected by measuring the static pressure of cylinders and comparing the results to the UF_6 phase diagram (when the UF_6 temperature is known).

UF_6 exhibits significant expansion when going from solid to liquid phase and continues to expand as the liquid temperature increases. This is illustrated in Figure 6.1-2, Densities of Solid and Liquid UF_6 . This figure shows that UF_6 expands roughly 53% going from a solid at 21°C (70°F) to a liquid at 113°C (235°F). Department of Transportation cylinder fill limits are based on UF_6 density at 121°C (250°F) and provide five percent ullage or free volume as a safety factor to prevent hydraulic rupture due to heating.

Other physical properties of UF_6 are presented in Table 6.1-5, Physical Properties of UF_6 .

6.1.2.1.2 Reactivity

UF_6 does not react with oxygen, nitrogen, carbon dioxide, or dry air, but it does react with water. For this reason, UF_6 is handled in leak tight containers and processing equipment. When UF_6 comes into contact with water, such as the water vapor in the air, the UF_6 and water react, forming HF gas and a solid uranium-oxyfluoride compound (UO_2F_2) which is commonly referred

6.1 Chemical Information

to as uranyl fluoride. Additional information on UF_6 reactions with water is provided in Section 6.2.1, Chemistry and Chemical Reactions.

UF_6 is also incompatible with a number of other chemicals including hydrocarbons and aromatics but none of these chemicals are used in or within proximity of UF_6 process systems.

6.1.2.1.3 Toxicological

If UF_6 is released to the atmosphere, the uranium compounds and HF that are formed by reaction with moisture in the air are chemically toxic. Uranium is a heavy metal that, in addition to being radioactive, can have toxic chemical effects (primarily on the kidneys) if it enters the bloodstream by means of ingestion or inhalation. HF is an extremely corrosive gas that can damage the lungs and cause death if inhaled at high enough concentrations. Additional information on the toxicological parameters used for evaluating exposure is provided in Section 6.3, Chemical Hazards Analysis.

6.1.2.1.4 Flammability

UF_6 is not flammable and does not disassociate to flammable constituents under conditions at which it will be handled at the facility.

6.1.2.2 Hydrogen Fluoride (HF) - Chemical Properties

HF is not a direct chemical of concern (NEF Class 1), however, it is one of two byproducts of concern that would be developed in the event of most accident scenarios at the facility. Understanding its properties therefore is important in evaluating chemical process conditions.

6.1.2.2.1 Physical

HF can exist as a gas or as a liquid under pressure (anhydrous HF) or as an aqueous solution of varying strengths (aqueous hydrofluoric acid). HF vapors are colorless with a pungent odor which is detectable at concentrations above 1 ppm. It is soluble in water with a release of heat.

Releases of anhydrous HF would typically fume (due to the reaction with water vapor) so that any significant release would be visible at the point of release and in the immediate vicinity.

6.1.2.2.2 Reactivity

In both gaseous and aqueous form, HF is extremely reactive, attacking certain metals, glass and other silicon-containing components, leather and natural rubber. Additional information regarding the corrosion properties and metal attack are provided in Section 6.2.1.3, UF_6 and Construction Materials.

6.1.2.2.3 Toxicological

HF in both gaseous and aqueous forms is strongly corrosive and causes severe burns to the skin, eyes and mucous membranes and severe respiratory irritation.

Inhalation of HF causes an intolerable prickling, burning sensation in the nose and throat, with cough and pain beneath the sternum. Nausea, vomiting, diarrhea and ulceration of the gums

6.1 Chemical Information

may also occur. In low concentrations, irritation of the nasal passages, dryness, bleeding from the nose and sinus disorders may result, while continued exposure can lead to ulceration and perforation of the nasal septum. Exposure to high concentrations can cause laryngitis, bronchitis and pulmonary edema which may not become apparent until 12-24 hours after the exposure.

Chronic exposure to excessive quantities of gaseous or particulate fluoride results in nausea, vomiting, loss of appetite and diarrhea or constipation. Fluorosis and other chronic effects may result from significant acute exposures. Systemic fluoride poisoning can cause hypocalcaemia which may lead to cardiac arrhythmias and/or renal failure. Chronic exposure to gaseous or particulate fluoride is not expected at the facility.

Skin exposure to concentrated liquid HF will result in aggressive chemical burns. Burns from exposure to dilute solutions (1-20%) of hydrofluoric acid (aqueous HF) or moderate concentrations of vapor may not be immediately painful or visible. Symptoms of skin exposure include immediate or delayed throbbing, burning pain followed by localized destruction of tissue and blood vessels that may penetrate to the bone. Exposure to liquid forms of HF is not expected at the facility.

Ocular exposure to HF causes a burning sensation, redness and secretion. Splashes of aqueous hydrofluoric acid to the eye rapidly produce conjunctivitis, keratitis and more serious destructive effects but these are not expected at the facility.

6.1.2.2.4 Flammability

HF is not flammable or combustible. HF can react exothermically with water to generate sufficient heat to ignite nearby combustibles. HF in reaction with certain metals can off gas hydrogen which is flammable. Both of these reactions would be more typical for bulk, concentrated HF interaction where large masses (i.e., bulk HF storage) of material are involved. These types of interactions are not expected at the facility.

6.1.2.3 Uranyl Fluoride - Chemical Properties

Uranyl fluoride (UO_2F_2) is not a direct chemical of concern (NEF Class 1), however, it is the second of two byproducts of concern (HF is the other) that would be developed in the event of a UF_6 release at the facility. Understanding its properties therefore is important in evaluating chemical process conditions.

6.1.2.3.1 Physical

UO_2F_2 is an intermediate in the conversion of UF_6 to a uranium oxide or metal form and is a direct product of the reaction of UF_6 with moisture in the air. It exists as a yellow, hygroscopic solid. UO_2F_2 formation and dispersion is governed by the conditions of the atmosphere in which the release is occurring. UF_6 will be continually hydrolyzed in the presence of water vapor. The resulting UF_6 /HF cloud will include UO_2F_2 particulate matter within the gaseous stream. As this stream diffuses into larger volumes and additional UF_6 hydrolysis occurs, UO_2F_2 particulate will settle on surfaces as a solid flake-like compound. This deposition will occur within piping/equipment, on lower surfaces within enclosures/rooms, and/or on the ground – wherever the UF_6 hydrolysis reaction is occurring.

6.1 Chemical Information

6.1.2.3.2 Reactivity

UO₂F₂ is reported to be stable in air to 300°C (570°F). It does not have a melting point because it undergoes thermal decomposition to triuranium octoxide (U₃O₈) above this temperature. When heated to decomposition, UO₂F₂ emits toxic fluoride fumes. UO₂F₂ is hygroscopic and water-soluble and will change in color from brilliant orange to yellow after reacting with water.

6.1.2.3.3 Toxicological

UO₂F₂ is radiologically and chemically toxic due to its uranium content and solubility. Once inhaled, uranyl fluoride is easily absorbed into the bloodstream because of its solubility. If large quantities are inhaled, the uranium in the uranyl complex acts as a heavy metal poison that affects the kidneys. Because of low specific activity values, the radiological toxicity of UF₆ and the UO₂F₂ byproduct are typically of less concern than the chemical toxicity.

6.1.2.3.4 Flammability

UO₂F₂ is not combustible and will not decompose to combustible constituents under conditions at which it will be handled at the facility.

6.2 Chemical Process Information

6.2 Chemical Process Information

This section characterizes chemical reactions between chemicals of concern and interaction chemicals and other substances as applicable. This section also provides a basic discussion of the chemical processes associated with UF₆ process systems.

6.2.1 Chemistry and Chemical Reactions

Although the separation of isotopes is a physical rather than chemical process, chemical principles play an important role in the design of the facility. The phase behavior of UF₆ is critical to the design of all aspects of the plant. UF₆ has a high affinity for water and will react exothermically with water and water vapor in the air. The products of UF₆ hydrolysis, solid UO₂F₂ and gaseous HF, are both toxic. HF is also corrosive, particularly in the presence of water vapor. Because this chemical reaction results in undesirable by-products, UF₆ is isolated from moisture in the air through proper design of primary containment (i.e., piping, components, and cylinders).

Other chemical reactions occur in systems that decontaminate equipment, remove contaminants from effluent streams, and as part of lubricant recovery or other cleansing processes. Side reactions can include the corrosion and deterioration of construction materials, which influences their specification. These reactions are further described below.

6.2.1.1 UF₆ and Water

Liquid and gaseous UF₆ react rapidly with water and water vapor as does the exposed surface of solid UF₆. UF₆ reacts with water so rapidly that the HF formed is always anhydrous when in the presence of UF₆, significantly reducing its corrosive potential in cylinders, piping, and equipment. The reaction of gaseous UF₆ with water vapor at elevated temperatures is shown in Equation 6.2-1.

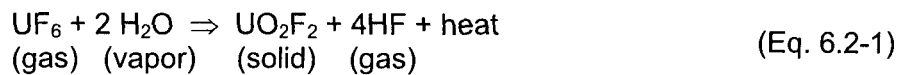

At room temperature, depending on the relative humidity of the air, the products of this reaction are UO₂F₂ hydrates and HF-H₂O fog, which will be seen as a white cloud. A typical reaction with excess water is given in Equation 6.2-2.

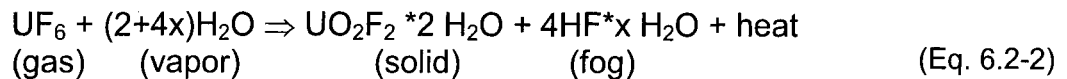

If, because of extremely low humidity, the HF-H₂O fog is not formed, the finely divided uranyl fluoride (UO₂F₂) causes only a faint haze. UO₂F₂ is a water-soluble, yellow solid whose exact coloring depends on the degree of hydration as well as the particle size.

6.2 Chemical Process Information

The heat release for the reaction in Equation 1 is 288.4 kJ/kg (124 BTU/lbm) of UF₆ gas reacted. The heat release is much larger if the UO₂F₂ is hydrated and HF-H₂O fog is formed with a heat release of 2,459 kJ/kg (1057 BTU/lbm) of UF₆ vapor.

These reactions, if occurring in the gaseous phase at ambient or higher temperatures, are very rapid, near instantaneous. Continuing reactions between solid UF₆ and excess water vapor occur more slowly as a uranyl fluoride layer will form on surface of the solid UF₆ which inhibits the rate of chemical reaction.

UF₆ reactions with interaction chemicals are discussed below. These include chemical reactions associated with lubricants and other chemicals directly exposed to UF₆, as well as chemicals used to recover contaminants from used lubricating oils, and capture trace UF₆, uranium compounds, and HF from effluent streams. UF₆ reactions with materials of construction are addressed in Section 6.2.1.3, UF₆ and Construction Material.

6.2.1.2 UF₆ and Interaction Chemicals

The chemistry of UF₆ is significantly affected by its fluorination and oxidation potential. Many of the chemical properties of UF₆ are attributable to the stability of the UO₂⁺⁺ ion, which permits reactions with water, oxides, and salts containing oxygen-bearing anions such as SO₄⁻⁻, NO₃⁻⁻, and CO₃⁻⁻ without liberation of the O₂ molecule.

The following subsection describes potential chemical interactions between the UF₆ process streams and interaction chemicals.

6.2.1.2.1 PFPE Oil

The reaction of UF₆ with hydrocarbons is undesirable and can be violent. Gaseous UF₆ reacts with hydrocarbons to form a black residue of uranium-carbon compounds. Hydrocarbons can be explosively oxidized if they are mixed with UF₆ in the liquid phase or at elevated temperatures. It is for this reason that non-fluorinated hydrocarbon lubricants are not utilized in any UF₆ system at the NEF.

UF₆ vacuum pumps are lubricated using PFPE (Perfluorinated Polyether) oil. PFPE oil is inert, fully fluorinated and does not react with UF₆ under any operating conditions.

Small quantities of uranium compounds and traces of hydrocarbons may be contained in the PFPE oil used in the UF₆ vacuum pumping systems. The UF₆ degrades in the oil or reacts with trace hydrocarbons to form crystalline compounds – primarily uranyl fluoride (UO₂F₂) and uranium tetrafluoride (UF₄) particles – that gradually thicken the oil and reduce pump capacity.

Recovery of PFPE oil for reuse in the system is conducted remotely from the UF₆ process systems. The dissolved uranium compounds are removed in a process of precipitation, centrifugation, and filtration. Anhydrous sodium carbonate (Na₂CO₃) is added to contaminated PFPE oil. Uranium compounds react to form sodium uranyl carbonate, which precipitates out. A filter removes the precipitate during subsequent centrifugation of the oil.

Trace amounts of hydrocarbons are then removed by adding activated carbon to the PFPE oil and heating causing absorption of the hydrocarbons. The carbon is in turn removed through a bed of celite.

6.2 Chemical Process Information

Failures associated with PFPE oil and PFPE oil recovery is evaluated in the Integrated Safety Analysis.

6.2.1.2.2 Chemical Traps - Activated Carbon, Aluminum Oxide, and Sodium Fluoride

Adsorption is the attraction of gas molecules to the surface of an activated solid. There are two classifications of adsorption: physical and chemical. At ordinary temperatures, adsorption is usually caused by molecular forces rather than by the formation of chemical bonds. In this type of adsorption, called physical adsorption, very little heat is evolved. If a chemical reaction takes place between the gas and the solid surface, the process is known as chemisorption. In chemisorption the reaction between surface and gas molecules occurs in a stoichiometric manner, and heat is liberated during the reaction.

Chemisorption is used in the removal of UF_6 and HF from gaseous effluent streams. It is also used to remove oil mist from vacuum pumps operating upstream of gaseous effluent ventilation systems. Adsorbent materials are placed on stationary beds in chemical traps downstream of the various cold traps. These materials capture HF and the trace amounts of UF_6 that escape desublimation during feed purification or during venting of residual UF_6 contained in hoses and/or piping that is bled down before disconnection.

The chemical traps are placed in series downstream of the cold traps in the exhaust streams to the GEVS and may include one or more of a series of two different types of chemical traps. The first type of trap contains a charge of activated carbon to capture the small amounts of UF_6 that escape desublimation. Since chemisorption is a pressure sensitive process, HF is not fully adsorbed on carbon at low pressures. This necessitates a second type of trap containing a charge of aluminum oxide (Al_2O_3) to remove HF from the gaseous effluent stream. One or more of a series of these traps is used depending on the process system being served. Additionally, a carbon trap is present on the inlet of the vacuum pumps which discharge to the GEVS to prevent any of the pump oil from migrating back into the UF_6 cold traps.

Chemisorption of UF_6 on activated carbon evolves considerable thermal energy. This is not normally a problem in the chemical traps downstream of the cold traps because very little UF_6 escapes desublimation. If multiple equipment failures and/or operator errors occur, significant quantities of UF_6 could enter the chemical traps containing activated carbon. This could cause significant overheating leading to release. Failures associated with the carbon traps were evaluated in the Integrated Safety Analysis.

Activated carbon cannot be used in the Contingency Dump System because the relatively high UF_6 flow rates during this non-routine operation could lead to severe overheating. A chemical trap containing sodium fluoride (NaF) is installed in the contingency dump flow path to trap UF_6 . NaF is used because the heat of UF_6 chemisorption on NaF is significantly lower than the heat of UF_6 chemisorption on activated carbon. Failures associated with the NaF traps were evaluated in the integrated safety analysis.

There are no specific concerns with heat of adsorption of either UF_6 or HF with Al_2O_3 . Failures associated with the aluminum oxide traps were evaluated in the Integrated Safety Analysis.

The properties of these chemical adsorbents are provided in Table 6.2-1, Properties of Chemical Adsorbents.

6.2 Chemical Process Information

6.2.1.2.3 Decontamination – Citric Acid

Contaminated components (e.g., pumps, valves, piping), once they are removed from the process areas, undergo decontamination. Oily parts are washed in a hot water wash that will remove the bulk of oil including residual uranic compounds. Once the hot water wash is complete, citric acid is used to remove residual uranic fluoride compound layers that are present on the component surfaces. The reaction of the uranium compounds with the citric acid solution produces various uranyl citrate complexes. After citric acid cleansing, the decontaminated component is subject to two additional water wash/rinse cycles. The entire decontamination operation is conducted in small batches on individual components.

Decontamination of sample bottles and valves is also accomplished using citric acid.

Decontamination was evaluated in the Integrated Safety Analysis. Adequate personnel protective features are in place for safely handling decontamination chemicals and byproducts.

6.2.1.2.4 Nitrogen

Gaseous nitrogen is used in the UF₆ systems for purging and filling lines that have been exposed to atmosphere for any of several reasons including: connection and disconnection of cylinders, preparing lines/components for maintenance, providing an air-excluding gaseous inventory for system vacuum pumps, and filling the interstitial space of the liquid sampling autoclave (secondary containment) prior to cylinder liquefaction.

The nitrogen system consists of liquid nitrogen bulk storage vessels, vaporizers, and liquid and gaseous nitrogen distribution lines and instrumentation. Liquid nitrogen is delivered by tanker and stored in the storage vessels.

Nitrogen is not reactive with UF₆ in any plant operational condition. Failures of the nitrogen system were evaluated in the Integrated Safety Analysis.

6.2.1.2.5 Silicone Oil

Silicone oil is used as a heat exchange medium for the heating/chilling of various cold traps and for the CTF Huber heating units. This oil is external to the UF₆ process stream in all cases and is not expected to interact with UF₆. Failures in the heating/chilling systems were evaluated in the Integrated Safety Analysis.

6.2.1.2.6 Halocarbon Refrigerants

Halocarbon refrigerants (including R23 trifluoromethane, R404A fluoromethane blend, and R507 penta/trifluoromethane) are used in individual package chillers that will provide cooling of UF₆ cylinders and/or silicon oil heat exchange media for take-off stations, CTF take-off vessel, CTF centrifuge enclosure, and cold traps. These halocarbons were selected due to good heat transfer properties, because they satisfy environmental restrictions regarding ozone depletion, and are non-flammable. All halocarbon refrigerants are external to the UF₆ process stream in all cases and are not expected to interact with UF₆. Failures in the heating/chilling systems were evaluated in the Integrated Safety Analysis.

6.2 Chemical Process Information

6.2.1.2.7 Deleted

6.2.1.2.8 Centrifuge Cooling Water

(See 12.2.3.1) Centrifuge cooling water is provided from the Centrifuge Cooling Water Distribution System. The function of this system is to provide a supply of deionized cooling water to the cooling coils of the centrifuges. This system provides stringent control over the operating temperature of the centrifuges to enable their efficient operation. A supplemental cooling supply (plate and frame heat exchanger located in the CUB) is provided to augment the normal cooling water from the towers during extreme hot weather conditions. Additionally, since the plant will be brought online incrementally the cooling towers may not be utilized for First Cascade Online. A bypass line has been installed to isolate the cooling towers at this point and allowing the chiller units associated with the Centrifuge Cooling Water System to provide the initial cooling. When the cooling towers become available or the heat load of the enrichment plant is high enough so that the cooling towers will be necessary the Centrifuge Cooling Water System will be lined up to direct flow through the cooling towers.

CCWS initial fill may be accomplished by using an outside source via, tanker truck rather than DI system. Hose connection with 6" isolation valve is provided for this purpose. Centrifuge cooling water is external to the UF₆ process stream in all cases and is not expected to interact with UF₆. Failures in the centrifuge cooling water distribution system were evaluated in the Integrated Safety Analysis.

6.2.1.3 UF₆ and Construction Materials

The corrosion of metallic plant components and the deterioration of non-metallic sealing materials is avoided by specifying resistant materials of construction and by controlling process fluid purity.

Direct chemical attack by the process fluid on metallic components is the result of chemical reactions. In many cases, the affinity of the process fluid for the metal produces metallic compounds, suggesting that rapid destruction of the metal would take place. This is usually prevented by the formation of a protective layer on the surface of the metal.

Deterioration of non-metallic materials is caused by exposure to process fluids and conditions. Materials used in gaskets, valves, flexible hoses, and other sealants must be sufficiently inert to have a useful service life.

UF₆ and some of its reaction products are potentially corrosive substances, particularly HF. UF₆ is a fluorinating agent that reacts with most metals. The reaction between UF₆ and metals such as nickel, copper, and aluminum produces a protective fluoride film over the metal that inhibits further reaction. These materials are therefore relatively inert to UF₆ corrosion after passivation and are suitable for UF₆ service. Aluminum is used as piping material for UF₆ systems because it is especially resistant to corrosion in the presence of UF₆. Carbon steels and stainless steels can be attacked by UF₆ at elevated temperatures but are not significantly affected by the presence of UF₆ at the operating temperatures for the facility.

Light gas impurities such as HF and air are removed from UF₆ during the purification process. Although HF is a highly corrosive substance when in solution with water as aqueous hydrofluoric acid, it contributes very little to metal corrosion when in the presence of UF₆. This is

6.2 Chemical Process Information

due to the fact that UF_6 reacts with water so rapidly that HF remains anhydrous when in the presence of UF_6 .

Corrosion rates of certain metals in contact with UF_6 are presented in Table 6.2-2, UF_6 Corrosion Rates, for two different temperatures. Resistant metal such as stainless steel are used in valve bellows and flex hoses. Aluminum piping is bent to minimize the use of fittings. Connections are welded to minimize the use of flanges and gaskets. As a standard practice, the use of sealant materials is minimized to reduce the number of potential leak paths.

Non-metallic materials are required to seal connections in UF_6 systems to facilitate valve and instrument replacement as well as cylinder connections. They are also used in valve packing and seating applications. All gasketing and packing material used at the facility will be confirmed as appropriate for UF_6 services. Typical materials that are resistant to UF_6 through the range of plant operating conditions include butyl rubber, Viton, and Kel-F.

The materials used to contain UF_6 are provided in Table 6.2-3, Materials of Construction for UF_6 Systems. The cylinders to be used at the facility are standard Department of Transportation approved containers for the transport and storage of UF_6 , designed and fabricated in accordance with ANSI N14.1. The nominal and minimum (for continued service) wall thickness for cylinders listed in Table 6.2-3, are taken from this standard.

The remaining system materials are relatively inert in the presence of UF_6 and the corrosion rates given in Table 6.2-2, indicate that these materials are acceptable for UF_6 service over the life of the plant.

As shown in Table 6.2-3, the cylinders used to store and transport UF_6 are made of carbon steel. Uranium Byproduct Cylinders (UBCs) are stored outside in open air where they are exposed to the elements. Atmospheric corrosion is determined by the exposure to moisture (e.g., rain, snow, atmospheric humidity) and the impurities in the air (such as sulfur). The corrosion rate on the outside surfaces of the carbon steel cylinders therefore varies accordingly with these conditions. Carbon steel storage cylinders are painted to provide a corrosion barrier to external elements.

External corrosion can occur on the outside cylinder surface and at interface points such as the contact point with the resting blocks and in skirt depressions (at the cylinder ends). According to a paper entitled Monitoring of Corrosion in ORGDP Cylinder Yards (DOE, 1988), the average corrosion rate experienced by UBCs is less than 0.051 mm/yr (2 mils/yr). This corrosion rate is almost exclusively due to exterior rust on the carbon steel. Another report – Prediction of External Corrosion for Steel Cylinders – 2001 Report (ORNL, 2001) – sampled exterior steel cylinders (30A) at Oak Ridge National Laboratories that had been subject to intermittent contact with the ground and found to have average corrosion rates of approximately 0.041 mm/yr (1.6 mils/yr). These values indicate that the expected service life would be greater than 50 years. These rates are conservative based on the UBC storage arrangement at the NEF. Cylinders subject to weather conditions (i.e., UBCs) will be periodically inspected to assess corrosion and corrosion rate.

6.2.2 Process - General Enrichment Process

Uranium enrichment is the process by which the isotopic composition of uranium is modified. Natural uranium consists of three isotopes, uranium 234 (^{234}U), uranium 235 (^{235}U), and uranium

6.2 Chemical Process Information

238 (^{238}U), approximately 0.0058 w/o, 0.711 w/o and 99.28 w/o respectively. ^{235}U , unlike ^{238}U , is fissile and can sustain a nuclear chain reaction. Light water nuclear power plants (the type in the United States) normally operate on fuel containing between 2 w/o and 5 w/o ^{235}U (low-enriched uranium); therefore, before natural uranium is used in uranium fuel for light water reactors it undergoes "enrichment."

In performing this enrichment, the NEF will receive and enrich natural uranium hexafluoride (UF_6) feed. The isotopes are separated in gas centrifuges arranged in arrays called cascades.

This process will result in the natural UF_6 being mechanically separated into two streams: (1) a product stream which is selectable up to a maximum 5 w/o ^{235}U enrichment, and (2) a tails stream which is depleted to low percentages of ^{235}U (0.32 w/o on average). No chemical reaction occurs during enrichment. Other processes at the plant include product blending, homogenizing and liquid sampling to ensure compliance with customer requirements and to ensure a quality product.

The enrichment process is comprised of the following major systems:

- UF_6 Feed System
- Cascade System
- Product Take-Off System
- Tails Take-Off System
- Product Blending System
- Product Liquid Sampling System.

UF_6 is delivered to the plant in ANSI N14.1 standard Type 48Y international transit cylinders, which are placed in a feed station and connected to the plant via a common manifold. Heated air is circulated around the cylinder to sublime UF_6 gas from the solid phase. The gas is flow controlled through a pressure control system for distribution to the cascade system at subatmospheric pressure.

Individual centrifuges are not able to produce the desired product and tails concentration in a single step. They are therefore grouped together in series and in parallel to form arrays known as cascades. A typical cascade is comprised of many centrifuges.

UF_6 is drawn through cascades with vacuum pumps and compressed to a higher subatmospheric pressure at which it can desublime in the receiving cylinders. Highly reliable UF_6 resistant pumps will be used for transferring the process gas.

Tails material and product material are desublimed at separate chilled take-off stations. Tails material is desublimed into 48Y cylinders. Product material is desublimed into 30B cylinders.

With the exception of liquid sampling operations, the entire enrichment process operates at subatmospheric pressure. This safety feature helps ensure that releases of UF_6 or HF are minimized because leakage would typically be inward to the system. During sampling operations, UF_6 is liquefied within an autoclave which provides the heating required to homogenize the material for sampling. The autoclave is a rated pressure vessel which serves as secondary containment for the UF_6 product cylinders while the UF_6 is in a liquid state.

6.2 Chemical Process Information

There are numerous subsystems associated with each of the major enrichment process systems as well as other facility support and utility systems. These include systems supporting venting, cooling, electrical power, air and water supply, instrumentation and control and handling functions among others.

6.2.3 Process System Descriptions

Detailed system descriptions and design information for enrichment process and process support systems are provided in the NEF Integrated Safety Analysis Summary. These descriptions include information on process technology including materials of construction, process parameters (e.g., flow, temperature, pressure, etc.), key instrumentation and control including alarms/interlocks, and items relied on for safety (IROFS).

6.2.4 Utility and Support System Descriptions

The UF₆ Enrichment Systems also interface with a number of supporting utility systems. Detailed system descriptions and design information for these utility and support systems are provided in the NEF Integrated Safety Analysis Summary. These descriptions include information on process technology including materials of construction; process parameters (e.g., flow, temperature, pressure, etc.), key instrumentation and control including alarms/interlocks, and (IROFS).

6.2.5 Safety Features

There are a number of safety features in place to help prevent, detect, and mitigate potential releases of UF₆. Some of these features are classified as (IROFS) as determined in the Integrated Safety Analysis (ISA). A listing of IROFS associated with process, utility and supporting systems as well as those applicable to the facility and its operations (e.g., administrative controls) is presented in the NEF Integrated Safety Analysis Summary.

In addition to IROFS, there are other process system features that are intended to protect systems from damage that would result in an economic loss. Many of these features have a secondary benefit of enhancing safety by detecting, alarming, and/or interlocking process equipment – either prior to or subsequent to failures that result in a release of material.

6.3 Chemical Hazards Analysis

6.3 Chemical Hazards Analysis

6.3.1 Integrated Safety Analysis

LES has prepared an Integrated Safety Analysis (ISA) as required under 10 CFR 70.62 (CFR, 2003c). The ISA:

- Provides a list of the accident sequences which have the potential to result in radiological and non-radiological releases of chemicals of concern
- Provides reasonable estimates for the likelihood and consequences of each accident identified
- Applies acceptable methods to estimate potential impacts of accidental releases.

The ISA also:

- Identifies adequate engineering and/or administrative controls (IROFS) for each accident sequence of significance
- Satisfies principles of the baseline design criteria and performance requirements in 10 CFR 70.61 (CFR, 2003b) by applying defense-in-depth to high risk chemical release scenarios
- Assures adequate levels of these controls are provided so those items relied on for safety (IROFS) will satisfactorily perform their safety functions.

The ISA demonstrates that the facility and its operations have adequate engineering and/or administrative controls in place to prevent or mitigate high and intermediate consequences from the accident sequences identified and analyzed.

6.3.2 Consequence Analysis Methodology

This section describes the methodology used to determine chemical exposure/dose and radiochemical exposure/dose criteria used to evaluate potential impact to the workers and the public in the event of material release. This section limits itself to the potential effects associated with accidental release conditions. Potential impacts from chronic (e.g., long-term) discharges from the facility are detailed in the Environmental Report.

6.3.2.1 Defining Consequence Severity Categories

The accident sequences identified by the ISA need to be categorized into one of three consequence categories (high, intermediate, or low) based on their forecast radiological, chemical, and/or environmental impacts. Section 6.1.1, Chemical Screening and Classification, presented the radiological and chemical consequence severity limits defined by 10 CFR 70.61 (CFR, 2003b) for the high and intermediate consequence categories.

To quantify criteria of 10 CFR 70.61 (CFR, 2003b) for chemical exposure, standards for each applicable hazardous chemical must be applied to determine exposure that could: (a) endanger the life of a worker; (b) lead to irreversible or other serious long-lasting health effects to an individual; and (c) cause mild transient health effects to an individual. Per NUREG-1520, acceptable exposure standards include the Emergency Response Planning Guidelines (ERPG) established by the American Industrial Hygiene Association and the Acute Exposure Guideline Levels (AEGL) established by the National Advisory Committee for Acute Guideline Levels for

6.3 Chemical Hazards Analysis

Hazardous Substances. The definitions of various ERPG and AEGL levels are contained in Table 6.3-1, ERPG and AEGL Level Definitions.

The consequence severity limits of 10 CFR 70.61 (CFR, 2003b) has been summarized and presented in Table 6.3-2, Licensed Material Chemical Consequence Categories. The severity limits defined in this table are developed against set criteria.

The toxicity of UF_6 is due to its two hydrolysis products, HF and UO_2F_2 . The toxicological effects of UF_6 as well as these byproducts were previously described in Section 6.1.2. AEGL and NUREG-1391 values for HF and UF_6 were utilized for evaluation of chemotoxic exposure. Additionally, since the byproduct uranyl fluoride is a soluble uranium compound, the AEGL values were derived for evaluating soluble uranium (U) exposure in terms of both chemical toxicity and radiological dose. In general, the chemotoxicity of uranium inhalation/ingestions is of more significance than radiation dose resulting from internal U exposure. The ERPG and AEGL values for HF are presented in Table 6.3-3, ERPG and AEGL values for HF. The ERPG and AEGL values for UF_6 (as soluble U) are presented in Table 6.3-4, ERPG and AEGL values for Uranium Hexafluoride (as soluble U). The values from NUREG-1391 for soluble uranium are presented in Table 6.3-6, Health Effects from Intake of Soluble Uranium.

Table 6.3-5, Definition of Consequence Severity Categories, presents values for HF and UF_6 (as soluble U) from the AEGL and NUREG-1391.

6.3.2.1.1 Worker Exposure Assumptions

“Consequences to the facility worker” (facility worker) covers all workers including an operator working on or operating a piece of plant equipment that unexpectedly causes a release near his/her vicinity; and a worker that may be present in a room (or inadvertently enter a room) where an unanticipated release has occurred. The release of UF_6 in an accident would be primarily a toxic chemical hazard rather than a radiological hazard. The use of a 2.5 minute exposure time is appropriate for consequence assessments.

For the facility worker that operates or works on equipment in the immediate vicinity that causes the release, they are not assumed to receive any significant exposure at the immediate vicinity because:

- UF_6 systems at the NEF are at negative (sub-atmospheric) pressure. No outflow of UF_6 vapor occurs during the initial time of air in-leakage, which is typically on the order of 5 to 20 seconds for ruptures of 100mm (4-inches) in diameter or less. It is likely that the worker will respond to the sound of in-rushing air and the worker can be expected to evacuate the immediate area promptly. It can be assumed that a rupture of greater than 4-inches should be immediately obvious to the worker and the worker will respond immediately. (Vacuum system delay)
- Any release from UF_6 systems/cylinders at the facility would predominantly consist of HF with some potential entrainment of uranic particulate. An HF release would cause a visible cloud and a pungent odor. The odor threshold for HF is less than 1 ppm and the irritating effects of HF are intolerable at concentrations well below those that could cause permanent injury or which produce escape-impairing systems. Employees are trained in proper actions to take in response to a release and workers should take immediate self-

6.3 Chemical Hazards Analysis

protective action to escape a release area upon detecting any significant HF odor. (See and flee)

- Other facilities have successfully assumed that the gas hemisphere radius expands at a rate of 1 m/s and the receptor (facility worker) walks away from the release point at 1 m/s within the cloud. This assumption is supported by the Society of Fire Protection Engineers which reference:
 - 1.27 m/s (250 ft/min) for minimum crowd conditions, and
 - 1.02 m/s (200 ft/min) for moderate crowd conditions for fire evacuation.

Workers in restricted areas could evacuate at a faster rate, putting themselves ahead of the leading edge of the expanding cloud or minimizing exposure during evacuation even if they evacuate in the direction of the plume. At a speed of 1 m/s, facility workers originally at the release point are outside the immediate area of the release (i.e., 1.5 m radius) in less than 2 seconds, and are accurately classified as facility workers for consequence assessments. (Worker evacuation speed)

- Consistent with the Safety Evaluation Report for the NEF, Appendix A (Reference 9), a time weighted average (TWA) of dose or exposure is acceptable to calculate consequences to the workers in the room. The use of the TWA concept combined with the other concepts discussed here demonstrated that the risk of exposure is minimal to the facility worker that causes the release. For example, at the intermediate consequence threshold of 78 mg/m³ HF, the TWA contribution of the former "local worker" 10-second exposure over 2.5 minutes is merely 5.2 mg/m³ HF (78 mg/m³ HF x 10 sec/150 sec). (Time weighted average)
- Consequence methodology applies the 10-minute AEGL limits for the facility worker. These limits are 10-minute exposures that are applied to the 2.5-minute exposure; therefore, there is a built-in conservatism that applies to all consequence analysis. The conservatism is due to the more stringent AEGL values for 10-minute exposure being applied to the shorter 2.5-minute facility worker exposure. (AEGL 10-min limit)

IROFS39c administratively limits exposure by requiring worker action to evacuate the area(s) of concern in the event of a release to ensure worker consequences of inhalation of uranic material and HF is low. Management measures provide reasonable assurance that IROFS39c will be an effective control when required. Implementation of IROFS39c through an approved procedure ensures that workers will respond promptly to any chemical release and take immediate action to avoid ever-exposures.

Another assumption made in conducting consequence severity analysis is that for releases precipitated by a fire event, only public exposure was considered in determining consequence severity; worker exposures were not considered. The worker is assumed to evacuate the area of concern once the fire is detected by the worker. Fires of sufficient magnitude to generate chemical/radiological release must either have caused failure of a mechanical system/component or involve substantive combustibles containing uranic content. In either case, the space would be untenable for unprotected workers. Sufficient time is available for the worker to reliably detect and evacuate the area of concern prior to any release. Fire brigade/fire department members responding to emergencies are required by emergency response procedure (and regulation) to have suitable respiratory and personal protective equipment.

6.3 Chemical Hazards Analysis

It is recognized that there are still locations within the ISA where the "local worker" receptor is still referenced in HAZOP and Risk Assessments. This is acceptable because in all cases the local worker maintains at least the same level of conservative assumptions as the facility worker; therefore, in all cases the local worker is bounded within the safety basis. The "consequences to the worker elsewhere in the room" (Area Worker) is identical to the facility worker described above; therefore, in all cases the area worker is bounded within the safety basis. The local and area worker receptors will be revised to facility worker throughout the entire ISA as part of the ISA update process.

6.3.2.1.2 Public Exposure Assumptions

Potential exposures to members of the public were also evaluated assuming conservative assumptions for both exposure concentrations and durations. Exposure was evaluated for consequence severity against chemotoxic, radiotoxic, and radiological dose.

Public exposures were estimated to last for a duration of 30 minutes. This is consistent with self-protective criteria for UF₆/HF plumes listed in NUREG-1140.

6.3.2.2 Chemical Release Scenarios

The evaluation level chemical release scenarios based on the criteria applied in the Integrated Safety Analysis are presented in the NEF Integrated Safety Analysis Summary. Information on the criteria for the development of these scenarios is also provided in the NEF Integrated Safety Analysis Summary.

6.3.2.3 Source Term

The methodologies used to determine source term are those prescribed in NUREG/CR-6410 and supporting documents. The following methodologies are approved by the U.S. Nuclear Regulatory Commission:

The meteorological data is five years (1987-1991) collected at Midland/Odessa, Texas, which is the closest first order National Weather Service Station to this site. This station was judged to be representative of the NEF site because the Midland Odessa National Weather Service Station site and the NEF site have similar climates and topography. Under assumed worse case conditions, the NEF uses stability class F at 0.6 meter per second wind speed.

6.3.2.3.1 Regulatory Guide 1.145 Dispersion Methodology

In estimating the dispersion of chemical releases from the facility, conservative dispersion methodologies were utilized. Site boundary atmospheric dispersion factors were generated using a computer code based on Regulatory Guide 1.145 (NRC, 1982) methodology.

The specific modeling methods utilized follow consistent and conservative methods for source term determination, release fraction, dispersion factors, and meteorological conditions as prescribed in NRC Regulatory Guide 1.145 (NRC, 1982).

6.3 Chemical Hazards Analysis

6.3.2.3.2 ARCON96 Dispersion Methodology

The NRC recognized dispersion methodology is the ARCON96 model developed by the NRC and documented in NUREG/CR-6331, Rev.1 (NRC, 1997).

The specific modeling methods utilized follow consistent and conservative methods for source term determination, release fraction, dispersion factors, and meteorological conditions as prescribed by the NRC. The NEF may use a Hand Calculation to determine the dispersion or the NEF may use the code ARCON96 with validation and verification documentation.

6.3.2.3.3 RASCAL 3.0.5 Dispersion Methodology

The NRC recognized dispersion methodology is the RASCAL 3.0.5 model developed by the NRC and documented in NUREG-1887 (NRC, 2007).

The specific modeling methods utilized follow consistent and conservative methods for source term determination, release fraction, dispersion factors, and meteorological conditions as prescribed by the NRC. The NEF may use the RASCAL 3.0.5 with validation and verification documentation.

6.3.2.4 Chemical Hazard Evaluation

This section is focused on presenting potential deleterious effects that might occur as a result of chemical release from the facility. As required by 10 CFR 70 (CFR, 2003a), the likelihood of these accidental releases fall into either unlikely or highly unlikely categories.

6.3.2.4.1 Potential Effects to Workers/Public

The toxicological properties of potential chemicals of concern were detailed in Section 6.2, Chemical Process Information. The evaluation level accident scenarios identified in the Integrated Safety Analysis and the associated potential consequence severities to facility workers or members of the public are presented in the NEF Integrated Safety Analysis Summary.

All postulated incidents have been determined to present low consequences to the workers/public, or where determined to have the potential for intermediate or high consequences, are protected with IROFS to values less than the likelihood thresholds required by 10 CFR 70.61 (CFR, 2003b).

6.3.2.4.2 Potential Effects to Facility

All postulated incidents have been determined to present inherently low consequences to the facility. No individual incident scenarios were identified that propagate additional consequence to the facility process systems or process equipment. The impact of external events on the facility, and their ability to impact process systems or equipment of concern is discussed in the NEF Integrated Safety Analysis Summary.

6.4 Chemical Safety Assurance

6.4 Chemical Safety Assurance

The facility will be designed, constructed and operated such that injurious chemical release events are prevented. Chemical process safety at the facility is assured by designing the structures, systems and components with safety margins such that safe conditions are maintained under normal and abnormal process conditions and during any credible accident or external event.

6.4.1 Management Structure and Concepts

The criteria used for chemical process safety encompasses principles stated in NUREG-1601, Chemical Process Safety at Fuel Cycle Facilities. It is also supported by concepts advocated in 29 CFR 1910.119, Process Safety Management of Highly Hazardous Chemicals (CFR, 2003f), and 40 CFR, 68, Accidental Release Prevention Requirements (CFR, 2003g), although it is noted here that there are no chemicals at this facility which exceed threshold planning quantities of either standard.

The intent of chemical safety management principles is to identify, evaluate, and control the risk of chemical release through engineered, administrative, and related safeguards.

The chemical safety philosophy for the facility is to apply sufficient control to identify, evaluate, and control the risk of accidental chemical releases associated with licensed material production to acceptable levels in accordance with 10 CFR 70.61(b) and (c) (CFR, 2003b).

The identification and evaluation of chemical release risk has been developed through the conduct of an ISA. The development of these scenarios, and the dispersion analysis and chemical/radiological dose assessment associated with each accident sequence was performed and was conducted in accordance with NUREG/CR-6410, Nuclear Fuel Cycle Facility Accident Analysis Handbook as was described previously in Section 6.3, Chemical Hazards Analysis.

The control of chemical release risk is ensured through numerous features that are described in the following sections.

6.4.2 System Design

The design of chemical process systems includes numerous controls for maintaining safe conditions during process operations. This is accomplished through several means including managing the arrangement and size of material containers and processes, selection and use of materials compatible with process chemicals, providing inherently safer operating conditions (e.g., vacuum handling), providing process interlocks, controls, and alarming within the chemical processes. All of these plant and equipment features help assure prevention of chemical release. Process piping and components, (e.g., centrifuges, traps, vents, etc.) are maintained safe by limits placed on their operating parameters.

With respect to chemical process safety design features recommended in NUREG-1601, this section briefly details the features provided for the UF₆ system which is the only chemical of concern (Class 1) process system.

6.4 Chemical Safety Assurance

6.4.2.1 Physical Barriers

Double-Walled Piping and Tanks - The UF₆ system piping operates at subatmospheric pressure throughout the plant except for the liquid sampling operation which is conducted within a secondary containment autoclave. As such, UF₆ system piping is not double-walled. Criticality design has been addressed for this vessel.

Liquid Confinement Dikes – Dikes are provided in areas where uranic material is present in solution in tankage. Criticality design constraints were applied to these containment areas. Confinement dikes are also present for chemical spillage control in CRDB areas.

Glove Boxes – Glove boxes are utilized for a small number of decontamination operations (e.g., sample bottles, flex hoses). They are not needed for other operations as the levels of specific activity are low. To confine potential HF/uranic material effluent, flexible exhaust hoses connected to the GEVS are provided for locations where UF₆ systems will be opened (e.g., hose connect/disconnect, maintenance, etc.) to capture any fumes remaining after purging operations. GEVS flexible exhaust hoses and fume hoods are present in the CRDB where uranic material containers are opened during laboratory and waste handling operations.

Splash Shields – There are no areas where bulk liquid hazardous chemicals will be handled. Lab operations with hazardous chemicals will be conducted in hoods and/or with appropriate personnel protective equipment for these small-scale operations.

Fire Walls – Fire walls are provided to separate UF₆ and uranic material handling areas from other areas of the facility.

Protective Cages – Protective barriers are provided to protect UF₆ system susceptible components (e.g., piping, small equipment) in areas where there is major traffic.

Backflow Preventers and Siphon Breaks – Liquid systems with high uranic content (i.e., not trace waste streams) are provided with means to prevent backflow or siphon. For the UF₆ gaseous piping, design features are provided to prevent UF₆ migration into the few systems which are required to be interconnected to UF₆.

Overflow vessel – UF₆ is not handled in liquid form in any continuous process and any batch handling is performed in small lab quantities or in a secondary containment autoclave. For those systems where uranic material is in solution, overflow protection features are provided.

Chemical Traps and Filters - Chemical traps and filters are provided on vent and ventilation systems which capture UF₆ to remove HF and uranic contaminants prior to any discharge to atmosphere.

6.4.2.2 Mitigative Features

Driving Force Controls – Driving force controls are provided to isolate heating/cooling equipment at UF₆ take-off stations and cold traps as well as other uranic material containing systems. Other driving force controls include relief valves and cut-offs on the nitrogen system to protect the UF₆ system from overpressure.

6.4 Chemical Safety Assurance

Solenoid and Control Valves – These types of valves are provided to stop and/or regulate the flow of UF₆ in the event of abnormal operating conditions.

Spray Systems – Spray systems are not provided for UF₆ systems or system areas due to criticality control requirements.

Alarm Systems – Alarm systems are provided which will alarm in the Control Room for abnormal process parameter (e.g., flow, temperature, pressure, level, etc.) conditions in the UF₆ system and some supporting systems. Leak detection is also provided to detect the release of UF₆/HF in the facility GEVS systems and other ventilation systems. Alarm measures are in place to notify facility employees of the need to evacuate process areas and/or the facility in the event of a serious chemical release.

6.4.2.3 Baseline Design Criteria and Defense-In-Depth

The ISA demonstrates that the design and construction complies with the baseline design criteria (BDC) of 10 CFR 70.64(a) (CFR, 2003d), and the defense-in-depth requirements of 10 CFR 70.64(b) (CFR, 2003d). The design provides for adequate protection against chemical risks produced from licensed material, facility conditions which affect the safety of licensed material, and hazardous chemicals produced from licensed material. The NEF is not proposing any facility-specific or process-specific relaxation or additions to applicable BDC features.

6.4.3 Configuration Management

Configuration management includes those controls which ensure that the facility design basis is thoroughly documented and maintained, and that changes to the design basis are controlled. This includes the following:

- A. That management commitment and staffing is appropriate to ensure configuration management is maintained
- B. That proper quality assurance (QA) is in place for design control, document control, and records management
- C. That all structures, systems, and components, including IROFS, are under appropriate configuration management.

A more detailed description of the configuration management system can be found in Section 11.1, Configuration Management (CM).

6.4.4 Maintenance

The NEF helps maintain chemical process safety through the implementation of administrative controls that ensure that process system integrity is maintained and that IROFS and other engineered controls are available and operate reliably. These controls include planned and scheduled maintenance of equipment and controls so that design features will function when required. Appropriate plant management is responsible for ensuring the operational readiness of IROFS under this control. For this reason, the maintenance function is closely coupled to operations. The maintenance function plans, schedules, tracks, and maintains records for maintenance activities.

6.4 Chemical Safety Assurance

Maintenance activities generally fall into the following categories:

- A. Surveillance/monitoring
- B. Corrective maintenance
- C. Preventive maintenance
- D. Functional testing.

A more detailed description of the maintenance program and maintenance management system can be found in Section 11.2, Maintenance.

6.4.5 Training

Training in chemical process safety is provided to individuals who handle licensed materials and other chemicals at the facility. The training program is developed and implemented with input from the chemical safety staff, training staff, and management. The program includes the following:

- A. Development of chemical safety awareness throughout the facility so that individuals know their roles and responsibilities in coordinating chemical release mitigation activities – in support of the Emergency Plan – in the event of a severe chemical release.
- B. Information obtained from the analysis of jobs and tasks in accordance with Section 11.3

6.4.6 Procedures

A key element of chemical process safety is the development and implementation of procedures that help ensure reliable and safe operation of chemical process systems.

Generally, four types of plant procedures are used to control activities: operating procedures, administrative procedures, maintenance procedures, and emergency procedures.

Operating procedures, developed for workstation and Control Room operators, are used to directly control process operations. Operating procedures include:

- Directions for normal operations, including startup and some testing, operation, and shutdown, as well as off-normal conditions of operation, including alarm response
- Required actions to ensure radiological and nuclear criticality safety, chemical safety, fire protection, emergency planning, and environmental protection
- Operating limits, controls and specific direction regarding administrative controls to ensure operational safety
- Safety checkpoints such as hold points for radiological or criticality safety checks, QA verifications, or operator independent verification.

Administrative procedures are used to perform activities that support the process operations, including, but not limited to, management measures such as the following:

- Configuration management

6.4 Chemical Safety Assurance

- Nuclear criticality, radiation, chemical, and fire safety
- Quality assurance
- Design control
- Plant personnel training and qualification
- Audits and assessments
- Incident investigations
- Record keeping and document control
- Reporting.

Administrative procedures are also used for:

- Implementing the Fundamental Nuclear Material Control (FNMC) Plan
- Implementing the Emergency Plan
- Implementing the Physical Security Plan
- Implementing the Standard Practice Procedures Plan for the Protection of Classified Matter.

Maintenance procedures address:

- Preventive and corrective maintenance of IROFS
- Surveillance (includes calibration, inspection, and other surveillance testing)
- Functional testing of IROFS
- Requirements for pre maintenance activity involving reviews of the work to be performed and reviews of procedures.

Emergency procedures address the preplanned actions of operators and other plant personnel in the event of an emergency.

A more detailed description of the procedural development and management program can be found in Section 11.4, Procedures Development and Implementation.

6.4.7 Chemical Safety Audits

Audits are conducted to determine that plant operations are performed in compliance with regulatory requirements, license conditions, and written procedures. As a minimum, they assess activities related to radiation protection, criticality safety control, hazardous chemical safety, fire protection, and environmental protection.

Audits are performed in accordance with a written plan, which identifies and schedules audits to be performed. Audit team members shall not have direct responsibility for the function and area being audited. Team members have technical expertise or experience in the area being audited and are indoctrinated in audit techniques. Audits are conducted on an annual basis on select functions and areas as defined above. The chemical process safety functions and areas will be audited at least triennially.

Qualified staff personnel that are not directly responsible for production activities are utilized to perform routine surveillances/assessments. Deficiencies noted during the inspection requiring

6.4 Chemical Safety Assurance

corrective action are forwarded to the manager of the applicable area or function for action. Future surveillances/assessments include a review to evaluate if corrective actions have been effective.

A more detailed description of the audit program can be found in Section 11.5, Audits and Assessments.

6.4.8 Emergency Planning

The NEF has a facility emergency plan and program which includes response to mitigate the potential impact of any process chemical release including requirements for notification and reporting of accidental chemical releases.

The emergency response to a hazard release that results, or is likely to result, in an uncontrolled release of a hazardous substance will be from an offsite response agency. A release of a hazardous substance where there is no significant threat to the health and safety of employees is not considered to be an emergency response and will be attended to by site personnel. The LES fire brigade will be trained to a minimum of First Responder Operations Level per 29 CFR 1910.120, Hazard Waste Operations and Emergency Response (CFR, 2004), due to the potential of responding to incidents involving hazardous for the purposes of protecting nearby persons, property, or the environment and assisting offsite response agencies.

The City of Hobbs, NM Fire Department is the nearest offsite response agency who can supplement LES with additional Hazardous Waste Operations and Emergency Response (HAZWOPER) response teams. As a result of a baseline needs assessment conducted on offsite response, LES has committed to assist the local offsite fire agency, Eunice Fire and Rescue, in obtaining the equipment and training to also provide a HAZWOPER compliant response team.

Additional information on emergency response can be found in SAR Section 7.5.2, Fire Emergency Response, and in the NEF Emergency Plan.

6.4.9 Incident Investigation and Corrective Actions

A facility wide incident investigation process exists that includes chemical process related incidents. This process is available for use by any person at the facility for reporting abnormal events and potentially unsafe conditions or activities. Each event will be considered in terms of its requirements for reporting in accordance with regulations and will be evaluated to determine the level of investigation required. These evaluations and investigations will be conducted in accordance with approved procedures. The depth of the investigation will depend upon the severity of the classified incident in terms of the levels of uranium/chemical released and/or the degree of potential for exposure of workers, the public or the environment.

A detailed description of the incident investigation program can be found in Section 11.6, Incident Investigations and Corrective Action Process.

6.5 References

6.5 References

Edition of Codes, Standards, NRC Documents, etc that are not listed below are given in ISAS Table 3.0-1.

CFR, 2003a. Title 10, Code of Federal Regulations, Part 70, Domestic Licensing of Special Nuclear Material, 2003.

CFR, 2003b. Title 10, Code of Federal Regulations, Section 70.61, Performance requirements, 2003.

CFR, 2003c. Title 10, Code of Federal Regulations, Section 70.62, Safety program and integrated safety analysis, 2003.

CFR, 2003d. Title 10, Code of Federal Regulations, Section 70.64, Requirements for new facilities or new processes at existing facilities, 2003.

CFR, 2003e. Title 10, Code of Federal Regulations, Part 20 Appendix B, Annual Limit on Intake (ALIs) and Derived Air Concentrations (DACs) of Radionuclides for Occupational Exposure; Effluent Concentrations; Concentrations for Release to Sewerage, 2003.

CFR, 2003f. Title 29, Code of Federal Regulations, Section 1910.119, Process safety management of highly hazardous chemicals, 2003.

CFR, 2003g. Title 40, Code of Federal Regulations, Part 68, Accidental Release Prevention Requirements, 2003.

CFR, 2003h. Title 29, Code of Federal Regulations, Part 1910, Occupational Safety and Health Standards, 2003.

CFR, 2004. Title 29, Code of Federal Regulations, Section 1910.120, Hazardous waste operations and emergency response, 2004.

DOE, 1988. Monitoring of Corrosion in ORGDP Cylinder Yards, presented at DOE Conference – Uranium Hexafluoride - Safe Handling, Processing, and Transporting, Henson, H.M., et al, 1988.

NAP, 2004. "Acute Exposure Guideline Levels for Selected Airborne Chemicals," Volume 4, National Research Council of the National Academies, National Academies Press, 2004.

NRC, 1982. Atmospheric Dispersion Models for Potential Accident Consequence Assessments at Nuclear Power Plants, Regulatory Guide 1.145, Revision 1, U.S. Nuclear Regulatory Commission, November 1982. (Reissued February 1983 to correct page 1.145-7)

NRC, 1997. Atmospheric Relative Concentrations in Building Wakes, NUREG/CR-6331, Rev.1

U.S. Nuclear Regulatory Commission, May 1997

NRC, 2007. RASCAL 3.0.5: Description of Models and Methods, NUREG-1887, U.S. Nuclear Regulatory Commission, August 2007

6.5 References

ORNL, 2001. Prediction of External Corrosion for Steel Cylinders – 2001 Report, ORNL/TM-2001/164, Oak Ridge National Laboratory, Schmoyer and Lyon, September, 2001.

6.6 Chapter 6 Tables

6.6 Chapter 6 Tables

6.6 Chapter 6 Tables

Table 6.1-1 Chemicals – Hazardous Properties

Form	Chemical	Class	Chemical Formula	Corrosive	Flammable	Combustible	Oxidizer	Reactive	Toxic	Radioactive	Hazard	Irritant	Remarks
Liquid	Uranium hexafluoride	1	UF ₆	X				X	X	X			
	Uranium compounds (residual)		UO ₂ F ₂						X	X			Byproduct – no NEF class
	Hydrogen fluoride		HF	X					X				Byproduct – no NEF class
Gas	Uranium hexafluoride	1	UF ₆	X				X	X	X			
	Uranium compounds (residual)		UO ₂ F ₂						X	X			Byproduct – no NEF class
	Hydrogen fluoride		HF	X					X				Byproduct – no NEF class
Solid	Uranium hexafluoride	1	UF ₆	X				X	X	X			
	Uranium compounds		UO ₂ F ₂						X	X			

6.6 Chapter 6 Tables

Chemical/Product			Inventory by Location					Notes
Name	Formula	Physical State	UBC Storage Pad (outdoor) – see Note 3, 5	UF ₆ Handling Area (All SBMs)	Cascade Halls	Second Floor Process Services Area	Blending and Liquid Sampling Area (All SBMs)	1, 2, and 3
Uranium hexafluoride	UF ₆	Solid	2.15 E8 kg (4.75 E8 lb)	4.23 E5 kg (9.32 E5 lb)			9,108 kg (20,079 lb)	1
Uranium hexafluoride	UF ₆	Liquid					2,277 kg (5,020 lb)	4
Uranium hexafluoride	UF ₆	Gas		piping	SBM-1001 256 kg/hall (565 lb/hall) SBM-1003 TBD kg/hall (TBD lb/hall)	SBM-1001 13.8 kg/hall (30.4 lb/hall) SBM-1003 TBD kg/hall (TBD lb/hall)	3 kg (6.6 lb)	
Hydrogen fluoride	HF	gas		Piping (trace)				

Notes:

- The Blending and Liquid Sampling Area can have up to 2 (30B) cylinders in donor stations and 2 (30B) cylinders in receiver stations. One (30B) cylinder can be present in liquid sampling autoclaves and will be in various physical states depending on sampling in progress.
- UF₆ Handling Area inventory is maximum estimated operational inventory (5 feed [48Y], 11 tails [48Y], and 5 product [30B] cylinders).
- The UBC Storage Pad is located outside of and detached from the Separations Building.
- Normal estimated operational inventory in piping. Gas flows in piping routed from the UF₆ Handling Area to the Cascade Halls and back. The Process Services Area contains the main manifolds and valve stations.
- Not to exceed Material License Condition 8.A for natural and depleted uranium of 136,120,000 kg U

6.6 Chapter 6 Tables

Table 6.1-3 Centrifuge Assembly Building (CAB)

Chemical/Product			Inventory by Location	Notes
Name	Formula	Physical State	Centrifuge Test Facility – see Note 1	
Uranium hexafluoride	UF ₆	Gas/Solid	~ 20 kg (44 lb)	2, 3, and 4
Hydrogen fluoride (residual)	HF	gas	Inside pumps	

Notes:

1. The Centrifuge Test Facility and Post Mortem Facility are housed in the same room in the CAB.
2. Centrifuges in the Centrifuge Post Mortem Facility are considered contaminated based on previous operation with UF₆. Once in the Centrifuge Post Mortem Facility, they will not contain significant amounts of UF₆.
3. In the Centrifuge Test Facility 50kg (110 lb) of UF₆ is contained in a feed vessel, test centrifuges, and a take-off vessel. Physical state will vary depending on testing in progress. This 50 kg (110 lb) of UF₆ is the maximum amount allowed in the CAB per Materials License condition 27 and includes the residual amount listed for the Post Mortem Facility, approximately 20 kg (44 lb).
4. Initial UF₆ fill is supplied in ANSI N14.1 30B containers.

6.6 Chapter 6 Tables

Table 6.1-4 Cylinder Receipt and Dispatch Building

Chemical/Product			Inventory by Location								
Name	Formula	Physical State	Container Storage and Preparation Areas	Laundry System	Ventilated Room	Decon Workshop	Liquid Effluent Collection and Treatment System	Solid Waste Collection System	Gaseous Effluent Vent System (CRDB)	Chemical Lab	Mass Spec Lab
Uranium hexafluoride	UF ₆	Solid	2.87 E6 kg (6.33 E6 lb)		2300 – 12,500 kg (5071 – 27,563 lb) 48Y cylinder	residual				250 kg (551 lb)	0.5 kg (1.1 lb)
Uranium hexafluoride	UF ₆	gas							Trace piping		
Hydrogen fluoride	HF	gas			residual	residual			Trace piping	residual	
Uranium compounds	UO ₂ F ₂	gas			residual						
Uranium compounds	UO ₂ F ₂	solid		residual		residual		residual			
Uranium compounds	UO ₂ F ₂	solution					residual			residual	0.5 kg (1.1 lb)
Uranium compounds	UO ₂ F ₂	aerosol							Trace piping		

6.6 Chapter 6 Tables

Table 6.1-5 Physical Properties of UF₆

Property	Value
Sublimation Point at 1.01 bar abs (14.7 psia)	56.6°C (133.8°F)
Triple Point	1.52 bar abs (22 psia) 64.1°C (147.3°F)
Density	
Solid @ 20°C (68°F)	5.1 g/cc (317.8 lb/ft ³)
Liquid @ 64.1°C (147.3°F)	3.6 g/cc (227.7 lb/ft ³)
Liquid @ 93°C (200°F)	3.5 g/cc (215.6 lb/ft ³)
Liquid @ 113°C (235°F)	3.3 g/cc (207.1 lb/ft ³)
Liquid @ 121°C (250°F)	3.3 g/cc (203.3 lb/ft ³)
Heat of Sublimation @ 64.1°C (147.3°F)	135,373 J/kg (58.2 BTU/lb)
Heat of Fusion @ 64.1°C (147.3°F)	54,661 J/kg (23.5 BTU/lb)
Heat of Vaporization @ 64.1°C (147.3°F)	81,643 J/kg (35.1 BTU/lb)
Specific Heat	
Solid @ 27°C (81°F)	477 J/kg/°K (0.114 BTU/lb/°F)
Liquid @ 72°C (162°F)	544 J/kg/°K (0.130 BTU/lb/°F)
Critical Pressure	46.10 bar abs (668.8 psia)
Critical Temperature	230.2°C (446.4°F)

Table 6.2-1 Properties of Chemical Adsorbents

Adsorbent (solid)/ Adsorbate (gas)	Heat of Adsorption	Capacity of Adsorption by weight
Activated Carbon/UF ₆	293 kJ/kg (126 BTU/lb)	1:1
Activated Carbon/HF	negligible	negligible at low pressure
Aluminum Oxide/UF ₆	negligible	0.2:1
Aluminum Oxide/HF	negligible	0.2:1
Activated NaF/UF ₆	186 kJ/kg (80 BTU/lb)	1.0-1.5:1
Activated NaF/HF	4,052 kJ/kg (1,742 BTU/lb)	1:0.5

6.6 Chapter 6 Tables

Table 6.2-2 UF₆ Corrosion Rates

Material	Corrosion Rate @ 20°C (68°F) per year	Corrosion Rate @ 100°C (212°F) per year
Aluminum	6.6E-7 mm (2.6E-5 mils)	8.4E-5 mm (3.3E-3 mils)
Stainless Steel	1.4E-4 mm (5.5E-3 mils)	0.03 mm (1.2 mils)
Copper	1.2E-4 mm (4.7E-3 mils)	3.3E-3 mm (1.3E-1 mils)
Nickel	< 0.05 mm (< 2.0 mils)	< 0.05 mm (< 2.0 mils)

Table 6.2-3 Materials of Construction for UF₆ Systems

Component	Material	Wall Thickness (nominal)	Wall Thickness (minimum)
UF ₆ Feed Cylinders (48Y) and UBCs (48Y)	Carbon Steel ASTM A516	16 mm (0.625 inch)	12.7 mm (0.5 inch)
UF ₆ Product Cylinder (30B)	Carbon Steel ASTM A516	12.7 mm (0.5 inch)	8 mm (0.3125 inch)
Sample Bottle (1S)	Nickel/Monel ASTM B162	1.6 mm (0.0625 inch)	1.6 mm (0.0625 inch)
Sample Bottle (2S)	Nickel/Monel ASTM B162	2.8 mm (0.112 inch)	1.6 mm (0.0625 inch)
Sample Bottle (ETC Designed)	Stainless Steel 316L	2.77 mm (0.1091 inch)	n/a
UF ₆ Piping	Aluminum & Stainless Steel	3.7 mm (0.147 inch)	Determined During Final Design
UF ₆ Valves	Aluminum & Stainless Steel	> 3.7 mm (> 0.147 inch)	Determined During Final Design
Cold Trap	Stainless Steel	8 mm (0.315 inch)	not applicable

6.6 Chapter 6 Tables

Table 6.3-1 ERPG and AEGL Level Definitions

Emergency Response Planning Guideline (ERPG)		Acute Exposure Guideline Level (AEGL)	
General Definition	Values intended to provide estimates of concentration ranges above which one could be responsibly anticipate observing health effects.	General Definition	Threshold exposure limits for the protection of the general public, which are applicable to emergency exposure periods ranging from 10 minutes to 8 hours. It is believed that the recommended exposure levels are applicable to general population including infants and children, and other individuals who may be sensitive and susceptible.
ERPG-1	The maximum airborne concentration below which it is believed nearly all individuals could be exposed for up to 1 hour without experiencing more than mild, transient adverse health effects or without perceiving a clearly defined objectionable odor.	AEGL-1 (non-disabling)	The airborne concentration of a substance above which it is predicted that the general population, including susceptible individuals, could experience notable discomfort, irritation or certain asymptomatic, non-sensory effects. However, the effects are not disabling and are transient and reversible upon cessation of exposure.
ERPG-2	The maximum airborne concentration below which it is believed nearly all individuals could be exposed for up to 1 hour without experiencing or developing irreversible or other serious health effects or symptoms that could impair an individual's ability to take protective action.	AEGL-2 (disabling)	The airborne concentration of a substance above which it is predicted that the general population, including susceptible individuals, could experience irreversible or other serious, long-lasting adverse health effects, or an impaired ability to escape.
ERPG-3	The maximum airborne concentration below which it is believed nearly all individuals could be exposed for up to 1 hour without experiencing or developing life-threatening health effects.	AEGL-3 (lethality)	The airborne concentration of a substance above which it is predicted that the general population, including susceptible individuals, could experience life-threatening health effects or death.

6.6 Chapter 6 Tables

Table 6.3-2 Licensed Material Chemical Consequence Categories

	Workers	Offsite Public	Environment
Category 3 High Consequence	Radiation Dose (RD) >1 Sievert (Sv) (100 rem) For the worker (elsewhere in room), except the worker (local), Chemical Dose (CD) > AEGL-3 For worker (local), CD > AEGL-3 for HF CD > * for U	RD > 0.25 Sv (25 rem) 30 mg sol U intake CD > AEGL-2	—
Category 2 Intermediate Consequence	0.25 Sv (25 rem) <RD ≤ 1 Sv (100 rem) For the worker (elsewhere in room), except the worker (local), AEGL-2 < CD ≤ AEGL-3 For the worker (local), AEGL-2 < CD ≤ AEGL-3 for HF ** < CD ≤ * for U	0.05 Sv (5 rem) < RD ≤ 0.25 Sv (25 rem) AEGL-1 < CD ≤ AEGL-2	Radioactive release > 5000 x Table 2 Appendix B of 10 CFR Part 20
Category 1 Low Consequence	Accidents of lower radiological and chemical exposures than those above in this column	Accidents of lower radiological and chemical exposures than those above in this column	Radioactive releases with lower effects than those referenced above in this column

Notes:

*NUREG-1391 threshold value for intake of soluble U resulting in permanent renal failure

**NUREG-1391 threshold value for intake of soluble U resulting in no significant acute effects to an exposed individual

Table 6.3-3 ERPG and AEGL values for HF

ERPG and AEGL Values For HF (values in mg HF/m³)							
ERPG		AEGL					
	1-hr		10-min	30-min	1-hr	4-hr	8-hr
ERPG-1	1.6	AEGL-1	0.8	0.8	0.8	0.8	0.8
ERPG-2	16.4	AEGL-2	78	28	20	9.8	9.8
ERPG-3	41	AEGL-3	139	51	36	18	18

6.6 Chapter 6 Tables

Table 6.3-4 ERPG and AEGL values for Uranium Hexafluoride (as soluble U)

ERPG and AEGL Values For UF_6 (values in mg soluble U/m^3)							
ERPG		AEGL					
	1-hr		10-min	30-min	1-hr	4-hr	8-hr
ERPG-1	3.4	AEGL-1	2.4	2.4	2.4	NR	NR
ERPG-2	10	AEGL-2	19	13	6.5	1.6	0.8
ERPG-3	20	AEGL-3	146	49	24	6.1	3.1

Table 6.3-5 Definition of Consequence Severity Categories

		High Consequence (Category 3)	Intermediate Consequence (Category 2)
Acute Radiological Doses	Worker	>100 rem TEDE	>25 rem TEDE
	Outside Controlled Area	>25 rem TEDE	>5 rem TEDE
Acute Radiological Exposure	Worker	not applicable	not applicable
	Outside Controlled Area	>30 mg U intake	>5.4 mg U/m^3 (24-hr average)
Acute Chemical Exposure	Worker	>146 mg U/m^3 ; > 139 mg HF/m^3	>19 mg U/m^3 ; >78 mg HF/m^3
	Outside Controlled Area (30-min exposure)	>13 mg U/m^3 ; >28 mg HF/m^3	>2.4 mg U/m^3 ; >0.8 mg HF/m^3

Table 6.3-6 Health Effects from Intake of Soluble Uranium

Health Effects	Uranium Intake (mg) by 70 kg Person
50% Lethality	230
Threshold for Intake Resulting in Permanent Renal Damage	40
Threshold for Intake Resulting in No Significant Acute Effects	10
No Effect	4.3

6.7 Chapter 6 Figure

6.7 Chapter 6 Figure

6.7 Chapter 6 Figure

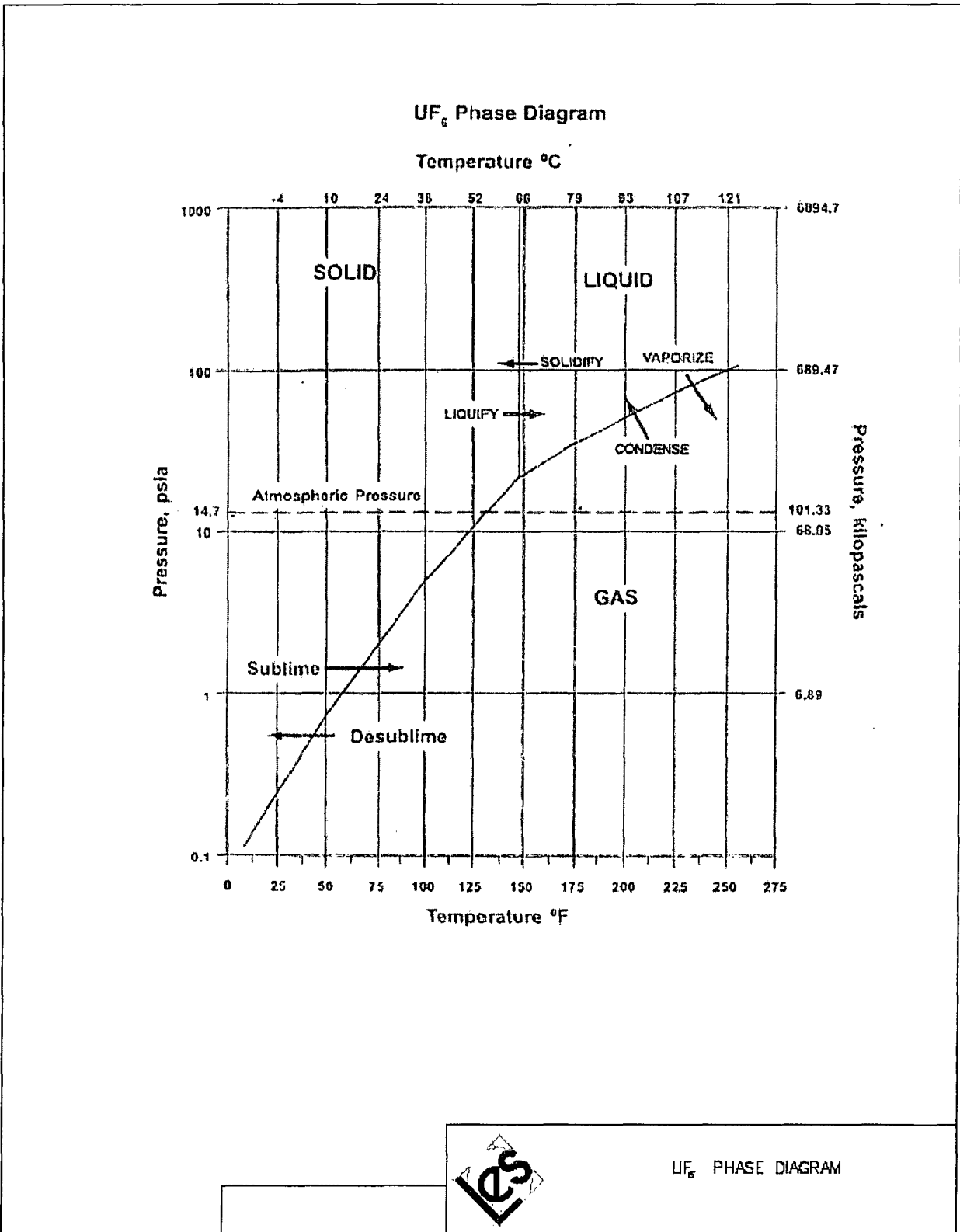

Figure 6.1-1 UF₆ Phase Diagram

6.7 Chapter 6 Figure

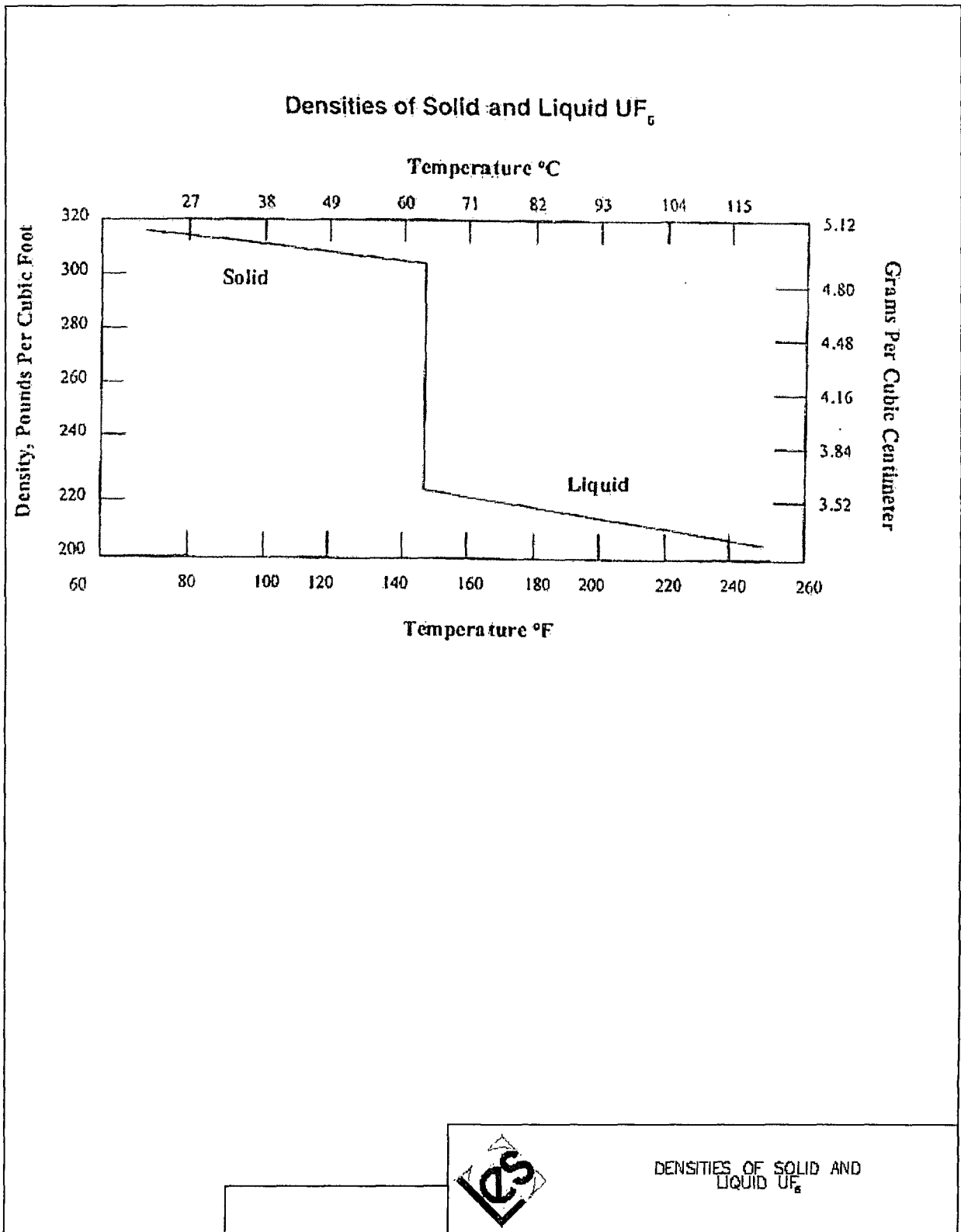

Figure 6.1-2 Densities of Solid and Liquid UF₆

7.0 Fire Safety

7.0 Fire Safety

This chapter documents the National Enrichment Facility (NEF) fire safety program. The fire safety program is intended to reduce the risk of fires and explosions at the facility. The fire safety program documents how the facility administers and ensures fire safety at the facility.

The NEF fire safety program meets the acceptance criteria in Chapter 7 of NUREG-1520 and is developed, implemented and maintained in accordance with the requirements of 10 CFR 70.62(a) (CFR, 2003a), 10 CFR 70.22 (CFR, 2003b) and 10 CFR 70.65 (CFR, 2003c). In addition, the fire safety program complies with 10 CFR 70.61 (CFR, 2003d), 10 CFR 70.62 (CFR, 2003a) and 10 CFR 70.64 (CFR, 2003e). NUREG/CR-6410, NUREG-1513 NRC Generic Letter 95-01 (NRC, 1995) and NFPA 801 were utilized as guidance in developing this chapter.

The information provided in this chapter, the corresponding regulatory requirement and the section of NUREG-1520, Chapter 7 in which the Nuclear Regulatory Commission (NRC) acceptance criteria are presented is summarized below:

Information Category and Requirement	10 CFR 70 Citation	NUREG-1520 Chapter 7 Reference
Section 7.1 Fire Safety Management Measures	70.62(a), (d) & 70.64(b)	7.4.3.1
Section 7.2 Fire Hazards Analysis	70.61(b), (c) & 70.62(a)&(c)	7.4.3.2
Section 7.3 Facility Design	70.62(a), (c) & 70.64(b)	7.4.3.3
Section 7.4 Process Fire Safety	70.64(b) & 70.64(b)	7.4.3.4
Section 7.5 Fire Protection and Emergency Response	70.62(a), (c) & 70.64(b)	7.4.3.5

7.1 Fire Safety Management Measures

7.1 Fire Safety Management Measures

Fire safety management measures establish the fire protection policies for the site. The objectives of the fire safety program are to prevent fires from starting and to detect, control, and extinguish those fires that do occur. The fire protection organization and fire protection systems at the NEF provide protection against fires and explosions based on the structures, systems, and components (SSC) and defense-in-depth practices described in this chapter.

7.1.1 Fire Protection IROFS

IROFS associated with fire protection are specified in the NEF Integrated Safety Analysis Summary.

7.1.2 Management Policy and Direction

Louisiana Energy Services (LES) is committed to ensuring that the IROFS, as identified in the ISA Summary, are available and reliable, and that the facility maintains fire safety awareness among employees, controls transient ignition sources and combustibles, and maintains a readiness to extinguish or limit the consequences of fire. The facility maintains fire safety awareness among employees through its General Employee Training Program. The training program is described in Chapter 11, Management Measures.

The responsibility for fire protection rests with the Health, Safety and Environmental Manager who reports directly to the Vice President of Compliance/General Counsel. The Health, Safety and Environmental Manager is assisted by the Fire Protection Officer. Fire protection engineering support is provided by the Engineering Manager. The personnel qualification requirements for the Plant Support Director and the Fire Protection Officer are presented in Chapter 2, Organization and Administration.

The Fire Protection Officer is trained in the field of fire protection and has practical day-to-day fire safety experience at nuclear facilities. The Fire Protection Officer is responsible for the following:

- Fire protection program and procedural requirements
- Fire safety considerations
- Maintenance, surveillance, and quality of the facility fire protection features
- Review of design changes and training programs as they relate to fire protection
- Documentation and record keeping as they relate to fire protection
- Fire prevention activities (i.e., administrative controls and training)
- Fire brigade organization and training
- Pre-fire planning.

The facility maintains a Safety Review Committee (SRC) that reports to the Plant Manager. The SRC performs the function of a fire safety review committee. The SRC provides technical and administrative review and audit of plant operations including facility modifications to ensure that fire safety concerns are addressed.

7.1 Fire Safety Management Measures

Engineering review of the fire safety program is accomplished by configuration management and the SRC. Configuration management is discussed in Chapter 11, Management Measures, and the SRC is discussed in Chapter 2, Organization and Administration.

7.1.3 Fire Prevention

Administrative controls are used to maintain the performance of the fire protection systems and delineate the responsibilities of personnel with respect to fire safety. The primary fire safety administrative controls are those that relate to fire prevention. These fire prevention controls, in the form of procedures, primarily control the storage and use of combustible materials and the use of ignition sources. These controls include, but are not limited to, the following:

- Governing the handling of transient combustibles in buildings containing IROFS, including work-generated combustibles
- Implementing a permit system to control ignition sources that may be introduced by welding, flame cutting, brazing, or soldering operations
- Ensuring that the use of open flames or combustion-generated smoke for leak testing is not permitted
- Conducting formal periodic fire prevention inspections to (1) ensure that transient combustibles adhere to established limits based on the Fire Hazard Analysis; (2) ensure the availability and acceptable condition of fire protection systems/equipment, fire stops, penetration seals, and fire-retardant coatings; and (3) ensure that prompt and effective corrective actions are taken to correct conditions adverse to fire protection and preclude their recurrence
- For an IROFS that is found to be degraded or impaired by planned operations, maintenance, or construction activities: a compensatory measure may be used to ensure that the function of the IROFS is compensated until it is returned to service. For example, a continuous fire watch may be used to compensate for a degraded IROFS barrier.
- Performing periodic housekeeping inspections
- Implementing a permit system to control the disarming of fire detection or fire suppression systems, including appropriate compensatory measures
- Implementing fire protection system inspection, testing, and maintenance procedures.

7.1.4 Inspection, Testing, and Maintenance of Fire Protection Systems

An inspection, testing and maintenance program is implemented to ensure that fire protection systems and equipment remain operable and function properly when needed to detect and suppress fire. Fire protection procedures are written to address such topics as training of the fire brigade, reporting of fires, and control of penetration seals. The Fire Protection Officer has responsibility for fire protection procedures in general; with the facility's maintenance section having responsibility for certain fire protection procedures such as control of repairs to facility penetration seals. Refer to SAR Chapter 11, Management Measures, for additional information on procedures and maintenance activities.

7.1.5 Emergency Organization Qualifications, Drills and Training

The qualifications, drills and training of the fire brigade members who are part of the Emergency Organization are in accordance with NFPA 600. The primary purpose of the Fire Brigade

7.1 Fire Safety Management Measures

Training Program is to develop a group of facility employees trained in fire prevention, fire fighting techniques, first aid procedures, and emergency response. They are trained and equipped to function as a team for the fighting of fires.

The Fire Brigade Program provides entrance and educational requirements for fire brigade candidates as well as the medical- and job-related physical requirements. The Fire Brigade Training Program provides for initial training of all new fire brigade members, semi-annual classroom training and drills, annual practical training, and leadership training for fire brigade leaders.

The NEF Emergency Plan also discusses the use of offsite emergency organizations, drills and training.

7.1.6 Pre-Fire Plans

Detailed pre-fire plans will be developed for use by the facility fire brigade.

The pre-fire plans include the location of fire protection equipment, approach paths for fire response, potential hazards in the area, power supply and ventilation isolation means, important plant equipment in the area and other information considered necessary by fire emergency response personnel.

7.2 Fire Hazards Analysis

7.2 Fire Hazards Analysis

A Fire Hazards Analysis (FHA) has been conducted for the facility including the fire areas and fire zones which if uncontrolled, could release UF₆ in quantity and form that could cause an intermediate or high consequence, as defined in 10 CFR 70.61 (CFR, 2003d). UF₆ is present in the Separations Building Modules (SBMs), Cylinder Receipt and Dispatch Building (CRDB), Centrifuge Test and Post Mortem Facilities in the Centrifuge Assembly Building (CAB) and the UBC Storage Pad.

The FHA develops bounding credible fire scenarios and then assesses the consequences of unmitigated fire.

The FHA for the facility consists of the following:

- A description of the facility's use and function
- The specific fire hazards and potential fire scenarios within the fire areas and fire zones
- The methods of consequence analysis
- The occupancy and construction requirements
- Life safety requirements
- The boundaries of the fire areas and fire zones
- The IROFS affected by the postulated fire scenarios within the fire area
- The facility response to the postulated fires
- Defense or mitigation strategy for overall facility protection.

The results of the FHA are utilized in the Integrated Safety Analysis (ISA) to identify possible fire initiators and accident sequences leading to radiological consequences or toxic chemical consequences resulting from interaction with UF₆.

The FHA is updated and controlled by configuration management as discussed in Chapter 11, Management Measures, to ensure that the information and analysis presented in the FHA are consistent with the current state of the facility. The FHA is reviewed and updated as necessary to incorporate significant changes and modifications to the facility, its processes, or combustible inventories.

7.3 Facility Design

7.3 Facility Design

The design of the facility incorporates the following:

- Limits on areas and equipment subject to contamination
- Design of facilities, equipment, and utilities to facilitate decontamination.

7.3.1 Building Construction

The facility consists of several different buildings or functional areas:

- Visitor Center (within the Security Building)
- Security Building and Gatehouses
- Administration Building
- Technical Services Building (TSB)
- Central Utilities Building (CUB)
- Separations Building Modules (SBMs), which include:
 - UF₆ Handling Area
 - Cascade Halls
 - Process Services Corridor
- Cylinder Receipt and Dispatch Building (CRDB)
- Centrifuge Assembly Building (CAB)
- Centrifuge Test and Centrifuge Post Mortem Facilities (within the CAB)
- UBC Storage Pad
- Fire Water Pump Building
- Domestic Water/Process Water Pump House

The Security Buildings, Administration Building, Fire Water Pump Building and Tanks, and CUB are independent of the rest of the plant main buildings. The CAB, Security Building, Administration Building, TSB, Fire Water Pump Building, and CUB are provided with automatic sprinkler protection. The CRDB and SBMs have no automatic sprinkler protection.

SBM-1001 and the Bunkered Area inside the CRDB are classified as Type I-B Construction by the New Mexico Commercial Building Code (NMCBC) and Type II (222) Construction by NFPA 220.

SBM-1003 is classified as Type I-B Construction by the New Mexico Commercial Building Code (NMCBC) and Type II (222) Construction by NFPA 220.

The CAB, TSB, Administration Building, and Fire Water Pump Building are classified as Type II-B Construction by the NMCBC and Type II (000) Construction by NFPA 220.

The Site Security Buildings are steel frame buildings with insulated metal panel exterior walls and with built-up roofing on metal deck roof. This is classified as Type II-B Construction by the NMCBC and Type II (000) Construction by NFPA 220.

7.3 Facility Design

The UBC Storage Pad is an open lay-down area and consists of a concrete pad with a dedicated collection and drainage system. Cradles are used for storage of cylinders approximately 200 mm (8 in) above ground level. There is no building for the UBC Storage Pad.

7.3.2 Fire Area Determination and Fire Barriers

The facility is subdivided into fire areas by barriers with fire resistance commensurate with the potential fire severity, in accordance with International Fire Code and the NMCBC. The design and construction of fire barrier walls is in accordance with NFPA 221. These fire areas are provided to limit the spread of fire, protect personnel and limit the consequential damage to the facility. The fire resistance rating of fire barrier assemblies is determined through testing in accordance with NFPA 251. Openings in fire barriers are protected consistent with the designated fire resistance rating of the barrier. Penetration seals provided for electrical and mechanical openings are listed to meet the guidance of ASTM E-814 or UL 1479. Penetration openings for ventilation systems are protected by fire dampers having a rating equivalent to that of the barrier. Door openings in fire rated barriers are protected with fire rated doors, frames and hardware in accordance with NFPA 80.

7.3.3 Electrical Installation

All electrical systems at the facility are installed in accordance with the New Mexico Electric Code (based on the National Electric Code, NFPA 70). Switchgear, motor control centers, panel boards, variable frequency drives, uninterruptible power supply systems and control panels are mounted in metallic enclosures and contain only small amounts of combustible material. Cable used in this equipment is flame retardant and tested (FT1 or VW-1 type test) in accordance with the guidance of UL 1581, UL 508A, UL 1063, or UL 83. Cable trays and conduits are metallic and the cables in the cable trays are flame retardant and tested (FT4 or IEEE 1202 type test) in accordance with the guidance provided in ANSI/IEEE 383, IEEE 1202, UL 1277, UL 1685, UK 83 (FT4), UL 1581 (FT4), CSA C22.2 (FT4), or ICEA T-30-520.

Lighting fixtures are constructed of non-combustible materials and their ballasts are electronic and contain only an insignificant amount of combustible material.

All indoor transformers are dry type. Outdoor oil filled transformers are located in the local utilities substation yard which is located at the south end of the NEF property between the CAA fence and the property line of the facility.

An auxiliary power system is provided to supply power for temporary lighting, ventilation and radiation-monitoring equipment where potential radiation hazard exists.

Electrical conduits leading to or from areas with uranic material are sealed internally to prevent the spread of radioactive materials. Only utilities required for operation within areas having uranic material enter into these areas.

7.3.4 Life Safety

The buildings are provided with means of egress, illumination, and protection in accordance with International Fire Code. Barriers with fire resistance ratings consistent with International Fire Code and the FHA are provided to prevent unacceptable fire propagation.

7.3 Facility Design

All buildings are provided with emergency lighting for the illumination of the primary exit paths and in critical operations areas where personnel are required to operate valves, dampers and other controls in an emergency. Emergency lighting is considered as a critical load. All critical loads are fed from the uninterruptible power supplies (UPS) in areas where the normal lighting power source is not diesel backed adequate emergency lighting will be provided for egress in accordance with requirements for life safety. Subsequent entries into these area made by personnel may require portable lighting. In critical operation areas the UPS are connected to power sources which can be fed from diesel powered electric generators.

Marking of means of egress, including illuminated exit signs, are provided in accordance with the International Fire Code and the NMCBC.

7.3.5 Ventilation

The building heating, ventilating and air conditioning (HVAC) system provides the primary form of ventilation employed at the facility. The HVAC system is designed to maintain room temperature and the specific environmental conditions associated with processes undertaken within a particular area. The CRDB HVAC System also performs a confinement ventilation function to effectively reduce the potential chronic exposure of individuals working at the plant and to the public, to hazardous materials.

The ventilation system is not engineered for smoke control. It is designed to shutdown in the event of a fire except for the centrifuge test and post mortem facilities exhaust filtration system. Ductwork, accessories and support systems are designed and tested in accordance with NFPA 801, NFPA 90A, NFPA 90B, and NFPA 91. Flexible air duct couplings in ventilation and filter systems are noncombustible. Air entry filters are UL Class I.

The power supply and controls for mechanical ventilation systems are located outside the fire area served, with the exception of the HVAC units serving the CAB electrical rooms. The ventilation system is designed such that the areas containing dispersible radioactive materials remain at a lower pressure than that of adjoining areas of the facility. These areas include the Mass Spectrometry Laboratory, the Chemical Laboratory, the Ventilated Room, and the Decontamination Workshop. Ductwork from areas containing radioactive materials that pass through non-radioactive areas are constructed of non-combustible material and are protected from possible exposure to fire by materials having an appropriate fire resistance rating.

HEPA filtration systems are utilized in various areas in the plant in the confinement ventilation function of the CRDB HVAC System, the GEVS and in the Centrifuge Test and Post Mortem Facilities Exhaust Filtration System. HEPA filters are UL 586 and UL 900 Class I, which are non-combustible. In the GEVS and, the Centrifuge Test and Post Mortem Exhaust Filtration System, and the Confinement Ventilation function of the CRDB HVAC System, the HEPA filters are enclosed in ductwork. The HEPA filtration systems are analyzed in the FHA. They are designed to shutdown in the event of a fire.

Smoke control is accomplished by the Fire Brigade and off-site Fire Department utilizing portable smoke removal equipment.

7.3 Facility Design

7.3.6 Drainage

Water that may escape from the fire water system or from fire fighting activities could be contaminated with radioactive materials or flammable and combustible liquids, potentially resulting in a release to the environment. If contamination is suspected in any water that is not contained, the affected environmental areas will be sampled, analyzed, and appropriate actions taken based on results of the analysis. Water runoff from the UBC Storage Pad will be collected in the UBC Storage Pad Stormwater Retention Basin. Liquid effluent monitoring associated with the UBC Storage Pad Stormwater Retention Basin is discussed in the Environmental Report.

7.3.7 Lightning Protection

Lightning protection for the facility is in accordance with NFPA 780.

7.3.8 Criticality Concerns

Criticality controls will be provided by employing the basic principals of criticality safety. The premise of nuclear criticality prevention is that at least two, unlikely, independent, and concurrent changes in process conditions must occur before a criticality accident is possible. This double contingency principal is described in ANSI/ANS-8.1. Controls or systems of controls are used to limit process variables in order to maintain safe operating conditions.

Moderation control is applied for criticality safety of UF₆ at this facility. Automatic sprinklers are excluded from the SBMs and CRDB. Fire protection standpipes are located in enclosed stairwells, or are arranged such that flooding from these sources is highly unlikely. Procedures and training for both onsite fire brigade and offsite fire department emphasize the need for moderator control in these areas.

Fire protection concerns are addressed in the moderation control areas by fire protection IROFS. The IROFS define administrative controls which limit the transient and in-situ combustibles, the ignition sources in these areas and isolate these areas from other areas of the plant with appropriately rated fire barriers to preclude fire propagation to or from these areas. There are automatic detection and manual alarm systems located in these areas. Fires will be extinguished in these areas by the fire brigade and / or local fire department with the use of portable extinguishers. In the unlikely event that extinguisher cannot control or extinguish the fire, then the fire brigade, local fire department and the Emergency Operations Center will work together to ensure that moderator control is maintained in these areas. If deemed appropriate, hose streams are available from fire hydrants located throughout the facility.

See Chapter 5, Nuclear Criticality Safety, for additional discussion on criticality control.

7.3.9 Hydrogen Control

Hydrogen is utilized within the Cylinder Receipt and Dispatch Building Chemical Laboratory. In order to prevent the possibility of fire or explosion in the laboratory, areas where hydrogen might accumulate will be protected by one or a combination of following features:

- Hydrogen piping will be provided with excess flow control.
- Hydrogen supply will be isolated by emergency shutoff valves interlocked with hydrogen detection in the area(s) served by the hydrogen piping.

7.3 Facility Design

- Natural or mechanical ventilation will be provided to ensure that hydrogen concentrations do not exceed 25% of the lower explosive limit. If mechanical ventilation is provided, it will be continuous or will be interlocked to start upon the detection of hydrogen in the area. Mechanical ventilation will also be provided with airflow sensors to sound an alarm if the fan becomes inoperative.
- Hydrogen may also be generated at battery charging stations in the facility. In order to prevent the possibility of explosion or fire, areas where hydrogen might accumulate will be protected by a design which incorporates the following measures, as necessary, that are identified in NFPA 70E and/or ANSI C2.
- Natural or mechanical ventilation will be provided to ensure that hydrogen concentrations do not exceed 25% of the lower explosive limit. If mechanical ventilation is provided, it will be continuous or will be interlocked to start upon the detection of hydrogen in the area. Mechanical ventilation will also be provided with airflow sensors to sound an alarm if the fan becomes inoperative.

7.3.10 Environmental Concerns

Radiological and chemical monitoring and sampling will be performed as specified in NEF Environmental Report, Chapter 6, Environmental Measurements and Monitoring Programs, on the contaminated and potentially contaminated facility liquid effluent discharge including water used for fire fighting purposes. Discharges from the Liquid Effluent Collection and Treatment System will be routed to the Treated Effluent Evaporative Basin. Surface water runoff will be diverted into water collection basins. Water runoff from the UBC Storage Pad will be collected in the UBC Storage Pad Stormwater Retention Basin. Water runoff from the remaining portions of the site will be collected in the Site Stormwater Detention Basin.

7.3.11 Physical Security Concerns

In no cases will security requirements prevent safe means of egress as required by the NFPA 5000 and the NMCBC.

The Physical Security Plan (PSP) addresses the establishment of permanent and temporary Controlled Areas. The PSP identifies the ingress and egress methodology during both normal and emergency conditions. This includes emergency response personnel both onsite and offsite. Two means of access to the site are provided, one via one of the two controlled gates continuously manned by Security and the other via designated emergency access gates (i.e., crash gates). Refer to the PSP for additional details.

7.3.12 Baseline Design Criteria and Defense-In-Depth

The FHA and the ISA demonstrate that the design and construction of the facility complies with the baseline design criteria (BDC) of 10 CFR 70.64(a) (CFR, 2003e), the defense-in-depth requirements of 10 CFR 70.64(b) (CFR, 2003e) and are consistent with the guidance provided in NFPA 801. The design provides for adequate protection against fire and explosion by incorporating defense-in-depth concepts such that health and safety are not wholly dependent on any single element of the design, construction, maintenance or operation of the facility. This is accomplished by achieving a balance between preventing fires from starting, quickly detecting, controlling and promptly extinguishing those fires that do occur and protecting

7.3 Facility Design

structures, systems and components such that a fire that is not promptly extinguished or suppressed will not lead to an unacceptable consequence.

7.4 Process Fire Safety

7.4 Process Fire Safety

Chapter 6, Chemical Process Safety, describes the chemical classification process, the hazards of chemicals, chemical process interactions affecting licensed material and/or hazardous chemicals produced from licensed material, the methodology for evaluating hazardous chemical consequences, and chemical safety assurance. The only process chemical of concern is uranium hexafluoride (UF_6). UF_6 is not flammable and does not disassociate to flammable constituents under conditions at which it will be handled at the NEF. The two byproducts in the event of a UF_6 release are HF and uranyl fluoride (UO_2F_2) and neither presents a process fire safety hazard. The Integrated Safety Analysis has analyzed the hazards associated with the processes performed at the facility. The analysis did not identify any processes which represented a process fire safety hazard.

7.5 Fire Protection and Emergency Response

7.5 Fire Protection and Emergency Response

This section documents the fire protection systems and fire emergency response organizations provided for the facility.

7.5.1 Fire Protection System

The facility fire protection systems consist of a dedicated fire water supply and distribution system, automatic suppression systems, standpipe and hose systems, portable fire extinguishers, fire detection and alarm systems, fire pump control systems, valve position supervision, system maintenance and testing, fire prevention program, fire department/fire brigade response and pre-fire plans.

In the SBM cascade halls, the CAAS is utilized for both criticality and fire/general emergency condition evacuation notification. In the unlikely event of a criticality accident, the CAAS uses a criticality tone in the SBM cascade halls and a criticality tone and blue flashing lights in other process areas in initiate area evacuation. For fire/emergency conditions notification, the CAAS utilizes a tone readily discernable from the criticality tone and there are no flashing lights for fire/emergency condition notification in the cascade halls. Due to the high ambient noise level in the SBM cascade halls a PA system is not utilized.

7.5.1.1 Fire Water Supply and Distribution System

A single Fire Protection Water Supply System provides storage and distribution of water to the Fire Protection System that protects the entire facility as shown in Figure 7.5-1, Exterior Fire Protection System Overall Site Plan.

7.5.1.1.1 System Description

A reliable fire protection water supply and distribution system of adequate flow, pressure, and duration is provided based on the characteristics of the site and the FHA. The fire protection water supply and distribution system is based on the largest fixed fire suppression system demand, including a hose stream allowance, in accordance with NFPA 13. The fire protection water supply consists of two 946,074 L (250,000-gal) (minimum) water storage tanks designed and constructed in accordance with NFPA 22. The tanks are used for both fire protection water supply and process water supply. A reserve quantity of 681,173 L (180,000 gal) is maintained in the bottom of each tank for fire protection purposes. The elevation of the suction line for the process water pump is above the level of the required fire protection water supply in each tank. Thus the process water pump cannot pump water required for fire protection purposes. The fire protection water supply in each tank is sized for the maximum anticipated water supply needed to control and extinguish the design basis fire at the facility. Two horizontal, centrifugal, fire pumps designed and installed in accordance with NFPA 20 are provided. For redundancy the capacity of the fire protection water supply is designed to ensure that 100% of the required flow rate and pressure are available in the event of failure of one of the water storage tanks or fire pumps. The maximum demand anticipated is based on the maximum combined sprinkler and hose stream demand and duration determined in accordance with NFPA 13. The tanks are arranged so that one will be available for suction at all times.

Fill and make up water for the storage tanks is from the city water supply and/or the Process Water system. Each tank can be filled:

7.5 Fire Protection and Emergency Response

- Using process water pumps taking suction from the process water tank
- Using the city water supply
- Using a combination of the above methods.

Using any of the methods, the firewater reserve portion of either tank can be filled in an 8-hour period.

The fire water service main for the plant is designed and installed in accordance with NFPA 24. The distribution system, including piping associated with the fire pumps is looped and arranged so that a single pipe break or valve failure will not totally impair the system per the Fire Hazard Analysis and NFPA 801. Through appropriate valve alignment, either fire pump can take suction from either storage tank and discharge through either leg of the underground piping loop. The system piping is sized so that the largest sprinkler system demand (including hose stream allowance) is met with the hydraulically shortest flow path assumed to be out of service. Sectional control valves are arranged to provide adequate sectional control of the fire main loop to minimize protection impairments. All fire protection water system control valves are monitored under a periodic inspection program and their proper positioning is supervised in accordance with NFPA 801. Exterior fire hydrants, equipped with separate shut-off valves on the branch connection, are provided at intervals to ensure complete coverage of all facility structures, including the UBC Storage Pad.

The fire pumps are separated from each other by fire-rated barrier construction. One pump is driven by an electric motor and one pump is diesel engine-driven. Each pump is equipped with a dedicated listed controller. The pumps are arranged for automatic start functions upon a drop in the system water pressure as detected by pressure switches contained within the pump controllers. The start pressure logic prevents simultaneous start of both pumps. Each fire pump controller interfaces with the site-wide protective signaling system for all alarm and trouble conditions recommended by NFPA 20, which are monitored and annunciated at the central alarm panel in the Control Room. Once activated, the fire pumps can only be shut-off at the pump controller location. Pumps, suction and discharge piping and valves are all provided and arranged in accordance with NFPA 20 recommendations. A dedicated fuel tank for the diesel fire pump is located in the Fire Water Pump Building. The tank is sized to provide a minimum eight hour supply of fuel in accordance with the recommendations of NFPA 20. The Fire Water Pump Building is provided with automatic sprinkler protection.

A jockey pump is provided in the Fire Water Pump Building to maintain pressure in the fire protection system during normal operation.

7.5.1.1.2 System Interfaces

The city water supply interfaces and provides fill and make up water to the Fire Protection Water Supply System storage tanks. Safety Considerations

Failure of the Fire Water Supply and Distribution System will not endanger public health and safety. The Fire Water Supply and Distribution System is designed to ensure sufficient water supply to automatic fire protection systems, standpipe systems and to fire hydrants located around the facility. This is accomplished by providing redundant water storage tanks and redundant fire pumps which are not subject to a common electrical or mechanical failure.

7.5 Fire Protection and Emergency Response

7.5.1.2 Standpipe and Hose Systems

As required by the FHA, standpipe systems and interior fire hose stations are provided and installed in accordance with NFPA 14 in the following locations:

- Class I or Class II standpipe systems for are provided in the CUB, CAB, CRDB, TSB, and the SBMs.

The systems are designed in accordance with NFPA 14. The systems are separated from the building sprinkler system either by check valve or separate piping. Where the standpipe and sprinkler systems are fed from a common lead in to the building, connections are provided to allow pressurizing the standpipe or sprinkler system or both, from a nearby fire hydrant separated from the lead in supply line. The separation ensures that a single impairment will not disable both the sprinklers and the hose systems.

In addition to fixed standpipes and fire hose stations, the NEF will be provided with fire hose on mobile apparatus and/or at strategic locations throughout the facility. The amount of hose provided will be sufficient to ensure that all points within the facility will be consistent with NFPA 1410. These lines are intended for use by the fire brigade in the event of a structural fire. Hydraulic margin for these hose lines will be sufficient to ensure minimum nozzle pressures for attack hose line(s) and for the backup hose line.

7.5.1.3 Portable Extinguishers

Portable fire extinguishers are installed throughout all buildings in accordance with NFPA 10. Multi-purpose extinguishers are provided generally for Class A, B, or C fires.

The portable fire extinguishers are spaced within the travel distance limitation and provide the area coverage specified in NFPA 10. Specialized extinguishers are located in areas requiring protection of particular hazards.

In areas with moderator control issues, the fill for the extinguishers has been selected so as not to create an uncontrolled moderator source.

7.5.1.4 Automatic Suppression Systems

Wet pipe sprinkler systems are engineered to protect specific hazards in accordance with parameters established by the FHA. Water flow detectors are provided to alarm and annunciate sprinkler system actuation. Sprinkler system control valves are monitored under a periodic inspection program and their proper positioning is supervised in accordance with NFPA 801 to ensure the systems remain operable.

Automatic wet pipe sprinkler systems, designed and tested in accordance with NFPA 13, are provided in the following buildings:

- Administration Building
- Technical Services Building (TSB)
- Centrifuge Assembly Building (CAB)
- Fire Pump House

7.5 Fire Protection and Emergency Response

- Security Building/Visitor Center

A pre-action sprinkler system, designed and tested in accordance with NFPA 13, is provided in the Central Utilities Building (CUB) for added protection for the electrical equipment against inadvertent discharge.

7.5.1.5 Fire Detection Systems

All facility structures are provided with automatic fire detectors in accordance with NFPA 72 and as required by the FHA. Automatic fire detectors are installed in accordance with NFPA 72, International Fire Code and as required by the FHA.

7.5.1.6 Manual Alarm Systems

All facility structures are provided with manual fire alarm pull stations in accordance with NFPA 72, International Fire Code and as required by the FHA.

7.5.1.7 Fire Alarm System

Each building of the facility is equipped with a listed, fire alarm control panel installed in accordance with NFPA 72. Each panel has a dual power supply, consisting of normal building power and backup power by either 24-hour battery or the facility UPS. The panel and system use individually-addressable devices. Sprinkler system and hose station water flow devices are installed. Smoke and/or heat detectors, as well as manual pull stations are also employed. Each device can be removed from service for maintenance or trouble shooting without disabling the entire system. Features to avoid detector false alarms are also incorporated into the design. Activation of a fire detector, manual pull station or water flow detector results in an audible and visual alarm at the building control panel and the central alarm panel.

The central alarm panel, located in the Control Room, is a listed, microprocessor-based addressable console. The central alarm panel has dual power supplies, consisting of normal building power and backup power by either 24-hour battery or the facility UPS. The central alarm panel monitors all functions associated with the individual building alarm panels and the fire pump controllers. All alarm and trouble functions are audibly and visually annunciated by the central alarm panel and automatically recorded via printout. Central alarm panel failure will not result in failure of any building fire alarm control panel functions.

The following conditions are monitored by the central alarm console through the fire pump controllers:

- Pump running
- Pump failure to start
- Pump controller in "off" or "manual" position
- Battery failure
- Diesel overspeed
- Diesel high engine jacket coolant temperature
- Diesel low oil pressure
- Battery charger failure.

7.5 Fire Protection and Emergency Response

Both pumps are maintained in the automatic start condition at all times, except during periods of maintenance and testing. Pumps are arranged for manual shut-off at the controllers only.

All fire protection water system control valves are monitored under a periodic inspection program and their proper positioning is supervised in accordance with NFPA 801.

7.5.2 Fire Emergency Response

7.5.2.1 Fire Brigade

The facility maintains a fire brigade made up of employees trained in fire prevention, fire fighting techniques, first aid procedures, emergency response, and criticality safety. The criticality safety training addresses water moderation, water reflection, product cylinder safety by moderation control, and water flooding. The fire brigade is organized, operated, trained and equipped in accordance with NFPA 600. The fire brigade is considered an incipient fire brigade as classified under NFPA 600, e.g., not required to wear thermal protective clothing nor self-contained breathing apparatus during firefighting. The intent of the facility fire brigade is to be able to handle all minor fires and to be a first response effort designed to supplement the local fire department for major fires at the plant. The fire brigade members are trained and equipped to respond to fire emergencies and contain fire damage until offsite help from a neighboring fire department arrives. This will include the use of hand portable and wheeled fire extinguishers as well as hoselines to fight interior/exterior incipient fires and to fight larger exterior fires in a defensive mode (e.g., vehicle fires). When the local fire department arrives onsite, the local fire department assumes control and is responsible for all fire fighting activities. The plant fire brigade, working with the plant's Emergency Operations Center, will coordinate offsite fire department activities to ensure moderator control and criticality safety.

The fire brigade is staffed so that there are a minimum of four (4) individuals, a Fire Brigade leader who acts as the team's Incident Commander, and three (3) incipient firefighters. The Fire Brigade consists of any qualified plant personnel. Building Operators that make up the minimum shift crew composition can also be assigned to the fire brigade. One qualified member of the Fire Brigade will be assigned the function of Fire Brigade Safety Officer. The Fire Brigade Safety Officer is responsible to ensure that moderator concerns are considered for criticality safety during firefighting activities.

Periodic training is provided to offsite assistance organization personnel in the facility emergency planning procedures. Facility emergency response personnel meet at least annually with each offsite assistance group to accomplish training and review items of mutual interest including relevant changes to the program. This training includes facility tours, information concerning facility access control (normal and emergency), potential accident scenarios, emergency action levels, notification procedures, exposure guidelines, personnel monitoring devices, communications, contamination control, moderator control issues, and the offsite assistance organization role in responding to an emergency at the facility, as appropriate.

7.5.2.2 Off-Site Organizations

LES will use the services of local, offsite fire departments to supplement the capability of the facility Fire Brigade. The two primary agencies that will be available for this response are the City of Eunice, New Mexico Fire and Rescue Agency and the City of Hobbs, New Mexico Fire Department. Both agencies are signatories to the Lea County, New Mexico Mutual Aid

7.5 Fire Protection and Emergency Response

agreement and can request additional mutual aid from any of several county fire departments/fire districts.

A Memorandum of Understanding is in place between LES and these two local fire departments. The Memorandum of Understanding defines the fire protection and emergency response commitments between the organizations. The training and conduct of emergency drills and the Memoranda of Understanding are discussed in the NEF Emergency Plan.

LES has performed a baseline needs assessment evaluating the response to fires and related emergencies to confirm adequacy of the response considering both facility resources and response of the two primary response agencies. This assessment identified that with some supplemental resource and training development, adequate response is assured.

Eunice Fire and Rescue is the initial response agency and is comprised of volunteers. Firefighters are trained to a minimum Firefighter Level I and ambulance personnel to a minimum of Emergency Medical Technician (EMT) – Basic per New Mexico standards.

The Hobbs Fire Department is the secondary response agency and is comprised of paid personnel. Firefighters are required to be a minimum Firefighter Level I and EMT – Basic per New Mexico standards. Shift assigned ambulance personnel are EMT – Paramedics per New Mexico standards.

The estimated response time to NEF for a basic life support ambulance is 11 minutes with a second ambulance available within an additional seven minutes. NEF personnel will be trained and equipped to provide first aid and circulatory/respiratory support in the interim (e.g., provide CPR, apply automatic external defibrillation, and administer oxygen).

The estimated response time to NEF for a structural fire engine and full structural crew from Eunice Fire and Rescue is between 11 and 15 minutes. In the event of a fire, the NEF fire brigade will respond and Eunice Fire and Rescue will be notified to respond. If the fire is incipient, the NEF fire brigade will fight the fire utilizing hand portable/wheeled fire extinguishers and/or 38 mm (1½-in) hose lines. In the event that structural fire response is needed, the Hobbs Fire Department will also be notified to respond and the 38 mm (1½-in) and/or 64 mm (2½-in) hose lines from the NEF fire water supply system to the nearest points to the fire will be extended by the NEF fire brigade, where it can be done safely. The latter activity will minimize deployment time for the offsite responders upon their arrival. To ensure that application of water or other firefighting activities are consistent with moderator concerns for criticality safety, the NEF fire brigade safety officer is trained and equipped to don structural firefighting gear and will accompany offsite responders to the firefighting location. In the event that offsite responders are needed in more than one facility location, the criticality safety role of the NEF fire brigade safety officer is fulfilled by appropriately trained NEF personnel (typically fire brigade members). These NEF personnel are trained in criticality safety and trained and equipped to don structural firefighting gear to accompany the offsite responders to required facility locations.

The emergency response to a hazardous release that results, or is likely to result, in an uncontrolled release of a hazardous substance will be from an offsite response agency.

This is further described in SAR Section 6.4.8, Emergency Planning.

7.5 Fire Protection and Emergency Response

Through a combination of onsite capability, offsite responders, or through contract arrangements, LES will ensure that capabilities are in place to respond to other events such as confined space rescue, trench rescue, high angle rescue, and other technical emergencies as required. The NEF fire brigade/emergency response team equipment will also be inventoried, inspected and tested in accordance with recognized standards. Final needs for these response areas and response equipment will be reassessed after detailed facility design to ensure adequate response capabilities are in place and training completed prior to any construction activities.

7.6 References

7.6 References

Edition of Codes, Standards, NRC Documents, etc that are not listed below are given in ISAS Table 3.0-1.

CFR, 2003a, Title 10, Code of Federal Regulations, Section 70.62, Safety program and integrated safety analysis, 2003.

CFR, 2003b, Title 10, Code of Federal Regulations, Section 70.22, Contents of applications, 2003.

CFR, 2003c, Title 10, Code of Federal Regulations, Section 70.65, Additional content of applications, 2003.

CFR, 2003d, Title 10, Code of Federal Regulations, Section 70.61, Performance requirements, 2003.

CFR, 2003e., Title 10, Code of Federal Regulations, Section 70.64, Requirements for new facilities or new processes at existing facilities, 2003.

NRC, 1995, NRC Staff Technical Position on Fire Protection for Fuel Cycle Facilities, Generic Letter 95-01, U.S. Nuclear Regulatory Commission, January 1995.

ASTM E84, 2001, Test Method For Surface Burning Characteristics of Building Material.

ASTM E 119, 2000, Standard Test Methods for Fire tests of Building Construction and Materials.

ASTM E814, 2002, Standard test Method for Fire test of Through-Penetration Fire Stops.

NFPA 8-, 1999, Standard for Fire Doors and Fire Windows.

NFPA 80A, 1993, Exterior Fire Exposures.

NFPA 90A, 2002, Standard for the Installation of Air Conditioning and Ventilating Systems.

NFPA 221, 1997, Standard for Fire Walls and Fire Barrier Walls.

NFPA 251, 1995, Standard Methods of Tests of Fire Endurance of Building Construction and Materials.

NFPA 252, 1999, Standard Methods of Fire Tests of Door Assemblies.

NFPA 801, 2003, Standard for Fire Protection for Facilities Handling Radioactive Materials.

UL Fire Resistance Directory, 2000 or later.

UL 10B, 1997, Standard for Safety Fire Tests of Door Assemblies

UL 555, 1999, Standard for Safety Fire Dampers

7.6 References

NFPA 220, 1999, Standard on Types of Building Construction

International Building Code, 2003, (as amended by the New Mexico Commercial Building Code)

7.7 Chapter 7 Figures

7.7 Chapter 7 Figures

7.7 Chapter 7 Figures

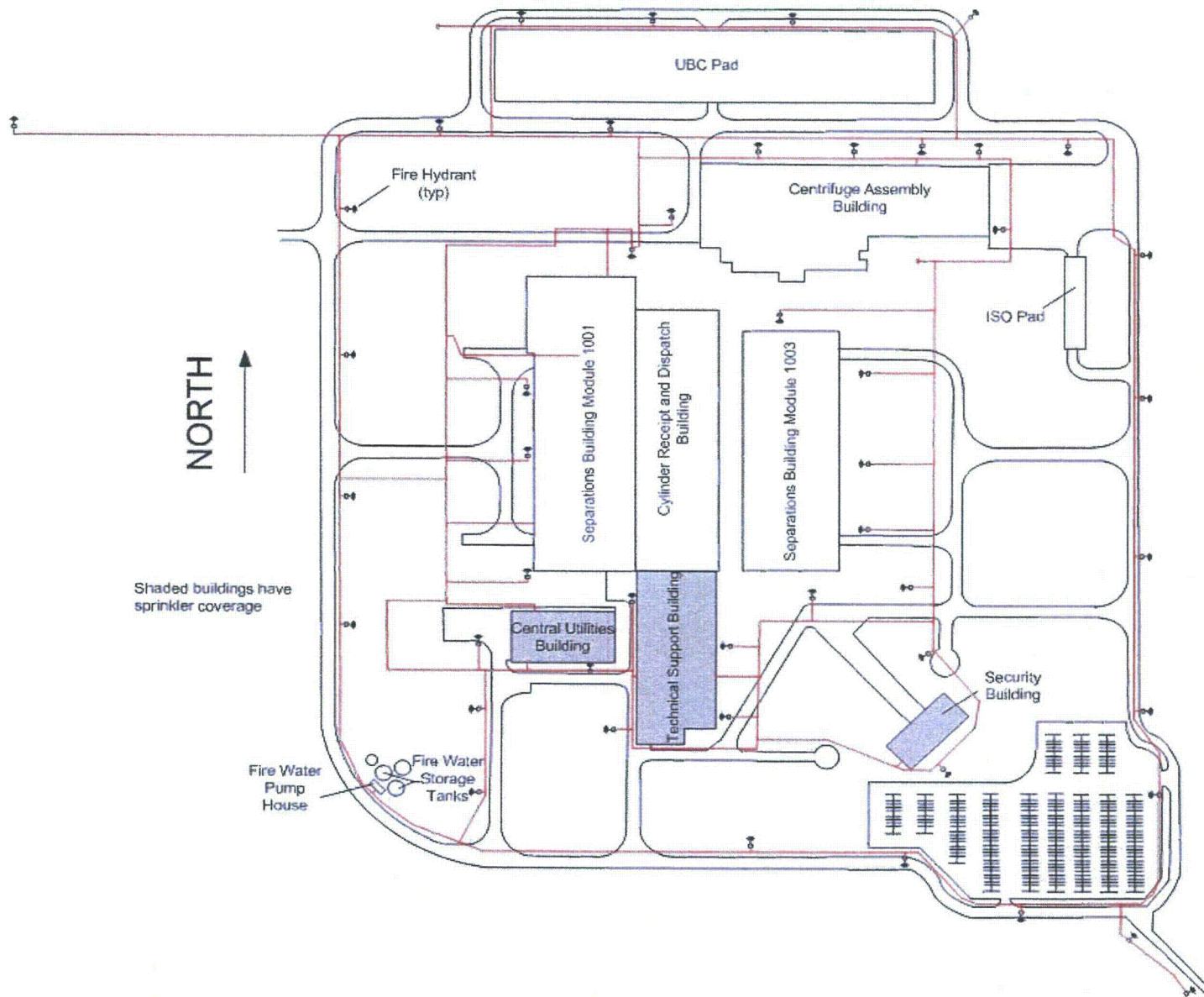

7.7 Chapter 7 Figures

Figure 7.5-1 Exterior Fire Protection System Overall Site Plan Sheet 1 of 2

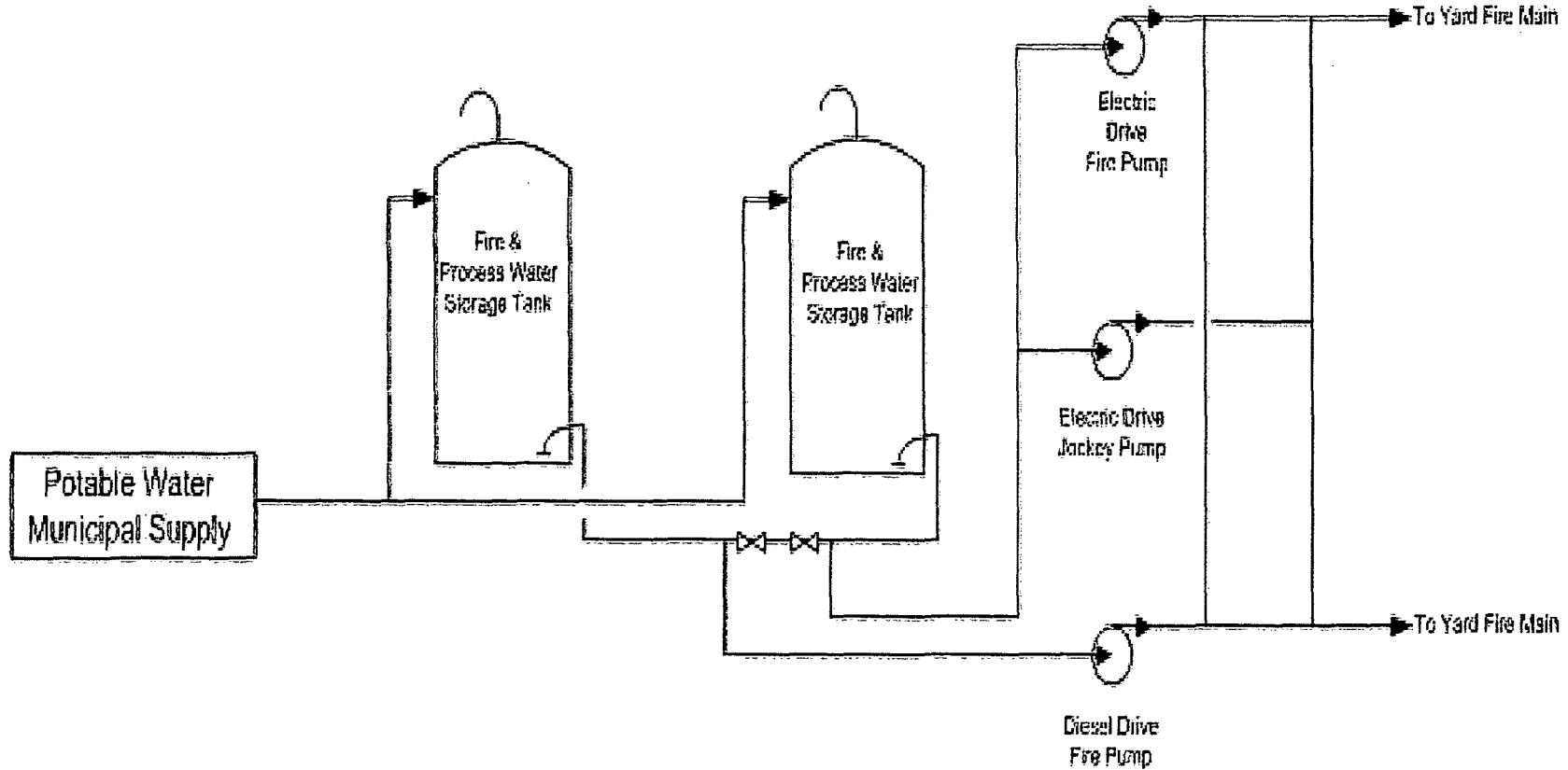

Figure 7.5-1 Exterior Fire Protection System Overall Site Plan Sheet 2 of 2

8.0 Emergency Management

8.0 Emergency Management

The plans for coping with emergencies at the National Enrichment Facility are presented in the facility Emergency Plan. The Emergency Plan has been developed in accordance with 10 CFR 70.22(i) (CFR, 2003a) and 10 CFR 40.31(j) (CFR, 2003b). The Emergency Plan conforms to the guidance presented in Regulatory Guide 3.67, Standard Format and Content for Emergency Plans for Fuel Cycle and Materials Facilities. The facility Emergency Plan also addresses the specific acceptance criteria in NUREG-1520, Standard Review Plan for the Review of a License Application for a Fuel Cycle Facility, Chapter 8, Emergency Management.

The Emergency Plan identifies the offsite organizations that reviewed the Emergency Plan pursuant to the requirement in 10 CFR 70.22(i)(4) (CFR, 2003a) and 10 CFR 40.31(j)(4) (CFR, 2003b). Memorandums of Understanding with the off-site organizations are provided in the Emergency Plan.

8.1 References

8.1 References

Edition of Codes, Standards, NRC Documents, etc that are not listed below are given in ISAS Table 3.0-1.

CFR, 2003a. Title 10, Code of Federal Regulations, Section 70.22, Contents of applications, 2003.

CFR, 2003b. Title 10, Code of Federal Regulations, Section 40.31, Application for specific licenses, 2003.

9.0 Environmental Protection

9.0 Environmental Protection

Louisiana Energy Services (LES) documents demonstrate that its proposed environmental protective measures are adequate to protect the environment and the health and safety of the public as well as comply with the regulatory requirements imposed in 10 CFR 20 (CFR, 2003a), 10 CFR 30 (CFR, 2003b), 10 CFR 40 (CFR, 2003c), 10 CFR 51 (CFR, 2003d), and 10 CFR 70 (CFR, 2003e). Summarized below are the chapter section, general information category, the corresponding regulatory requirement, and the NUREG-1520 section identifying the NRC acceptance criteria.

Chapter Section	Information Category	10 CFR Citation	NUREG-1520 Reference
9.1	Environmental Report	70.21(h)	9.4.3.1.1
9.1.1	Date of Application	70.21(f)	9.4.3.1.1(1)
9.1.2	Environmental Considerations	51.45(b)	9.4.3.1.1(2)
9.1.3	Analysis of Effects of Proposed Action and Alternatives	51.45(c)	9.4.3.1.1(3)
9.1.4	Status of Compliance	51.45(d)	9.4.3.1.1(4)
9.1.5	Adverse Information	51.45(e)	9.4.3.1.1(5)
9.2	Environmental Protection Measures	70.22(a)(8)	9.4.3.2
9.2.1	Radiation Safety	20.1101(a)	9.4.3.2.1
	• ALARA Controls and Reports	20.1101(d)	9.4.3.2.1(1)-(3)
	• Waste Minimization	20.1406	9.4.3.2.1(4)
9.2.2	Effluent and Environmental Controls and Monitoring	70.59(a)(1)	9.4.3.2.2
9.2.2.1	Effluent Monitoring	20.1501(a)	9.4.3.2.2(1)
9.2.2.2	Environmental Monitoring	20.1501(a)	9.4.3.2.2(2)
9.2.2.3	ISA Summary	70.65(b)	9.4.3.2.2(3)

This Safety Analysis Report (SAR) Chapter documents the potential environmental impacts associated with construction and operation of the NEF and indicates that adverse impacts are small. These impacts are outweighed by the substantial socioeconomic benefits associated with plant construction and operation. Additionally, the NEF will meet the underlying need for additional reliable and economical uranium enrichment capacity in the United States, thereby serving important energy and national security policy objectives. Accordingly, because the impacts of the proposed NEF are minimal and acceptable, and the benefits are desirable, the no-action alternative has been rejected in favor of the proposed action.

9.1 Environmental Report

9.1 Environmental Report

The LES Environmental Report (ER) meets the requirements contained in 10 CFR Part 51 (CFR, 2003d), Subpart A. In particular, the ER addresses the requirements in 10 CFR 51.45(b)-(e) (CFR, 2003f) and follows the general format of NUREG-1748.

The ER presents the proposed action, purpose of the proposed action, and applicable regulatory requirements (Chapter 1), discusses alternatives (Chapter 2), describes the facility and the affected environment (Chapter 3), and potential impacts of the proposed action (Chapter 4). Mitigation measures are described in Chapter 5, environmental measurements and monitoring programs in Chapter 6, a cost-benefit analysis in Chapter 7, and a summary of environmental consequences in Chapter 8. References and preparers are listed in Chapters 9 and 10, respectively.

9.1.1 Date of Application

The effective date of the ER is December 16, 2003. As required by 10 CFR 70.21(f) (CFR, 2003g), this date was at least nine months before facility construction that was scheduled to begin in 2006.

9.1.2 Environmental Considerations

The ER adequately addresses the requirements of 10 CFR 51.45(b) (CFR, 2003f) as follows:

9.1.2.1 Description of the Proposed Action

The proposed action, described in ER Section 1.2, Proposed Action, is the issuance of an NRC specific license under 10 CFR 30 (CFR, 2003b), 10 CFR 40 (CFR, 2003c) and 10 CFR 70 (CFR, 2003e) to possess and use byproduct material, source material and special nuclear material (SNM) and to construct and operate a uranium enrichment facility in Lea County, New Mexico. The enriched uranium is intended for use primarily in domestic commercial nuclear power plants.

Significant characteristics of the facility are described in ER Chapters 1, Introduction of the Environmental Report and Chapter 3, Description of Affected Environment. Major site features, along with plant design and operating parameters are included. A discussion of how the special nuclear material (SNM), in this case uranium hexafluoride (UF₆), is processed to produce enriched uranium-235 (²³⁵U) is described in ER Section 1.2, Proposed Action, which also includes the proposed project schedule.

9.1.2.2 Purpose of Proposed Action

ER Section 1.1, Purpose and Need for the Proposed Action, demonstrates the need for the facility. The demonstration provides the

- Quantities of SNM used for domestic benefit
- A projection of domestic and foreign requirements for services
- Alternative sources of supply for LES' proposed services.

9.1 Environmental Report

ER Section 1.1, Purpose and Need for the Proposed Action, also discusses the effects to the nation's energy program or LES' business such as loss of contracts.

9.1.2.3 Description of the Affected Environment

Chapter 3 of the ER contains detailed descriptions of the affected environment. The chapter provides a baseline characterization of the site and its environs prior to any disturbances associated with construction or operation of the facility. The following topics and corresponding ER chapter section include:

- Site location (including longitude and latitude) and facility layout (1.2)
- Regional demography (3.10) and land use (3.1)
- Socioeconomic information (3.10), including low-income and minority populations within 130 km² (50 mi²) as directed by NUREG-1748 (4.11)
- Regional historic (3.8), archeological (3.8), architectural (3.9), scenic (3.9), cultural (3.8), and natural landmarks (3.9)
- Local meteorology and air quality (3.6)
- Local surface water and ground water hydrology (3.4)
- Regional geology and seismology (3.3)
- Local terrestrial and aquatic ecology (3.5).

The baseline descriptions presented were from the most current information available. It was gathered from Federal, State, and County sources along with existing on-site data. Therefore, the information represents both seasonal and long-term environmental trends.

9.1.2.4 Discussion of Considerations

Three ER chapters discuss the potential environmental impacts. Chapter 4 details environmental and socioeconomic effects due to site preparation and facility construction and operation. Chapter 2 describes alternatives to the proposed action, including siting and designs. Chapter 7 provides a discussion of the costs and benefits for each alternative as well as the relationship between short-term use and long-term productivity of the environment, and resources committed. In addition, Chapter 8 provides a summary of environmental consequences from all actions. The associated regulatory criteria and corresponding ER section are as follows.

A. Impact on the Environment

- Effects of site preparation and construction on land (4.1) and water use (4.4)
- Effects of facility operation on human population (including consideration of occupation and public radiation exposure) and important biota (4.10, 4.11, and 4.12)
- Any irreversible commitments of resources because of site preparation and facility construction and operation, such as destruction of wildlife habitat, removal of land from agriculture, and diversion of electrical power (4.1, 7.0, and 8.2)
- Plans and policies regarding decommissioning and dismantling at the end of the facility's life (8.9)

9.1 Environmental Report

- Environmental effects of the transportation of radioactive materials to and from the site (4.2)
- Environmental effects of accidents (4.12)
- Impacts on air (4.6) and water quality (4.4)
- Impacts on cultural and historic resources (4.8).

B. Adverse Environmental Effects

ER chapters 3, 4 & 8 discuss adverse environmental effects.

C. Alternatives to the Proposed Action

ER Chapter 2 provides a complete description of alternatives considered. Included are the no action alternative scenarios as well as the siting criteria and technical design requirements in sufficient detail that provided a fair and reasonable comparison between the alternatives.

D. Relationship between Short- and Long-term Productivity

ER Chapter 7, the cost-benefit analysis, includes the consideration of the short-term uses and productivity of the site during the active life of the facility. No adverse impacts on the long-term productivity of the environment after decommissioning of the facility have been identified. The European experience at the Almelo enrichment plant demonstrates that a centrifuge technology site can be returned to a greenfield site for use without restriction.

E. Irreversible and Irrecoverable Commitments of Resources

Irreversible environmental commitments and irretrievable material resources also are included in the cost-benefit analysis in ER Chapter 7. They are part of the capital costs associated with the land and facility and operating and maintenance costs. The site should be available for unrestricted use following decommissioning. Some components may be reused or sold as scrap during the plant life or following decommissioning.

9.1.3 Analysis of Effects of Proposed Action and Alternatives

ER Chapter 2 discusses the analysis of effects of the proposed action and alternatives in accordance with 10 CFR 51.45(c) (CFR, 2003f). The analysis considers and balances the environmental effects of the proposed action and alternatives available to reduce or avoid both environmental and socioeconomic effects and other benefits of the proposed action.

9.1.4 Status of Compliance

ER Section 1.3 summarizes, as required in 10 CFR 51.45(d) (CFR, 2003f), the applicability of environmental regulatory requirements, permits, licenses, or approvals as well as the current status of each on the effective date of the ER.

Many federal laws and regulations apply to the facility during site assessment, construction, and operation. Some of these laws require permits from, consultations with, or approvals by, other governing or regulatory agencies. Some apply only during certain phases of facility development, rather than the entire life of the facility. Federal statutes and regulations (non-nuclear) have been reviewed to determine their applicability to the facility site assessment, construction, and operation.

9.1 Environmental Report

9.1.5 Adverse Information

In accordance with 10 CFR 51.45(e) (CFR, 2003f), various sections throughout the ER discuss adverse environmental effects. In particular, Chapter 4 details environmental and socioeconomic effects due to site preparation and facility construction and operation. Chapter 2 compares potential impacts from alternatives. Lastly, Chapter 8 provides a summary of environmental consequences from all actions.

9.2 Environmental Protection Measures

9.2 Environmental Protection Measures

LES is committed to protecting the public, plant workers, and the environment from the harmful effects of ionizing radiation due to plant operation. Accordingly, LES is firmly committed to the "As Low As Reasonably Achievable," (ALARA) philosophy for all operations involving source, byproduct, and special nuclear material. This commitment is reflected in written procedures and instructions for operations involving potential exposures of personnel to radiation (both internal and external hazards) and the facility design. Written procedures for effluent monitoring address the need for periodic (monthly) dose assessment projections to members of the public to ensure that potential radiation exposures are kept ALARA (i.e., not in excess of 0.1 mSv/yr (10 mrem/yr)) in accordance with 10 CFR 20.1101(d).

LES' environmental protective measures are described in the ER. In particular, Chapter 4 discusses the radiation protection program with regard to ALARA goals and waste minimization. Chapter 6 discusses the environmental controls and monitoring program.

A detailed description of the LES' radiation protection program is provided in SAR Chapter 4. Similarly, LES' provisions for a qualified and trained staff, which also is part of the environmental protection measures required, are described separately in the SAR as part of Chapter 11.

9.2.1 Radiation Safety

The four acceptance criteria that describe the facility radiation safety program are divided between two documents.

SAR Chapter 4, Radiation Protection, addresses:

- Radiological (ALARA) Goals for Effluent Control, and
- ALARA Reviews and Reports to Management.

ER Chapter 4, Environmental Impacts, addresses:

- Effluents controls to maintain public doses ALARA, and
- Waste Minimization.

In particular, ER Section 4.12 describes public and occupational health effects from both non-radiological and radiological sources. This section specifically addresses calculated total effective dose equivalent to an average member of critical groups or calculated average annual concentration of radioactive material in gaseous and liquid effluent to maintain compliance with 10 CFR 20 (CFR, 2003a).

ER Section 4.13 contains a discussion on facility waste minimization that identifies process features and systems to reduce or eliminate waste. It also describes methods to minimize the volume of waste.

9.2.2 Effluent and Environmental Controls and Monitoring

LES has designed an environmental monitoring program to provide comprehensive data to monitor the facility's impact on the environment. The preoperational program focused on collecting data to establish baseline information useful in evaluating changes in potential

9.2 Environmental Protection Measures

environmental conditions caused by facility operation. The preoperational program will be initiated at least one year prior to facility operation.

The operational program conducts monitoring to ensure facility emissions are maintained ALARA. Monitoring is of appropriate pathways up to a 2-mile radius beyond the site boundary.

ER Chapter 6 describes environmental measurement and monitoring programs as they apply to preoperation (baseline), operation, and decommissioning conditions for both the proposed action and each alternative.

9.2.2.1 Effluent Monitoring

ER Section 6.1 presents information relating to the facility radiological monitoring program. This section describes the location and characteristics of radiation sources and radioactive effluent (liquid and gaseous). It also describes the various elements of the monitoring program, including:

- Number and location of sample collection points
- Measuring devices used
- Pathway sampled or measured
- Sample size, collection frequency and duration
- Method and frequency of analysis, including lower limits of detection.

Based on recorded plant effluent data, dose projections to members of the public are performed monthly to ensure that the annual dose to members of the public does not exceed the ALARA constraint of 0.1 mSv/yr (10 mrem/yr). If the monthly dose impact assessment indicates a trend in effluent releases that, if not corrected, could cause the ALARA constraint to be exceeded, appropriate corrective action are initiated to reduce the discharges to assure that subsequent releases are in compliance with the annual dose constraint. In addition, an evaluation of the need for increased sampling is performed. Corrective actions may include, for example, change out of Pumped Extract GEVS or CRDB GEVS filters, replacement of spent cleanup resins for liquid waste or reprocessing collected waste prior to release to the Treated Effluent Evaporative Basin.

Lastly, this section justifies the choice of sample locations, analyses, frequencies, durations, sizes, and lower limits of detection.

9.2.2.2 Environmental Monitoring

ER Section 6.1 also includes information relating to the facility environmental monitoring program. The information presented is the same as that included in the effluent monitoring program, i.e., number and location of sample collection points, etc.

9.2 Environmental Protection Measures

9.2.3 Integrated Safety Analysis

LES has prepared an integrated safety analysis (ISA) in accordance with 10 CFR 70.60 (CFR, 2003h). The ISA

- Provides a complete list of the accident sequences that if uncontrolled could result in radiological and non-radiological releases to the environment with intermediate or high consequences
- Provides reasonable estimates for the likelihood and consequences of each accident identified
- Applies acceptable methods to estimate environmental effects that may result from accidental releases.

The ISA also

- Identifies adequate engineering and/or administrative controls for each accident sequence of environmental significance
- Assures adequate levels are afforded so those items relied on for safety (IROFS) will satisfactorily perform their safety functions.

The ISA demonstrates that the facility and its operations have adequate engineering and/or administrative controls in place to prevent or mitigate high and intermediate consequences from the accident sequences identified and analyzed.

9.3 References

9.3 References

Edition of Codes, Standards, NRC Documents, etc that are not listed below are given in ISAS Table 3.0-1.

CFR, 2003a. Title 10, Code of Federal Regulations, Part 20, Standards for Protection Against Radiation, 2003.

CFR, 2003b. Title 10, Code of Federal Regulations, Part 30, Rules of General Applicability to Domestic Licensing of Byproduct Material, 2003.

CFR, 2003c. Title 10, Code of Federal Regulations, Part 40, Domestic Licensing of Source Material, 2003.

CFR, 2003d. Title 10, Code of Federal Regulations, Part 51, Environmental Protection Regulations for Domestic Licensing and Related Regulatory Functions, 2003.

CFR, 2003e. Title 10, Code of Federal Regulations, Part 70, Domestic Licensing of Special Nuclear Material, 2003.

CFR, 2003f. Title 10, Code of Federal Regulations, Section 51.45, Environmental report, 2003.

CFR, 2003g. Title 10, Code of Federal Regulations, Section 70.21, Filing, 2003.

CFR, 2003h. Title 10, Code of Federal Regulations, Section 70.60, Applicability, 2003.

10.0 Decommissioning

10.0 Decommissioning

This chapter presents the National Enrichment Facility (NEF) Decommissioning Funding Plan. The Decommissioning Funding Plan has been developed following the guidance provided in NUREG-1757. Louisiana Energy Services (LES) commits to decontaminate and decommission the enrichment facility and the site at the end of its operation so that the facility and grounds can be released for unrestricted use. The Decommissioning Funding Plan will be reviewed and updated as necessary at least once every three years starting from the time of issuance of the license. Prior to facility decommissioning, a Decommissioning Plan will be prepared in accordance with 10 CFR 70.38 (CFR, 2003a) and submitted to the NRC for approval.

This chapter fulfills the applicable provisions of NUREG-1757 through submittal of information in tabular form as suggested by the NUREG. Therefore a matrix showing compliance requirements and commitments is not provided herein.

10.1 Site-Specific Cost Estimate

10.1 Site-Specific Cost Estimate

10.1.1 Cost Estimate Structure

The decommissioning cost estimate is comprised of three basic parts that include:

- A facility description
- The estimated costs (including labor costs, non-labor costs, and a contingency factor)
- Key assumptions.

10.1.2 Facility Description

The NEF is fully described in other sections of this License Application and the NEF Integrated Safety Analysis Summary. Information relating to the following topics can be found in the referenced chapters listed below:

A general description of the facility and plant processes is presented in Chapter 1, General Information. A detailed description of the facility and plant processes is presented in the NEF Integrated Safety Analysis Summary.

A description of the specific quantities and types of licensed materials used at the facility is provided in Chapter 1, Section 1.2, Institutional Information.

A general description of how licensed materials are used at the facility is provided in Chapter 1, General Information.

10.1.3 Decommissioning Cost Estimate

10.1.3.1 Summary of Costs

The decommissioning cost estimate for the NEF is approximately \$942 million (January, 2004 dollars). The decommissioning cost estimate and supporting information are presented in Tables 10.1-1A through 10.1-14, consistent with the applicable provisions of NUREG-1757, NMSS Decommissioning Standard Review Plan.

More than 97% of the decommissioning costs (except tails disposition costs) for the NEF are attributed to the dismantling, decontamination, processing, and disposal of centrifuges and other equipment in the Separations Building Modules (SBMs), which are considered classified. Given the classified nature of these buildings, the data presented in the Tables at the end of this chapter has been structured to meet the applicable NUREG-1757 recommendations, to the extent practicable. However, specific information such as numbers of components and unit rates have been intentionally excluded to protect the classified nature of the data.

The remaining 3% of the decommissioning costs are for the remaining systems and components in other buildings. Since these costs are small in relation to the overall cost estimate, the cost data for these systems has also been summarized at the same level of detail as that for the SBMs.

10.1 Site-Specific Cost Estimate

The decommissioning project schedule is presented in Figure 10.1-1, National Enrichment Facility – Conceptual Decommissioning Schedule. Dismantling and decontamination of the equipment in the three SBMs will be conducted sequentially (in three phases) over a nine year time frame. SBM-1001 will be decommissioned during the first three-year period, followed by SBM-1002, and then SBM-1003. Termination of SBM-1003 operations will mark the end of uranium enrichment operations at the NEF. Decommissioning of the remaining plant systems and buildings will begin after SBM-1003 operations have been permanently terminated.

10.1.3.2 Major Assumptions

Key assumptions underlying the decommissioning cost estimate are listed below:

- Inventories of materials and wastes at the time of decommissioning will be in amounts that are consistent with routine plant operating conditions over time.
- Costs are not included for the removal or disposal of non-radioactive structures and materials beyond that necessary to terminate the NRC license.
- Credit is not taken for any salvage value that might be realized from the sale of potential assets (e.g., recovered materials or decontaminated equipment) during or after decommissioning.
- Decommissioning activities will be performed in accordance with current day regulatory requirements.
- LES will be the Decommissioning Operations Contractor (DOC) for all decommissioning operations. However, in the event that LES is not able to fulfill this role, an adjustment to account for use of a third party for performing decommissioning operations is provided in Table 10.1-14, Total Decommissioning Costs.
- Decommissioning costs, with the exception of tails disposition costs, are presented in January 2002 dollars. In Table 10.1-14, tails disposition costs are presented in January 2004 dollars. In addition, the costs of decommissioning presented in Table 10.1-14 are escalated from January 2002 dollars to January 2004 dollars to provide the total decommissioning costs in January 2004 dollars.

10.1.4 Decommissioning Strategy

The plan for decommissioning is to promptly decontaminate or remove all materials from the site which prevent release of the facility for unrestricted use. This approach, referred to in the industry as DECON (i.e., immediate dismantlement), avoids long-term storage and monitoring of wastes on site. The type and volume of wastes produced at the NEF do not warrant delays in waste removal normally associated with the SAFSTOR (i.e., deferred dismantlement) option.

At the end of useful plant life, the enrichment facility will be decommissioned such that the site and remaining facilities may be released for unrestricted use as defined in 10 CFR 20.1402 (CFR, 2003b). Enrichment equipment will be removed; only building shells and the site infrastructure will remain. All remaining facilities will be decontaminated where needed to acceptable levels for unrestricted use. Confidential and Secret Restricted Data material, components, and documents will be destroyed and disposed of in accordance with the facility Standard Practice Procedures Plan for the Protection of Classified Matter.

10.1 Site-Specific Cost Estimate

Depleted UF₆ (tails), if not already sold or otherwise disposed of prior to decommissioning, will be disposed of in accordance with regulatory requirements. Radioactive wastes will be disposed of in licensed low-level radioactive waste disposal sites. Hazardous wastes will be treated or disposed of in licensed hazardous waste facilities. Neither tails conversion (if done), nor disposal of radioactive or hazardous material will occur at the plant site, but at licensed facilities located elsewhere.

Following decommissioning, no part of the facilities or site will remain restricted to any specific type of use.

Activities required for decommissioning have been identified, and decommissioning costs have been estimated. Activities and costs are based on actual decommissioning experience in Europe. Urenco has a fully operational dismantling and decontamination facility at its Almelo, Netherlands plant. Data and experience from this operating facility have allowed a very realistic estimation of decommissioning requirements. Using this cost data as a basis, financial arrangements are made to cover all costs required for returning the site to unrestricted use. Updates on cost and funding will be provided periodically and will include appropriate treatment for any replacement equipment. A detailed Decommissioning Plan will be submitted at a later date in accordance with 10 CFR 70.38 (CFR, 2003a).

The remaining subsections describe decommissioning plans and funding arrangements, and provide details of the decontamination aspects of the program. This information was developed in connection with the decommissioning cost estimate. Specific elements of the planning may change with the submittal of the decommissioning plan required at the time of license termination.

10.1.5 Decommissioning Design Features

10.1.5.1 Overview

Decommissioning planning begins with ensuring design features are incorporated into the plant's initial design that will simplify eventual dismantling and decontamination. The plans are implemented through proper management and health and safety programs. Decommissioning policies address radioactive waste management, physical security, and material control and accounting.

Major features incorporated into the facility design that facilitate decontamination and decommissioning are described below.

10.1.5.2 Radioactive Contamination Control

The following features primarily serve to minimize the spread of radioactive contamination during operation, and therefore simplify eventual plant decommissioning. As a result, worker exposure to radiation and radioactive waste volumes are minimized as well.

- Certain activities during normal operation are expected to result in surface and airborne radioactive contamination. Specially designed rooms are provided for these activities to preclude contamination spread. These rooms are isolated from other areas and are provided with ventilation and filtration. The Solid Waste Collection Room, Ventilated Room and the Decontamination Workshop meet these specific design requirements.

10.1 Site-Specific Cost Estimate

- All areas of the plant are sectioned off into the Restricted Area and Radiologically Controlled Area (RCA). RCAs limit access for the purpose of protecting individuals against undue risks from exposure to radiation and radioactive materials. Radiation Areas and Airborne Contamination Areas have additional controls to inform workers of the potential hazard in the area and to help prevent the spread of contamination. All procedures for these areas fall under the Radiation Protection Program, and serve to minimize the spread of contamination and simplify the eventual decommissioning.
- Non-radioactive process equipment and systems are minimized in locations subject to potential contamination. This limits the size of RCAs and limits the activities occurring inside these areas.
- Local air filtration is provided for areas with potential airborne contamination to preclude its spread. Fume hoods filter contaminated air in these areas.
- Curbing, pits, or other barriers are provided around tanks and components that contain liquid radioactive wastes. These serve to control the spread of contamination in case of a spill.

10.1.5.3 Worker Exposure and Waste Volume Control

The following features primarily serve to minimize worker exposure to radiation and minimize radioactive waste volumes during decontamination activities. As a result, the spread of contamination is minimized as well.

- During construction, a washable epoxy coating is applied to floors and paint is applied to walls that might be radioactively contaminated during operation. The coating will serve to lower waste volumes during decontamination and simplify the decontamination process. The coating is applied to floors and walls that might be radioactively contaminated during operation that are located in an RCA.
- Sealed, nonporous pipe insulation is used in areas likely to be contaminated. This will reduce waste volume during decommissioning.
- Ample access is provided for efficient equipment dismantling and removal of equipment that may be contaminated. This minimizes the time of worker exposure.
- Tanks are provided with accesses for entry and decontamination. Design provisions are also made to allow complete draining of the wastes contained in the tanks.
- Connections in the process systems provided for required operation and maintenance allow for thorough purging at plant shutdown. This will remove a significant portion of radioactive contamination prior to disassembly.
- Design drawings, produced for all areas of the plant, will simplify the planning and implementing of decontamination procedures. This in turn will shorten the durations that workers are exposed to radiation.
- Worker access to contaminated areas is controlled to assure that workers wear proper protective equipment and limit their time in the areas.

10.1 Site-Specific Cost Estimate

10.1.5.4 Management Organization

An appropriate organizational strategy will be developed to support the phased decommissioning schedule discussed in Section 10.1.3.1, Summary of Costs. The organizational strategy will ensure that adequate numbers of experienced and knowledgeable personnel are available to perform the technical and administrative tasks required to decommission the facility.

LES intends to be the prime Decommissioning Operations Contractor (DOC) responsible for decommissioning the NEF. In this capacity, LES will have direct control and oversight over all decommissioning activities. The role will be similar to that taken by Urenco at its facilities in Europe. In that role, Urenco has provided operational, technical, licensing, and project management support of identical facilities during both operational and decommissioning campaigns. LES also plans to secure contract services to supplement its capabilities as necessary.

Management of the decommissioning program will assure that proper training and procedures are implemented to assure worker health and safety. Programs and procedures, based on already existing operational procedures, will focus heavily on minimizing waste volumes and worker exposure to hazardous and radioactive materials. Qualified contractors assisting with decommissioning will likewise be subject to facility training requirements and procedural controls.

10.1.5.5 Health and Safety

As with normal operation, the policy during decommissioning shall be to keep individual and collective occupational radiation exposure as low as reasonably achievable (ALARA). A health physics program will identify and control sources of radiation, establish worker protection requirements, and direct the use of survey and monitoring instruments.

10.1.5.6 Waste Management

Radioactive and hazardous wastes produced during decommissioning will be collected, handled, and disposed of in accordance with all regulations applicable to the facility at the time of decommissioning. Generally, procedures will be similar to those described for wastes produced during normal operation. These wastes will ultimately be disposed of in licensed radioactive or hazardous waste disposal facilities located elsewhere. Non-hazardous and non-radioactive wastes will be disposed of consistent with good industrial practice, and in accordance with applicable regulations.

10.1.5.7 Security/Material Control

Requirements for physical security and for material control and accounting will be maintained as required during decommissioning in a manner similar to the programs in force during operation. The LES plan for completion of decommissioning, submitted near the end of plant life, will provide a description of any necessary revisions to these programs.

10.1 Site-Specific Cost Estimate

10.1.5.8 Record Keeping

Records important for safe and effective decommissioning of the facility will be stored in the LES Records Management System until the site is released for unrestricted use. Information maintained in these records includes:

1. Records of spills or other unusual occurrences involving the spread of contamination in and around the facility, equipment, or site. These records may be limited to instances when contamination remains after any cleanup procedures or when there is reasonable likelihood that contaminants may have spread to inaccessible areas as in the case of possible seepage into porous materials such as concrete. These records will include any known information on identification of involved nuclides, quantities, forms, and concentrations.
2. As-built drawings and modifications of structures and equipment in restricted areas where radioactive materials are used and/or stored and of locations of possible inaccessible contamination such as buried pipes which may be subject to contamination. Required drawings will be referenced as necessary, although each relevant document will not be indexed individually. If drawings are not available, appropriate records of available information concerning these areas and locations will be substituted.
3. Except for areas containing only sealed sources, a list contained in a single document and updated every two years, of the following:
 - (i) All areas designed and formerly designated as Restricted Areas as defined under 10 CFR 20.1003; (CFR, 2003c)
 - (ii) All areas outside of Restricted Areas that require documentation specified in item 1 above;
 - (iii) All areas outside of Restricted Areas where current and previous wastes have been buried as documented under 10 CFR 20.2108 (CFR, 2003d); and
 - (iv) All areas outside of Restricted Areas that contain material such that, if the license expired, the licensee would be required to either decontaminate the area to meet the criteria for decommissioning in 10 CFR 20, subpart E, (CFR, 2003e) or apply for approval for disposal under 10 CFR 20.2002 (CFR, 2003f).
4. Records of the cost estimate performed for the decommissioning funding plan or of the amount certified for decommissioning, and records of the funding method used for assuring funds if either a funding plan or certification is used.

10.1 Site-Specific Cost Estimate

10.1.6 Decommissioning Process

10.1.6.1 Overview

Implementation of the DECON alternative for decommissioning may begin immediately following SBM equipment shutdown, since only low radiation levels exist at this facility. In the phased approach presented herein, dismantling and decontamination of the equipment in the three SBMs will be conducted sequentially (in three phases) over a nine year time frame. SBM-1001 will be decommissioned during the first three year period, followed by SBM-1002 in the next three years, and then SBM-1003 in the final three years. Termination of SBM-1003 operations will mark the end of uranium enrichment operations at the facility. Decommissioning of the remaining plant systems and buildings will begin after SBM-1003 operations have been permanently terminated. A schematic of the NEF decommissioning schedule is presented in Figure 10.1-1, NEF – Conceptual Decommissioning Schedule.

Prior to beginning decommissioning operations, an extensive radiological survey of the facility will be performed in conjunction with a historical site assessment. The findings of the radiological survey and historical site assessment will be presented in a Decommissioning Plan to be submitted to the NRC. The Decommissioning Plan will be prepared in accordance with 10 CFR 70.38 (CFR, 2003a) and the applicable guidance provided in NUREG-1757.

Decommissioning activities will generally include (1) installation of decontamination facilities, (2) purging of process systems, (3) dismantling and removal of equipment, (4) decontamination and destruction of Confidential and Secret Restricted Data material, (5) sales of salvaged materials, (6) disposal of wastes, and (7) completion of a final radiation survey. Credit is not taken for any salvage value that might be realized from the sale of potential assets (e.g., recovered materials or decontaminated equipment) during or after decommissioning.

Decommissioning, using the DECON approach, requires residual radioactivity to be reduced below specified levels so the facilities may be released for unrestricted use. Current Nuclear Material Safety and Safeguards guidelines for release serve as the basis for decontamination costs estimated herein. Portions of the facility that do not exceed contamination limits may remain as is without further decontamination measures applied. The intent of decommissioning the facility is to remove all enrichment-related equipment from the buildings such that only the building shells and site infrastructure remain. The removed equipment includes all piping and components from systems providing UF₆ containment, systems in direct support of enrichment (such as refrigerant and chilled water), radioactive and hazardous waste handling systems, contaminated HVAC filtration systems, etc. The remaining site infrastructure will include services such as electrical power supply, treated water, fire protection, HVAC, cooling water and communications.

Decontamination of plant components and structures will require installation of two new facilities dedicated for that purpose. Existing plant buildings, such as the Centrifuge Assembly Building, are assumed to house the facilities. These facilities will be specially designed to accommodate repetitive cleaning of thousands of centrifuges, and to serve as a general-purpose facility used primarily for cleaning larger components. The two new facilities will be the primary location for decontamination activities during the decommissioning process. The small decontamination area in the Cylinder Receipt and Dispatch Building, used during normal operation, may also handle small items at decommissioning.

10.1 Site-Specific Cost Estimate

Decontaminated components may be reused or sold as scrap. All equipment that is to be reused or sold as scrap will be decontaminated to a level at which further use is unrestricted. Materials that cannot be decontaminated will be disposed of in a licensed radioactive waste disposal facility. As noted earlier, credit is not taken for any salvage value that might be realized from the sale of potential assets (e.g., recovered materials or decontaminated equipment) during or after decommissioning.

Any UF₆ tails remaining on site will be removed during decommissioning. Depending on technological developments occurring prior to plant shutdown, the tails may have become marketable for further enrichment or other processes. The disposition of UF₆ tails and relevant funding provisions are discussed in Section 10.3, Tails Disposition. The cost estimate takes no credit for any value that may be realized in the future due to the potential marketability of the stored tails.

Contaminated portions of the buildings will be decontaminated as required. Structural contamination should be limited to structures in the RCAs. The liners and earthen covers on the facility evaporative basins are assumed to be mildly contaminated and provisions are made for appropriate disposal of these materials in the decommissioning cost estimate. Good housekeeping practices during normal operation will maintain the other areas of the site clean.

When decontamination is complete, all areas and facilities on the site will be surveyed to verify that further decontamination is not required. Decontamination activities will continue until the entire site is demonstrated to be suitable for unrestricted use.

10.1.6.2 Decontamination Facility Construction

New facilities for decontamination can be installed in existing plant buildings to avoid unnecessary expense. Estimated time for equipment installation is approximately one year. These new facilities will be completed in time to support the dismantling and decontamination of SBM-1001. These facilities are described in Section 10.1.7, Decontamination Facilities.

10.1.6.3 System Cleaning

At the end of the useful life of each SBM, the enrichment process is shut down and UF₆ is removed to the fullest extent possible by normal process operation. This is followed by evacuation and purging with nitrogen. This shutdown and purging portion of the decommissioning process is estimated to take approximately three months.

10.1.6.4 Dismantling

Dismantling is simply a matter of cutting and disconnecting all components requiring removal. The operations themselves are simple but very labor intensive. They generally require the use of protective clothing. The work process will be optimized, considering the following.

- Minimizing the spread of contamination and the need for protective clothing
- Balancing the number of cutting and removal operations with the resultant decontamination and disposal requirements
- Optimizing the rate of dismantling with the rate of decontamination facility throughput

10.1 Site-Specific Cost Estimate

- Providing storage and laydown space required, as impacted by retrievability, criticality safety, security, etc
- Balancing the cost of decontamination and salvage with the cost of disposal.

Details of the complex optimization process will necessarily be decided near the end of plant life, taking into account specific contamination levels, market conditions, and available waste disposal sites. To avoid laydown space and contamination problems, dismantling should be allowed to proceed generally no faster than the downstream decontamination process. The time frame to accomplish both dismantling and decontamination is estimated to be approximately three years per SBM.

10.1.6.5 Decontamination

The decontamination process is addressed separately in detail in Section 10.1.7.

10.1.6.6 Salvage of Equipment and Materials

Items to be removed from the facilities can be categorized as potentially re-usable equipment, recoverable scrap, and wastes. However, based on a 30 year facility operating license, operating equipment is not assumed to have reuse value. Wastes will also have no salvage value.

With respect to scrap, a significant amount of aluminum will be recovered, along with smaller amounts of steel, copper, and other metals. For security and convenience, the uncontaminated materials will likely be smelted to standard ingots, and, if possible, sold at market price. The contaminated materials will be disposed of as low-level radioactive waste. No credit is taken for any salvage value that might be realized from the sale of potential assets during or after decommissioning.

10.1.6.7 Disposal

All wastes produced during decommissioning will be collected, handled, and disposed of in a manner similar to that described for those wastes produced during normal operation. Wastes will consist of normal industrial trash, non-hazardous chemicals and fluids, small amounts of hazardous materials, and radioactive wastes. The radioactive waste will consist primarily of crushed centrifuge rotors, trash, and citric cake. Citric cake consists of uranium and metallic compounds precipitated from citric acid decontamination solutions. It is estimated that approximately 5,000 m³ (6,539 yd³) of radioactive waste will be generated over the nine-year decommissioning operations period. (This waste is subject to further volume reduction processes prior to disposal).

Radioactive wastes will ultimately be disposed of in licensed low-level radioactive waste disposal facilities. Hazardous wastes will be disposed of in hazardous waste disposal facilities. Non-hazardous and non-radioactive wastes will be disposed of in a manner consistent with good industrial practice and in accordance with all applicable regulations. A complete estimate of the wastes and effluent to be produced during decommissioning will be provided in the Decommissioning Plan that will be submitted prior to initiating the decommissioning of the plant.

Confidential and Secret Restricted Data components and documents on site shall be disposed of in accordance with the requirements of 10 CFR 95 (CFR, 2003g). Such classified portions of

10.1 Site-Specific Cost Estimate

the centrifuges will be destroyed, piping will likely be smelted, documents will be destroyed, and other items will be handled in an appropriate manner. Details will be provided in the facility Standard Practice Procedures Plan for the Protection of Classified Matter and Information, submitted separately in accordance with 10 CFR 95 (CFR, 2003g).

10.1.6.8 Final Radiation Survey

A final radiation survey must be performed to verify proper decontamination to allow the site to be released for unrestricted use. The evaluation of the final radiation survey is based in part on an initial radiation survey performed prior to initial operation. The initial survey determines the natural background radiation of the area; therefore it provides a datum for measurements which determine any increase in levels of radioactivity.

The final survey will systematically measure radioactivity over the entire site. The intensity of the survey will vary depending on the location (i.e. the buildings, the immediate area around the buildings, and the remainder of the site). The survey procedures and results will be documented in a report. The report will include, among other things, a map of the survey site, measurement results, and the site's relationship to the surrounding area. The results will be analyzed and shown to be below allowable residual radioactivity limits; otherwise, further decontamination will be performed.

10.1.7 Decontamination Facilities

10.1.7.1 Overview

The facilities, procedures, and expected results of decontamination are described in the paragraphs below. Since reprocessed uranium will not be used as feed in the NEF, no consideration of ^{232}U , transuranic alpha-emitters and fission product residues is necessary for the decontamination process. Only contamination from ^{238}U , ^{235}U , ^{234}U , and their daughter products will require handling by decontamination processes. The primary contaminant throughout the plant will be in the form of small amounts of UO_2F_2 , with even smaller amounts of UF_4 and other compounds.

10.1.7.2 Facilities Description

A decontamination facility will be required to accommodate decommissioning. This specialized facility is needed for optimal handling of the thousands of centrifuges to be decontaminated, along with the UF_6 vacuum pumps and valves. Additionally, a general purpose facility is required for handling the remainder of the various plant components. These facilities are assumed to be installed in existing plant buildings (such as the Centrifuge Assembly Building).

The decontamination facility will have four functional areas that include (1) a disassembly area, (2) a buffer stock area, (3) a decontamination area, and (4) a scrap storage area for cleaned stock. The general purpose facility may share the specialized decontamination area. However, due to various sizes and shapes of other plant components needing handling, the disassembly area, buffer stock areas and scrap storage areas may not be shared. Barriers and other physical measures will be installed and administrative controls implemented, as needed, to limit the spread of contamination.

Equipment in the decontamination facility is assumed to include:

10.1 Site-Specific Cost Estimate

- Transport and manipulation equipment
- Dismantling tables for centrifuge externals
- Sawing machines
- Dismantling boxes and tanks, for centrifuge internals
- Degreasers
- Citric acid and demineralized water baths
- Contamination monitors
- Wet blast cabinets
- Crusher, for centrifuge rotors
- Smelting and/or shredding equipment
- Scrubbing facility.

The decontamination facilities provided in the CRDB for normal operational needs would also be available for cleaning small items during decommissioning.

10.1.7.3 Procedures

Formal procedures for all major decommissioning activities will be developed and approved by plant management (applicable Functional Area Managers) to minimize worker exposure and waste volumes, and to assure work is carried out in a safe manner. The experience of decommissioning European gas centrifuge enrichment facilities will be incorporated extensively into the procedures.

At the end of plant life, some of the equipment, most of the buildings, and all of the outdoor areas should already be acceptable for release for unrestricted use. If they are accidentally contaminated during normal operation, they would be cleaned up when the contamination is discovered. This limits the scope of necessary decontamination at the time of decommissioning.

Contaminated plant components will be cut up or dismantled, then processed through the decontamination facilities. Contamination of site structures will be limited to areas in the SBMs, CRDB, and CAB will be maintained at low levels throughout plant operation by regular cleaning. The Decontamination Workshop Area, Ventilated Room, Vacuum Pump Rebuild Workshop, and the Contaminated Material Handling Room are included as permanent Restricted Areas. Through the application of special protective coatings, to surfaces that might become radioactively contaminated during operation, and good housekeeping practices, final decontamination of these areas is assumed to require minimal removal of surface concrete or other structural material.

The centrifuges will be processed through the specialized facility. The following operations will be performed.

- Removal of external fittings
- Removal of bottom flange, motor and bearings, and collection of contaminated oil
- Removal of top flange, and withdrawal and disassembly of internals
- Degreasing of items as required

10.1 Site-Specific Cost Estimate

- Decontamination of all recoverable items for smelting
- Destruction of other classified portions by shredding, crushing, smelting, etc.

10.1.7.4 Results

Urenco plant experience in Europe has demonstrated that conventional decontamination techniques are effective for all plant items. Recoverable items have been decontaminated and made suitable for reuse except for a very small amount of intractably contaminated material. The majority of radioactive waste requiring disposal in the NEF will include crushed centrifuge rotors, trash, and residue from the effluent treatment systems.

European experience has demonstrated that the aluminum centrifuge casings can be successfully decontaminated and recycled. However, as a conservative measure for this decommissioning cost estimate, the aluminum centrifuge casings for the NEF are assumed to be disposed of as low-level radioactive waste.

Overall, no problems are anticipated that will prevent the site from being released for unrestricted use.

10.1.7.5 Decommissioning Impact on Integrated Safety Analysis (ISA)

As was described in Section 10.1.3.1, Summary of Costs, dismantling and decontamination of the equipment in the three SBMs will be conducted sequentially (in three phases) over a nine year time frame. SBM-1001 will be decommissioned during the first three-year period, followed by SBM-1002, and then SBM-1003. Termination of SBM-1003 operations will mark the end of uranium enrichment operations at the NEF. Decommissioning of the remaining plant systems and buildings will begin after SBM-1003 operations have been permanently terminated.

Although decommissioning operations are planned to be underway while all the activities considered in the ISA continue to occur in the other portions of the plant, the current ISA has not considered these decommissioning risks. An updated ISA will be performed at a later date, but prior to decommissioning, to incorporate the risks from decommissioning operations on concurrent enrichment operations.

10.2 Financial Assurance Mechanism

10.2 Financial Assurance Mechanism

10.2.1 Decommissioning Funding Mechanism

LES intends to utilize a surety method to provide reasonable assurance of decommissioning funding as required by 10 CFR 40.36(e)(2) (CFR, 2003h) and 70.25(f)(2) (CFR, 2003i). Finalization of the specific incremental financial instruments to be utilized will be completed, and signed originals of those instruments will be provided to the NRC, prior to LES receipt and introduction of UF₆ into a building module. LES intends to provide continuous financial assurance from the time of receipt of licensed material to the completion of decommissioning and termination of the license. Since LES intends to sequentially install and operate the SBMs over time, financial assurance for decommissioning will be provided during the operating life of the NEF at a rate that is in proportion to the decommissioning liability for these facilities as they are phased in. Similarly, LES will provide decommissioning funding assurance for disposition of depleted tails at a rate in proportion to the amount of accumulated tails onsite up to the maximum amount of the tails as described in Section 10.3, Tails Disposition. An exemption request to permit this incremental financial assurance is provided in Section 1.2.5, "Special Exemptions or Special Authorizations."

The surety method adopted by LES will provide an ultimate guarantee that decommissioning costs will be paid in the event LES is unable to meet its decommissioning obligations at the time of decommissioning. The surety method will also be structured and adopted consistent with applicable NRC regulatory requirements and in accordance with NRC regulatory guidance contained in NUREG-1757. Accordingly, LES intends that its surety method will contain, but not be limited to, the following attributes:

- The surety method will be open-ended or, if written for a specified term, such as five years, will be renewed automatically unless 90 days or more prior to the renewal date, the issuer notifies the NRC, the trust to which the surety is payable, and LES of its intention not to renew. The surety method will also provide that the full face amount be paid to the beneficiary automatically prior to the expiration without proof of forfeiture if LES fails to provide a replacement acceptable to the NRC within 30 days after receipt of notification of cancellation.
- The surety method will be payable to a trust established for decommissioning costs. The trustee and trust will be ones acceptable to the NRC. For instance, the trustee may be an appropriate State or Federal government agency or an entity which has the authority to act as a trustee and whose trust operations are regulated and examined by a Federal or State agency.
- The surety method will remain in effect until the NRC has terminated the license.
- Unexecuted copies of the surety method documentation are provided in Appendices 10A through 10F. Prior to LES receipt of licensed material, the applicable (incremental) unexecuted copies of the surety method documentation will be replaced with the finalized, signed, and executed surety method documentation, including a copy of the broker/agent's power of attorney authorizing the broker/agent to issue bonds.

10.2 Financial Assurance Mechanism

10.2.2 Adjusting Decommissioning Costs and Funding

In accordance with 10 CFR 40.36(d) (CFR, 2003h) and 70.25(e) (CFR, 2003i), LES will update the decommissioning cost estimate for the NEF, and the associated funding levels, over the life of the facility. These updates will take into account changes resulting from inflation or site-specific factors, such as changes in facility conditions or expected decommissioning procedures. These funding level updates will also address anticipated operation of additional SBMs and accumulated tails.

As required by the applicable regulations 10 CFR 70.25(e) (CFR, 2003i), such updating will occur approximately every three years. A record of the update process and results will be retained for review as discussed in Section 10.2.3, below. The NRC will be notified of any material changes to the decommissioning cost estimate and associated funding levels (e.g., significant increases in costs beyond anticipated inflation). To the extent the underlying instruments are revised to reflect changes in funding levels, the NRC will be notified as appropriate.

In addition to the triennial update of the decommissioning cost estimate described above, LES has committed to supplemental updates as described in the request for exemption in SAR Section 1.2.5 in order to ensure adequate financial assurance on an incremental basis. Specifically, LES commits to update the decommissioning cost estimates and to provide to the NRC a revised funding instrument for facility decommissioning prior to the operation of each SBM at a minimum. LES also commits to updating the cost estimates for the disposition of the depleted uranium byproduct on an annual forward-looking incremental basis and to providing the NRC revised funding instruments that reflect these projections of depleted uranium byproduct production. If any adjustments to the funding assurance are determined to be needed during this annual period due to production variations, they would be made promptly and a revised funding instrument would be provided to the NRC.

The phased incremental decommissioning Funding Plan cost estimate shall be updated as follows:

1. Phase 1: Prior to the receipt of "test material" (≤ 50 kg natural or depleted UF_6), LES will submit an executed financial assurance instrument providing full funding for decontamination and decommissioning of the Centrifuge Test Facility (CTF), the Post-Mortem Facility (PMF), and the Cylinder Receipt and Dispatch Building (CRDB).
2. Phase 2: Prior to introduction of "feed material" (> 50 kg UF_6) into SBM-1001, LES will submit an executed financial assurance instrument providing full funding for decontamination and decommissioning of SBM-1001 and the licensee shall provide funding for the disposition of depleted uranium tails in an amount needed to disposition the first three years of deleted uranium tails generation.
3. Phase 3: Prior to introduction of "feed material" (> 50 kg of UF_6) into SBM-1003, LES will submit an executed financial assurance instrument increasing full funding for decontamination and decommissioning from that required in Phase 2 to specifically include SBM-1003.
4. Phase 4: Prior to introduction of "feed material" (> 50 kg of UF_6) into SBM-1005, LES will submit an executed financial assurance instrument increasing full funding for decontamination and decommissioning from that required in Phase 3 to specifically include SBM-1005.

10.2 Financial Assurance Mechanism

5. Subsequent updated decommissioning funding estimates and revised funding instruments for facility decommissioning shall be provided, at a minimum, every three years.
6. Subsequent updated decommissioning cost estimates and revised funding instruments for depleted uranium disposition shall be provided on a forward-looking basis to reflect projections of depleted uranium byproduct generation. The depleted uranium disposition cost estimate shall include an update to the DOE depleted uranium disposition cost estimate. The total amount funded for depleted uranium disposition shall be no less than the updated DOE cost estimate.

For the first triennial period, LES intends to provide decommissioning funding assurance for the entire facility, incorporating the three SBMs, and the amount of depleted uranium byproduct that would be produced by the end of that first three year period. In 2004 dollars, the following cost estimates would be assured: 1) the total facility decommissioning cost estimate of \$131,103,000 from Table 10.1-14, "Total Decommissioning Costs," 2) the cost for dispositioning 4,861 MT of depleted uranium byproduct, the amount produced at the end of the first three years of operation, based on a projected nominal 30 years of operation, and using a cost of \$4.68 per kg of depleted uranium byproduct, (\$4,680 per MT depleted uranium byproduct) from SAR Section 10.3, yielding a total of \$22,749,480, and 3) applying a 25% contingency factor to the total, or \$38,463,120. Accordingly the total projected decommissioning cost estimate for the first triennial period of NEF operation for which financial assurance would be provided would be \$192,315,600. However, if significant deviations to the facility construction or initial operation schedules are encountered after the first triennial period, LES may instead provide decommissioning funding assurance on the incremental basis described above, i.e., prior to the operation of a SBM and on an annual basis for the depleted uranium byproduct.

10.2.3 Recordkeeping Plans Related to Decommissioning Funding

In accordance with 10 CFR 40.36(f) (CFR, 2003h) and 70.25(g) (CFR, 2003i), LES will retain records, until the termination of the license, of information that could have a material effect on the ultimate costs of decommissioning. These records will include information regarding: (1) spills or other contamination that cause contaminants to remain following cleanup efforts; (2) as-built drawings of structures and equipment, and modifications thereto, where radioactive contamination exists (e.g., from the use or storage of such materials); (3) original and modified cost estimates of decommissioning; and (4) original and modified decommissioning funding instruments and supporting documentation.

10.3 Tails Disposition

10.3 Tails Disposition

The disposition of tails from the NEF is an element of authorized operating activities. It involves neither decommissioning waste nor is it a part of decommissioning activities. The disposal of these tails is analogous to the disposal of radioactive materials generated in the course of normal operations (even including spent fuel in the case of a power reactor), which is authorized by the operating license and subject to separate disposition requirements. Such costs are not appropriately included in decommissioning costs (this principle (in the 10 CFR 50 context) is discussed in Regulatory Guide 1.159 (NRC, 1990), Section 1.4.2, page 1.159-8). Further, the "tails" products from the NEF are not mill tailings, as regulated pursuant to the Uranium Mill Tailings Radiation Control Act, as amended and 10 CFR 40, Appendix A (CFR, 2003j), and are not subject to the financial requirements applicable to mill tailings.

Nevertheless, LES intends to provide for expected tails disposition costs (even assuming ultimate disposal as waste) during the life of the facility. Funds to cover these costs are based on the amount of tails generated and the unit cost for the disposal of depleted UF₆.

It is anticipated that the NEF will generate 132,942 MT of depleted uranium over a nominal 30 year operational period. This estimate is conservative as it assumes continuous production of tails over 30 years of operation. Actual tails production will cease prior to the end of the license term as shown in Figure 10.1-1, NEF – Conceptual Decommissioning Schedule.

Waste processing and disposal costs for UF₆ tails are currently estimated to be \$5.50 per kg U or \$5,500 per MT U. This unit cost was obtained from four sets of cost estimates for the conversion of DUF₆ to DU₃O₈ and the disposal of DU₃O₈ product, and the transportation of DUF₆ and DU₃O₈. The cost estimates were obtained from analyses of four sources: a 1997 study by the Lawrence Livermore National Laboratory (LLNL) (Elayat, 1997), the Uranium Disposition Services (UDS) contract with the Department of Energy (DOE) of August 29, 2002 (DOE, 2002), information from Urenco, and the costs submitted to the Nuclear Regulatory Commission as part of the Claiborne Enrichment Center (CEC) license application (LES, 1993a) in the 1990s.

The four sets of cost estimates obtained are presented in Table 10.3-1, Summary Of Depleted UF₆ Disposal Costs From Four Sources, below, in 2002 dollars per kg of uranium (kg U). Note that the Claiborne Energy Center cost had a greater uncertainty associated with it. The UDS contract does not allow the component costs for conversion, disposal and transportation to be estimated. The costs in the table indicate that \$5.50 per kg U (\$2.50 per lb U) is a conservative and, therefore, prudent estimate of total depleted UF₆ disposition cost for the LES NEF. That is, the historical cost estimates from LLNL and CEC and the more recent actual costs from the UDS contract were used to inform the LES cost estimate. Urenco has reviewed this estimate and, based on its current cost for UBC disposal, finds this figure to be prudent.

In May 1997, the LLNL published UCRL-AR-127650, Cost Analysis Report for the Long-Term Management of Depleted Uranium Hexafluoride (Elayat, 1997). The report was prepared to provide comparative life-cycle cost data for the Department of Energy's (DOE's) Draft 1997 Programmatic Environmental Impact Statement (PEIS) (DOE, 1997) on alternative strategies for management and disposition of DUF₆. The LLNL report is the most comprehensive assessment of DUF₆ disposition costs for alternative disposition strategies available in the public domain.

The technical data on which the LLNL report is based is principally the May 1997 Engineering Analysis Report (UCRL-AR-124080, Volumes 1 and 2) (Dubrin, 1997).

10.3 Tails Disposition

When the LLNL report was prepared in 1997, more than six years ago, the cost estimates in it were based on an inventory of 560,000 MT of DUF_6 , or 378,600 MTU after applying the 0.676 mass fraction multiplier. This amount corresponds to an annual throughput rate of 28,000 MT of UF_6 or about 19,000 MTU of depleted uranium. The costs in the LLNL report are based on the 20 year life-cycle quantity of 378,600 MTU. The LLNL annual DUF_6 quantities are about 3.6 times the annual production rate of the proposed NEF.

The LLNL cost analyses assumed that the DUF_6 would be converted to DU_3O_8 , the DOE's preferred disposal form, using one of two dry process conversion options. The first --- the anhydrous hydrogen fluoride (AHF) option ---- upgrades the HF product to anhydrous HF (< 1.0% water). In the second option --- the HF neutralization option --- the hydrofluoric acid would be neutralized with lime to produce calcium fluoride (CaF_2). The LLNL cost analyses assumed that the AHF and CaF_2 conversion products are of sufficient purity that they could be sold for unrestricted use (negligible uranium contamination). LES will not use a deconversion facility that employs a process that results in the production of anhydrous HF.

The costs in Table 10.3-1, represent the LLNL-estimated life-cycle capital, operating, and regulatory costs, in 2002 dollars, for conversion of 378,600 MTU over 20 years, of DUF_6 to DU_3O_8 by AHF processing, followed by DU_3O_8 long-term storage disposal in a concrete vault, or in an exhausted underground uranium mine in the western United States, at or below the same cost. An independent new underground mine production cost analysis confirmed that the LLNL concrete vault alternative costs represent an upper bound for under ground mine disposal. The discounted 1996 dollar costs in the LLNL report were undiscounted and escalated to 2002 dollars. The LLNL life-cycle costs in 1996 dollars were converted to per kgU costs and adjusted to 2002 dollars using the Gross Domestic Product (GDP) Implicit Price Deflator (IPD). The escalation adjustment resulted in the 1996 costs being escalated by 11%.

On August 29, 2002, the DOE announced the competitive selection of Uranium Disposition Services, LLC to design, construct, and operate conversion facilities near the DOE enrichment plants at Paducah, Kentucky and Portsmouth, Ohio. UDS will operate these facilities for the first five years, beginning in 2005. The UDS contract runs from August 29, 2002 to August 3, 2010. UDS will also be responsible for maintaining the depleted uranium and product inventories and transporting depleted uranium from Oak Ridge East Tennessee Technology Park (ETTP) to the Portsmouth site for conversion. The DOE-UDS contract scope includes packaging, transporting and disposing of the conversion product DU_3O_8 .

UDS is a consortium formed by Framatome ANP Inc., Duratek Federal Services Inc., and Burns and Roe Enterprises Inc. The DOE-estimated value of the cost reimbursement contract is \$558 million (DOE Press Release, August 29, 2002) (DOE, 2002). Design, construction and operation of the facilities will be subject to appropriations of funds from Congress. On December 19, 2002, the White House confirmed that funding for both conversion facilities will be included in President Bush's 2004 budget. However, the Office of Management and Budget has not yet indicated how much funding will be allocated. The UDS contract quantities and costs are given in Table 10.3-2, DOE-UDS August 29, 2002, Contract Quantities and Costs.

Urenco is currently contracted with a supplier for DUF_6 to DU_3O_8 conversion. The supplier has been converting DUF_6 to DU_3O_8 on an industrial scale since 1984.

The CEC costs given in Table 10.3-1, are those presented to John Hickey of the NRC in the CEC letter of June 30, 1993 (LES, 1993b) as adjusted for changes in units and escalated to

10.3 Tails Disposition

2002 (\$6.74 per kgU). The conversion cost of \$4.00 per kg U was provided to CEC by Cogema at that time. It should also be noted that this highest cost estimate is at least 10 years old and was based on the information available at that time. The value of \$5.50 per kgU used in the decommissioning cost estimate is 22% above the average of the more recent LLNL and UDS cost estimates, which is \$4.49 per kgU $\{(5.06+3.92)/2\}$. The LLNL Cost Analysis Report (page 30) states that its cost estimate already includes a 30% contingency in the capital costs of the process and manufacturing facilities, a 20% contingency in the capital costs of the balance of plant; and a minimum of a 30% contingency in the capital costs of process and manufacturing equipment.

Also, the 1997 LLNL cost information is five years older than the more recent 2002 UDS cost information. The value of \$5.50 per kgU used in the decommissioning cost estimate for tails disposition is 40% greater than the 2002 UDS-based cost estimate of \$3.92 per kgU, which does not include offset credits for HF sales or proceeds from the sale of recycled products.

The costs in Table 10.3-1, indicate that \$5.50 is a conservative and, therefore, prudent estimate of total DU disposition cost for the NEF. Urenco has reviewed this estimate and, based on its current cost after tails disposal, finds this figure to be prudent.

In summary, there is already substantial margin between the value of \$5.50 per kgU being used by LES in the decommissioning cost estimate and the most recent information (2002 UDS) from which LES derived a cost estimate of \$3.92 per kgU.

Based on information from corresponding vendors, the value of \$5.50 per kgU (2002 dollars), which is equal to \$5.70 per kgU when escalated to 2004 dollars, was revised in December 2004 to \$4.68 per kgU (2004 dollars). The value of \$4.68 per kgU was derived from the estimates of costs from the three components that make up the total disposition cost of DUF₆ (i.e., deconversion, disposal, and transportation). The estimate of \$4.68 per kgU supports the Preferred Plausible Strategy of U.S. Private Sector Conversion and Disposal identified in section 4.13.3.1.3 of the ER as Option 1. In addition, \$0.60 per kgU has been added to this estimate to cover the cost of managing the empty UBCs once the DUF₆ has been removed for conversion.

In support of the Option 2 Plausible Strategy identified in Section 4.13.3.1.3 of the ER, "DOE Conversion and Disposal," considered the backup option, LES requested a cost estimate from the Department of Energy (DOE). On March 1, 2005, DOE provided a cost estimate to LES for the components that make up the total disposition cost (i.e., deconversion, disposal, and transportation, excluding the cost of loading the UBCs at the NEF site) (DOE, 2005). This estimate, which was based upon an independent analysis undertaken by DOE's consultant, LMI Government Consulting, estimated the cost of disposition to total approximately \$4.91 per kgU (2004 dollars). This estimate was subsequently corrected to \$4.68 per kgU (2004 dollars) and no additional amounts were added to account for UBC loading at the NEF site since this cost is minimal and the DOE transportation estimate is highly conservative. The Department's cost estimate for deconversion, storage, and disposal of the DU is consistent with the contract between UDS and DOE. The cost estimate does not assume any resale or reuse of any products resulting from the conversion process.

10.3 Tails Disposition

For purposes of determining the total tails disposition funding requirement and the amount of financial assurance required for this purpose, the value of \$5.28 per kgU (based upon the cost estimate for the Preferred Plausible Strategy) was selected. Based on a computed tails production of 132,942 MTU during a nominal 30 years of operation and a tails processing cost of \$5.28 per kgU or \$5,280 per MTU, the total tails disposition funding requirement is estimated at \$701,933,760. This sum will be included as part of the financial assurance for decommissioning (see Table 10.1-14, Total Decommissioning Costs). Furthermore, this financial assurance will always cover the backup DOE option cost estimate, plus a 25% contingency, via the periodic update mechanism. See Environmental Report Section 4.13.3.1.6, Costs Associated with UF₆ Tails Conversion and Disposal, for additional details.

10.4 References

10.4 References

Edition of Codes, Standards, NRC Documents, etc that are not listed below are given in ISAS Table 3.0-1.

CFR, 2003a. Title 10, Code of Federal Regulations, Section 70.38, Expiration and termination of licenses and decommissioning of sites and separate buildings or outdoor areas, 2003.

CFR, 2003b. Title 10, Code of Federal Regulations, Section 20.1402, Radiological criteria for unrestricted use, 2003.

CFR, 2003c. Title 10, Code of Federal Regulations, Part 20.1003, Definitions, 2003.

CFR, 2003d. Title 10, Code of Federal Regulations, Part 20.2108, Records of waste disposal, 2003.

CFR, 2003e. Title 10, Code of Federal Regulations, Part 20, Subpart E, Radiological Criteria for License Termination, 2003.

CFR, 2003f. Title 10, Code of Federal Regulations, Part 20.2002, Method for obtaining approval of proposed disposal procedures, 2003.

CFR, 2003g. Title 10, Code of Federal Regulations, Part 95, Security Facility Approval and Safeguarding of National Security Information and Restricted Data, 2003.

CFR, 2003h. Title 10, Code of Federal Regulations, Section 40.36, Financial assurance and recordkeeping for decommissioning, 2003.

CFR, 2003i. Title 10, Code of Federal Regulations, Section 70.25, Financial assurance and recordkeeping for decommissioning, 2003.

CFR, 2003j. Title 10, Code of Federal Regulations, Part 40, Appendix A, Criteria Relating to the Operation of Uranium Mills and the Disposition of Tailings or Wastes Produced by the Extraction or Concentration of Source Material From Ores Processed Primarily for Their Source Material Content, 2003.

DOE, 1997. Programmatic Environmental Impact Statement for Alternative Strategies for the Long-Term Management and Use of Depleted Uranium Hexafluoride, U.S. Department of Energy, December 1997.

DOE, 2002. Department of Energy Selects Uranium Disposition Services for Uranium Hexafluoride Conversion Plants in Ohio and Kentucky, Department of Energy News Release R-02-179, August 29, 2002.

DOE, 2005. Letter from P.M. Golan (Department of Energy) to R.M. Krich (Louisiana Energy Services) regarding Conversion and Disposal of Depleted Uranium Hexafluoride (DUF₆) Generated by Louisiana Energy Services, LP (LES), March 1, 2005.

Dubrin, 1997. "Depleted Uranium Hexafluoride Management Program", UCRL-AR-124080 Vol. 1 Rev. 2 and Vol. 2, Lawrence Livermore National Laboratory, Dubrin, J.W., et. al., May 1997.

10.4 References

Elayat, 1997. "Cost Analysis Report For the Long-Term Management of Depleted Uranium Hexafluoride", UCRL-AR-127650, Lawrence Livermore National Laboratory, Elayat, Hatem, J.Zoller, L. Szytel, May 1997.

LES, 1993a. Clairborne Enrichment Center Safety Analysis Report, Section 11.8, Decommissioning, Louisiana Energy Services, 1993.

LES, 1993b. Letter from Peter G. LeRoy, Louisiana Energy Services, to John W.N. Hickey, U.S. Nuclear Regulatory Commission, June 30, 1993.

NRC, 1990. Assuring the Availability of Funds for Decommissioning Nuclear Reactors, Regulatory Guide 1.159, U.S. Nuclear Regulatory Commission, August 1990.

NRC, 1994. Safety Evaluation Report for the Claiborne Enrichment Center, Homer, Louisiana, NUREG-1491, U.S. Nuclear Regulatory Commission, January 1994.

10.5 Chapter 10 Tables

10.5 Chapter 10 Tables

10.5 Chapter 10 Tables

Table 10.1-1A Number and Dimensions of Facility Components

Separations Building Modules (Note 1)

Component	Number of Components	Dimensions of Components	Total Dimensions
Glove Boxes			
Fume Cupboards			
Lab Benches			
Sinks			
Drains			
Floors			
Walls			
Ceilings			
Ventilation/Ductwork			
Hot Cells			
Equipment/Materials			
Soil Plots			
Storage Tanks			
Storage Areas			
Radwaste Areas			
Scrap Recovery Areas			
Maintenance Shop			
Equipment Decontamination Areas			
Other			

Notes:

1. More than 97% of the decommissioning costs for the facility are attributed to the dismantling, decontamination, processing, and disposal of centrifuges and other equipment in the Separations Building Modules, which are considered classified. Given the classified nature of these buildings, the data presented in these Tables have been structured to meet the applicable NUREG-1757 recommendations, to the extent practicable. However, specific information regarding numbers of components, dimensions of components, and total dimensions, has been intentionally excluded to protect the classified nature of the data.

10.5 Chapter 10 Tables

Table 10.1-1B Number and Dimensions of Facility Components

Decommission Decontamination Facility

Component	Number of Components	Dimensions of Components	Total Dimensions
Glove Boxes	None	NA	NA
Fume Cupboards	None	NA	NA
Lab Benches	10	Various sizes of lab and workshop benches ranging from 6.5 to 13 feet long by 2.5 feet wide	(Note 1)
Sinks	6	Standard laboratory sinks and hand wash basins	(Note 1)
Drains	6	Standard laboratory type drains	(Note 1)
Floors	1 Lot (Note 2)	(Note 1)	(Note 1)
Walls	1 Lot (Note 2)	(Note 1)	(Note 1)
Ceilings	1 Lot (Note 2)	(Note 1)	(Note 1)
Ventilation/Ductwork	(Note 3)	Various sizes of ductwork ranging from 3 to 18 inches plus dampers, valves and flexibles	640 feet
Hot Cells	None	NA	NA
Equipment/Materials	20	Various pieces of equipment including citric cleaning tanks, centrifuge cutting machines	(Note 1)
Soil Plots	None	NA	NA
Storage Tanks	1 Lot (Note 2)	Various storage tanks	(Note 1)
Storage Areas	1	Storage area for centrifuges and pipe work	(Note 1)
Radwaste Areas	None	NA	NA
Scrap Recovery Areas	None	NA	NA
Maintenance Shop	None	NA	NA
Equipment Decontamination Areas	None	NA	NA
Other	1 Lot (Note 2)	Hand tools and consumables that become contaminated while carrying out dismantling and decontamination work, unmeasured work and scaffolding	(Note 1)

Notes:

1. Total dimensions not used in estimating model.
2. Allocation based on Urenco decommissioning experience.
3. Total dimensions provided.

10.5 Chapter 10 Tables

Table 10.1-1C Number and Dimensions of Facility Components

Cylinder Receipt and Dispatch Building

Component	Number of Components	Dimensions of Components	Total Dimensions
Glove Boxes	None	NA	NA
Fume Cupboards	18	Standard laboratory fume cupboards, approx 6.5 - 8 feet high x 5 feet wide	(Note 1)
Lab Benches	25	Various sizes of lab and workshop benches ranging from 6.5 – 13 feet long by 2.5 feet wide	(Note 1)
Sinks	12	Standard laboratory sinks and hand wash basins	(Note 1)
Drains	12	Standard Laboratory type drains	(Note 1)
Floors	(Note 3)	Floor area covers all Workshops and Labs in the Technical Services Bldg that may be exposed to contamination	26,340 ft ²
Walls	(Note 3)	Wall area covers all Workshops and Labs in the Technical Services Bldg that may be exposed to contamination	40,074 ft ²
Ceilings	(Note 3)	Ceiling area covers all Workshops and Labs in the Cylinder Receipt and Dispatch Building that may be exposed to contamination	26,340 ft ²
Ventilation/ Ductwork	(Note 3)	Various pieces of equipment including, filter banks, extractor fans, vent stack, dampers and approx 2,034 feet of large and small ductwork	2,034 feet
Hot Cells	None	NA	NA
Equipment/ Materials	57	Various pieces of equipment including, mass spectrometers, hydraulic lift tables, cleaning cabinets	(Note 1)
Soil Plots	None	NA	NA
Storage Tanks	1	Waste oil storage tank (53 gal)	(Note 1)
Storage Areas	2	Storage area for product removal, dirty pumps	(Note 1)
Radwaste Areas	1	Storage are for containers awaiting Radiation Protection survey to be transferred to Solid Waste Collection	(Note 1)
Scrap Recovery Areas	None	NA	NA
Maintenance Shop	None	NA	NA
Equipment Decontamination Areas	None	NA	NA
Other	1 Lot (Note 2)	Hand tools and consumables that become contaminated while carrying out dismantling/decontamination work, unmeasured work and scaffolding	(Note 1)

Notes:

1. Total dimensions not used in estimating model.
2. Allocation based on Urenco decommissioning experience.
3. Total dimensions provided.

10.5 Chapter 10 Tables

Table 10.1-1D Number and Dimensions of Facility Components

Gaseous Effluent Vent (GEV) System Throughout Plant

Component	Number of Components	Dimensions of Components	Total Dimensions
Glove Boxes	None	NA	NA
Fume Cupboards	None	NA	NA
Lab Benches	None	NA	NA
Sinks	None	NA	NA
Drains	None	NA	NA
Floors	None	NA	NA
Walls	None	NA	NA
Ceilings	None	NA	NA
Ventilation/Ductwork	(Note 3)	Various sizes of ductwork ranging from 3 to 18 inches plus dampers, valves and flexibles	5,656 feet
Hot Cells	None	NA	NA
Equipment/Materials	None	NA	NA
Soil Plots	None	NA	NA
Storage Tanks	None	NA	NA
Storage Areas	None	NA	NA
RadWaste Areas	None	NA	NA
Scrap Recovery Areas	None	NA	NA
Maintenance Shop	None	NA	NA
Equipment Decontamination Areas	None	NA	NA
Other	1 Lot (Note 2)	Hand tools and consumables that become contaminated while carrying out dismantling/decontamination work, unmeasured work and scaffolding	(Note 1)

Notes:

1. Total dimensions not used in estimating model.
2. Allocation based on Urenco decommissioning experience.
3. Total dimensions provided.

10.5 Chapter 10 Tables

Table 10.1-1E Number and Dimensions of Facility Components

Blending and Sampling

Component	Number of Components	Dimensions of Components	Total Dimensions
Glove Boxes	None	NA	NA
Fume Cupboards	None	NA	NA
Lab Benches	None	NA	NA
Sinks	None	NA	NA
Drains	None	NA	NA
Floors	None (Note 4)	NA	NA
Walls	None (Note 4)	NA	NA
Ceilings	None (Note 4)	NA	NA
Ventilation/Ductwork	Covered in GEV System estimate	Covered in GEV System estimate	Covered in GEV System estimate
Hot Cells	None	NA	NA
Equipment/Materials	(Note 3)	Various sizes of pipe-work ranging from DN25 to DN65	2,461 feet
	38 Valves	Various types of valve ranging from 0.6 to 2.5 inches and manual to control	(Note 1)
	12	Various pieces of equipment including hot boxes and traps	(Note 1)
Soil Plots	None	NA	NA
Storage Tanks	None	NA	NA
Storage Areas	None	NA	NA
Radwaste Areas	None	NA	NA
Scrap Recovery Areas	None	NA	NA
Maintenance Shop	None	NA	NA
Equipment Decontamination Areas	None	NA	NA
Other	1 Lot (Note 2)	Hand tools and consumables that become contaminated while carrying out dismantling/decontamination work, unmeasured work and scaffolding	(Note 1)

Notes:

1. Total dimensions not used in estimating model.
2. Allocation based on Urenco decommissioning experience.
3. Total dimensions provided.
4. No floors, walls or ceilings are anticipated needing decontamination.

10.5 Chapter 10 Tables

Table 10.1-1F Number and Dimensions of Facility Components

Centrifuge Test and Post Mortem

Component	Number of Components	Dimensions of Components	Total Dimensions
Glove Boxes	None	NA	NA
Fume Cupboards	None	NA	NA
Lab Benches	4	Various sizes of lab and workshop benches ranging from 6.5 – 13 feet long by 2.5 feet wide	(Note 1)
Sinks	2	Standard laboratory sinks and hand wash basins	(Note 1)
Drains	2	Standard laboratory type drains	(Note 1)
Floors	None (Note 4)	NA	NA
Walls	None (Note 4)	NA	NA
Ceilings	None (Note 4)	NA	NA
Ventilation/ Ductwork	None	NA	NA
Hot Cells	None	NA	NA
Equipment/ Materials	(Note 3)	Various sizes of pipe-work ranging from DN16 to DN40	164 feet
	56 Valves	Various types of valve ranging from 0.6 to 1.6 inches and manual to control	(Note 1)
	7	Various pieces of equipment including feed take off vessels and traps	(Note 1)
Soil Plots	None	NA	NA
Storage Tanks	None	NA	NA
Storage Areas	None	NA	NA
Radwaste Areas	None	NA	NA
Scrap Recovery Areas	None	NA	NA
Maintenance Shop	None	NA	NA
Equipment Decontamination Areas	None	NA	NA
Other	1 Lot (Note 2)	Hand tools and consumables that become contaminated while carrying out dismantling/decontamination work, unmeasured work and scaffolding	(Note 1)

Notes:

1. Total dimensions not used in estimating model.
2. Allocation based on Urenco decommissioning experience.
3. Total dimensions provided.
4. No floors, walls or ceilings are anticipated needing decontamination.

10.5 Chapter 10 Tables

Table 10.1-2 Planning and Preparation

Activity	Costs (\$000)	Labor Shift-worker (multi-functional) (Man-days)	Labor Project Management (Man-days)	Labor HP&S (Man-days)	Activity Duration (Months)
Project Plan & Schedule	100	0	178	0	4
Site Characterization Plan	200	0	356	0	4
Site Characterization	300	82	368	144	4
Decommissioning Plan	350	0	622	0	6
NRC Review Period	50	0	89	0	12
Site Services Specifications	100	0	178	0	2
Project Procedures	100	0	178	0	4
TOTAL	1,200	82	1,969	144	(Note 1)

Note:

1. Some activities will be conducted in parallel to achieve a 24 month time frame.

10.5 Chapter 10 Tables

**Table 10.1-3 Decontamination or Dismantling of Radioactive Components
(Man-Hours)**

Other Buildings (Note 1)

Component	Decon Method (Note 4)	Craftsman	Supervision (Note 2)	Project Management	HP&S/Chem (Note 3)
Glove Boxes		0	0	0	0
Fume Cupboards		312	62	53	66
Lab Benches		324	64	55	68
Sinks		101	20	17	21
Drains		102	20	17	21
Floors		647	129	111	136
Walls		422	84	72	89
Ceilings		275	55	47	58
Ventilation/Ductwork		8,468	1,693	1,447	1,780
Hot Cells		0	0	0	0
Equipment/Materials		1,533	307	262	322
Soil Plots		0	0	0	0
Storage Tanks		14	3	2	3
Storage Areas		110	22	19	23
Radwaste Areas		0	0	0	0
Scrap Recovery Areas		0	0	0	0
Maintenance Shop		0	0	0	0
Equipment Decontamination Areas		0	0	0	0
Other		1,913	382	327	402
TOTAL Hours	--	14,221	2,841	2,430	2,990

Notes:

1. Includes the Decontamination Facility, Cylinder Receipt and Dispatch Building, GEVS Throughout Plant, Blending and Sampling, and Centrifuge Test and Post Mortem Facilities.
2. Supervision at 20%.
3. Supply ongoing monitoring and analysis service for dismantling teams.
4. Specific details of decontamination method not defined at this time.

10.5 Chapter 10 Tables

Table 10.1-4 Restoration of Contaminated Areas on Facility Grounds (Work Days)

Activity	Labor Category	Labor Category	Labor Category	Labor Category	Labor Category	Labor Category
Backfill and Restore Site (Note 1)						
TOTAL						

Note:

1. Deviates from NUREG-1757 because cost is based on volume and unit cost associated with removal and disposal of liners and earthen covers of the facility Treated Effluent Evaporative Basin. The cost (see Table 10.1-14) assumes transport and disposal of approximately 33,000 ft³ of contaminated soil and basin membrane. The cost of removal of the facility Treated Effluent Evaporative Basin material (33,000 ft³) is based on a \$30/ft³ disposal cost and includes the cost of excavation (\$5.00/yd³ which includes labor and equipment costs) and cost of transportation (\$4.00/mile for approximately 1,100 miles from the NEF site to the Envirocare facility in Utah). Based on Urenco experience, other areas outside of the plant buildings are not expected to be contaminated.

Table 10.1-5 Final Radiation Survey

Activity	Costs (\$000)	Labor Shift-worker (multi-functional) (Man-days)	Labor Project Management (Man-days)	Labor HP&S (Man-days)	Activity Duration (Months)
Prepare Survey Plans and Grid Areas	500	439	334	360	8
Collect Survey Readings and Analyze Data	1,400 (Note 1)	1,261	343	1,013	16
Sample Analysis			568		
Final Status Survey Report and NRC Review	300	0	533	0	8
Confirmatory Survey and Report	200	0	355	0	6
Terminate Site License	100	0	178	0	2
TOTAL	2,500	1,700	2,311	1,373	(Note 2)

Notes:

1. The \$1.4 million cost assigned to the conduct of the final radiation survey includes a cost of \$365,000 to conduct the sampling and perform the sample analysis by a contractor. The sampling labor cost component (\$45,000) was estimated assuming \$60/hr (HP&S man-hour rate) for an estimated 500 samples with an average sample duration of 1.5 hours/sample. The analysis cost component (\$320,000) for the 500 samples was estimated using a conservative \$640/sample based on recent actual 2004 lab analysis costs. Because of the modeling for this activity, this sample analysis cost is expressed in terms of equivalent man-hours at the Project Management man-hour rate.
2. Some activities will be conducted in parallel to achieve a 36 month time frame.

10.5 Chapter 10 Tables

Table 10.1-6 Site Stabilization and Long-Term Surveillance (Work Days)

Activity	Labor Category	Labor Category	Labor Category	Labor Category	Labor Category	Labor Category
(Note 1)	N/A	N/A	N/A	N/A	N/A	N/A

Note:

1. Urenco experience with decommissioning gas centrifuge uranium enrichment plants has been that there is no resultant ground contamination. As a result, site stabilization and long-term surveillance will not be required and associated decommissioning provisions are not provided.

10.5 Chapter 10 Tables

Table 10.1-7 Total Work Days by Labor Category (Based on a 7.5 hr Working Day)

Task	Shift- worker (multi-functional)	Craftsman	Supervision	Project Management	HP&S	Cleaner
Planning and Preparation (see Table 10.1-2)	82	0	0	1,969	144	0
Decontamination and/or Dismantling of Radioactive Facility Components (Note 2)	56,067	1,896	6,156	1,478	1,828	2,897
Restoration of Contaminated Areas on Facility Grounds (Note 1) (see Table 10.1-4)	-	-	-	-	-	-
Final Radiation Survey (see Table 10.1-5)	1,700	0	0	2,311	1,373	0
Site Stabilization and Long-Term Surveillance (see Table 10.1-6)	0	0	0	0	0	0

Notes:

1. Cost estimate is activity-based.
2. The values shown are inclusive of the Separations Building Module input derived using the total costs in Table 10.1-9 and dividing by the cost per day for each labor category.

10.5 Chapter 10 Tables

Table 10.1-8 Worker Unit Cost Schedule

Labor Cost Component	Shift- worker (multi-functional)	Craftsman	Supervision	Project Management	HP&S	Cleaner
Salary & Fringe (\$/year)	73,006	65,184	96,000	120,000	96,000	73,006
Overhead Rate (%)	excluded	excluded	excluded	excluded	excluded	excluded
Total Cost Per Year (\$)	73,006	65,184	96,000	120,000	96,000	73,006
Total Cost Per Work Day (\$/day) (Note 1)	342	306	450	563	450	342

Note:

1. Based on 213.33 work days per year at 7.5 hrs per day (1,600 hrs per year).

10.5 Chapter 10 Tables

Table 10.1-9 Total Labor Costs by Major Decommissioning Task (\$000)

Task	Shift-worker (multi-functional)	Craftsman	Supervision	Project Management	HP&S	Cleaner
Planning and Preparation (see Table 10.1-2)	28	0	0	1,109	65	0
Decontamination and/or Dismantling of Radioactive Facility Components	19,175	579	2,770	832	823	991
Restoration of Contaminated Areas on Facility Grounds (Note 1) (see Table 10.1-4)	-	-	-	-	-	-
Final Radiation Survey (see Table 10.1-5)	581	0	0	1,301	618	0
Site Stabilization and Long-Term Surveillance (see Table 10.1-6)	0	0	0	0	0	0

Note:

1. Cost estimate is activity-based.

10.5 Chapter 10 Tables

Table 10.1-10 Packaging, Shipping and Disposal of Radioactive Wastes (Excluding Labor Costs)

(a) Waste Disposal Costs (includes packaging & shipping costs)

Waste Type	Disposal Volume (m ³ (ft ³))	Unit Cost (\$/ft ³)	# of drums	Total Disposal Costs (\$000)
Other Buildings :				
Miscellaneous low level waste	83 (2,930)	150	400	440
Separation Building Modules:				
Solidified Liquid Wastes	TBD	TBD	TBD	TBD
Centrifuge Components, Piping and Other Parts	TBD	TBD	TBD	TBD
Aluminum	TBD	TBD	TBD	TBD
TOTAL	TBD	TBD	TBD	TBD

(b) Processing Costs

Materials	Disposal Weight (tons)	Unit Cost (\$/lb)	Total Disposal Costs (\$000)
Aluminum	10,177	0.14	2,860
Other materials	155	2.67	830
TOTAL	10,332	--	3,690

10.5 Chapter 10 Tables

Table 10.1-11 Equipment and Supply Costs (Excluded Containers)

(a) Equipment

Equipment	Quantity	Unit Cost (\$/unit)	Total Cost Equipment (\$000)
Separations Building Modules			
Dismantling and decontamination building	45,210 ft2	1,545	6,490
Special floor and vent system	45,210 ft2	294	1,240
Plant equipment			
Basic decontamination equipment	lot (Note 1)	600,000	600
Decontamination line equipment	2 units	3,908,850	7,820
Evaporation installation	lot (Note 1)	390,000	390
Radiation and control equipment	lot (Note 1)	410,000	410
Electrical and Instrumentation			
Electrical system	lot (Note 1)	500,000	500
Instrumentation	lot (Note 1)	590,000	590
Design and Engineering			
Building	-	20% (Note 1)	1,550
Plant and equipment	-	15% (Note 1)	1,400
Electrical and Instrumentation	-	25% (Note 1)	270
Other Buildings:			
Dismantling/Cleaning Tools, Equipment and Consumables	lot (Note 1)	100,000	100
TOTAL	--	--	21,360

Note:

1. Allocation based on Urenco decommissioning experience.

(b) Supply

Equipment	Quantity	Unit Cost (\$/ft ³)	Total Cost Equipment (\$000)
Electricity kwh	2,910,344	0.062	180
Water ft ³	86,300	0.035	3
Materials	lot (Note 1)		653
TOTAL	--	--	910

Note:

1. Allocation based on Urenco decommissioning experience.

10.5 Chapter 10 Tables

Table 10.1-12 Laboratory Costs

Activity	Quantity	Unit Cost (\$)	Total Costs (\$000)
Analysis of batch samples (Note 1)	931	934	870
TOTAL	--	--	870

Note:

1. Sample analysis costs are for aluminum only. The unit cost for this sampling is the cost of performing the analysis using onsite laboratory equipment and assumes 8 samples for each of the estimated 931 batch melts. Costs associated with other sampling and analysis are included in Table 10.1-5, Final Radiation Survey.

10.5 Chapter 10 Tables

Table 10.1-13 Period Dependent Costs

Cost Item	Total Cost (\$000)
License Fees	(Note 1)
Insurance	(Note 1)
Taxes	(Note 1)
Other	(Note 1)
TOTAL	10,000

Note:

1. Period Dependent Costs include management, insurance, taxes, and other costs for the period beginning with the termination of operations of Separations Building Module 1003 and the remaining plant facilities. This assumes \$2,000,000 per year for each of the five years at the end of the project. It has been assumed that the period dependent decommissioning costs incurred during concurrent enrichment operations will be funded from operating plant funding and not the decommissioning trust fund.

10.5 Chapter 10 Tables

Table 10.1-14 Total Decommissioning Costs

(Note 7)

Task/Components	Costs (\$000)		Total (\$000)	Percentage	Notes
	Separations Building Modules	Other Buildings			
Planning and Preparation (see Table 10.1-2)	1,200	0	1,200	1%	1
Decontamination and Dismantling of Radioactive Facility Components (see Table 10.1-9)	24,060	1,110	25,170	20%	8
Restoration of Contamination Areas on Facility Grounds (see Table 10.1-4)	1,357	0	1,357	1%	2
Final Radiation Survey (see Table 10.1-5)	2,500	0	2,500	2%	3
Cost of Third Party Use	39,829	1,232	41,061	32%	11
Site Stabilization and Long-term Surveillance	0	0	0	0%	4
Waste Processing Costs (see Table 10.1-10)	3,690	0	3,690	3%	5
Waste Disposal Costs (see Table 10.1-10)	17,904	440	18,344	14%	6
Equipment Costs (see Table 10.1-11)	21,260	100	21,360	17%	--
Supply Costs (see Table 10.1-11)	910	0	910	1%	--
Laboratory Costs (see Table 10.1-12)	870	0	870	1%	--
Period Dependent Costs (see Table 10.1-13)	10,000	0	10,000	8%	--
SUBTOTAL (2002)	123,580	2,882	126,462		--
SUBTOTAL (with escalation to 2004)	128,115	2,988	131,103		12
Tails Disposition (2004)	--	--	701,934		9
Contingency (25%)	--	--	208,259		--
TOTAL (2004)	--	--	1,041,296		10

10.5 Chapter 10 Tables

Table 10.1-14 Total Decommissioning Costs

Notes:

1. The \$1,200 includes planning, site characterization, Decommissioning Plan preparation, and NRC review for the entire plant.
2. Cost provided is for removal and disposal of liners and earthen covers of the facility Treated Effluent Evaporative Basin. The cost assumes transport and disposal of approximately 33,000 ft³ of contaminated soil and basin membrane at recent commercial rates. The cost of removal of the facility Treated Effluent Evaporative Basin material (33,000 ft³) is based on a \$30/ft³ disposal cost and includes the cost of excavation (\$5.00/yd³ which includes labor and equipment costs) and cost of transportation (\$4.00/mile for approximately 1,100 miles from the NEF site to the Envirocare facility in Utah). Other areas outside of the plant buildings are not expected to be contaminated.
3. The \$2,500 includes the Final Radiation Survey, NRC review, confirmatory surveys and license termination for the entire plant.
4. Site stabilization and long-term surveillance will not be required.
5. Waste processing costs are based on commercial metal melting equipment and unit rates obtained from Urenco experience in Europe.
6. Includes waste packaging and shipping costs. Waste disposal costs for Other Buildings are based on a \$150 per cubic foot unit rate which includes packaging, shipping and disposal at Envirocare in Utah.
7. More than 97% of the decommissioning costs for the facility are attributed to the dismantling, decontamination, processing, and disposal of centrifuges and other equipment in the Separations Building Modules, which are considered classified. Given the classified nature of these buildings, the data presented in these Tables have been structured to meet the applicable NUREG-1757 recommendations, to the extent practicable. However, specific information such as numbers of components and unit rates has been intentionally excluded to protect the classified nature of the data. The remaining 3% of the decommissioning costs are for the remaining systems and components in Other Buildings.
8. The \$1,110 for Other Buildings includes the decontamination and dismantling of contaminated equipment in the TBS, Blending and Liquid Sampling Area, Centrifuge Test and Post Mortem Facilities, and Gaseous Effluent Vent System.
9. Refer to Section 10.3, for Tails Disposition discussion.
10. Combined total for both decommissioning and tails disposition.
11. An adjustment has been applied to account for use of a third party for performing decommissioning operations associated with planning and preparation, decontamination and dismantling of radioactive facility components, restoration of contaminated grounds, and the final radiation survey. The adjustment includes an overhead rate on direct staff labor of 110%, plus 15% profit on labor and its overheads.
12. The escalation cost factor applied is based on the Gross Domestic Product (GDP) implicit price deflator. The resulting escalation cost factor for January 2002 to January 2004 is a 3.67% increase. The escalation cost factor is not applied to the tails disposition costs since these costs are provided in 2004 dollars.

10.5 Chapter 10 Tables

Table 10.3-1 Summary of Depleted UF₆ Disposal Costs from Four Sources

Source	Costs in 2002 Dollars per kgU			
	Conversion	Disposal	Transportation	Total
LLNL (UCRL-AR-127650) (a)	2.64	2.17	0.25	5.06
UDS Contract (b)	(d)	(d)	(d)	3.92
URENCO (e)	(d)	(d)	(d)	(d)
CEC Cost Estimate (c)	4.93	1.47	0.34	6.74

Notes:

- (a) 1997 Lawrence Livermore National Laboratory cost estimate study for DOE, discounted costs in 1996 dollars were undiscounted and escalated to 2002 by ERI.
- (b) Uranium Disposition Services (UDS) contract with DOE for capital and operating costs for first five years of Depleted UF₆ conversion and Depleted U₃O₈ conversion product disposition.
- (c) Based upon Depleted UF₆ and Depleted U₃O₈ disposition costs provided to the NRC during Claiborne Enrichment Center license application in 1993.
- (d) Cost component is proprietary or not made available.
- (e) The average of the three costs is \$5.24/kg U. LES has selected \$5.50/kg U as the disposal cost for the National Enrichment Facility. Urenco has reviewed this cost estimate, and based on its current experience with UF₆ disposal, finds this figure to be prudent.

10.5 Chapter 10 Tables

Table 10.3-2 DOE-UDS August 29, 2002, Contract Quantities and Costs

	Target Million kgU	
	DUF ₆ (a)	U (b)
UDS Conversion and Disposal Quantities:		
FY 2005 (August-September)	1.050	0.710
FY 2006	27.825	18.800
FY 2007	31.500	21.294
FY 2008	31.500	21.294
FY 2009	31.500	21.294
FY 2010 (October-July)	26.250	17.745
Total:	149.625	101.147
Nominal Conversion Rate (c) and Target Conversion Rate (Million kgU/Yr)		21.3
UDS Contract Workscope Costs: (d)		Million \$
Design, Permitting, Project Management, etc.		27.99
Construct Paducah Conversion Facility		93.96
Construct Portsmouth Conversion Facility		90.40
Operations for First 5 Years DUF ₆ and DU ₃ O ₈ (e)		283.23
Contract Estimated Total Cost ^{w/o} Fee		495.58
Contract Estimated Value per DOE PR, August 29, 2003		558.00
Difference Between Cost and Value is the Estimated Fee of 12.6%		62.42
Capital Cost ^{w/o} Fee		212.35
Capital Cost with Fee		239.10
First 5 Years Operating Cost with Fee		318.92
Estimated Unit Conversion and Disposal Costs:		
Unit Capital Cost (f)		\$0.77/kgU
2005-2010 Unit Operating Costs in 2002 \$		\$3.15/kgU
Total Estimated Unit Cost		\$3.92/kgU

Notes:

- (a) As on page B-10 of the UDS contract.
- (b) DUF₆ weight multiplied by the uranium atomic mass fraction, 0.676.
- (c) Based on page H-34 of the UDS contract.
- (d) Workscope costs as on UDS contract pages B-2 and B-3.
- (e) Does not include any potential off-set credit for HF sales.
- (f) Assumed operation over 25 years, 6% government cost of money, and no taxes.

10.6 Chapter 10 Figures

10.6 Chapter 10 Figures

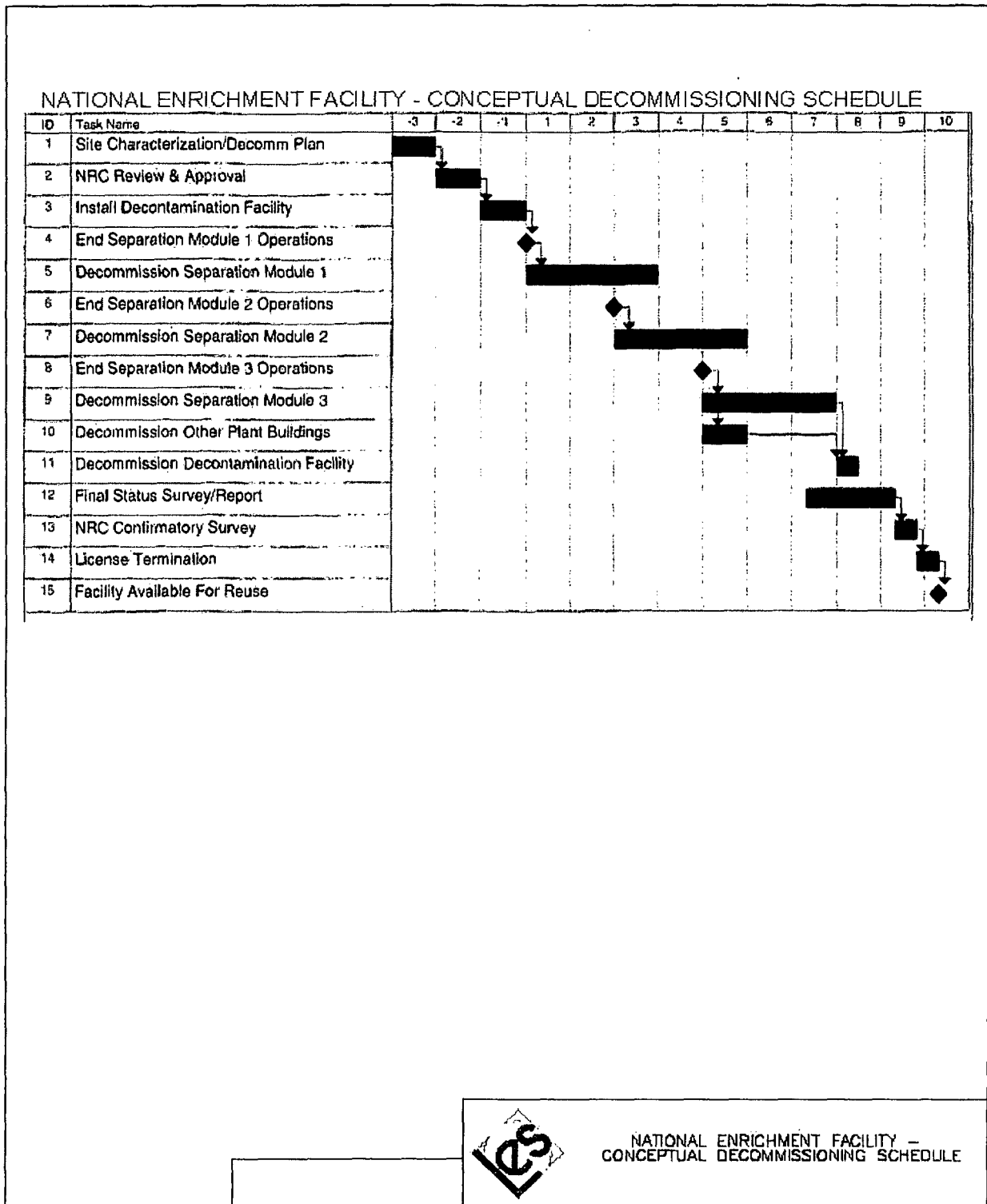

Figure 10.1-1 Conceptual Decommissioning Schedule

10.7 Appendix 10A - Payment Surety Bond

10.7 Appendix 10A - Payment Surety Bond

PAYMENT SURETY BOND

Date bond executed: _____

Effective date: _____

Principal: Louisiana Energy Services, L.P.
100 Sun Avenue NE, Suite 204
Albuquerque, NM 87109

Type of organization: Limited Partnership

State of incorporation: Delaware

NRC license number, name and address of facility, and amount for decommissioning activities guaranteed by this bond: _____

Surety: [*Insert name and business address*]

Type of organization: [*Insert "proprietorship," "partnership," or "corporation"*]

State of incorporation: _____ (*if applicable*)

Surety's qualification in jurisdiction where licensed facility is located.

Surety's bond number: _____

Total penal sum of bond: \$_____

Know all persons by these presents, that we, the Principal and Surety hereto, are firmly bound to the U.S. Nuclear Regulatory Commission (hereinafter called NRC) in the above penal sum for the payment of which we bind ourselves, our heirs, executors, administrators, successors, and assigns jointly and severally; provided that, where the Sureties are corporations acting as co-sureties, we, the Sureties, bind ourselves in such sum "jointly and severally" only for the purpose of allowing a joint action or actions against any or all of us, and for all other purposes each Surety binds itself, jointly and severally with the Principal, for the payment of such sum

10.7 Appendix 10A - Payment Surety Bond

only as is set forth opposite the name of such Surety; but if no limit of liability is indicated, the limit of liability shall be the full amount of the penal sum.

WHEREAS, the NRC, an agency of the U.S. Government, pursuant to the Atomic Energy Act of 1954, as amended, and the Energy Reorganization Act of 1974, has promulgated regulations in title 10, Chapter I of the *Code of Federal Regulations*, Parts 30, 40, and 70, applicable to the Principal, which require that a license holder or an applicant for a facility license provide financial assurance that funds will be available when needed for facility decommissioning;

NOW, THEREFORE, the conditions of the obligation are such that if the Principal shall faithfully, before the beginning of decommissioning of each facility identified above, fund the standby trust fund in the amount(s) identified above for the facility;

Or, if the Principal shall fund the standby trust fund in such amount(s) after an order to begin facility decommissioning is issued by NRC or a U.S. District Court or other court of competent jurisdiction;

Or, if the Principal shall provide alternative financial assurance, and obtain NRC's written approval of such assurance, within 30 days after the date a notice of cancellation from the Surety is received by both the Principal and NRC, then this obligation shall be null and void; otherwise it is to remain in full force and effect.

The Surety shall become liable on this bond obligation only when the Principal has failed to fulfill the conditions described above. Upon notification by NRC that the Principal has failed to perform as guaranteed by this bond, the Surety shall place funds in the amount guaranteed for the facility into the standby trust fund.

The liability of the Surety shall not be discharged by any payment or succession of payments hereunder, unless and until such payment or payments shall amount in the aggregate to the penal sum of the bond, but in no event shall the obligation of the Surety hereunder exceed the amount of said penal sum.

The Surety may cancel the bond by sending notice of cancellation by certified mail to the Principal and to NRC provided, however, that cancellation shall not occur during the 90 days beginning on the date of receipt of the notice of cancellation by both the Principal and NRC, as evidenced by the return receipts.

The Principal may terminate this bond by sending written notice to NRC and to the Surety 90 days prior to the proposed date of termination, provided, however, that no such notice shall become effective until the Surety receives written authorization for termination of the bond from NRC.

The Principal and Surety hereby agree to adjust the penal sum of the bond yearly so that it guarantees a new amount, provided that the penal sum does not increase by more than 20 percent in any one year and no decrease in the penal sum takes place without the written permission of NRC.

10.7 Appendix 10A - Payment Surety Bond

If any part of this agreement is invalid, it shall not affect the remaining provisions that will remain valid and enforceable.

In Witness Whereof, the Principal and Surety have executed this financial guarantee bond and have affixed their seals on the date set forth above.

The persons whose signatures appear below hereby certify that they are authorized to execute this surety bond on behalf of the Principal and Surety.

Principal

[Signatures]

E. James Ferland
President, Louisiana Energy Services, L.P.

[Corporate seal]

Corporate Surety

[Name and address]

State of incorporation: _____

Liability limit: \$ _____

[Signatures]

[Names and titles]

[Corporate seal]

Bond Premium: \$ _____

10.8 Appendix B - Standby Trust Agreement

10.8 Appendix B - Standby Trust Agreement

STANDBY TRUST AGREEMENT

TRUST AGREEMENT, the Agreement entered into as of *[insert date]* by and between Louisiana Energy Service, L. P., a Delaware limited partnership, herein referred to as the "Grantor," and *[insert name and address of a trustee acceptable to NRC]*, the "Trustee."

WHEREAS, the U.S. Nuclear Regulatory Commission (NRC), an agency of the U.S.

Government, pursuant to the Atomic Energy Act of 1954, as amended, and the Energy Reorganization Act of 1974, has promulgated regulations in title 10, Chapter I, of the *Code of Federal Regulations*, Parts 30, 40, and 70. These regulations, applicable to the Grantor, require that a holder of, or an applicant for, a materials license issued pursuant to 10 CFR Parts 30, 40, and 70 provide assurance that funds will be available when needed for required decommissioning activities.

WHEREAS, the Grantor has elected to use a surety bond to provide all of such financial assurance for the facilities identified herein; and

WHEREAS, when payment is made under a surety bond, this standby trust shall be used for the receipt of such payment; and

WHEREAS, the Grantor, acting through its duly authorized officers, has selected the Trustee to be the trustee under this Agreement, and the Trustee is willing to act as trustee;

NOW, THEREFORE, the Grantor and the Trustee agree as follows:

Section 1. Definitions. As used in this Agreement:

- (a) The term "Grantor" means the NRC licensee who enters into this Agreement and any successors or assigns of the Grantor.
- (b) The term "Trustee" means the trustee who enters into this Agreement and any successor trustee.

Section 2. Costs of Decommissioning. This Agreement pertains to the costs of decommissioning the materials and activities identified in License Number *[insert license number]* issued pursuant to 10 CFR Parts 30, 40, and 70, as shown in Schedule A.

Section 3. Establishment of Fund. The Grantor and the Trustee hereby establish a standby trust fund (the Fund) for the benefit of NRC. The Grantor and the Trustee intend that no third party shall have access to the Fund except as provided herein.

Section 4. Payments Constituting the Fund. Payments made to the Trustee for the Fund shall consist of cash, securities, or other liquid assets acceptable to the Trustee. The Fund is established initially as consisting of the property, which is acceptable to the Trustee, described

10.8 Appendix B - Standby Trust Agreement

in Schedule B attached hereto. Such property and any other property subsequently transferred to the Trustee are referred to as the "Fund," together with all earnings and profits thereon, less any payments or distributions made by the Trustee pursuant to this Agreement. The Fund shall be held by the Trustee, IN TRUST, as hereinafter provided. The Trustee shall not be responsible nor shall it undertake any responsibility for the amount of, or adequacy of the Fund, nor any duty to collect from the Grantor, any payments necessary to discharge any liabilities of the Grantor established by NRC.

Section 5. Payment for Required Activities Specified in the Plan. The Trustee shall make payments from the Fund to the Grantor upon presentation to the Trustee of the following:

- (a) A certificate duly executed by the Secretary of the Grantor's Management Committee attesting to the occurrence of the events, and in the form set forth in the attached Certificate of Events, and
- (b) A certificate attesting to the following conditions:
 - (1) that decommissioning is proceeding pursuant to an NRC-approved plan;
 - (2) that the funds withdrawn will be expended for activities undertaken pursuant to that plan; and
 - (3) that NRC has been given 30 days prior notice of Louisiana Energy Service's intent to withdraw funds from the trust fund.

No withdrawal from the Fund for a particular license can exceed 10 percent of the remaining funds available for that license unless NRC written approval is attached.

In addition, the Trustee shall make payments from the Fund as NRC shall direct, in writing, to provide for the payment of the costs of required activities covered by this Agreement. The Trustee shall reimburse the Grantor or other persons as specified by NRC from the Fund for expenditures for required activities in such amounts as NRC shall direct in writing. In addition, the Trustee shall refund to the Grantor such amounts as NRC specifies in writing. Upon refund, such funds shall no longer constitute part of the Fund as defined herein.

Section 6. Trust Management. The Trustee shall invest and reinvest the principal and income of the Fund and keep the Fund invested as a single fund, without distinction between principal and income, in accordance with general investment policies and guidelines which the Grantor may communicate in writing to the Trustee from time to time, subject, however, to the provisions of this section. In investing, reinvesting, exchanging, selling, and managing the Fund, the Trustee shall discharge its duties with respect to the Fund solely in the interest of the beneficiary and with the care, skill, prudence and diligence under the circumstances then prevailing which persons of

prudence, acting in a like capacity and familiar with such matters, would use in the conduct of an enterprise of a like character and with like aims, except that:

10.8 Appendix B - Standby Trust Agreement

- (a) Securities or other obligations of the Grantor, or any other owner or operator of the facilities, or any of their affiliates as defined in the Investment Company Act of 1940, as amended (15 U.S.C. 80a-2(a)), shall not be acquired or held, unless they are securities or other obligations of the Federal or a State government;
- (b) The Trustee is authorized to invest the Fund in time or demand deposits of the Trustee, to the extent insured by an agency of the Federal government, and in obligations of the Federal government such as GNMA, FNMA, and FHLM bonds and certificates or State and Municipal bonds rated BBB or higher by Standard & Poor's or Baa or higher by Moody's Investment Services; and
- (c) For a reasonable time, not to exceed 60 days, the Trustee is authorized to hold uninvested cash, awaiting investment or distribution, without liability for the payment of interest thereon.

Section 7. Commingling and Investment. The Trustee is expressly authorized in its discretion:

- (a) To transfer from time to time any or all of the assets of the Fund to any common, commingled, or collective trust fund created by the Trustee in which the Fund is eligible to participate, subject to all of the provisions thereof, to be commingled with the assets of other trusts participating therein; and
- (b) To purchase shares in any investment company registered under the Investment Company Act of 1940 (15 U.S.C. 80a-1 et seq.), including one that may be created, managed, underwritten, or to which investment advice is rendered, or the shares of which are sold by the Trustee. The Trustee may vote such shares in its discretion.

Section 8. Express Powers of Trustee. Without in any way limiting the powers and discretion conferred upon the Trustee by the other provisions of this Agreement or by law, the Trustee is expressly authorized and empowered:

- (a) To sell, exchange, convey, transfer, or otherwise dispose of any property held by it, by public or private sale, as necessary to allow duly authorized withdrawals at the joint request of the Grantor and NRC or to reinvest in securities at the direction of the Grantor;
- (b) To make, execute, acknowledge, and deliver any and all documents of transfer and conveyance and any and all other instruments that may be necessary or appropriate to carry out the powers herein granted;
- (c) To register any securities held in the Fund in its own name, or in the name of a nominee, and to hold any security in bearer form or in book entry, or to combine certificates representing such securities with certificates of the same issue held by the Trustee in other fiduciary capacities, to reinvest interest payments and funds from matured and redeemed instruments, to file proper forms concerning securities held in the Fund in a timely fashion with appropriate government agencies, or to deposit or arrange for the deposit of such securities in a qualified central depository even though, when so deposited, such securities may be merged and held in bulk in the name of the nominee

10.8 Appendix B - Standby Trust Agreement

or such depository with other securities deposited therein by another person, or to deposit or arrange for the deposit of any securities issued by the U.S. Government, or any agency or instrumentality thereof, with a Federal Reserve Bank, but the books and records of the Trustee shall at all times show that all such securities are part of the Fund;

- (d) To deposit any cash in the Fund in interest-bearing accounts maintained or savings certificates issued by the Trustee, in its separate corporate capacity, or in any other banking institution affiliated with the Trustee, to the extent insured by an agency of the Federal government; and
- (e) To compromise or otherwise adjust all claims in favor of or against the Fund.

Section 9. Taxes and Expenses. All taxes of any kind that may be assessed or levied against or in respect of the Fund and all brokerage commissions incurred by the Fund shall be paid from the Fund. All other expenses incurred by the Trustee in connection with the administration of this Trust, including fees for legal services rendered to the Trustee, the compensation of the Trustee to the extent not paid directly by the Grantor, and all other proper charges and disbursements of the Trustee shall be paid from the Fund.

Section 10. Annual Valuation. After payment has been made into this standby trust fund, the Trustee shall annually, at least 30 days before the anniversary date of receipt of payment into the standby trust fund, furnish to the Grantor and to NRC a statement confirming the value of the Trust. Any securities in the Fund shall be valued at market value as of no more than 60 days before the anniversary date of the establishment of the Fund. The failure of the Grantor to object in writing to the Trustee within 90 days after the statement has been furnished to the Grantor and NRC shall constitute a conclusively binding assent by the Grantor, barring the Grantor from asserting any claim or liability against the Trustee with respect to the matters disclosed in the statement.

Section 11. Advice of Counsel. The Trustee may from time to time consult with counsel with respect to any question arising as to the construction of this Agreement or any action to be taken hereunder. The Trustee shall be fully protected, to the extent permitted by law, in acting on the advice of counsel.

Section 12. Trustee Compensation. The Trustee shall be entitled to reasonable compensation for its services as agreed upon in writing with the Grantor. (See Schedule C.)

Section 13. Successor Trustee. Upon 90 days notice to NRC and the Grantor, the Trustee may resign; upon 90 days notice to NRC and the Trustee, the Grantor may replace the Trustee; but such resignation or replacement shall not be effective until the Grantor has appointed a successor Trustee, the successor accepts the appointment, the successor is ready to assume its duties as trustee, and NRC has agreed, in writing, that the successor is an appropriate Federal or State government agency or an entity that has the authority to act as a trustee and whose trust operations are regulated and examined by a Federal or State agency. The successor Trustee shall have the same powers and duties as those conferred upon the Trustee hereunder. When the resignation or replacement is effective, the Trustee shall assign, transfer, and pay over to the successor Trustee the funds and properties then constituting the Fund. If for

10.8 Appendix B - Standby Trust Agreement

any reason the Grantor cannot or does not act in the event of the resignation of the Trustee, the Trustee may apply to a court of competent jurisdiction for the appointment of a successor Trustee or for instructions. The successor Trustee shall specify the date on which it assumes administration of the trust, in a writing sent to the Grantor, NRC, and the present Trustee, by certified mail 10 days before such change becomes effective. Any expenses incurred by the Trustee as a result of any of the acts contemplated by this section shall be paid as provided in Section 9.

Section 14. Instructions to the Trustee. All orders, requests, and instructions by the Grantor to the Trustee shall be in writing, signed by such persons as are signatories to this Agreement or such other designees as the Grantor may designate in writing. The Trustee shall be fully protected in acting without inquiry in accordance with the Grantor's orders, requests, and instructions. If NRC issues orders, requests, or instructions to the Trustee these shall be in writing, signed by NRC or its designees, and the Trustee shall act and shall be fully protected in acting in accordance with such orders, requests, and instructions. The Trustee shall have the right to assume, in the absence of written notice to the contrary, that no event constituting a change or a termination of the authority of any person to act on behalf of the Grantor or NRC hereunder has occurred. The Trustee shall have no duty to act in the absence of such orders, requests, and instructions from the Grantor and/or NRC, except as provided for herein.

Section 15. Amendment of Agreement. This Agreement may be amended by an instrument in writing executed by the Grantor, the Trustee, and NRC, or by the Trustee and NRC if the Grantor ceases to exist. All amendments shall meet the relevant regulatory requirements of NRC.

Section 16. Irrevocability and Termination. Subject to the right of the parties to amend this Agreement as provided in Section 15, this trust shall be irrevocable and shall continue until terminated at the written agreement of the Grantor, the Trustee, and NRC, or by the Trustee and NRC if the Grantor ceases to exist. Upon termination of the trust, all remaining trust property, less final trust administration expenses, shall be delivered to the Grantor or its successor.

Section 17. Immunity and Indemnification. The Trustee shall not incur personal liability of any nature in connection with any act or omission, made in good faith, in the administration of this trust, or in carrying out any directions by the Grantor or NRC issued in accordance with this Agreement. The Trustee shall be indemnified and saved harmless by the Grantor or from the trust fund, or both, from and against any personal liability to which the Trustee may be subjected by reason of any act or conduct in its official capacity, including all expenses reasonably incurred in its defense in the event the Grantor fails to provide such defense.

Section 18. This Agreement shall be administered, construed, and enforced according to the laws of the State of *[insert name of State]*.

Section 19. Interpretation and Severability. As used in this Agreement, words in the singular include the plural and words in the plural include the singular. The descriptive headings for each section of this Agreement shall not affect the interpretation or the legal efficacy of this Agreement. If any part of this Agreement is invalid, it shall not affect the remaining provisions which will remain valid and enforceable.

10.8 Appendix B - Standby Trust Agreement

IN WITNESS WHEREOF the parties have caused this Agreement to be executed by the respective officers duly authorized and the incorporate seals to be hereunto affixed and attested as of the date first written above.

Louisiana Energy Services, L. P.
[Signature of E. James Ferland]
E. James Ferland
President, Louisiana Energy Services, L. P

ATTEST:
[Title]
[Seal]

[Insert name and address of Trustee]
[Signature of representative of Trustee]
[Title]

ATTEST:
[Title]
[Seal]

10.9 Appendix 10C - Standby Trust Agreement Schedules

10.9 Appendix 10C - Standby Trust Agreement Schedules

STANDBY TRUST AGREEMENT SCHEDULES

Schedule A

This Agreement demonstrates financial assurance for the following cost estimates or prescribed amounts for the following licensed activities:

<u>U.S. NUCLEAR REGULATORY COMMISSION LICENSE NUMBER(S)</u>	<u>NAME AND ADDRESS OF LICENSEE</u>	<u>ADDRESS OF LICENSED ACTIVITY</u>	<u>COST ESTIMATES FOR REGULATORY ASSURANCES DEMONSTRATED BY THIS AGREEMENT</u>
	Louisiana Energy Services, L.P. 100 Sun Avenue NE, Suite 204 Albuquerque, NM 87109		

The cost estimates listed here were last adjusted and approved by NRC on *[insert date]*.

Schedule B

DOLLAR AMOUNT _____

AS EVIDENCED BY _____

Schedule C

[Insert name, address, and phone number of Trustee.]

Trustee's fees shall be \$ _____ per year.

10.10 Appendix 10D - Specimen Certificate of Events

10.10 Appendix 10D - Specimen Certificate of Events

SPECIMEN CERTIFICATE OF EVENTS

[Insert name and address of trustee]

Attention: Trust Division

Gentlemen:

In accordance with the terms of the Agreement with you dated _____, I, _____, Secretary of the Management Committee of Louisiana Energy Services, L. P., hereby certify that the following events have occurred:

1. Louisiana Energy Services, L. P., is required to commence the decommissioning of its facility located in Lea County, New Mexico (hereinafter called the decommissioning).
2. The plans and procedures for the commencement and conduct of the decommissioning have been approved by the United States Nuclear Regulatory Commission, or its successor, on _____ (copy of approval attached).
3. The Management Committee of Louisiana Energy Services, L. P., has adopted the attached resolution authorizing the commencement of the decommissioning.

Secretary of the Management Committee of
Louisiana Energy Services, L. P.

Date

10.11 Appendix 10E - Specimen Certificate of Resolution

10.11 Appendix 10E - Specimen Certificate of Resolution

SPECIMEN CERTIFICATE OF RESOLUTION

I, _____, do hereby certify that I am Secretary of the Management Committee of Louisiana Energy Services, L. P., a Delaware Limited Partnership, and that the resolution listed below was duly adopted at a meeting of this Limited Partnership's Management Committee on _____, 20__.

IN WITNESS WHEREOF, I have hereunto signed my name and affixed the seal of this Limited Partnership this ___ day of _____, 20__.

Secretary of the Management Committee of
Louisiana Energy Services, L. P.

RESOLVED, that this Management Committee hereby authorizes the President, or such other employee of the Limited Partnership as he may designate, to commence decommissioning activities at the National Enrichment Facility in accordance with the terms and conditions described to this Management Committee at this meeting and with such other terms and conditions as the President shall approve with and upon the advice of Counsel.

10.12 Appendix 10F - Letter of Acknowledgment

10.12 Appendix 10F - Letter of Acknowledgment

LETTER OF ACKNOWLEDGMENT

STATE OF _____

To Wit: _____

CITY OF _____

On this ___ day of _____, before me, a notary public in and for the city and State aforesaid, personally appeared _____, and she/he did depose and say that she/he is the [insert title] of _____ [if applicable, insert “, national banking association” or “, State banking association”], Trustee, which executed the above instrument; that she/he knows the seal of said association; that the seal affixed to such instrument is such corporate seal; that it was so affixed by order of the association; and that she/he signed her/his name thereto by like order.

[Signature of notary public]

My Commission Expires: _____
[Date]

10.12 Appendix 10F - Letter of Acknowledgment

11.0 Management Measures

11.0 Management Measures

Management measures are functions applied to item(s) relied on for safety (IROFS) and any items which are essential to the function of IROFS to provide reasonable assurance that the IROFS are available and able to perform their functions when needed. This chapter addresses each of the management measures included in the 10 CFR 70.4 definition of management measures.

Management measures are applied to the attributes of Administrative Control IROFS Support Equipment and other equipment attributes. These attributes are listed in SAR Table 3.4-1 and are defined in the respective IROFS Boundary Definition Document. Management measures are also applied to Administrative Control IROFS Support Equipment as defined in the Quality Assurance Program Description for QL-2AC equipment. Administrative Control IROFS Support Equipment is identified in SAR Table 3.4-1.

Management measures are implemented through a quality assurance (QA) program in accordance with 10 CFR 50, Appendix B (CFR, 2003b). The QA program also provides additional measures for ensuring that the design, construction, operation and decommissioning of IROFS are controlled commensurate with their importance to safety. The Louisiana Energy Services (LES) Quality Assurance Program is described in the LES QA Program Description document included as Appendix A to this chapter. The NRC has evaluated the LES QA Program Description and concluded that the application of QA elements as described in the QA Program Description meets the requirements of 10 CFR 70 (CFR, 2003g) and provides reasonable assurance of protection of public and worker health and safety and the environment (NRC, 2004).

LES maintains full responsibility for assuring that the National Enrichment Facility (NEF) is designed, constructed, tested, and operated in conformance with good engineering practices, applicable regulatory requirements and specified design requirements and in a manner to protect the health and safety of the public. To this end, the LES Quality Assurance Program conforms to the criteria established in 10 CFR 50, Appendix B, Quality Assurance Criteria For Nuclear Power Plants and Fuel Reprocessing Plants (CFR, 2003b). The criteria in 10 CFR 50, Appendix B (CFR, 2003b), are implemented following the commitment to ASME NQA-1, Quality Assurance Program Requirements for Nuclear Facilities.

The QA Program described herein includes design, construction, pre-operational testing, and operation of the facility. This QA Program describes the requirements to be applied for those systems, components, items, and services that have been determined to be QA Level 1 as defined in Appendix A. LES and their contractors implement these requirements through the use of approved procedures. In addition, a quality assurance program as described in Appendix A is applied to certain other systems, components, items, and services which are not QA Level 1. The information provided in this chapter, the corresponding regulatory requirement, and the section of NUREG-1520, Chapter 11 in which the NRC acceptance criteria are presented is summarized below.

11.0 Management Measures

Information Category and Requirement	10 CFR 70 Citation	NUREG-1520 Chapter 11 Reference
Section 11.1 Configuration Management	70.62(d) & 70.72	11.4.3.1
Section 11.2 Maintenance	70.62(d)	11.4.3.2
Section 11.3 Training and Qualifications	70.62(d) & 10CFR19	11.4.3.3
Section 11.4 Procedures Development and Implementation	70.62(d) & 70.22(a)(8)	11.4.3.4
Section 11.5 Audits and Assessments	70.62(d)	11.4.3.5
Section 11.6 Incident Investigations and Corrective Action Process	70.74(a)&(b) 70.62(a)(3)	11.4.3.6
Section 11.7 Records Management	70.62(a)(2)&(3) 70.62(d)	11.4.3.7
Section 11.8 Other QA Elements	70.62(d)	11.4.3.8
Appendix A: LES QA Program Description	70.62(d)	11.4.3.8

11.1 Configuration Management (CM)

11.1 Configuration Management (CM)

This section describes the configuration management program for the National Enrichment Facility (NEF). Configuration management (CM) for the NEF is implemented through the requirements of Appendix A of the Safety Analysis Report, Quality Assurance Program Description (QAPD). Configuration Management is a core Administrative Control implementing Management Measures at the NEF.

The LES President is the executive responsible for quality assurance and is the highest level of management responsible for LES's QA policies, goals, and objectives. The President receives policy direction from the LES Board of Managers. The LES organization construction and operation phases, is presented in Chapter 2, Organization and Administration. This organizational structure is implemented for the design, construction and operation of the NEF. Implementation of QA requirements is directed by the LES Quality Assurance Manager.

11.1.1 Configuration Management Policy

CM for the NEF is established in accordance with the requirements of 10 CFR 70.72 and 10 CFR 70.62(d).

Configuration management is maintained throughout facility design, construction, testing, and operation of the NEF. Configuration management is an administrative management measure that establishes and maintains the NEF safety bases by maintaining a technical baseline for the facilities, processes and procedures utilized at the NEF. The level of rigor for CM is established based on risk to the public, worker and environment and is implemented by the QAPD which prescribes Quality Assurance Levels commensurate with risk(s). The QAPD categorizes the safety significance of structures, systems and components (SSCs) as Quality Assurance (QA) Level 1, QA Level 1 Graded, QA Level 2AC, QA Level 2 and QA Level 3.

During design and construction, Project Engineering has responsibility for configuration management through established design control processes. Documentation for Items Relied On For Safety (IROFS), including the Integrated Safety Analysis (ISA), is controlled under the configuration management system which implements the procedures associated with design control, document control, and records management, etc. Design changes undergo formal review, including interdisciplinary reviews as appropriate, in accordance with these procedures. Interdisciplinary reviews include as a minimum, a review for ISA impacts.

Configuration management provides the means to establish and maintain the essential features of the design basis of Item Relied On For Safety IROFS, including the ISA. As the project progresses from design and construction to operation, configuration management is maintained by the Engineering organization. Responsibility for CM activities is clearly defined for SSCs throughout their life cycle.

Integrated Safety Analysis Summary Section 4.0, Phased Operation, described ongoing construction activities during the operations phase. In addition to the Configuration Management controls specified above for the construction phase, these activities will be reviewed to identify and minimize any adverse effect upon plant operation.

11.1 Configuration Management (CM)

11.1.2 Configuration Management Scope

Configuration Management is a cross disciplinary activity impact all elements of the QA Program include:

- Design Control
- Procurement Document Control
- Instructions, Procedures, and Drawings
- Document Control
- Control of Purchased Material, Equipment and Services
- Identification and Control Materials, Part and Components
- Control of Special Processes
- Inspection
- Test Control
- Control of Measuring and Test Equipment
- Handling, Storage, and Shipping
- Inspection, Test, and Operating Status
- Nonconforming Items
- Correction Action
- Quality Assurance Records
- Audits
- Provisions for Change

These QA elements maintain configuration management by approved processes and procedures.

11.1.3 Scope of Structures, Systems, and Components

The scope of SCCs under CM includes all IROFS identified by the integrated safety analysis of the design bases and any items which are essential to the function of the IROFS. Provisions are provided within the QAPD to control design related activities. Design documents subject to configuration management include calculations, safety analyses, design criteria, engineering drawings, system descriptions, technical documents, and specifications that establish design requirements for IROFS and items essential to the function of IROFS. Design documents are maintained under configuration management commencing with initial approval.

Drawings and specifications related to IROFS or items essential to the functions of IROFS are prepared and issued for procurement, fabrication, or construction and are placed under configuration management.

As the plant transitions from construction to operations, the scope of documents under configuration management broadens to include, as appropriate: vendor data; nonconformance reports; test data; inspection data; initial startup; and, operating and administrative documents and procedures applicable to IROFS. These documents include documentation related to IROFS that is generated through functional interfaces with QA, maintenance, and training and

11.1 Configuration Management (CM)

qualifications of personnel. In summary, CM procedures will provide for evaluation, implementation, and tracking of changes to IROFS and activities that are essential to the function of IROFS.

11.1.4 Configuration Management Applications

Configuration management processes are prescribed for IROFS SSCs and activities performed in support of IROFS SSCs which include, but are not limited to the following:

- Integrated Safety Analysis
- Evaluations of Proposed Changes 10 CFR 70.72(c)
- SSC Design
- SSC Design modification including temporary modifications
- Safe By Design SSCs
- Calculations
- Design software
- Design analysis and design analysis software
- Tests
- Experiments
- Procurement
- Procedures

11.1.5 Interfaces with Other Management Measures

Configuration management is a key element of other management measures as described below:

- Quality Assurance - The QAPD establishes the framework for configuration management and other management measures for IROFS and items essential to the function of the IROFS as described in Section 11.8.
- Records Management - Records associated with IROFS and items essential to the function of IROFS are generated and processed in accordance with the applicable requirements of the QAPD and provide evidence of the conduct of activities associated with configuration management as described in Section 11.7.
- Maintenance – Maintenance requirements are established as part of the design basis, which is controlled under CM. Maintenance records for IROFS and items essential to the function of IROFS provide evidence of compliance with preventative and corrective maintenance as described in Section 11.2.
- Training and Qualifications - Training and qualification are controlled in accordance with the applicable provisions of the QAPD. Personnel qualifications and/or training to specific processes and procedures are management measures that support the safe operation, maintenance, or testing of IROFS. Work activities associated with IROFS are accomplished through procedure or work instructions. Personnel are trained and qualified to administratively controlled IROFS procedures. Training and qualification requirements for IROFS and documentation of training support the design basis and are controlled under CM as described in Section 11.3.

11.1 Configuration Management (CM)

- Incident Investigation/Audits and Assessments - Audits, assessments, and incident investigations can result in corrective actions which are maintained in the corrective action program (CAP). Corrective actions identified as a result of these management measures may result in changes to design features, administrative controls, or other management measures (e.g., operating procedures). Changes are evaluated under the provisions of CM through the QAPD and procedures. Periodic assessments of the CM program are also conducted in accordance with the audit and assessment processes as described in Sections 11.5 and 11.6.

Procedures - Operating, administrative, maintenance, and emergency procedures are used to conduct various operations associated with IROFS and items essential to the function of IROFS and will be reviewed for potential impacts to the design basis. Work activities associated with IROFS are accomplished through procedures or work instructions. Procedures are maintained in a CM control system as described in Section 11.4.

11.1.6 Design Requirements

Design requirements and associated design bases are established and maintained by the Engineering organization during design and construction. This responsibility is assumed by the Technical Services organization for the operations phase.

The design bases are documented in the Functional Specification and Licensing Bases Documents (LBDs). The NEF is designed and built to the NEF Licensing Code of Record identified in the Integrated Safety Analysis Summary.

Design requirements are codified in design documents such as calculations, safety analysis, design criteria, engineering drawings, technical documents, and specifications. The design requirements are controlled under the design control provisions of the CM program as described above and are subject to the same change control as analysis, specifications, and drawings.

IROFS, any items that are essential to the function of the IROFS are designated as QA Level 1. QA-1 design documents are subject to interdisciplinary reviews and design verification. Modifications to the design are evaluated to ensure consistency with the design bases. Computer codes used in the design of IROFS are also subject to design control measures including requirements for software control, verification, and validation.

Design documents are prepared in accordance with codes, standards and licensing commitments by technically qualified personnel. Deviations from codes and standards are documented in the design package. Design documents are reviewed by a second qualified individual and subsequently approved by a functional area manager (FAM). Reviews are performed by personnel independent of the proposed design. Engineering Management documents the review process in accordance with approved procedures. CM requirements commence with the approvals of the initial design.

Design reviews, alternative calculations, or qualification testing provide verification of design bases documents and processes. The bases for a design, such as analytical models, theories, examples, tables, codes and computer programs must be referenced in the design document and their application verified during design review. Model tests, when required to prove the adequacy of a concept or a design, are reviewed and approved by responsible qualified personnel. Testing used for design verification shall demonstrate adequacy of performance

11.1 Configuration Management (CM)

under conditions that simulate the most adverse design conditions. The tests used for design verification must meet all the design requirements.

Independent design verification shall be accomplished before the design document is used by other organizations for design work or to support other activities such as procurement, construction, or installation. When this is not practical due to time constraints, the unverified portion of the document is identified and controlled and subject to the design review and verification process. In all cases, the design verification shall be completed before relying on the item to perform its function. Any changes to the design and procurement documents, including field changes, must be reviewed, checked and approved commensurate with the original approval requirements.

Completed design documents and supporting documents are maintained in the Document Control Center.

11.1.6.1 Configuration Management Controls of the Design Requirements

Configuration control of design activities is accomplished through processes and procedures. Design documents are assessed for QA level classification which determines the level of rigor required for CM processes. Modifications to the approved design are reviewed to ensure consistency with the design bases of IROFS.

Configuration verification is also accomplished through design verification, which ensures design documents and design requirements are consistent for IROFS. Construction and testing CM includes verification of the as-built configurations which ensures consistency with the design and performance requirements of IROFS. The QA Program requires procedures that direct work performance to be compliant with the requirements and guidelines imposed by applicable specifications, drawings, codes, standards, regulations, quality assurance criteria and site characteristics.

Acceptance criteria established by the designer are incorporated in the instructions, procedures and drawings used to perform the work. Documentation is maintained, including test results and inspection records, that demonstrates the work has been properly performed.

Maintenance, modification, and inspection procedures are reviewed by qualified personnel knowledgeable in the quality assurance disciplines to determine:

- The need for inspection, identification of inspection personnel, and documentation of inspection results.
- That the necessary inspection requirements, methods, and acceptance criteria have been identified.

Facility procedures shall be reviewed by an individual knowledgeable in the area affected by the procedure on a frequency determined by the age and use of the procedure to determine if changes are necessary or desirable. Procedures are also reviewed to ensure consistency with as-built facility configuration.

11.1 Configuration Management (CM)

11.1.7 Document Control

Procedures control the preparation and issuance of documents such as manuals, instructions, drawings, procedures, specifications, and procurement documents. Measures are established to ensure documents, including revisions, are adequately reviewed, approved, and released for use by authorized personnel.

Document control procedures require documents to be transmitted and received in a timely manner at appropriate locations including the location where the prescribed activity is to be performed. Controlled copies of these documents and their revisions are distributed to and used by the persons performing the activity.

Superseded documents are destroyed or are retained only when they have been properly labeled. Indexes of current documents and their revision levels are maintained and controlled.

Document control is implemented in accordance with procedures. An electronic document management system is used both to file project records and to ensure accessibility of the latest revision (i.e., the controlled copy) of design documents. The system provides an "official" copy of the current document. Personnel are trained to retrieve controlled documents. Controlled documents are maintained until cancelled or superseded, Cancelled or superseded documents are maintained as a record for the life of the project or termination of the license, whichever occurs later. A proceduralized back-up system for hard-copy distribution is maintained in the event the electronic system is unavailable).

The following documents are included within the Document Control System

- Design requirements, through the controlled copy of design requirements documents
- The design bases, through the controlled copy of the basis of design documents
- The integrated safety analysis of the design bases of IROFS, through the controlled copies of supporting analyses
- Nuclear Criticality Safety Analyses
- Nuclear Criticality Safety Evaluations
- As-built drawings
- Specifications
- Procedures
- QA
- Maintenance
- Audit and assessment reports
- Emergency response plans
- System modification documents
- Engineering documents including analyses, specifications, technical reports, and drawings.

These items are documented in approved procedures.

11.1 Configuration Management (CM)

11.1.8 Change Control

Change control for the NEF is provided throughout the design, construction and operation phases. Change control is directed by procedures and includes an appropriate level of technical, management, and safety reviews commensurate with the risk associated with the function or operation of SSCs. Maintenance of change control during these phases is summarized below. Detail change control requirements associated with quality levels are established in the QAPD.

11.1.8.1 Design Phase

Changes to the design definition are included in the change control systematic review process. Changes to the design are reviewed for 10 CFR 70.72 impacts through an Integrated Safety Analysis process. This process includes a systematic review of the design bases for consistency with LBDs. Changes that affect design or operation of IROFS are reviewed, and approved prior to implementation.

The configuration management process includes interdisciplinary reviews which ensure design changes either (1) do not impact the ISA, (2) are accounted for in subsequent changes to the ISA, or (3) are not approved or implemented.

11.1.8.2 Construction Phase

During the construction phase, changes to documents issued for construction, fabrication, and procurement will be documented, reviewed, approved, and posted in conjunction with design documents. Vendor drawings and data undergo an interdisciplinary review to ensure compliance with procurement specifications and drawings, and to incorporate interface requirements into facility documents.

During construction, design changes will be evaluated against the approved design bases. A systematic process will be used to evaluate changes in the design against the design bases of IROFS and the ISA. The configuration change process will implement the provisions of 10 CFR 70.72 (CFR, 2003e), including reporting of changes made without prior NRC approval as required by 10 CFR 70.72(d)(2) and (3). Any change that requires Commission approval, will be submitted as a license amendment request as required by 10 CFR 70.72(d)(1) and the change will not be implemented without prior NRC approval.

11.1.8.3 Operations Phase

During the operations phase and while transitioning between construction and operation, changes to design will be documented, reviewed, and approved prior to implementation. These processes implements the provisions of 10 CFR 70.72 (CFR, 2003e). Measures are provided to ensure responsible facility personnel are made aware of design changes and modifications that may affect the performance of their duties.

Planned changes (modifications) are analyzed to ensure safe and reliable operation of SSCs. Modifications are evaluated for any required changes to the facility's procedures, personnel training, testing program, or regulatory documents. For changes such as new design(s) or operation(s), or modification(s) to the facility or to activities of personnel, which include or could affect uranium on site, an NCS evaluation and, if required, an NCS analysis shall be prepared

11.1 Configuration Management (CM)

and approved. Prior to implementing the change, it shall be determined that the entire process will be subcritical (with applicable margin for safety) under both normal and credible abnormal conditions.

Changes such as new designs, operations or modifications to the facility or to activities of personnel, which include or have the potential to include radiological hazards, are also evaluated and documented for radiation exposure to minimize worker exposures in keeping with the NEF ALARA program.

Other areas of consideration in evaluating modifications may include, but are not limited to the review of:

- Operating Experience from similar completed modifications
- QA requirements
- Potential operability or maintainability concerns
- Constructability concerns
- Post-modification testing requirements
- Environmental considerations
- Human factors.
- Special Nuclear Material Safeguards
- Security

These reviews are intended to ensure that any modifications to facility systems, structures or components are reflected in current maintenance, operations and other facility procedures.

Change control processes include formality of notification and prompt distribution of affected design and operations documents.

11.1.9 Assessments

Periodic audits and assessments of the configuration management program are conducted to determine the system's effectiveness and to correct deficiencies. These assessments include review of the adequacy of documentation and system walk downs of the as-built facility. Such audits and assessments are discussed in Section 11.5.

Periodic audits and assessments of the configuration management program and of the design confirm that the systems meets their goals and the design is consistent with the design bases. Incident investigations are performed in accordance with the QA Program and associated CAP procedures. Corrective actions are developed as a result of incident investigations and adverse audit/assessment results, in accordance with CAP procedures. The incident investigation process is further described in Section 11.6.

11.2 Maintenance

11.2 Maintenance

This section defines the maintenance and functional testing programs to be implemented for the start-up and operations phase of the facility. Maintenance and functional testing implement management measures to ensure IROFS, as identified in the ISA Summary, will be available and reliable to perform their safety functions for start-up and operations.

- Surveillance/monitoring
- Corrective maintenance
- Preventive maintenance
- Functional testing.

Each of these functions provides important elements of maintaining IROFS as defined in the IROFS Boundary Definitions.

11.2.1 Maintenance Program Description

The Maintenance Program is responsible for all aspects of maintaining SSCs within the IROFS boundaries after turnover of the facility from Construction to Operations. Contractors supporting maintenance activities are subject to the requirements defined in implementing policies and procedures.

The Maintenance Program reports to the Vice President of Operations through the Technical Services Director. The Maintenance Program provides trained and qualified personnel, equipment and procedures for performance of maintenance and functional testing of SSCs at the NEF. The Maintenance organization plans, schedules, tracks, and maintains records for maintenance activities.

11.2.2 Maintenance Interfaces and Functions

Maintenance organizational and functional interfaces provide key elements of IROFS maintenance. Following is a description of key organizational and functional interfaces:

- A. Operations - Operations is a primary interface with maintenance operations. Communications regarding status of systems, planned outages, start-up, unexpected degradations and failures and surveillances all require close coordination between these organizations.
- B. Quality Assurance - The QA Organization provides the requirements for QA Level(s) associated with SSCs through implementation of the QAPD. QA is an approving function for QA Level 1, QA Level 1 Graded, QA Level 1-Fire Protection (QL-1F), QA Level 2AC and QA Level 2 activities as defined in the QAPD, for IROFS related activities.
- C. Procedures - Procedures associated with IROFS maintenance activities are developed and approved in accordance with LES approved processes as described in Section 11.4 of the Safety Analysis Report (SAR).
- D. Engineering - Engineering provides systems descriptions, systems boundaries, as built system drawings and performance specifications which are used to determine maintenance requirements.
- E. Calibration - The calibration of measuring and test equipment is a maintenance function and is maintained in accordance with the QAPD, Section 12.

11.2 Maintenance

11.2.3 Surveillance Monitoring

Surveillance/monitoring is utilized to detect degradation and adverse trends of IROFS so that action may be taken prior to component failure. The monitored parameters are selected based upon their ability to detect the predominant failure modes of the critical components. Data sources include; surveillance, periodic and diagnostic test results, plant computer information, operator rounds, walk downs, as-found conditions, failure trending, and predictive maintenance. Surveillance/monitoring and reporting is required for SSCs that are identified as IROFS and any SSC essential to the function of an IROFS.

Plant performance criteria are established to monitor plant performance and to monitor IROFS functions and component parameters. These criteria are established using Urenco industry experience, operating data, surveillance data, and plant equipment operating experience. These criteria ensure the reliability and availability of IROFS. The performance criteria are also used to demonstrate that the performance or condition of an IROFS is being effectively controlled through appropriate predictive and repetitive maintenance strategies so that IROFS remain capable of performing their intended function.

Surveillance of IROFS is performed at specified intervals. The purpose of the surveillance program is to measure the degree to which IROFS meet performance specifications. The results of surveillances are trended, and when the trend indicates potential IROFS performance degradation, preventive maintenance frequencies are adjusted or other appropriate corrective action is taken.

Incident investigations may identify root causes of failures that are related to the type or frequency of maintenance. The lessons learned from such investigations are factored into the surveillance/monitoring and preventive maintenance programs as appropriate.

Maintenance procedures prescribe compensatory measures, if appropriate, for surveillance tests of IROFS that can be performed only while equipment is out of service.

Records showing the current surveillance schedule, performance criteria, and test results for all IROFS will be maintained in accordance with the Record Management System.

Results of surveillance/monitoring activities related to IROFS via the configuration management program will be evaluated by all safety disciplines to determine any impact on the ISA and any updates needed.

11.2.4 Corrective Maintenance

Corrective maintenance involves repair or replacement of equipment that has unexpectedly degraded or failed. Corrective maintenance of IROFS restores the equipment to acceptable performance through a planned, systematic, controlled, and documented approach for the repair and replacement activities.

Following corrective maintenance on IROFS, and before returning an IROFS to operational status, functional testing of the IROFS, if necessary, is performed to ensure the IROFS performs its intended safety function as described in the ISA.

11.2 Maintenance

The CAP requires facility personnel to determine the cause of conditions adverse to quality and promptly act to correct these conditions.

Results of corrective maintenance activities related to IROFS via the configuration management program will be evaluated by all safety disciplines to determine any impact on the ISA and any updates needed.

11.2.5 Preventive Maintenance

Preventive maintenance (PM) includes preplanned and scheduled periodic refurbishment, partial or complete overhaul, or replacement of IROFS, if necessary, to ensure continued performance of their safety function. Planning for preventive maintenance includes consideration of results of surveillance and monitoring, including failure history. PM also includes instrument calibration and testing.

The PM program procedures and calibration standards (traceable to the national standards system or to nationally accepted calibration techniques, as appropriate) enable facility personnel to calibrate equipment and monitoring devices important to plant safety and safeguards. Testing performed on IROFS that are not redundant will provide for compensatory measures to be put into place to ensure that the IROFS function is performed until it is put back into service.

Urenco's extensive experience in the industry (30 years) is used to determine initial PM frequencies and procedures. Feedback from PM and corrective maintenance and the results of incident investigations and identified root causes are used, as appropriate, to modify the frequency or scope of PM. The rationale for deviations from industry standards or vendor recommendations for PM is documented.

After conducting preventive maintenance on IROFS, and before returning an IROFS to operational status, functional testing of the SSC, if necessary, is performed to ensure the IROFS performs its intended safety function.

All records pertaining to preventive maintenance will be maintained in accordance with the Records Management System.

Off normal results of preventive maintenance activities related to IROFS will be evaluated by all safety disciplines to determine any impact on the ISA and any updates needed.

11.2.6 Functional Testing

Functional testing of IROFS is performed as appropriate following initial installation, as part of periodic surveillance testing, and, as applicable, after corrective or preventive maintenance or calibration to ensure that the item is capable of performing its safety function when required.

The testing program for IROFS consists of Preoperational Functional Testing and Operational Functional Testing.

Results of surveillance/monitoring activities related to IROFS via the configuration management program will be evaluated by all safety disciplines to determine any impact on the ISA and any updates needed.

11.2 Maintenance

11.2.6.1 Functional Testing Objectives

The objectives of the overall facility preoperational and operational testing programs are to ensure that items relied on for safety:

- A. Have been adequately designed and constructed
- B. Meet contractual, regulatory, and licensing requirements
- C. Do not adversely affect worker or the public health and safety
- D. Can be operated in a dependable manner so as to perform their intended function.

Additionally, the preoperational and operational testing programs ensure that operating and emergency procedures are correct and that personnel have acquired the correct level of technical expertise.

Periodic testing at the facility consists of that testing to monitor various facility parameters and to verify the continuing integrity and capability of IROFS.

Special testing at the facility consists of testing not falling under any other testing program. This testing is of a non-recurring nature and is intended to enhance or supplement existing operational testing rather than replace or supersede other testing or testing programs.

11.2.6.2 Content and Format Requirements for Test Procedures

Test Procedures should be sufficiently detailed that qualified personnel can perform the required functions without direct supervision. Test procedures for IROFS testing will be developed and maintained in accordance with the LES procedure development process.

Minimum content of test procedures includes:

- Title
- Purpose
- Prerequisites
- Required System Conditions
- Limit and Precautions
- Acceptance Criteria
- Instructions on how to perform the test in the degree of detail necessary that qualified personnel can perform the required functions without direct supervision.

Test procedures applicable for QL-1 SSCs (typically IROFS) shall be developed, formatted and executed in accordance with Section 11 of the NEF QAPD. Section 21 of the QAPD also provides guidance for Quality Level 1 Graded application. Section 23 of the QAPD also provides guidance for QA Level 1-Fire Protection (QL-1F) application. Administrative IROFS are included within the scope of all testing programs.

Tests are designed to simulate upset conditions for IROFS to the extent practicable.

11.2 Maintenance

11.2.6.3 IROFS Preoperational Functional Testing

Preoperational Functional Tests are completed prior to UF₆ introduction into an SSC to which the particular IROFS applies.

The IROFS Preoperational Functional Test Plan is available to the NRC prior to the start of testing. Revisions to the Preoperational Functional Test Plan are also made available to the NRC. Preoperational Functional Testing as a minimum includes all system or component tests required by the pertinent design code which were not performed by the constructor prior to turnover. In addition, preoperational tests include all testing necessary to demonstrate that the IROFS are capable of performing their intended function.

Preoperational Functional Testing is conducted to determine facility parameters and to verify the capability of IROFS SSCs to meet performance requirements.

The overall Preoperational Functional Testing program is reviewed, prior to initial UF₆ introduction, by the Plant Manager and all affected Functional Area Managers to ensure that all prerequisite testing is complete.

11.2.6.4 IROFS Operational Functional Testing

The Operational Testing program consists of periodic testing and special testing. Periodic testing is conducted at the facility to monitor various facility parameters and to verify the continuing integrity and capability of facility IROFS. Special testing which may be conducted at the facility is testing which does not fall under any other testing program and is of a non-recurring nature.

The Maintenance Manager has overall responsibility for the development and conduct of the Operational Functional Testing program and in conjunction with the Shift Operations Manager and the Licensing Manager ensures that all testing commitments and applicable regulatory requirements are met.

The Health, Safety, and Environmental Manager and Plant Support Director shall ensure that new surveillance requirements or testing commitments are identified to the Maintenance Manager. The Maintenance Manager assigns responsibility for new testing requirements.

Surveillance requirements and procedures are identified and responsibility assigned to complete these requirements within specified intervals.

Operations Shift Managers or designees are also used for operational testing. The Operations Shift Managers or designee has the responsibility to be thoroughly familiar with the SSCs and the procedure(s) used for testing.

The Operations Shift Managers or designees have the following responsibilities regarding the conduct of testing:

- A. Verification of all system and facility prerequisites
- B. Observance of all limits and precautions during the conduct of the test
- C. Compliance with the requirements of the facility license and any other facility directives regarding procedure changes and documentation

11.2 Maintenance

- D. Identifying and taking corrective actions necessary to resolve system deficiencies or discrepancies observed during the conduct of the test
- E. Verification of proper data acquisition, evaluation of results, and compliance with stated acceptance criteria
- F. Ensuring that adequate personnel safety precautions are observed during the conduct of the test
- G. Coordinating and observing additional manpower and support required from other departments or organizations.

The periodic testing program at the facility consists of testing to verify the continuing capability of IROFS to meet performance requirements. The facility periodic test program verifies that the facility:

- A. Complies with all regulatory and licensing requirements
- B. Does not endanger health and minimizes danger to life or property
- C. Is capable of operation in a dependable manner so as to perform its intended function.

The facility periodic testing program begins during the preoperational testing stage and continues throughout the facility's life. A periodic testing schedule is established to ensure that all required testing is performed and properly evaluated on a timely basis. The schedule is reviewed and revised as necessary, to reflect plant operating experience. Testing is scheduled such that the safety of the plant is never dependent on the performance of an IROFS that has not been tested within its specified testing interval.

Periodic test scheduling is implemented by the Maintenance department. The Maintenance department maintains the periodic test status index on a computer database. The database includes all periodic testing, calibration or inspection required by regulatory requirements or licensing commitments, and provides the following information for each test and/or surveillance:

- Test #
- Title
- Equipment #
- Work Request # (if applicable)
- Test Frequency
- Structure / System / Component #
- Last date test was performed
- Next date test is due.

In the event that a test cannot be performed within its required interval due to system or plant conditions, the responsible department promptly notifies the on-duty Shift Manager and processes the condition in accordance with the CAP. The responsible department lists the earliest possible date the test could be performed and the latest date along with the required system or facility condition. The responsible department will ensure that the test is performed as soon as practical once required conditions are met, regardless of the estimated date given earlier.

11.2 Maintenance

Periodic testing and surveillance associated with QA Level 1, QA Level 1 Graded, QA Level 2AC, and QA Level 2 SSCs are performed in accordance with written procedures.

Special testing is testing conducted at the facility that is not a facility Preoperational Functional Test, periodic test, post-modification test, or post-maintenance test. Special testing is of a non-recurring nature and is conducted to determine facility parameters and/or to verify the capability of IROFS to meet performance requirements. Purposes of special testing include, but are not necessarily limited to, the following:

- A. Acquisition of particular data for special analysis
- B. Determination of information relating to facility incidents
- C. Verification that required corrective actions reasonably produce expected results and do not adversely affect the safety of operations
- D. Confirmation that facility modifications reasonably produce expected results and do not adversely affect systems, equipment and/or personnel by causing them to function outside established design conditions; applicable to testing performed outside of a post-modification test.

The determination that a certain plant activity is a Special Test is intended to exclude those plant activities which are routine surveillances, normal operational evolutions, and activities for which there is previous experience in the conduct and performance of the activity. At the discretion of the Plant Manager, any test may be conducted as a special test. In making this determination, facility management includes the following evaluations of characteristics of the activity:

- A. Does the activity involve an unusual operational configuration for which there is no previous experience?
- B. Does the activity have the propensity, if improperly conducted, to significantly affect important facility parameters?
- C. Does the activity involve seldom-performed evolutions, meeting one of the above criteria, in which the time elapsed since the previous conduct of the activity renders prior experience not useful?

11.3 Training and Qualifications

11.3 Training and Qualifications

This section describes the training program for the operations phase of the facility, including preoperational functional testing and initial startup testing. The operations phase is defined as the commercial production of enriched material. The training program requirements apply to those plant personnel who perform activities that affect IROFS, or items that are essential to the function of IROFS.

The QAPD provides training and qualification requirements, during the design, construction, and operations phases, for QA training of personnel performing QA levels 1, QA level 1 Graded, QA Level 1-Fire Protection (QL-1F), QA Level 2AC and QA level 2 work activities; for nondestructive examination, inspection, and test personnel; and for QA auditors.

The principle objective of the LES training program system is to ensure job proficiency of facility personnel through effective training and qualification. The training program system is designed to accommodate future growth and meet commitments to comply with applicable established regulations and standards. Employees are provided with training to establish the knowledge foundation and on-the-job training to develop work performance skills. Continuing training is provided, as required, to maintain proficiency in these knowledge and skill components, and to provide further employee development.

Qualification is indicated by successful completion of prescribed training, demonstration of the ability to perform assigned tasks and the maintenance of requirements established by regulation. Training is designed, developed and implemented according to a systematic approach. A systematic approach may be a graded approach that applies the level of detail needed relative to safety. A graded approach incorporates other acceptable methods to accomplish the analysis, design, development, implementation, and evaluation of training.

11.3.1 Organization and Management of the Training Function

Line managers have responsibility for and authority to develop and effectively conduct training for their personnel. Training responsibilities for line managers are included in position descriptions. The training organization provides support to line managers by facilitating the planning, directing, analyzing, developing, conducting, evaluating, and controlling of a systematic performance-based training process. Performance-based training is used as the primary management tool for analyzing, designing, developing, conducting, and evaluating training.

Facility procedures establish the requirements for the training of personnel performing activities related to IROFS. Additionally they ensure the training program is conducted in a reliable and consistent manner. Procedures also allow for exceptions from training when justified and properly documented and approved by appropriate management.

Lesson plans or other approved process controlling documents are used for classroom and on-the-job training to provide consistent presentation of subject matter. When design changes or facility modifications are implemented, updates of applicable lesson plans are included in the change control process of the configuration management program. During the design and construction phase of this project, initial lesson plans are developed as the material is finalized.

11.3 Training and Qualifications

Training programs and training records at the facility are the responsibility of the Training Manager. Training records are maintained to support management information needs associated with personnel training, job performance, and qualification. Records are maintained on each employee's qualifications, experience, and training. The employee training file shall include records of all general employee training, technical training, and employee development training conducted at the facility. The employee training file shall also contain records of special company sponsored training conducted by others. The training records for each individual are maintained so that they are accurate and retrievable. Training records are retained in accordance with the records management procedures.

11.3.2 Analysis and Identification of Functional Areas Requiring Training

A needs/job analysis is performed and tasks are identified to ensure that appropriate training is provided to personnel working on tasks related to IROFS. Identification of job hazards are referred to as precautions and limitations in the procedure related to that task. These limits and precautions will be part of the needs/job analysis performed for that task.

The training organization consults with management personnel to develop a list of tasks for which personnel training for specific jobs is required. The list of tasks selected for training is reviewed and compared to the training materials as part of the systematic evaluation of training effectiveness. The task list is also updated periodically as necessitated by changes in procedures, processes, plant systems, equipment, or job scope.

11.3.3 Position Training Requirements

Minimum training requirements are developed for those positions whose activities are related to IROFS. Entry-level criteria (e.g., education, technical background, and/or experience) for these positions are contained in position descriptions.

The training program is designed to prepare initial and replacement personnel for safe, reliable and efficient operation of the facility. Appropriate training for personnel of various abilities and experience backgrounds is provided. The level at which an employee initially enters the training program is determined by an evaluation of the employee's past experience, level of ability, and qualifications.

Facility personnel may be trained through participation in prescribed parts of the training program that consists of the following:

- General Employee Training
- Technical Training
- Employee Development/Management-Supervisory Training.

Training is made available to facility personnel to initially develop and maintain minimum qualifications outlined in Chapter 2, Organization and Administration, as described in 2.2.4, Personnel Qualification Requirements. The objective of the training shall be to ensure safe and efficient operation of the facility and compliance with applicable established regulations and requirements. Training requirements shall be applicable to, but not necessarily restricted to, those personnel within the plant organization who have a direct relationship to the operation, maintenance, testing or other technical aspect of the facility IROFS. Training courses are updated prior to use to reflect plant modifications and changes to procedures when applicable.

11.3 Training and Qualifications

Continuing training courses shall be established when applicable to ensure that personnel remain proficient. The training may consist of periodic exercises, instruction, and review of subjects as appropriate to maintain proficiency of personnel assigned to the facility. Section 7, Maintenance of Radiological Contingency Preparedness Capability, of the Emergency Plan provides additional information on personnel training for emergency response tasks.

11.3.3.1 General Employee Training

General Employee Training encompasses those Quality Assurance, radiation protection, safety, emergency and administrative procedures established by facility management and applicable regulations. The safety training for the NEF complies with the applicable sections of Occupational Safety and Health Administration (OSHA) regulations such as 29 CFR 1910 (Occupational Safety and Health Standards), 1910.1200 (Hazard Communication), and with NRC regulations such as 10 CFR 20 (Standards for Protection Against Radiation) and

10 CFR 19 (Notices, Instructions and Reports to Workers: Inspection and Investigations). Continuing training in these areas is conducted as necessary to maintain employee proficiency. All persons under the supervision of facility management (including contractors) must participate in General Employee Training; however, certain facility support personnel, depending on their normal work assignment, may not participate in all topics of this training. Temporary maintenance and service personnel receive General Employee Training to the extent necessary to assure safe execution of their duties.

General Employee Training topics are listed below:

- General administrative controls and procedure use
- Quality Assurance policies and procedures
- Facility systems and equipment
- Nuclear safety (See Section 11.3.3.1.1 - includes the use of dosimetry, protective clothing and equipment)
- Industrial safety, health and first aid
- Emergency Plan and implementing procedures
- Facility Security Programs (includes the protection of classified matter)
- Chemical Safety
- Fire Protection and Fire Brigade (see Section 11.3.3.1.2)

11.3.3.1.1 Nuclear Safety Training

Training programs are established for the various types of job functions (e.g., operations, maintenance, radiation protection technician, contractor personnel) commensurate with criticality safety and/or radiation safety responsibilities associated with each such position. Visitors to the Controlled Access Area are escorted by trained personnel while in the Controlled Access Area.

Nuclear Safety training is highlighted to stress the high level of importance placed on the radiological, criticality and chemical safety of plant personnel and the public. This training is structured as follows:

11.3 Training and Qualifications

- A. Personnel access procedures ensure the completion of nuclear safety training prior to permitting unescorted access into the Controlled Access Area.
- B. Training sessions covering criticality safety, radiation protection and emergency procedures are conducted on a regular basis to accommodate new employees or those attending continuing training. Topics covered in these sessions depend upon the job responsibilities and include the following – when applicable to the job responsibility:
- Notices, reports and instructions to workers
 - Practices designed to keep radiation exposures ALARA
 - Methods of controlling radiation exposures
 - Contamination control methods (including decontamination)
 - Use of monitoring equipment
 - Emergency procedures and actions
 - Nature and sources of radiation
 - Safe use of chemicals
 - Biological effects of radiation
 - Use of personnel monitoring devices
 - Principles of nuclear criticality safety
 - Risk to pregnant females
 - Radiation protection practices
 - Protective clothing
 - Respiratory protection
 - Personnel surveys.

Criticality safety training shall be in accordance with ANSI/ANS-8.19 and ANSI/ANS-8.20.

Individuals attending these sessions must pass an initial examination covering the training contents to assure the understanding and effectiveness of the training. The effectiveness of the training programs is also evaluated by audits and assessments of operations and maintenance personnel responsible for following the requirements related to the topics listed above.

Newly hired or transferred employees reporting for work prior to the next regularly scheduled training session must complete nuclear safety training prior to unescorted access into the Controlled Access Area.

Since contractor employees perform diverse tasks in the Controlled Access Area, training for these employees is designed to address the type of work they perform. In addition to applicable radiation safety topics, training contents may include Radiation Work Permits, special bioassay sampling, and special precautions for welding, cutting, and grinding in the Controlled Access Area.

These training programs are conducted by instructors assigned by the Training and Support Services Manager as having the necessary knowledge to address criticality safety and radiation protection. Records of the training programs are maintained as described in Section 11.7, "Records Management."

- C. Individuals requiring unescorted access to the Controlled Access Area receive annual continuing training.

11.3 Training and Qualifications

- D. Contents of the nuclear safety training programs and the radiation protection programs are reviewed and updated through curriculum meetings at least every two years. These curriculum meetings are chaired by the Plant Support Director, or designee.
- E. Operational personnel are further instructed in the specific safety requirements of their work assignments by qualified personnel during on-the-job training. Employees must demonstrate understanding of work assignment requirements based on observations by qualified personnel before working without direct supervision. Changes to work procedures including safety requirements are reviewed with operational personnel by their immediate supervisor or delegate.

11.3.3.1.2 Fire Brigade Training

The primary purpose of the Fire Brigade Training Program is to develop a group of facility employees skilled in fire prevention, fire fighting techniques, first aid procedures, and emergency response. They are trained and equipped to function as a team for the fighting of fires. The intent of the facility fire brigade is to be a first response effort designed to supplement the local fire department for fires at the plant. The facility fire brigade is not intended to replace local fire fighters.

The Fire Brigade Training Program provides for initial training of all new fire brigade members, semi-annual classroom training and drills, annual practical training, and leadership training for fire brigade leaders.

11.3.3.2 Technical Training

Technical training is designed, developed and implemented to assist facility employees in gaining an understanding of applicable fundamentals, procedures, and practices related to IROFS. Also, technical training is used to develop manipulative skills necessary to perform assigned work related to IROFS. Technical training consists of four segments:

- Initial Training
- On-the-Job Training and Qualifications
- Continuing Training
- Special Training.

11.3.3.2.1 Initial Training

Initial job training is designed to provide an understanding of the fundamentals, basic principles, and procedures involved in work related to IROFS that an employee is assigned. This training may consist of, but is not limited to, live lectures, taped and filmed lectures, self-guided study, demonstrations, laboratories and workshops and on-the-job training.

Certain new employees or employees transferred from other sections within the facility may be partially or wholly qualified by reason of previous applicable training or experience. The extent of further training for these employees is determined by applicable regulations, performance in review sessions, comprehensive examinations, or other techniques designed to identify the employee's present level of ability.

Initial job training and qualification programs are developed for operations, maintenance and technical services classifications. Training for each program is grouped into logical blocks or

11.3 Training and Qualifications

modules and presented in such a manner that specific behavioral objectives are accomplished. Trainee progress is evaluated using written examinations, oral or practical tests. Depending upon the regulatory requirements or individual's needs and plant operating conditions, allowances are made to suit specific situations. Brief descriptions of modules that may be contained in the initial training programs are as follows:

Operator Initial Training

- A. **Fundamentals**
This training module provides the trainee with basic concepts and fundamentals.
- B. **Plant Familiarization**
The Plant Familiarization module provides for the orientation of employees to plant layout, plant systems, and practical laboratory and equipment work at the facility.
- C. **Specific Systems**
This training module provides instruction in system and component identification and system operating characteristics. It provides specific instruction on enrichment plant equipment and acquaints the trainees with enrichment plant terminology and nomenclature.
- D. **On the Job Training**
This training provides the student with hands-on training to safely operate enrichment systems.

Mechanical Maintenance Initial Training

- A. **General Maintenance Fundamentals**
This training module provides the trainee with basis maintenance concepts and fundamentals as well as an introduction to plant systems.
- B. **Shop Basic Skills**
This training module provides instruction in fundamentals of mechanical maintenance performance. It combines academic instruction with hands-on training to familiarize trainees with design, operational, and physical characteristics of enrichment facility components, and basic skills and procedures used to perform mechanical repairs and/or equipment replacement.
- C. **Advanced Skills**
This training module provides plant specific component related training for designated mechanics.

Plant Control and Energy Systems Initial Training

- A. **General Maintenance Fundamentals**
This training module provides the trainee with basis maintenance concepts and fundamentals as well as an introduction to the plant systems.
- B. **Basic Instrument and Electrical Skills**

11.3 Training and Qualifications

This training module provides the trainee with refresher training in Electrical and Electronic Fundamentals, Digital Techniques and Application, Instrumentation and Control Theory and Application, and an introduction to the types and proper use of measuring and test equipment commonly used in enrichment facilities, including the hazards of calibration errors and calibration during plant operation

C. Advanced Skills

This training module provides plant specific component related training for designed Technicians.

Health Physics and Chemistry Initial Training

A. Fundamental Health Physics

The Fundamental Health Physics Module presents to the trainees a more comprehensive and theoretical understanding of the nuclear processes with which they are involved. This module also provides for the orientation of employees to plant systems and basic Radiation Protection topics.

B. Health Physics Specific

This training includes the use of plant specific equipment including portable instruments, lab equipment, and plant equipment. Administrative material is also presented in a more detailed manner.

C. Fundamental Chemistry

The Fundamental Chemistry module provides familiarization with chemistry theory, techniques, and procedures. This module also provides for the orientation of employees to plant systems and basic Chemistry topics. The overall goal of this module is familiarization necessary for chemistry technicians to be able to work safely and competently at the NEF.

D. Chemistry Specific

This training includes the use of plant specific equipment including portable instruments, lab equipment, and plant installed equipment.

Engineer/ Support Personnel Initial Training

This training is part of the Engineering and Support Personnel training program and includes ISA Engineers.

A. Orientation

This training module covers administrative procedures, systems and components, and fundamental information related to enrichment plant operations including a basic understanding of how uranium is enriched.

B. Position Specific Training

Provides training on job responsibilities and processes that prepare and qualify individuals to independently perform selected activities safely and effectively. The qualification guide identifies job performance requirements that must be accomplished while working in this section.

11.3 Training and Qualifications

11.3.3.2.2 On-the-Job Training and Qualifications

On-the-job training (OJT) is a systematic method of providing the required job related skills and knowledge for a position. This training is conducted in an environment as close to the work environment as feasible. Applicable tasks and related procedures make up the OJT/qualifications program for each technical area. Training is designed to supplement and complement training received through classroom, laboratory, and/or the part-task trainer (PCS Trainer).

11.3.3.2.3 Continuing Training

Continuing training is any training not provided as initial qualification or basic training that maintains and improves job-related knowledge and skills such as the following:

- Facility systems and component changes
- Policy and procedure changes
- Operating experience program documents review to include Industry and in-house operating experiences
- Continuing training required by regulation (e.g., emergency plan training)
- General employee, special, administrative, vendor, and/or advanced training topics supporting tasks that are elective in nature
- Training identified to resolve deficiencies (task-based) or to reinforce seldom used knowledge skills
- Refresher training on initial training topics
- Structured pre-job instruction, mock-up training, and walk throughs
- Quality awareness.
- Requalification Training
- Training designed to maintain proficiency

Continuing Training consists of classroom and other components performed on a frequency needed to maintain proficiency on the job. Each Section's Continuing Training Program is developed from a systematic approach.

Once the objectives for Continuing Training have been established, the methods for conducting the training may vary. The method selected must provide clear evidence of objective accomplishment and consistency in delivery.

11.3.3.2.4 Special Training

Special training involves those subjects of a unique nature required for a particular area of work.

11.3.4 Basis and Objectives for Training

Learning objectives identify the training content, as established by needs/job analyses and position-specific requirements. The task list from the needs/job analysis is used to develop action statements that describe the desired post-training performance. Objectives include the knowledge, skills, and abilities the trainee should demonstrate; the conditions under which

11.3 Training and Qualifications

required actions will take place; and the standards of performance the trainee should achieve upon completion of the training activity.

11.3.5 Organization of Instruction, Using Lesson Plans and Other Training Guides

Lesson plans are developed from the learning objectives that are based on job performance requirements. Lesson plans and other training guides are developed under the guidance of the training function. Lesson plans are reviewed by the training function and, generally, by the organization cognizant of the subject matter. Lesson plans or other approved process controlling documents are approved prior to issue or use. Lesson plans are used for classroom training and on-the-job training as required and include Standards for evaluating acceptable trainee performance.

11.3.6 Evaluation of Trainee Learning

Trainee understanding and command of learning objectives is evaluated through observation/demonstration or oral or written tests as appropriate. Such evaluations measure the trainee's skills and knowledge of job performance requirements.

Evaluations are performed by individuals qualified in the training subject matter.

11.3.7 Conduct of On-the-Job Training

On-the-Job Training is an element of the technical training program (see Section 11.3.3.2.2, On-the-Job Training and Qualifications). On-the-job training is used in combination with classroom training for activities that are IROFS. Designated personnel who are competent in the program standards and methods of conducting the training conduct on-the-job training using current performance-based training materials. Completion of on-the-job training is demonstrated by actual task performance or performance of a simulation of the task with the trainee explaining task actions using the conditions encountered during the performance of the task, including references, tools, and equipment reflecting the actual task to the extent practical.

11.3.8 Evaluation of Training Effectiveness

Periodically the training program is systematically evaluated to measure the program's effectiveness in producing competent employees. The trainees are encouraged to provide feedback after completion of classroom training sessions to provide data for this evaluation for program improvements. These evaluations identify program strengths and weaknesses, determine whether the program content matches current job needs, and determine if corrective actions are needed to improve the program's effectiveness. The training function is responsible for leading the training program evaluations and for implementing any corrective actions. Program evaluations may consist of an overall periodic evaluation or a series of topical evaluations over a given period.

Evaluation objectives that are applicable to the training program or topical area being reviewed are developed and may address the following elements of training:

- Management and administration of training and qualification programs
- Development and qualification of the training staff
- Position training requirements

11.3 Training and Qualifications

- Determination of training program content, including its facility change control interface with the configuration management system
- Design and development of training programs feedback, including lesson plans
- Conduct of training
- Trainee examinations and evaluations
- Training program assessments and evaluations.

Evaluation results are documented, with program strengths and weaknesses being highlighted. Identified weaknesses are reviewed, improvements are recommended, and changes are made to procedures, practices, or training materials as necessary.

Periodically, training and qualifications activities are monitored by designated facility and/or contracted training personnel. The Quality Assurance Department audits the facility training and qualification system. In addition, trainees and vendors may provide input concerning training program effectiveness. Methods utilized to obtain this information include, among other things surveys, questionnaires, performance appraisals, staff evaluation, and overall training program effectiveness evaluation instruments. Frequently conducted classes are not evaluated each time. However, they are routinely evaluated at a frequency sufficient to determine program effectiveness. Evaluation information may be collected through:

- Verification of program objectives as related to job duties for which intended
- Periodic working group program evaluations
- Testing to determine trainee accomplishment of objectives
- Trainee evaluation of the instruction
- Supervisor's evaluation of the trainee's performance after training on-the-job
- Supervisor's evaluation of the instruction.

Unacceptable individual performance is transmitted to the appropriate Line Manager.

11.3.9 Personnel Qualification

The qualification requirements for key management positions are described in Chapter 2, Organization and Administration. Training and qualification requirements associated with QA personnel are provided in Appendix A to this chapter. In addition, qualification and training requirements for operators shall be established and implemented in plant procedures.

11.3.10 Periodic Personnel Evaluations

Personnel performing activities related to IROFS are evaluated at least biennially (once every two years) to determine whether they are capable of continuing their activities that are related to IROFS. The evaluation may be by written test, oral test, or on-the-job performance observation by the supervisor. The results of the evaluation are documented. When the results of the evaluation dictate, retraining or other appropriate action is provided. Continuing training is also required due to plant modifications, procedure changes, and QAPD changes that result in new or revised information.

11.4 Procedures Development and Implementation

11.4 Procedures Development and Implementation

The requirements for independent verification are consistent with the applicable guidance provided in ANSI/ANS-3.2, "Administrative Controls and Quality Assurance for the Operational Phase of Nuclear Power Plants."

All activities involving licensed materials or IROFS are conducted in accordance with approved procedures. Procedures are made available to the NRC for their inspection. As noted throughout this document, procedures are used to control activities in order to ensure the activities are carried out in a safe manner and in accordance with regulatory requirements.

Generally, four types of plant procedures are used to control activities: operating procedures, administrative procedures, maintenance procedures, and emergency procedures.

Operating procedures, developed for workstation and Control Room operators, are used to directly control process operations. Operating procedures include, as applicable:

- Purpose of the activity
- Regulations, polices, and guidelines governing the procedure
- Type of procedure
- Steps for each operating process phase:
 - Initial startup
 - Normal operations
 - Temporary operations
 - Emergency shutdown
 - Emergency operations
 - Normal shutdown
 - Startup following an emergency or extended downtime.
- Hazards and safety considerations
- Operating limits
- Precautions necessary to prevent exposure to hazardous chemicals (resulting from operations with Special Nuclear Material (SNM)) or to licensed SNM.
- Measures to be taken if contact or exposure occurs
- IROFS associated with the process and their functions
- The timeframe for which the procedure is valid.

Applicable safety limits and IROFS are clearly identified in the procedures. LES will incorporate methodology for identifying, developing, approving, implementing, and controlling operating procedures. Identifying needed procedures will include consideration of ISA results. The method will ensure that, as a minimum:

- Operating limits and IROFS are specified in the procedure
- Procedures include required actions for off-normal conditions of operation, as well as normal operations
- If needed safety checkpoints are identified at appropriate steps in the procedure
- Procedures are validated through field tests

11.4 Procedures Development and Implementation

- Procedures are approved by Functional Area Managers responsible and accountable for the operation
- A mechanism is specified for revising and reissuing procedures in a controlled manner
- The QA elements and CM Program at the facility provide reasonable assurance that current procedures are available and used at all work locations
- The facility training program trains the required persons in the use of the latest procedures available.

Administrative procedures are used to perform activities that support the process operations, including management measures such as the following:

- Configuration management
- Nuclear criticality, radiation, chemical, and fire safety
- Quality Assurance
- Design control
- Plant personnel training and qualification
- Audits and assessments
- Incident investigations
- Record keeping and document control
- Reporting
- Procurement.

Administrative procedures are also used for:

- Implementing the Fundamental Nuclear Material Control (FNMC) Plan
- Implementing the Emergency Plan
- Implementing the Physical Security Plan
- Implementing the Standard Practice Procedures Plan for the Protection of Classified Matter.

Maintenance procedures address:

- Preventive and corrective maintenance of IROFS
- Surveillance (includes calibration, inspection, and other surveillance testing)
- Functional testing of IROFS
- Requirements for pre-maintenance activity involving reviews of the work to be performed and reviews of procedures.

Emergency procedures address the preplanned actions of operators and other plant personnel in the event of an emergency.

Procedures will be established and implemented for nuclear criticality safety in accordance with ANSI/ANS-8.19. The NCS procedures will be written such that no single, inadvertent departure from a procedure could cause an inadvertent criticality. Nuclear criticality safety postings at the NEF are established that identify administrative controls applicable and appropriate to the activity or area in question. Nuclear criticality safety procedures and postings are controlled by procedure to ensure that they are maintained current.

Periodic reviews will be performed on procedures to assure their continued accuracy and usefulness. Specifically, reviews of operating procedures and radiation protection procedures

11.4 Procedures Development and Implementation

will be conducted at a minimum of every five years and reviews of emergency procedures will be conducted at a minimum of every year. In addition, applicable procedures will be reviewed after unusual incidents, such as an accident, unexpected transient, significant operator error, or equipment malfunction, or after any modification to a system, and procedures will be revised as needed.

11.4.1 Preparation of Procedures

Each procedure is assigned to a member of the facility staff or contractor for development. Initial procedure drafts are reviewed by other appropriate members of the facility staff, by personnel from the supplier of centrifuges (Urenco), and other vendors, as appropriate for inclusion and correctness of technical information, including formulas, set points, and acceptance criteria and includes either a walkdown of the procedure in the field or a tabletop walkthrough. Procedures that are written for the operation of IROFS shall be subjected to a peer review. The Functional Area Manager shall determine whether or not any additional, cross-disciplinary review is required and shall approve all procedures.

11.4.2 Administrative Procedures

Facility administrative procedures are written by each department as necessary to control activities that support process operations, including management measures. Listed below are several areas for which administrative procedures are written, including principle features:

- A. Operator's authority and responsibility: The operator is given the authority to manipulate controls which directly or indirectly affect the enrichment process, including a shut down of the process if deemed necessary by the Shift Manager. The operators are also assigned the responsibility for knowing the limits and set points associated with safety-related equipment and systems as specified in designated operating procedures.
- B. Activities affecting facility operation or operating indications: All facility maintenance personnel performing support functions (e.g., maintenance, testing) which may affect unit operation or Control Room indications are required to notify the Control Room Operator and/or Shift Manager, as appropriate, prior to initiating such action.
- C. Manipulation of facility control: No one is permitted to manipulate the facility controls who is not an operator, except for operator trainees under the direction of a qualified operator.
- D. Relief of Duties: This procedure provides a detailed checklist of applicable items for shift turnover.
- E. Equipment control: Equipment control is maintained and documented through the use of tags, labels, stamps, status logs or other suitable means.
- F. Master surveillance testing schedule: A master surveillance testing schedule is documented to ensure that required testing is performed and evaluated on a timely basis. Surveillance testing is scheduled such that the safety of the facility is not dependent on the performance of a structure, system or component which has not been tested within its specified testing interval. The master surveillance testing schedule identifies surveillance and testing requirements, applicable procedures, and required test frequency. Assignment of responsibility for these requirements is also indicated.
- G. A Control Room Operations Logbook is maintained. This logbook contains significant events during each shift such as enrichment changes, alarms received, or abnormal operational conditions.

11.4 Procedures Development and Implementation

- H. Fire Protection Procedures: Fire protection procedures are written to address such topics as training of the fire brigade, reporting of fires, and control of fire stops. The Fire Protection Officer has responsibility for fire protection procedures in general, with the facility's maintenance section having responsibility for certain fire protection procedures such as control of repairs to facility fire stops.

The administrative control of maintenance is maintained as follows:

- A. In order to assure safe, reliable, and efficient operation, a comprehensive maintenance program for the facility's IROFS is established.
- B. Personnel performing maintenance activities are qualified in accordance with applicable codes and standards and procedures.
- C. Maintenance is performed in accordance with written procedures that conform to applicable codes, standards, specifications, and other appropriate criteria.
- D. Maintenance is scheduled so as not to jeopardize facility operation or the safety of facility personnel.
- E. Maintenance histories are maintained on facility IROFS.

The administrative control of facility modifications is discussed in Section 2.3.1, Configuration Management.

11.4.3 Procedures

All activities involving licensed materials or IROFS are conducted in accordance with approved procedures. These procedures are intended to provide a pre-planned method of conducting operations of systems in order to eliminate errors due to on-the-spot analysis and judgments.

All procedures are sufficiently detailed that qualified individuals can perform the required functions without direct supervision. However, written procedures cannot address all contingencies and operating conditions. Therefore, they contain a degree of flexibility appropriate to the activities being performed. Procedural guidance exists to identify the manner in which procedures are to be implemented. For example, routine procedural actions may not require the procedure to be present during implementation of the actions, while complex jobs, or checking with numerous sequences may require valve alignment checks, approved operator aids, or in-hand procedures that are referenced directly when the job is conducted.

Examples of operating activities are:

- Evacuation and Preparatory Work Before Run Up of a Cascade
- Run Up of a Cascade
- Run Down of a Cascade
- Calibration of Pressure Transmitter
- Taking UF₆ Samples of a Cascade
- Installation of UF₆ Cylinders in Feed/Take-off Stations and Preparation for Operation
- Removal of UF₆ Cylinder from Feed/Take-off Stations
- Installation of UF₆ Cylinders in Take-off Stations
- UF₆ Gas Sampling in Take-off Lines
- UF₆ Sampling in Product Liquid Sampling Autoclaves

11.4 Procedures Development and Implementation

- Emptying of Cold Trap
- Exchange of Chemical Traps in Vent Systems.

Plant specific procedures for abnormal events are written for the facility. These procedures are based on a sequence of observations and actions, with emphasis placed on operator responses to indications in the Control Room. When immediate operator actions are required to prevent or mitigate the consequences of an abnormal situation, procedures require that those actions be implemented at the earliest possible time, even if full knowledge of the abnormal situation is not yet available. The actions outlined in abnormal event procedures are based on a conservative course of action to be followed by the operating crew.

Typical abnormal event procedures include:

- Power Failure
- Loss of Heat Tracing
- Damaged UF₆ Cylinder Repairs
- Communicator alarms (procedures to include alarm set points, probable causes, automatic actions, immediate manual actions, supplementary actions and applicable references).

Temporary changes to procedures are issued for operating activities that are of a nonrecurring nature. Temporary changes to procedures are used when revision of an operating or other permanent procedure is not practical. Temporary changes to procedures shall not involve a change to the ISA and shall not alter the intent of the original procedure. Examples of uses of temporary changes to procedures are:

- To direct operating activities during special testing or maintenance
- To provide guidance in unusual situations not within the scope of normal procedures
- To ensure orderly and uniform operations for short periods of time when the facility, a unit, a cascade, a structure, a system or a component is performing in a manner not addressed by existing procedures or has been modified in such a manner that portions of existing procedures do not apply.

The temporary changes to procedures are approved by two members of the facility management staff, at least one of whom is a shift manager. Temporary changes to procedures are documented, reviewed and approved with the process described in Section 11.4.4, Changes to Procedures, within 14 days of implementation.

Maintenance of facility structures, systems and components is performed in accordance with written procedures, documented instructions, checklists, or drawings appropriate to the circumstances (for example, skills normally possessed by qualified maintenance personnel may not require detailed step-by-step delineation in a written procedure) that conform to applicable codes, standards, specifications, and other appropriate criteria.

The facility's maintenance department under the Maintenance Manager has responsibility for preparation and implementation of maintenance procedures. The maintenance, testing and calibration of facility IROFS is performed in accordance with approved written procedures.

Testing conducted on a periodic basis to determine various facility parameters and to verify the continuing capability of IROFS to meet performance requirements is conducted in accordance

11.4 Procedures Development and Implementation

with approved, written procedures. Periodic test procedures are utilized to perform such testing and are sufficiently detailed that qualified personnel can perform the required functions without direct supervision. Testing performed on IROFS that are not redundant will provide for compensatory measures to be put into place to ensure that the IROFS performs until it is put back into service.

Periodic test procedures are performed by the facility's Operations and Maintenance departments. The Maintenance Manager has overall responsibility for assuring that the periodic testing is in compliance with the requirements.

Chemical and radiochemical activities associated with facility IROFS are performed in accordance with approved, written procedures. The facility's chemistry department has responsibility for preparation and implementation of chemistry procedures.

Radioactive waste management activities associated with the facility's liquid, gaseous, and solid waste systems are performed in accordance with approved written procedures. These procedures will be prepared and implemented by one or more facility departments (e.g., waste processing, environmental, chemistry, radiation protection, operations), as appropriate.

Likewise, other departments at the facility develop and implement activities at the facility through the use of procedures.

Procedures will include provisions for operations to stop and place the process in a safe condition if a step of a procedure cannot be performed as written.

11.4.4 Changes to Procedures

Changes to procedures shall be processed as described below.

- A. The preparer documents the change as well as the reason for the change.
- B. An evaluation shall be performed in accordance with 10 CFR 70.72 (CFR, 2003e) as appropriate. If the evaluation reveals that a change to the license is needed to implement the proposed changes, the change is not implemented until prior approval is received from the NRC.
- C. The procedure with proposed changes shall be reviewed by a designated reviewer.
- D. The Functional Area Manager shall be responsible for approving procedure changes, and for determining whether a cross-disciplinary review is necessary, and by which department(s). The need for the following cross-disciplinary reviews shall be considered, as a minimum:
 1. For proposed changes having a potential impact on chemical or radiation safety, a review shall be performed for chemical and radiation hazards.
 2. Proposed changes having a potential impact on criticality safety shall be reviewed by a criticality safety engineer. Any necessary controlled parameters, limits, IROFS, management measures, or NCS analyses that must be imposed or revised are adequately reflected in appropriate procedures and/or design basis documents.
 3. For proposed changes potentially affecting Material Control and Accounting, a material control review shall be performed.

11.4 Procedures Development and Implementation

Records of completed cross-functional reviews shall be maintained in accordance with Section 11.7, Records Management, for all changes to procedures involving licensed materials or IROFS.

11.4.5 Distribution of Procedures

Originally issued approved procedures and approved procedure revisions are distributed in a controlled manner by document control.

Document Control shall establish and maintain an index of the distribution of copies of all facility procedures. Revisions are controlled and distributed in accordance with this index. Indexes are reviewed and updated on a periodic basis or as required.

Functional Area Managers or their designees shall be responsible for ensuring all personnel doing work which require the use of the procedures have ready access to controlled copies of the procedures.

11.5 Audits and Assessments

11.5 Audits and Assessments

LES will have a tiered approach to verifying compliance to procedures and performance to regulatory requirements.

11.5.1 ASSESSMENTS

Assessments are focused on effectiveness of activities and ensuring that IROFS, and any items that are essential to the function of IROFS, are reliable and are available to perform their intended safety functions. This approach includes performing Assessments on critical work activities associated with facility safety, environmental protection and other areas as identified via trends.

Assessments are divided into two categories that will be owned and managed by the line organizations as follows:

- Management Assessments conducted by the line organizations responsible for the work activity
- Independent Assessments conducted by individuals not involved in the area being assessed.

Assessments are performed to assure that facility activities are conducted in accordance with the written procedures and that the processes reviewed are effective. As a minimum, these assessments shall assess activities related to radiation protection, criticality safety control, hazardous chemical safety, industrial safety including fire protection, and environmental protection.

Personnel performing assessments do not require certification, but they are required to complete QA orientation training, as well as training on the assessment process. The nuclear criticality safety assessments are performed under the direction of the criticality safety staff. Personnel performing these assessments do not report to the production organization and have no direct responsibility for the function or area being assessed. Assessments are conducted using approved procedures that meet the QAPD requirements. A schedule is established and maintained that identifies assessments to be performed and the responsible organization assigned to conduct the activity.

Assessments shall be performed routinely by qualified staff personnel that are not directly responsible for production activities. Deficiencies identified during the assessments requiring corrective action shall be forwarded to the responsible manager of the applicable area or function for action in accordance with the CAP procedure.

The Operations Group is assessed periodically to ensure that nuclear critical safety procedures are being followed and the process conditions have not been altered to adversely affect nuclear criticality safety. The frequency of these assessments is based on the controls identified in the NCS analyses and NCS evaluations. Assessments are conducted at least semi-annually. In addition, weekly nuclear criticality safety walkthroughs of UF₆ process areas are conducted and documented.

Assessment results are tracked and the data is periodically analyzed for potential trends. Needed program improvements are identified to prevent recurrence and/or for continuous

11.5 Audits and Assessments

program improvements. The resulting trend is evaluated and reported to applicable management. This report documents the effectiveness of management measures in controlling activities, as well as deficiencies. Deficiencies identified in the trend report require corrective action in accordance with the applicable CAP procedure.

Assessments of nuclear criticality safety, performed in accordance with ANSI/ANS-8.19, will ensure that operations conform to criticality requirements.

11.5.2 AUDITS

Audits of the QA Level 1, QA Level 1 Graded, and QA Level 1-Fire Protection (QI-1F) work activities are performed in accordance with the QAPD. The audit scope will include those activities associated with IROFS and any items that are essential to the function of the IROFS and items required to satisfy regulatory requirements for which QA Level 1, QA Level 1 Graded, and QL-1F requirements are applied will be the responsibility of the QA Department. Audits are focused on verifying compliance with regulatory and procedural requirements and licensing commitments.

Audits are performed to assure that facility activities are conducted in accordance with the written procedures and that the processes reviewed are effective. As a minimum, they shall assess activities related to radiation protection, criticality safety control, hazardous chemical safety, industrial safety including fire protection, and environmental protection.

Audits shall be performed routinely by qualified staff personnel that are not directly responsible for production activities. Deficiencies identified during the audits requiring corrective action shall be forwarded to the responsible manager of the applicable area or function for action in accordance with the CAP procedure. Future audits shall include a review to evaluate if corrective actions have been effective.

The Quality Assurance Department shall be responsible for performing the audits. Audits shall be performed in accordance QAPD requirements. The Audit Team members shall not have direct responsibility for the function and area being audited. Team members shall have technical expertise or experience in the area being audited and shall be indoctrinated in audit techniques. Audits shall be conducted on an annual basis periodically as described in the QAPD. The frequency of audits is based upon the status and safety importance of the activities being performed and upon work history. All major activities will be audited on an annual basis. The audit schedule is reviewed periodically and revised as necessary to ensure coverage commensurate with current and planned activities. All aspects of the Nuclear Criticality Safety Program will be audited at least every two years.

Corrective actions following issuance of the audit report require compliance with the applicable CAP procedures. Audit reports are required to contain an effectiveness evaluation and statement for each of the applicable QA program elements reviewed during the audit. The audit is closed with the proper documentation as required by the applicable audit procedure. The QA organization will conduct follow-up audits to verify that corrective actions were taken in a timely manner. In addition, future audits will include a review to evaluate if corrective actions have been effective.

The QA Manager initiates audits. The responsible Lead Auditor and QA Manager determine the scope of each audit and may initiate special audits or expand the scope of scheduled audits.

11.5 Audits and Assessments

The Lead Auditor directs the audit team in developing checklists, instructions, or plans and performance of the audit in accordance with the QAPD.

The results of the audits shall be provided in a written report in a timely manner to the Plant Manager, the Safety Review Committee (SRC), and the Managers responsible for the activities audited. Any deficiencies noted in the audits shall be entered into the CAP, responded to promptly by the responsible Managers or designees, and tracked to completion and re-examined during future audits to ensure completion of corrective actions.

Auditors and lead auditors are responsible for performing audits in accordance with the applicable QA procedures. Auditors and lead auditors hold certifications as required by the QAPD. Certification of auditors and lead auditors is based on the QA Manager's evaluation of education, experience, professional qualifications, leadership, sound judgment, maturity, analytical ability, tenacity, and past performance and completion of QA training courses. A lead auditor must also have participated in a minimum of five QA audits or audit equivalent within a period of time not to exceed three years prior to the date of certification. Audit equivalents include assessments, pre-award evaluations or comprehensive surveillances (provided the prospective lead auditor took part in the planning, checklist development, performance, and reporting of the audit equivalent activities). One audit must be a nuclear-related QA audit or audit equivalent within the year prior to certification.

QAPD, Section 18 "Audits" provides additional details regarding the QA Audit program requirements.

Records of the instructions and procedures, persons conducting the audits or assessments, and identified violations of license conditions and corrective actions taken shall be maintained.

11.6 Incident Investigations and Corrective Action Process

11.6 Incident Investigations and Corrective Action Process

Procedures are established to ensure conditions adverse to quality, such as failures, malfunctions, deficiencies, deviations, defective material and equipment and nonconformances are promptly identified and corrected as soon as practicable. Significant conditions adverse to quality are investigated to determine the cause, and corrective actions are taken to preclude repetition. For significant conditions adverse to quality, the causes and corrective actions are documented and reported to the appropriate management personnel. Follow-up action is performed to verify implementation of the corrective actions.

The corrective action program provides for reporting abnormal events as required by 10 CFR 70.50 (CFR, 2003c) and 70.74 (CFR, 2003f).

Failures and degradation of IROFS and management measures are recorded in the corrective action program upon discovery. Subsequent investigations and records are recorded promptly and are maintained within the corrective action program. Records of IROFS and management measure failures and degradations required by 10 CFR 70.62(a)(3) (CFR, 2003d) include the IROFS or management measure, the affected safety function, date of discovery and date of failure (or estimated date), the duration or estimated duration that the item was unable to perform its safety function, other affected IROFS or management measures and their safety function, affected processes, cause of the failure, a determination of whether the failure was in the context of the performance requirements or upon demand or both, and any compensatory or corrective actions taken.

QAPD, Section 16 "Corrective Action" provides additional details regarding the CAP requirements.

11.7 Records Management

11.7 Records Management

Records management shall be performed in a controlled and systematic manner in order to provide identifiable and retrievable documentation. Applicable design specifications, procurement documents, or other documents specify the QA records to be generated by, supplied to, or held, in accordance with approved procedures. QA records are not considered valid until they are authenticated and dated by authorized personnel.

The QAPD requires procedures for reviewing, approving, handling, identifying, retention, retrieval and maintenance of quality assurance records. These records include the results of tests and inspections required by applicable codes and standards, construction, procurement and receiving records, personnel certification records, design calculations, purchase orders, specifications and amendments, procedures, incident investigation results and approvals or corrective action taken, various certification forms, source surveillance and audit reports, component data packages, and any other QA documentation required by specifications or procedures. These records are maintained at locations where they can be reviewed and audited to establish that the required quality has been assured.

For computer codes and computerized data used for activities relied on for safety, as specified in the ISA Summary, procedures are established for maintaining readability and usability of older codes and data as computing technology changes. For example, procedures allow older forms of information and codes for older computing equipment to be transferred to contemporary computing media and equipment.

The facility maintains a Master File that access to, and use of is controlled. Documents in the Master File shall be legible and shall be identifiable as to the subject to which they pertain. Documents shall be considered valid only if stamped, initialed, signed or otherwise authenticated and dated by authorized personnel. Documents in the Master File may be originals or reproduced copies. Computer storage of data may be used in the Master File.

In order to preclude deterioration of records in the Master File, the following requirements are applicable:

- A. Records shall not be stored loosely. Records shall be firmly attached in binders or placed in folders or envelopes. Records should be stored in steel file cabinets.
- B. Special processed records, e.g., radiographs, photographs, negatives, microfilm, which are light-sensitive, pressure-sensitive and/or temperature-sensitive, shall be packaged and stored as recommended by the manufacturer of these materials.
- C. Computer storage of records shall be done in a manner to preclude inadvertent loss and to ensure accurate and timely retrieval of data. Dual-facility records storage uses an electronic data management system and storage of backup tapes in a fireproof safe.

The Master File storage system shall provide for the accurate retrieval of information without undue delay. Written instructions shall be prepared regarding the storage of records in a Master File, and a supervisor shall be designated the responsibility for implementing the requirements of the instructions. These instructions shall include, but not necessarily be limited to the following.

- A. A description of the location(s) of the Master File and an identification of the location(s) of the various record types within the Master File

11.7 Records Management

- B. The filing system to be used
- C. A method for verifying that records received are in agreement with any applicable transmittal documents and are in good condition. This is not required for documents generated within a section for use and storage in the same sections' satellite files.
- D. A method for maintaining a record of the records received
- E. The criteria governing access to and control of the Master File
- F. A method for maintaining control of and accountability for records removed from the Master File
- G. A method for filing supplemental information and for disposing of superseded records.

A qualified Fire Protection Engineer will evaluate record storage areas (including satellite files) to assure records are adequately protected from damage.

Records related to health and safety shall be maintained in accordance with the requirements of Title 10, Code of Federal Regulations. The following records shall be retained for at least the periods indicated in accordance with the Records Management procedures which specifies retention periods

The following are examples of records that will be retained:

- Operating logs
- Procedures
- Supplier QA documentation for equipment, materials, etc.
- Nonconforming item reports
- Test documentation/test results - preoperational/operational
- Facility modification records
- Drawings/specifications
- Procurement documents (e.g., purchase orders, purchase requisitions)
- Nuclear material control and accounting records
- Maintenance activities including calibration records
- Inspection documentation (plant processes)
- Audit reports
- Reportable occurrences and compliance records
- Completed work orders
- License conditions (specifications) records
- Software verification records
- System descriptions
- As-built design documentation packages
- Regulatory reports and corrective action.

Other retention times are specified for other facility records as necessary to meet applicable regulatory requirements. These retention times are indicated in facility administrative procedures.

11.7 Records Management

QAPD, Section 17 "Quality Assurance Records" provides additional details regarding records management requirements.

11.8 Other QA Elements

11.8 Other QA Elements

The QA Program and its supporting manuals, procedures and instructions are applicable to items and activities designated as QA Level 1, 1 Graded, QA Level 1-Fire Protection (QL-1F), 2AC, and 2.

The Vice President of Compliance/General Counsel is responsible for developing and revising the QA Program and assuring it is in compliance with applicable regulations, codes and standards.

The QA Program specifies mandatory requirements for performing activities affecting quality and is set forth in procedures which are distributed on a controlled basis to organizations and individuals responsible for quality. Revisions to these procedures are also distributed on a controlled basis. Applicable portions of the QA Program are documented, approved and implemented prior to undertaking an activity.

A management assessment of the QA program is performed at least six months prior to scheduled receipt of licensed material on the site. Items identified as needing completion or modification are entered into the CAP and corrective action completed before scheduled receipt of licensed material. LES Management monitors the QA program prior to this initial management assessment through project review meetings and annual assessments. This management assessment along with integrated schedules and program review meetings ensure that the QA program is in place and effective prior to receiving licensed material.

The LES QA program for design, construction, and preoperational testing continues simultaneously with the QA program for the operational phase while construction activities are in progress.

Anyone may propose changes to the QA Program supporting manuals and procedures. When reviewed by the Vice President of Compliance/General Counsel and found acceptable and compatible with applicable requirements, guidelines and LES policy, the changes may be implemented. The QA Program and supporting manuals and procedures are reviewed periodically to ensure they are in compliance with applicable regulations, codes, and standards. New or revised regulations, codes, and standards are reviewed for incorporation into the QA Program and supporting manuals and procedures as necessary.

Personnel performing activities covered by the QA program shall perform work in accordance with approved procedures, and must demonstrate suitable proficiency in their assigned tasks. Formal training programs are established for quality assurance policies, requirements, procedures, and methods. Ongoing training is provided to ensure continuing proficiency as procedural requirements change. New employees are required to attend a QA indoctrination class on authority, organization, policies, manuals, and procedures.

Additional formal training is conducted in specific topics such as NRC regulations and guidance, procedures, auditing, and applicable codes and standards. Supplemental training is performed as required. On-the-job training is performed by the employee's supervisor in QA area-specific procedures and requirements. Training records are maintained for each person performing quality-related job functions.

11.8 Other QA Elements

The Vice President - Operations and Chief Nuclear Officer and President assesses the scope, status, adequacy and regulatory compliance of the QA Program through regular meetings and correspondence with the Vice President of Compliance/General Counsel and the LES QA organization. Additionally, LES QA, through the Vice President of Compliance/General Counsel, periodically informs the LES Plant Manager or President of quality concerns that need management resolution.

LES participates in the planning and scheduling for system turnover as construction is completed. Prior to system turnover, written procedures are developed for control of the transfer of systems, structures, components and associated documentation. The procedures include checklists, marked drawings, documentation lists, system status, and receipt control.

Major work activities contracted by LES shall be identified and controlled. Principal contractors shall be required to comply with the applicable portions of 10 CFR 50, Appendix B (CFR, 2003b), as determined by LES. The performance of contracted activities shall be formally evaluated by LES commensurate with the importance of the activities to safety.

Facility components and processes are assigned a QA level based on their safety significance. Each component will receive a classification of QA Level 1, QA Level 1 Graded, QA Level 1-Fire Protection (QL-1F), QA Level 2AC, QA Level 2, or QA Level 3 that applies throughout the life of the facility and is based on the following definitions:

QA Level 1 Requirements

The QA Level 1 Program shall conform to the criteria established in 10 CFR 50, Appendix B (CFR, 2003b). These criteria shall be met by commitments to follow the guidelines of ASME NQA-1 as specified in the QA Program Description. The QA Level 1 QA program shall be applied to those structures, systems, components, and administrative controls that have been determined to be IROFS (except IROFS27e to which QA Level 1 Graded and fire protection features designated as IROFS to which QL-1F applies), items that are essential to the functions of the IROFS, and items required to satisfy regulatory requirements for which QA Level 1 requirements are applied.

QA Level 1 Graded Requirements

The QA Level 1 Graded QA Program applies exclusively to IROFS27e structures. IROFS27e structures are structures whose failure has been analyzed to result in consequences that exceed the 10 CFR 70.61 performance requirements. The QA Level 1 Graded program is applied to design, procurement, construction and other activities as described in Section 21 of the QAPD. The QA Level 1 Graded Program applies to:

- Separation Building Modules (SBMs) with the exception of slab on grade or supports for internally housed QA Level 1 IROFS that are required to perform a safety function for a seismic event.
- Cylinder Receipt and Dispatch Building (CRDB) superstructure with the exception of the Bunkered Area structure which is designated QL-1. The non-bunkered area foundation is designated QL-1G; slab on grade is designated QL-3.

QA Level 1-Fire Protection (QL-1F Requirements)

11.8 Other QA Elements

QA Level 1-Fire Protection Program shall conform to applicable portions of 10 CFR 50, Appendix B (CFR, 2003b) and shall be met by commitments to follow the guidelines as specified in the QA Program Description. The graded QL-1F Program shall be applied exclusively to those fire protection features designated as IRPFS. Such IROFS designated fire protection features are those whose failure has been analyzed to result in consequences that exceed the 10 CFR 70.61 performance requirements. The QL-1F program is applied to design, procurement, and other activities as described in Section 23 of the QAPD.

QA Level 2AC Requirements

QA Level 2AC is applied to certain Support Equipment for Administrative Control IROFS. The QA Level 2AC Support Equipment activities shall be identified in applicable QA procedures, implementing documents, and documents specifying quality requirements or prescribing activities affecting quality. These requirements are implemented by LES and LES contractors through the use of approved QA programs and procedures.

Any removal of the management measure designed to provide assurance of the Support Equipment relied upon by the worker, or removal of the Support Equipment quality requirements from the Administrative Control IROFS Boundary, would be considered a reduction in commitment and require regulatory approval prior to implementation.

QA Level 2 Requirements

The QA Level 2 program is an owner defined QA program that uses the ASME NQA 1. General QA Level 2 requirements are described in Section 20, "Quality Assurance Program for QA Level 2 Activities". For contractors, the QA Level 2 program shall be described in documents that must be approved by LES. The QA Level 2 program shall be applied to Owner designated structures, systems, components, and activities. An International Organization for Standardization (ISO) 9000 series QA program may be acceptable for QA Level 2 applications provided it complies with LES Quality Assurance Program Description requirements. The QA program manual must be reviewed and accepted by the LES QA Manager.

QA Level 3 Requirements

The QA Level 3 program is defined as standard commercial practice. A documented QA Level 3 program is not required. QA Level 3 governs all activities not designated as QA Level 1, QA Level 1 Graded, QA Level 2AC or QA Level 2. Any removal of the management measures designed to provide assurance of other equipment attributes, identified in Table 3.4-1 of the SAR, that are used by the worker would be considered a reduction in commitment and require regulatory approval prior to implementation.

Appendix A, "LES Quality Assurance Program Description" of this chapter provides additional details and commitments to other QA elements that will be implemented to support the Management Measures described in this chapter.

11.9 References

11.9 References

Edition of Codes, Standards, NRC Documents, etc that are not listed below are given in ISAS Table 3.0-1.

CFR, 1994. Title 10, Code of Federal Regulations, Part 50, Appendix B, Quality Assurance Criteria for Nuclear Power Plants and Fuel Processing Plants, 1994.

CFR, 2003a. Title 10, Code of Federal Regulations, Part 21, Reporting of Defects and Noncompliance, 2003.

CFR, 2003b. Title 10, Code of Federal Regulations, Part 50, Appendix B, Quality Assurance Criteria for Nuclear Power Plants and Fuel Processing Plants, 2003.

CFR, 2003c. Title 10, Code of Federal Regulations, Section 70.50, Reporting requirements, 2003.

CFR, 2003d. Title 10, Code of Federal Regulations, Section 70.62, Safety program and integrated safety analysis, 2003.

CFR, 2003e. Title 10, Code of Federal Regulations, Section 70.72, Facility changes and change process, 2003.

CFR, 2003f. Title 10, Code of Federal Regulations, Section 70.74, Additional reporting requirements, 2003.

CFR, 2003g. Title 10, Code of Federal Regulations, Part 70, Domestic Licensing of Special Nuclear Material, 2003.

NRC, 2004. Safety Evaluation Report: Louisiana Energy Services Quality Assurance Program Description for the National Enrichment Facility, U.S. Nuclear Regulatory Commission, April 9, 2004.

12.0 PHASED OPERATION

12.0 PHASED OPERATION

The continued startup of the National Enrichment Facility does not include all facilities, systems, processes, and IROFS described in ISA Summary § 3.3 through § 3.8. The startup of the facility is performed in a phased approach to begin operation as soon as the required facilities, systems, processes, and IROFS are operational to support Initial Plant Operation (IPO). As delineated in SAR § 2.1.4, Transition from Design and Construction to Operations, LES is responsible for the design, quality assurance, construction, testing, initial startup, and operation of the facility. As the construction of systems is completed, or is nearing completion, the systems are turned over from construction organization (Projects) responsibility to operations organization responsibility. The turnover is documented by memoranda clearly stating the scope of the turnover, listing any identified deficiencies associated with the system, and clearly describing the operational and safety state and status of the system.

The facility will operate in a series of phases determined by operational requirements. IPO phase included all safety systems necessary to safely conduct enrichment operations.

An Operate While Constructing program is necessary to implement controls for continued construction during facility operation. The Operate While Constructing program is necessary until all cascades and expansion modifications are implemented and accepted by Operations.

Operate While Constructing is a process that implements controls to ensure that the Integrated Safety Analysis for the National Enrichment Facility remains valid during operations when part of the facility is still being constructed. The process of Phased Operation, placing cascades on-line and facility expansion is estimated to take several years; therefore, Operate While Constructing is an essential safety process for the operation of the National Enrichment Facility.

The following sections provide a description of the operations that differ between final operation of the facility and the interim operation for the Phased Operation approach. Applicable portions of SAR Chapter 12 are referenced by all other LBDs impacted by the Phased Operation approach.

The following general Accident Sequences and associated IROFS are applicable to all areas containing UF₆. Because the CRDB is not operational and contains no UF₆, these accident sequences are not applicable to any room in the CRDB:

General Accident Sequences	
• EE-SEISMIC-WORKER EVAC	IROFS39a
• FF-WORKER EVAC	IROFS36a, 36d, & 36i, IROFS39b
• EE-CHEM RELEASE-WORKER EVAC	IROFS39c
• EE-TORNADO MISSILE-SBM-CRDB SHELL & BUNKER WORKER	IROFS39d

12.1 INITIAL PLANT OPERATIONS (IPO)

12.1 INITIAL PLANT OPERATIONS (IPO)

LES received authorization from the NRC to bring UF6 on site on June 10, 2010. The first delivery was received on June 13, 2010. First Cascade on Line (FCOL) was on June 25, 2010.

12.2 Production Phases 1a and 1b

12.2 Production Phases 1a and 1b

The difference between Production Phase 1a and Production Phase 1b is that the Product Blending and Liquid Sampling System in SBM-1001 will NOT be available in Production Phase 1a. This is identified in the text below by specifically indicating when the discussion is applicable to Production Phase 1a only (this applies to the Product and Liquid Sampling Sections 12.2.1.1.2, 12.2.1.1.3, 12.2.2.5, and 12.2.2.6.)

12.2.1 Facility Differences for Production Phase 1a and 1b

12.2.1.1 Separations Building Modules

12.2.1.1.1 Process Services Corridor (PCS)

The SBMs are as described in ISA Summary § 3.3.1.1 except the Process Services Corridor (PSC) for SBM-1001 will be operational (ISA Summary § 3.3.1.1.2.2), which lacks gas transport equipment for cascades that are not on line (NaF Traps, Pump and Trap Sets, process headers, etc). This equipment is installed and operated as additional cascades are completed.

Accident Sequence EE-SEISMIC-SBM and associated IROFS27e and IROFS41 are applicable to the SBM.

12.2.1.1.2 Blending System

The Blending Receiving and Donor Stations are not needed for Production Phase 1a. However, the Blending Donor and Receiver Stations are operable for storage of empty or full product cylinders.

Accident sequences PB1-1 and PB2-1 and associated IROFS1, 2, 4, and 5 are applicable .

12.2.1.1.3 Product Liquid Sampling System

The Product Liquid Sampling System autoclaves are not available and not needed for Production Phase 1a. Without these components, product cylinders can not be shipped to customers but can be shipped off site for temporary storage.

Because the autoclaves are not available, accident sequences PB4-1, PB4-2, PB4-3 ,PB4-4, EE-TORNADO MISSILE-SBM PUBLIC, and EE-SEISMIC-SBM and associated IROFS10, 11, 12, and 28 are not applicable. Note that the seismic events are applicable to the SBM but the autoclave contribution to the total release is not applicable.

12.2.1.1.4 Rail Transporter

The Rail Transporter travels on rails embedded in the floor of the UF₆ Handling Area. These rails run the entire width of the module; east to the CRDB and west through doors onto a concrete pad where cylinders are delivered. The rail transporter transfers 30B and 48Y cylinders to and from the appropriate feed, feed purification, tails, or blending stations, product sampling autoclaves, or the temporary scale in SBM-1001.

There is no accident sequence or IROFS directly associated with the Rail Transporter.

12.2 Production Phases 1a and 1b

12.2.1.1.5 Mobile Pressure Transducer Calibration Rig

The pressure transducer calibration rig is limited to use in non UF₆ contaminated systems. Initial calibrations of pressure transducers on non UF₆ contaminated systems are performed prior to operations. If a pressure transducer fails there are installed backups that can be used.

Because the pressure transducer calibration rig is limited to use in non UF₆ contaminated systems, accident sequences MR3-1 and MR3-2 in addition to associated IROFSC21 are not applicable.

12.2.1.2 Technical Services Building (TSB)

12.2.1.2.1 Medical Room

The Medical Room is operational for general first aid cases. Injuries requiring more than general first aid are transported off site to local area medical facilities.

There is no accident sequence or IROFS directly associated with the Medical Room.

12.2.1.2.2 Break Room

The Break Room is not operational.

There is no accident sequence or IROFS directly associated with the Break Room.

12.2.1.2.3 I&C Electrical Shop

The I&C Electrical Shop is not operational. The I&C Electrical Shop serves as a work area for general electrical and I&C components and maintenance. Maintenance on non-contaminated equipment is delayed until the I&C Electrical Shop is available or is conducted in other locations on-site or off-site, as necessary, based on the equipment and maintenance required.

There is no accident sequence or IROFS directly associated with the I&C Electrical Shop.

12.2.1.2.4 Mechanical Shop

The Mechanical Shop is not operational. The Mechanical Shop serves as a work area for general mechanical maintenance and work such as painting or welding. Maintenance on non-contaminated equipment is delayed until the Mechanical Shop is available or conducted in other locations on-site or off-site, as necessary, based on the equipment and maintenance required.

There is no accident sequence or IROFS directly associated with the Mechanical Shop.

12.2.1.2.5 Waste Processing Room

The Waste Processing Room is not operational. The Waste Processing Room serves as a handling area for non-radioactive waste. Non-radioactive waste is either stored under appropriate safety controls until handling systems are available, or shipped off-site to a processing facility for treatment and/or disposal at a licensed facility.

12.2 Production Phases 1a and 1b

There is no accident sequence or IROFS directly associated with the Waste Processing Room.

12.2.1.2.6 Environmental Monitoring Laboratory

The Environmental Monitoring Laboratory is not operational. Instead, samples are collected and shipped to a certified testing facility for analysis. The sample containers are not returned to LES, but are disposed of by the receiving facility.

There is no accident sequence or IROFS directly associated with the Environmental Monitoring Laboratory

12.2.1.3 Cylinder Receipt and Dispatch Building (CRDB)

12.2.1.3.1 Solid Waste Collection Room

The Solid Waste Collection Room is not operational. The Solid Waste Collection Room is designed to package both wet and dry low-level radioactive solid waste.

The small quantity of solid waste that is expected to be generated prior to the Solid Waste Collection Room becoming operational is placed in a lined 55 gal drum with <300 g ^{235}U as determined through bookkeeping. Once the drums have been filled they are sealed with a tamper-indicating device (TID) and placed into the Material Control and Accountability (MC&A) item control program. Up to four drums are stored in the Ventilated Storage Room in the UF_6 Handling Area in SBM-1001. A qualified contracted company conducts non-destructive assay (NDA) on the drums to determine the final ^{235}U content. Once the assay is complete Radiation Protection and MC&A Departments can release the drums from the MC&A item control inventory to radioactive material storage areas (RMAs) external to the SBM. The drums will remain in storage until either further evaluation by radiation protection free releases the material or sufficient quantity is accumulated to prepare an offsite shipment. Because the Solid Waste Collection Room is not completed, accident sequences SW1-1 and SW1-2 and associated IROFS14a and IROFS 14b are not applicable to this room.

Transitional accident sequences TVR1-1, TVR1-2, and TVR1-3 have been identified that require implementation of existing IROFS14a and 14b, and IROFS31a, 31b, and 31c to the Ventilated Storage Room. See ISA Summary Tables 4.1-4, Transitional Accident Sequence and Risk Index, and 4.1-5, Transitional Accident Sequence Descriptions.

12.2.1.3.2 Vacuum Pump Rebuild Workshop

The Vacuum Pump Rebuild Workshop is not operational. Rebuilding vacuum pumps is a planned evolution. In the unlikely event that a rebuild of a vacuum pump containing UF_6 is required, the pump is replaced with a clean vacuum pump and the contaminated pump stored in accordance with appropriate radiological controls until the Vacuum Pump Rebuild Workshop is completed.

There is no accident sequence or IROFS directly associated with the Vacuum Pump Rebuild Workshop.

12.2 Production Phases 1a and 1b

12.2.1.3.3 Decontamination Workshop

The Decontamination Workshop is not operational. The decontamination systems in this workshop are designed for radioactive decontamination of materials and equipment used in uranium hexafluoride systems, waste handling systems, and other areas of the plant. The small quantity of contaminated equipment that is expected is stored in accordance with appropriate chemical, radiological, and criticality safety controls until the Decontamination Workshop is completed or shipped off site to a processing facility for treatment and/or disposal at a licensed facility.

Equipment, other than pumps, requiring radioactive decontamination is placed in a lined 55 gal drum with <300 g ^{235}U as determined through bookkeeping. Once the drums have been filled they are sealed with a tamper-indicating device (TID) and placed into the Material Control and Accountability (MC&A) item control program. Up to four drums are stored in the Ventilated Storage Room in the UF_6 Handling Area in SBM-1001. A qualified contracted company conducts non-destructive assay (NDA) on the drums to determine the final ^{235}U content. Once the assay is complete Radiation Protection and MC&A Departments can release the drums from the MC&A item control inventory to radioactive material storage area (RMAs) external to the SBM. The drums will remain in storage until either further evaluation by radiation protection free releases the material or sufficient quantity is accumulated to prepare an offsite shipment.

Pumps requiring decontamination will be stored in place until the decontamination workshop is completed and running.

Because the Decontamination Workshop is not completed, accident sequence LOSS OF SAFE-BY-DESIGN ATTRIBUTE is not applicable to this room.

12.2.1.3.4 Ventilated Room

The Ventilated Room is not operational. The main activities carried out in the Ventilated Room are servicing chemical traps by removing spent carbon, aluminum oxide, and sodium fluoride and replacing damaged and leaking valves on cylinders which contain UF_6 . Servicing chemical traps is a planned evolution and is not required or planned before Ventilated Room is completed.

Because the Ventilated Room is not available, accident sequences VR1-1, VR1-2, VR1-3, VR1-5, VR2-1, VR2-2, VR2-7, FF24-1, FF25-1, and FF25-2 and associated IROFS3, 21, 23a, 23b, 24a, 35, 36d, 37, 47b and accident sequence LOSS OF SAFE-BY-DESIGN ATTRIBUTE are not applicable for the Ventilated Room.

12.2.1.3.5 Reserved

12.2.1.3.6 Contaminated Material Handling Room

The Contaminated Material Handling Room is not operational. Instead, contaminated disposable protective clothing is collected, monitored and either shipped off site to a licensed disposal facility or stored on site in accordance with appropriate controls until the Contaminated Material Handling Room and Solid Waste Collection Room are completed and implemented.

12.2 Production Phases 1a and 1b

Radioactive waste is placed in a lined 55 gal drum with $< 300 \text{ g } ^{235}\text{U}$ as determined through bookkeeping. Once the drums have been filled they are sealed with a tamper-indicating device (TID) and placed into the Material Control and Accountability (MC&A) item control program. Up to four drums are stored in the Ventilated Storage Room in the UF_6 Handling Area in SBM-1001. A qualified contracted company conducts non-destructive assay (NDA) on the drums to determine the final ^{235}U content. Once the assay is complete Radiation Protection and MC&A Departments can release the drums from the MC&A item control inventory to radioactive material storage areas (RMAs) external to the SBM. The drums will remain in storage until either further evaluation by radiation protection free releases the material or sufficient quantity is accumulated to prepare an offsite shipment.

Equipment, other than pumps, requiring radioactive decontamination is treated the same as radioactive waste (described above) except that it is stored until decontamination facilities are available on site. Pumps requiring decontamination will be stored in place until the decontamination workshop is completed and running.

There is no accident sequence or IROFS directly associated with the Contaminated Material Handling Room.

12.2.1.3.7 Gaseous Effluent Ventilation System (GEVS) Room

The Gaseous Effluent Ventilation System (GEVS) is constructed as two separate systems, Pumped Extract GEVS and CRDB GEVS. Pumped Extract GEVS is permanently installed in the UF_6 Handling Area of SBM-1001 and is operational. Because the CRDB is not operational, local extract ductwork is temporarily connected to the Pumped Extract GEVS in SBM-1001 to support operations there. All GEVS accident sequences (CL3-1, CL3-2, CL3-3, VR1-1, VR1-2, VR2-2, and FF25-2) and associated IROFS (IROFS20, 21, 24a, 24b, and 37) are for CRDB operations and therefore not applicable for this room.

Accident sequence LOSS OF SAFE-BY-DESIGN ATTRIBUTE is applicable for the Pumped Extract GEVS.

There is no accident sequence or IROFS directly associated with the local extract function of the CRDB GEVS, but not applicable to CRDB GEVS.

12.2.1.3.8 Mass Spectrometry Laboratory

The Mass Spectrometry Laboratory is not operational. Instead, samples are collected and shipped to a certified testing facility for analysis.

Because the Mass Spectrometry Laboratory is not completed, accident sequence LOSS OF SAFE-BY-DESIGN ATTRIBUTE is not applicable to this room.

12.2.1.3.9 Chemical Laboratory

The Chemical Laboratory is not operational. Instead, samples are collected and shipped to a certified testing facility for analysis. Contaminated sample containers are not returned to LES, but are disposed of by the facility.

12.2 Production Phases 1a and 1b

Because the Chemical Laboratory is not completed, accident sequences CL3-1, CL3-2, and CL3-3 and associated IROFS24b, 43, and 46 and LOSS OF SAFE-BY-DESIGN ATTRIBUTE are not applicable to this room.

12.2.1.3.10 Radiation Monitoring Laboratory

The Radiation Monitoring Laboratory is not operational. Instead, samples are collected and shipped to a certified testing facility for analysis.

There is no accident sequence or IROFS directly associated with the Radiation Monitoring Laboratory.

12.2.1.3.11 Truck Bay/Shipping and Receiving Area

Commercial transport tractors are disconnected from the trailers carrying containers and connected to LES yard tractors which comply with IROFS36c (i.e., diesel fuel capacity less than 280 L (74 gal)). The yard tractor delivers UF₆ cylinders to the Vehicle Loading and Unloading Area on the west side of SBM-1001 in the southwest corner.

Cylinders are unloaded with a gantry crane at the Vehicle Loading and Unloading Area of SBM-1001. The gantry crane lifts and transfers the cylinder to the rail transporter that sits on rails extended outside the SBM into the Vehicle Loading and Unloading Area. On completion of receipt inspection, the rail transporter will move the cylinder inside the UF₆ Handling Area. Cylinders are removed from the facility in the same fashion.

There is no accident sequence or IROFS directly associated with the Gantry Crane at the SBM Vehicle Loading and Unloading Area.

12.2.1.3.12 Cylinder Storage Areas

- Full feed cylinders may be stored in the UF₆ Handling Area in available Solid Feed, Feed Purification, and Tails Stations. When the UBC Storage Pad or the CRDB is ready to accept cylinders for storage the cylinders stored in the stations may be transferred, but continued storage in the stations is not prohibited.

Accident sequences UF1-1, UF2-1, and TT2-1, and associated IROFS1, 2, 4, and 5 are applicable.

- Full product cylinders can be stored in available Product Take-off Stations and Blending Donor and Take-off Stations. When the CRDB is ready to accept cylinders for storage the cylinders stored in the stations may be transferred, but continued storage in the stations is not prohibited. However, it is preferable to ship the full product cylinders to clients.

Accident sequences PT2-1, PT2-2, PB1-1, PB2-1, PB2-2, and CP1-2 and associated IROFS1,2,4,5, and 16a are applicable.

- Full tails cylinders are stored in available Tails Take-off Stations. When the UBC Storage Pad or the CRDB is ready to accept cylinders for storage cylinders stored in the stations may be transferred, but continued storage in the stations is not prohibited.

Accident sequence TT2-1, and associated IROFS1 and 2 are applicable.

12.2 Production Phases 1a and 1b

12.2.1.4 Uranium Byproduct Cylinder (UBC) Storage Pad

The UBC Storage Pad and UBC Basin are not fully operational as described in ISA Summary § 3.3.1.6. The UBC Pad is being constructed in sections and expanded as required to accept additional cylinder storage. The UBC Pad Stormwater Retention Basin is a 2 section basin. Initially, only the west section will be built. However, the west side of the UBC Pad Stormwater Retention Basin contains sufficient capacity for the entire UBC Pad as currently designed. Additional cylinder storage areas are discussed in Sections 12.2.1.3.12, Cylinder Storage Areas and 12.2.2.9.4., Storage.

Although the UBC Storage Pad is not fully built out, it is in use. Accident sequences FF42-1, FF43-1, FF43-2, and FF44-1 and associated IROFS36c, 36e, 36f, and 36g are applicable.

There is no accident sequence directly associated with the UBC Basin.

12.2.1.5 Central Utilities Building (CUB)

The CUB is not fully operational as described in ISA Summary § 3.3.1.7. However, systems required for Production Phase 1a and 1b are ready in sufficient capacity to support plant operations. Systems within the CUB that are required to support Production Phases 1a and 1b are described in Section 12.2.4, Utility and Support System Differences for Production Phase 1a and 1b.

12.2.1.6 Administration Building

The Administration Building is not operational. Until building completion, the staff will continue to be housed in temporary buildings on the east end of the facility. The Administration Building lobby is designed to act as an assembly area for emergency planning purposes. Alternate assembly areas are designated for assembly until completion for the Administration Building.

There is no accident sequence or IROFS directly associated with the Administration Building.

12.2.1.7 Site Security Buildings

The main Security Building is operational for access to the Controlled Access Area (CAA). Vehicular traffic passes through additional security checkpoints before being allowed to park. Parking is located outside of the Controlled Access Area (CAA) security fence. Visitor passes are issued at a temporary security trailer located at the south east entrance to the facility.

There is no accident sequence or IROFS directly associated with the Security Building

12.2.2 Process Differences for Initial Production Phase 1a and 1b

12.2.2.1 UF₆ Feed System

The UF₆ Feed and Feed Purification Systems are operational as described in ISA Summary § 3.4.2 except a minimum of three (3) Solid Feed Stations (SFS) and one (1) Feed Purification Low temperature Take-off Station (LTTS) are required to be operable for FCOL enrichment operations. As construction progresses, additional stations are completed and brought online as needed to support the incremental start up of cascades. The second Feed Purification

12.2 Production Phases 1a and 1b

Station (if operable) and all operable SFS not in use for enrichment operations may contain a 48Y cylinder (Feed, empty or full Tails, or test weight). When additional storage locations become available, the stored cylinders may be transferred from the stations, however, continued storage in the stations is not prohibited.

Accident sequences UF1-1, UF2-1, and associated IROFS4 and 5 are applicable.

12.2.2.2 Cascade System

The Cascade System is operational as described in ISA Summary § 3.4.3 with the exception that not all individual cascades are operable. Cascade modules are brought online incrementally when the centrifuges within each cascade and all support equipment related to each cascade module are commissioned. Cascade modules 1 through 6 may be operating at the beginning of Production Phase 1a.

Accident sequence EE-SEISMIC-SBM and associated IROFS41 is applicable.

12.2.2.3 Product Take-off System

The Product Take-off System is operational as described in ISA Summary § 3.4.4 except a minimum of three (3) Product LTTS are required to be operable for FCOL enrichment operation. As construction progresses, additional Product LTTS are brought online as needed to support the incremental start up of cascades. All operable Product LTTS not in use for enrichment operations may contain an empty or full 30B cylinder or test weight. When additional storage locations become available, the stored cylinders may be transferred from the stations, however, continued storage in the stations is not prohibited.

Accident sequences PT2-1 and PT2-2 and associated IROFS1 and IROFS2 are applicable.

12.2.2.4 Tails Take-off System

The Tails Take-off System is operational as described in ISA Summary § 3.4.5 except a minimum of three (3) Tails LTTS are required to be operable for FCOL enrichment operations. As construction progresses, additional Tails LTTS are brought online as needed to support the incremental start up of cascades. All operational stations not in use for enrichment operations may contain a 48Y cylinder (Feed, empty or full Tails, or test weight). When additional storage locations become available, the stored cylinders may be transferred from the stations, however, continued storage in the stations is not prohibited. Once an in-service feed cylinder is emptied, it is switched with a full feed cylinder from a tails station. The empty feed cylinder is then used for normal tails take-off. This cylinder storage strategy will allow approximately 3 months of operation before additional cylinder storage space is required. Accident sequence TT2-1 and associated IROFS1 and 2 are applicable.

12.2.2.5 Product Blending System

The Product Blending System is not operational and is not needed for Production Phase 1a; however, the Blending Donor and Receiver Stations are operable for storage of full product cylinders.

Accident sequences PB1-1 and PB2-1 and associated IROFS1, 2, 4, and 5 are applicable.

12.2 Production Phases 1a and 1b

12.2.2.6 Product Liquid Sampling System

The Product Liquid Sampling System is not operational and is not required for Production Phase 1a. The Product Liquid Sampling autoclaves are unavailable. Because the autoclaves are not available, accident sequences PB4-1, PB4-2, PB4-3, and PB4-4, EE-TORNADO MISSILE-SBM PUBLIC, and EE-SEISMIC-SBM and associated IROFS10, 11, 12, and 28 are not applicable to the autoclave. (**Note:** EE-TORNADO MISSILE-SBM PUBLIC, and EE-SEISMIC-SBM are applicable to the SBM but the autoclave contribution to the total release [and therefore IROFS28] is not applicable.)

12.2.2.7 Contingency Dump System

The Contingency Dump System is operational as described in ISA Summary § 3.4.8 for each operating Cascade Module. Each operating cascade module has its own dedicated Contingency Dump System available for use. As additional cascades are completed, additional contingency dump components are installed and made operational in the process services corridor to support incremental plant start up and expansion.

There is no accident sequence or IROFS directly associated with the Contingency Dump System.

12.2.2.8 Gaseous Effluent Vent Systems (GEVS)

The Gaseous Effluent Ventilation System (GEVS) is constructed as two separate systems, Pumped Extract GEVS and CRDB GEVS. Pumped Extract GEVS is permanently installed in the UF₆ Handling Area of SBM-1001 and is operational to support SBM-1001 operations. The local extract ductwork that is used in the SBM is temporarily connected to the Pumped Extract GEVS. Because of this temporary cross-connection, there are limitations to the local extract capability. The following measures are in place to ensure adequate flow is provided at each local extract station:

- Only two local extract flexible hose stations are allowed to be open at any one time (IF the Ventilated Storage Room is online, THEN only one flexible hose station is allowed to be in use).
- Configuration control is maintained by the Shift Manager and the use of caution tags on the local extract flexible hose station isolation valves.

All GEVS accident sequences (CL3-1, CL3-2, CL3-3, VR1-1, VR1-2, VR 2-2, and FF25-2) and associated IROFS (IROFS20, 21, 24a, 24b, and 37) are for CRDB operations and therefore not applicable to Production Phase 1a and 1b.

Accident sequence LOSS OF SAFE-BY-DESIGN ATTRIBUTE is applicable for the pumped Extract GEVS.

There is no accident sequence or IROFS directly associated with the local extract function of the CRDB GEVS.

12.2 Production Phases 1a and 1b

12.2.2.9 Material Handling Processes

12.2.2.9.1 Cylinder Receipt and Shipping

Until the CRDB becomes available, cylinders are shipped, received, and transferred via a Vehicle Loading and Unloading Area on the west side of the UF₆ Handling Area of SBM-1001. The Vehicle Loading and Unloading Area provide space for the following services:

- Cylinder loading and unloading
- Preparation for overpack/protective structural packaging.

The cylinders are received, shipped, and transferred to and from the UF₆ Handling Area at the Vehicle Loading and Unloading Area until the CRDB and becomes operational.

12.2.2.9.2 Description

Commercial transport tractors are disconnected from the trailers carry containers and connected to LES yard tractors which comply with IROFS36c (diesel fuel capacity less than 280 L (74 gal)). The yard tractor delivers UF₆ cylinders (i.e., full 48Y feed cylinders, and new or cleaned 30B product cylinders) to the Vehicle Loading and Unloading Area on the west side, south end of SBM-1001. Cylinders are unloaded with a gantry crane. The gantry crane lifts and transfers the cylinder to the rail transporter that sits on rails that are extended outside the SBM into the Vehicle Loading and Unloading Area. Upon completion of receipt inspection, the rail transporter moves the cylinder inside the UF₆ Handling Area. Cylinders are removed from the facility in the same fashion.

12.2.2.9.3 Equipment

The following equipment is used for cylinder handling on the West side SBM-1001 receipt platform.

A. Vehicle Loading and Unloading Area

The Vehicle Loading and Unloading Area is located adjacent to the west side SBM-1001 equipment hatch. This provides a safe method of transfer from the vehicle trailer to rail transporter located on the platform.

Accident sequence FF7-1 and associated IROFS36c is applicable to the LES yard tractor at the Vehicle Loading and Unloading Area.

B. Gantry Crane

A dedicated gantry crane is used to handle cylinders on the vehicle loading and unloading area. The crane spans the width of the loading platform to access vehicle trailers and the rail transporter. The hoist has a maximum lift of approximately 6.1 m (20 ft). Crane specifications are as follows:

- | | | |
|---|-------------------|--|
| • | Span | 11.3 m (37 ft) |
| • | Capacity | 20 MT (44,100 lb) |
| • | Hoist lift height | 3.1 m (20 ft) |
| • | Hoist lift speed | 3 m/min & 0.5 m/min (10 ft/min & 1.6 ft/min) |

12.2 Production Phases 1a and 1b

- Travel length 7.9 m (26 ft)
- Bridge travel speed (VFD) 19.8 m/min (65 ft/min)
- Brake type Direct Current Disk

There is no accident sequence or IROFS directly associated with the gantry crane.

C. Scale

Inventory Weighing is performed using a temporary scale in the UF₆ Handling Area of SBM-1001. The scale is identical to the scales described in ISA Summary § 3.4.11.1.2 C. Each cylinder that enters or exits the UF₆ Handling Area is weighed. A weigh scale capable of weighing a load of 17 MT (37,500 lb) and capable of accepting a load of 20 MT (44,100 lb) is installed. The scale is capable of weighing to a tolerance of ±2.5 kg (±5.5 lb). The scale has reader and printout facilities.

There is no accident sequence or IROFS directly associated with the weigh scales.

D. Powered Vehicles and Rail Transporters

LES yard tractors that comply with IROFS36c (diesel fuel capacity less than 280 L) are utilized to deliver the vehicle trailer containing cylinders to the Vehicle Loading and Unloading Area. The gantry crane lifts and transfers the cylinder to the rail transporter that sits on rails extended outside the SBM into the Vehicle Loading and Unloading Area. On completion of receipt inspection, the rail transporter retrieves the cylinder for use. Cylinders are removed from the facility in the same fashion.

Accident sequence FF7-1 and associated IROFS36c is applicable to the LES yard tractors at the Vehicle Loading and Unloading Area.

There is no accident sequence or IROFS directly associated with the Rail Transporter.

12.2.2.9.4 Storage

- All available operable feed, feed purification, and tails, stations that are not in operation for enrichment can be used for 48Y cylinder storage (Feed, empty or full Tails, or test weight). All Product and Blending System Stations not in use for enrichment operations can be used for 30B cylinder storage.
- A switch process is used to maximize storage in the stations during phased operations. When a product cylinder is filled, the process will shift to the standby product station. The full product cylinder may be switched with an empty product cylinder being stored in a Blending System Donor or Receiver Station. The full product cylinder will be stored in the now empty Blending System Donor or Receiver station that previously contained the empty product cylinder. When available Blending System Donor or Receiver stations may contain full product cylinders, additional filled product cylinders will simply remain in their respective Product LTTS for storage. This switching process is also used for feed and tails cylinders. As the feed cylinder empties, the process will shift to the standby feed station. The empty feed cylinder is then switched with a full feed cylinder from a Tails or Feed Purification LTTS. The empty feed cylinder is installed into the now empty Tails or Feed Purification LTTS that previously contained the full feed cylinder. This switching of cylinders will allow approximately 3 months of operation before additional storage space is required.

- C. In the event that additional storage is required, filled tails cylinders may be shipped off-site to a licensed facility. When additional storage capabilities are established, these cylinders may be shipped back to the site.

Accident sequences UF1-1, UF2-1, PT2-1, PT2-2, TT2-1, PB1-1, PB2-1, PB2-2, and CP1-2 and associated IROFS1, 2, 4, 5, and 16a are applicable.

12.2.3 Utility and Support System Differences for Production Phase 1a and 1b

12.2.3.1 Centrifuge Cooling Water System (CCWS)

The Centrifuge Cooling Water (CCW) System is operational with the exception of the cooling water towers. The cooling water towers are bypassed and heat removal is performed by the CCW heat exchanger cooled by the CCW chiller units. This arrangement supports all operable cascades for Production Phase 1a and 1b.

There is no accident sequence or IRORS directly associated with CCWS.

12.2.3.2 Reserved

12.2.3.3 Solid Waste Collection System

The Solid Waste Collection System is not operational. Solid wastes will either be stored on site using appropriate chemical, radiological, and criticality safety controls until the Solid Waste Collection Room is completed or shipped off site to a processing facility for treatment and/or disposal at a licensed facility.

Because the Solid Waste Collection Room is not completed, accident sequences SW1-1 and SW1-2 and associated IROFS14a and IROFS14b are not applicable to this system.

12.2.3.4 Decontamination Workshop

The Decontamination Workshop is not operational. Contaminated equipment is stored in accordance with appropriate chemical, radiological, and criticality safety controls until the Decontamination Workshop is completed or shipped off site to a processing facility for treatment and/or disposal at a licensed facility.

Because the Decontamination Workshop is not completed, accident sequence LOSS OF SAFE-BY-DESIGN ATTRIBUTE is not applicable to this room.

12.2.3.5 PFPE Oil Recovery System

The PFPE Oil Recovery System is not operational; however, the system has no impact on any safety aspect of facility operation. PFPE oil will either be appropriately stored on site until the system is operational or disposed of at a certified disposal facility.

Because the PFPE Oil Recovery System is not completed, accident sequences FR1-1, FR1-2, FR2-1, and FR2-2 and associated IROFS14a and 14b and accident sequence LOSS OF SAFE-BY-DESIGN ATTRIBUTE are not applicable to this system.

12.2.3.6 Ventilated Room

The Ventilated Room is not operational. A Ventilated Storage Room has been constructed in the UF₆ Handling Area in SBM-1001 for limited storage. This room is connected to the Pumped Extract GEVS. The room is used for storage only; no processing of equipment or materials is conducted. Although a leaking valve on a cylinder containing UF₆ is not expected, if one is identified, the potential leakage is stopped in one of three ways depending on the nature of the damage. The valve is capped, the valve stem is tightened or the packing gland is tightened and the cylinder stored in an appropriate (feed or product) station until repairs can be conducted or the cylinder can be returned to the vendor.

Transitional accident sequences TVR1-1, TVR1-2, and TVR1-3 have been identified that require implementation of existing IROFS14a and 14b, and IROFS31a, 31b, and 31c. See ISA Summary Tables 4-4, Transitional Accident Sequence and Risk Index, and 4-5, Transitional Accident Sequence Descriptions.

12.2.3.7 Chemical Laboratory

The Chemical Laboratory is not operational. Instead, samples are collected and shipped to a certified testing facility for analysis.

Because the Chemical Laboratory is not completed, accident sequences CL3-1, CL3-2, and CL3-3 and associated IROFS24b, 43, and 46 and LOSS OF SAFE-BY-DESIGN ATTRIBUTE are not applicable to this room.

12.2.4 Safety Significance

Section 12.0 of the Safety Analysis Report has been initially established as an administrative change to describe the Phased Operation concept. There is no safety significance because none of the identified changes will be finalized and implemented until reviewed and approved in accordance with the LES configuration management program as described in § 11.1, Management Measures. Pursuant to 10 CFR 70.72, LES has established a system to evaluate, implement, and track each change to the site, structures, processes, systems, equipment, components, computer programs, and activities of personnel. Configuration management of IROFS, and any items that may affect the function of IROFS, is applied to all items identified within the scope of the IROFS boundary. All changes to structures, systems, equipment, components, and activities of personnel within the identified IROFS boundary are evaluated before the change is implemented. If the change requires an amendment to the License, Nuclear Regulatory Commission approval is received prior to implementation.

All proposed changes described in Section 12.0 are tracked and evaluated per the LES configuration management program prior to implementation. As the changes are processed, Section 12.0 will be revised to incorporate changes to the facility, processes, and programs. Section 12.0 documents all site changes facilitated as a result of the Phased Operation approach.

12.3 Production Phase 2

Functions supporting sample analysis, wet and dry low level waste collection and treatment, and radioactive decontamination and maintenance of plant equipment are available. Additional cascades and support equipment are added to increase production, but the plant is fully capable of carrying out continuous commercial production.

12.4 Production Phase 3

Cascade modules in Cascade Hall 1002 are started up incrementally as needed to support continued plant expansion. This incremental start up continues until Cascade Halls 1001 and 1002 are fully operational.

12.5 Production Phase 4

Construction of remaining SBMs is completed and cascade modules started up incrementally as needed to support final plant expansion. This incremental start up continues until all Cascade Halls are fully operational. The duration of this phase is dependent on the final approved design and SWU capacity.