



Indian Point Energy Center
450 Broadway, GSB
P.O. Box 249
Buchanan, N.Y. 10511-0249
Tel (914) 734-6700

Fred Dacimo
Vice President License Renewal

April 28, 2008
Indian Point Unit Nos. 2 and 3
NL-08-059

Mr. Andrew Feeney
First Deputy Director
New York State Emergency Management Office
1220 Washington Avenue
Public Security Building 22
Albany, New York 12226-2251

Subject: Indian Point Energy Center Alert and Notification System Final Design Report


- Reference:**
1. Entergy letter (NL-08-032), "Siren Project Milestone Schedule," Mr. Michael Balduzzi to NRC Document Control Desk, dated February 8, 2008
 2. Entergy letter (NL-08-024), "Indian Point Energy Center Alert and Notification System Design Report," Mr. Fred Dacimo to Mr. Andrew Feeney, New York State Emergency Management Office (SEMO), dated January 31, 2008
 3. FEMA letter, "Indian Point Energy Center Alert and Notification System Design Report," Mr. Stephen Kempf, Jr. to Mr. Andrew X. Feeney, New York State Emergency Management Office, dated March 7, 2008

Dear Mr. Feeney:

Enclosed for your review is the Indian Point Energy Center (IPEC) Final Design Report for the new Alert and Notification System. This final Design Report includes Section 14.1 discussing siren signal steadiness, repeatability, and reproducibility previously submitted by reference 2 and approved by reference 3. Transmittal of this report is in accordance with the milestone schedule provided by reference 1.

Should you have any questions regarding this matter, please contact Mr. Michael J. Slobodien, Director, Emergency Planning, Entergy at (914) 272-3352.

Sincerely yours,


Fred R. Dacimo
Vice President License Renewal
Indian Point Energy Center

A128
AX45
NSIR

Enclosure: 1. Indian Point Energy Center Alert and Notification System Final Design Report

cc: Document Control Desk (w/1 Enclosure)
U.S. Nuclear Regulatory Commission
Mail Stop O-P1-17
Washington, DC 20555-0001

Mr. Samuel J. Collins (w/1 Enclosure)
Regional Administrator
Region I
Nuclear Regulatory Commission
475 Allendale Road
King of Prussia, Pennsylvania 19406-1415

Mr. Robert Kahler (w/1 Enclosure)
Office of Nuclear Security and Incident Response
Division of Preparedness and Response
Licensing and Inspection Branch
Nuclear Regulatory Commission
One White Flint North
11555 Rockville Pike
Rockville, MD 20852-2738

Ms. Rebecca S. Thomson (w/3 enclosures)
REP Branch Chief
Federal Emergency Management Agency
Region II
26 Federal Plaza, 13th Floor, Suite 1337
New York, NY 10278-0002

Mr. Stephen Kempf, Jr. (w/1 Enclosure)
Regional Administrator
Federal Emergency Management Agency
Region II
26 Federal Plaza
New York, NY 10278

Mr. Daniel Greeley (w/1 Enclosure)
Deputy Director
Rockland County Fire and Emergency Services
35 Fireman's Memorial Drive
Pomona, New York 10970

Mr. Adam Stiebeling (w/1 Enclosure)
Deputy Commissioner
Putnam County Bureau of Emergency Services
112 Old Route 6
Carmel, New York 10512

Mr. Anthony Sutton (w/1 Enclosure)
Commissioner
Westchester County
Department of Emergency Services
4 Dana Road
Valhalla, New York 10595

Mr. Seamus Leary (w/1 Enclosure)
Deputy Commissioner
Orange County
Department of Emergency Services
225 Main Street
Goshen, New York 10924

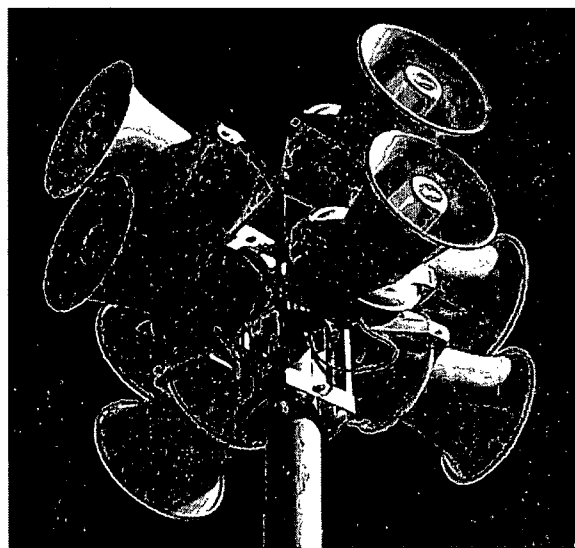
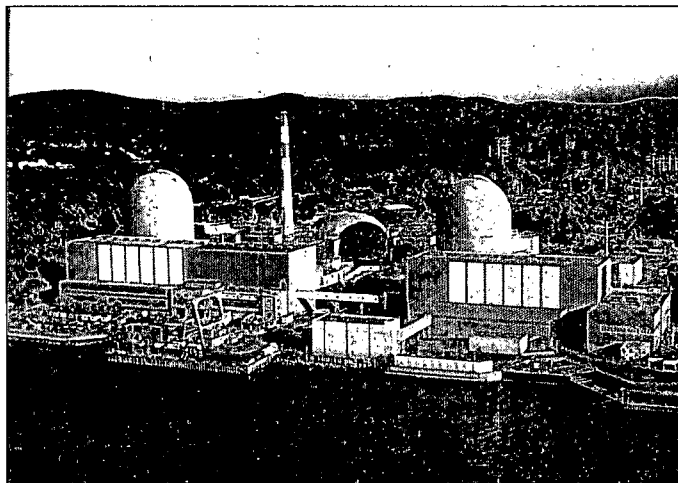
Resident Inspector's Office (w/1 Enclosure)
Nuclear Regulatory Commission
Indian Point Unit Nos. 2 and 3

Indian Point Energy Center Alert and Notification System Final Design Report



Entergy

Indian Point Energy Center



**Alert & Notification System
Design Report**

**Alert and
Notification System
for the
Indian Point Energy Center
Energy Nuclear**

April, 2008

**PREPARED BY:
ENERGY NUCLEAR
AND
ACOUSTIC TECHNOLOGY, INC.
EAST BOSTON, MASSACHUSETTS**

THIS DOCUMENT CONTAINS PROPRIETARY INFORMATION OF ACOUSTIC TECHNOLOGY, INC. (ATI) It is submitted with the express understanding, to which the recipient agrees, that its contents or any part of them will not be duplicated or disclosed to third parties, nor will proprietary information herein be used to or for any other purpose except review and implementation of the design system, with the prior written consent of ATI having been obtained in each instance. "Proprietary information" means information not previously known to the recipient so long as not generally and properly available to the public.

TABLE OF CONTENTS

1	SUMMARY	1-1
2	INTRODUCTION AND BACKGROUND	2-1
3	SITE DESCRIPTION	3-1
4	DEMOGRAPHIC CHARACTERISTICS	4-1
5	PARKS, MILITARY AND SPECIAL USE FACILITIES	5-1
6	METEROLOGICAL CONSIDERATIONS	6-1
7	SIREN CHARACTERISTICS	7-1
8	GENERAL SYSTEM OVERVIEW	8-1
9	SIREN COMMUNICATION AND CONTROL	9-1
10	COMMUNICATION AND CONTROL SYSTEM RELIABILITY	10-1
11	ACOUSTIC CRITERIA OF SIREN SYSTEM	11-1
12	SIREN ACOUSTIC COMPUTER MODEL BASIS	12-1
13	VERIFICATION OF ATI SIREN ACOUSTIC COMPUTER MODEL	13-1
14	ACOUSTIC TESTING AND ANALYSIS	14-1
15	BACKUP POWER	15-1
16	FAILURE MODES AND EFFECTS ANALYSIS	16-1
17	CONFIGURATION MANAGEMENT	17-1
18	SYSTEM TRAINING	18-1
19	SYSTEM OPERATIONS, TESTING AND MAINTENANCE PROCEDURES	19-1
20	SIREN SYSTEM ROUTINE TESTING	20-1
21	QUALITY CONTROL	21-1
22	CONCLUSION	22-1
	APPENDIX A LISTING OF ACRONYMS	A-1
	APPENDIX B INDEPENDENT TEST OF THE IPEC PROMPT ALERT NOTIFICATION SYSTEM	B-1

APPENDIX C	AMBIENT NOISE SURVEY	C-1
APPENDIX D	INITIAL TESTING	D-1
APPENDIX E	LESSONS LEARNED	E-1
APPENDIX F	SYSTEM EQUIPMENT DATA	F-1
APPENDIX G	SUPPORTING DOCUMENTATION/REFERENCES	G-1
APPENDIX H	CONTROL SYSTEM RELIABILITY TESTING RESULTS	H-1
APPENDIX I	SIMULCAST RADIO SYSTEM	I-1
APPENDIX J	LOCATIONS OF SIRENS, CONTROL STATIONS, AND REPEATERS (MAP)	J-1
APPENDIX K	SIREN COVERAGE WITHIN THE EPZ OF INDIAN POINT ENERGY CENTER (MAP)	K-1

LIST OF TABLES

TABLE 7-1	SIREN CHARACTERISTICS	7-2
TABLE 8-1	NUMBER OF SIRENS BY COUNTY	8-1
TABLE 8-2	LOCATIONS OF SIREN SYSTEM CONTROL STATIONS	8-6
TABLE 9-1	TRANSMISSION TOWER CHARACTERISTICS	9-4
TABLE 10-1	OPERATIONAL STATES FOR COMMUNICATION AND CONTROL SYSTEM	10-1
TABLE 13-1	FAR FIELD MEASUREMENTS COMPARED TO ATI MODEL PREDICTIONS AUGUST 11 – AUGUST 14, 2007	13-2
TABLE 14-1	STEADINESS OF OMNI-DIRECTIONAL SIREN SYSTEM MEASURED AT THE CENTER MICROPHONE LOCATION (#3)	14-7
TABLE 14-2	SUMMARY OF TEST RESULTS FROM ANECHOIC CHAMBER TESTS OF NEW OMNI-DIRECTIONAL SIRENS	14-13
TABLE 14-3	BULK RESULTS FROM THE TESTING OF THE OMNI-DIRECTIONAL SIRENS	14-15
TABLE C-1	LOCATION AND DESCRIPTION OF THE AMBIENT MEASUREMENT LOCATIONS	C-1
TABLE C-2	THE CUMULATIVE EXCEEDANCES FOR THE 28 TH TOB (630 HZ)	C-2
TABLE E-1	ENERGY CONDITION REPORTS (CR) FROM JANUARY 2004 TO FEBRUARY 2006	E-4
TABLE E-2	COMPARISON OF FORMER AND NEW SYSTEMS	E-7
TABLE H-1	IPEC ANS RELIABILITY TESTING	H-2
TABLE H-2	IPEC ANS DIAGNOSTIC TESTING (2 PAGES)	H-3
TABLE H-3	ACTIVATION LOCATIONS FOR PERFORMED SEPTEMBER 6-17, 2007	H-5
TABLE H-4	CONTROL SYSTEM TEST RESULTS FOR TESTING PERFORMED SEPTEMBER 6-17, 2007	H-6

LIST OF FIGURES

FIGURE 3-1	POPULATION DENSITY FROM YEAR 2000 CENSUS DATA WITHIN THE EPZ OF INDIAN POINT ENERGY CENTER	3-2
FIGURE 8-1	TYPICAL STATIONARY OMNI-DIRECTIONAL SIREN IN NEW SYSTEM	8-2
FIGURE 8-2	TYPICAL STATIONARY BY-DIRECTIONAL SIREN IN NEW SYSTEM	8-2
FIGURE 8-3	TYPICAL SIREN EQUIPMENT AND CONTROL ENCLOSURE	8-4
FIGURE 8-5	TYPICAL RACK MOUNT CONTROL STATION COMPONENTS	8-7
FIGURE 8-6	TYPICAL COMMUNICATION SYSTEM	8-8
FIGURE 9-1	SCHEMATIC LAYOUT OF FULLY REDUNDANT REPEATER SYSTEM	9-6
FIGURE 12-1	CALCULATION OF SOUND CONTOUR GRID SYSTEM	12-4
FIGURE 14-1	MICROPHONE ARRAY IN ANECHOIC CHAMBER	14-4
FIGURE 14-2	TIME HISTORY OF EACH SPL FOR EACH MICROPHONE IN THE ARRAY DURING THE SOUNDING OF SIREN 331 f=576 Hz	14-4
FIGURE 14-3	TIME HISTORY OF EACH SPL FOR EACH MICROPHONE IN THE ARRAY DURING THE SOUNDING OF SIREN 315 f=576 Hz	14-5
FIGURE 14-4	TIME HISTORY OF EACH SPL FOR EACH MICROPHONE IN THE ARRAY DURING THE SOUNDING OF SIREN 213 f=576 Hz	14-5
FIGURE 14-5	TIME HISTORY OF EACH SPL FOR EACH MICROPHONE IN THE ARRAY DURING THE SOUNDING OF SIREN 113 f=576 Hz	14-6
FIGURE 14-6	STEADY, REPEATABLE, AND REPRODUCIBLE RESULTS FOR BI-DIRECTIONAL SIRENS	14-6
FIGURE 14-7	CONTOUR MAP OF FREQUENCY AND TIME DOMAIN OF A TYPICAL SIREN SOUNDING	14-8
FIGURE 14-8	REPEATABILITY OF ACOUSTIC MEASUREMENTS ON SIREN #331; MICROPHONE #3 DATA	14-8

FIGURE 14-9	REPEATABILITY OF ACOUSTIC MEASUREMENTS ON SIREN #113; MICROPHONE #3 DATA	14-9
FIGURE 14-10	REPEATABILITY OF ACOUSTIC MEASUREMENTS ON SIREN #315; MICROPHONE #3 DATA	14-9
FIGURE 14-11	REPEATABILITY OF ACOUSTIC MEASUREMENTS ON SIREN #213; MICROPHONE #3 DATA	14-10
FIGURE 14-12	OUTDOOR SIREN REPEATABILITY TESTS RESULTS FROM 2007	14-10
FIGURE 14-13	REPRODUCIBILITY OF OMNI-DIRECTIONAL SIRENS TESTED IN ANECHOIC CHAMBER IN 2007	14-11
FIGURE 14-14	OUTDOOR SIREN REPRODUCIBILITY TEST RESULTS FROM 2007	14-11
FIGURE 14-15	REPRESENTATIVE TIME HISTORIES OF ANECHOIC CHAMBER DATA SHOWING STEADINESS OF ALL TEN OMNI-DIRECTIONAL SIRENS	14-16
FIGURE 14-16a	AERIAL VIEW OF OUTDOOR GTRI TEST SITE	14-17
FIGURE 14-16b	CLOSER AERIAL VIEW OF OUTDOOR GTRI TEST SITE	14-17
FIGURE 14-17	SCHEMATIC SHOWING RELATIVE MEASUREMENT LOCATIONS AT THE GTRI OUTDOOR TEST SITE	14-18
FIGURE 14-18	VARIABILITY IN MEASURED SOUND LEVEL WITH INCREASES IN MEASUREMENT DISTANCE	14-18
FIGURE 14-19	SIREN TEST SAMPLE DATA SHEET	14-23
FIGURE C-1	TIME HISTORY OF HOURLY EXCEEDANCES FOR PEEKSKILL, NY	C-3
SCHEMATIC	SIMULCAST RADIO SYSTEM	I-2
MAP 1	LOCATIONS OF SIRENS, CONTROL STATIONS, AND REPEATERS	J-2
MAP 2	SIREN COVERAGE WITHIN THE EPZ OF INDIAN POINT ENERGY CENTER	MAP POCKET

1 SUMMARY

This report describes the Alert and Notification System (ANS) for the Indian Point Energy Center (IPEC) in Buchanan, New York.

The IPEC ANS consists of sirens, broadcasted emergency information, and high speed telephone notification. This system meets the guidelines set forth in the Federal Emergency Management Agency's (FEMA's) regulations, 44 CFR Part 350, Planning Standard E, Appendix 3 of NUREG-0654/FEMA-REP-1, and the Guide for the Evaluation of Alert and Notification Systems for Nuclear Power Plants (FEMA-REP-10).

The siren system described in this report, in conjunction with other elements of the ANS, achieves the design objectives for coverage specified in Appendix 3 of NUREG-0654/FEMA-REP-1, and FEMA-REP-10 section E.6.2 in that together they meet the following criteria:

"Capability for providing both an alert signal and informational or instructional message to the population on an area wide basis throughout the EPZ, within 15 minutes."

"The initial notification system will assure direct coverage of essentially 100% of the population within 5 miles of the site."

"Special arrangements will be made to assure 100% coverage within 45 minutes of the population who may not have received the initial notification within the entire plume exposure EPZ."

The ANS relies on omni-directional and bi-directional electronic sirens broadcasting an audible sound tone signal at 576 Hertz to alert the public to obtain information. This information is provided from commercial broadcast networks that participate in the Emergency Alert System (EAS).

The counties located in the Emergency Planning Zone (EPZ) also have arrangements to assure that there is essentially 100% coverage of the population who may not have received the initial alert. In the event of a siren failure, backup alerting will be provided by a high speed telephone calling system capable of delivering geographically customized pre-recorded emergency messages. Geographic Information Systems (GIS) were used to define the messaging area for each siren based on the acoustic coverage that would be potentially affected by a failure of that siren.

Additionally, Tone Alert Radios (TARs) are distributed to special use facilities such as schools and hospitals within the EPZ. Special use facilities are defined as those facilities where a concentration of people are located such as schools, hospitals and industrial or commercial facilities. The TARs are a discretionary method used to augment the siren alerting system; they are not a primary alerting method. On an annual basis, IPEC provides guidance to these facilities on the use and testing of the TARs.

This report describes the technical features of the siren system including siren features and placement, sound propagation acoustic modeling, control and communications systems, system operation, testing and maintenance, and backup power capabilities.

2 INTRODUCTION AND BACKGROUND

In compliance with Section 651(b) of the Energy Policy Act of 2005, IPEC installed a new ANS system consisting of fixed electronic sirens capable of providing an alert for 24 hours after a loss of normal AC power. The battery backup power feature ensures system components operate securely in the event of power failure.

Fixed omni-directional and bi-directional sirens were selected over rotating sirens to maximize the reliability of the system and avoid the problems the previously installed rotating sirens had experienced.

Fixed sirens also provide a uniform sound output which provides better sound coverage than rotating sirens. The number of sirens was also increased over the previous system to provide better sound coverage. As a result, route alerting was able to be eliminated in the Harriman and Bear Mountain Parks.

The sirens were installed on steel poles which extend pole life and withstand environmental challenges. Additionally, susceptible siren wiring is protected from damage because they are installed within the metal poles.

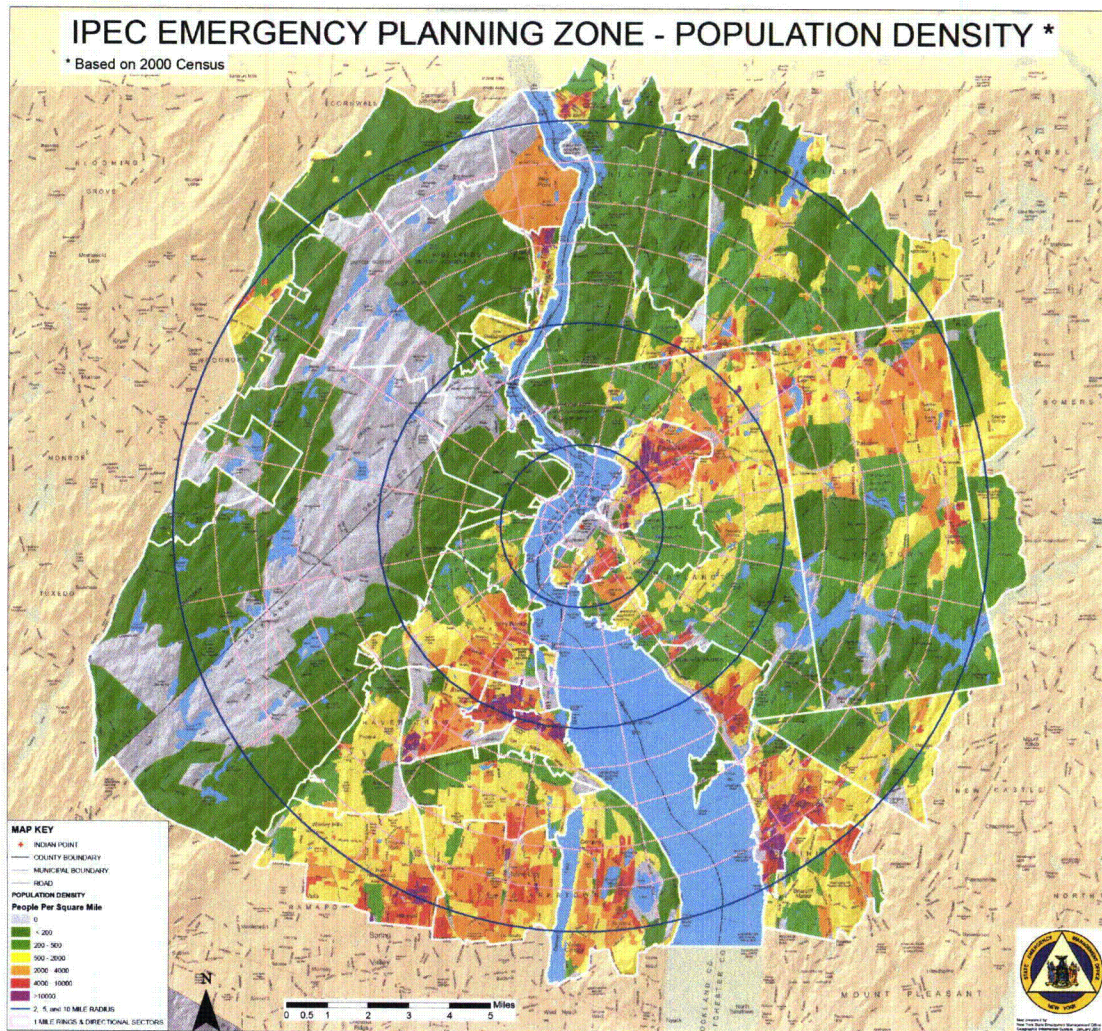
The design of the new system minimizes single points of failure. For example, numerous design features have been incorporated to provide for multiple communication paths.

3 SITE DESCRIPTION

The Indian Point Energy Center (IPEC) is located on the east side of the Hudson River in the Village of Buchanan, New York. Two active and one partially decommissioned nuclear generating units are located at the site and are owned and operated by Entergy Nuclear. The area within the EPZ is entirely within New York State, and includes portions of four counties: Orange, Putnam, Rockland and Westchester. Population densities within the EPZ range are indicated in Figure 3-1. Population density data are also shown in Map 2 (Appendix K).

The general landscape of the area around Indian Point consists of bedrock-supported ridges that generally follow northeasterly structural trends with rather steep and broad swampy valleys. The entire EPZ is mostly characterized by heavy tree cover. Deciduous species constitute the majority of this cover. In the low-lying areas, elevations range from 50 to 300 feet above mean sea level. The highest elevations in the region are within the Palisades Interstate Park System and are approximately 1,300 feet. These steep, heavily wooded slopes of the Dunderberg and West Mountains to the west-southwest typify the western area of the EPZ. To the east, peaks are generally lower than those to the north and west. In this area, Spitzenberg and the Blue Mountains average 600 feet in height and there is a weak, poorly defined series of ridges, which run mainly in a north-northwesterly direction.

Figure 3-1. Population Density from Year 2000 Census Data within the EPZ of Indian Point Energy Center



The EPZ is bisected in a north-south direction by the Hudson River, which separates Westchester and Putnam Counties on the east from Rockland and Orange Counties on the west.

4 DEMOGRAPHIC CHARACTERISTICS

The following demographic features characterize the area around the Indian Point Energy Center:

- Areas with population densities above 2000 people per square mile
- Inhabited areas with population densities below 2000 people per square mile
- Rural areas with sparse population densities
- Parklands, and
- Military facilities.

The Indian Point Energy Center is located on the eastern bank of the Hudson River, in Westchester County, approximately 35 miles north of Times Square in New York City and approximately two miles southwest of the City of Peekskill.

The major populated areas are located in the northwest region of Westchester County and the northeast region of Rockland County. In Westchester, the municipalities that contain areas that exceed 2000 people per square mile are Peekskill, Ossining, Cortlandt, Yorktown, Croton-on-Hudson and Lake Mohegan. In Rockland County, Stony Point, Haverstraw and Clarkstown have areas that exceed 2000 people per square mile. Other municipalities with populations exceeding 2000 people per square mile are Lake Peekskill and Putnam Valley in Putnam County, and Highland Falls and Fort Montgomery in Orange County.

The 2000 Census is the source of the population data used in the design report. The 2000 Census data showed that the population within the plume exposure Emergency Planning Zone of Indian Point was 297,733 people. The total resident population within a two mile radius of Indian Point is 12,154 and within a five-mile radius is 77,331. Population density data was determined by the State of New York and is shown on Figure 3-1.

5 PARKS, MILITARY AND SPECIAL USE FACILITIES

Within the EPZ of the Indian Point Energy Center there are several parks and military facilities, especially on the west side of the Hudson River in Rockland and Orange Counties. These include Harriman and Bear Mountain State Parks in the Palisades Interstate Park System (PIP), and the U.S. Military Academy at West Point. Camp Smith is a military facility on the east side of the Hudson River north of IPEC. The siren system described herein covers these locations except as noted below.

Alerting at the West Point Military Academy is provided by a combination of sirens and their own institutional alerting system. A special Radiological Emergency Communications System (RECS) telephone line has been installed between the control rooms at the Indian Point Energy Center and the West Point Military Police/Operations Center and is tested routinely. Alerting information is provided to West Point in the same time frame as the state and county officials. Upon receiving a notification on the RECS telephone line, West Point will initiate its own alert / notification actions.

Siren sound coverage is provided to Camp Smith. Upon activation of the sirens and receipt of the alert message, Camp Smith initiates actions based on their procedures.

6 METEOROLOGICAL CONSIDERATIONS

The EPZ climate is broadly representative of the humid continental type, which prevails in the northeastern United States. Winters can bring periods of below freezing temperatures and snowfall to the area while the spring, summer and fall are generally mild. There is occasional humidity in the summer. FEMA-REP-10 guidelines state that the average summer daytime weather conditions be used to calculate siren sound contours. Average summer daytime weather conditions from the IPEC Met Tower and surrounding airports were used as input for the computer model analyses for siren acoustic coverage.

Conditions for June, July and August were used to assess levels of temperature, relative humidity, and wind speed to determine the summer daytime averages for these parameters.

The following data for the average daytime meteorological conditions were used in the computer analysis for the siren sound coverage:

Temperature:	78 degrees Fahrenheit
Relative Humidity:	61 %
Wind Speed:	7.9 mph
Wind Direction (from):	210 degrees

As FEMA's CPG -1-17 (Section V) explains, as sound propagates outdoors, it is affected by among other things, atmospheric conditions. Slight changes in the wind speed and direction, variability in the temperature, and small scale local turbulence in the air all contribute to the variations in the sound propagation path from the source to the receiver. For small propagation distances, the variations are small. However, when the propagation distances become large, the effects increase. For a steady, omnidirectional source propagating across 5000 feet of flat ground, micro variations in the atmospheric conditions can produce as much as a 10 dB fluctuation in the received noise over just a few seconds. These impacts have been studied over the years and several research papers have been written about this effect. Because of this variability, it is not possible to infer the steadiness of a signal after it has propagated over long distances. In other words, a variable signal measured far from the source does not imply that the source itself is unsteady. This is backed by a long history of outdoor noise measurements and modeling.

The recent testing conducted for Entergy at the Georgia Tech Research Institute showed significant variation in the received siren signal for distances as short as 400 feet. Several cases show that, while general meteorological conditions remained steady, the received noise from a steady signal varied as much as 8 dB over the 4 minutes of the test.

7 SIREN CHARACTERISTICS

The IPEC siren system design utilizes fixed (non-rotating) outdoor electronic warning sirens manufactured by Acoustic Technology Inc. (ATI). Specifically, the ATI HPSS32 stationary siren model, primarily in an omni-directional configuration, is used. Sirens are mounted on Class II steel poles at 50 feet above the ground with the exception of five sirens (246, 247, 248, 370, and 371) that are currently mounted on wood poles. The wood poles are scheduled to be replaced with steel poles during the project to remove the old system.

A statistical analysis was performed utilizing 52 independent speaker pair measurements that were taken in the Georgia Tech Research Institute (GTRI) anechoic chamber. The mean sound pressure level of the sample population was 115 dBC Leq with a standard deviation of 0.5 dBC. Using a Chi-Squared analysis, the minimum siren level output is 114 dBC Leq, at the 95% confidence level, for any remaining siren in the total population. Field testing was also performed on 28 siren speaker pairs. The range of the sample pairs for this field testing was 115.2 to 117.4 dBC Leq. In addition, Lmax was consistently measured about 2-3 dBC higher than the Leq value.

The statistically minimum siren output of 114 dBC Leq is used in the sound contour model notwithstanding the fact that the actual output was measured at consistently higher values, thus providing a margin in sound coverage.

At 15 locations, a bi-directional beam configuration, rather than omni-directional, is used to direct sound in two primary directions to provide the most effective coverage of the area. In these cases, an 800-watt or 1600-watt speaker-pair produces a sound output level of 114 dBC Leq and 116 dBC Leq, respectively at 100 feet in the direction of each speaker-pair based on measurements taken at GTRI. For both the omni-directional and bi-directional configurations, a 576 Hz fundamental tone frequency was used in the computer analysis of the model.

According to ANSI 12.14-1992, the sound pressure level contour calculation depends upon the accuracy of the determination of siren output at 100 feet from the siren, on-axis at siren height. There are two acceptable methods to determine siren output in accordance with FEMA-REP-10: (1) field measurements around at least one siren of each type used within the Emergency Planning Zone (EPZ) or (2) anechoic chamber tests, in a laboratory whose chamber meets qualification standards, on sirens that are representative of each type used in the EPZ. Because of the variability of field measurements which can be significantly affected by uncontrollable environmental factors, IPEC concluded that the anechoic chamber measurements extrapolated out to 100 feet would provide a conservative representation of the true siren output, thereby providing margin in sound coverage.

The independent acoustic rating from the Georgia Tech Research Institute – Anechoic Chamber Testing for both the omni-directional and the bi-directional sirens is provided in Appendix B.

Table 7-1 provides the location and type (omni-directional or bi-directional) of each of the sirens in the system.

Table 7-1. Siren Characteristics

Current Siren No.	Former Siren No.	County	Latitude N (Decimal Degrees)^	Longitude W (Decimal Degrees)^	Siren Model	Siren Type	Bi-Directional Angles (Degrees from True North)	
							1st	2nd
101	O-1	Orange	41.3904	-73.9733	HPSS32	Omni-Directional	N/A	N/A
102	O-2	Orange	41.3931	-74.0647	HPSS32	Omni-Directional	N/A	N/A
103	O-3	Orange	41.3329	-74.1206	HPSS32	Bi-Directional	85	175
104	O-4	Orange	41.3439	-74.0562	HPSS32	Omni-Directional	N/A	N/A
105	O-5	Orange	41.3547	-74.1027	HPSS32	Omni-Directional	N/A	N/A
106	O-6	Orange	41.3145	-74.1370	HPSS32	Bi-Directional	85	175
107	O-7	Orange	41.3209	-74.0755	HPSS32	Omni-Directional	N/A	N/A
108	O-8	Orange	41.3060	-74.0373	HPSS32	Omni-Directional	N/A	N/A
109	O-9	Orange	41.2604	-74.0863	HPSS32	Omni-Directional	N/A	N/A
110	O-10	Orange	41.2739	-74.1173	HPSS32	Omni-Directional	N/A	N/A
111	O-11	Orange	41.3716	-73.9641	HPSS32	Omni-Directional	N/A	N/A
112	O-12	Orange	41.3365	-73.9822	HPSS32	Omni-Directional	N/A	N/A
113	O-113	Orange	41.3503	-73.9697	HPSS32	Omni-Directional	N/A	N/A
114	O-115	Orange	41.3282	-74.0025	HPSS32	Omni-Directional	N/A	N/A
115	O-116	Orange	41.3734	-74.0145	HPSS32	Omni-Directional	N/A	N/A
116	N/A*	Orange	41.3797	-74.0986	HPSS32	Bi-Directional**	45	135
117+	N/A*	Orange	41.3884	-74.0144	HPSS32	Bi-Directional**	20	290
118	N/A*	Orange	41.4261	-74.0383	HPSS32	Bi-Directional**	130	220
119+	N/A*	Orange	41.2116	-74.1422	HPSS32	Bi-Directional**	15	195
120+	N/A*	Orange	41.2334	-74.1647	HPSS32	Bi-Directional**	20	195
121	N/A*	Orange	41.2749	-74.1494	HPSS32	Bi-Directional**	25	155
122	N/A*	Orange	41.2758	-74.0875	HPSS32	Bi-Directional**	25	335
123	N/A*	Orange	41.1134	-74.1057	HPSS32	Omni-Directional	N/A	N/A
201	R-13	Rockland	41.2965	-73.9901	HPSS32	Omni-Directional	N/A	N/A
202	R-14	Rockland	41.2632	-73.9909	HPSS32	Omni-Directional	N/A	N/A
203	R-15	Rockland	41.1356	-74.0382	HPSS32	Omni-Directional	N/A	N/A

Current Siren No.	Former Siren No.	County	Latitude N (Decimal Degrees) ^A	Longitude W (Decimal Degrees) ^A	Siren Model	Siren Type	Bi-Directional Angles (Degrees from True North)	
							1st	2nd
204	R-16	Rockland	41.2289	-74.1160	HPSS32	Omni-Directional	N/A	N/A
205	R-17	Rockland	41.2081	-74.0923	HPSS32	Omni-Directional	N/A	N/A
206	R-18	Rockland	41.2322	-74.0448	HPSS32	Omni-Directional	N/A	N/A
207	R-19	Rockland	41.2212	-74.0265	HPSS32	Omni-Directional	N/A	N/A
208	R-20	Rockland	41.1888	-74.0284	HPSS32	Omni-Directional	N/A	N/A
209	R-21	Rockland	41.1961	-74.0600	HPSS32	Omni-Directional	N/A	N/A
210	R-22	Rockland	41.1701	-74.0678	HPSS32	Omni-Directional	N/A	N/A
211	R-24	Rockland	41.2352	-73.9852	HPSS32	Omni-Directional	N/A	N/A
212	R-27	Rockland	41.2042	-73.9835	HPSS32	Omni-Directional	N/A	N/A
213	R-28	Rockland	41.1868	-73.9577	HPSS32	Omni-Directional	N/A	N/A
214	R-29	Rockland	41.1868	-73.9950	HPSS32	Omni-Directional	N/A	N/A
215	R-30	Rockland	41.1766	-73.9620	HPSS32	Omni-Directional	N/A	N/A
216	R-31	Rockland	41.1584	-73.9882	HPSS32	Omni-Directional	N/A	N/A
217	R-32	Rockland	41.1600	-73.9697	HPSS32	Omni-Directional	N/A	N/A
218	R-34	Rockland	41.1349	-73.9909	HPSS32	Omni-Directional	N/A	N/A
219	R-35	Rockland	41.1348	-73.9754	HPSS32	Omni-Directional	N/A	N/A
220	R-209	Rockland	41.0846	-73.5703	HPSS32	Omni-Directional	N/A	N/A
221	R-201	Rockland	41.2414	-73.9991	HPSS32	Omni-Directional	N/A	N/A
222	R-202	Rockland	41.2045	-74.0246	HPSS32	Omni-Directional	N/A	N/A
223	R-204	Rockland	41.2210	-74.0050	HPSS32	Omni-Directional	N/A	N/A
224	R-208	Rockland	41.1351	-73.9505	HPSS32	Omni-Directional	N/A	N/A
225	R-210	Rockland	41.1605	-73.9450	HPSS32	Omni-Directional	N/A	N/A
226	R-211	Rockland	41.1977	-73.9702	HPSS32	Omni-Directional	N/A	N/A
227	R-212	Rockland	41.1992	-74.0101	HPSS32	Omni-Directional	N/A	N/A
228	R-240	Rockland	41.1305	-73.9273	HPSS32	Omni-Directional	N/A	N/A
229	R-243	Rockland	41.1705	-73.9783	HPSS32	Omni-Directional	N/A	N/A
230	R-244	Rockland	41.1691	-74.0039	HPSS32	Omni-Directional	N/A	N/A

Current Siren No.	Former Siren No.	County	Latitude N (Decimal Degrees)^\	Longitude W (Decimal Degrees)^\	Siren Model	Siren Type	Bi-Directional Angles (Degrees from True North)	
							1st	2nd
231	R-246	Rockland	41.1361	-74.0075	HPSS32	Omni-Directional	N/A	N/A
232	R-248	Rockland	41.1495	-74.0145	HPSS32	Omni-Directional	N/A	N/A
233	R-251	Rockland	41.1699	-74.0501	HPSS32	Omni-Directional	N/A	N/A
234	R-252	Rockland	41.1578	-74.0692	HPSS32	Omni-Directional	N/A	N/A
235	R-253	Rockland	41.1516	-74.0513	HPSS32	Omni-Directional	N/A	N/A
236	R-256	Rockland	41.1641	-74.0827	HPSS32	Omni-Directional	N/A	N/A
237	R-257	Rockland	41.3119	-73.9913	HPSS32	Omni-Directional	N/A	N/A
238	R-258	Rockland	41.1714	-74.0257	HPSS32	Omni-Directional	N/A	N/A
239	R-259	Rockland	41.2257	-73.9706	HPSS32	Omni-Directional	N/A	N/A
240	R-260	Rockland	41.2505	-74.0129	HPSS32	Omni-Directional	N/A	N/A
241+	N/A*	Rockland	41.1256	-74.0028	HPSS32	Omni-Directional	N/A	N/A
242+	N/A*	Rockland	41.1803	-74.1296	HPSS32	Bi-Directional**	80	170
243	N/A*	Rockland	41.1997	-74.1290	HPSS32	Bi-Directional**	20	200
244+	N/A*	Rockland	41.2277	-74.0844	HPSS32	Bi-Directional**	45	135
245+	N/A*	Rockland	41.2695	-74.0304	HPSS32	Bi-Directional**	225	315
246	R-207	Rockland	41.1426	-73.9753	HPSS32	Omni-Directional	N/A	N/A
247	R-237	Rockland	41.2245	-73.9843	HPSS32	Omni-Directional	N/A	N/A
248	R-247	Rockland	41.1432	-74.0302	HPSS32	Omni-Directional	N/A	N/A
249	R-203	Rockland	41.1150	-73.5946	HPSS32	Omni-Directional	N/A	N/A
250	N/A*	Rockland	41.0707	-73.5654	HPSS32	Omni-Directional	N/A	N/A
251	R-23	Rockland	41.0949	-74.0159	HPSS32	Omni-Directional	N/A	N/A
252	R-33	Rockland	41.0849	-73.5925	HPSS32	Omni-Directional	N/A	N/A
253#	R-36	Rockland	41.1465	-73.9350	HPSS32	Omni-Directional	N/A	N/A
301	W-37	Westchester	41.1501	-73.8599	HPSS32	Omni-Directional	N/A	N/A
302	W-38	Westchester	41.1559	-73.8354	HPSS32	Omni-Directional	N/A	N/A
303	W-40	Westchester	41.1679	-73.8383	HPSS32	Omni-Directional	N/A	N/A
304	W-41	Westchester	41.1771	-73.8485	HPSS32	Omni-Directional	N/A	N/A

Current Siren No.	Former Siren No.	County	Latitude N (Decimal Degrees)^	Longitude W (Decimal Degrees)^	Siren Model	Siren Type	Bi-Directional Angles (Degrees from True North)	
							1st	2nd
305	W-42	Westchester	41.1763	-73.8697	HPSS32	Omni-Directional	N/A	N/A
306	W-43	Westchester	41.1888	-73.8381	HPSS32	Omni-Directional	N/A	N/A
307	W-44	Westchester	41.1829	-73.8139	HPSS32	Omni-Directional	N/A	N/A
308	W-45	Westchester	41.2106	-73.7989	HPSS32	Omni-Directional	N/A	N/A
309	W-46	Westchester	41.2080	-73.8358	HPSS32	Omni-Directional	N/A	N/A
310	W-47	Westchester	41.1894	-73.8676	HPSS32	Omni-Directional	N/A	N/A
311	W-49	Westchester	41.2075	-73.8816	HPSS32	Omni-Directional	N/A	N/A
312	W-50	Westchester	41.1839	-73.8984	HPSS32	Omni-Directional	N/A	N/A
313	W-51	Westchester	41.2138	-73.8993	HPSS32	Omni-Directional	N/A	N/A
314	W-53	Westchester	41.2413	-73.8816	HPSS32	Omni-Directional	N/A	N/A
315	W-55	Westchester	41.2247	-73.8766	HPSS32	Omni-Directional	N/A	N/A
316	W-56	Westchester	41.2375	-73.8504	HPSS32	Omni-Directional	N/A	N/A
317	W-57	Westchester	41.2547	-73.7725	HPSS32	Omni-Directional	N/A	N/A
318	W-58	Westchester	41.2593	-73.8103	HPSS32	Omni-Directional	N/A	N/A
319	W-59	Westchester	41.2702	-73.7801	HPSS32	Omni-Directional	N/A	N/A
320	W-60	Westchester	41.2658	-73.8368	HPSS32	Omni-Directional	N/A	N/A
321	W-62	Westchester	41.2919	-73.8246	HPSS32	Omni-Directional	N/A	N/A
322	W-63	Westchester	41.2897	-73.8549	HPSS32	Omni-Directional	N/A	N/A
323	W-64	Westchester	41.2668	-73.8729	HPSS32	Omni-Directional	N/A	N/A
324	W-65	Westchester	41.2589	-73.9161	HPSS32	Omni-Directional	N/A	N/A
325	W-66	Westchester	41.2669	-73.9468	HPSS32	Omni-Directional	N/A	N/A
326	W-67	Westchester	41.2734	-73.9290	HPSS32	Omni-Directional	N/A	N/A
327	W-68	Westchester	41.2850	-73.9261	HPSS32	Omni-Directional	N/A	N/A
328	W-70	Westchester	41.2998	-73.9259	HPSS32	Omni-Directional	N/A	N/A
329	W-71	Westchester	41.2987	-73.9472	HPSS32	Omni-Directional	N/A	N/A
330	W-72	Westchester	41.3181	-73.9057	HPSS32	Omni-Directional	N/A	N/A
331	W-73	Westchester	41.2926	-73.8815	HPSS32	Omni-Directional	N/A	N/A

Current Siren No.	Former Siren No.	County	Latitude N (Decimal Degrees)^	Longitude W (Decimal Degrees)^	Siren Model	Siren Type	Bi-Directional Angles (Degrees from True North)	
							1st	2nd
332	W-74	Westchester	41.3116	-73.8709	HPSS32	Omni-Directional	N/A	N/A
333	W-75	Westchester	41.3218	-73.8457	HPSS32	Omni-Directional	N/A	N/A
334	W-76	Westchester	41.3213	-73.8150	HPSS32	Omni-Directional	N/A	N/A
335	W-79	Westchester	41.3295	-73.8423	HPSS32	Omni-Directional	N/A	N/A
336	W-301	Westchester	41.2566	-73.9580	HPSS32	Omni-Directional	N/A	N/A
337	W-303	Westchester	41.2847	-73.9151	HPSS32	Omni-Directional	N/A	N/A
338	W-304	Westchester	41.3198	-73.9422	HPSS32	Omni-Directional	N/A	N/A
339	W-305	Westchester	41.3239	-73.8012	HPSS32	Omni-Directional	N/A	N/A
340	W-306	Westchester	41.3272	-73.7859	HPSS32	Omni-Directional	N/A	N/A
341	W-307	Westchester	41.2838	-73.8947	HPSS32	Omni-Directional	N/A	N/A
342	W-308	Westchester	41.3040	-73.8578	HPSS32	Omni-Directional	N/A	N/A
343	W-309	Westchester	41.3020	-73.9076	HPSS32	Omni-Directional	N/A	N/A
344	W-310	Westchester	41.3091	-73.8966	HPSS32	Omni-Directional	N/A	N/A
345	W-314	Westchester	41.2552	-73.9349	HPSS32	Omni-Directional	N/A	N/A
346	W-315	Westchester	41.2780	-73.8575	HPSS32	Omni-Directional	N/A	N/A
347	W-316	Westchester	41.3283	-73.9146	HPSS32	Omni-Directional	N/A	N/A
348	W-317	Westchester	41.2396	-73.9346	HPSS32	Omni-Directional	N/A	N/A
349	W-318	Westchester	41.2315	-73.9073	HPSS32	Omni-Directional	N/A	N/A
350	W-319	Westchester	41.2544	-73.8807	HPSS32	Omni-Directional	N/A	N/A
351	W-321	Westchester	41.1600	-73.8662	HPSS32	Omni-Directional	N/A	N/A
352	W-323	Westchester	41.3121	-73.8342	HPSS32	Omni-Directional	N/A	N/A
353	W-324	Westchester	41.3277	-73.8773	HPSS32	Omni-Directional	N/A	N/A
354	W-326	Westchester	41.3029	-73.7947	HPSS32	Omni-Directional	N/A	N/A
355	W-327	Westchester	41.2946	-73.8052	HPSS32	Omni-Directional	N/A	N/A
356	W-328	Westchester	41.3059	-73.7782	HPSS32	Omni-Directional	N/A	N/A
357	W-329	Westchester	41.3278	-73.8613	HPSS32	Omni-Directional	N/A	N/A
358	W-331	Westchester	41.3297	-73.8231	HPSS32	Omni-Directional	N/A	N/A

Current Siren No.	Former Siren No.	County	Latitude N (Decimal Degrees)^	Longitude W (Decimal Degrees)^	Siren Model	Siren Type	Bi-Directional Angles (Degrees from True North)	
							1st	2nd
359	W-333	Westchester	41.2841	-73.7842	HPSS32	Omni-Directional	N/A	N/A
360	W-335	Westchester	41.1387	-73.8306	HPSS32	Omni-Directional	N/A	N/A
361	W-358	Westchester	41.2668	-73.7937	HPSS32	Omni-Directional	N/A	N/A
362	W-380	Westchester	41.2803	-73.8278	HPSS32	Omni-Directional	N/A	N/A
363	W-382	Westchester	41.2411	-73.9056	HPSS32	Omni-Directional	N/A	N/A
364	W-384	Westchester	41.2265	-73.8070	HPSS32	Omni-Directional	N/A	N/A
365	W-386	Westchester	41.2240	-73.8237	HPSS32	Omni-Directional	N/A	N/A
366	N/A*	Westchester	41.3191	-73.7802	HPSS32	Bi-Directional**	30	120
367	N/A*	Westchester	41.2964	-73.7575	HPSS32	Bi-Directional**	30	120
368	N/A*	Westchester	41.2593	-73.7476	HPSS32	Omni-Directional	N/A	N/A
369	N/A*	Westchester	41.2271	-73.7644	HPSS32	Omni-Directional	N/A	N/A
370	W-48	Westchester	41.1937	-73.8796	HPSS32	Omni-Directional	N/A	N/A
371	W-322	Westchester	41.1626	-73.8464	HPSS32	Omni-Directional	N/A	N/A
372	W-54	Westchester	41.1500	-73.5637	HPSS32	Omni-Directional	N/A	N/A
373	W-311	Westchester	41.1755	-73.5341	HPSS32	Omni-Directional	N/A	N/A
374	W-312	Westchester	41.1837	-73.5302	HPSS32	Omni-Directional	N/A	N/A
375	W-52	Westchester	41.1415	-73.5511	HPSS32	Omni-Directional	N/A	N/A
376	N/A*	Westchester	41.1858	-73.4753	HPSS32	Omni-Directional	N/A	N/A
401	W-78	Putnam	41.3418	-73.7980	HPSS32	Omni-Directional	N/A	N/A
402	P-80	Putnam	41.3520	-73.8210	HPSS32	Omni-Directional	N/A	N/A
403	P-81	Putnam	41.3684	-73.8671	HPSS32	Omni-Directional	N/A	N/A
404	P-82	Putnam	41.3458	-73.8773	HPSS32	Omni-Directional	N/A	N/A
405	P-83	Putnam	41.3491	-73.9180	HPSS32	Omni-Directional	N/A	N/A
406	P-84	Putnam	41.3606	-73.8350	HPSS32	Omni-Directional	N/A	N/A
407	P-85	Putnam	41.3802	-73.9411	HPSS32	Omni-Directional	N/A	N/A
408	P-86	Putnam	41.3864	-73.8989	HPSS32	Omni-Directional	N/A	N/A
409	P-87	Putnam	41.3666	-73.9002	HPSS32	Omni-Directional	N/A	N/A

Current Siren No.	Former Siren No.	County	Latitude N (Decimal Degrees)^	Longitude W (Decimal Degrees)^	Siren Model	Siren Type	Bi-Directional Angles (Degrees from True North)	
							1st	2nd
410	P-88	Putnam	41.3812	-73.8604	HPSS32	Omni-Directional	N/A	N/A
411	P-89	Putnam	41.4240	-73.9527	HPSS32	Omni-Directional	N/A	N/A
412#	N/A*	Putnam	41.4076	-73.9202	HPSS32	Omni-Directional	N/A	N/A
413	N/A*	Putnam	41.3887	-73.8141	HPSS32	Omni-Directional	N/A	N/A
414	N/A*	Putnam	41.3700	-73.7847	HPSS32	Omni-Directional	N/A	N/A
415#	N/A*	Putnam	41.2030	-73.5327	HPSS32	Omni-Directional	N/A	N/A

* Newly added siren locations.

**Sirens using TH400 speakers.

+ Siren powered by solar panels.

Final locations pending as of 4/7/08.

^ Latitude/longitude coordinates are referenced to datum GCS WGS.1984.

8 GENERAL SYSTEM OVERVIEW

The number of sirens in each of the four counties within the EPZ is summarized in the table below:

Table 8-1. Number of Sirens by County

County	New System – Number of Sirens
	Total
Westchester	76
Rockland	53
Orange	23
Putnam	15
Total	167

Sirens

Electronic stationary sirens are used in this system. The sirens provide reliable alarm tone notification for warning areas in a community and are capable of voice reproduction when enabled. This omni-directional electronic siren configuration (Figure 8-1) is certified to produce a 360-degree pattern of at least 114 dBC Leq sound pressure (rated at 100 feet on axis at siren height). The bi-directional electronic siren configuration (Figure 8-2) is certified to produce a sound pressure level of at least 114 dBC Leq for each 800 watt beam or 116 dBC Leq for each 1600 watt beam (rated at 100 feet on axis at siren height). The sound pattern from multiple fixed omni-directional sirens is designed to provide a greater added effect by creating an increased sound level exposure at full volume, compared to the previous design that used rotating sirens. Stationary sirens are advantageous since they maintain a constant output level in all directions. The design of the speaker assembly allows the siren to still operate even if some drivers were to fail although there would be a reduction in sound output. The siren units are driven by battery power with sufficient capacity to provide 15 minutes of operation after a 24 hour loss of external power. There are 167 sirens in the Indian Point warning system. Of those, 136 sirens use essentially the same locations as the previous rotating sirens they are replacing, while the remaining 31 are in new locations.

Figure 8-1. Typical Stationary Omni-Directional Siren in New System



One hundred and fifty-two (151) sirens are omni-directional and fifteen (15) use the bi-directional configuration (Figure 8-2).

Figure 8-2. Typical Stationary Bi-Directional Siren in New System



Siren Station Components

Each omni-directional siren includes the following components:

- Eight Horns (HPSS32), each containing four 100-watt compression drivers
- NEMA 4X Stainless Steel Enclosure with three separate compartments: an upper compartment for the electronics and two lower ventilated compartments for the batteries.
- Siren Amplifier Controller Board
- Auxiliary Amplifier Board
- Wireless Radio
- Wireless Modem
- Temperature-compensated Battery Charger
- On/Off Switch for the Battery Charger
- On/Off Circuit Breakers for Siren Power
- On/Off Circuit Breakers for heater
- Four 12V, Gel Cell Batteries
- Intrusion Switch
- Battery Heater and Thermostat
- Cell Antenna
- Omni-Directional or YAGI (directional) Antenna with low loss coaxial cable

The omni-directional High Power Speaker Station (HPSS32) in the IPEC system utilizes the model TH 300 speaker and is a state-of-the-art electronic siren capable of producing 3200 watts of audio power (400 watts per speaker) and includes all of the above components. It uses advanced microprocessor-based circuitry.

Two different bi-directional configurations are used. In the first configuration, the bi-directional HPSS32 which utilizes the model TH 400 speaker is capable of producing 3200 watts (800 watts per speaker) and also includes all of the above components, except that it uses four speakers (two per direction, configured vertically), each containing two 400-watt compression drivers.

In the second configuration, the bi-directional HPSS32 which is an omni-directional HPSS32 (utilizing the model TH 300 speaker) with two pairs of speakers enabled, is capable of producing 1600 watts (400 watt per speaker), and includes all of the above

components, except uses four speakers (two per direction, configured vertically), each containing four 100-watt compression drivers.

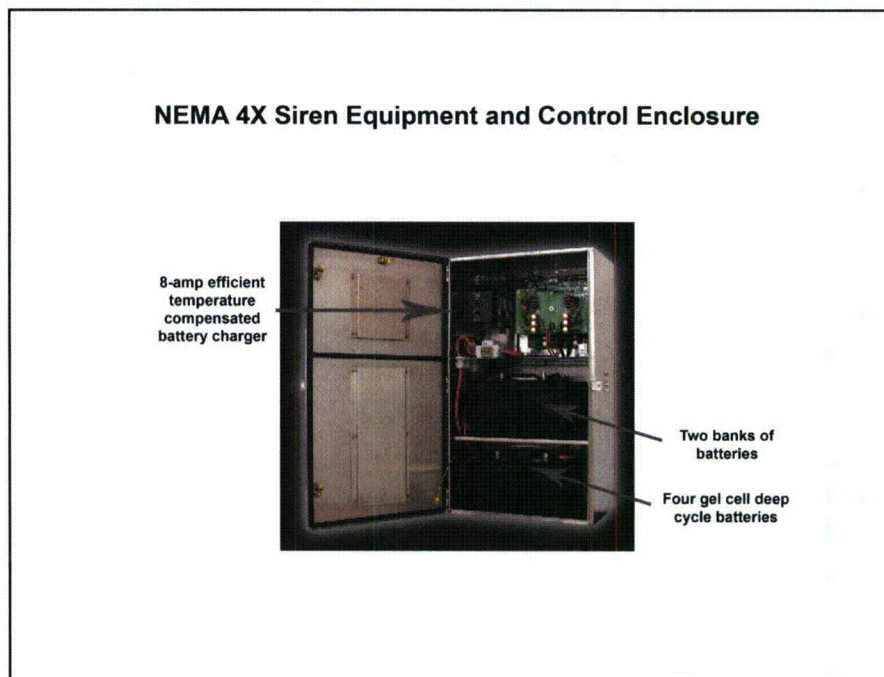
The HPSS32 sirens are 24V DC powered sirens using deep cycle gel cell batteries which are trickle charged with an 8 Amp temperature-compensated Battery Charger. Seven (7) sirens are solar powered.

The electronics and batteries are housed in a stainless steel NEMA 4X enclosure (see Figure 8-3) as a standard feature, providing protection from adverse outdoor weather conditions. With AC power available, the battery compartment is heated, thus enabling the batteries to function at full capacity when the outside temperature drops.

The HPSS enclosure (NEMA 4X) contains the ATI Siren Amplifier Controller Board (SAB), which integrates both the microprocessor control and audio amplifier circuitries. It contains a control section, communication section, input/output section, and 1600W amplifier section. The Auxiliary Amplifier Board contains an additional 1600 W amplifier section.

The HPSS enclosure also contains a highly efficient audio amplifier design (up to 95%), resulting in very low heat dissipation during standard operation with lower power requirements, leading to longer battery life.

Figure 8-3. Typical Siren Equipment and Control Enclosure



The SAB board is a microprocessor-based board. It has an embedded modem, analog to digital converter, serial port interfaces, and a wireless communication interface. The board is programmed from a regular PC using a special utility program.

The communication section of the board interfaces to an off-the-shelf wireless radio. The radio is used to send and receive wireless messages to and from the control station incorporating Frequency Shift Keying (FSK) data transmission schemes. The board will perform specific activations dependent upon the wireless messages sent by the control station in addition to responding to other types of service messages, (i.e. polling, acknowledgements, and synchronization messages). The board will report to the control station any local faults, such as intrusion, AC and/or charger failures, and low battery conditions.

A redundant communication path using TCP/IP protocol is also available. The siren controller board interfaces to a wireless modem.

The board monitors the battery voltage of the siren internally and the charger voltage. It will enter Power Shutdown Mode if the battery voltage goes below a pre-set value and generates an alarm report.

Control System

The communication control system uses eleven (11) control stations that are designed to have complete control and monitoring capabilities over all sirens in the system. Each control station includes a REACT-4000 Communication Control Unit (CCU), TCP/IP cell modem with an attached computer, LCD monitor, printer, keyboard, track ball, batteries, and uninterruptible power supply, all generally within a rack-mounted enclosure (See Figure 8-5). There are two (2) control stations located at Indian Point Energy Center that control all 167 sirens. There are three (3) control stations located in Westchester County controlling 76 sirens, two (2) control stations located in Putnam County controlling 15 sirens, two (2) control stations located in Orange County controlling 23 sirens, and two (2) control stations located in Rockland County controlling 53 sirens. Table 8-2 lists the locations of the control stations.

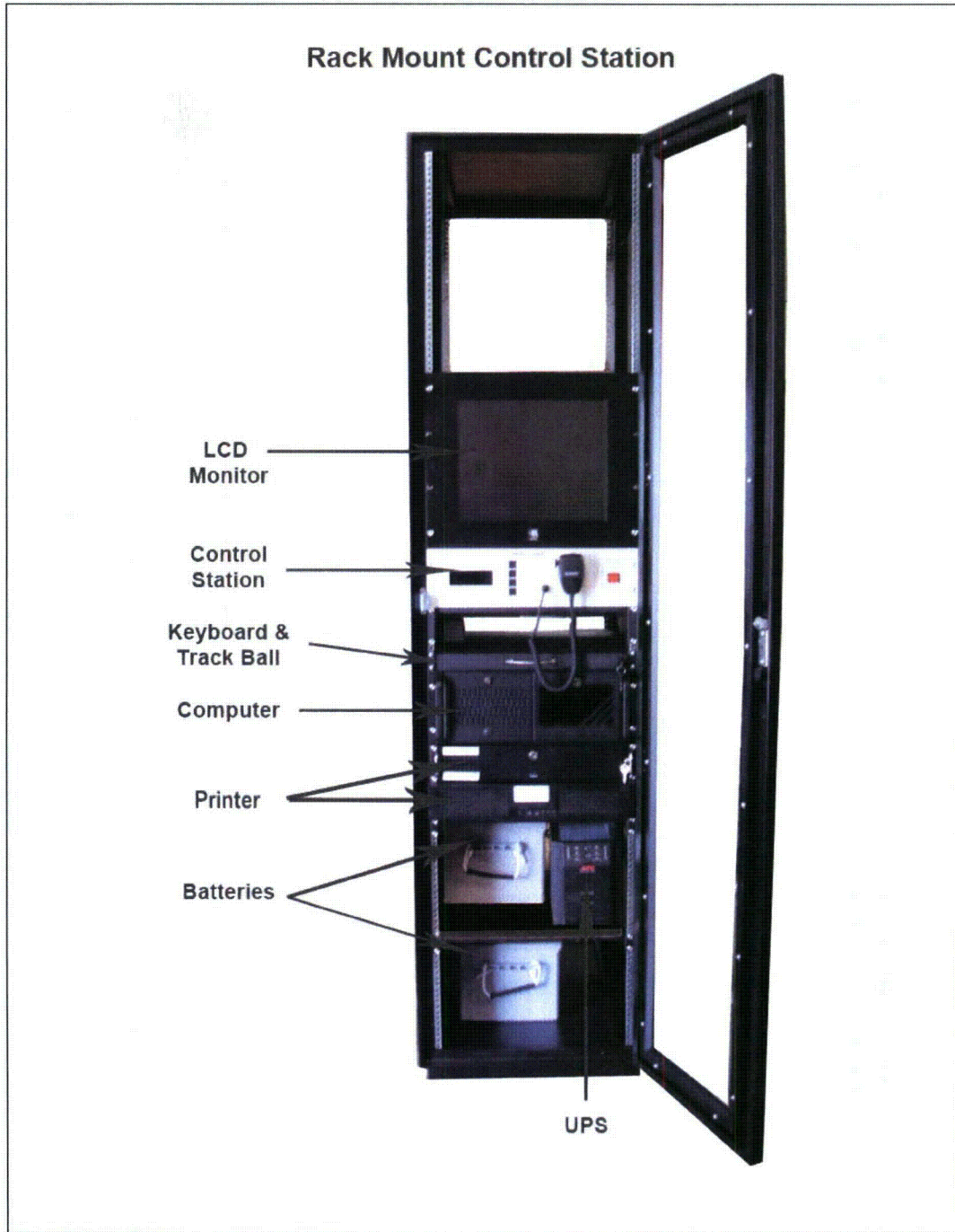
Each county has complete activation control and monitoring over the sirens used to alert its county from all control stations located within its county and can monitor the activation of all sirens via the computer display. Each county can also monitor sirens from bordering counties that may affect their county. All counties can also activate other counties' sirens if agreed upon. The two control stations at IPEC can also activate all of the sirens if needed.

All control stations have battery back-up power capable of providing a minimum of twenty-four (24) hours of operation in case of primary power failure. The system incorporates reliable communication and post activation polling using radio and TCP/IP communication.

Table 8-2. Locations of Siren System Control Stations

Location	Address
Indian Point Emergency Operations Center (EOF)	Indian Point Energy Center 450 Broadway Buchanan, NY 10511
Indian Point General Service Building (GSB)	Indian Point Energy Center 450 Broadway Buchanan, NY 10511
Westchester Co. EOC	Hudson Valley Traffic Management Center 200 Bradhurst Avenue Hawthorne, NY 10532
Westchester Co. Alternate EOC	Michaelian Office Building 148 Martine Ave. White Plains, NY 10601
Westchester 60 Control	4 Dana Road Valhalla, NY 10595
Rockland Co. EOC	Fire Training Center 35 Fireman's Memorial Drive Pomona, NY 10970
Rockland Co. Warning Point	44 Control Fire Training Center 35 Fireman's Memorial Drive Pomona, NY 10970
Orange Co. EOC	22 Wells Farm Road Goshen, NY 10924
Orange Co. Warning Point	911 Center 22 Wells Farm Road Goshen, NY 10924
Putnam Co. EOC	Putnam County Training & Operations Center 112 Old Route 6 Carmel, NY 10512
Putnam Co. Warning Point	Putnam County Sheriff's Department 3 County Center Carmel, NY 10512

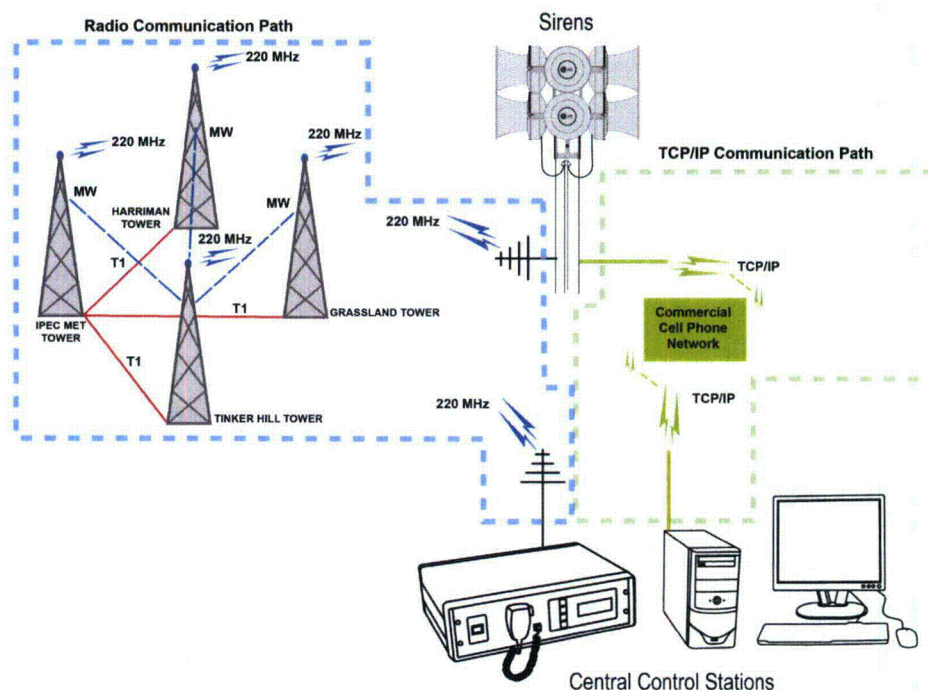
Figure 8-5. Typical Rack Mount Control Station Components



Communication System

There are two separate and distinct communication paths used to convey activation and monitoring messages between the control stations and the remote sirens: dedicated redundant simulcast radio systems and a cellular TCP/IP system. The overall system showing both paths is illustrated in Figure 8-6. The design eliminates single points of siren communication failures since multiple control stations can communicate to every assigned siren by either communication path. To further increase the Radio Frequency (RF) system reliability, all activation transmission messages are sent out multiple times. By sending out multiple redundant activation messages, the probability of all desired sirens activating is increased even in the presence of random radio interference.

Figure 8-6. Typical Communication System



The dedicated simulcast radio system uses redundant transmitters and associated equipment operating in the 220 MHz range to communicate between the control stations, towers and sirens, and it uses either microwave or Telco T1 paths for inter-tower communications. Only one of the redundant simulcast paths is configured to be used at a time to transmit signals. Dual antennas (one for each radio path) are located at each of the four tower sites (IPEC Met Tower, Harriman, Grasslands, and Tinker Hill Towers), and they are used in the communication paths between the control stations, towers, and sirens.

All radio communication equipment used in the microwave communication path (control stations, towers and sirens) has a confirmed battery backup for at least twenty-four (24) hours of operation in case of AC power loss. This same backup is provided for the Telco T1 path with the exception that the commercial carrier has not confirmed a 24-hour backup capability for the Telco T1 lines.

A cellular TCP/IP data network that uses cellular data modems provides redundant communications between all control stations and sirens. Cell modems and antennas are located at all sirens and control stations. Signals are transmitted using commercial carriers, and they seek out appropriate paths between the control stations and sirens. Communications equipment that is physically located at the sirens and control stations use the same backup battery supplies that are used for the radio communications channel. However, the cell modem commercial carrier has not confirmed a 24-hour backup capability on loss of AC power.

By using the simulcast radio system and the cellular modem communications paths concurrently and in a parallel manner for all communications between the control stations and the sirens, a reliable communication system is achieved. Each communication path is designed to achieve reliable delivery of a successful activation message from any control stations.

9 SIREN COMMUNICATION AND CONTROL

Control

Control, as used herein, refers to those functions that are used to activate the sirens, monitor siren system functionality, and receive condition status and alarms from the sirens.

The siren control system consists of eleven independent and redundant control stations. Each county has at least two control stations. One is located at each county's Warning Point (WP) that is manned continually on a round-the-clock basis. Another station is located at each county's Emergency Operations Center (EOC). Westchester County has a third control station located at its backup EOC. Two control stations are located at IPEC.

Each control station consists of one computer system, one cell modem for TCP/IP communications, one REACT 4000 Communications Control Unit (CCU) for radio communications, and a UPS and backup batteries. The computer runs control and monitoring software.

The Internet/Cellular system utilizes the computer, cell transceiver, and cell antenna at each control station to initiate activation and polling commands to the sirens and to monitor results. The computer is programmed to activate a pre-defined group of sirens and is the main component used to activate and monitor the sirens using the TCP/IP path. Transmission paths between the control stations and sirens use commercial carriers that are independent of the Radio System.

The Radio System uses a REACT 4000 to initiate and monitor activation and polling commands to the sirens. It is also programmed to activate a pre-defined group of sirens. It can operate independently without the computer, but is normally aligned so that it processes activation and polling commands initiated by the computer. Activation using the Radio System sends activation signals to the Internet/Cellular system and vice versa.

Typically, the control stations in the individual counties of Orange, Putnam, Rockland, and Westchester are set to activate and monitor only those sirens within their own jurisdictions. However, the control units can be set up with the ability to activate sirens in any and all jurisdictions. In this way, the control units provide redundancy and backup to other control stations. If a control station in one of the counties were out of service, its sirens could be activated by another control station within the county, or if agreed, by another county. All of the computer/REACT-4000/cell modem units have battery backup power capable of providing a minimum of 24-hours of operation in case of primary power failure.

Sirens can be activated by either the REACT-4000 alone (radio) or the computer (REACT 4000 or TCP/IP). Upon initiation, activation signals can be sent over the following two pathways simultaneously:

- The 220 MHz radio to the radio transmission towers, which then transmits signals to the siren network via 220 MHz, and

- Commercial cell phone modem network/internet (TCP/IP, Transmission Control Protocol/Internet Protocol) to the individual sirens and control stations where cellular modems receive the signals.

The 220 MHz radio interface is built into the REACT-4000 unit and the TCP/IP interface is connected through the computer. In normal operation, the REACT-4000 and the computer communicate so that activations, initiated by either unit, are sent out over both paths. If either the REACT-4000 or the computer is non-functional, the other component can still transmit activations over the remaining path.

The use of either of these two pathways is sufficient to activate the sirens. The control stations poll the individual sirens using the same communications pathways to determine siren status and function. The control station computer is password-controlled so that it can be set for use in its primary county, or as a backup for other counties as required.

Sirens are routinely polled to report on operational readiness. Key system parameters that are monitored include communications, AC power availability, siren and control station operability and battery status.

Communication – General Overview

There are two separate and distinct communications paths between the control stations and sirens:

- Redundant 220 MHz simulcast radio networks linking all sirens and CCUs through repeater towers
- Commercial cellular TCP/IP connectivity to all sirens and control stations

The radio pathway and cellular TCP/IP pathway operate concurrently.

The dedicated simulcast radio network is comprised of four towers sites, each with redundant radio hardware to communicate activation and status monitoring signals between the control stations and sirens. Signals received by any tower will result in these signals being communicated to all towers. The signals are then re-sent in a coordinated manner to all sirens and control stations as appropriate, to minimize signal interference. There are two redundant radio paths used to communicate between the control stations and sirens. Each path includes radio antennas at each tower, radio frequency transmitters/receivers at each tower and a communication link between towers. Only one of these paths is in full operation at a time, with the other normally in standby. The receiver paths at the towers are always maintained in operation and can therefore process any signals received, but only one transmitter can operate depending on which one is selected to be in service. Failure of the in-service path would result in automatic transfer to the standby path. There are no shared components in the signal transmission path used to activate and monitor the sirens except for the equipment building and tower structure, the equipment maintaining the time stamp for synchronization with the sirens, and both paths share the same battery backup. The control circuits used for tower alarms and channel switching are also shared.

The towers communicate to each other through redundant communication links. One of these communication links uses microwaves and the other uses Telco T1 telephone lines. The redundant controlling electronics for processing the multiple signals received by the towers are located in different facilities. For the T1 path, it is the IPEC Met Tower and for the microwave path it is Tinker Hill Tower.

Control signals to transfer between communication links are processed through the IPEC General Support Building (GSB) with the capability to manually transfer this function to the IPEC EOF as a backup. Loss of one of the tower communication links would not prevent the Radio System from activating or monitoring the sirens.

One complete radio path for status monitoring and activation (microwave path) has a confirmed 24-hour battery backup capability via one channel of the radio system. Most of the redundant path (Telco T1) in the radio system also has a confirmed 24-hour battery backup capability. The one exception is the communication link between the towers that uses Telco T1 lines operated by the local telephone carrier. Table 9-1 describes the characteristics for the transmission towers. The locations of the sirens, control stations, and repeaters are depicted on Map 1.

The cellular TCP/IP siren activation and monitoring pathway does not rely on the repeater towers; it processes signals directly between the control stations and the sirens.

Alarms and status monitoring of signals to and from the sirens are processed using the same dual paths that are used for siren activation.

Each repeater tower also has a monitoring unit which provides alarm monitoring and control for the radio system at the towers and communicates to the control stations by a separate radio and TCP/IP cell modem, each having its own antenna. The monitor processes signals to indicate alarm conditions at the repeater towers resulting from component failures, activates or blocks either the microwave transceivers or the Telco T1 line transceivers depending on which tower communication path is desired, powers down several components in the standby channel if there is a loss of AC power at the towers, and initiates a transfer between the microwave mode and Telco T1 mode when conditions dictate (manually, automatically on a major component failure, or automatically on a regular schedule, if selected). Each control and alarm communication path to the towers is independent of the other except where these signals are processed through common circuit boards and where components in the redundant communication paths are housed in common enclosures at the control stations and towers. The monitoring units at the towers share the 24-hour battery backup supply.

Table 9-1. Transmission Tower Characteristics

Tower	Latitude N (Decimal Degrees)*	Longitude W (Decimal Degrees)*	Primary RF Antenna Type / Height	Secondary RF Antenna Type / Height	Microwave Dish Height
IPEC Met Tower	41.2706	-73.9500	Omni-directional 220 MHz / 340'	Omni-directional 220 MHz / 320'	208'
Harriman	41.3033	-74.1150	Omni-directional 220 MHz / 80'	Omni-directional 220 MHz / 38'	55'
Tinker Hill	41.3847	-73.8368	Omni-directional 220 MHz / 120'	Omni-directional 220 MHz / 100'	50', 100', 180' (3 dishes)
Grasslands	41.0804	-73.8065	Omni-directional 220 MHz / 294'	Omni-directional 220 MHz / 294' (inverted)	338'

* Latitude/longitude coordinates are referenced to datum GCS WGS 1984.

Radio Path

Primary communications from the control stations to the individual sirens are distributed through the four simulcast radio towers described in Table 9-1. The transmitter towers are linked to provide simulcast operation. The Effective Radiated Power (ERP) from the transmitter towers is 200 watts with 50 watts ERP talkback power. Using the four towers in simulcast mode, coverage is obtained from any of the eleven (11) control stations to all assigned siren sites.

Each simulcast radio site is comprised of two separate and redundant 100 watt simulcast radio repeaters. Each of the sirens and each of the CCUs are equipped with a 25 watt radio to communicate over the simulcast network. The simulcast radio network uses 220 MHz frequencies licensed to Entergy through the National Rural Telecommunication Cooperative (NRTC).

In addition to redundant communications, the siren system has other redundant features that were designed to ensure operability of the siren network.

Specifically:

Each CCU operates independently and can communicate with every siren in the system using any one of the communications paths.

All sirens, CCUs and the synchronized microwave simulcast radio sites are battery backed up for a minimum of 24-hours.

All activation messages are sent out multiple times to ensure that they are received.

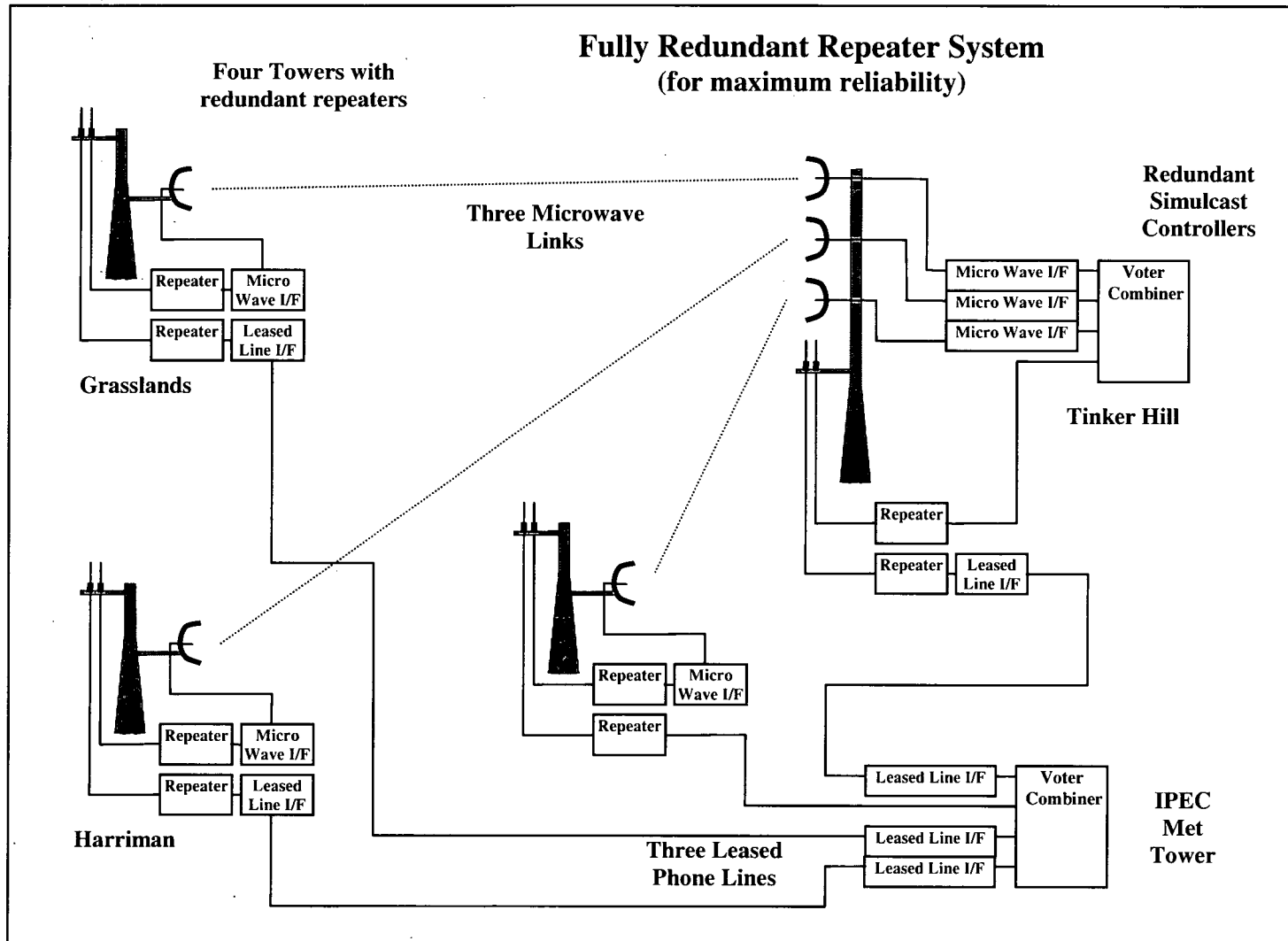
Wireless TCP/IP Networks

The cellular data network uses modems to provide a redundant communication pathway between all control units and the sirens. Several methods are employed to prevent unauthorized access to the siren system via these cellular links. Data are extensively checked. The modems are programmed to respond only to other modems within an assigned block of static IP (internet protocol) addresses.

The cellular system is provided by a commercial carrier regulated by the Federal Communications Commission and the New York State Public Service Commission. These systems have backup power capabilities. The cellular networks use data transmission channels and are faster and more reliable than voice carrying channels. Cellular networks automatically seek out and utilize the most efficient pathway. Field tests have verified that the connectivity between and among the sirens in the EPZ is of high quality such that no additional network capability is required.

Figure 8-6 provides a diagram of the redundant simulcast communication system. Figure 9-1 provides a simplified schematic diagram for the repeater system. A detailed schematic of the simulcast radio system is located in Appendix I.

Figure 9-1. Schematic Layout of Fully Redundant Repeater System



10 COMMUNICATION AND CONTROL SYSTEM RELIABILITY

The design of the ATI siren system facilitates reliability testing. The entire system can be tested from end to end as a means of ensuring that all components are functioning in accordance with the design. Due to the large number of independent control stations and the modes of operation, there are a large number of possible combinations of control stations and transmission pathways. There are eleven independent control stations. Each station can operate in one of five modes or it can be in a "not in service" condition, for a total of six possible states for each control station. The possible operational states for each control station are shown in Table 10-1.

Table 10-1. Operational States for Communication and Control System

TCP/IP alone
Microwave Synchronized Radio alone
T-1 Telco Synchronized Radio alone
TCP/IP plus Microwave Synchronized Radio
TCP/IP plus T-1 Telco Synchronized Radio
Not in Service

System reliability testing was conducted during the period August 1-14, 2007, including two full system soundings on August 11 and 14, 2007. A "Student T" test was employed to determine the statistical basis for the portion of this reliability testing program that used the microwave radio communication pathway. The "Student T" test is a statistical method of determining if the averages and variances between two populations are likely to have occurred by chance or because there is a real difference in the populations. This statistical method is suitable for small populations.

The results of the August 1-14, 2007 reliability testing are tabulated in Appendix H. The data tables show the date of the test, the locations from which the testing took place, and the communication pathway(s) that were used for the testing. Test results are provided on a county by county basis and on an overall system basis.

10.1 System Performance

There was no instance in which a hardware failure caused a system-wide inability to activate sirens. One of the significant advantages of the new system is that is designed to address the potential for individual hardware failures. The system incorporates the physical separation of redundant components to enable activation from other locations within the affected county and from locations outside of the county. Furthermore, the failures observed in the testing all occurred when the system was placed in an off-normal configuration to test a single activation pathway. In normal use, the configuration utilizes all three independent activation pathways. If a large fraction of an individual county's sirens or even all of the sirens in a single county were to fail to sound on the first activation demand in an actual emergency condition, the following alternatives would be available:

- 1) The affected county could utilize its other control station(s) to activate sirens.
- 2) The affected county could request one of the other counties to activate the sirens in the failed county jurisdiction.

- 3) The affected county could request IPEC to activate the sirens from one of its control stations.
- 4) Finally, the affected county could utilize the back-up methods for alert and notification.

The above strategy would successfully address each of the three siren failures noted below.

10.2 History of Significant Activation Failures

During the new system reliability testing conducted August 1–14, 2007, there were three instances during the reliability testing in which a significant fraction of the sirens failed to activate in an individual county. The causes of these events, corrective actions, and actions to prevent recurrence are described below.

During the testing, there was one instance when an entire county's sirens failed. This event occurred on Tuesday, August 14, when Westchester County's 71 sirens failed to activate during a TCP/IP only signal test from the county Emergency Operations Center (EOC). A review of this event established that the failure was the result of an artificial siren system configuration put in place in order to test one of the three activation communication pathways. The normal siren system configuration keeps all three communication pathways active. In order to test one particular communication path, the other two must be placed into a shutdown condition. Investigation of the event on August 14 revealed that the Westchester County control station had been shutdown at the completion of the prior test. Since the unit was inactive for a period of time, the cellular modem went into the sleep mode and therefore was unresponsive for the first test. The "sleep" mode is a condition in which the component is in a reduced power configuration to conserve battery power. In normal use, this condition does not occur because the periodic testing keeps the component in an active or "awake" mode. The modem was reset, the scheduled second test was performed, and all but one Westchester County siren activated. This condition would not occur during a normal configuration. In an actual event, the control station at the county's other activation location would be used to activate the sirens immediately as described above. This event was documented in IPEC Condition Report CR-IP2-2007-3254.

There were two other instances that occurred in Orange County during testing where a significant number of the county's sirens failed to activate. These tests occurred on August 1 and August 8. Both tests used only the radio/microwave communication signal. The August 1 test resulted in 19 of the 22 sirens not receiving an activation signal. The August 8 test resulted in 10 sirens not receiving the activation signal. These events were caused by a failure to reboot a computer at the CCU following software updating. The software was not activated until the reboot occurred. This was attributed to technician error. In an actual event, the control station at the county's other activation location would be used to activate the sirens immediately as described above. This event was documented in IPEC Condition Report CR-IP2-2007-3209.

The cause for each of these failures was identified and corrective action was taken to address them.

10.3 Continued Testing

IPEC continued to conduct communication and control system reliability testing that expanded on the statistically based testing that was conducted in August and September 2007. This round of reliability testing concluded on September 17, 2007. The test results for the complete testing are also included in Appendix H. The testing regime demonstrated that overall system reliability is well above 90% as called for in the applicable FEMA guidance. Given the

configuration of the communication and control system, there are many combinations of activation and communication control. The testing regime tested those that are most likely to be used including individual county activations from EOCs and warning points in various combinations and the ability of both Westchester County and Rockland County to activate sirens on behalf of all four counties. The testing provides reasonable assurance that the installed communication and control system will function in all modes as designed. As suggested by FEMA, testing concentrated on, but was not limited to, the microwave synchronized simulcast radio communication and control mode. In that mode, overall reliability is in the range of 97-98 percent.

10.4 Reliability Testing and Performance Results

The testing performed in August and September has been sufficient to provide a greater than 95% confidence level that the results of the microwave synchronized simulcast radio activation and control mode reflected actual system capability and did not occur merely by random chance. Those results have demonstrated high reliability (greater than 97%) for that activation and control mode. Furthermore, the testing has not revealed any unanticipated failure modes. Overall success rates for all activation modes were also greater than 97 percent.

11 ACOUSTIC CRITERIA OF SIREN SYSTEM

NUREG-0654 and FEMA-REP-10 indicate that adequate siren sound levels are as follows:

- The expected siren sound pressure level generally exceeds 70 dBC where the population exceeds 2,000 persons per square mile and 60 dBC in other inhabited areas; or
- The expected siren sound pressure level generally exceeds the average measured summer daytime ambient sound pressure levels by 10 dBC (geographical areas with less than 2,000 persons per square mile).

Additionally, the NUREG 0654 Appendix 3 guidance that the notification system will "assure direct coverage of essentially 100% of the population within 5 miles of the site" has been further defined in the Shearon Harris Atomic Safety and Licensing Board (ASLB) decisions to mean "...the required essentially 100% which we equate with greater than 95% during summer nighttime conditions within 5 miles" ...and 90% within 10 miles.

Inhabited areas are depicted on Map 2 (Appendix K).

12 SIREN ACOUSTIC COMPUTER MODEL BASIS

The siren sound contours of 60 and 70 dBC, within the IPEC EPZ, were calculated by a computer model developed by ATI. These contours are shown on Map 2. The computer model evaluates meteorological factors, topographical factors and ground conditions. These factors affect the propagation of the sound signal generated by a siren. FEMA-REP-10 guidelines state that the average summer daytime weather conditions should be used to calculate siren sound contours since they are the most conservative conditions where sound propagation is most challenged. Average summer daytime weather conditions were used as input for the model analyses for siren acoustic coverage.

In accordance with relevant sections of ISO 9613-2 and ANSI S12.18-1994, the acoustic model is programmed with appropriate information pertaining to a source-receiver orientation, source sound characteristics, and path obstructions and characteristics. There are three types of data inputs required for the program:

- Siren Data – The siren dominant frequency in hertz and sound output at 100 feet on axis at siren height in dBC.
- Meteorological Conditions – Meteorological information, including temperature, wind speed, wind direction, relative humidity and barometric pressure.
- Topographical and Ground Conditions – A receiver grid system is established for the entire EPZ. Each source-receiver path is then scanned and relevant path information including effective source and receiver heights, ground characteristics, major obstructions and intervening tree cover is derived. Available topographical and ground cover condition data are used to determine sound attenuation factors (See Figure 12-1).

The various sound attenuation factors considered in the sound propagation analysis by the computer model are summarized below.

Spherical Wave Divergence

The change in the sound pressure level from spherical divergence is uniform in all directions and occurs at a rate of 6 dB per doubling of distance from the sound source. This non-dissipative sound pressure level attenuation is a result of the decrease in energy density (energy per unit area) of the propagating sound wave. The energy density of a sound wave decreases as the distance from a sound source increases because of the increase in the surface area over which the constant energy of the wave is distributed.

Atmospheric Absorption

Molecular (atmospheric) absorption further reduces the sound energy. This dissipative sound level attenuation is from inelastic collisions of air molecules. Absorption is dependent on the temperature and the relative humidity of the air, and is proportional to distance and pronounced at frequencies higher than the frequency of 576 Hz selected for the IPEC sirens.

Barrier Attenuation Effects

A mound of earth, a hill or a structure, if large enough, is a partial barrier to sound and can reduce sound levels within its shadow zone. The sound attenuation caused by a barrier is estimated by the computer model. The ATI computer model determines the effective barrier height, which is the height above the line-of-sight from the siren to the receiver location.

The other two essential dimensions are the distance from the siren to the barrier, and the distance from the barrier to the receiver. These dimensions are used to calculate the attenuation of sound from the barriers. Topographical data from USGS maps are used to calculate the sound attenuation from barrier effects caused by the high elevations generating acoustic shadow zones behind ridges and hills.

There are well developed analytical methods for calculating the extent of attenuation of sound by barriers. In general, these methods have been experimentally verified. These are used to calculate this effect. The model considers single or multiple barriers interrupting the siren signal. If multiple barriers exist, the most prominent barrier is utilized. The barrier effect is calculated. Field verification from these methods has been conducted and modified for accuracy.

Near-Field Interference Factors

All of the siren locations were surveyed to evaluate potential near-field obstructions that can attenuate the sound from the siren. Tree trimming was required and completed at many locations to mitigate this attenuation. This effort is described in the IPEC reports entitled "Report on Trees and Tree Trimming at the Indian Point Energy Center (IPEC) Alert Notification Siren Sites, September 24, 2007 to November 17, 2007," Volumes I and II, November 30, 2007. Additionally, the effect of co-located sirens was documented in CR-IP2-2007-04611 and concluded that there is not significant degradation in sound propagation from co-located sirens such that the function to alert the public is impaired.

Ground Effects

Sound attenuation is also a function of the ground cover and the siren's height. The ground cover conditions were determined directly from USGS maps at various directions and distances from the installed siren location. These conditions were used to calculate the sound attenuation due to the absorptive effect of the different ground coverings.

The primary path of the outdoor sound propagation is the direct line-of-sight path; the secondary path is the ground-reflected path. Both of these paths are subject to sound attenuation due to the effect of ground cover between the sound source and distant locations.

In general, five types of ground cover are distinguishable from USGS maps for evaluation by the ATI computer model:

Dense vegetation – forests and thick brush are the kinds of ground cover that attenuate sound to the greatest extent.

Wooded marsh – vegetation attenuates sound, but water reflects sound to a certain extent, so attenuation by this ground cover is not as great as that caused by denser vegetation.

Water, marshes – water acts as a reflector for sound propagation, so attenuation over water is very slight.

Open fields – where there is no dense vegetation or other barriers to sound, attenuation is slight.

Urban and suburban areas – sound reflects well from pavement at acute incidence angles. Sound is attenuated to a significant extent, however, in urban areas close to the siren because buildings act as sound barriers and reflection is poor because of high incidence angles. In urban areas further away from the siren, sound propagates with a low attenuation rate as a result of increased reflection due to the lowered angle of incidence.

Wind Shadows

Wind gradients near the ground are usually positive; that is, wind speed increases with height. As a result, a wind shadow zone is most commonly encountered upwind of a siren because headwinds with positive wind gradients bend sound upward. Downwind, the sound rays are bent downward and no shadow zone is produced. Crosswind, there is a zone of transition which is more difficult to model.

ATI starts with established formulas for wind attenuation. ATI then modifies those formulas utilizing proprietary factors developed by its extensive field measurements from sirens around nuclear sites.

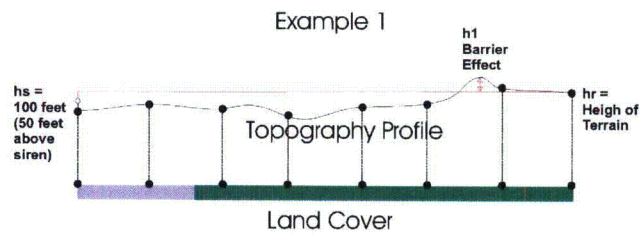
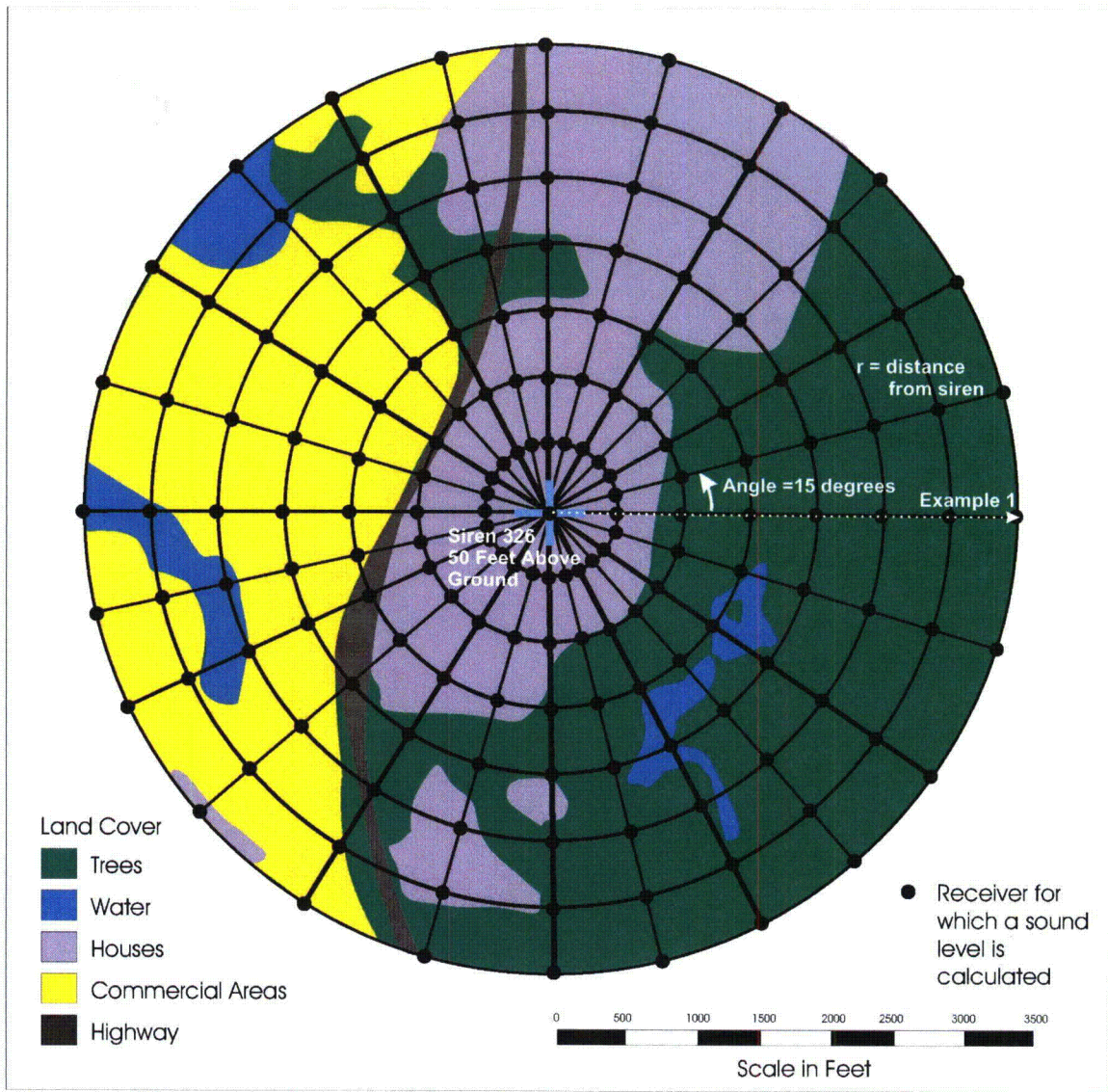
Foliage Attenuation

ATI uses empirical data to evaluate the effect of tree foliage.

Methodology

For each siren, the area around the siren is divided into Polar coordinates of 24 15° segments and the radial distance (r) from the siren. For each segment an acoustic ray is projected based on the rated sound pressure level output, as described in Section 14. The acoustic ray sound pressure level is reduced by each of the applicable attenuation factors and site specific terrain factors described above. For each sound ray, the distance from the source corresponding to C-weighted 70 dBC and 60 dBC is determined as a point (X, Y) coordinate for a Cartesian coordinate grid system. The contours are scaled and overlaid on US Geological Survey topographical maps. This entire process is then repeated for each and every set of source-receiver pairs and used to develop a matrix of values from which the sound contours can be extrapolated for the entire EPZ.

Figure 12-1. Calculation of Sound Contour Grid System



13 VERIFICATION OF ATI SIREN ACOUSTIC COMPUTER MODEL

The ATI acoustic model was used to predict the sound coverage of the new sirens in the IPEC EPZ. The siren locations and designated siren sound pressure level output in dBC Leq were input into the model. The ATI model then computed expected siren levels throughout the EPZ.

ATI produced a sound contour map which depicts 70 dBC and 60 dBC contour lines over the IPEC EPZ. Individual locations have specific predicted values based on GPS coordinates. The input value for each siren output was 114 dBC Leq.

To verify the accuracy of the ATI model, IPEC contracted with Wyle Laboratories to use its "Sound Acoustic Model" (SAM) to prepare a similar sound contour map. The identical sound pressure level of 114 dBC Leq was used as input to produce the sound contour map. The two maps were compared for similarities and differences. The two acoustic consultants produced nearly the same results. The contours lines were in essentially the same locations. The two acoustic consultants compared their results and were satisfied that both maps reasonably predicted the actual sound coverage.

To further confirm the quality of the ATI predictions, 24 high population density locations in the far field were measured during full alert siren soundings on August 11 and 14, 2007. The actual measurements are shown in Table 13.1. The input values for the ATI model predictions were siren height values (approximately 114 dBC) correlated from actual ground level readings. These measurements were compared to the predicted sound pressure levels for these locations. A bulk average deviation method, as described in Section 14.4, was used to analyze this data. Extremely close alignment was shown.

Thus, the ATI model has been demonstrated to be reasonably accurate in predicting sound coverage in the EPZ.

**Table 13-1. Far Field Measurements Compared to ATI Model Predictions
August 11 - August 14, 2007**

Location	Date	Latitude	Longitude	ATI Prediction (dBC)	Lmax (dBC)	L10 (dBC)	Leq (dBC)
Cortlandt	8/11/2007	41.2530639	-73.9622806	71	83.3	77.6	74.8
Cortlandt	8/14/2007	41.2511944	-73.9453500	72	79.9	77.4	73.7
Croton-On-Hudson	8/11/2007	41.2026972	-73.8823083	71	75.7	72.3	68.3
Croton-On-Hudson	8/14/2007	41.2111750	-73.8909528	72	89.2	78.9	75.6
Fort Montgomery	8/14/2007	41.3402639	-73.9923167	64	63.0	54.2	52.4
Haverstraw	8/11/2007	41.1992250	-73.9807972	71	90.6	76.7	75.3
Haverstraw	8/14/2007	41.1941861	-73.9636528	73	83.4	78.8	75.3
Highland Falls	8/11/2007	41.3570639	-73.9695278	72	85.1	80.0	76.8
Highland Falls	8/14/2007	41.3665194	-73.9655833	73	79.0	69.9	67.9
Lake Peekskill	8/11/2007	41.3490111	-73.8686833	71	75.7	70.7	67.6
Lake Peekskill	8/14/2007	41.3380750	-73.8791278	71	66.2	61.8	58.9
Mohegan Lake	8/11/2007	41.3119056	-73.8513861	73	83.6	77.7	74.7
Mohegan Lake	8/14/2007	41.3194306	-73.8558500	73	80.9	75.3	72.3
New City	8/14/2007	41.1535111	-73.9881222	75	91.1	86.3	82.8
Ossining	8/11/2007	41.1459306	-73.8654167	69	77.4	69.2	66.4
Ossining	8/14/2007	41.1643611	-73.8540889	71	73.3	70.7	67.7
Peekskill	8/11/2007	41.2810472	-73.9227972	72	82.2	74.5	71.5
Peekskill	8/14/2007	41.2948833	-73.9155417	72	78.9	73.9	71.1
Putnam Valley	8/14/2007	41.3861806	-73.8509139	70	69.9	68.2	66.2
Putnam Valley	8/11/2007	41.3766139	-73.8599917	75	87.4	82.9	79.3
Stony Point	8/11/2007	41.2325111	-73.9798500	74	76.7	73.1	70.4
Stony Point	8/14/2007	41.2409667	-73.9909056	80	92.9	89.6	86.4
Yorktown Heights	8/11/2007	41.3089528	-73.7904056	75	73.8	69.5	66.3
Yorktown Heights	8/14/2007	41.3159472	-73.7970111	71	74.7	70.6	66.3

14 ACOUSTIC TESTING AND ANALYSIS

14.1 Steady, Repeatable, and Reproducible

This section of the design report addresses the siren output characteristics of steadiness, repeatability, and reproducibility. Set forth below are the definition of each characteristic, how such characteristic was determined, and the documentation of test results. Georgia Tech Research Institute (GTRI) in Smyrna, Georgia established the testing methodology, conducted the testing, and provided the testing results which establish that the new Indian Point Alert and Notification System (ANS) sirens meet all applicable FEMA standards and guidance.

Figure 14-1 shows the location of the nine (9) microphone cruciform array in relation to the siren speaker array inside the anechoic chamber. This equipment arrangement is consistent for all of the tests performed by GTRI in the anechoic chamber. The central microphone was aligned with the center of the siren speaker array and data from this microphone were used in test results and analyses.

Steadiness

The definition of siren steadiness is the ability to maintain an alerting signal at a constant sound pressure level and signal frequency as a function of time. The standard for steadiness is ± 2.0 dBC established by FEMA during the technical meeting held between ENOI and FEMA on November 9, 2007 and is based on the caption to Figure 1 in CPG 1-17.

The GTRI testing demonstrates that the siren output is steady in accordance with FEMA guidance in CPG 1-17 and as discussed below.

Siren time history curves depict sound pressure level (SPL) versus time. Siren time history curves for four omni-directional sirens are provided in Figures 14-2 through 14-5. Each of the nine (9) time history curves associated with individual microphones follows the same pattern but at different sound pressure levels. Time history data recorded from the center microphone (#3) in the array for multiple activations are shown in figures 14-8 through 14-11. The center microphone was selected because it represents the on-axis center of the siren array location. Table 14-1 lists the range of siren sound variation for 28 independent speaker pair tests from four omni-directional sirens.

The GTRI data demonstrate that the omni-directional siren sound output during normal operation, which excludes an initial transient, varies between 0.16 and 0.49 dBC or 0.34 dBC on average over a 3-4 minute time period. Excluding the transient sound pressure level that occurs with signal initiation, the omni-directional sirens demonstrate a steady signal with sound pressure levels varying by less than 0.5 dBC over a 3-4 minute sounding period. The initial transient sound pressure level reduction of approximately 1.0 dBC over the first 20-24 seconds of siren operation is due to the initial electrical burst from the siren amplifiers. The ANSI S12.14-1992 criteria allows for initial transients in accordance with paragraph 6.2.3.1 which states "Observations shall be made over a period of at least 30 seconds after the warning sound source has reached steady operation."

Results of the GTRI tests indicated that the bi-directional siren sound output, excluding the initial transient varied by less than 0.40 dBC over a 3-4 minute sounding period. Figure 14-6 shows the data that demonstrate signal steadiness for the bi-directional siren system.

Based on the GTRI testing data, the steadiness range for both the omni-directional and bi-directional sirens is within 0.5 dBC over a 3-4 minute sounding period and meet the applicable FEMA standards and guidance.

Steady frequency output was measured for the siren activations of both omni-directional and bi-directional sirens at the standard operating frequency of 576 Hz as well as other frequencies including 660, 675, and 780 Hz. Frequency of the siren output was steady to within ± 1.0 Hz over a 3-4 minute sounding period. Figure 14-7 shows the constancy of frequency during a representative siren sounding.

The independent GTRI testing results demonstrate that both the omni-directional and bi-directional sirens produce a steady alerting tone frequency in accordance with FEMA standards and guidance.

Repeatability

The definition of repeatability is the ability of a siren to produce the same sound level output and tone frequency during multiple activations. The standard for repeatability is ± 2.0 dBC established by FEMA during the technical meeting held between ENOI and FEMA on November 9, 2007 and is based on the caption to Figure 1 in CPG 1-17, page 10.

The GTRI testing demonstrates that the siren output is repeatable as discussed below.

Figures 14-8 through 14-11 show the representative test results of four different omni-directional sirens during several different activations. Data from the central microphone show sound pressure level variation ranging between 0.8 and 1.4 dBC. These data demonstrate that the omni-directional siren system is repeatable within a 1.4 dBC range over a 3-4 minute sounding period. Figure 14-6 shows that the bi-directional siren is repeatable within a 0.6 dBC range over a 3-4 minute sounding period.

In addition, *in situ* outdoor testing performed in the summer of 2007 within the Indian Point EPZ and shown in Figure 14-12 indicates very similar repeatability results for both the omni-directional and bi-directional sirens. The maximum *in situ* outdoor repeatability range for 5 omni-directional siren tests was 1.1 dBC and for the two bi-directional siren tests was 0.3 dBC.

The independent GTRI testing results demonstrate that both the omni-directional and bi-directional sirens are repeatable in accordance with the FEMA standard established by the FEMA staff.

Reproducibility

Reproducibility is defined as the ability of a group of sirens to produce acoustic output that is consistent from one siren to another. The standard for reproducibility was established by the FEMA staff at a technical meeting between ENOI and FEMA on November 9, 2007.

The GTRI testing demonstrates that the siren output is reproducible as discussed below.

Reproducibility was demonstrated by comparing the sound pressure level output of different sirens. Figure 14-13 shows anechoic chamber results from twenty-eight (28) sound tests from four different omni-directional sirens with different speaker pairs facing the microphone array.

The data demonstrate that the omni-directional siren systems are reproducible to within a ± 2.0 dBC band. This is further demonstrated by outdoor tests results performed *in situ* within the Indian Point EPZ in the summer of 2007 and shown in Figure 14-14. Excluding one outlier (siren 213), outdoor *in situ* testing on the remaining 16 sirens measured on axis at 100 feet at siren height had a ± 2.0 dBC band. Anechoic chamber test results for siren 213 projected to 100 feet are well within the ± 2.0 dBC range. Additionally, outdoor tests results obtained from siren 213 at GTRI were also within the ± 2.0 dBC range. These results suggest that the outlying reading for siren 213 shown in Figure 14-14 was due to outdoor environmental effects.

Anechoic chamber and *in situ* outdoor tests described above demonstrate that the omni-directional sirens are reproducible.

Figure 14-6 shows the reproducibility of two bi-directional sirens to be within 1.0 dBC. This reproducibility is further supported by *in situ* outdoor tests whose data are shown in Figure 14-12. The *in situ* outdoor reproducibility test between bi-directional sirens 116 and 120 using the worst case combination is 0.6 dBC. Therefore, the bi-directional sirens are reproducible to within a ± 2.0 dBC band over a 3-4 minute sounding period.

The independent GTRI testing results demonstrate that both the omni-directional and bi-directional sirens are reproducible in accordance with the standard established by the FEMA staff.

Figure 14-1. Microphone Array in Anechoic Chamber

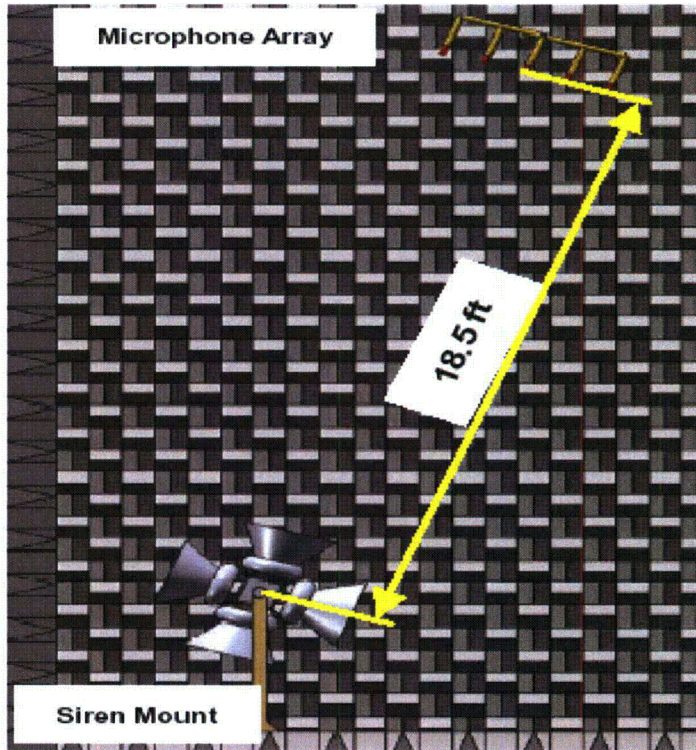


Figure 14-2. Time History of Each SPL for Each Microphone in the Array during the Sounding of Siren 331 $f = 576$ Hz
 (Source: GTRI Report D5600 – Vol. 1 Dated 3/08)

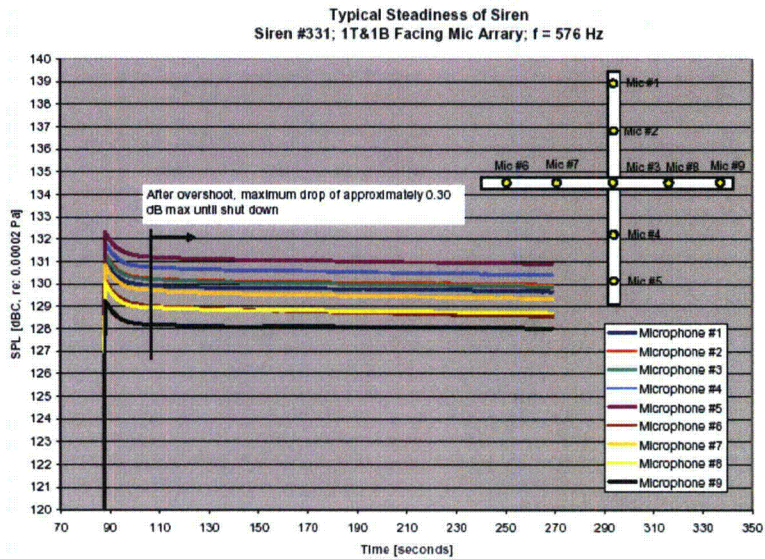


Figure 14-3. Time History of Each SPL for Each Microphone in the Array during the Sounding of Siren 315 $f = 576$ Hz
 (Source: GTRI Report D5600 – Vol. 1 Dated 3/08)

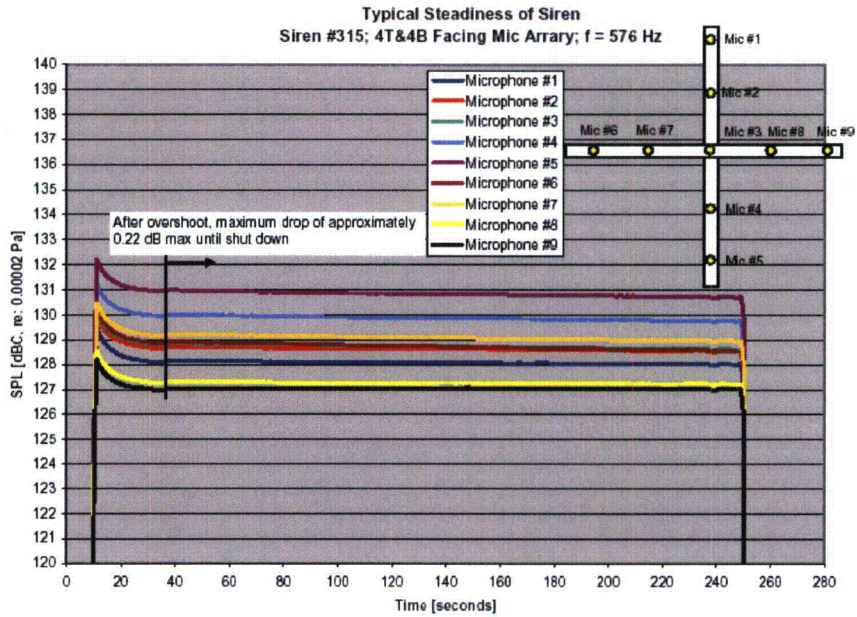


Figure 14-4. Time History of Each SPL for Each Microphone in the Array during the Sounding of Siren 213 $f = 576$ Hz
 (Source: GTRI Report D5600 – Vol. 1 Dated 3/08)

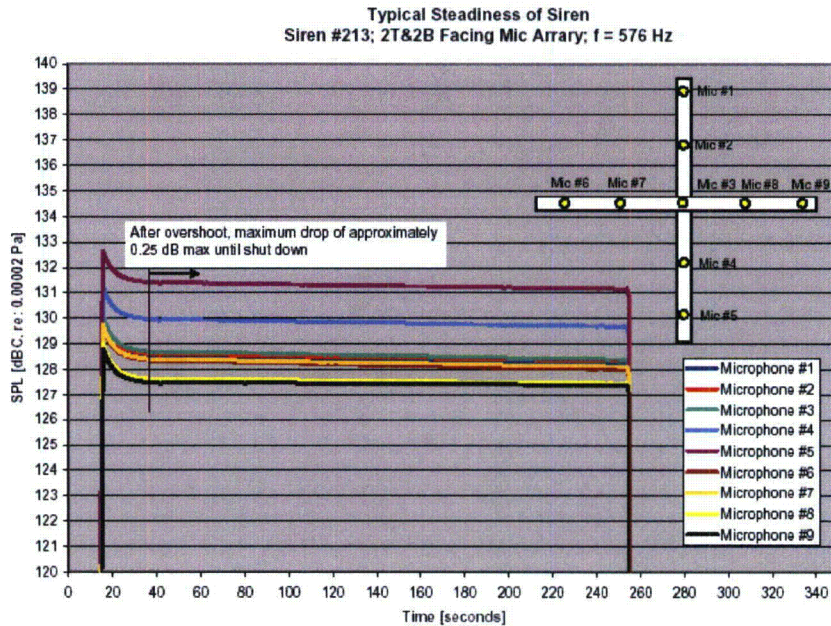


Figure 14-5. Time History of Each SPL for Each Microphone in the Array during the Sounding of Siren 113 $f = 576$ Hz (Source: GTRI Report D5600 – Vol. 1 Dated 3/08)

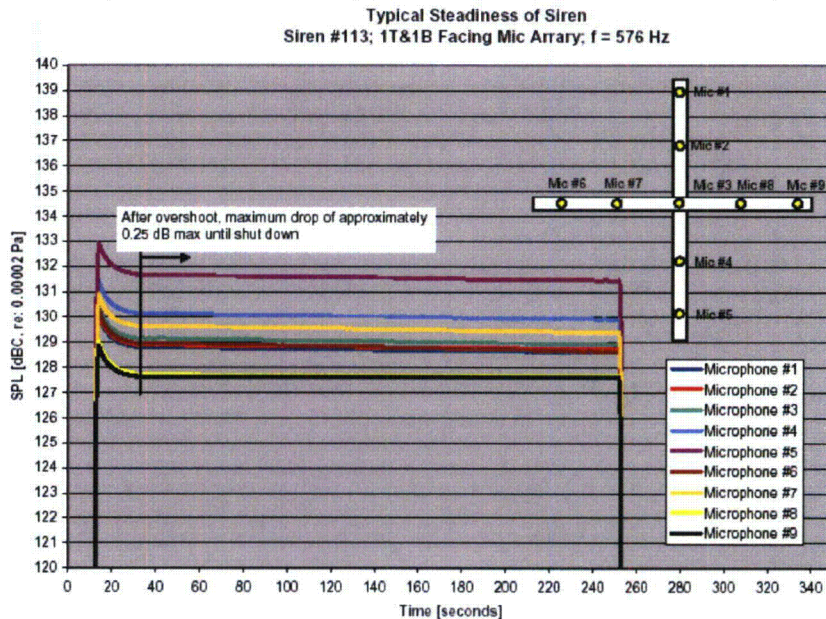


Figure 14-6. Steady, Repeatable, and Reproducible Results from Bi-Directional Sirens (Source: GTRI Report D5600 – Vol. 1 Dated 3/08)

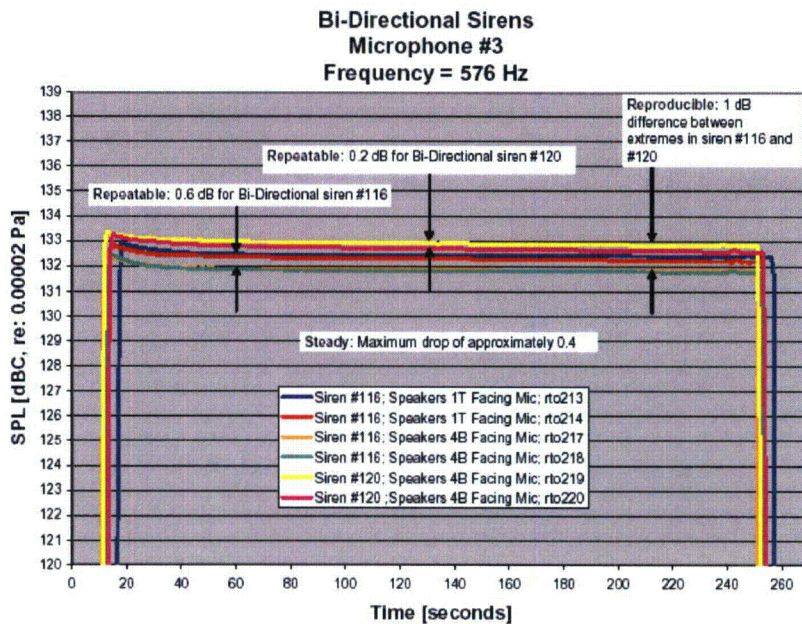


Table 14-1. Steadiness of Omni-Directional Siren System
 Measured at the Center Microphone Location (#3)
 (Source: GTRI Report D5600 – Vol. 1 Dated 3/08)

Run Number	Drop in SPL Over Sound Duration (Δ dB)
rto040	0.37
rto045	0.49
rto046	0.35
rto047	0.26
rto063	0.32
rto064	0.43
rto065	0.26
rto069	0.36
rto070	0.42
rto071	0.35
rto074	0.27
rto075	0.35
rto155	0.32
rto157	0.34
rto158	0.34
rto159	0.31
rto165	0.24
rto166	0.30
rto169	0.32
rto170	0.35
rto171	0.39
rto172	0.38
rto197	0.23
rto198	0.16
rto199	0.34
rto200	0.39
rto201	0.37
rto202	0.48
Min	0.16
Max	0.49
Avg.	0.34

Figure 14-7. Contour Map of Frequency and Time Domain of a Typical Siren Sounding
 (Source: GTRI Report D5600 – Vol. 1 Dated 3/08)

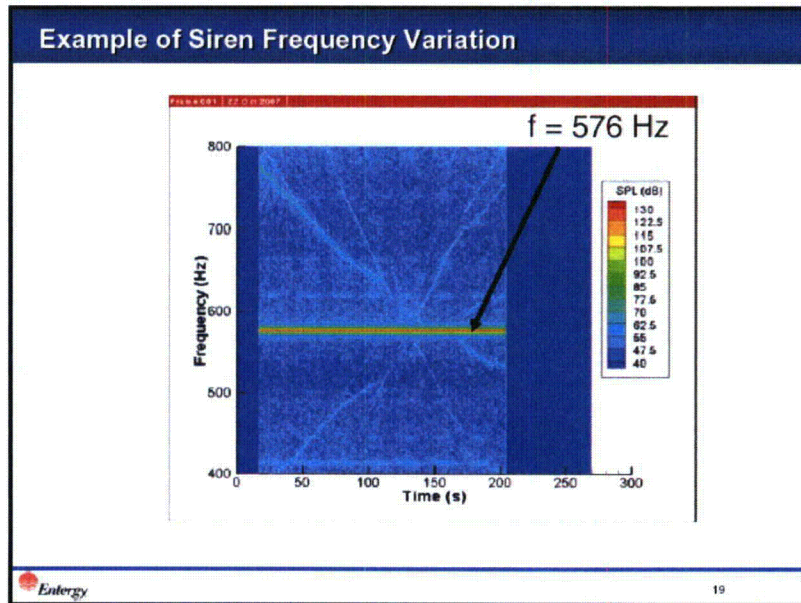
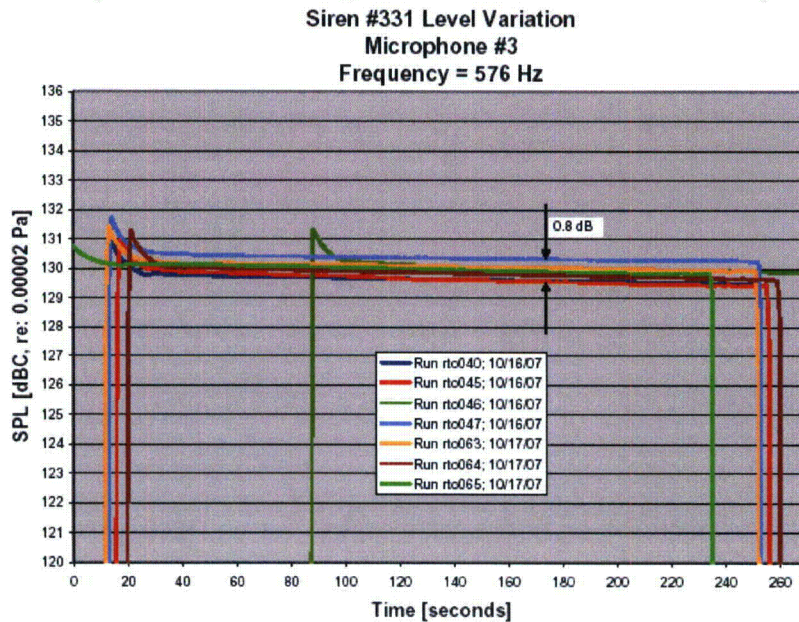
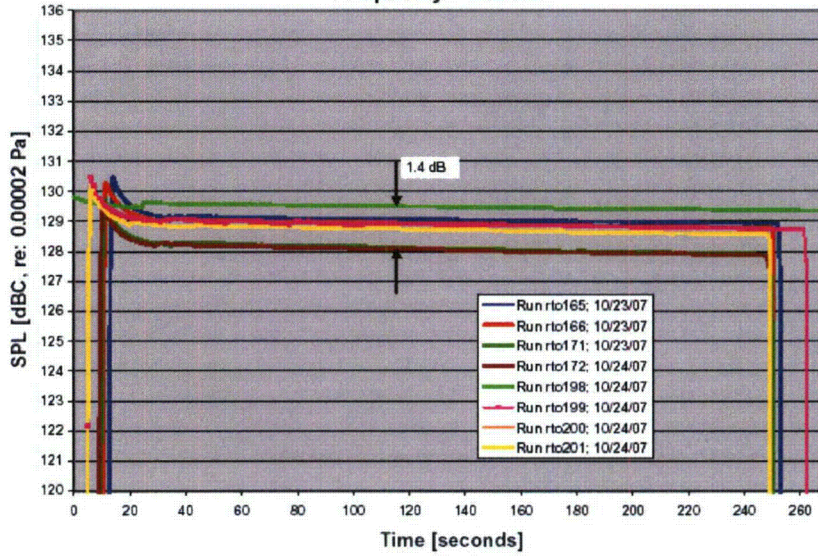


Figure 14-8. Repeatability of Acoustic Measurements on Siren #331;
 Microphone #3 Data
 (Run 46 Sounding Started After Start of Data Collection)
 (Source: GTRI Report D5600 – Vol. 1 Dated 3/08)



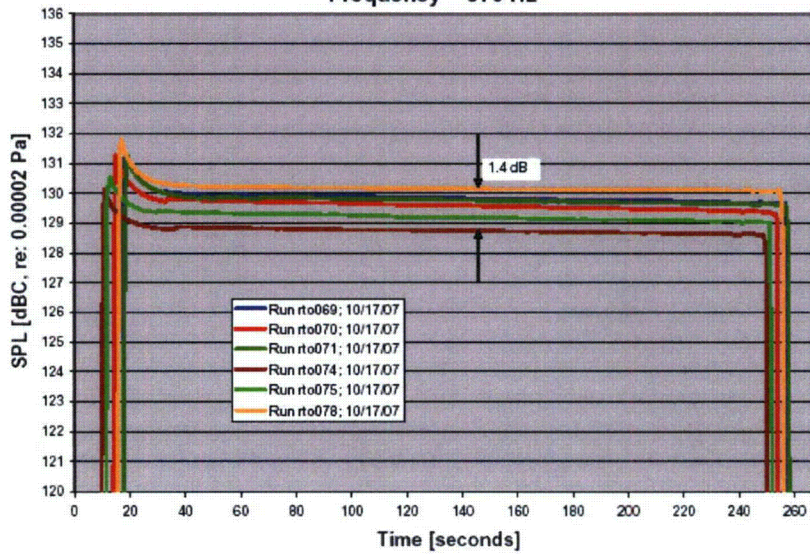
**Figure 14-9. Repeatability of Acoustic Measurements on Siren #113;
Microphone #3 Data
(Source: GTRI Report D5600 – Vol. 1 Dated 3/08)**

Siren #113 Level Variation
Microphone #3
Frequency = 576 Hz

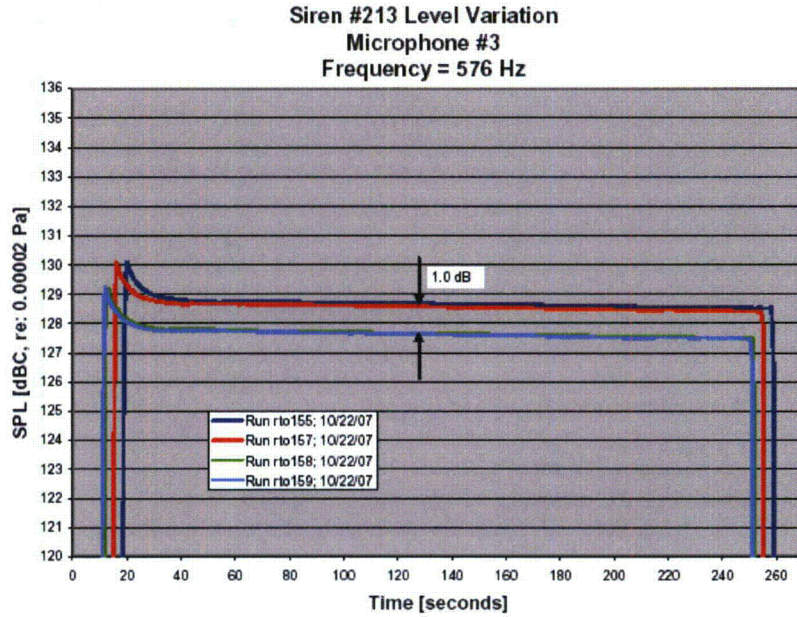


**Figure 14-10. Repeatability of Acoustic Measurements on Siren #315;
Microphone #3 Data
(Source: GTRI Report D5600 – Vol. 1 Dated 3/08)**

Siren #315 Level Variation
Microphone #3
Frequency = 576 Hz



**Figure 14-11. Repeatability of Acoustic Measurements on Siren #213;
Microphone #3 Data
(Source: GTRI Report D5600 – Vol. 1 Dated 3/08)**



**Figure 14-12. Outdoor Siren Repeatability Test Results from 2007
(Source: BRRC Final Report Dated 8/07)**

Siren Output Repeatability					
Siren #	1st Test	2nd Test	3rd Test	4th Test	dBC Range
<u>Omni Sirens</u>					
102	113.9	114.1			0.2
213	111.3	111.6	111.1	110.9	0.7
369	114.1	113.3			0.8
329	113.6	112.6			1
336	114.3	113.8	113.2		1.1
<u>Bi-Directional Sirens</u>					
116	116.1	115.9			0.2
120	115.5	115.8			0.3

Note: all measurements in dBC on axis

Entergy

Figure 14-13. Reproducibility of Omni-Directional Sirens Tested in Anechoic Chamber in 2007
 (Source: GTRI Report D5600 – Vol. 1 Dated 3/08)

Speaker Pair Repeatability
 Omni Sirens; Microphone #3
 Standard Deviation = 0.9 dBC

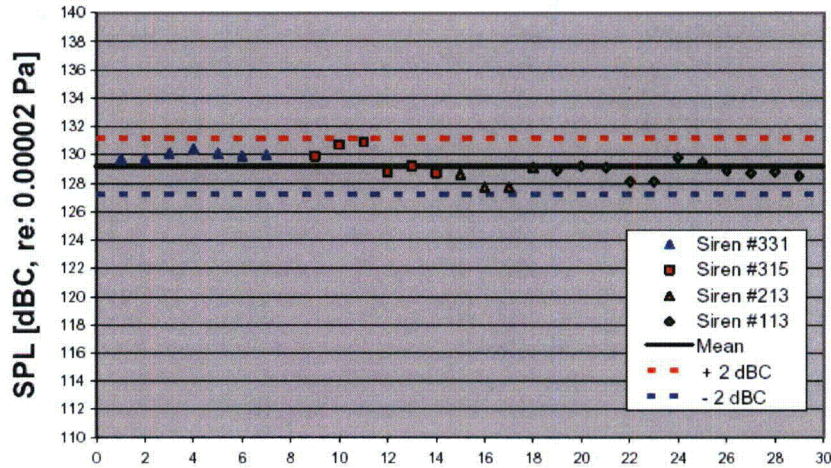
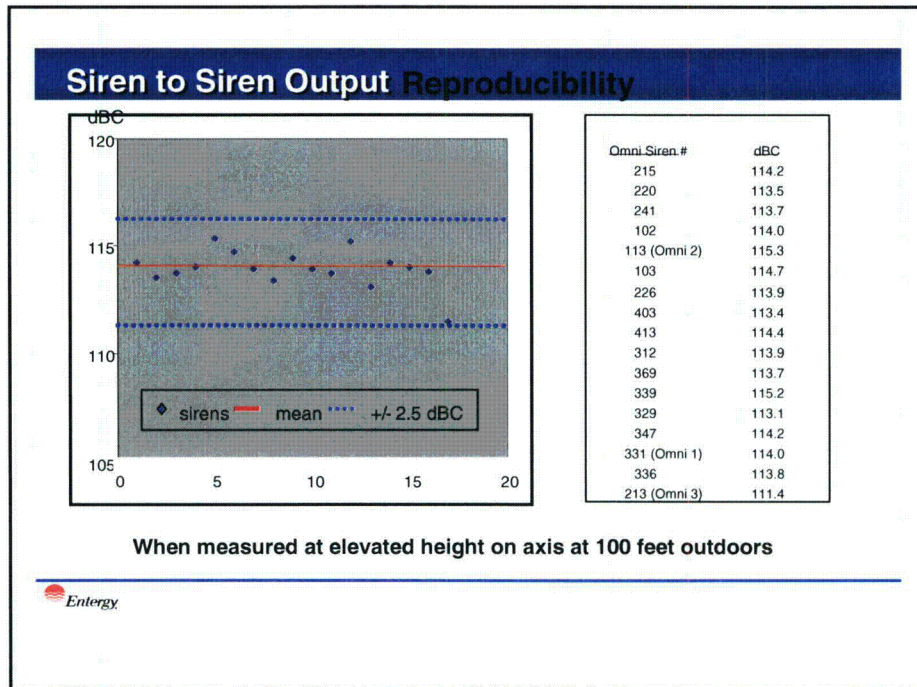


Figure 14-14. Outdoor Siren Reproducibility Test Results from 2007
 (Source: BRRC Final Report Dated 8/07)



14.2 Siren Performance Testing

This section of the design report describes the extensive testing of sirens conducted at the Georgia Tech Research Institute (GTRI) in Smyrna, Georgia. Testing was conducted both within the GTRI anechoic chamber and outside in an open field. The results presented here are provided in more detail in two reports from GTRI.

A total of sixteen (16) Acoustic Technologies, Inc. (ATI) sirens were tested including fourteen omni-directional sirens and two bi-directional sirens. Of these, four of the omni-directional sirens and both of the bi-directional siren speakers and amplifier boards had been installed within the IPEC EPZ and were removed and shipped to GTRI for these tests. The remaining ten omni-directional siren components were acquired new from ATI for these tests.

The ten new sirens were all tested first in the anechoic chamber at GTRI. Then three of these new sirens were selected to be tested outside along with six sirens that had been installed in the EPZ.

Anechoic Chamber Testing

The testing protocol for the anechoic chamber tests followed the same procedure as described in section 14.1. The same cruciform microphone array as shown in Figure 14-1 was used for the measurements. The test plan called for sounding each omni-directional siren with each set of horns facing the microphone array in turn.

The results from these tests show that the new sirens behave similarly to the sirens that were removed from poles and tested in the anechoic chamber (section 14.1). Typical results for these tests are shown in Figure 14-15 which shows selected time histories of soundings for all ten new sirens. Table 14-2 shows the sound pressure level results for the ten new sirens in the chamber.

The sirens were steady, and the results were repeatable from test to test. In addition, the sound pressure level results from the new omni-directional sirens were in close agreement with the results from the previous testing of existing sirens (see Section 14.1).

Table 14-2. Summary of Test Results from Anechoic Chamber Tests of the New Omni-Directional Sirens (Source: GTRI Report D5600 – Vol. 3 Dated 3/08)

Siren #	Orientation	Test #	Mic #3 Leq
N-1	1 up	rbo289	130.0
N-1	1 up	rbo290	129.9
N-1	2 up	rbo291	129.7
N-1	2 up	rbo292	129.7
N-1	3 up	rbo293	129.3
N-1	3 up	rbo294	129.3
N-1	3 up	rbo295	129.6
N-1	4 up	rbo296	129.6
N-2	1 up	rbo254	129.7
N-2	1 up	rbo255	129.5
N-2	2 up	rbo256	128.8
N-2	2 up	rbo257	128.7
N-2	3 up	rbo260	129.4
N-2	3 up	rbo262	128.5
N-2	4 up	rbo263	130.0
N-2	4 up	rbo264	129.9
N-3	1 up	rbo268	129.6
N-3	1 up	rbo269	129.6
N-3	2 up	rbo270	128.9
N-3	2 up	rbo271	128.8
N-3	3 up	rbo272	129.2
N-3	3 up	rbo273	129.2
N-3	4 up	rbo274	129.3
N-3	4 up	rbo275	129.3
N-4	1 up	rbo277	129.2
N-4	1 up	rbo278	129.1
N-4	2 up	rbo279	128.9
N-4	2 up	rbo280	128.8
N-4	3 up	rbo281	129.2
N-4	3 up	rbo282	129.2
N-4	4 up	rbo283	128.7
N-4	4 up	rbo284	128.6
N-4	4 up	rbo288	130.0

Siren #	Orientation	Test #	Mic #3 Leq
N-5	1 up	rbo298	129.7
N-5	2 up	rbo299	129.8
N-5	3 up	rbo300	129.6
N-5	4 up	rbo301	129.6
N-6	1 up	rbo303	130.5
N-6	2 up	rbo307	129.8
N-6	3 up	rbo309	129.6
N-6	4 up	rbo310	129.4
N-7	1 up	rbo312	127.8
N-7	2 up	rbo313	129.8
N-7	3 up	rbo314	129.6
N-7	4 up	rbo315	130.0
N-8	1 up	rbo319	129.4
N-8	2 up	rbo320	129.7
N-8	3 up	rbo323	129.9
N-8	4 up	rbo325	129.5
N-9	1 up	rbo329	130.0
N-9	2 up	rbo331	130.0
N-9	3 up	rbo332	129.7
N-9	4 up	rbo338	130.2
N-10	1 up	rbo343	130.2
N-10	2 up	rbo344	130.1
N-10	3 up	rbo345	130.2
N-10	4 up	rbo346	129.9
N-10	1 up	rbo348	130.4
N-10	1 up	rbo349	130.3
N-10	1 up	rbo350	130.2

Outdoor Testing

The outdoor tests at GTRI's outdoor testing facility were performed to corroborate the predicted sound pressure level at 100 feet from the anechoic chamber using a steady microphone as well as a moving microphone which followed the ANSI standard S12.14-1992 for the purpose of comparing both values. This testing was augmented with the use of additional microphones at various heights and distances.

The test site was located on the premises of GTRI in Smyrna, Georgia. It is an elongated field (approximately 200 ft by 600 ft in extent) used for radar range testing. Figures 14-16a and 14-

16b show this field from an aerial vantage point and show its location relative to Dobbins AFB and surrounding commercial real estate. The western end of the field was surrounded by trees (mostly pine) at a height of approximately 75 ft or higher. A pole was installed and the sirens were mounted at this end of the field. The opposite end of the field opened up over generally flat terrain. A radar tower stood in this end of the field. The radar tower was approximately 500 feet from the pole, and the field was covered with grass.

Each siren was mounted on top of the 50 foot pole using the same brace that was used in the anechoic chamber tests. The brace was designed so that the entire siren assembly could be rotated on top of the pole to allow testing in all speaker orientations. For the six EPZ sirens, a similar cruciform microphone rig using five microphones, instead of the nine used in the chamber, was used in the field and was mounted 18.5 feet from the sirens. There were two microphones placed at 100 feet from the siren at 50 feet above the ground. One microphone was held steady on the siren axis. The second microphone was scanned in accordance with the methodology recommended in ANSI S12.14-1992. The scanning motion was performed either manually or by using a mechanical rig. For some of these tests there was also a microphone at 200 feet (50 feet off of the ground) and for some of the tests a microphone was placed at 400 feet (50 feet off of the ground). In addition, there were also two microphones placed 5 feet off of the ground at 100 feet, and for some tests, at 200 feet from the siren. Figure 14-17 shows the arrangement of the microphones.

The results from these field tests corroborate the results from the previous anechoic chamber. However, the average of the results from the field test suggests that the sound pressure level of the sirens at 100 feet is closer to 115 to 117 dBC (based on the stationary and moving microphone method outlined in ANSI S12.14-1992). This difference is likely caused by the addition of sound gained from the combination of the direct sound from the siren and the ground reflection. Table 14-3 lists the sound level results from all of the omni-directional siren tests. It should be noted that favorable propagation conditions on the last two days of testing appear to have increased the measured sound on those days.

**Table 14-3. Bulk Results from the Testing of the Omni-Directional Sirens
(Source: GTRI Report D5600 – Vols. 2 and 3 Dated 3/08)**

Date	Siren #	Ambient Temp (F)	Humidity (%)	Stationary Mic Leq @100' (dBC)	Moving Mic Leq @ 100' (dBC)	Moving Mic Max Leq @ 100' (dBC)	Test Condition/ Configuration
11/8/2007	331	61.5	48	114.7	117.9	120.6	1T;1B
"	331	62.6	48	116.3	115.9	119.1	1T;1B
"	331	67.9	48	116.3	115.3	119.1	2T;2B
"	331	59.6	48	116.0	115.4	119.4	3T;3B
"	331	56.3	50	117.3	112.5	118.1	4T;4B
11/9/2007	213	65.2	50	116.5	115.9	116.4	1T;1B
"	213	65.2	50	117.2	115.2	119.0	1T;1B
"	213	62.3	50	118.1	116.5	119.9	2T;2B
"	213	60.7	50	118.3	115.9	120.6	3T;3B
"	213	59.2	50	116.9	116.1	119.0	4T;4B
11/27/2007	315	61.4	45	117.2	116.5	120.0	1T;1B
"	315	57.6	45	115.4	117.7	119.9	2T;2B
"	315	51.5	45	114.8	117.0	119.9	3T;3B
"	315	49.2	45	112.9	116.2	119.5	4T;4B
"	315	55.1	45	114.2	117.3	120.0	1T;1B
"	315	55.2	45	113.6	117.4	120.6	1T;1B
"	113	63.4	50	114.8	115.3	119.5	1T;1B
"	113	63.5	50	114.5	115.5	119.0	2T;2B
"	113	59.2	50	115.4	115.7	118.3	3T;3B
"	113	57.7	50	114.5	115.3	119.7	4T;4B
12/19/2007	N2	49.0	65	114.4	118.7	121.2	1T;1B
"	N2	49.0	65	115.3	118.3	121.2	2T;2B
"	N2	49.0	67	114.3	118.4	121.2	3T;3B
"	N2	49.0	74	113.9	118.1	120.9	4T;4B
"	N3	49.0	75	114.3	117.8	120.1	1T;1B
"	N3	49.0	76	114.7	118.0	121.0	2T;2B
"	N3	48.0	76	114.7	118.1	120.8	3T;3B
"	N3	48.0	76	114.3	118.0	120.7	4T;4B
12/20/2007	N4	48.0	92	115.4	117.1	120.3	4T;4B
"	N4	49.0	90	115.4	117.3	119.9	1T;1B
"	N4	50.0	89	114.8	117.4	120.6	2T;2B
"	N4	50.0	87	113.2	117.4	120.4	3T;3B

As the distance between the microphone and siren increased, the sound became more variable over time. Figure 14-18 shows the results of the testing of siren 331. In this plot, all of the microphones are kept steady, but as the distance between the microphones (receptor) and the siren increases, the variation in recorded sound level also increases. This increase in variation is due to unmeasured changes in the micro-meteorological conditions and is an expected result of outdoor testing.

In addition to the testing of the omni-directional sirens, two bi-directional sirens were tested. The anechoic chamber data agrees well (within 2 dB) with the outdoor data at 18.5 ft and the

prediction at 100 feet using a steady microphone. The measurement shows that on average, the bi-directional sirens measured approximately 118 dBC at 100 ft.

Figure 14-15. Representative Time Histories of Anechoic Chamber Data Showing Steadiness of All Ten New Omni-Directional Sirens (Source: GTRI Report D5600 – Vol. 3 Dated 3/08)

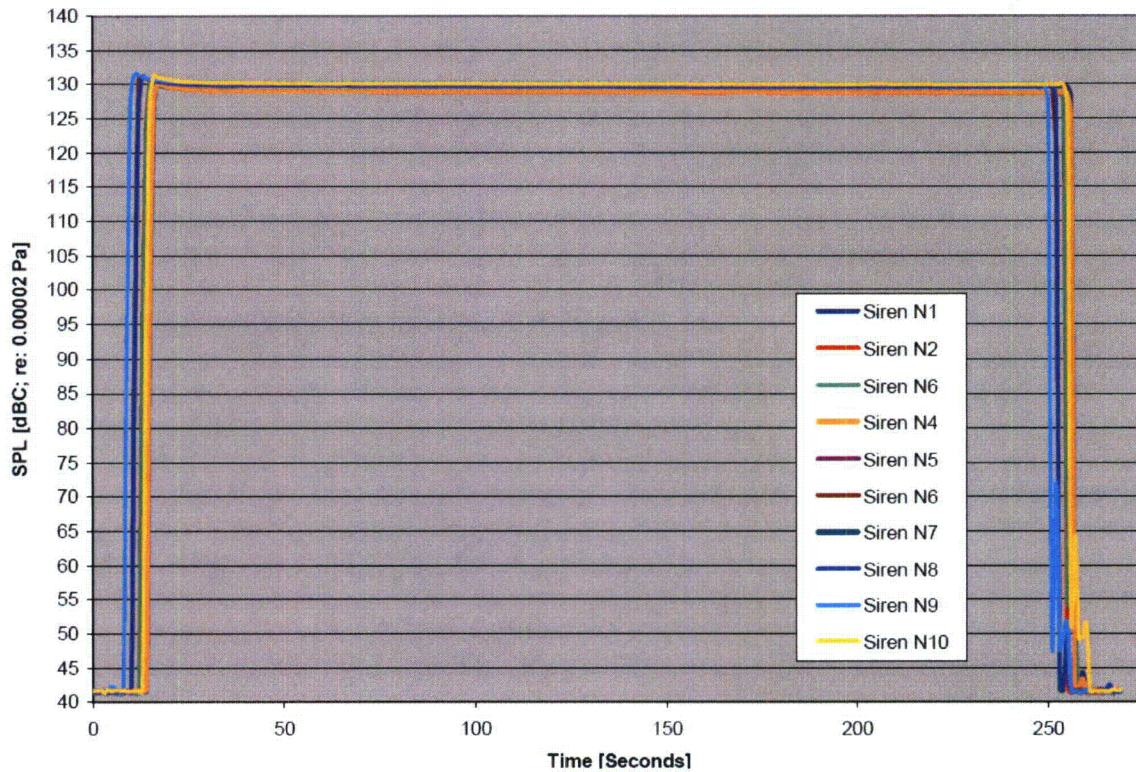


Figure 14-16a. Aerial View of Outdoor GTRI Test Site



Figure 14-16b. Closer Aerial View of Outdoor GTRI Test Site

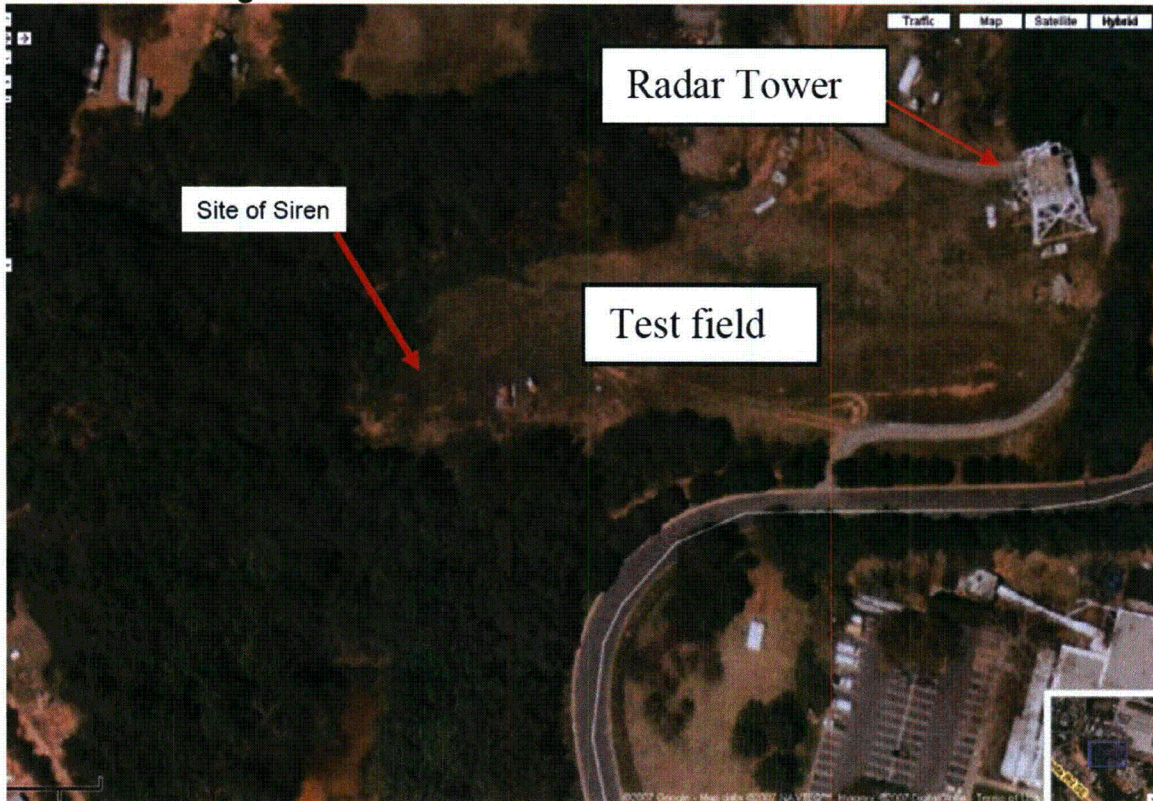


Figure 14-17. Schematic Showing Relative Measurement Locations at the GTRI Outdoor Test Site
 (Source: GTRI Report D5600 – Vol. 2 Dated 3/08)

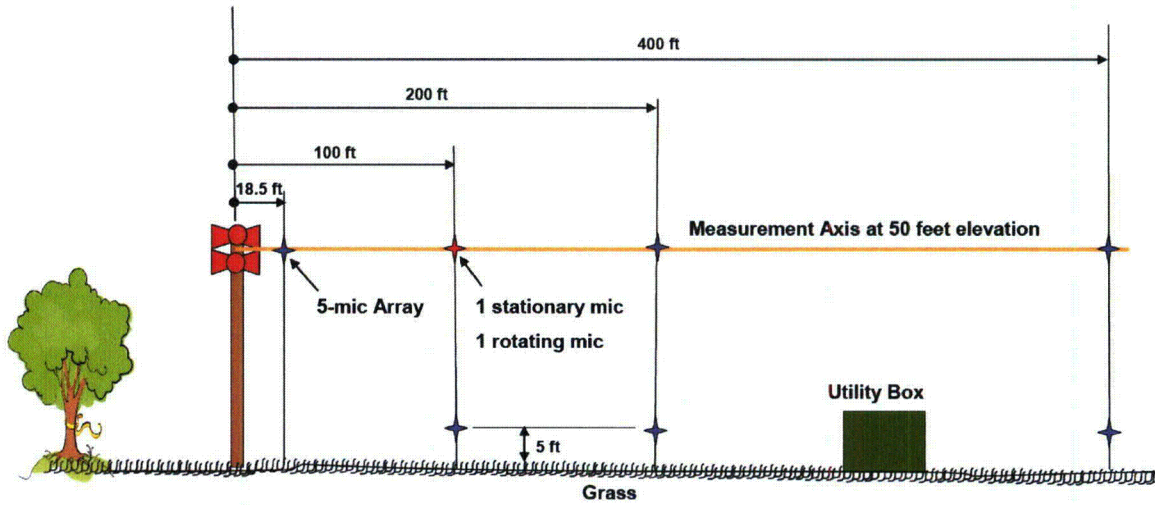
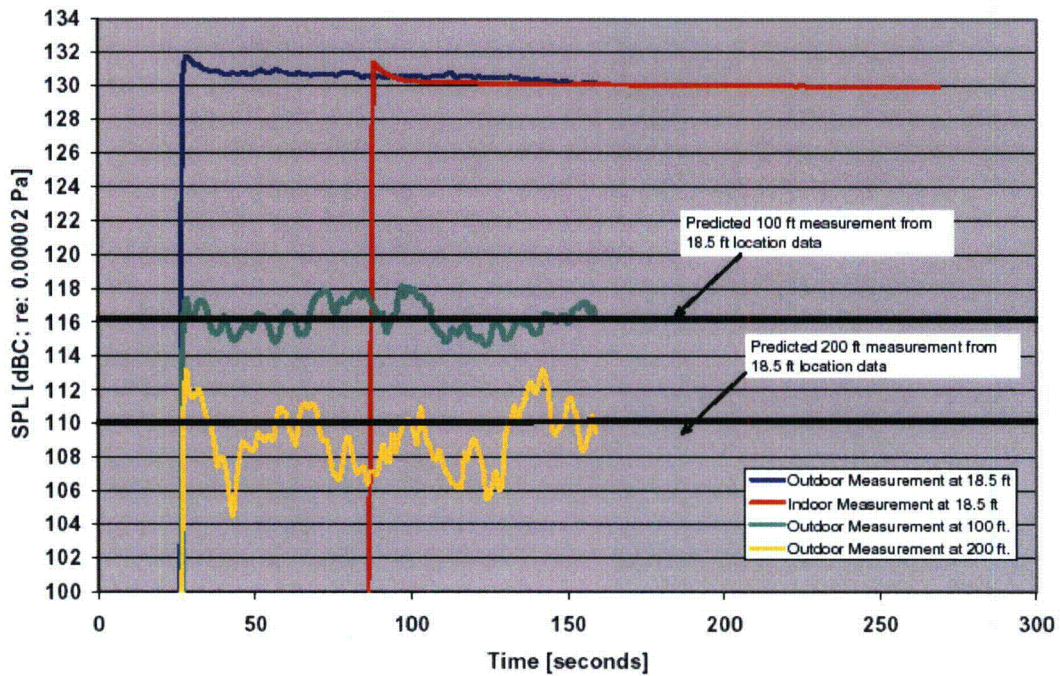


Figure 14-18. Variability in Measured Sound Level with Increases in Measurement Distance
 (Source: GTRI Report D5600 – Vol. 2 Dated 3/08)



14.3 Acoustic Coverage in the EPZ

The design objective of the installed siren system is to provide full acoustic coverage for the populated sections of the IPEC EPZ in compliance with FEMA guidelines. A siren output of 114 dBC Leq (omni-directional) and 116 dBC Leq (bi-directional) both at 100 ft. on axis at siren elevation was utilized, although as explained below this is a conservative approach based on actual measured sound output.

GTRI conducted independent acoustic testing of the IPEC ANS sirens. Six sirens installed in the new system within the IPEC EPZ were removed from their respective poles and delivered to GTRI in addition to ten new sirens. The siren acoustic testing at the GTRI facilities included two separate programs: anechoic chamber testing and open field testing.

Testing of the 14 omni-directional and 2 bi-directional sirens in the anechoic chamber resulted in an average of 115 dBC Leq for the omni-directional sirens and an average of 117.3 dBC Leq for the bi-directional sirens both projected at 100 feet. In the field testing at GTRI, results showed up to 2 dBC higher measurements than predicted in the anechoic chamber, with the actual numbers of 115.2 to 117.4 dBC Leq for the omni-directional and 116.7 to 118.7 dBC Leq for the bi-directional sirens. Furthermore, the Lmax readings in the field, determined after the initial transient response from the sirens, showed at least an additional 2 to 3 dBC higher sound pressure level, ranging from 119 to 121 dBC Lmax.

A statistical analysis was performed utilizing 52 independent speaker pair measurements that were taken in the GTRI anechoic chamber. The mean sound pressure level of the sample population was 115 dBC Leq with a standard deviation of 0.5 dBC. Using both a Chi-Squared and a Student T analysis, the minimum siren level output, at the 95% confidence level, for any siren in the total population is 114 dBC Leq. Therefore, to provide sound coverage margin, a conservative siren output level of 114 dBC Leq was used in the sound contour model, notwithstanding the fact that the actual output was measured at higher values.

FEMA-REP-10 specifies that the siren sound pressure level should generally exceed 70 dBC where the population density exceeds 2000 people per square mile in the EPZ. In areas with a population density below 2000 people per square mile the siren sound pressure level should generally exceed 60 dBC.

The ATI model demonstrates that the 70 dBC sound output criterion is met in high population areas requiring 70 dBC coverage. The 60 dBC sound output criterion is met in low population areas requiring 60 dBC coverage with the exception of four small areas in the EPZ that are sparsely populated or unpopulated (mostly parkland) and largely inaccessible. Though these areas project to be less than 60 dBC, the one area in Putnam County where population resides was actually measured to have a sound pressure level of 62 dBC. Thus, there is minimal effect on the notification of residents of the EPZ.

Additionally, Blue Ridge Research and Consulting (BRRC) performed an ambient noise survey in high population density areas in thirteen locations within the EPZ for three consecutive days in August of 2007 to determine the outdoor summer daytime ambient sound level in areas within the EPZ. The daytime (7 AM to 10 PM) noise data from these measurements was used to compute the local ambient noise environment. The exceedance levels of L10, L50, and L90 were computed in the 28th third octave band, centered on 630 Hz. The L90 levels, representative of the ambient background sound levels, ranged from 25 dB to 46 dB. The L50 levels, representative of the average sound conditions, ranged from 28 dB to 59 dB. The L10

levels, representative of the infrequent and transient noise intrusions, ranged from 35 dB to 52 dB. Complete details and results from the survey are provided in Appendix C.

The measured sound pressure levels from the siren full sounding in the far field exceeded the L50 value (which is most representative of average background conditions) by 15 to 30 dBC in the third octave band.

The siren sound level coverage is provided on Map 2. The map indicates areas with 60 dBC and 70 dBC coverage and the population density in the EPZ.

Based on the sound contours presented in Map 2, IPEC concludes that the siren system as designed meets or exceeds FEMA-REP-10 guidance for sound pressure levels and population coverage.

14.4 Far Field Measurements Methodology

The purpose of the measurements described herein is to characterize the amplitude of sound produced by the complete siren system around the Indian Point Energy Center. The results from these measurements will be compared with the results from the model developed by ATI to confirm the quality of the prediction reflected in the ATI model.

Equipment

ANSI certified Type 1 Sound Level Meters (SLMs) will be used in the measurements as per ANSI S12.18. Before and after each measurement the calibration of each sound level meter will be checked, and the calibration tone will be recorded for at least 30 seconds. Each sound level meter will be capable of recording noise data at one-second intervals. The SLMs will be set to record the C-Weighted values. The 1 second Leq and the 1 second third octave band data will be recorded wherever possible based on equipment availability. Each SLM microphone will be fitted with a wind screen and will be mounted on a tripod or other suitable firm mounting device at a height of approximately 5 feet above ground level. Each SLM clock will be synchronized with the clock used to initiate the siren test. In addition, meteorological data will be collected including wind speed and direction, temperature and humidity within the EPZ. Multiple locations within the EPZ will be used to collect this data for each full siren test and recorded at the highest possible sample rate.

Measurement Locations

Twenty (20) measurement locations will be selected within the EPZ. Locations of interest will include: areas along the sound contour lines; areas downwind, cross wind or surrounded by sirens; areas of challenging topography; high population density areas and those locations previously identified with potentially lower projected sound levels, where additional sirens were added. Each measurement position should be greater than 50 feet from the nearest reflecting surface such as buildings, boulders, walls, and other obstacles. General guidelines for selecting measurement locations are that the measurements should be greater than 1,000 feet from the nearest siren. The precise location of each measurement location with GPS coordinates will be determined and recorded, together with any additional details about the measurement location. Also locations that have been previously identified as being within the shadow created by a co-located siren should be avoided. Multiple test days will be planned to maximize the opportunity

to have the appropriate weather conditions for testing. Test day weather conditions will be factored into the correlation of predicted to measured sound pressure levels.

Measurement Procedure

The SLMs will start recording data approximately 2 minutes or more prior to the full system sounding and will continue to record data for approximately 2 minutes or more after the siren sounding has concluded. The testing personnel should be careful not to make any noise during the period while the SLM is running including the periods prior to and after siren sounding while the SLM is operating.

Each operator of an SLM will be given a data sheet (Figure 14-19) that will be filled out completely. Each data sheet will have all of the information about the test including the date, time, location, SLM serial number, and calibration. In addition, the operator will record the local ambient noise level before and after the siren system sounding. Each operator will note on the data sheet any significant intruding noise sources that occur during the test. This is intermittent noise that is above background. The operator will record the source and time of the intrusion on the data sheet.

Testing will not be conducted if meteorological conditions such as precipitation and elevated wind exist. ANSI S12.18 provides guidelines for appropriate atmospheric conditions. Every effort will be made to collect data under the conditions stated in ANSI S12.18. The determination to take measurements will be made by the Test Director on the day of the test.

Data Analysis

The data from the SLMs will be analyzed to determine the sound level produced during the full siren system activation. The third-octave band with the majority of the siren energy will be identified and used for part of the analysis, including the difference above ambient. Data will be reported by identifying the C-weighted L_{max} (maximum 1 second Leq during the test) and the C-weighted L₁₀. In addition, the complete time history of each measurement will be recorded.

Comparison with Modeled Results

The measured metric, C-weighted L₁₀, will be compared to the output from ATI's sound propagation model. L_{max} will be reviewed for a more complete understanding of additional margin. For this analysis, the sound level predicted by the model will be compared with the measured L₁₀ at each location. To evaluate the quality of the sound propagation model, the data will be analyzed by a bulk average deviation method as shown in Eq. 1 below.

Any significant outlier will be identified and considered. If there are extenuating circumstances that are identified and justify exclusion, these outliers will be removed from the bulk average calculation. Examples of outlier circumstances include: siren material condition, instrument problems, interfering noise events, etc. An outlier is defined as a measurement greater than 3 standard deviations of the difference in predicted and measured sound pressure level data. Any exclusion will be documented.

$$(Eq. 1) \quad Q = \frac{\sum (P_i - M_i)}{N}$$

Where:

Q is the measure of model quality

P_i is the predicted Leq sound pressure level at the i^{th} location

M_i is the measured Leq sound pressure level at the i^{th} location

N is the total number of measurements

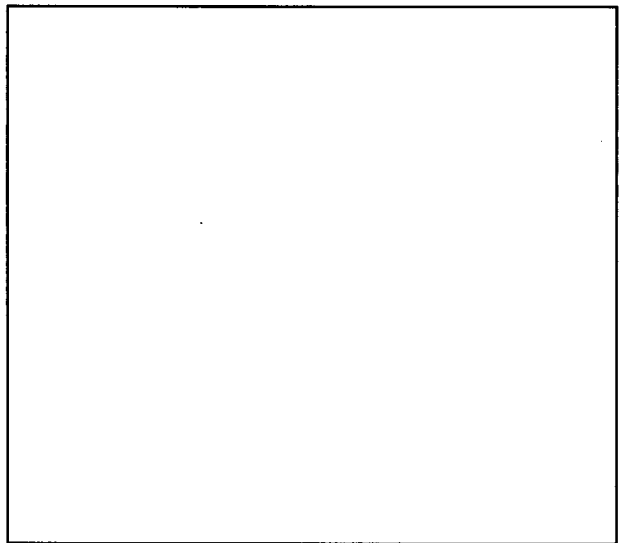
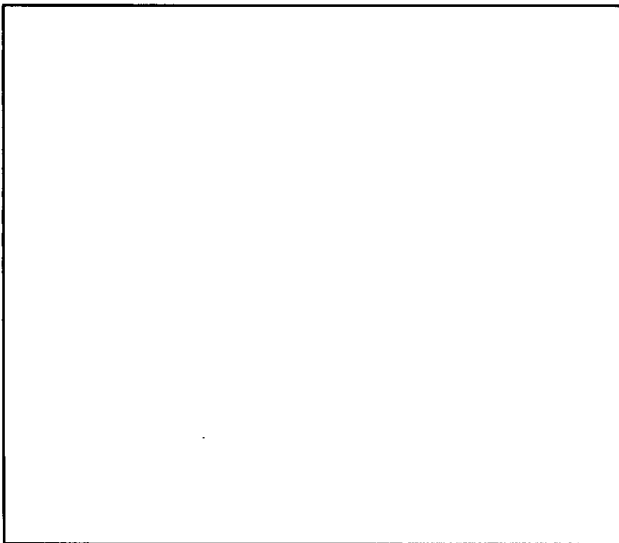
A value for Q of positive 3 dBC or less is indicative of a high level of model quality. Since this is a one-sided test any negative value of Q is acceptable, since that means the measured values are predominately higher than the predicted and thus the model would be conservative.

Figure 14-19.

Indian Point Siren Test Sample Data Sheet

Date: _____ Time: _____
SLM Model: _____ SLM Serial Number: _____
Tester's Name: _____
Measurement Location: _____
GPS Coordinates: _____ West _____ North
Checked Battery? Yes No
Checked Clock? Yes No
Calibration level before test: _____ dBC
30 second calibration tone recorded before test? Yes No
Calibration level after test: _____ dBC
30 second calibration tone recorded after test? Yes No
Calibrator Model: _____ Calibrator SN: _____

Location Drawing:



Microphone height: _____ ft.
Taken Photo? Yes No
Meter Recording? Yes No
Weather Station on and wind cover removed? Yes No
Ambient noise level before test: _____ dBC
Maximum level observed during the test: _____ dBC
Ambient noise level after test: _____ dBC
Notes about test (including noise intrusions):

Tester's Signature: _____

15 BACKUP POWER

Twenty-four hour battery capability is provided to meet the backup power requirements of the Energy Policy Act. The design includes this capability for each siren (Remote Terminal Unit or RTU), each control station and one of the redundant radio paths (Repeater Towers). Twenty-four hour battery backup capability is also provided for the second redundant radio path and the TCP/IP equipment installed at the sirens, control stations and repeaters, with the exception of the T1 telephone lines and the TCP/IP network, which are maintained by Verizon (Telco).

Sirens (RTU)

Each of the 167 siren/control panels contains a 24V DC battery system for normal operation of the electronics, radio transceiver and cell/modem transceiver. The typical installation consists of four 12V DC maintenance-free gel-type batteries connected in a series/parallel configuration to provide for 24V DC operation (the 7 solar installations each use 8 batteries). The total number of batteries provided to meet the power requirements are based on a worst case assumption of a temperature of zero degrees F, end of battery life, a 24 hour standby period (without recharging) and a 15-minute activation of the siren.

For the 160 sirens receiving utility power, a built-in rectifier/charger converts the input 120V AC to 24V DC, to float charge the batteries which provide DC power to the respective siren power units. The remaining 7 sirens are solar powered and have a photovoltaic charge controller to float charge the batteries. Upon loss of the normal AC input power (or solar charging), the batteries will continue to supply DC power to the respective circuitry with no interruption of DC power to the siren pole circuitry. Following discharge of the batteries, the chargers connected to the 120V AC supply have the capability to recharge the batteries to 80% capacity within 24-hours. An alarm message is initiated and the batteries will continue to supply power for the specified time whenever the normal AC input power source (or solar charging) to the rectifier/charger deviates from the specified tolerances or fails completely. Both types of chargers are temperature compensated for the system to operate in a harsh outdoor environment. The battery compartment on the AC supplied sirens is fitted with a battery compartment heater and thermostat which are powered from the line voltage of the incoming source.

Control Stations

Each of the control stations contains an Uninterruptible Power Supply (UPS) unit that provides 120V AC power for normal operation of the electronics, radio transceiver, cell modem transceiver, a computer work station and a printer. The UPS unit normally receives power from the utility grid and is provided with an external connection to a 24V DC battery system for backup power. The typical battery installation consists of eight 12V DC maintenance-free gel-type batteries connected in a series/parallel configuration to provide for 24V DC operation. Eight batteries are provided to meet power requirements for a 24-hour standby period (without recharging), and the power required to support periodic polling, silent tests and monitoring of the system at end of battery life. Following discharge, the battery charger incorporated within the UPS units has the capability to recharge the batteries to 80% capacity within 24-hours. An alarm message

is initiated whenever the normal AC input power source to the rectifier/charger deviates from the specified tolerances or fails completely.

The Orange County EOC has additional battery chargers, batteries and 12V DC systems for the remotely located radio transceivers that are sized to meet the same requirements.

The control station cabinets are located in facilities with heating and air conditioning so that the battery capacity requirements do not need to be adjusted to account for low temperature conditions.

Repeater Towers

Each of the four Repeater Towers enables communication to the control stations and siren pole locations via VHF radio with coordination (simulcasting) between the towers, linked by Telco "T1" line or microwave. Dual sets of equipment are provided in racks for the redundant microwave and Telco channels and are powered from two separate UPS units (one for the microwave path and the other for the Telco T1 path). The UPS units normally receive power from the power grid and are provided with an external connection to the 24V DC battery systems for backup power. The typical battery installation consists of twenty four 12V DC maintenance-free gel-type batteries connected in a series/parallel configuration to provide for 24V DC operation. Twenty-four batteries are provided to meet the power requirements of a 24-hour standby period (without recharging), and the power required to support periodic polling, silent tests and monitoring of the system, at worst case temperature of zero degrees F at end of battery life. To conserve power, automatic load stripping is provided to de-energize the main radios and access server, and filters on the channel that is not in service when normal AC power is not available. A separate AC power supply is also provided for the monitoring unit electronics that provide for monitoring system status using a separate radio and Internet/Cellular radio. The battery system also provides backup power to the monitoring unit.

Following discharge, the battery chargers incorporated within the two UPS units, two separate battery chargers and a charger in the Monitoring Unit have the capability to recharge the batteries to 80% capacity within 24-hours. An alarm message is initiated whenever the normal AC input power source to the rectifier/charger deviates from the specified tolerances or fails completely.

With the exception of Harriman, the repeater locations are all located within facilities with heating and air conditioning. The Harriman repeater enclosure itself has a thermostatically controlled space heater and air conditioning which is AC powered.

There is one communications channel (the radio/microwave channel) for the repeater towers that has battery power supplies confirmed to provide 24-hour backup power in the event of a loss of normal AC power.

16 FAILURE MODES AND EFFECTS ANALYSIS

A Failure Modes and Effects Analysis (FMEA) of the new IPEC Prompt Alert and Notification System was performed to identify failure vulnerabilities. This analysis is documented in the report entitled "Failure Modes and Effects Analysis (FMEA) of the New Siren System for Indian Point Energy Center." The recommendations of this analysis were entered into the IPEC corrective action program for evaluation and consideration for implementation. The analysis was based on system testing, review of drawings, design reports, contract and vendor documents and discussions with IPEC and contractor staff.

FMEA Methodology

FMEA is a methodology for analyzing potential reliability problems and identifying actions to overcome these issues, thereby enhancing reliability. FMEA is used to identify potential failure modes, determine their effect on the operation of the system and identify actions to mitigate the failures. This is a crucial step in anticipating what might go wrong with the system. The FMEA development team formulated an extensive list of potential failure modes using military guidance MIL-STD-1629, MIL-STD-882 and MIL-HDBK-217. This analysis was set up in three categories:

- System Category – focuses on global system functions (such as activation, and routine operations of polling, monitoring, and control)
- Design Category– focuses on components and subsystems
- Software Category– focuses on software functions

For each of the above listed categories, spread sheets were populated with the components, functions, or items. For each of these, potential failure modes were identified; potential effects and their severity were discussed; potential causes were listed; and system failures and means for detecting those failures were identified. Design controls to mitigate failures were then evaluated and recommendations to minimize or detect failures were provided.

The analysis calculated a Risk Probability Number (RPN), which is the product of the three terms evaluated during the FMEA. The Severity (S) of the potential effects of failure, the probability of Occurrence (O) of the failure, and the ability to Detect (D) the failure. $RPN = (S)*(O)*(D)$. The bounds of the RPN are therefore from a minimum value of one (1) to the maximum of one thousand (1,000). The larger the value of RPN, the more critical it becomes to evaluate that process or component under analysis. Actions and process changes to mitigate issues with elevated RPN were recommended.

Six FMEA functional areas were prepared as follows:

System Category

Single Occurrence Process (Functional Area 1):

The analysis contained within this section addresses the potential failure modes arising during a required full Alert Notification System activation. The system-wide objectives analyzed are: first, the physical sounding of the sirens at their field locations and second, the subsequent reporting of the post activation status of those sirens.

Continuous Operational Processes (Functional Area 2):

The analysis contained within this section addresses the routine operation, control and functions and capabilities of the Alert Notification System and includes polling (including queries of control stations), silent tests, growl tests, full volume tests, monitoring and external notification.

Design Category

Component Level Analysis:

The analysis contained within this section addresses the potential failure modes of each component and their affects on activation, control and monitoring of the siren system. Separate spreadsheets were prepared for the Sirens (**Functional Area 3**), Control Stations (**Functional Area 4**) and Simulcast Towers (**Functional Area 5**).

Software Category

Software Applications Processes (Functional Area 6):

The analysis contained within this section addresses software programs used at the control stations, simulcast towers and the sirens for activation, monitoring, and testing.

FMEA Results Summary

Overall, the FMEA review concluded that the design provides redundant and distinct communication paths for activating the siren system and monitoring results and that the system will be able to provide alert notification when required. The design incorporates a high level of features for self-monitoring of the system and for conducting routine testing to confirm that communication channels are operating satisfactorily or to report problems. The review also concluded that multiple failures would have to occur for the system to be unable to activate sirens when needed. Typically, all of the control stations and sirens are capable of being polled regularly during the day, unsolicited alarm messages are provided for major component failures at the simulcast towers, sirens and control stations, and alarm messages are generated for communication path failures. Loss of normal AC supply power at each location and siren system communication failures are reported externally to station personnel.

There is one communications channel, including control station, repeater tower, and sirens, that has battery power supplies credited for being capable of providing power for 24 hours on loss of normal AC power.

For each of the areas where potential failures were identified, recommendations, such as to conduct automatic routine polling of control stations and sirens and to review computer logs for results, were made to detect any failures that may have occurred and confirm that the system is in a ready state. Additionally, maintenance activities were identified to minimize potential failures, or additional testing or monitoring was recommended if there could be hidden problems that may not be identified by routine testing, thereby ensuring high system reliability to activate the sirens and verify their activation. Recommended maintenance activities were captured in the corrective action program to track implementation of these activities.

17 CONFIGURATION MANAGEMENT

The objective of configuration management is to maintain consistency between the design requirements and the physical siren system installation arrangement (as-built). Procedures controlling the process for documenting as-built conditions, evaluating the need to change siren system configuration, determining the impact of the change and completing the necessary development and approval steps to produce an approved, implemented and documented change to the siren system are identified below. This ensures that information necessary to construct, operate and maintain the siren system so that it will continue to meet regulatory requirements is controlled and managed.

Walkdowns, testing, inspections and assessments have been performed to document and create a permanent validated record of the system configuration.

IPEC has various procedures in place to control configuration changes to the siren system. Descriptions of the procedures in place at time of report writing are as follows:

- EN-DC-112 – “Engineering Change Request and Project Initiation Process” This is a fleet standard engineering change and projects procedure which defines the process for initiation, funding, resources and approval.
- EN-DC-115 – “Engineering Change Development” will work together with EN-DC-112 and will govern the preparation, review, approval and processing of an Engineering Change. The scope of the work to be performed is defined pursuant to this procedure.
- EN-DC-116 – “Engineering Change Installation” applies to and defines the installation phase of the Engineering Change.
- EN-DC-117 – “Post Modification Testing & Special Instructions” is applied after the Engineering Change is installed. This procedure gives guidance for functional testing to verify that objectives of configuration changes authorized by an Engineering Change are satisfied and/or verify required performance of associated equipment that may have been affected by the configuration change.
- EN-DC-118 – “Engineering Change Closure” establishes the requirements and responsibilities for the Return to Service, Post Return to Service and Closeout of the Engineering Change including verification and documentation of the as-built configuration.
- EN-WM-100 – “Work Request Generation, Screening and Classification” is the procedure that governs the generation, screening and classification of work requests for changes to the siren system.
- IP-EP-AD31 – “IPEC ATI Siren System Maintenance Administration” is the IPEC Emergency Plan Administrative Procedure which is used to provide guidance for the inspection and maintenance of the siren system. If deficiencies are found while performing IP-EP-AD31, appropriate action will be determined to correct or install the required components while maintaining configuration of the siren system.
- EN-IT-104 - Software Quality Assurance (SQA) Program will govern and control software/firmware upgrades to the siren system and ensure that they have been thoroughly reviewed and tested before being installed and implemented.

All changes to the approved, as-built siren system will be documented and controlled following the above mentioned procedures as appropriate for a commercial modification.

18 SYSTEM TRAINING

Operator Training

The training familiarizes the user with basic functions of the system. Personnel responsible for operation of the system receive training covering the following topics:

- Characteristics and capabilities of the system
- Tour of the graphical user interface
- Procedure for testing the system
- Procedure for performing an alert
- Procedure for resetting the system after an alert has occurred
- Powering the control stations and starting the application
- Understanding system status
- Understanding system reports
- Using a control station to work as a backup to other control stations

A lesson plan and handouts have been prepared to conduct this training.

Maintenance Training

The training familiarizes the user with maintenance and troubleshooting of the system. Personnel responsible for maintaining the system receive training covering the following topics:

- Recommended test schedule
- Preventive maintenance schedule
- Maintenance report and error log analysis
- Troubleshooting basic communication problems
- Troubleshooting basic hardware problems
- Troubleshooting basic software problems
- How to change field replaceable units

19 SYSTEM OPERATIONS, TESTING AND MAINTENANCE PROCEDURES

The procedures referenced below are procedures in place at time of report writing.

System Operations Procedures

IPEC Procedure IP-EP-AD32 establishes the methods required to perform routine testing of the siren system. The procedure provides details on how to conduct a silent test, growl test, and full volume test, and polling of the system.

An Indian Point Alert Notification Siren System manual has been prepared for each county which provides detailed instructions on how to activate, test, and poll the system. This manual also provides log in instructions, instructions for sounding sirens/cancelling activation from the computer and the REACT-4000, instructions for sounding other sirens/canceling activation from the computer, and printing reports. The manual contains color screen shots of the computer to facilitate the operation of the system.

Additionally, operator aids containing abbreviated instructions have been provided to each county for display at each siren control station.

System Testing Procedures

IPEC Procedure IP-EP-AD30 establishes the administrative controls for the routine conduct of testing, test scheduling and coordination, test result reporting, and monitoring of the siren system.

This procedure also provides examples of typical annual siren test schedules, sample siren test plans, guidelines for siren system quarterly and annual testing, system periodic testing, and sample siren test reports.

System Maintenance Procedures

IPEC Procedure IP-EP-AD31 provides guidance for the maintenance of the siren system.

This procedure discusses the preventive and corrective maintenance performed on the system.

Preventive maintenance is performed in three (3) areas: sirens sites, control stations, and tower repeater sites. This procedure details quarterly maintenance, semi-annual maintenance, and annual maintenance and provides checklists for each.

The siren system preventative maintenance program consists of:

- Visual inspection of the siren site which includes all external components and their mounting and connections (speakers, cabinet, and antenna, solar panels) pole integrity, grounding, foliage encroachment, and utility AC power feed. *Internal inspections of each speaker and cabinet are performed to look for corrosion on components as well as verification that all connections are tight and*

properly seated. Incoming AC power (not on solar), charger voltage (or solar regulator voltage) and DC battery voltage are checked and documented. Radio and cell modem operation and alarm communications are checked locally and verified remotely with the control station.

- Visual inspection of the control station includes the external antenna and cable installation outside the building as well as the control station cabinet to look for damaged or missing components as well as dust and debris. All connections, internally on the communications unit and externally to the computer, cell modem, printer, antennas, batteries and backup power supply are checked to look for corrosion on components as well as verification that all connections are tight and properly seated. Battery voltage is measured and recorded before, during and after performance testing. AC power to the control station is disconnected and a poll and silent test of the sirens is performed and documented while under battery power. Radio and cell modem operation and alarm communications are checked and verified.
- Each control station computer is re-booted quarterly to ensure that no software or operational processes are in a "hung-up" state. Data network lines provided by commercial carriers are analyzed periodically for network errors.
- Visual inspection of the tower repeater site includes the external antennas, microwave dish and cable installations outside the building as well as looking for damaged or missing components. The general condition of the repeater racks are noted for dust, debris and any loose, broken or missing hardware. All connections to equipment in and between the racks are checked for corrosion on components as well as verification that all connections are tight and properly seated. Battery voltage is measured and recorded as well as battery charger output voltage. Repeater components are monitored for proper operation and any alarming conditions during the performance of a siren poll and silent test.

Corrective maintenance will be performed to remedy conditions identified during routine monitoring of the system.

20 SIREN SYSTEM ROUTINE TESTING

Routine testing of the system will be performed from the control stations. The following will be performed as a minimum as suggested in NUREG-0654 and FEMA-REP-10 and IPEC's Failure Modes and Effects Analysis:

- Routine polling will be performed to validate communications between control stations, towers, and sirens. Success will be confirmed by feedback to the control station.
- A weekly test of all sirens will be initiated from a control station to ensure the transmission path and the siren audio drivers are functional. Testing will be initiated from various control stations using typical communications paths. The test makes a brief sound, which is audible to the public. The siren test checks the communication with the sirens in addition to checking the audio drivers. Success will be confirmed by feedback to the control station.
- A quarterly growl (10-second activation) test will be initiated for each siren from a control station. Success will be confirmed by feedback to the control station.
- An annual full activation test will be conducted. The full activation is an alert activation, which produces 3-5 minutes tone. Success will be confirmed by feedback to the control station(s).

Additionally, the following testing will be performed:

- A silent test will be performed following preventative maintenance at a siren. Success will be confirmed by feedback to the control station.
- Additional testing will be performed by each county at their discretion.

21 QUALITY CONTROL

An overall quality control program has been implemented to ensure the reliability of the siren system. Elements of the program include: design (configuration) control, document control, and software control as discussed in section 17, procedure use as discussed in section 19, and inspection and testing as discussed in this Section. Existing IPEC procedures and programs are used as applicable for many of these elements. The IPEC corrective action program is used to identify issues and track associated corrective actions.

This program has been implemented during factory testing and testing both at installation and post installation. Testing was also conducted for several siren configurations in a test lab. Additionally, a Failure Modes and Effects Analysis, discussed in section 16, was conducted to identify system vulnerabilities as part of this quality control effort.

Factory Testing

ATI performed and documented acceptance tests on the Siren Cabinets (RTUs) and control stations in the factory before shipment to IPEC. The Siren Cabinet (RTU) inspection consisted of basic identification data being recorded including serial numbers, wiring diagrams, software/firmware versions, radio type and frequency used. The inspection also included checking all equipment mounting, connections and the condition of wiring to all components. The units were powered up, and a checklist was completed based on measuring and documenting speaker resistance and DC voltages at various locations within the cabinet. In addition, the board-mounted function push buttons (reset, calibration, steady tone, silent test, low power and off) were tested to verify that their respective functions performed satisfactorily with the proper illumination of their LEDs. Lastly, the installed software was tested to verify successful programming, polling and reporting of required alarms.

The control stations were tested at the factory as follows: Identifying information for each location was recorded which consists of serial numbers, wiring diagrams, software version, radio type and frequency used, wattage and DIP switch settings and battery information. The inspection included verification that all equipment connections and the condition of wiring to all components were correct. Voltage measurements were taken on the REACT-4000 circuit boards and battery voltage was recorded. REACT-4000 software was programmed and verified and then polling was performed using radio only, IP link only and both paths to ensure software performed as designed. A silent test was performed as well as REACT-4000 alarm verification for various alarm features. Additional polling and activations were performed and documented using the software with the computer turned off and using the REACT 4000 unit only.

A factory test was performed by Microwave Data Systems (MDS) on the microwave and simulcast system for the repeater equipment located at Harriman, Grasslands, Tinker and the IPEC Met Tower. The radios and the Harris multiplex equipment were powered up per their operating manuals, and function was verified and documented. Signal strength was measured and "end to end" radio tests were performed to verify the ability of the radio to send tones to "key" the repeater. This was done on both the microwave and the "T1" side of the equipment. The radio system was powered OFF then ON to

verify link synchronization without triggering alarms. Also, the GPS clock signal was turned ON and OFF to verify the ability to keep link synchronization in both conditions.

Results of the factory acceptance tests were reviewed. See Appendix D for an overview of the General Factory Acceptance Test steps.

Software Quality Assurance

Software Quality Assurance (SQA) was performed to provide adequate confidence that software conforms to established requirements throughout its life cycle.

The scope of the SQA inspection ensured that the delivered Alert and Notification System software component is complete, correct, and meets the specified requirements. The inspection was conducted on the available software media, documents or other formal deliverable products.

The following SQA activities were performed:

- Collected documentation
- Conducted a software requirements review
- Reviewed the relevant process documentation to ensure that evidence exists that the required procedures for software acceptance have been completed
- Documented findings in the corrective action program
- Reviewed the current corrective action status and the software to ensure that evidence exists that all previously noted deficiencies have been resolved
- Verified that all deficiencies from peer reviews, and tests have been resolved

Field Testing

Testing at Installation

ATI documented the installation and initial setup of each RTU siren cabinet in the field on a Field Checkout sheet. Siren numbers were recorded as well as firmware version loaded and radio serial numbers. The overall condition of the siren installation was checked including proper mounting of all equipment, checking wiring and connections on circuit boards, antenna connections, measurement of speaker impedances, battery voltage, charger voltage and voltage measurements on the siren boards, radio and modem. The sirens were calibrated and the unit was programmed from a REACT-4000 and verified for normal radio contact. A silent test was performed and the door switch, thermostat and heater were checked.

Control stations and repeater equipment were installed in their required locations and inspected for overall condition. All wiring and connections were inspected.

Post Installation Testing and Inspection

Post installation testing and inspections have been performed in accordance with approved procedures. Testing included operation under degraded battery conditions, verification of polling and siren activation, and verification of alarms for loss of AC power. This testing is further discussed in Appendix D.

Inspections have been performed to verify that the siren system configuration and condition is acceptable prior to declaring system operability. Following installation, an independent verification inspection of the overall condition of the siren installation was performed which included checking the proper mounting of all equipment, checking wiring, polarity and connections on circuit boards and speakers, antenna connections, measurement of speaker impedances, battery voltage, charger voltage and voltage measurements on the siren boards, radio and modem. A silent test was then performed and the sirens were calibrated and verified for normal radio and TCP/IP contact. The door switch, thermostat and heater were also checked.

At the towers, hardware and software configuration settings as well as switch and jumper settings were documented. All wiring and connections were inspected and verified to conform to the applicable vendor wiring diagrams. Corrections to these diagrams were made based on these inspections.

The post installation inspections addressed the following:

- The stiff speaker wiring cables in the siren control cabinet can be made more flexible by stripping back the outer cable jacket allowing connections to be maintained more reliably.
- Nyogel grease should be applied to driver terminal connections to prevent corrosion.
- Silicone should be applied to the cell modem antennas to prevent water intrusion.
- A weep hole should be drilled into the bottom of the speaker cover to prevent water accumulation inside the cover.
- Local calibration and silent testing of the siren is required for successful operation.
- Speaker wires need to be checked for correct phasing for proper sound output.
- Speaker wire connectors in the cabinet need to be checked for proper contact with the wire.
- The driver and cable resistance should be satisfactory prior to performing calibration.
- The timing signals for the control stations should be connected to a national time standard.
- Siren amplifier boards should to be reprogrammed and reconfigured for the particular application.

Anomalies discovered during the testing and inspections were documented and resolved using the corrective action program.

Acoustic Testing

Georgia Tech Research Institute (GTRI) conducted acoustic testing for the IPEC sirens. This testing included both anechoic chamber and open field testing. The testing collected data to support the determination of the siren characteristics pertinent to their acoustic performance. This testing is further discussed in section 14. Results of this testing are also provided in Appendix B.

22 CONCLUSION

As a result of the Energy Policy Act of 2005, IPEC elected to install a new ANS system consisting of fixed electronic sirens capable of providing an alert for twenty-four (24) hours after a loss of normal AC power. The battery backup power feature ensures system components operate securely in the event of power failure. The design of the new system also minimizes single points of failure.

The IPEC ANS consists of sirens, broadcasted emergency information, and high speed telephone notification. This system meets the guidelines set forth in the Federal Emergency Management Agency's (FEMA) regulations, 44 CFR Part 350, Planning Standard E, Appendix 3 of NUREG-0654/FEMA-REP-1, and the Guide for the Evaluation of Alert and Notification Systems for Nuclear Power Plants (FEMA-REP-10).

The sirens were installed on steel poles which extend pole life and withstand environmental challenges. Additionally, susceptible siren wiring is protected from damage because they are installed within the metal poles.

One hundred and fifty-two (152) sirens are omni-directional and fifteen (15) use the bi-directional configuration.

The communication control system uses eleven control stations that are designed to have complete control and monitoring capabilities over all sirens in the system. Each county has complete activation control and monitoring over the sirens used to alert its county from all control stations located within its county and can monitor the activation of all sirens via the computer display. Each county can also monitor sirens from bordering counties that may affect their county. All counties can also activate other counties' sirens if agreed upon. The two control stations at IPEC can also activate all of the sirens if needed.

Twenty-four hour battery capability is provided to meet the backup power requirements of the Energy Policy Act. The design includes this capability for each siren, each control station and one of the redundant radio paths at the repeater towers. Twenty-four hour battery capability is also provided for the second redundant radio path and the wireless TCP/IP equipment installed at the sirens, control stations and repeaters, with the exception of the T1 telephone lines and the TCP/IP network, which are maintained by Verizon (Telco).

The system incorporates reliable communication and post activation polling using radio and TCP/IP communication.

There are two separate and distinct communication paths used to convey activation and monitoring messages between the control stations and the remote sirens: dedicated redundant simulcast radio systems and a cellular TCP/IP system. The design eliminates single points of siren communication failures since multiple control stations can communicate to every assigned siren by either communication path.

The communication and control system reliability testing performed in 2007 for the microwave synchronized simulcast radio activation and control mode has demonstrated high reliability (greater than 97%) with a greater than 95% confidence. This activation and control mode has battery power supplies confirmed to provide 24-hour backup

power in the event of a loss of normal AC power. Furthermore, the testing has not revealed any unanticipated failure modes.

Acoustic testing at Georgia Tech Research Institute (GTRI) included both anechoic chamber and open field testing. The testing collected data to support the determination of the siren characteristics pertinent to their acoustic performance. The testing demonstrated that the siren output is steady, repeatable, and reproducible.

The siren sound contours of 60 and 70 dBC within the IPEC EPZ were calculated by a computer model developed by ATI. The ATI model demonstrates that the 70 dB sound output criterion is met in high population areas requiring 70 dB coverage and the 60 dB sound output criterion is met in low population areas requiring 60 dB coverage. To further confirm the quality of the ATI predictions, acoustic measurements were also taken in the far field. These measurements were compared to the predicted sound pressure levels for these locations. A bulk average deviation method was used to analyze this data. Close alignment was shown between the predicted values and measured values using this bulk average method.

The siren system as designed exceeds FEMA-REP-10 guidance based on the sound contours generated by the ATI acoustic model using 114 dBC as siren output. Modeling indicates that sound coverage meets requirements down to a siren output of 112 dBC. The controlled testing at GTRI showed an average siren output range of 115.2 to 117.4 dBC measured during outdoor testing. This design using a 114 dBC siren output is conservative by up to 5.4 dBC of margin.

Inspections have been performed to verify that the siren system configuration and condition is acceptable prior to declaring system operability. These inspections have ensured a high level of material readiness that will be maintained through an ongoing siren maintenance program.

APPENDIX A**LISTING OF ACRONYMS**

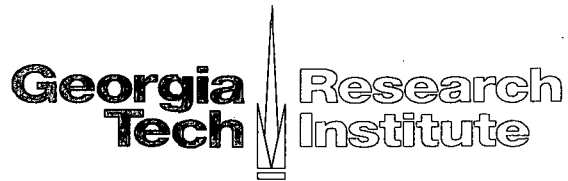
AC	Alternating Current
ANS	Alert and Notification System
ANSI	American National Standards Institute
ATI	Acoustic Technology, Inc.
CAP	Common Alerting Protocol
CCU	Communications Control Unit
CR	Condition Report
dB	Decibel
dB(A)	Decibels (A- weighted scheme)
dB(C)	Decibels (C-weighted scheme)
DC	Direct Current
DOD	Department of Defense
DTMF	Dual Tone Multi-Frequency
EAS	Emergency Alert System
EOC	Emergency Operations Center
EOF	Emergency Operations Facility
EPZ	Emergency Planning Zone
ERP	Effective Radiated Power
F	Fahrenheit
FEMA	Federal Emergency Management Agency
FMEA	Failure Modes and Effects Analysis
FSK	Frequency Shift Keying

GIS	Geographical Information Service
GPS	Global Positioning System
HPSS	High Power Speaker Station
Hz	Hertz
IP	Internet Protocol
IPEC	Indian Point Energy Center
LAN	Local Area Network
LED	Light Emitting Diode
Leq	Equivalent Sound Pressure Level
Ln	Sound Pressure Level exceeded n percent of the time
M	Meter
MHz	Megahertz
MPH	Miles Per Hour
NEMA	National Electrical Manufacturers Assoc.
NRC	Nuclear Regulatory Commission
NRTC	National Rural Telecommunications Cooperative
PIP	Palisades Interstate Park System
RECS	Radiological Emergency Communications System
RF	Radio Frequency
RH	Relative Humidity
RPM	Revolutions Per Minute

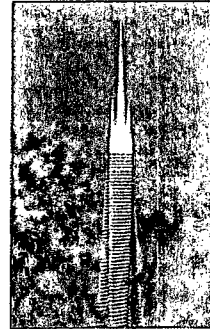
RTU	Remote Terminal Unit
SAB	Siren Amplifier Board
SAIC	Science Applications International Corporation
SPL	Sound Pressure Level
TAR	Tone Alert Radio
TCP	Transmission Control Protocol
TCP/IP	Transmission Control Protocol/Internet Protocol
UPS	Uninterruptible Power Supply
USGS	United State Geographical Survey
VAC	Volts Alternating Current
VDC	Volts Direct Current

APPENDIX B

**INDEPENDENT TEST OF THE IPEC PROMPT ALERT
NOTIFICATION SYSTEM**



400 W. 10th Street, N.W.
Atlanta, GA 30332-0844



**Independent Test
of the
IPEC Prompt Alert Notification System**

Prepared by:

R. J. Gaeta, Ph.D.
Senior Research Engineer
rick.gaeta@gtri.gatech.edu
404-407-7805

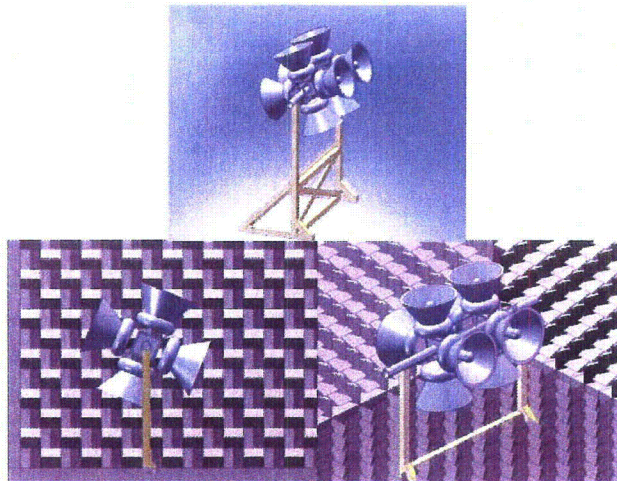
Aerospace and Acoustics Technologies Division
Aerospace, Transportation, and Advanced Systems Laboratory

Georgia Tech Research Institute

Independent testing of the Indian Point Energy Center's (IPEC) Prompt Alert Notification System Sirens were performed by the Georgia Tech Research Institute (GTRI) during the time frame of October 16th, 2007 and December 19th, 2007. Tests were performed in an anechoic chamber and at an outdoor test site, both GTRI test facilities. This document certifies that GTRI measured and reported sound pressure levels of these sirens using accepted and standard research techniques.

Anechoic Chamber Siren Acoustic Measurements

Testing of both omni-directional and bi-directional siren systems (produced by Acoustic Technology, Inc.) were performed in GTRI's large anechoic facility. A special mount was designed and fabricated for testing in the anechoic chamber. The sirens were mounted horizontally on a spit-like apparatus that was conducive to rotation and ease of testing alternate speaker horn pairs. Figure 1a shows a schematic of this siren mount. Figure 1b shows a photograph of the actual installation.



a. Siren mounting design for anechoic chamber testing.



b. Actual siren installed in anechoic chamber.

Figure 1 Siren mounting apparatus used for anechoic chamber testing at GTRI.

Instrumentation

The sound pressure level transducers used during the test were ¼-inch Bruel & Kjaer (B&K) 4939 condenser microphones. These microphones use a ¼-inch to ½-inch adaptor to a B&K 2669 pre-amplifier (factory specification: <0.05 dB @ 500 Hz). The acoustic signals were conditioned with a B&K 2690 Nexus instrumentation amplifier (factory specification: +/- 0.02 dB accuracy) before being processed by a multi-channel Data Physics Abacus dynamic signal analyzer (factory specification: +/- 0.02 dB). Calibration of microphones was performed each day of testing. The effect of all of the instrumentation is that the sound pressure levels are measured with an accuracy less than 0.1 dB and the measured frequency is within +/- 1 Hz.

Data Acquisition

Acoustic sound pressure levels (SPLs) were acquired using condenser microphones. The electronic signals from the microphones were conditioned through a pre-amplifier, an instrumentation amplifier and filter, and a dynamic signal analyzer. These components are standard considered state-of-the-art for measuring acoustic pressures with the types of condenser microphones used in these experiments. A total of 12 microphones were used in the anechoic chamber. Nine microphones were arranged in a cross-array on 1 foot centers, see Figure 2. The three remaining microphones were placed in reference locations near the siren, and at positions midway (but off axis) from the siren to the microphone array.

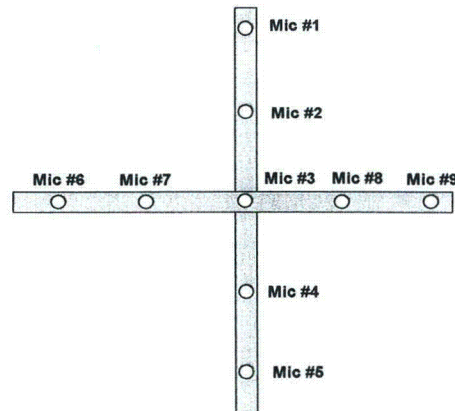


Figure 2 Microphone array as seen by the siren speakers in the anechoic chamber.

Figure 3 shows how this microphone array was positioned relative to the siren in the anechoic chamber. The center of the array (microphone #3) was 18.5 feet from the siren center axis.

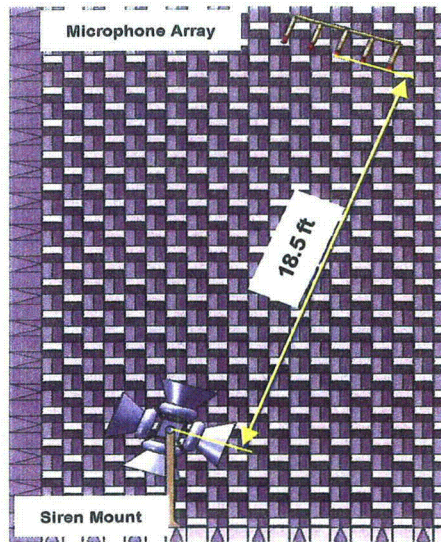


Figure 3 Orientation of microphone array relative to siren mount in anechoic chamber.

Results of Anechoic Chamber Measurements

Table 1 shows the average sound pressure levels (SPLs) recorded from the microphone array located approximately 18.5 feet from the siren axis. Shown are the average L_{eq} levels for 14 omni-directional sirens (four sirens taken from the field at IPEC and 10 new sirens delivered by ATI) and the bi-directional sirens for all runs sounded at 576 Hz and with all nominal systems working. The average L_{eq} at microphone #3 (see figure 2) is shown. A summary of the individual tests that contributed to the values in Table 1 is contained in the first and third volume of GTRI's final report to Entergy [GTRI D5600_Volume 1 Final Report, GTRI D5600_Volume 3 Final Report].

		Mic #3 Leq
Omni Directional Sirens	Average =>	129.7 dBC
	Predicted at 100 ft =>	115.0 dBC
Bi-Directional Sirens	Average =>	132.0 dBC
	Predicted at 100 ft =>	117.3 dBC

Table 1 Average results for omni-directional and bi-directional sirens tested in GTRI's anechoic chamber. Levels measured at a nominal 18.5 ft sounding at 576 Hz.

Outdoor Siren Acoustic Measurements

Acoustic Technology, Inc. (ATI) sirens were tested outdoors adhering to ANSI S12.14-1992 standard. The test site was located in Smyrna, GA on the properties of the Georgia Tech Research Institute (GTRI). The ATI omni-directional siren system consists of eight speaker horns. These speaker horns are mounted on top of a 50 foot pole with two horns



Figure 4 ATI omni-directional siren system mounted at the GTRI outdoor test facility.

pointing in orthogonal directions (each pair facing 90° apart). Figure 4 shows a photograph of this siren system mounted on a pole at the test site. Each speaker horn is driven by four acoustic drivers, each with an average power output of 100 Watts. Thus, the entire siren system has 3200 Watts of power.

A total of seven omni-directional sirens were tested outdoors. These were provided by Entergy, Inc. The first four were taken off poles in the field and first tested in GTRI's anechoic chamber before being tested outside. The last three were new siren systems from the factory. In addition, amplifier boards, batteries and the field box used

to store the electronics was also supplied to GTRI.

Site Description

The selected site for outdoor testing was part of a GTRI radar testing range. The site consisted of a mostly flat, large field approximately 200 feet by 600 feet in extent. At one far corner was a radar tower. The opposite end of the field was bounded by a horseshoe of trees over 75 in height. At this location, a wooden pole was installed that rose 50 feet from the ground. Atop this pole the sirens were affixed. The radar tower was approximately 500 feet from the pole and the field was covered in grass. Figure 5 shows a photograph of the test site as seen from the top of the radar tower.



Figure 5 GTRI outdoor test site.

Measurement Position

Measurements were made at several locations along a line that was in the direction of a speaker horn pair. In addition to measurements at 100 ft in accordance with the ANSI standard, measurements were made at 18.5 feet, 200 feet, and for selected soundings 400 feet. Microphones were installed along the measurement axis on man lifts that positioned the microphones 50 feet above the ground. An array of five microphones was placed at 18.5 feet. A fixed microphone placed at the 100 foot location. In addition (in accordance with the ANSI standard), a person held a microphone on a boom and rotated around the fixed microphone slowly in a two foot

radius. At the base of the 100 foot location, a microphone was installed on a tripod about 5 feet off the ground. Fixed microphones were placed at the 200 foot and 400 foot locations. Figures 6 and 7 show the microphone set up at the GTRI outdoor facility.

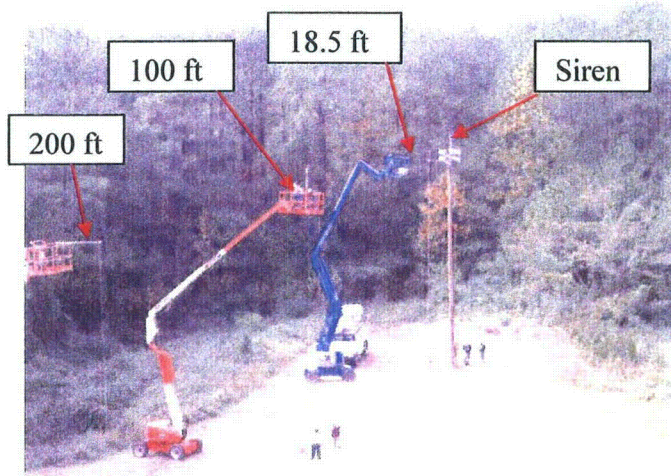


Figure 6 Measurement positions at 18.5 ft, 100 ft, and 200 ft.



Figure 7 Microphone measurement positions at the GTRI outdoor test site.

A schematic of the microphone measurement locations are shown in Figure 8. A utility box about 7 feet tall was located near 300 ft from the siren pole. This was not a big structure and didn't interfere with the ANSI standard 100 ft measurement location.

All distances both along the ground and vertically were accurate to within 6 inches. The microphones were sighted along the 50 foot measurement axis with a surveyor's transit. For the last three sirens tested, microphones were placed only the 100 ft location.

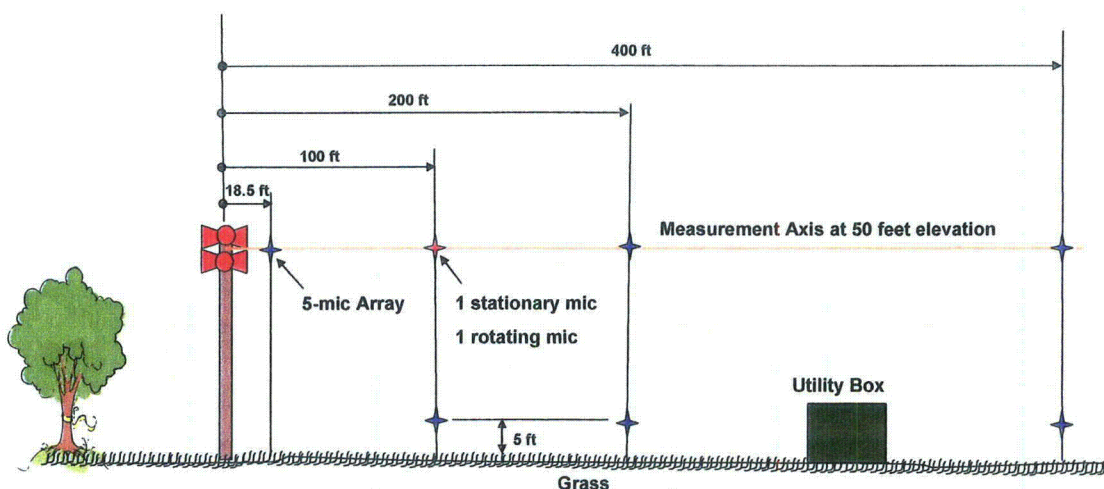


Figure 8 Schematic showing relative measurement locations at the GTRI outdoor test site.

Weather Conditions

The weather conditions during the measurements were very mild. Wind speed and direction, temperature, pressure, and humidity were measured at the 100 ft (50 ft elevation) location as well as at the top of the siren location using a Young Model 81000 3-Axis Ultrasonic Anemometer weather station. Generally there was little or no cloud cover for these readings. Temperatures ranged from 49.2 °F to 67.9 °F with the relative humidity ranging from 45% to 50%. The ambient pressure varied from 14.15 psia to 14.23 psia. No measurements were recorded with greater than 10 mph wind speed.

Ambient Noise Level

Ambient noise at the GTRI test site fluctuated with automobile traffic and aircraft traffic from the adjacent Naval Air Station and Lockheed-Martin flight line operations. Testing was never initiated while planes were taking off or landing or taxiing. Over the course of the outdoor testing the ambient noise levels were between 60 and 75 dBC. These levels are at least 30 dB lower than the sound of interest (the sirens) ensuring uncorrupted sound measurements.

Instrumentation

The sound pressure level transducers used during the test were ¼-inch Bruel & Kjaer (B&K) 4939 condenser microphones. These microphones use a ¼-inch to ½-inch adaptor to a B&K 2669 pre-amplifier (factory specification: <0.05 dB @ 500 Hz). The acoustic signals were conditioned with a B&K 2690 Nexus instrumentation amplifier (factory specification: +/- 0.02 dB accuracy) before being processed by a multi-channel Data Physics Abacus dynamic signal analyzer (factory specification: +/- 0.02 dB). Calibration of microphones was performed each day of testing. The effect of all of the

instrumentation is that the sound pressure levels are measured with accuracy less than 0.1 dB and the measured frequency is within +/- 1 Hz.

Test Results

Table 2 summarizes the results of the Omni-directional and Bi-directional speakers tested outdoors for a sounding frequency of 576 Hz. Both the moving microphone average L_{eq} and the stationary microphone L_{eq} at 100 ft on axis are shown. A summary of the individual tests that contributed to the values in Table 2 is contained in the second and third volume of GTRI's final report to Entergy [GTRI D5600_Volume 2 Final Report and GTRI D5600_Volume 3 Final Report].

		Moving Mic L_{eq} @100' [dBC]	Stationary Mic L_{eq} @100' [dBC]
Omni Directional Sirens	Average =>	117.4 dBC	115.2 dBC
Bi-Directional Sirens	Average =>	118.7 dBC	116.7 dBC

Table 2 Average L_{eq} results for omni-directional and bi-directional sirens tested in GTRI's outdoor testing range. Levels measured at a nominal 100 ft sounding at 576 Hz. Measurements made using ANSI S12.14-1992 Standard



21 MARCH 2008

R. J. Gaeta, Ph.D.
 Senior Research Engineer
 Aerospace, Transportation, and Advanced Systems Laboratory
 Georgia Tech Research Institute

APPENDIX C AMBIENT NOISE SURVEY

Blue Ridge Research and Consulting, LLC (BRRC) collected ambient sound levels at 13 locations within the IPEC EPZ. These locations were selected to coincide with locations where the sound level of a full system test was also collected. These locations were selected to generally be in high population density areas. The GPS coordinates and maps of the measurement locations can be found in BRRC's Final Report¹. The thirteen locations are briefly described in the next table. Note that all of these locations were selected because they are generally in high density population areas with greater than 2,000 people per square mile.

Table C-1. Location and Description of the Ambient Measurement Locations.

Location	Description	County
Cortlandt	Off of Tate Ave. in Cortlandt NY	Westchester
Peekskill	Off of Ringgold St. in Peekskill NY	Westchester
Croton-on-Hudson	Off of High St. in Croton-on-Hudson NY	Westchester
Yorktown	Off of London Rd. in Yorktown NY	Westchester
Mohegan Lake	Off of Lawrence Rd. in Mohegan Lake NY	Westchester
Ossining	Off of Fairview Pl. in Ossining NY	Westchester
Lake Peekskill	Off of Point Dr. N. in Lake Peekskill NY	Putnam
Putnam Valley	Off of Mountain View Rd. in Putnam Valley NY	Putnam
Highland Falls	Off of Walker Ave. in Highland Falls NY	Orange
Fort Montgomery	Off of Locust Ln. in Fort Montgomery NY	Orange
Haverstraw	Off of Hoover Ave. in Haverstraw NY	Rockland
New City	Off of Omni Ct. in New City NY	Rockland
Stony Point	Off of Adams Dr. in Stony Point NY	Rockland

Type 1 Sound Level Meters (SLMs) were used to collect the ambient data. The SLMs used for this project were the Larson Davis 824s² and 831s³. Before each meter was put into service, its calibration was checked, and a calibration tone was recorded on each meter. After each test, another calibration tone was recorded on each of the meters to verify proper functioning.

The Model 831 SLMs were programmed to collect data every 1 second, while the Model 824s were only able to collect data every 6 seconds (due to memory limitations). Each SLM was programmed to collect third octave band data over the entire period they were in the field. The data was collected from August 16 through August 18, 2007.

¹ "General Acoustical Analysis of the New Indian Point Siren System – Final Report", August 2007, Blue Ridge Research and Consulting.

² Larson Davis, 2004, "Model 824 Sound Level Meter Reference Manual"

³ Larson Davis, 2006, "Model 831 Sound Level Meter Operation Manual"

Since weather plays an important role in noise propagation, and has an effect on the local ambient noise, weather data for the three days was also collected during the acoustic measurements.

There are many different ways to examine the ambient acoustical environment from data collected by a SLMs. The primary method utilizes the percent time exceeded metrics, such as the L50, which represents the sound level that is exceeded 50 percent of the time. For ambient sound levels the L50 represents a conservative representation of the currently occurring sound levels at a location. However, looking at the L90 helps to describe the quieter sound levels. The L90 represents the sound level that is exceeded 90% of the time and generally indicates the background levels of neighborhood without any noise intrusions. The L10, on the other hand, is the level that is only exceeded 10 percent of the time and provides insight into the level of major noise intrusions occurring within a neighborhood.

Table C-2 shows the cumulative L10, L50, and the L90 percent time exceedances for all of the areas measured. The data is presented for the 28th third octave band (TOB) (centered at 630 Hz) which is third octave band where the majority of siren energy is. The data was processed only for the hours from 7 AM to 10 PM.

Table C-2. The Cumulative Exceedances for the 28th TOB (630 Hz).

Location	Exceedance in dB		
	L10	L50	L90
Cortlandt	43.0	38.0	33.0
Peekskill	40.0	35.0	28.0
Lake Peekskill	44.0	34.0	27.0
Putnam Valley	39.0	32.0	25.0
Croton	52.0	49.0	46.0
Yorktown	44.0	38.0	32.0
Mohegan Lake	35.0	28.0	24.0
Ossining	45.0	38.0	33.0
Fort Montgomery	36.2	30.2	28.2
Haverstraw	44.6	40.6	37.9
Highland Falls	41.4	37.2	32.9
New City	44.4	37.9	33.1
Stony Point	42.8	40.8	39.4

None of the L50 levels are higher than 49 dB. This means that any siren level that reaches the required 70 dB for high population density areas will be clearly audible above the ambient background noise.

Ambient Sound Variation with Time

The background noise level changes with time. This change is due to random activity during any given day, and it is also a function of the change in daily activity for both the people and the animals living in the area. Figure C-1 shows a sample of the hourly exceedances for Peekskill NY. This figure shows the hourly L10, L50, and the L90 for the three days that the meter was in the field. Here, both the daily cycle of the background noise as well as random intrusions into the background noise can be seen. Note that the large increases shown in the L10 levels are not represented in the L50 nor

the L90. This is because the L10 represents momentary intrusions into the background noise while the L50 and the L90 represent the more constant noise levels in the background. From this plot it appears that, for this location, the quietest hour is shortly after midnight, and the loudest part of the day is around noon daily.

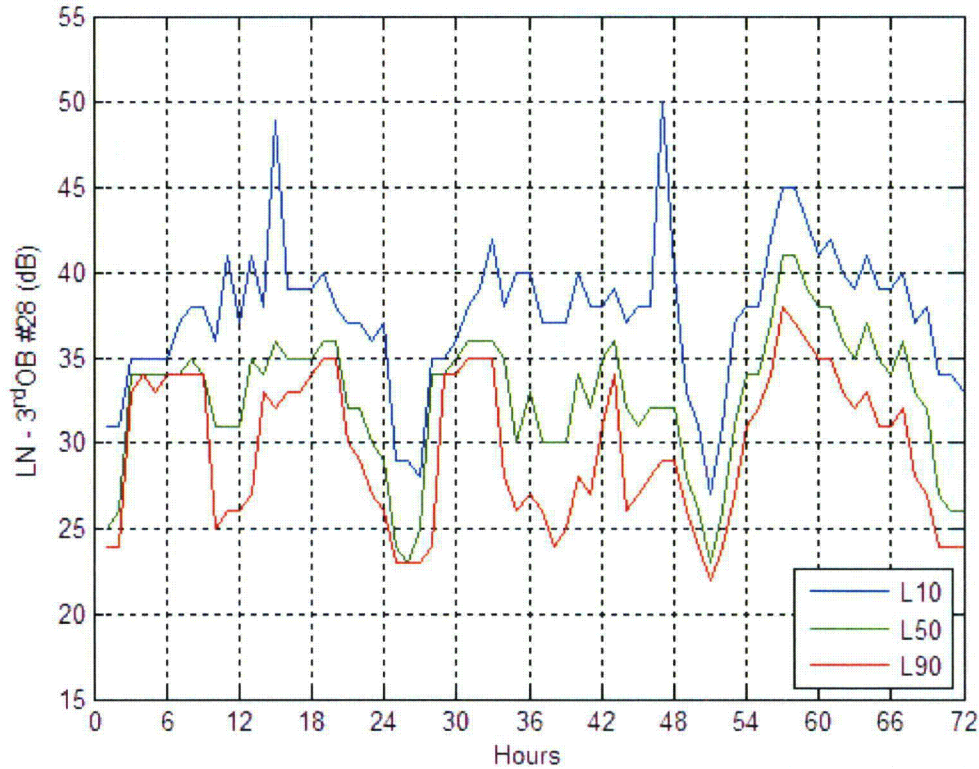


Figure C-1. Time History of Hourly Exceedances for Peekskill, NY.

Conclusion

BRRC conducted ambient noise measurements in thirteen locations within the EPZ for three consecutive days in August of 2007. The daytime (7 AM to 10 PM) noise data from these measurements was used to compute the local ambient noise environment. The exceedance levels of L10, L50, and L90 were computed in the 28th third octave band, centered on 630 Hz. The L90 levels, representative of the ambient background sound levels, ranged from 25 dB to 46 dB. The L50 levels, representative of the average sound conditions, ranged from 28 dB to 59 dB. The L10 levels, representative of the infrequent and transient noise intrusions, ranged from 35 dB to 52 dB.

APPENDIX D INITIAL TESTING

Siren system testing was performed in two parts: factory acceptance testing and the installation/start-up site testing.

GENERAL FACTORY ACCEPTANCE TEST PLAN

A. Siren Test

For each siren, the following steps were taken:

- 1) Visually inspect unit wiring, connectors, boards, and mounting hardware.
- 2) Verify battery charger operation and battery voltage level.
- 3) Verify battery heater is operational.
- 4) Verify address and configuration settings.
- 5) Verify local and remote status reporting.
- 6) Verify local and remote silent tests.
- 7) Verify Motorola signal capability: talk around communication, addresses, and Frequency Shift Keying (FSK) data communication.
- 8) Verify remote controller monitoring and site status conditions using radio and TCP/IP communications.
- 9) Verify activation commands.
- 10) Verify intrusion and loss of AC power reporting, driver alarms failures, door open alarm, and temperature alarm.

B. Control Station Test

For each control station, the following steps were taken:

- 1) Visually inspect unit wiring, connectors, boards, and mounting hardware.
- 2) Verify that the workstation computer correctly operates with all installed software.
- 3) Verify the three levels of passwords.
- 4) Verify monitor and display maps.
- 5) Verify alarm monitoring.
- 6) Activate the system and verify correct display results.

- 7) Verify correct monitoring, displaying, and logging of unsolicited system messages from remote sites.
- 8) Perform and verify single, group, and total activations.
- 9) Verify automatic scheduled polling, activations, and siren silent test.
- 10) Verify archive and report printouts are performed for all system activities.
- 11) Verify that there is supervised communication between all communications control units. (NOTE: "Supervised communication" means that the communications is monitored.)
- 12) Perform and verify all activation using only the front panel of the REACT-4000.
- 13) Verify that the control station UPS operates as specified by simulating the loss of AC input power.

INSTALLATION START-UP SITE TEST PLAN

A. Control Station Verification

- 1) Visually verify proper equipment installation and wiring.
- 2) Verify proper software installation and operation.
- 3) Verify communication using both the RF link and the TCP/IP link separately.
- 4) Verify that the control station UPS holds the control station monitoring equipment loads under normal operation and under loss of AC input power.

B. Repeater Site Verification

- 1) Visually verify proper equipment installation and wiring.
- 2) Verify all repeater tower radio equipment is functional, including talk around communication and battery backup function.

C. Siren Pole Verification

- 1) Visually verify proper equipment installation and wiring.
- 2) Verify AC power is supplied and correctly wired.
- 3) Verify the batteries are installed and correctly wired.
- 4) Verify correct siren address and DIP switch settings.
- 5) Verify and check radio communication.
- 6) Verify and check TCP/IP communication

- 7) Perform and verify both local and remote siren tests.
- 8) Perform a remote silent test and verify status reporting to the control station.
- 9) Verify status monitoring of the siren at the control station.

D. System Activation Verification

- 1) Perform a county-wide silent test activation for all sirens within each county and verify the results.
- 2) Perform both GROUP (for each of the four counties) and TOTAL silent test activations from the IPEC control stations and verify the results.
- 3) Repeat the above tests from each control station.

E. Backup Power Verification

Post installation testing and inspections have been performed in accordance with approved procedures. This testing was conducted to demonstrate satisfactory performance of the siren system components as required by the NRC Order. Testing included:

- Operation of the system with simulated degraded battery voltage was tested for at least 24 hours for four selected sirens, five control stations, and all four simulcast repeater towers. During this time, the system was maintained in the standby mode with periodic polling and monitoring of communication activity conducted. The test simulated the functioning of the batteries in an end-of-life and design temperature condition and included all tested components in a simulated degraded battery condition concurrently. At the end of the 24 hour period, there was a simulated 15 minute siren sounding for the four selected sirens being tested after which the batteries at the tested locations were re-charged to at least 80% within a 24-hour period.
- Verification that on a loss of AC power to the tested locations, indication of this loss was automatically provided to IPEC and notification messages to designated IPEC personnel were received.
- Integrated siren activation/communication system reliability was tested as discussed in Section 10.

Additionally, other testing included:

- Verifying the ability of alarm and control circuits at the simulcast repeater towers to report back to IPEC and initiate and complete an automatic transfer between the microwave and Telco channels for a fault condition.
- Verifying the ability of the alarm and control circuits at the simulcast repeater towers to detect a loss of AC power to the simulcast system and perform necessary load shedding.

- Verifying capability of each communication channel (radio microwave, radio telco, and TCP/IP cellular) to conduct polling both individually and collectively.

APPENDIX E LESSONS LEARNED

In 2005, an evaluation of the former electro-mechanical IPEC alert and notification siren system was conducted to evaluate failure modes and causes. The following lessons were learned:

Points of Failure

Within the former electro-mechanical siren system there were several single points of failure that had system-wide repercussions. The most significant of these was the primary communications device that transmitted activation signals to the sirens and received siren performance feedback data. The system used the IPEC meteorology tower, a 100-meter tall structure, to support the transmitter. If this transmitter was not available, it was not possible to activate sirens.

Each siren was itself also a potential point of failure. Because the siren consisted of a single rotating element, any failure that disabled that element prevented either siren rotation or siren sounding or both. Failure in this mode could have occurred as a result of a power outage or mechanical interference with the mechanical components.

The pair of host computers that sent activation signals was located at the IPEC Emergency Operations Facility (EOF). Even though these were redundant computers, their proximity made them susceptible to common failure modes.

Subgroups of sirens were activated via transmission of radio signals from repeaters located on selected sirens. A repeater failure could have constituted a single point of failure for a subgroup of sirens.

To avoid these failure modes, the new siren system has the following features:

- Siren activation and monitoring is accomplished using simultaneous transmission over a variety of pathways. These include a radio system utilizing higher power radios with a 4-tower simulcast repeater system that is independent of the sirens (sirens are not used as store/forward repeaters to siren subgroups as in the former system) to broadcast activation signals and receive monitoring information. A wireless TCP/IP communications system broadcasts activation signals and receives monitoring information. The TCP/IP mode operates in parallel with the radio communications mode. This design eliminates single point communications failures.
- The siren rotation sensor that could cause an electro-mechanical single point of failure was eliminated through the installation of fixed omni-directional and fixed bi-directional electronic sirens.
- Each omni-directional siren pole has a total of eight siren horns mounted in two banks of four. Each of the siren horns has four independent speaker-drivers. A

failure in a single driver leaves three remaining drivers within that siren horn. Failure of a single driver associated with speaker horns in one direction does not reduce sound coverage in the EPZ below an acceptable level.

- Host computers for the siren system are located at multiple locations. In each county, host computers are located at not less than two locations (warning point and emergency operations center). Those locations are physically separated and have separate backup power supplies. In this way, a failure of a single computer will not disable the system.

Communications Monitoring

The former electro-mechanical siren system utilized frame relay telephone connectivity from activation sites to the host computer. The frame relay system was monitored at the host computer but failures were not automatically reported to responsible personnel until two modifications were made to the frame relay system in 2005 that caused responsible personnel to be notified of pathway failures.

The new siren system provides for automatic notification of responsible persons in the event of communications pathway failures. Sirens and control stations are polled on a regular basis; the polling is normally initiated from the GSB or EOF control stations and may be conducted over the two radio paths or over the TCP/IP paths. Failures are displayed on the control station and trigger a notification to responsible personnel. Upon loss of AC power at any control station, notification is made to selected IPEC personnel. The display status changes for loss or inoperability of any county control station or for complete loss of any siren within that county.

Diagnostic Device Failures

The former electro-mechanical siren system employed a series of diagnostic devices and computer logic relating the monitoring of these devices to determine whether or not the siren was in a ready state and, if activation was demanded, whether or not the siren performed its intended function. Several of these diagnostic devices had histories of failure as described below. These included the siren rotation sensor and sound detection acoustic sensor. The design of the new system eliminates these problematic diagnostic devices. In the new system, there are no rotation sensors because these are fixed sirens. The amplifier includes sensitive power monitoring circuits that monitor the state of the amplifier, speakers, and cables without external devices.

Failure History

The former system utilized electro-mechanical sirens installed in the 1980's. A 10 or 15 HP AC motor was used to compress air between a stator and rotor to generate the siren discrete tones. The noise generated was projected to a larger distance by a horn. That same motor was used to rotate the horn to generate 360° of sound coverage. The horn rotated at low speed (3-4 rpm) through the use of gears and a chain. To operate, the siren needed a 208-230 volt AC power feed and was activated by a radio signal.

In order to understand the failure modes of the former system, IPEC analyzed it over a three year period (2003, 2004, and 2005). The data provided were collected through several sensors such as an audio (acoustic) sensor, rotation sensor, etc. During the period reported, 1,560 activations were evaluated. The system reported 101 siren failures.

The failures during activations, as reported, were:

- Rotation sensor 58 failures
- Audio sensor (siren noise) 22 failures
- Communications 8 failures
- AC power 12 failures
- Other 1 failure

The operational experience of the former system indicated that rotation failures had a major impact on the system performance. If a siren failed to rotate, the horn projected sound in only one direction. This led to only 10% of the 360° expected sound coverage for the failing siren.

Table E-1 provides a failure history as documented in IPEC Condition Reports. These reports document conditions adverse to quality during activations or discovered during preventive maintenance. In addition, Table E-1 identifies the features of the new system that address those failures.

**Table E-1. Entergy Condition Reports (CR)
from January 2004 to February 2006**

CR	Condition	Design Feature of New System
IP2-05-00399	Add Battery Water for Electronic Siren.	Gel cell batteries do not require water addition and are low maintenance.
IP2-05-00316 IP2-05-00487 IP2-05-01467 IP2-05-03245 IP2-05-01099 IP2-05-05359 IP3-05-00075 IP2-05-02709 IP2-05-04670 IP2-04-03786 IP2-04-04552 IP2-04-04899 IP2-04-06122 IP2-04-01150 IP2-06-00596 IP2-06-00974	Communication Failure Control Station to Siren and Return.	Higher power for radios, simulcast repeater system, and a second high speed communication path that is redundant to the simulcast radio system.
IP2-05-00417 IP2-05-04991 IP2-04-00367 IP2-04-00448	Icing affects rotation of siren.	Stationary sirens do not rotate.
IP2-05-01549 IP2-04-04471 IP2-04-04496 IP2-04-04498 IP2-04-04538 IP2-04-04539 IP2-04-04502 IP2-04-04542 IP2-04-04545 IP2-04-04503 IP2-04-04547 IP2-04-04551	Loose control system wires due to vibration from motor activation.	No rotation to cause vibration.

CR	Condition	Design Feature of New System
IP2-05-02022 IP2-04-04351 IP2-04-04370 IP2-04-04369 IP2-04-04371 IP2-04-03938 IP2-04-02080 IP2-04-02799 IP2-04-02812 IP2-04-02814 IP2-04-02842 IP2-04-02676 IP2-04-02915 IP2-04-03303 IP2-04-02858 IP2-03-05400 IP2-04-06434 IP3-04-01124 IP3-04-03202 IP3-04-04108 IP2-05-00530 IP2-05-02709 IP2-05-03682 IP2-05-04170 IP2-05-04670 IP2-06-00646	Faulty or jammed rotation sensor by bird nesting.	No rotation and no rotation sensor.
IP2-05-04683 IP2-05-01294 IP2-04-00366 IP2-04-02675 IP2-04-02841 IP2-04-03608 IP2-04-04212	Motor and motor protection related failures.	No motor or motor protection or controls to fail due to stress of starting under high voltage and current.
IP2-04-02860 IP2-04-02888 IP2-04-02946 IP2-04-03788 IP2-04-03918 IP2-04-03919 IP2-04-03920 IP2-04-03935 IP2-04-03936 IP2-04-04214 IP2-04-04435 IP3-04-02771 IP2-06-00246 IP3-06-00152 IP2-04-01124 IP2-04-01124 IP3-04-02134 IP2-05-02209 IP2-05-03682 IP2-05-04170	Power failures for driving siren motor to generate sound.	Sirens are DC powered from the battery so they are designed to operate without AC power for at least 24 hours in "Standby" mode and 15 minute activation. A motor is not required to generate sound.

CR	Condition	Design Feature of New System
IP2-04-00914	Speaker wire chewed by vermin disabling siren partially.	Susceptible wires are protected from damage by being installed in metal poles.
IP2-05-04996	Notification of personnel turned off by accident for period so no indication of system problems available.	Notification of personnel feature cannot be turned off inadvertently.
IP2-05-04482 IP2-06-00648 IP2-06-00659	No auto trending capability. Data must be manually compiled and thus not easy to see degrading conditions to take action to repair/connect.	Design has auto monitoring. Ability to more readily extract pertinent alarm conditions for information recorded and logged is recommendation of Failure Modes and Effects Analysis.
IP2-05-02345 IP2-05-03618 IP2-05-04001 IP2-05-04002 IP2-05-04248 IP2-05-04483 IP2-05-03345 IP2-05-03376 IP2-04-00438 IP2-04-00543 IP3-04-02434 IP3-04-04208 IP2-06-00149 IP2-06-00973	Failure of frame relay from County control station to host computer.	No frame relay connecting control stations; radio and cellular communication to communicate between each control station and sirens.
IP2-05-02987 IP2-05-02992	Loss of power to primary radio for siren system.	Backup power provided at all critical control locations in communication network. Multiple radios installed at multiple locations, no single point of failure.
IP2-05-03748	Back up communication from County control did not work.	System includes a redundant communication system through radio and TCP/IP protocol. Multiple communication control stations each containing radio and TCP/IP protocol at each county and IPEC.
IP2-05-04484	Radio failure at repeater affects many sirens.	Redundant communications systems provided. Sirens do not communicate with each other only through repeater towers.
IP2-05-04713	Long distance and series repeater can cause loss of control station signal.	Series repeater not used, radio power increased and use of simulcast repeaters.

CR	Condition	Design Feature of New System
IP2-05-04598 IP2-05-05116	Electronic siren speakers found faulty by field examination at siren site.	System has remote monitoring and periodic silent tests to verify problems with speaker/drivers.
IP2-04-04352 IP2-04-01124 IP3-04-03202 IP3-04-04108 IP2-04000964 IP2-06-00516	Acoustic sensor failures result in false negative siren activation report.	The system does not use acoustic sensors. Failure of sirens is based on amperage measurements.
IP2-05-04992 IP2-04000964	Radio failures at sirens.	TCP/IP and radio communications systems are redundant.
IP2-05-04395	Software slowing down due to no auto clearing and archiving. Potential to affect activation and monitoring.	Archiving is independent of other system activities.
IP2-06-00780 IP2-06-00779 IP2-06-00768 IP2-06-00767 IP2-06-00724 IP2-06-00515 IP2-06-00304	Control system fabrication and installation errors – wiring and antenna orientation.	Significant testing and inspection have been performed to address issues.

Table E-2 compares and contrasts the design features of the former and new systems.

Table E-2. Comparison of Former and New Systems

No.	Item	Former System	New System
1	Communication	Low power radio system and siren acts as repeater	Simultaneous high power radio and TCP/IP communication systems. Sirens not used as repeaters
2	Siren Rotation	Rotating electro-mechanical siren	Non-rotating (fixed) solid-state electronic siren
3	Power Feed	AC powered	Battery operated or battery backup
4	Moving Parts	Several moving parts	No moving parts
5	Extreme Weather Conditions	Major parts can freeze in extreme cold weather	Heated battery compartment to withstand component extreme weather conditions
6	Siren Component Failure	Can cause total siren failure	Failure of a single speaker-driver will not cause total siren failure.

APPENDIX F

SYSTEM EQUIPMENT DATA

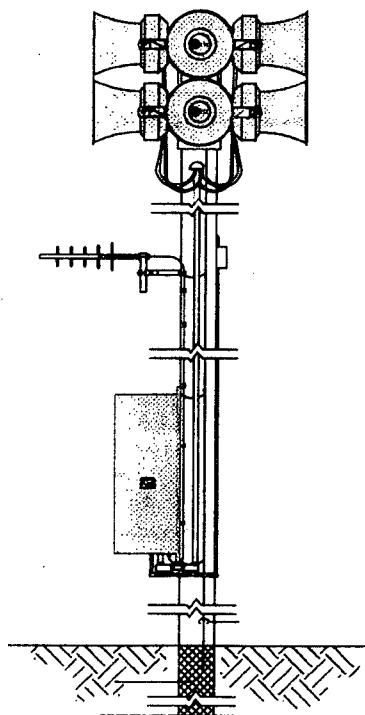
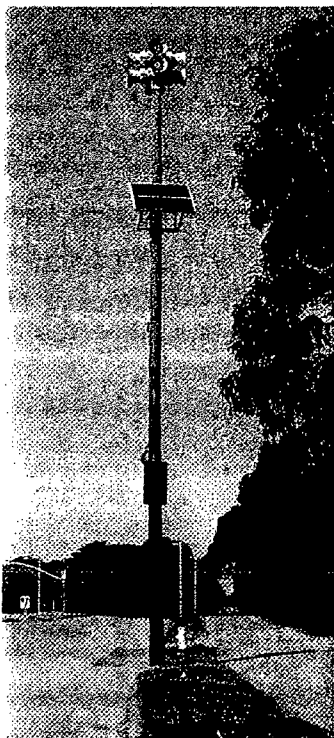


Outdoor High Powered Speaker Station

HPSS32

HPSS32 Omni-Directional Stationary Sound Pattern

Model HPSS32 This omni-directional speaker assembly can be configured for operation of up to 3200 Watts of continuous audio output power; provides clear, reliable alarm tone notification and voice instructions for emergency warning and notification.



3200 Watts of Output Power (127 dBC at 100')

- Includes eight 400 Watt speaker assemblies with mounting bracket, 50 feet of speaker cable and a speaker pole mounting kit
- One auxiliary Class D Amplifier with an interconnecting cable and mounting screws
- An additional ventilated and attached Stainless Steel battery compartment

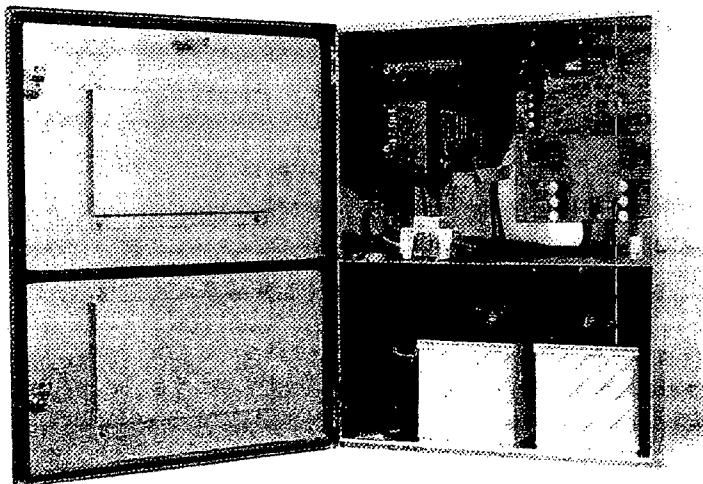


Outdoor High Powered Speaker Station

HPSS

Tone & Voice System

Model HPSS



This unit is configurable for operation of up to 3200 Watts of continuous audio output power. Provides clear, reliable alarm tone notification and voice instructions for emergency warning and notification.

- Compliant with the UFC and FEMA requirements
- 30 minutes of full, continuous operation
- Seamless replacement for Electronic Mechanical Sirens

STANDARD EQUIPMENT

Includes a NEMA4X Stainless Steel Siren control enclosure with an attached isolated and ventilated battery compartment, enclosure mounting bracket and mounting hardware. The siren enclosure contains a Class D Amplifier integrated with a high performance controller section, a conventional VHF or UHF radio and mounting hardware, an intrusion switch, a temperature compensated battery charger and power ON/OFF circuit breakers.

- Antenna equipment sold separately per site requirements.
- Batteries are not included.**

FEATURES

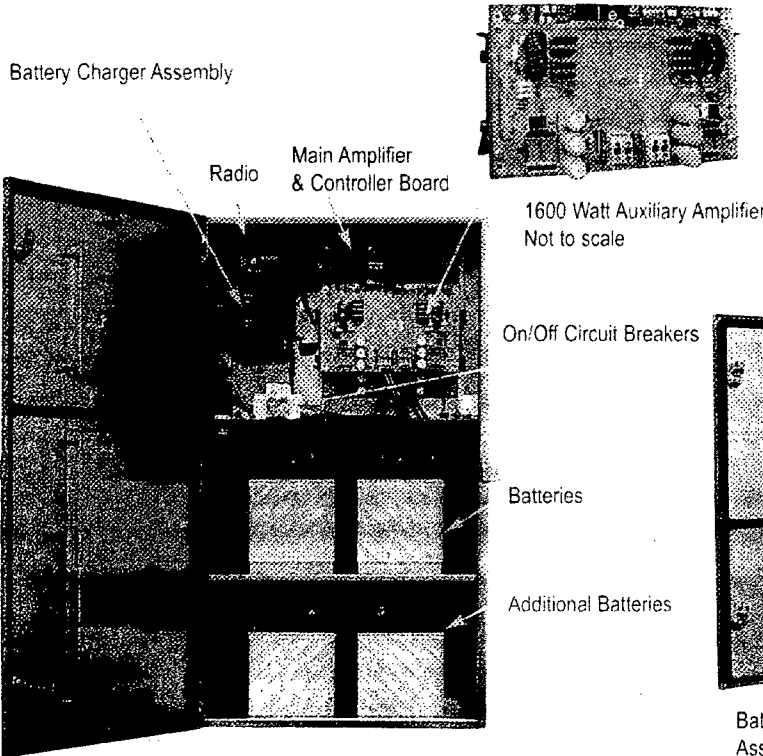
- NEMA4X Stainless Steel Enclosure
- Produces eight standard alarm tones and live PA broadcast.
- Custom alarm tones and digital messages.
- Automatic Gain Control (AGC) for consistent output volume on live voice announcements.
- Local and remote activation, testing and status reporting. One compact Class D Amplifier integrated with a high performance controller RTU, capable of producing 1600 watts RMS of continuous output audio power.
- Local and remote silent test
- A second (non-integrated) Class D Amplifier is required for 3200 watt operation.
- Our Patent Pending Class D Amplifier is a robust and highly efficient amplifier design that maintains an efficiency of over 90% independent of the input waveform shapes or amplitude.
- ATI's Class D Amplifier uses a unique drive method that reduces stress, improves efficiency and reduces failures of the output audio drivers.
- Very low amplifier popping during turn on and turn off further reduces premature and preventable sound driver failures.
- All Printed Circuit Boards are conformal coated permitting the operation of ATI's siren in harsh environments.
- Very high MTBF (Mean Time Between Failures)
- New compact and robust siren system.
- In the standard configured system, a radio is used to receive and transmit FSK data signals. (Other Communication Media available.)
- All Communication Transmissions use a revolving security coding method to prevent unauthorized system activations.



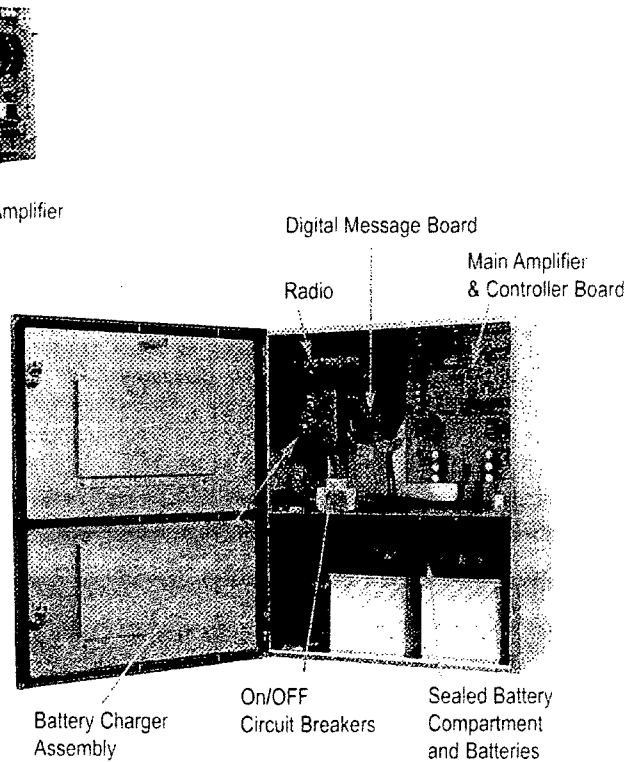
Outdoor High Powered Speaker Station

1000

HPSS Enclosure Cabinets



Model HPSS32 Enclosure



Model HPSS16 Enclosure

OPTIONAL FEATURES

1. Pre-Recorded Voice Message Option

This option includes a pre-recorded Digital Message Board and storage PROMs. The pre-recorded messages are professionally recorded and then digitized and stored; available in blocks of 10, 50, or 100 individual messages. If additional messages are required, consult factory (up to 254 messages are possible).

2. Solar Power Options

Includes solar panels sized for your location, a regulator, 30 feet of power cable and solar panel mounting bracket(s). Available in 55W, 75W, or 100W solar panels

3. Enclosure Upgrade

The enclosure upgrade holds four batteries; this is required for both the HPSS16 and R-HPSS16 using solar power.

4. Trunked Radio Upgrade

Replaces the standard, conventional radio with a 400, 800 or 900 MHz trunked radio to interface with your existing trunking radio system

5. Antenna Surge Protector Option

Used in high lightning areas. Rated for 50,000 amps IEC

6. Strobe Output Option

Controls a string of Strobe Lights of up to 10 amps of total current draw. Refer to the Strobe Selection Chart to order the strobes separately.

7. Speaker Cable Upgrade

Custom speaker cable lengths available in (10) foot increments



Outdoor High Powered Speaker Station

HPSS

SPECIFICATIONS FOR THE HPSS

General

Operating Temperature	-20°C to +85°C (-40°C with battery heater)
Humidity	0 to 95% Non-Condensing
Standby without AC	8 days (2 batteries with 100 Ahr capacity)
Maximum Alarm Duration	30 minutes
Enclosure Weight (without batteries)	1600 Watt = 90 lbs (without batteries) 3200 Watt = 125 lbs (without batteries)
Enclosure size HPSS16 (in inches)	28" H x 22" W x 14" D
Enclosure size HPSS32 (in inches)	44" H x 22" W x 14" D
400 Watt Speaker Weight	50 lbs

Electrical

AC Input Voltage	120 VAC or 240 VAC 50/60 Hz
Maximum Operating Current	3.5 A at 120 VAC or 2 A at 240 VAC

Communications

Modem Modulation	FSK (preferred) or DTMF
Radio Output Power	1 to 25 Watts

Amplifier Section

Audio Output Power	1600 Watts RMS Continuous per Amplifier, 3200 Watts Maximum
THD	Less than 0.5%
Power Bandwidth	250 Hz - 5 Hz
Class of Operation	True Class D
Efficiency	> 90%
Operation Temperature	-40°C to +85°C
Output Regulation	1 dB or better, no load to full load
Operating Voltage Range	21 to 32 VDC
Protection	Protected against primary over current, output over current or shorts & output voltage spikes.

Controller Section

Program Storage	256K Flash Memory/100 yrs. data retention
Addressing	Dip switches for easy address selection
Local Activation	Six pushbuttons for local testing and activation
Radio Interface	Universal radio interface and power connectors
Expansion Ports	RS485, RS232 and a second 1600 Watt amplifier
Other Ports	Interface port for up to two Digital Message Boards
Other Features	Build in AGC circuit, tone generator, and digital adjustable audio gain.
Active Power without radio	< 100 milliamperes
Standby Power	< 5 milliamperes

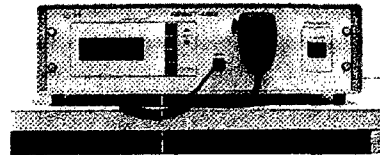
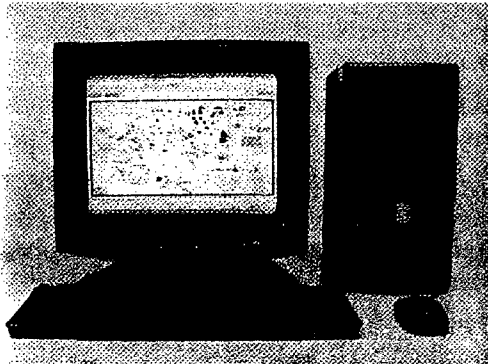
Batteries (not included)

**Recommended battery types Everstart #27DC-6 or Interstate #SRM-29 (Non-Sealed)
 Interstate #31-MHD or MK Batteries 8G31DT (Sealed)
www.everstart-batteries.com, www.interstatebattery.com, www.mkbattery.com



Control Station

Model CS



The Control Station consists of a Communication Unit that interfaces to a computer station running ATI software. The ATI Software Package controls, operates, displays, and documents all system activities.

OPTIONAL FEATURES & UPGRADES

1. Touch Screen Monitor Upgrade
2. Flat Screen Monitor Upgrade
3. Laser Jet Printer Upgrade
4. Pager Interface
Allows alphanumeric pagers to display emergency information when the system is activated.
5. Weather Station Interface
Allows the computer to display weather information.
6. Rack Mount Station Upgrade
Includes a vertical rack mount cage, shelves, and glass door which holds the REACT 4000 CCU, computer equipment and printer.
7. Message Sign Interface
Allows outdoor text message signs to display emergency information when the system is activated.

8. Customized Map
Displays your facility and the location of the indoor and outdoor emergency warning equipment.
9. Trunk Radio Upgrade
Replaces standard radio with a 800 or 900 MHz Trunked Radio to interface with an existing trunked system.
10. Strobe Output Option
Controls a string of Strobe Lights of up to 2 amps of total current draw. Refer to the Strobe Selection Chart to order the Strobes separately.
11. Antenna Surge Protector Option
Used in high lightning areas. Rated for 50,000 Amps IEC.

FEATURES

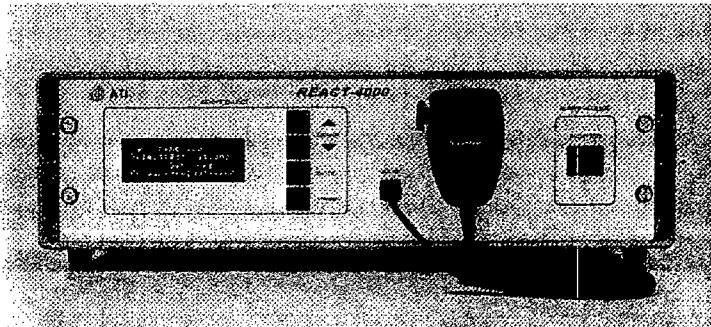
- Performs Alarms, Live P.A., Silent Test and Cancel operations.
- Easy to use operator interface requires minimal training.
- Activates the system and displays results.
- Operates all Indoor and Outdoor equipment.
- Monitors and displays unsolicited system messages from remote sites.
- Single (Individual), group (Zone) or (Total) activations.
- Configurable automatic scheduled polling, activations and silent test operations
- Configurations of various alarms
- Archive and report printouts are available for all system activities.
- Simple to use activation alarm software buttons.
- Three levels of configurable password protection.
- Supervised communications and redundant activation points with additional Communication Control Units.



REACT-4000 Communication Control Unit

00000000

Model CCU



The Communication Control Unit provides communications to control and monitor remote equipment.

STANDARD EQUIPMENT

Includes a desktop cabinet, display screen, microprocessor controller, front panel push buttons, rear entry connections, microphone, UHF or VHF conventional radio, N-Type RF connector and internal power supply.

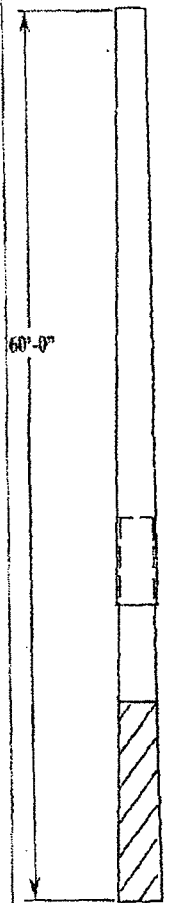
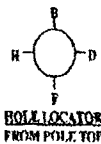
* Battery is not included. Requires one 12VDC, 7AH battery.

Battery Manufacturer and Part Number is: Yuasa NP7-12.

* Antenna equipment sold separately. The radio output power and antenna type are tailored for individual site requirements.

FEATURES

- Simple front panel controls allow the user to select the activation type and address (Total, Group or Single) using only a few steps
- Cancel function to halt an alarm that is already in progress
- Allows full functional testing of sirens without making noise (Silent Test)
- LCD display guides the user through the necessary steps to activate and then reports system status information.
- Handheld microphone to perform live public address. Desktop microphone optional
- Includes eight SPST relays and eight opto-coupler inputs to interface with external devices and four analog inputs
- Uses ATI's advanced and secure FSK protocol and/or DTMF or two tones for old systems
- Configuration program allows the user to construct alarm sequences. Programmable for: alarm tone types, tone durations, pre-recorded message and number of cycles.
- All FSK transmissions include a security method to prevent unauthorized activations.
- Interfaces to a conventional or trunking radio system, base station or leased line circuit
- Operates an internal mounted UHF or VHF conventional radio to communicate with the siren system, which can be upgraded to trunked system 400, 000 or 900 MHz. Other communication media may be used (consult factory for details)
- Fully functional two-way stand alone unit



60T2 POLE

GENERAL ASSEMBLY

- a) Where space near the foundation and lifting capabilities permit, it is preferable to assemble the complete structure (pole and attachments) on the ground and erect it as a unit. The sections and attachments of the pole should be aligned on the ground and supported, typically with wood blocks, in such a manner that they will readily fit together. Care should be taken to prevent dirt, stones, etc. from getting trapped between the mating surfaces.
- b) If the structure (pole and attachments) is assembled vertically, extra care may be needed to assure that all joints are properly assembled.

Slip Joints

Proper alignment of the pole sections is facilitated by the location of the weld seam.

- a) To facilitate the assembly, mating surfaces may be lubricated. Care should be taken not to use a lubricant that will later leak from the joint and stain the pole. Soapy water has been used successfully for this purpose.
- b) The nominal splice lengths for Valmont of El Dorado can be found on the pole assembly drawing.
- c) A number of methods have been considered for applying the necessary force to achieve a tight joint. The method selected may depend upon the size of the pole sections, the type of pole design, and the equipment available. The two most common methods are:
 - Use of two (or more) ratchet chain hoists or similar devices on opposing sides of the pole sections. These may pull on cables secured to the pole sections with a choker type hitch or attached to bolts installed in appropriate through holes. Equal forces should be applied by the hoists simultaneously. If bolts are used, forces must be applied no more than 1 1/2 inches from the surface of the pole section.
 - Use of a hydraulic jacking device which requires welded nuts attached to the pole sections (not a standard);
- d) When the forces are applied as a slow steady pull, joint tightening will be facilitated by oscillating the advancing section with the supporting crane or by striking the pole in the joint area with a hammer using a cushioning block of wood. These forces should be applied until the joint is tight with no more than small gaps (which can sometimes be caused by a slight mismatch in the shapes of the mating sections)
- e) A final check should be made to assure that the specified minimum overlap has been achieved. An overlap between minimum and maximum (nominal) splice is considered an acceptable joint provided the minimum force has been applied and no additional movement of the joint result from an increase in applied force.

POLE DESIGN INFORMATION

WELD SEAM IS THE MATCH MARK FOR THE ALIGNMENT OF THE TOP AND STUB SECTION

SLIP JOINT DESIGN LENGTH:	30"
MINIMUM SLIP JOINT LENGTH:	20.10"
POLE ASSEMBLY WEIGHT:	1128
TOP SECTION WEIGHT:	713
STUB SECTION WEIGHT:	415

PROPRIETARY INFORMATION

THESE DOCUMENTS, DRAWINGS, AND/OR CALCULATIONS AND ALL INFORMATION RELATED TO THEM ARE THE EXCLUSIVE PROPERTY AND THE PROPRIETARY INFORMATION OF VALMONT INDUSTRIES, INC. AND ARE FURNISHED SOLELY UPON THE CONDITIONS THAT THEY WILL BE RETAINED IN STRICTEST CONFIDENCE AND SHALL NOT BE DUPLICATED, USED OR DISCLOSED IN WHOLE OR IN PART FOR ANY PURPOSE, IN ANY WAY, WITHOUT THE PRIOR WRITTEN PERMISSION OF VALMONT INDUSTRIES, INC.

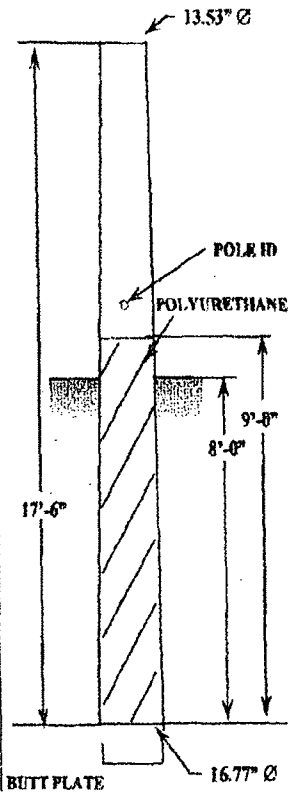


CUSTOMER			
ENTERGY			
DRAWN BY	SCALE	DATE DRAWN	DWG. NO.
JG	NTS	10/5/2007	AGH060T2Z
WORK ORD 10180298	REV. NO.	CUST. REF. NO.	
58352-1-1	0		
APPROVED BY CUSTOMER - SIGNATURE			
APPROVED		APPROVED	
DISTRIBUTOR		DATE OF APPROVAL	
ENTERGY			
PO#	10169298		
SHOP REV. NO.	SHOP REV. BY		
	SHOP REV. DATE		
NO. REQD			
10			
PAGE 1 OF 3			



STUB SECTION

NO DRILL



60T2 STUB

SHOP INSTRUCTIONS:

* UPPER & LOWER GALV HOLES WITHIN 2" - 6" FROM BOTTOM OF STUB; OPPOSING ANY UNDRILLED PLANE.

DRAWING NUMBER TO BE STAMPED ON ID FACE OF POLE SECTION AT TIP END, BY VALMONT.

* 4 - 23/32" J-BOLT HOLES 2.5" FROM POLE BOTTOM

DRILLING

GALVANIZER INSTRUCTIONS:

SHIPPING

1. BUTT PLATE & POLE ID TAG INSTALLED BY GALVANIZER.
2. POLE ID TO BE 13'-0" FROM BOTTOM OF STUB SECTION IN QUAD B & INCLUDES: VALMONT, MO/D7 & 60T2

GROUNDLINE PROTECTION

9'-0" BAND OF POLYURETHANE TO EXTEND TO 9'-0" FROM BOTTOM OF STUB SECTION INCLUDING BEARING PLATE TO BE POLYURETHANE ON BOTH SIDES
 POLYURETHANE TO BE MIN. 20MILS THICK & FEATHERED AT TIP END.
 RIVNUTS

ALL THREADED GALVANIZED ATTACHMENTS TO BE FREE FROM EXCESS GALVANIZATION, SO AS NOT TO IMPEDE FASTENER INSTALLATION.

ALL STAINLESS STEEL THREADED ATTACHMENTS TO BE PLUGGED PRIOR TO GALVANIZATION.

ALL POLES TO BE HOT DIPPED GALVANIZED



CUSTOMER

ENTERGY

DRAWN BY	SCALE	DATE DRAWN	DWG. NO.
JG	NTS	10/5/2007	AGH060T2A

WORK ORDER NO.	REV. NO.	CUST. REF. NO.
58352-1-1	0	

APPROVED BY CUSTOMER - SIGNATURE

APPROVED

APPROVED

DISTRIBUTOR	DATE OF APPROVAL
ENTERGY	

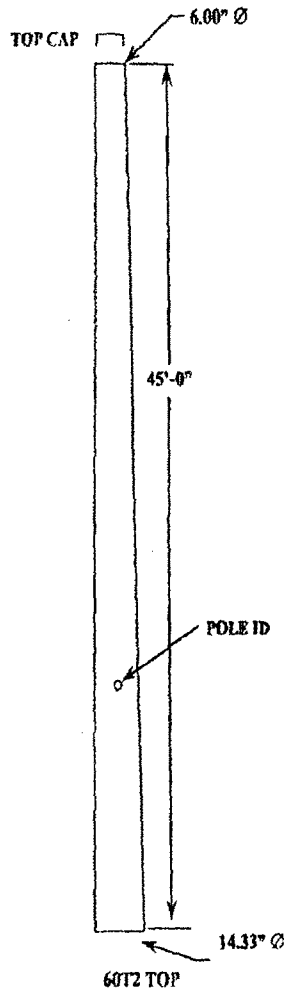
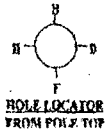
PO#	10169288
-----	----------

SHOP REV. NO.	SHOP REV. BY
SHOP REV. DATE	

NO. REQD

10

PAGE 2 OF 3



TOP SECTION

NO DRILL

SHOP INSTRUCTIONS:

* UPPER & LOWER GALV HOLES WITHIN 2" - 6" FROM TOP OF POLE OPPOSING ANY UNDRILLED PLANE. DRAWING NUMBER TO BE STAMPED ON ID FACE OF POLE SECTION AT TIP END, BY VALMONT.
* PLASTIC TOP CAP REQUIRED

DRILLING

GALVANIZER INSTRUCTIONS:

SHIPPING

1. TOP CAP & POLE ID TAG INSTALLED BY GALVANIZER.
2. POLE ID TO BE 3'-6" FROM BOTTOM OF TOP SECTION IN QUAD B INCLUDES: VALMONT, MO/07 & 60T2

RIVNUTS

ALL THREADED GALVANIZED ATTACHMENTS TO BE FREE FROM EXCESS GALVANIZATION, SO AS NOT TO IMPEDE FASTENER INSTALLATION.

ALL STAINLESS STEEL THREADED ATTACHMENTS TO BE PLUGGED PRIOR TO GALVANIZATION.

ALL POLES TO BE HOT DIPPED GALVANIZED



CUSTOMER			
ENERGY			
DRAWN BY	SCALE	DATE DRAWN	DWG. NO.
JG	NTS	10/5/2007	AGH060T2B
WORK ORDER NO.	REV. NO.	CUST. REF. NO.	
56352-1-1	0		
APPROVED BY CUSTOMER - SIGNATURE			

APPROVED		APPROVED	
DISTRIBUTOR		DATE OF APPROVAL	
ENERGY			
PO#	10169298		
SHOP REV. NO.	SHOP REV. BY		
	SHOP REV. DATE		

NO. REQD

10

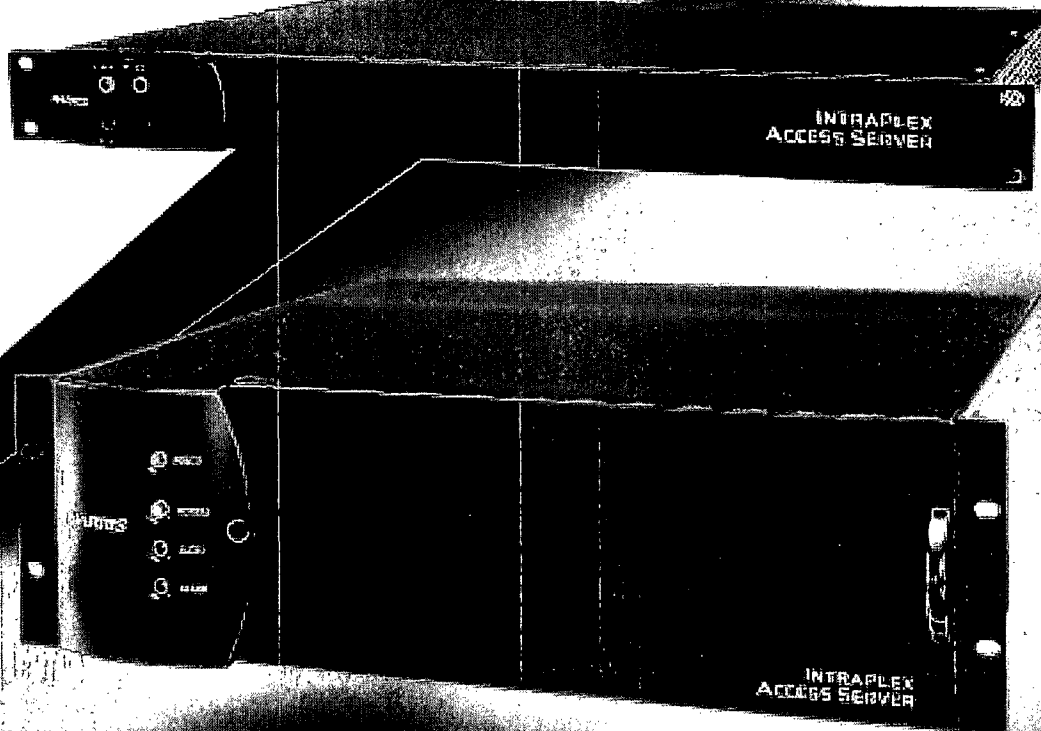
HARRIS

Network Access Products

***Intraplex
Access Server***

*Reduce costs, simplify management, and
maximize network availability by combining
multiple applications including voice, data,
audio, and video on a single digital link*

next level solutions



Intraplex Access Servers provide a single, high-reliability multiplexing platform that enables a wide range of voice, data, audio, and video applications to share bandwidth on digital T1/E1 circuits.

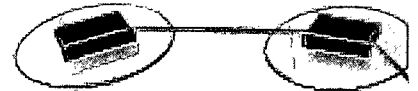
SIMPLIFY YOUR NETWORK AND LOWER COSTS

Today, many managers find that application growth threatens to increase network complexity, overhead requirements and recurring transmission costs beyond their existing resources. Intraplex Access Servers offer an alternative by delivering an integrated network access platform that allows multiple applications to efficiently share private or public network circuits. As a result, network managers can significantly reduce the need to add and manage additional, multivendor access equipment and circuits, while actually increasing performance and uptime.

Intraplex Access Servers feature a common architecture and platform that can seamlessly support almost any combination of T1, E1 or Nx64 transmission requirements over copper and fiber-based services, as well as licensed microwave, spread spectrum or satellite links in point-to-point or drop and insert configurations. Application modules are available for voice; LAN, synchronous or asynchronous data; audio and video. Product design allows application modules, network interface modules, and power supplies to be shared and swapped between units for additional flexibility and savings. The Access Server is available in a 3 rack-unit package providing maximum application flexibility or a space saving 1 rack-unit enclosure.

UNMATCHED PERFORMANCE

Intraplex Access Servers outperform other multiplexing products by incorporating unique transmission techniques that deliver enhanced robustness and maximize end-to-end circuit availability for real-time application traffic and services. As a result, these products can maintain connectivity, even under network conditions and error rates that would cause other equipment to fail.



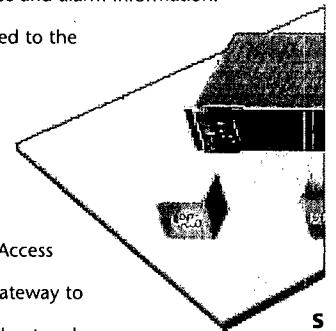
The product can be configured to provide power supply and common equipment hardware redundancy, with automatic switchover when any failure is detected. Complete automatic line protection switching options are also available.

The T1 Access Server includes an integrated Channel Service Unit (CSU) that provides performance monitoring and electrical protection, allowing for direct connection to public networks.

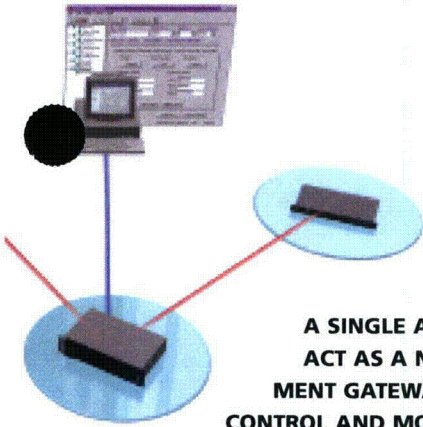
REDUCE THE NETWORK MANAGEMENT BURDEN

Integrating transmission requirements on the Intraplex Access Server eliminates the need to configure, maintain, and manage a proliferation of specialized equipment. The product's Windows-based graphical user interface and command line interface simplifies local or remote configuration, system diagnostics and monitoring of performance and alarm information.

Bandwidth can be allocated to the Server's built-in network management communications channel for remote monitoring, and a single Access Server can be used as a gateway to collect, store, and forward network management information from other Access Servers located in one network.



INTRAPLEX ACCESS PRODUCTS AC RANGE OF PLUG-IN VOICE, DATA, VIDEO MODULES WHICH ALLOW CUSTOMIZED COMBINATIONS OF CHANNELS TO MEET SPECIFIC AP REQUIREMENTS.



A SINGLE ACCESS SERVER CAN ACT AS A NETWORK MANAGEMENT GATEWAY ALLOWING REMOTE CONTROL AND MONITORING OF OTHER ACCESS SERVERS IN THE SAME NETWORK.

INTRAPLEX CHANNEL MODULES

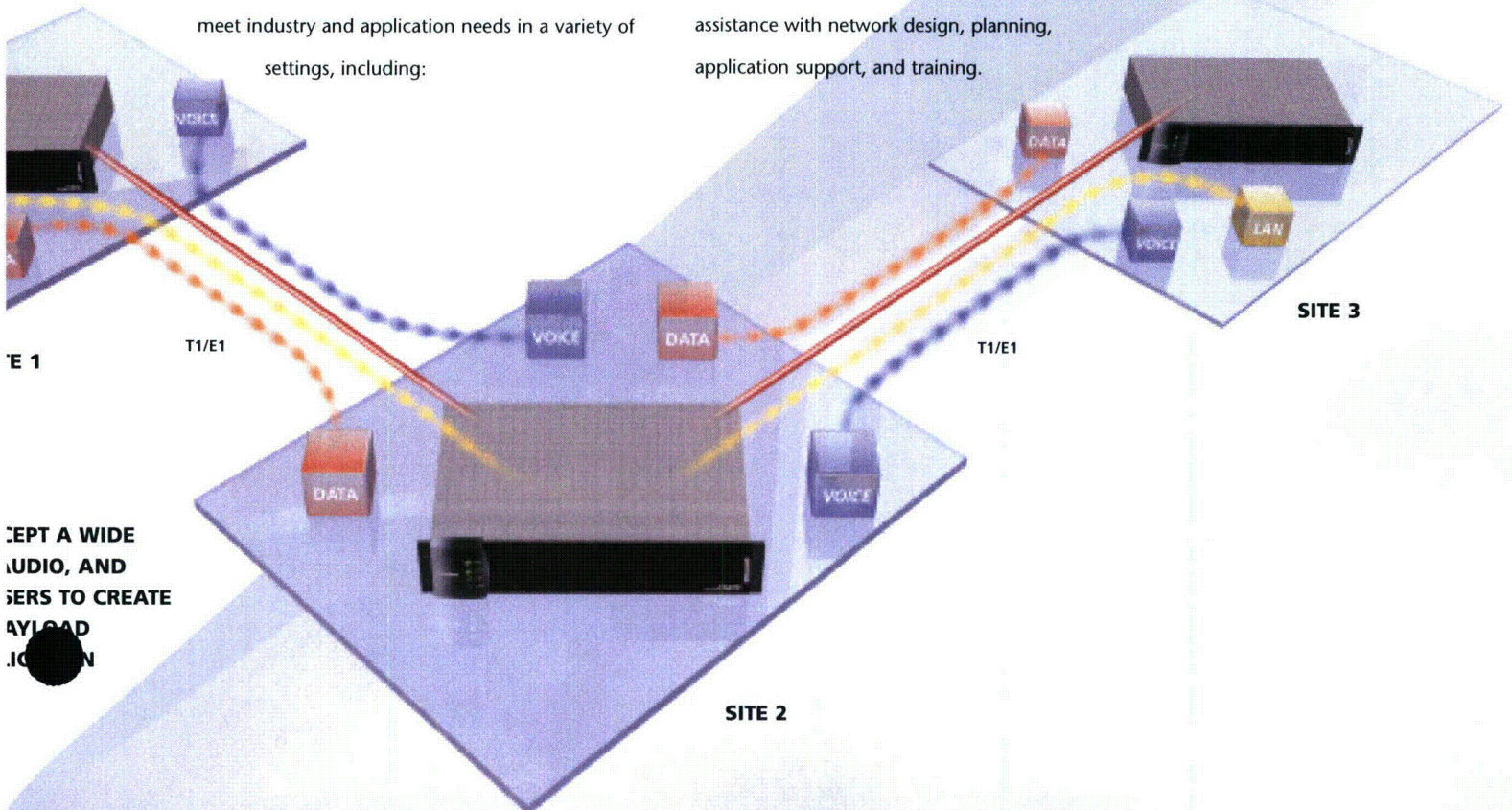
In addition to standard voice and data modules, the Intraplex Access Server also supports specialized channel cards for variable-rate transmission at non-standard data rates, variable bit rate/resolution video, audio encoding and user-programmable delay for synchronizing payloads from multiple network destinations. For a complete list of modules, please see the Intraplex Network Access Product Summary.

MEETING APPLICATION AND INDUSTRY REQUIREMENTS

Intraplex Access Servers are in daily use, helping to meet industry and application needs in a variety of settings, including:

- Mobile Radio—For transmission of two-way radio traffic, including Motorola SECURENET™, between dispatch centers and transmitter sites
- PCS/Cellular—For interconnection of cell sites, base transceiver stations, and mobile switching centers, including remote control and order wire applications
- Satellite Applications—Applications include variable data satellite networks supporting point-to-point and point-to-multipoint networks, both full-duplex and one-way
- LAN Connectivity—For LAN extension and bridging, including distance learning networks
- Specialized Audio—For transmission of linear uncompressed as well as compressed high-quality audio in a variety of formats including MPEG Layer 2 and 3, apt-X100 and J.41

Intraplex Transmission Solutions offers customer assistance with network design, planning, application support, and training.



CEPT A WIDE AUDIO, AND SERS TO CREATE PAYLOAD .IC ON

Intraplex Access Server T1/E1 Specifications

INTRAPLEX ACCESS SERVERS:

Access Server ACS-160 Series	3RU	1RU
T1 Terminal multiplexer	ACS-163	ACS-167
T1 Drop & Insert multiplexer	ACS-165	ACS-168
T1 Dual Terminal multiplexer	ACS-166	ACS-169

Access Server ACS-260 Series	3RU	1RU
E1 Terminal multiplexer	ACS-263	ACS-267
E1 Drop & Insert multiplexer	ACS-265	ACS-268
E1 Dual Terminal multiplexer	ACS-266	ACS-269

T1 INPUTS/OUTPUTS

Connector

RJ-48C, 100 ohms or
DB-15, 100 ohms

Frame Formats

Extended Superframe (ESF)
D4/Superframe (SF)
Per ANSI T1.403-1995 and AT&T Pubs 62411

Line Codes

Bipolar with 8 Zero Substitution (B8ZS)
Alternate Mark Inversion (AMI)

Timing

Internal, 1.544 Mbps \pm 30 ppm output
External, RS-422 clock input
Loop

Line Build Out (LBO)

Up to 655 feet from standard DSX or
CSU LBO 0, -7.5 or -15 dB

Integral CSU

Does not require external CSU for connection
to public network
FCC Part 68 Registered

E1 INPUT/OUTPUTS

Connector

BNC, 75 ohms or
DB-15, 120 ohms or
RJ-48C, 120 ohms

Frame Formats

Channel Associated Signaling (CAS)
Common Channel Signaling (CCS)
Per ITU G.703, G.704 and G.706

Line Codes

High Density Bipolar 3 (HDB3)
Alternate Mark Inversion (AMI)

Timing

Internal, 2.048 Mbps \pm 30 ppm
External, RS-422 clock input
Loop

STATUS & DIAGNOSTICS

LED Indicators

Shelf Power, Normal, Alert, Alarm

Contact Closures

Alert, Alarm

Loopbacks

Line loopback, Equipment loopback,
Payload loopback

Test Access

Bantam jacks for T1/E1 input/output signal and
T1/E1 input/output monitoring

CSU Performance Monitoring (T1)

Compliant with ANSI T1.403-1995
Compliant with AT&T Pub 54016
(standard and enhanced parameters)

REMOTE ACCESS & CONTROL

User Interface

Remote programming and monitoring using ISiCL
command-line interface or IntraGuide™ graphical user
interface software

Control Interface

RS-232C and RS-485 asynchronous for user interface
ANSI T1.403 Performance Report Messages
on T1 Facility Data Link
AT&T Pub 54016 Polled Performance Reports
on T1 Facility Data Link

Network Management Communications

Remote control and monitoring of Access Server(s)
over the network using fractional DS0 timeslot

PHYSICAL & ENVIRONMENTAL

Power Requirements

3 RU: Universal AC standard
Optional -48VDC, -24VDC or +24VDC
Optional hot-standby redundant supply
1 RU: Universal AC

Nominal Power Consumption

3RU: Fully loaded system less than 40 watts typical
1RU: Fully loaded system less than 13 watts typical

Temperature

0°–50°C Operating

Humidity

10%–90% Non-condensing

Dimensions

3 RU: 5.25" (13.4 cm) H x 14.75" (36.8 cm) D x
19" (48.3 cm) W rack-mount
1 RU: 1.75" (4.5 cm) H x 14.75" (36.8 cm) D x
19" (48.3 cm) W rack-mount

Regulatory Compliance

CE Compliant
FCC Part 15, Part 68
UL 1950
CS-03
CTR12, CTR13



assuredcommunications™

Networking Solutions

**Intraplex™
SynchroCast System**

SynchroCast System

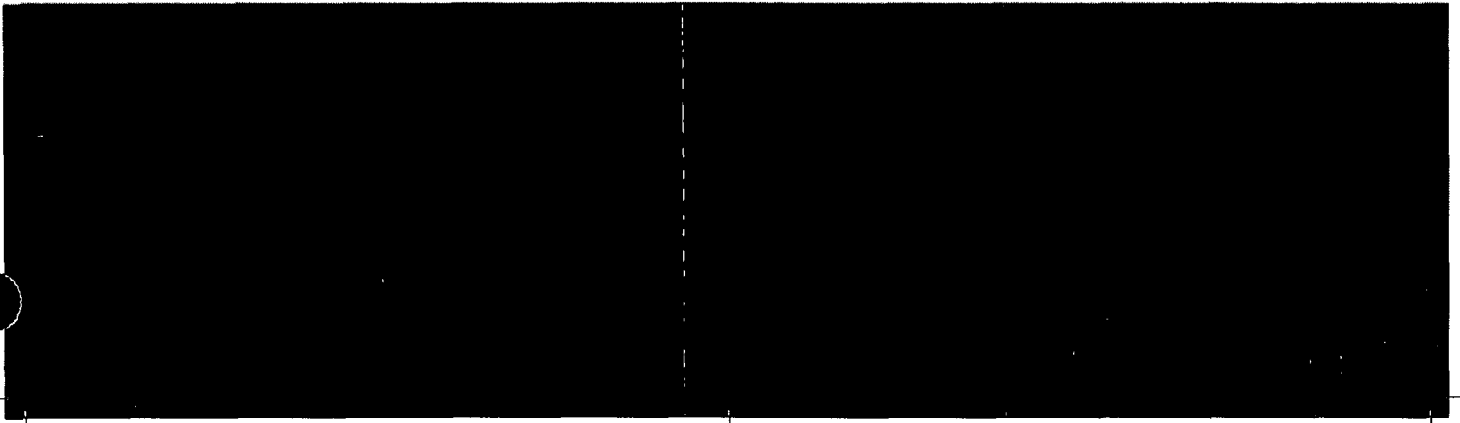
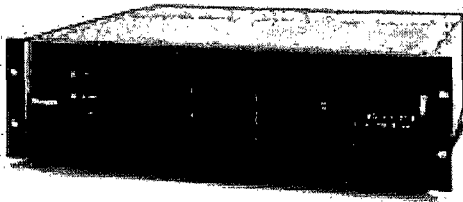
- > Make better use of available frequencies
- > Improve coverage area including in-building use
- > Fill in shadowed areas with booster transmitters

Proven Harris Intraplex Technology

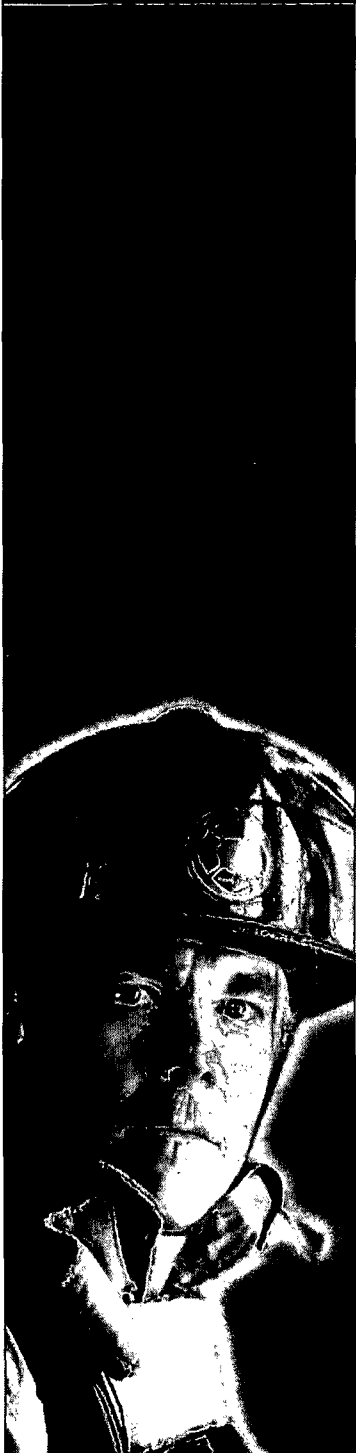
SynchroCast is based on the Intraplex Access Server, a proven multiplexing product for the mobile radio and critical communications markets. It uses GPS technology to establish radio frequency and networking delay references.

Intraplex SynchroCast

Allows you to use a limited number of radio frequencies to cover a wide area of coverage. Turning a portion of your mobile radio network into a simulcast radio improves penetration in areas with marginal coverage. Adding simulcast can also allow you to increase the channel capacity of your radio system without adding additional frequencies to your network. Smaller radio systems can now gain the advantages of proven Intraplex SynchroCast technology without the need to install a completely new radio system.



Intraplex Products



Using Precise Timing from GPS Satellites

Now, for the first time, mobile radio system operators can install a simulcast radio system on a single channel or an entire mobile radio system without having to install a completely new system. The SynchroCast system makes new GPS-based technology available to older mobile radio networks. It gives users easy control of system functions that are critical to adjusting the coverage area to achieve desired performance. The Harris product also provides reference signals to the base station for precise control of channel frequencies. The system uses either T1 or E1 transmission lines now readily available from Telco carriers or via private networks. These can be traditional land based, microwave or fiber optic links. In fact, these systems can include a combination of public and private network links and still precisely control the necessary parameters to achieve peak simulcast performance.

Why use SynchroCast?

Make better use of available frequencies

With a limited set of frequencies available for mobile radio applications, getting to most from the ones you own is essential. By simulcasting the current frequencies, the operator can increase the coverage and typically the channels of the radio system.

Increase coverage and channels without adding frequencies.

A simple radio system may use 3 frequencies distributed over an area to provide coverage. Converting this to a simulcast system allows the user to cover the same area with one frequency. This will release the two additional frequencies for reuse as more channels on the radio system or for use by another agency.

Improve in-building coverage

Simulcast often improves coverage inside of buildings. This is driven by the RF penetrating the exterior from different sides and thus increasing the likelihood of having radio access inside the building.

Adding fill-in transmitters for shadowed areas.

A location that is shadowed because of a geographical feature can now use simulcast to add the necessary coverage without having to apply for an additional frequency.

SynchroCast automatically adjusts for network links delays

The SynchroCast system works with most Harris Intraplex channels modules. For conventional radio systems, model numbers VF-25 (4 Wire) or VF-28 (4 Wire Tx only) can be used for the voice channels of the system. The standard voice channels may also be used for simulcast paging systems. Data channels operating at 9.6 kbps are available for newer digital voice mobile radio systems. The SynchroCast system will automatically adjust for any link delays that occur from network rerouting. The delay is sampled once per second. If a change in delay persists for two seconds SynchroCast will initiate a delay correction. Once the delay correction is started the shift in delay time is done seamlessly without interruption to the system operation.

SynchroCast System Requirements

SynchroCast is ordered as an add-on package to the Intraplex Access Server system. The SynchroCast Package includes the timing modules, data transmission modules, and digital delay modules necessary for synchronizing the control site and two base station sites.

SynchroCast Expansion

The expansion package includes the timing module, data transmission modules, and digital delay module for each additional basestation site beyond the first two.

GPS Receiver

One GPS receiver is required for each base station site in the system and the control point site.

Consult Harris Networking and Government solutions for recommended models.



Specifications are subject to change. For a complete listing of the most current specifications, please visit our Website at www.harris.com.



Harris Corporation | 4393 Digital Way | Mason, OH USA 45040
 phone: +1 888-796-9827 | email: intraplex@harris.com | www.harris.com/publicsafety

Trademarks and tradenames are the property of their respective companies.
 Copyright © 2005 Harris Corporation
 Printed in USA on Recyclable Paper HMC 16591 PP ADV. 3224A 07/05

Intraplex CrossConnect Systems & Servers:

DCS-9500
6 Port T1 CrossConnect System, 1 RU package, protection switching and multicasting capability

DCS-9530
6 Port T1 CrossConnect System, 3 RU package, protection switching and multicasting capability with future migration to DCS-9560

DCS-9560
6 Port T1 CrossConnect Server, 3 RU package, up to 24 DS0 terminations (capacity of one T1 line), includes the functions of the DCS-9500, accepts Intraplex plug-in channel modules for integrated voice, data, video and program audio applications

DCS-9565
6 Port T1 CrossConnect Server, 3 RU package, up to 48 DS0 terminations, includes the functions of the DCS-9500, accepts Intraplex plug-in channel modules for integrated voice, data, video and program audio applications

DCS-9500E
6 Port E1 CrossConnect System, 1 RU package, protection switching and multicasting capability

DCS-9530E
6 Port E1 CrossConnect System, 1 RU package, protection switching and multicasting capability with future migration to DCS-9560E

DCS-9560E
6 Port E1 CrossConnect Server, 3 RU package, up to 31 DS0 terminations (capacity of one E1 line), includes the functions of the DCS-9500E, accepts Intraplex plug-in channel modules for integrated voice, data, video and program audio applications

DCS-9565E
6 Port E1 CrossConnect Server, 3 RU package, up to 62 DS0 terminations, includes the functions of the DCS-9500E, accepts Intraplex plug-in channel modules for integrated voice, data, video and program audio applications

T1 Inputs/Outputs

Electrical Interface
Six DSX-1 interface ports per ANSI T1.102

Output Timing
Internal, 1.544 Mbps +/- 30PPM
External, RS-422 input
Any of the 6 T1 inputs

Frame Formats
Extended Superframe (ESF)
D4/Superframe (SF)

Line Codes
Bipolar with 8 Zero Substitution (B8ZS)
Alternate Mark Inversion (AMI)

Line Build Out (LBO)
Up to 655 feet from standard DSX or CSU LBO
0, -7.5. or -15 dB

Input Connector
8-pin RJ-48C for CSU applications
DB-15 for non-CSU applications
100 Ω resistive (nominal)

E1 Inputs/Outputs

Electrical Interface
Six E1 interface ports per ITU-T G.703, G.704, G.706

Output Timing
Internal, 2.048 Mbps +/- 30 PPM
External, RS-422 input
Any of the 6 E1 inputs

Frame Formats
Channel Associated Signaling (CAS)
Common Channel Signaling (CCS)

Line Codes
High-Density Bipolar 3 (HDB3)
Alternate Mark Inversion (AMI)

Connector
75 ohm BNC (standard)
120 ohm DB-15 (optional)

Throughput Delay
One to three T1/E1 frames 125 to 375µS
Two frames average 250µS

DS0 Interfaces (CrossConnect Server)
Optional 4W VF, 2W VF, sync, async and variable rate data, program audio, video

Time Slot Mapping

Maps Supported
Eight: Two normal service maps and six alternate service maps configurable to switch based on T1 or E1 port failure (BER, LOS, AIS, LOF), external contact closure inputs or ASCII command.

Switch Time
Protection switching delay programmable down to 1 ms

Status & Diagnosis
LED Indicators
Shelf Power, Normal, Alert, Alarm
DCS Port Status, Alert, Alarm

Contact Closures
Shelf Alert, Alarm
DCS Alert, Alarm, Active Map Indicators

Diagnostics
T1, E1 and timeslot loopback

Remote Access & Control

Functionality
Remote programming and monitoring, PC-based Graphical User Interface and command line interfaces. Off-line copying and editing of cross-connect maps

Interface
RS-232C & RS-485 asynchronous

PHYSICAL & ENVIRONMENTAL
Power Requirements
3RU: Universal AC standard
Optional 48VDC or 24VDC
Optional hot-standby redundant supply
1RU: Universal AC

Nominal Power Consumption
DCS-9500/9530: 5 watts
DCS-9560: 8 watts
DCS-9565: 11 watts

Temperature
0° - 50°C operating

Humidity
0% to 90% non-condensing

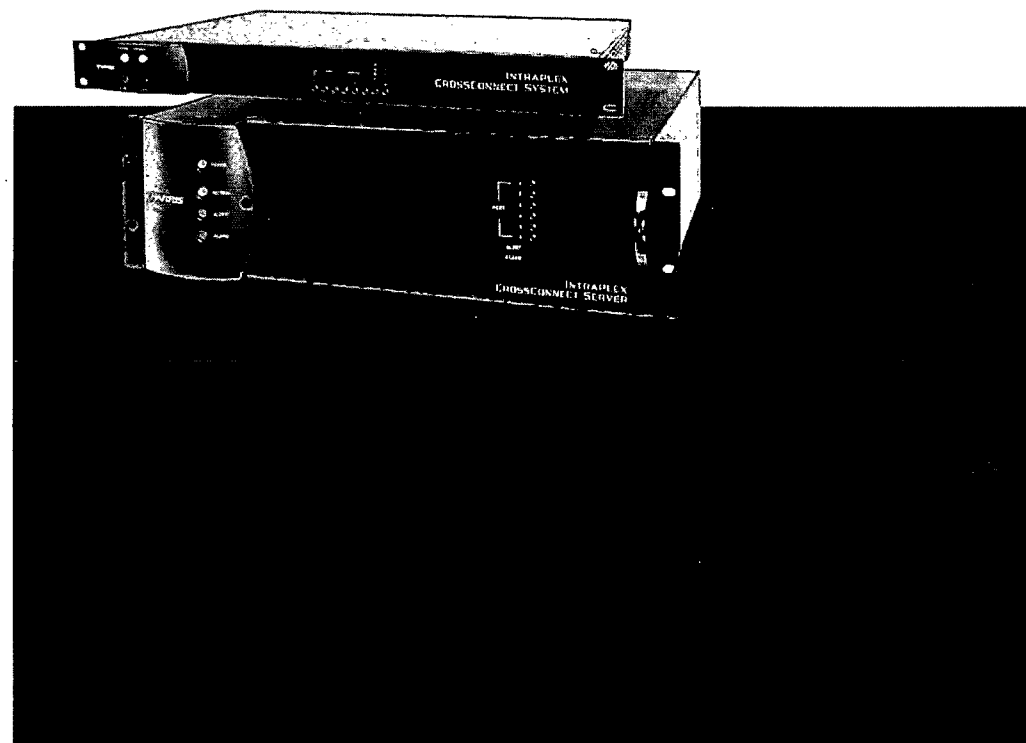
Dimensions
3 RU - 5.25" x 14.5" x 19" rack-mount
1 RU - 1.75" x 14.5" x 19" rack-mount


Regulatory Compliance
CE Approved
UL 1950
FCC Part 15, FCC Part 68
CS-03

Networking Solutions

**Intraplex
CrossConnect System
and CrossConnect Server**

Increase the efficiency of digital transmission networks, reduce recurring costs and protect critical T1/E1 network traffic



 Specifications are subject to change. For a complete listing of the most current specifications, please visit our Website at www.harris.com

Intraplex CrossConnect Systems and Servers allow network operators to reduce recurring transmission costs, while enhancing their ability to manage and protect critical T1/E1 network traffic across multiple digital facilities.

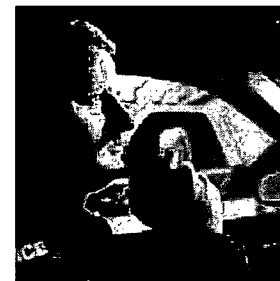
INTRAPLEX CROSSCONNECT SYSTEMS INCREASE OVERALL TRANSMISSION EFFICIENCY

T1 and E1 digital transmission services allow users to combine voice, data, LAN, video, program audio and other specialized communications services on a single circuit. This can result in significant cost savings over use of individual, un-bundled services, while providing the high quality transmission capabilities available only through digital facilities.

When communications requirements or geography demand connectivity among several different sites, the network fabric may grow to include multiple, meshed T1 or E1 lines. Intraplex CrossConnect Systems and Servers can help manage these lines to ensure the most efficient use of the available transmission capacity and reduce costs. For example, circuits carrying phone traffic during the day can be reconfigured to carry batch data traffic at night, while existing, underutilized timeslots can be redeployed to accommodate network growth.

Intraplex CrossConnect Systems and Servers give users complete flexibility to combine, interconnect and multicast traffic among up to six T1 or E1 lines. In addition, the CrossConnect Server accepts a wide variety of plug-in modules for integrated drop and insert of voice, data, program audio, and video services.

Users can program and monitor both systems remotely, using the IntraGuide™ Windows-based user interface. Visual timeslot mapping features allow users to easily program CrossConnect links. CrossConnect maps can be copied for off-line editing and then uploaded to the unit.



INTRAPLEX CROSSCONNECT SYSTEMS PROTECT VALUABLE T1/E1 NETWORK TRAFFIC

Automatic protection switching and backup capabilities are essential for maintaining network performance and ensuring continuous service for all links on your digital network. Intraplex CrossConnect Systems and Servers can instantaneously detect any degradation or failure of a controlled T1/E1 line, seamlessly switching traffic to predesignated backup facilities, eliminating costly down-time.

Telephone company circuits or microwave radio links can be used for back-up. Both point-to-point and ring protection configurations are supported.



CROSSCONNECT HIGHLIGHTS:

- Reduce transmission costs in PCS, cellular and mobile radio networks
- > Groom, concentrate and hub up to six T1 or E1 circuits from remote cell sites or base stations
- > Upgrade, reconfigure and manage your network facilities remotely
- > Integrate CDPD, mobile data, enhanced services and control channels with voice backhaul traffic, without adding capacity
- > Manage analog-to-digital migration or co-location

Consolidate traffic in enterprise networks

- > Combine PBX, Internet, LAN and video conferencing traffic from multiple locations into common T1 or E1 circuits
- > Provide a single point of connectivity for integrated access to voice, video and data services



Maximize radio broadcast resources

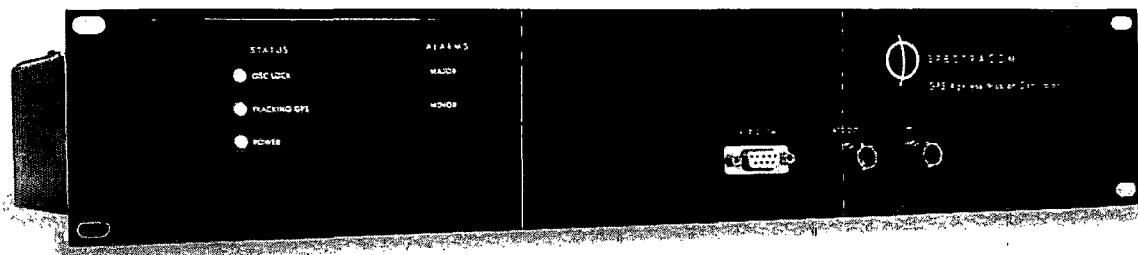
- > Mix and match program audio, voice and data feeds among multiple studio and transmitter locations
- > Save on programming, talent and administrative costs by sharing transmission resources among stations
- > Provide automatic backup protection and switching for studio-to-transmitter (STL) links
- > Multicast encoded audio or video feeds from a studio to multiple receive sites



SPECTRACOM

Synchronizing Critical Operations™

Ageless® GPS Master Oscillator Model 8195B



- **Simulcast Transmitter Frequency Control ± 0.01 Hz at 800 MHz**
- **Precision Frequency Offsets Improve Simulcast Reception**
- **Zero Calibration Costs**
- **Reduce HDTV Adjacent Channel Interference**
- **T1/E1, SONET, and ATM Synchronization**
- **Calibration Labs, Engineering Labs and Factory Reference**
- **GPS Time RAIM Satellite Error Detection**
- **5-Year Limited Warranty**

The patented Spectracom Ageless® Master Oscillators are highly accurate frequency and timing sources. This model uses an Oven Controlled Crystal Oscillator internal reference. See Model 8197B for the Rubidium reference. Outputs are locked to the U.S. Naval Observatory via the NAVSTAR Global Positioning System (GPS). T-RAIM (Time Receiver Autonomous Integrity Monitor) algorithm detects and disqualifies faulty satellites to maintain the reliability of system outputs.

Spectracom's field-proven Ageless Oscillator technology provides continual automatic frequency control, compensating for aging and temperature drift. They are ideally suited as a site master oscillator for communication systems. Typical applications include calibration, land mobile simulcast, narrow band land mobile radio, SMR (Specialized Mobile Radio), paging simulcast, satellite/microwave communication links, T1/E1, cellular telephone, SONET and ATM enterprise timing and broadcast radio and television.

In simulcast systems, the precision frequency offset feature minimizes carrier phase cancellation in overlap areas. The CTCSS generator outputs are aligned site to site.

If AC power fails, an optional battery maintains the oscillator at its operational temperature thereby reducing the recovery period by eliminating oscillator warm-up and retrace. In addition, the battery keeps the electronics in standby mode to allow rapid recovery of the GPS 1PPS, Data Clock, and Data Sync outputs once power is restored.

Spectracom offers other system components, including distribution amplifiers, frequency synthesizers, clock selectors and clock converters.

www.spectracomcorp.com • sales@spectracomcorp.com
95 Methodist Hill Drive • Rochester, NY 14623 USA
Phone: +1.585.321.5800 • Fax: +1.585.321.5218



**OUTPUT ACCURACY:**

locked: $\pm 1 \times 10^{-11}$ typical, 24-hour average
 unlocked: $\pm 2 \times 10^{-9}$ /week typical aging

FRONT PANEL**10 MHz:**

One 10 MHz output (BNC Female); 750 mVrms sinewave, 50 ohm impedance
 30 dB harmonic suppression.

1 PPS:

TTL signal (BNC Female), accuracy is ± 500 nanosecond typical with SA off and
 in position hold.

DATA COMM PORT:

RS-232 (DB 9 Female) interface for maintenance and performance monitoring.

REAR PANEL**10 MHz:**

Four 10 MHz outputs (BNC Female); 750 mVrms sinewave, 50 ohm impedance
 30 dB harmonic suppression.

PHASE NOISE AT 10 MHz OUTPUTS:

Phase Noise:	Offset:
<97 dBc	1 Hz
<110 dBc	10 Hz
<125 dBc	100 Hz
<135 dBc	1000 Hz

Programmable Precision Frequency Offsets:

Zero offset plus 4 positive and negative steps. Step sizes in Hz: $\pm 3, 5, 7, 9$
 at VHF Hi and 0.5, 1, 1.5, 2 at UHF

TIMING OUTPUTS:

1544 kHz (T1 rate) and 2048 kHz (E1 rate) @ RS-485 levels (RJ-11)

DATA CLOCK OUTPUTS:

9.6 kHz, 18 kHz, and disciplined 1PPS at RS-485 levels (DB 9 Female)

DATA SYNC OUTPUTS:

64 kHz, 18 kHz, 17-2/3 Hz, 33-1/3 Hz at RS-485 levels (DB 15 Female)

ALARM OUTPUTS:

Relay contacts SPDT, 2A @ 30 VDC (terminal strip)

DATA COMM PORT:

RS-485 (RJ-11) interface for maintenance and performance monitoring.

GPS ANTENNA:

L1, C/A Code transmitted at 1575.42 MHz ("N" Type Female)

Received Frequency: 1575.42 MHz

Satellites Tracked: Up to 12, simultaneous, GPS TRAIM satellite error management

POWER:

115/230 VAC $\pm 15\%$, 50/60 Hz. (3-prong connector, 7' cord included)
 Maximum power consumption, 60W. Option 03 adds 30W.

OPTIONS**Battery:**

Option 02 Internal Battery, available only with 8195B with 115/230 VAC
 power. After power failure of up to 18 hours with 8195B reduces oscillator lock
 time to 2 hours, from 3-4 hours, and enables rapid recovery of GPS 1PPS, Data
 Clock, and Data Sync outputs. Option 02, Internal Battery, not available with
 SP294 or SP295.

Built-In Distribution Amplifier:

Option 03 converts (4) 10 MHz rear panel outputs to the equivalent of Model
 8140. Provides 10 MHz and +12 VDC to power LineTaps, MultiTaps, and
 VersaTaps which can also provide frequencies other than 10 MHz. For more infor-
 mation, see Model 8140 data sheet.

Frequency Outputs:

(4) 10 MHz rear panel outputs are converted to 12.8 MHz (Option 06), or 5 MHz
 (Option 07)

CTCSS Outputs:

Option 14 provides two low-frequency RS-485 outputs, to nearest 1/3 Hz, syn-
 chronized to GPS on-time point. Uses Data Sync Output connector. Option 17

provides 2 additional integer frequencies on DB9 Data Clock Connector. One
 Model 1118-2: CTCSS Filter Board is required per base station to be synchro-
 nized.

Power:

12 VDC; Option 52, ± 13.8 VDC $\pm 20\%$ (terminal strip)
 24 VDC; Option 53, ± 27.6 VDC $\pm 20\%$ (terminal strip)
 48 VDC; Option 54, ± 55.2 VDC $\pm 20\%$ (terminal strip)

T1/E1 Outputs:

SP294: Adds (2) T1 (DS1 Framed All 1's) outputs (terminal block)
 SP295: Adds (2) E1 (All 1's - CAS multiframe) outputs (terminal block)
 Option 02, Internal Battery, not available with SP294 or SP295

1PPS Outputs:

1PPS TTL outputs in place of frequency outputs 3 and 4.

Mounting Slides:

Option 11 provides mounting slides to enable rack mounting in a
 19-inch rack with slide-out capabilities.

PHYSICAL & ENVIRONMENTAL**SIZE/WEIGHT:**

EIA 19" w X 3.5" h (2ru) x 12.5" D/20 lbs. maximum

INDICATORS:

Power, tracking GPS, oscillator locked, battery ready, battery charging, battery
 fault, minor alarm, major alarm

ENVIRONMENTAL:

-30°C to +60°C (-22°F to +140°F) operating range
 95% R.H. non-condensing

FCC INFORMATION

This equipment has been tested and found to comply with the limits for a Class A digital device,
 pursuant to Part 15 of the FCC Rules. These limits are designed to provide reasonable protec-
 tion against harmful interference when the equipment is operated in a commercial environment.
 This equipment generates, uses, and can radiate radio frequency energy and, if not installed
 and used in accordance with the instruction manual, may cause harmful interference to radio
 communications. Operation of this equipment in a residential area is likely to cause harmful
 interference in which case the user will be required to correct the interference at his own
 expense.

ORDERING INFORMATION

- Specify Spectracom Model 8195B, plus:
 - Option 02: Battery Backup (on 8195B AC version only)
 - Option 03: Internal Frequency Distribution Amplifier
 - Option 06: 12.8 MHz outputs
 - Option 07: 5 MHz outputs
 - Option 11: Mounting Slides
 - Option 14: CTCSS outputs 1 and 2
 - Option 16: 1PPS TTL outputs in place of frequency outputs 3 and 4
 - Option 17: CTCSS outputs 3 and 4 (integers)
 - Option SP294: T1
 - Option SP295: E1
- For power input other than 115/230 VAC:
 - Option 52: 12 VDC
 - Option 53: 24 VDC
 - Option 54: 48 VDC
- Specify Antenna and Accessories:
 - GPS outdoor antenna, Model 8225 and mounting hardware
 - Antenna Preamplifier, Model 8227
 - Antenna Surge Protector, GPS, Model 8226
 - Antenna Flat Roof Mount, Model 8213
 - Antenna Cable, UMR-400 equivalent, CAL7xxx, xxx=length in feet
- Specify Model 1118-2: CTCSS Filter Board (one per Base Station)
 Example: Model 8195B-02, Model 8225, Model 8226, CAL7100

WARRANTY:

5-Year Limited Warranty

CTCSS Tone Generator Specifications

The Model 1118 CTCSS Tone Generator is used in conjunction with the Model 8195A or 8197 Ageless Oscillator to generate precision synchronized CTCSS tones. The master oscillator must be equipped with the appropriate option 14 output. There are 2 versions of the 1118; the 1118-2 a version with an enclosure, and the 1118-1, a rail mount version. This manual lists the pins and connectors for the 1118-2 first, then the pins and connections for the 1118-1 in brackets [].

1.1 FEATURES

The Spectracom CTCSS Tone Generator offers the following features:

- Accuracy: Continuous self-calibrated to GPS provides $\pm 1.0 \times 10^{-11}$ frequency accuracy.
- PTT input and an adjustable delayed PTT output.
- TIA compliant CTCSS reverse burst.
- Inhibit input that disables CTCSS tone generation.

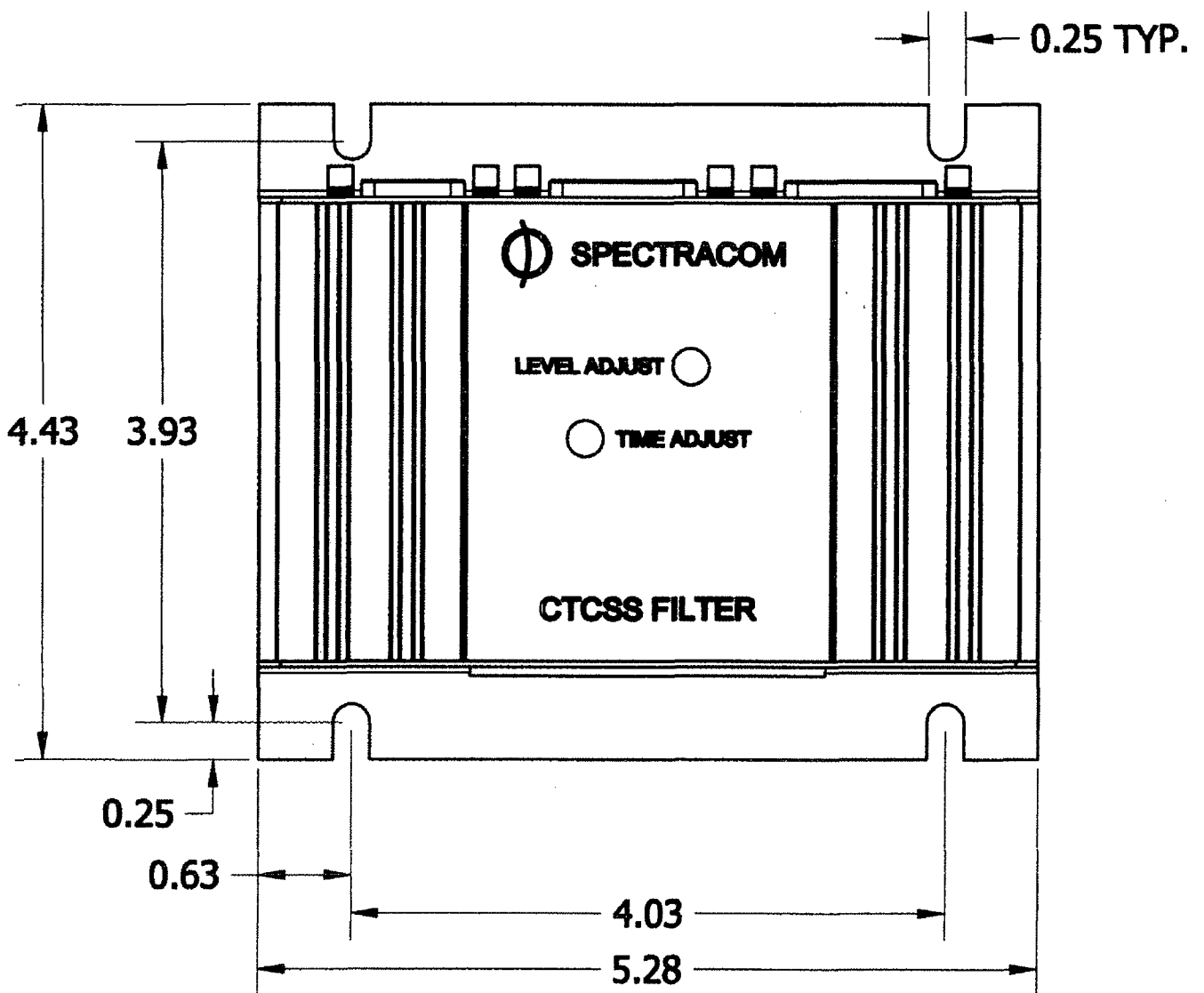
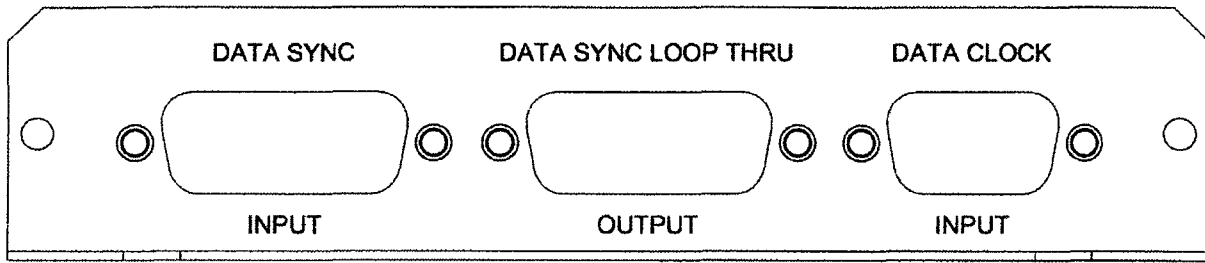
Section 1: Specifications

1.2 SPECIFICATIONS

1.2.1 OUTPUTS

**1.2.1.1 STANDARD CTCSS FREQUENCY OUTPUT
(CONTINUOUS TONE CONTROLLED SQUELCH SYSTEM)**

Signal:	67-254Hz sinewave derived from GPS disciplined oscillator with configurable 180-degree inverted "reverse burst" tone during delayed PTT output. See table 1-1 for tone frequencies and H1 jumper position.
Connector:	12 pin pluggable header J4 pins 6 and 7 [or 6 Pin Header J6 pin 1, and 3 Pin Header J5 pin 1].
Signal Level:	Adjustable with a potentiometer from 0.0 to 4.0 volts P-P (1.4 Vrms) into 600 ohms.
Source Impedance:	33 ohms
Harmonics:	25dB below the CTCSS fundamental minimum
Spurious:	25dB below the CTCSS fundamental minimum
PTT Operation:	CTCSS tones are gated by PTT with a configurable PTT hold or millisecond reverse burst.

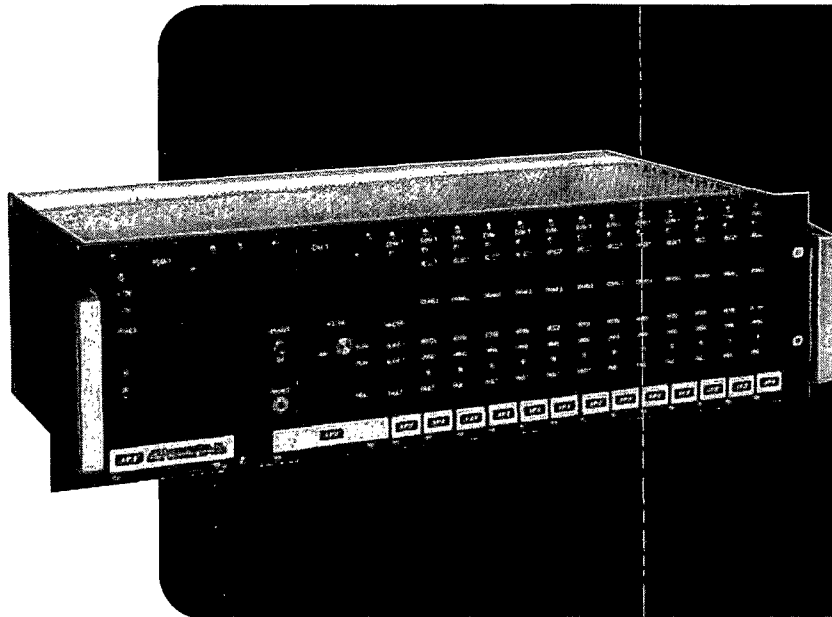


Raytheon

JPS Communications

SNV-12

Signal-To-Noise Voter



The **SNV-12** is a modular receiver voting system which uses individual Digital Signal Processing (DSP) channels to measure the signal-to-noise ratio of received signals for fast and optimum determination of the best received signal. The unit accommodates from 2 to 12 receiver Site Voter Modules in a chassis and interfaces easily with standard dispatch consoles.

ADVANTAGES

- Independent DSP Inputs Vote the Best Voice or Data Channel.
- DSP Signal-to-Noise Ratio Determination for Each Site Input.
- Up to 12 Site Inputs Voted Per Chassis.
- Console Interface Module Interfaces with Industry Standard Dispatch Consoles
- Multiple Types of Repeater Control and Transmit Steering Capability.
- Provides Tone Keying and Repeat Mode.
- Digital Delay Compensates for Differences in Link Paths.
- Local Control plus Parallel and Serial Remote Control.
- System Expansion to 36 Sites by Daisy-Chaining Multiple SNV-12s.
- 5.25" High by 19" Wide Rack-Mount Modular Card-Cage Package.

The SNV-12 uses separate Digital Signal Processors (DSPs) to continuously select the receiver with the best Signal-to-Noise Ratio (SNR) from multiple remote sites. This is a vital function in two types of applications. The first is a two-way radio application in which mobiles and portables can hear a repeater, but the repeater can not always hear the mobiles and portables. By positioning remote receivers in the communications deadspots, audio from each receiver can be linked to the voter via microwave, landline, twisted pair or fiber optics. With the unit providing the "voted" (best SNR) output to the repeater for rebroadcast, all mobiles and portables can hear each other since the repeater can hear them all. The second application involves a critical message sent simultaneously via several transmission mediums, or by several transmitters on different frequencies in the same frequency band. In this "Diversity Reception" application, the message is picked up by multiple receivers while the SNV-12 always selects the signal with the best SNR at any given moment.

SNV-12 Signal-To-Noise Voter

DSP Voting

The Site Voter Module uses an spectral approach to continuously measure the Signal-to-Noise Ratio (SNR) of the audio signal received from each receiver site. The signal amplitude is measured by a JPS proprietary speech detection and measurement algorithm. Noise is measured separately by the same algorithm. The SNR result is calculated by dividing the signal amplitude by that of the noise and operates from -6 dB to +36 dB in approximately 1.4 dB steps. The SNV-12 continuously checks all inputs and ensures that the best SNR signal is voted. Thus, even if the signal is emanating from a moving vehicle, the SNV-12 will output the best signal at all times.

Voting voice signals allows transitions in mid-syllable without

harm to the intelligibility, but when voting data, transitions from one receiver site to another causes bit errors and synchronization problems. Thus, to vote data, the Site Voter Modules make a decision initially on the best data signal and then lock onto that receiver path until the data transmission is complete. Data voting algorithms and software are special order options to the SNV-12, since the Site Voter Modules must be equipped with software defining the data's characteristics for the spectral measurement of SNR. The DSP SNR determination makes the SNV-12 an extremely accurate selector of the best available voice or data channel.

Local and Remote Control

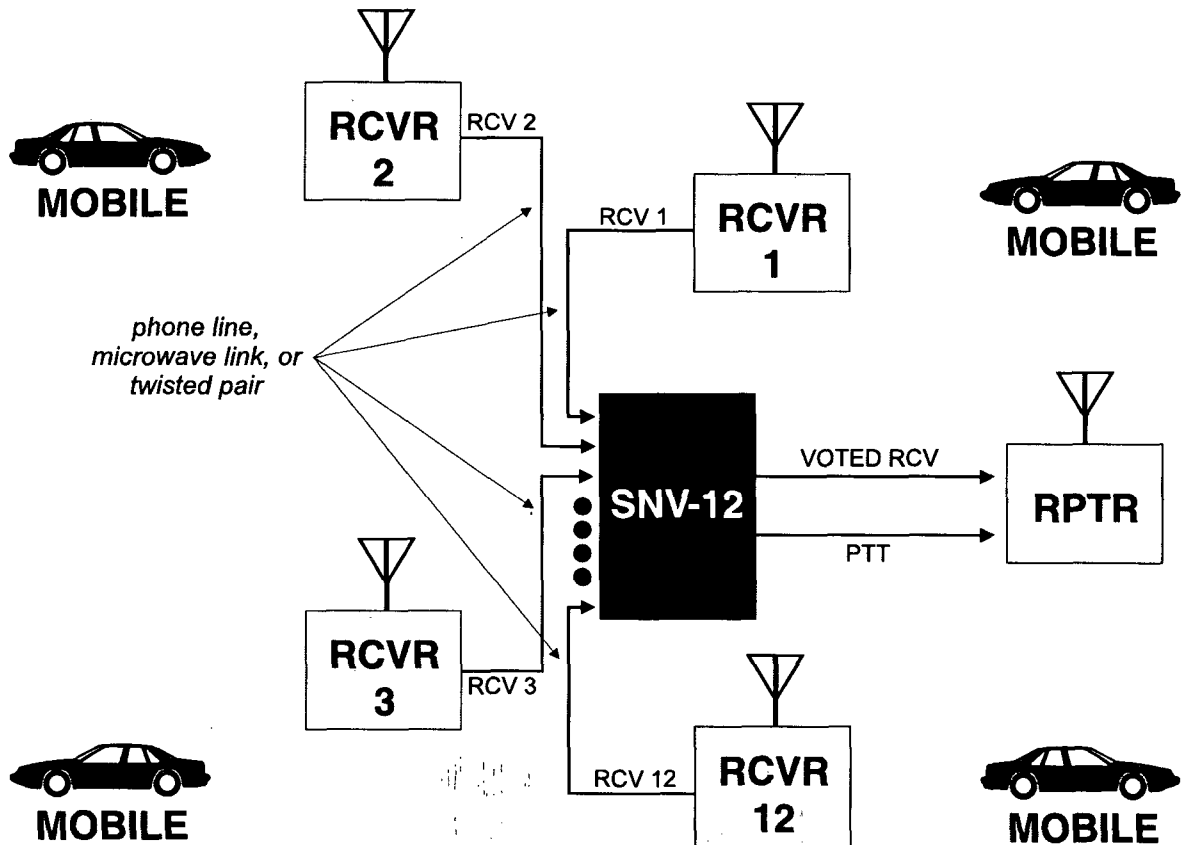
Front panel switches and status LEDs offer local control of the

unit by allowing receiver sites to be forcibly selected, disabled and monitored. The SNV-12 provides both parallel and serial remote control, so interfacing with a PC or with any of a variety of industry-standard dispatch consoles is straightforward. Fault indicators on each of the modules provide quick warning of problems. A faulty Site Voter Module is automatically and immediately removed from voting consideration. A front panel speaker and headphone jack on the Console Interface Module allow continuous monitoring of the currently voted receiver audio.

Repeater Control

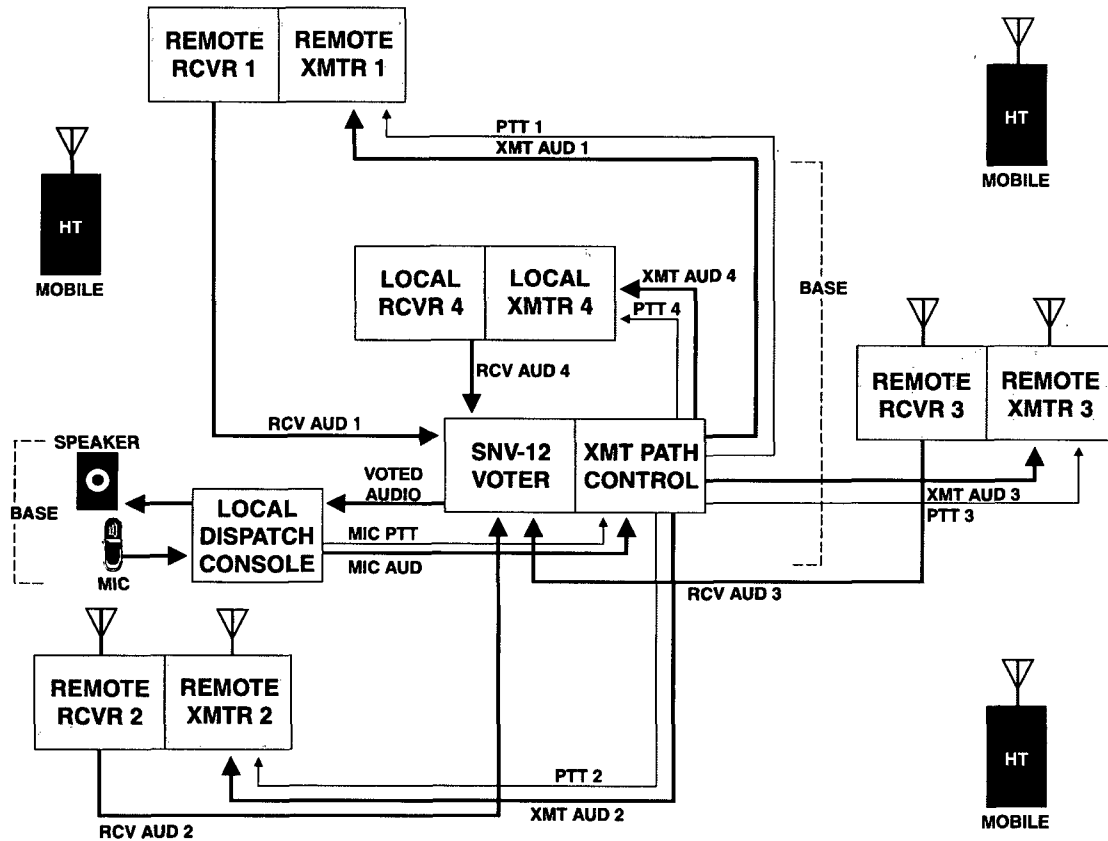
When controlling a repeater, the SNV-12 offers three means of producing the necessary COR signal. Two of these approaches

are common in public safety applications since both offer a quick method of detecting a faulty remote receiver or a faulty link. In the first, the voter produces a COR output signal for the repeater which is derived from COR inputs provided by each remote receiver. In the second case, the voter's COR output is derived from the absence of pilot tones (line proving tones) which each remote receiver produces until it becomes unscelched. Pilot tone frequencies of 1950 Hz, 2175 Hz and 2700 Hz are supported; others are available on special order. The other approach is less common: remote receivers are squelched when not in use and the DSP uses its voice recognition algorithm to issue the COR signal.



Repeater System Using the SNV-12 Voter with 12 Receivers

SNV-12 Signal-To-Noise Voter



Remote Transmitter Associated With Voted Receiver Used For Reply to Remote Mobile

System Expansion

Two additional SNV-12s may be connected to the first, each expanding the number of voting sites by up to twelve additional inputs. This expansion capability is implemented by daisy-chaining one SNV-12 to the next via rear panel connectors, up to a practical maximum of three chassis or 36 site inputs. Signals between master and slave units include a serial data bus which allows one SNV-12 to exchange information with the next one in the chain. A Voted Audio bus transfers the best voted audio signal between units.

Transmit Steering

In transmit steering applications, the transmitter associated with the current best voted receiver is used for a reply to a nearby mobile or portable radio. In this situation, the CPU Module provides for automatic routing of console transmit audio and keying information to the proper remote transmitter site. If automatic transmitter steering is enabled, this module keeps the proper transmitter selected until the reply is complete and a new receiver site is voted. In manually controlled applications, the dispatcher decides which transmit-

ter site to use for reply by issuing a Transmit Select signal to the proper Site Voter Module. The Voter can also group multiple voted receivers around separate remote transmitters. Tone Keying operation and Repeat Mode (Voted Site Talkthrough) are also provided within the Transmit Steering function.

Modular Packaging

The SNV-12 is packaged in a 19" wide EIA standard rack-mounted Eurocard cage equipped with a backplane board. A Power Supply Module, Console Interface Module, CPU Module, and two to

twelve Site Voter Modules are plugged into the card cage backplane. Remote receiver signals are connected to the Site Voter Modules via barrier terminal strips on the backplane board for ease of hook-up. Each plug-in module has a front panel handle for removal and insertion. The unit is designed for hot plugging so that any module in the chassis may be inserted or removed with power applied without damage

SNV-12 Signal-To-Noise Voter

SPECIFICATIONS

Site Voter Module Audio Inputs	
Input Impedance	Balanced or unbalanced 600 Ohms or 10k Ohms.
Input Level	-30 to -10 dBm, adjustable.
Frequency Response	200 to 3200 Hz \pm 2 dB.
Minimum Pilot Tone Sensitivity	-25 dBm.
Voting Audio Output	
Output	Balanced 600 Ohms.
Output Level	-20 to +11 dBm, adjustable.
Frequency Response	200 to 3200 Hz \pm 2 dB.
Absolute Output Delay	Less than 10 msec.
Distortion	Less than 1%, 200 to 3200 Hz @ 0 dBm.
Voting Comparator	
Switching Time Between Sites	Less than 1 msec.
Unselected Output Rejection	Greater than 60 dBm.
Output Impedance	Balanced 600 Ohms.
Voting Threshold	1 through 7 dB in 1 dB steps.
Voting Delay	0 to 5 sec.
Parallel Control Inputs	
Input Impedance	22k Ohms pullup to +5 VDC.
Threshold	+2.5 V nominal.
Input Signal Range	+30 VDC.
Protection	Up to 200 VDC.
Parallel Control Outputs	
Output Type	N-channel open collector transistor.
Maximum Sink Current	100 mA.
Maximum Open Circuit Voltage	+60 VDC.
General/Environmental	
Audio Delay	0 to 450 msec in 30 msec steps.
Serial Port	RS-232 DCE connector (female db9). Baud rates: 300, 1200, 2400, 4800, 9600, 19200, 38400, and 57600.
Power Supply Front Panel (PSM-1)	Power on/off Switch; AC on LED, DC on LED, +12 VDC LED, -12 VDC LED.
Console Interface Front Panel (CIM-1)	Speaker, Speaker on/off Switch, 1/8" Headphone jack, Volume control, Norm audio level LED, Peak audio level LED, Fault LED, Remote LED.
Control Processor Front Panel (CPM-1)	Master LED, Slave 1 LED, Slave 2 LED, Fault LED.
Site Voter Module Front Panel (SVM-1)	Disable Switch and LED, Select Switch and LED, Voted LED, Unselected LED, TX LED, Fault LED.
Rear Panel	DC fuseholder, AC filter module, Connectors to interface up to 12 site voter modules, Serial remote connector, Console interface connector, and Expansion connector for daisy chaining SNV-12s for voting of up to 36 sites.
AC Input Power	115 or 230 VAC \pm 15%, 47-63 Hz, 100 VA typical, 130 VA maximum.
DC Input Power	+11 to +15 VDC @ 5 A, nominal.
Size	5.25" H x 19" W x 11" D (13.3 x 48.3 x 28 cm).
Temperature	Operating: -20 to +60 degrees C. Storage: -40 to +85 degrees C.
Humidity	Up to 95% @ 55 degrees C.
Shock	MIL-STD-810D, Method 516.3, Procedure VI.
Vibration	MIL-STD-810D, Method 514.3, Category I.

JPS Communications, Inc.
5800 Departure Drive
Raleigh, NC 27616

Phone: (919) 790-1011
Fax: (919) 790-1456
E-Mail: jps@jps.com
Web: www.jps.com

Specifications subject to change without notice.
NXU-2™ is a trademark of JPS Communications.
Copyright © 2003 JPS Communications.
All rights reserved.

Ver.1 8/21/03

Raytheon
JPS Communications

T1/E1 Copper to Fiber

Remote In-Band Management

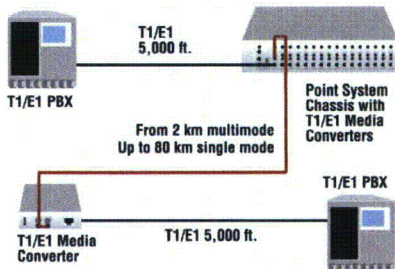
Stand-Alone Media Converters

SSDTFx0xx-1xx



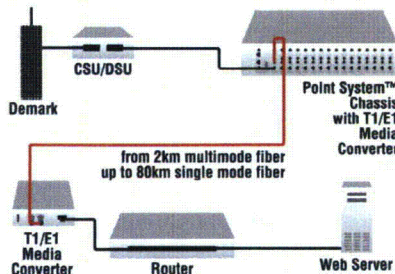
Convert Copper to Fiber

► Provide Campus Interconnects



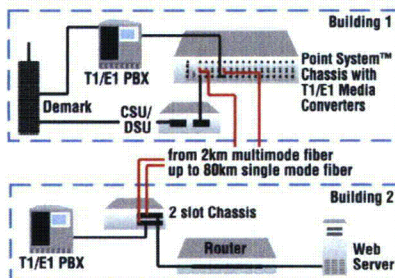
With the exception of Ethernet, T1/E1 is one of the most common campus/ metropolitan area networking interconnects. A copper to fiber conversion on the premise side of the T1/E1 makes it easier to integrate voice traffic, frame relay or IP type traffic on your fiber network.

► Remote Management



Stand-alone can be managed remotely when used with a managed chassis.

► Extend T1 Networks



Extend T1 to other buildings in a campus or MAN from 2 km to 80 km for voice or data applications.

- Remote management in a stand-alone device.** When used in conjunction with a managed Point System chassis, this stand-alone unit can be managed remotely.
- The Remotely Managed T1/E1 copper to fiber media converter will provide a solution for users who desire to extend their T1 or E1 circuits over fiber and remotely manage them "in-band" from admin locations.
- Features**
- Remote unit in-band management
 - Local or Remote Loopbacks on copper or fiber in software mode
 - Loopback switch facilitates local installation
 - Converts the copper ports on T1/E1 devices, such as a PBX or T1/E1 Router, to multimode or single mode fiber
 - Switch selectable RJ-48 connectors for T1 or E1
 - Jitter attenuators optimize Bit Error Rate (BER) performance
 - Network debug procedures make BER testing more convenient
 - Built-in troubleshooting with the addition of a selectable TAOS (Transmit All Ones) switch on the fiber and copper interfaces allows the network engineer to test all T1/E1 equipment on that network segment and ensure the network link
 - Dry relay contacts enable the media converter to be tied into a separate alarm circuit commonly found in a T1/E1 twisted pair environment. Contacts will be activated on loss of power or loss of fiber link.
 - LED provides Alarm Indication Signal (AIS)
 - Can be used with fractional T1/E1 circuits
 - Report converter status
 - Copper & Fiber Link status
 - Hardware switch settings: LBO, AIS Copper, AIS Fiber, HW/SW
 - AIS detected Copper & Fiber
 - Model Number
 - Copper & Fiber Connector
 - Remote commands:
 - Loopback Copper & Fiber
 - AIS transmitted on Fiber on loss of Copper link
 - AIS Transmitted on Copper on loss of Fiber link

Ordering Information: T1/E1 Stand-Alone Media Converters

Product Number	Port One	Port Two	Product Number	Port One	Port Two
SSDTF1011-105	Twisted Pair (RJ-48) [1.5 km/0.9 mi.]	850nm multimode (ST) [2 km / 1.2 miles]	SSDTF3011-115	(2) Coax (BNC) [100 m / 328 ft.]	850nm multimode (ST) [2 km / 1.2 miles]
SSDTF1013-105	Twisted Pair (RJ-48) [1.5 km/0.9 mi.]	850nm multimode (SC) [2 km / 1.2 miles]	SSDTF3013-115	(2) Coax (BNC) [100 m / 328 ft.]	850nm multimode (SC) [2 km / 1.2 miles]
SSDTF1018-105	Twisted Pair (RJ-48) [1.5 km/0.9 mi.]	1300nm multimode (MT-RJ) [2 km / 1.2 miles]	SSDTF3018-115	(2) Coax (BNC) [100 m / 328 ft.]	1300nm multimode (MT-RJ) [2 km / 1.2 miles]
SSDTF1027-105	Twisted Pair (RJ-48) [1.5 km/0.9 mi.]	1300nm multimode (ST) [5 km / 3.1 miles]	SSDTF3027-115	(2) Coax (BNC) [100 m / 328 ft.]	1300nm multimode (ST) [5 km / 3.1 miles]
SSDTF1012-105	Twisted Pair (RJ-48) [1.5 km/0.9 mi.]	1310nm single mode (ST) [8 km / 5 miles]	SSDTF3012-115	(2) Coax (BNC) [100 m / 328 ft.]	1310nm single mode (ST) [8 km / 5 miles]
SSDTF1022-105	Twisted Pair (RJ-48) [1.5 km/0.9 mi.]	1310nm single mode (ST) [15 km / 9.3 miles]	SSDTF3022-115	(2) Coax (BNC) [100 m / 328 ft.]	1310nm single mode (ST) [15 km / 9.3 miles]
SSDTF1014-105	Twisted Pair (RJ-48) [1.5 km/0.9 mi.]	1310nm single mode (SC) [20 km/12.4 miles]	SSDTF3014-115	(2) Coax (BNC) [100 m / 328 ft.]	1310nm single mode (SC) [20 km/12.4 miles]
SSDTF1015-105	Twisted Pair (RJ-48) [1.5 km/0.9 mi.]	1310nm single mode (SC) [40 km/24.9 miles]	SSDTF3015-115	(2) Coax (BNC) [100 m / 328 ft.]	1310nm single mode (SC) [40 km/24.9 miles]
SSDTF1016-105	Twisted Pair (RJ-48) [1.5 km/0.9 mi.]	1310nm single mode (SC) [60 km/37.3 miles]	SSDTF3016-115	(2) Coax (BNC) [100 m / 328 ft.]	1310nm single mode (SC) [60 km/37.3 miles]
SSDTF1017-105	Twisted Pair (RJ-48) [1.5 km/0.9 mi.]	1550nm single mode (SC) [80 km/49.7 miles]	SSDTF3017-115	(2) Coax (BNC) [100 m / 328 ft.]	1550nm single mode (SC) [80 km/49.7 miles]
SSDTF1035-100	Twisted Pair (RJ-48) [1.5 km/0.9 mi.]	1550nm single mode (SC) [125 km/74.6 miles]	SSDTF3035-110	(2) Coax (BNC) [100 m / 328 ft.]	1550nm single mode (SC) [125 km/74.6 miles]
Single Fiber Products <i>Note: Recommended use in pairs (see next page)</i>			Single Fiber Products <i>Note: Recommended use in pairs (see next page)</i>		
SSDTF1029-105	Twisted Pair (RJ-48) [1.5 km/0.9 mi.]	1310nm TX / 1550nm RX single fiber single mode (SC) [20 km/12.4 miles]	SSDTF3029-115	(2) Coax (BNC) [100 m / 328 ft.]	1310nm TX / 1550nm RX single fiber single mode (SC) [20 km/12.4 miles]
SSDTF1029-106	Twisted Pair (RJ-48) [1.5 km/0.9 mi.]	1550nm TX / 1310nm RX single fiber single mode (SC) [20 km/12.4 miles]	SSDTF3029-116	(2) Coax (BNC) [100 m / 328 ft.]	1550nm TX / 1310nm RX single fiber single mode (SC) [20 km/12.4 miles]
SSDTF1029-107	Twisted Pair (RJ-48) [1.5 km/0.9 mi.]	1310nm TX / 1550nm RX single fiber single mode (SC) [40 km/24.9 miles]	SSDTF3029-117	(2) Coax (BNC) [100 m / 328 ft.]	1310nm TX / 1550nm RX single fiber single mode (SC) [40 km/24.9 miles]
SSDTF1029-108	Twisted Pair (RJ-48) [1.5 km/0.9 mi.]	1550nm TX / 1310nm RX single fiber single mode (SC) [40 km/24.9 miles]	SSDTF3029-118	(2) Coax (BNC) [100 m / 328 ft.]	1550nm TX / 1310nm RX single fiber single mode (SC) [40 km/24.9 miles]

Switch Settings

Long Haul (SW1-3 unused)			
SW1-1	SW1-2		
Down	Down	0 db output pulse	
Up	Down	-7.5db output pulse	
Down	Up	-15db output pulse	
Up	Up	-22.5db output pulse	
Short Haul (SW1-4 unused)			
SW1-1	SW1-2	SW1-3	
Up	Up	Down	DSX-1, 0-133 ft.
Down	Down	Up	DSX-1, 133 - 266 ft.
Up	Down	Up	DSX-1, 266 - 399 ft.
Down	Up	Up	DSX-1, 399 - 533 ft.
Up	Up	Up	DSX-1, 533 - 655 ft.
Up	Up	Down	ANSI, T1.403
Down	Up	Down	DSX-1, 6.0 V

Optional Accessories (sold separately)

Product Number	Description
SPS-1872-PS	Wide Input (18-72VDC) Piggy Back Power Supply
SPS-1872-SA	Wide Input (18-72VDC) Stand-Alone Power Supply
E-MCR-04	12-slot Media Converter Rack
WMBD	DIN Rail Mount Bracket 5.0" [127 mm]
WMBD-F	DIN Rail Mount Bracket (flat) 3.3" [84 mm]
WMBL	Wall Mount Bracket 4.0" [102 mm]
WMBV	Vertical Wall Mount Bracket 5.0" [127 mm]

Specifications

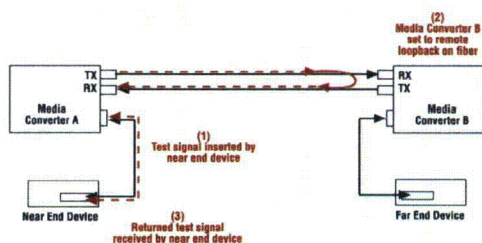
Standards	ITU-T, ANSI, AT&T, ETSI
Fiber Optic Connector Specs	
SSDTFx011-1x5 & SSDTFx013-1x5	Min TX PWR: -19.0 dBm Max TX PWR: -14.0 dBm RX Sensitivity: -32.5 dBm Max In PWR: -14.0 dBm Link Budget: 13.5 dB
SSDTFx018-1x5	Min TX PWR: -19.0 dBm Max TX PWR: -14.0 dBm RX Sensitivity: -30.0 dBm Max In PWR: -14.0 dBm Link Budget: 11.0 dB
SSDTFx027-1x5	Min TX PWR: -19.0 dBm Max TX PWR: -15.0 dBm RX Sensitivity: -32.5 dBm Max In PWR: -14.0 dBm Link Budget: 13.5 dB
SSDTFx012-1x5	Min TX PWR: -27.0 dBm Max TX PWR: -10.0 dBm RX Sensitivity: -34.0 dBm Max In PWR: -14.0 dBm Link Budget: 7.0 dB
SSDTFx022-1x5	Min TX PWR: -20.0 dBm Max TX PWR: -5.0 dBm RX Sensitivity: -35.0 dBm Max In PWR: -14.0 dBm Link Budget: 15.0 dB
SSDTFx014-1x5	Min TX PWR: -15.0 dBm Max TX PWR: -8.0 dBm RX Sensitivity: -31.0 dBm Max In PWR: -8.0 dBm Link Budget: 16.0 dB
SSDTFx015-1x5	Min TX PWR: -8.0 dBm Max TX PWR: -2.0 dBm RX Sensitivity: -38.0 dBm Max In PWR: -8.0 dBm Link Budget: 30.0 dB
SSDTFx016-1x5 & SSDTFx017-1x5	Min TX PWR: -5.0 dBm Max TX PWR: 0.0 dBm RX Sensitivity: -34.0 dBm Max In PWR: -7.0 dBm Link Budget: 29.0 dB
SSDTFx035-1x0	Min TX PWR: 0.0 dBm Max TX PWR: 5.0 dBm RX Sensitivity: -36.0 dBm Max In PWR: -3.0 dBm Link Budget: 36.0 dB
Single Fiber Products	
SSDTFx029-1x5 & SSDTFx029-1x6	Min TX PWR: -13.0 dBm Max TX PWR: -6.0 dBm RX Sensitivity: -32.0 dBm Max In PWR: -3.0 dBm Link Budget: 19.0 dB
SSDTFx029-1x7 & SSDTFx029-1x8	Min TX PWR: -8.0 dBm Max TX PWR: -3.0 dBm RX Sensitivity: -33.0 dBm Max In PWR: -3.0 dBm Link Budget: 25.0 dB
Switches	SW1 1, 2, 3: Line Build out for short haul/DB in Long Haul (see table) Short Haul mode: SW1: Pos 4 not used SW2 - 1: Transmit all ones into copper on loss of fiber link (Up = Disabled) SW2 - 2: Transmit all ones (AIS) into fiber on loss of copper link (Up = Disabled) SW2 - 3: Long Haul/Short Haul (Up = Short Haul) SW2 - 4: T1/E1 selection (Up = T1)
3-position Jumper	Hardware: Converter mode is determined by 4-position switch settings Software: Converter mode is determined by most recently saved on-board microprocessor settings.
Status LEDs	PWR (Power): Steady green LED indicates connection to external AC power SDC (Signal Detect/Copper): On indicates twisted pair link is up SDF (Signal Detect/Fiber): On indicates fiber link is up
Dimensions	Width: 3.25" [82 mm] Depth: 4.8" [122 mm] Height: 1.0" [25 mm]
Power	External AC/DC provided; 12V DC; 5A; unregulated; standard; UL listed
Environment	0 - 50°C, 5% - 95% humidity (non-condensing), 0 - 10,000 feet
Shipping Weight	2 lbs. [0.9 kg]
Safety Compliance	Wall Mount Power Supply: CSA certified
Regulatory Compliance	CISPR/EN55022 Class A; FCC Class A; CE Mark
Warranty	Lifetime

ADVANCED PRODUCT FEATURES & CERTIFICATION

▶ Loopback

Select Transition Networks products are equipped with Loopback. This feature puts a converter in a special mode that enables the device to loop back the signal from the RX port to the TX port on either media for testing and troubleshooting purposes. Test signals from a tester (Firebird, etc.) can then be inserted into the link and looped back as received by a device to test a particular segment of the link (i.e. copper or fiber). Loopback can be either local or remote depending on the location of the converter in the link.

- ▶ Allows network diagnostics from local or remote location
- ▶ Quickly pinpoints problem areas of end to end link by testing a particular segment



Some converters have separate copper and fiber loopback functions that can be enabled separately, while others will loopback both copper and fiber at the same time when enabled. Please refer to the specific product page for details.

If someone tells you media conversion is a commodity product that anyone can bring to market, they probably haven't looked at the extensive product suite offered by Transition Networks. With the industry's most comprehensive offering of full-featured products, Transition's media converters stand out as "the choice" among industry IT professionals.

Generally, media converters are low-level OSI model devices with no IP or MAC addresses and therefore are transparent to the network. This "transparency" makes them very inexpensive and easy to use, but also can make troubleshooting the network very difficult. In an effort to overcome this difficulty and to make media converters "visible" to network managers, Transition has designed their full-featured products to include the most advanced features on the market today.

▶ Remote Management

All chassis-based converters from Transition Networks® can be managed through SNMP. Now, select stand-alone products can also be managed through SNMP when used in conjunction with a chassis based converter. While chassis based products are generally placed in the telecommunications room, stand-alone converters are generally placed in remote locations away from network administrators. Remote in-band management over fiber allows administrators access to the remote device to check status and enable/disable features or the device itself.

- ▶ Visibility of remote converters for network administrators
- ▶ Allows for centralized management of media converters

▶ Single Fiber

Single fiber technology offers a 50% savings in fiber utilization. It is an attractive solution to maximize the usage of a limited number of fiber runs.

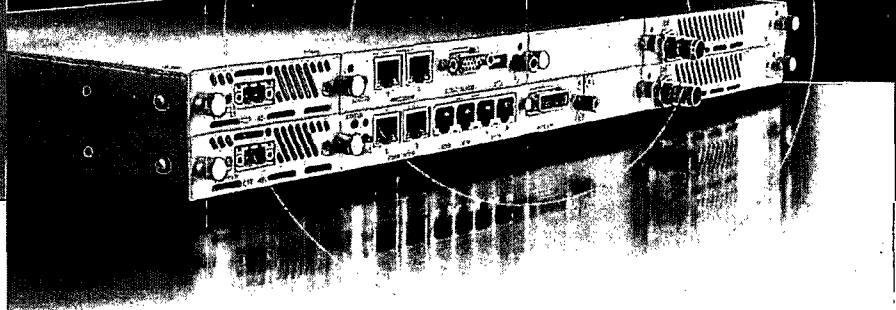
In a traditional optical link, a fiber pair consists of two uni-directional strands. The single fiber technology multiplexes two optical wavelengths of 1310nm and 1550nm into a single strand fiber. In a single fiber media converter each wavelength is responsible for either the transmit or receive function. Consequently, the bi-directional transmission is achieved by using a single strand. The converters in a single fiber scenario "match" each other's wavelengths. Converter A transmits at the wavelength of 1310nm and receives at 1550nm while the other converter transmits at 1550nm and receives at 1310nm. Therefore, converters are usually used in pairs.

Single Fiber



Single fiber technology is available on all Transition Networks Media Converters in maximum distance ranges from 20 to 80km.

MDS FIVE.8™ & MDS FIVE.3™ WIDEBAND Consecutive Point



Features

- Fast Ethernet—Scalable from 25 Mbps to 100 Mbps
- Scalable to up to 16 T1/E1s
- Scalable and Spectrally Efficient
- ISM 5.8 GHz Unlicensed Band
- UNII 5.3 GHz Unlicensed Band
- Adaptive Power Control
- Easily Deployed and Activated
- Ring Architecture Minimizes Interruptions

Applications

- Connect Buildings, Campuses, etc.
- Backhaul/Extend IP Networks, SANs
- Utility Monitoring, Control, Data Network Aggregation
- Eliminate Monthly Leased Line Fees Means Quick ROI

MDS...Global wireless solutions. Industrial Wireless Performance.

For nearly two decades, Microwave Data Systems (MDS) has been providing highly secure, industrial strength mission critical wireless communications solutions for a broad spectrum of public and private sector clients worldwide. With an installed base approaching 1,000,000 radios in 110 countries, MDS offers both licensed and license-free solutions with applications in SCADA, telemetry, public safety, tele-communications, and online transaction markets.

Introducing MDS FIVE.8™ and MDS FIVE.3™

The MDS FIVE Series consists of an open front/rear Software Defined Indoor Unit (IDU) and Outdoor Unit (ODU). The MDS FIVE Series radios are spectrum and data rate scalable, enabling utilities or other organizations to trade-off system gain with spectral efficiency and channel availability for optimal network connectivity. The MDS FIVE.8™ radio delivers aggregate rates up to 200 Mbps within the 5.7 – 5.8 GHz ISM band for distances of up to 20 miles. The MDS FIVE.3™ is also available supporting the 5.25 – 5.35 GHz UNII band. A common platform supports plug-in 100 Mbps Ethernet.

Why use an MDS FIVE Series Solution?

- Quick return on investment—replaces leased-lines.
- Consecutive point architecture configurable—able to support a ring/consecutive point configuration with special set-up (see diagram on back of data sheet).
- Self-healing redundancy—more reliable than traditional point-to-point networks.
- Automatically adjusts transmit power in response to RF interference, simplifying deployment, network management, and enabling dense deployment.

MDS

INDUSTRIAL WIRELESS PERFORMANCE

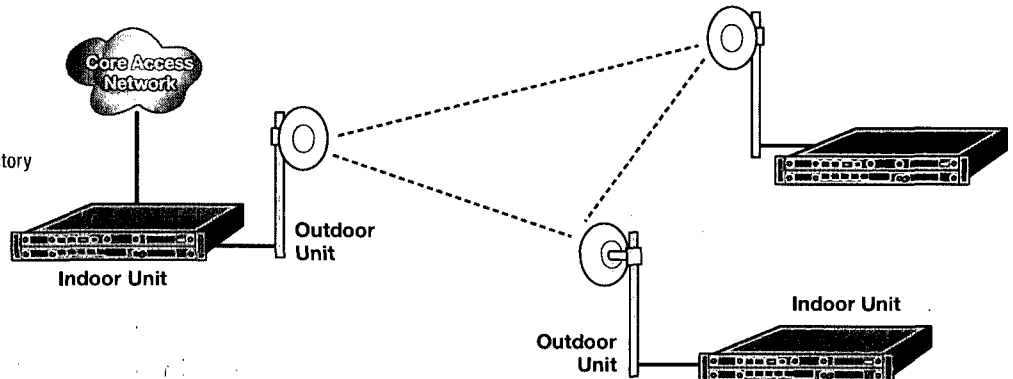
MDS FIVE Series Specifications

MODEL	THROUGHPUT DATA	INTERFACE	WAYSIDE
MDS-FIVE Series - 050	100 Mbps Aggregate (50 Mbps full-duplex)	100 Base TX	Two T1/E1s
MDS FIVE Series - 100	200 Mbps Aggregate (100 Mbps full-duplex)	100 Base TX	Two T1/E1s
MDS FIVE Series - 160	70 - 200 Mbps Aggregate (35 - 100 Mbps full duplex)	1-16 x T1/E1	scalable Ethernet

General	FIVE.8 (ISM)	FIVE.3 (UNII)
Frequency Range	5,725 - 5,850 MHz	5,250 - 5,350 MHz
Average Output Power	-8 to 23 dBm RMS	-18 to +13 dbm RMS
Max EIRP	+46 dBm RMS (with integrated antenna)	+30 dbm
Capacity Options	Ethernet: Spectrum scalable from 25 Mbps to 100 Mbps full duplex +2 T1/E1 Wayside Channels	
Modulation	QPSK, 16-QAM, 32-QAM, 64-QAM	
FEC	Trellis Coded Modulation concatenated with Reed-Solomon Coding	
Receive Sensitivity	100 Mbps 25 MHz: -67 dBm 50 Mbps 25 MHz (50FE2): -73 dBm 25 Mbps 25 MHz (25FE2): -79 dBm 16 T1 25 MHz: -79 dBm 16 E1 25 MHz: -77 dBm	
Antenna Gain	23 dBi (integrated antenna)	
Antenna Connector	N-Type Female for optional external antenna	
Distance	Up to 20 miles (or greater, depending on antenna)	
Power	-48 volts +/- 10%, <70 watts; Optional 100-240 Volts AC, 47-63 Hz power supply	
Encryption*	Encryption based upon a 128-bit key is available for select markets and is applicable for the MDS FIVE Series -50 and -100 products only	
Protected Option*	Configurable for 1+1, hot standby, hitless switching, spacial diversity (not for diversity combining)	
Data Interface		
Physical	100BaseTX Full duplex E1/T1	
Connector	Ethernet: RJ-45 Nx E1/T1: 2xRJ-48C, HD60	

Data Interface Continued	
Compliance	Ethernet: IEEE 802.3 Nx E1/T1: ITU-T
Auxiliary Connections	Wayside Channels T1/E1 - Interface DSX-1 - Connector RJ-48C Alarm Port - 2 Form C relay alarm outputs, 2 TTL outputs Voice Service Channel - 6 wire, PTT handset
Network Management	
Support	- Network management config. tool - SNMP v1, 2, 3, and web-based config. - Built-in Web browser
Connector	RJ-45, 10/100BaseTX
Environmental	
Temperature	IDU -5° to 55°C (32° to 131°F) ODU -30° to 55°C (-22° to 131°F)
Humidity	IDU: 0 to 95%, non-condensing ODU: Up to 100% at 45°C (113°F)
Altitude	IDU/ODU: 4500 m (14,100 ft.)
Mechanical	
Size	IDU: 1RU, ETSI Compliant 17.5 x 9.4 x 1.75 inches (445x238.5x44.5mm) rack mount 19 inches, (48.2 cm) ODU: 15.7 x 14.5 x 2.1 inches (39.9x36.8x5.33cm)
Weight	IDU: 7 lbs. (3.17 kg) ODU: 15 lbs. (6.8 kg)
Agency Approvals	FCC approved IC approved

FIVE Series Simplified Ring-Architecture Diagram (6 units needed - consult factory for details)



* Release II



Microwave Data Systems Inc.
175 Science Parkway
Rochester, New York 14620, USA
Phone (585) 242-9600
Fax (585) 242-9620
www.microwavedata.com

MDS products are manufactured under a quality system certified to ISO 9001. MDS reserves the right to make changes to specifications of products described in this data sheet at any time without notice and without obligation to notify any person of such changes.
© 2005 MDS Inc. (MDS FIVE Series SL0124) Rev. B, 03-06-06

INDUSTRIAL WIRELESS PERFORMANCE

The RXR Series amplifiers are our most popular cost effective, continuous duty power amplifiers. This package will accept any TPL amplifier from low band through 960 MHz, with output levels up to 150 watts.

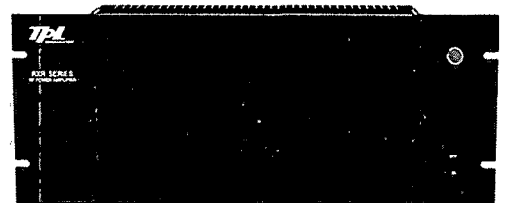
The vertical fins provide excellent convection cooling, or if conditions warrant, a cooling fan will be installed. All configurations use 7" of vertical rack space and are designed with a flat front panel allowing for installation into a cabinet leaving sufficient room for airflow with the door closed. These amplifiers have a circuit breaker/on-off switch conveniently located on the front panel and can be supplied with or without a switching power supply. This series is the most versatile unit of its type on the market today.

RF Power Amplifiers

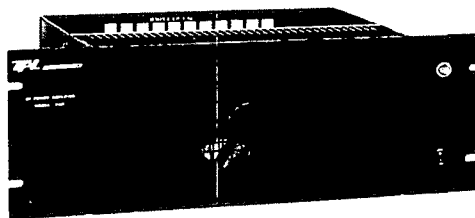
RXR



RXRF



RXRF-PS



RXR Amplifier Series

TPL
COMMUNICATIONS
Employee Owned Company

Specifications

Power Input	Standard TPL amplifier input levels, optional to 10mW or less.
Power Output	50 to 150 watts.
Frequencies	VHF Low Band, VHF High Band, 220 MHz, UHF, 700-960 MHz.
Voltage	13.8 VDC, 120 or 240 VAC (24 VDC or 48 VDC available).
Current	5-24 Amps DC/1-4 Amps AC.
Harmonic Attenuation	Exceeds FCC specifications.
RF Connectors	Type N, 50 Ohms.
Operating Temperature	-30 to +50 degrees C.
Duty Cycle	Continuous (100%).
Weight	7 lbs., 14 lbs., w/power supply.
Configuration	19" W x 7" H x 3" D (without fan) 19" W x 7" H x 5" D (with fan). 8" D w/power supply.

Features

- Cooling fan provided for power levels exceeding 80 watts.
- Accommodates all bands from 35 to 960 MHz.
- Vertical fins for efficient convection cooling.
- 100% duty cycle operation.
- Repeater or base station operation (with bypass relay option).
- 19" rack mountable configuration.
- Available with or without self-contained switching power supply.
- Front panel circuit breaker/on-off switch.
- Flat front panel allows for cabinet door closure.
- Cost effective design.

3370 San Fernando Road, #206 • Los Angeles, CA 90065-1437
(323) 256-3000 • (800) HI POWER • FAX (323) 254-3210
Email: sales@tplcom.com • www.tplcom.com
Specifications subject to change without notice.



MOTOROLA
intelligence everywhere™

Assembled Trunking System Base Station/Repeater Portfolio

PassPort®, LTR® and Conventional Compatible

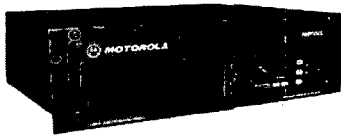
An increasing number of forward-thinking businesses are utilizing the power of trunking for their two-way radio communication. Cost-effective and efficient, LTR and PassPort trunked communication provides wide calling range, great privacy, and fast channel access to help workers connect without delays—as well as high user and talkgroup capacity to enhance system efficiency. And by purchasing their own trunked systems, companies can gain the control and flexibility they need to keep costs low and communication quality high.

Motorola delivers all the expertise and equipment required to create a fully functioning, integrated two-way radio trunked network—quickly and easily. Your choice of repeater components below provides your business the coverage and capacity flexibility of the Motorola Assembled Trunking System (ATS).

Radius R1225™/RKR1225™

Ideal for desktop use in an office setting, the R1225/RKR1225 can also become a base station allowing a dispatch operator to communicate with other radios in the field. It has built-in basic repeater capabilities. Optional controllers can be added for enhanced features such as telephone interconnect, multiple PL/DPL codes and signaling.

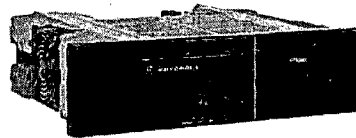
Available in UHF (444-474 MHz) and VHF (146-174 MHz)



MTR2000™

The MTR2000 Station/Repeater provides unmatched flexibility in a compact design. This product offers features such as Tone Remote Control and continuous duty cycle operation. In addition, the MTR2000 unit is available in 100-25 Watt, 40-2 Watt, and 30-2 Watt variable power models.

Available in UHF (403-470 MHz) and VHF (136-174 MHz)



“Limited” Quantar™

The “Limited” Quantar Station/Repeater helps maximize system up time by providing reliable solid state performance and self-testing capabilities. Available in 110-25 Watt or 100-25 Watt variable models, the “Limited” Quantar is also available with battery reverting to help maintain system operation in the event of a site power failure.

Available in UHF (470-494 MHz and 494-520 MHz)



MX800

The MX800 Base Station Repeater, manufactured by Spectra Engineering Pty, is the repeater component intended for use in Motorola's PassPort and LTR ATS systems in 200 and 700 MHz frequency bands. Offering wide RF switching bandwidth with superior blocking, intermodulation, and adjacent channel performance, the MX800 also comes with fully welded steel housing, a built-in NTS Trunking Controller interface, and provides a 50 Watt power output.

Available in 200 MHz (217-221 MHz) and 700 MHz (746-764 MHz)



Limited product specifications appear on the reverse of this sheet. For full product information and specifications, please refer to the dedicated product and specification sheets.

Base Station/Repeater Portfolio Specifications

	R1225/RKR1225		MTR2000	MTR2000	Quantar Limited	Spectra MX800	Spectra MX800
	VHF	UHF	VHF	UHF	UHF	200 MHz	700 MHz
Model Number	1-10W: M03GRC 25-50W: M43GRC	1-10W: M04GRC 25-45W: M44GRC	T5769, 15769	T5766, 15769	C99ED/001C Factory ID: T5365	DDN6725	DDN6726
Frequency	146-174 MHz	444-474 MHz	132-174 MHz	403-470 MHz	470-494 MHz, 494-520 MHz	217-222 MHz	746-794 MHz
Adjustable RF Power Output	1-10 Watts or 25-50 Watts		X345 (132-174 MHz) 30 Watts X330 (132-174 MHz) 40 Watts X530 (132-154, 150-174 MHz) 100 Watts	X341 (403-470 MHz) 30-2 Watts X340 (403-470 MHz) 40-2 Watts X540 (403-435 MHz, 435-470 MHz) 100-25 Watts	X640 (470-494 MHz) 110-25 Watts X640 (494-520 MHz) 100-25 Watts	5-50 Watts	
Channel Spacing	12.5/20/25/30 kHz		12.5 kHz/25 kHz/30 kHz	12.5 kHz/25 kHz	12.5 kHz/25 kHz	12.5 kHz	
RF Channel Capacity	up to 16		up to 32	up to 32	up to 16	up to 255	
Mode of Operation	Full Duplex		Simplex/Semi-duplex/Duplex	Full Duplex	Full Duplex	Full Duplex	
Duty Cycle	Continuous @ 25W and 1-10W 50% @ 45/50W (5 min. on/5 min. standby)		14.2 VDC (40/30 Watt Station) 28.6 VDC (100 Watt Station)	14.2 VDC (40/30 Watt Station) 28.6 VDC (100 Watt Station)	Continuous	Continuous transmit with thermally controlled fan	
Dimensions	5.25" x 19" x 13.5" (133 x 482 x 343 mm)		5.25" x 19" x 16.5" (133 x 483 x 419 mm)	5.25" x 19" x 16.5" (133 x 483 x 419 mm)	8.75" x 19" x 17"	3.6" x 19" x 13.2" (2RU high, 19" standard rack mounting)	
Weight	22 lbs. (10 kg)		40 lbs. (19 kg)	40 lbs. (19 kg)	55 lbs. (25 kg) Applies to station with option X87 Omit Cabinet without triple circulator option	19.8 lbs. (9 kg)	
Temperature Range	-30° C to +60° C		-30° C to +60° C	-30° C to +60° C	-30° C to +60° C	-10° C to +60° C (reduced specs from -30° C to -10° C)	

	R1225/RKR1225		MTR2000	MTR2000	Quantar Limited	Spectra MX800	Spectra MX800
	VHF	UHF	VHF	UHF	UHF	200 MHz	700 MHz
Frequency Range	146-174 MHz	444-474 MHz	30 Watt: 132-174 MHz 40 Watt: 132-174 MHz 100 Watt: 132-154 MHz, 150-174 MHz	30 Watt: 403-470 MHz 40 Watt: 403-470 MHz 100 Watt: 403-435 MHz, 435-470 MHz	470-494 MHz 494-520 MHz	217-221 MHz	746-764 MHz
Frequency Stability	± 2.5 ppm (-30° C to +60° C)	± 1.5 ppm (-30° C to +60° C)	1.5 ppm/ External Ref	1.5 ppm/ External Ref	1.5 ppm/ External Ref (Optional)	± 2.5 ppm	± 1.0 ppm
FM Deviation						± 2.5 kHz	
Spurious	-23 dBm		-85 dBc	-85 dBc	90 dB	-90 dBc	
Audio Distortion	< 3% EIA (@ 1000 Hz 60% rated maximum deviation)		< 3%	< 3%	< 2% 1000 Hz @ 60% RSD	< 2% EIA	
FM Hum and Noise	20/25/30 kHz -45 dB Normal 12.5 kHz -40 dB Normal	20/25/30 kHz -45 dB Normal 12.5 kHz -40 dB Normal	300 to 3000 Hz bandwidth, 60% RSD, 30 (VHF) 25 kHz: 50 dB Normal 12.5 kHz: 45 dB Normal	300 to 3000 Hz bandwidth, 60% RSD, 30 (VHF) 25 kHz: 50 dB Normal 12.5 kHz: 45 dB Normal	300 to 3000 Hz bandwidth, 60% RSD, 750µs de-emphasis 25 kHz: 50 dB Normal 12.5 kHz: 45 dB Normal	12.5 kHz: -44 dB Typical	
Emission Designators	12.5 kHz: 11K0F3E 20/25/30 kHz: 16K0F3E		25 kHz: 16K0F3E, 13K6F1D, 13K6F1D 12.5 kHz: 11K0F3E, 10K0F1D, 8K60F1D	25 kHz: 16K0F3E, 13K6F1D 12.5 kHz: 11K0F3E, 8K60F1D	16K0F3E, 16K0F1D, 20K0F1E, 20K0F1D, 11K0F3E, 8K10F1E, 10K0F1D	11K0F3E	

	R1225/RKR1225		MTR2000	MTR2000	Quantar Limited	Spectra MX800	Spectra MX800
	VHF	UHF	VHF	UHF	UHF	200 MHz	700 MHz
Frequency Range	146-174 MHz	444-474 MHz	132-174 MHz	403-470 MHz	470-494 MHz 494-520 MHz	219-222 MHz	776-794 MHz
Frequency Stability	± 2.5 ppm	± 1.5 ppm	1.5 ppm/ External Ref	1.5 ppm/ External Ref	1.5 ppm/ External Ref (Optional)	± 1.5 ppm -10° C to +60° C; ± 2.5 ppm -30° C to -10° C	
Sensitivity @ 12 dB SINAD	0.35µV (-116.1 dBm)		.35µV	0.35µV	0.35µV	0.3µV (-117 dBm)	
Selectivity	20/25/30 kHz: -85 dB 12.5 kHz: -65 dB	20/25/30 kHz: -80 dB 12.5 kHz: -65 dB	25/30 kHz: 80 dB 12.5 kHz: 75 dB	25/30 kHz: 80 dB 12.5 kHz: 75 dB	25 kHz: 85 dB 12.5 kHz: 75 dB	75 dB	65 dB
Intermodulation	-80 dB		(12.5 and 25/30 kHz) 80 dB/ 85 dB	(12.5 and 25/30 kHz) 80 dB/ 85 dB	85 dB	80 dB	
Spurs and Image	-85 dB		85 dB Nominal	-85 dB Nominal	100 dB	90 dB	
FM Hum and Noise	20/25/30 kHz: -45 dB Normal 12.5 kHz: -40 dB Normal	20/25/30 kHz: -45 dB Normal 12.5 kHz: -40 dB Normal	1000 Hz tone @ 60% RSD 25 kHz: 50 dB Nominal 12.5 kHz: 45 dB Nominal	1000 Hz tone @ 60% RSD 25 kHz: 50 dB Nominal 12.5 kHz: 45 dB Nominal	100 Hz tone @ 60% RSD 25 kHz: 50 dB Normal 12.5 kHz: 45 dB Normal	12.5 kHz: -44 dB Typical	



MOTOROLA and the Stylized M Logo are registered in the US Patent and Trademark Office. All other product or service names are the property of their respective owners.

© Motorola, Inc. 2005. www.motorola.com/cgiss

6880309S39

MX800 BASE STATION SPECIFICATIONS

Recently enhanced and updated specifications in blue.

Minimum performance to exceed the following for 30MHz to 960MHz*:

AS4295-1995,
R&TTE EC Directive 1995/05/EC,
EN300 086 -1,2 (2001- 03),
EN 300 113, EN 301 489 - 1,5 (2002 - 08),
EN 60950 (2000),
RFS25, RFS26, RFS32,
TIA/EIA-603,
BAPT 225 ZV 1/2098 (German soft keying),
FCC Part 22, 74, 90, 90.210, 80.475,
MIL-STD-810E (Parts thereof),

*Conforms but not all bands approved.

GENERAL

Frequency Range:

Coverage 30-960 MHz.

Band A2	30-39 MHz
Band A3	39-50 MHz
Band A	66-80 MHz
Band B°	70-88 MHz
Band C	135-160 MHz
Band D3°	148-174 MHz
Band E	177-207 MHz
Band F	195-225 MHz
Band H	245-275 MHz
Band J	295-325 MHz
Band J2	300-337 MHz
Band K	320-350 MHz
Band L	345-375 MHz
Band M	370-400 MHz
Band N2°	400-435 MHz

Band O2	435-470 MHz
Band P	455-490 MHz
Band P2°	450-485 MHz
Band Q°	485-520 MHz
Band Q2	500-532 MHz
Band R2	746-764 MHz
Band R3	776-794 MHz
Band R	805-825 MHz
Band S	824-849 MHz
Band T	850-870 MHz
Band U	870-905 MHz
Band V	890-915 MHz
Band V2	900-925 MHz
Band W	917-950 MHz
Band X	925-960 MHz

Notes:

1. Band, Q2, R3 are RX only; R2, V2 are TX only.
2. ° Standard Preferred Frequency Band.
3. Band A2, A3 have 4 MHz RX VCO Sw BW.

SPECTRA ENGINEERING PTY LTD

9 Trade Road, Malaga 6090
Western Australia
Telephone: +61-8-92482755
Facsimile: +61-8-92482756

Web page: www.spectraeng.com.au
e-Mail: info@spectraeng.com.au

Rev 10.0 August 2006

MX800 BASE STATION SPECIFICATIONS

Synthesis Method:	Non-mixing PLL. Fractional N synthesizer.
Modulation:	Direct FM two-point method.
System Deviation:	+/-5.0kHz max (WB), +/-2.5kHz max (NB)
Channel Spacing:	Programmable 25kHz/12.5kHz, Special on request.
Synthesizer Step Size:	12.5kHz, 10kHz, 6.25kHz or 5kHz.
Channels:	255 Software or switch selectable, 1-99 BCD or 255 Binary parallel selection.
Supply Voltage:	13.8 +/- 20%.
Power Consumption:	<500 mA receive, typ 460mA. 220mA opt. <10A for 50W TX RF output. <17A for 100W TX RF output D3 band.
Operating Temperature:	-30 to +60C, -30 or -40C test option.
MX800 Size:	2RU Case, 325mm deep including fan.
Standard LED indicators:	Power, RX, TX, CTCSS, Aux/Lock, Alarm.

TRANSMITTER

MEASURED IN ACCORDANCE WITH TIA/EIA-603 STANDARDS

RF Power Output:	1W to 50W variable. 1W nominal UHF PA opt. 100W option, 5W to 100W variable for D3 band.
Frequency Stability:	1.5PPM std, UHF. 2.5PPM VHF 20PPM VHF-Low. 1.0PPM opt 800MHz.
Audio Response:	Flat within +1,-3dB across BW.
Audio Bandwidth:	DC to 3400Hz (DC FM input). 300Hz to 3400Hz (VF input).
Modulation Distortion:	Less than 2% @ 60% deviation.
S/N Ratio below 700MHz:	Better than 50dB (WB), 45dB (NB).
S/N Ratio 700-900MHz:	Better than 50dB (WB), 44dB (NB).
S/N Ratio above 900MHz:	Better than 47dB (WB), 41dB (NB).
Spurii and Harmonics:	More than 100dB below carrier.
RF Switching Bandwidth Exciter:	Same as band allocation.
RF Switching Bandwidth PA:	Same or greater than band allocation.
Duty Cycle:	100% for 50W RF output.
RF Rise Time:	4mS with continuous VCO selected.
Typical Supply current (470MHz):	50W:8.6A, 25W:6.2A, 15W:5A, 10W:4.3A, 5W:3.3A, 1W:2.1A. 15A. D3 band.
Typical Supply current for 100W output:	15A. D3 band.
VCO Conducted Emissions:	Less than -70dBm with TX off.
VCO Radiated Emissions:	Less than 1uV/m @ 3m.
Adjacent Channel Power:	78dB (WB), 72dB (NB)
Transmitter IM conversion loss:	Better than 40dB
Automatic VSWR foldback:	Trips at nominal VSWR >3:1
Output Load Impedance:	50 Ohms nominal (VSWR <2:1)
Antenna connector:	N-Type Female

SPECTRA ENGINEERING PTY LTD

9 Trade Road, Malaga 6090
Western Australia
Telephone: +61-8-92482755
Facsimile: +61-8-92482756

Web page: www.spectraeng.com.au
e-Mail: info@spectraeng.com.au

Rev 10.0 August 2006

MX800 BASE STATION SPECIFICATIONS

RECEIVER

MEASURED IN ACCORDANCE WITH TIA/EIA-603 STANDARDS

Sensitivity for 12dB SINAD:	Better than -117dBm (0.32uV).
Sensitivity for 20dB SINAD:	Better than -115dBm (0.40uV)
Selectivity 30-50MHz:	More than 90dB for 25kHz adj channel, more than 80dB for 12.5kHz adj channel.
Selectivity 66-88MHz:	More than 85dB for 25kHz adj channel, more than 75dB for 12.5kHz adj channel.
Selectivity 135-520MHz:	More than 84dB for 25kHz adj channel, more than 77dB for 12.5kHz adj channel. 90dB option available on special request.
Selectivity 700-900MHz:	More than 80dB for 25kHz adj channel, more than 70dB for 12.5kHz adj channel.
Selectivity 900-960MHz:	More than 75dB for 25kHz adj channel, more than 65dB for 12.5kHz adj channel.
Audio Bandwidth VF output:	300Hz to 3000Hz (+1,-3dB).
Discriminator Output Bandwidth:	DC to 3400Hz (-3dB).
Spurious Response Immunity:	Better than 90dB.
Intermodulation Immunity:	Better than 82dB (WB), 80dB (NB).
Blocking Rejection:	Better than 110dB at +/- 1MHz point.
Distortion:	Less than 2% @ 60% deviation.
S/N Ratio below 700MHz:	Better than 50dB (WB). Better than 45dB (NB).
S/N Ratio 700-900MHz:	Better than 50dB (WB), 45dB (NB).
S/N Ratio above 900MHz:	Better than 46dB (WB), 41dB (NB).
Co-Channel Rejection:	Better than 5dB.
RF Switching Bandwidth:	Equal to band allocation.
Receiver Front End BW:	Equal to band allocation, no retuning.
VCO Conducted Emissions:	Less than -70dBm.
VCO Radiated Emissions:	Less than 1uV/m @ 3m.
Input Load Impedance:	50 Ohms nominal (VSWR <2:1)
RF Input protection:	No damage at input +20dBm
Antenna connector:	BNC Female, N-Type Female option.
Receiver type:	Double Conversion Superheterodyne.
IF Frequency:	90MHz first, 455kHz second 70MHz first for band A3, 45MHz first for band A&B
Local oscillator Injection:	Low side above 400MHz, High side below 400MHz.

SPECTRA ENGINEERING PTY LTD

9 Trade Road, Malaga 6090
Western Australia
Telephone: +61-8-92482755
Facsimile: +61-8-92482756

Web page: www.spectraeng.com.au
e-Mail: info@spectraeng.com.au

Rev 10.0 August 2006

MX800 BASE STATION SPECIFICATIONS

ANCILLARIES

Tx Timer:	Programmable, on/off selectable.
VF Level to Line:	+6 to -15dBm, 600 ohms unbalanced or differential.
VF Level from Line:	+6 to -15dBm, 600 ohms unbalanced.
De / Pre-Emphasis Accuracy:	Within +/- 1dB of 6dB per octave curve.
VF Compressor Range:	>30dB for line input.
Control Outputs:	1K ohm 5V source/sink available.
Alarm Output:	Open collector.
PTT Input:	Logic CMOS/TTL compatible.
Channel Select:	8 way Dip switch or RS232 or BCD/ Binary.
Repeater Tail Timer:	Programmable.
Audio Output:	1 Watt for speaker, -10dBm standard for line.
Audio Input:	-10dBm standard from line.

Due to ongoing development we reserve the right to alter specifications without notice.

SPECTRA ENGINEERING PTY LTD

9 Trade Road, Malaga 6090
Western Australia
Telephone: +61-8-92482755
Facsimile: +61-8-92482756

Web page: www.spectraeng.com.au
e-Mail: info@spectraeng.com.au

Rev 10.0 August 2006

DUPLXERS - BASE STATION ANTENNA

118 - 440 MHz

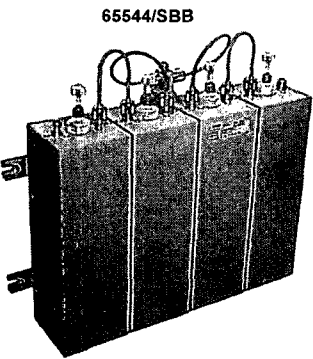
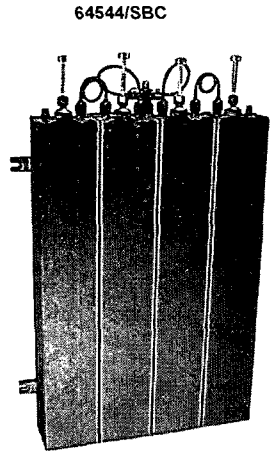
ELECTRICAL SPECIFICATIONS

Model Number	Contact Factory (623) 581-2875	64544/SBC	Contact Factory (623) 581-2875	65544/SBB
Frequency Band (MHz)	118-138	144-190	190-300	375-440
Input Power	↑	150 W	↑	150 W
Spacing	Min Space	5.0 MHz		5.0 MHz
vs	Loss	1.5 dB		1.5 dB
Max Loss				
Isolation @ min Spacing		55+ dB		55+ dB
Cavities	Size / Qty.	4" / 4		4" / 4
List Price		\$1,455.00		\$1,440.00

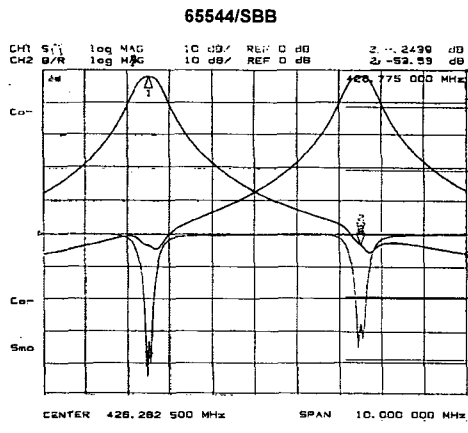
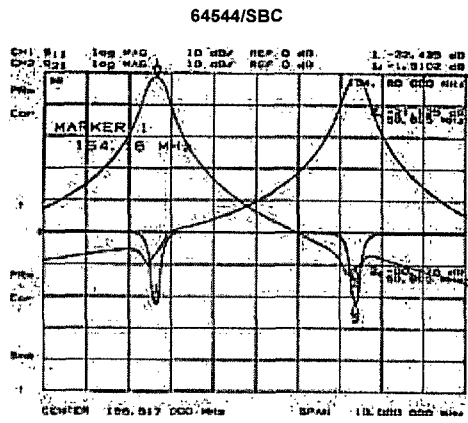
MECHANICAL SPECIFICATIONS

Dim (HxWxD) (Max.)	Inches	32 1/2 x 19 x 4 1/2	19 x 19 x 4 1/2
	Metric	826 x 483 x 115	483 x 483 x 115
Connectors		N Female	N Female
Finish		EMR Gray	EMR Gray
Ship Weight: lbs.		33	19
kg.		15.0	8.4

Dimensions are based on mounted position in a standard relay rack.



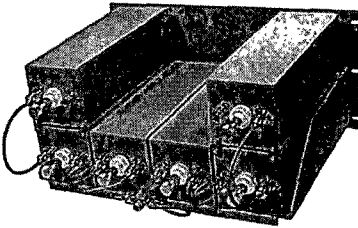
BAND-PASS



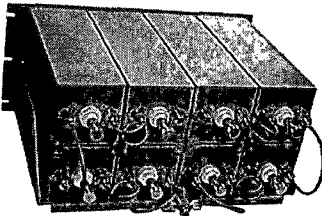
DUPLEXERS - BASE STATION ANTENNA

375 - 440 MHz

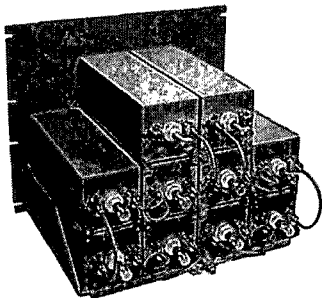
65546/SBB



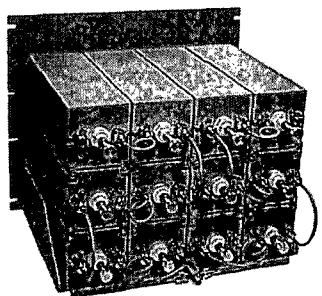
65548/SBB



655410/SBB



655412/SBB



ELECTRICAL SPECIFICATIONS

Model Number	65546/SBB	65548/SBB	655410/SBB	655412/SBB		
Frequency Band (MHz)	375-440	375-440	375-440	375-440		
Input Power	150 W	150 W	150 W	150 W		
Spacing	Min Space	5.0 MHz	5.0 MHz	5.0 MHz		
vs	Loss	Max Loss	2.3 dB	2.7 dB	3.3 dB	4.0 dB
Isolation @ min Spacing	70+ dB	70+ dB	75+ dB	75+ dB		
Cavities	Size / Qty.	4" / 6	4" / 8	4" / 10	4" / 12	
List Price	\$2,190.00	\$2,865.00	\$3,615.00	\$4,375.00		

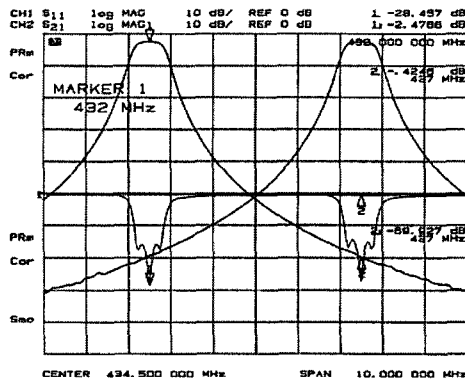
MECHANICAL SPECIFICATIONS

Dim (HxWxD) (Max.)	Inches	8 3/4 x 19 x 19	8 3/4 x 19 x 19	15 3/4 x 19 x 19	15 3/4 x 19 x 19
	Metric	223 x 483 x 483	223 x 483 x 483	401 x 483 x 483	401 x 483 x 483
Connectors		N Female	N Female	N Female	N Female
Finish		EMR Gray	EMR Gray	EMR Gray	EMR Gray
Ship Weight: lbs.		33	42	50	55
kg.		15.0	19.1	22.7	25.0

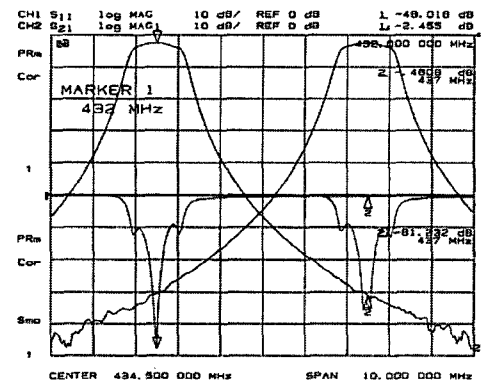
Dimensions are based on mounted position in a standard relay rack

BAND PASS

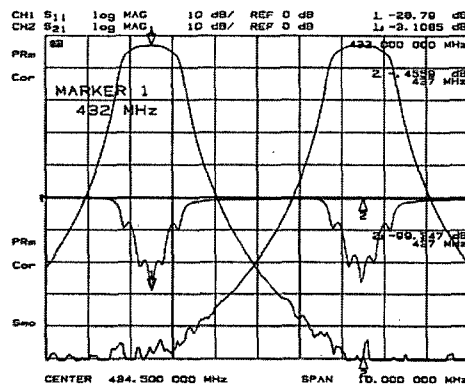
65546/SBB



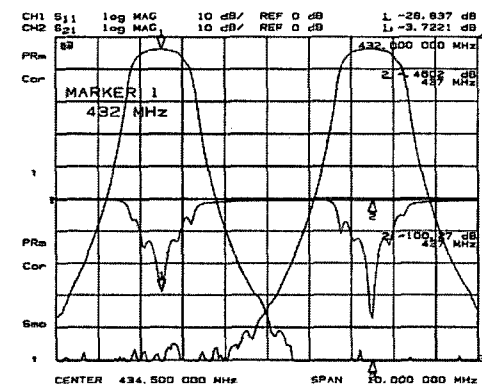
65548/SBB



655410/SBB

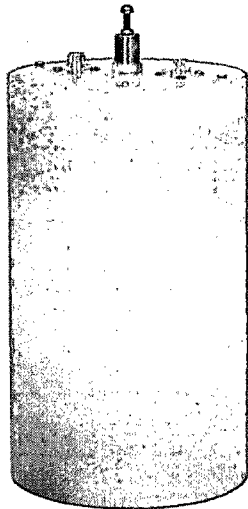


655412/SBB

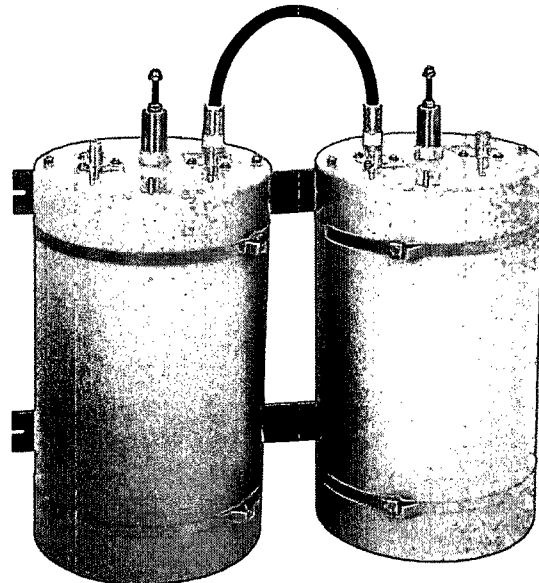


200 - 300 MHz

TWPC-2208-1, 2 BANDPASS CAVITIES



TWPC-2208-1



TWPC-2208-2

The Telewave TWPC-2208-1 and 2208-2 are 8" diameter, $\frac{1}{4}$ -wavelength, high "Q" bandpass cavity filters with superior selectivity. Bandpass cavities reject all frequencies outside a narrow pass band. These cavities reduce transmitter sideband noise, and also protect receivers against desensitization.

TWPC-2208 cavities cover 200-300 MHz. All cavities are tuned to specified frequencies prior to shipping, and no further adjustments should be required. The positive locking mechanism allows for quick field retuning if frequency changes become necessary.

These cavities also feature calibrated adjustable coupling, and insertion loss can be easily set

from 0.5 dB to 2 dB or more to improve selectivity. This allows cavity response to be optimized for any operating environment. At densely populated sites, the 2208-2 cavity filters provide greater selectivity with minimum insertion loss. Multiple cavities can also provide a wider passband when required. Mounting rails are provided for all multiple-cavity filters.

Excellent frequency stability is achieved by the use of a specially machined compensator and Invar rod. The pass frequency is temperature stable from -30°C to $+70^{\circ}\text{C}$. Telewave Ground Loop technology places the center conductor of each coupling loop at DC ground potential for lightning protection and noise reduction.

Heavy duty materials are used throughout each cavity to insure high performance and long life. Cavity top plates are machined from $\frac{1}{4}$ -inch aluminum, and are heliarc welded to the cavity body at the high current point for improved conductivity and strength. This allows Telewave cavities to handle up to 350 watts, depending on insertion loss.

Rigid foam inserts support the tuner assembly allowing vertical or horizontal mounting. Similar metals and alodined aluminum help prevent galvanic corrosion. Silver plated tuners and beryllium copper finger stock provide non-corrosive low loss contact, and ensure reliable, long-term performance.

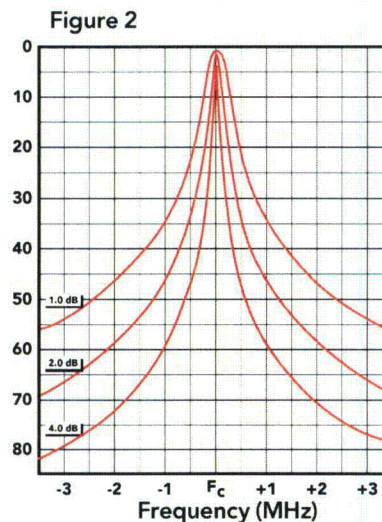
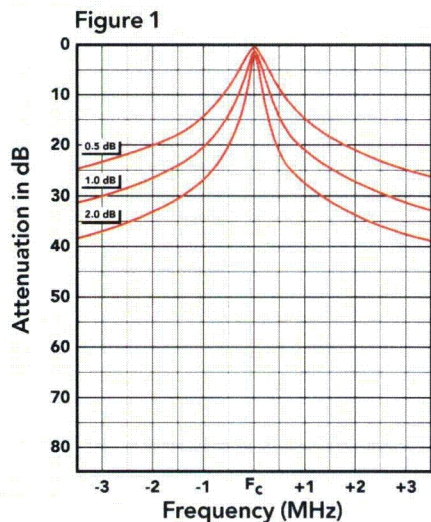


660 Giguere Court, San Jose CA
1-800-331-3396 • 408-929-4400
www.telewave.com

All specifications subject
to change without notice
TWDS-5015 Rev. 12/06

TWPC-2208-1, 2

TYPICAL SELECTIVITY CHARACTERISTICS



MODEL	TWPC-2208-1	TWPC-2208-2
Insertion loss (adjustable)	0.15 to 2.0 dB	0.5 to 4.0 dB
Attenuation	See figure 1	See figure 2
Maximum dimensions with tuners extended in. (cm)	8 x 22 (25 x 56)	8 x 19 x 22 (25 x 48 x 56)
Net weight lb. (kg)	7 (3.2)	15 (6.8)
Shipping weight lb. (kg)	9 (4.1)	19 (8.6)

COMMON SPECIFICATIONS	
Tuning frequency range	200-300 MHz
Nominal impedance	50 ohms
VSWR at resonance (max)	1.5:1
Input power (max) vs. insertion loss	0.5 dB - 350 watts, 1 dB - 250 watts, 2 dB - 150 watts
Temperature range	-30°C to +70°C
Cavity electrical length	¼ wavelength
Outer conductor, end plates	6061-T6 aluminum
Inner conductor, coupling loops	Silver plated copper
Tuning rod	Invar
Contactors, fingerstock	Beryllium copper
Cavity dimensions (Diam. x H) in. (cm)	8 x 18 (20 x 46)
Connectors	N or UHF female (opt.)
Finish	Gray acrylic enamel

NOTE: When ordering be sure to specify exact frequency and model number. Contact the factory if additional information or assistance is required.

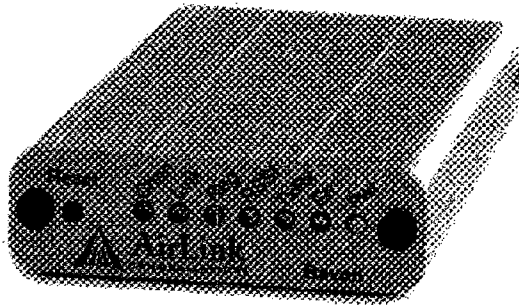


660 Giguere Court, San Jose CA
 1-800-331-3396 • 408-929-4400
 www.telewave.com

All specifications subject to change without notice
 TWDS-5015 Rev. 12/06



Raven CDMA/1x



User Guide



AirLink Communications, Inc.

version 2.23

May 2006

Specifications for the Raven CDMA

Physical Characteristics:

- Weight: < 1 lb.
- Size: 3" x 1.1" x 5.1"
- RF Antenna Connector: 50 Ohm TNC
- Serial Interface: RS232 DB-9F with 1200-115200 bps
- Status LEDs

Data Services & RF Features: CDMA

- Full duplex transceiver
- Dual-band support for both 800 MHz cellular and 1.9 GHz PCS bands
- Dual band Receive Diversity
- Adheres to CDMA authentication as specified in CDMA2000 1X
- 224 mW RF output (+23.5 dBm)
- Data rates up to 153.6 kbps (forward channel) and 76.8 kbps (reverse channel)

Environmental:

- Operating ranges: -30°C to +70°C

- Humidity: 5%-95% Non-condensing

Power Management:

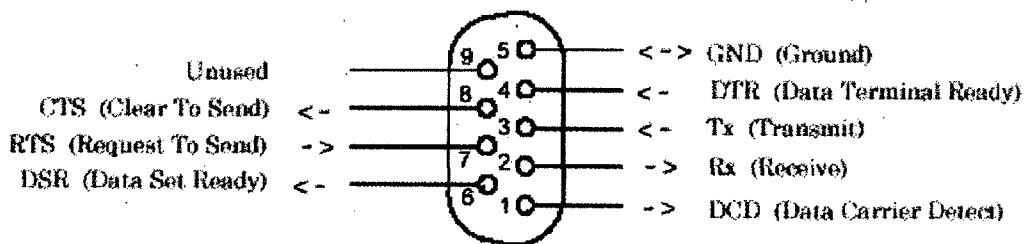
- Low power consumption
- Dormant connection (idle for 10-20 seconds): at 12 VDC
- Input Voltage: 10 VDC to 28 VDC
- Input Current: 20 mA to 350 mA
- Low power mode: at 12 VDC

Power consumption

Modem	Idle	Transmitting
Raven C3211	50 mAh	200-300 mAh
Raven C3210	50 mAh	250-300 mAh

Serial Port Pin-outs

The cable between the modem and a computer or other serial device needs to be wired straight-through (pin 1 goes to pin 1, pin 2 to pin 2, etc).



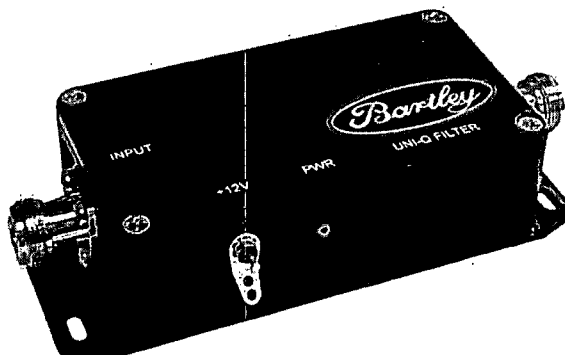


Active Front End Crystal Filter

“When Communication Is Critical You Can’t Afford Interference”

Features

- Eliminates Adjacent Channel Interference
- Entire Receiver Front End Solution: Includes Pre-Amplifier, and Channel Selection Filtering
- Fixed Frequency Filter, No Tuning Required
- Factory Set Gain From 0 to 10 dB
- Very Low Noise Figure
- Available Bandwidths: 6.25 kHz, 12.5 kHz, or 25 kHz
- 4-Pole or 8-Pole Filter Response from 10 – 250 MHz
- DC: Into Side Terminal or External Bias Tee on Output



Description

The UNI-Q is an active bandpass filter designed to solve interference problems by eliminating unwanted signals before they get to the receiver. The UNI-Q is factory tuned to pass your specific receive frequency at the gain you choose. A channel that was once plagued by interference and rendered useless can be made useful again with the UNI-Q filter. With wireless technology becoming more widely used, the issue of receiver interference is getting worse. Giving up a channel isn't feasible, especially with today's demands to keep the lines of communication open. Typical applications include Police, Fire, EMS, SCADA, and commercial two-way radio systems.

Electrical Specifications

Parameter ¹	Frequency	Min.	Typ.	Max.	Units
Gain (Customer Specified)	10 - 250 MHz	0		10	dB
Noise Figure	10 - 250 MHz		1.0	1.2	dB
Intermodulation Products ²	10 - 250 MHz			-100	dBm
Input Power for 1 dB Compression	10 - 250 MHz	-2	0		dBm
VSWR (I/O)	10 - 250 MHz		1.4:1	1.5:1	
6.25 kHz Bandwidth Availability	10 – 150 MHz				
12.5 kHz Bandwidth Availability	10 – 200 MHz				
25 kHz Bandwidth Availability	10 – 250 MHz				
Bandwidth Tolerance	-/+ 5 %				
Channel Ripple	1 dB max				
Channel Configuration	1 Simplex Channel				
I/O Impedance	50 Ω				
I/O Connectors	Type N Female (Other Connectors Available Upon Request)				
Power Requirement	70 mA @ 12V DC Stand-Alone (115V AC, 9 - 36V DC, or 18 - 75V DC in 19" Rack)				
Weight	< 1 lb Stand-Alone (< 5 lbs in 1U 19" Rack Mount Chassis)				
Size	2.4" x 4.4" x 1.3" Stand-Alone (1U 19" Rack Mount Chassis 19" x 8" x 1.75")				

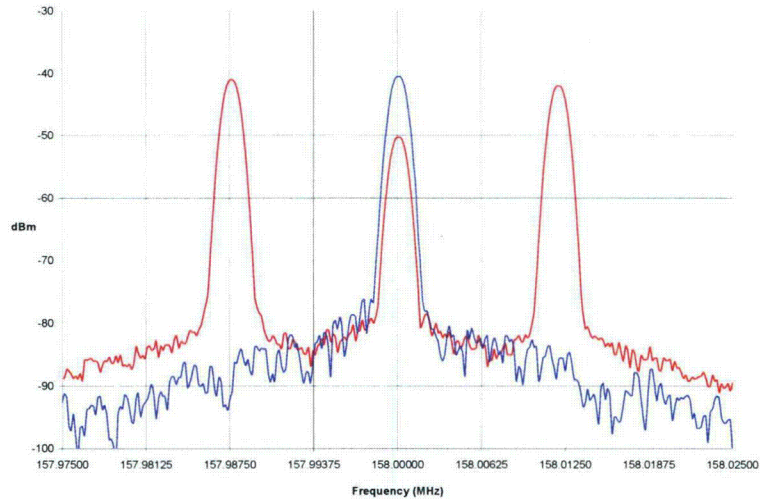
1. All measurements made in a 50 Ω system

2. Intermodulation product tone spacing = 500 kHz, Pin per tone = -40 dBm

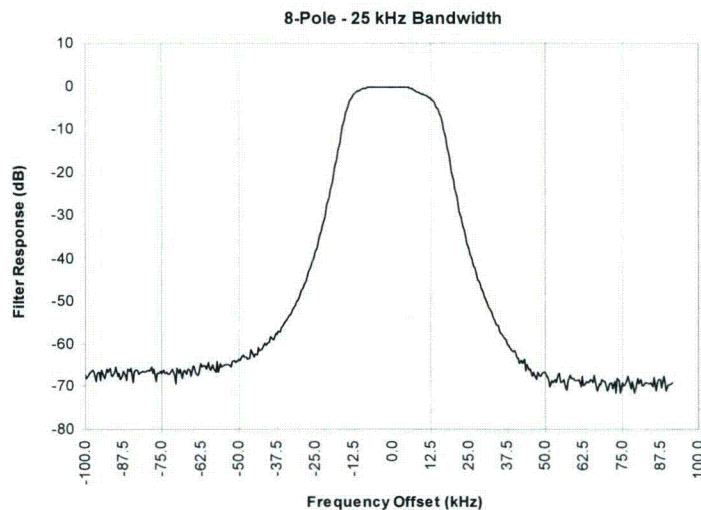


Performance Data

The red trace shows 50 kHz of VHF spectrum measured at a receiver site in a heavily populated metropolitan area. The blue trace shows the same spectrum measured after installation of the UNI-Q filter. The desired signal is amplified while interference is eliminated. The lines of communication are kept clear.



Filter Response Data – Normalized to 0 dB Gain



Absolute Maximum Ratings

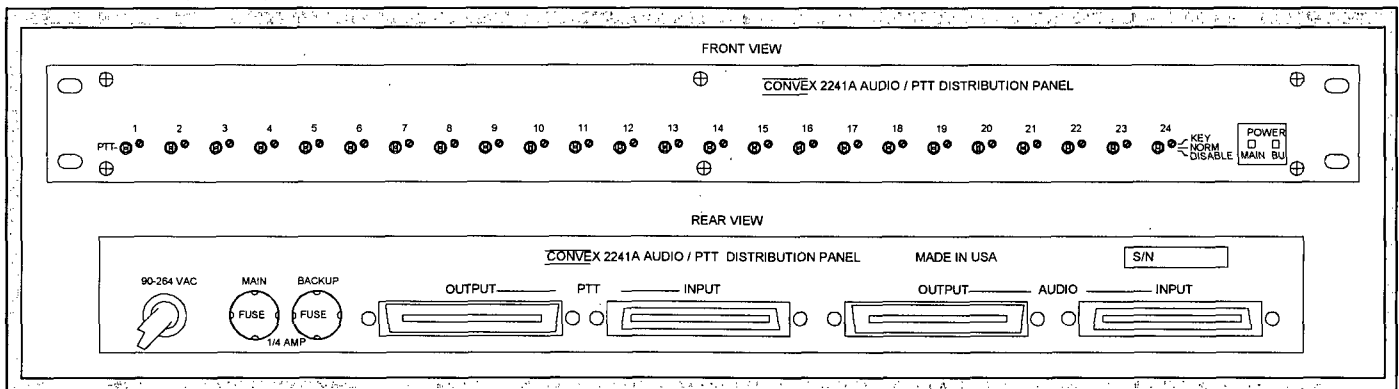
Characteristic	Value
RF Input Power	-15 dBm - Gain
Operating Temperature	-20°C to +60°C
Storage Temperature	-40°C to +85°C

Note: Exceeding these parameters may cause permanent damage.



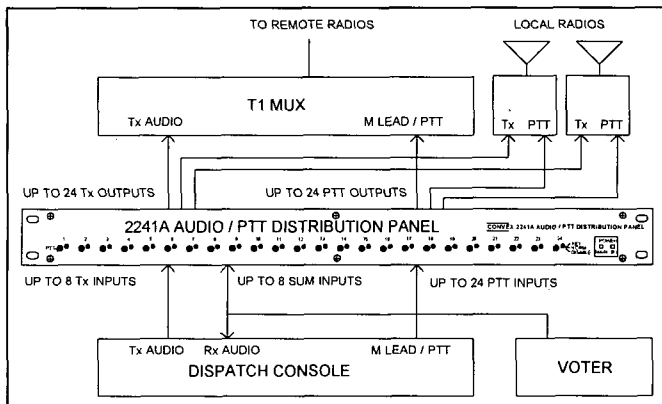
CONVEX

AUDIO / PTT DISTRIBUTION PANEL 2241A



2241A AUDIO / PTT DISTRIBUTION PANEL

The 2241A Panel provides a compact means of distributing audio and Push to Talk (PTT) signals to as many as 24 base stations. In addition, it provides manual PTT override for individual transmitters. 24, lighted, front panel switches permit each radio to be keyed, disabled, or track normal console control. Manual PTT control is used for installation and management of radio networks. It is also used to align simulcast networks by enabling one transmitter at a time to measure delay.



The 2241A is packaged in a 1U high, rack mounting, panel. Power options include a universal **AC Supply**; or **12, 24, or 48 Volt DC Supplies**. **Redundant** power modules can be replaced while the panel is in service. Front panel LEDs indicate the status of each power module. A contact closure is provided across pins 25/50 on the Audio Output Connector to alarm in the event of a power module failure.

Audio and PTT distribution is configured by 7 internal switches which can be set to fan out a single input to up to 24 outputs, 2 inputs to 12 outputs, or various other configurations.

- Distribution Capacity:**
- 24 Audio Outputs per 2241A
 - 8 Audio Inputs per 2241A
 - 8 Summing Inputs per 2241A
 - 24 PTT Outputs per 2241A
 - 8 PTT Inputs can be distributed
 - 24 PTT Inputs for buffering, or logic conversion

PTT BUFFERING High current PTT Outputs permit direct drive of equipment requiring up to 100 mA keying current. The Panel accepts 12 or 24 low current PTT inputs and provides high current outputs.

PTT LOGIC CONVERSION Independent PTT Input and Output Logic Selectors permit PTT logic conversion among: E/M, TTL, and *Digitac.

SPECIFICATIONS

AUDIO DISTRIBUTION AMPS

- Frequency Range: 20 Hz to 5000 Hz
- Tx Inputs: 8 Floating, Balanced, 600 Ohm
- Sum Inputs: 8 Floating, Balanced, 600 / Hi Z
- Outputs: 24 Floating, Balanced, 600 Ohm
- Gain: 0 dB, +/- 10 dB / 24 FP controls
- I/O Return Loss: Greater than 26 dB
- Input/Output Level: +10 dBm maximum
- Noise: Less than -60 dBmC

PTT CIRCUITS

- Outputs: 24 High Current (100 mA) Outputs
E/M, TTL, or *Digitac / Relay Closure
- Inputs: 24 E/M Type 1-5, TTL, or *Digitac
8 Inputs for distribution applications
M Type I,II,III: Key <-20 V / Idle >-20 V
M Type IV, V; E: Key >-20 / Idle <-20 V
TTL: Key < +2.5 V / Idle > +2.5 V
*Digitac: Key < +6 V / Idle > +6 V
* Digitac is a Trademark of Motorola Inc.

AUDIO / PTT DISTRIBUTION CONTROL

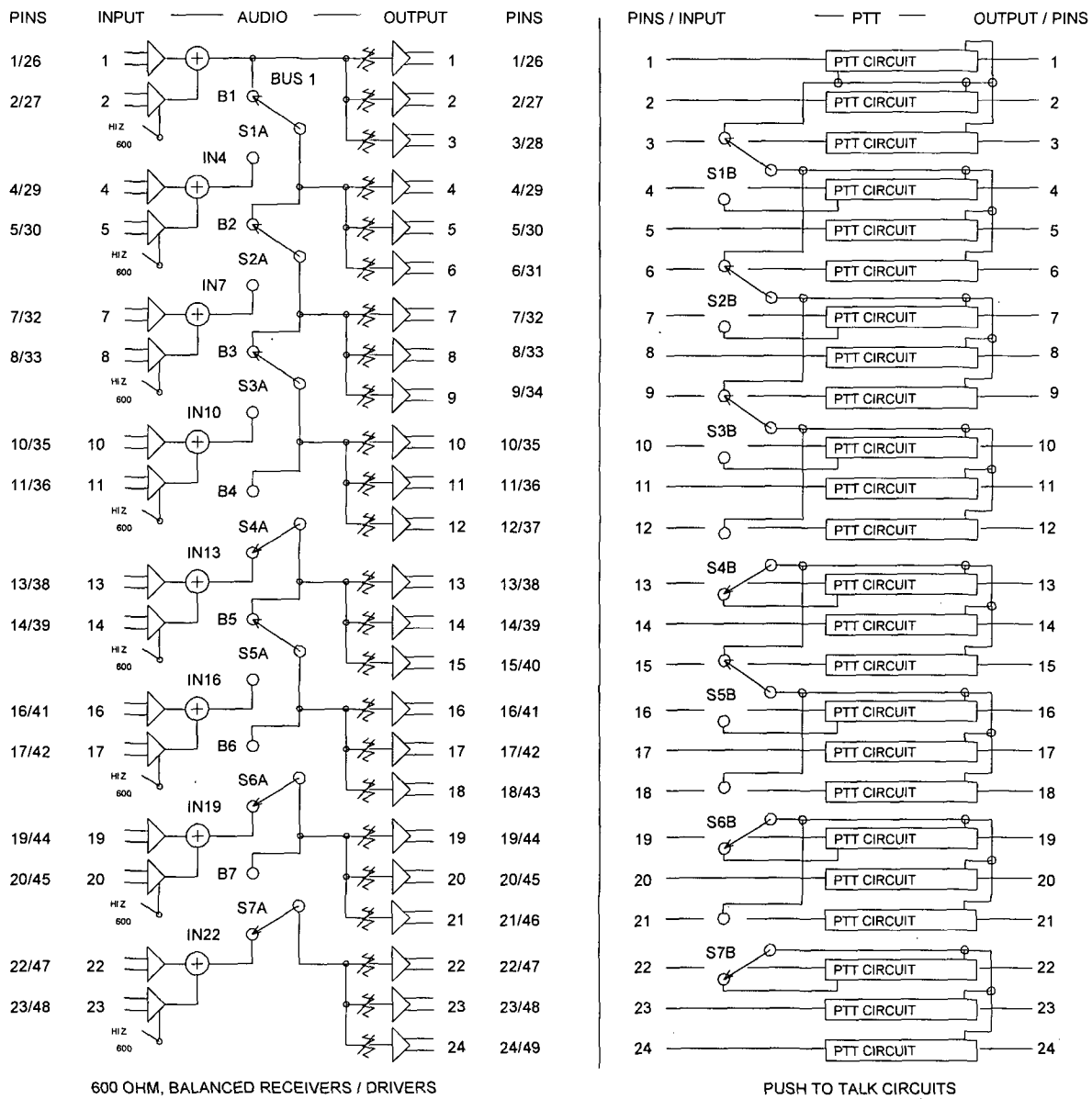
- 7 Switches: 1 Input to 24 Outputs, or
2 Inputs to 12 Outputs each, or
numerous other distribution options.

MANUAL PTT CONTROL

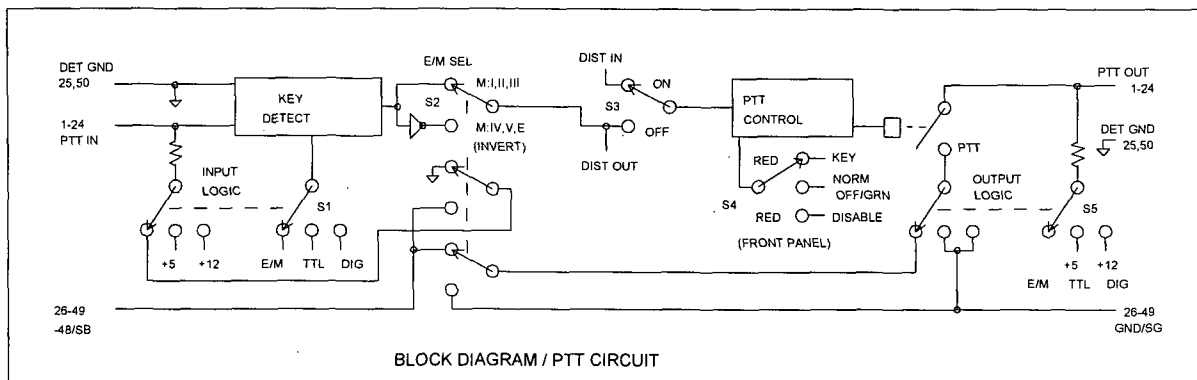
- PTT Switches 24 (3 Position) Front Panel Switches
- KEY:** Keys transmitter / Lit Red
- NORMAL** Console control / Lit Green = PTT
- DISABLE** Disables PTT / Lit Red

- ENVIRONMENT:** -30 to 60° C, 95% R.H.
- I/O CONNECTORS:** 2 sets of 50 pin "Telco" type
- DIMENSIONS:** 1.7" H x 10" D x 19" W. / 6 lbs.
- POWER** 90-264 VAC; Order: 2241A-AC
12, 24, or 48 VDC, Order: 2241A-XX

WARRANTY All Convex Products are warranted to be free of manufacturing defects for a period of one year.



BLOCK DIAGRAM / 2241A AUDIO / PTT DISTRIBUTION PANEL



APPENDIX G SUPPORTING DOCUMENTATION/REFERENCES

Code of Federal Regulations, Title 44, Chapter I, Part 350, "Review and Approval of State and Local Radiological Emergency Plans and Preparedness", Planning Standard E

NUREG-0654/FEMA-REP-1, Rev. 1, "Criteria for Preparation and Evaluation of Radiological Emergency response Plans and Preparedness in Support of Nuclear Power Plants", U.S. Nuclear Regulatory Commission/ Federal Emergency Management Agency, November 1980

FEMA-REP-10, "Guide for the Evaluation of Alert and Notification Systems for Nuclear Power Plants", Federal Emergency Management Agency, November 1985

Energy Policy Act of 2005, Public Law 109-58, section 651(b), "Backup Power for Certain Emergency Notification Systems." August 8, 2005

CPG 1-17, "Outdoor Warning Systems Guide", Federal Emergency Management Agency, March 1, 1980

American National Standards Institute (ANSI) S12.14-1992, "Methods for the Fixed Measurement of the Sound Output of Audible Public Warning Devices Installed at Fixed Locations Outdoors"

International Organization for Standardization ISO 9613-2:1996, International Standard, "Acoustics – Attenuation of Sound During Propagation Outdoors"

American National Standards Institute (ANSI) S12.18-1994, "Procedures for Outdoor Measurements of Sound Pressure Level"

Entergy Nuclear Northeast "Report on Trees and Tree Trimming at the Indian Point Energy Center (IPEC) Alert Notification Siren Sites, September 24, 2007 to November 17, 2007," Volume I – Putnam and Westchester Counties, November 30, 2007

Entergy Nuclear Northeast "Report on Trees and Tree Trimming at the Indian Point Energy Center (IPEC) Alert Notification Siren Sites, September 24, 2007 to November 17, 2007," Volume II – Orange and Rockland Counties, November 30, 2007

"Acoustic Testing of Prompt Alert Notification System Sirens from Indian Point Energy Center", Volume I Chamber Testing, Georgia Tech Research Institute GTRI Report D5600-Volume I, Wyle Laboratories Report WR-07-25, Volume I, dated 3/08

"Acoustic Testing of Prompt Alert Notification System Sirens from Indian Point Energy Center", Volume II Outdoor Siren Testing, Georgia Tech Research Institute GTRI Report D5600-Volume II, Wyle Laboratories Report WR-07-25, Volume II, dated 3/08

"Acoustic Testing of Prompt Alert Notification System Sirens from Indian Point Energy Center", Volume III New Omni-Directional Siren Output Validation, Georgia Tech Research Institute GTRI Report D5600-Volume III, Wyle Laboratories Report WR-07-25, Volume III, dated 3/08

"General Acoustical Analysis of the New Indian Point Siren System – Final Report", August 2007, Blue Ridge Research and Consulting

Entergy Nuclear Failure Modes and Effects Analysis (FMEA) of the New Siren System for Indian Point Energy Center, IP-RPT-08-00005, April 2008

MIL-STD-1629, "Procedures for Performing a Failure Mode, Effects and Criticality Analysis", Military Standards and Specifications, November 24, 1980

MIL-STD 882, "Safety System Program Requirements", Military Standards and Specifications, July 15, 1969

MIL-HDBK-217F, "Reliability Prediction of Electronic Equipment", US Department of Defense, December 2, 1991

Table H-1
IPC ANS RELIABILITY TESTING

TEST	DATE	LOCATION	METHOD	TIME	WESTCHESTER			PUTNAM			ORANGE			ROCKLAND			ALL COUNTIES			RELIABILITY
					PASS	FAIL	% SUCCESS	PASS	FAIL	% SUCCESS	PASS	FAIL	% SUCCESS	PASS	FAIL	% SUCCESS	PASS	FAIL	% SUCCESS	
1	Wednesday, August 01, 2007	WP	MICROWAVE	11:00	67	2	97.10%	14	0	100.00%	22	0	100.00%	44	1	97.78%	147	3	98.00%	98.00%
2	Wednesday, August 01, 2007	WP	MICROWAVE	11:45	67	2	97.10%	14	0	100.00%	22	0	100.00%	44	1	97.78%	147	3	98.00%	98.00%
3	Wednesday, August 01, 2007	EOC	MICROWAVE	13:00	68	1	98.55%	14	0	100.00%	2	19	13.84%	45	0	100.00%	130	20	86.67%	94.22%
4	Wednesday, August 01, 2007	EOC	MICROWAVE	13:45	67	2	97.10%	14	0	100.00%	22	0	100.00%	45	0	100.00%	148	2	98.67%	95.33%
5	Wednesday, August 01, 2007	IPC	MICROWAVE	18:00	69	0	100.00%	14	0	100.00%	22	0	100.00%	45	0	100.00%	150	0	100.00%	96.27%
6	Wednesday, August 01, 2007	IPC	MICROWAVE	18:45	69	0	100.00%	14	0	100.00%	22	0	100.00%	45	0	100.00%	150	0	100.00%	96.89%
7	Thursday, August 02, 2007	IPC	MICROWAVE	08:30	69	0	100.00%	14	0	100.00%	22	0	100.00%	45	0	100.00%	150	0	100.00%	97.33%
8	Thursday, August 02, 2007	IPC	MICROWAVE	09:15	69	0	100.00%	14	0	100.00%	22	0	100.00%	45	0	100.00%	150	0	100.00%	97.67%
9	Thursday, August 02, 2007	WP	MICROWAVE	15:00	69	0	100.00%	14	0	100.00%	22	0	100.00%	43	2	95.56%	148	2	98.67%	97.78%
10	Thursday, August 02, 2007	WP	MICROWAVE	15:45	69	0	100.00%	14	0	100.00%	22	0	100.00%	44	1	97.78%	149	1	99.33%	97.93%
11	Thursday, August 02, 2007	EOC	MICROWAVE	17:00	69	0	100.00%	14	0	100.00%	21	1	95.45%	44	1	97.78%	148	2	98.67%	98.00%
12	Thursday, August 02, 2007	EOC	MICROWAVE	17:45	69	0	100.00%	14	0	100.00%	21	1	95.45%	44	1	97.78%	148	2	98.67%	98.06%
13	Friday, August 03, 2007	EOC	MICROWAVE	10:00	69	0	100.00%	12	2	85.71%	22	0	100.00%	45	0	100.00%	148	2	98.67%	98.10%
14	Friday, August 03, 2007	EOC	MICROWAVE	10:45	69	0	100.00%	14	0	100.00%	19	3	86.36%	45	0	100.00%	147	3	98.00%	98.10%
15	Friday, August 03, 2007	IPC	MICROWAVE	15:00	69	0	100.00%	14	0	100.00%	22	0	100.00%	44	1	97.78%	149	1	99.33%	98.18%
16	Friday, August 03, 2007	IPC	MICROWAVE	15:45	68	1	98.55%	14	0	100.00%	22	0	100.00%	44	1	97.78%	148	2	98.67%	98.21%
17	Friday, August 03, 2007	WP	MICROWAVE	17:00	69	0	100.00%	13	1	92.86%	22	0	100.00%	45	0	100.00%	149	1	99.33%	98.27%
18	Friday, August 03, 2007	WP	MICROWAVE	17:45	69	0	100.00%	14	0	100.00%	22	0	100.00%	45	0	100.00%	150	0	100.00%	98.37%
19	Saturday, August 04, 2007	EOC	MICROWAVE	09:30	68	1	98.55%	14	0	100.00%	22	0	100.00%	43	2	95.56%	147	3	98.00%	98.35%
20	Saturday, August 04, 2007	EOC	MICROWAVE	10:15	69	0	100.00%	14	0	100.00%	22	0	100.00%	45	0	100.00%	150	0	100.00%	98.43%
21	Saturday, August 04, 2007	WP	MICROWAVE	12:00	69	0	100.00%	14	0	100.00%	22	0	100.00%	45	0	100.00%	150	0	100.00%	98.51%
22	Saturday, August 04, 2007	WP	MICROWAVE	12:45	69	0	100.00%	14	0	100.00%	22	0	100.00%	45	0	100.00%	150	0	100.00%	98.58%
23	Saturday, August 04, 2007	IPC	MICROWAVE	17:00	69	0	100.00%	14	0	100.00%	22	0	100.00%	45	0	100.00%	150	0	100.00%	98.64%
24	Saturday, August 04, 2007	IPC	MICROWAVE	17:45	69	0	100.00%	14	0	100.00%	22	0	100.00%	45	0	100.00%	150	0	100.00%	98.69%
25	Monday, August 06, 2007	IPC	MICROWAVE	10:30	69	0	100.00%	14	0	100.00%	22	0	100.00%	45	0	100.00%	150	0	100.00%	98.75%
26	Monday, August 06, 2007	IPC	MICROWAVE	11:15	69	0	100.00%	14	0	100.00%	22	0	100.00%	45	0	100.00%	150	0	100.00%	98.79%
27	Monday, August 06, 2007	WP	MICROWAVE	15:00	69	0	100.00%	14	0	100.00%	22	0	100.00%	45	0	100.00%	150	0	100.00%	98.84%
28	Monday, August 06, 2007	WP	MICROWAVE	15:45	69	0	100.00%	14	0	100.00%	22	0	100.00%	45	0	100.00%	150	0	100.00%	98.88%
29	Monday, August 06, 2007	EOC	MICROWAVE	17:00	69	0	100.00%	14	0	100.00%	22	0	100.00%	45	0	100.00%	150	0	100.00%	98.92%
30	Monday, August 06, 2007	EOC	MICROWAVE	17:45	69	0	100.00%	14	0	100.00%	22	0	100.00%	45	0	100.00%	150	0	100.00%	98.96%
**31	Tuesday, August 14, 2007	EOC	TCP/IP	09:30	0	71	0.00%	14	0	100.00%	22	0	100.00%	48	0	100.00%	84	71	54.19%	97.47%
**32	Tuesday, August 14, 2007	EOC	TCP/IP	10:15	70	1	98.59%	13	1	92.86%	20	2	90.91%	48	0	100.00%	151	4	97.42%	97.46%
33	Tuesday, August 07, 2007	IPC	TCP/IP	15:00	70	1	98.59%	13	1	92.86%	21	1	95.45%	48	0	100.00%	152	3	98.06%	97.48%
34	Tuesday, August 07, 2007	IPC	TCP/IP	15:45	69	2	97.18%	14	0	100.00%	21	1	95.45%	48	0	100.00%	152	3	98.06%	97.50%
35	Tuesday, August 07, 2007	WP	TCP/IP	17:30	71	0	100.00%	14	0	100.00%	21	1	95.45%	48	0	100.00%	154	1	99.35%	97.55%
36	Tuesday, August 07, 2007	WP	TCP/IP	18:15	71	0	100.00%	14	0	100.00%	21	1	95.45%	48	0	100.00%	154	1	99.35%	97.61%
37	Wednesday, August 08, 2007	WP-OBS-S	MICROWAVE	11:00	71	0	100.00%	14	0	100.00%	22	0	100.00%	48	0	100.00%	155	0	100.00%	97.67%
38	Wednesday, August 08, 2007	WP	MICROWAVE	11:45	69	2	97.18%	14	0	100.00%	22	0	100.00%	47	1	97.92%	152	3	98.06%	97.68%
39	Wednesday, August 08, 2007	EOC	MICROWAVE	13:00	71	0	100.00%	14	0	100.00%	12	10	54.55%	47	1	97.92%	144	11	92.90%	97.56%
40	Wednesday, August 08, 2007	EOC	MICROWAVE	13:45	71	0	100.00%	14	0	100.00%	22	0	100.00%	48	0	100.00%	155	0	100.00%	97.62%
41	Wednesday, August 08, 2007	IPC	MICROWAVE	19:00	71	0	100.00%	14	0	100.00%	22	0	100.00%	48	0	100.00%	155	0	100.00%	97.68%
42	Wednesday, August 08, 2007	IPC	MICROWAVE	19:45	70	1	98.59%	13	1	92.86%	22	0	100.00%	47	1	97.92%	152	3	98.06%	97.69%
**43	Monday, August 13, 2007	IPC	T1	09:00	68	3	95.77%	14	0	100.00%	22	0	100.00%	47	1	97.92%	151	4	97.42%	97.68%
**44	Monday, August 13, 2007	IPC	T1	09:45	71	0	100.00%	14	0	100.00%	22	0	100.00%	44	4	91.67%	151	4	97.42%	97.68%
**45	Monday, August 13, 2007	WP	T1	15:30	70	1	98.59%	14	0	100.00%	22	0	100.00%	47	1	97.92%	153	2	98.71%	97.69%
**46	Monday, August 13, 2007	WP	T1	16:15	71	0	100.00%	14	0	100.00%	22	0	100.00%	47	1	97.92%	154	1	99.35%	97.72%
**47	Monday, August 13, 2007	EOC	T1	17:45	69	2	97.18%	14	0	100.00%	21	1	95.45%	45	3	93.75%	149	6	96.13%	97.94%
**48	Monday, August 13, 2007	EOC	T1	18:30	71	0	100.00%	14	0	100.00%	22	0	100.00%	47	1	97.92%	154	1	99.35%	97.95%
49	Friday, August 10, 2007	Westchester	INTEGRATED/MICRO	11:00	70	1	98.59%	14	0	100.00%	22	0	100.00%	48	0	100.00%	154	1	99.35%	97.77%
50	Friday, August 10, 2007	WP	INTEGRATED/MICRO	11:45	71	0	100.00%	14	0	100.00%	22	0	100.00%	48	0	100.00%	155	0	100.00%	97.82%
***51	Friday, August 10, 2007	EOC	INTEGRATED/MICRO	14:00	71	0	100.00%	14	0	100.00%	22	0	100.00%	48	0	100.00%	155	0	100.00%	97.86%
***52	Friday, August 10, 2007	EOC	INTEGRATED/MICRO	14:45	71	0	100.00%	14	0	100.00%	22	0	100.00%	48	0	100.00%	155	0	100.00%	97.90%
53	Friday, August 10, 2007	IPC	INTEGRATED/MICRO	17:00	71	0	100.00%	14	0	100.00%	22	0	100.00%	48	0	100.00%	155	0	100.00%	97.94%
54	Friday, August 10, 2007	IPC	INTEGRATED/MICRO	17:45	71	0	100.00%	14	0	100.00%	22	0	100.00%	48	0	100.00%	155	0	100.00%	97.98%
55	Saturday, August 11, 2007	EOC-OBS-F	MICROWAVE	10:00	67	4	94.37%	14	0	100.00%	21	1	95.45%	47	1	97.92%	149	6	96.13%	97.95%
56	Tuesday, August 14, 2007	Westchester OBS-F	INTEGRATED/MICRO		71	0	100.00%	14	0	100.00%	22	0	100.00%	48	0	100.00%	155	0	100.00%	97.98%
RELIABILITY					3818	98	97.50%	778	6	99.23%	1190	42	96.59%	2572	26	99.00%	8358	172	97.96%	98.00%

NOTES:
* ORIGINALLY SCHEDULED FOR TUESDAY, AUGUST 7, 2007. TESTING WAS SUSPENDED DUE TO A CHEMICAL SPILL IN WESTCHESTER COUNTY.
** ORIGINALLY SCHEDULED FOR THURSDAY, AUGUST 9, 2007. TESTING WAS SUSPENDED DUE TO T1/RADIO COMMUNICATIONS ISSUES. REF: CR-IP2-2007-03209
*** WESTCHESTER ALTERNATE EOC (MARTINE AVENUE) RATHER THAN WESTCHESTER EOC.

Table H-2
IPEC ANS DIAGNOSTIC TESTING

DATE	TIME	ACTIVATION TYPE	ACTIVATION LOCATION	SIREN	# OF SIRENS TESTED	# OF SIRENS PASSED	# OF SIRENS FAILED
Wednesday, August 01, 2007	9:45 AM	SINGLE	EOF	205	1	1	0
Wednesday, August 01, 2007	10:08 AM	SINGLE	EOF	353	1	1	0
Wednesday, August 01, 2007	10:41 AM	SINGLE	EOF	221	1	0	1
Wednesday, August 01, 2007	11:44 AM	SINGLE	EOF	233	1	1	0
Wednesday, August 01, 2007	12:55 PM	SINGLE	EOF	236	1	1	0
Wednesday, August 01, 2007	1:02 PM	SINGLE	EOF	302	1	0	1
Wednesday, August 01, 2007	1:08 PM	SINGLE	EOF	316	1	1	0
Wednesday, August 01, 2007	2:53 PM	GROUP	EOC	ALL	150	149	1
Wednesday, August 01, 2007	3:49 PM	SINGLE	EOF	302	1	1	0
Thursday, August 02, 2007	11:04 AM	SINGLE	EOF	405	1	1	0
Thursday, August 02, 2007	2:43 PM	SINGLE	EOF	406	1	1	0
Thursday, August 02, 2007	6:05 PM	GROUP	EOF	ALL	150	149	1
Thursday, August 02, 2007	6:31 PM	GROUP	EOF	ALL	150	141	9
Thursday, August 02, 2007	6:46 PM	GROUP	EOF	ALL	150	150	0
Thursday, August 02, 2007	7:27 PM	GROUP	EOF	ALL	150	150	0
Thursday, August 02, 2007	7:45 PM	SINGLE	EOF	325	1	1	0
Friday, August 03, 2007	3:19 PM	SINGLE	EOF	221	1	1	0
Monday, August 06, 2007	8:00 PM	GROUP	EOF	ALL	155	152	3
Monday, August 06, 2007	8:27 PM	GROUP	MOBILE CCU	ALL	155	154	1
Tuesday, August 07, 2007	7:40 AM	GROUP	MOBILE CCU	ALL	0	0	0
Tuesday, August 07, 2007	7:42 AM	GROUP	MOBILE CCU	ALL	155	155	0
Tuesday, August 07, 2007	8:06 AM	GROUP	MOBILE CCU	ALL	155	154	1
Tuesday, August 07, 2007	8:36 AM	GROUP	EOF	ALL	155	154	1
Tuesday, August 07, 2007	9:07 AM	SINGLE	EOF	107	1	1	0
Tuesday, August 07, 2007	9:27 AM	SINGLE	EOF	371	1	1	0
Tuesday, August 07, 2007	9:34 AM	GROUP	MOBILE CCU	ALL	155	152	3
Tuesday, August 07, 2007	10:07 AM	SINGLE	GSB	371	1	1	0
Tuesday, August 07, 2007	10:13 AM	SINGLE	EOF	247	1	1	0
Tuesday, August 07, 2007	10:29 AM	SINGLE	EOF	371	1	0	1
Tuesday, August 07, 2007	10:37 AM	SINGLE	GSB	246	1	1	0
Tuesday, August 07, 2007	11:00 AM	SINGLE	EOF	246	1	1	0
Tuesday, August 07, 2007	11:11 AM	SINGLE	GSB	370	1	0	1
Tuesday, August 07, 2007	11:40 AM	GROUP	GSB	ALL	155	152	3
Tuesday, August 07, 2007	11:43 AM	GROUP	MOBILE CCU	ALL	155	155	0
Tuesday, August 07, 2007	12:22 PM	GROUP	MOBILE CCU	ALL	155	155	0
Tuesday, August 07, 2007	1:45 PM	SINGLE	EOF	371	1	1	0
Wednesday, August 08, 2007	8:02 AM	GROUP	EOF	ALL	155	155	0
Wednesday, August 08, 2007	10:07 AM	SINGLE	EOF	370	1	1	0
Wednesday, August 08, 2007	3:49 PM	SINGLE	EOF	325	1	1	0
Wednesday, August 08, 2007	3:54 PM	SINGLE	EOF	248	1	1	0
Wednesday, August 08, 2007	4:00 PM	GROUP	MOBILE CCU	ALL	155	154	1
Wednesday, August 08, 2007	4:23 PM	SINGLE	EOF	308	1	1	0
Wednesday, August 08, 2007	5:35 PM	SINGLE	EOF	102	1	0	1
Wednesday, August 08, 2007	6:23 PM	GROUP	NEM	ALL	155	155	0
Thursday, August 09, 2007	9:38 AM	GROUP	EOF	ALL	155	0	155
Thursday, August 09, 2007	10:12 AM	SINGLE	EOF	331	1	1	0
Thursday, August 09, 2007	10:15 AM	SINGLE	EOF	320	1	1	0
Thursday, August 09, 2007	10:22 AM	SINGLE	EOF	318	1	1	0
Thursday, August 09, 2007	10:31 AM	SINGLE	EOF	322	1	1	0
Thursday, August 09, 2007	10:33 AM	SINGLE	GSB	365	1	0	1
Thursday, August 09, 2007	10:38 AM	SINGLE	EOF	344	1	0	1
Thursday, August 09, 2007	11:13 AM	GROUP	EOF	ALL	155	105	50
Thursday, August 09, 2007	1:18 PM	GROUP	EOF	ALL	155	109	46
Thursday, August 09, 2007	1:54 PM	GROUP	EOF	ALL	155	154	1
Thursday, August 09, 2007	2:51 PM	SINGLE	EOF	115	1	1	0
Thursday, August 09, 2007	2:51 PM	SINGLE	EOF	212	1	1	0
Thursday, August 09, 2007	2:51 PM	SINGLE	EOF	218	1	1	0
Thursday, August 09, 2007	2:51 PM	SINGLE	EOF	301	1	1	0
Thursday, August 09, 2007	2:51 PM	SINGLE	EOF	306	1	1	0

Table H-2 (Cont'd)
IPEC ANS DIAGNOSTIC TESTING

DATE	TIME	ACTIVATION TYPE	ACTIVATION LOCATION	SIREN	# OF SIRENS TESTED	# OF SIRENS PASSED	# OF SIRENS FAILED
Thursday, August 09, 2007	2:51 PM	SINGLE	EOF	343	1	1	0
Thursday, August 09, 2007	3:21 PM	SINGLE	EOF	232	1	1	0
Thursday, August 09, 2007	3:21 PM	SINGLE	EOF	304	1	1	0
Thursday, August 09, 2007	3:21 PM	SINGLE	EOF	319	1	1	0
Thursday, August 09, 2007	3:38 PM	SINGLE	EOF	229	1	1	0
Thursday, August 09, 2007	3:44 PM	SINGLE	EOF	369	1	1	0
Thursday, August 09, 2007	3:44 PM	SINGLE	EOF	371	1	1	0
Thursday, August 09, 2007	4:02 PM	SINGLE	GSB	353	1	0	1
Thursday, August 09, 2007	4:04 PM	SINGLE	GSB	353	1	0	1
Thursday, August 09, 2007	4:14 PM	SINGLE	EOF	227	1	1	0
Thursday, August 09, 2007	4:26 PM	GROUP	EOF	ALL	155	154	1
Thursday, August 09, 2007	5:52 PM	GROUP	EOF	ALL	155	151	4
Thursday, August 09, 2007	6:22 PM	GROUP	EOF	ALL	155	152	3
Thursday, August 09, 2007	6:39 PM	SINGLE	EOF	307	1	1	0
Thursday, August 09, 2007	6:41 PM	SINGLE	EOF	119	1	1	0
Thursday, August 09, 2007	6:43 PM	SINGLE	EOF	235	1	1	0
Thursday, August 09, 2007	6:48 PM	GROUP	EOF	ALL	155	153	2
Thursday, August 09, 2007	7:08 PM	GROUP	EOF	ALL	155	153	2
Thursday, August 09, 2007	7:27 PM	GROUP	EOF	ALL	155	155	0
Thursday, August 09, 2007	7:38 PM	GROUP	EOF	ALL	155	155	0
Friday, August 10, 2007	1:07 PM	SINGLE	EOF	353	1	1	0
Saturday, August 11, 2007	12:20 PM	SINGLE	EOF	120	1	1	0
Saturday, August 11, 2007	12:25 PM	SINGLE	EOF	321	1	1	0
Saturday, August 11, 2007	1:48 PM	SINGLE	EOF	102	1	1	0
Saturday, August 11, 2007	3:14 PM	SINGLE	EOF	233	1	1	0
Sunday, August 12, 2007	10:58 AM	SINGLE	EOF	345	1	1	0
Sunday, August 12, 2007	11:56 AM	SINGLE	EOF	321	1	1	0
Sunday, August 12, 2007	1:42 PM	SINGLE	EOF	362	1	1	0
Sunday, August 12, 2007	3:05 PM	SINGLE	EOF	355	1	1	0
Sunday, August 12, 2007	6:48 PM	SINGLE	EOF	120	1	1	0
Monday, August 13, 2007	2:18 PM	SINGLE	EOF	218	1	1	0
TOTALS					4376	4079	297
% RELIABILITY: 93.21%							

Table H-3. Activation Locations for Testing Performed September 6-17, 2007

TEST	Westchester	Putnam	Orange	Rockland
1	WP	WP	WP	EOC
2	WP	WP	WP	EOC
3	WP	EOC	EOC	WP
4	WP	EOC	EOC	WP
5	WP	WP	WP	WP
6	WP	WP	WP	WP
7	WP	EOC	EOC	EOC
8	WP	EOC	EOC	EOC
9	EOC	EOC	WP	WP
10	EOC	EOC	WP	WP
11	EOC	WP	EOC	EOC
12	EOC	WP	EOC	EOC
13	EOC	WP	EOC	EOC
14	EOC	WP	EOC	EOC
15	EOC	EOC	WP	WP
16	EOC	EOC	WP	WP
17	Both tests performed by activating sirens in all four counties from the Rockland EOC			
18				
19	Both tests performed by activating sirens in all four counties from the Rockland WP			
20				

- Four tests conducted on each of 5 days (September 6, 7, 10, 11, and 17) for a total of 20 tests
- Test Method: Tests 1 through 16: Microwave Tests 17 through 20: TCP/IP
- Activation Location: See following Table

Table H-4. Control System Test Results for Testing Performed September 6 – 17, 2007

TEST	Westchester		Putnam		Orange		Rockland		All Counties	
	Fail	% Success	Fail	% Success	Fail	% Success	Fail	% Success	Fail	% Success
1	0	100%	0	100%	1	95.4%	0	100%	1	99.3%
2	0	100%	0	100%	1	95.4%	0	100%	1	99.3%
3	0	100%	0	100%	1	95.4%	0	100%	1	99.3%
4	0	100%	0	100%	1	95.4%	6	87.5%	7	95.4%
5	0	100%	0	100%	1	95.4%	0	100%	1	99.3%
6	0	100%	0	100%	1	95.4%	1	97.9%	2	98.7%
7	0	100%	0	100%	1	95.4%	0	100%	1	99.3%
8	0	100%	0	100%	1	95.4%	0	100%	1	99.3%
9	0	100%	0	100%	2	90.9%	0	100%	2	98.7%
10	0	100%	0	100%	1	95.4%	0	100%	1	99.3%
11	0	100%	0	100%	1	95.4%	0	100%	1	99.3%
12	0	100%	0	100%	1	95.4%	0	100%	1	99.3%
13	0	100%	0	100%	1	95.4%	0	100%	1	99.3%
14	0	100%	0	100%	1	95.4%	0	100%	1	99.3%
15	0	100%	0	100%	1	95.4%	0	100%	1	99.3%
16	0	100%	0	100%	1	95.4%	0	100%	1	99.3%
17	1	98.5	0	100%	1	95.4%	0	100%	2	98.7%
18	1	98.5	0	100%	1	95.4%	0	100%	2	98.7%
19	1	98.5	0	100%	2	90.9	0	100%	3	98.0%
20	1	98.5	0	100%	2	90.9	0	100%	3	98.0%

Total success rate: 98.9%

Activation Results:

All 20 tests involved activation of all 155 installed sirens
(Westchester: 71, Putnam: 14, Orange: 22, and Rockland 48)

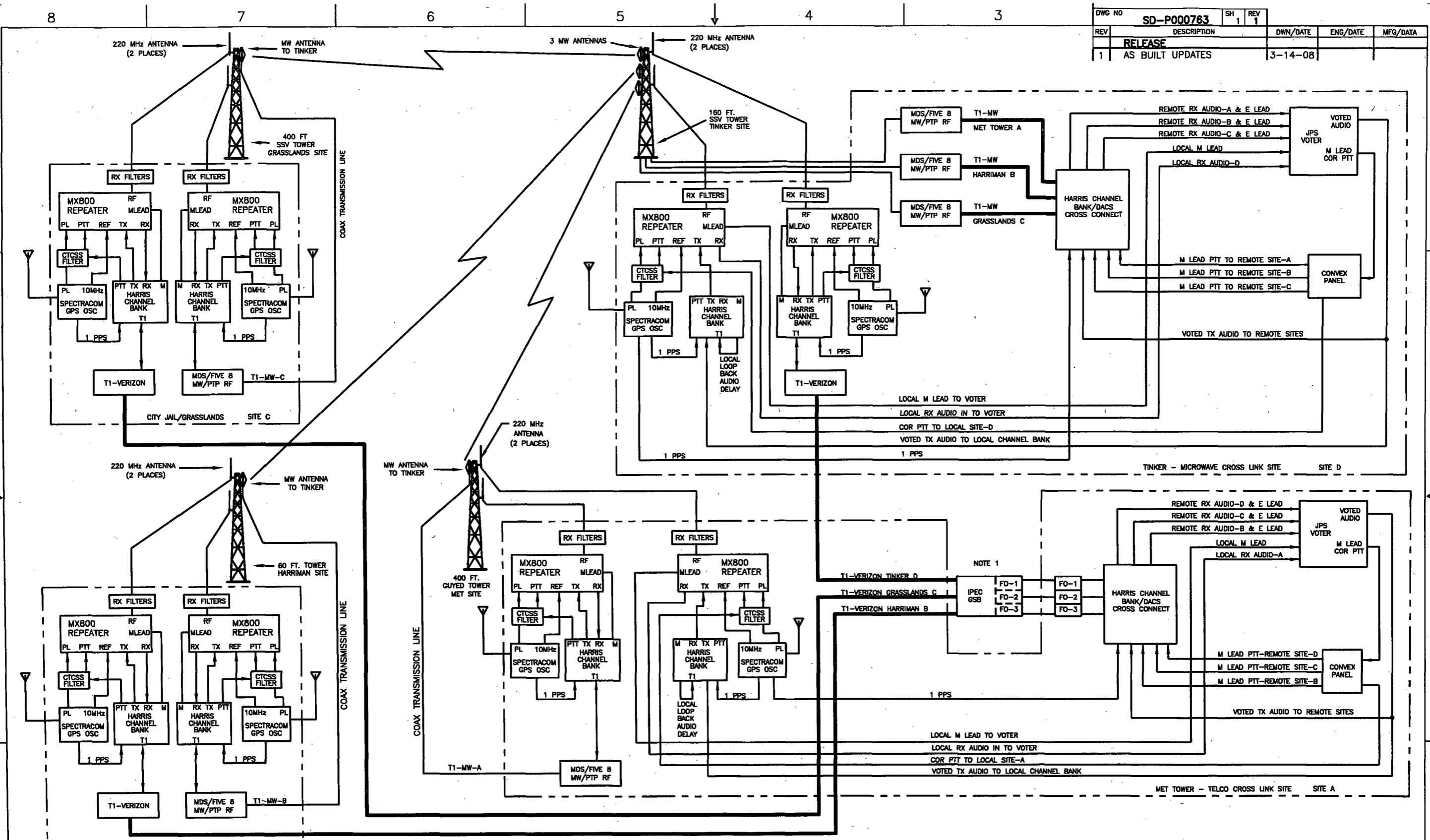
• **Evaluation of Results**

Siren 122 in Orange County had been placed in a maintenance mode. It was a siren that was in the process of being converted from solar-battery power to A/C - battery power and was unavailable for testing. It was recorded as a failure for the purposes of these tests.

In one test on September 6, 2007, six failures were recorded in Rockland County. IPEC consulted with SAIC and determined that the most likely cause of this condition was sporadic radio interference due the close proximity and orientation of several antennas on the roof the Rockland County emergency services building in Pomona, NY. Entergy subsequently confirmed that the transmitter causing the interference had been retired and removed by the county. It was determined that there no longer was 200 MHz interference at this site.

APPENDIX I SIMULCAST RADIO SYSTEM (SCHEMATIC DIAGRAM)

DWG NO	SD-P000763	SH 1	REV 1
REV	DESCRIPTION	DWN/DATE	ENG/DATE
1	RELEASE		
	AS BUILT UPDATES	3-14-08	



NOTES:
 1. VERIZON T1 LINES ARE TERMINATED AT THE GSB & THEN GO TO MET TOWER VIA FIBER OPTICS CONVERTERS.

SIMILAR TO:
 PROPRIETARY DATA
 THE DATA DISCLOSED IN THIS DOCUMENT WAS ORIGINATED BY MICROWAVE DATA SYSTEMS INC. AND IS TO BE UTILIZED ONLY FOR THE SPECIFIC PURPOSE FOR WHICH IT WAS SUPPLIED. IT IS NOT TO BE DISCLOSED TO OTHERS OR REPRODUCED WITHOUT THE PRIOR WRITTEN CONSENT OF MICROWAVE DATA SYSTEMS INC.

UNLESS OTHERWISE SPECIFIED ALL DIMENSIONS IN INCHES TOLERANCES	DRAWN & BUILT CHECKED	DATE 9/29/08	MDS Microwave Data Systems Inc. 175 Science Parkway Rochester, NY 14820 U.S.A.
FRACTIONS ±1/64 ANGLES ±1° DEC XX ±.02 XXX ±.005	ENGR	APPROVED	TITLE IPEC SIREN SIMULCAST RADIO SYSTEM
MATERIAL:	FACTORY ORDER NO.	DEPT WSG	SIZE CAGE CODE DRAWING NO. REV D OSF21 SD-P000763 1
NEXT ASSY USED ON APPLICATION	FINISH	DESIGN ACTIVITY APPROVAL	SCALE NONE WEIGHT SHEET 1 OF 1

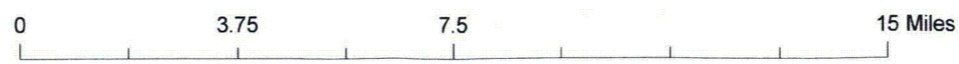
APPENDIX J

**LOCATIONS OF SIRENS, CONTROL STATIONS, AND
REPEATERS (MAP)**



- Legend**
- | | | | |
|---------------------------|----------------|------------|--------------------|
| EPZ | Limited Access | Minor Road | Rivers and Streams |
| Siren Locations (167) | Highway | Other Road | Water Bodies |
| Control Station Locations | Major Road | Ramp | Counties |
| Repeater Tower Locations | Local Road | Ferry | |

**Indian Point Energy Center
Siren, Control Station, and Repeater Locations**



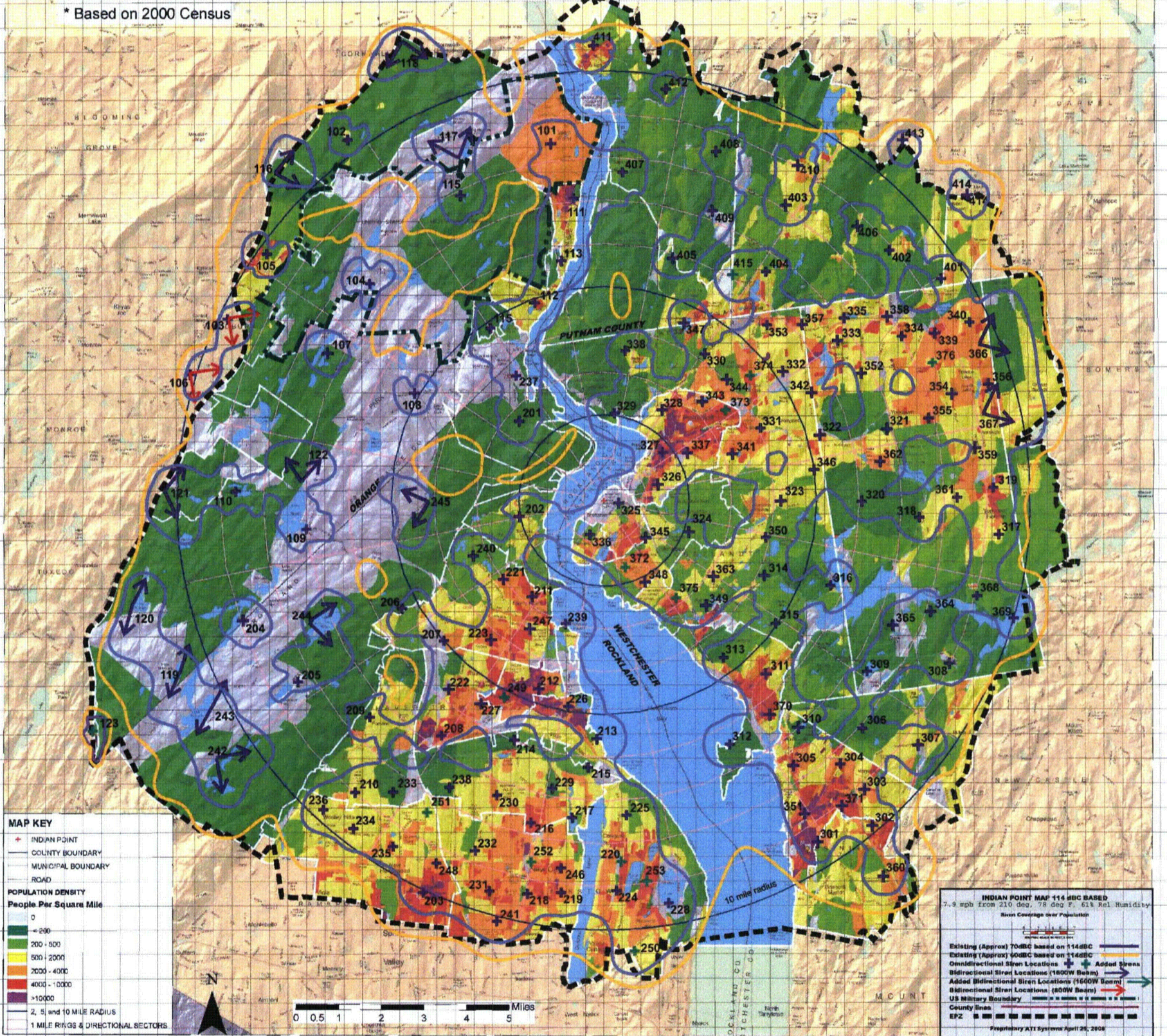
Proprietary ATI
March 19, 2008

APPENDIX K

**SIREN COVERAGE WITHIN THE EPZ OF INDIAN POINT
ENERGY CENTER (MAP)**

IPEC EMERGENCY PLANNING ZONE - POPULATION DENSITY *

* Based on 2000 Census



MAP KEY

- INDIAN POINT
- COUNTY BOUNDARY
- MUNICIPAL BOUNDARY
- ROAD

POPULATION DENSITY

- People Per Square Mile
- 0
 - 0 - 200
 - 200 - 500
 - 500 - 2000
 - 2000 - 4000
 - 4000 - 10000
 - >10000
- 2, 5 and 10 MILE RADIUS
- 1 MILE RINGS & DIRECTIONAL SECTORS



INDIAN POINT MAP 114 SBC BASED
 7.9 mph from 210 deg, 78 deg F, 61% Rel Humidity

Notes Coverage Area Population

- Existing (Approx) 70dB based on 114SBC
- Existing (Approx) 60dB based on 114SBC
- Omnidirectional Siren Locations
- Bidirectional Siren Locations (1800W Beam)
- Added Sirens
- Added Bidirectional Siren Locations (1600W Beam)
- Bidirectional Siren Locations (800W Beam)
- US Military Boundary
- County lines
- EPZ

Proprietary ATIS Systems April 28, 2008