

BESSEY® clamping and cutting technology

Complete catalogue 2011/2012

Effective April 1 2011.



Simply better.

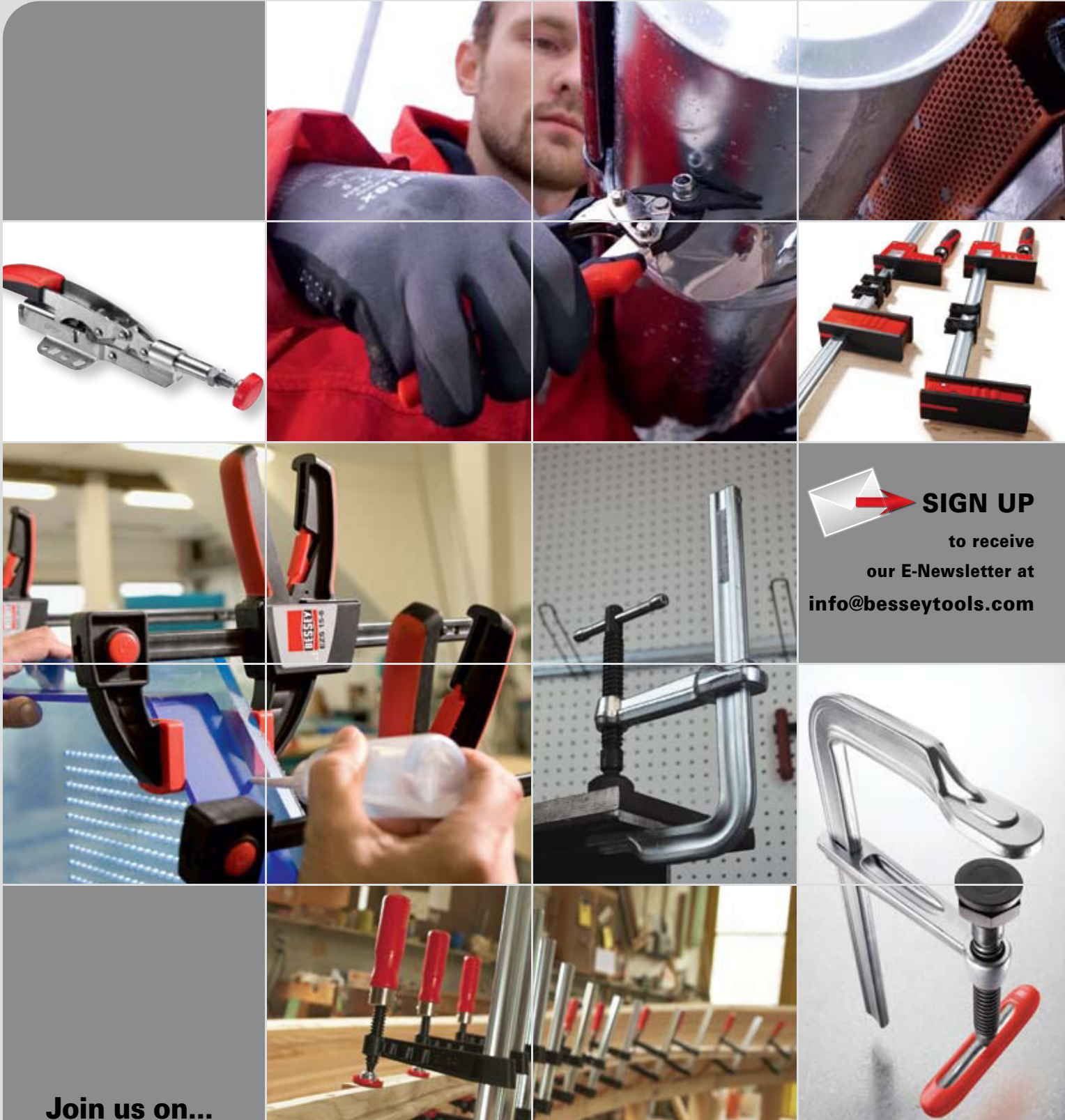

 **SIGN UP**
to receive
our E-Newsletter at
info@besseytools.com

Join us on...

Table of contents

1-2 High-performance clamps

Medium duty (1800-S)
Regular duty (2400S)
Regular duty (2400S) with extra deep reach
Heavy duty (4800S)
Extra heavy duty (7200S)
Extra high pressure (8500HPC)



13-14 Parallel clamps

K Body® REVO™
Vario K Body® REVO™
K Body® REVO™ JR
UniKlamp®, large surface case clamp



23-24 One-handed, light duty & clutch style clamps

Light duty, zinc die cast, step over (LMU)
Light duty zinc die cast (LM)
Clutch style (GSCC)
Clutch style (DHBC) with double jaw
PowerGrip (PG) heavy duty one-hand clamp
DuoKlamp®, large surface one handed clamp
DuoKlamp® combo kit
DuoKlamp®, accessory, DKX DuoKlamp® Extender



3 Multi-Purpose clamp KombiKlamp™

KombiKlamp™



15-16 K Body® REVO™ kits & accessories

KR-AS jaw adapter
KBX20 Extender
Extender kits
KP Blocks
Framing kit
KR-V0 variable jaw
KR-J2K sliding jaw
KR-JP jaw pads
KR-EC end clips
KR-RPP rail protection pieces
2K handle
Wood handle
KBTP-4 end-clips (classic style)
Table mount clamp (TK)



25 Edge clamps

Edge clamp, one hand (EKT)
Edge clamp (KF2-4)
3-way edge clamp, light duty (EC)
Spindle clamps



4-6 Shop floor clamps

Light duty (MMS, 660-S, 1200-S)
Medium duty (SGL)
Regular duty (SQ)
Heavy duty (STB)
Claw clamp (CL)
Lever clamps
Power clamp (TSC)
OMEGA bend clamps (RSC)



26 Strap clamps

Variable angle (VAS)
Vario corner clips (VAC)
Ratchet tie down, base (BAN)



7 classiX®

classiX® - Standard pad
classiX® - Heavy duty pad



17-20 Malleable cast bar clamps

Light duty (TG & TGJ) series
Medium duty (TG & TGJ) series
Heavy duty (TGK) series
Deep reach (CDS)
TC series
Bar clamp kits



27 Angle & miter clamp

Angle clamps (WS)
Corner clamp (WS)
Irregular angle clamp set (ES)



8 J series clamps

Light duty (J18)
Regular duty (2400J)
Heavy duty (4800J)



21 Lever clamps

Lever clamps
KliKlamp®, light duty lever clamp
Wood Klemmy clamp



28 Pipe clamps

Pipe clamp, H style (BPC)
Pipe clamp, traditional style (PC)



9-12 Toggle Clamps

Horizontal toggle clamp
Inline toggle clamp



22 EZS one-hand clamp

EZS clamps
EZS combo
EZS-D - 18 piece display



29 Seaming tools

Extra large solid surface seaming tool (PS)
Solid surface seaming tool (PS)

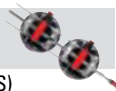

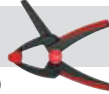
30-31 Spring clamps

VarioClippix® (XV) variable spring clamp
 VarioClippix® (XV) variable spring clamp, double jaw
 Clippix® needle nose plastic spring clamps (XCL)
 Clippix® (XC) plastic spring clamps
 Plastic spring clamp set
 Ratcheting spring clamps, deep reach (XCRU)
 Ratcheting spring clamp set (XCR)
 Steel spring clamps (XM)

32 Welding angle clamps

Angle clamp (WSM)
 Multi-angle vise set (WVS)

33-35 C-clamps

540 series ductile alloy
 Regular duty (CDF)
 Regular duty (CDFCHV), copper spindle, Hi-Vis
 Heavy duty (100 Series)
 Heavy service (HS Series)
 Light duty (CM), malleable cast
 Quick release (QRCC)
 Double head (DHCC)

36 Grip pliers

SuperGrips™ with profiled rail (SG)
 SuperGrips™ pipe clamp (SG)
 SuperGrips™ deep reach clamp (SG)
 SuperGrips™ welder's fork (SG)

37-38 Hold down products

RiteHite (Model L)
 RiteHite (Model S)
 Hold down table clamp
 Claw machine clamp (MCL)
 Jig & fixture clamp (FC)

39-40 Vises

Multi-purpose vise
 Heavy duty workshop vises
 Homeowners bench vise
 Drill press vise
 Light duty clamp-on vise
 Vacuum base vise
 Multi-purpose vise jaws
 Light duty wood vise

41-42 Industrial magnets

Magnetic squares (WMS)
 Double magnetic square (WMS)
 Multi-angle square (WMS)
 Arrowhead magnetic square (WMS)
 "Chunky" magnetic square (CMS)
 "Big Daddy" magnetic square (BDMS)
 "On/Off" magnetic square (WMS)
 Magnetic ground clamps (MGC)
 Mag Pick-Up (MPU)
 MagStick (MS)
 MagWand (MW)
 MagSweep (MSP)

43 Other clamps

Portable mini-vise (S)
 Wood handscrew clamps (HS)
 Table mount clamp (TK)
 Panel carrier (KF)
 T-bar sash clamps
 Flooring strap clamps (SVH)

44-45 Accessories

Plastic replacement caps
 Standard pads
 MorPads
 Clamp force indicator (FIN)
 Variable angle device (VAD)
 Grip handles
 Sliding arm assembly combi-set
 Spindles
 Sliding arms
 Wedges

46-51 Snips & knives

Multi-use snip, compact aviation (D15A)
 Aviation snips (D16)
 Special hard cutting snips (D29SS)
 Offset snips, optimized (D29ASS)
 Offset, extra hard, high tolerance (D27AH)
 Long-nose, multi-purpose (D22AL)
 Strap cutter (D123)
 Super nibbler (D24)
 MultiSnip - Straight (D47, D48)
 MultiSnip - Offset (D48A)
 Cable cutter (D49)
 Combinox (D50)
 MultiSnip master (D51)
 SuperPower snips - Straight blade (DSPS)
 SuperPower snips - Offset blade (DSPC)
 DMT multi-function tool

46-51 Snips & knives (continued)

Double blade folding tool
 Folding utility knife - Aluminum handle
 Folding utility knife - Wood handle
 Folding utility knife - ABS comfort grip handle
 Folding utility knife set - ABS comfort grip handle
 Snip display rack (32 pc with display)

52-53 Industrial fluids & compounds

Lab-metal®
 Hi-Temp Lab-metal®
 Lab-solvent
 Heat block
 Spatter release
 Stick-Kut™ lubricating stick wax
 Thread cutting oil
 Rel-Saw band saw fluid
 Relton cutting fluids
 Relton Air-Flo air tool oil

54 Specialty products

Torque multipliers (X4)
 Anti-Backlash torque multiplier

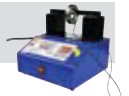
55 Reco induction bearing heaters

Reco induction bearing heaters
 Cross bars for bearing heaters
 Cone style bearing heaters
 Raising blocks
 Pyrometer/Thermometer

56-58 Index

High-performance clamps

Bar clamps for welding and fabricating

Your benefits at a glance:

1 High stability

Patented rail profile offers more clamp force with fewer spindle turns.

2 BESSEY® MorPad

MorPad tilts to 35°. Patented construction extends clamp life at full capacity.

3 Tempered spindle

Heat treated, high carbon Acme threaded screw – tempered and quenched to give greater load capacity with longer service life. Spatter resistant.

4 Sturdy Tommy bar

High-strength electro-galvanized sliding pin T-handle – rounded ends for comfort, size engineered to load capacity. Ergonomic grip is standard equipment on 1800-S and 2400S series.

5 U-shaped sliding arm

New u-shaped sliding arm offers straight line power transmission. Great stability.



Ball-in-socket technology means greatly extended clamp life and, at full pressure ... by BESSEY®. Patented.

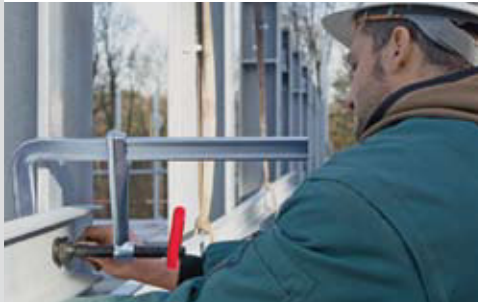

Medium duty (1800-S)

BESSEY® Product #	Throat Depth Inches	Clamping Capacity Inches	Clamping Force Pounds	Approx. Weight Pounds	Case qty.
1800-S8	4 3/4	8	1980	4.00	5
1800-S12	4 3/4	12	1980	4.75	5
1800-S18	4 3/4	18	1980	5.75	5
1800-S24	4 3/4	24	1980	6.25	5

Regular duty (2400S)

BESSEY® Product #	Throat Depth Inches	Clamping Capacity Inches	Clamping Force Pounds	Approx. Weight Pounds	Case qty.
2400S-8	5 1/2	8	2800	5.50	5
2400S-12	5 1/2	12	2800	6.80	5
2400S-16	5 1/2	16	2800	7.15	5
2400S-20	5 1/2	20	2800	7.50	5
2400S-24	5 1/2	24	2800	7.85	5
2400S-36	5 1/2	36	2800	10.75	5
2400S-48	5 1/2	48	2800	12.30	1
2400S-60	5 1/2	60	2800	14.25	1



High-performance clamps



Regular duty (2400S) with extra deep reach

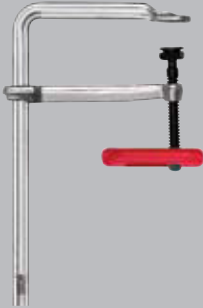

BESSEY® Product #	Throat Depth	Clamping Capacity	Clamping Force	Approx. Weight	Case
	Inches	Inches	Pounds	Pounds	qty.
DT 2400-12	8	12	1770	7.50	1
DT 2400-24	8	24	1770	10.00	1

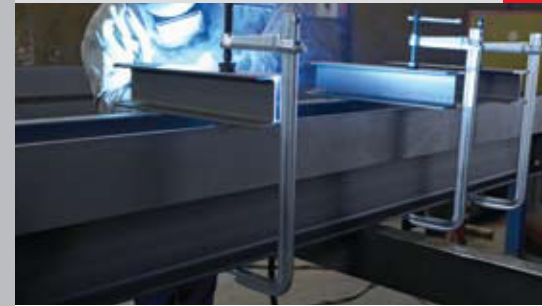

- An extended throat depth of 8" comes standard
- MorPad tilts to 35°. Patented construction extends clamp life at full capacity.
- Ergonomic grip is standard equipment on 1800-S and 2400S series

Heavy duty (4800S)



BESSEY® Product #	Throat Depth	Clamping Capacity	Clamping Force	Approx. Weight	Case
	Inches	Inches	Pounds	Pounds	qty.
4800S-12	7	12	4880	12.00	1
4800S-18	7	18	4880	14.50	1
4800S-24	7	24	4880	16.00	1
4800S-36	7	36	4880	20.00	1
4800S-48	7	48	4880	22.00	1
4800S-60	7	60	4880	28.00	1

* Comes standard with a 19 mm hex head spindle.

- Forged sliding arm is made from tempered, drop-forged steel for long service life
- High-strength electro-galvanized sliding pin T-handle - rounded ends for comfort, size engineered to load capacity
- Heat treated, high carbon Acme threaded screw - tempered and quenched to give greater load capacity with longer service life. Spatter resistant.

Extra heavy duty (7200S)



BESSEY® Product #	Throat Depth	Clamping Capacity	Clamping Force	Approx. Weight	Case
	Inches	Inches	Pounds	Pounds	qty.
7200S-12	8	12	7770	24.00	1
7200S-18	8	18	7770	28.00	1
7200S-36	8	36	7770	38.00	1

* Comes standard with a 36 mm hex head spindle.



Extra high pressure (8500HPC)



BESSEY® Product #	Throat Depth	Clamping Capacity	Clamping Force	Approx. Weight	Case
	Inches	Inches	Pounds	Pounds	qty.
8500HPC-6	4	6	8500	9.75	1
8500HPC-14	4	14	8500	11.00	1

Multi-Purpose clamp KombiKlamp™

Your benefits at a glance:

1 Multi-angle pad

Robust Variable Angle Device (VAD) allows for a solid grip on odd shapes - also reverses for spreading. Jaws swivel $\pm 60^\circ$.

2 Removable end stop

The end stop can be removed – to allow the sliding arm to be quickly turned around for spreading.

3. Replaceable pressure plate

For enhanced serviceability, the pressure plate can be replaced quickly and easily without the need for special tools.

4. Tommy bar with ergonomic BESSEY® Grip

Ergonomic BESSEY® Grip offers greater comfort and slides with the T-handle.

5. Easily converts to a spreading device

Remove the end stop, reverse the cross arm, and reverse the VAD and this clamp becomes a very versatile spreading device.

6. Made in Germany

All components produced and assembled under rigid controls in BESSEY®'s German factory.



■ Clamping and spreading of flat, round, oval and angled workpieces

■ Pressure plates can easily be replaced without using any tools (see page 44)



Multi-Purpose (KombiKlamp™)

BESSEY® Product #	Throat Depth Inches	Clamping Capacity Inches	Clamping Force Pounds	Approx. Weight Pounds	Case qty.
SG30VAD	4 3/4	*12	2600	6.00	6

* 11 inch capacity with VAD in place.



Bar clamps for welding and fabricating



Your benefits at a glance:

- 1 Enhanced clamp force and high stability**
Patented rail profile offers more clamp force with fewer spindle turns.
(For 660 & 1200)
- 2 Standard swivel pads**
Standard pads are field replaceable.
(For 660 & 1200)
- 3 Tempered spindle**
Heat treated, high carbon Acme threaded screw – tempered and quenched to give greater load capacity and longer service life. Spatter resistant.
- 4 Sturdy Tommy bar**
High-strength electro-galvanized sliding pin T-handle – rounded ends for comfort, size engineered to load capacity.
- 5 U-shaped sliding arm**
New u-shaped sliding arm offers straight line power transmission. Great stability.
(For 660 & 1200)

Light duty (MMS)



BESSEY® Product #	Throat Depth Inches	Clamping Capacity Inches	Clamping Force Pounds	Approx. Weight Pounds	Case qty.
MMS-4	2 1/4	4	400	0.55	10
MMS-8	2 1/4	8	400	0.70	6
MMS-12	2 1/4	12	400	0.80	10

Light duty (660-S, 1200-S)



BESSEY® Product #	Throat Depth Inches	Clamping Capacity Inches	Clamping Force Pounds	Approx. Weight Pounds	Case qty.
660-S8	4	8	726	1.85	10
660-S12	4	12	726	2.15	10
660-S18	4	18	726	2.75	10
1200-S8	4 3/4	8	1320	3.75	10
1200-S12	5 1/2	12	1320	4.25	10
1200-S18	4 3/4	18	1320	4.75	5
1200-S24	4 3/4	24	1320	5.25	5



■ Ergonomic grip is available as an accessory

Shop floor clamps



- Heavy duty pad tilts to 35°. Patented construction extends clamp life at full capacity.
- Forged sliding arm is made from tempered, drop-forged steel for long service life
- High-strength electro-galvanized sliding pin T-handle - rounded ends for comfort, size engineered to load capacity
- Ergonomic grip is available as an accessory
- Heat treated, high carbon Acme threaded screw - tempered and quenched to give greater load capacity with longer service life. Spatter resistant.



Medium duty (SGL)

BESSEY® Product #	Throat Depth Inches	Clamping Capacity Inches	Clamping Force Pounds	Approx. Weight Pounds	Case qty.
SGL-8	4 3/4	8	1800	4.00	5
SGL-12	4 3/4	12	1800	4.75	5
SGL-18	4 3/4	18	1800	5.75	5
SGL-24	4 3/4	24	1800	6.25	5



Regular duty (SQ)

BESSEY® Product #	Throat Depth Inches	Clamping Capacity Inches	Clamping Force Pounds	Approx. Weight Pounds	Case qty.
SQ-4*	4 3/4	6	1330	2.50	10
SQ-8	5 1/2	8	2660	5.50	5
SQ-12	5 1/2	12	2660	6.30	5
SQ-16	5 1/2	16	2660	7.00	5
SQ-20	5 1/2	20	2660	7.30	5
SQ-24	5 1/2	24	2660	8.00	5

* SQ-4 comes with standard pad.



Heavy duty (STB)

BESSEY® Product #	Throat Depth Inches	Clamping Capacity Inches	Clamping Force Pounds	Approx. Weight Pounds	Case qty.
STB-12	7	12	4880	12.00	1
STB-18	7	18	4880	14.95	1
STB-24	7	24	4880	16.00	1
STB-36	7	36	4880	20.00	1

* Comes standard with hex head spindle.

- Spindle mechanism can be positioned outside working area for use in confined spaces
- A special V-grooved pressure plate is made of high grade cast iron... swivels up to 30°
- Removable end stop to allow the sliding arm to be quickly turned around for spreading (needs optional CLS Shoe)



Claw clamp (CL)

BESSEY® Product #	Throat Depth Inches	Clamping Capacity Inches	Clamping Force Pounds	Approx. Weight Pounds	Case qty.
CL-24	4	24	1775	7.15	5
CLS-Shoe				0.75	2

- Large tilting pressure plate
- Secure ratchet mechanism for rapid vibration-resistant clamping
- Torsion-resistant, fixed bracket and pressure plate produced and tempered in one piece for maximum tensile strength and sturdiness



Lever clamps

BESSEY® Product #	Throat Depth Inches	Clamping Capacity Inches	Clamping Force Pounds	Approx. Weight Pounds	Case qty.
LC4	2 3/8	4	400	1.10	10
LC8	4	8	660	2.50	10
LC12	5 1/2	12	1200	5.00	10
LC20	4 3/4	20	1200	5.75	5
1800L12	5 1/2	10	1800	7.00	5

Shop floor clamps



Power clamp (TSC) with aluminum handle



BESSEY® Product #	Throat Depth	Clamping Capacity	Clamping Force	Approx. Weight	Case
	Inches	Inches	Pounds	Pounds	qty.
TSC4.516	4 1/2	16	1880	4.10	10



- Improves productivity over hand tightening manual clamps by using air tools or ratchets in high volume production shops to tighten clamps
- The BESSEY® power clamp is an all steel clamp made with heavy duty components to ensure a lifetime of use
- 15/16 hex nut allows the BESSEY® power clamp to be tightened and loosened with an air tool - the maximum torque value for air tool tightening is 15 lb/ft
- Safety stop collar ensures safety when tightening and loosening with an air/electric impact wrench
- Heat treated, high carbon Acme threaded screw - tempered and quenched to give greater load capacity with longer service life. Spatter resistant.

OMEGA bend clamps (RSC)



BESSEY® Product #	Throat Depth	Clamping Capacity	Clamping Force	Approx. Weight	Case
	Inches	Inches	Pounds	Pounds	qty.
RSC-8	4	8	770	1.90	10
RSC-12	5 1/2	12	1100	4.15	10
RSC-18	4 3/4	18	1100	4.90	5
RSC-24	4 3/4	20	1100	5.40	5



- Patented OMEGA bend maintains positive pressure longer under heavy vibration
- Forged sliding arm is made from tempered, drop-forged steel for long service life
- High-strength electro-galvanized sliding pin t-handle - rounded ends for comfort, size engineered to load capacity
- Ergonomic grip is available as an accessory
- Heat treated, high carbon Acme threaded screw - tempered and quenched to give greater load capacity with longer service life. Spatter resistant.
- Standard pads are field replaceable

classiX® International line of welding clamps

Your benefits at a glance:

1 Global product platform

A common global platform of clamp styles, openings and pressure capabilities.

2 Quality control

Internationally sourced components coordinated by BESSEY® quality control and engineering departments ensure great prices and great quality.

3. Great value

Profiled rail, spatter resistant spindle and simplified heavy duty pad offer great value for industrial use.



■ BESSEY®'s international line of high-value clamps

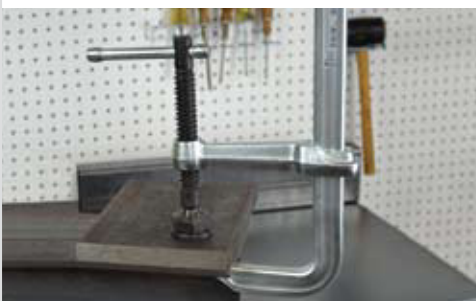

classiX® - Standard pad



BESSEY® Product #	Throat Depth	Clamping Capacity	Clamping Force	Approx. Weight	Case
	Inches	Inches	Pounds	Pounds	qty.
GS12-8K	3 1/8	4	550	0.5	10
GS16K	3 1/8	6	550	0.6	10
GS20K	4	8	880	1.8	10
GS16-12K	4 3/4	6	1000	2.0	10
GS25K	4 3/4	10	1000	2.5	10
GS30K	5 1/2	12	1200	4.3	10
GS60K	4 3/4	24	1200	5.1	5

classiX® - Heavy duty pad



BESSEY® Product #	Throat Depth	Clamping Capacity	Clamping Force	Approx. Weight	Case
	Inches	Inches	Pounds	Pounds	qty.
GSL30	4 3/4	12	1880	5.0	5
GSL60	4 3/4	24	1880	6.5	5
GSM20	4 3/4	7 1/2	2660	5.2	5
GSM25	5 1/2	9	2660	6.0	5
GSM30	5 1/2	12	2660	7.0	5
GSM40	5 1/2	16	2660	7.5	5
GSM50	5 1/2	20	2660	7.7	5
GSM60	5 1/2	24	2660	8.0	5

J Series clamps

Step-Over steel clamps



Ball-in-socket technology means greatly extended clamp life and, at full pressure ... by BESSEY®. Patented.



Your benefits at a glance:

- 1 Extremely sturdy**
The return rail lets the J clamps "step-over" the lip on channel iron, angle-iron, I-beam or other obstructions.
- 2 BESSEY® MorPad**
MorPad tilts to 35°. Patented construction extends clamp life at full capacity.
- 3. Forged sliding arm**
Forged sliding arm is made from tempered, drop-forged steel for long service life.
- 4. Tempered spindle**
Heat treated, high carbon Acme threaded screw - tempered and quenched to give greater load capacity with longer service life. Spatter resistant.
- 5. Sturdy Tommy bar**
High-strength electro-galvanized sliding pin T-handle - rounded ends for comfort, size engineered to load capacity.



Step-Over steel clamps

BESSEY® Product #	Throat Depth Inches	Clamping Capacity Inches	Clamping Force Pounds	Approx. Weight Pounds	Case qty.
Light duty (J18) - Rail Step-Over up to 2 1/4"					
J18-8	4 3/4	10	880	3.20	10



Step-Over steel clamps with MorPad

BESSEY® Product #	Throat Depth Inches	Clamping Capacity Inches	Clamping Force Pounds	Approx. Weight Pounds	Case qty.
Regular duty (2400J) - Rail Step-Over up to 4"					
2400J-12	5 1/2	12	2660	8.00	5
Heavy duty (4800J) - Rail Step-Over up to 6"					
4800J-20	7	20	4880	18.00	1



- Comes with standard swivel pad that is built for solid and dependable performance
- MorPad tilts to 35°. Patented construction extends clamp life at full capacity.
- Ergonomic grip is standard equipment on 2400J series
- Hex head (19 mm) is standard on 4800J-20

BESSEY® Auto-Adjust Toggle Clamps

Auto-Adjust Toggle Clamp for rapid clamping

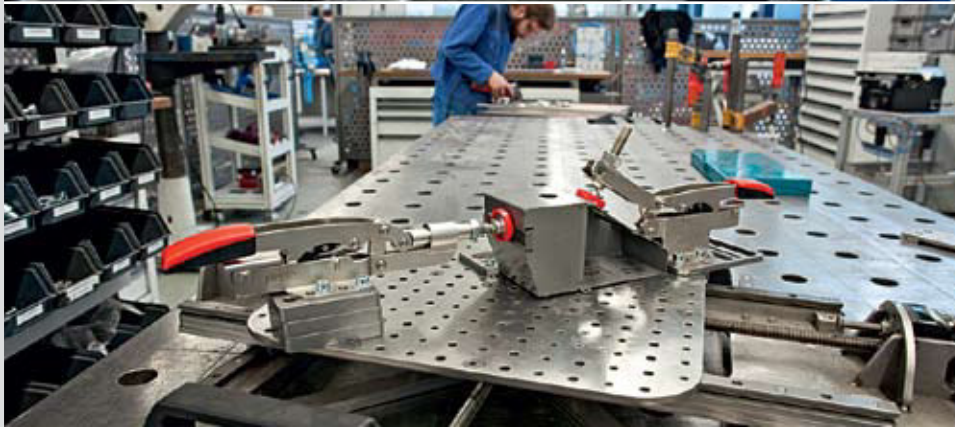

The power to be in position fast!

The Auto-Adjust Toggle Clamp series from BESSEY® brings significant and positive innovation to the toggle clamp market. First, clamping force can be adjusted within a range of 25-550 lbs of pressure with the turn of an integrated pressure screw. Second, the clamp will auto-adjust to varying work piece heights without significant change in applied clamping force. Third, the holding capacity of the BESSEY® toggle clamp series is quite high, close to 700 lbs of holding capacity. The combination of these features presents a strong argument for cost-savings, enhanced productivity and greater

workplace safety. How? BESSEY toggle clamps can replace a broad range of competitive toggle clamp styles when a range of clamping force and capacity is required. This means lower tool inventories and enhanced set-up time. The clamps are also perceived to be safer for real-world applications where variations in work piece height can lead to applied clamping force being too high or too low (with the resulting safety hazards these conditions present). Ideal for job-shop operations or short-run set-ups; the BESSEY® Auto-Adjust Toggle Clamps add value to any operation. BESSEY®. Simply better.



GENERAL INFORMATION

Toggle-clamp principles:

All toggle clamps operate on the same basic principle. There are a series of fixed lengths and pivots that form a linkage that can stretch or compress to apply clamping force. One end is anchored (and pivoting); the other parts of the linkage pivot from this initial anchored point to apply clamping force. As the levers and pivots extend from a contracted position they approach the fully-extended position. This is the point at which they will realize their maximum clamping force. This position is not a stable position for clamping as it does not allow for vibration or load changes. To lock a toggle clamp linkage, the levers must be pivoted past the fully-aligned position and into a stable and locked position against an end point stop. This locked position is commonly referred to as the “over-center” position and cannot be reversed without the linkages being moved.

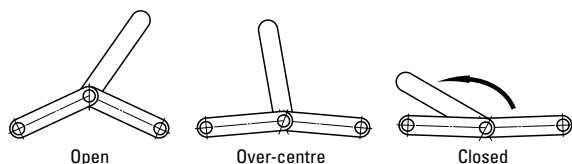

Holding capacity versus clamping force:

- Clamping Force: The amount of force the clamp applies to the work piece when closed and locked. The clamping force depends on the relative position of the clamp’s components and on work piece variation
- The holding capacity is the optimized and maximum force that the clamp can sustain in its closed and locked position without permanent yielding and/or damage to the clamp’s components. Holding capacity is measured when the clamp is in its over-center condition. A clamp’s rated holding capacity should never be exceeded.

Toggle Clamp Safety:

- Toggle clamps should engage firmly. Too tight can result in tool failure or operator injury while too loose can result in a work piece coming unclamped.
- Most clamps are metallic and will conduct electricity and heat – take precautions
- Repetitive actions can lead to fatigue and related problems – take precautions
- Do not expose toggle clamps to heat in excess of 140 F – corrosion resistance and handle functionality is impaired.
- Metal components should not be exposed to temperatures beyond 200 F
- Composite handles are resistant to salt solutions and alkalis but should not be exposed to phenols, acids or oxidizing agents
- Do not strike, or lift with, toggle clamps.
- Do not use secondary tools to augment applied clamping force
- Failure to use common sense and/or follow these guidelines will void warranties and increase the chance for failure or injury. Always wear protective gear.



Choosing a Toggle Clamp:

Choosing a specific toggle clamp is a multi-step process:

1. Select the appropriate clamp action, base style, bar style
2. Review the size, shape and consistency of parts to be clamped
3. Determine the tool clamping forces and holding capacity that is required
4. Consider the frequency, duration and cycle time of the operation
5. Decide upon the number of clamps to use.

Determining tool specifications and designing a set-up is a complex issue and should be the responsibility of a qualified fixture designer/engineer.

Construction:

BESSEY® Auto-Adjust Toggle Clamps are made with the finest materials. Steel content is typically 1035 or 1045 steel and hardened completely through. The large and ergonomic handles are a combination of polypropylene and thermo-plastic and resistant to heat. Nickel plating is the standard coating unless otherwise indicated. Base hole diameters are designed for M6 or 1/4 In. fasteners. The InLine plunger thread and spindle threads, are M8.

Clamping Force Range:

The BESSEY® Auto-Adjust Toggle Clamps will adjust automatically to variations in work piece height once the clamping force has been set. The integrated pressure screw has a range of clamping force (25-550 lbs nominal) that should be considered. Counter-clockwise rotation of the pressure screw increases clamping force and clockwise rotation decreases clamping force. Spindle location (at base or tip) can also affect clamping force. A visual representation at 30 mm clamp height is included in the chart below.

For more information email info@besseytools.com or call 1-800-828-1004

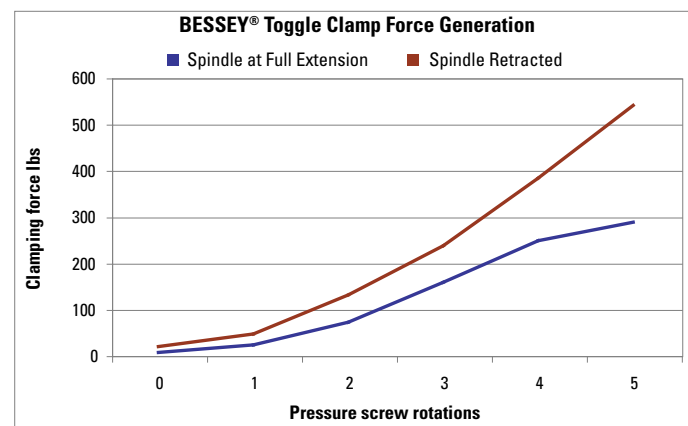

Clamping height set at 30 mm. Pressure screw set initially to lowest clamp force (0) and, with one full rotation for each measurement point.

BESSEY® Auto-Adjust Toggle Clamps

Auto-Adjust Toggle Clamp for rapid clamping

Your benefits at a glance:

1 Auto-Adjust

The BESSEY Auto-Adjust Toggle Clamp automatically adjusts to variations in work piece dimensions while maintaining constant clamping force. No more time-consuming manual adjustment of the spindle height to maintain safe and correct clamping force. The removable non-marring plastic cap is included on the 7/8" diameter pads.

2 Adjustable Clamping Force

The integrated clamping force adjustment screw can be used to create an actually applied clamping force from 25 to 550 lbs. (max holding capacity 700 lbs.) One BESSEY® Auto-Adjust Toggle Clamp can replace a range of competitive clamps.

3 Adaptable Base Plate

The large (2 1/4" by 2 1/2") flanged base is designed for use with 1/4" or M6 fasteners. Mounting holes are sized & spaced for easy mounting and versatility.

4 Extra large handle

The large 1" x 2 1/8" handle offers greater user comfort and ease of operation.



Coming in
June 2011



NEW Horizontal toggle clamps

BESSEY® Product #	Opening Inches	Clamping Force Range Pounds	Holding Capacity Pounds	Approx. Weight Pounds	Case qty.
STC-HH50	2	25-550 *	700	0.77	6
STC-HH70	2 3/4	25-550 *	700	0.86	6

* Variable and dependent on spindle settings, pressure screw setting, force applied etc.

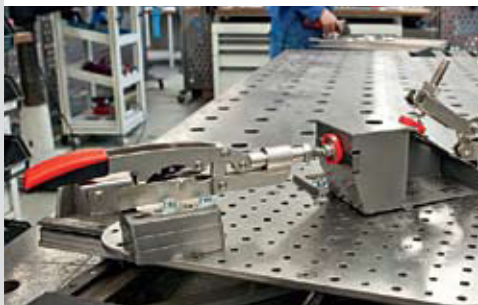

NEW Inline toggle clamp

BESSEY® Product #	Opening Inches	Clamping Force Range Pounds	Holding Capacity Pounds	Approx. Weight Pounds	Case qty.
STC-IHH25	1	25-550 *	700	0.86	6

* Variable and dependent on spindle settings, pressure screw setting, force applied etc.

BESSEY® Auto-Adjust Toggle Clamps



STC-HH50 - Horizontal low profile

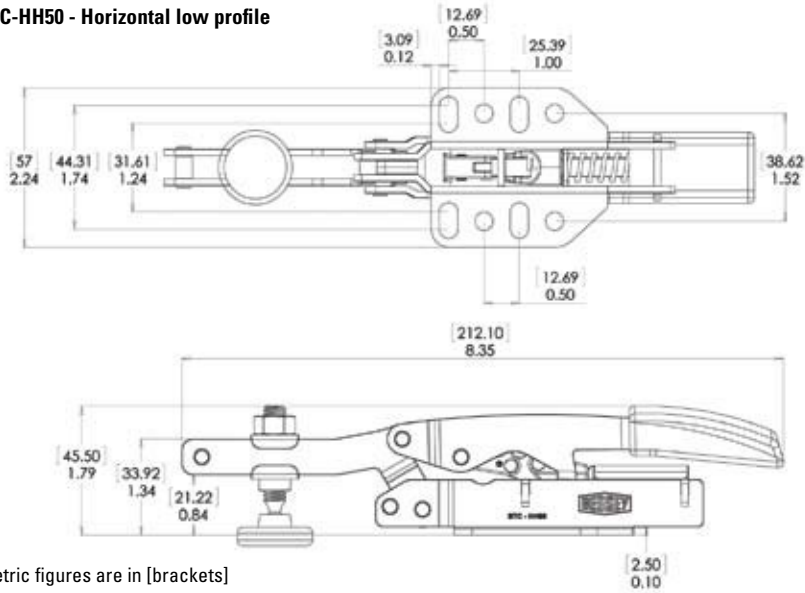

- In the clamped position the handle is horizontal
- Turn the pressure screw counter-clockwise to increase pressure and, clockwise to decrease (See chart page 10)
- Easy access mounting holes are optimized for 1/4" fasteners (M6)

STC-HH70 - Horizontal high profile

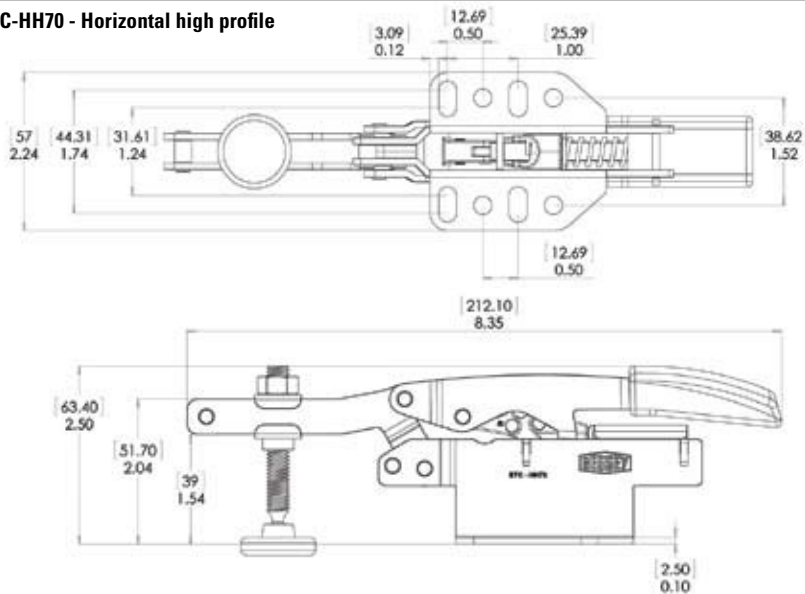

- Replace a range of competitive clamps with each BESSEY® model
- Spindle thread is M8
- Nut size is .540" (14mm)
- Pad diameter is 7/8"

STC-IHH25 - In-line

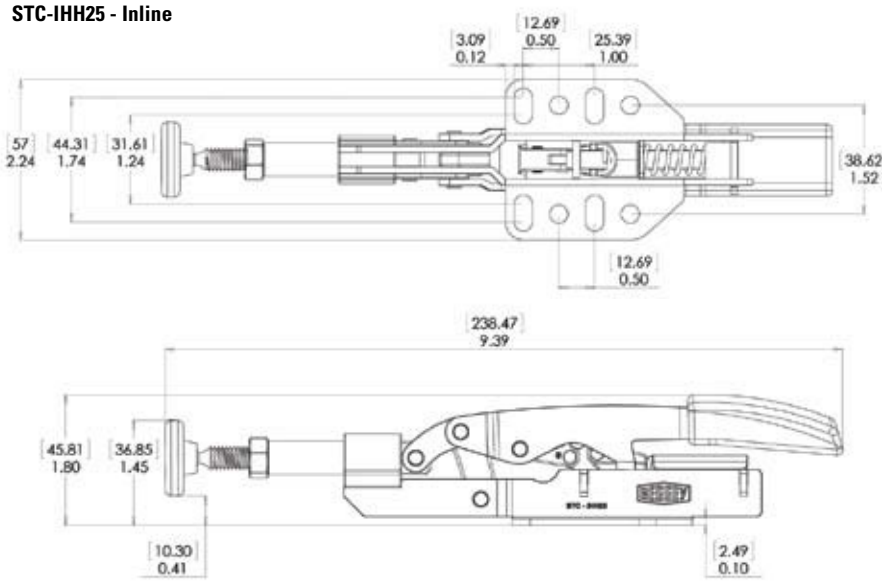

- High quality construction
- Plunger thread is M8
- Plunger diameter is .465"
- Snap off plastic cap is standard on all models

Powerful parallel clamping at its best

Your benefits at a glance:

1 Parallel clamping surface with jaw protection pads

These are arguably the most powerful and most parallel clamps in the world. The three large removable (if you want to clean or replace them) pressure caps are resistant to glue, paint and solvents.

2 Large 2K composite handle

High quality 2K composite handle with soft plastic insert for comfort while working.

3 Rail protection pieces

The rail protection pieces (made from impact resistant polyamide) prevent glue dripping on to the rail. With TK-6 table (see page 43) clamps you can easily fasten the rail protection pieces to a work surface.

4 Removable end-clip

End-clip ensures clamp sits parallel to work surface and is removable to reverse sliding arm for use as spreader.

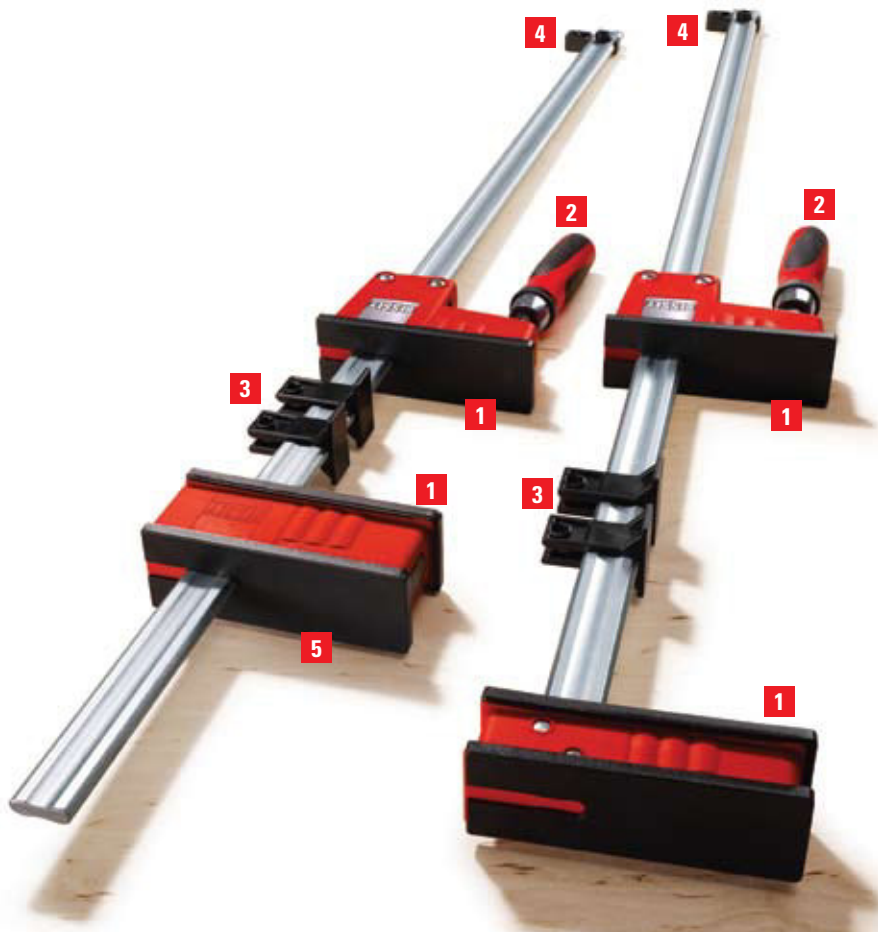

- Jaws clamp at accurate 90 degree angles
- Everyday clamp force up to 1500 lbs
- Large handles and clamping surface
- Replacement parts for all components



K Body® REVO™, parallel clamps

BESSEY® Product #	Throat Depth Inches	Clamping Capacity Inches	Clamping Force Pounds	Approx. Weight Pounds	Case qty.
KR3.512	3 3/4	12	1500	4.50	2
KR3.524	3 3/4	24	1500	5.50	2
KR3.531	3 3/4	31	1500	6.50	2
KR3.540	3 3/4	40	1500	7.30	2
KR3.550	3 3/4	50	1500	8.00	2
KR3.560	3 3/4	60	1500	9.30	2
KR3.582	3 3/4	82	1500	11.50	2
KR3.598	3 3/4	98	1500	13.50	2



Vario K Body® REVO™, variable jaw parallel clamp

BESSEY® Product #	Throat Depth Inches	Clamping Capacity Inches	Clamping Force Pounds	Approx. Weight Pounds	Case qty.
KRV-40	3 3/4	40	1500	8.55	2
KRV-60	3 3/4	60	1500	9.44	2
KRV-78	3 3/4	78	1500	12.22	2
KRV-98	3 3/4	98	1500	14.00	2





Size comparison chart

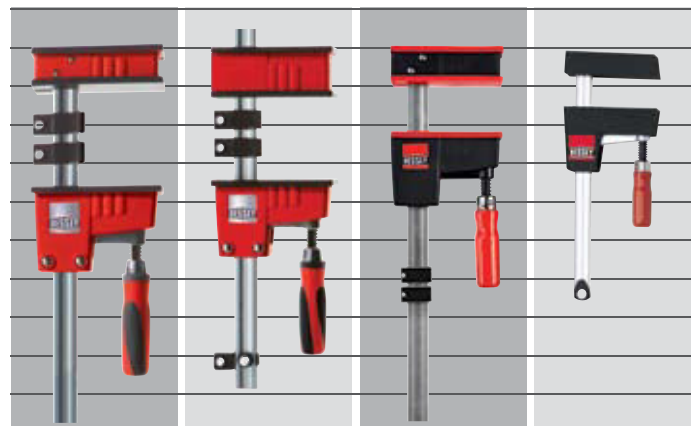

Up to 1500 lbs.
Clamping Force

Up to 1500 lbs.
Clamping Force

Up to 900 lbs.
Clamping Force

Up to 330 lbs.
Clamping Force

Your benefits at a glance:

5 The Moveable 'Fixed' Jaw

For the first time ever, BESSEY® offers the opportunity to adjust both jaws to optimize clamping set-up. With the push of a button the 'fixed' jaw can be moved to where you want it.

6 Wood handle

Ergonomically shaped wood handle.



NEW K Body® REVO™ JR parallel clamps

BESSEY® Product #	Throat Depth Inches	Clamping Capacity Inches	Clamping Force Pounds	Approx. Weight Pounds	Case qty.
KRJR-12	3 1/4	12	900	2.50	2
KRJR-18	3 1/4	18	900	2.80	2
KRJR-24	3 1/4	24	900	3.10	2
KRJR-36	3 1/4	36	900	3.70	2
KRJR-50	3 1/4	50	900	4.50	2



- Mid-sized version of the REVO, jaws are slightly narrower with 3-1/4" throat depth
- 30-40% lighter than the REVO
- Everyday clamp force of 900 lbs
- Large handles and clamping surface
- Replacement parts for all components



UniKlamp® case clamp

BESSEY® Product #	Throat Depth Inches	Clamping Capacity Inches	Clamping Force Pounds	Approx. Weight Pounds	Case qty.
UK3.006	3 1/8	6	330	1.40	6
UK3.012	3 1/8	12	330	1.60	6
UK3.024	3 1/8	24	330	1.90	6

- Large contact surfaces
- Light duty universal clamp/spreader for bench top projects
- Easily converts to a spreader without tools

K-Body® REVO™ kits & accessories



K Body® REVO™ accessory, KR-AS jaw adapter

BESSEY® Product #	Suitable for	Width	Length	Case
		Inches	Inches	qty.
KR-AS	K Body® REVO™ (KR and KRV)	1.0	7.0	12

- KR-AS effortlessly slides onto the jaws of the K Body® REVO™ to create clamping optimized for irregular shapes
- Pivoting jaws will clamp or spread irregular angles from -15° to +15°
- Connects two K Body® REVO™ clamps (or K Body® classic style) for extended reach
- K Body® Extender suitable for the K Body® REVO™ (KR and KRV)
- Durable aluminum construction for rigid accurate linkage



K Body® REVO™ accessory, KBX20 Extender

BESSEY® Product #	Includes	Approx. Weight	Case
		Pounds	qty.
KBX20	Extender, bolts, nuts and washers	1.6	12

- Set of 4 K Body® REVO™ and 2 x KBX20 Extender
- KRX2440 (2 x 24", 2 x 40", 2 x KBX20)
- KRX2450 (2 x 24", 2 x 50", 2 x KBX20)

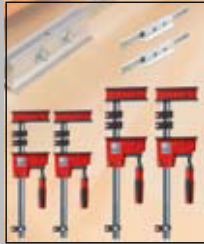

K Body® REVO™ Extender kits

BESSEY® Product #	Includes	Approx. Weight
		Pounds
KRX2440	2 x KR3.524 (24" K Body® REVO™ clamps) 2 x KR3.540 (40" K Body® REVO™ clamps) 2 x K Body® Extenders	28.00
KRX2450	2 x KR3.524 (24" K Body® REVO™ clamps) 2 x KR3.550 (50" K Body® REVO™ clamps) 2 x K Body® Extenders	29.00

- Quick accurate set up of raised panel doors, frames, boxes etc
- KP Blocks made especially for the K Body® REVO™ (KR and KRV)



K Body® REVO™ accessory, KP Blocks

BESSEY® Product #	Includes	Approx. Weight	Case
		Pounds	qty.
KP	(4 per set)	1.10	4 pack
KP Block adaptor	(4 per set)	0.50	4 pack

K Body® REVO™ framing kits

BESSEY® Product #	Includes	Approx. Weight
		Pounds
KRK2440	2 x KR3.524 (24" K Body® REVO™ clamps) 2 x KR3.540 (40" K Body® REVO™ clamps) 1 set of KP BLOCKS (4 blocks per set)	26.00
KRK2450	2 x KR3.524 (24" K Body® REVO™ clamps) 2 x KR3.550 (50" K Body® REVO™ clamps) 1 set of KP Blocks (4 blocks per set)	27.00

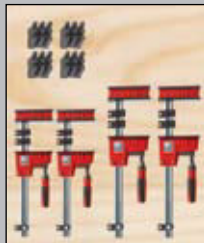

- Set of 4 K Body and 1 x KP Block Set
- KRK2440 (2 x 24" 2 x 40", 1 x KP Blocks)
- KRK2450 (2 x 24", 2 x 50", 1 x KP Blocks)

K-Body® REVO™ accessories



K Body® REVO™ accessory, KR-VO variable jaw

BESSEY® Product #	Suitable for	Throat Depth Inches	Approx. Weight Pounds	Case qty.
KR-VO	K Body® REVO™ (KR & KRV)	3 3/4	2	1

- Replacement variable jaw as a single unit suitable for the K Body® REVO™ (KR & KRV)
- Can be added to any K Body® REVO™ to create multiple glue ups or make a custom clamp



K Body® REVO™ accessory, KR-J2K sliding jaw

BESSEY® Product #	Suitable for	Throat Depth Inches	Approx. Weight Pounds	Case qty.
KR-J2K	K Body® REVO™ (KR & KRV)	3 3/4	2	1

- Replacement sliding jaw as a single unit suitable for the K Body® REVO™ (KR & KRV)
- Can be added to any K Body® REVO™ to create multiple glue ups or make a custom clamp



K Body® REVO™ accessory, KR-JP jaw pads

BESSEY® Product #	Includes	Approx. Weight Pounds	Case qty.
KR-JP	2 jaw pads per set	1	12

- Replacement jaw pads suitable for the K Body® REVO™ (KR & KRV)
- Jaw pads are resistant to glue, paint and grease solvents



K Body® REVO™ accessory, KR-EC end clips

BESSEY® Product #	Includes	Approx. Weight Pounds	Case qty.
KR-EC	1 rail end clip per set	1	24

- Replacement rail end clips suitable for the K Body® REVO™ (KR & KRV)



K Body® REVO™ accessory, KR-RPP rail protection pieces

BESSEY® Product #	Includes	Approx. Weight Pounds	Case qty.
KR-RPP	2 rail protection pieces per set	1	24

- Replacement rail protection pieces suitable for the K Body® REVO™ (KR & KRV)
- Elevates work piece from the rail



K Body® REVO™ accessory, 2K handle

BESSEY® Product #	Includes	Approx. Weight Pounds	Case qty.
3101370	1-2K handle, Formerly "H/S-REVO2K"	0.6	1

- Replacement 2K handle suitable for the K Body® REVO™ (KR & KRV)



K Body® REVO™ accessory, wood handle

BESSEY® Product #	Includes	Approx. Weight Pounds	Case qty.
3101371	1 wood handle, Formerly "H/S-REVOW"	0.5	1

- Replacement wood handle suitable for the K Body® REVO™ (KR & KRV)



K Body® Classic accessory, KBTP-4 end-clips (classic style)

BESSEY® Product #	Includes	Approx. Weight Pounds	Case qty.
KBTP-4	4 end-clips per set	2	4 pack

- Replacement end-clips suitable for K Body® clamps produced before July, 2008
- End-clips ensure clamp sits parallel to work surface

* Only for clamps produced before July 1st, 2008.



Table mount clamp (TK)

BESSEY® Product #	Works with...	Approx. Weight Pounds	Case qty.
TK-6	Fits WS-3, WS-6, S-10, S-15, and K-Body® REVO™ (KR & KRV)	0.45	1 pair

- Holds BESSEY® WS-3, WS-6, S-10, S-15, and K-Body® REVO™ (KR & KRV) to work surface

Malleable cast bar clamps

BESSEY® quality, durability and strength



Integrated anti-slip system.
The harder one clamps, the tighter the grip.

The original BESSEY® malleable cast iron bar clamp is available in two different designs. Either with the tried-and-true wooden handle, or with the modern BESSEY® 2K handle. The 2K handle allows you to complete tasks more effectively and with less hand fatigue. This is possible thanks to the high quality 2K composite handle with a comfort insert.

Your benefits at a glance:

1 Integrated anti-slip system

Maximum safety is available with the integrated anti-slip system. A set screw that is molded into the sliding arm interlocks with the serration on the rail to prevent the clamp from slipping.

2 Reinforced malleable cast iron jaw and sliding arm

Corrugated malleable cast iron fixed jaw and sliding arm generate powerful, rigid clamping. Top jaw is press fitted to the rail. No mechanical fasteners to loosen. Powder coating protects against corrosion.

3 High quality profiled rail

The BESSEY® profiled rail from our own German steel plant has been optimized for clamps. The profile acts as a reliable reinforcement against torsional forces, while the serration on six faces additionally prevents the clamp from slipping.

4 BESSEY® smooth running spindle

The smooth running spindle with Acme thread allows for more clamping with less effort. Replaceable pressure plates can be easily changed without tools.

5 BESSEY® comfort

With the TG series you have the choice of the tried-and-true wooden handle or the 2K composite handle with a comfort insert. Replaceable pressure pads come standard with 2K handle.



Malleable cast bar clamps



Light duty (TGK) with 2K handle



BESSEY® Product #	Throat Depth	Clamping Capacity	Clamping Force	Approx. Weight	Case
	Inches	Inches	Pounds	Pounds	qty.
TGJ2.506+2K	2 1/2	6	600	1.50	5
TGJ2.512+2K	2 1/2	12	600	2.00	5
TGJ2.518+2K	2 1/2	18	600	2.30	5
TGJ2.524+2K	2 1/2	24	600	2.50	5
TGJ2.530+2K	2 1/2	30	600	3.00	5
TGJ2.536+2K	2 1/2	36	600	3.50	5
TG4.008+2K	4	8	880	2.50	10
TG4.012+2K	4	12	880	2.80	10
TG4.016+2K	4	16	880	3.00	10
TG4.024+2K	4	24	880	3.50	10



- 2K composite handle with comfort insert
- Profiled rail is extremely rigid
- Standard pads are field replaceable
- Malleable cast jaws feature corrugated design for strength and durability

Light duty (TG & TGJ) with wood handle



BESSEY® Product #	Throat Depth	Clamping Capacity	Clamping Force	Approx. Weight	Case
	Inches	Inches	Pounds	Pounds	qty.
TGJ2.506	2 1/2	6	600	1.50	5
TGJ2.512	2 1/2	12	600	2.00	5
TGJ2.518	2 1/2	18	600	2.30	5
TGJ2.524	2 1/2	24	600	2.50	5
TGJ2.530	2 1/2	30	600	3.00	5
TGJ2.536	2 1/2	36	600	3.50	5
TG4.008	4	8	880	2.50	10
TG4.012	4	12	880	2.80	3
TG4.016	4	16	880	3.00	10
TG4.024	4	24	880	3.50	3



- Ergonomically shaped wood handle
- Profiled rail is extremely rigid
- Standard pads are field replaceable
- Malleable cast jaws feature corrugated design for strength and durability

Medium duty (TG & TGJ) with 2K handle



BESSEY® Product #	Throat Depth	Clamping Capacity	Clamping Force	Approx. Weight	Case
	Inches	Inches	Pounds	Pounds	qty.
TG4.512+2K	4 1/2	12	1000	3.30	10
TG4.518+2K	4 1/2	18	1000	4.05	10
TG4.524+2K	4 1/2	24	1000	4.80	5
TG4.530+2K	4 1/2	30	1000	5.55	5
TG4.540+2K	4 1/2	40	1000	6.30	5
TG5.512+2K	5 1/2	12	1320	5.00	10
TG5.518+2K	5 1/2	18	1320	5.65	5
TG5.524+2K	5 1/2	24	1320	6.30	5
TG7.016+2K	7	16	1320	6.00	5
TG7.024+2K	7	24	1320	7.00	1
TG7.048+2K	7	48	1320	10.00	1

- 2K composite handle with comfort insert
- Profiled rail is extremely rigid
- Standard pads are field replaceable
- Malleable cast jaws feature corrugated design for strength and durability

Malleable cast bar clamps



- Ergonomically shaped wood handle
- Profiled rail is extremely rigid
- Standard pads are field replaceable
- Malleable cast jaws feature corrugated design for strength and durability
- 2K composite handle with comfort insert



Medium duty (TG) with wood handle

BESSEY® Product #	Throat Depth	Clamping Capacity	Clamping Force	Approx. Weight	Case
	Inches	Inches	Pounds	Pounds	qty.
TG4.512	4 1/2	12	1000	3.30	10
TG4.518	4 1/2	18	1000	4.05	10
TG4.524	4 1/2	24	1000	4.80	5
TG4.530	4 1/2	30	1000	5.55	5
TG4.540	4 1/2	40	1000	6.30	3
TG5.512	5 1/2	12	1320	5.00	10
TG5.518	5 1/2	18	1320	5.65	5
TG5.524	5 1/2	24	1320	6.30	5
TG7.016	7	16	1320	6.00	5
TG7.024	7	24	1320	7.00	1
TG7.048	7	48	1320	10.00	1

Heavy duty (TGK) with 2K handle

BESSEY® Product #	Throat Depth	Clamping Capacity	Clamping Force	Approx. Weight	Case
	Inches	Inches	Pounds	Pounds	qty.
TGK4.516+2K	4 1/2	16	1540	6.00	5
TGK4.524+2K	4 1/2	24	1540	7.00	5
TGK4.540+2K	4 1/2	40	1540	9.00	5
TGK4.550+2K	4 1/2	50	1540	10.50	1
TGK4.579+2K	4 1/2	79	1540	14.50	1



Heavy duty (TGK) with wood handle

BESSEY® Product #	Throat Depth	Clamping Capacity	Clamping Force	Approx. Weight	Case
	Inches	Inches	Pounds	Pounds	qty.
TGK4.516	4 1/2	16	1540	6.00	5
TGK4.524	4 1/2	24	1540	7.00	5
TGK4.540	4 1/2	40	1540	9.00	5
TGK4.550	4 1/2	50	1540	10.50	1
TGK4.579	4 1/2	79	1540	14.50	1



- Ergonomically shaped wood handle

Deep reach (CDS) (Flat rail)

BESSEY® Product #	Throat Depth	Clamping Capacity	Clamping Force	Approx. Weight	Case
	Inches	Inches	Pounds	Pounds	qty.
CDS24-10 WP	10	24	1550	12.50	1
CDS24-12 WP	12	24	1550	14.50	1
CDS24-20 WP	20	24	990	20.50	1



- Up to 20" throat depth available
- Tommy bar with rounded ends for simple transfer of force when clamping
- Large, stable solid flat rail with serration

Light duty (TC) (Flat rail)

BESSEY® Product #	Throat Depth	Clamping Capacity	Clamping Force	Approx. Weight	Case
	Inches	Inches	Pounds	Pounds	qty.
TC4.008	4	8	800	2.85	10



Medium duty (TC) (Flat rail)

BESSEY® Product #	Throat Depth	Clamping Capacity	Clamping Force	Approx. Weight	Case
	Inches	Inches	Pounds	Pounds	qty.
TC4.512	4 1/2	12	950	3.36	10
TC5.512	5 1/2	12	1200	5.25	5
TC7.016	7	16	1200	6.25	5



- Ergonomically shaped wood handle
- Stable, solid flat rail with serration
- Flat rails are an economical alternative - German quality at an appealing price for industrial applications

Malleable cast bar clamps



NEW Large TG clamp set (16 pc with display)



BESSEY® Product #	Kit includes	Approx. Weight Pounds
BTBTG5	4 x TG4.008+2K (8" malleable cast bar clamp) 4 x TG5.512+2K (12" malleable cast bar clamp) 4 x TG7.016+2K (16" malleable cast bar clamp) 2 x TGK4.524+2K (24" malleable cast bar clamp) 2 x TGK4.540+2K (40" malleable cast bar clamp) 1 x A Frame Display (Sturdy, mobile display)	96.00

NEW Clutch clamp kit (24 pc)



BESSEY® Product #	Kit includes	Approx. Weight Pounds
BTBSV24	8 x GSCC2.506+2K (6" clutch style clamp) 4 x GSCC2.512+2K (12" clutch style clamp) 2 x GSCC3.512+2K (12" clutch style clamp) 4 x GSCC3.518+2K (18" clutch style clamp) 2 x GSCC5.018+2K (18" clutch style clamp) 4 x GSCC5.024+2K (24" clutch style clamp) 1 x A Frame Display (Sturdy, mobile display)	42.00

General clamp kit (10 pc)



BESSEY® Product #	Kit Includes	Approx. Weight Pounds
BGP	2 x TGJ2.506 (6" malleable cast bar clamp) 2 x TG4.008 (8" malleable cast bar clamp) 2 x LM2.004 (4" zinc die cast bar clamp) 2 x PC34 (3/4" pipe clamp) 2 x XM5 (2" metal spring clamp)	17.00

Small TG Kit (30 pc)



BESSEY® Product #	Kit Includes	Approx. Weight Pounds
BTB30	4 x TGJ2.506 (6" malleable cast bar clamp) 6 x TGJ2.512 (12" malleable cast bar clamp) 4 x TGJ2.518 (18" malleable cast bar clamp) 8 x TGJ2.524 (24" malleable cast bar clamp) 4 x TGJ2.530 (30" malleable cast bar clamp) 4 x TGJ2.536 (36" malleable cast bar clamp)	38.00

Small TG Kit (30 pc with display)



BESSEY® Product #	Kit Includes	Approx. Weight Pounds
BTB30A	4 x TGJ2.506+2K (6" malleable cast bar clamp) 6 x TGJ2.512+2K (12" malleable cast bar clamp) 4 x TGJ2.518+2K (18" malleable cast bar clamp) 8 x TGJ2.524+2K (24" malleable cast bar clamp) 4 x TGJ2.530+2K (30" malleable cast bar clamp) 4 x TGJ2.536+2K (36" malleable cast bar clamp) 1 x A Frame Display (Sturdy, mobile display)	65.00

■ Top selling larger format malleable cast clamps plus an A-frame display

■ Top selling clutch style clamps plus an A-frame display

■ A selection of top selling multi purpose clamps

■ A selection of top selling smaller malleable cast clamps

■ Top selling smaller malleable cast clamps plus an A-frame display

■ Note for Distributors:
For information on a full range of merchandising options please request the BESSEY® Merchandising Guide

Lever clamps

Rapid-Action, lever clamps

Your benefits at a glance

1 Secure ratchet mechanism

The ratchet mechanism ensures rapid, vibration-resistant clamping. Hardened cam at the end of the lever ensures a long service life.

2 Extremely sturdy

Torsion-resistant, fixed bracket and pressure plate are produced and tempered in one piece for maximum tensile strength and sturdiness.

3 Forged sliding arm

Forged sliding-arm is made from tempered, drop-forged steel for long service life.

4 Extremely sturdy handle

Ergonomically shaped powder-coated clamping lever and plastic-coated release for comfort and power.

5 Trigger protection

Trigger protection means fewer pinched fingers.

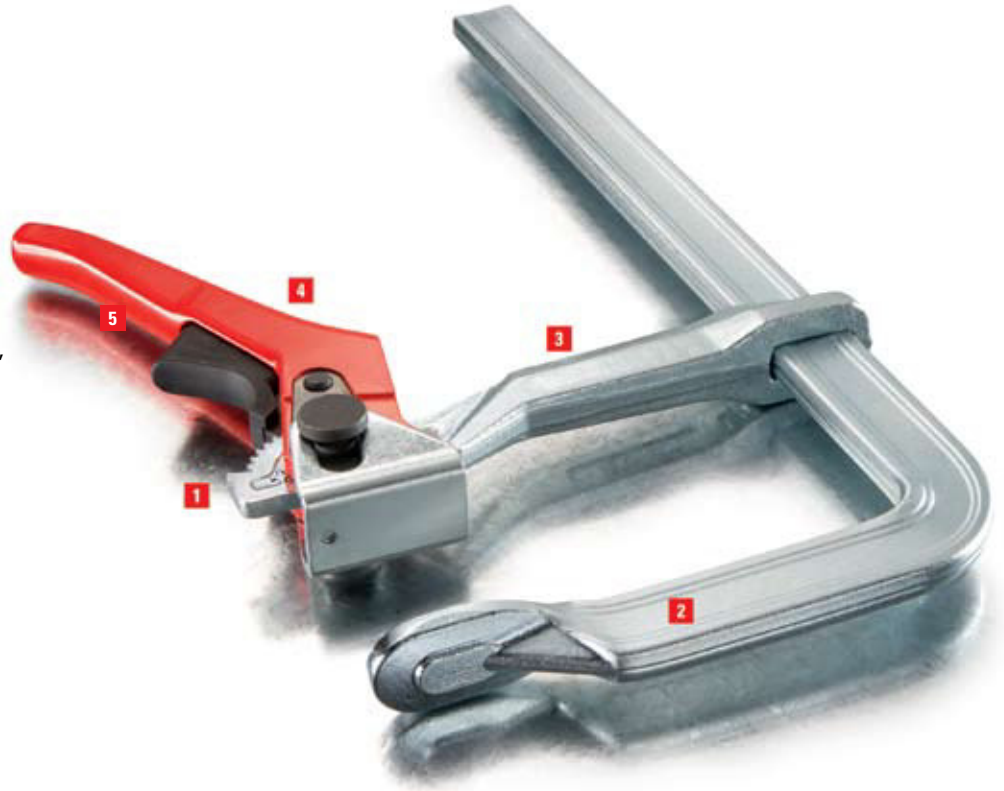

■ Large tilting pressure plate

- Sturdy fixed and sliding arms made from lightweight magnesium
- Vibration resistant ratchet mechanism
- Ergonomically shaped clamping lever

- Ideal for light touch clamping or delicate tasks such as antique restoration, veneering and making or repairing musical instruments
- Upper and lower arms and lever made from high quality hardwood
- Cork protective pads for gentle clamping



Lever clamps

BESSEY® Product #	Throat Depth	Clamping Capacity	Clamping Force	Approx. Weight	Case
	Inches	Inches	Pounds	Pounds	qty.
LC4	2 3/8	4	400	1.10	10
LC8	4	8	660	2.50	10
LC12	5 1/2	12	1200	5.00	10
LC20	4 3/4	20	1200	5.75	5
1800L12	5 1/2	10	1800	7.00	5

KliKlamm®, light duty lever clamp

BESSEY® Product #	Throat Depth	Clamping Capacity	Clamping Force	Approx. Weight	Case
	Inches	Inches	Pounds	Pounds	qty.
KLI3.004	3	4	260	0.70	10
KLI3.008	3	8	260	0.80	10
KLI3.012	3	12	260	1.00	10

Wood Klemmy clamps

BESSEY® Product #	Throat Depth	Clamping Capacity	Approx. Weight	Case
	Inches	Inches	Pounds	qty.
KLW4.012	4	12	1.00	10
KLW4.024	4	24	1.50	10

One handed, light duty & clutch style clamps

One-handed clamping or spreading



Your benefits at a glance

1 Powerful technology

The extremely sophisticated technology makes it possible - single-handed clamping and spreading of workpieces with up to 445 lb clamping force.

2 Intelligent release mechanism

Thanks to the intelligent release mechanism, the upper section can be quickly converted from clamping to spreading.

3 Handle behind the rail

The ergonomically shaped 2-component plastic handle with pump level is positioned behind the rail, enabling a powerful grip.

4 Soft pressure caps

Soft pressure caps optimize material protection and secure clamping.

5 Internal components that ...

Reflect German engineering ... heavy duty for sure!

EZS Clamps



BESSEY® Product #	Throat Depth Inches	Clamping Capacity Inches	Clamping Force Pounds	Approx. Weight Pounds	Case qty.
EZS15-8	3 1/2	6	445	1.2	6
EZS30-8	3 1/2	12	445	1.8	6
EZS45-8	3 1/2	18	445	2.0	6
EZS60-8	3 1/2	24	445	2.3	6
EZS90-8	3 1/2	36	445	2.5	6

EZS Combo

BESSEY® Product #	Kit Includes	Approx. Weight Pounds
EZS Combo	2 x EZS15-8 2 x EZS30-8 2 x EZS45-8	11.00

NEW EZS-D - 18 piece display

BESSEY® Product #	Package Includes	Approx. Weight Pounds
EZS-D	6 x EZS15-8 6 x EZS30-8 6 x EZS45-8 1 x Display stand	37.00



- Clamping force up to 445 lb
- No tools required for conversion to spreading
- Available in sizes 6" to 36"



One handed, light duty & clutch style clamps



- Small and very handy
- Light weight
- Comes with two plastic pressure caps
- Helps to clamp in hard to reach spots



Light duty, zinc die cast, step over (LMU)

BESSEY Product #	Throat Depth	Clamping Capacity	Clamping Force	Approx. Weight	Case
	Inches	Inches	Pounds	Pounds	qty.
LMU2.004*	2	4	330	0.55	24
LMU2.006*	2	6	330	0.62	24
LMU2.008*	2	8	330	0.68	24

* Comes packed in a retail ready full colour shelf display - must order case qty to get shelf display.



- Zinc die cast jaws are light weight
- Serrated rail for slip resistant grip
- Non-marring plastic caps on pressure pad



Light duty, zinc die cast (LM)

BESSEY Product #	Throat Depth	Clamping Capacity	Clamping Force	Approx. Weight	Case
	Inches	Inches	Pounds	Pounds	qty.
LM2.004*	2	4	330	0.55	36
LM2.006	2	6	330	0.62	10
LM2.008	2	8	330	0.68	10
LM2.012	2	12	330	0.81	10
LM3.006	3	6	330	1.19	10
LM3.012	3	12	330	1.40	10
LM3.024	3	24	330	2.50	10
LM3.036	3	36	330	3.00	10
LM4.008	4	8	440	2.00	10
LM4.012	4	12	440	2.50	10
LM4.016	4	16	440	2.70	10
LM4.024	4	24	440	3.00	10

- Powder coated, malleable cast iron jaws
- 2 piece slip clutch plates
- Nickel plated, drawn serrated rail
- Non-marring pads on the top and bottom jaws
- Ergonomically shaped wood handle



Clutch style (GSCC)

BESSEY Product #	Throat Depth	Clamping Capacity	Load Limit	Approx. Weight	Case
	Inches	Inches	Pounds	Pounds	qty.
GSCC2.506	2 1/2	6	600	0.66	6
GSCC2.512	2 1/2	12	600	0.77	6
GSCC2.518	2 1/2	18	600	0.92	6
GSCC2.524	2 1/2	24	600	1.00	6
GSCC2.530	2 1/2	30	600	1.20	6
GSCC2.536	2 1/2	36	600	1.33	6
GSCC3.512	3 1/2	12	1000	1.25	6
GSCC3.518	3 1/2	18	1000	1.38	6
GSCC3.524	3 1/2	24	1000	1.55	6
GSCC5.012	5	12	1200	2.08	6
GSCC5.018	5	18	1200	2.25	6
GSCC5.024	5	24	1200	2.50	6

One handed, light duty & clutch style clamps



Clutch style (DHBC) with double jaw

BESSEY Product #	Throat Depth	Clamping Capacity	Load Limit	Approx. Weight	Case
	Inches	Inches	Pounds	Pounds	qty.
DHBC-12	3 1/2	12	400	2.20	4
DHBC-24	3 1/2	24	400	2.80	4
DHBC-36	3 1/2	36	400	3.40	4



PowerGrip (PG) heavy duty one-hand clamp

BESSEY® Product #	Throat Depth	Clamping Capacity	Clamping Force	Approx. Weight	Case
	Inches	Inches	Pounds	Pounds	qty.
PG12	4	12	1000	2.40	5
PG24	4	24	1000	3.50	5



DuoKlamp®, large surface one handed clamp

BESSEY® Product #	Throat Depth	Clamping Capacity	Clamping Force	Approx. Weight	Case
	Inches	Inches	Pounds	Pounds	qty.
DU016-8	3 1/4	6	260	1.13	6
DU030-8	3 1/4	12	260	1.35	6
DU045-8	3 1/4	18	260	1.60	6
DU065-8	3 1/4	24	260	1.91	6

DuoKlamp® Combo

BESSEY® Product #	Kit Includes	Approx. Weight
		Pounds
DuoKlamp® Combo	2 x DU016-8 2 x DU030-8 2 x DU045-8	7.60



DuoKlamp® accessory, DKX DuoKlamp® Extender

BESSEY® Product #	Opening Capacity	Spreading Capacity	Pressure Capacity	Approx. Weight	Case
	Inches	Inches	Pounds	Pounds	qty.
DKX	6 - 65	7.5 - 70	260	3.5	1

* Does not include DuoKlamp®. Sold Separately.

- Powder coated, ductile cast iron jaws
- 2 piece slip clutch plates
- Nickel plated, drawn serrated rail
- Non-marring pads on the top and bottom jaws

- Easy slide button for positioning
- Pump handle to clamp with 100-200 lbs pressure
- Handle/Spindle combo, for heavy tightening



- Change from clamping to spreading by simply twisting the dial - no disassembling
- Handle with pump lever parallel to the rail
- Convenient one-handed operation
- All around clamping - in front of, behind and at the side of the rail



- Used with a DuoKlamp® (and most similar sized clamps) one can spread up to 65"
- DuoKlamp® fits snugly into Extender clamp, no tools required

Edge clamps

Your benefits at a glance

1 Unique twin spindle

Outer spindle acts on the clamping jaws – inner spindle applies pressure to the front edge. Impact resistant plastic handle for one-handed use.

2 Large jaws

Two large non-slip, opposing, gentle jaws for positive grip.

3 Swivel pressure plate

The large pressure plate swivels to apply pressure on demand. Removable protective cap.

4 Light aluminum housing

Lightweight, corrosion-resistant aluminum housing designed for high static stress load for convenient, one-handed edge clamp EKT.



- For quick one-handed operation
- Light weight

- For quick one-handed operation
- Non-slip rubber lining
- Ergonomic wood handle

- Light duty clamp for basic edging projects
- Comes packaged on retail ready backer card

- Choice of single or double spindle design
- For use with bar clamps with rails up to 1/2" thick



Edge clamp, one hand (EKT)

BESSEY® Product #	Throat Depth Inches	Clamping Capacity Inches	Clamping Force Pounds	Approx. Weight Pounds	Case qty.
EKT-55	3	2 1/8	500	2.00	6

Edge clamp (KF2-4)

BESSEY® Product #	Throat Depth Inches	Clamping Capacity Inches	Approx. Weight Pounds	Case qty.
KF2	3	1/2 - 2	1.68	1
KF4	4.3	1/2 - 3	3.48	1
KF4 Pads	Replacement pads (2 pack)			

3-way edge clamp, light duty (EC)

BESSEY® Product #	Throat Depth Inches	Clamping Capacity Inches	Clamping Force Pounds	Approx. Weight Pounds	Case qty.
B-EC3	2 1/2	2 1/2	300	0.95	3

Spindle clamps

BESSEY® Product #	Description	Approx. Weight Pounds	Case qty.
KT5-1CP	1 spindle	0.75	1
KT5-2	2 spindles	1.30	1

Strap clamps



Your benefits at a glance:

- 1 Band is drawn in on both sides**
Strap draws simultaneously from both sides ensuring pressure is applied equally on all corners without distortion.
- 2 Integrated coiling mechanisms**
Integrated rewind mechanism operates by a cranking handle which eliminates tangling and damage to the band.
- 3 Practical Vario corners**
Vario clip corners with twin-tilting pressure pads auto-adjust from 60° to 180° for easy assembly of any multi-angle project.
- 4 Extremely tearproof**
The special woven polyester band guarantees a high resistance to tearing, and a clamping range of 23 ft. The steel wire loop opens quickly and simply to adjust or release glue-up.

Variable angle (VAS)



BESSEY® Product #	Clamping Capacity	Range of Angle Degrees	Approx. Weight Pounds	Case qty.
VAS-23	Up to 23 feet	60° to 180°	1.40	3



- Even pressure on mitre joints
- High quality strap clamp
- Comes with 4 pivoting Vario corners

Vario corner clips (VAC)



BESSEY® Product #	Package includes	Range of Angle Degrees	Approx. Weight Pounds	Case qty.
VAC-6	6 corner clips per package	60° to 180°	0.26	5 pkg/ case

- Vario corner clips have twin-tilting pressure pads that auto adjust from 60° to 180°

Ratchet tie-down, base (BAN)



BESSEY® Product #	Strap Length Feet	Strap Width Inches	Clamping Force Pounds	Approx. Weight Pounds	Case qty.
BANR400	13	0.95	up to 400	0.75	6

- For clamping awkward and irregular shape objects

Angle & miter clamp

Your benefits at a glance:

1 Sturdy frame

Die-cast jaws plastic coated to protect work.

2 Versatility

Designed for clearance of dowels, screws or staples while gluing.

3. Right angle clamping

Holds and aligns material at 90° angle.

4. Wood handle

Ergonomically shaped wood handle.

5. Adjustable

Adjust automatically to wood thickness.

A. Note: TK-6 Table mount clamp in picture is sold separately.



- Galvanized spindle, Acme thread
- Economical alternative for fixed 90° angle for miter or butt joints
- Mounting holes to fix to work surface
- Adjusts to various sized work pieces with 2 spindles
- For light duty clamping
- Ideal for securing glued miter joints and angled joint faces
- Used with BESSEY® TGK & TGJ bar clamps
- Ball & socket system applies direct force on angle for 15° to 180°



Angle clamps (WS)

BESSEY® Product #	Maximum Clamping Capacity Inches	Max. Passage for joints Inches	Approx. Weight Pounds	Case qty.
WS-3	Both sides-max 4" thick	1 1/8	2.40	3
WS-6	Both sides-max 8" thick	2 7/16	5.25	4

* Packaged in a retail ready clamshell package.



Corner clamp (WS)

BESSEY® Product #	Clamping Capacity	Angle Degrees	Approx. Weight Pounds	Case qty.
WS-1	Up to 3" per side	90°	0.50	10

Mounted on retail-ready backer card.



Irregular angle clamp set (ES)

BESSEY® Product #	Set Contains ...	Approx. Weight Pounds	Case qty.
ES Set	Includes 2 blocks and 2 caps	0.85	1

*Clamps not included.

TK-6 Table mount clamp is sold separately. See page 43.

Pipe clamps

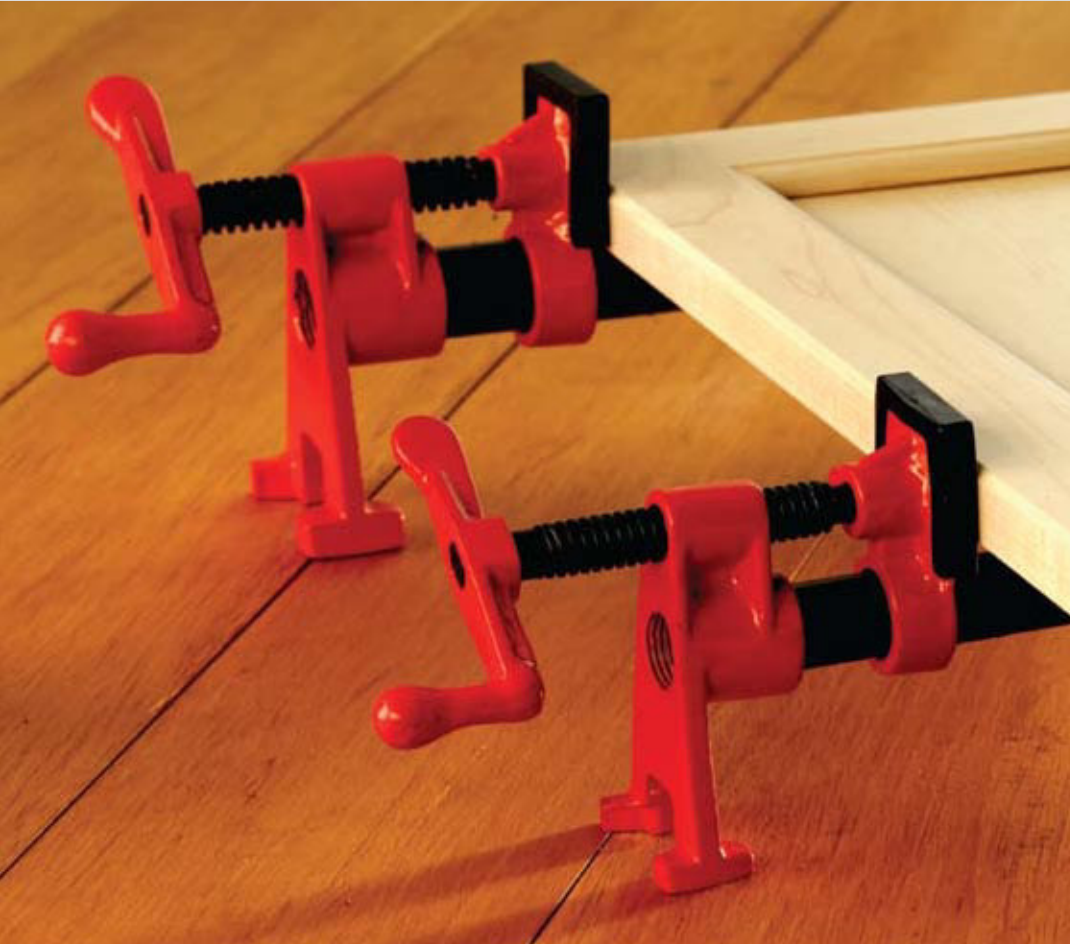

Your benefits at a glance:

- 1 H shape foot assembly**
"H" shape foot assembly stabilizes clamp in two dimensions giving dual-axis stability.
- 2 Extra high base**
Extra high base provides industry leading clearance from the work surface.
- 3. Cast jaws**
Cast jaws for durability.
- 4. Smooth spindle**
Smooth action spindle.



Pipe clamp, H style (BPC)

BESSEY® Product #	Black Pipe Diameter Inches	Approx. Weight Pounds	Case qty.
BPC-H34	3/4	3.05	4
BPC-H12	1/2	2.05	4

* BPC comes in retail ready full colour clamshell packaging



- BPC-H12 = 1/2"
- BPC-H34 = 3/4"



Pipe clamp, traditional style (PC)

BESSEY® Product #	Black Pipe Diameter Inches	Approx. Weight Pounds	Case qty.
PC34	3/4	2.40	20
PC12	1/2	1.65	20
PC34-DR	3/4	2.15	12

- PC12 = 1/2"
- PC34 = 3/4"
- PC34DR = Deep reach (2 1/2")

Seaming tools

Your benefits at a glance

1 Vacuum cups

Twin vacuum cups secure the PS units to any smooth, non-porous material or solid surface such as granite, marble, corian, plastic or glass.

2 Vacuum operating button

Activates and locks the vacuum seal on the work surface. (Not on PS55)

3 Steel spindle

Smoothly draws the deck seams together with just the right pressure.

4 Guide rails

Create a solid, rigid frame for supporting vacuum cups.



- Twin vacuum cups for clamping non-porous, solid surface material such as granite, marble, corian, plastic or glass
- Levelling toggles ensure smooth surface joint, reduces grinding, sanding and finishing

- Twin vacuum cups for clamping non-porous, solid surface material such as granite, marble, corian, plastic or glass
- Levelling toggles ensure smooth surface joint, reduces grinding, sanding and finishing

NEW Extra large solid surface seaming tool (PS)



BESSEY® Product #	Clamping Capacity Inches	Cup Diameter Inches	Clamping Force Pounds	Approx. Weight Pounds	Case qty.
PS130*	3 1/8	8 1/4	265	9	1

* Special order only.

Solid surface seaming tool (PS)

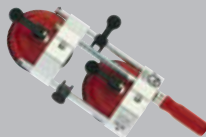

BESSEY® Product #	Clamping Capacity Inches	Cup Diameter Inches	Clamping Force Pounds	Approx. Weight Pounds	Case qty.
PS55	2 1/8	4.72	48	3.80	1



Your benefits at a glance

1 Sliding clamping arm

Rapid-action, polyamide, sliding top jaw infinitely adjusts to fit project ... the clamping capacity of a 4" spring clamp with the comfort of a 2" clamp.

2 Ergonomic 2-component handle

Soft, anti-slip two component handle for comfort.

3 Softpads

Soft-touch pads protect sensitive workpieces and eliminate marring of work.



VarioClippix® (XV) variable spring clamp*

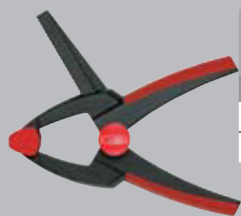

BESSEY® Product #	Throat Depth Inches	Clamping Capacity Inches	Approx. Weight Pounds	Case qty.
XV3-50	1 1/2	2 1/8	0.19	10
XV5-100	2	4	0.40	12

VarioClippix® (XV) variable spring clamp, double jaw*



BESSEY® Product #	Throat Depth Inches	Clamping Capacity Inches	Approx. Weight Pounds	Case qty.
XV5-170	2	6 1/2	0.45	12

* VarioClippix® come on backer cards in a retail ready full colour shelf display - must order case qty to get shelf display.



■ Unique design allows you to adjust the clamp up to 4" ... it does the work of 4 different spring clamps, offering optimum handling

■ Polyamide material is lightweight, strong and corrosion resistant

■ Sliding top jaw and sliding bottom jaw infinitely adjusts up to 6 1/2"

■ Polyamide material is lightweight, strong and corrosion resistant

Spring clamps

- Long tapered nose for hard to reach spaces
- Ergonomic 2-component handle designed for comfort and a firm grip
- Soft-touch pads for a non-marring grip



Clippix® needle nose plastic spring clamps (XCL)

BESSEY® Product #	Throat Depth Inches	Clamping Capacity Inches	Approx. Weight Pounds	Case qty.
XCL2	2	2	.04	12
XCL2-Set (2xXCL2)	2	2	.08	24
XCL5	4	3	.07	8

- Made from durable, lightweight polyamide
- Ergonomic 2-component handle designed for comfort and a firm grip
- Light duty spring clamps



Clippix® (XC) plastic spring clamps - Premium

BESSEY® Product #	Throat Depth Inches	Clamping Capacity Inches	Approx. Weight Pounds	Case qty.
XC1	3/4	3/4	0.02	96
XC2	1 1/8	1	0.04	20
XC3	1 1/2	1 3/4	0.11	36
XC5	1 15/16	2	0.26	20
XC7	2 3/4	3	0.46	10

- Light duty spring clamps for home or shop



NEW Clippix® (XC) plastic spring clamps - Econo

BESSEY® Product #	Throat Depth Inches	Clamping Capacity Inches	Approx. Weight Pounds	Case qty.
XC1-2	3/4	3/4	0.02	72
XC2-2	1 1/8	1	0.06	48
XC5-2	1 1/2	2	0.26	48
XC7-2	2 3/4	3	0.39	16

- Light duty spring clamps for home or shop
- 4 popular sizes, conveniently packaged in a mesh bag

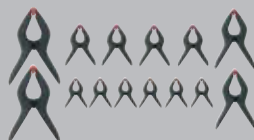

Plastic spring clamp set

BESSEY® Product #	Includes	Approx. Weight Pounds	Case qty.
XC-14PC	2 x 3" clamps 2 x 2" clamps 4 x 1" clamps 6 x 3/4" clamps	2.06	4

- Heavy duty resin construction with pivoting jaw
- Ratcheting mechanism – quick action, quick release



Ratcheting spring clamps, deep reach (XCRU)

BESSEY® Product #	Throat Depth Inches	Clamping Capacity Inches	Approx. Weight Pounds	Case qty.
XCRU3	2	2	0.50	12
XCRU5	4	4	0.75	12

- Heavy duty resin construction with pivoting jaw
- Ratcheting mechanism – quick action, quick release



Ratcheting spring clamp set (XCR)

BESSEY® Product #	Includes	Approx. Weight Pounds	Case qty.
XCR-4PC	4 x 2" clamps	2.20	6

- Vinyl tips and handles prevent marring
- Heavy duty springs for firm grip
- Nickel plating resists corrosion



Steel spring clamps (XM)

BESSEY® Product #	Throat Depth Inches	Clamping Capacity Inches	Approx. Weight Pounds	Case qty.
XM3	1	1 1/4	0.17	48
XM5	2	2 1/4	0.40	24
XM7	3	3 5/16	0.80	6
XM10	4	5	1.00	6



* All items come packed in retail ready full colour shelf display - must order case qty to get shelf display.

Welding angle clamps

Clamping angles and miters

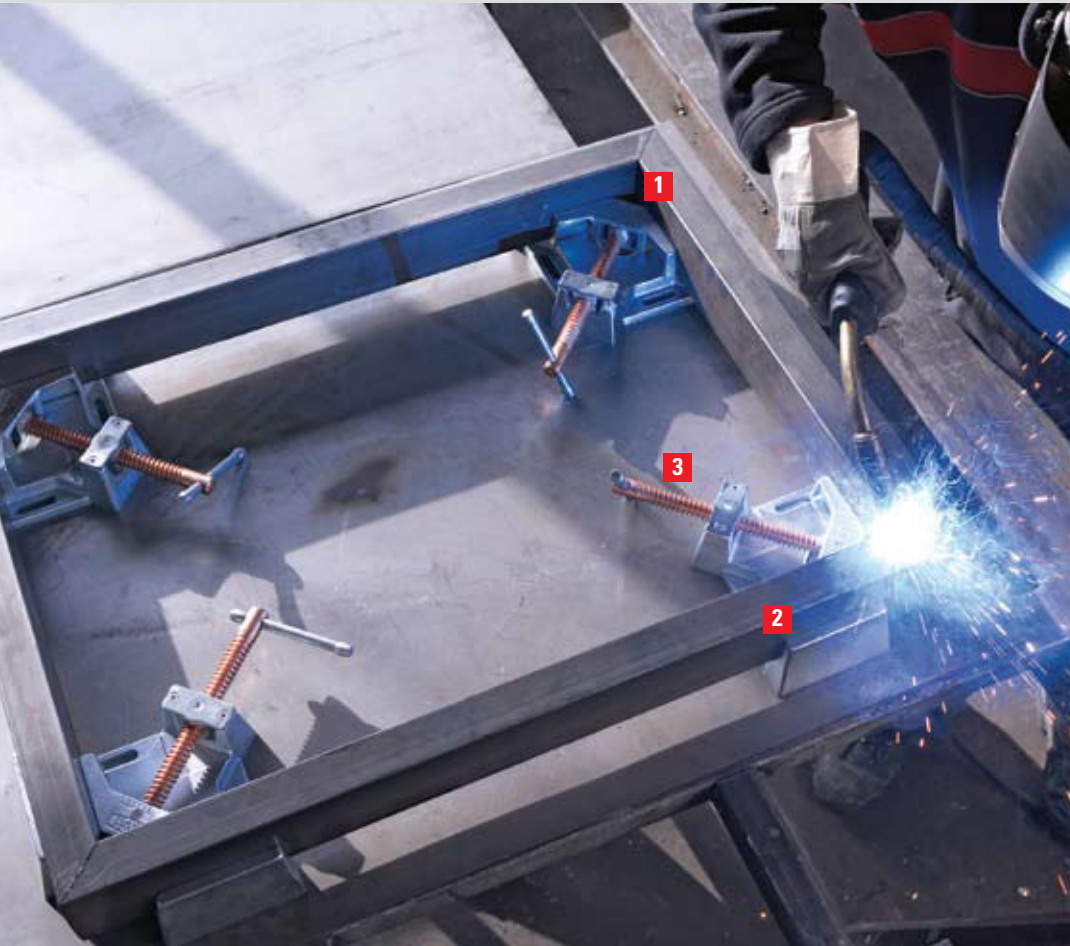

Your benefits at a glance:

- 1. Right angle clamping**
The angle clamp has been developed for a wide range of applications, holding, fixing, and aligning material at an exact right angle.
- 2. Workpieces of different thicknesses**
The angle clamp is designed for holding workpieces of different thicknesses at a precise 90° angle.
- 3. Copper spindle**
Copper spindle to resist spatter.
- 4. Sturdy frame**
Sturdy jaws and base made from high grade cast iron.
- 5. Clear working area**
Access to the workpiece is unhindered during welding and assembly work and when fixing T-joints.

Angle clamps (WSM)



BESSEY® Product #	Jaw Height Inches	Capacity for both sides Inches	Max. Passage for Mitres Inches	Approx. Weight Pounds	Case qty.
WSM-9	1 3/8	7	3 1/2	8.10	1
WSM-12	2 3/8	9 1/2	4 3/4	16.55	1



- Automatic adjustment to work pieces of different thicknesses
- Precise 90° angles

Multi-angle vise set (WVS)



BESSEY® Product #	Clamping Capacity Inches	Jaw Height Inches	Range of Angle Degrees	Approx. Weight Pounds	Case qty.
WVS-4	4 3/8	1 3/8	5° to 180°	23.00	1

- Clamping aid for clamping components of different thicknesses at any chosen angle
- Angle range: 5° to 180°
- Individual clamps pivot on a fixture to produce an incredible range of angles

C-clamps

Your benefits at a glance

1 International offering

A globally sourced platform of products

2 Choices

Tremendous range of pressures, capacities and applications

3 Clamping force

Clamping force offerings from 400 to 40 000 lbs



- **NEW** 540 series C-clamps made of high tensile ductile alloy casting which provides excellent strength in a cast clamp

- Black oxide spindle to resist corrosion



540 series ductile alloy C-clamps



BESSEY® Product #	Throat Depth Inches	Clamping Capacity Inches	Clamping Force Pounds	Approx. Weight Pounds	Case qty.
540-2-1/2	1 3/4	0- 2 1/2	1100	1.20	6
540-3	1 7/8	0-3	1800	1.60	6
540-4	2 1/16	0-4	2150	2.23	6
540-5	2 1/2	0-5	2250	2.69	6
540-6	2 3/4	0-6	2450	3.20	6
540-8	3 1/4	0-8	2750	4.74	1
540-10	3 5/8	0-10	2850	7.56	1
540-12	3 5/8	0-12	2850	8.18	1
540-14	3 3/4	0-14	2850	8.18	1

C-clamps



Regular duty (CDF), extra deep throat C-clamps



BESSEY® Product #	Throat Depth	Clamping Capacity	Clamping Force	Approx. Weight	Case
	Inches	Inches	Pounds	Pounds	qty.
CDF402	2	0-2	3,500	1.40	1
CDF403	2 3/8	0-3	3,500	1.90	1
CDF404	2 3/4	0-4	6,200	3.50	1
CDF406	3 5/8	0-6	6,900	5.40	1
CDF408	4 1/2	0-8	6,900	7.90	1
CDF410	5 3/8	0-10	8,000	11.60	1
CDF412	5 3/4	0-12	9,300	14.00	1

- Black oxide spindle to resist corrosion
- Powder coated frame
- Ball-in-swivel pad

Regular duty (CDFCHV), copper spindle, HiVis



BESSEY® Product #	Throat Depth	Clamping Capacity	Clamping Force	Approx. Weight	Case
	Inches	Inches	Pounds	Pounds	qty.
CDF402CHV	2	0-2	3,500	1.40	1
CDF403CHV	2 3/8	0-3	3,500	1.90	1
CDF404CHV	2 3/4	0-4	6,200	3.50	1
CDF406CHV	3 5/8	0-6	6,900	5.40	1
CDF408CHV	4 1/2	0-8	6,900	7.90	1
CDF410CHV	5 3/8	0-10	8,000	11.60	1
CDF412CHV	5 3/4	0-12	9,300	14.10	1

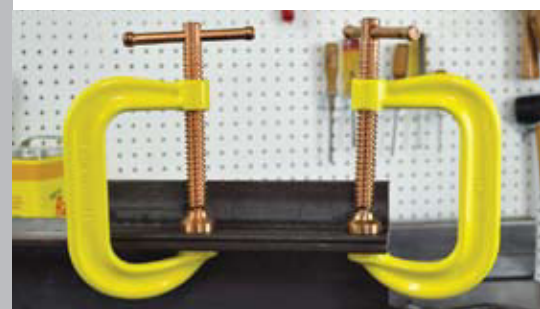

- HiVis frame, copper spindle
- Powder coated frame
- Ball-in-swivel pad

Heavy duty (100 Series)



BESSEY® Product #	Throat Depth	Clamping Capacity	Clamping Force	Approx. Weight	Case
	Inches	Inches	Pounds	Pounds	qty.
B-102	1 1/2	0-2	7,500	1.50	1
B-103	2	0-3	8,750	2.65	1
B-104	2 1/4	0-4	10,000	4.15	1
B-106	2 1/2	2-6	11,250	6.00	1
B-108	2 1/4	4-8	12,500	7.80	1
B-110	2 7/8	6-10	13,750	8.70	1
B-112	2 15/16	8-12	15,000	12.10	1

- Hex head on T-handle
- Made in USA

Heavy service (HS Series) (Fully closing)



BESSEY® Product #	Throat Depth	Clamping Capacity	Clamping Force	Approx. Weight	Case
	Inches	Inches	Pounds	Pounds	qty.
B-HS0	1 1/16	0-3/4	2,800	0.33	1
B-HS1	1 3/32	0-1 3/8	5,600	1.00	1
B-HS1.5	1 7/16	0-1 13/16	8,750	1.80	1
B-HS2	1 7/8	0-2 3/8	12,500	4.50	1
B-HS3	2 1/2	0-3 5/16	16,250	7.10	1
B-HS4	2 7/8	0-4 5/8	20,000	11.00	1
B-HS5	3 1/16	0-5 3/8	23,800	14.90	1
B-HS6	3 1/2	0-6 5/8	27,500	19.30	1
B-HS8	4 1/8	0-8 1/4	31,250	27.50	1
B-HS10	4	0-10 3/8	35,000	40.10	1
B-HS12	4	0-12 1/2	40,000	47.80	1



- Hex head on spindle
- Made in USA

C-clamps



- General purpose C clamp
- A range of openings and clamping force
- Galvanized finish: Models CM10-CM30
- Powder coated: Models CM40-CM80



Light duty (CM), malleable cast

BESSEY® Product #	Throat Depth	Clamping Capacity	Clamping Force	Approx. Weight	Case
	Inches	Inches	Pounds	Pounds	qty.
CM34DR	4 1/2	0-3	500	1.50	6
CM10	1	0-1	400	0.25	24
CM15*	1 1/2	0-1 1/2	400	0.30	24
CM20	1 1/2	0-2	400	0.40	18
CM22*	1 3/8	0-2 1/2	600	0.45	18
CM30*	1 3/4	0-3	800	0.90	12
CM40*	3 1/4	0-4	1,200	1.80	9
CM50	3 1/4	0-5	1,200	2.40	9
CM60*	3 1/2	0-6	1,200	2.70	6
CM80*	4	0-8	1,200	3.75	6

* Comes packed in retail ready full colour shelf display - must order case qty to get shelf display.



- Malleable cast-iron frame, powder coated to resist corrosion - ideal for DIY
- Red quick-release button for rapid opening and closing
- Chrome plated spindle and swivel pad



Quick release (QRCC)

BESSEY® Product #	Throat Depth	Clamping Capacity	Clamping Force	Approx. Weight	Case
	Inches	Inches	Pounds	Pounds	qty.
QRCC3	1 3/4	0-3 1/2	1,200	1.87	6
QRCC4	2 1/4	0-4 3/8	1,200	2.37	6
QRCC6	3 7/8	0-6 5/8	1,200	4.07	6



- Provides twin top pressure points in light duty clamping applications – ideal for hobbies, crafts and light trades



Double head (DHCC)

BESSEY® Product #	Throat Depth	Clamping Capacity	Clamping Force	Approx. Weight	Case
	Inches	Inches	Pounds	Pounds	qty.
DHCC-4	2 1/4	0-4	1,200	1.60	6
DHCC-6	2 7/8	0-6	1,200	3.00	6

SuperGrips™ Grip pliers



Your benefits at a glance:

- 1 Adjustable top handle**
Adjustable screw/lock nut (on top handle) adjusts clamping force.
- 2 Adjustable bottom handle**
Adjustable screw/lock nut (on lower lever) adjusts jaw angle (up to 7°) for clamping tapered parts
- 3 Adjustable sliding arm**
Infinitely adjustable jaw for a quick parallel clamp.
- 4. Sturdy rail**
Cold drawn, profiled steel rail.

SuperGrips™ with profiled rail (SG)



BESSEY® Product #	Throat Opening	Jaw Force	Clamping Force	Approx. Weight	Case
	Inches	Inches	Pounds	Pounds	qty.
SG-4WP	2 1/2	4	440	2.50	10
SG-8WP	2 1/2	8	440	2.70	10
SG Pads (pair)	Replaceable pads			0.10	1 pr

SuperGrips™ pipe clamp (SG)



BESSEY® Product #	Throat Depth	Clamping Capacity	Clamping Force	Approx. Weight	Case
	Inches	Inches	Pounds	Pounds	qty.
SG24-PC	2 3/4	4 1/2	310	2.75	10

SuperGrip™ deep reach clamp



BESSEY® Product #	Throat Depth	Clamping Capacity	Clamping Force	Approx. Weight	Case
	Inches	Inches	Pounds	Pounds	qty.
SG5-DR	3	4 1/2	310	2.50	10

SuperGrip™ welder's fork (SG)



BESSEY® Product #	Throat Depth	Clamping Capacity	Clamping Force	Approx. Weight	Case
	Inches	Inches	Pounds	Pounds	qty.
SG24-VWF	3	4	310	3.05	10



- Grip plier and clamp in one tool
- Cradle jaw aligns and holds pipe firmly in place
- Clamps over angle iron, channel iron and other obstacles
- Two independently adjustable sliding heads can be set at different heights and depths

Hold down products

Your benefits at a glance:

- 1. Single component design**
Self-positioning, single component design.
- 2. Workpieces of different thicknesses**
Wide clamping range. Adjustments up to 5".
- 3. T-slot table ready**
For T-slot hold down tables in machine shop applications.
- 4. Sturdy frame**
Strong, ductile iron body.
- 5. Swivel rocker**
Swivel rocker attached to body to prevent loss.



- Self-positioning, single component design
- Swivel rocker attached to body
- Strong, ductile iron body
- For T-slot hold down tables in machine shop applications
- L Series has a longer throw than S series

RiteHite (Model L)



BESSEY Product #	Bolt Size	Max Clamping Height	Nominal Dimensions	Recommended Load Limit	Max Torque	Approx. Weight	Case
	Inches	Inches	Inches	Pounds	LB-FT	Pounds	qty.
375L	3/8	1 1/4	3 3/4 x 1 1/8 x 1 1/4	7,000	43	0.56	1
500L	1/2	2 1/2	5 3/4 x 1 7/16 x 1 1/2	8,800	73	1.50	1
625L	5/8	3 1/2	6 3/4 x 1 3/4 x 1 5/8	14,500	163	2.62	1
750L	3/4	5	9 x 2 1/8 x 2 1/4	19,000	237	5.00	1
1000L	1	5	11 1/8 x 2 7/8 x 3 3/8	51,000	850	12.25	1

RiteHite (Model S)



BESSEY Product #	Bolt Size	Max Clamping Height	Nominal Dimensions	Recommended Load Limit	Max Torque	Approx. Weight	Case
	Inches	Inches	Inches	Pounds	LB-FT	Pounds	qty.
376S	3/8	1	3 x 1 1/8 x 1 1/4	8,800	55	0.50	1
501S	1/2	1 3/4	4 1/4 x 1 7/16 x 1 1/2	13,200	110	1.10	1
626S	5/8	2 3/4	5 1/2 x 1 3/4 x 1 5/8	19,000	213	2.12	1
751S	3/4	3 1/2	7 x 2 1/8 x 2 1/4	27,600	345	4.20	1
1001S	1	3	9 x 2 7/8 x 3 3/8	67,000	1,116	10.25	1

RiteHite charts are for general guidelines only. Specific values may vary depending on but not limited to bolt size and strength, condition, size and pitch of threads, coefficient of friction between parts and other variable factors.

Hold down clamps

Hold down table clamp



BESSEY® Product #	Throat Depth	Clamping Capacity	Clamping Force	Approx. Weight	Case
	Inches	Inches	Pounds	Pounds	qty.
2400HD-10	4 3/4	9 1/2	2220	7.85	1



- Vibration proof, ratchet action
- Tilting and height-adjustable
- Mounting hole accepts 5/8" bolts

Claw machine clamp (MCL)



BESSEY® Product #	Throat Depth	Clamping Capacity	Clamping Force	Approx. Weight	Case
	Inches	Inches	Pounds	Pounds	qty.
MCL-8	4 3/4	8	1450	6.75	1



- Cantilever jaw for clamping in tight space with screw positioned outside of work area
- Full rotation outside of work area
- For drilling and light milling work
- Mounting hole accepts 5/8" diameter bolts

Jig & fixture clamp (FC)



BESSEY® Product #	Throat Depth	Clamping Capacity	Clamping Force	Approx. Weight	Case
	Inches	Inches	Pounds	Pounds	qty.
FC24-8	5 1/2	8	2660	6.50	5

- Rotates 360° for easy work-piece removal
- Pressure plate swivels up to 35°
- Bushing O/D is 1 13/16"

Vises

Your benefits at a glance

1 Choices

A range of products from light duty to heavy duty

2 Made for everyday work

Robust designs

3 Robust construction

30 000 psi cast iron construction

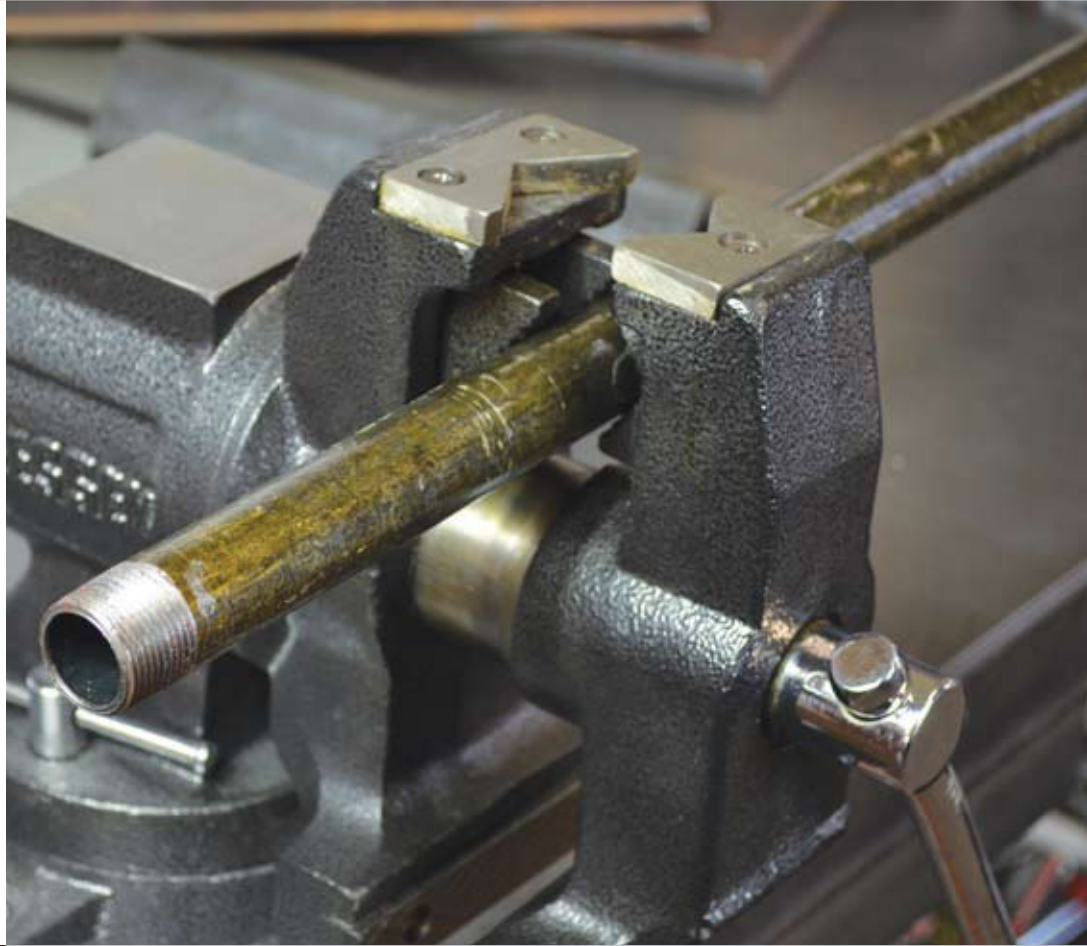

Multi-purpose vise

BESSEY® Product #	Jaw Width Inches	Jaw Opening Inches	Throat Depth Inches	Pipe Capacity Inches	Approx. Weight Pounds	Case qty.
BV-MPV5	5	5	3	2	43	1

- 360° swivel base with 3 mounting holes and 2 lockdowns
- Built-in anvil
- Cast iron body

Heavy duty workshop vises



BESSEY® Product #	Jaw Width Inches	Jaw Opening Inches	Throat Depth Inches	Approx. Weight Pounds	Case qty.
BV-HD40	4	4	2	17	1
BV-HD60	6	6	3	44	1

- 360° swivel base with 3 mounting holes and 2 lockdowns
- Built-in anvil

Vises

Homeowners bench vise



BESSEY® Product #	Jaw Width Inches	Jaw Opening Inches	Throat Depth Inches	Pipe Capacity Inches	Approx. Weight Pounds	Case qty.
BV-HW45	4 1/2	4 1/2	1 3/4	1	11	1

- 270° swivel base with 4 mounting holes and 1 lockdown
- Built-in anvil
- Cast iron body

Drill press vise

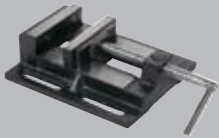

BESSEY® Product #	Jaw Width Inches	Jaw Opening Inches	Throat Depth Inches	Approx. Weight Pounds	Case qty.
BV-DP40	4	4 1/4	1 1/8	9	1

- Grooved jaws provide a firm secure grip
- Elongated holes for easy fastening onto a drill press or work surface

Light duty clamp-on vise



BESSEY® Product #	Jaw Width Inches	Jaw Opening Inches	Throat Depth Inches	Pipe Capacity Inches	Approx. Weight Pounds	Case qty.
BV-C030	3	3	1 1/2	3/4	5	1

- Cast in pipe jaws
- Double steel guide bars
- Clamps on work surfaces up to 1.5"

Vacuum base vise



BESSEY® Product #	Jaw Opening Inches	Approx. Weight Pounds	Case qty.
BV-VB	2 3/4	4.50	1

- Lightweight sturdy cast aluminum body
- Replaceable steel jaws
- 360° swivel rotation head allows to be used in any position
- Convenient vacuum base for mounting on any smooth surface

Multi-purpose vise jaws

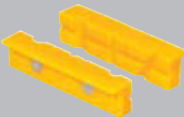

BESSEY® Product #	Jaw Opening Inches	Approx. Weight Pounds	Case qty.
BV-NVJ	3-6	0.50	1

- Designed to fit any 3-6 in. vise jaw
- Magnetic back
- Great for holding wood, metal & tubing

Light duty wood vise



BESSEY® Product #	Jaw Width Inches	Jaw Opening Inches	Throat Depth Inches	Approx. Weight Pounds	Case qty.
BV-WV65	6	6	2 5/8	8.50	1

- Cast iron body

Industrial magnets

Your benefits at a glance

- 1 Quality**
Quality magnets for fast, simple set-ups
- 2 Flexibility**
Often referred to as "an extra set of hands"
- 3 Variety**
The wide variety of BESSEY® industrial magnets will offer most metal workers an option that fits their needs



- Simple magnet holds work at set angle
- Double magnets are joined at a pivot point and can hold work at any angle
- Quality magnetic multi-angle square for fast, simple set-up
- Quality magnetic multi-angle square for fast, simple set-up

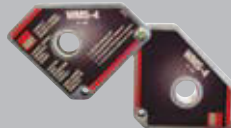

Magnetic squares (WMS)

BESSEY® Product #	Pull	Nominal Dimensions	Pre-set Angles	Approx. Weight	Case
	Pounds		Inches		
WMS-1	66	3 ³ / ₄ x 4 ³ / ₈ x 3 ³ / ₄	90/45	1.10	10
WMS-3	48.5	3 ³ / ₈ x 3 ³ / ₈ x 5 ⁵ / ₈	90/45	0.70	15
WMS-5	112	3 ³ / ₄ x 4 ³ / ₈ x 3 ³ / ₄	90/45	1.35	10

Double magnetic square (WMS)

BESSEY® Product #	Pull	Nominal Dimensions	Angle Range	Approx. Weight	Case
	Pounds		Inches		
WMS-4	110	6 ¹ / ₈ x 3 ³ / ₈ x 5 ⁵ / ₈	0 to 180	1.30	6

Multi-angle magnetic square (WMS)

BESSEY® Product #	Pull	Nominal Dimensions	Pre-set Angles	Approx. Weight	Case
	Pounds		Inches		
WMS-6	35	4 x 2 ¹ / ₂ x 9 ⁹ / ₁₆	30/45/60/75/90	0.62	10

Arrowhead magnetic square (WMS)

BESSEY® Product #	Pull	Nominal Dimensions	Pre-set Angles	Approx. Weight	Case
	Pounds		Inches		
WMS-7	41	4 ³ / ₄ x 3 ¹ / ₄ x 9 ⁹ / ₁₆	90/45	0.76	15

Industrial magnets



“Chunky” magnetic square (CMS)



BESSEY® Product #	Pull	Nominal Dimensions	Pre-set Angles	Approx. Weight	Case
	Pounds	Inches	Degrees	Pounds	qty.
CMS-1	100	3 ³ / ₄ x 4 ³ / ₈ x 1 ⁵ / ₈	90/45	2.70	6

“Big Daddy” magnetic square (BDMS)



BESSEY® Product #	Pull	Nominal Dimensions	Pre-set Angles	Approx. Weight	Case
	Pounds	Inches	Degrees	Pounds	qty.
BDMS-1	100	8 x 8 x 1 ⁵ / ₈	90/45	7.70	1

“On/Off” magnetic square (WMS)



BESSEY® Product #	Pull	Nominal Dimensions	Pre-set Angles	Approx. Weight	Case
	Pounds	Inches	Degrees	Pounds	qty.
WMS-8	75	3 ³ / ₈ x 4 ³ / ₈ x 1 ¹ / ₄	90/45	2.25	10

Magnetic ground clamps (MGC)



BESSEY® Product #	Pull	Nominal Dimensions	Amps	Approx. Weight	Case
	Pounds	Inches		Pounds	qty.
MGC-1	55	3 ¹ / ₂ x 2	250	1.75	4
MGC-2	55	3 ¹ / ₂ x 2	800	1.85	4

Mag Pick-Up (MPU)



BESSEY® Product #	Description	Approx. Weight	Case
		Pounds	qty.
MPU-1	Magnetic disc on 35” tubular shaft	1.35	1

MagStick (MS)



BESSEY® Product #	Description	Approx. Weight	Case
		Pounds	qty.
MS-1	Magnet on a 26” telescopic shaft, pocket clip	0.16	25

MagWand (MW)

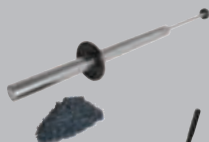

BESSEY® Product #	Description	Approx. Weight	Case
		Pounds	qty.
MW-1	22” length	1.70	1

MagSweep (MSP)



BESSEY® Product #	Description	Approx. Weight	Case
		Pounds	qty.
MSP-24	Shop floor magnet on wheels, 24” swath	45.00	1

- T-handle for easy release of the magnet

- T-handle for easy release of the magnet

- On and Off switch on magnet

- Ground clamps only need base surface metal for clamping

- Magnetic disc on 35” tubular shaft for picking up small metal parts – also useful during clean-up

- 5 1/2” “pen-sized” pocket magnet extends to 26” to pick-up hard to reach small metal objects

- Can collect up to 12 lb of swarf in a pass for a cleaner safer welding and machine shop
- Rolls easily over industrial work surfaces and dumps waste by simply pulling sliding magnetic insert

- Rolling shop-floor magnet on wheels, 24” swath

Other clamps

- Non-marring glue resistant jaws
- Can be clamped to work surface with TK-6 table clamps
- TK-6 clamps included with S-10



Portable mini-vise (S)

BESSEY® Product #	Jaw Width Inches	Clamping Capacity Inches	Approx. Weight Pounds	Case qty.
S-10	3 5/8	4	1.80	6
TK-6	Holds vise clamps to flat work surface			

- Cold-drawn, carbon-steel spindles and swivel nuts
- Large handles for comfort and torque
- Oiled maple jaws



Wood handscrew clamps (HS)

BESSEY® Product #	Jaw Length Inches	Clamping Capacity Inches	Throat Depth Inches	Spindle Diameter Inches	Approx. Weight Pounds	Case qty.
HS-6	6	3	3	5/16	1.00	12
HS-8	8	5	4	7/16	1.25	6
LHS-10	10	7	6	7/16	2.24	3
HS-12	12	9 1/4	6	7/16	4.00	3

- Holds BESSEY® WS-3, WS-6, S-10, S-15, and K-Body® REVO™ (KR & KRV) to work surface



Table mount clamp (TK)

BESSEY® Product #	Works with...	Approx. Weight Pounds	Case qty.
TK-6	Fits WS-3, WS-6, S-10, S-15, and K-Body® REVO™ (KR & KRV)	0.45	1 pair

- For safe transportation of panels of a variety of materials
- High-friction rubber coating on the moving clamping jaws
- 150 lb weight carrying capacity



Panel carrier (KF)

BESSEY® Product #	Opening Inches	Approx. Weight Pounds	Case qty.
KFP	1/2 - 2.5	2.2	1

- Fast-easy adjusting moveable jaw – simply slide to work piece and place lock pin in perforated rail
- Rugged construction – cast iron jaw, steel rail



T-bar sash clamps

BESSEY® Product #	Throat Depth Inches	Clamping Capacity Inches	Clamping Force Pounds	Approx. Weight Pounds	Case qty.
BT-36	2	39	3990	18.00	1
BT-96	2	98	3330	32.00	1
BT-120	2	120	2660	40.00	1

- For laying parquet, plank and laminate flooring
- 157 in. strap



Flooring strap clamps (SVH)

BESSEY® Product #	Strap Length Inches	Clamp Plate Width Inches	Clamping Force Pounds	Approx. Weight Pounds	Case qty.
SVH400XL	157	4 3/4	220	1.80	5

Accessories



Service part, plastic replacement caps



BESSEY® Product #	Suitable for ...	Approx. Weight	Case
		Pounds	qty.
3101392	TGJ2.5 (set of 10) (Previously TRP2.5)	0.25	1
3101394	TG4.0 (set of 10) (Previously TRP4.0)	0.25	1
3101395	TG4.5 (set of 10) (Previously TRP4.5)	0.25	1
3101396	TGK, TG5.5, & TG7.0 (set of 10) (Previously TRP5.5)	0.25	1



- Soft plastic cap for non-slip, gentle clamping

Service part, standard pads



BESSEY® Product #	Suitable for ...	Approx. Weight	Case
		Pounds	qty.
3101339	MMS (4 pc) (Previously SOP-SMNPV1)	0.45	1
3101180	TGJ2.5, GS16K, GS12-8K (4 pc)	0.45	1
3101183	TG4.0, RSC-8, 660S, J18, GS16-12K, GS25K, GS20K (4 pc) (Previously SOP-SMNPV2)	0.45	1
3101188	TG5.5, TG7.0, TGK4.5, RSC-12 et 24, 1200S, SQ, SGL, SG30VAD, TSC4, SQ-J, GS30K (4 pc) (Previously SOP-SMNPV3)	0.45	1

* Replaceable pads have a snap ring on the inside. Put spindle 'ball' in the opening, apply pressure and the pad attaches.

Service part, MorPads



BESSEY® Product #	Suitable for ...	Approx. Weight	Case
		Pounds	qty.
3100736	12/18/24/4800 Series, GSL & GSM (Previously 12/18/24/48P)	0.45	1
3100737	7200 Series (Previously 7200P)	0.50	1
3101192 (Rough Face)	12/18/24/4800 Series, GSL & GSM (Previously MPD-R)	0.45	1
3101193 (V Groove)	12/18/24/4800 Series, GSL & GSM (Previously MPD-V)	0.45	1



Clamp force indicators (FIN)



BESSEY® Product #	Suitable for ...	Approx. Weight	Case
		Pounds	qty.
FIN250	TG4, 660S, RSC 8	.5	1
FIN350	TGK4.5, RSC-12-24, 1200S-12-24	.5	1

- No tools required to change. Remove pads from clamps and re-attach FIN in its place.
- Green zone only indicates approximate pressure: FIN250 = 550 lbs, FIN350 = 700 lbs

Variable angle device (VAD)



BESSEY® Product #	Range of Angle	Swivel	Approx. Weight	Case
	Degrees	Degrees	Pounds	qty.
VAD	up to 60°	360°	2.00	1

- Floating pads tilt 60° inward or outward – ideal for clamping or aligning round, oval and angular pieces
- Easy to install and remove; swivel 360°
- Fits up to 2400 series clamps

Accessories



■ Made from soft hand-friendly plastic

■ For items 660-S, RSC-8, VC950 and J-18 spare part for Tommy Bar and Spindle is special order number 3100120 (RSC-12 and RSC-24 is 3100121)



Accessory, BESSEY® Grip handles

BESSEY® Product #	Suitable for ...	Approx. Weight	Case
		Pounds	qty.
3006786	RSC-8, 660S, SQ-4 (Previously BGSM-100)	0.30	25
3006727	TG5.5, TG7.0, TGK4.5, RSC-12 & 24, 1200S, SQ, SGL, 2400S, SG30VAD, 1800-S (Previously BGLG-120)	0.20	25

Service part, screw and pad assembly



BESSEY® Product #	Suitable for ...	Approx. Weight	Case
		Pounds	qty.
3100398	1200/1800 Screw (.700" Dia.)	1.1	1
3100399	2400 Screw (.775" Dia.) (also fits SQ, VC2220)	1.3	1
3100400	4800/8500 Screw (.850" Dia.)	1.5	1
3100401	7200 Screw (.925 Dia.)	3.5	1

Combi-set includes a handle, spindle, MorPad and pin

Service part, spindle



BESSEY® Product #	Suitable for ...	Approx. Weight	Case
		Pounds	qty.
3100119	GS12-8K, GS16K	0.60	1
3100120	GS20K, GS16-12K, GS25K, 660S	0.70	1
3100121	GS30K, 1200S	0.80	1
3101012	MMS	0.40	1

Service part, sliding arm



BESSEY® Product #	Suitable for ...	Approx. Weight	Case
		Pounds	qty.
3000157	Arm only for old style 1200 (Previously 1200A)	1.00	1
3008019	Arm only for new style 1200	1.00	1
3000159	Arm only for old style 1800 (Previously 1800A)	1.25	1
3007855	Arm only for new style 1800	1.25	1
3001411	Arm only for old style 2400S (Previously 2400A)	1.45	1
3007822	Arm only for new style 2400S	1.45	1
3005120	Arm only (Previously HPCA)	3.00	1
3001412	Arm only (Previously 4800A)	3.05	1
3001413	Arm only (Previously 7200A)	5.75	1
3100579	Nut & lock ring for 7200 Series (Previously NLR7200)	1.00	1



Service part, wedges for 7200/8500

BESSEY® Product #	Suitable for ...	Approx. Weight	Case
		Pounds	qty.
3000689	For 7200 series (Previously 7200W)	0.30	1
3005122	For 8500 series (Previously 8500W)	0.25	1



Traditional tin snips



Compound leverage snips



Ideal snips

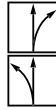

Continuous, straight and curved cuts, right



Continuous, straight and curved cuts, left

Outline cutting snips

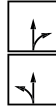

Short, straight and narrow curved cuts, right



Short, straight and narrow curved cuts, left

Straight cutting snips



Straight and curved cuts, large radius in both left and right directions



Short, straight cuts, notch

Left cutting snips



Right cutting snips



1. Types

Traditional tin snips

Edges and handle are traditionally forged into one unit. The force required for cutting is determined by the ratio of edge length to the handle length.

Compound leverage snips

The cutting heads and handles are made separately and are both hinged. When they're attached to each other, this double hinged (double fulcrumed) assembly greatly increases the leverage, requiring less physical effort.

2. Models

Ideal snips

These multi-purpose snips can cut through a metal sheet (straight-cut) as well as cut large and small contours or radii (outline-cut). It doesn't matter whether you're cutting at the edge (edge cut) or at the centre of a sheet. You can naturally use ideal snips for notching-operations.

Outline cutting snips

Best suited for fine and narrow radius cuts near the edges of a metal sheet. You can use the delicately shaped edge of these snips to cut extremely narrow shapes or curves without any problem.

Straight cutting snips

Ideal for cutting a metal sheet at the centre and/or near the edges. You can use long edges of this tool to cross-cut and notch large metal sheets quickly and precisely with less effort.

3. Right cutting or left cutting snips. What's the difference?

Right cutting snips are designed so that they can cut right radii, a curve from left to right easily. Left cutting snips are the best for radius cuts from right to left.

The common perception is that, right cutting snips are for right-handers, and left cutting snips for left-handers. This is not true. If a right-handed person is cutting a radius from left to right, using right cutting snips (radius from left to right), you have to cut outwards from your wrist. With left cutting snips, (radius is then from right to left) you can cut inwards from your wrist. This is considerably more ergonomic. Try it out once!

4. Grades

The service life of cutting edges depends directly on the grade of steel used and the processing. High-performance snips with case-hardened HSS – edges fulfill the most stringent requirements regarding service life and cutting performance. Cutter heads of the HSS-Tin grade are additionally coated with extremely hard titanium nitride that reduces wear and tear. Other cutting materials, namely special high quality steel, quality steel and standard quality steel, are available depending on the application and the frequency of use.

Grades of blade steel	min. HRC	Durability	Approx. Tensile Strength of Blade PSI	Max. Sheet thickness at tensile strength of:		
				58 000 PSI Mild Carbon Steel	116 000 PSI Hard Carbon Steel	159 000 PSI Very Hard Stainless
HSS D27AH	64	++++	370,000	1.5 mm/16 ga	1.2 mm/18 ga	0.6 mm/25 ga
Special High Grade Steel D29SS; D29ASS; D123S	60	+++	320,000	1.5 mm/16 ga	1.2 mm/18 ga	/
High Grade Steel D22A; D27; D-SPC; D-SPS	58	++	300,000	1.5 mm/16 ga	1.2 mm/18 ga	/
Standard Quality Steel	54	+	266,000	1.2 mm/18 ga	0.8 mm/22 ga	/

Snips & knives

D15A Compact aviation snip

Your benefits at a glance:

1 100% Power, 75% of the size

The D15A Compact Aviation Snip has all the power of a full size aviation snip but, is 25% smaller. This makes the whole snip more manoeuvrable to get into even the most cramped spaces.

2 Extremely compact cutting head

Extremely compact cutting head for great manoeuvrability, cutting the narrowest radii. The "Ideal" design allows the surface being cut to slide past beneath your fingers and reduces chance of injury.

3 Practical locking mechanism

The practical locking mechanism allows one to open & close with one hand and limits the maximum opening of the snip.

4 Compound leverage

Compound leverage considerably reduces effort required, improving productivity while reducing hand fatigue.

5 Ergonomic handle

Ergonomic handles keeps hand from slipping.



- For long continuous, straight and curved cuts
- Compact design for high performance with minimum effort
- 10 carded pieces per display box

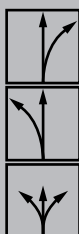

NEW Multi-use snip, compact aviation snip (D15A)

BESSEY® Product #	Overall Length	Blade Length	Cutting Capacity (Regular metal)	Approx. Weight	Case
	Inches	Inches	Gauge	Pounds	qty.
D15A-BE	7 3/16	13/16	18	0.44	10
D15AL-BE	7 3/16	13/16	18	0.44	10
D15S-BE	7 3/16	13/16	18	0.44	10
D15-SET	Includes: 1 x D15S-BE, 1 x D15A-BE, 1 x D15AL-BE in a nylon pouch				



D15 Snip compared to a full size aviation snip.

Aviation snips (D16)



BESSEY® Product #	Overall Length	Blade Length	Cutting Capacity (Regular metal)	Approx. Weight	Case
	Inches	Inches	Gauge	Pounds	qty.
D16S-BE	9 1/2	1 3/4	18	1.25	5
D16L-BE	9 1/2	1 9/16	18	1.25	5
D16-BE	9 1/2	1 9/16	18	1.25	5
D16-SET	Includes: 1 x D16S-BE, 1 x D16L-BE, 1 x D16-BE in a nylon pouch				



- High grade steel cutting blades – up to HRC 59
- Micro-serrations for slip proof cutting

Special hard cutting snips (D29SS)

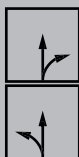

BESSEY® Product #	Overall Length	Blade Length	Cutting Capacity (Regular metal)	Approx. Weight	Case
	Inches	Inches	Gauge	Pounds	qty.
D29SS-BE	10 1/4	1 9/16	18	1.25	5
D29SSL-BE	10 1/4	1 9/16	18	1.25	5



- High grade steel cutting blades – HRC up to 61
- Micro-serrations for slip proof working
- Right or left cutting versions

Offset snips, optimized (D29ASS)



BESSEY® Product #	Overall Length	Blade Length	Cutting Capacity (Regular metal)	Approx. Weight	Case
	Inches	Inches	Gauge	Pounds	qty.
D29ASS-BE	10 1/4	1 5/16	18	1.25	5
D29ASSL-BE	10 1/4	1 5/16	18	1.25	5



- High grade steel cutting blades – HRC up to 61
- Optimized leverage ratio - 25% less effort
- Compact cutter head
- Right or left cutting versions

Offset, extra hard, high tolerance (D27AH)

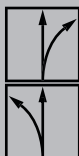

BESSEY® Product #	Overall Length	Blade Length	Cutting Capacity (Regular metal)	Approx. Weight	Case
	Inches	Inches	Gauge	Pounds	qty.
D27AH-BE	10 1/4	1 5/16	18	1.25	1
D27AHL-BE	10 1/4	1 5/16	18	1.25	1



- Case-hardened, high-speed steel edges – HRC up to 68
- For long continuous, straight and curved cuts
- Available in right or left cutting versions

Long-nose, multi-purpose (D22AL)



BESSEY® Product #	Overall Length	Blade Length	Cutting Capacity (Regular metal)	Approx. Weight	Case
	Inches	Inches	Gauge	Pounds	qty.
D22AL-BE	11	2 1/2	18	1.25	5



- High grade steel, extra long cutting blade designed for continuous cuts – HRC up to 59
- Angled cutter heads keep hands free from work
- For long continuous straight and large radius cuts
- Available in left cutting version only

Snips & knives



- Cuts steel straps up to 32 x 1mm (1 1/4 x 1/32) with one hand
- Holds banding tightly during cut to prevent banding from springing up
- Ergonomic handle and compound leverage for comfort and ease of use

- Capable of cutting a 2" (50 mm) hole (starting hole of 8.5 mm required)
- Distortion free cuts of up to 1.2 mm thick in normal sheet metal
- Integrated chip-separator for cleanly cut notches

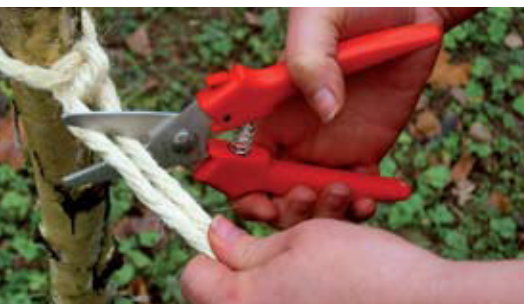

- Stainless steel blade
- Spring opens cutter automatically
- Thumb operated lock

- Stainless steel blade
- For multi-core cable with diameters up to 10 mm (3/8")

- Stainless steel blade cuts wide range of material
- Spring opens cutter automatically, thumb operated lock
- Ergonomic handle with soft-insert
- Notched blade for wire stripping

Strap cutter (D123)



BESSEY® Product #	Overall Length	Blade Length	Approx. Weight	Case
	Inches	Inches	Pounds	qty.
D123S-SB	10 1/4	1 1/2	1.3	5

Super nibbler (D24)



BESSEY® Product #	Overall Length	Blade Length	Approx. Weight	Case
	Inches	Inches	Pounds	qty.
D24-SB	10 1/2	N/A	1.0	5

MultiSnip - Straight (D47, D48)



BESSEY® Product #	Overall Length	Blade Length	Approx. Weight	Case
	Inches	Inches	Pounds	qty.
D47-BE	5 1/2	1 1/4	0.13	15
D48	7 3/4	1 5/8	0.25	10

MultiSnip - Offset (D48A)



BESSEY® Product #	Overall Length	Blade Length	Approx. Weight	Case
	Inches	Inches	Pounds	qty.
D48A	7 1/2	1 3/8	0.25	10

Cable cutter (D49)



BESSEY® Product #	Overall Length	Blade Length	Approx. Weight	Case
	Inches	Inches	Pounds	qty.
D49-BE	6 1/2	NA	0.25	10

Combinox (D50)



BESSEY® Product #	Overall Length	Blade Length	Approx. Weight	Case
	Inches	Inches	Pounds	qty.
D50-BE	7 1/2	1 3/8	0.25	10

Snips & knives



MultiSnip master (D51)



BESSEY® Product #	Overall Length	Blade Length	Approx. Weight	Case
	Inches	Inches	Pounds	qty.
D51A-BE	9 1/4	2	0.25	10

- Stainless steel cutter edge cuts wide range of material
- Angled cutter head keeps hands safely free from work
- Handle made of robust fibreglass-reinforced plastic with soft-insert

SuperPower snips - Straight blade (DSPS)



BESSEY Product #	Overall Length	Blade Length	Sheet Thickness	Approx. Weight	Case
	Inches	Inches	mm	Pounds	qty.
D-SPS8	8 1/2	1 3/4	1.2	0.75	24
D-SPS11	11 1/2	2 1/4	1.2	1.25	18

SuperPower snips - Offset blade (DSPC)



BESSEY Product #	Overall Length	Blade Length	Sheet Thickness	Approx. Weight	Case
	Inches	Inches	mm	Pounds	qty.
D-SPC8	8 1/2	1 3/4	1.2	0.75	24
D-SPC11	11 1/2	2 1/4	1.2	1.25	18

*All SuperPower snips come packed in retail ready full colour shelf display - must order case qty to get shelf display.



- (DSPS) Straight jaws
- (DSPC) Offset jaws
- Compound SuperPower snips need 50 % less hand force than ordinary pattern snips
- Cuts up to 19 ga. (1.0 mm) cold rolled steel or 25 ga. (0.6 mm) stainless steel – HRC up to 62

NEW DMT multi-function tool



BESSEY Product #	Handle Length	Cutting edge Length	Total Length	Approx. Weight	Case
	Inches	Inches	Inches	Pounds	qty.
DMT	4	2 1/8	7	0.66	8



- 1 multi tool with 7 options: Shears, blade, saw, file, Phillips head screwdriver and large and small slotted screwdriver
- Cuts: Leather, rope, vinyl, thin cable, cord, thin plastic, paper etc.
- Belt pouch for handy storage



Snips & knives



- Quick blade change mechanism
- Folding stainless steel blade with serrated cut
- Release lever unlocks the knife to be folded safely

All knives include:

- Folding and locking blades with belt-clip
- Quick blade exchange - uses standard blades
- Spring blade release

Model D-BKPH also features:

- Thumb cushion for maximum contact pressure
- Blade compartment for replacement blades
- 5 extra blades included

- 4 types of blades: normal, scoring, linoleum and rug
- Comes in a convenient case

- Contains a good selection of BESSEY® snips
- Includes display rack
- Mix & match to make a set of your own. Call for details.

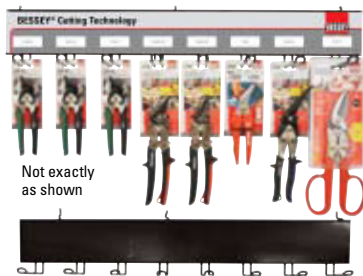

NEW Double blade folding tool

BESSEY Product #	Handle Length Inches	Cutting edge Length Inches	Blade Length Inches	Approx. Weight Pounds	Case qty.
DBKAH-2B	3 3/4	3	1	0.37	10

Folding utility knife - Aluminum handle



BESSEY Product #	Overall Length Inches	Blade Length Inches	Approx. Weight Pounds	Case qty.
D-BKAH	6 1/4	2 1/4	0.30	12

Folding utility knife - Wood handle



BESSEY Product #	Overall Length Inches	Blade Length Inches	Approx. Weight Pounds	Case qty.
D-BKWH	6 1/4	2 1/4	0.30	12

Folding utility knife - ABS comfort grip handle



BESSEY Product #	Overall Length Inches	Blade Length Inches	Approx. Weight Pounds	Case qty.
D-BKPH	6 1/4	2 1/4	0.40	12

Folding utility knife set - ABS comfort grip handle



BESSEY Product #	Overall Length Inches	Blade Length Inches	Approx. Weight Pounds	Case qty.
D-BKPH Set	6 1/4	2 1/4	0.70	8



**All knives come packed in retail ready full colour shelf display - must order case qty to get shelf display.*

NEW Snip display rack (32 pc with display)

BESSEY® Product #	Kit Includes	Approx. Weight Pounds
SDR-32	5 x D15A-BE (Multi-use snip-Right cut) 5 x D15S-BE (Multi-use snip-Straight cut) 5 x D15AL-BE (Multi-use snip-Left cut) 2 x D29ASS-BE (Offset snip-Right cut) 2 x D29ASSL-BE (Offset snip-Left cut) 5 x D48A (MultiSnip-Offset) 4 x D22AL-BE (Long-nose) 4 x D-SPC11 (SuperPower snips-Offset) 1 x MERCH1072-Display hardware	26.80

Industrial fluids & compounds



Lab-metal®



BESSEY® Product #	Unit/Container	Approx. Weight	Case
			Imperial/Metric
LM-06	6 oz/170 g	6.00	12
LM-12	12 oz/340 g	13.00	12
LM-24	24 oz/680 g	23.00	12
LM-48	48 oz/1.4 g	42.00	12

Hi-Temp Lab-metal®



BESSEY® Product #	Unit/Container	Approx. Weight	Case
			Imperial/Metric
HT-14	14 oz/397 g	15.00	12
HT-24	24 oz/680 g	23.00	12

Lab-solvent



BESSEY® Product #	Unit/Container	Approx. Weight	Case
			Imperial/Metric
LS-16	16 oz/473 ml	16.00	12
LS-128	1 gal/3.8L	19.00	2

Heat block



BESSEY® Product #	Unit/Container	Approx. Weight	Case
			Imperial/Metric
HB-PNT	1 pint/.47L	5.00	12

Spatter release



BESSEY® Product #	Unit/Container	Description	Approx. Weight	Case
				Imperial/Metric
16300-16	16 oz/473 ml	Water based	16.00	12
1620-16	16 oz/473 ml	Solvent based	19.00	12

Stick-Kut™ lubricating stick wax



BESSEY® Product #	Unit/Container	Approx. Weight	Case
			Imperial/Metric
15-SK	15 oz stick	12	12

*Only available for sale in Canada.

- The original ready-to-use metal putty
- To build up, apply in thin layers, allow to dry and repeat
- Drying time for 1/8" = 3-4 hours
- Can be drilled, tapped, ground, milled, chisselled, sanded, etc.

- The original ready-to-use metal putty
- To build up, apply in thin layers, allow to dry and repeat
- Dry for 24 hours then cure at 425° for 1 hour
- Can be drilled, tapped, ground, milled, chisselled, sanded, etc.

- Surface-prep for regular & Hi-Temp Lab-metal
- Thins Lab-Metal for brushing or spraying - leaves no film

- Heat absorbing, insulating paste
- Insulates adjacent material against heat transfer during welding, soldering brazing or other heat treatment
- Non-toxic and easily applied direct from container

- Water based version is non-toxic and biodegradable, safe for use outdoors
- Paint friendly - no silicones
- Non-flammable CO₂ propellant
- No CFC's or trichloroethylene

- For grinding wheels, sanding belts and saw blades
- Eliminates heat build up and belt loading - extends wheel life

Industrial fluids & compounds

- Reduces friction; longer tool life; clean burr-free thread
- Forms tough film – for use on a wide variety of materials



- Reduces friction; longer tool life; clean burr-free thread
- Forms tough film – for use on a wide variety of materials



- Improves blade life; reduces machine wear
- Contains rust and corrosion inhibitors



- Water based; Non-WHMIS – environmentally friendly
- No chlorine, no sulfur, non-toxic formula-safe to use



- Specifically for aluminum – use for tapping, drilling, boring, milling, turning, broaching, reaming and sawing
- May be used on other metals
- Non-WHMIS - environmentally friendly



- High quality air tool and air line lubricant



- Fine machined finish even on tough materials such as aluminum, beryllium, brass, bronze, cast iron, copper, inconel, magnesium, molybdenum, stainless steel, and stellite
- No 1,1,1 Trichloroethane – ozone friendly, non-toxic, and non-flammable; non-WHMIS



Relton dark thread cutting oil

BESSEY® Product #	Unit/Container	Approx. Weight	Case
	Imperial/Metric	Pounds	qty.
TCO14-01G ¹²	1 US gal/3.785L	36	4
TCO14-05G ¹²	5 US gal/18.925L	45	1

Relton light thread cutting oil

BESSEY® Product #	Unit/Container	Approx. Weight	Case
	Imperial/Metric	Pounds	qty.
TCO16-01G ¹²	1 US gal/3.785L	36	4
TCO16-05G ¹²	5 US gal/18.925L	45	1

Relton Rel-Saw band saw fluid

BESSEY® Product #	Unit/Container	Approx. Weight	Case
	Imperial/Metric	Pounds	qty.
01G-RS ¹²	1 US gal/3.785L	38	4
05G-RS ¹²	5 US gal/18.925L	45	1

Relton OPTION 1® cutting fluid

BESSEY® Product #	Unit/Container	Approx. Weight	Case
	Imperial/Metric	Pounds	qty.
OPT114 ¹	4 oz/118 ml	7.4	24
OPT455 ¹	16 oz/473 ml	14.8	12
OPT4 ¹	1 US gal/3.785L	36.1	4
OPT20 ¹	5 US gal/18.925L	47	1
OPT205 ¹²	55 US gal/205L	500	1

Relton A-9® aluminum cutting fluid

BESSEY® Product #	Unit/Container	Approx. Weight	Case
	Imperial/Metric	Pounds	qty.
A9114 ¹	4 oz/118 ml	9	24
A9455 ¹	16 oz/473 ml	16	12
A94 ¹	1 US gal/3.785L	33	4
A920 ¹	5 US gal/18.925L	42	1
A9205 ¹²	55 US gal/205L	450	1

Relton Air-Flo air tool oil

BESSEY® Product #	Unit/Container	Approx. Weight	Case
	Imperial/Metric	Pounds	qty.
AF-PNT ¹²	1 pint/473 ml	13.50	12
AF-01G ¹²	1 US gal/3.785L	36	4

Relton Rapid Tap® cutting fluid

BESSEY® Product #	Unit/Container	Approx. Weight	Case
	Imperial/Metric	Pounds	qty.
RT114 ¹	4 oz/118 ml	11	24
RT455 ¹	16 oz/455 ml	17	12
RT4 ¹	1 US gal/3.785L	42	4
RT20 ¹	5 US gal/18.925L	45	1
RT205 ¹²	55 US gal/205L	500	1

¹Relton fluids and compounds are available for sale but only in Canada.

²Available as a special order only. Non-stock.

Specialty products



Torque multipliers (X4)



BESSEY Product #	Input Capacity	Output Capacity	Input Drive	Output Drive	Ratio	Approx. Weight	Case
	Foot/Pounds	Foot/Pounds	Inches	Inches		LB-FT	Pounds
JM-750	250	1,000	1/2	3/4	4:01	7.00	1
JM-1000	500	2,000	3/4	1	4:01	14.00	1
JM-1200 ¹	209	3,000	3/4	1 1/2	14.3:1	30.00	1
JM-1500 ¹	923	4,000	1	1 1/2	4.33:1	30.00	1
JM-2000 ¹	1739	8,000	1	1 1/2	4.6:1	47.00	1
JM-2500 ¹	2000	12,000	1	2 1/2	6:01	73.00	1

¹Available for sale as a special order item. Non-stock item.

- Geared head offers 4X the power of an ordinary wrench alone
- Requires no air or electricity
- Up to 12,000 ft. lbs. of torque
- Use with a torque wrench when precision required (always calibrate to be sure)
- X4 Units can be stacked for higher power

Anti-Backlash torque multiplier

BESSEY Product #	Input Capacity	Output Capacity	Input Drive	Output Drive	Ratio	Approx. Weight	Case
	Foot/Pounds	Foot/Pounds	Inches	Pounds		LB-FT	Pounds
JM-1000-R ¹	500	2,000	3/4	1		15.00	1

¹Available for sale as a special order item. Non-stock item.

- Limits risk of "spring back" when extender bar is used
- Coupled with larger model – makes entire system anti-backlash

Reco induction bearing heaters

- Extend bearing life and cut operating cost by eliminating hammering and pounding to cold-mount bearings
- Works on bearings, sprockets, gears, couplings, sleeves
- Reduces risk to operator from flames, torches or oil baths
- Demagnetizes bearings – easy to use, ready in minutes

Model SC110D (110V or 220V)

- Bearing capacity: 4" x 11" O.D. (14"OD with optional raising blocks)
- Computer chip monitors and stabilizes temperature
- Display panel (pre-set times, temperatures) & auto shut off

Model SC110V (110V or 220V)

- Bearing capacity: 4" x 11" O.D. (14"OD with optional raising blocks)

Model BC (220V, or 440V or 550V)

- Bearing capacity: 7 1/2" x 22" O.D. (32"OD with optional raising blocks)

Model BC Special (110V or 220V)

- Bearing capacity: 11 1/2" x 22" O.D. (32"OD with optional raising blocks)

- All Bearing heaters are single phase 60 hz units
- 50 hz versions available as special request

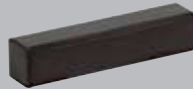

- Increases the maximum size of bearing that can be heated
- SCRBR fits SC Models
- BCRB fits BC and BCS Models

- Multi-purpose measuring device for bearings, gears, etc.
- Digital readout from -200°C (-328°F) to +1372°C (+1999°F)
- Probe max rated for 650° (1200°F)



Reco induction bearing heaters

BESSEY® Product #	Voltage	Standard Cross Bars	Optional Cross Bars	Approx. Weight	Case
	Volts(amps)	Inches	Inches	Pounds	qty.
SC 110D	110V (17 amp)	3/4, 2	1/2*, 1 1/4	56.00	1
SC 110V	110V (17 amp)	3/4, 2	1/2*, 1 1/4	52.00	1
SC 220V	220V (9 amp)	3/4, 2	1/2*, 1 1/4	52.00	1
BC 220V	220V (30 amp)	1 1/4, 3	3/4, 1, 2	200.00	1
BC 440V	440V (20 amp)	1 1/4, 3	3/4, 1, 2	200.00	1
BC 550V	550V (20 amp)	1 1/4, 3	3/4, 1, 2	200.00	1
BCS 220	220V (30 amp)	1 1/4, 3	1*, 2	235.00	1
BCS 440	440V (20 amp)	1 1/4, 3	1*, 2	235.00	1
BCS 550	550V (20 amp)	1 1/4, 3	1*, 2	235.00	1

*Only available in the USA.

WARNING: Do NOT operate an induction heater if you wear a heart pace-maker. The strong magnetic field emitted by the heater may affect operation of such devices.

Cross bars for SC, BC, BSC bearing heater models

BESSEY® Product #	Suitable for ...	BESSEY® Product #	Suitable for ...
	Fits model #		Pounds
SC 1/2"*	SC	BCS 1"*	BC Special
SC 3/4"	SC	BCS 1 1/4"	BC Special
SC 1 1/4"	SC	BCS 2"	BC Special
SC 2"	SC	BCS 3"	BC Special
BC 3/4"	BC	SC on/off	On/Off switch for SC
BC 1"	BC	BC on/off	On/Off switch for BC
BC 1 1/4"	BC		
BC 2"	BC		
BC 3"	BC		

*Only available in the USA.

NEW Cone style bearing heaters

BESSEY® Product #	Bearing I.D. Range	Watts	Width	Height	Approx. Weight	Case
	Inches		Inches	Inches	Pounds	qty.
GCS 38534*	3/8 - 5 3/4	725	9	10	4.77	1
GCS 34534*	3/4 - 5 3/4	725	9	10	4.77	1
GCST 3480**	3/4 - 8	725	12	10	5.99	1
GCST 5518**	5 1/2 - 18	1450	23	19	17.13	1

*Includes 250°F temperature indicator crayon

**Automatic temperature regulation preset at 250°F

Raising blocks for SC, BC, BSC models

BESSEY® Product #	Fits model	Height	Width	Approx. Weight	Case
	#	Inches	Inches	Pounds	qty.
SCRBR	SC	2 3/8	2 5/8	7.50	1
BCRB	BC, BCS	5	3 5/8	31.00	1

Pyrometer/Thermometer

BESSEY® Product #	Description	Approx. Weight	Case
		Pounds	qty.
HH11B	Pyrometer/Thermometer w/probe & flex cord	2.00	1
SMP-HT-K-6H	Replacement probe with handle	1.50	1

Index



Catalog Number	UPC	Page Number	Catalog Number	UPC	Page Number	Catalog Number	UPC	Page Number
01G-RS	7 85401 94128 1	53	3000689	7 88502 00938 6	45	BANR400	0 91162 00063 2	26
05G-RS	7 85401 94640 8	53	3001411	7 88502 00912 6	45	BC 1"	7 88502 16056 8	55
15-SK	7 85401 08015 7	52	3001412	7 88502 00914 0	45	BC 1-1/4"	7 88502 16057 5	55
375L	7 88502 14100 0	37	3001413	7 88502 00917 1	45	BC 2"	7 88502 16058 2	55
376S	7 88502 14101 7	37	3005120	7 88502 00919 5	45	BC 3"	7 88502 16059 9	55
500L	7 88502 14110 9	37	3005122	7 88502 00939 3	45	BC 3/4"	7 88502 16055 1	55
501S	7 88502 14111 6	37	3006727	7 88502 20101 8	45	BC 220V	7 88502 16000 1	55
540-2-1/2	7 88502 20054 7	33	3006786	7 88502 20102 5	45	BC 440V	7 88502 16010 0	55
540-3	7 88502 20055 4	33	3007822	7 88502 00893 8	45	BC 550V	7 88502 16020 9	55
540-4	7 88502 20056 1	33	3007855	7 88502 20104 9	45	BC on/off	7 88502 16291 3	55
540-5	7 88502 20061 5	33	3008019	7 88502 20103 2	45	BCRB	7 88502 16050 6	55
540-6	7 88502 20057 8	33	3100119	7 88502 20105 6	45	BCS 1"	7 88502 16155 8	55
540-8	7 88502 20058 5	33	3100120	7 88502 20106 3	45	BCS 1-1/4"	7 88502 16156 5	55
540-10	7 88502 20059 2	33	3100121	7 88502 20107 0	45	BCS 2"	7 88502 16157 2	55
540-12	7 88502 20060 8	33	3100398	7 88502 00547 0	45	BCS 3"	7 88502 16158 9	55
540-14	7 88502 20062 7	33	3100399	7 88502 00548 7	45	BCS 220	7 88502 16100 8	55
625L	7 88502 14120 8	37	3100400	7 88502 00549 4	45	BCS 440	7 88502 16110 7	55
626S	7 88502 14121 5	37	3100401	7 88502 00550 0	45	BCS 550	7 88502 16120 6	55
660-S8	7 88502 20012 7	4	3100579	7 88502 00940 9	45	BDMS-1	7 88502 09030 8	42
660-S12	7 88502 20013 4	4	3100736	7 88502 00920 1	44	BGP	0 91162 69012 3	20
660-S18	7 88502 20014 1	4	3100737	7 88502 00924 9	44	BPC-H12	0 91162 00943 7	28
750L	7 88502 14130 7	37	3101012	7 88502 20108 7	45	BPC-H34	0 91162 00942 0	28
751S	7 88502 14131 4	37	3101180	7 88502 20110 0	44	BT-36	7 88502 01300 0	43
1000L	7 88502 14140 6	37	3101183	7 88502 00751 1	44	BT-96	7 88502 01302 4	43
1001S	7 88502 14141 3	37	3101188	7 88502 00750 4	44	BT-120	7 88502 01303 1	43
1200-S8	7 88502 20032 5	4	3101192	7 88502 00921 8	44	BTB30	0 91162 69000 0	20
1200-S12	7 88502 20015 8	4	3101193	7 88502 00922 5	44	BTB30A	0 11962 69016 1	20
1200-S18	7 88502 20016 5	4	3101339	7 88502 20109 4	44	BTBSV24	N/A	20
1200-S24	7 88502 20017 2	4	3101370	0 91162 00644 3	16	BTBTG5	N/A	20
1620-16	7 88502 06201 5	52	3101371	0 91162 00645 0	16	BV-C030	0 91162 00836 2	40
1800-S8	7 88502 20000 4	1	3101392	7 88502 20097 4	44	BV-DP40	0 91162 00837 9	40
1800-S12	7 88502 20001 1	1	3101394	7 88502 20098 1	44	BV-HD40	0 91162 00831 7	39
1800-S18	7 88502 20002 8	1	3101395	7 88502 20099 8	44	BV-HD60	0 91162 00832 4	39
1800-S24	7 88502 20003 5	1	3101396	7 88502 20100 1	44	BV-HW45	0 91162 00834 8	40
1800L12	7 88502 00986 7	5 & 21	A94	7 85401 20128 6	53	BV-MPV5	0 91162 00833 1	39
2400HD-10	7 88502 00995 9	38	A920	7 85401 20640 3	53	BV-NVJ	0 91162 00839 3	40
2400J-12	7 88502 19032 9	8	A9114	7 85401 20004 3	53	BV-VB	0 91162 00835 5	40
2400S-8	7 88502 00801 3	1	A9205	7 85401 27040 4	53	BV-WV65	0 91162 00838 6	40
2400S-12	7 88502 00803 7	1	A9455	7 85401 20016 6	53	CDF402	7 88502 01460 1	34
2400S-16	7 88502 00807 5	1	AF-01G	7 85401 80128 8	53	CDF402CHV	7 88502 01497 7	34
2400S-20	7 88502 00804 4	1	AF-PNT	7 85401 80016 8	53	CDF403	7 88502 01461 8	34
2400S-24	7 88502 00808 2	1	B-102	7 88502 02062 6	34	CDF403CHV	7 88502 01498 4	34
2400S-36	7 88502 00809 9	1	B-103	7 88502 02063 3	34	CDF404	7 88502 01462 5	34
2400S-48	7 88502 00815 0	1	B-104	7 88502 02064 0	34	CDF404CHV	7 88502 01499 1	34
2400S-60	7 88502 00806 8	1	B-106	7 88502 02065 7	34	CDF406	7 88502 01463 2	34
4800J-20	7 88502 19043 5	8	B-108	7 88502 02066 4	34	CDF406CHV	7 88502 01501 1	34
4800S-12	7 88502 00810 5	2	B-110	7 88502 02067 1	34	CDF408	7 88502 01464 9	34
4800S-18	7 88502 00818 1	2	B-112	7 88502 02068 8	34	CDF408CHV	7 88502 01502 8	34
4800S-24	7 88502 00819 8	2	B-EC3	0 91162 00818 8	25	CDF410	7 88502 01465 6	34
4800S-36	7 88502 00823 5	2	B-HS0	7 88502 02071 8	34	CDF410CHV	7 88502 01503 5	34
4800S-48	7 88502 00813 6	2	B-HS1	7 88502 02072 5	34	CDF412	7 88502 01466 3	34
4800S-60	7 88502 00814 3	2	B-HS1.5	7 88502 02073 2	34	CDF412CHV	7 88502 01504 2	32
7200S-12	7 88502 00820 4	2	B-HS2	7 88502 02074 9	34	CDS24-10 WP	7 88502 00952 2	19
7200S-18	7 88502 00824 2	2	B-HS3	7 88502 02075 6	34	CDS24-12 WP	7 88502 00953 9	19
7200S-36	7 88502 00825 9	2	B-HS4	7 88502 02076 3	34	CDS24-20 WP	7 88502 00954 6	19
8500HPC-6	7 88502 00850 1	2	B-HS5	7 88502 02077 0	34	CL-24	7 88502 00833 4	5
8500HPC-14	7 88502 00852 5	2	B-HS6	7 88502 02078 7	34	CLS-Shoe	7 88502 00830 3	5
16300-16	7 88502 06200 8	52	B-HS8	7 88502 02079 4	34	CM10	0 91162 00026 7	35
3000157	7 88502 00910 2	45	B-HS10	7 88502 02080 0	34	CM15	0 91162 00028 1	35
3000159	7 88502 00911 9	45	B-HS12	7 88502 02081 7	34	CM20	0 91162 00029 8	35

Index

Catalog Number	UPC	Page Number	Catalog Number	UPC	Page Number	Catalog Number	UPC	Page Number
CM22	0 91162 00030 4	35	EZS Combo	7 88502 20063 9	22	KLI3.012	0 91162 00992 5	21
CM30	0 91162 00032 8	35	EZS D	N/A	22	KLW4.012	0 91162 01226 0	21
CM34DR	0 91162 00038 0	35	ES Set	0 91162 00725 9	27	KLW4.024	0 91162 01228 4	21
CM40	0 91162 00033 5	35	FC24-8	7 88502 00990 4	38	KP Block adaptor	0 91162 00664 1	15
CM50	0 91162 00034 2	35	FIN250	0 91162 00089 2	44	KP	0 91162 00665 8	15
CM60	0 91162 00035 9	35	FIN350	0 91162 00082 3	44	KR3.512	0 91162 00624 5	13
CM80	0 91162 00036 6	35	GCS 38534	7 88502 17000 0	55	KR3.524	0 91162 00625 2	13
CMS-1	7 88502 09040 7	42	GCS 34534	7 88502 17001 7	55	KR3.531	0 91162 00626 9	13
D15A-BE	7 88502 01131 0	47	GCST 3480	7 88502 17002 4	55	KR3.540	0 91162 00627 6	13
D15AL-BE	7 88502 01132 7	47	GCST 5518	7 88502 17003 1	55	KR3.550	0 91162 00628 3	13
D15S-BE	7 88502 01133 4	47	GS12-8K	7 88502 20090 5	7	KR3.560	0 91162 00629 0	13
D15-SET	7 88502 01136 5	47	GS16-12K	7 88502 20091 2	7	KR3.582	0 91162 00630 6	13
D16-BE	7 88502 01174 7	48	GS16K	7 88502 20070 7	7	KR3.598	0 91162 00631 3	13
D16L-BE	7 88502 01175 4	48	GS20K	7 88502 20071 4	7	KR-AS	0 91162 00642 9	15
D16S-BE	7 88502 01173 0	48	GS25K	7 88502 20072 1	7	KR-EC	0 91162 00663 4	16
D16-SET	7 88502 01135 8	48	GS30K	7 88502 20073 8	7	KR-J2K	0 91162 00640 5	16
D22AL-BE	7 88502 01111 2	48	GS60K	7 88502 20075 2	7	KR-JP	0 91162 00639 9	16
D24-SB	7 88502 01124 2	49	GSCC2.506	0 91162 00959 8	23	KR-RPP	0 91162 00641 2	16
D27AH-BE	7 88502 01151 8	48	GSCC2.512	0 91162 00960 4	23	KR-VO	0 91162 00650 4	16
D27AHL-BE	7 88502 01150 1	48	GSCC2.518	0 91162 00961 1	23	KRJR-12	0 91162 00140 0	14
D29ASS-BE	7 88502 01169 3	48	GSCC2.524	0 91162 00962 8	23	KRJR-18	0 91162 00141 7	14
D29ASSL-BE	7 88502 01170 9	48	GSCC2.530	0 91162 00963 5	23	KRJR-24	0 91162 00142 4	14
D29SS-BE	7 88502 01154 9	48	GSCC2.536	0 91162 00964 2	23	KRJR-36	0 91162 00143 1	14
D29SSL-BE	7 88502 01166 2	48	GSCC3.512	0 91162 00966 6	23	KRJR-50	0 91162 00144 8	14
D47-BE	7 88502 01103 7	49	GSCC3.518	0 91162 00967 3	23	KRK2440	0 91162 00633 7	15
D48A	0 91162 01100 3	49	GSCC3.524	0 91162 00968 0	23	KRK2450	0 91162 00634 4	15
D48	7 88502 01104 4	49	GSCC5.012	0 91162 00972 7	23	KRV-40	0 91162 00646 7	13
D49-BE	7 88502 01105 1	49	GSCC5.018	0 91162 00973 4	23	KRV-60	0 91162 00647 4	13
D50-BE	7 88502 01108 2	49	GSCC5.024	0 91162 00974 1	23	KRV-78	0 91162 00648 1	13
D51A-BE	7 88502 00028 4	50	GSL30	7 88502 20078 3	7	KRV-98	0 91162 00649 8	13
D123S-SB	7 88502 01123 5	49	GSL60	7 88502 20079 0	7	KRX2440	0 91162 00619 1	15
D-BKAH	0 91162 00953 6	51	GSM20	7 88502 20089 9	7	KRX2450	0 91162 00620 7	15
D-BKAH-2B	0 11962 00982 6	51	GSM25	7 88502 20080 6	7	KT5-1CP	0 91162 00675 7	25
D-BKPH	0 91162 00954 3	51	GSM30	7 88502 20081 3	7	KT5-2	0 91162 00676 4	25
D-BKPH Set	0 91162 00977 2	51	GSM40	7 88502 20082 0	7	LC4	0 91162 00984 0	5 & 21
D-BKWH	0 91162 00955 0	51	GSM50	7 88502 20083 7	7	LC8	7 88502 20004 2	5 & 21
D-SPC8	7 88502 00552 4	50	GSM60	7 88502 20084 4	7	LC12	7 88502 20006 6	5 & 21
D-SPC11	7 88502 00553 1	50	HB-PNT	7 88502 14787 3	52	LC20	7 88502 20007 3	5 & 21
D-SPS8	7 88502 00555 5	50	HH-11B		55	LHS-10	0 91162 00824 9	43
D-SPS11	7 88502 00556 2	50	HS-6	0 91162 00822 5	43	LM-06	7 88502 14700 2	52
DHBC-12	0 91162 00930 7	24	HS-8	0 91162 00823 2	43	LM-12	7 88502 14701 9	52
DHBC-24	0 91162 00931 4	24	HS-12	0 91162 00825 6	43	LM-24	7 88502 14702 6	52
DHBC-36	0 91162 00932 1	24	HT-14	7 88502 14720 0	52	LM-48	7 88502 14703 3	52
DHCC-4	0 91162 00933 8	35	HT-24	7 88502 14721 7	52	LM2.004	0 91162 01300 7	23
DHCC-6	0 91162 00934 5	35	J18-8	7 88502 19030 5	8	LM2.006	0 91162 01301 4	23
DKX	0 91162 00088 5	24	JM-750	7 88502 18800 5	54	LM2.008	0 91162 01302 1	23
DMT	7 88502 20092 9	50	JM-1000	7 88502 18810 4	54	LM2.012	0 91162 01303 8	23
DT 2400-12	7 88502 00816 7	2	JM-1000-R	7 88502 18860 9	54	LM3.006	0 91162 01304 5	23
DT 2400-24	7 88502 00817 4	2	JM-1200	7 88502 18820 3	54	LM3.012	0 91162 01306 9	23
DUO16-8	0 91162 00044 1	24	JM-1500	7 88502 18830 2	54	LM3.024	0 91162 01317 5	23
DUO30-8	0 91162 00045 8	24	JM-2000	7 88502 18840 1	54	LM3.036	0 91162 01319 9	23
DUO45-8	0 91162 00046 5	24	JM-2500	7 88502 18850 0	54	LM4.008	0 91162 01309 0	23
DUO65-8	0 91162 00047 2	24	KBTP-4	0 91162 00638 2	16	LM4.012	0 91162 01311 3	23
DuoKlamp® Combo	0 91162 00061 8	24	KBX20	0 91162 00810 2	15	LM4.016	0 91162 01312 0	23
EKT-55	0 91162 00679 5	25	KF2	0 91162 00104 2	25	LM4.024	0 91162 01314 4	23
EZS15-8	7 88502 20021 9	22	KF4	0 91162 00105 9	25	LMU2.004	0 91162 01324 3	23
EZS30-8	7 88502 20022 6	22	KF4 Pads	0 91162 00106 6	25	LMU2.006	0 91162 01325 0	23
EZS45-8	7 88502 20023 3	22	KFP	0 91162 00107 3	43	LMU2.008	0 91162 01326 7	23
EZS60-8	7 88502 20024 0	22	KLI3.004	0 91162 00990 1	21	LS-16	7 88502 14730 9	52
EZS90-8	7 88502 20053 0	22	KLI3.008	0 91162 00991 8	21	LS-128	7 88502 14731 6	52

Catalog Number	UPC	Page Number	Catalog Number	UPC	Page Number	Catalog Number	UPC	Page Number
MCL-8	7 88502 00987 4	38	SQ-16	7 88502 01371 0	5	TGJ2.536+2K	0 91162 00905 5	18
MGC-1	7 88502 09050 6	42	SQ-20	7 88502 01375 8	5	TGK4.516	0 91162 00708 2	19
MGC-2	7 88502 09060 5	42	SQ-24	7 88502 01372 7	5	TGK4.516+2K	0 91162 00925 3	19
MMS-4	7 88502 00998 0	4	STB-12	7 88502 19060 2	5	TGK4.524	0 91162 00710 5	19
MMS-8	7 88502 00999 7	4	STB-18	7 88502 19062 6	5	TGK4.524+2K	0 91162 00926 0	19
MMS-12	7 88502 00996 6	4	STB-24	7 88502 19061 9	5	TGK4.540	0 91162 00712 9	19
MPU-1	7 88502 09088 9	42	STB-36	7 88502 19066 4	5	TGK4.540+2K	0 91162 00927 7	19
MS-1	7 88502 09082 7	42	STC-HH50	7 88502 19043 5	11	TGK4.550	0 91162 00713 6	19
MSP-24	7 88502 09080 3	42	STC-HH70	7 88502 20093 6	11	TGK4.550+2K	0 91162 00928 4	19
MW-1	7 88502 09070 4	42	STC-IHH25	7 88502 20094 3	11	TGK4.579	0 91162 00716 7	19
OPT114	7 85401 40004 7	53	SVH400XL	0 91162 02014 2	43	TGK4.579+2K	0 91162 00929 1	19
OPT20	7 85401 40640 7	53	TC4.008	0 91162 00777 8	19	TK-6	0 91162 05502 1	16 & 43
OPT205	7 85401 47040 8	53	TC4.512	0 91162 00780 8	19	TSC4.516	0 91162 00789 1	6
OPT4	7 85401 40128 0	53	TC5.512	0 91162 00783 9	19	UK3.006	0 91162 00668 9	14
OPT455	7 85401 40016 0	53	TC7.016	0 91162 00785 3	19	UK3.012	0 91162 00669 6	14
PC12	0 91162 01055 6	28	TCO14-01G	7 85401 50128 7	53	UK3.024	0 91162 00670 2	14
PC34	0 91162 01050 1	28	TCO14-05G	7 85401 50640 4	53	VAC-6	0 91162 00570 5	26
PC-34DR	0 91162 00039 7	28	TCO16-01G	7 85401 60128 4	53	VAD	7 88502 00730 6	44
PG12	0 91162 02101 9	24	TCO16-05G	7 85401 60640 1	53	VAS-23	0 91162 00556 9	26
PG24	0 91162 02102 6	24	TG4.008	0 91162 00704 4	18	WMS-1	7 88502 09000 1	41
PS55	0 91162 02020 3	29	TG4.008+2K	0 91162 00906 2	18	WMS-3	7 88502 09020 9	41
PS130	0 91162 00099 1	29	TG4.012	0 91162 00751 8	18	WMS-4	7 88502 09025 4	41
QRCC3	0 91162 00944 4	35	TG4.012+2K	0 91162 00907 9	18	WMS-5	7 88502 09027 8	41
QRCC4	0 91162 00945 1	35	TG4.016	0 91162 00752 5	18	WMS-6	7 88502 09028 4	41
QRCC6	0 91162 00952 9	35	TG4.016+2K	0 91162 00908 6	18	WMS-7	7 88502 00029 1	41
RSC-8	7 88502 00700 9	6	TG4.024	0 91162 00753 2	18	WMS-8	7 88502 09001 8	42
RSC-12	7 88502 00701 6	6	TG4.024+2K	0 91162 00909 3	18	WS-1	0 91162 00040 3	27
RSC-18	7 88502 00702 3	6	TG4.512	0 91162 00703 7	19	WS-3	0 91162 00501 9	27
RSC-24	7 88502 00703 0	6	TG4.512+2K	0 91162 00910 9	18	WS-6	0 91162 00502 6	27
RT114	7 88502 07510 7	53	TG4.518	0 91162 00754 9	19	WSM-9	7 88502 00840 2	32
RT20	7 88502 07525 1	53	TG4.518+2K	0 91162 00911 6	18	WSM-12	7 88502 00841 9	32
RT205	7 88502 07530 5	53	TG4.524	0 91162 00757 0	19	WVS-4	7 88502 00836 5	32
RT4	7 88502 07520 6	53	TG4.524+2K	0 91162 00912 3	18	XC1	0 91162 00054 0	31
RT455	7 88502 07515 2	53	TG4.530	0 91162 00758 7	19	XC1-2	0 91162 00090 8	31
S-10	0 91162 05501 4	43	TG4.530+2K	0 91162 00913 0	18	XC-14PC	0 91162 00939 0	31
SC 1/2"	7 88502 16255 5	55	TG4.540	0 91162 00759 4	19	XC2	0 91162 00050 2	31
SC 1-1/4"	7 88502 16257 9	55	TG4.540+2K	0 91162 00914 7	18	XC2-2	0 91162 00091 5	31
SC 2"	7 88502 16258 6	55	TG5.512	0 91162 00706 8	19	XC3	0 91162 00051 9	31
SC 3/4"	7 88502 16256 2	55	TG5.512+2K	0 91162 00915 4	18	XC5	0 91162 00052 6	31
SC 110D	7 88502 16201 1	55	TG5.518	0 91162 00760 0	19	XC5-2	0 91162 00062 5	31
SC 110V	7 88502 16200 5	55	TG5.518+2K	0 91162 00916 1	18	XC7	0 91162 00053 3	31
SC 220V	7 88502 16202 9	55	TG5.524	0 91162 00763 1	19	XC7-2	0 91162 00092 2	31
SC on/off	7 88502 16290 6	55	TG5.524+2K	0 91162 00917 8	18	XCL2	0 91162 00068 7	31
SDR-32	N/A	51	TG7.016	0 91162 00707 5	19	XCL2-Set	0 91162 00069 4	31
SCRB	7 88502 16250 0	55	TG7.016+2K	0 91162 00920 8	18	XCL5	0 91162 00070 0	31
SG-4WP	0 91162 15200 6	36	TG7.024	0 91162 00767 9	19	XCR-4PC	0 91162 00937 6	31
SG-8WP	0 91162 05201 3	36	TG7.024+2K	0 91162 00921 5	18	XCRU3	0 91162 00058 8	31
SG5-DR	7 88502 05213 9	36	TG7.048	0 91162 00770 9	19	XCRU5	0 91162 00059 5	31
SG24-PC	7 88502 05216 0	36	TG7.048+2K	0 91162 00924 6	18	XM3	0 91162 01001 3	31
SG24-VWF	7 88502 05207 8	36	TGJ2.506	0 91162 00601 6	18	XM5	0 91162 01002 0	31
SG30VAD	7 88502 00545 6	3	TGJ2.506+2K	0 91162 00900 0	18	XM7	0 91162 01003 7	31
SG Pads (Pair)	7 88502 05281 8	36	TGJ2.512	0 91162 00602 3	18	XM10	0 91162 01004 4	31
SGL-8	7 88502 29470 6	5	TGJ2.512+2K	0 91162 00901 7	18	XV3-50	0 91162 00048 9	30
SGL-12	7 88502 29474 4	5	TGJ2.518	0 91162 00603 0	18	XV5-100	0 91162 00049 6	30
SGL-18	7 88502 29478 2	5	TGJ2.518+2K	0 91162 00902 4	18	XV5-170	0 91162 00073 1	30
SGL-24	7 88502 29480 5	5	TGJ2.524	0 91162 00604 7	18			
SMP-HT-K-6H	7 88502 16477 1	55	TGJ2.524+2K	0 91162 00903 1	18			
SQ-4	7 88502 01350 5	5	TGJ2.530	0 91162 00605 4	18			
SQ-8	7 88502 01360 4	5	TGJ2.530+2K	0 91162 00904 8	18			
SQ-12	7 88502 01370 3	5	TGJ2.536	0 91162 00606 1	18			



1. BESSEY® General Cautions & Warnings

PRICING: Retail prices of our products can change at any time as they are impacted by a wide range of business factors (including transportation, staffing, local /regional taxes and other overhead expenses). Your distributor incurs these expenses in doing business in your community.

PRODUCT INFORMATION: BESSEY® Tools North America reserves the right to alter technical and physical specifications at any time. Some product specifications may vary from region to region to meet the requirements of the international marketplace. Errors and omissions excepted, BESSEY® believes that to the best of its knowledge the product illustrations and descriptions provided in the current BESSEY® catalog are accurate. However, such descriptions and illustrations are for the sole purpose of identification, and do not express or imply any warranty or condition that the products are merchantable or fit for a particular purpose or that the products will necessarily conform to the illustrations or descriptions. The customer is solely responsible for reliance on, or use of, any information, and for the use or application of any product. BESSEY® expressly disclaims any liability for direct, indirect, consequential or incidental damages in all events. In addition, all claims for damages, losses and causes of action shall be limited to the purchase price paid for the products in question. Note: "Clamping Force" is an estimation (nominal info.)

CAUTION: Clamping tools are not suitable for lifting, pulling or transporting. Improper use may lead to personal injuries or material damages. Clamping tools should only be clamped manually and without the use of any auxiliary tools or other devices. Please also see website for further information.

CAUTION: Cutting Technology

Always wear appropriate protection including goggles and gloves while working. Sheared parts may injure workers and bystanders. Disconnect the power supply while working on electrical devices to avoid the risk of electric shock. Always ensure the cutting direction while using snips, knives and cutters is away from your body. Only use original replacement parts whenever required. Tools should only be used manually without using any auxiliary tools. Improper use may lead to personal injuries, material damages, personal injuries or even death. Please also see website for further information.



2. BESSEY® Terms and Conditions - Distributor

PRICING: All prices, sizes and product specifications are subject to change without notice. Orders accepted only at price in effect at date of shipment.

QUOTATIONS: Quotations expire thirty days from date issued unless otherwise specified in writing.

FREIGHT TERMS: All prices are F.O.B. (BESSEY® US). Prepaid shipping is based on minimum invoice values and, are subject to change without notice. Please contact BESSEY® Tools North America for this information. All prepaid orders are shipped by ground transportation and using a provider of BESSEY®'s choice. If customers request another carrier, or another method of delivery, they must provide their own billing information in advance. Shipping errors must be reported within 10 days of product receipt.

TERMS OF PAYMENT: All orders are subject to BESSEY®'s credit approval and are due and payable thirty days (net) from the shipment date. Past due accounts are subject to interest at 1.5% per month (18% per annum).

RETURN GOODS: Products returned for credit will not be accepted. Goods are not returnable unless permission has previously been received in writing from our office. Returned goods are subject to the following conditions:

1. Incoming transportation charges, if not prepaid, will be deducted from credit memorandum.
2. All material returned must be found by BESSEY®, upon arrival, to be in first class saleable condition. If not, the cost of putting it in such condition will be deducted from any credit memorandum.
3. A restocking charge of 20% plus an additional 2% per each month elapsed since date of purchase, of the original invoice cost, will be deducted from any credit memorandum.
4. Products returned must be current products in the BESSEY® product offering.



3. BESSEY® Tools North America Warranty Policy

BESSEY® brand clamping products are warranted under a Limited Lifetime program. We warranty that the products will be free from defects in material and workmanship for the life of the tool or we will replace, refund or repair it; provided that this warranty does not cover any damage caused by abuse, misuse, improper handling, negligence, alteration or normal wear and tear. Other tools including but not limited to snips, c-clamps, some specialty clamps, magnets, vises, bearing heaters and pyrometers are guaranteed for 1 year. For all products, BESSEY® Tools North America reserves the right to refuse either a repair or a replacement.

BESSEY® Tools North America makes no other warranties, express or implied, with respect to the tools or their suitability for specific applications. BESSEY® Tools North America neither assumes, nor authorizes any person to assume for it, any other warranty, or obligation express or implied. For a more detailed listing of Terms, Conditions and Warranty please contact BESSEY® Tools North America direct and toll-free at 1.800.828.1004.

BESSEY® Tools North America will, at its sole discretion, define if a product submitted for warranty evaluation is eligible for a warranty return and then, if eligible, offer to repair, refund or replace any defective product. To initiate such a claim, please call and request a return authorization number then, return all parts of the broken tool(s) plus a written warranty evaluation request (with contact information) in a freight prepaid format to BESSEY® Tools North America.

This warranty gives you specific legal rights. Please note: you may also have other rights, which could vary depending upon state, federal and provincial law.

For more information, email info@besseytools.com or call 1-800-828-1004.

4. Return Procedures

RETURN GOODS – Purchased direct from a Tool Distributor: Please initiate returns of any sort with the distributor where the tool was purchased.

RETURN GOODS – Purchased direct from BESSEY® Tools: Products purchased directly from BESSEY® which are returned for credit (only permitted if incorrectly shipped or if the product is found to be defective upon receipt), warranty or repair will not be accepted unless permission has previously been received in writing from our office. Please contact BESSEY® at info@besseytools.com to initiate a return. You may be asked for invoice numbers, packing slips or proof of delivery; please have this information ready.

Returned goods are subject to the following conditions:

1. Incoming transportation charges, if not prepaid, will be deducted from credit memorandum.
2. All material returned must be found by BESSEY®, upon arrival, to be in first class saleable condition. If not, the cost of putting it in such condition will be deducted from any credit memorandum.
3. A restocking charge of 20% plus an additional 2% per each month elapsed since date of purchase, of the original invoice cost, will be deducted from any credit memorandum.
4. Products returned must be current products in the BESSEY® product offering



5. Calprop Statement (North America)

Proposition 65 (formally titled "The Safe Drinking Water and Toxic Enforcement Act of 1986") is a California law that has been in effect since 1986 to promote clean drinking water and keep toxic substances that cause cancer and birth defects out of consumer products. It is administered by Cal/EPA's California Office of Environmental Health Hazard Assessment (OEHHA). Proposition 65 regulates substances listed by California as causing cancer or birth defects or other reproductive harm in two ways. The first regulatory arm of Proposition 65 prohibits businesses from knowingly discharging listed substances into drinking water sources, or onto land where the substances can pass into drinking water sources. The second regulatory arm of Proposition 65 prohibits businesses from knowingly exposing individuals to listed substances without providing a clear and reasonable warning.

BESSEY® branded products do not, to the best of our knowledge, expose individuals to harmful substances as listed by the Cal Prop 65 Legislation.



6. Contact Us

BESSEY® Tools North America
 Tel: 1 519 621 7240
 Fax: 1 519 621 3442
 Toll free Customer Line: 1 800 828 1004

We welcome your feedback, and are happy to assist with your questions.



7. Downloads - See www.besseytools.com

SALES SHEETS

Produced over the years and continuously updated the BESSEY® sales sheets are a great snapshot of the tool, how it works and its vital statistics. Available as a PDF for easy downloads and for quick reading.



CATALOGUE IMAGES

We quite often get requests for images to put into catalogs, articles and even for reference in working drawings in the field. Compiled into one handy location for your reference.



BESSEY® PRESENTATIONS CATALOGUES VIDEOS





Simply better.

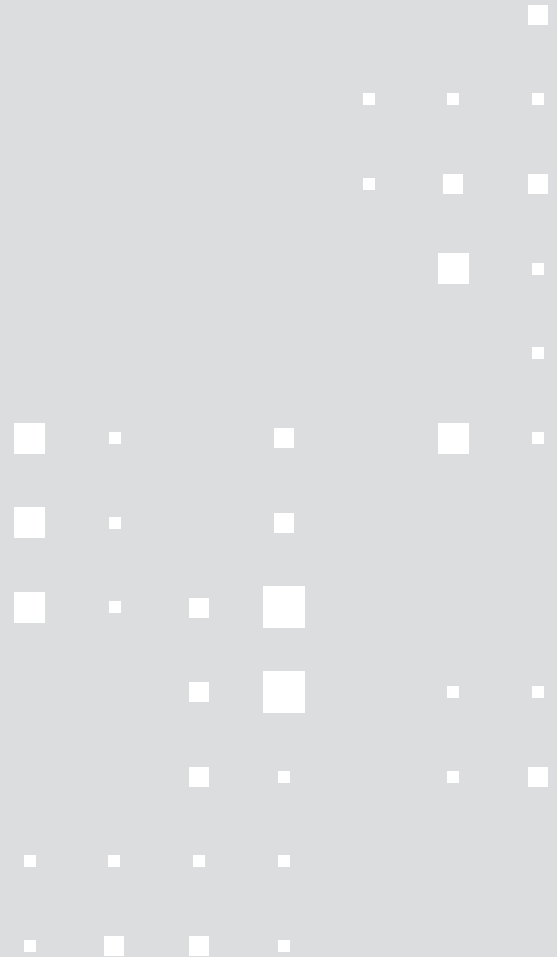

BESSEY® Tools North America
Telephone: 800.828.1004

www.besseytools.com

Join us on...

 <http://www.facebook.com/BesseyToolsNorthAmerica>

 <http://twitter.com/BesseyTools>

 <http://www.youtube.com/user/BesseyTools>

 <http://www.besseytools.com/>



Sign up to receive our E-Newsletter at info@besseytools.com