



IGNITION
PARTS

MOTORCYCLE AND ATV CATALOGUE 2022/23



STEPHEN DAVISON



www.ngkntk.com/uk

CONTENTS

SPARK PLUG TECHNICAL INFORMATION

Spark Plug Design _____	2	Spark Plug Installation Tips _____	8
NGK's Copper Core Technology _____	3	Spark Plug Gap Settings _____	8
The Best Spark Plug for every occasion _____	4	Design Symbols _____	9
Fitting the Correct Spark Plug _____	5	New Additions and Part Numbers _____	10
The Iridium IX Spark Plug _____	6-7		

2 Wheel

Adly _____	11
AJS _____	11
Aprilia _____	11-13
Atala _____	13
Bajaj _____	13
Baotian _____	13
Barossa _____	14
Bashan _____	14
Batavus _____	14
Beeline _____	14
Benelli _____	14-15
Benzhou _____	15
Beta / Betamotor _____	15-16
Bimota _____	16-17
BMW _____	17-19
BSA _____	19
Buell _____	19
Cagiva _____	19-20
Can-Am (BRP) _____	20
CCM (Armstrong-CCM) _____	20-21
CF Moto _____	21
Cossack _____	21
CPI _____	21
CZ (See Jawa-CZ) _____	-
Daelim _____	21-22
Derbi _____	22
Ducati _____	22-24
EBR _____	25
Fantic _____	25
Gas Gas _____	25-26
Generic _____	26-27
Gilera _____	27
Harley Davidson _____	27-28
Herald Motor Company _____	28
Hero-Puch _____	28
Hesketh _____	28
Honda _____	28-34
Huoniao _____	34
Husaberg _____	34
Husqvarna _____	34-36
Hymoto _____	36
Hyosung _____	36-37
Indian _____	37
Italjet _____	37
Jawa-CZ _____	37
Jialing _____	38
Jianshe _____	38
Jinlun _____	38
Jonway _____	38
Kawasaki _____	38-43
Keeway _____	43
Kenos _____	43
Kreidler _____	43
KSR Moto _____	43
KTM _____	43-46
Kymco _____	46-47
Lambretta _____	47
Laverda _____	47
LEM _____	47
Lexmoto _____	47-48
Lifan _____	48
LML _____	48
Magni _____	48
Maico _____	48
Malaguti _____	48-49
MBK _____	49
Montesa _____	49
Moto Guzzi _____	49-50
Moto Morini _____	51
Moto Roma _____	51
Motobecane _____	51
Motorhispania _____	51
MS _____	51
MV Agusta _____	51-52
MZ _____	52
Neval _____	52
Nipponia _____	52
Norton _____	52-53
Ossa _____	53
Peugeot _____	53-54
PGO _____	54
Piaggio / Vespa _____	54-56
Pioneer _____	56
Puch _____	56

SPARK PLUG APPLICATIONS

Pulse _____	56-57
Regal Raptor _____	57
Regent _____	57
Riders _____	57
Rieju _____	57
Rovigo _____	57
Royal Enfield (1980→) _____	57
RTX _____	58
Sachs _____	58
Scorpa _____	58
Sherco _____	58-59
Simson _____	59
Sinnis _____	59
Skyteam _____	59
SMC _____	59
Superbyke _____	59
Suzuki _____	59-63
SWM _____	63
SYM _____	63-64
Tamoretti _____	64
TGB _____	64
The Black Douglas Motorcycle Co. _____	65
TM Racing _____	65
Tomos _____	65
Triumph Pre-1989 _____	65
Triumph 1991-On _____	65-67
Uralmoto _____	67
Vertemati _____	67
Vespa (See Piaggio) _____	-
Victory (Polaris) _____	67
Vixen (See Bashan) _____	-
VOR _____	67
White Knuckle (See WK) _____	-
WK _____	68
Wuyang _____	68
Xispa _____	68
Yamaha _____	68-73
Yamasaki _____	73
Yiyi (See Benzhou) _____	-
Zing (See Lifan) _____	-
Znen _____	74
Zongshen _____	74

ATV Quad

Adly _____	75
Apache _____	75
Arctic Cat _____	75
Ausa _____	75
Blast (LEM) _____	75
Bombardier (→05) _____	75-76
Can-Am (BRP) _____	76
Cectek _____	76
Club Car _____	76
CPI _____	76
Cub Cadet _____	76
Cushman _____	77
Dinli _____	77
E-Ton _____	77
E-Z-Go _____	77
Gas Gas _____	77
Honda _____	77-78
Hymoto _____	78
Hyosung _____	78
John Deere _____	78
Kawasaki _____	78-79
Kazuma _____	79
KTM _____	79
Kubota _____	79
Kymco _____	79
LEM _____	79
Masai _____	79
Massey Ferguson _____	79-80
Mota Roma _____	80
Polaris _____	80
Puzey _____	80
Quadzilla _____	80-81
Quantum _____	81
Skyteam _____	81
Storm _____	81
Suzuki _____	81
SYM _____	82
TGB _____	82
Yamaha _____	82-83
Conversion Chart _____	84-113

SPARK PLUG COVERS

NGK Resistor Plug Covers _____	114	Spark Plug Covers _____	116-118
Cover Symbols Explanation Chart _____	115		

LAMBDA SENSORS

NTK Lambda Sensors for Motorcycles _____	119	Technical Information _____	119
Aprilia _____	120	Moto Guzzi _____	121
BMW _____	120	Moto Morini _____	121
Ducati _____	120	MV Agusta _____	121
Honda _____	120	Suzuki _____	121
Husqvarna _____	121	Triumph _____	122
Hyosung _____	121		
KTM _____	121	Connector Types and OE Info _____	123
Kymco _____	121		

This catalogue is intended for vehicles/engines officially imported or manufactured in the UK and supersedes all previous versions, which should be disposed of. Whilst every care is taken in compiling these lists of applications, they are given for general guidance only, and do not constitute any contractual term, representation, or warranty and as such NGK Spark Plugs (UK) Ltd. do not accept any responsibility in respect of any claim whatsoever and howsoever caused arising from the publication of this catalogue.

NGK and NTK products **distributed by NGK Spark Plugs (UK) Ltd** are designed solely for use in automotive, motorcycle, marine, horticultural, agricultural, commercial, industrial, and stationary engines. **They should not be used in aircraft engines.** NGK goods destined for aviation use are likely to differ in specification and should be purchased through the OES parts supplier for the engine.

Resistor spark plugs should always be used where they are recommended by the manufacturer. The use of non-resistor plugs could, in some cases, result in interference with and/or damage to electronic components.

Specifications subject to change without notice.

NGK and NTK products listed in these application guides do not apply to racing or modified engines, except where explicitly stated.

SPARK PLUG DESIGN

SPARK PLUG DESIGN

Every year the range of NGK spark plugs grows to accommodate the ever increasing demands of modern engines. Spark plug design must take into consideration many features of an engine including physical dimensions, combustion chamber shape, cooling abilities, fuel and ignition systems. Spark plugs play a vital role in producing the maximum power from an engine whilst keeping fuel consumption and emissions to a minimum. Choosing the correct spark plug type will help a vehicle manufacturer meet legislated emission targets and assists the motorist in getting the best from their engine.

Increases in the size and the requirement to improve the cooling of the inlet and exhaust valves have meant that the space available for the spark plug is severely restricted on some cylinder heads. A change in spark plug design, possibly the adoption of a taper seat and extended reach (threaded portion) or even the use of a smaller diameter is often the answer. Some engines require the use of two spark plugs per cylinder and again due to space restrictions these might be of different sizes.

Changes in fuelling systems and the fuel itself have meant some special features being adopted at the 'firing end' of the spark plug. Extra projected types push the spark position into the heart of the combustion chamber to promote better combustion of the fuel/air mixture, which is weaker than ever in an effort to improve economy. Modern engine manufacturers often require increased spark gaps to allow a longer spark duration, which again aids more efficient combustion.

To combat the 'cold fouling' effect that can occur in some engines using unleaded fuels specially arranged ground electrodes are sometimes used. These can force the spark to discharge across the insulator and thus burn away any built up carbon that could cause poor starting or misfires. It is not uncommon to find two, three or four ground electrode arrangements in new vehicles. The use of precious metals on the tips of the spark plug electrodes is not uncommon especially on higher performance engines. Whilst these spark plugs do have increased service life they are often specified because of their superior ignition qualities.

Our engineering departments work very closely with the engine and vehicle manufacturers to produce the ideal spark plug type for each application. Any change in production is expensive for a manufacturer and therefore new spark plug types are only produced where necessary. NGK employ the very latest production technology to ensure that every aspect is catered for – performance, economy and value.



HEAT RANGE AND HEAT DISSIPATION

Spark plugs do not produce heat in the combustion chamber. One of the functions of the spark plug is to dissipate some of the heat produced during combustion. This is mostly transferred into the cylinder head. The 'Heat Range' indicates the measure of the spark plug's ability to do this.

A 'hot' spark plug is designed to maintain a sufficiently high temperature at the insulator nose to burn off carbon and oil deposits. A 'cold' spark plug is designed to allow a faster transfer of heat to the cylinder head thus preventing overheating and premature failure.

The heat range selection is obviously a complex task with many factors to take into account. NGK engineers therefore make specific recommendations for each engine and the use to which it is put.

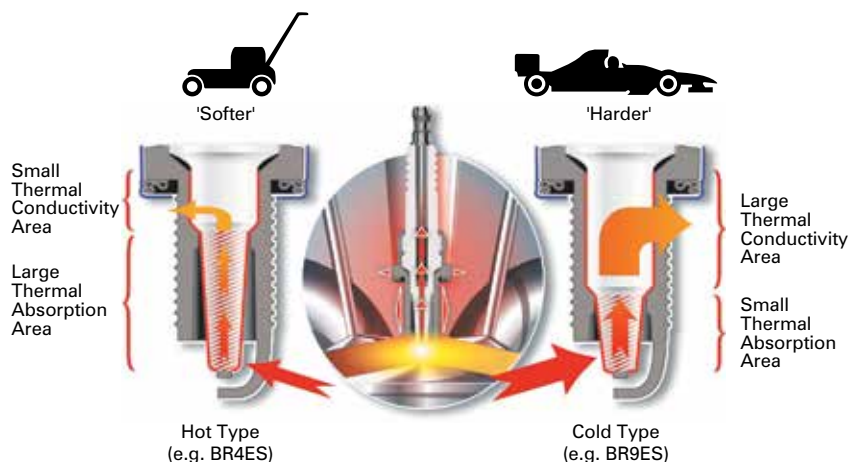

NGK'S COPPER CORE TECHNOLOGY

WIDE HEAT RANGE

A wide range spark plug is more flexible and performs equally well in a hot or cold engine under stop and go city driving or fast motorway cruising. Engines that tend to run hot need cold type plugs. Those that run cold demand a hotter type. The specific plug for any engine is determined by the plug's heat range. That is the minimum and maximum temperatures between which the plug will offer optimum performance.

The heat range of NGK Spark Plugs is wider than ordinary plugs therefore they are suitable for both high speed and low speed driving. Compared with conventional plugs of the same pre-ignition rating they have more resistance to fouling. Compared to ordinary plugs with equal anti-fouling resistance, NGK Spark Plugs have a higher pre-ignition rating.

NGK'S HEART OF COPPER

Copper wire used in place of the iron core in conventional plugs is the secret of NGK's Wide Heat Range. Copper's superior heat conductivity dissipates heat quicker. It cools the electrode tip and insulator tip which prevents hot spots that could cause pre-ignition. Increased heat resistance does not affect fouling resistance, which is primarily determined by the insulator nose length. The longer the nose, the more susceptible it is to heat and the more free from fouling. By raising the pre-ignition rating with the high conduction copper and leaving the insulator nose long, NGK produces the Wide Range Plug. One that meets the broad thermal requirements of engines under high and low RPM conditions. With the exception of a couple of older applications, all the spark plugs in this catalogue employ copper core technology.



FIRING END APPEARANCE

<p>Firing end temperature °C</p> <p>Overheating area</p> <p>870°</p>		<ul style="list-style-type: none"> • Overheating The insulator is white and sometimes blistered. If the insulator temperature is over 870°C pre-ignition may occur. Engine power will be reduced and the piston may be damaged. 	<ul style="list-style-type: none"> • Causes • Over advanced ignition timing • Too lean a fuel mixture • Blocked injectors • Insufficient cooling • Excessive deposits in the combustion chamber
<p>Optimum temperature area</p> <p>450°</p>		<ul style="list-style-type: none"> • Good condition The insulator is brown or light grey. 	<p>Even if the spark plug is used under good conditions, deposits will accumulate. Regular inspection and replacement is advisable.</p>
<p>Fouling area</p> <p>Idle Temp { 250° 150°</p>		<ul style="list-style-type: none"> • Fouling Carbon accumulates on the insulator nose forming a leakage path to earth. The engine misfires resulting in bad starting and poor acceleration. Particularly common with unleaded fuel. 	<ul style="list-style-type: none"> • Causes • Too rich a fuel mixture • Excessive use of choke • Prolonged slow speed driving or idling • Blocked air filter • Spark plug heat range too cold

THE BEST SPARK PLUG FOR EVERY OCCASION

As a result of our policy of continuous research and development NGK can offer special spark plugs designed to give optimum performance under a high range of conditions.

'S' TYPE (e.g. BP6ES)

NGK standard spark plugs with copper cored centre electrodes for wide heat range. Copper's superior heat conductivity dissipates the heat of combustion away from the firing end, preventing hot spots that can lead to pre-ignition. Copper cored electrodes also mean that longer insulator noses can be used to protect against fouling.



'G' TYPE (e.g. B10EG)

These plugs feature a smaller diameter centre electrode tip made of conventional nickel alloy. The smaller diameter centre electrode means the voltage required to produce a spark is reduced. However as the tip is made of conventional nickel alloy the service life is reduced and these plugs are best used in applications where plugs are frequently changed.



'V' TYPE (e.g. B10EV)

These 'V' types have been discontinued and replaced with 'VX' or 'IX' equivalents. The centre electrode of the 'V' type is made of gold palladium alloy.



'VX' TYPE (e.g. DR8EVX)

These plugs have an even smaller centre electrode (0.8mm) than the V types and this is made of platinum. This combined with a taper cut ground electrode means an even lower required voltage than the V types. The result is better ignitability along with improved starting, idle stability and anti-fouling performance. These 'VX' types have mostly been discontinued and replaced by the 'IX' types.



'IX' TYPE (e.g. BR8EIX)

Similar in design to the Platinum VX spark plug, the use of the precious metal Iridium allows us to manufacture a spark plug with an even smaller diameter centre electrode (0.6mm) without compromising durability. This extremely small Iridium tip centre electrode concentrates the available electrical energy and combined with the taper cut ground electrode provides the best performance in terms of starting, idling and especially throttle response.



FITTING THE CORRECT SPARK PLUG

NGK spark plugs are designed using the latest technology to give optimum performance over the engine's entire rev. range. Fitting the correct type of spark plug is essential. Many changes in engine technology has meant changes in spark plug design. Some NGK spark plugs may have a similar appearance, however the internal and or external design can differ sufficiently to cause engine damage should the incorrect part be installed. The examples below display some of the different design features employed in typical motorcycle applications and hopefully help to explain the reason for some application specific part numbers.

CR8EH-9

- Used on some Honda designed engines
- Special thread can only be used in specific engines or the cylinder head will be damaged

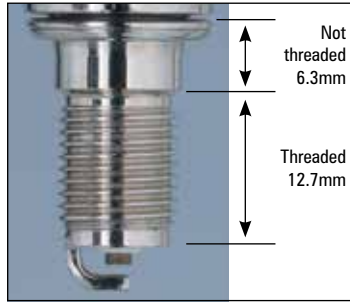

BR10ECM

- Compact style, mainly used by KTM and Suzuki
- For use where space is restricted

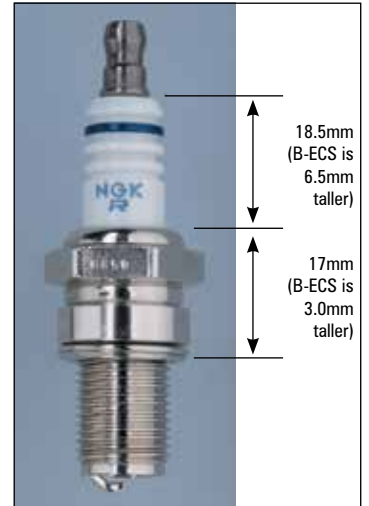

CR6HSA

- Centre electrode is 0.2mm wider than CR6HS for improved durability
- Short metal shell design



CR9EK, JR9C

- Used by Kawasaki and Suzuki
- 2 ground electrodes for improved durability



CR9EK thread diameter Ø 10mm



JR9C thread diameter Ø 12mm

ER9EH

- Used by Honda, Ø 8mm thread with 13mm hex
- Do not exceed the tightening torque of 0.8 - 1.0kg/m

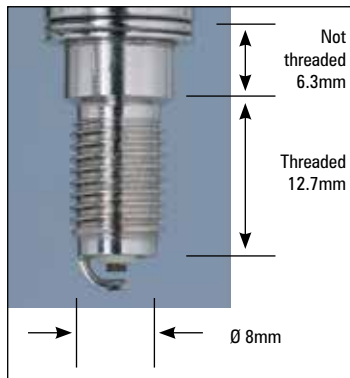

BR9ECS

- Short ground electrode for strength and to prevent overheating
- For competition use



THE IRIIDIUM IX SPARK PLUG

The Iridium IX spark plug benefits from the use of the precious metal Iridium on its centre electrode. Iridium is harder than other precious metals used in spark plug manufacture, has an extremely high melting point and offers greater protection from chemical attack. These features allow the use of an extremely small diameter electrode (0.6mm) without compromising the spark plug's service life. When compared to nickel plugs, service life is greatly extended. Combined with the use of the taper cut ground electrode this spark plug has superior gas flow properties and lower voltage requirements, which offers further improvements in starting, idling and throttle response.



BR8EIX

Iridium spark plugs are used in many high performance engines and in competition. Owners who want the very best performance will want the best spark plug we can offer with Iridium IX.



Iridium IX

A small diameter electrode that gives good gas flow and less restriction of flame kernel

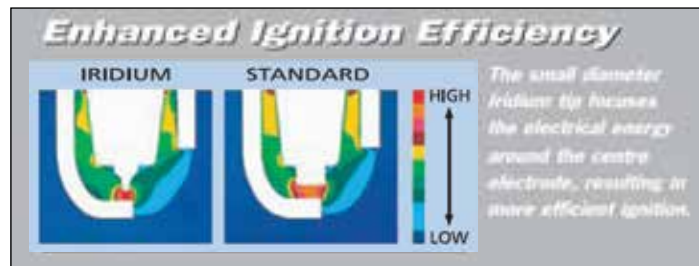

Iridium IX packaging

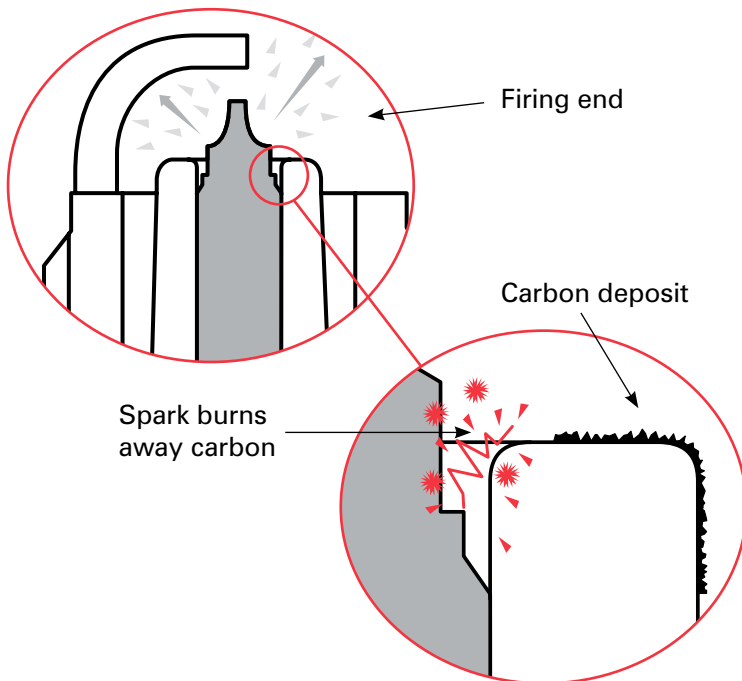

The close up section shows the annular gap between the centre electrode and insulator nose which provides cold fouling protection.

Should current try to leak away across a carbonised insulator a spark can occur between the electrode and the insulator thus burning away the carbon deposit.

THE IRIIDIUM IX SPARK PLUG

The tables below show the Iridium IX upgrade from standard copper core. For specific model application refer to the Iridium column in the main data pages.

STANDARD COPPER CORE		IRIDIUM IX	
PART NO.	PART NO.	PART NO.	STOCK NO.
BK6E	BKR6E	BKR6EIX	6418
	BKR6E-11	BKR6EIX-11	3764
	BKR7E	BKR7EIX	2667
BP5ES	BPR5ES	BPR5EIX	6597
BP6ES	BPR6ES	BPR6EIX	6637
	BPR6ES-11	BPR6EIX-11	3903
BP6HS	BPR6HS	BPR6HIX	4085
BP6HS-10	BPR6HS-10		
	BR6HSA		
BP7ES	BPR7ES	BPR7EIX	4055
BP7HS	BPR7HS	BPR7HIX	5944
BP7HS-10	BPR7HS-10		
BP8HS	BPR8HS	BPR8HIX	6742
BP8HS-10	BR8HSA		
B6HS	BR6HS	BR6HIX	3419
B6HS-10	BR6HS-10		
B7ES	BR7ES	BR7EIX	6664
B7HS	BR7HS	BR7HIX	7067
B7HS-10	BR7HS-10		
B8ES	BR8ES	BR8EIX	5044
B8HS	BR8HS	BR8HIX	7001
B8HS-10	BR8HS-10		
B9ES	BR9ES	BR9EIX	3981
	BR10ES	BR10EIX	6801
C6HSA	CR6HSA	CR6HIX	7274
	CR6HS		
	CR7E	CR7EIX	7385

STANDARD COPPER CORE		IRIDIUM IX	
PART NO.	PART NO.	PART NO.	STOCK NO.
C7HSA	CR7HSA	CR7HIX	7544
	CR7HS		
	CR8EH-9	CR8EHIX-9	3797
C8E	CR8E	CR8EIX	4218
	CR8EK		
C8HSA	CR8HSA	CR8HIX	7669
	CR8HS		
	CR9EH-9	CR9EHIX-9	6216
C9E	CR9E	CR9EIX	3521
	CR10E	CR10EIX	6482
	CR10EK		
	DCPR7E	DCPR7EIX	6046
	DCPR8E	DCPR8EIX	6546
	DCPR8EK		
	DCPR9E	DCPR9EIX	2316
	DPR7EA-9	DPR7EIX-9	7803
DP8EA-9	DPR8EA-9	DPR8EIX-9	2202
	DPR9EA-9	DPR9EIX-9	5545
D8EA	DR8EA	DR8EIX	6681
	DR8ES-L		
D9EA	DR9EA	DR9EIX	4772
	DR8ES*		
	JR9B		

*The upgrade from DR8ES to DR9EIX is correct

The IX range took over the premium motorcycle spark plug position from the popular Platinum VX range. Most contemporary machines demand the use of resistor types, and most older machines can and do use them quite happily.

Below is a chart to show the VX plugs affected.

Platinum VX		replaced by	Iridium IX	
Platinum VX	Stock No.		Iridium IX	Stock No.
B7EVX	6934	→	BR7EIX	6664
B7HVX	7836	→	BR7HIX	7067
B8EVX	7051	→	BR8EIX	5044
B8HVX	2634	→	BR8HIX	7001
B9EVX	7254	→	BR9EIX	3981
B10EVX	7335	→	BR10EIX	6801
B10HVX	2940	→	BR10HIX	6692
BKR6EVX	3539	→	BKR6EIX	6418
BKR7EVX	3544	→	BKR7EIX	2667
BP5EVX	5470	→	BPR5EIX	6597
BP7EVX	7270	→	BPR7EIX	4055
BPR5EVX	4875	→	BPR5EIX	6597
BPR6EVX	6764	→	BPR6EIX	6637

Platinum VX		replaced by	Iridium IX	
Platinum VX	Stock No.		Iridium IX	Stock No.
BPR9EVX	5576	→	BPR9EIX	6853
BR8EVX	1262	→	BR8EIX	5044
BR9EVX	1265	→	BR9EIX	3981
CR8EHVX-9	4546	→	CR8EHIX-9	3797
CR8EVX	6487	→	CR8EIX	4218
CR9EHVX-9	3872	→	CR9EHIX-9	6216
CR9EVX	5943	→	CR9EIX	3521
D8EVX	2850	→	DR8EIX	6681
D9EVX	2834	→	DR9EIX	4772
DCPR7EVX	1179	→	DCPR7EIX	6046
DPR7EVX-9	7682	→	DPR7EIX-9	7803
DPR8EVX-9	2872	→	DPR8EIX-9	2202
DPR9EVX-9	3854	→	DPR9EIX-9	5545

SPARK PLUG INSTALLATION TIPS

- Refer to current NGK catalogue for correct spark plug selection
- Check condition and cleanliness of threads in cylinder head
- Ensure plug is gapped according to manufacturers specification (fig 1). Extreme care must be taken if attempting to adjust the gap of a precious metal spark plug
- Multi ground electrode plugs cannot be regapped - visual inspection only
- Install new spark plug *by hand* until it seats - (fig 2) a length of rubber tubing pushed over the insulator can be a useful aid for plug installation where access is difficult
- Tighten to specified torque setting as shown in the chart below (fig 3)
- If a torque wrench is unavailable then refer to vehicle/engine manufacturers installation instructions or the tightening angle advice which is displayed on current NGK packaging (excluding specialist race plugs). Note that this angle advice can differ between part numbers due to individual spark plug design (e.g. seating type, thread diameter and gasket material)
- It is important not to over or under tighten spark plugs during installation. Over-tightening can lead to distortion of the spark plug. Under-tightening can cause overheating due to poor heat dissipation. *In extreme cases incorrect tightening can cause spark plug breakage and/or engine damage*
- NGK does not recommend the application of lubricant to spark plug threads as the resultant reduction of frictional forces at the thread faces will render the torque charts inaccurate and over tightening could occur
- If a gasket type spark plug is re-installed, it should only require a further 1/12 of a turn after it has been seated
- Always carefully use the correct tools for removal/installation to prevent damage to the spark plug or engine
- Inspect spark plug cover and renew if necessary

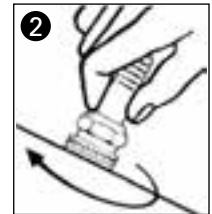
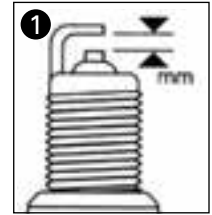

3	FOR FLAT SEAT TYPE (WITH GASKET)					TAPER SEAT TYPE		
	Thread Ø	18 mm	14 mm	12 mm	10 mm	8 mm	18 mm	14 mm
Cast iron head		35-45Nm (3.5-4.5kgm) (25.3-32.5lbs ft)	25-35Nm (2.5-3.5kgm) (18.0-25.3lbs ft)	15-25Nm (1.5-2.5kgm) (10.8-18.0lbs ft)	10-15Nm (1.0-1.5kgm) (7.2-10.8lbs ft)	-	20-30Nm (2.0-3.0kgm) (14.5-21.6lbs ft)	15-25Nm (1.5-2.5kgm) (10.8-18.0lbs ft)
Aluminium head		35-40Nm (3.5-4.0kgm) (25.3-28.9lbs ft)	25-30Nm (2.5-3.0kgm) (18.0-21.6lbs ft)	15-20Nm (1.5-2.0kgm) (10.8-14.5lbs ft)	10-12Nm (1.0-1.2kgm) (7.2-8.7lbs ft)	8-10Nm (0.8-1.0kgm) (5.8-7.2lbs ft)	20-30Nm (2.0-3.0kgm) (14.5-21.6lbs ft)	10-20Nm (1.0-2.0kgm) (7.2-14.5lbs ft)

Important: Some spark plugs differ in gasket design or material, refer to tightening advice on specific spark plug packaging

SPARK PLUG GAP SETTINGS

Important: Spark plug gap settings are given in millimetres. Practical equivalents are shown below.

mm	0.4	0.5	0.6	0.7	0.8	0.9	1.0	1.1	1.3	1.4	1.5	1.6	1.8	2.0
ins	.016	.020	.024	.028	.032	.035	.039	.043	.051	.055	.059	.063	.071	.079

DESIGN SYMBOLS

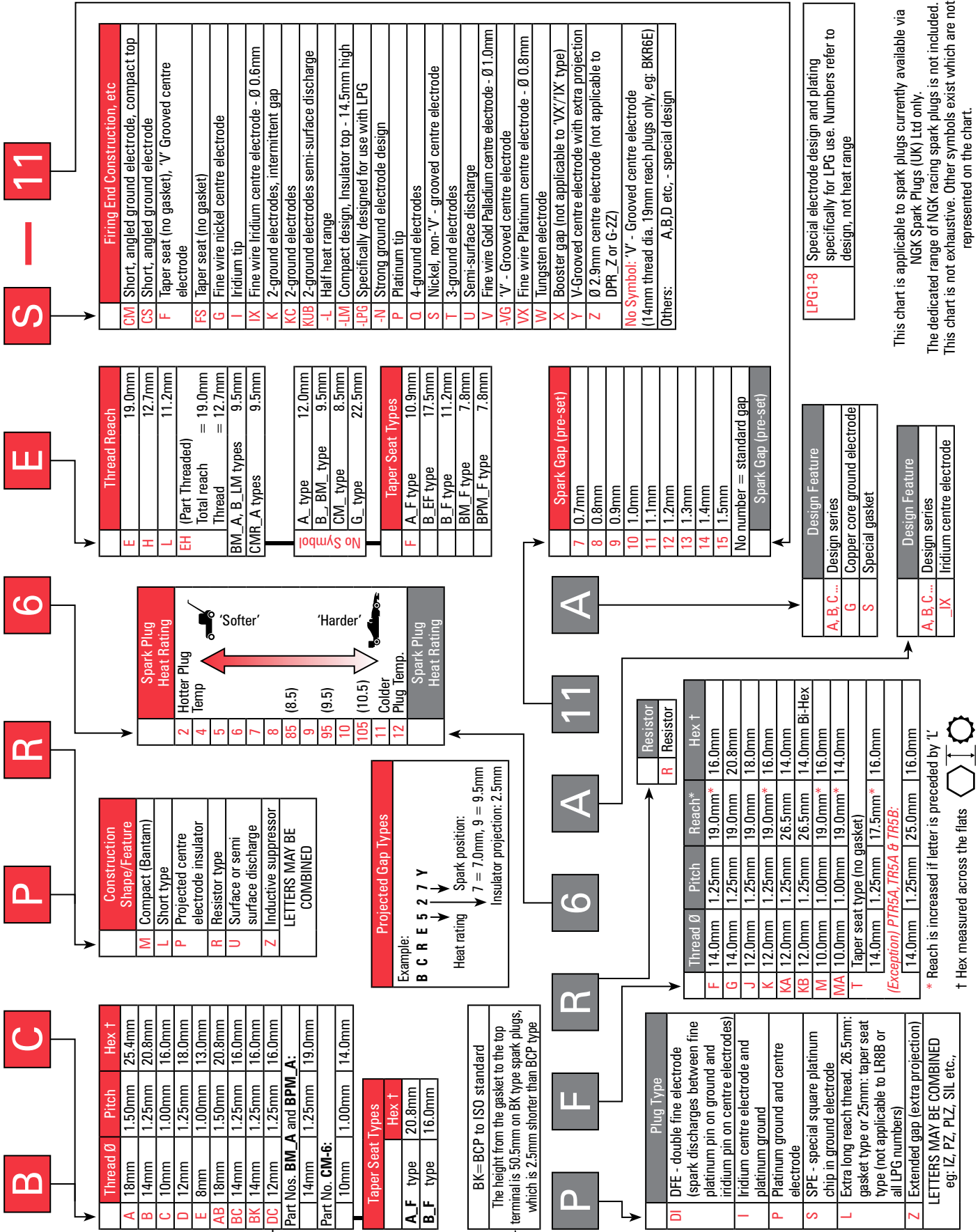

NEW ADDITIONS AND PART NUMBERS

These are new additions to this catalogue that have new part numbers not previously stocked by NGK Spark Plugs (UK) Ltd.

PART NO.	STOCK NO.	APPLICATION	
CR6EB	90071	PEUGEOT	Speedfight 4 50cc
LMAR8L-9	91131	HONDA	PCX125
LMAR8GI-8	92729	YAMAHA	Wolverine 1000
LMAR9J-9E	94162	BMW	F850 GS Adventure F900 R, XR
LZMAR8A1-10	94021	INDIAN	Challenger Limited, Dark Horse
MAR8AI-10DS	92997	BMW	R18 Cruiser

These Spark Plugs will become available during 2022

Listed below is a selection of new applications for existing spark plugs

MAKE	MODEL	PART NO.	STOCK NO.
BMW	M1000RR	LMAR9FI-10G	92850
	S1000 XR	LMAR9FI-10G	92850
CAN-AM (BRP)	Ryker 600	CR8EB	7784
DUCATI	Supersport 950	MAR9A-J	6869
	Panigale V2 955	MAR9A-J	6869
	Superleggera V4 998	LMDR10A-JS	97718
	Streetfighter V4 1103	LMDR10A-JS	97718
HONDA	CB125R	CPR8EA-9	2306
	CBF125M	CPR8EA-9	2306
	PCX125	MR8K-9	93844
	SH125i	LMAR8L-9	91131
	CBR1000RR Fireblade	SILMAR10C9S	95468
	CBR1000RR-R Fireblade	SILMAR10C9S	95468
	CRF1100L Africa Twin	SILMAR8A9S	90992
HUSQVARNA	FE450 16→19	LMAR9AI-10	93188
	FE450 20→	LZMAR8BI-10	95680
	Norden 901	LMAR9AI-10	93188
KAWASAKI	KLE650 E,F,H (Versys)	CR9EIA-9	6289
	Z650RS (ER650M, Classic)	CR9EIA-9	6289
	ZR900RS (Classic)	CR9EIA-9	6289
	ZX1000Z (Ninja ZX-10RR)	SILMAR9B9	95399
	ZX1002 (Ninja ZX-10R)	SILMAR9B9	95399
	ZX1002N (Ninja ZX-10RR)	SILMAR9B9	95399

MAKE	MODEL	PART NO.	STOCK NO.
LAMBRETTA	V50 18→20	CR7HSA	4549
	V125 18→20	CR7HSA	4549
	V200 18→20	CR7HSA	4549
MOTO GUZZI	V85 TT (Incl. Travel) 19→	MR8BI-8	91360
SUZUKI	Katana 1000 19→	CR9EIA-9	6289
TRIUMPH 1991-ON	Tiger Sport, Trident 22→	CR9EK	4548
	Tiger 900 Rally, Pro 20→	CR9EK	4548
	Speed Triple 1200 RS 21→	LMAR9E-J	6884
	Rocket 3 GT 2500 20→	LMAR8A-9	4313
YAMAHA	YFZ50 (ATV)	CR6HSA	2983
	YFM90R (ATV)	CR6HSA	2983
	MT-125	MR8E-9	90527
	XSR125	MR8E-9	90527
	YZF-R125	CR9E	6263
	YZF-R125	MR8E-9	90527
	WR250F	LMAR8G	90527
	MT-03	LMAR8A-9	4313
	XSR700	LMAR8A-9	4313
	XTZ690D Tenere	LMAR8A-9	4313
	YZX1000 SS SE (ATV)	CR9EB	6955

The above tables are intended as a stock purchase guide.
Refer to the relevant model listing in the main application section for product selection.



CC	MODEL	DATE	STANDARD COPPER CORE	STOCK NUMBER	PLATINUM OR GOLD PALLADIUM	STOCK NUMBER	IRIDIUM	STOCK NUMBER	GAP MM
ADLY									
50	Citybird, Crosser, Fox, Jet X1, Pista, Predator	97→	BPR7HS	6422			BPR7HIX	5944	0.6
100	Cat, Predator, Jet, X1	97→	BPR7HS	6422			BPR7HIX	5944	0.6
125	Activator 125	99→	CR7HSA	4549			CR7HIX	7544	0.5
	AJP 125 PR4	03→	DPR7EA-9	5129			DPR7EIX-9	7803	0.9
	Cat 125	97→	CR7HSA	4549			CR7HIX	7544	0.5

AJS									
50	Chipmunk 50	03→	BP4HS	3611					0.6
	DD50 Regal Raptor	03→	CR7HS	7223			CR7HIX	7544	0.7
	JSM 50 Motard	11→	BR8ES	5422			BR8EIX	5044	0.6
80	Coyote 80	03→	BP6HS	4511			BPR6HIX	4085	0.6
100	Cougar 100 (Jincheng)	03→	BP7HS	5111			BPR7HIX	5944	0.6
	DD100 Regal Raptor	03→	CR7HS	7223			CR7HIX	7544	0.7
125	CR3-125 Super Sports	08→	DR8EA	7162	DR8EVX	6354	DR8EIX	6681	0.6
	Eco-2 125	11→15	CR6HSA	2983			CR6HIX	7274	0.6
	Eco-3 125	16→	CR6HSA	2983			CR6HIX	7274	0.6
	JS125Y Tiger	03→	DR8ES	5423			DR9EIX	4772	0.7
	JSM125 Motard / Trail	10→	CR6HSA	2983			CR6HIX	7274	0.6

APRILIA									
50	AF1 50	88→92	B8ES	2411			BR8EIX	5044	0.5
	Amico 50	92→94	BR7HS	4122			BR7HIX	7067	0.6
	Area 51 (Liquid Cooled 2-Stroke)	98→	BR8HS	4322			BR8HIX	7001	0.5
	Extrema 50	93→	B8ES	2411			BR8EIX	5044	0.5
	Gulliver	97→99	BR7HS	4122			BR7HIX	7067	0.6
	Habana 50, Custom & Retro	99→05	BPR8HS	3725			BPR8HIX	6742	0.6
	Mojito Custom 50	05→08	BR9ES	5722			BR9EIX	3981	0.7
	MX50	03→07	BR9ES	5722			BR9EIX	3981	0.7
	Rally 50 (Air Cooled)	95→99	BR7HS	4122			BR7HIX	7067	0.7
	Rally 50 (Liquid Cooled)	97→03	BR8HS	4322			BR8HIX	7001	0.5
	Red Rose 50	93→00	B8ES	2411			BR8EIX	5044	0.5
	RS 50 (Minarelli engine)	93→00	B8ES	2411			BR8EIX	5044	0.6
	RS 50 (Minarelli engine)	01→05	BR9ES	5722			BR9EIX	3981	0.7
	RS 50 (Derbi engine)	06→	BR9ES	5722			BR9EIX	3981	0.5
	RS4 50	11→13	BR8ES	5422			BR8EIX	5044	0.6
	RX 50 (Minarelli engine)	97→10	B9ES	2611			BR9EIX	3981	0.6
	Scarabeo 50 Carb (Minarelli engine) 12.7mm Thread Reach	93→04	BR7HS	4122			BR7HIX	7067	0.6
	Scarabeo 50 Carb (Piaggio engine) 19mm Thread Reach	05→11	BR8ES	5422			BR8EIX	5044	0.6
	Scarabeo 50 Di Tech (Injection) 2-Stroke	01→04	CPR8E	7411			CR8EIX	4218	0.8
	Scarabeo 50 4T (4-Stroke) 2-valve Ø10mm Plug	06→09	CR9EB	6955			CR9EIX	3521	0.6
	Scarabeo 50 4T (4-Stroke) 4-valve Ø8mm Plug	08→12	ER9EH-6N	1673					0.6
	Sonic FT 50 (Air Cooled 2-Stroke)	98→01	BR8HS	4322			BR8HIX	7001	0.5
	Sonic GP 50 (Liquid Cooled 2-Stroke)	98→05	BR8HS	4322			BR8HIX	7001	0.5
	Sportcity One (4-Stroke)	08→11	CR8EB	7784			CR8EIX	4218	0.7
	Sportcity One Street (2-Stroke)	08→11	BR9ES	5722			BR9EIX	3981	0.6
	SR 50 (Air Cooled)	94→	BR7HS	4122			BR7HIX	7067	0.7
	SR 50 Stealth / LC / Racing (Liquid Cooled)	96→	BR7HS	4122			BR7HIX	7067	0.7
	SR 50 Carb (19mm Thread Reach)	04→	BR9ES	5722			BR9EIX	3981	0.6
	SR 50 Di Tech Injection	01→04	CPR8E	7411			CR8EIX	4218	0.8
	SR 50 Di Tech Injection	05→				ZMR7AP	6914		0.8
	SR 50 i.e. Pure Jet	04→				ZMR7AP	6914		0.8
	SR 50 WWW	01→02	BR7HS	4122			BR7HIX	7067	0.6
	SR 50R	05→	BR9ES	5722			BR9EIX	3981	0.6
SR Motard 50 (2-Stroke)	12→	BR9ES	5722			BR9EIX	3981	0.5	
SX 50	06→10	BR9ES	5722			BR9EIX	3981	0.6	
100	Scarabeo 100 2-Stroke (12.7mm Thread Reach)	99→01	BR8HS	4322			BR8HIX	7001	0.6
	Scarabeo 100 4-Stroke (19mm Thread Reach)	01→12	CR9EB	6955			CR9EIX	3521	0.5
125	AF1 125	88→93	BR10EG	3830			BR10EIX	6801	0.5
	AF1 Futura	90→93	BR10EG	3830			BR10EIX	6801	0.5
	Atlantic 125	03→13	CR8EB	7784			CR8EIX	4218	0.8
	Classic 125	99→06	BR10EG	3830			BR10EIX	6801	0.6



CC	MODEL	DATE	STANDARD COPPER CORE	STOCK NUMBER	PLATINUM OR GOLD PALLADIUM	STOCK NUMBER	IRIDIUM	STOCK NUMBER	GAP MM
APRILIA (CONTINUED)									
125	ETX 125 (Liquid Cooled 2-Stroke)	98→01	BR8ES	5422			BR8EIX	5044	0.5
	Europa 125	90→92	BR10EG	3830			BR10EIX	6801	0.5
	Habana 125 Custom & Retro (4-Stroke)	99→	CR8E	1275			CR8EIX	4218	0.6
	Leonardo 125	95→98	CR8E	1275			CR8EIX	4218	0.6
	Leonardo 125 & ST	99→04					CR8EIX	4218	0.6
	Mojito Custom 125	05→	CR7EB	4663			CR7EIX	7385	0.6
	MX125	04→07	BR8ES	5422			BR8EIX	5044	0.6
	Pegaso 125	92→96	BR10EG	3830			BR10EIX	6801	0.5
	Rally 125	89→90	B10EG	3630			BR10EIX	6801	0.5
	Red Rose 125	88→94	BR10EG	3830			BR10EIX	6801	0.5
	RS 125 (12BHP Restricted)	93→12	BR8ES	5422			BR8EIX	5044	0.5
	RS 125 (35BHP Unrestricted)	93→12	BR10EG	3830			BR10EIX	6801	0.5
	RS 125R Extrema (12BHP Restricted)	93→12	BR8ES	5422			BR8EIX	5044	0.5
	RS 125R Extrema (35BHP Unrestricted)	93→12	BR10EG	3830			BR10EIX	6801	0.5
	RS125 Tuono	03→12	BR8ES	5422			BR8EIX	5044	0.6
	RS4 125	11→	CR9EB	6955			CR9EIX	3521	0.5
	RX125	94→96	BR10EG	3830			BR10EIX	6801	0.5
	RX125 (15BHP Restricted)	08→	BR8ES	5422			BR8EIX	5044	0.7
	RX125 (22BHP Unrestricted)	08→	BR10EG	3830			BR10EIX	6801	0.7
	Scarabeo 125cc (4-Stroke)	99→06	CR8E	1275			CR8EIX	4218	0.6
	Scarabeo 125cc (4-Stroke)	07→10			PMR9B	4717	CR9EIX	3521	0.7
	Sport City 125	04→08	CR8E	1275			CR8EIX	4218	0.6
	Sportcity Cube 125	08→11	CR7EB	4663			CR7EIX	7385	0.7
	Sportcity One 125	08→11	CR7EB	4663			CR7EIX	7385	0.7
	Sport Pro 125	92→93	BR10EG	3830			BR10EIX	6801	0.5
	SR 125	04/99→	BR8ES	5422			BR8EIX	5044	0.5
	SR 125AC	00→	BR8ES	5422			BR8EIX	5044	0.5
	SR MAX 125	11→	CR8EKB	4374			CR8EIX	4218	0.7
	SR Motard 125	12→	CR7EB	4663			CR7EIX	7385	0.7
	SX125 (15BHP Restricted)	08→	BR8ES	5422			BR8EIX	5044	0.7
SX125 (22BHP Unrestricted)	08→	BR10EG	3830			BR10EIX	6801	0.7	
Tuareg Wind 125	89→91	B10EG	3630			BR10EIX	6801	0.5	
150	Leonardo 150	98→01	CR8E	1275			CR8EIX	4218	0.6
	Leonardo 150 ST	02→04					CR8EIX	4218	0.6
	Scarabeo 150 (4-Stroke)	99→	CR8E	1275			CR8EIX	4218	0.6
200	Atlantic 200	03→07	CR8EB	7784			CR8EIX	4218	0.8
	Scarabeo 200 (4-Stroke)	00→06	CR8E	1275			CR8EIX	4218	0.6
	Scarabeo 200 (4-Stroke)	07→10			PMR9B	4717	CR9EIX	3521	0.7
	Sportcity 200	04→08	CR7EB	4663			CR7EIX	7385	0.6
	Sportcity Cube 200	08→	CR7EB	4663			CR7EIX	7385	0.7
250	Atlantic 250	04→08	CR8EB	7784			CR8EIX	4218	0.7
	Leonardo 250	99→03	DR8EA	7162	DR8EVX	6354	DR8EIX	6681	0.6
	RS 250	94→04	BR9ECM	3252			BR9ECMIX	2707	0.7
	Scarabeo 250	04→06	CR8EB	7784			CR8EIX	4218	0.7
	Scarabeo 250	07→09			PMR8B	6378			0.7
	Sport City 250	04→10	CR8EB	7784			CR8EIX	4218	0.7
280	Climber trials bike	89→					BPR6EIX	6637	0.6
300	Leonardo 300	04→	DR8EA	7162	DR8EVX	6354	DR8EIX	6681	0.6
	Sportcity Cube	08→	CR8EKB	4374			CR8EIX	4218	0.7
	SR MAX 300	11→	CR8EKB	4374			CR8EIX	4218	0.7
400	Atlantic 400 Sprint	06→10	CR7EKB	4455			CR7EIX	7385	0.8
450	MXV 450	09→10	CR8EKB	4374			CR8EIX	4218	0.7
	RXV 4.5	06→08	CR8EB	7784			CR8EIX	4218	0.7
	RXV 4.5	09→	CR8EKB	4374			CR8EIX	4218	0.7
	SXV 4.5	06→08	CR8EB	7784			CR8EIX	4218	0.7
	SXV 4.5	09→	CR8EKB	4374			CR8EIX	4218	0.7
500	Atlantic 500	01→10	CR7EKB	4455			CR7EIX	7385	0.8
	Atlantic 500 Sprint	05→10	CR7EKB	4455			CR7EIX	7385	0.8
	Scarabeo 500	03→08	CR7EKB	4455			CR7EIX	7385	0.8
550	RXV 5.5	06→08	CR8EB	7784			CR8EIX	4218	0.7
	RXV 5.5	09→	CR8EKB	4374			CR8EIX	4218	0.7
	SXV 5.5	06→08	CR8EB	7784			CR8EIX	4218	0.7
	SXV 5.5	09→	CR8EKB	4374			CR8EIX	4218	0.7



CC	MODEL	DATE	STANDARD COPPER CORE	STOCK NUMBER	PLATINUM OR GOLD PALLADIUM	STOCK NUMBER	IRIDIUM	STOCK NUMBER	GAP MM
APRILIA (CONTINUED)									
600	Pegaso 600	92→94	D8EA	2120	DR8EVX	6354	DR8EIX	6681	0.6
	Tuareg 600	88→92	D8EA	2120	DR8EVX	6354	DR8EIX	6681	0.6
650	Moto 6.5 (650)	95→03	D8EA	2120	DR8EVX	6354	DR8EIX	6681	0.7
	Pegaso 650 (Carburettor)	93→00	D8EA	2120	DR8EVX	6354	DR8EIX	6681	0.6
	Pegaso 650 (Injection) Ø12mm Plug	01→04	DR8EB	4855	DR8EVX	6354	DR8EIX	6681	0.7
	Pegaso Strada & Trail 650 Ø10mm Plug	05→09	CR7E	4578			CR7EIX	7385	0.7
	Pegaso Factory	02/07→09	CR7E	4578			CR7EIX	7385	0.7
750	Shiver GT (Half faired) (Incl. ABS)	09→16	CR7EKB	4455			CR7EIX	7385	0.8
	SL 750 Shiver (Incl. ABS)	07→16	CR7EKB	4455			CR7EIX	7385	0.8
	SMV 750 Dorsoduro / Factory	07→16	CR7EKB	4455			CR7EIX	7385	0.8
839	Mana GT ABS (Twin Spark)	09→	CR7EKB	4455			CR7EIX	7385	0.8
	NA 850 Mana (Incl. ABS) (Twin Spark)	08→	CR7EKB	4455			CR7EIX	7385	0.8
	SRV850 (Twin Spark)	12→	CR7EKB	4455			CR7EIX	7385	0.8
896	Dorsoduro 900	18→					MR8BI-8	91360	0.8
	Shiver 900	17→					MR8BI-8	91360	0.8
1000	ETV 1000 Caponord	01→	DCPR9E	2641			DCPR9EIX	2316	0.6
	RST 1000 Futura	01→03	DCPR9E	2641			DCPR9EIX	2316	0.6
	RSV 1000 R Factory	04→	DCPR9E	2641			DCPR9EIX	2316	0.6
	RSV 4 Factory	09→14	CR9EB	6955			CR9EIX	3521	0.7
	RSV 4 R	09→14	CR9EB	6955			CR9EIX	3521	0.7
	RSV 4 RF	15→	CR9EKB	2305			CR9EIX	3521	0.8
	RSV Mille	98→	DCPR9E	2641			DCPR9EIX	2316	0.6
	RSV Mille R	98→03	DCPR9E	2641			DCPR9EIX	2316	0.6
	RSV Mille R	04→	DCPR9E	2641			DCPR9EIX	2316	0.6
	RSV Mille SP (Sport Production)	00→03	R0045Q-10	4216					1.1
	RSV Mille Tuono	02→	DCPR9E	2641			DCPR9EIX	2316	0.6
	SL 1000 Falco	99→06	DCPR9E	2641			DCPR9EIX	2316	0.6
	Tuono 1000	04→	DCPR9E	2641			DCPR9EIX	2316	0.6
	Tuono 1000 R	05→	DCPR9E	2641			DCPR9EIX	2316	0.6
Tuono V4R	05/11→14	CR9EKB	2305			CR9EIX	3521	0.8	
1077	Tuono V4 1100 RR	15→	CR9EKB	2305			CR9EIX	3521	0.8
1197	1200 Dorsoduro	11→	CR8EKB	4374			CR8EIX	4218	0.7
	Caponord (Twin Spark)	13→	CR8EKB	4374			CR8EIX	4218	0.7
	Caponord Rally (Twin Spark)	15→	CR8EKB	4374			CR8EIX	4218	0.7

ATALA									
50	Byte	97→98	B7HS	5110			BR7HIX	7067	0.5
	Carosello	97→00	B7HS	5110			BR7HIX	7067	0.5
	Hacker AT 12, Hacker Racing	97→98	BPR6HS	7022			BPR6HIX	4085	0.6
	Master	98→99	B6HS	4510			BR6HIX	3419	0.6
	Skeggia	99→00	BPR6HS	7022			BPR6HIX	4085	0.6

BAJAJ									
50	Sunny, Bonnie 50	93→	B6HS	4510			BR6HIX	3419	0.5
100	KB100	93→	B8ES	2411			BR8EIX	5044	0.5
125	Vespa, Chetak (Scooter)	93→	B6HS	4510			BR6HIX	3419	0.5
150	Chetak 150	01→	BPR5HS	6222					0.7
200	Pulsar 200 NS (Triple Spark)	Ø10mm Plug x 2 Ø12mm Plug x 1	13→14	CR8E	1275		CR8EIX	4218	0.7
				LKAR8A-9	4786		LKAR8AI-9	6706	0.9
	Pulsar AS200 (Triple Spark)	Ø10mm Plug x 2 Ø12mm Plug x 1	15→16	CR8E	1275		CR8EIX	4218	0.7
				LKAR8A-9	4786		LKAR8AI-9	6706	0.9
	Pulsar NS200 (Triple Spark)	Ø10mm Plug x 2 Ø12mm Plug x 1	17→	CR8E	1275		CR8EIX	4218	0.7
				LKAR8A-9	4786		LKAR8AI-9	6706	0.9

BAOTIAN									
50	BT49QT-9 / -11 / -12 Ø10mm Plug	04→	CR7HSA	4549			CR7HIX	7544	0.6
110	BT110-2	04→	CR7HSA	4549			CR7HIX	7544	0.6
125	Citibike 125	04→	CR7HSA	4549			CR7HIX	7544	0.6
	Monza 125	11→	CR7HSA	4549			CR7HIX	7544	0.6
	Tanco 125	04→	CR7HSA	4549			CR7HIX	7544	0.6



CC	MODEL	DATE	STANDARD COPPER CORE	STOCK NUMBER	PLATINUM OR GOLD PALLADIUM	STOCK NUMBER	IRIDIUM	STOCK NUMBER	GAP MM
BAROSSA									
125	XS125T-13	12/07 →	CR7HSA	4549			CR7HIX	7544	0.6

BASHAN									
110	BS110 GY	01 →	C7HSA	4629			CR7HIX	7544	0.6
125	BS125 GY	01 →	D8EA	2120	DR8EVX	6354	DR8EIX	6681	0.6
200	BS200 GY	01 →	D8EA	2120	DR8EVX	6354	DR8EIX	6681	0.6
250	Vixen VX250	06 →	DR8EA	7162	DR8EVX	6354	DR8EIX	6681	0.7

BATAVUS									
50	Mondial	80 →	B6HS	4510			BR6HIX	3419	0.4
	Starglo	76 →	B7HS	5110			BR7HIX	7067	0.5

BEELINE									
50	Veloce GT 50	09 →	C7HSA	4629			CR7HIX	7544	0.6
	Veloce Racing	09 →	C7HSA	4629			CR7HIX	7544	0.6

BENELLI									
50	491 Sport, ST GP, Rage, RR SBK, RR GP	98 →	BR8HS	4322			BR8HIX	7001	0.5
	49X Quattro Nove	08 →	BR8HSA	5539			BR8HIX	7001	0.8
	49X Road	08 →	BR8HSA	5539			BR8HIX	7001	0.8
	49X Trek	08 →	BR8HSA	5539			BR8HIX	7001	0.8
	50 Cross	64 →	B6ES	7310					0.5
	G2	75 →80	B6ES	7310					0.5
	G2 Elle	75 →80	B6ES	7310					0.5
	K2, K2 Air	98 →	BR8HS	4322			BR8HIX	7001	0.5
	Motorella	65 →	B6ES	7310					0.5
	Namur 50	98 →01	BR8HS	4322			BR8HIX	7001	0.5
	Pepe	00 →	BR8HS	4322			BR8HIX	7001	0.5
100	K2 100	99 →	BR8HS	4322			BR8HIX	7001	0.5
124	124	80 →86	C7HSA	4629			CR7HIX	7544	0.5
125	125 Roadster/Cross	71 →	B7ES	1111			BR7EIX	6664	0.5
	Adiva	01 →06	CR8EB	7784			CR8EIX	4218	0.8
	TnT 125	17 →	CR7HSA	4549			CR7HIX	7544	0.6
	Velvet 125	99 →	CR8E	1275			CR8EIX	4218	0.6
150	Adiva 150	01 →06	CR8E	1275			CR8EIX	4218	0.6
231	250 Quattro (4-cyl.)	76 →77	C7HSA	4629			CR7HIX	7544	0.5
	254	77 →83	C7HSA	4629			CR7HIX	7544	0.5
	304	84 →88	C7HSA	4629			CR7HIX	7544	0.5
250	250 Super	72 →	B8ES	2411			BR8EIX	5044	0.5
	Adiva 250	08 →	CR8EB	7784			CR8EIX	4218	0.8
	Cafénero 250	12 →	CR8E	1275			CR8EIX	4218	0.6
	Velvet 250	00 →	CR8E	1275			CR8EIX	4218	0.6
300	BN 302	14 →	CR9EB	6955			CR9EIX	3521	0.7
350	354 Sei	80 →	D8EA	2120	DR8EVX	6354	DR8EIX	6681	0.5
400	Velvet 400	03 →04	CR9E	6263			CR9EIX	3521	0.7
500	Leoncino, Leoncino Trail	18 →	CR8E	1275			CR8EIX	4218	0.6
	Quattro 500	73 →83	D8EA	2120	DR8EVX	6354	DR8EIX	6681	0.5
	TRK502	17 →	CR8E	1275			CR8EIX	4218	0.6
	TRK502X	18 →	CR8E	1275			CR8EIX	4218	0.6
600	BN 600 GT	14 →	CR9E	6263			CR9EIX	3521	0.7
	BN 600 I	14 →	CR9E	6263			CR9EIX	3521	0.7
	BN 600 R	14 →	CR9E	6263			CR9EIX	3521	0.7
650	654 Sei	80 →	D8EA	2120	DR8EVX	6354	DR8EIX	6681	0.5
750	750 Sei	72 →78	D8EA	2120	DR8EVX	6354	DR8EIX	6681	0.5
900	900 Sei	79 →	D8EA	2120	DR8EVX	6354	DR8EIX	6681	0.5
	TNT 899/S/T (Tornado Naked Tre)	08 →	CR9E	6263			CR9EIX	3521	0.7
	Tornado Tre 900/903 RS	02 →	CR9E	6263			CR9EIX	3521	0.7
	Tornado Tre 903	08 →	CR9EB	6955			CR9EIX	3521	0.7
	Tre-K 899	09 →	CR9EB	6955			CR9EIX	3521	0.7



CC	MODEL	DATE	STANDARD COPPER CORE	STOCK NUMBER	PLATINUM OR GOLD PALLADIUM	STOCK NUMBER	IRIDIUM	STOCK NUMBER	GAP MM
BENELLI (CONTINUED)									
1130	TNT R160	10→	CR9EB	6955			CR9EIX	3521	0.7
	TNT 1130, K	04→	CR9E	6263			CR9EIX	3521	0.7
	TNT 1130 Titanium	06→	CR9E	6263			CR9EIX	3521	0.8
	TNT 1130 Sport Evo (Tornado Naked Tre)	07→	CR9E	6263			CR9EIX	3521	0.8
	TNT Café Racer 1130	01/06→	CR9E	6263			CR9EIX	3521	0.8
	Tornado Tre 1130	06→	CR9E	6263			CR9EIX	3521	0.7
	Tornado Tre K	06→	CR9E	6263			CR9EIX	3521	0.7
	Tre-K 1130K (Incl. Amazonas)	07→	CR9EB	6955			CR9EIX	3521	0.7

BENZHOU									
50	YY50QT	08→	CR7HSA	4549			CR7HIX	7544	0.6
125	YY125T		CR7HSA	4549			CR7HIX	7544	0.6
150	YY150		CR7HSA	4549			CR7HIX	7544	0.6
250	YY250	07→	DR8EA	7162	DR8EVX	6354	DR8EIX	6681	0.6

BETA / BETAMOTOR									
50	Ark (Air Cooled)	98→	BR7HS	4122			BR7HIX	7067	0.6
	Ark (Liquid Cooled)	97→	BR8HS	4322			BR8HIX	7001	0.7
	Eikon 50	99→	BR8HS	4322			BR8HIX	7001	0.7
	Enduro 50		BR10ES	4832			BR10EIX	6801	0.7
	Mini Cross 10/10, 12/13, 12/15 & Mini Trial	05→07	B7HS	5110			BR7HIX	7067	0.6
	Quadra	97→	BR7HS	4122			BR7HIX	7067	0.6
	R10 (12.7mm Thread Reach)	08→09	B7HS	5110			BR7HIX	7067	0.6
	R12 (12.7mm Thread Reach)	08→09	B7HS	5110			BR7HIX	7067	0.6
	R10, R12 (19mm Thread Reach)	10→12	BR8ES	5422			BR8EIX	5044	0.6
	Rev 50	03→	B9ES	2611			BR9EIX	3981	0.5
	RR Enduro 50	98→05	BR10ES	4832			BR10EIX	6801	0.7
	RR Enduro 50, Racing 50 (Euro 2)	04→	BR9ES	5722			BR9EIX	3981	0.6
	RR 50 Motard	08→	BR9ES	5722			BR9EIX	3981	0.6
	Supermotard 50	02→05	BR10ES	4832			BR10EIX	6801	0.7
	Supermoto 50		BR10ES	4832			BR10EIX	6801	0.7
	Tempo		BR7HS	4122			BR7HIX	7067	0.6
Zero		B8ES	2411			BR8EIX	5044	0.5	
70	Supermoto 72, Enduro 72						BR10HIX	6692	0.6
80	EVO 80, Junior	09→	BR8ES	5422			BR8EIX	5044	0.6
	Rev 80	03→	B9ES	2611			BR9EIX	3981	0.5
107	R107-4T		C7HSA	4629			CR7HIX	7544	0.7
125	125 E6G		B7HS	5110			BR7HIX	7067	0.5
	125 Enduro		B7HS	5110			BR7HIX	7067	0.5
	125 Trial		B6ES	7310					0.5
	Alp 4T 125	00→	DR8EA	7162	DR8EVX	6354	DR8EIX	6681	0.6
	Eikon 125	99→	DPR7EA-9	5129			DPR7EIX-9	7803	0.9
	Euro 125		DR8EA	7162	DR8EVX	6354	DR8EIX	6681	0.6
	EVO 125 2T	09→16	BR7ES	5122			BR7EIX	6664	0.6
	EVO 125 2T	17→					GR7CI-8	95476	0.8
	Minicross R 125 4T	08→	C7HSA	4629			CR7HIX	7544	0.7
	RE 125 4T	08→09	CR7HSA	4549			CR7HIX	7544	0.6
	REV 3 125 Trials	00→07	BP7ES	2412			BPR7EIX	4055	0.6
	REV 3 125 Trials	08→	BR7ES	5122			BR7EIX	6664	0.7
	RR 125 4-Stroke Enduro, Motard (Air Cooled)	08→11	CR7HSA	4549			CR7HIX	7544	0.6
	RR 125 4-Stroke Enduro, Motard (Liquid Cooled)	10→	CR8E	1275			CR8EIX	4218	0.6
	Synt	92→	B8ES	2411			BR8EIX	5044	0.5
	TR32	85→	B8ES	2411			BR8EIX	5044	0.5
	TR34	87→	B8ES	2411			BR8EIX	5044	0.5
TR35	90→	B8ES	2411			BR8EIX	5044	0.5	
Urban 125	08→	CR7HSA	4549			CR7HIX	7544	0.6	
Zero	92→	B8ES	2411			BR8EIX	5044	0.5	
150	Eikon 150	99→	DPR7EA-9	5129			DPR7EIX-9	7803	0.9
200	Alp 4T 200	00→	DR8EA	7162	DR8EVX	6354	DR8EIX	6681	0.6
	EVO 200 2T	09→16	BR7ES	5122			BR7EIX	6664	0.6
	EVO 200 2T	17→					GR7CI-8	95476	0.8



CC	MODEL	DATE	STANDARD COPPER CORE	STOCK NUMBER	PLATINUM OR GOLD PALLADIUM	STOCK NUMBER	IRIDIUM	STOCK NUMBER	GAP MM
BETA / BETAMOTOR (CONTINUED)									
200	REV 3 200 Trials	00→07	BP7ES	2412			BPR7EIX	4055	0.6
	REV 3 200 Trials	08→	BR7ES	5122			BR7EIX	6664	0.7
	Techno 200 Trial	→96	BR8ES	5422			BR8EIX	5044	0.6
	Techno 200 Trial	96→	BP7ES	2412			BPR7EIX	4055	0.6
	Urban 200	08→	DR8EA	7162	DR8EVX	6354	DR8EIX	6681	0.6
240	Super Trial	92→93	B8ES	2411			BR8EIX	5044	0.5
	TR33	86→	B6ES	7310					0.5
	Trial	85→	B6ES	7310					0.5
250	EVO 250 2T	09→16	BR7ES	5122			BR7EIX	6664	0.6
	EVO 250 2T	17→					GR7CI-8	95476	0.8
	EVO 250 4T	09→17	CR7EB	4663			CR7EIX	7385	0.6
	GS Enduro	77→	B7HS	5110			BR7HIX	7067	0.5
	REV 3 250 2T Trials	00→07	BP7ES	2412			BPR7EIX	4055	0.6
	REV 3 250 2T Trials	08→	BR7ES	5122			BR7EIX	6664	0.7
	REV 4T 250 Trials	07→17	CR7EB	4663			CR7EIX	7385	0.6
	RR 250 2-stroke	13→15	BR7ES	5122			BR7EIX	6664	0.6
	RR 250 2-stroke	16→	BR8ES	5422			BR8EIX	5044	0.6
	RR 250 4T	05→06	DCPR8E*	4339			DCPR8EIX	6546	0.7
	Techno 250 Trial	→96	BR8ES	5422			BR8EIX	5044	0.6
	Techno 250 Trial	96→	BP7ES	2412			BPR7EIX	4055	0.6
	TR32	85→	B8ES	2411			BR8EIX	5044	0.5
260	Synt	92→	B8ES	2411			BR8EIX	5044	0.5
	TR34	87→	B8ES	2411			BR8EIX	5044	0.5
	TR35	90→	B8ES	2411			BR8EIX	5044	0.5
	Zero Gara	93→	B8ES	2411			BR8EIX	5044	0.5
270	REV 3 270 Trials	00→07	BP7ES	2412			BPR7EIX	4055	0.6
	REV 3 270 Trials	08→	BR7ES	5122			BR7EIX	6664	0.7
	Techno 270 Trial	→96	BR8ES	5422			BR8EIX	5044	0.6
	Techno 270 Trial	96→	BP7ES	2412			BPR7EIX	4055	0.6
290	EVO 290 2T	09→	BR7ES	5122			BR7EIX	6664	0.6
300	Xtrainer	15→					GR7CI-8	95476	0.8
	EVO 300 2T	11→16	BR7ES	5122			BR7EIX	6664	0.6
	EVO 300 2T	17→					GR7CI-8	95476	0.8
	EVO 300 4T	09→17	CR7EB	4663			CR7EIX	7385	0.6
	EVO 300 4T	18→					MR7BI-8	90982	0.8
	RR 300 2-stroke	13→	BR7ES	5122			BR7EIX	6664	0.6
350	Alp 4.0 (Suzuki engine)	08→	CR9EK	4548			CR9EIX	3521	0.7
	Euro 350	01→	CR9EK	4548			CR9EIX	3521	0.7
	Jonathan 350	99→06	CR9EK	4548			CR9EIX	3521	0.7
	Motard 4.0, M4	08→14	CR9EK	4548			CR9EIX	3521	0.7
	RR 350	11→	LKAR8A-9	4786			LKAR8AI-9	6706	0.9
386	RR 390	15→	LKAR8A-9	4786			LKAR8AI-9	6706	0.9
	RS 390	15→	LKAR8A-9	4786			LKAR8AI-9	6706	0.9
400	RR 400 4T	05→09	DCPR8E*	4339			DCPR8EIX	6546	0.7
	RR 400 4-stroke	10→	LKAR8A-9	4786			LKAR8AI-9	6706	0.9
	RS 400	11→14	LKAR8A-9	4786			LKAR8AI-9	6706	0.9
430	RR 430	15→	LKAR8A-9	4786			LKAR8AI-9	6706	0.9
	RS 430	15→	LKAR8A-9	4786			LKAR8AI-9	6706	0.9
450	RR 450 4T	05→09	DCPR8E*	4339			DCPR8EIX	6546	0.7
	RR 450 4-stroke	10→14	LKAR8A-9	4786			LKAR8AI-9	6706	0.9
	RS 450	11→14	LKAR8A-9	4786			LKAR8AI-9	6706	0.9
480	RR 480	15→	LKAR8A-9	4786			LKAR8AI-9	6706	0.9
500	RR 500	13→14	LKAR8A-9	4786			LKAR8AI-9	6706	0.9
	RS 500	15→	LKAR8A-9	4786			LKAR8AI-9	6706	0.9
	RR 520 4-stroke	10→14	LKAR8A-9	4786			LKAR8AI-9	6706	0.9
	RS 520	11→14	LKAR8A-9	4786			LKAR8AI-9	6706	0.9
525	RR 525 4T	05→09	DCPR8E*	4339			DCPR8EIX	6546	0.7

BIMOTA

500	500 V-Due		BR9ES	5722			BR9EIX	3981	0.7
600	YB9 SRi		CR9E	6263			CR9EIX	3521	0.7
900	DB3 Mantra		DPR8EA-9	4929			DPR8EIX-9	2202	0.6





CC	MODEL	DATE	STANDARD COPPER CORE	STOCK NUMBER	PLATINUM OR GOLD PALLADIUM	STOCK NUMBER	IRIDIUM	STOCK NUMBER	GAP MM
BIMOTA (CONTINUED)									
900	DB4		DPR8EA-9	4929			DPR8EIX-9	2202	0.6
	Mantra		DPR7EA-9	5129			DPR7EIX-9	7803	0.9
992	DB5	05→	DCPR8E*	4339			DCPR8EIX	6546	0.9
	DB6 Delirio	06→	DCPR8E*	4339			DCPR8EIX	6546	0.9
1000	BB3	08/14→16	LMAR9D-J	1633					0.8
	Mono, Biposto	91→93	D8EA	2120	DR8EVX	6354	DR8EIX	6681	0.6
	SB8R/S	99→00	CR9EK	4548			CR9EIX	3521	0.7
	YB11 Superleggera	00→	DR8EA	7162	DR8EVX	6354	DR8EIX	6681	0.7
1078	DB5R/S	07→	DCPR8E*	4339			DCPR8EIX	6546	0.9
	DB6R/S	08→	DCPR8E*	4339			DCPR8EIX	6546	0.9
	DB10 bimotard	12→16	DCPR8E*	4339			DCPR8EIX	6546	0.9
	DBx	13→16	DCPR8E*	4339			DCPR8EIX	6546	0.9
	Tesi 3D	07→16	DCPR8E*	4339			DCPR8EIX	6546	0.9
1098	DB7	09→	MAR10A-J	4706					0.8
1100	SB6, SB6R	97→	CR9E	6263			CR9EIX	3521	0.7
1198	DB8	10→16	MAR10A-J	4706					0.8
	DB9 Brivido, S	12→16	MAR9A-J	6869					0.8

BMW									
125	C1	00→04	CR8EB	7784			CR8EIX	4218	0.7
175	C1 200	01→04	CR8EB	7784			CR8EIX	4218	0.7
313	G310 GS	18→	LMAR9D-J	1633					0.8
	G310 R	17→	LMAR9D-J	1633					0.8
350	C400 GT	19→	LMAR8J-9E	93972					0.9
	C400 X	18→	LMAR8J-9E	93972					0.9
450	G450X	08→11	CR9EKB	2305			CR9EIX	3521	0.8
	R45	78→85	BP7ES	2412			BPR7EIX	4055	0.6
600	R60/7	76→78	BP7ES	2412			BPR7EIX	4055	0.6
650	C600 Sport	12→15	LMAR8D-J	93444					0.8
	C650 GT	12→	LMAR8D-J	93444					0.8
	C650 Sport	16→	LMAR8D-J	93444					0.8
	F650	94→99	D8EA	2120	DR8EVX	6354	DR8EIX	6681	0.7
	F650ST Strada	97→99	D8EA	2120	DR8EVX	6354	DR8EIX	6681	0.7
	F650GS, GSD	00→02	DR8EB	4855	DR8EVX	6354	DR8EIX	6681	0.7
	F650CS, GS, GS Dakar	02→05	DR8EB	4855	DR8EVX	6354	DR8EIX	6681	0.7
	F650GS, GS Dakar (Single cylinder Twin Spark)	11/05→11/07	DR8EB	4855	DR8EVX	6354	DR8EIX	6681	0.7
	G650GS (Twin Spark)	03/11→	DR8EB	4855	DR8EVX	6354	DR8EIX	6681	0.7
	G650GS Sertão (Twin Spark)	03/12→	DR8EB	4855	DR8EVX	6354	DR8EIX	6681	0.7
	G650 Xchallenge, Xcountry, Xmoto (Twin Spark)	07→09	DR8EB	4855	DR8EVX	6354	DR8EIX	6681	0.7
	R65	78→93	BP7ES	2412			BPR7EIX	4055	0.6
	R65/GS	87→92	BP6ES	7811			BPR6EIX	6637	0.6
	R65LS	81→85	BP7ES	2412			BPR7EIX	4055	0.6
750	K75 (Plug requires terminal nut)	85→97	D7EA	7912					0.6
	R75/7	76→79	BP7ES	2412			BPR7EIX	4055	0.6
800	F650GS (Twin cylinder 798cc)	11/07→12	DCPR8E*	4339			DCPR8EIX	6546	0.7
	F700 GS	13→17	DCPR8E*	4339			DCPR8EIX	6546	0.8
	F800S/ST	05/06→12	DCPR8E*	4339			DCPR8EIX	6546	0.8
	F800 GT	13→	DCPR8E*	4339			DCPR8EIX	6546	0.8
	F800GS	11/07→17	DCPR8E*	4339			DCPR8EIX	6546	0.8
	F800R	05/09→19	DCPR8E*	4339			DCPR8EIX	6546	0.8
	R80GS	80→94	BP6ES	7811			BPR6EIX	6637	0.6
	R80RT	82→95	BP6ES	7811			BPR6EIX	6637	0.6
	R80ST	82→85	BP6ES	7811			BPR6EIX	6637	0.6
	R80TIC	80→85	BP6ES	7811			BPR6EIX	6637	0.6
850	F750 GS	18→	LMAR8J-9E	93972					0.9
	F850 GS	18→21	LMAR8J-9E	93972					0.9
	F850 GS, Adventure	21→	LMAR9J-9E	94162					0.9
	R850C, R850GS, R850R	10/96→00	BKR7EKC	7354			BKR7EIX	2667	0.8
	R850RT	10/96→02/06	BKR7EKC	7354			BKR7EIX	2667	0.8



* Please note DCPR8E 4339 has a removable terminal nut, whereas DCPR8E 4179 has a fixed terminal nut





CC	MODEL	DATE	STANDARD COPPER CORE	STOCK NUMBER	PLATINUM OR GOLD PALLADIUM	STOCK NUMBER	IRIDIUM	STOCK NUMBER	GAP MM
BMW (CONTINUED)									
895	F900 R	20→	LMAR9J-9E	94162					0.9
	F900 XR	20→	LMAR9J-9E	94162					0.9
900	R90/6	73→76	BP6ES	7811			BPR6EIX	6637	0.6
	R90S	73→76	BP6ES	7811			BPR6EIX	6637	0.6
1000	K1 (Plug requires terminal nut)	89→93	D7EA	7912					0.6
	K100, C, LT, R, RS, RT 8 Valve (Plug requires terminal nut)	83→90	D7EA	7912					0.6
	K100, C, LT, R, RS, RT 16 Valve (Plug requires terminal nut)	91→92	D7EA	7912					0.6
	M1000RR	20→					LMAR9FI-10G	92850	1.0
	R100/7	76→79	BP7ES	2412			BPR7EIX	4055	0.6
	R100RS, S	76→85	BP7ES	2412			BPR7EIX	4055	0.6
	R100RT	79→85	BP7ES	2412			BPR7EIX	4055	0.6
	R100GS, RS, RT (Re-introduced)	87→93	BP6ES	7811			BPR6EIX	6637	0.6
	S1000R	11/13→	LMAR9D-J	1633					0.8
	S1000RR (Incl. HP4)	12/09→18	LMAR9D-J	1633					0.8
	S1000RR	19→					LMAR9FI-10G	92850	1.0
	S1000 XR	06/15→19	LMAR9D-J	1633					0.8
	S1000 XR	20→					LMAR9FI-10G	92850	1.0
	1100	K1100LT/SE	92→99	DR7EA	7839				
K1100RS		92→96	DR7EA	7839					0.6
R1100GS		04/93→99	BKR7EKC	7354			BKR7EIX	2667	0.8
R1100R		95→03	BKR7EKC	7354			BKR7EIX	2667	0.8
R1100RS/RT		93→01	BKR7EKC	7354			BKR7EIX	2667	0.8
R1100S		12/96→03	BKR7EKC	7354			BKR7EIX	2667	0.8
R1100S (Twin Spark)		Ø12mm Plug Ø14mm Plug	03→05	DCPR8EKC BKR7EKC	7168 7354		DCPR8EIX BKR7EIX	6546 2667	0.9 0.9
1130	R1150GS/R/RS/RT	99→03	BKR7EKC	7354			BKR7EIX	2667	0.9
	R1150GS/R/S (Twin Spark)	Ø12mm Plug Ø14mm Plug	03→05	DCPR8EKC BKR7EKC	7168 7354		DCPR8EIX BKR7EIX	6546 2667	0.9 0.9
1157	K1200R	01/05→08					KR9CI	7795	0.8
	K1200R Sport	11/07→09					KR9CI	7795	0.8
	K1200S	09/04→09					KR9CI	7795	0.8
1170	HP2 Enduro (Twin Spark)	Ø12mm Plug Ø14mm Plug	05→08	DCPR8EKC BKR7EKC	7168 7354		DCPR8EIX BKR7EIX	6546 2667	0.9 0.9
	HP2 Megamoto (Twin Spark) Ø12mm Plug		07→08	DCPR8EKC	7168		DCPR8EIX	6546	0.9
	HP2 Sport		08→12	MAR9B-JDS	1316				0.8
	K1200GT		03→11/05	DCPR7E	3932		DCPR7EIX	6046	0.8
	K1200GT		01/06→08				KR9CI	7795	0.8
	K1200RS/LT		97→05	DCPR7E	3932		DCPR7EIX	6046	0.8
	R1200C Classic, Avantgarde, Independent		97→04	BKR7EKC	7354		BKR7EIX	2667	0.9
	R1200GS (Twin Spark) Ø12mm Plug		04→09	DCPR8EKC	7168		DCPR8EIX	6546	0.9
	R1200GS (Twin Spark) Ø10mm Plug (19mm Thread Reach)		10→02/13	MAR8B-JDS	8765				0.8
	R1200GS (Liquid Cooled) (26.5mm Thread Reach)		03/13→17	LMAR8D-J	93444				0.8
	R1200GS Adventure (Liquid Cooled) (26.5mm Thread Reach)		10/13→17	LMAR8D-J	93444				0.8
	R1200R SOHC (Twin Spark) Ø12mm Plug		06→10	DCPR8EKC	7168		DCPR8EIX	6546	0.9
	R1200R, Classic DOHC (Twin Spark) Ø10mm Plug (19mm Thread Reach)		03/11→14	MAR8B-JDS	8765				0.8
	R1200 R (26.5mm Thread Reach)		02/15→18	LMAR8D-J	93444				0.8
	R1200 RS (26.5mm Thread Reach)		06/15→18	LMAR8D-J	93444				0.8
	R1200RT (Twin Spark) Ø12mm Plug		03/05→09	DCPR8EKC	7168		DCPR8EIX	6546	0.9
	R1200RT (Twin Spark) Ø10mm Plug (19mm Thread Reach)		09→10/13	MAR8B-JDS	8765				0.8
	R1200RT (Liquid Cooled) (26.5mm Thread Reach)		11/13→17	LMAR8D-J	93444				0.8
	R1200S (Twin Spark)		06→07	DCPR8EKC	7168		DCPR8EIX	6546	0.9
	R1200ST (Twin Spark)		03/05→11/07	DCPR8EKC	7168		DCPR8EIX	6546	0.9
	R nineT (Twin Spark)		14→	MAR8B-JDS	8765				0.8
	R nineT Pure, Racer (Twin Spark)		16→	MAR8B-JDS	8765				0.8
	R nineT Scrambler (Twin Spark)		16→	MAR8B-JDS	8765				0.8
R nineT Urban (Twin Spark)		16→	MAR8B-JDS	8765				0.8	
1254	R1200GS Adventure	2018					LMAR8AI-10	94319	1.0
	R1200RT	2018					LMAR8AI-10	94319	1.0
	R1250 GS, GS Adventure	19→					LMAR8AI-10	94319	1.0
	R1250 R	19→					LMAR8AI-10	94319	1.0
	R1250 RS	19→					LMAR8AI-10	94319	1.0



CC	MODEL	DATE	STANDARD COPPER CORE	STOCK NUMBER	PLATINUM OR GOLD PALLADIUM	STOCK NUMBER	IRIDIUM	STOCK NUMBER	GAP MM
BMW (CONTINUED)									
1254	R1250 RT	19→					LMAR8AI-10	94319	1.0
1293	K1300GT (Incl. Exclusive Edition)	09→13					KR9CI	7795	0.8
	K1300R	09→15					KR9CI	7795	0.8
	K1300S (Incl. HP)	09→16					KR9CI	7795	0.8
1640	K1600GT, GTL	11→					LMAR8AI-8	92288	0.8
1802	R18 Cruiser	20→	MAR8AI-10DS	92997					1.0

BSA									
50	Beaver, Brigand, Boxer		B6HS	4510			BR6HIX	3419	0.5
	ER1K, Junior, Easy Rider ER1/ER2	80→	BP6ES	7811			BPR6EIX	6637	0.5
	NVT Models: Easy Rider ER1/2/4, Ranger	80→	BP6ES	7811			BPR6EIX	6637	0.5
125	Rambler 125, Tracker 125	79→	B9ES	2611			BR9EIX	3981	0.5
175	Rambler 175, Tracker 175, Trials 175	79→	B8ES	2411			BR8EIX	5044	0.5
400	Gold SR 400	99→03	BPR6ES	7822			BPR6EIX	6637	0.7
500	Gold SR 500	99→	BPR7ES	2023			BPR7EIX	4055	0.7
	Victor, B50 Moto-Cross	66→67	B8EG	3430			BR8EIX	5044	0.5
650	Golden Flash (A10) (½", 12.7mm Thread Reach)	50→54	B6HS	4510			BR6HIX	3419	0.5
	Road Rocket (¾", 19mm Thread Reach)	54→56	B7ES	1111			BR7EIX	6664	0.5
	Rocket Gold Star	62→63	B7ES	1111			BR7EIX	6664	0.5
	Super Rocket	57→62	B7ES	1111			BR7EIX	6664	0.5
750	A75 and Rocket 3	→75	B8ES	2411			BR8EIX	5044	0.6

BUELL									
984	Firebolt XB9R	02→	DCPR9E	2641			DCPR9EIX	2316	0.9
	Lightning CityX XB9SX	05→	DCPR9E	2641			DCPR9EIX	2316	0.9
	Lightning XB9S	02→	DCPR9E	2641			DCPR9EIX	2316	0.9
	XB9X (City X)	09→10	DCPR9E	2641			DCPR9EIX	2316	0.9
1125	1125R	08→10	CR9EKB	2305			CR9EIX	3521	0.8
	1125CR (Café Racer)	09→10	CR9EKB	2305			CR9EIX	3521	0.8
1200	Firebolt XB12R	03→	DCPR9E	2641			DCPR9EIX	2316	0.9
	Lightning XB12S/Ss	04→10	DCPR9E	2641			DCPR9EIX	2316	0.9
	Lightning XB12Scg	06→10	DCPR9E	2641			DCPR9EIX	2316	0.9
	Lightning XB12STT	07→10	DCPR9E	2641			DCPR9EIX	2316	0.9
	M2 Cyclone	97→03	DCPR9E	2641			DCPR9EIX	2316	0.9
	S1 Lightning	97→99	DCPR9E	2641			DCPR9EIX	2316	0.9
	S1W White Lightning	1998	DCPR9E	2641			DCPR9EIX	2316	0.9
	S3 Thunderbolt	97→99	DCPR9E	2641			DCPR9EIX	2316	0.9
	Ulysses XB12X	05→	DCPR9E	2641			DCPR9EIX	2316	0.9
	X1 Lightning	99→03	DCPR9E	2641			DCPR9EIX	2316	0.9

CAGIVA									
50	City 50	94→	BPR8HS	3725			BPR8HIX	6742	0.5
	Mito 50 (Standard)	98→	B9ES	2611			BR9EIX	3981	0.5
	Prima 50	92→	B8ES	2411			BR8EIX	5044	0.5
	Supercity 50	92→	B8ES	2411			BR8EIX	5044	0.5
	W4 50	92→	B8ES	2411			BR8EIX	5044	0.5
75	Prima 80	92→	B8ES	2411			BR8EIX	5044	0.5
	Supercity 80	92→	B8ES	2411			BR8EIX	5044	0.5
	W4 80	92→	B8ES	2411			BR8EIX	5044	0.5
125	Blues 125	91→93					BR10EIX	6801	0.5
	Freccia C12/C12R	89→	B9ES	2611			BR9EIX	3981	0.5
	K7	90→					BR10EIX	6801	0.5
	Mito 125	91→	BR9EG	3230			BR9EIX	3981	0.6
	Mito 125 (Race)						BR10EIX	6801	0.7
	Mito (Le Lawson)	92→					BR10EIX	6801	0.5
	Mito 525SP	04/08→	BR9EG	3230			BR9EIX	3981	0.6
	Planet 125	98→					BR10EIX	6801	0.6
	Raptor (2-Stroke)	04→	BR9EG	3230			BR9EIX	3981	0.6
	Roadster 125	92→	B9ES	2611			BR9EIX	3981	0.6
Super City 125	→02/95	B9EG	3530			BR9EIX	3981	0.5	



CC	MODEL	DATE	STANDARD COPPER CORE	STOCK NUMBER	PLATINUM OR GOLD PALLADIUM	STOCK NUMBER	IRIDIUM	STOCK NUMBER	GAP MM
CAGIVA (CONTINUED)									
125	Super City 125	06/98 →					BR10EIX	6801	0.6
	W8 125	→12/92	B9EG	3530			BR9EIX	3981	0.6
	W8 125	07/98 →	B9ES	2611			BR9EIX	3981	0.6
	WMX 125		B10EG	3630			BR10EIX	6801	0.5
	WSXT 125	82 →	B9EG	3530			BR9EIX	3981	0.5
250	SST 250	81 →	B8ES	2411			BR8EIX	5044	0.5
	WMX 250						BR10EIX	6801	0.5
350	Indiana 350	78 →89	BP7HS	5111			BPR7HIX	5944	0.5
	W12 350	93 →	DPR8EA-9	4929			DPR8EIX-9	2202	0.6
500	Canyon 500	02/98 →	DCPR8E*	4179			DCPR8EIX	6546	0.6
	River 500	99 →	DCPR8E*	4179			DCPR8EIX	6546	0.6
600	Canyon 600	→03/97	BCP7ES	5030			BCPR7EIX	5690	0.8
	River 600	95 →	BCP7ES	5030			BCPR7EIX	5690	0.8
	W16 600	→95	C7E	5096			CR7EIX	7385	0.6
	W16 600	95 →	BCP7ES	5030			BCPR7EIX	5690	0.8
650	Alazzurra 650	85 →88	BP7HS	5111			BPR7HIX	5944	0.5
	Indiana 650		BP7HS	5111			BPR7HIX	5944	0.5
	Raptor	00 →	CR8E	1275			CR8EIX	4218	0.7
	V Raptor	00 →	CR8E	1275			CR8EIX	4218	0.7
750	Elefant 750	87 →	DPR8EA-9	4929			DPR8EIX-9	2202	0.6
	Indiana 750		BP7HS	5111			BPR7HIX	5944	0.5
900	900GT	91 →	DR9EA	3437			DR9EIX	4772	0.5
	900 i.e.	91 →	DR9EA	3437			DR9EIX	4772	0.5
	Elefant 900	91 →	DPR8EA-9	4929			DPR8EIX-9	2202	0.9
	Gran Canyon	99 →	DCPR8E*	4179			DCPR8EIX	6546	0.6
1000	Navigator/T	00 →	CR8EK	3478			CR8EIX	4218	0.7
	Raptor	00 →	CR8EK	3478			CR8EIX	4218	0.7
	V Raptor	00 →	CR8EK	3478			CR8EIX	4218	0.7
	Xtra Raptor	02 →	CR8EK	3478			CR8EIX	4218	0.7

CAN-AM (BRP)									
600	Ryker	19 →	CR8EB	7784			CR8EIX	4218	0.8
998	Spyder RS	08 →12	DCPR9E	2641			DCPR9EIX	2316	0.7
	Spyder RS Ø12mm Plug	13 →					KR8BI	4347	0.7
	Spyder RT Ø12mm Plug	10 →11	DCPR9E	2641			DCPR9EIX	2316	0.7
	Spyder RT Ø12mm Plug	12 →13					KR8BI	4347	0.7
	Spyder ST Ø12mm Plug	13 →					KR8BI	4347	0.7
1330	Spyder RT Ø10mm Plug	14 →					MR7BI-8	90982	0.8
	Spyder F3	15 →					MR7BI-8	90982	0.8

CCM (ARMSTRONG-CCM)									
125	CMX 125 L/C	83 →85	B9EG	3530			BR9EIX	3981	0.5
	Moto-X Hiro 125	79 →80	B10EG	3630			BR10EIX	6801	0.5
240	Trials CMT 240		BP5ES	6511			BPR5EIX	6597	0.5
250	CMT 250 Trials		BP5ES	6511			BPR5EIX	6597	0.5
	CMX 250 1982	1982	B8EG	3430			BR8EIX	5044	0.5
	CMX 250, 250 L/C	83 →85	B9EG	3530			BR9EIX	3981	0.5
	Moto-X Hiro 250	79 →81	B9EG	3530			BR9EIX	3981	0.5
310	CMT 310 Trials		BP5ES	6511			BPR5EIX	6597	0.5
320	CMT 320 Trials		BP5ES	6511			BPR5EIX	6597	0.5
350	350 Trials	1978	B6ES	7310					0.5
	CMT 350 Trials		BP5ES	6511			BPR5EIX	6597	0.5
400	404E/DS	03 →	CR8E	1275			CR8EIX	4218	0.7
	404XC-Trail		CR8E	1275			CR8EIX	4218	0.7
	FT35	05 →	CR8E	1275			CR8EIX	4218	0.7
	R35	06 →	CR8E	1275			CR8EIX	4218	0.7
	SR40	07 →	CR8E	1275			CR8EIX	4218	0.7
434	R35 Factory Big Bore Conversion	06 →	CR8E	1275			CR8EIX	4218	0.7
450	CMX 450	82 →	B8EG	3430			BR8EIX	5044	0.5
490	CMX 490		B8EG	3430			BR8EIX	5044	0.5



CC	MODEL	DATE	STANDARD COPPER CORE	STOCK NUMBER	PLATINUM OR GOLD PALLADIUM	STOCK NUMBER	IRIDIUM	STOCK NUMBER	GAP MM
CCM (ARMSTRONG-CCM) (CONTINUED)									
500	CMX 500 (4-Stroke)		D8EA	2120	DR8EVX	6354	DR8EIX	6681	0.5
	Moto-X (4-Stroke) 2 valve models	72→79	B8EG	3430			BR8EIX	5044	0.5
	Moto-X (4-Stroke) 4 valve models	79→81					CR8EIX	4218	0.5
	MTT 500		D8EA	2120	DR8EVX	6354	DR8EIX	6681	0.5
560	CCM 560		D8EA	2120	DR8EVX	6354	DR8EIX	6681	0.5
	CMX 560 (4-Stroke)		D8EA	2120	DR8EVX	6354	DR8EIX	6681	0.5
600	604E Sport & Supermoto	98→02	D8EA	2120	DR8EVX	6354	DR8EIX	6681	0.5
	604R / RS / R30	98→02	D8EA	2120	DR8EVX	6354	DR8EIX	6681	0.5
	600 Spitfire Blackout		CR8EB	7784					0.8
640	640 RS (Rotax engine)	99→00	D8EA	2120	DR8EVX	6354	DR8EIX	6681	0.5
644	644 (Suzuki engine)	02→07	CR10E	6264			CR10EIX	6482	0.7
	R30 (Suzuki engine)	05→07	CR10E	6264			CR10EIX	6482	0.7
710	R30 (Suzuki engine)	05→07	CR10E	6264			CR10EIX	6482	0.7

CF MOTO									
250	V3 Auto 250T-3	07→	DPR8EA-9	4929			DPR8EIX-9	2202	0.9
	V5 Auto 250T-5		DPR8EA-9	4929			DPR8EIX-9	2202	0.9

COSSACK									
350	Jupiter	73→79	BR6HS	3922			BR6HIX	3419	0.6
	Planeta	73→79	BR6HS	3922			BR6HIX	3419	0.6
650	Dnepr, Ural	73→79	BR6HS	3922			BR6HIX	3419	0.6

CPI									
50	Aragon 50	06→	BR7ES	5122			BR7EIX	6664	0.7
	Aragon GP50	06→	BR7ES	5122			BR7EIX	6664	0.7
	Formula R (Euro 1, 12.7mm Thread Reach)	→05	BR7HS	4122			BR7HIX	7067	0.7
	Formula R (Euro 2, 19mm Thread Reach)	06→	BR7ES	5122			BR7EIX	6664	0.7
	GTR 50 (12.7mm Thread Reach)	03→04	BR7HS	4122			BR7HIX	7067	0.7
	GTR 50 (19mm Thread Reach)	05→	BR10EG	3830			BR10EIX	6801	0.6
	GTS 50 (12.7mm Thread Reach)	03→04	BR7HS	4122			BR7HIX	7067	0.7
	GTS 50 (19mm Thread Reach)	05→	BR10EG	3830			BR10EIX	6801	0.6
	Hussar 50, Mars JP50, Baby J 50 (Euro 1)		BR8HSA	5539			BPR8HIX	6742	0.6
	Hussar 50 (Euro 2)	03→	BR7ES	5122			BR7EIX	6664	0.7
	Oliver 50 (Euro 2)	03→	BR7ES	5122			BR7EIX	6664	0.7
	Popcorn 50 (Euro 2)	03→	BR7ES	5122			BR7EIX	6664	0.7
	Supercross 50 (Euro 1, 12.7mm Thread Reach)		BR7HS	4122			BR7HIX	7067	0.7
	Supercross 50 (Euro 2, 19mm Thread Reach)	03→05	BR7ES	5122			BR7EIX	6664	0.7
	Supercross 50 SX	06→07	BR7ES	5122			BR7EIX	6664	0.7
	Supermoto 50 (Euro 1, 12.7mm Thread Reach)		BR7HS	4122			BR7HIX	7067	0.7
	Supermoto 50 (Euro 2, 19mm Thread Reach)	03→	BR7ES	5122			BR7EIX	6664	0.7
125	GTS 125	02→03	BR7HS	4122			BR7HIX	7067	0.7
	Hussar JU 125	04→	CR7HSA	4549			CR7HIX	7544	0.6
	Oliver City 125	06→	CR7HSA	4549			CR7HIX	7544	0.6
	QT4A ARN 125		CR7HSA	4549			CR7HIX	7544	0.6
	X-Large 125		BR7HS	4122			BR7HIX	7067	0.7
150	GTS 150		BR7HS	4122			BR7HIX	7067	0.7
	X-Large 150		BR7HS	4122			BR7HIX	7067	0.7
200	GTS 200		BR7HS	4122			BR7HIX	7067	0.7
	X-Large 200		BR7HS	4122			BR7HIX	7067	0.7

CZ (SEE JAWA-CZ)

DAELIM									
50	Cordi	04→	BPR6HS	7022			BPR6HIX	4085	0.6
	E Five	03→	B8HS	5510			BR8HIX	7001	0.7
	Message 49	98→	BR8HSA	5539			BPR8HIX	6742	0.7



CC	MODEL	DATE	STANDARD COPPER CORE	STOCK NUMBER	PLATINUM OR GOLD PALLADIUM	STOCK NUMBER	IRIDIUM	STOCK NUMBER	GAP MM
DAELIM (CONTINUED)									
50	S Five	02→	B8HS	5510			BR8HIX	7001	0.7
100	Delfino 100	99→	BR8HS	4322			BR8HIX	7001	0.7
110	Citi Ace 110	03→	C7HSA	4629			CR7HIX	7544	0.7
125	Altino NF125ES	03→	CR8EH-9	5666			CR8EHIX-9	3797	0.9
	History 125	04→	CR8EH-9	5666			CR8EHIX-9	3797	0.9
	NS125 Trans Eagle	98→	CR8EH-9	5666			CR8EHIX-9	3797	0.9
	Roadwin (Incl. R)	04→	CR8EH-9	5666			CR8EHIX-9	3797	0.9
	VEE125		CR8EH-9	5666			CR8EHIX-9	3797	0.9
	VL125 Daystar		CR8EH-9	5666			CR8EHIX-9	3797	0.9
	VS125	97→	CR8EH-9	5666			CR8EHIX-9	3797	0.9
250	Roadsport	12→	CR9EH-9	7502			CR9EHIX-9	6216	0.9
	VJF250 (Roadwin)	12→	CR9EH-9	7502			CR9EHIX-9	6216	0.9

DERBI									
50	Atlantis 50 (4-Stroke)	04→	CR8EB	7784			CR8EIX	4218	0.7
	Atlantis 50 (Air Cooled, 12.7mm Thread Reach)	99→02	B8HS	5510			BR8HIX	7001	0.5
	Atlantis 50 (Air Cooled, 19mm Thread Reach)	03→	BR9ES	5722			BR9EIX	3981	0.6
	Atlantis 50 (Liquid Cooled)	00→	BR9ES	5722			BR9EIX	3981	0.6
	Black Devil	03→	B8ES	2411			BR8EIX	5044	0.6
	Black Edition	03→	B8ES	2411			BR8EIX	5044	0.6
	Black Mini	03→	CR9E	6263			CR9EIX	3521	0.6
	Dirt Boy, Dirt Kid	03→	CR9E	6263			CR9EIX	3521	0.6
	DRD 50 Supermoto	02→	B8ES	2411			BR8EIX	5044	0.5
	GP1	03→	BR10ES	4832			BR10EIX	6801	0.7
	GPR 50-R	97→	B8ES	2411			BR8EIX	5044	0.5
	GPR 50 (Standard power)	02→09	B8ES	2411			BR8EIX	5044	0.5
	GPR 50 (Full power)	02→	B9ES	2611			BR9EIX	3981	0.6
	GPR 50	10→	BR8ES	5422			BR8EIX	5044	0.6
	Hunter	96→98	B8HS	5510			BR8HIX	7001	0.5
	Predator LC	98→	B8ES	2411			BR8EIX	5044	0.5
	Senda 50 / R / SM (Standard power)	95→	B8ES	2411			BR8EIX	5044	0.5
	Senda 50 / R / SM (Full power)	95→	B9ES	2611			BR9EIX	3981	0.6
	Sonar 50 2T	09→	BR8ES	5422			BR8EIX	5044	0.6
Vamos	95→97	B8HS	5510			BR8HIX	7001	0.5	
85	Atlantis 100	00→	BR9ES	5722			BR9EIX	3981	0.7
	Senda 100	97→	B9ES	2611			BR9EIX	3981	0.6
125	Boulevard 125 4T	03→	CPR8E	7411			CR8EIX	4218	0.6
	Cross City 125	07→	D8EA	2120	DR8EVX	6354	DR8EIX	6681	0.8
	GP1 125	06→	CR9EB	6955			CR9EIX	3521	0.6
	GPR 125 (Yamaha engine)	04→09	BR8ES	5422			BR8EIX	5044	0.7
	GPR 125	10→	CR8EB	7784			CR8EIX	4218	0.7
	HDR Cabriolet 125	00→	CR7E	4578			CR7EIX	7385	0.5
	Mulhacén Café 125	07→	CR8EB	7784			CR8EIX	4218	0.7
	Rambla 125	08→	CR8EB	7784			CR8EIX	4218	0.7
	Senda 125 4T (Honda engine)	03→	DPR8EA-9	4929			DPR8EIX-9	2202	0.7
	Senda Baja R 125	07→	D8EA	2120	DR8EVX	6354	DR8EIX	6681	0.8
	Senda DRD 125 4S 4V R	10→	CR8EB	7784			CR8EIX	4218	0.7
Sonar 125 (4-Stroke)	09→11	CR7EB	4663			CR7EIX	7385	0.6	
Terra 125	07→09	CR8EB	7784			CR8EIX	4218	0.7	
150	Boulevard 150 4T	03→	CPR8E	7411			CR8EIX	4218	0.6
250	GP1 250	06→	CR9EB	6955			CR9EIX	3521	0.6
	Rambla 250	08→09	CR9EB	6955			CR9EIX	3521	0.6
300	Rambla 300i	10→	CR8EKB	4374			CR8EIX	4218	0.7
660	Mulhacén 659 / Café	06→	CR7E	4578			CR7EIX	7385	0.5

DUCATI									
250	250 Desmo, Monza, Sebring	71→74	B6HS	4510			BR6HIX	3419	0.5
350	350 Desmo, Sebring	71→74	B6HS	4510			BR6HIX	3419	0.5
	350 Sport	91→	BP7HS	5111			BPR7HIX	5944	0.6
399	Scrambler Sixty2	16→	KR8C-G	97516					0.7
400	400 SS, Junior	91→94	BP7HS	5111			BPR7HIX	5944	0.6



CC	MODEL	DATE	STANDARD COPPER CORE	STOCK NUMBER	PLATINUM OR GOLD PALLADIUM	STOCK NUMBER	IRIDIUM	STOCK NUMBER	GAP MM
DUCATI (CONTINUED)									
450	450 Desmo, Sebring	71→74	B6HS	4510			BR6HIX	3419	0.5
500	500 Desmo	78→83	B6HS	4510			BR6HIX	3419	0.5
	500 Pantah	80→84	BP7HS	5111			BPR7HIX	5944	0.6
600	600 Monster, Monster S, Monster Dark	94→01	DCPR8E*	4339			DCR8EIX	3606	0.7
	600 Pantah	80→85	BP7HS	5111			BPR7HIX	5944	0.6
	600 SS	→94	DCPR8E*	4339			DCR8EIX	3606	0.7
	600 SS	94→98	DCPR8E*	4339			DCR8EIX	3606	0.7
620	620 i.e., S i.e. & i.e. Dark	02→06	DCPR8E*	4339			DCR8EIX	3606	0.7
	Multistrada 620	04→06	DCPR8E*	4339			DCR8EIX	3606	0.7
650	Indiana 650	86→88	BP7HS	5111			BPR7HIX	5944	0.6
695	Monster 695	06→08	DCPR8E*	4339			DCR8EIX	3606	0.7
696	Monster 696	08→14	DCPR8E*	4339			DCR8EIX	3606	0.7
748	748, 748 Biposto	95→04					DCR9EIX	6650	0.6
	Dark	04→06	CR9EB	6955			CR9EIX	3521	0.6
	748 R	00→04	R2349-10	6839					0.6
	748 S	00→04					DCR9EIX	6650	0.6
	748 SP	95→98	R2349-10	6839					0.6
	748 SPS	98→00	R2349-10	6839					0.6
	749 (‡ Socket Ø <20.5mm)	02→06	CR9EB	6955			CR9EIX	3521	0.6
	749, R, S (‡ Socket Ø <20.5mm)	03→06	CR9EB	6955			CR9EIX	3521	0.6
	750 Sport	00→02	DCPR8E*	4339			DCR8EIX	3606	0.7
	750	750 F1	86→88	BP7HS	5111			BPR7HIX	5944
750 F1		89→	DCPR8E*	4339			DCR8EIX	3606	0.7
750 GT			B7HS	5110			BR7HIX	7067	0.5
750 Monster		96→02	DCPR8E*	4339			DCR8EIX	3606	0.7
750 Montjuich			BP7HS	5111			BPR7HIX	5944	0.6
750 Paso		86→90	DCPR8E*	4339			DCR8EIX	3606	0.7
750 SS		→90	B7HS	5110			BR7HIX	7067	0.5
750 SS		91→01	DCPR8E*	4339			DCR8EIX	3606	0.7
750 SS i.e.		98→02	DCPR8E*	4339			DCR8EIX	3606	0.7
803	800 Sport	03→04	DCPR8E*	4339			DCR8EIX	3606	0.7
	800 i.e. Monster	03→05	DCPR8E*	4339			DCR8EIX	3606	0.7
	Hypermotard 796 (Twin Spark)	10→12	DCPR8E*	4339			DCR8EIX	3606	0.7
	Monster 796	10→14	DCPR8E*	4339			DCR8EIX	3606	0.7
	S2R 800	05→08	DCPR8E*	4339			DCR8EIX	3606	0.7
	Scrambler Classic, Full Throttle, Icon, Urban Enduro	15→	DCPR8E*	4339			DCR8EIX	3606	0.7
	Scrambler Flat Track Pro	16→	DCPR8E*	4339			DCR8EIX	3606	0.7
	SS 800	03→04	DCPR8E*	4339			DCR8EIX	3606	0.7
821	Hypermotard	13→15	MAR9A-J	6869					0.8
	Hyperstrada	13→15	MAR9A-J	6869					0.8
	Monster 821, Monster 821 Dark	14→	MAR9A-J	6869					0.8
	Monster 821 Stripe	15→	MAR9A-J	6869					0.8
849	848	08→13	MAR10A-J	4706					0.8
	848 Evo, Evo Dark Stealth, Corse SE	07/10→13	MAR10A-J	4706					0.8
	Streetfighter 848	11/11→15	MAR10A-J	4706					0.8
851	851						DR9EIX	4772	0.6
	851 Strada	89→92					DR9EIX	4772	0.6
860	860 GT, GTS		B5HS	4210					0.6
888	851 SP (Sport Production)	90→92					DR9EIX	4772	0.6
	888 SP (Sport Production)	92→94					DCR9EIX	6650	0.8
	888 Strada	→93					DR9EIX	4772	0.6
	888 Strada	94→	DR9EA	3437			DR9EIX	4772	0.6
898	899 Panigale	13→15	MAR9A-J	6869					0.8
900	900 Darmah SS, SD		B6HS	4510			BR6HIX	3419	0.5
	900 i.e. Monster, Monster Dark	99→02	DCPR8E*	4339			DCR8EIX	3606	0.9
	900 Injection		DCPR8E*	4339			DCR8EIX	3606	0.9
	900 Monster, Monster S	97→	DCPR8E*	4339			DCR8EIX	3606	0.9
	900 SS, SSD, S2, Hailwood Replica	79→	B7HS	5110			BR7HIX	7067	0.6
	900 SS	91→	DCPR8E*	4339			DCR8EIX	3606	0.9
	900 Superlight	92→	DCPR8E*	4339			DCR8EIX	3606	0.9
	900 Supersport, FE	97→02	DCPR8E*	4339			DCR8EIX	3606	0.9
	906 Paso	88→94	DCPR8E*	4339			DCR8EIX	3606	0.9
	907 I.E.	91→	DCPR8E*	4339			DCR8EIX	3606	0.9

‡ Early Ducati Testastretta bikes (749, 998, 999 models) can have very little clearance between the plug hex and the cylinder head that may require a thin walled socket, no larger than 20.5mm OD to allow the plug to be fitted.



* Please note DCPR8E 4339 has a removable terminal nut, whereas DCPR8E 4179 has a fixed terminal nut





CC	MODEL	DATE	STANDARD COPPER CORE	STOCK NUMBER	PLATINUM OR GOLD PALLADIUM	STOCK NUMBER	IRIDIUM	STOCK NUMBER	GAP MM
DUCATI (CONTINUED)									
916	916 (All models except SP)	94→01					DCR9EIX	6650	0.8
	916 SP	94→	R2349-10	6839					0.6
	S4 Monster	01→02					DCR9EIX	6650	0.8
	ST4	98→03					DCR9EIX	6650	0.7
937	Hypermotard 939, 939 SP	16→18	MAR9A-J	6869					0.8
	Hypermotard 950	19→	MAR9A-J	6869					0.8
	Hyperstrada 939	16→	MAR9A-J	6869					0.8
	Multistrada 950 (Twin Spark)	17→	MAR9A-J	6869					0.8
	Supersport, S	17→20	MAR9A-J	6869					0.8
	Supersport 950	21→	MAR9A-J	6869					0.8
944	ST2	97→03	DCPR8E*	4339			DCR8EIX	3606	0.9
955	959 Panigale, R	16→19	MAR9A-J	6869					0.8
	Panigale V2	20→	MAR9A-J	6869					0.8
989	Desmosedici RR	07→08	MAR10A-J	4706					0.8
992	GT1000 (Twin Spark)	06→10	DCPR8E*	4339			DCR8EIX	3606	0.9
	Monster 1000 i.e. (Twin Spark)	03→05	DCPR8E*	4339			DCR8EIX	3606	0.9
	Multistrada 1000DS, MTS 1000DS (Twin Spark)	03→06	DCPR8E*	4339			DCR8EIX	3606	0.9
	Paul Smart 1000 Limited Edition (Twin Spark)	05→06	DCPR8E*	4339			DCR8EIX	3606	0.9
	Monster S2R, Dark 1000 (Twin Spark)	10/05→07	DCPR8E*	4339			DCR8EIX	3606	0.9
	Sport 1000 (Twin Spark)	05→09	DCPR8E*	4339			DCR8EIX	3606	0.9
	SS 1000 DS (Twin Spark)	03→06	DCPR8E*	4339			DCR8EIX	3606	0.9
	ST3, S (Twin Spark)	03→07	CR9EB	6955			CR9EIX	3521	0.6
996	916 SPS Fogarty Replica	1998	R2349-10	6839					0.6
	996 B/S, Biposto	98→01					DCR9EIX	6650	0.8
	996 S	00→02					DCR9EIX	6650	0.8
	996 SPS	97→02	R2349-10	6839					0.6
	S4R Monster	03→06					DCR9EIX	6650	0.8
	ST4S	00→05					DCR9EIX	6650	0.8
998	996 R (‡ Socket Ø <20.5mm)	00→02	CR9EB	6955			CR9EIX	3521	0.6
	998 Biposto, R, S (‡ Socket Ø <20.5mm)	01→03	CR9EB	6955			CR9EIX	3521	0.6
	998 Matrix (‡ Socket Ø <20.5mm)	2003	CR9EB	6955			CR9EIX	3521	0.6
	999, R, S (‡ Socket Ø <20.5mm)	02→06	CR9EB	6955			CR9EIX	3521	0.6
	Panigale V4R	19→	LMDR10A-JS	97718					0.8
	S4RS Monster (‡ Socket Ø <20.5mm)	06→08	CR9EB	6955			CR9EIX	3521	0.6
	S4R Monster (‡ Socket Ø <20.5mm)	07→08	CR9EB	6955			CR9EIX	3521	0.6
	Superleggera V4	20→	LMDR10A-JS	97718					0.8
1079	Hypermotard, S, Evo, Evo SP	07→12	DCPR8E*	4339			DCR8EIX	3606	0.9
	Monster 1100, S, Evo, Diesel	09→13	DCPR8E*	4339			DCR8EIX	3606	0.9
	Multistrada 1100, S	06→09	DCPR8E*	4339			DCR8EIX	3606	0.9
	Scrambler 1100, 1100 Special, 1100 Sport	18→	DCPR8E*	4339			DCR8EIX	3606	0.9
1098	1098, 1098S / Tricolore	07→08	MAR10A-J	4706					0.8
	Streetfighter S	09→13	MAR10A-J	4706					0.8
1103	Panigale V4 (Incl. S, 25° Anniversario 916)	18→	LMDR10A-JS	97718					0.8
	Streetfighter V4	20→	LMDR10A-JS	97718					0.8
1198	1098R (Incl. Bayliss LE)	2008	MAR10A-J	4706					0.8
	1198 R Corse	2010	MAR10A-J	4706					0.8
	1198, S, SP	09→11	MAR10A-J	4706					0.8
	1199 Panigale, R, S, S Tricolore (Incl. Senna)	12→14	MAR9A-J	6869					0.8
	Diavel (Incl. AMG, Carbon, Cromo & Diesel)	11→19	MAR9A-J	6869					0.8
	Monster 1200, S, Stripe	14→	MAR9A-J	6869					0.8
	Monster 1200 R (Twin Spark)	16→	MAR9A-J	6869					0.8
	Multistrada 1200, S (Incl. Pikes Peak, Sport & Touring)	10→12	MAR9A-J	6869					0.8
	Multistrada 1200, S (Incl. Pikes Peak, Sport & Touring) Twin Spark	13→14	MAR10A-J	4706					0.8
	Multistrada 1200, D Air, S (Twin Spark)	2015	MAR9A-J	6869					0.8
	Multistrada 1200 Enduro, Pikes Peak, Pro (Twin Spark)	2016	MAR9A-J	6869					0.8
	1199 Superleggera	2014	MAR9A-J	6869					0.8
1262	Diavel 1260, 1260S	19→	MAR9A-J	6869					0.8
	Multistrada 1260, D Air, Enduro, Pike Peak (Twin Spark)	18→	MAR9A-J	6869					0.8
	Multistrada 1260 S, S Grand Tour (Twin Spark)	18→	MAR9A-J	6869					0.8
	XDiavel, S	16→	MAR9A-J	6869					0.8
1285	1299 Panigale, R, S (Incl. Anniversario)	15→	MAR9A-J	6869					0.8

‡ Early Ducati Testastretta bikes (749, 998, 999 models) can have very little clearance between the plug hex and the cylinder head that may require a thin walled socket, no larger than 20.5mm OD to allow the plug to be fitted.





CC	MODEL	DATE	STANDARD COPPER CORE	STOCK NUMBER	PLATINUM OR GOLD PALLADIUM	STOCK NUMBER	IRIDIUM	STOCK NUMBER	GAP MM
EBR									
1190	1190RX	04/14→	CR9EKB	2305			CR9EIX	3521	0.8
	1190SX	07/14→	CR9EKB	2305			CR9EIX	3521	0.8

FANTIC									
50	Caballero 50	06→	BR9ES	5722			BR9EIX	3981	0.7
	Gran Turismo, Lei 50, Issimo (all models)		B6HS	4510			BR6HIX	3419	0.5
	Trial 50	79→	B7HS	5110			BR7HIX	7067	0.5
80	Caballero 80		B8EG	3430			BR8EIX	5044	0.5
	Enduro 80		B8EG	3430			BR8EIX	5044	0.5
	RSX 80		B8EG	3430			BR8EIX	5044	0.5
	Section	95→97	BCP7ES	5030			BCPR7EIX	5690	0.5
125	Caballero 125		B9EG	3530			BR9EIX	3981	0.5
	Cross 125		B9EG	3530			BR9EIX	3981	0.5
	Professional 125		B6HS	4510			BR6HIX	3419	0.5
	RSX 125		B9EG	3530			BR9EIX	3981	0.5
	Trial 125	77→	B6HS	4510			BR6HIX	3419	0.5
160	TX160		B8EG	3430			BR8EIX	5044	0.5
175	Enduro 175		B8EG	3430			BR8EIX	5044	0.5
200	Trial 200	79→	B6HS	4510			BR6HIX	3419	0.5
240	Trial 240	82→	B6HS	4510			BR6HIX	3419	0.5
250	Section	95→97	BCP7ES	5030			BCPR7EIX	5690	0.5
	TX250		B8EG	3430			BR8EIX	5044	0.5
260	TX260		B8EG	3430			BR8EIX	5044	0.5
300	Professional 300		B8EG	3430			BR8EIX	5044	0.5
330	TX330		B8EG	3430			BR8EIX	5044	0.5

GAS GAS									
50	Contact, Endurocross		B8HS	5510			BR8HIX	7001	0.5
	EC 50 Boy (12.7mm Thread Reach)		B8HS	5510			BR8HIX	7001	0.5
	EC Boy, Rookie 50 (19mm Thread Reach)	04→	B9ES	2611			BR9EIX	3981	0.6
	SM 50 Supermotard	04→	B9ES	2611			BR9EIX	3981	0.6
	TXT Boy	06→	BPR5ES	7422			BPR5EIX	6597	0.5
65	MC65	06→	BR10ES	4832			BR10EIX	6801	0.7
75	Husqvarna (TM)		B10EG	3630			BR10EIX	6801	0.5
80	TXT 80	06→07	BPR5ES	7422			BPR5EIX	6597	0.5
	TXT PRO Racing	15→	BPR5ES	7422			BPR5EIX	6597	0.5
125	Contact T12	1993	BP5ES	6511			BPR5EIX	6597	0.5
	EC 125 Endurocross	97→	B9EG	3530			BR9EIX	3981	0.7
	EC 125 Racing, EC 125 SIX	10→	BR9EG	3230			BR9EIX	3981	0.7
	Enduro 125	02→	BR8EG	3130			BR8EIX	5044	0.5
	Endurocross TT125, Cross TT125	→00					BR10EIX	6801	0.5
	GT12 (Liquid Cooled)	1993	BP5ES	6511			BPR5EIX	6597	0.5
	Halley 125	2009	BR9ES	5722			BR9EIX	3981	0.7
	Husqvarna (TM)		B10EG	3630			BR10EIX	6801	0.5
	Pampera 125	02→05	BPR5ES	7422			BPR5EIX	6597	0.5
	SM 125 Supermotard	03→07	BR9EG	3230			BR9EIX	3981	0.7
	Trial 125	→91	BP5ES	6511			BPR5EIX	6597	0.5
	TX, TXT 125 Ø14mm Plug	99→	BPR5ES	7422			BPR5EIX	6597	0.5
	TX Randonne Ø10mm Plug	11→	CR6HSA	2983			CR6HIX	7274	0.6
TXT Pro, Racing	11→	BPR5ES	7422			BPR5EIX	6597	0.6	
143	Contact T16	1993	BP5ES	6511			BPR5EIX	6597	0.5
160	GT16 (Liquid Cooled)	1993	BP5ES	6511			BPR5EIX	6597	0.5
200	EC 200 Endurocross	99→					BR10EIX	6801	0.6
	EC 200 Endurocross (2002 models)	02→	BR8EG	3130			BR8EIX	5044	0.5
	EC 200 Racing	11→	BR8EG	3130			BR8EIX	5044	0.7
	Trial 200	→91	BP5ES	6511			BPR5EIX	6597	0.5
	TX, TXT 200	99→	BPR5ES	7422			BPR5EIX	6597	0.5
238	Contact JT25	94→95	BP5ES	6511			BPR5EIX	6597	0.5
249	TX, TXT 249	99→	BPR5ES	7422			BPR5EIX	6597	0.5
250	Contact 250	15→	BPR5ES	7422			BPR5EIX	6597	0.6
	Delta 25 GT	→91	BP5ES	6511			BPR5EIX	6597	0.5



CC	MODEL	DATE	STANDARD COPPER CORE	STOCK NUMBER	PLATINUM OR GOLD PALLADIUM	STOCK NUMBER	IRIDIUM	STOCK NUMBER	GAP MM
GAS GAS (CONTINUED)									
250	EC 250 Endurocross	1997	B8EG	3430			BR8EIX	5044	0.5
	EC 250 Racing, EC 250 SIX (Incl. Replica) (2-Stroke)	10→	BR8EG	3130			BR8EIX	5044	0.7
	ECF250 4T, ECF250 SIX (4-Stroke)	10→11	CR8E	1275			CR8EIX	4218	0.7
	ECF250 4T, ECF250 SIX (4-Stroke)	12→	CR9E	6263			CR9EIX	3521	0.6
	Enduro 250	02→	BR8EG	3130			BR8EIX	5044	0.5
	Endurocross 250	→00					BR10EIX	6801	0.5
	Husqvarna (TM)		B10EG	3630			BR10EIX	6801	0.5
	Pampera 250	02→05	BPR5ES	7422			BPR5EIX	6597	0.5
	Supermotard SM 250	03→05	BR8EG	3130			BR8EIX	5044	0.5
	Trial 250 (Air & Liquid Cooled models)	→91	BP5ES	6511			BPR5EIX	6597	0.5
TXT Pro, Raga Replica	03→	BPR5ES	7422			BPR5EIX	6597	0.6	
270	TX, TXT 270	98→	BPR5ES	7422			BPR5EIX	6597	0.5
280	Pampera 280	02→05	BPR5ES	7422			BPR5EIX	6597	0.5
	Trial 280	→91	BP5ES	6511			BPR5EIX	6597	0.5
	TX, TXT 280	00→	BPR5ES	7422			BPR5EIX	6597	0.5
	TXT Pro, Racing, Raga Replica	11→	BPR5ES	7422			BPR5EIX	6597	0.6
300	EC 300	98→02	BR8EG	3130			BR8EIX	5044	0.7
	EC 300 Endurocross	03→09					BR10EIX	6801	0.6
	EC 300 F (4-Stroke)	13→	CR9E	6263			CR9EIX	3521	0.6
	EC 300 Racing, EC 300 SIX (Incl. Replica) (2-Stroke)	10→	BR8EG	3130			BR8EIX	5044	0.7
	Enduro 300	02→	BR8EG	3130			BR8EIX	5044	0.5
	Trial 300	→91	BP5ES	6511			BPR5EIX	6597	0.5
	TXT 300	04→	BPR5ES	7422			BPR5EIX	6597	0.5
TXT Pro, Racing, Raga Replica	11→	BPR5ES	7422			BPR5EIX	6597	0.6	
321	TX, TXT 321	99→	BP5ES	6511			BPR5EIX	6597	0.5
325	Trial Halley PXC 325	→91	B9ES	2611			BR9EIX	3981	0.5
327	Trial 327	→91	BP5ES	6511			BPR5EIX	6597	0.5
330	Delta 32 GT	→91	BP5ES	6511			BPR5EIX	6597	0.5
400	Pampera 400	06→	CR8E	1275			CR8EIX	4218	0.7
	SM 400FSE-4T	02→	CR8E	1275			CR8EIX	4218	0.7
450	EC 450 (4-Stroke)	08→10	CR8E	1275			CR8EIX	4218	0.7
	EC 450 F (4-Stroke)	13→	CR8E	1275			CR8EIX	4218	0.7
	FSE 450	03→	CR8E	1275			CR8EIX	4218	0.7
	Halley 450 R	08→	CR8E	1275			CR8EIX	4218	0.7
	SM 450	04→	CR8E	1275			CR8EIX	4218	0.7
	SM Halley 450	2009	CR8E	1275			CR8EIX	4218	0.7
492	EC 515 FSR	08→10	CR8E	1275			CR8EIX	4218	0.7
	SM 515	08→10	CR8E	1275			CR8EIX	4218	0.7
500	Normada 500		D8EA	2120	DR8EVX	6354	DR8EIX	6681	0.5

GENERIC									
50	Cracker 50 (19mm Thread Reach)	07→11	BR7ES	5122			BR7EIX	6664	0.7
	Cracker SM 50 (12.7mm Thread Reach)	11→12	BR8HSA	5539			BPR8HIX	6742	0.7
	Epico 50	11→12	BR8HSA	5539			BPR8HIX	6742	0.7
	Evolution 50 (19mm Thread Reach)	07→11	BR7ES	5122			BR7EIX	6664	0.7
	Evolution 50 (12.7mm Thread Reach)	11→12	BR8HSA	5539			BPR8HIX	6742	0.7
	Ideo 50 (19mm Thread Reach)	07→11	BR7ES	5122			BR7EIX	6664	0.7
	Ideo 50 (12.7mm Thread Reach)	11→12	BR8HSA	5539			BPR8HIX	6742	0.7
	Race 50 (19mm Thread Reach)	→11	BR7ES	5122			BR7EIX	6664	0.7
	Race 50 (12.7mm Thread Reach)	11→12	BR8HSA	5539			BPR8HIX	6742	0.7
	ROC 50 (19mm Thread Reach)	→11	BR7ES	5122			BR7EIX	6664	0.7
	Trigger SM 50 (19mm Thread Reach)	07→11	BR7ES	5122			BR7EIX	6664	0.7
	Trigger SM 50 (12.7mm Thread Reach)	11→12	BR8HSA	5539			BPR8HIX	6742	0.7
	Trigger SM Competition (Restricted)	→11	BR7ES	5122			BR7EIX	6664	0.7
	Trigger SM Competition (Unrestricted)	→11	BR9ES	5722			BR9EIX	3981	0.7
	Trigger X 50 (19mm Thread Reach)	07→11	BR7ES	5122			BR7EIX	6664	0.7
	Trigger X 50 (12.7mm Thread Reach)	11→12	BR8HSA	5539			BPR8HIX	6742	0.7
	Trigger X Competition (Restricted)	→11	BR7ES	5122			BR7EIX	6664	0.7
	Trigger X Competition (Unrestricted)	→11	BR9ES	5722			BR9EIX	3981	0.7
	XOR 50 (19mm Thread Reach)	07→11	BR7ES	5122			BR7EIX	6664	0.7
	XOR 50 (12.7mm Thread Reach)	11→12	BR8HSA	5539			BPR8HIX	6742	0.7
XOR 50 Competition (19mm Thread Reach)	07→11	BR7ES	5122			BR7EIX	6664	0.7	



CC	MODEL	DATE	STANDARD COPPER CORE	STOCK NUMBER	PLATINUM OR GOLD PALLADIUM	STOCK NUMBER	IRIDIUM	STOCK NUMBER	GAP MM
GENERIC (CONTINUED)									
50	XOR Stroke 50 (2-Stroke)	07→11	BR7ES	5122			BR7EIX	6664	0.7
	XOR 50 Williams (19mm Thread Reach)	→11	BR7ES	5122			BR7EIX	6664	0.7
125	Soho 125	09→11	CR8E	1275			CR8EIX	4218	0.7
	XOR 125	07→11	CR7HSA	4549			CR7HIX	7544	0.7
	XOR 125 Williams	08→11	CR7HSA	4549			CR7HIX	7544	0.7

GILERA									
50	DNA 50 (2-Stroke catalyst)	00→	BR9ES	5722			BR9EIX	3981	0.7
	DNA 50 GP	02→	BR9ES	5722			BR9EIX	3981	0.6
	GSM 50 (Gilera 2-Stroke)	00→	BR9ES	5722			BR9EIX	3981	0.7
	H@K 50 (Gilera 2-Stroke)	00→	BR9ES	5722			BR9EIX	3981	0.7
	ICE 50 (Gilera 2-Stroke)	01→	BR9ES	5722			BR9EIX	3981	0.7
	Jetrunner	03→	CPR8E	7411			CR8EIX	4218	0.8
	Pure Jet 50 Direct Injection (2-Stroke)	04→	CPR8E	7411			CR8EIX	4218	0.8
	RCR 50 (2-Stroke Derbi engine)	04→	BR9ES	5722			BR9EIX	3981	0.5
	Runner 50 (2-Stroke)	97→02	BR9ES	5722			BR9EIX	3981	0.6
	Runner 50 (4-Stroke)	04→	CPR8E	7411			CR8EIX	4218	0.8
	SKP 50	97→	BR9ES	5722			BR9EIX	3981	0.5
	SMT 50	05→	BR9ES	5722			BR9EIX	3981	0.6
	Stalker 50	03→	BR9ES	5722			BR9EIX	3981	0.5
	Storm 50	09/07→	BR9ES	5722			BR9EIX	3981	0.6
125	125T G1,125GR1		B8ES	2411			BR8EIX	5044	0.5
	Cougar 125	00→03	DPR8EA-9	4929			DPR8EIX-9	2202	0.8
	Crono		B10EG	3630			BR10EIX	6801	0.6
	CX 125 Apache		B10EG	3630			BR10EIX	6801	0.6
	DNA 125 (4-Stroke)	01→	CR9EB	6955			CR9EIX	3521	0.7
	Freestyle (2-Stroke)		B10EG	3630			BR10EIX	6801	0.6
	GFR125						BR10EIX	6801	0.6
	Nexus 125	07→	CR8EB	7784			CR8EIX	4218	0.7
	Runner ST 125 (4-Stroke)	09→	CR9E	6263			CR9EIX	3521	0.6
	Runner FX125 (2-Stroke)	97→01	BR9ES	5722			BR9EIX	3981	0.6
	Runner VX 125 (4-Stroke)	01→08	CR9EB	6955			CR9EIX	3521	0.7
	RV 125	86→90	B10EG	3630			BR10EIX	6801	0.6
	SC125 (2-Stroke)	06→	BR8ES	5422			BR8EIX	5044	0.7
	SC125 (4-Stroke Yamaha engine)	07→	BR8ES	5422			BR8EIX	5044	0.7
180	DNA 180 (4-Stroke)	01→	CR9EB	6955			CR9EIX	3521	0.7
	Runner FXR180 (2-Stroke)	98→00	BR9ES	5722			BR9EIX	3981	0.6
	Runner VXR 180 (4-Stroke)	01→08	CR9EB	6955			CR9EIX	3521	0.7
200	Runner ST 200	08→	CPR8E	7411			CR8EIX	4218	0.7
	Runner VXR 200 (4-Stroke)	02→08	CPR8E	7411			CR8EIX	4218	0.7
250	Nexus 250 SP	06→	CR8EB	7784			CR8EIX	4218	0.6
300	Nexus 300		CR8EKB	4374			CR8EIX	4218	0.7
	Dakota 350 (4-Stroke)		DPR8EA-9	4929			DPR8EIX-9	2202	0.6
350	Saturno 350 (4-Stroke)	90→	DPR8EA-9	4929			DPR8EIX-9	2202	0.6
	Nexus 500	04→	CR7EKB	4455			CR7EIX	7385	0.8
500	Dakota 500 (4-Stroke)		DPR8EA-9	4929			DPR8EIX-9	2202	0.6
	Fuoco 500	07→	CR7EKB	4455			CR7EIX	7385	0.8
	Saturno 500 (4-Stroke)	90→93	DPR8EA-9	4929			DPR8EIX-9	2202	0.6
560	Nordwest 600 (4-Stroke)	91→95	DPR9EA-9	5329			DPR9EIX-9	5545	0.6
	RC600 (4-Stroke)		DPR8EA-9	4929			DPR8EIX-9	2202	0.6
600	Supersport 600	02→	CR9E	6263			CR9EIX	3521	0.6
839	GP800 (Twin Spark)	08→	CR7EKB	4455			CR7EIX	7385	0.8

HARLEY DAVIDSON									
500	Street 500	15→	CR8E	1275			CR8EIX	4218	0.7
700	Street 750	15→	CR8E	1275			CR8EIX	4218	0.7
883	XL53C, Sportster 883 (All Models)	86→	DCPR7EA-9	6651			DCPR7EIX	6046	0.9
	XL883 Iron	09→	DCPR7EA-9	6651			DCPR7EIX	6046	0.9
1000	XL, XLH, XLCH	→78	B-6L	3212					0.7
	XLCR	→79	B-6L	3212					0.7
	XLH, XLS, XLCH	79→	BP6HS	4511			BPR6HIX	4085	1.0



CC	MODEL	DATE	STANDARD COPPER CORE	STOCK NUMBER	PLATINUM OR GOLD PALLADIUM	STOCK NUMBER	IRIDIUM	STOCK NUMBER	GAP MM
HARLEY DAVIDSON (CONTINUED)									
1000	XR1000	83→85	BPR6ES-11	4824			BPR6EIX-11	3903	1.0
1100	Sportster 1100	86/87	DCPR7E	3932			DCPR7EIX	6046	1.0
1130	VRSC V-Rod, Night Rod, Street Rod	02→	DCPR8E*	4339			DCR8EIX	3606	0.9
1200	FL, FLH, FX, FXE, Super Glide	48→74	BP5S	3011					0.7
	FLH, FLHR, FX, FXE, FXEF, FXS	75→81	BPR5ES-11	4424			BPR5EIX	6597	1.0
	Forty Eight	10→	DCPR7E	3932			DCPR7EIX	6046	1.0
	Sportster 1200 (All Models)	88→	DCPR7E	3932			DCPR7EIX	6046	1.0
	XL1200	88→	DCPR7E	3932			DCPR7EIX	6046	1.0
	XR1200	08→12	DCPR9E	2641			DCPR9EIX	2316	0.9
1250	V-Rod Anniversary	11→	DCPR9E	2641			DCPR9EIX	2316	0.6
	VRSC Screamin' Eagle V-Rod	04→	DCPR9E	2641			DCPR9EIX	2316	0.6
	VRSCF V-ROD MUSCLE	09→14	DCPR9E	2641			DCPR9EIX	2316	0.6
1340	All Evolution engines	84→98	BPR5ES-11	4424			BPR5EIX	6597	1.0
	All Shovel Head engines	82→84	ZGR5A	5839					1.0
1450	All 1450cc Models	99→	DCPR7E	3932			DCPR7EIX	6046	1.0
	FXDBi	06→	DCPR7E	3932			DCPR7EIX	6046	1.0
1584	Blackline	11→	DCPR8E*	4339			DCR8EIX	3606	0.9
	FLST Fat Boy	08/06→	DCPR8E*	4339			DCR8EIX	3606	0.9
	Twin Cam 96B Models	06/06→	DCPR8E*	4339			DCR8EIX	3606	0.9
	Wide Glide	10→	DCPR8E*	4339			DCR8EIX	3606	0.9
1690	FL1690 Screamin' Eagle Electra Glide	04→	DCPR8E*	4339			DCR8EIX	3606	0.9
	FL1690 Screamin' Eagle, Fat Boy	04→	DCPR8E*	4339			DCR8EIX	3606	0.9
	FXSB	13→	DCPR8E*	4339			DCR8EIX	3606	0.9
	Switchback	11→	DCPR8E*	4339			DCR8EIX	3606	0.9
1745	Twin spark heads	17→	CR9EB	6955			CR9EIX	3521	0.6
1800	FLHR Road King	13→	DCPR7E	3932			DCPR7EIX	6046	1.0
	FLHTCUSE Screamin' Eagle, Ultra Classic Electra Glide	06/06→	DCPR7E	3932			DCPR7EIX	6046	1.0

HERALD MOTOR COMPANY									
125	Classic 125	06/12→	CR7E	4578			CR7EIX	7385	0.5
250	Classic 250	06/12→	DR8EA	7162			DR8EIX	6681	0.5
	Nomad 250 custom	04/16→	DR8EA	7162			DR8EIX	6681	0.5
	Rambler 250 custom	04/16→	DR8EA	7162			DR8EIX	6681	0.5
	Roamer 250 custom	04/16→	DR8EA	7162			DR8EIX	6681	0.5
	Vagabond 250 custom	04/16→	DR8EA	7162			DR8EIX	6681	0.5

HERO-PUCH									
50	Blinker, Stark, Turbo Sport	94→	BP5ES	6511			BPR5EIX	6597	0.5

HESKETH									
1000	V1000	82→	DR8ES	5423			DR9EIX	4772	0.7

HONDA									
50	C50	66→78	C7HSA	4629			CR7HIX	7544	0.7
	C50C	82→86	CR7HS	7223			CR7HIX	7544	0.7
	C50-E Super Cub	84→85	CR7HS	7223			CR7HIX	7544	0.7
	C50L, C50LA-C, C50LA-E	82→88	CR7HS	7223			CR7HIX	7544	0.7
	C50ZZ, C50Z2	77→83	CR7HS	7223			CR7HIX	7544	0.7
	CB50J	77→86	CR6HS	7023			CR6HIX	7274	0.7
	CR50R-E/F/G	84→86	BR9ES	5722			BR9EIX	3981	0.7
	CRF50F	04→	CR6HSA	2983			CR6HIX	7274	0.6
	MB50A-B	80→82	BR7HS	4122			BR7HIX	7067	0.7
	MBX50S-D	83→86	BR6ES	4922					0.7
	Melody, Mini Melody, Vision	83→85	BPR6HSA	4632			BPR6HIX	4085	0.7
	MT50A-B, MT50S-L	80→93	BR7HS	4122			BR7HIX	7067	0.7
	MTX50S-C	82→85	BR7HS	4122			BR7HIX	7067	0.7
	NC50 Express	77→84	BPR4HS	7823					0.7
	ND50M-C	83→85	BPR6HSA	4632			BPR6HIX	4085	0.7
	NE50	85→90	BPR6HSA	4632			BPR6HIX	4085	0.7



CC	MODEL	DATE	STANDARD COPPER CORE	STOCK NUMBER	PLATINUM OR GOLD PALLADIUM	STOCK NUMBER	IRIDIUM	STOCK NUMBER	GAP MM
HONDA (CONTINUED)									
50	NPS50 Zoomer	06→12	ER8EH-N	5606					0.7
	NS50MS	81→85	BPR6HSA	4632			BPR6HIX	4085	0.7
	NSC50 Vision	12→	CR7HSA-9	5147			CR7HIX	7544	0.9
	NSC50R	13→	CR7HSA-9	5147			CR7HIX	7544	0.9
	NT50-H	87→94	BPR6HSA	4632			BPR6HIX	4085	0.7
	NU50M-C	82→85	BPR5HS	6222					0.7
	NV50MS-D	82→87	BPR5HS	6222					0.7
	NX50M	80→83	BPR5HS	6222					0.7
	PA50VC	86→91	BPR6HS	7022			BPR6HIX	4085	0.7
	PC50 (OHC)	→69	C6HSA	3228			CR6HIX	7274	0.6
	PC50K (OHV)	70→79	C7HSA	4629			CR7HIX	7544	0.6
	PF50MR2	75→78	B6HS	4510			BR6HIX	3419	0.7
	PX50	81→86	BPR5HS	6222					0.7
	PXR50	85→87	BPR4HS	7823					0.7
	QR50-D, QR50-F/R	82→03	BPR4HS	7823					0.7
	SA50-J, SA50M/N/P	88→95	BPR6HSA	4632			BPR6HIX	4085	0.7
	SFX50 S, T, V, W, X, Y	95→03	BR6HSA	4296			BPR6HIX	4085	0.6
	SGX50 V, W, X, Y (Sky)	97→03	BR6HSA	4296			BPR6HIX	4085	0.6
	SH50E-S	84→96	BPR6HS	7022			BPR6HIX	4085	0.7
	SH50T-X-Y Bali	96→03	BR6HSA	4296			BPR6HIX	4085	0.6
	SJ50 PR, S, V, W	93→99	BR6HSA	4296			BPR6HIX	4085	0.6
	SRX50 Shadow	2003	BR6HSA	4296			BPR6HIX	4085	0.6
	SS50	67→80	C7HSA	4629			CR7HIX	7544	0.6
	ST50J DAX, ST50J/K	88→93	CR6HSA	2983			CR6HIX	7274	0.7
	SZX-50 (X8R-S, X8R-X)	98→04	BR6HSA	4296			BPR6HIX	4085	0.6
	TLM50	85→86	B8ES	2411			BR8EIX	5044	0.7
	X8R S/X	98→03	BR6HSA	4296			BPR6HIX	4085	0.6
	XR50	96→02	CR6HSA	2983			CR6HIX	7274	0.7
	XR50R	00→03	CR6HSA	2983			CR6HIX	7274	0.7
	XR50 Motard	05→06	CR6HSA	2983			CR6HIX	7274	0.9
Z50R-D	79→99	CR6HS	7023			CR6HIX	7274	0.7	
60	CR60R-G	83→86	BR9ES	5722			BR9EIX	3981	0.7
70	C70C/E	82→86	CR7HS	7223			CR7HIX	7544	0.7
	CRF70F	04→12	CR6HSA	2983			CR6HIX	7274	0.6
	CZ70ZZ, CZ70Z2, C70/C, CF70/C	77→83	CR7HS	7223			CR7HIX	7544	0.7
	XR70V, XR70R	97→03	CR6HSA	2983			CR6HIX	7274	0.6
80	CR80RB	81→82	B9EG	3530			BR9EIX	3981	0.7
	CR80R-D/E/F/2F/G/2G	83→86	BR9ES	5722			BR9EIX	3981	0.7
	CR80RH-RS/T/V	87→99	BR10EG	3830			BR10EIX	6801	0.5
	CR80R, CR80R2	00→02	BR10EG	3830			BR10EIX	6801	0.5
	MBX80FWD-D	83→86	BR9ES	5722			BR9EIX	3981	0.7
	MTX80R-E	83→86	BR8ES	5422			BR8EIX	5044	0.7
	NH80MD/H-P	82→96	BPR6HS	7022			BPR6HIX	4085	0.7
	XR80R-J	79→03	CR7HS	7223			CR7HIX	7544	0.7
85	CR85R/R2	03→06	BR10EG	3830			BR10EIX	6801	0.5
90	C90 ZZ (Step Thru)	79→83	D6HA	6512					0.7
	C90E-C/E/G, C90MF-T (Step Thru)	84→96	CR7HS	7223			CR7HIX	7544	0.7
	C90MT (Step Thru)	96→03	CR6HSA	2983			CR6HIX	7274	0.6
	CM90, CM91	67→69	D6HA	6512					0.7
	EZ90-M	90→96	BR7HS	4122			BR7HIX	7067	0.7
	S90	64→69	D6HA	6512					0.7
	SRX90 Joker	96→00	BR6HSA	4296			BPR6HIX	4085	0.6
100	CB100 (N/NA/NB)	78→86	DR8ES-L	2923	DR8EVX	6354	DR8EIX	6681	0.7
	CRF100F	04→13	CR7HSA	4549			CR7HIX	7544	0.6
	H100A/B/S2G	80→92	BR7HS	4122			BR7HIX	7067	0.7
	H100SE/J	86→93	BR8HS	4322			BR8HIX	7001	0.7
	SCV100 Lead	03→06	CR6HSA	2983			CR6HIX	7274	0.6
	SJ100T-V-W (Bali)	97→99	BR6HSA	4296			BPR6HIX	4085	0.6
	XR100 Motard	05→06	CR7HSA	4549			CR7HIX	7544	0.9
	XR100R	85→03	CR7HSA	4549			CR7HIX	7544	0.6
108	NHX110 Lead (Fi)	08→10	CR8EH-9	5666			CR8EHIX-9	3797	0.9
	NSC110 Vision	11→16	CPR8EA-9	2306			CR8EIX	4218	0.9
	NSC110 Vision	17→	MR8C-9N	97985					0.9



CC	MODEL	DATE	STANDARD COPPER CORE	STOCK NUMBER	PLATINUM OR GOLD PALLADIUM	STOCK NUMBER	IRIDIUM	STOCK NUMBER	GAP MM
HONDA (CONTINUED)									
109	AFS110 Wave 110i	12→	CPR6EA-9S	1582					0.9
	CRF110F	12→13	CPR6EA-9S	1582					0.9
125	ANF125 Innova	03→06	CPR6EA-9	6899			CR6EIA-9	7967	0.9
	ANF125i Innova	07→	CPR6EA-9	6899			CR6EIA-9	7967	0.9
	C125 Super Cub	18→	CPR6EA-9	6899			CR6EIA-9	7967	0.9
	CA125S	95→99	CR6HSA	2983			CR6HIX	7274	0.6
	CB92 Ø10mm Plug	59→64	CR7HS	7223			CR7HIX	7544	0.7
	CB92 Ø12mm Plug	59→64	D8HA	7112					0.7
	CB125 (S/S1/J)	71→79	D8EA	2120	DR8EVX	6354	DR8EIX	6681	0.7
	CB125F	15→	CPR7EA-9	3901			CR7EIX	7385	0.9
	CB125R	21→	CPR8EA-9	2306			CR8EIX	4218	0.9
	CB125RS-D/E	83→86	DR8ES-L	2923	DR8EVX	6354	DR8EIX	6681	0.7
	CB125T (2/B/D-C/D/D-E)	82→88	CR8HS	7423			CR8HIX	7669	0.7
	CBF125	08→14	CPR7EA-9	3901			CR7EIX	7385	0.9
	CBF125M	20→	CPR8EA-9	2306			CR8EIX	4218	0.9
	CBR125R	04→	CR8E	1275			CR8EIX	4218	0.7
	CD125 Benly	82→85	CR7HS	7223			CR7HIX	7544	0.7
	CG125 C→T	76→96	DR8ES-L	2923	DR8EVX	6354	DR8EIX	6681	0.7
	CG125 W→	97→08	DPR8EA-9	4929			DPR8EIX-9	2202	0.9
	CH125-D/E	83→87	DPR7EA-9	5129			DPR7EIX-9	7803	0.9
	CLR125 City Fly	98→03	DPR8EA-9	4929			DPR8EIX-9	2202	0.8
	CM125C-C	82→86	CR7HS	7223			CR7HIX	7544	0.7
	CR125/RB	80→82	B9EG	3530			BR9EIX	3981	0.5
	CR125R D-Y	83→00	BR9EG	3230			BR9EIX	3981	0.5
	CRF125F	14→	CPR6EA-9	6899			CR6EIA-9	7967	0.9
	CT125C	82→85	DR8ES-L	2923	DR8EVX	6354	DR8EIX	6681	0.7
	FES 125 Pantheon (2-Stroke)	98→02	BR8ES	5422			BR8EIX	5044	0.6
	FES 125 Pantheon (4-Stroke)	03→07	CR8EH-9	5666			CR8EHIX-9	3797	0.9
	FES 125 S-Wing 125	07→12	CR8EH-9	5666			CR8EHIX-9	3797	0.9
	MBX125FE/RW-F/H/L	84→86	BR8ES	5422			BR8EIX	5044	0.7
	Monkey 125	18→	CPR6EA-9	6899			CR6EIA-9	7967	0.9
	MSX125	13→	CPR6EA-9	6899			CR6EIA-9	7967	0.9
	MTX125R-D/E/F	83→94	BR8ES	5422			BR8EIX	5044	0.7
	NES125 @	00→03	CR8EH-9	5666			CR8EHIX-9	3797	0.9
	NH125MD-D	83→87	BPR6HS	7022			BPR6HIX	4085	0.7
	NS125FG/FH/RK-RP	86→93	BR7ES	5122			BR7EIX	6664	0.7
	NSR125 F R/S	88→89	BR9ECS	3570					0.7
	NSR125R-R-S-V	90→03	BR9ECS	3570					0.7
	NSS125 Forza	15→					SILMAR8C9	90097	0.9
	PCX125 (WW)	10→17	CPR7EA-9	3901			CR7EIX	7385	0.9
	PCX125	18→20	MR8K-9	93844					0.9
	PCX125	20→	LMAR8L-9	91131					0.9
	PS125i (PES125i)	07→13	CR8EH-9	5666			CR8EHIX-9	3797	0.9
	SES125 Dylan	02→07	CR8EH-9	5666			CR8EHIX-9	3797	0.9
SH125	01→08	CR8EH-9	5666			CR8EHIX-9	3797	0.9	
SH125i	09→12	CR8EH-9	5666			CR8EHIX-9	3797	0.9	
SH125i	13→19	CPR7EA-9	3901			CR7EIX	7385	0.9	
SH125i	20→	LMAR8L-9	91131					0.9	
SH Mode 125	14→16	CPR7EA-9	3901			CR7EIX	7385	0.9	
SH Mode 125	17→	MR7G-9E	90312					0.9	
SS125	67→69	D8HA	7112					0.7	
VT125 /C2 Shadow	98→07	CR8EH-9	5666			CR8EHIX-9	3797	0.8	
XL125 (S/SA/SB/RO/RF)	75→87	DR8ES-L	2923	DR8EVX	6354	DR8EIX	6681	0.7	
XL125V Varadero	01→	CR8EH-9	5666			CR8EHIX-9	3797	0.9	
XLR125R	97→99	DPR8EA-9	4929			DPR8EIX-9	2202	0.8	
XR125L	03→13	DPR8EA-9	4929			DPR8EIX-9	2202	0.8	
150	FES150 Pantheon	05→09	CR8EH-9	5666			CR8EHIX-9	3797	0.9
	CRF150R/R2	07→	CR8EH-9	5666			CR8EHIX-9	3797	0.9
	CRF150R/B	09→	CR8EH-9	5666			CR8EHIX-9	3797	0.9
175	CB175 (Incl. 'Sloper')	68→73	D8HA	7112				0.6	
185	CD185T	78→82	CR7HS	7223			CR7HIX	7544	0.7
	XL185S (2/A/B)	79→84	DR8ES-L	2923	DR8EVX	6354	DR8EIX	6681	0.7



CC	MODEL	DATE	STANDARD COPPER CORE	STOCK NUMBER	PLATINUM OR GOLD PALLADIUM	STOCK NUMBER	IRIDIUM	STOCK NUMBER	GAP MM
HONDA (CONTINUED)									
200	CB200	76→79	D8EA	2120	DR8EVX	6354	DR8EIX	6681	0.7
	CD200T (A/B), CM200T (A/B)	80→85	CR7HS	7223			CR7HIX	7544	0.7
	MTX200RW-D	83→86	BR9ES	5722			BR9EIX	3981	0.7
	TLR200R-E/F	83→87	DR8ES-L	2923	DR8EVX	6354	DR8EIX	6681	0.7
	XR200 (A/R-C)	80→83	DR8ES-L	2923	DR8EVX	6354	DR8EIX	6681	0.7
230	CRF230F	03→12	DPR8EA-9	4929			DPR8EIX-9	2202	0.8
250	CB250 K2,K3,K4,G5	73→77	B8ES	2411			BR8EIX	5044	0.7
	CB250N A/B/DXB	78→83	DR8ES	5423			DR9EIX	4772	0.7
	CB250N/T/W	92→03	CR6HSA	2983			CR6HIX	7274	0.7
	CB250RS (A/B)	80→83	DR8ES-L	2923	DR8EVX	6354	DR8EIX	6681	0.7
	CB250RSD-C	82→84	DR8ES	5423			DR9EIX	4772	0.7
	CB250T Dream	77→81	DR8ES-L	2923	DR8EVX	6354	DR8EIX	6681	0.7
	CBF250	04→06	CR8EH-9S	7750			CR8EHIX-9	3797	0.9
	CBR250R	11→14					SIMR8A9	91064	0.9
	CBX250RSE	84→86	DPR8EA-9	4929			DPR8EIX-9	2202	0.9
	CD250U-J/K	88→93	CR6HSA	2983			CR6HIX	7274	0.7
	CH250F/G (Spacy)	85→87	DPR6EA-9	5531					0.9
	CL250S-C	82→84	DR8ES-L	2923	DR8EVX	6354	DR8EIX	6681	0.7
	CM250T	82→84	DR8ES	5423			DR9EIX	4772	0.7
	CMX250C-T	95→99	CR6HSA	2983			CR6HIX	7274	0.6
	CN250-L/M/N	90→92	DPR6EA-9	5531					0.9
	CR250 R3/R-D/E/F/G/H		BR8EG	3130			BR8EIX	5044	0.5
	CR250R-J		BR9EG	3230			BR9EIX	3981	0.5
	CR250R-S/T/V		BR8EG	3130			BR8EIX	5044	0.5
	CR250R K5	05→	BR9EG-N-8	2689					0.8
	CRF250L	12→					SIMR8A9	91064	0.9
	CRF250M	13→					SIMR8A9	91064	0.9
	CRF250R K5/K6 (19mm Thread Reach)	04→09					R0409B-8	7791	0.7
	CRF250R (26.5mm Thread Reach)	10→					R0451B-8	9356	0.7
	CRF250RX	18→19					R0451B-8	9356	0.7
	CRF250X K5-L4	04→					IMR8C-9H	3653	0.9
	FES250 W-X-Y (Foresight)	97→03	DPR7EA-9	5129			DPR7EIX-9	7803	0.9
	RTL250		D6EA	7512					0.7
	TL250		D7EA	7912					0.7
	TLR250F		DR8ES-L	2923	DR8EVX	6354	DR8EIX	6681	0.7
	VT250F-D	83→87	DPR8EA-9	4929			DPR8EIX-9	2202	0.9
	XL250/K3		D8EA	2120	DR8EVX	6354	DR8EIX	6681	0.7
	XL250R-C	82→84	DR8ES-L	2923	DR8EVX	6354	DR8EIX	6681	0.7
	XL250RE	84→86	DPR9Z	4830					0.7
	XL250S (A/B/Z)	73→82	DR8ES-L	2923	DR8EVX	6354	DR8EIX	6681	0.7
	XR250	→84	D8EA	2120	DR8EVX	6354	DR8EIX	6681	0.7
	XR250RE	84→95	DPR9Z	4830					0.7
	XR250RT/V	96→01	CR9EH-9	7502			CR9EHIX-9	6216	0.9
XR250	01→04	CR9EH-9	7502			CR9EHIX-9	6216	0.9	
280	SH300i	07→	LMAR8A-9	4313					0.9
	NSS300 Forza	13→	LMAR8A-9	4313					0.9
286	CB300R Neo Sports Café	18→					SIMR8A9	91064	0.9
	CBR300R	15→					SIMR8A9	91064	0.9
350	CB350SG	86→88	DR8ES-L	2923	DR8EVX	6354	DR8EIX	6681	0.7
	XR350R-D		DPR8EA-9	4929			DPR8EIX-9	2202	0.9
	XR350R-E		DPR7EA-9	5129			DPR7EIX-9	7803	0.9
360	CB360G		B8ES	2411			BR8EIX	5044	0.7
400	CB400 (N/NA/NC/T)	78→85	DR8ES	5423			DR9EIX	4772	0.7
	CB400F1, F2	89→91	D8EA	2120	DR8EVX	6354	DR8EIX	6681	0.7
	NS400RF	85→88	BR9ES	5722			BR9EIX	3981	0.7
	VF400F-D	83→86	DPR8EA-9	4929			DPR8EIX-9	2202	0.9
	VFR400 R3-L-P	90→93	ER9EH	5869					0.7
	XR400RT/V		DPR8Z	4730					0.6
450	CB450DX-K	89→92	DR8ES	5423			DR9EIX	4772	0.7
	CRF450L	19→					SILMAR9A9S	6213	0.9
	CRF450R (19mm Thread Reach)	02→08					IFR8H11	5068	1.1
	CRF450R (26.5mm Thread Reach)	09→					SILMAR9A9S	6213	0.9
	CRF450RX	17→					SILMAR9A9S	6213	0.9



CC	MODEL	DATE	STANDARD COPPER CORE	STOCK NUMBER	PLATINUM OR GOLD PALLADIUM	STOCK NUMBER	IRIDIUM	STOCK NUMBER	GAP MM
HONDA (CONTINUED)									
450	CRF450X	05→					IFR8H11	5068	1.1
480	CR480R-D		B8EG	3430			BR8EIX	5044	0.5
500	CB500F	03/13→	CPR8EA-9	2306			CR8EIX	4218	0.9
	CB500 T	75→80	B8ES	2411			BR8EIX	5044	0.7
	CB500 R, T, V, W, X, Y	94→	CR8EH-9	5666			CR8EHIX-9	3797	0.9
	CB500S-W (Half Fairing)	98→	CR8EH-9	5666			CR8EHIX-9	3797	0.9
	CB500X	05/13→	CPR8EA-9	2306			CR8EIX	4218	0.9
	CBF500	04→	CR8EH-9S	7750			CR8EHIX-9	3797	0.9
	CBR500R	03/13→	CPR8EA-9	2306			CR8EIX	4218	0.9
	CR500R-E S, T, V, W, X	93→	BR8EG	3130			BR8EIX	5044	0.5
	CX500 (Z, A, B, CA, DA, CB, EC)	78→84	DR8ES-L	2923	DR8EVX	6354	DR8EIX	6681	0.7
	CX500 TURBO	82→84					DPR8EIX-9	2202	0.9
	FT500-C	82→84	DR8ES	5423			DR9EIX	4772	0.7
	GL500 Silverwing	82→84	DR8ES-L	2923	DR8EVX	6354	DR8EIX	6681	0.6
	VF500F 2E/2F	84→87	DPR8EA-9	4929			DPR8EIX-9	2202	0.9
	VT500E-D/F	83→88	DPR8EA-9	4929			DPR8EIX-9	2202	0.9
	XBR500F/H/SJ	85→89	DPR8EA-9	4929			DPR8EIX-9	2202	0.9
	XL500 (SA,RC)	79→84	DR8ES-L	2923	DR8EVX	6354	DR8EIX	6681	0.7
	XR500		DR8ES-L	2923	DR8EVX	6354	DR8EIX	6681	0.7
550	CB550		DR7ES	3123					0.7
	CBX550F (C,2-C)	82→86	DR8ES	5423			DR9EIX	4772	0.7
600	CB600F (Hornet)	98→06	CR9EH-9	7502			CR9EHIX-9	6216	0.9
	CB600F (Hornet)	07→	CR9EH-9	7502			CR9EHIX-9	6216	0.9
	CB600FA (Hornet with ABS)	08→	CR9EH-9	7502			CR9EHIX-9	6216	0.9
	CBF600 N/S (Incl. ABS)	04→07	CR9EH-9	7502			CR9EHIX-9	6216	0.9
	CBF600 N/S (Incl. ABS)	08→	CR8EH-9	5666			CR8EHIX-9	3797	0.9
	CBR600F H, J	87→88	DPR8EA-9	4929			DPR8EIX-9	2202	0.9
	CBR600F K, L	89→90	DPR9EA-9	5329			DPR9EIX-9	5545	0.9
	CBR600F M, N, P, R, S, T, V, W	91→98	CR9EH-9	7502			CR9EHIX-9	6216	0.9
	CBR600F X, Y	99→00	CR9EH-9	7502			CR9EHIX-9	6216	0.9
	CBR600FI / FSI Injection	2001					IMR9A-9H	6966	0.9
	CBR600F Injection	02→07					IMR9C-9H	6777	0.9
	CBR600F Sport	02→07					IMR9C-9H	6777	0.9
	CBR600F	03/11→	CR9EH-9	7502			CR9EHIX-9	6216	0.9
	CBR600RR	03/03→08					IMR9C-9HES	5766	0.9
	CBR600RR (Incl. ABS)	09→					IMR9E-9HES	7556	0.9
	FJS600 Silverwing (Incl. ABS)	01→	CR8EH-9	5666			CR8EHIX-9	3797	0.9
	NTV600K/M Revere	88→93	DPR8EA-9	4929			DPR8EIX-9	2202	0.9
	VT600C N, P, R, S, T, V, W	92→01	DPR8EA-9	4929			DPR8EIX-9	2202	0.9
	XL600LM-F	84→86	DPR8EA-9	4929			DPR8EIX-9	2202	0.9
XL600R D, E	84→86	DPR8EA-9	4929			DPR8EIX-9	2202	0.9	
XL600VH-VX (Transalp)	87→00	DPR8EA-9	4929			DPR8EIX-9	2202	0.9	
XR600R-V		DPR8EA-9	4929			DPR8EIX-9	2202	0.8	
650	CB650 Z, 2, B	78→82	DR8ES-L	2923	DR8EVX	6354	DR8EIX	6681	0.7
	CB650 SC-C (Nighthawk)	82→84	DR8ES-L	2923	DR8EVX	6354	DR8EIX	6681	0.7
	CB650FA	14→	CR9EH-9	7502			CR9EHIX-9	6216	0.9
	CBR650FA	14→	CR9EH-9	7502			CR9EHIX-9	6216	0.9
	CX650E-D	83→86	DPR8EA-9	4929			DPR8EIX-9	2202	0.9
	CX650TC-D	83→85	DPR8EA-9	4929			DPR8EIX-9	2202	0.9
	FMX650	05→08	DPR8EA-9	4929			DPR8EIX-9	2202	0.9
	FX650 Vigor	99→03	DPR8EA-9	4929			DPR8EIX-9	2202	0.9
	GL650 Silverwing	83→87	DPR8EA-9	4929			DPR8EIX-9	2202	0.9
	NT650V-W-X-Y (Deauville)	98→05	DPR8EA-9	4929			DPR8EIX-9	2202	0.9
	NTV650P-T/V	92→97	DPR8EA-9	4929			DPR8EIX-9	2202	0.9
	NX650K-T-V-W-X Dominator	88→03	DPR8EA-9	4929			DPR8EIX-9	2202	0.9
	SLR650	96→99	DPR8EA-9	4929			DPR8EIX-9	2202	0.8
	XL650 /-V (Transalp)	00→07	DPR8EA-9	4929			DPR8EIX-9	2202	0.9
	XR650R, R-2		BKR7E-11	1283					1.0
670	NC700D Integra	12→13					IFR6G-11K	1314	1.1
	NC700S/X	12→13					IFR6G-11K	1314	1.1
680	DN-01	08→11					SIMR8A9	91064	0.9
	NT700V Deauville (Incl. ABS)	06→	CPR8EA-9	2306			CR8EIX	4218	0.9
	XL700V Transalp (Incl. ABS)	08→	CPR8EA-9	2306			CR8EIX	4218	0.9



CC	MODEL	DATE	STANDARD COPPER CORE	STOCK NUMBER	PLATINUM OR GOLD PALLADIUM	STOCK NUMBER	IRIDIUM	STOCK NUMBER	GAP MM
HONDA (CONTINUED)									
745	NC750 Integra	14→					IFR6G-11K	1314	1.1
	NC750S/X	14→					IFR6G-11K	1314	1.1
	NM4 Vultus	14→					IFR6G-11K	1314	1.1
750	CB750 (SOHC)	70→78	D8EA	2120	DR8EVX	6354	DR8EIX	6681	0.7
	CB750 (DOHC)	79→84	DR8ES	5423			DR9EIX	4772	0.7
	CB Seven Fifty	92→02	DPR8EA-9	4929			DPR8EIX-9	2202	0.9
	CBX750FE	84→86	DPR8EA-9	4929			DPR8EIX-9	2202	0.9
	NR (750)	1992	ER9EH	5869					0.7
	RVF750R-S (RC45)	94→98					CR9EHIX-9	6216	0.9
	VF750 (C/F/S)		DPR8EA-9	4929			DPR8EIX-9	2202	0.9
	VF750CP-S		CR8EH-9	5666			CR8EHIX-9	3797	0.9
	VFR750F G, F, K	86→88	DPR9EA-9	5329			DPR9EIX-9	5545	0.9
	VFR750F L-V	89→97	CR8EH-9	5666			CR8EHIX-9	3797	0.9
	VFR750R-K/L (RC30)	88→92	CR9EH-9	7502			CR9EHIX-9	6216	0.9
	VT750C2 VT750 V/W Shadow	97→00	DPR8EA-9	4929			DPR8EIX-9	2202	0.8
	VT750DC Shadow	01→06	DPR8EA-9	4929			DPR8EIX-9	2202	0.8
	VT750C NEC Shadow Spirit	07→09	DPR7EA-9	5129			DPR7EIX-9	7803	0.9
	VT750DC Shadow Spirit	07→09	DPR7EA-9	5129			DPR7EIX-9	7803	0.9
	VT750C Shadow Black Spirit	10→	DPR7EA-9	5129			DPR7EIX-9	7803	0.9
	VT750S	10→	DPR7EA-9	5129			DPR7EIX-9	7803	0.9
	XRV750L V, W, X, Y (Africa Twin)	90→03	DPR8EA-9	4929			DPR8EIX-9	2202	0.9
800	VFR800F-W Fi X-Y (781cc)	97→01	CR9EH-9	7502			CR9EHIX-9	6216	0.8
	VFR800F-W K2→Fi VTEC (Incl. ABS) (782cc)	02→					IMR9B-9H	4888	0.9
	VFR800X Crossrunner (782cc)	05/11→					IMR9D-9H	6544	0.9
900	CB900F/F2 (Z, D, 2-D)	79→85	DR8ES	5423			DR9EIX	4772	0.7
	CB900F Hornet	02→08	CR8EH-9	5666			CR8EHIX-9	3797	0.9
	CBR900RR-N-S Fireblade (893cc)	92→95	CR9EH-9	7502			CR9EHIX-9	6216	0.9
	CBR900RR T, V, W, X Fireblade (918cc)	96→99	CR9EH-9	7502			CR9EHIX-9	6216	0.9
	CBR900RR Y Fireblade (929cc Injection Model)	00→01					CR9EHI-9	6419	0.9
	CBR900RR K2 Fireblade (954cc '02 model)	02→03					IMR9C-9H	6777	0.9
1000	CB1000 F-V	92→97	DPR9EA-9	5329			DPR9EIX-9	5545	0.9
	CB1000R/RA	08→17					IMR9E-9HES	7556	0.9
	CB1000R Neo Sports Café	18→					IMR9E-9HES	7556	0.9
	CBF1000 (Incl. ABS)	06→10	CR8EH-9	5666			CR8EHIX-9	3797	0.9
	CBF1000A (Incl. ABS)	10→					IMR8C-9HES	5990	0.9
	CBF1000F (Incl. ABS & GT)	10→					IMR8C-9HES	5990	0.9
	CBR1000FH-FX	87→99	DPR9EA-9	5329			DPR9EIX-9	5545	0.9
	CBR1000RR Fireblade	04→07					IMR9C-9HES	5766	0.9
	CBR1000RR Fireblade (Incl. ABS)	08→13					IMR9E-9HES	7556	0.9
	CBR1000RR Fireblade	14→16					IMR9E-9HES	7556	0.9
	CBR1000RR Fireblade SP	14→16					IMR9E-9HES	7556	0.9
	CBR1000RR Fireblade	17→20					SILMAR10C9S	95468	0.9
	CBR1000RR-R Fireblade	20→					SILMAR10C9S	95468	0.9
	CRF1000L Africa Twin (Twin Spark)	12/15→					SILMAR8A9S	90992	0.9
	CRF1000L Africa Twin Adventure Sports (Twin Spark)	18→					SILMAR8A9S	90992	0.9
	GL1000 (Gold Wing)	75→79	DR8ES-L	2923	DR8EVX	6354	DR8EIX	6681	0.7
	VF1000F2F Bol d'Or	85→86	DPR9EA-9	5329			DPR9EIX-9	5545	0.9
	VF1000FE	84→85	DPR8EA-9	4929			DPR8EIX-9	2202	0.9
	VF1000FF	85→87	DPR9EA-9	5329			DPR9EIX-9	5545	0.9
	VF1000RE-Standard	84→85	DPR8EA-9	4929			DPR8EIX-9	2202	0.9
	VF1000RE-High Speed	84→85	DPR9EA-9	5329			DPR9EIX-9	5545	0.9
	VF1000RF	85→88	DPR9EA-9	5329			DPR9EIX-9	5545	0.9
	VTR1000 F W-Y (Firestorm)	97→08					DPR9EIX-9	5545	0.9
	VTR1000 SP1	00→01					FR9BI-11	4709	1.1
	VTR1000 SP2	02→07					IFR9H11	6588	1.1
	XL1000V-Y (Varadero)	98→02					DPR8EIX-9	2202	0.8
XL1000V Varadero (Incl. ABS)	03→12					IJR8B9	4873	0.9	
1050	CBX1000B,C (6-cyl.)	78→84	DR8ES-L	2923	DR8EVX	6354	DR8EIX	6681	0.7
1100	CB1100 (RB,RC,RD) Road Use	82→84	DR8ES	5423			DR9EIX	4772	0.7
	CB1100SF-Y (X11)	99→02					CR8EHIX-9	3797	0.9
	CBR1100 XX V-Y (Super Blackbird)	96→00					CR9EHIX-9	6216	0.9
	CBR1100 XX K1 (Super Blackbird)	2001					IMR9A-9H	6966	0.9
	CBR1100 XX K2 (Super Blackbird) 3405930→	02→07					IMR9C-9H	6777	0.9



CC	MODEL	DATE	STANDARD COPPER CORE	STOCK NUMBER	PLATINUM OR GOLD PALLADIUM	STOCK NUMBER	IRIDIUM	STOCK NUMBER	GAP MM
HONDA (CONTINUED)									
1100	CRF1100L Africa Twin	20→					SILMAR8A9S	90992	0.9
	GL1100B (Gold Wing)	80→83	DR8ES-L	2923	DR8EVX	6354	DR8EIX	6681	0.7
	ST1100 ABS/TCS/T/V	95→03	CR8EH-9	5666			CR8EHIX-9	3797	0.9
	ST1100/L S-Y (Pan European)	89→03	CR8EH-9	5666			CR8EHIX-9	3797	0.9
1140	CB1100	13→	LMAR8A-9S	6817					0.9
	CB1100EX	14→	LMAR8A-9S	6817					0.9
1200	GL1200-EDE/IE/AE/AF/AH (Gold Wing)	84→88	DPR7EA-9	5129			DPR7EIX-9	7803	0.9
1237	VFR1200F/FD	10→					IMR9E-9HES	7556	0.9
	VFR1200X Crosstourer (Incl. Highlander-T)	04/12→					IMR8E-9HES	95397	0.9
1260	CTX1300	14→	CR8EH-9	5666			CR8EHIX-9	3797	0.9
	ST1300 Pan European (Incl. ABS)	02→14	CR7EH-9	3486			CR7EIX	7385	0.9
1300	CB1300 (Incl. ABS)	03→13	DPR8EA-9	4929			DPR8EIX-9	2202	0.9
	CB1300S (Incl. ABS)	05→13	DPR8EA-9	4929			DPR8EIX-9	2202	0.9
	VTX1300, VT1300CX	03→09	DCPR6E	3481					0.9
1500	GL1500 J-L, GL1500 SE M-Y (Gold Wing)	88→01	DPR6EA-9	5531					0.9
	GL1500CT (Gold Wing)	97→00	DPR7EA-9	5129			DPR7EIX-9	7803	0.9
	GL1500C-V-W-(F6C) (Gold Wing)	96→03	DPR7EA-9	5129			DPR7EIX-9	7803	0.9
1800	GL1800 (Gold Wing) (Incl. ABS)	01→17	BKR6E-11	2756			BKR6EIX-11	3764	1.1
	GL1800 F6B (Gold Wing Bagger)	14→17	BKR6E-11	2756			BKR6EIX-11	3764	1.1
	GL1800 F6C (Gold Wing)	14→17	BKR6E-11	2756			BKR6EIX-11	3764	1.1
	GL1800 (Gold Wing) (Incl. ABS)	18→	CR6HSB-9	97276					0.9
	VTX1800/C	01→08					IFR6L11	3678	1.1

HUONIAO									
50	HN50-QT8	07→	C7HSA	4629			CR7HIX	7544	0.7
125	HN125-8	06→	D8EA	2120			DR8EIX	6681	0.7

HUSABERG									
125	TE125	12→					BR9ECMIX	2707	0.6
250	FE250 (19mm Thread Reach)	2013	CR9EKB	2305			CR9EIX	3521	0.8
	FE250 (26.5mm Thread Reach)	14→					LMAR9AI-10	93188	1.0
	TE250	11→	BR7ES	5122			BR7EIX	6664	0.7
300	TE300	11→	BR7ES	5122			BR7EIX	6664	0.7
350	FE350	13→					LMAR9AI-8	97225	0.8
390	FE390	10→					LKAR8AI-9	6706	0.9
400	FE, FS 400E/C	00→	DCPR8E*	4179			DCR8EIX	3606	0.6
450	FE450	09→					LKAR8AI-9	6706	0.9
470	FC, FX 470/6, E	00→	DCPR8E*	4179			DCR8EIX	3606	0.6
510	FE501	13→					LKAR8AI-9	6706	0.9
550	FC550/4/6	00→	DCPR8E*	4179			DCR8EIX	3606	0.6
565	FE570	09→					LKAR8AI-9	6706	0.9
	FS570	10→					LKAR8AI-9	6706	0.9
650	FE, FS, FX 650 Supermoto	00→	DCPR8E*	4179			DCR8EIX	3606	0.6

HUSQVARNA									
50	CR50	11→	BR8ECM	3035			BR8ECMIX	3520	0.7
	Husky Boy Basic	00→04	B8HS	5510			BR8HIX	7001	0.5
	Husky Boy Junior (12.7mm Thread Reach)	99→02	B6HS	4510			BR6HIX	3419	0.5
	Husky Boy Junior (19mm Thread Reach)	03→					BR10EIX	6801	0.6
	Husky Boy Racing	01→	B6HS	4510			BR6HIX	3419	0.5
	Husky Boy Senior (12.7mm Thread Reach)	99→02	B6HS	4510			BR6HIX	3419	0.5
	Husky Boy Senior (19mm Thread Reach)	03→					BR10EIX	6801	0.6
	SM50	02→10	BR9ES	5722			BR9EIX	3981	0.7
	SM50	11→	BR8ECM	3035			BR8ECMIX	3520	0.7
	WRS 50 (Scooter)		B9ES	2611			BR9EIX	3981	0.7
	WSM 50	03→	BR9ES	5722			BR9EIX	3981	0.7
	WXE 50	03→	BR9ES	5722			BR9EIX	3981	0.7
	65	CR65	06/11→	BR8ECM	3035			BR8ECMIX	3520
125	CR125	→91	B9EG	3530			BR9EIX	3981	0.5
	CR125	92→01					BR10EIX	6801	0.5



CC	MODEL	DATE	STANDARD COPPER CORE	STOCK NUMBER	PLATINUM OR GOLD PALLADIUM	STOCK NUMBER	IRIDIUM	STOCK NUMBER	GAP MM
HUSQVARNA (CONTINUED)									
125	CR125	02→05	BR9EG	3230			BR9EIX	3981	0.5
	CR125	10→	BR9EG	3230			BR9EIX	3981	0.6
	SM125 /S	98→	BR9EG	3230			BR9EIX	3981	0.5
	SMS4 125	11→	CR8E	1275			CR8EIX	4218	0.7
	TE125 Ø10mm Plug	11→13	CR8E	1275			CR8EIX	4218	0.7
	TE125 Ø14mm Plug	14→					BR9ECMIX	2707	0.6
	TX125	19→					BR9ECMIX	2707	0.6
	WR125	→91	B9EG	3530			BR9EIX	3981	0.5
	WR125	92→					BR10EIX	6801	0.5
	WR125	02→	BR9EG	3230			BR9EIX	3981	0.5
	WRE125	94→97	B10EG	3630			BR10EIX	6801	0.5
	WRE125 (Restricted)	98→04	BR9EG	3230			BR9EIX	3981	0.5
	WRE125 (Restricted)	09→12	BR9EG	3230			BR9EIX	3981	0.6
	WRK125	→89					BR10EIX	6801	0.5
	WSM125	04→	CR7HSA	4549			CR7HIX	7544	0.7
	WXE125	04→	CR7HSA	4549			CR7HIX	7544	0.7
150	TX 150 TPi	20→					GR8DI-12	90908	1.2
240	WR240		B8EG	3430			BR8EIX	5044	0.5
250	CR250	92→00					BR10EIX	6801	0.5
	CR250	01→04	B8EG	3430			BR8EIX	5044	0.5
	CR250	04→	BR8EG	3130			BR8EIX	5044	0.6
	FE250	14→					LMAR9AI-10	93188	1.0
	TC250	02→05	CR8EB	7784			CR8EIX	4218	0.7
	TC250 (4-Stroke) Ø10mm Plug	10→	CR9EB	6955			CR9EIX	3521	0.7
	TC250 (2-Stroke) Ø14mm Plug	14→	BR8ECM	3035			BR8ECMIX	3520	0.6
	TE250	02→	CR8EB	7784			CR8EIX	4218	0.7
	TE250 i.e (4-Stroke) Ø10mm Plug	10→12	CR9EB	6955			CR9EIX	3521	0.7
	TE250 (4-Stroke) Ø10mm Plug	2013					CR9EIA-9	6289	0.9
	TE250 (2-Stroke) Ø14mm Plug	14→17	BR7ES	5122			BR7EIX	6664	0.6
	TE250 (2-Stroke) Ø14mm Plug	18→					ZGR7GI-13G	96760	1.3
	TXC250	10→	CR9EB	6955			CR9EIX	3521	0.7
	WR250	92→01					BR9EIX	3981	0.5
	WR250	02→	BR8EG	3130			BR8EIX	5044	0.6
	WRK250	→89					BR10EIX	6801	0.5
260	WRK260	→89					BR10EIX	6801	0.5
300	TE300 (2-Stroke) Ø14mm Plug	14→17	BR7ES	5122			BR7EIX	6664	0.6
	TE300 (2-Stroke) Ø14mm Plug	18→					ZGR7GI-13G	96760	1.3
	WR300	09→	BR8EG	3130			BR8EIX	5044	0.6
302	TE310 (4-Stroke) Ø10mm Plug	09→10	CR8EB	7784			CR8EIX	4218	0.7
	TE310 (4-Stroke) Ø10mm Plug	11→12	CR9EB	6955			CR9EIX	3521	0.7
	TE310 (4-Stroke) Ø10mm Plug	2013					CR9EIA-9	6289	0.9
350	FE350	14→16					LMAR9AI-8	97225	0.8
	FE350	17→					LMAR9AI-10	93188	1.0
	TE350	90→95	C8E	7471			CR8EIX	4218	0.5
	WR350	92→02					BR9EIX	3981	0.5
360	CR360	92→94					BR8EIX	5044	0.5
	WR360	02→	B8EG	3430			BR8EIX	5044	0.5
390	CR390		B8EG	3430			BR8EIX	5044	0.5
400	SM400	02→05	CR8EB	7784			CR8EIX	4218	0.7
	TE400	01→	CR8EB	7784			CR8EIX	4218	0.7
	WR400		B8EG	3430			BR8EIX	5044	0.5
410	TE410	96→00	C8E	7471			CR8EIX	4218	0.5
	TE410e	99→00	CR7E	4578			CR7EIX	7385	0.6
430	CR430		B8EG	3430			BR8EIX	5044	0.5
	WR430		B8EG	3430			BR8EIX	5044	0.5
435	CR435		B8EG	3430			BR8EIX	5044	0.5
450	FE450	14→15					LKAR8AI-9	6706	0.9
	FE450	16→19					LMAR9AI-10	93188	1.0
	FE450	20→					LZMAR8BI-10	95680	1.0
	SM450R	03→07	CR8EB	7784			CR8EIX	4218	0.7
	SM450RR	08→	CR9EKB	2305			CR9EIX	3521	0.8
	TC449	11→	CR9EKB	2305			CR9EIX	3521	0.8
	TC450	04→	CR8EB	7784			CR8EIX	4218	0.7



CC	MODEL	DATE	STANDARD COPPER CORE	STOCK NUMBER	PLATINUM OR GOLD PALLADIUM	STOCK NUMBER	IRIDIUM	STOCK NUMBER	GAP MM
HUSQVARNA (CONTINUED)									
450	TE449	11→	CR9EKB	2305			CR9EIX	3521	0.8
	TE450	03→	CR8EB	7784			CR8EIX	4218	0.7
478	SMR511	11→	CR9EKB	2305			CR9EIX	3521	0.8
	TE511	11→	CR9EKB	2305			CR9EIX	3521	0.8
500	CR500		B8EG	3430			BR8EIX	5044	0.5
	WR500		B8EG	3430			BR8EIX	5044	0.5
	TC500 (Air Cooled)	→5/86	D8EA	2120	DR8EVX	6354	DR8EIX	6681	0.5
510	FE501	14→					LKAR8AI-9	6706	0.9
	SM510 R i.e	10→	CR8EB	7784			CR8EIX	4218	0.7
	TC510 (Liquid Cooled)	06/86→90	C7E	5096			CR7EIX	7385	0.5
	TE510 (Air Cooled)	→5/86	D8EA	2120	DR8EVX	6354	DR8EIX	6681	0.5
	TE510 (Liquid Cooled)	06/86→90	C7E	5096			CR7EIX	7385	0.6
	TE510	04→	CR8EB	7784			CR8EIX	4218	0.7
530	SM530RR	09→	CR9EKB	2305			CR9EIX	3521	0.8
570	SM570	01→04	CR7EB	4663			CR7EIX	7385	0.6
	SM570R	02→04	C7E	5096			CR7EIX	7385	0.6
	SM570R 2004 (Competition Plug)	04→	C8E	7471			CR8EIX	4218	0.5
	TC570	01→02	CR7EB	4663			CR7EIX	7385	0.6
	TE570	01→03	CR7EB	4663			CR7EIX	7385	0.6
600	SMS630 i.e	11→	CR8EB	7784			CR8EIX	4218	0.7
	TE630 i.e	11→	CR8EB	7784			CR8EIX	4218	0.7
610	SM610 S (Std. Plug)	98→05	CR7E	4578			CR7EIX	7385	0.6
	SM610 S (Competition Plug)	03→	C8E	7471			CR8EIX	4218	0.5
	SM610	06→	CPR8E	7411			CR8EIX	4218	0.8
	TC610	91→00	C7E	5096			CR7EIX	7385	0.5
	TE610	91→00	C8E	7471			CR8EIX	4218	0.5
	TE610e	98→05	CR7E	4578			CR7EIX	7385	0.6
630	SMR630	04→	R0045Q-10	4216					1.1
650	TR650 Strada (Twin Spark)	10/12→	MAR9A-6J	91321					0.8
	TR650 Terra (Twin Spark)	10/12→	MAR9A-6J	91321					0.8
692	701 Enduro (Twin spark)	18→	Ø10mm Plug Ø12mm Plug				LMAR7DI-10	96956	1.0
							LKAR9BI-10	95371	1.0
890	Norden 901	22→					LMAR9AI-10	93188	1.0
900	Nuda 900, 900R	12→	LMAR8C-9	93833					0.9

HYMOTO									
50	HY50		C7HSA	4629			CR7HIX	7544	0.7
	MP DB701 2-Stroke		BPM7A	7321					0.7
70	HY70		C7HSA	4629			CR7HIX	7544	0.7
90	HY90		C7HSA	4629			CR7HIX	7544	0.7
110	HY110		C7HSA	4629			CR7HIX	7544	0.7
125	HY125		C7HSA	4629			CR7HIX	7544	0.7
	HY125S		C7HSA	4629			CR7HIX	7544	0.7

HYOSUNG									
50	SD50, Sense50	99→05	BP6HS	4511			BPR6HIX	4085	0.7
	SF50	99→05	BR8HSA	5539			BPR8HIX	6742	0.7
100	EZ100	99→	BP7HS	5111			BPR7HIX	5944	0.7
110	FX110		C6HSA	3228			CR6HIX	7274	0.7
	Midas DLX 110	99→	C6HSA	3228			CR6HIX	7274	0.7
125	Cruise 1 125	96→	D8EA	2120	DR8EVX	6354	DR8EIX	6681	0.7
	Cruise 2 125	99→	CR8EH-9	5666			CR8EHIX-9	3797	0.9
	GA125 Cruise III	00→	CR8EH-9	5666			CR8EHIX-9	3797	0.9
	GF125	99→	CR8EH-9	5666			CR8EHIX-9	3797	0.9
	Grand Prix 125, GP-Plus	99→	DR8EA	7162	DR8EVX	6354	DR8EIX	6681	0.7
	GT125	03→	CR8E	1275			CR8EIX	4218	0.6
	GT125R	06→	CR8E	1275			CR8EIX	4218	0.6
	GV125 Aquila	00→	CR8E	1275			CR8EIX	4218	0.6
	GV125C	08→	CR8E	1275			CR8EIX	4218	0.8
	HD125 Hyper	04→06	DR8EA	7162	DR8EVX	6354	DR8EIX	6681	0.8
	MS3-125	07→	CR8E	1275			CR8EIX	4218	0.8



CC	MODEL	DATE	STANDARD COPPER CORE	STOCK NUMBER	PLATINUM OR GOLD PALLADIUM	STOCK NUMBER	IRIDIUM	STOCK NUMBER	GAP MM
HYOSUNG (CONTINUED)									
125	RT125 (SOHC engine)	04→07	CR8EH-9	5666			CR8EHIX-9	3797	0.9
	RT125D (DOHC engine)	07→	CR8E	1275			CR8EIX	4218	0.8
	RX125 (SOHC engine)	00→07	CR8EH-9	5666			CR8EHIX-9	3797	0.9
	RX125D-E (DOHC engine)	07→	CR8E	1275			CR8EIX	4218	0.8
	RX125D SM (DOHC engine)	07→	CR8E	1275			CR8EIX	4218	0.8
	XRX125 (SOHC engine)	→07	CR8EH-9	5666			CR8EHIX-9	3797	0.8
250	GT250, Comet	03→	CR8E	1275			CR8EIX	4218	0.8
	GT250 EFI, Comet	08→	CR8E	1275			CR8EIX	4218	0.8
	GT250R	06→08	CR8E	1275			CR8EIX	4218	0.8
	GT250R EFI	08→	CR8E	1275			CR8EIX	4218	0.8
	GV250, Aquila	00→	CR8E	1275			CR8EIX	4218	0.8
	GV250 EFI, Aquila	08→	CR8E	1275			CR8EIX	4218	0.8
	MS3-250	07→	CR8E	1275			CR8EIX	4218	0.8
650	GT650, Comet	03→	CR8E	1275			CR8EIX	4218	0.8
	GT650 EFI, Comet	08→	CR8E	1275			CR8EIX	4218	0.8
	GT650N	12→	CR8E	1275			CR8EIX	4218	0.8
	GT650R	06→08	CR8E	1275			CR8EIX	4218	0.8
	GT650R EFI	08→	CR8E	1275			CR8EIX	4218	0.8
	GT650S	06→08	CR8E	1275			CR8EIX	4218	0.8
	GV650, Aquila	06→08	CR8E	1275			CR8EIX	4218	0.8
	GV650 EFI, Aquila	08→	CR8E	1275			CR8EIX	4218	0.8
680	GV700C EFI	10→	CR8E	1275			CR8EIX	4218	0.8

INDIAN									
1130	Scout, Scout Sixty	15→	MR7F	95897					0.8
1768	Challenger - Limited, Dark Horse	20→					LZMAR8AI-10	94021	1.0
1850	Dakota 4 - Classic, Highway, 4 si (Carb)		BPR6HS	7022			BPR6HIX	4085	0.6
	Dakota 4 - Classic, Highway, 4 si (Injection)		BPR7HS	6422			BPR7HIX	5944	0.6

ITALJET									
50	Dragster D50 LC (Liquid Cooled)	98→04	BR8HS	4322			BR8HIX	7001	0.6
	Formula 50, 50 A, Formula 50 Williams (Air Cooled)	96→04	BPR6HS	7022			BPR6HIX	4085	0.6
	Formula 50 LC	98→04	BR7HS	4122			BR7HIX	7067	0.6
	Jetset 50 2T	01→04	BR9ES	5722			BR9EIX	3981	0.7
	Torpedo 50/T50	97→04	BPR6HS	7022			BPR6HIX	4085	0.6
	Velocifero 50/V50	96→	BPR6HS	7022			BPR6HIX	4085	0.6
100	Millennium 100	00→04	BR7HS	4122			BR7HIX	7067	0.6
125	Dragster D125LC (2-Stroke Liquid Cooled)	99→04	BR9ES	5722			BR9EIX	3981	0.7
	Formula 125 LC (Liquid Cooled)	97→04	BR7HS	4122			BR7HIX	7067	0.6
	Jetset 125 4T	01→04	CR7E	4578			CR7EIX	7385	0.6
	Millennium (4-Stroke Liquid Cooled)	00→04	CR8E	1275			CR8EIX	4218	0.7
	Torpedo T125 4T		CR8E	1275			CR8EIX	4218	0.6
150	Jetset 150 4T	01→04	CR7E	4578			CR7EIX	7385	0.6
	Millennium 150	00→04	CR7E	4578			CR7EIX	7385	0.6
176	Dragster D180LC (2-Stroke Liquid Cooled)	99→04	BR9ES	5722			BR9EIX	3981	0.7
250	Jupiter 250	01→04	DR8EA	7162	DR8EVX	6354	DR8EIX	6681	0.7

JAWA-CZ									
50	Jawa Economy, Jive, Jazz		B6HS	4510			BR6HIX	3419	0.5
	MJ50, Korado Basic/K'start, Lux		B6HS	4510			BR6HIX	3419	0.5
125	CZ125	→84	B8HS	5510			BR8HIX	7001	0.5
	CZ125 Oilmaster	84→	B8HS	5510			BR8HIX	7001	0.5
175	CZ175	→84	B8HS	5510			BR8HIX	7001	0.5
	CZ175	84→	B8HS	5510			BR8HIX	7001	0.5
180	CZ180	84→	B8HS	5510			BR8HIX	7001	0.5
250	CZ250 Single/DeLuxe	→84	B8HS	5510			BR8HIX	7001	0.5
	CZ250	84→	B8HS	5510			BR8HIX	7001	0.5
350	CZ350	→84	B8HS	5510			BR8HIX	7001	0.5
	CZ350 Classic/Style/Sport/Chopper	84→	B8HS	5510			BR8HIX	7001	0.7
500	Jawa 500R	86→90	D8EA	2120	DR8EVX	6354	DR8EIX	6681	0.5



CC	MODEL	DATE	STANDARD COPPER CORE	STOCK NUMBER	PLATINUM OR GOLD PALLADIUM	STOCK NUMBER	IRIDIUM	STOCK NUMBER	GAP MM
JIALING									
50	CJ50F/K		BPR6HS	7022			BPR6HIX	4085	0.7
	JD50, JL50	97→00	BPR6HSA	4632			BPR6HIX	4085	0.6
	JH50	95→	C7HSA	4629			CR7HIX	7544	0.7
	LX50		BPR6HSA	4632			BPR6HIX	4085	0.7
	QM50		BPR4HS	7823					0.7
	TA55		BPR6HSA	4632			BPR6HIX	4085	0.7
70	CJ70		CR7HSA	4549			CR7HIX	7544	0.7
	JD70, JH70	94→00	C7HSA	4629			CR7HIX	7544	0.7
90	JH90	94→96	C6HSA	3228			CR6HIX	7274	0.7
	K90		BP7HS	5111			BPR7HIX	5944	0.7
100	K100		BP7HS	5111			BPR7HIX	5944	0.7
	QM100		BP7HS	5111			BPR7HIX	5944	0.7
125	JH125	94→02	DR8ES-L	2923	DR8EVX	6354	DR8EIX	6681	0.7
	Sanyang Duke 125		DPR7EA-9	5129			DPR7EIX-9	7803	0.9
	Sanyang Wolf 125		DR8ES-L	2923	DR8EVX	6354	DR8EIX	6681	0.7

JIANSHE									
125	JS125Y Tiger	03→	DR8ES	5423			DR9EIX	4772	0.7

JINLUN									
50	JL50QT	04→	CR7HSA	4549			CR7HIX	7544	0.7
125	Hornet 125	08→	CR7HSA	4549			CR7HIX	7544	0.7
	JL125-11/13	06→	CR7HSA	4549			CR7HIX	7544	0.7
	JL125-C/Y	05→	CR7HSA	4549			CR7HIX	7544	0.7
	JL125T	05→	CR7HSA	4549			CR7HIX	7544	0.7
150	JL150	05→	D8EA	2120	DR8EVX	6354	DR8EIX	6681	0.7
250	JL250	06→	CR7HSA	4549			CR7HIX	7544	0.7

JONWAY									
50	Madness 50		C7HSA	4629			CR7HIX	7544	0.7
125	Adventure	09→	C7HSA	4629			CR7HIX	7544	0.7

KAWASAKI									
50	AE50 A1/A2, AR50 A1/C1-C10	81→97	B6ES	7310					0.7
60	KX60 A, B1-B13	83→97	B9EG	3530			BR9EIX	3981	0.7
	KX60 B14-B17	98→01	BR9EG	3230			BR9EIX	3981	0.5
65	KX65 A1-A6	00→05	BR10EG	3830			BR10EIX	6801	0.7
80	AE80 A, AR80 A	81→82	BP8ES	2912			BPR8EIX	6684	0.7
	AE80 B, AR80 C1-C8	83→93	BPR8ES	3923			BPR8EIX	6684	0.7
	KX80 A, B	79→80	B8EG	3430			BR8EIX	5044	0.5
	KX80 C-R1	81→91	BR9EG	3230			BR9EIX	3981	0.5
	KX80 R2-R7	92→97	R6252K-105	2741					0.7
	KX80 W1, W2	98→99	R6252K-105	2741					0.7
	KX80 W3	00→	R6252K-105	2741					0.7
85	KX85 A1-A5/B1-B5	01→05	R6252K-105	2741					0.7
	KX85 A6F/B6F	06→13	R6252K-105	2741					0.7
	KX85 II	14→	R6252K-105	2741					0.7
90	KM90A	73→80	B7HS	5110			BR7HIX	7067	0.5
100	G7TA	73→76	B8HS	5510			BR8HIX	7001	0.6
	KC100 C1-C4	79→86	B8ES	2411			BR8EIX	5044	0.7
	KE100 A7-A10, B1-B15	78→99	BR8ES	5422			BR8EIX	5044	0.7
	KH100 A1-A4 (KH100EL)	77→81	B8ES	2411			BR8EIX	5044	0.7
	KH100 G2-G8 (KH100EX)	81→93	B8ES	2411			BR8EIX	5044	0.7
	KM100 A1-A4, A6-A7	76→81	B7HS	5110			BR7HIX	7067	0.6
	KX100 A1-A2, B1	89→91	BR9EG	3230			BR9EIX	3981	0.5
	KX100 B2-B7	92→97	R6252K-105	2741					0.7
	KX100 C1-C3	98→00	R6252K-105	2741					0.7
	KX100 D1-D5, D6F-D9F	01→09	R6252K-105	2741					0.7



CC	MODEL	DATE	STANDARD COPPER CORE	STOCK NUMBER	PLATINUM OR GOLD PALLADIUM	STOCK NUMBER	IRIDIUM	STOCK NUMBER	GAP MM
KAWASAKI (CONTINUED)									
110	KLX110 A1/A2	02→	CR6HSA	2983			CR6HIX	7274	0.6
	KSR110	03→	CR6HSA	2983			CR6HIX	7274	0.6
125	AR125 A1, A1A, A1B, A2-A7, B1-B8	82→94	BR8ES	5422			BR8EIX	5044	0.7
	BN125 A1-A8 (Eliminator)	98→05	CR7E	4578			CR7EIX	7385	0.7
	BN125 A6F-A7F, A9F (Eliminator)	06→	CR7E	4578			CR7EIX	7385	0.7
	BR125 (Z125)	19→	LMAR8G	95627					0.8
	BX125 (Ninja 125)	19→	LMAR8G	95627					0.8
	D-Tracker	10→	CR7HSA	4549			CR7HIX	7544	0.7
	KDX125 A1/A2, B1/B2	90→94	BR8ES	5422			BR8EIX	5044	0.7
	KE125 A3-A6	76→79	B8HS	5510			BR8HIX	7001	0.6
	KE125 A7-A8	80→81	B8ES	2411			BR8EIX	5044	0.7
	KE125 A9-A12	82→87	B9ES	2611			BR9EIX	3981	0.7
	KH125 A/L/K/K4/K7-K9	82→99	BR8ES	5422			BR8EIX	5044	0.7
	KLX125	10→	CR7HSA	4549			CR7HIX	7544	0.7
	KMX125 A1-A5/B1-B12	86→02	BR8ES	5422			BR8EIX	5044	0.7
	KX125 A1-A5	74→79	B9EG	3530			BR9EIX	3981	0.6
	KX125 A6-A7, B1	80→82					BR9EIX	3981	0.6
	KX125 B2, D-G, H1	83→90	BR10EG	3830			BR10EIX	6801	0.6
	KX125 H2	1991	R6252E-105	2396					0.6
	KX125 J1, J2	92→93	R6252K-105	2741					0.7
	KX125 K1-K5, L1-L4	94→02					BR9EIX	3981	0.6
	KX125 M1	2003					BR9EIX	3981	0.6
	KX125 M2-M3	04→05				R6918B-9	2954		0.8
	KX125 M6, M7F	06→					BR9ECMIX	2707	0.8
	SC125 (J125)	16→	CR7E	4578			CR7EIX	7385	0.7
175	KDX175 A1-A2	80→81	B9ES	2611			BR9EIX	3981	0.7
	KDX175 A3, B1-B2	82→83					BR9EIX	3981	0.6
	KE175 B1-B3	76→79	B9HS	5810			BR9HIX	5687	0.6
	KE175 D1	1979	B9ES	2611			BR9EIX	3981	0.6
	KE175 D2-D5	80→84	B7ES	1111			BR7EIX	6664	0.7
200	KDX200 E1-E6	89→94	BR9ES	5722			BR9EIX	3981	0.7
	KDX200 H1-H10	95→04	BR8ES	5422			BR8EIX	5044	0.7
	KMX200 A2-A4	88→90	BR8ES	5422			BR8EIX	5044	0.7
	Z200 A1-A4	77→81	B7ES	1111			BR7EIX	6664	0.7
	Z200 A5-A6	82→88	BR7ES	5122			BR7EIX	6664	0.7
220	KDX220 A4-A7	97→00	BR8ES	5422			BR8EIX	5044	0.7
	KDX220 A8-A12	01→05	BR8ES	5422			BR8EIX	5044	0.7
250	A1 (Samurai)	67→71	B8HS	5510			BR8HIX	7001	0.6
	BR250 (Z250SL)	15→					MR8CI-8	96973	0.8
	BX250 (Ninja 250SL)	15→					MR8CI-8	96973	0.8
	EL250 D4-D5	93→96	CR8HSA	2086			CR8HIX	7669	0.7
	EL250 F2 (EL252)	97→99	CR8HSA	2086			CR8HIX	7669	0.7
	ER250 B1-B3 (Z250T)	83→90	DPR9EA-9	5329			DPR9EIX-9	5545	0.9
	EX250 F2-F8 (GPX250), H1-H2 (ZZ-R250)	88→92	CR8HSA	2086			CR8HIX	7669	0.6
	EX250 F9 (GPX250R)	1995	CR8HSA	2086			CR8HIX	7669	0.6
	EX250 K8F (Ninja 250R)	08→12	CR8E	1275			CR8EIX	4218	0.7
	F11	72→75	B9HS	5810			BR9HIX	5687	0.6
	KDX250 B2-B4, C1-C3	82→85	BR8ES	5422			BR8EIX	5044	0.7
	KDX250 D1-D5, E1-E2	91→95	BR9ES	5722			BR9EIX	3981	0.7
	KH250 B1-B5	76→82	B9HS	5810			BR9HIX	5687	0.6
	KL250 A1-A4	77→83	B7ES	1111			BR7EIX	6664	0.7
	KL250 C1-C2	83→85	BR8ES	5422			BR8EIX	5044	0.7
	KL250 D2-D11, D16 (KLR250)	85→01	DPR9EA-9	5329			DPR9EIX-9	5545	0.9
	KLX250 B1-B2	81→82	BR7ES	5122			BR7EIX	6664	0.7
	KLX250 D1-D2	93→94	CR8E	1275			CR8EIX	4218	0.7
	KLX250 G1	94→97	CR8E	1275			CR8EIX	4218	0.7
	KLX250 T9F, TAF	09→	CR8E	1275			CR8EIX	4218	0.7
	KR250 B1, B2, B3 (KR-1)	89→90	BR9ES	5722			BR9EIX	3981	0.7
	KR250 C2, C3 (KR-1S)	90→92	BR10ES	4832			BR10EIX	6801	0.7
	KX250 A1-A7, B1	75→82	BR9EG	3230			BR9EIX	3981	0.7
	KX250 C1-C2, D1	83→85	BR8EG	3130			BR8EIX	5044	0.6
	KX250 D2, E1, F1, G1, H1-H2	86→91	BR9EG	3230			BR9EIX	3981	0.7
	KX250 K1-K5, L1-L4	94→02					BR8EIX	5044	0.6



CC	MODEL	DATE	STANDARD COPPER CORE	STOCK NUMBER	PLATINUM OR GOLD PALLADIUM	STOCK NUMBER	IRIDIUM	STOCK NUMBER	GAP MM
KAWASAKI (CONTINUED)									
250	KX250 M1-M2	03→04					BR8EIX	5044	0.6
	KX250 R1, R6F-R7F	05→07					BR8ECMIX	3520	0.6
	KX250 N1-N2 (KX250F 4-Stroke)	04→05	CR8EB	7784			CR8EIX	4218	0.7
	KX250 T6F-XAF (KX250F 4-Stroke)	06→10	CR8E	1275			CR8EIX	4218	0.7
	KX250 YBF Fi (KX250F 4-Stroke)	11→16	CPR8EB-9	6607					0.9
	KX252 (KX250F)	17→19	CPR8EB-9	6607					0.9
	KX252 (KX250)	20→					CR9EIB-9	92579	0.9
	S1 A, B, C (Mach 1)	72→75	B9HS	5810			BR9HIX	5687	0.6
	Z250 A1-A3, B1-B2	79→82	DR8ES	5423			DR9EIX	4772	0.6
Z250 C1-C2, G1-G2 (250LTD)	80→83	B7ES	1111			BR7EIX	6664	0.7	
300	KLE300 (Versys-X 300)	17→	CR8E	1275			CR8EIX	4218	0.7
	KLX300 A2-A8, B1-B3	97→03	CR8E	1275			CR8EIX	4218	0.7
	ER300 (Z300)	15→	CR8E	1275			CR8EIX	4218	0.7
	EX300 (Ninja 300)	13→	CR8E	1275			CR8EIX	4218	0.7
	SC300 (J300)	14→	CR7E	4578			CR7EIX	7385	0.7
305	EX305 A1 (GPz305)	83→84	DPR9EA-9	5329			DPR9EIX-9	5545	0.9
	EX305 B2-B10 (GPz305)	84→96	DPR9EA-9	5329			DPR9EIX-9	5545	0.9
350	A7 (Avenger)	67→71	B9HS	5810			BR9HIX	5687	0.6
	S2, S2A (Mach II)	72→73	B9HS	5810			BR9HIX	5687	0.6
400	KH400 A3-A5	76→78	B8HS	5510			BR8HIX	7001	0.7
	KX400 A	75→76	B9EG	3530			BR9EIX	3981	0.6
	S3, S3A	74→75	B9HS	5810			BR9HIX	5687	0.7
	EX400 (Ninja 400)	18→	LMAR9G	97476					0.8
	Z400 D3-D4	76→77	B8ES	2411			BR8EIX	5044	0.7
	Z400 B1-B2, G1	78→79	B7ES	1111			BR7EIX	6664	0.7
	Z400 J1-J2	80→81	D8EA	2120	DR8EVX	6354	DR8EIX	6681	0.7
	Z400 J3	82→83	DR8EA	7162	DR8EVX	6354	DR8EIX	6681	0.7
	ZR400 A (A400F)	83→84	DR8ES	5423			DR9EIX	4772	0.7
	ZR400 B1	84→85	DPR9EA-9	5329			DPR9EIX-9	5545	0.9
	ZX400 C2-C3	85→87	DPR9EA-9	5329			DPR9EIX-9	5545	0.9
ZX400 L1-L9 (ZXR400)	91→99	CR9EK	4548			CR9EIX	3521	0.7	
420	KX420A	80→81	B9EG	3530			BR9EIX	3981	0.6
440	Z440 A2-A3 (LTD), C1-C2	80→82	BR7ES	5122			BR7EIX	6664	0.6
	Z440 H1-H2, D4-D6 (LTD Belt Drive)	82→84	BR7ES	5122			BR7EIX	6664	0.6
450	EN450 A1-A5 (LTD Belt Drive)	85→90	DR8ES	5423			DR9EIX	4772	0.7
	KLX450 A8F	07→	CPR8EB-9	6607					0.9
	KX450 D6F	06→08	CPR8EB-9	6607					0.9
	KX450F	09→18	CPR8EB-9	6607					0.9
	KX450	19→	CPR8EB-9	6607					0.9
500	EN500 A1-A3	90→93	DR8ES	5423			DR9EIX	4772	0.7
	EN500 B2	94→	DR9EA	3437			DR9EIX	4772	0.7
	EN500 C1	96→99	DR9EA	3437			DR9EIX	4772	0.7
	ER500 A1-A4, C3, C4P (ER-5)	97→	DR9EA	3437			DR9EIX	4772	0.7
	ER500 C5P (ER-5)	06→07	DR9EA	3437			DR9EIX	4772	0.7
	EX500 A1-A6 (GPz500S)	87→93	DR8ES	5423			DR9EIX	4772	0.7
	EX500 D1-D3, D5-D7 (GPz500S)	94→00	DR9EA	3437			DR9EIX	4772	0.7
	EX500 E10	02→04	DR9EA	3437			DR9EIX	4772	0.7
	H1 (Mach III), H1A-H1F, KH500A8	69→76	B9HS-10	3626			BR9HIX	5687	1.0
	KLE500 A1-A13	91→03	DR9EA	3437			DR9EIX	4772	0.7
	KLE500 B6F, B7F	05→	DR9EA	3437			DR9EIX	4772	0.7
	KX500 A1-A2	83→84	BR9EG	3230			BR9EIX	3981	0.6
	KX500 B, C, D, E1-E16	85→04	BR8EG	3130			BR8EIX	5044	0.5
Z500 B1-B4	79→82	D8EA	2120	DR8EVX	6354	DR8EIX	6681	0.7	
550	Z550 A1-A3	80→83	DR8ES	5423			DR9EIX	4772	0.7
	Z550 C1-C2 (LTD)	81→83	D8EA	2120	DR8EVX	6354	DR8EIX	6681	0.7
	Z550 D1 (GPz550)	81→82	D8EA	2120	DR8EVX	6354	DR8EIX	6681	0.7
	Z550 G1-G9 (GT550)	83→01	DR8ES	5423			DR9EIX	4772	0.7
	Z550 H1-H2 (GPz550), ZR550 A1 (Z550F)	82→85	DR8ES	5423			DR9EIX	4772	0.7
	ZR550 B2-B6 (Zephyr 550)	91→98	DR9EA	3437			DR9EIX	4772	0.6
	ZX550 A2-A4 (GPz550)	85→91	DPR9EA-9	5329			DPR9EIX-9	5545	0.9
600	KL600 A1	84→85	D8EA	2120	DR8EVX	6354	DR8EIX	6681	0.7
	KL600 B1-B2, B4	85→90	DPR8EA-9	4929			DPR8EIX-9	2202	0.9
	ZL600 B1 (Eliminator 600)	95→97	DR9EA	3437			DR9EIX	4772	0.7



CC	MODEL	DATE	STANDARD COPPER CORE	STOCK NUMBER	PLATINUM OR GOLD PALLADIUM	STOCK NUMBER	IRIDIUM	STOCK NUMBER	GAP MM
KAWASAKI (CONTINUED)									
600	ZX600 A1-A5 (GPZ600R)	85→90	DR9EA	3437			DR9EIX	4772	0.7
	ZX600 C1-C7 (GPX600R)	88→96	DR9EA	3437			DR9EIX	4772	0.7
	ZX600 D1-D3, E1-E12 (ZZ-R600)	90→04	CR9E	6263			CR9EIX	3521	0.7
	ZX600 E6F (ZZR600)	06→	CR9E	6263			CR9EIX	3521	0.7
	ZX600 F1-F3 (Ninja ZX6R)	95→97	CR9E	6263			CR9EIX	3521	0.7
	ZX600 G1-G2 (ZX-6R)	98→99	CR9E	6263			CR9EIX	3521	0.7
	ZX600 J1-J2 (ZX-6R)	00→01	CR9E	6263			CR9EIX	3521	0.7
	ZX600 K1H-N6F (Ninja ZX-6RR)	03→06	CR9E	6263			CR9EIX	3521	0.7
ZX600 P7F-P8F, R9F-RCF (Ninja ZX-6R)	07→	CR9E	6263			CR9EIX	3521	0.7	
636	ZX636 A1P, B1H-B2H (Ninja ZX-6R)	02→04	CR9E	6263			CR9EIX	3521	0.7
	ZX636 C1H-C6F (Ninja ZX-6R)	05→06	CR9E	6263			CR9EIX	3521	0.7
	ZX636 (Ninja ZX-6R 636)	13→	CR9E	6263			CR9EIX	3521	0.7
650	EJ650 A1-A2, C1, C5, C6P (W650)	99→05	CR8E	1275			CR8EIX	4218	0.7
	EN650 (Vulcan S)	15→					CR9EIA-9	6289	0.9
	ER650 A7F-C9F (ER-6n)	06→16					CR9EIA-9	6289	0.9
	ER650 (Z650)	17→					CR9EIA-9	6289	0.9
	EX650 A7F-A8F, B7F-B8F (ER-6f)	06→16					CR9EIA-9	6289	0.9
	EX650 KH (Ninja 650)	17→					CR9EIA-9	6289	0.9
	KL650 A1-A3	87→90	DPR8EA-9	4929			DPR8EIX-9	2202	0.9
	KL650 B1-B3 (Tengai)	89→92	DPR8EA-9	4929			DPR8EIX-9	2202	0.9
	KL650 C1-C5 (KLR 650)	94→02	DPR8EA-9	4929			DPR8EIX-9	2202	0.9
	KLE650 A7F-FGF (Versys)	07→14					CR9EIA-9	6289	0.9
	KLE650 E,F,H (Versys)	15→					CR9EIA-9	6289	0.9
	KLX650 C1-C2	93→96	DPR8EA-9	4929			DPR8EIX-9	2202	0.9
	W650 (EJ650 A1-A2, C1, C5, C6P)	99→05	CR8E	1275			CR8EIX	4218	0.7
	Z650 B1-B3, C2-C3 (Custom)	77→79	B7ES	1111			BR7EIX	6664	0.7
	Z650 D2-D3 (SR)	79→82	B7ES	1111			BR7EIX	6664	0.7
	Z650 F1-F4	82→84	B7ES	1111			BR7EIX	6664	0.7
	Z650RS (ER650M, Classic)	22→					CR9EIA-9	6289	0.9
	750	H2 (Mach IV), H2A, H2B, H2C	72→75	B9HS-10	3626			BR9HIX	5687
VN750 A2-A10 (Vulcan)		86→94	DPR7EA-9	5129			DPR7EIX-9	7803	0.9
Z750 B1-B2		76→77	B8ES	2411			BR8EIX	5044	0.7
Z750 E1, H1-H2 (LTD), L1-L4		80→85	BR8ES	5422			BR8EIX	5044	0.7
Z750 P1-P5 (GT750)		82→92	BR8ES	5422			BR8EIX	5044	0.7
Z750 P7-P9 (GT750)		91→96	DR8ES	5423			DR9EIX	4772	0.6
Z750 R1 (GP)		82→83	BR8ES	5422			BR8EIX	5044	0.7
Z750 Y1 (LTD Twin)		82→83	BPR6ES	7822			BPR6EIX	6637	0.7
ZR750 C1-C4 (Zephyr 750)		91→94	DR8ES	5423			DR9EIX	4772	0.6
ZR750 C5 (Zephyr 750)		1995	DR9EA	3437			DR9EIX	4772	0.7
ZR750 D1 (Zephyr 750)		96→99	DR9EA	3437			DR9EIX	4772	0.7
ZR750 F1-F5 (ZR-7), H1-H3 (ZR-7S)		05/99→03	DR9EA	3437			DR9EIX	4772	0.7
ZR750 J1H (Z750)		04→	CR9EK	4548			CR9EIX	3521	0.7
ZR750 J6F (Z750)		05→	CR9EK	4548			CR9EIX	3521	0.7
ZR750 K6F (Z750s)		06→	CR9EK	4548			CR9EIX	3521	0.7
ZR750 L7F, L8F, L9F, LAF, M7F, M8F (Z750)		03/07→10	CR9EK	4548			CR9EIX	3521	0.7
ZR750 N (Z750R)		11→	CR9EK	4548			CR9EIX	3521	0.7
ZX750 A1-A3, A5 (GPz750)		83→89	BR9ES	5722			BR9EIX	3981	0.7
ZX750 E1-E2 (Turbo)		83→87					BR9EIX	3981	0.6
ZX750 F1-F5 (GPX750R)		87→91	DR8ES	5423			DR9EIX	4772	0.7
ZX750 G2-G3 (GPz750R)		84→87	D8EA	2120	DR8EVX	6354	DR8EIX	6681	0.7
ZX750 H1-H2 (ZXR750)		89→91	CR9E	6263			CR9EIX	3521	0.7
ZX750 J1-J2 (ZXR750)		91→93	CR9E	6263			CR9EIX	3521	0.7
ZX750 M1-M2 (ZXR750R)		92→94	CR9E	6263			CR9EIX	3521	0.7
ZX750 L3 (ZXR750)		94→96	CR9E	6263			CR9EIX	3521	0.7
ZX750 N1 (Ninja ZX-7RR)		96→99	CR9E	6263			CR9EIX	3521	0.7
ZX750 P1-P7 (Ninja ZX-7R)		96→03	CR9E	6263			CR9EIX	3521	0.7
773		EJ800A (W800 Incl. Café, Street)	11→	CR8E	1275			CR8EIX	4218
800	VN800 A1-3	95→98	CR7E	4578			CR7EIX	7385	0.7
	VN800 B2-B8 (Classic), C1-C2, E1-E2 (Drifter)	96→	CR7E	4578			CR7EIX	7385	0.8
	Z800 (Incl. Sugomi)	14→	CR9EK	4548			CR9EIX	3521	0.7
	Z800E	14→	CR9EK	4548			CR9EIX	3521	0.7
900	VN900 A6F, B7F (Classic)	06→	CPR7EA-9	3901			CR7EIX	7385	0.9
	VN900 C7F (Custom)	07→	CPR7EA-9	3901			CR7EIX	7385	0.9



CC	MODEL	DATE	STANDARD COPPER CORE	STOCK NUMBER	PLATINUM OR GOLD PALLADIUM	STOCK NUMBER	IRIDIUM	STOCK NUMBER	GAP MM
KAWASAKI (CONTINUED)									
900	Z1, Z1A, Z1B, Z900 A4	73→76	B8ES	2411			BR8EIX	5044	0.7
	ZX900 A1-A8 (GPZ900R)	84→96	DR8ES	5423			DR9EIX	4772	0.7
	ZX900 B1-B4 (ZX9R Ninja)	94→98	CR9EK	4548			CR9EIX	3521	0.7
	ZX900 C1-C2, E1-E2 (ZX9R Ninja)	98→	CR9EK	4548			CR9EIX	3521	0.7
	ZX900 F1/H/P, F2/H/P (ZX9R)	02→04	CR9EK	4548			CR9EIX	3521	0.7
950	Z900 (Incl. Café, Performance, RS)	17→					CR9EIA-9	6289	0.9
	ZR900RS (Classic)	18→					CR9EIA-9	6289	0.9
1000	KLV1000	05→	CR8EK	3478			CR8EIX	4218	0.7
	Z1000 A1-A3, A4 (Mark II), D1 (Z1-R), E1-E2 (ST), H1 (Fi)	77→81	B8ES	2411			BR8EIX	5044	0.7
	Z1000 J1-J3, R1-R2, K1 (LTD)	81→84	B8ES	2411			BR8EIX	5044	0.7
	ZG1000 A1-A7 (1000GTR)	86→94	DR8ES	5423			DR9EIX	4772	0.7
	ZG1000 A9-A14 (1000GTR)	94→99	DR9EA	3437			DR9EIX	4772	0.7
	ZL1000 A1 (ZL1000)	87→90	DR8ES	5423			DR9EIX	4772	0.7
	ZR1000 A1H-A3H (Z1000)	03→05	CR9EK	4548			CR9EIX	3521	0.7
	ZR1000 A6F (Z1000)	06→07	CR9EK	4548			CR9EIX	3521	0.7
	ZR1000 B7F-B8F, C7F-C8F, DAF (Z1000)	07→09					CR9EIA-9	6289	0.9
	ZR1000KLF (Z H2)	20→					SILMAR9E9	95123	0.9
	ZX1000 A1-A3 (GPZ1000RX)	85→89	DR8ES	5423			DR9EIX	4772	0.7
	ZX1000 B1-B3 (ZX-10)	88→91	CR9E	6263			CR9EIX	3521	0.7
	ZX1000 C1H (ZX10R)	04→					CR9EIA-9	6289	0.9
	ZX1000 D6F-D7F, E8F-JFF (Ninja ZX-10R)	06→15					CR9EIA-9	6289	0.9
	ZX1000 RGF (Ninja ZX-10R)	16→18					SILMAR9B9	95399	0.9
	ZX1000NF, PF (Ninja H2, H2R)	15→					SILMAR9B9	95399	0.9
	ZX1000Z (Ninja ZX-10RR)	17→18					SILMAR9B9	95399	0.9
	ZX1002 CJF (Ninja ZX-10R SE)	18→					SILMAR9B9	95399	0.9
	ZX1002 AJF, BJF (Ninja H2 SX, H2 SX SE)	18→					SILMAR9E9	95123	0.9
	ZX1002 (Ninja ZX-10R)	18→					SILMAR9B9	95399	0.9
ZX1002N (Ninja ZX-10RR)	21→					SILMAR9B9	95399	0.9	
1043	KLZ1000 ACF (Versys 1000)	12→					CR9EIA-9	6289	0.9
	ZR1000 DAF-FGF (Z1000 Incl. Sugomi)	10→					CR9EIA-9	6289	0.9
	ZX1000G, H (Z1000SX, Tourer)	11→19					CR9EIA-9	6289	0.9
	ZX1002 KLF (Ninja 1000SX)	20→					CR9EIA-9	6289	0.9
1100	Z1100 A1-A3 (Shaft drive)	81→85	BR8ES	5422			BR8EIX	5044	0.7
	Z1100 B1-B2 (GPz1100)	81→83	BR8ES	5422			BR8EIX	5044	0.7
	Z1100 R1	84→85	BR8ES	5422			BR8EIX	5044	0.7
	ZR1100 A1-A4 (Zephyr) Twin Spark	92→95	CR9E	6263			CR9EIX	3521	0.7
	ZR1100 B1 (Zephyr) Twin Spark	96→97	CR9E	6263			CR9EIX	3521	0.7
	ZR1100 C1-C4 (ZRX 1100)	97→01	CR9EK	4548			CR9EIX	3521	0.7
	ZX1100 A1-A3 (GPz1100)	83→88	BR8ES	5422			BR8EIX	5044	0.7
	ZX1100 C1-C3, D1-D9 (ZZ-R1100)	90→01	CR9E	6263			CR9EIX	3521	0.7
	ZX1100 E1-E5 (GPZ1100)	95→99	CR9EK	4548			CR9EIX	3521	0.7
ZX1100 F1 (GPZ1100 ABS)	96→98	CR9EK	4548			CR9EIX	3521	0.7	
1200	ZR1200 A1-A4H, B1-B3P (ZRX 1200)	01→05	CR9EK	4548			CR9EIX	3521	0.7
	ZR1200 A6F (ZRX1200R)	05→	CR9EK	4548			CR9EIX	3521	0.7
	ZX1200 A1-A2 (ZX-12R)	99→01			CR9EKPA	7785	CR9EIX	3521	0.8
	ZX1200 B1H-B3H (Ninja ZX-12R)	02→07			CR9EKPA	7785	CR9EIX	3521	0.8
	ZX1200-C1H/C2H (ZZ-R1200)	02→04	CR9E	6263			CR9EIX	3521	0.7
1300	Z1300 A1	78→79	BR8ES	5422			BR8EIX	5044	0.7
	Z1300 A2-A5	80→83	BPR6ES	7822			BPR6EIX	6637	0.7
	ZG1300 A1-A3 Fuel Injection	84→90	BPR6ES	7822			BPR6EIX	6637	0.7
1352	ZG1400 A8F-CCF (1400GTR)	07→					CR9EIA-9	6289	0.9
	ZX1400 A6F-D8F (ZZ-R1400)	06→11					CR9EIA-9	6289	0.9
1441	ZX1400 ECF (ZZ-R1400)	12→					CR9EIA-9	6289	0.9
1500	VN1500 B2-B6, C1-C2	88→95	DPR7EA-9	5129			DPR7EIX-9	7803	0.9
	VN1500 D1-D2 (VN1500 Classic)	96→98	DPR5EA-9	2887					0.9
	VN1500 E1-E2 (Classic)	98→99	DPR5EA-9	2887					0.8
	VN1500 G2 (Nomad)	1999	DPR5EA-9	2887					0.8
	VN1500 J1-J2 Drifter	99→00	DPR6EA-9	5531					0.9
	VN1500 L1-L4 Fi (Classic Tourer Fi)	99→03	DPR6EA-9	5531					0.9
	VN1500 N1-N3H	99→04	DPR6EA-9	5531					0.9
	VN1500 P1H-P2H (Mean Streak)	01→04	DPR6EA-9	5531					0.9
	VN1500 R1-R2H (Drifter)	01→04	DPR6EA-9	5531					0.9

2 Wheel



CC	MODEL	DATE	STANDARD COPPER CORE	STOCK NUMBER	PLATINUM OR GOLD PALLADIUM	STOCK NUMBER	IRIDIUM	STOCK NUMBER	GAP MM
KAWASAKI (CONTINUED)									
1552	VN1600 A1H-A7F Classic	03→07	DPR6EA-9	5531					0.9
	VN1600 B1H-B7F Mean Streak	04→07	DPR6EA-9	5531					0.9
	VN1600 D1H-D8F Classic Tourer	05→08	DPR6EA-9	5531					0.9
1700	VN1700 Classic, Classic Tourer, Voyager	09→					ILZKAR7B11	1654	1.1
2050	VN2000 A1H-A6F	04→					IZFR6F11	4095	1.1

KEEWAY									
50	Hurricane (2-Stroke) Ø14mm Plug	08→	BPR7HS	6422			BPR7HIX	5944	0.6
	Hurricane (4-Stroke) Ø10mm Plug	08→	C7HSA	4629			CR7HIX	7544	0.7
	Matrix Sport 50	06→	BPR7HS	6422			BPR7HIX	5944	0.6
125	ARN 125	08→	DPR7EA-9	5129			DPR7EIX-9	7803	0.9
	Hacker 125	08→	DPR7EA-9	5129			DPR7EIX-9	7803	0.9
	Speed 125	08→	DPR7EA-9	5129			DPR7EIX-9	7803	0.9
	Superlight 125	08→	DPR7EA-9	5129			DPR7EIX-9	7803	0.9
250	Cruiser	06→	D7EA	7912					0.7

KENOS									
125	125-12B	12/07→	CR8E	1275			CR8EIX	4218	0.7

KREIDLER									
50	Florett (RM, RMS, RMC), GS50	57→	B7HS	5110			BR7HIX	7067	0.5
	MC-5-50		B7HS	5110			BR7HIX	7067	0.5

KSR MOTO									
50	Epico 50	12→	BR8HSA	5539			BPR8HIX	6742	0.7
	Onyx 50	13→	BR8HSA	5539			BPR8HIX	6742	0.7
	Sirion 50	12→	BR8HSA	5539			BPR8HIX	6742	0.7
125	Code 125	12→	DR8EA	7162	DR8EVX	6354	DR8EIX	6681	0.6
	GSR 125	15→	DR8EA	7162	DR8EVX	6354	DR8EIX	6681	0.6
	Soho 125	12→	CR8E	1275			CR8EIX	4218	0.7
	TR 125	12→	CR8E	1275			CR8EIX	4218	0.7
	TW 125	14→	DR8EA	7162	DR8EVX	6354	DR8EIX	6681	0.6
	Vertigo 125	12→	CR7HSA	4549			CR7HIX	7544	0.7
	Worx 125	12→	DR8EA	7162	DR8EVX	6354	DR8EIX	6681	0.6
	Zion 125	12→	CR8E	1275			CR8EIX	4218	0.7

KTM									
50	50 Pro-Junior, Senior (12.7mm Thread Reach)	2000	B8HS	5510			BR8HIX	7001	0.6
	50 Adventure Mini, Junior & Senior (12.7mm Thread Reach)	→02	BR8HS	4322			BR8HIX	7001	0.6
	50 Adventure Mini, Junior & Senior (19mm Thread Reach)	03→08	BR8ECM	3035			BR8ECMIX	3520	0.6
	50 SX Junior/Senior LC (19mm Thread Reach)	2002	BR10EG	3830			BR10EIX	6801	0.6
	50 SX Pro-Junior LC (Beta engine)	2003	BR8ECM	3035			BR8ECMIX	3520	0.6
	50 SX	09→	LR8B	6208			CR8HIX	7669	0.6
60	60 SX	98→					R7436-10	4900	0.6
65	65 SX	→03	BR10EG	3830			BR10EIX	6801	0.6
	65 SX Beta engine (19mm Thread Reach)	03→07	BR8ECM	3035			BR8ECMIX	3520	0.6
	65 SX KTM engine (12.7mm Thread Reach)	08/08→	LR8B	6208			CR8HIX	7669	0.6
80	Moto-X models with ½", 12.7mm Thread Reach	→85					BR8HIX	7001	0.6
	80 MX	1986	B10EG	3630			BR10EIX	6801	0.6
85	85 SX	03→06					BR10ECMIX	3006	0.7
	85 SX	07→					BR9ECMIX	2707	0.6
125	Moto-X models with ½", 12.7mm Thread Reach (Not GP)	→85					BR8HIX	7001	0.6
	125 SX	96→97					BR10EIX	6801	0.6
	125 EXC, EGS, SX	98→00			R6918B-8	4492			0.8
	125 EXC, SX	01→07					BR9EIX	3981	0.6
	125 EXC, EXC, SX, Six Days	08→					BR9ECMIX	2707	0.6
	125 GS	1986	B10EG	3630			BR10EIX	6801	0.6
	125 LC/LCPA	→85	B9EG	3530			BR9EIX	3981	0.6



CC	MODEL	DATE	STANDARD COPPER CORE	STOCK NUMBER	PLATINUM OR GOLD PALLADIUM	STOCK NUMBER	IRIDIUM	STOCK NUMBER	GAP MM
KTM (CONTINUED)									
125	125 MX	1986	B10EG	3630			BR10EIX	6801	0.6
	125 MX	87/88	B9EG	3530			BR9EIX	3981	0.6
	125 MX	89/90					BR10EIX	6801	0.6
	125 SM		BR8HS	4322			BR8HIX	7001	0.6
	LC125, LC 2 125 (Duke 125)	96→98	BR9ES	5722			BR9EIX	3981	0.6
	SX 125 (2001)	01→					BR9ECMIX	2707	0.6
144	144 SX	08→					BR9ECMIX	2707	0.6
	150 EXC TPI	20→					GR8DI-12	90908	1.2
	150 SX	09→					BR9ECMIX	2707	0.6
175	Moto-X models with ½", 12.7mm Thread Reach	→85					BR8HIX	7001	0.6
200	200 Duke	11→	LKAR8A-9	4786			LKAR8AI-9	6706	0.9
	200 EGS, EXC, MXC	98→03	BR8EG	3130			BR8EIX	5044	0.6
	200 EXC, SX	03→05					BR9EIX	3981	0.6
	200 EXC	06→16	BR8EG	3130			BR8EIX	5044	0.6
	200 XC, XC-W	07→10	BR8EG	3130			BR8EIX	5044	0.6
	RC200	15→	LKAR8A-9	4786			LKAR8AI-9	6706	0.9
250	Moto-X models with ½", 12.7mm Thread Reach	→85					BR8HIX	7001	0.6
	250 EXC (2-Stroke) Ø14mm Plug	97→02	BR8ECM	3035			BR8ECMIX	3520	0.6
	250 EXC (2-Stroke) Ø14mm Plug	03→17	BR7ES	5122			BR7EIX	6664	0.7
	250 EXC Racing (4-Stroke) Ø10mm Plug	01→02	CR8EK	3478			CR8EIX	4218	0.7
	250 EXC Racing (4-Stroke) Ø12mm Plug	03→06	DCPR8E*	4179			DCR8EIX	3606	0.6
	250 EXC-F Incl. Fi (4-Stroke) Ø10mm Plug (19mm Thread Reach)	07→13	CR9EKB	2305			CR9EIX	3521	0.8
	250 EXC-F Incl. Fi (4-Stroke) Ø10mm Plug (26.5mm Thread Reach)	14→					LMAR9AI-10	93188	1.0
	250 EXC TPI	17→					ZGR7GI-13G	96760	1.3
	250 GS	1986	B10EG	3630			BR10EIX	6801	0.6
	250 LCPA	→85	B10EG	3630			BR10EIX	6801	0.6
	250 MC/GS	→85	B9EG	3530			BR9EIX	3981	0.6
	250 MX	1986	B10EG	3630			BR10EIX	6801	0.6
	250 MX	87/88	B9EG	3530			BR9EIX	3981	0.6
	250 MX	89/90					BR9EIX	3981	0.6
	250 SX	97→	BR8ECM	3035			BR8ECMIX	3520	0.6
	250 SX (2-Stroke) Ø14mm Plug	03→05	BR8ECM	3035			BR8ECMIX	3520	0.6
	250 SX	06→	BR8ECM	3035			BR8ECMIX	3520	0.6
	250 SX-F (4-Stroke) Ø10mm Plug (19mm Thread Reach)	06→12	CR9EKB	2305			CR9EIX	3521	0.8
	250 SX-F (4-Stroke) Ø10mm Plug (26.5mm Thread Reach)	13→					LMAR9AI-8	97225	0.8
	Freeride 250	13→17	BR7ES	5122			BR7EIX	6664	0.7
Freeride 250-F	18→					LMAR9AI-10	93188	1.0	
300	300 EXC	97→02	BR8ECM	3035			BR8ECMIX	3520	0.6
	300 EXC	03→06	BR7ES	5122			BR7EIX	6664	0.7
	300 EXC	07→16	BR7ES	5122			BR7EIX	6664	0.7
	300 EXC TPI	17→					ZGR7GI-13G	96760	1.3
	300 GS	1986	B10EG	3630			BR10EIX	6801	0.6
	300 MXC	97→02	BR8ECM	3035			BR8ECMIX	3520	0.6
	300 MXC	03→	BR7ES	5122			BR7EIX	6664	0.7
	300 XC	06→	BR7ES	5122			BR7EIX	6664	0.7
350	350 EXC-F, Six Days (4-Stroke)	11→					LMAR9AI-8	97225	0.8
	350 MX	87→95	B9EG	3530			BR9EIX	3981	0.6
	350 SX-F	10→					LMAR9AI-8	97225	0.8
	Freeride 350	12→17					LMAR9AI-10	93188	1.0
373	Duke 390	12→	LKAR8A-9	4786			LKAR8AI-9	6706	0.9
	RC390	15→	LKAR8A-9	4786			LKAR8AI-9	6706	0.9
380	380 EXC, 380 SX		BR8ECM	3035			BR8ECMIX	3520	0.6
390	390 GS	→85	B9EG	3530			BR9EIX	3981	0.6
400	Moto-X models with ½", 12.7mm Thread Reach	→85	B9HS	5810			BR9HIX	5687	0.7
	400 EGS-E	97→	DR8EA	7162	DR8EVX	6354	DR8EIX	6681	0.6
	400 EXC, MXC, SX Ø10mm Plug	99→02	CR8EK	3478			CR8EIX	4218	0.7
	400 EXC Ø12mm Plug (19mm Thread Reach)	02→08	DCPR8E*	4179			DCR8EIX	3606	0.6
	400 EXC Ø12mm Plug (26.5mm Thread Reach)	09→11					LKAR8AI-9	6706	0.9
	400 LSE		DR8EA	7162	DR8EVX	6354	DR8EIX	6681	0.6
LC4 400		DR8EA	7162	DR8EVX	6354	DR8EIX	6681	0.7	
420	420 AC	→85	B9EG	3530			BR9EIX	3981	0.6



* Please note DCPR8E 4339 has a removable terminal nut, whereas DCPR8E 4179 has a fixed terminal nut





CC	MODEL	DATE	STANDARD COPPER CORE	STOCK NUMBER	PLATINUM OR GOLD PALLADIUM	STOCK NUMBER	IRIDIUM	STOCK NUMBER	GAP MM
KTM (CONTINUED)									
450	450 EXC-F, Six Days	17→19					LMAR9AI-10	93188	1.0
	450 EXC-F, Six Days	20→					LZMAR8BI-10	95680	1.0
	450 EXC Racing, SX Racing (4-Stroke)	03→07	DCPR8E*	4179			DCR8EIX	3606	0.6
	450 EXC-R (26.5mm Thread Reach)	2008	LKAR8A-9	4786			LKAR8AI-9	6706	0.9
	450 EXC-R, Six Days (26.5mm Thread Reach)	09→16					LKAR8AI-9	6706	0.9
	450 RALLY Replica	2014	CR9EKB	2305			CR9EIX	3521	0.8
	450 RALLY Replica	15→17					LKAR8AI-9	6706	0.9
	450 RALLY Replica	19→					LMAR9AI-10	93188	1.0
	450 SMR Ø12mm Plug	04→07	DCPR8E*	4179			DCR8EIX	3606	0.6
	450 SMR Ø10mm Plug	08→12	CR9EKB	2305			CR9EIX	3521	0.8
	450 SMR Ø12mm Plug (26.5mm Thread Reach)	13→14					LKAR8AI-9	6706	0.9
	450 SX-F	07→12	CR9EKB	2305			CR9EIX	3521	0.8
	450 SX-F	13→15					LKAR8AI-9	6706	0.9
	450 SX-F	16→					LMAR9AI-8	97225	0.8
480	505 SX-F	07→08	CR9EKB	2305			CR9EIX	3521	0.8
495	495 AC	→85	B9EG	3530			BR9EIX	3981	0.6
500	500 MX, 500 MXC	1986	B9EG	3530			BR9EIX	3981	0.6
	500 MX	87/88	B9EG	3530			BR9EIX	3981	0.6
	500 MX	89/90					BR9EIX	3981	0.6
510	500 EXC, Six Days	12→16					LKAR8AI-9	6706	0.9
	500 EXC-F	17→19					LMAR9AI-10	93188	1.0
	500 EXC-F, Six Days	20→					LZMAR8BI-10	95680	1.0
	530 EXC-R	07→08	LKAR8A-9	4786			LKAR8AI-9	6706	0.9
	530 EXC-R	09→11					LKAR8AI-9	6706	0.9
520	520 EXC, MXC, SX	99→02	CR8EK	3478			CR8EIX	4218	0.7
525	525 EXC Racing, MXC, SX	03→07	DCPR8E*	4179			DCR8EIX	3606	0.6
560	560-4S	→85	D8EA	2120	DR8EVX	6354	DR8EIX	6681	0.6
600	600-C4S	→85	D8EA	2120	DR8EVX	6354	DR8EIX	6681	0.6
	600 4S	86→88	D8EA	2120	DR8EVX	6354	DR8EIX	6681	0.6
	600 EGS-E		DR8EA	7162	DR8EVX	6354	DR8EIX	6681	0.6
	LC4 640		DR8EA	7162	DR8EVX	6354	DR8EIX	6681	0.7
620	620 Adventure, 620LSE, 620 Duke	96→	DR8EA	7162	DR8EVX	6354	DR8EIX	6681	0.6
625	625 Enduro, Super Moto	02→	DPR8EA-9	4929			DPR8EIX-9	2202	0.9
	625 SMC	03→06	DCPR8E*	4179			DCR8EIX	3606	0.6
	625 SXC	03→	DCPR8E*	4179			DCR8EIX	3606	0.6
	640 LC4, Duke, Duke II	03→	DCPR8E*	4179			DCR8EIX	3606	0.6
	640 Super Moto	02→	DCPR8E*	4179			DCR8EIX	3606	0.6
	R640 Adventure	03→	DCPR8E*	4179			DCR8EIX	3606	0.6
	654	660 SMC	03→06	DCPR8E*	4179			DCR8EIX	3606
690	690 Duke	07→11					LKAR8AI-9	6706	0.9
	690 Enduro R	09→11					LKAR8AI-9	6706	0.9
	690 LC4 Supermoto / Prestige	07→					LKAR8AI-9	6706	0.9
	690 SMC	08→11					LKAR8AI-9	6706	0.9
	690 SM R	08→11					LKAR8AI-9	6706	0.9
	690 Duke R	10→11					LKAR8AI-9	6706	0.9
800	690 Duke, R (Twin spark)	12→	Ø10mm Plug Ø12mm Plug	LMAR7A-9	4908		LMAR7DI-10	96956	0.9
	LKAR8BI9						1553	0.9	
	690 Enduro R	12→13					LKAR8AI-9	6706	0.9
	690 Enduro R (Twin spark)	14→	Ø10mm Plug Ø12mm Plug	LMAR7A-9	4908		LMAR7DI-10	96956	0.9
	LKAR8BI9						1553	0.9	
	690 SMC R	12→13					LKAR8AI-9	6706	0.9
690 SMC R (Twin spark)	14→	Ø10mm Plug Ø12mm Plug	LMAR7A-9	4908		LMAR7DI-10	96956	0.9	
LKAR8BI9						1553	0.9		
800	790 Adventure, R, Rally	19→					LMAR9AI-10	93188	1.0
	790 Duke	18→					LMAR9AI-10	93188	1.0
890	890 Duke R	20→					LMAR9AI-10	93188	1.0
950	950 Adventure / Rally	03→05	CR8EK	3478			CR8EIX	4218	0.7
	950 Supermoto / Super Enduro R	05→08	CR8EK	3478			CR8EIX	4218	0.7
1000	990 Adventure / Supermoto	06→08	DCPR8E*	4339			DCPR8EIX	6546	0.9
	990 Adventure / R	09→12					LKAR8BI9	1553	0.9
	990 SM-R	09→11					KR8DI	4742	0.8
	990 SM-R	12→13					LKAR8BI9	1553	0.9
	990 SM-T	09→10					KR8DI	4742	0.8



* Please note DCPR8E 4339 has a removable terminal nut, whereas DCPR8E 4179 has a fixed terminal nut





CC	MODEL	DATE	STANDARD COPPER CORE	STOCK NUMBER	PLATINUM OR GOLD PALLADIUM	STOCK NUMBER	IRIDIUM	STOCK NUMBER	GAP MM
KTM (CONTINUED)									
1000	990 SM-T ABS	11→13					LKAR8BI9	1553	0.9
	990 Super Duke	04→06	DCPR8E*	4339			DCPR8EIX	6546	0.9
	990 Super Duke (19mm Thread Reach)	07→11					KR8DI	4742	0.8
	990 Super Duke R (19mm Thread Reach)	2007					KR8DI	4742	0.8
	990 Super Duke R (26.5mm Thread Reach)	08→11					LKAR8AI-9	6706	0.9
	990 Super Duke R (19mm Thread Reach)	12→13					KR8DI	4742	0.8
1050	1050 Adventure (Twin spark)	15→	Ø10mm Plug				LMAR7DI-10	96956	1.0
	Ø12mm Plug					LKAR9BI-10	95371	1.0	
1148	1190 RC8	08→10				LKAR9BI9	6205	0.9	
1195	1190 Adventure, R (Twin spark)	13→	Ø10mm Plug	LMAR7A-9	4908		LMAR7DI-10	96956	0.9
	Ø12mm Plug					LKAR9BI9	6205	0.9	
	RC8R (Incl. Track model)	09→11				LKAR9BI9	6205	0.9	
	RC8R (Incl. Track model) Twin spark	11→	Ø10mm Plug	LMAR7A-9	4908		LMAR7DI-10	96956	0.9
Ø12mm Plug					LKAR9BI9	6205	0.9		
1301	1290 Super Adventure (Twin spark)	15→21	Ø10mm Plug				LMAR7DI-10	96956	1.0
	Ø12mm Plug					LKAR9BI-10	95371	1.0	
	1290 Super Duke GT, R, S (Twin spark)	14→	Ø10mm Plug	LMAR7A-9	4908		LMAR7DI-10	96956	0.9
	Ø12mm Plug					LKAR9BI9	6205	0.9	

KYMCO									
50	Agility 50	05→	CR7HSA	4549			CR7HIX	7544	0.7
	Cobra 50		BR8HSA	5539			BPR8HIX	6742	0.6
	Fever 50		BR8HSA	5539			BPR8HIX	6742	0.6
	Filly 50	98→	CR7HSA	4549			CR7HIX	7544	0.7
	Filly LX 50	99→	CR7HSA	4549			CR7HIX	7544	0.7
	Like 50 (2-Stroke)	10→	BR8HSA	5539			BPR8HIX	6742	0.6
	People 50	04→06	BR8HSA	5539			BPR8HIX	6742	0.6
	Scout 50	97→	BR8HSA	5539			BPR8HIX	6742	0.6
	Spacer 50		BR8HSA	5539			BPR8HIX	6742	0.6
	Super 8 50 (2-Stroke) Ø14mm Plug	07→	BR8HSA	5539			BPR8HIX	6742	0.6
	Super 8 50 (4-Stroke) Ø10mm Plug	11→	CR7HSA	4549			CR7HIX	7544	0.7
	Super 9 50 (Liquid Cooled)	99→	BR8HSA	5539			BPR8HIX	6742	0.6
	Super 9 50 (Air Cooled)	01→	BR8HSA	5539			BPR8HIX	6742	0.6
	Super 9 50 (Air Cooled) (Euro 2)	01→	BR8HSA	5539			BPR8HIX	6742	0.6
	Vitality 50 (2-Stroke)	04→	BR8HSA	5539			BPR8HIX	6742	0.6
	Vitality 50 (4-Stroke)		CR7HSA	4549			CR7HIX	7544	0.7
	Yup 50	00→	BR8HSA	5539			BPR8HIX	6742	0.6
	ZX 50		BR8HSA	5539			BPR8HIX	6742	0.6
	100	Cobra 100	99→03	BR6HSA	4296			BPR6HIX	4085
125	Agility 125	05→	CR7HSA	4549			CR7HIX	7544	0.7
	CK125	05→	DR8EA	7162	DR8EVX	6354	DR8EIX	6681	0.7
	Cruiser 125	03→	CR8E	1275			CR8EIX	4218	0.7
	Downtown 125i	13→	CR7E	4578			CR7EIX	7385	0.7
	Ego 125		DPR7EA-9	5129			DPR7EIX-9	7803	0.9
	Heroism 125		C7HSA	4629			CR7HIX	7544	0.7
	Hipster 125 (2 Valve)	01→	DR8EA	7162	DR8EVX	6354	DR8EIX	6681	0.7
	Hipster 125 (4 Valve)		CR8E	1275			CR8EIX	4218	0.7
	Hipster 125 (4 Valve) (Euro 2)		CR8E	1275			CR8EIX	4218	0.7
	Miler 125 (Grand Dink)	03→	DPR7EA-9	5129			DPR7EIX-9	7803	0.9
	Movie XL125	02→	CR7HSA	4549			CR7HIX	7544	0.7
	People One 125i	13→	CR7E	4578			CR7EIX	7385	0.7
	People S 125 (Euro 3)	05→	CR7HSA	4549			CR7HIX	7544	0.7
	Pulsar 125		DR8EA	7162	DR8EVX	6354	DR8EIX	6681	0.7
	Sector 125		DR8EA	7162	DR8EVX	6354	DR8EIX	6681	0.7
	Spacer 125 (Liquid Cooled)		DPR7EA-9	5129			DPR7EIX-9	7803	0.9
	Stryker 125		DR8EA	7162	DR8EVX	6354	DR8EIX	6681	0.7
	Super 8 125 Ø12mm Plug	07→	DPR7EA-9	5129			DPR7EIX-9	7803	0.9
	Super 8 125 (4-Stroke) Ø10mm Plug		CR7HSA	4549			CR7HIX	7544	0.7
	Vivio 125		CR7HSA	4549			CR7HIX	7544	0.7
Yager GT125	08→	DPR7EA-9	5129			DPR7EIX-9	7803	0.9	
Zing 125	97→	DR8EA	7162	DR8EVX	6354	DR8EIX	6681	0.7	
163	Like 200i (4-Stroke)	11→	CR7HSA	4549			CR7HIX	7544	0.7





CC	MODEL	DATE	STANDARD COPPER CORE	STOCK NUMBER	PLATINUM OR GOLD PALLADIUM	STOCK NUMBER	IRIDIUM	STOCK NUMBER	GAP MM
KYMCO (CONTINUED)									
200	Yager 200i		DPR6EA-9	5531					0.9
250	Dink 250		DPR7EA-9	5129			DPR7EIX-9	7803	0.9
	Ego 250		DPR7EA-9	5129			DPR7EIX-9	7803	0.9
	Grand Dink 250	01→	DPR7EA-9	5129			DPR7EIX-9	7803	0.9
	People 250	05→	DPR7EA-9	5129			DPR7EIX-9	7803	0.9
	Venox 250	03→	CR8E	1275			CR8EIX	4218	0.7
	Xciting 250 (Carb)	→08	DPR7EA-9	5129			DPR7EIX-9	7803	0.9
	Xciting 250i	06→08	DPR6EA-9	5531					0.9
	Xciting 250i, 250Ri	08→	DPR6EA-9	5531					0.9
300	Downtown 300i	11→	CR7E	4578			CR7EIX	7385	0.7
400	Xciting 400i	13→	CR7E	4578			CR7EIX	7385	0.7
500	Xciting 500 (Carb)	05→06	CR8E	1275			CR8EIX	4218	0.7
	Xciting 500i	07→	CR7E	4578			CR7EIX	7385	0.7

LAMBRETTA									
50	V50	18→20	CR7HSA	4549			CR7HIX	7544	0.7
125	LI125, SL125, SI125	58→	B7ES	1111			BR7EIX	6664	0.5
	V125	18→20	CR7HSA	4549			CR7HIX	7544	0.7
150	GP150	76→98	B7ES	1111			BR7EIX	6664	0.5
200	GP200, SXJet 200, SX200, Links 200	78→	B7ES	1111			BR7EIX	6664	0.5
	V200	18→20	CR7HSA	4549			CR7HIX	7544	0.7

LAVERDA									
500	500 Alpino S, Montjuic	78→84	D9EA	2420			DR9EIX	4772	0.7
650	650 i.e, Sport, Formula, Ghost, Diamante	94→98	DCPR9E	2641			DCPR9EIX	2316	0.6
	650, GT, GTL, American Eagle	94→98	B9ES	2611			BR9EIX	3981	0.7
668	668, Ghost, Ghost Strike	96→98	DCPR9E	2641			DCPR9EIX	2316	0.6
750	750, GT, GTL, American Eagle		B8ES	2411			BR8EIX	5044	0.7
	750 S, Ghost 750 Strike, Diamante 750, 750 S Formula	97→02	DCPR9E	2641			DCPR9EIX	2316	0.6
	SF, SFL, SF2, SF3, SFC Twins	68→78	B8ES	2411			BR8EIX	5044	0.7
1000	1000EC, 3C(E), 1000 2CL, Jota, Jarama	76→82	B8ES	2411			BR8EIX	5044	0.7
	RGA, RGS	82→87	B8ES	2411			BR8EIX	5044	0.7
	SFC	85→89	B9ES	2611			BR9EIX	3981	0.7
1200	1200, T, Mirage, TS, Jota American	78→83	B8ES	2411			BR8EIX	5044	0.7

LEM									
50	LX 1,2,3,4 Super & Sport 50 (12.7mm Thread Reach)		B7HS	5110			BR7HIX	7067	0.6
	LX4 (19mm Thread Reach)		BR9ES	5722			BR9EIX	3981	0.7

LEXMOTO									
50	Flash ZN50QT-15A		C7HSA	4629			CR7HIX	7544	0.7
	Hunter	17→	CR7HSA	4549			CR7HIX	7544	0.7
	LSM 50	12→	BR8ES	5422			BR8EIX	5044	0.6
	Milano FT50QT-27	07/15→	C7HSA	4629			CR7HIX	7544	0.7
	Tornado SB50QT-16(B08)		C7HSA	4629			CR7HIX	7544	0.7
	Tommy ZN50QT-A		C7HSA	4629			CR7HIX	7544	0.7
	Tommy II ZN50QT-E		C7HSA	4629			CR7HIX	7544	0.7
125	Adrenaline XFLM125GY-2B	05/15→	CR8E	1275			CR8EIX	4218	0.7
	Arizona ZS125-30		D8EA	2120			DR8EIX	6681	0.7
	Arrow HT125-4F		D8EA	2120			DR8EIX	6681	0.7
	Diablo LJ125T-8M	05/15→	CR7HSA	4549			CR7HIX	7544	0.6
	Firenze ZN125T-F		C7HSA	4629			CR7HIX	7544	0.7
	FMS125 ZN125T-7H	15→	CR7HSA	4549			CR7HIX	7544	0.6
	FMX125 WY125T-108	15→	CR7HSA	4549			CR7HIX	7544	0.6
	Gladiator SB125T-23B		C7HSA	4629			CR7HIX	7544	0.7
	Ranger ZS125-50		D8EA	2120			DR8EIX	6681	0.7
	Street DFE125-8A		CR7E	4578			CR7EIX	7385	0.7
	Tommy ZN125T-E		C7HSA	4629			CR7HIX	7544	0.7
	Tornado SB125T-21(B08)		C7HSA	4629			CR7HIX	7544	0.7



CC	MODEL	DATE	STANDARD COPPER CORE	STOCK NUMBER	PLATINUM OR GOLD PALLADIUM	STOCK NUMBER	IRIDIUM	STOCK NUMBER	GAP MM
LEXMOTO (CONTINUED)									
125	Valencia	12→	C7HSA	4629			CR7HIX	7544	0.7
	Valiant XF125R	07/15→	CR8E	1275			CR8EIX	4218	0.7
	Venom SK125-22	03/15→	CPR6EA-9	6899			CR6EIA-9	7967	0.9
	Vixen HT125-8		D8EA	2120			DR8EIX	6681	0.7
	XTR KS125-23		D8EA	2120			DR8EIX	6681	0.7
	XTR S KS125-24		D8EA	2120			DR8EIX	6681	0.7
	Zoom II SB125T-21(B10)		C7HSA	4629			CR7HIX	7544	0.7

LIFAN									
50	Aero 50 (LF50QT-26A) 2-Stroke		BPR7HS	6422			BPR7HIX	5944	0.6
	Aero 50 (LF50QT-26) 4-Stroke		CR7HSA	4549			CR7HIX	7544	0.6
	Echo (LF50QT-8D)		C7HSA	4629			CR7HIX	7544	0.6
	Jet 50		C7HSA	4629			CR7HIX	7544	0.7
110	Wacky 110		C7HSA	4629			CR7HIX	7544	0.7
125	Aero 125		C7HSA	4629			CR7HIX	7544	0.7
	Beat 125 (LF125-9A)		C7HSA	4629			CR7HIX	7544	0.6
	Blaze (LF125-30)		D8EA	2120			DR8EIX	6681	0.7
	Earth Dragon		D8EA	2120			DR8EIX	6681	0.7
	Mirage 125 (LF125-J)		D8EA	2120	DR8EVX	6354	DR8EIX	6681	0.6
	Samurai (LF125-30)		D8EA	2120			DR8EIX	6681	0.7
	Sprint (LF125-30)		D8EA	2120			DR8EIX	6681	0.7

LML									
125	Star CVT Automatica 4-Stroke	06/13→	CR8EH-9	5666			CR8EHIX-9	3797	0.7
	Star Deluxe 2-Stroke		BP8HS	2630			BPR8HIX	6742	0.7
	Star Deluxe 4-Stroke	11/09→	CR8EH-9	5666			CR8EHIX-9	3797	0.7
	Via Toscana 2-Stroke	09→	BP8HS	2630			BPR8HIX	6742	0.7
150	Star Deluxe 2-Stroke		BPR6ES	7822			BPR6EIX	6637	0.7
	Star Deluxe 4-Stroke	11/09→	CR8EH-9	5666			CR8EHIX-9	3797	0.7
200	Star Deluxe 4-Stroke	11→	CR8EH-9	5666			CR8EHIX-9	3797	0.7

MAGNI									
1000	Australia		D9EA	2420			DR9EIX	4772	0.7
	Sfida 1000		BP6ES	7811			BPR6EIX	6637	0.5
	Sfida Ottovalvole						DR9EIX	4772	0.6

MAICO									
Various	Moto-X models with 1/2", 12.7mm Thread Reach						BR9HIX	5687	0.5
	Moto-X models with 3/4", 19mm Thread Reach		B9EG	3530			BR9EIX	3981	0.5

MALAGUTI									
50	Ciak 50	00→02	BR8HS	4322			BR8HIX	7001	0.6
	Crosser	99→01	BPR6HS	7022			BPR6HIX	4085	0.5
	Drakon 50	04→06	BR9ES	5722			BR9EIX	3981	0.7
	F-10 Jetline	96→06	BR7HS	4122			BR7HIX	7067	0.5
	F-12 Dragon	96→	BR7HS	4122			BR7HIX	7067	0.5
	F-12 Phantom	96→06	BR7HS	4122			BR7HIX	7067	0.5
	F-15 Firefox	97→	BR8HS	4322			BR8HIX	7001	0.5
	F-15 GSE Replica		BR8HS	4322			BR8HIX	7001	0.5
	Foggy Replica		BR8HS	4322			BR8HIX	7001	0.5
	RCX10 (50cc Franco Morini)		B7HS	5110			BR7HIX	7067	0.5
	RCX12 (50cc Franco Morini)		B7HS	5110			BR7HIX	7067	0.5
	Wild Attack F12		BR8HS	4322			BR8HIX	7001	0.5
	XSM 50	04→06	BR9ES	5722			BR9EIX	3981	0.7
	XTM 50	04→06	BR9ES	5722			BR9EIX	3981	0.7
	Yesterday 50	98→00	BR8HS	4322			BR8HIX	7001	0.5
70	F-69 Phantom	97→99	BR7HS	4122			BR7HIX	7067	0.5



CC	MODEL	DATE	STANDARD COPPER CORE	STOCK NUMBER	PLATINUM OR GOLD PALLADIUM	STOCK NUMBER	IRIDIUM	STOCK NUMBER	GAP MM
MALAGUTI (CONTINUED)									
100	Ciak 100	00→04	BR8HS	4322			BR8HIX	7001	0.6
	F-12 Phantom 100TD	99→03	BR7HS	4122			BR7HIX	7067	0.6
125	Ciak 125	01→04	BR7HS	4122			BR7HIX	7067	0.6
	Madison 125	99→04	CR8E	1275			CR8EIX	4218	0.7
	X3M Motard 125	10→	CR7HSA	4549			CR7HIX	7544	0.6
150	F-18 Warrior	01→	DPR7EA-9	5129			DPR7EIX-9	7803	0.9
250	Madison 250cc	99→04	DPR9EA-9	5329			DPR9EIX-9	5545	0.9
400	Madison K400	02→04	CR9E	6263			CR9EIX	3521	0.7
500	Spidermax 500 GT	04→06	CR7EKB	4455			CR7EIX	7385	0.8

MBK									
50	Booster 50 NG	99→02	BR8HS	4322			BR8HIX	7001	0.5
	Flipper 50		BR8HS	4322			BR8HIX	7001	0.5
	Mach-G (Air Cooled)		BR8HS	4322			BR8HIX	7001	0.6
	Mach-G (Liquid Cooled)		BR8HS	4322			BR8HIX	7001	0.6
	Nitro 50	99→	BR8HS	4322			BR8HIX	7001	0.5
	Nitro-Jaguar F1		BR8HS	4322			BR8HIX	7001	0.5
	Ovetto 50	99→	BR7HS	4122			BR7HIX	7067	0.6
	Stunt 50	00→	BR9HS	4522			BR9HIX	5687	0.6
	X-Limit 50 Supermotard, Enduro	05→	BR9ES	5722			BR9EIX	3981	0.7
	X-Power 50	03→	BR9ES	5722			BR9EIX	3981	0.7
100	Nitro 100	01→	BR8HS	4322			BR8HIX	7001	0.5
	Ovetto 100	01→	BR8HS	4322			BR8HIX	7001	0.6
125	Doodo 125	01→	CR8E	1275			CR8EIX	4218	0.7
	Flame X 125		CR7E	4578			CR7EIX	7385	0.8
	Skycruiser 125	06→	CPR9EA-9	2308			CR9EIX	3521	0.9
	Skyliner 125	01→	CR8E	1275			CR8EIX	4218	0.7
	Thunder 125	01→	CR8E	1275			CR8EIX	4218	0.7
260	Kilibre 300	03→	DR8EA	7162	DR8EVX	6354	DR8EIX	6681	0.7

MONTESA									
123	Cota 123		B6ES	7310					0.5
125	MH123 (Honda engine)		BR7ES	5122			BR7EIX	6664	0.7
175	Cota 172		B6ES	7310					0.5
	Cota 200		B6ES	7310					0.5
200	MH200 (Honda engine)		BPR7ES	2023			BPR7EIX	4055	0.5
250	310		BPR7ES	2023			BPR7EIX	4055	0.5
	4Ride	16→	CR6EH-9	2688			CR6EIA-9	7967	0.9
	Cota 242		BP6ES	7811			BPR6EIX	6637	0.5
	Cota 247		B6HS	4510			BR6HIX	3419	0.6
	Cota 248		BP5ES	6511			BPR5EIX	6597	0.5
	Cota 315 (Honda engine)	97→99	BR6ES	4922					0.6
	Cota 4T (Honda engine)	05→07	CR6EH-9	2688			CR6EIA-9	7967	0.9
260	304, 307, 309		BPR5ES	7422			BPR5EIX	6597	0.5
	311		BPR5ES	7422			BPR5EIX	6597	0.5
	314		BR6ES	4922					0.6
	Cota 4RT	08→14	CR6EH-9	2688			CR6EIA-9	7967	0.9
289	Cota 300RR	15→	CR6EH-9	2688			CR6EIA-9	7967	0.9
310	348		BPR5ES	7422			BPR5EIX	6597	0.5
330	330		BPR5ES	7422			BPR5EIX	6597	0.5
350	335		BPR5ES	7422			BPR5EIX	6597	0.5
	Cota 349		BP5ES	6511			BPR5EIX	6597	0.5

MOTO GUZZI									
231	254	77→81	C7HSA	4629			CR7HIX	7544	0.5
350	V35 (Mark II)	84→87	B8ES	2411			BR8EIX	5044	0.5
500	V50 (Mark II & III)	79→86	B8ES	2411			BR8EIX	5044	0.5
650	V65	84→93	B8ES	2411			BR8EIX	5044	0.5
750	Breva 750 i.e.	04→09	BR8ES	5422			BR8EIX	5044	0.6
	Nevada 750 NT/Nevada club (with Digiplex)	90→03	BR8ES	5422			BR8EIX	5044	0.6



CC	MODEL	DATE	STANDARD COPPER CORE	STOCK NUMBER	PLATINUM OR GOLD PALLADIUM	STOCK NUMBER	IRIDIUM	STOCK NUMBER	GAP MM
MOTO GUZZI (CONTINUED)									
750	V7 Classic	07/08→12	BR8ES	5422			BR8EIX	5044	0.6
	V7 Café Classic	09→13	BR8ES	5422			BR8EIX	5044	0.6
	V7 Café Racer Ø14mm Plug	11/10→11	BR8ES	5422			BR8EIX	5044	0.6
	V7 Café Racer Ø10mm Plug	12→13	CPR8EB-9	6607					0.9
	V7 Special, Stone Ø10mm Plug	12→13	CPR8EB-9	6607					0.9
	V7 II Racer, Special, Stone, Stornello	14→	CPR8EB-9	6607					0.9
	V7 III Anniversario, Racer, Special, Stone	17→	CPR8EB-9	6607					0.9
	V75	86→88	B8ES	2411			BR8EIX	5044	0.5
850	Le Mans II & III	78→82	BP6ES	7811			BPR6EIX	6637	0.7
	Series V850	82→85	BP6ES	7811			BPR6EIX	6637	0.7
	V9 Bobber	16→	CPR8EB-9	6607					0.9
	V9 Roamer	16→	CPR8EB-9	6607					0.9
853	V85 TT (Incl. Travel)	19→					MR8BI-8	91360	0.8
940	Bellagio 940 (Twin Spark)	07→13	Ø10mm Plug	BPR6ES	7822	PMR8B	6378		0.7
	Ø14mm Plug		BPR6EIX					6637	0.7
950	Series 1000 (1000SP Mark II & III)	84→93	BP6ES	7811			BPR6EIX	6637	0.7
1000	California III I.E.	87→93	BP7ES	2412			BPR7EIX	4055	0.5
	California III with Digiplex	91→93	BP7ES	2412			BPR7EIX	4055	0.5
	Centaurio V10, Centaurio Sport/GT	97→00	DR9EA	3437			DR9EIX	4772	0.6
	Daytona 1000	92→98	D9EA	2420			DR9EIX	4772	0.7
	Daytona 1000 RS	96→00	DR9EA	3437			DR9EIX	4772	0.6
	Le Mans IV 1000	82→03/85	BP7ES	2412			BPR7EIX	4055	0.5
	Le Mans V (Le Mans 1000)	85→94	BP7ES	2412			BPR7EIX	4055	0.5
	Quota 1000	92→97	BP7ES	2412			BPR7EIX	4055	0.5
	1100	Breva V 1100 (Twin Spark)	05→07	Ø10mm Plug	BPR6ES	7822	PMR8B	6378	
Ø14mm Plug		BPR6EIX		6637					0.7
California 1100 Carb		94→96	BPR6ES	7822			BPR6EIX	6637	0.6
California 1100 Inj (Inc. EV, Jackal, Special, Stone & Touring)		94→12	BPR6ES	7822			BPR6EIX	6637	0.7
California Vintage (Twin Spark)		06→10	Ø10mm Plug	BPR6ES	7822	PMR8B	6378		0.7
Ø14mm Plug			BPR6EIX					6637	0.7
Griso 1100 (Twin Spark)		05→07	Ø10mm Plug	BPR6ES	7822	PMR8B	6378		0.7
Ø14mm Plug			BPR6EIX					6637	0.7
Quota 1100 ES		98→01	BPR6ES	7822			BPR6EIX	6637	0.5
Sport 1100 (Carb)		94→08/96	BP6ES	7811			BPR6EIX	6637	0.7
Sport 1100 (Injection)		96→99	BPR6ES	7822			BPR6EIX	6637	0.6
V11 (Twin Spark)		2005	Ø10mm Plug	BPR6ES	7822	PMR8B	6378		0.7
Ø14mm Plug			BPR6EIX					6637	0.7
V11 1100cc	01→05	BPR6ES	7822			BPR6EIX	6637	0.6	
V11 Le Mans	03→05	BPR6ES	7822			BPR6EIX	6637	0.6	
1150	Breva V 1200 (Twin Spark)	08→11	Ø10mm Plug	BPR6ES	7822	PMR8B	6378		0.7
	Ø14mm Plug		BPR6EIX					6637	0.7
	Griso 8V	08→13			PMR8B	6378		0.7	
	Griso 8V SE	09→13			PMR8B	6378		0.7	
	Griso	14→16	CR8EKB	4374			CR8EIX	4218	0.7
	Norge 1200 (Twin Spark)	06→08	Ø10mm Plug	BPR6ES	7822	PMR8B	6378		0.7
	Ø14mm Plug		BPR6EIX					6637	0.7
	Norge 1200 GT 8V	09→15	CR8EKB	4374			CR8EIX	4218	0.7
	Sport 1200 (Twin Spark)	07→08	Ø10mm Plug	BPR6ES	7822	PMR8B	6378		0.7
	Ø14mm Plug		BPR6EIX					6637	0.7
	Sport 1200 4V	09→13			PMR8B	6378		0.7	
	Stelvio 1200 4V	08→10			PMR8B	6378		0.7	
	Stelvio 1200 8V	11→16	CR8EKB	4374			CR8EIX	4218	0.7
Stelvio 1200 TT (NTX)	09→10			PMR8B	6378		0.7		
Stelvio 1200 8V NTX	11→16	CR8EKB	4374			CR8EIX	4218	0.7	
1225	MGS-01 Corsa	05→07					DCR9EIX	6650	0.6
1380	Audace (Twin Spark)	15→	LMAR8F-9	90894					0.9
	California (Twin Spark)	13→	LMAR8F-9	90894					0.9
	Eldorado (Twin Spark)	15→	LMAR8F-9	90894					0.9
	MGX-21 (Twin Spark)	17→	LMAR8F-9	90894					0.9



CC	MODEL	DATE	STANDARD COPPER CORE	STOCK NUMBER	PLATINUM OR GOLD PALLADIUM	STOCK NUMBER	IRIDIUM	STOCK NUMBER	GAP MM
MOTO MORINI									
250	250, Sport	80→85	BP7ES	2412			BPR7EIX	4055	0.7
350	350 3½ Sport/Strada	74→84	BP7ES	2412			BPR7EIX	4055	0.7
	Kanguro 350	82→87	BP7ES	2412			BPR7EIX	4055	0.7
500	Excaliber 500/501	86→93	BP8ES	2912			BPR8EIX	6684	0.5
	Maestro	81→	BP7ES	2412			BPR7EIX	4055	0.7
	Sahara 500	81→89	BP7ES	2412			BPR7EIX	4055	0.7
1187	9½	06→	CR9E	6263			CR9EIX	3521	0.7
	Corsaro	06→	CR9E	6263			CR9EIX	3521	0.7

MOTO ROMA									
50	Bee 50		BPR7HS	6422			BPR7HIX	5944	0.6
	GoGo 50	02→	BPR7HS	6422			BPR7HIX	5944	0.6
	Grand Prix 50		BPR7HS	6422			BPR7HIX	5944	0.6
	MRX1		B8HS	5510			BR8HIX	7001	0.6
	MRX2		B8HS	5510			BR8HIX	7001	0.6
	MRX2 Sprint	02→	B7HS	5110			BR7HIX	7067	0.6
	MRX3	02→	B6HS	4510			BR6HIX	3419	0.6
	MRX3 Sprint	02→	B7HS	5110			BR7HIX	7067	0.6
	MRX4	03→	BR10ES	4832			BR10EIX	6801	0.7
	Roadrunner 50		BP7HS	5111			BPR7HIX	5944	0.6
	RT 50 (2-Stroke)	02→	BPR7HS	6422			BPR7HIX	5944	0.6
	Scrambler 50		BPR7HS	6422			BPR7HIX	5944	0.6
	Stinger, Stinger II		BPR7HS	6422			BPR7HIX	5944	0.6
	Wasp		BPR7HS	6422			BPR7HIX	5944	0.6
Wasp II		BPR7HS	6422			BPR7HIX	5944	0.6	
90	RT 90 (4-Stroke)	02→	BPR7HS	6422			BPR7HIX	5944	0.6
100	Grand Prix 100		BPR7HS	6422			BPR7HIX	5944	0.6
	Roadrunner 100		BPR7HS	6422			BPR7HIX	5944	0.6
110	GoGo 110	02→	CR7HS	7223			CR7HIX	7544	0.6
125	Grand Prix 125		CR7HS	7223			CR7HIX	7544	0.6
	MRX125	02→03	D8EA	2120	DR8EVX	6354	DR8EIX	6681	0.6
	MRX125B	04→05	CR7HSA	4549			CR7HIX	7544	0.6
	Road Runner 125	02→	C7HSA	4629			CR7HIX	7544	0.6
	SK125	10→	DR8EA	7162	DR8EVX	6354	DR8EIX	6681	0.6
	SMX125		CR7HSA	4549			CR7HIX	7544	0.6
	Virage 125		D8EA	2120	DR8EVX	6354	DR8EIX	6681	0.6

MOTOBECANE									
50	Mobylette	49→83	B5HS	4210					0.4

MOTORHISPANIA									
50	Furia 50, Furia Cross (½", 12.7mm Thread Reach)		BPR7HS	6422			BPR7HIX	5944	0.6
	Furia 50, Furia Cross (¾", 19mm Thread Reach)	99→	BR9ES	5722			BR9EIX	3981	0.6
	RX50	00→	BR9ES	5722			BR9EIX	3981	0.6
	RYZ 50 Cross, Supermoto	02→	BR9ES	5722			BR9EIX	3981	0.6
125	Duna SM125	07→	CR6HSA	2983			CR6HIX	7274	0.7
	Duna SX125	07→	CR6HSA	2983			CR6HIX	7274	0.7
	MH7	10→	CR6HSA	2983			CR6HIX	7274	0.7
	RYZ 125 (Yamaha engine)	05→	CR7HSA	4549			CR7HIX	7544	0.6

MS									
50	Sprite		BP6ES	7811			BPR6EIX	6637	0.7
	Steward		BP6ES	7811			BPR6EIX	6637	0.7

MV AGUSTA									
675	Brutale 675 Trepistone	02/12→	CR9EKB	2305			CR9EIX	3521	0.8
	F3 (Incl. Serie Oro)	11/11→	CR9EKB	2305			CR9EIX	3521	0.8
750	Brutale S	02→06	CR9EKB	2305			CR9EIX	3521	0.8



CC	MODEL	DATE	STANDARD COPPER CORE	STOCK NUMBER	PLATINUM OR GOLD PALLADIUM	STOCK NUMBER	IRIDIUM	STOCK NUMBER	GAP MM
MV AGUSTA (CONTINUED)									
750	F4, F4S 1+1, F4 SPR	99→04	CR9EKB	2305			CR9EIX	3521	0.8
	F4 Senna	02→04	CR9EKB	2305			CR9EIX	3521	0.8
	F4 all models, track/race use only.	99→04	R0045Q-10	4216					1.1
800	Brutale 800	13→					CR9EIB-9	92579	0.9
	Dragster 800	14→					CR9EIB-9	92579	0.9
	F3	13→					CR9EIB-9	92579	0.9
	Rivale 800	13→					CR9EIB-9	92579	0.9
	Turismo Veloce 800	14→					CR9EIB-9	92579	0.9
910	Brutale 910, 910 R, 910 S	05→08	CR9EKB	2305			CR9EIX	3521	0.8
921	Brutale 920	04/11→	CR9EB	6955			CR9EIX	3521	0.7
982	Brutale 989 R	08→09	CR9EB	6955			CR9EIX	3521	0.7
1000	Brutale 990 R	09→12	CR9EB	6955			CR9EIX	3521	0.7
	F4 1000 S	04→09	CR9EKB	2305			CR9EIX	3521	0.8
	F4 1000 R (Incl. Senna)	06→09	CR9EB	6955			CR9EIX	3521	0.7
	F4 AGO	04→05	CR9EB	6955			CR9EIX	3521	0.7
	F4 R 312	07→08	CR9EB	6955			CR9EIX	3521	0.7
	F4	10→	CR9EB	6955			CR9EIX	3521	0.7
	F4 R	12→	CR9EB	6955			CR9EIX	3521	0.7
	F4 RR	11→	CR9EB	6955			CR9EIX	3521	0.7
	F4 all models, track/race use only.	04→	R0045Q-10	4216					1.1
	1078	Brutale 1078 RR	08→	CR9EB	6955			CR9EIX	3521
Brutale 1090 R		12→	CR9EB	6955			CR9EIX	3521	0.7
Brutale 1090 RR		10→	CR9EB	6955			CR9EIX	3521	0.7
F4 RR 312		08→09	CR9EB	6955			CR9EIX	3521	0.7

MZ									
50	Moskito 50		BR7HS	4122			BR7HIX	7067	0.7
	Moskito SX 50		BR7HS	4122			BR7HIX	7067	0.9
125	ETZ 125	86→99	B8HS	5510			BR8HIX	7001	0.6
	Moskito 125		C7HSA	4629			CR7HIX	7544	0.6
	RT/SX/SM 125		CR8E	1275			CR8EIX	4218	0.7
	Saxon Sportstar 125		B8HS	5510			BR8HIX	7001	0.7
	TS125	76→86	B8HS	5510			BR8HIX	7001	0.6
150	ETZ 150	86→95	B8HS	5510			BR8HIX	7001	0.6
	TS150	75→86	B8HS	5510			BR8HIX	7001	0.6
250	ETZ 250/251	81→97	B8HS	5510			BR8HIX	7001	0.6
	TS250-1	76→83	B8HS	5510			BR8HIX	7001	0.6
300	ETZ 300/301 Series	87→97	B8HS	5510			BR8HIX	7001	0.6
500	MZ500, 500R	92→96	D8EA	2120	DR8EVX	6354	DR8EIX	6681	0.7
	Saxon (494cc Rotax engine) Country, Silver Star, Tour	93→98	D8EA	2120	DR8EVX	6354	DR8EIX	6681	0.7
650	Baghira, Black Panther, Mastiff, Supermoto	98→	DPR8EA-9	4929			DPR8EIX-9	2202	0.9
659	Skorpion 659 Replica, Sport, Tour, Traveller	94→	DPR8EA-9	4929			DPR8EIX-9	2202	0.9
	Skorpion Cup 659cc		DPR9EA-9	5329			DPR9EIX-9	5545	0.9
1000	1000S, SF, ST	04→	BCPR6ET	2197			BKR6EIX	6418	0.8

NEVAL									
650	Dnepr Classic, Roadster, Phoenix, Soviet, Soviet Knight	78→	B7HS	5110			BR7HIX	7067	0.5
	Ural 650cc	85→	B6HS	4510			BR6HIX	3419	0.6

NIPPONIA									
50	Neon	12→	BPR7HS	6422			BPR7HIX	5944	0.6
125	Brio	12→	CR7HSA	4549			CR7HIX	7544	0.6
	Dion	12→	CR7HSA	4549			CR7HIX	7544	0.6
	Miro	12→	CR7HSA	4549			CR7HIX	7544	0.6

NORTON									
750	Atlas	62→68	BP8ES	2912			BPR8EIX	6684	0.5
	Commando	67→73	BP7ES	2412			BPR7EIX	4055	0.6
850	Commando	73→78	BP7ES	2412			BPR7EIX	4055	0.6



CC	MODEL	DATE	STANDARD COPPER CORE	STOCK NUMBER	PLATINUM OR GOLD PALLADIUM	STOCK NUMBER	IRIDIUM	STOCK NUMBER	GAP MM
NORTON (CONTINUED)									
961	Commando SE	10→	CR9EB	6955			CR9EIX	3521	0.8
	Commando Café Racer	11→	CR9EB	6955			CR9EIX	3521	0.8
	Commando Sport	10→	CR9EB	6955			CR9EIX	3521	0.8
Rotary	F1, Commander	88→93	C8E	7471			CR8EIX	4218	0.6

OSSA									
272	TR280i	11→	BPR5ES	7422			BPR5EIX	6597	0.5

PEUGEOT									
50	Buxy / Buxy RS 50 (Air Cooled)	95→97	B7HS	5110			BR7HIX	7067	0.6
	Django 50	15→	BR7HS	4122			BR7HIX	7067	0.6
	Elyseo 50 (Air Cooled)	98→	BR7HS	4122			BR7HIX	7067	0.6
	Elystar 50P	02→05	CPR8E	7411			CR8EIX	4218	0.8
	Jet Force 50	03→	CPR8E	7411			CR8EIX	4218	0.8
	Jet Force C-Tech	06→	CR7EB	4663			CR7EIX	7385	0.6
	Jet Force TSDI	05→	CR7EKA	1462			CR7EIX	7385	0.7
	Looxor 50	01→04	BR7HS	4122			BR7HIX	7067	0.6
	Looxor 50 TSDI Inj. (2-Stroke)	02→	CPR8E	7411			CR8EIX	4218	0.8
	Ludix 50 Blaster, Elegance, Snake Ø14mm Plug	04→07	BR7HS	4122			BR7HIX	7067	0.6
	Ludix Blaster Ø10mm Plug	08→	CR7EB	4663			CR7EIX	7385	0.6
	Ludix Blaster RS12 Ø10mm Plug	06→	CR7EB	4663			CR7EIX	7385	0.6
	Metal-X	02→	BR7HS	4122			BR7HIX	7067	0.6
	Speedake 50 (Air Cooled)	95→97	BR7HS	4122			BR7HIX	7067	0.6
	Speedfight 50 (All models Air Cooled)	96→00	BR7HS	4122			BR7HIX	7067	0.6
	Speedfight 50 LCD/P (Liquid Cooled)	96→00	BR7HS	4122			BR7HIX	7067	0.6
	Speedfight 2 50 (Air Cooled)	00→	BR7HS	4122			BR7HIX	7067	0.6
	Speedfight 2 50 (Liquid Cooled)	01→	BR7HS	4122			BR7HIX	7067	0.6
	Speedfight 2 Motorsport 50 LC	07→	BR7HS	4122			BR7HIX	7067	0.6
	Speedfight 3 Air (Air Cooled)	09→	BR7HS	4122			BR7HIX	7067	0.6
	Speedfight 3 Darkside, Iceblade, Liquid, Team (Liquid Cooled)	09→14	CR7EB	4663			CR7EIX	7385	0.6
	Speedfight 4	15→	CR6EB	90071					0.8
	Squab (Air Cooled)	96→97	BR7HS	4122			BR7HIX	7067	0.6
	TKR 50	02→	BR7HS	4122			BR7HIX	7067	0.6
	TKR 50 307 WRC	05→	BR7HS	4122			BR7HIX	7067	0.6
	Trekker 50 Road, Off Road	97→04	BR7HS	4122			BR7HIX	7067	0.6
	Tweet 50	12→	CR6HSA	2983			CR6HIX	7274	0.7
	Vivacity 50, Vivacity 50P	99→10	BR7HS	4122			BR7HIX	7067	0.6
	Vivacity 50 Sportline	00→10	BR7HS	4122			BR7HIX	7067	0.6
	Vivacity 3 Sixties	11→	CR6HSA	2983			CR6HIX	7274	0.7
	V-Clic	07→	CR7HSA	4549			CR7HIX	7544	0.6
	XPS 50 Enduro, Trail, Supermotard 50	03→	BR9ES	5722			BR9EIX	3981	0.7
XR6 50	03→	BR9ES	5722			BR9EIX	3981	0.7	
Zenith 50 L, M, LS, N	95→00	BR7HS	4122			BR7HIX	7067	0.6	
100	Elyseo 100	98→	BR8ES	5422			BR8EIX	5044	0.6
	Looxor 100	01→04	BR8ES	5422			BR8EIX	5044	0.6
	Metal X 100	02→	BR8ES	5422			BR8EIX	5044	0.6
	Speedfight 100 (Air Cooled)	97→	BR8ES	5422			BR8EIX	5044	0.6
	Speedfight WRC 206 (Air Cooled)	01→	BR8ES	5422			BR8EIX	5044	0.6
	Speedfight 2	00→08	BR8ES	5422			BR8EIX	5044	0.6
	Trekker 100 (Air Cooled)	97→00	BR8ES	5422			BR8EIX	5044	0.6
	Vivacity 100, Vivacity 100 Sportline	99→08	BR8ES	5422			BR8EIX	5044	0.6
125	Citystar	11→	CR8EB	7784			CR8EIX	4218	0.8
	Django 125	15→	CR7HSA	4549			CR7HIX	7544	0.7
	Elyseo 125 (Liquid Cooled)	99→	CR7E	4578			CR7EIX	7385	0.6
	Elystar 125	02→05	CR7EB	4663			CR7EIX	7385	0.6
	Elystar 125 Injection	05→11	CR7EB	4663			CR7EIX	7385	0.6
	Geopolis Executive 125	07→	CR9EB	6955			CR9EIX	3521	0.6
	Jet Force F.I.	03→	CR7EB	4663			CR7EIX	7385	0.6
	Jet Force EFI Compressor	05→	CR8EK	3478			CR8EIX	4218	0.7
	Looxor 125	02→	CR7EB	4663			CR7EIX	7385	0.6
	Satelis 125	05→10	CR9EB	6955			CR9EIX	3521	0.6



CC	MODEL	DATE	STANDARD COPPER CORE	STOCK NUMBER	PLATINUM OR GOLD PALLADIUM	STOCK NUMBER	IRIDIUM	STOCK NUMBER	GAP MM
PEUGEOT (CONTINUED)									
125	Satelis 125 Compressor	07→10	CR9EB	6955			CR9EIX	3521	0.6
	Satelis 125 Executive	06→10	CR9EB	6955			CR9EIX	3521	0.6
	Satelis 2 125	15→	CR8EB	7784			CR8EIX	4218	0.8
	Satelis LFE 125i	13→	CR8EB	7784			CR8EIX	4218	0.8
	Speedfight 3	14→	CR7HSA	4549			CR7HIX	7544	0.7
	Sum Up 125	08→	CR7HSA	4549			CR7HIX	7544	0.7
	SV125	91→94	BP6HS	4511			BPR6HIX	4085	0.6
	Tweet 125	10→	CR7HSA	4549			CR7HIX	7544	0.7
	XPS CT125	06→08	CR7HSA	4549			CR7HIX	7544	0.7
	Vivacity 125	10→	CR7HSA	4549			CR7HIX	7544	0.7
150	Django 150	15→	CR7HSA	4549			CR7HIX	7544	0.7
	Elyseo 150 (Liquid Cooled)	00→02	CR7E	4578			CR7EIX	7385	0.6
	Elystar 150	02→	CR7EB	4663			CR7EIX	7385	0.6
	Looxor 150	02→	CR7EB	4663			CR7EIX	7385	0.6
200	Citystar 200i	16→	CR8EB	7784			CR8EIX	4218	0.8
250	Geopolis Executive 250	07→	CR9EB	6955			CR9EIX	3521	0.6
	Satelis 250	07→	CR9EB	6955			CR9EIX	3521	0.6
300	Satelis 2 300	15→	CR7EKB	4455			CR7EIX	7385	0.8
400	Metropolis 400i LFE	13→	CPR9EB-9	6508			CR9EIX	3521	0.9
	Satelis 2 400	15→	CPR8EB-9	6607					0.9
	Satelis 2 400RS	15→	CPR8EB-9	6607					0.9
500	Satelis 500	08→	CR7EKB	4455			CR7EIX	7385	0.8

PGO									
50	Big Max, Galaxy 50, G-Max, Mega, Tornado	98→	BPR7HS	6422			BPR7HIX	5944	0.6
	Comet 50, PMX Sport 50, Rodoshow 50, T-Rex 50	98→	BPR7HS	6422			BPR7HIX	5944	0.6
	Libra 50	08→	BPR7HS	6422			BPR7HIX	5944	0.6
	Ligero 50	08→	BPR7HS	6422			BPR7HIX	5944	0.6
	PMX Naked 50	07→	BPR7HS	6422			BPR7HIX	5944	0.6
125	G-Max 125	05→	CR7HSA	4549			CR7HIX	7544	0.6
	Libra 125	08→	C7HSA	4629			CR7HIX	7544	0.6
	Ligero 125	08→	C7HSA	4629			CR7HIX	7544	0.6
	T-Rex 125	98→	CR7HSA	4549			CR7HIX	7544	0.6
250	G-Max 250	05→07	DPR7EA-9	5129			DPR7EIX-9	7803	0.7

PIAGGIO / VESPA									
50	50 Special	83→	B6HS	4510			BR6HIX	3419	0.5
	Fly 50 (2-Stroke)	04→	BR9ES	5722			BR9EIX	3981	0.6
	Fly 50 (4-Stroke) 2V Ø10mm Plug	06→13	CR8EB	7784			CR8EIX	4218	0.8
	Fly 50 (4-Stroke) 4V Ø8mm Plug	14→	ER9EH-6N	1673					0.6
	Free 50 (All versions)	93→97	BR9ES	5722			BR9EIX	3981	0.5
	Liberty 50 (2-Stroke)	97→05	BR9ES	5722			BR9EIX	3981	0.5
	Liberty 50 (4-Stroke)	02→05	CR9EB	6955			CR9EIX	3521	0.7
	Liberty 50 (4-Stroke)	06→16	CR8EB	7784			CR8EIX	4218	0.8
	Liberty 50 (i-Get 4-Stroke Euro 4)	17→					MR8BI-8	91360	0.8
	NRG 50, NRG Power DD/DT Ø14mm Plug	97→	BR9ES	5722			BR9EIX	3981	0.6
	NRG mc3 Pure Jet Ø10mm Plug	02→05	CPR8E	7411			CR8EIX	4218	0.8
	NRG mc3 Pure Jet Ø10mm Plug	06→			ZMR7AP	6914			0.8
	PK50S	83→87	B6HS	4510			BR6HIX	3419	0.5
	Primavera 50 (2-Stroke)	13→15	BR9ES	5722			BR9EIX	3981	0.5
	Primavera 50 (4-Stroke)	13→16	ER9EH-6N	1673					0.6
	Primavera 50 (i-Get 4-Stroke Euro 4)	17→					MR8BI-8	91360	0.8
	Sfera 50	91→97	BR9ES	5722			BR9EIX	3981	0.5
	Typhoon 50	93→05	B9ES	2611			BR9EIX	3981	0.5
	Typhoon 50	06→15	BR9ES	5722			BR9EIX	3981	0.5
	Velofax, Quartz, Zip, Zip SP (2-Stroke)	93→	BR9ES	5722			BR9EIX	3981	0.5
	Vespa ET2 (2-Stroke)	97→05	BR9ES	5722			BR9EIX	3981	0.5
	Vespa ET4 50 (4-Stroke)	01→05	CR9EB	6955			CR9EIX	3521	0.6
	Vespa LX50 (2-Stroke)	98→05	BR9ES	5722			BR9EIX	3981	0.6
	Vespa LX50 (2-Stroke)	05→13	BR9ES	5722			BR9EIX	3981	0.6
	Vespa LX50 (4-Stroke) Ø10mm Plug	06→09	CR8EB	7784			CR8EIX	4218	0.8



CC	MODEL	DATE	STANDARD COPPER CORE	STOCK NUMBER	PLATINUM OR GOLD PALLADIUM	STOCK NUMBER	IRIDIUM	STOCK NUMBER	GAP MM
PIAGGIO / VESPA (CONTINUED)									
50	Vespa LX50 4V (4-Stroke) Ø8mm Plug	10→	ER9EH-6N	1673					0.6
	Vespa LXV 50 (2-Stroke)	06→	BR9ES	5722			BR9EIX	3981	0.6
	Vespa S 50 (2-Stroke) Ø14mm Plug	07→	BR9ES	5722			BR9EIX	3981	0.6
	Vespa S 50 (4-Stroke) Ø8mm Plug	08→	ER9EH-6N	1673					0.6
	Vespa Zafferano 50	08→09	BR9ES	5722			BR9EIX	3981	0.6
	Zip 50 (2-Stroke)	93→15	BR9ES	5722			BR9EIX	3981	0.7
	Zip 50 (4-Stroke)	02→16	CR8EB	7784			CR8EIX	4218	0.7
	Zip 50 (i-Get 4-Stroke Euro 4)	17→					MR8BI-8	91360	0.8
80	Sfera 80	93→98	BR9ES	5722			BR9EIX	3981	0.5
	Typhoon 80	94→00	B9ES	2611			BR9EIX	3981	0.5
100	Diesis 100	02→03	BR9ES	5722			BR9EIX	3981	0.6
	Fly 100 (4-Stroke)	08→	CR8EB	7784			CR8EIX	4218	0.7
	PK 100 S	83→93	B6HS	4510			BR6HIX	3419	0.5
	Zip 100 (4-Stroke)	06→08	CR9EB	6955			CR9EIX	3521	0.7
125	Ape		BR7HS	4122			BR7HIX	7067	0.7
	B 125 Beverly (Liquid Cooled 4-Stroke)	02→	CR8EB	7784			CR8EIX	4218	0.8
	Carnaby 125	07→	CR8EB	7784			CR8EIX	4218	0.8
	Cosa, Cosa II (125)	90→95	BR9ES	5722			BR9EIX	3981	0.6
	Fly 125 (4-Stroke)	05→13	CR7EB	4663			CR7EIX	7385	0.6
	Fly 125 (4-Stroke) 3V	14→	CR8EB	7784			CR8EIX	4218	0.7
	Hexagon 125	94→98	BR9ES	5722			BR9EIX	3981	0.5
	Hexagon GTX 125	00→02	CR9EB	6955			CR9EIX	3521	0.7
	Hexagon LX 125	98→00	BR9ES	5722			BR9EIX	3981	0.6
	Liberty 125 (4-Stroke)	98→	CR9E	6263			CR9EIX	3521	0.6
	Liberty 125 Leader		CR8EB	7784			CR8EIX	4218	0.7
	Medley 125	16→					LMAR8EI-7	92499	0.7
	MP3 125	06→	CR8EB	7784			CR8EIX	4218	0.8
	P125X		B6HS	4510			BR6HIX	3419	0.5
	Primavera & PK 125		B6HS	4510			BR6HIX	3419	0.5
	Primavera ET3		B7HS	5110			BR7HIX	7067	0.5
	Primavera 3V (4-Stroke)	13→15	CR8EB	7784			CR8EIX	4218	0.8
	Sfera 125 (4-Stroke)	96→98	CR9E	6263			CR9EIX	3521	0.6
	Skipper	93→98	B9ES	2611			BR9EIX	3981	0.5
	Skipper 125 (2-Stroke)	98→01	BR9ES	5722			BR9EIX	3981	0.5
	Skipper ST 125 (4-Stroke)	00→04	CR7EB	4663			CR7EIX	7385	0.6
	Sprint 3V	14→	CR8EB	7784			CR8EIX	4218	0.8
	Typhoon 125	95→03	B9ES	2611			BR9EIX	3981	0.5
	Typhoon 125	10→	CR7EB	4663			CR7EIX	7385	0.6
	Vespa 946	13→	CR8EB	7784			CR8EIX	4218	0.8
	Vespa ET4 125 (4-Stroke)	96→05	CR8EB	7784			CR8EIX	4218	0.8
	Vespa GT 125 Granturismo	03→07	CR8EB	7784			CR8EIX	4218	0.8
	Vespa GT V 125	06→	CR8EB	7784			CR8EIX	4218	0.8
	Vespa GTS 125	07→15	CR8EB	7784			CR8EIX	4218	0.8
	Vespa GTS 125	16→					LMAR8EI-7	92499	0.7
	Vespa GTS 125 Super i.e.	09→15	CR8EKB	4374			CR8EIX	4218	0.7
	Vespa LX 125 (4-Stroke)	05→11	CR7EB	4663			CR7EIX	7385	0.6
	Vespa LX 125 3V (4-Stroke)	12→	CR8EB	7784			CR8EIX	4218	0.8
	Vespa LX V 125	06→	CR7EB	4663			CR7EIX	7385	0.6
	Vespa PX125E (Electric Start)	82→93	BR7HS	4122			BR7HIX	7067	0.5
	Vespa PX125T5, T5 Classic (2-Stroke)	85→99	B9ES	2611			BR9EIX	3981	0.5
	Vespa PX125 (2-Stroke, Euro 1)	00→08	B6HS	4510			BR6HIX	3419	0.5
	Vespa PX125 (2-Stroke, Euro 3)	11→16	BR6HS	3922			BR6HIX	3419	0.6
	Vespa S 125	07→12	CR7EB	4663			CR7EIX	7385	0.6
	Vespa Zafferano 125	08→09	CR7EB	4663			CR7EIX	7385	0.6
	X7 125	2008	CR8EB	7784			CR8EIX	4218	0.6
	X7 125	09→	CR8EKB	4374			CR8EIX	4218	0.7
	X8 125	06→08	CR8EB	7784			CR8EIX	4218	0.6
	X9 125 (Piaggio 4-Stroke)	01→07	CR8EB	7784			CR8EIX	4218	0.6
	X10	14→	CR8EKB	4374			CR8EIX	4218	0.7
	Xevo 125 (Incl. Sport)	07→	CR8EB	7784			CR8EIX	4218	0.7
	Zip 125	01→04	CR7EB	4663			CR7EIX	7385	0.6
150	Cosa 150		BR9ES	5722			BR9EIX	3981	0.6
	Medley 150	16→					LMAR8EI-7	92499	0.7



CC	MODEL	DATE	STANDARD COPPER CORE	STOCK NUMBER	PLATINUM OR GOLD PALLADIUM	STOCK NUMBER	IRIDIUM	STOCK NUMBER	GAP MM
PIAGGIO / VESPA (CONTINUED)									
150	Vespa GTS 150	16→					LMAR8EI-7	92499	0.7
	Vespa PX150	83→08	B6HS	4510			BR6HIX	3419	0.5
	Vespa PX150 (2-Stroke, Euro 3)	11→16	BR6HS	3922			BR6HIX	3419	0.6
180	Hexagon 180LXT	98→00	BR9ES	5722			BR9EIX	3981	0.6
190	Ape		BR7HS	4122			BR7HIX	7067	0.7
200	Beverly 200 (4-Stroke)		CR8EB	7784			CR8EIX	4218	0.8
	Cosa 200, P200E		B6ES	7310					0.5
	Cosa II 200	88→98	B7ES	1111			BR7EIX	6664	0.5
	Vespa 200 Rally	72→79	B7ES	1111			BR7EIX	6664	0.5
	Vespa GT 200 Granturismo	03→07	CR7EB	4663			CR7EIX	7385	0.6
	Vespa PX200	86→97	B7ES	1111			BR7EIX	6664	0.5
	Vespa PX200 E Disc	98→05	BR6ES	4922					0.6
	X8 200	05→	CR7EKB	4455			CR7EIX	7385	0.8
220	Ape		BR7HS	4122			BR7HIX	7067	0.7
250	Hexagon GT 250, GTX 250 (Honda 4-Stroke)	98→01	DPR6EA-9	5531					0.9
	MP3 250	06→			PMR8A	5851	CR8EIX	4218	0.6
	Super Hexagon GTX250	00→	CR9E	6263			CR9EIX	3521	0.7
	Vespa GTS 250i.e.	05→			PMR8A	5851	CR8EIX	4218	0.6
	Vespa GTV 250i.e.	06→			PMR8A	5851	CR8EIX	4218	0.6
	X7 250	08→			PMR8A	5851	CR8EIX	4218	0.6
	X8 250	06→08	CR8EB	7784			CR8EIX	4218	0.6
	X9 250cc (Honda 4-Stroke)	00→03	DPR7EA-9	5129			DPR7EIX-9	7803	0.9
	X9 250cc Evolution (Quasar 4-Stroke + carb)	04→07	CR8EB	7784			CR8EIX	4218	0.6
	XEvo 250	07→			PMR8A	5851	CR8EIX	4218	0.6
300	MP3 300 (Incl. LT)	10→	CR8EKB	4374			CR8EIX	4218	0.7
	Vespa GTS 300 (Incl. Super, Touring)	08→	CR8EKB	4374			CR8EIX	4218	0.7
	Vespa GTV 300	09→15	CR8EKB	4374			CR8EIX	4218	0.7
350	Beverly 350 Sport Touring	12→	CR8EKB	4374			CR8EIX	4218	0.7
	X10	12→	CR7EKB	4455			CR7EIX	7385	0.8
400	MP3 400	07→10	CR7EKB	4455			CR7EIX	7385	0.8
	X8 400	06→08	CR7EKB	4455			CR7EIX	7385	0.8
	Xevo 400	07→	CR7EKB	4455			CR7EIX	7385	0.8
460	B500	03→	CR7EKB	4455			CR7EIX	7385	0.8
	X9 500 (Fuel Injection 4-Stroke)	02→	CR7EKB	4455			CR7EIX	7385	0.8
	X9 500 Evolution (Fuel Injection 4-Stroke)	04→08	CR7EKB	4455			CR7EIX	7385	0.8
500	MP3 500 LT Sport	11→	CR7EKB	4455			CR7EIX	7385	0.8
	X10	14→	CR7EKB	4455			CR7EIX	7385	0.8

PIONEER									
125	Nevada 125	08→	D8EA	2120			DR8EIX	6681	0.7
	Torro 125	08→	D8EA	2120			DR8EIX	6681	0.7

PUCH									
50	Magnum		B-4H	4110					0.5
	Maxi: 1.0 HP Models		B-4H	4110					0.5
	Maxi: 1.5 HP Models		B5HS	4210					0.5
	Maxi: 2.0 HP Models		B6HS	4510			BR6HIX	3419	0.5
	Monza 50, Ranger 50, X40		B7HS	5110			BR7HIX	7067	0.5

PULSE									
50	Evo SM	11→	BR8ES	5422			BR8EIX	5044	0.6
	HT50QT-36 Force 50 (2-valve)		CR7HS	7223			CR7HIX	7544	0.7
	Advert, Ghost		BPR7HS	6422			BPR7HIX	5944	0.6
	Force 50 (2-Stroke)	08→	BPR7HS	6422			BPR7HIX	5944	0.6
	Lightspeed 2 WY50QT-58	08→	CR7HS	7223			CR7HIX	7544	0.7
	Rhythm, Scout		CR7HS	7223			CR7HIX	7544	0.7
125	Adrenaline 125 XF125GY-2B	08→	CR8E	1275			CR8EIX	4218	0.7
	HT125T-9 Vijo 125		D8EA	2120			DR8EIX	6681	0.7
	Lightspeed 2 WY125T-74	12→	CR7HS	7223			CR7HIX	7544	0.7
	LK125GY-2 Rage 125		CR7HS	7223			CR7HIX	7544	0.7



CC	MODEL	DATE	STANDARD COPPER CORE	STOCK NUMBER	PLATINUM OR GOLD PALLADIUM	STOCK NUMBER	IRIDIUM	STOCK NUMBER	GAP MM
PULSE (CONTINUED)									
125	Phantom ZN125T-32A		CR7HS	7223			CR7HIX	7544	0.7
	Zoom		CR7HSA	4549			CR7HIX	7544	0.6
250	Adrenaline 250 XF250GY	08→	DR8EA	7162			DR8EIX	6681	0.7

REGAL RAPTOR									
50	DD50QE-2	03→	CR7HS	7223			CR7HIX	7544	0.7
100	DD100E	03→	CR7HS	7223			CR7HIX	7544	0.7

REGENT									
125	Roadster, Deluxe, Sports Tourer, Super RT125		B7HS	5110			BR7HIX	7067	0.6
150	Roadster, Trail, Deluxe	95→97	B7HS	5110			BR7HIX	7067	0.6
175	Roadster, Trail, Deluxe, Sports Tourer, Super RT175	95→97	B7HS	5110			BR7HIX	7067	0.6

RIDERS									
50	Riders Super Cub	11→	CR7HSA	4549			CR7HIX	7544	0.6
110	Riders Super Cub	11→	CR7HSA	4549			CR7HIX	7544	0.6

RIEJU									
50	MRT 50 (Incl. Pro, SM)		BR9ES	5722			BR9EIX	3981	0.6
	MRX 50 (Minarelli engine)	03→	BR9ES	5722			BR9EIX	3981	0.8
	MRX 50 Pro	03→	BR9ES	5722			BR9EIX	3981	0.8
	MX50 (Morini S5 engine)	03→	B6HS	4510			BR6HIX	3419	0.5
	RR50 / Spike / Supermotard / RR50 Castrol	97→	BR9ES	5722			BR9EIX	3981	0.8
	RRX Spike 50 Supermoto	07→	BR8ES	5422			BR8EIX	5044	0.5
	RS1 Evolution	98→04	BR9ES	5722			BR9EIX	3981	0.8
	RS2 50 Matrix (Incl. Pro)	03→	BR9ES	5722			BR9EIX	3981	0.7
	RS2 50 NKD		BR9ES	5722			BR9EIX	3981	0.7
	RS3	11→	BR9ES	5722			BR9EIX	3981	0.7
	RS3 NKD	13→	BR9ES	5722			BR9EIX	3981	0.7
	SMX (Minarelli engine)	03→	BR9ES	5722			BR9EIX	3981	0.8
	SMX Pro 50	04→	BR9ES	5722			BR9EIX	3981	0.7
	Spike 50		BR9ES	5722			BR9EIX	3981	0.7
	Tango 50, Tango0! 50	07→	BR9ES	5722			BR9EIX	3981	0.7
125	Marathon (Endura / Pro / SM)		CR8E	1275			CR8EIX	4218	0.7
	MRX (Yamaha 4-Stroke)	03→	CR7HSA	4549			CR7HIX	7544	0.6
	RS2 125 Matrix	06→	CR7HSA	4549			CR7HIX	7544	0.6
	RS2 125 NKD	06→07	CR7HSA	4549			CR7HIX	7544	0.6
	RS2 125 Pro	07→11	CR7HSA	4549			CR7HIX	7544	0.6
	RS3	11→	CR8E	1275			CR8EIX	4218	0.7
	RS3 NKD	13→	CR8E	1275			CR8EIX	4218	0.7
	SMX (Yamaha 4-Stroke)	03→	CR7HSA	4549			CR7HIX	7544	0.6
	Tango 125	07→	CR7HSA	4549			CR7HIX	7544	0.6
200	Marathon, Marathon Pro	10→	CR8E	1275			CR8EIX	4218	0.7
250	Marathon	10→	CR8E	1275			CR8EIX	4218	0.7
	Tango 250		D8EA	2120			DR8EIX	6681	0.7
450	Marathon	10→	CR8E	1275			CR8EIX	4218	0.7

ROVIGO									
50	Spoletto 50, Tempesta 50	99→	BPR7HS	6422			BPR7HIX	5944	0.6

ROYAL ENFIELD (1980→)									
350	Bullet Classic models	80→	B7HS	5110			BR7HIX	7067	0.5
500	Bullet Classic models	80→08	BR8ES	5422			BR8EIX	5044	0.5
	Bullet Electra X Lean Burn engine models	04→08	BR9ES	5722			BR9EIX	3981	0.8



CC	MODEL	DATE	STANDARD COPPER CORE	STOCK NUMBER	PLATINUM OR GOLD PALLADIUM	STOCK NUMBER	IRIDIUM	STOCK NUMBER	GAP MM
RTX									
125	Cross C125, Trials T125		B7HS	5110			BR7HIX	7067	0.6
212	Cross C212, Trials T212		B8HS	5510			BR8HIX	7001	0.6

SACHS									
50	Dirty Devil	04→	BP5HS	4111					0.6
	MadAss 50	04→	CR7HSA	4549			CR7HIX	7544	0.6
	Speedjet R	05/09→	BPR7HS	6422			BPR7HIX	5944	0.7
	Speedjet RS	06/11→	BPR7HS	6422			BPR7HIX	5944	0.7
110	Dirty Devil	04→	C7HSA	4629			CR7HIX	7544	0.6
125	MadAss 125	06→	C7HSA	4629			CR7HIX	7544	0.6
	Roadster 125	00→05	CR6HSA	2983			CR6HIX	7274	0.8
	XTC 125, ZX Enduro 125, ZZ 125 (Ø14mm Plug)	00→01	BR9ES	5722			BR9EIX	3981	0.8
	XTC 125 (Ø10mm Plug) 4-Stroke	02→07	CR8E	1275			CR8EIX	4218	0.7
650	Roadster 650	00→06	CR10E	6264			CR10EIX	6482	0.8
805	B 805	02→	DPR8EA-9	4929			DPR8EIX-9	2202	0.9
	Roadster 800	00→05	DPR8EA-9	4929			DPR8EIX-9	2202	0.9

SCORPA									
70	4-Tricks	06→07	CR7HSA	4549			CR7HIX	7544	0.7
125	125 Twenty	15→	BP5ES	6511			BPR5EIX	6597	0.8
	SR125R	11→	BP5ES	6511			BPR5EIX	6597	0.5
	SY 125 FR	03→09	CR7HSA	4549			CR7HIX	7544	0.7
	TY-S 125F	04→06	CR7HSA	4549			CR7HIX	7544	0.7
	TY 125F	12→	CR6HSA	2983			CR6HIX	7274	0.7
175	SY 175 F	03→09	CR7HSA	4549			CR7HIX	7544	0.7
	TY-S 175 F	03→09	CR7HSA	4549			CR7HIX	7544	0.7
250	SY 250						BPR6EIX	6637	0.7
	SY 250 FR	07→	CR8E	1275			CR8EIX	4218	0.7
	SY 250 Long Ride	06→09			BKR5EVX	2546	BKR5EIX	6341	0.6
	SY 250 Racing	01→09			BKR5EVX	2546	BKR5EIX	6341	0.6
	T-Ride 250F	08→	CR8E	1275			CR8EIX	4218	0.7
	TY 250 / E						BKR6EIX	6418	0.7
272	SR280R	11→	BP5ES	6511			BPR5EIX	6597	0.5
300	294, 295		BP5ES	6511			BPR5EIX	6597	0.5

SHERCO									
50	0.5 Kid	03→	B9ES	2611			BR9EIX	3981	0.6
	Base		BR9ES	5722			BR9EIX	3981	0.7
	Champion Replica 50		BR9ES	5722			BR9EIX	3981	0.7
	Enduro 50	03→	BR9ES	5722			BR9EIX	3981	0.7
	HRD50	03→	BR9ES	5722			BR9EIX	3981	0.7
	Ipone Replica		BR9ES	5722			BR9EIX	3981	0.7
	Supermotard 50	03→	BR9ES	5722			BR9EIX	3981	0.7
80	80 ST	14→	BP5ES	6511			BPR5EIX	6597	0.8
	ST 0.8	04→	BP5ES	6511			BPR5EIX	6597	0.5
125	Academy 125	2009	BP5ES	6511			BPR5EIX	6597	0.6
	City Corp 125	04→	CR7HSA	4549			CR7HIX	7544	0.6
	ST 1.25	99→	BP5ES	6511			BPR5EIX	6597	0.6
	125 SE-R	18→					BR9ECMIX	2707	0.7
	125 ST	14→	BP5ES	6511			BPR5EIX	6597	0.6
200	2.0	99→	BP5ES	6511			BPR5EIX	6597	0.6
250	2.5i-F	08→11	CR8EK	3478			CR8EIX	4218	0.7
	Access 2.5 (2-Stroke)	2010	BP5ES	6511			BPR5EIX	6597	0.6
	SE 250i	12→	CR8EK	3478			CR8EIX	4218	0.7
	ST 2.5	99→10	BP5ES	6511			BPR5EIX	6597	0.6
	ST 2.5	11→13	BP5ES	6511			BPR5EIX	6597	0.6
	250 SE-R	15→	BR8ES	5422			BR8EIX	5044	0.7
	250 ST	14→	BP5ES	6511			BPR5EIX	6597	0.6
272	290 X-Ride	12→	BPR5ES	7422			BPR5EIX	6597	0.6
290	3.0i-F	10→11	CR8EK	3478			CR8EIX	4218	0.7



CC	MODEL	DATE	STANDARD COPPER CORE	STOCK NUMBER	PLATINUM OR GOLD PALLADIUM	STOCK NUMBER	IRIDIUM	STOCK NUMBER	GAP MM
SHERCO (CONTINUED)									
290	Access 2.9 (2-Stroke)	2010	BP5ES	6511			BPR5EIX	6597	0.6
	300 SE-R	15→	BR8ES	5422			BR8EIX	5044	0.7
	SE 300i	12→	CR8EK	3478			CR8EIX	4218	0.7
	ST 2.9	99→10	BP5ES	6511			BPR5EIX	6597	0.6
	ST 2.9	11→	BP5ES	6511			BPR5EIX	6597	0.6
320	3.2 4T	05→			PFR6B	3500			0.6
450	4.5i-F 4T	04→	CR8EK	3478			CR8EIX	4218	0.7
	4.5i Enduro	05→	CR8EK	3478			CR8EIX	4218	0.7
510	5.1i	05→	CR8EK	3478			CR8EIX	4218	0.7

SIMSON									
50	S51 Series SR50		B7HS	5110			BR7HIX	7067	0.5
70	S70 C&E	83→	B7HS	5110			BR7HIX	7067	0.5

SINNIS									
50	Eagle, Hawk (2-Stroke)	06/06→	BPR7HS	6422			BPR7HIX	5944	0.6
	Falcon, Jet (4-Stroke)	06/06→	CR7HSA	4549			CR7HIX	7544	0.6
	Flair	05/12→	CR7HSA	4549			CR7HIX	7544	0.6
	Ghost, Nitro, Pioneer, Strike (2-Stroke)	06/06→09	BPR7HS	6422			BPR7HIX	5944	0.6
	Phoenix	05/12→	BPR7HS	6422			BPR7HIX	5944	0.6
110	Breeze	06/06→09	CR7HSA	4549			CR7HIX	7544	0.6
125	Apache, Blade, Max, Stealth, Vista	12/07→	CR8E	1275			CR8EIX	4218	0.7
	Eagle, Matrix, Matrix II, Nitro, Pioneer, Sublime (4-Stroke)	01/07→	CR7HSA	4549			CR7HIX	7544	0.6
	Eco City	01/10→	CR7HSA	4549			CR7HIX	7544	0.6
	Spirit	05/12→	CR7HSA	4549			CR7HIX	7544	0.6
	Trackstar	05/10→	CR8E	1275			CR8EIX	4218	0.7
200	Apache, Blade	12/07→09	DR8ES-L	2923	DR8EVX	6354	DR8EIX	6681	0.7

SKYTEAM									
125	Wacky ST125/Y		C7HSA	4629			CR7HIX	7544	0.7

SMC									
50	NAF 50 Navigator		BPR7HS	6422			BPR7HIX	5944	0.6
	NGF 50 Sports Force		BPR7HS	6422			BPR7HIX	5944	0.6
	NKF 50 on/off road		BPR7HS	6422			BPR7HIX	5944	0.6
	NLFR 50 Caprillio		BPR7HS	6422			BPR7HIX	5944	0.6
	PAF 50 Partner		BPR7HS	6422			BPR7HIX	5944	0.6
	SBF 50 Super		BPR7HS	6422			BPR7HIX	5944	0.6
90	NGN 90 Sports Force		BPR7HS	6422			BPR7HIX	5944	0.6
	SBN 90 Super		BPR7HS	6422			BPR7HIX	5944	0.6
100	NKO 100 on/off road		BPR7HS	6422			BPR7HIX	5944	0.6
	SBO 100 Super		BPR7HS	6422			BPR7HIX	5944	0.6
125	CHP 125 Chopper		DR8EA	7162	DR8EVX	6354	DR8EIX	6681	0.7

SUPERBYKE									
50	M-PED 50	06→	CR7HSA	4549			CR7HIX	7544	0.6
	Powerband 50 (2-Stroke) Ø14mm Plug	06→	BPR7HS	6422			BPR7HIX	5944	0.6
	Powermax 50 (2-Stroke) Ø14mm Plug	08→	BPR7HS	6422			BPR7HIX	5944	0.6
125	Powerband 125	06→	CR7HSA	4549			CR7HIX	7544	0.6
	RBP125	06→	D8EA	2120			DR8EIX	6681	0.7
	RMR125		CR8E	1275			CR8EIX	4218	0.7
	RSP125	10→	DR8EA	7162			DR8EIX	6681	0.7
	SMax125	08→	CR7HSA	4549			CR7HIX	7544	0.6

SUZUKI									
50	AE50 L, M, N, P, R, T	90→99	BPR6HS	7022			BPR6HIX	4085	0.6
	AH50	93→96	BPR6HS	7022			BPR6HIX	4085	0.6



CC	MODEL	DATE	STANDARD COPPER CORE	STOCK NUMBER	PLATINUM OR GOLD PALLADIUM	STOCK NUMBER	IRIDIUM	STOCK NUMBER	GAP MM
SUZUKI (CONTINUED)									
50	AP50 T, V, W	96→02	BPR6HS	7022			BPR6HIX	4085	0.7
	AY50 Katana (Incl. R) Air cooled (Ø14mm Plug)	97→04	BPR6HS	7022			BPR6HIX	4085	0.8
	AY50W, WR Katana (Incl. R) Liquid cooled (Ø14mm Plug)	98→04	BPR6HS	7022			BPR6HIX	4085	0.8
	AY50A Katana (Incl. R) Liquid cooled (Ø10mm Plug)	05→06	CPR8E	7411			CR8EIX	4218	0.8
	CL50D, CS50D Roadie, FS50 Snip	82→88	BPR4HS	7823					0.7
	CP50	85→92	BPR6HS	7022			BPR6HIX	4085	0.6
	DR50	86→94	BR7HS	4122			BR7HIX	7067	0.6
	FR50	81→86	BPR4HS	7823					0.7
	FZ50 Suzy	80→86	BPR4HS	7823					0.7
	JR50	85→06	BPR4HS	7823					0.7
	RM50	78→99	B7HS	5110			BR7HIX	7067	0.6
	RMX 50	96→01	BPR8ES	3923			BPR8EIX	6684	0.7
	SMX 50	96→02	BPR8ES	3923			BPR8EIX	6684	0.7
	TR50S	97→00	BPR6HS	7022			BPR6HIX	4085	0.6
	TS50	71→78	BP6HS	4511			BPR6HIX	4085	0.6
	TS50ER (½", 12.7mm Thread Reach)	79→83	BP6HS	4511			BPR6HIX	4085	0.7
	TS50ER (¾", 19mm Thread Reach)	79→83	BPR6ES	7822			BPR6EIX	6637	0.7
	TS50X	84→00	BPR6ES	7822			BPR6EIX	6637	0.7
	UF 50 Estilete	99→01	BPR7HS	6422			BPR7HIX	5944	0.6
	UX50W-X-Y Zillion	99→01	BPR6HS	7022			BPR6HIX	4085	0.6
ZR50	83→99	BP6ES	7811			BPR6EIX	6637	0.7	
65	RM65 K3-K5	03→05	B10EG	3630			BR10EIX	6801	0.6
70	DR-Z70	08→	CR7HSA	4549			CR7HIX	7544	0.6
80	CP80	85→94	BPR6HS	7022			BPR6HIX	4085	0.7
	CS80CD	83→87	BPR6HS	7022			BPR6HIX	4085	0.7
	FR80D	84→87	BPR6HS	7022			BPR6HIX	4085	0.7
	RM80T	78→85	B10EG	3630			BR10EIX	6801	0.6
	RM80X G, H, J, K, L	86→90	B9EG	3530			BR9EIX	3981	0.7
	RM80X M, N, P, R, S, T, V	91→99	B10EG	3630			BR10EIX	6801	0.7
	RM80 K1	00→01	BR10ES	4832			BR10EIX	6801	0.8
85	RM85 /L K3-K9, L0-L6	02→	BR10ES	4832			BR10EIX	6801	0.8
100	AH100	94→97	BPR7HS	6422			BPR7HIX	5944	0.6
	GP100 All models	78→92	B8HS	5510			BR8HIX	7001	0.7
	RM100	76→81	B9EG	3530			BR9EIX	3981	0.7
	RM100 K4	03→04	R6252K-105	2741					0.7
	TS100ER, TS100ERZ	78→89	B8ES	2411			BR8EIX	5044	0.7
110	UG 110 Hokuto	99→02	BPR7HS	6422			BPR7HIX	5944	0.6
	UK110 Address	15→	CPR7EA-9	3901			CR7EIX	7385	0.9
125	AN125 S	95→96	CR8E	1275			CR8EIX	4218	0.6
	AN125 T,V,W	96→11/98	CR7E	4578			CR7EIX	7385	0.6
	AN125 X	11/98→	CR8E	1275			CR8EIX	4218	0.7
	CS125D	83→87	D8EA	2120	DR8EVX	6354	DR8EIX	6681	0.7
	DR125 SEX-SEY	99→01	DR8EA	7162	DR8EVX	6354	DR8EIX	6681	0.7
	DR125S D/F/H/J	82→94	DR8ES-L	2923	DR8EVX	6354	DR8EIX	6681	0.7
	DR125SM	08→12	CR8E	1275			CR8EIX	4218	0.7
	DR-Z125L	10→	DR8EA	7162	DR8EVX	6354	DR8EIX	6681	0.7
	FL125 S Address	07→14	CR8E	1275			CR8EIX	4218	0.7
	GN125 W-X	93→01	DR8EA	7162	DR8EVX	6354	DR8EIX	6681	0.7
	GP125 All models	78→89	B8HS	5510			BR8HIX	7001	0.7
	GS125ES, D All models	82→00	DR8ES-L	2923	DR8EVX	6354	DR8EIX	6681	0.7
	GSX-R125	17→	MR8E-9	90527					0.9
	GSX-S125	17→	MR8E-9	90527					0.9
	GT125	74→80	B8HS	5510			BR8HIX	7001	0.6
	GZ125 W, X, Y, K1-K3 Marauder	98→03	DR8EA	7162	DR8EVX	6354	DR8EIX	6681	0.6
	GZ125 K4-L1	04→11	CR8E	1275			CR8EIX	4218	0.7
	RG125 UC, G, H, J, J2	85→94	BR8ES	5422			BR8EIX	5044	0.6
	RG125FU-N, P, R	91→95	BR9ECM	3252			BR9ECMIX	2707	0.7
	RG125U Wolf	91→95	BR9ECM	3252			BR9ECMIX	2707	0.6
	RM125 E, F, G, H, J	84→88	BR9EG	3230			BR9EIX	3981	0.5
	RM125 K, L, M	89→91	B9EG	3530			BR9EIX	3981	0.5
	RM125 N, R, S	92→95			R4118S-9	3245			0.6
	RM125 T, V, W, K1-K8	96→08			R6918B-8	4492			0.6
	RV125 Van Van K4-K5	03→05	CR8E	1275			CR8EIX	4218	0.7



CC	MODEL	DATE	STANDARD COPPER CORE	STOCK NUMBER	PLATINUM OR GOLD PALLADIUM	STOCK NUMBER	IRIDIUM	STOCK NUMBER	GAP MM
SUZUKI (CONTINUED)									
125	TS125 (A/B)	76→77	B8HS	5510			BR8HIX	7001	0.7
	TS125 (C,ER/X/Z/D/XUE/XE)	78→88	B8ES	2411			BR8EIX	5044	0.7
	TS125R K, L, M, N, P, R	89→96	BR9ES	5722			BR9EIX	3981	0.7
	UC125 X Epicuro	99→02	CR8E	1275			CR8EIX	4218	0.7
	UH125 K2-K9, L0-L5 Burgman	02→	CR8E	1275			CR8EIX	4218	0.7
	UX125 Sixteen 125	07→11	CR8E	1275			CR8EIX	4218	0.7
	VL125 Y, K1-K5 Intruder	99→08	CR8E	1275			CR8EIX	4218	0.7
200	AN200 K7 Burgman	07→	CR8EK	3478			CR8EIX	4218	0.7
	DR200S	86→	DR8ES-L	2923	DR8EVX	6354	DR8EIX	6681	0.6
	GT200X5	79→82	B8ES	2411			BR8EIX	5044	0.7
	SB200	79→83	B8ES	2411			BR8EIX	5044	0.7
250	AN250 W, X, Y, K1-K3 Burgman	→03	CR8EK	3478			CR8EIX	4218	0.7
	AN250 K4-K6 Burgman	04→06	CR7EK	7546			CR7EIX	7385	0.7
	DL250 V-Strom	17→	CPR7EA-9	3901			CR7EIX	7385	0.9
	GN250 F, J, K, L, M, N, P, R, T	87→97	DR8EA	7162	DR8EVX	6354	DR8EIX	6681	0.6
	GS250T, T/X	80→84	DR8ES	5423			DR9EIX	4772	0.7
	GSX250E T, X, Z	80→85	DR8ES	5423			DR9EIX	4772	0.7
	GSX250R	17→	CPR7EA-9	3901			CR7EIX	7385	0.9
	GT250K, L, M	73→75	B8ES	2411			BR8EIX	5044	0.7
	GT250A/B/C (½", 12.7mm Thread Reach)	76→78	B8HS	5510			BR8HIX	7001	0.7
	GT250A/B/C (¾", 19mm Thread Reach)	76→78	B9ES	2611			BR9EIX	3981	0.7
	GT250X7 EN/EX	78→83	B9ES	2611			BR9EIX	3981	0.7
	GW250 L2-L5 Inazuma, Z	12→	CR7E	4578			CR7EIX	7385	0.7
	PE250 B/C	77→78	B8EG	3430			BR8EIX	5044	0.5
	PE250 N/T/X/Z	79→82	BR10EG	3830			BR10EIX	6801	0.6
	RG250 Gamma	83→89	BR9ES	5722			BR9EIX	3981	0.7
	RGV250K, L	89→90	BR9ES	5722			BR9EIX	3981	0.7
	RGV250M, N, P, R	90→97	BR9ECM	3252			BR9ECMIX	2707	0.6
	RM250 Z/D	82→83	B8EG	3430			BR8EIX	5044	0.5
	RM250 E, F, G, H, J, K, L, M	84→91	B8EG	3430			BR8EIX	5044	0.5
	RM250 N, P, R, S	92→95			R4118S-8	3236			0.6
	RM250 T, V, W	96→99			R6918B-7	6259			0.6
	RM250 K1-K5	01→05	BR8EG	3130			BR8EIX	5044	0.6
	RMX250 K, L, M, N	89→92					BR8EIX	5044	0.5
	RMX250 P, R, S	93→95					BR9EIX	3981	0.5
	RMX250 T, V, W, X	96→99					BR9EIX	3981	0.5
	RM-Z250 K4-K5 (4-Stroke)	04→06	CR8EB	7784			CR8EIX	4218	0.7
	RM-Z250 K7-K9, L0-L3 (4-Stroke)	07→13					CR8EIA-10	4708	1.0
	RM-Z250 L4→	14→					CR8EIB-10	4948	1.0
	TS250 X	85→89	BR8ES	5422			BR8EIX	5044	0.6
	TS250ER N/T/X	79→83	BP7ES	2412			BPR7EIX	4055	0.7
	TU250 X, V, W	97→00	DR8EA	7162	DR8EVX	6354	DR8EIX	6681	0.6
	350	DR350S L, M, N, P, R	91→94	DPR9EA-9	5329			DPR9EIX-9	5545
DR350SE R, S, V, W, X		94→99	CR9EK	4548			CR9EIX	3521	0.7
380	GT380	72→78	B8ES	2411			BR8EIX	5044	0.7
400	AN400 X, Y, K1-K6 Burgman	99→07	CR7E	4578			CR7EIX	7385	0.7
	AN400 K7-K9, L0-L6 Burgman, Z	10/07→16	CR7E	4578			CR7EIX	7385	0.7
	AN400 L7 Burgman	17→					CR7EIA-9	91175	0.9
	DR400	80→82	DR8ES-L	2923	DR8EVX	6354	DR8EIX	6681	0.7
	DR-Z400E Y, K1-K5, DR-Z400S Y, K1-K5	99→07	CR8E	1275			CR8EIX	4218	0.7
	DR-Z400SM K5-K7	05→07	CR8E	1275			CR8EIX	4218	0.7
	GN400T	80→82	DR8ES-L	2923	DR8EVX	6354	DR8EIX	6681	0.7
	GS400 B/C	76→78	B8ES	2411			BR8EIX	5044	0.7
	GSF400M/N	91→92	CR8EK	3478			CR8EIX	4218	0.7
	GSF400P-R	93→95	CR9EK	4548			CR9EIX	3521	0.7
	GSX400E T/X, GSX400F, X/Z/D	80→84	DR8ES-L	2923	DR8EVX	6354	DR8EIX	6681	0.7
	GSX-R400H	86→89	C8HSA	6821			CR8HIX	7669	0.6
	PE400 T, X, Z	80→82	BR9EG	3230			BR9EIX	3981	0.7
	SP400	80→82	DR8ES-L	2923	DR8EVX	6354	DR8EIX	6681	0.7
	450	GS450	85→88	B8ES	2411			BR8EIX	5044
RMX450Z L0, L1		10→11					CR8EIB-10	4948	1.0
RMX450Z L4→		14→					CR8EIB-10	4948	1.0
RM-Z450 K4-K6 (4-Stroke)		04→06					CR8EIB-10	4948	1.0



CC	MODEL	DATE	STANDARD COPPER CORE	STOCK NUMBER	PLATINUM OR GOLD PALLADIUM	STOCK NUMBER	IRIDIUM	STOCK NUMBER	GAP MM
SUZUKI (CONTINUED)									
450	RM-Z450/Z K7-K9, LO-L6 (4-Stroke)	07→					DIMR8C10	92743	1.0
500	GS500E K, L, M, N, P, R, S, T, V, W, X, Y, K1-K3	89→05	DPR8EA-9	4929			DPR8EIX-9	2202	0.9
	GS500E / F K4-K9	04→09	DPR8EA-9	4929			DPR8EIX-9	2202	0.9
	GT500	75→77	B7HS	5110			BR7HIX	7067	0.6
	RG500 Gamma	85→89	BR9ES	5722			BR9EIX	3981	0.6
	RM500D	83→85	B8EG	3430			BR8EIX	5044	0.6
	T500	68→75	B8HS	5510			BR8HIX	7001	0.6
550	GS550 All models	77→85	B8ES	2411			BR8EIX	5044	0.7
	GSX550 EE/ESD/ESE/EFE	83→88	DR8ES	5423			DR9EIX	4772	0.7
600	GSF600 S, T, V, W, Y, K1-K4 Bandit Naked (Unfaired)	95→05	CR9EK	4548			CR9EIX	3521	0.7
	GSF600S T, V, W, Y, K1-K4 Bandit (Faired)	95→05	CR9EK	4548			CR9EIX	3521	0.7
	GSR600/S K6-K9, LO	06→10	CR9E	6263			CR9EIX	3521	0.7
	GSX600F J, K, L, M, N, P, R, S, V	88→97	DR8ES	5423			DR9EIX	4772	0.7
	GSX600F T, V, W, X, Y, K1-K4	97→04	CR9EK	4548			CR9EIX	3521	0.7
	GSX-R600 V, W, X, K1-K7	97→07	CR9E	6263			CR9EIX	3521	0.7
	GSX-R600 K8-K9, LO-L6 (Incl. Tyco)	08→					CR9EIA-9	6289	0.9
	RF600R P/R/S/V	93→97	CR9E	6263			CR9EIX	3521	0.7
	VS600 GLS	95→97	DPR8EA-9	4929			DPR8EIX-9	2202	0.9
650	AN650 K3-K5 Burgman	03→05	CR8E	1275			CR8EIX	4218	0.7
	AN650A K4-K9, L1-L6 Burgman	04→	CR8E	1275			CR8EIX	4218	0.7
	DL650 K4-K6 V-Strom	03→06	CR8E	1275			CR8EIX	4218	0.7
	DL650 K7-K9, LO V-Strom (Twin Spark)	07→10	CR8E	1275			CR8EIX	4218	0.7
	DL650A V-Strom XP (Twin Spark)	2010	CR8E	1275			CR8EIX	4218	0.7
	DL650AL1 V-Strom 650 ABS (Twin Spark)	2011	CR8E	1275			CR8EIX	4218	0.7
	DL650AL2-AL6 V-Strom 650 ABS (Twin Spark)	12→16					CR8EIA-9	4286	0.9
	DL650AL7 V-Strom 650 Incl. XT & GTA (Twin Spark)	17→	MR8E-9	90527					0.9
	DR650RSE Models and RE models	91→95	DPR9EA-9	5329			DPR9EIX-9	5545	0.9
	DR650SET	95→97	CR10E	6264			CR10EIX	6482	0.7
	GS650 All models (Incl. Katana)	81→84	DR8ES-L	2923	DR8EVX	6354	DR8EIX	6681	0.7
	GSF650 K5, K6 Bandit	05→06	CR8EK	3478			CR8EIX	4218	0.7
	GSF650 K7 Bandit (Liquid Cooled)	2007	CR9E	6263			CR9EIX	3521	0.6
	GSF650 K8-K9, LO Bandit (Liquid Cooled)	08→10	CR8E	1275			CR8EIX	4218	0.7
	GSX650F	2007	CR9E	6263			CR9EIX	3521	0.6
	GSX650F	08→16	CR8E	1275			CR8EIX	4218	0.7
	LS650 All models	87→98	DPR8EA-9	4929			DPR8EIX-9	2202	0.9
	SFV650 Gladius (Twin Spark)	09→15					CR8EIA-9	4286	0.9
	SV650, SV650S X/Y/K1-K6	99→06	CR8E	1275			CR8EIX	4218	0.7
	SV650, SV650S K7-K9, LO-L5	07→15	CR8E	1275			CR8EIX	4218	0.7
SV650 (Twin Spark)	16→	MR8E-9	90527					0.9	
XF650 V-W-X-Y Freewind	97→02	CR10E	6264			CR10EIX	6482	0.7	
670	XN85 650 Turbo	83→86	DR8ES	5423			DR9EIX	4772	0.7
750	DR750 SJ/SK	88→90	DPR9EA-9	5329			DPR9EIX-9	5545	0.9
	GS750 DB, EC, EN, GL	76→81	B8ES	2411			BR8EIX	5044	0.7
	GSR750 (Incl. GSR750Z)	11→					CR9EIA-9	6289	0.9
	GSX750 W, X, Y, K1	97→01	CR9EK	4548			CR9EIX	3521	0.7
	GSX750E T/EX/ESD/ESE/ESF/ESG	83→89	DR8ES-L	2923	DR8EVX	6354	DR8EIX	6681	0.7
	GSX750F K/L/M/N/P/R/S/T	89→96	JR9C	6193					0.7
	GSX750F W, X, Y, K1-K5	97→05	CR9EK	4548			CR9EIX	3521	0.7
	GSX750SZ,SD Katana	82→83	D7EA	7912					0.7
	GSX750SE,SF Katana	84→85	DR8ES-L	2923	DR8EVX	6354	DR8EIX	6681	0.7
	GSX-R750 F, G, H	85→88	DR8ES	5423			DR9EIX	4772	0.7
	GSX-R750 J, K	88→89	JR9C	6193					0.7
	GSX-R750 L, M	89→92	CR10EK	2360			CR10EIX	6482	0.7
	GSX-R750 WN, WP, WR, WS	91→96	CR9E	6263			CR9EIX	3521	0.7
	GSX-R750 T, V, W, X, Y, K1-K7	96→07	CR9E	6263			CR9EIX	3521	0.7
	GSX-R750 K8-K9, LO-L6	08→					CR9EIA-9	6289	0.9
	GSX-S750	17→					CR9EIA-9	6289	0.9
VS750GLP F, G, H, J, K, L, M	85→91	DPR8EA-9	4929			DPR8EIX-9	2202	0.9	
800	DR800 SL, SM	90→92	DPR9EA-9	5329			DPR9EIX-9	5545	0.9
	VL800 K1-K5	01→05	DPR7EA-9	5129			DPR7EIX-9	7803	0.9
	VL800 K6 C800 Intruder	06→09	DPR7EA-9	5129			DPR7EIX-9	7803	0.9
	VL800 LO Intruder C800	10→	DR7EA	7839					0.7
	VS800GL M, P, R, S, T, V	91→97	DPR8EA-9	4929			DPR8EIX-9	2202	0.9



CC	MODEL	DATE	STANDARD COPPER CORE	STOCK NUMBER	PLATINUM OR GOLD PALLADIUM	STOCK NUMBER	IRIDIUM	STOCK NUMBER	GAP MM
SUZUKI (CONTINUED)									
800	VX800 L/M/R	90→96	DPR8EA-9	4929			DPR8EIX-9	2202	0.9
	VZ800 V, W, X, Y, K1 Marauder	97→01	DPR8EA-9	4929			DPR8EIX-9	2202	0.9
	VZ800 K5→Intruder M800	05→09	DPR7EA-9	5129			DPR7EIX-9	7803	0.9
	VZ800 L0 Intruder M800	10→	DR7EA	7839					0.7
850	GS850 GN/GT/GX/GZ/GD/GE/GG	79→88	B8ES	2411			BR8EIX	5044	0.7
900	RF900R R, S, T, V, W	94→99	CR9E	6263			CR9EIX	3521	0.7
1000	DL1000 K2-K9 V-Strom	02→09	CR8EK	3478			CR8EIX	4218	0.7
	GS1000 EC/EN/ET/GT/GX/SN	80→82	B8ES	2411			BR8EIX	5044	0.7
	GSX1000 SZ/SD Katana	81→85	DR8ES-L	2923	DR8EVX	6354	DR8EIX	6681	0.7
	GSX-R1000 K1-K6	00→06	CR9E	6263			CR9EIX	3521	0.7
	GSX-R1000 K6 Phantom	2006	CR9E	6263			CR9EIX	3521	0.7
	GSX-R1000 K7-K9, L0-L6	07→16					CR9EIA-9	6289	0.9
	GSX-R1000, GSX-R1000R L7→	17→					CR9EIA-9	6289	0.9
	GSX-R1000ZSE	2014					CR9EIA-9	6289	0.9
	GSX-S1000	15→20					CR9EIA-9	6289	0.9
	Katana 1000	19→					CR9EIA-9	6289	0.9
	SV1000/S K3-K5	03→05	CR8EK	3478			CR8EIX	4218	0.7
	SV1000 Classic	07→08	CR8EK	3478			CR8EIX	4218	0.7
	TL1000R W, Y, K1-K3	98→03	CR9EK	4548			CR9EIX	3521	0.7
	TL1000S V, W, X, Y	97→01	CR8EK	3478			CR8EIX	4218	0.7
1037	DL1000 L4 V-Strom (Twin Spark)	14→19					LMAR8BI-9	91909	0.9
	V-STROM 1050, 1050 XT (Twin Spark)	20→					LMAR8BI-9	91909	0.9
1100	GS1100GZ	82→86	B8ES	2411			BR8EIX	5044	0.7
	GSX1100 ET/X/Z/S/ESD,SZ,SD (Katana)	79→85	DR8ES-L	2923	DR8EVX	6354	DR8EIX	6681	0.7
	GSX1100 EFE/EF/EFF/EG/EFG	84→88	DR8ES	5423			DR9EIX	4772	0.7
	GSX1100 FJ, FK, FL, FM, FN, FP, FR, FS	87→96	JR9B	3188			DR9EIX	4772	0.6
	GSX1100 GM, GN, GP, GR	91→94	JR9B	3188			DR9EIX	4772	0.6
	GSX-R1100 G, H, J	86→89	JR9B	3188			DR9EIX	4772	0.6
	GSX-R1100 K, L, M, N	89→93	JR9B	3188			DR9EIX	4772	0.6
	GSX-R1100 W-P, R, S, T	93→96	CR9E	6263			CR9EIX	3521	0.7
1200	GSF1200S T, V, W, X, Y, K1-K6 Bandit (Faired)	96→06	JR9B	3188			DR9EIX	4772	0.6
	GSF1200 T, V, W, X, Y, K1-K6 Bandit Naked (Unfaired)	96→06	JR9B	3188			DR9EIX	4772	0.6
1250	GSF1250/SA Bandit K7-K9, L0→	07→	CR7E	4578			CR7EIX	7385	0.8
1255	GSX1250FA Bandit (Incl. GSX1250FA Z)	10→	CR7E	4578			CR7EIX	7385	0.7
1300	GSX1300 B-King	07→12					CR9EIA-9	6289	0.9
	GSX1300R X, Y, K1-K5 Hayabusa	99→07	CR9E	6263			CR9EIX	3521	0.7
1340	GSX1300R Hayabusa	08→17					CR9EIA-9	6289	0.9
1400	GSX1400 K2-K6	01→06	CR8EK	3478			CR8EIX	4218	0.7
	GSX1400 FE - K7	06→09	CR8EK	3478			CR8EIX	4218	0.7
	VS1400GLP-H, J, R, S, T, V, W (Intruder)	87→99	DPR8EA-9	4929			DPR8EIX-9	2202	0.9
1500	C1500T Intruder	13→	CPR6EA-9	6899			CR6EIA-9	7967	0.9
	VL1500 LC/X	98→03	DPR7EA-9	5129			DPR7EIX-9	7803	0.9
	VL1500 →K5	→05	DPR7EA-9	5129			DPR7EIX-9	7803	0.9
	VZ1500 L0 Intruder M1500	10→	CR6E	6965					0.7
1600	VZ1600 K4-K5	03→04	DPR6EA-9	5531					0.9
1800	VLR1800 C1800R/RT Intruder	08→12	CR8EK	3478			CR8EIX	4218	0.7
	VZR1800 M1800R Intruder K6-K9, L0→	06→	CR8EK	3478			CR8EIX	4218	0.7

SWM									
125	125TLM	77→84	BP5ES	6511			BPR5EIX	6597	0.4
200	TL200	→84	BP5ES	6511			BPR5EIX	6597	0.4
240	TL240	82→84	BP5ES	6511			BPR5EIX	6597	0.4
320	320TLM	77→84	BP5ES	6511			BPR5EIX	6597	0.4
350	TL350	83→84	BP5ES	6511			BPR5EIX	6597	0.4

SYM									
50	City Hopper	98→03	BR8HSA	5539			BPR8HIX	6742	0.6
	DD50 City Trek / Sport	02→	BR8HSA	5539			BPR8HIX	6742	0.6
	Fiddle	98→	BR8HSA	5539			BPR8HIX	6742	0.6
	Fiddle II 50	08→13	BR8HSA	5539			BPR8HIX	6742	0.7
	Jet 50	98→	BR8HSA	5539			BPR8HIX	6742	0.6



CC	MODEL	DATE	STANDARD COPPER CORE	STOCK NUMBER	PLATINUM OR GOLD PALLADIUM	STOCK NUMBER	IRIDIUM	STOCK NUMBER	GAP MM
SYM (CONTINUED)									
50	Jet 50 Sport X S/SE/SR/XS	06→	BR8HSA	5539			BPR8HIX	6742	0.7
	Jungle	98→02	BR8HSA	5539			BPR8HIX	6742	0.6
	Mask	98→	BR8HSA	5539			BPR8HIX	6742	0.6
	Mio 50	06→	CR6HSA	2983			CR6HIX	7274	0.7
	Red Devil	98→	BR8HSA	5539			BPR8HIX	6742	0.6
	Simply 50	08→10	CR7HSA	4549			CR7HIX	7544	0.7
	Super Fancy	98→03	BR8HSA	5539			BPR8HIX	6742	0.6
100	Jet 100	99→	BR8HSA	5539			BPR8HIX	6742	0.6
	Jet 100 Sport X S/SR Jet		BR8HSA	5539			BPR8HIX	6742	0.6
	Mio 100		CR6HSA	2983			CR6HIX	7274	0.7
125	Attila, Super Duke	98→00	CR7HSA	4549			CR7HIX	7544	0.6
	Euro MX 125	05→	CR8E	1275			CR8EIX	4218	0.7
	Fiddle II 125	08→13	CR7HSA	4549			CR7HIX	7544	0.6
	GTS Voyager 125	05→07	CR8E	1275			CR8EIX	4218	0.8
	HD Orbit 125	04→	CR8E	1275			CR8EIX	4218	0.7
	Husky	98→	DR8EA	7162	DR8EVX	6354	DR8EIX	6681	0.6
	Joyride 125 (12.7mm Thread Reach)	02→04	CR7HSA	4549			CR7HIX	7544	0.6
	Joyride 125 (19mm Thread Reach)	05→	CR8E	1275			CR8EIX	4218	0.7
	Megalo 125	01→	CR7HSA	4549			CR7HIX	7544	0.6
	Shark 125 / R	99→05	CR8E	1275			CR8EIX	4218	0.8
	Simply 125	08→	CR7HSA	4549			CR7HIX	7544	0.7
	Symphony SR125	09→	CR7HSA	4549			CR7HIX	7544	0.7
	Voyager 125		CR8E	1275			CR8EIX	4218	0.7
	VS125	06→	CR8E	1275			CR8EIX	4218	0.7
	Wolf 125		DR7EA	7839					0.7
XS 125		DR7EA	7839					0.7	
150	Symphony SR150	09→	CR7HSA	4549			CR7HIX	7544	0.7
180	HD Orbit 180	04→	CR8E	1275			CR8EIX	4218	0.7
	Joyride 180	02→	CR8E	1275			CR8EIX	4218	0.7
200	HD Orbit 200		CR8E	1275			CR8EIX	4218	0.7
	Joyride 200	09→	CR8E	1275			CR8EIX	4218	0.7
250	GTS Voyager 250	05→	CR8E	1275			CR8EIX	4218	0.7
300	Citycom 300	08→	CR8E	1275			CR8EIX	4218	0.7
	GTS 300		CR8E	1275			CR8EIX	4218	0.7
500	500 GT/XP	04→	CR7EKB	4455			CR7EIX	7385	0.8

TAMORETTI									
50	Retro 50 ZN50QT-E	05→	CR7HSA	4549			CR7HIX	7544	0.7
125	Retro 125 TN125-E	09→	CR7HSA	4549			CR7HIX	7544	0.7
	Stealth 125	08→	CR7HSA	4549			CR7HIX	7544	0.7

TGB									
50	202 Classic	02→	BPR7HS	6422			BPR7HIX	5944	0.5
	302 Sport	02→	BPR7HS	6422			BPR7HIX	5944	0.5
	303R Hawk	04→10	BPR7HS	6422			BPR7HIX	5944	0.5
	AKROStec	03→05	BPR7HS	6422			BPR7HIX	5944	0.5
	Delivery 50	03→	BPR7HS	6422			BPR7HIX	5944	0.5
	R50X	05→	BPR7HS	6422			BPR7HIX	5944	0.5
125	204 Classic	02→07	CR7HSA	4549			CR7HIX	7544	0.7
	303R Hawk	07→10	CR7HSA	4549			CR7HIX	7544	0.7
	304 Sport	02→	CR7HSA	4549			CR7HIX	7544	0.7
	404 Executive	02→07	CR7HSA	4549			CR7HIX	7544	0.7
	Bellavita 125i	13→	CR7E	4578			CR7EIX	7385	0.7
	Delivery 125	05→	CR7HSA	4549			CR7HIX	7544	0.7
	R125X	08→	CR7HSA	4549			CR7HIX	7544	0.7
	X-Motion 125	09→	CR8E	1275			CR8EIX	4218	0.7
300	Bellavita 300i	13→	CR8E	1275			CR8EIX	4218	0.7



CC	MODEL	DATE	STANDARD COPPER CORE	STOCK NUMBER	PLATINUM OR GOLD PALLADIUM	STOCK NUMBER	IRIDIUM	STOCK NUMBER	GAP MM
THE BLACK DOUGLAS MOTORCYCLE CO.									
125	Claret Classic	13→	DR8EA	7162	DR8EVX	6354	DR8EIX	6681	0.8
	Countryman Deluxe	13→	DR8EA	7162	DR8EVX	6354	DR8EIX	6681	0.8
	Jade Wonder	13→	DR8EA	7162	DR8EVX	6354	DR8EIX	6681	0.8
	Original Drayton	13→	DR8EA	7162	DR8EVX	6354	DR8EIX	6681	0.8
	Silent Grey	13→	DR8EA	7162	DR8EVX	6354	DR8EIX	6681	0.8
	Sport Imperial	13→	DR8EA	7162	DR8EVX	6354	DR8EIX	6681	0.8
230	Claret Classic	13→	DR8EA	7162	DR8EVX	6354	DR8EIX	6681	0.8
	Countryman Deluxe	13→	DR8EA	7162	DR8EVX	6354	DR8EIX	6681	0.8
	Jade Wonder	13→	DR8EA	7162	DR8EVX	6354	DR8EIX	6681	0.8
	Original Drayton	13→	DR8EA	7162	DR8EVX	6354	DR8EIX	6681	0.8
	Silent Grey	13→	DR8EA	7162	DR8EVX	6354	DR8EIX	6681	0.8
	Sport Imperial	13→	DR8EA	7162	DR8EVX	6354	DR8EIX	6681	0.8

TM RACING									
85	MX85	12→	BR9EG	3230			BR9EIX	3981	0.6
100	MX100	12→	BR9EG	3230			BR9EIX	3981	0.6
125	MX125	12→	BR9EG	3230			BR9EIX	3981	0.6
	SMM/SMR125	12→	BR9EG	3230			BR9EIX	3981	0.6
144	MX144	12→	BR9EG	3230			BR9EIX	3981	0.6
250	EN250 (2-stroke)	12→	BR8EG	3130					0.6
	MX250 (2-stroke)	12→	BR8EG	3130					0.6
	SMM, SMR250 (2-stroke)	12→	BR8EG	3130					0.6
300	EN300 (2-stroke)	12→	BR8EG	3130					0.6
	MX300 (2-stroke)	14→	BR8EG	3130					0.6
	SMM, SMR300 (2-stroke)	12→	BR8EG	3130					0.6
450	EN450Fi	14→					CR9EIX	3521	0.8
	MX450Fi	14→					CR9EIX	3521	0.8
	SMM, SMR, SMX450Fi	14→					CR9EIX	3521	0.8
530	EN530F	14→	CR8E	1275			CR8EIX	4218	0.8
	MX530F	14→	CR8E	1275			CR8EIX	4218	0.8
	SMM, SMR, SMX530F	14→	CR8E	1275			CR8EIX	4218	0.8

TOMOS									
50	A3/A5K	84→96	B6HS	4510			BR6HIX	3419	0.5
	AT50, ATX50, NTX50	86→91	B6HS	4510			BR6HIX	3419	0.5

TRIUMPH PRE-1989									
250-500	Twins with 3/4", 19mm Thread Reach		B8ES	2411			BR8EIX	5044	0.6
650	T120, R, V Bonneville	→68	B7ES	1111			BR7EIX	6664	0.6
	T120, R, V Bonneville	68→74	B8ES	2411			BR8EIX	5044	0.6
	TR6 (12.7mm Thread Reach)	56→60	B7HS	5110			BR7HIX	7067	0.6
	TR6 Thunderbird/Daytona	67→73	B6ES	7310					0.6
	TR6C Trophy (19mm Thread Reach)	67→73	B8ES	2411			BR8EIX	5044	0.6
	TR65 Thunderbird	81→83	B6ES	7310					0.6
	TR65T Tiger Trail	1982	B6ES	7310					0.6
750	T140E, T140D Bonneville, TSX4	78→	B6ES	7310					0.6
	T140V Bonneville	73→88	B8ES	2411			BR8EIX	5044	0.6
	T150/160 Trident (Incl. BSA, A75 and Rocket 3)	→75	B8ES	2411			BR8EIX	5044	0.6
	TR7T Tiger Trail	81→82	B6ES	7310					0.6
	TSX8, TSS		C8E	7471			CR8EIX	4218	0.6

TRIUMPH 1991-ON									
600	Daytona 600	03→04	CR9EK	4548			CR9EIX	3521	0.7
	TT 600	99→03	CR9EK	4548			CR9EIX	3521	0.7
	Speed Four	02→	CR9EK	4548			CR9EIX	3521	0.7
650	Daytona 650	04→05	CR9EK	4548			CR9EIX	3521	0.7
660	Street Triple S (A2 Licence)	17→					CR9EIA-9	6289	0.9
	Tiger Sport, Trident	22→	CR9EK	4548			CR9EIX	3521	0.7



CC	MODEL	DATE	STANDARD COPPER CORE	STOCK NUMBER	PLATINUM OR GOLD PALLADIUM	STOCK NUMBER	IRIDIUM	STOCK NUMBER	GAP MM
TRIUMPH 1991-ON (CONTINUED)									
675	Daytona 675 Triple	05→08	CR9EK	4548			CR9EIX	3521	0.7
	Daytona 675 Triple	12/08→12	CR9EK	4548			CR9EIX	3521	0.7
	Daytona 675 (Incl R)	13→					CR9EIA-9	6289	0.9
	Street Triple	07→16	CR9EK	4548			CR9EIX	3521	0.7
	Street Triple R, RX	08→16	CR9EK	4548			CR9EIX	3521	0.7
750	Speed Triple 750	1997	DPR8EA-9	4929			DPR8EIX-9	2202	0.9
	Trident, Daytona	91→98	DPR8EA-9	4929			DPR8EIX-9	2202	0.9
765	Daytona Moto2™ 765	2019					CR9EIA-9	6289	0.9
	Street Triple R, RS, S	17→					CR9EIA-9	6289	0.9
790	America	04→06	DPR8EA-9	4929			DPR8EIX-9	2202	0.9
	Bonneville (Incl. Black)	00→06	DPR8EA-9	4929			DPR8EIX-9	2202	0.9
	Bonneville America	01→06	DPR8EA-9	4929			DPR8EIX-9	2202	0.9
	Bonneville T100	02→04	DPR8EA-9	4929			DPR8EIX-9	2202	0.9
	Speedmaster	02→	DPR8EA-9	4929			DPR8EIX-9	2202	0.9
799	Tiger 800, Tiger 800 XC (Incl. ABS & SE)	11→19	CR9EK	4548			CR9EIX	3521	0.7
865	America 900	06→	DPR8EA-9	4929			DPR8EIX-9	2202	0.9
	America LT	14→	DPR8EA-9	4929			DPR8EIX-9	2202	0.9
	Bonneville 900 (Incl. Black)	06→15	DPR8EA-9	4929			DPR8EIX-9	2202	0.9
	Bonneville SE	12/08→15	DPR8EA-9	4929			DPR8EIX-9	2202	0.9
	Bonneville T100 (Incl. all special editions)	04→15	DPR8EA-9	4929			DPR8EIX-9	2202	0.9
	Bonneville T100 50th SE	07/14	DPR8EA-9	4929			DPR8EIX-9	2202	0.9
	Scrambler	05→	DPR8EA-9	4929			DPR8EIX-9	2202	0.9
	Speedmaster	05→	DPR8EA-9	4929			DPR8EIX-9	2202	0.9
	Thruxton 900	03→	DPR8EA-9	4929			DPR8EIX-9	2202	0.9
	Thruxton SE (Incl. Ace)	10→	DPR8EA-9	4929			DPR8EIX-9	2202	0.9
885	Adventurer	96→01	DPR8EA-9	4929			DPR8EIX-9	2202	0.9
	Daytona, Daytona Super III	91→96	DPR8EA-9	4929			DPR8EIX-9	2202	0.9
	Legend TT	98→01	DPR8EA-9	4929			DPR8EIX-9	2202	0.9
	Speed Triple	94→96	DPR8EA-9	4929			DPR8EIX-9	2202	0.9
	Sprint	91→96	DPR8EA-9	4929			DPR8EIX-9	2202	0.9
	T509 Speed Triple	96→10/98	DPR8EA-9	4929			DPR8EIX-9	2202	0.9
	T709 Tiger	98→	DPR8EA-9	4929			DPR8EIX-9	2202	0.9
	Thunderbird	95→04	DPR8EA-9	4929			DPR8EIX-9	2202	0.9
	Thunderbird Sport	98→04	DPR8EA-9	4929			DPR8EIX-9	2202	0.9
	Tiger	91→98	DPR8EA-9	4929			DPR8EIX-9	2202	0.9
	Trident	91→98	DPR8EA-9	4929			DPR8EIX-9	2202	0.9
	Trophy	91→01	DPR8EA-9	4929			DPR8EIX-9	2202	0.9
900	Bonneville T100	16→	LMAR8A-9	4313					0.9
	Street Cup	15→	LMAR8A-9	4313					0.9
	Street Scrambler	19→	LMAR8A-9	4313					0.9
	Street Twin	15→	LMAR8A-9	4313					0.9
	Tiger 900 Rally, Pro	20→	CR9EK	4548			CR9EIX	3521	0.7
955	Daytona 955i (Ø12mm Plug)	98→01	DPR8EA-9	4929			DPR8EIX-9	2202	0.9
	Daytona 955i (Ø10mm Plug)	01→06	CR9EK	4548			CR9EIX	3521	0.7
	Speed Triple (Ø12mm Plug)	10/98→01	DPR8EA-9	4929			DPR8EIX-9	2202	0.9
	Speed Triple (Ø10mm Plug)	01→04	CR9EK	4548			CR9EIX	3521	0.7
	Sprint RS (Ø12mm Plug)	99→00	DPR8EA-9	4929			DPR8EIX-9	2202	0.9
	Sprint RS (Ø10mm Plug)	01→05	CR9EK	4548			CR9EIX	3521	0.7
	Sprint ST (Ø12mm Plug)	98→00	DPR8EA-9	4929			DPR8EIX-9	2202	0.9
	Sprint ST (Ø10mm Plug)	01→04	CR9EK	4548			CR9EIX	3521	0.7
	T595 Daytona	97→98	DPR8EA-9	4929			DPR8EIX-9	2202	0.9
Tiger EFI	00→07	DPR8EA-9	4929			DPR8EIX-9	2202	0.9	
1000	Daytona	91→93	DPR8EA-9	4929			DPR8EIX-9	2202	0.9
1050	Speed 94, 94R	04/15→	CR8EK	3478			CR8EIX	4218	0.7
	Speed Triple (Incl. R)	05→15	CR8EK	3478			CR8EIX	4218	0.7
	Speed Triple R, S	16→17					CR8EIA-9	4286	0.9
	Speed Triple RS, S	18→					CR9EIA-9	6289	0.9
	Sprint GT	10→	CR8EK	3478			CR8EIX	4218	0.7
	Sprint ST (Incl. ABS)	04→	CR8EK	3478			CR8EIX	4218	0.7
	Tiger (Incl. ABS)	06→	CR8EK	3478			CR8EIX	4218	0.7
	Tiger Sport	13→15	CR8EK	3478			CR8EIX	4218	0.7
	Tiger Sport	16→					CR8EIA-9	4286	0.9
1160	Speed Triple 1200 RS	21→	LMAR9E-J	6884					0.7



CC	MODEL	DATE	STANDARD COPPER CORE	STOCK NUMBER	PLATINUM OR GOLD PALLADIUM	STOCK NUMBER	IRIDIUM	STOCK NUMBER	GAP MM
TRIUMPH 1991-ON (CONTINUED)									
1180	Daytona 1200	91→00	DPR8EA-9	4929			DPR8EIX-9	2202	0.9
	Trophy 1200	91→03	DPR8EA-9	4929			DPR8EIX-9	2202	0.9
1200	Bonneville Speedmaster, T120, T120 Black	15→	LMAR8A-9	4313					0.9
	Scrambler 1200 XC, XE, Steve McQueen	19→	LMAR8A-9	4313					0.9
	Speed Twin	19→	LMAR8A-9	4313					0.9
	Thrupton, Thrupton R	15→	LMAR8A-9	4313					0.9
1215	Tiger Explorer	12→	CR8EK	3478			CR8EIX	4218	0.7
	Trophy (Incl. SE)	11/12→	CR8EK	3478			CR8EIX	4218	0.7
1600	Thunderbird (Twin Spark)	09→	DPR6EA-9	5531					0.9
1700	Thunderbird (Twin Spark) 1700cc option engine	09→	DPR6EA-9	5531					0.9
	Thunderbird Commander (Twin Spark)	03/14→	DPR6EA-9	5531					0.9
	Thunderbird LT (Twin Spark)	03/14→	DPR6EA-9	5531					0.9
	Thunderbird Storm (Twin Spark)	11→	DPR6EA-9	5531					0.9
2300	Rocket III Incl. X (Twin Spark)	04→	DPR7EA-9	5129			DPR7EIX-9	7803	0.9
	Rocket III Classic (Twin Spark)	06→	DPR7EA-9	5129			DPR7EIX-9	7803	0.9
	Rocket III Touring (Twin Spark)	07→	DPR7EA-9	5129			DPR7EIX-9	7803	0.9
2500	Rocket 3 GT	20→	LMAR8A-9	4313					0.9

URALMOTO

650	Cobra, Red Star, Voyage	→00	BP7HS	5111			BPR7HIX	5944	0.8
750	Classic, Wolf	00→07	BP6HS	4511			BPR6HIX	4085	0.6

VERTEMATI

500	S501		CR9EK	4548			CR9EIX	3521	0.7
	SR501		CR9EK	4548			CR9EIX	3521	0.7
570	S570	03→	CR9EK	4548			CR9EIX	3521	0.7

VESPA (SEE PIAGGIO)**VICTORY (POLARIS)**

1507	V92C and all 92 cu.inch models	99→01	DCPR6E	3481					1.0
	V92C and all 92 cu.inch models	02→04	CPR6EB-9	5958					0.8
1634	Hammer, Kingpin, Touring Cruiser	05→08	CPR6EB-9	5958					0.9
	Hammer 8-Ball, Kingpin 8-Ball, Vegas, Vegas 8-Ball, Vegas Jackpot	05→	CPR6EB-9	5958					0.9
1731	Arlen Ness Vision, Cory Ness Jackpot	10→	DCPR6E	3481					0.8
	Broadwalk	13→	DCPR6E	3481					0.8
	Cross Country, Cross Country Tour, Cross Roads, Jackpot, Vision 8-Ball	10→	DCPR6E	3481					0.8
	Hammer/S, Vegas Jackpot, Vision Street/Tour	08→	DCPR6E	3481					0.8
	High Ball	12→	DCPR6E	3481					0.8

VIXEN (SEE BASHAN)**VOR**

400	EN, MX, SM	00→	CR8EK	3478			CR8EIX	4218	0.7
503	EN, MX, SM	99→	CR8EK	3478			CR8EIX	4218	0.7
530	530 (2002)	02→	CR8EK	3478			CR8EIX	4218	0.7

WHITE KNUCKLE (SEE WK)



CC	MODEL	DATE	STANDARD COPPER CORE	STOCK NUMBER	PLATINUM OR GOLD PALLADIUM	STOCK NUMBER	IRIDIUM	STOCK NUMBER	GAP MM
WK									
50	Bellissima	13→	CR7HSA	4549			CR7HIX	7544	0.7
	Go 50	13→	CR7HSA	4549			CR7HIX	7544	0.7
	GP50 (Air Cooled)	10→	BPR7HS	6422			BPR7HIX	5944	0.6
	Mii 50	14→	CR7HSA	4549			CR7HIX	7544	0.7
	WASP R50	14→	CR7HSA	4549			CR7HIX	7544	0.7
125	Bellissima	14→	CR7HSA	4549			CR7HIX	7544	0.7
	GP125	13→	CR7HSA	4549			CR7HIX	7544	0.7
	RT125	14→	CR6HSA	2983			CR6HIX	7274	0.7

WUYANG									
50	WY50QT Scooter	06→	C7HSA	4629			CR7HIX	7544	0.6
125	WY125-12	06→	DPR8EA-9	4929			DPR8EIX-9	2202	0.9
	WY125-16C	06→	DPR8EA-9	4929			DPR8EIX-9	2202	0.9
	WY125-24B Cub	06→	C7HSA	4629			CR7HIX	7544	0.6

XISPA									
125	X125R	07→08	BP5ES	6511			BPR5EIX	6597	0.6
250	X250R	07→08	BP5ES	6511			BPR5EIX	6597	0.6
273	X280R	07→08	BP5ES	6511			BPR5EIX	6597	0.6

YAMAHA									
50	CA50 (Salient)	84→87	BP6HS	4511			BPR6HIX	4085	0.6
	CG50E Jog	88→92	BPR7HS	6422			BPR7HIX	5944	0.6
	CS50 Jog R (Air Cooled)	02→07	BR8HS	4322			BR8HIX	7001	0.6
	CS50 Jog-RR (Liquid Cooled 2-Stroke)	03→07	BR8HS	4322			BR8HIX	7001	0.7
	CS50Z Jog RR	07→12	BR8HS	4322			BR8HIX	7001	0.7
	CW50 RSP (Spy)	96→98	BR8HS	4322			BR8HIX	7001	0.6
	CW50/BW50 NG Bi-Wizz, Booster, Rocket	90→95	BPR7HS	6422			BPR7HIX	5944	0.6
	CW50/BW50 NG Bi-Wizz, Booster, Rocket	96→13	BR8HS	4322			BR8HIX	7001	0.6
	CW50T/BW	90→95	BPR7HS	6422			BPR7HIX	5944	0.6
	CW50T/BW	96→13	BR8HS	4322			BR8HIX	7001	0.6
	CY50 Jog-in	90→98	BPR7HS	6422			BPR7HIX	5944	0.5
	DT50	2004	BR7HS	4122			BR7HIX	7067	0.6
	DT50M/MX	86→95	BR7HS	4122			BR7HIX	7067	0.6
	DT50R	03→06	BR9ES	5722			BR9EIX	3981	0.7
	DT50SM	2004	BR9ES	5722			BR9EIX	3981	0.7
	EW 50 Slider / Stunt	00→02	BR9HS	4522			BR9HIX	5687	0.6
	FS1	87→91	BR7HS	4122			BR7HIX	7067	0.6
	FS1E	77→78	B7HS	5110			BR7HIX	7067	0.6
	LC50 Bop 2	80→81	BP4HS	3611					0.7
	MA50 M	86→93	BP4HS	3611					0.7
	MS50	85→87	BPR6HS	7022			BPR6HIX	4085	0.6
	NS50 Aerox R	13→	BR8HS	4322			BR8HIX	7001	0.6
	PW50 H/J/K/L	81→87	BP4HS	3611					0.6
	PW50S	88→	BPR4HS	7823					0.6
	QT50	86→93	BP4HS	3611					0.7
	RD50M/MX	86→89	B7HS	5110			BR7HIX	7067	0.6
	SA50 Pasola	82→86	BP4HS	3611					0.7
	T50	86→89	CR6HS	7023			CR6HIX	7274	0.6
	TT-R50E	06→	CR7HSA	4549			CR7HIX	7544	0.6
	TY50M	77→80	B7HS	5110			BR7HIX	7067	0.6
	TZR50 X-Power	03→04	BR9ES	5722			BR9EIX	3981	0.7
	U50/AD/C/E	65→71	B7HS	5110			BR7HIX	7067	0.6
	V50	83→86	BR6ES	4922					0.6
	V50FM	80→85	B7HS	5110			BR7HIX	7067	0.6
	V50MA	80→85	B6HS	4510			BR6HIX	3419	0.6
	XF50 Giggle	07→09	CR7E	4578			CR7EIX	7385	0.8
	YH50 WHY	99→03	BR8HS	4322			BR8HIX	7001	0.6
	YN50 Neo's, Ovetto	98→08	BR7HS	4122			BR7HIX	7067	0.6
	YN50 Neo's Easy (2-Stroke)	13→	BR8HS	4322			BR8HIX	7001	0.6



CC	MODEL	DATE	STANDARD COPPER CORE	STOCK NUMBER	PLATINUM OR GOLD PALLADIUM	STOCK NUMBER	IRIDIUM	STOCK NUMBER	GAP MM
YAMAHA (CONTINUED)									
50	YN50 Neo's 4s	09 →	CR7E	4578			CR7EIX	7385	0.8
	YQ50 Aerox, Nitro	98 →07	BR8HS	4322			BR8HIX	7001	0.6
	YQ50 Aerox R	04 →	BR8HS	4322			BR8HIX	7001	0.6
	YZ50H	80 →81	B9ES	2611			BR9EIX	3981	0.6
	ZE50 (Zest)	93 →96	BR7HS	4122			BR7HIX	7067	0.6
65	YZ65	18 →	BR9ECM	3252			BR9ECMIX	2707	0.7
70	V70	71 →80	B7HS	5110			BR7HIX	7067	0.6
80	CV80	82 →86	BPR6HS	7022			BPR6HIX	4085	0.6
	DT80MX	82 →85	B8HS	5510			BR8HIX	7001	0.6
	DT80MXS	86 →87	BP8HS	2630			BPR8HIX	6742	0.6
	LB2-80 Chappy	81 →85	B6HS	4510			BR6HIX	3419	0.6
	PW80K	82 →95	BP6HS	4511			BPR6HIX	4085	0.6
	PW80S	96 →11	BPR6HS	7022			BPR6HIX	4085	0.6
	RD80LC11A	82 →84	B8ES	2411			BR8EIX	5044	0.6
	T80 Townmate	83 →97	CR7HS	7223			CR7HIX	7544	0.6
	TY80B	73 →84	B6HS	4510			BR6HIX	3419	0.6
	V80	79 →87	BPR6HS	7022			BPR6HIX	4085	0.6
	YZ80 (1/2", 12.7mm Thread Reach)	1974	B7HS	5110			BR7HIX	7067	0.5
	YZ80 B (1/2", 12.7mm Thread Reach)	1975	B8HS	5510			BR8HIX	7001	0.6
	YZ80 (3/4", 19mm Thread Reach)	76 →80	B8ES	2411			BR8EIX	5044	0.6
	YZ80 (3/4", 19mm Thread Reach)	81 →83	B9ES	2611			BR9EIX	3981	0.6
	YZ80 (3/4", 19mm Thread Reach)	84 →92	BR9EG	3230			BR9EIX	3981	0.5
	YZ80	93 →99	B10EG	3630			BR10EIX	6801	0.5
YZ80	00 →01	BR10EG	3830			BR10EIX	6801	0.6	
85	YZ85	03 →	BR10EG	3830			BR10EIX	6801	0.6
90	TT90-R	03 →07	CR6HSA	2983			CR6HIX	7274	0.7
	V90	71 →80	B7HS	5110			BR7HIX	7067	0.5
100	DT100 A/B (1/2", 12.7mm Thread Reach)	74 →75	B8HS	5510			BR8HIX	7001	0.5
	DT100 C (3/4", 19mm Thread Reach)	1976	B7ES	1111			BR7EIX	6664	0.5
	DT100	77 →83	B8ES	2411			BR8EIX	5044	0.5
	RS100 (B/X/DX/S)	75 →76	B8HS	5510			BR8HIX	7001	0.5
	RS100P	1978	BP6HS	4511			BPR6HIX	4085	0.5
	RT100	92 →00	B7ES	1111			BR7EIX	6664	0.6
	RXS100	83 →97	BR8HS	4322			BR8HIX	7001	0.6
	YB100	87 →92	B7HS	5110			BR7HIX	7067	0.5
	YN100 Neos, Ovetto	11/99 →03	BR8HS	4322			BR8HIX	7001	0.5
	YQ100 Aerox, Nitro	00 →04	BR8HS	4322			BR8HIX	7001	0.5
	YZ100H	76 →82					BR10EIX	6801	0.5
	YZ100K	1983	B9EG	3530			BR9EIX	3981	0.5
YZ100L	1984	BR9EG	3230			BR9EIX	3981	0.6	
114	XC115S D'elight	14 →	CR6HSA	2983			CR6HIX	7274	0.6
125	AS3	71 →76	B8HS	5510			BR8HIX	7001	0.6
	BL125 Beluga	85 →87	BPR8HS	3725			BPR8HIX	6742	0.6
	Black X-max 125	09 →	CPR9EA-9	2308			CR9EIX	3521	0.9
	BW's 125	10 →11	CR7E	4578			CR7EIX	7385	0.8
	DT125 (E/ED/MX)	74 →83	B8ES	2411			BR8EIX	5044	0.5
	DT125LC	84 →87	BR8ES	5422			BR8EIX	5044	0.6
	DT125R	88 →04	BR9ES	5722			BR9EIX	3981	0.6
	DT125RE	04 →07	BR8ES	5422			BR8EIX	5044	0.7
	DT125X	04 →07	BR8ES	5422			BR8EIX	5044	0.6
	GPD125A N-Max	15 →	CPR8EA-9	2306			CR8EIX	4218	0.9
	HW125 Xenter	12 →	CPR9EA-9	2308			CR9EIX	3521	0.9
	IT125 G, H, J	80 →84	B9EG	3530			BR9EIX	3981	0.6
	MT-125	14 →18	CR9E	6263			CR9EIX	3521	0.8
	MT-125	20 →	MR8E-9	90527					0.9
	MW125 Tricity	14 →	CR7E	4578			CR7EIX	7385	0.8
	NXC125 Cygnus X	04 →	CR7E	4578			CR7EIX	7385	0.8
	RD125 (1/2", 12.7mm Thread Reach)	1975	B8HS	5510			BR8HIX	7001	0.6
	RD125 C-DX, DX, D-DX (3/4", 19mm Thread Reach)	76 →84	B8ES	2411			BR8EIX	5044	0.6
	RD125LC	85 →86	BR9ES	5722			BR9EIX	3981	0.7
	RDZ125	87 →89	BR9ES	5722			BR9EIX	3981	0.7
	RS125 (Z/DX)	76 →84	B8HS	5510			BR8HIX	7001	0.5
	RS125E	74 →80	B7HS	5110			BR7HIX	7067	0.6



CC	MODEL	DATE	STANDARD COPPER CORE	STOCK NUMBER	PLATINUM OR GOLD PALLADIUM	STOCK NUMBER	IRIDIUM	STOCK NUMBER	GAP MM	
YAMAHA (CONTINUED)										
125	SR125	81→85	D8EA	2120	DR8EVX	6354	DR8EIX	6681	0.7	
	SR125	89→03	DR8EA	7162	DR8EVX	6354	DR8EIX	6681	0.6	
	TDR 125	93→97	BR9ES	5722			BR9EIX	3981	0.7	
	TT-R125/LW	00→	CR7HSA	4549			CR7HIX	7544	0.7	
	TT-R125E	05→	CR7HSA	4549			CR7HIX	7544	0.7	
	TW125	98→04	DR8EA	7162	DR8EVX	6354	DR8EIX	6681	0.6	
	TY125	75→89	B7ES	1111			BR7EIX	6664	0.6	
	TZR125	87→93	BR9ES	5722			BR9EIX	3981	0.7	
	TZR125R	93→97	BR9ECM	3252			BR9ECMIX	2707	0.7	
	VP125 X-City	07→12	CPR9EA-9	2308			CR9EIX	3521	0.9	
	WR125R	09→	CR8E	1275			CR8EIX	4218	0.7	
	WR125X	09→	CR8E	1275			CR8EIX	4218	0.7	
	XC125	92→96	CR6HSA	2983			CR6HIX	7274	0.6	
	XC125 Cygnus	95→99	CR7E	4578			CR7EIX	7385	0.8	
	XC125 Vity 125	08→	CR7E	4578			CR7EIX	7385	0.6	
	XC125R Majesty S	14→	CPR8EA-9	2306			CR8EIX	4218	0.9	
	XN125 Teos, Doodo	00→03	CR8E	1275			CR8EIX	4218	0.5	
	XQ125 Maxster, Thunder	01→03	CR8E	1275			CR8EIX	4218	0.7	
	XSR125	21→	MR8E-9	90527					0.9	
	XT125	82→85	D8EA	2120	DR8EVX	6354	DR8EIX	6681	0.7	
	XT125R	05→	CR7HSA	4549			CR7HIX	7544	0.7	
	XT125X	05→	CR7HSA	4549			CR7HIX	7544	0.7	
	XV125 Virago	97→01	CR6HSA	2983			CR6HIX	7274	0.6	
	XVS125 Drag Star	99→04	CR7HSA	4549			CR7HIX	7544	0.7	
	YA6	64→67	B7HS	5110			BR7HIX	7067	0.6	
	YBR125	05→	CR6HSA	2983			CR6HIX	7274	0.6	
	YBR125 Custom	09→	CR6HSA	2983			CR6HIX	7274	0.6	
	YP125 Majesty, Skyliner	99→13	CR8E	1275			CR8EIX	4218	0.7	
	YP125R X-Max 125	00→05	CR8E	1275			CR8EIX	4218	0.7	
	YP125R X-Max 125	06→13	CPR9EA-9	2308			CR9EIX	3521	0.9	
	YP125RA X-MAX 125	14→	CPR9EA-9	2308			CR9EIX	3521	0.9	
	YZ125 (Air Cooled)	74→80	B9EG	3530			BR9EIX	3981	0.5	
	YZ125 (Liquid Cooled)	81→91	B9EG	3530			BR9EIX	3981	0.5	
	YZ125	91→96	BR9EG	3230			BR9EIX	3981	0.5	
	YZ125	96→98	B9EG	3530			BR9EIX	3981	0.5	
	YZ125	98→05	BR9EG	3230			BR9EIX	3981	0.5	
	YZ125	05→					BR9EIX	3981	0.5	
	YZF-R125	08→13	CR8E	1275			CR8EIX	4218	0.7	
	YZF-R125	14→17	CR9E	6263			CR9EIX	3521	0.8	
	YZF-R125	18→21	MR8E-9	90527					0.9	
	175	DT175 (E/MX)	78→85	B8ES	2411			BR8EIX	5044	0.5
		IT175H	81→83	B9EG	3530			BR9EIX	3981	0.5
TY175 (E/JC)		74→81	B7ES	1111			BR7EIX	6664	0.5	
200	CS5E	72→73	B8HS	5510			BR8HIX	7001	0.6	
	RD200 (All models except B)	76→83	B8ES	2411			BR8EIX	5044	0.6	
	RD200B (1/2", 12.7mm Thread Reach)	1976	B8HS	5510			BR8HIX	7001	0.6	
	RD200B (3/4", 19mm Thread Reach)	1976	B8ES	2411			BR8EIX	5044	0.6	
	RS200	79→81	B8ES	2411			BR8EIX	5044	0.6	
	WR200E	91→92	BR9ES	5722			BR9EIX	3981	0.6	
250	Black X-max 250	09→	DR8EA	7162	DR8EVX	6354	DR8EIX	6681	0.7	
	DT250 (E/MX)	75→79	B8EG	3430			BR8EIX	5044	0.6	
	IT250 D-K	77→83	B9EG	3530			BR9EIX	3981	0.6	
	MX250	1975	B8EG	3430			BR8EIX	5044	0.6	
	RD250 (D)	1977	B8ES	2411			BR8EIX	5044	0.6	
	RD250 (E/F)	78→79	B9ES	2611			BR9EIX	3981	0.7	
	RD250 (LC)	80→85	BR8ES	5422			BR8EIX	5044	0.6	
	SR250	80→82	BP7ES	2412			BPR7EIX	4055	0.7	
	SR250S	93→95	BP7ES	2412			BPR7EIX	4055	0.7	
	TDR250	88→92	BR9ES	5722			BR9EIX	3981	0.7	
	TT250R	03→05	CR9E	6263			CR9EIX	3521	0.8	
	TY250 A-D	73→77	B7ES	1111			BR7EIX	6664	0.5	
	TY250N	84→85	BR8ES	5422			BR8EIX	5044	0.6	
	TY250R	86→91	BR6ES	4922					0.6	



CC	MODEL	DATE	STANDARD COPPER CORE	STOCK NUMBER	PLATINUM OR GOLD PALLADIUM	STOCK NUMBER	IRIDIUM	STOCK NUMBER	GAP MM
YAMAHA (CONTINUED)									
250	TY250Z	93→96					BPR6EIX	6637	0.7
	TZR250	87→91	BR9ES	5722			BR9EIX	3981	0.6
	VP250 X-City	07→	DPR8EA-9	4929			DPR8EIX-9	2202	0.9
	WR250F	01→03	CR8E	1275			CR8EIX	4218	0.7
	WR250F (S)	04→06	CR8E	1275			CR8EIX	4218	0.7
	WR250F (S)	07→14	CR9E	6263			CR9EIX	3521	0.8
	WR250F	15→	LMAR8G	95627					0.8
	WR250R	08→	CR9EK	4548			CR9EIX	3521	0.7
	WR250X	08→	CR9EK	4548			CR9EIX	3521	0.7
	WR250Z	93→98	B8EG	3430			BR8EIX	5044	0.5
	XS250 (E/CW/SE/C)	77→80	BP7ES	2412			BPR7EIX	4055	0.7
	XT250	80→83	BP7ES	2412			BPR7EIX	4055	0.7
	XV250 Virago	95→00	CR6HS	7023			CR6HIX	7274	0.6
	XVS250 Drag Star	01→04	CR6HSA	2983			CR6HIX	7274	0.7
	YBR250	09→11	DR8EA	7162	DR8EVX	6354	DR8EIX	6681	0.7
	YP250 Majesty	96→04	DR8EA	7162	DR8EVX	6354	DR8EIX	6681	0.8
	YP250R X-Max	05→11	DR8EA	7162	DR8EVX	6354	DR8EIX	6681	0.8
	YP250RA X-MAX 250	12→	DPR8EA-9	4929			DPR8EIX-9	2202	0.9
	YZ250	74→77	B8EG	3430			BR8EIX	5044	0.6
	YZ250	78→81	B9EG	3530			BR9EIX	3981	0.6
YZ250 (2-Stroke)	82→	BR8EG	3130			BR8EIX	5044	0.6	
YZ250F (4-Stroke)	01→13	CR8E	1275			CR8EIX	4218	0.7	
YZ250F	14→	LMAR8G	95627					0.8	
YZ250WR	93→04	B8EG	3430			BR8EIX	5044	0.6	
264	VP300 Versity	03→04	DR8EA	7162	DR8EVX	6354	DR8EIX	6681	0.7
321	MT-03	16→17	CR8E	1275			CR8EIX	4218	0.7
	MT-03	18→20	LMAR8A-9	4313					0.9
	YZF-R3	15→	CR8E	1275			CR8EIX	4218	0.7
350	RD350 (Air Cooled) (1/2", 12.7mm Thread Reach)	73→74	B8HS	5510			BR8HIX	7001	0.6
	RD350 (Air Cooled) (3/4", 19mm Thread Reach)	1975	B8ES	2411			BR8EIX	5044	0.6
	RD350LC-YPVS (Liquid Cooled)	83→85	BR8ES	5422			BR8EIX	5044	0.6
	RD350 (Liquid Cooled)	86→95	BR9ES	5722			BR9EIX	3981	0.6
	XT350	85→92	DR8ES-L	2923	DR8EVX	6354	DR8EIX	6681	0.6
400	DT400 (E/MX)	75→79	B9ES	2611			BR9EIX	3981	0.6
	FZR400 Genesis	86→87	CR8E	1275			CR8EIX	4218	0.7
	FZR400 EXUP	88→90	CR8E	1275			CR8EIX	4218	0.7
	FZR400 RR/SP	91→95	CR8E	1275			CR8EIX	4218	0.7
	IT400	76→79	B8EG	3430			BR8EIX	5044	0.6
	MX400	1975	B8EG	3430			BR8EIX	5044	0.6
	RD400 (C/D)	76→77	B8ES	2411			BR8EIX	5044	0.6
	RD400 (E/F)	78→79	B9ES	2611			BR9EIX	3981	0.6
	SR400	14→	BPR6ES	7822			BPR6EIX	6637	0.8
	WR400	98→00	CR8E	1275			CR8EIX	4218	0.7
	XS400 (E/2-E/F) (Ø14mm Plug)	77→82	BP7ES	2412			BPR7EIX	4055	0.6
	XS400 (Ø12mm Plug)	82→83	D8EA	2120	DR8EVX	6354	DR8EIX	6681	0.7
	YP400 Majesty	04→11	CR7E	4578			CR7EIX	7385	0.8
	YP400R X-MAX	13→	CR7E	4578			CR7EIX	7385	0.8
	YZ400 (C/E)	76→79	B8EG	3430			BR8EIX	5044	0.6
YZ400F	98→99	CR8E	1275			CR8EIX	4218	0.7	
426	WR426F Enduro	01→02	CR8E	1275			CR8EIX	4218	0.7
	YZ426F Motocross	00→03	CR8E	1275			CR8EIX	4218	0.7
450	WR450F (S)	04→11	CR8E	1275			CR8EIX	4218	0.7
	WR450F Injection	12→	CR8E	1275			CR8EIX	4218	0.8
	YZ450F	03→17	CR8E	1275			CR8EIX	4218	0.7
	YZ450F	18→19	CPR8EA-9	2306			CR8EIX	4218	0.9
	YZ450F	20→	LMAR8G	95627					0.8
465	IT465H	81→82	B8EG	3430			BR8EIX	5044	0.6
	YZ465H	80→82	B8EG	3430			BR8EIX	5044	0.6
490	YZ490 (J/K/L/N/S/T/U)	82→90	B8EG	3430			BR8EIX	5044	0.6
500	HL500	78→79	BP7ES	2412			BPR7EIX	4055	0.6
	RD500LC	84→87	BR9HS	4522			BR9HIX	5687	0.6
	SR500/E	78→83	BP7ES	2412			BPR7EIX	4055	0.6
	XP500 TMAX	01→11	CR7E	4578			CR7EIX	7385	0.7



CC	MODEL	DATE	STANDARD COPPER CORE	STOCK NUMBER	PLATINUM OR GOLD PALLADIUM	STOCK NUMBER	IRIDIUM	STOCK NUMBER	GAP MM
YAMAHA (CONTINUED)									
500	XS500/E	75→78	D9EA	2420			DR9EIX	4772	0.6
	XT500 (C/E)	77→83	BP7ES	2412			BPR7EIX	4055	0.6
530	XP500 TMAX	12→	CR7E	4578			CR7EIX	7385	0.7
535	XV535/S/DX (Virago)	88→04	BPR7ES	2023			BPR7EIX	4055	0.7
550	XJ550	81→85	D8EA	2120	DR8EVX	6354	DR8EIX	6681	0.6
	XT550	82→84	DR7ES	3123					0.7
	XZ550	82→85	DR8ES	5423			DR9EIX	4772	0.7
600	FZ600 (Air Cooled)	86→88	DR8ES-L	2923	DR8EVX	6354	DR8EIX	6681	0.7
	FZ6-S / Fazer	04→06	CR9EK	4548			CR9EIX	3521	0.7
	FZ6-S S2 / Fazer S2	07→	CR9EK	4548			CR9EIX	3521	0.7
	FZR600 (Liquid Cooled)	89→94	CR9E	6263			CR9EIX	3521	0.8
	FZR600R	94→96	CR9E	6263			CR9EIX	3521	0.8
	FZS600 Fazer	98→04	CR8E	1275			CR8EIX	4218	0.6
	SRX600	86→89	DPR7EA-9	5129			DPR7EIX-9	7803	0.9
	TT600	86→03	DPR8EA-9	4929			DPR8EIX-9	2202	0.9
	TT600RE	2004	DPR8EA-9	4929			DPR8EIX-9	2202	0.9
	XJ6 (Incl. ABS, Naked & SP)	08→16	CR9E	6263			CR9EIX	3521	0.8
	XJ6 Diversion (Incl. ABS)	08→16	CR9E	6263			CR9EIX	3521	0.8
	XJ6 Diversion F ABS	10→16	CR9E	6263			CR9EIX	3521	0.8
	XJ600	84→91	DR8ES-L	2923	DR8EVX	6354	DR8EIX	6681	0.7
	XJ600S/N (Diversion)	92→02	CR8E	1275			CR8EIX	4218	0.6
	XT600	84→88	DPR7EA-9	5129			DPR7EIX-9	7803	0.9
	XT600E	90→02	DPR8EA-9	4929			DPR8EIX-9	2202	0.9
	XT600Z Tenere	84→90	DPR7EA-9	5129			DPR7EIX-9	7803	0.9
	XT600ZE	86→91	DPR7EA-9	5129			DPR7EIX-9	7803	0.9
	YZF600R Thunder Cat	96→03	CR9E	6263			CR9EIX	3521	0.8
	YZF-R6	99→05	CR10EK	2360			CR10EIX	6482	0.7
	YZF-R6	06→	CR10EK	2360			CR10EIX	6482	0.7
650	XJ650	80→84	BP7ES	2412			BPR7EIX	4055	0.7
	XJ650T	82→85	BPR8ES	3923			BPR8EIX	6684	0.7
	XS2	72→73	B8ES	2411			BR8EIX	5044	0.6
	XS650 (E, SE, Special)	78→82	BP7ES	2412			BPR7EIX	4055	0.7
	XVS650 Drag Star	97→02	DPR7EA-9	5129			DPR7EIX-9	7803	0.9
	XVS650A Drag Star	98→06	DPR7EA-9	5129			DPR7EIX-9	7803	0.9
660	MT-03	05→12	CR7E	4578			CR7EIX	7385	0.8
	SZR660	95→97	DPR9EA-9	5329			DPR9EIX-9	5545	0.9
	XT660 R/X	04→14	CR7E	4578			CR7EIX	7385	0.8
	XT660Z Tenere	08→15	CR7E	4578			CR7EIX	7385	0.8
	XTZ660 Tenere	91→99	DPR8EA-9	4929			DPR8EIX-9	2202	0.9
689	MT-07	14→	LMAR8A-9	4313					0.9
	Tracer 700	16→	LMAR8A-9	4313					0.9
	XSR700	15→19	LMAR8A-9	4313					0.9
	XSR700	21→	LMAR8A-9	4313					0.9
	XTZ690D Tenere	21→	LMAR8A-9	4313					0.9
750	FZ750	85→91	DR8ES-L	2923	DR8EVX	6354	DR8EIX	6681	0.6
	FZR750R	87→89	DR8ES-L	2923	DR8EVX	6354	DR8EIX	6681	0.6
	FZR750R OW01	89→91	DR9EA	3437			DR9EIX	4772	0.6
	FZX750	87→89	DR8ES-L	2923	DR8EVX	6354	DR8EIX	6681	0.6
	XJ750 (SECA)	82→84	BPR7ES	2023			BPR7EIX	4055	0.7
	XS750 (C, D, E, SE)	80→82	BPR7ES	2023			BPR7EIX	4055	0.7
	XTZ750 Super Tenere	89→95	DPR8EA-9	4929			DPR8EIX-9	2202	0.9
	XV750 SE	81→83	BPR7ES	2023			BPR7EIX	4055	0.7
	XV750 Virago	92→96	BPR7ES	2023			BPR7EIX	4055	0.7
	YZF750R	93→96	CR9E	6263			CR9EIX	3521	0.7
	YZF750-R7 OW02	1999					R0373A-10	4940	0.8
	YZF750SP	93→96	CR9E	6263			CR9EIX	3521	0.7
779	FZ8, Fazer8	10→	CR9E	6263			CR9EIX	3521	0.7
850	MT-09 (Incl. SP & Tracer)	13→20	CPR9EA-9	2308			CR9EIX	3521	0.9
	MXT850 Niken	18→20	MR9K-9	97162					0.9
	MXT850D Niken GT	19→20	MR9K-9	97162					0.9
	TDM850	91→95	DPR9EA-9	5329			DPR9EIX-9	5545	0.9
	TDM850	96→01	DPR8EA-9	4929			DPR8EIX-9	2202	0.9
	Tracer 900 (Incl. GT)	16→	CPR9EA-9	2308			CR9EIX	3521	0.9

2 Wheel



CC	MODEL	DATE	STANDARD COPPER CORE	STOCK NUMBER	PLATINUM OR GOLD PALLADIUM	STOCK NUMBER	IRIDIUM	STOCK NUMBER	GAP MM
YAMAHA (CONTINUED)									
850	TRX850	96→99	DPR8EA-9	4929			DPR8EIX-9	2202	0.9
	XS850	80→85	BP7ES	2412			BPR7EIX	4055	0.7
	XSR900	02/16→20	CPR9EA-9	2308			CR9EIX	3521	0.9
900	TDM 900	02→10	DPR8EA-9	4929			DPR8EIX-9	2202	0.9
	XJ900F/S	83→94	BPR8ES	3923			BPR8EIX	6684	0.7
	XJ900S Diversion	95→04	DPR8EA-9	4929			DPR8EIX-9	2202	0.8
950	XV950, R	14→	CPR7EA-9	3901			CR7EIX	7385	0.9
	XVS950A Midnight Star	09→12	CPR7EA-9	3901			CR7EIX	7385	0.9
	XVS950XR SCR950	17→	CPR7EA-9	3901			CR7EIX	7385	0.9
1000	FZR1000	87→88	DR8ES-L	2923	DR8EVX	6354	DR8EIX	6681	0.7
	FZR1000 EXUP	89→93	DR8ES-L	2923	DR8EVX	6354	DR8EIX	6681	0.7
	FZR1000 EXUP	93→95	DR8EA	7162	DR8EVX	6354	DR8EIX	6681	0.8
	FZS1000 Fazer	01→05	CR9E	6263			CR9EIX	3521	0.7
	FZ-1 / Fazer	06→12	CR9EK	4548			CR9EIX	3521	0.7
	GTS1000A	93→96	DPR8EA-9	4929			DPR8EIX-9	2202	0.9
	MT-10	05/16→	LMAR9E-J	6884					0.7
	TR1	81→85	BP7ES	2412			BPR7EIX	4055	0.7
	XV1000SE	86→88	BPR7ES	2023			BPR7EIX	4055	0.7
	YZF1000R Thunderace	96→02	DR8EA	7162	DR8EVX	6354	DR8EIX	6681	0.8
	YZF-R1	98→01	CR9E	6263			CR9EIX	3521	0.7
	YZF-R1	02→03					CR9EIA-9	6289	0.9
	YZF-R1 (19mm Thread Reach)	04→08	CR9EK	4548			CR9EIX	3521	0.7
	YZF-R1SP (19mm Thread Reach)	2006	CR9EK	4548			CR9EIX	3521	0.7
	YZF-R1 (Incl. Anniversary) (26.5mm Thread Reach)	09→	LMAR9E-J	6884					0.7
1100	BT1100 Bulldog	02→06	BPR7ES	2023			BPR7EIX	4055	0.7
	FJ1100	84→85	DPR8EA-9	4929			DPR8EIX-9	2202	0.9
	XS1100 (E/S)	81→84	BP6ES	7811			BPR6EIX	6637	0.7
	XV1100 Virago	89→98	BPR7ES	2023			BPR7EIX	4055	0.7
	XVS1100/A Drag Star / Classic	99→06	BPR7ES	2023			BPR7EIX	4055	0.7
1200	FJ1200/A, XVZ12TD	86→96	DPR8EA-9	4929			DPR8EIX-9	2202	0.9
	V-Max 1200	91→02	DPR8EA-9	4929			DPR8EIX-9	2202	0.9
	XJR1200	95→98	DPR8EA-9	4929			DPR8EIX-9	2202	0.8
	XT1200Z Super Tenere (Twin Spark)	10→	CPR8EB-9	6607					0.9
	XT1200Z World Crosser (Twin Spark)	12→	CPR8EB-9	6607					0.9
	XVZ12TD Venture	85→86	DPR8EA-9	4929			DPR8EIX-9	2202	0.8
1300	FJR1300/A	01→05	CR8E	1275			CR8EIX	4218	0.7
	FJR1300A/AS	06→12	CR8E	1275			CR8EIX	4218	0.7
	FJR1300A/AS	13→	CPR8EA-9	2306			CR8EIX	4218	0.9
	XJR1300/SP	99→	DPR8EA-9	4929			DPR8EIX-9	2202	0.9
	XJR1300 Racer	15→	DPR8EA-9	4929			DPR8EIX-9	2202	0.9
	XVS1300A Midnight Star	07→	LMAR7A-9	4908			LMAR7DI-10	96956	0.9
	XVS1300CU Custom	14→	LMAR7A-9	4908			LMAR7DI-10	96956	0.9
	XVZ1300 TF Venture Star	99→01	DPR8EA-9	4929			DPR8EIX-9	2202	0.8
	XVZ13A Royal Star	96→98	DPR7EA-9	5129			DPR7EIX-9	7803	0.9
1600	XV1600/A Wild Star	99→02	DPR7EA-9	5129			DPR7EIX-9	7803	0.9
1670	MT-01 1600 (Twin Spark)	05→08	DPR7EA-9	5129			DPR7EIX-9	7803	0.9
1679	VMAX 1700	08→					CR9EIA-9	6289	0.9
1700	XV1700 Road Star	03→08	DPR7EA-9	5129			DPR7EIX-9	7803	0.9
1900	XV1900 Midnight Star (Twin Spark)	06→13	DPR8EA-9	4929			DPR8EIX-9	2202	0.8

YAMASAKI

125	YM125-3	11→	D8EA	2120	DR8EVX	6354	DR8EIX	6681	0.6
-----	---------	-----	------	------	--------	------	--------	------	-----

YIYING (SEE BENZHOU)

ZING (SEE LIFAN)



2 Wheel

CC	MODEL	DATE	STANDARD COPPER CORE	STOCK NUMBER	PLATINUM OR GOLD PALLADIUM	STOCK NUMBER	IRIDIUM	STOCK NUMBER	GAP MM
ZNEN									
125	ZN125F Firenze 125		C7HSA	4629			CR7HIX	7544	0.6

ZONGSHEN									
125	Arktix, Predator ZS125-GY10		DR8EA	7162	DR8EVX	6354	DR8EIX	6681	0.7
250	Storm ZS250GS		D8EA	2120	DR8EVX	6354	DR8EIX	6681	0.6

ATV Quad



CC	MODEL	DATE	STANDARD COPPER CORE	STOCK NUMBER	PLATINUM OR GOLD PALLADIUM	STOCK NUMBER	IRIDIUM	STOCK NUMBER	GAP MM
ADLY									
103	ATV-110 Fun bike	10→	BP7HS	5111			BPR7HIX	5944	0.7
300	ATV-300XS	07→11	DR8EA	7162	DR8EVX	6354	DR8EIX	6681	0.7
320	ATV-320S, ATV-320U	07→	CR8E	1275			CR8EIX	4218	0.7

APACHE									
50	RLX 50	08→	BR8HSA	5539			BPR8HIX	6742	0.7
	Tomahawk Mini 50 (4-Stroke)	→07	CR7HSA	4549			CR7HIX	7544	0.6
	Tomahawk Mini 50 (2-Stroke)	08→	BR8HSA	5539			BPR8HIX	6742	0.7
100	Army 100	05→	BR8HSA	5539			BPR8HIX	6742	0.6
	RLX 100	05→	BR8HSA	5539			BPR8HIX	6742	0.6
	SX 100	04→09	BR8HSA	5539			BPR8HIX	6742	0.6
	ZX100	08→09	BR8HSA	5539			BPR8HIX	6742	0.7
150	RLX 150 H	06→	CR7HSA	4549			CR7HIX	7544	0.6
	RLX 150	06→	CR7HSA	4549			CR7HIX	7544	0.6
	Superbug 150	06→	CR7HSA	4549			CR7HIX	7544	0.6
170	RLX 170 S	06→	DR8EA	7162	DR8EVX	6354	DR8EIX	6681	0.6
250	RLX 250 AX	06→08	DR8EA	7162	DR8EVX	6354	DR8EIX	6681	0.6
	RLX 250 S	06→07	CR8HS	7423			CR8HIX	7669	0.7
	RLX 250 SX	06→07	CR8HS	7423			CR8HIX	7669	0.7
280	RLX 320	07→	DPR7EA-9	5129			DPR7EIX-9	7803	0.9
360	RLX 400	10→	CR8E	1275			CR8EIX	4218	0.7
450	RLX 450	08→	CR8E	1275			CR8EIX	4218	0.7
500	RLX F500	10→	DPR7EA-9	5129			DPR7EIX-9	7803	0.9

ARCTIC CAT									
50	50	06→	CR7HSA	4549			CR7HIX	7544	0.6
90	90	06→	CR7HSA	4549			CR7HIX	7544	0.6
150	150	09→	DR8EA	7162	DR8EVX	6354	DR8EIX	6681	0.7
250	250	01→	DR7EA	7839					0.6
300	300	05→	DR7EA	7839					0.6
	DVX 300	08→	DPR7EA-9	5129			DPR7EIX-9	7803	0.9
366	400 H1	08→	CR7E	4578			CR7EIX	7385	0.7
400	400	03→	CR7E	4578			CR7EIX	7385	0.7
	DVX 400	04→08	CR7E	4578			CR7EIX	7385	0.7
500	500	97→	CR6E	6965					0.8
550	550	09→	CPR8E	7411			CR8EIX	4218	0.8
650	650	04→05	CR7E	4578			CR7EIX	7385	0.7
	650 H1	05→	CPR8E	7411			CR8EIX	4218	0.8
700	700 H1	09→	CPR8E	7411			CR8EIX	4218	0.8
	Wildcat Trail	14→	CR8EB	7784			CR8EIX	4218	0.7
950	1000 Thundercat H2	09→	CPR8E	7411			CR8EIX	4218	0.8

AUSA									
400	Task M50	04→	DCPR8E*	4179			DCPR8EIX	6546	0.7

BLAST (LEM)									
50	50		B7HS	5110			BR7HIX	7067	0.6
100	100		B7HS	5110			BR7HIX	7067	0.6

BOMBARDIER (→05)									
50	DS 50 (Rotax)	02→03	BPR7HS	6422			BPR7HIX	5944	0.6
	DS 50	04→05	BR9ECS	3570					0.7
90	DS 90 (Rotax 2-Stroke)	02→03	BPR7HS	6422			BPR7HIX	5944	0.6
	DS 90 (Rotax 2-Stroke)	04→05	BR9ECS	3570					0.7
	DS 90 (Rotax 4-Stroke)	02→	CR7HSA	4549			CR7HIX	7544	0.6
200	Rally (Rotax)	03→05	CR8E	1275			CR8EIX	4218	0.7
330	Outlander 330 HO (Rotax 4-TEC)	04→05	BR9ECS	3570					0.7
400	Outlander 400 HO (Rotax 4-TEC) (Dia. 12 mm plug)	03→	DCPR8E*	4179			DCPR8EIX	6546	0.6



* Please note DCPR8E 4339 has a removable terminal nut, whereas DCPR8E 4179 has a fixed terminal nut





CC	MODEL	DATE	STANDARD COPPER CORE	STOCK NUMBER	PLATINUM OR GOLD PALLADIUM	STOCK NUMBER	IRIDIUM	STOCK NUMBER	GAP MM
BOMBARDIER (→05) (CONTINUED)									
400	Outlander 400 (Dia. 14 mm plug)	04→	BR9ECS	3570					0.7
500	Traxter (Rotax) (Dia. 12 mm plug)	98→02	DR8EA	7162	DR8EVX	6354	DR8EIX	6681	0.7
	Traxter (Rotax) (Dia. 14 mm plug)	03→	BR9ECS	3570					0.7
	Traxter CVT	05→05	DCPR8E*	4179			DCPR8EIX	6546	0.7
650	DS 650 (Rotax) (Dia. 12 mm plug)	00→05	DR8EA	7162	DR8EVX	6354	DR8EIX	6681	0.7
	Quest 650 (Rotax 4-TEC) (Dia. 12 mm plug)	02→03	DR8EA	7162	DR8EVX	6354	DR8EIX	6681	0.7
	Quest 650 (Dia. 14 mm plug)	03→	BR9ECS	3570					0.7
	Traxter CVT	05→05	DCPR8E*	4179			DCPR8EIX	6546	0.7

CAN-AM (BRP)									
50	DS 50	06→06	BR9ECS	3570					0.7
70	DS 7	08→	CR7HSA	4549			CR7HIX	7544	0.7
90	DS 90 (Rotax 2-Stroke)	06→06	BR9ECS	3570					0.7
	DS 90 (Rotax 4-Stroke)	06→	CR7HSA	4549			CR7HIX	7544	0.6
200	Rally (Rotax)	06→07	CR8E	1275			CR8EIX	4218	0.7
250	DS 250	06→	CR8E	1275			CR8EIX	4218	0.7
400	Outlander 400 HO (Rotax 4-TEC) (Dia. 12 mm plug)	06→	DCPR8E*	4179			DCPR8EIX	6546	0.6
	Outlander 400 (Dia. 14 mm plug)	06→	BR9ECS	3570					0.7
	Outlander MAX	13→	DCPR8E*	4179			DCPR8EIX	6546	0.7
450	DS 450	08→	DCPR9E	2641			DCR9EIX	6650	0.7
	Outlander L, L MAX	15→	LMAR8D-J	93444					0.8
500	Outlander 500	07→14	DCPR8E*	4179			DCPR8EIX	6546	0.7
	Outlander L, L MAX	15→	DCPR8E*	4179			DCPR8EIX	6546	0.7
	Renegade 500	08→	DCPR8E*	4179			DCPR8EIX	6546	0.7
	Traxter (Rotax) (Dia. 14 mm plug)	06→	BR9ECS	3570					0.7
570	Outlander L MAX	15→	DCPR8E*	4179			DCPR8EIX	6546	0.7
650	DS 650 (Rotax) (Dia. 12 mm plug)	06→07	DR8EA	7162	DR8EVX	6354	DR8EIX	6681	0.7
	Outlander 650	06→	DCPR8E*	4179			DCPR8EIX	6546	0.7
	Outlander 6x6	15→	DCPR8E*	4179			DCPR8EIX	6546	0.7
	Quest 650 (Dia. 14 mm plug)	06→	BR9ECS	3570					0.7
800	Commander 800	11→	DCPR8E*	4179			DCPR8EIX	6546	0.7
	Outlander 800 (Incl. R, X & XC models)	06→	DCPR8E*	4179			DCPR8EIX	6546	0.7
	Renegade 800	07→	DCPR8E*	4179			DCPR8EIX	6546	0.7
1000	Commander 1000	11→	DCPR8E*	4179			DCPR8EIX	6546	0.7
	Maverick	05/13→	LMAR8C-9	93833					0.9
	Outlander 6x6	15→	DCPR8E*	4179			DCPR8EIX	6546	0.7

CECTEK									
497	Gladiator	09→	CR7E	4578			CR7EIX	7385	0.7
	Quadrift	09→	CR7E	4578			CR7EIX	7385	0.7

CLUB CAR									
719	Carryall 294, 295 (Kubota D722 diesel engine)	04→	YE01	2649					-

CPI									
50	ATV 50	09→	BPR7HS	6422			BPR7HIX	5944	0.7
	XT50R	09→	BR7HS	4122			BR7HIX	7067	0.7
100	ATV 100	03→	BPR7HS	6422			BPR7HIX	5944	0.7
200	ATV 200		BR7HS	4122			BR7HIX	7067	0.7

CUB CADET									
624	Volunteer 4x4 (Kohler CH640 engine)	09→	BCPR5ES	6130			BCPR5EIX	5688	0.7
747	Volunteer 4x4 EFI (Kohler Aegis LH775 engine)	12→	BPR5E	7075			BPR5EIX	6597	0.7
854	Volunteer 4x4D (Yanmar diesel engine)		Y1021J	97627					-





CC	MODEL	DATE	STANDARD COPPER CORE	STOCK NUMBER	PLATINUM OR GOLD PALLADIUM	STOCK NUMBER	IRIDIUM	STOCK NUMBER	GAP MM
CUSHMAN									
400	Hauler 800, 1200, 1200X	16→	BPR2ES	2264					0.7
	Refresher FS2, FS4, Oasis	16→	BPR2ES	2264					0.7
	Shuttle 2, 4, 6, 8	16→	BPR2ES	2264					0.7
720	Hauler 4x4 (720cc EFI)	16→	BPR5ES	7422			BPR5EIX	6597	0.7

DINLI									
50	JP 502	04→	BPR7HS	6422			BPR7HIX	5944	0.7
110	Diablo 110	04→	BPR7HS	6422			BPR7HIX	5944	0.7
150	Diablo 150	05→07	C7HSA	4629			CR7HIX	7544	0.7
265	270 Sport	06→	DPR7EA-9	5129			DPR7EIX-9	7803	0.7
450	450 Sport	07→	DCPR8E*	4339			DCPR8EIX	6546	0.8

E-TON									
40	JXL40 Viper	03→	BPM7A	7321					0.6
	RXL40E	01→07	BPM7A	7321					0.6
50	RXL50 Viper	02→	BPR7HS	6422			BPR7HIX	5944	0.7
70	RXL70	05→	BPR7HS	6422			BPR7HIX	5944	0.7
90	DXL90 Sierra	03→	BPR7HS	6422			BPR7HIX	5944	0.7
	RXL90 R	03→07	BPR7HS	6422			BPR7HIX	5944	0.7
	RXL90 Viper	02→	BPR7HS	6422			BPR7HIX	5944	0.7
150	CXL150 Challenger	99→	C7HSA	4629			CR7HIX	7544	0.7
	EXL ST150	04→11	C7HSA	4629			CR7HIX	7544	0.7
	RXL150 Viper	09→	C7HSA	4629			CR7HIX	7544	0.7
	YXL150 Yukon	99→	C7HSA	4629			CR7HIX	7544	0.7
250	VXL250 Vector	07→	CR8E	1275			CR8EIX	4218	0.6
300	VXL-300ST Vector	10→	CR8E	1275			CR8EIX	4218	0.6

E-Z-GO									
400	Hauler 800, 1200, 1200X	16→	BPR2ES	2264					0.7
	Refresher FS2, FS4, Oasis		BPR2ES	2264					0.7
	Shuttle 2, 4, 6, 8	16→	BPR2ES	2264					0.7
	RXV Golf Kart (FJ400D engine)	16→	BPR2ES	2264					0.7
	TXT Golf Kart (FJ400D engine)	14→	BPR2ES	2264					0.7
720	Hauler 4x4 (720cc EFI)	16→	BPR5ES	7422			BPR5EIX	6597	0.7

GAS GAS									
50	Quad 50	04→07	B9ES	2611			BR9EIX	3981	0.6
250	Quad 250	07→	DPR7EA-9	5129			DPR7EIX-9	7803	0.7
300	Wild HP	03→	BR8EG	3130			BR8EIX	5044	0.5
450	Wild HP	03→	CR8E	1275			CR8EIX	4218	0.7

HONDA									
70	ATC70, ATC70-D	78→85	CR7HS	7223			CR7HIX	7544	0.7
90	TRX90 Sportrax	94→	CR6HSA	2983			CR6HIX	7274	0.6
110	ATC110	79→85	DR8HS	5123					0.7
125	ATC125M	84→87	DR8ES-L	2923	DR8EVX	6354	DR8EIX	6681	0.7
	TRX125 All variants	85→88	DR8ES-L	2923	DR8EVX	6354	DR8EIX	6681	0.7
185	ATC185S-D	79→82	DR8ES-L	2923	DR8EVX	6354	DR8EIX	6681	0.7
200	ATC200 (EC/XD/ESE)	81→84	DR8ES-L	2923	DR8EVX	6354	DR8EIX	6681	0.7
	TRX200 All variants	84→97	DR8ES-L	2923	DR8EVX	6354	DR8EIX	6681	0.7
250	ATC250R-D	81→83	BR8ES	5422			BR8EIX	5044	0.7
	ATC250R-F/G	85→86	BR9ES	5722			BR9EIX	3981	0.7
	TRX250 RH, RJ, RK	86→89	BR9ES	5722			BR9EIX	3981	0.7
	TRX250 EX Sportrax	01→08	DPR8EA-9	4929			DPR8EIX-9	2202	0.9
	TRX250 TM/TE Fourtrax S/ES	02→	DPR8EA-9	4929			DPR8EIX-9	2202	0.9
300	TRX300FW-V	94→99	DPR8EA-9	4929			DPR8EIX-9	2202	0.9
	TRX300EX	00→01	DR8ES-L	2923	DR8EVX	6354	DR8EIX	6681	0.7
350	TRX350-H, J, K, L, M, N, P	86→93	DR8ES-L	2923	DR8EVX	6354	DR8EIX	6681	0.7



* Please note DCPR8E 4339 has a removable terminal nut, whereas DCPR8E 4179 has a fixed terminal nut





CC	MODEL	DATE	STANDARD COPPER CORE	STOCK NUMBER	PLATINUM OR GOLD PALLADIUM	STOCK NUMBER	IRIDIUM	STOCK NUMBER	GAP MM
HONDA (CONTINUED)									
350	TRX350 TM/TE Fourtrax S/ES	01→06	DPR7EA-9	5129			DPR7EIX-9	7803	0.9
400	TRX400AT Fourtrax	05→07	DPR8EA-9	4929			DPR8EIX-9	2202	0.9
	TRX400EX Sportrax	05→	DPR8Z	4730					0.9
420	TRX420 FE/FM/FPM/TE/TM Fourtrax ES	07→	BKR5E-11	6953			BKR5EIX-11	5464	1.1
450	TRX450 FE/FM ES/S	97→04	DPR7EA-9	5129			DPR7EIX-9	7803	0.9
	TRX450R Sportrax	04→05					IFR8H11	5068	1.1
	TRX450-ER Sportrax	06→09					IFR7L11	5114	1.1
475	TRX500 ES/FM/FE Foreman (Dia. 14 mm plug) (Manual) 475cc	05→18	BKR5E-11	6953			BKR5EIX-11	5464	1.1
	TRX500 FA Foreman (Dia. 14 mm plug) (Auto) 475cc	15→18	BKR5E-11	6953			BKR5EIX-11	5464	1.1
500	TRX500 FA1, FA2, FA3 Foreman AT (Dia. 12 mm plug) (Auto) 499cc	01→14					IJR7A9	7901	0.9
518	TRX520 Fourtrax, Foreman	19→	BKR5E-11	6953			BKR5EIX-11	5464	1.1
650	TRX650FA Rincon AT	03→05					IFR5L11	6502	1.1
675	SXS 700 M2, M4 Pioneer	18→	BKR5E-11	6953			BKR5EIX-11	5464	1.1
	TRX680FA Rincon (Dia. 14 mm plug)	05→14					IFR5L11	6502	1.1
	TRX680FA Rincon (Twin Spark) (Dia. 10 mm plug)	15→	CPR6EB-9	5958			CR6EIA-9	7967	0.9

HYMOTO									
70	HQ70		C7HSA	4629			CR7HIX	7544	0.7
110	HQ110	09→	C7HSA	4629			CR7HIX	7544	0.7
200	HQ200SRL	10→	DR8EA	7162	DR8EVX	6354	DR8EIX	6681	0.7
300	HQ300 4x4 / SRL	07→	DR8EA	7162	DR8EVX	6354	DR8EIX	6681	0.7

HYOSUNG									
50	TE50	07→	BPR6HS	7022			BPR6HIX	4085	0.7
90	TE90	07→	BPR7HS	6422			BPR7HIX	5944	0.7
100	TE100R	04→	BPR7HS	6422			BPR7HIX	5944	0.7
450	TE450 Rapier	07→	CR8E	1275			CR8EIX	4218	0.7

JOHN DEERE									
586	XUV 590i	17→					BKR6EIX-11	3764	0.8
812	XUV 825i	10→					BKR6EIX-11	3764	0.8
854	XUV 855D Gator (Yanmar 3-cyl. diesel)		Y1021J	97627					-

KAWASAKI									
50	KFX50 A	03→	BPR4HS	7823					0.7
220	KLF220 A	88→02	DR8ES	5423			DR9EIX	4772	0.7
250	KLF250	03→	DR8ES	5423			DR9EIX	4772	0.6
300	KAF300 A-C (Mule 500/550)	91→04	BPR5ES	7422			BPR5EIX	6597	0.8
	KLF300 (Dia. 14 mm plug)	86→88	BR8ES	5422			BR8EIX	5044	0.6
	KLF300 (Dia. 12 mm plug)	89→	DR8EA	7162	DR8EVX	6354	DR8EIX	6681	0.7
	KVF300	99→04	DR8EA	7162	DR8EVX	6354	DR8EIX	6681	0.7
	KVF300 Brute Force 300	12→	DPR7EA-9	5129			DPR7EIX-9	7803	0.9
360	KVF360	02→	DPR8EA-9	4929			DPR8EIX-9	2202	0.9
400	KAF400 A, B (Mule 600/610)	05→16	BPR5ES	7422			BPR5EIX	6597	0.8
	KAF400 Pro-SX	17→	BPR5ES	7422			BPR5EIX	6597	0.8
	KFX400	03→	CR7E	4578			CR7EIX	7385	0.7
	KLF400 B	93→99	DPR8EA-9	4929			DPR8EIX-9	2202	0.9
	KVF400	99→	DPR8EA-9	4929			DPR8EIX-9	2202	0.9
450	KAF450 (Mule 1000)	88→	D6EA	7512					0.7
	KFX450R	08→	CPR8EB-9	6607			CR8EIX	4218	0.9
540	KAF540 C (Mule 2010)	02→05	BP5ES	6511			BPR5EIX	6597	0.5
620	KAF620-A (Mule 2510 - 4 Wheel drive)	92→00	BMR2A	7677					0.7
	KAF620-C (Mule 2500 - 2 Wheel drive)	93→00	BMR2A	7677					0.7
	KAF620-D (Mule 2500E - 2 Wheel drive) Road version	93→96	BMR4A	5728					0.7
	KAF620-E (Mule 3010 - 4 Wheel drive)	01→06	BPR2ES	2264					0.7
	KAF620-G (Mule 3000 - 2 Wheel drive)	01→06	BPR2ES	2264					0.7
650	KVF650	02→	CR7E	4578			CR7EIX	7385	0.7
700	KAF700 Pro-MX	19→	CR7E	4578			CR7EIX	7385	0.7

ATV Quad



CC	MODEL	DATE	STANDARD COPPER CORE	STOCK NUMBER	PLATINUM OR GOLD PALLADIUM	STOCK NUMBER	IRIDIUM	STOCK NUMBER	GAP MM
KAWASAKI (CONTINUED)									
700	KFX700 V Force	04→	CR7E	4578			CR7EIX	7385	0.7
	KVF700 A	04→	CR7E	4578			CR7EIX	7385	0.7
750	KVF750 A-D	05→13	CR7E	4578			CR7EIX	7385	0.7
	KVF750 Brute Force 750	14→14	CR7E	4578			CR7EIX	7385	0.7
	KVF750 Brute Force 750	15→	CPR7EA-9	3901			CR7EIX	7385	0.9
950	KAF950 A-D Diesel (Mule 2510, 3010)	98→08	Y-706R	3041					-
	KAF950 F-H Diesel (Mule 4010)	09→13	Y-601J	92785					-

KAZUMA									
50	Meerkat	08→	C7HSA	4629			CR7HIX	7544	0.6
90	Falcon	05→	C7HSA	4629			CR7HIX	7544	0.6
110	Baby Falcon, Falcon, Panda Lacoste	05→	C7HSA	4629			CR7HIX	7544	0.6
150	Dingo, Falcon	03→	C7HSA	4629			CR7HIX	7544	0.6
500	Jaguar	07→	BKR6E	6962			BKR6EIX	6418	0.7
800	Mammoth	07→	BPR6ES	7822			BPR6EIX	6637	0.6

KTM									
450	450 SX (Dia. 10 mm plug)	09→	CR9EKB	2305			CR9EIX	3521	0.8
	450 XC (Dia. 12 mm plug)	08→	DCPR8E*	4179			DCPR8EIX	6546	0.6
477	505 SX (Dia. 10 mm plug)	09→	CR9EKB	2305			CR9EIX	3521	0.8
510	525 XC (Dia. 12 mm plug)	08→	DCPR8E*	4179			DCPR8EIX	6546	0.6

KUBOTA									
400	RTV400Ci	13→	BR6HS	3922			BR6HIX	3419	0.6
500	RTV500	13→					BKR4EIX	5693	0.7
898	RTV900 Diesel	04→	YE01	2649					-
1123	RTV1100 Diesel	07→	YE01	2649					-
	RTV1140 Diesel	09→	YE01	2649					-

KYMCO									
50	KXR 50		BR8HSA	5539			BPR8HIX	6742	0.6
90	KXR 90		C7HSA	4629			CR7HIX	7544	0.7
150	MXer 150 /RL	01→	DR8EA	7162	DR8EVX	6354	DR8EIX	6681	0.7
	MXU 150 RL	05→	DR8EA	7162	DR8EVX	6354	DR8EIX	6681	0.7
250	KXR 250 /RL	01→	DPR7EA-9	5129			DPR7EIX-9	7803	0.9
	MXU 250 RL, Maxxer 250		DPR7EA-9	5129			DPR7EIX-9	7803	0.9
300	MXU 300 RL, Maxxer 300	05→	DPR7EA-9	5129			DPR7EIX-9	7803	0.9
400	MXU 400		CR8E	1275			CR8EIX	4218	0.7
443	MXU 450i	12→	CR7E	4578			CR7EIX	7385	0.6
500	MXU 500	→11	CR7E	4578			CR7EIX	7385	0.6
	MXU 500i IRS	12→	CR7E	4578			CR7EIX	7385	0.6
	UXV 500		CR7E	4578			CR7EIX	7385	0.9

LEM									
50	Beetlebug, Cayman, Condor	97→	B7HS	5110			BR7HIX	7067	0.6

MASAI									
265	A300	07/05→	DCPR7E	3932			DCPR7EIX	6046	0.8
450	A450	07/05→	DCPR8E*	4179			DCPR8EIX	6546	0.6

MASSEY FERGUSON									
250	MF250 2WD	06→08	DR7EA	7839					0.6
350	MF350MRP 4WD Manual 5 Speed	06→08	DR7EA	7839					0.6
400	MF400MRP 4WD Manual 5 Speed	06→08	CR6E	6965					0.8
450	MF450MRP 4WD Automatic	06→08	CR6E	6965					0.8
500	MF500MRP 4WD Automatic & Manual 5 Speed	06→08	CR6E	6965					0.8



* Please note DCPR8E 4339 has a removable terminal nut, whereas DCPR8E 4179 has a fixed terminal nut





CC	MODEL	DATE	STANDARD COPPER CORE	STOCK NUMBER	PLATINUM OR GOLD PALLADIUM	STOCK NUMBER	IRIDIUM	STOCK NUMBER	GAP MM
MASSEY FERGUSON (CONTINUED)									
500	MF500TBX 4WD Automatic	06→08	CR6E	6965					0.8

MOTO ROMA									
50	Blazer 50		B8HS	5510			BR8HIX	7001	0.5
	Blazer 50DL		BP7HS	5111			BPR7HIX	5944	0.6
90	Sport 90		BP7HS	5111			BPR7HIX	5944	0.7
100	Blazer 100		BP7HS	5111			BPR7HIX	5944	0.5
	Roadrunner 4	04→	BP7HS	5111			BPR7HIX	5944	0.6
	Sport 100		BP7HS	5111			BPR7HIX	5944	0.6
125	Sportsman 125	03→	C7HSA	4629			CR7HIX	7544	0.6
	SS Buggy (AB125E,R)		C7HSA	4629			CR7HIX	7544	0.6
150	DS Buggy (AB150IIR)		C7HSA	4629			CR7HIX	7544	0.6
	Sport/Sportsman 150		C7HSA	4629			CR7HIX	7544	0.6
	X Machine		C7HSA	4629			CR7HIX	7544	0.6
250	Sport 250		C7HSA	4629			CR7HIX	7544	0.6
	Sportsman 250		C7HSA	4629			CR7HIX	7544	0.6
282	Geko 300	05→	DR8EA	7162	DR8EVX	6354	DR8EIX	6681	0.7

POLARIS									
50	Predator 50	03→	BPR7HS	6422			BPR7HIX	5944	0.6
90	Predator 90	03→	BPR7HS	6422			BPR7HIX	5944	0.6
	Sportsman 90		BPR7HS	6422			BPR7HIX	5944	0.6
200	Phoenix 200	05→	CR6HSA	2983			CR6HIX	7274	0.7
	Sawtooth	06→	CR7HSA	4549			CR7HIX	7544	0.7
250	Trail Blazer 250		BR8ES	5422			BR8EIX	5044	0.7
300	Hawkeye 300 2x4, 4x4	06→	CR8EB	7784			CR8EIX	4218	0.8
330	Magnum 330		BKR6E	6962			BKR6EIX	6418	0.9
	Trail Boss 330		BKR6E	6962			BKR6EIX	6418	0.9
400	Sportsman 400 H.O.	09→	BKR6E	6962			BKR6EIX	6418	0.9
450	Sportsman 450		BKR6E	6962			BKR6EIX	6418	0.9
500	Predator 500	05→	DCPR8E*	4339			DCPR8EIX	6546	0.9
	Predator Troy Lee	06→	DCPR8E*	4339			DCPR8EIX	6546	0.9
	Ranger 4x4 EFI		BKR6E	6962			BKR6EIX	6418	0.9
	Scrambler 500		BKR6E	6962			BKR6EIX	6418	0.9
	Sportsman 500 EFI		BKR6E	6962			BKR6EIX	6418	0.9
	Sportsman 500 H.O. EFI (Incl. Touring)	09→	BKR6E	6962			BKR6EIX	6418	0.9
570	Sportsman 570EFI	13→	MR7F	95897					0.8
650	Ranger TM	06→	BPR5ES	7422			BPR5EIX	6597	0.9
680	Ranger 6x6 EFI		BKR7E	6097			BKR7EIX	2667	0.9
	Ranger XP		BKR7E	6097			BKR7EIX	2667	0.9
700	Sportsman 700 EFI		BKR7E	6097			BKR7EIX	2667	0.9
	Sportsman 700 Twin		BKR7E	6097			BKR7EIX	2667	0.9
800	RZR 800 EFI	07→14	BKR7E	6097			BKR7EIX	2667	0.9
	RZR S 800 EFI	09→14	BKR7E	6097			BKR7EIX	2667	0.9
	Sportsman 800 EFI	05→14	BKR7E	6097			BKR7EIX	2667	0.9
850	Sportsman XP 850	→02/09	LKAR8A-9	4786					0.9
	Sportsman XP 850	03/09→11	LZKAR7B	5942			ILKAR7J7G	91121	0.9
	Sportsman XP 850	12→	LKAR8A-9	4786					0.9
875	Ranger RZR 900	14→	MR7F	95897					0.8
	Ranger RZR 4 XP 900	14→	MR7F	95897					0.8
925	RZR XP Turbo	15→16	MR8F	90299					0.8
	RZR XP Turbo	17→	MR9F	95424					0.8

PUZEY									
125	Madix 125	13→	DR8EA	7162			DR8EIX	6681	0.7

QUADZILLA									
50	Buzz	03→07	BPR7HS	6422			BPR7HIX	5944	0.6
	PGO 50E Bugrider		BPR7HS	6422			BPR7HIX	5944	0.6



CC	MODEL	DATE	STANDARD COPPER CORE	STOCK NUMBER	PLATINUM OR GOLD PALLADIUM	STOCK NUMBER	IRIDIUM	STOCK NUMBER	GAP MM
QUADZILLA (CONTINUED)									
100	M100		BP7HS	5111			BPR7HIX	5944	0.7
	ProShark	04 →	BP8ES	2912			BPR8EIX	6684	0.6
	ProShark E		BR8HSA	5539			BPR8HIX	6742	0.6
	ProShark Type R		BP8ES	2912			BPR8EIX	6684	0.6
	R100		BPR7HS	6422			BPR7HIX	5944	0.6
	X100 Single piece head (12.7mm Thread Reach)		BR8HSA	5539			BPR8HIX	6742	0.6
	X100 Twin piece head (19mm Thread Reach)		BP8ES	2912			BPR8EIX	6684	0.6
150	PGO 150E Bugrider		CR7HSA	4549			CR7HIX	7544	0.6
165	R170E Stinger	03 →06	DR8EA	7162	DR8EVX	6354	DR8EIX	6681	0.7
200	200E 4 Cross		DR8EA	7162	DR8EVX	6354	DR8EIX	6681	0.7
	ST200E	06 →07	CR7HSA	4549			CR7HIX	7544	0.6
250	PGO 250E Bugrider		DPR7EA-9	5129			DPR7EIX-9	7803	0.9
	R250E Stinger		CR8HS	7423			CR8HIX	7669	0.7
	R250E Triple Disc		CR8HS	7423			CR8HIX	7669	0.7
	XRV 250	06 →07	DPR7EA-9	5129			DPR7EIX-9	7803	0.9
300	300E SUV 4 Valve		DR8EA	7162	DR8EVX	6354	DR8EIX	6681	0.7
500	XLC500	08 →	DCPR8E*	4339			DCPR8EIX	6546	0.9
700	RS7	10 →	CR6E	6965					0.8
750	RS8	11 →	CR6E	6965					0.8

QUANTUM

150	Dingo, Falcon		C7HSA	4629			CR7HIX	7544	0.6
500	NF500L		BKR6E	6962			BKR6EIX	6418	0.7

SKYTEAM

50	LX50ST-C		CR7HSA	4549			CR7HIX	7544	0.6
200	ST200 Quad		DR8EA	7162	DR8EVX	6354	DR8EIX	6681	0.7

STORM

110	Panther	12 →	CR7HSA	4549			CR7HIX	7544	0.6
-----	---------	------	--------	------	--	--	--------	------	-----

SUZUKI

50	LT50 →K4/K5 (Dia. 14 mm plug)	→05	BPR4HS	7823					0.7
	LT-A50 →K4/K5 (Dia. 14 mm plug)	→05	BPR4HS	7823					0.7
	LT-Z50 K5/K6 (Dia. 10 mm plug)	05 →	CR6HSA	2983			CR6HIX	7274	0.7
80	LT80 P-R-S		BP7HS	5111			BPR7HIX	5944	0.7
	LT80 T-V-W-X-Y K1-K5		BPR7HS	6422			BPR7HIX	5944	0.7
90	LT-Z90	06 →	CR6HSA	2983			CR6HIX	7274	0.7
250	LT-4WD	87 →98	DR7ES	3123					0.7
	LT-F250F Ozark	99 →02	DR7EA	7839					0.6
	LT-F250	03 →	DR7EA	7839					0.6
	LT-Z250 K4-K5	04 →	DR7EA	7839					0.6
300	LT-F300F	99 →02	DR7EA	7839					0.7
400	LT-A400F K2 (Eiger)	02 →	CR7E	4578			CR7EIX	7385	0.7
	LT-F400 Eiger 2WD		CR7E	4578			CR7EIX	7385	0.7
	LT-F400F Eiger 4WD	02 →09	CR7E	4578			CR7EIX	7385	0.7
	LT-F400FSi KingQuad	10 →13	CR7E	4578			CR7EIX	7385	0.7
	LT-F400FSi KingQuad	14 →					CR7EIA-9	91175	0.9
	LT-Z400	03 →13	CR7E	4578			CR7EIX	7385	0.7
450	LT-A450X	07 →10	CR6E	6965			CR6EIA-9	7967	0.8
	LT-R450	06 →	CR8EB	7784			CR8EIX	4218	0.7
500	LT-A500XP KingQuad (19mm Thread Reach)	10 →14	CR6E	6965			CR6EIA-9	7967	0.8
	LT-A500XP KingQuad (Twin Spark) (26.5mm Thread Reach)	15 →	LMAR6A-9	5946					0.9
	LT-F500F	98 →07	CR7E	4578			CR7EIX	7385	0.7
700	LT700A K5-K6	05 →06	CR6E	6965					0.8
	LT-A700X K7	07 →07	CR6E	6965			CR6EIA-9	7967	0.8
722	LT-A750X (19mm Thread Reach)	08 →13	CR6E	6965			CR6EIA-9	7967	0.8
	LT-A750X (Twin Spark) (26.5mm Thread Reach)	14 →	LMAR7A-9	4908					0.9



* Please note DCPR8E 4339 has a removable terminal nut, whereas DCPR8E 4179 has a fixed terminal nut





CC	MODEL	DATE	STANDARD COPPER CORE	STOCK NUMBER	PLATINUM OR GOLD PALLADIUM	STOCK NUMBER	IRIDIUM	STOCK NUMBER	GAP MM
SYM									
200	TrackRunner 200	06→	CR8HSA	2086			CR8HIX	7669	0.6
250	QuadLander 250	06→	BR8HSA	5539			BPR8HIX	6742	0.6

TGB									
90	Hornet 90		BPR7HS	6422			BPR7HIX	5944	0.6
250	Blade 250		CR8E	1275			CR8EIX	4218	0.8
287	Blade 325 SL 2WD		CR8E	1275			CR8EIX	4218	0.8
	Target 325 SL 2WD		CR8E	1275			CR8EIX	4218	0.8
403	Blade 425 SL 4WD	10→	CR7E	4578			CR7EIX	7385	0.7
	Blade 450 SE IRS 4WD	10→	CR7E	4578			CR7EIX	7385	0.7
460	Blade 460 R 2WD	12→	CR7E	4578			CR7EIX	7385	0.7
503	Blade 550 LT 4WD	11→	CR7E	4578			CR7EIX	7385	0.7
	Blade 550 SE IRS 4WD	11→	CR7E	4578			CR7EIX	7385	0.7
	Target 550 IRS 4WD	11→	CR7E	4578			CR7EIX	7385	0.7

YAMAHA									
50	YFM50 Mini Raptor	03→05	CR7HS	7223			CR7HIX	7544	0.6
	YFM50 Mini Raptor	06→	CR7HSA	4549			CR7HIX	7544	0.7
	YFZ50		CR6HSA	2983			CR6HIX	7274	0.7
60	YT60L (Tri-Moto)		BP6HS	4511			BPR6HIX	4085	0.6
80	YFM80	92→03	CR7HS	7223			CR7HIX	7544	0.7
	YFM80 Badger	04→	CR7HSA	4549			CR7HIX	7544	0.7
	YFM80 Raptor	06→	CR7HSA	4549			CR7HIX	7544	0.7
90	YFM90R		CR6HSA	2983			CR6HIX	7274	0.7
125	YFA1 Breeze	90→03	CR7HS	7223			CR7HIX	7544	0.7
	YFA1 Breeze	04→	CR7HSA	4549			CR7HIX	7544	0.7
	YFM125S Grizzly	04→	CR7HSA	4549			CR7HIX	7544	0.7
200	YTM200EL Yamahauler	84→	D7EA	7912					0.7
	YFM200N (Moto-4)	85→90	D7EA	7912					0.6
	YFS200 Blaster	88→	BR8ES	5422			BR8EIX	5044	0.6
	YTM200EK (Tri-Moto)		D7EA	7912					0.6
215	G1A Utility/Golf Kart	79→	BP5HS	4111					0.7
225	YFM225		DR7ES	3123					0.6
230	YFU1 Pro Hauler	89→90	DR7EA	7839					0.7
250	YFB250 Timberwolf 2WD/4WD	92→97	DR7EA	7839					0.6
	YFM250	88→90	DR7EA	7839					0.7
	YFM250X Bear Tracker	99→04	DR7EA	7839					0.7
	YFM250 Bear Tracker	05→	DR7EA	7839					0.6
	YFM250B Bruin/Big Bear	05→	DR7EA	7839					0.6
	YFM250R Raptor	08→	DR7EA	7839					0.6
	YTZ250	85→88	B8ES	2411			BR8EIX	5044	0.7
285	G2A, G5A, G8A, G9A Utility/Golf Kart	85→	BR4ES	1097					0.8
	G3A Utility/Golf Kart	86→	BP5HS	4111					0.7
287	YFM30GB Grizzly	12→	CR8E	1275			CR8EIX	4218	0.8
350	Drive2 EFi, Drive2 Carb	17→	BPR2ES	2264					0.7
	G23A Utility/Golf Kart	03→06	BPR2ES	2264					0.7
	YFM350 Big Bear 2WD		DR8ES-L	2923	DR8EVX	6354	DR8EIX	6681	0.6
	YFM350 Big Bear 4WD	87→93	DR8ES-L	2923	DR8EVX	6354	DR8EIX	6681	0.6
	YFM350 Big Bear 4WD	94→97	DR8EA	7162	DR8EVX	6354	DR8EIX	6681	0.8
	YFM350A, FWA Bruin 2WD/4WD	03→	DR8EA	7162	DR8EVX	6354	DR8EIX	6681	0.8
	YFM350ER	93→95	DR8ES	5423			DR9EIX	4772	0.7
	YFM350FWB	97→01	DR8EA	7162	DR8EVX	6354	DR8EIX	6681	0.7
	YFM350FX Wolverine	95→99	DR8EA	7162	DR8EVX	6354	DR8EIX	6681	0.7
	YFM350R Raptor	05→	DR8EA	7162	DR8EVX	6354	DR8EIX	6681	0.8
	YFM350U	96→01	DR8EA	7162	DR8EVX	6354	DR8EIX	6681	0.7
	YFM350X Warrior	87→04	DR8EA	7162	DR8EVX	6354	DR8EIX	6681	0.8
	YFZ350 Banshee	87→	BR8ES	5422			BR8EIX	5044	0.6
360	G27A U-Max Utility/Golf Kart	04→06	BPR2ES	2264					0.7
	G29A	10→	BPR2ES	2264					0.7
	YDR-A (The DRIVE)	07→	BPR2ES	2264					0.7
	YTF2	10→	BPR2ES	2264					0.7

ATV Quad



CC	MODEL	DATE	STANDARD COPPER CORE	STOCK NUMBER	PLATINUM OR GOLD PALLADIUM	STOCK NUMBER	IRIDIUM	STOCK NUMBER	GAP MM
YAMAHA (CONTINUED)									
400	YFM400 Big Bear Professional Manual	00→06	DR8EA	7162	DR8EVX	6354	DR8EIX	6681	0.7
	YFM40 Big Bear Manual	07→	DR8EA	7162	DR8EVX	6354	DR8EIX	6681	0.7
	YFM400FWE Kodiak	93→93	DR8ES-L	2923	DR8EVX	6354	DR8EIX	6681	0.7
	YFM400 Kodiak Manual	94→99	DR8EA	7162	DR8EVX	6354	DR8EIX	6681	0.7
	YFM400 Kodiak Auto	00→05	DR8EA	7162	DR8EVX	6354	DR8EIX	6681	0.7
	YFM4FAV Kodiak Auto	06→06	DR8EA	7162	DR8EVX	6354	DR8EIX	6681	0.7
450	YFM450F Kodiak	03→05	DR8EA	7162	DR8EVX	6354	DR8EIX	6681	0.8
	YFM45 Kodiak	06→06	DR8EA	7162	DR8EVX	6354	DR8EIX	6681	0.8
	YFM45 Grizzly	07→	DR8EA	7162	DR8EVX	6354	DR8EIX	6681	0.8
	YFM45 Grizzly EPS	10→	DR8EA	7162	DR8EVX	6354	DR8EIX	6681	0.8
	YFZ450	03→	CR8E	1275			CR8EIX	4218	0.8
	YFZ450R	09→	CR8E	1275			CR8EIX	4218	0.8
558	YFM550FWAD Grizzly	09/08→	LMAR6A-9	5946					0.9
600	YFM600FWA Grizzly	98→01	DPR8EA-9	4929			DPR8EIX-9	2202	0.9
660	YFM660FWA Grizzly	02→	DPR8EA-9	4929			DPR8EIX-9	2202	0.9
	YFM660R Raptor	01→05	DPR8EA-9	4929			DPR8EIX-9	2202	0.9
	YXR660 Rhino	04→07	DPR8EA-9	4929			DPR8EIX-9	2202	0.9
686	YXM700PE Viking	01/14→	CPR7EA-9	3901			CR7EIX	7385	0.8
700	YXR70FX Rhino Fi	08→	CPR7EA-9	3901			CR7EIX	7385	0.8
	YFM700R Raptor	06→	CR8E	1275			CR8EIX	4218	0.6
	YFM700 Grizzly Fi (19mm Thread Reach)	07→08	CPR7EA-9	3901			CR7EIX	7385	0.9
	YFM700FWAD Grizzly Fi (26.5mm Thread Reach)	09→13	LMAR6A-9	5946					0.9
	YFM700FWA Grizzly 700 EPS (19mm Thread Reach)	14→	CPR7EA-9	3901			CR7EIX	7385	0.9
1000	YZX1000 SS SE		CR9EB	6955			CR9EIX	3521	0.8
	Wolverine RMAX 2	21→					LMAR8GI-8	92729	0.8

CONVERSION CHART

IMPORTANT:

This chart is furnished as a guide only. Certain design differences may exist between our spark plugs and another manufacturer's; heat ratings can also vary. Always refer to the main application data to select the recommended item for specific engines.

AC DELCO	→ NGK	AC DELCO	→ NGK	AC DELCO	→ NGK	AC DELCO	→ NGK
12620540	ILTR5D (5476)	B4031	B4 (3210)	FR3LSK	BKR5E (7938)	R44CXL	BR6ES (4922)
40TS	BP7FS (3612)	B43	B6S (3510)	FR4LE	ZFR4F-11 (4043)	R44CXLS	BPR5ES (7422)
41-108	ILTR5D (5476)	B44S	BP5S (3011)	FR5LS	BCPR5ES (6130)	R44F	BR5HS (3722)
41-2XLS	BP7ES (2412)	B45	B4 (3210)	LM46	B4LM (3410)	R44LTS	BPR5EFS (2223)
41-4XLS	BP6ES (7811)	C42-1	B6S (3510)	LM49	B4LM (3410)	R44N	BR6ES (4922)
41-932	PTR5D-13 (6644)	C42CFS	BP6HS (4511)	M40FFX	B9HS-10 (3626)	R44NS	BPR5ES (7422)
41-933	PTR4B-15 (5146)	C42CLTS	BP6EFS (3812)	M41FF	B8HS (5510)	R44S	BP5S (3011)
41-950	PTR5C-13 (7740)	C42CXLS	BP6ES (7811)	M41K	B8S (3810)	R44T	BR5FS (4123)
41-983	PZTR5A-15 (7862)	C42LTS	BP6EFS (3812)	M42FF	B7HS (5110)	R44TS	BPR5FS (2423)
41-993	PTR4B-15 (5146)	C42N	B7ES (1111)	M42K	B7S (3710)	R44TSX	BPR5FS-15 (3124)
41TS	BP6FS (3512)	C42XLS	BP5ES (6511)	M43FF	B6HS (4510)	R44XL	BR6ES (4922)
41XL	B9ES (2611)	C43	B6S (3510)	M44C	B6S (3510)	R44XLS	BPR5ES (7422)
41XLS	BP7ES (2412)	C43CXLS	BP6ES (7811)	M44L	B6L (3212)	R44XLSE	ZGR5C (6334)
420Z	B4H (4110)	C43L	B6L (3212)	M45	B4 (3210)	R44XLSM	ZGR5C (6334)
422Z	B5HS (4210)	C43N	B6ES (7310)	M45FF	B5HS (4210)	R45NS	BPR5ES (7422)
425Z	B6HS (4510)	C44	B6S (3510)	M47	B4 (3210)	R45NSX	BPR5ES-13 (3154)
426FS	BP6HS (4511)	C44N	B6ES (7310)	MB42K	B6S (3510)	R45S	BP5S (3011)
42F	B6HS (4510)	C44NS	BP5ES (6511)	MR42K	BR6S (3522)	R45T	BR5FS (4123)
42FS	BP6HS (4511)	C44S	BP5S (3011)	MR43LTS	BPR6EFS (3623)	R45TS	BPR4FS (1127)
42TS	BP6FS (3512)	C44XL	B6ES (7310)	MR43T	BR6FS (4323)	R45TSX	BPR4FS-15 (2727)
42XL	B8ES (2411)	C45	B4 (3210)	MR44C	BR6S (3522)	R45XL	BR6ES (4922)
42XLS	BP6ES (7811)	C45L	B4L (3112)	MR44T	BR5FS (4123)	R45XLS	BPR5ES (7422)
42ZZ	B6HS (4511)	C49	B2 (3110)	R41-5TS	BPR6FS (2623)	R46	BR6S (3522)
430Z	B7HS (5110)	C73	G2Z (3320)	R41CF	BR7HS (4122)	R46LTS	BPR5EFS (2223)
436XLS	BP9ES (7526)	C75	G2Z (3320)	R41CXL	BR9ES (5722)	R46N	BR5ES (4722)
438XL	B8ES (2411)	C81	AB8 (7909)	R41CXLS	BPR7ES (2023)	R46S	BP4 (2911)
438XLS	BP8ES (2912)	C82	AB7 (3010)	R41TS	BPR6FS (2623)	R46T	BR5FS (4123)
43FS	BP6HS (4511)	C83	AB7 (3010)	R42-5LTS	BPR6EFS (3623)	R46TS	BPR4FS (1127)
43N	B7ES (1111)	C86	AB6 (2910)	R42-5TS	BPR6FS (2623)	R46TSX	BPR4FS-15 (2727)
43TS	BP6FS (3512)	C87	AB6 (2910)	R42-6FS	BPR6HS (7022)	R46XL	BR5ES (4722)
43XL	B7ES (1111)	C88	AB2 (3020)	R42CF	BR6HS (3922)	R46XLS	BPR4ES (7222)
43XLS	BP6ES (7811)	C88L	AB2 (3020)	R42CFS	BPR6HS (7022)	R47S	BP4 (2911)
44	B6S (3510)	CFR1CLS	BCPR7ES (3330)	R42CLTS	BPR6EFS (3623)	R83CTS	APR6FS (2922)
44.5V	B6S (3510)	CFR2CLS	BKR6E (6962)	R42CT	BR6FS (4323)	R83TS	APR6FS (2922)
440T	B7FS (3027)	CR42CFS	BPR6FS (2623)	R42CTS	BPR6FS (2623)	R84TS	APR5FS (3122)
440XLS	BP8ES (2912)	CR42CXLS	BPR6ES (7822)	R42CXL	BR8ES (5422)	R85TS	APR5FS (3122)
445Z	B8HS (5510)	CR42N	BR7ES (5122)	R42CXLS	BPR6ES (7822)	S102F	C7HSA (4629)
44F	B5HS (4210)	CR43	BR6S (3522)	R42FS	BPR6HS (7022)	S104F	C6HSA (3228)
44FF	B5HS (4210)	CR43CXLS	BPR6ES (7822)	R42LTS	BPR6EFS (3623)	S121F	D8HA (7112)
44FFS	BP5HS (4111)	CR43K	BR6S (3522)	R42T	BR6FS (4323)	S121XL	D8EA (2120)
44N	B6ES (7310)	CR43N	BR6ES (4922)	R42TS	BPR6FS (2623)	S122F	D8HA (7112)
44NS	BP5ES (6511)	CR43TS	BPR5FS-11 (2924)	R42TSM	BPR6FS (2623)	S123XL	D7EA (7912)
44S	BP5S (3011)	CR43TSM	BPR5FS-11 (2924)	R42XL	BR8ES (5422)	S124FS	D6HA (6512)
44TS	BP5FS (3412)	CR44N	BR6ES (4922)	R42XLS	BPR6ES (7822)	S404XLG	B10EG (3630)
44XL	B6ES (7310)	CR44NS	BPR5ES (7422)	R42XLSM	ZGR5C (6334)	S408XLG	B9EG (3530)
44XLO	BP5ES (6511)	CR44TS	BPR5FS-11 (2924)	R43	BR6S (3522)	S40FR	BR9HS (5810)
44XLS	BP5ES (6511)	CR45TS	BPR5FS (2423)	R43C	BR6S (3522)	S40XLR	BR9HS (4522)
45	B4 (3210)	CS40	BM7A (6521)	R43CFS	BPR6HS (7022)	S40XLG	B9ECS (7058)
45F	B5HS (4210)	CS41	BM7A (6521)	R43CT	BR6FS (4323)	S40XLR	BR8ES (5422)
45FFS	BP5HS (4111)	CS41T	BM7F (6421)	R43CTS	BPR6FS (2623)	S41F	B8HS (5510)
45L	B4L (3112)	CS42	BM7A (6521)	R43CTS6	BPR6FS (2623)	S41FR	BR8HS (4322)
45NS	BP5ES (6511)	CS42S	BM7A (6521)	R43CXL	BR7ES (5122)	S41XL	B9ES (2611)
45S	BP5S (3011)	CS42T	BM6F (6221)	R43CXLS	BPR6ES (7822)	S41XLG	B8ECS (2821)
45XL	B6ES (7310)	CS45	BM6A (5921)	R43FS	BPR6HS (7022)	S41XLR	BR9ES (5722)
45XLS	BP5ES (6511)	CS45T	BM6F (6221)	R43LTS	BPR6EFS (3623)	S42	B7S (3710)
46	B4 (3210)	CS49	BM4A (5628)	R43N	BR7ES (5122)	S42F	B7HS (5110)
46F	B5HS (4210)	CSR45	BMR6A (7421)	R43T	BR6FS (4323)	S42FR	BR7HS (4122)
46FFS	BP5HS (4111)	FR2LS	BKR6E (6962)	R43TS	BPR6FS (2623)	S42XL	B8ES (2411)
46N	B5ES (6410)	FR2LSK	BKR6E (6962)	R43TSK	BPR6FS (2623)	S42XLR	BR8ES (5422)
46S	BP5S (3011)	FR3CLS	BKR5E (7938)	R43TSX	BPR6FS (2623)	S43XL	B7ES (1111)
46XL	B5ES (6410)	FR3CLS6	BKR5E-11 (6953)	R43XL	BR7ES (5122)	S43XLR	BR7ES (5122)
47XL	B4ES (4129)	FR3LM	ZFR5A-11 (5084)	R43XLS	BPR6ES (7822)	S44	B6S (3510)
83CTS	AP6FS (2710)	FR3LS	BKR5E (7938)	R44	BR6S (3522)	S44F	B5HS (4210)
83TS	AP6FS (2710)	FR3LS6	BKR5E-11 (6953)	R44CF	BR5HS (3722)	S44XL	B6ES (7310)

AC DELCO - continued

AC DELCO	→ NGK
S45F	B5HS (4210)
S46	B4 (3210)
S81F	AB8 (7909)
S82F	AB8 (7909)
S83F	AB7 (3010)
S85F	AB6 (2910)
SB41	B7S (3710)
SV41XL	BUE (2322)
V40FFK	BUHW-2 (5626)
V40FFM	BUHW (2622)
V40FFS	BUH (2422)
VB40FFM	BUHXW-1 (5526)
VR40FFK	BUZHW-2 (2173)
VR40FFM	BUZHW (2147)
ACTIVE	→ NGK
AX80	BM6A (5921)
AX70	BPM6A (7021)
RAX90	BR2LM (5798)
RAX80	BMR6A (7421)
MR80	CMR5H (7599)
ALFA ROMEO	→ NGK
4644 9690	BKR6ECPA (2513)
5518 2623	FR5CP (6368)
5519 0788	ZKR7A-10 (1691)
5521 0685	IKR9J8 (93311)
5521 7232	ILKAR7D6G (93607)
5524 9868	IKR9J8 (93311)
6056 9086	PGR6A (4984)
6056 9957	PFR6B (3500)
6057 9903	PFR6B (3500)
6059 9495	PMR7A (4259)
7173 6281	CR7EB (4663)
7173 6282	BKR6EKC (2848)
ALLIS CHALMERS	→ NGK
232560	AB-6 (2910)
45NS	BPR4ES (7222)
4513315	AB-6 (2910)
4516333	BPR4ES (7222)
4516353	BPR4ES (7222)
4613261	AB-6 (2910)
4660976	AB-6 (2910)
4810105	AB-6 (2910)
4905798	B6ES (7310)
4905800	AB-6 (2910)
4907334	BMR6A (7421)
4908597	AB-6 (2910)
4910105	AB-6 (2910)
4916015	AB-6 (2910)
4920323	BP5EY (7327)
4933394	BPR4ES (7222)
4948894	BMR6A (7421)
8762050	BP2ES (3467)
9001652	BMR6A (7421)
DCR42CLTS	BPR6EFS (3623)
DLM46	B4LM (3410)
DLM49	B4LM (3410)
DR42CLTS	BPR6EFS (3623)
DR42LTS	BPR6EFS (3623)
ALM	→ NGK
8	BM6A (5921)
19	B2LM (1147)
ALM 8	BM6A (5921)
ALM 19	B2LM (1147)
APRILIA	→ NGK
0297542	DR8EA (7162)
0297830	BR10EG (3830)
0297921	CR8E (1275)
0297942	DCPR9E (2641)
0297945	R0045J-10 (7400)

APRILIA	→ NGK
0897055	BR8ES (5422)
2BEN000088	BPR8HS (3725)
2BEN000181	CPR8E (7411)
8122586	DR7EA (7839)
8206870	BR7HS (4122)
8206871	BR8HS (4322)
8550352	CR7E (4578)
8600008	BR9ECM (3252)
ASTON MARTIN	→ NGK
021-007-0145	C7HSA (4549)
048-007-0149	BPR6ES (7822)
07-10056	IFR7N10 (97105)
07-14641	BPR5EIX (6597)
07-20987	BPR6EY (6427)
07-21106	BPR7EIX (4055)
07-21300	BPR8EIX (6684)
07-22846	BPR8ES (3923)
07-23116	BCPR6E (1269)
07-26330	BP6ES (7811)
07-38800	BCPR7E (1272)
07-70920	BCR8ES (5430)
2W93-12405-CCA	IFR7N10 (97105)
2W93-12405-CCB	IFR7N10 (97105)
6G43-07-10056-PK	IFR7N10 (97105)
CD33-12405-AA	SITR7A11G (94949)
AUDI - See VW GROUP	→ NGK
-	-
AUTOLITE	→ NGK
12	BP7FS (3612)
13	BP6FS (3512)
14	BP6FS (3512)
15	BP5FS (3412)
23	BPR6FS (2623)
24	BPR6FS (2623)
25	BPR5FS (2423)
26	BPR4FS-15 (2727)
27	BPR4FS-15 (2727)
34	AP6FS (2710)
43	APR6FS (2922)
44	APR6FS (2922)
45	APR5FS (3122)
46	APR5FS (3122)
52	BP7ES (2412)
53	BP6ES (7811)
54	BP6ES (7811)
55	BP5ES (6511)
56	BP5ES (6511)
62	BP7ES (2412)
63	BPR6ES (7822)
64	BPR6ES (7822)
65	BPR5ES (7422)
66	BPR5ES (7422)
67	BPR4ES (7222)
75	BP5S (3011)
76	BP5S (3011)
77	BP4 (2911)
85	BP5S (3011)
86	BP4 (2911)
87	BP4 (2911)
94	BP7EFS (3526)
102	BP7EFS (3526)
103	BPR6EFS (3623)
104	BPR6EFS (3623)
105	BPR5EFS (2223)
106	BPR5EFS (2223)
135	B7FS (3027)
143	BR6FS (4323)
144	BR6FS (4323)
145	BR6FS (4323)
146	BR5FS (4123)
147	BR5FS (4123)

AUTOLITE	→ NGK
166	APR5FS (3122)
175	BP5S (3011)
203	BPR6FS (2623)
215	B6L (3212)
216	B6L (3212)
217	B4L (3112)
218	B4L (3112)
235	BM6A (5921)
245	BMR6A (7421)
253	BM7A (6521)
254	BM6A (5921)
255	BM6A (5921)
258	BM4A (5628)
273	BP6HS (4511)
274	BP6HS (4511)
275	BP5HS (4111)
276	BP5HS (4111)
283	BPR7HS (6422)
284	BPR6HS (7022)
292	B8S (3810)
294	B6S (3510)
295	B4 (3210)
297	B4 (3210)
298	B2 (3110)
302	BR6S (3522)
303	BR6S (3522)
304	BR6S (3522)
306	B4 (3210)
308	B2 (3110)
312	B8S (3810)
313	B7S (3710)
314	B6S (3510)
315	B6S (3510)
316	B6S (3510)
317	B4 (3210)
318	B2 (3110)
353	B8S (3810)
354	B6S (3510)
355	B6S (3510)
356	B4 (3210)
357	B4 (3210)
358	B2 (3110)
363	BR6S (3522)
372	AB8 (7909)
373	AB7 (3010)
374	AB7 (3010)
375	AB6 (2910)
376	AB6 (2910)
377	AB6 (2910)
378	AB6 (2910)
379	AB2 (3020)
386	AB6 (2910)
393	B7ES (1111)
394	B6ES (7310)
395	B5ES (6410)
396	B5ES (6410)
397	B5ES (6410)
398	B4ES (4129)
402	BR8ES (5422)
403	BR6ES (4922)
404	BR6ES (4922)
405	BR5ES (4722)
406	BR5ES (4722)
411	B9HS (5810)
413	B7HS (5110)
414	B6HS (4510)
415	B5HS (4210)
416	B5HS (4210)
417	B4H (4110)
424	B6HS (4510)
425	BR5HS (3722)
426	BR5HS (3722)
436	B6L (3212)
437	B4L (3112)

AUTOLITE	→ NGK
456	B4LM (3410)
458	B2LM (1147)
483	BR7EFS (1094)
494	B6L (3212)
495	B6L (3212)
497	B4L (3112)
517	BP4HS (3611)
536	B4H (4110)
664	BPR6FS (2623)
665	BPR5FS-15 (3124)
666	BPR4FS-15 (2727)
667	BPR4FS-15 (2727)
723	BPR6FS (2623)
724	BPR6FS (2623)
725	BPR5FS-11 (2924)
726	BPR4FS (1127)
727	BPR4FS-11 (2527)
744	APR5FS (3122)
746	APR5FS (3122)
747	APR5FS (3122)
764	BPR6EFS (3623)
765	BPR5EFS (2223)
766	BPR5EFS (2223)
865	BPR5EFS (2223)
915	ZGR5C (6334)
925	ZGR5C (6334)
935	BPR5ES (7422)
945	BPR5ES (7422)
996	B6L (3212)
2413	B10EGP (5224)
2414	B10EG (3630)
2415	B9EG (3530)
2416	B8EG (3430)
2417	B7ECS (2528)
2585	BPR5ES (7422)
2593	B9ES (2611)
2594	B9ES (2611)
2612	B9ES (2611)
2613	B9ES (2611)
2614	B8ES (2411)
2615	B7ES (1111)
2616	B6ES (7310)
2634	B9HS-10 (3626)
2635	B8HS (5510)
2636	B7HS (5110)
2652	B9HS-10 (3626)
2653	B7HS (5110)
2654	B7HS (5110)
2655	B6HS (4510)
2656	B5HS (4210)
2675	B6L (3212)
2676	B6L (3212)
2695	AB8 (7909)
2696	AB7 (3010)
2697	AB6 (2910)
2715	D8HA (7112)
2716	D6HA (6512)
2735	D6HA (6512)
2755	D8EA (2120)
2772	AB8 (7909)
2775	AB6 (2910)
2794	C8HSA (6821)
2795	C7HSA (4629)
2796	C6HSA (3228)
2852	BUH (2422)
2872	BUHW (2622)
2892	BUHX (2522)
2932	BUE (2322)
2954	BM7F (6421)
2956	BM6F (6221)
2974	BPM7A (7321)
2976	BPMR7A (4626)
3013	B7S (3710)
3014	B6S (3510)

AUTOLITE	→ NGK	AUTOLITE	→ NGK	BERU	→ NGK	BERU	→ NGK
3035	AB6 (2910)	4093	B7HS (5110)	14-5AU	B7HS (5110)	14FGH-6DTUR	BKUR7ET (7873)
3036	BPR4FS-15 (2727)	4113	BP6HS (4511)	14-5B	BP7HS (5111)	14FGH-7DTURX	BKUR6ET-10 (2397)
3074	GZZ (3320)	4114	BP6HS (4511)	14-5BU	BP7HS (5111)	14FGH-8DPURX2	PFR5G-11 (2647)
3075	GZZ (3320)	4123	BPR6HS (7022)	14-5C	B7ES (1111)	14FGH-8DTURX0	BKUR5ET (2789)
3116	AB6 (2910)	4132	D8EA (2120)	14-5CS	B7ECS (2528)	14FGR-6DDU	BKR6EKUB (3584)
3203	BPR6ES (7822)	4143	DR8ES-L (2923)	14-5D	BP7ES (2412)	14FGR-7CTU	BCPR7ET (2164)
3204	BPR6ES (7822)	4153	DPR8EA-9 (4929)	14-5D1	BP7ES (2412)	14FGR-8DQU7	BKR5EQUB (1567)
3205	BPR5ES (7422)	4162	DPR9EA-9 (5329)	14-5DP1	BP7ES (2412)	14FLR-8LDUX	BKR5EK (7956)
3206	BPR5ES (7422)	4163	DR8ES-L (2923)	14-5DTU	BP6ET (1263)	14FR-5DTU	BCPR7ET (2164)
3207	BPR5ES (7422)	4164	D7EA (7912)	14-5DU	BP7ES (2412)	14FR-5DU	BCPR7ES (3330)
3225	BP5S (3011)	4173	D8HA (7112)	14-5DUO	BP7ES (2412)	14FR-6DU	BKR6E (6962)
3226	BP5S (3011)	4193	C7HSA (4629)	14-5E	B7S (3710)	14FR-6DUX	BCPR6ES-11 (7121)
3227	BP5S (3011)	4203	CR7HS (7223)	14-6B	BP6HS (4511)	14FR-6LDU3	BKR6EKE (5649)
3243	BPR6EFS (3623)	4251	BP8ES (2912)	14-6BU	BP6HS (4511)	14FR-7DU	BKR6E (6962)
3244	BPR6EFS (3623)	4252	BP7ES (2412)	14-6C	B6ES (7310)	14FR-7DU2	BKR6EZ (4619)
3245	BPR5EFS (2223)	4253	BP6ES (7811)	14-6D	BP6ES (7811)	14FR-7DUX	BKR6E-11 (2756)
3246	BPR5EFS (2223)	4263	BPR6ES (7822)	14-6D1	BP6ES (7811)	14FR-7KPU	BKR6EP-8 (2215)
3264	B7FS (3027)	4265	BPR5ES (7422)	14-6DPO	BP6ES (7811)	14FR-7KPUV	BCPR6EP-11 (3350)
3265	BR6FS (4323)	4275	BP5S (3011)	14-6DTU	BP6ET (1263)	14FR-7KPUX	BCPR6EP-11 (3350)
3266	BR5FS (4123)	9062	BP6ET (1263)	14-6DU	BP6ES (7811)	14FR-7KU	BKR6EY (3696)
3267	BR5FS (4123)	9063	BP6ET (1263)	14-6DUO	BP6ESZ (7639)	14FR-7KUO	BKR6EYA (2249)
3286	APR6FS (2922)	9064	BP5ET (2287)	14-7A	B6HS (4510)	14FR-7KUOX	BKR6EYA-11 (4073)
3303	BPR6FS (2623)	9921	BCPR6ET (2197)	14-7AU	B6HS (4510)	14FR-7LDU	BKR6EKC (2848)
3325	B6L (3212)	AE6	B5HS (4210)	14-7B	BP6HS (4511)	14FR-7LUX	ZFR6F-11 (4291)
3327	B4L (3112)			14-7BU	BP6HS (4511)	14FR-8DU	BKR5E (7938)
3345	BMR7A (4226)			14-7C	B6ES (7310)	14FR-8DUX	BCPR5ES-11 (3524)
3364	BPR6HS (7022)			14-7CU	B6ES (7310)	14FR-8HU	BCRE527Y (2074)
3382	BR6S (3522)			14-7D	BP6ES (7811)	14FR-8KU	BKR5EY (7390)
3383	BR6S (3522)			14-7DTU	BP6ET (1263)	14FR-8KUO	BKR5EYA (2087)
3384	BR6S (3522)			14-7DU	BP6ES (7811)	14FR-8KUOU	BKR5EYA-11 (2526)
3386	BR6S (3522)			14-7DUO	BP6ESZ (7639)	14G-8DTU	BP6ET (1263)
3388	BR6S (3522)			14-7E	B6S (3510)	14GH-7DTUR	BUR6ET (3172)
3423	B8S (3810)			14-8A	B5HS (4210)	14GH-8DTUR	BUR5ET (3377)
3426	BR6S (3522)			14-8AU	B5HS (4210)	14GH-8DTURX	BUR5ET-10 (7264)
3462	BR7ES (5122)			14-8B	BP5HS (4111)	14GR-8DTU	BPR5EKU (5685)
3463	BR6ES (4922)			14-8BU	BP5HS (4111)	14K-5DU	BP7EFS (3526)
3464	BR6ES (4922)			14-8C	B5ES (6410)	14K-5DUO	BP7EFS (3526)
3465	BR5ES (4722)			14-8C	B6ES (7310)	14K-6D	BP6EFS (3812)
3466	BR5ES (4722)			14-8D	BP5ES (6511)	14K-6DU	BP6EFS (3812)
3485	BR5HS (3722)			14-8DTU	BP5ET (2287)	14K-6DUO	BP6EFS (3812)
3486	BR5HS (3722)			14-8DTU EA1,0	BP5ET-10 (5156)	14K-7D	BP6EFS (3812)
3507	B6L (3212)			14-8DU	BP5ES (6511)	14K-7DU	BP6EFS (3812)
3565	BPR5EFS (2223)			14-8DUO	BP5ES (6511)	14K-7DUO	BP6EFS (3812)
3604	BPR5FS-15 (3124)			14-8E	B4 (3210)	14K-8DU	BP5EFS (3712)
3605	BPR4FS-15 (2727)			14-8F	BP5S (3011)	14K-8DUO	BP5EFS (3712)
3606	BPR4FS-15 (2727)			14-8LUR	ZGR5A (5839)	14K-9DU	BP5EFS (3712)
3607	BPR4FS-15 (2727)			14-9C	B5ES (6410)	14K-9DUO	BP5EFS (3712)
3624	BR6FS (4323)			14-9D	BP5ES (6511)	14KGR-6KQU	BUR6EFSZ (6837)
3666	B4LM (3410)			14-9DTU	BP5ET (2287)	14KR-6BU	BPR6FS (2623)
3684	BR7HS (4122)			14-9DU	BP5ES (6511)	14KR-6DU	BPR6EFS (3623)
3686	BR6HS (3922)			14-9DUO	BP5ES (6511)	14KR-6ZPPV	PTR5A-10 (5055)
3702	BR9ES (5722)			14-9EUO	B4LM (3410)	14KR-7DUX	BPR6EFS (3623)
3703	BR9ES (5722)			14F-03DAR	BKR6EK (2288)	14KR-8MPX	TR5A-10 (0005)
3704	BR8ES (5422)			14F-5DPUR02	PFR7S8EG (1675)	14KR-8MUV	PTR5A-10 (5055)
3705	BR6ES (4922)			14F-5DPURS2	PFR7S8EG (1675)	14R-11F	BP4 (2911)
3706	BR6ES (4922)			14F-5MIUR2L	ILFER7C8EG (91898)	14R-5DU	BPR7ES (2023)
3724	BPR5EFS (2223)			14F-5DU	BCP7ES (5030)	14R-6B	BPR6HS (7022)
3885	ZGR5C (6334)			14F-6DSR	BKR6E (6962)	14R-6BU	BPR6HS (7022)
3896	ZGR5C (6334)			14F-6DTU	BCP6ET (4563)	14R-6D	BPR6ES (7822)
3922	BCPR7ES (3330)			14F-6DUO	BCP6ES (4930)	14R-6DU	BPR6ES (7822)
3924	BKR6E (6962)			14F-6DUOR	BKR6E (6962)	14R-7B	BPR6HS (7022)
3926	BKR5E (7938)			14F-6DPUR021	PFR7B (4853)	14R-7BU	BPR6HS (7022)
3954	D8EA (2120)			14F-7DPURX2	IFR6D10 (5344)	14R-7CU	BR6ES (4922)
3964	DR8ES-L (2923)			14F-7DU	BCP6ES (4930)	14R-7D	BPR6ES (7822)
3985	BPR5FS-15 (3124)			14F-7DUO	BCP6ES (4930)	14R-7DU	BPR6ES (7822)
4043	BPR6ES-11 (4824)			14F-7DUOR	BKR6E (6962)	14R-7DUX	BPR6EY-11 (4228)
4052	B9ES (2611)			14F-7HUR2	ZFR5P-G (6893)	14R-8DU	BPR5EY (2828)
4053	B9ES (2611)			14F-7LDUR	BKR6EK (2288)	14R-8DUX	BPR5ES-11 (4424)
4054	B8ES (2411)			14F-7LDUR4	BKR6EK (2288)	14R-9DU	BPR5ES (7422)
4055	B7ES (1111)			14F-8DU	BCP5ES (7496)	14R-9EUO	BR6S (3522)
4056	B6ES (7310)			14F-8DUO	BCP5ES (7496)	14S-5F	BPM7A (7321)
4062	BR9ES (5722)			14F-8LDUSR	BKR6EK (2288)	14S-7E	BM6A (5921)
4063	BR9ES (5722)			14F-8LUR	ZFR5F (5165)	14S-7F	BPM6A (7021)
4092	B7HS (5110)			14F-9DUO	BCP5ES (7496)	14S-8F	BPM6A (7021)

BOSCH	→ NGK	BOSCH	→ NGK	BOSCH	→ NGK	BOSCH	→ NGK
+44	BKUR5ET-10 (7553)	0 241 256 522	B9ES (2611)	0 242 225 553	BPR5ES (7422)	0 242 235 740	PPR6Q (6458)
+45	PFR5G-11 (2647)	0 241 260 507	B9HS (5810)	0 242 225 571	BPR6EFIX-10 (94658)	0 242 235 743	ILFR6B (6481)
+47	BKR5EYA (2087)	0 241 260 508	BR10ES (4832)	0 242 225 573	BPR4FS (1127)	0 242 235 746	PTR5A-10 (5055)
+48	BKR6EQU (3199)	0 241 260 510	B9EFS (1085)	0 242 225 580	ZFR6V-G (8894)	0 242 235 748	BKR6EKUB (3584)
+49	PTR6F-13 (7569)	0 241 262 505	BR9HIX (5687)	0 242 225 622	BPR4FS (1127)	0 242 235 749	PPR6B (3500)
+51	ZFR5P-G (6893)	0 241 262 506	BR10EIX (6801)	0 242 225 641	BPR4FS-15 (2727)	0 242 235 756	ILZFR6C-K (6645)
+52	PZFR5D-11 (7968)	0 241 268 506	BR10EIX (6801)	0 242 225 659	TR5AI-13 (90813)	0 242 235 758	LFRC6-11 (5788)
+53	BKR6EK (2288)	0 241 274 504	BR10HIX (6692)	0 242 229 514	BPMR6A (6726)	0 242 235 776	IZFR6H11 (4294)
+57	ZFR5F (5165)	0 241 274 505	BR10EIX (6801)	0 242 229 524	BR6S (3522)	0 242 235 918	BKR6E (6962)
0 241 050 002	C7HSA (4629)	0 241 280 503	B11EGV (5831)	0 242 229 528	BPR5FS (2423)	0 242 235 948	BUR6ET (3172)
0 241 055 501	CR7HSA (4549)	0 241 325 509	APR5FS (3122)	0 242 229 529	BPR5FS-15 (3124)	0 242 235 953	BPR6HS (7022)
0 241 056 501	C7E (5096)	0 241 329 525	AB-6 (2910)	0 242 229 533	BR5ES (4722)	0 242 235 984	PZFR5D-11 (7968)
0 241 056 502	C7HSA (4629)	0 241 340 503	AP6FS (2710)	0 242 229 534	BR5HS (3722)	0 242 236 530	ZFR6T-11G (5960)
0 241 129 525	LZKR6AI-10G (97999)	0 242 035 500	CMR6H (3365)	0 242 229 537	BPR5EIX (6597)	0 242 236 541	BCPR6EY-11 (3720)
0 241 135 515	ZKER6A-10EG (96596)	0 242 040 003	CPR7EA-9 (3901)	0 242 229 544	ZFR5F-11 (2262)	0 242 236 542	ZFR6F-11 (4291)
0 241 135 520	ZKER6A-10EG (96596)	0 242 050 500	CR6HS (7023)	0 242 229 549	BPR5FS-11 (2924)	0 242 236 561	BKR5EYA (2087)
0 241 140 519	ZKER6A-10EG (96596)	0 242 055 500	CR7HS (7223)	0 242 229 555	BPR5ES (7422)	0 242 236 562	BKR6EQU (3199)
0 241 145 500	D7EA (7912)	0 242 055 501	CR7HS (7223)	0 242 229 556	BR5ES (4722)	0 242 236 563	PTR6F-13 (7569)
0 241 145 515	PZKER7B8EGS (93231)	0 242 060 501	CR8E (1275)	0 242 229 576	ZFR6F-11 (4291)	0 242 236 565	ZFR5P-G (6893)
0 241 150 504	D8EA (2120)	0 242 060 505	CR8EK (3478)	0 242 229 598	BKR5EIX (6341)	0 242 236 576	IGR6A11 (5743)
0 241 155 500	D9EA (2420)	0 242 065 502	IMR9C-9H (6777)	0 242 229 630	LFR5B (7113)	0 242 236 653	LZFR6AP11GS (95712)
0 241 200 500	BUH (2422)	0 242 068 500	CR9E (6263)	0 242 229 641	PTR5D-10 (3784)	0 242 236 670	DIFR5C (90911)
0 241 215 503	B4LM (3410)	0 242 068 501	CR9EH-9 (7502)	0 242 229 643	BMR6A (7421)	0 242 240 506	BPMR6A (6726)
0 241 219 540	B4H (4110)	0 242 074 500	CR9EK (4548)	0 242 229 648	BKR5EQU (1567)	0 242 240 520	BPR6FS (2623)
0 241 219 555	BPR4ES (7222)	0 242 080 500	CR10EK (2360)	0 242 229 654	BKR5EK (7956)	0 242 240 530	BKR6EP-8 (2215)
0 241 225 547	B4ES (4129)	0 242 129 503	LZKAR7A (6799)	0 242 229 655	BPR5EFS (2223)	0 242 240 533	BCPR6ES-11 (7121)
0 241 225 548	B4 (3210)	0 242 129 508	LZKAR7A (6799)	0 242 229 656	BPR5ES (7422)	0 242 240 561	BPR6HS (7022)
0 241 225 551	B4LM (3410)	0 242 129 510	LZKAR7A (6799)	0 242 229 657	BPR5HS (6222)	0 242 240 564	BKR7EKC-N (2095)
0 241 229 541	BM6F (6221)	0 242 129 512	PLZKBR7B8G (91530)	0 242 229 658	BUR5ET (3377)	0 242 240 590	ZFR6S-Q (6449)
0 241 229 549	B5HS (4210)	0 242 129 514	DILKAR6A11 (9029)	0 242 229 659	BKR5E (7938)	0 242 240 591	BPR6EFS (3623)
0 241 229 560	BM6A (5921)	0 242 129 515	LZKR6B-10E (1578)	0 242 229 660	BKR5E-11 (6953)	0 242 240 592	BPR6ES (7822)
0 241 229 561	BPM6A (7021)	0 242 129 521	LKR6D-10E (96569)	0 242 229 661	LTR6B-10T (5948)	0 242 240 593	BKR6E (6962)
0 241 229 580	B6S (3510)	0 242 129 524	ILZKR6F11 (97345)	0 242 229 671	BKR5EKB-11 (3967)	0 242 240 618	BKUR7ET (7873)
0 241 229 604	B5HS (4210)	0 242 135 501	DCPR8E-N (5692)	0 242 229 687	BPR5ES-11 (4424)	0 242 240 619	ILFR6A (3588)
0 241 229 673	BCPR5ES (6130)	0 242 135 502	DPR7EA-9 (5129)	0 242 229 699	ZFR5F (5165)	0 242 240 620	ITR6F13 (4477)
0 241 229 712	BCP5ES (7496)	0 242 135 509	PLKR7A (4288)	0 242 229 706	BKUR5ET-10 (7553)	0 242 240 628	PPR6B (3500)
0 241 229 714	BP5HS (4111)	0 242 135 510	IZKR7B (7563)	0 242 229 708	PLFR5A-11 (6240)	0 242 240 648	BKR6EK (2288)
0 241 229 715	BP5ES (6511)	0 242 135 515	DCPR7E-N-10 (4983)	0 242 229 713	PPR5G-11 (2647)	0 242 240 648	BKR6EK (2288)
0 241 229 716	BP5ET (2287)	0 242 135 518	PLZKBR7B8G (91530)	0 242 229 715	ZFR5F (5165)	0 242 240 665	PZFR6R (5758)
0 241 235 089	B6ES (7310)	0 242 135 524	PLZKAR6A-11 (5118)	0 242 229 724	BKR6EZB (4293)	0 242 240 852	BKR6E (6962)
0 241 235 607	B6HS (4510)	0 242 135 527	LKR7B-9 (5847)	0 242 229 739	PTR5A-10 (5055)	0 242 240 853	BPR6ES (7822)
0 241 235 715	PZFR5D-11 (7968)	0 242 135 529	ILKAR7B11 (4912)	0 242 229 779	ZGR5A (5839)	0 242 245 018	BKR7EKC (7354)
0 241 235 718	PZFR6J-11 (3586)	0 242 135 531	DILKAR7E11HS (97439)	0 242 229 785	TR5B-13 (4559)	0 242 245 514	BPR7EIX (4055)
0 241 235 730	ZFR5P-G (6893)	0 242 135 554	SILKR6C10E (97098)	0 242 229 797	LFR6B (6677)	0 242 245 517	BR7HS (4122)
0 241 235 750	BCP6ES (4930)	0 242 135 557	DILZKR7B11GDS (95710)	0 242 229 798	BKR5EYA-11 (2526)	0 242 245 521	BR7ES (6122)
0 241 235 752	BKUR6ET-10 (2397)	0 242 135 563	ZKR7BI-10 (95536)	0 242 229 883	BKR5E (7938)	0 242 245 531	BPR7HS (6422)
0 241 235 753	BP6EFS (3812)	0 242 140 504	DCPR8EKC (7168)	0 242 229 902	TR5B-13 (4559)	0 242 245 533	BPMR7A (4626)
0 241 235 754	BP6HS (4511)	0 242 140 512	PLKR7B8E (94716)	0 242 229 983	BKR5EK (7956)	0 242 245 536	BCPR7ES (3330)
0 241 235 755	BP6ES (7811)	0 242 140 519	DCPR7EA-9 (6651)	0 242 229 984	BPR5ES (7422)	0 242 245 539	BCPR7ET (2164)
0 241 235 756	BP6ET (1263)	0 242 140 528	ILZKR7A (1961)	0 242 229 985	TR5B-13 (4559)	0 242 245 550	BCPR7ES-11 (1095)
0 241 235 757	BUR6ET (3172)	0 242 140 530	LZKAR7B (5942)	0 242 230 500	PPR5G-11 (2647)	0 242 245 552	BPR7ES (2023)
0 241 236 834	BPM6A (7021)	0 242 140 536	DILKAR7E9HS (95003)	0 242 230 506	IZFR5B (4080)	0 242 245 559	BKR7EQU (4285)
0 241 240 575	BPR6EIX-11 (3903)	0 242 140 560	ZKBR7A-HTU (91785)	0 242 230 519	IFR5E13 (6903)	0 242 245 576	PPR7S8EG (1675)
0 241 240 585	BKR6EIX (6418)	0 242 145 500	DR7EA (7839)	0 242 230 528	BPR6EFIX-10 (94658)	0 242 250 503	BR8ES (5422)
0 241 240 609	BCP6ET (4563)	0 242 145 523	LKAR8A-9 (4786)	0 242 230 534	IFR5N10 (7866)	0 242 250 506	BR8HS (4322)
0 241 245 539	BM7F (6421)	0 242 145 524	LKAR8A-9 (4786)	0 242 235 529	BPR6ES (7822)	0 242 255 501	BR9ET (4528)
0 241 245 554	BM7A (6521)	0 242 145 550	LKR8A (5214)	0 242 235 532	BR6ES (4922)	0 242 255 502	BR9ES (5722)
0 241 245 555	BPM7A (7321)	0 242 145 573	SILZNR8C7H (93593)	0 242 235 533	BR6HS (3922)	0 242 265 500	BR10ES (4832)
0 241 245 580	B7HS (5110)	0 242 145 584	ILNAR8B7G (91970)	0 242 235 541	PPR6B (3500)	0 242 268 500	BR9HS (4522)
0 241 245 581	B7ES (1111)	0 242 150 500	DR8HS (5123)	0 242 235 547	BKR6E-11 (2756)	0 242 335 504	APR6FS (2922)
0 241 245 592	B7S (3710)	0 242 150 501	DR8ES (5423)	0 242 235 556	BKR6E (6962)	AR5SII3320S	SILZNR8C7H (93593)
0 241 245 636	BP7EFS (3526)	0 242 150 505	DPR8EA-9 (5129)	0 242 235 567	ZFR6F-11 (4291)	AR5NII332	ILNAR8B7G (91970)
0 241 245 641	PFR7B (4853)	0 242 160 501	DR8ES (5423)	0 242 235 642	BKR6EKUB (3584)	D10BC	APR5FS (3122)
0 241 245 655	BCP7ES (5030)	0 242 160 502	JR9C (6193)	0 242 235 661	BPR6EFS (3623)	D6B	AP6FS (2710)
0 241 245 673	PLFER7A8EG (94833)	0 242 160 503	DR9EA (3437)	0 242 235 663	BPR6ES (7822)	D6BC	AP6FS (2710)
0 241 245 872	BP7ES (2412)	0 242 215 502	BR4LM (4133)	0 242 235 664	BUR6ET (3172)	D6BP	AP6FS (2710)
0 241 248 538	B8ES (2411)	0 242 219 004	BR4HS (3322)	0 242 235 665	BPR6HS (7022)	D7B	AP6FS (2710)
0 241 252 522	BR8EIX (5044)	0 242 219 512	BP4 (2911)	0 242 235 666	BKR6E (6962)	D7BC	AP6FS (2710)
0 241 255 505	B8EFS (1049)	0 242 219 514	BR5FS (4123)	0 242 235 667	BCPR6ES-11 (7121)	D7BP	AP6FS (2710)
0 241 256 503	BP8ES (2912)	0 242 219 517	BPR4FS-11 (2527)	0 242 235 668	BKR6EK (2848)	D8BC	APR5FS (3122)
0 241 256 512	B8HS (5510)	0 242 225 523	BR5ES (4722)	0 242 235 690	PPR6N-11 (3546)	D9BC	APR5FS (3122)
0 241 256 514	BR8HIX (7001)	0 242 225 526	BP5S (3011)	0 242 235 715	BKR6EQU (3199)	DR10B	APR5FS (3122)
0 241 256 515	BR9EIX (3981)	0 242 225 528	ZGR5C (6334)	0 242 235 725	BMR6A (7421)	DR10BC	APR5FS (3122)
0 241 256 517	BPR8EIX (6684)	0 242 225 537	ZFR4F-11 (4043)	0 242 235 738	BKR6E (6962)	DR6BC	APR6FS (2922)
						DR6BP	APR6FS (2922)

BOSCH - continued

BOSCH	→ NGK	BOSCH	→ NGK	BOSCH	→ NGK	BOSCH	→ NGK
DR7BC	APR6FS (2922)	FR5DC +	BCPR7ES (3330)	FR7SE	LFRC6-11 (5788)	HR10AC	BR5FS (4123)
DR7BP	APR6FS (2922)	FR5DCX	BCPR7ES-11 (1095)	FR7SI30	ILZFR6C-K (6645)	HR10B	BPR4FS (1127)
DR8B	APR5FS (3122)	FR5DP	BCPR7ES (3330)	FR7SPP302U	LZFR6AP11GS (95712)	HR10BC	BPR4FS (1127)
DR8BC	APR5FS (3122)	FR5DTC	BCPR7ET (2164)	FR8D +	BKR5E (7938)	HR10BCX	BPR4FS-11 (2527)
DR8BP	APR5FS (3122)	FR5KPP332S	PFR7S8EG (1675)	FR8D + X	BKR5E-11 (6953)	HR10BCY	BPR4FS-15 (2727)
DR9B	APR5FS (3122)	FR5LDC	BKR7EKC (7354)	FR8DC	BKR5E (7938)	HR10BX	BPR4FS-11 (2527)
DR9BC	APR5FS (3122)	FR6D +	BKR6ES (3783)	FR8DC +	BKR5E (7938)	HR10BY	BPR4FS-15 (2727)
F04DAR	BKR6EK (2288)	FR6DC	BKR6E (6962)	FR8DC0	BKR5E (7938)	HR6B	BPR6FS (2623)
F5DC	BCP7ES (5030)	FR6DC +	BKR6E (6962)	FR8DCU	BKR5E-11 (6953)	HR6BC	BPR6FS (2623)
F5DP	BCP7ES (5030)	FR6DC2	BKR6E (6962)	FR8DCX	BKR5E-11 (6953)	HR6BP	BPR6FS (2623)
F5DPOR	PFR7B (4853)	FR6DCX	BCPR6ES-11 (7121)	FR8DCX +	BKR5E-11 (6953)	HR6D	BPR6EFS (3623)
F5DTC	BCP7ET (2078)	FR6DDC	BKR7EKC-N (2095)	FR8DE	BKR5EZ (7642)	HR6D +	BPR6EFS (3623)
F6DC	BCP6ES (4930)	FR6DE	BKR6E (6962)	FR8DII33X	IFR5N10 (7866)	HR6DC	BPR6EFS (3623)
F6DC0	BCP6ES (4930)	FR6DP	BKR6EP-8 (2215)	FR8DPP33	PFR5G-11 (2647)	HR6DC +	BPR6EFS (3623)
F6DCOR	BKR6E (6962)	FR6DP1X	BKR6EP-11 (2978)	FR8DPP33 +	PFR5G-11 (2647)	HR6DP	BPR6EFS (3623)
F6DCX	BCPR6ES-11 (7121)	FR6DPP332	PFR6B (3500)	FR8DPX	BKR5E-11 (6953)	HR6DPP33V	ITR6F13 (4477)
F6DP	BCP6ES (4930)	FR6DPX	BCPR6ES-11 (7121)	FR8DS	BKR5EIX (6341)	HR6DS	BPR6EFS (3623)
F6DPOR	PFR6Q (6458)	FR6DTC	BCPR6ET (2197)	FR8DX	BKR5E-11 (6953)	HR7D +	BPR6EFS (3623)
F6DSR	BKR6EIX (6418)	FR6DTCW	BCPR6ET (2197)	FR8HDC	BKR5EKB-11 (3967)	HR7DC	BPR6EFS (3623)
F6DTC	BCP6ET (4563)	FR6KDC	BKR6EK (2288)	FR8HDC +	BKR5EKB-11 (3967)	HR7DC +	BPR6EFS (3623)
F6KPP332S	PFR7S8EG (1675)	FR6KDC +	BKR6EK (2288)	FR8HP	ZFR5F-11 (2262)	HR7KPP33	PTR6F-13 (7569)
F6LTCR	BKUR7ET (7873)	FR6KII332S	IFR7X7G (91039)	FR8KC	BKR5EYA-11 (2526)	HR7KPP33 +	PTR6F-13 (7569)
F6MPP332	ILFR6A (3588)	FR6KPP332S	PFR6Q (6458)	FR8KC +	BKR5EYA-11 (2526)	HR7MEV	TR5B-13 (4559)
F7DC	BCP6ES (4930)	FR6KPP33	IFR6T11 (4589)	FR8KCU	BKR5EYA-11 (2526)	HR7MEV0	TR5A-10 (0005)
F7DC0	BCP6ES (4930)	FR6KPP33 +	IFR6T11 (4589)	FR8KI33V	IFR5E13 (6903)	HR7MPP	PTR5A-10 (5055)
F7DCOR	BKR6E (6962)	FR6LDC	BKR6EKC (2848)	FR8KII33X	BPR6EFIX-10 (94658)	HR7MPP +	PTR5A-10 (5055)
F7DCR4	BKR6E (6962)	FR6LTC	BKUR7ET (7873)	FR8KTC	BKUR5ET-10 (7553)	HR7MPP + V	PTR5A-10 (5055)
F7DCX	BCPR6ES-11 (7121)	FR6MPP10	ILFR6B (6481)	FR8KTC +	BKUR5ET-10 (7553)	HR7MPP302X	PTR5A-10 (5055)
F7DP	BCP6ES (4930)	FR6MPP332	ILFR6A (3588)	FR8KTCR	BKUR5ET (2789)	HR8A	BR5FS (4123)
F7DPER	IFR6D10 (5344)	FR7DII35V	DIFR6D13 (94167)	FR8LCX	ZFR6F-11 (4291)	HR8AC	BR5FS (4123)
F7DTC	BCP6ET (4563)	FR7D +	BKR6ES (3783)	FR8LDC	BKR5EK (7956)	HR8AP	BR5FS (4123)
F7HER02	ZFR6T-11G (5960)	FR7D + X	BKR6E-11 (2756)	FR8LDC4	BKR5EK (7956)	HR8B	BPR5FS (2423)
F7HER2	ZFR5P-G (6893)	FR7DC	BKR6E (6962)	FR8LI332S	IZFR5B (4080)	HR8BC	BPR5FS (2423)
F7HPP22	PZFR5D-11 (7968)	FR7DC +	BKR6E (6962)	FR8LPP302T	IZFR5R7G (94123)	HR8BCY	BPR5FS-15 (3124)
F7HPPRX	PZFR5D-11 (7968)	FR7DC0	BKR6E (6962)	FR8ME	LFRC5B (7113)	HR8BP	BPR5FS (2423)
F7KPP332U	PFR6X-11 (5757)	FR7DC2	BKR6E (6962)	FR8NEU	LFRC6-11 (5788)	HR8BPX	BPR5FS-11 (2924)
F7KTCR	BKUR6ET (6437)	FR7DC9	BKR6E (6962)	FR8SC	LFRC6B (6677)	HR8BPY	BPR5FS-15 (3124)
F7LCOR2	ZFR6F-11 (4291)	FR7DCX	BCPR6ES-11 (7121)	FR8SC +	LFRC6B (6677)	HR8BY	BPR5FS-15 (3124)
F7LCR	ZFR6A-11 (1041)	FR7DCX +	BCPR6ES-11 (7121)	FR8SE0	LFRC6B (6677)	HR8D +	BPR5EFS (2223)
F7LDCR	BKR6EK (2288)	FR7DE	BKR6EZ (4619)	FR8SPP332	PLFR5A-11 (6240)	HR8DC +	BPR5EFS (2223)
F7LTCR	BKUR6ET-10 (2397)	FR7DP	BKR6E (6962)	FR9HC	ZFR4F-11 (4043)	HR8DPP22U	PTR5D-10 (3784)
F8DC	BCP5ES (7496)	FR7DP1X	PFR6B-11 (4014)	FR9LCX	ZFR6V-G (8894)	HR8MCV	TR5B-13 (4559)
F8DC0	BCP5ES (7496)	FR7DPP +	PFR6B (3500)	H10BC	BPR4FS (1127)	HR8MCV +	TR5B-13 (4559)
F8DCOR	BCPR5ES (6130)	FR7DPP10	BKR6EIX (6418)	H2CS	B9EFS (1085)	HR8MEV	TR5B-13 (4559)
F8DC4	BCP5ES (7496)	FR7DPP22U	PFR6N-11 (3546)	H3CS	B8EFS (1049)	HR8NPP302	PTR5A-10 (5055)
F8DCX	BCPR5ES-11 (3524)	FR7DPP33	PFR6Q (6458)	H5D	BP7EFS (3526)	HR9A	BR5FS (4123)
F8DPER	PFR5G-11 (2647)	FR7DPX	BKR6E-11 (2756)	H5DC	BP7EFS (3526)	HR9AC	BR5FS (4123)
F8KTCR	BKUR5ET (2789)	FR7DTC	BCPR6ET (2197)	H5DC0	BP7EFS (3526)	HR9AP	BR5FS (4123)
F8LCR	ZFR5F (5165)	FR7HC	ZFR5P-G (6893)	H5DP	BP7EFS (3526)	HR9B	BPR4FS (1127)
F8LCR2	ZFR5F (5165)	FR7HC +	ZFR5P-G (6893)	H6B	BP6FS (3512)	HR9BC	BPR4FS (1127)
F8LDCR	BKR6EK (2288)	FR7HE02	ZFR6T-11G (5960)	H6BC	BP6FS (3512)	HR9BC +	BPR4FS (1127)
F9LCR	ZFR4F-11 (4043)	FR7HPP33	PZFR5D-11 (7968)	H6D	BP6EFS (3812)	HR9BCY	BPR4FS-15 (2727)
FGR5KQEO	BKR7EQUP (4285)	FR7HPP33 +	PZFR5D-11 (7968)	H6DC	BP6EFS (3812)	HR9BCY +	BPR4FS-15 (2727)
FGR6HQEO	ZFR6S-Q (6449)	FR7HPP332	PZFR5N-11T (7742)	H6DC0	BP6EFS (3812)	HR9BP	BPR4FS (1127)
FGR6KQC	BKR6EQUP (3199)	FR7KC	BKR5EYA (2087)	H6DP	BP6EFS (3812)	HR9BPX	BPR4FS-11 (2527)
FGR7DQE	BKR6EKUB (3584)	FR7KC +	BKR5EYA (2087)	H7CC	BR6EF (3177)	HR9BPY	BPR4FS-15 (2727)
FGR7DQE +	BKR6EKUB (3584)	FR7KCV	BKR5EYA (2087)	H7CP	BR6EF (3177)	HR9BY	BPR4FS-15 (2727)
FGR7DQEO	BKR6EKUB (3584)	FR7KCX	BCPR6EY-11 (3720)	H7D	BP6EFS (3812)	HR9D	BPR5EFS (2223)
FGR7DQP	BKR6EQUP (3199)	FR7KCX +	BCPR6EY-11 (3720)	H7DC	BP6EFS (3812)	HR9DC	BPR5EFS (2223)
FGR7DQP +	BKR6EQUP (3199)	FR7KDC	BKR6EKC (2848)	H7DC0	BP6EFS (3812)	HR9DPX	BPR6EFIX-10 (94658)
FGR7KQC	BKR6EQUP (3199)	FR7KII335T	DIFR5C (90911)	H7DP	BP6EFS (3812)	HR9KII33Y	TR5A1-13 (90813)
FGR7KQE	BKR6EQUP (3199)	FR7KPP332	IZFR6H11 (4294)	H8B	BP5FS (3412)	HS5E	BM7F (6421)
FGR7KQEO	BKR6EQUP (3199)	FR7KTC	BKUR6ET-10 (2397)	H8BC	BP5FS (3412)	HS8E	BM6F (6221)
FGR8KQEO	BKR5EQUB (1567)	FR7LC2	BKR6E (6962)	H8BP	BP5FS (3412)	M10A	AB6 (2910)
FLR7HTCO	BKUR6ET-10 (2397)	FR7LCX	ZFR6F-11 (4291)	H8DC	BP5EFS (3712)	M10A0	AB6 (2910)
FLR8LDCU	BKR5EK (7956)	FR7LCX +	ZFR6F-11 (4291)	H8DC0	BP5EFS (3712)	M10AC	AB6 (2910)
FLR8LDCU +	BKR5EK (7956)	FR7LD	BKR6EK (2288)	H8DP	BP5EFS (3712)	M10AC0	AB6 (2910)
FLR8LDU +	BKR5EK (7956)	FR7LD +	BKR6EK (2288)	H9BC	BPR4FS (1127)	M12B	AB6 (2910)
F03DAR	BKR6EK (2288)	FR7LDC	BKR6EKC (2848)	H9BCY	BPR4FS-15 (2727)	M145T1	AB6 (2910)
F05NPP332S	PLFER7A8EG (94833)	FR7LDC +	BKR6EKC (2848)	H9DC	BP5EFS (3712)	M145T5	AB6 (2910)
FQR8DE	BKR6EZB (4293)	FR7ME	LFRC6B (6677)	H9DC0	BP5EFS (3712)	M175T1	AB6 (2910)
FQR8LE2	ZFR5F (5165)	FR7MPP10	ILFR6B (6481)	H9HP	BP5EFS (3712)	M225T1	AB7 (3010)
FQR8LEU2	ZFR5F (5165)	FR7NI33	ILFR6B (6481)	HLR8STEX	LTR6B-10T (5948)	M240T1	AB7 (3010)
FR5DC	BCPR7ES (3330)	FR7NPP33	ILZFR6C-K (6645)	HR10A	BR5FS (4123)	M280T1	AB8 (7909)

BOSCH	→ NGK	BOSCH	→ NGK	BOSCH	→ NGK	BOSCH	→ NGK
M45T1	AB6 (2910)	W12E	B2 (3110)	W310S2S	BR10EIX (6801)	W7EC	B6S (3510)
M4A	AB7 (3010)	W145T1	B5HS (4210)	W45T1	B4H (4110)	W7EP	B6S (3510)
M4A1	AB8 (7909)	W145T1.1	B5HS (4210)	W4A	B8HS (5510)	W7LTCR	BUR6ET (3172)
M4A2	AB7 (3010)	W145T2	B5ES (6410)	W4A1	B8HS (5510)	W8A	B5HS (4210)
M4AC	AB7 (3010)	W145T3	B6S (3510)	W4A2	B8HS (5510)	W8A0	B5HS (4210)
M5A	AB7 (3010)	W145T30	BP5ES (6511)	W4A5	B8HS (5510)	W8AC	B5HS (4210)
M5AC	AB7 (3010)	W145T35	BP5HS (4111)	W4AC	B8HS (5510)	W8AP	B5HS (4210)
M7A	AB6 (2910)	W145TR2	BR5ES (4722)	W4AP	B8HS (5510)	W8B	BP5HS (4111)
M7AC	AB7 (3010)	W145TR3	BR6S (3522)	W4AS	BR8HIX (7001)	W8BC	BP5HS (4111)
M8A	AB6 (2910)	W145TR30	BPR5ES (7422)	W4C	B8ES (2411)	W8BP	BP5HS (4111)
M8A0	AB6 (2910)	W175T1	B6HS (4510)	W4C1	B8ES (2411)	W8C	B5ES (6410)
M8AC	AB6 (2910)	W175T2	B6ES (7310)	W4C2	B7ES (1111)	W8C0	B5ES (6410)
M95T1	AB6 (2910)	W175T3	B6S (3510)	W4C3	B7HS (5110)	W8CC	B5ES (6410)
M95T5	AB6 (2910)	W175T30	BP6ES (7811)	W4CC	B8ES (2411)	W8CCX	B5ES (6410)
MA145TR7	APR5FS (3122)	W175T35	BP6HS (4511)	W4CP	BR8EIX (5044)	W8CP	B5ES (6410)
MA175T7	AP6FS (2710)	W175TR1	BR6HS (3922)	W4CS	BR8EIX (5044)	W8D	BP5ES (6511)
MA200T7	AP6FS (2710)	W175TR30	BPR6ES (7822)	W4DP	BPR7EIX (4055)	W8DC	BP5ES (6511)
U3AC	C7HSA (4629)	W175Z1	B6HS (4510)	W4DPO	BPR7EIX (4055)	W8DC0	BP5ES (6511)
U3CC	C7E (5096)	W2A	B9HS (5810)	W4E2	B7S (3710)	W8DP	BP5ES (6511)
U4AC	C7HSA (4629)	W2AC	B9HS (5810)	W5A	B7HS (5110)	W8DTC	BP5ET (2287)
UR07CDC	CR9EK (4548)	W2AP	BR9HIX (5687)	W5AC	B7HS (5110)	W8E	B6S (3510)
UR08CC	CR9E (6263)	W2AS	BR9HIX (5687)	W5AP	B7HS (5110)	W8EC	B6S (3510)
UHR08CC	CR9EH-9 (7502)	W2CS	BR10EIX (6801)	W5AS	BR7HIX (7067)	W8F	BP5S (3011)
UHR09CI30	IMR9C-9H (6777)	W2D	BP9ES (7526)	W5B	BP7HS (5111)	W8FC	BP5S (3011)
UR06CDC	CR10EK (2360)	W200T30	BP6ES (7811)	W5BC	BP7HS (5111)	W8LCR	ZGR5A (5839)
UR2AS	CR8HS (7423)	W200T35	BP6HS (4511)	W5BP	BP7HS (5111)	W8LDCR	BUR6ET (3172)
UR2CC	CR8E (1275)	W200TR30	BPR6ES (7822)	W5C	B7ES (1111)	W8LPR	ZGR5A (5839)
UR2CDC	CR8EK (3478)	W215T30	BP6ES (7811)	W5CC	B7ES (1111)	W8LTCR	BUR5ET (3377)
UR3AC	CR7HSA (4549)	W225T1	B7HS (5110)	W5CP	B7ES (1111)	W95T1	B4H (4110)
UR3AS	CR7HS (7223)	W225T2	B7ES (1111)	W5CS	BR7EIX (6664)	W95T2	B4ES (4129)
UR4AS	CR6HS (7023)	W225T3	B7S (3710)	W5D	BP7ES (2412)	W95T3	B4 (3210)
UR5	CR7HSA (4549)	W225T35	BP7HS (5111)	W5D1	BP7ES (2412)	W95T6	BP4 (2911)
UR6DC	CPR7EA-9 (3901)	W225TR30	BPR7ES (2023)	W5DC	BP7ES (2412)	W9A	B4H (4110)
USR4AC	CMR6H (3365)	W230T30	BP7ES (2412)	W5DC0	BP7ES (2412)	W9A0	B4H (4110)
USR7AC	CMR6H (3365)	W240M1	B8HS (5510)	W5DP	BP7ES (2412)	W9AC	B5HS (4210)
V6SII332S	SILZKFR8D7S (95875)	W240MZ1	B8HS (5510)	W5DPO	BPR7EIX (4055)	W9ACO	B5HS (4210)
VR5NC	LKAR8A-9 (4786)	W240T1	B8HS (5510)	W5DTC	BP6ET (1263)	W9C	B4ES (4129)
VR5NE	LKAR8A-9 (4786)	W240T2	B8ES (2411)	W5E	B7S (3710)	W9CC	B4ES (4129)
VR6NE	LZKAR7B (5942)	W240T3	B7S (3710)	W5EC	B7S (3710)	W9D	BP5ES (6511)
VR6NII35T	DILKAR7E9HS (95003)	W250P21	BP7ES (2412)	W5EP	B7S (3710)	W9DC	BP5ES (6511)
VR6NII33S	SILKAR8D6 (95768)	W250T1	B8HS (5510)	W6B	BP6HS (4511)	W9DP	BP5ES (6511)
VR7NII33X	ILKAR7B11 (4912)	W250T2	B8ES (2411)	W6BC	BP6HS (4511)	W9DTC	BP5ET (2287)
VR7SPP33	PLZKAR6A-11 (5118)	W255T30	BP7ES (2412)	W6BP	BP6HS (4511)	W9E	B4 (3210)
VR7TII35U	DILKAR7E11HS (97439)	W260M1	B8HS (5510)	W6D	BP6ES (7811)	W9E0	B4LM (3410)
VR8NII35U	DILKAR6A11 (9029)	W260MZ1	B8HS (5510)	W6D1	BP6ES (7811)	W9EC	B4 (3210)
VR8SC	LZKAR7A (6799)	W260MZ2	B9ES (2611)	W6DC	BP6ES (7811)	W9ECO	B4LM (3410)
VR8SC+	LZKAR7A (6799)	W260S1S	BR8HIX (7001)	W6DC	BP6ES (7811)	W9F	BP5S (3011)
VR8SE	LZKAR7A (6799)	W260T1	B8HS (5510)	W6DC0	BP6ES (7811)	W9FC	BP5S (3011)
VR8SEW	LZKAR7A (6799)	W260T2	B9ES (2611)	W6DC0	BP6ESZ (7639)	W9LC	ZGR5A (5839)
VR8SII33X	ILKAR7B11 (4912)	W260T20	B8ES (2411)	W6DP	BPR6EIX (6637)	WA125TR30	BPR5EFS (2223)
W06AS	BR10HIX (6692)	W275T1	B8HS (5510)	W6DPO	BPR6EIX (6637)	WA200T30	BP6EFS (3812)
W06CS	B11EGV (5831)	W275T2	B9ES (2611)	W6DPX	BPR6EIX-11 (3903)	WA200TR30	BPR6EFS (3623)
W07AS	BR10HIX (6692)	W280MZ1	B8HS (5510)	W6DTC	BP6ET (1263)	WA225T30	BP7EFS (3526)
W07CS	BR10EIX (6801)	W280MZ2	B9ES (2611)	W7A	B6HS (4510)	WAK145T3	BM6F (6221)
W08AS	BR9HIX (5687)	W280S1S	BR9HIX (5687)	W7A0	B6HS (4510)	WAK225T3	BM7F (6421)
W08CS	BR10EIX (6801)	W280S2S	BR9EIX (3981)	W7AC	B6HS (4510)	WEA	BUH (2422)
W10A	B4H (4110)	W280T30	BP8ES (2912)	W7AP	B6HS (4510)	WEC	BUE (2322)
W10AC	B4H (4110)	W3A	B8HS (5510)	W7B	BP6HS (4511)	WET1	BUH (2422)
W10C	B4ES (4129)	W3A0	B8HS (5510)	W7BC	BP6HS (4511)	WET2	BUE (2322)
W10CC	B4ES (4129)	W3AC	B8HS (5510)	W7BP	BP6HS (4511)	WKA145T3	BM6A (5921)
W10DC	BPR4ES (7222)	W3AP	B8HS (5510)	W7C	B6ES (7310)	WKA145T6	BPM6A (7021)
W10E	B4 (3210)	W3AS	BR8HIX (7001)	W7CC	B6ES (7310)	WKA175T3	BM6A (5921)
W10F	BP4 (2911)	W3C	B9ES (2611)	W7CC0	B6ES (7310)	WKA175T6	BPM6A (7021)
W10FC	BP4 (2911)	W3CO	B9ES (2611)	W7CP	B6ES (7310)	WKA200TR6	BPMR6A (6726)
W11E0	B4LM (3410)	W3CC	B9ES (2611)	W7D	BP6ES (7811)	WKA225T3	BM7A (6521)
W125T1	B4H (4110)	W3CP	B9ES (2611)	W7D0	BP6ES (7811)	WKA225T6	BPM7A (7321)
W125T2	B4ES (4129)	W3CS	BR9EIX (3981)	W7D0	BP6ES (7811)	W06CS	B11EGV (5831)
W125T3	B4 (3210)	W3D	BP8ES (2912)	W7DC	BP6ES (7811)	WR08AC	BR9HS (4522)
W125T30	BP5ES (6511)	W3DP	BPR8EIX (6684)	W7DC0	BP6ESZ (7639)	WR09CC	BR10ES (4832)
W125T4	B4H (4110)	W3DPO	BPR8EIX (6684)	W7DCR	BPR6ES (7822)	WR10A	BR4HS (3322)
W125TR2	BR5ES (4722)	W3DP2	BP8ES (2912)	W7DCX	BPR6ES-11 (4824)	WR10AC	BR4HS (3322)
W125TR3	BR6S (3522)	W300T1	B9HS (5810)	W7DP	BP6ES (7811)	WR10DC	BPR4ES (7222)
W125TR30	BPR5ES (7422)	W300T30	BP9ES (7526)	W7DTC	BP6ET (1263)	WR10E	BR6S (3522)
W12A	B4H (4110)	W310S1S	BR9HIX (5687)	W7E	B6S (3510)	WR10F	BP4 (2911)

BOSCH - continued

BOSCH	→ NGK	BOSCH	→ NGK	BOSCH	→ NGK	BRISK	→ NGK
WR10FC	BP4 (2911)	WR8HP	ZGR5C (6334)	YR7MPP33	PLKR7A (4288)	77-316	BM7F (6421)
WR11E0	BR4LM (4133)	WR8LC	ZGR5A (5839)	YR7NE	LKR7B-9 (5847)	77-317	B6S (3510)
WR240T1	BR8HS (4322)	WR8LC+	ZGR5A (5839)	YR7SII3520X	DILZKR7B11GS (95710)	77-318	BPM6F (5950)
WR3CC	BR9ES (5722)	WR8LTC+	BUR5ET (3377)	YR8MEU	LKR6D-10E (96569)	77-319	BPMR4A (6028)
WR3CTC	BR9ET (4528)	WR9A0	BR5HS (3722)	YR8SEU	LZKR6B-10E (1578)	77-320	BP4HS (3611)
WR4AC	BR8HS (4322)	WR9C	BR5ES (4722)	YR8SII30W	LZKR6AI-10G (97999)	77-321	B6HS (4510)
WR4CC	BR8ES (5422)	WR9CC	BR5ES (4722)	YR8SII33U	ILZKR6F11 (97345)	77-323	B8ES (2411)
WR4CP	BR8EIX (5044)	WR9D	BPR5ES (7422)	ZGR6STE2W	ZKBR7A-HTU (91785)	77-324	BPMR7A (4626)
WR5A	BR7HS (4122)	WR9D+	BPR5ES (7422)	ZMR5TPP33	SILZKBR8D8S (97506)	77-325	BPR6HS (7022)
WR5AC	BR7HS (4122)	WR9DC	BPR5ES (7422)	ZQR8SI302	PLZKBR7B8G (91530)	77-350	BR4LM (4133)
WR5BC	BPR7HS (6422)	WR9DC+	BPR5ES (7422)	ZR5TPP330	SILZKBR8D8S (97506)	77-351	B6S (3510)
WR5CC	BR7ES (5122)	WR9DCX	BPR6ES-11 (4824)	ZR7SI332S	PLZKBR7B8G (91530)	77-352	BP5HS (4111)
WR5CP	BR7ES (5122)	WR9DCX+	BPR6ES-11 (4824)			77-354	BMR7A (4226)
WR5D	BPR7ES (2023)	WR9DCY	BPR5ES-13 (3154)			AR08GS	R0045Q-10 (4216)
WR5D+	BPR7ES (2023)	WR9DP	BPR5ES (7422)	BRIGGS & STRATTON → NGK		AR08S	CR10E (6264)
WR5DC	BPR7ES (2023)	WR9DPX	BPR5ES-11 (4424)	BS19LM	B2LM (1147)	AR10S	CR9E (6263)
WR5DC+	BPR7ES (2023)	WR9E	BR6S (3522)	BS-SV	BR2LM (5798)	AR12YS	CPR8E (7411)
WR5DP	BPR7ES (2023)	WR9E0	BR6S (3522)	BS-SVCU	BR2LM (5798)	AR14YS	CR7E (4578)
WR5DS	BPR7EIX (4055)	WR9EC	BR6S (3522)	BS-OHV	BCPR5ES (6130)	B10C	D9EA (2420)
WR6BC	BPR6HS (7022)	WR9ECO	BM6 (2027)	BS-OHV-HT	BCPR5ES (6130)	B12C	D8EA (2120)
WR6D	BPR6ES (7822)	WR9F	BP5S (3011)	491043	BCPR5ES (6130)	B12YC	DPR9EA-9 (5329)
WR6D+	BPR6ES (7822)	WR9FC	BP5S (3011)	491055E	BCPR5ES (6130)	B14C	D7EA (7912)
WR6DC	BPR6ES (7822)	WR9FP	BP5S (3011)	491055S	BCPR5ES (6130)	B14YC	DPR8EA-9 (4929)
WR6DC+	BPR6ES (7822)	WR9HC	ZGR5C (6334)	492167	BR2LM (5798)	B15YC	DPR7EA-9 (5129)
WR6DCX	BPR6ES-11 (4824)	WR9HP	ZGR5C (6334)	496018E	BCPR5ES (6130)	BR10S	DR9EA (3437)
WR6DP	BPR6ES (7822)	WR9LE	ZGR5A (5839)	496018S	BCPR5ES (6130)	BR10YS-9	DPR9EIX-9 (5545)
WR6DPO	BPR6ES (7822)	WR9LS	ZGR5A (5839)	591868	BR2LM (5798)	BR12S	DR8EA (7162)
WR6DPX	BPR6ES-11 (4824)	WS5E	BM7A (6521)	6093E	BCPR5ES (6130)	BR12YC	DCPR8E (4339)
WR6DS	BPR6EIX (6637)	WS5F	BPM7A (7321)	6099E	BR2LM (5798)	BR12YC-9	DCPR8E (4339)
WR6DTC	BP6ET (1263)	WS7E	BM6A (5921)	696202	BKR5EIX (6341)	BR12YP	DCPR8EIX (6546)
WR7A	BR6HS (3922)	WS7F	BPM6A (7021)	692720	BCPR5ES (6130)	BR14S	DR7ES (3123)
WR7AC	BR6HS (3922)	WS8E	BM6A (5921)	691043	BCPR5ES (6130)	BR14YC	DCPR7E (3932)
WR7B	BPR6HS (7022)	WS8F	BPM6A (7021)	692051	BCPR5ES (6130)	BR14YC-9	DCPR7EA-9 (6651)
WR7B+	BPR6HS (7022)	WSR5F	BPMR7A (4626)	692720	BCPR5ES (6130)	BR15YC	DCPR6E (3481)
WR7BC	BPR6HS (7022)	WSR6E	BMR6A (7421)	694385	BKR5EIX (6341)	D12YC	BCP7ES (5030)
WR7BC+	BPR6HS (7022)	WSR6F	BPMR6A (6726)	697451	BR2LM (5798)	D14Y	BKR6E (6962)
WR7BP	BPR6HS (7022)	WSR7E	BMR6A (7421)	711252	BCPR5ES (6130)	D14YC	BCP7ES (5030)
WR7C	BR6ES (4922)	WSR8E	BMR6A (7421)	796112S	BR2LM (5798)	D15Y	BKR6E (6962)
WR7CC	BR6ES (4922)	WSR8F	BPMR6A (6726)	797434	BCPR5ES (6130)	D15YC	BCP6ES (4930)
WR7CP	BR6ES (4922)	WSR9E	BMR4A (5728)	799876	BPMR6A (6726)	D17Y	BKR5E (7938)
WR7D	BPR6ES (7822)	X3CPO	D9EA (2420)	802592S	BR2LM (1147)	D17YC	BCP5ES (7496)
WR7D+	BPR6ES (7822)	X4CC	D8EA (2120)	992039	BR2LM (5798)	DOX15LE	ZFR6T-11G (5960)
WR7DC	BPR6ES (7822)	X4CS	D8EA (2120)	992041	BR2LM (5798)	DR12YC	BKR7E (6097)
WR7DC+	BPR6ES (7822)	X5DC	D7EA (7912)	992300	BR2LM (5798)	DR14YC	BCPR7E (3330)
WR7DCX	BPR6ES-11 (4824)	XR2AS	DR8HS (5123)	992300C	BR2LM (5798)	DR14ZC	ZFR7F-11 (2975)
WR7DCX+	BPR6ES-11 (4824)	XR2CE0	DR9EA (3437)	992301	BR2LM (5798)	DR14ZC-1	BCPR7ES-11 (1095)
WR7DP	BPR6EIX (6637)	XR2CS	DR8ES (5423)	992301C	BR2LM (5798)	DR15TC	BKUR5ET-10 (7553)
WR7DS	BPR6EIX (6637)	XR2DDC	JR9C (6193)	992302	BR2LM (5798)	DR15YC	BKR6E (6962)
WR7KI33S	IGR6A11 (5743)	XR4AS	DR8HS (5123)	992304	BCPR5ES (6130)	DR15Z	BKR6E (6962)
WR7LTC	BUR6ET (3172)	XR4CS	DR8ES (5423)	992305	BCPR5ES (6130)	DR15Z-1	BCPR6ES-11 (7121)
WR7LTC+	BUR6ET (3172)	XR4DC	DPR8EA-9 (4929)	992306	BCPR5ES (6130)	DR17YC	BCPR5ES (6130)
WR8AC	BR5HS (3722)	XR5DC	DPR7EA-9 (5129)	992340	BCPR5ES (6130)	F14YC	AP7FS (2127)
WR8AC+	BR5HS (3722)	XR7DC	DPR7EA-9 (5129)	992359C	BR2LM (5798)	F15YC	AP6FS (2710)
WR8B+	BPR5HS (6222)	Y5KPP332S	PZKER7B8EGS (93231)	992360C	BR2LM (5798)	FR14YC	APR6FS (2922)
WR8BC+	BPR5HS (6222)	Y6NPP332	PLKR7B8E (94716)	992361	BCPR5ES (6130)	FR15YC	APR6FS (2922)
WR8C	BR5ES (4722)	Y6LER	ZKER6A-10EG (96596)	992362	BCPR5ES (6130)	G12YC	BP7EFS (3526)
WR8CC	BR5ES (4722)	Y7LER02	ZKER6A-10EG (96596)			G14Y	BP7EFS (3526)
WR8CP	BR5ES (4722)	Y7MPP33	PLKR7A (4288)	BRISK → NGK		G14YC	BP7EFS (3526)
WR8D	BPR5ES (7422)	YR5DII33S	IKR9J8 (93311)	77-300	BPM7A (7321)	G15Y	BP6EFS (3812)
WR8D+	BPR5ES (7422)	YR5DDE	KR9CI (7795)	77-301	BR2LM (5798)	G15YC	BP6EFS (3812)
WR8DC	BPR5ES (7422)	YR5LDE	DCPR8EKC (7168)	77-302	BM6A (5921)	G17Y	BP5EFS (3712)
WR8DC+	BPR5ES (7422)	YR5NDE	LKR8A (5214)	77-303	BCPR5ES (6130)	G17YC	BP5EFS (3712)
WR8DC0	BPR5ES (7422)	YR6DES	DCPR7EA-9 (6651)	77-304	BM6F (6221)	GR15YC	BPR6EFS (3623)
WR8DC4	BPR6ES (7822)	YR6KI332S	DCPR8EIX (6546)	77-305	BR2LM (5798)	GR17YC	BPR5EFS (2223)
WR8DCX	BPR5ES-11 (4424)	YR6LDE	DCPR8EKC (7168)	77-306	BMR6A (7421)	J17	B4LM (3410)
WR8DCX+	BPR5ES-11 (4424)	YR6NPP332	PLKR7B8E (94716)	77-307	BPMR7A (4626)	J19	B2LM (1147)
WR8DP	BPR5ES (7422)	YR8SEU	LZKR6B-10E (1578)	77-308	BM7A (6521)	JR17	BR4LM (4133)
WR8DPX	BPR5ES-11 (4424)	YR6TI330T	ILZKR7A (1961)	77-309	BPM6A (7021)	JR19	BR2LM (5798)
WR8E	BR6S (3522)	YR7DC	DCPR7E-N-10 (4983)	77-310	BP5ES (6511)	K17C	B6S (3510)
WR8EC	BR6S (3522)	YR7DC+	DCPR7E-N-10 (4983)	77-311	BPM7A (7321)	K17Y	BP5S (3011)
WR8EP	BR6S (3522)	YR7DE	DCPR8E-N (5692)	77-312	BPR6ES (7822)	K19	B4 (3210)
WR8F	BP5S (3011)	YR7KII33T	ZKR7BI-10 (95536)	77-313	B4LM (3410)	L08JW	BR10EIX (6801)
WR8FC	BP5S (3011)	YR7LPP332W	IZKR7B (7563)	77-314	BPR5ES (7422)	L08W	B11EGV (5831)
WR8FP	BP5S (3011)	YR7MII33X	SILKR6C10E (97098)	77-315	BP6ES (7811)	L10JW	BR8EIX (5044)

CHAMPION - continued

CHAMPION	→ NGK	CHAMPION	→ NGK	CHAMPION	→ NGK	CHAMPION	→ NGK
K13	AB6 (2910)	L92Y	BP5HS (4111)	N86	B9EG (3530)	OE060	ZGR5B (7345)
K15J	AB6 (2910)	L92YC	BP5HS (4111)	N86G	BR9EIX (3981)	OE061	AP7FS (2127)
K3G	AB8 (7909)	L95Y	BP4HS (3611)	N87	B8EG (3430)	OE062	BKR6E-11 (2756)
K5G	AB8 (7909)	N1	BR10ES (4832)	N87G	BR8EIX (5044)	OE063	BKR6E-11 (2756)
K7	AB8 (7909)	N1C	BR10ES (4832)	N9BMC	BPR5EKU (5685)	OE064	BPR6HS (7022)
K8	AB8 (7909)	N10PY	BPR6EIX (6637)	N9BYC	BP6ET (1263)	OE065	BP5ES (6511)
K8G	AB8 (7909)	N10Y	BP6ES (7811)	N9BYC4	BP5ET-10 (5156)	OE066	ZFR6F-11 (4291)
K9	AB7 (3010)	N10Y4	BPR6ES-11 (4824)	N9Y	BP6ES (7811)	OE067	BP7EFS (3526)
KA6ZPHPB-1	PZKER7B8EGS (93231)	N11Y	BP5ES (6511)	N9YC	BP6ES (7811)	OE068	B8ES (2411)
KA8ZYCC-1	ZKER6A-10EG (96596)	N11YC	BP5ES (6511)	N9YC4	BPR6ES-11 (4824)	OE069	BCP6ES (4930)
KC10PYPB4	PFR5G-11 (2647)	N11YCC	BP5ES (6511)	N9YCC	BP6ES (7811)	OE070	BP6HS (4511)
KC6PYPBX	PFR7Q (7963)	N12Y	BP5ES (6511)	N9YCX	BP6ES (7811)	OE071	BPR6HS (7022)
KC7PYPB	PFR7W-TG (5592)	N12YC	BP5ES (6511)	NA10	B8ES (2411)	OE072	BP5EFS (3712)
KC7ZPMPBX4	PZFR5N-11T (7742)	N12YCC	BP5ES (6511)	NA8	B6ES (7310)	OE073	DCPR9E (2641)
KC7ZYPB4	PZFR6R (5758)	N13L	ZGR5C (6334)	OBL9Y	BPR6FS (2623)	OE074	B6ES (7310)
KC7ZTMC4	BKUR6ET-10 (2397)	N13Y	BP5ES (6511)	OE001	BP6ES (7811)	OE075	BCP7ES (5030)
KC8PYP4	PFR5G-11 (2647)	N14LY	ZGR5C (6334)	OE002	BKR6E (6962)	OE076	BCP7ET (2078)
KC8WYP4	IFR6D10 (5344)	N14Y	BP5ES (6511)	OE003	BCP6ES (4930)	OE077	BCPR6ET (2197)
KC8ZMCC	ZFR5P-G (6893)	N19V	BUE (2322)	OE004	BPR6ES (7822)	OE078	BR8EIX (5044)
KC8ZYPB4	PZFR5N-11T (7742)	N2	B9ES (2611)	OE005	BKR6E (6962)	OE079	B7ES (1111)
KEC6PYPB-1	PLFER7A8EG (94833)	N21	B4ES (4129)	OE006	BPR6ES (7822)	OE080	BKR7E-11 (1283)
KEC6WYPB-1	ILFER7C8EG (91898)	N2C	B9ES (2611)	OE007	BP6HS (4511)	OE081	BKR6E-11 (2756)
KER4PYPB	PLKR7A (4288)	N2G	BR9EIX (3981)	OE008	BPR7ES (2023)	OE082	BP7EFS (3526)
L10	B6HS (4510)	N279YC	BP7ES (2412)	OE009	BP6EFS (3812)	OE084	BP8ES (2912)
L10S	B6HS (4510)	N281YC	BP6ES (7811)	OE010	BP7ES (2412)	OE085	BKR5EKU (3964)
L11S	B7HS (5110)	N288	B5ES (6410)	OE011	BPR6EFS (3623)	OE086	BR6HS (3922)
L12Y	BP5HS (4111)	N3	B8ES (2411)	OE012	BP6ET (1263)	OE087	BP8ES (2912)
L14	B4H (4110)	N3C	B8ES (2411)	OE013	BKR5E (7938)	OE088	BCPR6ES (2330)
L15Y	BP4HS (3611)	N3G	BR8EIX (5044)	OE014	BKR7E (6097)	OE089	ZFR6F-11 (4291)
L19V	BUH (2422)	N4	B7ES (1111)	OE015	BP5ES (6511)	OE090	BP7EFS (3526)
L2G	BR9HIX (5687)	N4C	B7ES (1111)	OE016	BKR6E (6962)	OE091	BR9ES (5722)
L20V	BUH (2422)	N4G	BR7EIX (6664)	OE017	BCP7ES (5030)	OE092	CR9E (6263)
L288	B5HS (4210)	N4YC	BP9ES (7526)	OE018	BPR7ES (2023)	OE093	BKR6ES (3783)
L3G	BR8HIX (7001)	N5	B6ES (7310)	OE019	BKR5EK (7956)	OE094	BCPR7ES (3330)
L4G	BR7HIX (7067)	N5C	B6ES (7310)	OE020	BPR6EFS (3623)	OE095	BP6ET (1263)
L4J	B7HS (5110)	N52R	B11EGP (2191)	OE021	BCPR6ET (2197)	OE096	B6HS (4510)
L5	B7HS (5110)	N54R	B10EGP (5224)	OE022	BP6ES (7811)	OE098	BR7ES (5122)
L55G	BR10HIX (6692)	N56R	B11EGP (2191)	OE023	BCP6ES (4930)	OE099	BP5EFS (3712)
L6G	BR7HIX (7067)	N57	BR10ES (4832)	OE024	BCPR6ES-11 (7121)	OE100	BPR5EKU (5685)
L61Y	BP8HS (2630)	N57R	B10EGP (5224)	OE025	BUR6ET (3172)	OE101	BPR5ES-11 (4424)
L64Y	BP7HS (5111)	N58R	B10EGP (5224)	OE026	BKR6EK (2288)	OE102	BKR6EKE (5649)
L66Y	BP6HS (4511)	N59G	BR10EIX (6801)	OE027	BUR5ET-10 (7264)	OE104	BP6HS (4511)
L7	B6HS (4510)	N6	B6ES (7310)	OE028	BP5ET-10 (5156)	OE106	BP5ES (6511)
L7J	B6HS (4510)	N6BYC	BP6ET (1263)	OE029	PTR5A-10 (5055)	OE107	BPR7ES-11 (7226)
L76V	BUHW (2622)	N6GY	BPR8EIX (6684)	OE030	BKR6EK (2848)	OE108	BR8ES (5422)
L77J	B7HS (5110)	N6Y	BP8ES (2912)	OE031	TR5A-10 (0005)	OE109	BP6ES (7811)
L77J4	B7HS-10 (2129)	N6YC	BP8ES (2912)	OE032	BKUR6ET-10 (2397)	OE110	BCPR7ES (3330)
L77JC	B7HS (5110)	N6YCC	BP8ES (2912)	OE033	BKR6EZ (4619)	OE111	BPR6ES (7822)
L77JC4	B7HS-10 (2129)	N6O	B9ES (2611)	OE034	BKR6EZ (4619)	OE112	DR8EIX (6681)
L77V	BUHW (2622)	N6OR	B8EGP (2046)	OE035	LF5B (7113)	OE113	BPR6ES-11 (4824)
L78	B7HS (5110)	N62R	B8EGP (2046)	OE036	BP6EFS (3812)	OE115	FR5-1 (7252)
L78C	B7HS (5110)	N63Y	BP9ES (7526)	OE037	B6HS (4510)	OE116	BPR8ES (3923)
L78V	BUHW-2 (5626)	N64Y	BP8ES (2912)	OE038	BP6HS (4511)	OE117	BPR7ES-11 (7226)
L81	B7HS (5110)	N65Y	BP7ES (2412)	OE039	BCPR6ES-11 (7121)	OE118	BCPR6ET (2197)
L81Y	BP7HS (5111)	N66Y	BP6ES (7811)	OE040	B9ES (2611)	OE119	BKR6E (6962)
L82	B6HS (4510)	N7	B7ES (1111)	OE041	FR5-1 (7252)	OE121	BKR5E (7938)
L82C	B6HS (4510)	N7BMC	BP6ET (1263)	OE042	BPR5ES (7422)	OE122	PMR8A (5851)
L82Y	BP6HS (4511)	N7BYC	BP6ET (1263)	OE043	BCPR7ES (3330)	OE125	BR9EIX (3981)
L82YC	BP6HS (4511)	N7GY	BPR7EIX (4055)	OE044	BP6ET (1263)	OE126	PFR7B (4853)
L82YCC	BP6HS (4511)	N7Y	BP7ES (2412)	OE045	BPR5ES (7422)	OE127	BKR6E (6962)
L85	B6HS (4510)	N7YC	BP7ES (2412)	OE046	BP7ES (2412)	OE128	ZFR5F-11 (2262)
L85Y	BP6HS (4511)	N7YCC	BP7ES (2412)	OE047	BPR6ES-11 (4824)	OE129	BKR7EIX (2667)
L86	B6HS (4510)	N7YCX	BP7ES (2412)	OE048	BPR6ES-11 (4824)	OE130	LZKAR7A (6799)
L86C	B6HS (4510)	N79Y	BP6ES (7811)	OE049	BPR5ES-11 (4424)	OE131	PTR5D-10 (3784)
L86CC	B6HS (4510)	N8	B6ES (7310)	OE050	BP7EFS (3526)	OE134	BKR6EP-13 (2550)
L87C	B6HS (4510)	N8B	B6ES (7310)	OE051	BPR5ES (7422)	OE135	LF4AP-11 (5613)
L87Y	BP6HS (4511)	N8GY	BPR6EIX (6637)	OE052	DCPR8E-N (5692)	OE136	PFR6J-11 (2743)
L87YC	BP6HS (4511)	N8L	ZGR5C (6334)	OE053	APR6FS (2922)	OE137	BKR5E-11 (6953)
L87YCC	BP6HS (4511)	N8Y	BP6ES (7811)	OE054	APR6FS (2922)	OE138	PFR6N-11 (3546)
L88A	B6HS (4510)	N8O	B10EG (3630)	OE055	BP5ES (6511)	OE141	BKR6EIX (6418)
L89CM	BP5HS (4111)	N8OG	B11EGV (5831)	OE056	BKR7E-11 (1283)	OE143	PFR6G-9 (4377)
L9J	B6HS (4510)	N82	B10EG (3630)	OE057	BCP5ES (7496)	OE144	BKR6EIX (6418)
L9O	B5HS (4210)	N84	B9EG (3530)	OE058	BCP7ES (5030)	OE145	BKR6EIX (6418)
L9OC	B5HS (4210)	N84G	BR10EIX (6801)	OE059	BP5HS (4111)	OE146	PFR6N-11 (3546)

CHAMPION - continued

CHAMPION	→ NGK	CHAMPION	→ NGK	CHAMPION	→ NGK	CHAMPION	→ NGK
OE147	ZFR6F-11 (4291)	OJ12Y	BP5S (3011)	RBL13Y	BPR5FS (2423)	RC8WMP4	IFR6T11 (4589)
OE148	LFRA5-11 (6376)	OJ13Y	BP5S (3011)	RBL13Y6	BPR5FS-15 (3124)	RC8WYP4	IFR6J11 (7658)
OE150	PMR8A (5851)	ON11Y	BPR5ES (7422)	RBL15Y	BPR4FS (1127)	RC8YC	BKR6E (6962)
OE151	BPR5EFS (2223)	ON12Y	BPR5ES (7422)	RBL15Y4	BPR4FS-11 (2527)	RC8YC4	BKR6E-11 (2756)
OE152	BKR6E-11 (2756)	ON3	BR8ES (5422)	RBL15Y6	BPR4FS-15 (2727)	RC8YCC	BKR6E (6962)
OE153	BKR5EZ (7642)	P10Y	D6HA (6512)	RBL16Y	BPR4FS (1127)	RC8YCC4	BKR6E-11 (2756)
OE154	ZFR5F-11 (2262)	P7	D8HA (7112)	RBL17Y	BPR4FS (1127)	RC8YCL	BKR6EZ (4619)
OE155	APR6FS (2922)	P8Y	D6HA (6512)	RBL17Y6	BPR4FS-15 (2727)	RC8ZPYPB4	IZFR6K-11S (5266)
OE156	ZGR5C (6334)	PG2PHP	PMR8A (5851)	RBL8	BR6FS (4323)	RC87LYC	BKR6E (6962)
OE157	BCR8ES (5430)	PG4PHP	PMR7A (4259)	RBL9Y	BPR6FS (2623)	RC87PYC	BKR6EIX (6418)
OE162	BR6ES (4922)	P-G7C	C7E (5096)	RBN12Y	BPR5EFS (2223)	RC87YCC	BKR6ES (3783)
OE163	LZTR4A-11 (5444)	P-RG7C	CR7E (4578)	RBN13Y	BPR5EFS (2223)	RC87YCL	BKR6EZ (4619)
OE167	LZTR5AIX-13 (2314)	P-RZ9HC	CR7HSA (4549)	RBN14Y	BPR5EFS (2223)	RC89PYC	BKR6EIX (6418)
OE168	PTR5D-10 (3784)	PZ7HC	CR7HSA (4549)	RBN9Y	BPR6EFS (3623)	RC89WYP4	IFR6T11 (4589)
OE171	BPR6FS (2623)	Q504V	R2349-10 (6839)	RC10DMC	BKR5EK (7956)	RC89YCC	BKR6ES (3783)
OE175	LFRA5P-11 (4775)	QC12PEP	PZFR6H (7696)	RC10ECC	ZFR6F-11 (4291)	RC9BMC	BKR5EKK (3964)
OE176	PZFR5D-11 (7968)	QC12YC	BKR5E (7938)	RC10MCC	ZFR6V-G (8894)	RC9MC4	ZFR5F-11 (2262)
OE178	LFRA5B (7113)	QC501V	R7434-10 (4894)	RC10MCC6	ZFR6V-G (8894)	RC9MCC4	ZFR6F-11 (4291)
OE179	IFR6J11 (7658)	QC59C	BCR8ES (5430)	RC10MCCR6	ZFR6V-G (8894)	RC9QMP	BKR6EQUP (3199)
OE181	IFR6D10 (5344)	QC9MCC4	ZFR6F-11 (4291)	RC10PYC	BKR6EIX (6418)	RC9Y	BKR6E (6962)
OE182	IFR6T11 (4589)	QCJ8Y	BPMR6A (6726)	RC10OPY4	PFR5J-11 (4642)	RC9YC	BKR6E (6962)
OE183	ITR6F13 (4477)	QJ19LM	BR2LM (5798)	RC10OPYB4	PFR5G-11 (2647)	RC9YC4	BCPR6ES-11 (7121)
OE184	IZFR5B (4080)	QL16V	BUZ8H (7447)	RC10VTYC4	BKUR5ET-10 (7553)	RC9YC5	BCPR6ES-11 (7121)
OE185	IZFR6B (3116)	QL7J5	BR6HS (3922)	RC10WMP2	IZFR5B (4080)	RC9YCC	BKR6E (6962)
OE186	DCPR7E-N-10 (4983)	QL76V	BUZHW (2147)	RC10WMB3	IZFR5R7G (94123)	RC9YCC4	BCPR6ES-11 (7121)
OE188	IFR6T11 (4589)	QL77CC	BZ7HS-10 (3579)	RC10WVP4	IFR5N10 (7866)	RCJ4	BMR7A (4226)
OE190	ILFR6B (6481)	QL77J4	BZ7HS-10 (3579)	RC10YC	BCPR6ES (2330)	RCJ501H	BPMR4A (6028)
OE191	IFR6D10 (5344)	QL77JC4	BZ7HS-10 (3579)	RC10YC4	BKR6E-11 (2756)	RCJ6	BMR7A (4226)
OE192	PGR5C-11 (5760)	QL78C	BZ7HS-10 (3579)	RC10YCC	BKR6E (6962)	RCJ6Y	BPMR7A (4626)
OE195	IGR7A (6687)	QL78V	BUZHW-2 (2173)	RC10YCC4	BKR6E-11 (2756)	RCJ6YC	BPMR7A (4626)
OE196	DCPR7E-N-10 (4983)	QL82C	BR6HS (3922)	RC10YCL	BKR5EZ (7642)	RCJ7Y	BPMR7A (4626)
OE197	LKR6D-10E (96569)	QL82YC	BPR6HS (7022)	RC11PYPB4	PFR6N-11 (3546)	RCJ7YC	BPMR7A (4626)
OE198	ZFR6V-G (8894)	QL86	BR6HS (3922)	RC11ZYC4	ZFR5E-11 (4435)	RCJ8	BMR6A (7421)
OE199	DCPR8E (4339)	QL86C	BR6HS (3922)	RC12ECC	FR5-1 (7252)	RCJ8Y	BPMR6A (6726)
OE201	LZKR6B-10E (1578)	QL87YC	BPR6HS (7022)	RC12LC	ZFR5F (5165)	RCJ8YC	BPMR6A (6726)
OE204	PLZKBR7B8G (91530)	QN2	BR9ES (5722)	RC12LC4	ZFR5F-11 (2262)	RD14	AB6 (2910)
OE205	PLZKBR7B8G (91530)	QN2C	BR9ES (5722)	RC12LYC	FR5-1 (7252)	RD16	AB6 (2910)
OE206	ILFR6B (6481)	QN2G	BR9EIX (3981)	RC12MC4	ZFR5F-11 (2262)	RD16J	AB6 (2910)
OE207	PLZKAR6A-11 (5118)	QN3	BR8ES (5422)	RC12MC5	ZFR5F-11 (2262)	RD9	AB6 (2910)
OE208	IKR9J8 (93311)	QN3C	BR8ES (5422)	RC12MCC4	ZFR5F-11 (2262)	RDJ7J	BMR6F (2144)
OE209	PFR7W-TG (5592)	QN84	BR9EG (3230)	RC12PYC	PFR6B (3500)	RDJ7Y	BPMR6F (1270)
OE211	LKR8A (5214)	QN86	BR8EG (3130)	RC12PYP	BKR6EP-13 (2550)	RDJ8J	BMR6F (2144)
OE212	LKR7B-9 (5847)	R10	D6EA (7512)	RC12YC	BKR5E (7938)	RE14MCC4	LZTR4A-11 (5444)
OE213	PZFR6R (5758)	R6	D8EA (2120)	RC12YC5	BKR5E-11 (6953)	RE14MCC5	LZTR4A-11 (5444)
OE217	BKR6EKE (5649)	R6G	DR8EIX (6681)	RC12YCC	BKR5E (7938)	RE14PLP5	LZTR5AIX-13 (2314)
OE221	PLFER7A8EG (94833)	R8	D7EA (7912)	RC12YCC4	BKR5E-11 (6953)	RE7PYC5	PTR5A-10 (5055)
OE222	PFR7Q (7963)	RA2HC	DPR9EA-9 (5329)	RC14YC	BKR5E (7938)	RE7YCC	TR5A-10 (0005)
OE223	BKR6EQUP (3199)	RA2PYPB	IKR9J8 (93311)	RC6PYP	PFR7B (4853)	REA4PMPB4	ILZKAR7A10 (6043)
OE224	ILFR6A (3588)	RA4HC	DCPR8E (4339)	RC6VPYC	BKR7EIX (2667)	REA6PYPB	ILKAR7A7 (91432)
OE225	ILKAR7A7 (91432)	RA4HCC	DCPR8E (4179)	RC6YC	BCPR7ES (3330)	REA6YC	LKAR8A-9 (4786)
OE226	IKR6G11 (7980)	RA4HCX	DCPR8E-N (5692)	RC6YCC	BCPR7ES (3330)	REA8MCL	LZKAR7A (6799)
OE227	IZFR6B (3116)	RA4YC	DCPR8E (4179)	RC61YC	BCR8ES (5430)	REA8MCX	LZKAR7B (5942)
OE228	PFR5G-11 (2647)	RA59GC	DCR9EIX (6650)	RC7BMC	BCPR6ET (2197)	REA8MX	LZKAR7B (5942)
OE229	PLKR7A (4288)	RA6	DR8ES-L (2923)	RC7BYC	BKR6EKUB (3584)	REA8PMPB5	PLZKAR6A-11 (5118)
OE230	DCPR8E (4179)	RA6HC	DCPR8E (4339)	RC7BYC4	BCPR6ET (2197)	REA8WYPB4	ILKAR7L11 (94124)
OE231	LKAR8A-9 (4786)	RA6Y	DPR8EA-9 (4929)	RC7GYC	BKR7EIX (2667)	REA12WMB4	LZKAR6AP-11 (6643)
OE232	ILKR9G8 (97168)	RA6YC	DPR8EA-9 (4929)	RC7PYC	BKR6EIX (6418)	REC10PYC4	LFRA5P-11 (4775)
OE233	ILZKAR7A10 (6043)	RA7PYPB4	IKR6G11 (7980)	RC7PYCB4	PFR6B-11 (4014)	REC10WYPB4	ILFR6B (6481)
OE234	PZFR5N-11T (7742)	RA7YC	DCPR8E (4339)	RC7Y	BCPR7ES (3330)	REC10YC4	LFRA5A-11 (6376)
OE235	BKUR6ET-10 (2397)	RA8HC	DCPR7E (3932)	RC7YC	BCPR7ES (3330)	REC14PLP5	LZTR5AIX-13 (2314)
OE236	LFRA6D (4704)	RA8MCX4	ZKR7A-10 (1691)	RC7YC3	BKR7E (6097)	REC14PYC	LFRA4P-11 (5613)
OE237	BKR6EKUB (3584)	RA8Y	DPR7EA-9 (5129)	RC7YC4	BKR7E-11 (1283)	REC6TMC	LFRA6D (4704)
OE238	PLZFR6A11S (5987)	RA8YC	DPR7EA-9 (5129)	RC7YCC	BCPR7ES (3330)	REC7PMPB4	PLZFR6A11S (5987)
OE239	IZFR6K-11S (5266)	RA8YCX4	DCPR7E-N-10 (4983)	RC7YCC4	BKR7E-11 (1283)	REC8PYB	ILFR6B (6481)
OE240	LZKAR6AP-11 (6643)	RAX92C	DR9EA (3437)	RC78PYP	PFR7G-11S (7772)	REC8PYPB	ILFR6A (3588)
OE241	CR9EB (6955)	RAX92DC	JR9C (6193)	RC8BYC	BKR6EKC (2848)	REC9MCLX	LFRA5B (7113)
OE243	SILZKBR8D8S (97506)	RAX92YC	DPR9EA-9 (5329)	RC8DMC	BKR6EK (2288)	REC9YCL	LFRA5B (7113)
OE244	PZKER7B8EGS (93231)	RAX94C	DR8EA (7162)	RC8PMP8	IZFR6B (3116)	RER2PYPB	ILKR9G8 (97168)
OE245	SILZKGR8B8S (94201)	RAX94YC	DPR8EA-9 (4929)	RC8PYCB	PFR6G-9 (4377)	RER6YC	LKR7B-9 (5847)
OE246	ILFER7C8EG (91898)	RAX96C	DR7EA (7839)	RC8PYP	PFR6J-11 (2743)	RER8DMC	LKR8A (5214)
OE247	ZKER6A-10EG (96596)	RAX96YC	DPR7EA-9 (5129)	RC8PYPB4	PFR6N-11 (3546)	RER8MC	LZKR6B-10E (1578)
OE253	ILKAR7L11 (94124)	RBL11Y	BPR5FS (2423)	RC8PYX	BKR6EIX (6418)	RER8WYPB	SILKR6C10E (97098)
OE255	LTR6B-10T (5948)	RBL11Y6	BPR5FS-15 (3124)	RC8VTYC4	BKUR6ET-10 (2397)	RER8WYPB4	SILKR6C10E (97098)
OE258	SILZNA6D9 (94051)	RBL12	BR5FS (4123)	RC8WMP2	IZFR6B (3116)	RER8YC	LKR6D-10E (96569)

CHAMPION - continued

CHAMPION	→ NGK	CHAMPION	→ NGK	CHAMPION	→ NGK	CHINESE BRANDS	→ NGK
RERX4ZWYPB	SILZKGR8B8S (94201)	RL95YC	BPR5HS (6222)	RV15YC6	BPR4FS-15 (2727)	A7TC	C7HSA (4629)
RERX5ZPYPB	SILZKBR8D8S (97506)	RN1C	BR10ES (4832)	RV17YC	BPR4FS (1127)	A7TCI	CR7HIX (7544)
RERX6PMC84	PLZKBR7B8G (91530)	RN10GY	BPR6EIX (6637)	RV17YC6	BPR4FS-15 (2727)	A8C	C8HSA (6821)
RES9PYP4	PTR5A-10 (5055)	RN10PYP4	PGR5C-11 (5760)	RV19YC	BPR4FS (1127)	A8RC	CR8HSA (2086)
RES9YCC4	TR5A-10 (0005)	RN10VTYC	BUJ5ET (3377)	RV8C	BR6FS (4323)	A8RTC	CR8HSA (2086)
RES10TMC4	LTR6B-10T (5948)	RN10VTYC4	BUJ5ET-10 (7264)	RV9YC	BPR6FS (2623)	A8TC	C8HSA (6821)
RET4WYPBX	SILZNR6D9 (94051)	RN10Y	BPR6ES (7822)	RZ7C	CMR7H (3066)	B7	C7E (5096)
RF11Y	APR6FS (2922)	RN10YC	BPR6ES (7822)	RZ94C	CR8HS (7423)	B7R	CR7E (4578)
RF11YC	APR6FS (2922)	RN10Y4	BPR6ES-11 (4824)	RZ98C	CR6HS (7023)	B7RTC	CPR7EA-9 (3901)
RF14Y	APR5FS (3122)	RN11Y	BPR5ES (7422)	RZN12Y	BPR5EFS (2223)	B7RD	CR7EK (7546)
RF14YC	APR5FS (3122)	RN11YC	BPR5ES (7422)	RZN12Y5	BPR5EFS (2223)	B8	C8E (7471)
RF7YC	APR6FS (2922)	RN11YC4	BPR5ES-11 (4424)	S10YCC	BP5EFS (3712)	B9	C9E (7499)
RF7YCC	APR6FS (2922)	RN11YCC	BPR5ES (7422)	S12YC	BP5EFS (3712)	B9R	CR9E (6263)
RF9Y	APR6FS (2922)	RN11YCC4	BPR5ES-11 (4424)	S279YC	BP6EFS (3812)	B9RD	CR9EK (4548)
RF9Y5	APR6FS (2922)	RN12Y	BPR5ES (7422)	S281YC	BP6EFS (3812)	BM6A	BM6A (5921)
RF9YC	APR6FS (2922)	RN12YC	BPR5ES (7422)	S379YC	BP7EFS (3526)	CMR7H	CMR7H (3066)
RFN14LY	ZFR4F-11 (4043)	RN12YC4	BPR5ES-11 (4424)	S6YC	BP7EFS (3526)	D7C	D7EA (7912)
RG2PHP	CR8EIX (4218)	RN12YC6	BPR5ES-13 (3154)	S6YCC	BP7EFS (3526)	D7RC	DR7EA (7839)
RG4HC	CR9EB (6955)	RN12YCC	BPR5ES (7422)	S7YC	BP7EFS (3526)	D8C	D8EA (2120)
RG4HCX	CR9EB (6955)	RN13L	ZGR5C (6334)	S7YCC	BP7EFS (3526)	D8RC	DR8EA (7162)
RG4PHP	PMR8A (5851)	RN13LYC	ZGR5C (6334)	S9YC	BP6EFS (3812)	D8RTC	DR8EA (7162)
RG6PP	PMR8A (5851)	RN14LY	BPR4ES (6334)	S9YCC	BP6EFS (3812)	D8TC	D8EA (2120)
RG6YC	CPR8E (7411)	RN14MC5	BPR5EY-11 (3028)	UD16	AB6 (2910)	D9C	D9EA (2420)
RG6YCA	CPR8E (7411)	RN14PMP5	BPR5EP-11 (3971)	UF-11Y	APR5FS (3122)	D9RC	DR9EA (3437)
RG6YCH	CPR8E (7411)	RN14Y	BPR5ES (7422)	UF-14Y	APR5FS (3122)	DK6RTC	DCPR6E (3481)
RG92C	CR9E (6263)	RN14Y6	BPR5ES-13 (3154)	UF-9Y	APR6FS (2922)	DK7RTC	DCPR7E (3932)
RG92DC	CR9EK (4548)	RN14YC	BPR5ES (7422)	UJ12	B2 (3110)	DK8RTC	DCPR8E (4339)
RG94C	CR8E (1275)	RN16Y	BPR4ES (7222)	UJ18Y	BP4 (2911)	E5C	B5HS (4210)
RGU92C	CR9EH-9 (7502)	RN2	BR9ES (5722)	UJ2J	B8S (3810)	E5RC	BR5HS (3722)
RGU94C	CR8EH-9 (5666)	RN2C	BR9ES (5722)	UJ4J	B7S (3710)	E5RTC	BPR5HS (6222)
RH10C	B6L (3212)	RN2G	BR9EIX (3981)	UJ6	B6S (3510)	E5T	BP5HS (4111)
RH18Y	B-4L (3112)	RN3	BR8ES (5422)	UJ8	B6S (3510)	E5TC	BP5HS (4111)
RJ11	BR6S (3522)	RN3C	BR8ES (5422)	UJ81C	B7S (3710)	E6C	B6HS (4510)
RJ11Y	BP5S (3011)	RN3G	BR8EIX (5044)	UJ81J	B7S (3710)	E6RC	BR6HS (3922)
RJ12	BR6S (3522)	RN4	BR7ES (5122)	UK10	AB6 (2910)	E6RTC	BPR6HS (7022)
RJ12C	BR6S (3522)	RN4C	BR7ES (5122)	UL17V	BUHXW-1 (5526)	E6T	BP6HS (4511)
RJ12Y	BP5S (3011)	RN5	BR6ES (4922)	UL18V	BUHX (2522)	E6TC	BP6HS (4511)
RJ12YC	BP5S (3011)	RN5C	BR6ES (4922)	UL4J	B7HS (5110)	E7C	B7HS (5110)
RJ14Y	BP5S (3011)	RN57YC	BR10EG (3830)	UL77V	BUHXW-1 (5526)	E7RC	BR7HS (4122)
RJ14YC	BP5S (3011)	RN57YCC	BR10EG (3830)	UL81C	B7HS (5110)	E7RTC	BPR7HS (6422)
RJ17LM	BR4LM (4133)	RN6	BR6ES (4922)	UL81J	B7HS (5110)	E7TC	BP7HS (5111)
RJ18Y	BP4 (2911)	RN6Y	BPR8ES (3923)	UN12Y	BP5ES (6511)	E8C	B8HS (5510)
RJ18YC	BP4 (2911)	RN6YC	BPR8ES (3923)	UN19V	BUE (2322)	E8RC	BR8HS (4322)
RJ19HX	BR2LM (5798)	RN7GY	BPR7EIX (4055)	UN79Y	BP6ES (7811)	E8RTC	BPR8HS (3725)
RJ19LM	BR2LM (5798)	RN7Y	BPR7ES (2023)	V12YC	BP5FS (3412)	E8TC	BP8HS (2630)
RJ19LMC	BR2LM (5798)	RN7YC	BPR7ES (2023)	V4C	B7FS (3027)	F5TC	BP5ES (6511)
RJ2YLE	BPMR6A (6726)	RN7YC4	BPR7ES-11 (7226)	V59C	R5673-9 (3856)	F6C	B6ES (7310)
RJ20Y	BP4 (2911)	RN7YCC	BPR7ES (2023)	V9YC	BP6FS (3512)	F6RC	BR6ES (4922)
RJ6	BR6S (3522)	RN7YCC4	BPR7ES-11 (7226)	XC10YC	BCPR6ES (2330)	F6RJY	BUR6ET (3172)
RJ6C	BR6S (3522)	RN8	BR5ES (4722)	XC12YC	BCPR5ES (6130)	F6RTC	BPR6ES (7822)
RJ6J	BR6S (3522)	RN8L	ZGR5C (6334)	XC92YC	BCPR5ES (6130)	F6TC	BP6ES (7811)
RJ7	BR6S (3522)	RN8VTYC4	BUR6ET (3172)	XJ4J	B7S (3710)	F6TJC	BP6ET (1263)
RJ8	BR6S (3522)	RN8WYP	IGR7A (6687)	XJ-8	BR6S (3522)	F7C	B7ES (1111)
RJ8C	BR6S (3522)	RN9GY	BPR6EIX (6637)	XL-10	BR6HS (3922)	F7RC	BR7ES (5122)
RJ8J	BR6S (3522)	RN9LCC	ZGR5B (7345)	XN-8	BR6ES (4922)	F7RTC	BPR7ES (2023)
RL12Y	BPR6HS (7022)	RN9Y	BPR6ES (7822)	Y82	CM-6 (5812)	F7T	BP7ES (2412)
RL19	BR5HS (3722)	RN9YC	BPR6ES (7822)	Z10	C6HSA (3228)	F7TC	BP7ES (2412)
RL4J	BR7HS (4122)	RN9YC4	BPR6ES-11 (4824)	Z12	C6HSA (3228)	F8C	B8ES (2411)
RL7J	BR6HS (3922)	RN9YCC	BPR6ES (7822)	Z6	C8HSA (6821)	F8RC	BR8ES (5422)
RL77J	BR7HS (4122)	RN9YCC4	BPR6ES-11 (4824)			GL4	B4LM (3410)
RL78	BR7HS (4122)	RP10HC	DR5HS (4623)			K5RF	BKR5E (7938)
RL78C	BR7HS (4122)	RP7	DR8HS (5123)			K5RF-11	BKR5E-11 (6953)
RL82	BR6HS (3922)	RS12YC	BPR5EFS (2223)			K5RTC	BKR5E (7938)
RL82C	BR6HS (3922)	RS14YC	BPR5EFS (2223)			K5RTC-11	BKR5E-11 (6953)
RL82Y	BPR6HS (7022)	RS5C	BR7EFS (1094)			K6RF	BKR6E (6962)
RL82YC	BPR6HS (7022)	RS8WYP5	ITR6F13 (4477)			K6RF-11	BKR6E-11 (2756)
RL82YCC	BPR6HS (7022)	RS9PYP4	PTR5D-10 (3784)			K6RTC	BKR6E (6962)
RL85	BR6HS (3922)	RS9YC	BPR6EFS (3623)			K6RTC-11	BKR6E-11 (2756)
RL85C	BR6HS (3922)	RS9YCC	BPR6EFS (3623)			K7TC	BKR7E (6097)
RL86	BR6HS (3922)	RV12C	BR5FS (4123)			L4C	BM4A (5628)
RL86C	BR6HS (3922)	RV12YC	BPR5FS (2423)			L4RTC	BPMR4A (6028)
RL87Y	BPR6HS (7022)	RV12YC6	BPR5FS-15 (3124)			L6C	BM6A (5921)
RL87YC	BPR6HS (7022)	RV15YC	BPR4FS (1127)			L6RTC	BPMR6A (6726)
RL90	BR5HS (3722)	RV15YC4	BPR4FS-11 (2527)			L6TC	BPM6A (7021)
CHAMPION → NGK		CHAMPION → NGK		CHEVROLET → NGK		CHINESE BRANDS → NGK	
				25 186 682	ZFR6U-9 (90318)		
				25 193 474	ZFR6U-9 (90318)		
CHAMPION → NGK		CHAMPION → NGK		CHINESE BRANDS → NGK		CHINESE BRANDS → NGK	
				A5RC	CR5HS (2874)		
				A5RTC	CR5HS (2874)		
				A6C	C6HSA (3228)		
				A6RTC	CR6HSA (2983)		
				A6RC	CR6HSA (2983)		
				A6TC	C6HSA (3228)		
				A7C	C7HSA (4629)		
				A7RC	CR7HSA (4549)		
				A7RTC	CR7HSA (4549)		

CHINESE BRANDS - continued

CHINESE BRANDS → NGK	
L7C	BM7A (6521)
L7RTC	BPMR7A (4626)
L7TC	BPM7A (7321)
L8RTC	BPMR8Y (2218)
LR4C	BMR4A (5728)
LR6C	BMR6A (7421)
LR7C	BMR7A (4226)
T1137C	C7HSA (4629)
T4197JC	BP7ES (2412)
CHRYSLER GROUP → NGK	
04606402AB	LZTR4A-11 (5444)
04606591AB	ZFR5LP-13G (7781)
SP070507AC	IKR9J8 (93311)
SPZFR5LP13G	ZFR5LP-13G (7781)
SP000ZFR5N	ZFR5N (7917)
SPLZTR5A13	LZTR5AIX-13 (2314)
CITROEN → NGK	
1607577680	DILFR5A11 (93759)
5960.14	LFR5B (7113)
5960.57	LFR6B (6677)
5960.E3	LFR5B (7113)
5960.F0	BKR6EZ (4619)
5960.G1	LZKAR7A (6799)
5960.G4	PLZKBR7B8G (91530)
5960.H9	PLZKBR7B8G (91530)
5960.L0	PLZKBR7B8G (91530)
5960.L2	LFR6C-11 (5788)
5960.L5	ILZKBR7B8G (97968)
5962.2A	BPR6ES (7822)
5962.2T	BKR6EKC (2848)
5962.2X	BKR6E (6962)
5962.5G	BKR6EZ (4619)
5962.7Q	BKR6EZ (4619)
5962.7S	BKR6EZ (4619)
5962.IA	BP5ET (2287)
5962.IK	BKR6EK (2288)
5962.IL	BKR5EK (7956)
5962.OE	BKR6EK (2288)
5962.S7	BP5ES (6511)
5962.TO	BKR6E (6962)
5962.W1	BCPR5ES (6130)
5962.X8	BCP6ES (4930)
5962.Z1	BKR6EK (2288)
5962.Z6	BKR5EK (7956)
95 496 692	BP6HS (4511)
95 605 398	BHS (4510)
95 611 941	BP6EFS (3812)
95 619 043	BP6ES (7811)
96 000 090	BCP5ES (7496)
96 037 952	BCP5ES (7496)
96 039 962	BCP6ET (4563)
96 064 890	BCPR5ES (6130)
96 097 486	BCP7ET (2078)
96 145 071	BCPR6ET (2197)
96 762 881 80	LZKR6AI-10G (97999)
96 774 469 80	ILZKR8C8G (90909)
97 533 994	BP7EFS (3526)
AM212207A	B6HS (4510)
MKP00073	BP7ES (2412)
ZC9862090U	BP5ES (6511)
ZCT000011	BP6HS (4511)
ZCT000012	BP7ES (2412)
CLARK → NGK	
444771	BP2ES (3467)
446323	BPR5FS (2423)
446583	BMR6A (7421)
742159	AB-6 (2910)
784250	AB-6 (2910)
890210	BMR6A (7421)
890215	AB-6 (2910)
890217	AB-6 (2910)

CLARK → NGK	
890219	BMR6A (7421)
890220	BMR6A (7421)
890221	AB-6 (2910)
890222	AB-6 (2910)
890225	BMR6A (7421)
890227	AB-6 (2910)
890236	BMR6A (7421)
890245	AB-6 (2910)
890246	AB-6 (2910)
890247	AB-6 (2910)
890252	BMR6A (7421)
890253	BMR6A (7421)
890256	AB-6 (2910)
890264	AB-6 (2910)
890265	BMR6A (7421)
890267	BMR6A (7421)
890271	AB-6 (2910)
890272	AB-6 (2910)
890273	AB-6 (2910)
890274	AB-6 (2910)
890276	AB-6 (2910)
907621	AB-6 (2910)
909377	BPR4ES (7222)
909378	BP5EY (7327)
912703	BPR4ES (7222)
913628	AB-6 (2910)
913633	AB-6 (2910)
913638	AB-6 (2910)
913639	BPR4ES (7222)
913831	AB-6 (2910)
922786	BPR4FS (1127)
923702	PTR5D-10 (3784)
925049	BPR5FS (2423)
940328	AB-6 (2910)
1332679	BPR4ES (7222)
2385639	BPR4ES (7222)
3739054	AB-6 (2910)
4338827	BPR4ES (7222)
CROWN → NGK	
380013-001-02	B6ES (7310)
380013-002-02	BCPR5E-11 (1273)
380013-004-02	BPR4ES (7222)
380013-005-02	BPR2ES (2264)
380013-006-02	BP5EY (7327)
380013-007-02	BP2ES (3467)
380013-008-02	BPR5FS (2423)
380013-009-02	BPR5ES (7422)
380013-010-02	BPR5EY (2828)
300013-012-02	AB-6 (2910)
380013-013-02	BCPR6E (1269)
300013-014-02	PTR5D-10 (3784)
380013-016-02	BPR4FS (1127)
380013-017-02	BMR6A (7421)
380013-018-01	BPR6EFS (3623)
380013-019-01	BPR4ES (7222)
380105-051	B4LM (3410)
DAEWOO → NGK	
A218756	BPR5FS (2423)
A219024	BPR5FS (2423)
A218377	BPR5ES (7422)
A223103	BCPR6E (1269)
D141267	BMR6A (7421)
D700699	BMR6A (7421)
8N2236	BMR6A (7421)
DAIHATSU → NGK	
90048-51006-000	B8ES (2411)
90048-51008-000	B7ES (1111)
90048-51015-000	B6ES (7310)
90048-51020-000	B4H (4110)
90048-51022-000	B6HS (4510)
90048-51033-000	B5ES (6410)

DAIHATSU → NGK	
90048-51034-000	BP6ES (7811)
90048-51034-010	BP6ES (7811)
90048-51047-010	BP5EY (7327)
90048-51048-000	BPR5EY (2828)
90048-51053-000	BP5EY (7327)
90048-51054-000	BPR5EY (2828)
90048-51059-000	BPR6EY (6427)
90048-51069-000	BP6EY (7727)
90048-51072-000	BP5ES (6511)
90048-51077-000	BPR6EKN (1128)
90048-51093-000	BPR5EY-11 (3028)
90048-51096-000	BPR6ES (7822)
90048-51097-000	BP2ES (3467)
90048-51100-000	BKR6E-11 (2756)
90048-51104-000	BPR6EKN (1128)
90048-51105-000	BPR7EKN (7738)
90048-51114-000	BPR5ES (7422)
90048-51118-000	PFR6B-11 (4014)
90048-51136-000	BKUR6EK (2213)
90048-51137-000	BKUR6EK (2213)
90048-51152-000	BKR6E (6962)
90048-51169-000	BKUR6ETB-10 (5742)
90048-51185-000	LFR6C-11 (5788)
90048-51196-000	DCPR7EA-9 (6651)
90048-51200-000	IKR7D (4759)
90919-01061-000	BP5EY (7327)
90919-01116-000	BPR5EP-11 (3971)
99113-39236-100	AB6 (2910)
99123-11236-100	AB7 (3010)
99251-30200-100	B4 (3210)
99520-21236-132	B8HS (5510)
99934-00691-100	BPR6EIX (6637)
99934-01691-100	BPR5EIX (6597)
99934-03691-100	BR7EIX (6664)
99934-07691-100	BP5HS (4111)
99934-09691-100	BP6HS (4511)
DELCO-REMY → NGK	
C-86	AB-6 (2910)
C-87	AB-6 (2910)
R-45-RB	BPR4FS (1127)
R-45-TS	BPR5FS (2423)
DENSO → NGK	
3001	BRE529Y-11 (6429)
3002	BRE529Y-11 (6429)
3004	BPR5EP-11 (3971)
3005	BCPR5EP-11 (2097)
3007	BCPR6E (1269)
3008	BCPR6E-11 (3132)
3009	BCPR6EY-11 (3720)
3010	BCPR7ES (3330)
3018	BP5ES (6511)
3021	BPR5ES (7422)
3025	B5ES (6410)
3027	BP5EY (7327)
3027	BP5EY (7327)
3031	BPR5EY (2828)
3031	BPR5EY (2828)
3032	BPR5EY-11 (3028)
3033	BR5HS (3722)
3034	B5HS (4210)
3035	B6L (3212)
3043	BP6ES (7811)
3045	BPR6EIX (6637)
3047	BPR6ES (7822)
3049	BPR6ES-11 (4824)
3051	B6ES (7310)
3054	BR6ES (4922)
3056	BR6ES (4922)
3062	BP6EY (7727)
3063	BPR6EY-11 (4228)
3066	BPR6EY (6427)
3067	BPR6EY-11 (4228)

DENSO → NGK	
3068	BP6HS (4511)
3069	BPR6HSA (4632)
3070	BPR6HS (7022)
3073	B6HS (4510)
3074	BR6HIX (3419)
3075	B6S (3510)
3076	BR6S (3522)
3081	BR7ET (4121)
3082	BR7ET (4121)
3085	BP7ES (2412)
3086	BPR7EIX (4055)
3088	BPR7ES (2023)
3089	BPR7ES-11 (7226)
3093	B7ES (1111)
3095	BR7EIX (6664)
3098	BR7EY (5122)
3099	BPR7EY (1144)
3102	BR8ET (4221)
3103	BR8ET (4221)
3107	BR9ET (4528)
3110	BR5ES (4722)
3112	ZFR6A-11 (1041)
3113	BCPR6EP-N-8 (5275)
3117	BCPR6EP-11 (3350)
3119	BKR5EYA (2087)
3120	BKR5EYA-11 (2526)
3121	BKR6E-11 (2756)
3122	BKR6EYA (2249)
3123	BCPR5EP-8 (2950)
3125	BCP6ES (4930)
3127	BKR6EP-8 (2215)
3128	BKR6EP-11 (2978)
3130	BKR5E-11 (6953)
3131	ZFR5F-11 (2262)
3132	ZFR5J-11 (5584)
3133	ZFR6F-11 (4291)
3134	BKR5EP-11 (3440)
3135	ZFR5E-11 (4435)
3136	BCPR6E-11 (3132)
3137	BCPR5E (1145)
3139	BKR6EYA-11 (4073)
3140	BCPR6EY (1146)
3141	PFR6J-11 (2743)
3142	PFR6G-11 (5555)
3144	BKR6E-N-11 (5724)
3145	BKR6E (6962)
3146	R7435-9 (4896)
3156	BCPR5EIX (5688)
3157	BCPR6EIX (5689)
3162	BKR6EP-11 (2978)
3165	BKR7E (6097)
3166	BKR5EIX-11 (5464)
3167	ZFR4F-11 (4043)
3168	PFR6B-11 (4014)
3169	ZFR6J-11 (5585)
3172	PFR6G-N-11 (5555)
3173	PZFR6F (7550)
3174	PFR5J-11 (4642)
3175	PZFR5F (3741)
3176	DCP7E (2363)
3177	DCPR8E (4179)
3178	DCPR6E (3481)
3179	DCPR7E (3932)
3191	BKR5E (7938)
3192	BKR7E-11 (1283)
3194	BKR5EKB-11 (3967)
3195	BKR6EKB-11 (3583)
3196	BKUR6EK (2213)
3199	BPR5EY-11 (3028)
3200	BPR7ES-11 (7226)
3201	BPR5ES-11 (4424)
3223	BCPR6EP-N-8 (5275)
3225	BCPR6EIX-11 (4919)
3226	BKR6EP-13 (2550)

DENSO- continued

DENSO	→ NGK	DENSO	→ NGK	DENSO	→ NGK	DENSO	→ NGK
3231	BPR5EIX (6597)	3413	ZFR5F (5165)	4131	CR9E (6263)	5321	R7434-10 (4894)
3233	DCPR7EIX (6046)	3417	ILFR5T11 (96779)	4135	CR10EK (2360)	5326	BPR6EFIX-10 (94658)
3234	DCPR8EIX (6546)	3418	IFR6E11 (6741)	4137	C7E (5096)	5336	FR9BI-11 (4709)
3235	BCRE527Y (2074)	3419	IFR7G-11KS (7746)	4155	CR9EK (4548)	5337	DCPR9EIX (2316)
3240	GR4IX (97382)	3421	ILFR6T11 (4904)	4158	CR8EK (3478)	5338	LTR5IX-11 (4344)
3242	DCPR7EIX (6046)	3427	LZKAR7A (6799)	4159	BR9ECM (3252)	5339	PLTR6A-10G (3587)
3245	PFR7B (4853)	3432	IZFR6K-11S (5266)	4160	BR10ECS (5880)	5345	ILFR7H (5245)
3246	PZFR5F-11 (4363)	3439	PLZKAR6A-11 (5118)	4161	BPR6HSA (4632)	5348	BKR7EIX (2667)
3247	PZFR6F-11 (3271)	3443	IFR6G11K (1314)	4162	ER9EH (5869)	5349	LZTR5AIX-13 (2314)
3249	BKR7EKC-N (2095)	3444	ILKAR7B11 (4912)	4168	BP7HS-10 (7829)	5351	BKR5EIX-11 (5464)
3253	BKR6EKP-B (3452)	3449	IFR6J11 (7658)	4169	CR10EIX (6482)	5352	BKR6EIX-11 (3764)
3255	BCP7ES (5030)	3452	IKR6G11 (7980)	4171	CR5HS (2874)	5361	CR7EIX (7385)
3256	ZGR5A (5839)	4000	CR5HS (2874)	4172	DR9EIX (4772)	5362	CR8EIX (4218)
3257	BCPR7ES-11 (1095)	4002	C6HSA (3228)	4174	CR7E (4578)	5363	CR9EIX (3521)
3262	BKR6EIX-11 (3764)	4003	CR6HIX (7274)	4175	BR8EIX (5044)	5368	CR8EHIX-9 (3797)
3264	PFR5E-11 (2300)	4004	CR6HSA (2983)	4176	BR10ES (4832)	5369	CR9EHIX-9 (6216)
3265	PFR7G-11S (7772)	4006	C7HSA (4629)	4178	BP8HS (2630)	5372	DR8EIX (6681)
3267	ZFR6F-11 (4291)	4007	CR7HIX (7544)	4185	ER8EH (4011)	5373	DR9EIX (4772)
3268	BPR6HS-10 (2633)	4008	CR7HSA (4549)	4186	ER10EH (2862)	5375	DPR7EIX-9 (7803)
3270	BPR5EIX (6597)	4009	C8HSA (6821)	4187	CR10E (6264)	5376	DPR8EIX-9 (2202)
3272	BPR7EKN (7738)	4010	CR8HS (7423)	4188	BPR8HS (3725)	5377	DPR9EIX-9 (5545)
3273	PFR7B (4853)	4012	B4H (4110)	4189	CR8EIX (4218)	5378	BPR6HIX (4085)
3274	BPR8EIX (6684)	4014	BP4HS (3611)	4191	CR9EIX (3521)	5379	BR7HIX (7067)
3275	PFR5G-11 (2647)	4017	BR4HS (3322)	4192	BPR5HS (6222)	5380	BR8HIX (7001)
3276	BK6E (3536)	4018	BPR5EIX (6597)	4196	C8E (7471)	5383	CR7HIX (7544)
3277	BPR6EKN (1128)	4019	BP5HS (4111)	4203	CR9EHIX-9 (6216)	5384	CR8HIX (7669)
3279	BPR6EKN (1128)	4021	BP7HS (5111)	4206	CR8HSA (2086)	5388	CR9EHI-9 (6419)
3280	BKR5E-11 (6953)	4022	BPR7HS (6422)	4222	CR5EH-9 (6689)	5390	CR9EIA-9 (6289)
3281	BPR7EIX (4055)	4024	BR7HS (4122)	4223	CR8EB (7784)	5391	BR8ECMIX (3520)
3282	BCR8ES (5430)	4025	B7HS (5110)	4224	CR9EB (6955)	5392	BR9ECMIX (2707)
3284	PFR7G-11S (7772)	4026	BR7HIX (7067)	5008	APR5FS (3122)	5393	BR10ECMIX (3006)
3290	BKR7EIX (2667)	4027	B7S (3710)	5009	APR5FS (3122)	5502	BPR6EIX-LPG (2347)
3291	BPR6EIX (6637)	4028	BP8ES (2912)	5010	APR5FS (3122)	5603	IFR5J11 (7418)
3293	BKR5EIX (6341)	4030	B8ES (2411)	5012	AP6FS (2710)	5607	BPR7EIX (4055)
3295	ZFR5A-11 (5084)	4032	BR8EIX (5044)	5013	APR6FS (2922)	5614	IJR7A9 (7901)
3297	IFR6T11 (4589)	4033	BR8ES (5422)	5018	FR5-1 (7252)	5615	IFR6L11 (3678)
3302	PGR7A (3200)	4034	B8EG (3430)	5020	BPR4FS (1127)	5616	IFR8H11 (5068)
3303	IFR5T-8N (3508)	4035	BR8EG (3130)	5021	BPR4FS-15 (2727)	5618	ILFR6J-11K (4458)
3304	BKR6EKC (2848)	4037	BR8HS (4322)	5022	BPR5EFS (2223)	5619	ILFR7H (5245)
3306	PGR6A (4984)	4038	B8HS (5510)	5024	BP5FS (3412)	5623	HB6AIX-11P (5703)
3307	IFR6D10 (5344)	4039	BR8HIX (7001)	5025	BPR5FS (2423)	5625	HB6BIX-11P (5705)
3310	BR10ET (7480)	4040	B8S (3810)	5026	BPR5FS-11 (2924)	5628	IFR5L11 (6502)
3311	ZFR5F-11 (2262)	4045	BR9ES (5722)	5027	BPR5FS-15 (3124)	5629	IFR7L11 (5114)
3312	DCPR8E (4339)	4046	B9ES (2611)	5029	BR5FS (4123)	5630	IFR9H11 (6588)
3313	DCPR9E (2641)	4047	B9EG (3530)	5031	BP6EFS (3812)	5631	IMR9B-9H (4888)
3314	DCPR9EIX (2316)	4048	BR9EIX (3981)	5032	BPR6EFS (3623)	5633	IZFR6F11 (4095)
3315	BPR7EKN (7738)	4052	B9HS (5810)	5034	BP6FS (3512)	5642	IMR9C-9HES (5766)
3316	DCPR8EIX (6546)	4053	BR9HIX (5687)	5035	BPR6FS (2623)	5701	R7434-8 (4892)
3321	BPR6ES-11 (4824)	4054	BR9HS (4522)	5038	BR6FS (4323)	5702	R7434-9 (4658)
3322	BCPR6EP-N-11 (4497)	4057	BR10EIX (6801)	5040	BP7EFS (3526)	5703	R7434-10 (4894)
3322	BCPR6EIX-11 (4919)	4063	BR10EIX (6801)	5060	BKUR6ET (6437)	5704	R7434-8 (4892)
3324	IFR5T11 (4996)	4067	BR10HIX (6692)	5062	BKUR7ET (7873)	5705	R7434-9 (4658)
3327	BCPR7ES-11 (1095)	4075	DR5HS (4623)	5065	BP6ET (1263)	5706	R7434-10 (4894)
3329	BKR5EKC (5216)	4078	D6HA (6512)	5067	BUR6ET (3172)	5707	R7436-8 (4898)
3330	BKUR6ETB-10 (5742)	4080	DR6HS (4823)	5068	PTR5A-10 (5055)	5708	R7436-9 (4899)
3335	IFR6T11 (4589)	4086	DPR7EA-9 (5129)	5069	BCP7ET (2078)	5709	R7436-10 (4900)
3348	ZFR7F-11 (2975)	4090	D7EA (7912)	5070	PTR5D-10 (3784)	5710	R7436-8 (4898)
3354	IGR7A (6687)	4091	DR7ES (3123)	5086	TR5A-10 (0005)	5711	R7436-9 (4899)
3356	IFR5E11 (7994)	4093	DPR8EA-9 (4929)	5087	ITR6F13 (4477)	5712	R7436-10 (4900)
3370	IZFR5G (5887)	4096	DPR8EA-9 (4929)	5093	PTR5A-10 (5055)	5714	R7376-9 (7763)
3372	IFR7G-11KS (7746)	4099	D8EA (2120)	5301	BCPR5EIX-11 (3306)	5716	R7376-10 (4457)
3373	BKR6EP-8 (2215)	4101	DR8ES-L (2923)	5302	BCPR6EIX-11 (4919)	5724	R7282A-105 (4614)
3374	ZFR6K-11 (6711)	4103	D8HA (7112)	5303	BKR5EIX-11 (5464)	5725	R7282A-11 (4754)
3377	IZFR6K11 (6994)	4105	DR8HS (5123)	5304	BKR6EIX-11 (3764)	5735	R0373A-9 (3388)
3378	ZFR6FIX-11 (6441)	4106	DPR8Z (4730)	5306	BPR6EIX-11 (3903)	5736	R0373A-10 (4940)
3381	LFR6C-11 (5788)	4111	DPR9EA-9 (5329)	5307	BPR7EIX (4055)	5737	R0373A-11 (5566)
3392	PZFR6F-11 (3271)	4114	D9EA (2420)	5308	DCPR7EIX (6046)	5747	R7282-105 (4985)
3395	IFR5G-11K (3107)	4116	DR8ES (5423)	5309	DCPR8EIX (6546)	5748	R7282-11 (2001)
3397	BKR5E-11 (6953)	4117	DPR9Z (4830)	5310	BKR7EIX (2667)	5749	R7438-8 (4905)
3401	IZFR6K13 (6774)	4123	B11EGV (5831)	5311	BKR8EIX (2668)	5750	R7438-9 (4656)
3402	BKR6E-11 (2756)	4126	CR8E (1275)	5312	BKR9EIX (2669)	5752	R7440B-10T (5009)
3403	IFR6S (99404)	4127	CR8EH-9 (5666)	5316	BR8EIX (5044)	5754	R7440A-9L (3795)
3411	BPR6EKN (1128)	4128	C9E (7499)	5317	BR9EIX (3981)	6000	BUHX (2522)
3412	IFR5E11 (7994)	4129	CR9EH-9 (7502)	5319	BR10EIX (6801)	6001	BUHW (2622)

DENSO - continued

DENSO	→ NGK	DENSO	→ NGK	DENSO	→ NGK	DENSO	→ NGK
6002	BUHW-2 (5626)	IK27C11	FR9BI-11 (4709)	K16TNR-S9	BKR5EKC (5216)	PK22PR-TP	PFR7M (4877)
6004	B2 (3110)	IK31	R7434-10 (4894)	K16TR-11	BKR5EKB-11 (3967)	PKJ16CR-L11	PZFR5F-11 (4363)
6005	BP2ES (3467)	IKBH20TT	DFH6B-11A (6858)	K20BR-S10	BKUR6ETB-10 (5742)	PKJ20CR8	PZFR6F (7550)
6009	B4ES (4129)	IKH01-24	R7438-8 (4905)	K20HR-U11	LFRC6-11 (5788)	PKJ20CR-L11	PZFR6F-11 (3271)
6011	BPR4ES (7222)	IKH01-27	R7438-9 (4656)	K20PBR	BKUR6ET (6437)	PKJ20CR-M11	PZFR6F-11 (3271)
6013	B4L (3112)	IKH22	ILFR7H (5245)	K20PR-L11	BKR6E-N-11 (5724)	PQ16R	BCPR5EP-11 (2097)
6015	BM4A (5628)	IQ01-24	R7436-8 (4898)	K20PR-TP11	BKR6EIX-11 (3764)	PQ16R8	BCPR5EP-8 (2950)
6018	BPMR4A (6028)	IQ01-27	R7436-9 (4899)	K20PR-U	BKR6E (6962)	PQ20R	BCPR6EP-11 (3350)
6019	BMR4A (5728)	IQ01-31	R7436-10 (4900)	K20PR-U11	BKR6E-11 (2756)	PQ20R8	BCPR6EP-N-8 (5275)
6021	BP4 (2911)	IQ02-24	R7436-8 (4898)	K20PR-ZU11	BKR6EIX-11 (3764)	PQ20R8	BCPR6EIX-11 (4919)
6023	BPM6A (7021)	IQ02-27	R7436-9 (4899)	K20PSR-B8	IFR6S (99404)	PQ20R-P11	BCPR6EP-N-11 (4497)
6025	BMR6A (7421)	IQ02-31	R7436-10 (4900)	K20P-U	BK6E (3536)	PQ20R-P11	BCPR6EIX-11 (4919)
6028	B9HS-10 (3626)	IQ16	BCPR5EIX-11 (3306)	K20P-U11	BKR6E-11 (2756)	PQ20R-P8	BCPR6EP-N-8 (5275)
6033	B4 (3210)	IQ20	BCPR6EIX-11 (4919)	K20R-U	BKR6EYA (2249)	PT16EPR10	PTR5D-10 (3784)
6034	BM4A (5628)	IQ22	BCPR7EIX (5690)	K20R-U11	BKR6EYA-11 (4073)	PT16EPR13	PTR5D-10 (3784)
6035	B4LM (3410)	IRE01 27	R7420-9 (6448)	K20R-ZU11	BKR6EP-11 (2978)	PT16EPR13	PTR5D-10 (3784)
6036	BM6A (5921)	IRE01 31	R7420-10 (5501)	K20TNR	BKR6EKC (2848)	PT16VR10	PTR5A-10 (5055)
6039	BM6F (6221)	IRE01 34	R7420-11 (7756)	K20TNR-S	BKUR6EK (2213)	PT16VR-13	PTR5A-10 (5055)
6040	BPM6F (5950)	IRL01-27	R7440A-9L (3795)	K20TR-11	BKR6EKB-11 (3583)	PTJ16R15	PZTR5A-15 (7862)
6041	BM7F (6421)	IRT01-31	R7440B-10T (5009)	K20TRX	BKR6EKU (6993)	Q16PR-U	BCPR5E (1145)
6042	BPM7F (1268)	IT20	BPR6EFIX-10 (94658)	K20TXR	BKR6EKC (2848)	Q20PR-U	BCPR6E (1269)
6043	BPMR7A (4626)	IT22	TR7IX (96090)	K22PB	BCP7ET (2078)	Q20PR-U11	BCPR6E-11 (3132)
6044	BPR2ES (2264)	ITL16	LZTR5AIX-13 (2314)	K22PBR-S	BKUR7ET (7873)	Q20PR-ZU11	BCPR6EIX-11 (4919)
6047	B8HS-10 (5126)	ITV16	LTR5IX-11 (4344)	K22PR-U	BKR7E (6097)	Q20P-U	BKP6ES (4930)
6048	BM7A (6521)	IU01-27	R0373A-9 (3388)	K22PR-UR	BKR7E (6097)	Q20P-U11	BCPR6E-11 (3132)
6049	BPM7A (7321)	IU01-31	R0373A-10 (4940)	K22PR-U11	BKR7E-11 (1283)	Q20R-U11	BCPR6EY-11 (3720)
6050	CR5HSB (6535)	IU01-34	R0373A-11 (5566)	K22PR-ZU	BKR7EIX (2667)	Q22PR-U	BCPR7ES (3330)
6051	B7HS (5110)	IU22	CR7EIX (7385)	K22TMR	BKR7EKC-N (2095)	Q22PR-U11	BCPR7ES-11 (1095)
6052	B7HS-10 (2129)	IU24	CR8EIX (4218)	K22TMR11	BKR7EKC-N (2095)	Q22PR-ZU	BKR7EIX (2667)
6053	BR6HS (3922)	IU27	CR9EIX (3521)	K22TNR	BKR7EKC (7354)	Q22P-U	BCP7ES (5030)
6054	B6HS (4510)	IU27D	CR9EIA-9 (6289)	K22TNR-S	BKR7EKC (7354)	Q22P-U11	BCPR7ES-11 (1095)
6057	B2LM (1147)	IU31	CR10EIX (6482)	KJ14CR-L11	ZFR4F-11 (4043)	Q27A-Z	R7435-9 (4896)
6060	B8HS (5510)	IUF22	CR7HIX (7544)	KJ16CR	ZFR5F (5165)	Q27PR-ZU	BKR9EIX (2669)
6068	BR8ES (5422)	IUF24	CR8HIX (7669)	KJ16CR-11	ZFR5F-11 (2262)	QJ16AR-U	BCRE527Y (2074)
6069	BR9ES (5722)	IUH24	CR8EHIX-9 (3797)	KJ16CR-L11	ZFR5J-11 (5584)	QJ16CR11	ZFR5A-11 (5084)
6070	CR4HSB (4695)	IUH27	CR9EHIX-9 (6216)	KJ16CR-U11	ZFR5F-11 (2262)	QJ16HR-U	FR5-1 (7252)
6071	BR2LM (5798)	IUH27D	CR9EHI-9 (6419)	KJ20CR-11	ZFR6F-11 (4291)	QJ16HR-U9	FR5-1 (7252)
6073	B8HS-10 (5126)	IW01-27	R7376-9 (7763)	KJ20CR-L11	ZFR6J-11 (5585)	QJ20C11	ZFR6F-11 (4291)
6076	LFRA-11 (6376)	IW01-31	R7376-10 (4457)	KJ20CR-U11	ZFR6F-11 (4291)	QJ20CR-11	ZFR6A-11 (1041)
6079	CM-6 (5812)	IW06-27	R7376-9 (7763)	KJ20DR-M11	ZFR6K-11 (6711)	RU01-31	R0045Q-10 (4216)
90919-01217	IFR5T11 (4996)	IW06-31	R7376-10 (4457)	KJ20DR-M11S	ZFR6K-11 (6711)	RU01-34	R0045Q-11 (5957)
90919-01218	IFR5T11 (4996)	IW20	BPR6EIX-11 (3903)	KJ20SR-11	ZFR6FIX-11 (6441)	S22PR-A7	IGR7A (6687)
90919-01240	IFR5T11 (4996)	IW22	BPR7EIX (4055)	KJ22CR-L11	ZFR7F-11 (2975)	SC16HR11	ILKAR7B11 (4912)
9807B-5615P	ZFR6K-11 (6711)	IW24	BR8EIX (5044)	L14-U	AB6 (2910)	SC20HR11	ILKAR7B11 (4912)
9807B-5615W	IZFR6K11 (6994)	IW27	BR9EIX (3981)	M17	AB6 (2910)	SF-10	BUHX (2522)
DK20PR-D13	DIFR6D13 (94167)	IW31	BR10EIX (6801)	M22	AB7 (3010)	SF-50	BUHW (2622)
DXE22HCR11S	DILZKAR7C11S (90137)	IWF20	BPR6HIX (4085)	M24S	AB8 (7909)	SF-51	BUHW-2 (5626)
FK16HR11	DILFR5A11 (93759)	IWF22	BR7HIX (7067)	MA16PR-U	APR5FS (3122)	SK16HR11	ILFR5T11 (96779)
FK16HQR11	DILFR5A11 (93759)	IWF24	BR8HIX (7001)	MA16PR-U11	APR5FS (3122)	SK16PR11	IFR5G-11K (3107)
FK16R-A8	DIFR5C (90911)	IWM24	BR8ECMIX (3520)	MA16PR-U15	APR5FS (3122)	SK16PR-A11	IFR5E11 (7994)
FK20HBR-11	DFH6B-11A (6858)	IWM27	BR9ECMIX (2707)	MA17P-U	AP6FS (2710)	SK16PR-E11	IFR5E11 (7994)
FXE20HR11	PLZKAR6A-11 (5118)	IWM31	BR10ECMIX (3006)	MA20PR-U	APR6FS (2922)	SK16PR-L11	IFR5G-11K (3107)
FXE22HR11	DF7H-11B (1317)	IX22B	DPR7EIX-9 (7803)	MA20P-U	AP6FS (2710)	SK16R11	IFR5T11 (4996)
FXE24HR11	DF8H-11B (1305)	IX24	DR8EIX (6681)	P16PR8	BPR5EIX (6597)	SK16R-P8	IFR5T-8N (3508)
IA01-32	R7282A-105 (4614)	IX24B	DPR8EIX-9 (2202)	P16R	BPR5EP-11 (3971)	SK20BGR11	HB6AIX-11P (5703)
IA01-34	R7282A-11 (4754)	IX27	DR9EIX (4772)	P20PR8	PGR6A (4984)	SK20BR11	HB6AIX-11P (5703)
IAE01-32	R7282-105 (4985)	IX27B	DPR9EIX-9 (5545)	P22PR8	PGR7A (3200)	SK20HPRL11	ILFR6J-11K (4458)
IAE01-34	R7282-11 (2001)	IXU22	DCPR7EIX (6046)	PK16PR11	PFR5B-11 (2300)	SK20PR-A11	IFR6E11 (6741)
IK01-24	R7434-8 (4892)	IXU22I	IKR7D (4759)	PK16PR-L11	PFR5G-11 (2647)	SK20PR-L11	IFR6G11K (1314)
IK01-27	R7434-9 (4658)	IXU24	DCPR8EIX (6546)	PK16PR-P11	PFR5J-11 (4642)	SK20PR-L9	IFR6D10 (5344)
IK01-31	R7434-10 (4894)	IXU27	DCPR9EIX (2316)	PK16R11	BKR5EP-11 (3440)	SK20R11	IFR6T11 (4589)
IK02-24	R7434-8 (4892)	K14P-U11	BKR5E-11 (6953)	PK20PR11	PFR6B-11 (4014)	SK20R-P11	IFR6T11 (4589)
IK02-27	R7434-9 (4658)	K16GPR-U11	ZFR5E-11 (4435)	PK20PR-L11	PFR6G-11 (5555)	SK22PR-M11	IFR7G-11KS (7746)
IK02-31	R7434-10 (4894)	K16HR-U11	LFRC6-11 (5788)	PK20PR-P	PFR6B (3500)	SK22PR-M11S	IFR7G-11KS (7746)
IK16	BKR5EIX-11 (5464)	K16HPR-U11	LFRA-11 (6376)	PK20PR-P11	PFR6J-11 (2743)	SKJ16CR-A8	IZFR5G (5887)
IK16G	BKR5EIX-11 (5464)	K16PRP11	BKR5EIX (6341)	PK20PR-P8	PFR6B (3500)	SKJ20DR-M11	IZFR6K11 (6994)
IK16L	ZFR5FIX-11 (2477)	K16PR-TP11	BKR5EIX-11 (5464)	PK20R11	BKR6EP-11 (2978)	SKJ20DR-M11S	IZFR6K-11S (5266)
IK20	BKR6EIX-11 (3764)	K16PR-U	BKR5E (7938)	PK20R-13	BKR6EP-13 (2550)	SKJ20DR-M13	IZFR6K13 (6774)
IK20G	BKR6EIX-11 (3764)	K16PR-U11	BKR5E-11 (6953)	PK20R8	BKR6EP-8 (2215)	SVK20R-Z11	IFR6J11 (7658)
IK20L	ZFR6FIX-11 (6441)	K16PU	BKR5E (7938)	PK20TR11	BKR6EKP-11 (3452)	SVK20R-Z8	BKR6EP-8 (2215)
IK22	BKR7EIX (2667)	K16PU11	BKR5E-11 (6953)	PK22PR11	PFR7G-11S (7772)	SXE24HCR8S	ILZKAR8HS (95112)
IK22G	BKR7EIX (2667)	K16R-U	BKR5EYA (2087)	PK22PR8	PFR7B (4853)	SXU20HPR11	ILZKR6F11 (97345)
IK24	BKR8EIX (2668)	K16R-U11	BKR5EYA-11 (2526)	PK22PR-L11	PFR7G-11S (7772)	SXU22HCR11S	SILZKR7C11S (92932)
IK27	BKR9EIX (2669)	K16RZ-U11	BKR5EIX-11 (5464)	PK22PR-L11S	PFR7G-11S (7772)	SXU22PR9	IKR7D (4759)

DENSO - continued

DENSO	→ NGK	DENSO	→ NGK	DENSO	→ NGK	DENSO	→ NGK
T14PR-U	BPR4FS (1127)	VFXEHC22G	DILZKAR7C11S (90137)	W16FPR-U	BPR5HS (6222)	W22MP-U	BPM7A (7321)
T14PR-U15	BPR4FS-15 (2727)	VK16	IFR5J11 (7418)	W16FP-U	BP5HS (4111)	W22MP-US	BPM7A (7321)
T16EPR-U	BPR5EFS (2223)	VK16PR-Z11	IFR5L11 (6502)	W16FP-U10	BP5HS (4111)	W22M-U	BM7A (6521)
T16EX-U	BP5EFS (3712)	VK20PR-Z11	IFR6L11 (3678)	W16FP-UL	BP5HS (4111)	W22M-US	BM7A (6521)
T16PR-U	BPR5FS (2423)	VK20T	BKR6EIX-LPG (3356)	W16FS	B5HS (4210)	W22S	B7S (3710)
T16PR-U11	BPR5FS-11 (2924)	VK22	BKR7EIX (2667)	W16FSR	BR5HS (3722)	W22S-U	B7S (3710)
T16PR-U15	BPR5FS-15 (3124)	VK22PR-Z11	IFR7L11 (5114)	W16FS-U	B5HS (4210)	W24EMRC	BR8ECM (3035)
T16P-U	BP5FS (3412)	VK24PR-Z11	IFR8H11 (5068)	W16LS	B6L (3212)	W24EP	BP8ES (2912)
T16R-U	BR5FS (4123)	VK27PR-Z11	IFR9H11 (6588)	W16P-U	BP5S (3011)	W24EP-11	BP8ES (2912)
T16VR-U10	TR5A-10 (0005)	VKA20	HB6AIX-11P (5703)	W16S-U	BMR6A (7421)	W24EPR-U	BPR8ES (3923)
T20EPR-U	BPR6EFS (3623)	VKB20	HB6BIX-11P (5705)	W17ES	B6ES (7310)	W24EPR-ZU	BPR8EIX (6684)
T20EP-U	BP6EFS (3812)	VKH20	ILFR6J-11K (4458)	W20EPB	BP6ET (1263)	W24EP-U	BP8ES (2912)
T20EX-U	BP6EFS (3812)	VKH20Y	ILFR6B (6481)	W20EPBRS	BUR6ET (3172)	W24ES	B8ES (2411)
T20MP-U	BPM6F (5950)	VKH22	ILFR7H (5245)	W20EPGU	BPR6EIX (6637)	W24ES-GU	BR8EIX (5044)
T20M-U	BM6F (6221)	VKJ20RZ-M11	IZFR6F11 (4095)	W20EPR-U	BPR6ES (7822)	W24ESR	BR8ES (5422)
T20PR-U	BPR6FS (2623)	VNH27Z	IMR9B-9H (4888)	W20EPR-U10	BPR6ES-11 (4824)	W24ESR-U	BR8ES (5422)
T20PR-U15	BPR6FS (2623)	VUH24D	IMR8C-9H (3653)	W20EPR-U11	BPR6ES-11 (4824)	W24ESRV	BR8EG (3130)
T20P-U	BP6FS (3512)	VUH24ES	IMR8C-9HES (5990)	W20EPR-ZU	BPR6EIX (6637)	W24ESR-ZU	BR8EIX (5044)
T20R-U	BR6FS (4323)	VUH27D	IMR9C-9H (6777)	W20EP-U	BP6ES (7811)	W24ES-U	B8ES (2411)
T22EP-U	BP7EFS (3526)	VUH27ES	IMR9C-9HES (5766)	W20EP-ZU	BPR6EIX (6637)	W24ES-V	B8EG (3430)
T22MP-U	BPM7F (1268)	VUH27Z	IMR9A-9H (6966)	W20ES	B6ES (7310)	W24ES-ZU	BR8EIX (5044)
T22M-U	BM7F (6421)	VW20T	BPR6EIX-LPG (2347)	W20ES-L	BR6ES (4922)	W24FPR	BPR8HS (3725)
TR20	B6HS (4510)	VW22	BPR7EIX (4055)	W20ESR	BR6ES (4922)	W24FP-U	BP8HS (2630)
TR22	B7HS (5110)	VX22BC	IJR7A9 (7901)	W20ESR-L	BR6ES (4922)	W24FR-L	BR8HSA (5539)
TR22-10	B7HS-10 (2129)	VX22BZ	IJR7A9 (7901)	W20ESR-U	BR6ES (4922)	W24FS	B8HS (5510)
TR24	B8HS (5510)	VXEHC24G	ILZKAR8H8S (95112)	W20ES-U	B6ES (7310)	W24FS-GU	BR8HIX (7001)
TR24-10	B8HS-10 (5126)	VXU22I	IKR7D (4759)	W20ETR-L	BPR6EKN (1128)	W24FSR	BR8HS (4322)
U14FSR-UB	CR4HSB (4695)	VXUHC22G	ILZKR7A (1961)	W20EXR-U	BPR6EY (6427)	W24FSR-U10	BR8HS-10 (1134)
U16FER-9	CR5EH-9 (6689)	W14	B4 (3210)	W20EXR-U11	BPR6EY-11 (4228)	W24FS-U	B8HS (5510)
U16FSR-L	CR5HS (2874)	W14E	B4ES (4129)	W20EX-U	BP6EY (7727)	W24FS-U10	B8HS-10 (5126)
U16FSR-U	CR5HS (2874)	W14EPR-U	BPR4ES (7222)	W20FP	BP6HS (4511)	W24FS-ZU	BR8HIX (7001)
U16FSR-UB	CR5HSB (6535)	W14ER-U	BR4ES (1097)	W20FPR	BPR6HS (7022)	W24S	B8S (3810)
U16FS-UB	CR5HSB (6535)	W14F	B4H (4110)	W20FPR-U	BPR6HS (7022)	W24S-U	B8S (3810)
U20EPR-U	CPR6EA-9 (6899)	W14FP	BP4HS (3611)	W20FP-U	BP6HS (4511)	W25EB	BR8ET (4221)
U20ESR-N	CR6E (6965)	W14FP-L	BP4HS (3611)	W20FP-U10	BP6HS-10 (6326)	W25EBR	BR8ET (4221)
U20FS	C6HSA (3228)	W14FPR	BPR4HS (7823)	W20FR-L	BPR6HSA (4632)	W25EN	B8EG (3430)
U20FS-L	C6HSA (3228)	W14FPR-L	BPR4HS (7823)	W20FS	B6HS (4510)	W25EPT	B8EGP (2046)
U20FSR-U	CR6HSA (2983)	W14FPR-U	BPR4HS (7823)	W20FSR	BR6HS (3922)	W25FN	BR8HIX (7001)
U20FS-U	C6HSA (3228)	W14FPR-UL	BPR4HS (7823)	W20FSR-U	BR6HS (3922)	W27AZ	BR9HIX (5687)
U20M-U	CM-6 (5812)	W14FPR-UL10	BPR4HS-10 (5024)	W20FS-U	B6HS (4510)	W27EBR	BR9ET (4528)
U22EPR9	CPR7EA-9 (3901)	W14FP-U	BP4HS (3611)	W20M	BM6A (5921)	W27EMR-C	BR9ECM (3252)
U22ES-N	C7E (5096)	W14FP-UL	BP4HS (3611)	W20MP-U	BPM6A (7021)	W27EMR-ZU	BR9ECMIX (2707)
U22ESR-N	CR7E (4578)	W14FR-U	BR4HS (3322)	W20MR-U	BMR6A (7421)	W27EN	B9EG (3530)
U22ESR-NB	CR7EB (4663)	W14F-U	B4H (4110)	W20M-U	BM6A (5921)	W27ES	B9ES (2611)
U22FS	C7HSA (4629)	W14F-U10	B4H (4110)	W20M-US	BM6A (5921)	W27ESC	B9ECS (7058)
U22FS-L	C7HSA (4629)	W14L	B4L (3112)	W20S	B6S (3510)	W27ES-GU	BR9EIX (3981)
U22FSR-L	CR7HS (7223)	W14LMR-US	BR4LM (4133)	W20SR-U	BR6S (3522)	W27ESR	BR9ES (5722)
U22FSR-U	CR7HSA (4549)	W14LM-U	B4LM (3410)	W20S-U	B6S (3510)	W27ESR-U	BR9ES (5722)
U22FS-U	C7HSA (4629)	W14LM-US	B4LM (3410)	W22EB	BR7ET (4121)	W27ESRV	BR9EG (3230)
U24ES-N	C8E (7471)	W14MPR-U10	BPMR4A (6028)	W22EBR	BR7ET (4121)	W27ESR-ZU	BR9EIX (3981)
U24ESR-N	CR8E (1275)	W14MR-U	BMR4A (5728)	W22EP	BP7ES (2412)	W27ES-U	B9ES (2611)
U24ESR-NB	CR8EB (7784)	W14M-U	BM4A (5628)	W22EP-GU	BPR7EIX (4055)	W27ES-V	B9EG (3530)
U24ESR-NZU	CR8EIX (4218)	W14M-US	BM4A (5628)	W22EPR-U	BPR7ES (2023)	W27ES-ZU	BR9EIX (3981)
U24ETR	CR8EK (3478)	W14P	BP5S (3011)	W22EP-U	BP7ES (2412)	W27FS	B9HS (5810)
U24FER9	CR8EH-9 (5666)	W14PR-U	BP4 (2911)	W22EP-ZU	BPR7EIX (4055)	W27FS-GU	BR9HIX (5687)
U24FS	C8HSA (6821)	W14-U	B4 (3210)	W22ES	B7ES (1111)	W27FSR	BR9HS (4522)
U24FS-C	C8HSA (6821)	W14-US	B4 (3210)	W22ES-GU	BR7EIX (6664)	W27FSR-U10	BR9HS-10 (4551)
U24FS-L	C8HSA (6821)	W16EP-GU	BPR5EIX (6597)	W22ESR	BR7ES (5122)	W27FS-U	B9HS (5810)
U24FSR-C	CR8HSA (2086)	W16EPR-U	BPR5ES (7422)	W22ESR-U	BR7ES (5122)	W27FS-U10	B9HS-10 (3626)
U24FSR-U	CR8HS (7423)	W16EPR-U11	BPR5ES-11 (4424)	W22ES-U	B7ES (1111)	W27FS-ZU	BR9HIX (5687)
U24FS-U	C8HSA (6821)	W16EP-U	BP5ES (6511)	W22ES-ZU	BR7EIX (6664)	W29AZ	BR10EIX (6801)
U24ES-N	C9E (7499)	W16EP-U11	BPR5EY-11 (3028)	W22FP	BP7HS (5111)	W29EBR	BR10ET (7480)
U27ESR-N	CR9E (6263)	W16EP-ZU	BPR5EIX (6597)	W22FPR	BPR7HS (6422)	W29ES-GU	BR10EIX (6801)
U27ESR-NB	CR9EB (6955)	W16ES	B5ES (6410)	W22FPR-U	BPR7HS (6422)	W29ES-ZU	BR10EIX (6801)
U27ESR-NZU	CR9EIX (3521)	W16ES-L	BR5ES (4722)	W22FP-U	BP7HS (5111)	W31AZ	BR10EIX (6801)
U27ETR	CR9EK (4548)	W16ESR-U	BR5ES (4722)	W22FP-U10	BP7HS-10 (7829)	W31EMR-C	BR10ECS (5880)
U27FER-9	CR9EH-9 (7502)	W16ES-U	B5ES (6410)	W22FS	B7HS (5110)	W31EMR-ZU	BR10ECMIX (3006)
U27FER-ZU9	CR9EHIX-9 (6216)	W16EXR-U	BPR5EY (2828)	W22FS-GU	BR7HIX (7067)	W31EN	B10EG (3630)
U31ESR-N	CR10E (6264)	W16EXR-U11	BPR5EY-11 (3028)	W22FSR	BR7HS (4122)	W31EPT	B10EGP (5224)
U31ESR-NZU	CR10EIX (6482)	W16EXR-ZU	BPR5EIX (6597)	W22FS-U	B7HS (5110)	W31ES	BR10ES (4832)
U31ETR	CR10EK (2360)	W16EX-U	BP5EY (7327)	W22FS-U10	B7HS-10 (2129)	W31ES-GU	BR10EIX (6801)
VDCH22F	DILKAR8A8 (93026)	W16FP	BP5HS (4111)	W22FS-ZU	BR7HIX (7067)	W31ESR-U	BR10ES (4832)
VFKH16	DILFR5A11 (93759)	W16FP-L	BP5HS (4111)	W22M	BM7A (6521)	W31ESR-ZU	BR10EIX (6801)
VFXEH20	ILKAR7C10 (94940)	W16FPR	BPR5HS (6222)	W22MPR-U	BPMR7A (4626)	W31ES-U	BR10ES (4832)

DENSO	→ NGK
W31ES-ZU	BR10EIX (6801)
W31FS	B10HVX (2940)
W31FS-GU	BR10HIX (6692)
W31FS-ZU	BR10HIX (6692)
W32EPT	B11EGP (2191)
W34ES-ZU	B11EGV (5831)
W9	B2 (3110)
W9EP	BP2ES (3467)
W9EXR-U	BPR2ES (2264)
W9EX-U	BP2ES (3467)
W9FP	BP2HS (7926)
W9FP-L	BP2HS (7926)
W9FP-UL	BP2HS (7926)
W9LMR-US	BR2LM (5798)
W9LM-US	B2LM (1147)
W9P	BP4 (2911)
W9P-U	BP-4 (2911)
W9-U	B2 (3110)
WA20M	BM6F (6221)
WA20M-U	BM6F (6221)
WA22M	BM7F (6421)
WA22M-U	BM7F (6421)
X16EPR-U9	DPR5EA-9 (2887)
X16EP-U9	DPR5EA-9 (2887)
X16FSR-U	DR5HS (4623)
X16FS-U	DR5HS (4623)
X20EPR-U9	DPR6EA-9 (5531)
X20ES-U	D6EA (7512)
X20FSR-U	DR6HS (4823)
X20FS-U	D6HA (6512)
X22EPR-GL	DPR7EIX-9 (7803)
X22EPR-U9	DPR7EA-9 (5129)
X22EPR-ZU9	DPR7EIX-9 (7803)
X22EP-U9	DPR7EA-9 (5129)
X22EP-ZU9	DPR7EIX-9 (7803)
X22ESR-U	DR7ES (3123)
X22ES-U	D7EA (7912)
X24EPR-GL	DPR8EIX-9 (2202)
X24EPR-U9	DPR8EA-9 (4929)
X24EPR-ZU9	DPR8EIX-9 (2202)
X24EP-U	DPR8EA-9 (4929)
X24EP-U9	DPR8EA-9 (4929)
X24EP-ZU9	DPR8EIX-9 (2202)
X24ES-GU	DR8EIX (6681)
X24ESR-U	DR8ES-L (2923)
X24ESR-ZU	DR8EIX (6681)
X24ES-U	D8EA (2120)
X24ES-ZU	DR8EIX (6681)
X24FSR-U	DR8HS (5123)
X24FS-U	D8HA (7112)
X24GPR-U	DPR8Z (4730)
X24GP-U	DPR8Z (4730)
X27EPR-U9	DPR9EA-9 (5329)
X27EPR-ZU9	DPR9EIX-9 (5545)
X27EP-U9	DPR9EA-9 (5329)
X27ESR-U	DR8ES (5423)
X27ESR-ZU	DR9EIX (4772)
X27ES-U	D9EA (2420)
X27GPR-U	DPR9Z (4830)
XE20HR-U9	LZKAR7A (6799)
XU20EPR-U	DCPR6E (3481)
XU20EPR-ZU	DCPR7EIX (6046)
XU20EP-U	DCPR6E (3481)
XU22EPR-U	DCPR7E (3932)
XU22EPR-ZU	DCPR7EIX (6046)
XU22EP-U	DCP7E (2363)
XU22EP-ZU	DCPR7EIX (6046)
XU22HDR-9	LKR7B-9 (5847)
XU22PR-9	DCPR7EA-9 (6651)
XU24EPR-U	DCPR8E (4339)
XU24EPR-ZU	DCPR8EIX (6546)
XU24EP-U	DCPR8E (4339)
XU24EP-ZU	DCP8EVX (6546)
XU27EPR-U	DCPR9E (2641)

DENSO	→ NGK
XU27EPR-ZU	DCPR9EIX (2316)
Y24FER-C	ER8EH (4011)
Y27FER	ER9EH (5869)
Y27FER-C	ER9EH (5869)
Y31FER-C	ER10EH (2862)
Z20ES-U	D6EA (7512)
ZC20HPR11	ILKAR7L11 (94124)
ZT20EPR11	ITR6F13 (4477)
ZXU20PR11	IKR6G11 (7980)

DODGE - See CHRYSLER GROUP

DREXEL	→ NGK
1411740	BPR5FS (2423)

DUCATI	→ NGK
6704038A1	MAR10A-J (4706)
67040491	KR8C-G (97516)
67040491A	KR8C-G (97516)
67040511A	LMDR10A-JS (97718)

ECHO	→ NGK
A4255334-0000	BPMR8Y-5 (97759)

ENKER / BOSNA	→ NGK
F100C	B8HS (5510)
F45CP	BP4HS (3611)
F50C	B5HS (4210)
F55CP	BP5HS (4111)
F65CP	BP6HS (4511)
F75C	B6HS (4510)
F80C	B7HS (5110)
F85CP	BP7HS (5111)
FA50	B4L (3112)
FA70	B6L (3212)
FE100C	B9ES (2611)
FE30C	B4ES (4129)
FE45CP	BP5ES (6511)
FE50C	B5ES (6410)
FE55CP	BP5ES (6511)
FE55CPD	BP5ET (2287)
FE65CP	BP6ES (7811)
FE65CPD	BP6ET (1263)
FE70C	B6ES (7310)
FE75C	B7ES (1111)
FE80C	B8ES (2411)
FE85CP	BP7ES (2412)
FE95CP	BP8ES (2912)
FET65CP	BP5EFS (3712)
FET75CP	BP6EFS (3812)
FS20	B2 (3110)
FS30	B4 (3210)
FS50CP	BP5S (3011)
FS70	B6S (3510)
FS75C	B7S (3710)
FS80	B8S (3810)
FSC50C	BM6A (5921)
FSC50P	BPM6A (7021)
FSC70P	BPM6A (7021)
FSC75CP	BPM7A (7321)
FT45CP	BP5FS (3412)
FT55CP	BP6FS (3512)
FT85CP	BP7FS (3612)
M30	AB2 (3020)
M60	AB6 (2910)
M75	AB7 (3010)
M80	AB8 (7909)
MT55CP	AP6FS (2710)
MT65CP	AP7FS (2127)
SFE55CP	BCPR5ES (6130)
SFE65CP	BCPR6ES (2330)
SFE65CPD	BCP6ET (4563)
SFE85CP	BCPR7ES (3330)
SFE85CPD	BCP7ET (2078)

ENKER / BOSNA	→ NGK
T70	C6HSA (3228)
T90	C7HSA (4629)

EVINRUDE	→ NGK
204470091	BR7ES (5122)
278000237	BR7ES (5122)
278000608	BR7ES (5122)
278000609	BR8ES (5422)
MCBR10EG	BR10EG (3830)
MCBR8EG	BR8EG (3130)
MCBR8HS	BR8HS (4322)
MCBR9EG	BR9EG (3230)
MCBR9ES	BR9ES (5722)

EYQUEM	→ NGK
1000	B8HS (5510)
1000 MOTO	B8HS (5510)
1000CM	B7S (3710)
1000L	B8ES (2411)
1000L MOTO	B8HS (5510)
1000M	B8HS (5510)
100M	B8HS (5510)
1100	B9HS (5810)
1100L	B8ES (2411)
1100L MOTO	B8ES (2411)
1150L	B9ES (2611)
200	B4H (4110)
202CT	B2LM (1147)
300AM	B4L (3112)
30AM	B4L (3112)
400J	BR5FS (4123)
406	BP6HS (4511)
450JS	BPR4FS-15 (2727)
450L	B5ES (6410)
480CS	BP5S (3011)
500AM	B6L (3212)
500C	B6S (3510)
500CJT	BM6F (6221)
500CM	B6S (3510)
500CS	BP5S (3011)
500CT	BM6A (5921)
500J	BR6FS (4323)
500JS	BPR4FS (1127)
500M	B5HS (4210)
502 MOTO	B4H (4110)
502CT	B4LM (3410)
505JS	BP5FS (3412)
50AM	B6L (3212)
50M	B5HS (4210)
520CS	BP5S (3011)
550CS	BP5S (3011)
550JS	BPR5FS (2423)
550LS	BP5ES (6511)
550S	BP4HS (3611)
580LS	BP5ES (6511)
580S	BP4HS (3611)
600CS	BP5S (3011)
600JS	BPR6FS (2623)
600L	B6ES (7310)
600LS	BP6ES (7811)
600S	BP5HS (4111)
700	B6HS (4510)
700 MOTO	B6HS (4510)
700CM	B6S (3510)
700CTS	BPM6A (7021)
705JS	BP7FS (3612)
705L	B6ES (7310)
705L MOTO	B6ES (7310)
705S	BP6HS (4511)
707LS	BP6ES (7811)
70M	B6HS (4510)
750	BP6HS (4511)
750L	B6ES (7310)
750LJS	BP6EFS (3812)

EYQUEM	→ NGK
750LS	BP6ES (7811)
753LJS	BP6EFS (3812)
755	B6HS (4510)
755 MOTO	B6HS (4510)
755CJT	BM7F (6421)
755CM	B6S (3510)
755CT	BM7A (6521)
755L	B6ES (7310)
755L MOTO	B6ES (7310)
755LJS	BP6EFS (3812)
755LS	BP6ES (7811)
755LS MOTO	BP6ES (7811)
755M	B6HS (4510)
755S	BP6HS (4511)
75LM	B6ES (7310)
75M	B6HS (4510)
775SX	BP6HS (4511)
775X	B6HS (4510)
800L	B6ES (7310)
800LJS	BP6EFS (3812)
800LS	BP6ES (7811)
800LS MOTO	BP6ES (7811)
802L	B6ES (7310)
803LJS	BP6EFS (3812)
805L	B6ES (7310)
805L MOTO	B6ES (7310)
805LJS	BP7EFS (3526)
805LJSP	TR7IX (96090)
805LP	BR7EIX (6664)
850	B7HS (5110)
850 MOTO	B7HS (5110)
850LS	BP7ES (2412)
C32	B5HS (4210)
C32LS	BP5ES (6511)
C32S	BP5HS (4111)
C42LJS3	BP6EFS (3812)
C42S	BP6HS (4511)
C52LS	BP5ES (6511)
C62	B7HS (5110)
C62LJS	BP6EF (4666)
C62LJS	BP6EFS (3812)
C62LS	BP6E (7529)
C62LS	BP6ES (7811)
C62LS3X	BP5ET (2287)
C62S	BP7HS (5111)
C72LJS	BP7EFS (3526)
C72LS	BP7ES (2412)
C72LS3X	BP6ET (1263)
C82LJS	BP7EFS (3526)
C82LS	BP7ES (2412)
C92LS	BP9ES (2912)
D1000	D8HA (7112)
D1000 MOTO	D8HA (7112)
D1000L	D9EA (2420)
D1050L	D9EA (2420)
D755 MOTO	D6HA (6512)
D775	D6HA (6512)
D800L	D7EA (7912)
D800L MOTO	D7EA (7912)
D900L	D8EA (2120)
FC52LS	BCP5ES (7496)
FC52LS	BCP5ES (7496)
FC58LS	BCP6ES (4930)
FC62LS	BCP6ES (4930)
FC62LS2	BCP6ES (4930)
FC62LS3	BCP6ET (4563)
FC62LS3X	BCP6ET (4563)
FC72LS	BCP7ES (5030)
FC82LS	BCP7ES (5030)
FC82LS1	BCP7ES (5030)
FC82LS2	BCP7ES (5030)
K200M	AB6 (2910)
K300M	AB6 (2910)
K500M	AB6 (2910)

HONDA - continued

HONDA	→ NGK
12290-R1A-H011	SILZKR7C11S (92932)
12290-R1A-H011-M1	SILZKR7C11S (92932)
12290-R41-L01	DILZKR7B11GS (95710)
12290-R41-L010-M1	DILZKR7B11GS (95710)
12290-R71-L01	DILZKR7B11GS (95710)
12290-RBO-J01	DIFR6D13 (94167)
12290-RBO-J010	DIFR6D13 (94167)
12290-RBO-J11	DIFR6D13 (94167)
12290-RBO-J110	DIFR6D13 (94167)
12290-RBO-J110-M1	DIFR6D13 (94167)
12290-RBJ-003	DILFR6J11 (92491)
12290-RB1-0031	IZFR6K13 (6774)
12290-RMX-003	ILFR6J-11K (4458)
12290-RMX-013	ILFR6J-11K (4458)
12290-RSH-003	IFR6G11K (1314)
12290-RWO-003	DILFR6J11 (92491)
31908-KTW-901	LMAR8A-9 (4313)
31908-MGC-003	LMAR8A-9S (6817)
31909-MEN-A310-M1	SILMAR9A9S (6213)
31909-MJP-G51	SILMAR8A9S (90992)
31911-KRN-731	R0409B-8 (7791)
31911-MBW-E11	IMR8C-9H (3653)
31911-MEE-J01	IMR8C-9HES (5990)
31911-MKF-D71	SILMAR10C9S (95468)
31912-KRN-731	R0409B-9 (7792)
31912-MBW-E110	IMR9C-9H (6777)
31912-MCW-0030	IMR9B-9H (4888)
31912-MEL-003	IMR9C-9HES (5766)
31912-MGH-641	IMR8E-9HES (95397)
31915-ZOH-003	CMR5H (7599)
31916-KRM-841	CPR6EA-9 (2306)
31916-KWB-601	CPR6EA-9S (1582)
31916-MEH-003	SIMR8A9 (91064)
31916-ZOH-003	CMR6H (3365)
31917-KOR-V01	LMAR8L-9 (91131)
31917-K40-F01	SILMAR8C9 (90097)
31917-K77-V01	MR7G-9E (90312)
31917-MKC-A01	CR6HSB-9 (92726)
31918-K44-V01	MR8C-9N (97985)
31918-K97-T01	MR8K-9 (93844)
31918-MEB-671	IFR8H11 (5068)
31922-MGH-642	IMR8E-9HES (95397)
31988-GEV-761	ER8EH-N (5606)
94701-00408	CR9EIA-9 (6289)
98049-58716	ER8EH (4011)
98049-59716	ER9EH (5869)
98049-60716	ER10EH (2862)
98052-56471	CM-6 (5812)
98056-17U	IFR6L11 (3678)
98056-54757	CR4HSB (4695)
98056-55718	CR5HS (2874)
98056-55777	CR5HSB (6535)
98056-56713	C6HSA (3228)
98056-56716	CR6HS (7023)
98056-56718	CR6HSA (2983)
98056-57713	C7HSA (4629)
98056-57716	CR7HS (7223)
98056-57718	CR7HSA (4549)
98056-57918	CR7HSA-9 (5147)
98056-58713	C8HSA (6821)
98056-58716	CR8HS (7423)
98056-58718	CR8HSA (2086)
98059-55916	CR5EH-9 (6689)
98059-55918	CR7HSA (5147)
98059-57916	CR7EH-9 (3486)
98056-57918	CR7HSA-9 (5147)
98059-58916	CR8EH-9 (5666)
98059-59916	CR9EH-9 (7502)
98059-5991U	IMR9A-9H (6966)
98059-599U	CR9EHI-9 (6419)
98061-58616	DPR8Z (4730)
98061-59616	DPR9Z (4830)
98066-54716	DR4HS (3326)
98066-55716	DR5HS (4623)

HONDA	→ NGK
98066-56716	DR6HS (4823)
98066-56717	D6HA (6512)
98066-58716	DR8HS (5123)
98066-58717	D8HA (7112)
98069-38716	DR8ES-L (2923)
98069-55916	DPR5EA-9 (2887)
98069-56717	D6EA (7512)
98069-56916	DPR6EA-9 (5531)
98069-57716	DR7ES (3123)
98069-57717	D7EA (7912)
98069-5771P	DR7EA (7839)
98069-57911	DPR7EA-9 (5129)
98069-57912	DPR7EIX-9 (7803)
98069-57912	DPR7EIX-9 (7803)
98069-57916	DPR7EA-9 (5129)
98069-5791U	IJR7A9 (7901)
98069-58716	DR8ES (5423)
98069-58717	D8EA (2120)
98069-58912	DPR8EIX-9 (2202)
98069-58916	DPR8EA-9 (4929)
98069-59717	D9EA (2420)
98069-59912	DPR9EIX-9 (5545)
98069-59916	DPR9EA-9 (5329)
98069-5991F	DPR9EIX-9 (5545)
98073-52710	B2 (3110)
98073-54710	B4 (3210)
98073-54740	BM4A (5628)
98073-54744	BMR4A (5728)
98073-54776	BPMR4A (6028)
98073-54944	BPMR4A-10 (6328)
98073-56740	BM6A (5921)
98073-56741	BPM6A (7021)
98073-56744	BMR6A (7421)
98073-56944	BPMR6A-10 (1029)
98076-52711	BP2HS (7926)
98076-54710	B4H (4110)
98076-54711	BP4HS (3611)
98076-54716	BR4HS (3322)
98076-54717	BPR4HS (7823)
98076-54746	BR4HS (3322)
98076-54747	BPR4HS (7823)
98076-54914	BPR4HS-10 (5024)
98076-54944	BPR4HS-10 (5024)
98076-55711	BP5HS (4111)
98076-55716	BR5HS (3722)
98076-55717	BPR5HS (6222)
98076-55719	BP5HS (4111)
98076-55747	BPR5HS (6222)
98076-56711	B6HS (4510)
98076-56715	BPR6HSA (4632)
98076-56716	BR6HS (3922)
98076-56717	BPR6HS (7022)
98076-56719	BP6HS (4511)
98076-5671G	BR6HSA (4296)
98076-56741	B6HS (4510)
98076-56747	BPR6HS (7022)
98076-56917	BPR6HS-10 (2623)
98076-57710	B7HS (5110)
98076-57711	BP7HS (5111)
98076-57716	BR7HS (4122)
98076-57717	BPR7HS (6422)
98076-57740	B7HS (5110)
98076-58710	B8HS (5510)
98076-58711	BP8HS (2630)
98076-58716	BR8HS (4322)
98076-58717	BPR8HS (3725)
98076-5871G	BR8HSA (5539)
98076-58740	B8HS (5510)
98076-58747	BPR8HS (3725)
98076-59710	B9HS (5810)
98076-59716	BR9HS (4522)
98079-5414G	ZFR4F-11 (4043)
98079-54817	BPR4ES (7222)
98079-54846	BPR4ES (7222)

HONDA	→ NGK
98079-55145	BPR5ES-11 (4424)
98079-55146	BPR5EY-11 (3028)
98079-55147	BCPR5ES-11 (3524)
98079-55148	BCPR5E-11 (1273)
98079-5514E	BKR5E-11 (6953)
98079-5514H	PFR5G-11 (2647)
98079-5514P	ZFR5J-11 (5584)
98079-5515G	ZFR6F-11 (4291)
98079-5515U	IFR5L11 (6502)
98079-5517U	FR9BI-11 (4709)
98079-5517V	IFR5G-11K (3107)
98079-55810	B5ES (6410)
98079-55811	BP5ES (6511)
98079-55816	BR5ES (4722)
98079-55817	BPR5ES (7422)
98079-55840	B5ES (6410)
98079-55841	BP5ES (6511)
98079-55844	BPR5EIX (6597)
98079-55846	BPR5ES (7422)
98079-55847	BR5ES (4722)
98079-55941	BP5EY (7327)
98079-55946	BPR5EY (2828)
98079-56145	BPR6ES-11 (4824)
98079-56146	BPR6EY-11 (4228)
98079-56147	BCPR6ES-11 (7121)
98079-56148	BCPR6E-11 (3132)
98079-56149	BCPR6EY-11 (3720)
98079-5614E	BKR6E-11 (2756)
98079-5614G	ZFR6F-11 (4291)
98079-5614H	PFR6G-11 (5555)
98079-5614J	BKR6E-N-11 (5724)
98079-5614N	PZFR6F-11 (3271)
98079-5614P	ZFR6J-11 (5585)
98079-5615G	ZFR6F-11 (4291)
98079-5615N	PZFR6F-11 (3271)
98079-5617U	IFR6L11 (3678)
98079-56810	B6ES (7310)
98079-56811	BP6ES (7811)
98079-56817	BR6ES (4922)
98079-56840	B6ES (7310)
98079-56841	BP6ES (7811)
98079-56844	BPR6EIX (6637)
98079-56846	BPR6ES (7822)
98079-56847	BR6ES (4922)
98079-56941	BP6EY (7727)
98079-56946	BPR6EY (6427)
98079-57145	BPR7ES-11 (7226)
98079-5714E	BKR7E-11 (1283)
98079-5714G	ZFR7F-11 (2975)
98079-5714H	PFR7G-11S (7772)
98079-5715H	PFR7G-11S (7772)
98079-5715U	IFR7L11 (5114)
98079-5717U	IFR7L11 (5114)
98079-571BV	IFR7G-11KS (7746)
98079-57614	BR7EIX (6664)
98079-57810	B7ES (1111)
98079-57811	BP7ES (2412)
98079-57816	BR7ES (5122)
98079-57840	B7ES (1111)
98079-57841	BP7ES (2412)
98079-57846	BPR7ES (2023)
98079-57847	BR7ES (5122)
98079-57876	BR7ES (5122)
98079-57877	BR7ES (5122)
98079-57946	BPR7EIX (4055)
98079-58644	BR8EIX (5044)
98079-58646	BR8EIX (5044)
98079-58648	B8EG (3430)
98079-58649	BR8EG (3130)
98079-58678	B8EG (3430)
98079-58679	BR8EG (3130)
98079-58810	B8ES (2411)
98079-58816	BR8ES (5422)
98079-58819	BR8ECS (3972)

HONDA	→ NGK
98079-58840	B8ES (2411)
98079-58842	B8ECS (2821)
98079-58845	BR8ECM (3035)
98079-58846	BR8ES (5422)
98079-58847	BPR8ES (3923)
98079-58870	B8ES (2411)
98079-58876	BR8ES (5422)
98079-59644	BR9EIX (3981)
98079-59646	BR9EIX (3981)
98079-59648	B9EG (3530)
98079-59649	BR9EG (3230)
98079-59678	B9EG (3530)
98079-59679	BR9EG (3230)
98079-59810	B9ES (2611)
98079-59811	B9ES (2611)
98079-59816	BR9ES (5722)
98079-59819	BR9ECS (3570)
98079-59842	B9ECS (7058)
98079-59845	BR9ECM (3252)
98079-59847	BR9ES (5722)
98079-59870	B9ES (2611)
98079-59876	BR9ES (5722)
98079-60616	BR10EIX (6801)
98079-60646	BR10EIX (6801)
98079-60648	B10EG (3630)
98079-60649	BR10EG (3830)
98079-60676	BR10EIX (6801)
98079-60678	B10EG (3630)
98079-60679	BR10EG (3830)
98079-60817	BR10ES (4832)
98079-60819	BR10ECS (5880)
98079-60845	BR10ECM (4234)
9807B-561BW	IZFR6K-11S (5266)
9807B-561CW	IZFR6K-11S (5266)
9807B-5615W	IZFR6K11 (6994)
9807B-5617W	IZFR6K11 (6994)
98179-56841	BP6ES (7811)

HUSQVARNA	→ NGK
31909-MJP-G51	ZGR7GI-13G (96760)
3699-92672	BPMR8Y (2218)
501 60 11-02	BPMR7A (4626)
517 3919 3000	GR8DI-12 (90908)
574 51 96-01	CMR6H (3365)
584 96 81-01	BPMR8Y (2218)
8523867	MAR9A-6J (91321)

HYSTER	→ NGK
0028758	AB-6 (2910)
0079161	AB-6 (2910)
0123872	AB-6 (2910)
0138366	AB-6 (2910)
0197885	AB-6 (2910)
0281844	BPR4FS (1127)
0326827	BP2ES (3467)
0360046	BMR6A (7421)
1312459	AB-6 (2910)
1330468	BPR4FS (1127)
1332675	BPR5FS (2423)
1332676	BPR5FS (2423)
1332693	AB-6 (2910)
1361837	BPR2ES (2264)
1389133	PTR5D-10 (3784)
1451269	BPR5FS (2423)
1467579	BPR5FS (2423)
3001582	AB-6 (2910)
3001585	AB-6 (2910)
3001586	AB-6 (2910)
3001588	BMR6A (7421)
3001590	AB-6 (2910)
3002287	AB-6 (2910)
3002288	BP2ES (3467)
3002289	BMR6A (7421)
3002290	BPR4ES (7222)

HYSTER - continued

HYSTER → NGK		ISKRA → NGK		ITALJET → NGK		JENN FENG → NGK	
3002347 BPR4ES (7222)		M60 AB6 (2910)		94004 BR7HS (4122)		9111-310002 BPMR6F (1270)	
3002348 AB-6 (2910)		M75 AB7 (3010)		94015 DR8EA (7162)		9295-320001 BMR6F (2144)	
3002349 AB-6 (2910)		M80 AB8 (7909)		94025 BR8HS (4322)		9295-310002 BMR6F (1270)	
3002575 AB-6 (2910)		MT65PRS APR6FS (2922)		94029 BR9ES (5722)		9295-310502 CMR7H (3066)	
3002577 AB-6 (2910)		MT65PS AP6FS (2710)		94032 CR7E (4578)		9295-331501 BPMR7A (4626)	
3040014 AB-6 (2910)		SFE55LRS ZFR5F (5165)		JAGUAR → NGK		JG - See CHINESE BRANDS	
3050408 AB-6 (2910)		SFE55LXS ZFR5F (5165)		0C2D59621 ILTR6G8G (96621)		JIGUANG - See CHINESE BRANDS	
3051151 AB-6 (2910)		SFE55PRS BCPR5ES (6130)		02AJ812988 SILZKAR7E8S (93476)		JOHN DEERE → NGK	
3051322 AB-6 (2910)		SFE55PRS BKR5E (7938)		02JDE 38685 SILZKAR8G7Y (93710)		MIU12783 BKR6EIX-11 (3764)	
3057352 BPR4ES (7222)		SFE55PS BCP5ES (7496)		2W93 12405 CAA IFR5N10 (7866)		JOHNSON → NGK	
326827 BP2ES (3467)		SFE65LDRS BKR5EK (7956)		96JV12405 EAA PFR5G-11E (3000)		204470091 BR7ES (5122)	
360046 BMR6A (7421)		SFE65LRS ZFR6A-11 (1041)		96JV12405 FAA PFR5G-13E (2761)		278000237 BR7ES (5122)	
388361 BPR5FS (2423)		SFE65LTXS BKUR6ET (6437)		96JV12405 HAA PFR5G-13E (2761)		278000608 BR7ES (5122)	
HYUNDAI → NGK		SFE65LXS ZFR6A-11 (1041)		96JV12405 HBA PFR6G-13E (2341)		278000609 BR8ES (5422)	
18 827 090 80 LKR6D-10E (96569)		SFE65PDRS BKR6EK (2848)		AB3850DA5 BR6EF (3177)		MCBR10EG BR10EG (3830)	
18 829 110 50 ZFR5F-11 (2262)		SFE65PRS BKR6E (6962)		AJ812146 ILKAR7C10 (94940)		MCBR8EG BR8EG (3130)	
18 843 100 62 LKR6D-10E (96569)		SFE65PRS BKR6ES (3783)		AJ812988 SILZKAR7E8S (93476)		MCBR8HS BR8HS (4322)	
18 844 100 60 SILKR6C10E (97098)		SFE65PS BCP6ES (4930)		AJ813092 ILTR6G8G (96621)		MCBR9EG BR9EG (3230)	
18 846 100 60 SILZKR6B10E (93815)		SFE65PTRS BCP6ET (2197)		AJ84575 IFR5N10 (7866)		MCBR9ES BR9ES (5722)	
18 854 100 80 LZKR6B-10E (1578)		SFE65PTS BCP6ET (4563)		C2A1535 IFR5N10 (7866)		JONSERAD → NGK	
18 855 100 60 LZKR6B-10E (1578)		SFE85LDRS BKR6EK (2288)		C2C41805 IFR7N10 (97105)		574 51 96-01 CMR6H (3365)	
ISKRA → NGK		SFE85LTRS BKUR7ET (7873)		C2D59621 ILTR6G8G (96621)		JUNGHEINRICH → NGK	
F100RS BR8HS (4322)		SFE85PR5 BKR7E (6097)		C2P23089 ILKAR7C10 (94940)		14148410 BPR4FS (1127)	
F100S B8HS (5510)		SFE85PRS BCPR7ES (3330)		C2S46895 TR6AP-13E (4968)		K & N → NGK	
F20 B4H (4110)		SFE85PS BCP7ES (5030)		C2Z28434 SILZKAR7E8S (93476)		XP422 PFR6G-11 (5555)	
F50 B5HS (4210)		SFE85PTRS BCP7ET (2164)		CA 3850 DA2 PFR6G-13E (2341)		KAWASAKI → NGK	
F55PS BP5HS (4111)		SFE85PTS BCP7ET (2078)		CA 3850 FA1 PFR5G-13E (2761)		(E)92070-1063 BR9EG (3230)	
F65PRS BPR6HS (7022)		T90 C7HSA (4629)		CA 3850 HA2 PFR6G-13E (2341)		(E)92070-1064 BR8EG (3130)	
F65PS BP6HS (4511)		TWE85PRS DCPR8E (4179)		EAC8344 B8ES (2411)		(E)92070-1165 DR7EA (7839)	
F70 B5HS (4210)		TWE85PS DCP7E (2363)		EAC8554 BR7EFS (1094)		(E)92070-1173 BR10ES (4832)	
F75RS BR6HS (3922)		ISOLATOR → NGK		EBC11480 BCPR6ES (2330)		(E)92070-2077 BPR5ES (7422)	
F75S B6HS (4510)		6B BP6HS (4511)		EBC4021 BR7EF (3346)		92070-0010 R6918B-9 (2954)	
F805RS BR7HS (4122)		7A B6HS (4510)		EBC8523 B7ES (1111)		92070-0014 CR9EIA-9 (6289)	
F80S B7HS (5110)		7B BP6HS (4511)		JC2S 46895 TR6AP-13E (4968)		92070-0016 BR9ECMIX (2707)	
F85PS BP7HS (5111)		7D BP6ES (7811)		JDE 38685 SILZKAR8G7Y (93710)		92070-0020 CPR8EB-9 (6607)	
F95PS BP7HS (5111)		A5D BP7EFS (3526)		NCA 3850 DA2 PFR6G-13E (2341)		92070-0045 MR8CI-8 (96973)	
FE100RS BR9ES (5722)		A7D BP6EFS (3812)		NCA 3850 FA1 PFR5G-13E (2761)		92070-0047 SILMAR9B9 (95399)	
FE100S B9ES (2611)		FM14-145/2 BP5ES (6511)		NCA 3850 HA2 PFR6G-13E (2341)		92070-0716 LMAR9G (97476)	
FE145P BP9ES (7526)		FM14-175/2 BP6ES (7811)		XR819660 TR6AP-13E (4968)		92070-0720 SILMAR9E9 (95123)	
FE155P BPR8EIX (6684)		FM14-200/2 BP6ES (7811)		XR842795 TR6AP-13E (4968)		92070-1063 BR9EG (3230)	
FE45P BP5E (4669)		FM14-225/2 BP7ES (2412)		JAPCAR → NGK		92070-1064 BR8EG (3130)	
FE50 B5ES (6410)		M14-145 B5HS (4210)		123762 BP5ES (6511)		92070-1142 C9E (7499)	
FE55LRS ZGR5A (5839)		M14-175 B6HS (4510)		123770 BP6ES (7811)		92070-1146 D6EA (7512)	
FE55LTXS BUR5ET (3377)		M14-225 B7HS (5110)		123778 BPR5ES (7422)		92070-1153 CR6HSA (2983)	
FE55LXS ZGR5A (5839)		M14-240 B8HS (5510)		123789 BPR6ES (7822)		92070-1165 DR7EA (7839)	
FE55PRS BPR5ES (7422)		M14-260 B9HS (5810)		123801 BPR7ES (2023)		92070-1173 BR10ES (4832)	
FE55PS BP5ES (6511)		M14-95 B4H (4110)		123825 BPR5ES-11 (4424)		92070-1231 BR8EIX (5044)	
FE55PTS BP5ET (2287)		M18-225 AB7 (3010)		123834 BPR6ES-11 (4824)		92070-1241 R6252K-105 (2741)	
FE65LTXS BUR6ET (3172)		M18-240 AB7 (3010)		123887 BPR5ES (7422)		92070-1264 CR9EK (4548)	
FE65PP2 BPR6EIX (6637)		PM14-225 BP7HS (5111)		123899 BPR6ES (7822)		92070-1265 CR8EK (3478)	
FE65PRP2 BPR6ES (7822)		U7D BCP6ES (4930)		123908 BPR7ES (2023)		92070-1266 CR9E (6263)	
FE65PRS BPR6ES (7822)		U8D BCP5ES (7496)		123932 BPR5ES-11 (4424)		92070-2052 BP4HS (3611)	
FE65PS BP6ES (7811)		ZM14-260 B8HS (5510)		123940 BPR6ES-11 (4824)		92070-2061 BPR4HS (7823)	
FE65PTS BP6ET (1263)		ISUZU → NGK		123993 BPR7ES-11 (7226)		92070-2070 BR4HS (3322)	
FE75RS BR7ES (5122)		5-81380001-0 BPR5ES (7422)		123996 BR7ES (5122)		92070-2108 BPMR6A (6726)	
FE75S B7ES (1111)		5-81380003-0 BPR5EIX (6597)		124040 BPR7ES-11 (7226)		92070-2110 BPR2ES (2264)	
FE80RS BR8ES (5422)		5-81380004-0 BPR6EIX (6637)		124144 BPR6ES-11 (4824)		92070-3707 PMR9B (4717)	
FE80S B8ES (2411)		5-81380012-0 BP5EY (7327)		166573 BPR6ES (7822)		92070-7004 BPR4ES (7222)	
FE85PRS BPR7ES (2023)		5-81380013-0 BP6EY (7727)		167605 PFR6J-11 (2743)		E92070-0001 B7HS (5110)	
FE85PS BP7ES (2412)		8-94120560-0 BPR5ES-11 (4424)		170006 BPR6ES-11 (4824)		E92070-0020 CPR8EB-9 (6607)	
FET55PRS BPR5EFS (2223)		8-94217232-0 BPR6ES-11 (4824)		172988 BPR5ES (7422)		E92070-014 B6ES (7310)	
FET55PS BP5EFS (3712)		8-94219943-0 BPR6ES (7822)		173939 BKR6E-11 (2756)		E92070-036 B9HS (5810)	
FET65PRS BPR6EFS (3623)		8-94328373-0 BKR7E-11 (1283)		177391 BKR6E-11 (2756)		E92070-037 B8ES (2411)	
FET65PS BP6EFS (3812)		8-97012928-0 BKR6E (6962)		207417 PFR6J-11 (2743)		E92070-054 B9ES (2611)	
FET75PS BP7EFS (3526)		9-82513103-0 BP6ES (7811)		239214 PFR5J-11 (4642)		E92070-1002 B7ES (1111)	
FS50KR BR2LM (5798)		9-82513105-0 B6ES (7310)		277200 BKR5E-11 (6953)		E92070-0014 CR9EIA-9 (6289)	
FS70 B6S (3510)		9-82513106-0 BP5ES (6511)		277201 BKR5E-11 (6953)			
FS70C BPM6A (7021)		9-82513107-0 B5ES (6410)		279427 PFR5J-11 (4045)			
FS75 B7S (3710)		9-82513113-0 B7ES (1111)					
FS75C BPM7A (7321)				JEEP - See CHRYSLER GROUP			
FT65PS BP6FS (3512)							
FUT55PRP-13 PTR5A-10 (5055)							

KAWASAKI - continued

KAWASAKI	→ NGK
E92070-1014	BP8ES (2912)
E92070-1019	DR8ES (5423)
E92070-1022	BR8ES (5422)
E92070-1024	BP6ES (7811)
E92070-1025	BPR6ES (7822)
E92070-1026	BP7ES (2412)
E92070-1027	BPR7ES (2023)
E92070-1034	D9EA (2420)
E92070-1044	BPR8ES (3923)
E92070-1053	BR9ES (5722)
E92070-1057	B8EG (3430)
E92070-1058	B9EG (3530)
E92070-1063	BR9EG (3230)
E92070-1064	BR8EG (3130)
E92070-1065	DPR8EA-9 (4929)
E92070-1068	DPR9EA-9 (5329)
E92070-1109	BR9ES (5722)
E92070-1113	DR7ES (3123)
E92070-1114	C6HSA (3228)
E92070-1116	DR8ES-L (2923)
E92070-1125	DPR7EA-9 (5129)
E92070-1132	B10EG (3630)
E92070-1133	BR10EG (3830)
E92070-1138	DPR6EA-9 (5531)
E92070-1143	CR9E (6263)
E92070-1145	CR9EK (4548)
E92070-1153	CR6HSA (2983)
E92070-1154	CR7HSA (4549)
E92070-1155	CR8HSA (2086)
E92070-1157	BR9ES (5722)
E92070-1158	CR8EK (3478)
E92070-1169	CR8E (1275)
E92070-1173	BR10ES (4832)
E92070-1178	BP5ES (6511)
E92070-1186	BR10EIX (6801)
E92070-1189	DR9EA (3437)
E92070-1199	DR8EA (7162)
E92070-1209	CR7E (4578)
E92070-1212	BR9EIX (3981)
E92070-1215	BR8EIX (5044)
E92070-1250	DPR5EA-9 (2887)
E92070-1254	CR9EKPA (7785)
E92070-1266	CR9E (6263)
E92070-2072	BMR4A (5728)
E92070-2077	BPR5ES (7422)
E92070-2100	BMR2A (7677)

KIA	→ NGK
18 829 110 50	ZFR5F-11 (2262)
18 843 100 62	LKR6D-10E (96569)
18 844 100 60	SILKR6C10E (97098)
18 846 100 60	SILZKR6B10E (93815)
18 854 100 80	LZKR6B-10E (1578)
18 855 100 60	LZKR6B-10E (1578)
OK55818110	PPR6N-11 (3546)

KLK	→ NGK
F100	B8HS (5510)
F20	B4H (4110)
F220	B9HS (5810)
F50	B5HS (4210)
F55P	BP5HS (4111)
F65P	BP6HS (4511)
F70	B5HS (4210)
F75	B6HS (4510)
F80	B7HS (5110)
F85P	BP6HS (4511)
F95P	BP7HS (5111)
FA50	B4L (3112)
FA70	B6L (3212)
FE100	B8ES (2411)
FE125P	BP6ES (7811)
FE135P	BP7ES (2412)
FE145P	BP8ES (2912)

KLK	→ NGK
FE155P	BP8ES (2912)
FE220	B9ES (2611)
FE30	B4ES (4129)
FE45P	BP5ES (6511)
FE50	B5ES (6410)
FE55P	BP5ES (6511)
FE65P	BP6ES (7811)
FE70	B5ES (6410)
FE75	B6ES (7310)
FE80	B7ES (1111)
FE85P	BP6ES (7811)
FE95P	BP7ES (2412)
FS100	B8S (3810)
FS20	B2 (3110)
FS30	B4 (3210)
FS35P	BP4 (2911)
FS45P	BP5S (3011)
FS50	B6S (3510)
FS70	B6S (3510)
FS75	B7S (3710)
FS75H	B7S (3710)
FT55P	BP5FS (3412)
FT65P	BP5FS (3412)
FT85P	BP6FS (3512)
FT95P	BP7FS (3612)
GT4S	BP5S (3011)
GT5	BP5HS (4111)
GT5L	BP5ES (6511)
GT6	BP6HS (4511)
GT6L	BP6ES (7811)
GT6T	AP6FS (2710)
GT7	BP7HS (5111)
GT7L	BP7ES (2412)
GT8L	BP8ES (2912)
L777	B6HS (4510)
M30	AB2 (3020)
M50	AB6 (2910)
M60	AB6 (2910)
M75	AB7 (3010)
M80	AB8 (7909)
MT75P	AP6FS (2710)
MT85P	AP6FS (2710)
T30	C6HSA (3228)
T70	C7HSA (4629)
T90	C8HSA (6821)
TENL100	C8HSA (6821)
TENL30	C7HSA (4629)
TFS20	B2 (3110)
TFS30	B4 (3210)
TFS50	B6S (3510)
TW100	D6HA (6512)
TW220	D6HA (6512)
TW240	D8HA (7112)
TW270	D6HA (6512)
TW275	D6HA (6512)
TW280	D8HA (7112)
TWE270	D8EA (2120)
TWE275	D9EA (2420)

KOHLER	→ NGK
12 132 02	BCPR5ES (6130)
12 132 02S	BCPR5ES (6130)
14 132 11	DCPR7E (3932)
14 132 11S	DCPR7E (3932)
62 132 04S	BCPR6ES (2330)

KOMATSU	→ NGK
22401-58001	B6ES (7310)
22401-FU412	BCPR5E-11 (1273)
22401-M7714	B6ES (7310)
22401-M7716	B6ES (7310)
22401-V1414	BPR4ES (7222)
22401-W8914	BP2ES (3467)
37Z-02-SP02E	BP2ES (3467)

KOMATSU	→ NGK
37Z-02-SP04A	B6ES (7310)
37Z-02-SP05A	B6ES (7310)
HE0052048-00	BMR6A (7421)
HE0110256-00	BMR6A (7421)
HE0110526-00	BMR6A (7421)
HE40-2502314	BMR6A (7421)
HE52892	BMR6A (7421)
TJ-90098-09125	BP2ES (3467)
TJ-90919-01055	BP2ES (3467)
TJ-90919-01950-71	BP2ES (3467)

KTM	→ NGK
452390-93000	LR8B (6208)
515390-93000	BR9ECMIX (2707)
517391-93000	GR8DI-12 (90908)
554391-93000	ZGR7GI-13G (96760)
590390-93100	DCPR8E (4179)
604390-93000	LKAR9BI-10 (95371)
604390-94000	LMAR7DI-10 (96956)
610390-93000	DCPR8E (4339)
611390-93000	KR8DI (4742)
612390-93200	LKAR9BI9 (6205)
750390-93000	LKAR8AI-9 (6706)
780390-93000	LKAR8A-9 (4786)
797390-93000	LZMAR8BI-10 (95680)
901390-93000	LKAR8A-9 (4786)
902390-93000	LKAR8A-9 (4786)

KUBOTA	→ NGK
07909-2225-0	BM6A (5921)
07909-2226-0	BM7A (6521)
10202-6771-6	AB6 (2910)
10261-6771-6	G2Z (3320)
12268-6771-1	BP2ES (3467)
12366-6771-6	BR4HS (3322)
12392-6771-1	BP5ES (6511)
12647-6771-1	BPR6HS (7022)
12681-6774-1	BR5ES (4722)
12863-6771-1	BP5ES (6511)
12866-6771-1	BP5ES (6511)
12992-6771-1	BPR5ES (7422)
13078-6771-6	BP6ES (7811)
13157-6771-2	BM4A (5628)
13211-6771-6	B4 (3210)
13281-6771-6	B4H (4110)
13301-6771-6	AB2 (3020)
13373-6774-1	BMR4A (5728)
13374-6774-1	BPR4HS (7823)
13375-6774-0	BPR4HS (7823)
13375-6774-1	BPR4HS-10 (5024)
13401-6771-6	B6S (3510)
13412-6771-6	B7S (3710)
13451-6771-6	B6HS (4510)
13581-6771-6	B7HS (5110)
13582-6771-1	B6HS (4510)
13641-6771-1	B4H (4110)
13901-6771-6	BP6HS (4511)
13979-6771-1	BP4HS (3611)
EG523-6771-1	IFR6F8DN (96416)

LAND ROVER	→ NGK
LR005253	IFR5N10 (7866)
LR005483	ILFR6B (6481)
LR019484	ILKAR7C10 (94940)
LR021006	BKR6EQUP (3199)
LR025605	ILTR6G8G (96621)
LR032080	ILKAR7C10 (94940)
LR050998	SILZKAR7E8S (93476)
LR091617	SILZKAR8G7Y (93710)
LR123892	ILTR6G8G (96621)
RTC3812	BP6ES (7811)

LD - See CHINESE BRANDS.

LEXUS - See TOYOTA

LG - See CHINESE BRANDS

LIXIN - See CHINESE BRANDS

LODGE → **NGK**

15HLNY	BP6ES (7811)
2H	B7HS (5110)
2H12	D8HA (7112)
2HA	B6S (3510)
2HL	B7ES (1111)
2HL10	C7HSA (4629)
2HLD	BCP6ES (4930)
2HL-E	B7ES (1111)
2HLN	B7ES (1111)
2HLNY	BP7ES (2412)
2HN	B7HS (5110)
2HNY	BP7HS (5111)
2H-TNY	AP7FS (2127)
2HTY	BP6FS (3512)
2HV	AB8 (7909)
2XL	BP6ES (7811)
25HLD	BCP6ET (4563)
25HLNY	BP7ES (2412)
25XL	BP6ES (7811)
3HAN	B8S (3810)
3HLN	B8ES (2411)
3HLNY	BP7ES (2412)
3HN	B8HS (5510)
3HNY	BP8ES (2912)
4HLNY	BP8ES (2912)
5HLNY	BP8ES (2912)
B14	B4H (4110)
BAN	B4 (3210)
BANY	BP5S (3011)
BBANY	BP4 (2911)
BBL	AB6 (2910)
BBNY	BP4HS (3611)
BLN	B4ES (4129)
BLNY	BP5ES (6511)
BLTY	BPR5EFS (2223)
BN	B4H (4110)
B-TY	BP5FS (3412)
BV	AB2 (3020)
C3	AB6 (2910)
CAN	B6S (3510)
CANB	BPM6A (7021)
CANC	BM6A (5921)
CB14	B5ES (6410)
CL14	B5ES (6410)
CLN	B6ES (7310)
CLN14P	B5ES (6410)
CLNH	B5ES (6410)
CLNY	BP5ES (6511)
CN	B5HS (4210)
CNY	BP5HS (4111)
CSN	B4L (3112)
CTY	BP5FS (3412)
CV	AB6 (2910)
H	B6HS (4510)
H12	D6HA (6512)
H18	AB7 (3010)
HA	B7S (3710)
HAN	B7S (3710)
HAN/M	B7S (3710)
HB12	D6HA (6512)
HBAN	B6S (3510)
HBL12	D8EA (2120)
HBLN	B5ES (6410)
HBN	B5HS (4210)
HBSN	B6L (3212)
HBTNY	AP6FS (2710)
HBTY	BP5FS (3412)
HBV	AB6 (2910)

LODGE - continued

LODGE	→ NGK
HL	B6ES (7310)
HL12	D9EA (2420)
HL14	B6ES (7310)
HL-E	B6ES (7310)
HLN	B6ES (7310)
HLNP	B6ES (7310)
HLNY	BP6ES (7811)
HN	B6HS (4510)
HNY	BP6HS (4511)
HT14	BP5FS (3412)
HT18	AP6FS (2710)
HTNY	AP6FS (2710)
H-TY	BP6FS (3512)
HV	AB7 (3010)

MARCHAL/VALEO	→ NGK
17C	AB7 (3010)
19C	AB7 (3010)
19E	AB7 (3010)
19L	AB7 (3010)
2/13	AB8 (7909)
2/32	B8HS (5510)
2/32H	B8ES (2411)
2/33	B8HS (5510)
2/33H	B7ES (1111)
20C	AB6 (2910)
20E	AB6 (2910)
20L	AB6 (2910)
21C	AB6 (2910)
21E	AB6 (2910)
21L	AB6 (2910)
22L	AB2 (3020)
22LM	AB2 (3020)
34/5HS	BP6ES (7811)
34C	B7S (3710)
34CM	B7S (3710)
34HS	B7ES (1111)
34HSM	B7ES (1111)
34S	B7HS (5110)
35	B6HS (4510)
35/1	BP6HS (4511)
35/1B	BP6HS (4511)
35/1D	BP6HS (4511)
35/36D	B6HS (4510)
35/36P	B6HS (4510)
35/36R	B6HS (4510)
35B	B6HS (4510)
35C	B6S (3510)
35CM	B6S (3510)
35HA	BP6ES (7811)
35HS	B6ES (7310)
35M	B6HS (4510)
35P	B6HS (4510)
36	B5HS (4210)
36B	B5HS (4210)
36C	B4 (3210)
36CM	B4 (3210)
36D	B5HS (4210)
36HS	B5ES (6410)
36M	B5HS (4210)
36P	B5HS (4210)
37S	B5HS (4210)
4N	B7HS (5110)
5H	B7ES (1111)
5N	BP6HS (4511)
5N CYCLO	BP6HS (4511)
64H	BP7ES (2412)
67HP	BR8EIX (5044)
6H	BP7ES (2412)
6N	BP5HS (4111)
70H	BP6ES (7811)
76H	BP5ES (6511)
7H	BP6ES (7811)
84H	BP5ES (6511)

MARCHAL/VALEO	→ NGK
88N	B5HS (4210)
8H	BP6ES (7811)
9H	BP5ES (6511)
C64H	BP6EFS (3812)
C68H	BP6EFS (3812)
C7H	BP6EFS (3812)
F70H	BCP7ES (5030)
F74H	BCP6ES (4930)
F80H	BCP7ES (5030)
GT34	BP7HS (5111)
GT34/2H	BP6ES (7811)
GT34/5	BP6HS (4511)
GT34/5D	BP6HS (4511)
GT34/5H	BP6ES (7811)
GT34/5HA	BP6ES (7811)
GT34/5HD	BP6ES (7811)
GT34D	BP7HS (5111)
GT34H	BP7ES (2412)
GT34HD	BP6ES (7811)
GT35	BP5HS (4111)
GT35D	BP5HS (4111)
GT35H	BP5ES (6511)
GT35HD	BP5ES (6511)
H32RG	B9EG (3530)
H33RG	B8EG (3430)
H34F	B8ES (2411)
HA32/2	B8ES (2411)
HA32RS	B9EG (3530)
HF34	B7ES (1111)
HF34F	B8ES (2411)
RR31HS	B10EG (3630)
RR32HS	BR9EIX (3981)
RR33HSS	BR8EIX (5044)
SCGT34/5H	BP6EFS (3812)
SCGT35H	BP6EFS (3812)
V36A	B5HS (4210)
V6N SOLEX	B5HS (4210)

MARELLI	→ NGK
7LCR	BKR6E (6962)
7LPR	BKR6E (6962)
8LCR	BCPR7ES (3330)
8LDCR	PTR5A-10 (5055)
8LPR	BCPR7ES (3330)
AW56C	BM7A (6521)
AW5C	BM6A (5921)
CM1N	AB2 (3020)
CM2N	AB2 (3020)
CM3N	AB6 (2910)
CM4N	AB6 (2910)
CM5N	AB6 (2910)
CM6N	AB7 (3010)
CU7N	C7HSA (4629)
CW101L	B85EGV (7498)
CW10L	B8EG (3430)
CW112L	B9EG (3530)
CW11L	B9EG (3530)
CW12L	B9EG (3530)
CW12NV	BUH (2422)
CW13L	B10EG (3630)
CW14L	B10EG (3630)
CW225A	B6HS (4510)
CW250A	B7HS (5110)
CW25N	B4H (4110)
CW260N	B7HS (5110)
CW2C	B2 (3110)
CW2CJ	B2 (3110)
CW2L	B4ES (4129)
CW2N	B4H (4110)
CW3C	B4 (3210)
CW3CJ	B4 (3210)
CW3CP	BP4 (2911)
CW3L	B4ES (4129)
CW3N	B4H (4110)

MARELLI	→ NGK
CW4A	B5ES (6410)
CW4C	B4 (3210)
CW4CJ	B4 (3210)
CW4CP	BP4 (2911)
CW4L	B4ES (4129)
CW4N	B4H (4110)
CW4NJ	B4H (4110)
CW55N	B5HS (4210)
CW5C	B4 (3210)
CW5CP	BP5S (3011)
CW5L	B5ES (6410)
CW5LJ	B5ES (6410)
CW5LP	BP5ES (6511)
CW5LS	B5ES (6410)
CW5LSZ	B5ES (6410)
CW5N	B5HS (4210)
CW5NJ	B5HS (4210)
CW5NP	BP5HS (4111)
CW5NR	BR5HS (3722)
CW5NS	B5HS (4210)
CW5NSZ	B5HS (4210)
CW67L	B6ES (7310)
CW67LP	BP6ES (7811)
CW67N	BP6HS (4511)
CW67NJ	B6HS (4510)
CW67NR	BR6HS (3922)
CW67P	BP5ES (6511)
CW6C	B6S (3510)
CW6CE	BM6A (5921)
CW6CJ	B6S (3510)
CW6L	B5ES (6410)
CW6LJ	B5ES (6410)
CW6LP	BP5ES (6511)
CW6LR	BR5ES (4722)
CW6LS	B5ES (6410)
CW6LSZ	B5ES (6410)
CW6N	B6HS (4510)
CW6NE	BM6A (5921)
CW6NJ	B6HS (4510)
CW6NP	BP6HS (4511)
CW6NPR	BPR6HS (7022)
CW6NR	BR6HS (3922)
CW75LP	BP6ES (7811)
CW78L	B6ES (7310)
CW78LP	BP6ES (7811)
CW78LPR	BPR6ES (7822)
CW78LPS	BP6ES (7811)
CW7C	B6S (3510)
CW7L	B6ES (7310)
CW7LCR	BKR6E (6962)
CW7LJ	B6ES (7310)
CW7LP	BP6ES (7811)
CW7LPH	BP6ES (7811)
CW7LPR	BPR6ES (7822)
CW7LR	BR6ES (4922)
CW7N	B6HS (4510)
CW7NJ	B6HS (4510)
CW7NP	BP6HS (4511)
CW7NPR	BPR6HS (7022)
CW7NR	BR6HS (3922)
CW89LP	BP7ES (2412)
CW8CJ	B7S (3710)
CW8L	B7ES (1111)
CW8LCR	BCPR7ES (3330)
CW8LJ	B7ES (1111)
CW8LP	BP7ES (2412)
CW8LPR	BPR7ES (2023)
CW8LPS	BP7ES (2412)
CW8N	B7HS (5110)
CW8NP	BP7HS (5111)
CW8NR	BR7HS (4122)
CW9L	B8ES (2411)
CW9LJ	B8ES (2411)
CW9LP	BP8ES (2912)

MARELLI	→ NGK
CW9N	B8HS (5510)
CWC12NJ	B8HS (5510)
CWC67NJ	B6HS (4510)
CWC6NJ	B6HS (4510)
CWC7NJ	B6HS (4510)
CWC9NJ	B7HS (5110)
CWF11L	BR8EIX (5044)
CWP10L	BR9EIX (3981)
CWP10N	BR9HIX (5687)
CWP11L	BR10EIX (6801)
CWP8L	BR7EIX (6664)
CWP8N	BR7HIX (7067)
CWP9L	BR8EIX (5044)
CWP9N	BR8HIX (7001)
CX6N	D6HA (6512)
CX8L	D8EA (2120)
CX8N	D8HA (7112)
DW4CJR	BR6S (3522)
F6NC	BP5HS (4111)
F6NCR	BPR5HS (6222)
F7LC	BP6ES (7811)
F7LCR	BPR6ES (7822)
F7NC	BP6HS (4511)
F7NCR	BPR6HS (7022)
F8LC	BP7ES (2412)
F8LCR	BPR7ES (2023)
FC6N	B5HS (4210)
FC7N	B6HS (4510)
FC9L	BP8ES (2912)
SW5C	BM6F (6221)
T7LC	BP6EFS (3812)
T7LCR	BPR6EFS (3623)
T8LC	BP7EFS (3526)
TM4NP	AP6FS (2710)
TW4LP	BP5EFS (3712)
TW5NP	BP5FS (3412)
TW6NP	BP6FS (3512)
TW78LP	BP6EFS (3812)
TW78LPR	BPR6EFS (3623)
TW78NPR	BPR6FS (2623)
TW7LP	BP6EFS (3812)
TW7LPR	BPR6EFS (3623)
TW7NP	BP6FS (3512)

MASERATI	→ NGK
239242	PMR8C-H (96361)
310235	SILKAR8C6DS (96372)

MAZDA	→ NGK
0190 18 110	B6HS (4510)
0259 18 110	BP6ES (7811)
0370 18 110	BPR6EIX (6637)
0371 18 110	BPR5EIX (6597)
0376 18 110	BPR7EIX (4055)
0419 18 110	B7ES (1111)
0420 18 110	B8ES (2411)
0512 18 110	B6ES (7310)
0660 18 110	BP5ES (6511)
0745 18 110	BP7ES (2412)
1002 77 550	BP5EY (7327)
1003 77 550	BP6EY (7727)
1690 18 110	BPR6ES (7822)
1UX5-18-110	HB6AIX-11P (5703)
1UXQ-18-110	HB6BIX-11P (5705)
3648 18 600	BR7ET (4121)
3649 18 600	BR8ET (4221)
4885 18 110	BPR2ES (2264)
4894 18 110	BP2ES (3467)
8344 18 600	BR9ET (4528)
8914 18 110	BPR5ES (7422)
A501 18 110	BP6E (7529)
AY02 18 110	DCP7E (2363)
AZ08 18 110	BPR5E (7075)
B601 18 110	BPR5ES-11 (4424)

MAZDA - continued

MAZDA	→ NGK
B695 18 110	BCPR6E (1269)
B6B3 18 110	BCPR5E-11 (1273)
BP01 18 110	BKR5E-11 (6953)
BP03 18 110	BKR6E-11 (2756)
BP05 18 110	BKR7E-11 (1283)
BP13 18 110	BKR5E-11 (6953)
BP47 18 110	BKR5E (7938)
BP49 18 110	BKR6E (6962)
BP51 18 110	BKR7E (6097)
F201 18 110	ZFR6A-11 (1041)
F203 18 110	ZFR5A-11 (5084)
F210 18 110	BCPR5E (1145)
F220 18 110	BCPR6E-11 (3132)
F285 18 110	ZFR6F-11 (4291)
F287 18 110	ZFR5F-11 (2262)
F289 18 110	ZFR7F-11 (2975)
FE79 18 110	BPR6ES-11 (4824)
JE03 18 110	BCPR7E (1272)
KJ11 18 110	PZFR6F (7550)
L303 18 110	TR5AI-13 (90813)
L3K9 18 110	ILTR6A-8G (3787)
L3K9 18 110A	ILTR6A-8G (3787)
L3Y1 18 110	ILTR6A-13G (3789)
L3Y2 18 110	ILTR5A-13G (3811)
L3Y3 18 110	ILTR6A-8G (3787)
L3YD 18 110	SILTR6A7G (95369)
L813 18 110	ITR6F13 (4477)
L845 18 110	TR5AI-13 (90813)
N322 18 110	BR10ET (7480)
N342 18 110	BUR9EQ (5483)
N3A1 18 110	BUR9EQ (5255)
N3A3 18 110	BUR8EQ (4582)
N3Y4 18 110A	RE9B-T (2809)
N3Z2 18 110A	RE7C-L (6700)
N3Z4 18 110A	RE7C-L (6700)
N3Z5 18 110	RE8C-L (5745)
PE 5R 18 110	ILKAR7L11 (94124)
PE 5S 18 110	ILKAR7L11 (94124)
ZM0118110	IZFR5G (5887)
MCC - See SMART	
McCULLOCH → NGK	
9111-310002-CH	BPMR6F (1270)
SPO002	BPMR7A (4626)
MEGA FIRE → NGK	
SE8JC	BM6A (5921)
MERCEDES BENZ → NGK	
A004 159 76 03	SILZKFR8D7G (90912)
000 159 05 00	SILZKFR8F7S (97566)
002 159 18 03	BP7ES (2412)
002 159 22 03	BP5ES (6511)
002 159 24 03	BP6ES (7811)
002 159 27 03	BP7ES (2412)
002 159 28 03	BP6ES (7811)
002 159 29 03	BP5ES (6511)
002 159 31 03	BP5ES (6511)
002 159 41 03	BP6ES (7811)
002 159 42 03	BP6ES (7811)
002 159 48 03	BP5ES (6511)
002 159 49 03	BP6EFS (3812)
002 159 56 03	BP6EFS (3812)
002 159 57 03	BP5EFS (3712)
002 159 58 03	BP5EFS (3712)
002 159 64 03	BP7EFS (3526)
002 159 65 03	BP7EFS (3526)
002 159 68 03	BP6EFS (3812)
002 159 69 03	BP6EFS (3812)
002 159 76 03	BP5EFS (3712)
002 159 77 03	BCP5ES (7496)
003 159 04 03	BP5EFS (3712)
003 159 05 03	BP5EFS (3712)

MERCEDES BENZ	→ NGK
003 159 06 03	BP6EFS (3812)
003 159 07 03	BP6EFS (3812)
003 159 08 03	BP7EFS (3526)
003 159 12 03	BP6ESZ (7639)
003 159 13 03	BP6ESZ (7639)
003 159 14 03	BP7ES (2412)
003 159 16 03	BCP6ES (4930)
003 159 30 03	BCP5ES (7496)
003 159 31 03	BCP6ES (4930)
003 159 33 03	BP7EFS (3526)
003 159 34 03	BP6EFS (3812)
003 159 35 03	BP6EFS (3812)
003 159 36 03	BP5EFS (3712)
003 159 37 03	BCP5ES (7496)
003 159 40 03	BP5EFS (3712)
003 159 41 03	BP5EFS (3712)
003 159 42 03	BCP5ES (7496)
003 159 45 03	BP6ESZ (7639)
003 159 56 03	BP7ES (2412)
003 159 57 03	BP6ESZ (7639)
003 159 75 03	BKUR5ET (2789)
003 159 78 03	BKUR6ET-10 (2397)
003 159 91 03	BKR5EKUP (2890)
003 159 97 03	IFR6D10 (5344)
004 159 13 03	ILFR6A (3588)
004 159 14 03	IFR6Q-G (5648)
004 159 1803	PLKR7A (4288)
004 159 20 03	IFR6D10 (5344)
004 159 25 03	SILZKR7A-S (7718)
004 159 30 03	BKR6EZB (4293)
004 159 30 03 26	BKR6EZB (4293)
004 159 36 03	BKR6EZB (4293)
004 159 39 03	ILZKAR7A10 (6043)
004 159 44 03	PLKR7B8E (94716)
004 159 44 03 26	PLKR7B8E (94716)
004 159 45 03	ILFR6A (3588)
004 159 49 03	PLKR7A (4288)
004 159 58 03	PLKR7B8E (94716)
004 159 65 03	SILZKFR8D7S (95875)
004 159 68 03	SILZKFR8D7S (95875)
004 159 70 03	SILZKFR8D7S (95875)
004 159 75 03	SILZKFR8D7S (95875)
004 159 76 03	SILZKFR8D7G (90912)
004 159 79 03	SILZKFR8E7S (90654)
132 159 02 03	LKR7B-9 (5847)
MERCURUISER → NGK	
0509581	BUHW (2622)
0509583	BUHXW-1 (5526)
33-104	BR7ES (5122)
33-11458M	B6HS-10 (1052)
33-12127	BP6HS-10 (6326)
33-123	BR6ES (4922)
33-12343	BP8HS-10 (3823)
33-12343B	BP8HS-10 (3823)
33-136862	BU8H (6431)
33-136862B	BU8H (6431)
33-14	BP5S (3011)
33-14103550	BUZHW (2147)
33-14103568	BUZ8H (7447)
33-14103570	BUZHW-2 (2173)
33-14814548	BPZ8HS-10 (3133)
33-14814568	BPZ8HS-15 (3180)
33-17719547	BPR7HS-10 (1092)
33-18	BPR4FS-11 (2527)
33-18S	BPR4FS-11 (2527)
33-19424	BP8HS-15 (6729)
33-19796	BPR6HS-10 (2623)
33-306	B6HS (4510)
33-312	BP6HS-10 (6326)
33-327	BPR6HS (7022)
33-328	BP7HS (5111)
33-33828C	BZ7HS-10 (3579)
33-400	BR6FS (4323)

MERCURUISER	→ NGK
33-400S	BR6FS (4323)
33-401	BP6EFS (3812)
33-406	BPR6FS (2623)
33-41263B	B7HS-10 (2129)
33-41263M	B7HS-10 (2129)
33-592	BR6S (3522)
33-59571	BR6FS (4323)
33-59571B	BR6FS (4323)
33-63	BP5S (3011)
33-670	R5673-8 (4140)
33-803507	DCPR6E (3481)
33-807C	B8HS (5510)
33-807S	B8HS (5510)
33-809679	BR9ES (5722)
33-809679B	BR9ES (5722)
33-809680	BR8ES (5422)
33-809680B	BR8ES (5422)
33-811	B7HS (5110)
33-811S	B7HS (5110)
33-813413	B7S (3710)
33-813414	BP7HS (5111)
33-813415	B8S (3810)
33-813421	R5673-8 (4140)
33-813423	BPR6HS (7022)
33-813469	B6S (3510)
33-8134711	BR6ES (4922)
33-814	BPR7HS-10 (1092)
33-816336	BPR6EFS (3623)
33-8167372	BP8H-N-10 (4838)
33-8167372B	BP8H-N-10 (4838)
33-8168372	BPZ8H-N-10 (4495)
33-8168372B	BPZ8H-N-10 (4495)
33-818	BR9ES (5722)
33-818S	BR9ES (5722)
33-821916	BR7HS (4122)
33-821C	B9HS-10 (3626)
33-821S	B9HS-10 (3626)
33-823	B6S (3510)
33-82370M	B6HS (4510)
33-82370M1	B6HS (4510)
33-82371B	B7HS (5110)
33-82371M	B7HS (5110)
33-82372M	B8HS (5510)
33-823S	B6S (3510)
33-824	BUHX (2522)
33-825C	B7S (3710)
33-825S	B7S (3710)
33-827858	DPR6EA-9 (5531)
33-827859	CR6HS (7023)
33-827C	BUHW (2622)
33-828C	BZ7HS-10 (3579)
33-828S	BZ7HS-10 (3579)
33-833C	BUHW-2 (5626)
33-833S	BUHW-2 (5626)
33-838	BUZHW-2 (2173)
33-841C	B6S (3510)
33-84409B	B8HS-10 (5126)
33-84409M	B8HS-10 (5126)
33-84675M	B5HS (4210)
33-8556721	PZFR5F-11 (4363)
33-8557171	ZFR5F-11 (2262)
33-859495	LFRA5A-11 (6376)
33-874	BR7HS (4122)
33-876	BUZ8H (7447)
33-880	BR8ES (5422)
33-881284	LFRA6A-11 (3672)
33-883	BR7HS (4122)
33-885C	BU8H (6431)
33-885S	BU8H (6431)
33-886	BUZ8H (7447)
33-896	B5HS (4210)
33-898	BUZHW (2147)
33-918	ZFR6F-11 (4291)
33-924	BP8HS-15 (6729)

MERCURUISER	→ NGK
33-936C	BP8HS-10 (3823)
33-936S	BP8HS-10 (3823)
33-938	BPZ8HS-10 (3133)
33-938	BPZ8HS-10 (3133)
33-939	BPZ8HS-15 (3180)
33-941	BR8HS (4322)
33-97180	BUHW (2622)
33-97180B	BUHW (2622)
33-97180Q	BUHW (2622)
33-97182	BUHW-2 (5626)
33-97182Q	BUHW-2 (5626)
33-97184	BP7HS-10 (7829)
33-97186	B9HS-10 (3626)
33-97186B	B9HS-10 (3626)
33-97389	BPR6FS (2623)
509581	BUHW (2622)
509583	BUHXW-1 (5526)
MINI (BMW) → NGK	
12 12 0 030 548	BKR6EQUP (3199)
12 12 0 031 708	BKR7EQUP (4285)
12 12 0 034 098	PLZKBR7B8G (91530)
12 12 0 035 531	ILZKBR7B8G (97968)
12 12 2 158 165	PLZKBR7B8G (91530)
12 12 2 163 332	PLZKBR7B8G (91530)
12 12 2 293 697	PLZKBR7B8G (91530)
MITSUBISHI → NGK	
1017268	BPR4ES (7222)
1038083	BP5EY (7327)
1822A005	ILZFR6C-K (6645)
1822A021	ILKR8E6 (1422)
1822A022	ILFR7H (5245)
1822A068	DIFR5E11 (91112)
1822A071	DILFR6A11 (97362)
1822A079	DILKR8B6 (91448)
1822A085	DILFR5A11 (93759)
2A3643	AB-6 (2910)
8N2236	BMR6A (7421)
8N2630	AB-6 (2910)
90420-01620	PTR5D-10 (3784)
997476	BMR6A (7421)
MB 101 726 8	BPR4ES (7222)
MD 313 443	PFR6G-11 (5555)
MD 314 766	BKR7EKC-N (2095)
MD 338 991	PGR7A (3200)
MD 360 019	IZFR6B (3116)
MD 360 383	IZFR5B (4080)
MD 371 434	IGR7A (6687)
MD 372 588	IFR6E11 (6741)
MD 374 841	IGR7A-G (3106)
MD 997476	BMR6A (7421)
MN 119 487	IFR6S (99404)
MN 119 500	IGR6A11 (5743)
MN 137 919	LFRA6C-11 (5788)
MN 158 596	LZFR6AI (3656)
MN 163 235	FR5EI (1313)
MN 176 628	ILZFR6C-K (6645)
MS 851 022	BP5ES (6511)
MS 851 023	BP6ES (7811)
MS 851 024	BP7ES (2412)
MS 851 101	BP5EY (7327)
MS 851 102	BP5EY (7327)
MS 851 104	BP6EY (7727)
MS 851 111	B4 (3210)
MS 851 113	B6S (3510)
MS 851 121	BP4 (2911)
MS 851 126	BPR6E (6464)
MS 851 132	B5HS (4210)
MS 851 133	B6HS (4510)
MS 851 134	B7HS (5110)
MS 851 162	B5ES (6410)
MS 851 163	B6ES (7310)

MOTORCRAFT - continued

MOTORCRAFT	→ NGK
ASF52C	BPR5FS (2423)
AT1	B8S (3810)
AT10	B2 (3110)
AT2	B7S (3710)
AT3	B6S (3510)
AT4	B6S (3510)
AT42	BP5S (3011)
AT6	B6S (3510)
AT8	B4 (3210)
ATL3	B6L (3212)
ATL4	B6L (3212)
ATL8	B4L (3112)
AV1X	B8HS (5510)
AV22CU	BP6HS (4511)
AV2CU	B7HS (5110)
AV2X	B7HS (5110)
AV3CU	B6HS (4510)
AV4	B5HS (4210)
AV42	BP5HS (4111)
AV52	BP5HS (4111)
AV6	B4H (4110)
AV6CU	B4H (4110)
AV701CU10	B9HS-10 (3626)
AV82	BP4HS (3611)
AV901CU	B9HS (5810)
AV901X-4	B9HS-10 (3626)
AVKO	BUH (2422)
AVKOD	BUHW (2622)
AVZKO	BUHX (2522)
AWRF32	BPR6EFS (3623)
AWRF42	BPR5EFS (2223)
AWSF22C	BPR6EFS (3623)
AWSF22FS	PTR6D-13 (5598)
AWSF32	BPR6EFS (3623)
AWSF32C	BPR6EFS (3623)
AWSF32F	PTR5D-10 (3784)
AWSF32P	PTR5D-10 (3784)
AWSF32PM	PTR5D-10 (3784)
AWSF32PP	PTR5D-10 (3784)
AWSF42	BPR5EFS (2223)
AWSF42C	BPR5EFS (2223)
AWSF52C	BPR5EFS (2223)
AWSFA32C	BPR5EFS (2223)
AYFS092FEC	PLTR6A-10G (3587)
AYFS22C	TR5A-10 (0005)
AYFS22CB	TR5B-13 (4559)
AYFS22FE1J	PLTR6A-10G (3587)
AYFS22P1	PTR5A-10 (5055)
AYFS22PP1	PTR5A-10 (5055)
AYFS32CJ	TR5B-13 (4559)
AYRF22PP	PTR5A-10 (5055)
AYSF32YPC	ILTR5A-13G (3811)
AZ2	B7S (3710)
AZ3	B6S (3510)
AZ9	B4 (3210)
AZ901	B8S (3810)
AZFS22PP	PTR5A-10 (5055)
AZFS32FE	PTR5A-10 (5055)
B2W	AB8 (7909)
B3W	AB7 (3010)
B3X	AB7 (3010)
B4X	AB7 (3010)
B6W	AB6 (2910)
B8X	AB6 (2910)
BF12	AP8FS (2227)
BF22	AP6FS (2710)
BF22C	AP6FS (2710)
BF22CU	AP6FS (2710)
BF22CX	AP6FS (2710)
BF22X	AP6FS (2710)
BF32	AP6FS (2710)
BF32CU	AP6FS (2710)
BF32CX	AP6FS (2710)
BF32X	AP6FS (2710)

MOTORCRAFT	→ NGK
BR8	AB6 (2910)
BRF22	APR6FS (2922)
BRF22C	APR6FS (2922)
BRF32	APR6FS (2922)
BRF42	APR5FS (3122)
BRF82	APR5FS (3122)
BSF32C	APR6FS (2922)
BSF42C	APR5FS (3122)
BSF82	APR5FS (3122)
BSF92	APR5FS (3122)
BT10	AB6 (2910)
BT15	AB2 (3020)
BT2	AB8 (7909)
BT3	AB7 (3010)
BT4	AB7 (3010)
BT6	AB6 (2910)
BT8	AB6 (2910)
BT9	AB6 (2910)
BTRF42	APR5FS (3122)
BZ8	AB6 (2910)
CYFS12VN	LTR6A-10 (90338)
CYFS12YPC	ILTR6G8G (96621)
CYFS13YRC	ILZTR6A8G (94769)
HG2	D8EA (2120)
HG22	D8EA (2120)
HG2CU	D8EA (2120)
HGR2C	DR8ES-L (2923)
HV2	D8HA (7112)
HV22	D6HA (6512)
HV3	D6HA (6512)
HYFS094YEC	ILZNR8A7G (91924)
PV2	C7HSA (4629)
PV3	C6HSA (3228)
TT4	G2Z (3320)
TT8	G2Z (3320)
YN2F-12405A2A	TR5B-13 (4559)

MOUNTFIELD	→ NGK
118550219/0	BCPR5ES (6130)
9400-0244-00	BCPR5ES (6130)
9400-0225-00	BR2-LM (5798)

MV AGUSTA	→ NGK
7699116	CR9EKB (2305)
8000 99561	CR9EKB (2305)
8000 B 7884	CR9EIB-9 (92579)

NANDA - See CHINESE BRANDS-

NHSP LD - See CHINESE BRANDS-

NIPPON DENSO - See DENSO-

NISSAN	→ NGK
-01P15	BCPR5ES-11 (3524)
-01P16	BCPR6ES-11 (7121)
-01P17	BCPR7ES-11 (1095)
-02P15	BCPR5E-11 (1273)
-02P16	BCPR6E-11 (3132)
-10F15	BCP5ES (7496)
-10F16	BCP6ES (4930)
-10F17	BCP7ES (5030)
-12E15	BCPR5ES (6130)
-12E16	BKR6E (6962)
-12E17	BCPR7ES (3330)
-1P115	PFR5G-11 (2647)
-1P116	PFR6G-11 (5555)
-1P117	PFR7G-11S (7772)
-20J05	BKR5E (7938)
-20J06	BKR6E (6962)
-20J07	BKR7E (6097)
22401-00Q0K	ILKAR7F7G (90061)
22401-1HA1C	DILKAR7E11HS (97439)
22401-1HC1B	LZKAR6AP-11 (6643)

NISSAN	→ NGK
22401-1KC1C	DILKAR7C9H (91215)
22401-1KT1B	DILZKAR6A11 (91691)
22401-1P115	PFR5G-11 (2647)
22401-1TT1C	DILKAR7E9HS (95003)
22401-2047R	ILKAR7F7G (90061)
22401-27N65	PFR5B-11 (2300)
22401-5M015	PLFR5A-11 (6240)
22401-8H516	LFRR6A-11 (3672)
22401-9133R	ILKAR7J7G (91121)
22401-BC01B	LFRR5E-11 (1669)
22401-CK81B	PLZKAR6A-11 (5118)
22401-CK87B	PLZKAR6A-11 (5118)
22401-ED815	LZKAR6AP-11 (6643)
22401-EW61C	DF7H-11B (1317)
22401-FU412	FR2B-D (1598)
22401-FU42A	FR2B-D (1598)
22401-JA01B	DILKAR6A11 (9029)
22401-JD01B	PLZKAR6A-11 (5118)
22401-JF01D	DILKAR8A8 (93026)
22401-JK01D	DF8H-11B (1305)
22401-L1600	BPR4ES (7222)
22401-M7716	B6ES (7310)
22401-RS345-8	R7345-8 (4379)
22401-V1414	BPR4ES (7222)
22401-W8914	BPR4ES (7222)
B22401-HG00B	SILZKFR8E7S (90654)
BY483-HB6AX	HB6AIX-11P (5703)
BY483-HB6BX	HB6BIX-11P (5705)
CK913628	AB-6 (2910)
N-22401-M7716	B6ES (7310)
NF90420-01620	PTR5D-10 (3784)
-30R15	ZFR5E-11 (4435)
-50Y05	BKR5E-11 (6953)
-50Y06	BKR6E-11 (2756)
-53J05	BKR5EY (7390)
-53J06	BKR6EY (3696)
-53J16	PFR6G-9 (4377)
-53J66	PFR6G-9 (4377)
-58S16	PFR6A-11 (4045)
-85E15	BKR5E-11 (6953)
-85E16	BKR6E-11 (2756)
-85E17	BKR7E-11 (1283)
-99B07	BCPR7ES-11 (1095)
-99B09	BCPR6ES-11 (7121)
-99B12	BCPR5ES-11 (3524)
-F2000	BPR4ES (7222)
-P8315	BPR5ES-11 (4424)
-P8316	BPR6ES-11 (4824)
-P8317	BPR7ES-11 (7226)
-S2000	BPR5ES (7422)
-S2100	BPR6ES (7822)
-V1414	BPR4ES (7222)
-V1415	BPR5ES (7422)
-V1416	BPR6ES (7822)
-V1417	BPR7ES (2023)
-W8915	BP5ES (6511)
-W8916	BP6ES (7811)
-W8917	BP7ES (2412)

OMC	→ NGK
115206	BP6HS (4511)
387694	B7HS (5110)
437929	BPR7HS (6422)
445098	D6HA (6512)
502177	B6HS (4510)
502194	B7HS-10 (2129)
502196	BR6S (3522)
502894	BUZ8H (7447)
503948	BPR6HS (7022)
503949	BR6HS (3922)
503950	BR6HS (3922)
504082	BR6HS (3922)
509921	BUHW (2622)
509922	BUHW-2 (5626)

OMC	→ NGK
509924	BUZ8H (7447)
509925	BZ7HS-10 (3579)
509926	BUHXW-1 (5526)
509928	B6S (3510)
509929	B7HS (5110)
584918	DCPR7E (3932)
771770	BUZHW-2 (2173)

OPEL - See VAUXHALL

OREGON - See BRISK

PAL	→ NGK
14-5	B4H (4110)
14-5Y	BP4HS (3611)
14-7	B5HS (4210)
14-7Y	BP5HS (4111)
14-8	B6HS (4510)
14-8R	BR6HS (3922)
14-8Y	BP6HS (4511)
14-9	B8HS (5510)
14-9R	BR7HS (4122)
14-9Y	BP7HS (5111)
14K-5	B4 (3210)
14K-5Y	BP4 (2911)
14K-7Y	BP5S (3011)
14K-8	B6S (3510)
14L-5	B5ES (6410)
14L-5R	BR5ES (4722)
14L-5Y	BP5ES (6511)
14L-7	B6ES (7310)
14L-7R	BR6ES (4922)
14L-7Y	BP6ES (7811)
14L-8	B6ES (7310)
14L-8Y	BP6ES (7811)
14L-9	B7ES (1111)
14L-9Y	BP7ES (2412)
17-9	B7HS (5110)
18-5	AB6 (2910)
18-5R	AB6 (2910)
18-7	AB7 (3010)
B14YC	DPR8EA-9 (4929)
D14YC	BCP7ES (5030)
D15YC	BCP6ES (4930)
D17YC	BCP5ES (7496)
DR14YC	BCPR7ES (3330)
DR15YC	BKR6E (6962)
DR17YC	BCPR5ES (6130)
G14YC	BP7EFS (3526)
G15YC	BP6EFS (3812)
G17YC	BP5EFS (3712)
K17C	B6S (3510)
K17Y	BP5S (3011)
K19	B4 (3210)
L08W	B11EGV (5831)
L12W	BR9EIX (3981)
L12YC	BP9ES (7526)
L14C	B8ES (2411)
L14YC	BP7ES (2412)
L15C	B7ES (1111)
L15W	BR8EIX (5044)
L15YC	BP6ES (7811)
L17C	B6ES (7310)
L17YC	BP5ES (6511)
L19C	B5ES (6410)
L5Y	BP5ES (6511)
L7Y	BP6ES (7811)
L8	B6ES (7310)
L8Y	BP6ES (7811)
L9Y	BP7ES (2412)
LR12YC	BPR8ES (3923)
LR14YC	BPR7ES (2023)
LR15YC	BPR6ES (7822)
N12YC	BP8ES (2912)

PAL	→ NGK
N14C	B9HS (5810)
N14YC	BP7HS (5111)
N15C	B7ES (1111)
N15YC	BP6HS (4511)
N17C	B6HS (4510)
N17Y	BP4HS (3611)
N17YC	BP5HS (4111)
N19	B4H (4110)
N19C	B5HS (4210)
N7	B6HS (4510)
N7Y	BP6HS (4511)
N8	B7HS (5110)
N8Y	BP7HS (5111)
NR12YC	BPR8HS (3725)
NR15YC	BPR6HS (7022)
P15	BM7A (6521)
P15Y	BPM7A (7321)
P17	BM6A (5921)
P17Y	BPM6A (7021)
PR15Y	BPMR7A (4626)
PR17Y	BPMR6A (6726)
S14L-13	B8EG (3430)
S14L-15	B9EG (3530)
S14L-17	B10EG (3630)
U17	BM6F (6221)
PEUGEOT	→ NGK
1607577680	DILFR5A11 (93759)
17 098 377	CR6EB (90071)
5960.14	LF5B (7113)
5960.83	LZKAR7A (6799)
5960.92	PLZKBR7B8G (91530)
5960.93	PLZKBR7B8G (91530)
5960.A5	PLZKBR7B8G (91530)
5960.E1	PLZKBR7B8G (91530)
5960.E3	LF5B (7113)
5960.F0	BKR6EZ (4619)
5960.G1	LZKAR7A (6799)
5960.G4	PLZKBR7B8G (91530)
5960.H9	PLZKBR7B8G (91530)
5960.L0	PLZKBR7B8G (91530)
5960.L2	LF6C-11 (5788)
5960.L5	ILZKBR7B8G (97968)
5962.05	BP6EFS (3812)
5962.09	BP6EFS (3812)
5962.13	BP6ES (7811)
5962.14	BP6EFS (3812)
5962.15	BP6EFS (3812)
5962.16	BP6ES (7811)
5962.21	BP6ET (1263)
5962.22	BPR6EIX (6637)
5962.5G	BKR6EZ (4619)
5962.6V	BKR6EZ (4619)
5962.71	BKR6ES (3783)
5962.72	BP6EFS (3812)
5962.7S	BKR6EZ (4619)
5962.80	BP6HS (4511)
5962.82	BP6ES (7811)
5962.87	BP6EFS (3812)
5962.88	BP8ES (2912)
5962.90	BP6HS (4511)
5962.94	BP7ES (2412)
5962.98	BP7ES (2412)
5962.A1	BP7ES (2412)
5962.A2	BP6ES (7811)
5962.A3	BP6HS (4511)
5962.A5	PLZKBR7B8G (91530)
5962.A0	BP7ES (2412)
5962.C5	BKR6ES (3783)
5962.C6	BKR6ES (3783)
5962.CO	BP5EFS (3712)
5962.E2	BCP6ES (4930)
5962.F7	BCP6ES (4930)
5962.F8	BCP6ES (4930)

PEUGEOT	→ NGK
5962.G8	BP7ES (2412)
5962.H2	BKR6ES (3783)
5962.H8	BKR5E (7938)
5962.H9	BCPR5ES (6130)
5962.J9	BKR6ES (3783)
5962.J0	BCP6ES (4930)
5962.K1	BCPR7ES (3330)
5962.K3	BCP7ET (2078)
5962.K4	BKR6ES (3783)
5962.K6	BKR6ES (3783)
5962.K7	BCPR6ET (2197)
5962.K0	BCPR7ES (3330)
5962.R5	BCPR6ET (2197)
5962.R9	BKR6ES (3783)
59627Q	BKR6EZ (4619)
5962.S2	BKR6E (6962)
5962.S4	BKR5E (7938)
5962.T8	BKR6ES (3783)
5962.V6	BKR5E (7938)
5962.V7	BKR6ES (3783)
5962.V8	BCPR7ES (3330)
5962.W4	BCPR6ET (2197)
5962.W6	BCPR7ES (3330)
5962.W7	BCPR7ES (3330)
5962.W9	BKR5EK (7956)
5962.X5	BCP6ES (4930)
5962.Y2	BKR5EK (7956)
5962.Y8	2288 (2288)
5962.Z0	BKR6EK (2288)
800942	CR9EB (6955)
96 762 881 80	LZKRA6A-10G (97999)
96 774 469 80	ILZKRC8C8G (90909)
PE781757	CPR9EB-9 (6508)
PE783985	CR6EB (90071)
V 7534226803 03	PLZKBR7B8G (91530)
PIAGGIO	→ NGK
1A010638	MR8BI-8 (91360)
1D001003	LMAR8E-7 (92499)
641320	CR9EB (6955)
641546	ER9EH-6N (1673)
638049	BR7HS (4122)
POLARIS	→ NGK
3022662	MR7F (95897)
3022111	LKAR8A-9 (4786)
3022809	MR8F (90299)
3023173	MR9F (95424)
PORSCHE	→ NGK
999 170 103 90	PFR6B (3500)
999 170 195 90	BKR7EKC (7354)
999 170 223 90	BKR7EQU (4285)
101905606A	IZKR7B (7563)
PRESTOLITE	→ NGK
10E2	C7HSA (4629)
10E3	C7HSA (4629)
12E2	D8HA (7112)
12E3	D8HA (7112)
10E4	C6HSA (3228)
12E22	D6HA (6512)
12E42	D6HA (6512)
12G2	D8EA (2120)
12G3	D8EA (2120)
14-11	B2 (3110)
14-11N	BPM6A (7021)
14-11X	B2 (3110)
14-2X	B6S (3510)
14-3	B6S (3510)
14-3N	BM7A (6521)
14-3X	B6S (3510)
14-4	B6S (3510)
14-42	BP5S (3011)

PRESTOLITE	→ NGK
14-5	B6S (3510)
14-5X	B6S (3510)
14-52	BP5S (3011)
14-7	B4 (3210)
14-7N	BM6A (5921)
14-7X	B4 (3210)
14-82	BP4 (2911)
14-9	B4 (3210)
14-9X	B4 (3210)
14E1	B8HS (5510)
14E01	BUH (2422)
14E2	B7HS (5110)
14E3	B6HS (4510)
14E4	B5HS (4210)
14E6	B5HS (4210)
14E22	BP7HS (5111)
14E32	BP6HS (4511)
14E42	BP6HS (4511)
14E52	BP5HS (4111)
14E62	BP5HS (4111)
14E82	BP4HS (3611)
14ER4	BR6HS (3922)
14ER6	BR6HS (3922)
14F22	BP6FS (3512)
14F32	BP6FS (3512)
14F3N	BM7F (6421)
14F42	BP5FS (3412)
14F52	BPR4FS (1127)
14F7N	BM6F (6221)
14G01	BUE (2322)
14G1	B8ES (2411)
14G12	BP8ES (2912)
14G2	B7ES (1111)
14G22	BP6ES (7811)
14G3	B6ES (7310)
14G32	BP5ES (6511)
14G4	B6ES (7310)
14G42	BP5ES (6511)
14G5	B5ES (6410)
14G52	BP5ES (6511)
14G7	B5ES (6410)
14G902	BP8ES (2912)
14GF22	BP6EFS (3812)
14GR22	BPR6ES (7822)
14GR32	BPR5ES (7422)
14GR4	BR6ES (4922)
14GR42	BPR5ES (7422)
14GR52	BPR4ES (7222)
14GR53	ZGR5C (6334)
14GR7	BR5ES (4722)
14GRF22	BPR6EFS (3623)
14GRF32	BPR5EFS (2223)
14GRF52	BPR5EFS (2223)
14L4	B6L (3212)
14L7	B6L (3212)
14L9	B4L (3112)
14R3	BR6S (3522)
14R32	BP5S (3011)
14R4	BR6S (3522)
14R42	BP5S (3011)
14R5	BR6S (3522)
14R52	BP4 (2911)
14R53	BP4 (2911)
14R7N	BM6A (5921)
14R8	B6S (3510)
14RF22	BPR6FS (2623)
14RF32	BPR5FS (2423)
14RF32-6	BPR5FS-15 (3124)
14RF32A	BPR5FS-15 (3124)
14RF42	BPR5FS (2423)
14RF42-6	BPR5FS-15 (3124)
14RF42A	BPR5FS-15 (3124)
14RF52	BPR4FS (1127)
14RF52-6	BPR4FS-15 (2727)

PRESTOLITE	→ NGK
14RF52A	BPR4FS-15 (2727)
14RF62	BPR4FS (1127)
14RF62-6	BPR4FS-15 (2727)
14RF62A	BPR4FS-15 (2727)
18-3	AB6 (2910)
18-4	AB6 (2910)
18-8	AB6 (2910)
18-9	AB6 (2910)
18-10	AB6 (2910)
18F22	AP6FS (2710)
18F32	AP6FS (2710)
18RF32	APR6FS (2922)
18RF42	APR6FS (2922)
18RF82	APR6FS (2922)
1Y00-18-110	BPR5ES (7422)
394	B6ES (7310)
4056	B6ES (7310)
4253	BP5EY (7327)
43N	B6ES (7310)
43XL	B6ES (7310)
44N	B6ES (7310)
44NS	BP5EY (7327)
44XL	B6ES (7310)
78-10	G2Z (3320)
78-8	G2Z (3320)
AG3	B6ES (7310)
AG30C	B6ES (7310)
AG3CX	B6ES (7310)
AG3X	B6ES (7310)
B2401-89904	BP5EY (7327)
C43N	B6ES (7310)
C44N	B6ES (7310)
C44NS	BP5EY (7327)
MS851243	BP5EY (7327)
N288	B6ES (7310)
N5C	B6ES (7310)
S43XL	B6ES (7310)
S44XL	B6ES (7310)
PROTECNICA	→ NGK
4708	BR2LM (5798)
4843	BPM7A (7321)
PROTON	→ NGK
8200030765	LZKAR7A (6799)
LAP6FS	AP6FS (2710)
LBCPR6ES	BCPR6ES (2330)
LBCP6ES	BCP6ES (4930)
LBP6EFS	BPR6EFS (3623)
LBP5ES	BP5ES (6511)
LBP6EFS	BP6EFS (3812)
LBP6ES	BP6ES (7811)
MS851232E	BPR5ES (7422)
MS851233E	BPR6ES (7822)
MS851358E	BKR6E-11 (2756)
PW811750	BPR6EF-11 (95420)
RAM - See CHRYSLER GROUP	
RENAULT	→ NGK
22401-1TT1C	DILKAR7E9HS (95003)
22401-8760R	LZKAR7B (5942)
22401-9133R	ILKAR7J7G (91121)
22401-9185R	SILZKFR8D7G (90912)
77 00 101 401	BCPR5ES (6130)
77 00 103 502	BPR5ES (7422)
77 00 103 503	BPR5ES (7422)
77 00 103 533	BKR5EK (7956)
77 00 107 916	BKR5EK (7956)
77 00 260 637	BCP7ET (2078)
77 00 266 295	BPR6EFS (3623)
77 00 267 140	BPR6EFS (3623)
77 00 267 805	TR7IX (96090)
77 00 273 462	BKR6E (6962)

RENAULT	→ NGK
77 00 273 698	BKR6EIX (6418)
77 00 500 155	BKR6EZ (4619)
77 00 500 168	BKR5EK (7956)
77 00 500 192	LFRA4P-11 (5613)
77 00 553 622	BP6ES (7811)
77 00 565 155	BR9EIX (3981)
77 00 587 168	BP6HS (4511)
77 00 714 540	BPR6EFS (3623)
77 00 722 095	BP6EFS (3812)
77 00 724 821	BP6ES (7811)
77 00 725 302	BPR5ES (7422)
77 00 726 503	BP7EFS (3526)
77 00 727 383	BPR6ES (7822)
77 00 731 583	BP7EFS (3526)
77 00 732 626	BP8ES (2912)
77 00 733 422	BP5HS (4111)
77 00 736 149	BP7EFS (3526)
77 00 736 150	BP7EFS (3526)
77 00 737 457	BP7EFS (3526)
77 00 737 458	BP6EFS (3812)
77 00 737 459	BP7ES (2412)
77 00 737 612	BCP5ES (7496)
77 00 742 094	BPR7ES (2023)
77 00 743 137	BCP5ES (7496)
77 00 743 920	BP5ES (6511)
77 00 749 163	BCP5ES (7496)
77 00 824 821	BP6ES (7811)
77 00 852 522	BP6EFS (3812)
77 00 852 543	TR7IX (96090)
77 00 855 463	BCP6ET (4563)
77 00 855 918	BP5EFS (3712)
77 00 856 342	BCP6ET (4563)
77 00 859 910	BCP5ES (7496)
77 00 859 967	BP5ES (6511)
77 00 861 471	BP7ES (2412)
77 00 861 472	BP6ESZ (7639)
77 00 862 054	BP5ES (6511)
77 00 868 864	BPR7ES (2023)
77 00 871 617	BCPR6ET (2197)
77 01 021 767	BP6EFS (3812)
77 01 041 214	BP5ES (6511)
77 01 041 215	BP6EFS (3812)
77 01 042 816	BKR6E (6962)
77 01 043 624	BCPR6ET (2197)
77 01 045 018	BP7EFS (3526)
77 01 065 085	PLZKAR6A-11 (5118)
77 01 366 057	BP6HS (4511)
77 01 366 084	BR8EIX (5044)
77 01 366 085	BR7EIX (6664)
77 01 366 086	BP6ES (7811)
77 01 366 087	BP7ES (2412)
77 01 366 137	BP6EFS (3812)
77 01 366 267	BP6HS (4511)
77 01 366 268	BP7ES (2412)
77 01 366 269	BP6ES (7811)
77 01 366 270	BP6EFS (3812)
77 01 366 513	BP5HS (4111)
77 01 366 514	BP6EFS (3812)
77 01 366 515	BP6HS (4511)
77 01 366 516	BP6ES (7811)
77 01 366 533	B6HS (4510)
77 01 366 539	BP5ES (6511)
77 01 366 903	BP5ES (6511)
77 01 414 022	BP5HS (4111)
77 01 414 025	BP6ES (7811)
77 01 414 026	BP7EFS (3526)
77 01 414 027	BP7EFS (3526)
77 01 414 031	BPR6ES (7822)
82 00 030 765	LZKAR7A (6799)
82 00 020 796	BKR6EZ (4619)
82 00 314 928	PFR7G-9 (4371)
82 00 322 273	LZKAR7A (6799)
82 00 363 384	PFR6G-9 (4377)
82 00 492 426	PFR7Z-TG (5768)

RENAULT	→ NGK
82 00 587 901	ILKAR7A7 (91432)
82 00 592 215	LZKAR7B (5942)
82 00 662 185	LZKAR7A (6799)
82 01 001 947	IFR7X8G (95820)
83 04 504 277	ZFR5F (5165)
89 33 003 862	BKR6ES (3783)
96 26 575 480	BKR6EK (2288)

SAAB	→ NGK
12620540	ILTR5D (5476)
12788884	PLFR6C-10G (1959)
55564215	BKR7ESC-11 (6313)
55571391	PFR6T-10G (5542)
8819302	BCPR7EIX (5690)
9112541	BCPR7ES-11 (1095)
9117565	BCPR6ES-11 (7121)
9136276	BCPR5EIX (5688)
9139643	BCPR6EIX (5689)
9399866	PFR6H-10 (6290)

SEAT - See VW GROUP

SKODA - See VW GROUP

SMART	→ NGK
000 3085 V005 0000 00	BKR6EKE (5649)
001 2468 V002 000 00	LKR8A (5214)
A 003 159 92 03	BKR6EKE (5649)

SPLITFIRE	→ NGK
TP006A	BPR8EIX (6684)
TP006B	BPR7EIX (4055)
TP006C	BPR6EIX (6637)
TP006D	BPR5EIX (6597)
TP006E	BPR5EIX (6597)
TP406B	BR9EIX (3981)
TP406B	BR9EIX (3981)
TP406C	BR8EIX (5044)
TP406C	BR8EIX (5044)
TP430B	CR9EIX (3521)
TP430C	CR8EIX (4218)

STEINBOCK	→ NGK
8155723	BPR4FS (1127)

STIHL	→ NGK
144483	BP2ES (3467)
0000-400-7009	CMR6H (3365)
0000-400-7011	CMR6H (3365)

SUBARU	→ NGK
22401 AA020	BP6ES (7811)
22401 AA090	BP7ES (2412)
22401 AA120	BPR6ES-11 (4824)
22401 AA220	BPR6ES (7822)
22401 AA230	BPR7E (1142)
22401 AA310	BKR6E-11 (2756)
22401 AA370	PFR6B-11 (4014)
22401 AA400	PFR6B (3500)
22401 AA480	BPR5ES-11 (4424)
22401 AA500	BKR6EIX-11 (3764)
22401 AA510	BKR6EIX (6418)
22401 AA530	PFR6B (3500)
22401 AA531	PFR6B (3500)
22401 AA570	PFR6B (3500)
22401 AA630	ILFR6B (6481)
22401 AA670	SILFR6A (7913)
22401 AA720	SILFR6A11 (5468)
22401 AA730	SIFR6A11 (0127)
22401 AA740	SILFR6A6 (8659)
22401 AA820	DILZKAR7B11 (90935)
22401 AA870	SILKAR8D6 (95768)
22401 AA830	ILKAR8H6 (96024)
22401 KA080	BKR6E (6962)

SUBARU	→ NGK
22401 KA100	BCPR6E (1269)
22401 KA210	BKR5E-11 (6953)
32054 0800	B6ES (7310)
32054 1110	B7ES (1111)
32054 1120	BR7EIX (6664)
32054 5700	BR6ES (4922)
38242 0800	B5ES (6410)
42054 3200	BP5ES (6511)
49001 0003	BPR5EIX (6597)
49001 0013	BPR6EIX (6637)
49001 0023	BPR7EIX (4055)
49001 0033	BPR5ES (7422)
49001 0043	BP5EY (7327)
49001 0053	BP6EY (7727)
82054 1810	B6HS (4510)
82054 6010	B8HS (5510)
82054 8020	BR8HIX (7001)
82054 9310	B7HS (5110)
82054 9320	BR7HIX (7067)
88241 7800	B5HS (4210)
89057 3400	B6S (3510)

SUZUKI

SUZUKI	→ NGK
04982-00584	CR8EIB-10 (4948)
04982-00597	CR8EIA-10 (4708)
04982-02EA1	ZMR7AP (6914)
09482-00036	BP4HS (3611)
09482-00066	B9ES (2611)
09482-00082	B7HS (5110)
09482-00084	BP6HS (4511)
09482-00088	BR6HS (3922)
09482-00089	B7ES (1111)
09482-00091	B8ES (2411)
09482-00095	B6HS (4510)
09482-00098	BR9ES (5722)
09482-00102	BR8HS (4322)
09482-00105	BP7HS (5111)
09482-00115	BR9EIX (3981)
09482-00116	BR7HS (4122)
09482-00117	BR7ES (5122)
09482-00118	BP6ES (7811)
09482-00121	BR8ES (5422)
09482-00124	BP5HS (4111)
09482-00127	BR9ES (5722)
09482-00131	BP5ES (6511)
09482-00136	BPR4HS (7823)
09482-00139	BP7ES (2412)
09482-00141	BPR6HS (7022)
09482-00143	BR5HS (3722)
09482-00144	D8EA (2120)
09482-00147	BPR5HS (6222)
09482-00149	DR8ES-L (2923)
09482-00155	BPR5ES (7422)
09482-00157	BR8HS (4322)
09482-00167-000	BPR5EY (2828)
09482-00167-001	BPR5ES (7422)
09482-00167	BPR5ES (7422)
09482-00175	BP8ES (2912)
09482-00177	BP6ES (7811)
09482-00181	BR10EIX (6801)
09482-00182	D7EA (7912)
09482-00184	D9EA (2420)
09482-00198	B8HS (5510)
09482-00205	BPR4HS (7823)
09482-00208	BR8EIX (5044)
09482-00209	BR9EIX (3981)
09482-00210	BR10EIX (6801)
09482-00220	DR7ES (3123)
09482-00221	DR8ES (5423)
09482-00229	BPR6ES (7822)
09482-00230	BR8HS (4322)
09482-00237	B8HS (5510)
09482-00239	BPR8ES (3923)
09482-00244	BPR7HS (6422)

SUZUKI	→ NGK
09482-00255	BPR7HS (6422)
09482-00258	BPMR6A (6726)
09482-00259	BP6HS (4511)
09482-00261	BPMR4A (6028)
09482-00264	BP6HS-10 (6326)
09482-00269	B7HS-10 (2129)
09482-00277	BR7HS-10 (1098)
09482-00278	B8HS-10 (5126)
09482-00279	B8HS-10 (5126)
09482-00280	BR8HS-10 (1134)
09482-00285	BPR6ES-11 (4824)
09482-00290	BP4HS (3611)
09482-00299	BPR6ES (7822)
09482-00299-000	BPR6ES (7822)
09482-00316	BPR5HS (6222)
09482-00321	CH8SA (6821)
09482-00327	BR6HS-10 (1090)
09482-00330	DPR9EA-9 (5329)
09482-00332	DPR8EA-9 (4929)
09482-00334	DPR8EA-9 (4929)
09482-00338	B6HS-10 (1052)
09482-00340	CR6HS (7023)
09482-00341	BR6HS-10 (1090)
09482-00348	BR8ES (5422)
09482-00349	BR9ES (5722)
09482-00351	B9ES (2611)
09482-00354	DPR7EA-9 (5129)
09482-00358	BR4HS (3322)
09482-00359	BPR5HS (6222)
09482-00360	BR10ES (4832)
09482-00367	BPR4HS (7823)
09482-00370	BR8HS-10 (1134)
09482-00375	B8HS-10 (5126)
09482-00385	BP7ES (2412)
09482-00389	JR9B (3188)
09482-00391	JR10B (1299)
09482-00397	JR9C (6193)
09482-00398	DR7EA (7839)
09482-00399	DR8EA (7162)
09482-00400	DR9EA (3437)
09482-00406	CR6HSA (2983)
09482-00408	CR7HSA (4549)
09482-00409-001	BPR6ES (7822)
09482-00409	BPR6ES (7822)
09482-00410	CR9EK (4548)
09482-00412	CR8EK (3478)
09482-00414	CR7EK (7546)
09482-00426	BK6E (3536)
09482-00427	BKR6E (6962)
09482-00429-000	BKR6E (6962)
09482-00429-001	BKR6E (6962)
09482-00429	BKR6E (6962)
09482-00432	BPR5E (7075)
09482-00433	BPR5EY-11 (3028)
09482-00446	DCPR6E (3481)
09482-00448	DCPR7E (3932)
09482-00450	DCPR8E (4179)
09482-00456	CR8E (1275)
09482-00458	CR9E (6263)
09482-00460	CR10E (6264)
09482-00462	CR10EK (2360)
09482-00463	CR10EK (2360)
09482-00464	BR8HCS-10 (1157)
09482-00467	BR9HS-10 (4551)
09482-00470	BR8ECM (3035)
09482-00472	BR9ECM (3252)
09482-00474	BR10ECM (4234)
09482-00477	BKR5E (7938)
09482-00479	DCPR7EIX (6046)
09482-00485	CR8HSA (2086)
09482-00486	BR8HCS-10 (1157)
09482-00487	BPR6ES (7822)
09482-00491	JR9B (3188)
09482-00494	BKR6E-11 (2756)

SUZUKI - continued

SUZUKI	→ NGK
09482-00495	BPR7ES (2023)
09482-00499	R4118S-8 (3236)
09482-00500	BKR9EIX (3981)
09482-00504	BPR5EY (2828)
09482-00509	R6918B-8 (4492)
09482-00511	R6918B-7 (6259)
09482-00513	R0045J-10 (7400)
09482-00516	CR7E (4578)
09482-00519	BR9EYA (7548)
09482-00521	BPR5EIX (6597)
09482-00522	BPR7HS-10 (1092)
09482-00523	BPR8HS (3725)
09482-00528	CR6E (6965)
09482-00530	BPR6HS (7022)
09482-00531	BP6HS (4511)
09482-00532	B7HS-10 (2129)
09482-00533	BR7HS-10 (1098)
09482-00534	B6HS-10 (1052)
09482-00535	BR6HS-10 (1090)
09482-00537	DCPR9EIX (2316)
09482-00547	IFR5E11 (7994)
09482-00548	IFR6E11 (6741)
09482-00549	IFR5J11 (7418)
09482-00550	IFR6J11 (7658)
09482-00554	CR7EIA-9 (91175)
09482-00556	CR8EIA-9 (4286)
09482-00558	CR9EIA-9 (6289)
09482-00561	BR8EG (3130)
09482-00564	BR9EYA (7548)
09482-00590	CR6EIA-9 (7967)
09482-00597	CR8EIA-10 (4708)
09482-00600	DIMR8A10 (92743)
09482-00602	IKR6G11 (7980)
09482-00603	IKR6G11 (7980)
09482-00603-000	IKR6G11 (7980)
09482-00621	CPR7EA-9 (3901)
09482-00625	LMAR8A-9 (4313)
09482-00635	LMAR8BI-9 (91909)
09482-00642	ILZKR7D8 (96412)
09482-00646	MR8E-9 (90527)
09482-00647	ILZKR6F11 (97345)
09482-00649	LKR6E (92650)
09482-69001	BPR6HS (7022)
TCM	→ NGK
20801-0A041	BP2ES (3467)
N-22401-L1600	BPR4ES (7222)
N-22401-W8914	BP2ES (3467)
TORCH - See CHINESE BRANDS	
TOYOTA	→ NGK
00591-02042-81	BPR4ES (7222)
00591-03633-81	BPR4ES (7222)
00591-05493-81	BMR6A (7421)
00591-06165-81	BPR5FS (2423)
00591-06208-81	BP2ES (3467)
00591-06209-81	BP2ES (3467)
00591-07885-81	AB-6 (2910)
00591-07896-81	AB-6 (2910)
00591-10918-81	BPR5FS (2423)
00591-10919-81	BMR6A (7421)
00591-20174-81	BMR6A (7421)
00591-32673-81	BPR4ES (7222)
00591-32691-81	AB-6 (2910)
00591-32692-81	BPR5FS (2423)
00591-32695-81	BP2ES (3467)
00591-33646-81	BPR4ES (7222)
00591-33649-81	BP2ES (3467)
00591-33687-81	BMR6A (7421)
00591-42808-81	BPR5FS (2423)
00591-50969-81	BPR4ES (7222)
00591-50970-81	AB-6 (2910)
00591-50971-81	AB-6 (2910)

TOYOTA	→ NGK
00591-50973-81	BP2ES (3467)
00591-50976-81	BP2ES (3467)
00591-50978-81	BPR5FS (2423)
00591-50979-81	BPR4FS (1127)
00591-53307-81	AB-6 (2910)
00591-55310-81	BMR6A (7421)
150038500	BP2ES (3467)
150112478	BPR4ES (7222)
19111-31720-71	PTR5D-10 (3784)
19111-31721-71	PTR5D-10 (3784)
19111-90098-71	PTR5D-10 (3784)
19111-U2120-71	BPR4FS (1127)
19111-U3161-71	PTR5D-10 (3784)
220001599	BP2ES (3467)
220034475	BPR4ES (7222)
580052996	BPR6EFS (3623)
80098-76004-71	BMR6A (7421)
80098-76005-71	BMR6A (7421)
80098-76006-71	BP2ES (3467)
80919-76004-71	BP2ES (3467)
80919-76008-71	BP2ES (3467)
80919-76009-71	BP2ES (3467)
80919-76011-71	BP2ES (3467)
80999-76018-71	BP2ES (3467)
90053-7827	BP2ES (3467)
90098-09125	BP2ES (3467)
90098-14785	BPR4FS (1127)
90098-16785	BPR5FS (2423)
90098-20395	BP2ES (3467)
90098-64015	AB-6 (2910)
90098-66113-71	PTR5D-10 (3784)
90420-01190-71	PTR5D-10 (3784)
90919-01055-71	BP2ES (3467)
90919-01056	BPR4ES (7222)
90919-01021	BP2ES (3467)
90919-01176	BKR5EYA-11 (2526)
90919-01184	BKR6EYA-11 (4073)
90919-01193	BKR5EKB-11 (3967)
90919-01198	BKR6EKB-11 (3583)
90919-01210	IFR6T11 (4589)
90919-01215	IFR5T-8N (3508)
90919-01221	HB6AIX-11P (5703)
90919-01226	HB6BIX-11P (5705)
90919-01230	HB6BIX-11P (5705)
90919-01233	ILFR5T11 (96779)
90919-01234	ILFR5T11 (96779)
90919-01235	ILFR6C-11 (5788)
90919-01249	DFH6B-11A (6858)
90919-01253	ILKAR7B11 (4912)
90919-01265	DIFR5C (90911)
90919-01950-71	BP2ES (3467)
90919-01954	BP5EY (7327)
90919-01954-71	BPR2ES (2264)
90919-W1001	ILFR6C-11 (5788)
90999-09001-71	BP2ES (3467)
90999-09002-71	BP2ES (3467)
TRIUMPH	→ NGK
1290023	CR9EK (4548)
1290024	DPR8EA-9 (4929)
1290181	CR8EK (3478)
1290200	DPR9EA-9 (5329)
1290745	LMAR8A-9 (4313)
1291023	CR9EIA-9 (6289)
1295151	CR8EIA-9 (4286)
1296999	DPR6EA-9 (5531)
1290180	DPR7EA-9 (5129)
T1290023	CR9EK (4548)
T1290024	DPR8EA-9 (4929)
T1290180	DPR7EA-9 (5129)
T1290181	CR8EK (3478)
T1290745	LMAR8A-9 (4313)
T1291023	CR9EIA-9 (6289)
T1295151	CR9EK (4548)

TRIUMPH	→ NGK
T1296999	DPR6EA-9 (5531)
UNIPART	→ NGK
GSP130	B5ES (6410)
GSP131	BP5ES (6511)
GSP141	BP5ES (6511)
GSP151	BP6ES (7811)
GSP160	B6ES (7310)
GSP163	BP6ES (7811)
GSP171	BP6ES (7811)
GSP181	BP7ES (2412)
GSP191	BP8ES (2912)
GSP2001	BKR6E (6962)
GSP2002	BPR6ES (7822)
GSP2003	BKR6E (6962)
GSP2004	ZFR6F-11 (4291)
GSP2005	BCPR6ES-11 (7121)
GSP2006	BPR6EFS (3623)
GSP2007	BKR6E (6962)
GSP2008	BPR5ES (7422)
GSP2009	BPR6ES (7822)
GSP2010	BP6ET (1263)
GSP2013	ZGR5A (5839)
GSP2015	BKR6E (6962)
GSP2017	BKR5EK (7956)
GSP2018	BKR5EK (7956)
GSP2019	BPR6ES-11 (4824)
GSP2020	BPR5ES (7422)
GSP2021	AP6FS (2710)
GSP2022	BKR5E (7938)
GSP2023	BCPR7ES (3330)
GSP2024	BP6ET (1263)
GSP2025	ZFR5F (5165)
GSP2026	APR6FS (2922)
GSP2027	BPR6EFS (3623)
GSP2028	BKR6EKC (2848)
GSP2029	BPR6HS (7022)
GSP2030	BUR6ET (3172)
GSP2031	BP5ET (2287)
GSP2032	B5HS (4210)
GSP2033	APR5FS (3122)
GSP2034	BPR6ES (7822)
GSP2035	BCP5ES (7496)
GSP2036	BPR7ES (2023)
GSP2037	BCPR6ES-11 (7121)
GSP2038	BUR5ET (3377)
GSP2039	BPR5ES-11 (4424)
GSP2040	BP5EFS (3712)
GSP2041	BKR6EQUP (3199)
GSP2044	PFR7B (4853)
GSP2045	BKR5E-11 (6953)
GSP2046	B6ES (7310)
GSP2048	BKUR7ET (7873)
GSP2049	B6HS (4510)
GSP2050	B7HS (5110)
GSP2051	BR8ES (5422)
GSP2053	BKR6EK (2288)
GSP2055	PFR6B-11 (4014)
GSP2056	BP6HS (4511)
GSP2059	BKR6EQUP (3199)
GSP2064	BCPR6ET (2197)
GSP2065	BP5HS (4111)
GSP2066	BKR6EKC (2848)
GSP2070	BKR6EKC (2848)
GSP2071	ZFR4F-11 (4043)
GSP2072	ZFR6F-11 (4291)
GSP2073	BKUR5ET (2789)
GSP2074	BPR6EIX (6637)
GSP2075	BP7HS (5111)
GSP2081	BPR6ES-11 (4824)
GSP2082	BPR7EIX (4055)
GSP2085	BCPR7ES-11 (1095)
GSP2086	B8EFS (1049)
GSP2087	BKUR6ET-10 (2397)

UNIPART	→ NGK
GSP2088	BCPR6ET (2197)
GSP2090	BR7ES (5122)
GSP2094	BP5EFS (3712)
GSP2098	BP6ES (7811)
GSP2099	BP5ES (6511)
GSP2100	BCP6ES (4930)
GSP2101	BP6EFS (3812)
GSP2102	BP6EFS (3812)
GSP2103	BCP6ES (4930)
GSP2106	TR5A-10 (0005)
GSP2108	DCPR8E-N (5692)
GSP2110	BKR6E (6962)
GSP2111	BPR6ES (7822)
GSP2112	BKR6E (6962)
GSP2113	ZFR6F-11 (4291)
GSP2114	BCPR6ES-11 (7121)
GSP2115	BPR6EFS (3623)
GSP2116	BKR6E (6962)
GSP2117	BPR5ES (7422)
GSP2118	BPR6ES (7822)
GSP2119	BPR6ES-11 (4824)
GSP2120	BPR6EFS (3623)
GSP2121	BP5EFS (3712)
GSP2122	PPR6N-11 (3546)
GSP2136	BKR6EQUP (3199)
GSP2137	ILFR6B (6677)
GSP2138	ILFR5B (7113)
GSP2149	ZFR6S-Q (6449)
GSP2151	IZKR7B (7563)
GSP2212	PPR6N-11 (3546)
GSP244	BPR5ES (7422)
GSP263	BPR6ES (7822)
GSP264	BPR5ES (7422)
GSP281	BPR7ES (2023)
GSP30	B6S (3510)
GSP331	BP5EFS (3712)
GSP351	BP5EFS (3712)
GSP361	BP6EFS (3812)
GSP381	BP7EFS (3526)
GSP4154	AP6FS (2710)
GSP4266	B5HS (4210)
GSP4352	BP6ES (7811)
GSP4356	BP6HS (4511)
GSP4362	BP6ES (7811)
GSP4366	BP6HS (4511)
GSP4372	BP5ES (6511)
GSP4376	BP5HS (4111)
GSP4382	BP5ES (6511)
GSP4452	BPR7ES (2023)
GSP4462	BPR6ES (7822)
GSP4472	BPR5ES (7422)
GSP4552	BCP7ES (5030)
GSP4562	BCP6ES (4930)
GSP4563	BP6EFS (3812)
GSP4573	BP5EFS (3712)
GSP461	BPR6EFS (3623)
GSP4652	BCPR7ES (3330)
GSP4662	BKR6E (6962)
GSP4663	BPR6EFS (3623)
GSP531	BP5HS (4111)
GSP540	B5HS (4210)
GSP541	BP6HS (4511)
GSP550	B6HS (4510)
GSP560	B7HS (5110)
GSP571	BP7HS (5111)
GSP634	BCPR5ES (6130)
GSP6356	BP6HS (4511)
GSP6382	BP5ES (6511)
GSP6452	BPR7ES (2023)
GSP6462	BPR6ES (7822)
GSP6468	BPR6ES-11 (4824)
GSP6472	BPR5ES (7422)
GSP664	BKR6E (6962)
GSP665	BCP6ES (4930)

UNIPART	→ NGK
GSP6651	PTR5A-10 (5055)
GSP6652	BCPR7ES (3330)
GSP6658	BCPR7ES-11 (1095)
GSP6662	BKR6E (6962)
GSP6663	BPR6ES (3623)
GSP6668	BCPR6ES-11 (7121)
GSP684	BCPR7ES (3330)
GSP685	BCP7ES (5030)
GSP761	BP6FS (3512)
GSP881	BPR6FS (2623)
GSP9652	PFR6N-11 (3546)
GSP981	AP6FS (2710)

VAUXHALL / OPEL	→ NGK
12 140 00	BKR5EK (7956)
12 140 46	PFR6T-G (6314)
12 140 66	IFR7X7G (91039)
12 141 14	SILZNA6D9 (94051)
12 141 28	ILNAR8B7G (91970)
12 620 540	ILTR5D (5476)
12 637 197	SILZNA6D9 (94051)
12 656 517	ILNAR8B7G (91970)
12 659 684	SILZNA6D9 (94051)
12 788 884	PLFR6C-10G (1959)
25 186 682	ZFR6U-9 (90318)
25 193 473	ZFR6V-G (8894)
25 197 812	IZFR5R7G (94123)
55 490 097	ILNAR8B7G (91970)
55 562 534	PFR6T-G (6314)
55 564 748	DILFR7B10G (97218)
55 564 763	ZFR6BP-G (1748)
55 565 219	ZFR6V-G (8894)
55 576 026	IFR7X7G (91039)
90 239 568	BPR6ES (7822)
90 239 569	BPR6HS (7022)
90 336 461	BKR6ES (3783)
90 338 179	BCPR6ET (2197)
90 355 136	BPR6ES (7822)
90 356 323	BPR5ES (7422)
90 357 729	BKR6EK (2288)
90 357 780	BKR6ES (3783)
90 423 215	BKR6ES (3783)
90 512 989	BKR5EK (7956)
91 132 086	BKR5EQUB (1567)
91 132 099	LTR6B-10T (5948)
91 951 09	BKR5EK (7956)
91 958 68	BKR5EQUB (1567)
91 990 38	LTR6B-10T (5948)
93 161 199	PFR6G-9 (4377)
93 176 801	ZFR5F (5165)
95 528 735	IZFR5R7G (94123)

VESPA	→ NGK
137778	B6HS (4510)
137917	B6ES (7310)

VOLKSWAGEN - See VW GROUP

VOLVO	→ NGK
13 06 604	BPR6ES (7822)
13 06 605	BPR6ES (7822)
13 57 828	BPR7HS (6422)
13 67 528	BPR6ES (7822)
13 67 529	BPR6ES (7822)
27 16 03	BKR6E (6962)
27 17 27	BKR6E (6962)
21 72 07	BKR6EKUB (3584)
27 23 13	PFR6B (3500)
30 637 308	PFR6B (3500)
30 637 385	LF6R6D (4704)
30 650 379	PLFR6A-11 (7654)
30 731 425	TR5B-13 (4559)
30 751 468	ILFR6B (6481)
30 758 130	ILTR6G8G (96621)

VOLVO	→ NGK
30 777 349	TR6AP-13 (5809)
31 216 674	ILFR6K8 (94040)
31 286 359	DILFR6A11 (97362)
31 330 450	ILZTR6A8G (94769)
31 411 394	TR5AI-13 (90813)
35 179 80	BKR6E (6962)
86 584 74	PLFR6A-11 (7654)
86 947 49	ITR6F13 (4477)
91 467 75	BKR6ETUC (3384)
92 020 64	BKR6ETUC (3384)

VW GROUP	→ NGK
03C 905 601B	SIZFR6B8EG (96209)
03F 905 600A	IZFR6P7 (97153)
04C 905 606 A	ZKER6A-10EG (96596)
04C 905 616	ZKER6A-10EG (96596)
04E 905 601	PZKER7B8EGS (93231)
04E 905 602	PKER7A8EGS (95463)
04E 905 602D	IKER7A8EGS (94224)
04E 905 612	PZKER7B8EGS (93231)
06E 905 611	PFR6X-11 (5757)
06H 905 601A	PFR7S8EG (1675)
06H 601 621	PFR7S8EG (1675)
06K 905 601B	PLFER7A8EG (94833)
06K 905 601C	PLFER7A8EG (94833)
06K 905 601L	ILFER7C8EG (91898)
06K 905 601M	SILFER8C7ES (91006)
06K 905 611C	PLFER7A8EG (94833)
06M 905 606F	SILKGR9A7ES (93560)
06Q 905 601A	SILFER8C7ES (91006)
101 000 000AB	BP6ESZ (7639)
101 000 001AB	BP6ET (1263)
101 000 001AC	BP6ET (1263)
101 000 001AD	BP5ET-10 (5156)
101 000 001AE	BP5ET (2287)
101 000 002AB	BP6ESZ (7639)
101 000 003AA	BCP7ET (2078)
101 000 004AA	BCP7ET (2078)
101 000 005AA	BP6ET (1263)
101 000 005AB	BP6ET (1263)
101 000 005AD	BP5ET-10 (5156)
101 000 005AE	BP5ET (2287)
101 000 005AF	BP5ET (2287)
101 000 006AB	BP6ESZ (7639)
101 000 006AC	BP6ESZ (7639)
101 000 007AA	BP6ET (1263)
101 000 007AB	BP6ET (1263)
101 000 007AC	BP5ET-10 (5156)
101 000 007AD	BP6ET (1263)
101 000 016AA	PFR7B (4853)
101 000 016AB	PFR6Q (6458)
101 000 017AA	BCP7ET (2078)
101 000 026AA	BUR5ET (3377)
101 000 026AB	BUR6ET (3172)
101 000 027AA	BP6ET (1263)
101 000 027AB	BP5ET (2287)
101 000 027AC	BP5ET-10 (5156)
101 000 028AA	BCP7ET (2078)
101 000 029AB	BUR6EFSZ (6837)
101 000 033AA	BKUR6ET-10 (2397)
101 000 033AB	BKUR7ET (7873)
101 000 033AC	BKUR5ET (2789)
101 000 033AF	BKUR6ET (6437)
101 000 033AG	BKUR5ET-10 (7553)
101 000 034AA	BP6ESZ (7639)
101 000 035AB	BKR5EKU (3964)
101 000 035AH	BKR5EKUP (2890)
101 000 035HJ	BKR6EKUB (3584)
101 000 036AA	BUR6ET (3172)
101 000 036AB	BUR5ET (3377)
101 000 036AC	BUR5ET-10 (7264)
101 000 038AA	BPR5EKU (5685)
101 000 038AB	BPR5EKU (5685)
101 000 039AA	BPR5EKU (5685)

VW GROUP	→ NGK
101 000 039AB	BPR5EKU (5685)
101 000 040AC	BUR5ET (3377)
101 000 040AD	BUR6ET (3172)
101 000 040AE	BUR5ET-10 (7264)
101 000 041AC	BKUR6ET-10 (2397)
101 000 041AD	BKUR6ET (6437)
101 000 041AE	BKUR7ET (7873)
101 000 047AC	BKR6EIX (6418)
101 000 049AD	BKR6ETA-10 (7998)
101 000 050AA	BUR5ET (3377)
101 000 050AB	BUR5ET-10 (7264)
101 000 050AC	BUR6ET (3172)
101 000 051AA	BKUR6ET-10 (2397)
101 000 051AB	BKUR7ET (7873)
101 000 052AA	BUR6EFSZ (6837)
101 000 060AA	BKUR5ET-10 (7553)
101 000 062AB	PZFR5D-11 (7968)
101 000 063AA	PFR6Q (6458)
101 000 063AC	PFR7Q (7963)
101 000 065AA	BKR6ETA-10 (7998)
101 000 068AA	ZFR6S-Q (6449)
101 905 600	PZFR5J-11 (7743)
101 905 600A	PZFR6J-11 (3586)
101 905 600B	PZFR6Q-11 (5965)
101 905 601	PZFR5D-11 (7968)
101 905 601B	ZFR5P-G (6893)
101 905 601F	ZFR6T-11G (5960)
101 905 602	KR8BI (4347)
101 905 606A	IZKR7B (7563)
101 905 607	BKR6EKUE (7892)
101 905 611	PFR6U-11G (5874)
101 905 611A	PFR6X-11 (5757)
101 905 611G	PFR8S8EG (94460)
101 905 616	BKR6EQUA (6872)
101 905 617	ZFR5P-G (6893)
101 905 617C	ZFR6T-11G (5960)
101 905 618A	ZFR6T-11G (5960)
101 905 620	PZFR5N-11T (7742)
101 905 621	PFR7W-TG (5592)
101 905 621B	PFR6W-TG (5547)
101 905 621C	PFR7W-TG (5592)
101 905 622	ILZKR7A (1961)
101 905 622A	ILZKR8A (94290)
101 905 622B	ILZKR8A (94290)
101 905 626	PZFR6R (5758)
101 905 631C	PFR6Q (6458)
101 905 631G	PFR8S8EG (94460)
101 905 631H	PFR7S8EG (1675)
400 905 619	PFR7G (4364)
410 905 619	KR8BI (4347)
5F6 905 601	R7438-9 (4656)

WAUKESHA	→ NGK
110532	AB-6 (2910)
209316	AB-6 (2910)

WHITE MOBILITY	→ NGK
10-R-385	AB-6 (2910)
10R1191	AB-6 (2910)
20-7000680	AB-6 (2910)
20-7000681	AB-6 (2910)
20-7000949	AB-6 (2910)
20-7100035	AB-6 (2910)

WOLF	→ NGK
1015 306	AB6 (2910)
1018 301	BM6A (5921)
1022 304	AB6 (2910)
2000 305	BMR6A (7421)
2016 301	B7HS (5110)
2050 324	BMR6A (7421)
2085 300	BR6ES (4922)
2090 306	BPR6ES (7822)
016254800	AB-6 (2910)

YALE	→ NGK
016255000	AB-6 (2910)
016255100	AB-6 (2910)
031314500	AB-6 (2910)
063194200	AB-6 (2910)
150015100	AB-6 (2910)
150112405	AB-6 (2910)
150112406	AB-6 (2910)
150112407	AB-6 (2910)
150112408	AB-6 (2910)
150112409	AB-6 (2910)
150112410	AB-6 (2910)
150112411	AB-6 (2910)
150112413	AB-6 (2910)
150112420	AB-6 (2910)
150112427	AB-6 (2910)
150112453	BPR5FS (2423)
150112466	BPR4ES (7222)
150112473	BMR6A (7421)
150112490	BMR6A (7421)
150112494	BMR6A (7421)
220007428	AB-6 (2910)
220010987	AB-6 (2910)
220011080	AB-6 (2910)
220011107	AB-6 (2910)
220011205	AB-6 (2910)
220013371	BPR4FS (1127)
220052206	AB-6 (2910)
509295802	AB-6 (2910)
510764800	AB-6 (2910)
516484800	BPR5FS (2423)
517451800	AB-6 (2910)
5059605-35	BPR2ES (2264)
580000628	BPR4FS (1127)
580005036	BPR5FS (2423)
580008972	BPR5FS (2423)
580013445	BPR5FS (2423)

YAMAHA	→ NGK
14B-R465B-70	RO465B-10 (7506)
31926-KRM-841	CPR9EA-9 (2308)
90793 20029	BR10EIX (6801)
90793 20032	B10EG (3630)
90890 78082	BR10EIX (6801)
94700 00866	CPR8EA-9 (2306)
94700 00899	LMAR8GI-8 (92729)
94701 00039	B6HS (4510)
94701 00040	B7HS (5110)
94701 00041	B8HS (5510)
94701 00042	B9HS (5810)
94701 00043	B6ES (7310)
94701 00044	B7ES (1111)
94701 00045	B8ES (2411)
94701 00046	B9ES (2611)
94701 00050	BP7HS (5111)
94701 00061	BR8EIX (5044)
94701 00063	BR9EIX (3981)
94701 00069	B5HS (4210)
94701 00078	B5ES (6410)
94701 00108	BP6HS (4511)
94701 00110	BR7HS (4122)
94701 00111	BR6ES (4922)
94701 00112	BR7ES (5122)
94701 00113	BR8EIX (5044)
94701 00116	BP6ES (7811)
94701 00117	BP7ES (2412)
94701 00118	BP8ES (2912)
94701 00148	BR8HIX (7001)
94701 00157	D8EA (2120)
94701 00159	BP4HS (3611)
94701 00160	B8HS-10 (5126)
94701 00168	BP5HS (4111)
94701 00188	BR9ES (5722)
94701 00189	D7EA (7912)
94701 00193	BR9EIX (3981)

YAMAHA - continued

YAMAHA	→ NGK
94701 00195	BR8HS (4322)
94701 00198	BPR6HS (7022)
94701 00203	DR8ES-L (2923)
94701 00204	BR8ES (5422)
94701 00208	DR7ES (3123)
94701 00217	B7HS-10 (2129)
94701 00218	BPR7ES (2023)
94701 00219	BPR8ES (3923)
94701 00227	BPR7HS (6422)
94701 00232	BP6HS-10 (6326)
94701 00234	BPR6ES (7822)
94701 00237	BP8HS-10 (3823)
94701 00241	DPR8EA-9 (4929)
94701 00248	BR6HS (3922)
94701 00250	CR7HS (7223)
94701 00251	BR9HS (4522)
94701 00254	C7HSA (4629)
94701 00256	C6HSA (3228)
94701 00258	BPR4HS (7823)
94701 00262	DPR7EA-9 (5129)
94701 00264	BP7HS-10 (7829)
94701 00266	D9EA (2420)
94701 00268	BP8HS (2630)
94701 00273	B6HS-10 (1052)
94701 00274	BR6HS-10 (1090)
94701 00280	BPR8HS (3725)
94701 00282	CR6HS (7023)
94701 00284	BPR6EIX (6637)
94701 00285	BPR6EIX (6637)
94701 00287	DR8ES (5423)
94701 00292	BPR6HS-10 (2633)
94701 00300	CR5HS (2874)
94701 00309	BR9HS-10 (4551)
94701 00311	BR5ES (4722)
94701 00318	CR9E (6263)
94701 00328	BPR5ES (7422)
94701 00330	CR8E (1275)
94701 00333	DR8EA (7162)
94701 00340	DR9EA (3437)
94701 00345	DR7EA (7839)
94701 00353	CR7E (4578)
94701 00361	DPR9EA-9 (5329)
94701 00365	BR6FS (4323)
94701 00372	CR6HSA (2983)
94701 00375	DPR6EA-9 (5531)
94701 00395	CR9EK (4548)
94701 00403	CR9EK (4548)
94701 00406	DPR5EA-9 (2887)
94701 00408	CR9EIA-9 (6289)
94701 00422	LMAR7A-9 (4908)
94701 00434	LMAR8G (95627)
94701 00436	LMAR8A-9 (4313)
94701 00441	MR9K-9 (97162)
94702 00044	B7ES (1111)
94702 00045	B8ES (2411)
94702 00046	B9ES (2611)
94702 00149	B7HS (5110)
94702 00188	BR9ES (5722)
94702 00193	BR9EIX (3981)
94702 00195	BR8HS (4322)
94702 00204	BR8ES (5422)
94702 00211	BPMR6A (6726)
94702 00247	BR8HS-10 (1134)
94702 00248	BR6HS (3922)
94702 00249	BR5HS (3722)
94702 00271	BR7HS-10 (1098)
94702 00272	BR7HS (4122)
94702 00274	BR6HS-10 (1090)
94702 00309	BR9HS-10 (4551)
94702 00317	B9HS-10 (3626)
94702 00323	B8EG (3430)
94702 00324	BR9EG (3230)
94702 00325	B9EG (3530)
94702 00326	BR8EG (3130)

YAMAHA	→ NGK
94702 00331	BPR4ES (7222)
94702 00343	BR4ES (1097)
94702 00348	BPR2ES (2264)
94702 00349	BR7ES (5122)
94702 00357	BR9ECM (3252)
94702 00367	B10EG (3630)
94702 00368	BR10EG (3830)
94702 00372	CR6HSB (6500)
94702 00391	LF5A-11 (6376)
94702 00400	LF6A-11 (3672)
94702 00404	BKR7E (5881)
94702 00405	BKR6E (6993)
94702 00409	CR9EB (6955)
94702 00419	CR4HSB (4695)
94702 00429	LKR7E (1643)
94702 00437	LKR6E (92650)
94703 00277	BR9EIX (3981)
94703 00420	CPR7EA-9 (3901)
94709-00437	LKR6E (92650)
124190-78010	BPR4ES (7222)
160110-78011	B6HS (4510)
160232-78010	B4H (4110)
160560-78010	BPMR4A (6028)
160610-78010	BP4HS (3611)
160690-78010	BP6ES (7811)
160693-78010	BPR6ES (7822)
160769-78010	BR4HS (3322)
160793-78010	BPR5ES (7422)
160810-78010	BPR4HS (7823)
160998-78010	BPR6EY (6427)
181630-78010	BUHW (2622)

YHX - See CHINESE BRANDS

ZENOAH	→ NGK
3699-92672	BPMR8Y (2218)



IGNITION PARTS

SPARK PLUG COVERS

STANDARD PLUG COVERS



EPDM RUBBER PLUG COVERS



The NGK range of resistor covers are designed to give perfect noise suppression across all frequencies whilst engine performance is not adversely affected whatsoever.

Featuring a resistor element pressed in between the plug terminal and the high tension wire connection, the construction is extremely durable, the resistor element is long enough to prevent interior flashover, and steady resistance is maintained. Superlative ceramic materials are incorporated that resist deterioration and have small resistance variation under over-load, whilst the plug connector is made of sturdy phenolic resin, practically oblivious to tremendous heat and high tension, and very rugged rubber material. The heat press insertion makes the construction all the more tough and vibration-resistant. Special rubber liners on both ends prevent moisture from causing electrical leakage.

All motorcycle manufacturers now comply with current legislation which demands a standard of noise suppression on every vehicle. This is achieved usually by fitting NGK resistor covers though in many cases a combination of NGK resistor covers and NGK resistor spark plugs (R type) is necessary to satisfy the ministry tests. It is emphasized that despite the use of both resistor covers and spark plugs in such engines, due to the unique and superior construction of NGK products there is no loss of performance or shortening of service life.

LB05EMH and SD05FM being of tough EPDM rubber construction are intended for competition/trial applications.

COVER SYMBOLS EXPLANATION CHART

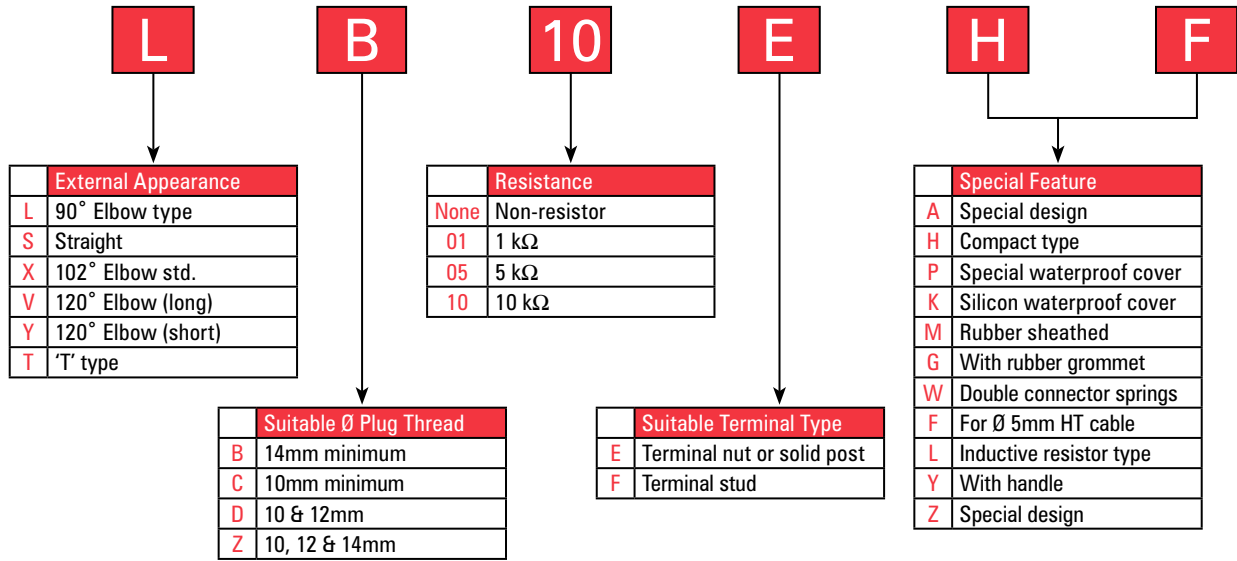

NGK RESISTOR PLUG COVERS

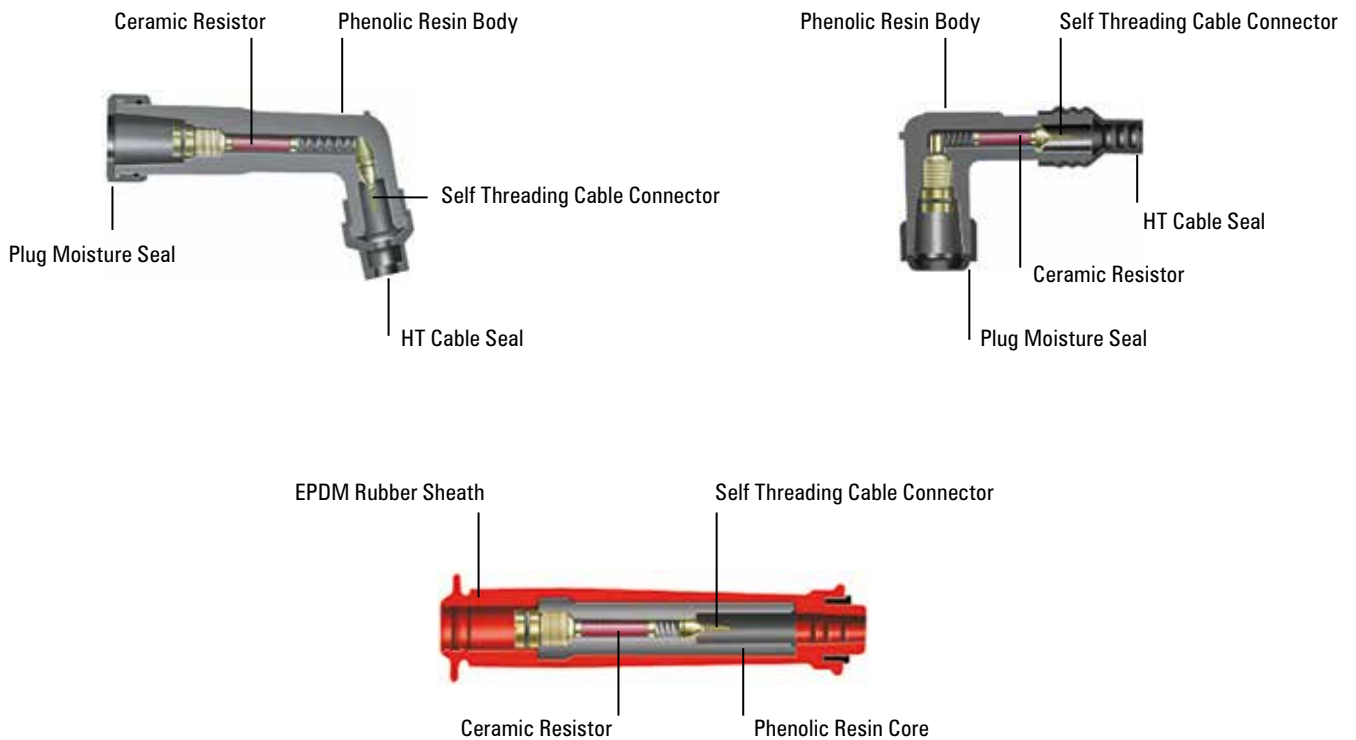

SPARK PLUG COVERS

Part No.	Stock No.	Colour	Resistor	Ø Plug	Terminal Type
LB05E	8031	Black	5 kΩ	14mm	
LB05E-R	8898	Red	5 kΩ	14mm	
LB05F	8051	Black	5 kΩ	14mm	
LB05F-R	8854	Red	5 kΩ	14mm	
LB10F-CS	8961	Black	10 kΩ	14mm	

Description: 90° Elbow Type Material: Phenolic Resin



Part No.	Stock No.	Colour	Resistor	Ø Plug	Terminal Type
LZFH	8710	Black	None	10 - 14mm	

Description: 90° Non-resistor type Material: Phenolic Resin



Part No.	Stock No.	Colour	Resistor	Ø Plug	Terminal Type
LB05EH	8334	Black	5 kΩ	14mm	
LB05EH-R	8688	Red	5 kΩ	14mm	
LB10EHF	8055	Black	10 kΩ	14mm	
LB10EHF-R	8058	Red	10 kΩ	14mm	

Description: 90° Elbow Type Material: Phenolic Resin



Part No.	Stock No.	Colour	Resistor	Ø Plug	Terminal Type
LB05EMH	8338	Black	5 kΩ	14mm	
LB05EMH-R	8160	Red	5 kΩ	14mm	

Description: 90° Rubber Sheathed Material: EPDM Rubber



Part No.	Stock No.	Colour	Resistor	Ø Plug	Terminal Type
LD05F	8060	Black	5 kΩ	10 - 12mm	
LD05F-R	8231	Red	5 kΩ	10 - 12mm	

Description: 90° Elbow Type Material: Phenolic Resin

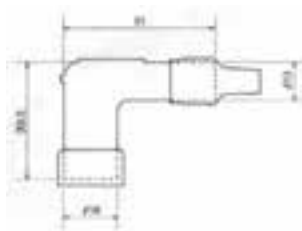

Part No.	Stock No.	Colour	Resistor	Ø Plug	Terminal Type
SB05E	8374	Black	5 kΩ	14mm	
SB05EC	8511	Red	5 kΩ	14mm	
SB05F	8080	Black	5 kΩ	14mm	
SB05F-R	8567	Red	5 kΩ	14mm	
SD05F	8022	Black	5 kΩ	10 - 12mm	
SD05F-R	8238	Red	5 kΩ	10 - 12mm	

Description: Straight Type Material: Phenolic Resin

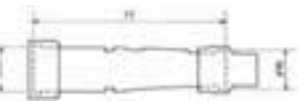

Part No.	Stock No.	Colour	Resistor	Ø Plug	Terminal Type
SD05FM	8392	Black	5 kΩ	10 - 12mm	
SD05FM-R	8673	Red	5 kΩ	10 - 12mm	

Description: Straight Rubber Sheathed Material: EPDM Rubber



Part No.	Stock No.	Colour	Resistor	Ø Plug	Terminal Type
TB05EMA	8636	Black	5 kΩ	14mm	

Description: 90° Rubber Sheathed Material: Silicon Rubber

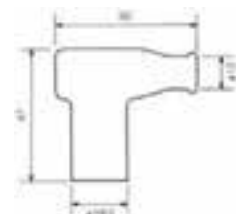



SPARK PLUG COVERS

Part No.	Stock No.	Colour	Resistor	Ø Plug	Terminal Type
XB05F	8062	Black	5 kΩ	14mm	
XB05F-R	8592	Red	5 kΩ	14mm	
XD05F	8072	Black	5 kΩ	10 - 12mm	
XD05F-R	8768	Red	5 kΩ	10 - 12mm	

Description: 102° Elbow Type Material: Phenolic Resin



Part No.	Stock No.	Colour	Resistor	Ø Plug	Terminal Type
VB05F	8032	Black	5 kΩ	14mm	
VB05F-R	8759	Red	5 kΩ	14mm	
VD05F	8052	Black	5 kΩ	10 - 12mm	
VD05F-R	8376	Red	5 kΩ	10 - 12mm	
VD05EG	5817	Black	5 kΩ	10 - 12mm	



Description: 120° Elbow (Long) Type Material: Phenolic Resin



Part No.	Stock No.	Colour	Resistor	Ø Plug	Terminal Type
YB05F	8082	Black	5 kΩ	14mm	
YB05F-R	8162	Red	5 kΩ	14mm	

Description: 120° Elbow (Short) Type Material: Phenolic Resin



Part No.	Stock No.	Colour	Resistor	Ø Plug	Terminal Type
LBER-R	8307	Red	None	14mm	
LBER-B	8308	Blue	None	14mm	

Description: 90° Rubber Sheathed Material: Silicon Rubber

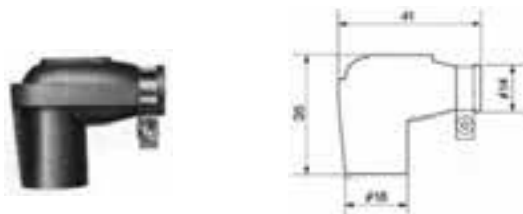

Part No.	Stock No.	Colour	Resistor	Ø Plug	Terminal Type
TRS1225-B	8787	Blue	5 kΩ	14mm	Special*

Description: 90° Compact Type Material: Silicon Rubber

***Suitable for use with R6120- □ racing spark plugs only**
***Suitable for use with R7282- □ racing spark plugs only**



Part No.	Stock No.	Colour	Resistor	Ø Plug	Terminal Type
TRS1408F-B	8871	Blue	5 kΩ	14mm	Special*

Description: 90° Compact Type Material: Silicon Rubber

***Suitable for use with R5300A- □ racing spark plugs only**

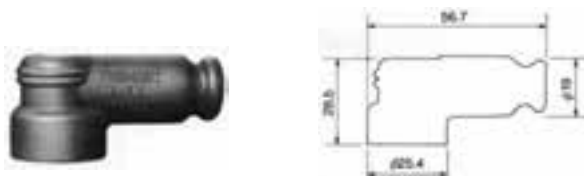

Part No.	Stock No.	Colour	Resistor	Ø Plug	Terminal Type
TRS1409-R	8733	Red	None	14mm	

Description: 90° Compact Type Material: Silicon Rubber

***Suitable for use with R5540F- □ racing spark plugs only**

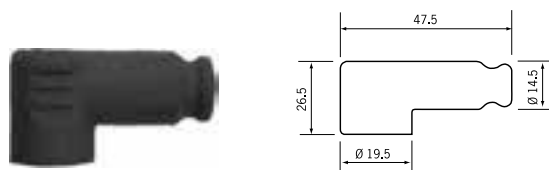

Part No.	Stock No.	Colour	Resistor	Ø Plug	Terminal Type
SD05EG	5818	Black	5 kΩ	10 - 12mm	

Description: Straight Type Material: Phenolic Resin

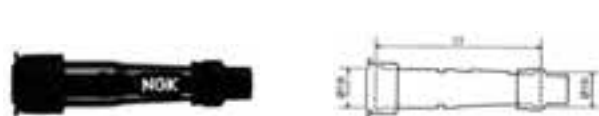

SPARK PLUG COVERS

Part No.	Stock No.	Colour	Resistor	Ø Plug	Terminal Type
L05EA	6667	Black	5 kΩ	14mm	

Description: 90° Elbow Type Material: Phenolic Resin

Application: Piaggio (various 125, 150cc)



Part No.	Stock No.	Colour	Resistor	Ø Plug	Terminal Type
V05E	6665	Black	5 kΩ	14mm	

Description: 120° Elbow (Long) Type Material: Phenolic Resin

Application: Piaggio (various 125, 150cc)



Part No.	Stock No.	Colour	Resistor	Ø Plug	Terminal Type
LB05EPK	8342	Black	5 kΩ	14mm	

Description: 90° Elbow Type Material: Phenolic Resin



Part No.	Stock No.	Colour	Resistor	Ø Plug	Terminal Type
VD05EM	8422	Black	5 kΩ	10 - 12mm	

Description: 120° Elbow (Long) Type Material: EPDM Rubber



Part No.	Stock No.	Colour	Resistor	Ø Plug	Terminal Type
LB05EZ	8744	Black	5 kΩ	14mm	

Description: 90° Elbow Type Material: Phenolic Resin

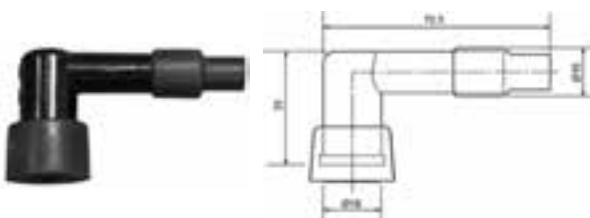

Part No.	Stock No.	Colour	Resistor	Ø Plug	Terminal Type
VD05EMH	7744	Black	5 kΩ	10 - 12mm	
VD05FMH	8425	Black	5 kΩ	10 - 12mm	

Description: 120° Elbow (Compact) Type Material: EPDM Rubber

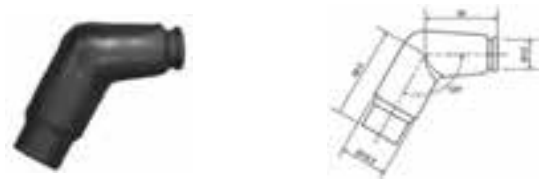

Part No.	Stock No.	Colour	Resistor	Ø Plug	Terminal Type
SD05FP	8325	Black	5 kΩ	10 - 12mm	

Description: Straight Type Material: Phenolic Resin



Part No.	Stock No.	Colour	Resistor	Ø Plug	Terminal Type
SD05FGA	8683	Black	5 kΩ	10 - 12mm	

Description: Straight with Grommet Material: Phenolic Resin

Application: Honda VT600, XL600



NTK LAMBDA SENSORS FOR MOTORCYCLES

Reducing the pollution created by the internal combustion engine is a great concern for us all. To ensure that manufacturers build cleaner engines, the allowable limits for certain polluting gases are set by various government bodies. These limits are getting ever tighter and engine designers are under great pressure to find ways of meeting the targets. A vital part of the pollution control used on many engines is the exhaust gas oxygen sensor - more commonly known as the Lambda sensor. Commonplace on cars since the 1990's, Lambda sensors have been used on motorcycles since 1999 and are now fitted to an increasing number of machines over 125cc.

WHAT DOES THE LAMBDA SENSOR DO?

The most popular method used by vehicle manufacturers to reduce engine emissions is the three-way catalyst (catalytic converter). This device has the ability to take the three main toxic gases produced by an engine which are carbon monoxide (CO), oxides of nitrogen (NO_x) and hydrocarbons (HC) and convert them to considerably less harmful, non-poisonous gases: carbon dioxide (CO₂), water (H₂O) and nitrogen (N₂).

To carry out this conversion of gases efficiently the catalyst must operate within a specified temperature range but also be provided with exhaust gases that are within certain very tight tolerances dependant predominantly on air/fuel ratio. The precise control required to operate this system is provided by the use of an exhaust gas oxygen (Lambda) sensor installed upstream of the catalyst. A Lambda sensor has the ability to precisely measure the residual oxygen present in exhaust gases. By sending a signal to the control unit it can initiate a change to keep the fuelling system operating within the very tight tolerances required. This is known as a closed-loop control system.

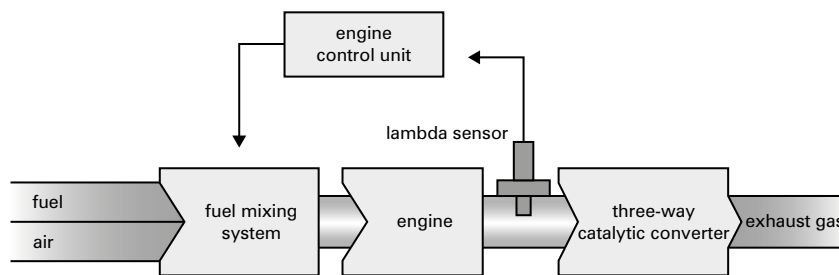

A worn or damaged sensor may affect the bike's general performance, increase fuel consumption, increase unwanted emissions and even damage the catalyst.

TECHNICAL INFORMATION

TORQUE FIGURES

Torque figures and thread form information:
M18 x 1.5 mm - 35 ~ 45Nm **M12 x 1.25 mm - 18 ~ 23Nm**

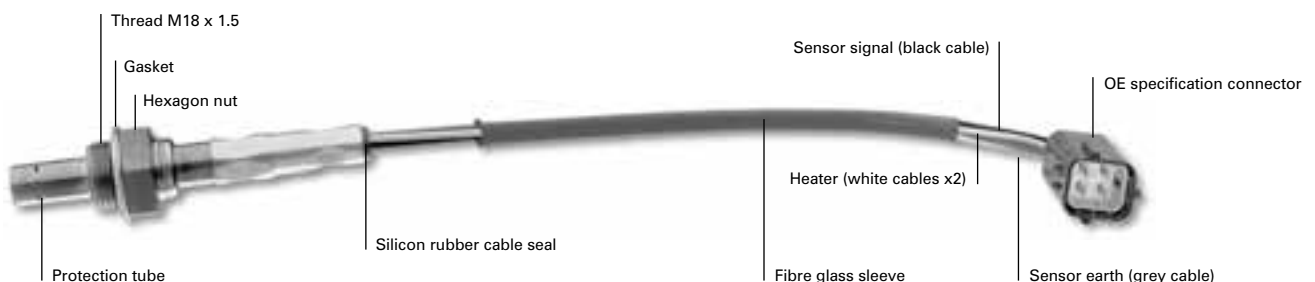

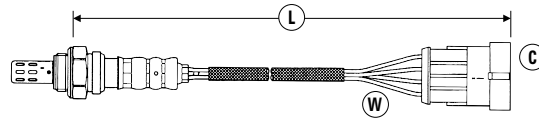

W = Number of Wires
C = Connector Type (see page 123)
L = Length of Sensor and lead (mm)

CC	MODEL	ADDITIONAL INFORMATION V: = Vin no.	ENG TYPE E: = Eng no.	DATE	W	C	L	PART NO.	STOCK NO.
APRILIA									
1000	RSV 1000 R		Rotax V2	04/04→	4	31	590	OZA591-SZ1	1767
	RSV 1000 R Factory		Rotax V2	10/03→	4	31	590	OZA591-SZ1	1767
	ETV 1000 Caponord			04→07	4	33	890	OZA222-SG2	0034

BMW									
650	F650 CS			11/01→12/03	4	68	341	OZA630-BM3	0074
	F650 CS			01/04→12/05	4	68	341	OZA630-BM3	0074
	F650 GS/GS Dakar			09/99→12/03	4	68	341	OZA630-BM3	0074
	F650 GS/GS Dakar			12/03→11/07	4	68	341	OZA630-BM3	0074
	G650 Xchallenge, Xcountry, Xmoto			07→09	4	99	231	OZA630-BM1	0072
	G650 GS			03/11→	4	68	341	OZA630-BM3	0074
	G650 GS Sertão			03/12→	4	68	341	OZA630-BM3	0074
800	F650 GS/GS Dakar			11/07→	4	99	521	OZA630-BM2	0073
	F800 GS			11/07→	4	99	521	OZA630-BM2	0073
	F800 R			05/09→	4	99	521	OZA630-BM2	0073
	F800 S/ST			12/05→	4	99	521	OZA630-BM2	0073
850	R850 R			07/02→08/05	4	69	922	OZA522-BM1	0053
	R850 RT			03/01→12/04	4	69	922	OZA522-BM1	0053
1085	R1100 S			01/03→12/03	4	69	922	OZA522-BM1	0053
1150	R1150 GS			11/01→12/03	4	69	922	OZA522-BM1	0053
	R1150 GS Adventure			11/01→09/06	4	69	922	OZA522-BM1	0053
	R1150 R			10/02→08/05	4	69	922	OZA522-BM1	0053
	R1150 RS/RT			03/01→12/04	4	69	922	OZA522-BM1	0053
1170	HP2 Enduro			12/05→11/08	4	99	231	OZA630-BM1	0072
	HP2 Megamoto			07→08	4	99	231	OZA630-BM1	0072
	HP2 Sport			08→	4	99	521	OZA630-BM2	0073
1200	K1200 GT			11/02→08/05	4	69	922	OZA522-BM1	0053
	K1200 GT			12/05→	4	99	521	OZA630-BM2	0073
	K1200 R			03/05→	4	99	521	OZA630-BM2	0073
	K1200 R Sport			11/07→	4	99	521	OZA630-BM2	0073
	K1200 S			06/04→	4	99	521	OZA630-BM2	0073
	K1200 RS			01/01→12/04	4	69	922	OZA522-BM1	0053
	R1200 C/CL			02/02→12/04	4	69	922	OZA522-BM1	0053
	R1200 GS			11/03→09	4	99	231	OZA630-BM1	0072
	R1200 RT			10/04→09	4	99	231	OZA630-BM1	0072
	R1200 S			10/05→07	4	99	231	OZA630-BM1	0072
	R1200 ST			12/04→11/07	4	99	231	OZA630-BM1	0072
1300	K1300 GT			09→	4	99	521	OZA630-BM2	0073
	K1300 R			09→	4	99	521	OZA630-BM2	0073
	K1300 S			09→	4	99	521	OZA630-BM2	0073

DUCATI									
695	Monster 695			06/04→	4	40	880	OZA591-BB3	0066
992	GT 1000			01/06→	4	40	880	OZA591-BB3	0066
	Monster S2R 1000			01/06→	4	40	880	OZA591-BB3	0066
	Paul Smart 1000			01/06→	4	40	880	OZA591-BB3	0066
	ST3, ST3S			01/04→	4	40	880	OZA591-BB3	0066
	Sport 1000			01/06→	4	40	880	OZA591-BB3	0066
998	Monster S4RS			06/04→	4	40	880	OZA591-BB3	0066

HONDA									
125	PS125i			01/06→	4	96	210	OZA577-H15	0064
	SH125i			01/05→	4	96	210	OZA577-H15	0064
1000	CBF1000			01/06→	4	80	990	OZA577-H17	0007

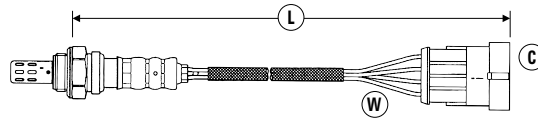

W = Number of Wires

C = Connector Type (see page 123)

L = Length of Sensor and lead (mm)

CC	MODEL	ADDITIONAL INFORMATION V: = Vin no.	ENG TYPE E: = Eng no.	DATE	W	C	L	PART NO.	STOCK NO.
HUSQVARNA									
450	TE450			09/07→	4	97	410	OZA591-WB1	0010
	SM450R			09/07→	4	97	410	OZA591-WB1	0010
510	SM510R			09/07→	4	97	410	OZA591-WB1	0010
610	SM610			10/06→	4	97	410	OZA591-WB1	0010
650	TR650 Strada			10/12→	4	99	231	OZA630-BM1	0072
	TR650 Terra			10/12→	4	99	231	OZA630-BM1	0072

HYOSUNG									
647	GT650i			01/08→	4	97	410	OZA591-WB1	0010

KTM									
999	990 Adventure / S			01/06→	4	97	500	OZA591-VB2	0009
	990 Superduke			01/06→	4	97	500	OZA591-VB2	0009

KYMCO									
200	Yager 200i			06/06→	4	31	590	OZA591-YB1	0011
250	Venox 250 Afi			06/06→	4	31	590	OZA591-YB1	0011
	Xciting 250i			06/06→	4	31	590	OZA591-YB1	0011

MOTO GUZZI									
750	Breva V750 i.e.			01/03→	4	40	310	OZA591-BB2	1710
	Nevada V750 i.e.			01/06→	4	40	310	OZA591-BB2	1710
877	Breva V850 i.e.			01/06→	4	40	310	OZA591-BB2	1710
	Griso V850 i.e.			01/06→	4	40	310	OZA591-BB2	1710
	Norge V850 i.e.			01/06→	4	40	310	OZA591-BB2	1710
1100	Breva V 1100			03/04→12/05	4	40	310	OZA341-BB1	0036
	Breva V 1100 i.e.			01/06→	4	40	310	OZA591-BB2	1710
	California			03/04→12/05	4	40	310	OZA341-BB1	0036
	California			01/06→	4	40	310	OZA591-BB2	1710
	Griso V 1100 i.e.			01/06→	4	40	310	OZA591-BB2	1710
	V11 Models			03/04→12/05	4	40	310	OZA341-BB1	0036
1150	Norge 1200			01/06→12/08	4	40	310	OZA591-BB2	1710
	Sport V 1200			01/06→12/08	4	40	310	OZA591-BB2	1710
	Stelvio 1200 4V			01/06→12/10	4	40	310	OZA591-BB2	1710

MOTO MORINI									
1187	9½			01/06→	4	40	310	OZA591-BB2	1710
	Corsaro			01/06→	4	40	310	OZA591-BB2	1710

MV AGUSTA									
910	F4 Brutale 910			10/06→12/08	4	40	310	OZA591-BB2	1710
989	Brutale 989			01/09→	4	40	310	OZA591-BB2	1710
998	F4 1000R			10/06→12/08	4	40	310	OZA591-BB2	1710
1078	Brutale 1078 RR			01/09→	4	40	310	OZA591-BB2	1710
	F4 1000			07/07→12/08	4	40	310	OZA591-BB2	1710
	F4 1078R			01/09→	4	40	310	OZA591-BB2	1710



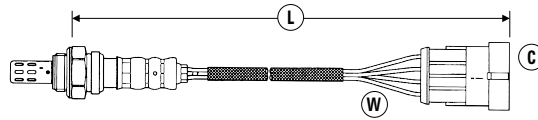



SUZUKI									
600	GSR600			01/07→12/10	4	80	690	OZA448-J4	0003
	GSX-R600			03/06→12/07	4	80	690	OZA448-J4	0003
750	GSX-R750			03/06→12/07	4	80	690	OZA448-J4	0003
1800	VZR1800 K6 M1800R Intruder			04/06→	4	80	370	OZA448-J5	0004

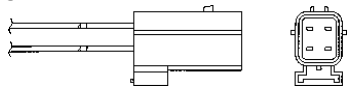
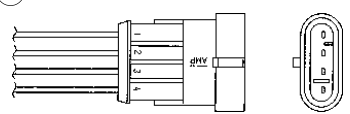

(W) = Number of Wires
 (C) = Connector Type (see page 123)
 (L) = Length of Sensor and lead (mm)

CC	MODEL	ADDITIONAL INFORMATION V: = Vin no.	ENG TYPE E: = Eng no.	DATE	(W)	(C)	(L)	PART NO.	STOCK NO.
TRIUMPH									
600	Daytona 600			01/03→12/04	4	97	640	OZA591-UB1	0067
650	Daytona 650			01/04→12/05	4	97	640	OZA591-UB1	0067
600	Speed Four			01/02→	4	97	640	OZA591-UB1	0067
885	Thunderbird Sport			01/03→12/04	4	97	640	OZA591-UB1	0067
955	Daytona 955i			01/01→12/04	4	33	890	OZA222-SG2	0034
	Speed Triple			01/01→12/05	4	33	890	OZA222-SG2	0034
	Sprint RS			01/01→12/04	4	33	890	OZA222-SG2	0034
	Sprint ST			01/01→12/04	4	33	890	OZA222-SG2	0034
	Tiger			01/03→12/07	4	33	890	OZA222-SG2	0034
1050	Sprint ST			01/05→	4	97	640	OZA591-UB1	0067
	Speed Triple			01/06→12/07	4	97	640	OZA591-UB1	0067
1600	Thunderbird			07/09→	4	80	250	AZD0101-VB004	7690
2300	Rocket III			01/04→	4	97	535	OZA591-UB2	0008
	Rocket III Classic			01/06→	4	97	535	OZA591-UB2	0008

CONNECTOR TYPES AND OE INFO

	PART NO.	STOCK NO.	MANUFACTURER	OE-No.
31 	OZA591-SZ1	1767	APRILIA	A2 C 53025886
	OZA591-YB1	0011	KYMCO	3160-0361
33 	OZA222-SG2	0034	APRILIA TRIUMPH	AP8127295 22 01 344 / 05LS002
40 	OZA341-BB1	0036	MOTO GUZZI	CA.0019 265
	OZA591-BB2	1710	MOTO GUZZI	CA.0083477.A
	OZA591-BB2	1710	MOTO MORINI	CA.0083477.A
	OZA591-BB2	1710	MV AGUSTA	CA.0083477.A
	OZA591-BB3	0066	DUCATI	CA.0083 476
68 	OZA630-BM3	0074	BMW	11787 685 320
69 	OZA522-BM1	0053	BMW	11787 671 756
80 	AZD0101-VB004	7690	TRIUMPH	22 06 500
	OZA448-J4	0003	SUZUKI	18213-01H00
	OZA448-J5	0004	SUZUKI	18213-48G00
	OZA577-H17	0007	HONDA	36531-MFA-D010-M1
96 	OZA577-H15	0064	HONDA	36531-KTF-6412-M1
97 	OZA591-UB1	0067	TRIUMPH	22 01 347
	OZA591-UB2	0008	TRIUMPH	22 01 247
	OZA591-VB2	0009	KTM	1614 833 0000
	OZA591-WB1	0010	HUSQVARNA	E 252 201
99 	OZA630-BM1	0072	BMW	11787 674 452
	OZA630-BM1	0072	HUSQVARNA	7674452
	OZA630-BM2	0073	BMW	11787 672 785

 facebook.com/ngksparkplugsuk

 [NGK UK YouTube](https://www.youtube.com/NGKUK)

 instagram.com/ngkntk_uk

 [NGK Spark Plugs \(UK\) Ltd](https://www.linkedin.com/company/ngk-spark-plugs-uk-ltd)

 ngkntk.com/uk



IGNITION
PARTS

THE OPEN ROAD AND NGK. A MATCH MADE IN HEAVEN.

Got a favourite ride? Share it with us
on instagram.com/ngkntk_uk

THE NO.1 CHOICE THE WORLD OVER

NGK Spark Plugs (UK) Limited
Maylands Avenue
Hemel Hempstead
Hertfordshire
HP2 4SD

Tel: 01442 281000
Fax: 01442 281001



IGNITION
PARTS

www.ngkntk.com/uk