

Hydraulic Hose CATALOG



MEMBERS OF THE INTERPUMP GROUP

Muncie Power Products is a leading manufacturer and distributor of power take-offs and fluid power components for the work truck industry. Since the company was founded in 1935, Muncie Power Products has taken great pride in providing unparalleled service to each and every customer.

As a member of the Interpump Group, Muncie Power Products is excited to expand its hydraulics offering by bringing the Interpump Fluid Solutions line of hose, fittings and crimpers – ***Built to INTERconnect*** – into North America. For more than 30 years, Interpump Fluid Solutions has been a leading producer of high-quality hose and fittings. With inventory available from locations in Indiana and Texas, Muncie Power Products is ready to meet the needs of the North American market.

Hydraulic Hose

International Standard Hose
High Performance Hose
Solutions for Applications
Thermoplastic Hose
P.T.F.E. Hose

We also have the following catalogs:

Introduction and Technical
Information
One-Piece Fittings
Accessories



International Standard Hose



Content Overview



Stocked in North America



Made to order

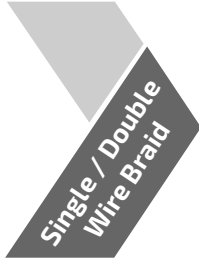

TFDM011



Hypress 15N

4

TFDM021



Hypress 25N

5

TFEM01K



INTERPUMP Hypress
15C

6

BFEM02K



INTERPUMP Hypress
25C

7

TFA001K



Hypress EASY K 15C

8

TFA002K



Hypress EASY K 25C

9



TFDM4SP



INTERPUMP Hypress
45P

10

TFD04SP



Hypress 45P

11

TFDM4SH



INTERPUMP Hypress
45H

12

TFD04SH



INTERPUMP Hypress
45H

13

TFSM012



INTERPUMP Hypress
R12

14

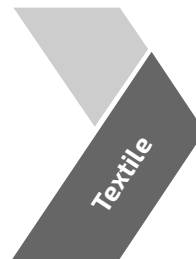

TFS0003



EN854 SAE 100R3

15

TFD02TE



Hypress 2TE

16

TFD03TE



EN 854 3TE

17

TFS0006



Hypress UniLock

18



TFS0004



INTERPUMP
Hy-Vacuum
- SAE 100R4

19

Single Wire Braid
Textile Cover

TFS0005



SAE 100R5

20

Isobaric

BFSM017



INTERPUMP Hypress
R17

21

TFSM013



INTERPUMP Hypress
R13

22

TFSM015



INTERPUMP Hypress
R15

23

HyPress 1SN

TFDM011



APPLICATIONS:



TYPE APPROVAL:
MSHA.

APPLICABLE SPECS.:

EXCEEDS EN 853 1SN - SAE 100R1AT - ISO 1436

No-Skive hose. Burst pressure exceeds EN standards. Impulse tested up to 2x EN standard.

Internal hose: Synthetic rubber, extruded whole without joints, of uniform thickness.

Reinforcement: 1 high tensile steel wire braid.

Covering: Anti-abrasive synthetic rubber, resistant to oils, fuels and atmospheric conditions.

Recommended fluid: Mineral and biological oils, glycol-water based, water, lubricants.

Operating temperature: -40°F to +212°F (-40°C to +100°C) Continuous; -40°F to +248°F (-40°C to +120°C) Intermittent; -40°F to +158°F (-40°C to +70°C) for water based fluids; +32°F to +158°F (0°C to +70°C) for water.

Part number	ID		Size	OD	Max WP		Min BP		Min BR		Weight		Ferrule
	in	mm		mm	bar	psi	bar	psi	mm	inch	kg/m	lb/ft	
	TFDM011-03	3/16"	4.8	03	11.8	250	3625	1000	14500	90	3.543	0.184	0.124
TFDM011-04	1/4"	6.4	04	13.4	225	3263	900	13050	100	3.937	0.231	0.155	001C-04
TFDM011-05	5/16"	8.0	05	15.0	215	3118	850	12325	115	4.528	0.254	0.171	001C-05
TFDM011-06	3/8"	9.5	06	17.4	180	2610	720	10440	130	5.118	0.338	0.227	001C-06
TFDM011-08	1/2"	12.7	08	20.6	160	2320	640	9280	180	7.087	0.415	0.279	001C-08
TFDM011-10	5/8"	16.0	10	23.7	130	1885	520	7540	200	7.874	0.477	0.321	001C-10
TFDM011-12	3/4"	19.0	12	27.7	105	1523	420	6090	240	9.449	0.618	0.415	001C-12
TFDM011-16	1 "	25.4	16	35.6	88	1276	350	5075	300	11.811	0.901	0.605	001C-16
TFDM011-20	1 1/4"	31.8	20	43.5	63	915	250	3625	420	16.535	1.270	0.853	001C-20
TFDM011-24	1 1/2"	38.1	24	50.8	50	725	200	2900	500	19.685	1.596	1.073	001C-24
TFDM011-32	2 "	50.8	32	63.6	40	580	160	2320	630	24.803	2.200	1.478	001C-32



Available with steel plated braided sleeve version (Use order code TFC0011) or stainless steel braided sleeve version (Use order code TFI0011).

Note: Approved for use with "G" Series One-Piece, No-Skive Fittings.

ih INTERPUMP **HyPress 1SN** EN 853 - DN 6 I.D. 1/4" - W.P. 225 bar/3263 psi

Hypress 2SN TFDM021

APPLICATIONS:



TYPE APPROVAL:

MSHA, LLOYD'S.

APPLICABLE SPECS.:

EN 853 2SN - SAE 100R2AT - ISO 1436



No-Skive hose. Burst pressure exceeds EN standards. Impulse tested up to 2x EN standard.

Internal hose: Synthetic rubber, extruded whole without joints, of uniform thickness.

Reinforcement: 2 high tensile steel wire braids.

Covering: Anti-abrasive synthetic rubber, resistant to oils, fuels and atmospheric conditions.

Recommended fluid: Mineral and biological oils, glycol-water based, water, lubricants.

Operating temperature: -40°F to +212°F (-40°C to +100°C) Continuous; -40°F to +248°F (-40°C to +120°C) Intermittent; -40°F to +158°F (-40°C to +70°C) for water based fluids; +32°F to +158°F (0°C to +70°C) for water.

Part number	ID		Size	OD	Max WP		Min BP		Min BR		Weight		Ferrule
	in	mm		mm	bar	psi	bar	psi	mm	inch	kg/m	lb/ft	
	TFDM021-03	3/16"	4.8	03	13.5	415	6018	1650	23925	90	3.543	0.317	
TFDM021-04	1/4"	6.4	04	15.0	400	5800	1600	23200	100	3.937	0.360	0.242	0022-04
TFDM021-05	5/16"	8.0	05	16.6	350	5075	1400	20300	115	4.528	0.416	0.280	0022-05
TFDM021-06	3/8"	9.5	06	19.0	330	4800	1320	19140	130	5.118	0.525	0.353	0022-06
TFDM021-08	1/2"	12.7	08	22.2	275	3988	1100	15950	180	7.087	0.620	0.417	0022-08
TFDM021-10	5/8"	16.0	10	25.4	250	3600	1000	14500	200	7.874	0.752	0.505	0022-10
TFDM021-12	3/4"	19.0	12	29.3	215	3118	850	12325	240	9.449	0.923	0.620	0022-12
TFDM021-16	1"	25.4	16	38.1	165	2393	650	9425	300	11.811	1.377	0.925	0022-16
TFDM021-20	1 1/4"	31.8	20	48.3	125	1813	500	7250	420	16.535	2.035	1.368	0022-20
TFDM021-24	1 1/2"	38.1	24	54.6	90	1305	360	5220	500	19.685	2.300	1.546	0022-24
TFDM021-32	2"	50.8	32	66.9	80	1160	320	4640	630	24.803	3.160	2.124	0022-32



Available with steel plated braided sleeve version (Use order code TFC0021) or stainless steel braided sleeve version (Use order code TFI0021).

Note: Approved for use with "G" Series One-Piece, No-Skive Fittings.

ih INTERPUMP **Hypress 2SN** EN 853 - DN 6 I.D. 1/4" - W.P. 400 bar/5800 psi



INTERPUMP Hypress 1SC TFEM01K



APPLICATIONS:



TYPE APPROVAL:

MSHA, ABS.

APPLICABLE SPECS.:

EXCEEDS EN 857 1SC - ISO 11237 1SC

No-Skive hose. Burst pressure exceeds EN standards. Impulse tested up to 2x EN standard.

Internal hose: Synthetic rubber, extruded whole without joints, of uniform thickness.

Reinforcement: 1 high tensile steel wire braid.

Covering: Anti-abrasive synthetic rubber, resistant to oils, fuels and atmospheric conditions.

Recommended fluid: Mineral and biological oils, glycol-water based, water, lubricants.

Operating temperature: -40°F to +248°F (-40°C to +120°C) Continuous; -40°F to +275°F (-40°C to +135°C) Intermittent; -40°F to +158°F (-40°C to +70°C) for water based fluids; +32°F to +158°F (0°C to +70°C) for water.

Part number	ID		Size	OD mm	Max WP		Min BP		Min BR		Weight		Ferrule
	in	mm			bar	psi	bar	psi	mm	inch	kg/m	lb/ft	
	TFEM01K-04	1/4"			6.4	04	12.3	225	3263	900	13050	50	
TFEM01K-05	5/16"	8.0	05	13.5	215	3118	850	12325	55	2.165	0.203	0.136	001C-05
TFEM01K-06	3/8"	9.5	06	15.7	180	2610	720	10440	60	2.362	0.248	0.167	001C-06
TFEM01K-08	1/2"	12.7	08	18.9	160	2320	640	9280	70	2.756	0.341	0.229	001C-08
TFEM01K-10	5/8"	16.0	10	22.4	130	1885	520	7540	90	3.543	0.421	0.283	001C-10
TFEM01K-12	3/4"	19.0	12	25.9	105	1523	420	6090	100	3.937	0.492	0.330	001C-12
TFEM01K-16	1"	25.4	16	33.7	88	1276	352	5104	180	7.087	0.742	0.499	001C-16

Note: Approved for use with "G" Series One-Piece, No-Skive Fittings.

ip INTERPUMP **Hypress 1SC** EN 857 - DN 12 I.D. 1/2" - W.P. 160 BAR/2320 PSI

INTERPUMP Hypress 2SC BFEM02K

APPLICATIONS:



TYPE APPROVAL:

MSHA, ABS.

APPLICABLE SPECS.:

EXCEEDS EN 857 2SC - SAE 100 R16 - ISO 11237 2SC



Compact hose with low bend radius (R16). No-Skive solution. Burst pressure exceeds EN standards. Impulse tested up to 2x EN standard.

Internal hose: Synthetic rubber, extruded whole without joints, of uniform thickness.

Reinforcement: 2 high tensile steel wire braids.

Covering: Anti-abrasive synthetic rubber, resistant to oils, fuels and atmospheric conditions.

Recommended fluid: Mineral and biological oils, glycol-water based, water, lubricants.

Operating temperature: -40°F to +248°F (-40°C to +120°C) Continuous; -40°F to +275°F (-40°C to +135°C) Intermittent; -40°F to +158°F (-40°C to +70°C) for water based fluids; +32°F to +158°F (0°C to +70°C) for water.

Part number	ID		Size	OD	Max WP		Min BP		Min BR		Weight		Ferrule
	in	mm		mm	bar	psi	bar	psi	mm	inch	kg/m	lb/ft	
	BFEM02K-04	1/4"	6.4	04	13.3	400	5800	1600	23200	50	1.969	0.281	0.189
* BFEM02K-05	5/16"	8.0	05	14.8	350	5075	1400	20300	55	2.165	0.327	0.220	001C-05
BFEM02K-06	3/8"	9.5	06	17.1	330	4785	1320	19140	65	2.559	0.418	0.281	001C-06
BFEM02K-08	1/2"	12.7	08	20.4	275	3988	1100	15950	90	3.543	0.525	0.353	001C-08
BFEM02K-10	5/8"	16.0	10	23.5	250	3625	1000	14500	100	3.937	0.627	0.421	001C-10
BFEM02K-12	3/4"	19.0	12	27.6	215	3118	860	12470	120	4.724	0.782	0.526	001C-12
BFEM02K-16	1"	25.4	16	35.8	165	2393	660	9570	150	5.906	1.176	0.790	001C-16

(*) Size -05 not currently stocked in North America.

Note: Approved for use with "G" Series One-Piece, No-Skive Fittings.



Stocked in North America

ih INTERPUMP **Hypress 2SC** EN 857 - DN 12 I.D. 1/2" - W.P. 275 BAR/3988 PSI

Hypress EASY K 1SC

TFA001K



APPLICATIONS:



APPLICABLE SPECS.:

EN 857 1SC - ISO 11237

Compact hose in accordance with EN 857 ISO 11237. No-Skive solution.

Internal hose: Synthetic rubber, extruded whole without joints, of uniform thickness.

Reinforcement: 1 high tensile steel wire braid.

Covering: Synthetic rubber resistant to oils, fuels and atmospheric conditions.

Recommended fluid: Mineral and biological oils, glycol-water based, water, lubricants.

Operating temperature: -40°F to +212°F (-40°C to +100°C); -40°F to +158°F (-40°C to +70°C) for water based fluids; +32°F to +158°F (0°C to +70°C) for water.

Part number	ID		Size	OD	Max WP		Min BP		Min BR		Weight		Ferrule
	in	mm		mm	bar	psi	bar	psi	mm	inch	kg/m	lb/ft	
	TFA001K-04	1/4"	6.4	04	12.3	225	3263	900	23200	75	2.953	0.182	0.122
TFA001K-05	5/16"	8.0	05	13.5	215	3118	860	20300	85	3.346	0.203	0.136	001C-05
TFA001K-06	3/8"	9.5	06	15.7	180	2610	720	19140	90	3.543	0.248	0.167	001C-06
TFA001K-08	1/2"	12.7	08	18.9	160	2320	640	15950	130	5.118	0.341	0.229	001C-08
TFA001K-10	5/8"	16.0	10	22.4	130	1885	520	14500	150	5.906	0.421	0.283	001C-10
TFA001K-12	3/4"	19.0	12	25.9	105	1523	420	12470	180	7.087	0.491	0.330	001C-12
TFA001K-16	1"	25.4	16	33.7	88	1276	352	9570	230	9.055	0.740	0.499	001C-16

Note: Approved for use with "G" Series One-Piece, No-Skive Fittings.

|| Hypress Easy K EN 857 - 1SC DN 19 I.D. 3/4" - W.P. 105 BAR/3118 PSI

Hypress EASY K 2SC TFA002K

APPLICATIONS:



APPLICABLE SPECS.:

EN 857 2SC - ISO 11237

Compact hose in accordance with EN 857 - ISO 11237. No-Skive solution.

Internal hose: Synthetic rubber, extruded whole without joints, of uniform thickness.

Reinforcement: 2 high tensile steel wire braids.

Covering: Synthetic rubber resistant to oils, fuels and atmospheric conditions.

Recommended fluid: Mineral and biological oils, glycol-water based, water, lubricants.

Operating temperature: -40°F to +212°F (-40°C to +100°C); -40°F to +158°F (-40°C to +70°C) for water based fluids; +32°F to +158°F (0°C to +70°C) for water.

Part number	ID		Size	OD	Max WP		Min BP		Min BR		Weight		Ferrule
	in	mm		mm	bar	psi	bar	psi	mm	inch	kg/m	lb/ft	
	TFA002K-04	1/4"	6.4	04	13.3	400	5800	1600	23200	75	2.953	0.281	0.189
TFA002K-05	5/16"	8.0	05	14.8	350	5075	1400	20300	85	3.346	0.327	0.220	001C-05
TFA002K-06	3/8"	9.5	06	17.1	330	4785	1320	19140	90	3.543	0.418	0.281	001C-06
TFA002K-08	1/2"	12.7	08	20.0	275	3988	1100	15950	130	5.118	0.525	0.353	001C-08
TFA002K-10	5/8"	16.0	10	23.2	250	3625	1000	14500	170	6.693	0.627	0.421	001C-10
TFA002K-12	3/4"	19.0	12	27.6	215	3118	860	12470	200	7.874	0.782	0.526	001C-12
TFA002K-16	1"	25.4	16	35.8	165	2393	660	9570	250	9.843	1.176	0.790	001C-16

Note: Approved for use with "G" Series One-Piece, No-Skive Fittings.

|| Hypress Easy K EN 857 - 2SC DN 6 I.D. 1/4" - W.P. 400 BAR/5800 PSI

INTERPUMP Hypress 4SP

TFDM4SP



APPLICATIONS:



TYPE APPROVAL:

MSHA, MED, DNV - GL, BV.

APPLICABLE SPECS.:

EN 856 4SP - ISO 3862 4SP

4 high tensile spiral high flexibility. High ozone and abrasion resistance.

Internal hose: Synthetic rubber, extruded whole without joints, of uniform thickness.

Reinforcement: 4 steel wire spirals.

Covering: Anti-abrasive synthetic rubber, resistant to oils, fuels and atmospheric conditions.

Recommended fluid: Petroleum-based hydraulic fluids (mineral oils), glycol-water based, water, lubricants.

Operating temperature: -40°F to +212°F (-40°C to +100°C) Continuous; -40°F to +248°F (-40°C to +120°C) Intermittent; -40°F to +158°F (-40°C to +70°C) for water based fluids; +32°F to +158°F (0°C to +70°C) for water.

Part number	ID		Size	OD mm	Max WP		Min BP		Min BR		Weight		Ferrule
	in	mm			bar	psi	bar	psi	mm	inch	kg/m	lb/ft	
	TFDM4SP-04	1/4"			6.4	04	17.8	450	6525	1800	26100	150	
TFDM4SP-06	3/8"	9.5	06	21.2	445	6453	1780	25810	180	7.087	0.790	0.531	0009-06
TFDM4SP-08	1/2"	12.7	08	24.3	415	6018	1660	24070	230	9.055	0.940	0.632	0009-08
TFDM4SP-10	5/8"	16.0	10	28.0	350	5075	1400	20300	250	9.843	1.125	0.756	0009-10
TFDM4SP-12	3/4"	19.0	12	32.0	350	5075	1400	20300	300	11.811	1.497	1.006	0009-12 (*)
TFDM4SP-16	1 "	25.4	16	39.5	280	4060	1120	16240	340	13.386	2.150	1.445	0009-16 (*)
TFDM4SP-20	1 1/4"	31.8	20	50.8	210	3045	840	12180	460	18.110	3.157	2.122	0009-20 (*)
TFDM4SP-24	1 1/2"	38.1	24	57.2	185	2683	740	10730	560	22.047	3.713	2.495	0009-24
TFDM4SP-32	2 "	50.8	32	69.8	165	2393	660	9570	660	25.984	4.870	3.273	0009-32

(*) Available no-skive solutions with ferrule BMC2-12, BMC1-16, BMC2-20.



Available with steel plated braided sleeve version (Use order code TFCM4SP) or stainless steel braided sleeve version (Use order code TFIM4SP).

Note: Approved for use with "X" Series One-Piece, No-Skive Fittings in sizes 3/4" through 2".

Hypress 4SP TFD04SP

APPLICATIONS:



APPLICABLE SPECS.:

EN 856 4SP - ISO 3862 4SP

4 high tensile spiral high flexibility. Burst pressure exceeds EN standards.

Internal hose: Synthetic rubber, extruded whole without joints, of uniform thickness.

Reinforcement: 4 steel wire spirals.

Covering: Anti-abrasive synthetic rubber, resistant to oils, fuels and atmospheric conditions.

Recommended fluid: Petroleum-based hydraulic fluids (mineral oils), glycol-water based, water, lubricants.

Operating temperature: -40°F to +212°F (-40°C to +100°C) Continuous; -40°F to +248°F (-40°C to +120°C) Intermittent; -40°F to +158°F (-40°C to +70°C) for water based fluids; +32°F to +158°F (0°C to +70°C) for water.

Part number	ID		Size	OD	Max WP		Min BP		Min BR		Weight		Ferrule
	in	mm		mm	bar	psi	bar	psi	mm	inch	kg/m	lb/ft	
	TFD04SP-04	1/4"		6.4	04	17.8	450	6525	1800	26100	150	5.906	
TFD04SP-06	3/8"	9.5	06	21.2	445	6453	1780	25810	180	7.087	0.790	0.531	0009-06
TFD04SP-08	1/2"	12.7	08	24.3	415	6018	1660	24070	230	9.055	0.940	0.632	0009-08
TFD04SP-10	5/8"	16.0	10	28.0	350	5075	1400	20300	250	9.843	1.125	0.756	0009-10
TFD04SP-12	3/4"	19.0	12	32.0	350	5075	1400	20300	300	11.811	1.497	1.006	0009-12 (*)
TFD04SP-16	1 "	25.4	16	39.5	280	4060	1120	16240	340	13.386	2.150	1.445	0009-16 (*)
TFD04SP-20	1 1/4"	31.8	20	50.8	210	3045	840	12180	460	18.110	3.157	2.122	0009-20 (*)
TFD04SP-24	1 1/2"	38.1	24	57.2	185	2683	740	10730	560	22.047	3.713	2.495	0009-24
TFD04SP-32	2 "	50.8	32	69.8	165	2393	660	9570	660	25.984	4.870	3.273	0009-32

(*) Available no-skive solutions with ferrule BMC2-12, BMC1-16, BMC2-20.



Available with steel plated braided sleeve version (Use order code TFCM4SP) or stainless steel braided sleeve version (Use order code TFIM4SP).



Compatible with Biological Oils.

Note: Approved for use with "X" Series One-Piece, No-Skive Fittings in sizes 3/4" through 2".



INTERPUMP Hypress 4SH

TFDM4SH



PREMIUM
LINE



APPLICATIONS:



TYPE APPROVAL:

MSHA, ABS, MED, DNV - GL, BV.

APPLICABLE SPECS.:

EXCEEDS EN 856 4SH - ISO 3862 4SH

Exceeds EN standard. Impulse tested up to 1,000,000 impulse cycles.

Internal hose: Synthetic rubber, extruded whole without joints, of uniform thickness.

Reinforcement: 4 steel wire spirals.

Covering: Anti-abrasive synthetic rubber, resistant to oils, fuels and atmospheric conditions. MSHA cover.

Recommended fluid: Petroleum-based hydraulic fluids (mineral oils), glycol-water based, water, lubricants.

Operating temperature: -40°F to +212°F (-40°C to +100°C) Continuous; -40°F to +248°F (-40°C to +120°C) Intermittent; -40°F to +158°F (-40°C to +70°C) for water based fluids; +32°F to +158°F (0°C to +70°C) for water.

Part number	ID		Size	OD	Max WP		Min BP		Min BR		Weight		Ferrule
	in	mm			mm	bar	psi	bar	psi	mm	inch	kg/m	
	TFDM4SH-12	3/4"	19.0	12	32.0	420	6090	1780	25810	210	8.268	1.572	1.057
TFDM4SH-16	1 "	25.4	16	38.4	385	5583	1750	25375	220	8.661	2.104	1.414	004N-16
TFDM4SH-20	1 1/4"	31.8	20	45.8	350	5075	1400	20300	400	15.748	2.550	1.714	004N-20
TFDM4SH-24	1 1/2"	38.1	24	53.5	300	4350	1250	18125	560	22.047	3.225	2.167	004N-24
TFDM4SH-32	2 "	50.8	32	68.0	250	3625	1000	14500	700	27.559	4.600	3.091	004N-32



Available with steel plated braided sleeve version (Use order code TFCM4SH) or stainless steel braided sleeve version (Use order code TFM4SH).

Note: Approved for use with "X" Series One-Piece, No-Skive Fittings.



Stocked in North America

INTERPUMP Hypress 4SH EXCEEDS ISO 3862/EN 856 - DN 19 I.D. 3/4" - W.P. 420 BAR/6090 PSI - MSHA IC 242/2

INTERPUMP Hypress 4SH TFD04SH

APPLICATIONS:



APPLICABLE SPECS.:

EXCEEDS EN 856 4SH - ISO 3862 4SH

Biological oils compatibility. Exceeds EN standard. Impulse tested up to 1,000,000 cycles. High ozone and abrasion resistance.

Internal hose: Synthetic rubber, extruded whole without joints, of uniform thickness.

Reinforcement: 4 steel wire spirals.

Covering: Anti-abrasive synthetic rubber, resistant to oils, fuels and atmospheric conditions.

Recommended fluid: Mineral and biological oils, glycol-water based, water, lubricants.

Operating temperature: -40°F to +212°F (-40°C to +100°C) Continuous; -40°F to +248°F (-40°C to +120°C) Intermittent; -40°F to +158°F (-40°C to +70°C) for water based fluids; +32°F to +158°F (0°C to +70°C) for water.

Part number	ID		Size	OD	Max WP		Min BP		Min BR		Weight		Ferrule
	in	mm		mm	bar	psi	bar	psi	mm	inch	kg/m	lb/ft	
	TFD04SH-12	3/4"		19.0	12	32.0	420	6090	1780	25810	210	8.268	
TFD04SH-16	1 "	25.4	16	38.4	385	5583	1750	25375	220	8.661	2.104	1.414	004N-16
TFD04SH-20	1 1/4"	31.8	20	45.8	350	5075	1400	20300	400	15.748	2.550	1.714	004N-20
TFD04SH-24	1 1/2"	38.1	24	53.5	300	4350	1250	18125	560	22.047	3.225	2.167	004N-24
TFD04SH-32	2 "	50.8	32	68.0	250	3625	1000	14500	700	27.559	4.600	3.091	004N-32

Note: Approved for use with "X" Series One-Piece, No-Skive Fittings.

ih INTERPUMP ■ **Hypress 4SH** EXCEEDS ISO 3862/EN 856 - DN 25 I.D. 1" - W.P. 385 BAR/5583 PSI

INTERPUMP Hypress R12

TFSM012



APPLICATIONS:



TYPE APPROVAL:

MSHA.

APPLICABLE SPECS.:

EN 856 R12 - SAE 100R12 - ISO 3862 R12

Burst pressure exceeds EN standards.

Internal hose: Synthetic rubber, extruded whole without joints, of uniform thickness.

Reinforcement: 4 steel wire spirals.

Covering: Anti-abrasive synthetic rubber, resistant to oils, fuels and atmospheric conditions. MSHA Cover.

Recommended fluid: Petroleum-based hydraulic fluids (mineral oils), glycol-water based, water, lubricants.

Operating temperature: -40°F to +250°F (-40°C to +121°C) Continuous; -40°F to +257°F (-40°C to +125°C) Intermittent; -40°F to +158°F (-40°C to +70°C) for water based fluids; +32°F to +158°F (0°C to +70°C) for water.

Part number	ID		Size	OD mm	Max WP		Min BP		Min BR		Weight		Ferrule
	in	mm			bar	psi	bar	psi	mm	inch	kg/m	lb/ft	
	** TFSM012-06	3/8"	9.5	06	20.2	280	4060	1580	22910	95	3.740	0.717	0.482
** TFSM012-08	1/2"	12.7	08	23.8	280	4060	1400	20300	110	4.331	0.881	0.592	0009-08
** TFSM012-10	5/8"	16.0	10	27.4	280	4060	1300	18850	130	5.118	1.049	0.705	0009-10
TFSM012-12	3/4"	19.0	12	30.6	280	4060	1300	18850	145	5.709	1.222	0.821	0009-12 (*)
TFSM012-16	1 "	25.4	16	37.9	280	4060	1200	17400	210	8.268	1.795	1.207	0009-16 (*)
TFSM012-20	1 1/4"	31.8	20	47.5	210	3045	1000	14500	240	9.449	2.780	1.868	0009-20
TFSM012-24	1 1/2"	38.1	24	53.8	176	2552	1000	14500	480	18.898	3.230	2.171	0009-24
TFSM012-32	2 "	50.8	32	67.0	176	2552	850	12325	600	23.622	4.290	2.883	004H-32

(*) Available in no-skive solutions using ferrule BMC1-12, BMC1-16.

(**) These sizes not currently stocked in North America.



Stocked in North America

EN854 SAE 100R3 TFS0003

APPLICATIONS:



APPLICABLE SPECS.:

SAE 100R3 - ISO 4079

Textile braided hose.

Internal hose: Oil resistant synthetic rubber.

Reinforcement: 2 textile braids.

Covering: Synthetic rubber resistant to oils, fuels and atmospheric conditions.

Recommended fluid: Petroleum-based hydraulic fluids (mineral oils), glycol-water based, water, lubricants.

Operating temperature: -40°F to +212°F (-40°C to +100°C); -40°F to +158°F (-40°C to +70°C) for water based fluids.

Part number	⊖		Size	⊘	💡		💡		🔗		Kg		Ferrule
	ID			OD	Max WP		Min BP		Min BR		Weight		
	in	mm		mm	bar	psi	bar	psi	mm	inch	kg/m	lb/ft	
TFS0003-03	3/16"	4.8	03	12.7	103	1494	412	5974	76	2.992	0.129	0.087	0003-03
TFS0003-04	1/4"	6.4	04	14.3	86	1247	344	4988	80	3.150	0.160	0.108	0003-04
TFS0003-05	5/16"	8.0	05	17.5	83	1204	332	4814	102	4.016	0.250	0.168	0003-05
TFS0003-06	3/8"	9.5	06	19.1	78	1131	312	4524	102	4.016	0.280	0.188	0003-06
TFS0003-08	1/2"	12.7	08	23.8	69	1001	276	4002	127	5.000	0.410	0.276	0003-08
TFS0003-10	5/8"	16.0	10	27.0	60	870	240	3480	140	5.512	0.470	0.316	0003-10
TFS0003-12	3/4"	19.0	12	31.8	52	754	208	3016	152	5.984	0.650	0.437	0003-12
TFS0003-16	1"	25.4	16	38.1	39	566	156	2262	203	7.992	0.830	0.558	0003-16
TFS0003-20	1 1/4"	31.8	20	44.5	26	377	104	1508	254	10.000	1.000	0.672	0003-20



Hypress 2TE

TFD02TE



APPLICATIONS:



APPLICABLE SPECS.:

EN 854 2TE

Textile braided hose.

Internal hose: Oil resistant synthetic rubber.

Reinforcement: 2 textile braids.

Covering: Synthetic rubber resistant to oils, fuels and atmospheric conditions.

Recommended fluid: Petroleum-based hydraulic fluids (mineral oils), glycol-water based, water, lubricants.

Operating temperature: -40°F to +212°F (-40°C to +100°C); -40°F to +158°F (-40°C to +70°C) for water based fluids; +32°F to +158°F (0°C to +70°C) for water.

Part number	ID		Size	OD	Max WP		Min BP		Min BR		Weight		Ferrule
	in	mm		mm	bar	psi	bar	psi	mm	inch	kg/m	lb/ft	
TFD02TE-03	3/16"	4.8	03	11.8	80	1160	320	4640	35	1.378	0.200	0.134	0007-03
TFD02TE-04	1/4"	6.4	04	13.4	75	1088	300	4350	40	1.575	0.150	0.101	0007-04
TFD02TE-05	5/16"	8.0	05	14.9	68	986	272	3944	50	1.969	0.170	0.114	0007-05
TFD02TE-06	3/8"	9.5	06	16.5	63	914	252	3654	60	2.362	0.185	0.124	0007-06
TFD02TE-08	1/2"	12.7	08	19.7	58	841	232	3364	70	2.756	0.240	0.161	0007-08
TFD02TE-10	5/8"	16.0	10	23.9	50	725	200	2900	90	3.543	0.320	0.215	0007-10
TFD02TE-12	3/4"	19.0	12	27.0	45	653	180	2610	110	4.331	0.380	0.255	0007-12
TFD02TE-16	1 "	25.4	16	34.4	40	580	160	2320	150	5.906	0.550	0.370	0007-16
TFD02TE-20	1 1/4"	31.8	20	41.4	35	508	180	1988	170	6.692	0.750	0.503	(*)

* Call our customer service team.

EN 854 3TE TFD03TE

APPLICATIONS:



APPLICABLE SPECS.:

EN 854 3TE

Textile braided hose.

Internal hose: Oil resistant synthetic rubber.

Reinforcement: 2 textile braids.

Covering: Synthetic rubber resistant to oils, fuels and atmospheric conditions.

Recommended fluid: Petroleum-based hydraulic fluids , glycol-water based, lubricants.

Operating temperature: -40°F to +212°F (-40°C to +100°C); -40°F to +158°F (-40°C to +70°C) for water based fluids; +32°F to +158°F (0°C to +70°C) for water.

Part number	ID		Size	OD mm	Max WP		Min BP		Min BR		Weight		Ferrule
	in	mm			bar	psi	bar	psi	mm	inch	kg/m	lb/ft	
	TFD03TE-03	3/16"	4.8	03	12.8	160	2320	640	9280	40	1.575	0.200	0.134
TFD03TE-04	1/4"	6.4	04	14.4	145	2103	580	8410	45	1.772	0.180	0.121	0003-04
TFD03TE-05	5/16"	8.0	05	16.9	130	1885	520	7540	55	2.165	0.240	0.161	0003-05
TFD03TE-06	3/8"	9.5	06	18.5	110	1595	440	6380	70	2.756	0.260	0.175	0003-06
TFD03TE-08	1/2"	12.7	08	21.7	93	1349	372	5394	85	3.346	0.330	0.222	0003-08
TFD03TE-10	5/8"	16.0	10	25.9	80	1160	320	4640	105	4.134	0.440	0.296	0003-10
TFD03TE-12	3/4"	19.0	12	29.0	70	1015	280	4060	130	5.118	0.490	0.329	0003-12
TFD03TE-16	1 "	25.4	16	35.9	55	798	220	3190	150	5.906	0.670	0.450	0003-16
TFD03TE-20	1 1/4"	31.8	20	42.3	45	653	180	2610	190	7.480	0.830	0.558	0003-20
TFD03TE-24	1 1/2"	38.1	24	49.6	40	580	160	2320	240	9.449	1.050	0.706	0003-24
TFD03TE-32	2 "	50.8	32	62.3	33	479	132	1914	300	11.811	0.200	0.134	*

* Call our customer service team.



Hypress UniLock

TFS0006



APPLICATIONS:



APPLICABLE SPECS.:

SAE 100R6 - EN 854 1TE

UniLock fittings series, easy assembly, no tools or clamps required. Safety factor 4:1. Do not use for compressed air braking systems and circuits subject to high pressure impulses.

Internal hose: Oil resistant synthetic rubber.

Reinforcement: 1 textile braid.

Covering: Synthetic rubber resistant to oils, fuels and atmospheric conditions.

Recommended fluid: Petroleum-based hydraulic fluids (mineral oils), glycol-water based, water, lubricants.

Operating temperature: -40°F to +212°F (-40°C to +100°C); -40°F to +158°F (-40°C to +70°C) for water based fluids; +32°F to +158°F (0°C to +70°C) for water.

Part number	ID		Size	OD Max		Max WP		Max WP Unilock		Min BR		Weight		Ferrule
	in	mm		mm	bar	psi	bar	psi	mm	inch	kg/m	lb/ft		
* TFS0006-03	3/16"	4.8	03	11.9	34	490	-	-	50	1.969	0.099	0.067	0007-03	
TFS0006-04	1/4"	6.4	04	13.5	28	400	18	261	65	2.559	0.100	0.067	0007-04	
TFS0006-05	5/16"	8.0	05	15.1	28	400	* - on request		75	2.953	0.125	0.084	0007-05	
TFS0006-06	3/8"	9.5	06	16.7	28	400	18	261	75	2.953	0.150	0.101	0007-06	
TFS0006-08	1/2"	12.7	08	20.6	28	400	15	218	100	3.937	0.200	0.134	0007-08	
TFS0006-10	5/8"	16.0	10	23.8	24	350	-	-	125	4.921	0.250	0.168	0007-10	
TFS0006-12	3/4"	19.0	12	27.8	21	300	15	218	150	5.906	0.300	0.202	0007-12	
TFS0006-16	1 "	25.4	16	33.4	12	174	12	174	135	5.315	0.450	0.302	0007-16	

(* Size -03 not currently stocked in North America.



Stocked in North America

INTERPUMP Hy-Vacuum - SAE 100R4 TFS0004

APPLICATIONS:



APPLICABLE SPECS.:

SAE 100R4

Vacuum-resistant in accordance with SAE 100R4 specifications.

Internal hose: Oil resistant synthetic rubber.

Reinforcement: 2 textile braids + 1 helical wire.

Covering: Synthetic rubber resistant to oils, fuels and atmospheric conditions.

Recommended fluid: Petroleum-based hydraulic fluids (mineral oils), glycol-water based, water, lubricants.

Operating temperature: -40°F to +212°F (-40°C to +100°C); -40°F to +158°F (-40°C to +70°C) for water based fluids; +32°F to +158°F (0°C to +70°C) for water.

Part number	ID		Size	OD mm	Max WP		Min BP		Min BR		Weight		Ferrule
	in	mm			bar	psi	bar	psi	mm	inch	kg/m	lb/ft	
	** BFS0004-10	5/8"			16.0	10	27.0	21	305	84	1220	112	
BFS0004-12	3/4"	19.0	12	29.5	21	305	84	1220	120	4.700	0.590	0.400	0003-12
BFS0004-16	1 "	25.0	16	35.5	17	247	68	988	145	5.700	0.740	0.490	0003-16
TFS0004-20	1 1/4"	32.0	20	42.5	14	203	56	812	195	7.700	0.900	0.600	0003-20
TFS0004-24	1 1/2"	38.0	24	49.0	10	145	40	580	228	9.000	1.110	0.740	0011-24
TFS0004-32	2 "	51.0	32	62.0	7	102	28	408	300	11.800	1.430	0.960	0011-32
TFS0004-40	2 1/2"	63.5	40	76.0	4	58	16	232	355	14.000	2.180	1.460	*
TFS0004-48	3 "	76.0	48	88.0	4	58	16	232	455	17.900	2.600	1.750	*
** TFS0004-56	3 1/2"	88.9	56	103.0	3	43.5	12.5	181	530	20.866	3.370	2.260	*
** TFS0004-64	4 "	102.0	64	115.0	2.5	36	10	145	610	24.000	3.840	2.580	*

* Call our customer service team.

(**) These sizes not currently stocked in North America.



Available with steel plated braided sleeve version (Use order code TFC0004) or stainless steel braided sleeve version (Use order code TFI0004)

Stocked in North America

ih INTERPUMP Hy-Vacuum SAE 100 R4 - DN 19 I.D. 3/4" - W.P. 21 BAR/300 PSI



SAE 100R5

TFS0005



APPLICATIONS:



APPLICABLE SPECS.:

SAE 100R5

Abrasion resistant textile braid cover. No-Skive solution available.

Internal hose: Synthetic rubber, extruded whole without joints, of uniform thickness.

Reinforcement: 1 high tensile steel wire braid.

Covering: Textile braided cover.

Recommended fluid: Petroleum-based hydraulic fluids (mineral oils), glycol-water based, water, lubricants.

Operating temperature: from -40 to +100° C petroleum based fluids (Intermittent 120°C),
from -40 to +70°C for water based fluids, from 0 to +70°C water.

Part number	ID**		OD	Max WP		Min BP		Min BR		Weight		Ferrule
	in	mm	mm	bar	psi	bar	psi	mm	inch	kg/m	lb/ft	
	TFS0005-04	3/16"	4.8	13.2	210	3045	840	12180	75	2.953	0.190	
TFS0005-05	1/4"	6.4	14.8	210	3045	840	12180	85	3.346	0.224	0.151	0003-04
TFS0005-06	5/16"	7.9	17.2	157	2277	628	9106	100	3.937	0.283	0.190	0003-05
TFS0005-08	13/32"	10.3	19.5	140	2030	560	8120	115	4.528	0.350	0.235	0003-06
TFS0005-10	1/2"	12.7	23.4	122	1769	488	7076	140	5.512	0.473	0.318	0003-08
TFS0005-12	5/8"	15.9	27.4	105	1523	420	6090	165	6.496	0.617	0.415	0003-10
TFS0005-16	7/8"	22.2	31.4	56	812	224	3248	185	7.283	0.570	0.383	0003-12
TFS0005-20	1 1/8"	28.6	38.1	43	624	172	2494	230	9.055	0.795	0.534	*
TFS0005-24	1 3/8"	34.9	44.5	35	508	140	2030	265	10.433	1.020	0.685	*
TFS0005-32	1 13/16"	46.0	56.4	24	348	96	1392	335	13.189	1.420	0.954	*

* Call our customer service team.

** SAE Dash Size is the same as the OD of tubing having approximately the same ID as the hose, expressed in 1/16's of an inch.

INTERPUMP Hypress R17 BFSM017

APPLICATIONS:



TYPE APPROVAL:

MSHA, ABS.

APPLICABLE SPECS.:

SAE 100R17 - SAE J 517 - ISO 11237 R17



Isobaric pressure rating 210 bar/3000 psi.

Internal hose: Synthetic rubber, extruded whole without joints, of uniform thickness.

Reinforcement: High tensile steel. 1 braid up to size 1/2", 2 braids from size 5/8" onwards.

Covering: Anti-abrasive synthetic rubber, resistant to oils, fuels and atmospheric conditions.

Recommended fluid: Mineral and biological oils, glycol-water based, water, lubricants.

Operating temperature: -40°F to +248°F (-40°C to +120°C); -40°F to +158°F (-40°C to +70°C) for water based fluids; +32°F to +158°F (0°C to +70°C) for water.

Part number	ID		Size	OD mm	Max WP		Min BP		Min BR		Weight		Ferrule
	in	mm			bar	psi	bar	psi	mm	inch	kg/m	lb/ft	
BFSM017-04	1/4"	6.4	04	12.3	210	3045	840	12180	50	1.969	0.185	0.124	001C-04
BFSM017-06	3/8"	9.5	06	15.7	210	3045	840	12180	65	2.559	0.256	0.172	001C-06
BFSM017-08	1/2"	12.7	08	19.4	210	3045	840	12180	90	3.543	0.378	0.254	001C-08
BFSM017-10	5/8"	16.0	10	23.5	210	3045	840	12180	100	3.937	0.624	0.419	001C-10
BFSM017-12	3/4"	19.0	12	27.6	210	3045	840	12180	120	4.724	0.764	0.513	001C-12
BFSM017-16	1"	25.4	16	36.2	210	3045	840	12180	150	5.906	1.233	0.829	001C-16

(*) Also stocked in bulk coils, use part number TF5M017-16 to order.

Note: Approved for use with "G" Series One-Piece, No-Skive Fittings.



Stocked in North America

ih INTERPUMP **Hypress R17** SAE 100R17 - DN 6 I.D. 1/4" - W.P. 210 BAR/3045 PSI



INTERPUMP Hypress R13

TFSM013



APPLICATIONS:



TYPE APPROVAL:

MSHA., ABS.

APPLICABLE SPECS.:

EXCEEDS EN 856 SAE 100R13 - ISO 3862 R13

Isobaric pressure rating 350 bar/5000 psi. Impulse tested up to 1,000,000 cycles.

Internal hose: Synthetic rubber, extruded whole without joints, of uniform thickness.

Reinforcement: 4 high tensile steel wire spirals up to size 1", 6-spirals from size 1 ¼".

Covering: Anti-abrasive synthetic rubber, resistant to oils, fuels and atmospheric conditions.

Recommended fluid: Petroleum-based hydraulic fluids (mineral oils), glycol-water based, water, lubricants.

Operating temperature: -40°F to +250°F (-40°C to +121°C) Continuous; -40°F to +257°F (-40°C to +125°C) Intermittent; -40°F to +158°F (-40°C to +70°C) for water based fluids; +32°F to +158°F (0°C to +70°C) for water.

Part number	ID		Size	OD	Max WP		Min BP		Min BR		Weight		Ferrule
	in	mm		mm	bar	psi	bar	psi	mm	inch	kg/m	lb/ft	
	BFSM013-12	3/4"	19.0	12	32.1	350	5075	1920	27840	240	9.449	1.641	1.103
TFSM013-16	1 "	25.4	16	38.7	350	5075	1660	24070	300	11.811	2.106	1.415	0013-16
TFSM013-20	1 1/4"	31.8	20	49.7	350	5075	1520	22040	420	16.496	3.891	2.615	0013-20
TFSM013-24	1 1/2"	38.1	24	57.8	350	5075	1600	23200	500	20.000	5.210	3.501	0013-24
TFSM013-32	2 "	50.8	32	71.5	350	5075	1500	21750	635	25.000	6.840	4.596	0013-32

Note: Approved for use with "X" Series One-Piece, No-Skive Fittings.



Stocked in North America

ih INTERPUMP ■■■ Hypress R13 ISO 3862/SAE 100R13 - DN 19 I.D. 3/4" - W.P. 350 BAR/5075 PSI - MSHA-IC 242/2

INTERPUMP Hypress R15 TFSM015

APPLICATIONS:



TYPE APPROVAL:

MSHA, ABS, BV.

APPLICABLE SPECS.:

EXCEEDS SAE 100R15 - ISO 3862 R15



Isobaric line 420 bar/6000 psi - up to 2". Severe applications where a high abrasion resistance is required.

Internal hose: Synthetic rubber, extruded whole without joints, of uniform thickness.

Reinforcement: 4 high tensile steel wire spirals up to size 1", 6 spirals from size 1 ¼".

Covering: Anti-abrasive synthetic rubber, resistant to oils, fuels and atmospheric conditions.

Recommended fluid: Petroleum-based hydraulic fluids (mineral oils), glycol-water based, water, lubricants.

Operating temperature: -40°F to +250°F (-40°C to +121°C) Continuous; -40°F to +257°F (-40°C to +125°C) Intermittent; -40°F to +158°F (-40°C to +70°C) for water based fluids; +32°F to +158°F (0°C to +70°C) for water.

Part number	ID		Size	OD mm	Max WP		Min BP		Min BR		Weight		Ferrule
	in	mm			bar	psi	bar	psi	mm	inch	kg/m	lb/ft	
	TFSM015-12	3/4"	19.0	12	32.0	420	6090	1750	25375	210	10.433	1.573	1.057
TFSM015-16	1"	25.4	16	38.7	420	6090	1700	24650	240	10.433	2.116	1.422	*
TFSM015-20	1 1/4"	31.8	20	49.7	420	6090	1680	24360	265	10.433	3.891	2.615	0013-20
TFSM015-24	1 1/2"	38.1	24	57.8	420	6090	1680	24360	310	12.205	5.182	3.482	0013-24
TFSM015-32	2"	50.8	32	72.0	420	6090	1680	24360	590	23.228	6.892	4.631	0013-32

* Call our customer service team.

Available on request with antiabrasion cover (Use order code TFSP015N).

Note: Approved for use with "X" Series One-Piece, No-Skive Fittings in sizes 3/4" through 2".



Stocked in North America

INTERPUMP ■■■ **Hypress R15** ISO 3862/SAE 100R15 - DN 31 I.D. 1.1/4" - W.P. 420 BAR/6090 PSI - MSHA-IC 242/2

High Performance Hose



Stocked in North America



Made to order

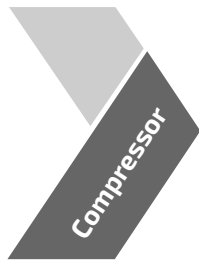

TFDC011B



INTERPUMP
Compressor

28



BFDQ011N



INTERPUMP HyCelsius
MSHA 15N

29

BFDQ021N



INTERPUMP HyCelsius
MSHA 25N

30

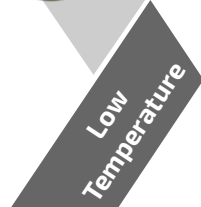

TFDL011N



INTERPUMP HyFreeze
15N

31

TFDL021N



INTERPUMP HyFreeze
25N

32



TFEM02KN



INTERPUMP HyOzone

33

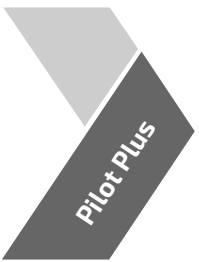

TFE0P15



INTERPUMP Pilot Plus
150

35



BHDM021



INTERPUMP Kaizen
25N

36



THEM01K



INTERPUMP 15C

37

THE002K



INTERPUMP 25C

38

THE003K



INTERPUMP 35C

39



LongLife

BHES01K



INTERPUMP LongLife
15C

40

THE102K



INTERPUMP LongLife
25C

41



Marathon

BHEMM2K



INTERPUMP
Marathon 25C

42



Green Spirals

TFDG015



INTERPUMP HyGreen
R15

43

THDB4SH



Bio-Flex

44



INTERPUMP Compressor

TFDC011B

APPLICATIONS:



APPLICABLE SPECS.:

IMM - EXCEEDS EN 853 1SN

Pinpricked hose for compressor. Do not use with bio-oil.

Internal hose: Synthetic rubber, extruded whole without joints, of uniform thickness.

Reinforcement: 1 high tensile steel wire braid.

Covering: Anti-abrasive synthetic rubber, resistant to oils, fuels and atmospheric conditions.

Recommended fluid: Mineral oils, glycols and polyglycols, transmission fluids, air, air with oil vapors, mineral oils in aqueous emulsion (up to +212°F/ + 100°C).

Operating temperature: -40°F to +248°F (-40°C to +120°C) Continuous; -40°F to +275°F (-40°C to +135°C) Intermittent.

Part number	ID		Size	OD	Max WP		Min BP		Min BR		Weight		Ferrule
	in	mm		mm	bar	psi	bar	psi	mm	inch	kg/m	lb/ft	
	TFDC011B04	1/4"	6.4	04	13.4	225	3263	900	13050	100	3.937	0.24	0.161
TFDC011B05	5/16"	8.0	05	15.0	215	3118	850	12325	115	4.528	0.278	0.187	0001-05
TFDC011B06	3/8"	9.5	06	17.4	180	2610	720	10440	130	5.118	0.367	0.247	0001-06
TFDC011B08	1/2"	12.7	08	20.6	160	2320	640	9280	180	7.087	0.437	0.294	0001-08
TFDC011B10	5/8"	16.0	10	23.7	130	1885	520	7540	200	7.874	0.524	0.352	0001-10
TFDC011B12	3/4"	19.0	12	27.7	105	1523	420	6090	240	9.449	0.653	0.439	0001-12
TFDC011B16	1 "	25.4	16	35.6	88	1276	350	5075	300	11.811	1.001	0.673	0001-16
TFDC011B20	1 1/4"	31.8	20	43.5	63	914	250	3625	420	16.535	1.435	0.964	0001-20
TFDC011B24	1 1/2"	38.1	24	54.6	50	725	200	2900	500	19.685	1.711	1.150	0001-24
TFDC011B32	2 "	50.8	32	66.9	40	580	160	2320	630	24.803	2.357	1.584	0001-32

Compressed air applications require additional safety devices. Hoses are not designed and not approved for "air brake" applications.

INTERPUMP HyCelsius 1SN

BFDQ011N

APPLICATIONS:



TYPE APPROVAL:

MSHA.

APPLICABLE SPECS.:

EN 853 1SN SAE 100R1AT



Wide temperature range. Hoses are not designed and not approved for "air brake" applications on railway and/or mobile equipment. Do not use with compressor.

Internal hose: Synthetic rubber, extruded whole without joints, of uniform thickness.

Reinforcement: 1 high tensile steel wire braid.

Covering: Anti-abrasive synthetic rubber, resistant to oils, fuels and atmospheric conditions.

Recommended fluid: Petroleum-based hydraulic fluids (mineral oils), glycol-water based, water, lubricants.

Operating temperature: -40°F to +275°F (-40°C to +135°C) Continuous; -40°F to +284°F (-40°C to +140°C) Intermittent.

Part number	ID		Size	OD mm	Max WP		Min BP		Min BR		Weight		Ferrule
	in	mm			bar	psi	bar	psi	mm	inch	kg/m	lb/ft	
	BFDQ011N04	1/4"			6.4	04	13.4	225	3263	900	13050	100	
BFDQ011N05	5/16"	8.0	05	15.0	215	3118	860	12325	115	4.528	0.252	0.169	0001-05
BFDQ011N06	3/8"	9.5	06	17.4	180	2610	720	10440	130	5.118	0.337	0.226	0001-06
BFDQ011N08	1/2"	12.7	08	20.6	160	2320	640	9280	180	7.087	0.404	0.271	0001-08
BFDQ011N10	5/8"	16.0	10	23.7	130	1885	520	7540	200	7.874	0.476	0.320	0001-10
BFDQ011N12	3/4"	19.0	12	27.7	105	1523	420	6090	240	9.449	0.601	0.404	0001-12
BFDQ011N16	1 "	25.4	16	35.6	88	1276	352	5075	300	11.811	0.903	0.607	0001-16
TFDQ011N20	1 1/4"	31.8	20	43.5	63	914	252	3625	420	16.535	1.272	0.855	0001-20
TFDQ011N24	1 1/2"	38.1	24	50.8	50	725	200	2900	500	19.685	1.596	1.073	0001-24
TFDQ011N32	2 "	50.8	32	63.6	40	580	160	2320	630	24.803	2.222	1.493	0001-32
TFDQ011N40	2 1/2"	63.5	40	77.4	30	435	120	1741	760	29.921	2.755	1.851	0001-40

Note: Approved for use with "G" Series One-Piece, No-Skive Fittings.

INTERPUMP HyCelsius 2SN

BFDQ021N



APPLICATIONS:



TYPE APPROVAL:

MSHA.

APPLICABLE SPECS.:

EN 853 2SN - SAE 100R2AT

Wide temperature range. Hoses are not designed and not approved for "air brake" applications on railway and/or mobile equipment. Do not use with compressor.

Internal hose: Synthetic rubber, extruded whole without joints, of uniform thickness.

Reinforcement: 2 high tensile steel wire braids.

Covering: Anti-abrasive synthetic rubber, resistant to oils, fuels and atmospheric conditions.

Recommended fluid: Petroleum-based hydraulic fluids (mineral oils), glycol-water based, water, lubricants.

Operating temperature: -40°F to +275°F (-40°C to +135°C) Continuous; -40°F to +284°F (-40°C to +140°C) Intermittent.

Part number	ID		Size	OD	Max WP		Min BP		Min BR		Weight		Ferrule
	in	mm		mm	bar	psi	bar	psi	mm	inch	kg/m	lb/ft	
	BFDQ021N04	1/4"	6.4	04	15.0	400	5800	1600	23200	100	3.937	0.357	0.240
BFDQ021N05	5/16"	8.0	05	16.6	350	5075	1400	20300	115	4.528	0.413	0.278	0002-05
BFDQ021N06	3/8"	9.5	06	19.0	330	4785	1320	19140	130	5.118	0.521	0.350	0002-06
BFDQ021N08	1/2"	12.7	08	22.2	275	3988	1100	15950	180	7.087	0.616	0.414	0002-08
BFDQ021N10	5/8"	16.0	10	25.4	250	3625	1000	14500	200	7.874	0.749	0.503	0002-10
BFDQ021N12	3/4"	19.0	12	29.3	215	3118	850	12325	240	9.449	0.920	0.618	0002-12
BFDQ021N16	1 "	25.4	16	38.1	165	2393	650	9425	300	11.811	1.375	0.924	0002-16

Note: Approved for use with "G" Series One-Piece, No-Skive Fittings.

INTERPUMP HyFreeze 1SN

TFDL011N

APPLICATIONS:



APPLICABLE SPECS.:

EN 853 1SN - SAE 100R1AT

Suitable for very cold environments.

Internal hose: Synthetic rubber, extruded whole without joints, of uniform thickness.

Reinforcement: 1 high tensile steel wire braid.

Covering: Anti-abrasive synthetic rubber, resistant to oils, fuels and atmospheric conditions.

Recommended fluid: Mineral and biological oils, glycol-water based, water, lubricants.

Operating temperature: -40°F to +212°F (-40°C to +100°C) Continuous; Minimum acceptable external temperature: -58°F (-50°C).

Part number	ID		Size	OD	Max WP		Min BP		Min BR		Weight		Ferrule
	in	mm			bar	psi	bar	psi	mm	inch	kg/m	lb/ft	
	TFDL011N04	1/4"	6.4	04	13.4	225	3263	900	13050	100	3.937	0.231	0.155
TFDL011N05	5/16"	8.0	05	15.0	215	3118	850	12325	115	4.528	0.254	0.171	0001-05
TFDL011N06	3/8"	9.5	06	17.4	180	2610	720	10440	130	5.118	0.338	0.227	0001-06
TFDL011N08	1/2"	12.7	08	20.6	160	2320	640	9280	180	7.087	0.415	0.279	0001-08
TFDL011N10	5/8"	16.0	10	23.7	130	1885	520	7540	200	7.874	0.477	0.321	0001-10
TFDL011N12	3/4"	19.0	12	27.7	105	1523	420	6090	240	9.449	0.618	0.415	0001-12
TFDL011N16	1 "	25.4	16	35.6	88	1276	350	5075	300	11.811	0.901	0.605	0001-16

Note: Approved for use with "G" Series One-Piece, No-Skive Fittings.



INTERPUMP HyFreeze 2SN

TFDL021N



APPLICATIONS:



APPLICABLE SPECS.:

EN 853 2SN - SAE 100R2AT

Suitable for very cold environments.

Internal hose: Synthetic rubber, extruded whole without joints, of uniform thickness.

Reinforcement: 2 high tensile steel wire braids.

Covering: Anti-abrasive synthetic rubber, resistant to oils, fuels and atmospheric conditions.

Recommended fluid: Mineral and biological oils, glycol-water based, water, lubricants.

Operating temperature: -40°F to +212°F (-40°C to +100°C) Continuous; Minimum acceptable external temperature: -58°F (-50°C).

Part number	ID		Size	OD	Max WP		Min BP		Min BR		Weight		Ferrule
	in	mm		mm	bar	psi	bar	psi	mm	inch	kg/m	lb/ft	
TFDL021N04	1/4"	6.4	04	15.0	400	5800	1600	23200	100	3.937	0.36	0.242	0002-04
TFDL021N05	5/16"	8.0	05	16.6	350	5075	1400	20300	115	4.528	0.416	0.280	0002-05
TFDL021N06	3/8"	9.5	06	19.0	330	4785	1320	19140	130	5.118	0.525	0.353	0002-06
TFDL021N08	1/2"	12.7	08	22.2	275	3988	1100	15950	180	7.087	0.62	0.417	0002-08
TFDL021N10	5/8"	16.0	10	25.4	250	3625	1000	14500	200	7.874	0.752	0.505	0002-10
TFDL021N12	3/4"	19.0	12	29.3	215	3118	850	12325	240	9.449	0.923	0.620	0002-12
TFDL021N16	1 "	25.4	16	38.1	165	2393	650	9425	300	11.811	1.377	0.925	0002-16
TFDL021N20	1 1/4"	31.8	20	48.3	125	1813	500	7250	420	16.535	1.99	1.337	0002-20
TFDL021N24	1 1/2"	38.1	24	54.6	90	1305	360	5220	500	19.685	2.318	1.557	0002-24
TFDL021N32	2 "	50.8	32	66.9	80	1160	320	4640	630	24.803	3.15	2.117	0002-32

Note: Approved for use with "G" Series One-Piece, No-Skive Fittings.

INTERPUMP HyOzone

TFEM02KN

APPLICATIONS:



TYPE APPROVAL:

MSHA.

APPLICABLE SPECS.:

EXCEEDS EN 857 2SC - SAE 100R16



Compact hose with low bend radius. Outstanding ozone resistance. Superior weather and UV resistance.

Internal hose: Synthetic rubber, extruded whole without joints, of uniform thickness.
Reinforcement: 2 high tensile steel wire braids.
Covering: Anti-abrasive synthetic rubber, resistant to oils, fuels and atmospheric conditions.
Recommended fluid: Mineral and biological oils, glycol-water based, water, lubricants.
Operating temperature: -40°F to +248°F (-40°C to +120°C) Continuous; -40°F to +275°F (-40°C to +135°C) Intermittent; -40°F to +158°F (-40°C to +70°C) for water based fluids.

Part number	ID		Size	OD	Max WP		Min BP		Min BR		Weight		Ferrule
	in	mm		mm	bar	psi	bar	psi	mm	inch	kg/m	lb/ft	
	TFEM02KN04	1/4"		6.4	04	13.3	400	5800	1600	23200	50	1.969	
TFEM02KN05	5/16"	8.0	05	14.8	350	5075	1400	20300	55	2.165	0.33	0.222	001C-05
TFEM02KN06	3/8"	9.5	06	17.1	330	4785	1320	19140	65	2.559	0.418	0.281	001C-06
TFEM02KN08	1/2"	12.7	08	20.4	275	3988	1100	15950	90	3.543	0.525	0.353	001C-08
TFEM02KN10	5/8"	16.0	10	23.5	250	3625	1000	14500	100	3.937	0.627	0.421	001C-10
TFEM02KN12	3/4"	19.0	12	27.6	215	3118	860	12470	120	4.724	0.782	0.526	001C-12
TFEM02KN16	1"	25.4	16	35.8	165	2393	660	9570	150	5.906	1.176	0.790	001C-16

Note: Approved for use with "G" Series One-Piece, No-Skive Fittings.

Note: This product is a 2SC hose with Ozone-resistant properties due to the MSHA-Approved outer cover. Hypress 2SC (Part Number: BFEM02K) is currently stocked in North America, and is identical in performance to Interpump HyOzone. Please refer to page 7 of this catalog to order Hypress 2SC.



Muncie®
Power
Products

INTERPUMP Pilot Plus 150

TFE0P15

APPLICATIONS:



APPLICABLE SPECS.:

IMM SPECIFICATION

Lightweight. Compact design. High flexibility. Impulse tested up to 1,000,000 cycles.

Internal hose: Synthetic rubber, extruded whole without joints, of uniform thickness.

Reinforcement: 1 high tensile steel wire braid.

Covering: Anti-abrasive synthetic rubber, resistant to oils, fuels and atmospheric conditions.

Recommended fluid: Mineral and biological oils, glycol-water based, water, lubricants.

Operating temperature: -40°F to +248°F (-40°C to +120°C) Continuous; -40°F to +275°F (-40°C to +135°C) Intermittent; -40°F to +158°F (-40°C to +70°C) for water based fluids; +32°F to +158°F (0°C to +70°C) for water.

Part number	ID		Size	OD mm	Max WP		Min BP		Min BR		Weight		Ferrule
	in	mm			bar	psi	bar	psi	mm	inch	kg/m	lb/ft	
	TFE0P15-03	3/16"	4.8	03	10.5	150	2175	600	8700	20	0.787	0.15	0.101
TFE0P15-04	1/4"	6.4	04	11.5	150	2175	600	8700	25	0.984	0.163	0.109	001C-04
TFE0P15-05	5/16"	8.0	05	13.1	150	2175	600	8700	30	1.181	0.193	0.130	001C-05
TFE0P15-06	3/8"	9.5	06	14.8	150	2175	600	8700	40	1.575	0.224	0.150	001C-06
TFE0P15-08	1/2"	12.7	08	17.9	150	2175	600	8700	50	1.969	0.285	0.191	001C-08

Note: Approved for use with "G" Series One-Piece, No-Skive Fittings.

ih INTERPUMP Pilot Plus 150 DN 5 I.D. 3/16" - W.P. 15 MPa/2175 PSI

INTERPUMP Kaizen 2SN

BHDM021



APPLICATIONS:

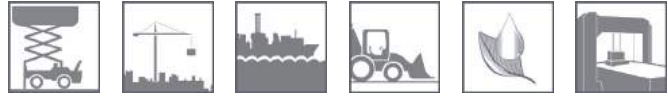

TYPE APPROVAL:

MSHA, ABS, MED, DNV - GL, RINA, BV, LLOYD'S.

APPLICABLE SPECS.:

IMM - EXCEEDS EN 853 2SN - ISO 1436 2SN

No-Skive hose. Exceeds EN specification. Impulse tested up to 1,000,000 cycles.

Internal hose: Synthetic rubber, extruded whole without joints, of uniform thickness.

Reinforcement: 2 high tensile steel wire braids.

Covering: Anti-abrasive synthetic rubber, resistant to oils, fuels and atmospheric conditions.

Recommended fluid: Mineral and biological oils, glycol-water based, water, lubricants.

Operating temperature: -40°F to +248°F (-40°C to +120°C) Continuous; -40°F to +275°F (-40°C to +135°C) Intermittent; -40°F to +158°F (-40°C to +70°C) for water based fluids; +32°F to +158°F (0°C to +70°C) for water.

Part number	ID		Size	OD	Max WP		Min BP		Min BR		Weight		Ferrule
	in	mm		mm	bar	psi	bar	psi	mm	inch	kg/m	lb/ft	
BHDM021-04	1/4"	6.4	04	15.0	420	6090	1750	25375	50	1.969	0.353	0.237	0022-04
BHDM021-06	3/8"	9.5	06	19.0	350	5075	1450	21025	70	2.756	0.515	0.346	0022-06
BHDM021-08	1/2"	12.7	08	22.2	290	4205	1200	17400	90	3.543	0.608	0.409	0022-08
BHDM021-10	5/8"	16.0	10	25.4	250	3625	1100	15950	110	4.331	0.740	0.497	0022-10
BHDM021-12	3/4"	19.0	12	29.3	215	3118	900	13050	130	5.118	0.909	0.611	0022-12
BHDM021-16	1 "	25.4	16	38.1	175	2538	700	10150	170	6.693	1.355	0.911	0022-16
THDM021-20	1 1/4"	31.8	20	48.3	140	2030	560	8120	390	15.354	2.035	1.368	0022-20
THDM021-24	1 1/2"	38.1	24	54.6	125	1813	500	7250	460	18.110	2.3	1.546	0022-24
THDM021-32	2 "	50.8	32	66.9	90	1305	420	6090	600	23.622	3.14	2.110	0022-32

Note: Approved for use with "G" Series One-Piece, No-Skive Fittings.



Stocked in North America until current quantities are depleted.

INTERPUMP 1SC

THEM01K

APPLICATIONS:



TYPE APPROVAL:

MSHA, BV.

APPLICABLE SPECS.:

EXCEEDS EN 857 1SC, ISO 11237 1SC



No-Skive hose. High abrasion resistance. Exceeds standard operating and burst pressures.

Internal hose: Synthetic rubber, extruded whole without joints, of uniform thickness.

Reinforcement: 1 high tensile steel wire braid.

Covering: Anti-abrasive synthetic rubber, resistant to oils, fuels and atmospheric conditions.

Recommended fluid: Mineral and biological oils, glycol-water based, water, lubricants.

Operating temperature: -40°F to +248°F (-40°C to +120°C) Continuous; -40°F to +275°F (-40°C to +135°C) Intermittent; -40°F to +158°F (-40°C to +70°C) for water based fluids; +32°F to +158°F (0°C to +70°C) for water.

Part number	ID		Size	OD	Max WP		Min BP		Min BR		Weight		Ferrule
	in	mm		mm	bar	psi	bar	psi	mm	inch	kg/m	lb/ft	
	THEM01KN04	1/4"		6.4	04	12.3	250	3625	1120	16240	50	1.969	
THEM01KN05	5/16"	8.0	05	13.5	250	3625	1000	14500	55	2.165	0.210	0.141	001C-05
THEM01KN06	3/8"	9.5	06	15.7	250	3625	1000	14500	60	2.362	0.248	0.167	001C-06
THEM01KN08	1/2"	12.7	08	18.9	200	2900	800	11600	70	2.756	0.391	0.263	001C-08
THEM01KN10	5/8"	16.0	10	22.4	150	2175	600	8700	90	3.453	0.410	0.276	001C-10
THEM01KN12	3/4"	19.0	12	26.0	150	2175	600	8700	100	3.937	0.534	0.359	001C-12
BHEM01K-16	1"	25.4	16	33.7	110	1595	440	6380	180	7.087	0.742	0.499	001C-16
THEM01K-20	1 1/4"	31.8	20	41.1	100	1450	400	5800	210	8.268	1.11	0.746	001C-20
THEM01K-24	1 1/2"	38.1	24	48.6	90	1305	360	5220	300	11.811	1.39	0.934	001C-24
THEM01K-32	2"	50.8	32	61.5	75	1088	300	4350	400	15.748	1.94	1.304	001C-32
THEM01K-40	2 1/2"	63.5	40	73.5	50	725	200	2900	700	29.134	2.22	1.492	001C-40
THEM01K-48	3"	76.2	48	86.0	40	580	160	2320	860	33.858	2.315	1.556	001C-48

Note: Approved for use with "G" Series One-Piece, No-Skive Fittings.

Sizes -16, -20, -24, and -32 stocked in North America.



INTERPUMP 2SC

THE002K



APPLICATIONS:

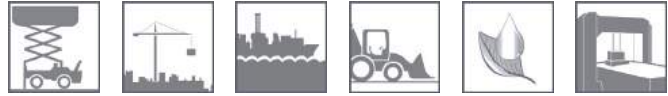

TYPE APPROVAL:

MED, DNV - GL, RINA, BV, LLOYD'S.

APPLICABLE SPECS.:

IMM - EXCEEDS DIN EN 857 2SC - ISO 11237 2SC

No-Skive hose. Exceeds EN specification. Impulse tested up to 1,000,000 cycles.

Internal hose: Synthetic rubber, extruded whole without joints, of uniform thickness.

Reinforcement: 2 high tensile steel wire braids.

Covering: Anti-abrasive synthetic rubber, resistant to oils, fuels and atmospheric conditions.

Recommended fluid: Mineral and biological oils, glycol-water based, water, lubricants.

Operating temperature: -40°F to +248°F (-40°C to +120°C) Continuous; -40°F to +275°F (-40°C to +135°C) Intermittent; -40°F to +158°F (-40°C to +70°C) for water based fluids; +32°F to +158°F (0°C to +70°C) for water.

Part number	ID		Size	OD mm	Max WP		Min BP		Min BR		Weight		Ferrule
	in	mm			bar	psi	bar	psi	mm	inch	kg/m	lb/ft	
	THE002K-04	1/4"			6.4	04	13.3	430	6235	1720	24940	50	
THE002K-05	5/16"	8.0	05	14.8	400	5800	1600	23200	60	2.362	0.329	0.221	001C-05
THE002K-06	3/8"	9.5	06	17.1	350	5075	1400	20300	70	2.756	0.422	0.283	001C-06
THE002K-08	1/2"	12.7	08	20.4	310	4495	1240	17980	80	3.150	0.517	0.347	001C-08
THE002K-10	5/8"	16.0	10	23.5	280	4060	1120	16240	100	3.937	0.626	0.421	001C-10
THE002K-12	3/4"	19.0	12	27.6	240	3480	960	13920	120	4.724	0.765	0.514	001C-12
THE002K-16	1"	25.4	16	35.8	210	3045	840	12180	160	6.299	1.171	0.787	001C-16
THE002K-20	1 1/4"	31.8	20	43.1	160	2320	640	9280	250	9.843	1.53	1.028	001C-20
THE002K-24	1 1/2"	38.1	24	50.6	150	2175	600	8700	260	10.236	2.12	1.425	001C-24
THE002K-32	2"	50.8	32	63.5	100	1450	400	5800	360	14.173	2.795	1.878	001C-32
THE002K-40	2 1/2"	63.5	40	75.6	80	1160	320	4640	600	23.622	3.224	2.167	001C-40
THE002K-48	3"	76.2	48	88.0	65	943	260	3770	760	29.921	3.471	2.333	001C-48

Note: Approved for use with "G" Series One-Piece, No-Skive Fittings.

INTERPUMP 3SC

THE003K

APPLICATIONS:

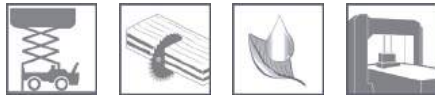

APPLICABLE SPECS.:

IMM SPECIFICATION

Compact hose. No-Skive construction. NBR tube compound compatible with several fluids. Approved up to 500,000 impulse cycles. Tested at 120% Max WP.

Internal hose: Synthetic rubber, extruded whole without joints, of uniform thickness.

Reinforcement: 3 high tensile steel wire braids.

Covering: Anti-abrasive synthetic rubber, resistant to oils, fuels and atmospheric conditions.

Recommended fluid: Mineral and biological oils, glycol-water based, water, lubricants.

Operating temperature: -40°F to +248°F (-40°C to +120°C) Continuous; -40°F to +275°F (-40°C to +135°C) Intermittent; -40°F to +158°F (-40°C to +70°C) for water based fluids; +32°F to +158°F (0°C to +70°C) for water.

Part number	ID		Size	OD	Max WP		Min BP		Min BR		Weight		Ferrule
	in	mm		mm	bar	psi	bar	psi	mm	inch	kg/m	lb/ft	
	THE003K-06	3/8"	9.5	06	18.8	500	7250	2000	29000	110	4.331	0.617	
THE003K-08	1/2"	12.7	08	22.4	475	6888	1900	27550	140	5.512	0.817	0.549	*
THE003K-10	5/8"	16.0	10	25.8	420	6090	1680	24360	200	7.874	0.931	0.625	*
THE003K-12	3/4"	19.0	12	29.7	380	5510	1520	22040	240	9.449	1.188	0.799	*
THE003K-16	1"	25.4	16	38.8	315	4568	1260	18270	300	11.811	1.946	1.308	*

* Call our customer service team.

INTERPUMP LongLife 1SC

BHES01K



APPLICATIONS:



TYPE APPROVAL:

MSHA, BV.

APPLICABLE SPECS.:

EXCEEDS EN 857 1SC- ISO 112237 1SC

No-Skive hose. High abrasion resistance. Pressure rating exceeds standards. Smooth cover.

Internal hose: Synthetic rubber, extruded whole without joints, of uniform thickness.

Reinforcement: 1 high tensile steel wire braid.

Covering: Smooth synthetic rubber, resistant to oils, fuels and atmospheric conditions.

Recommended fluid: Mineral and biological oils, glycol-water based, water, lubricants.

Operating temperature: -40°F to +248°F (-40°C to +120°C) Continuous; -40°F to +275°F (-40°C to +135°C) Intermittent; -40°F to +158°F (-40°C to +70°C) for water based fluids; +32°F to +158°F (0°C to +70°C) for water.

Part number	ID		Size	OD mm	Max WP		Min BP		Min BR		Weight		Ferrule
	in	mm			bar	psi	bar	psi	mm	inch	kg/m	lb/ft	
	BHES01K-04	1/4"			6.4	04	12.3	250	3625	1120	16240	50	
BHES01K-05	5/16"	8.0	05	13.5	250	3625	1000	14500	55	2.165	0.21	0.141	001C-05
BHES01K-06	3/8"	9.5	06	15.7	250	3625	1000	14500	60	2.362	0.248	0.167	001C-06
BHES01K-08	1/2"	12.7	08	18.9	200	2900	800	11600	70	2.756	0.391	0.263	001C-08
BHES01K-10	5/8"	16.0	10	22.4	150	2175	600	8700	90	3.543	0.41	0.276	001C-10
BHES01K-12	3/4"	19.0	12	26.0	150	2175	600	8700	100	3.937	0.534	0.359	001C-12

Note: Approved for use with "G" Series One-Piece, No-Skive Fittings.



Stocked in North America

ih INTERPUMP LongLife EXCEEDS EN 857 - 1SC DN 6 I.D. 1/4" - W.P. 25,0 MPa/3625 PSI

INTERPUMP LongLife 2SC

THE102K

APPLICATIONS:



TYPE APPROVAL:

BV.

APPLICABLE SPECS.:

EXCEEDS EN 857 2SC - ISO 11237



No-Skive hose. High abrasion resistance. Pressure rating exceeds standards. Smooth cover.

Internal hose: Synthetic rubber, extruded whole without joints, of uniform thickness.

Reinforcement: 2 high tensile steel wire braids.

Covering: Smooth synthetic rubber, resistant to oils, fuels and atmospheric conditions.

Recommended fluid: Mineral and biological oils, glycol-water based, water, lubricants.

Operating temperature: -40°F to +248°F (-40°C to +120°C) Continuous; -40°F to +275°F (-40°C to +135°C) Intermittent; -40°F to +158°F (-40°C to +70°C) for water based fluids; +32°F to +158°F (0°C to +70°C) for water.

Part number	ID		Size	OD mm	Max WP		Min BP		Min BR		Weight		Ferrule
	in	mm			bar	psi	bar	psi	mm	inch	kg/m	lb/ft	
	THE102K-04	1/4"			6.4	04	13.3	430	6235	1720	24940	50	
THE102K-05	5/16"	8.0	05	14.8	400	5800	1600	23200	60	2.362	0.324	0.218	001C-05
THE102K-06	3/8"	9.5	06	17.1	350	5075	1400	20300	70	2.756	0.418	0.281	001C-06
THE102K-08	1/2"	12.7	08	20.4	310	4495	1240	17980	80	3.150	0.521	0.350	001C-08
THE102K-10	5/8"	16.0	10	23.5	280	4060	1120	16240	100	3.937	0.626	0.421	001C-10
THE102K-12	3/4"	19.0	12	27.6	240	3480	960	13920	120	4.724	0.764	0.513	001C-12
THE102K-16	1"	25.4	16	35.8	185	2683	740	10730	160	6.299	1.171	0.787	001C-16

Note: Approved for use with "G" Series One-Piece, No-Skive Fittings.

ih INTERPUMP  **EXCEEDS EN 857 - 2SC DN 6 I.D. 1/4" - W.P. 43,0 MPa/6235 PSI**



INTERPUMP Marathon 2SC

BHEMM2K



APPLICATIONS:



TYPE APPROVAL:

MSHA, ABS, BV.

APPLICABLE SPECS.:

IMM - EXCEEDS EN 857 2SC - ISO 11237 2SC

No-Skive hose. Exceeds EN specification. Impulse tested up to 1,000,000 cycles.

Internal hose: Synthetic rubber, extruded whole without joints, of uniform thickness.

Reinforcement: 2 high tensile steel wire braids.

Covering: Anti-abrasive synthetic rubber, resistant to oils, fuels and atmospheric conditions.

Recommended fluid: Mineral and biological oils, glycol-water based, water, lubricants.

Operating temperature: -40°F to +248°F (-40°C to +120°C) Continuous; -40°F to +275°F (-40°C to +135°C) Intermittent; -40°F to +158°F (-40°C to +70°C) for water based fluids; +32°F to +158°F (0°C to +70°C) for water..

Part number	ID		Size	OD mm	Max WP		Min BP		Min BR		Weight		Ferrule
	in	mm			bar	psi	bar	psi	mm	inch	kg/m	lb/ft	
	BHEMM2K-04	1/4"			6.4	04	13.3	450	6525	1800	26100	50	
BHEMM2K-05	5/16"	8.0	05	14.8	420	6090	1680	24360	60	2.362	0.33	0.222	001C-05
BHEMM2K-06	3/8"	9.5	06	17.1	385	5583	1540	22330	70	2.756	0.422	0.284	001C-06
BHEMM2K-08	1/2"	12.7	08	20.4	350	5075	1500	21750	80	3.150	0.566	0.349	001C-08
BHEMM2K-10	5/8"	16.0	10	23.5	350	5075	1400	20300	90	3.543	0.665	0.447	001C-10
BHEMM2K-12	3/4"	19.0	12	27.6	280	4060	1120	16240	120	4.725	0.865	0.531	001C-12
BHEMM2K-16	1"	25.4	16	36.0	250	3625	1000	14500	140	5.512	1.39	0.934	0022-16

Note: Approved for use with "G" Series One-Piece, No-Skive Fittings.



Stocked in North America

ih INTERPUMP MARATHON 2SC EXCEEDS EN 857/ISO 11237 - 2SC DN 12 I.D. 1/2" - W.P. 350 BAR/5075 PSI

INTERPUMP HyGreen R15

TFDG015

APPLICATIONS:



APPLICABLE SPECS.:

EXCEEDS SAE 100R15 - ISO 3862

Compatible with biological oils. Exceeds EN standard. Impulse tested up to 1,000,000 cycles.

Internal hose: Synthetic rubber, extruded whole without joints, of uniform thickness.

Reinforcement: 4-6 high tensile steel wire spirals.

Covering: Anti-abrasive synthetic rubber, resistant to oils, fuels and atmospheric conditions.

Recommended fluid: Mineral and biological oils, glycol-water based, water, lubricants.

Operating temperature: -40°F to +250°F (-40°C to +121°C) Continuous; -40°F to +257°F (-40°C to +125°C) Intermittent; -40°F to +158°F (-40°C to +70°C) for water based fluids; +32°F to +158°F (0°C to +70°C) for water.

Part number	ID		Size	OD	Max WP		Min BP		Min BR		Weight		Ferrule
	in	mm		mm	bar	psi	bar	psi	mm	inch	kg/m	lb/ft	
	TFDG015-12	3/4"	19.0	12	32.0	420	6090	1750	25375	210	8.268	1.573	1.057
TFDG015-16	1 "	25.4	16	38.7	420	6090	1700	24650	240	9.449	2.116	1.422	004N-16
TFDG015-20	1 1/4"	31.8	20	49.7	420	6090	1680	24360	265	10.433	3.891	2.615	0013-20
TFDG015-24	1 1/2"	38.1	24	57.8	420	6090	1680	24360	310	12.205	5.182	3.482	0013-24
TFDG015-32	2 "	50.8	32	72.0	420	6090	1680	24360	590	23.228	6.892	4.631	0013-32

Note: Approved for use with "X" Series One-Piece, No-Skive Fittings.



Bio-Flex

THDB4SH



APPLICATIONS:



APPLICABLE SPECS.:

EXCEEDS EN 856 4SH - ISO 3862 4SH

Compatible with biological oils. Impulse tested up to 1,000,000 cycles. Reduced bend radius. High abrasion resistance. High ozone resistance.

Internal hose: Synthetic rubber, extruded whole without joints, of uniform thickness.

Reinforcement: 4 steel wire spirals.

Covering: Anti-abrasive synthetic rubber, resistant to oils, fuels and atmospheric conditions.

Recommended fluid: Biological and mineral oils, glycol-water based, water, lubricants.

Operating temperature: -40°F to +212°F (-40°C to +100°C) Continuous; -40°F to +248°F (-40°C to +120°C) Intermittent; -40°F to +158°F (-40°C to +70°C) for water based fluids; +32°F to +158°F (0°C to +70°C) for water.

Part number	ID		Size	OD	Max WP		Min BP		Min BR		Weight		Ferrule
	in	mm		mm	bar	psi	bar	psi	mm	inch	kg/m	lb/ft	
	THDB4SHN12	3/4"	19.0	12	32.0	420	6090	1680	24360	130	5.118	1.537	



Available with steel plated braided sleeve version (Use order code THCB4SH) or stainless steel braided sleeve version (Use order code THIB4SH).

Note: Approved for use with "X" Series One-Piece, No-Skive Fittings.

Solutions for Applications



Content Overview



Stocked in North America



Made to order



TFN0011/TFB0011



INTERPUMP Jet 1SN

48

TFN0021/TFB0021



INTERPUMP Jet 2SN

49

TFN001K/TFB001K



INTERPUMP Jet 1SC

50

TFN002K/TFB002K



INTERPUMP Jet 2SC

51



THN0011/THB0011



INTERPUMP Jet Plus
1SN

52

THN0021/THB0021



INTERPUMP Jet Plus
2SN

53

THN001K/THB001K



INTERPUMP Jet Plus
1SC

54

THN002K/THB002K



INTERPUMP Jet Plus
2SC

55



TSW2280



INTERPUMP SewerJet
280

56

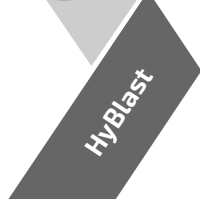

TFW0070



INTERPUMP HyBlast
10k

57

TFW0085



INTERPUMP HyBlast
12k

58

TFW0110/TFW0100



INTERPUMP HyBlast
15k

59

TFW0125/TFW0120



INTERPUMP HyBlast
18k

60

TFW0145/TFW0135



INTERPUMP HyBlast
20k

61



THL101K



INTERPUMP LongLift
15C

62

THL102K



INTERPUMP LongLift
25C

63



LongLife
Dual 15C/25C

TZE101K



INTERPUMP LongLife
Dual 15C

64

TZE102K



INTERPUMP LongLife
Dual 25C

65



Railway

TFDE011



Hypress Railway - Fire
Resistant

66



PowerLift

THE01K/THE02K



INTERPUMP PowerLift
- 15C/25C

67



HyJack

THE2J2K



INTERPUMP HyJack

68



Snow Storm

THEPS1K



Hypress Snow Storm
15C

69



HyTruck

TTRK200



INTERPUMP HyTruck
200 bar

70

TTRK250



INTERPUMP HyTruck
250 bar

71

TTRK350



INTERPUMP HyTruck
350 bar

72



Mega Drill

THEMMDR



INTERPUMP Mega
Drill

73



Mega Jet

TFS04JG/THS00JG



INTERPUMP Mega Jet

74



BOP

TBOP350



INTERPUMP BOP
Firecscreen 5000

75

INTERPUMP Jet 1SN

TFN0011 TFB0011

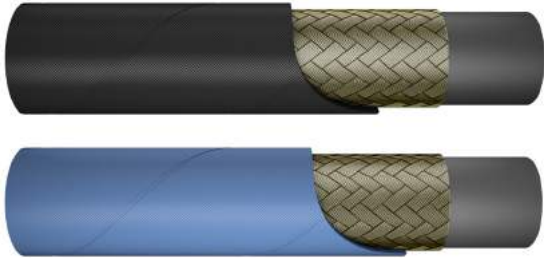

APPLICATIONS:



APPLICABLE SPECS.:

EXCEEDS EN 857 1SC - ISO 7751

No-Skive hose. Safety factor exceeds ISO 7751. Product designed for pressure wash applications. Any other use may reduce service life.

Internal hose: Synthetic rubber, extruded whole without joints, of uniform thickness.

Reinforcement: 1 high tensile steel wire braid.

Covering: Anti-abrasive synthetic rubber, resistant to oils, fuels and atmospheric conditions.

Recommended fluid: Water, water-soap based, glycol-water based.

Operating temperature: -40°F to +275°F (-40°C to +135°C) Continuous; -40°F to +311°F (-40°C to +155°C) Intermittent.

Part number	ID		Size	OD	Max WP		Min BP		Min BR		Weight		Ferrule
	in	mm		mm	bar	psi	bar	psi	mm	inch	kg/m	lb/ft	
	Black												
TFN0011N04	1/4"	6.4	04	13.4	250	3625	900	13050	100	3.937	0.231	0.155	001C-04
TFN0011N05	5/16"	8.0	05	15.0	250	3625	840	12180	115	4.528	0.254	0.171	001C-05
TFN0011N06	3/8"	9.5	06	17.4	250	3625	720	10440	130	5.118	0.338	0.227	001C-06
TFN0011N08	1/2"	12.7	08	20.6	250	3625	640	9280	180	7.087	0.415	0.279	001C-08
Blue													
TFB0011N04	1/4"	6.4	04	13.4	250	3625	900	13050	100	3.937	0.231	0.155	001C-04
TFB0011N05	5/16"	8.0	05	15.0	250	3625	840	12180	115	4.528	0.254	0.171	001C-05
TFB0011N06	3/8"	9.5	06	17.4	250	3625	720	10440	130	5.118	0.338	0.227	001C-06
TFB0011N08	1/2"	12.7	08	20.6	250	3625	640	9280	180	7.087	0.415	0.279	001C-08

Note: Approved for use with "G" Series One-Piece, No-Skive Fittings.

INTERPUMP Jet 2SN

TFN0021 TFB0021

APPLICATIONS:



APPLICABLE SPECS.:

EXCEEDS EN 853 2SN - ISO 7751

No-Skive hose. Safety factor exceeds ISO 7751. Product designed for pressure wash applications. Any other use may reduce service life.

Internal hose: Synthetic rubber, extruded whole without joints, of uniform thickness.

Reinforcement: 2 high tensile steel wire braids.

Covering: Anti-abrasive synthetic rubber, resistant to oils, fuels and atmospheric conditions.

Recommended fluid: Water, water-soap based, glycol-water based.

Operating temperature: -40°F to +275°F (-40°C to +135°C) Continuous; -40°F to +311°F (-40°C to +155°C) Intermittent.

Part number	ID		Size	OD	Max WP		Min BP		Min BR		Weight		Ferrule
	in	mm		mm	bar	psi	bar	psi	mm	inch	kg/m	lb/ft	
	Black												
TFN0021N04	1/4"	6.5	04	15.0	400	5800	1600	23200	100	3.937	0.359	0.241	0022-04
TFN0021N05	5/16"	8.0	05	16.6	400	5800	1400	20300	115	4.528	0.415	0.279	0022-05
TFN0021N06	3/8"	9.5	06	19.0	400	5800	1320	19140	130	5.118	0.525	0.353	0022-06
TFN0021N08	1/2"	12.7	08	22.2	400	5800	1100	15950	180	7.087	0.620	0.417	0022-08
Blue													
TFB0021N04	1/4"	6.5	04	15.0	400	5800	1600	23200	100	3.937	0.359	0.241	0022-04
TFB0021N05	5/16"	8.0	05	16.6	400	5800	1400	20300	115	4.528	0.415	0.279	0022-05
TFB0021N06	3/8"	9.5	06	19.0	400	5800	1320	19140	130	5.118	0.525	0.353	0022-06
TFB0021N08	1/2"	12.7	08	22.2	400	5800	1100	15950	180	7.087	0.620	0.417	0022-08

Note: Approved for use with "G" Series One-Piece, No-Skive Fittings.

INTERPUMP Jet 1SC

TFN001K TFB001K

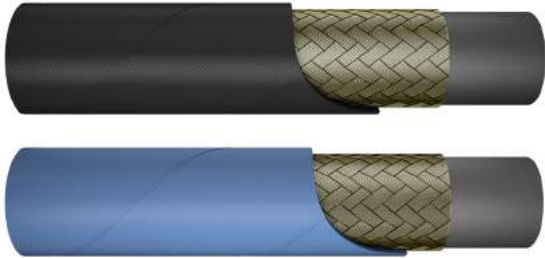

APPLICATIONS:



APPLICABLE SPECS.:

EXCEEDS EN 857 1SC - ISO 7751

No-Skive hose. Safety factor exceeds ISO 7751. Product designed for pressure wash applications. Any other use may reduce service life.

Internal hose: Synthetic rubber, extruded whole without joints, of uniform thickness.

Reinforcement: 1 high tensile steel wire braid.

Covering: Anti-abrasive synthetic rubber, resistant to oils, fuels and atmospheric conditions.

Recommended fluid: Water, water-soap based, glycol-water based.

Operating temperature: -40°F to +275°F (-40°C to +135°C) Continuous; -40°F to +311°F (-40°C to +155°C) Intermittent.

Part number	ID		Size	OD	Max WP		Min BP		Min BR		Weight		Ferrule
	in	mm		mm	bar	psi	bar	psi	mm	inch	kg/m	lb/ft	
	Black												
TFN001KN04	1/4"	6.4	04	12.3	250	3625	900	13050	75	2.953	0.182	0.122	001C-04
TFN001KN05	5/16"	8.0	05	14.0	250	3625	840	12180	85	3.346	0.203	0.136	001C-05
TFN001KN06	3/8"	9.5	06	15.6	250	3625	720	10440	90	3.543	0.256	0.172	001C-06
TFN001KN08	1/2"	12.7	08	18.7	250	3625	640	9280	130	5.118	0.341	0.229	001C-08
Blue													
TFB001KN04	1/4"	6.4	04	12.3	250	3625	900	13050	75	2.953	0.182	0.122	001C-04
TFB001KN05	5/16"	8.0	05	14.0	250	3625	840	12180	85	3.346	0.203	0.136	001C-05
TFB001KN06	3/8"	9.5	06	15.6	250	3625	720	10440	90	3.543	0.256	0.172	001C-06
TFB001KN08	1/2"	12.7	08	18.7	250	3625	640	9280	130	5.118	0.341	0.229	001C-08

Note: Approved for use with "G" Series One-Piece, No-Skive Fittings.

INTERPUMP Jet 2SC

TFN002K TFB002K

APPLICATIONS:



APPLICABLE SPECS.:

EXCEEDS EN 857 2SC - ISO 7751

No-Skive hose. Safety factor exceeds ISO 7751. Product designed for pressure wash applications. Any other use may reduce service life.

Internal hose: Synthetic rubber, extruded whole without joints, of uniform thickness.

Reinforcement: 2 high tensile steel wire braids.

Covering: Anti-abrasive synthetic rubber, resistant to oils, fuels and atmospheric conditions.

Recommended fluid: Water, water-soap based, glycol-water based.

Operating temperature: -40°F to +275°F (-40°C to +135°C) Continuous; -40°F to +311°F (-40°C to +155°C) Intermittent.

Part number	ID		Size	OD	Max WP		Min BP		Min BR		Weight		Ferrule
	in	mm		mm	bar	psi	bar	psi	mm	inch	kg/m	lb/ft	
	Black												
TFN002KN04	1/4"	6.5	04	13.3	400	5800	1600	23200	75	2.953	0.281	0.189	001C-04
TFN002KN05	5/16"	8.0	05	14.8	400	5800	1400	20300	85	3.346	0.327	0.220	001C-05
TFN002KN06	3/8"	9.5	06	17.1	400	5800	1320	19140	90	3.543	0.418	0.281	001C-06
TFN002KN08	1/2"	12.7	08	20.4	400	5800	1100	15950	130	5.118	0.525	0.353	001C-08
Blue													
TFB002KN04	1/4"	6.5	04	13.3	400	5800	1600	23200	75	2.953	0.281	0.189	001C-04
TFB002KN05	5/16"	8.0	05	14.8	400	5800	1400	20300	85	3.346	0.327	0.220	001C-05
TFB002KN06	3/8"	9.5	06	17.1	400	5800	1320	19140	90	3.543	0.418	0.281	001C-06
TFB002KN08	1/2"	12.7	08	20.4	400	5800	1100	15950	130	5.118	0.525	0.353	001C-08

Note: Approved for use with "G" Series One-Piece, No-Skive Fittings.

INTERPUMP Jet Plus 1SN

THN0011 THB0011

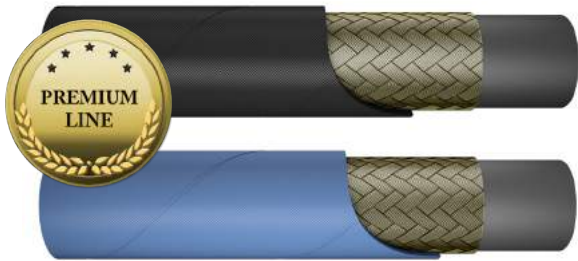

APPLICATIONS:



APPLICABLE SPECS.:

EXCEEDS EN 853 1SN - ISO 7751

No-Skive hose. Safety factor exceeds 4:1. Product designed for pressure wash applications. Any other use may reduce service life.

Internal hose: Synthetic rubber, extruded whole without joints, of uniform thickness.

Reinforcement: 1 high tensile steel wire braid.

Covering: Anti-abrasive synthetic rubber, resistant to oils, fuels and atmospheric conditions.

Recommended fluid: Water, water-soap based, glycol-water based.

Operating temperature: -40°F to +275°F (-40°C to +135°C) Continuous; -40°F to +311°F (-40°C to +155°C) Intermittent.

Part number	ID		Size	OD	Max WP		Min BP		Min BR		Weight		Ferrule
	in	mm		mm	bar	psi	bar	psi	mm	inch	kg/m	lb/ft	
Black													
THN0011-04	1/4"	6.4	04	13.4	250	3625	1000	14500	100	3.937	0.231	0.155	001C-04
THN0011-05	5/16"	8.0	05	15.0	250	3625	1000	14500	115	4.528	0.254	0.171	001C-05
THN0011-06	3/8"	9.5	06	17.4	250	3625	1000	14500	130	5.118	0.338	0.227	001C-06
THN0011-08	1/2"	12.7	08	20.6	250	3625	1000	14500	180	7.087	0.415	0.279	001C-08
Blue													
THB0011-04	1/4"	6.4	04	13.4	250	3625	1000	14500	100	3.937	0.231	0.155	001C-04
THB0011-05	5/16"	8.0	05	15.0	250	3625	1000	14500	115	4.528	0.254	0.171	001C-05
THB0011-06	3/8"	9.5	06	17.4	250	3625	1000	14500	130	5.118	0.338	0.227	001C-06
THB0011-08	1/2"	12.7	08	20.6	250	3625	1000	14500	180	7.087	0.415	0.279	001C-08

Smooth cover upon request. Available on request with AFPS GS 2014:1 - PAH Cat.2 Certified cover. Use order code THNOZ.

Note: Approved for use with "G" Series One-Piece, No-Skive Fittings.

ih INTERPUMP  **DN 6 I.D. 1/4" - W.P. 250 BAR/3625 PSI - MAX 155 °C**

INTERPUMP Jet Plus 2SN

THN0021 THB0021

APPLICATIONS:

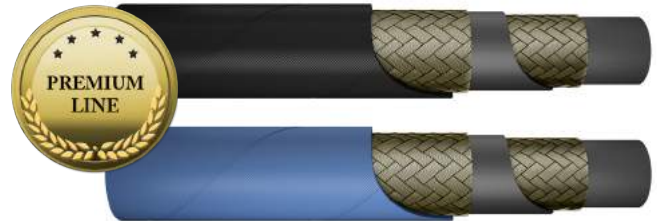

APPLICABLE SPECS.:

EXCEEDS EN 857 2SN - ISO 7751

No-Skive hose. Safety factor exceeds 4:1. Product designed for pressure wash applications. Any other use may reduce service life.

Internal hose: Synthetic rubber, extruded whole without joints, of uniform thickness.

Reinforcement: 2 high tensile steel wire braids.

Covering: Anti-abrasive synthetic rubber, resistant to oils, fuels and atmospheric conditions.

Recommended fluid: Water, water-soap based, glycol-water based.

Operating temperature: -40°F to +275°F (-40°C to +135°C) Continuous; -40°F to +311°F (-40°C to +155°C) Intermittent.

Part number	ID		Size	OD	Max WP		Min BP		Min BR		Weight		Ferrule
	in	mm		mm	bar	psi	bar	psi	mm	inch	kg/m	lb/ft	
Black													
THN0021-04	1/4"	6.5	04	15.0	400	5800	1600	23200	100	3.937	0.359	0.241	0022-04
THN0021-05	5/16"	8.0	05	16.6	400	5800	1600	23200	115	4.528	0.415	0.279	0022-05
THN0021-06	3/8"	9.5	06	19.0	400	5800	1600	23200	130	5.118	0.525	0.353	0022-06
THN0021-08	1/2"	12.7	08	22.2	400	5800	1600	23200	180	7.087	0.620	0.417	0022-08
Blue													
THB0021-04	1/4"	6.5	04	15.0	400	5800	1600	23200	100	3.937	0.359	0.241	0022-04
THB0021-05	5/16"	8.0	05	16.6	400	5800	1600	23200	115	4.528	0.415	0.279	0022-05
THB0021-06	3/8"	9.5	06	19.0	400	5800	1600	23200	130	5.118	0.525	0.353	0022-06
THB0021-08	1/2"	12.7	08	22.2	400	5800	1600	23200	180	7.087	0.620	0.417	0022-08

Smooth cover upon request. Available on request with AFPS GS 2014:1 - PAH Cat.2 Certified cover. Use order code THNOZ.

Note: Approved for use with "G" Series One-Piece, No-Skive Fittings.

ih INTERPUMP  **DN 10 I.D. 3/8" - W.P. 400 BAR/5800 PSI - MAX 155 °C**

INTERPUMP Jet Plus 1SC

THN001K THB001K

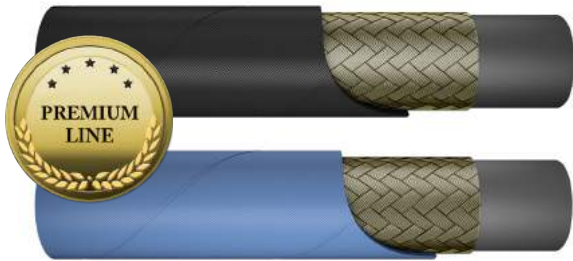

APPLICATIONS:



APPLICABLE SPECS.:

EXCEEDS EN 857 1SC - ISO 7751

No-Skive hose. Safety factor exceeds 4:1. Product designed for pressure wash applications. Any other use may reduce service life.

Internal hose: Synthetic rubber, extruded whole without joints, of uniform thickness.

Reinforcement: 1 high tensile steel wire braid.

Covering: Anti-abrasive synthetic rubber, resistant to oils, fuels and atmospheric conditions.

Recommended fluid: Water, water-soap based, glycol-water based.

Operating temperature: -40°F to +275°F (-40°C to +135°C) Continuous; -40°F to +311°F (-40°C to +155°C) Intermittent.

Part number	ID		Size	OD mm	Max WP		Min BP		Min BR		Weight		Ferrule
	in	mm			bar	psi	bar	psi	mm	inch	kg/m	lb/ft	
Black													
THN001KN04	1/4"	6.4	04	12.3	250	3625	1000	14500	75	2.953	0.182	0.122	001C-04
THN001KN05	5/16"	8.0	05	14.0	250	3625	1000	14500	85	3.346	0.203	0.136	001C-05
THN001KN06	3/8"	9.5	06	15.6	250	3625	1000	14500	90	3.543	0.256	0.172	001C-06
THN001KN08	1/2"	12.7	08	18.7	250	3625	1000	14500	130	5.118	0.341	0.229	001C-08
Blue													
THB001KN04	1/4"	6.4	04	12.3	250	3625	1000	14500	75	2.953	0.182	0.122	001C-04
THB001KN05	5/16"	8.0	05	14.0	250	3625	1000	14500	85	3.346	0.203	0.136	001C-05
THB001KN06	3/8"	9.5	06	15.6	250	3625	1000	14500	90	3.543	0.256	0.172	001C-06
THB001KN08	1/2"	12.7	08	18.7	250	3625	1000	14500	130	5.118	0.341	0.229	001C-08

Smooth cover upon request. Available on request with AFPS GS 2014:1 - PAH Cat.2 Certified cover. Use order code THNOZ.

Note: Approved for use with "G" Series One-Piece, No-Skive Fittings.

ih INTERPUMP **JETplus** **K DN 8 I.D. 5/16" - W.P. 250 BAR/3625 PSI - MAX 155 °C**

INTERPUMP Jet Plus 2SC

THN002K THB002K

APPLICATIONS:

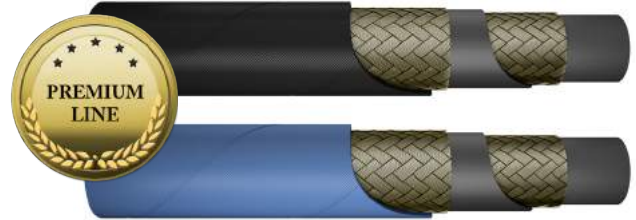

APPLICABLE SPECS.:

EXCEEDS EN 857 2SC - ISO 7751

No-Skive hose. Safety factor exceeds 4:1. Product designed for pressure wash applications. Any other use may reduce service life.

Internal hose: Synthetic rubber, extruded whole without joints, of uniform thickness.

Reinforcement: 2 high tensile steel wire braids.

Covering: Anti-abrasive synthetic rubber, resistant to oils, fuels and atmospheric conditions.

Recommended fluid: Water, water-soap based, glycol-water based.

Operating temperature: -40°F to +275°F (-40°C to +135°C) Continuous; -40°F to +311°F (-40°C to +155°C) Intermittent.

Part number	ID		Size	OD mm	Max WP		Min BP		Min BR		Weight		Ferrule
	in	mm			bar	psi	bar	psi	mm	inch	kg/m	lb/ft	
Black													
THN002KN04	1/4"	6.5	04	13.4	400	5800	1600	23200	75	2.953	0.281	0.189	001C-04
THN002KN05	5/16"	8.0	05	15.0	400	5800	1600	23200	85	3.346	0.327	0.220	001C-05
THN002KN06	3/8"	9.5	06	17.4	400	5800	1600	23200	90	3.543	0.418	0.281	001C-06
THN002KN08	1/2"	12.7	08	20.6	400	5800	1600	23200	130	5.118	0.574	0.385	001C-08
Blue													
THB002KN04	1/4"	6.5	04	13.4	400	5800	1600	23200	75	2.953	0.281	0.189	001C-04
THB002KN05	5/16"	8.0	05	15.0	400	5800	1600	23200	85	3.346	0.327	0.220	001C-05
THB002KN06	3/8"	9.5	06	17.4	400	5800	1600	23200	90	3.543	0.418	0.281	001C-06
THB002KN08	1/2"	12.7	08	20.6	400	5800	1600	23200	130	5.118	0.574	0.385	001C-08

Smooth cover upon request. Available on request with AFPS GS 2014:1 - PAH Cat.2 Certified cover. Use order code THNOZ.

Note: Approved for use with "G" Series One-Piece, No-Skive Fittings.

INTERPUMP  **K DN 6 I.D. 1/4" - W.P. 400 BAR/5800 PSI - MAX 155 °C - LPAH FREE**

INTERPUMP SewerJet 280

TSW2280



APPLICATIONS:



APPLICABLE SPECS.:

IMM SPECS - ISO 7751 ISO 7751

Designed for sewer jet applications. Safety factor 2.5:1. No-Skive compact hose. Smooth Cover. High abrasion resistance.

Internal hose: Synthetic rubber, extruded whole without joints, of uniform thickness.

Reinforcement: 1 or 2 high tensile steel wire braids.

Covering: Smooth synthetic rubber, resistant to oils, fuels and atmospheric conditions.

Recommended fluid: Water, water based fluids.

Operating temperature: +32°F to +158°F (0°C to +70°C) for water; -40°F to +158°F (-40°C to +70°C) for water based fluids.

Part number	ID		Size	OD	Max WP		Min BP		Min BR		Weight		Ferrule
	in	mm		mm	bar	psi	bar	psi	mm	inch	kg/m	lb/ft	
	TSW2280-06	3/8"	9.5	06	15.7	280	4000	700	10000	60	2.362	0.250	0.168
TSW2280-08	1/2"	12.7	08	20.4	280	4000	700	10000	90	3.543	0.530	0.356	001C-08
TSW2280-12	3/4"	19.0	12	27.6	280	4000	700	10000	100	3.937	0.780	0.524	001C-12
TSW2280-16	1"	25.4	16	35.8	280	4000	700	10000	130	5.118	1.170	0.787	001C-16
(*)TSW2280-20	1 1/4"	31.8	20	43.1	280	4000	700	10000	200	7.874	1.530	1.028	001C-20

(*) Available with standard wrapped cover only.

Note: Approved for use with "G" Series One-Piece, No-Skive Fittings.

ih INTERPUMP SEWERJET 280 DN 19 I.D. 3/4" - W.P. 280 BAR/4000 PSI

INTERPUMP HyBlast 10k

TFW0070

APPLICATIONS:



APPLICABLE SPECS.:

IMM SPECS - ISO 7751

Safety factor 2.5:1. Light and compact. Reliability and high performance.

Internal hose: Water resistant synthetic rubber.

Reinforcement: 4 steel wire spirals.

Covering: Anti-abrasive synthetic rubber, resistant to oils, fuels and atmospheric conditions.

Recommended fluid: Water, water-soap based, glycol-water based.

Operating temperature: +14°F to +158°F (-10°C to +70°C) Continuous; +14°F to +212°F (-10°C to +100°C) Intermittent.

Part number	ID		Size	OD	Max WP		Min BP		Min BR		Weight		Ferrule	Coupling Series
	in	mm		mm	bar	psi	bar	psi	mm	inch	kg/m	lb/ft		
TFW0070-16	1 "	25.4	16	38.8	700	10150	1750	25375	280	11.024	2.100	1.413	00S4-16	W series

ih INTERPUMP **HY-BLAST** **10k** ISO 7751/S.F. 2,5 - DN 25 I.D. 1" - W.P. 700 BAR/10150 PSI



INTERPUMP HyBlast 12k

TFW0085



APPLICATIONS:



APPLICABLE SPECS.:

IMM SPEC. - ISO 7751

Safety factor 2.5:1. Light and compact. Reliability and high performance.

Internal hose: Water resistant synthetic rubber.

Reinforcement: 4-6 high tensile steel wire spirals.

Covering: Anti-abrasive synthetic rubber, resistant to oils, fuels and atmospheric conditions.

Recommended fluid: Water, water-soap based, glycol-water based.

Operating temperature: +14°F to +158°F (-10°C to +70°C) Continuous; +14°F to +212°F (-10°C to +100°C) Intermittent.

Part number	ID		Max WP		Min BP		Min BR		Weight		Ferrule	Coupling Series
	in	mm	bar	psi	bar	psi	mm	inch	kg/m	lb/ft		
4 Spirals												
TFW0085-04	1/4"	6.4	850	12325	2125	30813	110	4.331	0.570	0.384	0019-04	M series
TFW0085-06	3/8"	9.5	850	12325	2125	30813	140	5.512	0.730	0.491	00S4-06	W series
TFW0085-08	1/2"	12.7	850	12325	2125	30813	170	6.693	0.840	0.565	00S4-08	W series
TFW0085-12	3/4"	19.0	850	12325	2125	30813	220	8.661	1.690	1.137	00S4-12	W series
6 Spirals												
TFW0085-16	1"	25.4	850	12325	2125	30813	330	12.992	3.200	2.150	00Y6-16	Y series

INTERPUMP HY-BLAST → 12k ISO 7751/S.F. 2,5 - DN 12 I.D. 1/2" - W.P. 850 BAR/12325 PSI

INTERPUMP HyBlast 15k

TFW0110 TFW0100

APPLICATIONS:

APPLICABLE SPECS.:

IMM SPECS - ISO 7751

Safety factor 2.5:1. Light and compact. Reliability and high performance.

Internal hose: Water resistant synthetic rubber.

Reinforcement: 4 steel wire spirals.

Covering: Anti-abrasive syntetic rubber, resistant to oils, fuels and atmospheric conditions.

Recommended fluid: Water, water-soap based, glycol-water based.

Operating temperature: +14°F to +158°F (-10°C to +70°C) Continuous; +14°F to +212°F (-10°C to +100°C) Intermittent.

Part number	ID		Size	OD mm	Max WP		Min BP		Min BR		Weight		Ferrule	Coupling Series
	in	mm			bar	psi	bar	psi	mm	inch	kg/m	lb/ft		
	TFW0110-04	1/4"			6.4	04	17.0	1100	15950	2750	39875	110		
TFW0110-06	3/8"	9.5	06	20.7	1100	15950	2750	39875	140	5.512	0.890	0.599	00S4-06	W series
TFW0110-08	1/2"	12.7	08	24.0	1100	15950	2750	39875	180	7.087	1.150	0.774	00S4-08	W series
TFW0100-12	3/4"	19.0	12	31.6	1000	14500	2500	36250	240	9.449	1.800	1.211	00Y4-12	Y series

ih INTERPUMP ■ **HY-BLAST** → **15k** ISO 7751/S.F. 2,5 - DN 10 I.D. 3/8" - W.P. 1100 BAR/15950 PSI



INTERPUMP HyBlast 18k

TFW0125 TFW0120

APPLICATIONS:



APPLICABLE SPECS.:

IMM SPEC. - ISO 7751

Safety factor 2.5:1. Light and compact. Reliability and high performance.

Internal hose: Water resistant synthetic rubber.

Reinforcement: 4 steel wire spirals.

Covering: Anti-abrasive syntetic rubber, resistant to oils, fuels and atmospheric conditions.

Recommended fluid: Water, water-soap based, glycol-water based.

Operating temperature: +14°F to +158°F (-10°C to +70°C) Continuous; +14°F to +212°F (-10°C to +100°C) Intermittent.

Part number	ID		Size	OD mm	Max WP		Min BP		Min BR		Weight		Ferrule	Coupling Series
	in	mm			bar	psi	bar	psi	mm	inch	kg/m	lb/ft		
	TFW0125-06	3/8"			9.5	06	20.7	1250	18125	3125	45313	160		
TFW0120-08	1/2"	12.7	08	24.0	1200	17400	3000	43500	200	7.874	1.190	0.801	00Y4-08	Y series

INTERPUMP HY-BLAST 18k ISO 7751/S.F. 2.5 - DN 10 I.D. 3/8" - W.P. 1250 BAR/18125 PSI

INTERPUMP HyBlast 20k

TFW0145 TFW0135

APPLICATIONS:



APPLICABLE SPECS.:

IMM SPECS ISO 7751

Safety factor 2.5:1. Light and compact. Reliability and high performance.

Internal hose: Water resistant synthetic rubber.

Reinforcement: 6 steel wire spirals.

Covering: Anti-abrasive syntetic rubber, resistant to oils, fuels and atmospheric conditions.

Recommended fluid: Water, water-soap based, glycol-water based.

Operating temperature: +14°F to +158°F (-10°C to +70°C) Continuous; +14°F to +212°F (-10°C to +100°C) Intermittent.

Part number	ID		Size	OD	Max WP		Min BP		Min BR		Weight		Ferrule	Coupling Series
	in	mm		mm	bar	psi	bar	psi	mm	inch	kg/m	lb/ft		
	TFW0145-06	3/8"	9.5	06	23.3	1450	21025	3625	52563	180	7.087	1.350	0.909	00Y6-06
TFW0145-08	1/2"	12.7	08	27.0	1450	21025	3625	52563	220	8.661	1.800	1.211	00Y6-08	Y series
TFW0135-12	3/4"	19.0	12	35.0	1350	19575	3375	48938	260	10.236	2.670	1.797	00Y6-12	Y series

ih INTERPUMP **HY-BLAST 20k** ISO 7751/S.F. 2,5 - DN 12 I.D. 1/2" - W.P. 1450 BAR/21025 PSI

INTERPUMP LongLift 1SC

THL101K



APPLICATIONS:



APPLICABLE SPECS.:

EXCEEDS EN 857 1SC- ISO 112237 1SC

No-Skive hose. High abrasion resistance. Pressure rating exceeds standards. Approved and released for lift truck applications. High elasticity and flexibility at small bend radius. Smooth cover.

Internal hose: Synthetic rubber, extruded whole without joints, of uniform thickness.

Reinforcement: 1 high tensile steel wire braid.

Covering: Smooth synthetic rubber, resistant to oils, fuels and atmospheric conditions.

Recommended fluid: Mineral and biological oils, glycol-water based, water, lubricants.

Operating temperature: -40°F to +248°F (-40°C to +120°C) Continuous; -40°F to +275°F (-40°C to +135°C) Intermittent; -40°F to +158°F (-40°C to +70°C) for water based fluids; +32°F to +158°F (0°C to +70°C) for water.

Part number	ID		Size	OD	Max WP		Min BP		Min BR		Weight		Ferrule
	in	mm		mm	bar	psi	bar	psi	mm	inch	kg/m	lb/ft	
	THL101K-04	1/4"		6.4	04	12.3	250	3625	1120	16240	50	1.969	
THL101K-05	5/16"	8.0	05	13.5	250	3625	1000	14500	55	2.165	0.210	0.141	001C-05
THL101K-06	3/8"	9.5	06	15.7	250	3625	1000	14500	60	2.362	0.248	0.167	001C-06
THL101K-08	1/2"	12.7	08	18.9	200	2900	800	11600	70	2.756	0.391	0.263	001C-08
THL101K-10	5/8"	16.0	10	22.4	150	2175	600	8700	90	3.543	0.410	0.276	001C-10
THL101K-12	3/4"	19.0	12	26.0	150	2175	600	8700	100	3.937	0.534	0.359	001C-12
THL101K-16	1"	25.4	16	33.7	110	1595	440	6380	180	7.087	0.742	0.499	001C-16

Note: Approved for use with "G" Series One-Piece, No-Skive Fittings.

INTERPUMP LongLift **EXCEEDS EN857 - 1SC DN10 I.D. 3/8" W.P. 25,0 Mpa (3600 PSI)**

INTERPUMP LongLift 2SC

THL102K

APPLICATIONS:



APPLICABLE SPECS.:

EXCEEDS EN 857 2SC - ISO 11237 2SC

No-Skive hose. High abrasion resistance. Pressure rating exceeds standards. Approved and released for lift truck applications. High elasticity and flexibility at small bend radius. Smooth cover.

Internal hose: Synthetic rubber, extruded whole without joints, of uniform thickness.

Reinforcement: 2 high tensile steel wire braids.

Covering: Smooth synthetic rubber, resistant to oils, fuels and atmospheric conditions.

Recommended fluid: Mineral and biological oils, glycol-water based, water, lubricants.

Operating temperature: -40°F to +248°F (-40°C to +120°C) Continuous; -40°F to +275°F (-40°C to +135°C) Intermittent; -40°F to +158°F (-40°C to +70°C) for water based fluids; +32°F to +158°F (0°C to +70°C) for water.

Part number	⊖		Size	⊕	💡		💡		🔗		⚖️		Ferrule
	ID			OD	Max WP		Min BP		Min BR		Weight		
	in	mm		mm	bar	psi	bar	psi	mm	inch	kg/m	lb/ft	
THL102K-04	1/4"	6.4	04	13.3	430	6235	1720	24940	50	1.969	0.283	0.190	001C-04
THL102K-05	5/16"	8.0	05	14.8	400	5800	1600	23200	60	2.362	0.324	0.218	001C-05
THL102K-06	3/8"	9.5	06	17.1	350	5075	1400	20300	70	2.756	0.418	0.281	001C-06
THL102K-08	1/2"	12.7	08	20.4	310	4495	1240	17980	80	3.150	0.521	0.350	001C-08
THL102K-10	5/8"	16.0	10	23.5	280	4060	1120	16240	100	3.937	0.626	0.421	001C-10
THL102K-12	3/4"	19.0	12	27.6	240	3480	960	13920	120	4.724	0.764	0.513	001C-12
THL102K-16	1"	25.4	16	35.8	210	3045	840	12180	160	6.299	1.171	0.787	001C-16

Note: Approved for use with "G" Series One-Piece, No-Skive Fittings.



INTERPUMP LongLife Dual 1SC

T2E101K



APPLICATIONS:



APPLICABLE SPECS.:

EXCEEDS EN 857 - ISO 11237 1SC

No-Skive hose. High abrasion resistance. Pressure rating exceeds standards. Smooth cover.

Internal hose: Synthetic rubber, extruded whole without joints, of uniform thickness.

Reinforcement: 1 high tensile steel wire braids.

Covering: Smooth synthetic rubber, resistant to oils, fuels and atmospheric conditions.

Recommended fluid: Mineral and biological oils, glycol-water based, water, lubricants.

Operating temperature: -40°F to +248°F (-40°C to +120°C) Continuous; -40°F to +275°F (-40°C to +135°C) Intermittent; -40°F to +158°F (-40°C to +70°C) for water based fluids; +32°F to +158°F (0°C to +70°C) for water.

Part number	Size	Dimensions			Max WP		Min BR		Weight		Ferrule
		OD mm	T.H. mm	T.H. Max mm	bar	psi	mm	inch	kg/m	lb/ft	
T2E101KI04	04	12.4	24.8	26	250	3625	50	1.969	0.364	0.244	001C-04
T2E101KI06	06	15.6	31.2	32.6	250	3625	60	2.362	0.420	0.282	001C-06
T2E101KI08	08	19.0	38	39.4	200	2900	70	2.756	0.782	0.525	001C-08

A machine is available to separate the twin hose. Use order code MHSXA001.



Note: Approved for use with "G" Series One-Piece, No-Skive Fittings.

INTERPUMP LongLife Dual EXCEEDS EN 857 - 1SC DN 10 I.D. 3/8" - W.P. 25.0 MPa/3625 PSI

INTERPUMP LongLife Dual 2SC

T2E102K

APPLICATIONS:

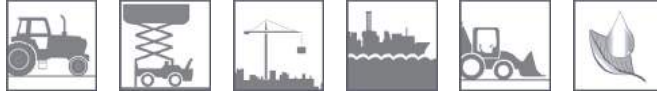

APPLICABLE SPECS.:

EXCEEDS EN 857 - ISO 11237 2SC

No-Skive hose. High abrasion resistance. Pressure rating exceeding standards. Smooth cover.

Internal hose: Synthetic rubber, extruded whole without joints, of uniform thickness.
Reinforcement: 2 high tensile steel wire braids.
Covering: Smooth synthetic rubber, resistant to oils, fuels and atmospheric conditions.
Recommended fluid: Mineral and biological oils, glycol-water based, water, lubricants.
Operating temperature: -40°F to +248°F (-40°C to +120°C) Continuous; -40°F to +275°F (-40°C to +135°C) Intermittent; -40°F to +158°F (-40°C to +70°C) for water based fluids; +32°F to +158°F (0°C to +70°C) for water.

Part number	Size	OD	T.H.	T.H. Max	Max WP		Min BR		Weight		Ferrule
		mm	mm	mm	bar	psi	mm	inch	kg/m	lb/ft	
T2E102KI04	04	13.3	26.6	27.8	430	6235	60	2.362	0.566	0.380	001C-04
T2E102KI06	06	17.1	34.2	32.6	350	5075	70	2.756	0.836	0.561	001C-06
T2E102KI08	08	20.5	41	42.4	310	4495	80	3.150	1.042	0.699	001C-08

A machine is available to separate the twin hose. Use order code MHSXA001.



Note: Approved for use with "G" Series One-Piece, No-Skive Fittings.

ih INTERPUMP LongLife Dual EXCEEDS EN857 - 2SC DN10 I.D. 3/8" W.P. 35.0 Mpa (5075 PSI)

Hypress Railway - Fire Resistant

TFDE011



APPLICATIONS:



TYPE APPROVAL:

AFNOR NF - EN ISO 11925.

APPLICABLE SPECS.:

IMM - SAE 100R1AT - EN 853 1SN

Fumes classification, according AFNOR NF 16.101: F1. Fire attitude: class 13, compound certified EN ISO 11925-2. Hose not designed nor approved for "air brake" applications.

Internal hose: Synthetic rubber, extruded whole without joints, of uniform thickness.

Reinforcement: 1 high tensile steel wire braid.

Covering: Synthetic rubber fire resistant.

Recommended fluid: Hydraulic fluids petroleum based, glycol-water based, lubricants.

Operating temperature: -40°F to +212°F (-40°C to +100°C) Continuous; -40°F to +230°F (-40°C to +110°C) Intermittent.

Part number	ID		Size	OD mm	Max WP		Min BP		Min BR		Weight		Ferrule
	in	mm			bar	psi	bar	psi	mm	inch	kg/m	lb/ft	
TFDE011N04	1/4"	6.4	04	13.4	225	3263	900	13050	100	3.937	0.231	0.155	001C-04
TFDE011N05	5/16"	8.0	05	15.0	215	3118	860	12470	115	4.528	0.254	0.171	001C-05
TFDE011N06	3/8"	9.5	06	17.4	180	2610	720	10440	125	4.921	0.338	0.227	001C-06
TFDE011N08	1/2"	12.7	08	20.6	160	2320	640	9280	180	7.087	0.415	0.279	001C-08
TFDE011N10	5/8"	16.0	10	23.7	130	1885	520	7540	200	7.874	0.477	0.321	001C-10
TFDE011N12	3/4"	19.0	12	27.7	105	1523	420	6090	240	9.449	0.618	0.415	001C-12
TFDE011N16	1 "	25.4	16	35.6	88	1276	352	5104	300	11.811	0.901	0.605	001C-16

Note: Approved for use with "G" Series One-Piece, No-Skive Fittings.

INTERPUMP PowerLift - 1SC/2SC

THE0L1K THE0L2K

APPLICATIONS:

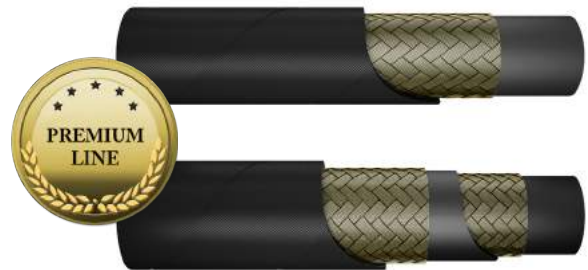

APPLICABLE SPECS.:

UNI EN 81-20 - EXCEEDS EN 857 - ISO 11237

Compact hose with low bend radius. For lift solutions. Safety factor 8:1.

Internal hose: Synthetic rubber, extruded whole without joints, of uniform thickness.

Reinforcement: 1 or 2 high tensile steel wire braids.

Covering: Anti-abrasive synthetic rubber, resistant to oils, fuels and atmospheric conditions.

Recommended fluid: Mineral and biological oils, glycol-water based, water, lubricants.

Operating temperature: -40°F to +212°F (-40°C to +100°C) Continuous; -40°F to +248°F (-40°C to +120°C) Intermittent; -40°F to +158°F (-40°C to +70°C) for water based fluids; +32°F to +158°F (0°C to +70°C) for water.

Part number	ID		Size	OD	Max WP		Min BP		Min BR		Weight		Ferrule
	in	mm			bar	psi	bar	psi	mm	inch	kg/m	lb/ft	
	THE0L1K-16	1"	25.4	16	33.7	50	725	400	5800	180	7.087	0.750	0.504
THE0L1K-20	1 1/4"	31.8	20	41.1	50	725	400	5800	210	8.268	1.280	0.860	001C-20
THE0L1K-24	1 1/2"	38.1	24	48.6	45	653	360	5220	300	11.811	1.390	0.934	001C-24
THE0L2K-24	1 1/2"	38.1	24	50.6	50	725	400	5800	300	11.811	2.100	1.411	001C-24
THE0L2K-32	2"	50.8	32	63.5	50	725	400	5800	400	15.748	1.176	0.790	001C-32

Note: Approved for use with "G" Series One-Piece, No-Skive Fittings.

INTERPUMP POWERLIFT EXCEEDS - ISO 11237/EN 857 - EN 81.2 1SC DN 38 I.D. 1.1/2" - W.P. 45 BAR/653 PSI



INTERPUMP HyJack

THE2J2K



APPLICATIONS:



APPLICABLE SPECS.:

IMM SPECS

Tested for jack applications up to a static pressure of 760 bar/11000 psi. Compact hose. Safety factor > 2:1. Smooth cover. Tested and released with dedicated fitting (002M bushing + Multispiral couplings).

Internal hose: Oil resistant synthetic rubber.

Reinforcement: 2 high-load steel wire braids.

Covering: Synthetic rubber resistant to oils, fuels, atmospheric conditions and abrasion.

Recommended fluid: Mineral and biological oils.

Operating temperature: -40°F to +212°F (-40°C to +100°C).

Part number	ID		Size	OD	Max WP		Min BP		Min BR		Weight		Ferrule
	in	mm		mm	bar	psi	bar	psi	mm	inch	kg/m	lb/ft	
	THE2J2K-04	1/4"		6.4	04	13.3	760	11000	1672	24200	75	2.953	
THE2J2K-06	3/8"	9.5	06	17.1	725	10500	1595	23100	90	3.543	0.422	0.284	002M-06

INTERPUMP HYJACK DN 10 I.D. 3/8" W.P. 725 bar / 10500 psi - S.F. 2,2:1

Hypress Snow Storm 1SC

THEPS1K

APPLICATIONS:



APPLICABLE SPECS.:

IMM - ISO 7751

Performs with air, water and under thermal shock. Excellent resistance to UV, ozone and abrasion. Safety factor 2.5:1.

Internal hose: Synthetic rubber, extruded whole without joints, of uniform thickness.

Reinforcement: 1 high tensile steel wire braid.

Covering: Anti-abrasive synthetic rubber, resistant to oils, fuels and atmospheric conditions with UHMWPE film.

Recommended fluid: Mineral and biological oils, glycol-water based, water, lubricants.

Operating temperature: -40°F to +212°F (-40°C to +100°C) Continuous; -40°F to +257°F (-40°C to +125°C) Intermittent; -40°F to +158°F (-40°C to +70°C) for water based fluids; +32°F to +158°F (0°C to +70°C) for water.

Part number	ID		Size	OD mm	Max WP		Min BP		Min BR		Weight		Ferrule
	in	mm			bar	psi	bar	psi	mm	inch	kg/m	lb/ft	
	THEPS1KB16	1"	25.4	16	34.2	100	1450	250	3625	200	7.874	0.742	0.499
THEPS1KB24	1 1/2"	38.1	24	47.7	100	1450	250	3625	400	15.748	1.390	0.934	001C-24
THEPS1KB32	2"	50.8	32	61.5	100	1450	250	3625	500	19.685	1.940	1.304	001C-32

Also available in black color THEPS1KN.

Note: Approved for use with "G" Series One-Piece, No-Skive Fittings.



INTERPUMP HyTruck 200 bar



APPLICATIONS:



APPLICABLE SPECS.:

IMM SPECS

No-Skive hose. A line dedicated to dump applications. Safety factor 2.5:1.

Internal hose: Synthetic rubber, extruded whole without joints, of uniform thickness oil and water resistant.

Reinforcement: 1 braid (-12) or 2 braids (-16) made of high tensile steel wire.

Covering: Synthetic rubber resistant to oils, fuels and atmospheric conditions.

Recommended fluid: Mineral and biological oils, glycol-water based, water, lubricants.

Operating temperature: -40°F to +212°F (-40°C to +100°C) Continuous; -40°F to +257°F (-40°C to +125°C) Intermittent; -40°F to +158°F (-40°C to +70°C) for water based fluids; +32°F to +158°F (0°C to +70°C) for water.

Part number	ID		Size	OD mm	Max WP		Min BP		Min BR		Weight		Ferrule
	in	mm			bar	psi	bar	psi	mm	inch	kg/m	lb/ft	
	TTRK200-12	3/4"			19.0	12	26.0	200	2900	500	7250	180	
TTRK200-16	1"	25.4	16	35.8	200	2900	500	7250	250	9.843	1.171	0.787	001C-16

Note: Approved for use with "G" Series One-Piece, No-Skive Fittings.

ih INTERPUMP **HYTRUCK** DN 19 I.D. 3/4" W.P. 200 bar/2900 psi - S.F. 2.5:1

INTERPUMP HyTruck 250 bar TTRK250

APPLICATIONS:



APPLICABLE SPECS.:

IMM SPECS



No-Skive hose. A line dedicated to dump applications. Safety factor 2.5:1.

Internal hose: Synthetic rubber, extruded whole without joints, of uniform thickness oil and water resistant.

Reinforcement: 1 braid (-12) or 2 braids (-16) made of high tensile steel wire.

Covering: Synthetic rubber resistant to oils, fuels and atmospheric conditions.

Recommended fluid: Mineral and biological oils, glycol-water based, water, lubricants.

Operating temperature: -40°F to +212°F (-40°C to +100°C) Continuous; -40°F to +257°F (-40°C to +125°C) Intermittent; -40°F to +158°F (-40°C to +70°C) for water based fluids; +32°F to +158°F (0°C to +70°C) for water.

Part number	ID		Size	OD	Max WP		Min BP		Min BR		Weight		Ferrule
	in	mm		mm	bar	psi	bar	psi	mm	inch	kg/m	lb/ft	
	TTRK250-12	3/4"	19.0	12	26.0	250	3625	625	9063	180	7.087	0.534	0.359
TTRK250-16	1"	25.4	16	35.8	250	3625	625	9063	250	9.843	1.171	0.787	001C-16

Note: Approved for use with "G" Series One-Piece, No-Skive Fittings.

INTERPUMP **HYTRUCK** DN 19 I.D. 3/4" W.P. 250 bar/3625 psi - S.F. 2.5:1

INTERPUMP HyTruck 350 bar TTRK350

APPLICATIONS:

APPLICABLE SPECS.:

IMM SPECS

No-Skive hose. A line dedicated to dump applications. Safety factor 2.5:1.

Internal hose: Synthetic rubber, extruded whole without joints, of uniform thickness oil and water resistant.

Reinforcement: 2 high tensile steel wire braids.

Covering: Synthetic rubber resistant to oils, fuels and atmospheric conditions.

Recommended fluid: Mineral and biological oils, glycol-water based, water, lubricants.

Operating temperature: -40°F to +212°F (-40°C to +100°C) Continuous; -40°F to +257°F (-40°C to +125°C) Intermittent; -40°F to +158°F (-40°C to +70°C) for water based fluids; +32°F to +158°F (0°C to +70°C) for water.

Part number	ID		Size	OD	Max WP		Min BP		Min BR		Weight		Ferrule
	in	mm		mm	bar	psi	bar	psi	mm	inch	kg/m	lb/ft	
	TTRK350-12	3/4"	19.0	12	26.0	350	5075	875	12688	200	7.874	0.782	
TTRK350-16	1"	25.4	16	35.8	350	5075	875	12688	250	9.843	1.171	0.787	001C-16

Note: Approved for use with "G" Series One-Piece, No-Skive Fittings.

ih INTERPUMP ■ **HYTRUCK** ■ DN 19 I.D. 3/4" W.P. 350 bar/5075 psi - S.F. 2.5:1

INTERPUMP Mega Drill THEMMDR

APPLICATIONS:

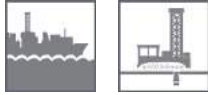

TYPE APPROVAL:

MSHA.

APPLICABLE SPECS.:

EXCEEDS ISO 3862 TYPE R13 - IMM SPECS



High pressure hoses. Power lines/severe applications. Drilling.

Internal hose: Synthetic rubber, extruded whole without joints, of uniform thickness.

Reinforcement: 6 high tensile steel spirals.

Covering: Abrasion resistant synthetic rubber resistant to oils, fuels, atmospheric conditions. MSHA.

Recommended fluid: Hydraulic fluids petroleum based (mineral oils), glycol-water based, water, lubricants.

Operating temperature: -40°F to +212°F (-40°C to +100°C) Continuous; -40°F to +248°F (-40°C to +120°C) Intermittent; -40°F to +158°F (-40°C to +70°C) for water based fluids; +32°F to +158°F (0°C to +70°C) for water.

Part number	ID		Size	OD mm	Max WP		Min BP		Min BR		Weight		Ferrule
	in	mm			bar	psi	bar	psi	mm	inch	kg/m	lb/ft	
	THEMMDRN40	2 1/2"			63.5	40	84.5	350	5075	1400	20300	900	
THEMMDRN48	3"	76.2	48	97.3	350 (*)	5075	880	12760	1000	39.370	9.515	6.393	0013-48
THEMMDRN48	3"	76.2	48	97.3	210 (**)	3045	880	12760	1000	39.370	9.515	6.393	0013-48

(*) Static Application.

(**) Dynamic Application Safety Factor > 4:1.

INTERPUMP Mega Jet

TFS04JG THS00JG



APPLICATIONS:



APPLICABLE SPECS.:

IMM - ISO 7751

High performance structure. High ozone and weather conditions resistance. Safety factor 2.5:1 or 3.5:1 according to ISO 7751.

Internal hose: Synthetic rubber, extruded whole without joints, of uniform thickness, abrasion resistant.

Reinforcement: 4-6 high tensile steel wire spirals.

Covering: Anti-abrasive synthetic rubber, resistant to oils, fuels and atmospheric conditions.

Recommended fluid: Water, water-soap based, water grout based.

Operating temperature: -40°F to +212°F (-40°C to +100°C); -40°F to +158°F (-40°C to +70°C) for water based fluids; +32°F to +158°F (0°C to +70°C) for water.

Part number	ID		Size	OD mm	Max WP		Min BP		Min BR		Weight		Ferrule
	in	mm			bar	psi	bar	psi	mm	inch	kg/m	lb/ft	
Safety factor 2.5:1													
4 Spirals													
TFS04JGN16	1"	25.4	16	38.4	550	7975	1375	19938	220	8.661	2.104	1.414	004N-16
TFS04JGN20	1 1/4"	31.8	20	45.8	450	6525	1125	16313	400	15.748	2.550	1.714	004N-20
TFS04JGN24	1 1/2"	38.1	24	53.5	450	6525	1125	16313	560	22.047	3.225	2.167	004N-24
TFS04JGN32	2"	50.8	32	67.0	420	6090	1050	15225	650	25.591	4.400	2.957	004N-32
Safety factor 3.5:1													
6 Spirals													
THS00JGN16	1"	25.4	16	42.2	600	8700	2100	30450	330	12.992	3.200	2.151	00J6-16
THS00JGN20	1 1/4"	31.8	20	49.7	550	7975	1925	27913	265	10.433	3.891	2.615	00J3-20
THS00JGN24	1 1/2"	38.1	24	57.8	500	7250	1750	25375	310	12.205	5.182	3.483	00J3-24
THS00JGN32	2"	50.8	32	71.5	480	6960	1680	24360	600	23.623	6.700	4.503	00J3-32

Available with external anti-abrasion UHMWPE film. Use order code TFS04JG.

Available with external anti-abrasion UHMWPE film. Use order code THS00JG.

INTERPUMP BOP Firescreen 5000

APPLICATIONS:



TYPE APPROVAL:

API16-D, LLOYD'S OD 1000/499.

APPLICABLE SPECS.:

API16-D - LLOYD'S REGISTER OD 1000/499 REV.2

TBOP350



Isobaric line 5000 psi. Flame resistance tested in accordance with API 16-D Integrated with Lloyd's Register OD 1000/499 rev 2 Flame Resistance Test.

Internal hose: Synthetic rubber, extruded whole without joints, of uniform thickness.

Reinforcement: 6 high tensile steel wire spirals.

Covering: Anti-abrasive synthetic rubber, resistant to oils, fuels and atmospheric conditions.

Recommended fluid: Hydraulic fluids petroleum based (mineral oils), glycol-water based, water, lubricants.

Operating temperature: -40°F to +248°F (-40°C to +120°C) Continuous; -40°F to +257°F (-40°C to +125°C) Intermittent; -40°F to +158°F (-40°C to +70°C) for water based fluids; +32°F to +158°F (0°C to +70°C) for water.

Part number	ID		Size	OD	Max WP		Min BP		Min BR		Weight		Ferrule
	in	mm		mm	bar	psi	bar	psi	mm	inch	kg/m	lb/ft	
	TBOP350N32	2"	50.8	32	71.5	350	5075	1400	20300	635	25.000	6.890	4.629

Thermoplastic Hose



Content Overview



Stocked in North America



Made to order



TFS0007



SAE 100R7

79



TFS0008



SAE 100R8

80



TFS00H1



One High Tensile Steel
Wire Braid

81



TFS00H2

Two High Tensile Steel
Wire Braid

82



TFS00HP

INTERPUMP HyUltra

83



TFS0018

R18 - Isobaric - Low
Temperature

84



TFS00CP

Constant Pressure
Low Temperature

87



TFS00MP



Mini-Flexible

85



T100C02



INTERPUMP HyFire

86

SAE 100R7

TFS0007

APPLICATIONS:



TYPE APPROVAL:

MSHA.

APPLICABLE SPECS.:

EXCEEDS SAE 100R7 - ISO 3949 R7



Light, flexible and abrasion resistant. Pinpricked cover.

Internal hose: Polyester elastomer.

Reinforcement: 1 or 2 braids of synthetic fiber.

Covering: Polyurethane, black, pinpricked, white ink-jet branding.

Recommended fluid: Petroleum based hydraulic fluids, glycol-water based, lubricants.

Operating temperature: -40°F to +212°F (-40°C to +100°C); -40°F to +158°F (-40°C to +70°C) for water based fluids.

Part number	ID		Size	Max WP			Min BP		Min BR		Weight		Ferrule
	in	mm		OD	bar	psi	bar	psi	mm	inch	kg/m	lb/ft	
	mm	mm		mm	bar	psi	bar	psi	mm	inch	kg/m	lb/ft	
TFS0007-02	1/8"	4.0	02	8.3	210	3045	840	12180	25	0.984	0.050	0.034	*
TFS0007-03	3/16"	5.0	03	9.6	210	3045	840	12180	25	0.984	0.060	0.040	0007-03
TFS0007-04	1/4"	6.5	04	11.8	210	3045	840	12180	35	1.378	0.090	0.060	0007-04
TFS0007-05	5/16"	8.1	05	13.9	190	2755	760	11020	60	2.362	0.115	0.077	0007-05
TFS0007-06	3/8"	9.7	06	16.0	160	2320	640	9280	55	2.165	0.145	0.097	0007-06
TFS0007-08	1/2"	13.0	08	20.1	140	2030	560	8120	75	2.953	0.210	0.141	0007-08
TFS0007-10	5/8"	16.3	10	23.7	105	1522	420	6090	110	4.331	0.280	0.188	0007-10
TFS0007-12	3/4"	19.5	12	27.1	90	1305	360	5220	140	5.512	0.335	0.225	0007-12
TFS0007-16	1"	25.9	16	34.0	70	1015	280	4060	190	7.480	0.455	0.305	0007-16

* Call our customer service team.

Also available in twin version. Use order code T2S0007.



Also available in "non-conductive" version. Use order code TFS0NC7.



Also available in "Neptune" version for marine applications. Use order code TFS00M7.



Also available in "Nautilus" version for off-shore equipment. Use order code TFS00V7.



Also available in "Solvent" version. Use order code TFS00V7.



SAE 100R8

TFS0008



APPLICATIONS:



TYPE APPROVAL:

MSHA.

APPLICABLE SPECS.:

EXCEEDS SAE 100R8 - ISO 3949 R8

Light, flexible and abrasion resistant. Pinpricked cover.

Internal hose: Polyester elastomer.

Reinforcement: 1 or 2 braids of Aramid fiber.

Covering: Polyurethane, black, pinpricked, white ink-jet branding.

Recommended fluid: Petroleum based hydraulic fluids, glycol-water based, lubricants.

Operating temperature: -40°F to +212°F (-40°C to +100°C); -40°F to +158°F (-40°C to +70°C) for water based fluids.

Part number	ID		Size	OD	Max WP		Min BP		Min BR		Weight		Ferrule
	in	mm		mm	bar	psi	bar	psi	mm	inch	kg/m	lb/ft	
TFS0008-02	1/8"	4.0	02	8.0	420	6090	1680	24360	25	0.984	0.045	0.030	0008-02
TFS0008-03	3/16"	5.0	03	8.9	350	5075	1400	20300	30	1.181	0.050	0.034	0008-03
TFS0008-04	1/4"	6.5	04	11.5	350	5075	1400	20300	50	1.969	0.085	0.057	0008-04
TFS0008-05	5/16"	8.1	05	13.4	300	4350	1200	17400	55	2.165	0.105	0.071	0008-05
TFS0008-06	3/8"	9.7	06	15.5	280	4060	1120	16240	60	2.362	0.135	0.091	0008-06
TFS0008-08	1/2"	13.0	08	19.9	245	3552	980	14210	80	3.150	0.200	0.134	0008-08
TFS0008-10	5/8"	16.3	10	23.4	200	2900	800	11600	125	4.921	0.250	0.168	0008-10
TFS0008-12	3/4"	19.5	12	27.1	165	2392	660	9570	150	5.906	0.320	0.215	0008-12
TFS0008-16	1"	25.9	16	34.2	140	2030	560	8120	200	7.874	0.435	0.292	0008-16

Also available in twin version. Use order code T2S0008.



Also available in "Nautilus" version for off-shore equipment. Use order code TFS00Y8.



Also available in "Neptune" version for marine applications. Use order code TFS00M7.



Also available in "Solvent" version. Use order code TFS00V8.



Also available in "non-conductive" version. Use order code TFS0NC8.



One High Tensile Steel Wire Braid

TFS00H1

APPLICATIONS:



TYPE APPROVAL:

MSHA.

APPLICABLE SPECS.:

SAE 100R1 - MEETS OR EXCEEDS PRESSURE LEVEL OF EN 853 15N - EN 857 15C



Slim line construction for compact installation and flexibility. Lightweight. Steel braid offers low volumetric expansion and optimum in length characteristics. Abrasion resistant.

Internal hose: Polyester elastomer.

Reinforcement: 1 high tensile steel wire braid.

Covering: Polyurethane, black, white ink-jet branding.

Recommended fluid: Petroleum based hydraulic fluids, glycol-water based, lubricants.

Operating temperature: -40°F to +212°F (-40°C to +100°C); -40°F to +158°F (-40°C to +70°C) for water based fluids.

Part number	ID		Size	OD	Max WP		Min BP		Min BR		Weight		Ferrule
	in	mm		mm	bar	psi	bar	psi	mm	inch	kg/m	lb/ft	
	TFS00H1-03	3/16"	5.0	03	9.7	360	5220	1440	20880	30	1.181	0.120	0.081
TFS00H1-04	1/4"	6.4	04	11.7	310	4495	1240	17980	40	1.575	0.165	0.111	0008-04
TFS00H1-05	5/16"	8.1	05	13.2	250	3625	1000	14500	55	2.165	0.190	0.128	0008-05
TFS00H1-06	3/8"	9.8	06	15.5	225	3263	900	13050	65	2.559	0.230	0.155	0008-06
TFS00H1-08	1/2"	13.0	08	18.8	190	2755	760	11020	85	3.346	0.300	0.202	0008-08
TFS00H1-10	5/8"	16.3	10	22.0	140	2030	560	8120	115	4.528	0.335	0.225	0008-10
TFS00H1-12	3/4"	19.5	12	25.8	115	1668	460	6670	145	5.709	0.460	0.309	0008-12
TFS00H1-16	1"	25.8	16	33.4	95	1378	380	5510	180	7.087	0.640	0.430	0008-16



Also available in "Neptune" version for marine applications. Use order code TFS0H1M. NO MSHA.



Also available in "Solvent" version. Use order code TFS00V1. NO MSHA.



Also available in twin version. Use order code T2500H1.



Two High Tensile Steel Wire Braids

TFS00H2

APPLICATIONS:



TYPE APPROVAL:

MSHA.

APPLICABLE SPECS.:

MEETS OR EXCEEDS SAE 100R2 PERFORMANCE

Rugged construction for HD applications and prolonged lifetime. Abrasion resistant.

Internal hose: Polyester elastomer.

Reinforcement: 2 high tensile steel wire braids.

Covering: Polyurethane, black, white ink-jet branding.

Recommended fluid: Petroleum based hydraulic fluids, glycol-water based, lubricants.

Operating temperature: -40°F to +212°F (-40°C to +100°C); -40°F to +158°F (-40°C to +70°C) for water based fluids.

Part number	ID		Size	OD	Max WP		Min BP		Min BR		Weight		Ferrule
	in	mm		mm	bar	psi	bar	psi	mm	inch	kg/m	lb/ft	
	TFS00H2-04	1/4"	6.4	04	12.8	400	5800	1600	23200	40	1.575	0.245	0.165
TFS00H2-06	3/8"	9.8	06	16.8	330	4785	1320	19140	65	2.559	0.370	0.249	0022-06
TFS00H2-08	1/2"	13.0	08	20.2	260	3770	1040	15080	85	3.346	0.455	0.306	0022-08
TFS00H2-10	5/8"	16.3	10	23.5	220	3190	880	12760	115	4.528	0.560	0.376	0022-10
TFS00H2-12	3/4"	19.5	12	27.5	150	2175	660	9570	170	6.693	0.700	0.470	0022-12

Also available in twin version. Use order code T2S00H2.



Also available in "Solvent" version. Use order code TFS00V2. NO MSHA.



INTERPUMP HyUltra TFS00HP

APPLICATIONS:



TYPE APPROVAL:
MSHA.



Combined Aramid and steel braid construction for compact design. Lightweight and flexible. Smaller bend radius for use on hose reels and in confined spaces. Anti-abrasion cover.

Internal hose: Polyester elastomer.

Reinforcement: 1 or 2 braid of Aramid fiber plus 1 high tensile steel wire braid.

Covering: Polyurethane, black, white ink-jet branding.

Recommended fluid: Petroleum based hydraulic fluids, glycol-water based, lubricants.

Operating temperature: -40°F to +212°F (-40°C to +100°C); -40°F to +158°F (-40°C to +70°C) for water based fluids.

Part number	ID		Size	OD	Max WP		Min BP		Min BR		Weight		Ferrule
	in	mm		mm	bar	psi	bar	psi	mm	inch	kg/m	lb/ft	
	TFS00HP-04	1/4"	6.6	04	12.7	700	10150	2800	40600	35	1.378	0.180	0.121
TFS00HP-06	3/8"	9.8	06	18.7	700	10150	2800	40600	90	3.543	0.330	0.222	*

* Call our customer service team.

Also available in twin version. Use order code T2500HP.

Also available in "non-conductive" version. Use order code TFSNCHP. NO MSHA.





R18 Low Pressure

TFS0018

APPLICATIONS:



APPLICABLE SPECS.:

MEETS OR EXCEEDS SAE 100R18

Special polyester cover for use in cold environments.

Internal hose: Polyester elastomer.

Reinforcement: 1 or 2 braids of synthetic fiber.

Covering: Special polyester, pinpricked.

Recommended fluid: Petroleum based hydraulic fluids, glycol-water based, lubricants.

Operating temperature: -67°F to +212°F (-55°C to +100°C); -67°F to +158°F (-55°C to +70°C) for water based fluids.

Part number	ID		Size	OD mm	Max WP		Min BP		Min BR		Weight		Ferrule
	in	mm			bar	psi	bar	psi	mm	inch	kg/m	lb/ft	
TFS0018-03	3/16"	5.0	03	9.6	210	3045	840	12180	25	0.984	0.060	0.040	*
TFS0018-04	1/4"	6.5	04	12.2	210	3045	840	12180	35	1.378	0.095	0.064	*
TFS0018-05	5/16"	8.1	05	14.3	210	3045	840	12180	45	1.772	0.130	0.087	*
TFS0018-06	3/8"	9.7	06	16.6	210	3045	840	12180	45	1.772	0.165	0.111	*
TFS0018-08	1/2"	13.0	08	22.5	210	3045	840	12180	70	2.756	0.295	0.198	*
TFS0018-10	5/8"	16.3	10	26.1	210	3045	840	12180	100	3.937	0.370	0.249	*

* Call our customer service team.

Also available in twin version. Use order code T250018.



Mini-Flexible

TFS00MP

APPLICATIONS:



Very flexible and lightweight. Kink resistant. Non-stick cover allows use of hose bundles for easy routing.

Internal hose: Polyester elastomer

Reinforcement: 1 braid of Aramid fiber.

Covering: Non-stick polyurethane, black, pinpricked.

Recommended fluid: Petroleum based hydraulic fluids, glycol-water based, lubricants.

Operating temperature: -40°F to +212°F (-40°C to +100°C); -40°F to +158°F (-40°C to +70°C) for water based fluids.

Part number	ID		Size	OD mm	Max WP		Min BP		Min BR		Weight		Ferrule
	in	mm			bar	psi	bar	psi	mm	inch	kg/m	lb/ft	
	TFS00MP-012	5/64"			2.0	02	5.0	630	9135	1900	27550	20	
TFS00MP-020	1/8"	3.0	03	6.0	630	9135	1900	27550	30	1.181	0.025	0.017	*
TFS00MP-025	5/32"	4.0	04	8.0	630	9135	1900	27550	40	1.575	0.045	0.030	*

* Call our customer service team.

INTERPUMP HyFire TI00CO2



APPLICATIONS:



TYPE APPROVAL:

MSHA.

APPLICABLE SPECS.:

MEETS OR EXCEEDS EN 853 15N - EN 854 15C
SAE 100R1 PERFORMANCE LEVEL

One steel wire braid design for increased mechanical and pressure resistance. Operating temperatures from -60°C to +93°C. Pinpricked cover. Also suitable for connections between bottles/valves and manifolds for CO2 fire extinguishing systems. Resistance to low temperature increases hose lifetime.

Internal hose: Polyester elastomer.

Reinforcement: 1 high tensile steel wire braid.

Covering: Polyurethane, black, pinpricked, white ink-jet branding.

Operating temperature: -76°F to +200°F (-60°C to +93°C).

Part number	ID		Size	OD	Max WP		Min BP		Min BR		Weight		Ferrule
	in	mm		mm	bar	psi	bar	psi	mm	inch	kg/m	lb/ft	
	TI00CO2-03	3/16"	5.0	03	9.7	300	4350	1200	17400	30	1.181	0.125	0.084
TI00CO2-04	1/4"	6.4	04	11.7	275	3988	1100	15950	40	1.575	0.155	0.104	*
TI00CO2-05	5/16"	8.0	05	13.2	212	3074	848	12296	55	2.165	0.190	0.128	*
TI00CO2-06	3/8"	9.8	06	15.5	212	3074	848	12296	65	2.559	0.230	0.155	*
TI00CO2-08	1/2"	13.0	08	18.8	175	2538	700	10150	85	3.346	0.300	0.202	*
TI00CO2-10	5/8"	16.3	10	22.0	140	2030	560	8120	115	4.528	0.320	0.215	*

* Call our customer service team.

Also available in twin version. Use order code T2500C02.



Constant Pressure Low Temperature TFS00CP

APPLICATIONS:



APPLICABLE SPECS.:

EXCEEDS SAE 100R18

Special polyester cover for use in cold environments. Pinpricked cover.

Internal hose: Polyester elastomer.

Reinforcement: 1 or 2 braids of synthetic fiber.

Covering: Special polyester, pinpricked.

Recommended fluid: Petroleum based hydraulic fluids, glycol-water based, lubricants.

Operating temperature: -67°F to +212°F (-55°C to +100°C); -67°F to +158°F (-55°C to +70°C) for water based fluids.

Part number	ID		Size	OD	Max WP		Min BP		Min BR		Weight		Ferrule
	in	mm		mm	bar	psi	bar	psi	mm	inch	kg/m	lb/ft	
	TFS00CP-03	3/16"	5.0	03	9.6	250	3600	1000	14400	25	0.984	0.060	0.040
TFS00CP-04	1/4"	6.5	04	13.0	250	3600	1000	14400	35	1.378	0.115	0.077	0008-04
TFS00CP-05	5/16"	8.1	05	15.0	250	3600	1000	14400	45	1.772	0.145	0.097	0008-05
TFS00CP-06	3/8"	9.7	06	18.0	250	3600	1000	14400	55	2.170	0.205	0.138	0008-06

P.T.F.E. Hose



Stocked in North America



Made to order



TF000T1



P.T.F.E. Type T1

91

TF00TP1



P.T.F.E. Type TP1

92

TF000T2



P.T.F.E. Type T2

93

TF00THP



P.T.F.E. Type THP

94

TF00LTC



P.T.F.E. Corrugated
Type LTC

95

P.T.F.E. Type T1

TF000T1

APPLICATIONS:



APPLICABLE SPECS.:

SAE 100 R14

Compatible with standard inserts.

Internal hose: Smooth P.T.F.E. thin wall.

Covering: 1 high-tensile stainless steel (AISI 304) wire braid.

Operating temperature: -94°F to +500°F (-70°C to +260°C).

Part number	ID			Wall thickness	OD	Max WP(23C°)		Min BP(23C°)		Min BR		Ferrule	
	in	mm	Dash			mm	bar	psi	bar	psi	inch		mm
TF000T1-03	3/16"	4.8	03	0.7	7.4	200	2900	800	11600	1.378	35	PTFE-03	
TF000T1-04	1/4"	6.35	04	0.7	9	175	2538	700	10150	1.772	45	PTFE-04	
TF000T1-05	5/16"	7.9	05	0.7	10.8	150	2175	600	8700	1.969	50	PTFE-05	
TF000T1-06	3/8"	9.50	06	0.7	12.4	135	1958	540	7830	2.165	55	PTFE-06	
TF000T1-08	1/2"	12.7	08	0.7	15.7	120	1740	480	6960	2.756	70	PTFE-08	
TF000T1-10	5/8"	15.90	10	0.8	19.1	100	1450	400	5800	5.118	130	PTFE-10	
TF000T1-12	3/4"	19.0	12	0.8	22.2	90	1305	360	5220	7.480	190	PTFE-12	
TF000T1-16	1"	25.40	16	1	29.7	65	943	260	3770	10.630	270	PTFE-16	

For temperature over 100°C, call our customer service team.



P.T.F.E. Type TP1

TF00TP1

APPLICATIONS:

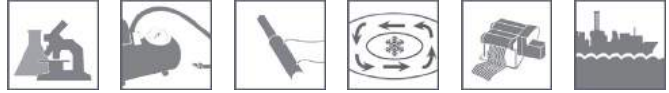

Compatible with standard inserts.

Internal hose: Smooth P.T.F.E. thin wall.

Covering: 1 high-tensile stainless steel (AISI 304) wire braid.

Operating temperature: -94°F to +500°F (-70°C to +260°C).

Part number	ID			Wall thickness	OD	Max WP(23C°)		Min BP(23C°)		Min BR		Ferrule	
	in	mm	Dash			mm	bar	psi	bar	psi	inch		mm
TF00TP1-03	3/16"	4.8	03	0.9	7.8	210	3045	840	12180	1.378	35	*	
TF00TP1-04	1/4"	6.35	04	0.9	9.4	185	2683	740	10730	1.772	45	*	
TF00TP1-05	5/16"	7.9	05	0.9	11.2	160	2320	640	9280	1.969	50	*	
TF00TP1-06	3/8"	9.5	06	0.9	12.8	140	2030	560	8120	2.165	55	*	
TF00TP1-07	13/32"	10.3	07	0.9	13.6	135	1958	540	7830	2.559	65	*	
TF00TP1-08	1/2"	12.7	08	0.9	16	125	1813	500	7250	2.756	70	*	
TF00TP1-10	5/8"	15.9	10	1	19.4	105	1523	420	6090	5.118	130	*	
TF00TP1-12	3/4"	19	12	1	22.5	95	1378	380	5510	7.480	190	*	
TF00TP1-14	7/8"	22.2	14	1.1	26	75	1088	300	4350	9.843	250	*	
TF00TP1-16	1"	25.4	16	1.1	29.4	67	972	268	3886	10.630	270	*	

(*) For temperature over 100°C, call our customer service team.

P.T.F.E. Type T2

TF000T2

APPLICATIONS:



Compatible with standard inserts.

Internal hose: Smooth P.T.F.E. thin wall.

Covering: 1 high-tensile stainless steel (AISI 304) wire braid.

Operating temperature: -94°F to +500°F (-70°C to +260°C).

Part number	ID			Wall thickness	OD	Max WP(23C°)		Min BR		Weight		Ferrule	
	in	mm	Dash			mm	bar	psi	inch	mm	gr/m		lb/ft
	TF000T2-03	3/16"	4.8			03	0.9	8.8	275	3988	1.181		30
TF000T2-04	1/4"	6.4	04	0.9	10.4	250	3625	1.378	35	183	0.123	*	
TF000T2-05	5/16"	7.9	05	0.9	12	225	3263	1.575	40	210	0.141	*	
TF000T2-06	3/8"	9.5	06	0.9	13.7	210	3045	1.969	50	243	0.163	*	
TF000T2-07	13/32"	10.3	07	0.9	14.6	200	2900	2.362	60	258	0.173	*	
TF000T2-08	1/2"	12.7	08	0.9	17	175	2538	2.756	70	374	0.251	*	
TF000T2-10	5/8"	15.9	10	1	20.5	160	2320	4.331	110	452	0.304	*	
TF000T2-12	3/4"	19	12	1	23.5	140	2030	7.087	180	532	0.358	*	
TF000T2-14	7/8"	22.2	14	1.1	27	125	1813	7.874	200	700	0.470	*	
TF000T2-16	1"	25.4	16	1.1	30.8	95	1378	11.024	280	730	0.491	*	

(*) For temperature over 100°C, call our customer service team.



P.T.F.E. Type THP

TF00THP

APPLICATIONS:



APPLICABLE SPECS.:

SAE 100 R8 - SAE 100 R9 - MIL. H38360

Compatible with standard inserts.

Internal hose: Smooth P.T.F.E. thin wall.

Covering: 1 high-tensile stainless steel (AISI 304) wire braid.

Operating temperature: -94°F to +500°F (-70°C to +260°C).

Part number	ID		OD	Max WP(23C°)		Min BP(23C°)		Min BR		Weight		Ferrule	
	in	mm		bar	psi	bar	psi	inch	mm	gr/m	lb/ft		
	TF00THP-04	1/4"	6	5.6	9.9	345	5003	1276	18502	1.496	38	149	0.100
TF00THP-05	5/16"	8	7.8	12.4	345	5003	1241	17995	2.480	63	243	0.163	*
TF00THP-06	3/8"	9.5	10.1	15.6	345	5003	1241	17995	2.874	73	345	0.232	*
TF00THP-08	1/2"	13	12.5	18.5	345	5003	1207	17502	3.228	82	484	0.325	*
TF00THP-10	5/8"	16	15.6	25.1	345	5003	1207	17502	3.858	98	982	0.660	*
TF00THP-14	7/8"	22	22	32.2	345	5003	1172	16994	5.000	127	1518	1.020	*
TF00THP-18	1 1/8"	28.5	28.4	42.1	345	5003	1138	16501	12.008	305	2753	1.850	*
TF00THP-20	1 1/4"	32	34.9	48.2	276	4002	1034	14993	14.016	356	2842	1.910	*

(* Call our customer service team. For impulse pressure, reduce the operating pressure by 69 bar. For use at a constant temperature of + 204 ° C, the max operating pressure for all diameters is 207 bar.

P.T.F.E. Corrugated Type LTC

TF00LTC

APPLICATIONS:



Compatible with standard inserts.

Internal hose: Corrugated P.T.F.E. thin wall.

Covering: 1 high-tensile stainless steel (AISI 304) wire braid.

Operating temperature: -94°F to +500°F (-70°C to +260°C).

Part number	ID			Wall thickness	OD	Tolerance	Max WP(23C°)		Min BR		Weight		Ferrule
	in	mm	Min				bar	psi	inch	mm	gr/m	lb/ft	
	TF00LTC-06	3/8"	9.5				06	0.9	15.5	0.5	125	1813	
TF00LTC-08	1/2"	12.7	08	0.9	18.5	0.5	110	1595	0.984	25	121	0.081	PTFE-08-C
TF00LTC-10	5/8"	15.9	10	0.9	22.5	0.5	80	1160	1.969	50	136	0.091	PTFE-10-C
TF00LTC-12	3/4"	19	12	0.9	26.7	0.7	70	1015	2.559	65	228	0.153	PTFE-12-C
TF00LTC-16	1"	25.4	16	1.1	33.7	0.7	50	725	3.543	90	281	0.189	PTFE-16-C
TF00LTC-20	1 1/4"	31.8	20	1.02	40.7	0.8	34	493	5.000	127	347	0.233	PTFE-20-C
TF00LTC-24	1 1/2"	38.1	24	1.12	48.3	0.8	30	435	5.984	152	473	0.318	PTFE-24-C
TF00LTC-32	2"	50.8	32	1.2	61.5	0.8	23	334	7.874	200	549	0.369	PTFE-32-C

For temperature over 100°C, call our customer service team.



Part Number Index

BFDQ011N / TFDQ011N	29	TFS0008.....	80
BFDQ021N.....	30	TFS0018.....	84
BFEM02K.....	7	TFS00CP	87
BFS0004 / TFS0004	19	TF500H1	81
BFSM013 / TFSM013	22	TF500H2.....	82
BFSM017 / TFSM017.....	21	TF500HP.....	83
BHDM021 / THDM021	36	TF500MP.....	85
BHEM01K / THEM01K.....	37	TF504JG / THS00JG	74
BHEMM2K.....	42	TFSM012.....	14
BHE501K	40	TFSM015.....	23
T2102K	65	TFW0070	57
T2E101K	64	TFW0085	58
TBOP350	75	TFW0110 / TFW0100	59
TF000T1	91	TFW0125 / TFW0120.....	60
TF000T2.....	93	TFW0145 / TFW0135.....	61
TF000TP1.....	92	THDB4SH	44
TF00LTC.....	95	THE002K	38
TF00THP	94	THE003K	39
TFA001K.....	8	THE01K / THE0L2K.....	67
TFA002K.....	9	THE102K	41
TFD02TE.....	16	THE2J2K.....	68
TFD03TE.....	17	THEMMDR	73
TFD04SH.....	13	THEPS1K	69
TFD04SP.....	11	THL101K	62
TFDC011B	28	THL102K.....	63
TFDE011	66	THN0011 / THB0011	52
TFDG015	43	THN001K / THB001K.....	54
TFDL011N	31	THN0021 / THB0021.....	53
TFDL021N.....	32	THN002K / THB002K	55
TFDM011.....	4	TI00CO2.....	86
TFDM021	5	TSW2280	56
TFDM4SH.....	12	TTRK200	70
TFDM4SP	10	TTRK250.....	71
TFE0P15.....	35	TTRK350.....	72
TFEM01K	6		
TFEM02KN.....	33		
TFN0011 / TFB0011	48		
TFN001K / TFB001K.....	50		
TFN0021 / TFB0021.....	49		
TFN002K / TFB002K	51		
TFS0003.....	15		
TFS0005.....	20		
TFS0006.....	18		
TFS0007.....	79		

International Standard Hose	1	INTERPUMP Jet Plus 1SN.....	52
Hypress 1SN	4	INTERPUMP Jet Plus 2SN	53
Hypress 2SN	5	INTERPUMP Jet Plus 1SC	54
INTERPUMP Hypress 1SC.....	6	INTERPUMP Jet Plus 2SC.....	55
INTERPUMP Hypress 2SC	7	INTERPUMP SewerJet 280	56
Hypress EASY K 1SC	8	INTERPUMP HyBlast 10k.....	57
Hypress EASY K 2SC	9	INTERPUMP HyBlast 12k.....	58
INTERPUMP Hypress 4SP MSHA	10	INTERPUMP HyBlast 15k.....	59
Hypress 4SP.....	11	INTERPUMP HyBlast 18k.....	60
INTERPUMP Hypress 4SH MSHA.....	12	INTERPUMP HyBlast 20k	61
Hypress 4SH	13	INTERPUMP LongLift 1SC.....	62
INTERPUMP Hypress R12.....	14	INTERPUMP LongLift 2SC	63
EN854 SAE 100R3.....	15	INTERPUMP LongLife Dual 1SC	64
Hypress 2TE.....	16	INTERPUMP LongLife Dual 2SC	65
EN 854 3TE.....	17	Hypress Railway - Fire Resistant.....	66
Hypress UniLock.....	18	INTERPUMP PowerLift 1SC/2SC	67
INTERPUMP Hy-Vacuum - SAE 100R4	19	INTERPUMP HyJack.....	68
SAE 100R5.....	20	Hypress Snow Storm 1SC.....	69
INTERPUMP Hypress R17.....	21	INTERPUMP HyTruck 200 bar.....	70
INTERPUMP Hypress R13.....	22	INTERPUMP HyTruck 250 bar	71
INTERPUMP Hypress R15.....	23	INTERPUMP HyTruck 350 bar	72
High Performance Hose.....	25	INTERPUMP Mega Drill.....	73
INTERPUMP Compressor	28	INTERPUMP Mega Jet	74
INTERPUMP HyCelsius MSHA 1SN	29	INTERPUMP BOP Firescreen 5000.....	75
INTERPUMP HyCelsius MSHA 2SN.....	30	Thermoplastic Hose	77
INTERPUMP HyFreeze 1SN	31	SAE 100R7	79
INTERPUMP HyFreeze 2SN	32	SAE 100R8.....	80
INTERPUMP HyOzone.....	33	One High Tensile Steel Wire Braid.....	81
INTERPUMP Pilot Plus 150.....	35	Two High Tensile Steel Wire Braid	82
INTERPUMP Kaizen 2SN.....	36	INTERPUMP HyUltra.....	83
INTERPUMP 1SC	37	R18 - Isobaric - Low Temperature	84
INTERPUMP 2SC	38	Mini-Flexible.....	85
INTERPUMP 3SC	39	INTERPUMP HyFire	86
INTERPUMP LongLife 1SC	40	Constant Pressure Low Temperature	87
INTERPUMP LongLife 2SC	41	P.T.F.E. Hose.....	89
INTERPUMP Marathon 2SC.....	42	P.T.F.E Type T1	91
INTERPUMP HyGreen R15	43	P.T.F.E. Type TP1.....	92
Bio-Flex.....	44	P.T.F.E. Type T2.....	93
Solutions for Applications	45	P.T.F.E Type THP.....	94
INTERPUMP Jet 1SN	48	P.T.F.E. Corrugated TYPE LTC	95
INTERPUMP Jet 2SN	49		
INTERPUMP Jet 1SC.....	50		
INTERPUMP Jet 2SC	51		

Built to INTERconnect.

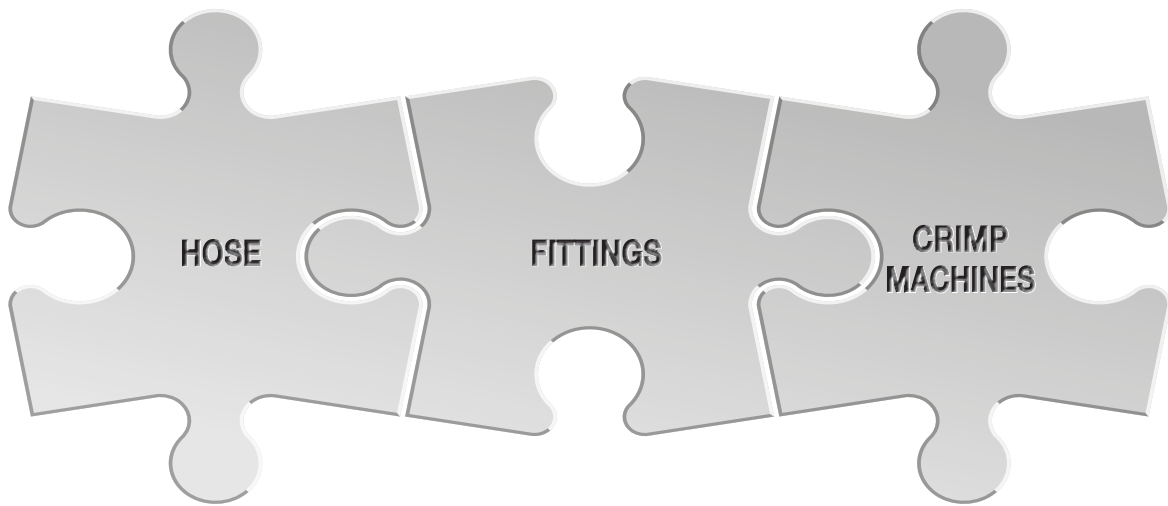



**Muncie[®]
Power
Products**



INTERPUMP
FLUID SOLUTIONS

MEMBERS OF THE INTERPUMP GROUP

One-Piece Fittings CATALOG



Muncie®
Power
Products



INTERPUMP
FLUID SOLUTIONS

MEMBERS OF THE INTERPUMP GROUP

Muncie Power Products is a leading manufacturer and distributor of power take-offs and fluid power components for the work truck industry. Since the company was founded in 1935, Muncie Power Products has taken great pride in providing unparalleled service to each and every customer.

As a member of the Interpump Group, Muncie Power Products is excited to expand its hydraulics offering by bringing the Interpump Fluid Solutions line of hose, fittings and crimpers – ***Built to INTERconnect*** – into North America. For more than 30 years, Interpump Fluid Solutions has been a leading producer of high-quality hose and fittings. With inventory available from locations in Indiana and Texas, Muncie Power Products is ready to meet the needs of the North American market.

One-Piece Fittings

Braided Hose No-Skive
Spiral Hose No-Skive

We also have the following catalogs:

Introduction and Technical
Information

Hydraulic Hose

Accessories



Braided Hose No-Skive



Content Overview



0370G



NPTF Male 30° Cone

7

037GG



NPTF Male Parallel
30° Cone Swivel

8

N051G



NPSM Female 30°
Cone Rolled Nut

8



0850G



JIC Male 37° Cone

9

0911G



JIC Female 37° Cone –
Rolled Nut

10

0900G

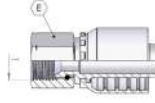

JIC Female 37° Cone –
Thrust Wire Nut

11

1001G



JIC 90° Swept Elbow
37° Cone – Rolled Nut

11

1000G



JIC 45° Swept Elbow
37° Cone – Slip-on Nut

12

0951G



JIC 90° Swept Elbow
37° Cone
– Rolled Nut

12

0950G



JIC 90° Swept Elbow
37° Cone
– Thrust Wire Nut

13

095LG



JIC 90° Swept Elbow
37° Cone – Long Drop
Rolled Nut

13

2971G



JIC 90° Compact
Elbow 37° Cone
– Crimped Nut

14

2970G



JIC 90° Compact
Elbow 37° Cone –
Thrust Wire Nut

14

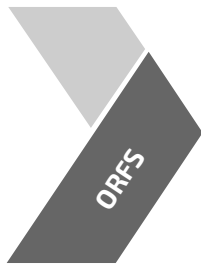

S350G



ORFS Male

15

S05TG



ORFS Female Double
Hexagon

15

S250G



ORFS 45° Swept
Elbow

15

S150G



ORFS 90° Swept
Elbow

17

S15LG



ORFS 90° Swept
Elbow – Long Drop

17

S15SG



ORFS 90° Swept
Elbow – Short Drop

18



0385G



SAE Male O-Ring Boss

19

0390G



Swivel Male O-Ring Boss

19

0395G



90° Male O-Ring Boss Swivel

20



IF00G



Straight Male Inverted Flare Swivel

20

IF45G



45° Male Inverted Flare Swivel

21

IF90G



90° Male Inverted Flare Swivel

21



0930G



JIS Female 60° Cone (Toyota)

22

0980G



90° JIS Swept Elbow (Toyota) – Welded

22



0940G



JIS Female 60° Cone (Komatsu)

23

1040G



45° JIS Swept Elbow (Komatsu) – Welded

23

0990G



90° JIS Swept Elbow (Komatsu) – Welded

24

1250G



Straight Komatsu Flange

24

1150G



45° Komatsu Flange

24

1150G



90° Komatsu Flange

24



K05BG



Kobelco Male

25

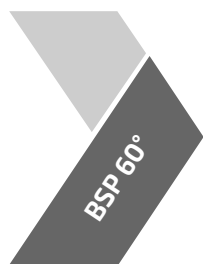

0360G



BSP Taper Male 60° Cone

26

0350G



BSP Male Parallel 60° Cone

27

0051G



BSP Female 60° Cone – Rolled Nut

28

0052G



BSP Female 60° Cone – Slip-on Nut

28



0050G



BSP Female 60° Cone
– Thrust Wire Nut

29

0251G



BSP 45° Swept Elbow
60° Cone – Rolled Nut

30

0252G



BSP 45° Swept Elbow
60° Cone – Slip-on Nut

30

0250G



BSP 45° Swept Elbow 60°
Cone – Thrust Wire Nut

31

0151G



BSP 90° Swept Elbow
60° Cone Rolled Nut

32

0152G



BSP 90° Swept Elbow
60° Cone – Slip-on Nut

32

0150G



BSP 90° Swept Elbow 60°
Cone – Thrust Wire Nut

33

0041G



BSP O-Ring Female
60° Cone – Rolled Nut

34

0042G



BSP O-Ring Female 60°
Cone – Slip-on Nut

34

0241G



BSP O-Ring 45° Swept
Elbow 60° Cone – Rolled Nut

35

0242G



BSP O-Ring 45° Swept Elbow
60° Cone – Slip-on Nut

35

0141G



BSP O-Ring 90° Swept Elbow
60° Cone – Rolled Nut

36

0142G



BSP O-Ring 90° Swept Elbow
60° Cone – Slip-on Nut

36

2321G



BSP 90° Compact Elbow
60° Cone – Rolled Nut

37

2320G



BSP 90° Compact Elbow
60° Cone – Thrust Wire Nut

37

0345G



BSP Male Flat Seal

38

0060G



BSP Female Flat Seal

38

1400G



BSP Banjo

39

1600-00



BSP Perforated Bolt

40

1600



BSP Double
Perforated Bolt

40

FK50G



Karcher Female

41

**Metric
Standpipe**

0550G



Metric Standpipe

42

0750G



45° Metric Standpipe

43

0750G



45° Metric Standpipe
(Welded)

43

0650G



90° Metric Standpipe

44

0650G



90° Metric Standpipe
(Welded)

44

**Metric
Banjo/Bolt**

1350G



Metric Banjo

45

1650



Metric Perforated Bolt

45

**French
Metric GAZ**

0430G



French Metric GAZ
Male 24° Cone

46

0030G



French Metric GAZ
Female 24° Cone

46

0130G



French Metric GAZ 90°
Swept Elbow 24° Cone

46

Metric 60°

0100G



Metric Female 60°
Cone

47

0200G



90° Metric Swept
Elbow 60° Cone

47

**Metric DIN 24°
DKL Multiseal**

0035G



Metric Female Light
Multiseal 24° Cone

48

0135G



90° Metric Multiseal
Swept Elbow 24° Cone

48

**Metric DIN
24° DKOL**

0500G



Metric Male 24°
Seat Light

49



0085G



Metric Female 24°
Seat Light

50

0085G



Metric Female 24°
Seat Light
(Rolled Nut)

50

0285G



45° Metric Swept
Elbow 24° Seat Light

51

0285G



45° Metric Swept
Elbow 24° Seat Light
(Rolled Nut)

51

0185G



90° Metric Swept
Elbow 24° Seat Light

52

0185G



90° Metric Swept
Elbow 24° Seat Light
(Rolled Nut)

52



0450G



Metric Male 24°
Seat Heavy

53

0084G



Metric Female 24°
Seat Heavy

54

0284G



45° Metric Swept
Elbow 24° Seat Heavy

55

0184G



90° Metric Swept
Elbow 24° Seat Heavy

56

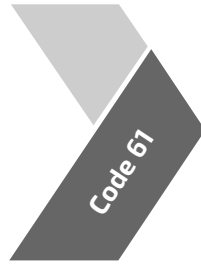

1260G



Straight SAE
Code 61 Flange

57

1160G



45° SAE
Code 61 Flange

57

1060G



90° SAE
Code 61 Flange

58

1060G



22.5°/30°/60°/67.5°/
110°/135° SAE Code
61 Flange

59

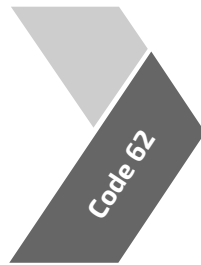

1310G



Straight SAE Code 62
Flange

60

1110G



90° SAE Code 62
Flange

61

1210G



45° SAE Code 62
Flange

62

1105G



90° 'CAT' Flange

62

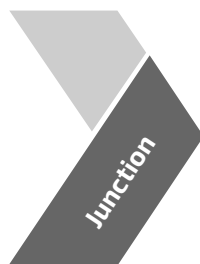

D050G



Hose Junction

63

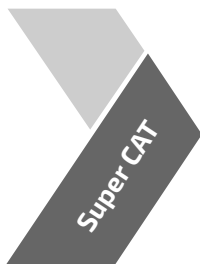

0370G

NPTF Male 30° Cone

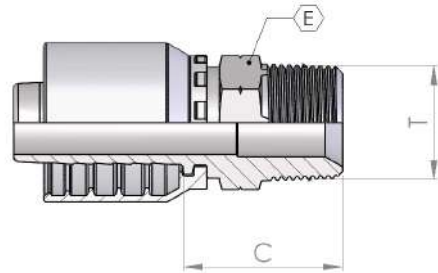

Part number	Hose I.D.		Dimension			
	in	mm	dash size	thread	hex	cut-off
				T	E	C
0370G03-02	3/16	4.8	03	1/8-27	12	22
0370G03-04	3/16	4.8	03	1/4-18	15	27
0370G04-02	1/4	6.4	04	1/8-27	12	22
0370G04-04	1/4	6.4	04	1/4-18	15	28
0370G04-06	1/4	6.4	04	3/8-18	19	28
0370G04-08	1/4	6.4	04	1/2-14	22	33.5
0370G05-04	5/16	7.9	05	1/4-18	15	28
0370G05-06	5/16	7.9	05	3/8-18	19	28
0370G05-08	5/16	7.9	05	1/2-14	22	34
0370G06-04	3/8	9.5	06	1/4-18	17	28
0370G06-06	3/8	9.5	06	3/8-18	19	28
0370G06-08	3/8	9.5	06	1/2-14	22	34
0370G08-06	1/2	12.7	08	3/8-18	19	29
0370G08-08	1/2	12.7	08	1/2-14	22	35
0370G08-12	1/2	12.7	08	3/4-14	27	36
0370G10-08	5/8	15.9	10	1/2-14	24	35
0370G10-12	5/8	15.9	10	3/4-14	27	36
0370G12-08	3/4	19.0	12	1/2-14	24	36
0370G12-12	3/4	19.0	12	3/4-14	27	37
0370G12-16	3/4	19.0	12	1 - 11 1/2	36	43
0370G16-12	1	25.4	16	3/4-14	32	38
0370G16-16	1	25.4	16	1 - 11 1/2	36	44
0370G16-20	1	25.4	16	1 1/4 - 11 1/2	46	46
0370G20-16	1 1/4	31.8	20	1 - 11 1/2	41	45
0370G20-20	1 1/4	31.8	20	1 1/4 - 11 1/2	46	47
0370G24-24	1 1/2	38.1	24	1 1/2 - 11 1/2	50	49
0370G32-32	2	50.8	32	2 - 11 1/2	65	55



037GG

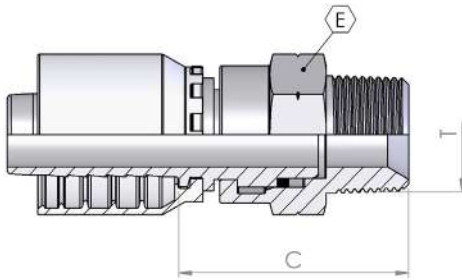

NPTF Male Parallel 30° Cone - Swivel

Part number	Hose I.D.		Dimension			
	in	mm	dash size	thread	hex	cut-off
				T	E	C
037GG04-04	1/4	6.4	04	1/4-18	19	39
037GG04-06	1/4	6.4	04	3/8-18	22	44
037GG04-08	1/4	6.4	04	1/2-14	27	52.5
037GG06-04	3/8	9.5	05	1/4-18	22	46.5
037GG06-06	3/8	9.5	06	3/8-18	22	43
037GG06-08	3/8	9.5	06	1/2-14	27	49
037GG08-06	1/2	12.7	08	3/8-18	22	45
037GG08-08	1/2	12.7	08	1/2-14	27	49
037GG10-12	5/8	15.9	10	3/4-14	32	52.5
037GG12-12	3/4	19.0	12	3/4-14	32	52
037GG16-16	1	25.4	16	1 - 11 1/2	38	65

N051G

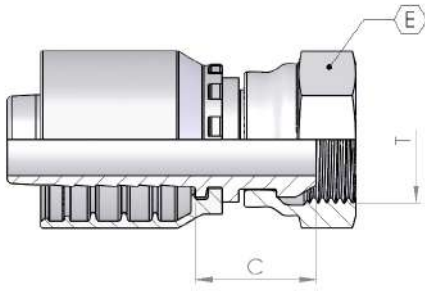

NPSM Female 30° Cone - Rolled Nut

Part number	Hose I.D.		Dimension			
	in	mm	dash size	thread	hex	cut-off
				T	E	C
N051G03-04	3/16	4.8	03	1/4-18	19	17
N051G04-04	1/4	6.4	04	1/4-18	19	17
N051G06-06	3/8	9.5	06	3/8-18	22	19
N051G08-06	1/2	12.7	08	3/8-18	22	20
N051G08-08	1/2	12.7	08	1/2-14	27	23
N051G12-12	3/4	19.0	12	3/4-14	32	25
N051G16-16	1	25.4	16	1 - 11 1/2	38	27

0850G

JIC Male 37° Cone

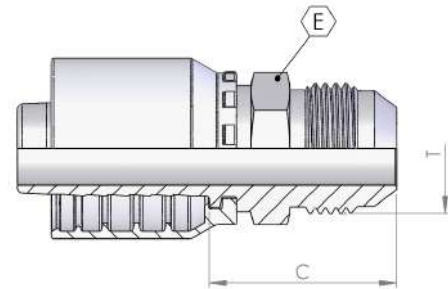

Part number	Hose I.D.		Dimension			
	in	mm	dash size	thread	hex	cut-off
				T	E	C
0850G03-04	3/16	4.8	03	7/16-20	12	26
0850G04-04	1/4	6.4	04	7/16-20	12	27
0850G04-05	1/4	6.4	04	1/2-20	14	27
0850G04-06	1/4	6.4	04	9/16-18	15	27
0850G05-05	5/16	7.9	05	1/2-20	14	27
0850G05-06	5/16	7.9	05	9/16-18	15	27
0850G05-08	5/16	7.9	05	3/4-16	19	30
0850G06-05	3/8	9.5	06	1/2-20	14	25
0850G06-06	3/8	9.5	06	9/16-18	15	27
* SAE 45° 0850G06-07	3/8	9.5	06	5/8-18	17	30
0850G06-08	3/8	9.5	06	3/4-16	19	30
0850G06-10	3/8	9.5	06	7/8-14	24	34
0850G08-06	1/2	12.7	08	9/16-18	19	28
0850G08-08	1/2	12.7	08	3/4-16	19	31
0850G08-10	1/2	12.7	08	7/8-14	24	35
0850G08-12	1/2	12.7	08	1 1/16-12	27	37
0850G10-10	5/8	15.9	10	7/8-14	24	35
0850G10-12	5/8	15.9	10	1 1/16-12	27	37
0850G12-10	3/4	19.0	12	7/8-14	24	36
0850G12-12	3/4	19.0	12	1 1/16-12	27	38
0850G12-14	3/4	19.0	12	1 3/16-12	32	41
0850G12-16	3/4	19.0	12	1 5/16-12	34	42
0850G12-20	3/4	19.0	12	1 5/8-12	42	45
0850G16-12	1	25.4	16	1 1/16-12	27	39
0850G16-14	1	25.4	16	1 3/16-12	32	42
0850G16-16	1	25.4	16	1 5/16-12	34	43
0850G16-20	1	25.4	16	1 5/8-12	42	46
0850G20-20	1 1/4	31.8	20	1 5/8-12	42	47
0850G20-24	1 1/4	31.8	20	1 7/8-12	50	52
0850G24-24	1 1/2	38.1	24	1 7/8-12	50	52
0850G32-32	2	50.8	32	2 1/2-12	65	62

* SAE 45°



0911G

JIC Female 37° Cone - Rolled Nut

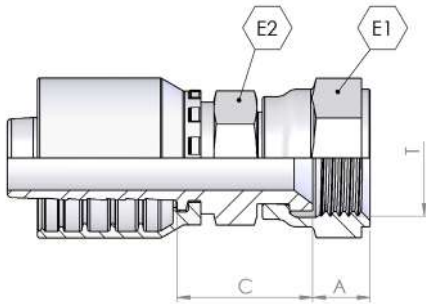

Part number	Hose I.D.		Dimension				
	in	mm	dash size	thread	hex	cut-off	
				T	E	C	A
0911G03-04	3/16	4.8	03	7/16-20	15	14	8.5
0911G03-05	3/16	4.8	03	1/2-20	17	14	9.5
0911G04-04	1/4	6.4	04	7/16-20	15	14	8.5
0911G04-05	1/4	6.4	04	1/2-20	17	15	9.5
0911G04-06	1/4	6.4	04	9/16-18	19	16	9
*SAE 45° 0911G04-07	1/4	6.4	04	5/8-18	22	17	11
0911G05-05	5/16	7.9	05	1/2-20	17	17	9.5
0911G05-06	5/16	7.9	05	9/16-18	19	16	9
*SAE 45° 0911G05-07	5/16	7.9	05	5/8-18	22	17	11
0911G05-08	5/16	7.9	05	3/4-16	24	17	10.5
0911G06-04	3/8	9.5	06	7/16-20	15	15	9
0911G06-05	3/8	9.5	06	1/2-20	17	15	9.5
0911G06-06	3/8	9.5	06	9/16-18	19	16	9
*SAE 45° 0911G06-07	3/8	9.5	06	5/8-18	22	16	11
0911G06-08	3/8	9.5	06	3/4-16	24	17	10.5
0911G06-10	3/8	9.5	06	7/8-14	27	21	13
0911G08-06	1/2	12.7	08	9/16-18	19	22	25
0911G08-08	1/2	12.7	08	3/4-16	24	18	10.5
0911G08-10	1/2	12.7	08	7/8-14	27	19	13
0911G08-12	1/2	12.7	08	1 1/16-12	32	24	13.5
0911G10-08	5/8	15.9	10	3/4-16	24	22	25
0911G10-10	5/8	15.9	10	7/8-14	27	19	13
0911G10-12	5/8	15.9	10	1 1/16-12	32	21	13.5
0911G12-10	3/4	19.0	12	7/8-14	27	20	13
0911G12-12	3/4	19.0	12	1 1/16-12	32	22	13.5
0911G12-14	3/4	19.0	12	1 3/16-12	36	23	14
0911G12-16	3/4	19.0	12	1 5/16-12	38	23	15.5
0911G16-12	1	25.4	16	1 1/16-12	32	23	13.5
0911G16-16	1	25.4	16	1 5/16-12	38	24	15.5

0900G

JIC Female 37° Cone - Thrust Wire Nut

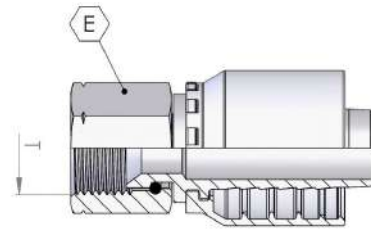

Part number	Hose I.D.		Dimension				
	in	mm	dash size	thread	hex	cut-off	
				T	E	C	A
*SAE 45° 0900G06-07	3/8	9.5	06	5/8-18	22	16	11
0900G16-12	1	25.4	16	1 1/16-12	32	23	13.5
0900G16-20	1 1/4	31.8	20	1 5/16-12	41	39	16.5
0900G20-16	1 1/4	31.8	20	1 5/16-12	41	39	15.5
0900G20-20	1 1/4	31.8	20	1 5/8-12	50	28	16.5
0900G24-24	1 1/2	38.1	24	1 7/8-12	55	31	19
0900G32-32	2	50.8	32	2 1/2-12	70	31	20

1001G

JIC 90° Swept Elbow 37° Cone - Rolled Nut

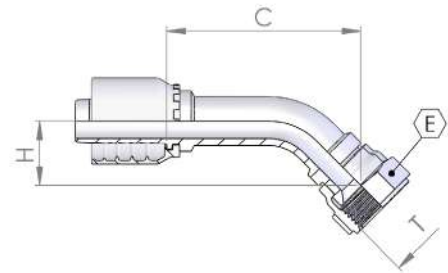

Part number	Hose I.D.		Dimension				
	in	mm	dash size	thread	hex	cut-off	drop
				T	E	C	H
1001G03-04	3/16	4.8	03	7/16-20	15	33	15
1001G04-04	1/4	6.4	04	7/16-20	15	38	13
1001G04-05	1/4	6.4	04	1/2-20	17	40	14
1001G04-06	1/4	6.4	04	9/16-18	19	47	18
1001G05-05	5/16	7.9	05	1/2-20	17	16	17
1001G05-06	5/16	7.9	05	9/16-18	19	47	18
1001G06-05	3/8	9.5	06	1/2-20	17	51	17
1001G06-06	3/8	9.5	06	9/16-18	19	51	17
*SAE 45° 1001G06-07	3/8	9.5	06	5/8-18	22	51	17
1001G06-08	3/8	9.5	06	3/4-16	24	52	19
1001G06-10	3/8	9.5	06	7/8-14	27	54	21
1001G08-08	1/2	12.7	08	3/4-16	24	62	22
1001G08-10	1/2	12.7	08	7/8-14	27	64	23
1001G08-12	1/2	12.7	08	1 1/16-12	32	68	25
1001G10-10	5/8	15.9	10	7/8-14	27	68	24
1001G10-12	5/8	15.9	10	1 1/16-12	32	70	25
Welded 1001G12-10	3/4	19.0	12	7/8-14	27	83	27
1001G12-12	3/4	19.0	12	1 1/16-12	32	84	28
1001G12-16	3/4	19.0	12	1 5/16-12	38	88	30
1001G16-12	1	25.4	16	1 1/16-12	32	103	32
1001G16-16	1	25.4	16	1 5/16-12	38	104	33



1000G

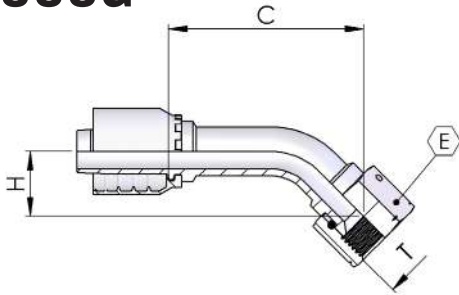

JIC 45° Swept Elbow 37° Cone - Slip on Nut

Part number	Hose I.D.		Dimension				
	in	mm	dash size	thread T	hex E	cut-off C	drop H
1000G16-20	1	25.4	16	1 1/16-12	32	103	32
1000G20-20	1 1/4	31.8	20	1 5/8-12	50	102	40
1000G20-24	1 1/4	31.8	20	1 7/8-12	55	89	39
1000G24-24	1 1/2	38.1	24	1 7/8-12	55	119	49
1000G32-32	2	50.8	32	2 1/2-12	70	142	65

0951G

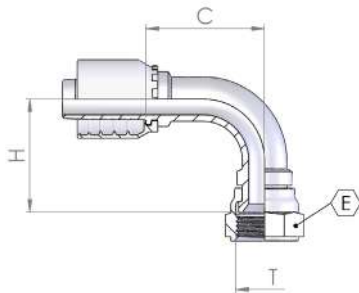

JIC 90° Swept Elbow 37° Cone - Rolled Nut

Part number	Hose I.D.		Dimension				
	in	mm	dash size	thread T	hex E	cut-off C	drop H
0951G03-04	3/16	4.8	03	7/16-20	15	22	22
0951G03-05	3/16	4.8	03	1/2-20	17	22	22
0951G04-04	1/4	6.4	04	7/16-20	15	25	24
0951G04-05	1/4	6.4	04	1/2-20	17	25	25
0951G04-06	1/4	6.4	04	9/16-18	19	25	27
0951G05-05	5/16	7.9	05	1/2-20	17	29	30
0951G05-06	5/16	7.9	05	9/16-18	19	29	31
0951G06-05	3/8	9.5	06	1/2-20	17	33	30
0951G06-06	3/8	9.5	06	9/16-18	19	31	32
*SAE 45° 0951G06-07	3/8	9.5	06	5/8-18	22	33	32
0951G06-08	3/8	9.5	06	3/4-16	24	33	34
0951G06-10	3/8	9.5	06	7/8-14	27	33	36
0951G08-08	1/2	12.7	08	3/4-16	24	41	41
0951G08-10	1/2	12.7	08	7/8-14	27	41	40
0951G08-12	1/2	12.7	08	1 1/16-12	32	39	43
0951G10-10	5/8	15.9	10	7/8-14	27	43	44
0951G10-12	5/8	15.9	10	1 1/16-12	32	45	47
Welded 0951G12-10	3/4	19.0	12	7/8-14	27	56	53
0951G12-12	3/4	19.0	12	1 1/16-12	32	56	54
0951G12-14	3/4	19.0	12	1 3/16-12	36	57	53
0951G12-16	3/4	19.0	12	1 5/16-12	38	55	56
0951G16-12	1	25.4	16	1 1/16-12	32	70	63
0951G16-16	1	25.4	16	1 5/16-12	38	70	65

0950G

JIC 90° Swept Elbow 37° Cone - Thrust Wire Nut

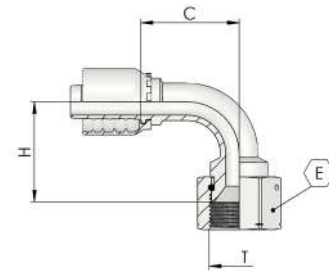

Part number	Hose I.D.		Dimension				
	in	mm	dash size	thread	hex	cut-off	drop
				T	E	C	H
*SAE 45° 0950G06-07	3/8	9.5	06	5/8-18	22	33	32
0950G20-20	1 1/4	31.8	20	1 5/8-12	50	87	83
0950G24-24	1 1/2	38.1	24	1 7/8-12	55	102	97
0950G32-32	2	50.8	32	2 1/2-12	70	125	134

095LG

JIC 90° Swept Elbow 37° Cone - Long Drop - Rolled Nut

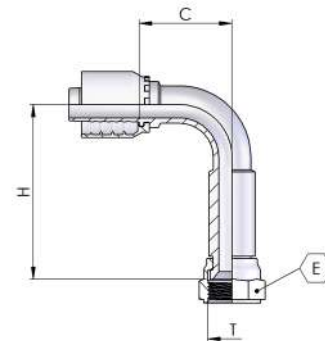

Part number	Hose I.D.		Dimension				
	in	mm	dash size	thread	hex	cut-off	drop
				T	E	C	H
095LG04-04	1/4	6.4	04	7/16-20	15	26.5	46
095LG04-06	1/4	6.4	04	9/16-18	19	25.5	54
095LG06-06	3/8	9.5	06	9/16-18	19	32.5	54
095LG06-08	3/8	9.5	06	3/4-16	24	33.5	64
095LG08-08	1/2	12.7	08	3/4-16	24	40.5	64
095LG08-10	1/2	12.7	08	7/8-14	27	40.5	70
095LG10-10	5/8	15.9	10	7/8-14	27	43	70
095LG10-12	5/8	15.9	10	1 1/16-12	32	45.5	96
095LG12-10	3/4	19.0	12	7/8-14	27	42.5	70
095LG12-12	3/4	19.0	12	1 1/16-12	32	70.5	96
095LG12-16	3/4	19.0	12	1 5/16-12	38	55.5	114
095LG16-16	1	25.4	15	1 5/16-12	38	69.5	114



2971G

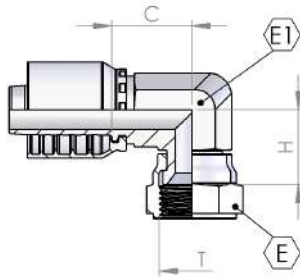

JIC 90° Compact Elbow 37° Cone - Crimped Nut

Part number	Hose I.D.		Dimension					
	in	mm	dash size	thread	hex		cut-off	drop
				T	E	E1	C	H
2971G04-04	1/4	6.4	04	7/16-20	15	15	19	17
2971G04-05	1/4	6.4	04	1/2-20	17	15	19	18
2971G04-06	1/4	6.4	04	9/16-18	19	15	19	19
2971G05-06	5/16	7.9	05	9/16-18	19	17	20	20
2971G06-06	3/8	9.5	06	9/16-18	19	17	23	20
2971G06-08	3/8	9.5	06	3/4-16	24	22	24	22
2971G08-08	1/2	12.7	08	3/4-16	24	22	26	23
2971G08-10	1/2	12.7	08	7/8-14	27	22	26	24
2971G12-12	3/4	19.0	12	1 1/16-12	32	27	32	29
2971G16-16	1	25.4	16	1 5/16-12	38	32	38	34

2970G

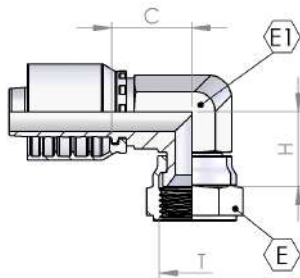

JIC 90° Compact Elbow 37° Cone - Thrust Nut Wire

Part number	Hose I.D.		Dimension					
	in	mm	dash size	thread	hex		cut-off	drop
				T	E	E1	C	H
2970G04-04	1/4	6.4	04	7/16-20	17	15	19	17
2970G04-06	1/4	6.4	04	9/16-18	19	15	19	19
2970G06-06	3/8	9.5	06	9/16-18	19	17	23	20
2970G06-08	3/8	9.5	06	3/4-16	24	22	24	22
2970G08-08	1/2	12.7	08	3/4-16	24	22	26	23
2970G08-10	1/2	12.7	08	7/8-14	27	22	26	24
2970G12-12	3/4	19.0	12	1 1/16-12	32	27	32	29

ORFS Male

S350G

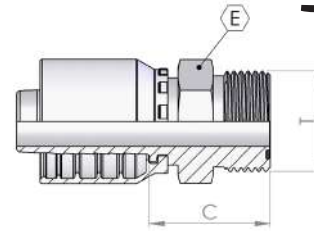

Part number	Hose I.D.		Dimension			
	in	mm	dash size	thread	hex	cut-off
				T	E	C
S350G04-06	1/4	6.4	04	9/16-18	17	23
S350G04-09	1/4	6.4	04	11/16-16	19	21
S350G05-09	5/16	7.9	05	11/16-16	19	26
S350G06-09	3/8	9.5	06	11/16-16	19	26
S350G06-11	3/8	9.5	06	13/16-16	22	29
S350G08-11	1/2	12.7	08	13/16-16	22	29
S350G08-13	1/2	12.7	08	1-14	27	34
S350G08-14	1/2	12.7	08	1 3/16-12	32	35
S350G10-13	5/8	15.9	10	1-14	27	33
S350G10-14	5/8	15.9	10	1 3/16-12	32	35
S350G12-14	3/4	19.0	12	1 3/16-12	32	36
S350G12-15	3/4	19.0	12	1 7/16-12	38	36
S350G16-15	1	25.4	16	1 7/16-12	38	37
S350G16-21	1	25.4	16	1 11/16-12	46	38
S350G20-21	1 1/4	31.8	20	1 11/16-12	46	39

With Cap and O-Ring.

ORFS Female Double Hexagon

S05TG

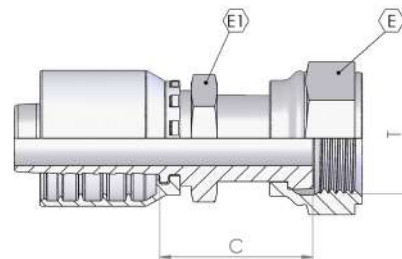

Part number	Hose I.D.		Dimension				
	in	mm	dash size	thread	hex	cut-off	
				T	E	E1	C
S05TG04-06	1/4	6.4	04	9/16-18	17	15	30
S05TG04-09	1/4	6.4	04	11/16-16	22	17	34
S05TG04-11	1/4	6.4	04	13/16-16	24	19	37
S05TG06-06	3/8	9.5	06	9/16-16	17	15	30
S05TG06-09	3/8	9.5	06	11/16-16	22	17	34
S05TG06-11	3/8	9.5	06	13/16-16	24	19	37
S05TG08-09	1/2	12.7	08	11/16-16	22	17	34
S05TG08-11	1/2	12.7	08	13/16-16	24	19	37
S05TG08-13	1/2	12.7	08	1-14	30	24	41
S05TG08-14	1/2	12.7	08	13/16-12	36	30	41
S05TG10-11	5/8	15.9	10	13/16-16	24	19	37
S05TG10-13	5/8	15.9	10	1-14	30	24	41
S05TG10-14	5/8	15.9	10	1 3/16-12	36	30	41
S05TG12-13	3/4	19.0	12	1-14	30	24	41
S05TG12-14	3/4	19.0	12	1 3/16-12	36	30	42
S05TG16-15	1	25.4	16	1 7/16-12	41	36	50
S05TG20-21	1 1/4	31.8	20	1 11/16-12	50	46	60
S05TG24-32	1 1/2	38.1	24	2-12	60	50	68



S250G

ORFS 45° Swept Elbow

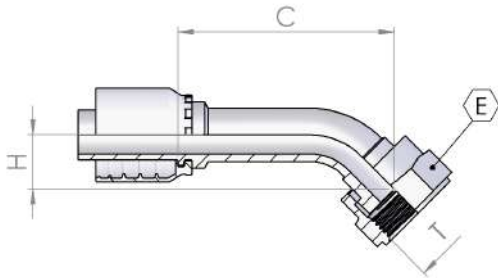

Part number	Hose I.D.		Dimension				
	in	mm	dash size	thread	hex	cut-off	drop
				T	E	C	H
S250G04-06	1/4	6.4	04	9/16-18	19	40	14
S250G04-09	1/4	6.4	04	11/16-16	22	38	14
S250G05-09	5/16	7.9	05	11/16-16	22	44	14
S250G06-09	3/8	9.5	06	11/16-16	22	52	17
S250G06-11	3/8	9.5	06	13/16-16	24	51	18
S250G08-09	1/2	12.7	08	11/16-16	22	38	14
S250G08-11	1/2	12.7	08	13/16-16	24	62	20
S250G08-13	1/2	12.7	08	1-14	30	64	23
S250G08-14	1/2	12.7	08	1 3/16-12	36	62	23
S250G10-13	5/8	15.9	10	1-14	30	67	22
Welded S250G10-14	5/8	15.9	10	1 3/16-12	36	44	18
Welded S250G12-13	3/4	19.0	12	1-14	30	40	15
S250G12-14	3/4	19.0	12	1 3/16-12	36	84	23
S250G12-15	3/4	19.0	12	1 7/16-12	41	84	26
S250G16-15	1	25.4	16	1 7/16-12	41	100	31
S250G16-21	1	25.4	16	1 11/16-12	50	60	24
Welded S250G20-21	1 1/4	31.8	20	1 11/16-12	50	125	44
Welded S250G24-32	1 1/2	38.1	24	2-12	60	78	29

ORFS 90° Swept Elbow

S150G

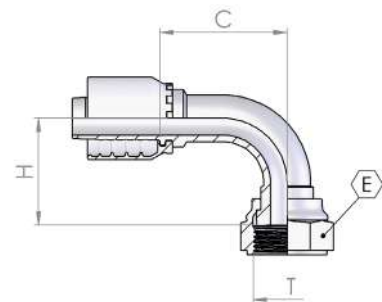

Part number	Hose I.D.		Dimension				
	in	mm	dash size	thread	hex	cut-off	drop
				T	E	C	H
S150G04-06	1/4	6.4	04	9/16-18	19	25	26
S150G04-09	1/4	6.4	04	11/16-16	22	25	23
S150G05-09	5/16	7.9	05	11/16-16	22	29	32
S150G06-09	3/8	9.5	06	11/16-16	22	33	33
S150G06-11	3/8	9.5	06	13/16-16	24	33	32
S150G08-09	1/2	12.7	08	11/16-16	22	31	37
S150G08-11	1/2	12.7	08	13/16-16	24	39	36
S150G08-13	1/2	12.7	08	1-14	30	39	40
S150G08-14	1/2	12.7	08	1 3/16-12	36	42	39
S150G10-13	5/8	15.9	10	1-14	30	47	39
Welded S150G10-14	5/8	15.9	10	1 3/16-12	36	42	39
Welded S150G12-13	3/4	19.0	12	1-14	30	42	39
S150G12-14	3/4	19.0	12	1 3/16-12	36	57	49
S150G12-15	3/4	19.0	12	1 7/16-12	41	56	51
S150G16-15	1	25.4	16	1 7/16-12	41	67	62
Welded S150G16-21	1	25.4	20	1 11/16-12	50	62	58
Welded S150G20-21	1 1/4	31.8	20	1 11/16-12	50	63	58
Welded S150G24-32	1 1/2	38.1	24	2-12	60	80	73

ORFS 90° Swept Elbow - Long Drop

S15LG

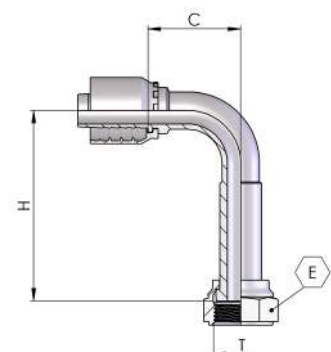

Part number	Hose I.D.		Dimension				
	in	mm	dash size	thread	hex	cut-off	drop
				T	E	C	H
S15LG08-11	1/2	12.7	08	13/16-16	24	40.5	64
S15LG12-14	3/4	19.0	12	1 3/16-12	36	57	96
S15LG16-15	1	25.4	16	1 7/16-12	41	68.5	114



S15SG

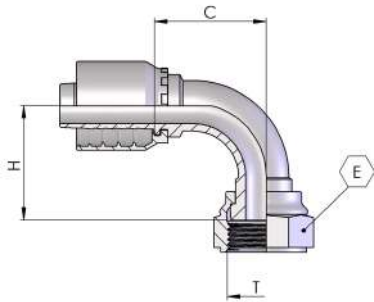

ORFS 90° Swept Elbow - Short Drop

Part number	Hose I.D.		Dimension				
	in	mm	dash size	thread	hex	cut-off	drop
				T	E	C	H
S15SG04-06	1/4	6.4	04	9/16-18	17	25.5	21
S15SG06-09	3/8	9.5	06	11/16-16	22	30	23
S15SG06-11	3/8	9.5	06	13/16-16	24	33	29
S15SG08-11	1/2	12.7	08	13/16-16	24	40	29

0385G

SAE Male O-Ring Boss

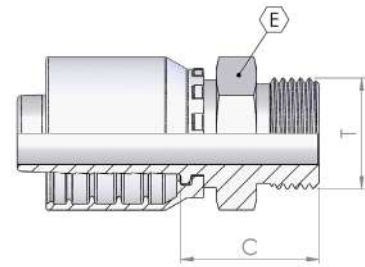

Part number	Hose I.D.		Dimension			
	in	mm	dash size	thread	hex	cut-off
				T	E	C
0385G04-04	1/4	6.4	04	7/16-20	14	24
0385G04-06	1/4	6.4	04	9/16-18	17	24
0385G05-06	5/16	7.9	05	9/16-18	17	24
0385G06-06	3/8	9.5	06	9/16-18	17	25
0385G06-08	3/8	9.5	06	3/4-16	22	28
0385G08-08	1/2	12.7	08	3/4-16	22	28
0385G08-10	1/2	12.7	08	7/8-14	27	30
0385G08-12	1/2	12.7	08	1 1/16-12	32	32
0385G10-08	5/8	15.9	10	3/4-16	22	28
0385G10-10	5/8	15.9	10	7/8-14	27	30
0385G10-12	5/8	15.9	10	1 1/16-12	32	32
0385G12-12	3/4	19.0	12	1 1/16-12	32	33
0385G12-16	3/4	19.0	12	1 5/16-12	38	36
0385G16-16	1	25.4	16	1 5/16-12	38	37

Fitting ships with O-Ring.

0390G

Swivel Male O-Ring Boss

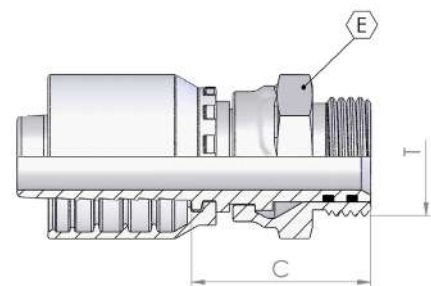

Part number	Hose I.D.		Dimension			
	in	mm	dash size	thread	hex	cut-off
				T	E	C
0390G08-10	1/2	12.7	08	7/8-14	27	39
0390G10-10	5/8	15.9	10	7/8-14	27	39
0390G12-12	3/4	19.0	12	1 1/16-12	32	43

Fitting ships with O-Ring.



0395G

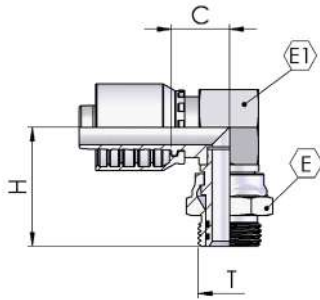

90° SAE Male O-Ring Boss Swivel

Part number	Hose I.D.		Dimension					
	in	mm	dash size	thread	hex		cut-off	drop
				T	E	E1	C	H
0395G08-08	1/2	12.7	08	3/4-16	24	27	28	42
0395G08-10	1/2	12.7	08	7/8-14	27	27	21	48
0395G10-10	5/8	15.9	10	7/8-14	27	27	21	48
0395G12-12	3/4	19.0	12	1 1/16-12	32	32	25	52

Fitting ships with O-Ring.

IF00G

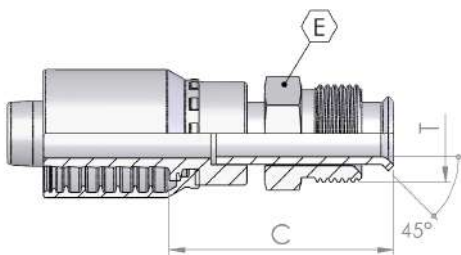

Straight Male Inverted Flare Swivel

Part number	Hose I.D.		Dimension			
	in	mm	dash size	thread	hex	cut-off
				T	E	C
IF00G04-04	1/4	6.4	04	7/16-24	12	38
IF00G04-05	1/4	6.4	04	1/2-20	14	55
IF00G05-04	5/16	7.9	05	7/16-24	12	56
IF00G05-05	5/16	7.9	05	1/2-20	14	56
IF00G05-07	5/16	7.9	05	5/8-18	17	56
IF00G06-04	3/8	9.5	06	7/16-24	12	56
IF00G06-05	3/8	9.5	06	1/2-20	14	56
IF00G06-07	3/8	9.5	06	5/8-18	17	57
IF00G06-09	3/8	9.5	06	11/16-18	19	42
IF00G08-08	1/2	12.7	08	3/4-18	19	60

IF45G

45° Male Inverted Flare Swivel

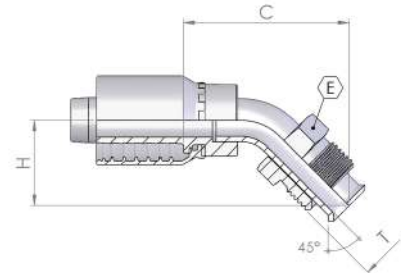

Part number	Hose I.D.		Dimension				
	in	mm	dash size	thread	hex	cut-off	drop
				T	E	C	H
IF45G04-04	1/4	6.4	04	7/16-24	12	48	24
IF45G04-05	1/4	6.4	04	1/2-20	14	48	24
IF45G06-04	3/8	9.5	06	7/16-24	12	48	25
IF45G06-05	3/8	9.5	06	1/2-20	14	48	25
IF45G06-07	3/8	9.5	06	5/8-18	17	54	30
IF45G06-09	3/8	9.5	06	11/16-18	19	54	30
IF45G08-08	1/2	12.7	08	3/4-18	19	60	35

IF90G

90° Male Inverted Flare Swivel

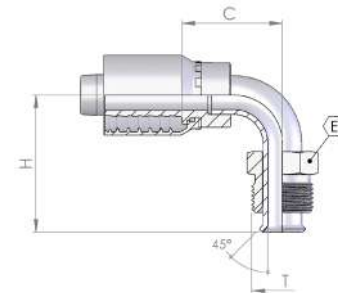

Part number	Hose I.D.		Dimension				
	in	mm	dash size	thread	hex	cut-off	drop
				T	E	C	H
IF90G04-04	1/4	6.4	04	7/16-24	12	29	36
IF90G04-05	1/4	6.4	04	1/2-20	14	30	34
IF90G05-04	5/16	7.9	05	7/16-24	12	24	38
IF90G05-05	5/16	7.9	05	1/2-20	14	30	35
IF90G05-07	5/16	7.9	05	5/8-18	17	30	43
IF90G06-04	3/8	9.5	06	7/16-24	12	30	35
IF90G06-05	3/8	9.5	06	1/2-20	14	30	35
IF90G06-07	3/8	9.5	06	5/8-18	17	31	44
IF90G06-09	3/8	9.5	06	11/16-18	19	31	42
IF90G08-08	1/2	12.7	08	3/4-18	19	35	45



0930G

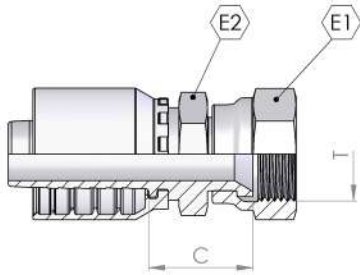

JIS Female 60° Cone (Toyota)

Part number	Hose I.D.		Dimension				
	in	mm	dash size	thread	hex		cut-off
				T	E	E1	C
0930G04-04	1/4	6.4	04	1/4-19	19	17	20
0930G06-06	3/8	9.5	06	3/8-19	22	19	22
0930G08-08	1/2	12.7	08	1/2-14	27	22	26
0930G12-12	3/4	19.0	12	3/4-14	32	30	29
0930G16-16	1	25.4	16	1-11	38	36	31
0930G20-20	1 1/4	31.8	20	1 1/4-11	50	46	35
0930G24-24	1 1/2	38.1	24	1 1/2-11	55	50	28

0980G

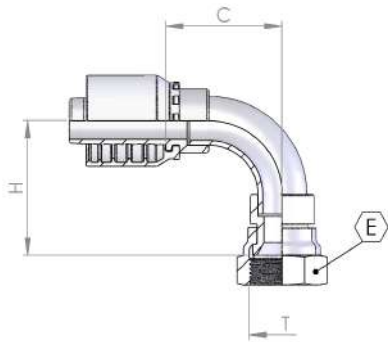

90° JIS Swept Elbow (Toyota) - Welded

Part number	Hose I.D.		Dimension				
	in	mm	dash size	thread	hex	cut-off	drop
				T	E	C	H
0980G04-04	1/4	6.4	04	1/4-19	19	38	35
0980G06-06	3/8	9.5	06	3/8-19	22	27	30
0980G08-08	1/2	12.7	08	1/2-14	27	33	39
0980G12-12	3/4	19.0	12	3/4-14	32	48	55
0980G16-16	1	25.4	16	1-11	38	57	62
0980G20-20	1 1/4	31.8	20	1 1/4-11	50	63	65
0980G24-24	1 1/2	38.1	24	1 1/2-11	55	80	83

JIS Female 60° Cone (Komatsu)

0940G

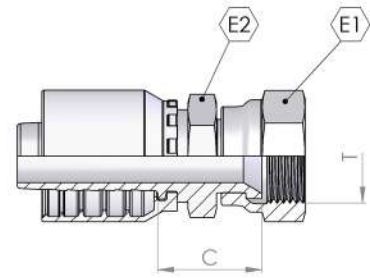

Part number	Hose I.D.		Dimension				
	in	mm	dash size	thread	hex		cut-off
				T	E	E1	C
0940G04-14	1/4	6.4	04	M14x1.5	19	17	22
0940G04-18	1/4	6.4	04	M18x1.5	24	19	21
0940G05-16	5/16	7.9	05	M16x1.5	22	17	22
0940G06-14	3/8	9.5	06	M14x1.5	19	17	22
0940G06-18	3/8	9.5	06	M18x1.5	24	19	21
0940G08-22	1/2	12.7	08	M22x1.5	27	22	27
0940G10-24	5/8	15.9	10	M24x1.5	30	27	26
0940G12-30	3/4	19.0	12	M30x1.5	36	30	30
0940G16-33	1	25.4	16	M33x1.5	41	36	33
0940G20-36	1 1/4	31.8	20	M36x1.5	46	46	37
0940G24-42	1 1/2	38.1	24	M42x1.5	50	50	38

45° JIS Swept Elbow (Komatsu) - Welded

1040G

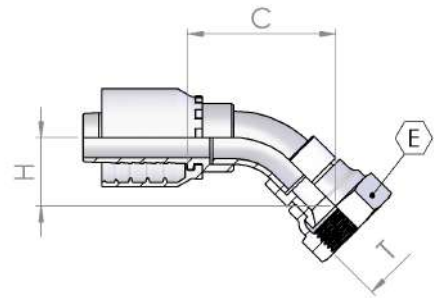

Part number	Hose I.D.		Dimension				
	in	mm	dash size	thread	hex	cut-off	drop
				T	E	C	H
1040G04-14	1/4	6.4	04	M14x1.5	19	44	18
1040G05-16	5/16	7.9	05	M16x1.5	22	38	18
1040G06-14	3/8	9.5	06	M14x1.5	19	41	18
1040G06-18	3/8	9.5	06	M18x1.5	24	43	18
1040G08-22	1/2	12.7	08	M22x1.5	27	40	20
1040G10-24	5/8	15.9	10	M24x1.5	30	50	26
1040G12-30	3/4	19.0	12	M30x1.5	36	56	26
1040G16-33	1	25.4	16	M33x1.5	41	65	33



0990G

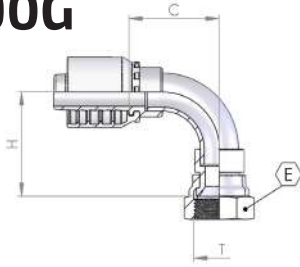

90° JIS Swept Elbow (Komatsu) - Welded

Part number	Hose I.D.		Dimension				
	in	mm	dash size	thread	hex	cut-off	drop
				T	E	C	H
0990G04-14	1/4	6.4	04	M14x1.5	19	38	35
0990G05-16	5/16	7.9	05	M16x1.5	22	27	30
0990G06-14	3/8	9.5	06	M14x1.5	19	31	33
0990G06-18	3/8	9.5	06	M18x1.5	24	31	33
0990G08-22	1/2	12.7	08	M22x1.5	27	33	39
0990G10-24	5/8	15.9	10	M24x1.5	30	42	48
0990G12-30	3/4	19.0	12	M30x1.5	36	48	43
0990G16-33	1	25.4	16	M33x1.5	41	57	62

1250G

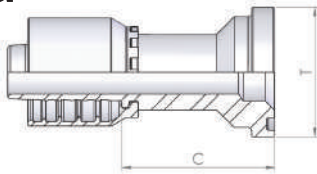

Straight Komatsu Flange

Part number	Hose I.D.		dash size	Dimension		
	in	mm		flange		cut-off
			T	mm	C	mm
1250G10-10	5/8	15.9	10	5/8	34	56

1150G

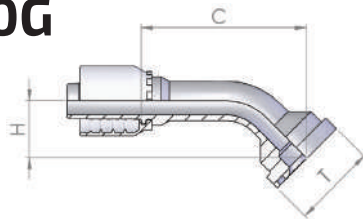

45° Komatsu Flange

Part number	Hose I.D.		dash size	Dimension			
	in	mm		flange		cut-off	drop
			T	mm	C	H	
Welded 1150G10-10	5/8	15.9	10	5/8	34	23	54

1050G

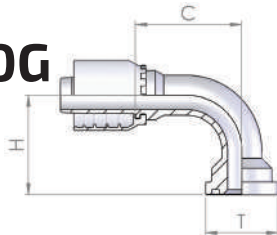

90° Komatsu Flange

Part number	Hose I.D.		dash size	Dimension			
	in	mm		flange		cut-off	drop
			T	mm	C	H	
Welded 1050G10-10	5/8	15.9	10	5/8	34	48	47

KO5BG

Kobelco Male

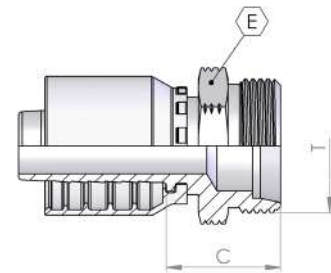

Part number	Hose I.D.		Dimension			
	in	mm	dash size	thread	hex	cut-off
				T	E	C
KO5BG10-30	5/8	15.9	10	M30x1.5	32	32
KO5BG12-30	3/4	19.0	12	M30x1.5	32	35
KO5BG12-36	3/4	19.0	12	M36x1.5	41	36
KO5BG16-36	1	25.4	16	M36x1.5	41	37
KO5BG16-45	1	25.4	16	M45x1.5	50	38



0360G

BSP Taper Male 60° Cone

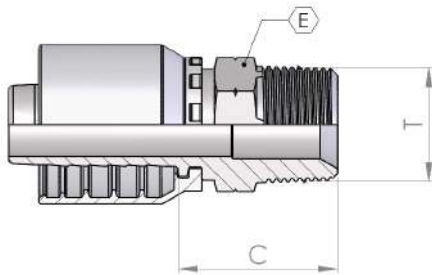

Part number	Hose I.D.		Dimension			
	in	mm	dash size	thread	hex	cut-off
				T	E	C
0360G03-02	3/16	4.8	03	1/8-28	12	21
0360G03-04	3/16	4.8	03	1/4-19	15	27
0360G04-02	1/4	6.4	04	1/8-28	12	22
0360G04-04	1/4	6.4	04	1/4-19	15	28
0360G04-06	1/4	6.4	04	3/8-19	19	28
0360G05-04	5/16	7.9	05	1/4-19	15	28
0360G05-06	5/16	7.9	05	3/8-19	19	28
0360G06-04	3/8	9.5	06	1/4-19	17	28
0360G06-06	3/8	9.5	06	3/8-19	19	28
0360G06-08	3/8	9.5	06	1/2-14	22	33
0360G08-06	1/2	12.7	08	3/8-19	19	29
0360G08-08	1/2	12.7	08	1/2-14	22	34
0360G08-12	1/2	12.7	08	3/4-14	27	36
0360G10-08	5/8	15.9	10	1/2-14	22	34
0360G10-10	5/8	15.9	10	5/8-14	24	35
0360G10-12	5/8	15.9	10	3/4-14	27	36
0360G12-12	3/4	19.0	12	3/4-14	27	37
0360G12-16	3/4	19.0	12	1-11	36	43
0360G16-12	1	25.4	16	3/4-14	32	38.5
0360G16-16	1	25.4	16	1-11	36	44
0360G16-20	1	25.4	16	1 1/4-11	46	46
0360G20-20	1 1/4	31.8	20	1 1/4-11	46	47
0360G20-24	1 1/4	31.8	20	1 1/2-11	50	49
0360G24-24	1 1/2	38.1	24	1 1/2-11	50	49
0360G24-32	1 1/2	38.1	24	2-11	65	55
0360G32-32	2	50.8	32	2-11	65	55

0350G

BSP Male Parallel 60° Cone

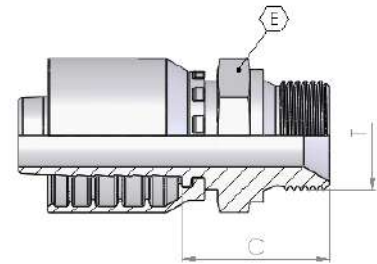

Part number	Hose I.D.		Dimension			
	in	mm	dash size	thread	hex	cut-off
				T	E	C
0350G03-02	3/16	4.8	03	1/8-28	14	21
0350G03-04	3/16	4.8	03	1/4-19	19	26
0350G04-02	1/4	6.4	04	1/8-28	14	21
0350G04-04	1/4	6.4	04	1/4-19	19	27
0350G04-06	1/4	6.4	04	3/8-19	22	28
0350G04-08	1/4	6.4	04	1/2-14	27	35
0350G05-04	5/16	7.9	05	1/4-19	19	27
0350G05-06	5/16	7.9	05	3/8-19	22	28
0350G05-08	5/16	7.9	05	1/2-14	27	32
0350G06-04	3/8	9.5	06	1/4-19	19	27
0350G06-06	3/8	9.5	06	3/8-19	22	29
0350G06-08	3/8	9.5	06	1/2-14	27	32
0350G08-06	1/2	12.7	08	3/8-19	22	29
0350G08-08	1/2	12.7	08	1/2-14	27	33
0350G08-10	1/2	12.7	08	5/8-14	30	34
0350G08-12	1/2	12.7	08	3/4-14	32	35
0350G10-08	5/8	15.9	10	1/2-14	27	33
0350G10-10	5/8	15.9	10	5/8-14	30	35
0350G10-12	5/8	15.9	10	3/4-14	32	35
0350G12-08	3/4	19.0	12	1/2-14	27	33.5
0350G12-12	3/4	19.0	12	3/4-14	32	36
0350G12-16	3/4	19.0	12	1-11	41	39
0350G16-12	1	25.4	16	3/4-11	32	37
0350G16-16	1	25.4	16	1-11	41	40
0350G16-20	1	25.4	16	1 1/4-11	50	44
0350G20-16	1 1/4	31.8	20	1-11	41	41
0350G20-20	1 1/4	31.8	20	1 1/4-11	50	45
0350G20-24	1 1/4	31.8	20	1 1/2-11	55	46
0350G24-24	1 1/2	38.1	24	1 1/2-11	55	46
0350G24-32	1 1/2	38.1	24	2-11	70	54
0350G32-24	2	50.8	32	1 1/2-11	65	50
0350G32-32	2	50.8	32	2-11	70	54



0051G

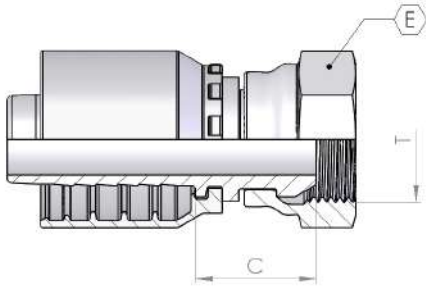

BSP Female 60° Cone - Rolled Nut

Part number	Hose I.D.		Dimension			
	in	mm	dash size	thread	hex	cut-off
				T	E	C
0051G03-02	3/16	4.8	03	1/8-28	14	15
0051G03-04	3/16	4.8	03	1/4-19	19	17
0051G04-02	1/4	6.4	04	1/8-28	14	15
0051G04-04	1/4	6.4	04	1/4-19	19	17
0051G04-06	1/4	6.4	04	3/8-19	22	19
0051G04-08	1/4	6.4	04	1/2-14	27	22
0051G05-04	5/16	7.9	05	1/4-19	19	17
0051G05-06	5/16	7.9	05	3/8-19	22	19
0051G05-08	5/16	7.9	05	1/2-14	27	22
0051G06-04	3/8	9.5	06	1/4-19	19	17
0051G06-06	3/8	9.5	06	3/8-19	22	19
0051G06-08	3/8	9.5	06	1/2-14	27	22
0051G08-06	1/2	12.7	08	3/8-19	22	20
0051G08-08	1/2	12.7	08	1/2-14	27	23
0051G08-10	1/2	12.7	08	5/8-14	30	20
0051G08-12	1/2	12.7	08	3/4-14	32	27
0051G10-08	5/8	15.9	10	1/2-14	27	23
0051G10-10	5/8	15.9	10	5/8-14	30	20
0051G10-12	5/8	15.9	10	3/4-14	32	25
0051G12-08	3/4	19.0	12	1/2-14	27	24
0051G12-12	3/4	19.0	12	3/4-14	32	25
0051G12-16	3/4	19.0	12	1-11	38	26
0051G16-12	1	25.4	16	3/4-14	32	27
0051G16-16	1	25.4	16	1-11	38	27

0052G

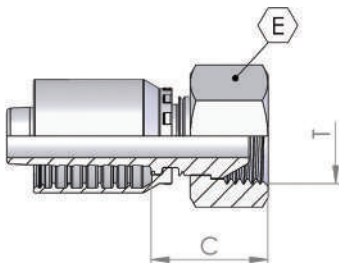

BSP Female 60° Cone - Slip-on Nut

Part number	Hose I.D.		Dimension			
	in	mm	dash size	thread	hex	cut-off
				T	E	C
0052G04-04	1/4	6.4	04	1/4 - 19	17	17
0052G06-06	3/8	9.5	06	3/8 - 19	19	17
0052G08-08	1/2	12.7	08	1/2 - 14	27	21

0050G

BSP Female 60° Cone - Thrust Wire Nut

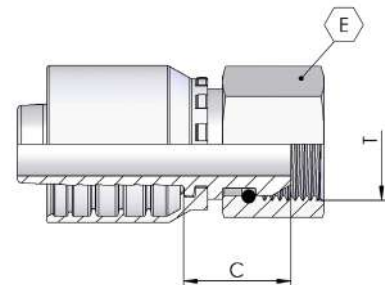

Part number	Hose I.D.		Dimension			
	in	mm	dash size	thread	hex	cut-off
				T	E	C
0050G16-20	1	25.4	16	1 1/4-11	50	30
0050G20-16	1 1/4	31.8	20	1-11	38	41
0050G20-20	1 1/4	31.8	20	1 1/4-11	50	32
0050G20-24	1 1/4	31.8	20	1 1/2-11	55	34
0050G24-24	1 1/2	38.1	24	1 1/2-11	55	34
0050G24-32	1 1/2	38.1	24	2-11	70	34
0050G32-32	2	50.8	32	2-11	70	30



0251G

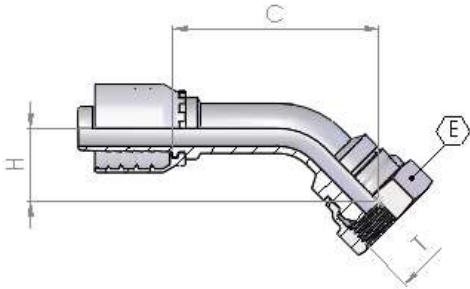

BSP 45° Swept Elbow 60° Cone - Rolled Nut

Part number	Hose I.D.		Dimension				
	in	mm	dash size	thread	hex	cut-off	drop
				T	E	C	H
0251G03-02	3/16	4.8	03	1/8-28	14	33	15
0251G03-04	3/16	4.8	03	1/4-19	19	35	15
0251G04-02	1/4	6.4	04	1/8-28	14	40	14
0251G04-04	1/4	6.4	04	1/4-19	19	41	15
0251G04-06	1/4	6.4	04	3/8-19	22	44	18
0251G05-04	5/16	7.9	05	1/4-19	19	47	16
0251G05-06	5/16	7.9	05	3/8-19	22	51	19
0251G06-04	3/8	9.5	06	1/4-19	19	50	16
0251G06-06	3/8	9.5	06	3/8-19	22	52	19
0251G06-08	3/8	9.5	06	1/2-14	27	55	21
0251G08-06	1/2	12.7	08	3/8-19	22	63	22
0251G08-08	1/2	12.7	08	1/2-12	27	65	24
0251G08-10	1/2	12.7	08	5/8-14	30	64	21
0251G08-12	1/2	12.7	08	3/4-14	32	67	26
0251G10-08	5/8	15.9	10	1/2-14	27	68	24
0251G10-10	5/8	15.9	10	5/8-14	30	68	23
0251G10-12	5/8	15.9	10	3/4-14	32	72	27
0251G12-12	3/4	19.0	12	3/4-14	32	86	30
0251G12-16	3/4	19.0	12	1-11	38	88	32
0251G16-16	1	25.4	16	1-11	38	107	35

0252G

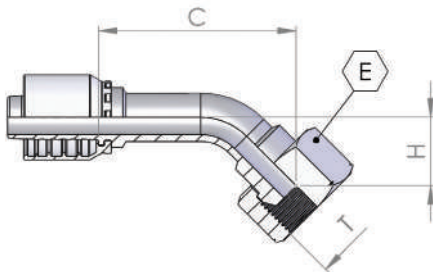

BSP 45° Swept Elbow 60° Cone – Slip-on Nut

Part number	Hose I.D.		Dimension				
	in	mm	dash size	thread	hex	cut-off	drop
				T	E	C	H
0252G04-04	1/4	6.4	04	1/4-19	17	41	15
0252G06-06	3/8	9.5	06	3/8-19	19	49	15
0252G08-08	1/2	12.7	08	1/2-14	27	61	19

0250G

BSP 45° Swept Elbow 60° Cone - Thrust Wire Nut

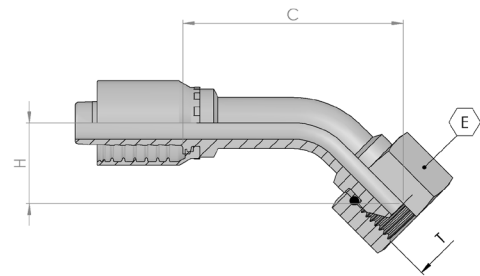

Part number	Hose I.D.		Dimension				
	in	mm	dash size	thread	hex	cut-off	drop
				T	E	C	H
0250G16-20	1	25.4	16	1 1/4-11	50	70	33
0250G20-20	1 1/4	31.8	20	1 1/4-11	50	107	40
0250G20-24	1 1/4	31.8	20	1 1/2-11	55	91	41
0250G24-24	1 1/2	38.1	24	1 1/2-11	55	117	47
0250G32-32	2	50.8	32	2-11	70	142	65



0151G

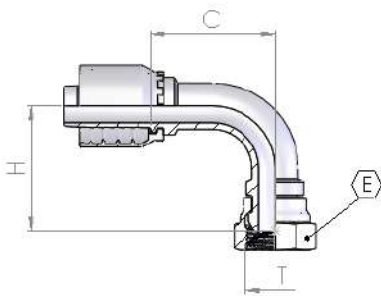

BSP 90° Swept Elbow 60° Cone - Rolled Nut

Part number	Hose I.D.		Dimension				
	in	mm	dash size	thread	hex	cut-off	drop
				T	E	C	H
0151G03-02	3/16	4.8	03	1/8-28	14	22	23
0151G03-04	3/16	4.8	03	1/4-19	19	22	25
0151G04-02	1/4	6.4	04	1/8-28	14	25	25
0151G04-04	1/4	6.4	04	1/4-19	19	25	27
0151G04-06	1/4	6.4	04	3/8-19	22	25	31
0151G05-04	5/16	7.9	05	1/4-19	19	31	31
0151G05-06	5/16	7.9	05	3/8-19	22	29	36
0151G06-04	3/8	9.5	06	1/4-19	19	31	33
0151G06-06	3/8	9.5	06	3/8-19	22	33	35
0151G06-08	3/8	9.5	06	1/2-14	27	31	40
0151G08-06	1/2	12.7	08	3/8-19	22	39	42
0151G08-08	1/2	12.7	08	1/2-14	27	39	41
0151G08-10	1/2	12.7	08	5/8-14	30	40	41
0151G08-12	1/2	12.7	08	3/4-14	32	41	46
0151G10-08	5/8	15.9	10	1/2-14	27	42	45
0151G10-10	5/8	15.9	10	5/8-14	30	43	43
0151G10-12	5/8	15.9	10	3/4-14	32	45	50
0151G12-12	3/4	19	12	3/4-14	32	56	57
0151G12-16	3/4	19	12	1-11	38	56	60
0151G16-16	1	25.4	16	1-11	38	70	67

0152G

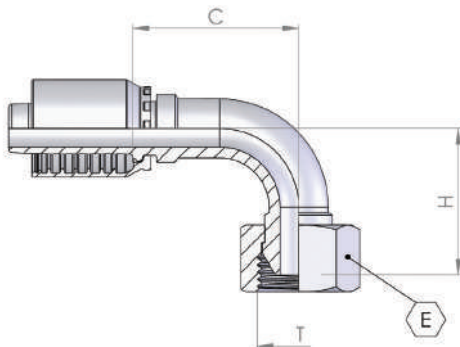

BSP 90° Swept Elbow 60° Cone - Slip-on Nut

Part number	Hose I.D.		Dimension				
	in	mm	dash size	thread	hex	cut-off	drop
				T	E	C	H
0152G04-04	1/4	6.4	04	1/4-19	17	27	26
0152G06-06	3/8	9.5	06	3/8-19	19	34	30
0152G08-08	1/2	12.7	08	1/2-14	27	42	38

0150G

BSP 90° Swept Elbow 60° Cone - Thrust Wire Nut

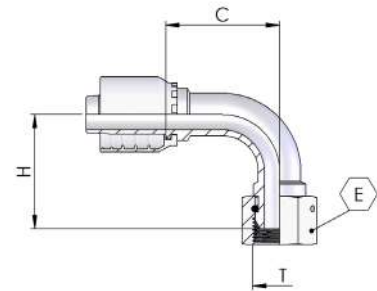

Part number	Hose I.D.		Dimension				
	in	mm	dash size	thread	hex	cut-off	drop
				T	E	C	H
0150G20-20	1 1/4	31.8	20	1 1/4-11	50	86	81
0150G20-24	1 1/4	31.8	20	1 1/2-11	55	81	89
0150G24-24	1 1/2	38.1	24	1 1/2-11	55	103	95
0150G32-32	2	50.8	32	2-11	70	122	135



0041G

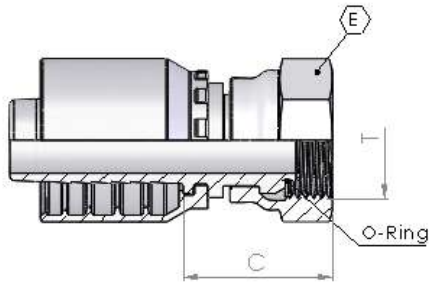

BSP O-Ring Female 60° Cone- Rolled Nut

Part number	Hose I.D.		Dimension			
	in	mm	dash size	thread	hex	cut-off
				T	E	C
0041G04-04	1/4	6.4	04	1/4-19	19	17
0041G06-06	3/8	9.5	06	3/8-19	22	19
0041G08-08	1/2	12.7	08	1/2-14	27	21
0041G10-10	5/8	15.9	10	5/8-14	30	21
0041G12-12	3/4	19.0	12	3/4-14	32	26
0041G16-16	1	25.4	16	1-11	38	28

0042G

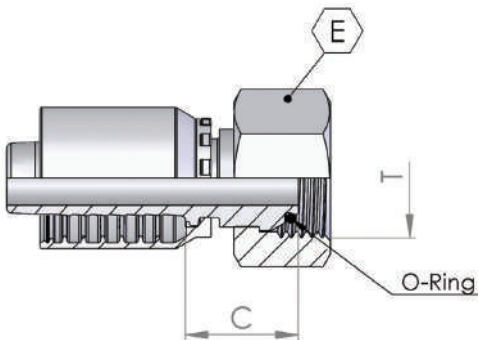

BSP O-Ring Female 60° Cone - Slip-on Nut

Part number	Hose I.D.		Dimension			
	in	mm	dash size	thread	hex	cut-off
				T	E	C
0042G04-04	1/4	6.4	04	1/4 - 19	17	17
0042G06-06	3/8	9.5	06	3/8 - 19	19	17
0042G08-08	1/2	12.7	08	1/2 - 14	27	20

0241G

BSP O-Ring 45° Swept Elbow 60° Cone - Rolled Nut

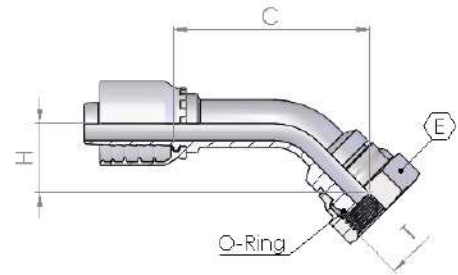

Part number	Hose I.D.		Dimension				
	in	mm	dash size	thread	hex	cut-off	drop
				T	E	C	H
0241G04-04	1/4	6.4	04	1/4-19	19	41	15
0241G06-06	3/8	9.5	06	3/8-19	22	52	21
0241G08-08	1/2	12.7	08	1/2-14	27	63	22
0241G10-10	5/8	15.9	10	5/8-14	30	68	23
0241G12-12	3/4	19.0	12	3/4-14	32	88	28
0241G16-16	1	25.4	16	1-11	38	83	32

0242G

BSP O-Ring 45° Swept Elbow 60° Cone - Slip-on Nut

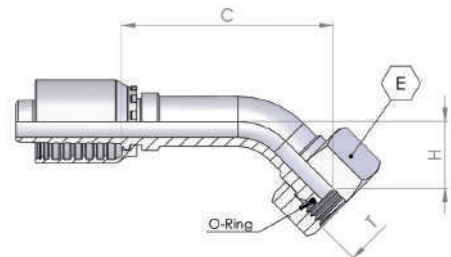

Part number	Hose I.D.		Dimension				
	in	mm	dash size	thread	hex	cut-off	drop
				T	E	C	H
0242G04-04	1/4	6.4	04	1/4-19	17	41	15
0242G06-06	3/8	9.5	06	3/8-19	19	49	15
0242G08-08	1/2	12.7	08	1/2-14	27	63	19



0141G

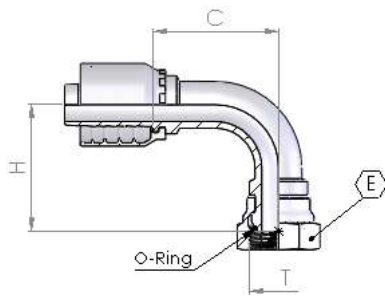

BSP O-Ring 90° Swept Elbow 60° Cone - Rolled Nut

Part number	Hose I.D.		Dimension				
	in	mm	dash size	thread	hex	cut-off	drop
				T	E	C	H
0141G04-04	1/4	6.4	04	1/4-19	19	25	27
0141G06-06	3/8	9.5	06	3/8-19	22	33	34
0141G08-08	1/2	12.7	08	1/2-14	27	41	40
0141G10-10	5/8	15.9	10	5/8-14	30	43	55
0141G12-12	3/4	19.0	12	3/4-14	32	56	54
0141G16-16	1	25.4	16	1-11	38	70	67

0142G

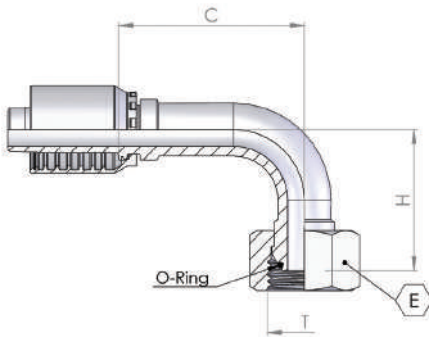

BSP 90° Swept Elbow 60° Cone - Slip-on Nut

Part number	Hose I.D.		Dimension				
	in	mm	dash size	thread	hex	cut-off	drop
				T	E	C	H
0142G04-04	1/4	6.4	04	1/4 - 19	17	27	24
0142G06-06	3/8	9.5	06	3/8 - 19	19	34	28
0142G08-08	1/2	12.7	08	1/2 - 14	27	42	37

2321G

BSP 90° Compact Elbow 60° Cone - Rolled Nut

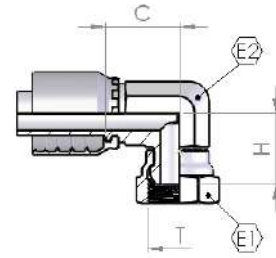

Part number	Hose I.D.		Dimension					
	in	mm	dash size	thread	hex		cut-off	drop
				T	E	E1	C	H
2321G04-04	1/4	6.4	04	1/4-19	19	15	19	20
2321G04-06	1/4	6.4	04	3/8-19	22	17	24	29
2321G05-06	5/16	7.9	05	3/8-19	22	17	24	23
2321G06-06	3/8	9.5	06	3/8-19	22	17	23	23
2321G06-08	3/8	9.5	06	1/2-14	27	19	28	26
2321G08-08	1/2	12.7	08	1/2-14	27	22	26	27
2321G12-12	3/4	19.0	12	3/4-14	32	27	32	32
2321G16-16	1	25.4	16	1-11	38	32	38	36

2320G

BSP 90° Compact Elbow 60° Cone – Thrust Wire Nut

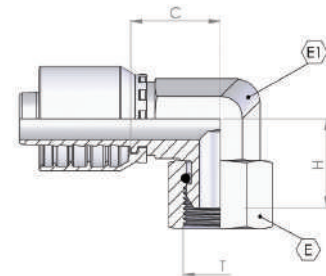

Part number	Hose I.D.		Dimension					
	in	mm	dash size	thread	hex		cut-off	drop
				T	E1	E2	C	H
2320G04-04	1/4	6.4	04	1/4-19	19	15	19	20
2320G08-08	1/2	12.7	08	1/2-14	27	22	26	27



0345G

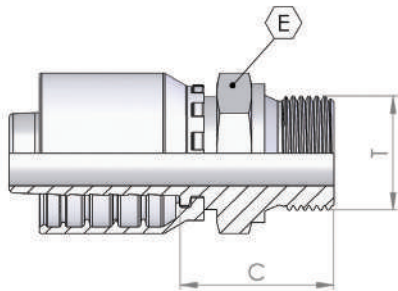

BSP Male Flat Seat

Part number	Hose I.D.		Dimension			
	in	mm	dash size	thread	hex	cut-off
				T	E	C
0345G04-04	1/4	6.4	04	1/4-19	19	27
0345G06-06	3/8	9.5	06	3/8-19	22	29
0345G06-08	3/8	9.5	06	1/2-14	27	32
0345G08-08	1/2	12.7	08	1/2-14	27	33
0345G12-12	3/4	19.0	12	3/4-14	32	36

0060G

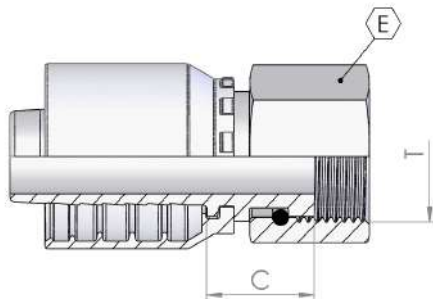

BSP Female Flat Seal

Part number	Hose I.D.		Dimension			
	in	mm	dash size	thread	hex	cut-off
				T	E	C
0060G04-04	1/4	6.4	04	1/4-19	19	14
0060G04-06	1/4	6.4	04	3/8-19	22	15
0060G05-04	5/16	7.9	05	1/4-19	19	14
0060G05-06	5/16	7.9	05	3/8-19	22	15
0060G05-08	5/16	7.9	05	1/2-14	27	17
0060G06-06	3/8	9.5	06	3/8-19	22	15
0060G06-08	3/8	9.5	06	1/2-14	27	16
0060G08-08	1/2	12.7	08	1/2-14	27	16
0060G08-10	1/2	12.7	08	5/8-14	30	16
0060G08-12	1/2	12.7	08	3/4-14	32	23
0060G10-10	5/8	15.9	10	5/8-14	30	16
0060G10-12	5/8	15.9	10	3/4-14	32	20
0060G12-12	3/4	19.0	12	3/4-14	32	21
0060G12-16	3/4	19.0	12	1-11	38	23
0060G16-16	1	25.4	16	1-11	38	22
0060G24-24	1 1/2	38.1	24	1 1/2-11	55	27

1400G

BSP Banjo

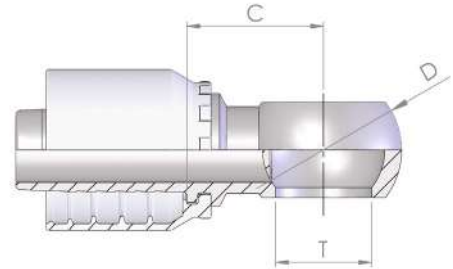

Part number	Hose I.D.		Dimension				
	in	mm	dash size	hole T	flange mm	D Øball	cut-off C
1400G03-02	3/16	4.8	03	1/8-28	10.2	17	19
1400G03-04	3/16	4.8	03	1/4-19	13.3	24	26
1400G04-02	1/4	6.4	04	1/8-28	10.2	17	25
1400G04-04	1/4	6.4	04	1/4-19	13.3	24	26
1400G04-06	1/4	6.4	04	3/8-19	17	28	26
1400G05-04	5/16	7.9	05	1/4-19	13.3	24	26
1400G05-06	5/16	7.9	05	3/8-19	17	28	26
1400G06-04	3/8	9.5	06	1/4-19	13.3	24	26
1400G06-06	3/8	9.5	06	3/8-19	17	28	26
1400G06-08	3/8	9.5	06	1/2-14	21.2	36	31
1400G08-06	1/2	12.7	08	3/8-19	17	28	27
1400G08-08	1/2	12.7	08	1/2-14	21.2	36	31
1400G08-10	1/2	12.7	08	5/8-14	23.1	38	29
1400G08-12	1/2	12.7	08	3/4-14	26.5	45	38
1400G10-10	5/8	15.9	10	5/8-14	23.1	39	29
1400G10-12	5/8	15.9	10	3/4-14	26.5	45	38
1400G12-12	3/4	19.0	12	3/4-14	26.5	45	38
1400G12-16	3/4	19.0	12	1-11	33.5	58	49
1400G16-16	1	25.4	16	1-11	33.5	58	50



1600-00

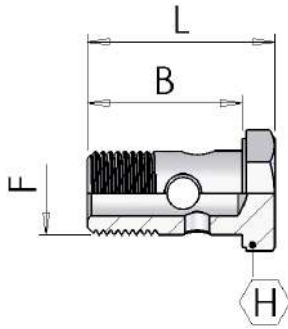

BSP Perforated Bolt

Part number	Dimension			
	F	B	L	hex H
1600-00-02	1/8-28	19	24	14
1600-00-04	1/4-19	29	34	19
1600-00-06	3/8-19	33	41	22
1600-00-08	1/2-14	38	46	27
1600-00-10	5/8-14	44	54	30
1600-00-12	3/4-14	47	56	32
1600-00-16	1-11	58	69	41

1600

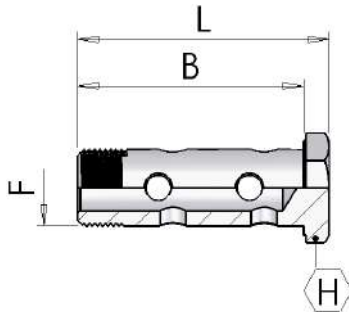

BSP Double Perforated Bolt

Part number	Dimension			
	F	B	L	hex H
1600-04-04	1/4-19	43	49	19
1600-06-06	3/8-19	49	57	22
1600-08-08	1/2-14	62	70	27
1600-12-12	3/4-14	78	87	32
1600-16-16	1-11	98	109	41

FK50G

Karcher Female

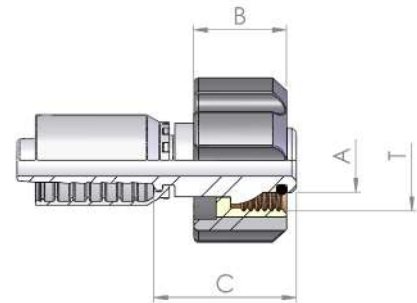

Part number	Hose I.D.		Dimension				
	in	mm	dash size	thread	cut-off		
				T	C	A	B
FK50G04-22	1/4	6.4	04	M22x1.5	31	14	20
FK50G05-22	5/16	7.9	05	M22x1.5	31	14	20
FK50G06-22	3/8	9.5	06	M22x1.5	31	14	20
FK50G04022	1/4	6.4	04	M22x1.5	31	14	27
FK50G05022	5/16	7.9	05	M22x1.5	31	14	27
FK50G06022	3/8	9.5	06	M22x1.5	31	14	27



0550G

Metric Standpipe

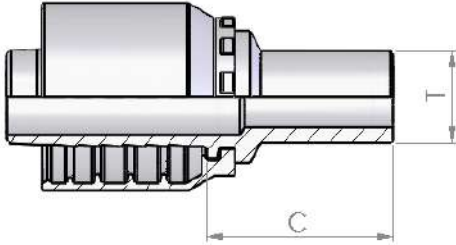

Part number	Hose I.D.		Dimension			
	in	mm	dash size	pipe	Type	cut-off
				T		C
0550G03-04	3/16	4.8	03	4	L/S	30
0550G03-06	3/16	4.8	03	6	L/S	30
0550G03-08	3/16	4.8	03	8	L/S	29
0550G04-06	1/4	6.4	04	6	L/S	32
0550G04-08	1/4	6.4	04	8	L/S	30
0550G04-10	1/4	6.4	04	10	L/S	33
0550G04-12	1/4	6.4	04	12	L/S	30
0550G05-08	5/16	7.9	05	08	L/S	31
0550G05-10	5/16	7.9	05	10	L/S	31
0550G05-12	5/16	7.9	05	12	L/S	33
0550G06-08	3/8	9.5	06	08	L/S	33
0550G06-10	3/8	9.5	06	10	L/S	33
0550G06-12	3/8	9.5	06	12	L/S	32
0550G06-14	3/8	9.5	06	14	S	37
0550G06-15	3/8	9.5	06	15	L	32
0550G08-12	1/2	12.7	08	12	L/S	36
0550G08-14	1/2	12.7	08	14	S	39
0550G08-15	1/2	12.7	08	15	L	34
0550G08-16	1/2	12.7	08	16	S	39
0550G08-18	1/2	12.7	08	18	L	35
0550G08-20	1/2	12.7	08	20	S	45
0550G10-18	5/8	15.9	10	18	L	35
0550G10-20	5/8	15.9	10	20	S	45
0550G10-22	5/8	15.9	10	22	L	33
0550G12-18	3/4	19.0	12	18	L	37
0550G12-20	3/4	19.0	12	20	S	46
0550G12-22	3/4	19.0	12	22	L	38
0550G12-25	3/4	19.0	12	25	S	49
0550G12-28	3/4	19.0	12	28	L	40
0550G16-25	1	25.4	16	25	S	51
0550G16-28	1	25.4	16	28	L	41
0550G16-30	1	25.4	16	30	S	54
0550G16-38	1	25.4	16	38	S	60
0550G20-30	1 1/4	31.8	20	30	S	58
0550G20-35	1 1/4	31.8	20	35	L	48
0550G20-38	1 1/4	31.8	20	38	S	62
0550G24-38	1 1/2	38.1	24	38	S	63
0550G24-42	1 1/2	38.1	24	42	L	50

45° Metric Standpipe

0750G

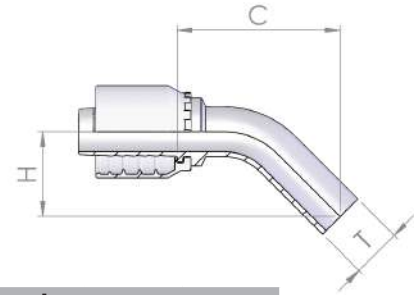

Part number	Hose I.D.		Dimension				
	in	mm	dash size	pipe	Type	cut-off	Drop
				T		C	H
0750G03-06	3/16	4.8	03	6	L/S	41	24
0750G04-06	1/4	6.4	04	6	L/S	41	24
0750G04-08	1/4	6.4	04	8	L/S	43	25
0750G04-10	1/4	6.4	04	10	L/S	47	30
0750G05-10	5/16	7.9	05	10	L/S	49	30
0750G05-12	5/16	7.9	05	12	L/S	53	32
0750G06-12	3/8	9.5	06	12	L/S	52	33

45° Metric Standpipe (Welded)

0750G

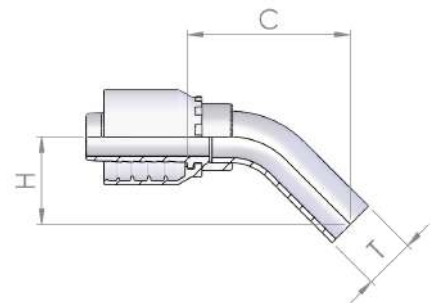

Part number	Hose I.D.		Dimension				
	in	mm	dash size	pipe	Type	cut-off	Drop
				T		C	H
0750G04-12	1/4	6.4	04	12	L/S	54	29
0750G06-14	3/8	9.5	06	14	S	50	27
0750G06-15	3/8	9.5	06	15	L	54	29
0750G08-14	1/2	12.7	08	14	S	50	27
0750G08-15	1/2	12.7	08	15	L	55	29
0750G08-16	1/2	12.7	08	16	S	54	27
0750G08-18	1/2	12.7	08	18	L	56	29
0750G10-18	5/8	15.9	10	18	L	56	29
0750G10-20	5/8	15.9	10	20	S	56	34
0750G10-22	5/8	15.9	10	22	L	66	35
0750G12-20	3/4	19.0	12	20	S	63	34
0750G12-22	3/4	19.0	12	22	L	65	35
0750G12-25	3/4	19.0	12	25	S	76	41
0750G16-25	1	25.4	16	25	S	76	41
0750G16-28	1	25.4	16	28	L	84	49
0750G16-30	1	25.4	16	30	S	86	44
0750G20-30	1 1/4	31.8	20	30	S	88	44
0750G20-35	1 1/4	31.8	20	35	L	94	47
0750G20-38	1 1/4	31.8	20	38	S	101	50
0750G24-38	1 1/2	38.1	24	38	S	100	50
0750G24-42	1 1/2	38.1	24	42	L	114	55



0650G

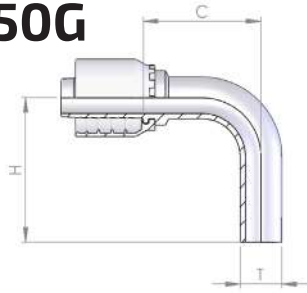

90° Metric Standpipe

Part number	Hose I.D.		Dimension				
	in	mm	dash size	pipe	Type	cut-off	Drop
				T		C	H
0650G03-06	3/16	4.8	03	6	L/S	20	32
0650G04-06	1/4	6.4	04	6	L/S	23	32
0650G04-08	1/4	6.4	04	8	L/S	25	34
0650G04-10	1/4	6.4	04	10	L/S	25	43
0650G05-10	5/16	7.9	05	10	L/S	29	40
0650G05-12	5/16	7.9	05	12	L/S	29	45
0650G06-10	3/8	9.5	06	10	L/S	27	40
0650G06-12	3/8	9.5	06	12	L/S	30	44

0650G

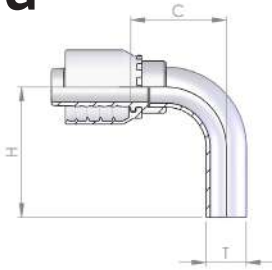

90° Metric Standpipe (Welded)

Part number	Hose I.D.		Dimension				
	in	mm	dash size	pipe	Type	cut-off	Drop
				T		C	H
0650G06-15	3/8	9.5	06	15	L	39	52
0650G03-08	3/16	4.8	03	8	L/S	25	41
0650G04-12	1/4	6.4	04	12	L/S	35	44
0650G05-08	5/16	7.9	05	8	L/S	27	41
0650G06-14	3/8	9.5	06	14	S	36	46
0650G08-12	1/2	12.7	08	12	L/S	33	44
0650G08-14	1/2	12.7	08	14	S	36	46
0650G08-15	1/2	12.7	08	15	L	39	52
0650G08-16	1/2	12.7	08	16	S	42	56
0650G08-18	1/2	12.7	08	18	L	42	56
0650G10-18	5/8	15.9	10	18	L	42	56
0650G10-20	5/8	15.9	10	20	S	48	65
0650G10-22	5/8	15.9	10	22	L	51	71
0650G12-20	3/4	19.0	12	20	S	48	65
0650G12-22	3/4	19.0	12	22	L	51	71
0650G12-25	3/4	19.0	12	25	S	57	75
0650G16-25	1	25.4	16	25	S	57	75
0650G16-28	1	25.4	16	28	L	60	89
0650G16-30	1	25.4	16	30	S	65	89
0650G20-30	1 1/4	31.8	20	30	S	66	89
0650G20-35	1 1/4	31.8	20	35	L	76	98
0650G20-38	1 1/4	31.8	20	38	S	83	102
0650G24-38	1 1/2	38.1	24	38	S	82	102
0650G24-42	1 1/2	38.1	24	42	L	106	125

1350G

Metric Banjo

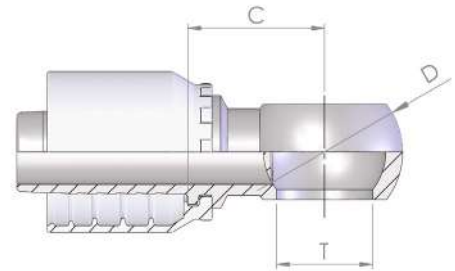

Part number	Hose I.D.		Dimension				
	in	mm	dash size	hole T	flange mm	D Øball	cut-off C
1350G03-10	3/16	4.8	03	M10x1.0	10.2	17	25
1350G03-12	3/16	4.8	03	M12x1.5	12.2	20	21
1350G04-10	1/4	6.4	04	M10x1.0	10.2	17	25
1350G04-12	1/4	6.4	04	M12x1.5	12.2	20	22
1350G04-14	1/4	6.4	04	M14x1.5	14.2	24	25
1350G05-14	5/16	7.9	05	M14x1.5	14.2	24	25
1350G05-16	5/16	7.9	05	M16x1.5	16.2	28	31
1350G05-18	5/16	7.9	05	M18x1.5	18.2	32	29
1350G06-14	3/8	9.5	06	M14x1.5	14.2	24	25
1350G06-16	3/8	9.5	06	M16x1.5	16.2	28	31
1350G06-18	3/8	9.5	06	M18x1.5	18.2	32	29
1350G06-22	3/8	9.5	06	M22x1.5	22.2	36	31
1350G08-16	1/2	12.7	08	M16x1.5	16.2	28	30
1350G08-18	1/2	12.7	08	M18x1.5	18.2	32	29
1350G08-22	1/2	12.7	08	M22x1.5	22.2	36	31
1350G10-22	5/8	15.9	10	M22x1.5	22.2	36	31
1350G10-26	5/8	15.9	10	M26x1.5	26.2	45	38
1350G12-22	3/4	19.0	12	M22x1.5	22.2	36	32

1650

Metric Perforated Bolt

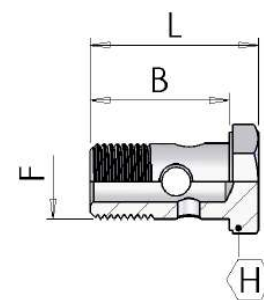

Part number	Dimension			
	F	B	L	hex H
1650-00-10	M10x1.0	19	24	14
1650-00-12	M12x1.5	26	31	17
1650-00-14	M14x1.5	29	34	19
1650-00-16	M16x1.5	33	41	22
1650-00-18	M18x1.5	37	44	24
1650-00-20	M20x1.5	38	46	27
1650-00-22	M22x1.5	38	46	27
1650-00-26	M26x1.5	47	56	32
1650-00-30	M30x1.5	58	68	36



0430G

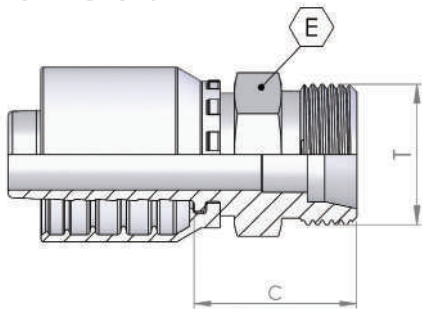

French Metric GAZ Male 24° Cone

Part number	Hose I.D.		Dimension				
	in	mm	dash size	thread	tube	hex	cut-off
				T		E	C
0430G08-24	1/2	12.7	08	M24x1.5	17	27	28
0430G10-30	5/8	15.9	10	M30x1.5	21.5	32	31
0430G12-36	3/4	19.0	12	M36x1.5	27	36	40
0430G16-45	1	25.4	16	M45x1.5	34	46	38

0030G

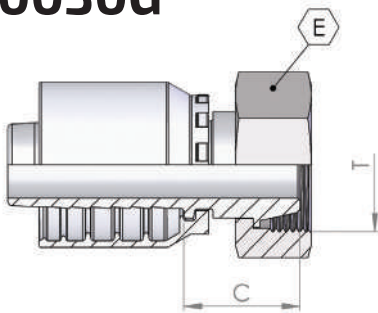

French Metric GAZ Female 24° Cone

Part number	Hose I.D.		Dimension			
	in	mm	dash size	thread	hex	cut-off
				T	E	C
0030G06-20	3/8	9.5	06	M20x1.5	24	26
0030G10-30	5/8	15.9	10	M30x1.5	36	25
0030G16-45	1	25.4	16	M45x1.5	55	40

0130G

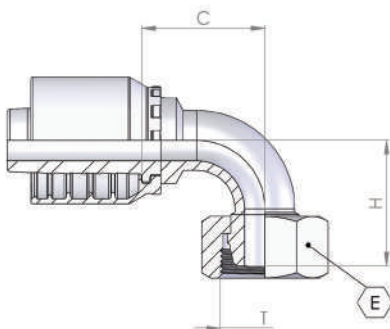

French Metric GAZ 90° Swept Elbow 24° Cone

Part number	Hose I.D.		Dimension				
	in	mm	dash size	thread	hex	drop	cut-off
				T	E	H	C
0130G10-30	5/8	15.9	10	M30x1.5	36	49	48

Metric Female 60° Cone

0100G

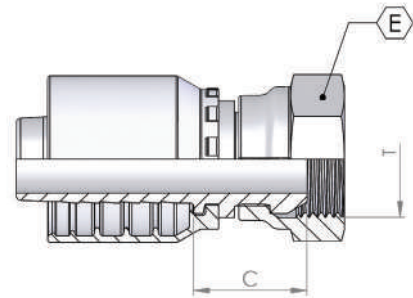

Part number	Hose I.D.		Dimension			
	in	mm	dash size	thread	hex	cut-off
				T	E	C
0100G12-30	3/4	19.0	12	M30x1.5	36	23
0100G20-45	1 1/4	31.8	20	M45x1.5	50	34

90° Metric Swept Elbow 60° Cone

0200G

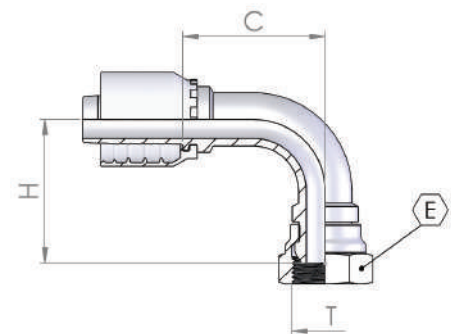

Part number	Hose I.D.		Dimension				
	in	mm	dash size	thread	hex	drop	cut-off
				T	E	H	C
0200G12-30	3/4	19.0	12	M30x1.5	36	57	48
0200G16-38	1	25.4	16	M38x1.5	46	71	70
Welded 0200G20-45	1 1/4	31.8	20	M45x1.5	50	71	63



0035G

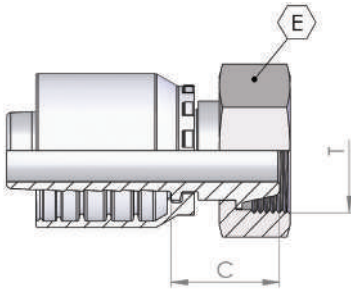

Metric Female Light Multiseal 24° Cone

Part number	Hose I.D.		Dimension				
	in	mm	dash size	thread	tube	hex	cut-off
				T		E	C
0035G03-12	3/16	4.8	03	M12x1.5	6	14	19
0035G04-14	1/4	6.4	04	M14x1.5	8	17	19
0035G04-16	1/4	6.4	04	M16x1.5	10	19	19
0035G06-18	3/8	9.5	06	M18x1.5	12	22	23
0035G08-22	1/2	12.7	08	M22x1.5	15	27	22
0035G10-26	5/8	15.9	10	M26x1.5	18	32	24

0135G

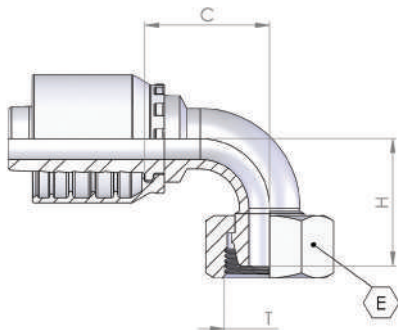

90° Metric Multiseal Swept Elbow 24° Cone

Part number	Hose I.D.		Dimension					
	in	mm	dash size	thread	tube	hex	drop	cut-off
				T		E	H	C
0135G04-14	1/4	6.4	04	M14x1.5	8	17	25	25
0135G04-16	1/4	6.4	04	M16x1.5	10	19	24	26
0135G06-16	3/8	9.5	06	M16x1.5	10	19	33	35
0135G06-18	3/8	9.5	06	M18x1.5	12	22	33	32
0135G08-22	1/2	12.7	08	M22x1.5	15	27	38	41
0135G10-26	5/8	15.9	10	M26x1.5	18	32	42	46

0500G

Metric Male 24° Seat Light

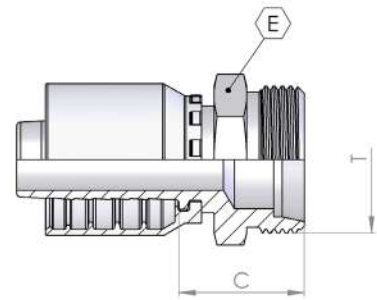

Part number	Hose I.D.		Dimension				
	in	mm	dash size	thread	tube	hex	cut-off
				T		E	C
0500G03-12	3/16	4.8	03	M12x1.5	6	14	22
0500G04-12	1/4	6.4	04	M12x1.5	6	14	23
0500G04-14	1/4	6.4	04	M14x1.5	8	14	22
0500G04-16	1/4	6.4	04	M16x1.5	10	17	23
0500G04-18	1/4	6.4	04	M18x1.5	12	19	24
0500G05-14	5/16	7.9	05	M14x1.5	8	14	22
0500G05-16	5/16	7.9	05	M16x1.5	10	17	23
0500G05-18	5/16	7.9	05	M18x1.5	12	19	24
0500G05-22	5/16	7.9	05	M22x1.5	15	22	25
0500G06-16	3/8	9.5	06	M16x1.5	10	17	23
0500G06-18	3/8	9.5	06	M18x1.5	12	19	24
0500G06-22	3/8	9.5	06	M22x1.5	15	22	25
0500G08-18	1/2	12.7	08	M18x1.5	12	19	25
0500G08-22	1/2	12.7	08	M22x1.5	15	22	26
0500G08-26	1/2	12.7	08	M26x1.5	18	27	27
0500G10-22	5/8	15.9	10	M22x1.5	15	22	26
0500G10-26	5/8	15.9	10	M26x1.5	18	27	27
0500G10-30	5/8	15.9	10	M30x2.0	22	30	32
0500G12-26	3/4	19.0	12	M26x1.5	18	27	28
0500G12-30	3/4	19.0	12	M30x2.0	22	30	33
0500G12-36	3/4	19.0	12	M36x2.0	28	36	31
0500G16-36	1	25.4	16	M36x2.0	28	36	32
0500G20-45	1 1/4	31.8	20	M45x2.0	35	46	36
0500G24-52	1 1/2	38.1	24	M52x2.0	42	55	38



0085G

Metric Female 24° Seat Light

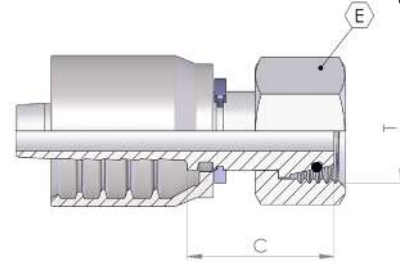

Part number	Hose I.D.		Dimension				
	in	mm	dash size	thread	tube	hex	cut-off
				T		E	C
0085G03-12	3/16	4.8	03	M12x1.5	6	14	23
0085G04-14	1/4	6.4	04	M14x1.5	8	17	24
0085G04-16	1/4	6.4	04	M16x1.5	10	19	24
0085G04-18	1/4	6.4	04	M18x1.5	12	22	25
0085G05-16	5/16	7.9	05	M16x1.5	10	19	24
0085G05-18	5/16	7.9	05	M18x1.5	12	22	25
0085G06-18	3/8	9.5	06	M18x1.5	12	22	25
0085G06-22	3/8	9.5	06	M22x1.5	15	27	29
0085G08-22	1/2	12.7	08	M22x1.5	15	27	29
0085G08-26	1/2	12.7	08	M26x1.5	18	32	29
0085G10-26	5/8	15.9	10	M26x1.5	18	32	29
0085G10-30	5/8	15.9	12	M30x2.0	22	36	29
0085G12-30	3/4	19.0	12	M30x2.0	22	36	29
0085G12-36	3/4	19.0	12	M36x2.0	28	41	28
0085G16-36	1	25.4	16	M36x2.0	28	41	30
0085G20-45	1 1/4	31.8	20	M45x2.0	35	50	40
0085G20-52	1 1/4	31.8	20	M52x2.0	42	60	77.5
0085G24-52	1 1/2	38.1	24	M52x2.0	42	60	41

0085G

Metric Female 24° Seat Light (Rolled Nut)

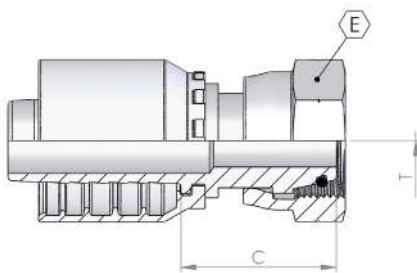

Part number	Hose I.D.		Dimension				
	in	mm	dash size	thread	tube	hex	cut-off
				T		E	C
0085G04-12	1/4	6.4	04	M12x1.5	6	14	25
0085G05-14	5/16	7.9	05	M14x1.5	8	19	26
0085G06-16	3/8	9.5	06	M16x1.5	10	19	25
0085G08-18	1/2	12.7	08	M18x1.5	12	24	28
0085G10-22	5/8	15.9	10	M22x1.5	15	27	32
0085G12-26	3/4	19.0	12	M26x1.5	18	32	36

0285G

45° Metric Swept Elbow 24° Seat Light

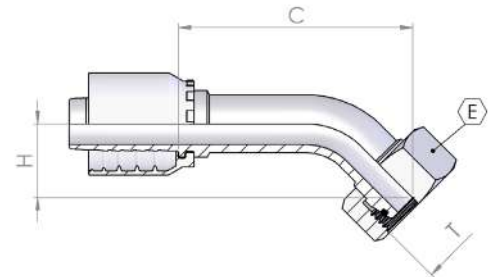

Part number	Hose I.D.		Dimension					
	in	mm	dash size	thread	tube	hex	cut-off	drop
				T		E	C	H
0285G03-12	3/16	4.8	03	M12x1.5	6	14	36	14
0285G04-14	1/4	6.4	04	M14x1.5	8	17	42	14
0285G04-16	1/4	6.4	04	M16x1.5	10	19	42	15
0285G04-18	1/4	6.4	04	M18x1.5	12	22	43	16
0285G05-16	5/16	7.9	05	M16x1.5	10	19	48	17
0285G05-18	5/16	7.9	05	M18x1.5	12	22	48	18
0285G06-18	3/8	9.5	06	M18x1.5	12	22	52	19
0285G06-22	3/8	9.5	06	M22x1.5	15	27	51	19
0285G08-22	1/2	12.7	08	M22x1.5	15	27	63	21
0285G08-26	1/2	12.7	08	M26x1.5	18	32	44	17
0285G10-22	5/8	15.9	10	M22x1.5	15	27	70	32
0285G10-26	5/8	15.9	10	M26x1.5	18	32	68	23
0285G12-26	3/4	19.0	12	M26x1.5	18	32	43	19
0285G12-30	3/4	19.0	12	M30x2.0	22	36	85	27
0285G16-36	1	25.4	16	M36x2.0	28	41	102	32
0285G20-45	1 1/4	31.8	20	M45x2.0	35	50	72	34
0285G24-52	1 1/2	38.1	24	M52x2.0	42	60	85	36

0285G

45° Metric Swept Elbow 24° Seat Light (Rolled Nut)

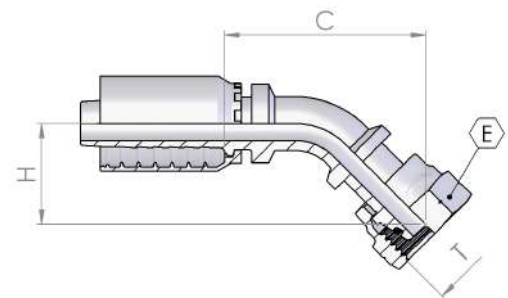

Part number	Hose I.D.		Dimension					
	in	mm	dash size	thread	tube	hex	cut-off	drop
				T		E	C	H
0285G04-12	1/4	6.4	04	M12x1.5	6	14	46	20
0285G06-16	3/8	9.5	06	M16x1.5	10	19	55	22



0185G

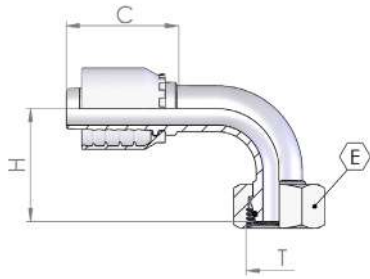

90° Metric Swept Elbow 24° Seat Light

Part number	Hose I.D.		Dimension					
	in	mm	dash size	thread	tube	hex	cut-off	drop
				T		E	C	H
0185G03-12	3/16	4.8	03	M12x1.5	6	14	22	23
0185G04-14	1/4	6.4	04	M14x1.5	8	17	26	26
0185G04-16	1/4	6.4	04	M16x1.5	10	19	25	27
0185G04-18	1/4	6.4	04	M18x1.5	12	22	27	30
0185G05-16	5/16	7.9	05	M16x1.5	10	19	31	31
0185G05-18	5/16	7.9	05	M18x1.5	12	22	31	32
0185G06-18	3/8	9.5	06	M18x1.5	12	22	32	35
0185G06-22	3/8	9.5	06	M22x1.5	15	27	32	35
0185G08-22	1/2	12.7	08	M22x1.5	15	27	41	38
0185G08-26	1/2	12.7	08	M26x1.5	18	32	41	39
0185G10-26	5/8	15.9	10	M26x1.5	18	32	44	44
0185G12-26	3/4	19.0	12	M26x1.5	18	32	42	44
0185G12-30	3/4	19.0	12	M30x2.0	22	36	58	52
0185G12-36	3/4	19.0	12	M36x2.0	28	41	49	51
0185G16-36	1	25.4	16	M36x2.0	28	41	72	62
0185G20-45	1 1/4	31.8	20	M45x2.0	35	50	63	73
0185G24-52	1 1/2	38.1	24	M52x2.0	42	60	81	83

0185G

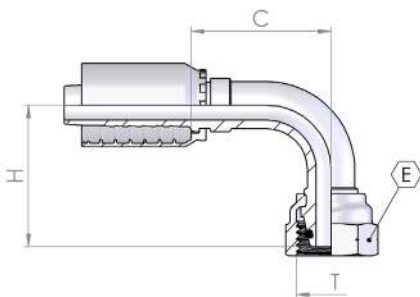

90° Metric Swept Elbow 24° Seat Light (Rolled Nut)

Part number	Hose I.D.		Dimension					
	in	mm	dash size	thread	tube	hex	cut-off	drop
				T		E	C	H
0185G04-12	1/4	6.4	04	M12x1.5	6	14	26	34
0185G05-14	5/16	7.9	05	M14x1.5	8	17	30	38
0185G06-16	3/8	9.5	06	M16x1.5	10	19	32	39
0185G08-18	1/2	12.7	08	M18x1.5	12	22	33	48
0185G10-22	5/8	15.9	08	M22x1.5	15	27	42	55

0450

Metric Male 24° Seat Heavy

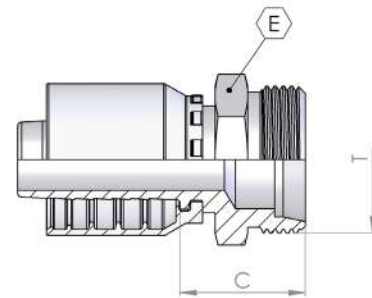

Part number	Hose I.D.		Dimension				
	in	mm	dash size	thread	tube	hex	cut-off
				T		E	C
0450G03-16	3/16	4.8	03	M16x1.5	8	17	26
0450G04-14	1/4	6.4	04	M14x1.5	6	14	25
0450G04-16	1/4	6.4	04	M16x1.5	8	17	27
0450G04-18	1/4	6.4	04	M18x1.5	10	19	27
0450G04-20	1/4	6.4	04	M20x1.5	12	22	29
0450G05-18	5/16	7.9	05	M18x1.5	10	19	27
0450G05-20	5/16	7.9	05	M20x1.5	12	22	29
0450G06-18	3/8	9.5	06	M18x1.5	10	19	27
0450G06-20	3/8	9.5	06	M20x1.5	12	22	29
0450G06-22	3/8	9.5	06	M22x1.5	14	22	31
0450G06-24	3/8	9.5	06	M24x1.5	16	24	31
0450G08-24	1/2	12.7	08	M24x1.5	16	24	32
0450G10-30	5/8	15.9	10	M30x2.0	20	30	34
0450G12-30	3/4	19.0	12	M30x2.0	20	30	35
0450G12-36	3/4	19.0	12	M36x2.0	25	36	38
0450G16-36	1	25.4	16	M36x2.0	25	36	39
0450G16-42	1	25.4	16	M42x2.0	30	46	42
0450G20-42	1 1/4	31.8	20	M42x2.0	30	46	43
0450G20-52	1 1/4	31.8	20	M52x2.0	38	55	45
0450G24-52	1 1/2	38.1	24	M52x2.0	38	55	45



0084G

Metric Female 24° Seat Heavy

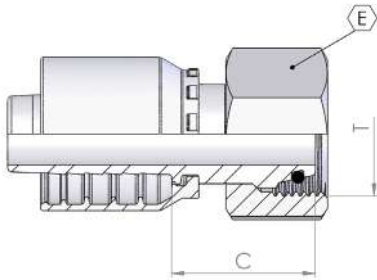

Part number	Hose I.D.		Dimension				
	in	mm	dash size	thread	tube	hex	cut-off
				T		E	C
0084G03-16	3/16	4.8	03	M16x1.5	8	19	25
0084G04-14	1/4	6.4	04	M14x1.5	6	17	23
0084G04-16	1/4	6.4	04	M16x1.5	8	19	25
0084G04-18	1/4	6.4	04	M18x1.5	10	22	24
0084G04-20	1/4	6.4	04	M20x1.5	12	24	25
0084G05-18	5/16	7.9	05	M18x1.5	10	22	24
0084G05-20	5/16	7.9	05	M20x1.5	12	24	26
0084G06-16	3/8	9.5	06	M16x1.5	8	19	26
0084G06-18	3/8	9.5	06	M18x1.5	10	22	25
0084G06-20	3/8	9.5	06	M20x1.5	12	24	25
0084G06-22	3/8	9.5	06	M22x1.5	14	27	29
0084G06-24	3/8	9.5	06	M24x1.5	16	30	29
0084G08-20	1/2	12.7	08	M20x1.5	12	27	28
0084G08-22	1/2	12.7	08	M22x1.5	14	27	17
0084G08-24	1/2	12.7	08	M24x1.5	16	30	30
0084G08-30	1/2	12.7	08	M30x2.0	20	36	33
0084G10-24	5/8	15.9	10	M24x1.5	16	30	31
0084G10-30	5/8	15.9	10	M30x2.0	20	36	33
0084G12-24	1/2	12.7	08	M24x1.5	16	30	30
0084G12-30	3/4	19.0	12	M30x2.0	20	36	34
0084G12-36	3/4	19.0	12	M36x2.0	25	46	40
0084G16-36	1	25.4	16	M36x2.0	25	46	41
0084G16-42	1	25.4	16	M42x2.0	30	50	43
0084G20-52	1 1/4	31.8	20	M52x2.0	38	60	44
0084G24-52	1 1/2	38.1	24	M52x2.0	38	60	44

0284G

45° Metric Swept Elbow 24° Seat Heavy

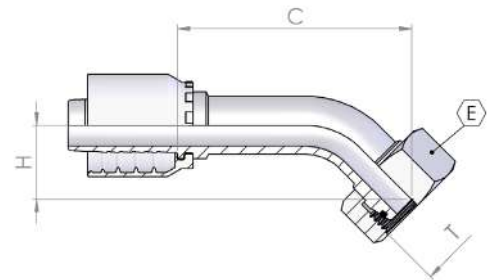

Part number	Hose I.D.		Dimension					
	in	mm	dash size	thread	tube	hex	cut-off	drop
				T		E	C	H
0284G03-16	3/16	4.8	03	M16x1.5	8	19	36	16
0284G04-14	1/4	6.4	04	M14x1.5	6	17	37	15
0284G04-16	1/4	6.4	04	M16x1.5	8	19	42	15
0284G04-18	1/4	6.4	04	M18x1.5	10	22	45	18
0284G05-20	5/16	7.9	05	M20x1.5	12	24	49	19
0284G06-18	3/8	9.5	06	M18x1.5	10	22	51	19
0284G06-20	3/8	9.5	06	M20x1.5	12	24	53	18
0284G06-22	3/8	9.5	06	M22x1.5	14	27	54	20
0284G08-24	1/2	12.7	08	M24x1.5	16	30	63	21
0284G10-30	5/8	15.9	10	M30x2.0	20	36	74	29
0284G12-30	3/4	19.0	12	M30x2.0	20	36	87	30
0284G12-36	3/4	19.0	12	M36x2.0	25	46	56	31
0284G16-36	1	25.4	16	M36x2.0	25	46	105	34
0284G16-42	1	25.4	16	M42x2.0	30	50	82	33
0284G20-52	1 1/4	31.8	20	M52x2.0	38	60	105	39
0284G24-52	1 1/2	38.1	24	M52x2.0	38	60	157	52



0184G

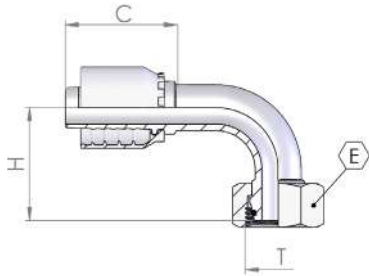

90° Metric Swept Elbow 24° Seat Heavy

Part number	Hose I.D.		Dimension					
	in	mm	dash size	thread	tube	hex	cut-off	drop
				T		E	C	H
0184G03-16	3/16	4.8	03	M16x1.5	8	19	22	25
0184G04-14	1/4	6.4	04	M14x1.5	6	17	27	26
0184G04-16	1/4	6.4	04	M16x1.5	8	19	26	26
0184G04-18	1/4	6.4	04	M18x1.5	10	22	27	31
0184G04-20	1/4	6.4	04	M20x1.5	12	24	27	30
0184G05-18	5/16	7.9	05	M18x1.5	10	22	33	33
0184G05-20	5/16	7.9	05	M20x1.5	12	24	30	34
0184G06-18	3/8	9.5	06	M18x1.5	10	22	34	35
0184G06-20	3/8	9.5	06	M20x1.5	12	24	34	34
0184G06-22	3/8	9.5	06	M22x1.5	14	27	33	33
0184G06-24	3/8	9.5	06	M24x1.5	16	30	33	35
0184G08-22	1/2	12.7	08	M22x1.5	14	27	40	41
0184G08-24	1/2	12.7	08	M24x1.5	16	30	40	41
0184G08-20	1/2	12.7	08	M30x2.0	20	36	41	47
0184G10-24	5/8	15.9	10	M24x1.5	16	30	42	60
0184G10-30	5/8	15.9	10	M30x2.0	20	36	46	50
0184G12-30	3/4	19.0	12	M30x2.0	20	36	58	56
0184G12-36	3/4	19.0	12	M36x2.0	25	46	56	59
0184G16-36	1	25.4	16	M36x2.0	25	46	69	67
0184G16-42	1	25.4	16	M42x2.0	30	50	69	67
0184G20-52	1 1/4	31.8	20	M52x2.0	38	60	84	82
0184G24-52	1 1/2	38.1	24	M52x2.0	38	60	99	94

1260G

Straight SAE Code 61 Flange

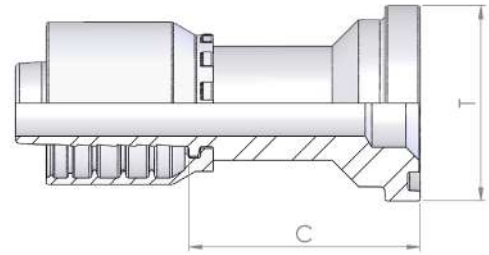

Part number	Hose I.D.		dash size	Dimension		cut-off
	in	mm		T	mm	
1260G08-08	1/2	12.7	08	1/2	30.2	45
1260G08-12	1/2	12.7	08	3/4	38.1	50
1260G10-08	5/8	15.9	10	1/2	30.2	45
1260G10-12	5/8	15.9	10	3/4	38.1	49
1260G12-12	3/4	19.0	12	3/4	38.1	50
1260G12-16	3/4	19.0	12	1	44.5	53
1260G16-12	1	25.4	16	3/4	38.1	51
1260G16-16	1	25.4	16	1	44.5	54
1260G16-20	1	25.4	16	1 1/4	50.8	57
1260G20-20	1 1/4	31.8	20	1 1/4	50.8	59
1260G20-24	1 1/4	31.8	20	1 1/2	60.3	62
1260G24-24	1 1/2	38.1	24	1 1/2	60.3	62
1260G24-32	1 1/2	38.1	24	2	71.4	67
1260G32-32	2	50.8	32	2	71.4	68
1260G32-40	2	50.8	32	2 1/2	84.1	76

1160G

45° SAE Code 61 Flange

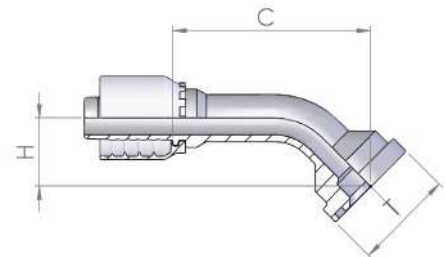

Part number	Hose I.D.		dash size	Dimension		cut-off	drop
	in	mm		T	mm		
1160G08-08	1/2	12.7	08	1/2	30.2	62	22
1160G08-12	1/2	12.7	08	3/4	38.1	67	25
1160G12-12	3/4	19.0	12	3/4	38.1	69	27
1160G12-16	3/4	19.0	12	1	44.5	88	30
1160G16-16	1	25.4	16	1	44.5	82	33
1160G16-20	1	25.4	16	1 1/4	50.8	108	37
1160G20-16	1 1/4	31.8	20	1	44.5	123	37
1160G20-20	1 1/4	31.8	20	1 1/4	50.8	102	38
1160G20-24	1 1/4	31.8	20	1 1/2	60.3	129	39
1160G24-24	1 1/2	38.1	24	1 1/2	60.3	114	44
1160G24-32	1 1/2	38.1	24	2	71.4	148	47
1160G32-32	2	50.8	32	2	71.4	130	58



1060G

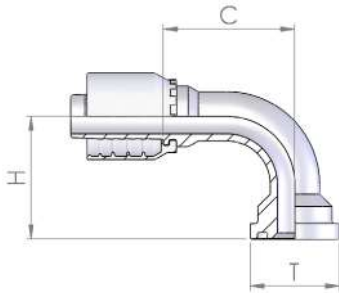

90° SAE Code 61 Flange

Part number	Hose I.D.		dash size	Dimension			
	in	mm		flange		cut-off	drop
				T	mm	C	H
1060G08-08	1/2	12.7	08	1/2	30.2	39	39
1060G08-12	1/2	12.7	08	3/4	38.1	39	44
1060G10-08	5/8	15.9	10	1/2	30.2	45	42
1060G10-12	5/8	15.9	10	3/4	38.1	45	47
1060G12-12	3/4	19.0	12	3/4	38.1	56	53
1060G12-16	3/4	19.0	12	1	44.5	56	58
1060G16-16	1	25.4	16	1	44.5	70	65
1060G16-20	1	25.4	16	1 1/4	50.8	70	70
1060G16-24	1	25.4	16	1 1/2	60.3	72	71
1060G20-16	1 1/4	31.8	20	1	44.5	81	77
1060G20-20	1 1/4	31.8	20	1 1/4	50.8	86	77
1060G20-24	1 1/4	31.8	20	1 1/2	60.3	85	81
1060G24-20	1 1/2	38.1	24	1 1/4	50.8	108	37
1060G24-24	1 1/2	38.1	24	1 1/2	60.3	98	89
1060G24-32	1 1/2	38.1	24	2	71.4	93	97
1060G32-32	2	50.8	32	2	71.4	123	121
1060G32-40	2	50.8	32	2 1/2	84.1	132	114

1060G

22.5°/30°/60°/67.5°/110°/135° SAE Code 61 Flange

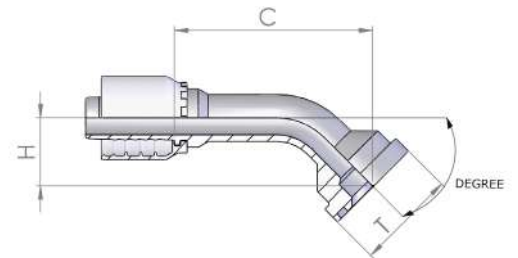

Part number	Hose I.D.		Dimension					Degree
	in	mm	dash size	flange		cut-off	drop	
				T	mm			
1060G08-08 22.5	1/2	12.7	08	1/2	30.2	66	9	22.5°
1060G12-12 22.5	3/4	19.0	12	3/4	38.1	76	11	22.5°
1060G12-16 22.5	3/4	19.0	12	1	44.5	88	13	22.5°
1060G16-16 22.5	1	25.4	16	1	44.5	89	14	22.5°
1050G16-20 22.5	1	25.4	16	1 1/4	50.8	116	17	22.5°
1060G20-20 22.5	1 1/4	31.8	20	1 1/4	50.8	111	14	22.5°
1060G20-24 22.5	1 1/4	31.8	20	1 1/2	60.3	137	17	22.5°
1060G24-24 22.5	1 1/2	38.1	24	1 1/2	60.3	124	17	22.5°
1060G32-32 22.5	2	50.8	32	2	71.4	144	28	22.5°
1060G12-12 30	3/4	19.0	12	3/4	38.1	75	16	30°
1060G12-16 30	3/4	19.0	12	1	44.5	88	18	30°
1060G16-16 30	1	25.4	16	1	44.5	87	19	30°
1060G16-20 30	1	25.4	16	1 1/4	50.8	99	47	60°
1060G20-20 30	1 1/4	31.8	20	1 1/4	50.8	109	26	30°
1060G20-24 20	1 1/4	31.8	20	1 1/4	60.3	136	22	30°
1060G24-24 30	1 1/2	38.1	24	1 1/2	60.3	122	23	30°
1060G24-32 30	1 1/2	38.1	24	1 1/2	71.4	155	25	30°
1060G32-32 30	2	50.8	32	2	71.4	142	35	30°
1060G12-12 60	3/4	19.0	12	3/4	38.1	76	36	60°
1060G16-16 60	1	25.4	16	1	44.5	95	43	60°
1060G16-20 60	1	25.4	16	1 1/4	50.8	99	47	60°
1060G20-20 60	1 1/4	31.8	20	1 1/4	50.8	116	49	60°
1060G20-24 60	1 1/4	31.8	20	1 1/2	60.3	119	48	60°
1060G24-24 60	1 1/2	38.1	24	1 1/2	60.3	138	55	60°
1060G24-32 60	1 1/2	38.1	24	2	71.4	134	63	60°
1060G32-32 60	2	50.8	32	2	71.4	170	80	60°
1060G12-12 67.5	3/4	19.0	12	3/4	38.1	72	41	67.5°
1060G12-16 67.5	3/4	19.0	12	1	44.5	74	45	67.5°
1060G16-16 67.5	1	25.4	16	1	44.5	91	48	67.5°
1060G16-20 67.5	1	25.4	16	1 1/4	50.9	93	51	67.5°
1060G20-20 67.5	1 1/4	31.8	20	1 1/4	50.8	110	56	67.5°
1060G24-24 67.5	1 1/2	38.1	24	1 1/2	60.3	131	63	67.5°
1060G32-32 67.5	2	50.8	32	2	71.4	158	92	67.5°
1060G32-40 67.5	2	50.8	32	2 1/2	84.0	168	85	67.5°
1060G24-24 110	1 1/2	38.1	24	1 1/2	60.3	91	104	110°
1060G32-32 110	2	50.8	32	2	71.4	100	125	110°
1060G16-16 135	1	25.4	16	1	44.5	52	80	135°



1310G

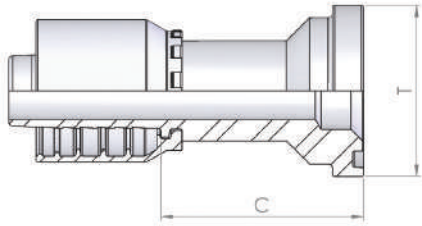

Straight SAE Flange – Code 62

Part number	Hose I.D.		Dimension			
	in	mm	dash size	flange		cut-off C
				T	mm	
1310G08-08	1/2	12.7	08	1/2	31.8	46
1310G10-08	5/8	15.9	10	1/2	31.8	46
1310G10-12	5/8	15.9	10	3/4	41.3	53
1310G10-16	5/8	15.9	10	1	47.6	59
1310G12-12	3/4	19.0	12	3/4	41.3	54
1310G12-16	3/4	19.0	12	1	47.6	60
1310G16-16	1	25.4	16	1	47.6	61
1310G16-20	1	25.4	16	1 1/4	54.0	68
1310G20-16	1 1/4	31.8	20	1	47.6	63
1310G20-20	1 1/4	31.8	20	1 1/4	54.0	70
1310G20-24	1 1/4	31.8	20	1 1/2	63.5	76
1310G24-24	1 1/2	38.1	24	1 1/2	63.5	76
1310G32-32	2	50.8	32	2	79.4	85

1110G

90° SAE Flange – Code 62

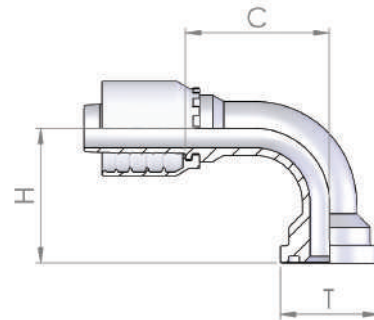

Part number	Hose I.D.		Dimension				
	in	mm	dash size	flange		cut-off	drop
				T	mm	C	H
1110G08-08	1/2	12.7	08	1/2	31.8	39	39
1110G08-12	1/2	12.7	08	3/4	41.3	39	48
1110G10-08	5/8	15.9	10	1/2	31.8	45	42
1110G10-12	5/8	15.9	10	3/4	41.3	44	52
1110G10-16	5/8	15.9	10	1	47.6	45	56
1110G12-12	3/4	19.0	12	3/4	41.3	56	55
1110G12-16	3/4	19.0	12	1	47.6	56	63
1110G16-12	1	25.4	16	3/4	41.3	68	64
1110G16-16	1	25.4	16	1	47.6	70	69
1110G16-20	1	25.4	16	1 1/4	54.0	71	74
1110G20-16	1 1/4	31.8	20	1	47.6	80	68
1110G20-20	1 1/4	31.8	20	1 1/4	54.0	97	83
1110G20-24	1 1/4	31.8	20	1 1/2	63.5	97	90
1110G24-24	1 1/2	38.1	24	1 1/2	63.5	102	99
1110G24-32	1 1/2	38.1	24	2	79.4	103	108
1110G32-32	2	50.8	32	2	79.4	125	136



1210G

45° SAE Flange - Code 62

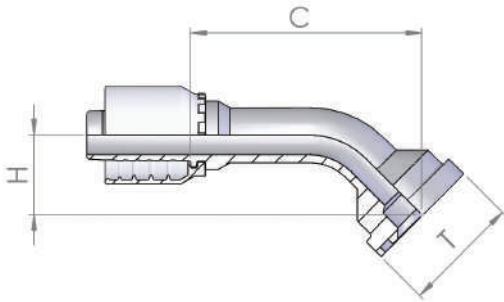

Part number	Hose I.D.		dash size	Dimension			
	in	mm		flange		cut-off	drop
				T	mm		
1210G10-08	5/8	15.9	10	1/2	31.8	66	21
1210G16-12	1	25.4	16	3/4	41.3	101	30
1210G16-16	1	25.4	16	1	47.6	86	34
1210G20-20	1 1/4	31.8	20	1 1/4	54.0	107	43
1210G24-32	1 1/2	38.1	24	2	79.4	163	66

110SG

90° 'CAT' Flange

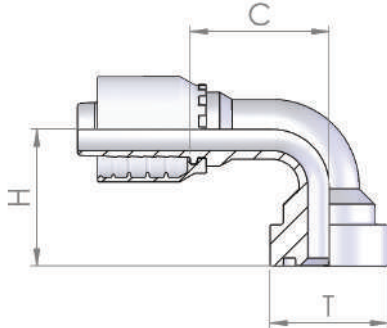

Part number	Hose I.D.		dash size	Dimension			
	in	mm		flange		cut-off	drop
				T	mm		
110SG12-12	3/4	19.0	12	3/4	41.3	56	62

D050G

Hose Junction

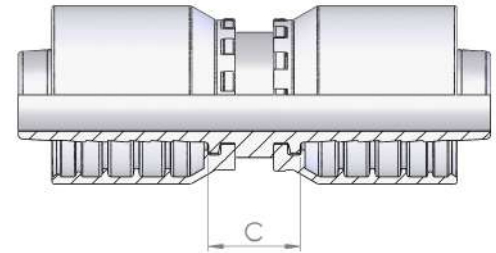

Part number	Hose I.D.		Dimension	
	in	mm	dash size	cut-off C
D050G03	3/16	4.8	03	17
D050G04	1/4	6.4	04	17
D050G05	5/16	7.9	05	17
D050G06	3/8	9.5	06	17
D050G08	1/2	12.7	08	18
D050G10	5/8	15.9	10	18
D050G12	3/4	19.0	12	19
D050G16	1	25.4	16	21
D050G20	1 1/4	31.8	20	24
D050G24	1 1/2	38.1	24	24
D050G32	2	50.8	32	26



Muncie®
Power
Products

Spiral Hose No-Skive



0370X



NPTF Male 30° Cone

68

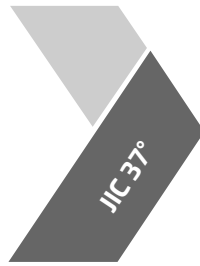

0850X



JIC Male 37° Cone

68

0900X



JIC Female 37° Cone

69

1000X



JIC 45° Swept Elbow
37° Cone

69

0950X



JIC 90° Swept Elbow
37° Cone

70



S350X



ORFS Male

71

S05TX



ORFS Female Double
Hexagon

72

S250X



ORFS 45° Swept
Elbow

72

S150X



ORFS 90° Swept
Elbow

73



0385X



SAE Male O-Ring Boss

73



0940X



JIS Female 60° Cone
(Komatsu)

74



K05BX



Kobelco Male

74



0360X



BSP Taper Male 60°
Cone

75

0350X



BSP Male Parallel 60°
Cone

76

0050X



BSP Female 60° Cone
Thrust Wire

77

0250X



BSP 45° Swept Elbow
60° Cone

77

0150X



BSP 90° Swept Elbow
60° Cone

78



0500X

 Metric Male 24° Seat
Light

78

0085X

 Metric Female 24°
Seat Light

79

0085X

 Metric Female 24°
Seat Light
(Rolled Nut)

79

0285X

 45° Metric Swept
Elbow 24° Seat Light

80

0185X

 90° Metric Swept
Elbow 24° Seat Light

80

**Metric DIN
24° DKOS**
0450X

 Metric Male 24° Seat
Heavy

81

0084X

 Metric Female 24°
Seat Heavy

81

0284X

 45° Metric Swept
Elbow 24° Seat Heavy

82

0184X

 90° Metric Swept
Elbow 24° Seat Heavy

82

Code 61
1250X

 Straight SAE
Code 61 Flange

83

1150X

 45° SAE Code 61
Flange

83

1050X

 90° SAE Code 61
Flange

84

1050X

 22.5°/30°/60°/67.5°/110°
SAE Code 61 Flange

85

Code 62
1300X

 Straight SAE Code 62
Flange

86

1200X

 45° SAE Code 62
Flange

86

1100X

 90° SAE Code 62
Flange

87

1100X

 22.5°/30°/60°/67.5°/110°
SAE Code 62 Flange

87

Super CAT
130SX

Straight 'CAT' Flange

88

120SX

45° 'CAT' Flange

88

110SX

90° 'CAT' Flange

89

0370X

NPTF Male 30° Cone

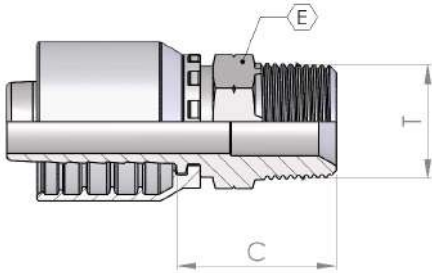

Part number	Hose I.D.		Dimension			
	in	mm	dash size	thread	hex	cut-off
				T	E	C
0370X12-12	3/4	19.0	12	3/4-14	27	39
0370X12-16	3/4	19.0	12	1-11 1/2	27	39
0370X16-12	1	25.4	16	3/4-14	32	40
0370X16-16	1	25.4	16	1-11 1/2	36	46
0370X16-20	1	25.4	16	1 1/4-11 1/2	46	48
0370X20-16	1 1/4	31.8	20	1-11 1/2	41	45
0370X20-20	1 1/4	31.8	20	1 1/4-11 1/2	46	47
0370X24-24	1 1/2	38.1	24	1 1/2-11 1/2	50	49
0370X32-24	2	50.8	32	1 1/2-11 1/2	65	63
0370X32-32	2	50.8	32	2-11 1/2	65	64

0850X

JIC Male 37° Cone

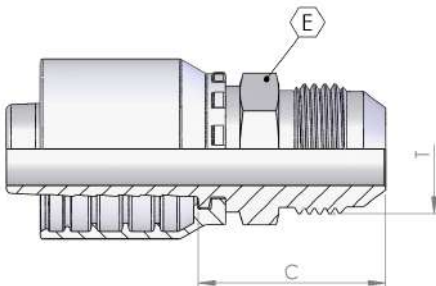

Part number	Hose I.D.		Dimension			
	in	mm	dash size	thread	hex	cut-off
				T	E	C
0850X12-10	3/4	19.0	12	7/8-14	24	38
0850X12-12	3/4	19.0	12	1 1/16-12	27	40
0850X12-14	3/4	19.0	12	1 3/16-12	32	45
0850X12-16	3/4	19.0	12	1 5/16-12	34	44
0850X12-20	3/4	19.0	12	1 5/8-12	42	47
0850X16-12	1	25.4	16	1 1/16-12	27	41
0850X16-14	1	25.4	16	1 3/16-12	32	44
0850X16-16	1	25.4	16	1 5/16-12	34	45
0850X16-20	1	25.4	16	1 5/8-12	42	48
0850X20-20	1 1/4	31.8	20	1 5/8-12	42	47
0850X20-24	1 1/4	31.8	20	1 7/8-12	50	52
0850X24-24	1 1/2	38.1	24	1 7/8-12	50	52
0850X32-32	2	50.8	32	2 1/2-12	65	72

0900X

JIC Female 37° Cone

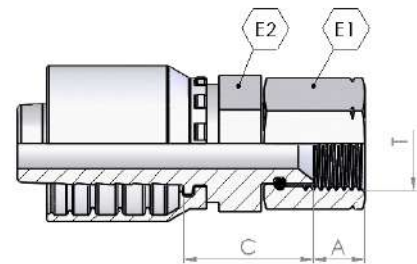

Part number	Hose I.D.		Dimension					
	in	mm	dash size	thread	hex	cut-off		
				T	E1	E2	C	A
0900X12-10	3/4	19.0	12	7/8-14	27	27	32.5	12
0900X12-12	3/4	19.0	12	1 1/16-12	32	27	32	13.5
0900X12-16	3/4	19.0	12	1 5/16-12	41	32	36	14.5
0900X16-12	1	25.4	16	1 1/16-12	32	32	34	14
0900X16-16	1	25.4	16	1 5/16-12	38	36	33	15.5
0900X16-20	1	25.4	16	1 5/8-12	50	41	44	16.5
0900X20-20	1 1/4	31.8	20	1 5/8-12	50	42	40	16.5
0900X20-24	1 1/4	31.8	20	1 7/8-12	55	42	43	19
0900X24-24	1 1/4	38.1	24	1 7/8-12	55	50	44	19
0900X32-32	2	50.8	32	2 1/2-12	70	65	58	20

1000X

JIC 45° Swept Elbow 37° Cone

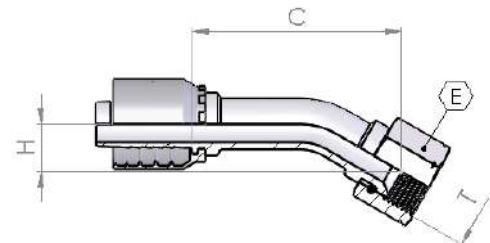

Part number	Hose I.D.		Dimension				
	in	mm	dash size	thread	hex	cut-off	Drop
				T	E	C	H
1000X12-12	3/4	19.0	12	1 1/16-12	32	85	28
1000X12-14	3/4	19.0	12	1 3/16-12	36	87	29
1000X12-16	3/4	19.0	12	1 5/16-12	41	89	30
1000X16-16	1	25.4	16	1 5/16-12	41	109	36
1000X16-20	1	25.4	16	1 5/8-12	50	72	68
1000X20-20	1 1/4	31.8	20	1 5/8-12	50	108	40
1000X20-24	1 1/4	31.8	20	1 7/8-12	55	89	39
1000X24-24	1 1/2	38.1	24	1 7/8-12	55	174	47
1000X32-32	2	50.8	32	2 1/2-12	70	155	65



0950X

JIC 90° Swept Elbow 37° Cone

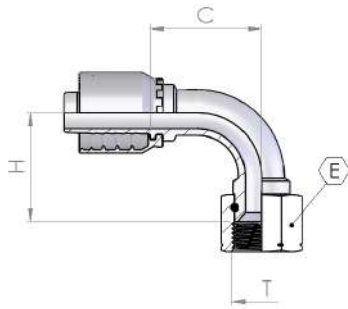

Part number	Hose I.D.		Dimension				
	in	mm	dash size	thread	hex	cut-off	Drop
				T	E	C	H
0950X12-12	3/4	19.0	12	1 1/16-12	32	58	54
0950X12-14	3/4	19.0	12	1 3/16-12	36	58	54
0950X12-16	3/4	19.0	12	1 5/16-12	41	72	68
0950X16-16	1	25.4	16	1 5/16-12	41	72	68
0950X16-20	1	25.4	16	1 5/8-12	50	72	74
0950X20-20	1 1/4	31.8	20	1 5/8-12	50	103	81
0950X20-24	1 1/4	31.8	20	1 7/8-12	55	81	88
0950X24-24	1 1/2	38.1	24	1 7/8-12	55	120	95
0950X32-32	2	50.8	32	2 1/2-12	70	139	133

S350X

ORFS Male

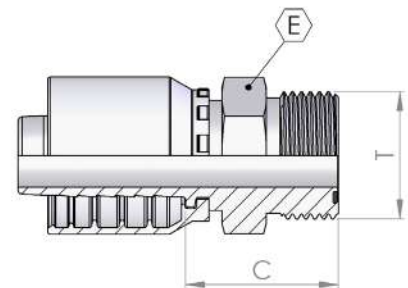

Part number	Hose I.D.		Dimension			
	in	mm	dash size	thread	hex	cut-off
				T	E	C
S350X12-14	3/4	19.0	12	1 3/16-12	32	36
S350X12-15	3/4	19.0	12	1 7/16-12	38	36
S350X16-15	1	25.4	16	1 7/16-12	38	37
S350X16-21	1	25.4	16	1 11/16-12	46	38
S350X20-21	1 1/4	31.8	20	1 11/16-12	46	39
S350X24-32	1 1/2	38.1	24	2-12	55	43

With Cap and O-Ring.

S05TX

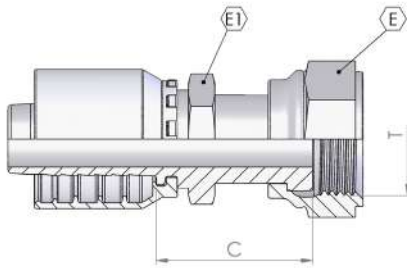

ORFS Female Double Hexagon

Part number	Hose I.D.		Dimension				
	in	mm	dash size	thread	hex	hex	cut-off
				T	E	E1	C
S05TX12-13	3/4	19.0	12	1-14	30	30	43
S05TX12-14	3/4	19.0	12	1 3/16-12	36	30	44
S05TX12-15	3/4	19.0	12	1 7/16-12	41	30	50
S05TX16-14	1	25.4	16	1 3/16-12	36	36	45
S05TX16-15	1	25.4	16	1 7/16-12	41	36	52
S05TX16-21	2	25.4	16	1 11/16-12	50	46	53
S05TX20-21	1 1/4	31.8	20	1 11/16-12	46	50	52.5
S05TX24-32	1 1/2	38.1	24	2-12	50	60	55.5

S250X

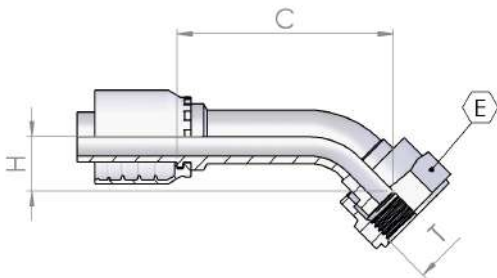

ORFS 45° Swept Elbow

Part number	Hose I.D.		Dimension				
	in	mm	dash size	thread	hex	cut-off	Drop
				T	E	C	H
S250X12-13	3/4	19.0	12	1-14	30	42	15
S250X12-14	3/4	19.0	12	1 3/16-12	36	86	23
S250X12-15	3/4	19.0	12	1 7/16-12	41	86	26
S250X16-15	1	25.4	16	1 7/16-12	41	102	31
S250X16-21	1	25.4	16	1 11/16-12	50	101	31
S250X20-21	1 1/4	31.8	20	1 11/16-12	50	137	37
S250X24-32	1 1/2	38.1	24	2 1/2-12	60	159	46

S150X

ORFS 90° Swept Elbow

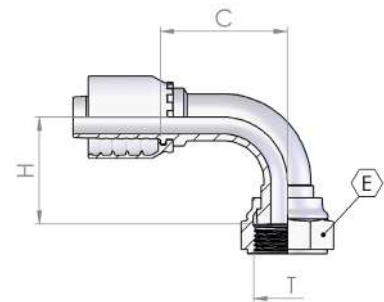

Part number	Hose I.D.		Dimension				
	in	mm	dash size	thread	hex	cut-off	Drop
				T	E	C	H
S150X12-13	3/4	19.0	12	1-14	30	44	39
S150X12-14	3/4	19.0	12	1 3/16-12	36	59	49
S150X12-15	3/4	19.0	12	1 7/16-12	41	58	51
S150X16-15	1	25.4	16	1 7/16-12	41	69	62
S150X16-21	1	25.4	20	1 11/16-12	50	64	58
S150X20-21	1 1/4	31.8	20	1 11/16-12	50	99	76
S150X24-32	1 1/2	38.1	24	2-12	60	80	73

0385X

SAE Male O-Ring Flat Seat

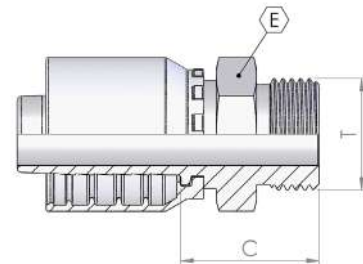

Part number	Hose I.D.		Dimension			
	in	mm	dash size	thread	hex	cut-off
				T	E	C
0385X12-12	3/4	19.0	12	1 1/16-12	32	35
0385X12-16	3/4	19.0	12	1 5/16-12	38	38
0385X16-16	1	25.4	16	1 5/16-12	38	39

Fitting ships with O-Ring.

0940X

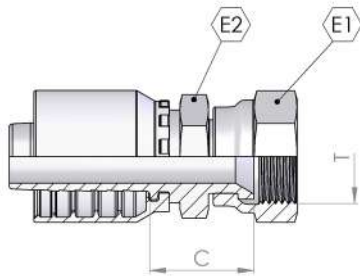

JIS Female 60° Cone (Komatsu)

Part number	Hose I.D.		Dimension				
	in	mm	dash size	thread	hex		cut-off
				T	E1	E2	C
0940X12-30	3/4	19.0	12	M30x1.5	36	30	32
0940X16-33	1	25.4	16	M33x1.5	41	36	35
0940X20-36	1 1/4	31.8	20	M36x1.5	46	46	37
0940X24-42	1 1/2	38.1	24	M42x1.5	50	50	38

K05BX

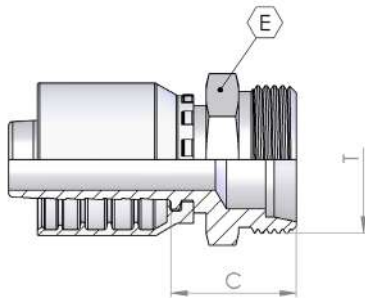

Kobelco Male

Part number	Hose I.D.		Dimension				
	in	mm	dash size	thread	hex	tube	cut-off
				T	E		C
K05BX12-30	3/4	19.0	12	M30x1.5	32	22	37
K05BX12-36	3/4	19.0	12	M36x1.5	41	28	38
K05BX16-36	1	25.4	16	M36x1.5	41	28	39
K05BX16-45	1	25.4	16	M45x1.5	50	35	40

0360X

BSP Taper Male 60° Cone

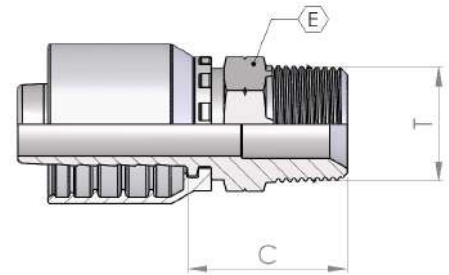

Part number	Hose I.D.		Dimension			
	in	mm	dash size	thread	hex	cut-off
				T	E	C
0360X12-12	3/4	19.0	12	3/4-14	27	39
0360X12-16	3/4	19.0	12	1-11	36	45
0360X16-16	1	25.4	16	1-11	36	46
0360X16-20	1	25.4	16	1 1/4-11	46	48
0360X20-20	1 1/4	31.8	20	1 1/4-11	46	47
0360X20-24	1 1/4	31.8	20	1 1/2-11	50	49
0360X24-24	1 1/2	38.1	24	1 1/2-11	50	49
0360X24-32	1 1/2	38.1	24	2-11	65	55
0360X32-32	2	50.8	32	2-11	65	68

0350X

BSP Male Parallel 60° Cone

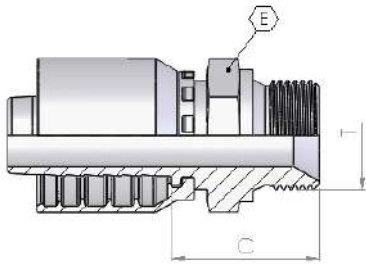

Part number	Hose I.D.		Dimension			
	in	mm	dash size	thread	hex	cut-off
				T	E	C
0350X12-12	3/4	19.0	12	3/4-14	32	38
0350X12-16	3/4	19.0	12	1-11	41	41
0350X16-16	1	25.4	16	1-11	41	42
0350X16-20	1	25.4	16	1 1/4-11	50	46
0350X20-16	1 1/4	31.8	20	1-11	41	41
0350X20-20	1 1/4	31.8	20	1 1/4-11	50	45
0350X20-24	1 1/4	31.8	20	1 1/2-11	55	46
0350X24-24	1 1/2	38.1	24	1 1/2-11	55	46
0350X24-32	1 1/2	38.1	24	2-11	70	54
0350X32-24	2	50.8	32	1 1/2-11	65	50
0350X32-32	2	50.8	32	2-11	70	54

0050X

BSP Female 60° Cone - Thrust Wire Nut

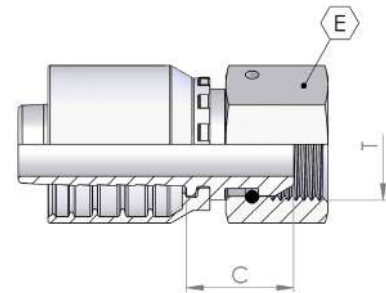

Part number	Hose I.D.		Dimension			
	in	mm	dash size	thread	hex	cut-off
				T	E	C
0050X12-12	3/4	19.0	12	3/4-14	32	27
0050X12-16	3/4	19.0	12	1-11	38	28
0050X16-16	1	25.4	16	1-11	38	30
0050X16-20	1	25.4	16	1 1/4-11	50	30
0050X20-16	1 1/4	31.8	20	1-11	38	33
0050X20-20	1 1/4	31.8	20	1 1/4-11	50	32
0050X20-24	1 1/4	31.8	20	1 1/2-11	55	34
0050X24-20	1 1/2	38.1	24	1/1/4-11	50	35
0050X24-24	1 1/2	38.1	24	1 1/2-11	55	37
0050X32-32	2	50.8	32	2-11	70	58

0250X

BSP 45° Swept Elbow 60° Cone

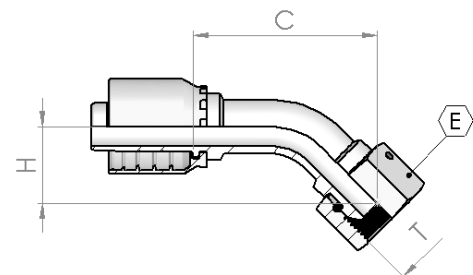

Part number	Hose I.D.		Dimension				
	in	mm	dash size	thread	hex	cut-off	Drop
				T	E	C	H
0250X12-12	3/4	19.0	12	3/4-14	32	87	29
0250X12-16	3/4	19.0	12	1-11	38	93	52
0250X16-16	1	25.4	16	1-11	38	108	35
0250X16-20	1	25.4	16	1 1/4-11	50	70	33
0250X20-20	1 1/4	31.8	20	1 1/4-11	50	107	40
0250X20-24	1 1/4	31.8	20	1 1/2-11	55	91	41
0250X24-24	1 1/2	38.1	24	1 1/2-11	55	117	47
0250X32-32	2	50.8	32	2-11	70	162	70

0150X

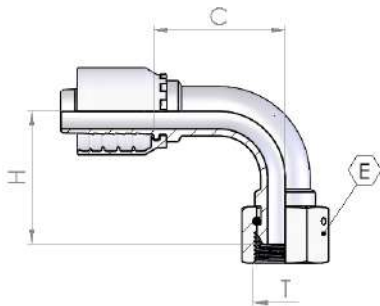

BSP 90° Swept Elbow 60° Cone

Part number	Hose I.D.		Dimension				
	in	mm	dash size	thread	hex	cut-off	Drop
				T	E	C	H
0150X12-12	3/4	19.0	12	3/4-14	32	58	56
0150X12-16	3/4	19.0	12	1-11	38	58	60
0150X16-16	1	25.4	16	1-11	38	72	68
0150X16-20	1	25.4	16	1 1/4-11	50	62	72
0150X20-20	1 1/4	31.8	20	1 1/4-11	50	86	81
0150X20-24	1 1/4	31.8	20	1 1/2-11	55	81	89
0150X24-24	1 1/2	38.1	24	1 1/2-11	55	103	95
0150X32-32	2	50.8	32	2-11	70	139	133

0500X

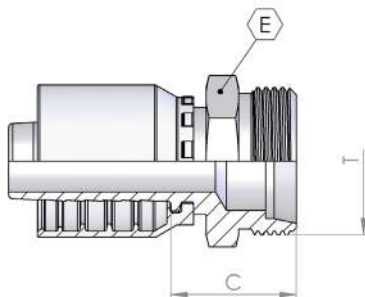

Metric Male 24° Seat Light

Part number	Hose I.D.		Dimension				
	in	mm	dash size	thread	tube	hex	cut-off
				T		E	C
0500X12-26	3/4	19.0	12	M26x1.5	18	27	30
0500X12-30	3/4	19.0	12	M30x2.0	22	30	35
0500X12-36	3/4	19.0	12	M36x2.0	28	26	32
0500X16-36	1	25.4	16	M36x2.0	28	36	34
0500X20-45	1 1/4	31.8	20	M45x2.0	35	46	36
0500X20-52	1 1/4	31.8	20	M52x2.0	42	55	41
0500X24-52	1 1/2	38.1	24	M52x2.0	42	55	38

0085X

Metric Female 24° Seat Light

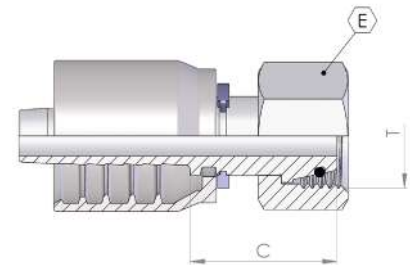

Part number	Hose I.D.		Dimension				
	in	mm	dash size	thread	tube	hex	cut-off
				T		E	C
0085X12-30	3/4	19.0	12	M30x2.0	22	36	31
0085X12-36	3/4	19.0	12	M36x2.0	28	41	30
0085X16-36	1	25.4	16	M36x2.0	28	41	32
0085X20-45	1 1/4	31.8	20	M45x2.0	35	50	40
0085X24-52	1 1/2	38.1	24	M52x2.0	42	60	41

0085X

Metric Female 24° Seat Light (Rolled Nut)

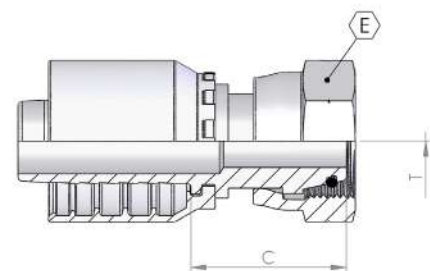

Part number	Hose I.D.		Dimension				
	in	mm	dash size	thread	tube	hex	cut-off
				T		E	C
0085X12-26	3/4	19.0	12	M26x1.5	18	32	38

0285X

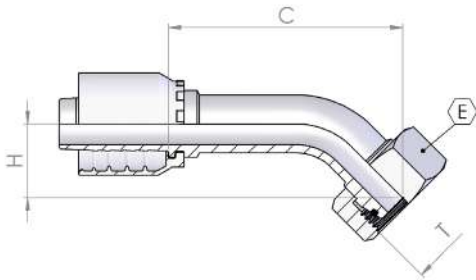

45° Metric Swept Elbow 24° Seat Light

Part number	Hose I.D.		Dimension					
	in	mm	dash size	thread	tube	hex	cut-off	Drop
				T		E	C	H
0285X12-26	3/4	19.0	12	M26x1.5	18	32	45	19
0285X12-30	3/4	19.0	12	M30x2.0	22	36	87	27
0285X16-36	1	25.4	16	M36x2.0	28	41	104	32
0285X20-45	1 1/4	31.8	20	M45x2.0	35	50	155	50
0285X24-52	1 1/2	38.1	24	M52x2.0	42	60	180	55

0185X

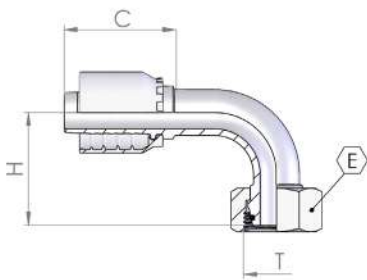

90° Metric Swept Elbow 24° Seat Light

Part number	Hose I.D.		Dimension					
	in	mm	dash size	thread	tube	hex	cut-off	Drop
				T		E	C	H
0185X12-26	3/4	19.0	12	M26x1.5	18	32	44	44
0185X12-30	3/4	19.0	12	M30x2.0	22	36	60	52
0185X12-36	3/4	19.0	12	M36x2.0	28	41	51	51
0185X16-36	1	25.4	16	M36x2.0	28	41	74	62
0185X20-45	1 1/4	31.8	20	M45x2.0	35	50	104	97
0185X24-52	1 1/2	38.1	24	M52x2.0	42	60	123	109

0450X

Metric Male 24° Seat Heavy

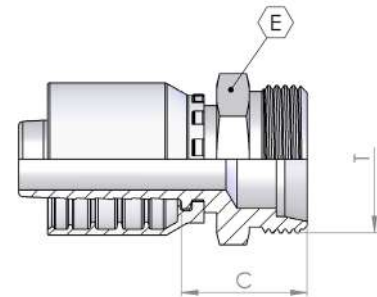

Part number	Hose I.D.		Dimension				
	in	mm	dash size	thread	tube	hex	cut-off
				T		E	C
0450X12-30	3/4	19.0	12	M30x2.0	20	36	36
0450X12-36	3/4	19.0	12	M36x2.0	25	36	40
0450X16-36	1	25.4	16	M36x2.0	25	36	41
0450X16-42	1	25.4	16	M42x2.0	30	46	44
0450X20-42	1 1/4	31.8	20	M42x2.0	30	46	43
0450X20-52	1 1/4	31.8	20	M52x2.0	38	55	45
0450X24-52	1 1/2	38.1	24	M52x2.0	38	55	45

0084X

Metric Female 24° Seat Heavy

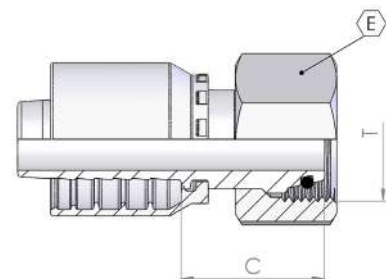

Part number	Hose I.D.		Dimension				
	in	mm	dash size	thread	tube	hex	cut-off
				T		E	C
0084X12-30	3/4	19.0	12	M30x2.0	20	36	35
0084X12-36	3/4	19.0	12	M36x2.0	25	46	41
0084X16-36	1	25.4	16	M36x2.0	25	46	43
0084X16-42	1	25.4	16	M42x2.0	30	50	45
0084X20-42	1 1/4	31.8	20	M42x2.0	30	50	47
0084X20-52	1 1/4	31.8	20	M52x2.0	38	60	44
0084X24-52	1 1/2	38.1	24	M52x2.0	38	60	44



0284X

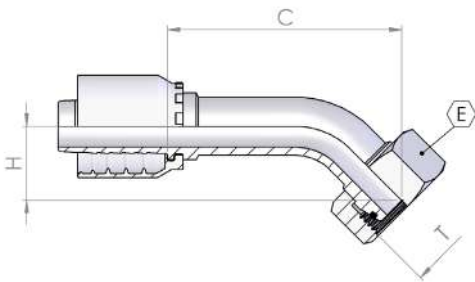

45° Metric Swept Elbow 24° Seat Heavy

Part number	Hose I.D.		Dimension					
	in	mm	dash size	thread	tube	hex	cut-off	drop
				T		E	C	H
0284X12-30	3/4	19.0	12	M30x2.0	20	36	91	30
0284X12-36	3/4	19.0	12	M36x2.0	25	46	91	31
0284X16-36	1	25.4	16	M36x2.0	30	46	106	34
0284X16-42	1	25.4	16	M42x2.0	38	50	107	33
0284X20-52	1 1/4	31.8	20	M52x2.0	38	60	157	50

0184X

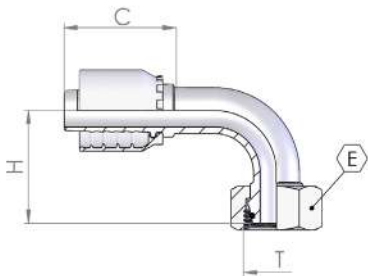

90° Metric Swept Elbow 24° Seat Heavy

Part number	Hose I.D.		Dimension					
	in	mm	dash size	thread	tube	hex	cut-off	drop
				T		E	C	H
0184X12-30	3/4	19.0	12	M30x2.0	20	36	59	56
0184X12-36	3/4	19.0	12	M36x2.0	25	46	58	59
0184X16-36	1	25.4	16	M36x2.0	25	46	70	67
0184X16-42	1	25.4	16	M42x2.0	30	50	74	67
0184X20-52	1 1/4	31.8	20	M52x2.0	38	60	84	82
0184X24-52	1 1/2	38.1	24	M52x2.0	38	60	99	94

1250X

Straight SAE Code 61 Flange

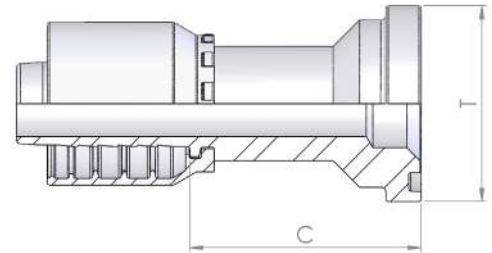

Part number	Hose I.D.		dash size	Dimension		cut-off
	in	mm		flange		
				T	mm	C
1250X12-12	3/4	19.0	12	3/4	38.1	51
1250X12-16	3/4	19.0	12	1	44.5	54
1250X16-16	1	25.4	16	1	44.5	56
1250X16-20	1	25.4	16	1 1/4	50.8	59
1250X20-20	1 1/4	31.8	20	1 1/4	50.8	59
1250X20-24	1 1/4	31.8	20	1 1/2	60.3	62
1250X24-24	1 1/2	38.1	24	1 1/2	60.3	62
1250X24-32	1 1/2	38.1	24	2	71.4	67
1250X32-32	2	50.8	32	2	71.4	75
1250X32-40	2	54.8	32	2 1/2	84.1	83

1150X

45° SAE Code 61 Flange

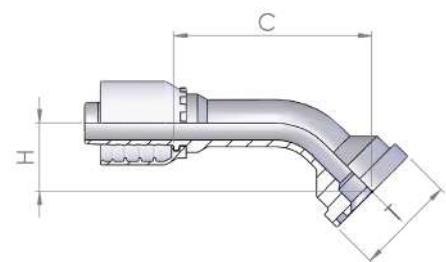

Part number	Hose I.D.		dash size	Dimension		cut-off	Drop
	in	mm		flange			
				T	mm	C	H
1150X12-12	3/4	19.0	12	3/4	38.1	84	27
1150X12-16	3/4	19.0	12	1	44.5	88	30
1150X16-16	1	25.4	16	1	44.5	106	33
1150X16-20	1	25.4	16	1 1/4	50.8	110	37
1150X20-20	1 1/4	31.8	20	1 1/4	50.8	102	38
1150X20-24	1 1/4	31.8	20	1 1/2	60.3	147	39
1150X24-24	1 1/2	38.1	24	1 1/2	60.3	114	44
1150X24-32	1 1/2	38.1	24	2	71.4	170	45
1150X32-32	2	50.8	32	2	71.4	196	56



1050X

90° SAE Code 61 Flange

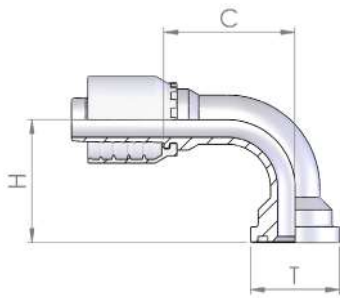

Part number	Hose I.D.		dash size	Dimension			
	in	mm		flange		cut-off	Drop
				T	mm	C	H
1050X12-12	3/4	19.0	12	3/4	38.1	58	53
1050X12-16	3/4	19.0	12	1	44.5	58	58
1050X16-16	1	25.4	16	1	44.5	72	65
1050X16-20	1	25.4	16	1 1/4	50.8	72	70
1050X20-16	1 1/4	31.8	20	1	44.5	81	77
1050X20-20	1 1/4	31.8	20	1 1/4	50.8	101	82
1050X20-24	1 1/4	31.8	20	1 1/2	60.3	106	80
1050X24-24	1 1/2	38.1	24	1 1/2	60.3	120	92
1050X24-32	1 1/2	38.1	24	2	71.4	120	93
1050X32-32	2	50.8	32	2	71.4	139	123

1050X

22.5°/30°/60°/67.5° SAE Code 61 Flange

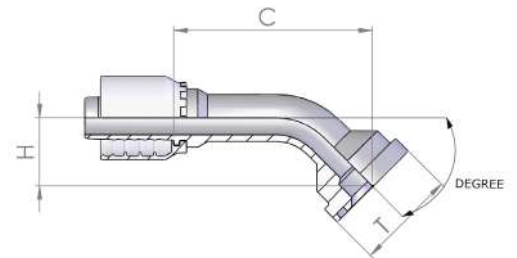

Part number	Hose I.D.		Dimension					Degree
	in	mm	dash size	flange		cut-off C	Drop H	
				T	mm			
1050X12-12 22.5	3/4	19.0	12	3/4	38.1	78	11	22.5°
1050X16-16 22.5	1	25.4	16	1	44.5	91	14	22.5°
1050X20-20 22.5	1 1/4	31.8	20	1 1/4	50.8	152	18	22.5°
1050X24-24 22.5	1 1/2	38.1	24	1 1/2	60.3	124	17	22.5°
1050X32-32 22.5	2	50.8	32	2	71.4	163	28	22.5°
1050X12-12 30	3/4	19.0	12	3/4	38.1	77	16	30°
1050X16-16 30	1	25.4	16	1	44.5	89	19	30°
1050X20-20 30	1 1/4	31.8	20	1 1/4	50.8	150	25	30°
1050X24-24 30	1 1/2	38.1	24	1 1/2	60.3	175	27	30°
1050X32-32 30	2	50.8	32	2	71.4	156	37	30°
1050X12-12 60	3/4	19.0	12	3/4	38.1	78	36	60°
1050X16-16 60	1	25.4	16	1	44.5	97	43	60°
1050X20-20 60	1 1/4	31.8	20	1 1/4	50.8	136	49	60°
1050X24-24 60	1 1/2	38.1	24	1 1/2	60.3	138	55	60°
1050-32-32 60	2	50.8	32	2	71.4	186	82	60°
1050X12-12 67.5	3/4	19.0	12	3/4	38.1	74	41	67.5°
1050X16-16 67.5	1	25.4	16	1	44.5	93	48	67.5°
1050X20-20 67.5	1 1/4	31.8	20	1 1/4	50.8	132	53	67.5°
1050X24-24 67.5	1 1/2	38.1	24	1 1/2	60.3	167	66	67.5°
1050X32-32 67.5	2	50.8	32	2	71.4	177	93	67.5°



1300X

Straight SAE Code 62 Flange

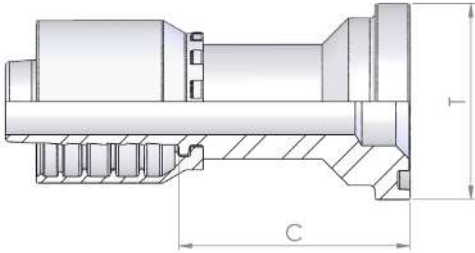

Part number	Hose I.D.		dash size	Dimension		cut-off
	in	mm		flange		
				T	mm	C
1300X12-12	3/4	19.0	12	3/4	41.3	55
1300X12-16	3/4	19.0	12	1	47.6	61
1300X16-12	1	25.4	16	3/4	41.3	57
1300X16-16	1	25.4	16	1	47.6	63
1300X16-20	1	25.4	16	1 1/4	54.0	70
1300X20-16	1 1/4	31.8	20	1	47.6	66
1300X20-20	1 1/4	31.8	20	1 1/4	54.0	70
1300X20-24	1 1/4	31.8	20	1 1/2	63.5	76
1300X24-20	1 1/2	38.1	24	1 1/4	54.0	80
1300X24-24	1 1/2	38.1	24	1 1/2	63.5	76
1300X24-32	1 1/2	38.1	24	2	79.4	85
1300X32-24	2	50.8	32	1 1/2	63.5	85.5
1300X32-32	2	50.8	32	2	79.4	92

1200X

45° SAE Code 62 Flange

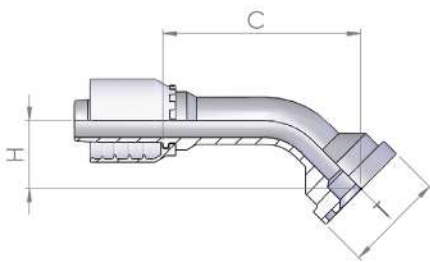

Part number	Hose I.D.		dash size	Dimension		cut-off	Drop
	in	mm		flange			
				T	mm	C	H
1200X12-12	3/4	19.0	12	3/4	41.3	87	30
1200X12-16	3/4	19.0	12	1	47.6	94	34
1200X16-12	1	25.4	16	3/4	41.3	112	35
1200X16-16	1	25.4	16	1	47.6	109	37
1200X16-20	1	25.4	16	1 1/4	54.0	115	41
1200X20-16	1 1/4	31.8	20	1	47.6	123	33
1200X20-20	1 1/4	31.8	20	1 1/4	54.0	155	43
1200X20-24	1 1/4	31.8	20	1 1/2	63.5	155	45
1200X24-24	1 1/2	38.1	24	1 1/2	63.5	122	50
1200X24-32	1 1/2	38.1	24	2	79.4	187	56
1200X32-32	2	50.8	32	2	79.4	161	71

1100X

90° SAE Code 62 Flange

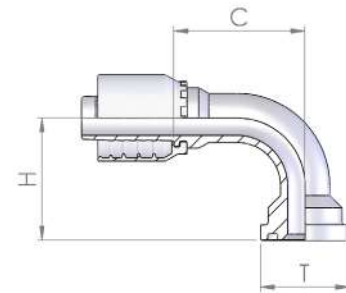

Part number	Hose I.D.		Dimension				
	in	mm	dash size	flange		cut-off C	Drop H
				T	mm		
1100X12-12	3/4	19.0	12	3/4	41.3	58	57
1100X12-16	3/4	19.0	12	1	47.6	56	63
1100X16-12	1	25.4	16	3/4	41.3	80	66
1100X16-16	1	25.4	16	1	47.6	72	69
1100X16-20	1	25.4	16	1 1/4	54.0	72	77
1100X20-16	1 1/4	31.8	20	1	47.6	104	70
1100X20-20	1 1/4	31.8	20	1 1/4	54.0	103	85
1100X20-24	1 1/4	31.8	20	1 1/2	63.5	114	91
1100X24-20	1 1/2	38.1	24	1 1/4	54.0	110	84
1100X24-24	1 1/2	38.1	24	1 1/2	63.5	118	102
1100X24-32	1 1/2	38.1	24	2	79.4	122	114
1100X32-32	2	50.8	32	2	79.4	147	143

1100X

22.5°/30°/60°/67.5°/110° SAE Code 62 Flange

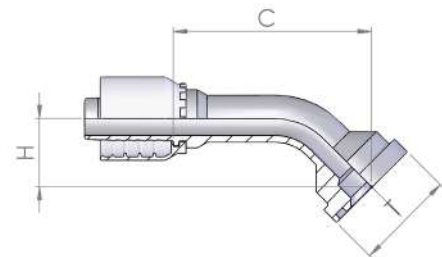

Part number	Hose I.D.		Dimension					Degree
	in	mm	dash size	flange		cut-off C	Drop H	
				T	mm			
1100X32-32 22.5	2	50.8	32	2	79.4	178	49	22.5°
1100X12-12 30	3/4	19.0	12	3/4	41.3	77	16	30°
1100X16-16 30	1	25.4	16	1	47.6	89	19	30°
1100X20-20 30	1 1/4	31.8	20	1 1/4	54.0	109	26	30°
1100X24-24 30	1 1/2	38.1	20	1 1/2	63.5	122	23	30°
1100X32-32 30	2	50.8	32	2	79.4	174	49	30°
1100X12-12 60	3/4	19.0	12	3/4	41.3	78	36	60°
1100X12-16 60	3/4	19.0	12	1	47.6	81	51	60°
1100X16-16 60	1	25.4	16	1	47.6	97	43	60°
1100X20-20 60	1 1/4	31.8	20	1 1/4	54.0	116	49	60°
1100X20-24 60	1 1/4	31.8	20	1 1/2	63.5	143	73	60°
1100X24-24 60	1 1/2	38.1	24	1 1/2	63.5	175	54	60°
1100X32-32 60	2	50.8	32	2	79.4	198	98	60°
1100X32-32 67.5	2	50.8	32	2	79.4	185	112	67.5°
1100X32-32 110	2	50.8	32	2	79.4	117	106.5	110°

130SX

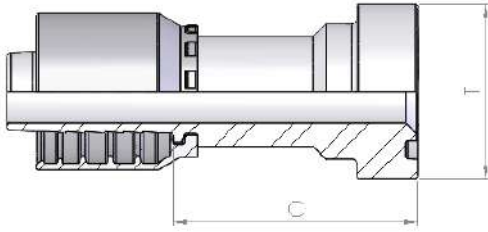

Straight 'CAT' Flange

Part number	Hose I.D.		dash size	Dimension		cut-off
	in	mm		flange		
				T	mm	C
130SX12-12	3/4	19.0	12	3/4	41.3	59
130SX12-16	3/4	19.0	12	1	47.6	66
130SX16-16	1	25.4	16	1	47.6	67
130SX16-20	1	25.4	16	1 1/4	54.0	75
130SX20-20	1 1/4	31.8	20	1 1/4	54.0	74
130SX20-24	1 1/4	31.8	20	1 1/2	63.5	78
130SX24-24	1 1/2	38.1	24	1 1/2	63.5	80
130SX32-24	2	50.8	32	1 1/2	63.5	71.5
130SX32-32	2	50.8	32	2	79.4	94

120SX

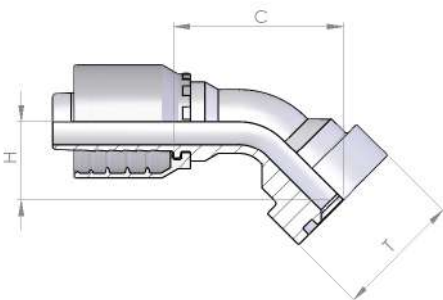

45° 'CAT' Flange

Part number	Hose I.D.		dash size	Dimension		cut-off	Drop
	in	mm		flange			
				T	mm	C	H
120SX12-12	3/4	19.0	12	3/4	41.3	90	32
120SX12-16	3/4	19.0	12	1	47.6	97	33
120SX16-16	1	25.4	16	1	47.6	121	40
120SX16-20	1	25.4	16	1 1/4	54.0	124	44
120SX20-20	1 1/4	31.8	20	1 1/4	54.0	146	44
120SX20-24	1 1/4	31.8	20	1 1/2	63.5	157	48
120SX24-24	1 1/2	38.1	24	1 1/2	63.5	172	52
120SX32-32	2	50.8	32	2	79.4	162	72

110SX

90° 'CAT' Flange

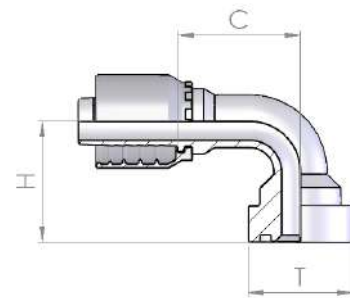

Part number	Hose I.D.		Dimension				
	in	mm	dash size	flange	cut-off	Drop	
				T	mm	C	H
110SX12-12	3/4	19.0	12	3/4	41.3	58	60
110SX12-16	3/4	19.0	12	1	47.6	58	67
110SX16-16	1	25.4	16	1	47.6	80	74
110SX16-20	1	25.4	16	1 1/4	54.0	79	80
110SX20-20	1 1/4	31.8	20	1 1/4	54.0	103	88
110SX20-24	1 1/4	31.8	20	1 1/2	63.5	96	95
110SX24-24	1 1/2	38.1	24	1 1/2	63.5	118	104
110SX24-32	1 1/2	38.1	24	2	79.4	122	118
110SX32-32	2	50.8	32	2	79.4	142	145

Braided Hose No-Skive

NPTF Male 30° Cone.....	0370G	7
NPTF Male 30° Cone - Swivel.....	037GG	8
NPSM Female 30° Cone - Rolled Nut.....	N051G	8
JIC Male 37° Cone.....	0850G.....	9
JIC Female 37° Cone - Rolled Nut	0911G.....	10
JIC Female 37° Cone - Thrust Wire Nut.....	0900G.....	11
JIC 45° Swept Elbow 37° Cone - Rolled Nut	1001G	11
JIC 45° Swept Elbow 37° Cone - Thrust Wire Nut.....	1000G.....	12
JIC 90° Swept Elbow 37° Cone - Rolled Nut	0951G	12
JIC 90° Swept Elbow 37° Cone - Thrust Wire Nut.....	0950G	13
JIC 90° Swept Elbow 37° Cone - Long Drop - Rolled Nut	095LG.....	13
JIC 90° Compact Elbow 37° Cone - Crimped Nut	2971G	14
JIC 90° Compact Elbow 37° Cone - Thrust Wire Nut.....	2970G	14
ORFS Male	S350G	15
ORFS Female Double Hexagon	S05TG	15
ORFS 45° Swept Elbow.....	S250G	16
ORFS 90° Swept Elbow.....	S150G	17
ORFS 90° Swept Elbow - Long Drop.....	S15LG.....	17
ORFS 90° Swept Elbow - Short Drop	S155G	18
SAE Male O-Ring Boss.....	0385G	19
Swivel Male O-Ring Boss.....	0390G.....	19
90° Male O-Ring Boss Swivel.....	0395G	20
Straight Male Inverted Flare Swivel	IF00G	20
45° Male Inverted Flare Swivel.....	IF45G.....	21
90° Male Inverted Flare Swivel	IF90G.....	21
JIS Female 60° Cone (Toyota)	0930G.....	22
90° JIS Swept Elbow (Toyota) - Welded	0980G.....	22
JIS Female 60° Cone (Komatsu)	0940G.....	23
45° JIS Swept Elbow (Komatsu) - Welded	1040G.....	23
90° JIS Swept Elbow (Komatsu) - Welded.....	0990G.....	24
Straight Komatsu Flange.....	1250G	24
45° Komatsu Flange	1150G.....	24
90° Komatsu Flange.....	1050G.....	24
Kobelco Male.....	K05BG.....	25
BSP Taper Male 60° Cone.....	0360G.....	26
BSP Male Parallel 60° Cone	0350G	27
BSP Female 60° Cone - Rolled Nut	0051G.....	28
BSP Female 60° Cone - Slip-on Nut	0052G	28
BSP Female 60° Cone - Thrust Wire Nut.....	0050G.....	29
BSP 45° Swept Elbow 60° Cone - Rolled Nut	0251G	30
BSP 45° Swept Elbow 60° Cone - Slip-on Nut.....	0252G	30
BSP 45° Swept Elbow 60° Cone - Thrust Wire Nut.....	0250G	31
BSP 90° Swept Elbow 60° Cone - Rolled Nut	0151G.....	32

BSP 90° Swept Elbow 60° Cone - Slip-on Nut.....	0152G.....	32
BSP 90° Swept Elbow 60° Cone - Thrust Wire Nut.....	0150G.....	33
BSP O-Ring Female 60° Cone - Rolled Nut.....	0041G.....	34
BSP O-Ring Female 60° Cone - Slip-on Nut.....	0042G.....	34
BSP O-Ring 45° Swept Elbow 60° Cone - Rolled Nut.....	0241G.....	35
BSP O-Ring 45° Swept Elbow 60° Cone - Slip-on Nut.....	0242G.....	35
BSP O-Ring 90° Swept Elbow 60° Cone - Rolled Nut.....	0141G.....	36
BSP O-Ring 90° Swept Elbow 60° Cone - Slip-on Nut.....	0142G.....	36
BSP 90° Compact Elbow 60° Cone - Rolled Nut.....	2321G.....	37
BSP 90° Compact Elbow 60° Cone - Thrust Wire Nut.....	2320G.....	37
BSP Male Flat Seal.....	0345G.....	38
BSP Female Flat Seal.....	0060G.....	38
BSP Banjo.....	1400G.....	39
BSP Perforated Bolt.....	1600-00.....	40
BSP Double Perforated Bolt.....	1600.....	40
Karcher Female.....	FK50G.....	41
Metric Standpipe.....	0550G.....	42
45° Metric Standpipe.....	0750G.....	43
90° Metric Standpipe.....	0650G.....	44
Metric Banjo.....	1350G.....	45
Metric Perforated Bolt.....	1650.....	45
French Metric GAZ Male 24° Cone.....	0430G.....	46
French Metric GAZ Female 24° Cone.....	0030G.....	46
French Metric GAZ 90° Swept Elbow 24° Cone.....	0130G.....	46
Metric Female 60° Cone.....	0100G.....	47
90° Metric Swept Elbow 60° Cone.....	0200G.....	47
Metric Female Light Multiseal 24° Cone.....	0035G.....	48
90° Metric Multiseal Swept Elbow 24° Cone.....	0135G.....	48
Metric Male 24° Seat Light (DKOL).....	0500G.....	49
Metric Female 24° Seat Light (DKOL).....	0085G.....	50
45° Metric Swept Elbow 24° Seat Light (DKOL).....	0285G.....	51
90° Metric Swept Elbow 24° Seat Light (DKOL).....	0185G.....	52
Metric Male 24° Seat Heavy (DKOS).....	0450G.....	53
Metric Female 24° Seat Heavy (DKOS).....	0084G.....	54
45° Metric Swept Elbow 24° Seat Heavy (DKOS).....	0284G.....	55
90° Metric Swept Elbow 24° Seat Heavy (DKOS).....	0184G.....	56
Straight SAE Code 61 Flange.....	1260G.....	57
45° SAE Code 61 Flange.....	1160G.....	57
90° SAE Code 61 Flange.....	1260G.....	58
22.5°/30°/60°/67.5° SAE Code 61 Flange.....	1260G.....	59
Straight SAE Code 62 Flange.....	1310G.....	60
90° SAE Code 62 Flange.....	1110G.....	61
45° SAE Code 62 Flange.....	1210G.....	62
90° 'CAT' Flange.....	1105G.....	62
Hose Junction.....	D050G.....	63

Spiral Hose No-Skive

NPTF Male 30° Cone.....	0370X	68
JIC Male 37° Cone.....	0850X	68
JIC Female 37° Cone.....	0900X.....	69
JIC 45° Swept Elbow 37° Cone.....	1000X.....	69
JIC 90° Swept Elbow 37° Cone.....	0950X	70
ORFS Male	S350X	71
ORFS Female Double Hexagon	S05TX	72
ORFS 45° Swept Elbow.....	S250X	72
ORFS 90° Swept Elbow.....	S150X.....	73
SAE Male O-Ring Boss.....	0385X	73
JIS Female 60° Cone (Komatsu).....	0940X.....	74
Kobelco Male.....	K05BX.....	74
BSP Taper Male 60° Cone.....	0360X.....	75
BSP Male Parallel 60° Cone	0350X	76
BSP Female 60° Cone - Thrust Wire Nut.....	0050X.....	77
BSP 45° Swept Elbow 60° Cone.....	0250X	77
BSP 90° Swept Elbow 60° Cone.....	0150X.....	78
Metric Male 24° Seat Light (DKOL)	0500X.....	78
Metric Female 24° Seat Light (DKOL)	0085X.....	79
45° Metric Swept Elbow 24° Seat Light (DKOL).....	0285X	80
90° Metric Swept Elbow 24° Seat Light (DKOL).....	0185X.....	80
Metric Male 24° Seat Heavy (DKOS).....	0450X.....	81
Metric Female 24° Seat Heavy (DKOS).....	0084X.....	81
45° Metric Swept Elbow 24° Seat Heavy (DKOS)	0284X.....	82
90° Metric Swept Elbow 24° Seat Heavy (DKOS)	0184X.....	82
Straight SAE Code 61 Flange.....	1250X	83
45° SAE Code 61 Flange.....	1150X.....	83
90° SAE Code 61 Flange.....	1050X.....	84
22.5°/30°/60°/67.5° SAE Code 61 Flange	1050X.....	85
Straight SAE Code 62 Flange.....	1300X.....	86
90° SAE Code 62 Flange	1200X.....	86
45° SAE Code 62 Flange	1100X.....	87
22.5°/30°/60°/67.5°/110° SAE Code 62 Flange.....	1100X.....	87
Straight 'CAT' Flange	1305X	88
45° 'CAT' Flange	1205X	88
90° 'CAT' Flange	1105X.....	89

Index by Part Number Prefix

0030G	French Metric GAZ Female 24° Cone.....	46
0035G.....	Metric Female Light Multiseal 24° Cone.....	48
0041G	BSP O-Ring Female 60° Cone - Rolled Nut.....	34
0042G	BSP O-Ring Female 60° Cone - Slip-on Nut.....	34
0050G.....	BSP Female 60° Cone - Thrust Wire Nut.....	29
0050X.....	BSP Female 60° Cone - Thrust Wire Nut.....	77
0051G	BSP Female 60° Cone - Rolled Nut	28
0052G.....	BSP Female 60° Cone - Slip-on Nut.....	28
0060G	BSP Female Flat Seal	38
0084G	Metric Female 24° Seat Heavy (DKOS).....	54
0084X	Metric Female 24° Seat Heavy (DKOS).....	81
0085G.....	Metric Female 24° Seat Light (DKOL).....	50
0085X.....	Metric Female 24° Seat Light (DKOL).....	79
0100G	Metric Female 60° Cone.....	47
0130G	French Metric GAZ 90° Swept Elbow 24° Cone.....	46
0135G.....	90° Metric Multiseal Swept Elbow 24° Cone.....	48
0141G	BSP O-Ring 90° Swept Elbow 60° Cone - Rolled Nut.....	36
0142G	BSP O-Ring 90° Swept Elbow 60° Cone - Slip-on Nut.....	36
0150G	BSP 90° Swept Elbow 60° Cone - Thrust Wire Nut.....	33
0150X.....	BSP 90° Swept Elbow 60° Cone	78
0151G	BSP 90° Swept Elbow 60° Cone - Rolled Nut	32
0152G.....	BSP 90° Swept Elbow 60° Cone - Slip-on Nut.....	32
0184G	90° Metric Swept Elbow 24° Seat Heavy (DKOS).....	56
0184X	90° Metric Swept Elbow 24° Seat Heavy (DKOS).....	82
0185G	90° Metric Swept Elbow 24° Seat Light (DKOL).....	52
0185X.....	90° Metric Swept Elbow 24° Seat Light (DKOL).....	80
0200G	90° Metric Swept Elbow 60° Cone.....	47
0241G	BSP O-Ring 45° Swept Elbow 60° Cone - Rolled Nut.....	35
0242G.....	BSP O-Ring 45° Swept Elbow 60° Cone - Slip-on Nut	35
0250G.....	BSP 45° Swept Elbow 60° Cone - Thrust Wire Nut.....	3
0250X.....	BSP 45° Swept Elbow 60° Cone	77
0251G.....	BSP 45° Swept Elbow 60° Cone - Rolled Nut	30
0252G.....	BSP 45° Swept Elbow 60° Cone - Slip-on Nut.....	30
0284G	45° Metric Swept Elbow 24° Seat Heavy (DKOS).....	55
0284X	45° Metric Swept Elbow 24° Seat Heavy (DKOS).....	82
0285G.....	45° Metric Swept Elbow 24° Seat Light (DKOL).....	51
0285X.....	45° Metric Swept Elbow 24° Seat Light (DKOL).....	80
0345G.....	BSP Male Flat Seal.....	38
0350G.....	BSP Male Parallel 60° Cone	27
0350X.....	BSP Male Parallel 60° Cone	76
0360G.....	BSP Taper Male 60° Cone.....	26
0360X.....	BSP Taper Male 60° Cone.....	75
0370G.....	NPTF Male 30° Cone.....	7



0370X.....	NPTF Male 30° Cone.....	68
037GG.....	NPTF Male 30° Cone - Swivel.....	8
0385G.....	SAE Male O-Ring Boss.....	19
0385X.....	SAE Male O-Ring Boss.....	73
0390G.....	Swivel Male O-Ring Boss.....	19
0395G.....	90° Male O-Ring Boss Swivel.....	20
0430G.....	French Metric GAZ Male 24° Cone.....	46
0450G.....	Metric Male 24° Seat Heavy (DKOS).....	53
0450X.....	Metric Male 24° Seat Heavy (DKOS).....	81
0500G.....	Metric Male 24° Seat Light (DKOL).....	49
0500X.....	Metric Male 24° Seat Light (DKOL).....	78
0550G.....	Metric Standpipe.....	42
0650G.....	90° Metric Standpipe.....	44
0750G.....	45° Metric Standpipe.....	43
0850G.....	JIC Male 37° Cone.....	9
0850X.....	JIC Male 37° Cone.....	68
0900G.....	JIC Female 37° Cone - Thrust Wire Nut.....	11
0900X.....	JIC Female 37° Cone.....	69
0911G.....	JIC Female 37° Cone - Rolled Nut.....	10
0930G.....	JIS Female 60° Cone (Toyota).....	22
0940G.....	JIS Female 60° Cone (Komatsu).....	23
0940X.....	JIS Female 60° Cone (Komatsu).....	74
0950G.....	JIC 90° Swept Elbow 37° Cone - Thrust Wire Nut.....	13
0950X.....	JIC 90° Swept Elbow 37° Cone.....	70
0951G.....	JIC 90° Swept Elbow 37° Cone - Rolled Nut.....	12
095LG.....	JIC 90° Swept Elbow 37° Cone - Long Drop - Rolled Nut.....	13
0980G.....	90° JIS Swept Elbow (Toyota) - Welded.....	22
0990G.....	90° JIS Swept Elbow (Komatsu) - Welded.....	24
1000G.....	JIC 45° Swept Elbow 37° Cone - Thrust Wire Nut.....	12
1000X.....	JIC 45° Swept Elbow 37° Cone.....	69
1001G.....	JIC 45° Swept Elbow 37° Cone - Rolled Nut.....	11
1040G.....	45° JIS Swept Elbow (Komatsu) - Welded.....	23
1050.....	90° Komatsu Flange.....	24
1050X.....	90° SAE Code 61 Flange.....	84
1050X.....	22.5°/30°/60°/67.5° SAE Code 61 Flange.....	85
1100X.....	45° SAE Code 62 Flange.....	87
1100X.....	22.5°/30°/60°/67.5°/110° SAE Code 62 Flange.....	87
1105G.....	90° 'CAT' Flange.....	62
1105X.....	90° 'CAT' Flange.....	89
1110G.....	90° SAE Code 62 Flange.....	61
1150G.....	45° Komatsu Flange.....	24
1150X.....	45° SAE Code 61 Flange.....	83
1160G.....	45° SAE Code 61 Flange.....	57
1200X.....	90° SAE Code 62 Flange.....	86

1205X.....	45° 'CAT' Flange	88
1210G.....	45° SAE Code 62 Flange	62
1250G.....	Straight Komatsu Flange.....	24
1250X.....	Straight SAE Code 61 Flange.....	83
1260G	Straight SAE Code 61 Flange.....	57
1260G	90° SAE Code 61 Flange.....	58
1260G	22.5°/30°/60°/67.5° SAE Code 61 Flange	59
1300X	Straight SAE Code 62 Flange	86
1305X.....	Straight 'CAT' Flange.....	88
1310G.....	Straight SAE Code 62 Flange	60
1350G.....	Metric Banjo.....	45
1400G.....	BSP Banjo.....	39
1600	BSP Double Perforated Bolt.....	40
1600-00.....	BSP Perforated Bolt.....	40
1650	Metric Perforated Bolt	45
2320G.....	BSP 90° Compact Elbow 60° Cone - Thrust Wire Nut.....	37
2321G.....	BSP 90° Compact Elbow 60° Cone - Rolled Nut	37
2970G.....	JIC 90° Compact Elbow 37° Cone - Thrust Wire Nut.....	14
2971G.....	JIC 90° Compact Elbow 37° Cone - Crimped Nut	14
D050G	Hose Junction	63
FK50G.....	Karcher Female.....	41
IF00G.....	Straight Male Inverted Flare Swivel	20
IF45G	45° Male Inverted Flare Swivel.....	21
IF90G	90° Male Inverted Flare Swivel.....	21
K05BG	Kobelco Male	25
K05BX	Kobelco Male	74
N051G.....	NPSM Female 30° Cone - Rolled Nut	8
S05TG.....	ORFS Female Double Hexagon	15
S05TX.....	ORFS Female Double Hexagon	72
S150G.....	ORFS 90° Swept Elbow.....	17
S150X.....	ORFS 90° Swept Elbow.....	73
S15LG.....	ORFS 90° Swept Elbow - Long Drop.....	17
S15SG.....	ORFS 90° Swept Elbow - Short Drop	18
S250G.....	ORFS 45° Swept Elbow.....	16
S250X.....	ORFS 45° Swept Elbow.....	72
S350G.....	ORFS Male	15
S350X.....	ORFS Male	71



Muncie®
Power
Products

Built to INTERconnect.





**Muncie[®]
Power
Products**



INTERPUMP
FLUID SOLUTIONS

MEMBERS OF THE INTERPUMP GROUP

Introduction and Technical Information



Muncie[®]
Power
Products



INTERPUMP
FLUID SOLUTIONS 

MEMBERS OF THE INTERPUMP GROUP

Muncie Power Products is a leading manufacturer and distributor of power take-offs and fluid power components for the work truck industry. Since the company was founded in 1935, Muncie Power Products has taken great pride in providing unparalleled service to each and every customer.

As a member of the Interpump Group, Muncie Power Products is excited to expand its hydraulics offering by bringing the Interpump Fluid Solutions line of hose, fittings and crimpers – ***Built to INTERconnect*** – into North America. For more than 30 years, Interpump Fluid Solutions has been a leading producer of high-quality hose and fittings. With inventory available from locations in Indiana and Texas, Muncie Power Products is ready to meet the needs of the North American market.

Introduction and Technical Information

We also have the following catalogs:

**Hydraulic Hose
One-Piece Fittings
Accessories**



Introduction

Table of Contents

- Evidence of Technical Specifications 3
- Certification and the Interpump Market 4
- Quality Certifications and Assurance 6
- Hose Legend 7
- Fitting Legend 8
- Piece by Piece, Step by Step – How to Order Fittings 11
- Connection Sealing Features 11
- Safety Indicators, Attention and Notes 14
- Safety Warnings 14
- Hose Assembly Selection 16
- Hose Size and Flow Rate 18
- Pressure 20
- Additional Information 22
- Hose Assembly Preparation 23
- Testing and Inspection 30
- Cleaning Hose 30
- Handling and storing 31
- Preventative Maintenance – According to SAE J1273 32
- Safety Instructions – SAE J1273 34
- Liability Statement 36
- UniLock Assembly Instructions 37
- Interpump Cover Solutions 39
- Technical Reference Tables 43

EVIDENCE OF TECHNICAL SPECIFICATIONS

Fitting Solutions:

- a. Interpump supplies fittings in both one-piece and two-piece solutions, highlighting the absolute ability to meet the demands of different markets globally.
- b. Interpump fittings can also be supplied in the stainless steel version as a proof of the ability to provide high value added solutions for the most demanding applications.

Surface Treatments on Fittings:

Interpump can provide different surface treatments according to clients' request, and also in this case highlight an important range of possible solutions:

- a. **Standard plating process:** high corrosion resistance, even in the presence of operating temperatures up to 212°F (100°C);
- b. **ir-zn-ir plating process:** used in automotive sector when a black color with high corrosion resistance is required;
- c. **Zinc Nickel Plating:** this coating is used when high corrosion resistance under heavy exposure is required;
- d. **E-Coat:** this coating is applied on the metal parts in order to protect them from corrosion and from the aggressive action of atmospheric agents.





Product Qualification:

All our products are qualified in accordance with the related construction standards and technical specifications. All required tests are performed in our test laboratory with the latest generation machines. In ongoing collaboration with the market, we provide dedicated testing solutions for all projects developed for our customers.

CERTIFICATION AND INTERPUMP MARKET

Along with certified Environment, Quality and Safety Management Systems, we also focus on Type Approvals, for example, Certification of International Organizations for Specific Products. This allows us to provide strategic and highly selective specialization in markets such as Mining, Naval, Offshore and Automotive. We understand market dynamics and needs through our strong, specialized and reliable team with wide-reaching distribution channels. We supply products and service to all industries requiring fluid line components and hose fittings, through our widespread network of centers across the world.

- DIRECT RETAIL SALES
- EXPRESS DELIVERY
- SALES AND AFTER SALES ASSISTANCE
- HOSE FITTINGS CENTER
- TEST AND REPORTING SERVICES

Your Hydraulic Partner

OUR QUALITY: EXTREME RELIABILITY

- IQNET -THE INTERNATIONAL CERTIFICATION NETWORK
- CISQ
- ASSOFLUID
- UNI – ITALIAN ORGANIZATION FOR STANDARDIZATION
- BUREAU VERITAS
- DNV-GL
- RINA
- LLOYD'S REGISTER
- MSHA
- MED
- ROHS
- REACH
- ABS

The continuous expansion, the continuous improvement of our range, our expertise in production and our excellent Quality Management System allow us to provide a wide range of suitable, compatible and efficient product solutions. With our control plans and testing machines we have achieved a series of International Certification Bodies Type Approvals.

INTERPUMP Quality Certificate & Assurance



ABS

Type Approval							Specific Qualification & Certification			
HOSE REFERENCE	Code	DNV-GL	ABS	LLOYD	BV	RINA	EN 81-20	API 16-D Fire Resistance test	Railway EN45545-2	MED
Hypress 25N	TFD0021			X						
Hypress 15C	TFE001K		X							
Hypress 25C MSHA	BFEM02K	X	X							X
Hypress 45P MSHA	TFDM45P	X			X					X
Hypress 45H MSHA	TFDM45H	X	X		X					X
Hypress R12 MSHA	TFDM012									
Hypress R17 MSHA	BFSM017	X	X							X
Hypress R13 MSHA	TFSM013		X							
Hypress R15 MSHA	TFSM015		X		X					
HyGreen 45H	TFDE45H	X	X							X
HyGreen R13	TFDR013	X	X							X
Kaizen 25N MSHA	BFSM017		X							
Long Life 15C MSHA	THE101K				X					
Long Life 25C	THE102K				X					
Marathon MSHA	THERMM2K	X	X							X
Power Lift 15C	THE0L1K						X			
Power Lift 25C	THE0L2K						X			
Hy Rail	TFDE011								X	
BOP Firescreen 5000	TBOP350							X		

INTERPUMP 2SC

THE002K



1

APPLICATIONS:

5



TYPE APPROVAL:

MED, DNV - GL, RINA, BV, LLOYD'S.

6

APPLICABLE SPECS.:

IMM - EXCEEDS DIN EN 857 2SC - ISO 11237 2SC

4

No -Skive hose - Exceed EN specification - Impulse tested up to 1.000.000 cycles MED certificate (ISO 15540/15541)

2

Internal hose: Synthetic rubber, extruded whole without joints, of uniform thickness.

Reinforcement: two high tensile steel wire braids.

Covering: Anti-abrasive synthetic rubber, resistant to oils, fuels and atmospheric conditions.

Recommended fluid: Hydraulic fluids petroleum based, glycol-water based, lubricant

Operating temperature: from -40° C to +120° C (Intermittent), from -40° C to +70° C for water based fluids

7 Part number	10 ID		Size	11 OD		12 Max WP		13 Min BP		14 Min BR		15 Weight		16 Ferrule
	in	mm		mm	bar	psi	bar	psi	mm	inch	kg/m	lb/ft		
THE002K-04	1/4"	6.4	04	13.3	430	6235	1720	24940	50	1.969	0.285	0.191	001C-04	
THE002K-05	5/16"	8.0	05	14.8	400	5800	1600	23200	60	2.362	0.329	0.221	001C-05	
THE002K-06	3/8"	9.5	06	17.1	350	5075	1400	20300	70	2.756	0.422	0.283	001C-06	
THE002K-08	1/2"	12.7	08	20.4	310	4495	1240	17980	80	3.150	0.517	0.347	001C-08	
THE002K-10	5/8"	16.0	10	23.5	280	4060	1120	16240	100	3.937	0.626	0.421	001C-10	
THE002K-12	3/4"	19.0	12	27.6	240	3480	960	13920	120	4.724	0.765	0.514	001C-12	
THE002K-16	1"	25.4	16	35.8	210	3045	840	12180	160	6.299	1.171	0.787	001C-16	
THE002K-20	1.1/4"	31.8	20	43.1	160	2320	640	9280	250	9.843	1.53	1.028	001C-20	
THE002K-24	1.1/2"	38.1	24	50.6	150	2175	600	8700	260	10.236	2.12	1.425	001C-24	

8 Note:

INTERPUMP

EXCEEDS ISO 11237/EN 857 - 2SC DN 6 I.D. 1/4" - W.P. 430 BAR/6235 PSI

9

1 Type description

5 Applications

9 Marking

13 Min. burst pressure

2 Features and recommendations

6 Type approval

10 Internal

14 Min. bend radius

3 Product code

7 Order code

11 External

15 Hose weight per meter

4 Applicable specs.

8 Note

12 Working pressure

16 Recommended ferrule

1

BSP Female 60° cone Thrust Wire

3

0050

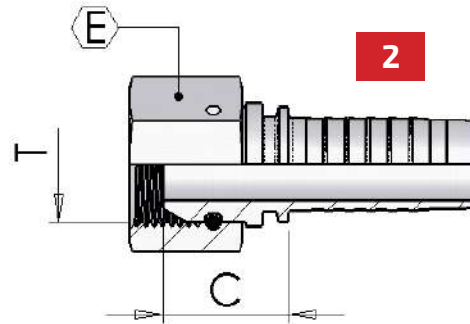

4

Part number	Hose I.D.		Dimension			
	in	mm	dash size	thread T	hex E	cut-off C
0050-03-02	3/16	4.8	03	1/8-28	14	15
0050-03-04	3/16	4.8	03	1/4-19	19	17
0050-04-02	1/4	6.4	04	1/8-28	14	15
0050-04-04	1/4	6.4	04	1/4-19	19	17
0050-04-06	1/4	6.4	04	3/8-19	22	19
0050-04-08	1/4	6.4	04	1/2-14	27	22
0050-05-04	5/16	7.9	05	1/4-19	19	17
0050-05-06	5/16	7.9	05	3/8-19	22	19
0050-05-08	5/16	7.9	05	1/2-14	27	22
0050-06-04	3/8	9.5	06	1/4-19	19	17
0050-06-06	3/8	9.5	06	3/8-19	22	19
0050-06-08	3/8	9.5	06	1/2-14	27	22
0050-08-06	1/2	12.7	08	3/8-19	22	20
0050-08-08	1/2	12.7	08	1/2-14	27	23
0050-08-10	1/2	12.7	08	5/8-14	30	20
0050-08-12	1/2	12.7	08	3/4-14	32	27
0050-10-08	5/8	15.9	10	1/2-14	27	23
0050-10-10	5/8	15.9	10	5/8-14	30	20
0050-10-12	5/8	15.9	10	3/4-14	32	25
0050-12-08	3/4	19.0	12	1/2-14	27	24
0050-12-12	3/4	19.0	12	3/4-14	32	25
0050-12-16	3/4	19.0	12	1-11	38	26
0050-16-12	1	25.4	16	3/4-14	32	27
0050-16-16	1	25.4	16	1-11	38	27
0050-16-20	1	25.4	16	1 1/4-11	50	30
0050-20-20	1 1/4	31.8	20	1 1/4-11	50	32
0050-20-24	1 1/4	31.8	20	1 1/2-11	55	34
0050-24-24	1 1/2	38.1	24	1 1/2-11	55	34
0050-24-32	1 1/2	38.1	24	2-11	70	34

7

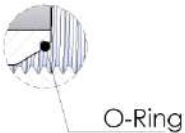

1 Type description

4 Order code

7 Note

2 Description

5 Internal hose diameter

3 Product code

6 Thread dimension



Agriculture



Cranes/lifting



Hydraulic rams



Lifts



**Air conditioning/
refrigeration systems**

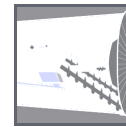

Mining & drilling



Test benches



Food industry



Ground movement



Chemistry

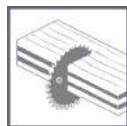

Wood industry



Biological oil



Compressors



Railway



Entertainment



Oil-gas



Industry



Jet grouting



Elevators



Cleaning



Swaging machines



Energy



Automatic machines



Hydraulic tools



Foundry-steel industry



Marine/off shore

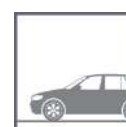

Vehicles



Sewer system



Truck



Lift truck

System subject to normal temperatures



System subject to low temperatures



System subject to high temperatures



The background features a light gray gradient. In the upper portion, there are several overlapping, semi-transparent dark gray shapes: a large circle on the left, a horizontal bar on the right, and a larger, irregular shape that encompasses the text. The text is white and centered within the dark gray area.

Technical Information Introduction

PIECE BY PIECE, STEP BY STEP

Interpump Hydraulics fittings are made of carbon steel (11SMnPb37) or stainless steel AISI 316L controlled and certified.

At the end of their production process, carbon steel fittings undergo an iridescent trivalent zinc plating (minimum thickness 8 microns) - Black zinc plating is also available, if required.

To order a stainless steel insert and/or a stainless steel adapter, insert the letter "X" at the beginning of the part number.

EXAMPLE CODE FOR CREATING ORDER

Type		Hose Dash Size		Thread Dash Size	Note	Part Number
0051	-	06	-	08	<i>Standard</i>	0051-06-08
0051	M	06	-	08	<i>Multispiral</i>	0051M06-08
0051	H	06	-	08	<i>Inter-Lock</i>	0051H06-08
0051	G	06	-	08	<i>One Piece Braided Hoses</i>	0051G06-08
0051	X	06	-	08	<i>One Piece Spiral Hoses</i>	0051X06-08
0051	W	06	-	08	<i>Waterblast*</i>	0051W06-08
0051	Y	06	-	08	<i>Waterblast**</i>	0051Y06-08
X0051	-	06	-	08	<i>Stainless Steel / Inox</i>	X0051-06-08

*, ** According to hose datasheet

Connections can be classified in different groups which depend on the final configuration which guaranon of the thread.

Sealing Features:

- a. **Sealing thread:** the sealing is achieved via the flattening of the thread edges as the male fitting is tightened into the female fitting or port.
- b. **With O-Ring:** with O-Ring: the sealing is achieved by the compression of an O-Ring. This connection is better suited for high pressure applications and systems where vibrations are present.
- c. **Metal to metal:** the sealing is achieved via two angled faces being wedged into one another by tightening a threaded nut.
- d. **Metal to metal combined with O-Ring:** metal to metal combined with O-Ring: the sealing is achieved via a combination an O-Ring and angled sealing faces. When the threaded nut is tightened, the sealing faces are wedged together while also compressing the O-Ring.

On the following page are the main connection types with corresponding standards. The choice of the correct connection type depends on several aspects such as combination type, working pressure, temperatures, chemical compatibility, corrosion resistance, vibrations presence, etc.

Metric Connections (1)

Known as DIN or metric fittings, the seal is achieved via angled sealing faces (metal-to-metal) or through a combination of metal-to-metal with O-Ring compression. The sealing faces are at a 24° angle with or without an O-Ring.

60° Conical Connections (2)

Known as BSP connections (British Standard Pipe) or known as a "Whitworth thread", which can be parallel (BSPP) or tapered (BSPT).

The sealing is achieved via angled sealing faces (metal-to-metal) or through a combination of metal-to-metal with O-Ring compression. The sealing faces are at a 60° angle, with or without an O-Ring.

BSPT Connections (3)

Known as BSPT connections (British Standard Pipe Taper), the sealing is achieved via thread deformation. Since sealing depends only upon thread deformation, the use of a sealant is suggested.

BSPT connections have a 55° thread angle, whereas NPT connections have a 60° thread angle.

JIC 37° Cone - SAE J1514 (4)

Known as JIC connections (Joint Industrial Council), the seal is achieved via angled sealing faces (metal-to-metal). The sealing faces are at a 37° angle. The threads are UNF straight threads.

Flat Sealing with O-Ring - SAE J1435 (5)

Known as JIC connections (Joint Industrial Council), the seal is achieved via angled sealing faces (metal-to-metal). The sealing faces are at a 37° angle. The threads are UNF straight threads.

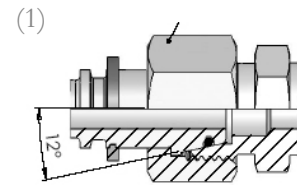

DKOL/DKOS

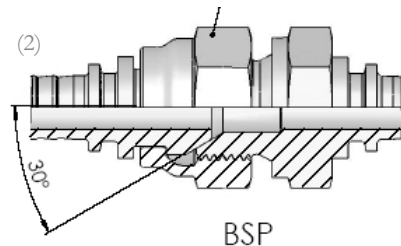

BSP

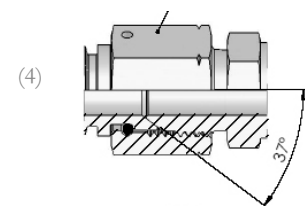
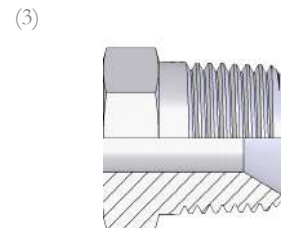

JIC

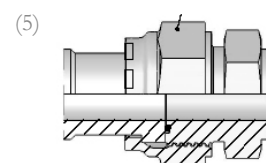

ORFS

SAE with O-Ring – SAE J516 Type BOSS

Male fittings known as ORB (Male O-Ring Boss) that achieve sealing via an O-Ring at the top of the threads which is compressed against a flat sealing face on the port. The threads are UNF straight threads.

These fittings are only compatible with SAE J1926 BOSS ports.

NPTF/NPSM - SAE J516

Known as NPTF connections (National Pipe Taper - Fuel), the sealing is achieved via thread deformation. These fittings are compatible with both NPFT and NPSM connections. NPTF male fittings achieve sealing on NPSM female fittings through metal-to-metal contact on 30° angled sealing faces.

These fittings are not compatible with BSPT threads, as they have a 60° thread angle, whereas BSPT fittings have a 55° thread angle.

24° Gas Cone - French Series

These fittings are similar to DIN fittings, but with thinner threads. The sealing is achieved via metal-to-metal contact on 24° angled sealing faces. The threads are metric straight threads.

JIS (Japanese Industrial Standard)

The sealing is achieved via metal-to-metal contact on 30° angled sealing faces. JIS fittings can be divided into the following types:

- **JIS Toyota:** BSPP thread connections with inverted sealing cones
- **JIS Komatsu:** Similar to JIS Toyota fittings, but with metric straight threads
- **JIS Nissan:** Similar to BSPP connections, but with slightly different cone dimensions

SAFETY INDICATORS, ATTENTION AND NOTES

This section explains three important safety indicators, listed in decreasing order of importance.



WARNING: This symbol is used in order to highlight potentially dangerous and life-threatening situations and/or procedures for the operator.



ATTENTION: This symbol is used in order to highlight situations and/or procedures that can cause potential damage to equipment.



NOTE: This symbol is used in order to highlight important information or references to International Standards.

The purpose of this handbook is to supply useful instruction and suggestions for the correct choice, installation, and maintenance of the assembly in order to assure a long service life.

SAFETY WARNINGS



WARNING: The following will endanger the safety of all persons near the hose assembly(s):

- An improper choice of product
- Incorrect assembly or installation
- Damage to the hoses

This handbook's intended use is to aid in the training, installation, operation, and maintenance of the hose assembly(s) to fundamentally avert potential dangers.

This handbook makes reference to SAE J1273 or ISO/TR 17165-2 "Practical Recommendations to Use Assembled Hoses", specifically paragraph 4, which lists increased risks to hydraulic systems and connections under pressure.

HOSE ASSEMBLY SELECTION



REMINDER: SAE J1273 clearly states that "...fittings of a producer are not generally compatible with hose supplied from another producer".

Normative reference: ISO 17165-2, SAE J1273, EN 982.

"Assembled hose" is defined as the complete hose assembly consisting of hydraulic hose with fittings and connectors. The characteristics of an assembly must include:

- **Flexibility:** resistance to bending and torsional stresses of mechanical machines
- **Stability:** for correct power transmission and flow control, the lowest volumetric expansion/process forming is necessary
- **Minimal flow resistance:** the choice of the correct assembly (hose and fittings) and the layout must guarantee the maximum efficiency of the hydraulic circuit



WARNING: Any hydraulic under pressure is extremely dangerous and may cause serious lesions or other life-threatening injury to the operator.

In order to select the appropriate hose for the application, consider the information below:

Application:

It is necessary to clearly define:

- type of application required (high pressure line, suction line, pilot line with etc.)
- where the hose will be installed (installation difficulty, heat source presence, external mechanical loads, delivery pump with etc.)
- type of machinery (presence of pressure spikes, vibrations, flexibility etc.)
- special required performances (electric conductivity, abrasion resistance, flame-retardant, etc.)
- required connections and thread types
- type of fluid and chemical compatibility
- temperature and environmental conditions (salt water, presence of chemical agents, direct and extended exposure to sunlight with etc.)
- eventual standard and/or local safety obligations

Pressure Lines:

- Working pressure up to ~ 5800 PSI and above (400 bar and above)
- High fluid speed up to ~ 26ft/sec (8 m/s)
- Severe working conditions, with possible pressure spikes (especially in delivery pump) and vibrations
- Generally medium to high pressure hoses are required.

Return Lines:

- Working pressure up to 725-1100 PSI (50-70 bar)
- Moderate fluid speed ~ 9.8-13.1 ft/s (3.0-4.0 m/s)

Suction Lines:

- Generally large diameter hoses are used to reduce pressure drops
- Low pressure: max. ~ 145 PSI (10 bar)
- Moderate fluid speed to avoid cavitation ~ 4.9 ft/s (1.5 m/s)
- Required load-less resistance up to 11.6 – 13.1 PSI (0.8 - 0.9 bar)
- Optimum solution is the chafing strip with steel spiral (ref. SAE 100 R4)

Pilot Lines:

- Average pressure line up to 1450 PSI (100 bar)
- Average fluid speed ~ 16.4 ft/s (5 m/s)
- Compactness and high flexibility are critical for installation

HOSE SIZE AND FLOW RATE

The component's dimension must be uniform to ensure a regular fluid flow rate in order to reduce the number of pressure drops and to avoid excessive speed of the conveyed fluid. For the hose diameter selection, it is possible to refer to the diagram on the following page. Proper selection of hose may be made if the maximum fluid speed and the flow rate of fluid is known.

The maximum speed advised for fluids depends on the application:

- Suction lines: 1.6 – 4.9 ft/s (0.5 – 1.5 m/s)
- Return lines: 4.9 – 11.5 ft/s (1.5 – 3.5 m/s)
- Pressure lines: 9.8 – 26.2 ft/s (3.0 – 8.0 m/s)
- Pilot lines: ~ 16.4 ft/s (~ 5.0 m/s)

The internal diameter measurement of the hose indicates the hose size. There are different ways to indicate the measure of internal diameter:

DASH SIZE	SAE DIMENSION	NOMINAL DIAMETER (MM)	REFERENCE DN
-03	$\frac{3}{16}$ "	4.8	5
-08	$\frac{8}{16}$ " OR $\frac{1}{2}$ "	12.7	12
-10	$\frac{10}{16}$ " OR $\frac{5}{8}$ "	15.8	16

If it is necessary to replace an assembly already installed on the hydraulic system, it is considered to be properly sized for the application.

If you have to define a new system or verify the efficiency of an existing one, it is possible to refer to the diagram on the following page and proceed as follows.

If it is necessary to replace an assembly already installed on a hydraulic system, it is considered to be properly sized for the application.

If it is necessary to design a new hydraulic system, or to verify the efficiency of an existing one, refer to the nomograph below and proceed as follows:

Recommended Fluid Velocity:

Pressure Lines: 9.8 - 26.2 ft/s (3 - 8 m/s)

Return Lines: 4.9 - 9.8 ft/s (1.5 - 3 m/s)

Suction Lines: 1.6 - 4.9 ft/s (0.5 - 1.5 m/s)

Pilot Lines: max 16.4 ft/s (5 m/s)

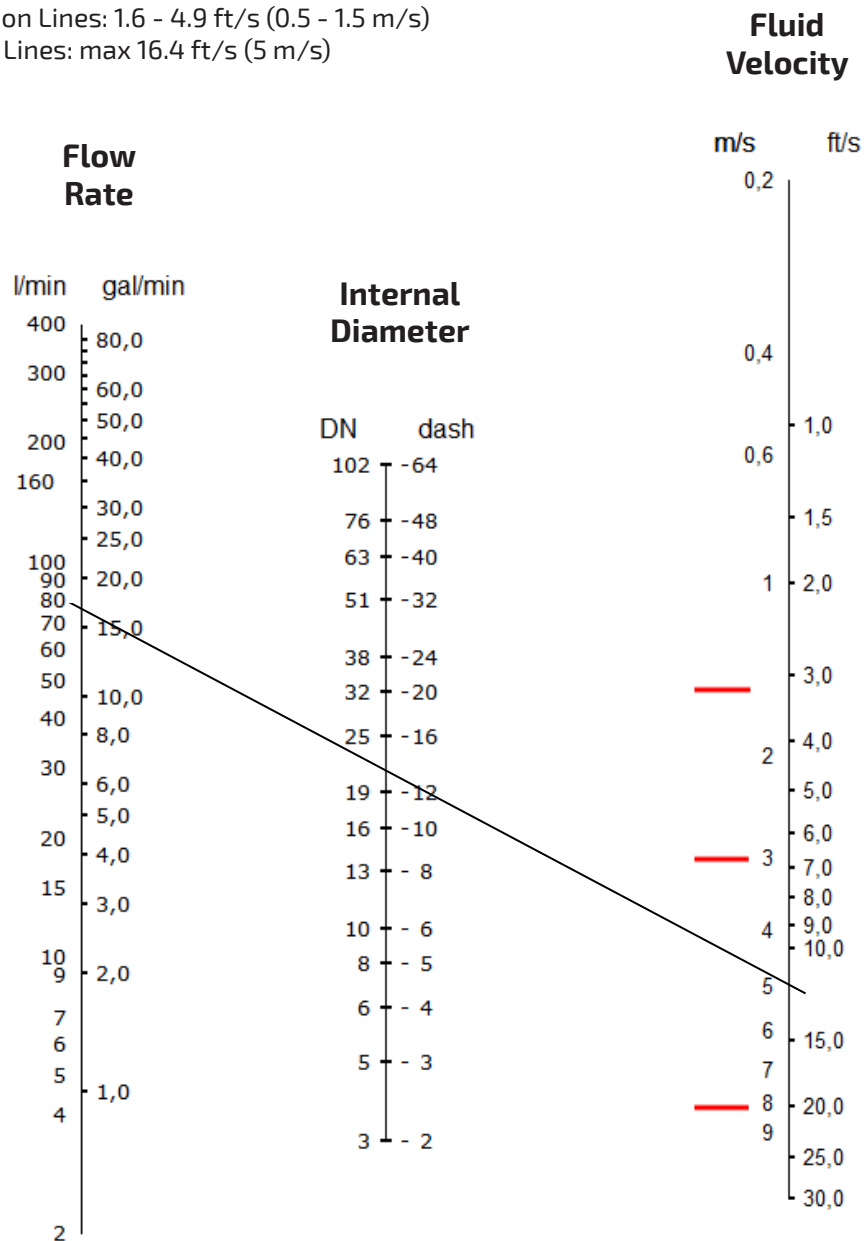

PRESSURE

To properly select the correct flexible hose and fittings, consider that the maximum working pressure for these components must be higher than the maximum system pressure of the application. It is necessary to consider both the static working pressure and the dynamic or "pulsing" pressure when pressure variations occur within a dynamic application.

SAE J1927 gives a method to define the reduction of the life of the flexible hose according to a specific hydraulic application when measuring pressure peaks and pulsing frequencies.



WARNING: Hose selection must be made according to the maximum pressure reached by the system.

Pressure spikes and drops can be verified through a device capable of recording sudden pressure changes. A hydraulic system can be calibrated by checking the safety valve placed in the circuit in order to protect against eventual pressure spikes and drops.

Hydraulics system classification can be made according the following pressure range:

- **Low pressures:** up to 1000 - 1600 PSI (70 - 110 bar)
- **Medium-high pressures:** 3000 - 5000 PSI (210 - 245 bar)
- **High to very high pressures:** up to 6000 PSI and above (420 bar and above)

FLUID TO CONVEY

Fluid type: chemical identification, concentration, temperature, etc. Flexible hose selection must consider chemical compatibility of the fluid being conveyed.

The enclosed summarizing sheet provides information regarding the rubber compound type used in Interpump's flexible hoses. Using this chart, chemical compatibility can be confirmed for Interpump hoses with different fluid types.

As a precaution for applications which emit fumes or use dangerous or aggressive fluids, an evaluation of the fluid will be required to determine if it is necessary to pin-prick the cover to allow permeability of the fluid through the hose.

TEMPERATURE

The internal temperature of the conveyed fluid must not exceed the stated temperature range on the hose data sheet. Temperatures higher than the stated maximum temperature will accelerate rubber aging and compromise the life of the flexible hose. Temperatures lower than the suggested minimum can greatly reduce the flexibility of the hose, causing the rubber to become brittle and crack.

Generally, most Interpump rubber compounds can work within a temperature range -40°F to +212°F (-40°C to +100°C) with possible intermittent temperature peaks of up to +257°F (+125°C).

The wide variety of variables in service can significantly alter the projected life of the hose assembly.



ATTENTION: Continuous operation at temperatures close to the stated minimum and maximum temperature limits will reduce hose life (SAE J1273, DIN 20066).

Special rubber compounds may allow for a greater temperature range.

For hoses used in extreme-temperature applications, refer to Interpump High- and Low-Temperature product lines.



NOTE: As clearly detailed in the preceding paragraphs, the temperature of the external environment greatly influences the life of the hose assembly. Avoid installation of the product(s) near heat sources or provide proper heat shielding. An increase of 50°F (10°C) above the maximum stated temperature may decrease expected hose life by as much as half. Cracks in the rubber cover can also be caused by flexing, especially as excessively low temperatures

CONNECTION TYPES

In order to achieve a long service life of a hose assembly, it is necessary to select the correct connection types.

It is critically important to follow the information contained in this catalog to select the correct connections. Each hose page lists the suggested ferrule and insert combination (or one-piece fitting configuration) as recommended through testing conducted by Interpump Fluid Solutions. Interpump, nor any of its subsidiaries or affiliates, does not guarantee any hose and fitting combinations which do not follow the recommendations listed in this catalog.

In accordance with SAE J1273, which states that components from two different manufacturers are not typically compatible, Interpump does not guarantee, nor will supply, any combinations of flexible hose and fittings which do not adhere to the suggested solutions listed in this catalog.

When choosing the correct connections, verify the following:

- the sealing capability at the required working pressure
- the corrosion resistance, fluid, and/or environmental conditions
- the presence of vibration (flanges and O-Rings are suggested where vibrations are present)
- in the case of O-Ring fittings, the working temperature(s) must be considered (specific O-Ring materials may be required to achieve proper sealing at certain temperatures)



ADDITIONAL INFORMATION

External Environment

Ozone, UV radiation, heat, or chemical agents can cause damage to flexible hoses and fittings, reducing service life. It is important to evaluate the characteristics of the external environment (in terms of temperature, ozone, chemical agents, and/or solvents) in order to select the proper external hose covering.

For particular requirements such as fire resistance, conductivity, etc., where the catalog information is not detailed enough to select the correct hose, contact Muncie Power Products' customer service team for assistance.

Vibrations

Vibrations can also reduce hose life.

Where necessary, perform tests for hose vibrations to check vibration amplitude and frequency. In the case of vibration, the use of collars or other similar systems may reduce the effects of vibration on the hose assembly.

HOSE ASSEMBLY PREPARATION

Hose Assembly Length:

Hose cut must be performed correctly with a proper device in order to ensure:

- A square cutting surface, perpendicular to the hose axis
- Avoiding damage to the hose reinforcement



ATTENTION: Remember, a cut that is not square will always cause:

- A lack of proper sealing and assembly leakage
- Irregular rubber compression during the swaging and possible ferrule fracture

When cutting spiral hose, use a lower cutting speed than is used for a braided hose (applies to both the cutting blade rotation speed and cutting speed).

Hose assembly length has to be calculated according the following indication: (refers to SAE J 517 – 10):

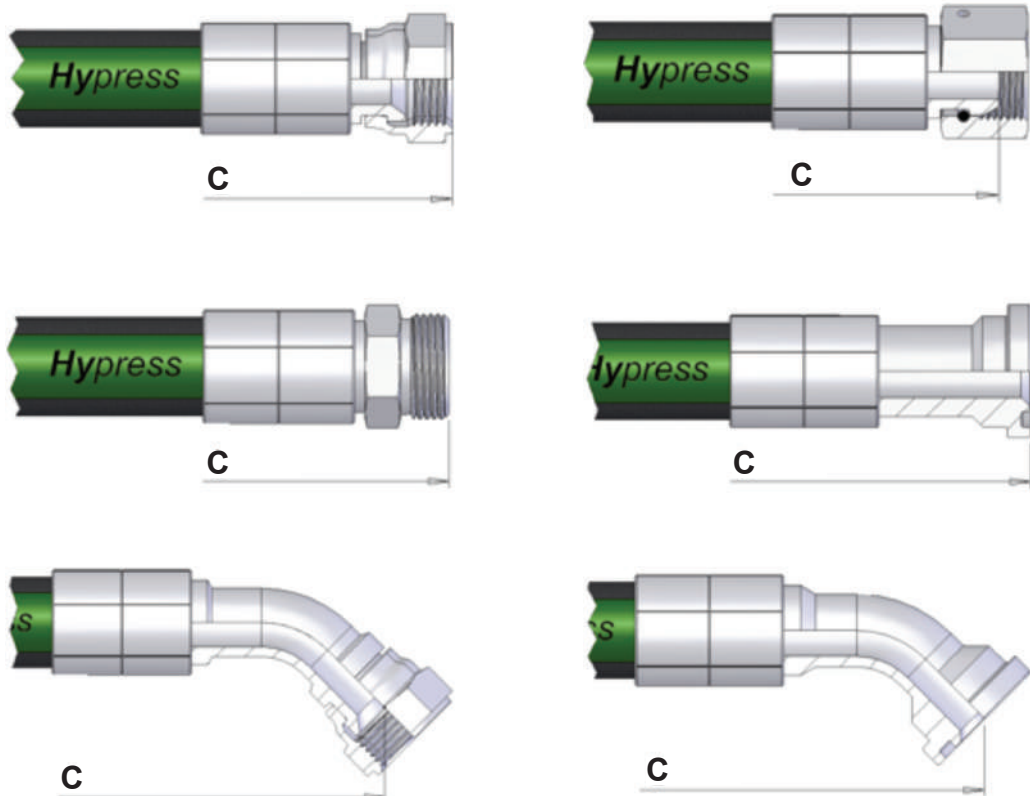

Several Standards (DIN 20066, EN 853 – 857, etc.) define the hose assembly length tolerances referring to the hose size and the total assembly length.

The following chart is an indication of hose length tolerances according to DIN20066:

LENGTH	UP TO -16 (DN 25)	-20, -24, & -32 (DN 32 - DN 50)	-38 AND LARGER (DN 60 - DN 100)
UP TO 24.803" (630 MM)	+0.275" / -0.118" (+7 MM / -3 MM)	+0.472" / -0.157" (+12 MM / -4 MM)	+0.984" / -0.236" (+25 MM / -6 MM)
24.842" – 49.212" (631 – 1250 MM)	+0.472" / -0.157" (+12 MM / -4 MM)	+0.787" / -0.236" (+20 MM / -6 MM)	+0.984" / -0.236" (+25 MM / -6 MM)
49.251 - 98.425" (1251 – 2500 MM)	+0.787" / -0.236" (+20 MM / -6MM)	+0.984" / -0.236" (+25 MM / -6 MM)	+0.984" / -0.236" (+25 MM / -6 MM)
98.464" - 314.960" (2501 – 8000 MM)	+1.5% / -0.5%	N/A	N/A
315.000" AND LARGER (>8001 MM)	+3% / -1%	N/A	N/A

Refer to the following picture to define the correct fitting orientation:

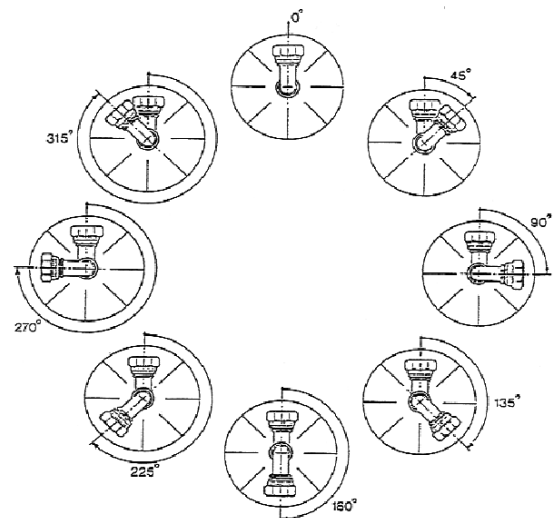

Refer to the following picture to define the correct fitting orientation:



NOTE: Always consider the natural hose bend in order to avoid unnatural stress on the hose and its reinforcement.

ROUTING

Use precaution when installing the hose assembly in order to avoid unnecessary hose damage and the seal being compromised:

1-Hose Assembly Length

Provide the right length for the assembly. Over length will cause pressure loss. Short length could cause hose traction. Always consider some slack in the hose to allow shortening or elongation.



Provide the correct length for the assembly. Too long of length will cause a pressure loss.

Hose length has to go along with the machine movement, in order to avoid kinks and stress.

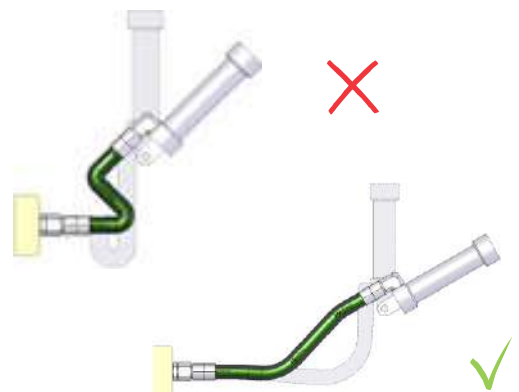

Consider hose length variation and define the correct length and the correct clamping position to fix the assembly.

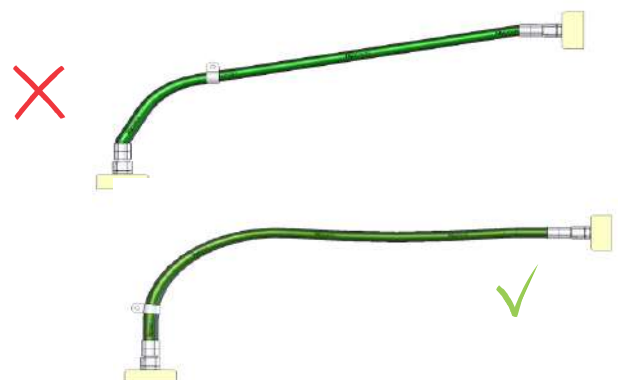



2 - Minimum Bend Radius:

Always consider the recommended minimum bend radius and provide sufficient hose so that the hose is not being stressed.

Installation with a tighter bend will reduce hose life.

A minimum length of 1.5 times the external hose diameter is required (D) between hose fittings and the bend.

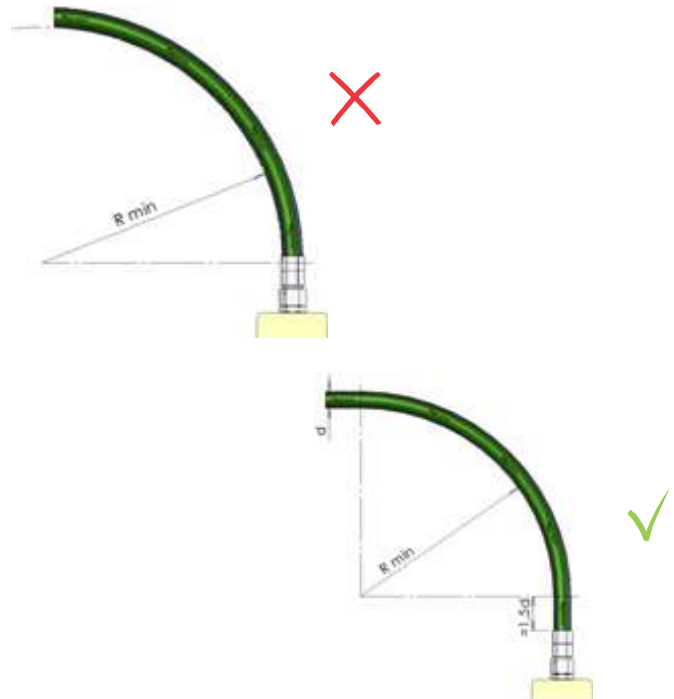

Use proper adapters and hose fitting terminations, in order to avoid a tight bend.

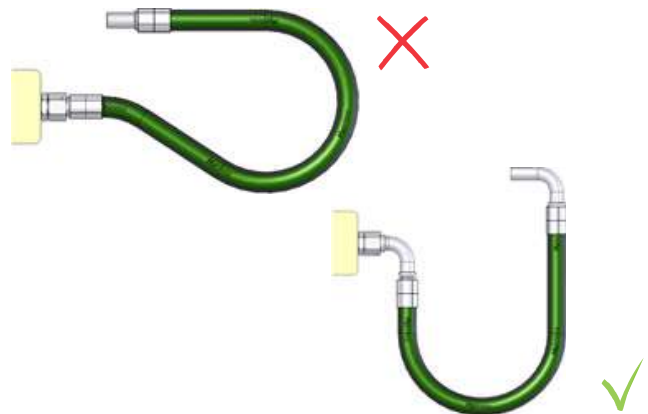

Too tight of a bend may kink the hose, restrict or stop the fluid flow, or damage the hose reinforcement.

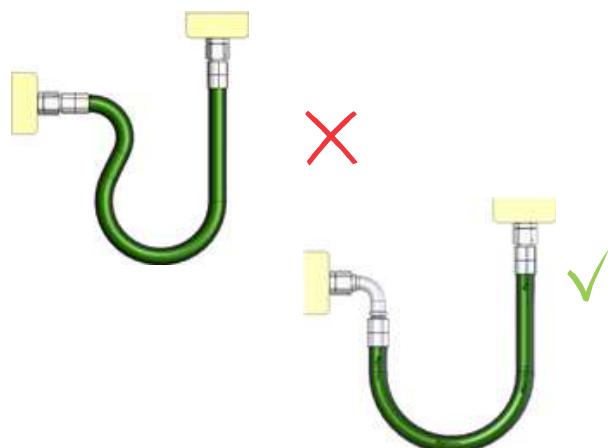

3 - Hose Protection:

Protect the hose against damage, abrasion and avoid contact with sharp and hard objects.

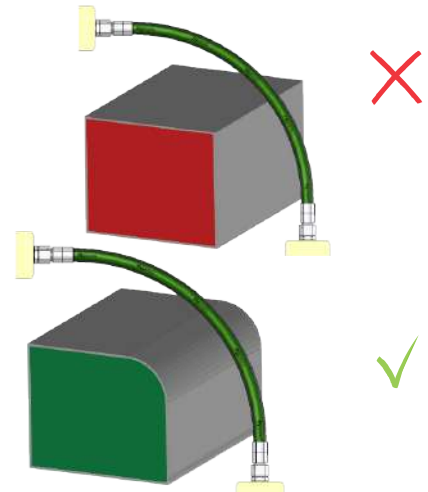

Insulate the hose assembly from heat source(s), using a shield, a fire sleeve, and/or metal protection.



4 - Hose Movement:

Take into consideration the relative movement between the two connected parts. Avoid hose torque: during the application the hose has to flex in one single plane.

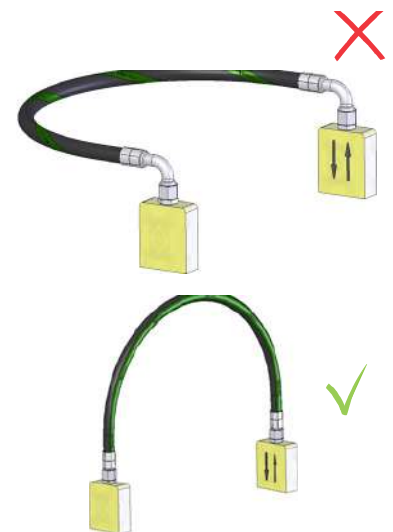

Do not install hose with a twist. Always consider the use of the correct adapter, swivel nut or swivel adapter to avoid twist.

To avoid torsion, use the branding line as a straight guide.

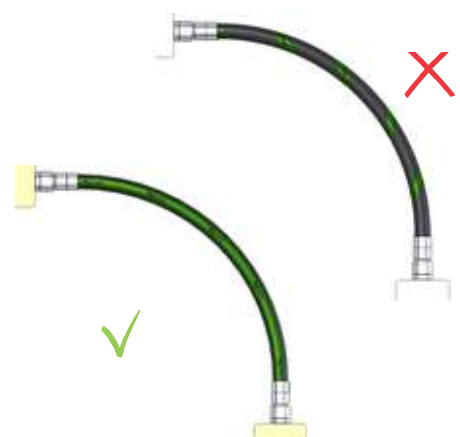



5 - Routing:

If the hose is linked at two different angles, fix the assembly at the point of the angle change, restricting movement to only one angle.

Always consider the use of 90° or 45° adapters in order to have a better layout. The system will result in an easier set up, easier maintenance, and easier inspection.

Always use clamps and wrappers to support long length assemblies.

Fix long length assemblies properly, with suitable clamps in order to avoid hose whipping and unnatural stress on the fittings.

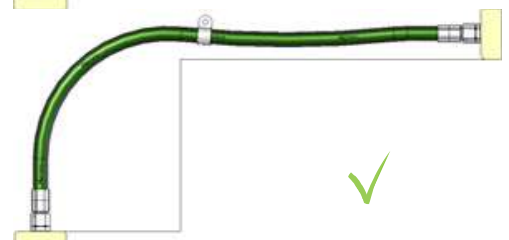
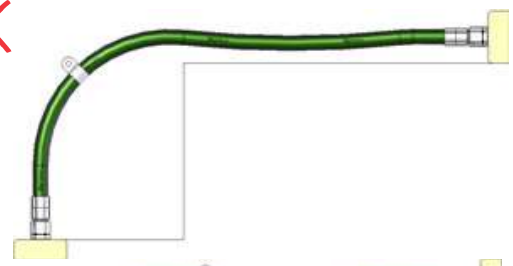
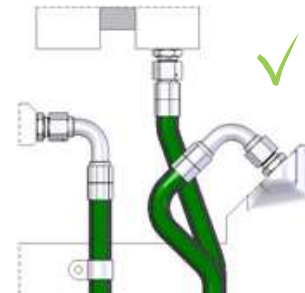
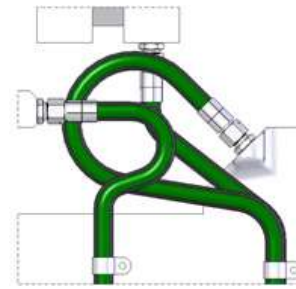
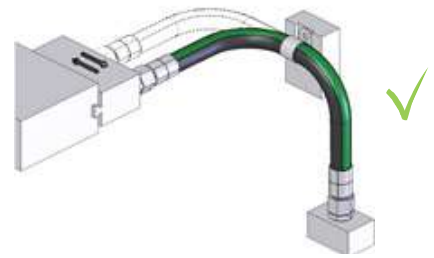
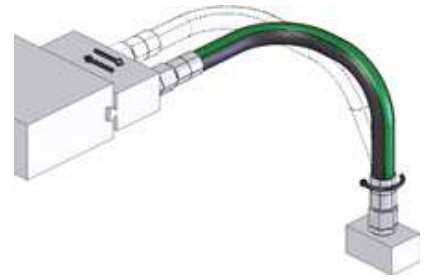

A misalignment between sealing cone and thread causes "leakage."



In reference to the warning above, always remember when tightening to:

- First, fasten the end without tightening
- Rotate the hose according to the natural bend
- Tighten the end avoiding twisting
- Mount the ends without damaging the thread (follow the suggested crimp specifications to guarantee the conformity of the thread)
- Always verify that the surface is dry (additional torque will be required if surface is wet)
- Verify the lubrication and cleanliness of the sealing surface
- Verify the presence of the O-Ring where it is requested

TESTING AND INSPECTION

Inspect the hose to verify the cut angle and any areas of abrasion or wear on the hose cover.

Perform the requested test if necessary (Ref. ISO 1402).

Clean the assembly using a "pig" and sponge or flushing the assembly to reach an optimal cleanliness level.

Once the installation is completed, let the air out, increase the pressure to the working rate and verify the fitting seal of the assembly.

In order to avoid injury during the final test:

- Do not touch any part of the system during the proof test
- Keep away from the test area
- Decrease the pressure until the system is discharged before loosening the connection.

CLEANING HOSE

Be sure that the assembly is cleaned to the level fit for the application.

Impurities and pollution could damage the system by:

- Blocking the hydraulic components, thus reducing efficiency
- Tube wear may cause a premature failure
- Lower heat dissipation

It is possible to use a special machine to flush the assembly using a filtered, water-based fluid. It is possible, in this way, to gain a high level of cleanliness (refer to international Standard NAS 1638, ISO 4406, SAE479, BS5540/4).



NOTE: After assembling the hose and performing the necessary test(s), remove all possible contamination.

The entire assembly should be protected by means of a proper vessel to avoid environmental pollution.

HANDLING AND STORING

Rubber and plastic products can alter their characteristics during time. It is necessary to store hoses in order to control their aging, implementing the FIFO (first-in, first-out), the manufacturing date of the hose and/or the assembly will give the priority.

Several Standards give useful indication on the storing:
ISO 2230 e ISO 8331, BS 5244, SAE J1273, DIN 7716, DIN 20066.

SAE J 517:

- Flexible rubber hose or a hose assembly has a total operative life of 40 quarters (ten years) depending upon inspection and pressure testing to verify the conformity.
- Thermoplastic hoses are often considered to have an unlimited operating life.

Maximum hose storage life depends on several parameters:

Area – Temperature – Humidity

Goods must be stored in a dry and fresh area, without dust.

Temperature should be between 41°-77° F (5°-25°C) (do not exceed 100° F or 38°C) and humidity should not exceed 65%.

Keep Far from Heat Sources

- Oxygen and ozone

Hose should be protected from the circulating air and placed in a closed box or covered by means of polyethylene cover. High voltage electrical equipment should be avoided because of the harmful effect of ozone.

- Oil, solvents, fumes

Avoid contact with corrosive agents, detergents, and other organic liquids. Some metals may also affect the rubber (manganese, iron, copper).

- Narrow spaces and bending

The internal diameter of the coil/bobbin must be higher than double the minimum bending radius of the product (according to the manufacturer indication). Do not bend or pile the hose. Avoid every mechanical stress (tension, compression) which can speed up the aging process.

- Protect the hose from insects and rodents.

- Sunlight and rain

Hose should be protected from sunlight and UV sources.



NOTE: Always check the hose integrity before delivery. It is recommended to perform further tests on the hose in cases of long periods of storage.

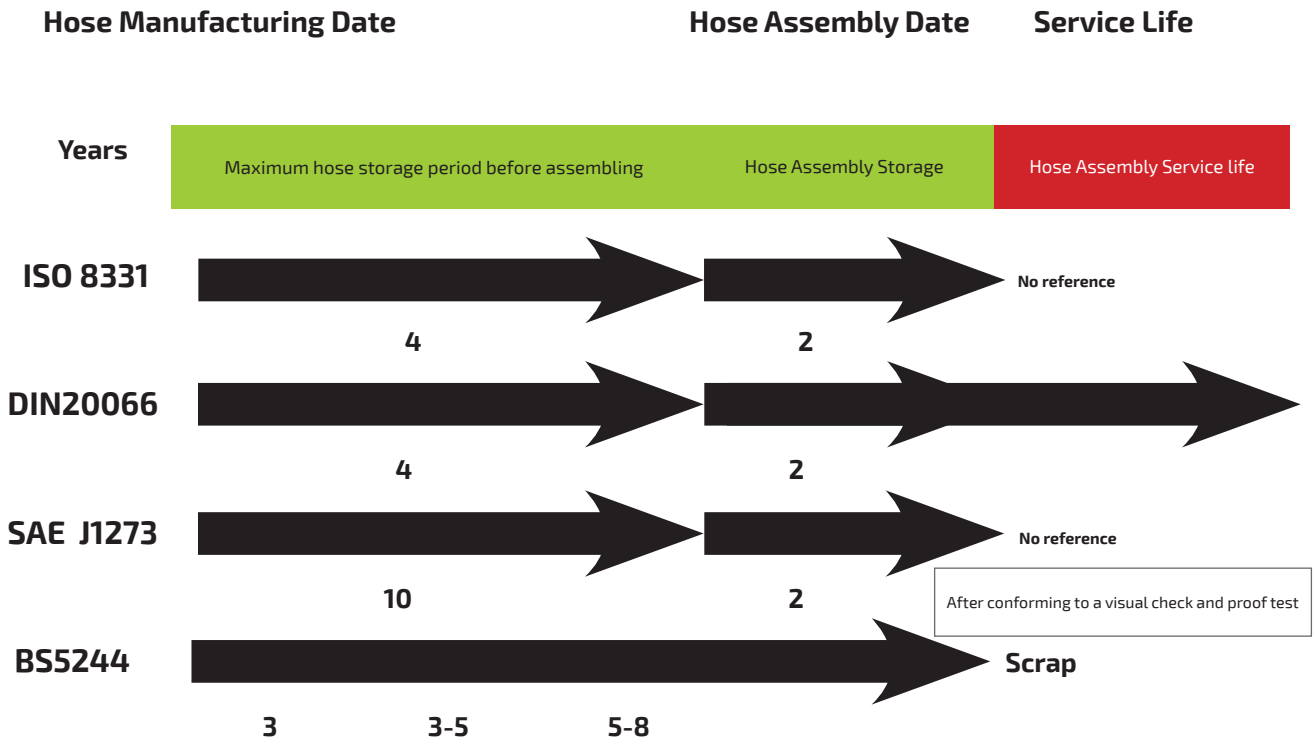

Hose: perform a proof test assembly - perform proof test on all the assemblies

PREVENTIVE MAINTANANCE - ACCORDING TO SAE J1273

A good preventative maintenance program can help to ensure reliable equipment function, avoid potential injuries, and keep the hydraulic system operating at its maximum efficiency.

Frequency of Inspection

The frequency of inspection is dependent upon all factors linked to the application and the past history of the machine.

Visually Check (hose and fittings)

Visual inspect hose and fittings to evaluate:

- a. Leakage
- b. Cover damage, cuts or abrasions
- c. Exposed Reinforcement
- d. Hose dents, bends under the specified minimum bend radius, or hoses in torsion
- e. Hose stiffening with a hard or burnt cover
- f. Cover slipping from reinforcement, or with a low adhesion to the reinforcement
- g. Fittings damaged or badly corroded
- h. Fittings not properly tightened
- i. Other possible nonconformities

Whenever a nonconformity has been detected, verify the assembly and replace it.

During hose and fittings inspection, verify all hydraulic components on the system are in order by checking:

- a. Connection seals
- b. Damage to the assembly due to missing guide(s), clamp(s), or guard(s)
- c. Excessive dirt and debris around hose
- d. Fluid: level, type, clearing ed absence if air

If any of these conditions are present, correct the problem(s) before starting the hydraulic circuit.

Functional Test

A functional test will determine if the system is functioning properly.

Perform a function test of the hydraulic circuit at normal working pressures to ensure that the system is operating according to the manufacturer's specifications.

SAFETY INSTRUCTIONS - SAE J1273- AUGUST 2004



WARNING: Improper selection, fabrication, installation, or maintenance of hose and hose assemblies for fluid-power systems may result in serious personal injury or property damage. These recommended practices can reduce the likelihood of component or system failure, thereby reducing the risk of injury or damage. It is important to consider all the aspects related to the application and to respect the following technical indications and suggestions inside this manual.

Listed are some potential conditions and situations that may lead to personal injury and/or property damage:

Fluid Injections

Fine streams of escaping pressurized fluid can penetrate skin and enter a human body. These fluid injections may cause severe tissue damage and loss of limb. Consider various means to reduce the risk of fluid injections, particularly in areas normally occupied by operators.

Consider careful routing, adjacent components, warnings, guards, shields, and training programs. Relieve pressure before disconnecting hydraulic or other lines. Tighten all connections before applying pressure.

Avoid contact with escaping fluids. Treat all leaks as though pressurized and hot enough to burn skin. Never use any part of your body to check a hose for leaks.

If a fluid-injection accident occurs, see a doctor immediately.

Do not delay or treat as a simple cut! Any fluid injected into the skin must be surgically removed within a few hours or gangrene may result.

Doctors unfamiliar with this type of injury should consult a knowledgeable medical source.

Whipping Hose

If a pressurized hose assembly blows apart, the fittings can be thrown off at high speed, and the loose hose can flail or whip with great force. This is particularly true in compressible-fluid systems.

When this risk exists, consider guards and restraints to protect against injury.

Fire and Explosions from Conveyed Fluids

Most fluid-power media, including fire-resistant hydraulic fluids, will burn under certain conditions. Fluids which escape from pressurized systems may form a mist or fine spray which can flash or explode upon contact with an ignition source.

Consider selecting, guarding, and routing hose to minimize the risk of combustion (ref to Section 5 ISO 3457).

Fire and Explosions from Static-Electric Discharge:

Fluid passing through hose can generate static electricity, resulting in a static-electric discharge.

This may create a spark that can ignite system fluids or gases in the surrounding atmosphere.

When this potential exists, select hose specifically designed to carry the static-electric charge to ground.

Electrical Shock:

Electrocution could occur if hose conducts electricity through a person. Some applications may require a non-conductive hose in order to avoid electricity (ref. ISO 3949).

Some applications may require a hose with sufficient conductivity to carry the static-electric charge to ground.

Mechanisms Controlled by Fluid Power:

Mechanisms controlled by fluids in hoses can become hazardous when a hose fails.

- Always install protective shield between operator and the mechanical device
- Do not work next to pressurized equipment
- Do not touch system under pressure
- Always use proper safety equipment, including eye protection, breathing apparatus, and adequate ventilation
- Staff should always be appropriately trained in the preparation, assembly and use of equipment
- The user should design and implement a maintenance program that suits the specific application and each specific hose in that application.



LIABILITY STATEMENT

Interpump hoses are designed as an engineered solution to be used only in conjunction with Interpump fittings. The use of Interpump fittings on hose supplied by other manufacturers and/or the use of Interpump hose with fittings supplied by other manufacturers may result in the production of unreliable and unsafe hose assemblies; which can lead to equipment damage, personal injury, or death. The use of Interpump fittings on hose supplied by other manufacturers and/or the use of Interpump hose with fittings supplied by other manufacturers is neither recommended nor authorized by Muncie Power Products or any of its affiliates. Muncie Power Products and the Interpump Group disclaim all liability for any hose assembly produced using hose-fitting combinations not specified in this catalog, incorrect fitting insertion depths, and/or final crimping specifications.

UNILOCK - ASSEMBLY INSTRUCTIONS

Cut the hose at a right angle using a sharp, non-serrated blade. If necessary, use a lubricant (water/soap solution of 5% soap and 95% water) for easier assembly.



Insert fitting into the hose, past the first barb on the fitting. Place the end of the fitting against a supported flat object (workbench, door, wall, etc.). Apply steady force while gripping the hose approximately one inch from the end until the fitting is fully inserted into the hose (the red plastic collar will cover the cut end of the hose).



During assembly, remember that Unilock fittings are ready for use after full insertion into the hose, where the end of the hose is cut square and completely covered by the plastic collar on the fitting.

UNILOCK - DISASSEMBLY INSTRUCTIONS

Cut lengthwise along a line, approximately one inch in length, at a 20° angle from the centerline of the hose. Be careful not to cut or nick the barks of the fitting while cutting the hose.



Firmly grip the hose and give a sharp downward tug to remove the fitting.



Before reusing a Unilock fitting, check for any signs of damage. A damaged fitting will cause leakage.

INTERPUMP COVER SOLUTIONS

The hose cover is a critical aspect of correctly meeting the customer needs and application requirements.

Interpump provides the following cover options:

Abrasion Resistant Cover Options

Cover



Super cover



Extra cover



Mega cover

Standard Cover

Competitive and reliable solution for general hydraulic applications where the hose is not exposed to direct sunlight or abrasion (hose-to-hose or hose-to-metal). The standard cover performs well at low temperatures. NOTE: this cover is not stocked in North America.

Super Cover

Solution with twice the ozone and abrasion resistance compared to standard cover. Suitable for potential aggressive conditions like ground movement and pressure washer applications.



NOTE: This cover is not stocked in North America.

Low Temperature Cover

This special blend of polymers and additive allows this rubber compound to perform well in cold environments and extreme conditions (minimum operating temperatures of -58°F (-50°C)).

Extra Cover

This cover can be used in applications requiring better abrasion and ozone resistance, such as:

- continuous flexing, even when small bend radius is combined with high abrasion (forklift masts and telescopic arms)
- direct exposure to sunlight (the hydraulic line mounted outside of the machine body)
- hose bundles subject to flexing and impulse at different pressure levels (hoses connecting excavator arms)
- hose exposed to hose-to-metal abrasion and impact with an external body

This cover is not recommended for applications with a very low external temperature. This cover is not stocked in North America.



MSHA Approved Cover

Interpump's MSHA cover performance in terms of abrasion and ozone resistance make this cover a perfect solution for any underground or open mining applications. This cover compound has been certified to meet the Flame-Resistance Designation "U.S. MSHA" by the U.S. Department of Labor, Mine Safety and Health Administration.

The combination of the high elasticity, extreme ozone and UV resistance makes the MSHA cover reliable in applications where exposure to direct sunlight and ozone are present, even when the hose is installed at a low bend radius.



NOTE: Hydraulic hoses stocked in North America feature the MSHA cover.



High Temperature Cover

This cover was developed as a solution for hoses exposed to ambient temperatures in excess of 212°F (100°C). The HT cover is recommended for these applications:

- applications in the engine compartment of trucks (e.g. power steering)
- injection molding heating circuits
- foundries

The special rubber compound used in the HT cover is not recommended in applications experiencing high ozone concentration and/or direct exposure to sunlight.



Mega Cover

Interpump's Mega cover (UHMWPE - Ultra-high Molecular Weight Polyethylene) is the best solution to protect against hose abrasion. This cover helps to eliminate both hose-to-hose and hose-to-external body abrasion.

In many applications, the use of the Mega cover can be a replacement for external hose protection (PU sleeves, Thermoplastic or steel wire springs), resulting in cost savings.

The favorable chemical stability, ozone, UV, and water resistance make this cover a good choice in extreme working environments, such as subsea applications, oil field applications, and snow gun applications.

A new MSHA-approved UHMWPE cover is available upon request.



IMM Cover Key Features

Abrasion Resistance according to
ISO 6945 (F= 25N – 2000 cycles):

EN std. Target: 0.50 g loss

IMM std. Cover: EN std.

IMM Super Cover: x 2 EN std.

IMM Extra Cover: x 50 EN std.

IMM MSHA Cover: x 10 EN std.

IMM Mega Cover: not measurable

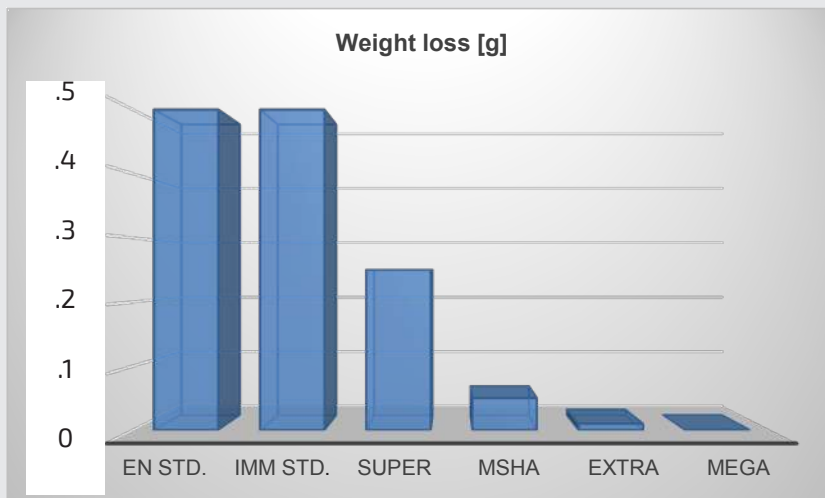

Ozone Resistance according to
ISO 7326 (50 pphm – T=104°F (40°C))

EN std. Target: 72 h

IMM std. Cover: EN std.

IMM Super Cover: better than EN std.

IMM Extra Cover: x 10 EN std.

IMM MSHA Cover: > 10 EN std.

IMM Mega Cover: > 10 EN std.

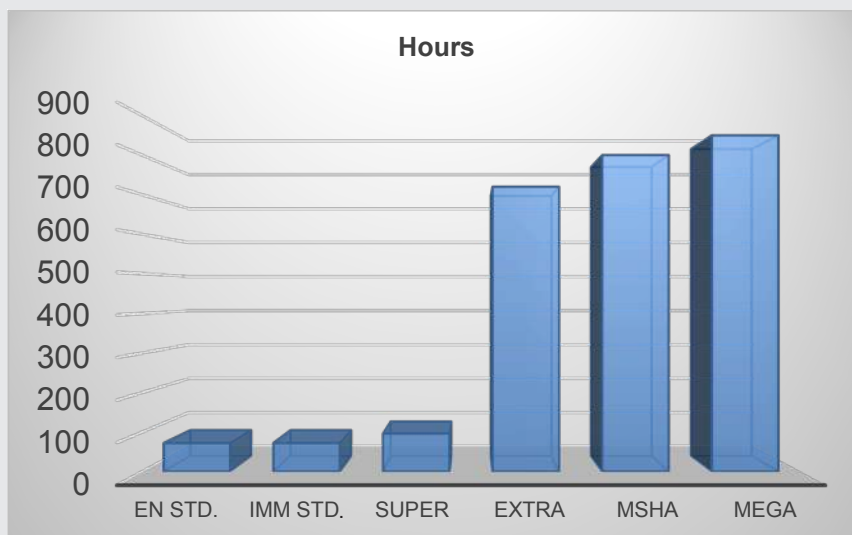

Thread Diameter

Type	thread	dash	male (mm)		female (mm)	
			size	max	min	max
BSP	1/8-28	02	9.7	9.5	8.8	8.6
Metric	M10x1	10	9.9	9.8	9.1	8.9
UNF	7/16-20	04	11.0	10.9	10.0	9.7
Metric	M12x1.5	12	11.9	11.7	10.6	10.4
UNF	1/2-20	05	12.6	12.5	11.6	11.3
BSP	1/4-19	04	13.1	12.9	11.8	11.4
Metric	M14x1.5	14	13.9	13.7	12.6	12.4
UNF	9/16-18	06	14.2	14.0	13.0	12.8
UNF	5/8-18	07	15.8	15.6	14.6	14.4
Metric	M16x1.5	16	15.9	15.7	14.6	14.4
BSP	3/8-19	06	16.6	16.4	15.3	15.0
UN	11/16-16	09	17.4	17.2	16.1	15.7
Metric	M18x1.5	18	17.9	17.7	16.6	16.4
UNF	3/4-16	08	19.0	18.8	17.6	17.3
Metric	M20x1.5	20	19.9	19.7	18.6	18.4
UN	13/16-16	11	20.5	20.4	19.2	18.9
BSP	1/2-14	08	20.9	20.7	19.1	18.6
Metric	M22x1.5	22	21.9	21.7	20.6	20.4
UNF	7/8-14	10	22.1	21.9	20.6	20.3
BSP	5/8-14	10	22.9	22.6	21.1	20.6
UNS	1-14	13	25.3	25.1	23.8	23.4
Metric	M26x1.5	26	25.9	25.7	24.6	24.4
BSP	3/4-14	12	26.4	26.2	24.6	24.1
UN	1 1/16-12	12	26.9	26.7	25.1	24.7
Metric	M30x1.5	30	29.9	29.7	28.6	28.4
Metric	M30x2	30	29.9	29.7	28.2	27.8
UN	1 3/16-12	14	30.1	29.8	28.3	27.9
UN	1 5/16-12	16	33.2	33.0	31.4	31.0
BSP	1-11	16	33.2	32.9	30.9	30.3
Metric	M36x2	36	35.9	35.7	34.2	33.8
UN	1 7/16-12	15	36.4	36.2	34.6	34.2
Metric	M38x1.5	38	37.9	37.7	36.6	36.4
UN	1 5/8-12	20	41.2	40.9	39.4	39.0
BSP	1 1/4-11	20	41.9	41.6	39.5	39.0
Metric	M42x2	42	41.9	41.7	40.2	39.8
UN	1 11/16-12	21	42.8	42.5	41.0	40.6
Metric	M45x1.5	45	44.9	44.7	43.6	43.4
Metric	M45x2	45	44.9	44.7	43.2	42.8
UN	1 7/8-12	24	47.5	47.3	48.7	45.3
BSP	1 1/2-11	24	47.8	47.4	45.4	44.8
UN	2-12	32	50.7	50.5	48.9	48.5
Metric	M52x2	52	51.9	51.7	50.2	49.8
BSP	2-11	32	59.6	59.3	57.2	56.7
UN	2 1/2-12	32	63.4	63.2	61.6	61.2



Manufacturing Standards

Description	Standards
Gas / BSP	BS 5200 ; ISO 8434-6 ; ISO 12151-6
Metric 24°	DIN 3861; DIN 3865 ; ISO 8434-1 ; ISO 8434-4 ; ISO12151-2
Metric 60°	DIN 7631; DIN 3863
ORFS	SAE J1453 ; ISO 8434-3 ; ISO12151-1
NPT	SAE J514
Jic 37°	SAE J514 ; ISO 8434-2 ; ISO 12151-5
SAE Code 61 Flange	SAE J518 ; ISO 6162-1 ; ISO 12151-3
SAE Code 62 Flange	SAE J518 ; ISO 6162-2 ; ISO 15151-3
Banjós	DIN 7642
JIS	JIS B 8363

Recommended Installation Torque

BSPP					
inch	dash size	with O-Ring		without O-Ring	
		Nm	lb.ft.	Nm	lb.ft.
1/8	02	15	11	20	15
1/4	04	20	15	25	18
3/8	06	27	20	34	25
1/2	08	47	35	59	44
5/8	10	56	41	85	63
3/4	12	80	59	118	87
1	16	109	80	137	101
1 1/4	20	133	98	167	123
1 1/2	24	164	121	206	152
2	32	196	145	245	181

JIC 37°					
inch	dash size	Nm	Nm	lb.ft.	lb.ft.
		min	max	min	max
7/16	04	15	17	11	13
1/2	05	19	22	14	16
9/16	06	27	30	20	22
5/8	07	40	45	30	33
3/4	08	59	65	44	48
7/8	10	68	79	50	58
1 1/16	12	107	119	79	88
1 3/16	14	128	140	94	103
1 5/16	16	158	170	117	125
1 5/8	20	215	237	159	175
1 7/8	24	254	288	187	212
2 1/2	32	339	384	250	283

SAE J518 Code 61 Flange Half Bolt					
inch	dash size	Nm	Nm	lb.ft.	lb.ft.
		min	max	min	max
1/2	08	15	19	11	14
3/4	12	21	29	15	21
1	16	27	35	20	26
1 1/4	20	35	46	26	34
1 1/2	24	46	58	34	43
2	32	54	66	40	49
2 1/2	40	79	91	58	67

SAE J518 Code 62 Flange Half Bolt					
inch	dash size	Nm	Nm	lb.ft.	lb.ft.
		min	max	min	max
1/2	08	15	19	11	14
3/4	12	25	33	18	24
1	16	42	50	31	37
1 1/4	20	62	75	46	55
1 1/2	24	116	133	86	98
2	32	199	216	147	159

Metric			
mm	dash size	Nm	lb.ft.
		M12-1.5	12
M14-1.5	14	26	19
M16-1.5	16	30	22
M18-1.5	18	41	30
M20-1.5	20	53	39
M22-1.5	22	76	56
M24-1.5	24	88	65
M26-1.5	26	106	78
M30-2	30	116	86
M36-2	36	133	98
M42-2	42	151	111
M45-2	45	173	128
M52-2	52	202	149

JIS 60°			
inch	dash size	Nm	lb.ft.
		1/4	04
3/8	06	34	25
1/2	08	59	44
5/8	10	85	63
3/4	12	118	87
1	16	137	101
1 1/4	20	167	123
1 1/2	24	206	152
2	32	245	181

ORFS			
inch	dash size	Nm	lb.ft.
		9/16	06
11/16	09	38	28
13/16	11	57	42
1	13	90	66
1 3/16	14	130	96
1 7/16	15	170	125
1 11/16	21	200	148
2 1/2	32	240	177

Conversion Unit

unit	from	to	coeff.
length	m meters	ft foot	3.281
length	mm millimeters	in inch	0.03934
area	m ² square meter	in ² square inch	1550
volume	l liters	gal gallon (UK)	0.264
weight	kg kilogram	lb pound	2.205
torque	Nm Newton-meters	lb ft pound foot	0.7374
velocity	m/s meters/second	ft/s feet per second	3.281
flow rate	l/min liters per minute	gal/min gallon per minute	0.264
pressure	bar (105N/m ²)	psi pound/square inch	14.503
temperature	C° celsius	°F fahrenheit	°C(9/5)+32

Pressure Conversion Factors

METRIC TO PSI			
1 kPa = 0.145 psi			
bar	Mpa	kPa	psi
40	4	4000	580
50	5	5000	725
60	6	6000	870
70	7	7000	1015
80	8	8000	1160
90	9	9000	1305
100	10	10000	1450
200	20	20000	2900
300	30	30000	4350
400	40	40000	5800
500	50	50000	7250
600	60	60000	8700
700	70	70000	10150
800	80	80000	11600
900	90	90000	13050
1000	100	100000	14500
2000	200	200000	29000
3000	300	300000	43500

PSI TO METRIC			
1 psi = 6.89 kPa			
psi	kPa	Mpa	bar
500	3445	3.4	34
600	4134	4.1	41
700	4823	4.8	48
800	5512	5.5	55
900	6201	6.2	62
1000	6890	6.9	69
2000	13780	13.8	138
3000	20670	20.7	207
4000	27560	27.6	276
5000	34450	34.5	345
6000	41340	41.3	413
7000	48230	48.2	482
8000	55120	55.1	551
9000	62010	62.0	620
10000	68900	68.9	689
20000	137800	137.8	1378
30000	206700	206.7	2067
40000	275600	275.6	2756



Thread Codes

	Gas BSP	Metric		Jic SAE / UN UNF	ORFS UN UNF UNS	NPTF
02	1/8"-28					1/8"-27
04	1/4"-19			7/16"-20		1/4"-18
05				1/2"-20		
06	3/8"-19			9/16"-18	9/16"-18	3/8"-18
07				5/8"-18		
08	1/2"-14			3/4"-16		1/2"-14
09					11/16"-16	
10	5/8"-14	M10x1	M10x1,5	7/8"-14		
11					13/16"-16	
12	3/4"-14	M12x1.5		1 1/16"-12		3/4"-14
13					1"-14	
14		M14x1.5		1 3/16"-12	1 3/16"-12	
15					1 7/16"-12	
16	1"-11	M16x1.5		1 5/16"-12		1"-11 1/2
18		M18x1.5				
20	1 1/4"-11	M20x1.5		1 5/8"-12		1 1/4"-11 1/2
21					1 11/16"-12	
22		M22x1.5				
24	1 1/2"-11	M24x1.5		1 7/8"-12		1 1/2"-11 1/2
26		M26x1.5				
30		M30x1.5	M30x2			
32	2"-11			2 1/2"-12	2"-12	2"-11 1/2
36		M36x1.5	M36x2			
38		M38x1.5				
40	2 1/2"-11					
42		M42x2				
45		M45x1.5	M45x2			
52		M52x1.5	M52x2			

ID Hose Size Identification

SAE dash	ISO ref		R5	
	mm	inches	mm	inches
-2	3.2	1/8	-	-
-3	5	3/16	-	-
-4	6.4	1/4	4.8	3/16
-5	8	5/16	6.4	1/4
-6	10	3/8	7.9	5/16
-	-	13/32	-	-
-8	12.5	1/2	10.3	13/32
-10	16	5/8	12.7	1/2
-12	19	3/4	15.9	5/8
-14	-	7/8	-	-
-16	25	1	22.2	7/8
-	-	1 1/8	-	-
-20	31.5	1 1/4	28.6	1 1/8
-	-	1.3/8	-	-
-24	38	1 1/2	34.9	1 3/8
-	-	1 13/16	-	-
-32	51	2	46	1 3/16
-36	-	2 1/4	-	-
-40	64	2 1/2	60.3	2 3/8
-48	76	3	-	-
-56	89	3 1/2	-	-
-64	102	4	-	-

Chemical resistance table

Chemical name \ Resistance	NBR	CR	NBR/PVC	PTFE
Petroleum based oil	1	3	2	1
Diesel fuel	1	2	2	1
Water oil emulsions	1	1	1	1
Water glycol emulsions	1	1	1	1
Phosphate esters	5	4	4	1
Gas permeation	3	3	3	3
Weathering	5	2	2	1
Ozone	3	1	2	1
Heat	3	3	3	1
Flame resistance	4	3	3	3
Flame resistance	5	1	2	1
Bio oil	1	5	4	1

Legend:

1- Excellent 2- Very Good 3- Good 4- Sufficient 5- Poor

These values are for guidance only and they are related to the hose liner. Several factors in working operations could affect hose service life. For details concerning specific fluid, contact Muncie Power Products Technical Department. The outer cover of the hose is intended to protect the reinforcement layer(s) from mechanical influences (abrasion, weathering, etc), cover compounds are not designed to exhibit the same chemical resistance as the tube compounds. Interpump Hydraulics should be consulted about the compatibility of the cover, should the application involve the extended exposure or immersion in a liquid. In general, the hydraulic hoses of the Interpump Fluid Solutions product range are not designed for immersion in the service fluid. These types of special applications should be avoided or carefully analyzed, taking care to provide additional external protections for the hoses or by selecting special types of hoses (e.g. hoses with a thermoplastic cover which have been validated for the specific application). The turbulence of the fluid, the high temperature and nature of the fluid as well as other elements may impact the properties or integrity of the hose cover material (the cover compound of the hose is designed to resist to oil drops and external agents, not immersion in the service fluid). For more detailed information or for any technical questions, contact Muncie Power Products.





















Polymer based compound:

NBR	TFS0017 - TFE002K - TFD0021 - TFE001K - TFD0011 - TFA201K - TFA202K - TFS0006 - TFS0003 - TFD03TE - TFD02TE TFS0004 - TFDH021B - TFDH011B - TFDL021N - TFDL011N - THE003K - THE002K - THD0021 - THE102K - THE101K TFEM02KN - TFDG4SH - TFDG015 - TFE0P10 - TFN002K - TFB002K - TFN001K - TFB001K - THE01K - THE02K TFDE011 - THE0M2K - TFS0005 - TFS00JG - THE001K
CR	TFSM013 - TFD4SH - TFD4SP - TFSM012 - TFD011B - TFSM015N - THM04SPN - THM04SHN
PTFE	TF00T1 - TF00TP1 - TF00T2 - TF00THP - TF00LTC

REFERENCE STANDARD	Max Working Pressure of main connections (design factor 4:1)							
	CONNECTION							
ISO 8434-6		Thread Size	1/8	1/4		3/8	1/2	5/8
	BSP 60° cone with O-Ring	MAX WP		400		400	350	350
	BSP 60° cone without O-Ring	MAX WP	350	350		350	315	315
ISO 8434-2	37° flared (JIC)	Thread size		7/16-20	1/2-20	9/16-18	3/4-16	7/8-14
		MAX WP		350	350	350	310	240
ISO 8434-3	O-Ring face seal (ORFS)	Thread size		9/16-18	5/8-18	11/16-16	13/16-16	1-14
		MAX WP		630	630	630	630	400
ISO 8434-1	24° cone light series	Thread size	M12X1.5 (6L)	M14X1.5 (8L)	M16X1.5 (10L)	M18X1.5 (12L)	M22X1.5 (15L)	M26X1.5 (18L)
		MAX WP	415	400	350	330	275	250
	24° cone heavy series	Thread size	M16X1.5(8S)	M18X1.5 (10S)	M20X15 (12S)	M22X1.5 (14S)	M24X1.5 (16S)	M30X2 (20S)
		MAX WP	630	630	630	630	420	420
SAE J518 ISO 6162-1 ISO 6162-2	Code 61 Flange (3000 PSI Flange)	Flange size					1/2	
	Code 62 Flange (6000 PSI Flange)	MAX WP					350	
SAE J514	NPTF (dry seal pipe)	Thread size	1/8	1/4		3/8	1/2	5/8
		MAX WP	345	275		275	240	
JIS B 8363	BSP 60° inverted cone (Toyota)	Thread size		1/4		3/8	1/2	5/8
		MAX WP		345		345	345	275
	BSP 60° inverted cone (Komatsu)	Thread size		M14X1.5	M16X1.5	M18X1.5	M22X1.5	M24X1.5
		MAX WP		345	345	345	345	280

REFERENCE STANDARD	Max Working Pressure of main connections (design factor 4:1)							
	CONNECTION							
ISO 8434-6		Thread Size	3/4	1	1 1/4	1 1/2	2	
	BSP 60° cone with O-Ring	MAX WP	315	250	200	160	125	
	BSP 60° cone without O-Ring	MAX WP	250	200	160	125	80	
ISO 8434-2	37° flared (JIC)	Thread size	1 1/16-12	1 5/16-12	1 5/8-12	1 7/8-12	2-1/2-12	
		MAX WP	240	210	170	140	105	
ISO 8434-3	O-Ring face seal (ORFS)	Thread size	1 3/16-12	1 7/16-12	1 11/16-12	2-12		
		MAX WP	400	400	250	250		
ISO 8434-1	24° cone light series	Thread size	M30X2 (22L)	M36X2 (28L)	M45X2 (35L)	M52X2 (42L)		
		MAX WP	215	165	125	100		
	24° cone heavy series	Thread size	M36X2 (25S)	M42X2 (30S)	M52X2 (38S)			
		MAX WP	420	420	420			
SAE J518 ISO 6162-1 ISO 6162-2	Code 61 Flange (3000 PSI Flange)	Flange size	3/4	1	1 1/4	1 1/2	2	
	Code 62 Flange (6000 PSI Flange)	MAX WP	350	350	280	210	210	
SAE J514	NPTF (dry seal pipe)	Thread size	3/4	1	1 1/4	1 1/2	2	
		MAX WP	210	170	150	140	140	
JIS B 8363	BSP 60° inverted cone (Toyota)	Thread size	3/4	1	1.1/4	1 1/2		
		MAX WP	275	205	170	105		
	BSP 60° inverted cone (Komatsu)	Thread size	M30x1.5	M33X1.5	M36X1.5	M42X1.5		
		MAX WP	280	205	170	105		

HOSE CHART																		
HOSE REFERENCE			Size	03	04	05	06	08	10	12	16	20	24	32	40	48	COVER	HOSE OPERATING TEMP
				DN	5	6	8	10	12	16	19	25	31	38	51	63		
Hose	Code	Reference Standard	MAX WORKING PRESSURE [bar]														ABRASION RESISTANCE LEVEL	Temp Range [°C]
International Standard	Hypress 1SN	TFD0011	EN 853-SAE 100R1AT-ISO 1436	250	225	215	180	160	130	105	88	63	50	40			I	-40 ÷ 100
	Hypress 2SN	TFD0021	EN 853-SAE 100R2AT-ISO 1436	415	400	350	330	275	250	215	165	125	90	80			I	-40 ÷ 100
	Hypress 1SC	TFE001K	EN 857-ISO 11237		225	215	180	160	130	105	88						I	-40 ÷ 120
	Hypress 2SC	BFEM02K	EN 857-SAE 100R16-ISO 11237		400	350	330	275	250	215	165						I	-40 ÷ 120
	EASY K 1SC	TFA201K	EN 857-ISO 11237		225	215	180	160	130	105	88						STD	-40 ÷ 100
	EASY K 2SC	TFA202K	EN 857-ISO 11237		400	350	330	275	250	215	165						STD	-40 ÷ 100
	Hypress 4SP	TFDM4SP	EN 856-ISO 3862		450	445	415	350	280	210	185	165					I	MSHA -40 ÷ 100
	Hypress 4SP	TFD04SP	EN 856-ISO 3862		450	445	415	350	280	210	185	165					I	-40 ÷ 100
	Hypress 4SH	TFDM4SP	EN 856-ISO 3862							420	385	350	300	250			I	MSHA -40 ÷ 100
	Hypress 4SH	TFD04SH	EN 856-ISO 3862							420	385	350	300	250			I	-40 ÷ 100
	Hypress R12	TFDM012	EN 856-SAE 100R12-ISO 3862				280	280	280	280	280	210	176	176			I	MSHA -40 ÷ 121
	SAE 100R3	TFS0003	SAE 100R3-ISO 4079	103	86	83	78	69	60	52	39	26					STD	-40 ÷ 100
	Hypress 2TE	TFD02TE	EN 854	80	75	68	63	58	50	45	40	35					STD	-40 ÷ 100
	Hypress 3TE	TFD03TE	EN 854	160	145	130	110	93	80	70	55	45	40	33			STD	-40 ÷ 100
	Unilock	BFS0006I	SAE 100R6	34	28	28	28	28	24	21	12						STD	-40 ÷ 100
	SAE 100R5	TFS0005	SAE 100R5		210	210	157	140	122	105	56	43	35	24			STD	-40 ÷ 100
	Hypress R17	BFSM017	ISO 11237-SAE 10017	210	210	210	210	210	210	210	210						I	MSHA -40 ÷ 100
	Hypress R13	TFSM013	EN 856-SAE 100R13-ISO 3862							350	350	350	350	350			I	MSHA -40 ÷ 121
Hypress R15	TFSM015	SAE 100R15-ISO 3862							420	420	420	420	420			I	MSHA -40 ÷ 121	
High performance	Compressor	TFDC011B	EN 853-SAE 100R2AT-ISO 1436		225	215	180	160	130	105	88	63	50	40			STD	-40 ÷ 135
	HyCelsius 1SN	TFDH011	EN 853-SAE 100R1AT-ISO 1436		225	215	180	160	130	105	88	63	50	40			STD	-40 ÷ 135
	HyCelsius 2SN	TFDH021	EN 853-SAE 100R2AT-ISO 1436		400	350	330	275	250	215	165	125	90	80	30		STD	-40 ÷ 135
	HyFreeze 1SN	TFDL011	EN 853-SAE 100R1AT-ISO 1436		225	215	180	160	130	105	88	63	50	40			STD	-50 ÷ 100
	HyFreeze 2SN	TFDL021	EN 853-SAE 100R2AT-ISO 1436		400	350	330	275	250	215	165	125	90	80			STD	-50 ÷ 100
	HyOzone	TFEM02K	EN 857-SAE 100R16-ISO 11237		400	350	330	275	250	215	165						I	MSHA -40 ÷ 120
	Pilot	TFE0P10	IMM Specs	100	100	100	100	100									I	-40 ÷ 100
	Pilot Plus 150	TFE0P15	IMM Specs	150	150	150	150	150									I	-40 ÷ 120
	Kaizen 2SN	BHDM021	EN 853-SAE 100R2AT-ISO 1436	420	420	360	350	290	250	215	175	140	125	90			I	MSHA -40 ÷ 120
	1SC	BHES01K	EN 857-ISO 11237		250	250	250	200	150	150	110	100	90	75	50	40	II	-40 ÷ 120
	2SC	THE002K	EN 857-SAE 100R16-ISO 11237		430	400	350	310	280	240	210	160	150	100	80	65	II	-40 ÷ 120
	3SC	THE003K	IMM Specs			500	475	420	380	315							II	-40 ÷ 120
	LongLife 1SC	BHES01K	EN 857-ISO 11237		250	250	250	200	150	150							I	-40 ÷ 120
	LongLife 2SC	THE102K	EN 857-SAE 100R16-ISO 11237		430	400	350	310	280	240	185						II	-40 ÷ 120
	Marathon	BHEMM2K	EN 857-SAE 100R16-ISO 11237		450	420	385	350	350	280	250						I	MSHA -40 ÷ 120
HyGreen R15	TFGD015	SAE 100R15-ISO 3862							420	420	420	420	420			II	-40 ÷ 121	
Bio - Flex	THDB4SH	EN 856-ISO 3862							420							II	-40 ÷ 100	

HOSE CHART																		COVER	HOSE OPERATING TEMP
HOSE REFERENCE		Size	03	04	05	06	08	10	12	16	20	24	32	40	48	ABRASION RESISTANCE LEVEL	Temp Range [°C]		
Hose	Code	Reference Standard	DN	5	6	8	10	12	16	19	25	31	38	51	63			78	
Jet 1SN/1SC	TFN0011/ TFN001K/ TFB0011/ TFB001K	ISO 7751		250	250	250	250										STD	-40 ÷ 135	
Jet 2SN/2SC	TFN0021/ TFN002K/ TFB0021/ TFB002K	ISO 7751		400	400	400	400										STD	-40 ÷ 135	
Jet Plus 1SN/1SC	THN0011/ THN001K/ THB0011/ THB001K	ISO 7751		250	250	250	250										STD	-40 ÷ 135	
Jet Plus 2SN/2SC	THN0021/ THN002K/ THB0021/ THB002K	ISO 7751		400	400	400	400										STD	-40 ÷ 135	
SewerJet 280	TSWR280	ISO 7751				280	280		280	280	280							-40 ÷ 70	
Hyblast 10k	TFW0070	IMM Specs								700								-10 ÷ 70	
Hyblast 12k	TFW0085	IMM Specs		850		850	850		850	850								-10 ÷ 70	
Hyblast 15k	TFW0110	IMM Specs		1100		1100	1100		1000									-10 ÷ 70	
Hyblast 18k	TFW0125	IMM Specs				1250	1200											-10 ÷ 70	
Hyblast 20k	TFW0145	IMM Specs				1450	1450		1350									-10 ÷ 70	
LongLift 1SC	THL101K	EN 857-ISO 11237		250	250	250	200	150	150									-40 ÷ 120	
LongLift 2SC	THL102K	EN 857-SAE 100R16-ISO 11237		430	400	350	310	280	240	185								-40 ÷ 120	
LongLife Dual 1SC	T2E101K	EN 857-ISO 11237		250		250	250											-40 ÷ 120	
LongLife Dual 2SC	T2E102K	EN 857-SAE 100R16-ISO 11237		430		350	310											-40 ÷ 120	
Railway	TFDE011	EN 853*SAE 100R1AT-ISO 1436		225	215	180	160	130	105	88							STD	-40 ÷ 100	
Power Lift 1SC	THE0L1K	EN 81-20								50	50	45						-40 ÷ 100	
PowerLift 2SC	THE0L2K	EN 81-20									50	50						-40 ÷ 100	
HyJack	THE2J2K	IMM Specs		760	725													-40 ÷ 100	
SnowStorm 1SC	THEPS1K	IMM Specs								100	100	100						-40 ÷ 100	
Hytruck 200	TTRK200	IMM Specs							200	200								-40 ÷ 100	
Hytruck 250	TTRK250	IMM Specs							250	250								-40 ÷ 100	
Hytruck 350	TTRK300	IMM Specs							350	350								-40 ÷ 100	
MegaDrill	THEMMDR	EN 857-SAE 100R16-ISO 11237							350	350 (210)							 MSHA	-40 ÷ 100	
MegaJet	TFS04JG	IMM Specs								550	450	450	420					-40 ÷ 100	
MegaJet	THS00JG	IMM Specs								600	550	500	480					-40 ÷ 100	
BOP Firescreen 5000	TBOP350	IMM Specs											350				STD	-40 ÷ 121	

Solution for applications

- 1-Refer to dedicated section for extended Temperature Range information
- 2-UNMWPE cover available as alternative (MEGA COVER)
- 3-Ask technical office for cover different configuration request

Built to INTERconnect.





**Muncie[®]
Power
Products**



INTERPUMP
FLUID SOLUTIONS

MEMBERS OF THE INTERPUMP GROUP