



1



2

Marine & Offshore

# SOLUTION GUIDE

Edition 1/19, valid from 09/2019



A Rolls-Royce  
solution

## PIONEERING THE POWER THAT MATTERS

Rolls-Royce provides world-class power solutions and complete life-cycle support under our product and solution brand MTU. Through digitalization and electrification, we strive to develop drive and power generation solutions that are even cleaner and smarter and thus provide answers to the challenges posed by the rapidly growing societal demands for energy and mobility. We deliver and service comprehensive, powerful and reliable systems, based on both gas and diesel engines, as well as electrified hybrid systems. These clean and technologically-advanced solutions serve our customers in the marine and infrastructure sectors worldwide.

### A solution provider

MTU systems power the largest yachts, the strongest tugboats and the biggest land vehicles and provide energy for the world's most important mission-critical applications. Through advanced solutions such as microgrids, we integrate renewable energies and manage the power needs of our customers.

Our customized service offerings help you maximize uptime and performance and are supported by our digital solutions, which enable remote monitoring, predictive maintenance and a range of other benefits that keep your systems running at their best.

For over 110 years, we have provided innovative power solutions for our customers – meeting even the most demanding drive requirements. Our products and services span a wide range of applications and power needs, with both standard and customized options.

### An expert in technology

As part of Rolls-Royce, we have long been known for cutting-edge innovation and technological leadership in product development. That same spirit of innovation inspires our sustainability efforts. Our focus is on developing and implementing system solutions that both maximize efficiency and reduce emissions -- which in turn work to reduce our impact on the environment.

### A passionate and reliable partner

We at Rolls-Royce spend every day working together with our customers, to deliver engines, systems and complete life-cycle solutions that best fit your needs. We understand that each application is different and has its own specific demands. Our engineers embrace the challenge of finding the perfect solution for your unique power requirements. Every step of the way – from project planning, through design, delivery and commissioning; to the lifetime care of your equipment – we are dedicated to helping you get the most from your MTU investment.



---

1 © Øyvind Hagen/Statoil

2 © Northrop Grumman



## CONTENTS

<b>Selection guideline</b>			
Marine and offshore service & supply	06		
Offshore exploration & production	08		
<b>Power range</b>			
Power range marine and offshore service & supply	10		
Power range offshore exploration & production	14		
<b>Rating philosophy</b>		<b>16</b>	
<b>Power definition</b>		<b>17</b>	
<b>Explanation engine and genset designation</b>		<b>18</b>	
<b>New product introduction</b>		<b>22</b>	
<b>Engines and gensets overview</b>			
Series 60	26		
Series 396	27		
Series 2000	28		
Series 4000	30		
Series 1163	32		
Series 8000	33		
Genset 2000	34		
Genset 4000	36		
<b>Engines and gensets marine and service &amp; supply</b>		<b>38</b>	
Engines for diesel-mechanic propulsion	40		
Engines and gensets for on-board power generation and diesel-electric-propulsion	46		
<b>Engines and gensets for exploration &amp; production</b>			<b>54</b>
Engines and gensets for offshore power generation – 50 Hz & 60 Hz			56
<b>Systems solutions marine and service &amp; supply</b>		<b>60</b>	
System expertise			62
SCR solutions			64
Combined propulsion solutions			66
Marine gensets			68
MTU Callosum - integrated ship automation system			70
Standardized propulsion automation systems:			
– BlueVision NewGeneration			72
– smartline, blueLine, bluevision			76
Standardized and system solutions genoline			78
<b>Systems solutions offshore exploration &amp; production</b>			<b>80</b>
Offshore generator sets			80
MTU P-engines for ATEX zone 2			82
Redundant controller for fire pump drive systems			84
<b>Parts &amp; Service</b>			<b>86</b>
<b>Exhaust emissions</b>			<b>96</b>
IMO			97
US EPA			98
EU 95			99
Examples for emission stages			100
Abbreviations			101
<b>Conversion table</b>			<b>103</b>

## Selection guideline

MARINE AND OFFSHORE  
SERVICE & SUPPLY

Application group >		1A	1B	1D	1DS
Mechanical propulsion engines					
Yacht	Planing			■	■
	Semi planing			■	■
	Small displ.		■	■	■
	Large displ. > 120 ft.	■	■	■	■
Cargo ships & tankers	Inland freighters	■			
	Coastal ships	■			
	Sea-river ships	■			
Passenger ships	Tourist boats	■	■		
	Passenger ferries		■		
	Cabin cruisers ships	■	■		
RoPax ferries	Double-ended ferries	■	■		
	Fast ferries < 50 m	■	■		
	Fast ferries > 50 m		■		
Tugs & push boats	Tow & push boats	■			
	Harbour tugs	■	■		
	Coastal tugs	■			
	Escort tugs	■	■		
Offshore vessels & crew boats	Crew boats	■	■		
	Offshore supply ves.	■	■		
	Anchor handl. tugs	■	■		
	Pilot boats	■	■		
	Trawler (fishing ves.)	■	■		
	Firefighting ves.	■	■	■	
	Rescue vessels	■	■	■	
	Research vess.	■	■	■	
	Dredgers	■	■		
	Cable laying ves.	■			

The guideline on page 6 - 7 gives a rough overview which application groups can be considered for which type of vessel or business model. To allocate which application group suits your demands best, the intended annual usage and the expected load profile have to be considered.

Application group >		1A	1B	1D	1DS
Mechanical propulsion engines					
Marine Naval Vessels	Fast attack crafts			■	■
	Corvettes			■	■
	Frigates and Destroyers		■	■	■
	Amphibious crafts		■	■	■
	Large amphibious and support vessels	■	■	■	
	Mine countermeasure vessels			■	
Patrol boats	Small patrol crafts		■	■	■
	Coastal patrol crafts	■	■	■	■
	Large patrol vessels > 120 ft.	■	■	■	■

Application group >		3A/3B	3A/3B
Power generation and diesel-electric propulsion		50 Hz	60 Hz
	On-board powergen	■	■
	Diesel-electric propulsion	■	■
	Emergency powergen	■	■

## Selection guideline

OFFSHORE EXPLORATION &  
PRODUCTION**Diesel engines for**

- Heavy lift vessel
  - Diving support vessel
  - Pipe-laying vessel
  - Cable-laying vessel
  - Subsea support vessel
  - Well intervention vessel
  - Accommodation vessel
  - Drill ship
  - Wind converter platform
  - Fixed platform
  - Tension-leg platform
- Jack-up rig
  - Spar
  - NUI
  - Conductor support system
  - Compliant power
  - FLNG
  - Semi-submersible
  - FPSO
  - Windfarm substation platforms

**Diesel engines for power generation****Power generation - constant speed**

Application group >	3A	3B	3C
Power generation	50/60Hz	50/60Hz	50/60Hz
Power generation	■	■	■
Electric firepump drives		■	■
Electric drilling drives	■	■	

The guideline above gives a rough overview which application groups can be considered for which type of vessel or business model. To allocate which application group suits your demands best, the intended annual usage and the expected load profile have to be considered.

## Power range

MARINE AND OFFSHORE  
SERVICE & SUPPLY

## Main propulsion:

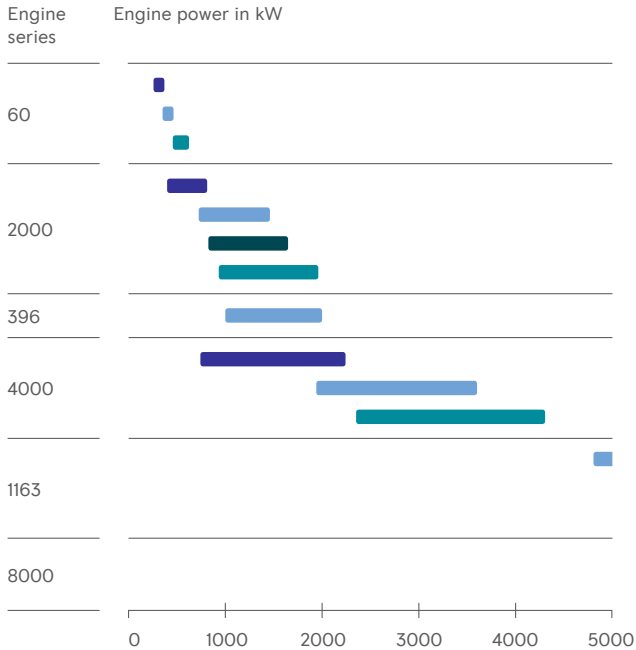

## Engine power in kW

Engines	1A	1B	1D	1DS
60	261 – 373	354 – 447	–	466 – 615
2000	400 – 800	720 – 1440	810 – 1630	932 – 1939
396	–	1000 – 2000	–	–
4000	746 – 2240	1920 – 3600	–	2340 – 4300
1163	–	4800 – 6000	5200 – 6500	5920 – 7400
8000	–	7280 – 9100	–	8000 – 10000

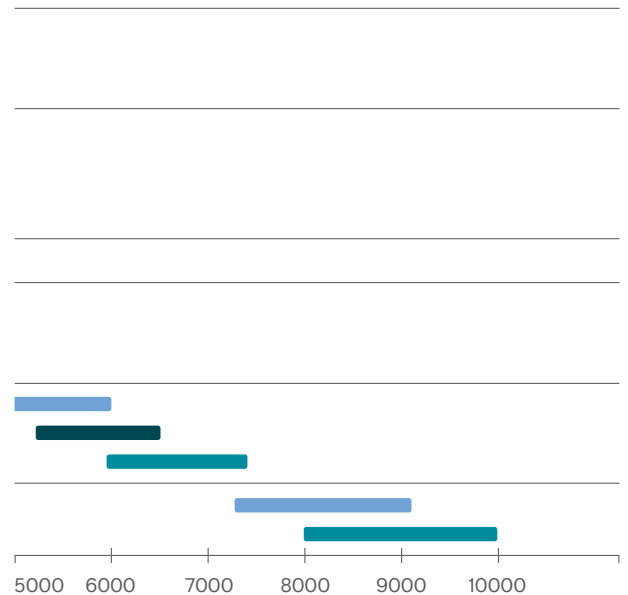
**1A** Engines for vessels w/ unrestricted continuous operation

Average load: 70 - 90% of rated power; Rating definition: ICFN, fuel stop; Typical annual usage: unrestricted\*

**1B** Engines for fast vessels with high load factors

Average load: 60 - 80% of rated power; Rating definition: ICFN, fuel stop; Typical annual usage: 5000 hours\*

**1D** Engines for fast vessels w/ intermittent load factors

Average load: ≤ 60% of rated power; Rating definition: ICFN, fuel stop; Typical annual usage: 3000 hours\*

**1DS** Engines for fast vessels with low load factors

Average load: ≤ 60% of rated power; Rating definition: ICFN, fuel stop; Typical annual usage: 1500 hours\*

\* Application groups (page 6-9) only indicate which MTU engine suits your demands best. For your type of vessel, you can also choose engines from other application groups than stated in the selection guideline.

## Power range

MARINE AND OFFSHORE  
SERVICE & SUPPLYMarine on-board power generation, diesel-electric drives  
and generator sets:

Engine series      Engine power in kW

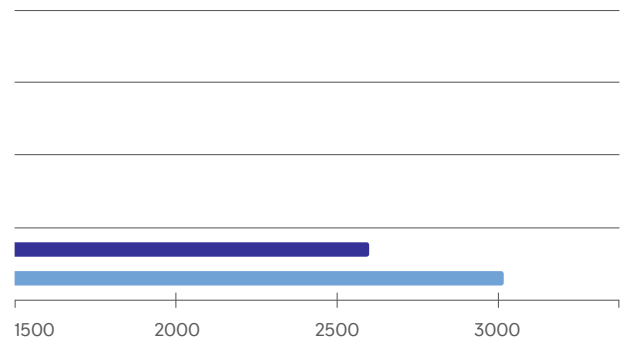
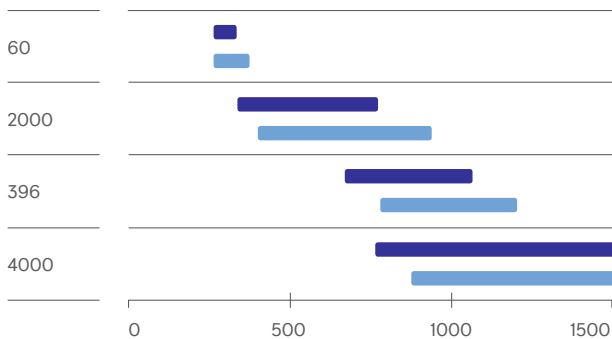

## Engine power in kW

Engines	3A/3B	3A/3B
Frequency	50 Hz	60 Hz
60	271 - 322	271 - 370
2000	332 - 770	400 - 930
396	680 - 1030	790 - 1200
4000	760 - 2600	895 - 3015

**3A/3B** Engines for onboard power generation and diesel-electric drive

Continuous operation 50 Hz;  
Rating definition: ICXN, 10% overload capability  
Continuous operation 60 Hz;  
Rating definition: ICXN, 10% overload capability

Application groups (page 6-9) only indicate which MTU engine suits your demands best. For your type of vessel, you can also choose engines from other application groups than stated in the selection guideline.

## Genset power in kW\*

Gensets	3A/3B	3A/3B
Frequency	50 Hz	60 Hz
MG 2000	310 - 730	370 - 880
MG 4000	720 - 1690	850 - 2150

\* alternator efficiency of 96% considered, excluding parasitic losses

## Power range

OFFSHORE EXPLORATION &  
PRODUCTION

## Engines and gensets for power generation:

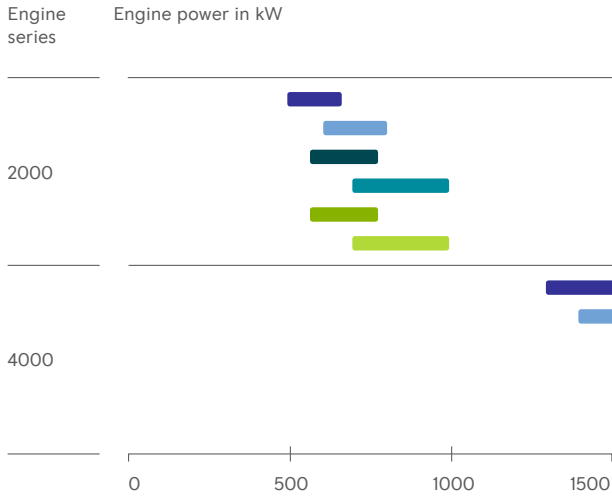

## Engine power in kW

Engines	3A	3A	3B	3B	3C	3C
Frequency	50 HZ	60 HZ	50 HZ	60 HZ	50 HZ	60 HZ
2000	498 - 664	600 - 800	575 - 770	695 - 980	575 - 770	695 - 980
4000	1350- 2245	1455- 2425	1560- 2600	1680- 2600	1560- 2600	1680- 2600

Gensets	3A	3A	3B	3B	3C	3C
Frequency	50 HZ	60 HZ	50 HZ	60 HZ	50 HZ	60 HZ
PP 4000	1295- 2155	1395- 2330	1500- 2500	1615- 2690	1500- 2500	1615- 2690

\* alternator efficiency of 96% considered, excluding parasitic losses

Application groups (page 6-9) only indicate which MTU engine suits your demands best. For your type of vessel, you can also choose engines from other application groups than stated in the selection guideline.

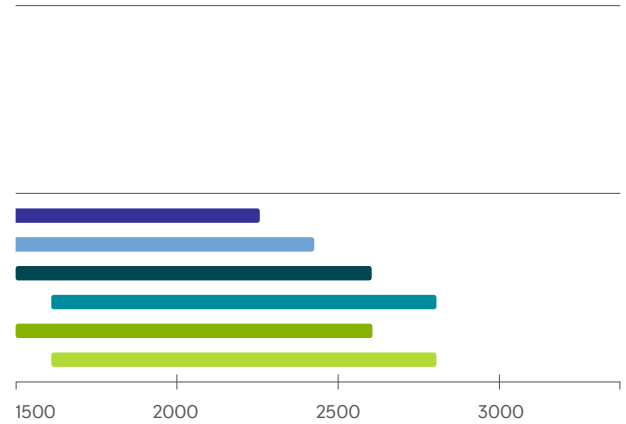

3A/3 B/3C	Engines for power generation, electric fire-pump drives and emergency power – constant speed
3A	Continuous Power
50 Hz	Continuous operation power, unrestricted Rating definition: ICXN, 10% overload capability
60 Hz	Continuous operation power, unrestricted; Rating definition: ICXN, 10% overload capability
3B	Prime Power
50 Hz	Continuous operation with variable load Rating definition: ICXN, 10% overload capability
60 Hz	Continuous operation with variable load; Rating definition: ICXN, 10% overload capability
3C	Prime Power limited
50 Hz	Standby operation with variable load Rating definition: ICXN, 10% overload capability
60 Hz	Standby operation with variable load Rating definition: ICXN, 10% overload capability



## RATING PHILOSOPHY

Application index: e.g. 1A, 3A, 1DS	Load factor:	Max. Load profile Load factor	Max. Utilization p.a. TBO
A	Unrestricted/ heavy duty 70-90% load factor		
B	High load/ medium duty 60-80% load factor		
C	Intermittent an low load/short time duty < 60% load factor		

We are working hard to meet and even exceed the increasing demands of ship owners and operators for cost-effective and eco-friendly solutions. One example is the engine TBO (Time Between Overhauls) which we optimize on the basis of field data analysis and close inspection of engines and components that have already proven their reliability in field operation. Depending on the analysis results, we extend maintenance and TBO intervals keeping safe operation assured.

We offer product lines specifically tailored to customer requirements. Some are laid out for high power density with ideal power-to-weight-ratios (application groups C, D and DS). Other product lines are specifically configured to achieve maximum service life at lower power densities. These are suitable for applications involving high load factors and runtimes up to 8,000 hours per year (application groups A and B).

## POWER DEFINITION

The rated power of diesel and gas engines stated in this sales program corresponds to ISO 3046-1:2002 (E) and ISO 15550:2002 (E). The power produced at the flywheel will be within the tolerance of 3% - according to ISO 15550:2002 (E) - up to 25°C (77°F) combustion air temperature measured at the air cleaner inlet and up to 25°C (77°F) sea or raw water temperature measured at the seawater pump suction inlet, unless other values mentioned explicitly.

ICFN = ISO standard (continuous) fuel stop power  
 ICXN = ISO standard (continuous) power exceedable by 10% (ratings also apply to ISO 8665 and SAE J1228 standard conditions)

Barometric pressure: 1000 mbar  
 Site altitude above sea level: 100 m  
 Fuel specification for diesel: EN 590 to ASTM D 975-00  
 (Fuel consumption [with all pumps] in accordance with DIN ISO 3046 [except Series 60], values stated for IMO certification.)

### General reference conditions for diesel engines and generator sets:

- Intake air temperature 25°C
- Sea water temperature 25°C
- Charge air coolant inlet temperature 45°C up to 65°C without deration

### All engines are designed and built according to classification requirements, certificate on request.

Classification with:

- Unrestricted service for engines with 10% overload capacity
- Restricted service for engines without overload capacity

## EXPLANATION OF THE ENGINE DESIGNATION

### Series 396 – Example

**16 V 396 TE 7 4 L**

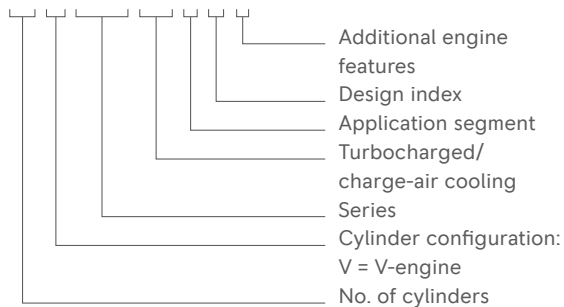

### Series 2000 / 4000 / 1163 / 8000 – Example

**16 V 4000 M7 3 L**

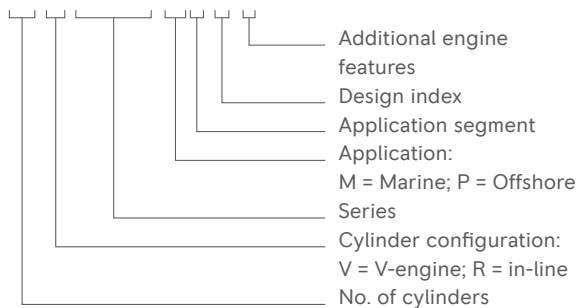

## EXPLANATION OF THE GENSET DESIGNATION

### Generator sets with Series 2000 / 4000 – Example

**MG 08 V 4000 M3 3 F**

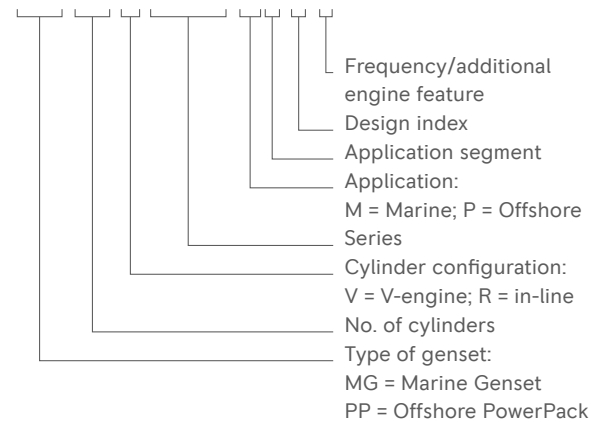

### Turbocharged engines/gensets with

Separate-circuit charge-air cooling	60 / 2000 P / 4000 P / 1163
Split-circuit charge-air cooling	2000 M / 4000 M / 396 TE / 8000 M

### Additional engine/gensets features

Power uprated	L
Gas Fuel	N
Power/speed reduced	R
Frequency	A or F (50 Hz); B or S (60 Hz)

# ENGINES OVERVIEW



New product introduction

## DIESEL ENGINE – 4000 M05

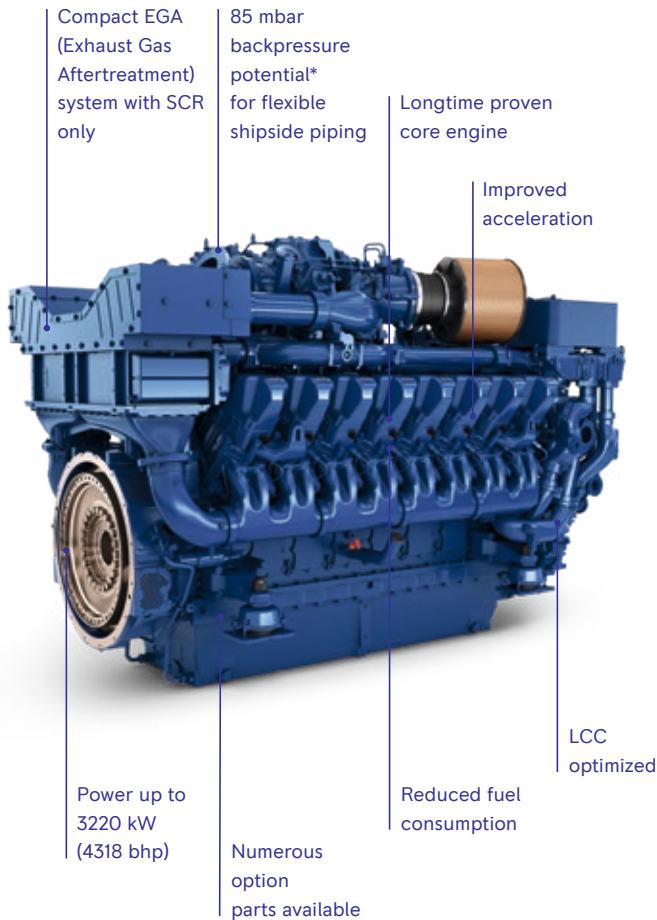

up to  
3220 kW  
(4318 BHP)

Our Series 4000 M05 for commercial marine applications is the latest marine engine of the powerful Series 4000 family. When designing the Series 4000 M05 we kept three topics always in our mind: Life-cycle costs, performance and ease of maintenance.

We used our legendary IRONMEN engines as a basis but finetuned it with high attention to detail to maximize durability, performance and efficiency. Only SCR is needed to fulfill IMO III and EPA Tier 4 emissions regulations.

We also help customers to design and integrate the engine/ SCR combination into their vessel design.

New product introduction

## PURE GAS ENGINE – 4000 M05-N

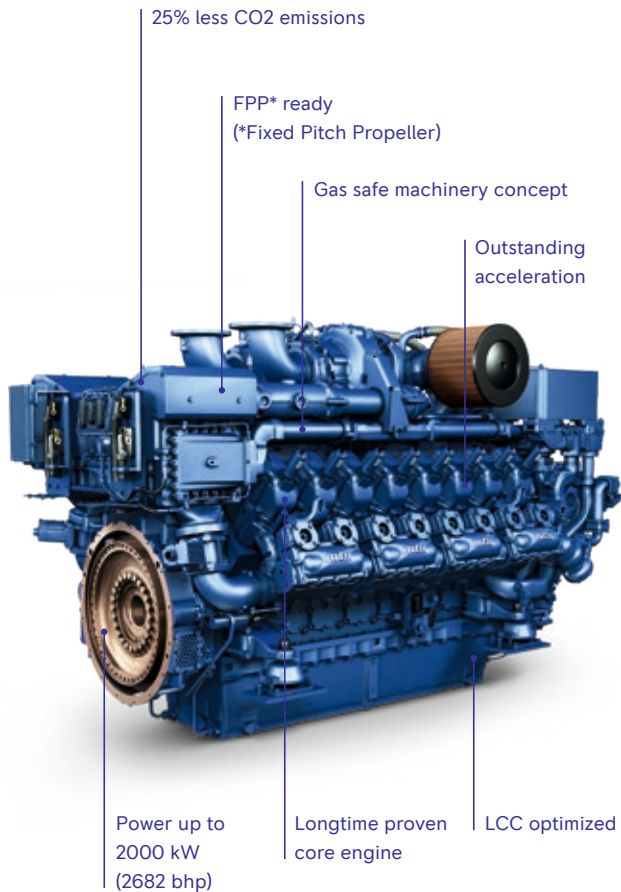

25%  
LESS CO2  
emissions

Our Series 4000 M05-N for commercial marine applications is the latest marine engine of the powerful Series 4000 family. When designing the Series 4000 M05-N we kept three topics always in our mind: Life-cycle costs, performance and environmental friendliness.

We used our legendary IRONMEN engines as a basis for the development of our pure gas engine. The engine will be equipped with a multipoint gas injection system, a dynamic motor management system and an advanced turbocharger design. The wide rpm range and engine map ensures that fixed pitch propellers can be used in the propulsion design.

On the test bench, it was possible to simulate real-life manoeuvres, which represented the dynamic acceleration behaviour of a diesel engine.

## SERIES 60

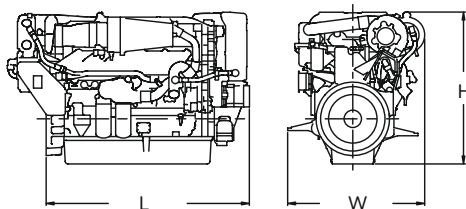

## Marine and offshore service &amp; supply

Engine	Displacem. total	Dimensions, max.	Mass, max.
Cylinder config.: 6 cyl./ in-line	l (cu in)	LxWxH mm (in)	(dry) kg (lbs.)
S60	14.0 (855)	1850x1035x1160 (73x41x46)	1633 (3600)

External heat exchanger version as standard, optional engine mounted.

## SERIES 396

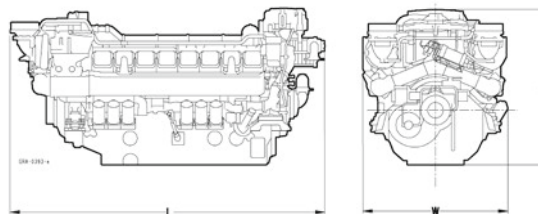
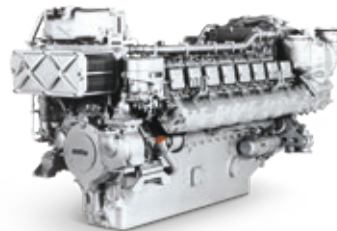

## Marine and offshore service &amp; supply

Engine	Displacem. total	Dimensions, max.	Mass, max.
Cylinder config.: 90°V	l (cu in)	LxWxH mm (in)	(dry) kg (lbs.)
8V 396	31.7 (1933)	2005x1525x1540 (79x60x61)	3800 (8377)
12V 396	47.5 (2900)	2535x1525x1695 (100x60x67)	4900 (10803)
16V 396	63.4 (3868)	3070x1530x1660 (121x60x65)	6140 (13536)

External heat exchanger version as standard, optional engine mounted.

## SERIES 2000

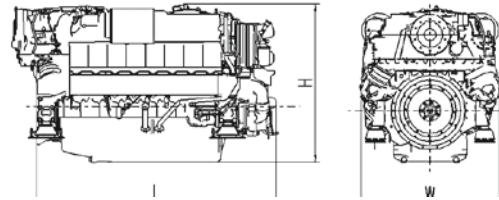

## Marine and offshore service &amp; supply

Engine	Displacem. total	Dimensions, max.	Mass, max.
Cylinder config.: 90°V	l (cu in)	LxWxH mm (in)	(dry) kg (lbs.)
8V 2000 M41/51/61	15.9 (970)	1435x1280x1315 (57x50x52)	1870 (4123)
12V 2000 M41/51/61	23.9 (1458)	2105x1400x1290 (83x55x51)	2756 (6064)
16V 2000 M41/51/61	31.8 (1943)	2525x1425x1290 (99x56x51)	3270 (7209)

Engine mounted heat exchanger as standard, external heat exchanger version as option.

8V 2000 M72/84/93/94	17.9 (1093)	1416x1130x1200 (56x45x47)	1970 (4343)
10V 2000 M72/86/96	22.3 (1361)	1604x1165x1347 (63x46x53)	2305 (5082)
12V 2000 M72/86/96	26.8 (1635)	1870x1295x1350 (74x51x53)	2810 (6195)
16V 2000 M72/86/96	35.7 (2179)	2258x1318x1455 (89x52x57)	3450 (7607)

Engine mounted heat exchanger as standard.

## Offshore exploration &amp; production

Engine	Displacem. total	Dimensions, max.	Mass, max.
Cylinder config.: 90°V	l (cu in)	LxWxH mm (in)	(dry) kg (lbs.)
12V 2000 P62/82	23.9 (1458)	2165x1340x1490 (85x53x58)	2650 (5842)
16V 2000 P62/82	31.8 (1943)	2502x1430x1495 (99x53x59)	3060 (6746)

Engine mounted heat exchanger as standard.

## SERIES 4000

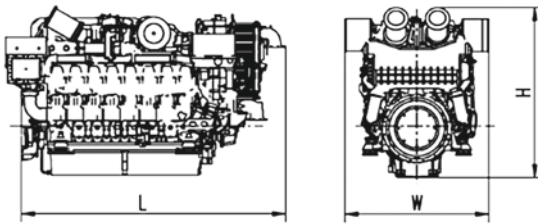

## Marine and offshore service &amp; supply

## Standard stroke (190 mm)

Engine	Displacem. total	Dimensions, max.	Mass, max.
Cylinder config.: 90°V	l (cu in)	LxWxH mm (in)	(dry) kg (lbs.)
12V 4000 M53B/73/93	51.7 (3155)	2870x1850x2185 (113x73x86)	8410 (18541)
16V 4000 M53B/73/93	69.0 (4210)	3510x1850x2185 (138x73x86)	9890 (21803)
20V 4000 M53B/73/93	86.2 (5260)	4040x1470x2440 (159x58x96)	12900 (28439)

Engine mounted heat exchanger as standard.

## Marine and offshore service &amp; supply

## Long stroke (210 mm)

Engine	Displacem. total	Dimensions, max.	Mass, max.
Cylinder config.: 90°V	l (cu in)	LxWxH mm (in)	(dry) kg (lbs.)
8V 4000 M23/24/33/53/54/63	38.2 (2331)	2386x1615x1972 (94x64x78)	5710 (12588)
8V 4000 M55RN	38.2 (2331)	2050 x 1820 x 2100 (81x72x83)	6100 (13448)
12V 4000 M23/33/53/63/24/34/54/64/25/35/65	57.2 (3491)	2750x1793x2370 (108x71x93)	8000 (17637)
16V 4000 M23/33/43/53/63/24/34/54/64/25/35/65	76.3 (4656)	3270x1570x2370 (129x62x93)	9460 (20856)
16V 4000 M55RN/55-N/65-N	76.3 (4656)	3233x1820x2100 (127x72x83)	9555 (21065)

Engine mounted heat exchanger as standard, external heat exchanger version as option.

## Offshore exploration &amp; production

## Long stroke (210 mm)

Engine	Displacem. total	Dimensions, max.	Mass, max.
Cylinder config.: 90°V	l (cu in)	LxWxH mm (in)	(dry) kg (lbs.)
12V 4000 P63/83	57.2 (3491)	2530x1590x2065 (100x63x81)	7300 (16093)
16V 4000 P63/83	76.3 (4656)	3000x1590x2065 (118x63x81)	8800 (19400)
20V 4000 P63/83	95.4 (5822)	3470x1590x2065 (137x63x81)	10680 (23545)

External heat exchanger version as standard.



## SERIES 1163

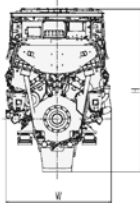
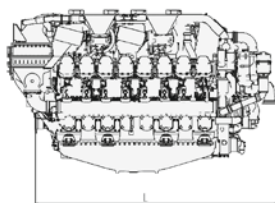
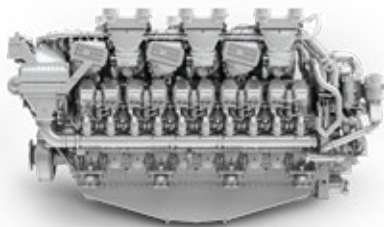

## Marine and offshore service &amp; supply

Engine	Displacem. total	Dimensions, max.	Mass, max.
Cylinder config.: 60°V	l (cu in)	LxWxH mm (in)	(dry) kg (lbs.)
16V 1163	186.1 (11357)	4687x1918x3040 (185x76x120)	20590 (45393)
20V 1163	232.7 (14200)	5353x1918x3040 (211x76x120)	25000 (55116)

External heat exchanger version as standard.

## SERIES 8000

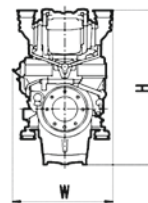
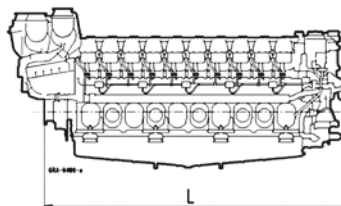
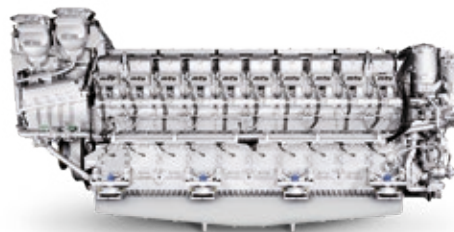

## Marine and offshore service &amp; supply

Engine	Displacem. total	Dimensions, max.	Mass, max.
Cylinder config.: 48°V	l (cu in)	LxWxH mm (in)	(dry) kg (lbs.)
16V 8000	278 (16965)	5698x2040x3375 (224x80x133)	42000 (92594)
20V 8000	347.4 (21200)	6645x2040x3375 (262x80x133)	49600 (109348)

External heat exchanger version as standard.

## SERIES 2000 GENSET

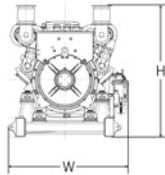
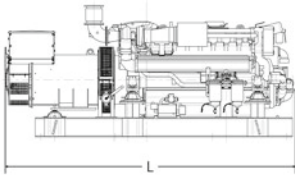
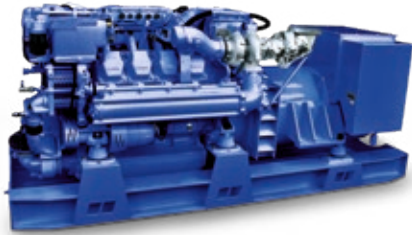

## Marine and offshore service &amp; supply

Genset type	Displacem. total	Dimensions, max.	Mass, max.
	l (cu in)	L x W x H mm (in)	(dry) kg (lbs.)
MG08V 2000 M51/41	15.9 (970)	2900x1680x1550 (114x66x61)	3950 (8708)
MG12V 2000 M51/41	23.9 (1458)	3550x1680x1680 (140x66x66)	5400 (11905)
MG16V 2000 M51/41	31.8 (1943)	3900x1680x1760 (154x66x70)	6300 (13890)

Engine mounted heat exchanger version as standard, optional external cooling.

## SERIES 4000 GENSET

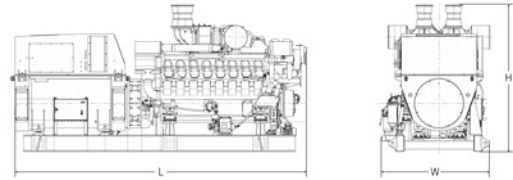

## Marine and offshore service &amp; supply

## Long stroke (210 mm)

Genset type	Displacem. total	Dimensions, max.	Mass, max.
	l (cu in)	LxWxH mm (in)	(dry) kg (lbs.)
MG08V 4000 M23/24/33	38.2 (2331)	4250x1825x2225 (167x72x87)	11240 (24780)
MG12V 4000 M23/24/33/34	57.2 (3491)	4700x1825x2285 (185x72x90)	14000 (30865)
MG16V 4000 M23/24/33/34/43	76.3 (4656)	5700x1965x2285 (225x78x90)	18500 (40786)

External heat exchanger version as standard, optional engine mounted.

## Offshore exploration &amp; production

## Long stroke (210 mm)

Genset type	Displacem. total	Dimensions, max.	Mass, max.
	l (cu in)	LxWxH mm (in)	(dry) kg (lbs.)
PP12V 4000 P63/83	57.2 (3491)	4850x1950x2450 (191x77x96)	14500 (31970)
PP16V 4000 P63/83	76.3 (4656)	5720x1950x2450 (225x77x96)	18500 (40786)
PP20V 4000 P63/83	95.4 (5822)	6950x1950x2450 (274x77x96)	24300 (53575)

External heat exchanger version as standard, optional engine mounted.

## DIESEL/GAS ENGINES FOR MECHANIC PROPULSION



## Diesel/gas engines for mechanic propulsion

261 kW - 1342 kW  
(350 BHP - 1800 BHP)

	Engine model	Rated power ICFN			Application group	
		kW	bhp	rpm	1A	1B
Series 60	60	261	350	1800	■	
	60	280	375	1800	■	
	60	298	400	1800	■	
	60	317	425	1800	■	
	60	336	450	1800	■	
	60	354	475	1800	■	
	60	354	475	2100		■
	60	373	500	1800	■	
	60	399	535	2100		■
	60	447	600	2100		■
	60	466	625	2300		
	60	499	670	2300		
	60	552	740	2300		
	60	597	800	2300		
	60	615	825	2300		
Series 2000	8V 2000 M61	400	536	1800	■	
	12V 2000 M61	600	805	1800	■	
	8V 2000 M72	720	966	2250		■
	16V 2000 M61	800	1070	1800	■	
	8V 2000 M84	810	1085	2450		
	8V 2000 M84L	895	1200	2450		
	10V 2000 M72	900	1205	2250		■
	8V 2000 M94	932	1250	2450		
	10V 2000 M86	1015	1360	2450		
	12V 2000 M72	1080	1450	2250		■
	10V 2000 M96	1120	1500	2450		
	10V 2000 M96L	1193	1600	2450		
	12V 2000 M86	1268	1700	2450		
	12V 2000 M96	1342	1800	2450		

Application group		Fuel consump. at rated power		Optim.	Emissions Optimization		
1D	1DS	g/kWh	l/h	g/kWh	IMO	EPA	EU
		206	65	REQ.	II	T2c*	-
		205	69	REQ.	II	T2c*	-
		198	71	REQ.	II	T2c*	-
		197	75	REQ.	II	T2c*	-
		196	80	REQ.	II	T2c*	-
		196	84	REQ.	II	T2c*	-
		203	87	REQ.	II	T2c*	-
		196	88	REQ.	II	T2c*	-
		205	98	REQ.	II	T2c*	-
		210	113	REQ.	II	T2c*	-
	■	216	121	REQ.	II	T2c*	-
	■	211	127	REQ.	II	T2c*	-
	■	215	143	REQ.	II	T2c*	-
	■	218	157	REQ.	II	T2c*	-
	■	219	162	REQ.	II	T2c*	-
		205	99	199	II	T2c*	CCNR II
		213	153	200	II	T2c*	CCNR II
		212	184	195	II	T2c*	IIIA
		207	200	201	II	T2c*	CCNR II
	■	218	213	192	II	T2c*	CCNR II
	■	227	245	194	II	T2c*	-
		215	233	197	II	T2c*	IIIA
	■	226	254	195	II	T2c*	CCNR II
	■	219	268	192	II	T3r	RCD 2
		208	271	195	II	T2c*	IIIA
	■	220	297	192	II	T3r	RCD 2
	■	223	320	192	II	T3r	RCD 2
	■	214	326	196	II	T3r	RCD 2
	■	215	347	195	II	T3r	RCD 2

\* emission stage has been superseded, local exemptions may apply

## Diesel/gas engines for mechanic propulsion

746 KW - 2000 KW  
(1000 BHP - 2682 BHP)

Series 2000

Engine model	Rated power ICFN			Application group	
	kW	bhp	rpm	1A	1B
12V 2000 M96L	1432	1920	2450		
16V 2000 M72	1440	1930	2250		■
16V 2000 M86	1630	2186	2450		
16V 2000 M96	1790	2400	2450		
16V 2000 M96L	1939	2600	2450		

Series 396

8V 396 TE74L	1000	1341	1900		■
12V 396 TE74L	1500	2012	1900		■
16V 396 TE74L	2000	2682	1900		■

Series 4000

8V 4000 M53R	746	1000	1600	■	
8V 4000 M55RN <sup>G</sup>	746	1000	1600	■	
8V 4000 M54R	746	1000	1600	■	
8V 4000 M54	895	1199	1800	■	
8V 4000 M53	920	1234	1800	■	
8V 4000 M63	1000	1340	1800	■	
12V 4000 M53R	1140	1529	1600	■	
12V 4000 M54	1193	1600	1800	■	
12V 4000 M53	1380	1851	1800	■	
12V 4000 M64	1398	1875	1800	■	
12V 4000 M65R	1492	2001	1600	■	
16V 4000 M53R	1492	2000	1600	■	
16V 4000 M55RN <sup>G</sup>	1492	2001	1600	■	
12V 4000 M63	1500	2012	1800	■	
16V 4000 M53R	1520	2038	1600	■	
16V 4000 M54	1685	2260	1800	■	
16V 4000 M53	1840	2467	1800	■	
16V 4000 M65R	1840	2467	1800	■	
16V 4000 M63R <sup>#</sup>	1920	2575	1600	■	
12V 4000 M73	1920	2575	1970		■
16V 4000 M64	1999	2681	1800	■	
16V 4000 M63	2000	2682	1800	■	

# 1840 kW with 1600 rpm available on request; G = Gas engine

Mechanic propulsion

Application group		Fuel consump. at rated power		Optim.	Emissions Optimization		
1D	1DS	g/kWh	l/h	g/kWh	IMO	EPA	EU
	■	216	373	193	II	T3r	RCD 2
		206	357	195	II	T2c*	IIIA
■		217	426	193	II	T3r	RCD 2
	■	215	463	190	II	T3r	RCD 2
	■	216	505	190	II	T3r	RCD 2
		217	261	213	I*	-	-
		214	387	203	I*	-	-
		212	511	199	I*	-	-
		206	185	196	II	T2c*	IIIA
		REQ.	REQ.	REQ.	III	-	-
		206	185	196	II	T3c	-
		212	228	196	II	T3c	-
		208	231	192	II	T2c*	IIIA
		209	252	189	II	T2c*	IIIA
		201	276	200	II	T2c*	IIIA
		209	300	REQ.	II	T3c*	-
		201	334	196	II	T2c*	IIIA
		211	355	REQ.	II	T3c*	-
		REQ.	REQ.	REQ.	II/III**	T4c	-
		199	358	REQ.	II	T2c*	IIIA
		REQ.	REQ.	REQ.	III	-	-
		201	363	196	II	T2c*	IIIA
		199	364	198	II	T2c*	IIIA
		206	417	195	II	T3c*	-
		199	441	198	II	T2c*	IIIA
		REQ.	REQ.	REQ.	II/III**	T4c	-
		203	468	203	II	-	-
		212	490	210	II	T2c*	-
		202	485	194	II	T3c*	-
		199	480	192	II	T2c*	IIIA

\* emission stage has been superseded, local exemptions may apply

\*\* fuel consumption values for IMO III on request

## Diesel/gas engines for mechanic propulsion

2000 KW - 10000 KW  
(2682 BHP - 13410 BHP)

	Engine model	Rated power ICFN			Application group	
		kW	bhp	rpm	1A	1B
Series 4000	16V 4000 M65RN <sup>6</sup>	2000	2682	1800	■	
	12V 4000 M73L	2124	2848	2050		■
	12V 4000 M73L	2160	2895	2050		■
	16V 4000 M65	2240	3004	1800	■	
	16V 4000 M63L	2240	3004	1800	■	
	12V 4000 M93	2340	3140	2100		
	16V 4000 M73	2560	3435	1970		■
	16V 4000 M65L	2560	3433	1800	■	
	12V 4000 M93L	2580	3460	2100		
	16V 4000 M73L	2832	3798	2050		■
	16V 4000 M73L	2880	3860	2050		■
	16V 4000 M93	3120	4185	2100		
	20V 4000 M73	3200	4290	1970		■
	16V 4000 M93L	3440	4615	2100		
	20V 4000 M73L	3540	4747	2050		■
	20V 4000 M73L	3600	4830	2050		■
	20V 4000 M93	3900	5230	2100		
20V 4000 M93L	4300	5766	2100			
Series 1163	16V 1163 M74	4800	6437	1250		■
	16V 1163 M84	5200	6975	1280		
	16V 1163 M94	5920	7940	1325		
	20V 1163 M74	6000	8045	1250		■
	20V 1163 M84	6500	8715	1280		
	20V 1163 M94	7400	9925	1325		
Series 8000	16V 8000 M71L	7280	9762	1150		■
	16V 8000 M91L	8000	10728	1150		
	20V 8000 M71	8200	10995	1150		
	20V 8000 M71L	9100	12205	1150		■
	20V 8000 M91L	10000	13410	1150		

\* emission stage has been superseded, local exemptions may apply

\*\* fuel consumption values for IMO III on request

	Application group		Fuel consump. at rated power		Optim.	Emissions Optimization		
	1D	1DS	g/kWh	l/h	g/kWh	IMO	EPA	EU
			REQ.	REQ.	REQ.	III	-	-
			REQ.	REQ.	REQ.	III**	-	-
			213	554	210	II	T2c*	-
			REQ.	REQ.	REQ.	II/III**	T4c	-
	■		195	526	194	II	T2c*	IIIA
		■	216	609	205	II/III**	T2c*	-
			218	672	205	II/III**	T2c*	-
			REQ.	REQ.	REQ.	II/III**	T4c	-
	■		217	675	205	II/III**	T2c*	-
			REQ.	REQ.	REQ.	II/III**	-	-
			220	763	205	II	T2c*	-
	■		224	842	205	II/III**	T2c*	-
			213	821	210	II	T2c*	-
	■		230	953	205	II	T2c*	-
			REQ.	REQ.	REQ.	II/III**	-	-
			212	920	210	II	T2c*	-
	■		212	996	205	II/III**	T2c*	-
	■		220	1140	210	II	T2c*	-
			210	1214	202	II	-	-
	■		207	1297	200	II	-	-
		■	212	1512	201	II	-	-
			208	1504	195	II	-	-
	■		208	1629	195	II	-	-
		■	210	1872	195	II	-	-
			196	1719	188	II	T2c*	-
	■		198	1908	-	II	-	-
		■	190	1877	184	II	T2c*	-
			196	2149	185	II	T2c*	-
	■		199	2398	192	II	-	-



## ENGINES AND GENSETS FOR ON-BOARD POWER GENERATION AND ELECTRIC PROPULSION





Engines and gensets for on-board power generation and electric propulsion – 50 Hz @ 1500 rpm

271 KW - 2600 KW  
(363 BHP - 3487 BHP)

	Engine model	Rated power ICXN		Genset model	Rated power	
		kW	bhp		kWe	kVA
Series 60	60	271	363	–		
	60	322	432	–		
Series 2000	8V 2000 M51A	332	445	MG08V2000M51A	310	388
	8V 2000 M41A	385	516	MG08V2000M41A	360	450
	12V 2000 M51A	498	668	MG12V2000M51A	465	581
	12V 2000 M41A	575	771	MG12V2000M41A	540	675
	16V 2000 M51A	664	890	MG16V2000M51A	630	788
	16V 2000 M41A	770	1033	MG16V2000M41A	690	863
Series 396	8V 396 TE54	680	912	■		
	12V 396 TE54	1030	1382	■		
Series 4000	8V 4000 M23F	760	1019	MG08V4000M23F	720	900
	8V 4000 M33F	880	1181	MG08V4000M33F	830	1037
	12V 4000 M23F	1140	1529	MG12V4000M23F	1080	1350
	12V 4000 M33F	1320	1770	MG12V4000M33F	1260	1575
	12V 4000 P63	1350	1810	■		
	12V 4000 M25F	1380	1851	REQ.	REQ.	REQ.
	16V 4000 M23F	1520	2038	MG16V4000M23F	1460	1825
	12V 4000 P63	1560	2092	■		
	12V 4000 M35F	1560	2092	REQ.	REQ.	REQ.
	16V 4000 M33F	1760	2360	MG16V4000M33F	1690	2112
	16V 4000 P63	1800	2414	■		
	16V 4000 P63	2080	2789	■		
20V 4000 P63	2245	3011	■			
20V 4000 P63	2600	3487	■			

\* emission stage has been superseded, local exemptions may apply

\*\* fuel consumption values for IMO III on request

■ on request

Application group	Fuel consump. at 75%				Emissions Optimization	
	at 75%		at 100%		IMO	EPA
3A	3B	g/kWh	l/h	g/kWh	l/h	
■		199	54	200	72	I* –
	■	197	63	195	83	I* –
■		213	64	205	82	II –
	■	210	73	203	94	II –
■		208	93	203	122	II –
	■	205	106	201	139	II –
		208	124	206	165	II –
	■	204	141	199	184	II –
■		207	127	205	167	II –
■		205	191	202	251	II –
■		216	148	207	189	II –
	■	211	167	205	217	II –
■		211	217	200	274	II –
	■	205	244	197	312	II –
■		204	248	204	331	II –
■		REQ.	REQ.	REQ.	REQ.	II/III** –
■		210	287	201	367	II –
	■	202	284	202	378	II –
	■	REQ.	REQ.	REQ.	REQ.	II/III** –
	■	205	325	199	420	II –
■		201	326	198	428	II –
	■	199	373	197	492	II –
■		210	425	207	558	II –
	■	206	482	211	659	II –

Engines and gensets for on-board power generation and electric propulsion – 60 Hz @ 1800 rpm

271 KW - 1999 KW  
(363 BHP - 2681 BHP)

	Engine model		Rated power ICXN		Genset model	Rated power	
	kW	bhp	kWe	kVA			
Series 60	60	271	363	–			
	60	322	432	–			
	60	322	432	–			
	60	370	496	–			
Series 2000	8V 2000 M51B	400	536	MG08V2000M51B	370	463	
	8V 2000 M41B	465	624	MG08V2000M41B	430	538	
	12V 2000 M51B	600	805	MG12V2000M51B	560	700	
	12V 2000 M41B	695	932	MG12V2000M41B	655	819	
	16V 2000 M51B	800	1073	MG16V2000M51B	750	938	
	16V 2000 M41B	930	1247	MG16V2000M41B	810	1013	
Series 396	8V 396 TE54	790	1059	■			
	12V 396 TE54	1200	1609	■			
Series 4000	8V 4000 M24S	895	1200	MG08V4000M24S	850	1062	
	8V 4000 M23S	920	1234	MG08V4000M23S	870	1090	
	8V 4000 M33S	1040	1395	MG08V4000M33S	990	1237	
	12V 4000 M24S	1193	1600	MG12V4000M24S	1140	1425	
	12V 4000 M23S	1380	1851	MG12V4000M23S	1310	1638	
	12V 4000 M34S	1398	1875	MG12V4000M34S	1340	1675	
	12V 4000 P83	1455	1951	■	1460	1825	
	12V 4000 M33S	1560	2092	MG12V4000M33S	1480	1850	
	12V 4000 M53B	1650	2213	■	REQ.	REQ.	
	12V 4000 P83	1680	2253	■	1690	2112	
	16V 4000 M24S	1685	2260	MG16V4000M24S	1620	2025	
	16V 4000 M23S	1840	2467	MG16V4000M23S	1750	2188	
	16V 4000 P83	1940	2602	■			
	16V 4000 M34S	1999	2681	MG16V4000M34S	1920	2400	

\* emission stage has been superseded, local exemptions may apply  
■ on request

Application group	Fuel consump.				Emissions Optimization	
	at 75%		at 100%		IMO	EPA
3A	3B	g/kWh	l/h	g/kWh	l/h	
■		200	49	197	64	II T2c*
■		200	58	197	76	II T2c*
	■	196	57	197	76	II T2c*
	■	196	65	200	89	II T2c*
■		212	77	207	100	II -
	■	210	88	208	116	II -
■		210	113	206	148	II -
	■	207	130	205	171	II -
■		207	149	202	194	II -
	■	204	171	201	224	II -
■		219	156	217	206	II -
■		216	233	215	310	II -
■		219	176	215	231	II T3c
■		221	183	211	233	II T2c*
	■	218	204	210	262	II T2c*
■		221	237	208	298	II T3c*
■		215	267	205	340	II T2c*
	■	223	499	210	352	II T3c*
■		211	276	203	355	II TINRMM*
	■	210	295	206	386	II T2c*
■		215	319	211	418	II -
■		207	313	207	418	II TINRMM*
■		REQ.	REQ.	REQ.	REQ.	II T3c*
■		214	355	207	457	II T2c*
	■	211	369	205	477	II TINRMM*
	■	228	410	202	484	II T3c*

Engines and gensets for on-board power generation and electric propulsion – 60 Hz @ 1800 rpm

## 2080 KW - 3015 KW (2789 BHP - 4043 BHP)

Series 4000

Engine model	Rated power ICXN		Genset model	Rated power	
	kW	bhp		kWe	kVA
16V 4000 M33S	2080	2789	MG16V4000M33S	1990	2488
16V 4000 M53B	2200	2950	■		
16V 4000 M25S	2240	3004	REQ.	REQ.	REQ.
16V 4000 M43S	2240	3004	MG16V4000M43S	2150	2688
16V 4000 P83	2240	3004	■		
20V 4000 P83	2425	3252	■		
16V 4000 M35S	2576	3454	REQ.	REQ.	REQ.
20V 4000 P83	2800	3755	■		
20V 4000 M53B	3015	4043	■		

\* emission stage has been superseded, local exemptions may apply

\*\* fuel consumption values for IMO III on request

■ on request

Application group	Fuel consump.				Emissions Optimization	
	at 75%		at 100%		IMO	EPA
3A	3B	g/kWh	l/h	g/kWh	l/h	
■		209	393	203	509	II T2c*
	■	208	414	208	551	II -
■		REQ.	REQ.	REQ.	REQ.	II/III** T4c
	■	208	421	203	548	II T2c*
	■	205	413	204	549	II TINRMM*
■		211	461	209	608	II TINRMM*
	■	REQ.	REQ.	REQ.	REQ.	II/III** T4c
	■	209	527	215	723	II -
	■	214	583	204	741	II -

## ENGINES AND GENSETS FOR OFFSHORE POWER GENERATION



Engines and gensets for offshore power generation –  
50 Hz @ 1500 rpm

498 kW - 2600 kW  
(668 BHP - 3487 BHP)

	Engine model	Rated power ICXN		Genset	Rated power	
		kW	bhp		kWe	kVA
Series 2000	12V 2000 P62	498	668	■		
	12V 2000 P62	575	771	■		
	16V 2000 P62	664	890	■		
	16V 2000 P62	770	1033	■		
Series 4000	12V 4000 P63	1350	1810	PP12V4000P63	1295	1620
	12V 4000 P63	1560	2092	PP12V4000P63	1500	1875
	16V 4000 P63	1800	2414	PP16V4000P63	1730	2160
	16V 4000 P63	2080	2789	PP16V4000P63	2000	2500
	20V 4000 P63	2245	3011	PP20V4000P63	2155	2695
	20V 4000 P63	2600	3487	PP20V4000P63	2500	3120

\* emission stage has been superseded, local exemptions may apply  
■ on request

Application group	Fuel consump.				Emissions Optimization		
	at 75%		at 100%		IMO	EPA	
	g/kWh	l/h	g/kWh	l/h			
3A	■	209	167	207	124	I*	-
3B	■	208	108	205	142	I*	-
3C	■	199	119	197	157	I*	-
	■	199	138	197	182	I*	-
	■	204	248	204	331	II	-
	■	202	284	202	378	II	-
	■	201	326	198	428	II	-
	■	199	373	197	492	II	-
	■	210	425	207	558	II	-
	■	206	482	211	659	II	-

Engines and gensets for offshore power generation –  
60 Hz @ 1800 rpm

## 600 kW - 2800 kW (805 BHP - 3755 BHP)

	Engine model	Rated power ICXN		Genset	Rated power	
		kW	bhp		kWe	kVA
Series 2000	12V 2000 P82	600	805	■		
	12V 2000 P82	695	932	■		
	16V 2000 P82	800	1073	■		
	16V 2000 P82	930	1247	■		
	16V 2000 P82L	980	1314	■		
Series 4000	12V 4000 P83	1455	1951	PP12V4000P83	1395	1745
	12V 4000 P83	1680	2253	PP12V4000P83	1615	2015
	16V 4000 P83	1940	2602	PP16V4000P83	1860	2330
	16V 4000 P83	2240	3004	PP16V4000P83	2150	2690
	20V 4000 P83	2425	3252	PP20V4000P83	2330	2910
	20V 4000 P83	2800	3755	PP20V4000P83	2690	3360

\* emission stage has been superseded, local exemptions may apply  
 ■ on request

Application group	Fuel consump.				Emissions Optimization			
	at 75%		at 100%		IMO	EPA		
3A	3B	3C	g/kWh	l/h	g/kWh	l/h		
■			217	117	214	154	II	T2NRMM*
	■	■	216	135	214	179	II	T2NRMM*
■			215	155	214	206	II	T2NRMM*
	■	■	210	176	223	249	II	T2NRMM*
	■	■	211	186	224	264	II	T2NRMM*
■			211	276	203	355	II	T2NRMM*
	■	■	207	313	207	418	II	T2NRMM*
■			211	369	205	477	II	T2NRMM*
	■	■	205	413	204	549	II	T2NRMM*
■			211	461	209	608	II	T2NRMM*
	■	■	209	527	215	723	II	T2NRMM*

# SYSTEMS SOLUTIONS



## Systems solutions

## SYSTEM EXPERTISE

We are one of the world's leading manufacturers of propulsion and power generation systems for marine applications: MTU products are used on all the world's oceans and in all marine areas.

For us, being a systems supplier means taking complete care of our customer's needs at any point of the life cycle. Our key technologies in diesel engine development and manufacturing comprising:

- Turbo charging units
- Fuel injection systems
- Engine management systems
- Automation systems

The key technologies are completed by validated and proven accessories like:

- Fuel treatment and filtration units
- Resilient engine mounts
- Resilient- and offset compensating couplings
- Gearboxes
- Exhaust silencers

### Noise reduction technology

Double resilient mounting systems and active mounting systems are available for applications with the highest acoustic demands, such as comfort yachts or research vessels.

### Emissions reduction technology

In addition to low emission diesel engines, we offer exhaust after treatment systems to meet the most stringent emissions requirements.

- Diesel particulate filters (DPF) with active regeneration:
  - Active filter regeneration via burner
  - Enabled for low load operation
  - Optimum in system reliability
  - PM-reduction up to 99%
  - Class certified: LR, GL
  - Typical usage: yachts or commercial vessels with significant low load operation
- Diesel particulate filters (DPF) with passive regeneration:
  - Passive filter regeneration via DOC
  - Uncoated sinter metal filter
  - Compact and weight optimized design
  - PM-reduction higher than 95%
  - Typical usage: commercial vessels with mainly high load operation like RoRo ferries
- Selective catalytic reduction (SCR) units:
  - Reduction of NOx emissions of diesel engines
  - Enables customers to achieve IMO Tier III emission levels with current Tier II engines.
- Combined DPF+SCR
 

The installation space required for conventional silencers can be reduced if the exhaust noise attenuation capabilities of the filter units and catalytic converters are taken into account.

### Gas-protected operation

In order to maintain a high level of safety in dangerous, explosive environments, some engines of the 4000 and 8000 Series can be equipped for gas protection around flammable or explosive gases. Engines are equipped with a safety package that meets with the related operational conditions.

For further information, please contact your distributor or visit [www.mtu-online.com/contact](http://www.mtu-online.com/contact)



## Systems solutions

## SCR SOLUTION

**SCR solution**

As installation space is always restricted inside the engine room, the inhouse developed airless SCR (Selective Catalytic Reduction) solution from MTU is compact and maintenance friendly. Besides easily accessible doors for replacement of the SCR catalysts, the system also features an integrated mixing pipe and dosing units. The integrated mixing pipe and DEF (Diesel Exhaust Fluid) dosing allows the shipyard highly flexible pipework between the engine and the SCR box. Additional space to fit the exhaust gas aftertreatment is reduced to a bare minimum. Ammonia slip is prevented under all operating conditions by a closed loop regulated control system. To lower life-cycle-costs, switching off the urea dosing while operating outside the emission controlled areas is possible (IMO II mode). Besides the exhaust emissions related features, our SCR system also reduces noise.

**SCR - the ideal solution for the marine world**

When using EGR (Exhaust Gas Recirculation) technology, the quality of the fuel is essential. Fuel with more than 15 ppm sulfur will lead to the formation of sulfur acid in the EGR cooling process. Sulfur acid will cause substantial engine failures over time. As many vessels operate worldwide, especially in the offshore service and supply business, we evaluate SCR as the preferred solution to maintain reliability of our engines and the safety of your vessel and crew. SCR technology allows operation with lower fuel quality. Developing all major key technologies inhouse like, SCR, EGR, turbocharging and common rail fuel injection, means we are able to shape the ideal solution to meet IMO III and EPA Tier 4 emissions regulations. At MTU we treat EGR as the ideal solution for applications like mining or oil&gas onshore, but within the marine world we are convinced that SCR technology grants much higher availability and component lifetime.

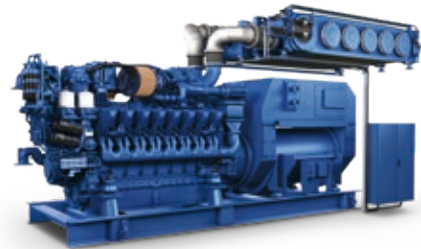
**SCR cubical-box for high-power application****Generator set with SCR box**

Systems solutions marine

## COMBINED PROPULSION SYSTEMS

Our engineering expertise and operating experience covers a large range of combined propulsion systems, such as:

- Combined Diesel and Diesel (CODAD)
- Combined Diesel and/or Gas Turbine (CODAG, CODOG)
- Combined Diesel-Electric and Gas Turbine (CODELAG)
- E-Drive Systems - Combined Diesel and/or Electric or Hybrid

The intelligent combination of diesel engines, electric motors, gas turbines and batteries allows optimal adaptation of the propulsion system to the various operational requirements.

In order to reduce emissions and operating costs, combined systems e.g. diesel-electric propulsion systems are the preferred solution: The mechanical energy produced by the diesel engine is converted into electricity using a generator and then transmitted to the electric motors driving the ship's propellers.

By adding battery modules for energy storage we can also provide cutting edge hybrid propulsion systems.

On request, we will serve as the general contractor, taking complete technical and commercial responsibility for the entire propulsion and power generation system as well as the automation system. From project engineering and project management to support and service, we are your single source partner for complete solutions.

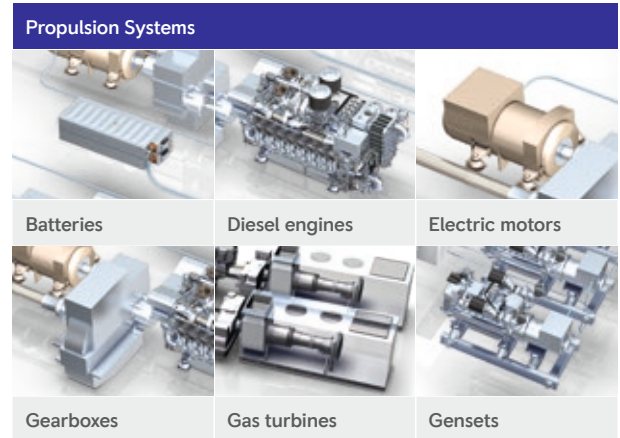

### Application example of complete propulsion system

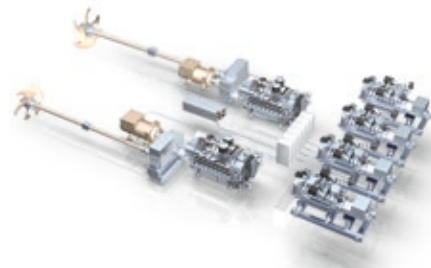

All systems can drive various kinds of propulsors, e.g. FPP, CPP, WJ, Voith Schneider, also in combination with CODAD, CODOG, CODAG, CODELAG or E-Drive propulsion systems.

Systems solutions marine

## MARINE GENSETS

Our gensets are based on Series 2000 and 4000 engines. Whether you are looking for onboard power, diesel-electric or hybrid propulsion, our gensets meet the full spectrum of requirements.



**Standardized commercial generator set shown with Series 4000**



**Our premium generator set. Here exemplarily shown with Series 4000**

Our gensets are available as a constant speed version in 50 or 60 Hz or as a variable speed configuration with added electronics. Our gensets are tailored to the specific needs of each application. Whether you are looking for a standardized cost-effective commercial genset or high-end yacht gensets.

We also provide emergency gensets for critical situations at sea, when absolute reliability is essential. In addition to gensets for main propulsion and onboard power, we also supply lower-power gensets which can be installed as separate power units in the engine room.

MTU's genset portfolio covers power outputs from 5 to 3,480 kW.

**Your benefits are:**

- Gensets based on proven Series 2000 and 4000 engines – of which over 90,000 have been sold worldwide
- Outstanding acoustic optimization for best-in-class comfort (noise and vibration levels can be contractually guaranteed, with all values proven on our test benches to minimize risk)
- Featuring special plug-and-play technology such as media plate and integrated piping for very easy installation
- All our gensets are classifiable according to e.g. DNV-GL, LRS
- Gensets with high quality finishing and painting dedicated for the yacht market

## Automation systems

INTEGRATED SHIP  
AUTOMATION SYSTEM  
MTU CALLOSUM

The integrated ship automation system Callosum provides optimal solutions for all types and sizes of ships to comply various requirements.

**Callosum\_MC – Monitoring and control system**

Callosum\_MC monitors and controls the entire drive system, onboard power supply, general areas

- Visualization and Equipment:
  - FPP/PPP/WJ/VS/POD/SDS/combined systems
  - Joystick control system
  - Dynamic positioning system
  - Integrated bridge system
  - Fire detection system
  - Duty alarm system
  - Machinery telegraph
  - CCTV system
  - Electrical power management system
  - Crew location system
  - Uninterruptible power supply
  - Consoles
  - Switchboards
  - Sensors
- Interfaces:
  - NET-DDE
  - OPC
  - NMEA0183
  - CANopen
  - Modbus

**Callosum\_DC – Damage control system**

Callosum\_DC ensures the precise localization of any type of damage caused by fire, flood, collision, grounding.



- Visualization:
  - 3-click technology
  - Static an/or dynamic automated kill cards
  - 3D isometric deck views
  - Plot function
  - Tailor made engineering
  - Situation management
  - Command state board
  - etc.

**Callosum\_MT – Maintenance support system**

Callosum\_MT provides support for the maintenance and upkeep onboard – 24 hours a day, 7 days a week.



- Visualization:
  - Online documentation
  - Trending
  - 3D video
  - Check list
  - Fault tree analysis
  - etc.

**Callosum\_TS – Onboard and land-based training system**

Callosum\_TS allows training and further education of the crew during ship operation.



- Visualization:
  - Onboard training
  - Land-based training

## Automation systems

STANDARDIZED PROPULSION  
AUTOMATION SYSTEMS  
BLUEVISION|NEWGENERATION

For many years, our sophisticated standard automation systems controlled, regulated and monitored the engine functions – always doing a perfect job!

BlueVision|NewGeneration automation solutions more convenient than ever before: easy to customize, easy to integrate, easy to operate.

BlueVision|NewGeneration is available both in the straightforward non-classifiable version BlueVision\_Basic|NewGeneration and in the expanded classifiable version BlueVision\_Advanced|NewGeneration – meeting different requirements according to boat design and customer budgets. The modular system design allows a flexible configuration; intelligent data bus technology ensures reliable data exchange and reduces cable efforts. Optimized interfaces between the propulsion and automation systems result in ideal total solutions that guarantee you security, efficiency and reliability.

With BlueVision|NewGeneration we offer you a complete and convenient system solution individually optimized for your ship, as well as comprehensive service – all from one source.

Thanks to “plug & play”, the system is as easily installed as it is operated.

Simple interfaces connect the Monitoring & Control System BlueVision|NewGeneration with the MTU diesel engine (via EIM) and the gearbox.

All components are type-approved und type-examination tested in shake / vibration / stress tests.

**Customer benefits**

BlueVision\_Basic|NewGeneration and BlueVision\_Advanced|NewGeneration are automation systems for propulsion plants in yachts and workboats with MTU Series 2000 or 4000 engines.

**BlueVision|NewGeneration offers the following benefits:**

- High operational availability and reliability of the propulsion plant
- High flexibility thanks to modular system structure and open architecture
- Simple, classifiable system in line with current directives
- Quicker and easier commissioning via structured user dialogue
- Type-tested components
- Development in accordance with current standards
- Optimized operation and visualization of the propulsion plant
- Uniform spare part concept across all MTU Series
- Global sales and service network
- Self-learning “Improved Crash-Stop” in order to stop the ship as quickly as possible

Automation systems

# STANDARDIZED PROPULSION AUTOMATION SYSTEMS BLUEVISION|NEWGENERATION

BlueVision\_Basic|NewGeneration

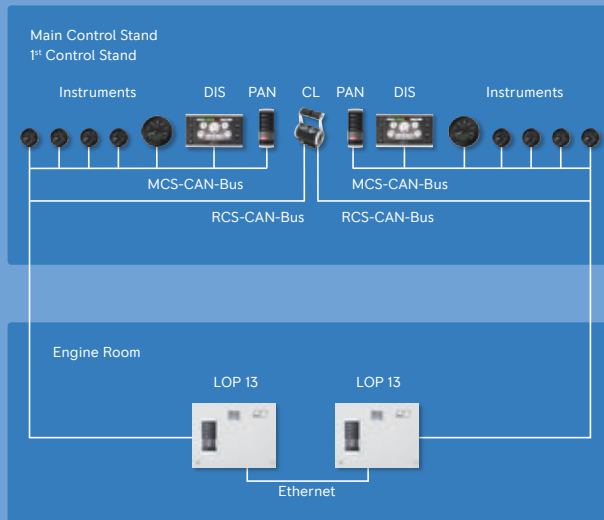

BlueVision\_Advanced|NewGeneration

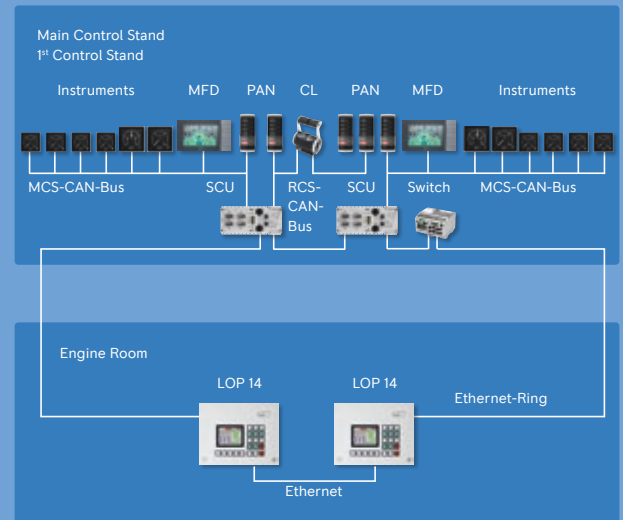

## Automation systems

STANDARDIZED PROPULSION  
AUTOMATION SYSTEMS  
SMARTLINE – BLUELINE –  
BLUEVISION

Perfectly balanced, standardized control and monitoring systems developed and manufactured inhouse, ensure that our proven marine propulsion technology functions exactly as you would expect it to. The integration of these cutting-edge automation systems provides optimum complete solutions which guarantee safety, efficiency and reliability. Without exception, we can always supply a complete system individually tailored to suit your vessel and backed up by a comprehensive service package – all from a single source.

## bluevision Series 2000/4000



TFT color monitor

Propulsion control levers

## System for

- Non-classified and classified applications
- FPP, CPP, WJ and VSP propulsion plants
- One to four engine propulsion plants

## Options

- Extended to 6 control stands
- Printer
- Hand-held control unit

## blueline Series 2000/4000

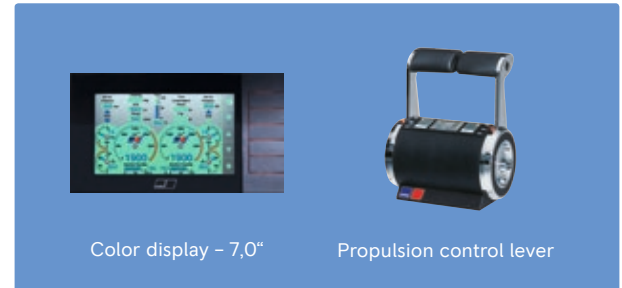

Color display – 7,0"

Propulsion control lever

## System for

- Non-classified applications
- FPP and SDS propulsion plants
- CPP and WJ by interface
- One to four engine propulsion plants

## Options

- Extended to 4 control stands
- Palm Beach control lever
- Hand-held control unit

## smartline Series 2000/4000



Color display – 6,5"

Propulsion control lever

## System for

- Non-classified applications
- Twin FPP engine installations
- CPP and WJ by interface

## Options

- Extended to 6 control stands
- Palm Beach control lever
- Hand-held control unit

## Automation systems

STANDARDIZED AND SYSTEM  
SOLUTIONS GENOLINE

genoline is an MTU non-classified and classified automation system for on-board power generation plants. The modular system design guarantees optimum adaptation of the diesel engine and generator to the diversity of operating conditions for the on board power generation. It is available for MTU Series 2000 and 4000 engines.

## genoline offers the following applications

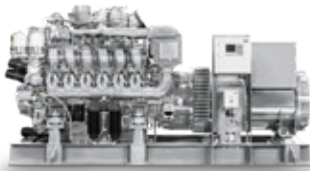

**On-board  
service power**  
non-classified  
and classified

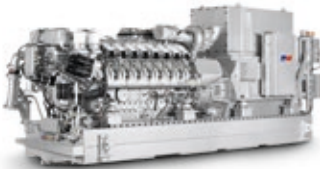

**Diesel-electric  
propulsion plant**  
non-classified  
and classified



**Special  
applications**  
- MIL  
- Shock  
- EMC etc.

genoline automation system is an innovative high-end developed system available in two installation versions, with LOP (Local Operating Panel) or as version with switchboard interface.

## Customer interfaces

Interfaces	I/O signals	Power supply	Power supply
RS422 option J1939 CANopen	(hardwired) for monitoring and control	main and emergency (redundant) 24 VDC	230 - 440 VAC (50/60 Hz)

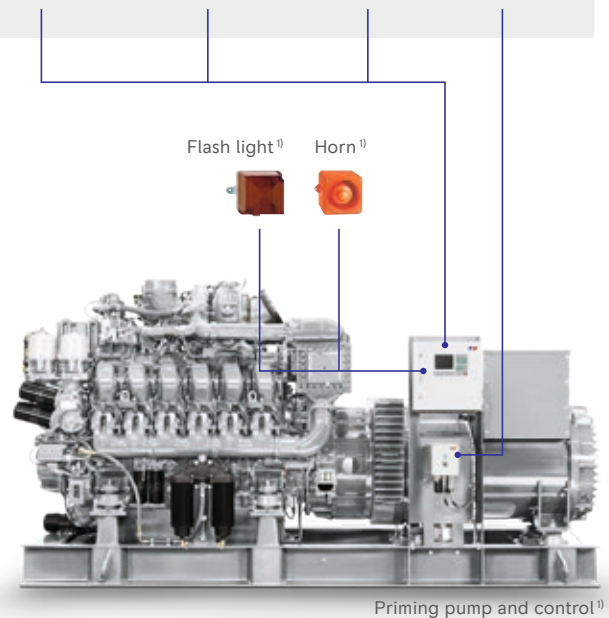

Priming pump and control<sup>1)</sup>

1) Optional features



Systems solutions offshore exploration & production

## OFFSHORE GENERATOR SETS

We offer complete solutions from a single supplier. All components are integrated, thoroughly tested and supported. Everything is designed to work together, which prolongs preventive maintenance and overhaul intervals. Decades of experience as an offshore specialist gives us the expertise and flexibility you need to keep your drilling operation productive and profitable.

### Our offshore product range includes diesel engines and systems for:

- Generator sets for emergency, essential, auxiliary and main power
- Fire pump drivers for mechanical/hydraulic/ electric installations
- Mud pump drivers
- Wellserve power packs
- Nitrogen units
- Cranes
- Cement pumps
- Hydraulic power packs

We also offer customized offshore documentation according to project specific requirements.

### Our systems solutions for offshore exploration & production applications

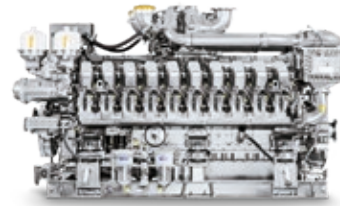

Engine plus system

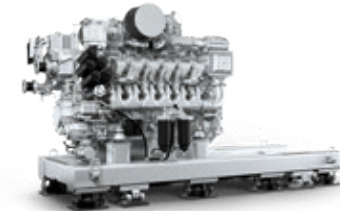

Modularized generator drive



Standardized generator set

Explosive problem. Integral solution.

## ATEX ZONE 2 3G IIB T3 CERTIFIED P-ENGINES

### Critical safety factors

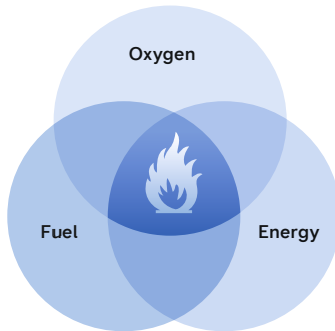

### Modifications of P-engines for ATEX zone 2

The combination of three factors makes an explosion possible:

- Oxygen
- Fuel/flammable substance (gas, vapors, mist, or dust)
- Energy/ignition source (devices, electrical plants, hot surfaces)

The exclusion of one of these three factors means the elimination of the risk. In order to guarantee safety in potentially explosive environments, a modification of factor 3 – the engine – is the most efficient solution both technically and economically. MTU engines are designed to minimize or even prevent the risk of high surface temperatures and spark generation.

On request MTU P-engines fulfill the requirements of ATEX zone 2 3G IIB T3 according to directive 94/9/EC. This means that they deliver an extremely high standard of safety in conjunction with superior cost efficiency.



Example of ATEX  
certificate for  
**16V 4000**  
**P63 & P83**  
ENGINES

### P-engines: certified safety according to ATEX zone 2 3G IIB T3 requirements

MTU P-engines need to fulfill the requirements for ATEX Zone 2 3G IIB T3 according to directive 94/9/EC.

- Zone 2:  
An area in which an explosive mixture of gas is not likely to occur in normal operation and if it occurs it will exist only for a short time
- Category 3G:  
Gas (Zone 2)
- Explosion group IIB:  
Explosive mixture of ethylene gas and air
- T3:  
Surface temperature < 200°C  
equivalent to class 1 division 2 (North America)

Safety is good. Redundancy is better.

## REDUNDANT CONTROLLER FOR FIRE PUMP DRIVE SYSTEMS (NFPA 20)

The NFPA-20 standard requires redundant engine controllers on fire-pump drive systems in order to prevent interruptions in the fire-pump water jet during an emergency. We are the first manufacturer in the world to offer redundant controllers for engines with common rail injection.

In accordance with this standard, the second controller must be installed on the engine and permanently wired. In the event of a fault on the first controller, it must take over the engine control automatically without interrupting the water jet. This measure increases the availability of your fire pumps and consequently the entire system.

The redundant controllers developed by us can be used in direct, hydraulic, and diesel-electric drive systems. To redundantly record all engine data required for controlling, a second sensor set is installed on the engine. The ECU7 engine control unit is used as a main and backup controller. Because the injectors and high-pressure fuel control block are not installed redundantly, triggering of these actuators must be switchable between the two controllers: and so the new SBX1 switch box forms the heart of this system.

### Switching

The MTU engine controller offers the option of manual switching, whereby the controller active at any given moment is displayed optically (via LED). The switching process is designed to guarantee the greatest possible redundancy of the system. Optimal use is made of the ECU7 plugs for logic switching and for supplying the new unit. This results in extremely simple wiring. If switching is necessary, drops in speed and excessively high rail pressure must be prevented. Our system guarantees that these demands are met for all types of applications (direct, diesel-electric, or diesel-hydraulic pump drive), all engine cylinder variants (12V, 16V, or 20V), and for every engine base speed (1,500 rpm for 4000 P63 or 1,800 rpm for 4000 P83).

### Benefits:

- Achieving the NFPA20 norm for Series 4000 P-engines
- Specifically designed for common rail injection
- Increased availability thanks to redundancy
- Simple retrofitting due to plug-and-play
- All components are developed to work together seamlessly
- All from one trusted source and in the quality you expect from us

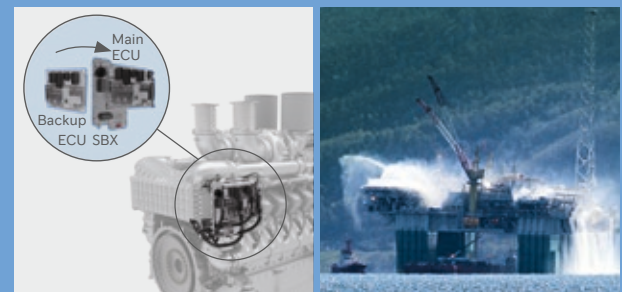
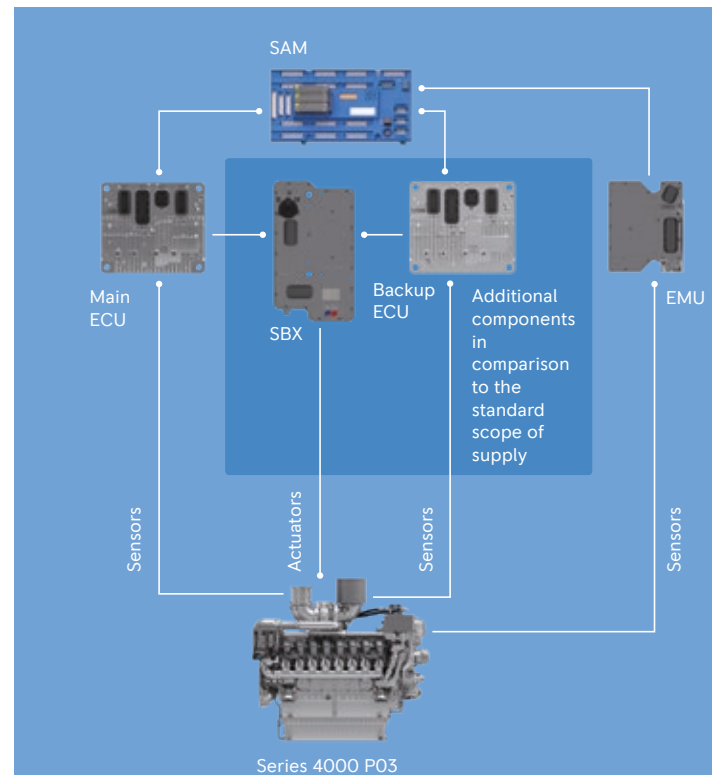

Complete lifecycle solutions.

## ENSURE A LONG, RELIABLE LIFE.

As your equipment ages, its needs—and yours—change. Our full portfolio of service solutions wrap around your investment, providing 360 degrees of customized support, for optimal value at every stage of life.

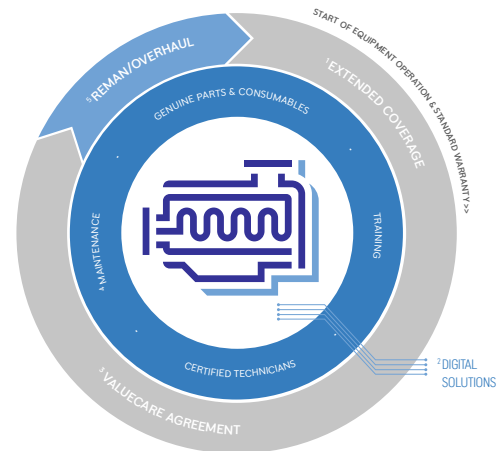

- 1 Avoid the unexpected with added protection beyond the standard warranty.
- 2 Make better decisions faster with digitally-enhanced tools.
- 3 Maximize availability and optimize lifecycle costs with a ValueCare Agreement.
- 4 Improve system performance and extend equipment life with on-demand support.
- 5 Keep a good thing going with factory reman/overhaul solutions.

Complete lifecycle solutions.

## RELY ON OUR EXPERTISE.

To give your equipment a long and productive life, choose a partner you can trust. Only factory-certified technicians know how to get the job done right using proven service methods, factory-specified maintenance schedules and genuine OEM parts.

From preventive maintenance to complete overhaul, we are your true lifecycle partner. Whatever level of support you need, our global network of factory-trained professionals knows all about your equipment and is ready to help you maximize performance and minimize lifecycle costs.

### Never compromise

MTU engines and systems are built to last with legendary high standards. When it's time for service, don't settle for anything less. Protect the life of your equipment with professional certified service technicians and genuine OEM parts and consumables—the only options that live up to our standards for craftsmanship, quality and performance. To get the most from your equipment, there are no shortcuts. For maximum reliability, performance and uptime, choose a name you can trust.

### If you need us a little:

On-Demand Support—including professional inspections and preventive maintenance recommendations from us—helps you identify and address problems early, save on repairs or unexpected downtime, and optimize your equipment's performance and longevity. Inspections include visual assessment, test run and leak check, on-site oil and coolant analysis, diagnostic evaluation and reporting.

### If you need us a lot:

ValueCare Agreements make it easy to keep your business running smoothly and reduce total cost of ownership by maximizing uptime, optimizing lifecycle costs and helping you avoid equipment-related business disruptions through preventive maintenance.



## MTU ValueCare

## PLAN AHEAD

The annual cost of maintenance can vary dramatically depending on how and where your equipment is used. When optimal equipment availability and performance are essential, and predictable costs are preferred, Long-term Service Agreements can help.

**Preventive**

All preventive maintenance services up to 10 years according to your approved maintenance schedule, performed by MTU-certified technicians at your local MTU-authorized distributor.

**All Inclusive**

All preventive maintenance services up to 10 years according to your approved maintenance schedule, performed by MTU-certified technicians at your local MTU-authorized distributor, including all necessary corrective services.

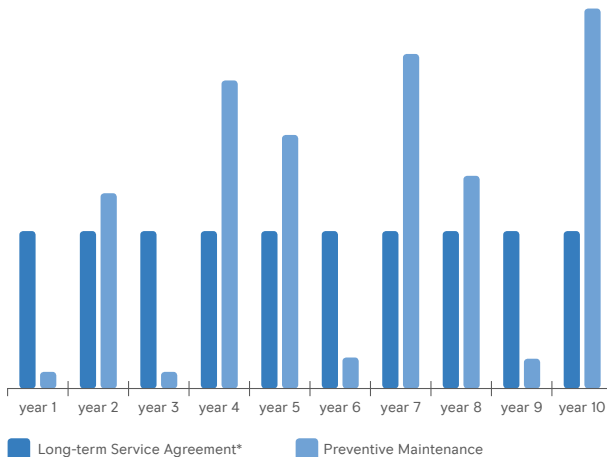
**Example: Scheduled Maintenance Costs**

## MTU ValueCare

## PROTECT YOUR INVESTMENT

MTU engines—backed by Extended Coverage—provide invaluable peace of mind beyond the standard warranty. With Extended Coverage, you can be assured that the costs of unexpected repairs are covered, with service performed by MTU-certified technicians—upholding resale value and ensuring long-term confidence in your investment.

Extended Coverage protects you from the cost of unexpected repairs beyond your standard warranty, with professional service from MTU-certified technicians and coverage tailored to your needs. Packages can also be extended up to 5 years and are fully transferrable, enhancing resale value. Coverage includes material and labor for troubleshooting, fault clearance and corrective services to engines and on-engine electronics (excluding gearbox, alternators, or similar components). To ensure maximum quality, all repairs are conducted using only genuine MTU parts.

Extended Propulsion Coverage—an exclusive offering for pleasure craft—protects against the cost of unexpected repairs to your complete propulsion system beyond the standard warranty. The package is fully transferable, which enhances resale value. And with expert service performed worldwide by MTU-authorized service centers, you gain invaluable peace of mind.

## MTU ValueCare

## MAKE BETTER DECISIONS—FASTER

Digitization is more than a buzzword—good data fuels smarter decisions. Data-Enhanced Solutions from us harness that power, giving you vital information and helpful tools to simplify and streamline MTU equipment ownership, operation and maintenance.

**Monitor activity from afar.**

Identify faults early and make informed decisions quickly—even thousands of miles from the work site—by accessing vital engine and system information online with Remote Services.

**Be proactive.**

Remote Services can improve your engine's performance, and your profitability, by helping you avoid downtime. Using a telemetric device, important data such as oil temperature, current location and hours of duty is recorded and transmitted in near real-time or at predetermined intervals. Through early fault identification, you can act decisively to increase engine efficiency, prevent damage, reduce downtime, identify necessary replacement parts and save on service and repairs. All you need is a computer with an Internet connection.

**Be secure.**

Your data is handled with the strictest confidentiality. We provide a secure infrastructure and user administration via our security design.



An onboard telemetric device transmits vital equipment data, accessible in near real-time on your computer screen.

## Factory reman/overhaul solutions

## KEEP A GOOD THING GOING



Your equipment was built to last, thanks to our legendary high engineering standards and unwavering commitment to service and support. And after a long and productive life, we provide options to help you go even further.

**Exchange and save.**

Factory Remanufactured Solutions involve replacing your existing engine and system with a remanufactured unit provided by your MTU service partner, and returning your original core for a credit. Utilizing the core exchange program minimizes downtime.

**Turn back the clock.**

Factory Overhaul Solutions involve the complete restoration of your original equipment. This solution is best for classic and specialized engines that lack the necessary population for a meaningful core exchange program or require a greater level of customization during the restoration and validation process, such as Series 183, 396, 493, 538, 595, 652, 956, 1163 and other engine Series (e.g. 2000 and 4000) on request.

**Set an age limit.**

Lifetime-Based Overhauls are ideal for engines that reach a lifetime limit (years) with low operating hours, such as emergency generator sets. This scheduled solution provides the same peace of mind as a traditional overhaul at a fraction of the cost because only timeworn components are replaced, and the removal and reinstallation of the engine is not required.

Service Network

## LOCAL SUPPORT. WORLDWIDE.

The most important part of your power system isn't a part at all—it's your local service team. With more than 1,200 service locations worldwide—backed by regional Parts Logistics Centers in Europe, Asia and America—you can count on responsive support by expert technicians, wherever work takes you. To find your local service partner, visit [www.mtu-solutions.com](http://www.mtu-solutions.com).

### Always on call, 24/7

Whether it's connecting you with a local service partner or assigning an urgent problem to a dedicated team of our experts, we're ready to assist you—wherever you are, whatever you need.

Europe, Middle East, Africa +49 7541 90-77777

Asia/Pacific +65 6860 9669

North and Latin America +1 248 560 8888

[info@ps.rolls-royce.com](mailto:info@ps.rolls-royce.com)





## EXHAUST EMISSIONS

Many countries have implemented environmental legislation to protect people from consequences of polluted air. For this reason an increasing number of countries regulate emissions from specific mobile and stationary sources. Emission standards may apply internationally, nationally and/or for specific areas. The enforcement of an emission legislation may depend for example on the area where the equipment is used and the way it is operated.

The emission legislations may be categorized by power range and/or cylinder capacity. Emission legislations generally require a certificate which states compliance. Stationary applications may require on-site approvals (on-site emission test) depending on the particular emission legislation.

**Please find as follows examples of emission standards which apply to the marine industry. For details please consult the applicable legislation and/or permitting authority.**

### IMO - International Maritime Organization

MARPOL Annex VI Regulation 13 (NOx) and NOx Technical Code 2008: Marine diesel engines > 130 kW for ships engaged on international voyages to which MARPOL Annex VI applies (= flying the flag of a signatory, or entering waters of the jurisdiction of a signatory to the Annex. Signatory overview see IMO webpage, „Status of Conventions“). Fixed & floating platforms, including drilling rigs and similar structures, are considered as ships. For those structures IMO regulations are in addition to any controls imposed by the government which has jurisdiction over the waters in which they operate.

Applicability of tiers:

For new ships date of construction of the ship, for engine replacement with non-identical engine or installation of additional engine date of installation. Exemption rules are in place.

Currently applicable emission stages:

- IMO Tier II outside of NOx Emission Control Areas (NOx ECA)
- IMO Tier III is applicable in NOx Emission Control Areas (NOx ECA) only

Emission Control Areas (ECA):

- An ECA may limit NOx, SOx and particulate matter (PM) emissions, or both. MARPOL Annex VI Regulation 14 (SOx and PM emission compliance) requires fuels with less than 1000 ppm (0.1 %) sulphur (since January 1st, 2015).
- The enforcement dates of an ECA will be specified for each ECA individually. For the North American & US Caribbean ECA this has been January 1st, 2016 with regard to NOx.
- Additionally to the North American & US Caribbean, the North Sea and the Baltic Sea are established as ECA for SOx and PM emissions.

## EXHAUST EMISSIONS

### US EPA - United States Environmental Protection Agency

40CFR1042: Marine diesel engines > 8 kW for vessels registered (flagged) in the United States.

Applicability of tiers:

Date of engine manufacture. Specific replacement engine rules are in place. Exemption rules are in place.

Currently applicable emission stages:

- < 600 kW EPA Tier 3
- < 1000 kW EPA Tier 3 - replaced by EPA Tier 4 latest by October 1st, 2017
- > 1000 kW EPA Tier 4
- > 600 kW EPA Tier 4 from October 1st, 2017
- Recreational engines: EPA Tier 3

### EU - European Union: Commercial Marine

EU Nonroad Directive 97/68/EC as amended by 2012/46/EC: Marine diesel propulsion engines  $\geq$  37 kW and auxiliary engines > 560 kW installed on vessels operating on inland waterways within EU territories (e.g. Rhine, Danube, Loire etc.).

Currently applicable emission stages:

- EU Stage IIIA  
Central Commission for Navigation on the Rhine (CCNR) rules are defined in the Rhine Vessel Inspection Regulation (RheinSchUO) valid for marine diesel engines  $\geq$  19 kW installed on vessels operating on the Rhine.
- CCNR Stage II  
Specific replacement engine rules are in place. Exemption rules are in place. Mutual recognition of CCNR and EU emission regulation is agreed.

### EU - European Union: Recreational Marine

EU Recreational Craft Directive (RCD) 94/25/EC as amended by 2003/44/EC and replaced by 2013/53/EU from January 18th, 2016: propulsion engines for recreational crafts from 2.5 to 24 m hull length operating within EU territories.

Applicability of stages:

Date of placing the engine/boat into the market. Exemption rules are in place.

Currently applicable emission stages:

- RCD 2

Additional to afore mentioned emission regulations we are able to deliver many engines also for regional emission standards such as BSO (Lake Constance) or SAV (Switzerland) on request.

Besides current emission standards we are able to deliver also replacement engines with outdated emission standards. Replacement engine rules need to be observed.

## EXHAUST EMISSIONS

### Samples for emission stages in marine industry:

#### IMO

IMO Seagoing ships

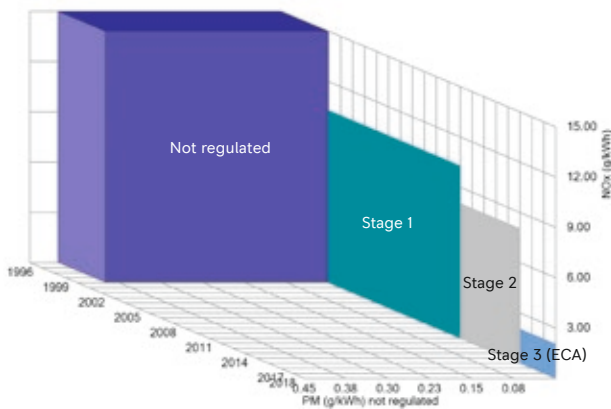

#### EPA

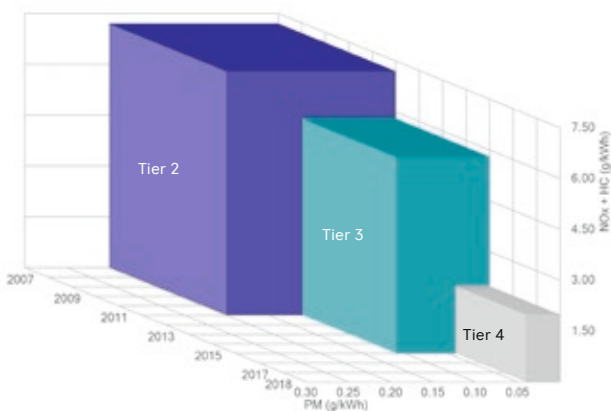

### Abbreviations

T3c	EPA Tier 3 for commercial use
T3r	EPA Tier 3 solely for recreational use
T4c	EPA Tier 4 for commercial use
CCNR II	European commercial inland waterway transport - mutual recognition with EU IIIA
EU IIIA	European commercial inland waterway transport - mutual recognition with CCNR II
RCD 2	European recreational craft directive
IMO I	International Maritime Organization Stage I (beginning form January 2000)
IMO II	International emission standard outside of emission control areas (ECA)
IMO III	International emission standard within emission control areas (ECA)
T1NRMM	EPA Tier 1 - Nonroad Mobile Machinery
T2NRMM	EPA Tier 2 - Nonroad Mobile Machinery

#### Please note

That the engines and systems (only) comply with country or region specific emission requirements and have appropriate emission certification(s) which are explicitly stated in respective technical specifications. Any Export/Import/Operation of the engine in countries or regions with different applicable emission law requirements is at the customers responsibility.



