

PRODUCT CATALOG



MINK[®]

**BUILDING THE WORLD
MADE IN AMERICA**





To Our Valued Customers,

Thank you for your continued support in MK Products! MK Products will be celebrating it's 50th year of manufacturing its Push-Pull GMAW products and 22+ years of Orbital GTAW products. This new catalog format is a combination of all our printed literature into this one full product color catalog. This now means one source for all our product information and specifications. We hope you find this new approach easy to use and helpful.

Introducing two new product lines for our 50 year celebration. The CobraMig 300 Aluminum push-pull Mig welder with "CobraLoc" and the X Series Digital Push-Pull guns. CobraLoc allows the user to unlock the feeder from the power supply giving full portability. The X Series Digital gun gives the user ultimate control at their fingertips. Remotely change the parameters or switch between memory programs directly from the gun. Our world-class **Cobra® Welding Systems** are distributed throughout more than 40 countries. For aluminum **GMAW**, the **Cobramatic®** name is unsurpassed. Our products and services are on display 24-hours a day, 7-days a week at our virtual showroom located at www.mkproducts.com. Our field sales force and distributors are always eager to demonstrate product capabilities and provide solutions for all your welding needs.

The **Cobramatic® Pro Series** Push-Pull Wire Feed cabinets accept our full line of welding guns to meet your toughest welding challenges. **Cobra® MX**...an updated version of our original gooseneck gun is back and better than ever in a small, lightweight design that is perfect for welding aluminum. If you want to go even smaller, then the **Cobra® SX** is the smallest Push-Pull gooseneck gun in the world.

MK continues to offer the **Python®** gooseneck gun for high performance and power...as well as the **Prince® XL** for versatile pistol grip performance. Both the Python and Prince XL offer unique versatility. Rotate the barrel 360°, replace with a straight or curved barrel version or use the "Flex Barrel" for unusual, hard to reach welding. Check out our complete line of **Spool Guns** - we have the "Top of the line" full size **Prince XL Spool Gun** to the smallest **MiniSpool™** gun.

"**Orbital Welding Made Easy™**" best describes our line of patented GTAW fusion tube welding products. **CobraTig® 150 SM**...perfect for portable contractor use in the field. **Advanced Color Logic®**...patented on-screen visual interface is ideal for manufacturing work cell applications where tough quality assurance standards are maintained. MK **Orbital™** weldheads are available for many special applications. **MiniMicro™**...is our smallest weldhead for Ultra High Purity welding applications. **CopperHead®**...our most popular and economical for sanitary, mid-range tube sizes. **DiamondBack™**...is our largest for tubes and pipe sizes up to 6-inch O.D.

For welding or positioning, our precision rotary tables turn heads with every revolution. The **AirCrafter™ 25** and the **CobraTurn™ Digital Turntable** positioners are available in 5" or 10" tabletop models or a 4" diameter 3-jaw chuck. Both models provide 90-degree tilt for vertical or horizontal positions. The CobraTurn™ provides speed ranges from .3 to 10 RPM's and the T-25 comes standard On\Off foot control.

Whether you are a new customer or a loyal MK user, we value your business and we look forward to providing you with the best welding products and services available.

Product Applications

Understanding the product icons



Push-Pull Wire Feed: Proven technology that provides smooth wire feeding for the GMA (MIG) Welding Process in gun lengths up to 50 feet.



Accessories and Consumables: A broad selection of contact tips, barrels, gas cups that further expands the flexibility and usability of the MK Products line.



Spool Guns: Include a patented spool brake and wire leveling arm, multi-turn speed control knob, and simple "one-hand" wire spool loading.



Orbital Equipment: Orbital-GTA (TIG) Welding systems designed for autogenous welds in the sanitary, ultra-high purity and high-pressure welds.



Positioners: Table-top positioners for manual or automatic welding. Designed for rotating welding jobs, they can also be used for non-welding applications.



Water Cooled: Guns that require a re-circulating radiator cooling system, because they use a smaller diameter copper cable compared to Air Cooled guns. Coolant flow rates should be a minimum of 10 GPH between 35 and 45PSI.



Air Cooled: These welding guns use the ambient air and shielding gas to dissipate excess heat. They have lighter and more flexible gun cables and the system's simpler design makes them easier to operate, assemble, maintain and transport.

For a complete price list of all MK available parts,
visit www.mkproducts.com

~	Terms and Conditions of Sale	4
	Cobramatic® Push-Pull Systems	5
	Accessories and Consumables	30
	Spool Guns	38
	Orbital Equipment	42
	Positioners	55
~	Limited Warranty	76
~	Index	79

Supersedes All Previous Terms and Conditions of Sale

PRICING

All shipments are priced from published lists or written quotations. Prices do not include taxes.

Prices include standard domestic packaging. For shipments that may be exported, please contact your freight forwarder for any special packaging or documentation.

PRINTED PRICES

Check all prices before ordering. MK Products reserves the right to make changes to this price list at any time. The latest revisions to this price list are posted on our web site at www.mkproducts.com. These prices supersede all previously published price lists.

INVOICE TERMS AND DISCOUNTS

Terms are NET 30 Days based on prior credit approval.

Credit card purchases using Visa, MasterCard, Discover and American Express are accepted.

PAST DUE ACCOUNTS

Accounts not paid within 30 days are past due and subject to a finance charge of 1½% per month (annual percentage rate of 18%).

TELEPHONE ORDERS

Telephone orders are confirmed and are acknowledged immediately. If changes are requested on any order placed, we cannot guarantee these changes without additional expense to the purchaser.

LABOR RATE

All labor is billed at \$90.00 per hour.

REPAIRS/WARRANTY REPAIR

All repairs, Standard or Warranty, will be performed under the MK Products Repair & Warranty Repair Policy. Full terms and conditions of this policy are available by contacting MK Products via phone, fax or e-mail.

EDUCATIONAL DISCOUNT

An educational discount off list price is available on most equipment sold directly by MK Products to a non-profit educational institution. This discount is not to be combined with any other special offer.

Equipment not eligible for discount:

- Special product items, used or reconditioned equipment
- Replacement and consumable parts

This Educational Discount Policy supersedes all previous publications.

TRANSFER OF TITLE

All merchandise is sold F.O.B. MK Products Inc., Irvine, California. Title to the merchandise is transferred to the purchaser at the time the carrier accepts shipment. The purchaser must file any claims for loss or damage in transit with the carrier. Upon request, MK Products Inc., will issue tracers on any shipment considered "lost" by the purchaser.

MINIMUM BILLING

Minimum billing on all domestic orders is \$25.00 USD NET.

Minimum billing on all export orders is \$50.00 USD NET.

CANCELLATION OF ORDERS

Except in the case of non-standard items, orders for standard items can be canceled without charge, provided notice is received at MK Products, Irvine, California, at least one week before scheduled delivery to the carrier.

In the case of non-standard items, the purchaser will be liable for full payment at the contract price for all finished units available prior to cancellation. Also, for all non-standard materials and components in semi-finished condition, the purchaser will be liable for purchased price plus 15%.

ORDER HANDLING

MK Products will make every effort to ship all sales orders within 1~2 working days for merchandise that is in stock.

For PRIORITY shipments, please have your purchase order in by 3:00pm Pacific Time to qualify. Your priority order must ship by NEXT DAY delivery service. We will make every reasonable effort to ship priorities.

MK PRODUCTS RETURN POLICY

NEW / UNUSED or DEFECTIVE

You have up to 30 calendar days from invoice date to request a return of new/unused or defective items. If the item(s) are sent back unused in the original packaging including any accessories or manuals that shipped with the product and follow the return procedures, MK Products will offer you a full refund, less shipping costs (unless the item is defective, which will receive full credit). You will be responsible for shipping the item(s) back to MK Products, including any shipping fees.

OPENED / USED

You have up to 15 calendar days from date receipt of product to request a return of opened/used items. These items will be subject to a 30% restocking fee and all shipping costs. No exceptions.

RMA(Return Material Authorization) All Returns MUST be accompanied by a valid RMA number

Prior to returning item(s), contact MK Products at 1-800-787-9707 or e-mail to sales@mkprod.com, to obtain an RMA number, along with complete instructions. Please have your order number ready along with the part number and quantity of item(s) being returned. Item(s) must be returned to MK Products within 15 calendar days of the issuance of the RMA. RMA number must be posted on the address label of the package. Packages without RMA will not be accepted by MK Products. If applicable, MK Products will issue credit after the item(s) has been received and inspected.

NOTE: MK Products recommends that you: (1) use a carrier that offers shipment tracking for all returns and (2) either insure your package for safe return to MK Products or declare the full value of the shipment so that you are completely protected if the shipment is lost or damaged in transit.

FREE FREIGHT PROGRAM

MK Products pays all UPS ground freight charges for orders \$150 or more, Net.

Does not include Internationals, Freight Forwarders or OEM orders. Applies to orders marked "Ship Complete", ONLY

Push - Pull Technology

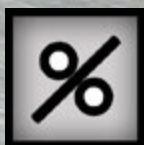

CobraMig® 300	6
Digital Gun Series	11
Python® Series	14
Python® LX Series	20
Cobra® MX Series	22
Cobra® SX Series	24
Prince® XL Series	26
Cobramatic® Pro Series	28

Aluminum Welding

Introducing the new

X Series Digital Push-Pull Guns

Giving the user ultimate control at their fingertips!



PRINCE[®]X



PYTHON[®]X



Cobra[®]X



Made EASY!

It's Back!!

300

CobraMig

The new CobraMig 300 now with a detachable Digital Wire Feeder!



Detachable digital wire feeder allows for Rail or Boom mounting applications. Interface extensions of 25', 50' or more provide remote adjustments of the power supply.



Simplified user interface allows quick and easy operations.

Extending the capabilities even further...

MK has developed a NEW series of Digital push-pull guns. The X Series digital guns give the user ultimate control at their fingertips. Remotely change parameters or switch between memory programs directly from the gun. Combining feeder separation length and gun cable length, operations can now be managed directly at the gun, allowing complete control 100 feet or more from the power supply.



Plug & play connection now available!

Detachable Wire Feeder



800-787-9707
sales@mkproducts.com

Cobra Welding Systems



CobraMig 300	List Price
CobraMig 300	\$4,855



CobraMig 300 Packages

Choose any X Series Digital Gun

15'	\$6,195
25'	\$6,295
35'	\$6,395
50'	\$6,495

Visit MK Products



Discover more products

Get Impressed!



Learn more about our CobraMig300

Python® X

X Series Digital Push-Pull Gun



Power and performance is the best way to describe a gun so advanced that even the competition is on edge. Taking a lesson from both the Cobra® X and (inline design) the Prince® X, (removable/rotatable barrel) the Python® X Digital gun adds its own unique set of features with time proven design to bring together the most advanced welding gun available.

- Improved handle design allows Snake Skin to "Tie" wrap to handle
- Ergonomic handle provides for hours of continuous fatigue free welding.
- Digital feature allows Scroll through menu remotely on CobraMig® 300 (WireSpeed, Voltage, Memory)
- Precision incremental adjustments digitally from gun. (Wire Speed, Voltage, Memory)
- Standard Python® consumable parts. (Gas cup, Contact tip, Barrel Liner, Drive / Idler Roll, Cable bundle).
- Can use MK Flex Barrel for hard to reach welds
- Direct Plug-in with MK CobraMig® 300 System
- EZ-Lock barrel can easily rotate 360* to provide the perfect weld angle for all jobs.
- Available in Air Cooled models only.

CobraMig® 300 Compatibility (Air Cooled Only)

LENGTH	MODEL NUMBER
15 ft (4.6 m)	341-815
25 ft (7.6 m)	341-825
35 ft (10.7 m)	341-835
50 ft (15.2 m)	341-850

Rated Output determined by the gun having an Air Cooled (A/C) barrel.

Duty Cycle 100%

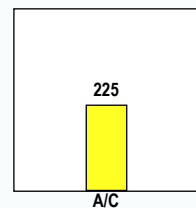

Call Factory for replacement parts



The Python® X can be used with MK's new Flex Barrel, which is designed for hard to reach welds. Air Cooled models only. See page 31 for part numbers.

Cobra® X

X Series Digital Push-Pull Gun



Familiar with Cobra® Gold? Cobra® X is a direct replacement with all of MK Products' latest features and manufacturing techniques. This Digitally Controlled gun features our famous push-pull gooseneck design and weighs only 2 lb 5 oz. The Patented Cobra® X is ready to fit all your aluminum welding needs.

- Direct Plug-in with MK CobraMig® 300 System
- Cobra® fix mount barrel with high temp barrel insulator
- Original rear Trigger location
- Digital feature allows Scroll through menu remotely on CobraMig® 300. (Wire Speed, Voltage, Memory)
- Precision incremental adjustments digitally from gun. (Wire Speed, Voltage, Memory)
- Standard Python® consumable parts. (Gas cup, Contact tip, Barrel Liner, Drive / Idler Roll, Cable bundle).

CobraMig® 300 Compatibility (Air Cooled Only)

LENGTH	MODEL NUMBER
15 ft (4.6 m)	343-815
25 ft (7.6 m)	343-825
35 ft (10.7 m)	343-835
50 ft (15.2 m)	343-850

Rated Output determined by the gun having an Air Cooled (A/C) barrel.

Duty Cycle 100%

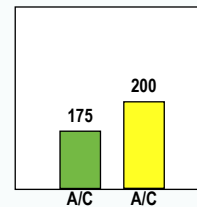

Call Factory for replacement parts

Prince® X

X Series Digital Push-Pull Gun



The Prince® X brings together all aspects of heavy duty dependability expected from the Prince XL Pistol Grip gun. With all new Digital Control, conveniently control nearly every aspect of your weld parameters remotely from the gun.

- Digital feature allows Scroll through menu remotely on CobraMig® 300. (Wire Speed, Voltage, Memory)
- Precision incremental adjustments digitally from gun. (Wire Speed, Voltage, Memory)
- Standard Prince® XL consumable parts. (Gas cup, Contact tip, Barrel Liner, Drive / Idler Roll, Cable bundle).
- Can use MK Flex Barrel for hard to reach welds
- Direct Plug-in with MK CobraMig® 300 System
- EZ-Lock barrel can easily rotate 360* to provide the perfect weld angle for all jobs.
- Available in Air Cooled models only.

CobraMig® 300 Compatibility (Air Cooled Only)

LENGTH	MODEL NUMBER
15 ft (4.6 m)	350-715
25 ft (7.6 m)	350-725
35 ft (10.7 m)	350-735
50 ft (15.2 m)	350-750

Rated Output determined by the gun having an Air Cooled (A/C) barrel.

Duty Cycle 100%

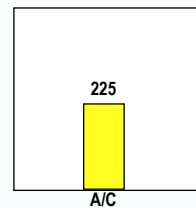

The Prince® X can be used with MK's new Flex Barrel, which is designed for hard to reach welds. Air Cooled models only. See page 31 for part numbers.

Call Factory for replacement parts

Python®

Advanced Gooseneck



Power and performance is the best way to describe a gun so advanced that even the competition is on edge. Taking a lesson from both the Cobra® gooseneck and the Prince® XL, the Python® adds its own unique set of features with time proven design to bring together the most advanced welding gun available.

- Optional Ultra Flex power cable offers more durability and less strain when welding.
- Air Cooled models can use the Flex Barrel for hard to reach welds.
- Plug-in direct compatibility with MK, Lincoln, Miller, Fronius, ESAB and Euro systems.
- Convenient “forward trigger” location.
- “Fingertip” wire speed adjustment.
- EZ-Lock® barrel can easily rotate 360° to provide the perfect angle for all jobs.
- Available in both Water and Air Cooled models.
- Provides hours of high speed continuous wire feed without welder fatigue.
- For aluminum, stainless, steel and flux cored wires.
- Wire feed speed 800 IPM.
- Wire type and diameter:
 - .030” - .045” solid and hard wire (0.8 mm - 1.1 mm)
 - .030” - 1/16” aluminum and cored wire (0.8 mm - 1.6 mm)

See pgs 30-36 for barrels, contact tips and gas cups.

Duty Cycle 100%

Rated Output determined by the gun having an Air Cooled (A/C) or Water Cooled (W/C) barrel.

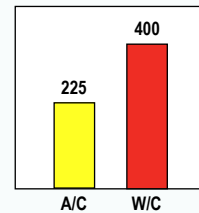

A
M
P
S

Cobramatic® Compatibility

AIR COOLED	
LENGTH	MODEL NUMBER
15 ft (4.6 m)	234-815
25 ft (7.6 m)	234-825
35 ft (10.7 m)	234-835
50 ft (15.2 m)	234-850

WATER COOLED	
LENGTH	MODEL NUMBER
15 ft (4.6 m)	235-815
25 ft (7.6 m)	235-825
35 ft (10.7 m)	235-835
50 ft (15.2 m)	235-850



For best performance, use only Cobra® Coolant. Failure to use Cobra® Coolant will void warranty.

1 Gallon (3.78L)
P/N 931-0060

1 Case (4 Gallons, 1 Gal ea.)
P/N 931-0060-4

5 Gallon (18.92L)
P/N 931-0060-5GAL

GUN LEAD ASSEMBLY COMPONENTS

LENGTH	GAS HOSE	CONTROL CABLE	POWER CABLE (A/C)	POWER CABLE (W/C)	WATER HOSE
15 ft (4.6 m)	552-0242-15	005-0690	843-0630-15	005-0387-15	552-0243-15
25 ft (7.6 m)	552-0242-25	005-0691	843-0630-25	005-0387-25	552-0243-25
35 ft (10.7 m)	552-0242-35	005-0740	843-0630-35	005-0387-35	552-0243-35
50 ft (15.2 m)	552-0242-50	005-0692	843-0630-50	005-0387-50	552-0243-50

STANDARD ON ALL PYTHON® MODELS

LENGTH	SNAKE SKIN
15 ft (4.6 m)	931-0110
25 ft (7.6 m)	931-0122
35 ft (10.7 m)	931-0132
50 ft (15.2 m)	931-0123

OPTIONAL LEAD ASSEMBLY COMPONENTS

LENGTH	ULTRA FLEX POWER CABLE*
15 ft (4.6 m)	843-0580-15
25 ft (7.6 m)	843-0580-25
35 ft (10.7 m)	843-0580-35
50 ft (15.2 m)	843-0580-50

ALUMINUM WELDING ONLY (MK CONNECTION)

LENGTH	CONDUIT ASSEMBLY
15 ft (4.6 m)	615-0601-15
25 ft (7.6 m)	615-0601-25
35 ft (10.7 m)	615-0601-35
50 ft (15.2 m)	615-0601-50

HARD WIRE WELDING* ONLY

LENGTH	FLAT SPIRAL STEEL CONDUIT ASSEMBLY
15 ft (4.6 m)	615-0208
25 ft (7.6 m)	615-0216
35 ft (10.7 m)	615-0219
50 ft (15.2 m)	615-0218

*Air Cooled models only

*Steel, stainless steel and flux core steel wires

See accessories and consumables for liners and contact tips (pgs 34-35).

Python® Compatibility

All Cobramatic® and Cobramatic® compatible guns are available in lengths of 15 ft, 25 ft, 35 ft, and 50 ft.

Lincoln Compatible guns used with Lincoln Power Feed 25M (model K2536-4) require a kit for adaptability. Call factory for details.



LINCOLN, 7 PIN COMPATIBILITY

AIR COOLED	
LENGTH	MODEL NUMBER
15 ft (4.6 m)	232-815
25 ft (7.6 m)	232-825
35 ft (10.7 m)	232-835
50 ft (15.2 m)	232-850
WATER COOLED	
15 ft (4.6 m)	293-815
25 ft (7.6 m)	293-825
35 ft (10.7 m)	293-835
50 ft (15.2 m)	293-850

MILLER, 14 PIN COMPATIBILITY

AIR COOLED	
LENGTH	MODEL NUMBER
15 ft (4.6 m)	291-815
25 ft (7.6 m)	291-825
35 ft (10.7 m)	291-835
50 ft (15.2 m)	291-850
WATER COOLED	
15 ft (4.6 m)	292-815
25 ft (7.6 m)	292-825
35 ft (10.7 m)	292-835
50 ft (15.2 m)	292-850

FRONIUS, 9 PIN COMPATIBILITY

AIR COOLED	
LENGTH	MODEL NUMBER
15 ft (4.6 m)	289-815
25 ft (7.6 m)	289-825
35 ft (10.7 m)	289-835
50 ft (15.2 m)	289-850
WATER COOLED	
15 ft (4.6 m)	290-815
25 ft (7.6 m)	290-825
35 ft (10.7 m)	290-835
50 ft (15.2 m)	290-850

EURO, 7 PIN COMPATIBILITY

AIR COOLED	
LENGTH	MODEL NUMBER
15 ft (4.6 m)	296-815
25 ft (7.6 m)	296-825
35 ft (10.7 m)	296-835
50 ft (15.2 m)	296-850
WATER COOLED	
15 ft (4.6 m)	297-815
25 ft (7.6 m)	297-825
35 ft (10.7 m)	297-835
50 ft (15.2 m)	297-850

MK Products compatible guns have interchangeable fittings, so you can match as needed for your cooler. Both fittings require a hose retainer. Call factory for pricing.



431-1898
5/16" Hose Retainer



431-1910
Quick Connect Fitting



431-1893* Nipple
753-3379* Left-Hand Threaded Fitting
**Must be ordered together*

GUN LEAD ASSEMBLY COMPONENTS - PYTHON® COMPATIBILITY MODELS

PYTHON® COMPATIBLE MODELS

LENGTH	POWER CABLE	
	GAS HOSE	(A/C) (W/C)
15 ft (4.6 m)	552-0241-15	843-0640-15 005-0388-15
25 ft (7.6 m)	552-0241-25	843-0640-25 005-0388-25
35 ft (10.7 m)	552-0241-35	843-0640-35 005-0388-35
50 ft (15.2 m)	552-0241-50	843-0640-50 005-0388-50

PYTHON® COMPATIBLE MODELS - CONTROL CABLES

LENGTH	(LINCOLN, 7 PIN)	(EURO, 7 PIN)	(MILLER, 14 PIN)	(FRONIUS, 9 PIN)
15 ft (4.6 m)		005-0690	005-0380-15	005-0381-15
25 ft (7.6 m)		005-0691	005-0380-25	005-0381-25
35 ft (10.7 m)		005-0740	005-0380-35	005-0381-35
50 ft (15.2 m)		005-0692	005-0380-50	005-0381-50

PYTHON® COMPATIBILITY WATER HOSE - BLUE

LENGTH	(LINCOLN, 7 PIN)	(EURO, 7 PIN)	(MILLER, 14 PIN)	(FRONIUS, 9 PIN)
15 ft (4.6 m)		552-0239-15		552-0238-15
25 ft (7.6 m)		552-0239-25		552-0238-25
35 ft (10.7 m)		552-0239-35		552-0238-35
50 ft (15.2 m)		552-0239-50		552-0238-50

PYTHON® COMPATIBILITY WATER HOSE - RED

(LINCOLN, 7 PIN)	(EURO, 7 PIN)	(MILLER, 14 PIN)	(FRONIUS, 9 PIN)
	552-0209*		552-0211*

* Used for all lead assembly lengths

OPTIONAL LEAD ASSEMBLY COMPONENTS

LENGTH	ULTRA FLEX POWER CABLE*
15 ft (4.6 m)	843-0715-15
25 ft (7.6 m)	843-0715-25
35 ft (10.7 m)	843-0715-35
50 ft (15.2 m)	843-0715-50

ALUMINUM WELDING ONLY (COMPATIBLE GUNS)

LENGTH	CONDUIT ASSEMBLY
15 ft (4.6 m)	615-0620-15
25 ft (7.6 m)	615-0620-25
35 ft (10.7 m)	615-0620-35
50 ft (15.2 m)	615-0620-50

HARD WIRE WELDING* ONLY

LENGTH	FLAT SPIRAL STEEL CONDUIT ASSEMBLY
15 ft (4.6 m)	615-0621-15
25 ft (7.6 m)	615-0621-25
35 ft (10.7 m)	615-0621-35
50 ft (15.2 m)	615-0621-50

*Air Cooled models only

*Steel, stainless steel and flux core steel wires
See accessories and consumables for liners and contact tips (pgs 34-35).

PYTHON®

Lincoln Compatible

**BEST ALUMINUM PUSH-PULL WELDING GUN
IN THE WORLD**

Available:

7 Pin Amphenol

12 Pin Amphenol



Air Cooled
232-XXX



Water Cooled
293-XXX

Compatible with:

Power Mig 300

Power Mig 350

C-300

25M Feeder

SALES@MKPRODUCTS.COM
WWW.MKPRODUCTS.COM



16882 ARMSTRONG AVE.
IRVINE, CA 92606
(800) 787-9707

PYTHON®

Miller Compatible

**BEST ALUMINUM PUSH-PULL WELDING GUN
IN THE WORLD**



Air Cooled
291-XXX



Water Cooled
292-XXX

Compatible with:
MM 252
MM350
350P
XR CONTROL WIRE FEEDER
XRS-XRD
ALUMA FEED

SALES@MKPRODUCTS.COM
WWW.MKPRODUCTS.COM



16882 ARMSTRONG AVE.
IRVINE, CA 92606
(800) 787-9707

PYTHON®

Fronius Compatible

BEST ALUMINUM PUSH-PULL WELDING GUN
IN THE WORLD



Air Cooled
289-XXX



Water Cooled
290-XXX

Compatible with:
TPS2700
TPS3200
TPS4000

SALES@MKPRODUCTS.COM
WWW.MKPRODUCTS.COM



16882 ARMSTRONG AVE.
IRVINE, CA 92606
(800) 787-9707

Call (800) 787-9707



Accessories and Consumables

For best performance, use only Cobra® Coolant. Failure to use Cobra® Coolant will void warranty.

SUBMERGED IN YOUR WORK?

Don't forget to protect your
MK Cobra Welding
System by

KEEPING IT
COOL

ALUMINUM PROTECTION

Formulated especially for use in systems where aluminum parts are used.

May also be used in any system where high frequency current is not present.

Contains additives to inhibit algae growth and protection from freezing.

PART No. 931-0060

1 GALLON (3.78 LITER)

PART No. 931-0060-4

1 CASE (4 GALLONS, 1 GAL EA)

PART No. 931-0060-5GAL

5 GALLONS (18.92 LITER)

Improved Gun Performance

For use with all

Water Cooled

MK Guns and

Orbital Welding Equipment



www.mkproducts.com

sales@mkproducts.com

800-787-9707

MK
PRODUCTS



Python® LX

Advanced Gooseneck



The NEW Python® LX combines the robust engineering of the Python® and the stylish design of the Cobra® MX. When connected with the Cobramatic® wire feed cabinet, you get the best push-pull wire feed equipment for welding aluminum. Completely and fully synergic, the one-knob control in the Python® LX returns precise and repeatable weld settings from 15 to 50 feet away.

- Optional Ultra Flex power cable offers more durability and less strain when welding.
- Air Cooled models can use the Flex Barrel for hard to reach welds.
- Plug-in direct compatibility with MK, Lincoln, Miller, Fronius, ESAB and Euro systems.
- Compatible with different generations of Cobramatic® cabinets.
- Fingertip speed control protected in handle.
- Mechanical gas valve integrated with trigger function (bypass for full auto control).
- Uses the legendary Cobra® rear trigger configuration.
- Patented EZ-Lock® rotatable and tapered barrel design.
- 12" and 18" straight/curved Air and Water Cooled barrel options.
- Wire feed speed 800 IPM.
- Wire type and diameter:
 - .030" - .045" solid and hard wire (0.8 mm - 1.1 mm)
 - .030" - 1/16" aluminum and cored wire (0.8 mm - 1.6 mm)

See pgs 30-36 for barrels, contact tips and gas cups.

Duty Cycle 100%

Rated Output determined by the gun having an Air Cooled (A/C) or Water Cooled (W/C) barrel.

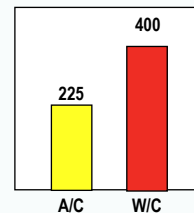

A
M
P
S

Cobramatic® Compatibility

AIR COOLED	
LENGTH	MODEL NUMBER
15 ft (4.6 m)	260-815
25 ft (7.6 m)	260-825
35 ft (10.7 m)	260-835
50 ft (15.2 m)	260-850

WATER COOLED	
LENGTH	MODEL NUMBER
15 ft (4.6 m)	261-815
25 ft (7.6 m)	261-825
35 ft (10.7 m)	261-835
50 ft (15.2 m)	261-850



For best performance, use only Cobra® Coolant. Failure to use Cobra® Coolant will void warranty.

1 Gallon (3.78L)

P/N 931-0060

1 Case (4 Gallons, 1 Gal ea.)

P/N 931-0060-4

5 Gallon (18.92L)

P/N 931-0060-5GAL

GUN LEAD ASSEMBLY COMPONENTS

LENGTH	GAS HOSE	CONTROL CABLE	POWER CABLE (A/C)	POWER CABLE (W/C)	WATER HOSE
15 ft (4.6 m)	552-0242-15	005-0690	843-0630-15	005-0387-15	552-0243-15
25 ft (7.6 m)	552-0242-25	005-0691	843-0630-25	005-0387-25	552-0243-25
35 ft (10.7 m)	552-0242-35	005-0740	843-0630-35	005-0387-35	552-0243-35
50 ft (15.2 m)	552-0242-50	005-0692	843-0630-50	005-0387-50	552-0243-50

STANDARD ON ALL PYTHON® LX MODELS

LENGTH	SNAKE SKIN
15 ft (4.6 m)	931-0110
25 ft (7.6 m)	931-0122
35 ft (10.7 m)	931-0132
50 ft (15.2 m)	931-0123

OPTIONAL LEAD ASSEMBLY COMPONENTS

LENGTH	ULTRA FLEX POWER CABLE*
15 ft (4.6 m)	843-0580-15
25 ft (7.6 m)	843-0580-25
35 ft (10.7 m)	843-0580-35
50 ft (15.2 m)	843-0580-50

ALUMINUM WELDING ONLY (MK CONNECTION)

LENGTH	CONDUIT ASSEMBLY
15 ft (4.6 m)	615-0601-15
25 ft (7.6 m)	615-0601-25
35 ft (10.7 m)	615-0601-35
50 ft (15.2 m)	615-0601-50

HARD WIRE WELDING* ONLY

LENGTH	FLAT SPIRAL STEEL CONDUIT ASSEMBLY
15 ft (4.6 m)	615-0208
25 ft (7.6 m)	615-0216
35 ft (10.7 m)	615-0219
50 ft (15.2 m)	615-0218

*Air Cooled models only

*Steel, stainless steel and flux core steel wires

See accessories and consumables for liners and contact tips (pgs 34-35).

Python® LX Compatibility

All Cobramatic® and Cobramatic® compatible guns are available in lengths of 15 ft, 25 ft, 35 ft, and 50 ft.

Lincoln Compatible guns used with Lincoln Power Feed 25M (model K2536-4) require a kit for adaptability. Call factory for details.



LINCOLN, 7 PIN COMPATIBILITY

AIR COOLED	
LENGTH	MODEL NUMBER
15 ft (4.6 m)	270-815
25 ft (7.6 m)	270-825
35 ft (10.7 m)	270-835
50 ft (15.2 m)	270-850
WATER COOLED	
15 ft (4.6 m)	271-815
25 ft (7.6 m)	271-825
35 ft (10.7 m)	271-835
50 ft (15.2 m)	271-850

MILLER, 14 PIN COMPATIBILITY

AIR COOLED	
LENGTH	MODEL NUMBER
15 ft (4.6 m)	272-815
25 ft (7.6 m)	272-825
35 ft (10.7 m)	272-835
50 ft (15.2 m)	272-850
WATER COOLED	
15 ft (4.6 m)	273-815
25 ft (7.6 m)	273-825
35 ft (10.7 m)	273-835
50 ft (15.2 m)	273-850

FRONIUS, 9 PIN COMPATIBILITY

AIR COOLED	
LENGTH	MODEL NUMBER
15 ft (4.6 m)	274-815
25 ft (7.6 m)	274-825
35 ft (10.7 m)	274-835
50 ft (15.2 m)	274-850
WATER COOLED	
15 ft (4.6 m)	275-815
25 ft (7.6 m)	275-825
35 ft (10.7 m)	275-835
50 ft (15.2 m)	275-850

EURO, 7 PIN COMPATIBILITY

AIR COOLED	
LENGTH	MODEL NUMBER
15 ft (4.6 m)	294-815
25 ft (7.6 m)	294-825
35 ft (10.7 m)	294-835
50 ft (15.2 m)	294-850
WATER COOLED	
15 ft (4.6 m)	295-815
25 ft (7.6 m)	295-825
35 ft (10.7 m)	295-835
50 ft (15.2 m)	295-850

MK Products compatible guns have interchangeable fittings, so you can match as needed for your cooler. Both fittings require a hose retainer. Call factory for pricing.



431-1898
5/16" Hose Retainer



431-1910
Quick Connect Fitting



431-1893* Nipple
753-3379* Left-Hand Threaded Fitting
**Must be ordered together*

GUN LEAD ASSEMBLY COMPONENTS - LX AND MX COMPATIBILITY MODELS

LX AND MX COMPATIBLE MODELS

LENGTH	GAS HOSE	POWER CABLE	
		(A/C)	(W/C)
15 ft (4.6 m)	552-0241-15	843-0640-15	005-0388-15
25 ft (7.6 m)	552-0241-25	843-0640-25	005-0388-25
35 ft (10.7 m)	552-0241-35	843-0640-35	005-0388-35
50 ft (15.2 m)	552-0241-50	843-0640-50	005-0388-50

LX AND MX COMPATIBLE MODELS - CONTROL CABLES

LENGTH	(LINCOLN, 7 PIN)	(EURO, 7 PIN)	(MILLER, 14 PIN)	(FRONIUS, 9 PIN)
15 ft (4.6 m)		005-0690	005-0380-15	005-0381-15
25 ft (7.6 m)		005-0691	005-0380-25	005-0381-25
35 ft (10.7 m)		005-0740	005-0380-35	005-0381-35
50 ft (15.2 m)		005-0692	005-0380-50	005-0381-50

LX AND MX COMPATIBILITY WATER HOSE - BLUE

LENGTH	(LINCOLN, 7 PIN)	(EURO, 7 PIN)	(MILLER, 14 PIN)	(FRONIUS, 9 PIN)
15 ft (4.6 m)		552-0239-15		552-0238-15
25 ft (7.6 m)		552-0239-25		552-0238-25
35 ft (10.7 m)		552-0239-35		552-0238-35
50 ft (15.2 m)		552-0239-50		552-0238-50

LX AND MX COMPATIBILITY WATER HOSE - RED

(LINCOLN, 7 PIN)	(EURO, 7 PIN)	(MILLER, 14 PIN)	(FRONIUS, 9 PIN)
	552-0209*		552-0211*

* Used for all lead assembly lengths

OPTIONAL LEAD ASSEMBLY COMPONENTS

LENGTH	ULTRA FLEX POWER CABLE*
15 ft (4.6 m)	843-0715-15
25 ft (7.6 m)	843-0715-25
35 ft (10.7 m)	843-0715-35
50 ft (15.2 m)	843-0715-50

ALUMINUM WELDING ONLY (COMPATIBLE GUNS)

LENGTH	CONDUIT ASSEMBLY
15 ft (4.6 m)	615-0620-15
25 ft (7.6 m)	615-0620-25
35 ft (10.7 m)	615-0620-35
50 ft (15.2 m)	615-0620-50

HARD WIRE WELDING* ONLY

LENGTH	FLAT SPIRAL STEEL CONDUIT ASSEMBLY
15 ft (4.6 m)	615-0621-15
25 ft (7.6 m)	615-0621-25
35 ft (10.7 m)	615-0621-35
50 ft (15.2 m)	615-0621-50

*Air Cooled models only

*Steel, stainless steel and flux core steel wires
See accessories and consumables for liners and contact tips (pgs 34-35).



Cobra® MX

Push-Pull Gooseneck Gun

Familiar with Cobra® Gold? Cobra® MX is a direct replacement with a gas valve in the gun and with all of MK Products' latest features and manufacturing techniques. This gun features our famous push-pull gooseneck design and weighs only 2 lb 5 oz. The Patented Cobra® MX is ready to fit all your aluminum and hard wire welding needs.



- Optional Ultra Flex power cable offers more durability and less strain when welding.
- Plug-in direct compatibility with MK, Lincoln, Miller, Fronius, ESAB and Euro systems.
- Cobra® fix mount barrel with high temp barrel insulator.
- Protected fingertip speed control in the handle.
- Uses the original Cobra® rear trigger location.
- Covered wire feed mechanism.
- Covered lever wire release in the handle.
- Wire feed speed 800 IPM.
- Wire type and diameter:
 - .030" - .045" solid and hard wire (0.6 mm - 1.1 mm)
 - .030" - 1/16" aluminum and cored wire (0.8 mm - 1.6 mm)

See pgs 30-36 for barrels, contact tips and gas cups.

Cobramatic® Compatibility

CLASSIC CUP, 1/4" TIP

AIR COOLED	
LENGTH	MODEL NUMBER
15 ft (4.6 m)	266-815
25 ft (7.6 m)	266-825
35 ft (10.7 m)	266-835
50 ft (15.2 m)	266-850
WATER COOLED	
15 ft (4.6 m)	262-815
25 ft (7.6 m)	262-825
35 ft (10.7 m)	262-835
50 ft (15.2 m)	262-850

MAX CUP, 3/8" TIP

AIR COOLED	
LENGTH	MODEL NUMBER
15 ft (4.6 m)	267-815
25 ft (7.6 m)	267-825
35 ft (10.7 m)	267-835
50 ft (15.2 m)	267-850
WATER COOLED	
15 ft (4.6 m)	263-815
25 ft (7.6 m)	263-825
35 ft (10.7 m)	263-835
50 ft (15.2 m)	263-850

GUN LEAD ASSEMBLY COMPONENTS					
LENGTH	GAS HOSE	CONTROL CABLE	POWER CABLE (A/C)	POWER CABLE (W/C)	WATER HOSE
15 ft (4.6 m)	552-0242-15	005-0690	843-0630-15	005-0387-15	552-0243-15
25 ft (7.6 m)	552-0242-25	005-0691	843-0630-25	005-0387-25	552-0243-25
35 ft (10.7 m)	552-0242-35	005-0740	843-0630-35	005-0387-35	552-0243-35
50 ft (15.2 m)	552-0242-50	005-0692	843-0630-50	005-0387-50	552-0243-50

OPTIONAL LEAD ASSEMBLY COMPONENTS	
LENGTH	ULTRA FLEX POWER CABLE*
15 ft (4.6 m)	843-0580-15
25 ft (7.6 m)	843-0580-25
35 ft (10.7 m)	843-0580-35
50 ft (15.2 m)	843-0580-50

ALUMINUM WELDING ONLY (MK CONNECTION)	
LENGTH	CONDUIT ASSEMBLY
15 ft (4.6 m)	615-0601-15
25 ft (7.6 m)	615-0601-25
35 ft (10.7 m)	615-0601-35
50 ft (15.2 m)	615-0601-50

HARD WIRE WELDING* ONLY	
LENGTH	FLAT SPIRAL STEEL CONDUIT ASSEMBLY
15 ft (4.6 m)	615-0208
25 ft (7.6 m)	615-0216
35 ft (10.7 m)	615-0219
50 ft (15.2 m)	615-0218

*Air Cooled models only

*Steel, stainless steel and flux core steel wires
See accessories and consumables for liners and contact tips (pgs 34-35).

Rated Output determined by the gun having an Air Cooled (A/C) or Water Cooled (W/C) barrel.

Duty Cycle 100%

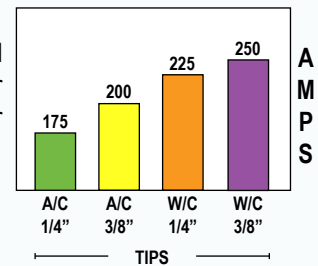

For best performance, use only Cobra® Coolant. Failure to use Cobra® Coolant will void warranty.

1 Gallon (3.78L)

P/N 931-0060

1 Case (4 Gallons, 1 Gal ea.)

P/N 931-0060-4

5 Gallon (18.92L)

P/N 931-0060-5GAL

STANDARD ON ALL COBRA® MX MODELS

LENGTH	SNAKE SKIN
15 ft (4.6 m)	931-0110
25 ft (7.6 m)	931-0122
35 ft (10.7 m)	931-0132
50 ft (15.2 m)	931-0123

Cobra® MX Compatibility

All Cobramatic® and Cobramatic® compatible guns are available in lengths of 15 ft, 25 ft, 35 ft, and 50 ft. Lincoln Compatible guns used with Lincoln Power Feed 25M (model K2536-4) require a kit for adaptability. Call factory for details.



LINCOLN, 7 PIN COMPATIBILITY

CLASSIC CUP, 1/4" TIP

AIR COOLED	
LENGTH	MODEL NUMBER
15 ft (4.6 m)	276-815
25 ft (7.6 m)	276-825
35 ft (10.7 m)	276-835
50 ft (15.2 m)	276-850
WATER COOLED	
15 ft (4.6 m)	278-815
25 ft (7.6 m)	278-825
35 ft (10.7 m)	278-835
50 ft (15.2 m)	278-850

MILLER, 14 PIN COMPATIBILITY

CLASSIC CUP, 1/4" TIP

AIR COOLED	
LENGTH	MODEL NUMBER
15 ft (4.6 m)	280-815
25 ft (7.6 m)	280-825
35 ft (10.7 m)	280-835
50 ft (15.2 m)	280-850
WATER COOLED	
15 ft (4.6 m)	282-815
25 ft (7.6 m)	282-825
35 ft (10.7 m)	282-835
50 ft (15.2 m)	282-850

FRONIUS, 9 PIN COMPATIBILITY

CLASSIC CUP, 1/4" TIP

AIR COOLED	
LENGTH	MODEL NUMBER
15 ft (4.6 m)	284-815
25 ft (7.6 m)	284-825
35 ft (10.7 m)	284-835
50 ft (15.2 m)	284-850
WATER COOLED	
15 ft (4.6 m)	286-815
25 ft (7.6 m)	286-825
35 ft (10.7 m)	286-835
50 ft (15.2 m)	286-850

EURO, 7 PIN COMPATIBILITY

CLASSIC CUP, 1/4" TIP

AIR COOLED	
LENGTH	MODEL NUMBER
15 ft (4.6 m)	298-815
25 ft (7.6 m)	298-825
35 ft (10.7 m)	298-835
50 ft (15.2 m)	298-850
WATER COOLED	
15 ft (4.6 m)	299-815
25 ft (7.6 m)	299-825
35 ft (10.7 m)	299-835
50 ft (15.2 m)	299-850

MAX CUP, 3/8" TIP

AIR COOLED	
LENGTH	MODEL NUMBER
15 ft (4.6 m)	277-815
25 ft (7.6 m)	277-825
35 ft (10.7 m)	277-835
50 ft (15.2 m)	277-850
WATER COOLED	
15 ft (4.6 m)	279-815
25 ft (7.6 m)	279-825
35 ft (10.7 m)	279-835
50 ft (15.2 m)	279-850

MAX CUP, 3/8" TIP

AIR COOLED	
LENGTH	MODEL NUMBER
15 ft (4.6 m)	281-815
25 ft (7.6 m)	281-825
35 ft (10.7 m)	281-835
50 ft (15.2 m)	281-850
WATER COOLED	
15 ft (4.6 m)	283-815
25 ft (7.6 m)	283-825
35 ft (10.7 m)	283-835
50 ft (15.2 m)	283-850

MAX CUP, 3/8" TIP

AIR COOLED	
LENGTH	MODEL NUMBER
15 ft (4.6 m)	285-815
25 ft (7.6 m)	285-825
35 ft (10.7 m)	285-835
50 ft (15.2 m)	285-850
WATER COOLED	
15 ft (4.6 m)	287-815
25 ft (7.6 m)	287-825
35 ft (10.7 m)	287-835
50 ft (15.2 m)	287-850

MAX CUP, 3/8" TIP

AIR COOLED	
LENGTH	MODEL NUMBER
15 ft (4.6 m)	300-815
25 ft (7.6 m)	300-825
35 ft (10.7 m)	300-835
50 ft (15.2 m)	300-850
WATER COOLED	
15 ft (4.6 m)	301-815
25 ft (7.6 m)	301-825
35 ft (10.7 m)	301-835
50 ft (15.2 m)	301-850

SEE PYTHON® LX COMPATIBILITY SECTION FOR COMPLETE GUN LEAD ASSEMBLY COMPONENTS

OPTIONAL LEAD ASSEMBLY COMPONENTS

LENGTH	ULTRA FLEX POWER CABLE*
15 ft (4.6 m)	843-0715-15
25 ft (7.6 m)	843-0715-25
35 ft (10.7 m)	843-0715-35
50 ft (15.2 m)	843-0715-50

ALUMINUM WELDING ONLY (COMPATIBLE GUNS)

LENGTH	CONDUIT ASSEMBLY
15 ft (4.6 m)	615-0620-15
25 ft (7.6 m)	615-0620-25
35 ft (10.7 m)	615-0620-35
50 ft (15.2 m)	615-0620-50

HARD WIRE WELDING* ONLY

LENGTH	FLAT SPIRAL STEEL CONDUIT ASSEMBLY
15 ft (4.6 m)	615-0621-15
25 ft (7.6 m)	615-0621-25
35 ft (10.7 m)	615-0621-35
50 ft (15.2 m)	615-0621-50

*Air Cooled models only

*Steel, stainless steel and flux core steel wires
See accessories and consumables for liners and contact tips (pgs 34-35).



Cobra® SX

Push-Pull Gooseneck Gun



With a striking resemblance to the original Cobra® gooseneck gun, the Cobra® SX is easy to use, easy to maintain, and utilizes the original Cobra® consumables. The ergonomic left/right handed speed control is perfect for every welder.

- Optional Ultra Flex power cable offers more durability and less strain when welding.
- Plug-in direct compatibility with MK, Lincoln, Miller, or Fronius.
- Cobra® fix mount barrel with high temp barrel insulator.
- MK Products' lightest, smallest push-pull gooseneck: **less than 2 lbs!**
- Feeds stainless and other hard wire materials.
- Air Cooled to reduce unnecessary cable weight and components.
- Handles more heat without the need for water cooling: no need for coolant recirculators.
- Original Cobra® rear trigger location.
- Thumb pressure wire release in the handle.
- Perfect for all aluminum welding.
- Wire feed speed 800 IPM.
- Wire type and diameter:
 - .023" - .035" solid and hard wire (0.6 mm - 0.9 mm)
 - .030" - .035" all wires (0.8 mm - 0.9 mm), with 3/64" Aluminum 4000 series and softer alloys capability

See pgs 30-36 for barrels, contact tips and gas cups.

Duty Cycle 100%

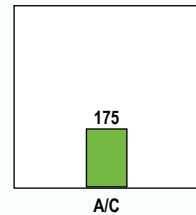

Rated Output determined by the gun having an Air Cooled (A/C) barrel.

Cobramatic® Compatibility

AIR COOLED	
LENGTH	MODEL NUMBER
15 ft (4.6 m)	325-815
25 ft (7.6 m)	325-825
35 ft (10.7 m)	325-835
50 ft (15.2 m)	325-850

GUN LEAD ASSEMBLY COMPONENTS			
LENGTH	GAS HOSE	CONTROL CABLE	POWER CABLE
15 ft (4.6 m)	552-0242-15	005-0690	843-0630-15
25 ft (7.6 m)	552-0242-25	005-0691	843-0630-25
35 ft (10.7 m)	552-0242-35	005-0740	843-0630-35
50 ft (15.2 m)	552-0242-50	005-0692	843-0630-50

STANDARD ON ALL COBRA® SX MODELS	
LENGTH	SNAKE SKIN
15 ft (4.6 m)	931-0110
25 ft (7.6 m)	931-0122
35 ft (10.7 m)	931-0132
50 ft (15.2 m)	931-0123

OPTIONAL LEAD ASSEMBLY COMPONENTS	
LENGTH	ULTRA FLEX POWER CABLE*
15 ft (4.6 m)	843-0580-15
25 ft (7.6 m)	843-0580-25
35 ft (10.7 m)	843-0580-35
50 ft (15.2 m)	843-0580-50

ALUMINUM WELDING ONLY (MK CONNECTION)	
LENGTH	CONDUIT ASSEMBLY
15 ft (4.6 m)	615-0601-15
25 ft (7.6 m)	615-0601-25
35 ft (10.7 m)	615-0601-35
50 ft (15.2 m)	615-0601-50

HARD WIRE WELDING* ONLY	
LENGTH	FLAT SPIRAL STEEL CONDUIT ASSEMBLY
15 ft (4.6 m)	615-0208
25 ft (7.6 m)	615-0216
35 ft (10.7 m)	615-0219
50 ft (15.2 m)	615-0218

*Air Cooled models only

*Steel, stainless steel and flux core steel wires
See accessories and consumables for liners and contact tips (pgs 34-35).

Cobra® SX Compatibility

All Cobramatic® and Cobramatic® compatible guns are available in lengths of 15 ft, 25 ft, 35 ft, and 50 ft.

Lincoln Compatible guns used with Lincoln Power Feed 25M (model K2536-4) require a kit for adaptability. Call factory for details.



LINCOLN, 7 PIN COMPATIBILITY

LENGTH	MODEL NUMBER
15 ft (4.6 m)	327-815
25 ft (7.6 m)	327-825
35 ft (10.7 m)	327-835
50 ft (15.2 m)	327-850

MILLER, 14 PIN COMPATIBILITY

LENGTH	MODEL NUMBER
15 ft (4.6 m)	326-815
25 ft (7.6 m)	326-825
35 ft (10.7 m)	326-835
50 ft (15.2 m)	326-850

FRONIUS, 9 PIN COMPATIBILITY

LENGTH	MODEL NUMBER
15 ft (4.6 m)	328-815
25 ft (7.6 m)	328-825
35 ft (10.7 m)	328-835
50 ft (15.2 m)	328-850

GUN LEAD ASSEMBLY COMPONENTS - COBRA® SX COMPATIBILITY MODELS

COBRA® SX COMPATIBLE MODELS

LENGTH	GAS HOSE	POWER CABLE
15 ft (4.6 m)	552-0241-15	843-0640-15
25 ft (7.6 m)	552-0241-25	843-0640-25
35 ft (10.7 m)	552-0241-35	843-0640-35
50 ft (15.2 m)	552-0241-50	843-0640-50

COBRA® SX COMPATIBLE MODELS - CONTROL CABLES

LENGTH	(LINCOLN, 7 PIN)	(MILLER, 14 PIN)	(FRONIUS, 9 PIN)
15 ft (4.6 m)	005-0690	005-0380-15	005-0381-15
25 ft (7.6 m)	005-0691	005-0380-25	005-0381-25
35 ft (10.7 m)	005-0740	005-0380-35	005-0381-35
50 ft (15.2 m)	005-0692	005-0380-50	005-0381-50

ALUMINUM WELDING ONLY (COMPATIBLE GUNS)

LENGTH	CONDUIT ASSEMBLY
15 ft (4.6 m)	615-0620-15
25 ft (7.6 m)	615-0620-25
35 ft (10.7 m)	615-0620-35
50 ft (15.2 m)	615-0620-50

HARD WIRE WELDING* ONLY

LENGTH	FLAT SPIRAL STEEL CONDUIT ASSEMBLY
15 ft (4.6 m)	615-0621-15
25 ft (7.6 m)	615-0621-25
35 ft (10.7 m)	615-0621-35
50 ft (15.2 m)	615-0621-50

*Steel, stainless steel and flux core steel wires
See accessories and consumables for liners and contact tips (pgs 34-35).

OPTIONAL LEAD ASSEMBLY COMPONENTS

LENGTH	ULTRA FLEX POWER CABLE*
15 ft (4.6 m)	843-0715-15
25 ft (7.6 m)	843-0715-25
35 ft (10.7 m)	843-0715-35
50 ft (15.2 m)	843-0715-50

*Air Cooled models only



Prince® XL

Push-Pull Pistol Grip Gun



The Prince® XL brings together every aspect of precision and dependability. High heat and heavy duty applications will benefit from the Water Cooled and lightweight pistol grip design.

- Optional Ultra Flex power cable offers more durability and less strain when welding.
- Air Cooled models can use the Flex Barrel for hard to reach welds.
- Plug-in direct compatibility with MK, Lincoln, Miller, Fronius, ESAB and Euro systems.
- Ingenious 3¾ turn pot easily adjustable and hidden in the base of the handle for added protection.
- EZ-Lock® barrel can easily rotate 360° to provide the perfect angle for all jobs when using curved barrels.
- Patented Water Cooling right to the end of the gas cup.
- Available with straight or curved barrels in 6", 12" and 18".
- Wire feed speed 800 IPM.
- Wire type and diameter:
 - .030" - .045" solid and hard wire (0.8 mm - 1.1 mm)
 - .030" - 1/16" aluminum and cored wire (0.8 mm - 1.6 mm)

See pgs 30-36 for barrels, contact tips and gas cups.

The Prince® XL can be used with MK's new Flex Barrel, which is designed for hard to reach welds. Air Cooled models only. (See page 31)



Duty Cycle 100%

Rated Output determined by the gun having an Air Cooled (A/C) or Water Cooled (W/C) barrel.

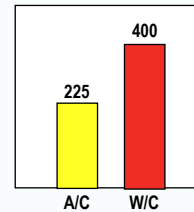

A
M
P
S

Cobramatic® Compatibility

AIR COOLED	
LENGTH	MODEL NUMBER
15 ft (4.6 m)	317-715
25 ft (7.6 m)	317-725
35 ft (10.7 m)	317-735
50 ft (15.2 m)	317-750

WATER COOLED	
LENGTH	MODEL NUMBER
15 ft (4.6 m)	318-715
25 ft (7.6 m)	318-725
35 ft (10.7 m)	318-735
50 ft (15.2 m)	318-750



For best performance, use only Cobra® Coolant. Failure to use Cobra® Coolant will void warranty.

- 1 Gallon (3.78L)**
P/N 931-0060
- 1 Case (4 Gallons, 1 Gal ea.)**
P/N 931-0060-4
- 5 Gallon (18.92L)**
P/N 931-0060-5GAL

GUN LEAD ASSEMBLY COMPONENTS - STANDARD ON ALL PRINCE® XL MODELS

LENGTH	GAS HOSE	CONTROL CABLE	POWER CABLE (A/C)	POWER CABLE (W/C)	WATER HOSE	SNAKE SKIN
15 ft (4.6 m)	552-0242-15	005-0268	843-0487	005-0387-15	552-0243-15	931-0110
25 ft (7.6 m)	552-0242-25	005-0269	843-0484	005-0387-25	552-0243-25	931-0122
35 ft (10.7 m)	552-0242-35	005-0307	843-0488	005-0387-35	552-0243-35	931-0132
50 ft (15.2 m)	552-0242-50	005-0272	843-0485	005-0387-50	552-0243-50	931-0123

OPTIONAL LEAD ASSEMBLY COMPONENTS

LENGTH	ULTRA FLEX POWER CABLE*
15 ft (4.6 m)	843-0707-15
25 ft (7.6 m)	843-0707-25
35 ft (10.7 m)	843-0707-35
50 ft (15.2 m)	843-0707-50

ALUMINUM WELDING ONLY (MK CONNECTION)

LENGTH	CONDUIT ASSEMBLY
15 ft (4.6 m)	615-0601-15
25 ft (7.6 m)	615-0601-25
35 ft (10.7 m)	615-0601-35
50 ft (15.2 m)	615-0601-50

HARD WIRE WELDING* ONLY

LENGTH	FLAT SPIRAL STEEL CONDUIT ASSEMBLY
15 ft (4.6 m)	615-0208
25 ft (7.6 m)	615-0216
35 ft (10.7 m)	615-0219
50 ft (15.2 m)	615-0218

*Air Cooled models only

*Steel, stainless steel and flux core steel wires

See accessories and consumables for liners and contact tips (pgs 34-35).

Prince® XL Compatibility

All Cobramatic® and Cobramatic® compatible guns are available in lengths of 15 ft, 25 ft, 35 ft, and 50 ft.

Lincoln Compatible guns used with Lincoln Power Feed 25M (model K2536-4) require a kit for adaptability. Call factory for details.



LINCOLN, 7 PIN COMPATIBILITY

AIR COOLED	
LENGTH	MODEL NUMBER
15 ft (4.6 m)	310-715
25 ft (7.6 m)	310-725
35 ft (10.7 m)	310-735
50 ft (15.2 m)	310-750
WATER COOLED	
15 ft (4.6 m)	311-715
25 ft (7.6 m)	311-725
35 ft (10.7 m)	311-735
50 ft (15.2 m)	311-750

MILLER, 14 PIN COMPATIBILITY

AIR COOLED	
LENGTH	MODEL NUMBER
15 ft (4.6 m)	332-715
25 ft (7.6 m)	332-725
35 ft (10.7 m)	332-735
50 ft (15.2 m)	332-750
WATER COOLED	
15 ft (4.6 m)	333-715
25 ft (7.6 m)	333-725
35 ft (10.7 m)	333-735
50 ft (15.2 m)	333-750

FRONIUS, 9 PIN COMPATIBILITY

AIR COOLED	
LENGTH	MODEL NUMBER
15 ft (4.6 m)	330-715
25 ft (7.6 m)	330-725
35 ft (10.7 m)	330-735
50 ft (15.2 m)	330-750
WATER COOLED	
15 ft (4.6 m)	331-715
25 ft (7.6 m)	331-725
35 ft (10.7 m)	331-735
50 ft (15.2 m)	331-750

EURO, 7 PIN COMPATIBILITY

AIR COOLED	
LENGTH	MODEL NUMBER
15 ft (4.6 m)	334-715
25 ft (7.6 m)	334-725
35 ft (10.7 m)	334-735
50 ft (15.2 m)	334-750
WATER COOLED	
15 ft (4.6 m)	335-715
25 ft (7.6 m)	335-725
35 ft (10.7 m)	335-735
50 ft (15.2 m)	335-750

MK Products compatible guns have interchangeable fittings, so you can match as needed for your cooler. Both fittings require a hose retainer. Call factory for pricing.

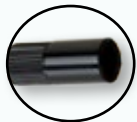

431-1898
5/16" Hose Retainer



431-1910
Quick Connect Fitting



431-1893* Nipple
753-3379* Left-Hand Threaded Fitting
**Must be ordered together*

GUN LEAD ASSEMBLY COMPONENTS - PRINCE® XL COMPATIBILITY MODELS

PRINCE® XL COMPATIBLE MODELS

LENGTH	POWER CABLE	
	GAS HOSE	(A/C) (W/C)
15 ft (4.6 m)	552-0241-15	843-0619 005-0388-15
25 ft (7.6 m)	552-0241-25	843-0620 005-0388-25
35 ft (10.7 m)	552-0241-35	843-0622 005-0388-35
50 ft (15.2 m)	552-0241-50	843-0621 005-0388-50

PRINCE® XL COMPATIBLE MODELS - CONTROL CABLES

LENGTH	(LINCOLN, 7 PIN)	(EURO, 7 PIN)	(MILLER, 14 PIN)	(FRONIUS, 9 PIN)
15 ft (4.6 m)		005-0268	005-0405-15	005-0406-15
25 ft (7.6 m)		005-0269	005-0405-25	005-0406-25
35 ft (10.7 m)		005-0307	005-0405-35	005-0406-35
50 ft (15.2 m)		005-0272	005-0405-50	005-0406-50

PRINCE® XL COMPATIBILITY WATER HOSE - BLUE

LENGTH	(LINCOLN, 7 PIN)	(EURO, 7 PIN)	(MILLER, 14 PIN)	(FRONIUS, 9 PIN)
15 ft (4.6 m)		552-0239-15		552-0238-15
25 ft (7.6 m)		552-0239-25		552-0238-25
35 ft (10.7 m)		552-0239-35		552-0238-35
50 ft (15.2 m)		552-0239-50		552-0238-50

PRINCE® XL COMPATIBILITY WATER HOSE - RED

(LINCOLN, 7 PIN)	(EURO, 7 PIN)	(MILLER, 14 PIN)	(FRONIUS, 9 PIN)
	552-0209*		552-0211*

* Used for all lead assembly lengths

OPTIONAL LEAD ASSEMBLY COMPONENTS

LENGTH	ULTRA FLEX POWER CABLE*
15 ft (4.6 m)	843-0687-15
25 ft (7.6 m)	843-0687-25
35 ft (10.7 m)	843-0687-35
50 ft (15.2 m)	843-0681-50

ALUMINUM WELDING ONLY (COMPATIBLE GUNS)

LENGTH	CONDUIT ASSEMBLY
15 ft (4.6 m)	615-0620-15
25 ft (7.6 m)	615-0620-25
35 ft (10.7 m)	615-0620-35
50 ft (15.2 m)	615-0620-50

HARD WIRE WELDING* ONLY

LENGTH	FLAT SPIRAL STEEL CONDUIT ASSEMBLY
15 ft (4.6 m)	615-0621-15
25 ft (7.6 m)	615-0621-25
35 ft (10.7 m)	615-0621-35
50 ft (15.2 m)	615-0621-50

*Air Cooled models only

*Steel, stainless steel and flux core steel wires
See accessories and consumables for liners and contact tips (pgs 34-35).



Cobramatic® Pro Series

Push-Pull Wire Feed System



MK Products introduces the NEW Cobramatic® Pro Series Wire Feed Cabinet. It has the same dedicated function and performance as expected from a Cobramatic®, but with a stylish and rugged design. The Pro Series cabinet utilizes many enhancements from the original, without sacrificing integrity and durability.

- Structural design allows for smaller compact size providing greater accessibility to tighter, more confined spaces (i.e., it fits through ship portholes).
- Half the weight yet twice as durable. Rugged enough for all weather environments.
- Visible in the brightest or darkest shops: a bright front panel LED displays Wire Feed Speed and Welding Arc Voltage.
- Advanced connectivity allows for universal input power from ALL welding power supplies.
- Offers classic MK or EURO style gun connections, consult factory for available guns.
- Wire type and diameter:
 .030" - 1/16" Aluminum (0.8 mm - 1.6 mm)
 .030" - .045" solid and hard wire* (0.8 mm - 1.1 mm)
 *Steel, stainless steel and flux core steel wires

Optional Kits

- 8 ft interface cable for Miller, 14 pin, 115VAC (005-0316)
- 8 ft interface cable for Lincoln, 14 pin, 115VAC (005-0608)
- 25 ft interface cable for Miller, 14 pin, 115VAC (005-0658)
- 25 ft interface cable for Lincoln, 14 pin, 115VAC (005-0659)
- 50 ft interface cable for Miller, 14 pin, 115VAC (005-0658-50)
- 50 ft interface cable for Lincoln, 14 pin, 115VAC (005-0659-50)
- 8 ft interface cable for Thermal Arc, 19 pin, 115VAC (005-0630)
- 8 ft interface cable for ESAB 460/450 (005-0705)

Installation available upon request, \$25.00 labor charge. Allow 2-3 days.



**STRUCTURAL DESIGN...COMPACT SIZE...
 FOR TIGHTER, MORE CONFINED SPACES**

MODEL NUMBER	POWER INPUT	WIRE SPOOL CAPACITY
150-007-M	115 VAC, 50/60 Hz	12" Standard (Insulated or Non-insulated)

Cobramatic® Pro Series: Connects to virtually all power supplies



MK Guns:
15 ft, 25 ft, 35 ft and 50 ft lengths
Air or Water Cooled



Connects to virtually
all power supplies!



Other models apply - call factory for details



Barrels

For Python®, Python® LX, and Prince® XL guns (Barrel images not to scale)

6 Inch

Straight



003-2330 (Air Only)
003-2151 (Air/Water)



003-2380
300A, WC



003-2315
400A, WC

45 Degree, Curved (Recommended for Prince® XL)



003-2331 (Air Only)
003-2152 (Air/Water)



003-2381
300A, WC



003-2316
400A, WC



003-2467
400A, WC
(4" Radius:
For hard wires)

60 Degree, Curved (Python® Only)



003-2272 (Air Only)
003-2147 (Air/Water)



003-2382
300A, WC



003-2317
400A, WC

12 Inch

Straight



003-2332 (Air Only)
003-2156 (Air/Water)



003-2318
400A, WC

45 Degree, Curved



003-2333 (Air Only)
003-2158 (Air/Water)



003-2319
400A, WC

18 Inch

Straight



003-2334 (Air Only)
003-2157 (Air/Water)



003-2320
400A, WC

45 Degree, Curved



003-2335 (Air Only)
003-2159 (Air/Water)



003-2321
400A, WC

NEW!

MK PRODUCTS FLEX BARREL

Designed for hard to reach welds



Python® LX



Prince® XL

Part Numbers

- 003-2495-12 Flex Barrel Assembly, 12"
- 003-2495-18 Flex Barrel Assembly, 18"
- 003-2495-24 Flex Barrel Assembly, 24"
- 003-2495-36 Flex Barrel Assembly, 36"

See pgs 30-36 for barrels, contact tips and gas cups.

- Designed to fit Prince® XL, Prince® XL Spool Gun, Python®, and Python® LX gun models
- Comes standard with 3/8" OD x .060" ID x 1.0" long tip and #8 x 1.45" long gas cup for easier reach in tough to weld spaces
- Can also be used for hard wire welding
- Can also be used with MAX™ cups and tips, and spring loaded tips
- Available in three lengths: 12", 24", and 36"
- Air Cooled only
- 200A @ 60% duty cycle



Prince® XL Spool Gun



Python®



Bends from 180 degrees to beyond 90!



Gas Cups



Flex Barrel Cup

CUP NUMBER	ID	PART NUMBER	COMPATIBLE GUNS WITH FLEX BARREL
8	1/2" (12.7 mm)	621-0465	Python® Python® LX
10	5/8" (15.9 mm)	621-0466	Prince® XL Prince® XL Spool Gun



Classic Cup

CUP NUMBER	ID	PART NUMBER	COMPATIBLE GUNS
6	3/8" (9.5 mm)	001-0137-4*	Cobra® MX (262, 266) Cobra® SX Prince® SG
8	1/2" (12.7 mm)	001-0138-4*	
		001-0138-200**	
10	5/8" (15.8 mm)	001-0139-4*	
		001-0139-200**	

* Sold in quantities of 4 ** Sold in quantities of 200



Quick Cup

CUP NUMBER	ID	PART NUMBER	COMPATIBLE GUNS
6	3/8" (9.5 mm)	621-0440	Sidewinder®
7	7/16" (11.1 mm)	621-0441	
8	1/2" (12.7 mm)	621-0442	
10	5/8" (15.9 mm)	621-0443	



MAX Cup

CUP NUMBER	ID	PART NUMBER	COMPATIBLE GUNS
6	3/8" (9.5 mm)	621-0420	Cobra® MX (263, 267) CobraMAX™
8	1/2" (12.7 mm)	621-0421	
10	5/8" (15.9 mm)	621-0422	



Finned, Heavy Duty

CUP NUMBER	ID	PART NUMBER	COMPATIBLE BARRELS
6	3/8" (9.5 mm)	621-0248	Python® and Python® LX Air Cooled Python® and Python® LX Air/Water Cooled
8	1/2" (12.7 mm)	621-0249	
10	5/8" (15.9 mm)	621-0250	Prince® XL Air Cooled Prince® XL Air/Water Cooled
10 HD	5/8" (15.9 mm)	621-0251	
12 HD	3/4" (19.05 mm)	621-0252	



Air Cooled Cup
300A

GAS CUPS FOR FULL WATER COOLED BARRELS			
CUP NUMBER	ID	PART NUMBER	AIR COOLED/WATER COOLED
6	3/8" (9.5 mm)	621-0170	Air Cooled*
8	1/2" (12.7 mm)	621-0159	Air Cooled*
10	5/8" (15.9 mm)	621-0160	Air Cooled*
10	5/8" (15.9 mm)	621-0065	Water Cooled, 400 Amp

* Must use Water Cooled cup adapter and chrome nut, P/N 621-0101 & 449-0193.



Chrome Nut
(449-0193)



Water Cooled Cup Adapter
(621-0101)



Water Cooled Cup, 400A
(621-0065)



Tip Extender, Classic Cup, 1/4" Tip
(Stackable)
621-0017

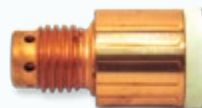

Tip Extender, MAX Cup, 3/8" Tip
(Stackable)
621-0423



Prince®/Python® Tip Extender
(Air/Water Barrels - Non-Stackable)
621-0424



Enhance Your Aluminum Capabilities

Contact Tips



3/8" DIAMETER FLEX BARREL TIPS - RECOMMENDED FOR FLEX BARREL, USED WITH FLEX BARREL CUPS 621-0465 AND 621-0466

WIRE SIZE	TIP ID	ARC	TIP LENGTH	QTY*	PART NUMBER
.030" (0.8 mm)	.041" (1 mm)	Spray	1.0" (25.4 mm)	25	621-0480-25
.035" (0.9 mm)	.044" (1.1 mm)	Spray	1.0" (25.4 mm)	25	621-0481-25
.040" (1 mm)	.053" (1.35 mm)	Spray	1.0" (25.4 mm)	25	621-0482-25
3/64" (1.2 mm)	.060" (1.5 mm)	Spray	1.0" (25.4 mm)	25	621-0483-25

* Sold in quantities of 25

3/8" DIAMETER SPRING LOADED CONTACT TIPS - PYTHON® LX, PYTHON®, PRINCE® XL, COBRA® MX (MAX CUP), COBRAMAX™

MK's line of spring loaded contact tips offers superior smooth arc control, and greatly reduces tip burn back issues while striking an arc or running longer continuous welds.



WIRE SIZE	TIP ID	ARC	TIP LENGTH	QTY	PART NUMBER
.030" (0.8 mm)	.041" (1 mm)	Spray	1.57" (39.9 mm)	EA	621-0331
.035" (0.9 mm)	.044" (1.1 mm)	Spray	1.57" (39.9 mm)	EA	621-0332
	.053" (1.3 mm)	Spray		EA	621-0333
3/64" (1.2 mm)	.060" (1.5 mm)	Spray	1.57" (39.9 mm)	EA	621-0334
1/16" (1.6 mm)	.074" (1.9 mm)	Spray	1.57" (39.9 mm)	EA	621-0335

1/4" DIAMETER - SIDEWINDER®, PRINCE® SG, COBRA® SX, COBRA® MX (CLASSIC CUP)



WIRE SIZE	TIP ID	ARC	TIP LENGTH	QTY*	PART NUMBER
.023" (0.6 mm)	.031" (0.8 mm)	Spray	1.50" (38.1 mm)	25	621-0057-25
.030" (0.8 mm)	.036" (0.9 mm)	Spray	1.50" (38.1 mm)	25	621-0325-25
.030"/.035" (0.8/0.9 mm)	.041" (1.0 mm)	Spray	1.50" (38.1 mm)	25	621-0076-25
.035" (0.9 mm)	.044" (1.1 mm)	Spray	1.50" (38.1 mm)	25	621-0001-25
3/64" (1.2 mm)	.053" (1.37 mm)	Spray	1.50" (38.1 mm)	25	621-0327-25
3/64" (1.2 mm)	.060" (1.5 mm)	Spray	1.50" (38.1 mm)	25	621-0003-25
1/16" (1.6 mm)	.074" (1.9 mm)	Spray	1.50" (38.1 mm)	25	621-0075-25
1/16" (1.6 mm)	.085" (2.1 mm)	Spray	1.50" (38.1 mm)	25	621-0153-25

* Sold in quantities of 25

3/8" DIAMETER - PYTHON® LX, PYTHON®, PRINCE® XL, COBRA® MX (MAX CUP), COBRAMAX



WIRE SIZE	TIP ID	ARC	TIP LENGTH	QTY*	PART NUMBER
.030" (0.8 mm)	.041" (1.0 mm)	Spray	1.57" (39.9 mm)	25	621-0390-25
.035" (0.9 mm)	.044" (1.1 mm)	Spray	1.57" (39.9 mm)	25	621-0391-25
3/64" (1.2 mm)	.053" (1.37 mm)	Spray	1.57" (39.9 mm)	25	621-0392-25
3/64" (1.2 mm)	.060" (1.5 mm)	Spray	1.57" (39.9 mm)	25	621-0393-25
1/16" (1.6 mm)	.074" (1.9 mm)	Spray	1.57" (39.9 mm)	25	621-0394-25
1/16" (1.6 mm)	.085" (2.16 mm)	Spray	1.57" (39.9 mm)	25	621-0395-25

* Sold in quantities of 25



Also available:
Tip Wrench (part number 931-0044)



Additional Enhancements For Aluminum Capabilities

Drive Roll Kits

Insulated Grooved Drive Roll Kits - Optional

The Insulated Grooved Drive Kits are designed to fit all models of MK welding guns. Insulated Grooved Drive Rolls are used to prevent preheating of the wire which may soften and clog the liner. The picking up of current at the drive rolls (rather than at the contact tip) is usually not a problem unless using too large of a contact tip or welding with excessively oxidized aluminum wire.

WIRE SIZE	KIT P/N
.030 (0.8 mm)	005-0715
.035 (0.9 mm)	005-0716
.040 (1.0 mm)	005-0717
3/64" (1.2 mm)	005-0718
1/16" (1.6 mm)	005-0719



Idler Roll

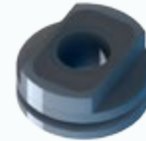

Grooved Drive Roll

(see table for corresponding kit number)

Knurled Drive Roll Kits - Standard

Our knurled drive rolls are designed to allow the wire to have more surface area contact. This extra contact means more grip and traction. Standard factory installed.

Idler Wire Feed Assembly Kit
(Includes washer and screw)
005-0686



Knurled Drive Roll
511-0101



Insulated Knurl Drive Roll Kits - Optional

Our insulated knurled drive rolls kits are designed to fit all models of MK welding guns. The picking up of current at the drive rolls (rather than at the contact tip) is usually not a problem unless using too large of a contact tip or welding with excessively oxidized aluminum wire.

Idler Wire Feed Assembly Kit
(Includes washer and screw)
005-0363



Insulated Knurl Drive Roll
511-0180



Also available: Drive Roll Removal Tool (part number 931-0100)

Contact Tips for Hard Wire Welding*

*Steel, stainless steel and flux core steel wires

1/4" DIAMETER - SIDEWINDER®, PRINCE® SG, COBRA® SX, COBRA® MX (CLASSIC CUP)



WIRE SIZE	TIP ID	ARC	TIP LENGTH	QTY	PART NUMBER
.023" (0.6 mm)	.031" (0.8 mm)	Short	1.75" (44.5 mm)	25	621-0328-25
.030" (0.8 mm)	.037" (0.9 mm)	Short	1.75" (44.5 mm)	25	621-0326-25
.035" (0.9 mm)	.040" (1.0 mm)	Short	1.75" (44.5 mm)	25	621-0077-25
.035" (0.9 mm)	.045" (1.1 mm)	Short	1.75" (44.5 mm)	25	621-0002-25

3/8" DIAMETER - COBRAMAX™, PYTHON®, PYTHON® LX, PRINCE® XL, COBRA® MX (MAX CUP)



WIRE SIZE	TIP ID	ARC	TIP LENGTH	QTY	PART NUMBER
.030" (0.8 mm)	.040" (1.0 mm)	Short	1.82" (46.2 mm)	25	621-0396-25
.035" (0.9 mm)	.045" (1.1 mm)	Short	1.82" (46.2 mm)	25	621-0397-25
.045" (1.2 mm)	.054" (1.37 mm)	Short	1.82" (46.2 mm)	25	621-0398-25



Barrel Liners

Aluminum Welding

MK's Teflon liner packages are truly One-Size-Fits-All. These packages will replace the need for individual liner lengths. Included on the back of each is a cutting length chart for true-length cuts regardless of Tip Extender, Cup/Tip Adapter or gun/barrel style.

Always measure the length of liner removed from gun/barrel prior to cutting to length.



Teflon Liner (Green)

Cobra® Gold

931-0135 Five-piece Teflon Liner Package



Teflon Liner (White)

Python®

Python® LX

Cobra® MX

Cobra® SX

CobraMAX™

Prince® XL

Prince® SG

931-0137 Five-piece Teflon Liner Package

Additional Teflon Liner

Sidewinder®: 931-0140 (Five-piece Teflon Liner Package)

Flex Barrels: 615-0178 (Sold by the foot)

Heavy Duty Teflon Liner

CobraMAX™

Prince® XL

Python®

931-0145 Five-piece Heavy Duty Teflon Liner Package

Hard Wire Welding

Spiral steel liners are used for steel, stainless steel and flux core steel wires.

Spiral Steel Liner

For Air, Air/Water, and Water Cooled barrels

BARREL LENGTH	DESCRIPTION	SPIRAL STEEL LINER PART NUMBER
6" (152.4 mm)	Straight	615-0343
	45° Curved	
	60° Curved (Python® only)	615-0338
12" (304.8 mm)	Straight	615-0258
	45° Curved	
18" (457.2 mm)	Straight	615-0259
	45° Curved	

Flex Barrels Spiral Steel Liner

BARREL LENGTH	COMPATIBLE GUNS	PART NUMBER
12" (304.8 mm)	Python®	615-0261-12
	Python® LX	
	Prince® XL Prince® XL Spool Gun	
18" (457.2 mm)	Python®	615-0261-18
	Python® LX	
	Prince® XL Prince® XL Spool Gun	
24" (609.6 mm)	Python®	615-0261-24
	Python® LX	
	Prince® XL Prince® XL Spool Gun	
36" (914.4 mm)	Python®	615-0261-36
	Python® LX	
	Prince® XL Prince® XL Spool Gun	

48° Curved Cup and Tips

For Air and Air/Water Barrels

Expand the aluminum welding capabilities of your Prince® XL, Python® & Python® LX welding guns with the addition of a Curved Gas Cup and Contact Tips.

Made to fit all current production Straight, Air/Water and Air Cooled barrels for the Prince® XL, Python® & Python® LX welding guns. The simple, curved design of these tips establishes a more positive electrical contact with the welding wire; enhancing arc strikes and arc characteristics. The narrow profile of the Curved Gas Cup (3/4" outside diameter) enables the operator to reach in and weld in very tight spaces, seams or gaps.

To adapt the curved front-end assembly to your straight barrel, choose from the part numbers shown below.

To adapt the curved front-end assembly to your straight barrel, choose from the part numbers shown below.

Choose Your 48° Curved Tip:



<u>Wire Size</u>	<u>Tip ID*</u>	<u>Tip P/N</u>
.035"	.044"	621-0451
.040" & 3/64"	.053"	621-0452
3/64"	.060"	621-0453
1/16"	.074"	621-0454

**Length of weld and heat may determine tip size*

Add these required parts:



Curved Gas Cup	P/N 621-0375
Chrome Nut	P/N 449-0193
Curved Tip Adapter	P/N 003-2230



Spool Guns

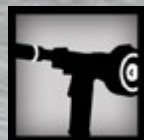

Prince® XL	38
Prince® SG	39
Sidewinder®	40



Prince® XL Spool Gun



The most versatile pistol grip welding gun in the world, the Prince® XL spool gun provides 1 or 2 lb wire spool flexibility and a pistol grip design weighing less than 3 lbs.

Connect the Prince® XL spool gun to any CV or CC power supply using the WC-1 Control or one of our simple interfaces to most any manufacturer's power supply.

- Optional Ultra Flex power cable offers more durability and less strain when welding.
- Can use the Flex Barrel for hard to reach welds.
- EZ-Lock® 360° rotating barrels in 6", 12", and 18", straight or curved. Uses Python® gun consumables and 1 or 2 lb spools.
- Can be easily converted to a push pull gun for use with a 12" spool in the Cobramatic® cabinet.
- 3¼ turn potentiometer provides easy control over a wide range of welding conditions.
- Wire feed speed 900 IPM
- Wire type and diameter:
 - .030" to .045" solid and hard wire (.08 ~ 1.2 mm)
 - .030" to 1/16" aluminum wire (.08 ~ 1.6 mm)

Popular Accessory

- Spool Gun Control Cable Extension 25 ft Kit, (005-0660)

See pgs 30-36 for barrels, contact tips and gas cups.

Duty Cycle 100%

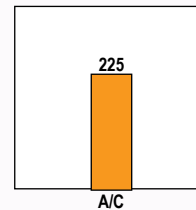

Rated Output determined by the gun having an Air Cooled (A/C) barrel.

AIR COOLED	
MODEL NUMBER	LENGTH
319-725	25 ft (7.6 m)
319-750	50 ft (15.2 m)

GUN LEAD ASSEMBLY COMPONENTS

LENGTH	GAS HOSE	CONTROL CABLE	POWER CABLE	ULTRA FLEX POWER CABLE	SNAKE SKIN
25 ft (4.6 m)	552-0244-25	005-0269	843-0484	843-0707-25	931-0122
50 ft (7.6 m)	552-0244-50	005-0272	843-0485	843-0707-50	931-0123

Spool Gun Adapter Selectors



005-0264
Generic, 24VAC
All Source



005-0676
Lincoln, 42VAC
14-Pin C/D Trigger



005-0261
Miller, 24VAC
14-Pin A/B Trigger



001-3066 MK200 Contactor Box



001-3062 WC-1 Spool Gun Control

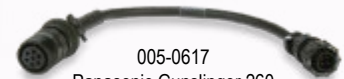

005-0617
Panasonic Gunslinger 260



005-0206
ESAB MigMaster 250



005-0689
ThermalArc Fabricator



Prince® SG Spool Gun



Prince® SG spool gun...when economy counts! Larger and more powerful than the Sidewinder® and utilizes a 1 lb wire spool for increased productivity, the Prince® SG is the most economical spool gun available anywhere.

Lighter than the competition and ready for any job, the Prince® SG is up to any challenge big or small, aluminum or steel. The Prince® SG includes genuine Cobra® consumables and more than 35 years of MK's spool gun expertise packaged into a ready to go, simple solution for all your spool gun needs.

- Wire retainer prevents wire backlash.
- Wire speed control in handle.
- 3¼ turn potentiometer provides easy control over a wide range of welding conditions.
- Quick release cover removes in second for changing spool.
- Uses 1/4" consumables.
- Wire feed speed 900 IPM
- Wire type and diameter:
 - .023" to .045" solid and hard wire* (.06 ~ 1.2 mm)
 - .030" to 1/16" aluminum wire (.08 ~ 1.6 mm)

*Steel, stainless steel and flux core steel wires

See pgs 30-36 for gas cups, barrels and contact tips.

Duty Cycle 100%

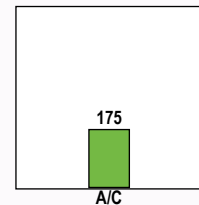

Rated Output determined by the gun having an Air Cooled (A/C) barrel.

AIR COOLED	
MODEL NUMBER	LENGTH
416-725	25 ft (7.6 m)
416-750	50 ft (15.2 m)

GUN LEAD ASSEMBLY COMPONENTS

LENGTH	GAS HOSE	CONTROL CABLE	POWER CABLE
25 ft (4.6 m)	552-0244-25	005-0269	843-0650-25
50 ft (7.6 m)	552-0244-50	005-0272	843-0650-50

Spool Gun Adapter Selectors



005-0264
Generic, 24VAC
All Source



005-0676
Lincoln, 42VAC
14-Pin C/D Trigger



005-0261
Miller, 24VAC
14-Pin A/B Trigger



001-3066 MK200 Contactor Box



001-3062 WC-1 Spool Gun Control

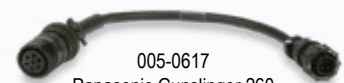

005-0617
Panasonic Gunslinger 260



005-0206
ESAB MigMaster 250



005-0689
ThermalArc Fabricator



Sidewinder[®] MiniSpool™ Gun



Size actually does matter, especially when you're welding in a tight and confined location such as auto body repair. Select the Sidewinder for ultra compact size and profile for limited access or confined welding areas. If reach is an important feature for special applications such as channel letter welding in the aluminum sign industry, the Sidewinder has a 7" barrel length for extended reach into deep channels with steep sidewalls and where other mechanical interference exists around the desired weld zone.

- Intended for applications with limited access, weight requirements or the need for a small footprint.
- Extended reach 7" barrel for getting down into the deepest narrow channel letters.
- Combine with SP control modules to connect to small inverters or portable engine-driven power sources.
- Wire feed speed 600 IPM.
- Wire type and diameter:
030", .035" aluminum wire (0.8 ~ 0.9 mm)
(MiniSpool™ 1/4 lb welding wire is required for use with this gun)

See pgs 30-36 for barrels, contact tips and gas cups.



Duty Cycle 100%

Rated Output determined by the gun having an Air Cooled (A/C) barrel.

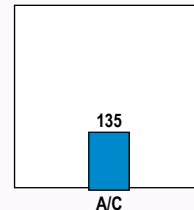

A
M
P
S

AIR COOLED			
MODEL NUMBER	BARREL P/N	LENGTH	
322-515	7"	003-2251	15 ft (4.6 m)
322-525	7"	003-2251	25 ft (7.6 m)

GUN LEAD ASSEMBLY COMPONENTS

LENGTH	GAS HOSE	CONTROL CABLE	POWER CABLE
15 ft (4.6 m)	552-0201	843-0555	843-0590
25 ft (7.6 m)	552-0202	843-0556	843-0591

MiniSpool™ Wire

The 1/4 lb MiniSpool™ is available in .030" and .035" wire size diameters in aluminum alloy. Each MiniSpool™ can hold over 300 ft of aluminum welding wire. MiniSpool™ is available by the case (54) for even greater savings. Contact factory for details.



WIRE SIZE	ALLOY	PART NUMBER
.030" (0.8 mm)	ER4043	909-030-4043
.035" (0.9 mm)	ER4043	909-035-4043
	ER5356	909-035-5356

Spool Gun Adapters

The Sidewinder[®] requires 12VDC to power the gun motor. Below are several adapters that provide DC power and connect to most power supplies available in the industry. Two of these require input power of 115VAC while the other two controls receive power from the power source.



DESCRIPTION	VAC	PART NUMBER	
SP-1	All Source	115	005-0355
SP-L1	14-C/D Trigger	42	005-0356
SP-M1	14-A/B Trigger	24	005-0357
SP-4A	4-1/2 Trigger	115	005-0358

Orbital Equipment



CobraTig®	43
CobraCooler®	43
Advanced Color Logic®	44
MiniMicro™	45
CopperHeads®	46
DiamondBack™	47

COBRATIG® 150 SM

Connects to all MK Products Weldheads

CobraTig® 150 SM
Portable GTAW Orbital Tube Welder
254-153



DiamondBack™ doesn't require CobraCooler®

CobraCooler®
Portable Coolant Recirculator
250-153

Optional cooler that provides recirculation of water for weldheads that have provisions for water cooling



MiniMicro™
4000*



CopperHead®
5001



CopperHead®
5002



CopperHead®
5003



DiamondBack®
5006

*MiniMicro™ requires the CobraCooler®

For best performance, use only Cobra® Coolant. Failure to use Cobra® Coolant will void warranty.

- 1 Gallon (3.78L)
P/N 931-0060
- 1 Case (4 Gallons, 1 Gal ea.)
P/N 931-0060-4
- 5 Gallon (18.92L)
P/N 931-0060-5GAL





CobraTig® 150 SM

Portable GTAW Orbital Tube Welder



The CobraTig® 150 SM is a portable, lightweight orbital welding power source with a digital controller that is the perfect solution for construction or rugged environments. User friendly LCD screen and simple menus guide users through powerful weld programming using SmartArc® logic, real-time data monitoring, plus a built-in thermal printer for weld data. Packaged for rugged construction environments or manufacturing work-cells.

- Provides automatic control for repeatability, verification and traceability.
- SmartArc software develops a near ideal weld procedure with Automatic Program Generator.
- Capable of going down to 0.1 Amps with MicroTig™ technology.
- High Voltage Pulse automatic arc starting from 0.5 to 25 Amps.
- SmartArc control provides flexibility for orbital and manual welding.
- Shipped in a sealed rugged case with wheels for easy mobility.
- Standard with extended memory.

Popular Accessory

- Thermal Printer Paper, 5 per package (P/N 921-0170)

MODEL NUMBER	LINE POWER (+/- 10%)
254-153	100VAC 50/60 Hz Single Phase, 15A 120VAC 50/60 Hz Single Phase, 15A 208VAC 50/60 Hz Single or Three Phase, 30A 230VAC 50/60 Hz Single or Three Phase, 30A



MicroTig™ Manual Weld kit (P/N 005-0670) includes gas-cooled hand TIG torch, variable foot control, ground cable with clamp and carry case.

CobraCooler®

Portable Coolant Recirculator

This recirculator is a separate stand-alone unit that conveniently attaches mechanically to an MK Products CobraTig® 150 SM welding power source.



Model Number 250-153

- Mechanically integrated assembly latches tightly under CobraTig® 150 SM power supply.
- Provides water cooling for any MK Water Cooled weldhead.
- Includes high impact shipping case.

Aluminum Protection

For best performance, use only Cobra® Coolant. **Failure to use Cobra® Coolant will void warranty.**



1 Gallon (3.78L)
P/N 931-0060

1 Case (4 Gallons, 1 Gal ea.)
P/N 931-0060-4

5 Gallon (18.92L)
P/N 931-0060-5GAL



Advanced Color Logic® GTAW Orbital Power Supply / Controller



The patented Advanced Color Logic® delivers controlled welding current needed to perform high-integrity orbital tube welds and is the perfect package for manufacturing environments.

Exclusive Auto Program Generator for easy weld setup and retrieval of saved procedures. Repeatability and precision, combined with real time data monitoring, traceability, and verification conform to most inspection and quality requirements.

Pentium® class processor for the fastest real time on-screen visual display of all welding parameters. Playback entire weld graphically for analysis or download to offline computer.

- Digital control and real-time graphics provide ease of operation and on-screen reference.
- Make your next weld while viewing the process in real time with 17" LCD flat screen monitor.
- Patented updated software now delivers more information, faster.
- USB equipped for moving, storing and transferring weld data and procedures.
- Programming is easy: just enter the tube diameter and wall thickness.
- Weld data monitoring can be printed or viewed as text, graphic on-screen displays or exported to a spreadsheet file.

Alternative or Additional Input Power Cords

- 120 VAC, Single Phase (P/N 843-0600)
- 208/240 VAC, Single Phase (P/N 843-0602)
- 208/240 VAC, Three Phase (P/N 843-0603)
- 220 VAC, Single Phase, Euro (P/N 843-0601)
- Universal 120 VAC, 30 A UL (P/N 843-0613)

Popular Accessory

- Orbital Power Supply Calibration Kit (P/N 005-0698)

MODEL NUMBER	LINE POWER (+/- 10%)
254-203	120VAC 50/60 Hz Single Phase, 15A 120VAC 50/60 Hz Single Phase, 15A, UL 208/240VAC 50/60 Hz Single or Three Phase, 30A

Pentium® registered trademark of Intel®



Sanitary, Short Ferrule Collets

Easy to use and cost effective collets to simplify your orbital welding applications. MK strives to make your job easier by providing off-the-shelf solutions to life's tough challenges. Collets designed for precise tungsten placement offer enhanced repeatability for each weld.



High-Pressure Weld Tooling

Custom machined collets combined with locating and threaded weld fitting mandrels position the electrode right where you want it. MK's ability to create standard and custom tooling can help make the difference in your critical welding applications, including aerospace.

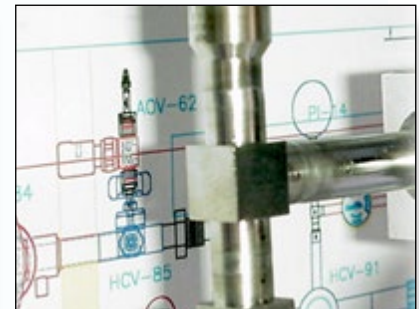

Sanitary • High-Pressure • Ultra High-Purity

Miniature weld fitting collets, tool mounting side plates and clamping jaws are made of nickel plated tool steel and each hardened for wear and toughness. These are just some of the standards that you have come to expect from MK, the leader in orbital welding systems.



MiniMicro™ Weldhead

The MiniMicro™ weldhead was designed for precision welding of small diameter tubes and fittings. It is controlled by an orbital power-supply motor-control circuit to turn the rotor at the precise speed to create a near perfect weld.



- Uses a 24VDC motor with TACH feedback.
- Capable of welding 1/8" to 1/2 inch OD tubes and associated fittings.
- Twist-lock cable-end connectors.
- Comes equipped with an integrated 12 foot cable.
- Connects directly to either the CobraTig® 150 or the ACL orbital power supply with the addition of Pig Tails and the CobraCooler®.

Popular Accessories

- Bench Mount Kit for 4000~5003 Weldheads (P/N 005-0634)
- 25 ft (7.6m) Extension Cable (P/N 005-0635)

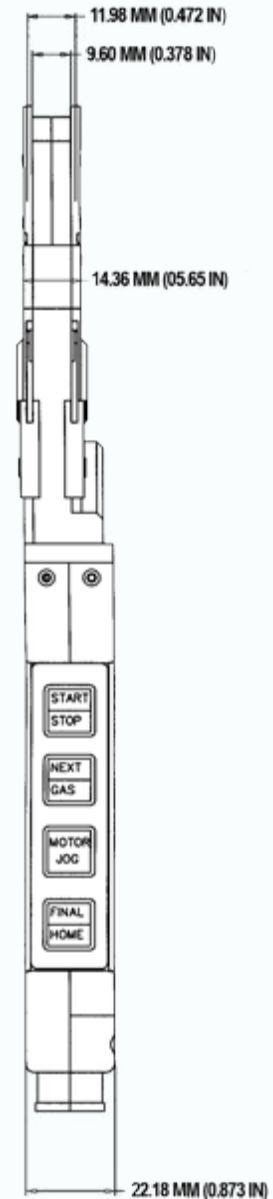

Coolant:

For this weld head only, use distilled water.

MODEL	DESCRIPTION	DIAMETER RANGE	COOLING REQUIREMENTS
4000	MiniMicro™	1/8" ~ 1/2" O.D.	Yes



CopperHeads®

GTAW Weldheads



Whether it's for bench or portable applications, MK Products provides a solution when it comes to orbital welding systems. As our most cost effective and rugged in-place orbital weldhead, the CopperHead® series is an ideal cost saver for sanitary and high pressure tube systems. All CopperHeads® are Water Cooled with fingertip controls in the weldhead handle and come ready to plug into the CobraTig® 150 SM and Advanced Color Logic® power sources.

- Perfect for sanitary and high pressure tube and pipe jobs.
- Weld fitting collets, mandrels and special tooling available.
- CopperHead® offers versatility and high-output production rates.
- Water Cooled, narrow profile CopperHeads® ideal for awkward welds with limited access.
- Standard cable lengths of 25ft (7.6m).

Popular Accessories

- CopperHeads® I-III Benchmount Kit (P/N 005-0634)
- 25 ft (7.6m) Extension Cable (P/N 005-0635)
- 50 ft (15.2m) Extension Cable (P/N 005-0635-50)

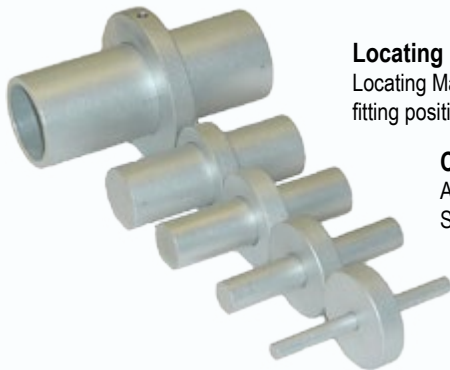

Locating Mandrels

Locating Mandrels are used for precise and repeatable tube and welding fitting positioning and alignment. See price book for part numbers.

Collets, Flush and Extended

A set of collets is defined as top and bottom halves for each side of the weldhead. See price book for part numbers. Typically, 2 sets are required per each weldhead.



Aluminum Protection

For best performance, use only Cobra® Coolant. Failure to use Cobra® Coolant will void warranty.

- 1 Gallon (3.78L)
P/N 931-0060
- 1 Case (4 Gallons, 1 Gal ea.)
P/N 931-0060-4
- 5 Gallon (18.92L)
P/N 931-0060-5GAL

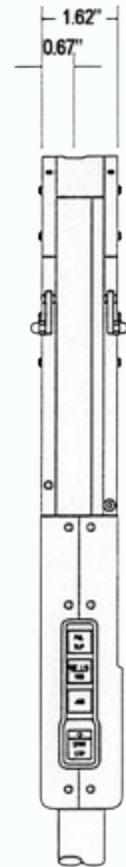

DIMENSION REFERENCE
For all CopperHead® models

MODEL NUMBER	DESCRIPTION	DIAMETER RANGE	COOLING REQUIREMENTS
5001	CopperHead® I	1/8" ~ 1" O.D.	Yes
5002	CopperHead® II	1/4" ~ 2" O.D.	Yes
5003	CopperHead® III	1/2" ~ 3" O.D.	Yes



DiamondBack™

GTAW Weldheads



The DiamondBack™ is our largest in-place orbital weldhead. Heavy duty and versatile, the DiamondBack™ has a narrow profile and is perfect for process piping and weld fitting applications found in food & beverage, dairy and other sanitary process piping installations. Also great for high-pressure aerospace applications, this easy to use weldhead is simple yet robust to meet the demands of field construction or manufacturing production environments.

- Weldable Tube Range: 2" Tube OD to 6" Tube OD
- Weldable Nominal Pipe Range: 2" Nominal Pipe to 5" Nominal Pipe.
- 3-Piece Collet Design for Precision Self-Centering of Tube or Pipe.
- Operator Flexibility: Flip-Top and View Lens aid Fit-Up, Alignment & Inspection.
- Ergonomically Perfect with 7 Function, Push Button Fingertip Control Built into the Weldhead.
- Advanced Design includes Jaw Style Clamping, 360° Head Rotation and 90° Tilt Action. Rugged Machined Aluminum Handles Eliminates Handling of Weldhead Body.
- Weld fitting collets, mandrels and special tooling available.
- Standard cable lengths of 25ft (7.6m).

Popular Accessories

- DiamondBack™ Benchmount Kit (P/N 005-0680)
- 25 ft (7.6m) Extension Cable (P/N 005-0635)
- 50 ft (15.2m) Extension Cable (P/N 005-0635-50)

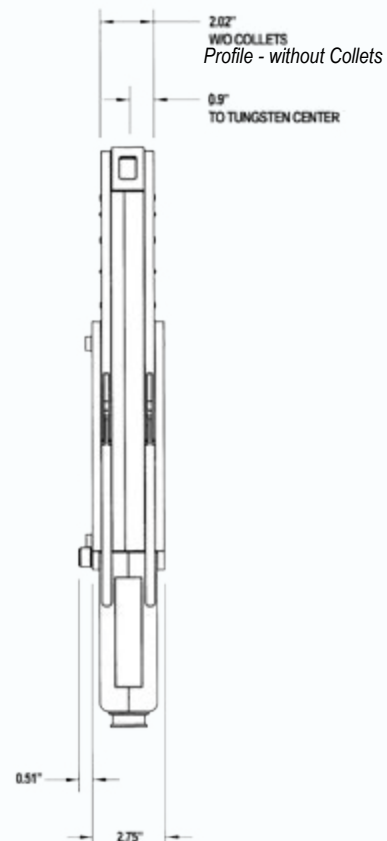
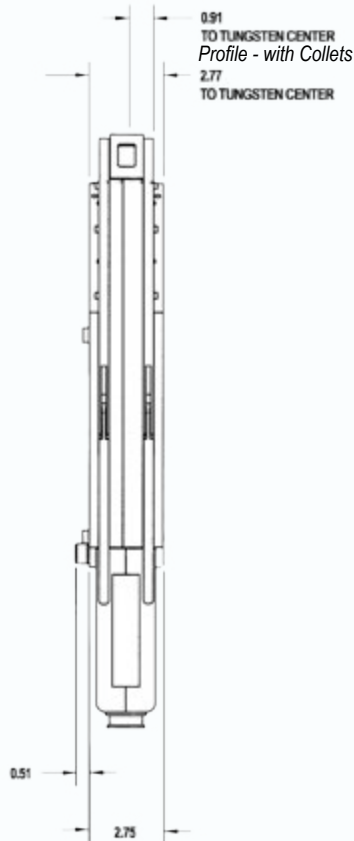

MODEL	DESCRIPTION	DIAMETER RANGE	COOLING REQUIREMENTS
5006	DiamondBack™	2" O.D. ~ 6" O.D.	No

Offset Tungsten Layout Configurations

2% Ceriated electrodes, pre-ground and cut to length, 18° included angle, .015" flat tip, .040" or 1/16" diameter. See page 49 for part numbers.

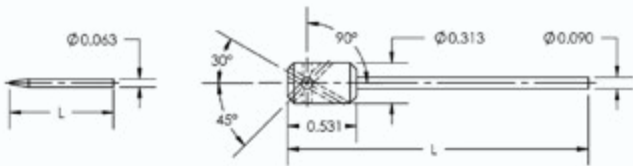

T
(TUNGSTEN
P/N: 635-063-SERIES)

X
(TUNGSTEN EXTENDER ASSEMBLY
P/N: 002-0770)

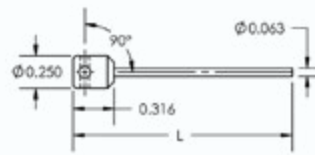

H-90
(TUNGSTEN HOLDER
ASSEMBLY 90 DEG
P/N: 002-0771)

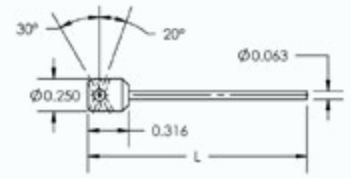

H-20/30
(TUNGSTEN HOLDER
ASSEMBLY 20 & 30 DEG
P/N: 002-0772)



T



T + X

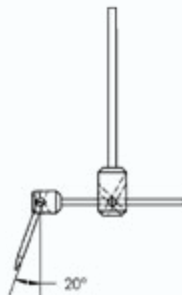

T + X + H-20/30

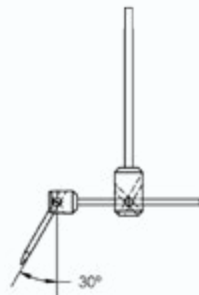

T + X + H-20/30

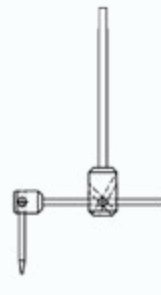

T + X + H-90



T + H-20/30

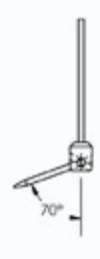

T + H-20/30

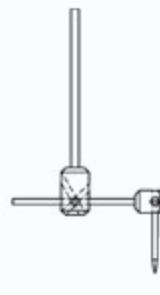
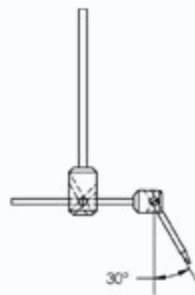
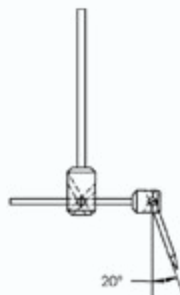

Tungsten and Collets

Pricing available at www.mkproducts.com

4000 Weldheads

OD	FLUSH COLLETS PART NUMBER	EXTENDED COLLETS PART NUMBER	TUNGSTEN PART NUMBER
	(\$637.24 ea)	(\$722.80 ea)	(\$91.79 ea)
1/8	623-4000-0.125	624-4000-0.125	635-063-0.468
3/16	***	***	635-063-0.437
1/4	623-4000-0.250	624-4000-0.250	635-063-0.406
5/16	623-4000-0.313	624-4000-0.313	635-063-0.377
7/16	***	***	635-063-0.312
3/8	623-4000-0.375	624-4000-0.375	635-063-0.343
1/2	623-4000-0.500	624-4000-0.500	635-063-0.281
4MM	623-4000-4.0MM	624-4000-4.0MM	635-063-0.452
6MM	623-4000-6.0MM	624-4000-6.0MM	635-063-0.413
8MM	623-4000-8.0MM	624-4000-8.0MM	635-063-0.377
10MM	623-4000-10.0MM	624-4000-10.0MM	635-063-0.339
12MM	623-4000-12.0MM	624-4000-12.0MM	635-063-0.295

Also available:
Tungsten diameters .040" and .093"
Call factory for details

5001 Weldheads

OD/NP	FLUSH COLLETS PART NUMBER	EXTENDED COLLETS PART NUMBER	TUNGSTEN PART NUMBER
	(\$263.92)	(\$285.06)	(\$91.79 ea)
1/8	623-0110-0.125	624-0110-0.125	635-063-0.984
3/16	623-0110-0.188	624-0110-0.188	635-063-0.953
1/4	623-0110-0.250	624-0110-0.250	635-063-0.922
5/16	623-0110-0.313	624-0110-0.313	635-063-0.891
3/8	623-0110-0.375	624-0110-0.375	635-063-0.859
7/16	***	***	635-063-0.828
.450	623-0110-0.450	***	635-063-0.828
1/2	623-0110-0.500	624-0110-0.500	635-063-0.797
9/16	623-0110-0.563	624-0110-0.563	635-063-0.766
5/8	623-0110-0.625	624-0110-0.625	635-063-0.734
11/16	***	***	635-063-0.703
3/4	623-0110-0.750	624-0110-0.750	635-063-0.672
13/16	623-0110-0.813	624-0110-0.813	635-063-0.641
7/8	623-0110-0.875	624-0110-0.875	635-063-0.609
15/16	623-0110-0.938	624-0110-0.938	635-063-0.578
1	623-0110-1.000	624-0110-1.000	635-063-0.547
1/8 NP	623-0110-1/8NP	624-0110-1/8NP	635-063-0.844
1/4 NP	623-0110-1/4NP	624-0110-1/4NP	635-063-0.766
3/8 NP	623-0110-3/8NP	624-0110-3/8NP	635-063-0.703
1/2 NP	623-0110-1/2NP	624-0110-1/2NP	635-063-0.625
3.0 MM	***	***	635-063-1.000
4.0 MM	***	***	635-063-0.969
5.0 MM	***	***	635-063-0.953

*** Call factory for details

For a complete price list of all MK available tungsten and collets, visit www.mkproducts.com

Also available:
Tungsten diameters .040" and .093"
Call factory for details

5001 Weldheads

OD/NP	FLUSH COLLETS PART NUMBER	EXTENDED COLLETS PART NUMBER	TUNGSTEN PART NUMBER
	(\$263.92)	(\$285.06)	(\$91.79 ea)
6.0 MM	623-0110-6.0MM	624-0110-6.0MM	635-063-0.922
7.0 MM	623-0110-7.0MM	624-0110-7.0MM	***
8.0 MM	623-0110-8.0MM	624-0110-8.0MM	635-063-0.891
10.0 MM	623-0110-10.0MM	624-0110-10.0MM	635-063-0.844
10.2 MM	623-0110-10.2MM	624-0110-10.2MM	635-063-0.844
12.0 MM	623-0110-12.0MM	624-0110-12.0MM	635-063-0.813
13.5 MM	623-0110-13.5MM	624-0110-13.5MM	635-063-0.781
14.0 MM	623-0110-14.0MM	624-0110-14.0MM	635-063-0.766
15.0 MM	623-0110-15.0MM	624-0110-15.0MM	635-063-0.750
16.0 MM	623-0110-16.0MM	624-0110-16.0MM	635-063-0.734
16.5 MM	623-0110-16.5MM	624-0110-16.5MM	635-063-0.719
17.2 MM	623-0110-17.2MM	624-0110-17.2MM	635-063-0.703
18.0 MM	623-0110-18.0MM	624-0110-18.0MM	635-063-0.688
19.1 MM	623-0110-19.1MM	***	635-063-0.672
20.0 MM	623-0110-20.0MM	624-0110-20.0MM	635-063-0.656
21.3 MM	623-0110-21.3MM	624-0110-21.3MM	635-063-0.625
22.0 MM	***	***	635-040-0.609
23.0 MM	623-0110-23.0MM	624-0110-23.0MM	635-063-0.594
25.0 MM	623-0110-25.0MM	***	635-063-0.547

Also available:
Tungsten diameter .093"
(Call factory for details)

5002 Weldheads

OD/NP	FLUSH COLLETS PART NUMBER	EXTENDED COLLETS PART NUMBER	TUNGSTEN PART NUMBER
	(\$292.60)	(\$323.88)	(\$91.79 ea)
1/4	623-0210-0.250	624-0210-0.250	635-063-1.609
.304	623-0210-0.304	***	***
5/16	623-0210-0.313	624-0210-0.313	635-063-1.578
3/8	623-0210-0.375	624-0210-0.375	635-063-1.547
7/16	623-0210-0.437	624-0210-0.437	635-063-1.516
1/2	623-0210-0.500	624-0210-0.500	635-063-1.484
9/16	***	***	635-063-1.453
5/8	623-0210-0.625	624-0210-0.625	635-063-1.422
.630	***	624-0210-0.630	***
11/16	***	***	635-063-1.391
.749	***	624-0210-0.749	***
3/4	623-0210-0.750	624-0210-0.750	635-063-1.359
13/16	***	***	635-063-1.332
7/8	623-0210-0.875	624-0210-0.875	635-063-1.302
15/16	***	***	635-063-1.277
1	623-0210-1.000	624-0210-1.000	635-063-1.238
1-1/8	623-0210-1.125	624-0210-1.125	635-063-1.171
1-1/4	623-0210-1.250	624-0210-1.250	635-063-1.102
1-3/8	***	***	635-063-1.047

*** Call factory for details

For a complete price list of all MK available tungsten and collets, visit www.mkproducts.com

Also available:
Tungsten diameter .093"
 (Call factory for details)

5002 Weldheads

OD/NP	FLUSH COLLETS PART NUMBER (\$292.60)	EXTENDED COLLETS PART NUMBER (\$323.88)	TUNGSTEN PART NUMBER (\$91.79 ea)
1-1/2	623-0210-1.500	624-0210-1.500	635-063-0.984
1-5/8	***	***	635-063-0.922
1-3/4	623-0210-1.750	624-0210-1.750	635-063-0.859
1-7/8	623-0210-1.875	624-0210-1.875	635-063-0.797
2	623-0210-2.000	624-0210-2.000	635-063-0.734
1/8 NP	623-0210-1/8NP	624-0210-1/8NP	635-063-1.531
1/4 NP	623-0210-1/4NP	624-0210-1/4NP	635-063-1.453
3/8 NP	623-0210-3/8NP	624-0210-3/8NP	635-063-1.391
1/2 NP	623-0210-1/2NP	624-0210-1/2NP	635-063-1.316
3/4 NP	623-0210-3/4NP	624-0210-3/4NP	635-063-1.203
			635-063-1.219
1 NP	623-0210-1NP	624-0210-1NP	635-063-1.073
1-1/4 NP	623-0210-1-1/4NP	624-0210-1-1/4NP	635-063-0.891
1-1/2 NP	623-0210-1-1/2NP	624-0210-1-1/2NP	635-063-0.781
5.1 MM	623-0210-5.1MM	624-0210-5.1MM	635-063-1.625
6.0 MM	623-0210-6.0MM	624-0210-6.0MM	635-063-1.625
6.6 MM	623-0210-6.6MM	624-0210-6.6MM	635-063-1.609
8.0 MM	623-0210-8.0MM	624-0210-8.0MM	635-063-1.578
10.0 MM	623-0210-10.0MM	624-0210-10.0MM	635-063-1.531
10.2 MM	623-0210-10.2MM	624-0210-10.2MM	635-063-1.531
12.0 MM	623-0210-12.0MM	624-0210-12.0MM	635-063-1.500
13.5 MM	623-0210-13.5MM	624-0210-13.5MM	635-063-1.469
14.0 MM	623-0210-14.0MM	624-0210-14.0MM	635-063-1.453
14.33 MM	623-0210-14.33MM	***	635-063-1.453
14.5 MM	623-0210-14.5MM	***	635-063-1.453
15.0 MM	623-0210-15.0MM	624-0210-15.0MM	635-063-1.438
16.0 MM	623-0210-16.0MM	624-0210-16.0MM	635-063-1.422
16.5 MM	623-0210-16.5MM	***	635-063-1.413
17.2 MM	623-0210-17.2MM	624-0210-17.2MM	635-063-1.391
18.0 MM	623-0210-18.0MM	624-0210-18.0MM	635-063-1.386
20.0 MM	623-0210-20.0MM	624-0210-20.0MM	635-063-1.343
21.2 MM	623-0210-21.2MM	624-0210-21.2MM	635-063-1.316
21.3 MM	623-0210-21.3MM	624-0210-21.3MM	635-063-1.316
21.4 MM	623-0210-21.4MM	***	635-063-1.316
22.4 MM	623-0210-22.4MM	624-0210-22.4MM	635-063-1.295
23.0 MM	623-0210-23.0MM	624-0210-23.0MM	635-063-1.277
25.0 MM	623-0210-25.0MM	624-0210-25.0MM	635-063-1.238
26.0 MM	623-0210-26.0MM	624-0210-26.0MM	635-063-1.228
26.9 MM	623-0210-26.9MM	624-0210-26.9MM	635-063-1.203
28.0 MM	623-0210-28.0MM	624-0210-28.0MM	635-063-1.187
30.0 MM	623-0210-30.0MM	624-0210-30.0MM	635-063-1.136
32.0 MM	623-0210-32.0MM	624-0210-32.0MM	635-063-1.102
33.7 MM	623-0210-33.7MM	624-0210-33.7MM	635-063-1.073

*** Call factory for details

For a complete price list of all MK available tungsten and collets, visit www.mkproducts.com

Also available:
Tungsten diameter .093"
 (Call factory for details)

5002 Weldheads

OD/NP	FLUSH COLLETS PART NUMBER	EXTENDED COLLETS PART NUMBER	TUNGSTEN PART NUMBER
	(\$292.60)	(\$323.88)	(\$91.79 ea)
35.0 MM	623-0210-35.0MM	624-0210-35.0MM	635-063-1.047
36.0 MM	623-0210-36.0MM	624-0210-36.0MM	635-063-1.020
36.5 MM	623-0210-36.5MM	624-0210-36.5MM	635-063-1.020
38.0 MM	623-0210-38.0MM	624-0210-38.0MM	635-063-0.984
40.0 MM	623-0210-40.0MM	624-0210-40.0MM	635-063-0.938
42.4 MM	623-0210-42.4MM	624-0210-42.4MM	635-063-0.891
43.0 MM	623-0210-43.0MM	624-0210-43.0MM	635-063-0.891
44.0 MM	623-0210-44.0MM	624-0210-44.0MM	635-063-0.859
44.5 MM	623-0210-44.5MM	624-0210-44.5MM	635-063-0.859
45.1 MM	623-0210-45.1MM	624-0210-45.1MM	635-063-0.844
48.3 MM	623-0210-48.3MM	624-0210-48.3MM	635-063-0.781

Also available:
Tungsten diameter .093"
 (Call factory for details)

5003 Weldheads

OD/NP	FLUSH COLLETS PART NUMBER	EXTENDED COLLETS PART NUMBER	TUNGSTEN PART NUMBER
	(\$338.51)	(\$379.37)	(\$91.79 ea)
5/16	623-0310-0.313	624-0310-0.313	***
1/2	623-0310-0.500	624-0310-0.500	635-063-1.891
9/16	***	***	635-063-1.859
5/8	623-0310-0.625	624-0310-0.625	635-063-1.828
11/16	***	***	635-063-1.797
3/4	623-0310-0.750	624-0310-0.750	635-063-1.766
.800	623-0310-0.800	624-0310-0.800	635-063-1.734
.830	623-0310-0.830	624-0310-0.830	635-063-1.719
13/16	***	***	635-063-1.734
7/8	623-0310-0.875	624-0310-0.875	635-063-1.703
.910	623-0310-0.910	624-0310-0.910	635-063-1.688
15/16	623-0310-0.938	624-0310-0.938	635-063-1.672
.955	623-0310-0.955	624-0310-0.955	635-063-1.656
1	623-0310-1.000	624-0310-1.000	635-063-1.641
1-1/8	623-0310-1.125	***	635-063-1.578
1-1/4	623-0310-1.250	624-0310-1.250	635-063-1.516
1-3/8	623-0310-1.375	***	635-063-1.453
1-1/2	623-0310-1.500	624-0310-1.500	635-063-1.391
1-5/8	623-0310-1.625	***	635-063-1.332
1-3/4	623-0310-1.750	624-0310-1.750	635-063-1.266
1-7/8	623-0310-1.875	624-0310-1.875	635-063-1.203
2	623-0310-2.000	624-0310-2.000	635-063-1.136
2-1/4	623-0310-2.250	624-0310-2.250	635-063-1.020
2-1/2	623-0310-2.500	624-0310-2.500	635-063-0.891
2-3/4	623-0310-2.750	624-0310-2.750	635-063-0.766
3	623-0310-3.000	624-0310-3.000	635-063-0.641
3-3/16	***	624-0310-3.188	***

*** Call factory for details

For a complete price list of all MK available tungsten and collets, visit www.mkproducts.com

Also available:
Tungsten diameter .093"
 (Call factory for details)

5003 Weldheads

OD/NP	FLUSH COLLETS PART NUMBER (\$338.51)	EXTENDED COLLETS PART NUMBER (\$379.37)	TUNGSTEN PART NUMBER (\$91.79 ea)
1/4 NP	623-0310-1/4NP	624-0310-1/4NP	635-063-1.859
3/8 NP	623-0310-3/8NP	624-0310-3/8NP	635-063-1.797
1/2 NP	623-0310-1/2NP	624-0310-1/2NP	635-063-1.719
3/4 NP	623-0310-3/4NP	624-0310-3/4NP	635-063-1.609
1 NP	623-0310-1NP	624-0310-1NP	635-063-1.469
1-1/4 NP	623-0310-1-1/4NP	624-0310-1-1/4NP	635-063-1.302
1-1/2 NP	623-0310-1-1/2NP	624-0310-1-1/2NP	635-063-1.187
2 NP	623-0310-2NP	624-0310-2NP	635-063-0.953
2-1/2 NP	623-0310-2-1/2NP	624-0310-2-1/2NP	635-063-0.688
13.5 MM	623-0310-13.5MM	624-0310-13.5MM	635-063-1.875
14.0 MM	623-0310-14.0MM	624-0310-14.0MM	635-063-1.859
15.0 MM	623-0310-15.0MM	624-0310-15.0MM	635-063-1.843
16.0 MM	623-0310-16.0MM	624-0310-16.0MM	635-063-1.828
17.2 MM	623-0310-17.2MM	624-0310-17.2MM	635-063-1.797
18.0 MM	623-0310-18.0MM	624-0310-18.0MM	635-063-1.781
19.0 MM	623-0310-19.0MM	***	***
20.0 MM	623-0310-20.0MM	624-0310-20.0MM	635-063-1.750
21.3 MM	623-0310-21.3MM	624-0310-21.3MM	635-063-1.719
22.4 MM	623-0310-22.0MM	***	635-063-1.703
23.0 MM	623-0310-23.0MM	624-0310-23.0MM	635-063-1.688
25.0 MM	***	624-0310-25.0MM	635-063-1.641
26.0 MM	623-0310-26.0MM	624-0310-26.0MM	635-063-1.625
26.9 MM	623-0310-26.9MM	624-0310-26.9MM	635-063-1.609
28.0 MM	623-0310-28.0MM	624-0310-28.0MM	635-063-1.594
29.0 MM	***	***	635-063-1.578
30.0 MM	623-0310-30.0MM	624-0310-30.0MM	635-063-1.547
32.0 MM	623-0310-32.0MM	624-0310-32.0MM	635-063-1.516
33.4 MM	623-0310-33.4MM	624-0310-33.4MM	635-063-1.484
33.7 MM	623-0310-33.7MM	624-0310-33.7MM	635-063-1.469
35.0 MM	623-0310-35.0MM	624-0310-35.0MM	635-063-1.453
38.0 MM	623-0310-38.0MM	624-0310-38.0MM	635-063-1.391
40.0 MM	623-0310-40.0MM	624-0310-40.0MM	635-063-1.359
41.0 MM	623-0310-41.0MM	***	***
42.4 MM	623-0310-42.4MM	624-0310-42.4MM	635-063-1.302
43.0 MM	623-0310-43.0MM	624-0310-43.0MM	635-063-1.295
44.0 MM	623-0310-44.0MM	624-0310-44.0MM	635-063-1.277
44.5 MM	623-0310-44.5MM	624-0310-44.5MM	635-063-1.266
48.3 MM	623-0310-48.3MM	624-0310-48.3MM	635-063-1.187
50.0 MM	623-0310-50.0MM	***	635-063-1.159
51.0 MM	623-0310-51.0MM	624-0310-51.0MM	635-063-1.136
53.0 MM	623-0310-53.0MM	624-0310-53.0MM	635-063-1.095
54.0 MM	623-0310-54.0MM	624-0310-54.0MM	635-063-1.073
57.0 MM	623-0310-57.0MM	624-0310-57.0MM	635-063-1.020

*** Call factory for details

For a complete price list of all MK available tungsten and collets, visit www.mkproducts.com

Also available:
Tungsten diameter .093"
 (Call factory for details)

5003 Weldheads

OD/NP	FLUSH COLLETS PART NUMBER	EXTENDED COLLETS PART NUMBER	TUNGSTEN PART NUMBER
	(\$338.51)	(\$379.37)	(\$91.79 ea)
60.3 MM	623-0310-60.3MM	624-0310-60.3MM	635-063-0.953
63.5 MM	623-0310-63.5MM	624-0310-63.5MM	635-063-0.891
65.0 MM	623-0310-65.0MM	***	***
68.0 MM	623-0310-68.0MM	624-0310-68.0MM	635-063-0.797
70.0 MM	623-0310-70.0MM	624-0310-70.0MM	635-063-0.766
76.1 MM	623-0310-76.1MM	624-0310-76.1MM	635-063-0.641

Also available:
Tungsten diameter .063"
 (Call factory for details)

5006 Weldheads

OD/NP	FLUSH COLLETS PART NUMBER	EXTENDED COLLETS PART NUMBER	TUNGSTEN PART NUMBER
	(\$550.78)	(CALL FACTORY FOR DETAILS)	(\$91.79 ea)
2	623-5006-2.000	624-5006-2.000	635-093-3.339
2-1/2	623-5006-2.500	624-5006-2.500	635-093-3.089
3	623-5006-3.000	624-5006-3.000	635-093-2.828
3-1/2	623-5006-3.500	624-5006-3.500	635-093-2.578
4	623-5006-4.000	624-5006-4.000	635-093-2.328
4-1/2	623-5006-4.500	624-5006-4.500	635-093-2.086
5	623-5006-5.000	624-5006-5.000	635-093-1.828
5-1/2	623-5006-5.500	624-5006-5.500	635-093-1.578
6	623-5006-6.000	624-5006-6.000	635-093-1.332
2 NP	623-5006-2NP	624-5006-2NP	635-093-3.147
2-1/2 NP	623-5006-2-1/2NP	624-5006-2-1/2NP	635-093-2.890
3 NP	623-5006-3NP	624-5006-3NP	635-093-2.578
3-1/2 NP	623-5006-3-1/2NP	624-5006-3-1/2NP	635-093-2.328
4 NP	623-5006-4NP	624-5006-4NP	635-093-2.067
5 NP	623-5006-5NP	624-5006-5NP	635-093-1.531
60.0 MM	623-5006-60.0MM	624-5006-60.0MM	635-093-3.147
72.0 MM	623-5006-72.0MM	624-5006-72.0MM	635-093-2.890
78.8 MM	623-5006-78.8MM	624-5006-78.8MM	635-093-2.781
80.0MM	623-5006-80.0MM	***	***
85.0MM	623-5006-85.0MM	***	***
104.0MM	623-5006-104.0MM	***	***
114.0 MM	623-5006-114.0MM	624-5006-114.0MM	635-093-2.086
115.0 MM	623-5006-115.0MM	624-5006-115.0MM	635-093-2.067

*** Call factory for details

For a complete price list of all MK available tungsten and collets, visit www.mkproducts.com

Turntables



AirCrafter™ T-25

56

CobraTurn™

57



AirCrafter™ T-25

Rotary Turntable



The AirCrafter™ T-25 positioner is ideal for lightweight applications. The most affordable rotary turntable, the T-25 is well suited for welding small, intricate assemblies, tube flanges and small aircraft-type parts as well as rotating lightweight non-welding items. The compact T-25 positioner has a maximum center load capacity of 25 lbs. and maximum welding ground capacity of 170 amps.

- Compact high performance turntable.
- Comes with 5" turntable top.
- Table angle control from 0 to 90°.
- Appropriate for GMAW or GTAW welding processes.
- High frequency protected.
- Perfect for small jobs.
- Includes a variable speed foot control.



The AirCrafter™ T-25 comes with a variable speed foot control.

MODEL NUMBER	OFFSET LOAD CAPACITY		TABLE DIAMETER	BALANCED LOAD CAPACITY		TABLE TILT	RPM RANGE
	HORIZONTAL - 0°	VERTICAL - 90°		HORIZONTAL	VERTICAL		
127-001	16 lb with Center of Gravity 1.78" off center	10 lb with Center of Gravity 2.5" from plate	5"	25 lb	10 lb	0 ~ 90°	0.5 ~ 10

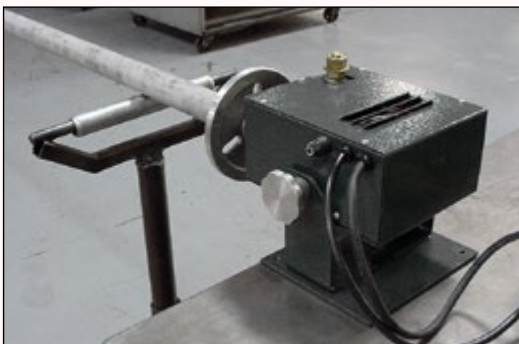

The AirCrafter™ has a long standing reputation for fine workmanship and durability. It's no wonder that the AirCrafter™ name is one of the most asked for brands in the welding industry. MK Products makes every turntable to exacting standards.



CobraTurn™ Digital Turntable



MK Products introduces the new CobraTurn™ Digital Turntable, designed for durability and performance with all welding processes. Utilized on small to large weld assemblies, the CobraTurn's™ ability to rotate welding jobs makes it ideal for all applications up to the rated load capacities.

- Simple illuminated control panel, with digital display.
- Power (On / Off) and Rotation direction (CW / CCW) push button switches.
- Linear single speed control knob, with center, push button start, stop or jog functions.
- Gas ID purge through the center shaft.
- High frequency interference protection.
- Simple push knob to adjust table angle.
- Grab handle for easy tilting and transporting.
- Standard On/ Off foot switch provided, or an optional variable foot switch may be purchased.
- Heavy-duty, compact, open frame design.
- Can be easily bolted to any flat surface.
- Gas fitting and grounding lug accept common gas hose and ground terminals used in the welding industry.
- Steel frame and control panel, powder coated grey.
- Lightweight, anodized aluminum gear housing.
- Heavy-duty steel cut gears.
- Spring loaded tapered pin lock mechanism to adjust table angle.
- 9 table angle locking positions from 0-90 degrees. Custom angle lock plates may be purchased.



The CobraTurn™ comes with:
On/Off Foot Switch
005-0747

* See manufacturing specifications for details

MODEL	BALANCED LOAD CAPACITY	OPTIONAL TURNTABLE DIAMETER	DEGREES TILT	SPEED RANGE R.P.M.	GROUND CAPACITY AMPS	INPUT VOLTAGE	SHIPPING WEIGHT	TRANSMISSION
127-006	300 lb*	10"	0° ~ 90°	0.3 ~ 10	400A 60% Duty Cycle	120VAC 50/60 Hz	38 lbs	Gear

Optional Accessories for CobraTurn™ Digital Turntable



005-0746
Heavy Duty
Variable Speed Foot Control



005-0677
10" Turntable



005-0040
Self-Centering 3-Jaw Chuck
Includes two sets of manually adjustable jaws from 7/8" - 3 3/4" internal and 1/8" - 4" external clamping.

Boxed Weight (approximate)

Guns	15 ft (m)	25 ft (m)	35 ft (m)	50 ft (m)
Cobra® X	10.7 (4.8)	15.5 (7)	20.4 (9.2)	27.1 (12.3)
Cobra® MX (Air Cooled)	10.7 (4.8)	15.5 (7)	20.4 (9.2)	27.1 (12.3)
Cobra® MX (Water Cooled)	11.4 (5.2)	17.2 (7.8)	22.1 (10)	29.6 (13.4)
Cobra® MX Compatible (Air Cooled)	11.6 (5.3)	16.6 (7.5)	21.3 (9.6)	28 (12.7)
Cobra® MX Compatible (Water Cooled)	13.1 (5.9)	17.9 (8.1)	22.8 (10.3)	29.5 (13.4)
Cobra® SX (Air Cooled)	10.5 (4.8)	17 (7.8)	23.5 (10.7)	26.1 (11.8)
Cobra® SX, Compatible (Air Cooled)	11 (5.8)	15.6 (7.9)	21 (9.5)	27.5 (12.5)
Prince® SG		17 (7.7)		25 (11.3)
Prince® X	13 (5.9)	18 (8.2)	23 (10.4)	33 (15)
Prince® XL (Air Cooled)	13 (5.9)	18 (8.2)	23 (10.4)	33 (15)
Prince® XL (Water Cooled)	14 (6.3)	20 (9.1)	26 (11.8)	35 (15.9)
Prince® XL Compatible (Air Cooled)	14.5 (6.6)	19.5 (8.8)	24.5 (11.1)	34.5 (15.6)
Prince® XL Compatible (Water Cooled)	15.5 (7.0)	21 (9.5)	26 (11.8)	36 (16.3)
Prince® XL Pool Gun		17 (7.7)		29 (13.2)
Python® X	13.1 (5.9)	19.3 (8.8)	25.5 (11.6)	29.9 (13.6)
Python® (Air Cooled)	13.1 (5.9)	19.3 (8.8)	25.5 (11.6)	29.9 (13.6)
Python® (Water Cooled)	13.6 (6.2)	19.7 (8.9)	25.8 (11.7)	34.8 (15.8)
Python® Compatible (Air Cooled)	14.6 (6.6)	20.8 (9.4)	27 (12.2)	31.4 (14.2)
Python® Compatible (Water Cooled)	15.1 (6.8)	21.2 (9.6)	27.3 (12.3)	36.3 (16.5)
Python® LX (Air Cooled)	11.6 (5.3)	16.6 (7.5)	21.3 (9.6)	28 (12.7)
Python® LX (Water Cooled)	12.4 (5.6)	17.2 (7.8)	22.1 (10)	28.8 (13)
Python® LX Compatible (Air Cooled)	13.1 (5.9)	17.9 (8.1)	22.8 (10.3)	29.5 (13.4)
Python® LX Compatible (Water Cooled)	13.9 (6.9)	18.7 (8.5)	23.6 (10.7)	30.3 (13.7)
Sidewinder®	6.2 (2.8)	8.2 (3.7)		

	lbs (kg)
ACL (palletized)	215 (97.5)
AirCrafter™ T-25	16 (7.3)
CobraTurn™ Digital Turntable	38 (17.2)
Cobramatic® Pro Series	30 (13.6)
CobraMig® 300 Power Supply and Feeder	280 (127.0)
CobraMig® 300 CV Power Supply	235 (106.6)
CobraMig® 300 CV Feeder	45 (20.4)
CobraCooler®	33 (15)
CobraTig® 150 SM	77 (34.9)

Orbital Weldheads (without collets)

4000 MiniMicro™	16 (7.3)
5001 CopperHead® I	29 (13.2)
5002 CopperHead® II	30 (13.6)
5003 CopperHead® III	31 (14.1)
5006 DiamondBack™	68 (30.8)

Boxed Dimensions (approximate)

Guns	6 ft/15 ft/25 ft 26 x 12 x 5 (660 x 305 x 127)	35 ft/50 ft 28 x 14 x 6 (711 x 356 x 152)
	L x D x H (in)	L x D x H (mm)
ACL (palletized)	40 x 40 x 30	1016 x 1016 x 762
AirCrafter™ T-25	14 x 13 x 10	356 x 330 x 254
CobraTurn™ Digital Turntable	16 1/6 x 11 9/16 x 12	411 x 284 x 305
Cobramatic® Pro Series	26 x 12 1/4 x 18 1/4	660 x 311 x 464
CobraMig® 300 Power Supply and Feeder	24 x 40 x 40	610 x 1016 x 1016
CobraMig® 300 CV Power Supply	24 x 15 x 24	610 x 381 x 610
CobraMig® 300 CV Feeder	23 x 12 x 16	584 x 305 x 406
CobraCooler®	26 x 8 x 16	660 x 203 x 406
CobraTig® 150 SM	34 x 11 x 21	864 x 279 x 533
Sidewinder	14 x 14 x 5	356 x 356 x 127
Weldheads		
4000 MiniMicro™	19 x 8 x 16	483 x 204 x 406
5001 CopperHead® I - 5003 CopperHead® III	18 x 9 x 21	457 x 229 x 533
5006 DiamondBack™	34 x 11 x 21	864 x 279 x 533

Products, Parts, and Accessories Pricing

Part #	Description	EA	List Price	Disc. Code	Part #	Description	EA	List Price	Disc. Code	
MK Products reserves the right to make changes to this price list at any time. These prices supersede all previous price lists.										
COBRAMIG® 300					PYTHON® LX					
187-001	COBRAMIG300 CV PWR SUPPLY & FEEDER	EA	\$4,855.00	F08	260-815	PYTHON LX 15FT AC	EA	\$1,995.00	F01	
187-201	COBRAMIG300 CV POWER SUPPLY - ONLY	EA	\$3,095.00	F08	260-825	PYTHON LX 25FT AC	EA	\$2,095.00	F01	
187-101	COBRAMIG FEEDER - ONLY	EA	\$2,695.00	F08	260-835	PYTHON LX 35FT AC	EA	\$2,195.00	F01	
187-001-341-815	CM300 PKG 15' AC PYTHON X	EA	\$6,195.00	F08	260-850	PYTHON LX 50FT AC	EA	\$2,295.00	F01	
187-001-341-825	CM300 PKG 25' AC PYTHON X	EA	\$6,295.00	F08	261-815	PYTHON LX 15FT WC	EA	\$2,195.00	F01	
187-001-341-835	CM300 PKG 35' AC PYTHON X	EA	\$6,395.00	F08	261-825	PYTHON LX 25FT WC	EA	\$2,295.00	F01	
187-001-341-850	CM300 PKG 50' AC PYTHON X	EA	\$6,495.00	F08	261-835	PYTHON LX 35FT WC	EA	\$2,395.00	F01	
187-001-343-815	CM300 PKG 15' AC X CLS	EA	\$6,195.00	F08	261-850	PYTHON LX 50FT WC	EA	\$2,495.00	F01	
187-001-343-825	CM300 PKG 25' AC X CLS	EA	\$6,295.00	F08	270-815	PYTHON LX 15FT AC - LE COMP	EA	\$1,995.00	F01	
187-001-343-835	CM300 PKG 35' AC X CLS	EA	\$6,395.00	F08	270-825	PYTHON LX 25FT AC - LE COMP	EA	\$2,095.00	F01	
187-001-343-850	CM300 PKG 50' AC X CLS	EA	\$6,495.00	F08	270-835	PYTHON LX 35FT AC - LE COMP	EA	\$2,195.00	F01	
187-001-345-815	CM300 PKG 15' AC X MAX	EA	\$6,195.00	F08	270-850	PYTHON LX 50FT AC - LE COMP	EA	\$2,295.00	F01	
187-001-345-825	CM300 PKG 25' AC X MAX	EA	\$6,295.00	F08	271-815	PYTHON LX 15FT WC - LE COMP	EA	\$2,195.00	F01	
187-001-345-835	CM300 PKG 35' AC X MAX	EA	\$6,395.00	F08	271-825	PYTHON LX 25FT WC - LE COMP	EA	\$2,295.00	F01	
187-001-345-850	CM300 PKG 50' AC X MAX...	EA	\$6,495.00	F08	271-835	PYTHON LX 35FT WC - LE COMP	EA	\$2,395.00	F01	
187-001-350-715	CM300 PKG 15' AC PRINCE X	EA	\$6,195.00	F08	271-850	PYTHON LX 50FT WC - LE COMP	EA	\$2,495.00	F01	
187-001-350-725	CM300 PKG 25' AC PRINCE X	EA	\$6,295.00	F08	272-815	PYTHON LX 15FT AC - MM COMP	EA	\$1,995.00	F01	
187-001-350-735	CM300 PKG 35' AC PRINCE X	EA	\$6,395.00	F08	272-825	PYTHON LX 25FT AC - MM COMP	EA	\$2,095.00	F01	
187-001-350-750	CM300 PKG 50' AC PRINCE X	EA	\$6,495.00	F08	272-835	PYTHON LX 35FT AC - MM COMP	EA	\$2,195.00	F01	
					272-850	PYTHON LX 50FT AC - MM COMP	EA	\$2,295.00	F01	
PYTHON®					273-815	PYTHON LX 15FT WC - MM COMP	EA	\$2,195.00	F01	
341-815	PYTHON X 15FT 14PIN AC PWR PIN	EA	\$1,995.00	F01	273-825	PYTHON LX 25FT WC - MM COMP	EA	\$2,295.00	F01	
341-825	PYTHON X 25FT 14PIN AC PWR PIN	EA	\$2,095.00	F01	273-835	PYTHON LX 35FT WC - MM COMP	EA	\$2,395.00	F01	
341-835	PYTHON X 35FT 14PIN AC PWR PIN	EA	\$2,195.00	F01	273-850	PYTHON LX 50FT WC - MM COMP	EA	\$2,495.00	F01	
341-850	PYTHON X 50FT 14PIN AC PWR PIN	EA	\$2,295.00	F01	274-815	PYTHON LX 15FT AC - FRONIUS COMP	EA	\$1,995.00	F01	
234-815	PYTHON 15FT AC MK	EA	\$1,995.00	F01	274-825	PYTHON LX 25FT AC - FRONIUS COMP	EA	\$2,095.00	F01	
234-825	PYTHON 25FT AC MK	EA	\$2,095.00	F01	274-835	PYTHON LX 35FT AC - FRONIUS COMP	EA	\$2,195.00	F01	
234-835	PYTHON 35FT AC MK	EA	\$2,195.00	F01	274-850	PYTHON LX 50FT AC - FRONIUS COMP	EA	\$2,295.00	F01	
234-850	PYTHON 50FT AC MK	EA	\$2,295.00	F01	275-815	PYTHON LX 15FT WC - FRONIUS COMP	EA	\$2,195.00	F01	
235-815	PYTHON 15FT WC MK	EA	\$2,195.00	F01	275-825	PYTHON LX 25FT WC - FRONIUS COMP	EA	\$2,295.00	F01	
235-825	PYTHON 25FT WC MK	EA	\$2,295.00	F01	275-835	PYTHON LX 35FT WC - FRONIUS COMP	EA	\$2,395.00	F01	
235-835	PYTHON 35FT WC MK	EA	\$2,395.00	F01	275-850	PYTHON LX 50FT WC - FRONIUS COMP	EA	\$2,495.00	F01	
235-850	PYTHON 50FT WC MK	EA	\$2,495.00	F01	294-815	PYTHON LX 15FT AC 7P EURO	EA	\$1,995.00	F01	
232-815	PYTHON 15FT AC - LE COMP	EA	\$1,995.00	F01	294-825	PYTHON LX 25FT AC 7P EURO	EA	\$2,095.00	F01	
232-825	PYTHON 25FT AC - LE COMP	EA	\$2,095.00	F01	294-835	PYTHON LX 35FT AC 7P EURO	EA	\$2,195.00	F01	
232-835	PYTHON 35FT AC - LE COMP	EA	\$2,195.00	F01	294-850	PYTHON LX 50FT AC 7P EURO	EA	\$2,295.00	F01	
232-850	PYTHON 50FT AC - LE COMP	EA	\$2,295.00	F01	295-815	PYTHON LX 15FT WC 7P EURO	EA	\$2,195.00	F01	
293-815	PYTHON 15FT WC - LE COMP	EA	\$2,195.00	F01	295-825	PYTHON LX 25FT WC 7P EURO	EA	\$2,295.00	F01	
293-825	PYTHON 25FT WC - LE COMP	EA	\$2,295.00	F01	295-835	PYTHON LX 35FT WC 7P EURO	EA	\$2,395.00	F01	
293-835	PYTHON 35FT WC - LE COMP	EA	\$2,395.00	F01	295-850	PYTHON LX 50FT WC 7P EURO	EA	\$2,495.00	F01	
293-850	PYTHON 50FT WC - LE COMP	EA	\$2,495.00	F01	302-815	PYTHON 15FT AC - ESAB COMP	EA	\$1,995.00	F01	
291-815	PYTHON 15FT AC MM COMP	EA	\$1,995.00	F01	302-825	PYTHON 25FT AC - ESAB COMP	EA	\$2,095.00	F01	
291-825	PYTHON 25FT AC MM COMP	EA	\$2,095.00	F01	303-815	PYTHON 15FT WC - ESAB COMP	EA	\$2,195.00	F01	
291-835	PYTHON 35FT AC MM COMP	EA	\$2,195.00	F01	303-825	PYTHON 25FT WC - ESAB COMP	EA	\$2,295.00	F01	
291-850	PYTHON 50FT AC MM COMP	EA	\$2,295.00	F01	303-835	PYTHON 35FT WC - ESAB COMP	EA	\$2,395.00	F01	
292-815	PYTHON 15FT WC MM COMP	EA	\$2,195.00	F01	303-850	PYTHON 50FT WC - ESAB COMP	EA	\$2,495.00	F01	
292-825	PYTHON 25FT WC MM COMP	EA	\$2,295.00	F01	COBRA®					
292-835	PYTHON 35FT WC MM COMP	EA	\$2,395.00	F01	343-815	COBRA X 15FT 14PIN AC CLS PWR PIN	EA	\$1,995.00	F01	
292-850	PYTHON 50FT WC MM COMP	EA	\$2,495.00	F01	343-825	COBRA X 25FT 14PIN AC CLS PWR PIN	EA	\$2,095.00	F01	
289-815	PYTHON 15FT AC FRONIUS COMP	EA	\$1,995.00	F01	343-835	COBRA X 35FT 14PIN AC CLS PWR PIN	EA	\$2,195.00	F01	
289-825	PYTHON 25FT AC FRONIUS COMP	EA	\$2,095.00	F01	343-850	COBRA X 50FT 14PIN AC CLS PWR PIN	EA	\$2,295.00	F01	
289-835	PYTHON 35FT AC FRONIUS COMP	EA	\$2,195.00	F01	266-815	COBRA MX 15FT AC CLASSIC CUP	EA	\$1,995.00	F01	
289-850	PYTHON 50FT AC FRONIUS COMP	EA	\$2,295.00	F01	266-825	COBRA MX 25FT AC CLASSIC CUP	EA	\$2,095.00	F01	
290-815	PYTHON 15FT WC FRONIUS COMP	EA	\$2,195.00	F01	266-835	COBRA MX 35FT AC CLASSIC CUP	EA	\$2,195.00	F01	
290-825	PYTHON 25FT WC FRONIUS COMP	EA	\$2,295.00	F01	266-850	COBRA MX 50FT AC CLASSIC CUP	EA	\$2,295.00	F01	
290-835	PYTHON 35FT WC FRONIUS COMP	EA	\$2,395.00	F01	267-815	COBRA MX 15FT AC MAX CUP	EA	\$1,995.00	F01	
290-850	PYTHON 50FT WC FRONIUS COMP	EA	\$2,495.00	F01	267-825	COBRA MX 25FT AC MAX CUP	EA	\$2,095.00	F01	
296-815	PYTHON 15FT AC 7P EURO	EA	\$1,995.00	F01	267-835	COBRA MX 35FT AC MAX CUP	EA	\$2,195.00	F01	
296-825	PYTHON 25FT AC 7P EURO	EA	\$2,095.00	F01	267-850	COBRA MX 50FT AC MAX CUP	EA	\$2,295.00	F01	
296-835	PYTHON 35FT AC 7P EURO	EA	\$2,195.00	F01	262-815	COBRA MX 15FT WC CLASSIC CUP	EA	\$2,195.00	F01	
296-850	PYTHON 50FT AC 7P EURO	EA	\$2,295.00	F01	262-825	COBRA MX 25FT WC CLASSIC CUP	EA	\$2,295.00	F01	
297-815	PYTHON 15FT WC 7P EURO	EA	\$2,195.00	F01	262-835	COBRA MX 35FT WC CLASSIC CUP	EA	\$2,395.00	F01	
297-825	PYTHON 25FT WC 7P EURO	EA	\$2,295.00	F01	262-850	COBRA MX 50FT WC CLASSIC CUP	EA	\$2,495.00	F01	
297-835	PYTHON 35FT WC 7P EURO	EA	\$2,395.00	F01	263-815	COBRA MX 15FT WC MAX CUP	EA	\$2,195.00	F01	
297-850	PYTHON 50FT WC 7P EURO	EA	\$2,495.00	F01	263-825	COBRA MX 25FT WC MAX CUP	EA	\$2,295.00	F01	
					263-835	COBRA MX 35FT WC MAX CUP	EA	\$2,395.00	F01	

FOR A COMPLETE PRICE LIST OF ALL MK AVAILABLE PARTS, VISIT WWW.MKPRODUCTS.COM

Products, Parts, and Accessories Pricing

Part #	Description	EA	List Price	Disc. Code	Part #	Description	EA	List Price	Disc. Code
263-850	COBRA MX 50FT WC MAX CUP	EA	\$2,495.00	F01	325-835	COBRA SX 35FT AC CLASSIC CUP	EA	\$2,195.00	F01
276-815	COBRA MX 15FT AC CLASSIC - LE	EA	\$1,995.00	F01	325-850	COBRA SX 50FT AC CLASSIC CUP	EA	\$2,295.00	F01
276-825	COBRA MX 25FT AC CLASSIC - LE	EA	\$2,095.00	F01	327-815	COBRA SX 15FT AC CLASSIC CUP LE	EA	\$1,995.00	F01
276-835	COBRA MX 35FT AC CLASSIC - LE	EA	\$2,195.00	F01	327-825	COBRA SX 25FT AC CLASSIC CUP LE	EA	\$2,095.00	F01
276-850	COBRA MX 50FT AC CLASSIC - LE	EA	\$2,295.00	F01	327-835	COBRA SX 35FT AC CLASSIC CUP LE	EA	\$2,195.00	F01
277-815	COBRA MX 15FT AC MAX CUP - LE	EA	\$1,995.00	F01	327-850	COBRA SX 50FT AC CLASSIC CUP LE	EA	\$2,295.00	F01
277-825	COBRA MX 25FT AC MAX CUP - LE	EA	\$2,095.00	F01	326-815	COBRA SX 15FT AC CLASSIC CUP MM	EA	\$1,995.00	F01
277-835	COBRA MX 35FT AC MAX CUP - LE	EA	\$2,195.00	F01	326-825	COBRA SX 25FT AC CLASSIC CUP MM	EA	\$2,095.00	F01
277-850	COBRA MX 50FT AC MAX CUP - LE	EA	\$2,295.00	F01	326-835	COBRA SX 35FT AC CLASSIC CUP MM	EA	\$2,195.00	F01
278-815	COBRA MX 15FT WC CLASSIC - LE	EA	\$2,195.00	F01	326-850	COBRA SX 50FT AC CLASSIC CUP MM	EA	\$2,295.00	F01
278-825	COBRA MX 25FT WC CLASSIC - LE	EA	\$2,295.00	F01	328-815	COBRA SX 15FT AC CLASSIC FRONIUS	EA	\$1,995.00	F01
278-835	COBRA MX 35FT WC CLASSIC - LE	EA	\$2,395.00	F01	328-825	COBRA SX 25FT AC CLASSIC FRONIUS	EA	\$2,095.00	F01
278-850	COBRA MX 50FT WC CLASSIC - LE	EA	\$2,495.00	F01	328-835	COBRA SX 35FT AC CLASSIC FRONIUS	EA	\$2,195.00	F01
279-815	COBRA MX 15FT WC MAX - LE	EA	\$2,195.00	F01	328-850	COBRA SX 50FT AC CLASSIC FRONIUS	EA	\$2,295.00	F01
279-825	COBRA MX 25FT WC MAX - LE	EA	\$2,295.00	F01					
279-835	COBRA MX 35FT WC MAX - LE	EA	\$2,395.00	F01					
279-850	COBRA MX 50FT WC MAX - LE	EA	\$2,495.00	F01					
280-815	COBRA MX 15FT AC CLASSIC - MM	EA	\$1,995.00	F01					
280-825	COBRA MX 25FT AC CLASSIC - MM	EA	\$2,095.00	F01					
280-835	COBRA MX 35FT AC CLASSIC - MM	EA	\$2,195.00	F01					
280-850	COBRA MX 50FT AC CLASSIC - MM	EA	\$2,295.00	F01					
281-815	COBRA MX 15FT AC MAX CUP - MM	EA	\$1,995.00	F01					
281-825	COBRA MX 25FT AC MAX CUP - MM	EA	\$2,095.00	F01					
281-835	COBRA MX 35FT AC MAX CUP - MM	EA	\$2,195.00	F01					
281-850	COBRA MX 50FT AC MAX CUP - MM	EA	\$2,295.00	F01					
282-815	COBRA MX 15FT WC CLASSIC - MM	EA	\$2,195.00	F01					
282-825	COBRA MX 25FT WC CLASSIC - MM	EA	\$2,295.00	F01					
282-835	COBRA MX 35FT WC CLASSIC - MM	EA	\$2,395.00	F01					
282-850	COBRA MX 50FT WC CLASSIC - MM	EA	\$2,495.00	F01					
283-815	COBRA MX 15FT WC MAX - MM	EA	\$2,195.00	F01					
283-825	COBRA MX 25FT WC MAX - MM	EA	\$2,295.00	F01					
283-835	COBRA MX 35FT WC MAX - MM	EA	\$2,395.00	F01					
283-850	COBRA MX 50FT WC MAX - MM	EA	\$2,495.00	F01					
284-815	COBRA MX 15FT AC CLASSIC - FRONIUS	EA	\$1,995.00	F01					
284-825	COBRA MX 25FT AC CLASSIC - FRONIUS	EA	\$2,095.00	F01					
284-835	COBRA MX 35FT AC CLASSIC - FRONIUS	EA	\$2,195.00	F01					
284-850	COBRA MX 50FT AC CLASSIC - FRONIUS	EA	\$2,295.00	F01					
285-815	COBRA MX 15FT AC MAX - FRONIUS	EA	\$1,995.00	F01					
285-825	COBRA MX 25FT AC MAX - FRONIUS	EA	\$2,095.00	F01					
285-835	COBRA MX 35FT AC MAX - FRONIUS	EA	\$2,195.00	F01					
285-850	COBRA MX 50FT AC MAX - FRONIUS	EA	\$2,295.00	F01					
286-815	COBRA MX 15FT WC CLASSIC - FRONIUS	EA	\$2,195.00	F01					
286-825	COBRA MX 25FT WC CLASSIC - FRONIUS	EA	\$2,295.00	F01					
286-835	COBRA MX 35FT WC CLASSIC - FRONIUS	EA	\$2,395.00	F01					
286-850	COBRA MX 50FT WC CLASSIC - FRONIUS	EA	\$2,495.00	F01					
287-815	COBRA MX 15FT WC MAX - FRONIUS	EA	\$2,195.00	F01					
287-825	COBRA MX 25FT WC MAX - FRONIUS	EA	\$2,295.00	F01					
287-835	COBRA MX 35FT WC MAX - FRONIUS	EA	\$2,395.00	F01					
287-850	COBRA MX 50FT WC MAX - FRONIUS	EA	\$2,495.00	F01					
298-815	COBRA MX 15FT AC 7P EURO CLASSIC	EA	\$1,995.00	F01					
298-825	COBRA MX 25FT AC 7P EURO CLASSIC	EA	\$2,095.00	F01					
298-835	COBRA MX 35FT AC 7P EURO CLASSIC	EA	\$2,195.00	F01					
298-850	COBRA MX 50FT AC 7P EURO CLASSIC	EA	\$2,295.00	F01					
299-815	COBRA MX 15FT WC 7P EURO CLASSIC	EA	\$2,195.00	F01					
299-825	COBRA MX 25FT WC 7P EURO CLASSIC	EA	\$2,295.00	F01					
299-835	COBRA MX 35FT WC 7P EURO CLASSIC	EA	\$2,395.00	F01					
299-850	COBRA MX 50FT WC 7P EURO CLASSIC	EA	\$2,495.00	F01					
300-815	COBRA MX 15FT AC 7P EURO MAX CUP	EA	\$1,995.00	F01					
300-825	COBRA MX 25FT AC 7P EURO MAX CUP	EA	\$2,095.00	F01					
300-835	COBRA MX 35FT AC 7P EURO MAX CUP	EA	\$2,195.00	F01					
300-850	COBRA MX 50FT AC 7P EURO MAX CUP	EA	\$2,295.00	F01					
301-815	COBRA MX 15FT WC 7P EURO MAX CUP	EA	\$2,195.00	F01					
301-825	COBRA MX 25FT WC 7P EURO MAX CUP	EA	\$2,295.00	F01					
301-835	COBRA MX 35FT WC 7P EURO MAX CUP	EA	\$2,395.00	F01					
301-850	COBRA MX 50FT WC 7P EURO MAX CUP	EA	\$2,495.00	F01					
	COBRA® SX								
325-815	COBRA SX 15FT AC CLASSIC CUP	EA	\$1,995.00	F01					
325-825	COBRA SX 25FT AC CLASSIC CUP	EA	\$2,095.00	F01					
						PRINCE®			
					350-715	PRINCE X 15FT 14PIN AC PWR PIN	EA	\$1,795.00	F01
					350-725	PRINCE X 25FT 14PIN AC PWR PIN	EA	\$1,895.00	F01
					350-735	PRINCE X 35FT 14PIN AC PWR PIN	EA	\$1,995.00	F01
					350-750	PRINCE X 50FT 14PIN AC PWR PIN	EA	\$2,095.00	F01
					317-715	PRINCE XL 15FT AC	EA	\$1,795.00	F01
					317-725	PRINCE XL 25FT AC	EA	\$1,895.00	F01
					317-735	PRINCE XL 35FT AC	EA	\$1,995.00	F01
					317-750	PRINCE XL 50FT AC	EA	\$2,095.00	F01
					318-715	PRINCE XL 15FT WC	EA	\$1,995.00	F01
					318-725	PRINCE XL 25FT WC	EA	\$2,095.00	F01
					318-735	PRINCE XL 35FT WC	EA	\$2,195.00	F01
					318-750	PRINCE XL 50FT WC	EA	\$2,295.00	F01
					310-715	PRINCE XL 15FT AC LE COMP	EA	\$1,795.00	F01
					310-725	PRINCE XL 25FT AC LE COMP	EA	\$1,895.00	F01
					310-735	PRINCE XL 35FT AC LE COMP	EA	\$1,995.00	F01
					310-750	PRINCE XL 50FT AC LE COMP	EA	\$2,095.00	F01
					311-715	PRINCE XL 15FT WC LE COMP	EA	\$1,995.00	F01
					311-725	PRINCE XL 25FT WC LE COMP	EA	\$2,095.00	F01
					311-735	PRINCE XL 35FT WC LE COMP	EA	\$2,195.00	F01
					311-750	PRINCE XL 50FT WC LE COMP	EA	\$2,295.00	F01
					332-715	PRINCE XL 15FT AC MM COMP	EA	\$1,795.00	F01
					332-725	PRINCE XL 25FT AC MM COMP	EA	\$1,895.00	F01
					332-735	PRINCE XL 35FT AC MM COMP	EA	\$1,995.00	F01
					332-750	PRINCE XL 50FT AC MM COMP	EA	\$2,095.00	F01
					333-715	PRINCE XL 15FT WC MM COMP	EA	\$1,995.00	F01
					333-725	PRINCE XL 25FT WC MM COMP	EA	\$2,095.00	F01
					333-735	PRINCE XL 35FT WC MM COMP	EA	\$2,195.00	F01
					333-750	PRINCE XL 50FT WC MM COMP	EA	\$2,295.00	F01
					330-715	PRINCE XL 15FT AC FRONIUS COMP	EA	\$1,795.00	F01
					330-725	PRINCE XL 25FT AC FRONIUS COMP	EA	\$1,895.00	F01
					330-735	PRINCE XL 35FT AC FRONIUS COMP	EA	\$1,995.00	F01
					330-750	PRINCE XL 50FT AC FRONIUS COMP	EA	\$2,095.00	F01
					331-715	PRINCE XL 15FT WC FRONIUS COMP	EA	\$1,995.00	F01
					331-725	PRINCE XL 25FT WC FRONIUS COMP	EA	\$2,095.00	F01
					331-735	PRINCE XL 35FT WC FRONIUS COMP	EA	\$2,195.00	F01
					331-750	PRINCE XL 50FT WC FRONIUS COMP	EA	\$2,295.00	F01
					334-715	PRINCE XL 15FT AC 7PIN EURO COMP	EA	\$1,795.00	F01
					334-725	PRINCE XL 25FT AC 7PIN EURO COMP	EA	\$1,895.00	F01
					334-735	PRINCE XL 35FT AC 7PIN EURO COMP	EA	\$1,995.00	F01
					334-750	PRINCE XL 50FT AC 7PIN EURO COMP	EA	\$2,095.00	F01
					335-715	PRINCE XL 15FT WC 7PIN EURO COMP	EA	\$1,995.00	F01
					335-725	PRINCE XL 25FT WC 7PIN EURO COMP	EA	\$2,095.00	F01
					335-735	PRINCE XL 35FT WC 7PIN EURO COMP	EA	\$2,195.00	F01
					335-750	PRINCE XL 50FT WC 7PIN EURO COMP	EA	\$2,295.00	F01
					336-715	PRINCE XL 15FT AC EURO ESAB COMP	EA	\$1,795.00	F01
					336-725	PRINCE XL 25FT AC EURO ESAB COMP	EA	\$1,895.00	F01
					336-735	PRINCE XL 35FT AC EURO ESAB COMP	EA	\$1,995.00	F01
					336-750	PRINCE XL 50FT AC EURO ESAB COMP	EA	\$2,095.00	F01
					337-715	PRINCE XL 15FT WC EURO ESAB COMP	EA	\$1,995.00	F01
					337-725	PRINCE XL 25FT WC EURO ESAB COMP	EA	\$2,095.00	F01
					337-735	PRINCE XL 35FT WC EURO ESAB COMP	EA	\$2,195.00	F01
					337-750	PRINCE XL 50FT WC EURO ESAB COMP	EA	\$2,295.00	F01
						CABINET			
					150-007-M	COBRAMATIC PRO SERIES MK CONNECT	EA	\$2,395.00	F01

FOR A COMPLETE PRICE LIST OF ALL MK AVAILABLE PARTS, VISIT WWW.MKPRODUCTS.COM

Products, Parts, and Accessories Pricing

Part #	Description	EA	List Price	Disc. Code	Part #	Description	EA	List Price	Disc. Code
SPOOL GUNS									
319-725	PRINCE XL SG 25FT 750 IPM	EA	\$1,695.00	F01	002-0629	ASSY CAM IDLER ARM PYTHON	EA	\$42.62	P01
319-750	PRINCE XL SG 50FT 750 IPM	EA	\$2,195.00	F01	002-0635	ASSY BRZ BBL COBRA MAX	EA	\$191.27	P01
416-725	PRINCE SG SPOOL GUN 25FT	EA	\$1,095.00	F01	002-0654	ASSY BRZ CTL ADPTR AC BODY	EA	\$82.66	P01
416-750	PRINCE SG SPOOL GUN 50FT	EA	\$1,395.00	F01	002-0657	ASSY BRZ CON PIN	EA	\$91.03	P01
322-515	SIDEWINDER 15FT W/7IN BBL	EA	\$399.00	F02	002-0658	ASSY BRZ PWR/GAS ADPTR	EA	\$64.57	P01
322-525	SIDEWINDER 25FT W/7IN BBL	EA	\$430.00	F02	002-0686	ASSY BRZ BODY REAR WC COBRA MX	EA	\$314.24	P01
ORBITAL									
250-153	COBRACOOOLER COOLANT RECIRC PKG	EA	\$2,695.00	F04	002-0738	ASSY GEAR 34T SPUR 5001	EA	\$88.21	P01
254-153	COBRATIG 150 SM/APS PKG	EA	\$12,433.20	F04	002-0739	ASSY GEAR 45T 5002	EA	\$106.37	P01
254-203	ADVANCED COLOR LOGIC PKG	EA	\$26,494.00	F04	002-0740	ASSY GEAR IDLER 5003	EA	\$99.47	P01
4000	MINIMICRO 1/8-1/2IN OD	EA	\$14,950.00	F05	002-0770	TUNGSTEN EXTENDER 30/45DEG	EA	\$79.00	A02
5001	COPPERHEAD I WELDHEAD PKG	EA	\$7,269.60	F04	002-0771	TUNGSTEN HOLDER 90DEG	EA	\$79.00	A02
5002	COPPERHEAD II WELDHEAD PKG	EA	\$7,878.00	F04	002-0772	TUNGSTEN HOLDER 20/30DEG	EA	\$79.00	A02
5003	COPPERHEAD III WELDHEAD PKG	EA	\$8,106.80	F04	003-0023	CHUCK STL 3-JAW 4 DIA	EA	\$468.03	P01
5006	DIAMONDBACK WELDHEAD PKG	EA	\$12,433.20	F04	003-0094	S/A REVERSE SWX WIRING	EA	\$52.06	P01
POSITIONERS									
127-001	AIRCRAFTER T-25	EA	\$995.90	F03	003-0095	S/A CTRL POT WIRING	EA	\$61.51	P01
127-006	COBRATURN TURNTABLE	EA	\$2,054.00	F03	003-0141	S/A FUSE HLDR W/LEADS	EA	\$21.03	P01
SPARE PARTS AND ACCESSORIES									
001-0137-4	GAS CUP #6 CLASSIC CUP 4PC PK	PK	\$37.80	C13	003-0162	LINE CORD SET W/TERM	EA	\$44.23	P01
001-0137-40	GAS CUP #6 CLASSIC CUP 40PC PK	PK	\$365.00	C13	003-0176	S/A KNOB SCR CONDUIT	EA	\$4.39	P01
001-0137-80	GAS CUP #6 CLASSIC CUP 80PC PK	PK	\$715.00	C13	003-0198	WIRE GUIDE ADPTR 1LB SPG	EA	\$11.99	C01
001-0138-4	GAS CUP #8 CLASSIC CUP 4PC PK	PK	\$37.80	C13	003-0233	ASSY 5 IN TURNTABLE	EA	\$155.99	P01
001-0138-40	GAS CUP #8 CLASSIC CUP 40PC PK	PK	\$365.00	C13	003-0302	ASSY TRIGGER W/SLV CB	EA	\$8.03	P01
001-0138-80	GAS CUP #8 CLASSIC CUP 80PC PK	PK	\$715.00	C13	003-0568	ASSY MICRO SWX PT	EA	\$39.35	P01
001-0139-4	GAS CUP #10 CLASSIC CUP 4PC PK	PK	\$37.80	C13	003-0585	ASSY TRIGGER PT	EA	\$10.91	P01
001-0139-40	GAS CUP #10 CLASSIC CUP 40PC PK	PK	\$365.00	C13	003-0590	PWR FTG #4 CBL T END CB	EA	\$27.04	P01
001-0139-80	GAS CUP #10 CLASSIC CUP 80PC PK	PK	\$715.00	C13	003-0773	S/A XFMR 120V CM/WC	EA	\$79.73	P01
001-0529	HOSE WTR 15 FT	EA	\$76.78	P01	003-0784	S/A CAM PAWL BRAKE	EA	\$24.09	P01
001-0530	HOSE WTR 25 FT	EA	\$74.91	P01	003-0796	CBL PWR FOR CTRL BX	EA	\$19.57	P01
001-0537	HOSE GAS 15FT	EA	\$56.46	P01	003-0855	ASSY PCB FILT AC INPUT TIG150	EA	\$64.65	P01
001-0538	HOSE GAS 25 FT	EA	\$74.91	P01	003-1050	ASSY PUSH FTTG GAS BLACK	EA	\$21.04	P01
001-0562	VALVE GAS CB	EA	\$27.90	P01	003-1051	ASSY PUSH FTTG WATER BLUE	EA	\$23.90	P01
001-0665	HOSE GAS 50 FT	EA	\$136.04	P01	003-1243	ASSY CUR SNSR CB I-II	EA	\$24.39	P01
001-1042	ASSY CBL PWR UTF 50 FT	EA	\$344.70	P01	003-1267	ASSY PCB CTRL PSNR 4	EA	\$546.27	P01
001-1230	XFMR 460/230VAC STEP DOWN	EA	\$3,289.76	A02	003-1268	ASSY PCB PNL FR PSNR 4	EA	\$429.68	P01
001-2521	ASSY CBL PWR/WTR 15 FT #4 CT	EA	\$194.52	P01	003-1269	ASSY PCB MTR RPM PSNR 4	EA	\$226.26	P01
001-2524	ASSY CBL PWR/WTR 25 FT #4 CT	EA	\$280.09	P01	003-1271	ASSY PCB PNL FR PSNR 4A	EA	\$204.72	P01
001-2527	ASSY CBL PWR UTF 15 FT	EA	\$146.38	P01	003-1272	ASSY PCB CTRL PSNR 4A	EA	\$345.09	P01
001-2528	ASSY CBL PWR UTF 25 FT	EA	\$163.19	P01	003-1277	ASSY RES MOT DISCH PSNR 4	EA	\$24.27	P01
001-3062	WC-1 115V ASSY W/POAST	EA	\$528.04	A01	003-1278	ASSY MOT PSNR 4A	EA	\$826.20	P01
001-3066	MK200 CONTACTOR CTRL	EA	\$550.34	A01	003-1287	ASSY PNL FR PSNR 4A	EA	\$257.37	P01
001-3789	CBL CTRL 30FT 7PW" CT&KT"	EA	\$158.76	P01	003-1301	ASSY CBL GRN & RED 18/2	EA	\$39.47	P01
001-3810	ASSY CBL PWR UTF 10 FT	EA	\$133.16	P01	003-1302	ASSY CBL BLK & WHT 18/2	EA	\$19.58	P01
001-3811	ASSY CBL PWR UTF 6 FT	EA	\$109.67	P01	003-1327	ASSY LUG PWR #4 CBL CB	EA	\$27.66	P01
001-3812	ASSY CBL PWR UTF 35 FT	EA	\$259.77	P01	003-1328	ASSY LUG PWR ULTRFX #2CBL	EA	\$39.70	P01
001-3813	ASSY CBL PWR UTF 3 FT	EA	\$94.22	P01	003-1332	RBN 8.50 CB II	EA	\$18.97	P01
002-0055	ASSY BRUSH HLDR	EA	\$36.09	P01	003-1341	ASSY CBL ADPTR SPG	EA	\$202.80	P01
002-0057	ADPTR CHUCK #3	EA	\$260.85	P01	003-1342	ASSY SPOOL ADPTR L-TEC	EA	\$52.19	P01
002-0066	ASSY WLD BASE SUPPORT 1A	EA	\$69.39	P01	003-1366	ASSY GEAR MAIN 5001	EA	\$225.64	P01
002-0154	HSG 1B MOT & CTRL	EA	\$68.31	P01	003-1374	ASSY BAKR CLAMP L WPS ACL	EA	\$298.24	P01
002-0262	ASSY FTG PWR/GAS L-TEC	EA	\$49.67	P01	003-1383	ASSY XFMR OUTPUT WPS ACL	EA	\$1,931.96	P01
002-0265	ASSY BRZ CUP ADPTR	EA	\$250.64	P01	003-1386	ASSY MAIN GEAR 5002	EA	\$237.23	P01
002-0494	ASSY BRUSH PLT 5001	EA	\$260.99	P01	003-1387	ASSY MAIN GEAR 5003	EA	\$226.15	P01
002-0495	ASSY GEAR 37T 5001	EA	\$85.84	P01	003-1389	ASSY SWX PLT WLDHD	EA	\$160.64	P01
002-0496	ASSY SPUR GEAR 44T 5002	EA	\$85.50	P01	003-1390	ASSY PCB STD WLDHD	EA	\$166.82	P01
002-0497	ASSY GEAR SPUR MAIN 5003	EA	\$79.04	P01	003-1391	ASSY MOTOR CH I & II	EA	\$1,401.66	P01
002-0503	ASSY BRUSH PLT 5002	EA	\$359.18	P01	003-1392	ASSY SWX REED 5002-3/6004	EA	\$74.88	P01
002-0506	ASSY BRUSH PLT 5003	EA	\$379.95	P01	003-1393	ASSY SWX REED 5001	EA	\$74.88	P01
002-0524	ASSY SHIELD WPS SERVO	EA	\$66.31	P01	003-1394	ASSY JUMP CBL MILLER TORP	EA	\$5.92	P01
002-0545	ASSY WLD FAN ADAPTR ACL	EA	\$125.69	P01	003-1396	ASSY CBL 24P 25FT WLDHD	EA	\$436.47	P01
002-0583	SCR ADJ PXL	EA	\$19.61	P01	003-1399	ASSY LATCH WLDHD/CH	EA	\$95.12	P01
002-0610	ASSY BRZ WTR CONN BASE CH	EA	\$54.87	P01	003-1414	ASSY PS 24V ACL	EA	\$1,760.01	P01
002-0611	ASSY BRZ WTR CONN CVR CH	EA	\$42.38	P01	003-1420	ASSY PCB WPS SERVO ACL	EA	\$803.89	P01
002-0612	ASSY BRZ BAR GND CH III	EA	\$97.86	P01	003-1421	ASSY PCB WPS DRVR ACL	EA	\$657.19	P01
002-0613	ASSY BRZ BAR GND CH I	EA	\$151.26	P01	003-1487	ASSY GAS CUP ADPTR HD PT KOOL CUP	EA	\$89.50	A01
002-0614	ASSY BRZ BAR GND CH II	EA	\$102.23	P01	003-1631	ASSY CBL PWR BD TO BD CBI	EA	\$18.43	P01
					003-1636	ASSY PCB MAIN 110V WCI	EA	\$295.21	P01
					003-1642	ASSY CON 7P W" CB"	EA	\$59.46	P01
					003-1644	ASSY PCB PNL FR WCI	EA	\$173.70	P01
					003-1645	ASSY CBL RBN WC1 WC2 WC3	EA	\$22.18	P01
					003-1646	CBL BD TO BD WC1 WC2 WC3	EA	\$12.95	P01
					003-1662	ASSY CBL 115V CNTOR	EA	\$21.74	P01

FOR A COMPLETE PRICE LIST OF ALL MK AVAILABLE PARTS, VISIT WWW.MKPRODUCTS.COM

Products, Parts, and Accessories Pricing

Part #	Description	EA	List Price	Disc. Code	Part #	Description	EA	List Price	Disc. Code
003-1669	ASSY CBL PWR IN LINE WC3 TPDO MILLER	EA	\$97.10	P01	003-2116	ASSY PCB SPEED CTRL PA-L1	EA	\$254.30	P01
003-1686	ASSY CBL ADPTR MILLER SPG	EA	\$17.63	P01	003-2121	ASSY FUSE HLDR PSNR 4/4A	EA	\$26.35	P01
003-1699	ASSY GAS SOL	EA	\$254.90	P01	003-2125	ASSY KNOB POT PYTHON	EA	\$14.37	P01
003-1810	ASSY SOL GAS ACL	EA	\$473.20	P01	003-2136	ASSY PCB GAS/TRIGGER CTRL	EA	\$224.15	P01
003-1816	ASSY HT SNK WPS ACL	EA	\$2,644.32	P01	003-2137	ASSY SOL GAS 24V CB	EA	\$185.11	P01
003-1818	ASSY W HARN CARD CAGE ACL	EA	\$460.96	P01	003-2138	ASSY SWX GAS/TRIGGER CB	EA	\$39.49	P01
003-1838	ASSY PCB TRPLOUTPT PS ACL	EA	\$336.62	P01	003-2141	ASSY BODY FR COBRA MAX	EA	\$303.98	P01
003-1865	ASSY PWR UP TIME DLY	EA	\$103.02	P01	003-2142	ASSY PCB DMDBK	EA	\$169.74	P01
003-1866	ASSY ARC ST TIME DLY ACL	EA	\$106.17	P01	003-2143	ASSY CBL GND PSNR 4A	EA	\$61.06	P01
003-1871	ASSY PCB MOT ACL	EA	\$469.93	P01	003-2147	ASSY BBL 60D A/W PYTHON	EA	\$364.85	P01
003-1872	ASSY PCB INTFC PS ACL	EA	\$878.04	P01	003-2148	ASSY PCB INTFC PCI/ACL	EA	\$1,959.52	P01
003-1873	ASSY PCB MOTHER ACL	EA	\$487.62	P01	003-2151	ASSY BBL STR A/W PXL	EA	\$256.02	P01
003-1877	ASSY FAN/REAR PNL ACL	EA	\$279.83	P01	003-2152	ASSY BBL 45D A/W PXL	EA	\$274.24	A01
003-1883	ASSY CNTOR WPS/PS ACL	EA	\$349.74	P01	003-2153	ASSY BOOT	EA	\$9.58	P01
003-1887	ASSY RLY WPS/PS ACL	EA	\$500.12	P01	003-2156	ASSY BBL 12IN STR A/W	EA	\$380.72	A01
003-1892	ASSY BASE SUPPLY WPS/ACL	EA	\$1,150.92	P01	003-2157	ASSY BBL 18IN STR A/W	EA	\$458.79	A01
003-1926	ASSY PCB BK PLANE TIG150	EA	\$285.91	P01	003-2158	ASSY BBL 12IN 45D A/W	EA	\$389.92	A01
003-1936	ASSY PCB PS CTRL TIG150	EA	\$771.65	P01	003-2159	ASSY BBL 18IN 45D A/W	EA	\$488.88	A01
003-1937	ASSY PRINTER MOD TIG150	EA	\$1,503.84	P01	003-2162	ASSY ROTOR DMDBK	EA	\$1,069.82	P01
003-1938	ASSY PWR MOD TIG150	EA	\$2,362.73	P01	003-2163	ASSY CLAMP RIGHT DMDBK	EA	\$1,034.06	P01
003-1948	ASSY PCB ARC START TIG150	EA	\$612.78	P01	003-2164	ASSY CLAMP CVR LEFT DMDBK	EA	\$1,034.06	P01
003-1949	ASSY PCB TIG CTRL TIG150	EA	\$906.91	P01	003-2165	ASSY MOT MNT DMDBK	EA	\$1,999.98	P01
003-1952	ASSY BODY RBK	EA	\$194.24	P01	003-2166	ASSY GEAR SPUR BEVEL DMDBK	EA	\$329.92	P01
003-1953	ASSY SOL GAS VALVE TIG150	EA	\$588.09	P01	003-2167	ASSY REED SWX DMDBK	EA	\$53.06	P01
003-1960	ASSY PCB OUTFILTR TIG150	EA	\$169.99	P01	003-2171	ASSY GEAR 48T DMDBK	EA	\$238.16	P01
003-1961	ASSY XFMR AC PWR DISTR TIG150	EA	\$329.98	P01	003-2173	ASSY GEAR BEVEL HUB DMDBK	EA	\$305.82	P01
003-1963	ASSY PCB FILTR INTFC TIG150	EA	\$78.09	P01	003-2174	ASSY TIG ARC PS PCI ACL	EA	\$3,187.10	P01
003-1964	ASSY PRINTER COBRATIG 150	EA	\$945.94	P01	003-2179	ASSY PNL REAR PS PCI ACL	EA	\$2,675.05	P01
003-1972	ASSY BODY PXL	EA	\$259.33	P01	003-2181	ASSY HIGH VOLTAGE PWR ACL	EA	\$1,925.05	P01
003-1974	ASSY REAR CLAMP WC PT	EA	\$17.92	P01	003-2190	ASSY POT SX/MX/LX	EA	\$93.32	P01
003-1975	ASSY PCB GENERIC TORP	EA	\$165.77	P01	003-2191	ASSY BODY COBRA SX	EA	\$152.27	P01
003-1996	ASSY RECTIFIER TIG150	EA	\$261.23	P01	003-2192	ASSY MOT STD SPEED SX	EA	\$332.05	P01
003-1999	ASSY RLY TIG150	EA	\$63.08	P01	003-2197	ASSY SWX COBRA SX/SDWDR	EA	\$13.08	P01
003-2000	ASSY PRINTER CTRL TIG150	EA	\$1,039.70	P01	003-2199	ASSY GAS VALVE MOD PSG	EA	\$30.63	P01
003-2002	ASSY SHUNT TIG150	EA	\$99.66	P01	003-2202	ASSY PCB SPD CTRL SDWDR	EA	\$88.28	P01
003-2003	ASSY CVR TIG150	EA	\$252.98	P01	003-2203	ASSY PCB SPD CTRL SP-1	EA	\$128.16	P01
003-2004	ASSY REG FLOW METR TIG150	EA	\$683.11	P01	003-2204	ASSY BBL AC CLS CUP PSG	EA	\$145.41	P01
003-2005	ASSY FOOT CTRL TIG150	EA	\$692.46	P01	003-2206	ASSY BODY PSG	EA	\$169.04	P01
003-2008	ASSY GASLINE FTG TIG150	EA	\$110.76	P01	003-2209	ASSY WIRE GUIDE PYTHON	EA	\$11.90	C01
003-2021	ASSY SPOOL SPG PXL	EA	\$64.90	P01	003-2210	ASSY GAS CUP ADPTR MAX/CG	EA	\$2.34	A01
003-2031	ASSY INDUCTOR DC TIG150	EA	\$110.52	P01	003-2214	ASSY PCB HV MODULE ACL	EA	\$1,713.81	P01
003-2036	ASSY SCR MNTG BENCH 5000	EA	\$17.82	P01	003-2216	ASSY TRIGGER SDWDR	EA	\$4.68	P01
003-2042	ASSY CVR HSG CH III	EA	\$295.00	P01	003-2224	ASSY RETNR QK CUP SWDR	EA	\$53.57	P01
003-2043	ASSY PLT SIDE CVR CH III	EA	\$854.90	P01	003-2230	ASSY GAS CUP ADPTR 48D A/W	EA	\$35.12	A01
003-2044	ASSY PLT SIDE BASE CH III	EA	\$765.70	P01	003-2232	ASSY BODY REAR A/W PYTHON	EA	\$231.55	P01
003-2045	ASSY CVR HSG CH I	EA	\$243.14	P01	003-2235	ASSY PNL FR 115V-V6 CB	EA	\$307.72	P01
003-2047	ASSY PLT SIDE CVR CH I	EA	\$740.13	P01	003-2236	ASSY PNL FR 42V-V6 CB	EA	\$353.07	P01
003-2048	ASSY PLT SIDE BASE CH I	EA	\$625.37	P01	003-2237	ASSY PNL FR 42V-V6 CB LE	EA	\$331.83	P01
003-2050	ASSY CBL/HDL CH	EA	\$1,834.75	P01	003-2244	ASSY REAR BODY	EA	\$165.77	P01
003-2050-8	ASSY CBL/HDL 8FT CH	EA	\$1,085.49	P01	003-2250	ASSY BBL 4IN STR SDWDR	EA	\$231.08	P01
003-2052	ASSY CVR CH II	EA	\$294.69	P01	003-2251	ASSY BBL 7IN STR SDWDR	EA	\$238.34	P01
003-2054	ASSY PLT SIDE CVR CH II	EA	\$836.73	P01	003-2267	ASSY REAR BODY AC MX	EA	\$255.67	P01
003-2055	ASSY PLT SIDE BASE CH II	EA	\$694.80	P01	003-2271	ASSY BODY FR AC PYTHON	EA	\$316.68	P01
003-2058	ASSY MOTOR CH III	EA	\$1,387.20	P01	003-2272	ASSY BBL 60D AC PYTHON	EA	\$308.37	P01
003-2060	ASSY MOT SLAVE 42V CB	EA	\$761.53	P01	003-2274	ASSY SWX MX/LX	EA	\$32.62	P01
003-2061	ASSY SPINDLE BK CB	EA	\$127.24	P01	003-2276	ASSY REAR BODY WC MX	EA	\$310.42	P01
003-2063	ASSY PWR BLK CB	EA	\$287.22	P01	003-2283	ASSY TUBE CONDUIT ESAB	EA	\$13.82	P01
003-2069	ASSY MOT TORQUE 115V CB	EA	\$470.44	P01	003-2285	SUPPORT ADPTR COMP/SPIRAL	EA	\$108.98	P01
003-2070	ASSY KNOB RETAINER SPG PXL	EA	\$7.01	P01	003-2286	ASSY HEAD LEVEL WC PYTHON	EA	\$1,088.87	P01
003-2071	ASSY CVR SPG PXL	EA	\$23.43	P01	003-2287	ASSY BODY REAR WC PYTHON	EA	\$244.25	P01
003-2072	ASSY BRAKE SPG	EA	\$18.29	P01	003-2288	ASSY BODY CTL ADPTR WC EURO	EA	\$110.01	P01
003-2078	ASSY MOT SLAVE 115V CB	EA	\$759.84	P01	003-2289	ASSY BODY REAR AC PYTHON	EA	\$181.20	P01
003-2089	ASSY CVR SPG LE	EA	\$23.43	P01	003-2290	ASSY BODY PXL 1/8ID HOSE	EA	\$291.84	P01
003-2090	ASSY SPOOL SPG LE	EA	\$64.90	P01	003-2296	ASSY CVR 4000	EA	\$5,782.36	P01
003-2102	ASSY POT CG	EA	\$53.68	P01	003-2302-25	LEAD 25FT AC PYTHON	EA	\$676.00	P01
003-2108	ASSY BODY FR PYTHON	EA	\$332.95	P01	003-2315	ASSY BBL STR WC 400AMP	EA	\$434.39	P01
003-2109	ASSY PNL FR 42V CB	EA	\$299.93	P01	003-2316	ASSY BBL 45D WC 400AMP	EA	\$475.95	A01
003-2110	ASSY PNL FR 115V CB	EA	\$276.98	P01	003-2317	ASSY BBL 60D WC 400AMP PYTHON	EA	\$490.24	P01
003-2112	ASSY PNL FR 42V CB LE	EA	\$269.97	P01	003-2318	ASSY BBL 12IN STR WC 400AMP	EA	\$531.61	A01
003-2113	ASSY MOT TORQUE 42V CB	EA	\$485.66	P01	003-2319	ASSY BBL 12IN 45D WC 400AMP	EA	\$542.22	A01

FOR A COMPLETE PRICE LIST OF ALL MK AVAILABLE PARTS, VISIT WWW.MKPRODUCTS.COM

Products, Parts, and Accessories Pricing

Part #	Description	EA	List Price	Disc. Code	Part #	Description	EA	List Price	Disc. Code
003-2320	ASSY BBL 18IN STR WC 400AMP	EA	\$542.22	A01	005-0261	KIT PXL ADPTR 14P PA-M1	EA	\$382.82	A01
003-2321	ASSY BBL 18IN 45D WC 400AMP	EA	\$572.35	A01	005-0264	KIT PXL ADPTR GEN PA-G1	EA	\$341.20	A01
003-2325	ASSY BODY PXL - OEM	EA	\$258.43	P01	005-0268	KIT CBL CTRL 15FT COBRA G/PXL	EA	\$118.09	P01
003-2330	ASSY BBL STR AC PYT/PXL	EA	\$235.81	P01	005-0269	KIT CBL CTRL 25FT COBRA G/PXL	EA	\$144.59	P01
003-2331	ASSY BBL 45D AC PXL	EA	\$226.90	P01	005-0272	KIT CBL CTRL 50FT COBRA G/PXL	EA	\$216.59	P01
003-2332	ASSY BBL 12IN STR AC	EA	\$306.69	A01	005-0307	KIT CBL CTRL 35FT COBRA G/PXL	EA	\$172.04	P01
003-2333	ASSY BBL 12IN 45D AC	EA	\$326.62	A01	005-0316	KIT CBL INTFC 115V MILLER	EA	\$150.32	A01
003-2334	ASSY BBL 18IN STR AC	EA	\$351.17	A01	005-0323	KIT CBL PC INTFC TIG150	EA	\$22.01	A01
003-2335	ASSY BBL 18IN 45D AC	EA	\$373.71	A01	005-0345	KIT STRP CHART ACL	EA	\$1,448.26	A02
003-2337	ASSY PWR MANIFOLD AC UNIV	EA	\$47.07	P01	005-0354	KIT STRP CHART TIG150	EA	\$984.82	A02
003-2338	ASSY POWER PIN ADPTR MILLER	EA	\$141.35	P01	005-0355	KIT SPG CTRL MODULE SP-1	EA	\$161.20	A03
003-2340	ASSY BBL AC CLASSIC CUP SX	EA	\$256.81	P01	005-0356	KIT SPG CTRL MODULE SP-L1 14P LINCOLN	EA	\$161.20	A03
003-2341	ASSY BBL AC CLASSIC CUP MX	EA	\$267.12	P01	005-0357	KIT SPG CTRL MODULE SP-M1 14P MILLER	EA	\$161.20	A03
003-2342	ASSY BBL WC CLASSIC CUP MX	EA	\$296.82	P01	005-0358	KIT SPG CTRL MODULE SP-4A	EA	\$161.20	A03
003-2343	ASSY BBL AC MAX CUP MX	EA	\$272.33	P01	005-0361	KIT MOTHERBOARD ASUS M2N-MX ACL	EA	\$712.25	P01
003-2344	ASSY BBL WC MAX CUP MX	EA	\$307.46	P01	005-0363	KIT DRV RL KNURL INSUL	EA	\$45.22	C01
003-2345	ASSY PWR MANIFOLD WC UNIV	EA	\$64.43	P01	005-0365	KIT PCB MAIN 115V	EA	\$418.74	P01
003-2346	ASSY POWER PIN ADPTR LE/TWECO	EA	\$97.81	P01	005-0366	KIT PCB MAIN 42V	EA	\$414.14	P01
003-2354	ASSY PWR MANIFOLD WC HGV - FRONIUS	EA	\$107.26	P01	005-0371	KIT ASSY HIGH VOLTAGE PWR ACL	EA	\$1,796.41	P01
003-2355	ASSY REAR BODY AC W/MOD GAS VAL. LX	EA	\$264.45	P01	005-0376	KIT XFMR REPL/UPGRADE COBRAMATIC	EA	\$229.22	P01
003-2358	ASSY FAN COBRA COOLER	EA	\$63.61	P01	005-0380-15	KIT CBL CTRL 15FT MM COMP PYTHON/SX/MXEA	EA	\$153.60	P01
003-2359	ASSY MOT PUMP COBRA COOLER	EA	\$424.47	P01	005-0380-25	KIT CABLE CTRL 25FT MM COMP	EA	\$175.15	P01
003-2364	ASSY FUSE COBRA COOLER	EA	\$27.85	P01	005-0380-35	KIT CBL CTRL 35FT MM PYT/SX/MX	EA	\$209.05	P01
003-2373	ASSY PWR MANIFOLD AC FRON 1/8" BARB	EA	\$57.36	P01	005-0380-50	KIT CBL CTRL 50FT MM PYT/SX/MX	EA	\$224.59	P01
003-2376	ASSY PWR MANIFOLD AC ESAB	EA	\$102.56	P01	005-0381-15	KIT CBL CTRL 15FT FRONIUS PYT/SX/MX	EA	\$201.69	P01
003-2377	ASSY TRIGGER PIN ESAB	EA	\$13.61	P01	005-0381-25	KIT CBL CTRL 25FT FRONIUS PYT/SX/MX	EA	\$224.36	P01
003-2378	ASSY PWR MANIFOLD WC FRON 1/8" BARB	EA	\$62.99	P01	005-0381-35	KIT CBL CTRL 35FT FRONIUS PYT/SX/MX	EA	\$249.05	P01
003-2379	ASSY PWR MANIFOLD WC ESAB	EA	\$152.10	P01	005-0381-50	KIT CBL CTRL 50FT FRONIUS PYT/SX/MX	EA	\$283.06	P01
003-2380	ASSY BBL STR WC 300AMP	EA	\$428.57	A01	005-0385-BLACK	KIT HANDLE WIREFEED EURO BLACK	EA	\$22.83	P01
003-2381	ASSY BBL 45D WC 300AMP	EA	\$470.23	A01	005-0385-BLUE	KIT HANDLE WIREFEED MM COMP BLUE	EA	\$22.83	P01
003-2382	ASSY BBL 60D WC 300AMP	EA	\$484.50	A01	005-0385-RED	KIT HANDLE WIREFEED LE COMP RED	EA	\$22.83	P01
003-2385	ASSY REAR BODY AC LX	EA	\$259.00	P01	005-0387-10	KIT CBL PWR/WTR 10FT MK CONN	EA	\$146.22	P01
003-2396	ASSY PCB FRONT PANEL COBRAMATIC	EA	\$416.31	P01	005-0387-15	KIT CBL PWR/WTR 15FT MK CONN	EA	\$169.92	P01
003-2397	ASSY REAR BODY AC W/MOD	EA	\$199.40	P01	005-0387-25	KIT CBL PWR/WTR 25FT MK CONN	EA	\$225.41	P01
003-2398	ASSY REAR BODY WC W/MOD GAS VAL MX	EA	\$376.38	P01	005-0387-3	KIT CBL PWR/WTR 3FT MK CONN	EA	\$106.92	P01
003-2401	ASSY FLOW INDICATOR COBRACOOLER	EA	\$161.37	P01	005-0387-30	KIT CBL PWR/WTR 30FT MK CONN	EA	\$258.19	A01
003-2416	ASSY PCB PS CTRL SMT TIG150	EA	\$767.10	P01	005-0387-35	KIT CBL PWR/WTR 35FT MK CONN	EA	\$280.87	P01
003-2435	ASSY BBL COBRA MAX	EA	\$212.15	A01	005-0387-50	KIT CBL PWR/WTR 50FT MK CONN	EA	\$360.00	P01
003-2440	ASSY BBL 45D A/W PYTHON	EA	\$235.27	A01	005-0387-6	KIT CBL PWR/WTR 6FT MK CONN	EA	\$125.24	P01
003-2450	ASSY CAM PAWL BRAKE COBRAMATIC	EA	\$9.05	P01	005-0388-10	KIT CBL PWR/WTR 10FT EURO CONN	EA	\$130.40	P01
003-2451	ASSY POWER BLOCK PRO-SERIES MK	EA	\$333.98	P01	005-0388-15	KIT CBL PWR/WTR 15FT EURO CONN	EA	\$158.90	P01
003-2452	ASSY GAS SOLENOID 24V PRO-SERIES	EA	\$155.69	P01	005-0388-25	KIT CBL PWR/WTR 25FT EURO CONN	EA	\$214.84	P01
003-2453	ASSY BRAKE SOLENOID 115V PRO-SERIES	EA	\$81.07	P01	005-0388-3	KIT CBL PWR/WTR 3FT EURO CONN	EA	\$102.84	P01
003-2454	ASSY FRONT PANEL 115VPRO-S	EA	\$469.37	P01	005-0388-30	KIT CBL PWR/WTR 30FT EURO CONN	EA	\$248.00	P01
003-2455	ASSY SPINDLE PRO-SERIES	EA	\$191.57	P01	005-0388-35	KIT CBL PWR/WTR 35FT EURO CONN	EA	\$274.70	P01
003-2457	ASSY DOOR LEFT PRO-SERIES	EA	\$132.55	P01	005-0388-50	KIT CBL PWR/WTR 50FT EURO CONN	EA	\$353.86	P01
003-2458	ASSY DOOR RIGHT PRO-SERIES	EA	\$132.55	P01	005-0388-6	KIT CBL PWR/WTR 6FT EURO CONN	EA	\$120.29	P01
003-2466	ASSY GAS SOLENOID 24V EURO PRO-SERIES	EA	\$162.91	P01	005-0393	KIT PWR MANIFOLD WC FRON/7P EURO	EA	\$76.43	P01
003-2470	ASSY TUBE SPIRAL CONDUIT LE	EA	\$11.95	P01	005-0394	KIT POWER MANIFOLD AC FRON/7P EURO	EA	\$69.76	P01
003-2495-12	ASSY BBL FLEXIBLE 12IN PXL\PYTHON	EA	\$333.23	A01	005-0395	KIT ASSY PWR CONN MM COMP	EA	\$195.15	P01
003-2495-18	ASSY BBL FLEXIBLE 18IN PXL\PYTHON	EA	\$357.43	A01	005-0396	KIT SPIRAL RING REPL MANIFOLD EURO	EA	\$15.41	P01
003-2495-24	ASSY BBL FLEXIBLE 24IN PXL\PYTHON	EA	\$383.47	A01	005-0405-15	KIT CBL CTRL 15FT MM COMP PXL	EA	\$118.27	P01
003-2495-36	ASSY BBL FLEXIBLE 36IN PXL\PYTHON	EA	\$436.22	A01	005-0405-25	KIT CBL CTRL 25FT MM COMP PXL	EA	\$141.45	P01
003-2498	ASSY BASE TURNTABLE	EA	\$192.16	P01	005-0405-35	KIT CBL CTRL 35FT MM COMP PXL	EA	\$189.88	P01
003-2499	ASSY MOTOR TURNTABLE	EA	\$672.84	P01	005-0405-50	KIT CBL CTRL 50FT MM COMP PXL	EA	\$208.50	P01
003-2502	ASSY PCB FR PNL CNTLR TURNTABLE	EA	\$408.74	P01	005-0406-15	KIT CBL CTRL 15FT FRONIUS COMP PXL	EA	\$160.14	P01
003-2503	ASSY GROUND CABLE TURNTABLE	EA	\$63.41	P01	005-0406-25	KIT CBL CTRL 25FT FRONIUS COMP PXL	EA	\$196.01	P01
003-2504	ASSY KNOB TURNTABLE	EA	\$23.59	P01	005-0406-35	KIT CBL CTRL 35FT FRONIUS COMP PXL	EA	\$236.33	P01
003-2507	ASSY HOUSING BUSHING TURNTABLE	EA	\$284.96	P01	005-0406-50	KIT CBL CTRL 50FT FRONIUS COMP PXL	EA	\$292.16	P01
003-2511	ASSY DISPLAY MOD COBRATIG 150	EA	\$926.47	P01	005-0608	KIT CBL INTFC 115V 14PIN 8FT LE	EA	\$163.22	A01
003-2513	ASSY PRINTER MODULE TIG150	EA	\$1,647.50	P01	005-0611	KIT PIGTAIL PUSH TO TWIST	EA	\$324.31	A02
003-2570	ASSY PCB FR PNL CNTLR TURNTABLE	EA	\$427.67	P01	005-0617	KIT CBL ADPTR SPG GSLGR	EA	\$179.00	A01
003-2593	ASSY CUP ADPTR AC PXL	EA	\$36.08	P01	005-0627	KIT FOOT SPD CTRL PSNR 4	EA	\$417.78	A04
003-2613	ASSY PCB MAIN 115V CM300	EA	\$611.00	P01	005-0628	KIT FOOT SWX CTRL PSNR 4	EA	\$126.09	A04
005-0040	KIT CHUCK 3JAW 3 & 4 PSNR	EA	\$584.40	A04	005-0630	KIT CBL INTFC THERMAL ARC	EA	\$196.32	A01
005-0162	KIT ADPTR 7 PIN W" CAB"	EA	\$78.15	P01	005-0632	KIT BRAKE SPOOL SPG PXL	EA	\$132.54	P01
005-0205	KIT MILLER 250 SPG CTRL	EA	\$281.48	A01	005-0633	KIT HDL W/SPCR PXL	EA	\$65.06	P01
005-0206	KIT L-TEC SPG MK	EA	\$282.00	A01	005-0634	KIT BENCH MNT 4000/5000-3	EA	\$288.50	A02
005-0214	KIT TOOL 5001-5003 WLDHHD	EA	\$59.04	P01	005-0635-50	KIT CBL EXT 50FT WC WELDHEAD	EA	\$1,923.12	A02
005-0255	KIT HDL COBRA TORCH	EA	\$48.19	P01	005-0648	KIT BK SOL 115V PL DR CB	EA	\$78.33	P01

FOR A COMPLETE PRICE LIST OF ALL MK AVAILABLE PARTS, VISIT WWW.MKPRODUCTS.COM

Products, Parts, and Accessories Pricing

Part #	Description	EA	List Price	Disc. Code	Part #	Description	EA	List Price	Disc. Code
005-0649	KIT BK SOL 42V METAL DR CB	EA	\$104.99	P01	005-0777	KIT ASSY PCB CNTLR TURNTABLE	EA	\$453.67	P01
005-0650	KIT BK SOL 115V METAL DR CB	EA	\$78.64	P01	007-0002	DIGITAL CONTROL UPGRADE	EA	\$8,918.00	F04
005-0651	KIT FUSE 4A/INFO SHEET	EA	\$3.39	P01	025-0025	LOCATING MANDREL 1/4	EA	\$265.31	A02
005-0654	KIT MOT W/CRMP TERM CG	EA	\$550.78	P01	025-0026	LOCATING MANDREL 5/16	EA	\$265.31	A02
005-0656	KIT POT REPL CG	EA	\$66.28	P01	025-0027	LOCATING MANDREL 3/8	EA	\$265.31	A02
005-0658	KIT CBL 115V 25FT MLR	EA	\$247.29	A01	025-0028	LOCATING MANDREL 1/2	EA	\$265.31	A02
005-0658-50	KIT CBL 115V 50FT MLR	EA	\$423.62	A01	025-0029	LOCATING MANDREL 5/8	EA	\$265.31	A02
005-0659	KIT CBL INTFC 115V 14PIN 25FT LE	EA	\$251.30	A01	025-0030	LOCATING MANDREL 3/4	EA	\$265.31	A02
005-0659-50	KIT CBL INTFC 115V 14PIN 50FT LE	EA	\$427.13	A01	025-0031	LOCATING MANDREL 1.00	EA	\$265.31	A02
005-0660	KIT CBL EXT 25FT 7PW	EA	\$198.09	A01	025-0040	LOCATING MANDREL 1 1/2	EA	\$265.31	A02
005-0661	KIT POT PXL	EA	\$114.92	P01	025-0041	LOCATING MANDREL 2	EA	\$265.31	A02
005-0670	KIT TIG MICRO ACCESSORY	EA	\$2,152.61	A02	025-0042	LOCATING MANDREL 2 1/2	EA	\$265.31	A02
005-0676	KIT PXL ADPTR 14PX PA-L1	EA	\$475.40	A01	025-0048	LOCATING MANDREL 1 1/4	EA	\$265.31	A02
005-0677	KIT TURNTABLE 10IN PSNR 4	EA	\$152.21	A04	025-0065	LOCATING MANDREL 3.00	EA	\$265.31	A02
005-0678	KIT PNL FR 42V CB	EA	\$180.74	P01	025-0078	LOCATING MANDREL 4.00	EA	\$265.31	A02
005-0679	KIT PNL FR 115V CB	EA	\$180.74	P01	101-0089	CAP MONO RD 100nF 63VDC	EA	\$1.03	P01
005-0680	KIT BENCH MNT 5006	EA	\$596.45	A02	117-0016	POT RHEO FT CTRL 7 FT CBL	EA	\$65.44	P01
005-0681	KIT SPOOL SPINDLE REPL CB	EA	\$178.88	P01	117-0520	POT WW 5K 3T 2W .68L SHFT	EA	\$44.00	P01
005-0682	KIT SPR STL HD SPG PXL	EA	\$29.82	P01	119-0023	POT TRM CM 5K 10T	EA	\$9.70	P01
005-0686	KIT IDLER ROLL	EA	\$16.87	P01	122-0021	XISTOR FET IVN5001 60V 700MA	EA	\$2.15	P01
005-0687	KIT TOOL 5006	EA	\$59.04	P01	122-0061	XISTOR MOD 900V 50A	EA	\$140.08	P01
005-0689	KIT CBL INTFC FAB 250	EA	\$179.00	A01	122-0069	XISTOR IGBT TO-247 600V 50A	EA	\$58.87	P01
005-0690	KIT CBL CTRL 15FT PYTHON/SX/MX	EA	\$118.09	P01	124-0003	DIO HEP170 1KV 2.5A	EA	\$5.90	P01
005-0691	KIT CBL CTRL 25FT PYTHON/SX/MX	EA	\$144.59	P01	124-0041	DIO FST 1N4448 75V 100MA	EA	\$1.03	P01
005-0692	KIT CBL CTRL 50FT PYTHON/SX/MX	EA	\$217.87	P01	124-0097	DIO FST MUR860 600V 8A	EA	\$8.12	P01
005-0693	KIT POT GAS/TRIGGER CB	EA	\$75.92	P01	125-0028	THY 400V 8A	EA	\$4.47	P01
005-0694	KIT TRIGGER PYTHON/MAX	EA	\$14.45	P01	127-0100	IC LIN MC33063	EA	\$3.90	P01
005-0695	KIT POT ASSY PYTHON/MAX	EA	\$102.42	P01	135-0015	XFMR TOROID	EA	\$41.59	P01
005-0696	KIT NUT/INSUL BBL	EA	\$30.57	P01	135-0024	XFMR PWR	EA	\$54.63	P01
005-0697	KIT THERMISTOR ACL	EA	\$178.34	P01	135-0060	XFMR PWR TIG150	EA	\$596.18	P01
005-0698	KIT CALIBRATION 200AMP	EA	\$1,889.68	A02	135-0062	XFMR ARC START TIG150	EA	\$145.78	P01
005-0699	KIT HDL PYTHON	EA	\$45.79	P01	135-0063	XFMR ARC START TIG150	EA	\$419.22	P01
005-0700	KIT HDL COBRAMAX	EA	\$48.19	P01	135-0065	XFMR PULSE 1:1 1916UH 17.5VUS	EA	\$7.81	P01
005-0701	KIT ASSY MICRO SWX PYTHON/MAX	EA	\$28.92	P01	137-0004	XFMR PWR 115/8V .4A	EA	\$40.60	P01
005-0705	KIT CBL INTFC 450I/460 ESAB	EA	\$167.04	A01	137-0050	XFMR PWR 115V/26.8V 1.7A	EA	\$62.18	P01
005-0710	KIT HDL COBRA SX	EA	\$37.89	P01	137-0093	XFMR 4 DISCRETE INPUTS 28V/2A RMS	EA	\$156.01	P01
005-0711	KIT HDL SIDEWINDER	EA	\$49.80	P01	145-0028	LMP GRN BEZEL 951-5	EA	\$10.54	P01
005-0713	KIT GAS/TRIG CTRL 115V	EA	\$601.53	P01	145-0041	BEZEL SNAP-IN BLACK	EA	\$1.56	P01
005-0714	KIT GAS/TRIG CTRL 42V	EA	\$644.16	P01	51-0001	FUSE FST 3AG 2A 250V	EA	\$2.00	P01
005-0715	KIT DRV RL .030 GRVD INSUL	EA	\$71.09	C01	151-0007	FUSE SLO 3AG 1A 250V	EA	\$4.27	P01
005-0716	KIT DRV RL .035 GRVD INSUL	EA	\$71.09	C01	151-0037	FUSE FST PICO 3A 125V	EA	\$2.86	P01
005-0717	KIT DRV RL .040 GRVD INSUL	EA	\$71.09	C01	151-0043	FUSE FST 3AG 4A 250V	EA	\$2.10	P01
005-0718	KIT DRV RL 3/64 GRVD INSUL	EA	\$71.09	C01	151-0044	FUSE FAST ACT 5X20MM 4A 125V	EA	\$3.59	P01
005-0719	KIT DRV RL 1/16 GRVD INSUL	EA	\$71.09	C01	151-0046	FUSE MED ACT 5X20MM 4A 125V	PK	\$20.51	P01
005-0720	KIT BASE COPPERHEAD I	EA	\$1,242.80	P01	151-0048	FUSE 6.3X32MM 5A 250V CCC	EA	\$5.84	P01
005-0721	KIT BASE COPPERHEAD II	EA	\$1,346.80	P01	151-0050	FUSE, 5AMP, 125V 2AG SLOW BLOW	EA	\$2.43	P01
005-0722	KIT BASE COPPERHEAD III	EA	\$1,554.80	P01	151-0197	FUSE NORM 3AG 5A 250V	EA	\$1.07	P01
005-0725	KIT HANDLE COBRA MX	EA	\$46.39	P01	152-0058	FUSE HLDR PNL 3AG 20A	EA	\$7.95	P01
005-0726	KIT TRIGGER COBRA MX	EA	\$14.45	P01	153-0008	CON HSG CRMP 5T .156 .045	EA	\$4.25	P01
005-0730	KIT HDL PRINCE SG	EA	\$57.34	P01	153-0304	CON TRM CRMP PIN .110 #18	EA	\$1.03	P01
005-0735	KIT FITTING PWR CBL	EA	\$67.60	P01	153-0322	CON CIR ST PLG 16S-1PW 7P	EA	26.25	P01
005-0738	KIT SOLENOID COBRAMATIC PRO-SERIES	EA	\$25.44	A01	153-0556	CON CIR ST PLG 24-28 24P	EA	135.09	P01
005-0740	KIT CBL CTRL 35FT PYTHON/SX/MX	EA	\$177.17	P01	153-0852	CON TRM CRMP PIN .064 #22	EA	\$1.03	P01
005-0745	KIT PCB MAIN 115V PRO-SERIES	EA	\$418.74	P01	153-0853	CON TRM CRMP SKT .064 #22	EA	\$1.03	P01
005-0746	KIT FOOT SWX VARIABLE TURNTABLE	EA	\$268.15	A04	153-0854	CON HSG CRMP 2T .100 .064	EA	\$1.89	P01
005-0747	KIT FOOT SWX ON/OFF TURNTABLE	EA	\$87.45	A04	153-0855	CON HSG CRMP 5T .100 .064	EA	\$2.15	P01
005-0750-BLACK	KIT HANDLE BLACK PYTHON LX	EA	\$45.79	P01	153-0856	CON HSG RCP 2T .100 .064	EA	\$2.15	P01
005-0750-BLUE	KIT HANDLE BLUE PYTHON LX	EA	\$45.79	P01	153-0857	CON HSG RCP 5T .100 .064	EA	\$2.70	P01
005-0750-GREEN	KIT HANDLE GREEN PYTHON LX	EA	\$45.79	P01	153-1255	COUPLER RJ45 SHIELDED	EA	\$10.22	P01
005-0750-RED	KIT HANDLE RED PYTHON LX	EA	\$45.79	P01	157-0022	RLY 4PDT 5A 24VAC PLUGIN	EA	\$41.16	P01
005-0752	KIT LCD MODULE / PRINTER REPL TIG150	EA	\$3,720.65	P01	157-0030	RLY ENC 14P 10A 24V DC	EA	\$50.01	P01
005-0753	KIT PCB DGTL CTRL SM TIG150	EA	\$1,096.08	P01	157-0031	RLY ADJ TIME DELAY 24VDC	EA	\$353.80	P01
005-0755-15	KIT HOSE GAS 15FT REPL MK - MX/LX	EA	\$48.70	P01	157-0034	RLY CNT SPDT 200A 24VDC	EA	\$404.34	P01
005-0755-25	KIT HOSE GAS 25FT REPL MK - MX/LX	EA	\$63.27	P01	157-0135	RLY 3PDT 24VAC PNL MTG	EA	\$70.25	P01
005-0755-35	KIT HOSE GAS 35FT REPL MK - MX/LX	EA	\$84.36	P01	157-0144	RLY RD 5V 500 OHM 200MA	EA	\$8.37	P01
005-0755-50	KIT HOSE GAS 50FT REPL MK - MX/LX	EA	\$106.86	P01	157-0150	RLY TIME DLY 120VAC 200K	EA	\$336.61	P01
005-0756-15	KIT HOSE WATER 15FT REPL MK - MX/LX	EA	\$90.28	P01	159-0159	SWX PB 1P FORM Z SNAP ACTION	EA	\$113.26	P01
005-0756-25	KIT HOSE WATER 25FT REPL MK - MX/LX	EA	\$114.73	P01	159-3586	SWX TGL SPDT 5A 125V PCB	EA	\$20.43	P01
005-0756-35	KIT HOSE WATER 35FT REPL MK - MX/LX	EA	\$157.48	P01	159-3587	SWX TGL DPDT 5A 125V PCB	EA	\$30.23	P01
005-0756-50	KIT HOSE WATER 50FT REPL MK - MX/LX	EA	\$193.48	P01	165-0001	FILT RFI 1A B 120/250VAC	EA	\$62.15	P01

FOR A COMPLETE PRICE LIST OF ALL MK AVAILABLE PARTS, VISIT WWW.MKPRODUCTS.COM

Products, Parts, and Accessories Pricing

Part #	Description	EA	List Price	Disc. Code	Part #	Description	EA	List Price	Disc. Code
170-0006	SNSR GAS FLOW 750SCC	EA	\$199.80	P01	301-0012	GROM RBR 3/8IDX21/32OD	EA	\$1.03	P01
170-0014	SNSR FLOW GAS 6.5 CFH AR	EA	\$338.63	P01	301-0019	BOOT AMP CBL #8 .437ID	EA	\$1.91	P01
176-0002	BRUSH MOD GND MTL/GRPH	EA	\$44.78	P01	301-0021	BOOT AMP CBL #10 .562ID	EA	\$4.32	P01
179-0016	MOD SPD 115V/90VDC PM	EA	\$239.31	P01	301-0023	GROM PNL MTG LED BLK	EA	\$1.03	P01
185-0532	TERM RING #1/4 12-10 IN	PK	\$5.25	P01	301-0026	BOOT AMP CBL #12 .63ID	EA	\$2.38	P01
185-0533	TERM RING #5/16 12-10 IN	PK	\$5.75	P01	301-0052	BOOT STOP CUR SNSR	EA	\$6.41	P01
185-0538	TERM RING #5/16 1/0GA NI	EA	\$6.92	P01	301-0054	BOOT AMP CBL #10 .562ID	EA	\$2.24	P01
185-0539	TERM RING #3/8 1/0GA NI	EA	\$5.56	P01	301-0055	BOOT PWR/GAS L-TEC ADPTR	EA	\$28.81	P01
186-0102	TERM BLK 4T 2.5mm 6A 63V GRN	EA	\$17.85	P01	301-0088	BOOT CBL 0.217OD BLUE	EA	\$1.56	P01
191-0002	PWR SPLY DC 24V	EA	\$1,688.15	P01	301-0089	BOOT WC FOR PXL & CG	EA	\$6.86	P01
191-0015	PWR SUPPLY SP400 400W	EA	\$353.94	P01	301-0094	BOOT CBL .228ID BLK	EA	\$1.56	P01
191-0016	PWR SUPPLY 12V 40W OPEN FRAME	EA	\$53.49	P01	301-0097	BOOT RBR WTR/PWR HD&CB	EA	\$11.85	P01
195-0017	PCB MOTHERBD BUNDLE ACL	EA	\$1,014.34	P01	301-0101	INSUL BBL	EA	\$8.68	P01
201-0009	FAN BLOW 115V 255CFM	EA	\$253.78	P01	301-0103	BUMPER RBR 15/16OD CB	EA	\$4.25	P01
201-0012	FAN FILT GUARD 4.7 30PPI	EA	\$14.97	P01	301-0107	BUMPER RBR 1.0X.5 W/WWSHR	EA	\$1.44	P01
201-0014	FAN FOAM FILT	EA	\$6.07	P01	301-0108	BOOT CBL SUPPORT PYTHON	EA	\$13.02	P01
201-0015	FAN GUARD #10	EA	\$15.04	P01	303-0010	O-RING 2-014 .489IDX.07W VITON	EA	\$1.03	P01
201-0019	FAN BLOW 24VDC 62CFM	EA	\$51.15	P01	303-0011	O-RING 2-016 .614 IDX.07W VITON	EA	\$1.07	P01
201-0020	FAN GUARD FILT 3.6IN	EA	\$12.12	P01	303-0012	O-RING 2-017 .676IDX.816OD VITON	EA	\$1.07	P01
201-0021	FAN MEDIA REPL 3.6IN SQ	EA	\$7.95	P01	303-0081	O-RING 5-108 .176IDX.276OD BUNA	EA	\$1.03	P01
201-0024	FAN FLTR SCR 3.61SQ ALUM	EA	\$21.38	P01	303-0093	O-RING 568-012 .364IDX.07W VITON	EA	\$1.07	P01
201-0025	FAN GUARD WIRE FORM 3-5/8	EA	\$3.08	P01	303-0094	O-RING 568-011 .301IDX.07W VITON	EA	\$1.03	P01
201-0027	FAN FILTER SCR 3.15SQ	EA	\$20.99	P01	303-0096	O-RING 2-007 .145IDX.07W BUNA N	EA	\$1.03	P01
201-0028	FAN GUARD WIRE 2.8SQ 80MM	EA	\$4.89	P01	303-0097	O-RING 2-005 .101IDX.07W BUNA	EA	\$1.03	P01
211-0034	MOT ASSY MOD 211-0033	EA	\$376.08	P01	303-0102	O-RING 2-112 0.487IDX.103 CS RBR	EA	\$1.07	P01
211-0066	MOTOR 96:1 RATIO CH I, II, III	EA	\$1,185.00	P01	303-0110	ORING 2-019 13/16 ID x 15/16 OD BUNA N 50	EA	\$1.07	P01
211-0071	MOT 31:1 RATIO 24VDC PT	EA	\$356.32	P01	303-0111	ORING 2-114 0.612IDX0.818OD BUNA	PK	\$6.89	P01
211-0077	MOT 24V 19.5:1 PYTHON	EA	\$269.80	P01	303-0112	ORING 2-210 0.734IDX1.012OD BUNA	PK	\$8.75	P01
211-0078	MOTOR 581:1 RATIO DMBK	EA	\$1,722.66	P01	303-0516	O-RING 2-010 .239IDX.07THK	EA	\$1.03	P01
211-0079	MOT 22MM 12VDC 23:1 SIDEWINDE	EA	\$164.46	P01	303-0540	O-RING 2-013 .426IDX.07W	EA	\$1.03	P01
211-0080	MOT 30.3V 10:1 HP PYTHON	EA	\$566.59	A01	311-0002	CPLR SHAFT MOT 6003/5001-5002	EA	\$28.74	P01
211-0082	MOT PLASTIC 8VDC C35-1 PSG	EA	\$84.75	P01	311-0008	CPLR SHAFT MOT 5003	EA	\$39.58	P01
211-0085	MOT 24V 19.5:1 COBRA MX/LX	EA	\$268.41	P01	313-0008	RING E RET EXT 3/16 DIA	EA	\$1.07	P01
211-0088	MOT 24VDC 31:1 RATIO PRINCE XL	EA	\$415.07	P01	313-0013	RING E RETAIN 3/4 DIA SHAFT STL	EA	\$1.25	P01
227-815	Cobra MAX 15FT AC	EA	\$1,995.00	F01	313-0021	STUD RCVR .250DIA PUSH-ON	EA	\$1.03	P01
227-825	Cobra MAX 25FT AC	EA	\$2,095.00	F01	313-0089	RING C RET EXT .312 DIA	EA	\$1.07	P01
227-835	Cobra MAX 35FT AC	EA	\$2,195.00	F01	313-0091	RING RET EXT .625 SHAFT CARB STL	PK	\$9.68	P01
227-850	Cobra MAX 50FT AC	EA	\$2,295.00	F01	313-0098	RING RET EXT 13/32 SHAFT STL ZINC	EA	\$1.03	P01
228-815	Cobra MAX 15FT WC	EA	\$2,195.00	F01	313-0140-0.500	RING RET MD 0.500 DIA SHAFT SPIRAL SST	PK	\$10.76	P01
228-825	Cobra MAX 25FT WC	EA	\$2,295.00	F01	313-0144	RING RET HD 1.062 DIA SHAFT SPIRAL STL	EA	\$1.97	P01
228-835	Cobra MAX 35FT WC	EA	\$2,395.00	F01	313-0197	RING WIRE 13/16SX.059T CL	EA	\$1.30	P01
228-850	Cobra MAX 50FT WC	EA	\$2,495.00	F01	315-0023	BUSH KEEPER .44ODX.25X.31 SST	EA	\$3.93	P01
230-0011	MONITOR FL PNL LCD17V BLK	EA	\$1,006.14	P01	315-0030	BRG SLV THRUST 3/4IDX1-1/4ODX1/16LG	EA	\$2.55	P01
230-0016	PRINTER HP DESKJET COLOR	EA	\$156.08	P01	315-0696	BUSH STRN RLF .625X.55X.06	EA	\$1.37	P01
230-0018	PRINTER MOD COBRATIG 150	EA	\$1,482.73	P01	318-0339	SCR PN S 10-32X1/4 NYL BLK	EA	\$1.07	P01
261-0069	INSUL SWX TERM MYLAR	EA	\$1.07	P01	319-0254	SCR F P 82D 4-40X3/8 SS	EA	\$0.99	P01
261-0085	INSUL SPD CTRL	EA	\$4.64	P01	319-0258	SCR F P 82D 4-40X5/8 SS	EA	\$0.99	P01
261-0094	WRAP SPL CORD 5.5" LG	EA	\$3.20	P01	319-0283	SCR F P 82D 8-32X1/2 SS	PK	\$7.95	P01
261-0094-13	WRAP SPL CORD 13.0" LG	EA	\$8.01	P01	320-0085	SCR BHSC 6-32X1/4 SS	EA	\$1.07	P01
261-0115	INSUL BASE SUPP BASE PLT WPS	EA	\$33.26	P01	320-0101	SCR BHSC 4-40X3/16 SST	EA	\$1.07	P01
261-0125	INSUL FILM SIL TO-220	EA	\$4.27	P01	320-0127	SCR BHSC 10-24X1/2 ST BLK ZINC	PK	\$10.35	P01
261-0141	INSUL BBL STR AW	EA	\$2.08	P01	321-0001	SSCR CUP 4-40X1/8 ST	EA	\$1.35	P01
261-0142	INSUL BBL KIT	EA	\$3.68	P01	321-0071	SSCR CUP 10-32X1/4 ST	PK	\$7.95	P01
261-0143	INSUL BBL CRV AW 60D	EA	\$2.83	P01	321-0081	SSCR CUP 1/4-20X1/4 ST	EA	\$1.07	P01
261-0153	INSUL HLDR CAL KIT	EA	\$54.03	P01	321-0424	SSCR CUP 4-40X1/8 SS	EA	\$1.03	P01
261-0155	INSUL BBL 12IN A/W PXL	EA	\$4.38	P01	321-0518	SSCR FP 1/4-20X3/8 ST	EA	\$1.03	P01
261-0158	INSUL BBL STR/45D WC	EA	\$1.97	P01	321-1074	SSCR 6-32-.50 MOD	EA	\$7.82	P01
261-0159	INSUL BBL 12IN WC PYT/PXL	EA	\$5.14	P01	321-1082	SSCR FP 1/4-20X3/8 SS	EA	\$1.07	P01
261-0167	SLEEVE HANDLE TURNTABLE	EA	\$5.46	P01	321-1093	SSCR CP 4-40X1/4 W/NYL SS	EA	\$3.23	P01
261-0234	INSUL ADPTR CUP KT	EA	\$23.43	P01	321-1102	SSCR BSTIP 10-32X3/16 ST	EA	\$3.87	P01
261-0240	INSUL ASSY #10 GAS CUP	EA	\$17.45	P01	321-1104	SSCR LK CONDUIT	EA	\$10.24	P01
261-0271	INSUL BBL SPANNER COL	EA	\$23.17	P01	321-1105	SSCR 1/4-20X1/4 BRS-TIP SS	PK	\$14.51	P01
261-0380	INSUL KC CUP	EA	\$17.84	P01	321-1111	SSCR CONE 1/4-20X3/8 SS	PK	\$7.50	P01
261-0381	INSUL S/A BBL WC CUP	EA	\$24.77	P01	321-1124	SSCR CONE M2X4MM SS	EA	\$3.29	P01
261-0452	INSUL 7IN BBL SDWDR	EA	\$5.09	P01	321-1130	SSCR ROTOR 4000	EA	\$2.10	P01
261-0454	INSUL BBL QKCUP PSG	EA	\$2.28	P01	321-1264	SSCR CUP 6-32X1/8 SS	EA	\$1.82	P01
261-0615	INSUL PCB WELD HEAD	EA	\$5.29	P01	321-1266	SSCR CUP 6-32X1/4 SS	EA	\$1.07	P01
261-0634	INSUL SPOOL CB	EA	\$7.05	P01	324-0169	SCR F S 80D 8-32X1/2	PK	\$8.85	P01
261-0635	INSUL PWR BLK CB	EA	\$8.25	P01	324-0421	SCR F S M1.6X2MM SS 4000	EA	\$3.91	P01
301-0004	BOOT AMP CBL #6 5/16ID	EA	\$2.09	P01	325-0025	SCR PN S 2-56X3/8	EA	\$1.03	P01

FOR A COMPLETE PRICE LIST OF ALL MK AVAILABLE PARTS, VISIT WWW.MKPRODUCTS.COM

Products, Parts, and Accessories Pricing

Part #	Description	EA	List Price	Disc. Code	Part #	Description	EA	List Price	Disc. Code
325-0206	SCR PN S 10-24X.340LG SST	EA	\$1.60	P01	341-0104	NUT 5/8HX 1/2-24 3/16THK	EA	\$2.04	P01
325-0426	SCR PN S 4-40X3/4 SS	EA	\$1.03	P01	341-0106	NUT HX 1/2-13UNC 5/16THK BRS	PK	\$19.25	P01
327-0012	SCR PN P T/F 6-32X1/4 ST	EA	\$1.03	P01	342-0039	NUT JAM 1/2-13 BS	EA	\$1.89	P01
327-0110	SCR PN P T/B #6X3/8 ST	EA	\$1.03	P01	342-0410	SPCR STACK #6-32X.534LG	EA	\$1.89	P01
327-0133	SCR HW S T/A #8X1/2 ST	PK	\$6.95	P01	345-0018	NUT HX LK #5/16-18UNC W/INSR NYLON	PK	\$5.36	P01
328-0002	SCR SHC 4-40X3/8 ST	EA	\$2.11	P01	345-0047	NUT ADJ PRESET TENSIONER	EA	\$8.35	P01
328-0003	SCR SHC 4-40X1/2 ST	EA	\$1.35	P01	345-0050	NUT CAP 4-40 BLK N	EA	\$2.92	P01
328-0012	SCR SHC 6-32X3/8 ST	EA	\$1.03	P01	351-0066	CAP PLG 5/16 DIA BLK	EA	\$1.03	P01
328-0013	SCR SHC 6-32X1/2	EA	\$2.03	P01	351-0266	STRAIN RELIEF SR 10N-2 BLK	EA	\$1.59	P01
328-0014	SCR SHC 6-32X5/8	EA	\$2.11	P01	351-0745	SNAP BUSH 15/16 ID NYL	EA	\$1.03	P01
328-0015	SCR SHC 6-32X3/4	EA	\$2.11	P01	351-0835	SNAP BTN 1/2 ID NYL BLK	PK	\$4.68	P01
328-0025	SCR SHC 8-32X1/2	EA	\$2.03	P01	401-0012	KNOB FLUTE 1 IN DIA BLK	EA	\$9.92	P01
328-0056	SCR SHC 1/4-20X1/2	EA	\$0.99	P01	401-0013	KNOB RHEOS 1-1/8DIA BLK	EA	\$7.34	P01
328-0063	SCR SHC 1/4-20X1-3/4	PK	\$8.27	P01	401-0015	KNOB 2 IN 3/8-16X3/4 AL	EA	\$31.78	P01
328-0237	SCR SHC 4-40X1/4 SS	EA	\$1.07	P01	401-0019	KNOB HAND STAR 3 IN DIA	EA	\$50.26	P01
328-0258	SCR SHC 1/4-20X3-1/2 ST	PK	\$10.14	P01	401-0029	SWX CAP BLK PSH BUTTON	EA	\$6.70	P01
329-0002	SCR HX 1/4-20X5/8 ST	PK	\$7.23	P01	401-0039	KNOB THUMBSCR #4-40X1/4	EA	\$1.59	P01
329-0236	SCR HX 1/2-13X1 1/2 BS	EA	\$7.33	P01	401-0119	LAMP FILAMENT T1-3/4MG 28V 40mA	EA	\$8.65	P01
329-1017	SCR HW S 8-32X1/4 ST	PK	\$7.95	P01	401-0521	KNOB .070DIA 1/4SHFT	EA	\$7.96	P01
330-0005	SCR SHDR 1/4X1 10-24	EA	\$4.52	P01	403-0008	DIAL PLT 1-3/4DIA 0-100 MARK	EA	\$8.10	P01
330-3063	SCR SHDR MOD	EA	\$7.79	P01	405-0958	MEMBRANE SWX DMDBK	EA	\$383.29	P01
331-0005	WSHR F #1/4 .50X.265X.063 ST	PK	\$6.19	P01	411-0025	CLAMP CBL SZ 16 BLK ZINC	EA	\$11.09	P01
331-0050	WSHR F .625X.265X.06 ST	EA	\$1.07	P01	411-0027	CLAMP CBL SZ 18 BLK ZINC	EA	\$37.02	P01
331-0063	WSHR F .505X.255X.015 ST	PK	\$5.19	P01	411-0045	TIE WRAP .750 DIA N BLK	EA	\$1.03	P01
331-0087	WSHR F .75X.453X.093 NEOP	EA	\$1.07	P01	411-0053	CLIP RBN CBL 1X1X.391 PVC	EA	\$4.70	P01
331-0094	WSHR F #1/4 .62X.28X.05 SS	PK	\$5.95	P01	411-0159	CLAMP CBL CB TORCH	EA	\$5.34	P01
331-0095	WSHR F #5/16 .75X.343X.05 SS	EA	\$3.90	P01	411-0200	TIE CBL MT ADH	EA	\$2.60	P01
331-0176	WSHR F 1.125x.50x.08 BS	EA	\$3.13	P01	411-0202	TIE WRAP CBL 1.88 DIA NYL	EA	\$1.07	P01
331-0188	WSHR FL 0.525ID X 0.875ODX0.063T BRASS	PK	\$16.25	P01	411-0243	TIE WIRE #4 SCR X 4.33LG NYLON	EA	\$1.03	P01
331-0200	WSHR F 1.38x.875x.031 ST	PK	\$10.14	P01	413-0017	BRKT IDLER ARM	EA	\$53.18	P01
331-0264	WSHR F .250X. 125X.022 SS	EA	\$1.03	P01	413-0049	BRKT IDLER COBRA G	EA	\$43.54	P01
331-0311	WSHR F .630X.390X.016 SS	EA	\$1.19	P01	413-0182	BRKT BRK SOL CB	EA	\$9.02	P01
331-0313	WSHR F 1.171X0.75X.125 LEATHER	EA	\$7.04	P01	415-0075	HINGE DOOR NYLON BLK	EA	\$21.33	P01
333-0003	WSHR SPR LK #4	EA	\$1.03	P01	415-0079	LATCH SLIDE .25x.045 GRIP	EA	\$7.20	P01
333-0005	WSHR SPR LK #6	EA	\$1.03	P01	415-0082	STRAP FSTNR HOOK & LOOP	EA	\$4.60	P01
333-0006	WSHR SPR LK #8 ST	EA	\$1.03	P01	415-0243	HDL CARRY 1010 STL	EA	\$23.41	P01
333-0009	WSHR SPR LK #1/4	EA	\$1.07	P01	419-0020	SPR COMP .290 ODX.047X.38	EA	\$1.48	P01
333-0013	WSHR SPR LK #1/2	EA	\$1.03	P01	419-0030	SPR TORS BRUSH	EA	\$17.06	P01
333-0039	WSHR LK #2 INTL STAR STL	EA	\$2.00	P01	419-0059	SPR COMP .468ODX.056X.437	EA	\$4.98	P01
333-0041	WSHR LK #4 INTL STAR STL	PK	\$5.19	P01	419-0063	SPR COMP .125ODX.017X.265	EA	\$4.63	P01
333-0082	WSHR LK #10	EA	\$1.03	P01	419-0080	SPR EXT .219ODX.014X.94LG	EA	\$4.31	P01
333-0084	WSHR SPR LK #4 HI COLLAR	PK	\$5.15	P01	419-0084	SPR COMP .609ODX.519x1.53	EA	\$12.42	P01
333-0254	WSHR LK #10 INTL STAR SS	PK	\$4.75	P01	419-0085	SPR COMP CB+	EA	\$8.87	P01
333-0260	WSHR SPR LK #6 SS	EA	\$1.03	P01	419-0089	SPR TORS RESTNR WIRE CB	EA	\$16.95	P01
333-0261	WSHR SPR LK #8 SST	EA	\$0.99	P01	419-0090	SPR TORS CATCH CB/CB+	EA	\$9.05	P01
336-0003	SCR PN 4-40X1/2 CROSS	EA	\$1.07	P01	419-0092	SPR COMP .320D X .055 WIRE MW	EA	\$9.62	P01
336-0020	SCR PN P 4-40X5/16 SS	EA	\$1.03	P01	419-0095	SPR COMP 0.850ODX0.690IDX0.75 LG	EA	\$7.08	P01
336-0049	SCR PN P 4-40X5/8 ST	EA	\$1.03	P01	419-0097	SPR COMP 0.360DX0.29ID	EA	\$9.46	P01
336-0056	SCR PN #4-40X1 1/2	EA	\$1.07	P01	419-0106	SPR WAVE 1.00DIA 3WAVE SST	EA	\$6.58	P01
336-0064	SCR PN P 6-32X3/4 ST	PK	\$5.95	P01	419-0108	SPR WAVE 1.25DIA 3WAVE SST	EA	\$6.90	P01
336-0070	SCR PN P 6-32X1-1/2 ST	EA	\$1.07	P01	419-0125	SPRING TOR DBL FLEX TRIGGER PYTHON	EA	\$4.63	P01
336-0071	SCR PN P 6-32X1-5/8 ST	EA	\$2.15	P01	419-0211	SPR COMP .50IDX.437.063WIRE	EA	\$6.98	P01
336-0073	SCR PN P 6-32X2.0 ST	EA	\$1.03	P01	419-0230	SPR COMP .92 ODX.135X2.0	PK	\$15.18	P01
336-0086	SCR PN P 6-32X1/4 SS	PK	\$4.95	P01	419-0742	SPR COMP .205 ODX.022X.38	EA	\$2.97	P01
336-0105	SCR PN P 4-40X3/16 SS	PK	\$5.95	P01	421-0001	KEY SQ. 3/32X3/32X3/4	EA	\$8.14	P01
336-0108	SCR PN P 4-40X3/8 SS	PK	\$7.95	P01	421-0016	PIN DWL 3/32X1.0 ST	EA	\$1.26	P01
336-0128	SCR PN P 8-32X1/4 SS	PK	\$7.95	P01	421-0018	PIN DWL 3/32X7/8 SS	EA	\$1.11	P01
336-0155	SCR PN P 10-32X3/8 SS	PK	\$6.99	P01	421-0128	PIN SPR 1/16X3/8 ST	EA	\$1.03	P01
336-0230	SCR PN P 8-32X1/4 ZBLK ST	EA	\$1.03	P01	421-0129	PIN SPR 1/16X7/16 ST	EA	\$1.07	P01
336-0231	SCR PN P 8-32X5/16 ZBLK ST	EA	\$1.03	P01	421-0211	PIN SPR 3/16X1 ST	EA	\$0.99	P01
336-0244	SCR PNP 1-72X3/8 SST	PK	\$9.31	P01	421-0223	PIN SPR 3/16X1 1/4 ST	EA	\$0.99	P01
338-0014	SCR SHC 4-40X1/2 SS	EA	\$1.03	P01	421-0408	PIN .093X2.0 ST	EA	\$1.93	P01
338-0020	SCR SHC 6-32X1/4 SS	EA	\$1.03	P01	421-0409	PIN DWL .093X1-1/4 SST	EA	\$1.37	P01
338-0022	SCR SHC 6-32X3/8 SS	EA	\$0.99	P01	421-0424	PIN DWL 1/4X5/8 SS	EA	\$2.15	P01
338-0034	SCR SHC 8-32X1/2 SS	EA	\$1.03	P01	421-0452	DWL PIN 0.093 DIA X 0.80LG SST	EA	\$2.27	P01
338-0153	SCR SHC 1-72X3/8 SST	EA	\$1.03	P01	421-0525	PIN DWL 1/8X7/8 416 SS	PK	\$10.40	P01
338-0156	SCR SHC M1.6 X 3MM SS	PK	\$21.96	P01	421-0714	PIN DWL 1/8X5/16 SS	EA	\$1.07	P01
341-0010	NUT HX PLAIN #1/4-20 UNC	PK	\$5.15	P01	421-0721	PIN DWL 3/32X1/4 SS	EA	\$1.13	P01
341-0011	NUT HX PLAIN #1/4-28 UNF	PK	\$4.94	P01	421-0742	PIN RING DETENT 1/4X2-3/4 ST	EA	\$6.86	P01
341-0072	NUT HX 10-32 THD SZ SS	PK	\$5.05	P01	421-3106	PIN DWL 1/8X3/4 ST	EA	\$1.03	P01

FOR A COMPLETE PRICE LIST OF ALL MK AVAILABLE PARTS, VISIT WWW.MKPRODUCTS.COM

Products, Parts, and Accessories Pricing

Part #	Description	EA	List Price	Disc. Code	Part #	Description	EA	List Price	Disc. Code
431-0015	SCR TORCH ADJ	EA	\$8.93	P01	431-1660	BOOT RING PYTHON/MAX	EA	\$3.84	P01
431-0115	WIRE GUIDE REAR	EA	\$9.58	C01	431-1663	SCR ADJ IDLER PYTHONMAX	EA	\$8.99	P01
431-0169	RTNR SPOOL	EA	\$15.18	P01	431-1670	BASE DMDBK	EA	\$885.93	P01
431-0429	CUP EXTENDER CB ADPTR	EA	\$15.49	P01	431-1671	CVR DMDBK	EA	\$722.68	P01
431-0432	BBL TIP EXTENDER	EA	\$7.55	P01	431-1672	PLT SIDE BASE DMDBK	EA	\$658.84	P01
431-0568	FTG GAS PSNR 4	EA	\$28.32	P01	431-1673	PLT SIDE CVR DMDBK	EA	\$658.84	P01
431-0580	STUD STL 3/8-16 X1-1/4	EA	\$14.04	P01	431-1674	HDL CLAMP DMDBK	EA	\$314.39	P01
431-0740	VALVE STEM	EA	\$7.89	P01	431-1675	LINK HDL CLAMP DMDBK	EA	\$55.88	P01
431-0743	WIRE GUIDE FR	EA	\$9.58	C01	431-1677	CLAMP FR RIGHT DMDBK	EA	\$222.84	P01
431-0802	MTG BLOCK MOT STD	EA	\$70.79	P01	431-1682	HSG CTRL RIGHT DMDBK	EA	\$443.20	P01
431-0873	DRV RL KNURL INSUL KT	EA	\$20.94	P01	431-1683	HSG CTRL LEFT DMDBK	EA	\$443.20	P01
431-0977	NUT RETAIN WTR/CUP KT	EA	\$14.76	P01	431-1684	STRAIN RLF CBL DMDBK	EA	\$62.62	P01
431-1079	BUSH INSR 5 IN TURNTABLE	EA	\$82.39	P01	431-1685	CLAMP CBL STRN RLF DMDBK	EA	\$38.29	P01
431-1080	VALVE STEM MODIF	EA	\$12.19	P01	431-1686	PIN DWL 1/4ODX.325LG DMDBK	EA	\$12.11	P01
431-1118	JACKET WTR BRASS	EA	\$26.04	P01	431-1690	BLK MOT MNT DMDBK	EA	\$153.23	P01
431-1247	PIN PVT BRK KIT	EA	\$15.75	P01	431-1693	LENS WLD CVR DMDBK	EA	\$186.22	P01
431-1266	RING BACKUP PLT	EA	\$15.02	P01	431-1694	RACE TEF DMDBK	EA	\$55.50	P01
431-1267	GEAR BX HSG GNK	EA	\$198.42	P01	431-1696	BUSH JOINT DMDBK	EA	\$32.96	P01
431-1369	SPCR L HDL CB	EA	\$3.16	P01	431-1702	CPLR MOT DMDBK	EA	\$25.24	P01
431-1370	SPCR R HDL CB	EA	\$2.83	P01	431-1704	FTTG GAS BARB DMDBK	EA	\$25.65	P01
431-1399	CON WTR	EA	\$6.30	P01	431-1705	SCREW SHDR MOD DMDBK	EA	\$13.32	P01
431-1416	TAPER LK NUT PXL	EA	\$14.70	P01	431-1708	GEAR PINION MOD DMDBK	EA	\$140.39	P01
431-1423	COLLAR TAPER LK PXL	EA	\$27.88	P01	431-1709	SPCR MOT MNT DMDBK	EA	\$34.53	P01
431-1424	IDLER ARM PXL	EA	\$64.86	P01	431-1724	FTG BRS 1/8IDX1/16-27NPT	EA	\$5.58	P01
431-1425	ADPTR PLT SOL CB	EA	\$8.66	P01	431-1728	SCR SHDR .093X4-40	EA	\$6.46	P01
431-1427	PIN PVT PXL	EA	\$14.51	P01	431-1729	PLG SLOT CH	EA	\$14.53	P01
431-1430	FTG CPLR MOD CH	EA	\$61.16	P01	431-1731	IDLER LEVER	EA	\$17.19	P01
431-1435	HSG GEAR CG	EA	\$200.61	P01	431-1744	DIFFUSER .281/.312OD FASTIP	EA	\$34.05	P01
431-1436	SSCR MOD CG	EA	\$3.54	P01	431-1749	SPCR WIRE RESTNR SDWDR	EA	\$1.45	P01
431-1438	ADPTR FAN PWR MOD	EA	\$105.67	P01	431-1750	IDLER LEVER SDWDR	EA	\$16.28	P01
431-1453	CPLR MOD 1/8PNTx1/4OD TIG150	EA	\$55.37	P01	431-1753	WIRE GUIDE SDWDR	EA	\$6.82	C01
431-1484	CLAMP BASE CH I	EA	\$213.67	P01	431-1754	VALVE STEM SDWDR	EA	\$7.89	P01
431-1485	FTG PLG MOD CH	EA	\$59.96	P01	431-1760	SCR SHDR 1/8DIA	EA	\$8.16	P01
431-1490	CLAMP CVR CH II	EA	\$273.23	P01	431-1786	FTTG CONDUIT LINER	EA	\$18.94	P01
431-1508	SPCR DRV SHAFT PSNR 4A	EA	\$5.78	P01	431-1788	FTTG CONDUIT LINER EURO CONN	EA	\$15.60	P01
431-1519	CASE PLUNGER PSNR 4	EA	\$35.12	P01	431-1810	TUBE CONDUIT XR	EA	\$4.82	P01
431-1520	NUT CPLR TIG150	EA	\$11.15	P01	431-1811	TUBE CONDUIT LE/7PIN MK EURO	EA	\$4.76	P01
431-1522	FTG GAS BARB CH	EA	\$13.25	P01	431-1817	OUTER SHELL BASE 4000	EA	\$2,872.43	P01
431-1525	ADPTR PLT SOL CB	EA	\$85.90	P01	431-1818	OUTER SHELL CVR 4000	EA	\$2,872.43	P01
431-1526	BEZEL LENS CH III	EA	\$96.71	P01	431-1820	LINK LONG RIGHT	EA	\$820.12	P01
431-1527	BEZEL LENS CH I	EA	\$74.74	P01	431-1821	LINK LONG LEFT	EA	\$735.72	P01
431-1539	WSHR SHDR 1/4-28LH DRV RL GRVD	EA	\$4.50	P01	431-1886	FTG 3/16HOSE 1/16-27 BRS	EA	\$6.02	P01
431-1549	NUT DRAG PYTHON	EA	\$10.12	P01	431-1890	CONDUIT LINER 7.32" LONG	EA	\$5.88	P01
431-1551	BRUSH COP CNCV PSNR 4	EA	\$9.34	P01	431-1892	SCR SHDR 1/8 DOOR MX	EA	\$16.20	P01
431-1553	PIN RTNR BENCH MNT CH	EA	\$30.37	P01	431-1893	NIPPLE MOD 1/8 ID HOSE	EA	\$13.69	P01
431-1574	BUSH FLG CLAMP CH	EA	\$3.48	P01	431-1897	ADPTR PWR MX MK3A RING LUG	EA	\$13.70	P01
431-1575	BUSH FLG SIDE PLT CH	EA	\$3.55	P01	431-1898	RETAINER HOSE TORCH	EA	\$6.54	P01
431-1576	BOLT SWG SLAVE MOT CB	EA	\$18.94	P01	431-1905	FTG BRS 1/8IDX1/16-27NPT	EA	\$6.17	P01
431-1579	PIVOT AXLE PSNR 4	EA	\$23.43	P01	431-1910	BARB HOSE QK CONN 1/8ID	EA	\$9.48	P01
431-1580	WSHR SHDR 1/4-28LH GOLD DRV RL CG	EA	\$4.18	P01	431-1936	MANIFOLD PWR AC CTRL BLK	EA	\$41.39	P01
431-1595	SLEEVE MOT MNT CH III	EA	\$5.50	P01	431-1948	CONNECTOR THREADED	EA	\$4.95	P01
431-1596	MANIFOLD PYTHON	EA	\$47.51	P01	431-1951	MANIFOLD PWR WC CTRL BLK UNIV	EA	\$41.74	P01
431-1598	ARM IDLER PYTHON	EA	\$34.63	P01	431-2011	SPCR CHUCK ALUM/BRZ	EA	\$3.56	P01
431-1602	SHAFT FLG PSNR 4A	EA	\$150.78	P01	431-2013	WIRE GUIDE PT	EA	\$11.45	C01
431-1603	GEAR MOD 48T PSNR 4A	EA	\$153.45	P01	431-2026	SLIDER PRINTER COBRATIG 150	EA	\$11.41	P01
431-1604	GEAR MOD 16T PSNR 4A	EA	\$113.01	P01	431-2030	TUBE SPIRAL CONDUIT LE	EA	\$25.31	P01
431-1605	PLUNGER PSNR 4A	EA	\$20.65	P01	431-2039	FTTG GAS 90DEG TURNTABLE	EA	\$60.06	P01
431-1606	KNOB STAR MOD PSNR 4A	EA	\$40.81	P01	431-2052	WASHER FOR EURO CONNECTION	EA	\$2.91	P01
431-1608	MANDREL CATCH CB+	EA	\$12.24	P01	431-2055	WASHER DELR TURNTABLE	EA	\$3.10	P01
431-1609	MANDREL RESTNR WIRE CB+	EA	\$9.08	P01	431-2057	INSUL WASHER TURNTABLE	PK	\$22.00	P01
431-1612	PWR BLK CB	EA	\$47.69	P01	431-2060	HANDLE TURNTABLE	EA	\$10.14	P01
431-1622	SCR SHDR 1/8X4-40 PYTHON	EA	\$6.55	P01	431-2061	BRUSH TURNTABLE	EA	\$4.52	P01
431-1627	BARB FTG	EA	\$3.19	P01	431-2064	SHAFT AXLE TURNTABLE	EA	\$19.13	P01
431-1630	CUP ADPTR HD COBRA GOLD	EA	\$15.60	P01	431-2065	KNOB PUSH TURNTABLE	EA	\$7.23	P01
431-1631	CUP ADPTR HD AC PXL	EA	\$38.10	P01	431-2072	PLUNGER LOCK TURNTABLE	EA	\$22.36	P01
431-1637	SCR 3/8-20X3/8 PYTHON	EA	\$7.87	P01	431-2097	WSHR DRIVE SHAFT TURNTABLE	PK	\$45.00	P01
431-1644	TIP HLD AC HD PYTHON	EA	\$14.99	P01	431-2099	DRIVE SHAFT TURNTABLE	EA	\$95.14	P01
431-1650	WSHR SHDR CB	EA	\$1.97	P01	431-2103	BRG SLV THRUST 1-1/16IDX1-1/2ODX1/8LG	PK	\$26.95	P01
431-1651	PWR BLK AW PYTHON	EA	\$20.12	P01	431-3117	DOOR MACH PT	EA	\$21.30	P01
431-1653	PIN FLG CH	EA	\$6.54	P01	431-3201	TUNG EXTENDER 1.0	EA	\$79.00	A02

FOR A COMPLETE PRICE LIST OF ALL MK AVAILABLE PARTS, VISIT WWW.MKPRODUCTS.COM

Products, Parts, and Accessories Pricing

Part #	Description	EA	List Price	Disc. Code	Part #	Description	EA	List Price	Disc. Code
431-3263	LOC POT PYTHON	EA	\$13.22	P01	437-0267	MLD CBL HDL	EA	\$6.65	P01
431-3505	BLOCK PWR CON CB	EA	\$53.86	P01	437-0268	MLD CVR POT PYTHON/MAX	EA	\$3.37	P01
431-3717	ENCLOSURE MOD TORP	EA	\$38.56	P01	437-0269	MLD SWX HLDR PYTHON/MAX	EA	\$9.11	P01
431-3726	ADPTR SPOOL SPINDLE C	EA	\$13.97	P01	437-0273	MLD TAIL PIECE	EA	\$3.43	P01
431-4013	BLOCK MOT MT 5003/6004	EA	\$56.80	P01	437-0277	MLD DOOR SDWDR	EA	\$2.53	P01
431-4023	RACK MTG BRKT R ACL	EA	\$125.12	P01	437-0292	MLD DOOR COBRA SX	EA	\$2.16	P01
431-4024	RACK MTG BRKT L ACL	EA	\$92.36	P01	437-0294	MLD POT LOCATOR	EA	\$6.88	P01
431-4054	NUT FR COBRA MAX	EA	\$8.31	P01	437-0299	MLD INSUL BBL COBRA MX	EA	\$15.65	P01
435-0255	CVR 1B MOT & CTRL BX	EA	\$43.52	P01	437-0305	MOLD HOUSING WIRE FEEDER MK CONN.	EA	\$189.04	P01
435-0931	PLT THD SMALL	EA	\$20.49	P01	437-0315-BLACK	MLD HDL RH BLACK - CABINET END	EA	\$6.93	P01
435-0933	LENS WELDING TINTED	EA	\$24.46	P01	437-0315-BLUE	MLD HDL RH BLUE - CABINET END	EA	\$8.55	P01
435-0986	HT SNK DRVR CARD TOP	EA	\$47.30	P01	437-0315-RED	MLD HDL RH RED - CABINET END	EA	\$8.61	P01
435-1111	CVR PNL PS ACL	EA	\$157.48	P01	437-0316-BLACK	MLD HDL LH BLACK - CABINET END	EA	\$6.93	P01
435-1120	PLT FAN ADPTR PS ACL	EA	\$24.40	P01	437-0316-BLUE	MLD HDL LH BLUE - CABINET END	EA	\$8.55	P01
435-1169	DEFLECTOR AIR PWR MODULE	EA	\$11.27	P01	437-0316-RED	MLD HDL LH RED - CABINET END	EA	\$8.61	P01
435-1171	IR FILTER 1X1-3/8 TIG150	EA	\$2.28	P01	437-0317	PLUG POT PYTHON	EA	\$16.04	P01
435-1186	STRAP MOT RTNG CG	EA	\$9.96	P01	437-0319	SLIDE KEEP COBRAMATIC	EA	\$4.52	P01
435-1201	BRASS SHIM 1.25ODX0.391IDX.010 DMNDBK	EA	\$2.02	P01	437-0645	MLD SPOOL SPINDLE	EA	\$65.89	P01
435-1203	BRASS SHIM 1.25ODX0.193IDX.010 CPERHD	EA	\$3.58	P01	437-0670	CTLR HAND HELD 45KEY ACL	EA	\$1,054.96	P01
435-1204	BRASS SHIM 1.25ODX0.250IDX.010 DMNDBK	EA	\$2.02	P01	437-0671	HLDR HAND HELD TERM	EA	\$169.76	P01
435-1205	WINDOW WLD VIEW DMDBK	EA	\$19.74	P01	438-0027	PAINT BASE ASSY PSNR 4	EA	\$229.80	P01
435-1210	BRASS SHIM 1.00ODX0.193IDX.010 CPERHD	EA	\$7.99	P01	438-0088	PAINT BACK PNL POSITIONER	EA	\$51.86	P01
435-1215	BRASS SHIM 0.63ODX0.193IDX.010 CPERHD	EA	\$3.81	P01	439-0090	NUT CONDUIT	EA	\$11.72	P01
435-1234	CLAMP LKG COMP INTFC ACL	EA	\$11.64	P01	449-0193	NUT RETAIN CHROME	EA	\$16.87	P01
435-1244	WINDOW VIEW COBRA COOLER	EA	\$6.15	P01	449-0542	NUT POT INJ MLD HDL	EA	\$7.30	P01
435-1247	BRACKET SENSOR COBRAMATIC	EA	\$10.55	P01	469-0161	FER BRS .400 OD HOSE	EA	\$1.03	P01
435-1250	WASHER 1.75OD X 0.203ID ALUM	EA	\$2.44	P01	501-0063	BRG FLG 3/4IDx1.0Dx1.25 BZ	EA	\$9.31	P01
435-1464	BRKT GAS SOL CB	EA	\$11.86	P01	501-0207	BRG DBL SHIELD 0.750DX.250IDX.281	EA	\$9.95	P01
435-1480	LINK BRK SOL CB	EA	\$7.64	P01	507-0128	PINION 10T	EA	\$45.20	C01
435-1484	BRKT ADPTR CNTOR BX	EA	\$23.62	P01	507-0130	GEAR SHAFT 34T	EA	\$89.60	P01
435-1485	BASE CNTOR BX	EA	\$61.04	P01	507-0139	GEAR BEVEL CT	EA	\$26.60	P01
435-1486	CVR CNTOR BX	EA	\$50.79	P01	507-0142	GEAR ROTOR 5003 ASSY	EA	\$1,647.16	P01
435-1558	PLT MEMBRANE PRT TIG150	EA	\$67.29	P01	507-0143	GEAR BEVEL SLIP64T WELDHD	EA	\$199.97	P01
435-1568	RETAINER PCB TIG150	EA	\$15.39	P01	507-0144	GEAR ASSY 24T SPUR WELDHD	EA	\$112.85	P01
435-1582	PLT LOCATE SLAVE MOT CB	EA	\$15.84	P01	507-0146	GEAR BEVEL 64T MOD.5 BORE	EA	\$130.52	P01
435-1585	STRAP MOTOR	EA	\$9.62	P01	507-0147	GEAR 32T MITTER WELDHD	EA	\$137.55	P01
435-1594	PNL SWX MNT ADPTR	EA	\$12.70	P01	507-0148	GEAR ROTOR 5001 ASSY	EA	\$910.38	P01
435-3038	PNL SWX MNT ADPTR	EA	\$16.91	P01	507-0194	GEAR WORM TURNTABLE MOD CWG1220-1	EA	\$88.59	P01
435-3124	DOOR SPR PXL	EA	\$16.47	P01	507-0211	GEAR SPUR INSUL DRV KT	EA	\$36.82	P01
435-3893	CLAMP SWX REED WELDHEAD	EA	\$12.60	P01	507-0217	GEAR IDLER .700PD KT	EA	\$34.01	P01
436-0103	SS PNL FR PS ACL	EA	\$130.47	P01	507-0228	GEAR ROTOR 5002 ASSY	EA	\$1,269.01	P01
436-0142	SS PNL FR PSNR 4A	EA	\$30.30	P01	507-0341	GEAR SPUR 32P 59T 1.84PD	EA	\$69.16	P01
436-0144	SS PNL FR CB	EA	\$34.30	P01	507-0349	GEAR DRV ASSY 6003	EA	\$72.61	P01
436-0148	SS PNL PWR CB	EA	\$24.87	P01	511-0001	ASSY IDLER RL WIRE FEED CB	EA	\$14.39	C01
436-0151	SS WRAP CB	EA	\$343.38	P01	511-0016	DRV RL CB	EA	\$13.20	C01
436-0164	SS KNOB POT	EA	\$9.57	P01	511-0087	ASSY IDLER RL INSUL KT	EA	\$54.16	C01
437-0180	WSHR DRAG BRK CB	EA	\$6.35	P01	511-0101	DRV RL COBRA G	EA	\$11.20	C01
437-0189	MLD HDL CBL R 5001-3	EA	\$44.23	P01	511-0113	ASSY IDLER RL .023/.035 WIRE	EA	\$11.78	C01
437-0190	MLD HDL CBL L 5001-3	EA	\$44.23	P01	511-0150	ASSY DRV RL .030 GRVD INSUL	EA	\$42.12	C01
437-0196	CLAMP HSG PT	EA	\$2.88	P01	511-0154	ASSY DRV RL .062 GRVD INSUL	EA	\$42.12	C01
437-0197	CLAMP PT	EA	\$2.31	P01	511-0176	ASSY DRV RL .035 GRVD INSUL	EA	\$42.12	C01
437-0225	MLD CLAMP REAR PXL	EA	\$5.95	P01	511-0178	ASSY DRV RL 3/64 GRVD INSUL	EA	\$42.12	C01
437-0226	MLD STRAIN RLF PXL	EA	\$3.00	P01	511-0206	DRV RL SLAVE CB	EA	\$36.08	C01
437-0230	MLD HSG SLAVE MOT CB	EA	\$42.81	P01	513-0006	CPLR 1/4OD DBL END SHTOFF	EA	\$79.96	P01
437-0231	MLD CAM ARM SLAVE MOT CB	EA	\$3.65	P01	513-0007	CONN Y ARGON YB420	EA	\$78.90	P01
437-0232	MLD IDLER ARM CB	EA	\$8.29	P01	552-0180	HOSE GAS PWR BLK SOL CB	EA	\$33.54	P01
437-0235	MLD SPINDLE SPG PXL	EA	\$7.07	P01	552-0201	HOSE GAS 15FT PSG/SDWDR	EA	\$59.13	P01
437-0237	MLD SPCR HDL SPG PXL	EA	\$5.21	P01	552-0202	HOSE GAS 25FT PSG/SDWDR	EA	\$85.42	P01
437-0242	MLD WIRE RESTNR CB+	EA	\$14.82	P01	552-0205	ASSY HOSE GAS SOL CB	EA	\$38.62	P01
437-0243	MLD CATCH RESTNR CB	EA	\$10.91	P01	552-0209	HOSE WTR RED 3FT W/ NIPPLE	EA	\$24.96	P01
437-0245	MLD CAP BRG SLAVE MOT CB	EA	\$2.92	P01	552-0211	HOSE WTR RED QK CON 3FT - EURO	EA	\$25.40	P01
437-0247	MLD BUSH FLG IDLER RL INSUL	EA	\$2.45	P01	552-0215	HOSE WTR RED QK CON - HG V	EA	\$75.75	P01
437-0253	MLD DOOR PYTHON	EA	\$7.14	P01	552-0216-15	HOSE WTR 15FT BLUE QK CON - HG V	EA	\$66.64	P01
437-0254	MLD SLEEVE SPR MOT CB	EA	\$9.47	P01	552-0216-25	HOSE WTR 25FT BLUE QK CON - HG V	EA	\$87.96	P01
437-0255	MLD PAD WIRE RESTNR CB	EA	\$12.27	P01	552-0216-35	HOSE WTR 35FT BLUE QK CON - HG V	EA	\$107.09	P01
437-0258	MLD RTNR SPOOL SPINDLE CB	EA	\$19.66	P01	552-0216-50	HOSE WTR 50FT BLUE QK CON - HG V	EA	\$157.42	P01
437-0259	MLD KNOB TENSION SPINDLE CB	EA	\$26.78	P01	552-0220	ASSY HOSE WTR 25FT CH	EA	\$69.96	P01
437-0260	MLD SPCR SPINDLE CB	EA	\$11.65	P01	552-0221	ASSY HOSE GAS 25FT CH	EA	\$120.54	P01
437-0264	HDL ADPTR SUPPORT	EA	\$41.23	P01	552-0224	HOSE GAS 15FT PYTHON	EA	\$51.47	P01
437-0265	NUT HDL ADPTR	EA	\$56.95	P01	552-0225	HOSE GAS 25FT PYTHON	EA	\$63.01	P01

FOR A COMPLETE PRICE LIST OF ALL MK AVAILABLE PARTS, VISIT WWW.MKPRODUCTS.COM

Products, Parts, and Accessories Pricing

Part #	Description	EA	List Price	Disc. Code	Part #	Description	EA	List Price	Disc. Code
552-0226	HOSE GAS 50FT PYTHON	EA	\$164.64	P01	615-0284	LINER SPL 5.656LG .077ID	EA	\$27.08	C01
552-0227	HOSE GAS 35FT PYTHON	EA	\$80.37	P01	615-0287	LINER TEF 5 23/32 SHORT	EA	\$3.42	C01
552-0238-15	HOSE WTR 15FT BLUE QK CON EURO	EA	\$36.30	P01	615-0319	LINER TEF 3.21LG .110ID	EA	\$3.56	C01
552-0238-25	HOSE WTR 25FT BLUE QK CON	EA	\$51.57	P01	615-0325	LINER TEF 5.41 1/16ID STR BBL HD PT	EA	\$3.42	C01
552-0238-35	HOSE WTR 35FT BLUE QK CON EURO	EA	\$67.87	P01	615-0326	LINER TEF 7.5 1/16ID CRV BBL HD PT	EA	\$3.42	C01
552-0238-50	HOSE WTR 50FT BLUE QK CON EURO	EA	\$96.98	P01	615-0334	LINER TEF 7.22LG .052ID	EA	\$4.64	C01
552-0239-15	HOSE WTR 15FT BLUE UNIV	EA	\$50.19	P01	615-0337	LINER TEF 7.35LG .052ID	EA	\$4.53	C01
552-0239-25	HOSE WTR 25FT BLUE UNIV	EA	\$67.09	P01	615-0338	LINER SPL 7.35LG .105ID PYTHON	EA	\$12.19	C01
552-0239-35	HOSE WTR 35FT BLUE UNIV	EA	\$85.51	P01	615-0341	LINER SPL 5.625LG .105ID COBRA MAX, MX	EA	\$22.42	C01
552-0239-50	HOSE WTR 50FT BLUE UNIV	EA	\$111.32	P01	615-0343	LINER SPL 7.58LG .105ID PXL	EA	\$12.38	C01
552-0241-10	HOSE GAS 10FT 1/8ID HOSE UNIV	EA	\$29.44	P01	615-0349	LINER INLET SDWDR	EA	\$1.03	P01
552-0241-15	HOSE GAS 15FT 1/8ID HOSE UNIV	EA	\$25.22	P01	615-0353-12	LINER SPL 12IN FLEX BBL PXL	EA	\$16.64	C01
552-0241-25	HOSE GAS 25FT 1/8ID HOSE UNIV	EA	\$40.59	P01	615-0353-18	LINER SPL 18IN FLEX BBL PXL	EA	\$21.21	C01
552-0241-35	HOSE GAS 35FT 1/8ID HOSE UNIV	EA	\$55.68	P01	615-0353-24	LINER SPL 24IN FLEX BBL PXL	EA	\$25.58	C01
552-0241-50	HOSE GAS 50FT 1/8ID HOSE UNIV	EA	\$78.10	P01	615-0353-36	LINER SPL 36IN FLEX BBL PXL	EA	\$34.49	C01
552-0242-15	HOSE GAS 15FT 1/8ID MK	EA	\$29.19	P01	615-0538	LINER TEF 10.63LG .084ID	EA	\$7.19	C01
552-0242-25	HOSE GAS 25FT 1/8ID MK	EA	\$39.86	P01	615-0544	LINER TEF 7.12LG .052ID	EA	\$4.57	C01
552-0242-35	HOSE GAS 35FT 1/8ID MK	EA	\$54.05	P01	615-0546	LINER TEF 8.12LG .052ID	EA	\$4.91	C01
552-0242-50	HOSE GAS 50FT 1/8ID MK	EA	\$69.58	P01	615-0547	LINER SPL 8.12LG .105ID	EA	\$28.79	C01
552-0242-6	HOSE GAS 6FT 1/8ID MK	EA	\$28.76	P01	615-0566	LINER TEF 12.0IN .084ID	EA	\$7.19	C01
552-0243-15	HOSE WTR 15FT	EA	\$37.14	P01	615-0567	LINER TEF 13.0IN .084ID	EA	\$7.19	C01
552-0243-25	HOSE WTR 25FT	EA	\$45.48	P01	615-0568	LINER TEF 18.0IN .084ID	EA	\$8.18	C01
552-0243-35	HOSE WTR 35FT	EA	\$71.36	P01	615-0601-15	CONDUIT 15FT NON-THD	EA	\$69.51	C01
552-0243-50	HOSE WTR 50FT	EA	\$76.82	P01	615-0601-25	CONDUIT 25FT NON-THD	EA	\$92.70	C01
552-0243-6	HOSE WTR 6FT	EA	\$57.70	P01	615-0601-35	CONDUIT 35FT NON-THD	EA	\$139.03	C01
552-0244-25	HOSE GAS 25FT 1/8ID PSG	EA	\$43.35	P01	615-0601-50	CONDUIT 50FT NON-THD	EA	\$154.70	C01
552-0244-50	HOSE GAS 50FT 1/8ID PSG	EA	\$90.98	P01	615-0620-15	CONDUIT 15FT TEF TUBE	EA	\$71.60	C01
552-0250-15	HOSE GAS 15FT MX/LX	EA	\$50.00	P01	615-0620-25	CONDUIT 25FT TEF TUBE	EA	\$95.46	C01
552-0250-25	HOSE GAS 25FT MX/LX	EA	\$68.22	P01	615-0620-35	CONDUIT 35FT TEF TUBE	EA	\$143.21	C01
552-0250-35	HOSE GAS 35FT MX/LX	EA	\$88.64	P01	615-0620-50	CONDUIT 50FT TEF TUBE	EA	\$158.20	C01
552-0250-50	HOSE GAS 50FT MX/LX	EA	\$118.16	P01	615-0621-15	CONDUIT SPL 15FT EURO	EA	\$197.22	C01
552-0251-15	HOSE WTR 15FT BLUE MX/LX	EA	\$50.00	P01	615-0621-25	CONDUIT SPL 25FT EURO	EA	\$270.90	C01
552-0251-25	HOSE WTR 25FT BLUE MX/LX	EA	\$68.22	P01	615-0621-35	CONDUIT SPL 35FT EURO	EA	\$344.54	C01
552-0251-35	HOSE WTR 35FT BLUE MX/LX	EA	\$88.64	P01	615-0621-50	CONDUIT SPL 50FT EURO	EA	\$455.54	C01
552-0251-50	HOSE WTR 50FT BLUE MX/LX	EA	\$118.16	P01	621-0001-25	TIP 1/4X.044ID SPRAY ARC 25PC PKG	PK	\$30.94	C19
552-0261-15	HOSE GAS 15FT FOR PUSH FTG	EA	\$49.44	P01	621-0002-25	TIP 1/4X.044ID SHORT ARC 25PC PKG	PK	\$35.96	C03
552-0261-25	HOSE GAS 25FT FOR PUSH FTG	EA	\$67.66	P01	621-0003-25	TIP 1/4X.060ID SPRAY ARC 25PC	PK	\$30.94	C19
552-0261-50	HOSE GAS 50FT FOR PUSH FTG	EA	\$117.60	P01	621-0017	ASSY TIP EXTENDER MX/SX	EA	\$21.58	P01
552-0270-15	HOSE GAS 15FT 3/16HOSE X 1/16NPT	EA	\$74.30	P01	621-0057-25	TIP 1/4X.031ID SPRAY ARC 25PC PKG	PK	\$30.94	C19
552-0270-25	HOSE GAS 25FT 3/16HOSE X 1/16NPT	EA	\$97.38	P01	621-0065	CUP GAS NO 10 WC KT	EA	\$89.94	C02
552-0270-35	HOSE GAS 35FT 3/16HOSE X 1/16NPT	EA	\$129.57	P01	621-0075-25	TIP 1/4X.074ID SPRAY ARC 25PC PKG	PK	\$30.94	C19
552-0270-50	HOSE GAS 50FT 3/16HOSE X 1/16NPT	EA	\$167.49	P01	621-0076-25	TIP 1/4X.041ID SPRAY ARC 25PC PKG	PK	\$30.94	C19
561-0016	SOL VALVE 2W NC 1/8NPT	EA	\$134.19	P01	621-0077-25	TIP 1/4X.041ID SHORT ARC 25PC PKG	PK	\$35.96	C03
561-0017	SOL VALVE 24V 2-WAY 1/8NPT	EA	\$197.54	P01	621-0079	GAS CUP #5 CLASSIC CUP	EA	\$32.40	C02
565-0002	REGULATOR ACL	EA	\$273.54	P01	621-0101	ASSY CUP ADPTR INSUL KT/WC PXL	EA	\$96.80	P01
565-0006	REGULATOR TIG150	EA	\$402.24	P01	621-0153-25	TIP 1/4X.085ID SPRAY ARC 25PC PKG	PK	\$30.94	C19
567-0012	FILTER INLINE 1/4IN BARB LOW PROFILE	EA	\$44.94	P01	621-0154-25	TIP 1/4X.085ID SHORT ARC 25PC PKG	PK	\$35.96	C03
569-0001	METER FLOW	EA	\$146.03	P01	621-0157-25	TIP 3/8X.045ID SPRAY ARC 25PC PKG	PK	\$53.54	C03
615-0054	BULK TUBE TEF .085ID X .117OD	FT	\$3.44	C11	621-0159	GAS CUP #8 WC ADAPTER	EA	\$22.44	C02
615-0057	LINER SPL 6.625LG .077ID	EA	\$7.34	C01	621-0160	GAS CUP #10 WC ADAPTER	EA	\$22.44	C02
615-0098	BULK TUBE TEF GLS .125ID X .173OD	FT	\$6.61	C11	621-0161-25	TIP 3/8X.054ID SPRAY ARC 25PC PKG	PK	\$53.54	C03
615-0178	BULK TUBE TEF 0.084ID X .174OD	FT	\$6.61	C11	621-0162-25	TIP 3/8X.060ID SPRAY ARC 25PC PKG	PK	\$53.54	C03
615-0186	BULK TUBE TEF 0.125ID X .173OD GRAY	FT	\$6.61	P02	621-0163-25	TIP 3/8X.074ID SPRAY ARC 25PC PKG	PK	\$53.54	C03
615-0208	CONDUIT SPL 15FT .093ID	EA	\$132.54	C01	621-0164-25	TIP 3/8X.085ID SPRAY ARC 25PC PKG	PK	\$53.54	C03
615-0209	BULK TUBE TEF .062ID X .125OD	FT	\$7.19	C11	621-0165-25	TIP 3/8X.040ID SHORT ARC 25PC PKG	PK	\$66.15	C03
615-0216	CONDUIT SPL 25FT .093ID	EA	\$174.71	C01	621-0166-25	TIP 3/8X.045ID SHORT ARC 25PC PKG	PK	\$66.15	C03
615-0218	CONDUIT SPL 50FT .093ID	EA	\$446.36	C01	621-0167-25	TIP 3/8X.054ID SHORT ARC 25PC PKG	PK	\$66.15	C03
615-0219	CONDUIT SPL 35FT .093ID	EA	\$330.87	C01	621-0168-25	TIP 3/8X.060ID SHORT ARC 25PC PKG	PK	\$66.15	C03
615-0223	LINER SPL 7.56IN .105ID 6IN CRV BBL	EA	\$29.17	C01	621-0169-25	TIP 3/8X.074ID SHORT ARC 25PC PKG	PK	\$66.15	C03
615-0225	LINER SPL 19.31IN .105ID 18IN CRV BBL	EA	\$64.56	C01	621-0170	GAS CUP #6 WC ADAPTER	EA	\$22.44	C02
615-0248	LINER SPL 6.70LG .105ID TIP EXT MAX/MX	EA	\$22.69	C01	621-0248	GAS CUP #6 COP	EA	\$21.58	C02
615-0250	LINER SPL 8.45LG .105ID TIP EXT PYTHON	EA	\$26.40	C01	621-0249	GAS CUP #8 COP	EA	\$21.58	C02
615-0257	LINER SPL 7.863LG X .105ID XR BBL	EA	\$12.63	C01	621-0250	GAS CUP #10 COP	EA	\$21.58	C02
615-0258	LINER SPL 12.135LG X .105ID 12IN CRV BBL	EA	\$15.69	C01	621-0251	GAS CUP #10 COP FINNED HD	EA	\$32.40	C02
615-0259	LINER SPL 18.127LG X .105ID 18IN CRV BBL	EA	\$20.18	C01	621-0252	GAS CUP #12 COP FINNED HD	EA	\$32.40	C02
615-0260-12	LINER TEF 12IN FLEX BBL	EA	\$5.45	P01	621-0325-25	TIP 1/4X.036ID SPRAY ARC 25PC PKG	PK	\$30.94	C19
615-0261-12	LINER SPL 12IN FLEX BBL PYTHON	EA	\$16.46	C01	621-0326-25	TIP 1/4X.037ID SHORT ARC 25PC PKG	PK	\$35.96	C03
615-0261-18	LINER SPL 18IN FLEX BBL PYTHON	EA	\$21.02	C01	621-0327-25	TIP 1/4X.053ID SPRAY ARC 25PC	PK	\$30.94	C19
615-0261-24	LINER SPL 24IN FLEX BBL PYTHON	EA	\$25.40	C01	621-0330	TIP 3/8X.036ID SPRING LOADED SPRAY ARC	EA	\$8.60	C04
615-0261-36	LINER SPL 36IN FLEX BBL PYTHON	EA	\$34.34	C01	621-0331	TIP 3/8X.041ID SPRING LOADED SPRAY ARC	EA	\$8.60	C04

FOR A COMPLETE PRICE LIST OF ALL MK AVAILABLE PARTS, VISIT WWW.MKPRODUCTS.COM

Products, Parts, and Accessories Pricing

Part #	Description	EA	List Price	Disc. Code	Part #	Description	EA	List Price	Disc. Code
621-0332	TIP 3/8X.044ID SPRING LOADED SPRAY ARC	EA	\$8.60	C04	753-0152	COUPLER DS 1/4BARB PANEL	EA	\$50.25	P01
621-0333	TIP 3/8X.053ID SPRING LOADED SPRAY ARC	EA	\$8.60	C04	753-0153	FTTG REDUCE CPLG 3/8X1/4 NYL	EA	\$4.42	P01
621-0334	TIP 3/8X.060ID SPRING LOADED SPRAY ARC	EA	\$8.60	C04	753-0154	FTTG QK CON 1/4ODX1/8NPT BRS	EA	\$7.42	P01
621-0335	TIP 3/8X.074ID SPRING LOADED SPRAY ARC	EA	\$8.60	C04	753-0155	PLUG VALVE DBL 1/8NPT	EA	\$29.83	P01
621-0366	GAS CUP #8 HD COBRA T	EA	\$39.48	C02	753-0159	NUT HOSE WE 14A 5/8-16 RH	EA	\$7.00	P01
621-0367	GAS CUP #10 HD COBRA T	EA	\$39.48	C02	753-0165	NUT 5/8-18 FEMALE RH	EA	\$3.54	P01
621-0375	GAS CUP CRV 48D PT	EA	\$44.74	C02	753-0168	MALE CONN 1/4OD X 1/16NPT BLUE INS.	EA	\$16.65	P01
621-0381	TIP 1/4X.044ID 48DEG	EA	\$22.01	C10	753-0169	MALE CONN 1/4OD X 1/16NPT BLACK INS.	EA	\$12.10	P01
621-0382	TIP 1/4X.053ID 48DEG	EA	\$22.01	C10	753-0172	FITTING 1/4NPT TO 1/8NPSM	EA	\$13.50	P01
621-0383	TIP 1/4X.060ID 48DEG	EA	\$22.01	C10	753-0182	ELBOW M/F 1/8 NPT	EA	\$4.82	P01
621-0384	TIP 1/4X.074ID 48DEG	EA	\$22.01	C10	753-0210	WIRE GUIDE SLAVE MOT	EA	\$18.02	C01
621-0386	GAS CUP #10 KOOL CUP ADPTR	EA	\$16.17	C02	753-0264	WIRE GUIDE OUTLET	EA	\$15.60	C01
621-0387	TIP 1/4X.041ID 48DEG	EA	\$22.01	C10	753-0265	WIRE GUIDE W/RET SCR	EA	\$26.30	C01
621-0388	GAS CUP #8 KOOL CUP ADPTR	EA	\$16.17	C02	753-0463	BARB INSR 1/8IDX1/8NPSM 225A	EA	\$7.52	P01
621-0390-25	TIP 3/8X.041ID HD SPRAY ARC 25PC PKG	PK	\$49.14	C20	753-0464	BARB INSR 3/16IDX1/8NPSM 225B	EA	\$3.95	P01
621-0391-25	TIP 3/8X.044ID HD SPRAY ARC 25PC PKG	PK	\$49.14	C20	753-0466	ADPTR ARC AW15-A RH	EA	\$9.48	P01
621-0392-25	TIP 3/8X.053ID HD SPRAY ARC 25PC PKG	PK	\$49.14	C20	753-0475	ADPTR 1/4 NPT 5/8-18	EA	\$9.48	P01
621-0393-25	TIP 3/8X.060ID HD SPRAY ARC 25PC PKG	PK	\$49.14	C20	753-0656	NIPPLE SSP NP-69MOD BRS	EA	\$6.95	P01
621-0394-25	TIP 3/8X.074ID HD SPRAY ARC 25PC PKG	PK	\$49.14	C20	753-3285	FTG 5/8-18 1/8 NPT	EA	\$23.00	P01
621-0395-25	TIP 3/8X.085ID HD SPRAY ARC 25PC PKG	PK	\$49.14	C20	753-3379	HOSE NUT WE AW14 MALE LH	EA	\$6.64	P01
621-0396-25	TIP 3/8X.041ID HD SHORT ARC 25PC PKG	PK	\$66.15	C03	757-0003	FTG .093 ID NUT END	EA	\$31.97	P01
621-0397-25	TIP 3/8X.044ID HD SHORT ARC 25PC PKG	PK	\$66.15	C03	757-0009	FTG HOSE 1/8NPT TO 1/4 ID	EA	\$6.20	P01
621-0398-25	TIP 3/8X.053ID HD SHORT ARC 25PC PKG	PK	\$66.15	C03	835-0024	SILICONE GREASE HVS-100 3OZ TUBE	EA	\$26.36	P01
621-0420	GAS CUP #6 MAX CUP	EA	\$24.29	C02	841-0064	CBL WLD 1GA 600V ORG	SPOOL	\$1,190.00	P01
621-0421	GAS CUP #8 MAX CUP	EA	\$24.29	C02	843-0001	CORD SET 8 FT 18/3	EA	\$12.32	P01
621-0422	GAS CUP #10 COBRA MAX	EA	\$24.29	C02	843-0019	CBL ASSY 7 FT 18/3 W/TERM	EA	\$26.72	P01
621-0423	ASSY TIP EXTENDER MAX	EA	\$43.21	A01	843-0064	CBL 8 FT CNTOR	EA	\$15.91	P01
621-0424	ASSY TIP EXT A/W BBL PYTHON/PXL	EA	\$49.40	A01	843-0327	CBL ASSY POSAST GND	EA	\$19.34	P01
621-0440	QK CUP #6 MINI	EA	\$42.35	C02	843-0338	ASSY CBL PWR/WTR 50 FT #4 CT	EA	\$514.82	P01
621-0441	QK CUP #7 MINI	EA	\$42.35	C02	843-0342	ASSY CBL PWR/WTR 35FT #4	EA	\$339.31	P01
621-0442	QK CUP #8 MINI	EA	\$42.35	C02	843-0396	CBL ASSY PS TO CTRLR ACL	EA	\$77.91	P01
621-0443	QK CUP #10 MINI	EA	\$42.35	C02	843-0400	CBL INTFC REAR PNL PS ACL	EA	\$97.00	P01
621-0451	TIP 3/8X.044ID 48DEG	EA	\$26.85	C10	843-0407	CBL ASSY LGC PS ACL	EA	\$22.08	P01
621-0452	TIP 3/8X.053ID 48DEG	EA	\$26.85	C10	843-0409	CBL ASSY WELDHD PS ACL	EA	\$387.92	P01
621-0453	TIP 3/8X.060ID 48DEG	EA	\$26.85	C10	843-0448	CBL FUSE/PWR OUTPUT ACL	EA	\$70.79	P01
621-0454	TIP 3/8X.074ID 48DEG	EA	\$26.85	C10	843-0464	CBL ASSY INTFC PWR DWAVPAC	EA	\$289.99	P01
621-0465	GAS CUP #8 FLEX BBL	EA	\$19.42	C02	843-0478	CBL ASSY TIG CTRL TO ARC START TIG150	EA	\$21.88	P01
621-0466	GAS CUP #10 FLEX BBL	EA	\$19.42	C02	843-0482	CBL ASSY SENSING TIG150	EA	\$44.52	P01
621-0480-25	TIP 3/8 X 0.041ID 1.0LG 25PC	PK	\$49.14	C03	843-0484	ASSY CBL PWR 25FT AC SPG PXL	EA	\$208.11	P01
621-0481-25	TIP 3/8 X 0.044ID 1.0LG 25PC	PK	\$49.14	C03	843-0485	ASSY CBL PWR 50FT AC SPG PXL	EA	\$383.75	P01
621-0482-25	TIP 3/8 X 0.053ID 1.0LG 25PC	PK	\$49.14	C03	843-0487	ASSY CBL PWR 15FT AC SPG PXL	EA	\$154.96	P01
621-0483-25	TIP 3/8 X 0.060ID 1.0LG 25PC	PK	\$49.14	C03	843-0488	ASSY CBL PWR 35FT AC SPG PXL	EA	\$288.34	P01
701-0052-1	COPPER WRAP 2.0" LG	EA	\$1.03	P01	843-0489	CBL ASSY RS 232 TIG150	EA	\$99.27	P01
701-0053	COP 110 .008 THK X 5/8W	FT	\$17.42	P01	843-0494	CBL ASSY INTFC FILTER TIG150	EA	\$399.76	P01
707-0118	FILT PLT 2X4-1/4 SHADE#10	EA	\$4.57	P01	843-0496	CBL INTFC 42V 8FT LE	EA	\$160.64	P01
707-0126	LENS CHEMCAST #2324 RED	EA	\$10.69	P01	843-0496-15	CBL INTFC 42V 15FT LE	EA	\$193.71	A01
723-0059	DISK RATCHET BRK CB II	EA	\$31.04	P01	843-0496-25	CBL INTFC 42V 25FT LE	EA	\$260.02	A01
751-0018	CAP PLUG .5ID.5 LG VINYL BLK ROUND	EA	\$3.64	P01	843-0497	CBL ASSY PWR TIG150	EA	\$102.63	P01
751-0025	CAP COOLER TANK CBCLR	EA	\$29.19	P01	843-0499	CBL PWR GND 13FT TIG150	EA	\$204.88	P01
753-0028	FTG BRUSH HLDR PSNR 2&3	EA	\$12.12	P01	843-0513	CBL ASSY ADPTR AA/ACL	EA	\$1,039.98	P01
753-0031	BARB HOSE 1/8-27NPTX3/16ID	EA	\$2.86	P01	843-0525	CBL INTFC THERMAL ARC	EA	\$189.34	P01
753-0063	WIRE GUIDE FTG CONDUIT	EA	\$42.17	C01	843-0529	ASSY CBL CTRL 14P PA-L1	EA	\$146.62	P01
753-0084	CON MALE 1/4 TUBE 1/4NPT	EA	\$12.84	P01	843-0530	CBL ASSY PNL PSNR 4	EA	\$32.74	P01
753-0085	CPLR GAS 1/4OD BRS	EA	\$97.58	P01	843-0531	CBL ASSY PWR IN-CON PSNR4	EA	\$22.22	P01
753-0086	FTG FEM CON 1/4OD 1/8NPT	EA	\$9.08	P01	843-0533	CBL ASSY MTR PSNR 4	EA	\$16.54	P01
753-0088	FITTING CONN POWER WELD	EA	\$4.75	P01	843-0534	CBL ASSY PWR PSNR 4	EA	\$21.57	P01
753-0096	FTG 1/8-1/8 M/F STR ELBOW	EA	\$4.09	P01	843-0535	CBL DGTL CTRL TO PRINTER TIG150	EA	\$18.48	P01
753-0097	CPLR 1/8 PTX1/4 OD BRS	EA	\$45.81	P01	843-0555	ASSY CBL CTRL 15FT SDWDR	EA	\$84.34	P01
753-0098	FTG ELBOW 1/4ODX1/8 PT MALE	EA	\$10.25	P01	843-0556	ASSY CBL CTRL 25FT SDWDR	EA	\$104.35	P01
753-0099	FTG MALE PIPE T 1/8 BRS	EA	\$48.51	P01	843-0562	ASSY CBL PWR 75FT AC SPG PXL	EA	\$538.18	P01
753-0112	FTG AW-32 BRS	EA	\$10.25	P01	843-0563	CBL SERIAL NULL MODEM	EA	\$20.36	P01
753-0114	FTG 1/8NPS-1/8NPT M-M	EA	\$13.43	P01	843-0564	CBL ASSY CTRL DMDBK	EA	\$332.57	P01
753-0115	BUSH 1/4NPT M1/8NPT F BRS	EA	\$3.00	P01	843-0578	ASSY CBL PWR 100FT AC SPG PXL	EA	\$586.14	P01
753-0117	CPLR M PIPE THD 1/4RED BRS	EA	\$178.18	P01	843-0580-15	ASSY CBL PWR 15FT ULTRA FLEX	EA	\$147.75	P01
753-0125	FTG ST ELBOW 1/4NPT BRS	EA	\$75.33	P01	843-0580-25	ASSY CBL PWR 25FT ULTRA FLEX	EA	\$231.46	P01
753-0127	CPLR 3/16 IN BARB DBL SHUT OFF	EA	\$42.18	P01	843-0580-35	ASSY CBL PWR 35FT ULTRA FLEX	EA	\$315.90	P01
753-0132	CPLR FTG PNL MNT COBRACOOOLER	EA	\$101.03	P01	843-0580-50	ASSY CBL PWR 50FT ULTRA FLEX	EA	\$440.23	P01
753-0134	NIPPLE NP-69 1/8ID HOSE	EA	\$4.61	P01	843-0590	ASSY CBL PWR 15FT SDWDR	EA	\$74.99	P01
753-0150	MALE CONN 1/4OD X 1/16NPT BLUE CAP	EA	\$15.20	P01	843-0591	ASSY CBL PWR 25FT SDWDR	EA	\$102.63	P01
753-0151	MALE CONN 1/4OD X 1/16NPT BLACK CAP	EA	\$16.08	P01	843-0594	ASSY CBL CONTACTOR SP-4A	EA	\$33.35	P01

FOR A COMPLETE PRICE LIST OF ALL MK AVAILABLE PARTS, VISIT WWW.MKPRODUCTS.COM

Products, Parts, and Accessories Pricing

Part #	Description	EA	List Price	Disc. Code	Part #	Description	EA	List Price	Disc. Code
843-0600	CBL PWR 120VAC SGL PHASE ACL	EA	\$380.17	A02	843-0715-50	ASSY CBL PWR EX-FLEX 50FT UNIV	EA	\$514.14	A01
843-0601	CBL PWR 220V EUROPEAN ACL	EA	\$376.38	A02	843-0720	ASSY CBL INTFC "A" 10PIN TO DP400/DM350	EA	\$167.33	A01
843-0602	CBL PWR 208-240V SGL UNIV	EA	\$446.14	A02	843-0721	ASSY CBL REMOTE "B" 6PIN TO DP400/DM350	EA	\$103.15	A01
843-0603	CBL PWR 208-240VAC 3 PHASE ACL	EA	\$610.04	A02	843-0726	ASSY CBL ADPTR 7PIN FEM TO 14PIN MALE	EA	\$69.00	P01
843-0605	ASSY CBL COMPUTER INTFC ACL	EA	\$142.80	P01	844-0079	CBL COILED 7 FT BLK ACL	EA	\$39.88	P01
843-0607	CBL USB PRINTER ACL	EA	\$8.01	P01	861-0003	RADIATOR 80MM ULTRA DUAL CORE	EA	\$116.88	P01
843-0613	CBL PWR UNIV 120V-30A UL LISTED	EA	\$550.25	A02	905-0089	CASE PELI TIG150	EA	\$678.45	P01
843-0619	ASSY CBL PWR AC 15FT	EA	\$129.05	P01	905-0090	CASE COOLER COBRATIG 150	EA	\$239.79	P01
843-0620	ASSY CBL PWR AC 25FT	EA	\$192.99	P01	905-0091	CASE PELI W/O FOAM CH	EA	\$394.43	P01
843-0621	ASSY CBL PWR AC 50FT	EA	\$355.27	P01	905-0094	CASE MICRO/MANUAL TIG ACC	EA	\$269.96	P01
843-0622	ASSY CBL PWR AC 35FT	EA	\$257.95	P01	909-030-4043	SPOOL WIRE 030 ALUM 4043	EA	\$8.30	C09
843-0624	ASSY CBL CTRL 15FT MM COMP	EA	\$123.82	P01	909-035-4043	SPOOL WIRE 035 ALUM 4043	EA	\$8.30	C09
843-0630-15	ASSY CBL PWR 15FT AC PYTHON	EA	\$97.22	P01	909-035-5356	SPOOL WIRE 035 ALUM 5356	EA	\$8.30	C09
843-0630-25	ASSY CBL PWR 25FT AC PYTHON	EA	\$148.19	P01	921-0071	SHAFT REPL J6171-0223	EA	\$78.05	P01
843-0630-35	ASSY CBL PWR 35FT AC PYTHON	EA	\$200.87	P01	921-0170	PAPER RL 112MM X 25M LG THERMAL	PK	\$43.68	A10
843-0630-50	ASSY CBL PWR 50T AC PYTHON	EA	\$276.66	P01	921-0171	MEMBRANE PNL REPL TIG150	EA	\$459.68	P01
843-0635	ASSY CBL PWR EX-FLEX 15FT	EA	\$195.08	A01	931-0019	WRENCH ALLEN 3/16	EA	\$1.79	P01
843-0636	ASSY CBL PWR EX-FLEX 25FT	EA	\$275.49	A01	931-0044	TOOL WRENCH 3/8" TORCH TIP	EA	\$17.72	P01
843-0637	ASSY CBL PWR EX-FLEX 50FT	EA	\$487.41	A01	931-0060	COBRA COOLANT 1 GALLON	EA	\$24.96	P01
843-0640-10	ASSY CBL PWR 10FT GLOBAL	EA	\$106.46	P01	931-0060-4	COBRA COOLANT 4 GL/CASE	CS	\$93.65	A09
843-0640-15	ASSY CBL PWR 15FT GLOBAL	EA	\$122.76	P01	931-0060-5GAL	COBRA COOLANT 5 GALLON	EA	\$111.13	A01
843-0640-25	ASSY CBL PWR 25FT GLOBAL	EA	\$186.90	P01	931-0100	TOOL DR ROLL REMOVAL	EA	\$28.52	A01
843-0640-3	ASSY CBL PWR 3FT GLOBAL	EA	\$50.59	P01	931-0105	TOOL GAS VALVE	EA	\$31.02	P01
843-0640-35	ASSY CBL PWR 35FT GLOBAL	EA	\$256.93	P01	931-0110	SNAKE SKIN CVR 15FT GUN	EA	\$68.97	P01
843-0640-50	ASSY CBL PWR 50FT GLOBAL	EA	\$314.96	P01	931-0122	SNAKE SKIN CVR 25FT GUN	EA	\$132.72	P01
843-0640-6	ASSY CBL PWR 6FT GLOBAL	EA	\$68.68	P01	931-0123	SNAKE SKIN CVR 50FT GUN	EA	\$214.87	P01
843-0643	ASSY CBL CTRL 6FT	EA	\$109.29	P01	931-0132	SNAKE SKIN CVR 35FT GUN	EA	\$160.42	P01
843-0650-25	ASSY CBL PWR 25FT PSG	EA	\$187.76	P01	931-0135	LINER PACKAGE COBRAGOLD	PK	\$9.50	C12
843-0650-50	ASSY CBL PWR 50FT PSG	EA	\$315.32	P01	931-0137	LINER PACKAGE MAXIPXL\PYTHON	PK	\$22.62	C12
843-0653	ASSY CBL ADPTR FRON/7P W CLOCK CONN	EA	\$231.24	A01	931-0140	LINER PACKAGE SDWDR	EA	\$22.18	C12
843-0655	ASSY CBL CTRL 15FT PYTHON FRONIUS	EA	\$206.70	P01	931-0145	LINER PACKAGE HD MAXIPXL\PYTHON	PK	\$22.62	C12
843-0656	ASSY CBL CTRL 25FT PYTHON FRONIUS	EA	\$216.02	P01					
843-0657	ASSY CBL CTRL 50FT PYTHON FRONIUS	EA	\$283.26	P01					
843-0658	ASSY CBL CTRL 35FT PYTHON FRONIUS	EA	\$240.76	P01					
843-0660-6	ASSY CBL CTRL 6FT PXL/SG	EA	\$93.97	P01					
843-0665-25	ASY CBL CTRL 25FT 4PIN EURO	EA	\$131.56	P01					
843-0669	CORD PWR PWD-402 2FT T-HEAD	EA	\$175.50	P01					
843-0671	ASSY CBL PWR PTR/MONITOR ACL	EA	\$53.93	P01					
843-0679	ASSY CBL ADPTR 7PIN TO 12PIN LE	EA	\$185.71	P01					
843-0680-10	ASSY CBL PWR/WTR 10FT EURO	EA	\$140.61	P01					
843-0680-15	ASSY CBL PWR/WTR 15FT EURO	EA	\$145.50	P01					
843-0680-25	ASSY CBL PWR/WTR 25FT EURO	EA	\$201.74	P01					
843-0680-35	ASSY CBL PWR/WTR 35FT EURO	EA	\$257.99	P01					
843-0680-50	ASSY CBL PWR/WTR 50FT EURO	EA	\$325.53	P01					
843-0680-6	ASSY CBL PWR/WTR 6FT EURO	EA	\$134.98	P01					
843-0685-15	ASSY CBL PWR/WTR 15FT	EA	\$150.03	P01					
843-0685-25	ASSY CBL PWR/WTR 25FT	EA	\$202.90	P01					
843-0685-30	ASSY CBL PWR/WTR 30FT	EA	\$253.71	P01					
843-0685-35	ASSY CBL PWR/WTR 35FT	EA	\$288.03	P01					
843-0685-50	ASSY CBL PWR/WTR 50FT	EA	\$354.41	P01					
843-0685-6	ASSY CBL PWR/WTR 6FT	EA	\$131.90	P01					
843-0687-15	ASSY CBL PWR EX-FLEX 15FT UNIV FTTG	EA	\$188.35	A01					
843-0687-25	ASSY CBL PWR EX-FLEX 25FT UNIV FTTG	EA	\$282.66	A01					
843-0687-35	ASSY CBL PWR EX-FLEX 35FT UNIV FTTG	EA	\$380.80	A01					
843-0687-50	ASSY CBL PWR EX-FLEX 50FT UNIV FTTG	EA	\$443.76	A01					
843-0688	ASSY CBL SOLENOID COBRAMATIC	EA	\$23.58	P01					
843-0690	ASSY CBL GROUND 25FT CH	EA	\$140.40	P01					
843-0691	ASSY CBL ELECTRODE 25FT CH	EA	\$145.74	P01					
843-0692	ASSY CBL GROUND 25FT DMBK	EA	\$144.62	P01					
843-0693	ASSY CABLE CAT6 SHIELDED	EA	\$30.12	P01					
843-0694	ASSY CBL PWR TURNTABLE	EA	\$18.58	P01					
843-0699-10	CBL CAT6 10FT BLACK SHIELDED	EA	\$22.45	P01					
843-0707-15	ASSY CBL PWR EX-FLEX 15FT LUG/THRD FTTG PXL	EA	\$214.03	A01					
843-0707-25	ASSY CBL PWR EX-FLEX 25FT LUG/THRD FTTG PXL	EA	\$307.98	A01					
843-0707-35	ASSY CBL PWR EX-FLEX 35FT LUG/THRD FTTG PXL	EA	\$421.17	A01					
843-0707-50	ASSY CBL PWR EX-FLEX 50FT LUG/THRD FTTG PXL	EA	\$609.94	A01					
843-0712	ASSY PWR CABLE MOD W/FUSE TURNTABLE	EA	\$42.88	P01					
843-0715-15	ASSY CBL PWR EX-FLEX 15FT UNIV	EA	\$174.69	A01					
843-0715-25	ASSY CBL PWR EX-FLEX 25FT UNI	EA	\$238.02	A01					
843-0715-35	ASSY CBL PWR EX-FLEX 35FT UNIV	EA	\$369.02	A01					

FOR A COMPLETE PRICE LIST OF ALL MK AVAILABLE PARTS, VISIT WWW.MKPRODUCTS.COM

LIMITED WARRANTY

This warranty supersedes all previous MK Products warranties and is exclusive, with no other guarantees or warranties expressed or implied.

LIMITED WARRANTY - MK Products Inc., Irvine, California warrants that all new and unused equipment furnished by MK Products is free from defects in workmanship and material as of the time and place of delivery by MK Products. No warranty is made by MK Products with respect to trade accessories or other items manufactured by others. Such trade accessories and other items are sold subject to the warranties of their respective manufacturers, if any.

MK Products' warranty does not apply to components having normal useful life of less than one (1) year, such as relay points, wire conduit, tungsten, and welding gun parts that come in contact with the welding wire, including gas cups, gas cup insulators, and contact tips where failure does not result from defect in workmanship or material.

MK Products shall, exclusively remedy the limited warranty or any duties with respect to the quality of goods, based upon the following options:

- (1) repair
- (2) replacement
- (3) where authorized in writing by MK Products, the reasonable cost of repair or replacement at our Irvine, California plant.

As a matter of general policy only, MK Products may honor an original user's warranty claims on warranted equipment in the event of failure resulting from a defect within the following periods from the date of delivery of equipment to the original user:

- 1. Power Supplies and Wire Feed Cabinets3 years**
- 2. Weldheads, Coolers, Positioners, and Push-Pull Guns ...1 year**
- 3. Spool Guns, and Spool Gun Modules 180 days**
- 4. Repairs/Exchanges/Parts 90 days**

Classification of any item into the foregoing categories shall be at the sole discretion of MK Products. Notification of any failure must be made in writing within 30 days of such failure.

A copy of the invoice showing the date of sale must accompany products returned for warranty repair or replacement.

All equipment returned to MK Products for service must be properly packaged to guard against damage from shipping. MK Products will not be responsible for any damages resulting from shipping.

Normal surface transportation charges (one way) for products returned for warranty repair or replacement will be borne by MK Products, except for products sold to foreign markets.

ANY EXPRESS WARRANTY NOT PROVIDED HEREIN AND ANY IMPLIED WARRANTY, GUARANTY, OR REPRESENTATION AS TO PERFORMANCE, AND ANY REMEDY FOR BREACH OF CONTRACT WHICH, BUT FOR THIS PROVISION, MIGHT ARISE BY IMPLICATION, OPERATION OF LAW, CUSTOM OF TRADE, OR COURSE OF DEALING, INCLUDING ANY IMPLIED WARRANTY OF MERCHANTABILITY OR OF FITNESS FOR PARTICULAR PURPOSE, WITH RESPECT TO ANY AND ALL EQUIPMENT FURNISHED BY MK PRODUCTS, IS EXCLUDED AND DISCLAIMED BY MK PRODUCTS.

EXCEPT AS EXPRESSLY PROVIDED BY MK PRODUCTS IN WRITING, MK's PRODUCTS ARE INTENDED FOR ULTIMATE PURCHASE BY COMMERCIAL/INDUSTRIAL USERS AND FOR OPERATION BY PERSONS TRAINED AND EXPERIENCED IN THE USE AND MAINTENANCE OF WELDING EQUIPMENT AND NOT FOR CONSUMERS OR CONSUMER USE. MK PRODUCTS' WARRANTIES DO NOT EXTEND TO, AND NO RE-SELLER IS AUTHORIZED TO EXTEND MK PRODUCTS' WARRANTIES TO ANY CONSUMER.

USE OF OTHER THAN **GENUINE** MK PRODUCTS' CONSUMABLES, PARTS, AND ACCESSORIES MAY INVALIDATE YOUR PRODUCT WARRANTY.



customer service:

making it easy
in an ever changing world

live chat support! extended hours
mkproducts.com 7 to 5 pst

more
phone support

simplified
distributor
discounts



* Does not include: International, freight forwarders, and/or OEM orders

**Does not include CobraMig 300 or CobraMig 300 packages

*** Applies to orders that are marked "Ship Complete" only

Going BEHIND

Since 1966, MK Products has built a reputation of design and manufacturing excellence. Many of our team members have over twenty years of experience manufacturing our welding equipment. We are proud to say all of our products are 100% assembled in the USA!

PUSH-PULL

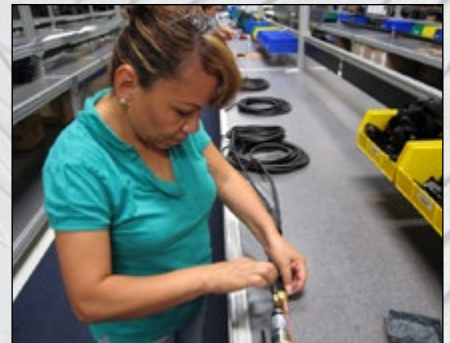

BUILDING THE WORLD MADE IN AMERICA

MK



CobraTig[®] 150 SM
Portable GTAW Orbital Tube Welder



CopperHead[®]
GTAW Orbital Weldhead

DiamondBack[®]
GTAW Orbital Weldhead

Whether it's for bench or portable applications, MK Products provides a solution when it comes to orbital welding systems. Making an orbital weld has never been this easy.

Orbital Weldheads
Sanitary • High-Pressure • Ultra High-Purity

Orbital Power Supplies
GTAW Performance from 0.1 to 150 AMPS



SALES@MKPRODUCTS.COM
WWW.MKPRODUCTS.COM

16882 ARMSTRONG AVE.
IRVINE, CA 92606
(800) 787-9707



**THIS CATALOG
PRESENTED BY:**

MK REPRESENTATIVE

sales@mkproducts.com
www.mkproducts.com
October 2015

mk
PRODUCTS

16882 Armstrong Ave.
Irvine, CA 92606
Tel (949) 863-1234 • Fax (949) 474-1428