

V826-C

ENGLISH



MITSUBISHI



To give attentive consideration to both humanity and nature.

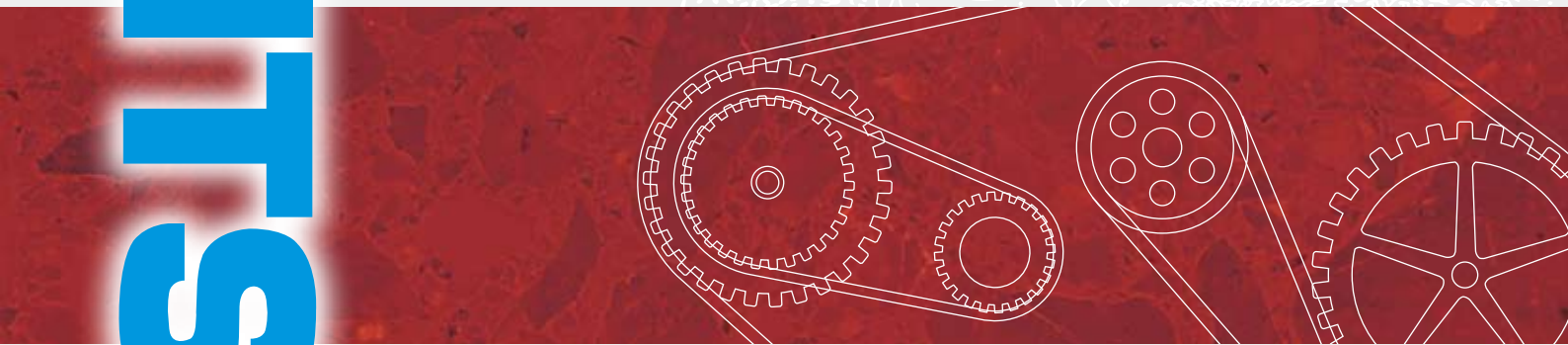

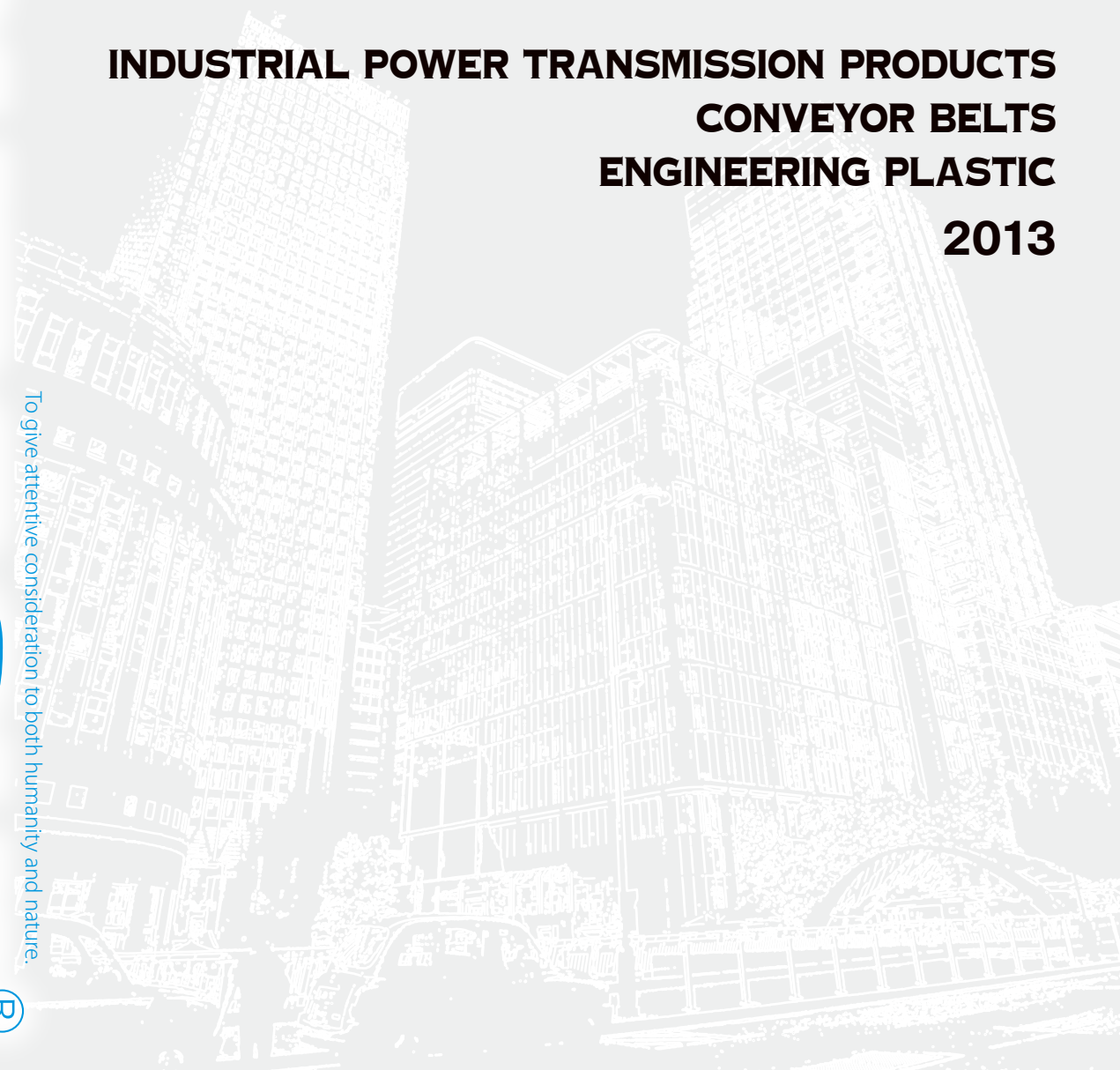

**INDUSTRIAL POWER TRANSMISSION PRODUCTS
CONVEYOR BELTS
ENGINEERING PLASTIC
2013**





Safety Precautions

Please read all the warnings!



- Please take all necessary precautions when using our products. Also, Please review relevant product catalog and design documents, etc.
Significances of safety precautions are categorized as follows:



Signs	Meanings
 Danger	Imminently causing death or severe injury to the user who misuses products.
 Warning	Possibly causing death or severe injury to the user who misuses products.
 Caution	Possibly causing personal injury or property damage if misused.

Power Transmission Products

Use	
 Danger	<ul style="list-style-type: none"> ● If you expect that a belt will fail and idle, free-run, or stop the system, thus causing a fatal or severe accident, please provide an extra safety device. ● Do not use a belt as a lifting or towing tool.
 Warning	<ul style="list-style-type: none"> ● If you expect that static electricity will come from the power transmission belt system, thus causing fire or malfunction of the controller, use an antistatic belt and set a neutralization apparatus in the system.
 Caution	<ul style="list-style-type: none"> ● Do not use a belt as an insulator. Contact us for information on insulation properties, which vary in belt type. ● For a belt that touches food directly, use one that complies with the applicable food hygiene law of your country ● Do not modify a belt, or its quality and performance could deteriorate.

Function & Performance	
 Caution	<ul style="list-style-type: none"> ● Do not use a belt beyond its capacity or for an application other than that specified by the catalog, design documents, etc. This can cause premature failure of the belt. ● If water, oil, chemical, paint, dust, etc. sticks to a belt or pulley, its power transmission could deteriorate and the belt may fail. ● A cogged belt makes louder noise during high-speed rotation. If this occurs, use a soundproof cover.

Storage & Transportation	
 Warning	<ul style="list-style-type: none"> ● To store a heavy belt, use a suitable jig or stopper to prevent accidents such as belt toppling or tumbling.
 Caution	<ul style="list-style-type: none"> ● Use suitable equipment to carry/handle a heavy belt or pulley. Otherwise, back injury may result. ● Do not put weight on or bend a belt forcibly to carry or store it. Otherwise, it will produce defects or scratches to the belt, resulting in damage. ● Store the belt in low humidity and a temperature range of -10°C to 40°C. Do not expose belts to direct sunlight.

Mounting & Operation	
 Danger	<ul style="list-style-type: none"> ● Install a safety cover over rotating components including belt/ pulley. Otherwise, hair, gloves and clothing can become entangled in the belt/ pulley. If a belt/pulley breaks, fragments may cause injuries. ● Take the following precautions to maintain, inspect and replace a belt. <ol style="list-style-type: none"> 1)Turn off power and wait until the belt and pulley have stopped completely. 2)Secure machinery so that it may not move during belt removal. 3)Use caution : Do not unintentionally turn on power.
 Caution	<ul style="list-style-type: none"> ● Use the same type of belts or pulleys per OEM specification. Use of a different type may cause premature failure. ● Misalignment of the pulleys can damage the belt and result in flange failure. Make proper adjustments to system. ● Loosen the belt tension when changing belts. Do not force or stretch a belt over the flange. Do not use a screw driver or other sharp objects into when replacing the belt as this will result in damage. ● Apply the appropriate belt tension as specified by the relevant catalog and design documents, etc. Inappropriate tension could result in damage of the belt and shaft. ● Take the following precautions to modify the pulley in use: <ol style="list-style-type: none"> 1)Remove burrs and maintain proper pulley angle; 2)Secure accurate dimensions after modification; 3)Maintain the pulley strength after modification. ● Before assembling the flange with the pulley, check for foreign materials between the pulley and flange. Fasten the flange with a caulking tool and so on. Inappropriate installation could result in the flange coming off.

Handling of Used items	
 Caution	<ul style="list-style-type: none"> ● Do not burn belt, or hazardous gas could be produced.

Plastic Conveyor Belts

Use

- Warning**
- Do not use the belt as a lifting or towing device.
 - To convey unpackaged food, use a belt that complies with the applicable food hygiene law of your country.

Storage & Transportation

- Warning**
- To store a large plastic conveyor belt, use a suitable jig or stopper to prevent accidents due to belt toppling or tumbling.

- Caution**
- Use suitable equipment to carry and handle large plastic conveyor belts. Otherwise, back injury may result.

Mounting & Operation

- Danger**
- Before fitting and inspecting the plastic conveyor belt, be sure to turn off the power of the conveyor and related systems and check to make sure that conveyor has stopped, so as to prevent accidents.
 - Fix a safety guard to avoid close contact with conveyor belt in use. Otherwise, you may become entangled in the conveyor system.

Installation Works

- Warning**
- Solvent and adhesive used for endless type belts is flammable. No open flames are allowed during operation.

Engineering Plastic Products

Use

- Warning**
- Do not use the product for medical purposes, such as transplantation or in such a way that it touches bodily fluids or tissues.

Storage & Transportation

- Caution**
- Injury may occur as a result of a product falling. Use proper equipment especially when carrying a large product and install it into processing machinery.
 - A pile of products on an uneven place could slip, collapse or topple by gravity. Store products on a flat shelf or pallet that won't bend under product weight.
 - Static electricity may spark. Do not rub products against insulators like paper, cloth, plastic.
 - Gas will occur from burning product. Keep away from fire.

Process

- Caution**
- Product may break up due to partial heat generated by forced processing. To reduce over heating, use air, cutting oil or a sharp cutting tool, and adjust its feeding speed. Pay special attention to bore processing which generates heat easily.
 - As the product is less elastic than metal, it could deform and come off the chuck, scattering materials if it doesn't fit properly on the processing machinery. Fix the product firmly, taking care not to deform materials.

Couplings

Use

- Danger**
- Provide an additional safety device if you expect that a fatal or severe accident may occur if the coupling breaks or comes off, and then idles, free-runs or stops the system.

Function & Performance

- Caution**
- Do not use product beyond its capacity or for applications other than specified in the catalog, design documents, etc. Otherwise, the product could fail prematurely.

Storage & Transportation

- Warning**
- Use an appropriate jig or stopper to prevent a large coupling from toppling and tumbling. Do not store coupling at a height where it could fall.

- Caution**
- Use suitable equipment when carrying or handling a large coupling, depending on its weight. Otherwise, back injury may result.

Mounting & Operation

- Danger**
- Be sure to put a safety cover over the rotating components including the coupling. Otherwise, hair, gloves or clothing may become entangled. Also, injury may occur if parts fly off.
 - Secure coupling. Otherwise, the coupling and its parts may come off.
 - Take the following precautions to maintain, inspect or replace coupling:
 - Turn off the power and wait until the machine stops completely.
 - Fix machinery so that it may not move during removal of the coupling.
 - Take care not to unintentionally turn on the switch.
 - Before you operate the machine, check to make sure unused bolts or tools do not remain after installation of the coupling. If operation starts with unused items being left behind, they could be flung off, causing injuries.

- Caution**
- Replace the same type of couplings. Use of a different type of coupling will result in earlier damage.
 - Adjust coupling properly. Otherwise, deflection or declination will damage or displace the coupling.

Handling of Used items

- Danger**
- Do not burn the coupling. Otherwise, hazardous gas could be produced.

CONTENTS

Safety Precautions	P1,2
1. Power Transmission Belts and Related Products	P4 ~ 70
2. Conveyor Belts	P71 ~ 80
3. Engineering Plastic Products	P82 ~ 89
Global Factories & Sales Offices	P90



1. Power Transmission Belts and Related Products

Application Examples	P5, 6
Lineup of Belts and Related Products	P7, 8
Industrial Power Transmission Product Selection Chart	P9,10
Dimensions	P11

I Synchronous Power Transmission

Round Tooth Timing Belt		H Series	P23
Belt Type, Dimensions & Product Code	P13	Trapezoidal Tooth Timing Belt	
SUPER TORQUE Timing Belt G	P14~16	Belt Type, Dimensions & Product Code	P24
SUPER TORQUE Timing Pulley	P17	green eco® Series	P25
MEGA TORQUE Timing Belt G&U	P18,19	Timing Belt G	P26~28
Mega Torque G II	P20	Timing Belt U	P29~31
Mega Torque EX	P21	LONG-SPAN Timing Belt	P32
Giga Torque GX	P22	Timing Pulley	P33, 34

II Frictional Forced Power Transmission

Classical V-Belt / Red label V-Belt	P36	RIBSTAR Belt G (Rubber V-Ribbed Belt)	P48
Classical V-Belts for DIN 2215/ISO4184		RIBSTAR Belt U (Polyurethane V-Ribbed Belt)	P49
Wrapped Type	P37	RIBSTAR Pulley (V-Ribbed Pulley)	P50
Classical V-Belts for DIN 2215/ISO4184		FLEXSTAR® Belt	P51
TRIPLEX® Raw Edge Cogged Type	P38~40	SUPER FLEXSTAR® Belt	P52
MAXSTAR WEDGE V-Belt	P41	FLEXSTAR® Belt J	P53
MAXSTAR WEDGE V-Belt for RMA / MPTA	P42	POLYMAX® Belt	P54
Narrow V-Belt for DIN7753 / ISO4184	P43	MB Belt	P55
SUPER VS® Belt (Variable Speed Belt)	P44	STARROPE®, SUPER STARROPE®	P56
MAXSTAR WEDGE Bushing Pulley	P45, 46	PRENE V-ROPE, PRENE HEXAGONAL-ROPE	P56
e-Power® V-Belt	P47	Flat Belt	P57

III Direct Connected Power Transmission

Chemi-Chan®	
(High Performance Miniature Coupling)	P59
HYPERFLEX® Coupling	P60
TSCHAN® Coupling NOR-MEX®	P61, 62
TSCHAN® Coupling S	P63

IV Other Related Products

SLEEVE ROLL (Polyurethane molded product)	P65
STARLOCK® (Shaft Fastener)	P66, 67

V Troubleshooting for Power Transmission Products

For Timing Belt	P69
For V-Belt	P70

Synchronous Power Transmission & Direct Connected Power Transmission

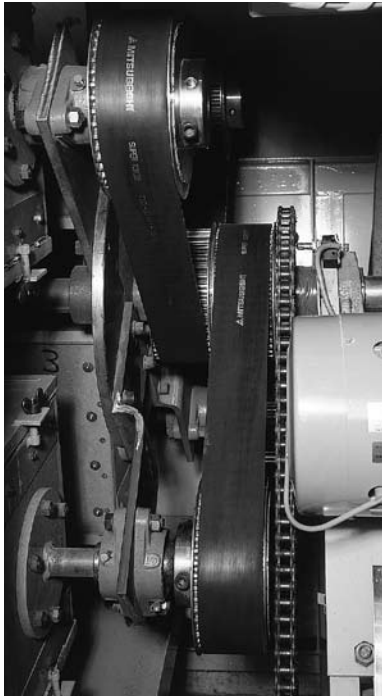

Polisher (SUPER TORQUE Timing Belt)



Large Knitting Machine (SUPER TORQUE Timing Belt)

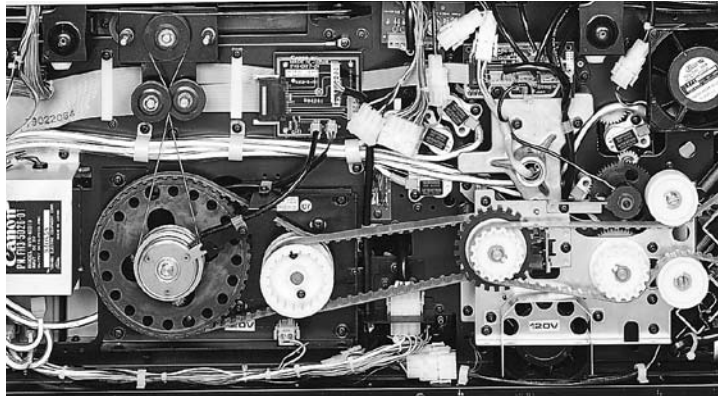

Copier (Rubber Timing Belt)

Application Example

Frictional Forced Power Transmission



Heavy Duty Polisher (MAXSTAR WEDGE V-Belt)



Combine (V-Belt for Agricultural Machines)

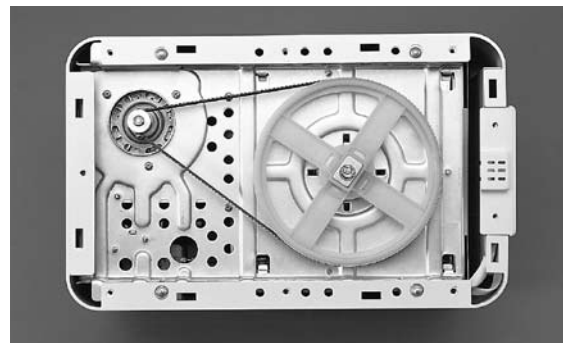

Food Processor (RIBSTAR Belt)

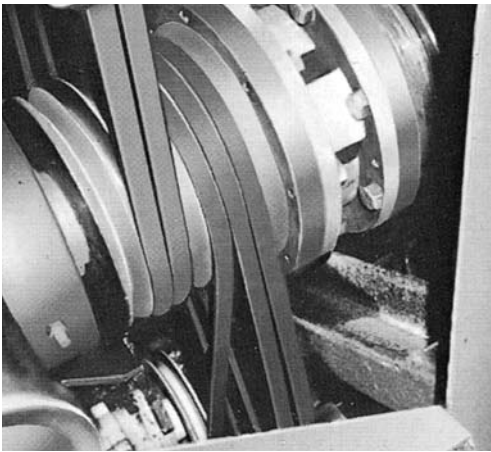

Marine Engine (TSCHAN® Coupling S)

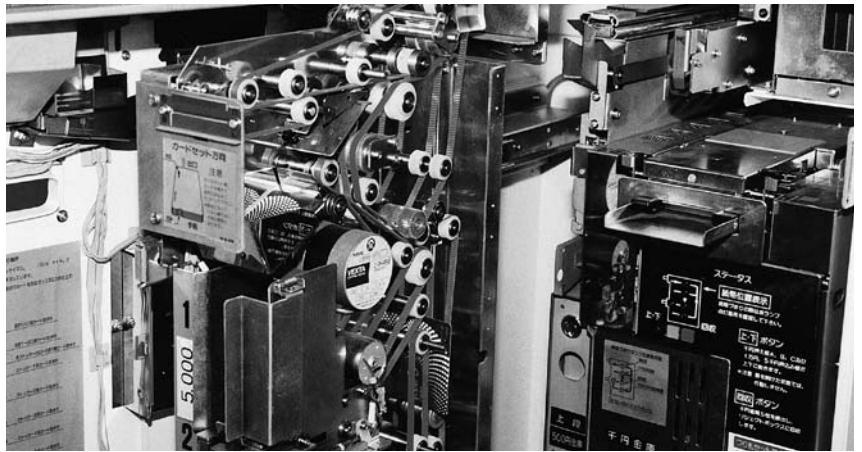

Plastic Card Vender (Polyurethane Timing Belt)

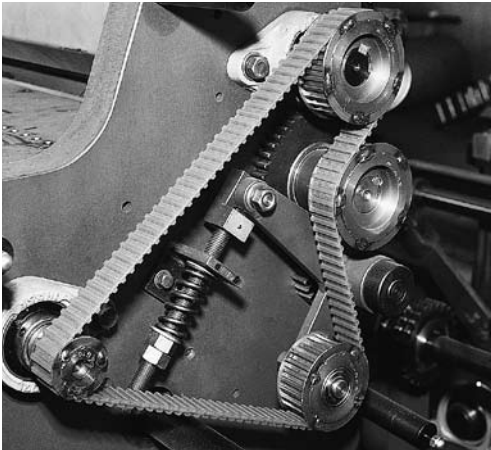

Packaging Machine (Polyurethane Double Timing Belt)

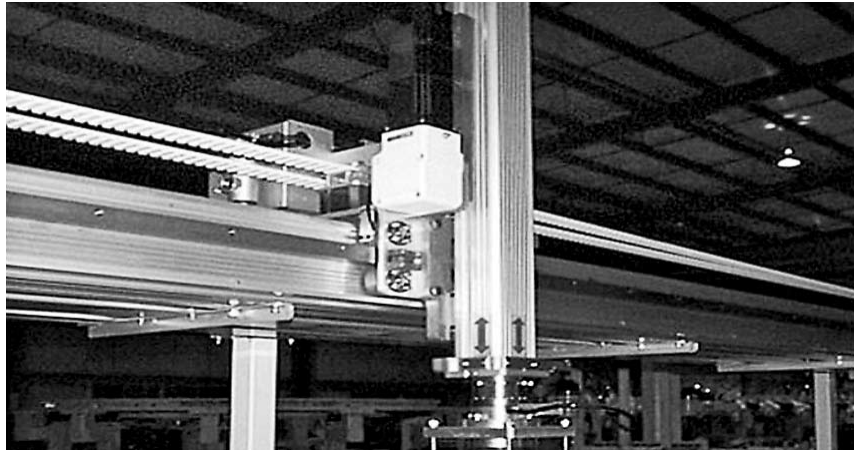

Large Industrial Robot (FREESPAN™ Belt)

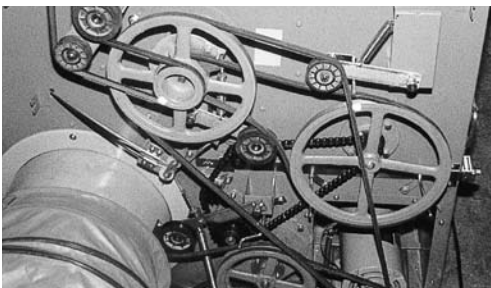

Dryer (V-Belt)

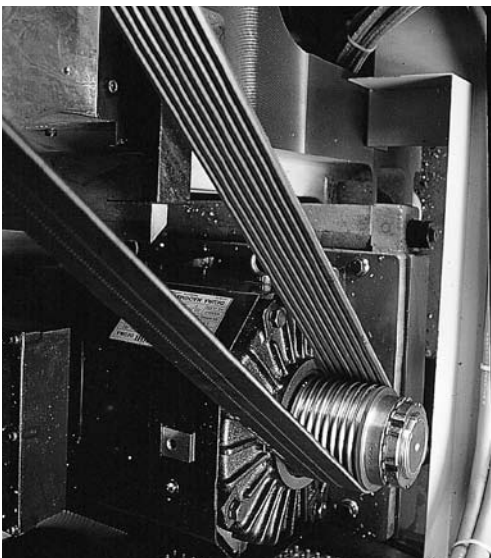



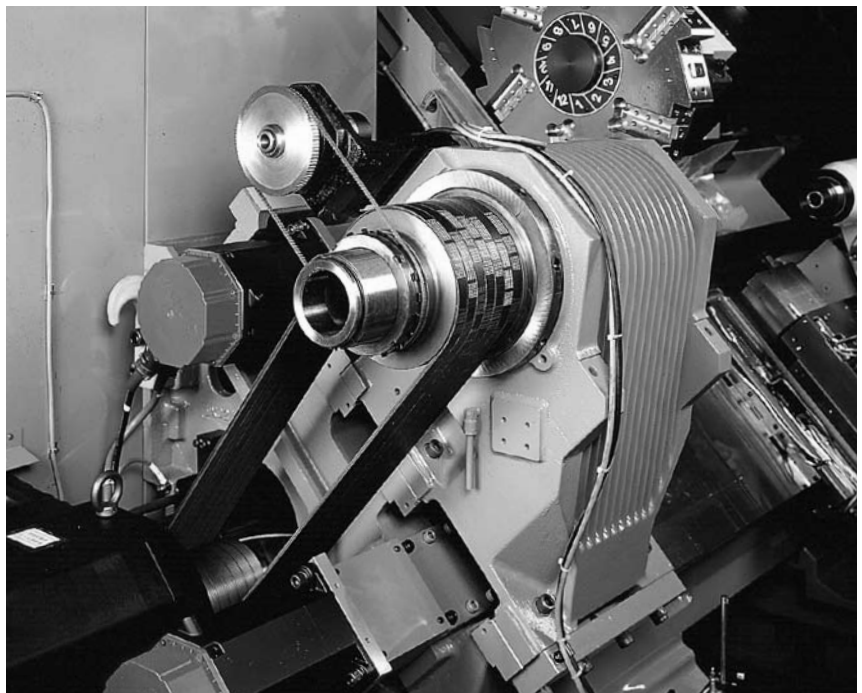





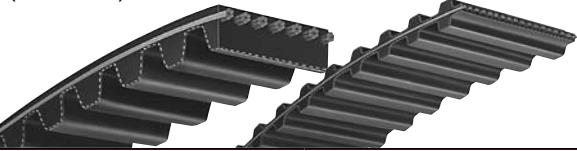
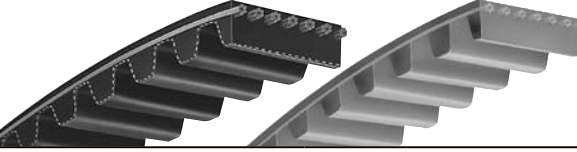

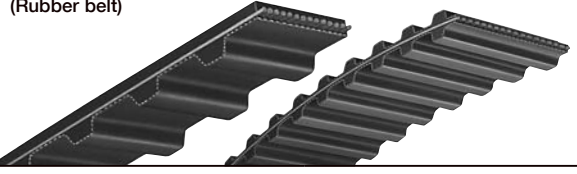
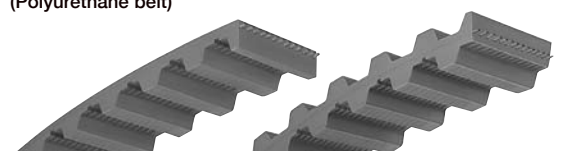

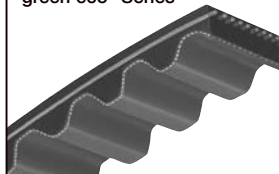



NC Lathe (Multi-POLYMAX Belt)

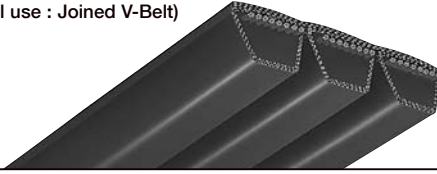

NC Lathe (RIBSTAR Belt)

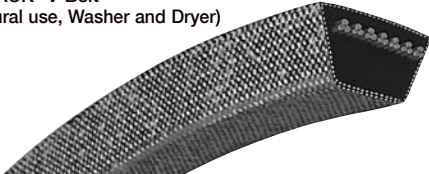
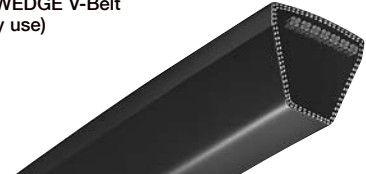
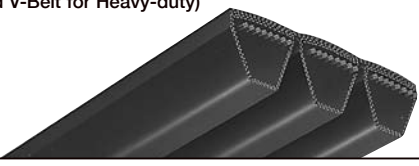
* To show the application examples clearly, safety covers are removed in the pictures on this page.
Always put on the safety covers when in use.

Product Name & Application	
Timing Belt	<p>SUPER TORQUE Timing Belt (General use)</p> 
	<p>MEGA TORQUE Timing Belt G&U, GII, EX <i>New!</i> (Heavy-duty use)</p> 
	<p>GigaTorque GX <i>New!</i></p> 
	<p>Timing Belt G (Rubber belt)</p> 
	<p>Timing Belt U (Polyurethane belt)</p> 
	<p>Rubber Timing Belt H-Series <i>New!</i></p>  <p>green eco® Series</p> 
Timing Pulley	<p>LONG-SPAN Timing Belt (Endless & Open-End)</p> 
	<p>Timing Pulley</p> 
Coupling	<p>Chemi-Chan® (High Performance Miniature Coupling)</p> 
	<p>TSCHAN® Coupling S and Coupling NOR-MEX®</p> 

Product Name & Application	
Wrapped Belt	<p>Classical V-Belt (General use)</p> 
	<p>Multi V-Belt (General use : Joined V-Belt)</p> 
	<p>Less Thickness Wrapped V-Belt (Agricultural use) Orange label SUPER AG-X <i>New!</i></p> 
	<p>BARE-BACK® V-Belt (Agricultural use, Washer and Dryer)</p> 
	<p>MAXSTAR WEDGE V-Belt (Heavy-duty use)</p> 
	<p>Multi MAXSTAR WEDGE V-Belt, Multi Super WEDGE II <i>New!</i> (Joined V-Belt for Heavy-duty)</p> 
	<p>e-POWER® Belt (Notched type) <i>New!</i></p> 
	<p>Perforated V-ROPE</p> 
	<p>V-Belt with lugs (Agricultural use)</p> 
	<p>HEXAGONAL V-Belt</p> 

	Product Name & Application
Raw Edge Belt	Raw Edge COGGED V-Belt (Agricultural use) Orange label SUPER GOLD 1000 AG COG 4 AG COG 20 New!
	Raw Edge COGGED V-Belt (Agricultural use) TRIPLEX e-POWER® New!
	Raw Edge MULTI-PLY V-Belt (Automotive use)
	Raw Edge COGGED V-Belt (Automotive use)
	Raw Edge COGGED Variable Speed Belt
Pulley	Pulley and Bushing for WEDGE V-Belt
	Pulley and Bushing for RIBSTAR Belt
Bushing	MB BUSHING
Polyurethane Molded	SLEEVE ROLL

	Product Name & Application
Ribbed Belt	RIBSTAR Belt G (Rubber)
	RIBSTAR Belt U (Polyurethane)
Polyurethane Belt	POLYMAX Belt (Wide-angle Polyurethane V-Belt)
	MB Belt (For Sewing Machine)
	STARROPE® & SUPER STARROPE® (Polyurethane Round Rope)
	PRENE V-ROPE & HEXAGONAL-ROPE (Polyurethane Rope)
	FREESPAN™ Belt Polyurethane Timing Belt New!
Flat Belt	FLEXSTAR®
	SUPER FLEXSTAR® (Heavy-duty use)
	FLEXSTAR® Belt J (For Conveyor)
	Flat Belt for general use and lifter

Industrial Power Transmission Product Selection Chart

How much slip can you allow?

How do you want to use it?

What features do you need?

Slip Tolerance	Drive Classification	Applications	Type of Belt / Pulley		Features	Mitsuboshi Products Lineup for Power Transmission Belts					
			Material	Tooth Shape or Form		Product Name	No	Type			
No slip allowed	Synchronous Power Transmission	Timing Belt	Rubber	Round tooth	High power transmission, heat resistance, water resistance, flex fatigue resistance	SUPER TORQUE G	1	S2M·S3M·S5M			
					Multi-pulley, double-sided drive	SUPER TORQUE G Double Timing	3	DS3M·DS5M·DS8M·DS14M			
					Long-span drive	SUPER TORQUE G Open-End	4	S2M·S3M·S5M·S8M·S14M			
					Synchronous transportation	SUPER TORQUE G Endless	5	S8M·S14M			
					Accurate positioning	STARMAX® G	6	ST1.5·ST5.5·ST80·ST83·ST2.0·ST1.0			
					Ozone resistance	green eco® Series	7	S2M·S3M·S5M			
					Low-speed, high-torque use	MEGA TORQUE G	8	MTS5M·MTS8M·MTS14M			
					High torque use	MEGA TORQUE G2	9	MTS8M, MTS14M			
					High precision positioning	MEGA TORQUE EX	10	MTS3M, MTS5M			
					High power transmission, heat, water and flex fatigue resistance	H Series	11	H8M, H14M			
					Heavy duty power transmission	GIGA TORQUE	12	G8M, G14M			
					Synchronous Power transmission	SYNCHROSTAR® G	13	MXL·XL·L·H·XH·XXH			
					Heat resistance	SYNCHROSTAR GA	14	ZA·ZAS·ZB·ZBS			
					Multi-pulley, double-sided drive	SYNCHROSTAR G Double Timing	15	DMXL·DXL·DL·DH			
		Long-span drive	SYNCHROSTAR G Open-End	16	MXL·XL·L·H						
		Synchronous transportation	SYNCHROSTAR G Endless	17	L·H·XH·XXH						
		Ozone resistance	green eco® Series	18	MXL						
		General use	Thermo-setting polyurethane	Round tooth	Clean drive	SUPER TORQUE U	19	S2M·S3M			
					Long-span drive	SUPER TORQUE U Open-End	20	S2M·S3M			
					Low-speed, high-torque use	MEGA TORQUE U	21	MTS8M			
					Accurate positioning	STARMAX® U	22	ST83·ST111			
					Accurate positioning	STARMAX® U	23	T80·T83·T111			
				Trapezoidal tooth	Clean drive	SYNCHROSTAR U	24	T80·T5·T10·AT5·AT10·XL·L			
					Multi-pulley, double-sided drive	SYNCHROSTAR U Double Timing	25	DT5·DT10			
					Long-span drive	SYNCHROSTAR U Open-End	26	T80·XL·L			
					Long-span drive	HTD5M·HTD8M·HTD14M	27				
					Synchronous transportation	FREESPAN™ Belt	28	T5·T10·AT5·AT10·L·H			
				General use	Thermo-plastic polyurethane	Round tooth	Long-span drive		29		
						Trapezoidal tooth	Synchronous transportation		30	3L·4L·5L	
Some slip is allowed. Note: Take slip ratio as approx. 1%	Friction Forced Transmission			V-Belt	Rubber	Standard	Less thickness	Light-duty use, compact design	FHP	31	
							General use	Classical V-Belt	31	K·M·A·B·C·D·E	
						Notched type	High power transmission	Red label V-Belt	32		
		Energy-saving	e-POWER®				33	A·B·C·D			
		Less thickness	Heavy-duty use, compact design			MAXSTAR WEDGE V	34	3V·5V·8V			
			Anti-vibration			Multi MAXSTAR WEDGE	35	R3V·R5V·R8V			
			Shock-load resistance			Multi Super WEDGE II	36	R5V, RBV			
			Flex resistance			L type	37				
			Heat resistance, flex resistance			Orange label L type	38				
			Heat resistance, flex resistance			Gold label L type	39	LA·LB·LC			
		Raw Edge Cogged	Less thickness type			High power transmission	Orange label Raw Edge COGGED	41			
						Low contraction	SUPER GOLD 1000 Raw Edge COGGED	42	LA·LB·LC		
			Standard type			Energy-Saving	e-POWER®	43	AX·BX·CX		
						High power transmission	TRIPLEX	44	AX·BX·CX		
			Narrow width type	High power transmission	Multi-VX	45	RAX·RBX·RCX				
				High power transmission	MAXSTAR WEDGE SUPREME®	46	3VX·5VX				
				High power transmission	Multi MAXSTAR WEDGE SUPREME®	47	R3VX·R5VX				
				High power transmission	Multi MAXSTAR WEDGE SUPREME®	47	R3VX·R5VX				
			Standard Flat	Rubber dust free, belt clutch	BARE-BACK® V	48	M·A·B·C				
				Rubber dust free, belt clutch	BARE-BACK® V	49	LA·LB·LC				
		Raw Edge	Plain	Abrasion resistance	REMF®	50	HM·A·B·BC				
				Low noise	MPMF®	51	HM·A·B				
			Cogged	Abrasion resistance, flex resistance	RECMF®	52	HM·A·B·BC·C·CD				
				Especially for small diesel automobiles	WFC®	53	A, B				
		Raw Edge Cogged (Variable speed)	Lateral pressure resistance	RCVS, SUPER VS®	54	Top width 10mm~120mm					
			Lateral pressure resistance, high power transmission	DCVS®	55	Top width 20mm~120mm					
		Wrapped (Variable speed)	High power transmission	AGVS®	56	HL·HM					
			High-speed revolution, compact design	POLYMAX	57	3M·5M·7M·11M					
		Cogged type	High-speed revolution, anti-vibration	Multi POLYMAX	58	R5M·R7M·R11M					
			Light-duty, clean drive	MB Belt	59	MB					
		Round edge	Round edge	Processed joint	PORT®, HARBOUR® SPECIAL PORT®	60	P·H·SP				
				Good flex resistance	ECHO®, PIONEER®	61	EC·P				
			Flat belt with V rail	Less stretch and runout	DRY FLEX®	62	AA·O·OW·TN				
				High-speed drive, compact design	FLEXSTAR®	63	FL·FM·FH·FLEG·FLG·FLE·FMG·FHG				
		Cord core flat type	High tensile force	SUPER FLEXSTAR®	64	FU·FW·FY					
			High tensile force	SUPER FLEXSTAR®	64	FU·FW·FY					
		Thin Flat Belt	Rubber	Cord core flat		65	J8GA·J8GE·J8H·J8HB·J8H·J8HB·J8H·J8H·J8HB				
				Laminated flat type	Good driving stability, compact design, maintenance-free	FLEXSTAR® Belt J	66	JL·JL3·JL3			
			Millable Polyurethane	No cord and canvas flat type		67	JN				
				No cord and canvas flat type		68	JU·JLU5·JLU6				
		V-Ribbed Belt	Rubber	Rib	Flex resistance, high power transmission, high-speed revolution	RIBSTAR G (Bare-back type)	69	HB			
					Flex resistance, high power transmission, high-speed revolution	RIBSTAR G	70	J·PK·L			
			Polyurethane	Flex resistance, high-speed revolution	RIBSTAR U	71	PK				
		Round Belt (Square Belt)	Rubber	Hexagonal	Multi-pulley, double-sided drive	HEXAGONAL V-Belt	73	AA·BB·CC			
					Adjustable belt length	Perforated V-Belt	74	M·A·B·C			
			Polyurethane	Round rope	Light-duty use	STARROPE®	75	Φ2~Φ10·Φ12·Φ15			
					Light-duty use	SUPER STARROPE®	76	Φ2~Φ10·Φ12·Φ15			
V rope	Adjustable belt length, processed joint	PRENE V-ROPE	77	M·A·B							
	Adjustable belt length, processed joint	PRENE HEXAGONAL-ROPE	78	AA·BB							
Special Belt	Rubber	Sponge backing type	Sponge backing	Sponge backing V-Belt	79	LA·LB·LC					
			Back protrusion for straw conveying	V-Belt with lugs	80	A·B·C					
Direct Connected Power Transmission	Coupling	Steel	general use, Office & Home appliance, agricultural use	NOR-MEX®	81	G·FG·LG·E·FE·LE					
			Shock absorption, anti-vibration	S	82	S·SV·SX·SZ					
			Shock absorption, anti-vibration	HYPERFLEX®	83	MT·MH					
			Good attenuation performance	Chemi-chan®	84	HAS					

Dimensions

Model	Material	Type	Cross-Sectional Dimensions top width (mm)×thickness (mm)×angle (°)	Minimum Pulley Diameter(mm)	Highest Speed (m/sec)	
SUPER TORQUE Timing Belt (Round tooth)	Rubber	S2M	Pitch (mm) 2.00	9	30 (40)	
		S3M	3.00	13	30 (40)	
S5M		5.00	22	30 (40)		
S8M		8.00	56	30 (40)		
S14M		14.00	125	30 (40)		
	Polyurethane	S2M	2.00	9	30 (40)	
S3M		3.00	13	30 (40)		
MEGA TORQUE Timing Belt	Rubber	MTS5M	Pitch (mm) 5.00	22	30	
		MTS8M	8.00	56	30	
MTS14M		14.00	125	30		
	Polyurethane	MTS8M	Pitch (mm) 8.00	61	30	
GIGA TORQUE Timing Belt	Rubber	G8M	Pitch (mm) 8.000	56	30	
		G14M	Pitch (mm) 14.00	125	30	
Timing Belt (Trapezoidal tooth)	Rubber	MXL	Pitch (mm) 2.032	7	30 (40)	
		XL	5.08	16	30 (40)	
		L	9.525	30	30 (40)	
		H	12.700	57	30 (40)	
		XH	22.225	127	30 (40)	
		XXH	31.750	182	30 (40)	
		Polyurethane	T80	Pitch (mm) 2.032	7	30 (40)
	T5•DT5		5.0	19	30 (40)	
	T10•DT10		10.0	45	30 (40)	
	XL		5.08	16	30 (40)	
L	9.525	30	30 (40)			
Classical V-Belt	Rubber	A	12.5×9.0×40	95 (67)	30	
		B	16.5×11.0×40	150 (118)	30	
		C	22.0×14.0×40	224 (180)	30	
		D	31.5×10.0×40	355 (300)	30	
		E	38.0×25.5×40	560 (450)	30	
MAXSTAR WEDGE V-Belt	Rubber	3V	9.5×8.0×40	67	40	
		5V	15.9×13.5×40	180	40	
		8V	25.4×22.0×40	315	40	
Multi MAXSTAR WEDGE V-Belt (Joined V-Belt)	Rubber	3V	—	67	40	
		5V	—	180	40	
		8V	—	315	40	
RIBSTAR Belt (V-Ribbed Belt)	Rubber	J	Pitch (mm) 2.34	31.5 (25)	40 (50)	
		PK	3.56	56 (50)	40 (50)	
		L	4.70	90 (80)	40 (50)	
	Polyurethane	JT•JBT	Pitch (mm) 2.34	20	30 (35)	
FLEXSTAR® Belt	Rubber	FL	Belt Thickness (mm) 1.5	16	40 (60)	
		FM	2.5	40	40 (60)	
		FH	3.5	80	40 (60)	
POLYMAX Belt	Polyurethane	3M	3.0×2.0×60	17	40	
		5M	5.0×3.0×60	26	40	
		7M	7.0×5.0×60	42	40	
		11M	11.0×7.0×60	67	40	
MB Belt (Polyurethane V-Belt)	Polyurethane	MB	6.0×4.0×40	16	10	
STARROPE® / SUPER STARROPE®	Polyurethane	2	Diameter φ mm 2	15/ 20 SUPER	10 and below	
		3	3	20/ 30	10	
		4	4	30/ 40	10	
		5	5	40/ 50	10	
		6	6	50/ 60	10	
		7	7	60/ 70	10	
		8	8	70/ 80	10	
		9	9	85/ 90	10	
		10	10	95/ 100	10	
		12	12	120/ 120	10	
15	15	150/ 150	10			
PRENE V-ROPE	Polyurethane	M	10.0×5.5×40	40	10 and below	
		A	12.5×8.5×40	85	10	
		B	16.5×10.5×40	100	10	
PRENE HEXAGONAL-ROPE	Polyurethane	AA	12.5×10.0×40	100	10 and below	
		BB	16.5×12.5×40	130	10	

Note 1 Values in () are only used under limited conditions. Avoid these values as much as possible.
The conditions of use such as pulley diameter and speed affect belt durability.
(Use the above table as a reference when selecting belts)

Note 2 For V-Belt and MAXSTAR WEDGE V-Belt, values are nominal.

I Synchronous Power Transmission

Round Tooth Timing Belt

Belt Type, Dimensions & Product Code	P13
SUPER TORQUE Timing Belt G	P14~16
SUPER TORQUE Timing Pulley.....	P17
MEGA TORQUE Timing Belt G&U	P18,19
Mega Torque G II	P20
Mega Torque EX	P21
Giga Torque GX.....	P22
H Series	P23

Trapezoidal Tooth Timing Belt

Belt Type, Dimensions & Product Code	P24
green eco® Series	P25
Timing Belt G	P26~28
Timing Belt U	P29~31
LONG-SPAN Timing Belt	P32
Timing Pulley	P33, 34



Round Tooth Timing Belt

Belt Type, Dimensions & Product Code

Belt Type	Standard Dimensions	Standard Width		Product Code	Minimum Pulley Size *1		Applications
		Code	Width		Pulley diameter (mm)	No. of teeth	
S2M	<p>Pitch Line</p> <p>Belt Tooth Pitch 2mm</p>	40	4mm	B 40 S2M 160 GB · (U) Belt Belt Type GB Type (bare back) Nominal Length (mm) Belt Width(mm)x10 U(polyurethane) Type	8.91	14	<ul style="list-style-type: none"> ● OA Equipment <ul style="list-style-type: none"> Copier Fascimille Printer Typewriter Wordprocessor Computer terminal Cash register X-Y plotter ● Automated Vending Machine <ul style="list-style-type: none"> Ticketing machine Ticket gate Bank teller Notes counter Money changing machine
		60	6mm				
S3M	<p>Pitch Line</p> <p>Belt Tooth Pitch 3mm</p>	60	6mm	B 100 (D)S3M 459 GB·(U) Belt Belt Type GB Type (bare back) * In case of double timing belt, use DS3M Nominal Length (mm) Belt Width(mm)x10 U(polyurethane) Type	13.37	14	<ul style="list-style-type: none"> ● Electronic Applications <ul style="list-style-type: none"> Computer VTR Fish sonar finder Flaw-detecting machine Depth finder Robot ● Instrumentation <ul style="list-style-type: none"> Rotary machine Recorder Oscillograph Data processing system Various test machines
		100	10mm				
		150	15mm				
S5M	<p>Pitch Line</p> <p>Belt Tooth Pitch 5mm</p>	100	10mm	B 250 (D)S5M 1125 GB Belt Belt Type GB Type (bare back) * In case of double timing belt, use DS5M Nominal Length (mm) Belt Width(mm)x10	22.28	14	<ul style="list-style-type: none"> ● Electrical Appliances <ul style="list-style-type: none"> Blender Mixer Sewing machine Vacuum cleaner Eletrical tools ● Others <ul style="list-style-type: none"> Toy Medical systems Health equipment
		150	15mm				
		250	25mm				
S8M	<p>Pitch Line</p> <p>Belt Tooth Pitch 8mm</p>	150	15mm	250 (D)S8M 2000 G Belt Width (mm)x10 Nominal Length (mm) * In case of double timing belt, use DS8M Belt Type G(rubber) Type	56.02	22	<ul style="list-style-type: none"> ● Woodworking machinery ● Textile machinery <ul style="list-style-type: none"> Textile spinning machine Yarn twisting machine ● Paper making machinery <ul style="list-style-type: none"> Mixer Dryer Calender ● Fan/ Blower ● Machine tools <ul style="list-style-type: none"> Drilling machine, lathe Screw cutting machine Boring machine Grinding machine Milling machine NC lathe ● Printer
		250	25mm				
		300	30mm				
		400	40mm				
		600	60mm				
S14M	<p>Pitch Line</p> <p>Belt Tooth Pitch 14mm</p>	400	40mm	800 (D)S14M 3150 G Belt Width (mm)x10 Nominal Length (mm) * In case of double timing belt, use DS14M Belt Type G(rubber) Type	124.78	28	<ul style="list-style-type: none"> ● Blower ● Screen ● Mill hammer <ul style="list-style-type: none"> Ball Rod Pebble ● Paper making machinery <ul style="list-style-type: none"> Mixer Dryer Calender
		600	60mm				
		800	80mm				
		1000	100mm				
		1200	120mm				

*1 Minimum pulley diameter / number of teeth depend on revolution.
Use Timing belt catalogue for design.

SUPER TORQUE Timing Belt G

Since this round tooth belt has a high power transmission property, it expands existing applications of timing belts significantly.

Also, it can be used as an alternative for chains and gears.

- It can be used in wide applications since it has a higher power transmission.
- Longer operating life
- Quiet operation
- Cost-Efficient

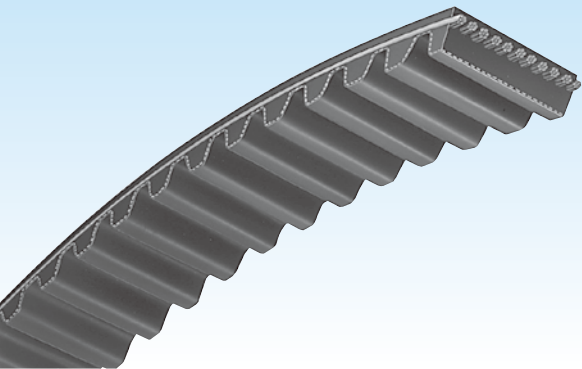

Standard Belt Sizes

Belt Type	S8M				S14M			
	8.0(mm)				14.0(mm)			
Tooth Pitch	8.0(mm)				14.0(mm)			
Code(width)	150(15mm)	250(25mm)	300(30mm)	400(40mm) 600(60mm)	400(40mm)	600(60mm)	800(80mm)	1000(100mm) 1200(120mm)
	Product Code	No. of Teeth	Pitch Length (mm)	Product Code	No. of Teeth	Pitch Length (mm)		
	S8M 376	47	376	S14M 1008	72	1,008		
	S8M 400	50	400	S14M 1120	80	1,120		
	S8M 408	51	408	S14M 1190	85	1,190		
	S8M 440	55	440	S14M 1246	89	1,246		
	S8M 436	60	480	S14M 1288	92	1,288		
	S8M 496	62	496	(D) S14M 1400	100	1,400		
	S8M 512	64	512	(D) S14M 1470	105	1,470		
	S8M 520	66	520	(D) S14M 1540	110	1,540		
	S8M 528	66	528	(D) S14M 1610	115	1,610		
	S8M 560	70	560	(D) S14M 1652	118	1,652		
	(D) S8M 584	73	584					
	S8M 600	75	600	(D) S14M 1708	122	1,708		
	S8M 632	79	632	(D) S14M 1736	124	1,736		
	S8M 640	80	640	(D) S14M 1750	125	1,750		
	S8M 656	82	656	(D) S14M 1778	127	1,778		
	S8M 680	85	680	(D) S14M 1806	129	1,806		
	S8M 712	89	712	(D) S14M 1890	135	1,890		
	S8M 720	90	720	(D) S14M 1932	138	1,932		
	S8M 760	95	760	(D) S14M 1960	140	1,960		
	S8M 800	100	800	(D) S14M 2002	143	2,002		
				(D) S14M 2100	150	2,100		
	S8M 824	103	824					
	S8M 840	105	840	(D) S14M 2198	157	2,198		
	S8M 848	106	848	(D) S14M 2240	160	2,240		
	S8M 856	107	856	(D) S14M 2310	165	2,310		
	S8M 880	110	880	(D) S14M 2380	170	2,380		
	S8M 896	112	896	(D) S14M 2450	175	2,450		
	S8M 912	114	912	(D) S14M 2506	179	2,506		
	S8M 920	115	920	(D) S14M 2590	185	2,590		
	S8M 928	116	928	(D) S14M 2660	190	2,660		
	S8M 944	118	944	(D) S14M 2800	200	2,800		
				(D) S14M 3150	225	3,150		
	S8M 952	119	952					
	S8M 960	120	960	(D) S14M 3360	240	3,360		
	S8M 976	122	976	(D) S14M 3500	250	3,500		
	S8M 984	123	984	(D) S14M 3556	254	3,556		
	S8M 1000	125	1,000	(D) S14M 3850	275	3,850		
	S8M 1024	128	1,024	(D) S14M 4004	286	4,004		
	S8M 1040	130	1,040	(D) S14M 4508	322	4,508		
	S8M 1056	132	1,056	(D) S14M 5012	358	5,012		
	S8M 1080	135	1,080					
	S8M 1120	140	1,120					
	(D) S8M 1128	141	1,128					
	(D) S8M 1136	142	1,136					
	(D) S8M 1152	144	1,152					
	(D) S8M 1160	145	1,160					
	(D) S8M 1184	148	1,184					
	(D) S8M 1200	150	1,200					
	(D) S8M 1216	152	1,216					
	(D) S8M 1224	153	1,224					
	(D) S8M 1248	156	1,248					
	(D) S8M 1256	157	1,256					
	(D) S8M 1280	160	1,280					
	(D) S8M 1296	162	1,296					
	(D) S8M 1304	163	1,304					
	(D) S8M 1312	164	1,312					
	(D) S8M 1320	165	1,320					
	(D) S8M 1352	169	1,352					
	(D) S8M 1360	170	1,360					
	(D) S8M 1384	173	1,384					
	(D) S8M 1400	175	1,400					
	(D) S8M 1424	178	1,424					
	(D) S8M 1440	180	1,440					
	(D) S8M 1480	185	1,480					
	(D) S8M 1488	186	1,488					
	(D) S8M 1520	190	1,520					
	(D) S8M 1522	194	1,522					
	(D) S8M 1600	200	1,600					
	(D) S8M 1640	205	1,640					
	(D) S8M 1648	206	1,648					
	(D) S8M 1680	210	1,680					
	(D) S8M 1696	212	1,696					
	(D) S8M 1728	216	1,728					
	(D) S8M 1760	220	1,760					
	(D) S8M 1776	222	1,776					
	(D) S8M 1792	224	1,792					
	(D) S8M 1800	225	1,800					
	(D) S8M 1816	227	1,816					
	(D) S8M 1832	229	1,832					
	(D) S8M 1880	235	1,880					
	(D) S8M 1912	239	1,912					
	(D) S8M 1960	245	1,960					
	(D) S8M 2000	250	2,000					
	(D) S8M 2040	255	2,040					
	(D) S8M 2048	256	2,048					
	(D) S8M 2064	258	2,064					
	(D) S8M 2104	263	2,104					
	(D) S8M 2120	265	2,120					
	(D) S8M 2160	270	2,160					
	(D) S8M 2240	280	2,240					
	(D) S8M 2272	284	2,272					
	(D) S8M 2304	288	2,304					
	(D) S8M 2376	297	2,376					
	(D) S8M 2400	300	2,400					
	(D) S8M 2496	312	2,496					
	(D) S8M 2600	325	2,600					
	(D) S8M 2800	350	2,800					
	(D) S8M 2920	365	2,920					
	(D) S8M 2944	368	2,944					
	(D) S8M 3048	381	3,048					
	(D) S8M 3200	400	3,200					
	(D) S8M 3248	406	3,248					
	(D) S8M 3272	409	3,272					
	(D) S8M 3440	430	3,440					
	(D) S8M 3680	460	3,680					
	(D) S8M 3720	465	3,720					
	(D) S8M 3904	488	3,904					
	(D) S8M 3928	491	3,928					
	(D) S8M 4400	550	4,400					

- Keep in mind that not all the sizes in above chart are in-stock items.
- (D) signifies the standard size of double timing belt G (rubber) type.

SUPER TORQUE Timing Pulley

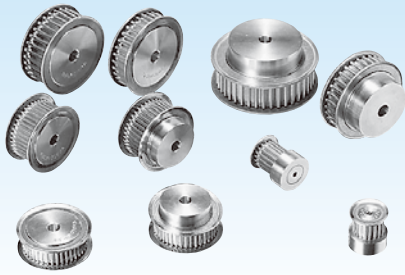

Timing belt power transmission system works the best when belt and pulley smoothly mesh with each other. Our SUPER TORQUE Timing Pulley is made with specially formed tooth shape and fine finishing.

Pulley Product Code

Example:

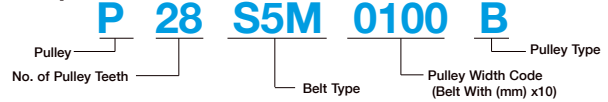

SUPER TORQUE Standard Pulley Types and Sizes

★ We add aluminum as a standard pulley for S3M and S5M

Belt Type	S2M				S3M			S5M		
	No. of Teeth	Product Code	PD	OD	Product Code	PD	OD	Product Code	PD	OD
Size	14	P 14S2M	8.91	8.40	P 14S3M	13.37	12.61	P 14S5M	22.28	21.32
	15	P 15S2M	9.55	9.04	P 15S3M	14.32	13.56	P 15S5M	23.87	22.91
	16	P 16S2M	10.19	9.68	P 16S3M	15.28	14.52	P 16S5M	25.46	24.50
	18	P 18S2M	11.46	10.95	P 18S3M	17.19	16.43	P 18S5M	28.65	27.69
	20	P 20S2M	12.73	12.22	P 20S3M	19.10	18.34	P 20S5M	31.83	30.87
	22	P 22S2M	14.01	13.50	P 22S3M	21.01	20.25	P 22S5M	35.01	34.05
	24	P 24S2M	15.28	14.77	P 24S3M	22.92	22.16	P 24S5M	38.20	37.24
	25	P 25S2M	15.92	15.41	P 25S3M	23.87	23.11	P 25S5M	39.79	38.83
	26	P 26S2M	16.55	16.04	P 26S3M	24.83	24.07	P 26S5M	41.38	40.42
	28	P 28S2M	17.83	17.32	P 28S3M	26.74	25.98	P 28S5M	44.56	43.60
	30	P 30S2M	19.10	18.59	P 30S3M	28.65	27.89	P 30S5M	47.75	46.79
	32	P 32S2M	20.37	19.86	P 32S3M	30.56	29.80	P 32S5M	50.93	49.97
	36	P 36S2M	22.92	22.41	P 36S3M	34.38	33.62	P 36S5M	57.30	56.34
	40	P 40S2M	25.46	24.96	P 40S3M	38.20	37.44	P 40S5M	63.66	62.70
	44	P 44S2M	28.01	27.50	P 44S3M	42.02	41.25	P 44S5M	70.03	69.07
	48	P 48S2M	30.56	30.05	P 48S3M	45.84	45.07	P 48S5M	76.39	75.43
	50	P 50S2M	31.83	31.32	P 50S3M	47.75	46.98	P 50S5M	79.58	78.62
	60	P 60S2M	38.20	37.69	P 60S3M	57.30	56.53	P 60S5M	95.49	94.53

Standard Sizes

Type	10mm	15mm	25mm	Rod Shape
S2M	—	—	—	○
S3M	A·B·C	A·B·C	—	○
S5M	A·B	A·B	A·B	○

Materials

Type	A·B	C	Rod Shape
S2M	—	—	Aluminum
S3M	Aluminum	Aluminum	Aluminum
S5M	Aluminum/Steel	—	Steel

Pulley Types

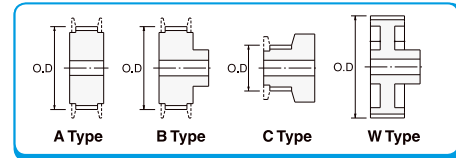

- Shape is a 100mm long round cylinder product.
- 22 teeth and below sizes of S3M are available only in rod shape and C type. Also, 24 teeth and above sizes are available only in A or B type.
- Only steel one is available for 25 mm width S5M type.
- Flange is not sold separately as a single item.

Belt Type	S8M						S14M						
	No. of Teeth	Product Code	PD	OD	A/B Type Standard Width	W Type Standard Width	No. of Teeth	Product Code	PD	OD	A Type Standard Width	B Type Standard Width	W Type Standard Width
Size	18	18S8M	45.84	44.46	15·25·30·40	—	28	P 28S14M	124.78	121.98	40·60·80	40·60	—
	19	19S8M	48.38	47.01		30	P 30S14M	133.69	130.90	—			
	20	20S8M	50.93	49.56		32	P 32S14M	142.60	139.81	—			
	21	21S8M	53.48	52.10		34	P 34S14M	151.52	148.72	—			
	22	22S8M	56.02	54.65		36	P 36S14M	160.43	157.63	—			
	24	24S8M	61.12	59.74		40	P 40S14M	178.25	175.46	—			
	25	25S8M	63.66	62.29		42	P 42S14M	187.17	184.37	—			
	26	26S8M	66.21	64.84		44	P 44S14M	196.08	193.28	—			
	28	28S8M	71.30	69.93		48	P 48S14M	213.90	211.11	—			
	30	30S8M	76.39	75.02		50	P 50S14M	222.82	220.02	—			
	32	32S8M	81.49	80.12	56	P 56S14M	249.55	246.76	—				
	34	34S8M	86.58	85.21	(60)	P 60S14M	267.38	264.59	—				
	36	36S8M	91.67	90.30	(64)	P 64S14M	285.21	282.41	40·60				
	38	38S8M	96.77	95.39	(72)	P 72S14M	320.86	318.06	—				
	40	40S8M	101.86	100.49	—	—	—	—	—				
	44	44S8M	112.05	110.67	—	—	—	—	—				
	48	48S8M	122.23	120.86	—	—	—	—	—				
	50	50S8M	127.32	125.95	—	—	—	—	—				
	60	60S8M	152.79	151.42	—	—	—	—	—				
	(72)	72S8M	183.35	181.97	—	15·25·40·60	—	—	—				
(84)	84S8M	213.90	212.53	—	—	—	—	—					
(96)	96S8M	244.46	243.09	—	25·40·60	—	—	—					
(120)	120S8M	305.58	304.21	—	—	—	—	—					

- No. of teeth in () is nonstocked item.
- Flange is not sold separately as a single item.
- A and B types are made from steel whereas W type is made from cast metal.

we revised the standard item lists in April, 2006.

MEGA TORQUE Timing Belt G&U

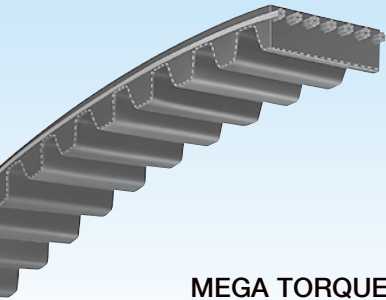

MEGA TORQUE Timing Belt G

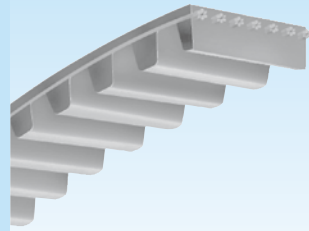

MEGA TORQUE Timing Belt U

Characteristics of low/high speed torque timing belt 'MEGA TORQUE' :

- Large transmission capacity is achievable, at about 2 times that of SUPER TORQUE G (Rubber) (variation subject to pulley diameter and revolution speed).
- Compact design possible. Compared to SUPER TORQUE G (Rubber), width is approximately 40% smaller on average for the same pulley diameter.
- Pulley of existing models can be used. SUPER TORQUE (S8M, S14M) pulleys can be used as per usual.
* Please contact us regarding pulley for MTS5M.

MEGA TORQUE Timing Belt G

Dimensions

- Tooth Shape & Product Code -

● MTS5M

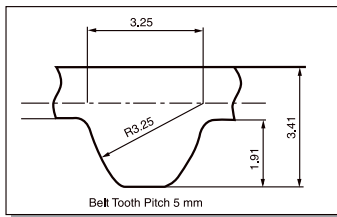

Standard Belt Width

Belt Width Code	Belt Width (mm)
100	10
150	15
250	25

2 5 0 | M T | S 5 M | 1 1 2 5 | G Rubber
 Belt Width (mm) x10 | MEGA TORQUE | Belt Type | Belt Length (mm)

● MTS8M

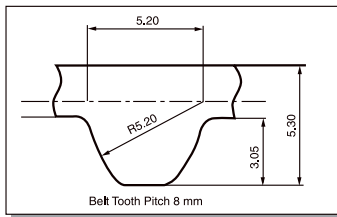

Standard Belt Width

Belt Width Code	Belt Width (mm)
150	15
250	25
300	30
400	40
600	60

2 5 0 | M T | S 8 M | 1 6 8 0 | G Rubber
 Belt Width (mm) x10 | MEGA TORQUE | Belt Type | Belt Length (mm)

● MTS14M

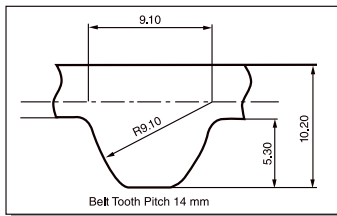

Standard Belt Width

Belt Width Code	Belt Width (mm)
400	40
600	60
800	80
1000	100
1200	120

6 0 0 | M T | S 1 4 M | 2 1 0 0 | G Rubber
 Belt Width (mm) x10 | MEGA TORQUE | Belt Type | Belt Length (mm)

Standard Belt Sizes

MTS5M(Pitch 5mm)			
Product Code	No. of Teeth	Product Code	No. of Teeth
MTS5M 225 G	45	MTS5M 830 G	166
MTS5M 255 G	51	MTS5M 845 G	169
MTS5M 260 G	52	MTS5M 850 G	170
MTS5M 295 G	59	MTS5M 870 G	174
MTS5M 300 G	60	MTS5M 890 G	178
MTS5M 305 G	61	MTS5M 900 G	180
MTS5M 320 G	64	MTS5M 930 G	186
MTS5M 325 G	65	MTS5M 950 G	190
MTS5M 340 G	68	MTS5M 965 G	193
MTS5M 350 G	70	MTS5M 975 G	195
MTS5M 370 G	74	MTS5M 980 G	196
MTS5M 375 G	75	MTS5M 1000 G	200
MTS5M 380 G	76	MTS5M 1025 G	205
MTS5M 390 G	78	MTS5M 1050 G	210
MTS5M 400 G	80	MTS5M 1055 G	211
MTS5M 410 G	82	MTS5M 1085 G	217
MTS5M 425 G	85	MTS5M 1090 G	218
MTS5M 435 G	87	MTS5M 1100 G	220
MTS5M 440 G	88	MTS5M 1105 G	221
MTS5M 450 G	90	MTS5M 1115 G	223
MTS5M 460 G	92	MTS5M 1120 G	224
MTS5M 470 G	94	MTS5M 1125 G	225
MTS5M 475 G	95	MTS5M 1135 G	227
MTS5M 490 G	98	MTS5M 1145 G	229
MTS5M 500 G	100	MTS5M 1160 G	232
MTS5M 520 G	104	MTS5M 1165 G	233
MTS5M 525 G	105	MTS5M 1195 G	239
MTS5M 530 G	106	MTS5M 1200 G	240
MTS5M 545 G	109	MTS5M 1225 G	245
MTS5M 550 G	110	MTS5M 1250 G	250
MTS5M 560 G	112	MTS5M 1270 G	254
MTS5M 575 G	115	MTS5M 1290 G	258
MTS5M 590 G	118	MTS5M 1295 G	259
MTS5M 595 G	119	MTS5M 1350 G	270
MTS5M 600 G	120	MTS5M 1420 G	284
MTS5M 615 G	123	MTS5M 1475 G	295
MTS5M 625 G	125	MTS5M 1500 G	300
MTS5M 640 G	128	MTS5M 1505 G	301
MTS5M 650 G	130	MTS5M 1530 G	306
MTS5M 665 G	133	MTS5M 1595 G	319
MTS5M 670 G	134	MTS5M 1605 G	321
MTS5M 675 G	135	MTS5M 1615 G	323
MTS5M 690 G	138	MTS5M 1680 G	336
MTS5M 695 G	139	MTS5M 1690 G	338
MTS5M 700 G	140	MTS5M 1715 G	343
MTS5M 710 G	142	MTS5M 1800 G	360
MTS5M 720 G	144	MTS5M 1945 G	389
MTS5M 725 G	145	MTS5M 2000 G	400
MTS5M 730 G	146	MTS5M 2145 G	429
MTS5M 740 G	148	MTS5M 2255 G	451
MTS5M 750 G	150	MTS5M 2480 G	496
MTS5M 765 G	153	MTS5M 2525 G	505
MTS5M 780 G	156	MTS5M 2980 G	596
MTS5M 800 G	160	MTS5M 3090 G	618
MTS5M 810 G	162		

MEGA TORQUE Timing Belt G&U

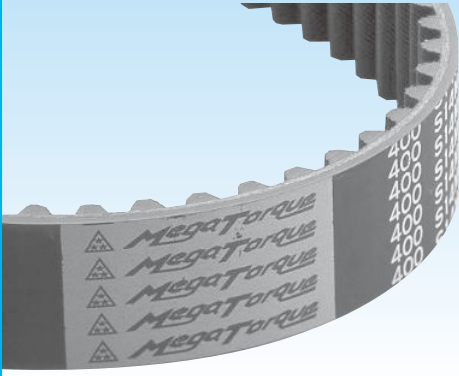

Standard Belt Sizes

MTS8M (Pitch 8 mm)				MTS14M (Pitch 14 mm)	
Product Code	No. of Teeth	Product Code	No. of Teeth	Product Code	No. of Teeth
MTS8M 528 G	66	MTS8M 1400 G	175	MTS14M 1008 G	72
MTS8M 560 G	70	MTS8M 1424 G	178	MTS14M 1120 G	80
MTS8M 584 G	73	MTS8M 1440 G	180	MTS14M 1190 G	85
MTS8M 600 G	75	MTS8M 1480 G	185	MTS14M 1246 G	89
MTS8M 632 G	79	MTS8M 1488 G	186	MTS14M 1288 G	92
MTS8M 640 G	80	MTS8M 1520 G	190	MTS14M 1400 G	100
MTS8M 656 G	82	MTS8M 1552 G	194	MTS14M 1470 G	105
MTS8M 712 G	89	MTS8M 1600 G	200	MTS14M 1540 G	110
MTS8M 720 G	90	MTS8M 1640 G	205	MTS14M 1610 G	115
MTS8M 760 G	95	MTS8M 1648 G	206	MTS14M 1652 G	118
MTS8M 800 G	100	MTS8M 1680 G	210	MTS14M 1708 G	122
MTS8M 824 G	103	MTS8M 1696 G	212	MTS14M 1736 G	124
MTS8M 840 G	105	MTS8M 1728 G	216	MTS14M 1750 G	125
MTS8M 848 G	106	MTS8M 1760 G	220	MTS14M 1778 G	127
MTS8M 856 G	107	MTS8M 1776 G	222	MTS14M 1806 G	129
MTS8M 880 G	110	MTS8M 1792 G	224	MTS14M 1890 G	135
MTS8M 896 G	112	MTS8M 1800 G	225	MTS14M 1932 G	138
MTS8M 912 G	114	MTS8M 1816 G	227	MTS14M 1960 G	140
MTS8M 920 G	115	MTS8M 1832 G	229	MTS14M 2002 G	143
MTS8M 928 G	116	MTS8M 1880 G	235	MTS14M 2100 G	150
MTS8M 944 G	118	MTS8M 1912 G	239	MTS14M 2198 G	157
MTS8M 952 G	119	MTS8M 1960 G	245	MTS14M 2240 G	160
MTS8M 960 G	120	MTS8M 2000 G	250	MTS14M 2310 G	165
MTS8M 976 G	122	MTS8M 2040 G	255	MTS14M 2380 G	170
MTS8M 984 G	123	MTS8M 2048 G	256	MTS14M 2450 G	175
MTS8M 1000 G	125	MTS8M 2064 G	258	MTS14M 2506 G	179
MTS8M 1024 G	128	MTS8M 2104 G	263	MTS14M 2590 G	185
MTS8M 1040 G	130	MTS8M 2120 G	265	MTS14M 2660 G	190
MTS8M 1056 G	132	MTS8M 2160 G	270	MTS14M 2800 G	200
MTS8M 1080 G	135	MTS8M 2240 G	280	MTS14M 3150 G	225
MTS8M 1120 G	140	MTS8M 2272 G	284	MTS14M 3360 G	240
MTS8M 1128 G	141	MTS8M 2304 G	288	MTS14M 3500 G	250
MTS8M 1136 G	142	MTS8M 2376 G	297	MTS14M 3556 G	254
MTS8M 1152 G	144	MTS8M 2400 G	300	MTS14M 3850 G	275
MTS8M 1160 G	145	MTS8M 2496 G	312	MTS14M 4004 G	286
MTS8M 1184 G	148	MTS8M 2600 G	325	MTS14M 4508 G	322
MTS8M 1200 G	150	MTS8M 2800 G	350	MTS14M 5012 G	358
MTS8M 1216 G	152	MTS8M 2920 G	365		
MTS8M 1224 G	153	MTS8M 2944 G	368		
MTS8M 1248 G	156	MTS8M 3048 G	381		
MTS8M 1256 G	157	MTS8M 3200 G	400		
MTS8M 1280 G	160	MTS8M 3248 G	406		
MTS8M 1296 G	162	MTS8M 3272 G	409		
MTS8M 1304 G	163	MTS8M 3440 G	430		
MTS8M 1312 G	164	MTS8M 3680 G	460		
MTS8M 1320 G	165	MTS8M 3720 G	465		
MTS8M 1352 G	169	MTS8M 3904 G	488		
MTS8M 1360 G	170	MTS8M 3928 G	491		
MTS8M 1384 G	173	MTS8M 4400 G	550		

MEGA TORQUE Timing Belt U

Dimensions

- Tooth Shape & Product Code -

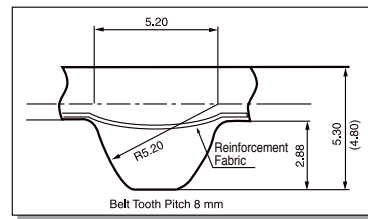

Standard Belt Width

Belt Width Code	Belt Width (mm)
150	15
250	25
400	40
600	60

2.50 | M T | S 8 M | 10.00 | U
 Belt Width (mm) x10 | MEGA TORQUE | Belt Type | Belt Length (mm) | Polyurethane

Standard Belt Sizes

MTS8M (Pitch 8 mm)		
Product Code		No. of Teeth
MTS8M 560		70
MTS8M 600		75
MTS8M 640		80
MTS8M 680		85
MTS8M 720		90
MTS8M 760		95
* MTS8M 800		100
MTS8M 848		106
MTS8M 896		112
MTS8M 960		120
MTS8M 1000		125
MTS8M 1056		132
MTS8M 1120		140
MTS8M 1200		150
MTS8M 1280		160
* MTS8M 1328		166
MTS8M 1360		170
MTS8M 1440		180
MTS8M 1520		190
MTS8M 1600		200
MTS8M 1696		212
* MTS8M 1792		224
* MTS8M 1888		236

● Total thickness of belt sizes with * mark is 4.8mm.

MegaTorque GII

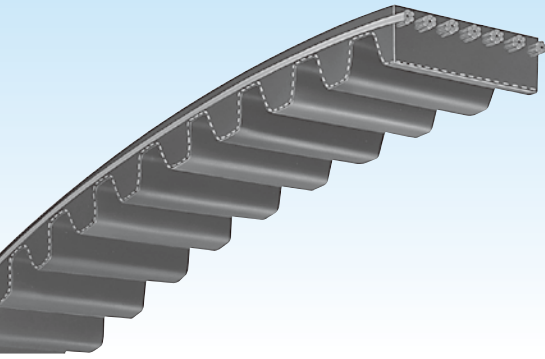

Characteristics and advantages of Extra High Torque Timing Belt

- Extra larger power transmission capacity
New material cord minimizes belt stretch and produces high power transmission capacity. Power transmission capacity is 1.5 times of MEGA TORQUE G .
- Long operation life
Introducing anti-abrasive low friction fabric brings high durability at higher torque. Belt life is 2 times longer than MEGA TORQUE G.
- Low noise
Running noise is reduced by 18% from regular timing belt when you use specially designed pulley and narrower width belt.
* Specially designed pulley is required.

● MTS8M

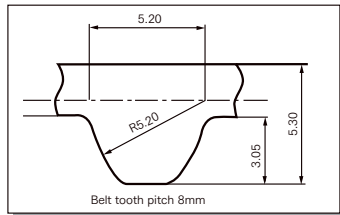

Standard Belt Width

Belt Width Code	Belt Width (mm)
150	15
250	25
300	30
400	40
600	60

250 | **MT** | **S8M** | **1680** | **G2**
 Belt Width (mm)x10 | MEGA TORQUE | Belt Type | Belt Length (mm) | G2 Specification

● MTS14M

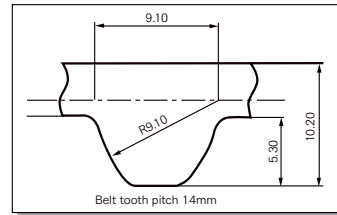

Standard Belt Width

Belt Width Code	Belt Width (mm)
400	40
600	60
800	80
1000	100
1200	120

600 | **MT** | **S14M** | **2100** | **G2**
 Belt Width (mm)x10 | MEGA TORQUE | Belt Type | Belt Length (mm) | G2 Specification

Standard Belt Sizes

MTS8M (Pitch 8 mm)

Product Code	No. of Teeth	Product Code	No. of Teeth	Product Code	No. of Teeth	Product Code	No. of Teeth
MTS8M 528 G2	66	MTS8M 1000 G2	125	MTS8M 1424 G2	178	MTS8M 2104 G2	263
MTS8M 560 G2	70	MTS8M 1024 G2	128	MTS8M 1440 G2	180	MTS8M 2120 G2	265
MTS8M 584 G2	73	MTS8M 1040 G2	130	MTS8M 1480 G2	185	MTS8M 2160 G2	270
MTS8M 600 G2	75	MTS8M 1056 G2	132	MTS8M 1488 G2	186	MTS8M 2240 G2	280
MTS8M 632 G2	79	MTS8M 1080 G2	135	MTS8M 1520 G2	190	MTS8M 2272 G2	284
MTS8M 640 G2	80	MTS8M 1120 G2	140	MTS8M 1552 G2	194	MTS8M 2304 G2	288
MTS8M 656 G2	82	MTS8M 1128 G2	141	MTS8M 1600 G2	200	MTS8M 2376 G2	297
MTS8M 712 G2	89	MTS8M 1136 G2	142	MTS8M 1640 G2	205	MTS8M 2400 G2	300
MTS8M 720 G2	90	MTS8M 1152 G2	144	MTS8M 1648 G2	206	MTS8M 2496 G2	312
MTS8M 760 G2	95	MTS8M 1160 G2	145	MTS8M 1680 G2	210	MTS8M 2600 G2	325
MTS8M 800 G2	100	MTS8M 1184 G2	148	MTS8M 1696 G2	212	MTS8M 2800 G2	350
MTS8M 824 G2	103	MTS8M 1200 G2	150	MTS8M 1728 G2	216	MTS8M 2920 G2	365
MTS8M 840 G2	105	MTS8M 1216 G2	152	MTS8M 1760 G2	220	MTS8M 2944 G2	368
MTS8M 848 G2	106	MTS8M 1224 G2	153	MTS8M 1776 G2	222	MTS8M 3048 G2	381
MTS8M 856 G2	107	MTS8M 1248 G2	156	MTS8M 1792 G2	224	MTS8M 3200 G2	400
MTS8M 880 G2	110	MTS8M 1256 G2	157	MTS8M 1800 G2	225	MTS8M 3248 G2	406
MTS8M 896 G2	112	MTS8M 1280 G2	160	MTS8M 1816 G2	227	MTS8M 3272 G2	409
MTS8M 912 G2	114	MTS8M 1296 G2	162	MTS8M 1832 G2	229	MTS8M 3440 G2	430
MTS8M 920 G2	115	MTS8M 1304 G2	163	MTS8M 1880 G2	235	MTS8M 3680 G2	460
MTS8M 928 G2	116	MTS8M 1312 G2	164	MTS8M 1912 G2	239	MTS8M 3720 G2	465
MTS8M 944 G2	118	MTS8M 1320 G2	165	MTS8M 1960 G2	245	MTS8M 3904 G2	488
MTS8M 952 G2	119	MTS8M 1352 G2	169	MTS8M 2000 G2	250	MTS8M 3928 G2	491
MTS8M 960 G2	120	MTS8M 1360 G2	170	MTS8M 2040 G2	255	MTS8M 4400 G2	550
MTS8M 976 G2	122	MTS8M 1384 G2	173	MTS8M 2048 G2	256		
MTS8M 984 G2	123	MTS8M 1400 G2	175	MTS8M 2064 G2	258		

MTS14M (Pitch 14 mm)

Product Code	No. of Teeth	Product Code	No. of Teeth	Product Code	No. of Teeth	Product Code	No. of Teeth
MTS14M 1008 G2	72	MTS14M 1708 G2	122	MTS14M 2198 G2	157	MTS14M 3360 G2	240
MTS14M 1120 G2	80	MTS14M 1736 G2	124	MTS14M 2240 G2	160	MTS14M 3500 G2	250
MTS14M 1190 G2	85	MTS14M 1750 G2	125	MTS14M 2310 G2	165	MTS14M 3556 G2	254
MTS14M 1246 G2	89	MTS14M 1778 G2	127	MTS14M 2380 G2	170	MTS14M 3850 G2	275
MTS14M 1288 G2	92	MTS14M 1806 G2	129	MTS14M 2450 G2	175	MTS14M 4004 G2	286
MTS14M 1400 G2	100	MTS14M 1890 G2	135	MTS14M 2506 G2	179	MTS14M 4508 G2	322
MTS14M 1470 G2	105	MTS14M 1932 G2	138	MTS14M 2590 G2	185	MTS14M 5012 G2	358
MTS14M 1540 G2	110	MTS14M 1960 G2	140	MTS14M 2660 G2	190		
MTS14M 1610 G2	115	MTS14M 2002 G2	143	MTS14M 2800 G2	200		
MTS14M 1652 G2	118	MTS14M 2100 G2	150	MTS14M 3150 G2	225		

MegaTorque EX

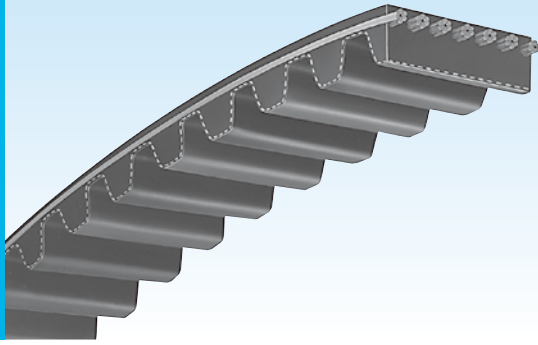

Characteristics and advantages of High Precision Positioning Timing Belt

- **Jumping resistance** By introducing extra high modulus cord, belt jumping torque extremely increase thus it prevent belt jumping against sudden acceleration and deceleration.
- **High damping characteristic** With using extra high modulus cord, damping characteristic is improved. It shorten the time for stopping the belt vibration and makes better accurate positioning efficiency.
- **High precision of positioning repeatability** Less stretch of the belt provides high accuracy of positioning repeatability. Belt positioning efficiency and repeatability extremely increase by using special pulley for minimum backlash.

● MTS3M

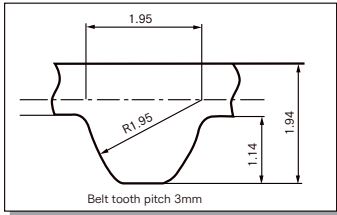

Standard Belt Width

Belt Width Code	Belt Width (mm)
60	6
100	10
150	15

100 | **MT** | **S3M** | **450** | **EX**
 Belt Width (mm)x10 | MEGA TORQUE | Belt Type | Belt Length (mm) | EX Specification

● MTS5M

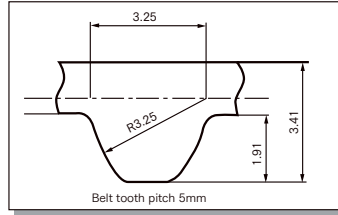

Standard Belt Width

Belt Width Code	Belt Width (mm)
100	10
150	15
250	25

100 | **MT** | **S5M** | **600** | **EX**
 Belt Width (mm)x10 | MEGA TORQUE | Belt Type | Belt Length (mm) | EX Specification

Standard Belt Sizes

MTS3M (Pitch 3 mm)			
Product Code	No. of Teeth	Product Code	No. of Teeth
MTS3M 240 EX	80	MTS3M 540 EX	180
MTS3M 270 EX	90	MTS3M 570 EX	190
MTS3M 300 EX	100	MTS3M 588 EX	196
MTS3M 324 EX	108	MTS3M 600 EX	200
MTS3M 330 EX	110	MTS3M 660 EX	220
MTS3M 360 EX	120	MTS3M 720 EX	240
MTS3M 390 EX	130	MTS3M 780 EX	260
MTS3M 420 EX	140	MTS3M 1035 EX	345
MTS3M 450 EX	150	MTS3M 1521 EX	507
MTS3M 480 EX	160	MTS3M 1788 EX	596
MTS3M 510 EX	170	MTS3M 2538 EX	846

Standard Belt Sizes

MTS5M (Pitch 5 mm)			
Product Code	No. of Teeth	Product Code	No. of Teeth
MTS5M 275 EX	55	MTS5M 690 EX	138
MTS5M 300 EX	60	MTS5M 700 EX	140
MTS5M 325 EX	65	MTS5M 720 EX	144
MTS5M 350 EX	70	MTS5M 750 EX	150
MTS5M 400 EX	80	MTS5M 800 EX	160
MTS5M 435 EX	87	MTS5M 850 EX	170
MTS5M 450 EX	90	MTS5M 880 EX	176
MTS5M 500 EX	100	MTS5M 900 EX	180
MTS5M 525 EX	105	MTS5M 950 EX	190
MTS5M 550 EX	110	MTS5M 1000 EX	200
MTS5M 575 EX	115	MTS5M 1780 EX	356
MTS5M 600 EX	120	MTS5M 3835 EX	767
MTS5M 650 EX	130		

GigaTorque GX

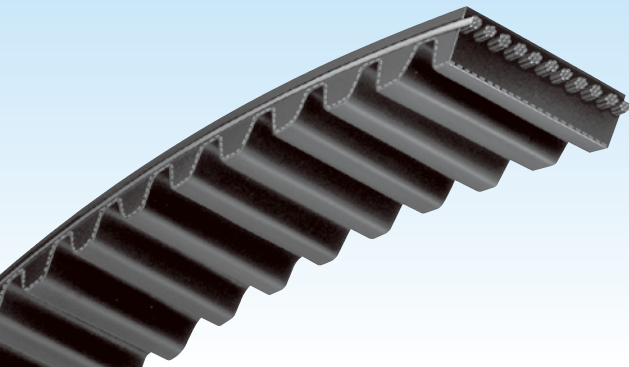

- Introducing high modulus but high flexibility carbon cord, this belt shows high tenacity and high flexibility.
- You may expect this belt to minimize space, weight and noise of machinery and equipment by applying narrower belt width compared to regular timing belt.
- This belt can be applied for the applicability of chain drive system.

Dimensions

- Tooth Shape & Product Code -

●G8M

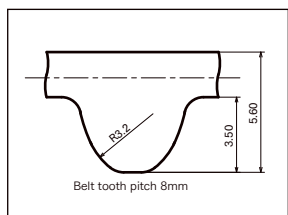

G8M Standard Belt Width

Belt Width(mm)	12	15	20	21	25	30	36	40	50	60	62	70	80
Belt Width Code	120	150	200	210	250	300	360	400	500	600	620	700	800

3 6 0 | **G 8 M** | **2 4 0 0** | **G X**
 Nominal Width (mm X 10) | Belt Type | Nominal Length (mm) | GX Spec.

●G14M

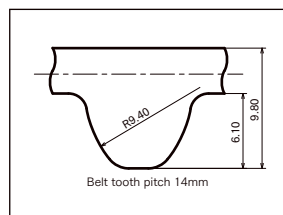

G14M Standard Belt Width

Belt Width(mm)	20	30	37	40	50	60	68	70	80	90	100	115	125	130
Belt Width Code	200	300	370	400	500	600	680	700	800	900	1000	1150	1250	1300

3 7 0 | **G 1 4 M** | **2 1 0 0** | **G X**
 Nominal Width (mm X 10) | Belt Type | Nominal Length (mm) | GX Spec.

Standard Belt Sizes

G8M			
Product Code	No. of Teeth	Product Code	No. of Teeth
G8M 640	80	G8M 2000	250
G8M 720	90	G8M 2200	275
G8M 800	100	G8M 2240	280
G8M 896	112	G8M 2400	300
G8M 960	120	G8M 2520	315
G8M 1000	125	G8M 2600	325
G8M 1040	130	G8M 2800	350
G8M 1120	140	G8M 2840	355
G8M 1200	150	G8M 3048	381
G8M 1224	153	G8M 3200	400
G8M 1280	160	G8M 3280	410
G8M 1440	180	G8M 3600	450
G8M 1600	200	G8M 4000	500
G8M 1760	220	G8M 4400	550
G8M 1792	224	G8M 4480	560

Standard Belt Sizes

G14M			
Product Code	No. of Teeth	Product Code	No. of Teeth
G14M 994	71	G14M 2450	175
G14M 1120	80	G14M 2520	180
G14M 1190	85	G14M 2590	185
G14M 1260	90	G14M 2660	190
G14M 1400	100	G14M 2800	200
G14M 1568	112	G14M 3136	224
G14M 1610	115	G14M 3304	236
G14M 1750	125	G14M 3360	240
G14M 1890	135	G14M 3500	250
G14M 1960	140	G14M 3850	275
G14M 2100	150	G14M 3920	280
G14M 2240	160	G14M 4326	309
G14M 2310	165	G14M 4410	315
G14M 2380	170		

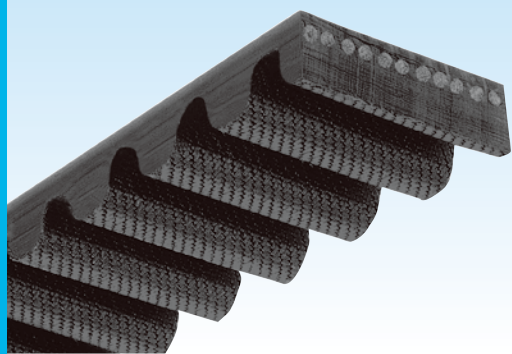

H Series

Round -shape belt teeth enable the distribution of load stress uniformly over the entire belt tooth. Since the belt tooth engages with the pulley groove without any interference, stress concentration at the root of the belt tooth can be eliminated. This belt can be used as an alternative for chains and gears with next advantages :

- High power transmission capacity
- Long operative life
- Quiet operation
- Cost-efficiency

Dimensions

- Tooth Shape & Product Code -

●H8M

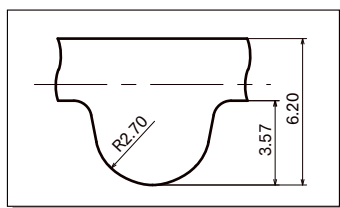

H8M Standard Belt Width

Belt Width (mm)	20.0	30.0	50.0	85.0
Belt Width Code	20	30	50	85

8 0 0 **H 8 M** **3 0**
 Belt Pitch Length Belt Type Belt Width

●H14M

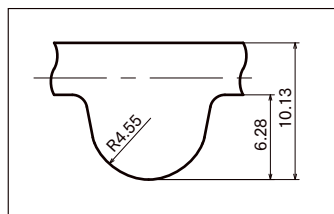

H14M Standard Belt Width

Belt Width (mm)	40.0	55.0	85.0	115.0
Belt Width Code	40	55	85	115

1 4 0 **H 1 4 M** **4 0**
 Belt Pitch Length Belt Type Belt Width

The above mentioned shapes and figures are only for reference.

Standard Belt Sizes

H8M (Pitch 8 mm)			
Product Code	No. of Teeth	Product Code	No. of Teeth
424 H8M	53	1280 H8M	160
480 H8M	60	1304 H8M	163
536 H8M	67	1320 H8M	165
560 H8M	70	1360 H8M	170
592 H8M	74	1392 H8M	174
600 H8M	75	1400 H8M	175
624 H8M	78	1424 H8M	178
632 H8M	79	1432 H8M	179
640 H8M	80	1440 H8M	180
656 H8M	82	1480 H8M	185
680 H8M	85	1520 H8M	190
720 H8M	90	1600 H8M	200
760 H8M	95	1680 H8M	210
776 H8M	97	1696 H8M	212
800 H8M	100	1728 H8M	216
840 H8M	105	1760 H8M	220
856 H8M	107	1800 H8M	225
880 H8M	110	1896 H8M	237
896 H8M	112	1904 H8M	238
912 H8M	114	1936 H8M	242
920 H8M	115	2000 H8M	250
936 H8M	117	2080 H8M	260
960 H8M	120	2104 H8M	263
968 H8M	121	2160 H8M	270
1000 H8M	125	2240 H8M	280
1040 H8M	130	2272 H8M	284
1056 H8M	132	2400 H8M	300
1064 H8M	133	2504 H8M	313
1080 H8M	135	2600 H8M	325
1120 H8M	140	2800 H8M	350
1128 H8M	141	3048 H8M	381
1152 H8M	144	3200 H8M	400
1160 H8M	145	3280 H8M	410
1200 H8M	150	3600 H8M	450
1224 H8M	153		
1248 H8M	156		

Standard Belt Sizes

H14M (Pitch 14 mm)			
Product Code	No. of Teeth	Product Code	No. of Teeth
784 H14M	56	1736 H14M	124
826 H14M	59	1778 H14M	127
924 H14M	66	1890 H14M	135
966 H14M	69	1932 H14M	138
1148 H14M	82	1946 H14M	139
1190 H14M	85	2002 H14M	143
1344 H14M	96	2100 H14M	150
1400 H14M	100	2198 H14M	157
1456 H14M	104	2310 H14M	165
1512 H14M	108	2450 H14M	175
1540 H14M	110	2590 H14M	185
1568 H14M	112	2940 H14M	210
1610 H14M	115	3150 H14M	225
1638 H14M	117	3500 H14M	250
1652 H14M	118	4578 H14M	327
1680 H14M	120		

Trapezoidal Tooth Timing Belt

Belt Type, Dimensions & Product Code

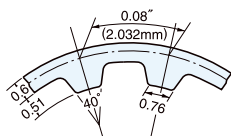
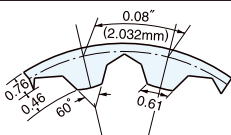
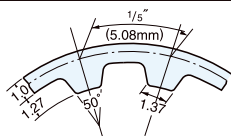
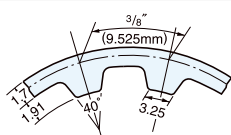
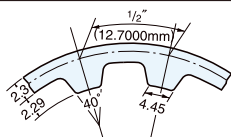
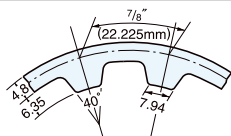
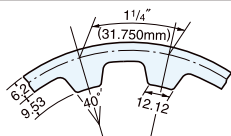
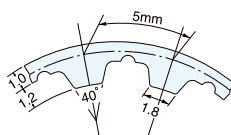
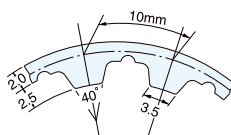
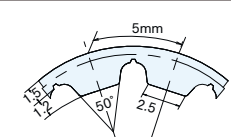
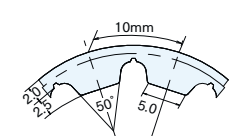
Belt Type	Standard Dimensions	Standard Width		Product Code	Minimum Pulley Size ¹		Applications
		Code	Width(mm)		Pulley Diameter(mm)	No. of teeth	
MXL (DMXL) GB		3.2 4.8 6.4 9.5 12.7	3.2 4.8 6.4 9.5 12.7	125 (D) MXL 6.4 No. of Teeth Belt Type Belt Width(mm)	6.47	10	Home sewing machine, typewriter, ATM, coin changer, cash register, printing machine, facsimile, measurement equipment, ticket machine, camera, paper feeder, printer, CPU peripherals, card reader, fish sonar finder, medical measurement equipment, radio-controlled model, audio player, VTR, editing equipment
T80 U		3.2 4.8 6.4 8.0 9.5	3.2 4.8 6.4 8.0 9.5	125 T80 6.4 No. of Teeth Belt Type Belt Width(mm)	6.47	10	Printer, copier, car antenna, projector
XL GB•U (DXL) GB		025 031 037 050	6.4 7.9 9.5 12.7	120 (D) XL 037 Double Type Belt Width (inch)×100 Belt Length (inch)×10 Belt Type	16.17	10	Home sewing machine, line printer, medical bed, electrical shaver, auto door, copier, massage machine, editing machine, ticket machine, mower, food processor, calculator, fish sonar finder, blood pump, home meat slicer
L G•U (DL) G		050 075 100 150	12.7 19.1 25.4 38.1	510 (D) L 100 Double Type Belt Width (inch)×100 Belt Length (inch)×10 Belt Type	36.38	12	Vending machine, wiper, packing machine, quenching machine, lift, ice crusher, industrial drier, automated golf cart, computer, copier, plastic lens polishing machine, food processing machine, seaweed collector
H (DH) G		075 100 150 200 300	19.1 25.4 38.1 50.8 76.2	510 (D) H 100 Double Type Belt Width (inch)×100 Belt Length (inch)×10 Belt Type	56.60	14	Small milling machine, mower, power generator, compressor, scrap chopper, hole finishing machine, drilling machine, glass bottle making machine, food processing machines, rope coiler, roll coater, mill roll, woodworking machinery
XH G		200 300 400 500 600	50.8 76.2 101.6 127.0 152.4	1120 XH 300 Belt Length (inch)×10 Belt Width (inch)×100 Belt Type	127.34	18	Saw mill, cutting machine, cutter, mixer, pump, welder, centrifuge, drilling machine, oscillating mill, lathe, wool loom, paper manufacturing machine, textile machine
XXH G		200 300 400 500 600	50.8 76.2 101.6 127.0 152.4	1200 XXH 300 Belt Length (inch)×10 Belt Width (inch)×100 Belt Type	181.92	18	Blower, high pressure pump, change gear, rod mill, compressor, NC lathe, vibrator, mixer, abrasive boring machine
T5 (DT5) U		05 10 15 20	5.0 10.0 15.0 20.0	(D) T5 - 20 - 100 Double Type Belt Type No. of Teeth Belt Width(mm)	19.10	12	Data writer, facsimile, sewing machine
T10 (DT10) U		15 20 25 30 40 50	15.0 20.0 25.0 30.0 40.0 50.0	(D) T10 - 20 - 100 Double Type Belt Type No. of Teeth Belt Width(mm)	44.56	14	Packaging machine, card reader, textile machine, paper manufacturing machine, NC lathe, conveyor
AT5 U		10 20 30	10.0 20.0 30.0	AT5 - 20 - 975 Belt Type Belt Length(mm) Belt Width(mm)	19.10	12	Machine tools, pumps, textile machinery
AT10 U		10 20 30	10.0 20.0 30.0	AT10 - 20 - 1280 Belt Type Belt Length(mm) Belt Width(mm)	47.75	15	Construction machines, pumps, paper-making machines, compressors, textile machinery, sanding machines, machine tools, roller-table conveyor drives.

●GB : Bare Back Rubber Timing Belt ●G : Rubber Timing Belt ●U : Polyurethane Timing Belt

(Note) 1. Maximum transmission power varies depending on belt width and operating speed with the same belt.

The values in above table are for your reference. Please use correct values from relevant design catalog when you design.

2. For G (rubber) type, use heat resistant or oil resistant specification when the belts are used in high temperature (up to 120 °C) or where oil may contaminate the belts.

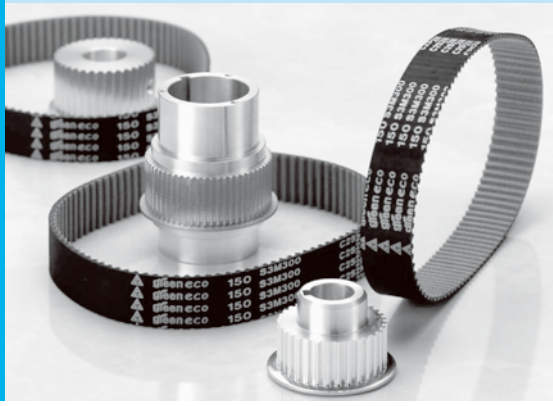

green eco® Series

Environmental-friendly rubber timing belts with EPDM compound rubber use.

- Excellent ozone resistance
- Less dispersion of rubber dust

Standard Dimensions and Product Code

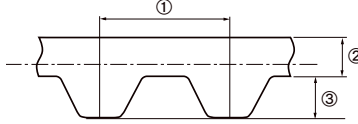
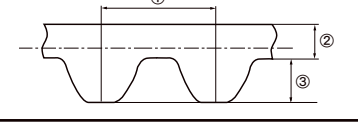
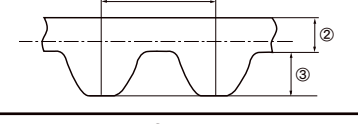
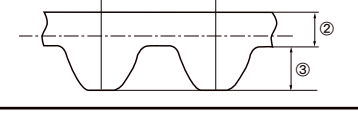
Belt Type	Standard Dimensions	Product Code
MXL	 <p>① 0.08" (2.032mm) ② 0.6mm ③ 0.51mm</p>	<p>125MXL12.7</p> <p>Belt Type</p> <p>No. of Teeth Belt Width (mm)</p>
S2M	 <p>① 2.0mm ② 0.6mm ③ 0.76mm</p>	<p>40S2M160</p> <p>Belt Type</p> <p>Belt Width (mm) x10 Nominal Length (mm)</p>
S3M	 <p>① 3.0mm ② 0.8mm ③ 1.14mm</p>	<p>100S3M459</p> <p>Belt Type</p> <p>Belt Width (mm) x10 Nominal Length (mm)</p>
S5M	 <p>① 5.0mm ② 1.5mm ③ 1.91mm</p>	<p>250S5M1125</p> <p>Belt Type</p> <p>Belt Width (mm) x10 Nominal Length (mm)</p>

Timing Belt G

Standard Belt Sizes

Belt Type	XH			XXH		
Tooth Pitch	22.225(mm)			31.750(mm)		
Code(Width)	200 (50.8 mm) 300 (76.2 mm) 400 (101.6 mm) 500 (127.0 mm) 600 (152.4 mm)			200 (50.8 mm) 300 (76.2 mm) 400 (101.6 mm) 500 (127.0 mm) 600 (152.4 mm)		
Size	Product Code	No.of Teeth	Belt Pitch Length(mm)	Product Code	No.of Teeth	Belt Pitch Length(mm)
	463 XH	53	1177.93	700 XXH	56	1778.00
	507 XH	58	1289.05	800 XXH	64	2032.00
	560 XH	64	1422.40	900 XXH	72	2286.00
	630 XH	72	1600.20	1000 XXH	80	2540.00
	700 XH	80	1778.00	1200 XXH	96	3048.00
	735 XH	84	1866.90	1400 XXH	112	3556.00
	770 XH	88	1955.80	1600 XXH	128	4064.00
	840 XH	96	2133.60	1800 XXH	144	4572.00
	927 XH	106	2355.85			
	980 XH	112	2489.20			
	1120 XH	128	2844.80			
	1260 XH	144	3200.40			
	1400 XH	160	3556.00			
	1540 XH	176	3911.60			
	1750 XH	200	4445.00			

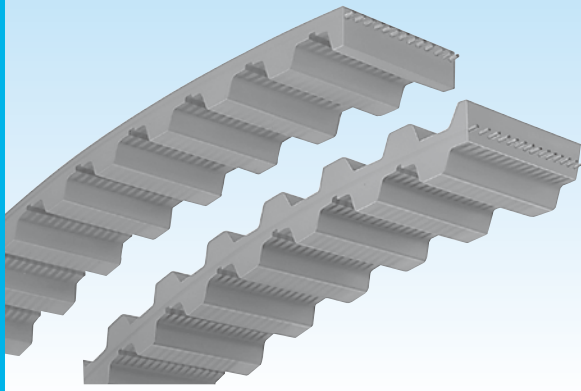

Timing Belt U

With its high abrasion resistance and lesser rubber dust dispersion, polyurethane timing belts are suitable for use in places where clean environments are required.

- The best for light-duty transmission which requires high precision
- Suitable for paper feeding use because it does not contaminate contact subject.
- Smooth and quiet operation as it is flexible to fit well in small diameter pulleys.
- Made-to-order system enables manufacture of special form orders.

Standard Belt Sizes

Belt Type	T80												
	2.032 (mm)												
	3.2 (3.2mm)			4.8 (4.8mm)			6.4 (6.4mm)			9.5 (9.5mm)			
Code(Width)	Product Code	No.of Teeth	Belt Pich Length(mm)	Product Code	No.of Teeth	Belt Pich Length(mm)	Product Code	No.of Teeth	Belt Pich Length(mm)	Product Code	No.of Teeth	Belt Pich Length(mm)	
Size	30 T80	30	60.96	104 T80	104	211.33	220 T80	220	447.04	358 T80	358	727.46	
	35 T80	35	71.12	105 T80	105	213.36	221 T80	221	449.07	360 T80	360	731.52	
	40 T80	40	81.28	106 T80	106	215.39	224 T80	224	455.17	370 T80	370	751.84	
	45 T80	45	91.44	108 T80	108	219.46	225 T80	225	457.20	380 T80	380	772.16	
	46 T80	46	93.47	110 T80	110	223.52	228 T80	228	463.30	390 T80	390	792.48	
	48 T80	48	97.54	112 T80	112	227.58	230 T80	230	467.36	397 T80	397	806.70	
	50 T80	50	101.60	114 T80	114	231.65	232 T80	232	471.42	400 T80	400	812.80	
	52 T80	52	105.66	115 T80	115	233.68	235 T80	235	477.52	403 T80	403	818.90	
	53 T80	53	107.70	118 T80	118	239.78	236 T80	236	479.55	420 T80	420	853.44	
	54 T80	54	109.73	120 T80	120	243.84	239 T80	239	485.65	434 T80	434	881.89	
	55 T80	55	111.76	121 T80	121	245.87	240 T80	240	487.68	473 T80	473	961.14	
	56 T80	56	113.79	122 T80	122	247.90	245 T80	245	497.84	474 T80	474	963.17	
	57 T80	57	115.82	123 T80	123	249.94	248 T80	248	503.94	500 T80	500	1016.00	
	59 T80	59	119.89	124 T80	124	251.97	249 T80	249	505.97	515 T80	515	1046.48	
	60 T80	60	121.92	125 T80	125	254.00	250 T80	250	508.00	550 T80	550	1117.60	
	63 T80	63	128.02	126 T80	126	256.03	255 T80	255	518.16	583 T80	583	1184.66	
	65 T80	65	132.08	130 T80	130	264.16	256 T80	256	520.19	916 T80	916	1861.31	
	67 T80	67	136.14	131 T80	131	266.19	260 T80	260	528.32				
	68 T80	68	138.18	132 T80	132	268.22	262 T80	262	532.38				
	70 T80	70	142.24	135 T80	135	274.32	265 T80	265	538.48				
	71 T80	71	144.27	140 T80	140	284.48	270 T80	270	548.64				
	72 T80	72	146.30	142 T80	142	288.54	275 T80	275	558.80				
	73 T80	73	148.34	144 T80	144	292.61	277 T80	277	562.86				
	74 T80	74	150.37	145 T80	145	294.64	279 T80	279	566.93				
	75 T80	75	152.40	148 T80	148	300.74	280 T80	280	568.96				
	77 T80	77	156.46	150 T80	150	304.80	285 T80	285	579.12				
	78 T80	78	158.50	155 T80	155	314.96	288 T80	288	585.22				
	80 T80	80	162.56	156 T80	156	316.99	290 T80	290	589.28				
	81 T80	81	164.59	157 T80	157	319.02	295 T80	295	599.44				
	82 T80	82	166.62	160 T80	160	325.12	296 T80	296	609.60				
	83 T80	83	168.66	165 T80	165	335.28	300 T80	300	601.47				
	85 T80	85	172.72	170 T80	170	345.44	304 T80	304	617.73				
	87 T80	87	176.78	175 T80	175	355.60	310 T80	310	629.92				
	88 T80	88	178.82	180 T80	180	365.76	312 T80	312	633.98				
	89 T80	89	180.85	184 T80	184	373.89	315 T80	315	640.08				
	90 T80	90	182.88	185 T80	185	375.92	318 T80	318	646.18				
	91 T80	91	184.91	190 T80	190	386.08	320 T80	320	650.24				
	93 T80	93	188.98	195 T80	195	396.24	324 T80	324	658.37				
	94 T80	94	191.01	200 T80	200	406.40	330 T80	330	670.56				
	95 T80	95	193.04	205 T80	205	416.56	336 T80	336	682.75				
	97 T80	97	197.10	208 T80	208	422.66	340 T80	340	690.88				
	98 T80	98	199.14	210 T80	210	426.72	341 T80	341	692.91				
	100 T80	100	203.20	212 T80	212	430.78	344 T80	344	699.01				
	102 T80	102	207.26	215 T80	215	436.88	350 T80	350	711.20				
	103 T80	103	209.30	219 T80	219	445.01	355 T80	355	721.36				

● This type is usually made-to-order. However, please check for stock availability when placing order.

Timing Belt U

Standard Belt Sizes

Belt Type	XL						L			
Tooth Pitch	5.08 (mm)						9.525 (mm)			
Code(Width)	025 (6.4mm)		031 (7.9mm)		037 (9.5mm)		050 (12.7mm)		075 (19.1mm) 100 (25.4mm) 150 (38.1mm)	
	Product Code	No. of Teeth	Belt Pich Length(mm)	Product Code	No. of Teeth	Belt Pich Length(mm)	Product Code	No. of Teeth	Belt Pich Length(mm)	
Size	60 XL	30	152.40	210 XL	105	533.40	124 L	33	314.33	
	64 XL	32	162.56	212 XL	106	538.48	150 L	40	381.00	
	66 XL	33	167.64	220 XL	110	558.80	165 L	44	419.10	
	70 XL	35	177.80	224 XL	112	568.96	173 L	46	438.15	
	76 XL	38	193.04	230 XL	115	584.20	187 L	50	476.25	
	78 XL	39	198.12	240 XL	120	609.60	210 L	56	533.40	
	80 XL	40	203.20	250 XL	125	635.00	225 L	60	571.50	
	84 XL	42	213.36	254 XL	127	645.16	240 L	64	609.60	
	90 XL	45	228.60	260 XL	130	660.40	255 L	68	647.70	
	94 XL	47	238.76	270 XL	135	685.80	270 L	72	685.80	
	100 XL	50	254.00	290 XL	145	736.60	285 L	76	723.90	
	102 XL	51	259.08	300 XL	150	762.00	300 L	80	762.00	
	104 XL	52	264.16	320 XL	160	812.80	304 L	81	771.53	
	106 XL	53	269.24	330 XL	165	838.20	322 L	86	819.15	
	108 XL	54	274.32	340 XL	170	863.60	345 L	92	876.30	
	110 XL	55	279.40	348 XL	174	883.92	367 L	98	933.45	
	114 XL	57	289.56	352 XL	176	894.08	375 L	100	952.50	
	116 XL	58	294.64	360 XL	180	914.40	390 L	104	990.60	
	120 XL	60	304.80	376 XL	188	955.04	420 L	112	1066.80	
	124 XL	62	314.96	384 XL	192	975.36	427 L	114	1085.85	
	126 XL	63	320.04	390 XL	195	990.60	450 L	120	1143.00	
	128 XL	64	325.12	396 XL	198	1005.84	480 L	128	1219.20	
	130 XL	65	330.20	414 XL	207	1051.56	510 L	136	1295.40	
	136 XL	68	345.44	430 XL	215	1092.20	525 L	140	1333.50	
	140 XL	70	355.60	460 XL	230	1168.40	540 L	144	1371.60	
	142 XL	71	360.68	480 XL	240	1219.20	600 L	160	1524.00	
	146 XL	73	370.84	490 XL	245	1244.60				
	148 XL	74	375.92	512 XL	256	1300.48				
	150 XL	75	381.00	540 XL	270	1371.60				
	152 XL	76	386.08	544 XL	272	1381.76				
	154 XL	77	391.16	564 XL	282	1432.56				
	160 XL	80	406.40	630 XL	315	1600.20				
	166 XL	83	421.64	670 XL	335	1701.80				
	168 XL	84	426.72	730 XL	365	1854.20				
	170 XL	85	431.80	842 XL	421	2138.68				
	176 XL	88	447.04							
	180 XL	90	457.20							
	186 XL	93	472.44							
	190 XL	95	482.60							
	200 XL	100	508.00							

T5 (DT5)								T10 (DT10)							
5.0 (mm)								10.0 (mm)							
05 (5.0mm)		10 (10.0mm)		15 (15.0mm)		20 (20.0mm)		40 (40.0mm)		50 (50.0mm)					
No. of Teeth	Belt Pitch Length (mm)	No. of Teeth	Belt Pitch Length (mm)	No. of Teeth	Belt Pitch Length (mm)	No. of Teeth	Belt Pitch Length (mm)	No. of Teeth	Belt Pitch Length (mm)	No. of Teeth	Belt Pitch Length (mm)	No. of Teeth	Belt Pitch Length (mm)	No. of Teeth	Belt Pitch Length (mm)
33	165	71	355	(D) 110	550	(D) 170	850	※(D) 36	360	(D) 80	800	114	1140	(D) 170	1700
37	185	72	360	112	560	(D) 172	860	37	370	81	810	115	1150	175	1750
40	200	73	365	115	575	(D) 180	900	40	400	(D) 84	840	(D) 120	1200	178	1780
43	215	75	375	(D) 118	590	(D) 188	940	41	410	85	850	(D) 121	1210	(D) 180	1800
44	220	78	390	(D) 120	600	195	975	44	440	88	880	(D) 124	1240	(D) 188	1880
45	225	(D) 80	400	122	610	198	990	45	450	89	890	(D) 125	1250	196	1960
49	245	(D) 82	410	(D) 124	620	200	1000	50	500	(D) 90	900	(D) 130	1300	216	2160
50	250	84	420	125	625	215	1075	(D) 53	530	91	910	(D) 132	1320	220	2200
51	255	85	425	126	630	(D) 220	1100	55	550	92	920	(D) 135	1350	221	2210
52	260	88	440	(D) 130	650	(D) 228	1140	56	560	94	940	138	1380	225	2250
54	270	89	445	132	660	243	1215	(D) 60	600	95	950	139	1390		
55	275	(D) 90	450	135	675	276	1380	61	610	96	960	(D) 140	1400		
56	280	91	455	138	690	288	1440	(D) 63	630	97	970	(D) 142	1420		
59	295	(D) 92	460	(D) 140	700			65	650	(D) 98	980	144	1440		
(D) 60	300	95	475	144	720			(D) 66	660	(D) 100	1000	145	1450		
61	305	(D) 96	480	145	725			69	690	101	1010	146	1460		
65	325	(D) 100	500	(D) 150	750			(D) 70	700	105	1050	(D) 150	1500		
66	330	102	510	156	780			(D) 72	720	108	1080	156	1560		
68	340	※(D) 103	515	(D) 160	800			(D) 75	750	(D) 110	1100	(D) 160	1600		
(D) 70	350	105	525	(D) 163	815			78	780	111	1110	(D) 161	1610		
		109	545	168	840										

● (D) signifies double timing belt.

Standard Belt Sizes

New!

Belt Type	AT5			AT10		
Tooth Pitch	5.0(mm)			10.0(mm)		
Code(Width)	10(10.0mm)	20(20.0mm)	30(30.0mm)	10(10.0mm)	20(20.0mm)	30(30.0mm)
Size	No.of Teeth	Belt Pitch Length(mm)		No.of Teeth	Belt Pitch Length(mm)	
		60	300		61	610
	68	340		66	660	
	75	375		70	700	
	78	390		78	780	
	84	420		80	800	
	90	450		84	840	
	100	500		89	890	
	109	545		92	920	
	120	600		98	980	
	122	610		105	1050	
	132	660		108	1080	
	142	710		110	1100	
	144	720		115	1150	
	150	750		120	1200	
	156	780		121	1210	
	172	860		125	1250	
	195	975		128	1280	
	210	1050		132	1320	
	300	1500		140	1400	
				148	1480	
				160	1600	
				180	1800	
				186	1860	
				194	1940	

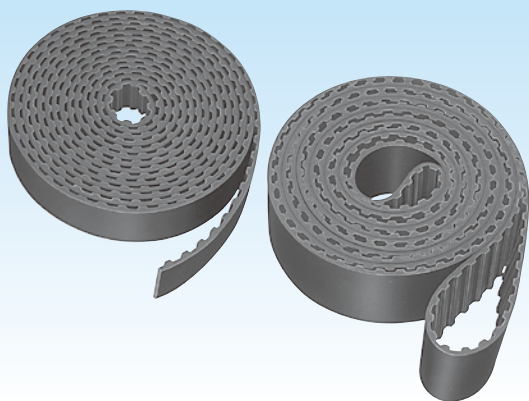

LONG-SPAN Timing Belt (Open-End & Endless)

This belt is for long-span linear drives and light-duty synchronous transmission and transportation.

- Freer design possible as the length can be extended.

● Rubber Timing Belt

Size Range for Open-End Type

Trapezoidal tooth (MXL, XL, L, H) (Unit: m)

Belt Type	Width (mm)	6.4	9.5	12.7	19.1	25.4	38.1
	Inch. x100	025	037	050	075	100	150
		67	44	34	—	—	—
		129	86	64	—	—	—
		—	—	72	47	34	—
		—	—	129	86	63	41

* Please order by above length unit.

Round tooth (S2M, S3M, S5M, S8M, S14M) (Unit: m)

Belt Type	Width (mm)	4	6	10	15	20	25	30	40	50	60
	S2M		89	58	35	—	—	—	—	—	—
S3M		—	110	65	43	—	—	—	—	—	—
S5M		—	—	78	50	87	68	—	—	—	—
S8M		—	—	124	82	60	48	55	39	30	24
S14M		—	—	—	—	—	58	48	34	27	—

* Please order by above length unit.

Size Range for Endless Type

Belt Type	Belt Width (mm)		Maximum Belt Length (m)
	Minimum	Maximum	
L	12.7	355	20.0
H	19.1	343	20.0
XH	50.8	406	20.0
XXH	50.8	406	20.0
S8M	19.0	342	20.0
S14M	50.0	406	20.0

* Please take the tension limit as around 1/2 that of common sized timing belt.

● Thermosetting Polyurethane Timing Belt

Size Range for Open-End Type

Trapezoidal tooth (T80, XL, L) (Unit: m)

Belt Type	Width (mm)	6.4	9.5	12.7	19.1
	Inch.	025	037	050	075
T80		52	35	—	—
XL		71	48	36	17
L		—	51	38	10

Trapezoidal tooth (T5, T10) (Unit: m)

Belt Type	Width (mm)	5	10	15	20	25
	T5		87	44	29	—
T10		—	49	32	17	13

Round tooth (S2M, S3M) (Unit: m)

Belt Type	Width (mm)	4	5	6	10	15	20	25
	S2M		99	80	67	—	—	—
S3M		—	98	82	50	33	—	—

Example

① Trapezoidal tooth (MXL*, XL, L, H)

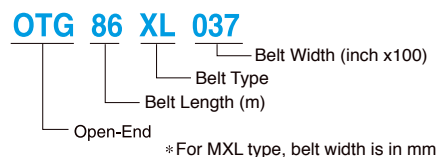

② Round tooth (S2M, S3M, S5M, S8M, S14M)

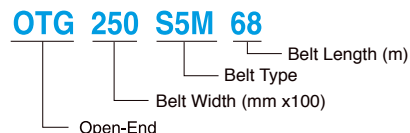

Example

① Trapezoidal tooth (L, H, XH, XXH)

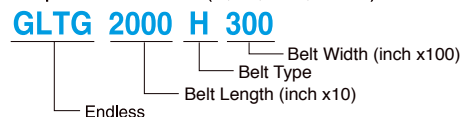

② Round tooth (S8M, S14M)

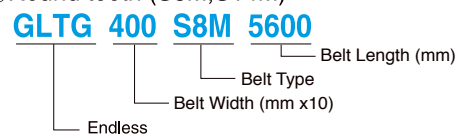

Example

① Trapezoidal tooth (T80, T5, T10, XL*, L*)

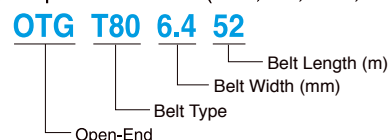

② Round tooth (S2M, S3M)

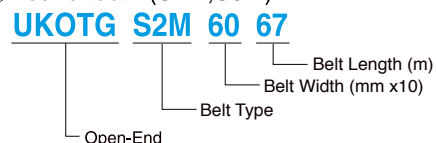

Timing Pulley

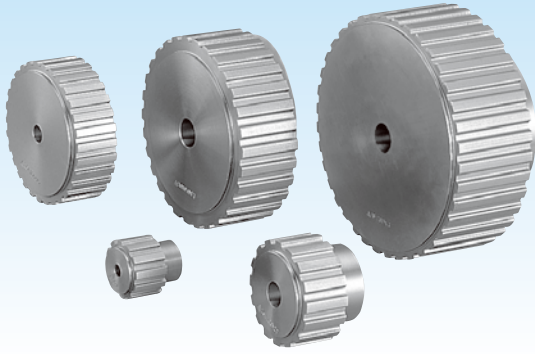

Timing belt power transmission systems work the best when high-accuracy belts and precisely processed pulleys smoothly mesh with each other.

- Cutting with hob cutter enables good power transmission.
- MBL accepts your request for material, form and processing method.
- Flange is not sold separately as a single item.

Standard Pulley Types & Sizes

Belt Type	MXL-Rod shape				
No. of Teeth	Length (mm)	Material	OD (mm)	PD (mm)	Product Code
10			5.96	6.47	P10 MXL 100
12			7.25	7.76	P12 MXL 100
13			7.90	8.41	P13 MXL 100
14			8.55	9.06	P14 MXL 100
15			9.19	9.70	P15 MXL 100
16			9.84	10.35	P16 MXL 100
17			10.49	11.00	P17 MXL 100
18			11.13	11.64	P18 MXL 100
19			11.78	12.29	P19 MXL 100
20			12.43	12.94	P20 MXL 100
21			13.07	13.58	P21 MXL 100
22			13.72	14.23	P22 MXL 100
23			14.37	14.88	P23 MXL 100
24			15.02	15.52	P24 MXL 100
25			15.66	16.17	P25 MXL 100
26			16.31	16.82	P26 MXL 100
27			16.96	17.46	P27 MXL 100
28			17.60	18.11	P28 MXL 100
30			18.90	19.40	P30 MXL 100
32			20.19	20.70	P32 MXL 100
34			21.48	21.99	P34 MXL 100
36			22.78	23.29	P36 MXL 100
38			24.07	24.58	P38 MXL 100
40			25.36	25.87	P40 MXL 100
42			26.66	27.17	P42 MXL 100
44			27.95	28.46	P44 MXL 100
48			30.54	31.05	P48 MXL 100
50			31.83	32.34	P50 MXL 100
52			33.13	33.63	P52 MXL 100
54			34.42	34.93	P54 MXL 100
56			35.71	36.22	P56 MXL 100
60			38.30	38.81	P60 MXL 100
64			40.89	41.40	P64 MXL 100
70			44.77	45.28	P70 MXL 100
72			46.06	46.57	P72 MXL 100
80			51.24	51.74	P80 MXL 100
84			53.82	54.33	P84 MXL 100
96			61.59	62.09	P96 MXL 100
100			64.17	64.68	P100 MXL 100
120			77.11	77.62	P120 MXL 100

Belt Type	MXL for Belt Width – 6.4mm				
No. of Teeth	Length (mm)	Material	OD (mm)	PD (mm)	Product Code
20	B		12.43	12.94	P20 MXL 6.4
21	B		13.07	13.58	P21 MXL 6.4
22	B		13.72	14.23	P22 MXL 6.4
23	B		14.37	14.88	P23 MXL 6.4
24	B		15.02	15.52	P24 MXL 6.4
25	B		15.66	16.17	P25 MXL 6.4
26	B		16.31	16.82	P26 MXL 6.4
27	B		16.96	17.46	P27 MXL 6.4
28	B		17.60	18.11	P28 MXL 6.4
30	B		18.90	19.40	P30 MXL 6.4
32	B		20.19	20.70	P32 MXL 6.4
36	B		22.78	23.29	P36 MXL 6.4
40	B		25.36	25.87	P40 MXL 6.4
48	B		30.54	31.05	P48 MXL 6.4
60	B		38.30	38.81	P60 MXL 6.4
72	B		46.06	46.57	P72 MXL 6.4
84	B		53.82	54.33	P84 MXL 6.4
96	B		61.59	62.09	P96 MXL 6.4
120	B		77.11	77.62	P120 MXL 6.4

Belt Type	XL				
No. of Teeth	Pulley Type	Material	OD (mm)	PD (mm)	Product Code
10	C		15.66	16.17	10 XL 037
11	C		17.28	17.79	11 XL 037
12	C		18.90	19.40	12 XL 037
14	C		22.13	22.64	14 XL 037
15	C		23.75	24.46	15 XL 037
16	B		25.36	25.87	16 XL 037
18	B		28.60	29.11	18 XL 037
19	B		30.22	30.72	19 XL 037
20	B		31.83	32.34	20 XL 037
21	B		33.45	33.96	21 XL 037
22	B		35.07	35.57	22 XL 037
24	B		38.30	38.81	24 XL 037
25	B		39.92	40.43	25 XL 037
26	B		41.53	42.04	26 XL 037
28	B		44.77	45.28	28 XL 037
30	B		48.00	48.51	30 XL 037
32	A•B		51.24	51.74	32 XL 037
34	A•B		54.47	54.98	34 XL 037
36	A•B		57.70	58.21	36 XL 037
38	A•B		60.94	61.45	38 XL 037
40	A•B		64.17	64.68	40 XL 037
42	A•B		67.41	67.91	42 XL 037
44	A•B		70.64	71.15	44 XL 037
48	W		77.11	77.62	48 XL 037
50	W		80.34	80.85	50 XL 037
60	W		96.51	97.02	60 XL 037
72	W		115.92	116.43	72 XL 037

Belt Type	L					
No. of Teeth	Pulley Type	Material	OD (mm)	PD (mm)	Product Code	
10	A•B		29.56	30.32	10 L 050	
12	A•B		35.62	36.38	12 L 050	12 L 075
14	A•B		41.68	42.45	14 L 050	14 L 075 14 L 100
15	A•B		44.72	45.48	15 L 050	15 L 075 15 L 100
16	A•B		47.75	48.51	16 L 050	16 L 075 16 L 100
17	A•B		50.78	51.54	17 L 050	17 L 075 17 L 100
18	A•B		53.81	54.57	18 L 050	18 L 075 18 L 100
19	A•B		56.84	57.61	19 L 050	19 L 075 19 L 100
20	A•B		59.88	60.64	20 L 050	20 L 075 20 L 100
21	A•B		62.91	63.67	21 L 050	21 L 075 21 L 100
22	A•B		65.94	66.70	22 L 050	22 L 075 22 L 100
24	A•B		72.00	72.77	24 L 050	24 L 075 24 L 100
25	A•B		75.04	75.80	25 L 050	25 L 075 25 L 100
26	A•B		78.07	78.83	26 L 050	26 L 075 26 L 100
28	A•B		84.13	84.89	28 L 050	28 L 075 28 L 100
30	A•B		90.20	90.96	30 L 050	30 L 075 30 L 100
32	A•B		96.26	97.02	32 L 050	32 L 075 32 L 100
34	A•B		102.32	103.08	34 L 050	34 L 075 34 L 100
36	A•B		108.39	109.15	36 L 050	36 L 075 36 L 100
38	A•B		114.45	115.21	38 L 050	38 L 075 38 L 100
40	A•B		120.51	121.28	40 L 050	40 L 075 40 L 100
44	A•B		132.64	133.40	44 L 050	44 L 075 44 L 100
48	W		144.77	145.53	48 L 050	48 L 075 48 L 100
50	W		150.83	151.60	50 L 050	50 L 075 50 L 100
60	W		181.15	181.91	60 L 050	60 L 075 60 L 100
72	W		217.53	218.30	72 L 050	72 L 075 72 L 100

Timing Pulley

Pulley Product Code

(Example) 38 XL 037 B

No. of Teeth: 38
 Belt Type: XL
 Belt Width (inch x 100): 037
 Pulley Type Form: B

Add "P" in front of the product code for MXL type
 (Ex) P26MXL6.4B

(Note: belt width is in mm for MXL type)

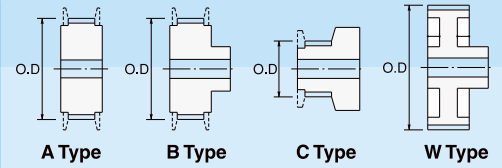

Tooth profile for standard pulleys is in-volute shape complying with ISO standards.

Standard Pulley Types & Sizes

Belt Type			H				
No. of Teeth	Pulley Type	Material	OD (mm)	PD (mm)	Product Code		
14	A•B	Steel	55.22	56.60	14H100	14H150	14H200
15	A•B		59.27	60.64	15H100	15H150	15H200
16	A•B		63.31	64.68	16H100	16H150	16H200
18	A•B		71.39	72.77	18H100	18H150	18H200
19	A•B		75.44	76.81	19H100	19H150	19H200
20	A•B		79.48	80.85	20H100	20H150	20H200
21	A•B		83.52	84.89	21H100	21H150	21H200
22	A•B		87.56	88.94	22H100	22H150	22H200
24	A•B		95.65	97.02	24H100	24H150	24H200
25	A•B		99.69	101.06	25H100	25H150	25H200
26	A•B	Cast Metal	103.73	105.11	26H100	26H150	26H200
28	A•B		111.82	113.19	28H100	28H150	28H200
30	A•B		119.90	121.28	30H100	30H150	30H200
32	A•B		127.99	129.36	32H100	32H150	32H200
34	A•B		136.07	137.45	34H100	34H150	34H200
36	A•B		144.16	145.53	36H100	36H150	36H200
40	A•B		160.33	161.70	40H100	40H150	40H200
44	W		176.50	177.87	44H100	44H150	44H200
48	W		192.67	194.04	48H100	48H150	48H200
50	W		200.76	202.13	50H100	50H150	50H200
60	W	241.18	242.55	60H100	60H150	60H200	
72	W	289.69	291.06	72H100	72H150	72H200	

Belt Type			T5				
No. of Teeth	Pulley Type	Material	OD (mm)	PD (mm)	Product Code		
12	C	Sintered Material	18.25	19.10	PT5-10-12		
14	C		21.45	22.28	PT5-10-14		
15	C		23.05	23.87	PT5-10-15		
16	B		24.60	25.46	PT5-10-16		
18	B		27.80	28.65	PT5-10-18		
20	B		31.00	31.83	PT5-10-20		
22	B		34.25	35.01	PT5-10-22		
24	B		37.40	38.20	PT5-10-24		
25	B		39.00	39.79	PT5-10-25		
26	B		40.60	41.38	PT5-10-26		
28	B	Steel	43.75	44.56	PT5-10-28		
30	B		46.95	47.75	PT5-10-30		
32	A•B		50.10	50.93	PT5-10-32		
36	A•B		56.45	57.30	PT5-10-36		
40	A•B		62.85	63.66	PT5-10-40		
44	W		Cast Metal	69.20	70.03	PT5-10-44	
48	W			75.55	76.39	PT5-10-48	
50	W			78.75	79.58	PT5-10-50	
60	W			94.65	95.49	PT5-10-60	

Belt Type			T10			
No. of Teeth	Pulley Type	Material	OD (mm)	PD (mm)	Product Code	
12	A•B	Steel	36.35	38.20	PT10-15-12	PT10-25-12
14	A•B		42.70	44.56	PT10-15-14	PT10-25-14
15	A•B		45.90	47.75	PT10-15-15	PT10-25-15
16	A•B		49.05	50.93	PT10-15-16	PT10-25-16
18	A•B		55.45	57.30	PT10-15-18	PT10-25-18
20	A•B		61.80	63.66	PT10-15-20	PT10-25-20
22	A•B		68.15	70.03	PT10-15-22	PT10-25-22
24	A•B		74.55	76.39	PT10-15-24	PT10-25-24
25	A•B		77.70	79.58	PT10-15-25	PT10-25-25
26	A•B		80.90	82.76	PT10-15-26	PT10-25-26
28	A•B	Cast Metal	87.25	89.13	PT10-15-28	PT10-25-28
30	A•B		93.65	95.49	PT10-15-30	PT10-25-30
32	A•B		100.00	101.86	PT10-15-32	PT10-25-32
36	A•B		112.75	114.59	PT10-15-36	PT10-25-36
40	A•B		125.45	127.32	PT10-15-40	PT10-25-40
44	W		138.20	140.06	PT10-15-44	PT10-25-44
48	W		150.95	152.79	PT10-15-48	PT10-25-48
50	W		157.30	159.15	PT10-15-50	PT10-25-50
60	W		189.10	190.99	PT10-15-60	PT10-25-60

II Frictional Forced Power Transmission Belt

Classical V-Belt / Red label V-Belt	P36
Classical V-Belts for DIN 2215/ISO4184	
Wrapped Type	P37
Classical V-Belts for DIN 2215/ISO4184	
TRIPLEX® Raw Edge Cogged Type	P38~40
MAXSTAR WEDGE V-Belt	P41
MAXSTAR WEDGE V-Belt for RMA / MPTA	P42
Narrow V-Belt for DIN7753 / ISO4184	P43
SUPER VS® Belt (Variable Speed Belt)	P44
MAXSTAR WEDGE Bushing Pulley	P45, 46
e-Power® V-Belt	P47
RIBSTAR Belt G (Rubber V-Ribbed Belt)	P48
RIBSTAR Belt U (Polyurethane V-Ribbed Belt)	P49
RIBSTAR Pulley (V-Ribbed Pulley)	P50
FLEXSTAR® Belt	P51
SUPER FLEXSTAR® Belt	P52
FLEXSTAR® Belt J	P53
POLYMAX® Belt	P54
MB Belt	P55
STARROPE®, SUPER STARROPE®	P56
PRENE V-ROPE, PRENE HEXAGONAL-ROPE	P56
Flat Belt	P57



Classical V-Belt/ Red label V-Belt

This type is most commonly used as a means for power transmission. Therefore, it is economic and available in the market. Also, it is easily replaced.

- Our "SET FREE®" system for multiple belt usage is very effective to reduce dimensional differences of each belt.
- Red label V-Belt is a heavy-duty power transmission belt, which has heat, oil and flex resistance as well as a high antistatic property

Product Code

A-50

Belt Type ———— Belt Code (inch)

- Belt code indicates effective pitch length of the belt in inches. (For M type, length is outer circumference)

Cross-Sectional Dimensions

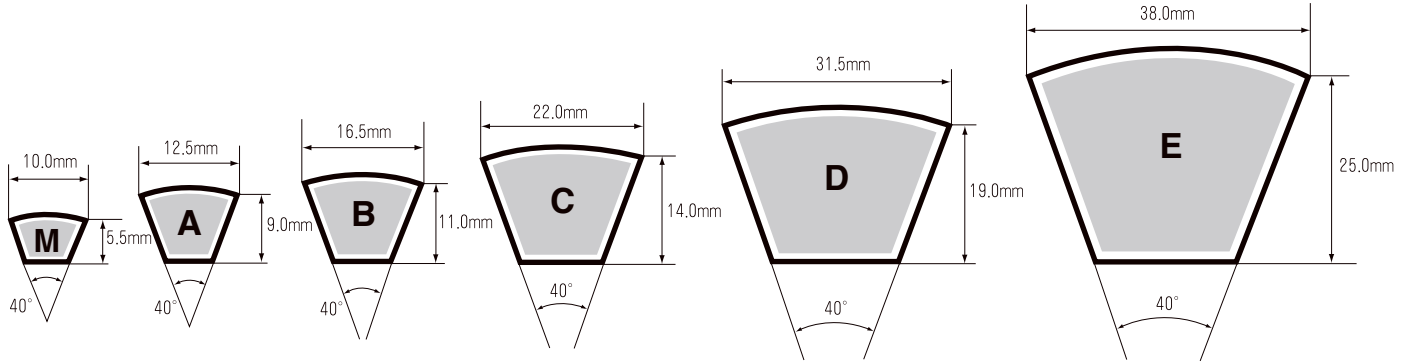

(Note) Above dimensions are nominal values.

Standard Belt Sizes

M Type (No.)	A Type (No.)			B Type (No.)			C Type (No.)			D Type (No.)	E Type (No.)
★ 20	★ 20	★ 60	★ 100	25	★ 65	★ 112	40	86	★ 190	★ 100	180
★ 21	★ 21	★ 61	★ 102	26	★ 66	★ 115	42	87	★ 200	★ 105	210
★ 22	★ 22	★ 62	★ 105	27	★ 67	★ 118	★ 45	★ 88	★ 210	★ 110	240
★ 23	★ 23	★ 63	★ 108	28	★ 68	★ 120	★ 48	89	★ 220	★ 115	270
★ 24	★ 24	★ 64	★ 110	29	★ 69	★ 122	★ 50	★ 90	★ 230	★ 120	300
★ 25	★ 25	★ 65	★ 112	★ 30	★ 70	★ 125	51	91	★ 240	★ 125	330
★ 26	★ 26	★ 66	★ 115	★ 31	★ 71	★ 128	★ 52	★ 92	★ 250	★ 130	360
★ 27	★ 27	★ 67	★ 118	★ 32	★ 72	★ 130	53	93	260	★ 135	390
★ 28	★ 28	★ 68	★ 120	★ 33	★ 73	★ 132	★ 54	94	270	★ 140	420
★ 29	★ 29	★ 69	★ 122	★ 34	★ 74	★ 135	★ 55	★ 95		★ 145	
								96			
★ 30	★ 30	★ 70	★ 125	★ 35	★ 75	★ 138	56			★ 150	
★ 31	★ 31	★ 71	★ 128	★ 36	★ 76	★ 140	57	97		★ 155	
★ 32	★ 32	★ 72	★ 130	★ 37	★ 77	★ 145	★ 58	★ 98		★ 160	
★ 33	★ 33	★ 73	★ 135	★ 38	★ 78	★ 150	59	99		★ 165	
★ 34	★ 34	★ 74	★ 140	★ 39	★ 79	★ 155	★ 60	★ 100		★ 170	
★ 35	★ 35	★ 75	★ 145	★ 40	★ 80	★ 160	61	★ 102		★ 180	
★ 36	★ 36	★ 76	★ 150	★ 41	★ 81	★ 165	★ 62	★ 105		★ 190	
★ 37	★ 37	★ 77	★ 155	★ 42	★ 82	★ 170	63	★ 108		★ 200	
★ 38	★ 38	★ 78	★ 160	★ 43	★ 83	★ 180	64	★ 110		★ 210	
★ 39	★ 39	★ 79	165	★ 44	★ 84	★ 190	★ 65	★ 112		★ 220	
							66	★ 115			
★ 40	★ 40	★ 80	★ 170	★ 45	★ 85	★ 200				★ 230	
★ 41	★ 41	★ 81	★ 180	★ 46	★ 86	★ 210	67	★ 118		★ 240	
★ 42	★ 42	★ 82		★ 47	★ 87		★ 68	★ 120		★ 250	
★ 43	★ 43	★ 83		★ 48	★ 88		69	★ 122		★ 260	
★ 44	★ 44	★ 84		★ 49	★ 89		★ 70	★ 125		★ 270	
★ 45	★ 45	★ 85		★ 50	★ 90		71	★ 128		★ 280	
★ 46	★ 46	★ 86		★ 51	★ 91		★ 72	★ 130		★ 300	
★ 47	★ 47	★ 87		★ 52	★ 92		73	★ 132		★ 310	
★ 48	★ 48	★ 88		★ 53	★ 93		74	★ 135		★ 330	
★ 49	★ 49	★ 89		★ 54	★ 94		★ 75	★ 138		360	
							76	★ 140			
★ 50	★ 50	★ 90		★ 55	★ 95						
	★ 51	★ 91		★ 56	★ 96		77	★ 142			
	★ 52	★ 92		★ 57	★ 97		★ 78	★ 145			
	★ 53	★ 93		★ 58	★ 98		79	★ 148			
	★ 54	★ 94		★ 59	★ 99		★ 80	★ 150			
	★ 55	★ 95		★ 60	★ 100		81	★ 155			
	★ 56	★ 96		★ 61	★ 102		★ 82	★ 160			
(* 10)	★ 57	★ 97	(* 11)	★ 62	★ 105	(* 13)	★ 83	★ 165	(* 24)	(* 80)	(* 96)
(* 120)	★ 58	★ 98	(* 370)	★ 63	★ 108	(* 660)	★ 84	★ 170	(* 660)	(* 85)	(* 96)
	★ 59	★ 99		★ 64	★ 110		★ 85	★ 180		(* 90)	(* 660)

★ : signifies standard size equivalent to JIS (K6323) standards
 * : Manufacturable sizes

Classical V-Belts for DIN 2215/ISO4184 Wrapped Type

Widely-used power transmission belt.
Cost efficient, readily available, easily changeable

Product Code

A-40

Belt Type

Belt Code (inch)

● Belt code is nominal length in inch

Cross-Sectional Dimensions

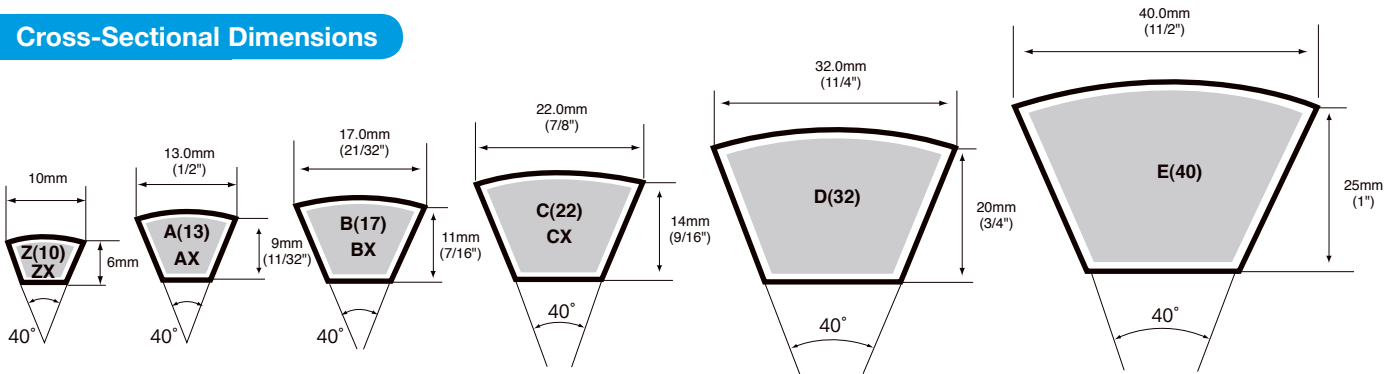

Standard Belt Sizes

Z(10), ZX					
Belt Code	Inside Length Li (mm)	Datum Length Ld (mm)	Belt Code	Inside Length Li (mm)	Datum Length Ld (mm)
20	515	537	38.5	975	997
20.5	525	547	39	990	1012
21	530	552	39.5	1000	1022
21.5	550	572	40	1016	1038
22	560	582	40.5	1030	1052
22.5	575	597	41	1041	1063
23	585	607	41.5	1050	1072
23.5	600	622	42	1060	1082
24	610	632	42.25	1075	1097
24.5	620	642	42.5	1080	1102
25	630	652	43	1090	1112
25.5	650	672	43.5	1105	1127
26	660	682	44	1120	1142
26.5	670	692	45	1140	1162
27	685	707	45.5	1150	1172
27.5	700	722	46	1165	1187
28	710	732	47	1194	1216
28.5	725	747	47.5	1215	1237
29	730	752	48	1225	1247
29.5	750	772	49	1250	1272
30	765	787	50	1270	1292
30.5	775	797	51	1295	1317
31	790	812	51.5	1310	1332
31.5	800	822	52	1320	1342
32	820	842	52.5	1330	1352
32.5	825	847	53	1346	1368
33	840	862	54	1371	1393
33.5	850	872	55	1400	1422
34	865	887	56	1422	1444
34.5	875	897	57	1450	1472
35	890	912	58	1475	1497
35.5	900	922	59	1500	1522
36	915	937	60	1525	1547
36.5	925	947			
37	940	962			
37.5	950	972			
38	965	987			

Size range : 18.5" - 93"

All dimensions are nominal values.

: Available sizes for raw edge cogged belt ZX

Classical V-Belts for DIN 2215/ISO4184

C(22), CX														
Belt Code	Inside Length Li(mm)	Datum Length Ld(mm)	Belt Code	Inside Length Li(mm)	Datum Length Ld(mm)	Belt Code	Inside Length Li(mm)	Datum Length Ld(mm)	Belt Code	Inside Length Li(mm)	Datum Length Ld(mm)	Belt Code	Inside Length Li(mm)	Datum Length Ld(mm)
30	762	814	67	1700	1752	104	2642	2694	162	4115	4167	270	6858	6910
31	787	839	68	1725	1777	105	2667	2719	164	4166	4218	275	6985	7037
32	813	865	69	1750	1802	106	2692	2744	168	4267	4319	280	7100	7152
33	838	890	70	1775	1827	107	2718	2770	170	4318	4370	290	7366	7418
34	864	916	71	1800	1852	108	2750	2802	173	4390	4442	300	7600	7652
35	889	941	72	1829	1881	110	2800	2852	175	4445	4497	320	8130	8182
36	914	966	73	1854	1906	111	2819	2871	177	4500	4552	330	8380	8432
37	940	992	74	1880	1932	112	2845	2897	180	4572	4624	340	8636	8688
38	950	1002	75	1900	1952	113	2870	2922	183	4648	4700	350	8900	8952
39	975	1027	76	1930	1982	114	2896	2948	185	4700	4752	360	9144	9196
40	1000	1052	77	1956	2008	115	2921	2973	187	4750	4802	370	9400	9452
41	1030	1082	78	1981	2033	116	2950	3002	190	4825	4877	380	9650	9702
42	1075	1127	79	2000	2052	118	3000	3052	195	4950	5002	400	10160	10212
43	1090	1142	80	2032	2084	120	3050	3102	197	5000	5052	415	10540	10592
44	1120	1172	81	2060	2112	122	3100	3152	200	5080	5132	434	11000	11052
45	1150	1202	82	2083	2135	123	3125	3177	202	5131	5183	473	12000	12052
46	1175	1227	83	2108	2160	124	3150	3202	204	5182	5234	492	12500	12552
47	1200	1252	84	2135	2187	125	3175	3227	205	5207	5259	512	13000	13052
48	1220	1272	85	2159	2211	126	3200	3252	210	5334	5386	550	14000	14052
49	1250	1302	86	2184	2236	128	3250	3302	215	5461	5513	590	15000	15052
50	1270	1322	87	2210	2262	129	3270	3322	220	5600	5652			
51	1295	1347	88	2240	2292	130	3300	3352	222	5639	5691			
52	1320	1372	89	2261	2313	132	3350	3402	224	5690	5742			
53	1350	1402	90	2286	2338	134	3400	3452	225	5715	5767			
54	1375	1427	91	2311	2363	136	3450	3502	228	5791	5843			
55	1400	1452	92	2337	2389	138	3500	3552	230	5842	5894			
56	1425	1477	93	2360	2412	140	3550	3602	235	5970	6022			
57	1450	1502	94	2388	2440	142	3600	3652	238	6045	6097			Size range : 30" - 660"
58	1475	1527	95	2413	2465	144	3658	3710	240	6096	6148			
59	1500	1552	96	2438	2490	146	3700	3752	246	6250	6302			
60	1525	1577	97	2465	2517	148	3750	3802	248	6300	6352			
61	1550	1602	98	2500	2552	150	3810	3862	250	6350	6402			
62	1575	1627	99	2525	2577	152	3861	3913	256	6500	6552			
63	1600	1652	100	2540	2592	154	3912	3964	258	6553	6605			
64	1625	1677	101	2560	2612	155	3937	3989	260	6600	6652			
65	1650	1702	102	2591	2643	158	4000	4052	264	6700	6752			
66	1675	1727	103	2616	2668	160	4064	4116	268	6800	6852			

All dimensions are nominal values.

: Available sizes for raw edge cogged belt CX

Classical V-Belts for DIN 2215/ISO4184

D(32)					
Belt Code	Inside Length Li(mm)	Datum Length Ld(mm)	Belt Code	Inside Length Li(mm)	Datum Length Ld(mm)
100	2540	2615	168	4267	4342
103	2616	2691	170	4320	4395
104	2650	2725	172	4370	4445
105	2675	2750	173	4390	4465
108	2750	2825	174	4420	4495
110	2800	2875	175	4450	4525
112	2850	2925	176	4470	4545
115	2925	3000	178	4525	4600
118	3000	3075	180	4570	4645
120	3048	3123	182	4620	4695
122	3100	3175	184	4675	4750
124	3150	3225	185	4700	4775
126	3200	3275	186	4725	4800
128	3250	3325	188	4775	4850
130	3300	3375	190	4825	4900
132	3350	3425	192	4875	4950
134	3400	3475	194	4925	5000
135	3425	3500	195	4950	5025
136	3450	3525	198	5025	5100
138	3500	3575	200	5080	5155
140	3550	3625	205	5200	5275
142	3600	3675	210	5330	5405
144	3658	3733	215	5450	5525
146	3700	3775	217	5500	5575
148	3750	3825	220	5600	5675
150	3810	3885	225	5715	5790
152	3860	3935	228	5790	5865
154	3900	3975	230	5850	5925
155	3925	4000	235	5970	6045
156	3950	4025	236	6000	6075
158	4000	4075	238	6045	6120
160	4060	4135	240	6096	6171
162	4115	4190	245	6225	6300
164	4165	4240	248	6300	6375
165	4200	4275	250	6350	6425
166	4225	4300	255	6475	6550
167	4250	4325	260	6600	6675

All dimensions are nominal values.

E(40)					
Belt Code	Inside Length Li(mm)	Datum Length Ld(mm)	Belt Code	Inside Length Li(mm)	Datum Length Ld(mm)
144	3650	3732	365	9275	9357
180	4575	4657	370	9400	9482
185	4700	4782	375	9525	9607
190	4825	4907	380	9650	9732
195	4950	5032	385	9775	9857
200	5080	5162	390	9900	9982
205	5200	5282	395	10025	10107
210	5300	5382	400	10160	10242
220	5600	5682	405	10300	10382
225	5715	5797	410	10400	10482
230	5850	5932	415	10550	10632
235	5970	6052	420	10670	10752
240	6100	6182	425	10800	10882
245	6225	6307	430	10925	11007
250	6350	6432	435	11050	11132
255	6475	6557	440	11200	11282
260	6600	6682	445	11300	11382
265	6730	6812	450	11430	11512
270	6850	6932	455	11550	11632
275	6985	7067	460	11700	11782
280	7100	7182	465	11800	11882
285	7250	7332	470	11950	12032
290	7375	7457	475	12050	12132
295	7500	7582	480	12190	12272
300	7620	7702	485	12325	12407
305	7750	7832	490	12500	12582
310	7875	7957	495	12575	12657
315	8000	8082	500	12700	12782
320	8125	8207	540	13720	13802
325	8250	8332	600	15240	15322
330	8380	8462	660	16760	16842
335	8500	8582			
340	8650	8732			
345	8750	8832			
350	8900	8982			
355	9000	9082			
360	9150	9232			

All dimensions are nominal values.

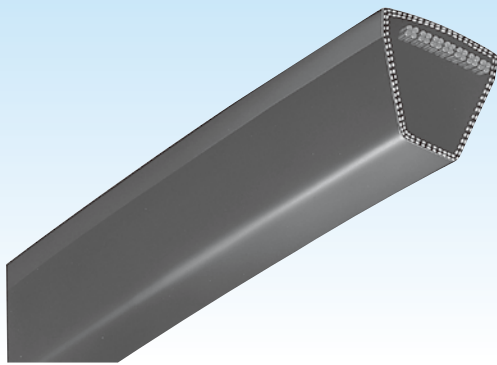

MAXSTAR WEDGE V-Belt

With its unique narrow width, this V-Belt has high power transmission capability.

- Energy-saving and compact design application
- Possible to operate with maximum speed of 40m/sec
- Excellent heat resistance and antistatic property
- Our "set-free" system for multiple belt usage is very effective to reduce dimensional differences of each belt.
- We standardize easy-to-install bussing types as our wedge pulley.

Product Code

5V-2000

Belt Type

Belt Code = Effective Belt Length (inch) x10

Comparison with Standard V-Belt

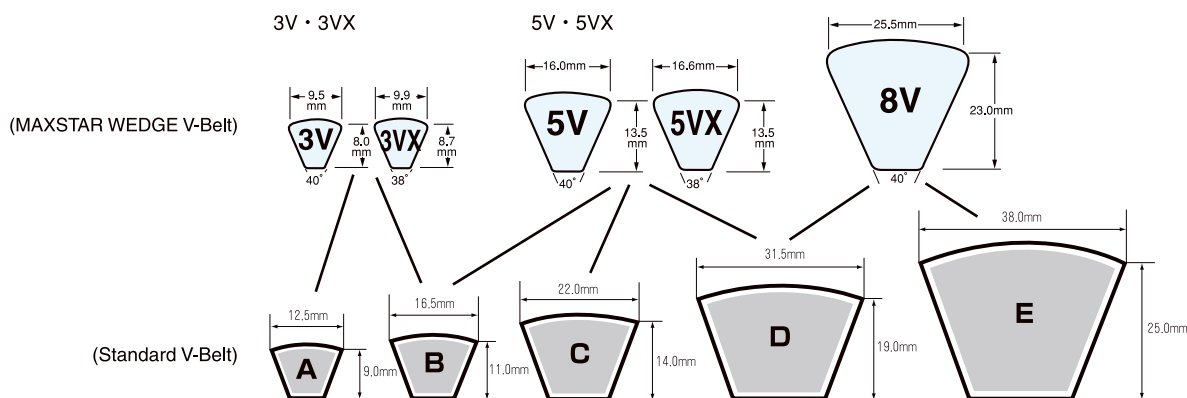

(Note) Above are nominal values.

Standard Belt Sizes

3V · 3VX			5V · 5VX			8V		
Product Code	Effective Belt Length (mm)	Belt Pitch Length (mm)	Product Code	Effective Belt Length (mm)	Belt Pitch Length (mm)	Product Code	Effective Belt Length (mm)	Belt Pitch Length (mm)
3V 250	635	631	5V 500	1270	1262	8V 1000	2540	2524
3V 265	673	669	5V 530	1346	1338	8V 1060	2692	2676
3V 280	711	707	5V 560	1422	1414	8V 1120	2845	2829
3V 300	762	758	5V 600	1524	1516	8V 1180	2997	2981
3V 315	800	796	5V 630	1600	1592	8V 1250	3175	3159
3V 335	851	847	5V 670	1702	1694	8V 1320	3353	3337
3V 355	902	898	5V 710	1803	1795	8V 1400	3556	3540
3V 375	953	949	5V 750	1905	1897	8V 1500	3810	3794
3V 400	1016	1012	5V 800	2032	2024	8V 1600	4064	4048
3V 425	1080	1076	5V 850	2159	2151	8V 1700	4318	4302
3V 450	1143	1139	5V 900	2286	2278	8V 1800	4572	4556
3V 475	1207	1203	5V 950	2413	2405	8V 1900	4826	4810
3V 500	1270	1266	5V 1000	2540	2532	8V 2000	5080	5064
3V 530	1346	1342	5V 1060	2692	2684	8V 2120	5385	5369
3V 560	1422	1418	5V 1120	2845	2837	8V 2240	5690	5674
3V 600	1524	1520	5V 1180	2997	2989	8V 2360	5994	5978
3V 630	1600	1596	5V 1250	3175	3167	8V 2500	6350	6334
3V 670	1702	1698	5V 1320	3353	3345	8V 2650	6731	6715
3V 710	1803	1799	5V 1400	3556	3548	8V 2800	7112	7096
3V 750	1905	1901	5V 1500	3810	3802	8V 3000	7620	7604
3V 800	2032	2028	5V 1600	4064	4056	8V 3150	8001	7985
3V 850	2159	2155	5V 1700	4318	4310	8V 3350	8509	8493
3V 900	2286	2282	5V 1800	4572	4564	8V 3550	9017	9001
3V 950	2413	2409	5V 1900	4826	4818	8V 3750	9525	9509
3V 1000	2540	2536	5V 2000	5080	5072	8V 4000	10160	10144
3V 1060	2692	2688	5V 2120	5385	5377	8V 4250	10795	10779
3V 1120	2845	2841	5V 2240	5690	5682	8V 4500	11430	11414
3V 1180	2997	2993	5V 2360	5994	5986	8V 4750	12065	12049
3V 1250	3175	3171	5V 2500	6350	6342	8V 5000	12700	12684
3V 1320	3353	3349	5V 2650	6731	6723	8V 5600	14224	14208
3V 1400	3556	3552	5V 2800	7112	7104	8V 6000	15240	15224
			5V 3000	7620	7612			
			5V 3150	8001	7993			
			5V 3350	8509	8501			
			5V 3550	9017	9009			

● signifies availability of Multi type MAXSTAR WEDGE Belt. Standard number of ribs is 2, 3, 4, 5 for all types (3V,5V,8V). We manufacture only standard sizes.

□ : Corresponding sizes for Raw Edge cogged Type "MAXSTAR WEDGE SUPREME" 3VX and 5VX. Those are nonstocked items.

MAXSTAR WEDGE V-Belt for RMA/MPTA

Unique narrow V belt with high power transmission capability
 Suitable for energy-saving / compact design and can be used for high-speed operation up to 40m /second

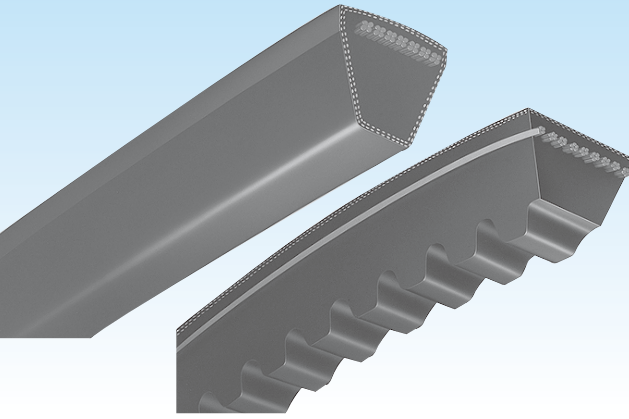

Product Code

5V-2500

Belt Type — Belt Code = Effective Belt Length (inch) x10

Cross-Sectional Dimensions

Belt Type	3VX		5VX	
Belt length range (inch)	25-95	96-270	25-95	96-270
a	9.9	8.6	16.6	15.7
b	8.7	9.0	13.5	13.7

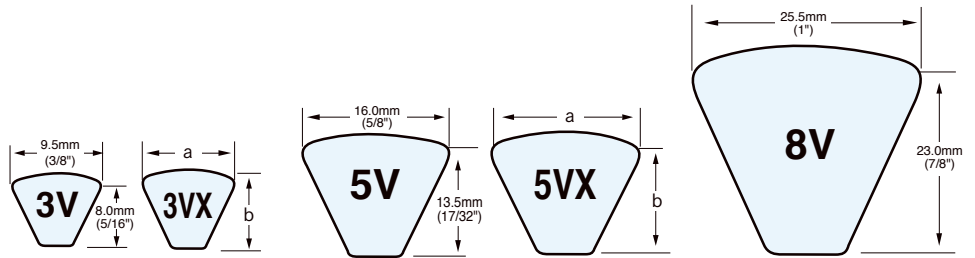

Standard Belt Sizes

3V · 3VX				5V · 5VX				8V		
Belt Code	Effective Outside Length La (mm)	3V	3VX	Belt Code	Effective Outside Length La (mm)	5V	5VX	Belt Code	Effective Outside Length La (mm)	8V
250	635	○	○	500	1270	○	○	1000	2540	○
265	673	○	○	530	1346	○	○	1060	2692	○
280	711	○	○	560	1422	○	○	1120	2845	○
300	762	○	○	600	1524	○	○	1180	2997	○
315	800	○	○	630	1600	○	○	1250	3175	○
335	851	○	○	670	1702	○	○	1320	3353	○
355	902	○	○	710	1803	○	○	1400	3556	○
375	953	○	○	750	1905	○	○	1500	3810	○
400	1016	○	○	800	2032	○	○	1600	4064	○
425	1080	○	○	850	2159	○	○	1700	4318	○
450	1143	○	○	900	2286	○	○	1800	4572	○
475	1207	○	○	950	2413	○	○	1900	4826	○
500	1270	○	○	1000	2540	○	○	2000	5080	○
530	1346	○	○	1060	2692	○	○	2120	5385	○
560	1422	○	○	1120	2845	○	○	2240	5690	○
600	1524	○	○	1180	2997	○	○	2360	5994	○
630	1600	○	○	1250	3175	○	○	2500	6350	○
670	1702	○	○	1320	3353	○	○	2650	6731	○
710	1803	○	○	1400	3556	○	○	2800	7112	○
750	1905	○	○	1500	3810	○	○	3000	7620	○
800	2032	○	○	1600	4064	○	○	3150	8001	○
850	2159	○	○	1700	4318	○	○	3350	8509	○
900	2286	○	○	1800	4572	○	○	3550	9017	○
950	2413	○	○	1900	4826	○	○	3750	9525	○
1000	2540	○	○	2000	5080	○	○	4000	10160	○
1060	2692	○	○	2120	5385	○	○	4250	10795	○
1120	2845	○	○	2240	5690	○	○	4500	11430	○
1180	2997	○	○	2360	5994	○	○	4750	12065	○
1250	3175	○	○	2500	6350	○	○	5000	12700	○
1320	3353	○	○	2650	6731	○	○	5600	14224	○
1400	3556	○	○	2800	7112	○	○	6000	15240	○
				3000	7620	○				
				3150	8001	○				
				3350	8509	○				
				3550	9017	○				

All dimensions are nominal values.

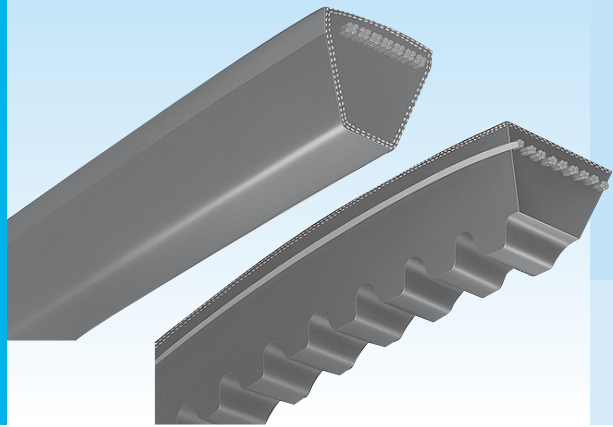

Narrow V-Belt for DIN 7753/ISO4184

Suitable for energy-saving / compact design
Reduces maintenance costs

Product Code

SPZ-1000

Belt Type

Belt Code (mm)

* Belt code = belt effective length (mm)

Cross-Sectional Dimensions

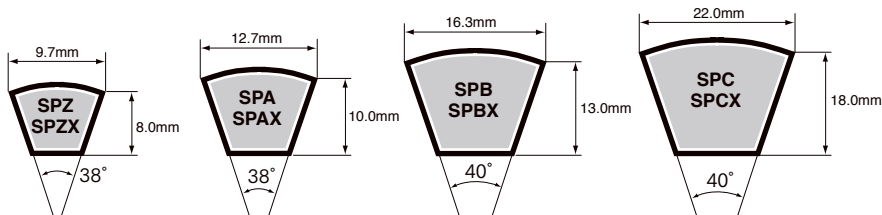

Standard Belt Sizes

SPZ (SPZX)			
Pitch Length LW (mm)	Pitch Length LW (mm)	Pitch Length LW (mm)	Pitch Length LW (mm)
487	1112	1937	3450
512	1120	1987	3550
562	1137	2000	3660
587	1140	2030	3750
612	1162	2037	4000
630	1180	2050	4500
637	1187	2060	
650	1200	2082	
655	1202	2087	
662	1212	2120	
665	1222	2137	
670	1237	2150	
687	1250	2160	
690	1262	2187	
710	1270	2200	
722	1282	2240	
737	1287	2262	
750	1300	2280	
760	1312	2287	
762	1320	2300	
772	1337	2337	
787	1340	2360	
800	1347	2387	
812	1362	2400	
825	1387	2410	
835	1400	2437	
837	1412	2450	
850	1420	2487	
862	1437	2500	
875	1462	2540	
885	1487	2580	
887	1500	2600	
900	1512	2637	
912	1520	2650	
925	1537	2670	
937	1560	2687	
940	1562	2690	
950	1587	2700	
962	1600	2712	
987	1612	2720	
1000	1637	2737	
1005	1662	2760	
1010	1687	2800	
1012	1700	2840	
1024	1737	2900	
1037	1762	3000	
1047	1787	3050	
1060	1800	3070	
1077	1812	3150	
1080	1837	3170	
1087	1862	3200	
1100	1887	3250	
1110	1900	3350	

SPA (SPAX)		
Pitch Length LW (mm)	Pitch Length LW (mm)	Pitch Length LW (mm)
732	1407	2360
735	1410	2373
742	1425	2382
757	1432	2407
760	1457	2410
782	1482	2432
800	1485	2482
807	1500	2500
832	1507	2532
850	1532	2550
857	1557	2568
860	1582	2582
882	1600	2600
885	1607	2607
900	1632	2632
907	1657	2650
932	1682	2682
950	1700	2732
957	1707	2773
967	1732	2782
982	1757	2800
1000	1782	2832
1007	1785	2847
1032	1800	2850
1057	1807	2882
1060	1832	2900
1082	1837	2932
1090	1857	2962
1107	1882	2982
1120	1900	3000
1132	1907	3032
1157	1932	3082
1180	1957	3132
1182	1982	3150
1200	2000	3182
1207	2032	3282
1210	2057	3350
1232	2082	3382
1235	2100	3482
1250	2120	3500
1257	2132	3550
1272	2157	3650
1282	2182	3750
1295	2200	3870
1300	2207	4000
1307	2232	4120
1320	2240	4250
1332	2260	4300
1357	2282	4500
1367	2300	4600
1382	2307	4750
1385	2330	4865
1400	2332	5000

SPB (SPBX)		
Pitch Length LW (mm)	Pitch Length LW (mm)	Pitch Length LW (mm)
1250	2680	4870
1260	2700	5000
1320	2720	5070
1340	2750	5300
1400	2800	5380
1410	2820	5500
1500	2840	5600
1510	2900	5680
1590	2990	5800
1600	3000	5990
1690	3070	6000
1700	3150	6300
1750	3170	6340
1800	3175	6700
1850	3200	6720
1900	3238	
1950	3250	
2000	3280	
2020	3328	
2030	3340	
2060	3350	
2120	3400	
2131	3412	
2137	3425	
2150	3450	
2180	3500	
2200	3550	
2240	3650	
2264	3675	
2280	3700	
2300	3750	
2310	3770	
2320	3800	
2330	3850	
2360	3870	
2390	3875	
2391	4000	
2410	4060	
2425	4100	
2430	4120	
2450	4250	
2473	4260	
2500	4296	
2518	4310	
2522	4318	
2530	4370	
2550	4500	
2575	4560	
2580	4600	
2600	4620	
2640	4720	up to
2650	4750	10000
2670	4820	

SPC (SPCX)	
Pitch Length LW (mm)	Pitch Length LW (mm)
2000	4380
2120	4400
2240	4420
2280	4445
2335	4450
2360	4500
2400	4530
2413	4650
2425	4720
2500	4750
2550	4850
2580	4900
2600	4970
2650	5000
2700	5030
2720	5070
2750	5200
2770	5300
2800	5330
2840	5400
2900	5500
2950	5600
3000	5700
3050	6000
3100	6200
3150	6300
3200	6480
3220	6500
3320	6700
3350	
3375	
3420	
3430	
3450	
3500	
3520	
3550	
3600	
3620	
3670	
3700	
3750	
3770	
3800	
3810	
3970	
4000	
4050	
4100	
4200	
4250	up to
4300	12500
4350	

All dimensions are nominal values.

□ : Available sizes for raw edge cogged belt SPZX, SPAX, SPBX, SPCX

SUPER VS® Belt (Variable Speed Belt)

Changes in speed can be accurately, smoothly and quietly transmitted from low to high speed.
 High precision and transmission efficiency as well as excellent durability.
 Almost no elongation. Excellent oil, heat and lateral pressure resistance.
 Specially for high performance and high quality transmission systems.

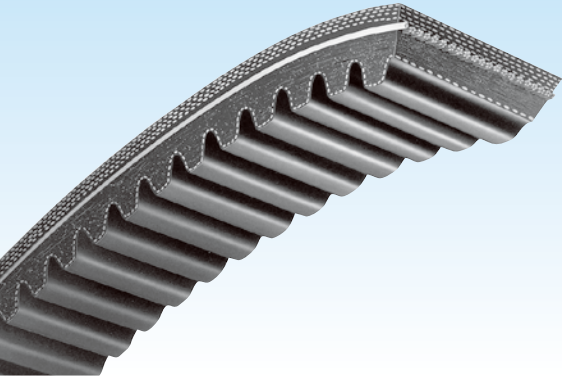

Cross-Sectional Diagram

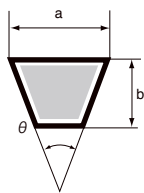

a(mm)	b(mm)	θ°
30	10	22
37	12	22
12	5	22
16	6	22
22	8	22
10	5	22
12	6	22
16	8	22
20	10	22
20	12	22

Product Code

SUPER VS 16-8-700



SUPER VS 22-8-700 = 14 22 V 270

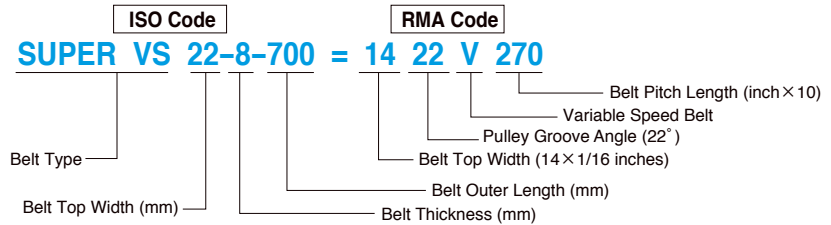

Standard Belt Sizes

ISO Code	RMA Code	ISO Code	RMA Code	ISO Code	RMA Code	ISO Code*1	ISO Code*2	ISO Code*3
30-10-668	1922V256	37-12-855	2322V329	22-8-615	1422V235	10-5-450	16-8-600	20-10-1600
30-10-723	1922V277	37-12-945	2322V364	22-8-625	1422V240	10-5-475	16-8-625	20-10-1650
30-10-733	1922V282	37-12-995	2322V384	22-8-648	1422V250	10-5-500	16-8-650	20-10-1700
30-10-773	1922V298	37-12-1030	2322V396	22-8-700	1422V270	10-5-525	16-8-675	20-10-1750
30-10-783	1922V302	37-12-1090	2322V421	22-8-755	1422V290	10-5-550	16-8-700	20-10-1800
30-10-813	1922V313	37-12-1120	2322V434	22-8-780	1422V300	10-5-575	16-8-725	20-10-1850
30-10-813	1922V314	37-12-1140	2322V441	22-8-855	1422V330	10-5-600	16-8-750	20-10-1900
30-10-838	1922V321	37-12-1190	2322V461	22-8-880	1422V340	10-5-625	16-8-775	20-10-1950
30-10-863	1922V332	37-12-1240	2322V481	22-8-930	1422V360	10-5-650	16-8-800	20-10-2000
30-10-878	1922V338	37-12-1255	2322V486	22-8-1030	1422V400	10-5-675	16-8-825	20-12-750
30-10-943	1922V363	37-12-1345	2322V521	22-8-1085	1422V420	10-5-700	16-8-850	20-12-800
30-10-988	1922V381	37-12-1395	2322V541	22-8-1135	1422V440	10-5-725	16-8-875	20-12-850
30-10-998	1922V386	37-12-1545	2322V601	22-8-1185	1422V460	10-5-750	16-8-900	20-12-900
30-10-1043	1922V403	37-12-1595	2322V621	22-8-1200	1422V466	12-6-500	16-8-925	20-12-950
30-10-1078	1922V417	37-12-1700	2322V661	22-8-1210	1422V470	12-6-525	16-8-950	20-12-1000
30-10-1098	1922V426	37-12-1750	2322V681	22-8-1235	1422V480	12-6-550	16-8-975	20-12-1050
30-10-1143	1922V443	37-12-1800	2322V701	22-8-1390	1422V540	12-6-575	16-8-1000	20-12-1100
30-10-1173	1922V454	37-12-1850	2322V721	22-8-1540	1422V600	12-6-600	20-10-750	20-12-1150
30-10-1188	1922V460	37-12-2055	2322V801	22-8-1690	1422V660	12-6-625	20-10-800	20-12-1200
30-10-1248	1922V484	37-12-2120	2322V826	22-8-1845	1422V720	12-6-650	20-10-850	20-12-1250
30-10-1353	1922V526	37-12-2170	2322V846	22-8-1995	1422V780	12-6-675	20-10-900	20-12-1300
30-10-1398	1922V544	37-12-2270	2322V886			12-6-700	20-10-950	20-12-1350
30-10-1553	1922V604	37-12-2360	2322V921			12-6-725	20-10-1000	20-12-1400
30-10-1618	1922V630	12-5-451	7.522V173			12-6-750	20-10-1050	20-12-1450
30-10-1663	1922V646	12-5-501	7.522V193			12-6-775	20-10-1100	20-12-1500
30-10-1708	1922V666	12-5-551	7.522V212			12-6-800	20-10-1150	20-12-1550
30-10-1758	1922V686	12-5-571	7.522V220			12-6-825	20-10-1200	20-12-1600
30-10-1813	1922V706	16-6-513	1022V196			12-6-850	20-10-1250	20-12-1650
30-10-1848	1922V721	16-6-548	1022V210			12-6-875	20-10-1300	20-12-1700
30-10-1863	1922V726	16-6-573	1022V220			12-6-900	20-10-1350	20-12-1750
30-10-1928	1922V751	16-6-578	1022V223			12-6-925	20-10-1400	20-12-1800
30-10-1938	1922V756	16-6-628	1022V247			12-6-950	20-10-1450	20-12-1850
30-10-2068	1922V806					12-6-975	20-10-1500	20-12-1900
30-10-2168	1922V846					12-6-1000	20-10-1550	20-12-1950
								20-12-2000

Note 1) *1, *2, *3 are only in ISO Code.

Note 2) Please contact us for sizes beyond the standard size.

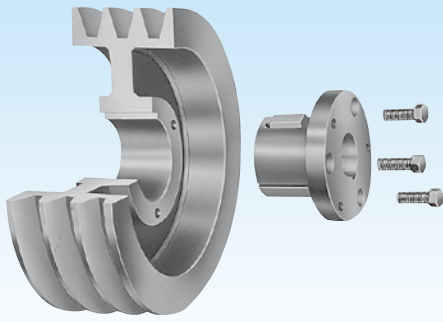

MAXSTAR WEDGE Bushing Pulley

For all wedge pulleys, we adopt a “bushing system” for easy attachment and removal from the shaft with one spanner.

- Long shaft life as it does not damage the shaft and shaft hole
- No need for additional processing of the shaft hole
- Easy centering and smooth positional change of rotating body such as the pulley
- Possible weight reduction of pulley as small bore width can be applied

Bushing Pulley Product Code

450-5V-3-R1

Pulley Diameter: 450, Belt Type: 5V, No. of Grooves: 3, Bushing Type: R1

Application chart for MB Bushing on MAXSTAR WEDGE Pulley

Belt Type	3V						Standard Pulley Diameter/Diameter Code(mm)	5V										Standard Pulley Diameter/Diameter Code(mm)	8V			
	No. of Grooves							No. of Grooves											No. of Grooves			
Standard Pulley Diameter/Diameter Code(mm)	1	2	3	4	5	6	2	3	4	5	6	8	10	Standard Pulley Diameter/Diameter Code(mm)	4	6	8	10				
67							150							300	*	*						
71			G				160							315				*				
75							170		Q1					335				*				
80							180					Q2	*	355				*				
85							190					*		375	S1		U1	*				
90		H					200						*	400				*				
95							212						*	425				*				
100							224					R2	*	450				*				
112							236						*	475				*				
125		P1					250		R1			S1	*	500	U0			*				
140							265							560				*				
150							280					S1	*	630				*				
160							300							710				*				
180	P1			Q1			315					*		800				*				
200							355					*		1000			W1	*				
250							400					S1	*	1250	*			*				
315							450					*		1600			*	*				
400	*	*					500					*				*	*					
500	*	*				R1	630					*										
630		*	*	*	*	*	800					U1	*									
							1000					*										
							1250	*	*	U0	*	*	*									

* mark signifies nonstocked item

● How to mount onto the shaft

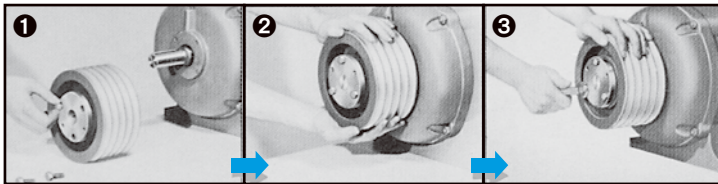

- Place the bushing in the pulley and loosen bolts by hand
- Attach the bushing pulley onto the shaft (it should fit smoothly.)
- Fasten tight with tightening bolts and fitting is completed.

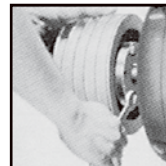

Mounting bushing pulley is easy even from the opposite side.

- Fasten bolts evenly
- Wear protective gear such as gloves while mounting and removing the pulley. Also, before starting any work, switch off the power and ensure that machine is completely stopped.

● How to detach from the shaft

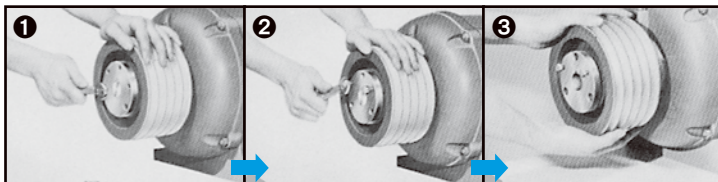

- Remove tightening bolts
- Screw the bolts into the taps for flange removal
- Remove the bushing pulley from the shaft

● Bolt Tightening Torque

Bolt Diameter	Bushing Type	Maximum Tightening Torque
M 6	G · H	9.8 N·m
M 8	P1	18.6 N·m
M10	Q1 · Q2 · R1 · R2	32.3 N·m
M12	S1	69.6 N·m
M16	U0 · U1	138.2 N·m
M20	W1	240.1 N·m

Number of Required Belts and Pulley Width

(Unit: mm)

	1	2	3	4	5	6	7	8	9	10	11	12	13	14	15	16	17	18
3V·3VX	18	28	38	49	59	69	80	90	100	111	121	131	141	152	162	172	183	193
5V·5VX	26	43	61	78	96	113	131	148	166	183	201	218	236	253	271	288	306	323
8V	38	67	96	124	153	181	210	239	267	296	324	353	382	410	439	467	496	525

● Pulley width can be derived from $e \times (\text{no. of belts} - 1) + 2f$.

MB Bushing Size Table

(Unit: mm)

Bushing Type	Sizes												Shaft Hole Diameter		Bolt		Mass (Average) kg
	L	U	T	D		H	V	W	X	Y	R	S	Type 1	Type 2	No.	Type 2	
				Outer Diameter	Inner Diameter												
G	25.4	6.3	19.1	29.769	28.775	50.1	39.7	—	15.9	4.8	3.2	4	10 - 20	22 - 25	2	M 6×16	0.23
H	31.7	6.3	25.4	41.275	39.888	63.2	50.8	—	22.2	4.8	3.2	4	20 - 30	32 - 38	2	M 6×20	0.34
P1	49.2	10.3	38.9	49.213	47.132	76.2	61.9	10	33.3	5.6	5.6	5.5	20 - 35	38 - 42	3	M 8×25	0.57
Q1	63.5	13.5	50.0	73.025	70.250	104.8	85.7	12	44.4	5.6	5.6	7	20 - 50	55 - 65	3	M10×35	1.6
Q2	88.9	13.5	75.4	73.025	68.662	104.8	85.7	12	69.8	5.6	5.6	7	28 - 50	55 - 65	3	M10×35	2.0
R1	73.0	15.9	57.1	101.600	98.425	136.5	117.5	20	50.8	6.3	6.3	7	30 - 70	75 - 95	3	M10×40	3.4
R2	123.8	15.9	107.9	101.600	95.250	136.5	117.5	20	101.6	6.3	6.3	7	38 - 70	75 - 90	3	M10×40	5.0
S1	111.1	19.1	92.0	117.425	112.219	161.7	136.5	20	84.1	7.9	7.9	8	48 - 80	85 - 100	3	M12×50	6.1
U0	125.4	19.1	106.3	152.400	146.450	212.5	117.8	32	95.2	11.1	11.1	10	65 - 100	110 - 130	3	M16×65	12
U1	181.0	27.0	154.0	152.400	143.469	212.5	117.8	32	142.9	11.1	11.1	10	65 - 100	110 - 130	3	M16×65	18
W1	209.5	36.5	173.0	215.900	205.781	317.4	254.0	32	161.9	11.1	11.1	13	90 - 150	160 - 190	4	M20×80	47

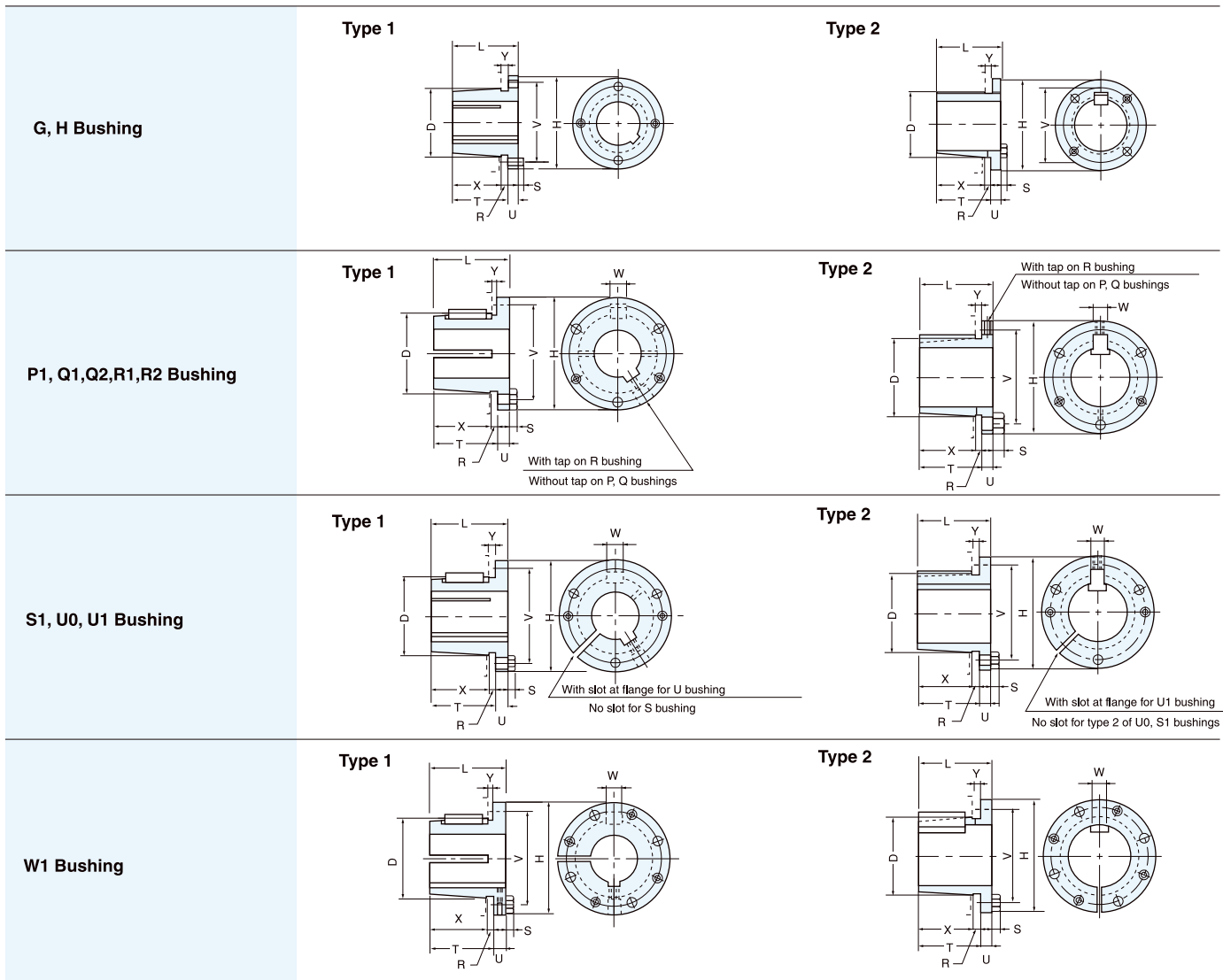

e-Power® V-Belt

This type has enhanced flexibility over standard V-Belts. Due to this flexibility, it reduces the energy loss from bending stress and thus is more efficient and energy-saving.

- It saves electricity.
- It is compatible with existing pulley designs.
- Compact design application.
- It has longer operating life.
- You can choose from 2 types depending on intended use :
Raw Edge Cogged type and Wrapped Notched type

Raw Edge Cogged Type

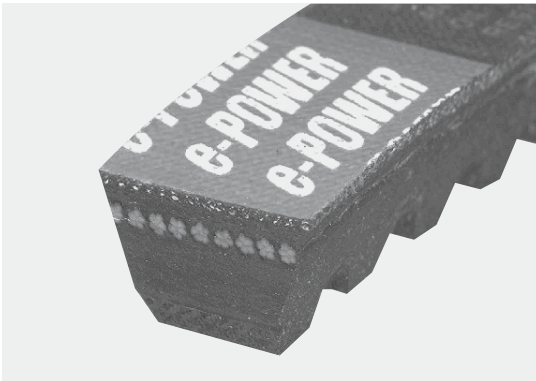

For the cogged type, to enhance flexibility, wave shape dents are added on the bottom of the Raw Edge Belt.

Wrapped Notched Type

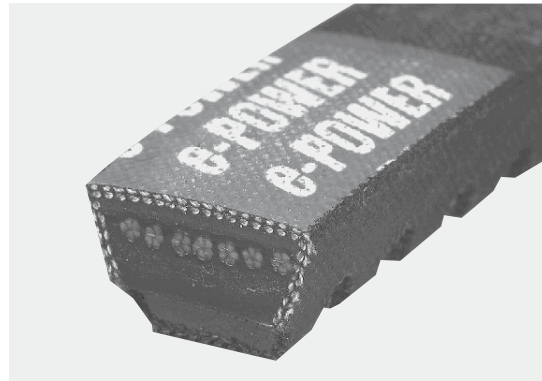

For the Notched type, to enhance flexibility, notches are added across the bottom of the Wrapped V-Belt.

Product Code

AX-50

Belt Type ———— Belt Code (inch)

- Belt code indicates belt effective pitch length in inches

A-50

Belt Type ———— Belt Code (inch)

- Belt code indicates belt effective pitch length in inches

Cross-Sectional Dimensions

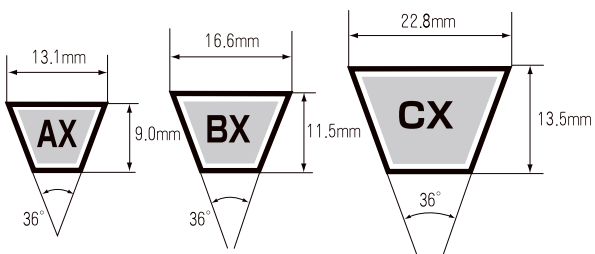

(Note) Above are nominal values.

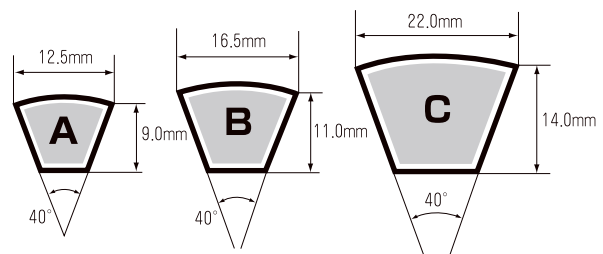

(Note) Above are nominal values.

Standard Belt Sizes

	Nominal Length
AX	20~180
BX	25~270
CX	40~270

	Nominal Length
A	30~200
B	30~200
C	45~200

RIBSTAR Belt G (Rubber V-Ribbed Belt)

This belt combines the properties of the V-Belt's high power transmission capability and the Flat Belt flexibility.

- High-efficiency operation at high speed
- It can be used on a small diameter pulley because of its enhanced flexibility.
- Excellent heat resistance and abrasion resistance
- Compact design application.
- Little belt vibration.

Product Code

(Example)

For PK type, the metric system is used



* Effective Length : The effective outer perimeter

Cross-Sectional Diagram

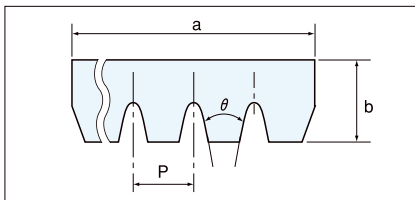

(Unit: mm)

Sign	Belt Type	J	PK	L
a		2.34×N	3.56×N	4.70×N
b		3.80	5.00	7.50
P		2.34	3.56	4.70
θ (°)		40	40	40

* N:No.of Ribs

Standard Sizes for Industrial RIBSTAR Belt

J				PK				L			
Product Code	Effective Length (mm)	Product Code	Effective Length (mm)	Product Code	Effective Length (mm)	Product Code	Effective Length (mm)	Product Code	Effective Length (mm)	Product Code	Effective Length (mm)
180J	457	440J	1,118	PK600	600	PK1250	1,250	345L	876	580L	1,473
190J	483	445J	1,130	PK615	615	PK1280	1,280	350L	889	590L	1,499
200J	508	450J	1,143	PK630	630	PK1320	1,320	355L	902	600L	1,524
210J	533	460J	1,168	PK650	650	PK1360	1,360	360L	914	615L	1,562
220J	559	470J	1,194	PK690	690	PK1400	1,400	370L	940	635L	1,613
235J	597	480J	1,219	PK710	710	PK1450	1,450	375L	953	650L	1,651
240J	610	490J	1,245	PK730	730	PK1500	1,500	380L	965	655L	1,664
245J	622	500J	1,270	PK750	750	PK1550	1,550	385L	978	675L	1,715
250J	635	510J	1,295	PK775	775	PK1600	1,600	390L	991	680L	1,727
260J	660	520J	1,321	PK800	800	PK1650	1,650	395L	1,003	690L	1,753
270J	686	525J	1,334	PK825	825	PK1700	1,700	400L	1,016	695L	1,765
280J	711	530J	1,346	PK850	850	PK1750	1,750	405L	1,029	725L	1,842
285J	724	540J	1,372	PK875	875	PK1800	1,800	410L	1,041	750L	1,905
290J	737	550J	1,397	PK900	900	PK1850	1,850	415L	1,054	765L	1,943
300J	762	560J	1,422	PK925	925	PK1900	1,900	420L	1,067	770L	1,956
310J	787	580J	1,473	PK950	950	PK1950	1,950	425L	1,080	780L	1,981
315J	800	590J	1,499	PK975	975	PK2000	2,000	430L	1,092	815L	2,070
320J	813	600J	1,524	PK1000	1,000	PK2120	2,120	450L	1,143	835L	2,121
330J	838	610J	1,549	PK1030	1,030	PK2240	2,240	460L	1,168	845L	2,146
340J	864	620J	1,575	PK1060	1,060	PK2360	2,360	470L	1,194	865L	2,197
345J	876	630J	1,600	PK1090	1,090	PK2500	2,500	480L	1,219	880L	2,235
350J	889	650J	1,651	PK1120	1,120	PK2650	2,650	500L	1,270	915L	2,324
360J	914	660J	1,675	PK1150	1,150	PK2800	2,800	510L	1,295	930L	2,362
370J	940	665J	1,689	PK1180	1,180	PK3000	3,000	520L	1,321	975L	2,477
375J	953	690J	1,753	PK1220	1,220			540L	1,372	990L	2,515
380J	965	700J	1,778					550L	1,397	1065L	2,705
390J	991	730J	1,854					560L	1,422	1120L	2,845
400J	1,016	750J	1,905					565L	1,435	1150L	2,921
410J	1,041	760J	1,930					570L	1,448		
415J	1,054	770J	1,956								
420J	1,067	780J	1,981								
425J	1,080	820J	2,083								
430J	1,092	890J	2,260								
435J	1,105	900J	2,286								

● Many more sizes are available for PK type. Please contact us for sizes beyond the standard size.

RIBSTAR Belt U (Polyurethane V-Ribbed Belt)

This polyurethane belt combines the features of both V-Belt and Flat Belt.

- Usable on small diameter pulleys (minimum ϕ 20mm) because of its enhanced flexibility with nylon cord.
- Excellent flex fatigue resistance.
- Smooth revolution with little vibration.
- It withstands high-speed operation
- Excellent abrasion, oil and ozone resistance

Product Code

(Example)

180 - JBT - 4

Belt Length : Pitch Length (inch) x 10
 Belt Type
 No. of Ribs (4 ribs)

Dimensions

Sectional Size	Belt Type	JT	JBT	HB
Rib Pitch	P (mm)	2.34	2.40	1.6
Rib Angle	θ (degree)	40	40	40
Rib Height	b_1 (mm)	1.8	1.8	1.0
Rib Bottom Thickness	b_2 (mm)	1.7	1.7	1.5
Total Thickness	$b_1 + b_2$ (mm)	3.5	3.5	2.5
Belt Width	w (mm)	Width varies depending on No. of ribs.		

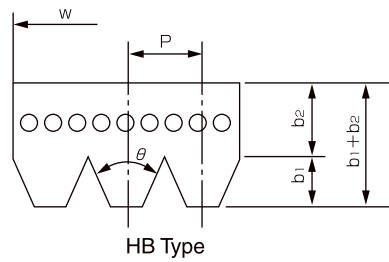
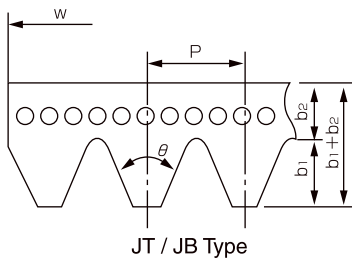

Standard Belt Sizes for JBT Type

No. of Ribs	Product Code	Pitch Length(mm)	Product Code	Pitch Length(mm)	Product Code	Pitch Length(mm)	Product Code	Pitch Length(mm)
3 Ribs	82	208	100	254	135	343	229	582
4 Ribs	84	213	102	259	175	445	235	597
5 Ribs	87	221	116	295	179	455	245	622
6 Ribs	89	226	123	312	180	457	247	627
8 Ribs	90	229	125	318	212	538	337	856
	97	246	130	330	226	573		

Form and Structure of Pulley Groove

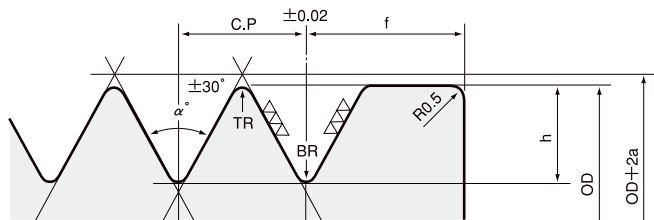

Groove Dimensions for RIBSTAR Pulley

(Unit: mm)

Belt Type	C . P	h	α (°)	TR min	BR	2a	f
JT	2.34	2.25	40	0.2	0.3	0.76	3.5
JBT	2.40	2.34	40	0.2	0.3	0.76	3.5
HB	1.6	1.52	40	0.15	0.2	0.51	1.9

Pulley Width = (groove number - 1) x rib pitch + (f+2)

RIBSTAR Pulley

Except for a few sizes, RIBSTAR pulleys adopt the “bushing system” for easy attachment and removal as well as positioning of pulley onto the shaft.



Pulley Product Code

(Example)

PK - 160 - 5 - 1210

Groove Form

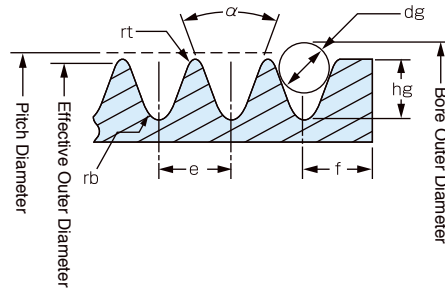
Diameter Code :
Effective Outer Diameter (mm)Bushing
Product
Code
No. of Grooves

Pulley Groove Dimensions

Unit: mm

Groove Form	Belt Type	e	rt	rb max	α (°)	f	Hg Reference Value
PK	PK	3.56 ± 0.05	0.35 ± 0.08	0.5	40 ± 0.5	5 ± 0.5	(3.4)

- Accumulated error of groove pitch is below ± 0.30 .

Pulley Sizes and Relevant Bushing Product Code

Unit: mm

No. of Grooves	4	5	6	8	10	12
Nominal Diameter (Outer Diameter)	Bushing Product Code	Bushing Product Code	Bushing Product Code	Bushing Product Code	Bushing Product Code	Bushing Product Code
50	Shaft hole type	Shaft hole type	Shaft hole type	Shaft hole type	—	—
56	Shaft hole type	Shaft hole type	Shaft hole type	Shaft hole type	—	—
63	1108	1108	1108	1108	—	—
71	1108	1108	1108	1108	—	—
80	1210	1210	1310	1310	1310	1610
90	1210	1210	1610	1610	1610	1610
100	1210	1210	1610	1610	1610	1610
112	1610	1610	1610	1610	1610	2012
125	1610	1610	1610	2012	2012	2012
140	1610	1610	1610	2012	2012	2012
160	1610	1610	2012	2012	2012	2517
180	1610	1610	2012	2517	2517	2517
200	2012	2012	2012	2517	2517	3020
224	2012	2012	2012	2517	2517	3020
250	2012	2012	2012	2517	2517	3020
280	2012	2012	2012	2517	2517	3020
315	2012	2517	2517	3020	3020	3020
355	2012	2517	3020	3020	3020	3020

- Up to 30m/sec of pulley rim speed is enabled. Please do not exceed 30m/sec.

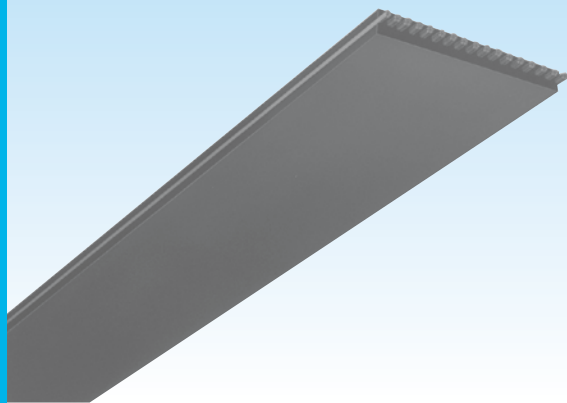



FLEXSTAR® Belt

Because of its large power transmission capacity, compact design application and cost reduction are possible.

- Smooth and quiet operation with little vibration. Withstands operation at a maximum speed of 60m/sec
- Excellent heat resistance, oil resistance and antistatic properties
- Almost no need for re-tension since the belt doesn't stretch much

Dimensions & Product Code

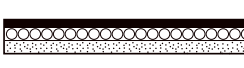
Belt Type	Thickness (mm)	Standard Belt Width (mm)	Product Code
FL		10, 15, 20, 25, 30, 35, 40, 50	<p>Example</p> <p>40 FM 1500</p> <p>— Belt Length(mm)</p> <p>— Belt Type</p> <p>— Belt Width(mm)</p>
FM		20, 30, 40, 50, 60, 80, 100	
FH		50, 75, 100, 125, 150, 175, 200	

● In addition, a belt known as FLEG for transportation is also available. Belt thickness of FLEG is 1,3mm.

Standard Belt Sizes

Belt Length (mm)	FL	FM	FH	Belt Length (mm)	FL	FM	FH	Belt Length (mm)	FL	FM	FH	Belt Length (mm)	FL	FM	FH
200	○			560	○	○		1000	○	○	○	1800	○	○	○
224	○			600	○	○		1060	○	○	○	1900	○	○	○
250	○			630	○	○		1120	○	○	○	2000	○	○	○
280	○			670	○	○		1180	○	○	○	2240		○	○
315	○			710	○	○		1250	○	○	○	2500		○	○
355	○			750	○	○		1320	○	○	○	2800		○	○
400	○			800	○	○	○	1400	○	○	○	3150		○	○
450	○			850	○	○	○	1500	○	○	○	3550		○	○
500	○	○		900	○	○	○	1600	○	○	○	4000		○	○
530	○	○		950	○	○	○	1700	○	○	○				

Applications

General Industrial Machinery	Machine Tool	Woodworks Machinery	Textile Machine	Paper Manufacturing Machinery	Electric Equipment	Other kinds of machinery
Various fans Blower Various pumps Compression machine Pulverizer Compressor Mixer Centrifuge Various press Mill	Lathe NC lathe Milling machine Grinder Various polishing machines Slotter Planer Hobbing machine Drilling machine Boring machine Shaver Shirring machine Power press Friction press	Router machine Bandsaw Chipper	Winder Draw texturizing machine Assemble winder Yarn twisting machine Twister Various spinning and weaving machines	Paper machine Rotary paper machine Holding feeder Packing sorting machine Paper tube machine	Generator Computer Power planer Auto dryer	Grinding mill Printing machine Precision equipment Leisure facilities Chemical equipment Automatic vending machine Money changing machine Copier Paper feeder Ticketing machine

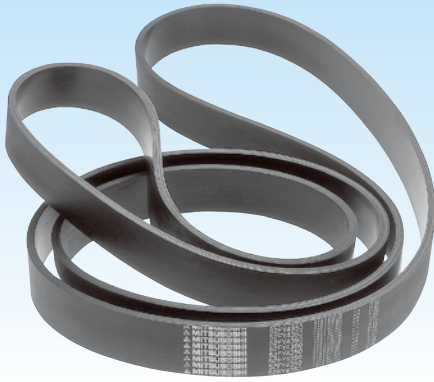

SUPER FLEXSTAR® Belt

SUPER FLEXSTAR® is a high tension flat belt developed for press application whereby a belt and a pulley sandwich and dewater objects.

- High belt tension
- Besides press application, it also suits applications like conveyance.

Product Code

(Example)

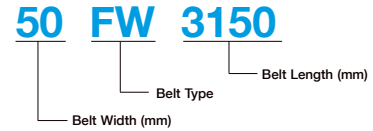

Cross-Sectional Diagram

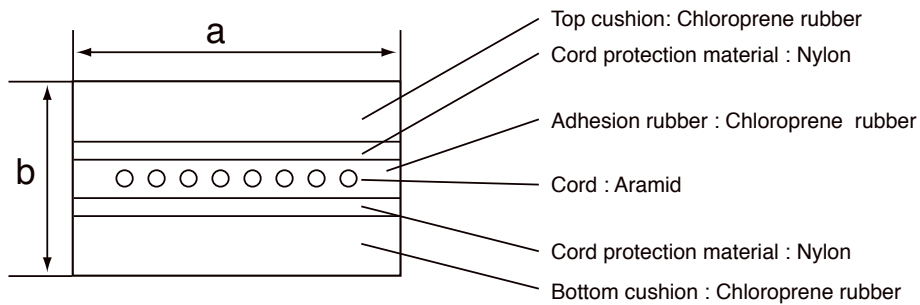

Belt Types

Belt Type	Application	a Standard Width (mm)	b Belt Thickness (mm)	Standard Size (mm)	Minimum Pulley Diameter(mm)	Belt Edge Finishing	Tensile Strength (kN/cm)
FW	For high pressure	50 (25~400)*	8.4	3150, 4800	300	No rubber ears	12
FY	For high pressure, anti-oil swelling	52	8.4	(2000~4800)*	300	With rubber ears	10

* () indicates manufacturable range.

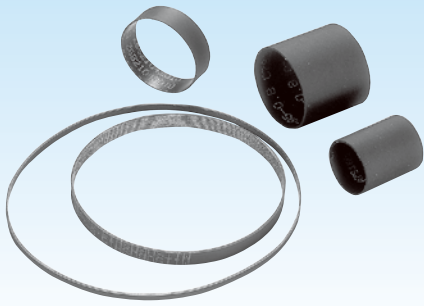

FLEXSTAR® Belt J

FLEXSTAR® Belt J is a thin, flexible and seamless high-precision flat belt, developed specially for conveyance of tickets, plastic cards, paper money, coins and so on.

- Good running stability
- Reliable conveyance
- Excellent abrasion resistance and adaptability
- Maintenance-free

Product Code

(Example)

10 - JLB - 500 - 1.0

Belt Width (mm)

Belt Type

Belt Length (mm)

Belt Thickness (mm)

Product Lineup

Model	Application	Belt Type	Min. Belt Width (mm)	Belt Thickness (mm)	Belt Length Range (mm)	Tension member Material	Fabric Material	Rubber Material	Surface Condition		Stable Shaft Load/ 10mm width		Min. Pulley Diameter (mm)	Force/ 10mm Width (N)	Elongation at Tearing Point (%)
									Outer	Inner	Belt Thickness (mm)				
Ultra High Modulus Model	Light-duty power transmission in applications where belt elongation needs to be controlled	J8GA	3	0.65	100~800	Glass	Nylon fabric	CR	Polished	Fabric	0.85	80N/0.1% elongation	10	1500	—
		J8GE	3	0.65	100~800	Glass	Nylon fabric	EPDM base	Polished	Fabric	0.85	80N/0.1% elongation	10	1500	—
	Ceramic resistor, chip pulverization	J8GC1	3	0.70	300~1800	Glass	Nylon fabric	H-NBR	Fabric	Fabric	0.70	80N/0.1% elongation	10	1500	—
		J8GC2	3	0.62	300~1800	Glass	Nylon fabric	H-NBR	Fabric	Fabric	0.62	80N/0.1% elongation	10	1500	—
High Modulus Model	Light-duty power transmission eg) ticket/paper conveyance (for train station service etc)	J8H	3	0.65~2.0	100~2800	Polyester	Nylon woven fabric	H-NBR	Polished	Metallic	1.00	80N/0.1% elongation	10	500	10
		J8HB	3	0.65~2.0	100~2800	Polyester	Nylon/ polyester woven fabric	H-NBR	Woven fabric	Polished	1.00	80N/0.1% elongation	10	500	10
		J6H	6	0.65~2.0	100~2800	Polyester	Nylon woven fabric	H-NBR	Polished	Metallic	1.00	60N/0.1% elongation	10	400	10
		J6HB	6	0.65~2.0	100~2800	Polyester	Nylon/ polyester woven fabric	H-NBR	Woven fabric	Polished	1.00	60N/0.1% elongation	10	400	10
		J3H	8	0.65~2.0	100~2800	Polyester	Nylon woven fabric	H-NBR	Polished	Metallic	1.00	30N/0.1% elongation	10	200	10
		J3HB	8	0.65~2.0	100~2800	Polyester	Nylon/ polyester woven fabric	H-NBR	Woven fabric	Polished	1.00	30N/0.1% elongation	10	200	10
Low Modulus Model	Multi-axial layout with fixed center distance eg) Ticket/paper conveyance (ATM machine, ticket machine)	JL	5	0.65~1.0	60~1300	—	Endless, Nylon, woven fabric	H-NBR	Polished	Metallic	1.00	8N/0.8% elongation	8	200	400
											0.80	7N/8% elongation	8	160	400
											0.65	6N/8% elongation	8	130	400
		JL3	8	0.65~1.0	60~800	—	Endless, Nylon, woven fabric	H-NBR	Polished	Metallic	1.00	23N/8% elongation	8	185	200
											0.80	18.5N/8% elongation	8	148	200
											0.65	15N/8% elongation	8	120	200
		JLB	5	0.65~1.0	60~1300	—	Endless, polyester, woven fabric	H-NBR	Woven fabric	Polished	1.00	8N/8% elongation	8	200	400
											0.80	7N/8% elongation	8	160	400
											0.65	6N/10% elongation	8	130	400
		JLU5	8	0.65~1.0	80~800	—	Endless, polyester, woven fabric	Millable urethane	Woven fabric	Polished	1.00	12.3N/5% elongation	8	108	120
											0.80	9.8N/5% elongation	8	86	12
											0.65	8N/5% elongation	8	70	120
All Rubber Model	Multi-axial layout with fixed center distance Light conveyance in applications where width warpage needs to be controlled eg) Ticket/paper conveyance (ATM machine, ticket machine)	JN	4	1.0	60~1300	—	—	H-NBR	Polished	Metallic	1.00	8N/8% elongation	8	200	400
				0.8							0.80	7N/8% elongation	8	160	400
		JU	5	0.65	60~800	—	—	Millable urethane	Polished	Metallic	0.65	7N/5% elongation	8	130	300

Values in the above table are central values, not standard values.

Best seller!

POLYMAX® Belt

This is a wide-angle belt with an angle of approx. 60°.

- High-speed power transmission with low vibration
- Compact design and cost efficient
- Maintenance-free and stretch resistance
- Excellent weather resistance
- MATCHED SET is available for both single and MULTI belts.
Ask for MATCHED SET to improve the performance of multi set system.

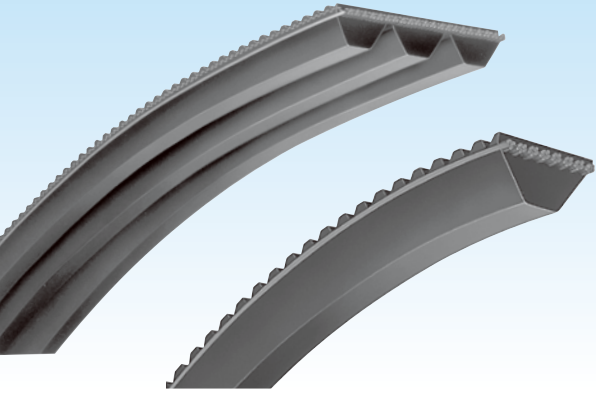

Cross-Sectional Sizes & Product Code

POLYMAX® Belt

Type	3M	5M	7M	11M
	3×2mm	5×3mm	7×5mm	11×7mm
Dimensions (a x b)				
Product Code	Example 7M 1000 Effective Length(mm) Belt Type			

Multi-POLYMAX® Belt

No. of Ribs	2			3		
Belt Type	5M	7M	11M	5M	7M	11M
a	9.8	15.6	24.4	15.1	24.1	37.6
b	3.5	5.3	7.0	3.5	5.3	7.0
P	5.3	8.5	13.2	5.3	8.5	13.2
Dimensions						
Product Code	Example 3R - 5M 1320 Effective Length(mm) Belt Type No. of Ribs					

Standard Belt Sizes

3M		5M		7M		11M	
3M180	3M425	5M280	* 5M 670	* 7M 500	* 7M1180	* 11M 710	* 11M1700
3M185	3M437	5M290	* 5M 690	* 7M 515	* 7M1220	* 11M 730	* 11M1750
3M190	3M450	5M300	* 5M 710	* 7M 530	* 7M1250	* 11M 750	* 11M1800
3M195	3M462	5M307	* 5M 730	* 7M 545	* 7M1280	* 11M 775	* 11M1850
3M200	3M475	5M315	* 5M 750	* 7M 560	* 7M1320	* 11M 800	* 11M1900
3M206	3M487	5M325	* 5M 775	* 7M 580	* 7M1360	* 11M 825	* 11M1950
3M212	3M500	5M335	* 5M 800	* 7M 600	* 7M1400	* 11M 850	* 11M2000
3M218	3M515	5M345	* 5M 805	* 7M 615	* 7M1450	* 11M 875	* 11M2060
3M224	3M530	5M355	* 5M 825	* 7M 630	* 7M1500	* 11M 900	* 11M2120
3M230	3M545	5M365	* 5M 850	* 7M 650	* 7M1550	* 11M 925	* 11M2180
3M236	3M560	5M375	* 5M 875	* 7M 670	* 7M1600	* 11M 950	* 11M2240
3M243	3M580	5M387	* 5M 900	* 7M 690	* 7M1650	* 11M 975	* 11M2300
3M250	3M600	5M400	* 5M 925	* 7M 710	* 7M1700	* 11M1000	
3M258	3M615	5M412	* 5M 950	* 7M 730	* 7M1750	* 11M1030	
3M265	3M630	5M425	* 5M 975	* 7M 750	* 7M1800	* 11M1060	
3M272	3M650	5M437	* 5M1000	* 7M 775	* 7M1850	* 11M1090	
3M280	3M670	5M450	* 5M1030	* 7M 800	* 7M1900	* 11M1120	
3M290	3M690	5M462	* 5M1060	* 7M 825	* 7M1950	* 11M1150	
3M300	3M710	5M475	* 5M1090	* 7M 850	* 7M2000	* 11M1180	
3M307	3M730	5M487	* 5M1120	* 7M 875	* 7M2060	* 11M1220	
3M315	3M750	* 5M500	* 5M1150	* 7M 900	* 7M2120	* 11M1250	
3M325		* 5M515	* 5M1180	* 7M 925	* 7M2180	* 11M1280	
3M335		* 5M530	* 5M1220	* 7M 950	* 7M2240	* 11M1320	
3M345		* 5M545	* 5M1250	* 7M 975	* 7M2300	* 11M1360	
3M355		* 5M560	* 5M1280	* 7M1000		* 11M1400	
3M365		* 5M580	* 5M1320	* 7M1030		* 11M1450	
3M375		* 5M600	* 5M1360	* 7M1060		* 11M1500	
3M387		* 5M615	* 5M1400	* 7M1090		* 11M1550	
3M400		* 5M630	* 5M1450	* 7M1120		* 11M1600	
3M412		* 5M650	* 5M1500	* 7M1150		* 11M1650	

* indicates availability of Multi- POLYMAX®

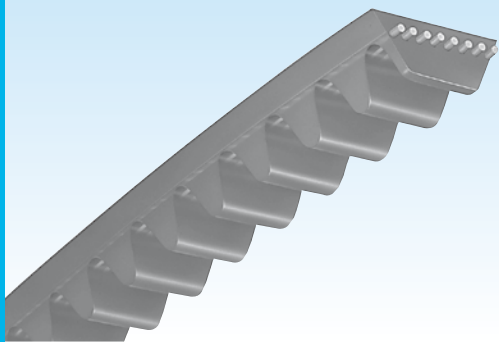

MB Belt (Polyurethane V-Belt)

A small transparent belt for light-duty power transmission

- With its high flexibility, it can be used with a small diameter pulley.
- Excellent abrasion resistance and thus clean operation
- Small slippage operation
- Excellent oil resistance

Cross-Sectional Dimensions & Product Code

Belt Type	Single Cog	Product Code
Belt Form	MB	Example
Top Width a (mm)	6.0	
Height b (mm)	4.0	
Angle θ (°)	40	
Dimensions (a x b)		<p>MB-360</p> <p>— Belt Length (Outer Perimeter in mm)</p> <p>— Belt Type</p>

Standard Belt Sizes

Belt Form	MB			
Belt Type	Single Cog			
a×b (mm)	6.0×4.0			
Belt Length	250	340	400	500
	260	345	410	510
	270	350	420	520
	280	360	430	530
	290	365	440	540
	300	370	450	550
	310	380	460	560
	315	385	470	640
	320	390	480	760
	330	395	490	

Form & Dimensions of Pulley Grooves

Belt	MB				Wo Reference (min)
	Belt Height 4.0mm				
	Min. Width (W)	Min. Height (h)	θ	R	
16~30mm	5.4	4.5	36°	0.8	5.6
30mm and above	5.4	4.5	38°	0.8	5.6

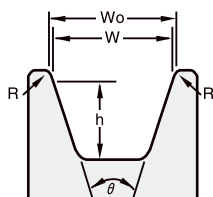

Minimum Pulley Diameter

Belt Type	Single Cog	Double Cog
Minimum Pulley Diameter (mm)	18	16

STARROPE® / SUPER STARROPE® / PRENE V-ROPE / PRENE HEXAGONAL-ROPE

This is an open-end polyurethane belt.

- It is easily applicable in complex power transmission system such as multi-axial and divertible power transmission.
- Thermal weld: Endless belt length possible.
- Excellent abrasion and oil resistance

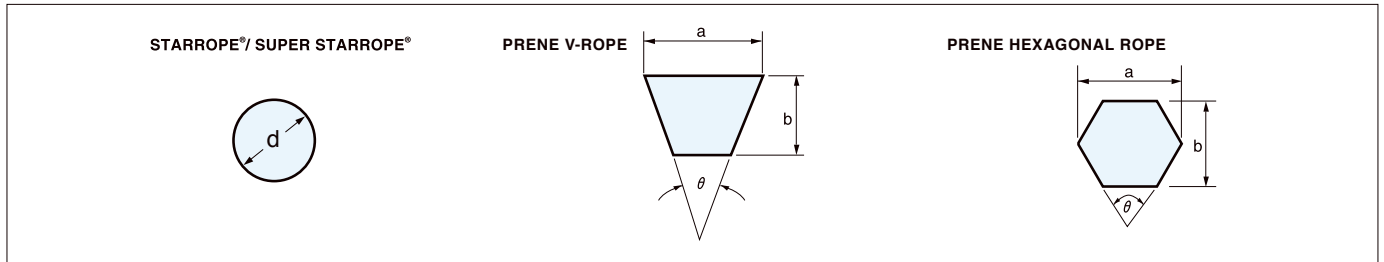
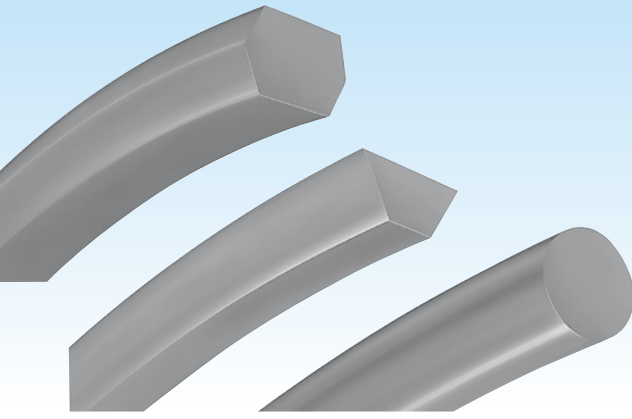

STARROPE® / SUPER STARROPE® Dimensions

Belt Code	2φ	3φ	4φ	5φ	6φ	7φ	8φ	9φ	10φ	12φ	15φ
d (mm)	2	3	4	5	6	7	8	9	10	12	15
Length of 1 Roll (m)	200	200	200	200	100	100	100	100	100	50	50

PRENE V-ROPE Cross-Sectional Dimensions

Dimensions	Belt Type	M	A	B
a (mm)		10.0	12.5	16.5
b (mm)		5.5	8.5	10.5
θ (°)		40	40	40
Length of 1 Roll (m)		100	50	50

PRENE HEXAGONAL-ROPE Cross-Sectional Dimensions

Dimensions	Belt Type	AA	BB
a (mm)		12.5	16.5
b (mm)		10.0	12.5
θ (°)		40	40
Length of 1 Roll (m)		50	50

Pulley for STARROPE® / SUPER STARROPE®

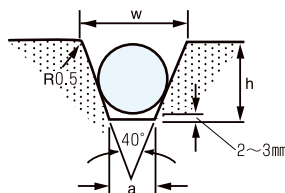

Pulley for PRENE V-ROPE / PRENE HEXAGONAL-ROPE

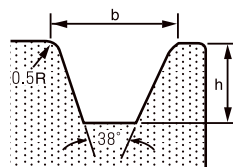

Dimensions	PRENE V-ROPE			PRENE HEXAGONAL-ROPE	
	M	A	B	AA	BB
b (mm)	9.7	12.3	16.3	12.3	16.3
h (mm)	9.0	12.5	15.0	12.5	15.0

● Dimensions of V pulley are specified by JIS-B1854.

Pulley Dimensions for STARROPE® / SUPER STARROPE®

Dimensions	Belt Code	2φ	3φ	4φ	5φ	6φ	7φ	8φ	9φ	10φ	12φ	15φ
a (mm)		0.6	0.6	0.6	1.3	2.0	2.7	3.4	4.1	4.8	6.2	8.3
w (mm)		2.9	4.3	5.7	7.1	8.6	10.0	11.4	12.9	14.3	17.1	21.4
h (mm)		3.0	5.0	7.0	8.0	9.0	10.0	11.0	12.0	13.0	15.0	18.0

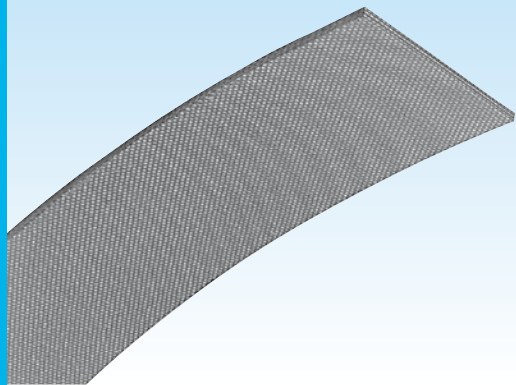

Flat Belt

This is a high-quality flat belt made from premium fabric and synthetic rubber.
 There is very little belt shrinkage.
 Excellent flex resistance
 Heat, water and oil resistance

- For textile and agricultural machines

Product Lineup

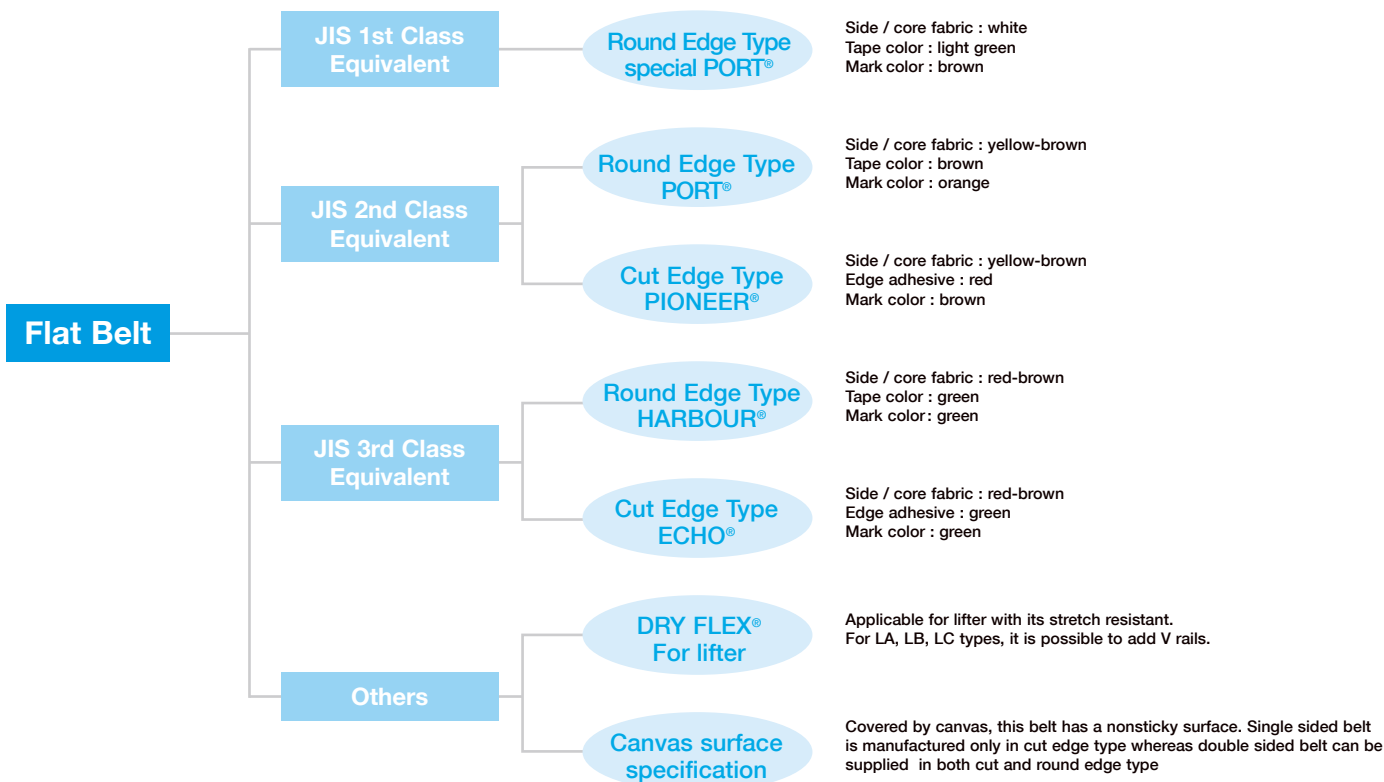

Standard Sizes for Round Edge Products

Belt Width \ No. of Plies	2P	3P	4P	5P	6P	7P	8P
20mm							
25mm		H•P					
30mm		H•P					
38mm		H•P	H				
50mm		H•P	H•P				
63mm		H•P	H•P				
75mm	H•P	H•P	H•P				
90mm	H•P	H	H•P				
100mm	H•P	H	H•P	P			
125mm	H•P	H	H	H•P			
150mm	H	H	H	P	H•P		
175mm	H	H			P		
200mm	H	H				P	P
250mm	H	H				P	P
300mm	H	H					P
350mm		H					
400mm							
500mm							
600mm							

● H: HARBOUR® P: PORT®
 ● Made-to-order for cut edge type (PIONEER®, ECHO®), DRY FLEX® and Canvas surface types.
 ● A lot for made-to-order items is 100m.

III Direct Connected Power Transmission

Chemi-Chan®

(High Performance Miniature Coupling) P59

HYPERFLEX® Coupling P60

TSCHAN® Coupling NOR-MEX® P61, 62

TSCHAN® Coupling S P63



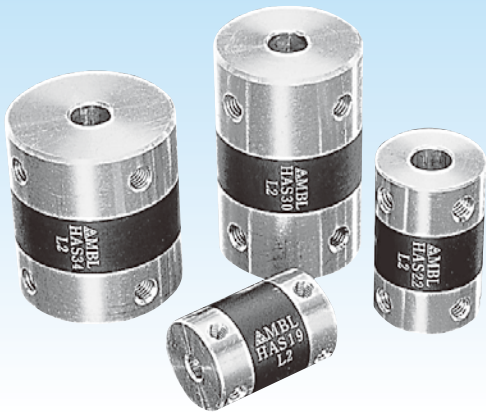

“Chemi-Chan®” (High Performance Miniature Coupling)

“Chemi-Chan®”, high-performance miniature coupling, launched on the market for high precision rotary transmission.

- Excellent vibration absorption
- Quiet operation
- Accurate positioning and transmission of rotating power
- High durability which withstands harsh start and stop of power shaft.

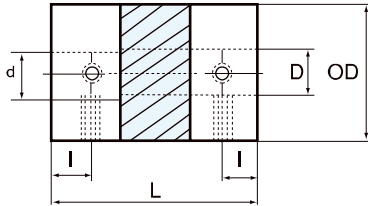

Coupling Product Code (Example) HAS - 22 - 8x6 - C(or F)

Coupling Code: HAS
Coupling Outer Diameter (φ22): 22
Duplex Shaft Diameter (large diameter x small diameter): 8x6
C: Clamp Type
F: With Flange (opaque ring)

Standard Sizes

Item		Product Name	HAS-19	HAS-22	HAS-30	HAS-34
Specifications	Rated Torque T_s	N·cm {kgf·cm}	98 {10}	196 {20}	392 {40}	588 {60}
	Torsional Rigidity	N·cm/rad {kgf·cm/rad}	4.9×10^2 { 0.5×10^2 }	32.36×10^2 { 3.3×10^2 }	79.43×10^2 { 8.1×10^2 }	138.27×10^2 { 14.1×10^2 }
	Allowed Misalignment	De-Centering (mm) Deviation Angle (degree)	0.1 0.2	0.1 0.2	0.1 0.2	0.1 0.2
	Inertial Moment	N·cm ² {gf·cm ² }	0.073 {7.4}	0.17 {17.3}	0.919 {93.7}	1.157 {118}
	Maximum Revolution Speed	rpm	20000	20000	15000	12000
	Temperature Range	°C	5~60	5~60	5~60	5~60
Dimensions	Outer Diameter OD	mm	φ 19	φ 22	φ 30	φ 34
	Standard Duplex Shaft Diameter large diameter D x small diameter d mm		φ 5 × φ 5	φ 6 × φ 6 φ 8 × φ 6	φ 14 × φ 8 φ 14 × φ 10	φ 14 × φ 8 φ 14 × φ 10
	Shaft Diameter Finishing H7		φ 8 × φ 5	φ 8 × φ 8	φ 14 × φ 12	φ 14 × φ 12
	Total Length L	mm	27.4	35.0	49.0	40.0
	Tap Position I	mm	3.60	5.50	9.00	6.75
	Tap Size		M4×0.7	M5×0.8	M5×0.8	M5×0.8
Product Mass	g	15	26	77	77	

(Note 1) Peak maximum torque should be twice less than rated torque.

(Note 2) Currently, we use a screw method to mount it onto the shaft.

(Note 3) We use a mass of coupling with a drilled hole as a standard product mass.

Applications

- Servo stepping motor equipment, encoder, tachometer generator, synchronous motor, etc
- Precision X-Y table, IC bonder
- Copier, controller, medical equipment, communication equipment

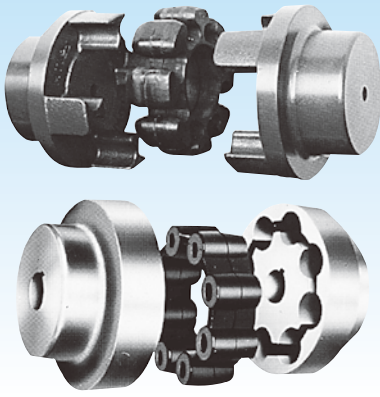

HYPERFLEX® Coupling (MT·MH)

Two types are available –MT type and MH type
 MT type is a compression stress type, which is compact design with large transmission torque.
 MH type is a model uses shearing stress of elastic rubber.

- MT Type**
- Applicable for all kinds of applications.
 - Compact size with large transmission torque.
 - Easy-to-install and maintenance-free
 - The polyurethane elastic body, which features excellent oil and abrasion resistance.
- MH Type**
- High flexibility and excellent shock absorption
 - Applicable as a torque limiter

Coupling Product Code (Example)

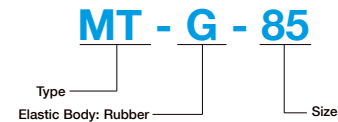

Standard Sizes for MT Type

Product Code	Regular Maximum Torque (N.m)		Maximum Revolution Speed (rpm)	Outer Diameter (mm)	Total Length (mm)
	Rubber (G)	Polyurethane(U)			
MT- 50	5.88	7.85	6,000	50	58
MT- 60	9.81	14.7	6,000	60	72
MT- 70	15.7	24.5	6,000	70	75
MT- 85	34.3	49.0	5,500	85	101
MT-100	53.9	78.5	5,500	100	115
MT-125	118	196	4,400	125	147
MT-140	157	245	4,200	140	160
MT-170	314	441	3,800	170	176
MT-185	441	588	3,800	185	193
MT-200	637	883	3,600	200	217
MT-225	980	1370	3,600	225	238

● Use MT type coupling when there is torque variation, forward reverse operation, shock, etc.

Standard Sizes for MH Type

Product Code	Regular Maximum Torque (N.m)		Maximum Revolution Speed (rpm)	Outer Diameter (mm)	Total Length (mm)
	Standard	Super※1			
MH- 45	0.98	1.96	6,000	45	49
MH- 55	1.96	3.92	6,000	55	57
MH- 65	3.92	6.86	6,000	65	63
MH- 80	8.83	15.7	5,500	80	73
MH- 90	10.8	36.3	5,000	90	83
MH-115	29.4	78.5	4,600	115	113
MH-130	37.3	118.0	4,400	130	123
MH-145	58.8	196.0	4,200	145	133
MH-175	147.0	422.0	3,800	175	163
MH-200	245.0	637.0	3,600	200	223

※1: MH Super type is the one with reinforcement iron core.

● Use MT type coupling when there is torque variation, forward reverse operation, shock, etc.

Applications

- Various pumps
- Fan
- Blower
- Compression machine
- Compressor
- Reducer
- Speed changer
- Mixer
- Generator
- Machine tools
- Chemical equipment
- Wood works machine
- Textile machine
- Paper making machine
- Conveyor system
- Injection molding system
- Construction machine
- Car wash machine

TSCHAN® Coupling NOR-MEX®

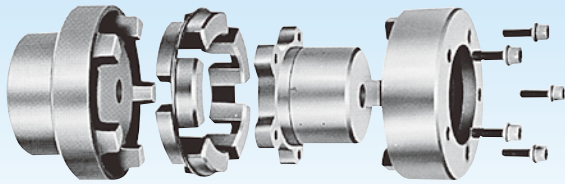

It consists of a flange and a unique shape elastic body, which withstands large transmission torque. 20 types available and 301 total combinations.

- Energy-saving since it transmits large torque with small body.
- Suitable for machineries with high-speed revolution
- Elastic body can be easily attached and removed without moving machinery.
- Compact design application, quiet operation and also maintenance-free.
- Wide variety of sizes and types.

Coupling Product Code (Example) **Nor - Mex G 148**



Standard Sizes

G						LG						FG					
Code	Regular Torque TN N-m	Max. Torque Mmax N-m	Max. Revolution Speed rpm	Outer Diameter mm	Total Length mm	Code	Regular Torque TN N-m	Max. Torque Mmax N-m	Max. Revolution Speed rpm	Outer Diameter mm	Total Length mm	Code	Regular Torque TN N-m	Max. Torque Mmax N-m	Max. Revolution Speed rpm	Outer Diameter mm	Total Length mm
G 82	49	88.3	8000	82	91.5	LG 82-120	49	88.3	8000	120	67.5	FG 82	49	88.3	8000	82	80
G 97	103	186	7000	97	113	LG 97-144	103	186	7000	144	83	FG 97	103	186	7000	97	92.5
G112	164	294	6000	112	133	LG112-158	164	294	6000	158	95	FG112	164	294	6000	112	110
G128	262	471	5000	128	153.5	LG128-180	262	471	5000	180	108.5	FG128	262	471	5000	128	121.5
G148	409	735	4500	148	175.5	LG148-200	409	735	4500	200	123.5	FG148	409	735	4500	148	140.5
G168	682	1230	4000	168	197.5	LG168-220	682	1230	4000	220	141.5	FG168	682	1230	4000	168	159
G194	1100	1960	3500	194	220.5	LG194-248	1100	1960	3500	248	158.5	FG194	1100	1960	3500	194	177.5
G214	1640	2940	3000	214	243	LG214-274	1640	2940	3000	274	175	FG214	1640	2940	3000	214	195.5
G240	2620	4710	2750	240	266	LG240-314	2620	4710	2750	314	191	FG240	2620	4710	2750	240	212.5
G265	4090	7350	2500	265	309.5	LG265-344	4090	7350	2500	344	219.5	FG265	4090	7350	2500	265	245.5
G295	5440	9810	2250	295	334	LG295-380	5440	9810	2250	380	236	FG295	5440	9810	2250	295	264
G330	7080	12700	2000	330	356	LG330-430	7080	12700	2000	430	252	FG330	7080	12700	2000	330	282.5
G370	9900	17800	1750	370	399	(LG370-480)	9900	17800	1750	480	281	FG370	9900	17800	1750	370	313
G415	14700	26500	1500	415	441	(LG415-575)	14700	26500	1500	575	306	FG415	14700	26500	1500	415	343
(G480)	19600	35300	1400	480	485												
(G575)	29400	53000	1200	575	525												
E						LE						FE					
Code	Regular Torque TN N-m	Max. Torque Mmax N-m	Max. Revolution Speed rpm	Outer Diameter mm	Total Length mm	Code	Regular Torque TN N-m	Max. Torque Mmax N-m	Max. Revolution Speed rpm	Outer Diameter mm	Total Length mm	Code	Regular Torque TN N-m	Max. Torque Mmax N-m	Max. Revolution Speed rpm	Outer Diameter mm	Total Length mm
E 50	12.7	22.6	13500	50	52												
E 67	21.6	39.2	10000	67	62.5	LE 67-106	21.6	39.2	10000	106	47.5						
E 82	49.0	88.3	8000	82	83	LE 82-120	49.0	88.3	8000	120	59	FE 82	49.0	88.3	8000	82	71.5
E 97	103	186	7000	97	103	LE 97-144	103	186	7000	144	73	FE 97	103	186	7000	97	82.5
E112	164	294	6000	112	123.5	LE112-158	164	294	6000	158	85.5	FE112	164	294	6000	112	100.5
E128	262	471	5000	128	143.5	LE128-180	262	471	5000	180	98.5	FE128	262	471	5000	128	111.5
E148	409	735	4500	148	163.5	LE148-200	409	735	4500	200	111.5	FE148	409	735	4500	148	128.5
E168	682	1230	4000	168	183.5	LE168-220	680	1230	4000	220	127.5	FE168	682	1230	4000	168	145
E194	1100	1960	3500	194	203.5	LE194-248	1100	1960	3500	248	141.5	FE194	1100	1960	3500	194	160.5
E214	1640	2940	3000	214	224	LE214-274	1640	2940	3000	274	156	FE214	1640	2940	3000	214	176.5
E240	2620	4710	2750	240	244	LE240-314	2620	4710	2750	314	169	FE240	2620	4710	2750	240	190.5
E265	4090	7350	2500	265	285.5	LE265-344	4090	7350	2500	344	195.5	FE265	4090	7350	2500	265	221.5
E295	5440	9810	2250	295	308	LE295-380	5440	9810	2250	380	210	FE295	5440	9810	2250	295	238
E330	7080	12700	2000	330	328	(LE330-430)	7080	12700	2000	430	224	FE330	7080	12700	2000	330	254.5
E370	9900	17800	1750	370	368	(LE370-480)	9900	17800	1750	480	250	FE370	9900	17800	1750	370	282
E415	14700	26500	1500	415	408	(LE415-575)	14700	26500	1500	575	273	FE415	14700	26500	1500	415	310

Sizes in () are made-to-order.

* TSCHAN® and NOR-MEX® are registered trademarks of TSCHAN® GmbH (Corporation).

TSCHAN® Coupling NOR-MEX® Series

Applications

- Water pump
- Hydraulic pump
- Blower
- Injection molding machine
- Paper manufacturing machine
- Compressor
- Rotary compressor
- Screw compressor
- Plate feeder
- Batch plant
- Ball mill
- Hydraulic pump
- Blower
- Injection molding machine
- Paper manufacturing machine

G Type	LG Type	FG Type	E Type	LE Type	FE Type
 NE-TSN NG-TSN	 NL-TSN NG-TSN	 NF-TSN NG-TSN	 NE-TSN NE-TSN	 NE-TSN NL-TSN	 NF-TSN NE-TSN

 G	 FG	 LG
 E	 FE	 LE

TSCHAN® Coupling S

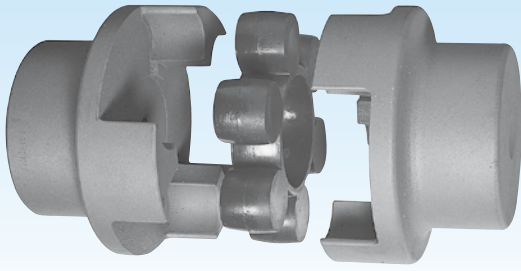

- Small size with large torque
- Light, compact and easy to install and remove
- Suitable for machinery with high revolution speed
- Quiet operation and longer operating life
- Maintenance-free

Applications

- Crane
- Hot run table
- NC mill
- Machining center
- Food manufacturing machinery
- Industrial sewing machine
- Centrifuge
- Generator
- Conveyor drive
- Screw compressor
- Water pump
- Two-way blower

Coupling Product Code (Example)

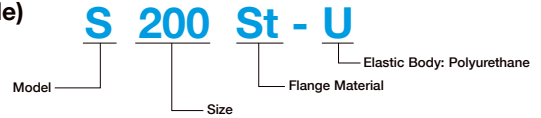

Standard Sizes for TSCHAN® Coupling S

S				SX			SV			SZ			Maximum No. of Revolution N _{max} (min ⁻¹)				
Code	Maximum Torque M _{max} (N·m) Elastic Body		Outer Diameter mm	Total Length mm	Code	Outer Diameter		Total Length mm	Code	Outer Diameter		Total Length mm	Code	Outer Diameter mm	Total Length mm	Aℓ	St
	Rubber	Polyurethane				ST mm	ZA mm			VS mm	ZA mm						
(S 20 Aℓ)	1.08	1.96	20	27												24000	—
(S 30 Aℓ)	5.79	11.8	30	35												16000	—
(S 40 Aℓ)	12.7	26.5	40	50												12000	—
S 50 St	17.7	35.3	50	75												—	15000
S 70 St	69.6	137	70	100												—	11000
S 85 St	98	196	85	110												—	9000
S 100 St	167	343	105	125	SX 100 St/Aℓ	105	145	84.5	SV 100 Aℓ/St	105	145	50	SZ 100 Aℓ	145	42	7250	7250
S 125 St	304	628	126	145	SX 125 St/Aℓ	126	170	97	SV 125 Aℓ/St	126	170	57	SZ 125 Aℓ	170	47	6000	6000
S 145 St	510	1040	145	160	SX 145 St/Aℓ	145	194	109	SV 145 Aℓ/St	145	194	65	SZ 145 Aℓ	194	55	5250	5250
S 170 St	790	1630	170	190	SX 170 St/Aℓ	170	220	126.5	SV 170 Aℓ/St	170	220	75	SZ 170 Aℓ	220	60	4500	4500
S 200 St	1380	2820	200	245	SX 200 St/Aℓ	200	252	156.5	SV 200 Aℓ/St	200	252	85	SZ 200 Aℓ	252	65	3750	3750
S 230 St	2140	4360	230	270	SX 230 St/Aℓ	230	290	171	SV 230 Aℓ/St	230	290	90	SZ 230 Aℓ	290	70	3250	3250
S 260 St	3350	6850	260	285	SX 260 St/Aℓ	260	335	187.5	SV 260 Aℓ/St	260	335	110	SZ 260 Aℓ	335	85	3000	3000
S 300 St	4960	10100	300	330	SX 300 St/Aℓ	300	385	218.5	SV 300 Aℓ/St	300	385	130	SZ 300 Aℓ	385	100	2500	2500
S 360 St	8200	16700	360	417	SX 360 St/Aℓ	360	455	271.5	SV 360 Aℓ/St	360	455	175	SZ 360 Aℓ	455	123	2150	2150
S 400 St	11300	22900	400	400	SX 400 St/Aℓ	400	514	265	SV 400 Aℓ/St	400	514	180	SZ 400 Aℓ	514	125	1900	1900

Sizes in () are not standard stocked items.
 Material of coupling flange Aℓ: Aluminum alloy
 St: Steel
 Gs: Cast steel

Combination Examples of Standard Types

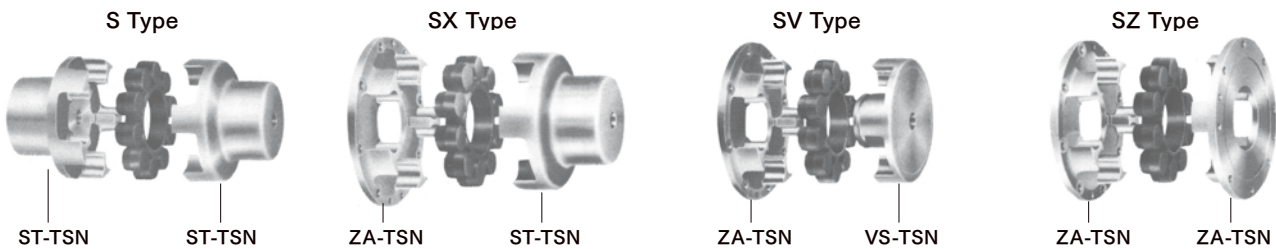

* TSCHAN® is a registered trademark of TSCHAN® Corporation.

Combination Examples

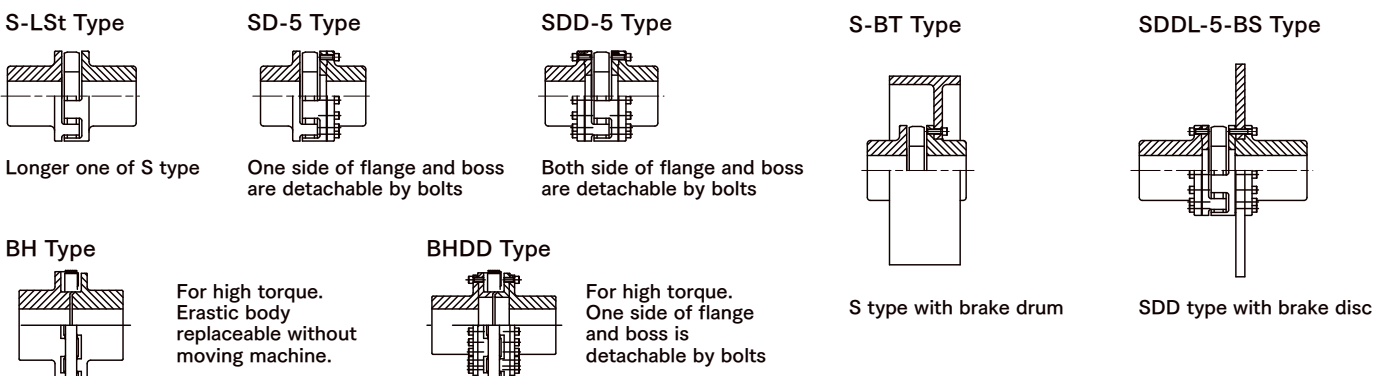

BH Type
 For high torque. Elastic body replaceable without moving machine.

BHDD Type
 For high torque. One side of flange and boss is detachable by bolts

S type with brake drum

SDD type with brake disc

IV Other Related Products

SLEEVE ROLL (Polyurethane molded product)..... P65

STARLOCK® (Shaft Fastener)P66, 67



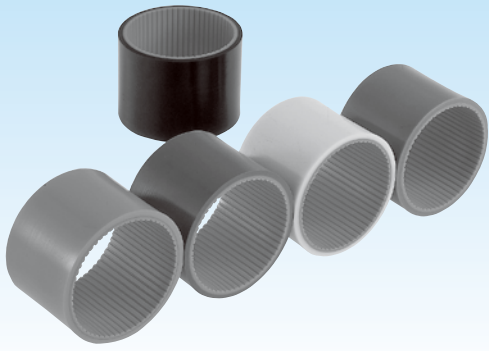

SLEEVE ROLL

(Polyurethane molded product)

It is a new press-in type roller coating and shock-absorption material, which is formed by jointing soft and hard urethane in two layers.

- It is easily put onto iron cores or rollers by pressing. Also, it has a strong grip.
- It is very economical as it doesn't require roll replacement caused by adhesive agents as well as thermal lining onto iron cores or rollers.
- Excellent abrasion and oil resistance compared to plastic and rubber made rolls. Also, it has excellent water and weather resistance.
- Two-layer structure of hard and soft urethane reduces shock and noise during back conveyance. Moreover, a clean conveyance is possible as the roller rust does not contaminate transporting items.

Applications

- Flat carrier roller, return roller
- Protection of transported items, surface rust prevention, water washing operation line
- Slate production line, glass panel/ cathode-ray tube production line
- Feeding roller
- Automated warehouse, carton boxes conveyor line

Product Code

(Example)

SR - 50 - 47

└─ Sleeve Roll ─┘ └─ Width ─┘ └─ Inner Diameter

Standard Sizes

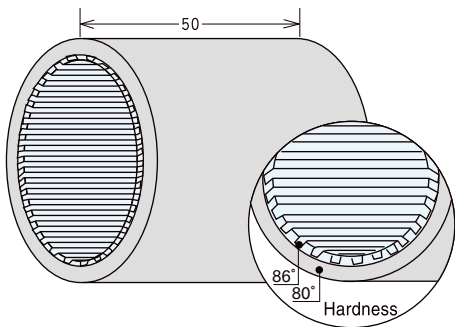

Code	Applicable Shaft Diameter(mm)	Thickness (mm)	Width (mm)	Hardness(°) Outer Layer+Inner Layer	Stock Availability			
SR-36	38.0	5	50	80+86 (Outer)(Inner)	Stocked			
SR-41	42.7							
SR-47	48.6							
SR-55	57.0							
SR-58	60.5							
SS-36	38.0	3			50	80+86 (Outer)(Inner)	Non-stocked	
SS-41	42.7							
SS-55	57.0							
SS-58	60.5							
SRD-36	38.0	5 (Surface Cog Type)						50
SRD-41	42.7							
SRD-47	48.6							
SRD-55	57.0							
SRD-58	60.5							

How to put on

(Example 1)

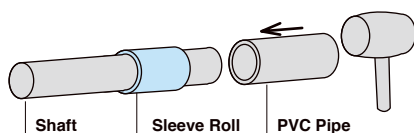

(Example 2)

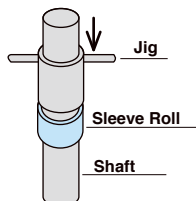

1. It is easy to insert if a jig (OVC pipe, etc) is slightly larger than the shaft diameter.
2. Quickly insert after applying small amount of solvent like thinner, acetone, alcohol to the inside of sleeve roll.

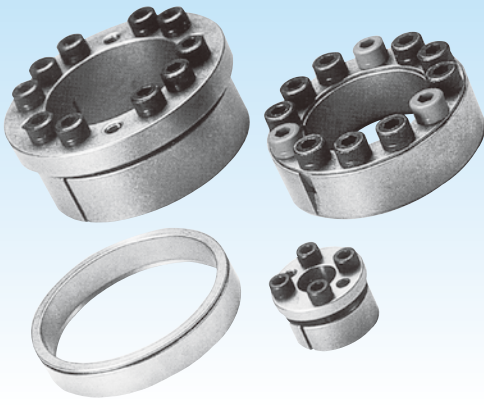

STARLOCK®

STARLOCK® is a lock system that offers simple yet secure and strong attachment of shaft and boss without troublesome key groove processing. Thus, it also saves calculation and control processes required for shrink and force fit methods.

With this system, shaft and boss are easily put together by high surface pressure.

- Absolutely no need for shaft hole and key groove processing
- Non-backlash
- Any positioning on the shaft is possible
- Easy attachment and detachment

STL-20S

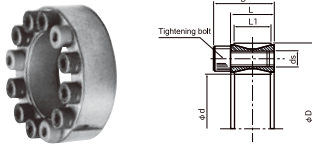

STL - 20S - 20 - 47

Outer Diameter
Inner Diameter
(Shaft Diameter)
Model Number
Starlock

STL-21S

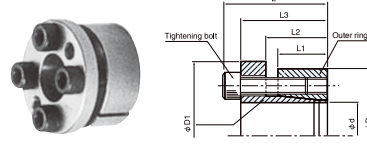

STL - 21S - 19 - 47

Outer Diameter
Inner Diameter
(Shaft Diameter)
Model Number
Starlock

Performance & Sizes

Product Code				Transmittable by Tightening Torque Ms:		
	STL-20S dXD (mm)	L (mm)	L1 (mm)	B (mm)	Torque M kN·m	Thrust Force F kN
19-47	20	17	26		0.26	27.1
20-47	20	17	26		0.27	27.1
22-47	20	17	26		0.29	27.1
24-50	20	17	26		0.36	30.5
25-50	20	17	26		0.38	30.5
28-55	20	17	26		0.47	33.8
30-55	20	17	26		0.51	33.8
32-60	20	17	26		0.65	40.7
35-60	20	17	26		0.71	40.7
38-65	20	17	26		0.89	47.5
40-65	20	17	26		0.94	47.5
42-75	24	20	32		1.55	73.7
45-75	24	20	32		1.67	73.7
48-80	24	20	32		1.78	73.7
50-80	24	20	32		1.86	73.7
55-85	24	20	32		2.37	86.3
60-90	24	20	32		1.59	86.3
65-95	24	20	32		3.21	98.1
70-110	28	24	38		4.71	133.4
75-115	28	24	38		5.00	133.4
80-120	28	24	38		5.30	133.4
85-125	28	24	38		6.47	153.0
90-130	28	24	38		6.86	153.0
95-135	28	24	38		8.14	172.6
100-145	33	26	45		9.71	194.2
110-155	33	26	45		10.7	194.2
120-165	33	26	45		13.3	222.6
130-180	38	34	50		18.0	278.5
140-190	38	34	50		21.4	306.0
150-200	38	34	50		25.0	333.4
160-210	38	34	50		28.9	361.9
170-225	44	38	58		34.9	410.9
180-235	44	38	58		40.3	448.2
190-250	52	46	66		79.6	522.7
200-260	52	46	66		56.0	560.0
220-285	56	50	72		72.7	661.0
240-305	56	50	72		91.5	763.0
260-325	56	50	72		112	864.0
280-355	66	60	84		140	1,000
300-375	66	60	84		170	1,130
320-405	78	72	98		229	1,430
340-425	78	72	98		244	1,430
360-455	90	84	112		321	1,780
380-475	90	84	112		338	1,780
400-495	90	84	112		356	1,780

Standard Size Range : d = φ20~φ280

Transmission torque and thrust shown above are maximum values.

Performance & Sizes

Product Code						Transmittable : —		
	STL-21S dXD (mm)	L (mm)	L3 (mm)	L2 (mm)	L1 (mm)	D1 (mm)	Torque M kN·m	Thrust Force F kN
19-47	38	32	24	20	46		0.29	30.4
20-47	38	32	24	20	46		0.30	30.4
22-47	38	32	24	20	46		0.33	30.4
24-50	38	32	24	20	49		0.46	38.2
25-50	38	32	24	20	49		0.48	38.2
28-55	38	32	24	20	54		0.54	38.2
30-55	38	32	24	20	54		0.58	38.2
32-60	38	32	24	20	59		0.74	45.6
35-60	38	32	24	20	59		0.80	45.6
38-65	38	32	24	20	64		0.87	45.6
40-65	38	32	24	20	64		0.91	45.6
42-75	48	40	29	24	74		1.78	84.3
45-75	48	40	29	24	74		1.98	84.3
48-80	48	40	29	24	79		2.03	84.3
50-80	48	40	29	24	79		2.12	84.3
55-85	48	40	29	24	84		2.72	98.1
60-90	48	40	29	24	89		2.96	98.1
65-95	48	40	29	24	94		3.67	112.8
70-110	62	52	37	30	109		5.43	154.9
75-115	62	52	37	30	114		5.83	154.9
80-120	62	52	37	30	119		6.21	154.9
85-125	62	52	37	30	124		7.54	176.5
90-130	62	52	37	30	129		7.98	176.5
95-135	62	52	37	30	134		10.5	220.6
100-145	74	64	46	39	144		11.1	220.6

Standard Size Range : d = φ5~φ100

Transmission torque and thrust shown above are maximum values.

STL-21F

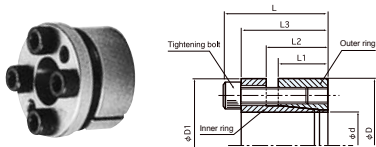

STL - 21F - 19 - 47

Outer Diameter
Inner Diameter
(Shaft Diameter)
Model Number
Starlock

STL-30R

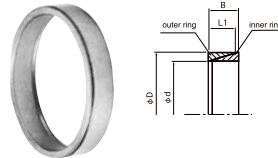

STL - 30R - 20 - 25

Outer Diameter
Inner Diameter
(Shaft Diameter)
Model Number
Starlock

Performance & Sizes

Product Code	Transmittable : -					Torque M kN·m	Thrust Force F kN {kgf}
	STL-21F d×D (mm)	L (mm)	L3 (mm)	L2 (mm)	L1 (mm)		
8-22	21	17	13	10	25	0.02	4.61
9-23	21	17	13	10	26	0.02	4.61
10-24	21	17	13	10	27	0.03	6.08
11-25	21	17	13	10	28	0.03	6.08
12-26	21	17	13	10	29	0.05	7.65
13-27	21	17	13	10	30	0.05	7.65
14-31	26	21	16	12.5	34	0.07	9.81
15-32	26	21	16	12.5	35	0.07	9.81
16-33	26	21	16	12.5	36	0.08	9.81
17-34	26	21	16	12.5	37	0.10	12.3
18-35	26	21	16	12.5	38	0.11	12.3
19-47	38	32	24	20	53	0.28	29.4
20-47	38	32	24	20	53	0.29	29.4
22-47	38	32	24	20	53	0.32	29.4
24-50	38	32	24	20	56	0.41	33.8
25-50	38	32	24	20	56	0.43	33.8
28-55	38	32	24	20	62	0.47	33.8
30-55	38	32	24	20	62	0.51	33.8
32-60	38	32	24	20	68	0.51	43.6
35-60	38	32	24	20	68	0.76	43.6
38-65	38	32	24	20	73	0.83	43.6
40-65	38	32	24	20	73	0.88	43.6
42-75	48	40	29	24	83	1.70	80.4
45-75	48	40	29	24	83	1.81	80.4
48-80	48	40	29	24	88	1.94	80.4
50-80	48	40	29	24	88	2.02	80.4
55-85	48	40	29	24	94	2.47	89.2
60-90	48	40	29	24	99	2.70	89.2
65-95	48	40	29	24	104	3.50	107.9
70-110	62	52	37	30	119	4.94	141.2
75-115	62	52	37	30	124	5.30	141.2
80-120	62	52	37	30	129	5.64	141.2
85-125	72	52	37	30	134	7.20	166.7
90-130	62	52	37	30	139	7.60	166.7
95-135	62	52	37	30	144	9.37	196.1
100-145	74	64	46	39	154	10.6	211.8

Performance & Sizes

Product Code	STL-30R d×D (mm)	B (mm)	L1 (mm)
5-8	4.5	3.7	3.7
6-9	4.5	3.7	3.7
7-10	4.5	3.7	3.7
8-11	4.5	3.7	3.7
9-12	4.5	3.7	3.7
9.5-12.5	4.5	3.7	3.7
10-13	4.5	3.7	3.7
11-14	4.5	3.7	3.7
12-15	4.5	3.7	3.7
13-16	4.5	3.7	3.7
14-18	6.3	5.3	5.3
15-19	6.3	5.3	5.3
16-20	6.3	5.3	5.3
17-21	6.3	5.3	5.3
18-22	6.3	5.3	5.3
19-24	6.3	5.3	5.3
20-25	6.3	5.3	5.3
22-26	6.3	5.3	5.3
24-28	6.3	5.3	5.3
25-30	6.3	5.3	5.3
28-32	6.3	5.3	5.3
30-35	6.3	5.3	5.3
32-36	6.3	5.3	5.3
35-40	7	6	6
36-42	7	6	6
38-44	7	6	6
40-45	8	6.6	6.6
42-48	8	6.6	6.6
45-52	10	8.6	8.6
48-55	10	8.6	8.6
50-57	10	8.6	8.6
55-62	10	8.6	8.6
56-64	12	10.4	10.4
60-68	12	10.4	10.4
63-71	12	10.4	10.4
65-73	12	10.4	10.4
70-79	14	12.2	12.2
71-80	14	12.2	12.2
75-84	14	12.2	12.2
80-91	17	15	15
85-96	17	15	15
90-101	17	15	15
95-106	17	15	15
100-114	21	18.7	18.7
110-124	21	18.7	18.7
120-134	21	18.7	18.7
130-148	28	25.3	25.3
140-158	28	25.3	25.3
150-168	28	25.3	25.3
160-178	28	25.3	25.3
170-191	33	30	30
180-201	33	30	30
190-211	33	30	30
200-224	38	34.8	34.8

30F



STL - 30F - 25 - 30

Outer Diameter
Inner Diameter
(Shaft Diameter)
Model Number
Starlock

Pressurized Flange

Product Code	Application
STL-30F d×D (mm)	STL-30R d×D (mm)
10-13	10×13
11-14	11×14
12-15	12×15
13-16	13×16
14-18	14×18
15-19	15×19
16-20	16×20
17-21	17×21
18-22	18×22
19-24	19×24
20-25	20×25
22-26	22×26
24-28	24×28
25-30	25×30
28-32	28×32
30-35	30×35
32-36	32×36
35-40	35×40
36-42	36×42
38-44	38×44
40-45	40×45
42-48	42×48
45-52	45×52
48-55	48×55
50-57	50×57
55-62	55×62
56-64	56×64
60-68	60×68
63-71	63×71
65-73	65×73
70-79	70×79
71-80	71×80
75-84	75×84
80-91	80×91
85-96	85×96
90-101	90×101
95-106	95×106
100-114	100×114

Standard Size Range : d = φ5~φ100

Transmission torque and thrust shown above are maximum values.

V Troubleshooting for Power Transmission Products

For Timing Belt..... P69

For V-Belt P70



- Failure during machinery operation is a serious matter. To resolve belt failure, determine cause of failure before replacing with a new belt. This will maximize the capability of the belt and extend its life. The following is an introduction to belt failure main causes. Please check the items in this table when failure occurs.

1. For Timing Belt

Occurrence	Cause	Measure
Abnormal side wear	● Poor alignment	Adjust the alignment
	● Base not adequately fixed	Strengthen the base fixture
	● Bending of the pulley flange	Correct flange bending
Abnormal wear at tooth surface where pressure is being exerted	● Overload	Amend the design and use better grade
	● Overstretched belt	Adjust the initial tension of the belt
Abnormal wear at contact point of pulley area	● Overstretched belt	Adjust the initial tension of the belt
	● Defective pulley tooth form	Replace using special attention on the R of the pulley tooth end
Tooth damage	● Pulley diameter too small	Change the system design
	● 6 teeth or less for T.I.M	Increase T.I.M or change the system design
	● Exertion of shock load	Ensure that shock is not exerted on the belt or increase the belt width
Breaking of tensile body	● Overload	Change the system design
	● Drop in elasticity or corrosion of tensile body	Check the storage condition and transport condition of the belt
	● Exertion of shock load	Ensure that shock is not exerted on the belt or increase the belt width
Crack at the back side	● Usage under -30°C	Raise the surrounding temperature
	● Pulley diameter too small	Use a bigger diameter pulley
Thermal ageing of rubber/ polyurethane	● Temperature of 80°C and above at the rubber/ polyurethane	Reduce the surrounding temperature
Swelling of the rubber	● Oil contamination	Use polyurethane or oil resistant rubber belt
Abnormal wear at pulley tooth	● Overload	Change the system design
	● Overstretched belt	Adjust the initial tension of the belt
	● Unsuitable pulley material (too soft)	Add surface treatment or change the material of pulley
Wear at pulley edge	● Pulley life	Change to a new pulley
	● Overstretched belt (Tensile body can be seen underneath the belt)	Change to new pulley and belt while loosening the tension
Abnormal operation sounds	● Poor alignment	Adjust the alignment
	● Overstretched belt	Adjust the initial tension of the belt
	● Overload	Change the system design
	● Pulley diameter too small	Change the system design
	● Defective pulley tooth form	Ensure that pulley tooth is accordance to standard dimensions
Belt looks elongated	● Short inter-shaft distance	Adjust to the correct inter-shaft distance
	● Loosening of the base	Strengthen the base fixture

2. For V-Belt

Occurrence	Cause	Measure
Slippage	● Loose belt tension	Apply appropriate tension
	● Overload	Increase belt width or increase the number of belt in use.
	● Minimum contact angle	Widen belt width or install an idler pulley of the appropriate diameter
	● Oil or water contamination	Completely remove the oil and water and prevent further contamination by placing the belt cover
Early failure	● Load variation/ large shock ● Use the belt above its transmission capacity ● Belts not mounted according to the specified number of belts ● Not using the specified belt type	While there are design elements to be altered, the specified type and number of belts should be installed (Depending on the application, please upgrade the belt specification by 1 level)
	● High heat generated and large flex fatigue (overly small pulley diameter/ bending angle and high revolution speed)	Take counter-measure on heat dissipation or change the system design - alter the pulley diameter, revolution speed, bending angle
	● Tension loss and slippage	Apply appropriate tension
Crack	● Tension loss and slippage	Apply appropriate tension
	● Use under high temperature	Take counter-measure on heat dissipation
	● Continuous sudden stoppage and start-up	Change the system design
	● Oil contamination	Fix oil leak and prevent oil contamination
	● Pulley diameter too small	Change the system design
	● Too strong reverse bending due to backside tension	
Base crack	● Direct exposure to sunlight	Install belt cover
	● Tension pulley diameter too small	Use a larger diameter tension pulley
	● Small bending angle	Decrease the bending angle
Wear	● Loose tension and occurrence of slippage	Apply appropriate tension
	● Rusty pulley groove or rough finishing of pulley groove surface	Perform uniform finishing on the pulley groove surface (Standard 12S to 6S)
	● Tension loss and slippage	Apply appropriate tension
	● Inappropriate pulley installation angle ● Defective pulley form ● Inappropriate pulley groove angle	Change alignment to 1/3° and below or replace the pulley
	● Damage on pulley groove	
Excessive vibration	● Resonance due to unstable fixture of machine body	Secure the fixtures
	● Weak belt tension	Change inter-shaft distance
	● Belt lengths not uniform	Use matched set
Peeling	● Belt used beyond its transmission capacity	Mount belts with the right specification, type, number
	● Usage under deformed condition	Change the system design
	● Usage method resulted in large flex fatigue	
Noise problem	● Sudden stop and start during usage	Consider changing the system design for smooth operation
	● Belt tension too loose	Apply appropriate tension
	● Overload	Increase belt width or increase the number of belt in use.
	● Wrong belt type	Select belt type, specification that matches the operating conditions
Overturning of belt	● Inappropriate pulley groove angle, installation angle	Change alignment to 1/3° and below
	● Pulley groove damage or sticking of belt due to roughly finished surface	Replace the pulley
	● Wear at pulley groove	
	● Belt lengths not uniform during multiple usage	Use matched set

2. CONVEYOR BELTS

Product Lineup P72

NEOFLEXSTART®P73~78

FREESPAN™ Belt P79, 80



Conveyor Belts

NEOFLEXSTART®

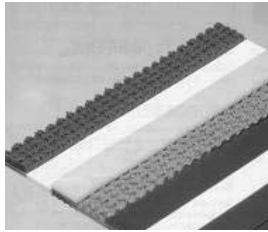

FREESPAN® Belt

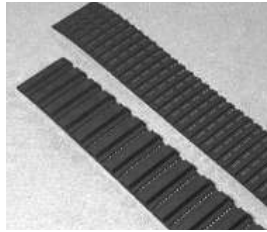

Conveyor Belt

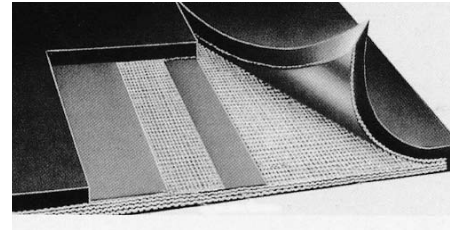

Related Products

Polyurethane Screen



ROUND CONVEYOR

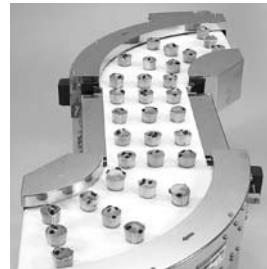

PORTFLEX®



Product Lineup

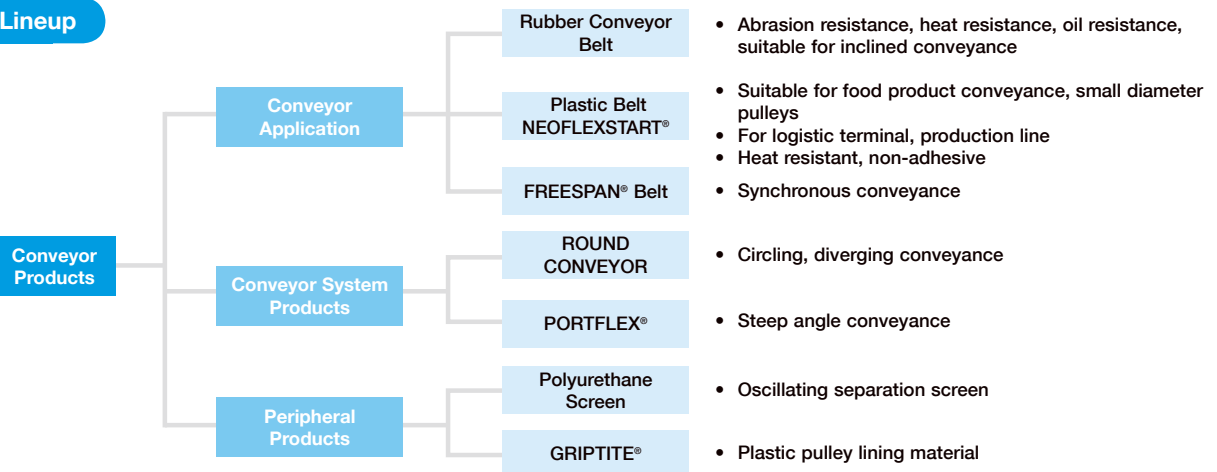

Application Examples

Light-duty Plastic Conveyor Belt
NEOFLEXSTART®



Synchronous Transportation Conveyor Belt
FREESPAN® Belt

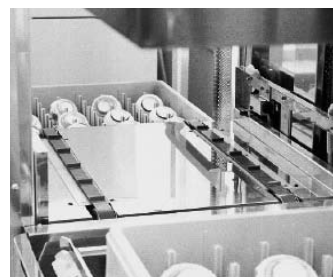
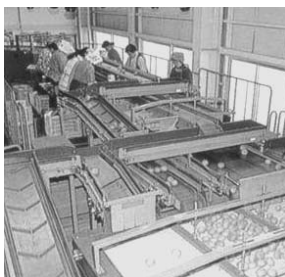
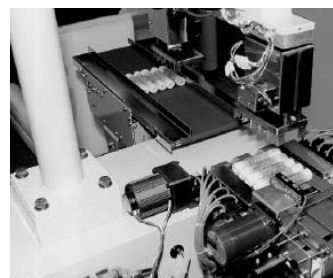

NEOFLEXSTART®

Characteristics & Use

The NEOFLEXSTART® will support automation and manpower reduction at production and logistics sites. This product will support a wide range of conveyor systems.

Each Mitsubishi "NEOFLEXSTART® U, V, F, P" has its own unique characteristics. Thus, it is most important to select the correct belt to maximize the belt's performance.

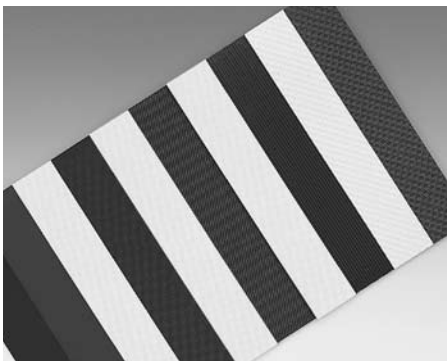

NEOFLEXSTART®-U

Safe, clean, stylish

It works well in many fields, but it is best used for conveyor lines that require cleanliness.

Using special polyurethane cover with excellent mildew resistance and water resistance,

It is most suitable for conveying food products.

Also, it has excellent anti-static properties.

Color : White, green, black

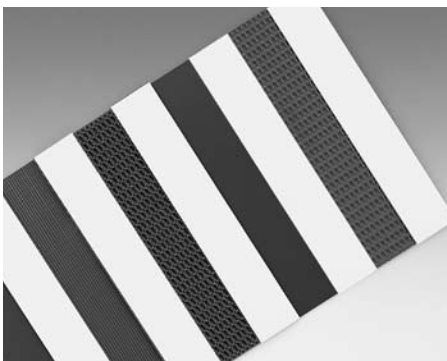

NEOFLEXSTART®-V

It fits in a wide-rang of applications.

Also, after-processing such as adding crosspieces is easy.

It works well in conveyance of oily items, plywood, chemical products and various kinds of loads.

Excellent abrasion, ozone and chemical resistance, as it is covered with high-quality PVC plastic.

Color : White, green, dark blue

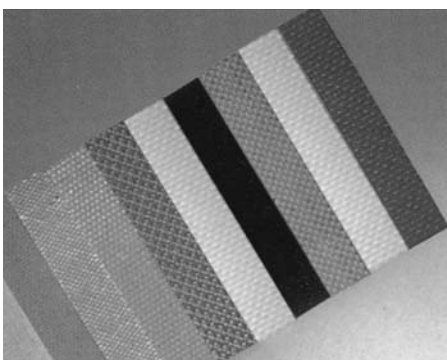

NEOFLEXSTART®-F

It is usable under various conditions in which cold / heat resistance and/or non-adhesive qualities are required.

Excellent heat resistance and non-adhesiveness as it is coated with Teflon or silicone.

It works well in the places where belt conveyance is difficult due to high temperature and characteristics of transporting items such as adhesive items and chemicals.

Color : Brown, black, white, red

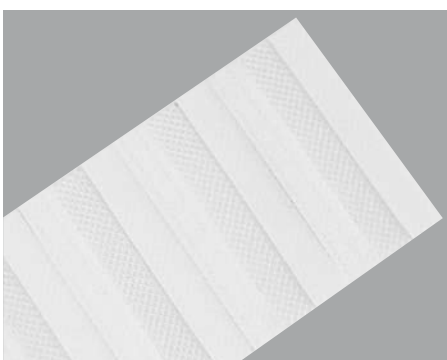

NEOFLEXSTART®-P

The best to be used in conveyance of sticky items like bread dough

Polyolefin resin provides superior performance when used in conveyance of sticky items like bread dough.

Excellent for food conveyance.

Color : Transparent

Oil and Chemical Resistance Table

Category	Name of Chemicals	NS-U				NS-V				NS-F			NS-P
		UG UFG UR UFR UHG	BK Type	UPG 0/0 Type	UKG	VG VN	SS Type	VKU	VKG	FG	FK	SG	PN
Oil & Lipids	Animal oil	○	○	○	○	○	△	△	△	○	○	○	○
	Vegetable oil	○	○	○	○	○	△	△	△	○	○	○	○
	Mineral oil	○	○	○	○	○	×	×	×	○	○	○	○
	DOS	△	○	△	○	△	×	×	×	○	○	○	△
	Grease	○	○	○	○	○	△	△	△	○	○	○	△
	Paraffin oil	○	○	○	○	○	○	○	○	○	○	○	○
	Cutting oil	×	○	×	○	○	×	×	×	○	○	×	×
Disinfectant	Sodium Hypochlorite 400ppm	○	△	○	○	○	△	△	△	○	○	○	○
	Methyl Alcohol (Methanol)	○	○	○	○	△	△	△	△	○	○	○	○
	Ethyl Alcohol	○	○	○	○	△	△	△	△	○	○	△	○
Solvent	Acetone	×	×	×	×	×	×	×	×	○	○	×	△
	Gasoline	×	×	×	×	×	×	×	×	○	○	×	△
	Toluene (Triol)	×	×	×	×	×	×	×	×	○	○	×	△
	Methyl Ethyl Ketone (MEK)	×	×	×	×	×	×	×	×	○	○	×	×
	Formaldehyde (Formalin) 37%	×	×	×	×	○	○	△	○	○	○	○	△
	Ammonia solution	○	△	○	△	○	○	△	○	○	○	○	○
	Sodium Hydroxide (Caustic Soda) 10%	×	×	×	×	△	△	×	△	○	○	○	○
Acids	Developing fluid (Hydroquinone)	○	○	○	○	○	○	○	○	○	○	○	○
	Nitric acid 5%	×	×	×	×	○	○	×	○	○	○	○	○
	Hydrochloric acid 5%	○	×	×	×	○	○	×	○	○	○	○	○
	Sulfuric acid 50%	×	×	×	×	△	△	×	△	○	○	×	△
Other chemicals	Acetic acid 10%	×	×	×	×	△	△	×	△	○	○	○	○
	Sodium Chloride (salt)	○	○	○	○	○	○	○	○	○	○	○	○
	Soap	○	○	○	○	○	○	○	○	○	○	○	○
	Fertilizer (general)	○	○	○	○	○	○	○	○	○	○	○	○

○ =Applicable △ = Possibility of damage × =Not applicable

Electrostatic Potential

*For antistatic belts such as NS82UG0/2G, NS-V, as they are processed for static prevention inside, the surface resistance values are the same as non-antistatic belts.

Test conditions:

Belt speed 150m/min
Temperature 25±5°C
Humidity 50±10%

Running Electrostatic Potential (Measured Values at Mitsubishi)

			Running Electrostatic Potential (V) (Absolute Value)
NS-U	All antistatic belts	NS82UG0/2G*	1000 & below
		NS41UG0/2BK NS82UG0/2BK	50 & below
NS-V	All antistatic belts		200~1000
NS-F	Antistatic belt	NS14FG-B NS15FK-B	50 & below
		Non-antistatic belt	
NS-P	Antistatic belt		1000 & below

Adding Profiles (NEOFLEXSTART®-U,V)

The following are the examples of profiles which can be added to the belt.

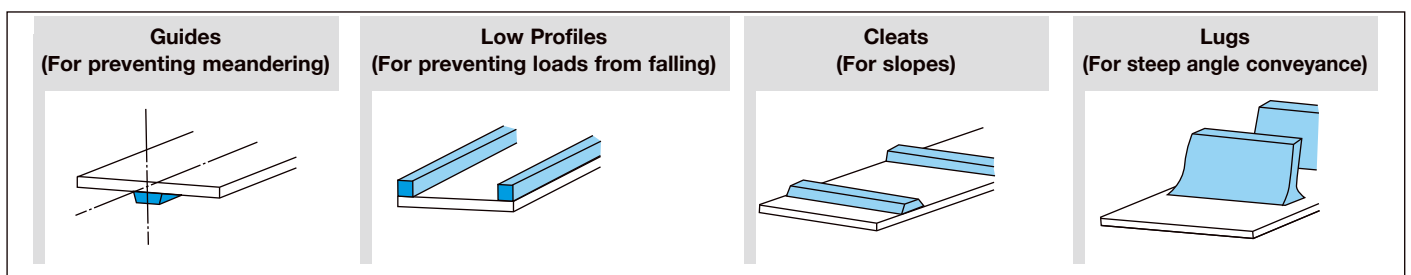

Hole Punching

We provide hole punching on your requests.

NEOFLEXSTART-U

Product Code	Cover						No. of Tension Member Ply	Total Thickness mm
	Top Surface			Underside				
	Color	Thickness mm	Surface Condition	Color	Thickness mm	Surface Condition		
Heat & Humidity Resistance/ Prevention of Loose Threads								
NS41UG0/2G	Green	0.2	Flat	Grey	–	Polyurethane impregnated conductive low noise fabric	1	0.8
NS41UG2/2G	Green	0.2	Flat	Green	0.2	Texture pattern (fine)	1	1.1
NS82UG0/2G	Green	0.2	Flat	White	–	Polyurethane impregnated conductive low noise fabric	2	1.4
NS82UG0/5G	Green	0.5	Flat	White	–	Polyurethane impregnated conductive low noise fabric	2	1.7
NS82UG2/2G	Green	0.2	Flat	Green	0.2	Texture pattern (fine)	2	1.7
NS123UG0/5G	Green	0.5	Flat	White	–	Polyurethane impregnated conductive low noise fabric	3	2.5
Antibacterial / Antifungal								
NS41UFG0/2W	White	0.2	Flat	White	–	Polyurethane impregnated conductive low noise fabric	1	0.8
NS41UFG2/2W	White	0.2	Flat	White	0.2	Texture pattern (fine)	1	1.1
NS82UFG0/2W	White	0.2	Flat	White	–	Polyurethane impregnated conductive low noise fabric	2	1.4
NS82UFG0/5WS	White	0.5	Texture pattern (coarse)	White	–	Polyurethane impregnated conductive low noise fabric	2	2
NS82UFG0/5W	White	0.5	Flat	White	–	Polyurethane impregnated conductive low noise fabric	2	1.7
NS82UF2/2WP	White	0.2	Flat	White	0.2	Flat	2	1.7
NS123UFG0/5W	White	0.5	Flat	White	–	Polyurethane impregnated conductive low noise fabric	3	2.5
Super Antistatic								
NS41UG0/2BK	Black	0.2	Flat	Grey	–	Polyurethane impregnated conductive low noise fabric	1	0.8
NS82UG0/2BK	Black	0.2	Flat	White	–	Polyurethane impregnated conductive low noise fabric	2	1.4
Slip, Accumulator (Storage)								
NS41UG0/0	White	–	Polyurethane impregnated conductive fabric	White	–	Polyurethane impregnated conductive low noise fabric	1	0.6
NS41UG0/0G	Green	–	Polyurethane impregnated conductive fabric	Green	–	Polyurethane impregnated conductive low noise fabric	1	0.6
NS82UG0/0	White	–	Polyurethane impregnated sideslip fabric	White	–	Polyurethane impregnated conductive low noise fabric	2	1.3
NS82UG0/0G	Green	–	Polyurethane impregnated sideslip fabric	Grey	–	Polyurethane impregnated conductive low noise fabric	2	1.3
NS41UHG0/2W	White	0.2	Flat	White	–	Polyurethane impregnated conductive low noise fabric	1	0.8
NS41UHG0/2G	Green	0.2	Flat	Grey	–	Polyurethane impregnated conductive low noise fabric	1	0.8
NS82UHG0/2W	White	0.2	Flat	White	–	Polyurethane impregnated conductive low noise fabric	2	1.4
NS82UHG0/2G	Green	0.2	Flat	White	–	Polyurethane impregnated conductive low noise fabric	2	1.4
Sideslip								
NS82UPG0/0	White	–	Polyurethane impregnated sideslip fabric	White	–	Polyurethane impregnated conductive low noise fabric	2	1.3
NS82UPG0/0G	Green	–	Polyurethane impregnated sideslip fabric	Grey	–	Polyurethane impregnated conductive low noise fabric	2	1.3
Sloped Conveyance								
NS41UKG0/5GT	Green	0.5	Longitudinal groove	Grey	–	Polyurethane impregnated conductive low noise fabric	1	1.4
NS82UKG0/8GT	Green	0.8	Longitudinal groove	Grey	–	Polyurethane impregnated conductive low noise fabric	2	2.3
Round Conveyor								
NS41UFR0/5W	White	0.5	Flat	White	–	Polyurethane impregnated conductive fabric	1	1.0
NS41UR0/5G	Green	0.5	Flat	Grey	–	Polyurethane impregnated conductive fabric	1	1.0
NS82UFR0/2W	White	0.2	Flat	White	–	Polyurethane impregnated conductive fabric	2	1.5
NS82UR0/2G	Green	0.2	Flat	White	–	Polyurethane impregnated conductive fabric	2	1.5

(Note): All types of NEOFLEXSTART-U can be used in metal detector machine (except BK)

NEOFLEXSTART-V

Product Code	Cover						No. of Tension Member Ply	Total Thickness mm
	Top Surface			Underside				
	Color	Thickne	Surface Condition	Color	Thickness mm	Surface Condition		
General Oil Resistance								
NS41VG5/5G	Green	0.5	Flat	Green	0.5	Texture pattern (fine)	1	1.7
NS82VG5/5W	White	0.5	Flat	White	0.5	Texture pattern (fine)	2	2.7
NS82VG5/5G	Green	0.5	Flat	Green	0.5	Texture pattern (fine)	2	2.7
NS183VN0/20W	White	2.0	Flat	White	–	Polyurethane impregnated conductive fabric	3	5.1
NS183VN0/20G	Green	2.0	Flat	White	–	Polyurethane impregnated conductive fabric	3	5.1
Low Noise								
NS82VG0/5G	Green	0.5	Flat	White	–	Polyurethane impregnated conductive low noise fabric	2	2.1
NS82VG0/5W	White	0.5	Flat	White	–	Polyurethane impregnated conductive low noise fabric	2	2.1
NS82VG0/20G	Green	2.0	Flat	White	–	Polyurethane impregnated conductive low noise fabric	2	3.6
Sloped Conveyance								
NS82VKG5/5DB	Dark Blue	0.5	Flat	Dark Blue	0.5	Texture pattern (fine)	2	2.7
NS82VKUG5/8DBT	Dark Blue	0.8	Longitudinal groove	Dark Blue	0.5	Texture pattern (fine)	2	3.1
NS82VKG0/20GD	Green	2.0	Deep groove	White	–	Polyurethane impregnated conductive low noise fabric	2	5.3
NS122VN0/20GSS	Green	2.0	Rough top	Grey	–	Polyurethane impregnated low noise fabric	2	5.5

Characteristics	Surface Condition	Color	【Product Code】		N	S	8	2	U	FG	0	/	5	W	S			
G=Loose threads prevention, side rigidity, low noise F=Antibacterial, antifungal H=Slippery, nonadhesive P=Sideslip (palletizer) K=Sloped conveyance R=Trough, round conveyer	S=Texture pattern (coarse) T=Longitudinal groove P=Two-sided, flat	W=White G=Green BK=Black	NEOFLEXSTART Abbreviation		Permitted Tension (kN/mm)	No. of Tension Member Ply	Material (Polyurethane)							Surface Figure	Color	Top Cover Thickness (1/10mm)	Underside Cover Thickness (1/10mm)	Characteristics

Weight kg/m ²	Allowable Tension N/mm	Minimum Pulley Diameter mm	Knife Edge Radius mm	Usable Temperature Range		Table- Drive	Antistatic Specification	Product Code
				Dry Heat Temperature *3°C	Wet Heat Temperature°C			
Heat & Humidity Resistance/ Prevention of Loose Threads								
0.7	4	15	R3	-30~100	0~80	○	○	NS41UG0/2G
1.0	4	30	×	-30~100	0~80	×	○	NS41UG2/2G
1.5	8	25 (15) *1	(R3) *2	-30~100	0~80	○	○	NS82UG0/2G
1.9	8	50	×	-30~100	0~80	○	○	NS82UG0/5G
1.9	8	70	×	-30~100	0~80	×	○	NS82UG2/2G
2.6	12	100	×	-30~100	0~80	○	○	NS123UG0/5G
Antibacterial/ Antifungal								
0.7	4	15	R3	-30~100	0~80	○	○	NS41UFG0/2W
1.0	4	30	×	-30~100	0~80	×	○	NS41UFG2/2W
1.5	8	25 (15) *1	(R3) *2	-30~100	0~80	○	○	NS82UFG0/2W
1.9	8	25 (15) *1	×	-30~100	0~80	○	○	NS82UFG0/5WS
1.9	8	50	×	-30~100	0~80	○	○	NS82UFG0/5W
2.0	8	70	×	-30~100	0~80	×	○	NS82UF2/2WP
2.6	12	100	×	-30~100	0~80	○	○	NS123UFG0/5W
Super Antistatic								
0.7	4	15	R3	-30~80	0~70	○	◎	NS41UG0/2BK
1.5	8	25 (15) *1	(R3) *2	-30~80	0~70	○	◎	NS82UG0/2BK
Slip, Accumulator (Storage)								
0.4	4	20	R3	-30~100	0~80	○	○	NS41UG0/0
0.4	4	20	R3	-30~100	0~80	○	○	NS41UG0/0G
1.1	8	40 (30) *4	×	-30~100	0~80	○	○	NS82UG0/0
1.1	8	40 (30) *4	×	-30~100	0~80	○	○	NS82UG0/0G
0.7	4	15	R5	-30~100	0~80	○	○	NS41UHG0/2W
0.7	4	15	R5	-30~100	0~80	○	○	NS41UHG0/2G
1.5	8	25 (15) *1	(R3) *2	-30~100	0~80	○	○	NS82UHG0/2W
1.5	8	25 (15) *1	(R3) *2	-30~100	0~80	○	○	NS82UHG0/2G
Sideslip								
1.1	8	30	×	-30~100	0~80	○	○	NS82UPG0/0
1.1	8	30	×	-30~100	0~80	○	○	NS82UPG0/0G
Sloped Conveyance								
1.0	4	25	×	-30~80	0~70	○	○	NS41UKG0/5GT
2.2	8	50 (25) *1	×	-30~80	0~70	○	○	NS82UKG0/8GT
Round Conveyer								
1.1	4	20	R5	-30~100	0~80	○	○	NS41UFR0/5W
1.1	4	20	R5	-30~100	0~80	○	○	NS41UR0/5G
1.6	8	30	×	-30~100	0~80	○	○	NS82UFR0/2W
1.6	8	30	×	-30~100	0~80	○	○	NS82UR0/2G

*1,2: () indicates values when permitted tension is 5N/mm and below. *3: For products indicated as Max 100°C, operating temperature is Max 80°C under continuous operation.
*4: Lightning Endless type

Characteristics	Surface Condition	Color	【Product Code】		N	S	8	2	V	G	0	/	20	G	D			
G=Loose threads prevention, side rigidity, low noise K=Sloped conveyance X= Low noise	R=Texture pattern (fine) D=Deep groove SS=Rough top M=Diamond pattern	W=White G=Green G2=Dark green GY=Grey DB=Dark blue	NEOFLEXSTART Abbreviation		Permitted Tension (kN/mm)	No. of Tension Member Ply	Material (Polyvinylchloride)							Surface Figure	Color	Top Cover Thickness (1/10mm)	Underside Cover Thickness (1/10mm)	Characteristics

Weight kg/m ²	Allowable Tension N/mm	Minimum Pulley Diameter mm	Knife Edge Radius mm	Usable Temperature Range		Table- Drive	Antistatic Specification	Product Code
				Dry Heat Temperature °C	Wet Heat Temperature°C			
General Oil Resistance								
1.9	4	35	×	-10~80	0~60	×	○	NS41VG5/5G
2.8	8	70	×	-10~80	0~60	×	○	NS82VG5/5W
2.8	8	70	×	-10~80	0~60	×	○	NS82VG5/5G
5.8	18	120	×	-10~80	0~60	○	○	NS183VN0/20W
5.8	18	120	×	-10~80	0~60	○	○	NS183VN0/20G
Low Noise								
2.3	8	50	×	-10~80	0~60	○	○	NS82VG0/5G
2.3	8	50	×	-10~80	0~60	○	○	NS82VG0/5W
4.1	8	100	×	-10~80	0~60	○	○	NS82VG0/20G
Sloped Conveyance								
2.8	8	75	×	-10~70	0~60	×	○	NS82VKG5/5DB
3.4	8	75	×	-10~70	0~60	×	○	NS82VKUG5/8DBT
4.2	8	80	×	-10~70	0~60	○	○	NS82VKG0/20GD
6.5	12	80	×	-10~70	0~60	○	○	NS122VN0/20GSS

NEOFLEXSTART®-F

Product Code	Total Thickness mm	Weight Kg/m ²	Allowable Tension N/mm	Surface		Tension Member	Cover Material	Table-Drive
				Color	Condition			
NS03FG-P	0.075	0.3	2	Brown	Flat	Glass fiber	Teflon	○
NS05FG-P	0.125	0.3	2	Brown	Flat	Glass fiber	Teflon	○
NS06FG-P	0.150	0.3	2	Brown	Flat	Glass fiber	Teflon	○
NS10FG-P	0.250	0.5	3	Brown	Flat	Glass fiber	Teflon	○
NS14FG-P	0.350	0.7	6	Brown	Flat	Glass fiber	Teflon	○
NS27FG-P	0.680	1.1	9	Brown	Flat	Glass fiber	Teflon	○
NS22FG-S	0.550	0.7	8	Brown	Flat	Glass fiber	Teflon	○
NS05FG-B	0.125	0.2	2	Black	Flat	Glass fiber	Teflon	○
NS06FG-B	0.150	0.3	2	Black	Flat	Glass fiber	Teflon	○
NS10FG-B	0.250	0.5	3	Black	Flat	Glass fiber	Teflon	○
NS14FG-B	0.350	0.7	6	Black	Flat	Glass fiber	Teflon	○
NS27FG-B	0.680	1.1	9	Black	Flat	Glass fiber	Teflon	○
NS06FG-TR	0.150	0.3	2	Brown	Flat	Glass fiber	Teflon	○
NS10FG-TR	0.250	0.5	3	Brown	Flat	Glass fiber	Teflon	○
NS19FG-M	0.600	0.5	6	Brown	Mesh	Glass fiber	Teflon	○
NS21FG-M	0.750	0.4	4	Brown	Mesh	Glass fiber	Teflon	○
NS30FG-M	0.920	0.4	3	Brown	Mesh	Glass fiber	Teflon	○
NS15FK	0.350	0.4	6	Brown	Flat	Aramid fiber	Teflon	○
NS15FK-B	0.350	0.3	6	Black	Flat	Aramid fiber	Teflon	○
NS30FK-M	0.700	0.4	8	Brown	Mesh	Aramid fiber	Teflon	○
NS24SG-R	0.610	0.8	8	Red	Flat	Glass fiber	Silicone	×
NS24SG-W	0.610	0.8	8	White	Flat	Glass fiber	Silicone	×
NS42SG-R	1.060	1.5	12	Red	Flat	Glass fiber	Silicone	×
NS42SG-W	1.060	1.5	12	White	Flat	Glass fiber	Silicone	×

NEOFLEXSTART®-P

Product Code	Cover						No. of Tension Member Ply	Total Thickness mm
	Top Surface			Underside				
	Color	Thickness mm	Surface Condition	Color	Thickness mm	Surface Condition		
NS32PN0/5NM	White transparent	0.5	Diamond pattern	White	–	Polyurethane impregnated conductive low noise fabric	2	1.9
NS11PN3/5NM	White transparent	0.5	Diamond pattern	White transparent	0.3	Flat	1	1.4
NS15PNM	Transparent	–	Diamond pattern	Transparent	–	Flat	–	1.5

(Note) NS15PNM is polyolefin sheet and cannot be used as a belt.

Characteristics

FG=*Teflon/ glass fiber
 FK=*Teflon/ aramid fiber
 SG= Silicone/ glass fiber
 (Cover material/ tension member material)
 * is registered trademarks of Dupont

Surface Condition

S=Standard Type (Standard specification)
 P=Premium Type (Flat and smooth specification)
 M=Mesh Type (Standard specification)
 TR=Tear Resistant Type

Color

W=White
 R=Red
 B=Black

【Product Code】

NEOFLEXSTART Abbreviation

N S 10 FG P

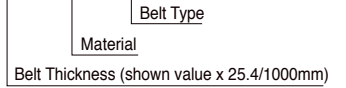

	Usable Temperature Range		Minimum Pulley Diameter mm	Knife Edge Radius mm	Antistatic Specification	Maximum Manufacturable Width mm	Specification, Category	Product code
	Dry Heat Temperature °C	Wet Heat Temperature °C						
	-150~270	0~80	70	×	×	1000	Premium series	NS03FG-P
	-150~270	0~80	70	×	×	1500	Premium series	NS05FG-P
	-150~270	0~80	70	×	×	1500	Premium series	NS06FG-P
	-150~270	0~80	70	×	×	2000	Premium series	NS10FG-P
	-150~270	0~80	70	×	×	1500	Premium series	NS14FG-P
	-150~270	0~80	70	×	×	2300	Premium series	NS27FG-P
	-150~270	0~80	70	×	×	1500	Standard series	NS22FG-S
	-150~270	0~80	70	×	○	1500	Antistatic type	NS05FG-B
	-150~270	0~80	70	×	○	1500	Antistatic type	NS06FG-B
	-150~270	0~80	70	×	○	2000	Antistatic type	NS10FG-B
	-150~270	0~80	70	×	○	1500	Antistatic type	NS14FG-B
	-150~270	0~80	70	×	○	2600	Antistatic type	NS27FG-B
	-150~270	0~80	70	×	×	1000	Tear resistance	NS06FG-TR
	-150~270	0~80	70	×	×	1000	Tear resistance	NS10FG-TR
	-150~270	0~80	100	×	×	1500	1mm mesh	NS19FG-M
	-150~270	0~80	100	×	×	1500	2mm mesh	NS21FG-M
	-150~270	0~80	100	×	×	2500	4mm mesh	NS30FG-M
	-150~180	0~100	70*	×	○	2000	Kevlar core	NS15FK
	-150~180	0~100	70*	×	×	1500	Aramid fiber core Antistatic type	NS15FK-B
	-150~180	0~100	30	×	×	2000	Aramid fiber core 4mm mesh	NS30FK-M
	-70~150	0~80	70	×	×	950	Silicone series	NS24SG-R
	-70~150	0~80	70	×	×	950	Silicone series	NS24SG-W
	-70~150	0~80	70	×	×	950	Silicone series	NS42SG-R
	-70~150	0~80	70	×	×	950	Silicone series	NS42SG-W

* φ30 can be used when permitted tension is 1 N/mm and below (except inter-open endless type).

Characteristics

PN=Polyolefin

Surface Condition

M=Diamond pattern

Color

N=Transparent

【Product Code】

NEOFLEXSTART Abbreviation

N S 3 2 PN 0 / 5 N M

Permitted Tension (N/mm)

No. of Tension Member Ply

Material (Polyolefin)

Surface Figure

Color

Top Cover Thickness (1/10mm)

Underside Cover Thickness (1/10mm)

Weight kg/m ²	Allowable Tension N/mm	Minimum Pulley Diameter mm	Knife Edge Radius mm	Operating Temperature Range		Table-Drive	Antistatic Specification	Product Code
				Dry Heat Temperature °C	Wet Heat Temperature °C			
1.7	3	40	×	-10~60	0~60	○	○	NS32PN0/5NM
1.0	1	40	×	-10~50	0~50	×	×	NS11PN3/5NM
1.0	-	-	-	-10~50	0~50	-	-	NS15PNM

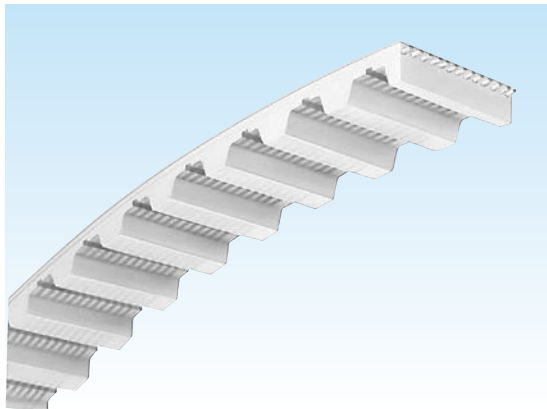

FREESPAN™ Belt

FREESPAN™ Belt is polyurethane timing belt consists of thermoplastic polyurethane and steel cords. This belt is suitable for synchronous transportation and power transmission requiring accurate positioning. The tension members are parallel to each other to ensure a suitable synchronous drive. Polyurethane also good physical properties and good chemical resistance.

Belt temperature range is from -30°C to 80°C .

Belt type, Dimensions & Product code

Trapezoidal Tooth Profile

Standard color : White

Polyurethane : Thermoplastic Polyurethane Shore A 92

Standard Cords : S and Z zincked steel cord

Tooth profile	Standard Dimensions	Standard			Minimum Pulley teeth		Product Code	Belt Options		
		Thickness (mm)	Roll Length	Width(mm)	2 shafts	Ω layout		Jointed belt	Cleats	Fabric Type
T5		2.2	100m	8 10 16 25 32 50 75 100	12	18		<input type="radio"/>	<input type="radio"/>	<input type="radio"/>
T10		4.5	100m	10 16 25 32 50 75 100	14	20		<input type="radio"/>	<input type="radio"/>	<input type="radio"/>
AT5		2.7	100m	8 10 16 25 32 50 75 100 150	15	25		<input type="radio"/>	<input type="radio"/>	<input type="radio"/>
AT10		4.5	100m	10 16 25 32 50 75 100 150	15	25		<input type="radio"/>	<input type="radio"/>	<input type="radio"/>
L		3.6	3937inch (100m)	0.37inch (9.53mm) 0.50inch (12.7mm) 0.75inch (19.1mm) 1.00inch (25.4mm) 1.50inch (38.1mm) 2.00inch (50.8mm) 3.00inch (76.1mm) 4.00inch (101.6mm)	14	20		<input type="radio"/>	<input type="radio"/>	<input type="radio"/>
H		4.36	3937inch (100m)	0.50 inch (12.7mm) 0.75 inch (19.1mm) 1.00 inch (25.4mm) 1.50 inch (38.1mm) 2.00 inch (50.8mm) 3.00 inch (76.1mm) 4.00 inch (101.6mm) 6.00 inch (152.4mm)	14	20		<input type="radio"/>	<input type="radio"/>	<input type="radio"/>

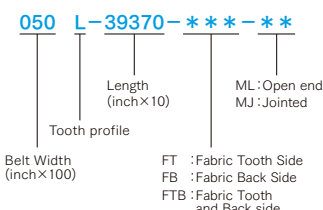
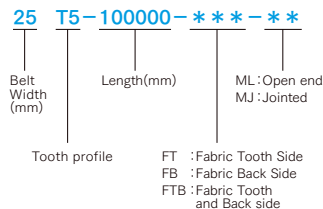

Belt type, Dementions & Product code

Round Tooth Profile

Standard color : White
 Polyurethane : Thermoplastic Polyurethane Shore A 92
 Standard Cords : S and Z zincked steel cord

Tooth profile	Standard Dimensions	Standard			Minimum Pulley teeth		Product Code	Belt Options		
		Thickness (mm)	Roll Length	Width(mm)	2 shafts	Ω layout		Jointed belt	Cleats	Fabric Type
HTD5M		3.6	100m	10	14	20	25 HTD5M-100000-***-*** 25: Belt Width (mm) 100000: Length (mm) ***: Tooth profile FT: Fabric Tooth Side FB: Fabric Back Side FTB: Fabric Tooth and Back side ML: Open end MJ: Jointed	<input type="radio"/>	<input type="radio"/>	<input type="radio"/>
15										
25										
50										
75										
100										
150										
HTD8M		5.6	100m	10	20	30		<input type="radio"/>	<input type="radio"/>	<input type="radio"/>
15										
20										
30										
50										
85										
100										
150										
HTD14M		10.0	50m	25	28	28		<input type="radio"/>	<input type="radio"/>	<input type="radio"/>
40										
55										
85										
100										
115										

Profile (Cleats)

Freespan belt can be welded variously shaped Cleats on the Belt.

Standard Rectangle Cleats

Standard color : White
 Polyurethane : Thermoplastic Polyurethane Shore A 92

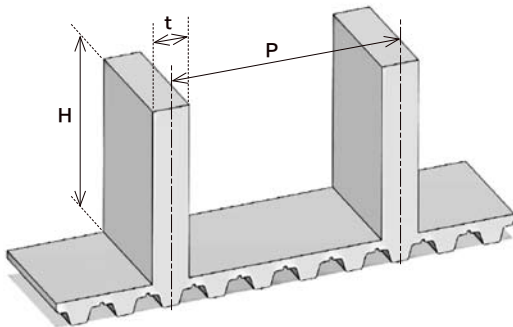

Thickness (t)	2mm ~ 10mm (± 0.5mm)	
Height (H)	20mm ~ 50mm (± 0.5mm)	
Tolerance of the positioning	± 0.5mm	
Cleats Pitch Tolerance (P)	≤ 250mm	± 0.5mm
	250mm < ≤ 500mm	± 1.0mm
	500mm <	± 2.0mm

Special Cleats

The special cleats are available. Please contact us for details.

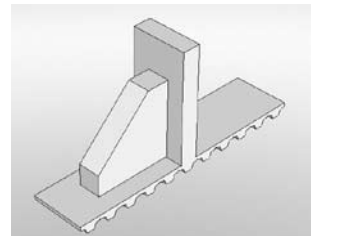
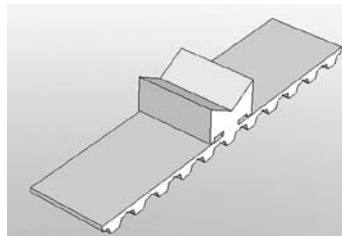
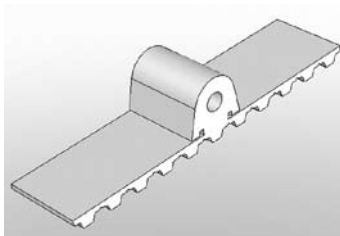
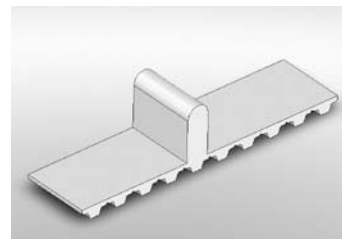
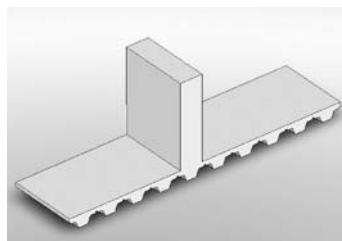
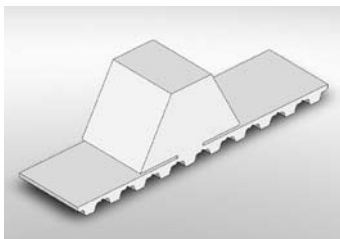

A series of horizontal dotted lines for writing.

3. ENGINEERING PLASTIC PRODUCTS

Engineering Plastics **MEP**[®]

MEP[®] Size Table.....P83, 84

General Purpose Engineering Plastics

1. Casting NylonP85

2. UHMW-PEP86, 87

3. PolyacetalP88

High Performance Engineering Plastics

1. PEEK[®]P89

Note 1. PEEK[®] is a registered trademark of Victrex[®].



MEP® Size Table

A: Rod Type Standard stocked item: ● Non-stocked item: △

Name	Grade	Characteristics	Outer Diameter																			
			Length	4	5	6	8	10	12.5	15	17.5	20	22.5	25	30	35	40	45				
Casting Nylon (CN)	UD (Ivory)	Improving mechanical strength significantly and reducing physical degradation under high temperature.	500L														●	●	●	●		
			1,000L															●	●	●	●	
	NB (Blue)	Blue colored grade which maintains physical properties of cast nylon UD.	500L															●	●	●	●	
			1,000L															●	●	●	●	
	CL (Green)	Improving frictional property substantially by our own lubricant formulation.	300L															●	●	●	●	
			500L															△	△	△	△	
	1,000L																	△	△	△	△	
		500L																●	●	●	●	
1,000L																	△	△	△	△		
Casting Nylon EX (CN-EX)	UD (Ivory) NB (Blue)	It has physical properties closer to casting nylon while mechanical strength is enhanced than standard nylon 6 extrusion products.							●	●	●	●	●	●	●	●	●	●	●	●		
								●	●	●	●	●	●	●	●	●	●	●	●	●	●	
Ultra-High Molecular Weight Polyethylene (UHMW-PE)	NA (White)	With small friction, it has excellent abrasion and shock resistance as well as antiadhesive properties. Also, nontoxic.	1,000L						●	●	●	●	●	●	●	●	●	●	●	●		
	ASB (Black)	Better abrasion, thermal ageing and UV resistance than UHMW-NA. Also, it has high antistatic property.	1,000L						△	△	△	△	△	△	△	△	●	●	●	●		
	ASG (Mint green)	Light color, antistatic. Less surface abrasion against plastic bottles.	1,000L																			
Polyacetal Engineering Polymers (POM)	Homopolymer (DELTRIN®) (White) (Black)	Excellent mechanical strength, fatigue resistance and dimension stability.	1,000L	●	●	●	●	●	●	●	●	●	●	●	●	●	●	●	●	●	●	
			1,000L					●	●	●	●	●	●	●	●	●	●	●	●	●	●	●
	Copolymer (DURACON®) (White) (Black)	Excellent mechanical strength, especially creep properties and fatigue resistance	1,000L	●	●	●	●	●	●	●	●	●	●	●	●	●	●	●	●	●	●	●
			1,000L					●	●	●	●	●	●	●	●	●	●	●	●	●	●	●
	Copolymer-BG (Green)	Excellent lubricity property addition to mechanical strength and dimension stability of polyacetal.	1,000L						●	●	●	●	●	●	●	●	●	●	●	●	●	●
			1,000L																			
PEEK® (Polyetheretherketone)	NA (Light brown)	Excellent mechanical properties and chemical resistance. All-purpose High performance engineering plastic with maximum continuous operating temperature of 240°C.	1,000L						●	●	●	●	●	●	●	●	●	●	●	●	●	

B: Plate Type Standard stocked item: ● Non-stocked item: △

(Unit:mm)

Name	Grade	Characteristics	Plate Thickness																									
			1	2	2	3	5	6	7	8	10	12	15	20	25	30	35	40	45	50	60	70	80	90	100	120		
Casting Nylon (CN)	1,000×2,000	UD·ENB					●	●	●	●	●	●	●	●	●	●	●	●	●	●	●	●	●	●	●	●	●	
		CL					●	●	●	●	●	●	●	●	●	●	●	●	●	●	●	●	●	●	●	●	●	
		MD					△	△	△	△	△	△	△	△	△	△	△	△	△	△	△	△	△	△	△	△	△	△
	1,000×1,000	UD·ENB					●	●	●	●	●	●	●	●	●	●	●	●	●	●	●	●	●	●	●	●	●	●
		CL					△	△	△	△	△	△	△	△	△	△	△	△	△	△	△	△	△	△	△	△	△	△
		MD					△	△	△	△	△	△	△	△	△	△	△	△	△	△	△	△	△	△	△	△	△	△
500×1,000	UD·ENB					●	●	●	●	●	●	●	●	●	●	●	●	●	●	●	●	●	●	●	●	●	●	
600×1,200	UD·ENB					●	●	●	●	●	●	●	●	●	●	●	●	●	●	●	●	●	●	●	●	●	●	
	CL					●	●	●	●	●	●	●	●	●	●	●	●	●	●	●	●	●	●	●	●	●	●	
	MD					●	●	●	●	●	●	●	●	●	●	●	●	●	●	●	△	△	△	△	△	△	△	
Ultra-High Molecular Weight Polyethylene (UHMW-PE)	940×1,920	NA				●	●	●																				
	1,000×2,000	ASB					●	●																				
Polyacetal Engineering Polymers (POM)	500×1,000	Copolymer (White)					●	●	●	●	●	●	●	●	●	●	●	●	●	●	●	●	●	●	●	●	●	
		(Black)					●	●	●	●	●	●	●	●	●	●	●	●	●	●	●	●	●	●	●	●	●	
		Homopolymer (DELTRIN®) (White)	●	●	●	●	●	●	●	●	●	●	●	●	●	●	●	●	●	●	●	●	●	●	●	●	●	●
		Copolymer (DURACON®) (White)(Black)	●	●	●	●	●	●	●	●	●	●	●	●	●	●	●	●	●	●	●	●	●	●	●	●	●	●
PEEK® (Polyetheretherketone)	500×1,000	Copolymer-BG (Green)					●	●	●	●	●	●	●	●	●	●	●	●	●	●	●	●	●	●	●	●	●	
		M5BK (Black)					●	●	●	●	●	●	●	●	●	●	●	●	●	●	●	●	●	●	●	●	●	●
		NA (Light brown)					△																					

(Unit:mm)

	50	55	60	65	70	75	80	85	90	100	110	120	130	140	150	160	170	180	190	200	210	220	230	240	250	260	270	280	290	300	310	320	330	340	350	380	400	450	500	550	600									
●	●	●	●	●	●	●	●	●	●	●	●	●	●	●	●	●	●	●	●	●	●	●	●	●	●	●	●	●	●	●	●	●	●	●	●	●	●	●	●	△	△	△	△							
●	●	●	●	●	●	●	●	●	●	●	●	●	●	●	●	●	●	●	●	●	●	●	●	●	●	●	●	●	●	●	●	●	●	●	●	●	●	●	●											
●	●	●	●	●	●	●	●	●	●	●	●	●	●	●	●	●	●	●	●	●	●	●	●	●	●	●	●	●	●	●	●	●	●	●	●	●	●	●	●	△	△	△	△							
●		△		△		△		△	△																																									
●	●	●	●	●	●	●	●	●	●	●	●	●																																						
△	△	△	△	△	△	△	△	△	△	△	△	△																																						
△	△	△	△	△	△	△	△	△	△	△	△	△																																						
●		△		△		△		△	△																																									
●		△		△		△		△	△																																									
●	●	●	●	●		●		●	●	●	●											●																												
●	●	●	●	●				△		△	△	△																																						
●	●	●	●	●	●	●	●	●	●	●	●	●	●	●	●	●	●	●	●	●	●	●	●	●	●	●	●	●	●	●	●	●	●	●	●	●	●	●	●	●	●	●	●	●	●	●	●	●		
●	●	●	●	●	●	●	●	●	●	●	●	●	●	●	●	●	●	●	●	●	●	●	●	●	●	●	●	●	●	●	●	●	●	●	●	●	●	●	●	●	●	●	●	●	●	●	●	●	●	
●	●	●		△		△		△	△			△																																						

C: Pipe Type Non-stocked item: △ (Unit:mm)

Name	Length	Grade	Outer Diameter	60	65	70	70	75	80	80	90	90	100	100	110	120	130	140	150	150	165	180	200	200	225	225	250	250	285	300	300	330	350	400	430													
			Inner Diameter	25	40	25	45	50	30	55	40	65	50	75	60	70	80	90	100	100	125	115	100	100	150	115	175	125	200	225	150	250	165	175	350	250												
Casting Nylon (CN)	1,200	UD·NB	△	△	△	△	△	△	△	△	△	△	△	△	△	△	△	△	△	△	△	△	△	△	△	△	△	△	△	△	△	△	△	△	△	△	△	△	△	△	△	△	△	△	△	△		
		MD	△	△	△	△	△	△	△	△	△	△	△	△	△	△	△	△	△	△	△	△	△	△	△	△	△	△	△	△	△	△	△	△	△	△	△	△	△	△	△	△	△	△	△	△	△	
	350	UD·NB	△	△	△	△	△	△	△	△	△	△	△	△	△	△	△	△	△	△	△	△	△	△	△	△	△	△	△	△	△	△	△	△	△	△	△	△	△	△	△	△	△	△	△	△	△	△
		CL MD	△	△	△	△	△	△	△	△	△	△	△	△	△	△	△	△	△	△	△	△	△	△	△	△	△	△	△	△	△	△	△	△	△	△	△	△	△	△	△	△	△	△	△	△	△	△

- Note
1. DELRIN® is a registered trademark of DuPont®.
 2. PEEK® is a registered trademark of Victrex®.
 3. DURACON® is a registered trademark of Polyplastics K.K.

1. Casting Nylon

1-1. MEP® Casting Nylon Grades

■ **CN-UD Ivory Load Bearing** ■ **CN-NB Blue Load Bearing**

By improving mechanical strength, a characteristic of casting nylon, and reducing physical degradation under high temperature, it can be used under heavy loads like machinery parts for where only metal is used. CN-NB is a blue colored grade of CN-UD and has the same properties as CN-UD.

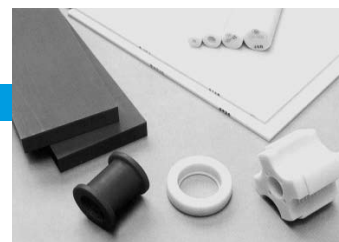

■ **CN-MD Black Light Load Sliding** ■ **CN-CL Green (Non-lubricated) Sliding**

It has enhanced sliding property base on excellent properties of casting nylon by evenly blending molybdenum disulfide.

By our own patented production method, it has outstandingly high abrasion resistance while maintaining the excellent properties of casting nylon. Also, it has lubrication performance which withstands prolonged operating time.

1-2. MEP® Casting Nylon EX Grades

■ **CN-UDE Ivory Light to medium withstand load** ■ **CN-NBE Blue Light to medium withstand load**

It has physical properties closer to casting nylon while mechanical strength is enhanced than standard nylon 6 extrusion products. It is economical and best to be used as machinery parts such as small sized gears, roller bearings, rollers, etc. CN-NBE is blue colored grade of CN-UDE with the same properties as CN-UDE.

1-3. Applications

- ① Metal and steel facility ② Transport equipment
- ③ Construction machinery ④ Machine tools
- ⑤ Industrial machinery ⑥ Shipbuilding, heavy industrial machinery
- ⑦ LCD, semiconductor manufacturing equipment

1-4. Properties of Casting Nylon

Table 1. Properties of Casting Nylon

Property	ASTM Test	Unit	CN-UD CN-NB	CN-MD	CN-CL	CN-UDE CN-NBE
Density	D792		1.15~1.16	1.16~1.17	1.12~1.13	1.15
Tensile Strength	D638	MPa	78 ~93	74~83	59~74	76
Tensile Elongation	D638	%	20~50	15~40	10~40	48
Secant Modulus	D638	10 ³ MPa	3.0~3.5	2.8~3.3	2.0~2.5	2.9
Compressive Strength	D695	MPa	93~108	88~98	74~83	91
Flexural Strength	D790	MPa	103~123	98~118	78~93	110
Izot Impact Strength (1/2in x 1/2in notched)	D256	J/m	34~54	30~50	37~65	33
Rockwell Hardness	D785	R scale	115~120	113~117	107~112	120
Thermal Conductivity	C177	W/(m·K)	0.20	0.20	0.20	0.20
Specific Heat Capacity	—	J/(KG·K)	1,046	1,046	1,046	1,250
Coefficient of Thermal Expansion	D696	10 ⁻⁵ °C	8.0	9.0	8.6	9.0
Continuous Use Temperature	—	°C	140~170	120~150	100~120	100~120
Heat Distortion	D648	°C	185~200	170~195	105~115	94
			210~215	205~210	170~180	193
Volume Resistance	D257	Ω · cm	10 ¹⁴	10 ¹⁴	10 ¹⁴	10 ¹⁴
Dielectric Strength (Short interval 3.2mm)	D149	KV/mm	18~22	18~22	18~22	25.0
Relative Permittivity	D150		3.7	3.7	3.7	4.0
			3.7	3.7	3.7	3.7
			3.7	3.7	3.7	3.4
Loss Tangent	D150		0.02	0.02	0.02	0.01
			0.02	0.02	0.02	0.04
			0.02	0.02	0.02	0.04
Water Absorption (24 hours 3.2mm)	D570	%	0.5~0.9	0.9~1.2	0.6~0.8	1.3
Allowable PV Index	—	kPa·m/sec	820	980	2,290	820

2. UHMW-PE (Ultra-High Molecular Weight Polyethylene)



2-1. MEP® UHMW-PE Grades

■ UHMW-NA White Standard Grade

UHMW-NA is a standard grade of Ultra-High Molecular Weight Polyethylene whose molecular weight is from 3.5 to 6.5 million. It has excellent abrasion resistance, low friction coefficient, antiadhesive property, chemical resistance, cold resistance and food safety.

■ UHMW-ASB Black High Antistatic Grade

UHMW-ASB is a grade with high antistatic performance. Its surface resistance is at a very low level of 10^4 , thus making it suitable to use as a static protection in LCD and semiconductor manufacturing equipment. Also it has excellent abrasion and weather resistance.

■ UHMW-ASG Light Green Antistatic Grade

UHMW-ASB is an upgrade of UHMW-ASG, which antistatic property is added. Its surface resistance is 10^{11} . It has high abrasion resistance and suitable for food production and bottling lines. Particularly, it has a low friction coefficient and good anti-abrasion, and does not scratch PET plastic containers.

2-2. Applications

- ① Food production facility
- ② Transport equipment
- ③ Cement facility
- ④ Coal storage facility
- ⑤ Fodder storage facility
- ⑥ LCD, semiconductor manufacturing equipment
- ⑦ Chemical facility

2-3. Properties of UHMW-PE

Table 2. Properties of UHMW-PE

Property	ASTM Test	Unit	UHMW-NA	UHMW-ASB	UHMW-ASG
Density	D792		0.94	0.96	0.98
Tensile Strength	D638	MPa	37	28	28
Tensile Elongation	D638	%	365	250	215
Secant Modulus	D638	10^3 MPa	0.5	0.6	0.4
Compressive Strength	D695	MPa	19	19	15
Flexural Strength	D790	MPa	26	25	15
Izot Impact Strength (1/2in x 1/2in notched)	D256	J/m	No damage	No damage	No damage
Rockwell Hardness	D785	R scale	52	55	53
Thermal Conductivity	C177	W/(m·K)	0.38	0.44	0.38
Specific Heat Capacity	—	J/(KG·K)	2,300	2,200	2,300
Coefficient of Thermal Expansion	D696	10^{-6} °C	20	19	19
Continuous Use Temperature	—	°C	80	80	80
Heat Distortion	D648	°C	—	—	—
			96	98	78
Volume Resistance	D257	$\Omega \cdot \text{cm}$	$>10^{13}$	10^4	10^{11}
Dielectric Strength (Short interval 3.2mm)	D149	KV/mm	—	—	—
Relative Permittivity	D150		2.3	2.3	2.3
			—	—	—
			—	—	—
Loss Tangent	D150		$1 \sim 2 \times 10^{-4}$	$1 \sim 2 \times 10^{-4}$	$1 \sim 2 \times 10^{-4}$
			$1 \sim 2 \times 10^{-4}$	$1 \sim 2 \times 10^{-4}$	$1 \sim 2 \times 10^{-4}$
			$1 \sim 2 \times 10^{-4}$	$1 \sim 2 \times 10^{-4}$	$1 \sim 2 \times 10^{-4}$
Water Absorption (24 hours 3.2mm)	D570	%	<0.01	<0.01	<0.01
Allowable PV Index	—	kPa·m/sec	490	490	490

2-4. UHMW Rail Dimensions

UHMW Rail

Flat Rail

Rail Thickness (mm)	Width (mm)	Roll Length (m)
3	15	50
3	20	50
3	25	50
3	30	50
3	40	50
3	50	50
4	25	40
4	30	40
4	40	40
4	50	40
5	20	30
5	25	30
5	30	30
5	40	30
5	50	30
6	20	25
6	30	25
6	40	25
6	50	25

Wear Tape

NO	Width (mm)	Roll Length (m)
1/4	6.35	15.5
1/2	12.7	15.5
3/4	19.05	15.5
1	25.4	15.5
1 1/4	31.75	15.5
2	50.8	15.5
3	76.2	15.5
4	101.6	15.5
6	152.4	15.5
12	304.8	15.5
18	457.2	15.5

Wear Tape
0.25mm thickness UHMW-NA tape with adhesive exfoliating paper on one side can be used on the places where rails cannot be mounted.

Chain Rail

Thickness (mm)	Width (mm)	Length (m)
5	20	500
5	25	500
5	40	500
6	20	500
6	25	500

End Plate for Chain Rail

Thickness (mm)	Width (mm)	Length (m)
5	20	65
5	25	65
5	40	65
6	20	65
6	25	65

L-Type Rail

Type	Type
L-type	White

(Note) Standard length is 50m/ a roll

H-Type Rail Color: White

Type
5 × 20 × 1,000
5 × 25 × 1,000

(Note) (1) Attachment bracket ST5S is JPY 500/piece.
(2) Standard length is 1000mm.

V-Type Rail Color: White

Type	Type
V3 -type	0
V6 -type	0

(Note) Standard lengths for V3 and for V6 are 100m and 50m/ roll respectively.

Snap-On Rail Color: White

Type	Length
SNP-type	30m

C-Type Rail Color: White

Type	Length
For φ 10	3m
For φ 12	3m

R-Type Rail Color: White

Type	Length
For φ 10	3m
For φ 12	3m

A-Type Rail Color: White

Type	Length
A -type Rail	3m
All-type Rail	3m

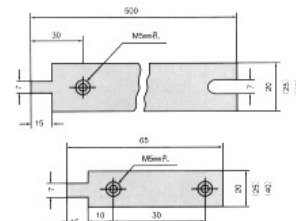

L-Type

H-Type

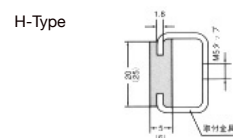

V3-Type

V6-Type

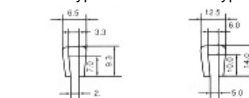

C-Type for φ 12

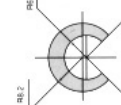

C-Type for φ 10

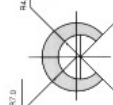

Snap-on Type

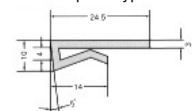

A-Type

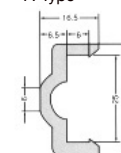

A II-Type

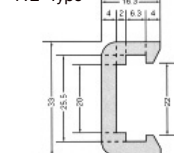

R-Type for φ 10

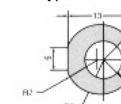

R-Type for φ 12

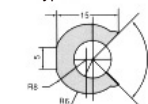

3. Polyacetal



3-1 MEP® Polyacetal Grades

■ Polyacetal Homopolymer White, Black (DELTRIN®)

Engineering plastics with well balanced properties of mechanical strength, electrical properties and dimension stability Also, it has good fatigue resistance and superior machining properties. Mass production of parts possible by injection molding.

■ Polyacetal Copolymer White, Black (DURACON®)

Engineering plastic with well balanced properties of mechanical strength, electrical properties and dimension stability Also, it has good cleavage resistance and superior machining properties. Mass production of parts possible by injection molding

■ Copolymer-BG Green High Sliding Performance Grade for light/medium load

A grade of polyacetal copolymer with special lubricant Excellent sliding performance for light to medium load with mechanical strength, electrical properties and dimension stability Not only use in industrial machinery, it is also used as a sliding component in LCD manufacturing system since it has well recognized wear resistant property.

■ M5BK Black High Sliding Performance Grade for medium/heavy load

A grade of Polyacetal copolymer with special lubricant Excellent sliding property with mechanical strength, electrical properties and dimension stability Not only use in industrial machinery, it is also used as a sliding component in construction machineries since it has well recognized wear resistant property.

- Note
1. DELTRIN® is a registered trademark of Dupont.
 2. DURACON® is a registered trademark of Polyplastics K.K.
 3. BESTAL® is a registered trademark of Bayer AG.

3-2 Applications

- | | |
|--|---|
| ① Food production facility | ② Transport equipment |
| ③ LCD, semiconductor manufacturing equipment | ④ Construction machineries |
| ⑤ Packing machines | ⑥ Electronic components manufacturing equipment |

3-3 Properties of Polyacetal

Table 3. Properties of Polyacetal

Property	ASTM Test	Unit	Homopolymer	Copolymer	Copolymer-BG	M5BK
Density	D792		1.42	1.41	1.38	1.38
Tensile Strength	D638	MPa	69	61	54	57
Tensile Elongation	D638	%	12	12	50	14
Secant Modulus	D638	10 ³ MPa	2.8	2.8	2.0	2.0
Compressive Strength	D695	MPa	124	108	74	66
Flexural Strength	D790	MPa	97	89	72	75
Izot Impact Strength (1/2in x 1/2in notched)	D256	J/m	69	69	59	40
Rockwell Hardness	D785	R scale	120	115	114	114
Thermal Conductivity	C177	W/(m·K)	0.17	0.17	0.17	0.17
Specific Heat Capacity	—	J/(KG·K)	1,460	1,460	—	—
Coefficient of Thermal Expansion	D696	10 ⁻⁵ °C	9	10	10	10
Continuous Use Temperature	—	°C	90	90	90	90
Heat Distortion	D648	°C	124	110	105	110
			170	158	—	—
			6 × 10 ⁴	6 × 10 ⁴	10 ⁴	—
Volume Resistance	D257	Ω ·cm	6 × 10 ¹⁴	6 × 10 ¹⁴	10 ¹⁴	—
Dielectric Strength (Short interval 3.2mm)	D149	KV/mm	15	20	18	—
			3.7	3.7	—	—
Relative Permittivity	D150		3.7	3.7	—	—
			3.7	3.1	—	—
			0.003	0.001	—	—
Loss Tangent	D150		0.002	0.002	—	—
			0.005	0.007	—	—
			0.25	0.22	0.22	0.22
Water Absorption (24 hours 3.2mm)	D570	%	0.25	0.22	0.22	0.22
Allowable PV Index	—	kPa·m/sec	490	490	1,300	1,600

4. High Performance Engineering Plastics

4-1 MEP® High Performance Engineering Plastics Grades

■ PEEK®-NA Light Brown Heat & Chemical Resistant Grade

A high performance engineering plastic with comparable to Teflon for its heat and chemical resistance. It also has mechanical strength, electrical properties and machinability to casting nylon. Injection molding possible. Used in many applications such as LCD / semiconductor manufacturing equipment, chemical equipment, plating equipment and logistic facility.

Note 1. PEEK® is a registered trademark of Victrex®.

4-2 Applications

- ① LCD, semiconductor manufacturing equipment
- ② Chemical production equipment
- ③ Plating industry
- ④ Aerospace industry
- ⑤ Medical equipment
- ⑥ Electronic component manufacturing equipment

4-3 Properties of PEEK®-NA

Table 4. Properties of High Performance Engineering Plastics

Property	ASTM Test	Unit	PEEK®-NA
Density	D792		1.30
Tensile Strength	D638	MPa	97
Tensile Elongation	D638	%	80
Secant Modulus	D638	10 ³ MPa	2.8
Compressive Strength	D695	MPa	127
Flexural Strength	D790	MPa	142
Izot Impact Strength (1/2in × 1/2in notched)	D256	J/m	59
Rockwell Hardness	D785	scale	M98
Thermal Conductivity	C177	W/(m·K)	0.2
Specific Heat Capacity	—	J/(KG·K)	1,330
Coefficient of Thermal Expansion	D696	10 ⁻⁵ °C	4.8
Continuous Use Temperature	—	°C	240
Heat Distortion	D648	°C	152
			—
Volume Resistance	D257	Ω·cm	10 ¹³ ~10 ¹⁴
Dielectric Strength (Short interval 3.2mm)	D149	KV/mm	19
Relative Permittivity	D150		3.2~3.3
			—
			—
Loss Tangent	D150		0.0016
			—
			—
Water Absorption (24 hours 3.2mm)	D570	%	0.14
Allowable PV Index	—	kPa·m/sec	—



PEEK®-NA

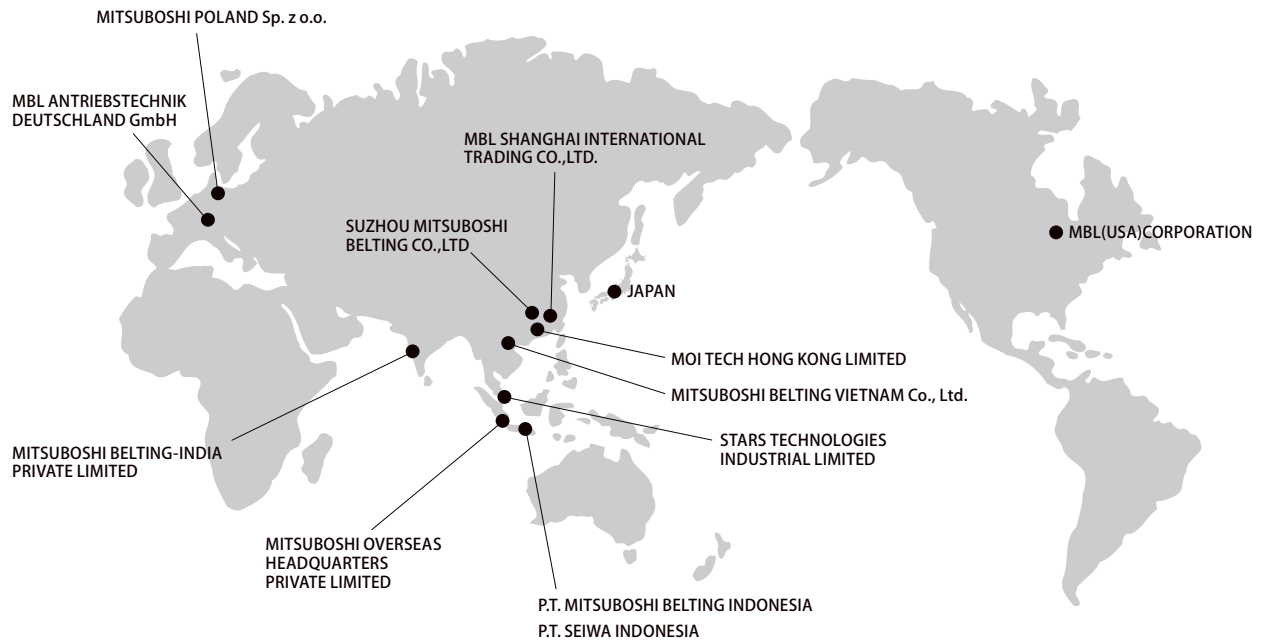

■ JAPAN

● MITSUBOSHI BELTING LTD.

(Kobe Head Office)
4-1-21 Hamazoe-dori, Nagata-ku,
Kobe 653-0024
Tel: +81-78-671-5071 Fax: +81-78-671-8879

(Tokyo Head Office)
Nihonbashi Plaza Bldg.10F
2-3-4 Nihonbashi, Chuo-ku,
Tokyo 103-0027
Tel: +81-3-5202-2500 Fax: +81-3-5202-2520

■ ASIA

● MITSUBOSHI OVERSEAS HEADQUARTERS PRIVATE LIMITED

14 Jurong Port Road, Singapore 619091
Tel:+65-6265-3933 Fax:+65-6265-0954
E-mail:sales@mitsuboshi.com.sg

● STARS TECHNOLOGIES INDUSTRIAL LIMITED

Eastern Seaboard Industrial Estate 64/40 Moo 4,
Tambon Pluakdaeng Amphur Pluakdaeng, Rayong 21140
THAILAND
TEL : +66-38-954-738 FAX : +66-38-954-740

● P.T. SEIWA INDONESIA

Blok M-2-2, Kawasan Berikat MM2100
Industrial Town, Cibitung, Bekasi Jawa Barat 17520, Indonesia
Tel:+62-21-898-0324 Fax:+62-21-898-0325

● P.T. MITSUBOSHI BELTING INDONESIA

Km. 8 Raya Serang
JN. Industri Raya Blok D No. 4
Desa Pasir Jaya, Jatiuwung Tangerang, Indonesia
Tel:+62-21-593-07118 Fax:+62-21-590-2071

● MBL SHANGHAI INTERNATIONAL TRADING CO.,LTD.

F8, NO.601 Tianshan Road, Shanghai, China
Tel:+86-21-5206-7008 Fax:+86-21-5206-7011

● SUZHOU MITSUBOSHI BELTING CO.,LTD

277 Liangang Road Suzhou New District Jiangsu, China
Tel:+86-512-6665-8880 Fax:+86-512-6665-8886

● MOI TECH HONG KONG LIMITED

Unit2, 21F, CCT Telecom Building, No.11 Wo Shing Street, Shatin,
New Territories, Hong Kong.
Tel:+852-2403-5978 Fax:+852-2422-8308

● MITSUBOSHI BELTING-INDIA PRIVATE LIMITED

W-191F, TTC Industrial Area, MIDC, Thane-Belapur Road,
Navi Mumbai 400710, Maharashtra, India
Tel:+91-022-27788431 Fax:+91-022-27788439
E-mail:customer@mitsuboshi.co.in

● MITSUBOSHI BELTING VIETNAM Co., Ltd.

Room No.19, 2nd Floor, Newlife Building
No.6 Nguyen Thi Thap St., Trung Hoa Ward,
Cau Gay Dist., Hanoi, VIETNAM
Tel:+84-4-3791-5142 Fax:+84-4-3791-6203

■ AMERICA

● MBL(USA)CORPORATION

601 Dayton Road, Ottawa IL 61350-9535 USA
Tel: +1-815-434-1282 Fax: +1-815-434-2897
E-mail: sales@mblusa.com
URL: <http://www.mblusa.com>

■ EUROPE

● MBL ANTRIEBSTECHNIK DEUTSCHLAND GmbH

Bussardweg 10, D-41468 Neuss, Germany
Tel:+49- 2131-740940 Fax:+49- 2131-7409424
E-mail: info@mitsuboshi.de

● MITSUBOSHI POLAND Sp. z o.o.

Budynek B8 ul. 3-go Maja 8, 05-800 Pruszkow, Poland
Tel:+48-22-7383930 Fax:+48-22-7383939



MITSUBOSHI BELTING LTD.

The information contained herein is for information purposes only, and does not enlarge, amend or imply any warranty other than provided by the manufacture with the product. Any use of the product not in conformance with the manufacture's instruction must be dangerous.